

MAVER'S WIRELESS TELEGRAPHY:

THEORY AND PRACTICE.

EMBRACING

Early Wireless Telegraph Systems—Induction Telegraphy—Hertzian Waves—
Electromagnetic Theory of Light—Electronic Theory—Theories of Elec-
tric-Wave Propagation—Syntonic Wireless Telegraphy—Wireless Tele-
graph Systems of Marconi, Lodge and Muirhead, Slaby-Arco,
Braun, Branly-Popp, Guarini, Ducretet-Poppoff, De Forest,
Fessenden, Stone, Shoemaker, Ehret, Bull, Musso, Armori,
Zickler, etc., etc.—Wireless Telephone Systems, Bell,
Ruhmer, Hayes, Collins, Armori—Speaking Arc,
Speaking Light, etc.—Sections on Detectors,
Coherers, Spark-Gap, Interrupters, Con-
densers, Oscillators—Practical Appli-
cation of, and Suggestions on,
Wireless Telegraphy, Signal-
ing, etc., etc.

BY WILLIAM MAVER, JR.,

EX-ELECTRICIAN BALTIMORE AND OHIO TELEGRAPH COMPANY; MEMBER OF THE AMERICAN
INSTITUTE OF ELECTRICAL ENGINEERS; AUTHOR OF "AMERICAN TELEGRAPHY AND
ENCYCLOPEDIA OF THE TELEGRAPH."

216 PAGES. - - - 128 ILLUSTRATIONS.

NEW YORK
MAVER PUBLISHING COMPANY.

1904.

COPYRIGHT, 1904,
By WILLIAM MAVER, Jr.

J. R. & R. B. SMITH,
TYPOGRAPHERS AND ELECTROTYPERS,
27 SPRUCE STREET, NEW YORK.

PRESS OF
MOLT BROTHERS,
17-27 VANDEWATER ST., NEW YORK

© 11 ap 06 E. S.

PREFACE.

THIS book was begun several years ago as an Appendix to the author's "American Telegraphy and Encyclopædia of the Telegraph."

ERRATA.

- Page 19, line 24, for "momentum" read "Inertia."
" 19, line 27, read "self-induced" magnetic lines of force.
" 36, line 36, for "2 w" read "2 π."
" 46, lines 26, 27, transpose "capacity" and "elasticity."
" 67, line 17, for "T²" read "T."
" 78, line 16, omit "but the."
" 88, in title, Figs. 56, 57, omit "and receiving."
" 105, in caption and elsewhere, for "Poppoff" read "Popoff."
" 116, line 12, after "length" insert " , cancelling each other—."
" 122, line 5, for "Ind." read "Md."
" 128, line 16, for "distributing" read "distributed."
" 137, line 14, for "l" read "l'."
" 174, for "Dorkum" read "Borkum."

which, with a few exceptions, has been done (the exceptions relating to certain peculiar types of systems, a brief account of which, it was thought, would be useful), but owing to the aforesaid rapid advance of the art, together with the wide territory over which that advance has been spread, some operating devices worthy of note may have escaped the attention of the author, in which event amends will be made in subsequent editions of the work.

It is believed, however, that the book will be found to contain much more than a mere account of the wireless systems at present in use. In fact, the aim has been to give a comprehensive statement of all that appertains to the art at this time, in the hope of supplying herein a complete practical hand-book of wireless telegraphy. With

145323

this object in view, information has been included from many sources, a general acknowledgment for which is hereby cordially tendered. It should also be noted that a number of passages were culled by the author from the opening pages of this work for an article in "Cassier's Magazine," which article has been quite widely reprinted.

As the result of long experience in the study and practical operation of electrical circuits and apparatus, the author considers that fully described, clear theoretical diagrams of systems and connections are of greater utility to the student than figures illustrating merely the external appearance of the apparatus, and hence the comparatively few illustrations of that nature herein given of apparatus employed in certain systems are introduced chiefly to typify the general appearance and construction of more or less similar apparatus used in other systems.

Inasmuch as when the first of these pages were written there was but one wireless system in operation, it may with some truth be said that the book has grown up with the art of which it treats, which fact has entailed a resort to considerable cross-reference in the text, and may require somewhat frequent reference to the index on the part of the reader to insure finding all that may be noted herein on a given subject. For this reason pains have been taken to make the index perhaps more than usually full.

The thanks of the author are due to the typographers for careful reading of the proof-sheets of the text, and for many useful suggestions relative thereto.

W. M., JR.

*182 Arlington Avenue,
Jersey City Heights, N. J.*

CONTENTS.

	PAGE
CHAPTER I.	
INTRODUCTORY	1
Torch, Semaphore, and Other Early Wireless Telegraph Systems.	
CHAPTER II.	
INDUCTION TELEGRAPHY	6
Phelps, Edison, Preece, Dolbear Systems.	
CHAPTER III.	
ELECTRIC OR HERTZIAN-WAVE TELEGRAPHY.....	15
Maxwell's Electromagnetic Theory of Light—Hertz Experiments— Electric Oscillations, etc.	
CHAPTER IV.	
EARLY EXPERIMENTS IN ELECTRIC-WAVE TELEGRAPHY.....	26
Branly Coherer—Lodge, Marconi Experiments.	
CHAPTER V.	
THEORIES OF ELECTRIC-WAVE PROPAGATION—THE ELECTRONIC THEORY.....	29
CHAPTER VI.	
SYNTONIC WIRELESS TELEGRAPHY.....	46
CHAPTER VII.	
MARCONI WIRELESS TELEGRAPH SYSTEMS.....	52
Tuned, Untuned, and Long-Distance—Military and Lightship Stations—Morse Alphabets, etc.	

CHAPTER VIII.

LODGE AND LODGE-MUIRHEAD WIRELESS TELEGRAPH SYSTEMS.....	75
Lodge Early Syntonic Work.	

CHAPTER IX.

THE SLARY-ARCO AND BRAUN WIRELESS TELEGRAPH SYSTEMS.....	PAGE 83
--	------------

CHAPTER X.

THE BRANLY-POPP, GUARINI, AND DUCRETET-POPPOFF WIRELESS TELEGRAPH SYSTEMS.....	98
--	----

CHAPTER XI.

THE DE FOREST WIRELESS TELEGRAPH SYSTEM.....	107
--	-----

CHAPTER XII.

THE FESSENDEN, STONE, SHOEMAKER, AND MUSSO SYSTEMS..	121
--	-----

CHAPTER XIII.

SIGNALING BY ULTRA-VIOLET RAYS—WIRELESS TELEPHONY— SPEAKING LIGHT, SPEAKING ARC, ETC.....	134
Zickler, Bell, Hayes, Ruhmer, Simon, Collins, Arnorn Systems.	

CHAPTER XIV.

DETECTORS.—INTERRUPTERS—TRANSFORMERS—OSCILLATORS— SPARK-GAP—CONDENSERS—ANTENNÆ.....	144
Theoretical and Practical Notes Thereon.	

CHAPTER XV.

PRACTICAL APPLICATIONS OF WIRELESS TELEGRAPHY.....	174
--	-----

APPENDIX.

THEORIES OF ELECTRIC-WAVE PROPAGATION—EHRET AND BULL WIRELESS SYSTEMS—PRACTICAL SUGGESTIONS ON TELE- GRAPH CODES AND SIGNALING, ETC.....	181
--	-----

WIRELESS TELEGRAPHY.

CHAPTER I.

INTRODUCTORY.

TORCH, SEMAPHORE, AND OTHER EARLY TELEGRAPH SYSTEMS, ETC.

LONG before the dawn of the Christian era wireless methods of communicating intelligence to a distance were employed—not electric telegraphs as the term is generally understood, it is true, but wireless they certainly were; and as these pages progress it will perhaps not be difficult to trace a close relationship, as regards the communicating medium employed, between some of the wireless telegraph systems in vogue over two thousand years ago, especially those that employed the luminiferous ether as the communicating medium, and the wireless telegraph systems of to-day.

The ancient Greeks were probably the first to adopt systematic methods of signaling to a distance, and some of the methods which they employed have come down to us. One of these is that known as the Polybius system, after the historian of that name. A description of this system, which was in use 300 B. C., is to be found in his writings. The method employed was as follows: At each station two walls about ten feet in length and about six feet high were built. These walls were separated by a space of about ten feet. At night torches were placed on the top of the walls, one or more torches on each wall, and certain combinations of the torches represented the letters of the Greek alphabet. A tablet showing the letters of the alphabet, as indicated in Fig. 1, was provided at each station. The torches placed on the right-hand wall represented the vertical row of

figures; those on the left wall, the horizontal row of figures. There were in all five torches on each side. In the figure the English alphabet is used for convenience. Using this code, the letter *m* would be signaled by placing three torches side by side on each wall; the letter *h* would be indicated by two torches on the right-hand wall and three on the left, as in the figure, and so on, the letters being found at the point of intersection of the horizontal and vertical rows of figures on the tablet.

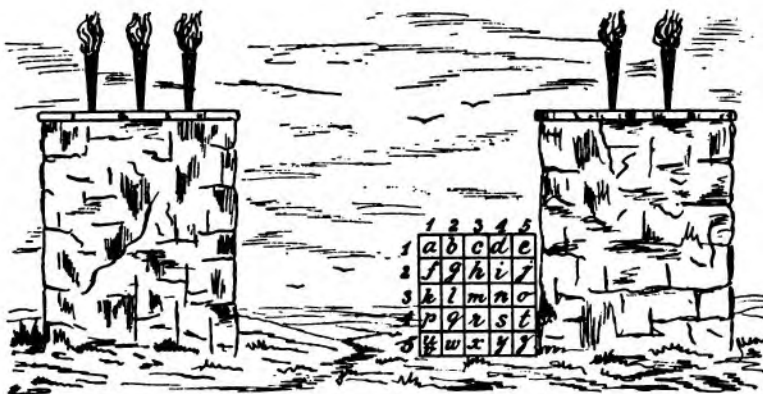

FIG. 1. POLYBIUS TELEGRAPH.

the two sets of torches, since at night the walls were not visible, a double tube was employed, and was so arranged that when the attendant looked through both tubes at once he saw both sets of torches; but when he looked through one tube he saw only one set, which insured a correct vision of the combination. When not in use for signaling, the torches were placed behind the walls. When it was desired to "call" a distant station, two torches were set on a wall and the call was answered by a similar signal.

It may be noted that the code here shown is, in a more or less modified form, in use to-day by the military departments of various countries as a means of telegraphing maps. For this purpose the map is drawn on a sheet of properly squared paper, of which there are duplicates at each station. The outlines of the map are indicated by sending, in a prearranged way, the numbered vertical and horizontal rows of squares intersected by the lines of the map.

The Gauls, also, were wont to transmit intelligence of importance to a distance by a cruder and simpler, if not as efficient, method. A messenger was despatched to a hillside, where he shouted or trumpeted his message apparently to the winds. Soon from afar a voice or trumpet answered him and repeated the message to another listener farther on, and thus from one point to another the message sped; and it is recorded that in this way a message calling all the tribes of Gauls to arms traveled in three days from Auvergne to the forests of Amoric in one direction and to the banks of the Rhine in another.

With perhaps a few exceptions, also, methods of transmitting intelligence to a distance have been and are practised by even the most uncivilized races. The use of fires by night and smoke by day as a means of communicating the whereabouts of an enemy, or other intelligence, has long been practised by various Indian tribes in this country. In the Cameroon country, Africa, the tribes employ an instrument which they term the *elliembec*, on which they tap, by some form of phonetic code known only to themselves, signals from one point to another in the densest forests, and up and down the rivers of that country. The *elliembec* is a sort of drum of cylindrical shape, about three feet long and six inches in diameter, having holes in the sides and in the end, through which the sound passes. According to Garner, messages are transmitted from town to town as far as three miles apart by means of this instrument.

Toward the close of the eighteenth century another wireless telegraph system, the semaphore, was invented by a Frenchman, Claude Chappé. The Chappé semaphore, like the signaling devices so commonly used on railroads to-day, consisted of an upright post, on the top of which movable arms were pivoted. In the Chappé semaphore, however, the arms were arranged quite differently from the ordinary railroad semaphore. Thus, the cross-arm on the top of the post was about fourteen feet in length; at each end of this long arm a shorter arm was pivoted. By a system of pulleys and ropes these arms could be placed in a great many different positions, and certain positions were allotted to the different letters of the alphabet. A miniature of the semaphore arms, operated also by the ropes and pulleys, was placed at the bottom of the post, by means of which the operator could see the position in which he was placing the arms.

These semaphores (Fig. 2) were placed on towers, hills, etc., six or ten miles apart, and expert operators could signal at the rate of

about three words per minute. To enable the operators to observe the distant signals telescopes were placed in every tower. This method of telegraphing was widely introduced in Europe, especially in France and Russia, and by repeating the signals from tower to tower, territory covering hundreds of miles was brought within signaling distance. In Russia alone a string of these towers extended from the Prussian frontier to St. Petersburg, a distance of over 1200 miles.



FIG. 2. CHAPPE SEMAPHORE.

Other wireless telegraph systems, in the strict sense of the word, are the well-known heliograph or mirror signaling systems, flash-light signaling, wig-wagging, torch signaling, etc., now in general use by the various army and navy signal corps of the world, and may be found described in the author's work "American Telegraphy."

After the semaphore system came the electric wire telegraph, and after that the electric wireless telegraph systems. In fact, it may be noted, contrary to the popular view, that electric wireless telegraphy was practised in a small way before the invention of wire telegraphy. Thus, over one hundred and fifty years ago electric signals were sent without wires through water, across rivers, lakes, etc. For example, Dr. Watson, Bishop of Llandaff, sent electric shocks across the Thames, and subsequently through the New River at Newington. Similar experiments were made by



FIG. 3. TELEGRAPHING THROUGH WATER.

Franklin in 1748 across the Schuylkill at Philadelphia, and by Du Luc a year later across the Lake of Geneva. Morse also, in 1842, transmitted signals across a canal eighty feet wide without wires, using the arrangement shown in Fig. 3, in which *w w* are insulated wires 200 to 400 feet in length; *G* is a galvanometer; the battery is shown

by vertical thick and thin dashes; c c are large copper plates about five feet long by two feet wide. A key was used to open and close the battery circuit. Similar experiments, but on a larger scale, in India and elsewhere have shown that the best results are obtained when the length of the wires on the shore is equal to the width of the river to be signaled over. But in all of these instances the water or earth was the conductor of the electric impulses or current.

It is evident that the systems just referred to are not wireless in any other sense than that named, for, in the instruments used, and outside of them, wires are still very much in evidence. The term is, however, a convenient one, and indicates clearly enough what is meant, namely, the absence of a connecting wire between stations, and more especially so when it is considered how absolutely necessary the connecting wire between stations of an electric telegraph system was at one time thought to be. Scarcely a writer on the subject of electric telegraphy forty or fifty years ago but felt bound to sing its praises. Thus,

"From clime to clime, from shore to shore,
Shall thrill the magic thread;
The new Prometheus steals once more
The fire that wakes the dead."

The term "wireless telegraphy" as now generally used, however, refers to the more recently devised electrical wireless methods, like Marconi's, De Forest's, etc., in which the wire between the transmitting and receiving stations is dispensed with, and in which electric or ether waves in free space are utilized between the sending and receiving stations. These, however, are not the only wireless telegraph systems in which electric waves are the important factor, for it is well known that during the past fifteen or eighteen years there have been in limited use a number of wireless electric telegraph systems, which have been sometimes called, perhaps for want of a more apt name, induction telegraph systems, some of which will be described.

The following are some of the other terms that have been suggested for the new telegraphy: space telegraphy, spark telegraphy, telegraphy without line wires, electric-wave telegraphy, ethereal-wave telegraphy, and Hertzian-wave telegraphy. In general, however, the term "wireless telegraphy" will be used in the following pages to denote electric-wave or Hertzian-wave telegraphy.

CHAPTER II.

INDUCTION TELEGRAPHY.

PHELPS, EDISON, PREECE, DOLBEAR SYSTEMS.

ELECTROMAGNETIC and electrostatic induction systems are based on the phenomena of mutual induction between wires. Electromagnetic induction was discovered by Faraday and Henry. Henry's experiments were chiefly with flat coils of wire, one placed above another. When a circuit containing such a coil and a battery was opened and closed, it was noticed that a current was induced in the neighboring wire, which current was in the opposite direction to that of the originating current. This current would be indicated by a galvanometer in the second circuit. This action may also take place between two straight parallel wires. In Fig. 4, for example, let A and B be two parallel circuits; *b* the source of electromotive force.

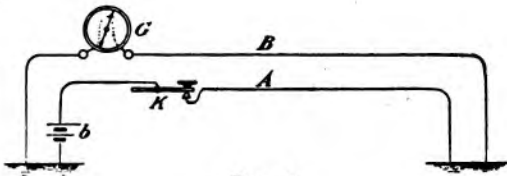

FIG. 4.

If the key *K* be opened and closed at intervals, it will be seen by the deflections of the galvanometer *G* that currents are at such times set up in *B*, and that

the current set up when the key is closed is opposite to that originated when the key is opened; and, further, that the current originated in *B* at the closing is opposite in direction to that of the current due to battery *b*, and vice versa.

This effect is explained by saying that the magnetic lines of force which surround a wire conveying a current, in rising and falling "cut" the parallel wire and induce in it currents which vary in strength and frequency with the current in the first wire. If the wires *A* and *B* are made sufficiently long and a sufficiently high electromotive force be employed, and the circuit be made and broken quickly in one of the wires, induced currents will be indicated in the second

wire, even when the wires have been widely separated. This fact is utilized in the Phelps, Preece, and other induction telegraph systems.

Electrostatic induction is explained by the fact that when a metal plate, wire, or other conductor of electricity receives a charge of positive or negative electricity it induces in a neighboring conductor a charge of opposite polarity. In the act of taking this charge, and also when the charge is dissipated, a momentary current is set up in the conductor. But in the case of static induction the current set up in the neighboring conductor, for example, B, Fig. 4, is in practically the same direction as that accompanying the currents of charge and discharge in wire A. (See pp. 25, 31.)

The Induction Coil.—This piece of apparatus, which is used extensively in wireless telegraphy, X-ray work, etc., is designed to avail of the mutual induction between parallel wires. The turns of the first or primary wire or coil (see c, Fig. 6) is wound over a core of small iron wires; the secondary wire or coil is also wound over this core, either side by side with, or above, the primary wire. The turns of the primary wire, in which the battery is placed, being adjacent to the turns of the secondary wire, the makes and breaks of the circuit, or rapid variations, however produced, in the strength of current in the primary circuit, set up currents of alternating polarity in the secondary coil. The number of turns in the primary wire of an induction coil are comparatively few, and the wire used is coarse; while the secondary wire is composed of many turns of a fine wire. The number of convolutions in the primary of an induction coil used in telephony may be 61, with a resistance of .25 ohm; the number of convolutions of the secondary 1950, resistance 100 ohms. In the larger induction coils, giving, for instance, a ten-inch spark, the resistance of the primary may be .3 ohm; that of the secondary, 12,000 ohms. The electromotive force developed in a circuit is proportional to the lines of force cutting the circuit in a given time. Hence, as the lines of force of the primary wire in rising and falling cut each turn of the secondary wire separately, the total electromotive force in the latter is amplified manifold, while, of course, the current is reduced, owing to the high resistance of the secondary wire. The strength of an induction coil is usually signified by the length of spark it will give through air, between the terminals of the secondary wire.

In the smaller sizes of induction coils the makes and breaks of the primary circuit are usually obtained by a device similar to that of the

“buzzer” or ordinary electric door-bell, as at B, Fig. 6, which is termed the interrupter or vibrator. A condenser is generally placed across the contact points of the vibrator, it having been found that this adds largely to the efficiency of the coil and diminishes sparking at the contacts. The electric condenser is virtually a Leyden jar arranged in a convenient form, usually consisting of sheets of tin-foil separated by paraffin paper or mica, the alternate sheets of tin-foil being connected together, making two series of sheets. The size of induction coils used in wireless telegraphy for setting up electric oscillations in the transmitting circuit varies from a few inches in

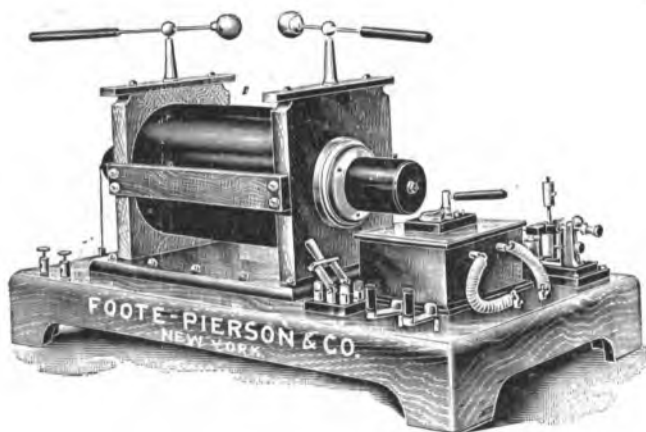

FIG. 5. INDUCTION COIL.

length and diameter to over a foot in length and eight inches in diameter, depending on the length of spark or power desired. The general external appearance of a fairly large induction coil is illustrated in Fig. 5. In coils of this size the vibrator is usually separate from the coil, owing to the rapid disintegration of the contacts at B under a heavy current. The vibrator in Fig. 5 is a magnetic interrupter. It is shown at the right of figure. The condenser is contained in the square box shown to left of the interrupter. The capacity of the condenser is varied by the handle on top of box. The switches shown are for opening and reversing battery as desired. Other forms of interrupters are also used in the primary of the induction coil. Some of these interrupters consist of devices by which the primary cir-

cuit is broken mechanically, as in the Preece system. In others the primary circuit is broken by lowering and raising contacts in and out of cups containing mercury, and by other means, some of the devices for which will be described and illustrated in a subsequent chapter. (See Index.)

For practical purposes it may be assumed that there is but one "rise" and one "fall" of the lines of force of the secondary circuit for each make and each break of the primary of the induction coil. For, while certain experiments of Bernstein and others have shown that there are surgings or oscillations of the current between the interruptions of the battery current, the extra pulsations are so quickly dampened their effect is not markedly appreciable. Further reference to electric oscillations will be made in connection with the subject of Hertzian waves.

THE PHELPS INDUCTION TELEGRAPH.

This was perhaps the first induction telegraph system put into practical operation either in this country or in Europe. It was

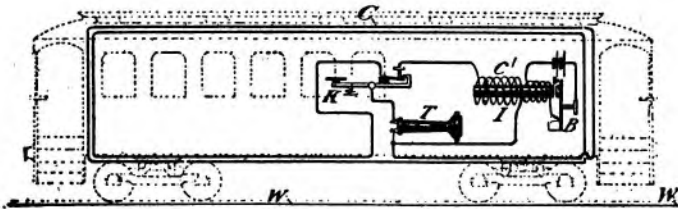

FIG. 6. PHELPS INDUCTION TELEGRAPH

devised in 1886 as a means of communicating between a moving train and railroad stations. The arrangement of the apparatus and circuits employed is shown in Fig. 6. An insulated wire *w* is laid between the rails of the track from station to station. A coil of wire *c* is wound in a suitable frame around the car, as shown by the black lines, the car itself being indicated by the dotted lines. An induction coil *I* is used to set up pulsations in the coil, which pulsations, by electromagnetic induction, are transmitted through the air to the wire *w* between the rails. A similar arrangement of induction coil, key, and telephone to that shown in the car is employed at the station. The pulsations thus developed in the wire *w* are heard in the tele-

phone at the station as a prolonged tone or "buzz" when the key or transmitter k is closed, but when the key is opened the tone ceases, as at such times the secondary coil c' is open. Then, by opening and closing the key k , long and short tones, corresponding to the dots and dashes of the Morse alphabet, may be transmitted by the operator in the car and received by the operator in the station. In like manner the induction coil in the station may be set in operation and the pulsations traversing the wire between the rails will induce pulsatory currents in the coil around the car, which pulsations may also be similarly broken into dots and dashes by the operator at the station and received as intelligible signals by the attendant in the car. It may be seen that the connections of the coil and telephone t are arranged so that when the transmitter is open the telephone is placed in the circuit, while the induction coil c' is out of circuit, and when the key is closed, as in the figure, the reverse is the case. In the figure, B is the armature or interrupter of the primary circuit of the induction coil. For clearness, the respective coils of the induction coil are placed end to end over the core of iron wires. This system was in use on a twelve- or fifteen-mile section of one of the railroads running out of New York, and the writer had several opportunities to observe it in actual operation. Morse signals, composed, as stated, of long and short tones in the telephone, were readily interchanged between stations and the car throughout the continuance of the trips. Even when the car equipped with the coil and apparatus was switched off to a side-track sixty feet from the track wire, it was quite possible to exchange messages with the car and station.

THE EDISON INDUCTION TELEGRAPH.

Another induction telegraph system, shown in Fig. 7, somewhat similar to the one just described, so far as the arrangement of the transmitting and receiving apparatus in the station and car is concerned, was also in actual operation for a similar purpose on the Lehigh Valley Railroad. This was an electrostatic induction system, and was devised by Wiley Smith in 1881. Later it was improved by Edison and Gilliland.

In this system the metallic roofing x of the car or cars of the train is used as one large plate of a condenser; the telegraph wires by the side of the track as the other plate; the insulating medium or dielectric being the intervening air. At the station x several ordinary

condensers are connected by one terminal to adjacent telegraph wires, while their other terminal is connected to the transmitter or key and thence through the apparatus to ground. In the car the metallic roofing is connected to the key and thence through the induction coil or telephone to ground. In this system, when the induction coil at either station is operated the condensers in the one case and the roofs and adjacent wires in the other are alternately charged and discharged; the currents thus produced setting up in the telephone at

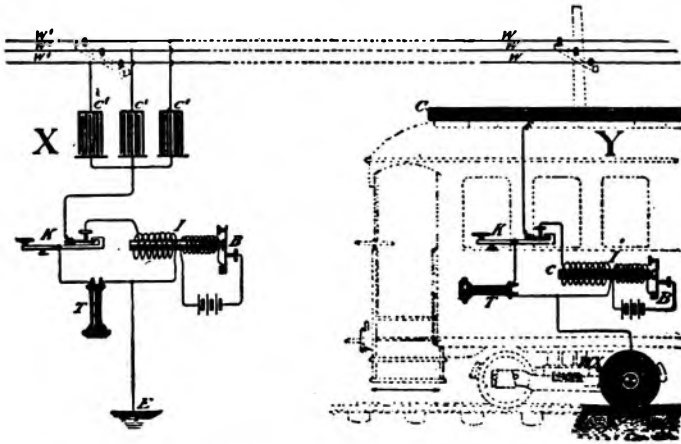

FIG. 7. EDISON INDUCTION TELEGRAPHY.

the receiving station a tone practically similar to that set up by the operation of the induction coil in the magnetic method.

When these systems were first introduced it was assumed that a general demand would arise for them on all railroads, the advocates of the system urging that they would afford a means of preventing accidents, collisions especially, and incidentally would keep travelers in continuous connection with the "stationary" world. The expectations in this respect, however, were not realized.

THE PREECE ELECTROMAGNETIC METHOD.

By an analogous method to that of the Phelps induction system, namely, the electromagnetic method, Sir W. H. Preece in 1892 succeeded in signaling to a distance of over three miles without intervening wires, between Penarth on the mainland, and the island of Flat Holm in the Bristol Channel. Two parallel wires on poles were

used, one on the mainland, the other on the island. The wires were from one to three miles in length. These wires served alternately as the primary or secondary wires, depending on which was employed as the transmitting or receiving wire. The respective wires were grounded at each end. Telephones were used as the receivers, as in the Phelps and Edison systems.

Instead of an induction coil to set up the electromagnetic impulses, Mr. Preece employed a motor-driven make-and-break wheel *B* (Fig. 8), by which means a sharper rise and fall of current is obtained, which in turn has a more pronounced effect upon the receiving instrument *T*. The break-wheel is shunted by a condenser *c*; *r* is an adjustable resistance. Battery *b* consists of about 100 dry cells. About 600 alternations per second were used. Mr.

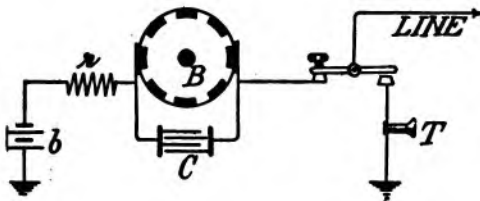

FIG. 8. PREECE INDUCTION TELEGRAPH (THEORY).

Preece states that the 100 cells with this break-wheel give as good results at 3.3 miles as $2\frac{1}{2}$ horse-power transformed into alternating currents by a transformer, or induction coil, owing to the smoother sinusoidal curves of the latter. When key *K* is closed the pulsations from *B* are transmitted to the line; when open, the telephone *T* is in circuit for receiving signals from the distant station.

More recently the same experimenter has succeeded in establishing a wireless telephone circuit by means of which speech is transmitted between the Skerries lightship and the mainland of Anglesey, a distance of nearly three miles; the parallel wire on the Skerries Islands being 750 yards in length, and that on the mainland 3.5 miles in length, the ends of each wire terminating in the sea. On these systems both magnetic induction and electric conduction through the earth and water are utilized. The ordinary telephone transmitter and receiver are employed. It was suggested that vessels could hold speech with one another, by this arrangement, a considerable distance apart, by having a copper wire carried from bow to stern and passing over the topmast, the ends of the wire being in the sea.

Evershed Calling Relay.—In the Phelps induction system it was at first attempted to operate a relay by the induced pulsations of current and cause the relay to operate—a sounder, in order that the

usual Morse method of receiving might be employed. Such a plan would also afford an audible method of calling a station. This arrangement was not, however, very satisfactory, and the telephone as a receiver was utilized. It will be obvious that in the latter case it is necessary that the attendant should keep the telephone constantly at his ear to be ready to acknowledge calls. In the Preece system this difficulty has been met by the use of a sensitive relay, due to Mr. S. Evershed. This relay consists of a rectangle of very fine wire, the free end of which is placed in the field of a strong magnet. The rectangle is supported at its fixed end by an insulating block. The wire forming the rectangle is made a part of the signaling circuit. When an alternating current is set up in the rectangle its free end vibrates up and down, due to the mutual effect of the field of the magnet and the magnetic field thus set up in the fine wire. A contact screw, or point, controlling the local circuit of a call-bell, is placed in such proximity to the free end of the rectangle that the local circuit is closed when the rectangle vibrates, by which means the call-bell is operated. A modification of this relay was also devised by Mr. Evershed, in which two rectangles are so placed that contact points attached to their free ends come together and close a local circuit when the magnetic pulsations traverse the receiving circuit. The connections of the respective coils are such that the pulsations cause them to oscillate in opposite phases, and the local contact points are so arranged that they close the local circuit at such times. When, on the other hand, the coils are mechanically shaken, they vibrate in unison and the contacts do not close the circuit. The advantage of this is that the jarring, etc., to which such instruments are liable on shipboard do not cause false "calls." The fundamental rate of vibration of these rectangles is sixteen periods per second. The method employed for setting up the calling pulsations is as follows: A small alternator, to the armature-shaft of which a heavy fly-wheel is attached, is set in operation by hand. It is first caused to revolve at a higher rate than necessary to set up pulsations of sixteen periods per second, whereupon "the exciting current is switched on and the machine is allowed to come gradually to rest, passing slowly through the synchronizing speed, so that the two rectangles have time to come to their maximum amplitude," and the call is given.

In these systems it has been found that the length of the parallel wires should be equal to the distance to be signaled across, as in the case cited of signaling through water.

Stevenson's Experiments.—Many experiments on a large scale have been made with coils of wire as a means of signaling by electromagnetic induction. In some of the experiments the coil has been in the shape of a ring, in others a triangle, rectangle, etc. As a result of some of these experiments Mr. C. A. Stevenson found that to signal across half a mile, nine turns of No. 8 iron wire, forming a coil 400 feet in diameter, and a current of one ampere, were requisite. Mr. Stevenson points out that the signaling distance by this method "is proportional to the square root of the diameter of one of the coils, so that with any given number of turns, to signal double the distance requires double the diameter of the coils, or double the number of turns. But this law does not hold when the coils are close together."

In other experiments, two coils, each 600 feet in diameter, and separated by a space of about 2550 feet, from center to center, were employed, and signals were easily received by the use of two telephones. A battery of 100 dry cells was used, but signals could still be read when the battery was cut down to 15 cells. The effect of putting the terminals of the coils to ground was tested as compared with the results when a complete metallic circuit was employed, and but little difference was noted.

In 1886 Mr. A. E. Dolbear patented a wireless telegraph system consisting of a vertical wire at each station, with means for establishing a positive potential at one ground and a negative at another, when by varying the potential at one ground the potential at the other ground would be varied, which variations, by causing currents to traverse the earth between the stations, would operate a telephone receiver. Mr. Dolbear experimented with these devices, using a kite to uphold the vertical wires, and was able to receive telegraph signals over short distances. (U. S. Patent, No. 350,299.)

In 1891 Mr. T. A. Edison patented an induction telegraph system designed for communicating between land stations and between vessels at sea. He also proposed to use vertical wires supported by the masts of ships or by captive balloons. He proposed to use an induction coil to set up rapid pulsations at the transmitting station, and a sensitive receiving instrument, such as a telephone receiver, at the receiving station. (U. S. Patent, No. 465,971.)

Mr. Edison's view was that the electrostatic impulses set up would be transmitted inductively through the intervening air.

CHAPTER III.

ELECTRIC OR HERTZIAN-WAVE TELEGRAPHY.

MAXWELL'S ELECTROMAGNETIC THEORY OF LIGHT—HERTZ EXPERIMENTS—ELECTRIC OSCILLATIONS, ETC.

It is not conceivable that action of any kind can take place at a distance without the aid of some intervening medium. When the old-fashioned door-bells were in vogue, the visible medium between the bell-pull at the door and the bell within the house was the wire with its crank-levers; the ringing of the church-bell in the belfry is accounted for by the connecting rope leading down to the sexton; and the fact that a voice, bell, or tuning-fork is heard across a comparatively short space is accounted for by the theory of the propagation of sound-waves in air.

The explanation of the manner in which this sound reaches the ear is that the voice, bell, or fork sets the surrounding air-particles into to-and-fro vibrations or excursions, which vibrations or waves are propagated from particle to particle of air, or from one series of particles to another series, in every direction radially from the source. In each full wave there are two condensations and two rarefactions of the air-particles. When the air-waves reach the drum of the ear the latter is set into corresponding vibration and the sensation of sound is produced. Sound-waves are thus said to oscillate longitudinally to the direction of propagation.

That the air is the medium by which sound is transmitted in the cases mentioned, may be demonstrated by the familiar experiment with a bell in an air-chamber from which it is possible to remove the air. An electric bell may be started ringing in the chamber, through the glass sides of which the bell may be seen and heard. When the air-pump is set in operation and the chamber is gradually exhausted of its air, the sound of the bell fades away and at last dies out, notwithstanding that its clapper is still to be seen in full operation; thus

proving that the air was the medium by which the sound of the bell was propagated to us. As just remarked, however, the bell is still visible. Evidently, then, since the idea of action at a distance without a connecting medium has been disavowed, the medium by which we see the bell has not been removed. Inasmuch as the air is not the medium by which the vibrating bell (or anything else) is visible to us, it is apparent that another medium exists by which light is propagated, a point which is still more obvious when it is considered that the atmosphere does not extend a thousand miles, at most, beyond the earth, and yet the light of the most distant visible stars reaches us. This medium is termed the ether, a substance which apparently pervades all space and all bodies, and to which the glass sides or walls of the air-chamber in the experiment referred to are as open as would be a bird-cage placed in a pond to the water, and vastly more so. Dr. Lodge has thus defined this medium: "The ether is a perfectly continuous, subtle, incompressible substance, pervading all space and penetrating between the molecules of all ordinary matter, which are imbedded in it and connected with one another by its means. And we must regard it as the one universal medium by which all actions between bodies are carried on; its function is to act as the transmitter of motion and energy."

It is assumed that the propagation of sound-waves in air, and also some of the phenomena connected therewith, are in some respects analogous to the propagation of light-waves in the ether. It will, perhaps, therefore be of service to touch briefly upon some of the known facts in connection with the more familiar subject, sound-waves.

When a tuning-fork is struck while held by its handle it vibrates at a given rate, depending upon the length, diameter, etc., of the fork; and, in doing so, gives out a sound or note of a certain pitch, which is termed its fundamental note. In transmitting sound air-waves travel at the rate of about 1120 feet per second (the speed or velocity varies somewhat with temperature). From this it follows that the length of a wave will depend upon the number of vibrations per second. Hence, if to produce the note *c* 261 to-and-fro vibrations or oscillations are required, the wave-length of that note will be $\frac{1120}{261}$, or, roughly, 4.3 feet. For the octave of that note the vibrations would be double, that is, 522 per second, and its wave-length will therefore be halved.

When the fundamental rate of vibration of forks, reeds, strings,

etc., is the same they are said to be in unison, harmony, or sympathy. When thus attuned, such forks or strings readily respond to sound-vibrations of their own rate, and continue to vibrate for a time after the originating cause has ceased. For example, if a tuning-fork is set in vibration adjacent to another exactly similar fork, the latter will presently begin to vibrate in response to the air-vibrations set up by the first fork, and will continue to vibrate for some time after the first fork is removed. But vibrations or waves of a different order, unless they be harmonics or octaves of the fundamental note, will not materially affect the forks. Fortunately, such things as the ear-drum and the diaphragm of a telephone receiver are quickly responsive to a large variety of vibrations and come to rest or are dampened practically concurrently with the originating cause of the vibrations. It is well known that sound-waves are reflected from an object which they cannot penetrate, giving rise thereby to the familiar echo. It is also known that sound-waves are refrangible; that is, they change their direction in passing from one medium to another, etc.

According to the undulatory theory of light, the atoms or molecules of a luminous body, such as an ordinary lamp, vibrate with exceeding rapidity, and these vibrations are communicated to the ether within and surrounding the luminous body, and thereby corresponding disturbances, vibrations, or undulations are set up in the ether, which radiate in every direction from the source. These waves or undulations in the ether when they reach the eye give rise to the sensation of light. Experiments and calculations have shown that light travels at the rate of about 186,000 miles per second. Also that the light-waves which when they fall upon the retina are manifested as red light, vibrate at the rate of about 400,000,000,000,000 per second; the waves that produce violet light, at the rate of 700,000,000,000,000 per second; while the undulations that produce yellow, blue, orange, etc., fall between those figures; and the combination of all these different undulations gives white or day light. The length of these waves is exceedingly small, about $\frac{1}{35000}$ inch for red light and $\frac{1}{85000}$ inch for violet light. It has long been known that the luminiferous waves, like other forms of wave motion, can be reflected, refracted, etc.

In 1864 Clerk-Maxwell demonstrated mathematically the electromagnetic theory of light, which, in effect, is, that electromagnetic manifestations are due to undulations of the all-pervading ether, of a more or less similar nature to the undulations which produce the

manifestations of light, and that in so far as they differ it is mainly a difference in degree as to the number of vibrations per second, the electric undulations of the ether varying from a few hundreds or thousands to many millions. In other words, it is a difference in the wave-length of the respective undulations. Further, the theory showed that light and electricity travel in free space at a corresponding speed.

Gordon states Clerk-Maxwell's electromagnetic theory of light thus: "Electromagnetic induction is propagated through space by strains or vibrations of the same ether which conveys the light-vibrations; or, in other words, light itself is an electromagnetic disturbance. . . . The chief point of resemblance between the modes of propagation of light and electromagnetic induction is that in both cases it can be shown mathematically that the disturbance is at right angles to the direction of propagation. It is known that the waves of light take place in directions at right angles to the ray. Maxwell has shown that the directions of both the magnetic and electric disturbances are also at right angles to the line of force. They are also at right angles to each other."

Following Clerk-Maxwell's announcement of his electromagnetic theory of light, which involved the existence of electric waves in free space, many physicists set themselves the task of demonstrating by experiment the truth of this theory. It was not, however, until 1887 that the actual existence of electric waves in free space was demonstrated, the great honor of this accomplishment falling to Prof. H. Hertz, some of whose experiments will be described shortly.

It was first shown by Lord Kelvin, in 1853, that when a Leyden jar or other highly insulated condenser is discharged, the previous charge is not dissipated at one rush, but gradually, in a series of oscillations. A mechanical analogy of this oscillatory action may be offered. Assume two equal inclined grooved boards to be placed to resemble somewhat a wide letter V. Let a ball be placed at the top of one of the planes. By reason of its position the ball now possesses a certain potential energy, or power to do work, due in this case to gravity, the work having been done against gravity in raising the ball to its present position. When the ball is let go it descends the inclined groove and at once begins to give up its potential energy, but as it does so it gains kinetic energy or energy of motion, or momentum (due to that property of matter termed inertia, by virtue of which

matter tends to continue at rest when at rest and to continue in motion when in motion), which carries it past the lowest or zero point, and on up the opposite inclined plane. As the ball ascends this plane it now gives up its kinetic energy, but is again acquiring potential energy. If there were no friction of the air, or of any other kind, to be overcome, the ball would rise to a point equal to that from which it had started, and would then reverse its direction and return to zero, acquiring kinetic energy as it fell, which would carry it back to its original starting-point, and it would thus oscillate indefinitely. But as friction cannot be wholly eliminated, it is evident that the amplitude of the oscillations would gradually shorten and the ball would come to rest at zero after a few oscillations, depending upon the amount of the friction, the height to which it had been raised originally, etc.

For momentum read inertia, p. 19.

stance.

It is well known that in an electric circuit containing coils of wire or magnets the current is retarded in rising and falling, which fact is due to the property termed self-induction, or inductance. On the contrary, when a wire possesses static capacity the current is assisted in rising and accelerated in falling. The property of inductance is usually likened to momentum, while capacity is likened to elasticity, in mechanics.

Briefly, inductance is that property of a circuit upon which depends the number of magnetic lines of force that will be set up around or in the circuit when the current in the circuit is varying. Capacity is that property of a circuit upon which depends the amount of charge the circuit will acquire with a given electromotive force; it might be termed the electricity-holding quality of a circuit. Resistance may be considered the molecular friction which the E. M. F. must overcome in forcing the current through the conductor. In a circuit that contains no magnetic material within or surrounding it, like iron, the inductance of the circuit is constant regardless of the strength of current. The capacity of a given circuit is also constant, as is also the resistance of a circuit if a uniform temperature of the conductor be maintained.

In setting up the magnetic lines of force (that accompany an elec-

tric current) in the medium or dielectric surrounding a circuit, a certain amount of energy is expended (and the starting of the current is retarded), but this energy is returned to the circuit as kinetic energy when the circuit is broken or when the current strength is decreased. In setting up the stress in the medium or dielectric surrounding a conductor having capacity, a certain amount of potential energy is stored, which is returned to the circuit as kinetic energy when the stress or pressure is decreased. In both cases, therefore, the energy of inductance and capacity is returned to the circuit practically as in the mechanical analogy cited. The electrical energy expended in overcoming the resistance of the circuit, however, is not returned to the circuit, but is dissipated in heating the conductor.

A charged condenser or conductor has acquired a potential energy due to the work done in charging it, which work is equal to $\frac{1}{2}QE$ ergs, or units of work, when E is the potential to or through which the electricity has been raised or displaced from zero, and Q is the charge; Q being equal to the product of E by the capacity of the condenser, K . As the potential starts from zero, the total work done is the average of the total potentials during the time that the electricity is being raised to maximum, which average it is known is one half of the maximum potential, namely, $\frac{1}{2}E$, and hence the total work is $\frac{1}{2}QE$.

The foregoing is more frequently stated as follows: Potential energy = $\frac{1}{2}\frac{Q^2}{K}$ ergs; which latter statement is the equivalent of the other and is derived by simple substitution of terms. Thus, if $Q = KE$, then $\frac{Q}{K} = E$ and $\frac{Q^2}{K} = QE$. Hence, $\frac{1}{2}QE = \frac{1}{2}\frac{Q^2}{K}$.

Taking a numerical example:

If $Q = 12$, $K = 3$, and $E = 4$,
then $12 = 3 \times 4$, or $\frac{12}{4} = \frac{3 \times 4}{4} = 3$, and $\frac{12^2}{3} = 12 \times 4 = 48$.

Hence, $(\frac{1}{2})12 \times 4 = (\frac{1}{2})\frac{12^2}{3}$.

In the act of discharging, the potential energy of the condenser or conductor decreases, while kinetic energy due to the current of discharge will be acquired. Hence, when potential energy has fallen to zero the current will still flow, due to its acquired kinetic energy. This will then charge the condenser oppositely and potential energy

is again acquired. Thus oscillations would be set up of prolonged duration, were there no resistance in the circuits; but as all circuits possess some resistance, heat will be generated in accordance with the C²R law, and obviously if the resistance be great the oscillations will quickly cease, or the potential energy may be dissipated in one quarter vibration.

Dr. Lodge has suggested the following as a perfect mechanical analogy to the charge, capacity, inductance, and resistance of a circuit, namely, a weighted spring bent back in a viscous medium. The bending or displacement of the spring corresponds to the charge; the tension or elasticity of the spring to capacity; the weight on the spring to inertia or inductance; and the friction of the viscous medium to resistance.

The rate at which electric oscillations occur in a suitable condenser or conductor may be many millions per second. According to the same authority, if an electrostatic charge on a metal sphere two feet in diameter be disturbed, the charge will oscillate at the rate of 300,000,000 periods per second, and this will radiate into space-waves about three feet in length. The shortest "ethereal" wave thus far produced by electromagnetic means is about .15 inch in length. This is still very much longer than the longest light-wave, and is sixty or seventy times longer than the longest dark heat-wave yet measured; the length of the heat-waves it is known falling between the light-waves and electromagnetic waves.

In the electrical circuits employed in wireless telegraphy the resistance is small (if the spark-gap and filings-coherer are eliminated) and is commonly disregarded in computing the components of the circuit. In fact, as noted, if the resistance be too great the discharge will not be oscillatory. The time of a period of oscillation of a circuit containing inductance and capacity is expressed by the formula $T = 2\pi\sqrt{KL}$, where T is the time in seconds, π is the ratio of circumference to diameter, K is the capacity in farads, and L the inductance in henrys, or

$$T = 6.2832\sqrt{KL}$$

Hertz Experiments.—In proceeding with his experiments Hertz reasoned that as those waves which correspond to light affect the eye when they fall upon it, so should the electric waves of the ether affect a suitable electric "eye," or detector, when they fall upon it. The apparatus employed by Hertz to show the existence of electric waves

in free space consisted essentially of an electric oscillator and an electric resonator, or wave-detector. The oscillator is a device for setting up electric oscillations in a circuit, which in turn radiate or emit electric waves in free space. Such an oscillator and detector is outlined in Fig. 9. The generator consists of the induction coil I, the

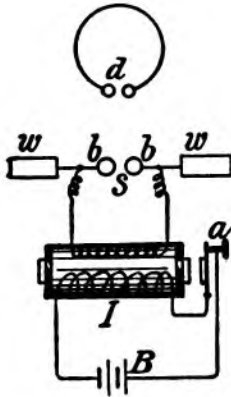

FIG. 9. OSCILLATOR AND DETECTOR.

terminals of the secondary wire being connected to small brass balls *bb*, to which short metal cylinders or wings *ww* are attached. The balls are separated by a short air-space or spark-gap *s*, across which sparks jump when the coil is in operation. At such times electric oscillations are set up in the oscillating circuit, the rate of which varies with the electrical dimensions of the circuit. The knobs and wings of the oscillator may be considered to correspond to the two widely separated plates of a condenser the dielectric of which is the air. The vibrations of the interrupter *a* set up pulsations of current in the primary circuit of the induction coil I, which by induction set up alternations of greatly enhanced electromotive force in the

secondary coil, which in turn produce oscillations in the circuit *bbww*, as stated, which circuit, it will be understood, is the oscillator proper.

These oscillations are due to the fact that the discharge of the induction coil raises the discharge knobs *bb* to a very high potential, this causing a disruptive spark across the air-space separating the knobs, which spark in turn reduces the resistance of the air to such an extent that oscillations are set up. Thus, as neatly stated by F. K. Vreeland: "Suppose the air-gap to break down. A current surges across the gap, the stress in the dielectric is relieved, and displacement currents begin to flow back along the lines of force. It is well known that a variable current in a conductor induces similar currents in neighboring parallel conductors. So also in the dielectric: the displacement currents suddenly set up by the discharge of the oscillator induce similar displacement currents in the adjoining portions of the dielectric, and so the disturbance is propagated outward from place to place in an ever-expanding wave. At the moment when the conductors or balls are completely discharged and the current flowing across the spark-gap

is a maximum the energy of the oscillation is entirely kinetic, that is, magnetic, and no lines of force proceed from the oscillator. As the conductors become charged again with opposite polarities this changes into potential energy, stored in the strained dielectrics, about the oscillator. And these alternations of potential and kinetic energy are transmitted outward in somewhat the same way as sound is transmitted from a vibrating tuning-fork—here a layer of moving air under normal pressure, next a layer of compressed air without motion, and so on, only in the case of electric waves the direction of the current and of the stress which alternates with it is perpendicular (transverse) to the line of propagation, while in the case of sound the action is in the direction of propagation. Indeed, the action of the ether may be compared to the motion of a series of incompressible plates, capable of sliding over each other, but bound together by an elastic connection which tends to make them slide back to the position of equilibrium after being displaced. ("El. World and Eng'r," Sept. 13, 1902.)

The rate at which the armature or other circuit-breaker of an induction coil vibrates may vary from fifty, or less, to hundreds of vibrations per second. The oscillations of the electric oscillator may be many millions per second. Some of the early oscillators employed in wireless telegraphy had an oscillation period of about 250,000,000 per second; some of the latest, about 1,000,000 per second or less. It is evident, therefore, that the induction coil, or other alternating current generator, merely serves to strike the blow, so to speak, that sets up the rapid electric oscillations in the oscillating circuit, analogously as if we wish to keep a tuning-fork in vibration it must be struck or otherwise acted upon at intervals.

It may be noted that the electromotive force at the terminals of the secondary wire of some of the induction coils used will reach 200,000 volts. The current strength is, however, comparatively small.

Hertz assumed that if the electric oscillations produced by the oscillator set up corresponding waves in the ether of free space, these waves should in turn set up electric oscillations in a suitable receiver, or "eye," within the range of their influence. He therefore employed as a detector of these waves a copper wire D (Fig. 9), of nearly circular shape, about sixteen inches in diameter, but broken at one point d . On the end d of this wire he placed small metal knobs, the distance between which could be accurately regulated by a microm-

eter screw. This wire was upheld by an insulated support, a few feet from the oscillator. With the room darkened minute sparks were observed passing between the discharge-knobs *d* of the detector when the oscillator was in operation, and the results of this simple experiment have been generally accepted as proof of the existence of electric waves in free space. Hertz, however, did not rest with this demonstration of the accuracy of Maxwell's theory, but also in the course of his subsequent masterly experiments showed that, like sound, heat, and light waves, these electric waves could be reflected, refracted, concentrated in parallel rays and to a focus, etc.

The foregoing and many other tests, according to De Tunzelman, were made by Hertz without particular regard to having the secondary circuit (that is, the detector or micrometer circuit) in strict sympathy or harmony with the primary or oscillator circuit. In order, therefore, De Tunzelman states in his detailed description of these tests, from which description these data are drawn (see Fleming's "Alternate Current Transformer"), to determine whether any change in the capacity or inductance of either of well-tuned circuits would be noticeable in the results, Dr. Hertz replaced the conductors *w w* (Fig. 9) by two straight wires each .19 inch diameter and 51 inches long. Two hollow spheres about 11.8 inch in diameter were arranged to slide over these wires, one on each side of the discharge-gap, and as the spheres were movable on the wires the length of the conductors could be varied by moving them either way, since they virtually formed the terminals of the conductor, electrically considered. The micrometer circuit was composed of a copper wire .078 inch diameter, in the form of a square, the sides of which were each 29.5 inches. This circuit was designed by Hertz to have a slightly shorter oscillatory period than the primary wires. One of the sides of the square was then placed within 11.8 inches of the primary wires and parallel thereto. When thus placed the sparking distance at the micrometer was .035 inch. Two metal spheres 3.14 inches in diameter were then placed in contact with the terminals of the micrometer circuit, which increased the sparking distance to .098 inch. Dr. Hertz found that the capacity of the micrometer circuit could be readily adjusted by the simple expedient of suspending from its terminals two parallel wires, the length and distance of which could be varied as desired. By this means he found that with a certain adjustment the sparking distance at the micrometer knobs could be in-

creased up to .117 inch; but this was the maximum, any further lengthening or shortening of these wires reducing the sparking distance. Further experiments were then made, including varying the capacity of the wires of the primary circuit to diminish its rate of oscillation, which experiments verified the results previously obtained, "and a series of experiments in which the length and capacities of the circuits were varied in different ways showed conclusively that the maximum effect does not depend on the conditions of either one of the circuits, but on the existence of the proper relation between them. The effect of varying the inductance of the circuit was also shown by experiment. This was done by varying the length of the rectangle, but leaving its breadth constant. The length varied from about four inches to about eight feet. It was found that the maximum sparking effect was reached with a length of about six feet."

Dr. Hertz also showed in his further experiments that very rapid electric oscillations such as he was dealing with, of the order of 100,000,000 per second, are confined to the outside portions, or "skin," of the conductors along which they are propagated, and that their propagation in a wire has a definite velocity independent of its dimensions and material, iron not being an exception. Also that the velocity of propagation of electric waves in air corresponded with the velocity of light, and this was afterward shown by Sarasin and De la Rive to be true of the velocity of these rapid electric waves along wires.

Hertz also showed that metals and other good conductors are opaque to and reflect electric waves. Further, that such conductors, when used as reflectors, to give best results, must be large relative to the length of the wave, and that the reflector must not be further than a quarter wave-length from the oscillator. These conditions have virtually prohibited the successful employment of reflectors to direct the waves in wireless telegraphy, although metallic reflectors have been tested for this purpose experimentally. Lodge has shown that such substances as the human body and a wet towel will also reflect the waves slightly, and that copper is a better reflector than lead in the ratio of 100 to 40. The fact that electric waves like light waves can be so reflected, and refracted, concentrated in parallel rays, etc., markedly differentiates electric radiation and electromagnetic induction; with the latter these phenomena are not producible. (See p. 31.) (See reflectors, p. 101.)

CHAPTER IV.

EARLY EXPERIMENTS IN ELECTRIC WAVE TELEGRAPHY.

BRANLY COHERER, LODGE EXPERIMENTS, ETC.

By the Hertz detector the distance at which electric waves could be detected was very limited, perhaps ten or twelve feet at most, and hence it is not likely that much would have been done in the utilization of these waves for telegraphic purposes had progress rested there, but fortunately it did not. Shortly after the experiments of Hertz Dr. Branly discovered that loose metal filings, which in a normal state have a high electrical resistance, lose this resistance in the presence of electric oscillations and become practically conductors of electricity. This Branly showed by placing metal filings in a glass box or tube *k*, Fig. 10, and making them part of an ordinary electric circuit.

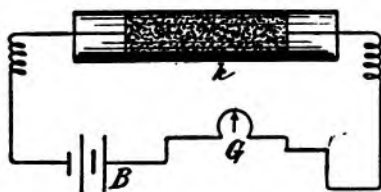

FIG. 10. BRANLY COHERER.

According to the common explanation, when electric waves are set up in the neighborhood of this circuit, electromotive forces are generated in it which appear to bring the filings more closely together, that is, to cohere, and thus their electrical resistance decreases, from which cause this piece of apparatus was termed by Dr. O. J. Lodge a coherer (although Dr. Branly himself termed it a radio-conductor). Hence the receiving instrument, *G* in the figure, which may be a telegraph relay, that normally would not indicate any sign of current from the small battery *B*, will be operated when electric oscillations are set up. Prof. Branly further found that when the filings had once cohered they retained their low resistance until shaken apart, for instance, by tapping on the tube. In 1894 Lodge showed that the Branly coherer could be employed to transmit telegraphic signals, and in order that the filings

should not remain "cohered" after the cessation of the electric oscillations, he devised an electro-mechanical "tapper" on the principle of the ordinary "buzzer," or electric door-bell, the hammer of which was caused to tap the glass tube as long as the electric oscillations continued. The filings thus virtually take the place of a key in the ordinary telegraph circuit. In the normal state the key is open; in the presence of electrical oscillations the key is closed. Thus, by opening and closing the key for a longer or shorter period, signals corresponding to dots and dashes may be produced. In other words, by setting up electric oscillations for periods of time corresponding to dots and dashes, messages may be transmitted from the sending station, and if, at the receiving station, a recording instrument (controlled by the coherer), such as the ordinary Morse register, be provided, a record of the message in dots and dashes may be obtained. Dr. Lodge (now Sir Oliver Lodge) in fact used a tapper operated continuously by clockwork.

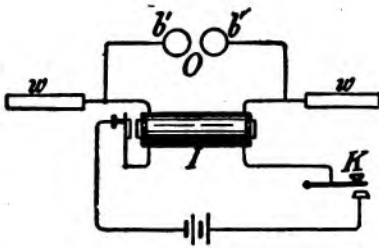

FIG. 11.

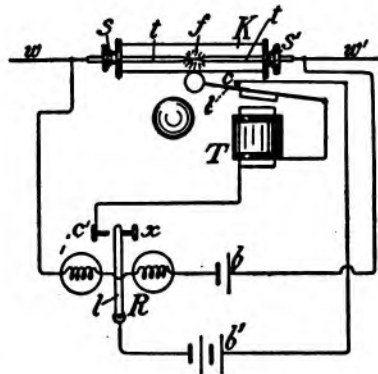

FIG. 12.

LODGE WIRELESS TELEGRAPH EXPERIMENT.

In 1895-96 Poppoff and others utilized the coherer to show the existence of atmospheric electricity, using for the purpose a vertical wire attached to the coherer. The transmitter and receiver apparatus of an experimental wireless telegraph outfit such as was used by Dr. Lodge in 1894 are outlined in Figs. 11 and 12. In Fig. 11 *o* is the oscillator apparatus, which comprises the primary wire and secondary wire of an ordinary induction coil *I*, the metal balls *b' b'*, and the metal "wings" *w w*. The terminals of the secondary wire of *I* are con-

nected as shown to $b' b'$ and $w w$. The balls $b' b'$ are about three fourths of an inch in diameter, and may be separated from one sixteenth to three fourths of an inch, depending on the strength of the coil, the capacity of the circuit, etc. The wings are brass or copper strips about one inch wide by twelve inches long. Ordinary No. 14 or 18 copper wire will serve as wings for simple experimental purposes. For transmitting signals across a distance of fifty feet these wires need not be over three or four feet in length, using an induction coil giving a two-inch spark. Signals are sent by opening and closing key κ in the primary wire of the coil. (See also description of Fig. 26.)

In Fig. 12, which represents the Lodge receiving apparatus, κ is a coherer; τ is the Lodge tapper and call-bell combined; r is a sensitive Morse relay. Wires $w w'$ are extended from the ends of the coherer analogously as in the case of the oscillator. This coherer consists of a glass tube about four inches in length, with small metal rods $t t'$, of suitable size to snugly fit the bore of the tube, and are inserted at each end as indicated. These rods come nearly to the middle of the tube, but do not touch, leaving a small space in which the filings f are placed. The filings may be of nickel. The rods in this case may be provided with adjusting-screws $s s'$ to regulate the distance between their ends in the tube.

A few words of description of the operation of the receiving apparatus will here suffice. Normally the armature-lever l' of the tapper is given a tension which holds it against the contact c . Normally also the armature-lever l of relay r is on its back or insulated stop x . Hence, at this time, the local circuit of battery b' is open. When the filings cohere, relay r is magnetized by one dry cell b and its lever l moves over to contact c' , closing circuit of battery b' ; when the electromagnet of τ attracts its armature, which opens the circuit of b' at contact c . At once the armature of τ flies back on its contact point, at the same time striking the tube, decohering the filings, and demagnetizing relay r , whose armature-lever l is brought to its back contact x by a retractile spring not shown in the figure. Immediately, however, the filings again cohere (assuming that the oscillations continue), with the result that r is magnetized, again closing circuit of b' at c' , whereby τ is again magnetized, and the actions just described are repeated many times in a second.

CHAPTER V.

THEORIES OF ELECTRIC-WAVE PROPAGATION—THE ELECTRONIC THEORY.

THEORIES OF ELECTRIC-WAVE PROPAGATION.

BEGINNING his experiments in Italy in 1895, with vertical wires twenty feet high, Marconi found that he could get signals at a distance of one mile, and that by doubling the height of the vertical wire at both stations, signals could be transmitted to four times that distance. Thus, with wires forty feet high he could signal four miles, and with wires eighty feet high, sixteen miles, and he thought the signaling distance would follow this rule, but subsequent experiments have shown that it requires some modification; and as a result of experiments by Captain Bonomo, of the Italian navy, it has been found that for the usual Marconi ship apparatus the signaling distance appears to vary according to the formula, $L = 0.15 \sqrt{D}$, where L is the length of the vertical wire, D is the distance in meters, and 0.15 is a constant. Subsequently, Marconi has employed in his transatlantic experiments many parallel wires, frequently termed antennæ, over two hundred feet high, and has succeeded in transmitting signals to a distance exceeding two thousand miles.

The amount of electrical energy employed in setting up the electric oscillations for a distance of about 20 miles is approximately 150 watts, furnished by five storage cells, at a pressure of about 10 volts and 15 amperes, giving about one fifth of a horse-power. These cells are frequently charged by a large number of dry cells in multiple. An ordinary telegraph relay may be operated at a distance of 200 miles at an expenditure of about 3 watts at the transmitting end of a telegraph wire, or with one fiftieth of the energy used in operating the electrical oscillator in question. The actual electrical energy required to operate the telegraph relay is about .24 watt, the rest of the energy being consumed in the line wire itself. It must not, how-

ever, be assumed from this that the coherer is a less sensitive electrical receiver than the Morse telegraph relay; nor will it be, when it is reflected that the electrical energy expended in the case of the relay is, so to speak, mainly confined to the wire, as, analogously, sound-waves are confined within a speaking-tube, whereas the electrical energy of the oscillator is radiated into space in every direction, and thus but a small portion of the total energy reaches the receiving vertical wire. It may readily be calculated that the electrical energy received on a surface one foot square at a distance of but one mile from the transmitter is less than the one three-hundred-and-fifty-millionth of the total energy radiated, and, it may be further noted, the energy actually radiated as electric waves is perhaps not more than six or eight one-hundredths of the energy developed at the oscillator, the remainder being lost in the induction coil as heat, etc., and at the spark-gap as heat, light, and sound. The foregoing with relation to the proportion of energy reaching the receiving wire and the amount of the energy radiated is based on the assumption that the waves are actually radiated in every direction in space, and that the rate at which the energy is radiated corresponds to the input at the oscillator, minus the losses. If it should develop that the atmosphere, earth, or ocean plays a part in guiding or conducting the waves, and that the energy thrown into the vertical wire is radiated at a greater rate than it is received (a view that was suggested by Mr. Edison in a conversation on this subject with the author several years ago), the view implied as to the super-sensitiveness of the receiver must be qualified.*

It was at first thought that signaling by wireless telegraphy would be limited by the curvature of the earth to comparatively short distances, inasmuch as it is not practicable to secure masts or other suitable supports for the vertical wires high enough to surmount the earth's convex surface between points several hundred miles apart, and it was assumed that the earth would prove to be a barrier to electric waves traveling in straight lines, like luminous waves, which, it is known, are obstructed by substances opaque to light—that is, to substances which are opaque to ether-waves of the length of light-waves. From the more recent long-distance experiments with wireless telegraphy, however, it would appear that given a sufficiently

* According to tests by Dr. De Forest, with a one-kilowatt transmitter, a hot-wire ammeter will indicate a current of three or more amperes in the vertical wire, with an E. M. F. of 20,000 volts at the oscillator, which gives, roughly, a calculated momentary rate of radiation of about 70 kilowatts—explainable, he notes, by Hertz's calculations of rate of energy radiated from a dumb-bell oscillator.

powerful transmitter and a sufficiently sensitive receiver, it is possible, as just intimated, to detect signals at a distance measured at least by the width of the Atlantic Ocean, and that with vertical wires not much exceeding two hundred feet in height.

A number of theories have been advanced to explain the fact that signals are thus received at distances much beyond what would be possible did the earth intercept the electric waves traveling in straight lines. Before enumerating some of these theories it may be premised that inasmuch as the mechanism of the ether is not yet understood, it is evident that attempts at explanations of the phenomena accompanying disturbances of or in that medium must at best be more or less hypothetical. At present we are, it may be admitted, with regard to our knowledge of the ether in somewhat the position of the ancients relative to their knowledge of the wind: we hear, so to speak, the sound of the ether, but we know not whence it cometh or whither it goeth. We can by suitable devices set up disturbances in the ether, analogously as we can set up disturbances in the air, but we are as yet ignorant of the action of the ether when so disturbed, and know nothing definitely of its constituents.

Among the theories relative to the manner in which the electric waves of wireless telegraphy are propagated are those in which it is assumed that the waves are diffracted or reflected around the natural curvature of the earth. Other theories are that the waves are propagated by electrostatic or electromagnetic induction; by oscillatory currents in the earth; by reflection between the upper atmosphere and the ocean; by disturbing the equilibrium of the earth's charge, known facetiously as "wobbling" the earth's charge; by bringing the vertical wire into resonance with the earth's capacity; and by sliding or gliding waves or half-waves over the surface of the earth and ocean.

As noted by Mr. J. E. Taylor in a very interesting article on electric radiation ("London Electrical Review," May 12, 19, 1899), the electrostatic and electromagnetic theories are hardly tenable, for the reason that electromagnetic induction effects decrease at least as the inverse cube of the distance, which, for long distances, would diminish the force so rapidly the effect would not be perceptible. An essential difference between electromagnetic induction and electromagnetic radiation is that the field of force of induction being, as it is termed, a volume effect, expands as a whole from the source, and is under the control of the source, increasing, decreasing, and dying out

with the source; whereas electromagnetic radiation, consisting of electric waves in free space, and assuming that it corresponds to luminous radiation, is independent of the source once it has been detached therefrom, and goes on traveling outward indefinitely, if it meets no obstacles, as an ever-expanding, self-closed line of force. It is necessary, as Taylor also observes, in order that an electric field may exist independent of any conductors, that the lines of electric force shall be self-closed. Such lines of strain are generally supposed to exist with both ends terminated on conductors, whereas in fact they can be cut up or subdivided and joined again, stretched out like elastic threads or allowed to contract and shorten themselves indefinitely.

Prior to making further reference to other theories of electric-wave propagation, the supposed action that takes place in and around the Hertz oscillator in the production and propagation of free electric waves in space, as expounded by Maxwell, Hertz, Heaviside, Poynting, J. J. Thomson, and others, may first be considered.

The Hertz oscillator, as stated elsewhere, corresponds to a condenser with widely separated plates. In Fig. 13, *a a* are rods of the Hertz oscillator, with the spark-balls *b*, placed vertically. In the act of charging the rods *a a*, so-called lines of electric force or strain *s s* spring out from the rods, not only in one section of the rods as indicated in the figure, but all around them, with the rods as a center. According to Maxwell's theory of displacement currents in dielectrics, when the circuit of a condenser is closed, in the ordinary sense, a current continues to flow in the circuit (considering the dielectric part of the circuit), but the dielectric, acting as though it were composed of innumerable small elastic rods, at once sets up an opposing force, which increases the more the rods are bent back, so to speak, until their opposing force equals the charging force, when the displacement current ceases to flow. At this time the condenser has acquired the potential of the charging E. M. F. When the electric pressure of the external E. M. F. breaks down the resistance at the spark-gap the potential energy stored in the dielectric is returned to the circuit and a current flows across the gap. The strain in the dielectric is thereby relieved, concurrently with which, according to Poynting, the ends of the positive lines of electric strain contract and run or slide down the rod, and the ends of the negative lines move up, as indicated in Fig. 14. The extreme outside portions of the lines of

strain also tend to contract, but as such portions of the lines move more slowly than the ends of the lines on the conductor, these ends meet, and as they cannot pass one another the respective ends are detached—snapped or whipped off—from the conductor, and, uniting, form closed electric lines of force, which are radiated into space as

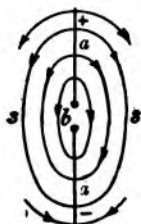

FIG. 13.

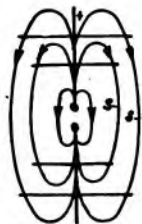

FIG. 14.

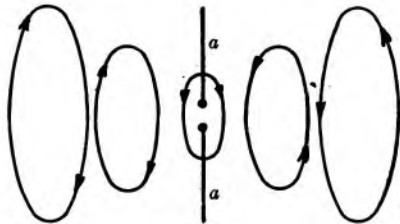

FIG. 15.

outlined in Fig. 15; the detached circles or lines of strain being shoved away, as it were, from the conductor by the succeeding detached circles. (This action has been variously likened to the action by which rings of smoke are shot out from a locomotive's smoke-stack, soap-bubbles snapped off from a pipe, etc.) Coincidentally also with and due to the collapse of the electric lines of strain, magnetic lines or circles of force are set up concentric with the rods $a a$, and at right angles to the electric lines of strain, as indicated by the transverse lines in Fig. 15. When the magnetic lines of strain are at a maximum, namely, at the end of a quarter-period (p. 20), the electric lines of strain, that is, the potential energy, will have disappeared. At once, however, the magnetic lines of force begin to collapse, thereby again setting up electric lines of strain (potential energy) in the dielectric as before, but in the opposite direction, so that the upper end of the rod in Fig. 13 will now be charged with negative and the lower with positive potential. Hence, at the next collapse of the electric lines of strain the magnetic lines of force will be of opposite sign to the preceding lines of magnetic force, as will also be the radiated or detached closed lines of electric and magnetic force, as indicated by the arrow-heads in Fig. 15. These processes are repeated until the energy of the system is exhausted, and the oscillations cease, to be renewed when the rods are again charged and the spark-gap breaks down.

The detached lines of electric and magnetic force thus jointly constitute electric radiation or free electric waves, which are propagated

in the ether as ever-expanding electromagnetic waves or undulations, which become more spherical as they proceed from their source. These are Hertzian or free waves in the strict sense, but Hertz also showed, in the course of the experiments referred to (p. 24), that these waves are guided or conducted, at the speed of light, by wires or conductors upon which they may converge, and that when conductors are led from the vicinity of the oscillator the waves may be detected at a greater distance than when such conductors are not present.

The reflection and diffraction theories assume that Hertz waves are propagated outward from the transmitter as light is propagated from its source in straight lines, and when the waves come to an obstacle, such as the curvature of the earth, they are reflected or diffracted around or past it. Since the days of Newton the characteristic colors of the sky have been attributed to the reflection of light-waves by particles of matter in the atmosphere, large by comparison with the length of the light-waves. Hence the reflection theory is objected to on the ground that particles large by comparison with the waves employed in wireless telegraphy do not exist in the atmosphere. The diffraction theory is not regarded as available, for the reason that it has been shown that diffraction phenomena on a suitably large scale are only obtainable when the thickness of the diffracting edge is at all comparable with the length of the wave, a requirement which is not supplied by the curved surface of the earth. (See p. 38.) The theory of a zigzag onward reflection of the waves between the surface of the ocean and the upper atmosphere is also by some considered unsound because of the assumed rapid diminution of intensity of the waves that this would involve.

It has also been suggested that the waves are propagated in straight lines from the vertical wire, and when they reach the convex surface of the sea pass through it as if it were a dielectric, but it has been pointed out that sea-water, as a conductor, is opaque to and reflects waves of the frequency used in wireless telegraphy. (See pp. 25, 182, 189.)

The fact that so much better results are obtained in electric-wave signaling when the vertical wire is grounded than when it is insulated from the earth, indicated that the earth must play an important part in the propagation of the waves, and this, with other reasons, has led to the supposition that the surface of the earth or sea, especially the latter, acts as a guide or conductor on which the waves converge (as in the Hertz experiments with conductors), the conductor holding the

waves, as it were, to a given course and preventing them from spreading out into free space. On this general view the waves are supposed to slide or glide over the surface of the earth or sea, hence this is termed the sliding-wave theory. As this theory appears to best explain the phenomena met with in the operation of wireless telegraphy, it has been in one form or another favorably received by some of the workers in this field.

The sliding-wave theory in its entirety was perhaps first proposed by Mr. Taylor in the article mentioned. The explanation of this theory may be aided by means of the accompanying diagrams. It is here assumed that the grounded vertical wire is equal to one half of a Hertz oscillator, the other half being the earth itself directly below the vertical wire. On this assumption the earth is a perfect conductor. Hence the vertical wire may be supposed to have a reflected counterpart directly below it, such as would be seen under a pencil standing vertically on the surface of a mirror lying horizontally on a table. This is in accordance with what is termed the image theory, first advanced by Delaricci and Blondel. Stated briefly in another way, such a vertical wire is a Hertz oscillator divided in the middle by a reflecting conducting surface. Inasmuch as this center is a point of zero potential, the conducting surface has no effect upon the oscillations except that it theoretically divides them into two half-systems of oscillations, either of which may be removed without affecting the other. Hence the grounded vertical wire with the conducting surface of the earth will have a real oscillatory system above the earth and an imaginary one below the conducting surface, as indicated by the dotted lines, Fig. 16. The oscillations occurring in this system may then correspond to those in the Hertz oscillator, a complete period of oscillations consisting of a wave from the spark-gap to the top of the antennæ, back to the spark-gap, thence to the foot of the reflected or imaginary wire and back to the spark-gap, which constitutes a wave-length four times that of the vertical wire proper. (As intimated elsewhere, this quarter-length may be increased by adding capacity or inductance to the antenna, inasmuch as wave-length $\lambda = 2w \sqrt{K L}$.)

Referring to Fig. 16, it is assumed, as in the case of the Hertz oscillator, that when the vertical wire A is charged, electric lines of force are set up in the dielectric, the air, one foot of which lines rests on the ground, the other on the vertical wire as indicated.

In many of Lodge's early experiments and lectures he showed results corresponding to those obtained by the Lecher system of wires (Figs. 87 and 88). In these experiments the source of the oscillating currents were Leyden jars connected in series. The wires were continued a long distance from the oscillator, and it was shown that the waves follow the wires around loops, curves, etc. Taylor, in propounding his theory, says if these wires or one of them is put to earth instead of being insulated, the waves will pass on and skim or glide over the surface of the earth indefinitely. If one jar and one wire only are used, waves will still be propagated. This arrangement may then be considered to correspond to the grounded vertical-wire system. The vertical wire is one coating of the jar, the earth's surface at the base of the wire is the other coating, and the earth itself



FIG. 16.

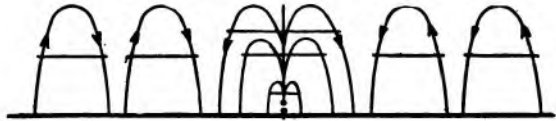

FIG. 17.

takes the place of the attached Lodge or Lecher wire. When the discharge occurs the upper ends of the lines glide down the wire in the manner described in connection with the Hertz oscillator, to the earth, forming waves similar to those which propagate themselves along wires. In this case the detached waves travel out radially in the shape of huge concentric circles, not into space, but sliding over the surface of the ground as indicated in Fig. 17. The magnetic field which accompanies the moving field of electric strain is in the shape of concentric circles (indicated by the transverse lines), which circles are of small density, owing to their large circumference. According to Poynting, the absorption of energy is proportional to the density of the magnetic field and also to the resistance of the earth. Consequently, in this case but little energy is absorbed, and it is still less as the conductivity of the sliding surface is increased, which, Taylor adds, doubtless explains the fact that better results are obtained over sea than over land. Further, this theory also explains why hills and the curvature of the earth are not obstacles to the propagation of

these waves, for on this theory the waves travel over or around such surfaces analogously as they travel over the bent or looped wire in Lodge's experiments. Since also with this form of wave sliding off from the grounded vertical wire there is no reflection from the earth into space and no radiation into space, as would be the case with vertical conductors without the ground connection or its equivalent, Mr. Taylor assumes that the intensity of the waves should not be much less than inversely as the distance from the source, and combining this with the increase of height of the vertical wire, the result of the variation of distance with the square of the length of the wire is obtained. According to Professor Blondel, the intensity diminishes inversely as the square of the distance.

Professor Fessenden, in a paper read before the American Institute of Electrical Engineers, November 22, 1899, discussed a sliding-wave theory on which it is assumed that the waves emitted from the vertical wire are propagated as sliding half-waves or loops over the surface of the sea or earth. As these waves proceed from the transmitter they expand, but their sides draw closer and closer together until they are nearly parallel. In tests made by Professor Fessenden in which the hot-wire barretter was used as a quantitative receiving instrument, it was ascertained that after the first few wave-lengths the intensity of the waves diminishes as the square of the distance, and that the height of the waves increases directly as the distance. The tests were made as follows:* The transmitting apparatus was placed on a boat on one side of an island, while the receiving apparatus, including a vertical wire in each case, was set up on the other side of the island on a wharf extending out over the water a distance of about three hundred feet. The apparatus employed in making these tests included three separate devices to detect the intensity of the waves at various distances, the height of the waves, and the presence of waves in the earth or water, namely: a detector in circuit with a vertical wire which was moved sideways; a detector in circuit with a bundle of fine iron wire around which were a few turns of copper wire moved vertically; and two large copper triangles placed apex to apex with their bases resting on the earth and with a detector between the apexes of the triangles. The tests demonstrated also that no currents are generated in the water or earth in the direction of propagation of the waves while the direction is unchanged, but that currents are generated

* See article by A. F. Collins, "Electrical World and Engineer," September 19, 1903.

when the direction of propagation is changed. The bank of the island was fifty feet high, and at the foot and top of the bank currents were detected which disappeared midway between the bottom and top of the bank, and at other level portions of the route. The tests also showed that at curvatures of the surface the intensity was greatest near the earth, this disproving the diffraction theory.

In this relation Professor Fessenden points out the advantages of the hot-wire barretter, namely, its great sensitiveness (page 158), its practical freedom from hysteresis, inductance and capacity, and the fact that it gives the cumulative effect of the received energy, besides possessing the quality that the relation between the energy absorbed and increase of resistance is a straight line up to the point of melting.

Another theory of electric-wave propagation, advanced by Sir O. Lodge, is that the transmitting and receiving vertical wires are plates of a huge condenser. Only one of the plates is charged during a sending operation, the other plate is at zero potential. He assumes that some trace of the electrostatic lines from the transmitter may extend to the elevated receiving wire. With the snap of the spark-gap and sudden discharge there is a cutting of the receiving wire by the electrostatic lines, with the resulting effect upon the detector.

Professor Fleming advances another theory, in which he assumes that there is a propagation of electric action through the earth, which action may consist in a motion or atomic exchange of electrons, together with the actions constituting a free electromagnetic wave in the ether above the earth. Each change or movement of a semi-loop of electric strain above ground, he further assumes, is accompanied by an equivalent action below ground in movements of the electrons on which the ends of the semi-loops of electric strain terminate. The office of the receiving vertical wire is to bring about a union between the two operations above and below ground. He, like Lodge, then likens the transmitting and receiving vertical wires and the earth to a large Hertz oscillator. Electric oscillations of a certain period are set up by the discharge of a condenser in one part of the system and are propagated to the other part. In the earth there is a propagation of electric oscillations; in the space above and between the vertical wires there is a propagation of electric waves. For other theories hereupon see Appendix, page 191.

THE ELECTRONIC THEORY.

From time immemorial it has been generally assumed that the atom of matter is indivisible—a body, as Clerk-Maxwell tersely puts it, that cannot be cut in two; but within a comparatively short time a new theory, termed the electric theory of matter, or the electronic theory, has been evolved, according to which the material atom, instead of being indivisible, is made up of positively and negatively charged electric units, or corpuscles, termed electrons. It may not be amiss to somewhat briefly review here the salient features of the theory as elucidated by the most active investigators of the phenomena concerned in the subject. One view is that the electron is a material corpuscle that has been detached or chipped in some way from an atom. Each chip so detached is an electron, a piece of detached matter carrying a negative charge of electricity. The part of matter which remains contains the positive electron, which has not yet been discovered free or isolated. In combination the negative and positive electrons form a neutral substance, namely, the chemical atom. A modification of this view is that the electron is the isolated charge of electricity itself, and that all matter consists of an equal number of positive and negative electrons interlaced or inter-revolving in the atom, electricity thus being the fundamental part of all matter. It has been pointed out, however, that if the atom were composed of equal numbers of positive and negative electrons they would neutralize one another and would have no mass, therefore no inertia. Other investigators contend that these “chips” or electrons are from the hydrogen atom, and M. Villard has shown that the electrons have the same spectroscopic lines as hydrogen, and if all trace of hydrogen is removed the cathode rays (mentioned subsequently) are suppressed.

It is assumed that the electrons of an atom are in stable orbital rotation around one another, that they possess inertia, are mutually attracted and repelled, and, in short, that each atom is a miniature solar system, in which the orbits of the various parts are calculated to be relatively as great as are those of the planets of that system. Since the electrons are assumed to possess the property of inertia, and inasmuch as the material atoms are by this theory aggregations of electrons, it is suggested that mechanical inertia may be explainable on the basis of electrical inertia or inductance.

Again, it is assumed by other workers that the material atoms are

made up of concentric layers of positive and negative electrons, with always a layer of negative electrons outside. To account for the stable formation of the elements it is postulated that at distances almost infinitely small all electrons repel one another, regardless of whether positive or negative, while at other distances similar electrons repel and dissimilar electrons attract one another. To explain gravitation by this theory it is assumed either that all electrons attract one another when gathered together in atoms, or that the attractive force of dissimilar electrons is greater than the repelling force of similar electrons. It is further supposed that the number and arrangement of the positively and negatively charged electrons of an atom are different for each element, but that in every case, starting from the smallest known atom, hydrogen, which was by many supposed to be the ultimate particle of all matter, the number of electrons in an atom is some multiple or sub-multiple of a smaller atom. For example, in the hydrogen atom there are, according to Dr. J. J. Thomson, the well-known authority on this subject, and other workers, 700 electrons; in the oxygen atom there are 16 times as many, or 11,200; in the sodium atom about 15,000; in the gold atom, 137,200; in the mercury atom, 140,000; and in the radium atom, 160,000 such electrons. It is thus apparently by the number of electrons in an atom, and by the particular manner in which they are arranged in the atom, that one atom is recognizable from another; analogously, perhaps, as different chemical combinations of molecules form different substances. It would seem that the possible stable combinations or groupings and the number of such units in atoms would be limitless, and therefore that the number of different elements would be limitless; but thus far such stable or seemingly stable combinations appear to be restricted to those of the known elements. It has, however, recently been suggested as within the possibilities that further investigations with radium may lead to the discovery of an entire series of new elements.

To fix an idea of the exceeding smallness of the electron, Sir O. Lodge has calculated that if the electron be considered as equal to the period at the end of a sentence, the atom of hydrogen would be relatively equal in size to a building 160 feet long, 80 feet broad, and 40 feet high. The diameter of the mercury atom is taken to be the one one-hundred-millionth of a meter, and, using an analogy due to Lodge, the 140,000 electrons composing this atom occupy this space

as a few scattered soldiers might occupy a country, not by bodily bulk but by forceful activity. The same authority, noting that the mass or inertia of an electric charge depends on two factors, quantity and potential, observes that with a given charge on a sufficiently small sphere the potential can be raised to any desired value; thus any required inertia can be obtained. Therefore, to account for the inertia of the electron, its diameter must be one ten-million-millionth meter. He also notes that the path open to a free electron in a body with the density of platinum is the one-millionth of a meter. Further, if the 140,000 electrons composing a mercury atom be arranged in rows of 50 across the diameter of the atom, the space left unoccupied by the electrons within the sphere is ten thousand million times the filled space. Hence the electrons may move comparatively unobstructedly in their orbits, but where collisions do occur it is assumed that they rarely collide directly. Dr. Thomson notes that a collision may be considered as occurring when an electron approaches so near a charged body that its direction of motion is appreciably changed.

According to the theory of the ether developed by Dr. J. Larmor, to whom is due the idea of the orbital rotation of the electrons in an atom, the ether possesses a rotational elasticity, but its various parts resist entire rotation round an axis, yet may be sheared or displaced over one another (page 23). The strain by which the displacement is brought about is due to an electric force, and the strain disappears when the electric force is withdrawn. In this ether the electron is the center of an enduring strain point which can be moved about in the ether as a kink can be moved about in a rope, but not set free. The electrons only can set up disturbances in the ether and the ether only can move them, as though each had a "grip" of the other.

That which has hitherto been considered as merely a charge of positive or negative electricity in a substance is by the electronic theory held to be due to an excess of free negative or a defect of positive electrons; in other words, a negative charge is due to an excess of negative electrons, and a positive charge is due to the removal of a negative electron from the atom, which latter thereupon becomes positive—a theory which to this extent conforms to Franklin's fluid theory, the difference being that what he termed negative electricity is known to be positive electricity, and vice versa. To account for the phenomena of current electricity, etc., by the electronic theory,

it is supposed that in addition to the neutral electrons composing the atoms there are many so-called free electrons intermingling and interchanging with the electrons of the atoms, and which, under the influence of an electric force, are capable of moving comparatively freely through metals or other good conductors; whereas the structure of non-conductors is such that the electrons cannot move freely through them. In this relation it may be noted that nearly all good conductors of electricity are composed of single elements, while dielectrics or insulators, such as air, glass, ebonite, mica, and gutta-percha, are compound, or combinations of elements. Assuming that an action is constantly taking place in which the atoms of metals are split up into negatively and positively charged corpuscles, which again recombine to form neutral atoms, Dr. J. J. Thomson notes that in the normal state the number of such corpuscles that recombine in the neutral atom will equal those that have been set free. Consequently, swarms of these corpuscles, moving in all directions, gain or lose energy by colliding with the atoms of the metal, and acquire an average velocity of about 10,000,000 centimeters. This swarm of electrons under an electric force will be sent drifting along in a direction opposite to the electric force, this constituting, as just intimated, the electric current. Assuming, further, that these electrons are moving in a metal at the stated average velocity, it might be expected, Dr. Thomson adds, that some of them would escape into the surrounding air; but to do so, he points out that the electrons would require to possess a certain definite amount of energy, for they are attracted by the positive electrons, and probably by the neutral atoms as well, which suffices to keep them within the metal. The electrons are known, however, to escape from or to be projected from an incandescent wire, from a cold metal when exposed to ultra-violet rays, from the cathode of a Crookes tube, and, as will be noted elsewhere, from radium. The same authority offers the following explanation why the electrical conductivity of metals increases with a decrease of temperature. He notes that the amount of current carried across unit area is determined, first, by the number of free electrons per unit volume of the metal, and, second, by the freedom with which these electrons can move, under the electric force, between the atoms of the metal. The freedom with which the electrons move depends upon the average velocity of the electrons, since if they are moving with very great velocity they cannot move far before they come into collision with an atom of the

metal, and thus the effect produced by the electric force is neutralized. The average velocity of the electron increases with the temperature, hence electric conductivity decreases with increased temperature.

By the electronic theory an alternating current is due to a to-and-fro motion or vibration of electrons under the influence of a comparatively slow alternating electric force, while a very rapid oscillation of the electrons in a conductor sets up, by reason of their intimate connection with the ether, a disturbance in the latter in the form of the so-called electric waves. It may be noted that although the electrons under the influence of the rapidly oscillating electric force vibrate at a very rapid rate, it does not follow that they traverse a large portion of the metal; their motion may be transmitted from particle to particle, analogously as air-particles propagate sound. In the latter case the total distance traveled by an air-particle may not be more than the one-millionth of an inch.

The electric theory of matter, although of comparatively recent origin in a number of its features, is not, however, altogether one of a day, nor is it the conception of one mind or of the researches of one man. Thus, as regards the view that the atom is not an indivisible particle of matter, many scientists have for years held that all the elements are modifications of a single hypothetical substance, protyle, "the undifferentiated material of the universe." Nor is the theory entirely new in its assumption that all matter is electrical. Faraday, Weber, Helmholtz, Clifford, and others had glimpses of this view; and the experimental work of Zeeman, Goldstein, Crookes, J. J. Thomson, and others has greatly advanced the theory. Over thirty-five years ago Weber predicted that electrical phenomena were due to the existence of electrical atoms, the influence of which on one another depended on their position and relative accelerations and velocities. Helmholtz and others also contended that the existence of electrical atoms followed from Faraday's laws of electrolysis, and Johnstone Stoney, to whom is due the term "electron," showed that each chemical ion of the decomposed electrolyte carries a definite and constant quantity of electricity; and, since these charged ions are separated on the electrodes as neutral substances, there is an instant, however brief, when the charges must be capable of existing separately as electrical atoms. Clifford, in 1887, wrote, "There is great reason to believe that every material atom carries upon it a small electric current, if it does not wholly consist of this current."

The investigation of cathode rays, which rays are established by the discharge of a powerful induction coil through an air-exhausted glass tube, also pointed to the probability of an electrical atom, for it was found that these rays, projected from the cathode (that is, the negative pole of the apparatus) in straight lines, like a shot from a gun, are deflected by a magnet, the direction in which the rays are deflected by the magnet proving that they are negatively charged. Dr. Thomson, it may be remarked, also succeeded in deflecting these rays by an electric charge, after some difficulty, occasioned by the fact that moving electrons electrify the gas through which they are passing, and thus screen themselves from the effect of an external electric force; but by reducing the pressure of the gas to a low point he succeeded in deflecting the rays as stated.

Cathode rays are now known to be electrons, that is, minute negatively charged particles moving at a speed variously estimated at one fifth, one third, or one half the speed of light, and which particles, prior to issuing from the conductor or cathode, must have existed in the conductor as an electric current, this giving strength to the supposition that an electric current consists of the movement of free electrons in a conductor. On the other hand, Roentgen rays, which are part of the observed phenomena accompanying the cathode rays, are not deflected by a magnet, and hence are not regarded as charged particles, but rather as electric disturbances or "splashes" in the ether, due to the suddenly arrested motion of rapidly moving electrons by their impact with fixed groups of electrons—in other words, with a solid substance as we know it. Lodge has stated that the energy expended in stopping an electron within the thickness of a molecule, and when moving at a speed of about 6200 miles per second, is about 10 watts (the minute time of stopping being the one-hundred-thousand-million-millionth of a second); but only a small fraction of this power goes out as electric radiation, namely, an amount equal to 100 ergs, the rest of the energy taking the form of heat. In order, he adds, that all the energy may be radiated it would be necessary to stop the electron in something like the one-tenth of its own diameter.

The investigations of Dr. Thomson have also shown that the charge on the negative electron is equal to that on the atom of hydrogen in electrolysis, but that the mass of the electron is only one-thousandth that of the hydrogen atom. Also that the mass of the negative electron and the charge on that electron are always invariable,

regardless of the nature of the gas in the tube or the substance of the electrodes, while, on the contrary, the positive electrification is always found to be associated with a mass corresponding with an ordinary atom, and it varies with the different gases in which the electrification is found.

The more recently discovered radioactive substances, such as uranium, thorium, polonium, and radium, are found to give out certain rays without any at present definitely known exciting cause. Radium, or rather a salt of that metal, such as radium bromide, is the most radioactive of these substances, and gives off at least three different kinds of rays, which Professor Rutherford has named the alpha, beta, and gamma rays. The alpha rays are feebly penetrating; the beta rays are deflected by a magnet and are akin to the cathode rays, that is, negative electrons thrown off at a high velocity; while the gamma rays are not deflected by a magnet, but are highly penetrating, like the Roentgen rays, affecting photographic plates, etc.

The investigations of these phenomena indicate that all matter is similarly radioactive, but in the majority of cases the radiation is so slow or so feeble that no perceptible diminution of the substance would be measurable in millions of years, while in the case of the most radioactive substances the process is still so slow that, according to Becquerel, the discoverer of radioactivity, a surface of one square centimeter covered with pure radium would lose but .001 milligram of its weight in one million years. From these facts, however, it is deduced that the processes of physical decay that are apparent to our senses all about us are also going on in the disintegration of the atoms themselves, and ultimately, unless there is a corresponding growth of the atoms, all matter will once more be resolved into "protyle."

Whether the electronic theory, which is in a measure a return to Newton's corpuscular theory, will survive or itself will in turn be replaced by some other more suitable theory, remains for the future to determine. At present, the theory serves the purpose of giving a common origin to matter, electricity, and the ether, the electron being the common tie between them.

The conception of the idea of a universal radiation of matter is attributed to M. G. Le Bon, who termed it "black light." The present writer very crudely, at the time of the announcement of the discovery of the Roentgen rays, independently expressed the same idea, in a letter to the "Electrical Engineer," New York.

CHAPTER VI.

SYNTONIC WIRELESS TELEGRAPHY.

At an early period of the practical history of wireless telegraphy it was seen that the usefulness of this art might be considerably curtailed by the fact that but one message at a time could be transmitted between any two stations within the sphere or radius of influence of a transmitter, since the attempt to send even two messages at once would render both messages unintelligible. A number of experimenters have endeavored to overcome this defect, notably Dr. Lodge, Sig. Marconi, and Dr. Slaby. The plan followed by these gentlemen has been that of employing a syntonic or tuning method; that is, a method by which the transmitting and receiving circuits are adjusted or attuned to a given rate of electrical oscillations.

The explanation of this method may be simplified by a reference to the tuning-fork experiment already mentioned. As stated, either fork may be set into vibration by air-waves set up by the other fork, and neither will be set into vibration by another fork of a different pitch. As already noted, the ear and the telephone are quick to respond to vibrations and quick to stop vibrating. On the other hand, the tuning-fork is a persistent vibrator by virtue of two qualities which it possesses, elasticity and inertia. When struck a smart blow, or plucked, it is moved from its point of rest; directly its elasticity returns it to its normal position, its inertia or momentum carries it past that point, its elasticity returns it to zero point, inertia carries it past, and so on, until the resistance of the air and molecular friction of the fork stop it. Analogously, an electrical conductor or circuit may be given, in almost any desired quantity, the equivalents of mechanical inertia, capacity, and resistance or friction, in inductance, elasticity, and ohmic resistance, respectively; and the rate of electric oscillation of a circuit may be varied by varying these factors—the smaller the factors the higher the rate of oscillations.

When the receiving circuit of a wireless telegraph system is accurately tuned to oscillate in harmony with the transmitting circuit, by giving the respective circuits practically equal inductance, capacity, and resistance, the receiving circuit will respond only to the oscillations set up by a correspondingly attuned transmitter. This is, in brief, the theory upon which syntonistic or tuned wireless telegraphy is based. In the original Hertz experiments, as has been noted in a previous chapter, the oscillation periods of the transmitter circuit and receiver or electric resonator were practically equal or in syntonistic. Marconi and others in their experiments have found that perfect syntonistic between the transmitting and receiving circuits is not essential, but that if there is a marked difference of frequency of oscillation between them the receivers will not respond to any but their correspondingly attuned transmitters. It was probably Sir O. Lodge who first employed the term "syntonistic" (equal or uniform tone) in connection with Leyden-jar experiments, and who also first devised a tuned transmitting and receiving wireless telegraph circuit (described subsequently).

It is perhaps not strictly correct to say that a tuned receiver will only respond to oscillations of its own periodicity. It may perform *forced* oscillations, if the exciting cause is sufficiently powerful, analogously as an elastic rod may be caused to move rapidly back

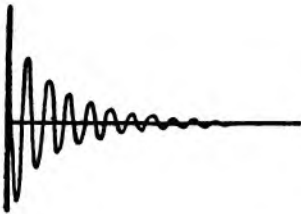

FIG. 20.

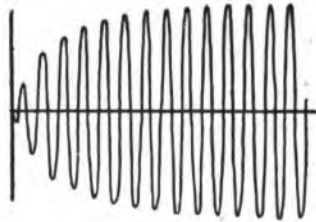

FIG. 21.

and forth by the hand, but if pulled back and let go it will vibrate at its natural rate, which may be termed *free* vibrations; and further, if it be struck blows at proper intervals its amplitude of vibration will be increased. In this latter case the principle of resonance enters, as it does also in tuned or syntonistic wireless telegraphy, it being understood in the latter case that the "blows" consist of consecutive series of electric waves falling upon or cutting the receiving wire.

Lodge, following Bjerknes, points out that an oscillator such as was used by Hertz makes a good radiator of electric waves, but "in consequence of this its vibrations are rapidly damped (Fig. 20), and it only gives three or four good strong swings," and it follows from this that it will set up oscillations in conductors not at all in tune with it. On the other hand, the Hertz circular receiver or resonator is a "persistent vibrator and well adapted for picking up waves of precise and measurable wave-length" (Fig. 21). (See Lodge's "The Work of Hertz," pp. 4, 5.)

It is known, also, that a vertical wire grounded at its lower end, such as is used in wireless telegraphy, is an excellent radiator of electric waves, but, as Marconi and others have pointed out, possesses very little capacity, and hence its waves, like those of the Hertz radiator, are quickly damped, and it is only the first few oscillations that have sufficient strength to affect a receiver, but these strong oscillations will, as just noted, affect almost any untuned conductor within the range of their influence and set up aperiodic oscillations therein.

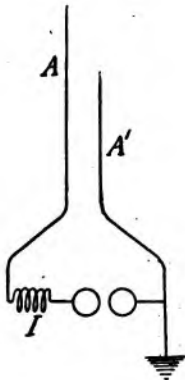

FIG. 22.

These considerations led Marconi to experiment with conductors of larger size in order to obtain greater capacity, and, consequently, more persistent vibration, but this plan he found neutralized itself, inasmuch as the greater surface gave increased facility for radiating the energy during the first oscillations. To avoid this defect Marconi availed of the fact that the capacity of a conductor is increased by bringing another conductor near it, and this without adding to the radiating surface of the first conductor. In the first experiments along this line he used an earthed conductor *A'* (Fig. 22), which was shorter than the transmitting wire *A*. Having thus added capacity to the wire, it was easy to add inductance to the circuit in the shape of a coil of wire *I*, and thus obtain a tuned and more persistent radiator. In the same way the receiving circuit similarly arranged becomes a more persistent vibrator, and hence a given amount of energy expended at the transmitter in producing a succession of oscillations of more uniform amplitude will have a cumulative or resonant effect upon the receiver and will eventually cause it to respond to the waves established by the transmitter, while an untuned receiving circuit containing a

detector fully as sensitive as the first one would probably not respond to those particular oscillations.

In general the spark-gap and the receiving apparatus of untuned circuits are connected directly to earth, in series with the vertical wire A, as indicated in Figs. 23, 25, 26, and thus the oscillations set up therein are of short duration, being quickly damped. The apparatus and circuits of tuned circuits, on the contrary, are usually separated by a transformer T and condensers from the vertical wire, as indicated in Figs. 24, 27. In Figs. 23, 24, *b b* are the spark-balls; P, S are the primary and secondary wires of induction coil I. In Fig. 24 the spark-gap *s*, condensers *c c*, and the primary of the transformer T, form a closed "oscillating circuit," in which the capacity

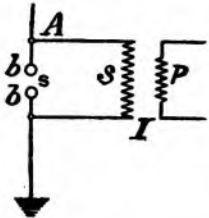

FIG. 23. OPEN CIRCUIT.

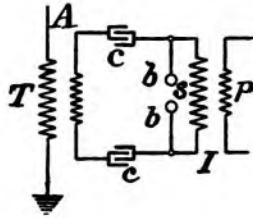

FIG. 24. CLOSED CIRCUIT.

and inductance may be of a desired amount, and are generally so chosen as to give a wave-length equal to four times the length of the vertical wire. (See pp. 35, 56, 63, 95.) When the condenser discharges into this oscillating circuit, the oscillations are of more or less prolonged duration, and oscillations of corresponding duration are set up by means of transformer T in the vertical wire, which in turn radiates electric waves of similar duration.

The oscillating circuits of untuned wireless systems are termed "open" circuits; those of tuned systems are termed "closed" circuits. Figs. 23 and 24 are examples of "open" and "closed" transmitting circuits, respectively. It may be noted that closed circuits are utilized in some systems in which syntony or tuning is not availed of. Further reference will be made to tuning, resonance, etc., elsewhere.

Experiments have shown that by means of tuned apparatus a much greater distance may be covered with a given amount of electrical energy and height of wires. Thus, Marconi states that a transmitter which would operate a tuned receiver 30 miles distant would not affect a non-tuned receiver 160 feet away. This, it may be assumed, and as already intimated, is because in the case of the tuned receiver the faintest oscillations, or electromotive forces, set up in

the receiving circuit by the incoming circles of waves are in unison with those waves, and successive incoming waves resonantly amplify the oscillations, or electromotive forces, in the receiving circuit until they affect the coherer; whereas, the oscillations which the same waves tend to set up in the non-tuned receiver are, as it were, out of step with the natural rate of oscillation of the non-tuned circuit, and thus as frequently oppose as assist the natural oscillations of the circuit, with practically a zero result. In tuned circuits it is therefore essential that the makes and breaks or variations of the transmitter primary circuit should follow each other very quickly in order that the full effects of resonance may be obtained; in other words, that the wave-crest between successive series of oscillations may not fall too low for best results. Indeed, the inability to obtain successful syntony is partly attributable to the difficulty in obtaining a sufficiently close succession of series of oscillations with the transmitting devices hitherto employed, owing to the resistance of the spark-gap, which increases with the length of the spark, and doubtless also varies with the variations in the temperature of the arc, and thus either by excess of resistance quickly damps the oscillations, or by rapid variations in the resistance varies the rate of oscillations, since, according to Kelvin, the number of oscillations per second equal $\frac{1}{2\pi} \sqrt{\frac{1}{LK} - \frac{R^2}{4L}}$, and when the resistance exceeds $\sqrt{\frac{4L}{K}}$ there will be no oscillations, but only a dead-beat discharge. Further, with the present type of transmitting devices a long spark-gap appears to be essential to the employment of high potentials in long-distance transmission. See in this relation air pressures at spark-gap, p. 166. The varying resistance of the filings coherer is also an impediment to the maintenance of syntony in the receiving circuit. Inasmuch, therefore, as it is easy to design the fixed apparatus and circuits of a wireless system to have almost any desired inductance, capacity, and resistance, it is in the directions mentioned that improvements in syntonizing may be expected. Already it has been suggested that a device such as that of Cooper Hewitt's, described in the section on interrupters, may be available for this purpose, and Marconi and others have pointed out that detectors of the magnetic type (see p. 71), by reason of their practically uniform resistance, and in other ways, may permit of more accurate tuning.

By the aid of electric syntony it is expected that it will be pos-

sible to send several messages between the same points at the same time without interference, by allotting different rates of oscillation periods to different sets of transmitting and receiving apparatus. It is also expected that one vertical wire will suffice for all the apparatus at one station. To those who are familiar with Gray's harmonic system of wire telegraphy (described in "American Telegraphy," p. 355a, 1903 edition), in which three and four instruments, attuned to transmit and to receive different rates of electrical current pulsations, have been successfully operated on one wire at the same time, this will not seem impossible if it be found that practical tuning is feasible. It is also quite possible that if a universal receiver like the telephone be employed, it will be feasible to receive a number of different tones at one and the same time in the one instrument, as has already been done in wire telegraphy. (See "Electrical World," October 6, 1888). It is known that the telephone can also be syntonized, and in fact has been proposed by M. Mercadier as a one tone instrument, adjusted to respond to a given rate of pulsations per second in multiplex telegraphy; and by Professor A. Blondel to respond to the frequency of charging the vertical wire; in other words, to the rate of interruption of the induction coil, in which case one, two, or more such telephones, each attuned to respond to a different rate of charging of the transmitting antennæ, may be placed directly in the circuit of the receiving antennæ, analogously as in the case of the harmonic system cited. Or they may be placed in shunt with a more sensitive detector, the latter being in series with the vertical wire. Here the chargings, or groupings, of waves, and not the oscillations proper of the antennæ, constitute the important feature. But, it may be noted, combinations of both features have been suggested. Thus far, however, it does not appear that more than one message at a time has been received at one station, except, perhaps, experimentally; and if the ill success and abandonment of Gray's harmonic system, after a long trial on wires, be any criterion, multiple wireless telegraphy between two given points will prove a difficult problem, although not an impossible one. But if by the use of tuned apparatus nothing else were gained than the ability, with a given amount of electrical energy and a given height of vertical wire, to transmit signals to a greater distance than is possible with untuned apparatus, it would be a decided advance in the art.

CHAPTER VII.

MARCONI WIRELESS TELEGRAPH SYSTEMS, TUNED, UNTUNED, AND LONG DISTANCE.

MILITARY AND LIGHTSHIP STATIONS—MORSE ALPHABETS, ETC.

THE distinction between tuned and untuned wireless telegraph systems has been noted in connection with the chapter on syntonistic wireless telegraphy.

The Lodge experiments of 1894 were followed by the experiments of Marconi a year later. The principal apparatus employed by Marconi in his original experiments consisted of an oscillator and a vertical wire at the transmitting station, and a filings-coherer, relay and tapper, and vertical wire at the receiving station. These devices, as previously intimated, were known to the art, but they were all more or less modified by Marconi, who also added other devices as found requisite to bring his system to a point of practical utility.

The earlier arrangement of apparatus employed by Marconi is outlined in Figs. 25 and 26. In Fig. 25, I is the induction coil of the oscillator; $b b'$ are the discharge-balls, between which is the spark-gap; K is a Morse key of heavy construction; B is a storage battery of about 5 cells. The vertical wire A , or antennæ, is connected at its lower end to ball b ; the other ball, b' , is connected to earth. The balls $b b'$ of the oscillator are thus in series with the aerial wire. The terminals $w w'$ of the secondary wire $s s$ of the induction coil are also connected respectively to b and b' .

The type of oscillator first employed by Marconi was that known as the Righi oscillator, which, in addition to the ordinary induction coil, consisted of two metal balls about four inches in diameter, connected with the terminals of the secondary wire of the induction coil. These balls and the spark-gap were immersed in oil in a suita-

ble receptacle, with the object of obtaining a sharper break and consequently a more efficient spark. The oil was also found to prevent the necessity for frequent cleaning of the balls. The oil-inclosed balls have, however, been abandoned in subsequent tests, and balls about one inch in diameter are now used. With a six-inch coil, the electric waves set up by this oscillator were about ten inches long.

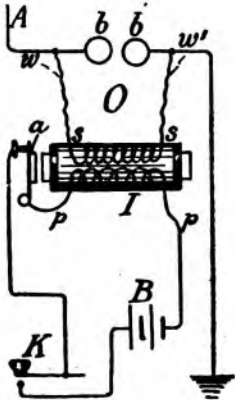

FIG. 25.

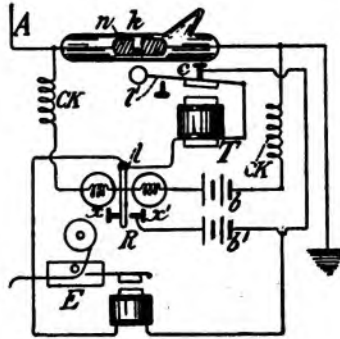

FIG. 26.

The actual transmission of messages is effected by means of key *K*. Each time the key is closed the vibrator *a* starts into operation, with the result that electric oscillations are set up in the aerial-wire circuit and electric waves are emitted. When the key is opened the oscillations cease, and in this way the duration of a train of waves or oscillations is made to correspond to dots and dashes of the Morse alphabet.

The receiving apparatus is indicated in Fig. 26. *k* is the Marconi coherer. It consists of a glass tube, properly supported, about 1.57 inches in length, and about .1 inch inside diameter. Small silver plugs *n*, of a size to snugly fit the tube, are inserted as indicated. There is a small space of about .05 inch between their ends. The filings are placed in this space. The plugs must so fit the tube that the filings cannot be scattered between the sides of the glass and the plugs. A comparatively small number of filings suffice. Marconi uses ninety per cent. of nickel and ten per cent. of silver filings, but this proportion may be varied as greater or less sensitiveness is desired, the sensitiveness increasing with an increased proportion of silver filings. Wires are led in from each end of the tube to the plugs,

and, to prevent oxidation of the filings, the tube is exhausted of air to about one thousandth of an atmosphere, after which it is hermetically sealed. T is a tapper; R is a sensitive relay—it may be a Morse or polarized relay; E is an ink recorder with paper reel, etc. (described in “American Telegraphy,” p. 70). The vertical wire A is connected to one terminal of the coherer, the other terminal of coherer is connected directly to earth. Relay R is in a local shunt circuit with the coherer and one cell of battery *b*. The armature-lever *l* of this relay controls the local circuit of the tapper and also of the ink recorder E, which circuits are fed by the local battery *b'*, consisting of four or six cells. *k* represents actual appearance of the coherer.

The operation of this apparatus is briefly as follows: When the electric waves set up by the distant transmitter arrive and oscillations are thereby set up in A, the resistance of the coherer *k* drops sufficiently to allow battery *b* to magnetize relay R, which attracts its armature, closing the circuit of *b'* at *x'*, as already described in connection with Fig. 12. Hence, while the oscillations are being received the tapper keeps up a buzz or hum, and stops when the oscillations cease. So, also, while the oscillations continue the Morse inker E is actuated, and a dot or dash, as the case may be, is impressed on the paper strip. The paper strip is started and stopped automatically by devices well known in telegraphy, when signals commence and when they cease. (See “American Telegraphy,” p. 373.)

In addition to the apparatus outlined in Fig. 26, a number of inductance or impedance “choke” coils CK CK and non-inductive shunt coils, essential to the practical operation of the system, are employed. The choke coils are furnished with iron cores to increase the magnetic effect, and are wound straight; the non-inductive coils are wound back upon themselves, and are thus rendered non-magnetic, offering resistance only to the current. Further details of these coils will be given shortly.

In a later arrangement Marconi introduced an induction coil or transformer, termed, in shop phrase, the jigger, between the vertical wire and the coherer, theoretically shown in Fig. 27, in which P is the primary wire of the transformer. The secondary wire is divided into two sections *s s*, as indicated, the coherer *k* being placed between them. A condenser *c* is placed as shown, forming a short circuit for the secondary oscillations to the coherer (for momentary currents a condenser is virtually a conductor), CK CK' acting as choke

coils, directing the oscillations across *c*, and preventing any dissipation of the current through the relay, which is made with as little self-induction as possible.

According to Marconi, these choke coils consist of a few inches of fine copper wire wound over a bit of iron wire 1.5 inches in length. The coils of the jigger, shown as *J* in subsequent figures, are wound over a small glass tube .3 inch in diameter. The secondary consists of 375 turns of copper wire about .002 inch in diameter, insulated with one covering of silk and having a resistance of 79 ohms. The primary is wound over the secondary, has 175 turns of wire about .0047 inch, and a resistance of about 7 ohms. Another form of jigger, as described by Marconi, is virtually as follows: The primary is wound on an ebonite or glass tube about .22 inch diameter. It consists of 100 turns of copper wire .014 inch diameter, about 4.5 ohms resistance, insulated with silk and coated with paraffin wax. The secondary is of copper wire .007 inch diameter, also insulated with silk. It is wound over the primary. The secondary is in two parts. Each half of the secondary is made up of 17 layers of wire, with a gradually decreasing number of turns in each layer, 77, 49, 46, 43, 40, 37, 34, 31, 28, 25, 22, 19, 16, 7, 3, respectively, making 500 turns in all, with a resistance of about 23 ohms. The condenser *c* is composed of twelve small tin-foil or copper plates connected in the ordinary way and insulated with paraffin paper. The plates, in size, are about 2 inches by 1.2 inches. Small Leyden jars are also used. It is claimed that the induction coil or jigger *J*, acting as a "step-up" transformer, largely increases the efficiency of the apparatus by enhancing the electromotive forces acting upon the coherer, and thus increases the signaling distance. Further, it measurably protects the apparatus against atmospheric electric currents (which would otherwise be more or less detrimental to the operation of the coherer), by giving these currents a practically direct path to earth.

In a system undergoing so many modifications as that under consideration, no fixed arrangement of apparatus can be expected for every station thus far equipped with this system. One practical arrangement of the Marconi transmitting and receiving apparatus is, however, shown

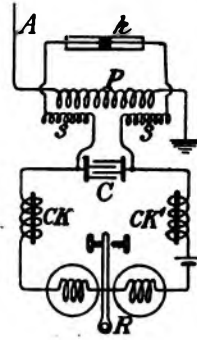

FIG. 27.

diagrammatically in Fig. 38. In practice it is found advisable to inclose the coherer *k*, jigger *j*, relay *R*, tapper *t*, and the wires connected therewith, in a metallically sheathed box *B*. This sheathing is connected to ground as at *G*. Since electric waves do not pass through metals, extraneous waves are, by this device, prevented from affecting the coherer. *R* is the relay controlled by the coherer; *CK CK* are the choke coils in the circuit of *R*; *b* is a single cell for the operation of

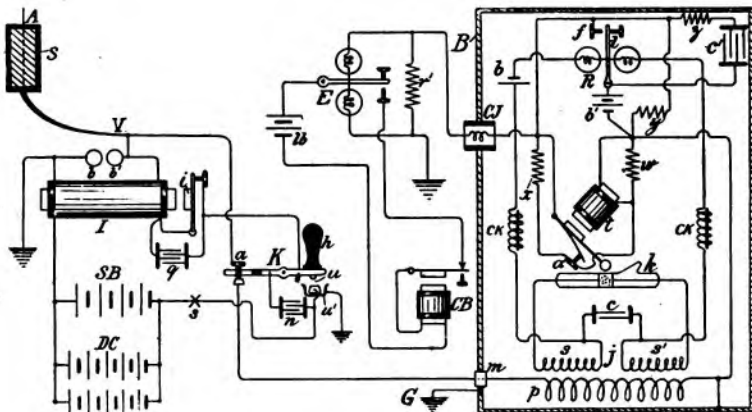

FIG. 28. DETAILS OF MARCONI UNTUNED SYSTEM.

R. *R* is a sensitive polarized relay of from 1200 to 10,000 ohms resistance, and is usually inclosed in a cylindrical case to exclude dust. It is known that the coherer decoheres more readily with a weak current than a strong one, hence a sensitive relay is desirable. Some of the relays employed will act with a current of $\frac{1}{50000}$ of an ampere. In order that a weak current may be obtained a resistance is sometimes placed in the circuit of *b*. A further reason for the use of a sensitive relay is that with a strong current the coherer may act continuously.

It is essential that no sparks shall be developed at any of the contact points of the relay *R* or the tapper *t*, as the oscillations coincident with such would affect the coherer. To prevent such sparks and oscillations the magnet coil of the tapper *t* is shunted by a non-inductive resistance *w* of 1000 ohms, its contact points *a* with a similar resistance *x*. The contact point *f* of relay *R* is shunted by

a non-inductive resistance y of 4000 ohms, also with a condenser c' , which has in its circuit a resistance of 500 ohms. It will be seen that one terminal of battery b' is earthed at g . The ink recorder E (resistance 400 ohms) is placed outside of box B , and, together with tapper t , is operated by battery b' , and controlled by the armature of relay R . The tapper is in a metallic circuit. The ink recorder is in a ground return circuit, from ground at g through b' , through lever l to f , through the sheathing of the box to E and earth. Recorder E is also shunted by a non-inductive resistance r' of 1000 ohms. In order that no stray electric waves may enter the box by the wire to E , that wire is caused to pass through an inductive coil or choke coil c J placed on the side of the box. For this purpose Marconi first employed a coil of about 4 ohms or 125 turns of No. 28 wire, insulated with gutta-percha and covered with strips of tin-foil which are connected to the metal sheathing of the box. In later experiments a coil of 45 ohms has been used by others. The coil is carefully protected against mechanical injury. A call-bell CB is controlled by the lever of E , and is shown as operated by a separate local battery lb . One terminal of the primary coil p of the jigger J is grounded by contact with sheathed frame B ; its other terminal goes to an insulated opening m in the box B . Here in some cases it is provided with a movable connection which places it in contact with the back contact of transmitting-key K , and in practice this movable contact consists of an arm, not shown, from the key K , which is inserted at m for "receiving," but is removed therefrom for "sending," by which means the box is entirely disconnected from the transmitter. In other cases the key is connected practically as shown, the air-space between the front and back of the key being sufficient to insure that no damage may occur to the receiving apparatus from the high potentials of the transmitter, the key having an up-and-down motion of several inches. The box B is made in two parts and can be readily opened for inspection and adjustment of the apparatus.

The transmitting apparatus is shown at the left of figure. K is a massive Morse key (rendered necessary by the heavy currents and high pressures used in the oscillator circuits) with front and back contacts, which are well insulated from each other. The key is provided with a large ebonite handle h . Its front contacts u are shunted by the condenser n . The lower contact is in an earthed metal cup u' , by which device high potential charges are diverted

from the key. The interrupter *i* of the induction coil is also shunted with a condenser *q*; *I* is the induction coil of the oscillator; *SB* is a storage battery for the operation of the induction coil. It will be

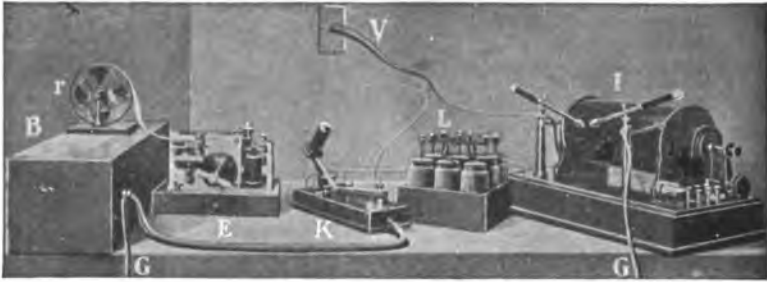

FIG. 29. GENERAL ARRANGEMENT OF MARCONI APPARATUS.

seen that it is controlled by the front contacts of *K*. DC are dry cells in multiple which charge the storage cells. A switch is usually inserted at *s* whereby the battery may be cut off, reversed, etc.

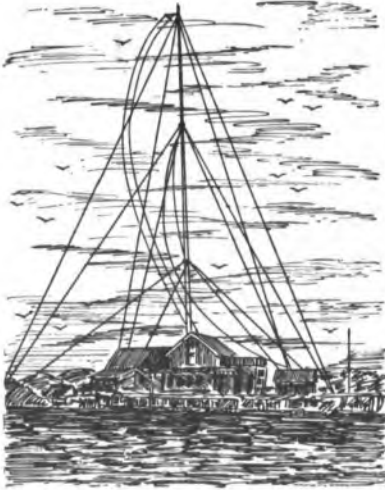

FIG. 30. SHORE STATION.

is usually covered with sheet rubber.

The vertical wire or wires for ships, and for comparatively short distance signaling, is usually of stranded copper, about .25 inch in

diameter, although Marconi has used also strips of wire netting about two feet broad. The wire or netting is supported by masts of proper

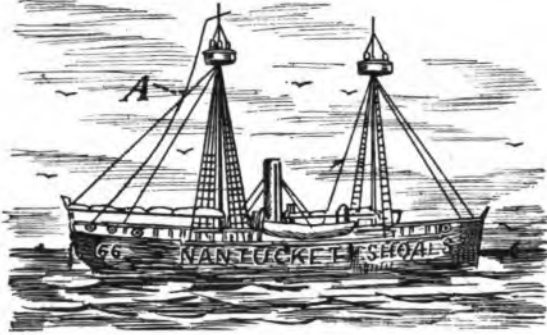

FIG. 31. LIGHTSHIP STATION.

strength and height, securely guyed, as indicated in Figs. 30, 32, which represent a wireless telegraph shore station and a military wireless telegraph outfit respectively. Some of the masts used for this purpose weigh over five tons. It is not essential that the wire be suspended strictly vertically if the necessary vertical height be obtained. Obviously, vertical masts several hundred miles apart will not, owing to the curvature of the earth, be parallel to each other. The wires must be insulated from the mast or tower by which they are suspended, otherwise in wet weather the electric charges would be dissipated to earth. Inasmuch as the electromotive force thrown on these wires is frequently sufficient to produce sparks of six, twelve, or more inches, it is evident the insulation must be thorough. For this reason the wires are separated from the masthead by long sticks of ebonite (A,



FIG. 32. FIELD WIRELESS TELEGRAPH.

Fig. 31), and, when feasible, are led in through an open window or hatchway to the room where the transmitting and receiving apparatus are situated, as outlined in the same figure which represents the lightship at Nantucket Shoals, off Massachusetts, equipped with the Marconi wireless telegraph system. At this latter station passing vessels are reported daily, and messages are transmitted and received between them and the lightship by wireless telegraphy when vessels are equipped with the necessary apparatus. When this is not the case, messages may be sent or received by means of steam-whistle or fog-horn, the continental Morse code being used for this purpose, a long and short blast corresponding to the dot and dash of that code, which code is given at the end of this chapter. Messages thus received are then forwarded from the lightship by wireless telegraphy to the mainland.

Another method of bringing the vertical wire into the operating-room of a ship is outlined at s in Fig. 28. A hole about four inches in diameter is made in the deck. This is sheathed with a tube of ebonite half an inch thick, which rises about 1.5 feet from the surface of deck, and is protected from mechanical injury by a thick brass sheathing. Through the center of this opening the vertical wire is led after it has been thickly insulated with india-rubber strips and oiled silk. The space between the ebonite tube and the vertical wire is filled with an insulating compound such as paraffin, and the tube is then capped with ebonite. Below this tube the insulation of the wire is gradually tapered off until it somewhat resembles a tail, *v*, from which fact this portion of the vertical wire has been dubbed the "cow's tail" (see Figs. 28, 29). Two wires are led from this wire, one to a ball *b'* of the oscillator, the other to the key or keyboard, as shown. The other ball *b* of the oscillator is connected to earth. On shipboard the ground or "earth" is taken from the metal plates of the vessel, the ground wire being riveted or otherwise clamped securely to a plate of the framework of ship.

In Fig. 33 is given a facsimile of messages "caught on the wing" during the yacht races of 1899 off New York Harbor. Bulletins of the progress of the race were being sent from the steamship *Ponce* to the Mackey-Bennett cable ship some miles away, both equipped with Marconi apparatus, when this specimen and many others were recorded by a set of wireless telegraph apparatus constructed by Mr. W. J. Clarke, which the writer was supervising on the steamship *La Grand*

Duchesse. This was probably the first instance of tapping Hertzian waves, in the United States at least. Abbreviations, such as Shr. for *Shamrock*, Col. for *Columbia*, the competing yachts, obt. for about,

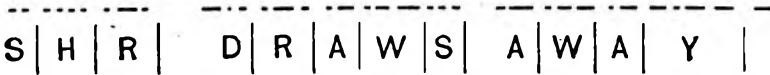

FIG. 33.

bd. for board, etc., were used in these despatches. The universal or continental alphabet was employed.

With the filings-coherer thus far described the speed of transmission is limited to twelve or fifteen words per minute, the cohering, tapping back, recording of the message, etc., all tending to slow speed. The type of key shown is also essentially a slow speed key. The degree of sensitiveness of the relay may be tested by shunting the coherer with a low resistance, such as a moistened string or fingers, when, if the relay is too sensitive, the tapper will vibrate. In that case the adjustment of the relay should be varied. On the other hand, this result may arise from a defective coherer, one of too low resistance initially, in which event it should be replaced by a perfect instrument. To test the general operativeness of the receiving apparatus a small electric buzzer is sometimes used in the vicinity of the vertical wire. Experience has demonstrated that the adjustment of this apparatus is not always easily obtained, and hence when obtained should not be needlessly varied. When an "exhausted" coherer becomes inoperative it cannot be restored to working condition. For this reason, among others, it is usual to keep a liberal supply of extra coherers on hand.

MARCONI SYNTONIC WIRELESS SYSTEMS.

One arrangement of Marconi's syntonizing transmitting and receiving circuits is outlined in Figs. 34, 35, the tapper, shunt coils, etc., being omitted for simplicity. Fig. 34 represents the transmitting circuits. A is the vertical wire attached at its lower end to a coil of wire w , which is connected to ground. One terminal of the secondary wire s of an induction coil T may be connected to any desired turn of the coil w . By this means the inductance of the vertical-wire "open" circuit may be varied and its oscillation period thereby be made to correspond with that of the "closed" circuit o of the oscillator, which includes the primary wire p of T . I is the induction coil; c is

an adjustable condenser of about .25 m.f. capacity, by varying which the oscillation period of the closed circuit may readily be varied. Leyden jars are often used for this purpose. The capacity is varied by moving inward or outward one or more plates of the condenser, or by adding or removing one or more of the Leyden jars. An adjustable capacity, not shown in figures, may also be placed in the vertical wire at A to facilitate tuning. The period of oscillation is increased by

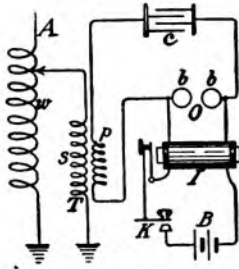

FIG. 34.

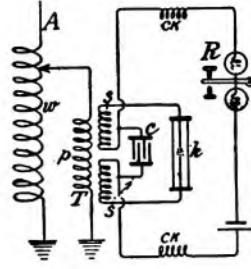

FIG. 35.

adding turns to coils w , and decreased by reducing the number of turns. The period is also decreased by adding to the capacity of a condenser in series with w , and vice versa. The various circuits will be in tune when the product of the capacity and inductance of each circuit is equal, since the period of a circuit is equal to 2π times the square root of the product of inductance and capacity.

The tuned receiving circuits are shown in Fig. 35. A is the vertical wire with the turns of wire w , to which is attached the primary wire p of the induction coil or "jigger" T . It is important that the oscillation period of the coherer circuit shall be the same as, or an octave of, the vertical-wire circuit. This, according to Marconi, may be done by making the secondary coil s of the coil T equal the length of the vertical wire A , in which case, as this coil has practically no capacity, while it may be assumed to have equal inductance with the vertical wire, its wave-length will be virtually one half of that wire, and its rate of oscillation will be an octave above it. The transmitter circuit is then adjusted so that its period corresponds with that of the receiving circuit. This is done by varying the capacity of the condenser c . The receiving condenser c consists of a few sheets of copper or tin-foil separated by thin sheets of paraffin paper, the alternate metal plates being connected together. The manner of

obtaining this "balance" is to begin with very little capacity in the condenser and adding plates until the best results are obtained at the receiving station, when if more capacity is added to the condenser the signals die away, showing that the circuits are now out of tune.

The inductance may be readily varied—that is, turns of coils w may be cut in or out by means of the sliding contacts shown in Figs. 34, 35, 36.

Marconi Cylinder Arrangement.—Another device due to Marconi, and which is also used in connection with tuned circuits, is shown in Fig. 36. In this arrangement the high vertical wire at each station is replaced by concentric metal cylinders A, the outer one of which is about 4 feet high and 1.3 feet in diameter. With this device signals have been transmitted over 31 miles. The outer cylinder is connected to the inductance wire w , the inner one to earth. The other connections are practically similar to those shown in Fig. 34. In other instances cylinders about 20 feet high and 5 feet in diameter have been used. The cylinders can be carried on a steam motor car and lowered when desired. In this case the earth connection is made by trailing a strip of wire netting on the ground; here a comparatively loose earth connection suffices. The cylinders as thus arranged form in effect two plates of a Leyden jar, or condenser, giving a large capacity, thereby providing a persistent vibrator, inasmuch as this property is increased in this arrangement in a greater ratio than its radiating property, and, as has been suggested, perhaps the proximity of the plates also tends to add magnetic energy to the circuit; these causes doubtless operating to give the device a very definite period of oscillations, for in practice it has been found to work successfully as a selective syntonic apparatus.

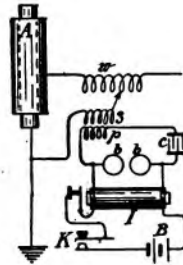

FIG. 36.

It was found essential in practice that the inductance of the inner cylinder should be less than the outer one and this was at first secured by making the earthed cylinder the shorter of the two, but subsequently the same result was obtained by the use of the inductance w , attached as shown, or placed between the spark-gap and the outer cylinder. Marconi considers that this inequality of inductance

is necessary to put the two cylinders out of phase, as otherwise the one would neutralize the effect of the other, hence no radiation would take place.

MARCONI LONG-DISTANCE WIRELESS TELEGRAPHY.

The general means by which long-distance transmission has been accomplished are increased electrical energy at the transmitting station and more sensitive apparatus at the receiving station, together with the employment of high towers or masts, and a multiplicity of aerial wires at the transmitting stations.

The first station equipped for long-distance service was that at Poldhu, Cornwall, England, the next at Glace Bay, Cape Breton, and the third at South Wellsfleet, Mass. In the first long-distance tests

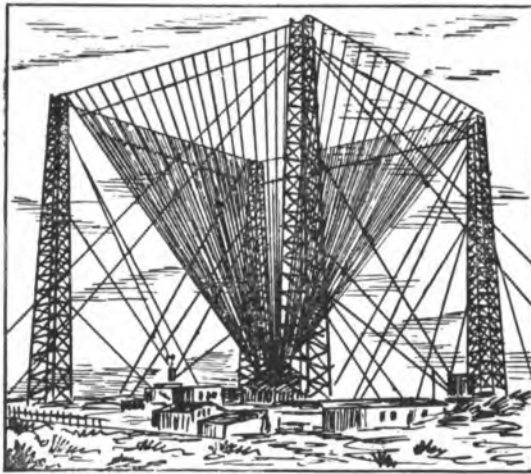

FIG. 37. SOUTH WELLSFLEET STATION.

at Poldhu there were two masts about 160 feet high and 200 feet apart. Between the tops of these masts a wire was strung from which 50 uninsulated wires were suspended. These wires converged at the bottom and were thence led into the instrument-room. Subsequently the long-distance stations were equipped with high masts arranged in a wide circle, with vertical wires depending from horizontal wires attached to the tops of the masts. This construction, however, was not of sufficient strength to resist storms, and in the later arrangements massive towers have been built. The arrangement depicted

in Fig. 37 is that of the South Wellsfleet station. Here there are four towers constructed of wood in the manner indicated. These towers are about 220 feet in height and stand on a sand cliff about 150 feet above sea-level. A large number of small copper wires are suspended vertically from horizontal wires strung from tower to tower, as shown. The vertical wires converge as indicated when they are led into the operating-room; they are carefully insulated at the top from the wooden towers.

Full details of the arrangement of these stations are not yet obtainable. At the Poldhu station it is understood that a 20-kilowatt generator developing 2000 volts was used, and more powerful generators will be used in subsequent long-distance tests. This voltage is raised by "step-up" transformers, a type of induction coil, to perhaps 100,000 volts on the aerial wire. As previously intimated, owing to the losses in transformation and at the spark-gaps only a small fraction of the energy of the generator is radiated. It is clear that means must be provided for obviating danger and damage at the opening and closing of the transmitting key when strong currents and high potential are used. This is sometimes done by opening the circuit in oil, by blowing out the spark, etc., special keys and devices being used for the purpose, some of which will be described or mentioned.

The Fleming Long-Distance Transmitting System.—One of a number of systems designed for long-distance wireless signaling by Prof. J. A. Fleming for the Marconi Wireless Telegraph Company is shown in Fig. 38, the following account of which is abstracted, with some changes, from the British patent specifications No. 3481, covering the same. In the figure, *D* is a 20 or 25 kilowatt alternator developing 2000 volts more or less, with a frequency of 50 per second; *T* is a transformer, or several transformers in parallel, the primaries of which are in series with *D*. It may be noted that the coils of this and other transformers outlined in the cuts herein are wound one over the other, or end to end, in the usual way, although shown conventionally as separated in the figures for the sake of clearness. The transformer *T* raises the E. M. F. to about 20,000 volts, charging condensers *c*, which thereupon discharge across spark-gap *s*, in the secondary of *T*. Oscillations of a higher order are thus set up in the primary of *T'*, which oscillations are again transformed to higher voltage in the secondary of *T'*, charging condenser or condensers *c'*, which discharge across spark-gap *s'*, setting up oscillations in the pri-

mary of T^2 , which further increases the E. M. F. thrown upon the vertical wire or wires A. By means of this double or treble transforming the E. M. F. upon the aerial wires is sufficient to give a

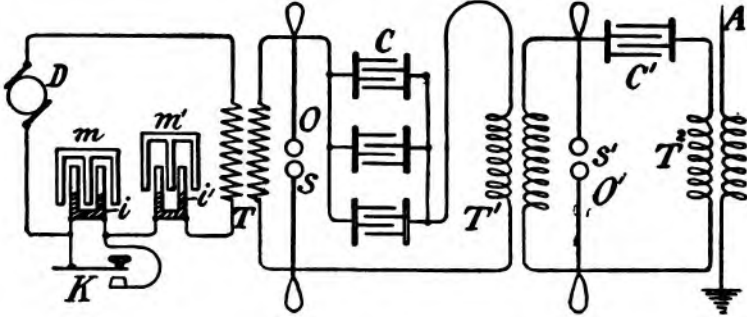

FIG. 38. FLEMING'S TRANSMITTING ARRANGEMENT.

spark of about twelve inches, or, as stated, an E. M. F. of about 100,000 volts. When it is desired to reduce the E. M. F. and frequency the oscillator circuit o' and transformer T^2 are omitted and the secondary of transformer T' is connected to the aerial wires.

Condensers C are of special construction, consisting of a number of stoneware boxes filled with double-boiled linseed oil, in which 20 glass plates, 15.5 inches square and coated with tin-foil on both sides, are placed. Eighteen such boxes in parallel give a total capacity of about one microfarad. These condensers are connected as shown at C in such a manner that the total length around and through any condenser and the spark-gap and primary T' shall be equal, to the end that all condenser discharges shall travel in the same time to spark-gap S and all have the same frequency.

The tuning of these circuits is effected practically in the following manner: The primary of transformer T^2 consists of seven No. 16 copper wires in a rubber-covered cable, wound once around a square or round wooden frame 18 inches in diameter, 7 to 10 of the strands being in parallel. The secondary of T^2 consists of 8 to 10 turns of the same cable wound over the primary. The condensers C' are so adjusted that circuit o' , consisting of S' , C' , and primary of T^2 , has a period equal to the aerial wire and the secondary of T^2 . To bring about this result, a hot wire voltmeter suitable for measuring 3 to 5 volts has its terminals placed to a piece of cable about two feet in length, which is inserted in the circuit of A and the secondary of T^2 . Oscil-

lations in the aerial circuit heat the voltmeter wire and cause a deflection of its needle. The exact size and length of cable to obtain a suitable deflection are ascertained by trial. Then if the capacity of c' be altered it is found that there is a certain capacity corresponding to which the oscillations in the aerial circuit are a maximum, as indicated by the voltmeter. The aerial circuit and first oscillator circuit $o s$ are then tuned. The oscillation circuit of $o s$ is then tuned to oscillation circuit $o' s'$ by placing an adjustable inductance coil in the circuit between the secondary of T' and the discharge-gap s' , and varying this inductance until the secondary spark is as long as possible. The circuit of the alternating current transformer T and the condenser c are then tuned by varying the number of transformers T joined in parallel, and the frequency of the alternations by varying the speed of the motor until the spark at s is as long as possible consistent with its remaining an oscillatory spark.

To obviate directly opening and closing the primary circuit of the alternating current transformer T' , two choke coils $i i'$, having movable iron cores $m m'$, are placed in that circuit as outlined. The iron core of m' is so adjusted that as much current as can safely be passed through the primary of T shall normally flow in the circuit. The core m of i is let all the way down, and it entirely impedes the flow of current in the primary of T , by reason of its inductance. The latter coil, however, can be short-circuited by key k , at which times the current in said primary circuit attains normal value. Thus the circuit is not opened in the usual sense. But to avoid sparking key k is of a type that is opened at a number of places, ten or twelve, and the switch is opened in insulating-oil.

In another patented device, due to Fleming, to avoid danger due to a sudden make and break in the primary of an alternating transformer, the circuit is kept closed and blasts of air from a tube or nozzle controlled by a spring or string attached to a signaling key are directed against the spark-gap, thereby interrupting the sparks in accordance with the movements of the key. For particulars of other variations of the apparatus described reference may be had to the patent specifications.

The vivid sparks and loud noises accompanying the operation of this and similar high potential transmitting apparatus has led to the application of the term "thunder factories" to long-distance wireless telegraph stations.

ANTI-COHERERS, AUTO-COHERERS, AUTO-DETECTORS.

As previously remarked, had the progress of wireless telegraphy rested with the discovery of the Hertz detector, the utility of electric waves for the purpose of telegraphy would have been very limited. It might now be said that if the development of this art had stopped with the discovery and utilization of the Branly filings-coherer, the distance to which messages could be successfully transmitted would have been limited to perhaps 400 or 500 miles, and the rate of signaling to perhaps ten or twelve words per minute, for the action of the filings-coherer is inherently sluggish in the production of perfect signals, the cohering and "tapping back," together with the mechanical inertia of the moving parts of the tapper, relays, etc., all tending to that result. Doubtless the distance mentioned as the probable commercial limit of signaling by the filings-coherer could be increased, as Marconi's experiments have shown, by the use of higher masts at both stations and an increased number of wires, and greater electrical energy at the transmitting station, but this would very likely be at the expense of a reduced speed of signaling.

It was therefore obvious to all concerned in the advancement of wireless telegraphy that the production of a coherer or other form of detector which would be more sensitive and reliable than the filings-coherer, and one which would, so to speak, "close" on the occurrence of electric oscillations in its circuit, and "open" automatically when the oscillations cease, and vice versa, was a thing much to be desired. As nearly always happens in such cases, this desideratum, or an approximation thereto, was not long in forthcoming.

Perhaps the first automatic or "self-righting" coherer produced was the carbon auto-coherer of Tomassini. It consists of powdered carbon, such as is used in microphone transmitters, placed in a small circular opening in a sheet of ebonite, one tenth of an inch thick. This was found to cohere in the presence of electric oscillations and to decohere without shaking on the cessation of the oscillations.

Another auto-coherer was that devised independently by Neugschwender and Aschkinass. This is a device in which scratches are made across the silvered back of a glass mirror. The mirror thus streaked is made part of an ordinary cohering circuit including a small battery and galvanometer. When moisture is thrown upon the streaked portion of the glass, for instance by the breath or other-

wise, the needle of the galvanometer is deflected. In this condition, if electric oscillations are set up in the circuit the needle returns to zero, and when the oscillations cease the needle is again deflected. The normal resistance of this arrangement is about 50 ohms; under the influence of electric oscillations it runs up to 80,000 ohms. Its action is thus opposite to that of the filings-coherer; hence it and other coherers of this type are termed anti-coherers.

Another somewhat similar type of anti-coherer, due to Schaefer, consists of a silvered glass across which scratches or slits are made. A film of celluloid is then placed over the scratches, when it is found that under the influence of electric oscillations the resistance of the circuit rises and decoheres automatically as in the case previously cited.

It has been surmised that the effect of the film of celluloid, which does not penetrate into the interior of the slits, is to prevent the dissipation of the particles of silver in the slits, and whose motion, under the influence of the electric oscillations, probably accounts in a measure for the variations in the resistance of the circuit. These devices, however, were not used in actual practice.

The next most important auto-coherer was probably that due to Solari, which was known for a time as the "Castelli" coherer, also as the Italian navy coherer, and was used by Marconi in some of his transatlantic experiments, to which further reference will be made. Within the past two years several other types of auto-detectors have been devised by different workers in this field, namely, Marconi in Europe and De Forest and Fessenden in this country. Owing to the sensitiveness of these auto-coherers, a telephone receiver is generally used in connection with them in place of the relay used with the filings-coherer.

The Solari Auto-Coherer.—This auto-coherer is shown in Fig. 39. It consists of a thin glass tube *k*, 1.7 inches long, suitably supported; *c* is a carbon rod or block; *i* is a plug of iron. A small drop of mercury *m*, not filling the space, is placed between *c* and *i*. A telephone receiver *t* and one cell of battery *b* are connected in circuit with the coherer, as shown. The E. M. F. of the cell should not exceed 1 to 1.5 volts. For untuned circuits the connections are virtually as in figure, A representing the connections to aerial wire, E those to

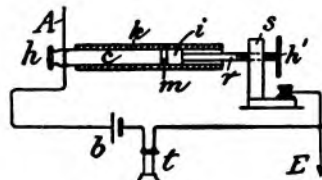

FIG. 39.

earth. In syntonistic systems the coherer would be placed in the "closed" circuit. The position of the iron plug is adjusted by the screw h' and rod r until the drop of mercury touches both the carbon and iron plugs, or until a continuous faint hissing sound is heard in the telephone. When oscillations occur in the coherer circuit the mercury coheres to the carbon and iron; when the oscillations cease the mercury automatically decoheres, with the result that variations of current sufficient to produce crackling noises in the telephone of long and short duration are set up during the reception of signals.

In the practice of the Italian navy, in which the Solari coherer was first used, a relay is employed to operate a bell for calling. When the telephone alone is used the operator must keep the instrument to his ear continuously to hear calls. It has been found by experience that when the tube of this coherer is not carefully closed, moisture enters and has a detrimental effect upon its operation. The size of the drop of mercury also has an important bearing on the operation of this coherer, and for proper working should not exceed .117 inch, nor be less than .058 inch, in diameter. The diameter of the tube should be chosen to meet these conditions. After this coherer has been in use for a time it loses its effectiveness, and must be renewed by putting in fresh mercury and thoroughly cleansing, the tube being easily dismantled for this purpose.

The Marconi Magnetic Detector.—This detector of electric oscillations is outlined in Fig. 40. According to Marconi's description it

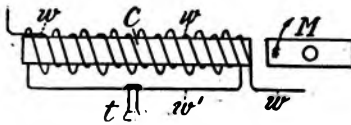

FIG. 40.

is constructed as follows: One layer of fine copper wire w , .007 inch in diameter and about 7.8 feet in length, is wound over a core C , made up of about 30 hard-drawn fine iron wires. The secondary wire w' of

the same size of copper wire is wound in as many layers over w as are necessary to give a resistance about equal to that of the telephone t , which is in the circuit of the secondary wire w' . There is no battery in either of these wires. The inner wire w may be connected to the vertical wire and earth, or to the terminals of a transformer, as described in connection with the filings-coherer. A permanent magnet M is placed near the end of the core C . The magnet is revolved by clockwork at the rate of about 30 revolutions per minute. This detector is based upon the observed fact, as Marconi states, that elec-

tric oscillations acting upon iron reduce the effects of magnetic hysteresis (that property of a magnet which retards magnetic changes), causing the metal thereby to respond readily to any influence which may tend to alter its magnetic condition, as Professors Gerosa, Finzi, and others have pointed out. Hence, when a magnet such as core *c* is undergoing regular slow changes of magnetism, which slow magnetization by reason of hysteresis is retarded and lags behind the magnetizing force (μ in this case), arriving electric oscillations in the wire *w* produce rapid changes in the magnetization of *c*, with the result that currents are set up in the coils surrounding the core, which currents are heard in the telephone receiver as long and short sounds when signals are being received.

A modification of this arrangement consists in replacing the core *c* "with an endless iron rope or core of thin wires revolving on pulleys worked by a clockwork arrangement which cause it to travel through the copper-wire windings, in proximity to a horseshoe magnet, or, preferably, two horseshoe magnets, with their poles close to the windings, and with their poles of the same sign adjacent. In this case the copper-wire windings are separated from the iron core by means of a stiff, thin pipe of insulating material, to prevent chafing of the wires. With this arrangement the signals appear to be quite uniform in strength."

Marconi further notes that this detector appears to be more sensitive and reliable than the filings-coherer, and does not require the careful adjustment and precautions which are necessary with the latter (such as choke coils, etc.). It will also have advantages over the filings-coherer when used in connection with tuned circuits in that its resistance is not only uniform, but is also much lower than the former when in its sensitive state, and "as it will work with a much lower E. M. F. the secondaries of the tuning transformers can be made to possess much less inductance, their period of oscillation being regulated by a condenser in circuit with them, which condenser may be much larger (in consequence of the smaller inductance of the circuit) than is used for the same period of oscillation in a coherer circuit, with the result that the receiving circuits can be tuned much more accurately to a particular radiator of fairly persistent electric waves."

With electric detectors of the automatic type the action seems to be practically instantaneous, unlike the filings-coherer, in which time is lost in cohering and decohering. In the latter, also, decoherence

is not always complete, which is another drawback to its use in syntonic wireless telegraphy, producing as this does variations in the resistance of the closed circuit, which, as already noted, produces variations in the period of oscillation. As previously remarked, the speed of signaling with the filings-coherer is ten to fifteen words per minute. With the magnetic coherer it is claimed that a speed of thirty words per minute is obtainable, and Marconi has intimated that it will ultimately be feasible to operate this device in connection with automatic transmitting and receiving apparatus.

Marconi has given interesting details of his transatlantic and other long-distance experiments, the first of which was between Poldhu and Signal Hill, Newfoundland, a distance of 2200 statute miles, in December of 1901. On this occasion the apparatus described was used at Poldhu, while a vertical wire 400 feet long, supported by a kite, was connected to a detector in Newfoundland. By prearrangement, the letter "S" (three dots in the Morse code) was transmitted from Poldhu at regular intervals. This letter was heard frequently, but no regular message was received at that time. It was found that owing to the variations in the capacity of the vertical wire at Signal Hill, due to fluctuations of the height of the kite, the ordinary tuned receiver was not suitable, and therefore a number of different types of carbon and carbon-cobalt auto-coherers were tried and found operative. These coherers were placed in the secondary wire of a transformer, the signals being read on a telephone. The Solari auto-coherer was also used successfully on this occasion.

In February, 1902, further experiments were made between Poldhu and the steamship *Philadelphia* while on a voyage to New York. The receiving aerial conductor on the *Philadelphia* consisted of four wires 197 feet in height above sea-level. These were attached to the mast of the ship, and were connected together at their lower ends to the receiving instrument. In these tests the filings-coherer in a syntonic circuit and auto-coherers in untuned circuits were used. In these tests "readable messages were received on tape at a distance of 1551 miles from Poldhu, and indications were received as far as 2099 miles, while signals could not be received at over 900 miles by any of the self-restoring coherers," the reason for this probably lying in the fact

that the tuned filings-coherer "when connected to a fixed aerial conductor is more efficient."

An interesting point observed during these tests was that signals could be received at a greater distance at night than during the day, which, it was surmised, might be due to the discharging effect of daylight upon the highly charged aerial wires at Poldhu, it having been observed by Hertz during his tests that the ultra violet rays when allowed to fall on the discharge-knobs facilitated the discharge. Other experiments by Marconi also gave this same result. Thus, between Poldhu and Dorset, 152 miles (109 miles over sea and 43 miles over land), signals were received during the night with wires 39 feet high, while during the day wires 60 feet high were required.

Further long-distance tests were conducted by Marconi between Poldhu and the Italian cruiser *Carlo Alberto* in July, 1902. The vertical conductor at Poldhu consisted of 100 thin copper wires supported from four towers 230 feet high; the E. M. F. employed at this station was practically equal to that already noted. On the *Carlo Alberto*, which was arranged as a receiving station only, with filings-coherer and a Morse recorder, Marconi's magnetic detector was also used in connection with a telephone. The vertical wires on the vessel were reinforced by a network of thin tinned copper wires suspended between the masts of the vessel. Messages were sent at pre-arranged times during the day from Poldhu. The cruiser first sailed for Denmark, and messages were distinctly received at a distance of 560 miles across the North Sea and England. Subsequently messages were transmitted from Poldhu to the *Carlo Alberto* at Gibraltar and beyond, a distance of 750 miles. In these experiments, also, the distance transmissible at night was greater than during the day. It was also found that the effects of atmospheric electricity made it necessary to reduce the sensitiveness of the detectors or to provide a shunt for the atmospheric discharges, which doubtless has the further effect of diminishing the effectiveness of the received oscillations. These tests, it is stated, also demonstrated the superiority of the magnetic detector over any coherer.

In the more recent experiments a despatch has been transmitted from South Wellsfleet Station to Poldhu, namely, the message of congratulation from President Roosevelt to King Edward VII.; but up to the end of June, 1903, nothing further of a commercial nature has transpired regarding transatlantic wireless telegraphy, owing, it

is said, to breakdowns in some parts of the apparatus. In the meantime, however, the system which Sig. Marconi has done so much to develop is being installed on numbers of vessels, naval and mercantile, on lightships, etc.

TELEGRAPHIC CODES.

LETTERS.	MORSE.	CONTINENTAL.*	LETTERS.	MORSE.	CONTINENTAL.
A	· —	— —	N	— ·	— —
À		— — — —	O	— ·	— — — —
B	— · · ·	— · · ·	Ö		— — — —
C	— · ·	— · · ·	P	— · · · ·	— · · · ·
Ch		— — — —	Q	— · · ·	— · · · ·
D	— · ·	— · ·	R	— · ·	— · ·
E	·	·	S	— · ·	— · ·
É		— · · · ·	T	—	—
F	· — ·	· — ·	U	— · —	— · —
G	— — ·	— — ·	Ü		— · — —
H	— · · ·	— · · ·	V	— · — —	— · — —
I	· ·	· ·	W	— · — ·	— · — ·
J	— · — —	— · — —	X	— · — ·	— · — ·
K	— · —	— · —	Y	— · — ·	— · — ·
L	— — —	— · — ·	Z	— · — ·	— · — ·
M	— —	— —	&	· — · ·	

NUMERALS.

	MORSE.	CONTINENTAL.		MORSE.	CONTINENTAL.
1	— — — —	— — — —	6	— · — ·	— · — ·
2	— · — ·	— · — ·	7	— · — ·	— · — ·
3	— · — ·	— · — ·	8	— · — ·	— · — ·
4	— · — ·	— · — ·	9	— · — ·	— · — ·
5	— · — ·	— · — ·	0	— — — —	— — — —

PUNCTUATIONS.

	MORSE.	CONTINENTAL.
. Period	— · — · — ·	— · — · — ·
: Colon	— — — —	— — — —
; Semicolon	— · — · — ·	— · — · — ·
, Comma	— · — ·	— · — ·
? Interrogation	— · — · — ·	— · — · — ·
! Exclamation	— — — —	— — — —

* Officially termed the "Universal" code.

NOTE.—Practical suggestions for learning these codes and on wireless telegraph signaling will be found in the Appendix, p. 194.

CHAPTER VIII.

LODGE AND LODGE-MUIRHEAD WIRELESS TELEGRAPH SYSTEMS.

LODGE EARLY SYNTONIC WORK.

REFERENCE has already been made in a preceding chapter to the early experiments of Sir O. Lodge in simple wireless telegraphy. As previously remarked, he was doubtless the first to devise syntonic, more especially selective syntonic, wireless telegraph methods, some of his British patents therefor having been issued in 1897. Lodge noted that the usual arrangement of the early transmitting circuit was calculated to produce waves of very limited duration; hence the effect upon the coherer is mainly due to the first swing, so to speak, of the oscillations. In order to obtain persistent oscillations Lodge first designed transmitting and receiving apparatus in which maxi-

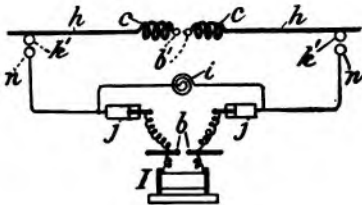

FIG. 41.

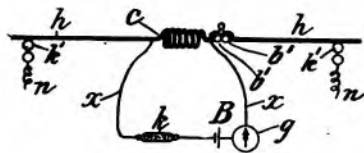

FIG. 42.

mum capacity and inductance with minimum resistance is sought, the transmitting and receiving circuits being constructed to have a corresponding oscillation period, thereby securing tuning and resonance.

This apparatus is indicated in Figs. 41, 42, in which *h h* are two triangular sheets, or capacity plates, of high-grade copper, six to eight feet in length (shown edgewise in figures), arranged relatively to each other as shown (see Fig. 43). Between the capacity plates *h h* are

inserted one or two coils $c c$ of a few turns of copper ribbon or wire well insulated, and designed to give inductance to the circuit. To this end finely divided iron rods may be inserted in the coil. Polished metal knobs $k' k'$ are placed on the side of each capacity plate, as indicated. The terminals of the secondary wire of the induction coil i are first brought to the inner coatings of Leyden jars $j j$ (Fig. 41), the outer coatings of which are connected to the discharge-knobs $n n$. The outer coatings of the jars are connected by an induction coil i of thin wire to insure thorough charging of the jars, which coil provides an alternative path for the discharge, but does not prevent sparking at discharge-knobs $k' k'$. Between the inner coatings of the jar and the induction coil i there is another spark-gap and knobs b . Other sparking knobs b' are placed at either end of the inductance coils $c c$.

When the arrangement is to be used as a transmitter the knobs b' are separated to a suitable sparking distance. The operation is as follows: The induction coil i sets up charges of high potential which break down the air-gap resistance at the knobs $k' k'$, which in this arrangement Dr. Lodge terms the "supply" knobs. Sparking follows, and oscillations are started in the capacity sheets and induction coil, which, in turn, spark into each other across the knobs $b' b'$. According to the inventor, it is the latter discharge which is the chief agent in starting the oscillations that radiate the electric waves. The waves will still be radiated, however, if the air-gap at $b' b'$ be closed or short-circuited, but in that case the polished knobs $k' k'$ must be protected from ultra violet light, for the reason stated elsewhere herein. The object in excluding this light is to conduce to a more intense rupture at the polished knobs $k' k'$ (for which purpose the Leyden jars also are employed), which in turn excites stronger oscillations in the oscillation circuit proper, $h h, c c$.

An advantage claimed at the early period mentioned (early in the history of this art) for this "closed" arrangement of the transmitting circuits, in addition to that due to the impulsive rush caused by charging the oscillation circuit through the supply-gaps $k' k'$, is that the said circuit has no direct metallic contact with the induction coil or other source of oscillations, "and therefore oscillates longer and more simply than when supplied by wires in the usual way."

When these capacity plates and inductance coils are to be used as a receiver, the air-gap at $b' b'$ is closed or short-circuited, and the coherer circuit $x x$ is attached to the plates near the terminals of the

inductance coils, as in Fig. 42, in which k is the coherer, B a cell of battery, g a galvanometer, or other receiving instrument, in series with the coherer. In this figure but one coil c is shown. The other letters in this figure refer to apparatus similarly lettered in Fig. 41. The tapper is not shown in these figures, which with much of the accompanying descriptive matter are adapted from the U. S. patent No. 609,154, 1898, covering these devices.

When it is desired to have transmitters and receivers of different rates of oscillations for selective signaling, Dr. Lodge employs oscillators with adjustable inductance coils which may readily be inserted between the capacity plates by means of a mercury or other suitable switch. By varying these coils this result is easily obtained, since the period of oscillation varies with the inductance as well as with the capacity. The plates and inductance coil of this arrangement can be used as transmitter and receiver by a slight change, therefore one set of plates is sufficient at each station. No ground connections or vertical wires are ordinarily used with this device, but the use of a ground connection is suggested. Dr. Lodge states that "radiation from an oscillator consisting of a pair of capacity areas is greater in the equatorial than in the axial direction. Consequently, when sending in all directions it is well to arrange the axis of the oscillator, or emitter, vertically. Moreover, with the axis thus arranged the emitted waves are less likely to be absorbed over partially conducting earth or water." A set of oscillators arranged vertically for signaling to a distance is shown in Fig. 43, the apparatus at the left representing the transmitter, that at the right the receiver.

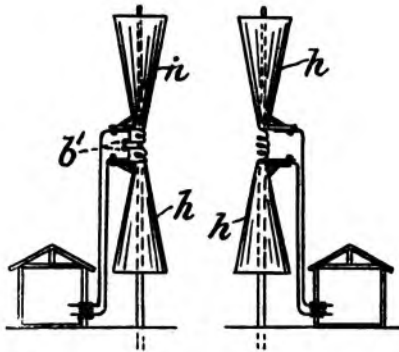

FIG. 43.

Another arrangement of this system as outlined by the inventor in the patent referred to is illustrated in Fig. 44, in which c is the primary and s the secondary of an ironless transformer, and e is a condenser or resistance shunting the coherer. The object in this use of the transformer is to make its secondary coil "a part of the coherer circuit so that it shall be secondarily affected by the alternating cur-

rents excited in the conductor of the resonator, and thus the coherer be stimulated by the currents in this secondary rather than primarily by the currents in the syntonizing coil itself; the idea being thus to leave the resonator freer to vibrate electrically without disturbance from attached wires"—in other words, to provide a "closed" circuit as distinguished from the "open" circuit.

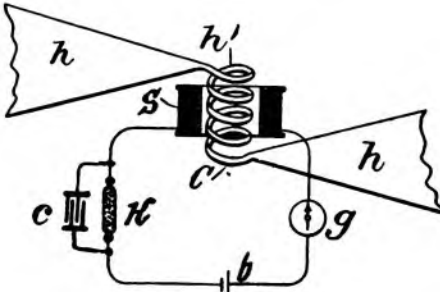

FIG. 44.

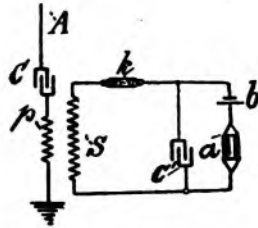

FIG. 45.

In a subsequent British patent, No. 18,644, 1897, to Lodge and Muirhead, a condenser is described as shunting the receiving instrument and battery, virtually as outlined in Fig. 45, and this is referred to as a distinct part of the invention, allowing as it does the coherer circuit to have a definite period of oscillation, and practically eliminating the said battery and receiving instrument so far as oscillations are concerned. Fig. 45 is not, however, taken from said patent.

Signals are said to have been received at a distance of one mile by the apparatus and system described. How much farther it may be capable of transmitting signals is not known to the writer, but the

Further allusion is made to Fig. 45 as representing a "closed" receiving circuit (p. 82). In the figure c' is a condenser, indicated as shunting a siphon recorder a , and battery b ; k is a coherer; c is a condenser and p is the primary of a transformer, both in the aerial circuit; s is the secondary of the transformer.

Lodge-Muirhead Single-Point Coherers.—One of the coherers used by Dr. Lodge, and known as a single-point coherer, consists of a suitably supported metal point resting easily on a light metal rod. The rod and the point are connected as in the case of the ordinary coherer. When electric waves occur the point slightly coheres to the

rod, thereby reducing the resistance of the circuit. The rod is maintained in a very slight state of tremor by means of a rotating wheel at its left end, which wheel is rotated by clockwork. This suffices to decohere the point, the effect being virtually similar to that of the filings-coherer upon the circuit.

A modification of this coherer is described in the patent last mentioned, and is outlined in Fig. 46, in which *c c c* are strips of metal resting lightly against contact-points indicated by the arrow-heads. Under the influence of electric oscillations in the circuit the points *c* cohere. These points, it will be seen, are in multiple with each other and in series with the receiving instrument *a*, a siphon recorder. Two or more points are used to insure that action will ensue. The coherers are in mechanical contact with a rotating cam *d* which at each revolution decoheres the points.

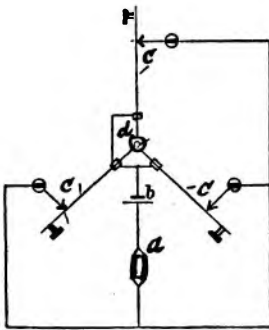

FIG. 46.

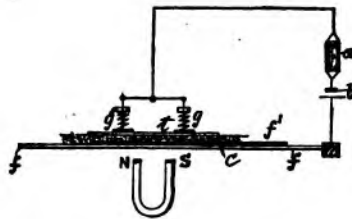

FIG. 47. MUIRHEAD FILINGS-COHERER.

Lodge-Muirhead Filings-Coherer.—These inventors have also devised a means of decohering filings without the aid of vibrating hammers or similar apparatus. The filings *c*, Fig. 47, are spread on a flexible light strip *f* which is suitably supported at its right end only, and is placed in the magnetic field of a permanent or electro-magnet *N S*. The filings are separated from the strip by a film of varnish *f'*, or other suitable insulating material, excepting for a short space at the left, as shown, where the filings rest on the strip. Another light metal strip *t* is held by small springs *g g* against the filings. When the filings cohere a current from the cell *b* flows through the strip, and by the joint action of the magnetic field and the field due to the current the strip is deflected, and in consequence the mass of the filings is disturbed and decoheres.

LODGE-MUIRHEAD WIRELESS TELEGRAPH SYSTEM.

More recently these gentlemen have put on the market a completed commercial system intended for signaling over short distances, say up to sixty or eighty miles, and for this purpose it is claimed to be superior to any previous system as regards reliability and clearness of signaling.

One of the objects of the inventors has been to follow as closely as * practicable upon the established methods of wire telegraphy so far as regards the actual transmission and reception of signals. To this end

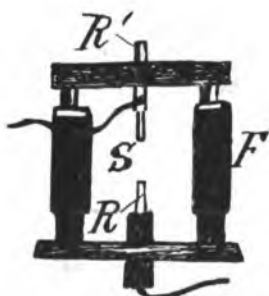

FIG. 48.

they provide a manually operated key, and also a perforator and automatic transmitter for sending, and a siphon recorder operated by a coherer for receiving. For moderate distances a ten-inch spark induction coil is used, but for long distances an alternating current generator is employed. The induction coil is provided with a spark-gap carried on an insulated frame, apart from the coil, as in Fig. 48, in which F is the frame, S is the air-gap, and R R' represent lower and upper rods connected with the secondary terminals of the induction coil by suitable insulated wires. The upper rod is adjustable by means of a set-screw.

A somewhat novel interrupter for the induction coil consists of an arrangement whereby, whether the signaling is by hand or automatically, the primary of the induction coil is opened and closed at a definite rate by a device consisting of two telegraphic sounders so connected as to act reciprocally, and are operated by a Morse key or automatic transmitter. One of these sounders controls a lever, from one end of which an aluminum arm terminating in a copper rod extends into a cup of mercury. This arrangement acts as a "buzzer," making and breaking the primary circuit at the rate of about ten times per second while the key is depressed. This apparatus is adjusted to meet best conditions by varying the play of the armatures or by varying the length of the dip of the arm in mercury. The record, it will be understood is made in consecutive dots and dashes in this sys-

* See article by H. C. Marillier, "London Electrician," Mar. 27, 1903.

tem, not in characters corresponding to those made by the siphon recorder in cable telegraphy—the record or line on one side of a zero line representing a dot, that on the other side a dash. It is found that when the rate of sparking is not sufficient the line produced by the recorder on the tape is uneven, while at a higher rate the pen is held over during the continuance of a dot or dash, thus giving even lines. It has also been found, however, that with the latest type of coherer employed in this system the siphon recorder indicates on the tape every variation in the form of the transmitted wave and is thus useful in providing a means of studying the variations in the modes of signaling. At the same time these inequalities in the lines on the paper tape do not affect the ability of the operator to translate the recorded signals.

When the system is arranged for ordinary open-circuit, or untuned, working, the aerial conductor consists of an elevated capacity, such as a globe or roof or an iron cage from which the vertical wire is suspended, and connections are made to the sparking knobs and to the ground in the usual way.

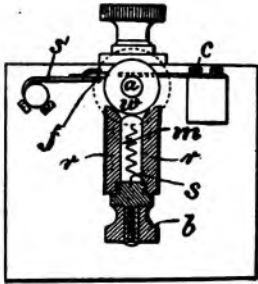

FIG. 49.

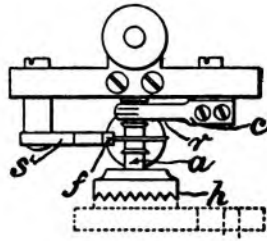

FIG. 50.

One of the most important features of this system is the new type of coherer employed. In practice it is inclosed in an iron case, and is shown in section in Fig. 49 and in top view in Fig. 50. In Fig. 49, *w* is a rotating steel disk, the periphery of which enters a vessel *r* containing mercury *m*, but is prevented from making contact with the mercury by a film of mineral oil; *s* is a spiral of amalgamated platinum wire, which insures connection between the mercury and the terminal-screw *b*; *s'* is a flat spring carrying at its right end a small piece of felt, which, resting lightly on the periphery of the disk *w*, keeps it free of dust. The disk *w* is rotated by clockwork, to which

it is geared by ebonite wheels *h* on axle *a*, Fig. 50. The coherer circuit is completed by wires connected to the terminal-screw *b* and to the upper brush *c*, which rests on the axle of the disk. In this circuit there is a battery of less than one volt, also the recorder, and in shunt with them a condenser when desired.

In the operation of this coherer the film of oil normally prevents contact between the disk *w* and the mercury *m*, but electric oscillations in the circuit cause the mercury and disk to cohere. By means of a potentiometer the normal voltage of the coherer circuit is maintained at from .03 to .5 volt; one volt being sufficient when the disk is rotating at a moderate speed to break down the normal insulation of the coherer and to bring about coherence.

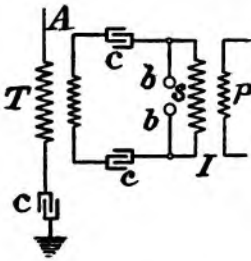

FIG. 51.

Figs. 51 and 45, which represent "closed" transmitting and receiving circuits respectively. In these figures, *T* is a transformer, *c c c* are condensers, *b b* the spark-balls, *s* the secondary and *p* the primary of the induction coil *I*; *a* is a siphon recorder, *κ* is the coherer.

CHAPTER IX.

THE SLABY-ARCO AND BRAUN WIRELESS TELEGRAPH SYSTEMS.

THE SLABY-ARCO SYNTONIC WIRELESS TELEGRAPH SYSTEM.

ACCORDING to Dr. Slaby, this system is based on the principle that when electric oscillations of high frequency and high potential are set up in a conductor, one end of which is free and the other end to earth, the greatest amplitude of oscillation will be at the free end of the wire; and, further, when electric waves are radiated from such a transmitting wire and fall upon a similar receiving wire, the greatest amplitude of the oscillations will also occur at the free end of that wire—it being assumed in each case that the wire is one quarter the wave-length of the transmitted wave. From this it follows that the coherer should be attached to the free or upper end of the receiving wire, but as this is not convenient, Slaby-Arco attach a horizontal wire to the foot or nodal point of the receiving wire. This horizontal wire takes up corresponding oscillations to those of the vertical wire. The wires are given equal inductance and capacity, to secure syntony.

In illustration of the foregoing theory, Dr. Slaby gives the following mechanical analogy: Referring to Fig. 52, *a b*, 2 3 4 is a steel wire so bent that the upright ends *a b* are each one sixth the length of the whole wire. When one of the free ends, say *a*, is caused to oscillate, the other end *b* likewise begins to oscillate. The nodes of the oscillation are at 1, 3, 5, while at 2, 4 and the upper end of *a b* the oscillation is a maximum. In the experiment the length of *a b* must be one quarter of the whole wave-length, or equal to the distance from 1 to 2. The length of *a* then corresponds to the trans-

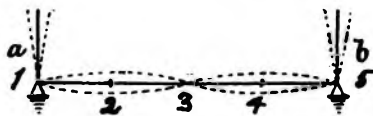

mitting vertical wire, connected to earth through the spark-gap, while b corresponds to the receiving vertical wire, the lower end of which is grounded and hence is a node of the electric oscillations.

The manner in which this theory is carried out in practice is shown theoretically in Figs. 53, 54, which represent the transmitting and receiving apparatus of this system. A is the vertical wire terminating directly in the earth; the horizontal wire is connected to the nodal point of A ; I is the oscillator; c is an adjustable condenser or battery of Leyden jars; m is an adjustable inductance coil.

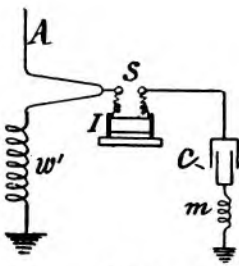

FIG. 53.

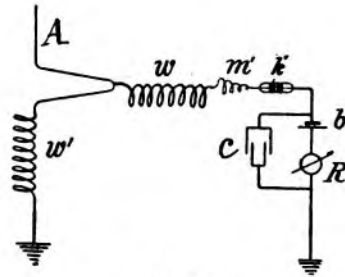

FIG. 54.

THEORY OF SLABY-ARCO CIRCUITS.

The aerial wire is looped into the operating-room. A coil of wire w' is inserted in the vertical wire for the usual purpose, namely, to increase the wave-length. A set of these coils, of different inductances, is provided in order that any desired wave-lengths may be obtained. Dr. Slaby, in common with others, finds it very necessary that the oscillator circuit be tuned in harmony with the vertical wire, which may readily be done by means of the adjustable coil m or the capacities c , which are suitably marked for the purpose.

In the receiving circuits (Fig. 54) A is the aerial wire, w is the horizontal wire connected to A . This wire may be wound on a spool in order to be accessible, and the coherer k is connected as indicated. Dr. Slaby states that the pressure, which is at its maximum at the end of w , is intensified by the tuning coil or multiplier m' , which is in the coherer circuit. R is a polarized relay in the coherer circuit. Its resistance is 2000 ohms, which is also the resistance of the coherer when cohered. c is a mica condenser having a capacity of .01 microfarad, and shunting the battery b of one dry cell and relay R , thereby preventing the inductance effects of the relay upon the

coherer. It also gives the oscillations a free path to earth. The capacity of the coherer is .001 microfarad.

The multiplier m' is a loosely wound coil of wire of a form and winding so proportioned that with the condenser c and inductance w a large increase of potential is resonantly obtained at its free end, to which the coherer is attached. This coil and w may be combined in a single coil with corresponding winding. When this coil is attached to the aerial wire for transmitting it imparts to that wire a higher potential than is obtainable by means of the induction coil alone.

Professor Slaby gives the following method of tuning by this system: Any two stations use a prearranged wave-length. Waves of this length are then the only ones that affect the coherer circuit, the other waves passing into the earth. When, however, it is desired to receive at this station with the same aerial wire waves of other lengths, it can readily be done. For instance, if the vertical wire be 120 feet in length the wave-length will be 480 feet, and if the horizontal wire is of the same dimensions it will reject all other wave-lengths, as stated. But if the whole length of the vertical wire and the horizontal wire combined is made equal to one half of the wave-length, the received waves will then be forced into the coherer circuit, for the earthed point is then no longer a node, but will only permit this special wave-length to enter. If it is desired to receive waves 600 feet long, the whole wire must be 300 feet, and the horizontal wire w , which is wound on a spool, must be 180 feet long. To facilitate the reception of signals of different wave-lengths, therefore, at any station, it is only necessary to provide a number of such spools capable of being readily attached to the lower end of the vertical wire, each of which coils is connected with a receiving apparatus.

Ordinarily, two vertical wires, joined at the top, with the usual spark-gap, shunted by a condenser, in series in the loop thus formed, will not act as a radiator, or at best very feebly, since the waves tending to be set up in one wire are neutralized by those in the other. Prof. Slaby has found that by giving one of the wires more inductance than the other, and by earthing the wire having the greater inductance, he obtains a looped system capable of radiating electric waves. This result is due to the fact that overtones, say the first odd harmonic, of the original oscillations are set up which produce nodes of potential at the bottom, and one third from the top, and an anti-node of potential at the top.

The Slaby-Arco Coherer.—The coherer *k* consists of silver or platinum and steel filings, the tube being exhausted of air to prevent oxidizing and to keep the filings dry and easily movable. The filings are decohered by a tapper. The coherer plugs are of silver, and fit the glass tube closely to prevent the powder from getting between the plugs and the glass. The leading-in wires are of platinum, and are fastened by metal caps to the ends of the tube. The inner ends of the coherer plugs are inclined so that the space or slit between them is wedge-shaped. The object of this device is to secure greater or less sensitiveness of the coherer, as desired. When the tube is so turned that the wider portion of the slit is below, the powder is spread over a large surface, and in consequence the pressure is loosened and the coherer is then at its point of least sensitiveness. When, on the other hand, the slit is turned with its narrow portion down, the filings are crowded together and the sensitiveness of the coherer is at a maximum. As means are provided for turning the coherer on its axis, its sensitiveness is thus readily adjustable. When the desired adjustment is obtained the coherer is locked in that position by a catch-spring.

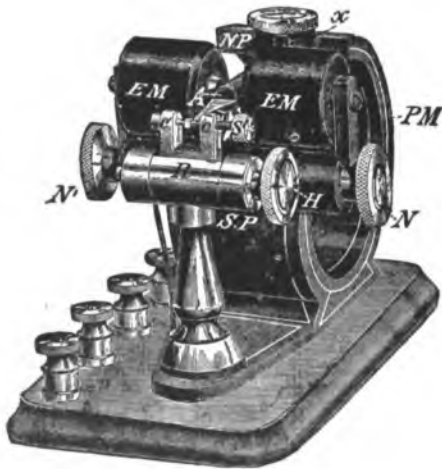

FIG. 55.

In practice these coherers are made in various degrees of sensitiveness, and when one becomes defective, or a change for any reason is desired, it is easily removed from its support.

The Polarized Relay.—

There are numerous different forms of polarized relays in use in wireless telegraphy, but the general principle, a brief description of which will be given, is the same in all, and is practically as follows: The form shown in Fig. 55 is known as the

Phelps relay, which was at one time in extensive use in the United States, but has been supplanted by forms in which the moving parts are lighter and the instrument generally is much more sensitive. The polarized relay is usually a combination of a permanent magnet and

electromagnet. In the type illustrated in the figure the permanent magnet PM, bent to the shape shown, rests on the base of the instrument. The yoke or cross-piece of the electromagnet rests on the lower end or south pole SP of the permanent magnet. A soft-iron armature A is pivoted to the upper part or north pole NP of PM at x , and extends between the pole-faces of EM. This armature is constantly magnetized by the permanent magnet, as are also the iron cores of the electromagnets, the outer end of the former to north polarity, the latter to south polarity, so that normally, when the armature is "centered," it will remain against either stop $c c'$, inasmuch as it is attracted equally by both poles. When, however, a current traverses the coils of the relay, the magnetism of the cores, due to the permanent magnet, is overcome or assisted, and the poles of EM become north or south poles according to the direction of the current in the coils, and the armature is attracted to the south pole. The play of the armature is adjusted by means of the small screw s' . Its position between the cores of the electromagnet is regulated by the front and back stops, one of which is the contact-point, the other being insulated or idle. These contacts ride in a carriage which is movable in the cylinder R by the screw H, and the armature may be placed in any position between the poles of EM by this screw. The cores of the relay may be independently moved to and from the armature by the screws N N'. If no retractile spring is used, the armature is given a slight bias by means of the adjusting-screw H sufficient to hold it normally against the insulated stop; a current in the coils then moves the armature against the contact-point, thereby operating a sounder, bell, or ink-recorder. In certain other types of polarized relays the armature or the cores only are polarized by the permanent magnet.

The Slaby-Arco system is designed for transmitting over distances ranging from 25 to 50 miles and more, over sea. For short distances a 6-inch spark induction coil is used with the ordinary interrupter. The primary battery consists of dry cells with an E. M. F. of about 15 volts and 3 to 6 amperes. For a distance of from 25 to 50 miles a more powerful induction coil, with a mercury turbine interrupter, which is driven by an electric motor, is employed (Fig. 57). In this case there are about 20 interruptions per second, and the E. M. F. and current strength of the primary current are 65 volts and 15

amperes respectively. For distances over 50 miles an alternating current generator of 3 kilowatts or more is used.

The transmitting apparatus for medium distances is shown in

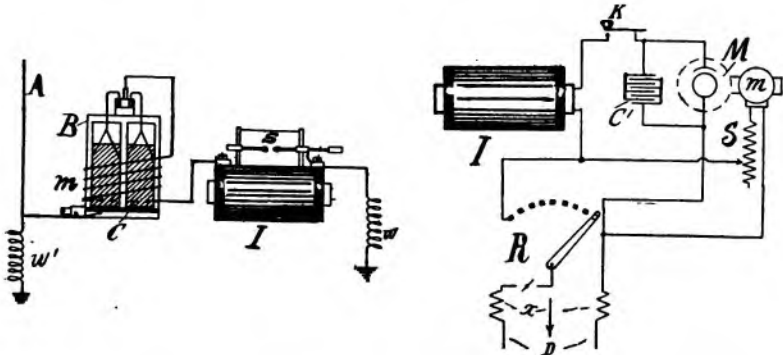

FIG. 56. SLABY-ARCO TRANSMITTING AND RECEIVING CIRCUITS. FIG. 57.

some detail in Fig. 56, in which the arrangement of circuits may be considered as practically similar to those of the theoretical diagram (Fig. 53). *c* is a battery of 3, 7, or 14 Leyden jars contained in the cylindrical box *B*; *m* is a tuning coil of about 4 turns of No. 12 wire wound around the micanite box *B*; *I* is the induction coil, *s* the spark-gap, *w w'* the coils already referred to, and *A* is the vertical wire.

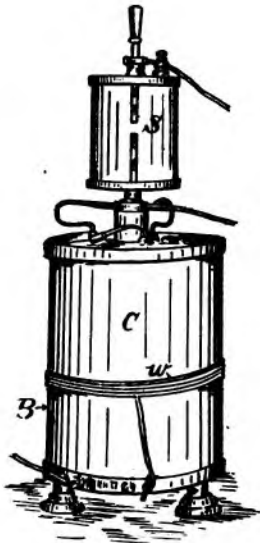

FIG. 58.

The high-tension discharge-rods *s* are arranged vertically on the top of a cylinder *B* of micanite or other insulating material, Fig. 58.

Fig. 57 represents the primary circuit connections of the oscillator. *I* is the induction coil; *K* is the transmitting key; *c'* is a condenser shunting the mercury interrupter *M*, operated by the motor *m*; *S* is a resistance with a sliding contact to regulate the speed of the motor, and by this means any number of interruptions from 10 to 10,000 per minute can be obtained; *R* is a resistance for regulating the current strength in the primary of *I*; *x* is a lightning arrester; *D* is the source of E. M. F.

The sparking-rods are inclosed in a micanite case to deaden the sound, and for ventilation an ebonite tube is provided. To minimize accidents the high-tension poles are painted red.

The usual tapper, signaling bell, and Morse ink-recorder are employed in this system, but these, with numerous other necessary practical details, are omitted to simplify the diagrams.

The Slaby-Arco system is exploited by the General Electric Company of Berlin, from whose publications on the subject a portion of this subject-matter is extracted. By this system signals have been transmitted over sea 60 miles with masts 164 feet high, and it is claimed that by means of the tuning devices employed the transmitter and receiver can be attuned to within three per cent. of exact syntony. It is also claimed that a radiation equal to that of other systems can be obtained by this apparatus with one half the electrical energy required by other wireless systems.

For portable outfits for military and similar purposes much simpler apparatus than that described is furnished. Kites or balloons in this case are utilized to support the aerial wire. Oscillations are set up by a Ruhmkorff coil. The Morse relay and ink-recorder are replaced by a head telephone receiver, and in place of the filings-coherer an auto-coherer placed in the secondary of a small transformer or branch circuit is employed. The coherer is in series with a dry cell and the telephone receiver. The received oscillations cause fluctuations in the current which are heard in the telephone. A frequency of at least 100 sparks per second in the transmitter is found essential to give audible signals in the telephone. The circuits are attuned to the wave-length emitted by the transmitter.

The following details of installations of this system on shipboard, lighthouses, etc., have been published by Count Arco, coinventor with Prof. Slaby of this system.

The outfit on the s. s. *Deutschland* is allotted a space of about 3×4.5 feet and 7 feet high. The oscillations are set up by an induction coil giving a 20-inch spark, supplied with alternating current of 5 to 20 amperes with a frequency of 25, thereby avoiding the need of an interrupter. The transmitting key is supplied with an electro-magnetic blow-out, so that no sparking occurs at the break. To compensate as far as possible for the rolling and pitching of the vessel, all movable parts, such as the relay armatures, are counterbalanced, and to diminish the vibration, which is most noticeable at half-speed

of the ship, felt and rubber packing is employed; but despite these precautions these causes reduce considerably the sensitiveness of the apparatus. The vertical conductor consists of a cable of twelve wires. This cable is not a permanent structure, but is raised to the mizzen-mast when required. The transmitting wire is insulated with india-rubber, .4 inch thick, to prevent contact with the deck.

Arrangements are provided to make it feasible to communicate with stations and vessels equipped with other systems than the Slaby-Arco. The quarter wave-length employed at Duhnen, Germany, is about 300 feet; that at Heligoland is about 150 feet. For the purpose stated a switch is provided on the *Deutschland* whereby the properly attuned coils may be switched in for the stations at Duhnen and at Nantucket lightship. The maximum distance at which communication has been made between the said vessel and Nantucket is about 50 miles, while from the ship to Duhnen a distance of 100 miles has been covered. It is assumed the ship's tackle intercepts the waves in the first instance. For communication between the lightship *Vyl* and the Blaavandshuk lighthouse off Denmark, a distance of about 19 miles, it was necessary to take into consideration the heavy rolling and pitching of the lightship in stormy weather. At this station an induction coil giving a 2-inch spark is operated by large dry cells which supply 2.5 amperes at 10 volts, and owing to the small energy available a condenser having a capacity of but .0005 microfarad can be employed.

No mast is employed at the lighthouse. A wire about 208 feet long is dropped from the lantern to a hut nearby, giving a vertical height of about 160 feet. Current in the lighthouse is furnished by a storage battery giving 20 amperes and 40 volts, the battery being charged once in two weeks. Inasmuch as the vertical wires at these two stations are of different lengths, the following plan is adopted to obtain syntony. When signals are being transmitted by the lightship both air-wires are tuned to the same frequency, at which time the vertical wire of the former oscillates in quarter waves and that of the lighthouse in three-quarter waves. Reversely, when the lighthouse is transmitting, both air-wires oscillate at a uniform rate, namely, in quarter waves, the fundamental rate of oscillation of the lightship being reduced by the insertion of a large inductance coil in its circuit.

Further advantages claimed for this system by the inventors are the entire absence of atmospheric disturbances during the reception

of signals; the possibility of using for the aerial wire, for transmitting and receiving, lightning-conductors, iron chimneys, or other similar earth conductors; and the possibility of receiving without interference messages from several transmitting stations, owing to the great intensity of the syntonizer employed.

THE BRAUN SYNTONIC WIRELESS TELEGRAPH SYSTEM.

This system, due to Prof. F. Braun, known also as the Braun-Siemens-Halske system, is established in a number of places in Europe.

The important features of the Braun system are closed transmitting and receiving circuits and the use of large capacity areas instead of earth connections at the base of the aerial wire. By the closed-circuit feature it is well known that more persistent oscillations are obtainable, and by avoiding direct earth connections atmospheric electric disturbances are obviated.

The theory of the Braun transmitting and receiving circuits is outlined in Figs. 59 and 60. In Fig. 59, *b* is the battery or E. M. F.

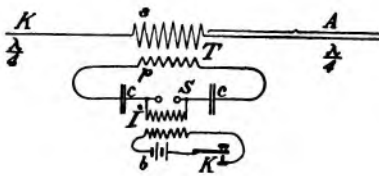

FIG. 59.

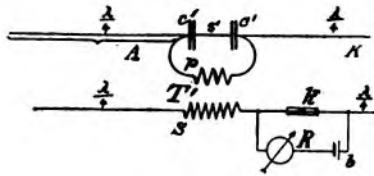

FIG. 60.

THEORY OF BRAUN SYNTONIC SYSTEM.

for the operation of the usual induction coil I, the interruptions of the primary circuit of which are made by a mercury circuit-breaker, or a Wehnelt interrupter, not shown in this figure; which interruptions are broken into Morse dots and dashes by a heavily constructed key *K*. A primary wire *p* of a spirally-wound inductance coil, termed an inductor, τ , Leyden jars *c c*, and the spark-gap *s*, form the closed transmitting oscillation circuit. The oscillations set up by the induction coil I are transformed up in the secondary wire *s*, one end of which is connected to the aerial wire *A*, the other end to a capacity consist-

ing of a large metal plate or cylinders κ , or the terminal may be coiled up loosely to avoid inductance. There is thus here the closed oscillating circuit to produce persistent high-frequency oscillations combined with the open circuit, consisting of κ and the aerial wire A , which is a powerful radiator, and which thus radiates strongly the persistent oscillations which have been transformed to a higher potential by transformer T . The aerial wire and κ are so chosen as to be each one fourth of the emitted wave-length, as indicated by the symbol $\frac{\lambda}{4}$; the frequency and consequently the wave-length of oscillations depending on the resistance, inductance, and capacity of the respective circuits, according to the formula given (see pp. 21, 50).

Concerning these features of his system Professor Braun remarks as follows: 'The condenser discharges through a primary circuit which excites the lower spirally-wound end of the transmitter, which remains insulated from the earth. Hence it follows that the function of the earth in increasing the transmitting distance cannot be explained in the usual manner; possibly the earth causes the transmitter to take up greater electromagnetic energy. Also in the primary circuit a large amount of energy can be employed usefully, and the action of the transmitter increases with the energy employed to a much greater extent than when the direct earth connection is employed. Further, the action of the transmitter can be augmented by increasing the capacity of the condensers as well as by an increase of potential. Again, the oscillations of the primary circuit are but slightly damped, and thus excite in the open circuit oscillations which are still less damped. He gives the following examples of the relative electromagnetic energy in the transmitter when directly excited, and when inductively excited, as by his method. With 2 amperes in the primary circuit the electromagnetic energy for direct excitation is 8; for inductive excitation, 26. With 6 amperes in the primary circuit the electromagnetic energy for direct excitation is 10; for inductive excitation, 62.

In Fig. 60, representing the receiving circuits, it will be seen that the arrangement of the transmitting apparatus is virtually reversed, the aerial wire A and κ being the primary circuit, the weak received oscillations being transferred to the closed circuit $p s' c' c'$, where in turn they are transformed to higher potential by the secondary s of transformer T' to the circuit of coherer k , which controls relay R

(operated by a cell *b*) in the usual way. These respective circuits are also arranged as indicated, to have one quarter the length of the received wave, the closed circuit *c' s' c' p* being tuned to the transmitting circuit, or to some multiple of that circuit, by means of the transformer, thereby "bringing about resonance in that circuit analogous to that obtained in acoustics." Inasmuch as the received oscillations are much weaker than those emitted, the size of the condensers *c' c'* and transformer *T'* is much less than those of the transmitting system, and are contained in small closed cases. The condensers are of the mica type and non-adjustable.

In the case of untuned circuits Professor Braun arranges the receiving system as outlined in Figs. 61 and 62. In the former the

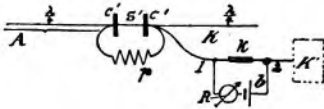

FIG. 61.

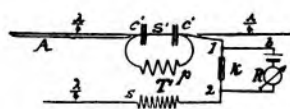

FIG. 62.

THEORY OF BRAUN UNTUNED SYSTEM.

transformer *T'* is not used, and terminal 1 of coherer *k* is connected to the right end of the closed oscillator circuit as shown, its other terminal 2 being connected to a large capacity plate *κ'*. In Fig. 62 terminal 1 of the coherer is connected to *c'*, while terminal 2 is connected to the secondary of the transformer *T'*. In these cases, of course, resonance is not sought.

The form of condensers adopted by Professor Braun for the transmitter is that of the miniature Leyden-jar arrangement shown separately in Fig. 63. This cylindrical form is chosen for compactness and ease of adjustment. Each cylinder consists of two tubes sliding one within the other. The tubes are of glass .078 inch thick, and have a diameter of about 1 inch. They are interchangeable within the limits of .19 inch and .008 inch, in steps of .08 inch. The cylinders vary in capacity from .0004 to .0005 microfarad, and thus with the sliding feature facilitate procuring either minute or comparatively wide variations in the fre-

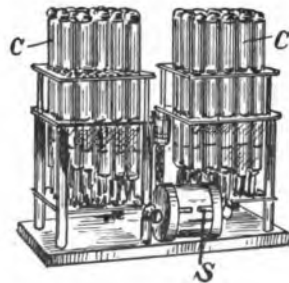

FIG. 63.

quency of the oscillations. The tubes are easily replaced when broken, or when necessary for other purposes, since it is only necessary to insert them in the appropriate rack to put them in service, suitable contact arrangements being provided therefor.

The spark-balls *s* are contained in a glass cylinder carried on the base of the Leyden-jar racks, as shown in Fig. 63. The cylinder has ebonite ends and is filled with oil, to obtain a higher inductive capacity than that of air.

The high-tension transformer or induction coil *T* of the transmitting system is depicted in Fig. 64. As this coil carries heavy currents, it is constructed accordingly. Its primary has four turns of heavy wire. The secondary consists of forty turns of comparatively large wire wound outside of the primary. This induction coil is not specially wound to give high electromotive force, but is designed to have low inductance and a small time constant, and also by reason of low inductance to admit of the use of comparatively large capacity in the circuit, thereby permitting more accurate tuning (see p. 71).

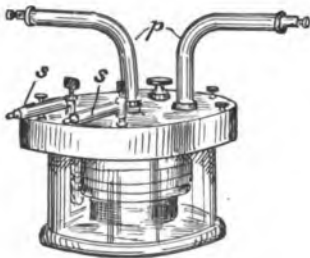

FIG. 64.
THE BRAUN INDUCTOR.

The large wire used also tends to low resistance and therefore small heat losses. When in use the coil is immersed in oil. All the features of this coil or inductor are carefully designed to conform to the wavelength that may be chosen, which, in order to obtain best results, should be four times that of the length of the vertical wire. The primary wire is utilized to supply inductance for the closed circuit, the desired tuning of which is secured by varying the capacity of the adjustable Leyden jars and the resistance of the spark-gap, the latter by increasing or decreasing its length. The secondary wire is also adjusted in harmony with the oscillations of the aerial wire. In other words, the different circuits by these means are brought into the required attunement necessary for best results.

The circuits and apparatus of the Braun system are shown diagrammatically in Fig. 65, the transmitting apparatus at the left, the receiving apparatus at the right. *I* is the induction coil; *w* is a Wehnelt or other electrolytic interrupter, described in the section on

interrupters. The Morse key k' is in the primary circuit of induction coil I . B is the source of E. M. F., which should be from 40 to 80 volts when an electrolytic interrupter is employed. When this voltage is not obtainable a turbine mercury interrupter is utilized. s is the spark-gap; $c c$ are the Leyden-jar capacities of Fig. 63; T is

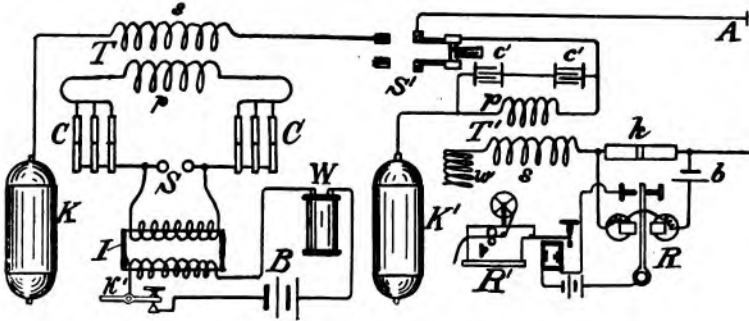

FIG. 65.

THE BRAUN TRANSMITTING AND RECEIVING APPARATUS AND CIRCUITS.

the inductor (Fig. 64), of which p and s are the primary and secondary wires. One terminal of s leads to K , which is a capacity in the shape of a large metal cylinder about two feet long, used in place of the earth. The other terminal leads to a contact of the large double-throw knife-switch s' . The aerial wire comes to the middle contact of the switch. By means of this switch the aerial wire A may be put in connection with the receiving or transmitting circuits at will. In the figure the vertical wire is connected with the receiving system. From the upper right-hand contact of s' a wire leads to the closed receiving circuit $c' p c'$, thence to another cylindrical capacity K' . One terminal of the secondary s of T' is connected to the coherer k ; the other terminal is coiled up loosely as at w . R is a Siemens polarized relay inclosed in a suitable case to exclude dust, and is adjustable from the outside of the case, as indicated in Fig. 68. A dry cell b is in series with the relay, and both are in circuit with the coherer. The polarized relay operates an ink-recorder R' . In practice the coherer connections are somewhat different to those shown in the figure, two wires leading from its terminals to contact parts on the switch s' , so arranged that when the switch is thrown to the left the coherer circuit is entirely disconnected from the rest of the apparatus.

A filings-coherer shown in Figs. 66 and 67 is used in this system. The filings are of hardened and sieved, powdered steel contained in an inner ebonite tube within the tube *k*. The tube is not exhausted,

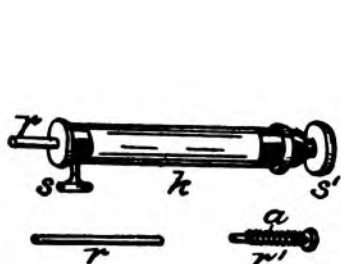

FIG. 66. THE BRAUN COHERER.

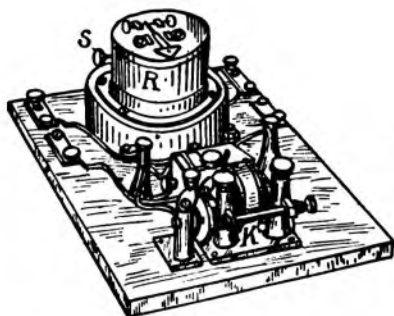

FIG. 67.

Professor Braun's experiments having shown that the vacuum coherer is not more sensitive and is far less easy of adjustment than the non-exhausted type. The leading-in rods *r* *r'* are of polished steel. The rod *r* is held in the tube by the set-screw *s*. Rod *r'* is adjustable to or from the filings by the adjusting-screw *s'*, the spiral spring *a* withdrawing the plug when *s'* is screwed outwardly. When the desired adjustment is secured the screw *s'* is locked by a jam-nut. The completed coherer is supported in its proper position by two metal posts, on the upper end of which are clutches forming the contacts leading to the relay and receiver transformer circuits, and into and out of which clutches the coherer may be quickly inserted or removed.

The sensitiveness of the coherer is increased by the use of coarser filings. Inasmuch as it has been found that a certain degree of magnetism in the conductor plugs adds to the sensitiveness of the coherer without impairing its reliability, a magnetic ring is placed over the tube and between the ends of the plugs. By turning this ring so that its magnetic poles approach the plugs at the proper distance the required degree of magnetization of the plugs is obtained. Instead of the electro-mechanical tapper so commonly employed, a tapper operated by clockwork is employed for decohering the filings in this system. An advantage of the spring tapper is that the blows are always struck with the same force, hence restoring the filings to the same position at each stroke. When the filings have cohered an

electrically operated spring clutch releases the tapper, and when the filings decohere the clutch automatically holds the tapper. An auto-coherer of the carbon type is utilized in connection with a telephone receiver when for any reason the filings-coherer is temporarily inoperative.

The Braun-Morse key is shown in Fig. 68. This key is capable of breaking a current of 50 amperes continuously without injury to the interrupter. To effect this result the primary circuit is by a suitable device closed and opened separately from the main contact, and hence there is no sparking at the main contact. The key proper is mounted in a box within which the opening of circuit occurs, and a magnetic blow-out is provided to diminish sparking. The sides of the box are perforated for ventilation.



FIG. 68.

The military outfit of the Braun system is carried on two carts, one of which holds the apparatus, the other a gasoline motor. Balloons or kites may be employed to sustain the vertical wire. A number of these outfits have been supplied to the United States government as well as to a number of European governments.

It has recently been announced that the Slaby-Arco and the Braun systems have been brought under one management.

CHAPTER X.

THE BRANLY-POPP AND GUARINI WIRELESS TELEGRAPH SYSTEMS.

THE BRANLY-POPP WIRELESS TELEGRAPH SYSTEM.

THIS system, which is being exploited in France, is the invention of Professor Branly, the discoverer of the filings-coherer, and M. Victor Popp of Paris. The transmitting apparatus consists of an induction coil operated by a mechanical interrupter (the latter driven by a small motor) and the usual spark-gap.

The most important feature of the system is perhaps a new form of coherer devised by M. Branly, the construction and operation of which are based upon the theory, confirmed by experiment, that a contact consisting of a polished metal and an oxidized metal constitute a coherer which not only possesses greater sensitiveness than the filings-coherer, but is also more regular in its action.

The new Branly coherer consists of a tripod of three tapering steel rods r (Fig. 69), joined together at the top by a metal disk d , and with their feet resting lightly on a polished disk of steel s . The rods are composed of tempered steel which has first been given a high polish, and upon which a thin layer of rust has been deposited by heating the rods to a desired temperature in a furnace. The coherer is about two inches high, and is inclosed in a glass case. A lifting-screw (Fig. 70) is provided by which the tripod may be raised from the lower disk when not in use.

Owing to the sensitiveness of the tripod coherer a very light tapping is sufficient to bring about decoherence, and of this fact M. Branly takes advantage in the general arrangement of his receiving apparatus, also shown in Fig. 69. In this figure, m is the magnet of a Morse ink-recorder or register; L is its armature-lever, which carries on its right end a small platinum contact, the latter being

insulated from the lever. To the right of the register there is a platform *p* supported by a standard *c*, on which platform the coherer is placed, as indicated. The lever *L* in descending strikes a lower insulated stop *k* with sufficient force to jar the platform and thus decohere the coherer. Normally, the lever *L* rests against an upper contact-stop *k'*, which is part of the coherer circuit, in which are also

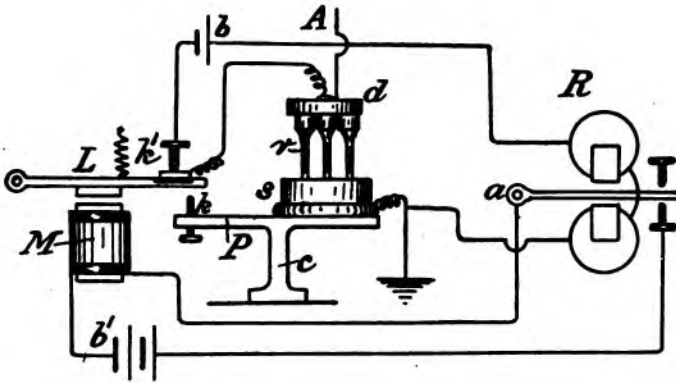

FIG. 69. BRANLY-POPP RECEIVING CIRCUITS AND COHERER.

a battery *b* of one volt or less, and a very sensitive polarized relay *R*, which latter operates the Morse register *M* by means of the lever *a* and battery *b'*.

The vertical wire *A* may be connected to the coherer and to earth in the manner shown, or in any other desired way.

When arriving oscillations reach the coherer its resistance is reduced and relay *R* is operated. This in turn operates magnet *M* of the Morse register, whose armature-lever descends on *k*, with the result stated upon the coherer. It is known that decoherence takes place more readily when no current is flowing through the coherer. In this system, when the lever *L* starts to descend upon the post *k*, it first opens the coherer circuit at *k'*, leaving the coherer free to decohere when shaken or jarred.

It is claimed that this arrangement of decohering, dispensing as it does with a separate decohering device, conduces to greater speed in the reception of signals, thirty-five words per minute having been taken down by this receiving apparatus. The Branly coherer is said to be about seven times more sensitive than the ordinary filings-

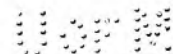

coherer, which it is thought will render it well adapted to long-distance signaling.

During the continuance of oscillations the ink-recorder prints the arriving signals in dots and dashes, as indicated in Fig. 70, which illustrates the actual appearance and arrangement of the recording apparatus and coherer. In this figure, *m* is the magnet; *s* is the support of the paper-reel, not shown; *p* is the paper, which passes from the reel to guide-wheels, thence to an inking-disk, which is raised to

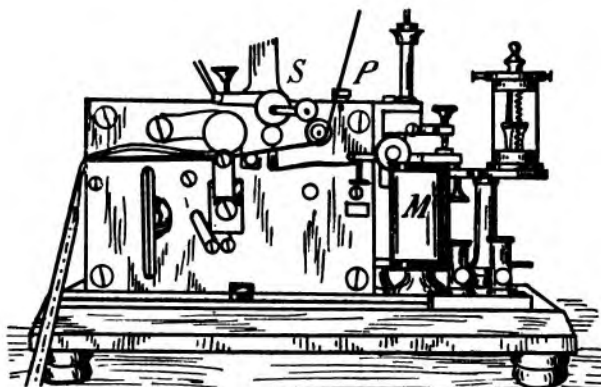

FIG. 70. BRANLY-POPP INK-RECORDER AND COHERER.

and from the paper by means of an arm extending from the lever of magnet *m*. The paper is drawn forward by rotating drums operated by clockwork within the brass case of the instrument.

It is proposed to utilize the Branly-Popp system as a means of distributing news from a central station in connection with branch offices, by masts 150 feet high placed on the tops of houses in cities; actual tests having shown that this is practicable for short distances. It is also intended to employ this system for signaling from coast station to coast station, and to passing ships. For the latter purpose stations have been equipped at Cape de la Hague and at Cape Griz Nez, the mast system of which is outlined in Fig. 71. This consists of three masts, each 130 feet high, arranged as a triangle with sides 130 feet in length. The vertical wires are supported by horizontal cables, as shown, and converge to a point *r* at the station, which, in practice, is situated at the center of the triangle. After converging the wires are bunched and brought into the operating-room at *v*. A



five horse-power gasoline motor is employed to drive a dynamo which charges a storage battery used for the induction coil and other purposes.

These two stations will, it is expected, cover a distance extending westward over 900 miles. It is intended to exchange messages with other stations and vessels equipped with the Slaby-Arco and Marconi systems, a syntonizing system devised by M. Branly being capable of receiving different wave-lengths. The details of this sytonic system are not yet available.

For the purpose of obtaining news from the races, or in case of accidents at points ten or twenty miles from the city, an automobile of special construction, in which a wireless outfit is placed, is employed. To support the aerial wire a high bamboo mast braced by wires and placed in a socket on the roof of the vehicle is used. The necessary current is supplied by a storage battery kept charged by a small dynamo driven by a gasoline motor in the automobile.

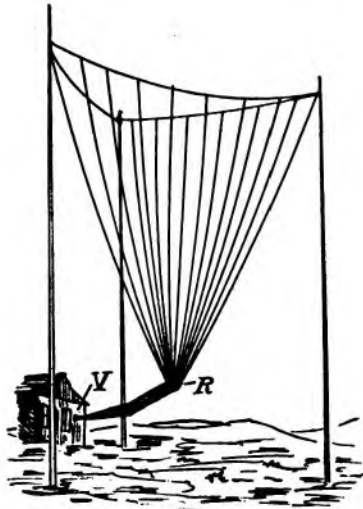

FIG. 71.
BRANLY-POPP AERIAL WIRES.

THE GUARINI WIRELESS TELEGRAPH AND RELAYING SYSTEM.

Marconi in his first experiments with wireless telegraphy endeavored to direct the electric waves in one direction by the use of a metallic reflector, but this was not found to be necessary in practice.

M. Guarini has devised a method by which more than one message may be sent or received from opposite directions simultaneously without resorting to syntonny. Taking advantage of the fact that conductors are opaque to electric waves of high frequency, he employs a long metallic tube terminating in a metallic cylinder with a slot in one side. The tube consists of a sheathed cable 57 feet long; the cylinder is 33 feet long, diameter 1.6 feet. The vertical wire proper is carried within the tube or cylinder and connects with the transmitting and receiving apparatus. The cylinders, etc., are supported from

towers and monuments as indicated in Fig. 72, in which also s represents the slotted cylinder, s' the slot, and c the conductor.

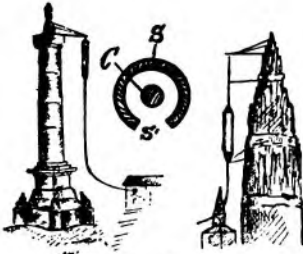

FIG. 72.

In operation the slot is placed opposite the place to which a message is to be sent or from which one is to be received. The incoming waves that fall upon the conductor through the slot set up oscillations that affect the coherer. The oscillations set up in the sheathing are diverted to earth, to which the sheathing is connected. Reversely, in transmitting signals waves are emitted through the slot only, and hence are

radiated in the direction in which the slot may be faced.

Guarini's Relaying System.—M. Guarini has also devised a method of repeating or relaying messages by wireless telegraphy. His experiments were made between Brussels and Antwerp, a distance of about 26 miles, with relaying apparatus about midway, namely, at Malines (Mechlin). The relaying is effected by practically the same method as that first employed by Morse, who caused the armature of a receiving instrument at a repeating or intermediate station to relay a message from, say, a southerly station, x , to a northerly station, y . Analogously, Guarini causes the armature-lever of a relay controlled by the coherer relay at a repeating station to operate the primary circuit of the oscillator, whereby a message is relayed from one station to another.

The theoretical connections of this arrangement are shown in Fig. 73, in which for clearness some of the shunt coils and the tapper are omitted. B is a metallicly sheathed box somewhat like that used by Marconi and for the same purpose. In this box are placed the coherer k , transformer T , condenser c , relay R , etc. The repeating relay R' , controlled by relay R , is placed outside of the box B . In the receiving position of the armature-lever l of repeating relay R' , the aerial wire A is connected to the primary coil p of transformer T . In the transmitting position the same lever closes the primary circuit xx of the oscillator I , the secondary of which is attached to the spark-balls in the usual way. Hence, when a signal is received at the intermediate station from, say, station x , the coherer is operated, with the result that relays R and R' are also operated. This closes

the primary circuit $x x$ of oscillator coil I , and the signal is transmitted to station Y . Instantly the coherer is decohered by the tap-
per, relay R is again connected with aerial wire A ready to receive other signals from station X , and so on; it being understood that these actions of the relays take place in a very brief space of time, approximately .01 second, in order to properly transmit the signals.

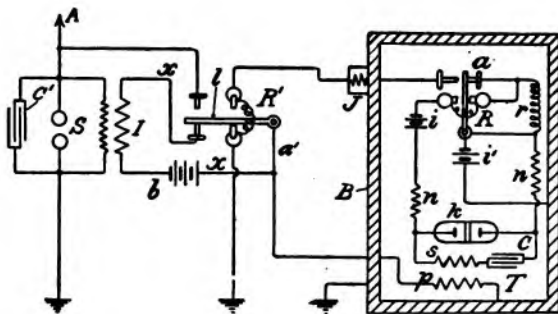

FIG. 73. GUARINI RELAYING SYSTEM.

As the repeating relay R' is not limited as to current by which it may be operated, and as a large space is required between its sending and receiving contacts, the armature-lever of the instrument is of special construction, and the relay itself with its armature is supported on two well-insulated cylinders. The lever is of metal and is about twelve inches long. It is divided into three parts, each part being insulated from the other by hard rubber. One part carries the vertical-wire contact, the middle part holds the armature of the relay, the third part carries the induction-coil current and contact of the primary wire.

The induction coil I used by Guarini at the repeating station gives a 10-inch spark, with a current of 3 amperes and 30 volts, it having been found that a stronger current quickly impaired the contact-points of the repeating relay R' . The condenser in the secondary of T effects two purposes—breaking the continuity and modifying the capacity of the circuit, according to the inventor.

To avoid the formation of arcs between the filings of the coherer itself (similar to “frying” in the telephone transmitter), due to an excess of current in that instrument, whereby the filings would self-cohere, Guarini employs a resistance coil r of 2000 ohms, which is

normally short-circuited at contact *a* of relay *R*, but when *a* is open that resistance is thrown into the circuit of the coherer. Relay *R* is sensitive to a current of $\frac{1}{20000}$ ampere; its resistance is 1100 ohms. It is of the polarized type. The condenser *c'*, according to Guarini, is employed to diminish the normal length of the spark, thus to lessen the travel of the armature of relay *R'*. The coherer employed by Guarini is of the Blondel regenerable type, described subsequently. The resistance of the primary wire of transformer *T* is about .75 ohm, that of the secondary wire *s*, 11000 ohms; the resistance and inductance of spool *J n n* are 40 ohms and 35 henrys respectively. The coil *J* is used to exclude extraneous waves from the coherer.

By the arrangement of the induction coil *T* used in the receiver circuit the effects of atmospheric electricity are obviated. At the terminal stations of this repeating system an induction coil and mechanical interrupter are employed, but the oscillator and spark-gap are dispensed with, the secondary wire being connected in series with the aerial wire and earth respectively. Hence the waves radiated thereby are of comparatively low frequency, unless, perhaps, the surgings in the induction coil noticed by Bernstein may have some effect in the transmission.

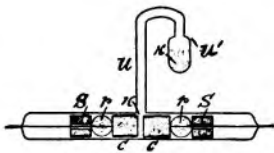

FIG. 74. BLONDEL COHERER.

The Blondel Regenerable Coherer.—This coherer is outlined in Fig. 74. *cc* are conductor plugs separated by a space of about .2 inch and between which are placed fine filings *k*, which are made of a mixture or alloy of oxidizable with non-oxidizable metals, such as silver with nickel or copper. *pp* is formed of an amalgam paste which hardens in a short time and makes a joint with the stoppers *ss*. The tube is made of glass and is exhausted of air.

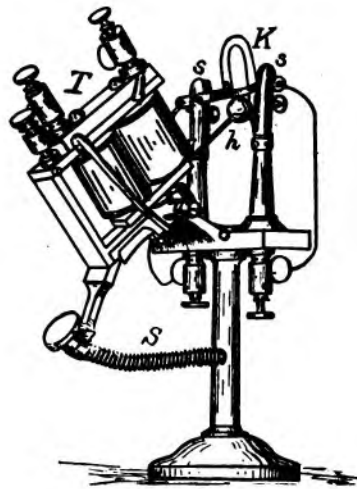

FIG. 75.

It has an extension u projecting from a point over the filings in the tube. Additional filings k are placed in the bulb u' , and by this means the amount of filings in the tube proper may be added to, or, if necessary, reduced.

This coherer and tapper are shown in Fig. 75 as arranged in practice by M. Guarini. κ is the Blondel coherer, upheld by supports $s s$; T is an electro-mechanical tapper; s is a spring by which the angle of T , and hence the position of the striker h relative to the coherer, may be adjusted. To guard the coherer from injury the ends of the tube are inclosed in copper sleeves which butt against the leading-in wires. The sleeves slip between the openings at $s s$, and are held in that position by suitable screws.

THE DUCRETET-POPPOFF WIRELESS TELEGRAPH.

M. Ducretet, alone and jointly with M. Poppoff, has devised several variations of transmitting and receiving wireless apparatus. With his earlier apparatus M. Ducretet transmitted signals to Eiffel Tower, Paris, from a distance of three or four miles, using the ordi-



FIG. 76.

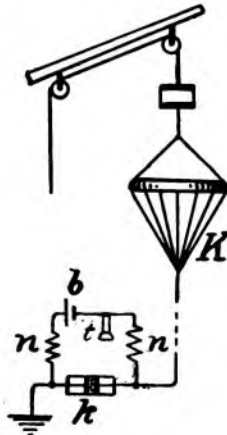

FIG. 77.

nary oscillator, filings-coherer, vertical wire, etc. The type of transmitting-key used is shown in Fig. 76. In this the contact is broken in mercury contained in a suitable vessel. A rotary mercury interrupter is employed for the primary current of the induction coi!.

In Fig. 77 is outlined the receiving apparatus and circuits used in the later arrangement of this system. A vertical wire terminating in a metallic cage κ is upheld by suitable supports. A telephone t is utilized as receiver; k is an auto-coherer of the carbon type; $n n$ are induction coils in the coherer circuit; b is a small battery. With this apparatus signals have been transmitted a distance of about 60 miles over water.

As previously remarked, Poppoff was perhaps the first to utilize the coherer in connection with a vertical wire, the arrangement of coherer, relay, and tapper being practically as appears in Fig. 12, except that the aerial wire and ground are not there shown. Several different types of coherers were used by M. Poppoff in the experiments relating to the detection of electrical vibrations. One consists of two strips of platinum foil pasted on the inside of a glass tube. One strip of the foil is brought out to the external surface at one end of the tube, the other strip to the opposite end. The tube is placed horizontally with the platinum strips in the lower portion of the tube, the powdered filings resting on the strips and covering them. The tube is about half filled with the filings. The most satisfactory results were obtained with iron filings. Powdered antimony and small bird-shot were also used in the coherer.

CHAPTER XI.

THE DE FOREST WIRELESS TELEGRAPH SYSTEM.

DE FOREST UNTUNED SYSTEM.

THIS system, due to Dr. Lee De Forest, of New York, is in successful operation in a large number of places in the United States and Canada. From the first the object of the inventor has been to eliminate as far as possible every feature of the conventional wireless apparatus that is liable to introduce trouble more or less frequently in the ordinary course of operation, with the result that the De Forest system is noted for its simplicity and freedom from complicated apparatus.

Thus the usual induction-coil generator is replaced by a motor-driven dynamo machine, and interrupters of all sorts are dispensed with. The filings-coherer, tapper, and relay are replaced in the De Forest system by a detector of electric waves termed a "responder," and a telephone-receiver, while the typical wireless transmitting key of cumbrous proportions is in this system supplanted by the ordinary Morse key used in wire telegraphy in this country.

One arrangement of the transmitting and receiving circuits and apparatus of the De Forest untuned system is shown in Fig. 78. In the figure, *A* is the vertical wire, which is permanently connected to the oscillator circuit and may be connected to the receiving circuit and apparatus of the system at will by means of the switch *sw*; *w* is a spring-jack by which the receiving apparatus may, when desired, be entirely disconnected from the transmitter and aerial wire; *c'* is an oil or gas engine used, where steam power or an electric motor is not available, to drive the alternating-current generator *D*. (In Fig. 80, the generator *D* is attached to the same shaft as an electric motor *c'*, by which the generator is rotated. This device is termed a motor-generator. The motor receives its current from any available source.) The

capacity of the generator varies from one to forty or fifty kilowatts at 500 volts, according to the distance to be signaled over. *E*, Fig. 78, is a small direct-current dynamo or exciter used to excite the magnetic field of the generator; *M* is a magnetic choke-coil of 5 ohms resistance, in the circuit of the generator and primary of a choke-transformer *U*.

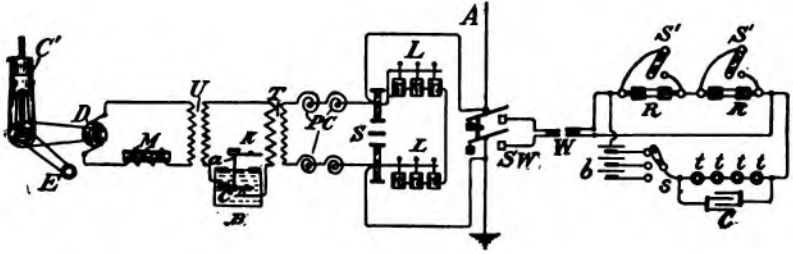

FIG. 78. DE FOREST TRANSMITTING AND RECEIVING CIRCUITS.

The choke-coil *M* is supplied with a core of soft-iron wires, the number of which may readily be varied when it is desired to increase or decrease the current strength for the purpose of fattening or thinning the spark at the discharge-gap *S*. The transformer *U* has a ratio of transformation of unity. Its function is to prevent the high potentials generated in the step-up transformer *T* from jumping through to the armature of *D*. The transformer *T* raises the voltage of the circuit to 25,000 or 50,000 volts. Spiral choke-coils *PC*, about five inches in diameter, composed of 22 feet of No. 14 B. and S. insulated copper wire, wound spirally, as indicated, are placed in the circuit between the secondary of *T* and the spark-gap *S*, for the purpose of confining the rapid oscillations set up by the oscillating circuit to the vertical wire *A*. The gap is shunted by four or six quart Leyden jars *L*, forming an oscillating circuit. The capacity of such jars is about .003 microfarad, but varies somewhat according to the thickness of the glass. They are in this instance connected in series multiple as indicated, that is, two sets of three cells in series connected in multiple, which gives a total capacity of about .045 microfarad. These Leyden jars are charged by transformer *T*, and, as described elsewhere, set up oscillations of high frequency when the spark-gap breaks down under the high potentials of the transformer. In other words, they store up electric energy during the time that the electromotive force is rising to the breaking-down point at the spark-gap, which energy is

dissipated in establishing oscillations in the antennæ that are radiated as electric waves. This energy is comparatively small. Fleming gives the energy thus stored up as .1 foot-pound in a vertical wire 150 feet long, having a capacity of .0003 microfarad, and in which the potential at the spark-gap is about 30,000 volts. Several different forms of sparking devices are used by De Forest. In one type two brass arrow-head points or straight points, with a metal disk between them, are used (see Fig. 86). In another form, shown separately in Fig. 79, three aluminum disks *a b c* are utilized. These disks are about 1.5 inch in diameter and about .25 inch thick. They are made up of strips of aluminum wound spirally to provide a large surface for heat radiation, and are separated by an air-space of .25 inch to .65 inch. Disks *a* and *c* are upheld in a vertical position

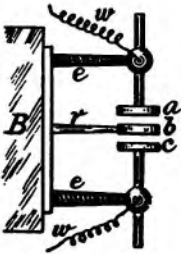

FIG. 79. DISK SPARK-GAP.

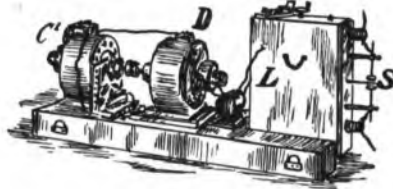

FIG. 80. MOTOR-GENERATOR.

by corrugated ebonite supports *e e*; the middle disk *b* is supported by a brass rod *r* from the insulated stand or base *B*. The outer disks *a c* are connected to the oscillator circuit *S L* and to the vertical wire *A* respectively, as shown in the preceding figure, constituting, with the spark-gap, a closed oscillating circuit which discharges into the vertical wire or wires. To secure sympathy between the condenser circuit and vertical wire an inductance may be introduced in series with the two sets of Leyden jars, or the capacity may be varied. To deaden the noise of the discharges at the spark-gap the sparking-disks are sometimes inclosed in a sound-proof box. In the operation of the one-kilowatt machines, however, the noise is not disturbing. In Fig. 80 *L* is a box containing the Leyden jars, and *s* is the spark-gap.

Key *k* is placed in the primary circuit of transformer *t*, Fig. 78, and, as superficially observed, is an ordinary Morse key, but it does not directly break the circuit. It does so, however, indirectly

by means of a projecting arm *a*, which normally rests on a strip key *c* immersed in oil in a box *B*. When the key is depressed it causes strip *c* to close the primary circuit of *T*. When it is raised the said circuit is opened. It is occasionally found after this contact-breaker has been operated for some time under oil that pure carbon is deposited on the contact-points, but this is not detrimental. For comparatively short distance signaling, that is, for instance, with the one-kilowatt generator, it is not found necessary to open the transmitting key under oil. With this type of key, shown on its baseboard, Fig. 86, the speed of signaling is equal to that at which signals are transmitted on land lines, say 25 to 30 words per minute, the make and break of the spark following every move of the transmitting key. (The writer has himself transmitted signals at approximately the lower rate mentioned by this key.) Similarly, the auto-coherer responds to every break in the continuity of the oscillations, the signals being received as a succession of short and long sounds in the telephone.

The arrangement of receiving circuits shown to the right of switch *sw* in Fig. 78 is designed for a single vertical wire (see Fig. 83). The coherers, when in operation, are in series with the vertical wire. Two responders *R R* are shown, either of which may be cut in or out of circuit by the two-point switches *s' s'* in the event of one or

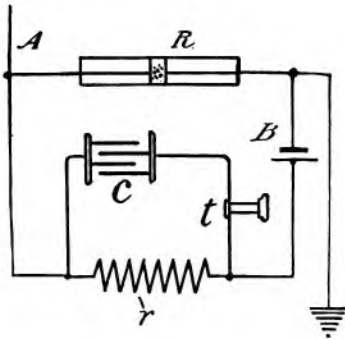

FIG. 81.

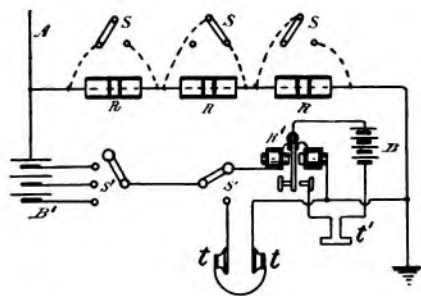

FIG. 82. CALLING RELAY.

other getting out of adjustment. A battery *b* of three cells and two pairs of head telephones *t* are in shunt with the responder *R*. By means of shunt-switch *s* one or more cells may be placed in service. Other variations of the De Forest receiving circuits are outlined in Figs. 81 and 82. In the former the telephone *t* is in series with a

condenser of about half a microfarad capacity, and both are shunted by a resistance r of about 5000 ohms, which is regulable according to requirements. In Fig. 82 three responders R are indicated. These can be put in circuit or not, as desired, by switches s . R is a sensitive relay used as a call or "step-up" signaling device to operate t' , which may be a bell or other suitable device easily operated by battery B . By means of switch s' head telephones tt are interchangeable with relay R' . More or less battery may be introduced into the coherer circuit by suitable manipulation of switch s .

De Forest uses two types of anti-coherers, one of which, termed in shop phrase the "goo" responder, is electrolytic in its action; the other is a "needle" anti-coherer; both will be described.

Another and later arrangement of the De Forest transmitting and receiving circuits is shown in Fig. 83.

In this, A represents the antennæ. Vertical wires ab are metallicly connected at the top. They are brought to small metal balls xx' respectively. These balls are opposite a larger ball y , from which they are separated by an air-space of about one thirty-second of an inch. The larger ball is connected to the transmitting circuit, as shown, s being the spark-gap, T the step-up transformer, and L the Leyden jars.

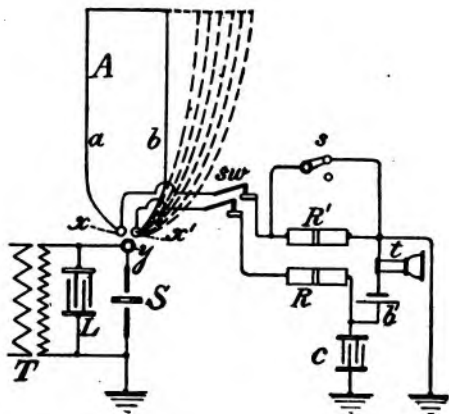

FIG. 83. DE FOREST MULTIPLE AERIAL WIRE SYSTEM OF CIRCUITS.

The receiving circuits are attached to the balls xx' . In this arrangement it may be seen the wires ab of the antennæ have separate routes to earth, one passing through a responder R' , the other via responder R and a small condenser c . On the other hand, the responders are in series with each other, with telephone t , battery b' , and wires ab . Thus the joint effect of both responders, due to received oscillations set up by the incoming waves in the vertical wires, is obtained in the telephone circuit. When "static" currents, due to atmospheric electricity, are preva-

lent, the responder R' is short circuited, or nearly so, by the switch s and a resistance not shown, this affording a direct path to earth for such currents, the condenser C assisting in this diversion, while the oscillations continue to pass through responder R and condenser C to earth. sw is the cut-out switch.

When a large number of vertical wires are used, one of them, a , is brought to ball x , as shown, the others, indicated by dotted lines, are connected to ball x' . It is found in practice that the short air-gap at $x x'$ has very little, if any, damping effect on the transmitted oscillations.

De Forest Anti-Coherers or Responders.—The De Forest electrolytic anti-coherer is shown as R in Fig. 84, which figure represents an early arrangement of the De Forest receiving system. This detector is an anti-coherer, inasmuch

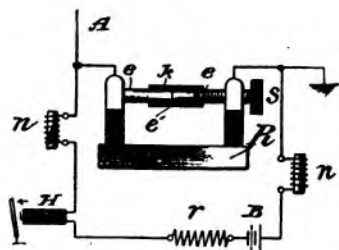

FIG. 84.

DE FOREST ELECTROLYTIC COHERER.

as its resistance increases under the influence of electric oscillations, and was invented by Dr. De Forest and Mr. E. H. Smythe. It is based on the fact that certain electrolytes separating two metal electrodes become conducting when a direct current is set up in the circuit. A

microscopic examination shows this to be due to an action in which metallic particles are detached from the positive electrode and deposited on the negative, until a "bridge" or threads of such particles reaches from one electrode to the other. When a suitable electrolyte is chosen, it is found that an oscillating current disrupts this bridge and thereby renders the electrolyte non-conducting. The substance used by the inventors consists of equal parts of fine filings of tin and oxide of lead formed into a sort of paste by vaseline or glycerine with a small amount of water or alcohol added. This is placed in a space e' between metal rods $e e$ in a suitable tube k . In operation, when a current from battery B alone is flowing, these filings build up bridges which close the gap, electrically considered; but when electric oscillations are set up in the circuit, disruptive electrolysis takes place with a mild explosive generation of hydrogen gas, which destroys the bridges, thereby largely increasing the resistance of the circuit. On the cessa-

tion of the oscillations the bridges at once reform automatically under the influence of battery B. The variations in the strength of current thus produced affect the receiver H, which may be any suitably sensitive instrument; but, in practice, head telephones are employed, as indicated in other figures. This responder is very sensitive, and, in consequence, the current strength required in the telephone circuit is very low, about one six-thousandth of an ampere, and it will respond accurately to the waves set up by a spark one sixty-fourth inch long, forty feet distant, with a metal wire two feet long, and without ground connection. nn are the usual inductances or choke-coils that may be employed to force the oscillations through the coherer circuit. In fact, however, the responders used in this system have, relatively considered, so little resistance the choke-coils are not required in practice. r is an adjustable resistance of perhaps 5000 ohms, to regulate the current strength furnished by the battery B to suit the requirements of the coherer. (See Appendix, p. 193.)

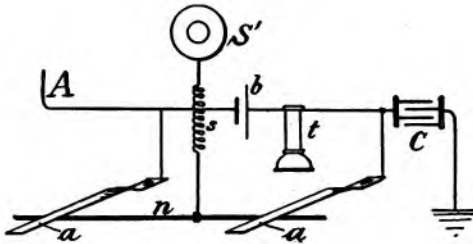

FIG. 85. DE FOREST NEEDLE COHERER AND CIRCUITS.

The De Forest needle anti-coherer, known as type No. 3, is simplicity itself. It consists of a steel needle n , Fig. 85, upheld against two aluminum rods $a a$ by a retractile spring s attached to the needle, as indicated, the pressure of needle n against the rods being regulated by the winding-screw s' . The rods are part of the usual coherer circuit, and the responder is connected as shown at RR' , Fig. 83. A film of oil and moisture held between the needle and aluminum makes the device an anti-coherer, but its resistance is varied by the oscillations, thus giving the characteristic signals in the telephone. The sound set up by this responder somewhat resembles that induced in a telephone whose circuit is adjacent to a direct-current dynamo circuit, but more uniform, this sound being broken into long and short intervals—that is, dots and dashes.

In Fig. 86 is outlined a shipboard outfit of this system, showing the principal transmitting and receiving apparatus. *s* is the spark-gap; *sw* is a double-throw switch; *K* is the key on the box *B* containing the circuit-breaker; *R R* are the anti-responders, and *t* the

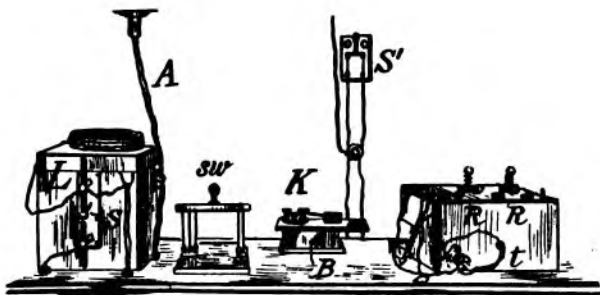

FIG. 86. SHIPBOARD OUTFIT.

head telephones; *L* is the box containing the Leyden jars. This figure virtually illustrates the arrangement of the De Forest apparatus in the cabin of the steam-yacht *Erin* during the international yacht races of 1903. *A* represents the wires leading to the antennæ. These consist of five No. 14 wires, stranded and insulated with rubber. These wires are strung taut and are kept six inches apart by spreaders. A special topmast gives a height of 120 feet from the roof insulator at the cabin to the yard peak. To supply necessary current a one-kilowatt alternating-current generator is belted direct to the dynamo engines of the yacht. This current is carried by special wires to the switch *s'*, thence to the transformer, not shown.

THE DE FOREST SYNTONIC SYSTEM.

The bulk of the success achieved by the De Forest system for the first three or four years of its existence has been obtained by the untuned system just described, which has been found ample for the distances to which it has been applied. Dr. De Forest, in common with other workers in this field, has recognized that for long-distance operations it is necessary to avail of the well-known advantages of syntony, and has worked out a number of syntonic methods, for which he has recently obtained several patents, amongst others U. S. patent No. 730,246.

The De Forest tuned circuits are based upon the principle involved in what is known as the Lecher system of wires, namely, that when

two parallel adjacent wires of equal length, such as are shown in Fig. 87, are connected to the terminals of an apparatus or oscillating system T capable of producing oscillations of high frequency, if the wire is one quarter, or any multiple of one quarter the wave-length of the oscillations, the waves will be reflected from the ends of the wire.

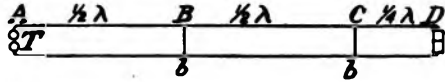

FIG. 87. LECHER SYSTEM OF WIRES.

Such a system of wires is assumed to be distortionless—that is, the inductance and capacity are uniformly distributed throughout its length—hence the waves undergo no attenuation, and stationary or standing waves due to the incident and reflected oscillations are set up in the system. The velocity of propagation of the waves in such a system will equal that of light when the resistance of the wires as compared with the inductance may be neglected, and when the inductance is the reciprocal of the capacity per unit length. These conditions will exist when the diameter of the wire does not exceed .019 inch and when its length is less than 328 feet.

In such a system, as De Forest and others point out, the capacity and the inductance cancel each other so far as the dimensions of the wire are concerned, and the period of vibration is independent of the diameters of the wires or of the distance by which they are separated. At any corresponding point of the two parallel wires the charges in them will be of exactly equal potential, but of opposite phase, that is, one will be positive, the other negative, while the currents in the wires will be in opposite directions at any corresponding point. As, however, the current differs in phase by one-quarter wave-length from the potential, the latter will be at maximum where the electromagnetic energy or current is zero, and vice versa.

If, then, sections AB and BC are one-half wave-length, the points B and C will be nodes, while D will be a loop of electrostatic energy. On the other hand, B and C will be loops and D a node of electromagnetic energy. Hence, as the maximum difference of potential exists at a loop of electrostatic energy, a coherer which is operated by electrostatic forces can be advantageously placed across D, while a detector responsive to current variations, like the De Forest responder, can be placed to advantage across the wires at C. (For a mechanical illustration of loops and nodes, see Fig. 52.)

Bridges *b b*, consisting of short pieces of wire, may be inserted between the two wires at B, C, or the wires may be grounded at those points without affecting the oscillations; in fact, if the wires be grounded at such points they will act beneficially in diverting all waves to earth that are not tuned to the period of the system.

In untuned wireless systems, as already noted, the oscillations are rapidly damped, consisting perhaps of two or three swings, and thus the effect upon the receiving instrument is not as great as would be a longer train of weaker waves. According to De Forest, he has found the Lecher system of wires an excellent resonant vibrator, having a very marked period of its own, and being but little responsive to waves that do not correspond to its own rate of vibration. Further, inasmuch as most of the lines of force lie in the space between the two conductors, it is a poor radiator of waves, and hence it is a persistent vibrator, continuing to vibrate for some time after the oscillations have been set up, in this way producing a long wave-train, which is slowly damped. By reason, also, of the ability to set up stationary waves higher potentials are obtainable. Inasmuch as the velocity of propagation in a simple Lecher system is equal to that of light, the frequency or wave-lengths may be readily determined. The system may thus be accurately attuned to any desired frequency, and as the nodes and loops of the stationary waves are fixedly located, connections may be made with the wires at any phase of the wave desired.

Since, as stated, it is a feature of the Lecher system of wires that the period of vibration is independent of the size of the wires or of the distance between their centers, the period of any section of such a system embraced between any two consecutive bridges, as *b b*, depends altogether upon the distance or length between such bridges. It is known that the mutual induction of such wires is diminished as

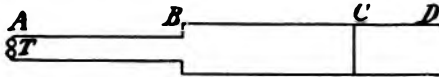

FIG. 88.

they are brought nearer together, while the capacity of the wires increases correspondingly. Hence, if, as in Fig. 88, the wires

of one section (AB) of such a system, equivalent to half a wave-length, be brought close together, it will possess comparatively high capacity and little inductance, whereas the further separated wires of section BC, also half a wave-length long, will have low capacity and high inductance.

The product of the inductance and capacity in each section will, however, be the same, but in the case of AB the electrostatic energy will be in excess, while in BC the electromagnetic energy will predominate. Thus, when two opposite charges pass from AB, in which the capacity is large and consequently the difference of potential is low, to BC, in which the capacity is small, the difference of potential is thereby increased, since it is well known that for a given charge in a conductor the potential is inversely proportional to the capacity. (A mechanical illustration of this effect may be offered: Suppose a gas-meter to hold a cubic foot of gas at a certain pressure; if the size of the meter be diminished by say one half, the amount of gas remaining the same, the pressure will be doubled.) Reversely, when two opposite charges pass from a section of low capacity to one of high capacity the electromagnetic energy is enhanced while the difference of potential is diminished. This system, therefore, provides a means of transforming oscillations from high to low potential and low to high electromagnetic energy.

In the application of these principles to practice, however, it would not always be convenient to separate the wires to obtain low capacity, nor would it be feasible in every case to extend the wires to the wave-length of the oscillations. De Forest has therefore adopted the plan of twisting together the wires of each section, as shown in Fig. 89, using insulated wires, his experience having shown

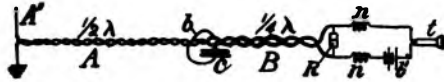

FIG. 89. DE FOREST TUNING METHOD.

that wires so arranged possess the characteristics of the Lecher system. Furthermore, this arrangement permits the wires to be wound in a coil on a spool, thus providing a portable device. To avoid induction between adjacent convolutions of the wires, De Forest states they should be laid with a pitch of at least three turns to the inch on a spool three inches in diameter, with successive turns separated by an eighth of an inch; but the use of the coils is not limited to the foregoing proportions.

In Fig. 89 the wires of a receiving circuit are shown extended in a straight line from the vertical wire A to the detector R. Here the detector is at the loop of an electrostatic wave. *n n* are choke-coils, *b'* is a local battery, and *t* is a telephone or other suitable receiver. It will be seen that the wires in the quarter-wave section B are more

widely separated than in the half-wave section A. This separation may be secured by using thicker insulation on one section than on the other. A bridge *b* and condenser *c* are placed across the wires, as shown, for the purpose of increasing the lag or to adjust the period of the system. To facilitate such adjustment the bridge is adapted to make connection at any desired part of the wires by means of a clip to which is attached two needle-points capable of perforating the insulating material.

Another means by which De Forest secures greater capacity in the wires is by immersing one section of the wires in oil, which has a higher specific inductive capacity than air. Of course, also, the methods of securing syntony or variations in the wave-lengths by this means are not limited to the methods described, inductance being used in some instances, etc.

In Fig. 90 is shown an application of the Lecher wires to a sending circuit. *p s* are the primary and secondary coils of an induction coil or transformer *T*; *s* is the spark-gap; *c* is a condenser; *B* is a section having a half wave-length, and connected to the vertical wire as indicated. The electrical energy is stored in the condenser *c* until the potential exceeds the breaking-down strength of the spark-gap, when oscillations are set up in section *B*, part of the energy of which is reflected back at *a*, forming stationary waves with nodes of potential at those points, and part of which enters the vertical wire.

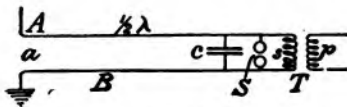

FIG. 90.

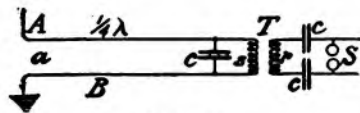

FIG. 91.

In another arrangement of the transmitting circuits the Lecher system is charged inductively, the secondary circuit of the transformer or induction coil being in circuit with the said system and oscillating with it. In still another arrangement of transmitting circuits, Fig. 91, the Lecher system, section *B*, is so disposed as to have one-quarter wave-length, the secondary coil of the transformer *T* being equivalent to one-half wave-length, in which case the point *a*, Fig. 8, would be a loop of potential. It is, however, preferable always to connect the antenna to a node in the parallel conductors. *A* is the vertical wire, grounded through the parallel conductors. Condenser *c* at the

left is the bridge or tuning condenser; *c c* at the right are the spark-gap condensers.

This method of electrical tuning has been used very successfully in tests between Washington and Annapolis, and its use is to be extended on the De Forest system. Besides the close and accurate tuning which this method gives, it possesses the further advantage that it is not affected by outside interference; De Forest has found that the period of the ordinary helix or coil used in tuning is easily disturbed by the proximity of masses of iron, or even by the approach of the hand.

De Forest Wireless Telegraph Stations.—The De Forest Wireless Telegraph Company already have in operation or under construction over twenty stations in the United States and Canada. Among these, New York City to Fort Hancock, 12 miles; Block Island to Point Judith, 15 miles; Toronto to Hamilton, Canada, 40 miles; Buffalo, N. Y., to Cleveland, Ohio, 180 miles; Cleveland, Ohio, to Detroit, Mich., 150 miles; Block Island to Cape Hatteras, 300 miles. Also between Chicago and St. Louis, about 300 miles overland.

Perhaps the most important work contemplated and under way is a circuit that will extend from Cape Flattery, Wash., at the junction of Strait San Juan de Fuca and the Pacific Ocean, to Dutch Harbor, Aleutian Islands, a distance of about 1800 miles. For these stations three latticed and girded wooden towers, each 225 feet high, and arranged as a triangle, with sides 275 feet long, are being constructed. The towers will be 25 feet square at the base. From the top of these towers a hexagonal net of cable will be strung horizontally, from which will hang six screens of vertical wires having an average length of 250 feet, 300 wires in all. These wires will converge into the station located at the base of the towers. The station-house will be equipped with a 90 horse-power steam-engine, a 60-kilowatt generator, transformers, etc.

The Cape Hatteras equipment consists of a single tower, 200 feet high and 23 feet square at base. The station-house is located between the four legs of the tower. The antennæ consist of 40 vertical wires suspended from the top of the tower and fastened to a bus bar at the base of the tower and carefully insulated therefrom. The power employed at the station is about 15 kilowatts. From this

station it is contemplated to communicate with Block Island and Havana, the latter 400 miles distant.

At Buffalo, Cleveland, and Detroit stations two masts, each 200 feet high and 100 feet apart, are being erected. The plane of these masts is faced in the direction of transmission of the signals. A horizontal cable between the mastheads suspends 20 vertical wires which converge in the station-house. Each of these vertical wires is composed of seven No. 21 B. and S. bare tinned wire, stranded. The power employed at these stations is about 7.5 kilowatts. The arrangement of these masts, vertical wires, and station is outlined in Fig. 91.

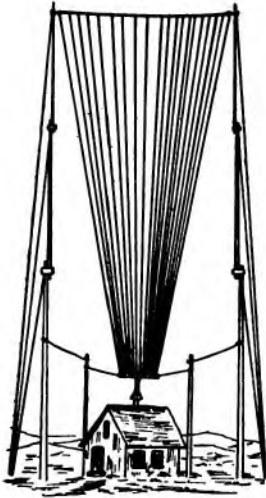

FIG. 92.
DE FOREST TWO-MAST ARRANGEMENT FOR 20 WIRES.

in Fig. 83, wires $w w$ leading to the receiving circuits, and s being the spark-gap.

For some time a number of automobiles have been fitted out with De Forest apparatus, and have been utilized in New York City as a means of transmitting items of stock news from the street into the offices of the *Wall Street Journal*. The vehicle carries a large glass case about three feet square, in which the apparatus is placed. A brass rod about seven feet high serves as the vertical wire. The oscillations are set up by a two-inch spark induction coil supplied by the storage battery of the vehicle.

The author is under obligations to Dr. De Forest for his courtesy in supplying many of the foregoing details of his system.

The arrangement of the Point Judith or Providence Journal vertical wires is outlined in Fig. 92. Here five vertical wires $A A$, supported by a mast 150 feet in height, are employed. The wires are held apart by wooden spreaders $s' s'$. The arrangement at the base of the wires is a slight variation of that shown

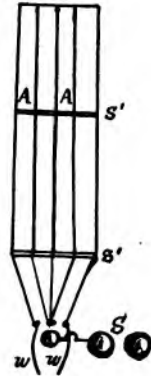

FIG. 93.

CHAPTER XII.

THE FESSENDEN, STONE, SHOEMAKER, EHRET, BULL, AND MUSSO SYSTEMS.

THE FESSENDEN SYNTONIC WIRELESS TELEGRAPH.

THE inventor of this system, Professor R. A. Fessenden, has carried on a multiplicity of experiments in wireless telegraphy in this country under the auspices of the United States Weather Bureau, and has made many notable discoveries and improvements in the art, for which a large number of patents have been issued.

Professor Fessenden has also made numerous practical experiments, some of which are described, relative to electric wave propagation, concerning which he states his belief that the waves radiated from the antennæ are not complete waves, but only half-waves, which travel over the surface of a conductor, and thus, unlike Hertz waves, can be deflected from a straight line. He found that for the proper transmission and reception of these waves it was essential that the surface at the base of the vertical wire should be a good conductor for a distance of at least a quarter of the wave-length from the foot of the vertical wire. He therefore devised the arrangement shown in Fig. 94, which he terms a wave-chute, to effect this result. It consists of the vertical wire *A* supported by a mast, in this case on the top of a building. From the foot of *A*, a conductor *h*, properly insulated, is led over the housetops, horizontally, to the required distance, and in the direction in which signals are to be transmitted, before ground-

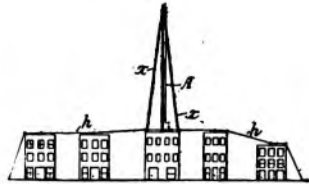

FIG. 94.
FESSENDEN'S WAVE-CHUTE.

ing. To prevent absorption of wave energy by the iron guy wires, coils xx are added thereto, this giving them a different oscillation period to that of the antennæ.

In actual practice the Fessenden system has been in successful operation between several places—for instance, from Cob Point, Ind., to Arlington, Va., a distance of 47 miles overland. This country is open, but well wooded with trees of considerable height. Professor Fessenden states that the strength of signals is varied to a marked degree by the temperature of the earth. Thus, measurements made during the prevalence of warm weather showed the signals to be seven times stronger than when the ground was frozen to a depth of several inches.

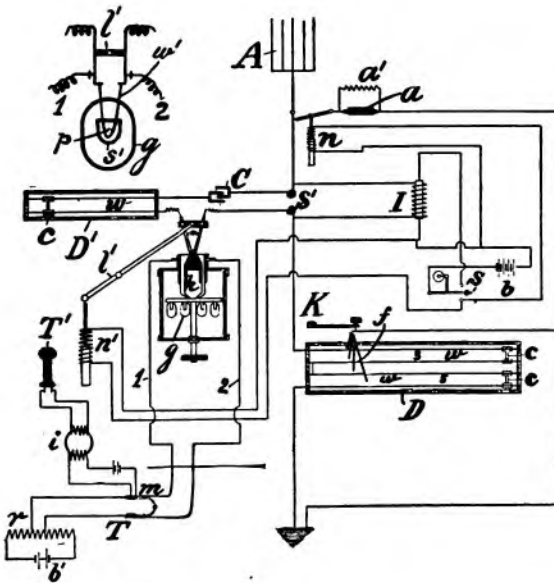

FIG. 95. FESSENDEN SYNTONIC CIRCUITS.

The transmitting and receiving circuits of one arrangement of this system are shown theoretically in Fig. 95. This is a tuned system. The tuning device employed is termed a tuning-grid, and consists of a combined inductance and capacity, made up of one or more pairs of parallel wires, which, to reduce their inductance, are bent back and forth, in box D , and to increase their capacity are immersed in oil (see Fig. 96). A is the vertical wire or wires.

In the practical operation of this system each station is allotted a certain oscillation period, as an ordinary Morse station would be allotted a certain letter of the alphabet. Normally, the receiving apparatus of each station is attuned to its given period of oscillation. Hence, when it is desired to call any station, a succession of waves of the proper frequency are transmitted from the sending station with the result desired. The transmitting circuit may be traced from A to the primary of inductance coil I (or other generator of oscillations), or to the spark-gap s' , thence to and through the wires $w w$ of the tuning-grid D , thence to earth. s is a switch by which the primary of induction coil I is opened when signals are to be received; b is the battery for the induction coil. It also operates, as required, solenoids $n n'$. This system may be operated by opening and closing the primary of induction coil in the usual way, but the inventor prefers to keep the coil in continuous operation, and to transmit signals by short-circuiting or varying the tuning device D , which throws the sending circuit out of tune with the receiving circuit.

To effect this short-circuiting of D , a key κ is employed, with fingers f , which fingers, when the key is depressed, touch one or other of the wires $w w$ in succession. By this arrangement, at each closing of key κ a series of oscillations of different periods are transmitted, any one of which the receiving station may select at will. Hence, if the receiving station considers that he is being interfered with by an outside station with one oscillation period, he can attune his receiving circuit to another of the oscillation periods being transmitted. The capacity and inductance of the wires w in box D can be varied by means of the movable contacts $c c$, which are arranged to be moved along the wires $w w$ in tuning the transmitting circuit, and in a practically similar way the receiving circuit may be attuned at D' .

The receiving circuit may be traced from aerial wires A to condenser c , to the combined capacity and inductance grid D' , to the detector k (an auto or self-restoring detector), to the grid D , and to earth, all in series. T is a head telephone in a shunt circuit 1, 2, from the detector k ; and in series, via resistance r , with a battery b' of two cells of slightly different voltage, arranged in opposition to each other.

The inventor of this system has devised a number of different types of detectors. The one k , shown in the accompanying figure, is termed by him the "barretter." It is based on the well-known fact that the resistance of a metal conductor varies with the tempera-

ture of the metal, and the construction of the barretter is accordingly designed to give rapid increments and decrements of temperature with increase and decrease of current in its circuit, thereby to obtain comparatively large variations of resistance in the circuit. The barretter is shown separately at the upper left corner of the figure. It consists of a very short, thin silver wire, having a core of platinum *p*. This wire is made from a very short silver wire .1 inch in diameter with a platinum core .003 inch in diameter. This wire is then drawn until it has an outside diameter of .002 inch, in which case the platinum wire will be .00006 inch thick. The wire is then formed into a loop. From a very small portion of this loop (a few hundredths of an inch) the silver is dissolved by immersion in nitric acid. The loop is then connected to platinum leading-in wires as shown. To avoid heat radiation, the loop is inclosed in a glass bulb *s'* about one inch long and one-half inch wide, filled with air or paraffin; or the bulb may be exhausted of air with a very considerable increase in sensitiveness. To further avoid the radiation of heat, the loop is inclosed in a very small silver shell *g*, suitably upheld.

The sensitiveness of the loop in this respect is further increased if only a portion of the silver wire composing the loop be dissolved, in order to obtain a composite wire with half the resistance of the platinum wire. This, according to the inventor, can best be done by removing all of the silver wire and then recoating the platinum wire with silver until the resistance of the loop is just one half that of the platinum alone.

This gain in sensitiveness is due to the fact that as the silver has one seventh the volume of platinum, and equal resistance, a given amount of current will heat the silver wire approximately seven times as hot as the platinum wire, thus bringing about a greater variation in the resistance with a given current. The resistance of the loop is in some instances as low as 30 ohms, while others less sensitive vary from 150 to 600 ohms. The importance of a low resistance detector in syntonistic wireless telegraphy has already been pointed out.

Owing to the slight difference in potential between the cells *b'*, a very weak current normally passes through the loop. When the currents due to the received electromagnetic waves traverse the loop *l*, they cause rapid increases in its temperature and consequently in its resistance, which results in a series of sounds in the telephone receiver *r*, which sounds are received as dots and dashes of a code.

This type of detector or auto-coherer differs from the filings-coherer in that in the latter the reduction in resistance is primarily due to the electromotive forces of the received oscillations, while the increased resistance of the former is primarily due to the currents set up by the received oscillations. A number of detectors of different degrees of sensitiveness may be grouped in the receptacle k , and means be provided for changing quickly from one to the other.

For calling purposes a less sensitive detector or loop is used, and in addition a microphone transmitter m with battery and induction coil i is placed opposite the diaphragm of the telephone receiver τ , with the result that the sound is heard in the calling receiver τ' . At other times a galvanometer or telephone is used for calling without the microphone contact. a is a lightning arrester, which, by means of switch s and the solenoid n , is put in service when the apparatus is set for receiving, and opened when the switch is set for sending. Somewhat similarly, the detector apparatus is detached from the vertical wire when switch s is set for sending, by the solenoid n' and the lever l' , in the manner outlined in the figure. The condenser c prevents the effects of atmospheric steady currents upon the detector when connected with the vertical wire, but repeats or transmits the received oscillating currents.

By means of clockwork, indicated at switch s , mechanism can be set in operation whereby at stated periods of one minute, more or less, the switch s may be thrown from sending to receiving automatically, when a station is not busy. Other stations listening in and hearing this regular signal know that the desired station is available, and proceed to call him. This automatic device is cut off when the station is busy.

The lightning arrester a consists of a Varley carbon coherer, or preferably a gold-bismuth filings-coherer, made of an alloy of gold and bismuth, with five per cent. of bismuth, placed in a glass tube and lying between electrodes tipped with an alloy of platinum-iridium. Still another device for this purpose is described, consisting of a small ring of aluminum and silver, resting on a knife-edge of gold-bismuth alloy. a' is an inductance coil across which any static charge from the antennæ leaks to ground.

The transmitting key used in this system is shown in Fig. 96. κ is an ordinary Morse key mounted on a suitable base. The extension l , when depressed by the key, causes the fingers f (Fig. 95) to

impinge against the wires or strips 6, in the manner and for the purpose stated. D is the box containing the wires 5 and the movable

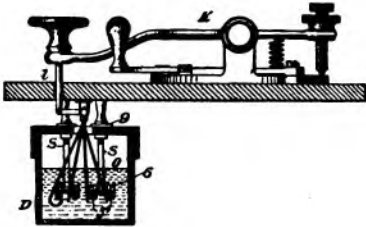

FIG 96.

FESSENDEN TRANSMITTING KEY.

contacts 6. These contacts are grooved wheels upheld by the bars *ss*, the wires or strips 5 resting in the grooves; *o* represents the oil in which the wires are immersed; *9* are adjusting arms by which the bars *s* are held in a desired position.

Besides the foregoing, a large number of variations of this system and apparatus are described in U. S. patents Nos. 706,735 to 706,747, to which the reader may be referred for a more detailed account of Professor Fessenden's work in almost every branch of this subject.

THE STONE MULTIPLEX SYNTONIC WIRELESS TELEGRAPH.

A large number of patents have been issued to the inventor of this system, Mr. John Stone Stone, of Boston. The general purpose of his inventions may be briefly described by an extract from U. S. patent 714,831, in which he claims a system for developing free or unguided simple harmonic electromagnetic signal waves of a definite frequency to the exclusion of the energy of signal waves of other frequencies, and an elevated conductor and means for developing therein forced simple electric vibrations of corresponding frequency. In a system for receiving the energy of free or unguided simple harmonic electromagnetic signal waves of a definite frequency to the exclusion of the energy of signal waves of other frequencies, he claims an elevated conductor and a resonant circuit associated with said conductor and attuned to the frequency of the waves, the energy of which is to be received.

From the many diagrams which accompany the specifications, the one shown in Fig. 97 may be selected. This represents a tuned selective multiplex system, the sending apparatus being shown on the left, the receiving apparatus on the right. *x* represents a receiving system tuned to respond to transmitting system *x'*; *y* is a receiving system tuned to respond to transmitting system *y'*; *c* are condensers, and *L* are inductances employed to secure the desired rate of oscillations in

the respective circuits. KK are transmitting keys; ww are circuit interrupters in the primary of inductance coil I , and $c'c'$ are the condensers used therewith; TT are transformers or induction coils; kk are coherers, decohered by tappers not shown in figure; RR are relays. To avoid repetition, it may be considered that the operation of the transmitting circuits is somewhat similar to that of the Fleming transmitting circuit previously described (Fig. 38). It will be observed that systems X' and Y' are both connected to the same vertical wire A' ; also that the receiving circuits X Y are likewise connected to one vertical wire A . Receiving system X , being attuned to transmitting system X' , will only respond to signals therefrom. Simi-

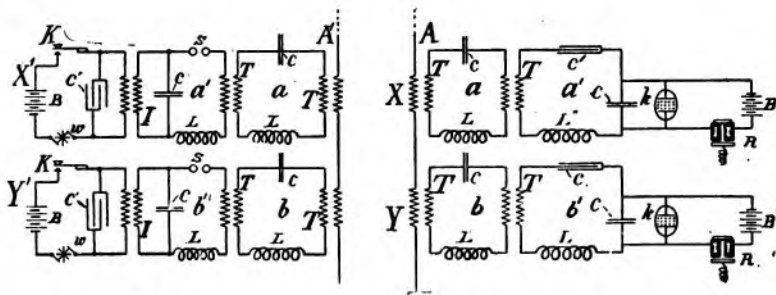

FIG. 97. STONE MULTIPLEX SYNTONIC SYSTEM.

larly, system Y will only respond to signals from Y' . As previously remarked (p. 52), if it is found feasible to secure sufficiently accurate tuning, such arrangements should be found practicable, and need not be limited to two sets of signals.

The oscillating circuits $a a'$ of the transmitting systems X' are attuned to the same period, the object of employing circuit a being to "weed" out any harmonic vibrations that may have been developed in circuit a' , thereby screening the vertical wire from such harmonics. This screening action of the interposed circuit a , as the inventor notes, is due to the property which such a resonant circuit possesses of opposing the development in it of other frequencies than that to which it is attuned, while it favors the development of the simple harmonic currents of the period to which it is attuned. Similarly, oscillating circuits $b b'$ of transmitting system Y' are tuned to a like period, but of course different from the period of X , for the purpose described. Likewise, also, in the receiving systems, the circuit a corresponds in

periodicity to a' , and b to b' , to screen the coherer circuits from any waves that may not be in tune with the vibrations assigned to the respective circuits. The inventor does not limit the number of such screening circuits to one, but adds as many such circuits, inductively connected, as may be found necessary, and operative.

In the operation of such multiplex systems, to which there are analogous a number of well-known systems in wire telegraphy, the different periodicities will be superposed on the vertical wire, which in such cases should be arranged as an aperiodic vibrator, the respective receiving systems in each case selecting the train of wave periods to which they are attuned.

For the inductance coils used in tuning in this system, and which, together with the condensers, are made adjustable, the coils are preferably wound in flat spirals, the separation between the turns and the size of the wire so diminished or constructed "as to decrease the distributing capacity without proportionately diminishing the inductance."

Successful tests of the Stone selective wireless telegraph system are reported as having been made between stations at Cambridge and Lynn, Mass., in which tests the masts were about 100 feet in height. The distance traversed was twelve miles. Presumably these are preliminary tests.

It may be noted in this relation that Dr. M. I. Pupin has devised a multiplex telegraph system, which it may be assumed is applicable to wireless telegraphy, in which the different rates of oscillation are set up by tuning-forks or generators of different periods, and in which receiving circuits are attuned to the respective transmitting circuits by a suitably chosen inductance and capacity in each of said receiving circuits. See U. S. patents Nos. 707,007 and 709,008.

THE SHOEMAKER WIRELESS TELEGRAPH SYSTEM.

The devices due to H. Shoemaker cover a wide range of circuits and apparatus for wireless telegraphy.

One of the earlier arrangements by Mr. Shoemaker is an oscillator consisting of two balls connected with the usual induction coil. These balls are separated by two other balls, the latter within a box containing a gas dielectric under high pressure. This arrangement, it

is claimed, obviates the retardation of sparking under oil. The coherer used with this system consists of a tube in which are contained the filings. Immediately above the filings a small iron ball is placed in a suitable receptacle. Above the ball is the pole-piece of a magnet controlled by the relay in the coherer circuit. The movement of this ball within the tube when acted upon by the magnet suffices to decohere the filings.

Another device by Mr. Shoemaker consists of a receiver which comprises a plurality of plates in inductive relation to one another, and means for permanently charging such plates, together with a microphone circuit operated by the plates.

Mr. Shoemaker has also designed a wireless telegraph repeater consisting of a detector and a relay controlled thereby; a circuit controlled by the relay which insulates the coherer and simultaneously closes the circuit; also means for restoring the coherer and for the generation of retransmitted energy. See U. S. patent No. 718,535.

Mr. Shoemaker's most important practical work, however, has been done in connection with the International Wireless Telegraph Company, the transmitting and receiving circuits of which are shown theoretically in Fig. 98*a*. The transmitting circuits are shown at the left, the receiving circuits at the right of the figure. The radiant energy is primarily set up by a generator *D* developing 110 volts, which are raised to 25,000 volts by transformer *T*. This E. M. F. charges a capacity *C*, which discharges into the closed oscillating circuit *s, c, L*, and thence into the aerial wires *A A'*, of which there may be two or more (not joined at the top), via small arcing spaces *b' b*, about .03 inch apart, similar to those shown in the De Forest system (Fig. 83).

Mr. Shoemaker finds that much depends on the form of energy transmitted, and has obtained best results with large capacity *c* and small inductance *L*. The capacity *c* consists of a number of large Leyden jars, arranged in multiple. These jars are described in Chapter XIV. The inductance *L* is in series with the antennæ. It consists of five turns of .25-inch copper tubing, 15 inches in diameter, wound around the side of a drum or reel formed of two thick pieces of mahogany, which are held apart by bars of ebonite 6 inches in length. The tubing rests in notches in the ebonite bars, and each turn is separated by an air space of one inch. The discharge-rods, which are adjustable, are in the center of the reel, the spark-gap

being in the middle of the reel. The adjustable contact, indicated by the arrow-head, is fixed laterally but is movable vertically. The reel is revolvable, and the adjustment is obtained by turning the reel around until the desired inductance is obtained. In practice about 2.5 turns of the tubing are used. The transmitting circuit may be detached from the receiving circuits by a suitable switching arrangement x , which is inclosed within the box containing the detector. The receiving apparatus is also separated from the transmitting system by the small air-gaps $b b'$. The fact that in systems employing tuned oscillating circuits the potential at the foot of the vertical wire is virtually zero, is found to render extra precautions as to insulation at this point not so requisite. This would follow from Hertz's dumb-bell oscillator experiments. For an opposite reason, it may be remarked, thorough insulation toward and at the top of the wire is very necessary, the maximum potential being there. The key k is of the Morse type,

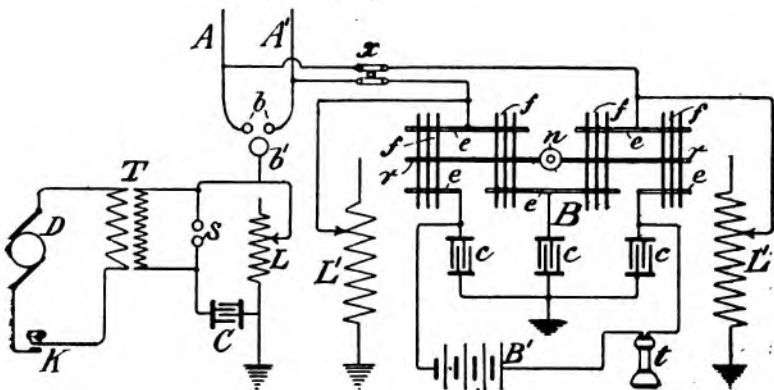

FIG. 98a. SHOEMAKER TRANSMITTING AND RECEIVING CIRCUITS.

but somewhat larger than the ordinary, and is provided with heavy platinum contact-points, which are opened in air. Auxiliary carbon contact-points attached to the key were tested, but were not found to possess any advantage.

The detector employed in this system is microphonic in its character, and is self-righting. It is indicated at B in Fig. 98a. In the figure, $f f$ are small pieces of incandescent-lamp filaments laid across steel knife-edges $e e$. The filaments are about 1.5 inches in length and

are highly elastic. Firm contact between the filaments and the steel edges is secured by means of a fine strip of hard rubber rr , which is pressed down upon the filaments by a spring n , the tension of which is easily regulated. There are four sets of filaments, three filaments in a set. It will be seen that each set of filaments is in series with the others and with a battery of four dry cells v and telephonic receiver t . The filaments are in series with the vertical wires and earth through small condensers ccc , as shown, the oscillations being more or less diverted to this route by the inductances $L'L'$. The tuning or adjustment at the receiving station is effected by adjustable inductances $L'L'$ and the capacities ccc , which, it will be observed, have a closed oscillating circuit through the detector. Each condenser is formed of three sheets of tin-foil about 1.5 inches long and .88 inch wide, separated by very thin sheets of mica. According to tests made, the capacity of these condensers is .0045 microfarad each. The inductances $L'L'$ are formed of 350 feet of No. 16 copper wire wound spirally on a bobbin ten inches long and four inches in diameter, and are adjustable by a sliding contact as indicated. In the adjustment of this detector it is found that best results are obtained by increasing the tension on the filaments for near-by signals and decreasing the tension for remote signals. When necessary to further vary the wave-length the vertical wires $A A'$ are lengthened out by the insertion of additional wire in the operating-room. Signals have been received by this detector at a distance of 140 miles, and it is in daily operation between Quogue, Long Island, and Highlands of the Navesink, New Jersey, a distance of 90 miles.

(See Appendix, pp. 191, 192, for Ehret and Bull Systems.)

THE MUSO SYNCHRONOUS SYSTEM.

This system, the invention of Signor Guiseppe Musso, of Italy, is a synchronous telegraph system, designed primarily to be operated by and in connection with wireless telegraph apparatus. It consists essentially of a fly-wheel or disk at a transmitting station, revolving synchronously with a similar fly-wheel at a receiving station, in the manner common to other synchronous telegraph systems. Usually, however, such other systems transmit signals by the Morse dot-and-dash method, or, if letters are printed at the receiving station, they

are printed on a strip of paper—not altogether a satisfactory method for public use. In the Musso system it is intended to print the message in page form. The principle of this synchronous system is not difficult to understand.

A fly-wheel *w*, Fig. 98, carried on shaft *s* and rotated by clock-work gearing, indicated at *s'*, is arranged at each station. Below this wheel is a stationary hard-rubber disk *D*. A pair of copper rings *c c*

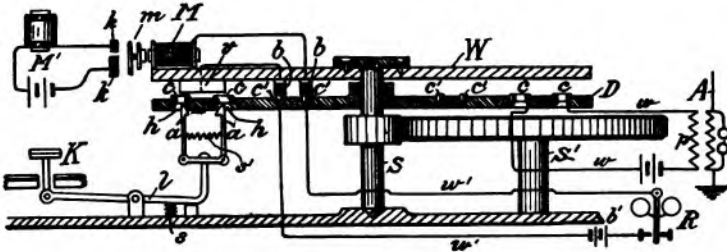

FIG. 98. MUSSO SYNCHRONOUS SYSTEM.

are inserted on the surface of the rubber. Holes *h h* are placed at regular intervals around these rings, one for each key, on a keyboard. From these rings, as indicated, wires *w w* lead to the primary *p* of the oscillator circuit. On the under side of the fly-wheel a metal wedge *v* is carried. This wedge is wide enough to span the space between rings *c c*, but does not touch them. When a given key *k* of the keyboard is depressed, its lever *l*, with its arms *a a*, which latter are drawn toward each other by a spring *s'*, is raised. The hook ends of the arms pass through the holes and are held in that position until wedge *v* arrives over them, when it passes between the hooks, separating them so that they fall below the rings *c c*, being withdrawn by spring *s*. At the same time the metal wedge, by contact with the metal hooks of *a a*, had closed the oscillator circuit, permitting oscillations to pass to the aerial wire *A*. So much for the transmitting arrangement.

The receiving system is attached to the same disk and fly-wheel. Two other copper rings *c' c'* are arranged around the disk. These are connected by wires *w' w'* with the armature-lever of coherer relay *R*. A pair of brushes *b b* carried on the under side of fly-wheel *w* in juxtaposition to the rings *c' c'*, and connected with wires leading to a magnet *M*, also carried on fly-wheel *w*, form a circuit controlled by relay *R*. Arranged concentrically around the periphery of fly-wheel *w* are a number of contact points *k k*, one pair for each key of the keyboard, or for each letter or other character on the keyboard. When

the coherer relay is actuated by an incoming signal, the magnet M allows its armature, carrying a metallic circuit-closer m , to bridge the contacts $k k$, thereby closing the circuit of a type magnet M' of a type-writer, and printing a letter.

Assuming the fly-wheels at each station to be in synchronism, it is clear that at the depression of a key when the wedge v at the transmitting station arrives at the said key arms, a train of oscillations will be set up, and inasmuch as at that instant the brushes $b b$ or the magnet M at the receiving station will have arrived opposite the contacts of the letter corresponding to the key so depressed, the desired letter or character will be printed.

Devices, not shown herein, for automatically stopping and starting the apparatus in the absence of an attendant are employed. Also devices whereby any one station may lock out all stations of the same system excepting the one with which it is desired to hold communication. See U. S. patent No. 707,612. Signor Musso has also devised a more sensitive relay than the ordinary filings-coherer for his system, consisting of fragments of magnetite and pure silver.

The speed of transmission by synchronous telegraph systems is not high, and the difficulty of maintaining the necessary synchronism is well known. It may be noted that wireless synchronous systems do not have to contend with the "tailing" effects due to static capacity of wire lines, but doubtless other troubles equally difficult to overcome will be met with. With a wheel or disk rotating say five times per second, and assuming thirty letters or contacts, the duration of the brush or wedge on any one segment would be about $\frac{1}{150}$ of a second in any revolution. At a rate of one revolution per second the duration on a segment would be $\frac{1}{30}$ second. It is perhaps doubtful that a filings-coherer and its relays could act efficiently in this time. Hence the speed of rotation would have to be reduced, probably to a rate of one revolution in three seconds, more or less, which would entail a slow rate of transmission, perhaps seven or eight words per minute. The writer has no knowledge that any wireless printing telegraph system or synchronous wireless telegraph system is as yet in actual operation.

CHAPTER XIII.

SIGNALING BY ULTRA-VIOLET RAYS—WIRELESS TELEPHONY— SPEAKING LIGHT, SPEAKING ARC, ETC.—ZICKLER, BELL, HAYES, RUHMER, SIMON, COLLINS, ARMORL SYSTEMS.

ZICKLER SYSTEM OF WIRELESS TELEGRAPHY BY ULTRA-VIOLET RAYS.

TAKING advantage of Hertz's discovery that when ultra-violet rays fall upon the sparking-balls of an induction coil the sparking is facilitated—in other words, that an E. M. F. which ordinarily will not be sufficiently powerful to jump across a given gap, but will do so when ultra-violet rays are thrown upon the electrodes, Professor Karl Zickler has devised a system of telegraphing without wires by means of such rays, the apparatus for which is shown in Figs. 99, 99*a*.

The transmitter is shown in Fig. 99. *c* is a case containing a powerful arc lamp *a*, using about 54 volts and 25 amperes with an arc of about .39 inch, the rays from which pass out normally at the opening *w*, at which is placed a shutter composed of one or more glass plates, glass being used for the reason that it allows the ordinary light rays to pass, but is opaque to the shorter ultra-violet rays. The shutter may be operated pneumatically, like photographic apparatus. The case *c* is adjustable in a horizontal or vertical plane, so that the rays issuing from the opening in the box may readily be directed toward the receiving station. To direct the rays a concave mirror or a double convex lens is employed at the transmitter, or a combination of both may be used, as shown in Fig. 99, at *l* and *q* respectively.

The receiver is outlined in Fig. 99*a*. It comprises a tubular glass case *G*, in which are two electrodes *d*'s, facing each other and supported in the positions shown by the glass case, into which they are melted. The electrode *s* is a sphere, a few tenths of an inch in

diameter; d is a small metal disk. The case is hermetically closed by a quartz plate q' , which is transparent to ultra-violet rays. A metal tube t , having a conical opening t' , is placed over the glass case as indicated. At the left end of t there is another quartz lens l' . R is a screw by which the tube t may be so adjusted that the light-rays from the transmitter are thrown in the shape of a small oval spot of light upon the disk, which is placed at an angle suitable to reflect the received rays on to sphere s .

The electrical connections of the receiver are also shown in Fig. 99a. The terminals of the electrodes are connected to the secondary of a

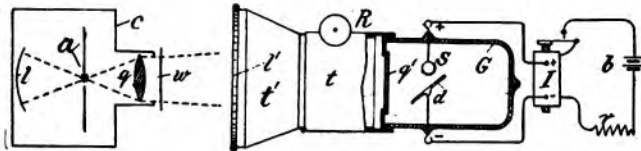

FIG. 99.
ZICKLER TRANSMITTER.

FIG. 99a.
ZICKLER RECEIVER.

small induction coil I , giving a spark of about .3 to .6 inch, adjustable by the resistance r ; b consists of two small storage cells providing a current of about 1.5 amperes; s is connected to the positive pole, d to the negative pole. The resistance r is adjusted to keep the E. M. F. just below the sparking point, normally, but sparking ensues when the ultra-violet rays fall upon the electrodes. A coherer, an ordinary relay, or a telephone may be placed in the secondary circuit to indicate the passage of sparks across the terminals.

The operation is then virtually as follows: The glass shutter at the sending station is opened and closed, thereby permitting the ultra-violet rays to pass at intervals corresponding, for example, to the dots and dashes of the Morse code. These ultra-violet rays reaching the disk d bring about the sparking in the manner aforesaid, and at intervals corresponding to the opening and closing of the glass shutter at the transmitting station.

In other experiments in connection with this system Zickler availed of another of the discoveries of Hertz, namely, that the length of spark when illuminated and not illuminated by the ultra-violet rays increased up to a certain point as the air pressure in the spark-gap is diminished, and accordingly rarefied the air in the glass tube.

The distance to which signals have thus far been transmitted by

ultra-violet waves has been quite limited, namely, six or seven hundred yards; but Professor Zickler expects to increase this distance considerably. It is, however, pointed out by other experimenters that owing to the rapidity with which these ultra-violet rays are absorbed in a humid atmosphere it is not likely that the distance reached by this method will ever exceed one mile.

BELL'S PHOTOPHONE OR SPEAKING LIGHT.

Systems or apparatus by which light-waves or the arc lamp are caused to reproduce articulate speech have been termed the "speaking light" and "speaking arc" respectively. Examples of each will be given.

The photophone is a device due to Alexander Graham Bell, the inventor of the telephone, by which speech is transmitted by light-waves. The principle is shown diagrammatically in Fig. 100. A



FIG. 100. BELL'S PHOTOPHONE.

beam of light is concentrated by means of a lens l upon a small concave mirror, carried on the exact center of a suitable diaphragm in proximity to a mouthpiece P . The reflected rays are directed upon the receiving station by a double convex lens l' .

The reflected rays are directed upon the receiving station by a double convex lens l' .

In the receiving system that property of selenium by which it varies its electrical resistance under fluctuations of light is utilized. s is a selenium cell, placed in the focus of a parabolic reflector r' . The cell s is part of a local circuit with a telephone receiver t and a cell of battery b . Then when sounds are uttered at the mouthpiece the diaphragm vibrates consonantly therewith, this causing variations in the reflected rays from P , these variations in turn being repeated at the selenium cell. Hence, corresponding variations are set up in the resistance of the local circuit, with the result that the sounds uttered at the mouthpiece are reproduced in the telephone.

The selenium cell consists of platinum wires in the shape of a grid, the two sections of which do not touch, but are connected by selenium, the wires and selenium together forming part of the circuit with b and t ; thus quick variations in the resistance of the selenium are easily detected in the telephone. The initial or normal resistance of the selenium cell is very high. One cell of which the author has

knowledge ranges from 300,000 ohms in the dark to about 75,000 ohms in the light, a ratio of 4 to 1. Other types range from 500,000 to 25,000 ohms, and others, like Ruhmer's cell, are still more efficient, and will be described. Giltay suggests cutting out the selenium cell by means of a switch before opening the telephone circuit, to prevent the extra current from short-circuiting the cell.

THE HAYES-CRAM RADIOPHONE.

This system, due to Messrs. Hayes and Cram, of Boston, Mass., has been in operation for comparatively short distances in this country since 1900, and perhaps prior thereto. The inventors have shown a number of variations of this device, one of which is indicated in Fig. 101.

This figure comprises parabolic reflectors l l' facing each other; an arc light a in the focus of l (a is connected by wires w w' to a generator D); M , a microphone transmitter in shunt with the arc by means of wires w w . In the focus of the receiving reflector l' , s is a substance extremely sensitive to heat. In this case a small quantity of carbonized fibrous material is used. T is a small glass bulb or tube in which the carbonized material is inclosed. Within the reflector the tube is sealed; outside of the tube it is open and is connected by

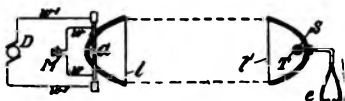

FIG. 101.

means of a rubber tube with two ear-tips e . When the sounds are spoken into the transmitter M , the current flowing across the arc is modified by the variations in the resistance in the shunt circuit, and accordingly corresponding variations occur in the light of the arc. The reflector l reproduces these variations, although they are so minute as not to be visible to the eye, and they are transmitted to reflector l' , by which they are focused upon the carbonized material s , and thereupon sounds corresponding to those uttered at the diaphragm of the transmitter M are emitted.

In other arrangements of this system the inventors show at the transmitter a transformer intervening between the microphone and the arc-lamp circuit, and in the receiving reflector a heat sensitive device, such as selenium. In practice, however, the receiver has hitherto consisted of the material mentioned, and the maximum distance at which speech has been transmitted by this device is about two miles.

THE RUHMER PHOTO-ELECTRIC PHONE.

This is another "speaking light" system, due to Mr. E. Ruhmer, which follows somewhat the line of Bell's photophone. The system is outlined schematically in Fig. 102, in which A is the sending and B is the receiving station. M is a microphone transmitter with its battery *b* and primary coil of transformer T, the secondary

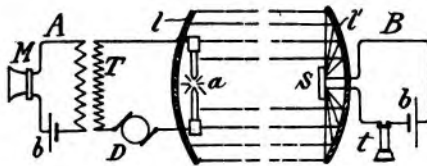

FIG. 102. RUHMER'S SPEAKING LIGHT.

of which is in series with a dynamo D which generates current for the arc lamp *a*. A cylindrical lens *l* directs the rays from the lamp to a lens *l'* at B, where the received rays are focused upon a selenium cell *s* by the

lens *l'*. In the circuit of *s* are the telephone *t* and battery *b*.

As in the analogous systems just described, the action of this system is due to the modifying effect of the microphone upon the current in the arc-light circuit, this producing varying degrees of illumination of the arc, which are detected by the sensitive selenium cell at the distant station, the whole resulting in the reproduction of speech in the telephone *t*.

The distance to which Ruhmer has succeeded in transmitting speech by means of his "speaking light" is about eight or ten miles. In his tests he employs a very sensitive microphone transmitter, using 6 or 8 volts in its local circuit. According to Ruhmer the degree of illumination at the arc that is best suited to the selenium cell must be carefully chosen and maintained during operation. For distances exceeding four miles he uses an E. M. F. of 62 volts and a current of about 14 amperes.

The selenium cell devised by Ruhmer for this service consists of a glass tube about .8 inch diameter and 1.7 inches long, around which are wound two fine platinum wires, over and between the interstices of which a coating of selenium is placed. The selenium takes the place of a dielectric, as it were, between the wires, separating them from each other, and as these wires are part of the local telephone circuit, the resistance of that circuit varies with that of the selenium. By making the selenium cell cylindrical a greater uniformity of the

light falling upon it is secured, which is desirable. To further maintain the uniformity of conditions surrounding the cell it is inclosed in an exhausted glass tube. The Ruhmer cell described has an unilluminated resistance of about 120,000 ohms, which falls to 1500 ohms in a bright light. This cell also has the property of varying its resistance almost instantly, like a good auto-coherer—in other words, it has a low time constant.

Obviously, ordinary telegraphic signals could be transmitted by using a sensitive relay in place of the telephone receiver, in which case presumably the signaling distance could be increased. The maximum distance at which the light from powerful search-lights is visible is about thirty miles.

THE SIMON SPEAKING ARC.

The discovery that the electric arc could be made to reproduce speech was made by Dr. Simon in 1897.

There are several ways in which this can be done. One of the simplest methods is outlined in Fig. 103. Here, a is the arc lamp; $R R'$ are resistances; $n n'$ are inductances; c is a condenser across the arc; B is a battery or dynamo; M is a microphone transmitter. When the voice is spoken into the transmitter the articulate sounds are reproduced by the arc. To obtain the loudest sounds the arc should be long. Arcs 3.9 inches in length have been used advantageously.

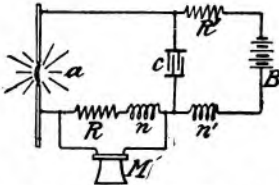

FIG. 103. SIMON SPEAKING ARC.

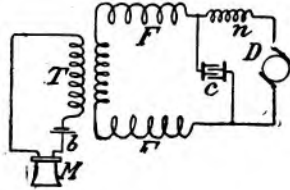

FIG. 104.

In Fig. 104 another somewhat similar arrangement is shown, by which the variations of current set up by the voice in the primary circuit of transformer T are thrown on the field-magnet circuit F of a dynamo machine D , with the result that all the arc lamps on the circuit reproduce the words spoken into the transmitter M . It has been suggested that by an arrangement of this kind a speaker could address an audience of any size by a suitable disposition of the lamps.

Simon has also experimented with a variation of Bell's speaking light, using as a receiver a selenium cell *s*, Fig. 105, in series with which is an inductance *n* and a battery *B*, and in shunt with the cell *s*

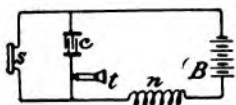

FIG. 105.
SIMON SPEAKING LIGHT.

a condenser *c* and telephone receiver *t*. For the transmitter he uses an arc light in which the positive carbon is .195 inch and the negative carbon .117 inch in diameter, supplied by a current of 3 to 5 amperes. The arc for best results should be very small. By this device speech has

been clearly transmitted 1.5 miles.

Mr. R. A. L. Snyder also has made successful experiments with the speaking arc, using an arrangement practically similar to that shown in Fig. 103. He employs a solid-back microphone transmitter and a lamp and impedance coil *n* shunted by a condenser *c*, the use of which, Snyder claims, adds materially to the successful reproduction of speech. The lamp used is a Schuster hot-wire arc lamp, operated at 110 volts direct current. Snyder employed a positive carbon impregnated with foreign substances, to take advantage of the fact that carbons so impregnated show a more uniform drop all the way across the arc, unlike the ordinary carbons, between which there is a great fall of potential close up to the positive carbon.

As noted by Snyder, the most generally accepted theory of the speaking action of the arc is that it is due to the sudden changes in the temperature of the arc, which cause rapid expansion and contraction of the heated air. The carbon vapor of the arc, being in a high state of molecular vibration, has a low specific heat. The temperature of the arc varies as the square of the current, and also varies almost concurrently with the current. Therefore, when the current is varied the temperature of the arc is rapidly and largely increased or decreased therewith, and the volume of vapor, varying as it does with the temperature, sets up sound-waves in the air surrounding the arc. (See Transactions A. J. E. E., March, 1903.)

THE COLLINS WIRELESS TELEPHONE.

Mr. A. F. Collins has consistently advocated the cause of wireless telephony for some years, and during that time has made numerous experiments to demonstrate its practicability, at least for short distances.

The details of his experiments, however, have not been given out,

pending the issuance of letters patent. In general, the Collins apparatus consists of an oscillator and a coherer with an electric-bell attachment for calling purposes, and a telephonic transmitter and receiver of special construction for the transmission and reception of articulate speech. Mr. Collins in some experiments has used the earth as the medium in which the electric waves set up by the voice are propagated. In this case the ground connections are quite close together, perhaps a foot or two apart. The distance covered thus far is about one mile. In other experiments in New York harbor masts have been placed on ferryboats with wires terminating in the water. Electric oscillations of low frequency are set up and upon these the vibrations of the voice are superposed by a microphone transmitter, thus varying the electric waves in a manner similar to that in which the speaking arc is varied. Speech has been carried on in this way over a distance of several hundred feet between ferryboats. The chief use of wireless telephony for such short distances would be in times of fog.

WIRELESS TELEGRAPH FOG-SIGNALS.

Mr. C. M. Kelway, of London, has devised and described a combination of wireless telegraphy with fog-whistles for the purpose of indicating not only the direction from which the fog-signals are coming, but also the distance of the fog-whistle station. The device is based on the velocity of sound, about 1100 feet per second, and the fact that the speed of wireless signals is practically instantaneous. Simultaneously with the blowing of the fog-whistle at a shore station a wireless signal is sent. By noting the time between the wireless signal and the sound of the whistle the distance is easily calculated.

To determine the direction of the fog-whistle station, since it is almost impossible to tell the direction from which sound emanates in a fog, Mr. Kelway's plan requires the following operation: Assuming the first signal to have shown the vessel to be ten miles from the fog-whistle in some direction, the vessel would then sail say three miles in some direction and get another signal. Assume that the distance of the vessel is then seven miles from the fog-whistle. This gives a triangle with sides of nine and seven miles and a base of three miles, which, by a simple mathematical calculation, shows the fog-whistle to be directly ahead. To avoid the trouble of constructing

triangles and making calculations, the inventor has designed a tele-meter, which is "a combination of three two-foot rules divided into inches representing miles, and these inches subdivided into tenths representing cable-lengths," and by means of which, with but little trouble, the direction and distance of the signal station are indicated.

Another inventor has devised a scheme by means of which vessels equipped with wireless telegraph apparatus may be apprised of their distance from a shore station during a fog. The shore station is equipped with vertical masts of say three different heights. Signals are sent at stated intervals from the shore from each of the masts consecutively. Obviously, the signals sent from the higher masts will affect a coherer at the greater distance. Hence, if a ship gets first a certain signal, say twice repeated, and then after sailing for some time gets a signal thrice repeated, it is evident the vessel is approaching the station, or vice versa.

THE ARMORL WIRELESS TELEGRAPH SYSTEM.

This system derives its name from the first syllable of the names of its inventors, Messrs. Armstrong and Orling. The device should

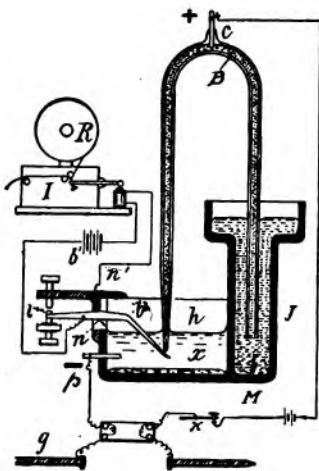

FIG. 106.
ARMORL WIRELESS SYSTEM.

hardly be included in the category of wireless telegraph systems proper, but may be described as a type of conduction systems.

The sending and receiving arrangements are indicated in Fig. 106. The receiver is a relay based on the capillary action of an electric current on a liquid contained in a tube. *J* is a vessel filled with mercury, into which one tube of a siphon *B* enters; the other end of the siphon enters a cell *h* containing acidulated water *x*. The siphon is open at both ends. A delicate metal balance or beam *b* is pivoted on an agate bearing *n*. The right-hand end of *b* descends, as shown, below the end of the siphon in *x* and almost touches it. The other end of *b* carries a contact *l* which controls a local circuit consist-

ing of the wire n' , a small battery b' , and the magnet of a Morse register r , with its paper-reel R . The siphon is also filled with mercury. The positive pole of the external circuit enters the siphon through a stopper at c , and the negative pole at the cell h , as indicated. When a current enters at the positive pole capillary action causes a small drop of mercury to pass from the lower end of the tube upon the end of the balance b . This raises the left end of that beam, closing the local circuit and opening the magnet. When the right end of b is thus depressed the mercury drops to the floor of the cell. This apparatus is said to be more sensitive than the telephone as a receiver.

In the transmission and reception of messages the iron spikes g are inserted in the earth to the depth of two feet and about fifteen feet apart. For transmitting, a Morse key k and a battery of about eight volts is used, and a telephone receiver, not shown in figure, is held by the operator. In receiving, the battery and telephone are cut out. It is stated that signals have been transmitted to a distance of fifteen miles through the earth with this apparatus, but authentic data on the

The same inventors have devised a wireless telephone system in which the transmitting apparatus in Fig. 106 is replaced by a telephone transmitter in shunt with an inductance coil. The transmitter is also in shunt with the local ground portion of the circuit between the stakes g . The current is supplied by a battery between one terminal of the inductance coil or transmitter and the earth. The function of the inductance coil is to augment the current variations. For example, according to the inventors, when the resistance of the transmitter is suddenly increased the current in the earth portion of the local circuit is thereby increased, which increase is augmented by the discharge or "kick" from the inductance coil which occurs at the same time. At the distant station the signals are received by a telephone receiver whose terminals are grounded a short distance apart. Experiment seems to show that the current does not follow a direct path from one stake g to the other, but appears to spread out over a large area like ripples over the surface of water, the ripples being about 180° apart in phase. Hence, if a receiver be so grounded that there is a difference in the potential at its respective terminals, sounds will be heard corresponding to the variations of current at the transmitter.

CHAPTER XIV.

DETECTORS—INTERRUPTERS—TRANSFORMERS—SPARK-GAP— CONDENSERS—ANTENNÆ. THEORETICAL AND PRACTICAL NOTES THEREON.

ELECTRIC WAVE DETECTORS.

THE term "coherer" was first used by Sir O. Lodge in connection with a phenomenon discovered by him, namely, that when two metal electrodes are in slight contact, electric oscillations in the circuit cause them to cohere; a slight tapping sufficing to decohere them. This term was subsequently applied to the filings-coherer, and more or less generally to all other types of electric wave detector. Inasmuch, however, as several of the newer detectors are in nowise coherers in the sense mentioned, other terms, such as the Marconi magnetic detector, the De Forest electrolytic responder, and the Fessenden barretter, have come into use, together with the terms auto-coherer, anti-coherer, etc., to indicate more definitely the particular types of detectors intended. As a generic term for all types of electric wave detectors, Professor J. A. Fleming has suggested the word "kumascop," from two Greek words signifying "wave spy." Following this suggestion, other writers have proposed the term "kumagram" for a wireless or wave message. The present writer has more than once proposed the terms "ondescope," "ondegraph," and "ondegram," from the French "onde" (wave), as being descriptive and euphonic, even if not altogether acceptable to philologists.

The cause of the change in the electrical resistance of the particles of a filings-coherer when acted upon by electric oscillations is not absolutely known. Arons and others have investigated their action under the microscope, and found that when the filings are brought into imperfect contact (having at such a time high resistance) almost perfect contact is made simultaneously with the occurrence of electric

oscillations. Arons noticed that the filings were violently agitated and saw sparks playing among them. It was also found that the contacts were destroyed after continued exposure to the waves, and that the coherers became fatigued after a time, which latter result has been observed by Marconi and others. It has been suggested that the effect mentioned is a magnetic one, but this view is not held to be tenable, because non-magnetic substances, such as powdered plaster of Paris, are also attracted under the influence of electric oscillations. The generally accepted explanation is that the filings are electrostatically attracted to one another with sufficient pressure in the case of metal filings to bring about a fall in their resistance. Lodge considers it a singular variety of electric welding. On this assumption, the filings should be few in number, that the E. M. F. may not be too much subdivided, light in weight, and not easily oxidizable. Aluminum has been proposed for its lightness, but is unsuitable owing to the readiness with which it takes on a coating of oxide, which introduces a high resistance that renders the metal too insensitive for the purpose. Tests have shown that after the filings have been acted upon by a heavy discharge and thus cohered, if then subjected to a lighter discharge the filings lose some of their conducting qualities. Lodge has shown that the resistance of the filings appears to vary directly with the intensity of the electric waves, and has availed of this fact to decohere the filings, namely, by sending weaker waves from an available source momentarily through the coherer. Still another theory to explain the said change of resistance in the coherer is that the air that is known to exist between particles, even when in so-called light contact, is dissipated by an increase of surface tension over such surfaces, due to the electric oscillations. It has been found that a certain minimum resistance exists during the time that the coherer is acted upon by the oscillations. If the normal stable equilibrium corresponds to a value nearly equal to this minimum, the condition is that of the ordinary coherer. If, contrariwise, the equilibrium is unstable, the coherer can decohere spontaneously, or is auto-decohering. An explanation of this by M. Hurmuzeseu is that the action of the electric oscillations produces sparks between the metallic filings, which cause them to weld, occasioning thereby real coherence, which requires tapping to decohere. Or the oscillations produce brush discharges which oxidize the particles, and thereby increases the resistance of the metallic chain, producing anti-

coherence. If the metal is not in an oxidizing atmosphere and the cohesion is not determined by welding, the brush discharge ceases with the oscillations, producing auto-coherence.

M. O. De Bast considers a filings or powder coherer as a group of very small condensers arranged in series parallel (see De Forest Leyden jar arrangement), each pair of particles being separated by a thin coating of oxide, thus forming opposite plates of a simple condenser of very small capacity. If the difference of potential of the vertical wire be sufficient to cause a spark in the coherer with which it is in series, the spark passes from particle to particle, tearing off at each gap a small part of the oxide coating and making a metallic contact which allows the battery current to flow, a slight tap separating the particles.

Experiments by Mr. Carl Kinsley have shown that the filings cohere under an E. M. F. of from 2.5 to 5 volts, depending on the sensitiveness of the coherer, there being apparently a critical E. M. F. for each coherer. This is tantamount to saying that each coherer possesses a "figure of merit," as the phrase has long been used in telegraphy, namely, the reciprocal of the least amount of E. M. F. or current to which it will respond operatively, and this applies to all types of wave detectors. (See Fessenden tests, end of this section.)

E. Dorn examined various metals under different conditions as to their suitability for coherers, and noticed that the noble metals, platinum, gold, and silver, gave practically no change of resistance. Copper filings at first gave no change of resistance, but after some hours a slight change was noticed, and in three weeks the initial resistance was 300,000 ohms instead of one ohm, as in the first instance. Then after exposure to electric oscillations the resistance fell to 10 ohms. After tapping, resistance rose to 187,000 ohms. A tuning-fork nearby reduced the resistance to 10,000 ohms. Some early experiments by E. Aschkinass demonstrated that powdered peroxide of lead acts as a coherer. No chemical reaction appears to take place even after prolonged exposure to the oscillations. He observed, somewhat contrary to Dorn, that some of the noble metals, like silver, gold, and platinum, acted as a coherer after severe shaking; further, that a gentle heat tends to restore coherers to their original resistance, and that a hot coherer is "self-righting," another term for auto-decohering. The chief difficulty now found with coherers of silver, gold, and platinum filings is their great sensitiveness; and,

as has been noted, Marconi uses a small percentage of silver in his coherer to increase its sensitiveness.

M. Turpain, in his work "Ondes Electrique," points out that if in a Hertz resonator R , Fig. 107, an opening s' of say 1.2 inches, independent of that at the micrometer-screw s , be made, and if a telephone t with battery b be placed in the opening s' , the resonator will work as efficiently as when complete. At the moment the sparks virtually close the circuit by reducing the resistance of the spark-gap s the effect is noticeable in the telephone. It is not the oscillations that

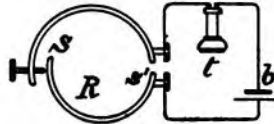

FIG. 107.
TURPAIN RESONATOR.

affect the telephone, but the closing of the circuit at the spark-gap that varies the E. M. F. of the battery and thus produces the sounds in the phone; this affording not only an easy means of studying the waves, but also providing a more delicate and satisfactory method, the ear being a much better organ for detecting the variation in the sound than the eye is of variations in light. The oscillations emitted by the exciter have a very short period, being of the order of billions per second, and the receiver, vibrating in unison with the exciter, has a similar period. The effect at the micrometer is not produced by a billion of sparks per second, but by billions of variations of potential per second. The eye as regards the sparks cannot take account of their extreme rapidity and sees them as one group, while in fact each group is made up of ten millions of oscillations. In short, M. Turpain adds, the telephone is in this respect about ten times more sensitive than the eye.

Mr. F. J. Jarvis-Smith states that very fine carbon powder, made from electric-lamp carbon, and placed in a small glass tube with suitable pointed electrodes, and in circuit with a galvanometer of 50 ohms, a resistance of 8000 ohms, and one dry cell of 1.4 volts, makes a detector very sensitive to electrical disturbances.

The utility of carbon powder, as well as many other types of auto-coherers, is somewhat limited by the fact that the variation in the resistance before and after cohering is very small, thus requiring a very sensitive instrument to detect the variations. Mr. S. A. Varley was probably the first to show the effect of high tension and alternating currents in breaking down the resistance of carbon particles, and before 1870 availed of this property of carbon for a form of

lightning arrester. He also showed that the resistance of carbon decreased with an increase of temperature.

Branly showed that two steel needles slightly rusted and laid across each other will act as a coherer. Fenyi notes that a very strong current can be used with a number of steel needle-coherers in series. With six such coherers in series they may be connected up with a primary cell of 1.5 volts. If several cells are to be used, three or four coherers must be added for every additional volt. In this way currents of one tenth of an ampere may be employed. In one experiment Fenyi had six needle-coherers in circuit with an electric bell and a Leclanche cell. A small spark excites the coherer and the bell rings. The vibration of the bell decoheres the coherer. This coherer may be used to announce distant thunder-storms if put to earth on one side and connected with an insulated wire 100 to 1000 feet long—the greater length of wire giving the best results.

Mr. R. H. Bell, San Francisco, finds that a simple mixture of silver and carbon filings with a very small amount of iron filings made an excellent powder for a coherer. He describes another coherer consisting of a microphone in which one set of carbon pencils is replaced by a narrow strip of tin-foil. The instrument is inclined until the foil rests lightly against the lower carbon. The foil is attached to the upper pencil, and the pressure of the foil is regulated by a delicate spring. The lower carbon is filed down to a rather sharp edge. A relay is connected in the usual way. Five Leclanche cells are used. An advantage claimed is that by varying the pressure of the foil on the carbon clear and decisive signals can be obtained.

Alex. Poppoff has described, practically as follows, an auto-coherer consisting of a glass tube with electrodes composed of small blades of platina lapping over each other in the tube. The filings are hard steel grains with sharply defined edges, and a granular fracture, prepared so as to permit of varying degrees of oxidation of surface. The grains are made from ordinary steel beads, crushed into splinters and oxidized. The rounded and polished exteriors take but a very thin layer of oxide; the inner or unpolished parts take a thicker layer; while those surfaces that correspond to the cleavage are almost exempt from oxide.

Mr. James Foster King has patented a coherer and receiving system which consists of an exhausted glass tube in which are two flat silver electrodes insulated from each other longitudinally. The filings,

which rest on these plates, have a magnetic core of iron, over which is a thin coating of platinum that resists sparks and is also a good conductor, hence allowing more current to flow than would otherwise do so. The top of the glass tube is attached to a magnet which in turn is connected to the core of an induction coil. The relay is in the secondary wire of this coil, the primary of which is in series with the coherer, a small battery, an inductance coil, and part of the aerial wire. The other terminal of the coherer is to earth. When oscillations occur, the particles cohere and a current flows through the primary wire. This induces a current in the secondary, which operates the relay and at the same time magnetizes the pole-piece which attracts the magnetic particles, decohering them.

Professor G. M. Minchin has devised an auto-coherer which he has found very sensitive, namely, a glass tube in which is placed a small carbon pencil about .5 inch in length, upheld by two aluminum stirrups, curved lower ends of which form a cradle in which the pencil loosely rests. The vertical wire, at the top of which is a large plate, is attached to one of the aluminum wires; the other is grounded through a coil of high inductance but low resistance. A small battery and a telephone receiver shunt the coherer in the usual way. A modification of this coherer comprises a glass tube on the bottom of which is placed some mercury. The carbon pencil is upheld by the aluminum stirrups as before. A platinum electrode is connected to both of the stirrups in parallel. The other electrode rests in the mercury. A platinum wire connects the pencil with the mercury. Before the tube is sealed the mercury is boiled, thus leaving a mercury vapor in the tube. This detector decoheres promptly with a telephone receiver, but as the aluminum stirrups are in parallel both must act before a relay will operate without tapping. In the arrangement first described a relay should operate when but one of the contacts acts.

A detector due to M. Righi consists of a tube in which are a rarefied gas and two electrodes very close together (.039 inch), in circuit with a battery the strength of which is just a little below that necessary to pass current. When electric waves are set up in its vicinity the tube is illuminated, and the illumination ceases with the waves or oscillations. A galvanometer, which will return to zero when the waves cease, may be placed in the circuit.

M. Tissot has designed a coherer the tube of which is carried by the armature-lever of a magnet. When the coherer is operated the

armature-lever of a polarized relay closes the circuit of said magnet and the coherer tube is attracted, imparting a slight shock to the coherer, decohering it. He also found that the sensitiveness of a nickel-iron filings-coherer is increased by placing the tube parallel with the lines of the magnetic field, which, it has been suggested, is due to increased cohesion of the filings. Mr. C. G. Brown describes a detector which is decohered by magnetism. He uses iron or nickel filings in a tube having iron electrodes. A permanent magnet is caused to revolve before the electrodes, or they may be surrounded by a coil carrying alternating currents. In the presence of oscillations the filings cohere in the usual way, but when the waves cease the filings decohere, the external magnetism evidently drawing the particles apart. Mr. Brown also showed that the resistance of a vibrating contact is decreased by electric oscillations. Another writer has noted the analogy between the microphone as an imperfect contact apparatus which detects minute sound-waves, and the coherer as an imperfect contact device for detecting the minute electric waves. With regard to the detector variously known as the Castelli, Solari, and Royal Italian navy coherer (page 69), it may be stated that this detector was first described by Professor Tommasina in a note to a Geneva society, which was published in "L'Elettricità," Milan, July 7, 1900, which note mentions, among other coherers, one consisting of a drop of mercury between two carbon electrodes. Mr. J. Gavey finds that a sharpened pencil, adjusted and resting lightly on a steel spring, with a little spot of oil at the point of contact, acts very well as a detector. With this receiver he has picked up signals of all sorts of wavelengths from stations in England and France.

The modification of the Marconi magnetic detector referred to on page 71 is outlined in Fig. 108. *P P* are the pulleys, about an inch

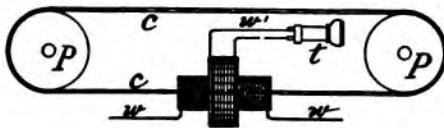

FIG. 108. MARCONI MAGNETIC DETECTOR.

in diameter, operated by clockwork; *c c* represents the iron band which passes through a small glass tube upon which coils *w w'* are wound. The iron band is about eighteen inches in

length, and is made up of a number of small iron wires, each about .005 inch in diameter, held together and covered by silk or cotton thread or braid, the outside diameter being nearly one eighth of an inch.

The band is magnetized by two ordinary horseshoe magnets (not shown in the figure), the ends of which are loosely laid, with their similar poles together, on the coils, and are adjusted as to their position on the coils until best results are obtained. The legs of the magnets are about four inches in length. While this detector is said to be very sensitive, the sounds which it produces in the telephone are very minute and require a keen ear to detect them. The writer's experience with several different forms of sensitive detectors in which the telephone is used would indicate that a sound-proof booth would be a valuable adjunct to the receiving system, as even the humming of an oil engine in an adjoining room has a disturbing effect upon the operator receiving the signals. In practice the filings-coherer and magnetic detector are interchangeable by means of a switch which connects one or other to the antenna as desired. In Marconi's latest form of filings-coherer the inner ends of the leading-in plugs are wedge-shaped, for a similar purpose to that described in connection with the Slaby-Arco coherer (page 86). The Marconi tapper is a small brass ball, less than .25 inch in diameter, carried on the end of an armature-lever; its motion is quite limited, and it strikes the tube lightly but rapidly.

Magnetic detectors in general are based upon the discovery of Professor E. Rutherford that when a very small magnetized iron wire is placed in the center of a coil of wire, the ends of which are connected to antennæ or wings, electric oscillations in the coil have the effect of hastening the demagnetizing of the iron, as mentioned on page 71, which effect Rutherford observed by means of a magnetometer, a device similar to the mirror of a Thomson reflecting galvanometer, the movement of which indicates a greater or lesser degree of magnetism in its vicinity.

Another magnetic detector employing this principle, due to Mr. H. Shoemaker, is shown in Fig. 109. In this a permanent magnet, with poles N S, is suspended by an arm or axle a , which is rigidly attached to the pulley p' . The latter is rotated by clockwork. A number of small iron wires c (No. 26 gauge), forming a core about .4 inch in diameter and 3 inches long, is surrounded by primary

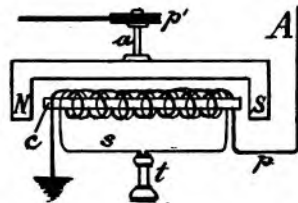

FIG. 109. SHOEMAKER MAGNETIC DETECTOR.

and secondary coils $p s$. The primary consists of one layer of No. 26 B. & S. wire; the secondary, of seven layers of No. 36 B. & S. wire. The terminals of the primary are connected with the aerial wire A and earth; the secondary has in its circuit a telephone receiver t . The rotation of the magnet around the core c produces changes of magnetism in the core which normally are not apparent in the telephone circuit. When, however, oscillations are set up in the aerial wire rapid changes of magnetism are effected in the core, and these set up currents in the secondary that are easily detected in the telephone t . This detector is not very sensitive, but has been found quite efficient up to distances of 25 miles with 24 vertical wires 160 feet in height.

Dr. Lee De Forest also employs a sensitive magnetic detector, based on the Rutherford principle, the details of which are not yet ready for publication.

Another utilization of the Rutherford discovery, due to Professor J. A. Fleming, is one for the purpose of determining quantitatively the wave-making power of different wave-radiators, the efficiency of different forms of spark-gaps, oscillating circuits, etc., and is described by the inventor as follows: A pasteboard tube .75 inch in diameter and 6 inches long is surrounded with 6 coils of No. 40 silk-covered copper wire, each containing about 6000 turns. The coils are joined in series and have a resistance of about 6000 ohms. Inside the tube are placed 8 small bundles of iron wire 6 inches in length, each bundle being composed of 8 wires of No. 26 S. W. G., previously well paraffined or painted with shellac. Each bundle is wound over uniformly with a magnetizing coil formed of No. 36 silk-covered copper wire in one layer; and over this, but separated from it by one or two layers of gutta-percha tissue, is wound a single layer of No. 26 wire, forming a demagnetizing coil. This last coil is, in turn, covered over with one or two layers of gutta-percha. The magnetizing coils are connected in series with one another, so that when a current passes through the whole of them it magnetizes all the bundles in the same sense. The outer or demagnetizing coils are joined in parallel. In addition to this coil there is a rotating commutator, consisting of a number of hard fiber disks, secured on a steel shaft driven by an electric motor at about 500 turns a minute. There are four of these disks, and each has let into its periphery a strip of brass, occupying a certain angle of the circumference. The brass

sector of the first disk occupies 95 degrees of the circumference. The brass sectors of the second and third disks occupy 135 degrees of the circumference, and that of the last disk, 140 degrees. Brass brushes make contact with these disks, and serve to interrupt or make electrical circuits as they revolve. The function of the first disk is to make and break the circuit of the magnetizing coils placed around the bundles of iron wire, thus applying a magnetizing current during a portion of one period of rotation of the disk, leaving them magnetized during the remaining portion. The function of the second and third disks is to short-circuit the terminals of the secondary coil of the bobbin during the time that the magnetizing current is being applied by the first disk. A sensitive movable-coil galvanometer is employed in connection with the secondary coil, one terminal of the galvanometer being permanently connected to one terminal of the secondary coil, and the other terminal connected through the intermittent contact made by the fourth disk. This disk is set so that the time the secondary coil is short-circuited, and while the battery current is being applied to magnetize the wires, the galvanometer circuit is opened. During one complete revolution the operation goes on as follows: First, the magnetizing current of a battery of secondary cells is applied to magnetize the iron bundles, and during the time that this magnetizing current is being applied, the terminals of the fine-wire secondary coil are short-circuited, and the galvanometer is disconnected. Shortly after the magnetizing current is interrupted, the secondary bobbin is un-short-circuited, and an instant afterward the galvanometer circuit is completed and remains completed during the remainder of one revolution. If, during the period when the galvanometer is connected to the secondary coil, an electrical oscillation is passed through the demagnetizing coils, an electromotive force is induced in the secondary bobbin by the demagnetization of the iron, and causes a deflection of the galvanometer. Since the rotation of the commutator is rapid, these impulses produce a continuous deflection of the galvanometer which is proportional to the demagnetizing force being applied to the iron. The instrument can be employed as a telegraphic receiving instrument, or it can be used to verify the law according to which radiation falls off with distance. For comparing together the wave-making power of different radiators the oscillation coils must be conducted to two long connecting wires, or one end may be connected to the earth and the other to a ver-

tical aerial. Professor Fleming suggests that this instrument will not only be found of great value in the design of radiators and transmitters for Hertzian-wave wireless telegraphy, but also in the investigation of the transparency or opacity of various substances to Hertzian waves. The instrument may be made as large as desirable, but it is necessary that the iron wires be quite small, and that they be assembled in small bundles. It is also necessary to short-circuit the fine-wire secondary coil, as described above, during the time of magnetization of the core.

Professor R. Fessenden has recently patented a liquid barretter, which is said to be much more sensitive than the hot-wire barretter mentioned in connection with the Fessenden wireless system. A number of such detectors are described. One such consists of a small cup across the inner center of which is placed a glass diaphragm. A small hole is formed in the center of this diaphragm, into which hole a capillary tube, having an inside diameter of about .003 inch, is cemented, after which the ends of the tube are ground off until they are flush with the diaphragm. The cup is filled with a liquid solution, and the diaphragm forms a partition between two portions of the solution, these portions being thus separated except by the thin column of the liquid in the capillary tube, which column forms the barretter. A small platinum wire connected with the vertical wire extends into the upper portion of the solution, while a similar platinum wire connected to earth enters the lower portion of the solution through the cup; or these wires may be in the secondary circuit of a transformer. Another form of liquid barretter consists of a minute fiber, such as a cotton thread, which is used as the loop of a barretter, the liquid being supplied to the loop by capillary action. Professor Fessenden has found that such liquids as carbonate of soda and nitrate of potash give good results, but nitric acid is preferred, as the effects obtained by its use are the strongest. Some of the advantages of liquid barretters noted by the inventor are that by reason of their nature they are not injured by excessive discharges; also, the specific resistance of liquids is much higher than that of metals, in some cases as much as a million times greater, and, consequently, to obtain the same resistance a very much smaller mass, capable of being heated to a much larger extent, may be used; further, the amount of change of resistance per degree of temperature is very much greater—for example, the resistance of sulphuric acid when not quite concentrated changes

approximately twelve per cent. per degree centigrade, while the change in platinum is only about one third of one per cent. With a liquid barretter having a resistance of 600 or 2000 ohms the increase of conductivity when the liquid is heated is so marked as to permit of the operation of a siphon recorder, though a telephone may be used when desired.

It has been noticed in practice that the precautions found necessary to protect the coherer from extraneous waves when very sensitive coherers are used are not so essential with less sensitive coherers. In the latter case, if the disturbing circuits are shunted with non-inductive resistance it is sufficient. The quality of the tap imparted to the tube has an important bearing on the facility with which the coherer will resume its original resistance. Some experimenters have found that blows at regular intervals are preferable to a series of blows at irregular intervals. Coherers made from the magnetic metals, iron, nickel, and cobalt, have been found to give best results in practice.

A common way of ascertaining the sensitiveness of a coherer or detector is to operate a small electric bell or buzzer in its vicinity with one or two dry cells. For instance, in the case of the De Forest responder, which is freely exposed to extraneous waves, as shown in Fig. 86, the adjustment of the instrument may be regulated by the waves set up by such a bell or buzzer, the distance of the bell from the antenna giving a clue to the sensitiveness of the adjustment. A filings-coherer for operating at a distance of about twelve miles should be sensitive to such a bell at a distance of at least six feet. A very sensitive coherer will be affected by the oscillations thus set up at a distance of forty or fifty feet and with doors and walls intervening. The opening of a switch of an electric light circuit or a near-by key of a telegraph circuit will also affect such a coherer or detector.

A crude but simple method employed by the writer for showing the action of electric waves upon filings is as follows: Strew some nickel filings on the center of a piece of drawing-paper or on a visiting-card. Filings obtained by filing a five-cent nickel piece with a rough file are suitable. Insert two common pins through the card so that their points come nearly together in the filings. Attach fine wire to the heads of the pins and lead them to the relay or galvanometer circuit. The writer has used for this purpose a 150-ohm Hughes relay. A common electric call-bell is placed in circuit with the armature-points of the relay. With a battery of five or six dry cells in

the call-bell circuit it is found that the sparks at the local contact points set up sufficiently energetic waves to affect the coherer. The sparks are first established by closing the armature of the relay with the finger. The filings then cohere and remain so until the card-board is tapped with the finger. A common static electric gas-lighter may also be used to set up the oscillations.

Mr. W. J. Clarke, of New York, who was perhaps the first experimenter with wireless telegraphy in this country, has designed several variations of the oscillator and coherer circuits and apparatus, some of which as used for simple experiments are shown in Figs. 110 and 111. In Fig. 110, ι is the two-inch spark induction coil of the

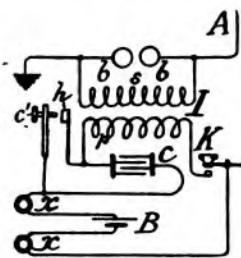

FIG. 110.

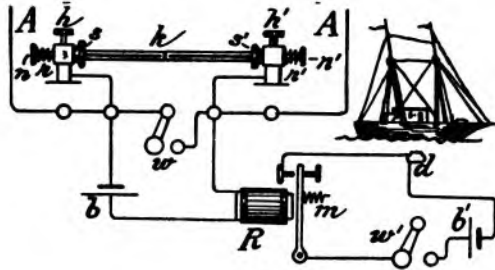

FIG. 111.

oscillator, which latter is placed at any proper distance from the receiver; bb are the spark-balls, about one inch in diameter, connected to a short wire A and ground, and to the secondary coil s ; p is the primary coil. The coil has a core (not shown) of small soft-iron wires, an end of which is opposite the hammer armature h , which, in operation, vibrates to and fro against contact-point c' . The hammer interrupter h is shunted by condenser c placed in the base of instrument. This condenser is made of about eighty sheets of tin-foil, eight inches long by four inches wide, each sheet separated by thin paraffin paper. The resistance of the primary wire is about 2 ohms, No. 17 wire, that of the secondary about 3200 ohms, No. 35 wire. k is a Morse key in the primary circuit. The battery B , which may consist of five or six dry cells, is connected to posts $x x$. Fig. 111 represents apparatus and circuits by means of which Mr. Clarke experimentally demonstrated the blowing up of miniature ships, etc., in a tank of water. This arrangement of a separate coherer may be used

for any purpose in which the closing of a circuit at a distance without wires is desired, as, for instance, in firing cannon, exploding mines, etc. For this work the coherer should not be too sensitive, as stray waves might prematurely close the circuit. In the figure, k is a coherer without the tapper; $b b'$ are batteries; R is a Morse relay of about 100 ohms resistance; d is a detonator placed under a boat or in the mine.

The filings are indicated by the dark vertical line at the center of the tube. Mr. Clarke uses 40 to 60 small nickel filings. Small brass rods attached to the milled heads $n n'$ are inserted in the tube. The position of the rods in the tube is adjusted by screws $s s'$, spiral springs $r r'$ tending to withdraw the rods, which are held in any position by set-screws $h h'$. Vertical wires $A A$ 10 to 20 feet high are attached to the outer screw posts; the wires of the relay and coherer circuit to the inner posts as indicated. In this use of the coherer the filings are decohered by tapping with the fingers or a pencil. The mode of adjusting this coherer is as follows: The rods in the tube are separated until the filings do not close the circuit. The coherer is then short-circuited by a piece of wire or a strap key κ . (As stated elsewhere, a very sensitive coherer may be short-circuited by touching the moistened fingers to its terminals.) This closes the relay circuit. The armature of the relay R is then adjusted by opening and closing the switch w , the play of the armature-lever between its contact-points being very small and the pull of the retractile spring m very weak, the relay being operated with one dry cell b . The strap key is then left open and the near-by oscillator I is operated. The transmitter is then operated and the coherer rods or electrodes are then pushed in until the filings cohere sufficiently under the influence of the electric waves to close the relay. The transmitter is opened and the coherer is decohered by tapping. Normally the circuit is open at the coherer. It is essential to place a switch w in the detonator circuit to hold the circuit open until the preliminary arrangements are made.

The detonator usually consists of a mixture of gunpowder with about 100 grains of fulminate of mercury placed in a one-ounce round vial. As this preparation is somewhat dangerous to transport, a two-ounce vial filled with about 1.25 ounces of F. F. G. rifle powder may be substituted. A "powder head" is placed in the vial, and the wires are led out at one side of the cork, the bottle then being sealed with

“electrical” cement. According to Mr. Clarke this cement is made as follows: 5 lbs. resin, 2 lbs. beeswax, $\frac{1}{2}$ lb. red ochre, 2 oz. plaster of Paris. Melt with gentle heat and rigidly exclude flames. The bottle is hung so that the cork is three or four inches below the bottom of the boat. In this experiment care should be exercised to see that the bottle hangs straight down in the water, as otherwise the glass of the vial may be driven out of the water by the explosion. If, however, a small quantity of the fulminate of mercury is used, the glass will be pulverized and thus rendered harmless. Otherwise the powder alone is sufficient.

When a sounder or register is placed in the circuit of *b'* in place of the detonator, and when a tapper is used, the latter is adjusted until the best results are obtained, which is indicated by the nature of the signals received. It may be noted that from the broken-up character of the signals received by a filings-coherer, careful adjustment of the register is necessary in order to obtain readable signals. The difficulty is increased, according to the writer's experience, when the attempt is made to receive the signals by sound on the ordinary Morse sounder. Signals may be read from the sounds of the tapper, which vibrates with the armature of the relay.

A number of inventors, notably Mr. Nikola Tesla, have suggested the use of coherers and wireless telegraphy for directing the movements of submarine or torpedo boats, and to ignite explosives on such boats. This would be effected by means of motors set to perform different operations upon such a vessel, each motor being controlled from a given point by a series of wireless telegraph receivers attuned to different rates of electric waves. One such motor might start the engine, one or more would operate the steering gear, etc.

Professor Fessenden gives the following valuable data as to the relative and absolute efficiencies of different wave detectors. Electrical energy required to operate the Marconi filings-coherer, 4 ergs per dot (one erg = one ten-millionth watt). The gold-bismuth detector (gold 95 per cent., bismuth 5 per cent., alloy), 1 erg per dot. Solari receiver and various types of carbon-steel, steel-aluminum, and steel-mercury detectors, 0.22 erg per dot. Magnetic hysteresis detector, 0.1 erg per dot. Hot-wire barretter, 0.080 erg per dot. Liquid barretter, 0.007 erg per dot. In the tests which gave these results the detectors were adjusted to their maximum operative sensitiveness, and the telephone indicator receivers were adjusted to a point at

which they were just stable when not acted upon, and to give a change of current of ten one-millionth amperes in the telephone.

Considered from a practical standpoint, there are, it may be said, two general types of electric-wave detectors, namely, the recording and non-recording. The first includes those detectors in which the variation of resistance or current produced by the oscillations is sufficient to operate a relay of some kind; the second includes those in which the variation of resistance or current is not sufficient to operate a relay, but yet suffices to produce signals in a telephone receiver, the supersensitiveness of which instrument is well known. (Calculations have shown that this instrument is responsive to an amount of electrical energy represented by the one-millionth of an erg, and it will indicate a variation of current of one sixty-millionth of an ampere.) Obviously the telephone can be used also with the less sensitive detector. A recording detector requires less skill on the part of an operator in the reception of signals, inasmuch as it is easier to learn to read the signals from a record than by sound. The telephone as a receiver has the advantage that in the event of interfering signals an expert operator can sometimes pick out the signals from his own station, and in the recent yacht races in New York Harbor it is said this was actually done by the De Forest operators. Such signals would be unreadable on an ordinary strip record. This advantage of the telephone as a receiver was also noticed on the wireless circuit between Jersey City and Philadelphia by Fessenden, who points out further that when the interfering signals were strengthened and the Philadelphia signals were weakened the reading of the messages was easy; and, he adds, this shows that if the difference in intensity is sufficiently great, within limits, both sounds are readily separated. (See page 51.)

INTERRUPTERS—TRANSFORMERS.

Hitherto the most common method of originating the electric oscillations employed in wireless telegraphy has been by means of a Ruhmkorff coil giving about a ten-inch spark. According to Fleming, the primary of a coil giving a ten-inch spark consists usually of 350 turns or 300 feet of heavy copper wire about .1 inch diameter, having a resistance of about .35 ohm, with an inductance of about .02 henry. The secondary wire consists of about 10 miles of copper

wire .008 inch diameter, giving 50,000 turns of wire, with a resistance of 6600 ohms and an inductance of 460 henrys.

Such coils, however, are giving way, in many cases, to motor-driven alternating current generators and step-up transformers. As previously noted (page 7), the ordinary interrupter of the induction coil is based on the principle of the electric door-bell, in which a soft-iron hammer carried on the end of a strip of springy metal is placed opposite the core of the coil (see Fig. 111). The contacts of the primary are carried on the spring and on a post adjacent thereto. This is termed a hammer interrupter, and its rate of vibration is about eight to twelve per second, depending somewhat on the tension of the spring. Owing to the comparatively strong currents employed (about eight amperes) in the primary circuit the contacts are rapidly worn, and it requires much attention to maintain them in proper adjustment. When currents of over ten amperes are used the platinum contacts are apt to fuse, this rendering necessary a resort to other and more practicable forms of interrupters.

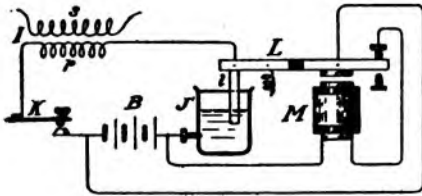

FIG. 112. MERCURY INTERRUPTER.

As intimated elsewhere, the E. M. F. employed with this induction coil is generally about 10 to 15 volts. This is furnished usually by a primary or storage battery. When current from street mains is available the voltage must be cut down by means

of incandescent lamps or other suitable resistances.

In modifications of the hammer interrupter, the primary circuit is broken independently of the core of the coil, as outlined in Fig. 112, in which *p* and *s* are the primary and secondary wires of the induction coil; *K* is a Morse key; *J* is a jar containing mercury; *l* is a metal arm extending from the lever *L* into the mercury; *M* is an electromagnet. The arrangement of the circuits is such that the lever *L* will vibrate continuously, the arm *l* rising out of the mercury at each upward motion, and thereby interrupting the circuit of battery *B* through primary wire *p* when key *K* is closed. When that key is open no current flows in the primary wire. A switch is provided to open the circuit of *M* when desired. To quickly break the spark when arm *l* leaves the mercury, and also to prevent oxidation, a layer

of water, alcohol, or petroleum is placed on the mercury. By some workers petroleum is given the preference for this purpose, as it has a high point of ignition and evaporates but slowly. An advantage of the mercury interrupter over the hammer interrupter is that the break is more sudden; also with the former the duration of the contact may be made longer. Lord Rayleigh has pointed out that if the interruption of the circuit could be made with sufficient rapidity, as by cutting the wire with a bullet from a rifle, the condenser in the induction coil could be dispensed with; and other experimenters have obtained a decided increase in the length of the spark, with a given E. M. F., by the use of devices that cause quick breaks of the primary circuit. To facilitate rapid breaks for this purpose, other forms of interrupters, known as mercury-jet interrupters, are employed, in which a jet of mercury is thrown against rapidly moving metal contacts rotated by suitable motors.

As another means of securing rapid breaks in the primary circuit of the induction coil, the Wehnelt interrupter, shown in Fig. 113, has been used in wireless telegraphy. This is an electrolytic interrupter, and is connected directly in the primary circuit of the induction coil, no condenser being required. In the figure, *J* is a quart glass jar, filled with a solution of one part of sulphuric acid to eight parts of water. The jar is provided with an insulated cover which up-

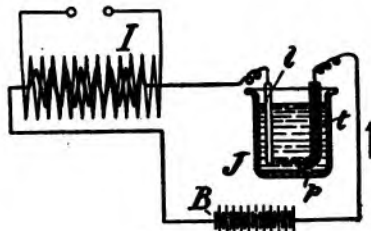

FIG. 113. WEHNELT INTERRUPTER.

holds a sheet of lead *l*, and a glass tube *t* about .25 inch in diameter, filled with mercury. The lead sheet is nearly the width of and reaches almost to the bottom of the jar. A platinum wire *p*, No. 20 gauge, extends outside of the tube, and is sealed in it. By turning the tube *t* the position of the lower end of the platinum wire relative to the sheet of lead may be readily adjusted. The upper end of *l* and the mercury in the tube are connected by clamps to a source of E. M. F., *B*, and to the primary of the induction coil *I*. At least 25 volts are required to operate this cell as an interrupter. When the circuit of *B* is closed the interruptions occur at the rate of 100 to 1700 per second, the rate of interruptions increasing with the voltage.

The efficiency of the apparatus is increased with whatever increases the self-induction in the circuit. Ordinarily the inductance of the primary of the induction coil is sufficient. An advantage of this interrupter is that the E. M. F. and strength of current may be increased beyond what would be feasible with platinum contacts of the ordinary contact interrupter, and in this way the output of the induction coil may be enhanced. Care must be taken that the tube does not break near its lower end, and for this reason an ebonite tube is preferable to glass. A number of theories have been offered to account for the action of this interrupter. According to Walter, when the current first begins to flow oxygen is formed on the positive pole, and the temperature rapidly rises until a layer of steam forms around that pole. This is sufficiently non-conducting to cause considerable reduction of current. The self-induction in primary thereupon produces considerable increase of E. M. F.; the layer of steam is electrolyzed into a mixture of explosive gases and is finally exploded by a spark. The explosion drives the liquid from the positive pole, producing thereby a rapid momentary cessation of current.

In the majority of transmitters now employed in wireless telegraphy the oscillations are not only rapidly damped, but also have a comparatively long interval between each interruption, all of which reacts against successful resonance. Hence it has frequently been suggested that to obtain more efficient resonance the transmitter should be supplied with high-pressure, high-frequency currents of uniform amplitude. Therefore the Wehnelt interrupter, with its capability for rapid interruptions, would seem excellent for this purpose were it not for the fact that at each interruption a capacity has to be charged—either the aerial wire or a condenser, now usually the latter, which discharges its stored energy into the aerial wire. And inasmuch as the time of charging a condenser is roughly about seven times greater than the time constant of the circuit, which constant, in turn, is equal to the product of the resistance in megohms and the capacity in microfarads of the circuit, the high resistance of the secondary wire of the induction coil used with the Wehnelt interrupter places a rather low limit on the number of interruptions per second that can be utilized with this apparatus or any other interrupter employing directly an induction coil. For example, if the resistance of the secondary be, say, 10,000 ohms (equal to .01 megohm) and the capacity of the circuit be .02 microfarads, the time constant

will be .0002 seconds, and the time during which the maximum E. M. F. should be applied to properly charge the condenser should be approximately one five-hundredth of a second, which would limit the number of interruptions in such a circuit to about 500 per second. There is, besides, the time of total charging and clearing out, which still further reduces this limit.

The mercury-vapor interrupter, which is a modification of the Hewitt mercury-vapor lamp, has also been proposed as available in wireless telegraphy to secure the desired resonance, because of the high rate and uniformity of its interruptions, but thus far it has not gone into practical operation. This interrupter is indicated at *v*, Fig. 114. It consists of a glass globe, at the bottom of which two tubes *tt* are sealed in.

These tubes are partially filled with mercury. The connections for this interrupter as arranged for wireless telegraphy are shown in the figure, in which *D* is an alternating current generator and *T* is a transformer for raising the potential to 10,000 or 14,000 volts, as desired. The interrupter here takes the place of the spark-gap, and is shunted by the condensers *cc*. *p* is the primary of an induction coil *I*, of which *s* is the secondary, connected in series with the vertical wire *A* and ground. In the operation of the Hewitt vapor-lamp it is found that the negative electrode offers a very high resistance to the passage of current through it until the E. M. F. reaches a certain critical value, say 10,000 to 14,000 volts, when this resistance suddenly collapses, whereupon current flows through the lamp or tubes. When, however, the E. M. F. now falls to a small value, the initial cathode (negative pole) resistance again instantly becomes operative, stopping current flow. When arranged as in the figure, the transformer charges the condensers during the short time that the cathode high resistance exists. As soon as this resistance falls as stated, the condenser discharges itself through the globe, setting up rapid oscillations in the aerial wire or other circuit, the rate of which is regulated at will by varying the capacity *cc* or inductance *I*. This interrupter differs from the ordinary spark-gap

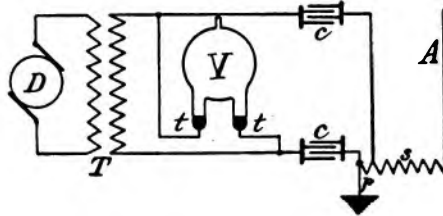

FIG. 114 HEWITT INTERRUPTER.

the place of the spark-gap, and is shunted by the condensers *cc*. *p* is the primary of an induction coil *I*, of which *s* is the secondary, connected in series with the vertical wire *A* and ground. In the operation of the Hewitt vapor-lamp it is found that the negative electrode offers a very high resistance to the passage of current through it until the E. M. F. reaches a certain critical value, say 10,000 to 14,000 volts, when this resistance suddenly collapses, whereupon current flows through the lamp or tubes. When, however, the E. M. F. now falls to a small value, the initial cathode (negative pole) resistance again instantly becomes operative, stopping current flow. When arranged as in the figure, the transformer charges the condensers during the short time that the cathode high resistance exists. As soon as this resistance falls as stated, the condenser discharges itself through the globe, setting up rapid oscillations in the aerial wire or other circuit, the rate of which is regulated at will by varying the capacity *cc* or inductance *I*. This interrupter differs from the ordinary spark-gap

in that when the half-period of the transformer is nearly complete, and thus the current is nearly at its zero value, the cathode resistance comes into play until the condenser is again charged. In this way, it is pointed out, a succession of rapid-current impulses, separated from each other by small intervals of time, is obtained; these time intervals depending on the rapidity with which the transformer can recharge the condenser after each disruptive discharge in the tubes. It has been estimated that with sufficiently high power in the dynamo and transformer the current impulses may be made to occur at the rate of several millions per second. In experiments described by the inventor, in which a small alternator of about 2 kilowatts was employed and in which the capacity of the condensers was .015 microfarad and the diameter of the secondary coils was 38 inches, a rate of discharge of one million per second was secured. This interrupter is markedly efficient, there being a drop of but 14 volts at all pressures in the tube; this loss of energy being used in vaporizing the mercury which condenses on the walls of the globe and runs back into the mercury receptacles, thereby assisting in cooling the globe.

Another interrupter, somewhat analogous to the foregoing, which has also been proposed for wireless telegraphy is known as the musical arc, due to W. Duddell, and described in British patent No. 21,629. Briefly, this interrupter is one in which a direct current is supplied to an arc lamp which is in parallel with a capacity and inductance. Under proper adjustment of the capacity and inductance rapidly alternating currents are set up.

The need of greater radiating power in long-distance transmission has, as already mentioned, led to the adoption of special oscillating inductors and transformers, of which examples have been given in the preceding pages. The transformers used by Marconi, De Forest, and others range in capacity from one kilowatt or less to fifty or more kilowatts, and transform the E. M. F. of the generator to 25,000 or 50,000 volts, as required. The frequency of alternations of the transformer depends on the design and frequency of the generator. The generators used by the International Wireless Telegraph Co. are operated at 60 cycles per second and have an output of 40 amperes at 100 volts.

A special form of induction coil now used in wireless telegraphy is about four feet in length. The iron core is made up of iron wires four feet long, forming a bundle about three inches in diameter. The

primary wire is composed of No. 16 copper wire measuring about 7 ohms. This is wound over the iron core, one terminal coming out at one end of the core, the other terminal at the other end. A tube of hard rubber, half an inch thick, is placed over the primary core from end to end. The secondary is wound outside of the primary in two sections, each section being composed of fine wire measuring about 6000 ohms. The finished coil is about ten inches in diameter. The completed coil is placed in a box which is filled with a liquid wax which speedily hardens to the consistency of resin. The primary terminals are connected to a generator giving current at a desired voltage and rate of alternation, which is raised to a high voltage at the secondary terminals, in some cases 20,000 to 40,000 volts.

The arrangement of coils and condensers forming an oscillating circuit, in which the condenser is charged by the secondary of a transformer or an inductance coil, and which condenser in turn discharges into the primary of another transformer, is sometimes termed the Tesla high-frequency coil. (See U. S. patent No. 454,622.)

A form of 10,000-volt induction coil or transformer made by Mr. W. J. Clarke, of New York, consists of a core composed of well-rusted soft-iron wire, No. 14 gauge, 14 inches long and 3.5 inches in diameter. Over this coil is wound 326 feet of No. 11 copper wire, or about three and one-eighth turns per volt. This coil and core are secured vertically on a thick wooden base by bolts. Its terminals are brought to clamps on the base. The secondary is wound on a paper tube 4.125 inches in diameter, and is composed of 56,000 feet of No. 32 wire, laid up in .25-inch sections, the walls of which are well insulated. This coil slips over the primary bobbin, and may be removed or replaced by another coil at will. This coil, when connected to a 104-volt alternating circuit, delivers 10,000 volts at the secondary; or it may be connected up with a mercury or Wehnelt interrupter.

A form of oscillator that may be employed in wireless telegraphy consists of a primary wire of one turn of half-inch tubing, brass or copper, arranged as a square with 50-inch sides. The secondary is a flat spiral of 110 turns of No. 18 B. and S. copper or brass wire, placed on a board or other suitable supports, the turns being well separated. The primary is placed five inches below or at the back of the secondary. The secondary is in series with a spark-gap and a 10-by-12-inch glass-plate condenser, adjustable by removing or adding plates. When the primary is connected with the secondary of

an induction coil giving 10,000 volts of 60 cycles per second, a beautiful 15-inch spark may be drawn from the center terminal into the air, the outer terminal being to ground. A 12-inch spark may be obtained between the inner and outer terminals. This coil is also manufactured by Mr. Clarke.

M. Lebedew and M. Bose devised an oscillator capable of producing oscillations the wave-length of which is not more than .23 inch. It comprises two cylinders of platinum .05 inch long and .019 inch in diameter, each placed in a glass tube with their sparking ends facing each other. Wires, in which is a condenser, connect the cylinders to the induction coil. This oscillator is placed on the focal line of a small cylindrical mirror having a focal length of .23 inch. The mirror and oscillator are immersed in oil.

SPARK-GAP—CONDENSERS—ANTENNÆ.

With comparatively small transformers only the ordinary precautions are necessary at the spark-gap to avoid short-circuiting; but when powerful transformers are used it is found that when the points are brought too close together an arc is formed, which tends to short-circuit the secondary circuit of the transformer and thereby give rise to heavy currents in the primary circuit. Even a partial short-circuiting stops the oscillations in the condenser circuit. As it is not permissible to increase the length of the spark beyond a certain point, owing to the resistance which this would introduce, various other means are employed to obviate this arc, some of which have already been noted, namely, the placing of a strong magnetic field transversely across the gap, also the use of an air-blast, which devices blow out the arc but do not prevent the operation of the oscillating sparks. (The air-blast also tends to keep the discharge points cool.) Fleming avoids this arcing by a certain arrangement of the magnetic coils in the primary circuit of the transformer of his transmitting circuit. Other experimenters have shortened the spark-gap while retaining a high E. M. F. by the use of compressed air or gases around the spark-balls or points. Fessenden, for instance, has found that an E. M. F. capable of giving a four-inch spark in ordinary air would only give a quarter-inch spark when the electrodes were placed under a pressure of 50 pounds to the square inch. He further found, by connecting a radiator of electric waves to one of the spark-balls, that up

to a pressure of 50 pounds per square inch the radiation was not improved, but above that pressure the radiation was greatly enhanced. For instance, at 80 pounds pressure the radiation was increased three and one half times, the E. M. F. being the same in each case.

The maximum length of the spark-gap employed in wireless telegraphy is about one inch. For high electromotive forces brass rods about five eighths of an inch in diameter, blunted at the sparking ends (in some cases tipped with aluminum or zinc), are now quite frequently used at the spark-gap. For transmitters employing two or more kilowatts, multiple spark-gaps are sometimes provided to dissipate the heat, and curved discs or adjustable balls, amongst which the spark is divided, are utilized for this purpose. This arrangement is found to augment the efficiency of transmission and to diminish the noise at the spark-gap.

To an experienced attendant the character of the spark is an index of the nature of the oscillations, and hence of the radiation, and he soon acquires the ability to adjust the length of the spark-gap and the amount of inductance and capacity necessary for best results from the general appearance of the spark. If the capacity is too small for the transformer or other source of energy, the spark will be yellow and flaming, like an arc. If too large, the length of gap must be decreased and spark will then be intermittent and irregular. With capacity constant the spark becomes fat and white as the inductance of the antenna oscillating system is cut out, and blue and stringy as inductance is added. (See auto-transformer L, Fig. 98*a*, also p. 67.)

It has been found advantageous in practice by some workers to employ in the oscillating circuit an excess of capacity over inductance in long-distance transmission. Lord Rayleigh, however, has shown that if the capacity of a radiating system exceeds a certain critical value its efficiency is diminished very materially. Actual experiments by Shoemaker have indicated that an excess of capacity in the oscillating circuit gives a curve of potential on the antenna that increases slowly till near the top, when it widens out abruptly. An excess of inductance gives a small loop of potential at the top, while equal inductance and capacity give a practically uniform curve, but a smaller maximum potential. The experimenter employed two long metal rods laid horizontally, to one of the terminals of which he connected an oscillating circuit. He bridged these rods at the first node of potential, as in the Lecher system of wires. Beyond this bridge he moved a stiff wire, one end of which was allowed to rest transversely on one of the rods, while the other end was approached to

the other parallel rod, measuring the length of the spark obtained as the wire was pushed along the parallel rods, when the results stated were obtained.

Professor Seibt shows the variation of potential in a wire by the following arrangement, Figs. 115 and 116, in which p s are the coils of a transformer T with an adjustable oscillating circuit s , L , c , c .

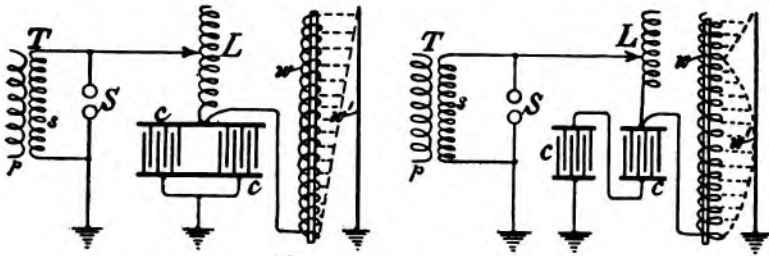

FIG. 115. SEIBT'S POTENTIAL INDICATOR. FIG. 116.

A long coil of fine wire w is wound on an insulated wooden rod six feet long and two inches in diameter, and is connected at its lower end to the oscillating circuit, as indicated. w' is a single wire held parallel to the coil w and earthed. When the inductance and capacity of the oscillating circuit are made to correspond with that of the natural periodicity of the coil w , luminous discharges may be seen to occur between the coil w and the grounded wire w' , the brightness of which increases with the potential, along the wire, which in the case in point would be as represented by the dotted lines in Fig. 115. If the period of the oscillating circuit is increased by varying the inductance and capacity of c , as by putting the condensers or jars in series, the wave-length is shortened as indicated by dotted lines in Fig. 116, which results may be varied at will by suitable arrangement of the inductance and capacity.

M. G. Ferrie describes a method which he employs to determine the wave-length of the oscillations produced in a vertical wire. He connects a horizontal wire to the vertical wire at a point between the oscillator and the ground. In the horizontal wire he places a hot-wire ammeter, which indicates by the movements of its pointer the amplitude of the oscillations. Then by varying the length of the horizontal wire, the amplitude of oscillations will vary between a maxi-

imum and a minimum: the maximum occurring when the wire is in tune with the oscillations. By this means the fundamental oscillation period as well as the harmonics of the oscillating system can be ascertained.

The main object, as previously intimated (page 48), in employing a number of vertical wires has been to obtain increased capacity wherein to store electrical energy to be radiated as electric waves, the vertical wire serving as one plate or plates of a condenser, the earth as the other, and the air as the insulating medium. The capacity of a vertical wire is obviously not uniform throughout its length, but decreases with its distance from the earth. Hence with a given charge oscillating in the wire, the potential at given points in the wire will increase as the capacity diminishes (see Lecher system of wires, p. 117), which will add somewhat to the amplitude of the potential loop at the top of the vertical wire, assuming a wave-length equal to four times that of the length of that wire. Fleming gives the capacity of a vertical wire .1 inch in diameter and 100 feet long, with its lower end 6 feet from the earth, as .0002 microfarad. It has been found that, owing perhaps to an opposing effect of mutual induction, the wires being charged with similar polarities, the effective capacity of adjacent parallel vertical wires is not equal to that of a similar number of widely separated single wires, but, according to tests by the authority just quoted, is about equal to the square root of the number of wires. He also points out ("Popular Science Monthly," August, 1903) that to store up a definite amount of electricity in a condenser, a certain definite amount of dielectric is required, regardless of how it is arranged. Thus, suppose a glass condenser of .0027 microfarad capacity, the dielectric of which is 12 inches square and .03 centimeters thick, giving a volume of 270 cubic centimeters, charged by 20,000 volts. The energy stored in the shape of electric strain is .5 joule. To store up one joule (equal to .7373 foot-pounds) would require 520 cubic centimeters of glass. In the case of air-condensers the energy storage is much less, being about one foot-pound per cubic foot or volume.

From a description of one of the Marconi station equipments, Koepsel has calculated there must have been a wave-length of 8528 feet, which would require a wire 1968 feet long to secure good resonance. The wire being only 295 feet in length, Koepsel assumes that the system of 400 vertical wires employed is necessary to shorten

the resonance when such large capacities and wave-lengths are used, and not for the purpose of increasing radiation into space.

The condensers for the transmitting circuits in wireless telegraphy are a very important part of the equipment. Generally speaking, Leyden jars are used for installations up to one or two kilowatts, owing to convenience of handling, cleanliness, etc., but for installations using more than two or three kilowatts glass-plate condensers are frequently utilized by Marconi, De Forest, and others (see page 66). The plate-glass condensers used by De Forest are 30 inches long by 15 inches wide, and are .25 inch thick. Tin-foil is so placed on each side of the plate as to leave a margin of four inches all around except at the connecting point. It is essential to thoroughly paste or glue the tin-foil to the glass to exclude air. The plates are generally immersed in a good quality of linseed oil, although some users of plate-glass condensers have obtained satisfactory results without oil. Domestic glass plates of the dimensions stated cost one dollar each. Imported German plates of the same size cost three dollars each in this country. The thickness of glass for this purpose should be at least one-tenth inch per 20,000 volts. The jar condensers used by Shoemaker are 16 inches high by 5.25 inches in diameter, and are specially made to withstand the pressures to which they are subjected, having a maximum thickness of .25 inch and a minimum of three sixty-fourths inch. Their cost is about seventy cents per jar. These jars have a capacity of .004 microfarad. In practice they have been found very durable, but ordinarily Leyden jars lose their efficiency after comparatively short service, owing to deterioration of the tin-foil due to brush discharges and sparking. The glass-plate condensers have the advantage as regards bulk. Where brush discharges must be eliminated to obtain sharp tuning and resonance, the use of plate-glass condensers in oil appears to be imperative. As inductive effects are proportional to the frequency, which in wireless telegraphy is high, inductance should be diminished wherever possible. To that end the length of the connecting wire should be the same to each condenser or jar (p. 66). When it is desired to avoid dielectric hysteresis metal plates with air as the dielectric are employed.

A number of different arrangements of the antennæ employed in wireless telegraphy have already been shown. In the Shoemaker system a latticed wooden tower supports the wires. From the top of a tower 160 feet in height, four well-insulated arms are projected. Each of these arms carries six No. 14 wires (held apart by spreaders), which drop vertically to within 15 or 20 feet of the earth, where they are

unitedly led into the instrument-room. In some of the recent inland stations of the Marconi company, as, for instance, at the 90-mile circuit between Milwaukee and Chicago, 15 wires are supported from one mast, as follows: The wires are suspended in series of five from the top of the mast, from which they are well insulated. The wires of each series are about 10 or 15 feet apart in the middle; each series is separated by a distance of 50 or 60 feet. Each wire of a series is attached at a distance of about 50 feet from the top of the mast M (Fig. 117) to a guy-rope r , which latter is attached to an anchor-post a in the earth, 40 feet or more from the base B of the mast. At its point of connection with the guy-rope each wire is drawn toward the foot of the mast, where all the vertical wires converge and are led into the operating-room. The wires thus form a $>$ with the mast as a base, and, being held well apart from one another, mutual static induction is measurably avoided. No spreaders are required. The mast at the Milwaukee station is situated about one-quarter mile from the lake shore. The station itself consists of a one-room wooden building about 18 feet long, 15 feet wide, and 10 or 12 feet in height, with an extension somewhat smaller, the latter containing the oil engine and generator.

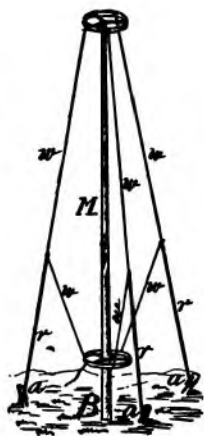

FIG. 117.

At Fessenden's Jersey City station, 20 wires, about No. 16 gauge, are suspended from a long wooden strip which is upheld by petticoat insulators supported by a rope between the tops of two masts about 150 feet high and 80 feet apart. The wires, two feet apart, drop vertically to a similar wooden strip, held parallel with the upper strip, where the wires are connected together and led into the hut through a bushing in a large plate-glass window.

As a means of elevating the vertical wire, kites and captive balloons have been proposed from the earliest days of the art of wireless telegraphy, and have frequently been used for temporary work. As pointed out by Marconi, the varying height of a kite would detrimentally affect the operation of syntonized systems. Edison, in his patent of 1891 on wireless telegraphy, proposed the employment of balloons for this purpose. The inclination of the angle of the vertical wires has been found not to make much difference in the results obtained,

but it must not exceed 40° . The material of the vertical wire does not appear to be very important except as regards strength, weight, and durability. As elsewhere remarked, the insulation of the vertical wires is very important, and some of the devices by which proper insulation is obtained have been noted. Metal and rope guy wires should be carefully insulated from the ground and mast. De Forest advises insulating iron guy wires in sections. According to Zenneck, a second vertical wire as long as the transmitting wire, erected near it and connected to earth, intercepts the electric waves, and hence prevents them from reaching distant stations in that direction. Braun has found that two vertical wires receive signals only when their planes nearly coincide with the direction of the incoming waves. In this way he notes the bearing of the sending station may be determined to within 10° , a result of special importance for nautical and military purposes.

The need of a good earth in wireless telegraphy has been found by most experimenters to be as essential as in wire telegraphy. This seems to be especially the case at the sending end, although in receiving also an improved earth connection has often resulted in improved signals. Mr. H. B. Jackson has found in the course of a number of experiments that the absence of grounding in the receiver reduced the signaling distance 50 or 70 per cent., and the absence of a ground in the transmitter, 85 per cent. The investigations of Professor Tanakadate have shown that large capacity in an earth plate is more important than merely good conductance, and therefore, that plates arranged in strips are superior for this purpose to square plates. To this end, probably, Marconi in some of his stations uses a long strip of metal inserted edgewise in the earth and projecting about one foot above the surface of the earth. Wires are run from various parts of this plate to the apparatus. De Forest in some cases uses a sheet of copper thirty feet long and four feet wide imbedded two or three feet in the earth, giving about 240 feet of surface. When practicable, the ground plate is sunk in the sea, which connection is considered by some workers to be the best. On shipboard, as previously noted, the earth is secured by attaching a wire to the bolts of the iron frame of the vessel. The experience of Braun in using capacity plates not directly connected to earth appears to be at variance with the experience of other workers, and hence it is thought that the capacities he employs are only apparently independent of the earth. It is under-

stood that in some of the latter installations of the Braun system a ground is employed. Jackson, in the experiments referred to elsewhere, found that a condenser of suitable capacity acts nearly as well as a ground. Guarini also transmitted signals between Brussels and Malines, in 1901, without a ground connection.

As noted on page 121, Professor Fessenden employs a wave-chute or artificial ground at the lower end of the antennæ. This chute may consist of a number of wires all connected together by transverse wires, or of a strip of metal; and where the waves are cut off by high buildings or high trees, this conductor should be extended until it passes beyond the limits of the obstacle and there grounded. This form of ground insures that the conditions near the antennæ shall be practically similar in all kinds of weather; and the inventor cites an instance where, without such an artificial conducting surface on rocky shores, the salt spray in stormy weather sometimes renders the ground surface near the antennæ conducting, while in fair weather it is insulating. He has found that even a few ohms resistance in the ground connection renders it impossible to send signals unless the artificial conducting surface is also present. In practice, the wires composing the wave-chute consist of ten or twelve galvanized iron wires, about No. 8 gauge, which, in the absence of buildings, extend along the surface of the earth for a distance of 100 feet or more, in the direction of transmission, when the wires are separately grounded by contact with metal rods stuck in the earth. M. Blondel does not consider this addition of a metallic conductor of half a wave-length under the vertical wires necessary, a large capacity or metallic earth-plates there sufficing.

In recent experiments in the vicinity of Detroit, Mich., Mr. T. E. Clark uses a large capacity at foot of a 65-foot transmitting aerial, not grounded, to avoid, as he states, overloading one side of the oscillator coil, and has obtained good results through a distance of twelve miles over a hilly, wooded country. The current strength in the primary wire of the induction coil is 1 ampere at 110 volts, direct current, broken by a magnetic vibrator in series with a liquid interrupter giving a high rate of interruptions. Spark-gap .25 inch. A hot-wire ammeter shows 1 to 1.3 amperes in transmitting antenna. A filings-coherer is used in series with a grounded vertical wire at the receiving station.

CHAPTER XV.

PRACTICAL APPLICATIONS OF WIRELESS TELEGRAPHY.

IN addition to the wireless circuits already mentioned as in operation, there is one from the Lizard to the Isle of Wight, 186 miles distant. There are also systems installed at different points on the coasts of European countries—at La Panne, Belgium, for example, and at Dorkum Island in the North Sea, off the mouth of the Ems. Many other lightships and lighthouses have also been equipped with wireless outfits, and eventually, no doubt, all lighthouses, lightships, and life-saving stations will be constituted wireless telegraph stations, whence messages may be signaled to and from passing vessels. Hundreds of mercantile steamships have already been equipped with wireless outfits, and it has become a common occurrence for such vessels to maintain communication with one another for hours in mid-ocean. In other instances vessels have been in wireless communication with one ship or another throughout the entire voyage. Wireless stations have also been erected on the piers of some of the large Atlantic liners, whereby the outgoing and incoming vessels may be in communication with their agents long after they leave, or before they arrive, at their docks. Doubtless, also, within a comparatively short period every steam-vessel of any consequence will be similarly equipped, and in time all kinds of craft, for the safety of officers and crew, and probably as a matter of economy as well, so far as relates to insurance, will be equipped with wireless apparatus sufficient at least for the purpose of transmitting code signals.

There is little question that the use of wireless telegraphy on warships will become general in the near future. Already many such ships are equipped with the Marconi, Braun, Slaby-Arco, or other systems. There are several reasons why such systems are especially applicable to and desirable on war-vessels, which depend so largely on signaling from ship to ship. In the first place, there is at present no

other practicable method of signaling at sea to a distance of even a few miles in foggy or hazy weather. Further, the officers of such ships, as a rule, already have, or can readily acquire, the necessary technical skill to successfully operate the system. Again, the vessels already carry the necessary masts for the vertical wires, and the apparatus and battery, or other source of E. M. F., do not require to be portable. These latter features, of course, also apply to mercantile vessels.

With regard to the use of wireless telegraphy for military purposes in actual warfare, the question is somewhat different, and the obstacles to its successful use for this work are considerable. Thus the question of obtaining and transporting masts or other suitable supports for the antenna is a serious one. This has already been found a difficulty in actual warfare in South Africa. Apparently captive balloons or kites have not been altogether suitable for this purpose, although such balloons have been used with some success in experimental work. In recent tests, signals have been transmitted from Portsmouth to Aldershot, England, about 70 miles inland, a captive balloon being employed at the last-named station. There is also the fact to be considered in this relation that signaling overland by electric-wave telegraphy is not as feasible as over water. It may be remarked in passing, that experiments by Fessenden have indicated that transmission over salt water is thirty times better than over fresh water. As noted elsewhere, distances of from 15 to 60 miles overland have been covered, but not always with satisfactory regularity. Even a distance of 15 to 30 miles would doubtless be a very valuable addition to military signaling in warfare. (See page 97.) There is, however, nearly always in land operations the alternative of wire telegraphy; and while the difficulties of transporting the poles or light rods and wire for overland wire telegraphy are frequently very great, they have rarely been found insurmountable, and where this may be the case, as when the enemy is between a relieving army and a beleaguered garrison, it is not unlikely that the enemy, by keeping up a cross-fire of electric waves, could prevent communication by means of wireless telegraphy. It may be noted that heliography was successfully maintained between the British relieving army and the Ladysmith garrison during the late South African war. A wireless telegraph system is now being installed in Alaska for the United States Signal Corps. This will probably be the most extensive overland system thus far established, and its progress will be watched with interest. It will

extend from Fort Gibbon to Chena, 200 miles, with an intermediate station at Tolovana, on the Tanana River. All of these stations are army posts. The United States government (or its various departments) has also experimented with the Marconi, the Fessenden, the De Forest, the Slaby-Arco, and Braun systems, at different places in this country.

It is proposed by Dr. Scholl to employ wireless telegraphy in connection with an expedition to the North Pole which is being organized in Munich. The plan includes a station equipped with the Braun system on Spitzbergen Island, of sufficient capacity to enable communication to be maintained with the exploring vessel, on which will be a similar wireless outfit.

Considerable progress with wireless telegraphy is reported from Japan. The first experiments were made between Yawata and Funabashi, a distance of eleven miles overland, and, afterward, between the shore and war-ships in Tokyo Bay, when a distance of twenty miles was covered. A large wireless plant is now being constructed, at a cost of over \$10,000, to operate between Japan and an island off Formosa, a distance of 850 miles. The system employed in Japan is due to a native of that country, and has not been described.

The attempt to utilize wireless telegraphy to and from moving trains has been tested in Canada and in Germany. In the German tests the conducting wire on the train was carried on insulators along the eaves of the cars, and the waves employed were 656 feet in length. The oscillations were transmitted to and from the cars on special wires which were strung on the telegraph wires along the track. The oscillatory currents did not disturb the signals passing on the contiguous telegraph or telephone wires, although a crackling sound was heard in the telephone. On the other hand, the wireless system was at first badly disturbed by the telegraph signals, the sparks at the opening and closing of the telegraph keys setting up oscillations that traveled along the conductor and affected the coherer. This defect was remedied by shunting the telegraph keys with non-inductive resistances. It may be added that there was no demand for a service of this kind in this country when it was offered in the shape of induction telegraphy. (See page 11.)

The utilization of wireless telegraphy when overland telegraph lines have been prostrated by violent storms has also been suggested. This, however, presupposes that the masts or towers of the wireless sys-

tem would be left intact at such times, which might not always be the case. In any event, until it is practicable to multiplex wireless telegraph circuits, the wireless system in such cases could only be availed of to a somewhat limited extent, which, however, might, at times, be of vast importance. In this relation Professor Fessenden points out that during the years 1900, 1901, 1902, there was no interruption of the wireless service on which his system is employed between Cape Hatteras and Roanoke Island, with masts 125 feet high; and between Fortress Monroe and Cape Charles City, Virginia, with masts 50 feet high. In the same period the telegraph and telephone wires were frequently down during severe storms. The same writer also states that with sharply selective systems there is no trouble from atmospheric electricity, but with non-selective systems the receivers, if directly in the aerial circuit, are liable to burn out; this is not the case, however, with liquid detectors. On the circuit last referred to the speed of transmission is reported to be about 25 words per minute.

The extreme distance to which signals may be transmitted by wireless telegraphy with sufficient accuracy and reliability to meet commercial requirements is not yet definitely determined. Every day sees improvements in large and small details, but it is too early to expect that the end of improvement in wireless telegraph apparatus has yet been reached. There are also to be overcome the interference from neighboring wireless systems as well as the variations in the signaling distances that are found to occur in practice, and which may be due to atmospheric changes or other causes; and also the variations in signaling distances between day-time and night-time, instances of which have already been given (page 73). The interferences from neighboring wireless systems will be overcome when successful syntony is accomplished (and improvements in methods and apparatus are rapidly advancing this feature of the art), and by an agreement between the different companies to adhere to prescribed wave-lengths. Tuning, however, will not avoid interference where the gamut of electrical oscillations is run by electric sirens in the neighborhood of receiving stations. (See page 13 for an instance of a variable-period generator.)

To obtain the best results when wireless telegraphy is employed for the regular commercial handling of business, it will also be necessary that the transmission and reception of messages shall go on simultaneously from the same stations. Devices for this purpose have been

patented by Fessenden and others. The variations in the signaling distance due to the effect of daylight may be measurably overcome by increasing the strength of transmitted signals or by increasing the sensitiveness of the receiver. To overcome the variations caused by atmospheric conditions which are more or less obscure will doubtless be more difficult. Captain H. B. Jackson, in a series of experiments on shipboard in the Mediterranean, noticed that a sirocco wind, holding moisture, salt, and dust in suspension, absorbs the electric waves to a great extent. Lightning flashes, he observed, always produce signals, and occasionally spell words in the Morse code, though the usual record is *e i*. Fessenden, on the other hand, states that with sharply selective systems the severest thunder-storms do not prevent the transaction of business, but occasionally a word is lost. Jackson also found, in signaling at sea across intervening land, that some waves pass through, over, and possibly round the land, but in doing so their energy is reduced to an amount depending on the length, height, and nature of the obstruction. In one instance, where an extremely precipitous and narrow promontory 800 feet high, consisting of hard rock containing iron ore, intervened between the transmitter and receiver, the signals were at once cut off, although over the open sea signals were readily exchanged at a distance of 45 miles under otherwise the same conditions.

In order that the advantages of wireless telegraphy may be secured to the largest extent in the matter of preventing collisions between ships at sea, for obtaining assistance, etc., when necessary, which are popularly supposed to be the uses to which this system is especially adapted, and in which it has already demonstrated its utility in numerous instances, it seems evident that the apparatus will have to be more or less simplified and improved as to reliability, especially as regards the sources of the oscillations. At present, it may be admitted, the apparatus requires an amount of skill in the handling that is not available on small craft. On the larger vessels a special operator may be employed, as is now the custom, and on steam-vessels of medium size the work of caring for the apparatus could be delegated to some of the junior officers. Doubtless a knowledge of the manner of operation of wireless apparatus will ultimately be made one of the essential qualifications of such officers. To meet the requirements of the larger vessels and important land stations in the matter of expert operators, more than one of the wireless telegraph companies have already established

training schools in this country and Europe, where pupils are taught the Morse alphabet, and are also given instruction in every detail of the operation of each piece of apparatus employed in the system. They are also instructed how to detect and remedy any defects that may occur in the apparatus, and to make any ordinary repairs that may be necessary. The time for this tuition varies from four to eight weeks, depending on the aptness of the pupil. This, it will be understood, refers to instruction in receiving by the Morse ink recorder, which is quickly learned. To learn to receive by sound requires a longer time.

For simple code signaling, of course, the amount of skill required is a minimum and can be supplied by any one capable of manipulating the marine flag code. There still remains, then, the simplification of the apparatus if the system is to be adapted to vessels of all kinds, to lightships, lighthouses, life-saving stations, etc. A long step in this direction would be the displacing of the primary or storage battery and interrupter by some form of manually operated source of E. M. F. of sufficient power to cover a distance of, say, five to ten miles, which for all ordinary purposes of code signaling would be ample. The received signals in this case would consist of the ringing of a bell, or tapping of a sounder, operated by the coherer relay a prearranged number of times for any given message. In cases of fog at sea the simple ability to ring a bell at intervals on a neighboring ship would serve at least to place the officers of the vessels on the alert. A still further simplification of apparatus and methods will doubtless ensue should wireless telephony become an assured success; although for some purposes, as when vessels of different nationalities require to communicate with one another, a system in which the universal code signals could be employed will perhaps be of the greatest general utility.

Various uses of wireless telegraphy are announced almost daily in the public press, such as the actual sending of money orders from one ship to another, playing chess by sending the moves by wireless, etc., which are on a par with analogous announcements that were wont to be made to excite the wonder of the public in the early days of wire telegraphy, such as the recapture of an escaping criminal by means of the telegraph; but it is obvious that such happenings are natural incidents in any form of telegraphy, wireless telegraphy's part being to

augment the sphere of usefulness of the telegraph, which it has already done to a very important degree.

Thus far wireless telegraphy has found its highest degree of usefulness in the transmission of intelligence between vessels at sea, between vessels and the mainland, between points divided by the sea, or between certain localities overland where it is not feasible or profitable to lay a cable. Transatlantic wireless telegraphy, or cableless telegraphy, as it has been called, is not yet (1904) an accomplished fact, considered from a commercial standpoint. As intimated in the preceding pages, considerable work has actually been done in the effort to establish wireless telegraphy as a competitor of wire telegraphy between points where the latter is already in successful operation, but not with marked success. Perhaps these attempts are not yet desirable. Wireless telegraphy has a special field for which it is preëminently adapted, and into which, in the nature of things, wire telegraphy cannot enter. It may develop that the reverse of this is measurably true, and that the field covered so successfully by wire telegraphy is one which the wireless system is not so well adapted to enter, but the present writer is not so unwise, in the light of what has been accomplished in the past in the art of electrical telegraphy, as to place any limitations on the possible applications of wireless telegraphy.

The application of wireless telegraphy to automatic fire-alarm telegraph purposes has also been proposed, and M. Guarini has experimented with apparatus designed therefor. The apparatus at the protected building consists of the usual induction coil, spark-gap, and vertical wire. A thermostat consisting of a tube containing mercury controls a local circuit. When the temperature at the tube exceeds a predetermined point the local circuit is closed, the closing of which operates an armature that releases a break-wheel which at once revolves, thereby opening and closing the induction-coil circuit, with the result that a certain number of high potential impulses are thrown upon the vertical wire. These in turn affect a coherer at the firemen's headquarters, giving the alarm, the number of transmitted signals indicating the location of the protected building in the well-known manner. (See Chapter XXVIII. author's "American Telegraphy and Encyclopedia of the Telegraph.")

APPENDIX.

(Reference to page 38.)

THEORIES OF ELECTRIC-WAVE PROPAGATION.

APPLYING the electronic theory to electric-wave propagation, it is assumed that under the electric force established by a source of electromotive force, the opposite plates of the condenser or vertical wire are charged with positive and negative electrons, respectively, until the pressure breaks down the spark-gap, whereupon there is an oscillation of the electrons analogous to that assumed in the case of electric charges in a condenser. The electrons being, as it is assumed, center of force in the ether, when they thus oscillate produce strains and contractions in the ether, which it is also assumed are radiated in the manner described as detached lines of force. These forces reaching the receiving wire or wires produce an electric force under which the electrons are set into oscillations in those wires.

A theory of electric-wave propagation, due to A. E. Kennelly, in the "Electrical World and Engineer," is as follows:

"According to the measurements of Prof. J. J. Thomson, air at a pressure of 1-100 millimeter of mercury has a conductivity for alternating currents approximately equal to that of a 25 per cent. aqueous solution of sulphuric acid. The latter is known to be roughly 1 mho-per-centimeter, so that a centimeter cube would have a resistance of about one ohm. Consequently, air at ordinary temperatures, and at a rarefaction 76,000 times greater than that at sea-level, has a conductivity some 20 times greater than that of ocean water, although about 600,000 times less than that of copper. If we apply the ordinary formula for finding the elevation corresponding to a given air rarefaction, we find that if the air had a uniform temperature of 0° C., the height of this stratum of air, with a rarefaction of 76,000, would be 55.77 miles. If the air had a uniform temperature of -50° C. this elevation would be reduced 18.3 per cent., or to 45.5 miles. The temperature of the earth's atmosphere

has only been measured within a range of a very few miles above the surface of the sea, and consequently the materials are not at hand for any precise calculation of the height of electrically conducting strata. It may be safe to infer, however, that at an elevation of about 50 miles a rarefaction exists which, at ordinary temperatures, accompanies a conductivity to low-frequency alternating currents about twenty times as great as that of ocean water.

“There is well-known evidence that the waves of wireless telegraphy, propagated through the ether and atmosphere over the surface of the ocean, are reflected by that electrically conducting surface. On waves that are transmitted but a few miles the upper conducting strata of the atmosphere may have but little influence. On waves that are transmitted, however, to distances that are large by comparison with 50 miles, it seems likely that the waves may also find an upper reflecting surface in the conducting rarefied strata of the air. It seems reasonable to infer that electromagnetic disturbances emitted from a wireless sending antennæ spread horizontally outward, and also upward, until the conducting strata of the atmosphere are encountered, after which the waves will move horizontally outward in a 50-mile layer between the electrically reflecting surface of the ocean beneath and an electrically reflecting surface, or successive series of surfaces, in the rarefied air above.

“If this reasoning is correct, the curvature of the earth plays no significant part in the phenomena, and beyond a radius of, say, 100 miles from the transmitter, the waves are propagated with uniform attenuation cylindrically, as though in two-dimensional space. The problem of long-distance wireless wave transmission would then be reduced to the relatively simple condition of propagation in a plane, beyond a certain radius from the transmitting station. Outside this radius the voluminal energy of the waves would diminish in simple proportion to the distance, neglecting absorption losses at the upper and lower reflecting surfaces, so that at twice the distance the energy per square meter of wave front would be halved. In the absence of such an upper reflecting surface the attenuation would be considerably greater. As soon as long-distance wireless waves come under the sway of accurate measurement, we may hope to find, from the observed attenuations, data for computing the electrical conditions of the upper atmosphere. If the attenuation is found to be nearly in sim-

ple proportion to the distance, it would seem that the existence of the upper reflecting surface could be regarded as demonstrated."

Prof. J. A. Fleming, lecturing before the Royal Institute, London, expressed the following views in connection with the effect of the curvature of the earth upon the propagation of electric waves. The electric waves employed in Marconi's transatlantic tests were about 1000 feet in length, which was not very small compared with the obstacles they had to encounter, that is, the hill of water formed by the curvature of the earth, which he calculated is about 110 miles above a straight line joining the Lizard and Newfoundland. The bending required, therefore, is not great compared with the distance, being comparable to a wave one one-hundredth of an inch in length bending round an obstacle one fifth of an inch high. He thought it an interesting question whether it is conceivably possible to send an electric wave around the world, and suggested that it is an interesting possibility. Water is opaque to the Hertzian waves, and he believed it likely that the upper strata of air, being highly rarefied, were also opaque to these waves. He imagined that by internal reflection between these two opacities a beam of rays could always, as it were, be confined between them, and so, provided the impulse was strong enough, it could be made to pass any distance sandwiched between them independently of the curvature of the earth.

Another theory, advanced by Rankin Kennedy, is here extracted from the "London Electrical Review," Vol. L.:

"The fact that Mr. Marconi has detected electromagnetic oscillations at a distance of 1500 miles from their source on the globe puts a different complexion on the wave theory of propagation as applied to Marconi's results. The result of the actual experiment cannot agree with the rectilinear propagation of the waves; the curvature of the globe seemingly having no effect, disposes of the straight-line propagation. A lump, however powerful, placed at Land's End could not throw a ray of light into a ship 1500 miles off; neither could an oscillator send waves around the earth if these waves travel in a straight line, as light does. To me it seems that the effects are not due to ethereal waves traveling as light does, but to electrical oscillations set up in the earth itself considered as a whole sphere, insulated in space, and the same effects can be reproduced on a small scale on a large ball, or artificial earth, as it might be called.

“Imagine a large globe suspended in space, practically a good conductor. Electrically the globe is nominally neutral, no difference of electrical potential existing between any portion; but let the electrical conditions be disturbed at any point—say that a sudden separation of electricity is made at the point A in Fig. 1a; we know from common knowledge that the disturbance at A will be propagated all over the sphere, much in the same way as it would if the ball were of ivory and struck at A by another ball, every particle of the ball would be disturbed by the blow at A. Or consider the bale covered all over by a sea of water, and at

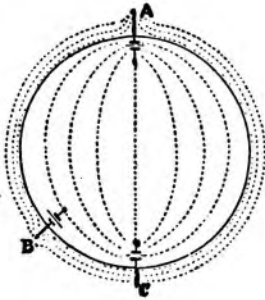

FIG. 1a.

A a submarine mine to be exploded, throwing up the water. A wave, or rather a series of waves, would be set up which would travel around the whole ball.

“In this view of the electromagnetic transmission of waves, we can imagine the rapid discharges at great potential at the point A agitating the whole electrical system of the earth, and that the earth is surrounded by an electrical atmosphere normally at rest and neutral, so that when disturbed at one point, this atmosphere vibrates or oscillates throughout its whole mass. And therefore there is no reason why communication between the antipodes, A and C, should not be practicable. A large globe upon which a spark coil and a radial conductor can be laid at A, as in a Marconi installation, could be utilized as a working model. There can be no doubt that a rapid and high potential series of charges and discharges at A could be detected at B or C by a Branly tube or otherwise.

“Considerations regarding results of experiments in laboratories or even within a few miles of area, are not of much value in this matter. Marconi has applied the test to the whole earth, with the result that, so far as one can foresee, every wireless telegram is actually an effect of the surface charge of the earth as a whole, and not at all due to radiant energy traveling in space like a ray of light. However that may be, the subject now calls for very different treatment from that which it has hitherto received, not so much perhaps in the interest of wireless telegraphy as in the interest of fundamental knowledge. Whether the earth as a whole is electrified as a ball with a charge

upon it matters little; if it is electrified, then the oscillator simply agitates this charge. Lord Kelvin forty years ago clearly proved the earth's surface to be charged, and suggested that the opposite charge might exist in the rarefied upper layer of the atmosphere; if this is so, then the gaseous dielectric is polarized vertically. He also pointed out that a very considerable electrification of the whole earth's surface could be effected by quite a small amount of charge. It is quite conceivable, then, that the earth's electrical equilibrium may be sufficiently disturbed by what seems a very feeble apparatus, compared with the dimensions of the globe, to operate the delicate detector on any part of its surface.

"This theory, of course, still rests upon the wave transmission, but not upon straight-line action, the vibrations being propagated through the mass, only it is not the matter which vibrates, but the electrical charge upon it. . . ."

Dr. Lee De Forest, in the "Electrical World and Engineer," May 17, 1902, writes:

". . . The grounded radiating wave will tend to follow and concentrate upon that path affording greatest conductivity, . . . the earth will tend to absorb energy-waves whose electric lines of displacement are parallel thereto, and thus arises the necessity for vertical rather than horizontal antennæ. . . ."

"As Hertz first pointed out, the energy of his wave decreases with the sine of the angle between the vector, leading from a point on its surface to the spark-gap, and the axis of the oscillator. Hence, the chief electrostatic energy also resides nearest the equatorial plane, at least over water where obstacles have not too far consumed the same. Very interesting in this connection are the experiments which have been made with receiving instruments attached to the upper ends of wires suspended from balloons at various distances from the sending antenna and at different altitudes. Thus Le Carme in his observations among the Alps obtained signals from a 54-yard wire suspended 654 yards directly above a similar upright on the earth's surface, showing that the same did not give off a purely transverse wave. By Hertz's theory this axial line was that of least radiation of energy. But when 3.7 miles from the sending wire, Le Carme reports signals obtainable at a greater height, 872 yards, thus illustrating the upward expansion of the wave which accompanies its outward radiation. . . ."

“In this connection it is of interest to note that the best effects were obtained here when the receiving wire was twice the length of the sending upright. This was to be expected, inasmuch as the one was a freely oscillating, unearthed system; the other grounded and representing but one-quarter wave-length. From such observations is made clear the role which the earth plays in transmission in preventing the dispersion of the field into space—another instance of Nature’s mercifulness to man. . . .

“Consider now the sending apparatus, using merely a capacity instead of ground connection. The reason that long-distance transmission is never accomplished by such arrangement is evident; but the influence of the earth as a conducting medium still exists, though diminished. If, as in Fig. 2a, we have two oppositely charged bodies, and near them a conducting plane $M M$, a portion of the lines of static displacement will run into the conductor as shown. When a discharge occurs between the two bodies all of the lines of force will not be sent off self-closed, but a portion will travel over or into the sheet $M M$.

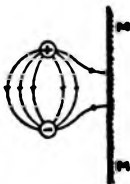

FIG. 2a.

Thus if the capacity at base of the spark-gap lies in the vicinity of earth, and the system be set into sufficiently rapid oscillation relative to its dimensions, we will still have to a certain extent transmission over the conducting surface. A large portion of the lines, however, being self-closed, will radiate rectilinearly into space, or be actually reflected from the earth’s surface. When the advancing wave-train encounters any conducting obstacle, sections of the lines of displacement composing such wave are cut out of it, as it were. The obstacle, if large relative to the wave-length, will cast an electromagnetic shadow, but where the wave-length is of several hundred feet an ordinary upright conductor, owing to the phenomenon of diffraction, will not essentially shield another situated a little behind it. As Heaviside has so well illustrated, the lines of the displacement wave advancing in a direction normal to their length will cut into a metallic conductor in their path, and entering therein in directions nearly perpendicular to the surface of the conductor, will, therefore, travel up or down the same as the wave advances. This action means merely the excitation in the skin of the conductor of actual conduction currents, of the same frequency as that of the exciting oscillation; or if this be strongly damped, or aperiodic, the single

impulsive charge will cause the conductor to discharge or oscillate at its own natural period of vibration. Thus the action upon the receiving upright is inductive, though not in the ordinary interpretation of the word. This, being a volume effect, would vary as the inverse cube of distance, while, were the action due simply to the static charge upon the top of the sending antenna, the law would be that of the inverse square; if from the wire, as the first power of the distance, as actually tested in the laboratory. Lietz, using as receivers a Klemencis thermo-element and Ruben's bolometer, has found this law to be intermediary between the two. On the other hand, the inductive effects from the two forces increase as the square and the first power respectively of the intensity of the source. Ascoli, reasoning from Neuman's formula, has shown that the mutual action between the two single antennæ should vary directly as the product of their heights, or, if equal, as the square of one, and inversely as the distance apart. Much data from the field corroborates the correctness of this law, making due allowance for the extra increase of range arising from better transmission over obstacles of the longer wave-lengths. With an antenna arrangement as shown in Fig. 3a, the quarter wave-length may be greatly increased, but there is also the liability of harmonics, or multiple vibrations, from the antenna as a whole and its component parts. If its electromagnetic pulsations be too slow, they are unaccompanied by any alternating static field, and do not emit radiant energy; the waves are not detached from the conductor, there is no Hertzian decrement of damping, and any action at a distance is by simple induction."

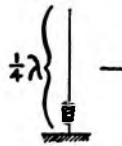

FIG. 3a.

In a further discussion of this general subject in the same periodical, July 5, 1902, Dr. De Forest writes:

" . . . While true that Hertz's most startling demonstration was that of the existence of free electromagnetic waves in the ether, as called for by Maxwell's theory, identical save in frequency with polarized light waves, yet it was only by 'electrical oscillations' in conductors that these Hertzian waves were generated, and only again by the electrical oscillations induced in his resonators by the free ether waves that the existence of these latter was demonstrated. Hertz was first to show that these very high frequency oscillations traveled along conductors, that they existed in the skin of the metal only, that they were reflected, formed standing waves with nodes and loops,

that their energy was in turn electromagnetic and electrostatic, that in the limiting case of an infinitely thin wire of perfect conductivity the pure etheric wave of transverse electrical displacement, with a velocity of propagation equal to that of light, was obtained. By common consent, then, such vibrations detached or traveling over a conducting surface have most appropriately been styled Hertzian waves. Most certainly also they are 'oscillating currents' when traversing conductors. This was Hertz's demonstration. Oscillations from a Leyden-jar discharge, of frequency much less than those from Hertz's radiator, are sometimes called Federsen oscillations. Obviously the border-line cannot be defined. But when an electrical system discharges, having so small a time constant that the pulsations occur at a rate of millions per second, we have very different conditions from those ordinarily classed with alternating or oscillatory currents. A large portion of the energy is electrostatic, and the force there involved may be conceived as lines of electric displacement perpendicular to the conducting surface, traveling along it away from the source of energy, following any zigzag path, rounding corners, reflected wholly or in part at all such sudden changes in shape or nature of the conductor. If near the end of a wire conducting these electrical waves a second wire parallel to the first be placed, the wave-train will be in whole or in part transferred to the second wire, and will run along that unchanged in phase. If the second wire or a metallic sheet be near the first and *perpendicular* thereto, the electrostatic line of the wave cutting into this obstruction will excite therein oscillatory currents or waves of like frequency, which will in turn traverse the length and breadth of this second conductor.

“Aside from simplest theoretical reasoning, the period of discharge of a vertical conductor to earth has been actually measured and found to be such as to make its height measure, approximately, one quarter of the wave-length of that oscillation. For a vertical wire of 54.5 yards, this means a frequency of 1,500,000 per second, assuming a velocity of propagation nearly that of light. In the laboratory with such frequencies we find all the wave phenomena and skin effect described above. Why not, then, in wireless telegraphy? We have a conducting plane surface, the sea, perpendicular to the oscillator at its base. Our lines of electrostatic displacement cannot penetrate this conductor, they must travel over it, be its contour what it will. By virtue of the tall oscillator, the crests or loops of

these displacement lines have been first well elevated (if the expression may be allowed). A hundred or a thousand miles distant is a second elevated conductor, say at an angle of 90° to the first, perhaps at an angle of 45° with the sea surface. Nevertheless, it has a vertical component, such as must cut out a shadow in the advancing vertical lines of force. Oscillatory currents or Hertzian waves are excited in this conductor by the cutting into it of these static lines, positive and negative; and a sensitive detector inserted in this conductor, whether it lead to earth, capacity, or to a symmetrical oscillator system, will be affected by the passage of the wave. In speaking of oscillating currents carried by the conducting salt water, it may be well to remember that with such frequencies as we have here, our 'conductor' has been well proven completely opaque, and that only by such phenomena as the above can transmission occur."

Prof. S. P. Thompson has designed a model, shown in Fig. 4a (reproduced from "L'Industrie Electrique," July 10, 1898), to illustrate in a tangible manner the oscillator, the propagation and detection of electric waves, after the experiments of Dr. Hertz. The oscillator is shown at a supported by framework. A row of leaden balls assumed to represent the ether are suspended as indicated, by pack-threads, which are attached to small hooks in the supporting beam. At the lower end the threads are fastened to the balls by small eyelets. The threads are connected together, two by two, in such a way as to form a V-shaped suspension. This method of suspension virtually prevents longitudinal vibration, gives a certain uniformity to the movements of the balls, and, in a sense, makes them a continuous body or medium. The receiver is a ring, B,

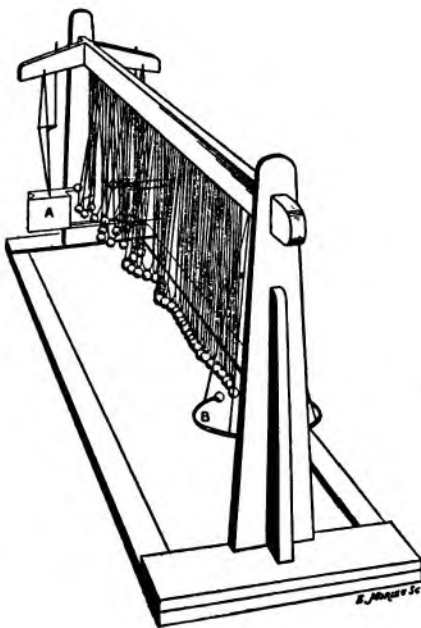

FIG. 4a. THOMPSON'S MODEL.

with knobs and an air-space to resemble the Hertz detector or resonator. This ring is upheld by three threads, one of which is fastened to a supporting thread of the nearest ball. The oscillator is arranged to vibrate at right angles to the supporting beam. When, therefore, it is caused to oscillate, it communicates transverse vibrations to the nearest ball. This in turn imparts energy to the next ball, and thus one ball after another is set in transverse vibration, while the direction of propagation of the wave is forward or longitudinal to the supporting beam. When the ball nearest the detector is set in motion it imparts a circular oscillation to the latter, due to the trifilar suspension of the ring, which motion is designed to illustrate the assumed circular electric oscillations in the Hertz ring form of detector.

It is pointed out by M. Guillaume that this arrangement insures a more or less uniform oscillation of the balls, while it is assumed that the ether takes indifferently all possible modes of vibration; still, on the whole, the model is in his view very true, and a sufficiently accurate approximation to the ether-wave motion is obtained by making the period of vibration of the balls superior to that of the exciter or oscillator.

A resonance theory of electric-wave propagation, advanced by Dr. Koepsel, is based on the assumption that the capacity of the earth can be calculated from the formula for potential of a charged globe, which would give the earth a total capacity of but 708 microfarads. This formula, however, requires the oppositely charged surface to be at a distance which, relative to the radius of the sphere, is great, a condition which perhaps is not met in this instance. Assuming the capacity of the earth to be 708 microfarads, Dr. Koepsel calculates that given a vertical wire with a capacity of .009 microfarad, the ratio would be .000013. The potentials vary inversely as the capacity. Hence, assuming an E. M. F. of 100,000 volts on the vertical wire, the variation of potential would be $100,000 \times .000013 = 1.3$ volt. By increasing the number of vertical wires, say to 400, twenty inches apart, to give the system a capacity of about .11 microfarad, the respective ratios would be .00016 and the variations of the earth's potential would be 16 volts. By still further lengthening the transmitted wave-length, Koepsel thinks that the vertical-wire system must act upon the earth, setting it into resonance as a tuning-fork placed on a resonance box sets the latter into resonant vibration, thereby largely amplifying the original effect.

Another theory of electric-wave propagation, due to Lecher, is that the electric waves are transmitted along the earth's crust as waves are along wires. Signals could in this way be transmitted around the earth if its potential could be raised a few volts. He assumes that the function of the vertical wire is to bring this about by conducting the opposite electrification away from the earth for some distance, say 150 feet, and then conducting it back again; hence its foot gets charged positively and negatively alternately, and these charges are transmitted at a rate depending on the dielectric constant and magnetic permeability of the earth.

(Reference to page 22.)

Lodge points out that "when the coatings of a Leyden jar are spread out it radiates better, owing to the fact that in true radiation the electrostatic and the magnetic energies are equal, whereas in a ring circuit the magnetic energy greatly predominates." ("Work of Hertz," p. 5.)

(Reference to page 131.)

EHRET SELECTIVE WIRELESS SYSTEMS.

A number of patents have been issued to Mr. C. D. Ehret for devices appertaining to wireless telegraphy, one of which may be briefly described.

This system comprises a vertical wire in which is the primary coil of a transformer. In the secondary of the latter are an inductance, a capacity, and the primary of a second transformer. In the secondary of the second transformer are another inductance, capacity, and the primary of a third transformer. In the secondary of the latter are the usual detector and relay, and an additional inductance and capacity.

These three circuits are, so to speak, arranged in tandem, and their adjustments are such that each has the same period, the product of the inductance and capacity of each circuit being equal. The circuits are so designed, however, that in the first circuit (the one next to the antenna) the capacity is large and the inductance is relatively small; in the second circuit the capacity is relatively smaller and the inductance is relatively greater; and so on to the third or coherer circuit. The object of this progressively increasing inductance and reciprocally diminishing capacity is to secure sharper selectivity, hence any stray harmonics will be obliterated. The chief

feature of this device is therefore progressively sharply selective receiving circuits in order that only the desired electro-radiant energy may influence the receiving apparatus.

Mr. Ehret has also devised several synchronous systems. In one of these systems a transmitter setting up a certain rate of oscillations is connected to one segment of a segmental disk. Another transmitter attuned to a different rate of oscillations is connected to another segment of the disk, and so on. A rotating arm or trailer attached to the antenna passes over the segments in rapid succession; consequently waves of different periods are successively radiated from the vertical wire. If, then, at another receiving station there is a corresponding disk, to the respective segments of which are connected wires leading to receiving apparatus attuned to the respective transmitters, and a trailer rotating synchronously with the first-mentioned trailer, each circuit will receive its allotted message.

The same transmitting arrangement may be utilized to transmit different messages by one vertical wire to a number of different stations, each attuned to the desired wave period and equipped with synchronous apparatus.

THE BULL SELECTIVE WIRELESS TELEGRAPH.

It was to be expected that variations from the beaten path of transmitting and receiving wireless telegraph signals by means of long and short trains of waves constituting the Morse alphabet would shortly appear. One such system, invented by Mr. Anders Bull, will be briefly described. Synchronously rotating disks are employed at the transmitting and receiving stations. A relay, whose armature acts like the key in the primary of an induction coil, is connected in such a way that when certain five contacts on the frame of a transmitting disk are consecutively closed, the oscillation circuit is closed five times. These five contacts are fixed on the disk at pre-arranged intervals. Similar contacts are provided on the frame of the receiving disk, but these are arranged in series in such a manner that when all are closed, and not until then, a Morse register is actuated, marking a dot on a paper strip.

In sending signals a Morse key is operated in the usual way. This key controls the relay, the armature of which normally holds a rotating wheel at rest by means of a hook engaging with a pin on the

wheel. When the wheel is allowed to revolve this pin closes a circuit in which is a battery and an electromagnet. This latter magnet is mounted in proximity to certain springs carried by the rotating disk. These springs are vertical and at their upper ends flexible. Normally they slide in a given channel or groove, in which they do not affect the five contacts before mentioned. When, however, the electromagnet on the disk is magnetized, it attracts one of the springs and switches it into another groove, where it impinges on the contact points and closes them. The receiving disk is similarly provided with vertical springs, which are diverted from the normal channel by a magnet controlled by the coherer.

When the Morse key is depressed, therefore, as in making a dot, the small wheel is released and makes one revolution, when it is again held by the hook on the armature. During this revolution the magnet at the transmitting disk has been closed, diverting one of the rotating springs into the channel, where they close the contacts and thereby transmit five impulses to the vertical wire. Concurrently, the coherer at the transmitting end is operated five times, closing the five contacts as stated, and recording a dot on the paper strip. When a dash is sent, the small wheel at the sending station makes two or three revolutions, and as a result two or three dots are recorded at the receiving end, these dots constituting a dash.

As the disks at each station are assumed to rotate synchronously, it is evident that unless the contacts on the respective disks are placed at corresponding intervals on the disks correct signals will not be recorded by incoming waves. By this means a number of different prearranged dispositions of the contacts may be made around the disks, and in this way different stations may be selected as desired.

(Reference to page 113.)

By forming the bridges of the responder in a mechanical manner, namely, by using fine platinum wires, .0001 inch diameter, with their ends very close together, in slightly acidulated water, De Forest finds that this anti-coherer is made absolutely reliable and much more sensitive than when the bridges are formed by the current. When the ends are withdrawn a counter E. M. F. of polarization is set up in the cell, which makes the apparent conductivity of the cell practically nil. Incoming oscillations cause a temporary annulment of the insulating film of oxygen gas surrounding the fine positive electrode, causing an

increase in the conductivity of the cell. The latter is a potential operated device. The variation of distance between the electrodes, therefore, changes the responder from a current-decreasing to a current-increasing device. The former will operate a relay. In either case two cells of battery are used in shunt with the detector. These detectors were employed in the recent successful experiments made with the De Forest system between Holyhead and Howth, Great Britain, a distance of sixty-five miles.

(Reference to page 74.)

PRACTICAL SUGGESTIONS FOR LEARNING CODES AND ON WIRELESS TELEGRAPH SIGNALING.

The American Morse telegraph code, which is in use exclusively on land lines in the United States and Canada, is composed, as will be seen by reference to page 74, of elements, termed dots, dashes, and spaces. These elements are formed by the length of time during which the key, or other transmitting instrument, may be held closed or open, the time of making a dot being taken as 1. The words "dot," "dash," and "space," therefore, stand for periods of time, so far as the transmission of signals is concerned; the received signals, however, when recorded on a paper strip, or sheet, are of course indicated as dots and dashes. Some of the letters of the American alphabet are composed of dots, some of dashes, others of dots and dashes, and others, again, of dots with spaces between. The latter are termed "spaced" letters.

The telegraph code in use in Europe and other countries outside of the United States and Canada is known variously as the European, Continental, or Universal. This latter alphabet is also very generally used by all the wireless telegraph companies excepting the American. Doubtless it will eventually be employed as the international telegraph signaling code. In the Continental or Universal alphabet, as may be observed on page 74, there are no "spaced" letters, that alphabet being made up of dots and dashes exclusively.

In length or duration one dash is theoretically equal to three dots. The dots and dashes are separated by intervals of time, termed spaces. The space between the elements of a letter is equal to one dot, the space between letters of a word to three dots, the space between words to five dots. The interval in "spaced" letters of the American Morse code is equal to three dots.

Before attempting to make, by means of the key, the letters forming the Morse alphabet, it is advisable that the beginner should familiarize himself with the characters of the code which he purposes to learn. This is best done, perhaps, by separating from the rest of the alphabet, first, all of the "dot" letters, thus: E ., I . ., S . . ., H, P; afterward, the letters and figures containing dashes only, thus: T —, M — —, O — — — (in the Universal Code), and so on.

After the alphabet, figures, and the important punctuations have been fairly mastered, the student may then begin the practice of making the letters by means of the key. The student should bear in mind that he is dealing with time intervals, and not with dots and dashes as such, although it will perhaps assist him in his practice to imagine that as he is forming the characters they are being reproduced on the paper strip at the receiving end as dots and dashes. The length of those dots and dashes, and the length of the spaces between them, will therefore correspond with the time during which he holds his key closed or open.

In making, for instance, the letter A, the key is pressed down firmly on its contact for a short time, then raised for an equal interval, then depressed for a time thrice as long as when making the dot, then raised. The letter B is formed by pressing the key down for a time equal to a dash, which act is quickly followed at regular intervals by three short depressions, or dots, and, of course, with spaces between.

With the comparatively large keys that are used by a number of the wireless telegraph companies, the manner of holding the key is not so important. It is generally true of this system, as of ordinary Morse manual signaling, that each individual will ultimately adopt a style of manipulating the key that becomes as characteristic as one's handwriting. An important point is to insure that all dots shall have the same duration; likewise that all spaces between elements of a letter shall be of uniform length; also that all dashes and spaces between letters shall be of equal length, and that all spaces between words shall be equal. For example, if at a certain rate of signaling the duration of a dot be .3 second, then the duration of a space between dots and dashes of a letter shall be .3 second; the duration of a dash shall be .9 second, the space between letters of a word shall be .9 second, and the space between words shall be 1.5 second; all as near as may be. With a faster rate of signaling the duration of each element will be shorter, and with a slower rate of signaling each element

will be longer. In holding down the key, sufficient time must be allowed to permit the proper operation of the transmitting as well as the receiving apparatus; and where the type of receiving apparatus may not be known, as in the case of vessels at sea, it is advisable to err on the side of slowness. Between established stations the proper speed attainable will quickly be ascertained.

These codes may be and are also used in signaling with flash lantern, heliograph, search-light shutter, fog-horn, or steam-whistle. In fog-horn or steam-whistle signaling, one short "toot" represents a dot, a longer "toot," or blast, a dash; the duration of the toot and blast being relatively as in the case of the dot and dash.

In the operation of Morse telegraphy it is the usual custom to allot each station a "call," consisting of one or two letters of the alphabet. For example, "N," "X," "NY," etc. To call up a station the letters allotted to that station are signaled repeatedly, followed by the "call" of the calling station. When, then, any station on a telegraph line hears his call being made (by sound), or sees it being recorded on the paper strip of a recording register, he opens his key and responds by saying, "I I" (. . .), and signing his "call," whatever it may be. This is likewise the course pursued in heliograph, flag, or flash-light signaling. (It is the custom, also, for operators to have a certain letter or letters which they give when sending a message and when acknowledging the receipt of one. This, however, is only really necessary when there is more than one operator in a station.) This process is also followed in wireless telegraphy when the calls of the station are known, except that in the ordinary arrangement of wireless apparatus at present the called operator cannot "break" in on the calling or sending operator, but must wait until the calling station ceases signaling before answering. In probably the majority of cases at the present time a call-bell operated by a relay is employed. Therefore, to call a station, the calling station by closing the transmitting key sets up a series of oscillations which operates the call-bell of any ship or other station within range. The answer may be made in the same manner, but to answer such a call it is better to signal "I" three or more times, followed by the call of the acknowledging station.

When the call of any vessel or station is unknown, as will often happen in wireless communications between vessels at sea, lightships, and elsewhere, signal the letter A continuously and await at intervals

signal seven or more consecutive dots and resume the message, beginning with the last word correctly sent. When the message is received accurately, the reply O K, or other similar sign, is sent, with the signature or call of the receiving operator or station. It is advisable to slow down the speed of transmitting when an unusual word occurs in a message, and to insure accuracy it may be well to state after the end of the message, "that is, ——," repeating the word.

Some of the foregoing methods for the transmission, reception, and correction of messages, and for calling and answering stations, are those adopted by the United States Signal Corps in all forms of flag, flash, and heliograph signaling, and are readily applicable to electric wireless signaling. (For further description of these forms of signaling, see author's "American Telegraphy and Encyclopedia of the Telegraph.")

The preceding suggestions relate more particularly to reception by a recording instrument. When a telephone is employed as a receiver the receiving operator must be able to read by sound. The sounds received in the telephone consist of short and long tones (more or less broken, perhaps), which are read as dots and dashes respectively. To learn to read by sound, while a somewhat slow process, is not an arduous one, and when one is thoroughly familiar with the alphabet in which the signals are transmitted, a message slowly sent may be received after comparatively little practice, which remark also applies to fog-horn and whistle signaling. (See p. 159.)

In transmitting signals, the switch is first turned to connect the transmitting circuit with the vertical wire. When the message is transmitted the switch is set for receiving and the acknowledgment of the distant station is awaited. The novice at transmitting will find it of advantage to have the characters of the alphabet printed on a sheet before him for immediate reference. Where registers or ink-ing-recorders are employed, it is advisable to set them in operation in advance, unless they are automatic in their action. Where call-bells are used, these should always be left in circuit awaiting communications. For best results with the register the pull of the armature-spring should be gentle, or a slow-acting magnet should be used, in order that the armature-lever may stay down during the receipt of signals, its tendency being to rise or clatter with too strong a spring. (See remarks on register, p. 158; also see "Adjustment of Apparatus," Index, under "Apparatus.")

The operator or attendant in charge of the apparatus should constantly be on the alert for imperfect or dirty contact-points, loose connections at binding-posts, run-down batteries, etc. The battery for the induction coil used in the majority of comparatively small installations requires very careful attention. For a ten-inch spark-coil, from 6 to 8 volts and 5 to 6 amperes may be necessary. Before the vibrator starts the current may run up to about 10 amperes; care is therefore essential to guard against the vibrator remaining idle when the battery circuit switches and key are closed, to avoid rapid running down of battery. The turns and resistance of the primary and secondary wires are usually chosen to suit a given voltage and current. The contacts of the hammer interrupter are subject to quick disintegration, and require somewhat frequent attention and adjustment. When everything is in good order the vibrator of the induction coil begins vibrating as soon as all switches and the key are closed. Sometimes a tap may be necessary to start it. By forestalling the defects indicated, and others of a more or less similar nature, many delays in operation will be avoided.

INDEX.

A B

Adjustment of apparatus, See Apparatus.
Air, blasts of at spark gap, 67; air chamber experiments, vibrations, 15; conductivity, rarefaction, temperature, 181; particle, movement of, 43; pressure at spark gap, 166; views of auctants on, 31.
Alternating currents, electron theory of, 43.
Alphabets, 2, 74.
Antenna, angle of, 171, 189; air gap at, 111, 129; an aperiodic vibrator, 128; as condenser, 36, 38, 162; as Hertz oscillator, 35; capacity of, 169; capacity ratio to earth, 190; cow's tail, 60; current in, 30; chimneys used for, 91; energy stored in, 109; height of, 29, 37, 65, 72, 89, 90, 119, 120, 128, 171, 177; insulation of, 59, 172; kites or balloons for, 89, 97, 171, 175; leading in wires, 60, 90, 100; material of, 172; mutual action between, 169, 187; number of, See Multiple aerials; potential on, quarter of wave length, 83; relation of height to signaling distance, 29, 37; towers for, 64; voltage on, 49; See Electromotive force; weight of masts for, 59; wire netting for, 59.
Anti, auto coherers, 68; See Coherers, Detectors.
Apparatus, adjustment and operation of, 27, 53, 54, 61, 63, 70, 80, 86, 87, 131, 156, 158, 167, 175, 193; simple operation of, 27, 28; simplification of, skill in handling, 179, 194.
Arc light, See Speaking arc.
Armorl wireless system, 142.
Armstrong, reference to, 142.
Aschkinass, coherer, 68, 146.
Ascola, on mutual action between antennae, 187.
Atmosphere as conductor, 30.
Atmospheric changes, 177.
Atmospheric electricity, diverted, 55, 91, 125; effects of obliterated, 73, 104.
Atom, 39, 44; electrical, 43.
Automobiles in wireless, 101, 120.
Auto-transformer, 167.
Balancing circuits, 63.
Barretter, 37, 38, 123, 154.
Battery, storage, dry, 29, 58, 90, 93, 95, 148, 156; symbols of, 5; See Electromotive force.
Becquerel, discoverer of radio activity, 45.
Bell coherer, 148.
Bell's photophone, 136.
Bernstein, experiments, 9, 104.
Blondel, earth plates, capacity, 173; coherer, 104; image theory, 35; intensity of waves, 37.

B C

Bolometer, 187.
Bonomo, formula for signaling distance, 29.
Bose oscillator, 166.
Branly coherer, filings, 26; needle, 99, 148.
Branly-Popp system, 99.
Braun wireless system, 91; capacity areas, 91, 172; inductor, spark gap, 94; key, 97; on electric oscillation, 92.
Brown magnetic decoherer, 150.
Bull selective system, 192.
Buzzer, 8, 61, 80, 156.
Cableless telegraphy, 180.
Call bell, 13, 57, 70, 141.
Call letter allotted, 51, 196.
Calling relay, Evershed, 12; De Forest, 110; Fessenden, 125; telephone used as, 70.
Capacity and inductance, 35, 71, 115, 123, 130, 167.
Capacity, 19, 20, 48; See Condenser; areas, 76, 91, 172, 173; effect on radiation, 167; effect on oscillations, 21; elevated, 81; how varied, 119; metallic cage, 106; of vertical wires, 169; of earth, 190; potential inversely proportional to, 117.
Carbon at contacts, 110; at key, at coherer, 130; See Coherer.
Castelli, coherer, 69.
Cathode rays, 39, 44.
Celluloid film, 69.
Cement, "electrical," 158.
Choke coils, See Coils.
Circuits, closed, open, 49, 61, 76, 78, 82; tuned, See Tuning.
Clark, T. E., experiments, 173.
Clarke, W. J., experiments, 60, 156.
Clifford on electrical atoms, 43.
Codes, Morse, American, Continental, Universal, 74, 194; Polybius, 2; signals, 179.
Coherer, See Detectors; adjustment of, 61, 70, 86, 96, 131, 157; Aschkinass, 68; Blondel, 104; box, 57; Branly, 26, 98, 148; Braun filings, 96; breaking down E. M. F., 146; Brown, iron, magnetically decohered, 150; carbon powder as, Jervis-Smith, 147; change of resistance in, 144; Clarke filings, 156; DeBast theory of, 146; De Forest anti, 113, 193; effect of magnetism on filings, 150; efficiency measurements, 158; exhausted, 61; figure of merit of, 146; Marconi, 151; frying in, 103; Gavey, 150; gold-bismuth, 125; Italian navy, Solari, Castelli, 70; items concerning, 145; King's, 148; lamp filament, 130; Lodge experiments with, 28; term due to, 144; Lodge-Muirhead oil film, 81; single

C D

point, 79; magnetic metals for, 155; magnetic ring for, 96; construction of, 53; Minchin, 149; needle, 113, 148; noble metals for, 146; operation of, 27; peroxide of lead, 146; Poppoff, 106; preventing arc in, 103; regenerable, 104; resistance of, 145, 146; Rigbl, 149; self-righting, 146; sensitiveness of, 30, 61, 86, 113, 150, 155; a simple, 155; speed of signaling with, 61, 68, 133; Shoemaker, filament, 130; theory of, 145; time of operation of, 71, 103, 133; Tissot, 149; Tomassini, 150; Varley carbon, 125.

Coherence, auto, anti, 145.

Colls, choke, 54, 57, 67; construction of Marconi, 55; Fleming, 67; De Forest spiral, 108; induction. See Induction coils; Henry's experiments with, 6; high frequency, 165; non-inductive, 54; Stevenson's experiments with, 14.

Collins wireless telephony, 140; reference to, 37.

Condensers, 8, 22, 32, 76, 93, 103, 104, 108, 131, 156; adjusting, 62; air, 170; at Interrupter, 8; at spark gap, 104; Braun, 93, 95; capacity of, 111; charged, 20, 32; mechanical analogy of, 18; cylinder arrangement, 63, 95; discharge into vertical wire, 162; energy stored in, 169; glass plate, 66, 165; as shunt, 58, 78; small mica, 131; paper, 156.

Conductors, opaque to, reflectors of, electric waves, 25, 33, 34, 36, 37, 56, 115, 182; electronic theory of variation of temperature of, 42; skin excitation in, 25, 186; water as a. See Sea water.

Contact breaker, Interrupter, 12; imperfect, vibrating, 150.

Contacts, disintegration of, 8, 160; prevention of sparks at, 56; sliding, 63, 88, 130, 192.

Continental code, 74.

Corpuscular theory, reference to, 45.

Crookes tube, 42, 44.

Cylinder arrangement, 63, 102.

Currents used. See Electromotive force and Electric oscillations; in earth, telephonic communication by, like ripples on water, 141, 143.

Decoherence, facilitated by weak current, 56, 99, 103.

Delaricel, image theory, 35.

De Forest, anti coherer, 110, 155, 193; calling relay, 110; magnetic detector, 152; on guy wire insulation, 172; shipboard outfits, 114; spiral choke coils, 108; syntonio or tuning system, 114; on theories, 185; tests, 30, 194; wireless system, 107; in yacht races, 159; stations, 119.

Detector, See Coherers; anti, auto, 68; automatic, advantages of, 71; barretter, 37, 123; carbon type, 97; carbonized fiber, 137; continued action of, 56, 103; electric age, 21; electrolyte, 112, 193; Fleming's quantitative, 152; Hertz, 23, 26; magnetic, 50, 70, 73, 151, 152; Neugschwender, Aschkinass, 68; recording and non-recording, 159; relay operated by sensitive, 155, 193; Ruhens holometer as, 187; resistance, 69; importance of

D E

low in, 71, 124; selenium cell, 136, 138; self-righting, Tomassini, 68; silver in, 69; terms applied to, 144; Turpain, 147; Feasenden, 123.

Detonator, 156, 157.

De Tunzelman, reference to, 24.

Dielectric, 20, 34, 35; compound elements, 42; gas, under pressure, 128.

Diffraction, 34, 186.

Discharge balls, knobs, 28, 52, 76, 167.

Disk spark gap, 109; transmitting, receiving, 131.

Dolbear wireless system, 14.

Dorn, reference to, 146.

Ducretet-Poppoff system, 105.

Duddell singing arc, 168.

Ear, as vibrator, 17, 46.

Earth, absorption of energy by, 36; as resonator, capacity of, 190; capacity in place of, 172, 173; charged surface, Kelvin on, 185; curvature of, 30, 59, 182; electrical equilibrium disturbed, 31; ground plates for antennæ, 60, 172, 173; resonance at, 173; trailing, 63.

Edison, induction telegraph, 10, 14; references to, 30, 171.

Efficiency tests of detectors, 159.

Ehret selective system, 191.

Electric bell tests of coherers, 155.

Elements, chemical, reference to, 40.

Electric oscillations, action upon filings, 26, 155; damping of, 17, 50, 116, 162; notes on, 187; determining wave length of, 168, directly, inductively excited, 92; effect on magnetic hysteresis, 71, 151; effect of resistance, capacity, inductance on, 21, 50, 72, 167; extraneous, effect of on coherer prevented, 56, 57, 104, 155; forced, free, 47; formulæ relating to, 20, 21, 35; from telegraph key, 176; harmonic, 128; Hertz experiments with, 21; how varied, 46, 62, 77, 187; in earth, 38; Kelvin on, 18; low frequency, 141; mechanical analogy of, 19; nodes and loops of, 83; octaves of, 17, 62; on a sphere, 21; period of, 21, 23, 50; persistent, 75, 116; rate of, 25; running gamut of, 177; shortest, 21; theory of, 22, 32; vibrating contact, resistance decreased by, 150.

Electric waves. See Conductors; detectors of, 144; extraneous, 56, 57, 104, 155; effect of ship tackle on, 90; of ultra violet waves on, 73, 76, 134; ever expanding, 32; frequency, length of, 21, 35, 53, 83, 90, 94, 115, 118, 169, 186, 188; on wires, 33, 36, 188; propagation, radiation of, 25, 29, 31, 34, 38, 92, 181, 189; sliding wave theory, 31, 35, 121, 188; intensity of, 34, 37, 38; not detached from conductor, 187; upward expansion of, 185.

Electric theory of matter, 39.

Electrical energy, 29.

Electrical Review, London, reference to, 31.

Electrical World and Engineer, 23, 37, 45, 51, 185, 187.

Electrician, London, reference to, 80.

Electrolysis, laws of, 43.

Electrolytic detector, 112; Interrupter, 95, 161.

EFG

Electromagnetic disturbances, 182; induction theory, 25, 31; shadow, 189; theory of light, 17.

Electromotive force, employed in practical working, also electric currents; by Branly-Popp, 101; Braun, 95; Clark, 173; De Forest, 108, 114, 120; Ducretet, 105; Guarini, 103; Lodge-Muirhead, 82; Marconi, 29, 53, 56, 65; Ruhmer, 138; Slaby-Arco, 87, 89, 90; Shoemaker, 129; condenser charged by, 169; for short distance signaling, 29; manually operated source of, 179; for Solari coherer, 69; induction coil, 23, 164; in telephone, 159; thrown on antennæ, 59; Wehnelt interrupter, 160.

Electronic theory, 39, 45, 181; alternating current, current electricity, explained by, 41, 43.

Electron, 39; as cathode rays, charge on, 44; chip from atom, 39; collisions of, 41, 42; deflected by magnet, energy expended in stopping, 44; inertia, mass, speed of, 40, 44; in metals, 42; negative charge of electricity, 39; negative, positive characteristics, 45; neutral, free, escape from incandescent wire, etc., 42; number in atoms, size of, stable formation accounted for, 40, 41; tie between ether and matter, 45; wave propagation theory, 38.

Energy, absorption of, 36, 182; cumulative effect, 38; electromagnetic, electrostatic, 188; kinetic, potential, 19, 33; radiated, amount required to affect coherer, 29, 30, 146.

Erg, 20, 158, 158, 159.

Ether, 30, 45, 181; constituents unknown, knowledge of, 31; definition of, 16; disturbance in, 31, 41, 43; Larmor theory of, 41.

Experiments, simple, 28, 156.

Evershed, calling relay, 12.

Faraday, references to, 6, 43.

Federsen oscillations, 188.

Ferrie, wave length experiments, 168.

Fessenden barretter, 123, 154; compressed air experiments, 166; system and stations, 121, 159, 171, 177; tests, 37, 158; tuning method, 123; wave chute, 121, 173.

Fillings coherer, 145; See Coherer; from nickel, 155; number of fillings used, 157.

Figure of merit, 146.

Fire alarm system, 180.

Fleming, references to, 38, 65, 109, 152, 166, 183.

Fog, horn signals, 60, 194; wireless, 141.

Franklin's fluid theory, 41.

Frequency, of generators, 164; of oscillations, 21, 23, 50.

Galvanometers, as receiver, 4, 26, 77.

Gavey, coherer, 150.

Generator or Dynamo as source of electromotive force, 65, 101, 107, 109, 114, 119, 129, 160, 164; variable period, 13.

Glass shutters, 135.

Gordon on Maxwell's theory of light, 18.

Gravitation, electron theory of, 40.

Gray's harmonic system, 51.

GHIJK

Ground, See Earth.

Grouped, signals, 51; oscillations, 123.

Guarini relaying method, system, 102.

Gullaume, 190.

Guy wires, 122, 172.

Harmonic system, Gray's, 51; vibrations, 85, 127, 187, 191.

Hayes-Cram radiophone, 137.

Henry's experiments, 6.

Heaviside, reference to, 32, 186.

Heliography, 4, 175.

Helmholtz, reference to, 43.

Hertz experiments, 21, 25; oscillator, 32, 35, 36, 38; references to, 30, 34, 130, 185, 189, 190.

Hertzian waves, 15; tapping, 61; Thompson's model of, 189.

Hewitt interrupter, 163.

Horse power, 29.

Hurmuzeseu, reference to, 145.

Hydrogen atom, 39, 40, 44.

Hysteresis, 38, 71, 170.

Image theory, 35.

Inductance, 19; adjustment of; in guy wires, 122; as inertia, 39; of transformer, 104.

Inductance coils, 63, 67, 77, 84, 122, 128, 130, 131.

Induction coil, 7, 14, 27, 58, 61, 76, 80, 89, 90, 94, 102, 103, 107, 120, 123, 128; Bernstein experiments with, 9; construction and resistance of, 7, 66, 156, 159, 165; currents employed with, 23, 164; inductance, resistance, operation of, 156, 159; "kick" from, 143; surging in, 9, 104; strength of defined, 7.

Induction, telegraphy, 6.

Inductive capacity, 94; coil, 57; non-inductive coils, 56, 57.

Inductor, Braun, 94.

Inertia, 18, 39.

Ink recorder, See Register.

Insulation, leading in wires, 60; guy wires, 170; of antennæ, 59, 130, 172.

International Wireless Telegraph Co., 129.

Interrupters, 58, 87, 89, 95, 127, 173; advantages of rapid break at, 8; Duddell singing arc, 164; electrolytic, 91, 95, 160, 162; hammer, 160; Hewitt, 50, 163; Lodge-Muirhead, 80; magnetic, 8, 160; mercury, 9, 105, 160, 161; rate of interruptions, 23, 80, 87, 88, 160, 161, 163, 164.

Insurance, affected by, 174.

Jackson experiments, 172, 178.

Japan, wireless telegraphy in, 176.

Jligger, 55, 62.

Joule, 169.

Kelway, fog signals, 141.

Kelvin, references to, 18, 50, 185.

Kennedy, theory, 183.

Kennelly, theory, 181.

Key, Braun, 91, 97; De Forest, 107, 109; Ducretet, 105; Fessenden, 123, 126; Fleming, 67; magnetic blow out for, 89; Marconi, 57, 58, 61; transmitting, 53; Shoemaker, 130.

King, coherer, 148.

Kinsley experiments, 146.

Kinetic energy, 19.

K L M

Koepsel, on wave lengths, 169; theory, 190.
 Kumascope, 144.

Lamp, search light, how far visible, 139, 183.
 Larmor, Dr. J., 41.
 Lebedew oscillator, 166.
 Le Carne experiments, 185.
 Lecher system of wires, 36, 115, 169; theory of wave propagation, 191.
 Leyden jar, See Condenser.
 Lletz experiments, 187.
 Light, electromagnetic, velocity, wave length, 17.
 Lightning arresters, 88, 125, 148; flashes, signals, 178.
 Lines of strain, force, 32.
 Lodge, capacity areas, 77; experiments, 26; references to, 36, 37, 38, 40, 44, 47, 48, 191; syntonics systems, 75.
 Lodge-Multhead system, spark gap, interrupter, 80; coherers, filings, single point, 79; oil film, 81.
 Long distance signaling, 30, 65, 73, 101, 119, 177, 180, 182.
 Loops and nodes of waves, 83, 115.

Magnets, permanent, horse-shoe, 70, 71, 86, 87.
 Magnetic, blow outs, 89, 97; decoherer, 129, 149, 150; metals for coherers, 155; interrupters, 8, 160; ring for coherer, 96.
 Manually operated sources of E. M. F., proposed, 179.
 Marconi apparatus, operation of, 54, 56, 58; capacity experiments, 48; coherer, 53, 150; cylinder arrangement of radiator, 63; metallic reflector, 25, 101; experiments, 29, 48, 72, 183; installations, 59, 64, 74, 169, 171; key, 56, 57; magnetic detectors, 50, 70, 150; system, 52; syntonics, 61; tapper, 54, 151; transformer, 55, 66; transmitting apparatus, 58.
 Masts, different heights for fog signals, 142; weight of, 59.
 Maxwell, references to, 17, 32, 39, 187.
 Mechanical analogy of electric oscillations, 19; model of, 189.
 Mercadier monotelephone, 51.
 Mercury, coherer, 70; contact, 143; fulminate of, 157; switch, 77; vapor lamp, 163.
 Messages, wireless, fac-simile of, 60, 197; forwarding by steam whistle or horn, 60, 141, 196; ondeggrams, 144.
 Microphone, coherer, 130; imperfect contact apparatus, 150; transmitter, 137, 138, 141.
 Military portable outfits, 89, 97.
 Minchin coherer, 149.
 Mirror, earth as, 35.
 Momentum, inertia, 18.
 Morse code, 74; dot and dash signals, See Signals; suggestions on learning, signaling by, 194.
 Motor generator, 107.
 Motors, for generators, 97, 107; interrupters, 87; oil, steam, 97, 119.
 Multiple aerials, 64, 73, 101, 111, 114, 119, 120, 171.
 Multiplex syntonics systems, 127.
 Multiplier, Slaby-Arco, 84.
 Musso synchronous device, 131.

N O P Q R

Newton, references to, 34, 45.
 Neugschwender coherer, 68.
 Neuman, reference to, 187.
 Nodes or loops of potential, 85, 115.
 Non-inductive, or non-magnetic resistance, 54.

Ocean, See Sea water.
 Octaves, See Harmonics.
 Oil, used in condensers, 66, 170; in coherers, 81, 150; in inductor, 94; in oscillator, 53, 165.
 Ondegram, scope, 144.
 Ondes Electrique, reference to, 147.
 Operation of wireless apparatus, See Apparatus.
 Operators, school for, 179; hints to novices, 194.
 Orling, reference to, 142.
 Oscillating circuits, 22, 65, 108, 123, 127, 130; closed, open, 49, 91; quickly damped, 49; varying the inductance of, 62, 77.
 Oscillating currents, in conductor, 189.
 Oscillator, energy expended at, input at, 30; gas lighter as, 156; Hertz, 22, 35; Right, 52; short wave, 166; spiral, 165; theory of, 32.
 Oscillations, See Electric oscillations.
 Overtones, See Harmonics.

Patents, on wireless telegraphy, 65, 77, 78, 114, 126, 128, 129; Tesla coil, 165.
 Phelps induction telegraph, 9; polarized relay, 86.
 Photo-electric phone, 138.
 Photophone, 136.
 Polarized relay, 50, 87.
 Polonium, 45.
 Polybius telegraph, 2.
 Popp, See Branly-Popp.
 Poppoff, experiments, 27; coherer, 106, 148.
Popular Science Monthly, reference to, 169.
 Portable outfits, 89, 97.
 Potential, billions of variations per second, 147; energy, 19, 32; indicator, 167, 168; nodes and loops of, 84, 85, 115.
 Powder head, 157.
 Poynting, reference to, 32, 36.
 Practical suggestions, 194.
 Preece induction telegraph, 11.
 Printing telegraph, See Musso.
 Protyle, 43, 45.
 Pupin, reference to, 128.

Quartz, transparent to ultra violet rays, 135.

Receivers, siphon recorder, 79, 81, 155;
 Radiation, See Electric waves; electric vs. induction, 25; loss by, rate of, 30, 44; rectilinear, 183; true, 191.
 Radiator, electric, 48, 77, 116; quantitative measurements of, 153.
 Radioactive matter, 45.
 Radioconductor, 26.
 Radiophone, 137.
 Radium, 42, 45.
 Rays, alpha, beta, gamma, cathode, Roentgen, 44, 45.
 Rayleigh, references to, 161, 167.

Reflection of waves, 25, 34, 37; by seawater, by upper atmosphere, 182, 183; colors in sky, due to, 34.

Reflectors, 29, 101.

Regulators, "Inkers," 54, 57, 95, 99, 100; adjustment of, 158, 196.

Relay, adjustment of, 61, 87; armatures counterbalanced on shipboard, 89; Evershed, 12; Hughes, 155; current required, energy, resistance, sparks at contacts, 29, 56, 84, 104; polarized, 54, 87, 95; repeating, Guarini, 103; Shoemaker, 129; time of operation of, 103, 133.

Right oscillator, 52.

Röntgen rays, 44, 45.

Ruhmkorf coil, See Induction coil.

Ruhmer, cell, 139; photoelectric phone, 138.

Rutherford, reference to, 45, 151.

Schaefer coherer, 69.

Scholl, Dr., 176.

Schools, for training operators, 179.

Schuster hot wire arc lamp, 140.

Sea water a conductor, 34, 37, 175, 182, 188.

Selective signalling systems, 51, 75, 177, 191, 192.

Selenium cells, 136, 138, 139, 140.

Semaphore signaling, 3.

Shipboard, jarring on, 13; outfits, provision for rolling, 59, 89, 114.

Shoemaker coherer, 130; magnetic detector, 151; potential indicator method, 167; repeater, tapper, 129; system, 128.

Siebt, potential indicator, 168.

Signals, recording on paper, 61, 80, 133, 197.

Signaling, by wireless, code, 179; distance, 49, 73, 78, 87, 89, 90, 105, 106, 122, 128, 131, 136, 137, 138, 139, 141, 143, 152, 155, 173, 176, 177, 178; effect of temperature of earth on, over frozen earth, 122; energy required in, 29; fog-horn, 60, 196; formula, 29; impeded by iron ore cliffs, 178; in warfare, items concerning, 175; Morse methods of, 10, 53, 54, 61, 64, 91, 135; overland, 175; prevented by cross-fire, 175; See Selective; speed of, 61, 68, 72, 99, 133, 177; by speaking light, 138; transatlantic, 72, 180, 183; variation in distance of, 177; by ultra violet rays, 134; whistle, 60.

Simon, speaking arc, 139.

Siphon, 142; recorder, 79, 81, 155.

Siren, electric, 13, 177.

Slaby-Arco system, 83; coherer, 86; multiplier, 85; tuning coil, 88; tuning fork or wire, analogy, 83; tuning methods, 84, 85; shipboard outfit, 89; vertical wires, 85, 89, 90.

Sliding wave theory, 31, 35, 37, 188.

Smith-Jervis coherer, 147.

Smoke rings, soap bubbles, analogy, 33.

Snyder experiments, 140.

Solenoids, 123.

Sound, analogy, 23, 30; length of waves, propagation, velocity of, 15, 18, 23, 43; waves, microphone detector of, 150.

Spark at contacts, See Contacts; at telegraph keys, switches, 155, 176; character of, adjusting by, 167; dis-

ruptive, 22, 32, 166, 181; blowing out by magnets, air blasts, 67, 89, 97; effect of ultra violet light on, 135.

Spark gap, air pressure at, 128, 135, 166; balls, knobs, size of, 28, 53, 76, 167; Braun, 93; De Forest, 109; disks at, 110, 167; effect of varying temperature, of resistance, at, 50, 140; heat at, length of, 30, 109, 166, 167; noise at, 61, 80, 109, 167; in oil, 53; Lodge-Multhead, 80; losses at, 30; multiple, 167; safety precautions at, 67, 89; Shoemaker, 130; Slaby-Arco, 88.

Speaking arc light, 137, 138; addressing audience by, 139; theory of, 140.

Stations, shore, lightship, military, 59, 65, 73, 80, 90, 100, 174.

Static currents, 111.

Stone Syntonic Wireless system, 120.

Stoney, Dr. J., 43.

Sulphuric acid, resistance of, 154, 181.

Switches, automatic, "busy" switch, 125; cut out, 57, 58, 130; knife, double throw, 95, 114; mercury, 77.

Synchronous systems, 131, 192.

Syntonic wireless systems, 46; Braun, 91; De Forest, 114; Ehret, 191; Fessenden, 121; Lodge, 77; Marconi, 61; Slaby-Arco, 83, 89; Stone, 126.

Syntony, 17, 47, 109, 177; close, 89.

Tanakate, on earth plate capacity, 172.

Tapper for coherer, operation, 27, 28, 54, 61, 151, 156; adjustable, 105; Branly-Popp, 99; clockwork operated, 96; magnetic, 129, 150; manual, 156, 157; quality of tap, 155; reading signals by, 158; Lodge clockwork, 27.

Taylor, on electric radiation, 31; sliding wave theory, 35.

Telegraph alphabets, 2, 74.

Telegraph, See Wireless telegraphy.

Telegraphing across water, 4, 12; versus over land, fresh versus salt water, 175; from moving trains, vessels, 10, 12, 176.

Telemeter, 142.

Telephone systems, See Wireless telephony.

Telephone, advantage of, 159; in induction telegraphy, 12, 14; one tone, universal receiver, 51; rapidly damped vibrations in, 17; receiver in wireless telegraphy, 87, 97, 111, 113, 123, 143; sounds received in, very weak from some detectors, sound-proof booths suggested, 151.

Temperature, of air, 181; effect on signalling distance, 123.

Terms applied to wireless telegraphy, coherers, 5, 144.

Tesla, references to, 158, 165.

Tests, of wave intensity, apparatus for, 37.

Theory, electronic, 39; of wave propagation, 22, 29, 34, 37, 38, 181, 183, 191; of Wehnelt interrupter, 162.

Thermostat, heat operated instrument, 180.

Thompson, Prof. S. P., model, 189.

Thomson, Dr. J. J., references to, 40, 41, 43, 44.

Thorium, reference to, 45.

Thunder factories, 67.

Time constant, 162.

T U V W

Tissot, coherer, 149.
 Tomassini, 68, 150.
 Torpedo boats directed by electric waves, 158.
 Transatlantic signaling, 72, 180, 183.
 Transformer, 49; auto, 167; De Forest, 108; frequency of, 164; Guarini, 104; Lodge Ironless, 77; Marconi, 55, 66; resistance of, 165; step-up, 65, 108, 160, 163, 165.
 Transmission, See Signaling.
 Transmitters, See Microphone.
 Transmitting circuits, Braun, 91, 95; Fleming, 65; Lodge, 77; Marconi, 52, 57, 61, 63; Slaby-Arco, 88.
 Transmitting key, See Key.
 Tuned circuits, 47, 50, 62.
 Tuning, 49, 70, 85; advantage of barretter in, 38; advantage of magnetic detector in, 71; coll., 88; disturbed easily, 119; grid, 122; varying capacity and inductance for, 62, 67, 77, 84, 85, 90, 94, 109, 116, 123, 168.
 Tuning fork analogy, experiments, 10, 23, 50, 83; a persistent vibrator, 46.
 Turpain resonator, 147.
 Ultra violet rays, 73, 76, 134; rapidly absorbed, 136.
 Undulatory theory of light, 17.
 United States Government experiments, 176; Signal Corps Stations, 175.
 Universal code or alphabet, 74.
 Uranium, 45.
 Varley, 125.
 Vibrations, superposed, 128, 141.
 Vibrator, persistent, See Air, 46, 116.
 Villard, 39.
 Voltmeter, hot wire tests, 66.
 Vreeland on oscillations, 22.
 Walter, on Wehnelt Interrupter, 162.
 Water, See Sea water, telegraphing.
 Watt, kilowatts, 29, 30.
 Wave chute, 121, 173.
 Waves, electric, See Electric waves;

W Z

ether, 30; grouped, 51, 123; sliding, 31, 35, 37, 188.
 Weber, reference to, 43.
 Wehnelt Interrupter, 91, 95, 161.
 Wig-wag signaling, 4, 196.
 Wireless apparatus, 58; See Apparatus.
 Wireless telegraph systems, Armory, 142; Branly-Popp, 99; Braun, 91; Bull, 192; De Forest, 107; Dolbear, 14; Ducretet-Popp, 105; Edison, 14; Ehret, 191; Fessenden, 121; Guarini, 101, 180; heliograph, 4, 196; induction, 6; Lodge-Mulrhead, 75; Marconi, 52; Pupin, 128; Ruhmer, 138; Slaby-Arco, 83; Shoemaker, 128; Stone, 126; Zickler, 134.
 Wireless telegraphy, apparatus for, See Apparatus; automobiles in, 101, 120; code signaling by, 179, 196; early experiments with, 26, 29; effect of lightning storms on, 178; exploding mines by, 157; fac-simile of message by, 61, 197; for fog signals, 141; from moving trains, 10, 176; general notes on, 175; interference with operation of, 177; in fire alarm signaling, 180; in Japan, 176; in news distribution, 100, 120; in warfare, 174; long distance, 30, 65, 73, 101, 119, 182; North Pole expedition, 176; on vessels, warships, 89, 174; on lightships, 59, 89, 90; operation of, See Apparatus; practical applications of, 174; receivers for, See Coherers, Detectors, Telephones; reliability of, 177, 193; See Stations; skill in handling apparatus, 178; suggestions on learning Morse code and signaling by, 179, 194; use of during storms; various applications of, 179.
 Wireless telephone systems, Armory, 143; Bell, 136; Collins, 140; Hayes-Cram, 137; Ruhmer, 138; Simon, 139.
 Wireless telephony, 179.
 Wires, vertical, See Antenna.
 Zickler wireless system, 134.
 Zeeman, 43.
 Zenneck, reference to, 172.

1903—NEW AND ENLARGED EDITION—1903

American Telegraphy and Encyclopedia of the Telegraph SYSTEMS—APPARATUS—OPERATION

BY

WILLIAM MAVER, JR.,

Ex-Electrician Baltimore and Ohio Telegraph Company, Member American Institute of Electrical Engineers, Author Maver's Wireless Telegraphy.

One Volume, Cloth, 656 Pages, 490 Excellent Diagrams and Illustrations.

"A book for Electricians, for Electrical Workers, for Students of Electricity. No mathematics. As useful in the Power House as in the Telegraph Office. Used as a hand-book in all the principal Telegraph and Telephone Electrical Departments, and as a text-book on Telegraph Engineering in many of the colleges of this country, and by the Signal Corps of the United States Army. Every subject treated in full detail and in the simplest possible language."

This work contains at least 22 books in one on Electricity, Telegraphy and Telegraph Engineering. The following is a brief summary of the subjects treated:

Elementary Electricity and Magnetism, Primary and Storage Batteries, Dynamos and Motors, etc.....	53	Pages,	33	Illustrations
Electrical Testing, Wheatstone Bridge, Line Testing, Wire and Cable Testing for Conductivity and Insulation Resistance, Localizing Faults in Wires and Cables, etc. No other book necessary for practical results....	40	"	35	"
The Condenser, Rheostat, Inductance, Capacity, Impedance, Galvanometers, etc.....	37	"	28	"
Morse Telegraphy and Apparatus, Alphabets, etc.....	43	"	51	"
Automatic Telegraph Repeaters, twenty-four different repeaters described.....	35	"	24	"
Duplex and Quadruplex Telegraphy, theory, practical management of, etc.....	50	"	55	"
Wireless Telegraphy, Marconi, De Forest Systems, Theory, etc.....	20	"	14	"
Simultaneous or Composite Telegraphy and Telephony, Edison Phonograph, Time Telegraph Service, etc....	26	"	17	"
Submarine Telegraphy, showing arrangement of siphon recorders, cable relays, artificial cables, etc.....	20	"	14	"
Automatic Telegraphy, Wheatstone System, Writing Telegraphy, Telautograph, Gray's Harmonic System, etc.,	50	"	43	"
Military and Naval Telegraph Signaling, Station and Field Kits, Codes, etc.....	10	"	6	"
Printing Telegraphy, including Stock Tickers, etc.....	70	"	45	"
American District Telegraph Service, Apparatus and Operation, etc.....	13	"	12	"
Burglar Alarm Telegraph Systems, Holmes, Wilder Systems, etc.....	9	"	6	"
Fire Alarm Telegraph Systems, Auxiliary, Automatic, etc.,	33	"	26	"
Police Patrol and Municipal Telegraph Systems, Telegraph and Telephone.....	22	"	23	"
Railroad Block Signal Systems, Miller Cab Signal, etc....	17	"	14	"
Manufacture of Wire, Construction and Maintenance of Telegraph Lines—Overhead, Underground, Submarine Cables, Conduits, etc., tables, etc.....	54	"	50	"

Including all the important systems of Telegraphy employed in the United States, Canada, Mexico, South America, Great Britain, Australia and New Zealand.

Sent postpaid to any part of the world, \$5.00.

Address, MAVER PUBLISHING COMPANY, 120 LIBERTY STREET, NEW YORK.

Wireless Telegraphy : Theory and Practice.

BY

William Maver, Jr.

Over 200 pages and 123 illustrations.

Embracing Early Wireless Telegraph Systems. Induction Telegraphy. Hertzian Waves. Electromagnetic Theory of Light. Electronic Theory. Theories of Propagation of Electric Waves. Syntonic Wireless Telegraphy. Wireless Telegraph Systems of Marconi, Lodge and Muirhead, S'aby-Arco, Braun, Branly-Popp, Guarini, Ducretet-Poppoff, De Forest, Fessenden, Stone, Shoemaker, Ehret, Bull, Musso, Armori, etc., etc. Telegraphing by Ultra Violet Waves. Wireless Telephone Systems of Bell, Ruhmer, Hays, Collins. Speaking Arc, Speaking Light, etc. Sections on Detectors, Coherers, Spark Gap, Interrupters, Aerial Wires, etc.

Sent to any part of the world, postage prepaid, on receipt of price, **\$2.00.**

Any other Electrical Book Supplied.

MAVER PUBLISHING CO.,

120 LIBERTY STREET, - - - NEW YORK.

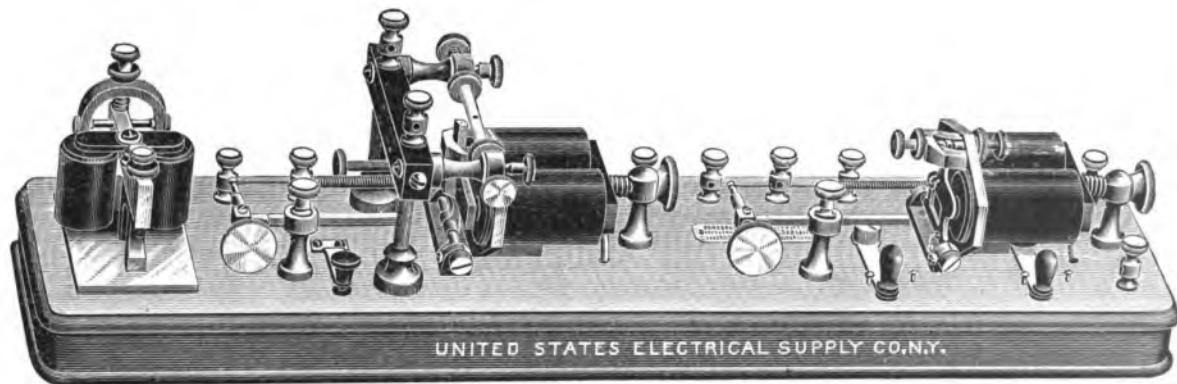

U. S. Electrical Supply Co., MOUNT VERNON, NEW YORK.
One half mile from New York City.
MANUFACTURERS OF
**EXPERIMENTAL APPARATUS, INDUCTION COILS,
COMBINATION TRANSFORMERS,
AND ALL KINDS OF WIRELESS TELEGRAPH APPARATUS.**

We were the first in this country to enter the wireless field
(see page 156), and therefore have the largest experience.

W. J. CLARKE, General Manager.