

# HARPER'S WIRELESS BOOK

HOW TO USE WIRELESS ELECTRICITY IN  
TELEGRAPHING, TELEPHONING, AND  
THE TRANSMISSION OF POWER

*Hyatt*  
BY  
A. HYATT VERRILL

AUTHOR OF —

"HARPER'S BOOK FOR YOUNG NATURALISTS"  
"HARPER'S AIRCRAFT BOOK"

FULLY ILLUSTRATED



HARPER & BROTHERS PUBLISHERS  
NEW YORK AND LONDON  
MCMXIII



**A YOUNG WIRELESS OPERATOR**



**HARPER'S "TELL ME HOW" BOOKS**

*A New Series*

HARPER'S GASOLINE ENGINE BOOK  
HARPER'S AIRCRAFT BOOK  
HARPER'S WIRELESS BOOK  
HARPER'S BEGINNING ELECTRICITY  
HARPER'S EVERY-DAY ELECTRICITY

Illustrated. Crown 8vo.

**HARPER'S PRACTICAL BOOKS**

HARPER'S BOOK FOR YOUNG GARDENERS  
HARPER'S BOOK FOR YOUNG NATURALISTS  
HARPER'S HOW TO UNDERSTAND ELECTRICAL WORK  
HARPER'S ELECTRICITY BOOK FOR BOYS  
HARPER'S BOATING BOOK FOR BOYS  
HARPER'S CAMPING AND SCOUTING  
HARPER'S OUTDOOR BOOK FOR BOYS  
HARPER'S INDOOR BOOK FOR BOYS  
HARPER'S MACHINERY BOOK FOR BOYS  
HARPER'S HANDY BOOK FOR GIRLS

Illustrated. Crown 8vo.

**THE STORY OF GREAT INVENTIONS**

Uniform in appearance with above.

**MOTOR BOATING FOR BOYS**

Illustrated. Crown 8vo.

**HARPER & BROTHERS, NEW YORK**

COPYRIGHT, 1913, BY HARPER & BROTHERS

PRINTED IN THE UNITED STATES OF AMERICA

PUBLISHED OCTOBER, 1913

A-P

# CONTENTS

INTRODUCTION . . . . .	PAGE vii
------------------------	-------------

## Part I

### THE WHY AND HOW OF WIRELESS

CHAPTER I.—WHY WIRELESS WORKS . . . . .	3
ELECTROMAGNETIC WAVES—HIGH-FREQUENCY OSCILLATIONS	
CHAPTER II.—WAYS AND MEANS . . . . .	8
VARIOUS TYPES OF AERIALS—METHODS OF CONNECTING AERIALS— MATERIALS FOR AERIALS—INSULATING—GROUNDING	
CHAPTER III.—INSTRUMENTS FOR SENDING . . . . .	17
PRINCIPLES OF THE INDUCTION-COIL—TRANSFORMERS—CONDENSERS —THE HELIX—SPARK-GAPS—AERIAL SWITCHES	
CHAPTER IV.—INSTRUMENTS FOR RECEIVING . . . . .	29
THE DETECTOR—TUNING—TUNING-COILS—A SIMPLE CARBON DE- TECTOR—A SIMPLE MINERAL DETECTOR—A SIMPLE POTENTIOMETER —CONNECTING A LOOSE-COUPLED COIL	
CHAPTER V.—TUNING . . . . .	41
DIRECTIVE WIRELESS TRANSMISSION	

## Part II

### HOW TO BUILD AND USE WIRELESS APPARATUS

CHAPTER VI.—ESTABLISHING A STATION . . . . .	51
SELECTING A SITE FOR THE STATION—CONSTRUCTING THE AERIALS— INSULATING—THE GROUND	
CHAPTER VII.—HOW TO MAKE INSTRUMENTS . . . . .	61
OUTFITS OF GREATER SCOPE—TELEGRAPHIC CODES	
CHAPTER VIII.—TALKING BY WIRELESS . . . . .	69
TRANSMITTING—RECEIVING—LAWS REGULATING WIRELESS OPERA- TION—INTERNATIONAL RULES	

# CONTENTS

	PAGE
CHAPTER IX.—VALUE AND USES OF WIRELESS . . . . .	80
CHAPTER X.—A BOY'S EXPERIENCE WITH WIRELESS TELEGRAPHY . . . . .	84
<b>Part III</b>	
<b>WIRELESS TELEPHONY</b>	
CHAPTER XI.—SOUNDS AND SOUND-WAVES . . . . .	95
THE THEORY AND PRINCIPLES OF SOUND—EXPERIMENTING WITH SOUND—MAKING SOUND-WAVES VISIBLE	
CHAPTER XII.—MAKING SOUND VISIBLE . . . . .	101
THE TELEPHONE—PHOTOPHONES	
CHAPTER XIII.—TALKING THROUGH THE AIR . . . . .	107
HOW WIRELESS SOUND-TRANSMISSION IS ACCOMPLISHED—INSTRUMENTS USED IN WIRELESS TELEPHONY—THE RECEIVING-APPARATUS—THE VANNI METHOD—THE VALUE OF WIRELESS TELEPHONY—EXPERIENCES OF A WIRELESS OPERATOR ON SHIPBOARD	
CHAPTER XIV.—WIRELESS OF THE PAST AND FUTURE . . . . .	127
WIRELESS OF THE FUTURE—TRANSMISSION OF POWER BY WIRELESS—TESLA'S OSCILLATORY CURRENTS—WIRELESS IN THE ARCTIC	
CHAPTER XV.—SOME ELECTRICAL TERMS EXPLAINED . . . . .	136
AMPERES, OHMS, AND VOLTS—SOURCES OF CURRENT—SPARK-COILS—BATTERIES	
CHAPTER XVI.—A WORD ABOUT TOOLS . . . . .	153
CARE AND USE OF TOOLS—VARIOUS USEFUL HINTS—BORING METALS, GLASS, ETC.—USING FILES—EMERGENCY PIPE-WRENCHES—HOLDING A ROD OR A PIPE IN A VISE—CUTTING RUBBER—DRILLING BRICK	
CHAPTER XVII.—A BOY'S SUCCESSFUL STATION . . . . .	163
THE BOY'S SENDING-APPARATUS—THE INTERRUPTER—THE FIXED CONDENSER—THE HELIX—THE RECEIVING-APPARATUS—THE DETECTOR—THE AERIAL—WHAT THIS BOY HAS ACCOMPLISHED—THE "TITANIC" DISASTER—A MESSAGE ABOUT THE WRECK	
CHAPTER XVIII.—SOME GENERAL CONSIDERATIONS . . . . .	173
STATIC—TELLING TIME BY WIRELESS—DOES WIRELESS PAY?	
APPENDIX.—USEFUL TABLES AND STANDARDS . . . . .	181
TO FIND SURFACE AND VOLUME—COMPARATIVE TABLE OF FRACTIONAL AND DECIMAL PARTS OF AN INCH—WIRE SIZES—METRIC WEIGHTS AND MEASURES—COMPARATIVE METRIC AND ENGLISH WEIGHTS AND MEASURES	
INDEX . . . . .	183

## INTRODUCTION

**N**O modern invention causes such a sense of wonder and mystery as the transmission of wireless messages.

Ordinary telegraphy is wonderful enough, but the wires stretching from pole to pole are something tangible. The wireless operator sits at his desk and flashes a message hundreds of miles across sea and land without visible connection of any sort. The very mystery of the wireless appeals to the mind and grips the imagination as we stand in a sending-room aboard ship and listen to the crackle and see the dull, lambent flash of the sparks and realize that from the lofty masts intelligible words are flashing through space to the distant land, carrying messages of safety and greetings to our waiting friends.

Perhaps the ship has met with disaster; a broken shaft, a fire, or a collision has rendered her unseaworthy, and passengers and crew are in peril. What is more thrilling, more comforting, and more wonderful than to feel that from the stricken ship quivering impulses are darting forth in every direction, calling for aid far and wide, and that within a few brief seconds every vessel's crew within a radius of hundreds of miles will know the plight and location of their helpless fellow-seamen, and will shift their course and rush to help as fast as steam can drive them. We all remember the part of the wireless in the loss of the *Republic* in 1909 and the great tragedy of the *Titanic* in 1912,

## INTRODUCTION

Mysterious as wireless may seem, yet in reality it is a very simple matter, easy of explanation, and so readily understood and mastered that mere boys can build and equip serviceable wireless stations and send and receive messages.

Few people realize the vast importance and wide-spread use of wireless telegraphy as employed to-day, or keep pace with its wonderful advances and constant improvement. It has become a part of our daily life, and until brought into close contact with its operation it passes almost unheeded.

Electricity always appeals strongly to boys, however, and with the advent of wireless many realized the new field for experiment and pleasure, and built wireless outfits, fitted up stations, and in a small way sent and received messages between one another, as well as messages from other stations that were never intended for their ears.

With the increase in these amateur stations, and their greater perfection as the boy owners improved in knowledge and technique, a new problem was presented. Boys will be boys, and if, when listening at their receivers, they caught a message from some distant ship or naval station, one can hardly blame them for attempting to decipher it or to reply.

Unfortunately, this "cutting in," or interrupting, proved a nuisance, and, finally, at the time of the stupendous disaster to the *Titanic*, actually jeopardized valuable lives.

As a result new and strict laws were passed with the object of preventing such troubles in the future, but not, as some think, with a view to preventing boys from equipping wireless stations or carrying on their experiments.

Wireless is yet in its infancy, and every one associated with it realizes how much is yet to be done, how much it

## INTRODUCTION

may yet be perfected, and what a vast field there is for experiment and invention in wireless transmission.

Many of the most important inventions in this and other arts have been made through accident, and by amateurs; and any boy who takes up electricity, and especially wireless, has a splendid opportunity to make some new and important discovery without interfering with legitimate or commercial messages in the least.

Even greater is the future promise of wireless telephony and the transmission of power or energy by wireless, and in these directions boys may experiment to their hearts' content without fear of trouble or hindrance.

Wireless telephony is an accomplished fact, but is far from perfection or even practical, every-day use; but sooner or later it will be as wide-spread and as important as wireless telegraphy is to-day.

The transmission of mechanical power by wireless can unquestionably be accomplished, and in a thousand and one ways it will prove of vast benefit to the world.

The unknowing may scoff at such prophecies, but they scoffed at aeroplanes, at submarines, and at wireless, and yet all are actualities to-day.

In this work the author has endeavored to explain the principles, operation, and construction of wireless transmission in the simplest and clearest way.

The object is to show boys what to do and how to do it in the lines of wireless telegraphy, telephony, and power transmission, and to point out exactly what has been accomplished in the past as well as what still remains to be done.

As far as possible all technicalities, hard problems, and higher mathematics have been omitted, and plain, intelligible words have been substituted.



## INTRODUCTION

The author and publishers believe that in this book the boy who is interested in wireless will find the information and help which he wants, and that many boys not hitherto attracted to this field will be led into wireless experiments and construction.

The illustrations are mainly original, having been prepared by the author in a simple, diagrammatic form, and it is hoped that they will prove far more helpful and more readily understood than many of the more detailed and more elaborate illustrations that have appeared in other works.

It is taken for granted that the majority of readers of this volume will already have some knowledge of electricity and its properties; but for those who are ignorant of the subject a chapter has been provided which explains in a most elementary and easily understood way the various electrical forces, measurements, and devices, and by comparing these with common well-known things renders them as simple as possible.

Aside from the training of mind and hand which boys may gain through building and equipping wireless outfits, the knowledge of telegraphy and telegraphic codes and operations will prove of vast benefit. In the mind of the author, telegraphic codes should be taught in every public school, and each boy should be as able to read and send a message by code as to read or write a letter.

One can never tell where such a training will prove of the utmost value; and, moreover, the boy or young man who is a competent telegrapher can always find remunerative employment.

The subject of electricity is a vast one, and many of its details can only be treated in a strictly technical manner and by the aid of very involved and abstruse calculations and

## INTRODUCTION

formulæ. Those who wish to carry their knowledge and research beyond the simpler stages of wireless should consult technical works. The mission of this book is to help beginners and blaze a way to a better knowledge of wireless, and if it succeeds in this the author will feel that his efforts have been amply repaid.

**Part I**

**THE WHY AND HOW OF WIRELESS**

# HARPER'S WIRELESS BOOK

## Chapter I

### WHY WIRELESS WORKS

**M**ANY years ago, when the first telegraph line was stretched across the state of Maine, an old farmer tied a pair of boots addressed to his son in Portland to a telegraph post. When, on the following morning, he found the boots still there, he grew mightily indignant because the package had not been delivered to his distant boy.

To-day the telegraph is too well known for this, and yet many intelligent people are almost equally as ignorant of the principles and properties of wireless, particularly wireless telephoning and wireless transmission of power. Yet the simplicity of wireless transmission is proven by the fact that numbers of school-boys have wireless outfits, and send and transmit messages for considerable distances—and at times prove a great nuisance to the regular operators.

Have you ever stood upon the bank of a pond or pool and thrown a stone into the water? As the stone strikes the calm surface there is a splash, and immediately little ripples commence traveling in circular form from the spot, gradually enlarging as they proceed until they break in tiny waves upon the shore.

## HARPER'S WIRELESS BOOK

There may seem to be little in common between the stone tossed into the pool and a wireless message traveling through space, but in reality they are much alike, and one serves as a very lucid explanation of the other.

As the waves from the stone travel in gradually widening circles from the splash, so the spark of the wireless transmitter sets up rapidly moving waves in the air which gradually spread, and if caught by a receiving-instrument break against it as did the ripples on the shore.

### Electromagnetic Waves

The waves set in motion by the wireless spark are known as *electromagnetic waves*, and the energy that starts them is *electrical energy*, just as the muscular or mechanical energy of your arm started the wavelets of water on their travels.

We speak of sending wireless messages through space or through the air; but, really, the medium which pervades all space, all solids, and, in fact, the whole vast universe, is an invisible, odorless, and almost weightless medium of extreme elasticity called *ether* or *luminiferous ether*. All our heat, light, and practically all our resources are transmitted to us from the sun in the form of vibrations, or waves, through this ether. Light and heat waves have long been known, and these, traveling at a speed of more than 180,000 miles a second, carry to the earth the energy of the great fiery, blazing sun and store up its heat and light in trees, coal, rivers, and other forms of available energy for man's use on earth.

So also the electromagnetic waves travel readily and with extreme rapidity through the ether. To start them on their way and collect and record them at our will, we have only to provide certain instruments adapted to the purpose.

## WHY WIRELESS WORKS

Nearly every one has seen electric sparks caused by spark-coils or Leyden jars. Any one fortunate enough to have been in a wireless operator's room has seen the crackling blue sparks that appear when a message is being sent. These sparks appear to the eye like single sparks; but in reality each is composed of a vast number of small sparks following each other with inconceivable rapidity. The sparks discharge electrical energy by a tremendous rush of current in one direction, and then another of less force in the opposite direction. In the case of the Leyden jar there ensues a series of these discharges in opposite directions, each decreasing in energy until all the stored electric force is exhausted. The entire series, however, is discharged in such a small fraction of time that it appears like a single discharge. From their extreme speed these repeated discharges are known in electrical parlance as *high-frequency oscillations*.

### High-Frequency Oscillations

The high-frequency oscillations of the electrical spark correspond to the stone thrown into the water. These oscillations thrown out by the wireless transmitter into the vast sea of ether set up invisible ripples or waves which follow the contour of the earth, and so find no barriers in mountains, valleys, buildings, or other objects.

The ethereal waves radiate from the wireless instrument like the ripples of water caused by the stone, and, like the ripples, they become longer and weaker as they radiate farther and farther from the spark that caused them.

The Leyden jar does not in itself have the power of creating electricity, but merely has the power to hold or store electricity generated by some other machine or apparatus. In its simple form the Leyden jar is merely a

## HARPER'S WIRELESS BOOK

glass jar coated outside and in with tin-foil or some other metallic *conductor* separated by the glass, which is a *non-conductor*. When the outer and inner conductors are connected by wires the stored electrical energy leaps across the extremities of the two wires and forms a spark.

Various other methods are known of producing sparks of high frequency, the commonest being an *induction-coil* or *spark-coil*, such as is used in producing the spark for ignition on gas-engines. A spark-coil, also known as a *transformer*, is an instrument which transforms low-voltage electricity passing through a coil of coarse wire, known as the *primary*, into high-voltage electricity in a coil of fine wire, known as the *secondary*.

If the terminals of the secondary are placed close together, and one of them is also connected with the primary and an electrical current from a dynamo or battery is turned through the coil, a bright spark will leap across the space between the two wires. As the Leyden jar consists of two conducting surfaces separated by a non-conductor, so in the wireless apparatus the atmosphere serves as the non-conductor, or *dielectric*, and the "aerial" and "ground" correspond to the two metal coatings.

By connecting one of the secondary terminals of a coil to a plate of metal in the ground and the other to wires high in the air, and passing the current through the coil, a spark will leap across the spark-gap, and the current surges back and forth through the aerial and sets up high-frequency oscillations, which cause a strain in the ether and cause the electromagnetic waves to travel outward in ever-widening circles.

By connecting the primary wires through a key or switch sparks and consequent oscillations may be produced of longer or shorter duration, or in any desired sequence or order.

The waves set in motion by the sending-apparatus and

## WHY WIRELESS WORKS

coil also have the property of starting oscillations in any conductor which they strike. If they strike the distant aerial of a wireless station they at once set up oscillations in it; but these are so weak that they would not be known unless some sort of a very sensitive instrument was employed to detect them. Such instruments are known as *detectors*, and consist of some sort of mineral crystal between two contact-points which are adjustable. From these, two terminal wires are led to a telephone receiver. The high-frequency oscillations cannot pass through the receiver, as they are *alternating* currents and are choked off by the little magnets in the telephone receiver. The mineral crystal, however, will permit the oscillations to pass through in one direction, but will not allow them to return, and it thus acts exactly as a check-valve in a water-pipe.

Owing to this peculiarity, the oscillating currents which flow back and forth are transformed to impulses flowing only in one direction and known as *direct* currents. Direct currents will flow through the telephone receiver and cause the diaphragm therein to vibrate and thus transmit sound-waves to the ear.

By adjusting the terminals nearer or closer to the crystal, and moving it about while listening to the receiver, the oscillations are finally heard, and if they are being sent in regular periods of greater or less duration, a code can be arranged and the sounds caught in the receiver become intelligible to the operator.

In the above explanations of the principles involved in sending and receiving messages by wireless, frequent mention has been made of "aerials," "ground," and "detectors." In the following chapters I will try to explain just what these things are, how they are made, and how important they are in the practice of wireless telegraphy.



## Chapter II

### WAYS AND MEANS

THE most important parts of any wireless station are three in number, and are as follows: First, the *transmitter*; second, the *receiver*; third, the *aerials*.

Each of these three elements is composed of a number of devices and apparatus designed for a specific purpose, and each may be simple or complicated according to the size and perfection of the station. The transmitter consists of various appliances and devices for creating waves in the air and sending messages. The receiver consists of all the devices for detecting the waves and receiving messages, and the aerials consist of a system of wires elevated high in the air, and from which are radiated the waves sent from the transmitter, and which also intercept or detect the waves that are made intelligible by the receiver.

Perhaps the aerials, or *antennæ*, are the most familiar part of a wireless system to the majority of people, for they are always visible, either on land or aboard ship, and serve as indications to all observers that a wireless apparatus is in the vicinity.

The aerials are, so to speak, the ears and mouth of the wireless station, and their arrangement and position have a great influence upon the distance to which messages may be sent or from which they may be received.

The location for aerials is selected in reference to surrounding objects, and they are always placed as far as pos-

## WAYS AND MEANS

sible from other tall objects such as trees, chimneys, telephone wires, masts, or tall buildings. Such objects absorb a certain amount of energy from the waves sent out, and, moreover, prevent incoming messages from reaching the aerials directly.

Another matter which influences the choice of a location for the aerials is the character of the surrounding ground or country. In traveling above the surface of the earth the electromagnetic waves generate minor currents in the earth beneath. If the surface is moist or is water, these small currents meet with but slight resistance, and the messages thus come with but little decreased power for long distances. If, on the other hand, the earth is dry, rocky, or stony, the small currents meet with great resistance, and the messages cannot be received for very long distances. This is the reason why messages sent from ships, or from one point to another over seas, are frequently understood for much greater distances than messages sent over land with much more powerful apparatus. Many stations which can send and receive messages for three or four hundred miles across water cannot accomplish satisfactory results for more than one hundred miles over land.

Heavy forests or timber lands also materially affect the efficiency of wireless apparatus. Each tall tree acts like an aerial in a small way, and each branch, twig, and leaf extending high in air absorbs a small amount of the wave's energies and reduces the power of the wave before it finally reaches the receiving-station. Messages sent from the same station in summer and winter vary greatly in range, for in summer the trees absorb a great deal more electricity than in winter, not only because they are covered with leaves, but also because they are full of sap and moisture, which are good conductors of electricity.

## HARPER'S WIRELESS BOOK

During the summer, also, the molecules of the air carry an appreciable electric charge, a condition known as "ionized." This same condition exists in the air during bright sunshine, and for this reason messages sent at night are usually transmitted farther and are more clearly heard than those sent in the daytime.

Another peculiarity of wireless transmission is the fact that certain localities are more favorable than others for no apparent reason. Thus, on the Pacific coast stations can send and receive messages for much greater distances than stations of the same capacity on the Atlantic coast, and tropical stations are very inefficient as compared to those in temperate or semi-arctic regions.

Natural atmospheric electricity produces very marked effects upon wireless waves, and at times the air is so filled with electrical energy that wireless stations are practically put out of commission.

This atmospheric electricity is known as "static," and it is much more prevalent in some localities than in others. On the eastern coasts of America it is far worse than on the western coasts, and before thunder-storms it is particularly in evidence. A wireless operator can usually predict an approaching electrical storm many hours in advance by the peculiar scratchy, rumbling sounds that the "static" produces in his receivers.

### Various Types of Aerials

Most amateurs or small stations employ a form of aerial known as the "flat-top" (Fig. 1). This is a form of aerial very easy to install and giving excellent all-around results.

The "umbrella" or "pyramid" form is another excellent arrangement (Fig. 2); but it is a little more complicated,

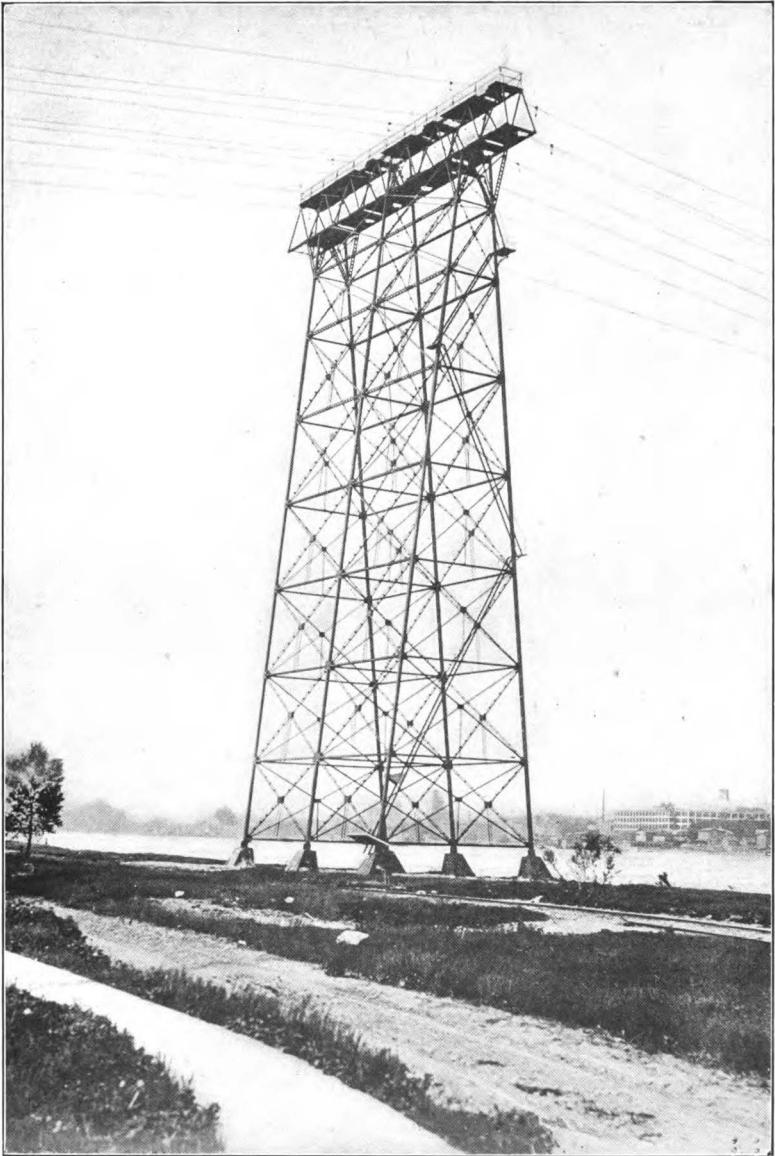

**HIGH TOWER TRANSMISSION LINES**

This style of skeleton construction is now being used for both wireless and non-wireless high power transmission stations



## WAYS AND MEANS

and in place of the wooden posts or masts used to support the flat-topped forms an iron pipe is used which supports the wires from its apex, and these in turn also serve as guys,

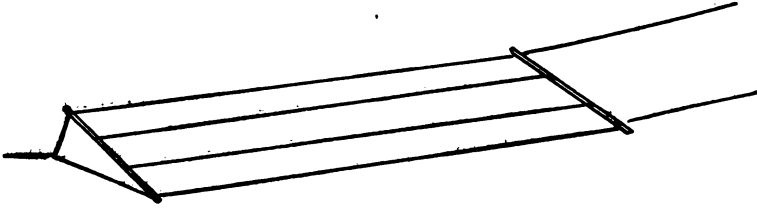

*Fig. 1*

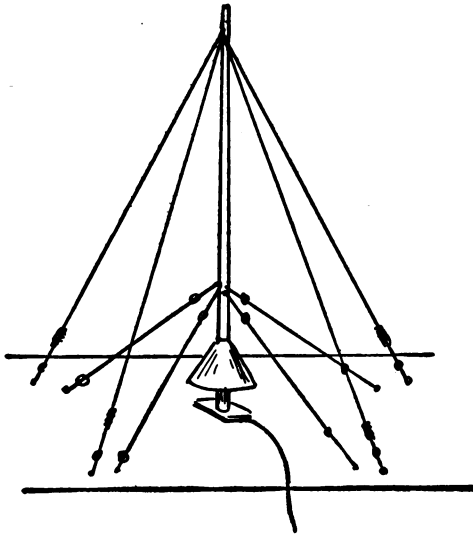

*Fig. 2*

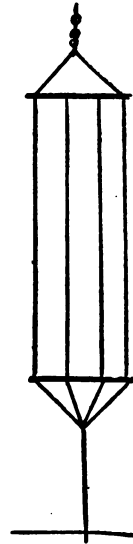

*Fig. 3*

or supports, to the pole. The base of the pole is placed on an insulated base protected from rain by an inverted cone, or shelter, and the wires are also insulated at their lower ends. The iron post itself is the main aerial, but the wires serve as extensions to increase the capacity.

Vertical aerials (Fig. 3) are not as efficient as either of the

## HARPER'S WIRELESS BOOK

above forms, and are usually 50 per cent. higher than the flat-topped form if of the same capacity.

“L” and “V” forms (Fig. 4) are used where the highest point is required near the station, with a lower point some distance away.

Each of these principal types has several minor forms or variations, and in vertical aerials we find the “grid,” “fan,” “inverted pyramid,” etc. (Fig. 5). Such aerials are often employed where long-distance messages or powerful ap-

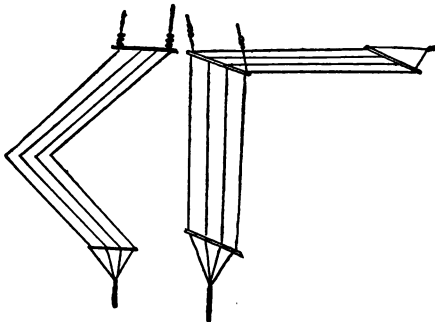

*Fig. 4*

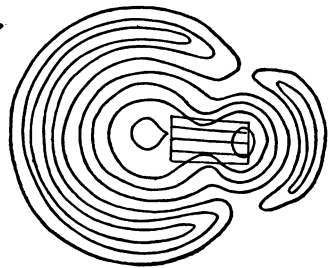

*Fig. 6*

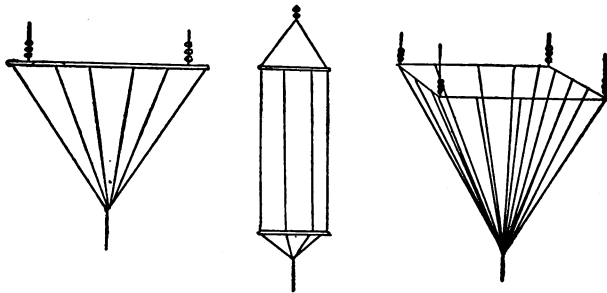

*Fig. 5*

paratus are necessary, such as the station installed by Marconi for sending messages from America to Europe. Umbrella and pyramid forms are used extensively in the

## WAYS AND MEANS

army and for portable outfits, while flat-topped types are employed exclusively aboard ships.

Each form consists of certain combinations of posts and wires, and in horizontal forms the wires have little effect in radiating waves, but serve mainly to increase the capacity; or, in other words, they enable more energy to be stored and radiated.

All flat-topped or horizontal forms possess a "directive" tendency; or, in other words, they radiate or receive waves more efficiently in one direction than in another, or in the direction that the ends point. This is clearly shown in Fig. 6, which shows the "directive" tendency of a common "L" type horizontal aerial. The same effects are produced in the "V" and inverted "L" forms, and so marked is the effect in these that a land station equipped with such aerials can often detect the bearing of a ship signaling from a distance.

Flat-topped aerials of the inverted "U" and "T" forms possess the advantages of both horizontal and vertical types (Fig. 7), and are widely used.

### Methods of Connecting Aerials

The methods of setting up aerials and connecting wires varies with the different types, but in each distinct form several methods may be employed. Thus, a flat-topped aerial may be either "straightaway" or "looped" (Fig. 8). In the former the free ends of the wires end in insulators, while in the latter they are all connected and then divided into two sections, each of which is led to the instruments separately.

Where a great height cannot be obtained or conditions necessitate the aerials being short, the loop form will serve



## HARPER'S WIRELESS BOOK

best; but where conditions will admit of its use the straight-away type is preferable.

### Materials for Aerials

The best materials possible should always be used in constructing aerials, or, in fact, any part of a wireless station, for the efficiency of a well-constructed small plant is far greater than that of a poorly constructed large station.

The best material for aerials is bare copper wire; but where the wires are over 100 feet in length phosphor-bronze should be used, as the copper will stretch and sag. Stranded wire is preferable for large aerials, and is almost universally used for naval and commercial stations; but for amateur use the single wires serve every purpose.

As the high-frequency currents used in wireless travel mainly on or near the surface of the wires, the stranded wires present a better conductor than a solid wire, as they have a greater surface area as compared with their size.

Aluminum wire is sometimes used, but when this material is employed it should be larger in size than copper, as it offers more resistance to the currents.

Iron wire should never be used for aerials, for even if tinned, coppered, or galvanized, it tends to choke off high-frequency currents.

### Insulating

A very important factor in a successful aerial is the care used in insulating it from surrounding objects.

The insulators used must not only be perfect under all conditions, but they must be strongly made to withstand the strains of supporting the aerial in all weathers.

The best insulators are made of molded insulating ma-

## WAYS AND MEANS

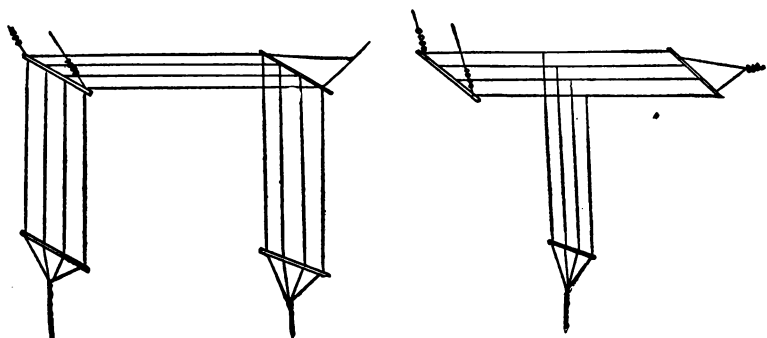

*Fig. 7*

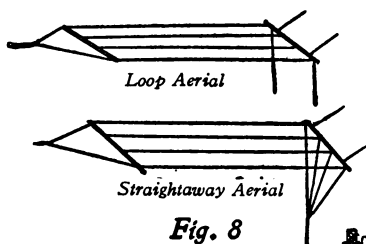

*Fig. 8*



*Fig. 9*

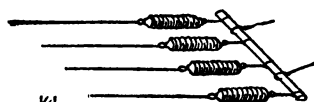

*Fig. 10*

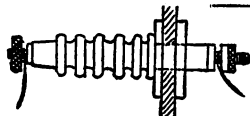

*Fig. 11*

terial with an iron ring embedded in each end (Fig. 9). Such insulators are cheap, and the ready-made ones are far better than you can possibly make yourself.

One end of a wire is fastened to one ring, and the spar, or support, is attached to the other (Fig. 10).

The wires connecting the aerial with the operating instruments should be very carefully insulated where they pass through the wall or window, and this is accomplished by using "leading-in" insulators (Fig. 11), or by leading the "rat-tail," or "lead-in," through a hole bushed with an insulator.

## HARPER'S WIRELESS BOOK

### Grounding

A very important matter in wireless installation is that of "grounding," or "earthing." This is accomplished in various ways, one of the commonest being to connect the ground-wire with copper plates buried in the earth or submerged in water.

On board of vessels it is merely necessary to connect the ground-wire to the metal plates of the hull; but on land it is far more difficult to secure a perfect grounding.

The easiest method for amateurs is to connect the wire to a gas or water pipe, preferably the latter; but when pipes are not available a piece of sheet metal (copper if possible) should be buried three or four feet beneath the surface of the earth.

Another excellent method of grounding is to connect the wires to a large strip of wire netting spread upon the ground, and this is often the only practicable method in very barren, dry, rocky, or sandy places.

## Chapter III

### INSTRUMENTS FOR SENDING

THE particular kind of instruments which comprise the transmitting, or sending, apparatus depends largely upon the supply of current. You may use a current already installed for electric power or lighting, or you may produce your own electricity by means of batteries or a dynamo.

The commonest source of current for small stations or amateur use is dry batteries, and, while these answer very well, a storage battery or wet batteries are superior for equipments of large size.

Perhaps the most important part of the transmitting apparatus is the *induction-coil* or *transformer*, and whether one or the other is used depends upon the kind of current.

Induction-coils may be operated by either direct or alternating current, but a transformer *must* be operated by the latter. An induction-coil when used on an alternating current acts as a transformer.

An alternating current is one which reverses its direction and flows first in one way and then in another, and may be compared to a curved line (Fig. 1). Starting at A it gradually increases to its maximum at B, and then gradually decreases until at C. It then passes in the opposite direction until it reaches D, and again dies down to E. This oscillation is repeated a certain number of times in a second, and each time that the current rises from its zero point to

## HARPER'S WIRELESS BOOK

its maximum, reverses, and returns to zero, it is said to have performed a "cycle." Thus, in the diagram, from A to E represents a cycle, while A to C represents an alternation. The usual frequency or "speed" of the alternations is 60 cycles a second, or 7,200 alternations per minute.

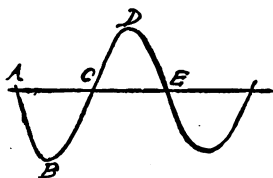

Fig. 1.

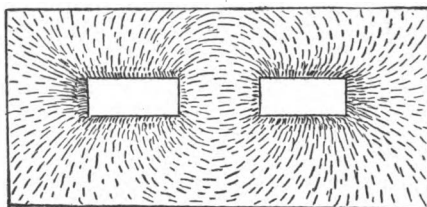

Fig. 2

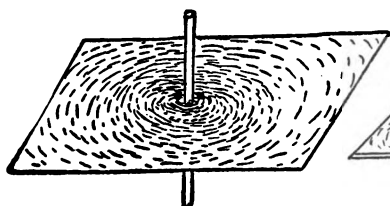

Fig. 3

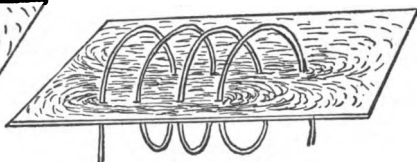

Fig. 4

A *direct current*, on the other hand, flows in a straight line, or in one direction only, and in order to produce interrupted high-frequency waves for wireless purposes some form of instrument must be employed to break up the straight, or direct-flowing, current into numerous interrupted currents or waves.

At the same time it is necessary to raise the voltage from a low voltage to a high voltage in order to properly charge the aerial and cause an electrostatic field in the atmosphere.

It is for this purpose that *induction-coils* or *transformers* are used. Both of these instruments depend upon magnetic induction for operation.

## INSTRUMENTS FOR SENDING

### Principles of the Induction-Coil

If a fine wire is coiled and a magnet suddenly placed within the coil, a current of electricity will be produced in the coil. This will be of but momentary duration, for as soon as the magnet remains stationary the current ceases. If moved back and forth, however, currents will be produced, the source of the energy being the mechanical force, or power used in moving the magnet.

This is a remarkable phenomena brought about by a medium known as the *magnetic field*, a peculiar condition existing in the space close to any magnet, and whose real nature is still but little understood.

It is, however, easy to demonstrate the existence of the magnetic field by means of a simple experiment. If a sheet of thin glass is placed over a horseshoe-magnet and iron filings are sprinkled over it, the latter will settle down in regular curved lines, as shown in Fig. 2. This is known as a "magnetic phantom," and the curved lines indicate the direction of the lines of force which comprise the magnetic field of the magnet. If a wire charged with electricity is passed through a card covered with filings, they will arrange themselves in circular form, as shown in Fig. 3. If the wire is coiled through holes in the card, the magnetic phantom will show that the magnetic field is much stronger, and will appear as in Fig. 4.

The principle of the magnetic field of a magnet inducing a current of electricity in a coil about it is employed in the induction-coil. In its simplest form it consists of a coil of wire, the "primary" (A, Fig. 5), wound about a soft-iron core (B, Fig. 5), and the whole surrounded by a secondary coil (C), composed of many thousands of turns of very fine

## HARPER'S WIRELESS BOOK

wire carefully insulated. When a current from the battery (D) is sent through the primary (A), a magnetic field is developed which induces a current in the secondary many times the voltage of the original current. If the secondary coil contains fifty times as many turns of wire as the primary coil the induced voltage will be practically fifty times as great as the original current.

As currents are induced only when the magnetic field is changing, a device known as an "interrupter," or "vibrator," is used to turn on and off the current flowing from the battery through the primary coil. This interrupter consists of a spring which presses against an adjustable point, both being provided at their contacts with platinum points (E, Fig. 5).

The spring is placed directly over the end of the core in the coil, and as soon as the current passes around this core

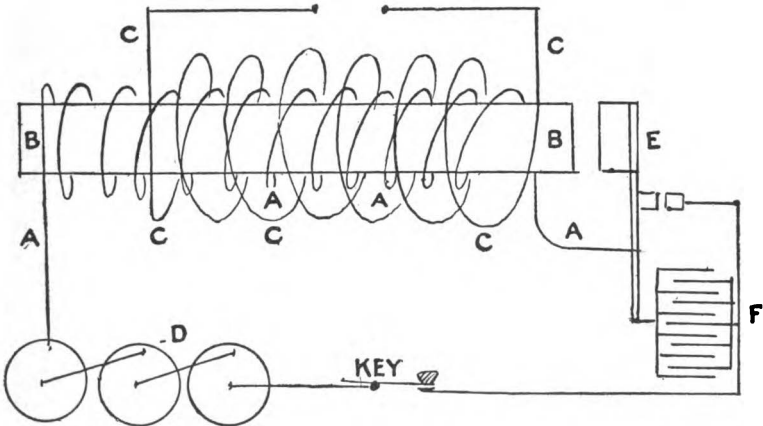

*Fig. 5*

through the primary winding the core becomes an electromagnet, which draws down the spring from the contact and thus breaks, or interrupts, the current. Just as soon as the

## INSTRUMENTS FOR SENDING

current is broken the core loses its magnetism, the spring is released and flies back against the contact, the current is again established and the operation repeated. Thus the primary is very rapidly broken and made, and a high-tension, interrupted current is induced in the secondary coil.

In addition to these parts the coils are also provided with a "condenser," a device made from sheets of tin-foil separated by waxed paper and connected with the terminals of the primary coil. This condenser stops sparking at the platinum points, and also adds to the intensity of the induced secondary current (F, Fig. 5).

The voltage of the secondary current is so high that it will readily leap, or "jump," across an air-gap in a shower of brilliant blue sparks, or will even pierce a card or a piece of paper placed between the terminals of the secondary wire.

A rapid vibrator giving high-pitched sparks is preferable for wireless work to a slow one, as the human ear can much more readily detect the high-pitched sounds in the receiver.

In large coils operated by powerful currents an electrolytic interrupter is usually employed in place of the mechanical device described. In this device (Fig. 6) one pole of the primary is connected with a lead plate within a jar containing sulphuric acid and water. The other end of the current is connected with a platinum wire placed in a porcelain tube so that only a small portion of the lower end is in the solution. As the current passes through a bubble forms at the end of the wire, thus protecting it from the liquid and breaking the current. The bubble is at once discharged, and the current flows freely until a second bubble forms. This is repeated over and over very rapidly, and such an interrupter will frequently produce currents at a frequency as great as one thousand per second.



## Transformers

Although transformers are acknowledged the best means of increasing the current for wireless purposes, they require an alternating current, which is seldom available for amateurs.

Transformers are of two kinds, *open-circuit* and *closed core*.

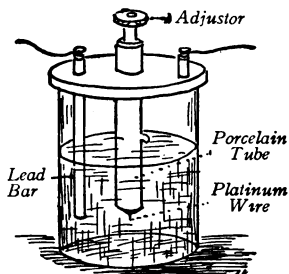

Fig. 6

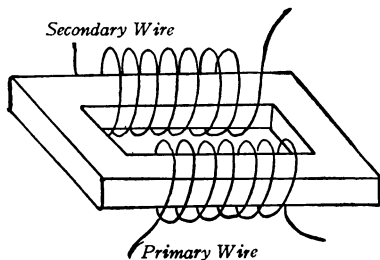

Fig. 8

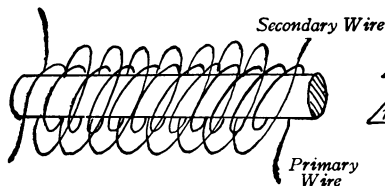

Fig. 7

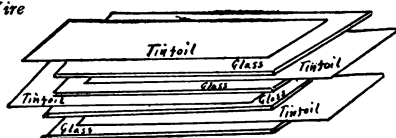

Fig. 9

The open-circuit type (Fig. 7) has a straight shape like an induction-coil, while the closed core (Fig. 8) forms a hollow rectangle or square.

The closed-core transformer consists of two coils of insulated wire which form a secondary and a primary, as in an induction-coil; but, in place of being wound one over the other, they are wound upon the opposite sides of a rectangle or square core. This core is made up of iron sheets called "laminations," which increase the power of the transformer and decrease the heat generated. As already ex-

## INSTRUMENTS FOR SENDING

plained, induced currents are only produced when the magnetic field is changing, and the interrupter of the induction-coil is used to change the current in such a coil. When an alternating current and transformer are used the interrupter may be dispensed with, for each time that the current rises and falls the magnetic field changes.

Care must be used in proportioning the windings to secure sufficient reactance, which is the tendency of a coil to resist the flow of an alternating current.

Sometimes a *reactance-coil* is placed in circuit with an open-core transformer, which prevents the spark from "arcking," which is the tendency of a spark to pass across from one side to the other without charging the condenser or creating the desired high-frequency waves.

### Condensers

These are very important parts of the coil or transformer, as without them the oscillations would be weak or absent, and sparks would occur at the interrupters or across the gaps.

The simplest form of condenser, and the kind used in practically all small coils, consists of a series of tin-foil sheets separated by waxed paper, mica, or glass, as shown in Fig. 9. The alternate sheets of tin-foil are connected together with wires, and are connected with the terminals of the primary circuit. They are usually made in units so that any desired capacity may be obtained by adding to or subtracting the right number of sheets.

The condenser has the property of storing up electrical energy and suddenly releasing it as the current is made and broken; and, while very essential, it is usually overlooked and unknown to most people, as it is hidden away in the coil-box out of sight.

## HARPER'S WIRELESS BOOK

Other forms of condensers are made by using several Leyden jars; but they are very cumbersome, and some energy is lost by the brush discharges around the tops of the jars. Other forms are "tubular" and "oil-immersed" condensers; but the function of each is the same, and its principle very similar.

### The Helix

As a certain quantity of *inductance* is desirable in the wireless, in order to develop the highest of high-frequency oscillations, an instrument known as a *helix* is employed. This consists of a coil of copper or brass wire around a frame of hard rubber, fiber, or even dry wood (Fig. 10). This is known as a *close-coupled helix*, and the proper inductance is obtained by snapping the wires on or off the coil with clips.

A better form of helix is the *loose-coupled* type, in which there are two coils, one over the other (Fig. 11), and by merely raising or lowering the upper, or secondary, helix the amount of inductance or "coupling" may be varied to suit requirements. Moreover, larger amounts of energy may be radiated by using the loose-coupled than by using the close-coupled helix.

### Spark-Gaps

In order to discharge the oscillations produced by the current in the coil or transformer and produce waves through the air a device known as the *spark-gap* is required. This usually consists of two electrodes mounted on standards and so constructed that the distance between them may be very accurately adjusted. A common form, shown in Fig. 12, has the electrodes in the form of hollow-

## INSTRUMENTS FOR SENDING

ended cylindrical rods, as this form prevents the spark from *arcking*, and also decreases the heat generated. To further radiate this heat the rods are ordinarily made with rings or flanges.

Silver is probably the most satisfactory metal for making

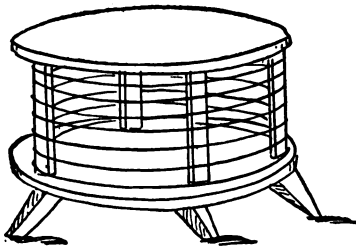

Fig. 10

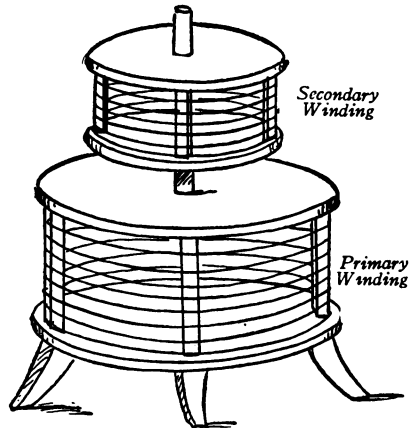

Fig. 11

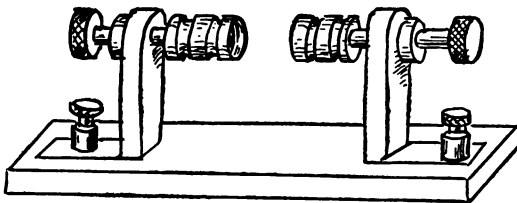

Fig. 12

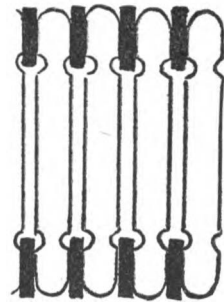

Fig. 13

spark-gaps, but its expense prevents its wide use, and a hard alloy of zinc is commonly used instead.

Various other forms of gaps are used, one of which is shown in Fig. 13. This is known as a *quenched gap*, and con-

## HARPER'S WIRELESS BOOK

sists of a number of brass or metal disks with thin mica washers set between them. This style of gap produces a great deal more energy than any other form, and is, moreover, nearly noiseless, whereas the discharge from an ordi-

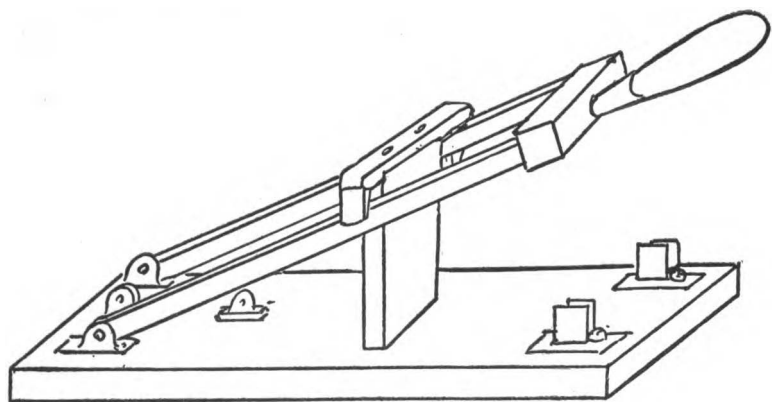

Fig. 14

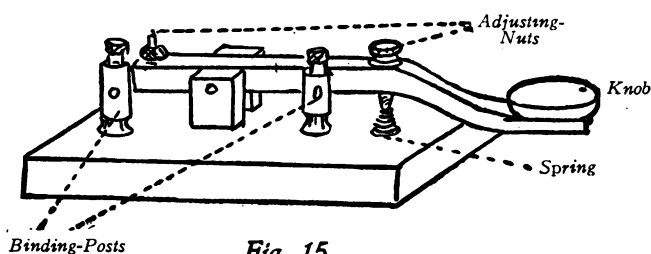

Fig. 15

nary gap produces a crashing, crackling sound which is very annoying.

Another form of gap is the *rotary gap*, consisting of a number of small electrodes set around the edge of a wheel mounted on the shaft of a small electric motor. Two adjustable electrodes are so arranged that the smaller revolving electrodes pass between them. When the motor is in

## INSTRUMENTS FOR SENDING

operation at a high speed the spark is interrupted and a peculiar musical sound is produced.

There are many other forms of gaps in use; but the action and principles are similar in all, and no description of the innumerable forms is necessary.

### Aerial Switches

In order to quickly connect the aerial and ground to either the sending or receiving apparatus an *aerial switch* is required. This may be a very simple *double-pole double-throw* switch, or it may be a larger special device such as shown in Fig. 14.

The key (Fig. 15) is a form of switch operated by hand, and which controls the current passing through the transmitting-apparatus, thus shutting them off or allowing them to pass at will of the operator. In this way the high-frequency oscillations from the aerials may be made long or short to correspond to the dots or dashes of the code, and thus rendered intelligible to the operator at the receiving-station.

Wireless-station keys are usually heavier and larger than those used in ordinary telegraphic work, as they carry heavier currents, but otherwise they are very similar, and for small amateur stations an ordinary key will answer.

When a loop-aerial is used an *anchor-gap* (Fig. 16) must be installed to divide and equalize the currents from the opposite sides of the aerial. The anchor-gap is merely a

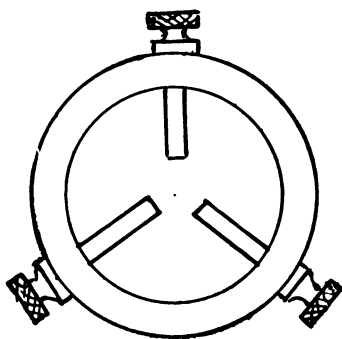
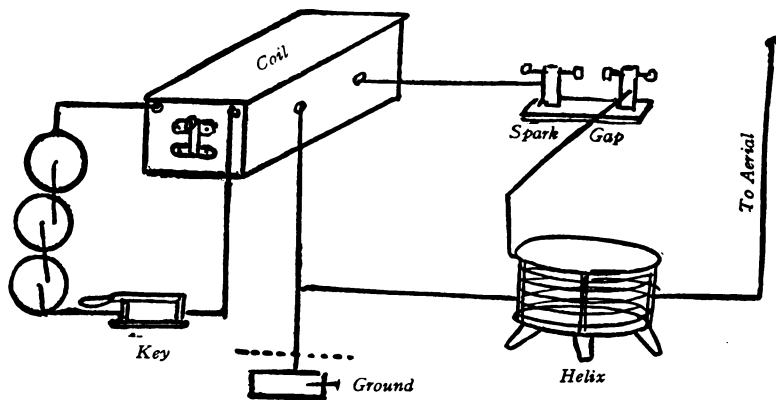

Fig. 16

## HARPER'S WIRELESS BOOK



*Fig. 17*

hard-rubber or fiber ring containing two or three small electrodes, or sparking-points. One electrode is connected to the transmitting-wire, and the other two to the opposite sides of the aerial wires.

By referring to the diagram (Fig. 17) the various instruments and apparatus of a transmitting-outfit may be seen in their proper relation and positions.

## Chapter IV

### INSTRUMENTS FOR RECEIVING

FULLY as important as the sending, or transmitting, apparatus is the receiving-apparatus.

Like the former, the latter depends as to type, size, and scope upon the kind of current used and the amount of the current available.

In a way the receiving-instruments are far more interesting than the sending-apparatus, for it seems a great deal more wonderful to receive or hear a message coming for miles and miles through the air than to tap a key and send a message which may not reach any one at all.

In a broad sense, the receiving-outfit is a duplicate of the transmitter, but reverses the operations. Thus, the transmitter is designed to transform the electrical current into electromagnetic waves which are sent forth from the station, whereas the receiver catches these waves in the air and transforms them into ordinary electrical currents which can then be heard in an ordinary telephone receiver.

The principal instruments in a receiving-station are the *detector*, the *condensers*, *tuning devices*, and *telephone receivers*. In addition to these there are *variable condensers*, *test buzzers*, *potentiometers*, *ammeters*, *variometers*, etc. And while this array may seem formidable at first, yet each is really very simple and its principle and operation very easily understood.



## The Detector

This instrument is perhaps the most important of all in the receiving-station, for without this simple affair it would be impossible to detect, or "catch," the waves sent forth from transmitters in other stations.

There are a great many kinds and forms of detectors in use; but as a rule they consist of some kind of mineral placed between two adjustable points, as shown in Fig. 1. To the two terminals (A, B) wires are connected with a telephone receiver (C), and the ground-wire (D). The other terminal of the receiver runs to the aerial (E).

In receiving a message the receiver is placed to the operator's ear, and the contact point (F) turned slowly up and down against a piece of suitable material (G), until the sounds of the message being sent from another station are audible.

The purpose of the detector is to act as a sort of valve to shut out a portion of the high-frequency waves and permit the receiver to carry them to the operator's ear.

In the telephone receiver are magnet-coils which shut out or choke off the alternating currents as sent from a transmitting-station; but the mineral used in the detector shuts off but one-half the alternations of the current and allows the current to pass through the receiver in one direction, but not in the other.

If we consider an alternating current as represented by a curved line (Fig. 2), and draw a straight line through the center of the loops, as at A and B, the resulting lower halves of the loops will represent the same current as acted upon by the detector.

Such a current can readily pass through the magnets of

## INSTRUMENTS FOR RECEIVING

the receiver and cause a sound on the diaphragm with each pulsation.

The commonest materials used in detectors are carborundum, silicon, galena, and iron pyrites. Each of these minerals

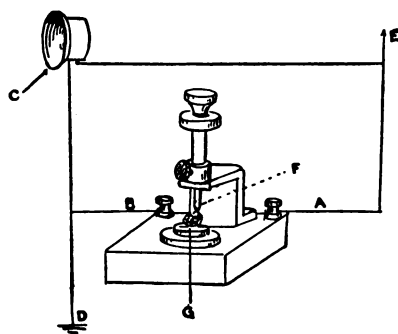

Fig. 1

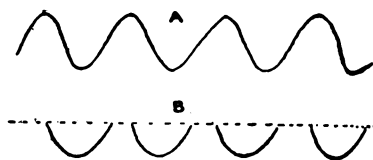

Fig. 2

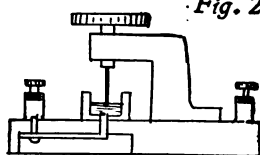

Fig. 3

possesses the power of reducing the alternation of the waves by half; and in addition other compounds and methods are used for the same purpose.

*Perikon* detectors are made with oxide of zinc and copper-iron sulphide mounted in cups and so arranged that the two substances may be adjusted closer or farther apart. *Electrolytic* detectors are exceedingly sensitive, and are made with a fine platinum wire entering a small receptacle filled with dilute nitric acid (Fig. 3).

When a current from a battery passes through the circuit a number of bubbles are formed at the wire, thus insulating it from the receivers; but as soon as high-frequency wireless waves arrive the bubbles are destroyed, and the current flows through. When the waves cease the bubbles again form.

This form of detector requires a battery current connected with it, as does also the carborundum detector, which

## HARPER'S WIRELESS BOOK

consists of crystals of carborundum between two carbon contacts (Fig. 4).

One great advantage that galena, iron pyrites, silicon, etc., possess is that they may be used without the battery.

With the detectors requiring a battery an instrument known as a *potentiometer* (Fig. 5) is also necessary. This is merely an arrangement for so regulating the voltage of the battery that it will render the detector as sensitive as possible, and it is connected with the receiver and detector, as shown in Fig. 6.

### Tuning

The process of *tuning* is very important in wireless telegraphy, for without proper tuning an operator would re-

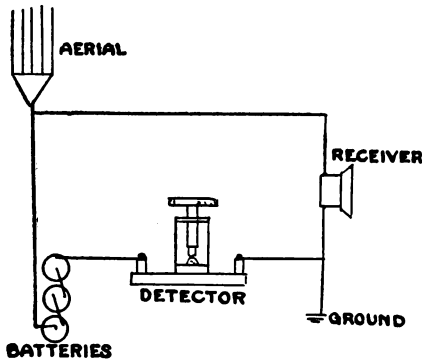

Fig. 4

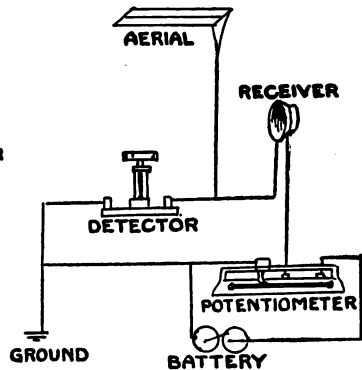

Fig. 6

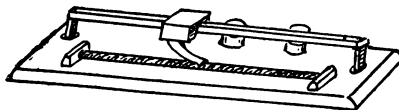

Fig. 5

ceive a hodge-podge of waves sent from various stations, and would be confused and unable to intelligently translate the messages detected by his instruments.

## INSTRUMENTS FOR RECEIVING

Just as vibrations of a certain sound cause a similar vibration in some other object, so the vibrations of waves of electricity may be tuned or adjusted to affect one receiver and not others.

The actual impulses of the waves striking the receiving-aerial are excessively weak and feeble, and in order to be effective they must be arranged to follow one another in rapid succession. If the transmitter and receiver are adjusted to the same wave-length, the minute currents caught by the aerial will surge back and forth in unison and create the same "notes" as sent from the transmitter.

In order to accomplish this result various *tuning-instruments* are used, and by their use an operator may receive a message from a particular transmitter without hearing any other waves, although a number of stations may be in his neighborhood, and various waves may be passing back and forth through the air at the same time.

Moreover, by the use of tuning-instruments an operator may place his receiver at his ear, and by operating the tuning-instrument catch any messages within its scope. For vessels in distress, or other important messages, this is of vast importance. If a ship's instruments could only be heard by certain prearranged stations on shore or on other ships, there would be but a small chance of a call being heard or understood, but within the range of her instruments dozens of operators may be listening at their receivers, sliding their tuning-coils back and forth, and adjusting their detectors in the expectation of "picking up" some stray message.

### Tuning-Coils

This important instrument is, like most wireless instruments, very simple, and consists of a thick cardboard tube

## HARPER'S WIRELESS BOOK

waterproofed with paraffin or some similar substance, and wound with bare copper wire spaced so that the turns do not touch (Fig. 7).

Above the wire are slide-rods bearing sliders (A, B), provided with light springs which touch the wires of the coil.

One of the slide-rods is connected with the ground-wire, the other with the receiver and detector, and the terminal of the wire is connected with the aerial. By moving the sliders back and forth over the coil the wave-length of the instruments may be adjusted to detect any impulse caught by the aerials.

Some tuning-coils have a single slide, others two, and others three, and where the instruments require adjusting for very long wave-lengths a single-slide coil is connected in series with the regular tuning-coil.

In receiving wireless messages a condenser is also employed in order to transform any direct currents to alternating currents.

The high-frequency currents caught by the aerial are transformed to direct currents by the detector, and these not being able to pass through the condenser, are forced to pass into the receiver and produce sounds.

Moreover, when a detector with a battery is employed, the condenser is necessary in order to prevent the direct current of the battery from flowing through the tuning-coil instead of through the detector.

Condensers are of various forms, the simplest being merely strips of tin-foil between mica or glass, as described in a preceding chapter. Other forms are the *rotary* and *sliding plate*. The former consists of a number of semicircular aluminum plates arranged so that they may be rotated or swung past a series of fixed disks (Fig. 8). The plates must not touch, as the air-space between them takes the place

## INSTRUMENTS FOR RECEIVING

of the glass in the other forms described. At the top of the rotary condenser there is a thumb-knob attached to the movable plates, and a number dial and pointer, so that the condenser may be adjusted to any desired capacity.

The *sliding-plate* form is a variable condenser in which the plates are square or rectangular, and slide back and forth in grooves in a wooden frame, as shown in Fig. 9.

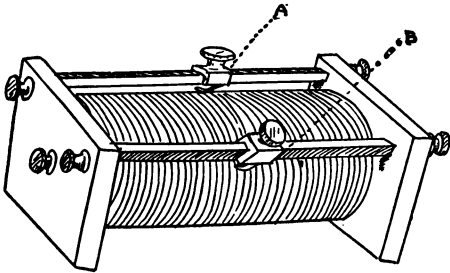

Fig. 7

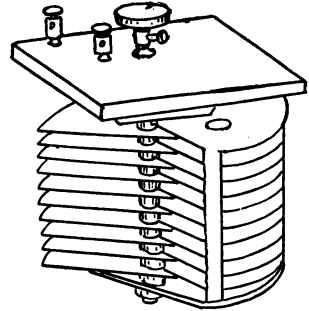

Fig. 8

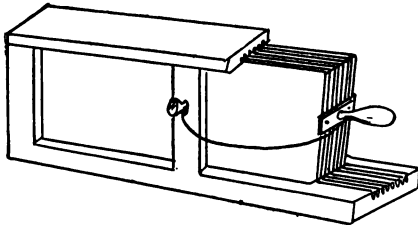

Fig. 9

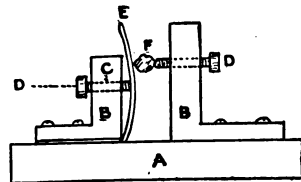

Fig. 10

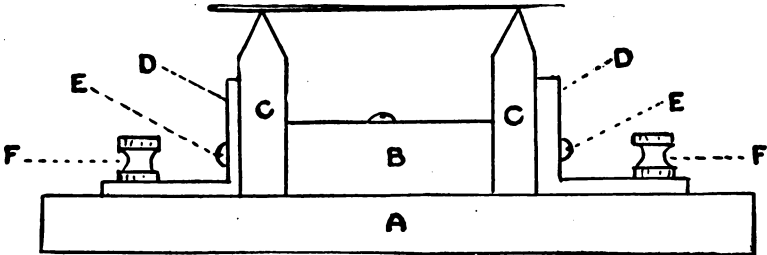

Fig. 11

## HARPER'S WIRELESS BOOK

These variable condensers are used in adjusting or tuning the receiving-circuit in much the same manner that the tuning-coil is employed, and when used the tuning-coil is not essential, as the condenser will increase or decrease the electrical waves to the proper lengths. Condensers are capable of being adjusted more delicately than regular tuning-coils, as the changes brought about by varying the interposition of the plates is very gradual and even, whereas in a tuning-coil the length of the waves jumps from one full turn of the wire to another.

It will be easily appreciated that if the particular wave-length of a message happened to occur between two wires on the coil, no message would be heard, whereas with the condenser the changes can be made gradually and every possible gradation of wave-length detected.

### A Simple Carbon Detector

A very simple and inexpensive carbon detector may be made at home from two pieces of old carbon taken from a dry battery, some old battery binding-posts, and some strips of brass or copper.

The base (Fig. 11, A) is a piece of wood to which is screwed a small piece of hard wood (B). The two pieces of carbon (C, C) are sharpened to a V-shaped point at one end, and are drilled with  $1/8''$  holes near the other ends. The carbons are then placed against the block B, and the strips of brass, bent as shown at D, screwed against the carbon by screws passing through both, as at E, E. The binding-posts are then screwed into the base through the outer portion of the strips at F, F. A fine steel needle laid across the carbon points completes the detector. In connecting the receivers of your wireless and using this detector the aerial

## INSTRUMENTS FOR RECEIVING

is connected to one binding-post, and one side of the telephone receiver to the other. One terminal of the battery is run to the other terminal of the receiver, and the other battery terminal to the ground.

### A Simple Mineral Detector

Any boy may readily construct an efficient mineral detector, such as is shown in Fig. 10, with a few odds and ends. The detector consists of a hard-wood or compressed-fiber base (A); a couple of brass or copper standards, and a piece of spring-brass. The base (A) is one inch wide, three inches long and  $3/8''$  thick. The brass standards (B, B) are each  $1/4''$  thick by  $3/8''$  wide. The upper portion of one standard should be one inch by one inch, the other one inch by  $1-3/8''$ . A hole (C) is then bored with a No. 31 drill  $1/4''$  below the top and in the center of each standard. The holes should be tapped with an  $8/32''$  screw tap and a  $3/4''$  No. 8 screw (this may be obtained from the carbon of an old dry battery) fitted in each hole as shown at D, D. Two holes are drilled through the base of each standard with a No. 10 drill, and the holes countersunk for brass wood-screws.

A piece of thin spring-brass  $3/8''$  wide and three inches long is next bent at right angles at one inch from one end, and placed under the short standard and drilled with holes to correspond with those in the standard E. The two standards should be mounted on the base facing each other and  $3/8''$  apart. A bit of silicon or carborundum is placed between the upper screw and the spring (F), and the adjustment is obtained by turning the lower screw in or out, thus tightening or loosening the tension of the spring. If a tiny needle is placed in a hole drilled in the upper screw,



## HARPER'S WIRELESS BOOK

much greater sensitiveness will be obtained. By soldering a piece of sheet platinum about  $3/8''$  square to the spring and placing a disk of lead—made from a flattened buck-shot—at the tip of the upper screw, the detector becomes a peroxide-of-lead detector. In using peroxide of lead in place of the mineral the lozenge should be kept moist to avoid the crackling sound which is a peculiarity of this form of detector if allowed to become dry.

One of the holding-down screws on each side may be replaced with a binding-screw if desired. This renders connections easier to make and insures perfect connection.

### A Simple Potentiometer

It is possible to make a very compact and effective unit mounting of the detector and potentiometer on a single base, as shown in Fig. 12.

A hard-wood base six inches wide, 20 inches long, and one inch thick should be beveled along its edge and well smoothed and varnished.

Twelve binding-posts should be mounted on this base, as shown at 1 to 12. Four feet of No. 32 bare German-silver wire is drawn tight around the six central posts forming the resistance from 1 to 6. The detector is mounted between binding-posts 7 and 8 and connected to them, and these posts serve also as the aerial and ground terminals. Between 9 and 10 one dry cell is connected, and 9 and 1 are connected together, as are 10 and 6. The receiver is connected between 11 and 12, and a flexible wire with a wedge-shaped terminal is connected to 11. This allows any point of resistance-wire being tapped, and the point at which the most audible sounds occur may thus be selected. The posts 7 and 10, 12 and 8, are con-

## INSTRUMENTS FOR RECEIVING

nected through small choke-coils which are mounted in hollows cut in the lower side of the base.

These coils are made by winding three layers of No. 24 single silk-covered copper wire on a piece of 1/8" iron wire three inches long, after which a layer of friction-tape is wound about it to protect the coil from injury.

### Connecting a Loose-Coupled Coil

The greatest difference between the close-coupled and loose-coupled systems is in the method of constructing and connecting the coils. In the close-coupled coils the

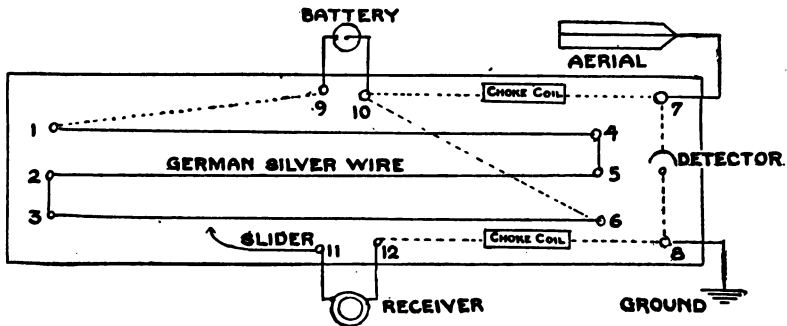

*Fig. 12*

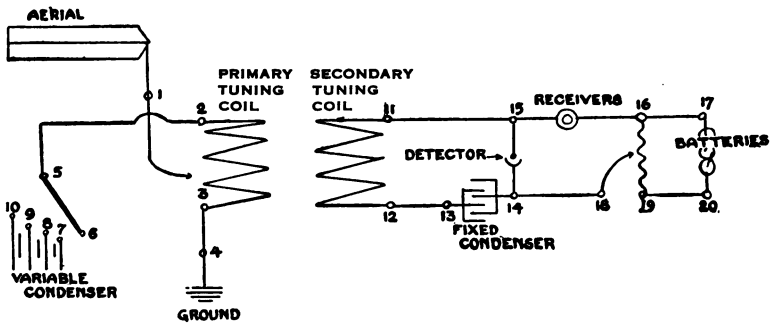

*Fig. 13*

## HARPER'S WIRELESS BOOK

coil may be said to consist of a single winding, while the detector, phones, and other instruments are in direct connection with the coils, whereas in the loose-coupled system the tuning-coil itself has two windings insulated from each other and depending upon induction, and with the aerial and grounds inductively connected.

In Fig. 13 a method of connecting a loose-coupled coil with a straightaway aerial is shown. The figures refer to binding-posts and contacts, connections, etc.

No. 1 is the terminal post for the aerial and the slider and selector on the primary of the tuning-coil, the ends of which terminate at posts 2 and 3.

A variable condenser is shunted around the primary of the coil, starting at 2 and passing switch 5 and any of the contacts 7, 8, 9, 10 on the variable condenser connecting to the ground-wire at post 4. The point 6 is dead, and is used merely as a rest for the switch-blade when thrown out.

Posts 11 and 12 are the terminals of the secondary of the tuning-coil. A fixed condenser is placed between the posts 13 and 14, while the electrolytic detector is connected between 14 and 15. The receivers are placed between 15 and 16; the battery resistance between 16 and 17, and the battery between 19 and 20. Post 18 is the terminal for the slider. In addition a switch may be mounted between 17 and 20 to open the battery circuit when not in use.

## Chapter V

### TUNING

**A**LTHOUGH tuning is generally considered of most importance as a means of receiving a message clearly and separating it from any other wireless oscillations which may be passing at the time, yet it is also of the greatest consequence in sending messages.

By proper tuning it is possible to send messages over great distances with small amounts of energy, and this is done by adjusting the electrical length of the circuits to such a point that they are in harmony or in perfect "resonance."

This may be rather difficult to understand at first, but it may be compared to striking a suspended weight on the end of a cord (Fig. 1).

If the weight is struck at the point B, it will swing away in the direction of A. On its return swing, if struck again before its full swing is accomplished, a large portion of the blow will be expended in overcoming the momentum of the weight (Fig. 2). If, on the other hand, the blow is struck just as the weight finishes its swing the full force will be delivered to drive the weight in the opposite direction (Fig. 3). By so adjusting the length of the cord, and the period between blows as to allow the blow to fall on the weight at regular intervals at the extreme end of

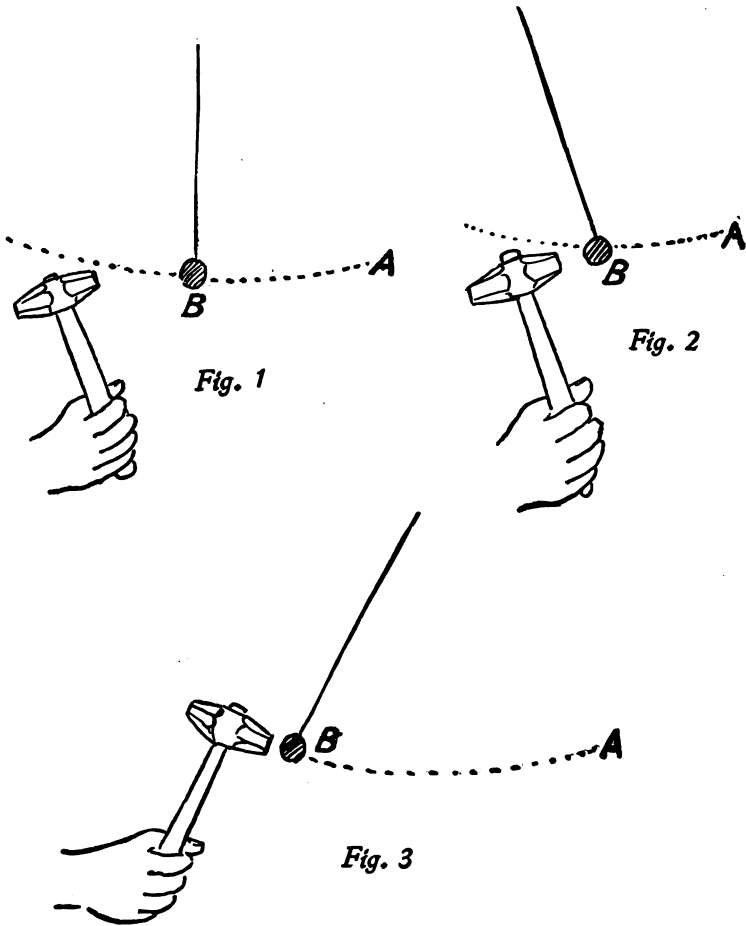

the swing, continuous motion with very light blows will be obtained.

In a similar manner, by lengthening or shortening the period of an electrical circuit, so that each succeeding wave will occur at just the right time to aid the one preceding, the oscillations may be sent for much longer distances with the same power than if each wave died down before

## TUNING

reinforced by the next one—a condition known to wireless operators as being “damped.”

The instruments used for tuning are known as the tuning-coil and the helix, the former being used in receiving and the latter in transmitting messages. The helix and tuning-coil are further divided into loose, or “inductive,” types, and close-coupled, or “direct,” types. Both of these instruments have been already described and illustrated; but in order to use the transmitting-helix a hot-wire ammeter is used. This is a very simple but very important instrument, the principle of which is illustrated in Fig. 4.

Electrical conductors have the peculiarity of becoming heated when a current passes through them, and the hot-wire ammeter is constructed in such a way as to take advantage of this property.

The ammeter consists of a platinum wire (A) fastened between two fixed supports (B, B), and from the center of

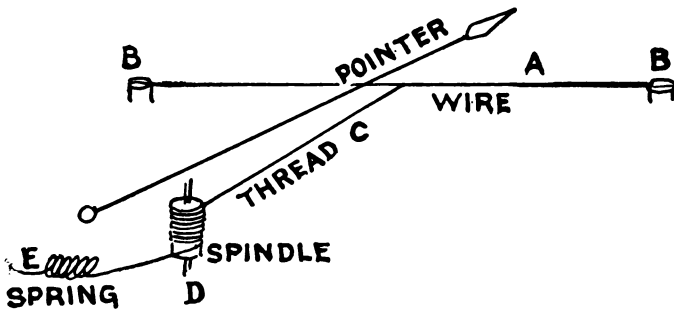

Fig. 4

this wire a thread (C) passes around a spindle (D), and thence to a spring (E), which keeps it tight.

To the upper end of the spindle D a needle, or pointer, is fastened. As soon as a current passes through the wire

## HARPER'S WIRELESS BOOK

A the platinum becomes heated and expands, thus permitting the thread C to slacken; and the spring, pulling at the other end, revolves the spindle D slightly, carrying with it the pointer. By arranging the pointer with a figured dial it is very easy to determine the strength of the current passing through the wire.

In use the ammeter is placed in series with the aerial, and the apparatus is then tuned or adjusted so that the maximum amount of current is indicated on the ammeter (Fig. 5).

In using a loose-coupled tuning-coil it is placed as shown in Fig. 6. This instrument consists of two windings over separate cylinders, one forming the primary and the other the secondary coil (Fig. 7).

The small, or inner, coil is the secondary, and this is so arranged that it may be slipped back and forth inside of the larger, or primary, coil, thus varying the "coupling," or induction, of the current. The primary circuit is also adjustable by means of a slider (A), and the secondary is adjusted by a multi-pointed switch (B).

Other loose-coupled coils are made in such a way that the secondary coil revolves instead of sliding within the primary, but in principle and use they are exactly like the sliding type.

As the waves emitted from a transmitting-station are really composed of two waves of different lengths, it is difficult to tune satisfactorily unless the coupling of the receiving-station may be varied to correspond to the transmitter, and it is to accomplish this purpose that the various forms of loose-coupled coils are used.

### Directive Wireless Transmission

When the ordinary wireless systems are used the messages travel outward from the transmitter in concentric

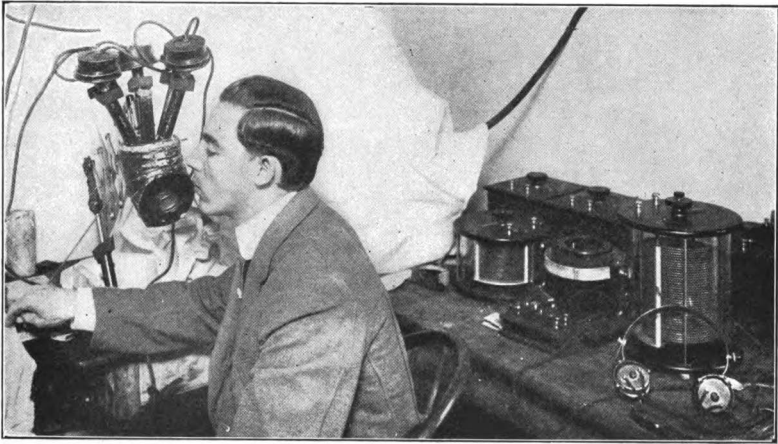

ELMER MYERS AND HIS WIRELESS TELEPHONE

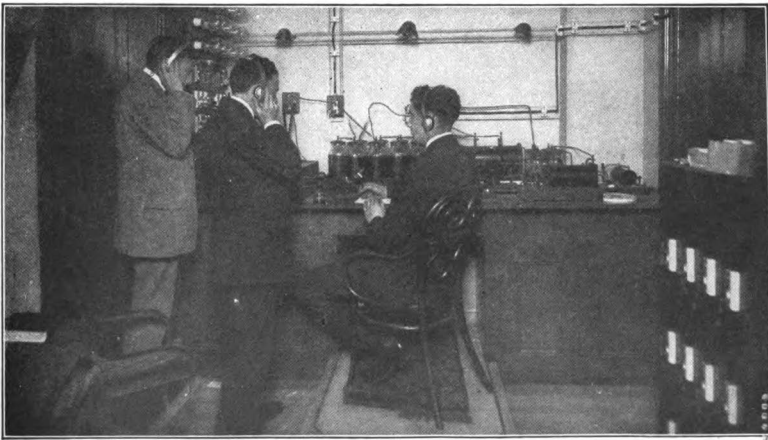

YOUNG WILLENBORG, "THE BOY WIRELESS KING," OF HOBOKEN, NEW JERSEY





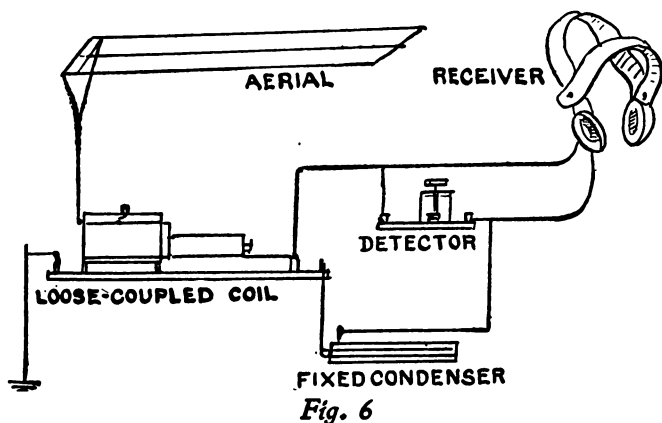
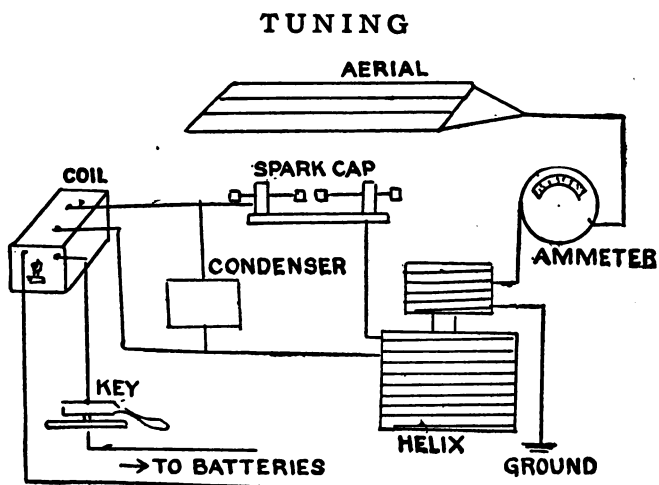

circles, as already explained, and as a great number of messages may be thus traveling in ever-widening waves at the same time, it is evident that any receiving-station within the radius of any of these waves may be so tuned as to receive any or all of the messages passing his station.

This fact is often very undesirable, for the enemy—in time of war—some competitor, or other undesirable

## HARPER'S WIRELESS BOOK

station may secure information not intended for it. In addition, the broadcast transmission of waves is very wasteful of energy, and if all the power could be arranged to transmit waves in one direction only, the waves would be far stronger, would carry farther, and would reach only the particular point for which they were intended.

Moreover, if the waves are thus sent in definite directions, one station may communicate with another without disturbing others, and a vessel may obtain its bearing by tuning its instruments to two different stations, the positions of which are known.

To accomplish these desirable results a great many experiments have been made, many of which are successful.

This particular phase of wireless telegraphy is known as "directive" transmission.

Some of the most important of these systems are the Braun, Berliani, and Tosi.

The Braun system consists of a number of metal strips arranged to form two curved surfaces (Fig. 8). The two surfaces are connected to the spark-gap and induction-coil, and are provided with a source of current—batteries or dynamo—and a key, etc., as usual. The curved surfaces act as aërials and send out waves in but one direction, and although in experimental form it operates, yet it has not proved practical for commercial use. Another system of Braun's consists of two or more aërials placed at definite distances apart, and by using alternating currents of different values at the same moment, it is possible to send messages for long distances in a direction lying in the same plane as the aërials.

The Berliani and Tosi systems are more complicated, and consist of aërials composed of two closed or nearly closed

## TUNING

circuits triangular in form in two perpendicular planes (Fig. 9). Each aerial contains a circular coil of wire crossing one another with their windings in the plane of the antenna circuits (A, A). A third coil is connected with the receiving-station apparatus when messages are being received, and to the transmitting instruments when messages are to be sent.

When waves arrive from any particular direction oscil-

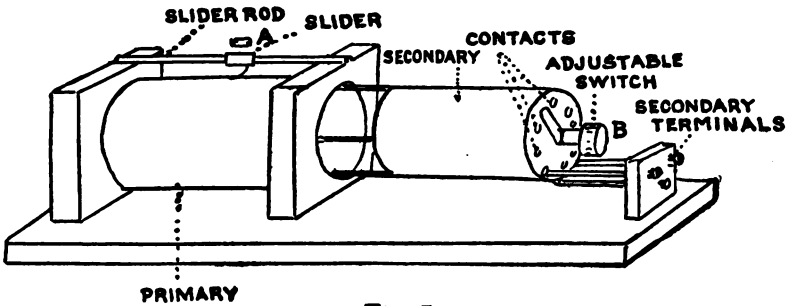

*Fig. 7*

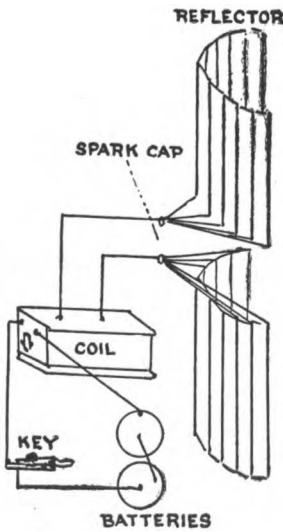

*Fig. 8*

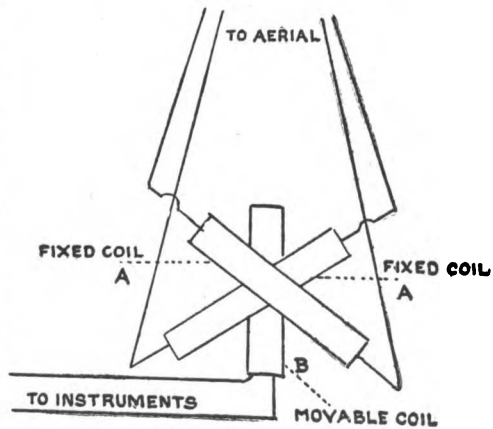

*Fig. 9*

## HARPER'S WIRELESS BOOK

lations are produced in the aerial circuits, and these vary in intensity according to the direction from which the waves come.

As the waves pass through the coils they generate a magnetic field with a direction perpendicular to that of the waves themselves, and as the strength of the currents in the movable coil will be in exact proportion to its position in this magnetic field, it will be at its maximum when the coil is in a position to include as many as possible of the magnetic lines of force. By using a pointer attached to the movable coil the plane or position of the station sending the message may be determined.

Of course, the station may be either directly in front of or behind the pointer, but a general knowledge of the location of stations will readily do away with any confusion brought about in this way.

In sending messages from this system the above process is reversed. The movable coil (B) is connected to the condenser, spark-gap and coil, and creates a magnetic field, inducing currents in the two fixed coils (A, A), and these produce waves in the aerials with the strongest oscillations in a plane determined by the movable coil's position. By merely shifting this coil the messages may be sent in any desired direction.

**Part II**  
**HOW TO BUILD AND USE WIRELESS  
APPARATUS**



## Chapter VI

### ESTABLISHING A STATION

A FEW years ago the boy interested in wireless telegraphy found it necessary to construct practically every piece of apparatus himself, for the art of wireless telegraphy was new, and ready-made appliances were very expensive.

To-day a number of large manufacturers devote their entire energies to producing cheap, efficient, and compact outfits especially for boys' use. Nevertheless, a large portion of the apparatus required for sending or receiving messages by wireless may be built by any smart boy, and such home-made appliances give just as good results as those purchased ready-made, and the user gets far greater pleasure from their use.

Certain things, such as keys, coils, batteries, condensers, and receivers, cost more to make than to buy, and in addition special tools and machines are necessary to produce them. Home-made coils seldom give satisfactory results, and batteries are very difficult to make.

On the other hand, such instruments and appliances as aerials, grounds, helixes, spark-gaps, tuning-coils, switches, etc., are readily made from odds and ends and with few and simple tools.

#### Selecting a Site for the Station

Before commencing to install a wireless outfit you should carefully select the location, for upon a proper situation



## HARPER'S WIRELESS BOOK

a great deal of your success will depend. Although low, obstructed, and small aerials will work—or for that matter aerials strung within the room itself will actually transmit and receive messages—yet for really good results, and especially for long-distance work, a high, large aerial free from obstructions or interfering objects must be installed.

Usually a house-top will serve excellently for an aerial site, and the chimneys may be used for masts or supports at a pinch.

Another excellent method is to erect a large pole on the roof and install an umbrella aerial. A very satisfactory method is to use a pole or mast set in the ground near the house or building used as a station, and string the aerial from this mast to a chimney, or even to the eaves. If two tall buildings are near together an aerial may be strung from one to the other; but whenever possible the wires should be considerably higher than the surrounding buildings and as far as possible from other tall objects such as trees, tall chimneys, spires, etc.

In the large cities it is at times difficult to find a suitable location for an aerial, but in the country there is always plenty of open space.

The receiving and transmitting apparatus should be in a room as near the aerials as possible, for the longer the wires the more difficult and expensive are they to install, and the greater the resistance they offer to the currents passing through them.

### Constructing the Aerials

Aerials, or more properly *antennæ*, are of various types or forms, as already described, and the particular kind you select for your station depends largely upon the size, power,

## ESTABLISHING A STATION

and scope of your instruments and the distances you wish to send or receive messages, as well as upon the location you have chosen.

As a rule the flat-topped aerial is the favorite amateur form, for it is easy to construct and is very good for all-around work.

When selecting the aerial to be used, bear in mind that the higher the upper end of the aerial, and the greater its length, the greater range will your station have. For long-distance work a large surface of wire, obtained by using numerous parallel wires, is of great assistance.

Slanting aerials, or "inclined" aerials (Fig. 1), are more

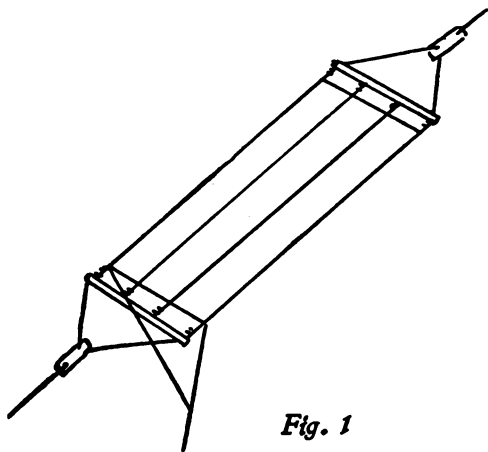

*Fig. 1*

or less directive; that is, they receive and send better in one direction than another, as already explained, whereas umbrella, vertical, or inverted-pyramid forms transmit and send in all directions equally well. On the other hand, they must be considerably higher than the horizontal forms to be of equal efficiency, and they are, moreover, far harder to construct and erect. For these reasons the flat-topped or

## HARPER'S WIRELESS BOOK

horizontal forms are to be most strongly recommended for amateur use.

The material used in constructing aerials may be either copper, aluminum, or stranded phosphor-bronze wire. Wire of about No. 14 size is about right, and aluminum or copper may be employed. The aluminum is lighter, but not quite

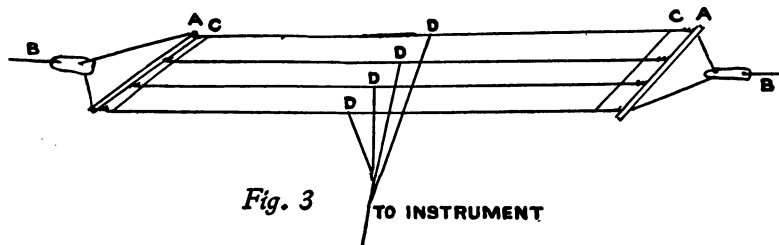
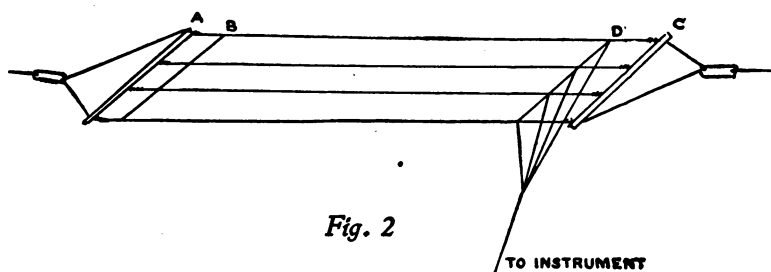

so efficient as the copper, and for very large or long aerials the stranded bronze should be used.

An aerial 35 to 50 feet long is large enough for most amateur use, and if placed from 40 to 60 feet above the ground it will seldom be obstructed by other objects.

The inverted "L" aerial shown in Fig. 2 is an excellent form, and is wired and insulated as shown in the diagram.

At one end is a wooden spreader (A), to which the four or six wires are attached by means of porcelain or fiber insulators. A wire is connected across the main wires (B), and the other ends of the wires are fastened to insulators

## ESTABLISHING A STATION

on a second wooden spreader (C). Near this second spreader each main wire is connected to a wire leading down to a single wire which passes to the instruments in the wireless room. These lead-wires form a triangular "grid," and each of these, as well as the connecting-wire B, should be soldered wherever it joins another wire.

In erecting this aerial it is advisable to place a second insulator at the spot where the supporting cable or wire is attached to the spreaders at the ends (D, D).

The "T" aerial (Fig. 3) is another simple form which is very satisfactory. In this aerial the main wires are attached to spreaders at each end (A, A), and are further insulated where the spreader is fastened to the supporting cables (B, B). Across both ends of the aerial are wires (C, C) connecting all the aerial wires, while from the center of the main wires leaders (D, D, D, D) are fastened to a single wire which passes to the instruments.

An inclined aerial is shown in Fig. 4, in which both the above systems are combined. In this the main aerial wires are connected together at each end, and from the outermost wires at one end (A) leaders are fastened which join to a single wire passing to the station (B).

A very simple loop form is shown in Fig. 5, in which the two aerial wires (A, A) are connected with a wire at B, and their other ends lead directly to the instruments.

### Insulating

In leading your wires to the station and instruments, and especially in running them through walls, the greatest care should be taken to see that they are thoroughly insulated. The first insulators you will use are those which insulate the aerial wires from the spreaders and the supporting cables.

## HARPER'S WIRELESS BOOK

For this purpose the ring-ended insulators shown in Fig. 6 will prove excellent, and, as they cost comparatively little and are far more perfect than anything you can make yourself, it is advisable to use them.

Where the wires are carried over or around buildings, eaves, roofs, or other out-of-doors objects, the common glass insulators (Fig. 7) may be used. These are fitted over screws of wood, which may be readily nailed to any con-

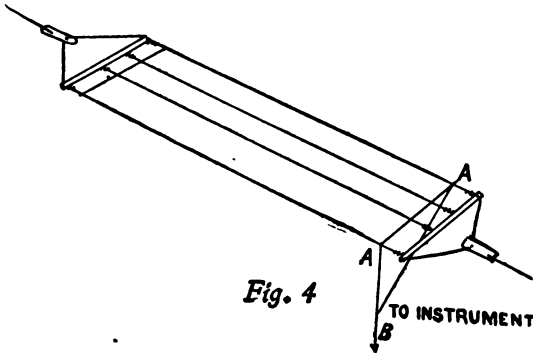

Fig. 4

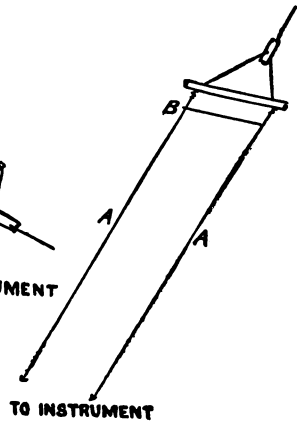

Fig. 5

venient spot, and they are about as perfect an outdoor insulator as can be made. They are widely used for telegraph, telephone, and other electrical wires, and cost less than five cents each.

In attaching wires to these insulators the wire should *not* be wrapped around the insulator, but a short wire should be twisted around the glass and the ends of this wire twisted around the wire to be insulated, as shown in Fig. 8.

A form of insulator which is excellent for stations using a spark coil and gap of two-inch capacity and under is the

## ESTABLISHING A STATION

porcelain cleat so commonly used in installing incandescent light wires (Fig. 9). By using two of these cleats—one over the other—very good insulation may be obtained. For inside work these porcelain cleats are excellent, but for outside wires the glass insulators are preferable. Whereas the aerials are best constructed of bare aluminum or copper wire, the wires leading from them to the instruments should be of well-insulated construction; but no matter how well

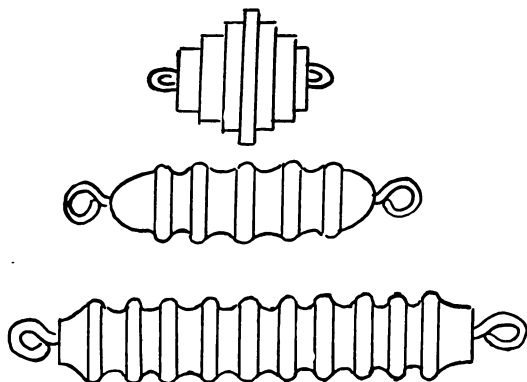

Fig. 6

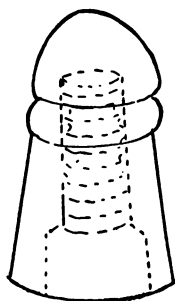

Fig. 7

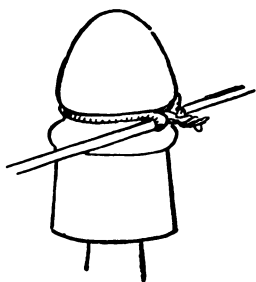

Fig. 8

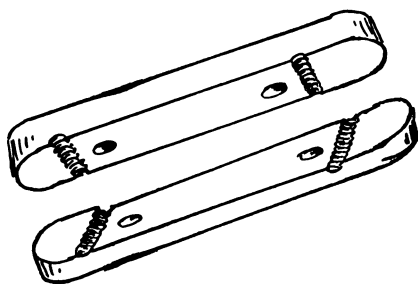

Fig. 9

insulated the wires may be, they should *never* be allowed to touch any object directly. Wood, stone, brick, etc., are splendid conductors of electricity when wet or damp, and

## HARPER'S WIRELESS BOOK

a very slight leakage of current will exhaust your batteries and prevent you from getting good results from your equipment.

Where the wires lead through the wall or window-frame to the instruments great care in insulation should be taken. Outfits of small capacity may have wires led through porcelain tubes, but for greater security the bushed insulator, shown in Fig. 11, Chapter II, should be used.

### The Ground

A good ground or earth connection is very important in wireless work, and practically no results in long-distance work can be obtained unless the ground is well and carefully made. Oddly enough, electricity will ground itself all too easily when you do not want it to; but it will stubbornly refuse to be grounded when you wish to have it, unless the ground connections are well made.

A large plate of copper buried in the earth is the ideal ground, but a more common and very satisfactory method is to fasten the ground-wire to a gas or water pipe, preferably the latter.

To connect the ground-wire to a pipe, scrape the latter until the metal is bright, and then wrap the wire several times around the pipe and solder it in place.

When pipes are not at hand the wire may be soldered to a metal rod driven into the earth for five or six feet. When using a rod in this way be sure and drive it in a spot that is always moist or shaded, for dry, sandy, or rocky ground makes a poor earth connection.

Many people object to wireless aerials on or near their buildings, as they fear that in thunder-storms the wires may "attract" the electricity and cause damage.

## ESTABLISHING A STATION

Wires do not "attract" electricity, but merely serve as such superior conductors that the electrical discharges are more apt to follow them than other objects in their travel to the earth. The damage done by lightning is not due to the lightning traveling *through* the objects to the ground, but to the resistance offered and the electricity "jumping," exactly as your wireless spark "jumps" the gap in your spark-gap.

If a free path over a good conductor is provided for lightning, no damage will result if the object is struck; and a

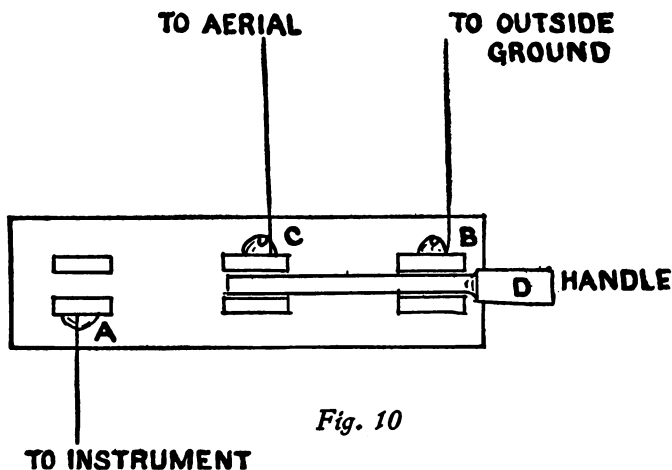

*Fig. 10*

wireless aerial, if properly "grounded," proves about as good a "lightning rod" as one could devise.

By using No. 4 or No. 6 copper wire for the ground connection, and installing a double-throw, single-pole switch, as shown in Fig. 10, there is no possible danger from lightning striking the aerials.

The switch should be mounted on a window-sill or some similar convenient spot outside the building, and the wire leading to the instruments should be connected to one ter-



## HARPER'S WIRELESS BOOK

minal (A), with an outside ground-wire attached to the other throw-terminal (B). The aerial wires should then be connected to the central pole (C).

When the station is in use throw the handle (D) over to A, thus connecting the aerial directly to the instruments. As soon as through using the instruments the switch should be thrown back, thus grounding the aerial outside the building.

The ground to which this switch is connected is not, however, the ground already described, but is a distinct and separate ground outside the building, and formed by driving a brass or iron rod well into the earth.

If outside aerials cannot be allowed, very satisfactory results may be obtained for short distances by using interior aerials. If an inside aerial 35 feet long and built of not less than six wires is used, messages may be received from commercial stations for thirty miles or more. Two stations, both using such inside aerials, can receive and transmit messages for a mile or so with a one-inch coil in the transmitting apparatus.

## Chapter VII

### HOW TO MAKE INSTRUMENTS

THE simplest apparatus that is possible for sending or transmitting wireless messages consists of the aerial, spark-gap, induction-coil, key, batteries, and ground (Fig. 1). Of these the most difficult to obtain is the coil, for it is practically impossible for an amateur to construct a good coil, and it is time and trouble wasted to attempt it.

Coils are cheap, and an efficient half-inch spark coil with a home-made spark-gap, four or six dry batteries, a simple key, and a two-strand aerial will enable the amateur to send messages for a distance of five miles or more.

By increasing the size of coil, number of batteries and strands in the aerial the range of the station will be greatly increased.

The spark-gap is a simple and easy instrument to build. It may be constructed of two pieces of copper or aluminum wire bent at right angles and with points close together (Fig. 2), or, better still, it may consist of zinc terminal points made from pieces cut from the round zinc rods used in wet batteries. Each of these pieces of zinc should be drilled and a copper wire fastened in the hole. The two wires are then passed through holes in wooden upright posts, and by moving the wires back and forth the gap may be adjusted to any desired size (Fig. 3).

The key may be purchased ready-made for one dollar, or

# HARPER'S WIRELESS BOOK

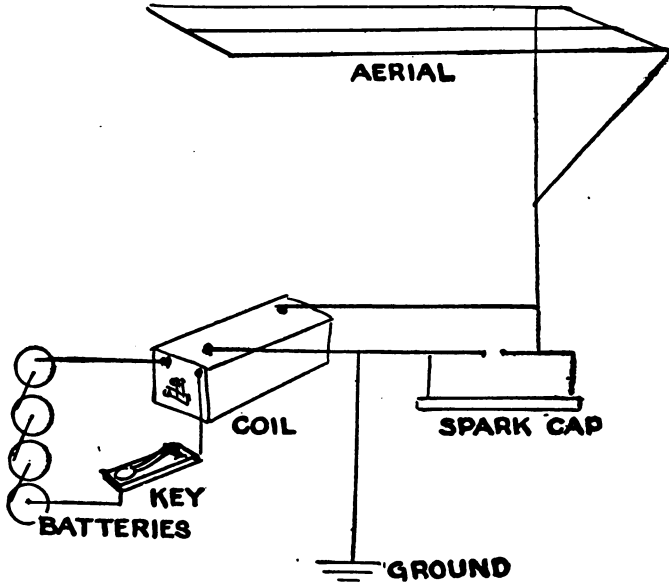

Fig. 1

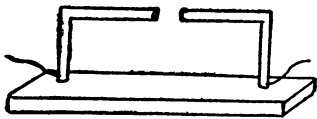

Fig. 2

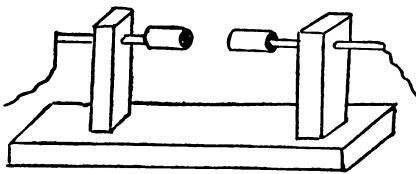

Fig. 3

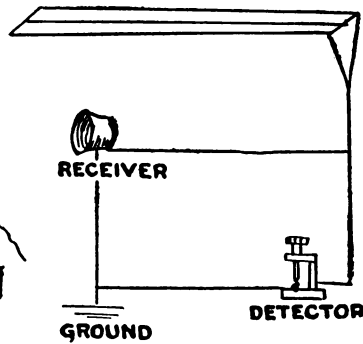

Fig. 4

a special wireless key may be purchased for about three dollars.

For a small and simple station an ordinary telegraph key, costing one dollar or less, will answer every purpose; but for larger and more powerful outfits the special keys are advisable.

## HOW TO MAKE INSTRUMENTS

Dry batteries cost 25 cents each, and an induction-coil may be obtained for two dollars and up. The cost of the home-made spark-gap should not be over 10 cents. Aerials may be constructed for less than two dollars, and the wire used in connecting it to the instruments, with the cost of insulators included, should not be more than three dollars. The entire transmitting-outfit, therefore, may be installed at a total outlay of less than ten dollars.

The simplest receiving-outfit possible to use with success consists of the aerial, tuning-coil, fixed condenser, detector, and telephone receivers (Fig. 4). The aerial used in transmitting will serve for receiving, and the same wiring may be employed to connect the various instruments. It is easy to build a tuning-coil by using a cardboard or wooden cylinder wound with bare copper wire; but it is far easier to use insulated wire and cut or scratch off the insulation where the "sliders" touch. Fig. 5 shows the details of con-

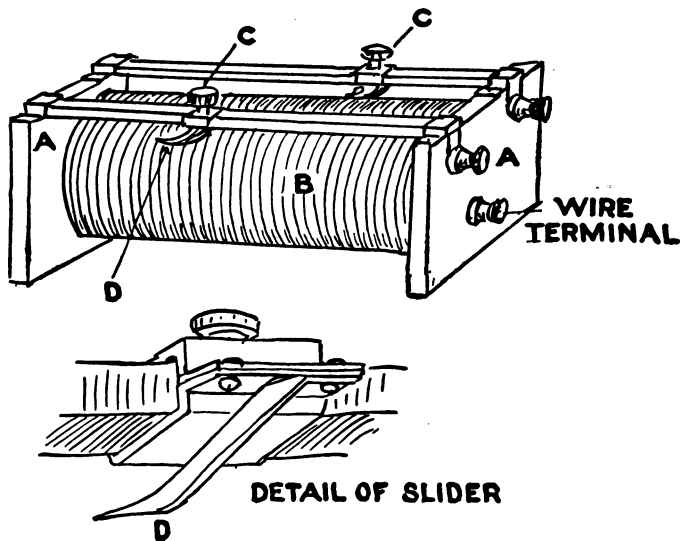

*Fig. 5*

## HARPER'S WIRELESS BOOK

struction of a simple two-slide coil. The wooden ends (A, A) carry the wire connections for the slide-rods and wire, and these may be made from old dry-battery terminals. The coil itself (B) is merely a stiff cardboard cylinder—or even a round wooden block—closely wound with No. 16 copper wire with single rubber or woven insulation. Between the two wooden ends square metal (brass or copper) rods are placed, and on each rod is a sliding contact (C, C) provided with a springpiece (D, D), which bears on the wires. The sliders may be made from sheet brass or copper bent to shape, and with a set-screw and thumb-nut for fastening them in position. Such a tuning-coil may be made in a short time at a cost of less than one dollar, whereas if bought ready-made it will cost four to five dollars.

The detector is a delicate instrument to build at home, and although a boy with ingenuity can construct a detector that will operate, yet it is better to purchase one. A fixed condenser costs but \$1.25 to \$2, and to purchase the tin-foil and connections and build one will usually cost more in the end. Telephone receivers cost from \$1.50 up, and counting the detector as worth \$5, the entire receiving-outfit may be installed for not over \$10.

It is perfectly feasible to install the transmitting and receiving outfits and aerial with all connections for less than \$20, and with such an equipment the boy operator may readily send from five to ten miles, and can receive messages from five hundred to eight hundred miles away.

The simplicity or complexity of the instruments has but little to do with the range of the station, for this depends mainly upon the power of the current, the size of the spark-coil, and the delicacy of adjustment of the tuning-coil, detector, etc.

An induction-coil of  $1/2''$  size will produce a spark about

## HOW TO MAKE INSTRUMENTS

1/8" long after overcoming the resistance of wires; but by using a larger coil and more batteries a much larger spark may be obtained.

### Outfits of Greater Scope

The above equipments are the simplest forms that it is possible to devise, and for ordinary experimental and amateur use they serve every purpose. After a little

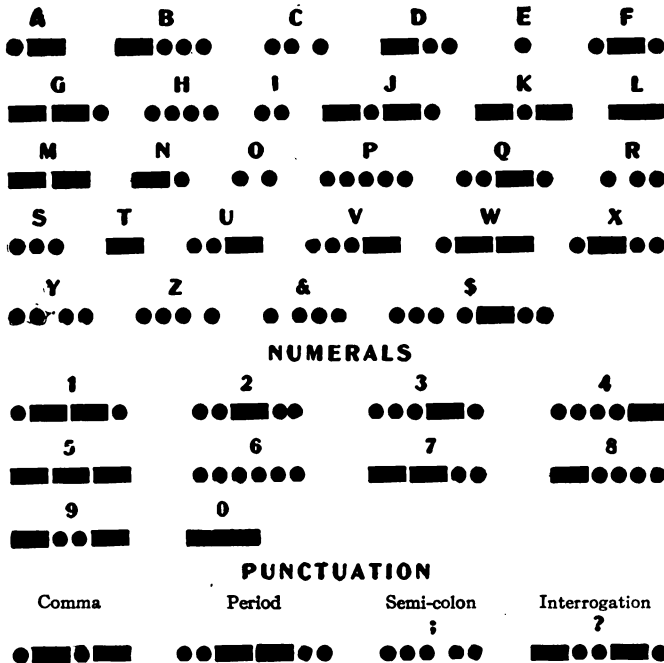
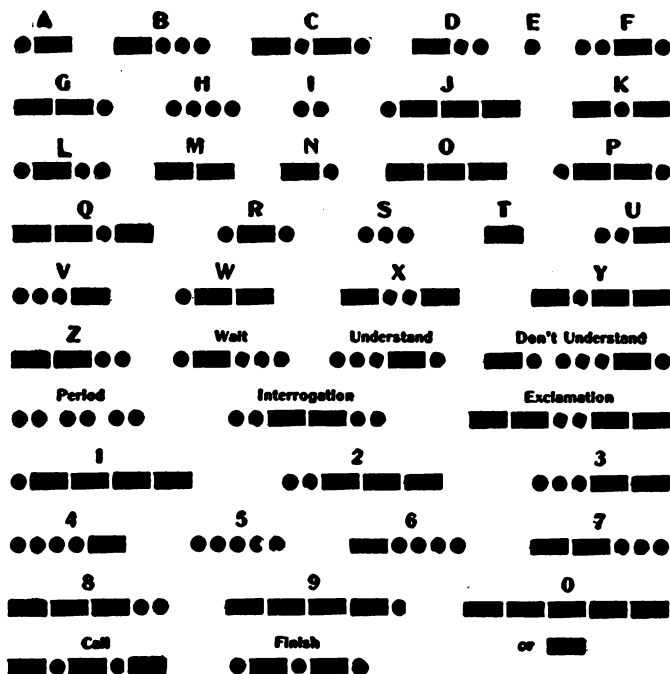

*Fig. 6*

practice in wireless operation the boy operator will undoubtedly wish to increase the scope and power of his station, and he may readily accomplish this by adding more and better instruments from time to time.

## HARPER'S WIRELESS BOOK

By installing a helix in the system greater inductance will be obtained, and messages may be sent for much greater distances. Any boy can make a helix, for it is simply a wire wound in a coil around four pieces of wood between



*Fig. 7*

two circular ends. A loose-coupled helix placed in the receiving circuit adds greatly to the efficiency of the station, and this instrument is just as simple to make as the ordinary helix. Still greater sensitiveness may be obtained by employing a loose-coupled tuning-coil, but these are hard to make at home, and it is best to purchase them.

Ammeters and potentiometers may be used if desired, but they are not at all essential, and as a rule the more

## HOW TO MAKE INSTRUMENTS

simple the outfit the easier it is to use, and the less likely it will be to get out of adjustment.

It is a wise plan to study one or two telegraph codes until fairly familiar with them before installing your instruments, as a knowledge of codes is absolutely necessary in order to either send or receive wireless messages.

### Telegraphic Codes

Telegraphic codes, or "alphabets," are merely prearranged systems of dots and dashes representing letters of the alphabet and numerals. The beginner will have some difficulty in distinguishing a dot from a dash when the message is being sent rapidly, for to the untrained ear the little clicks of the key seem meaningless and of practically the same length. After a little practice, however, you will find the short, abrupt ticks of the dots are very different from the longer and slower dashes, and you will have no trouble at all in reading the messages as they come in over the receivers.

On land the Morse code (Fig. 6) is almost universally used, and most coast-wise vessels also use it; but trans-Atlantic ships and foreign countries use the Continental code (Fig. 7). Still another code is the Navy, used by naval vessels and government stations (Fig. 8), and it is advisable to learn all three codes.

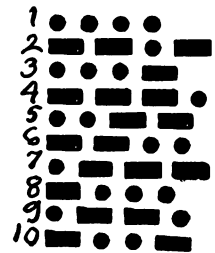
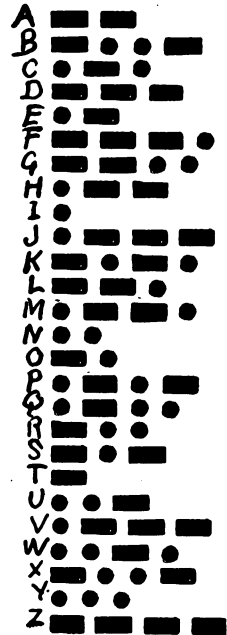

Fig. 8



## HARPER'S WIRELESS BOOK

Learn the Morse first, the Continental next, and leave the naval to the last. The Continental code is really the simplest of all, for there are no "spaced" letters as in the Morse. For example, the letter *C* in Morse is represented by *two dots*, a *space*, and a *dot*, whereas in the Continental it is *dash, dot, dash, dot*, and in the Navy code *dot, dash, dot*.

## Chapter VIII

### TALKING BY WIRELESS

**A**LTHOUGH I have advised learning the Morse code first, as it is more widely used and of greater importance than the Continental, yet the latter is so much simpler and more readily mastered that many amateurs will prefer to learn this first, and no doubt the first messages sent and received will be clearer and more legible if in the Continental code.

After the instruments are installed and connected you may attempt at once to send a message.

The purpose of the aerial switch is to disconnect the receiving instruments from the transmitting apparatus, and it is well to have such a switch in your outfit, as it saves the bother of connecting and disconnecting wires each time you wish to change from sending to receiving, and vice versa.

#### Transmitting

To send a message seat yourself at the table bearing the apparatus, throw the switch from the receiving to the sending instruments, and press the sending-key. If a spark leaps across the spark-gap you may be sure that a wireless wave has been produced, and that by the touch of your finger you have sent forth an invisible wave that is traveling rapidly through space in ever-widening circles, and that will

## HARPER'S WIRELESS BOOK

be heard by every wireless receiving-station within the radius of your instrument's power.

If no spark occurs it shows that the gap is too wide, the coil needs adjustment, or that some connection is wrong, loose, or broken.

If you find the spark occurs you may at once send out a message by merely pressing the key so as to deliver short and prolonged taps in their proper order.

Each station and ship has a distinct call-signal indicated by certain letters, as *AB*, *CD*, etc. For example, if you wish to call a station having *AC* as its call, spell out the letters *AC* three times with the key. After each set of three calls sign your own call. If your call is *EF*, and you wish to call *AC*, you should call *AC*, *AC*, *AC*, *EF*. Then throw your aerial switch onto the receiving-instruments and adjust your detector, and if *AC* has heard your call he will reply by calling *EF*, *EF*, *EF*, *AC*, or by *II*. Now throw your switch to the transmitting-line and proceed with your message, followed by your call *EF* and the *finish-signal*. If *AC* understands your message he will reply by *OK*, but if not he will ask you to repeat or will signal *don't understand*.

In professional use the letters *MSG* are usually inserted in the "call" to indicate a message coming, and *OK*, *GA* (all right, go ahead) are used in the reply from the station called.

### Receiving

Many simple and quite a number of complicated stations are obliged to cut out the receiving-instruments to send a message, and to close the sending-circuit to receive one. This may be obviated by installing a "breaking-in" system as shown in Fig. 1. By this method signals may be sent

## TALKING BY WIRELESS

and received at the same time, for the transmitting-key (A) is constructed with a second set of contacts so arranged that when the key is released between letters or messages the aerial and ground are instantaneously connected to the

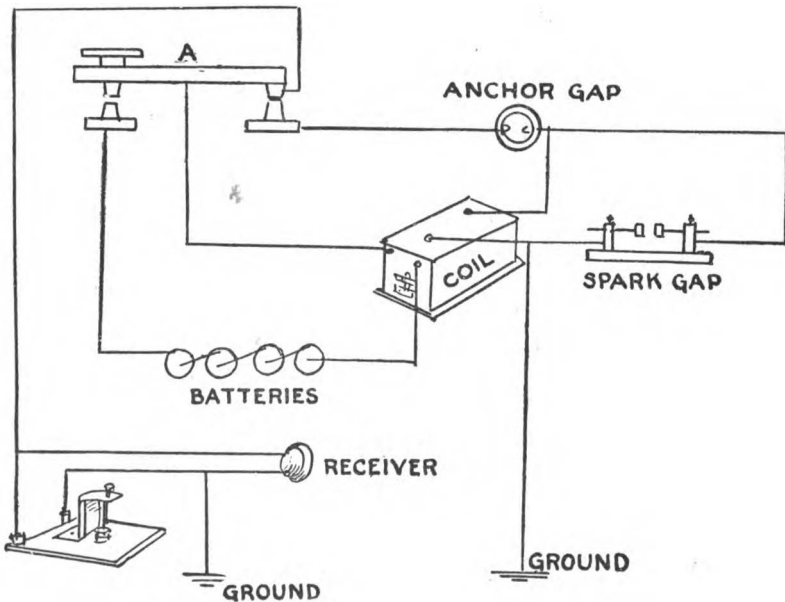

*Fig. 1*

receivers. As soon as the key is pressed to send a message the receivers are automatically cut off.

Any amateur can install a breaking-in switch in this way, and will find it a great advantage and far simpler than being obliged to throw over a switch or disconnect wires each time he wishes to change from sending to receiving.

Skill and rapidity in sending and receiving messages can only be obtained by practice and experience, and you should spend as much time as possible practising on your key

## HARPER'S WIRELESS BOOK

without actually sending messages until you can send and receive them with ease.

If you have some friend near at hand with a wireless outfit you can learn very rapidly, for, both being inexperienced, you will learn together.

It is far easier to receive than to send a message, for even if you cannot read or understand the messages you hear, yet there is an immense amount of pleasure and satisfaction in hearing the calls of various stations many miles distant.

Nearly every station has a different tone or sound to its transmitters, and you can very soon learn to distinguish the calls of various stations.

When you wish to receive you should throw your aerial switch into the receiving position, which will cut off the transmitting-instruments and will connect the detector, tuning-coil, and receiving-instruments with the aerial.

Now place the receivers on your ears, and you will probably hear a buzzing or humming noise without meaning or definite punctuation.

Turn the adjustable thumb-screw on the detector until a distinct snapping or tapping sound is heard. The sounds now audible will be confused and continual, for you will hear more or less distinctly every message being sent from stations within range of your instruments. In order to eliminate some and hear but one at a time you should carefully slide the "sliders" on the tuning-coil back and forth until the tapping of one message is clear and distinct. If your outfit embraces a variable condenser this should also be adjusted until the sounds of the message to which your instruments are tuned are as loud and distinct as possible. If you are familiar with a code you can listen carefully and spell out the message unless it is in "cipher," or a private code.



APR 1918  
RECEIVING AN INTERESTING MESSAGE

RECEIVING AN INTERESTING MESSAGE



## TALKING BY WIRELESS

If you cannot "read" the code you can amuse yourself by tuning the coil to various stations, and you will soon find that by placing your sliders in certain positions you will hear certain well-known calls which you will come to recognize like old friends.

And you can commence sending and receiving very slowly, and gradually increase your speed as your skill and experience increases.

If you attempt to send out messages before you are thoroughly familiar with the codes you will bother other operators, and if you attempt to receive professional messages until you have practised for some time you will be confused and discouraged, for the sounds denoting the various letters will come so rapidly and so close together that to your untrained and inexperienced ears it will seem a mere confusing jumble of meaningless sounds.

Practice makes perfect in any profession, and in telegraphy, and especially in wireless, this is particularly true.

### Laws Regulating Wireless Operation

So many amateurs have taken up wireless telegraphy that quite frequently they have proved a nuisance to regular operators, government stations, and vessels in trouble, and have seriously hampered the correct receipt of important messages.

In addition, many thoughtless or mischievous boys sent "faked" messages and reports until little dependence could be placed upon messages received by operators, unless sent in private codes.

At the time of the *Titanic* disaster the amateurs proved so troublesome that strict laws and regulations were made in regard to operating wireless stations. These rules were not



## HARPER'S WIRELESS BOOK

made for the purpose of hampering amateurs or experimenters, but merely to regulate the sending and receiving of wireless messages, and to license operators in such a way that a list of stations and operators might be filed.

The rules are undoubtedly of as great value to serious amateurs as to professionals, and every boy operator should be careful to abide by them, and should use every effort to see that they are enforced.

The rules and laws are very specific and numerous, and every boy who expects to operate either a sending or receiving outfit should write to the Department of Commerce and Labor, Bureau of Navigation, at Washington, and ask for a complete set of the Regulations Governing Radio Communication. The rules are furnished free of charge, and cover every possible phase of the subject.

Some of the regulations are very simple and important; as example, the rules governing the licensing of apparatus.

The act does not apply, either afloat or ashore, to apparatus for radio communication which merely receives messages and is not equipped for sending.

Neither is it necessary to license apparatus for transmission of messages exclusively between points in the same state, if the radius of the instruments does not extend beyond the state so as to interfere with communications in other states.

Any owner or operator of any apparatus who is in doubt in regard to licensing his apparatus should write all the facts to the radio inspector in his district, or to the Commissioner of Navigation, Department of Commerce and Labor, at Washington, D. C., before applying for a license. Any apparatus for communication on land within the jurisdiction of the United States, except the Philippine Islands and government stations, must be licensed if a means of com-

## TALKING BY WIRELESS

mercial intercourse outside of the state, or if the apparatus transmits messages beyond the state boundaries, or if it interferes with the receipt of messages in any state beyond the state where located.

Stations on land are divided into seven classes as follows:

1. Public-service stations.
2. Limited commercial stations.
3. Experiment stations.
4. Technical and training - school stations.
5. General amateur stations.
6. Special amateur stations.
7. Restricted amateur stations.

Each of these classes is subject to a certain form of license as follows:

Public-service stations are reserved for a limited service, and transmit and receive public messages to and from certain stations only, these stations being designated in the license.

Limited commercial stations are not open to public service, but are licensed for a certain service designated in the license. Such stations cannot transmit or accept public messages.

Experiment stations are stations actually engaged in conducting experiments to develop wireless communication. These stations are given special temporary licenses.

Technical and training-school stations are licensed in a separate class.

General amateur stations are restricted to a transmitting wave-length not exceeding 200 meters, and a transformer input not exceeding one kilowatt.

Special amateur stations are licensed to use a longer wave-length and a higher power, and must be operated by an amateur with at least two years' experience.

Restricted amateur stations are those within five miles of a naval or military station, and are restricted to a wave-

## HARPER'S WIRELESS BOOK

length not exceeding 200 meters, and to a transformer input not exceeding 1/2 kilowatt.

Operators of licensed stations must also be licensed, and must pass an examination.

Licensed operators are divided into eight grades as follows:

- |                          |                                      |
|--------------------------|--------------------------------------|
| I. Commercial operators. | II. Amateurs.                        |
| 1. First Grade.          | 6. First Grade.                      |
| 2. Second Grade.         | 7. Second Grade.                     |
| 3. Cargo Grade.          |                                      |
| 4. Extra Grade.          | III. Technical.                      |
| 5. Temporary Permit.     | 8. Experiment and Instruction Grade. |

The amateur wishing a license must have a sufficient knowledge of the adjustment and operation of apparatus and of the regulations of the international convention and government rules, and must be able to transmit and receive Continental Morse at a speed sufficient to enable him to recognize distress calls and "keep-out" signals. A speed of at least five words per minute (five letters to the word) must be attained.

### International Rules

In addition to the regulations and laws of the United States there are certain rules agreed upon by a number of foreign governments. These countries, known as the High Contracting Parties, ratified the rules at a convention, and the rules thus drawn up and ratified are known as the Regulations of the Berlin International Radiotelegraphic Convention. The countries concerned are Argentina, Austria-Hungary, Belgium, Brazil, Bulgaria, Chili, Denmark, Egypt, France, Germany, Great Britain (including Australia, India, Canada, New Zealand, South African Union), Greece, Italy, Mexico, Monaco, Morocco, Netherlands, Norway,

## TALKING BY WIRELESS

Persia, Portugal, Rumania, Russia, San Marino, Siam, Spain, Sweden, Turkey, and Uruguay, in addition to the United States.

As a knowledge of the rules of the Berlin convention is necessary in order to obtain a license, every boy operator should secure a copy of the rules from the Bureau of Commerce and Labor, and study them thoroughly.

They provide for a definite settlement of nearly every question, as well as regulating the charges for messages, the orders of sending messages, the form in which messages should be sent, the hours of service, directions for sending messages, and, most important in many ways, the accepted signals of transmission.

These should be memorized and posted in a prominent place in the instrument-room. They are most important, and are as follows:

The signals to be employed are those of the Morse International code. Ships in distress shall use the following:

• • • — — — • • • — — — • • •

repeated at brief intervals.

As soon as a station receives the signal above it shall cease all correspondence and not resume it until after it has made sure that the correspondence to which the distress signal has given rise is terminated. In case a ship in distress adds at the end of the series of calls the call-letters of a certain station, the reply to the call shall be incumbent upon that station alone. If the call does not designate any particular station, every station hearing the call shall be bound to reply.

The call-letters following the letters

• — — • • — — — • • • (P.R.B.)

show that the vessel or station making the call wishes to

## HARPER'S WIRELESS BOOK

communicate with the station by means of the International signal code. The combination of the letters "P.R.B." as a service signal for any other purpose is prohibited.

The call shall comprise the signal,

— · — · —

the call-letters of the station called repeated three times, the word "from" ("de"), followed by the call-letters of the sending-station repeated three times.

The called station shall reply by making the signal

— · — · —

followed by the call-letters of the corresponding station repeated three times, the word "from," its own call-letters, and the signal:

— · —

Before beginning an exchange of correspondence a coastal station shall commence with the signal

— · —

the invitation to transmit.

The transmission of the telegram shall be preceded by the signal

— · — · —

and terminated by the signal

· — · — ·

followed by the name of the sending-station.

When a wireless telegram contains more than forty words the sending-station shall interrupt the transmission after each series of twenty words by an interrogation-point—

· — · — ·

and shall not resume until after it has obtained a repetition

## TALKING BY WIRELESS

of the last word duly received, followed by the interrogation-point.

The conclusion of a correspondence between two stations shall be indicated by each station by the signal

• • • — • • —

followed by its call-letters.

## Chapter IX

### VALUE AND USES OF WIRELESS

**A**SIDE from the pleasure that the amateur may derive from the construction and operation of a station, the practice is of immense value.

Wireless telegraphy and telephony have now been perfected to such a state, and have become so vastly important in every-day use, that there is a constant demand for persons accustomed to use wireless instruments.

Practically every steamship is now equipped with wireless, and the boy fond of the sea and of travel may readily secure an opportunity to sail to distant ports while earning a good salary, if he has become proficient in sending and receiving wireless messages.

Even on land the demand for good wireless operators far exceeds the supply, and the work is easy, pleasant, and fairly remunerative.

Wireless is no longer a fad or a means of communication used only for special and unusual purposes, but has become as necessary and as universally used as ordinary telegraphy or cables.

With the numerous enormously powerful stations along the coasts, the splendid government stations, and the stations located on lightships, in lighthouses, and on isolated islands, the whole world is more or less directly connected by wireless communication.

## VALUE AND USES OF WIRELESS

Every battle-ship, cruiser, and other vessel of the navy is equipped with wireless instruments, and upon the completion of the powerful War Department station at Washington, it will be possible for the officials to keep in constant touch with each and every ship, no matter whether she is far out at sea or is lying at anchor in some distant port.

The first crude and cumbersome apparatus have now given way to light, compact, and very efficient outfits which are readily portable, and such portable stations have been found especially adapted to army and similar requirements.

An automobile wireless station is an important factor in modern army manœuvres, and is a most interesting example of the perfection and compactness of modern wireless outfits.

The machine is a standard touring-car provided with accommodations for six passengers, and arranged to store the entire wireless equipment and a large number of supplies, tools, etc.

A light steel mast divided into eight sections, each sliding into another, is used to elevate the aerials. The foot of the mast, when in use, is stepped in a socket in the center of the tonneau, and everything is so systematized and simplified that the mast and the aerial may be erected, a message sent, the reply received, and the outfit repacked and rapidly traveling to a new location all in a few minutes.

The motor of the automobile is also used to drive the small dynamo which furnishes the electricity for the wireless transmitting-instruments, and, although the entire equipment is so small and readily transported, yet communication may be readily established with other stations as far away as fifty or sixty miles.

With the advent of the successful aeroplane wireless instruments were devised to be used in aircraft during flight.



## HARPER'S WIRELESS BOOK

Many of the experiments made with aeroplane outfits have been most satisfactory, and two-seated aeroplanes equipped with wireless apparatus are now regularly used in government work.

An aeroplane thus equipped can hover far above an army and flash unseen messages to its own people miles away.

Newspapers and press bureaus were very quick to recognize the value of wireless as a means of obtaining important news with the least possible delay, and especially for reporting maritime news.

The New York *Herald* and various other large newspapers have very powerful and highly sensitive stations which are in constant operation.

Many railroads also have found wireless of the greatest benefit, especially in districts where heavy snow-storms, blizzards, and ice yearly destroy the telegraph and telephone wires and render them useless for days at a time.

During many of the severe Western storms large areas of country are entirely dependent upon wireless news from the outside world, and many more localities would be far better off if equipped with this system of communication with other places.

Probably the greatest value of wireless hitherto has been in connection with its use on shipboard.

Many disabled vessels would have foundered with great loss of life had it not been for wireless, and the unfortunate wreck of the *Titanic*, and the heroic rescue of the passengers and crew of the *Columbia*, made wireless at sea famous, and brought its importance more forcibly to the public mind than many years of pure commercial use would have done.

A few years ago a vessel could communicate with the shore for only a short time after sailing, and for a few hours

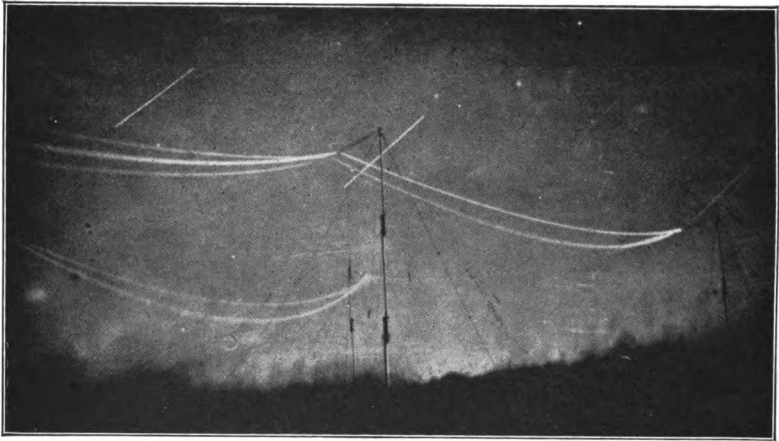

**A REMARKABLE PHOTOGRAPH TAKEN OUTSIDE OF THE CLIFDEN STATION WHILE MESSAGES WERE BEING SENT ACROSS TO CAPE RACE**

The camera was exposed for two hours, and the white bars show the sparks leaving the wires for their journey through the air for seventeen hundred miles.

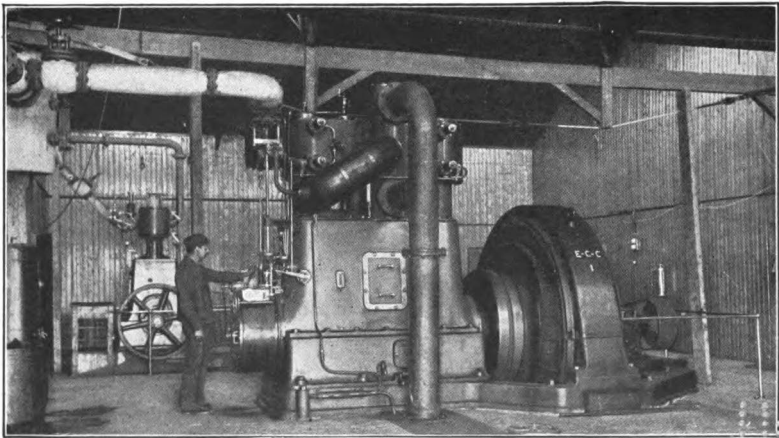

**MARCONI STATION AT CLIFDEN, IRELAND**

These dynamos send a message straight across the ocean.

14

## VALUE AND USES OF WIRELESS

before arriving; but now, with the more powerful and sensitive instruments and the establishment of huge aerials and wonderful stations along the coasts, a trans-Atlantic steamer can keep in touch with the land throughout her entire trip across the ocean. Many liners actually publish daily bulletins or papers containing all the daily news—even including baseball scores and stock-market quotations—during their voyage, and without the “wireless news” the palatial modern ship would be considered quite incomplete and out of date.

## Chapter X

### A BOY'S EXPERIENCE WITH WIRELESS TELEGRAPHY<sup>1</sup>

I HAD never realized how interesting and fascinating wireless telegraphy was until I happened one evening to visit a friend who had a complete and powerful outfit in his house. When I put on his receivers and heard the calls of stations, which he said were in New York, Boston, and other places along the coast, and when he showed me many interesting messages he had received, I determined to have an outfit of my own.

The one trouble was that I had very little money to use at this time. My friend had many up-to-date instruments, all finely finished and quite expensive. The only way out of it, as far as I could see, was to make my own, and although he seemed very doubtful whether home-made apparatus would work well or not, I had him explain the purpose of each instrument, and found out which were absolutely necessary and which could be dispensed with.

Of course, the receiving-outfit was the first thing to obtain. After eliminating all that was possible I found that the simplest, yet efficient, receiving-station consisted of the following instruments: tuning-coil, fixed condenser, detector, and receivers. I also procured all the catalogues I could get, and studied the different types of instruments in use, and examined my friend's outfit thoroughly.

<sup>1</sup>By Eric Thompson Bradley.

## A BOY'S EXPERIENCE

The detector seemed the simplest, so I built that first. I fastened a piece of  $3/4''$  strap brass, shaped like an inverted "L," to a piece of thin board  $3'' \times 5''$ , with a binding-post from the carbon of an old dry battery. Directly under the horizontal part of the "L," which was four inches high, I placed a flat piece of brass on which to put the mineral. I attached a fine wire to the horizontal part of the "L," and

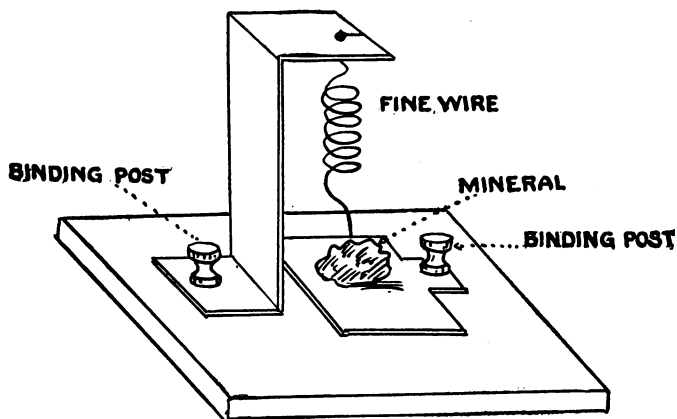

*Fig. 1*

the detector was adjusted by resting the end of the wire on different parts of the mineral until a sensitive place was found.

The brass plate holding the mineral was connected to another binding-post. This made a very neat and effective detector (Fig. 1).

Next came the condenser. I took two pieces of tin-foil five inches wide by one yard long, and placed a piece of wrapping-paper between them and a piece on both sides. The whole thing was then rolled up and placed in a paste-board box slightly larger than the roll. Each piece of foil was connected to a binding-post, and hot paraffin was then

## HARPER'S WIRELESS BOOK

poured in level with the top of the box. This condenser was very cheap, and when put in the place of one which cost four dollars in my friend's outfit, it worked fully as well as his.

The tuning-coil was the hardest proposition of all. I decided to copy as nearly as possible that of my friend's, which was of the double-slide type. I bought a ten-cent rolling-pin and one pound of No. 22 cotton-insulated magnet-wire. The handles were sawed off the rolling-pin, and square pieces of board nailed onto the ends. The wire was then wound on the pin as tightly as possible, with only the insulation to separate each strand.

With a red-hot iron I burnt off the insulation in two straight lines,  $1/4''$  wide, across the top of the coil. The slides, which were cubes of brass running on small brass rods, were adjusted so as just to touch the copper wire where the insulation was burned off. In order to make the sliders move smoothly and easily over the coil, and yet insure a perfect contact, small steel balls from the ball-bearing of an old bicycle were placed in a recess in the cube of brass, and were held firmly pressed against the wire coil by a spring, as shown in Fig. 2.

A small piece of brass rod was also screwed into the upper side of each slider for handles.

The receivers had to be bought. I could not afford 1,000-ohm receivers, so I purchased two of 75 ohms each, with a head-band, costing \$2 in all. Luckily, I secured a very sensitive pair, and obtained very good results with them.

Last of all came the aerial. This was made of two strands of No. 12 aluminum wire, using two porcelain insulators at either end of each strand.

We went to the woods and cut a hickory pole 12 feet long, and fastened this to the chimney of my house with

## A BOY'S EXPERIENCE

heavy wire. The aerial was stretched from the top of this pole, which was about 60 feet from the ground, to the cupola of the barn, about forty yards away. A lead-wire was fastened to each strand near the middle, and both leads ran to a single wire, which was carried to a switch on the window-sill of my room. The switch was single-pole, double-throw.

The wire to the instruments was fastened to one side, and from the other a wire was led to the ground so that the aerial could be grounded when not in use. If the switch is opened a little way during a heavy thunder-storm, a powerful spark will jump across the gap before each thunder-clap. I once succeeded in imitating Benjamin Franklin by

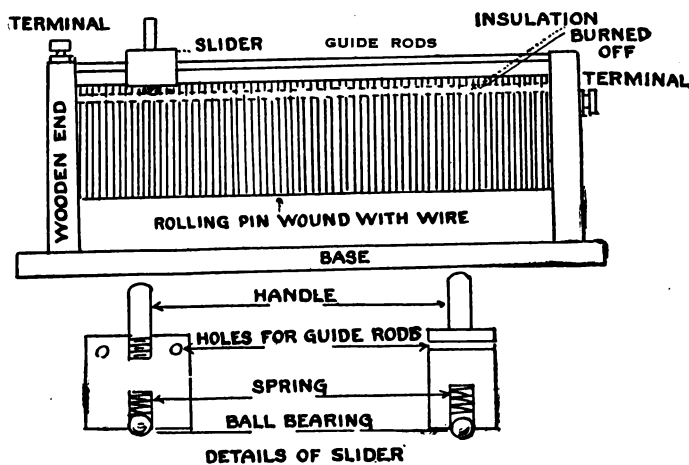

*Fig. 2*

charging a small Leyden jar from my aerial during a storm; but I happened to touch the top of the jar and received the full charge in myself, so did not try again.

For a ground-wire for the instruments I attached a heavy copper wire to the radiator beside my bed.



## HARPER'S WIRELESS BOOK

I now had all the necessary instruments for a receiving-outfit. My friend assisted me in putting up the aerial and wiring the instruments in proper order.

It took us all of an afternoon to do this, so we decided to leave the trying-out of the outfit until after supper. In the evening my friend brought with him an electric buzzer, which he used to adjust his detector. We wired this in with my detector, and he showed me how to adjust it by touching the wire of the detector to the mineral until the buzzer sounded very loud in the receivers.

This indicated that the wire was touching a sensitive place. We were using a piece of galena for a mineral, and, although I have tried a great many other minerals and pieces of the same material, I have never found anything which gave as good results with my detector as the piece which I used first.

I found a place on the mineral that seemed very sensitive, and then threw in the switch which connected the aerial to the instruments, and listened. I heard nothing at all but a sort of murmur, and was afraid that something was wrong. I carefully examined all the wiring to see if any contacts were loose, but everything seemed all right. I then moved one of the slides of the tuning-coil a little ways, and suddenly, loud and clear, I heard the deep, strong spark of the Waldorf-Astoria in New York, which I had learned to recognize on my friend's outfit.

I passed the receivers to him, and he read the first message, which was worded in some code which we couldn't understand; but I have always kept it as a souvenir. I took the receivers again and moved the slides of the tuner some more, and heard several stations; but they must have been very far away, because they were very weak.

I then left one slide at one end of the tuner and moved

## A BOY'S EXPERIENCE

the other to the opposite end and heard a very thin, high-pitched spark, which my friend said was Brant Rock, somewhere near Boston, over 150 miles away!

It was very evident that the receiving-outfit was a grand success. I sat up late into the night listening to the different stations and wishing very much that I could read what they were saying.

About five minutes before midnight the government station at Fire Island began ticking off the seconds, and exactly at twelve gave a long buzz. They did this at noon and at midnight, so that all clocks might be set right.

I now determined to learn to read the code as soon as possible. I knew the code well enough, but the operators sent so fast that I couldn't understand anything they were saying. My friend sent slowly to me, but it was not much fun, because I couldn't reply.

We had no city electricity on our street, and I couldn't afford a powerful sending-outfit, anyhow, so I decided to get a small coil with enough power to send to my friend's house, which was a mile away. I bought a Splitdorf jump-spark coil from a fellow for two dollars, which without a condenser gave a good spark not quite  $3/4$  of an inch long on five dry batteries.

The condenser was made by pasting pieces of tin-foil on both side of glass 10" x 12". At first, for a spark-gap, I merely fastened a piece of heavy aluminum wire to each of the two secondary binding-posts on top of the coil, and bent them so that the ends did not quite touch. The only adjustment to be had was by bending the wires. This worked all right, but later I made a better one on a board by itself. For a key I used one from an old telegraph outfit. As it was necessary to cut out the receiving-outfit when using the sending-apparatus, I bought a double-pole, double-

## HARPER'S WIRELESS BOOK

throw switch and wired it in a handy place near the table.

When the condenser was shunted across the secondary of the coil it gave a fat blue spark about  $1/8''$  long. This spark could be heard very clearly at my friend's house, and some fellows in a town five miles away have heard me at times.

As soon as my sending-outfit was running in good condition, I began to be able to receive faster.

At first I had to write every letter down as I received it, but soon I could wait until a word was finished before writing it down. Some of the messages were very interesting, others not at all so. One Sunday afternoon the Waldorf-Astoria sent out the report that Glenn Curtiss had just flown from Albany to New York. I received this fifteen minutes after he had landed, and it did not come out in the papers until the next morning.

When I had my outfit running for a couple of months some boys in a neighboring town invited my friend and myself to join a Wireless Club which they had formed. We accepted the invitation, and had some very enjoyable evenings at each other's houses.

Each boy would bring his own receivers, and we would fasten them all together in series so that all could listen to whatever messages might be coming in. We also subscribed to several of the electrical magazines, and anything of especial interest was read before the club.

One evening, when the members met at my house and we were all listening for messages, we suddenly heard two ladies talking to each other. Every one removed their receivers to see if it was not in the room or somewhere near; but it was certainly coming in over the aerial.

We could distinguish every word, and it was evident

## A BOY'S EXPERIENCE

that they were talking over the telephone. I ran downstairs, asked the central operator who it was, and she told me the names of two ladies in an entirely different part of the town.

Thus my receiving-outfit did service as a wireless telephone. It was very weird to sit in the room and hear the voices which we knew were really such a distance away and connected in no way with us.



**Part III**  
**WIRELESS TELEPHONY**



## Chapter XI

### SOUNDS AND SOUND-WAVES

**F**ROM the time that wireless telegraphy first proved successful many inventors and scientists have endeavored to perfect methods of transmitting sound by electromagnetic waves through the ether.

A great many difficulties had to be overcome which were not present in wireless telegraphy, and many problems were involved which rendered wireless telephony far more complicated and difficult than wireless telegraphy.

At the present time wireless telephony has been perfected to such a degree that the human voice, music, and similar sounds may be successfully transmitted for a distance of one hundred miles or more.

In this field the amateur has ample opportunity for experiment, with great rewards for new and practical appliances and inventions.

That boys may succeed in developing unlooked-for results in wireless telephony is proved by the fact that the boys of the Bancroft Foote Club, of New Haven, Connecticut, established a world's record for long-distance sound transmission by wireless during the past year.

#### The Theory and Principles of Sound

Before explaining the principles of wireless telephony it is necessary to understand just what sound is, how it is heard, and how it is caused.



## HARPER'S WIRELESS BOOK

Every body or object which causes sound is in a state of vibration while producing the sound, and it is these vibrations striking the delicate organ known as the ear that produce the sensation in our brains which we call "sound."

As a matter of fact, sound is nothing but a form of vibrating invisible waves in the atmosphere, and a very large proportion of the actual sound-waves are never heard by the human ear at all.

Many of the lower animals, insects, and other creatures can detect sounds that are inaudible to the human ear, and there is no doubt that a large number of vibrations escape even the most delicate ears of any living creatures.

Whenever a substance, whether solid, liquid, or gaseous, vibrates in the air it produces ripples, or waves, just as a stick moved back and forth in water will produce waves in the water.

These waves may be longer or shorter, slower or faster, larger or smaller, according to the force and quality of the vibrations of the substance creating them, and from the vibrating original source the sound-waves pass out in ever-widening circles, causing corresponding changes of pressure in the air.

The order and speed of these changes are distinct and different for every sound. If rapid and short, a "high" sound is recorded in our ears; while if long and slow, a "low" sound is heard. The ear records only those sounds which are of the proper length and speed to be recorded, and a vast number of vibrations occur which are too "high" or too "low" to be heard. Individuals vary in regard to the range of sound they can hear, and many musicians can distinguish, identify, and differentiate sounds which the ordinary person cannot distinguish from notes slightly higher or lower.

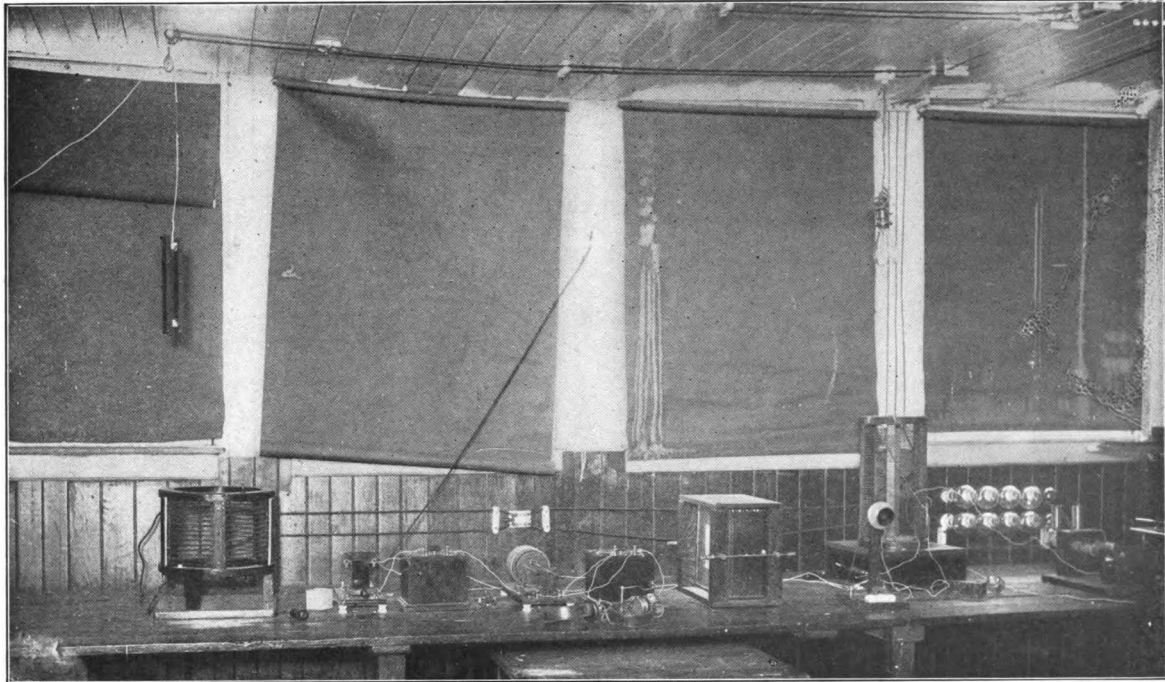

THE WIRELESS-TELEPHONE APPARATUS OF THE BANCROFT FOOTE BOYS' CLUB, Y. M. C. A., NEW HAVEN, CONNECTICUT



## SOUNDS AND SOUND-WAVES

Sound-vibrations may be *non-periodic*, or, in other words, irregular and conflicting, or they may overlap and blend and become "cyclic." In the former case the resulting sound is considered as "noise," or discord, and in the latter case "harmony," or music.

### Experimenting with Sound

It is a very easy matter to satisfy oneself that any substance producing sound is in a state of vibration, and that the particles or atoms of which it is composed are in motion.

If a tuning-fork or an upright piece of spring steel is struck with a light, swinging ball, or even a cork suspended by a fine thread, the metal will give out a musical note, and the cork or ball will be thrown quite violently away from the metal, proving that the fork or steel rod is in motion, although the vibration may be so slight and so rapid that the human eye cannot see the movement (Fig. 1).

Another interesting experiment consists in fastening a fine wire or hog's bristle to a tuning-fork or a piece of tempered steel, and making the fork trace a pattern of its vibrations on smoked glass.

If the fork is fastened horizontally and a guide placed below it, as shown in Fig. 2, a piece of smoked glass may be drawn evenly along beneath the fork, and the fine wire (A) will leave a smooth, clear scratch upon the smoked surface (Fig. 3).

If the fork is now struck so as to cause it to give forth a note of sound, and another glass is drawn along the guide, the resulting scratch will appear as in Fig. 4, thus proving that the fork or steel moved back and forth a great many times while the glass was being drawn beneath it.

By varying the force of the blow and the length and size

## HARPER'S WIRELESS BOOK

of the metal, wavy lines of varying width and shape will be obtained. You will find that large, long pieces of metal will produce heavy, deeply scalloped, and coarse patterns like

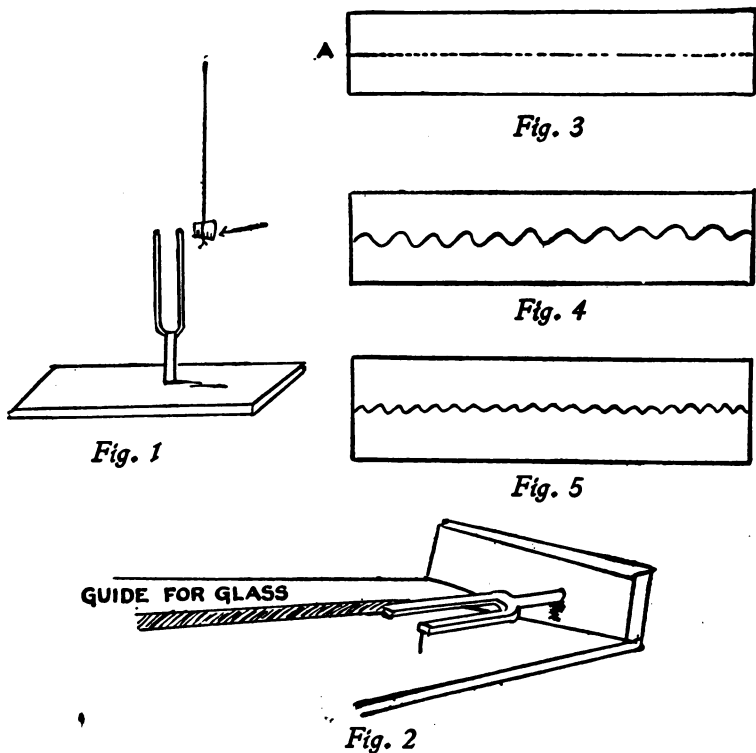

that shown in Fig. 4, whereas slender and shorter ones will produce finely scalloped, delicate lines like Fig. 5.

### Making Sound-Waves Visible

Every vibrating substance, whether giving forth audible sounds or not, produces waves in the air known as *sound-waves*.

## SOUNDS AND SOUND-WAVES

These consist of alternating condensations and rarefactions of the air something akin to the electromagnetic waves used in wireless telegraphy.

Although these sound-waves are not normally visible, yet they may be made so by very simple methods.

A small box is divided into two compartments by a rubber partition, and ordinary illuminating gas is led into one compartment by a rubber tube, and on the same side of the box a small gas-burner is attached (Fig. 6). To the other side of the box a mouthpiece, or small megaphone, is fastened. Behind the flame at the gas-jet a revolving or stationary mirror is arranged, and if a person now speaks into or near the mouthpiece the air-waves will strike the rubber parti-

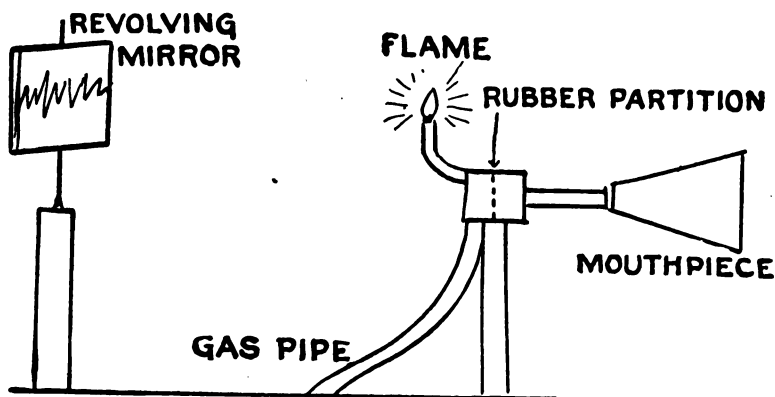

*Fig. 6*

tion and cause the pressure of the gas to vary, with resulting variations in the height of the flame. When viewed in the mirror the light resembles a rough-edged saw (Fig. 7), and each sound or change of tone produces a distinct band of light-form in the mirror.

A simple sound, such as oo in "tool," will produce a band

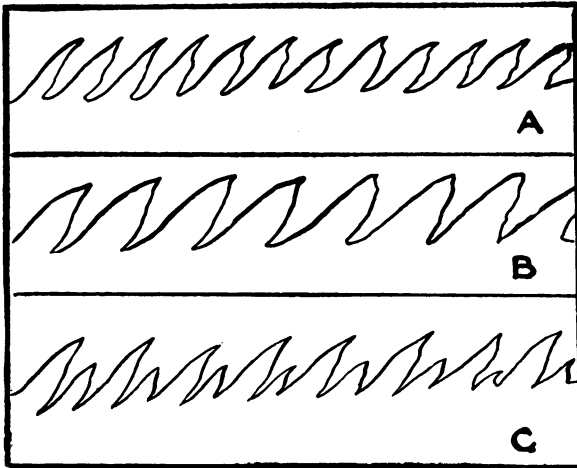

Fig. 7

of light similar to that shown at A. The same sound one octave lower will produce the form B with half as many serrations, whereas *o* will appear as in C, proving that the sound of *o* is compound, or made up of two separate sounds.

The principle difficulty in reproducing sounds by wireless telephony, by phonographs, or by ordinary telephones lies in producing apparatus so sensitive to the minute variations in waves of sound, so delicately adjusted, and so invariable that each and every wave sent forth by a certain vibration will be exactly duplicated in the transmitter, and thus precisely like the original sound.

## Chapter XII

### MAKING SOUND VISIBLE

IT is a very easy matter to imitate or duplicate *certain* sounds, for it is only necessary to construct an instrument which will produce the same kind of vibrations as those causing the sound we wish to duplicate.

To imitate or duplicate *every* vibration or sound which is audible to our ears is a very different matter, and it was not until the invention of the telephone that this was accomplished.

The modern telephone is a very highly perfected and sensitive instrument, but any boy can telephone for a considerable distance by using a couple of old tin cans and a piece of string.

If a piece of parchment or stiff paper is stretched tightly across the end of a tin cylinder, and another similar cylinder is connected with it by a string attached to the center of the parchment (Fig. 1), a fairly efficient telephone will result.

By speaking into one cylinder the parchment is made to vibrate, and the vibrations, tightening and loosening the string, cause the parchment at the opposite end to vibrate in unison. Speech may be carried on with such a simple apparatus for a distance of several hundred feet.

In the true telephone the cylinders of tin are replaced by the more highly perfected transmitter and receivers,



## HARPER'S WIRELESS BOOK

while the string is replaced by a wire. The wire of the real telephone does not, however, tighten and loosen with the vibrations of sound, but merely serves to carry an electrical current which surges or varies in accordance with the vibrations produced in the transmitter.

### The Telephone

A complete telephone consists of a transmitter and receiver with its attendant fixtures, wires, and batteries; and, while it may seem a very mysterious and complicated machine, yet it is really very simple and readily understood. The transmitter, or part into which the user of a telephone talks

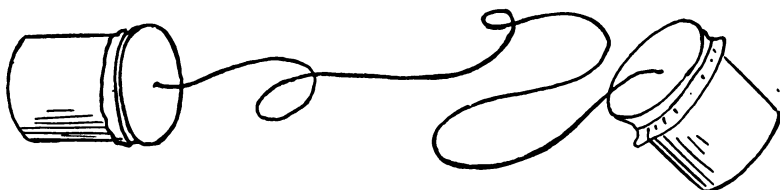

*Fig. 1*

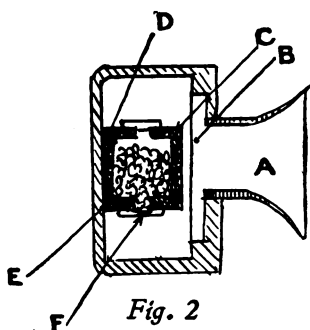

*Fig. 2*

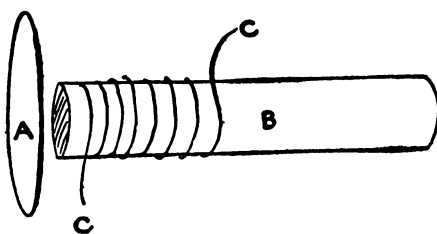

*Fig. 3*

(Fig. 2), consists of a mouthpiece (A), a diaphragm (B), a carbon cup attached to the back of the latter (C), and a second cup (D) fastened rigidly to the back of the trans-

## MAKING SOUND VISIBLE

mitter. The space between C and D is filled with small granules of carbon (E) held in position by a strip of flannel (F). The diaphragm is connected with an electric wire carrying a current from a battery and passing through the carbon granules. When these are perfectly free and loose their resistance to the current is very great, and no current flows from the transmitter to the wires leading to the other instrument. Just as soon as the grains are compressed or brought together they permit a current to pass, and this property is used in transmitting sounds.

Any variation of the diaphragm (B) causes the grains to be loosened or compressed, and the amount of current which passes through them is thus varied in exact proportion and in perfect unison with the vibrations of the diaphragm. In this way electric impulses of varying length and strength are sent over the wires as one speaks into the transmitter.

In order to render these electric waves audible a *receiver* is used at the other end of the wire.

The receiver (Fig. 3) consists of an iron disk, or diaphragm (A), located very close to, but not quite touching the end of a steel bar-magnet which is wound with fine, insulated wire.

The ends of this coil of wire (C) are connected to the wires leading from the transmitter and battery. With every variation in the diaphragm of the transmitter a varying current of electricity passes over the wire, thus altering the magnetism of the bar (B) in the receiver; and this magnet, by alternately attracting and repelling the diaphragm (A), causes the latter to vibrate in exactly the same way as the diaphragm in the transmitter. As the two disks are identical in material, the sounds thus produced are also identical.

## HARPER'S WIRELESS BOOK

### Photophones

The inventor of the electrical telephone, Mr. Alexander Graham Bell, was the first to succeed in transmitting sound without the aid of wires, and some of his experiments and discoveries, although not in practical use to-day, are most interesting and valuable.

The element *selenium* possesses the peculiar property of altering its electrical resistance under the influence of light, the resistance in the darkness being nearly twice the resistance when lighted.

Mr. Bell took advantage of this property and devised selenium cells in which the selenium was formed in narrow strips between wider conducting strips of brass.

By arranging a selenium cell in conjunction with a mirror, a mouthpiece, and a receiver, as illustrated in Fig. 4, sound may be transmitted for a considerable distance over the beam of light reflected by the mirror.

In this "photophone" the thin, silvered glass (A) acted like the diaphragm in the ordinary telephone; but instead of transmitting vibrations to a receiver the vibrations of the mirror caused varying degrees of reflected light to strike the parabolic reflector and selenium cell (B). This cell was connected in series with a battery and receiver, and thus the varying resistance caused by the alteration in the light striking the selenium cell caused the diaphragm of the receiver to vibrate, and thus transmit sounds exactly like those thrown into the transmitter.

This method was extremely limited in its practical application, and was greatly improved upon by using the manometric flame already described in place of the silvered mirror. Even in this form the photophone was more valuable

## MAKING SOUND VISIBLE

as an interesting experiment than as a practical means of transmitting speech without wires.

A better and more remarkable method of wireless telephony was invented by Ruhmer, who succeeded in trans-

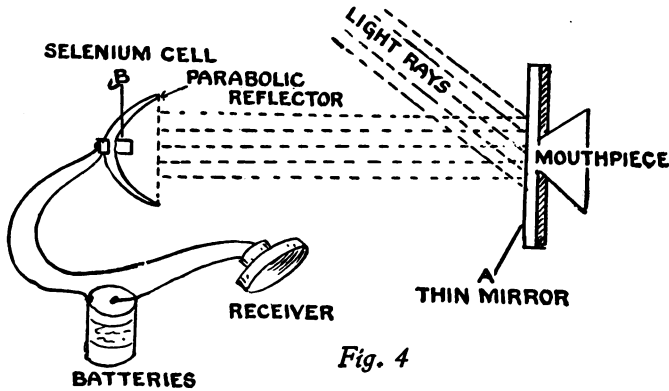

Fig. 4

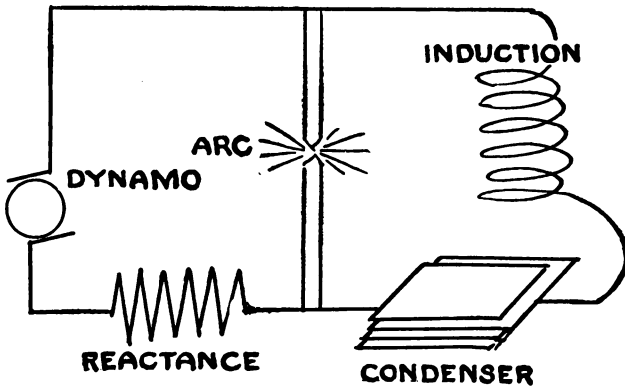

Fig. 5

mitting speech for several miles in 1902 by means of the *speaking arc*.

It had been observed that an arc-lamp gives forth a peculiar rattling noise if the current is altered or varied, and

## HARPER'S WIRELESS BOOK

this peculiarity was grasped by Ruhmer, who used the arc to transmit speech (Fig. 5).

By merely using the current passing through a telephone transmitter to vary the current to the arc-lamp, the latter could be made to sing, whistle, or reproduce various other sounds quite perfectly.

All of these methods of transmitting sounds by light or similar methods are limited in scope, for they depend upon light, which travels only in a direct line, and cannot pierce obstructions such as trees, buildings, etc.

With the discovery of wireless telegraphy the possibility of transmitting speech in a similar way at once attracted wide-spread attention, and, although a satisfactory method was long sought for and for a long time baffled experimenters, to-day wireless telephony is an accomplished fact, and in a short time will doubtless be perfected to such an extent that ordinary telephones will be practically discarded for long-distance service.

The greatest distance to which wireless telephone messages have yet been transmitted is about three hundred and ten miles. This record was established by the station at Nauen, near Berlin, Germany, and the messages were received at Vienna, Austria, at the technical museum. Articles from newspapers read aloud at Nauen could be distinctly heard at Vienna, as well as all the intermediate stations.

## Chapter XIII

### TALKING THROUGH THE AIR

**A**T first thought it would appear quite possible to merely connect a telephone transmitter and receiver to the ordinary wireless-telegraph apparatus and successfully talk by wireless.

This has frequently been attempted, and, although noises of certain kinds, such as musical tones, whistles, and some words, may be thus transmitted at times, yet the method is really impracticable for a very simple reason. As we have already learned, the sparks produced by the vibrator of the coil at the spark-gap are not continuous, but intermittent; and, while the flow of oscillations may appear as a steady stream to the eye, yet in reality there is a distinct pause after each one.

If a transmitter should be connected to the aerial wire, as shown in Fig. 1, each sound which causes the transmitter diaphragm to vibrate will vary the path of the electrical oscillations of the instruments, with a consequent variation in the waves sent out from the aerial. These varying waves may be caught by a receiver properly attached to a receiving-station, and sounds, as before stated, will be recorded. The sparks causing the waves being interrupted, or "damped," the sounds transmitted will, however, be received in sections, so to speak, instead of in a continuous flow of oscillations.

## HARPER'S WIRELESS BOOK

This effect may be more readily understood by reference to Fig. 2, in which A represents the variations in vibrations of a certain word, B the intermittent sparks from the coil, and C the manner in which the word would be broken up and received in the receiver. Of course, a word thus cut into numerous short sections would be quite unintelligible, while certain distinct sounds such as whistling, bell-ringing, etc., might be recognizable.

As the only fault in this method of sound-transmission lies in the fact that spaces occur in the waves carrying the sounds, you will readily understand that if the waves were continuous, or so extremely rapid that they would appear continuous, the sounds carried by them would be easily understood.

The means of producing such a continuous or extremely rapid series of waves is, therefore, the principal item in successful wireless telephony.

I have already mentioned the "speaking arc" and the peculiar property of an arc-light to produce certain musical sounds.

In wireless telephony the arc-light is used as a generator of undamped high-frequency oscillations.

### How Wireless Sound-Transmission Is Accomplished

If a condenser and inductance-coil are shunted across the current to an arc-light, the current to the latter is diminished as the condenser becomes charged, and the potential difference across the arc is also increased. This still further charges the condenser, which discharges through the coil and again becomes charged in the opposite direction, the operation being repeated over and over again with extreme rapidity—one million discharges a second being usual. These

# TALKING THROUGH THE AIR

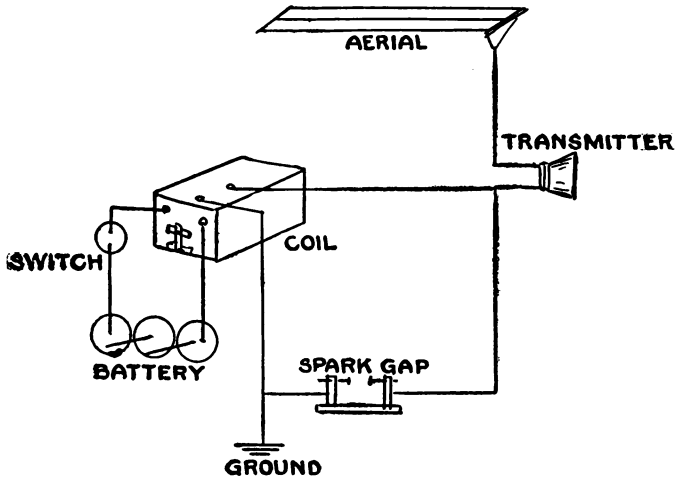

Fig. 1



Fig. 2

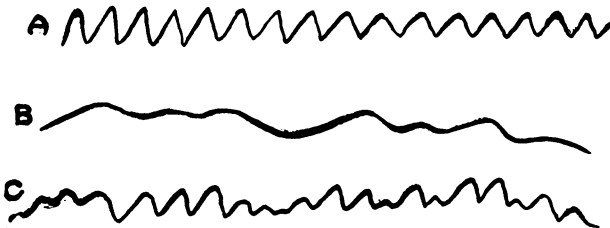

Fig. 3

extremely high-frequency oscillations are practically undamped and continuous, and a sound made in the transmitter is reproduced through the receiver by these undamped waves in a steady series of vibrations superimposed upon the oscillations. A diagrammatic illustration of this is shown in



## HARPER'S WIRELESS BOOK

Fig. 3, in which A represents the continuous oscillations, B the sound-waves of a word, and C the same waves carried by the oscillations. By comparing this figure with Fig. 2 it will be seen that in place of the broken-up sounds in Fig. 2 a continuous sound is transmitted.

Although the ordinary arc will answer for transmitting sounds as above described, yet if one of the arc-detectors is constructed of copper and is cooled by passing water through it, the distinctness of the sound transmitted will be wonderfully increased.

This invention, or discovery, of Poulsen was a great advance in wireless telephony, and still further efficiency was soon attained by surrounding the arc with hydrogen or hydrocarbon gas.

This resulted in far clearer sound-transmission, and even greater efficiency is now gained by placing the arc in a strong magnetic field wherein its voltage is vastly increased and its resistance is much greater.

The arrangement of the transmitter, condenser, coil, and arc is shown in Fig. 4. The condenser is composed of

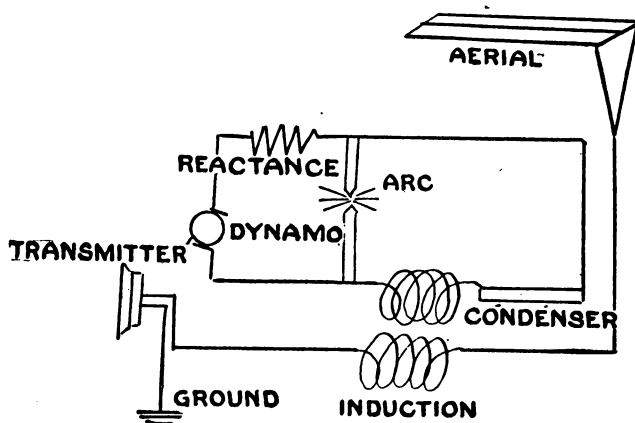

*Fig. 4*

## TALKING THROUGH THE AIR

several metal plates in a tank of oil, which serves as insulating material, and the coil may be a bare coiled wire or a simple helix.

### Instruments Used in Wireless Telephony

The ordinary telephone transmitter, with its carbon particles, cannot be used with large amounts of power, and therefore special forms of transmitters have been designed for use in wireless telephony.

Many of these are merely larger modified forms of a common transmitter, but those devised by the Italian inventor Majorana are very different and highly efficient.

A section of a Majorana transmitter is shown in Fig. 5. It consists of a tube or receptacle (A) in which water or some other liquid flows downward, as indicated by the arrow, through the narrow tube B, from the extremity of which it issues in a tiny jet. This tube is of unyielding and inelastic material, but at the spot C there is an opening covered with a thin, elastic diaphragm.

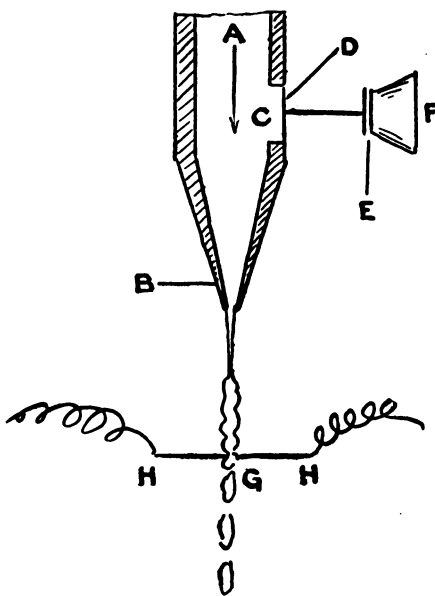

Fig. 5

This is connected by a short rod to another diaphragm (E), to which is fastened a mouthpiece (F).

Ordinarily the liquid flows out of the tube in a fine stream

## HARPER'S WIRELESS BOOK

and breaks into drops a little below the lower end, as indicated in the figure at G.

If the stream is interrupted or disturbed it will at once become broken into drops much nearer the tube. When any one speaks into the mouthpiece, the diaphragm E vibrates, thus causing the membrane D to vibrate in unison, and the pressure upon the water within the tube is consequently altered with each vibration, and each change in pressure shortens or lengthens the stream at the bottom.

Where the stream normally contracts almost to the dropping-point two fine wires are placed, with their ends close together and provided with an electrical current (H). When no water is passing the connection is broken; but as soon as a drop, or the stream itself, touches both wires connections are established through the water.

When the stream is narrow the resistance is greater than when it is wide, and as the stream actually moves up and down with the vibrations of the diaphragm caused by sounds, the amount of current passing through the wire varies in exact proportion.

### The Receiving-Apparatus

The wireless-telephone receiver consists of a detector, a telephone receiver, and a battery, just as the wireless-telegraph receiver consisted of a detector and a receiver. In the telephone station the apparatus is connected to the aerial and ground by a loose-coupled helix, which is made by giving a secondary winding to the helix placed in series with the arc and condenser.

Many forms of detectors have been used, the common form being electrolytic, but a form which is excessively delicate and of great interest is known as the "audion." This is a six-volt incandescent lamp provided with a nickel plate



THE WIRELESS-ROOM ON THE S.S. "AMERIKA"



CHIEF ELECTRICIAN USING THE WIRELESS TELEPHONE ON THE U.S.S. "KEARSARGE"



## TALKING THROUGH THE AIR

fastened near the filament, and with a grid of wire situated half-way between the filament and the plate.

When the filament is incandescent from the current passing through it it throws off a steady stream of extremely fine particles electrically charged, and known as *ions*. These pass through the grid and are discharged upon the nickel plate; and when the grid is connected with the aerial and the plate is grounded, the *ions* carry only that portion of the current from the aerial which flows in the same direction, but it does not permit the current to flow back or reverse in the opposite direction.

In this way it serves as a valve and alters the surging, alternating current to an intermittent direct current, just as the wireless-telegraph detectors operate, but with greater sensitiveness.

With such instruments speech, music, and other sounds are distinctly transmitted for several hundred miles, and as systems and instruments are further perfected there is no reason to suppose that wireless telephony will not soon have the range of wireless telegraphy.

When sound is transmitted by wireless the varying tones and variations of voice and music are much more distinct than by wire methods, and no rumbling, roaring, or other confusing sounds are heard as in the ordinary telephone.

### The Vanni Method

One of the most remarkable and successful systems of wireless telephony has been perfected by Professor Vanni, and with this system conversations have been successfully transmitted for over 600 miles.

Professor Vanni utilizes falling drops of water in a similar manner to that already described, but with very different instruments.

## HARPER'S WIRELESS BOOK

The Vanni system is in reality a combination of several inventions, for the Moretti apparatus, consisting of a series of drops of water passing between two copper electrodes, is used to produce the essential interrupted current of high intensity.

To vary this current to conform to the various modulations of the human voice a current-variator and microphone are used.

An ordinary carbon microphone cannot be utilized, as it will not withstand more than one or two amperes, and hence a hydraulic microphone is employed.

This instrument is based on the fact that a jet of water

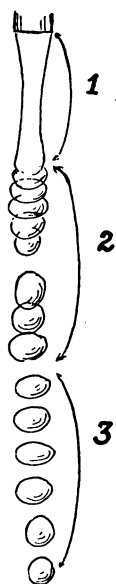

*Fig. 6*

under a known pressure possesses three distinctly separated parts. One is limpid, continuous, and resembles a crystal cylinder of constant section.

The second part is agitated, variable in section, and composed of more or less spherical drops succeeding one another, and each animated by a vibratory motion causing it to alter from an elongated sphere with a vertical axis to a flattened sphere with a horizontal axis.

The third and final part is a series of spheroidal drops separated by intervals. Only the last or third part is visible to the eye, as the changes take place too rapidly to be followed.

It may, however, be better understood by referring to Fig. 6, which represents falling drops of water, or, rather, a jet changing to drops.

If a sound is produced near such a jet of water the tendency to transform to drops will show nearer the starting-point of the jet, and the drops will be more numerous,

while the cylindrical portion will become shorter. As soon as the sound ceases, the unbroken part of the jet will increase to its original length.

As soon as the sound ceases, the unbroken part of the jet will increase to its original length.

As soon as the sound ceases, the unbroken part of the jet will increase to its original length.

As soon as the sound ceases, the unbroken part of the jet will increase to its original length.

As soon as the sound ceases, the unbroken part of the jet will increase to its original length.

As soon as the sound ceases, the unbroken part of the jet will increase to its original length.

## TALKING THROUGH THE AIR

When the sound is rhythmic, as in ordinary speech, the liquid cylinder will vibrate synchronously with the sound; and if the drops resulting are allowed to fall upon a diaphragm, the frequency with which they strike will cause the membrane to vibrate, and the water will thus reproduce the sound which caused the drops to vary in the frequency of their fall.

This remarkable property of falling water was the basis of the Bell microphone, perfected by Chichester Bell, and which consists of two parts — the transmitter and the collector. The transmitter is used to transmit the sound-waves to the jet of water, and the method of its operation and the arrangement of its various parts may be clearly understood by examining the diagram (Fig. 7). Upon the movable electrode (A) the jet of water issuing from the tube (T) falls from a height which may be regulated and at a given pressure. When one speaks into the mouthpiece (H) of the microphone the vibrations of the center of the diaphragm are increased by the induction-coil (P S), and are transmitted to the movable electrode (A), which they set in vibration, giving little shocks to the jet of falling water. These shocks alter the cylindrical jet to a flat film, which varies in thickness and electrical resistance with the variations of sound. This variation is further intensified by the electrode (A) dipping more or less into the layer of liquid on the plate (B) as it vibrates.

When this system of two electrodes vibrating with the liquid jet is interposed in the circuit between the aerial and the ground, the waves sent forth will vary according to the sounds produced before the mouthpiece. In order to operate this apparatus successfully the pressure of the jet of water must be accurately measured, and must be regulated within twelve or fifteen feet of pipe. This is accomplished by



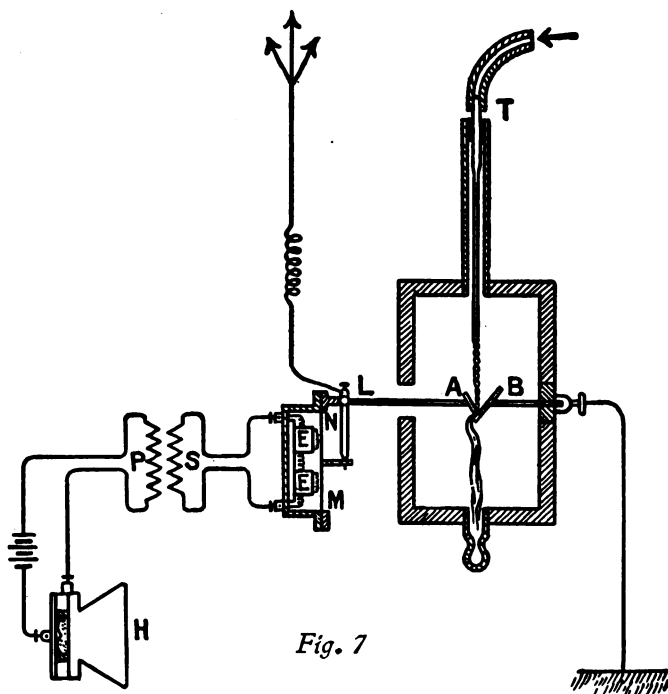

Fig. 7

means of a centrifugal pump between the entrance and exit of the microphone.

A remarkable fact in connection with this apparatus is that the varying drops of water in the vibrating jet are always characteristic of the particular sound which produces them.

Their changing forms may readily be thrown upon a screen, enormously magnified, and a true optical representation of sounds is thus produced. In other words, speech, by the use of the microphone and the cinematograph, becomes actually visible.

#### The Value of Wireless Telephony

While wireless telephony is at present perfectly practicable and in constant use, its future is more or less

## TALKING THROUGH THE AIR

problematical. There is no doubt that for many purposes wireless telephony would be more valuable and would largely supersede wireless telegraphy.

Wireless telephony is particularly well adapted to marine use, as no operator is required. A special man is necessary for the wireless-telegraph apparatus, but any one may readily use a wireless telephone.

It is also much quicker, for there is no necessity of calling a station, waiting for a reply, and then laboriously ticking off the message in code.

One may call up another station by wireless telephone, give the message, and receive a reply as rapidly and easily as with the ordinary telephone.

A passenger may talk directly with a friend at home, or the officers may call up the owners and receive orders or make reports, or passengers on two vessels may talk back and forth in midocean.

The present range of wireless telephony is too limited for it to compete seriously with wireless telegraphy, but if equally long distances can be reached with the wireless telephone it will prove invaluable for long-distance use.

Long-distance wires are very expensive, their maintenance is costly, and in storms they are often disabled or destroyed. On the other hand, long-distance wireless systems would not be hampered in the least by storms or bad weather; there would be no cost of wires, and nothing would be expended on maintenance. Moreover, the number of employees necessary would be greatly decreased, and the only breakdowns or troubles encountered would be at the terminal stations.

It would also be difficult for any one firm to secure franchises or charters, and competition would be stimulated.

For short distances and every-day use it is doubtful if

## HARPER'S WIRELESS BOOK

wireless telephony would be superior to existing systems. If it ever came into universal daily use each subscriber would probably have his own station, and it would be practically impossible for a firm or corporation to prevent any individual from equipping a station and calling up others direct.

### Experiences of a Wireless Operator on Shipboard<sup>1</sup>

I was still a small boy when I made my first experiments in wireless, and, although my home-made instruments were very crude, yet I succeeded in both sending and receiving messages between my own home and the homes of some of my schoolmates a mile or more distant.

So greatly did I become interested in the new science that I devoted all my spare time and spending-money to improving my station, making or purchasing new and better devices and instruments, and studying codes and wireless telegraphy.

My close application and interest was rewarded long before I expected, for a friend of my father—who had interests in a steamship line running to South America and the West Indies—offered me a position as wireless operator on one of his ships before I had finished the high school.

You may realize how tickled I was at the prospect of operating a real outfit, with a good salary, and also how I looked forward to the opportunity of sailing to the tropics and seeing strange lands and people.

In order to become familiar with the wireless-room on the *Lydia* I visited the ship as soon as she arrived in port and spent most of my time with the old operator while the vessel lay at her pier.

<sup>1</sup>As related by a professional operator.

## TALKING THROUGH THE AIR

By the time she was ready to sail I was thoroughly at home in my new quarters, and had memorized the various call-signals of the other vessels of the line, as well as those of most ports and stations that would be likely to communicate with us on the voyage.

As soon as the tug cast off the lines and we headed toward the open sea my duties commenced, and I found myself very fully occupied sending messages from the captain and officers to the owners, from passengers to friends at home, and many messages in code or cipher from business men who wished to make final arrangements with their firms on the shore we were so rapidly leaving behind.

When the last message was sent and the last call answered, I was well content to turn in on my small bunk in the wireless-room; but I had hardly closed my eyes when I was aroused by the first officer, who brought another message from the captain which was to be sent through at once. After some time I picked up Scotland Lightship and sent the message, for our sending-instruments were of small radius, although the receivers were very powerful.

While in communication with the lightship I heard the calls of several incoming ships, and, although I was very sleepy and tired, I listened with a great deal of interest to the various messages from these steamers returning from long trips.

My curiosity proved of benefit to us, for among the messages I received one from an incoming ship from the south which reported a dangerous derelict in our course. This I reported at once to the captain, as well as various items in regard to weather, ships in the neighborhood, etc.

We were now well outside the shelter of land, and the sea was becoming quite rough, and, unaccustomed as I was to ocean travel, and being cooped up in a small, stuffy room,

## HARPER'S WIRELESS BOOK

I soon felt decidedly seasick and took to my berth very hurriedly.

The rest of the night and the following day held no interest for me whatever, and I was thankful indeed that we were beyond the reach of wireless communication with the shore, and I devoutly hoped that no other vessel would be near and wish to communicate with us.

The next day I felt quite well, and ventured on deck. I was greatly surprised to find that the chill of the March weather ashore had given way to soft, balmy air and warm sunshine.

In a day or two I was entirely over my sickness, and had got on my "sea-legs," and thoroughly enjoyed the heave of the ship to the long ocean swell.

As we were now nearing the Bahamas, and as Florida-bound ships might be in our vicinity, the captain asked me to send out calls and try to get into communication with some ship or station in order to report our whereabouts.

After a few calls I picked up a Ward liner going north and talked with her for some time. It seemed very strange to be talking with another ship entirely out of sight, for from the deck the ocean appeared utterly deserted. I had never experienced the same sensation when operating on shore, for the presence of people, houses, and other objects, and the feeling that I was surrounded by life and business, had prevented me from feeling that I was talking to some one who was utterly beyond my sight or hearing.

A few hours later we got in touch with a shore station on the Bahamas, and, although we did not sight land, we knew that we would soon reach our first port of call.

The next morning we received a message from St. Thomas, and the first words we received were an account of the destruction of Kingston, Jamaica, by earthquake.

## TALKING THROUGH THE AIR

This caused a great deal of excitement among our passengers, for many of them had friends and interests in Jamaica, and for several hours I was kept busy trying to get details of the disaster.

Presently we sighted St. Thomas, and were soon anchored in the beautiful harbor.

While in port there was nothing for me to do on board, and I thoroughly enjoyed myself wandering about the quaint town and the surrounding country.

From St. Thomas our course lay along the Caribbean side of the Lesser Antilles, and we were almost constantly in communication with one port or another, and were usually in sight of land.

As the islands were Dutch, Danish, French, and English by turn, the messages sent were in various languages.

Most of the radiograms were from business houses or friends of passengers, and were of little interest or importance.

After a very pleasant trip along the islands we approached South America, and the passengers began to hustle about and prepare for landing. I was greatly surprised to find that so many small and out-of-the-way ports were equipped with wireless stations, and in many cases American operators were in charge. Later I found that inter-island communication is so infrequent and that cables are so often interrupted that the people have found wireless almost a necessity, and in many places prominent merchants and planters have installed stations at their own expense.

Among our passengers were several South-Americans who were supposed to be planning a revolution in their own country. As we neared the coast these men became very uneasy and spent money recklessly in sending strange messages to various addresses on shore. The messages and re-

## HARPER'S WIRELESS BOOK

plies were in Spanish, and, although I was not familiar with the language, I felt sure they were in cipher and related to political conditions, as some of the replies seemed to please the recipients immensely, while others set them to chattering and gesticulating in great excitement.

I felt quite important when sending and delivering these mysterious messages, for I was confident that I was unwittingly helping to overthrow some government.

Just as we sighted the South American coast a little white man-of-war was sighted heading toward us, and our South American passengers became more excited than ever. Officers and crew all thought that the gunboat was preparing to board us and demand the political disturbers on board, and we waited expectantly to see what would occur. Evidently, the little war-ship was not equipped with wireless, for our calls brought no response, and as she came nearer we saw that she carried no aerials.

Presently she ran up some signal flags, and one of the officers read them off and signaled in return. We were all anxious to know what the message meant; and, as our ship at once slowed down and finally stopped, we felt sure that our surmises in regard to the gunboat's intentions were correct.

When about a quarter of a mile away she stopped her engines and lowered a boat, which came dancing toward us with a gold-laced officer in the stern.

The gangway was lowered, and as the boat drew alongside the officer stepped out and ran nimbly up.

As he reached the deck our supposed revolutionists ran out of the saloon and fairly overwhelmed the visitor, not with pistols or daggers, but with pats on the back, affectionate embraces, and even kisses.

When we had recovered from our astonishment we learned

## TALKING THROUGH THE AIR

that our passengers were very prominent officials and attachés of the consulate, who had been touring the United States, and for several days I could not help feeling disappointed and somewhat chagrined to think I had been preparing a royal welcome for the travelers instead of a revolution.

The rest of our voyage was uneventful, and on the return trip nothing of interest or excitement occurred.

I now felt quite accustomed to the sea and to a ship's wireless-room, and thoroughly enjoyed my position. While in port I found a great deal of spare time on my hands, and this I employed in perfecting and improving the instruments, with the help of the chief engineer and his assistants.

I also determined to pick up as much of the various languages of the ports as possible, and first tackled Spanish, as I found that this was the language spoken in most of the ports where we stopped.

I was very glad that I studied this language, for after the first few trips our ship was put in dry-dock, and I was then put on another route through the Greater Antilles.

I found the large islands very interesting, and while in Cuba I had an opportunity to help the Y. M. C. A. establish an amateur wireless station.

The Cuban boys and the American boys in Cuba were very much interested in wireless, and very soon there were numerous amateur stations in operation on the island.

One of the most peculiar experiences I had while a wireless operator on shipboard happened near San Domingo. We were about two hundred miles off the coast, and I had been talking to a northern-bound fruit-steamer and was about to switch off the instruments when I heard a very distinct and clear call. I did not recognize the call at first, but answered with our number and waited for a reply. I



## HARPER'S WIRELESS BOOK

listened intently, but no reply came, and I was about to give up when I suddenly heard a burst of music as clear as if an orchestra was playing on deck. I was utterly nonplussed, and when a moment later a human voice came to my ears through the receivers I was still more wonderstruck, and listened with every nerve tense to hear more of these wonderful sounds from an unknown and unseen source.

Silence followed, however, and although I called repeatedly and tried every possible adjustment of my instruments in an endeavor to get in tune, I at last gave up in despair.

When I related my experience to the officers and some of the passengers at breakfast, they all laughed and thought I had been dreaming; but later, when I thought the matter over and heard of other operators sometimes hearing scraps of conversation, I knew that I had been fortunate enough to receive a wireless sound-communication through some peculiar atmospheric or electrical phenomena. In other words, my wireless instruments had received and recorded sound and had acted as a wireless telephone.

At another time I had a rather peculiar experience which proved how wide-spread is the interest in wireless, and under what difficulties amateurs will succeed in establishing practical stations and instruments.

We were approaching a little out-of-the-way port, and, as the captain hoped to communicate with another ship of the line which should have been in the vicinity, he asked me to call and see if I could get any reply.

I called several times with no result, and while moving the tuners back and forth on the coils I caught a very weak reply. After a little trouble I got my instruments in tune and received a message stating that the vessel had sailed some hours ahead of schedule and was beyond the reach of call. The message was quite understandable, but was



A MILITARY WIRELESS OUTFIT USED BY SIGNAL CORPS,  
CONNECTICUT NATIONAL GUARD

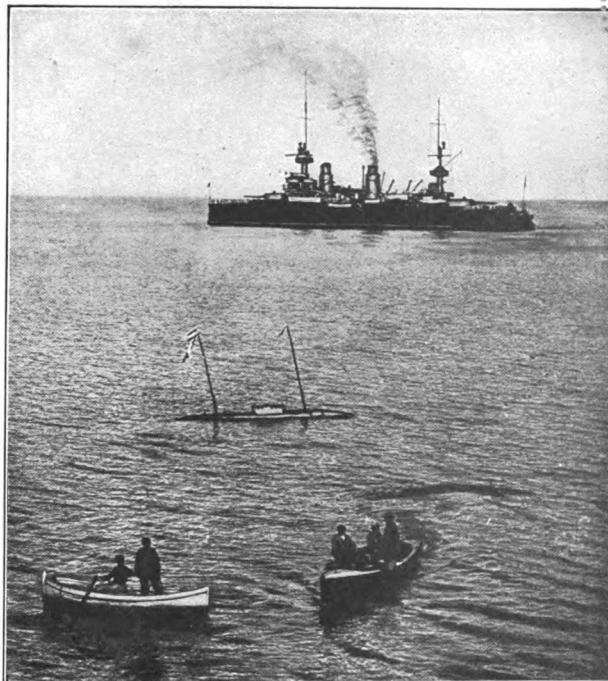

WIRELESS TORPEDO



## TALKING THROUGH THE AIR

weak and "jerky," and sent very slowly, evidently by some new and unskilled operator.

He finished the message properly, but I could not identify him by his code call-number, which was unfamiliar to me, although I knew the calls of practically every station in that part of the world as well as of most of the ships which were likely to be near. I decided that the message was probably from some yacht in the vicinity with an amateur operator, and dismissed the matter from my mind after giving the message to the captain.

The next day, while at the dock, a native gentleman appeared and introduced himself as Señor Galvan. He spoke English quite well, and at once inquired if I received the message he had sent me the preceding day in regard to the *Bertha*. I assured him that I had, and told him of my perplexity, and also manifested my curiosity to know how he had sent a message from a port where there was no station. He then related how he had become interested in wireless through newspaper accounts, and how with the greatest difficulty he had managed to set up instruments by reading what little he could find in regard to the subject in encyclopedias and other books at his command. I was certainly surprised to find that a man absolutely ignorant of electricity and telegraphy, and with only the crudest and poorest materials, could actually construct a set of wireless instruments and actually send messages in Morse for one hundred and fifty miles.

I gladly accepted his invitation to inspect his station, and after looking over the place I was even more surprised than before at the results he had accomplished.

In making the instruments he had availed himself of all sorts of odds and ends, and had exhibited marvelous ingenuity in overcoming difficulties.

## HARPER'S WIRELESS BOOK

While in port I did all I could to help him improve his station, and on my next trip brought down all the handbooks in Spanish and English I could secure.

I was amply rewarded for my trouble and interest, for long before I reached his island home I received well-sent messages from him, and long after the mountain peaks of his country had disappeared beneath the horizon his farewells and godspeeds reached me through my receivers.

## Chapter XIV

### WIRELESS OF THE PAST AND FUTURE

WE are accustomed to consider wireless of very recent origin, and, in fact, practical wireless *is* recent.

The idea of wireless transmission, however, is nearly one hundred years old, for scientific records prove conclusively that as long ago as in 1838 Prof. C. A. Steinhall, of Munich, Germany, gave out a very intelligent statement of the possibilities of electrical transmission of messages without wires.

Professor Steinhall's first experiments were made with railway rails instead of wires, but in this effort to transmit messages he was not successful owing to the imperfect connections of the rails.

In conducting these experiments, however, he discovered that the earth itself possessed a conductive power. This led him to conclude that it would be possible to send messages through the earth without wires, and in his account he says: "This is a hitherto unobserved fact, and may be classed among the most extraordinary phenomena science has yet revealed to us."

Steinhall actually transmitted messages through the earth for a distance of fifty feet, but his instruments failed at greater distances.

Following Steinhall's discovery Prof. Heinrich Hertz in 1888 discovered that the ether of the atmosphere also possessed the power of transmitting electrical waves, and

## HARPER'S WIRELESS BOOK

demonstrated that it was possible to transmit electrical impulses through space occupied by ether despite material obstacles such as mountains, water, etc.

Hertz's discovery was really the dawn of wireless transmission; but even before this Professor Morse had actually transmitted messages by wireless accidentally, for in attempting to send messages across a small stream by submerged wires the messages were actually received after the cable was broken and direct wire connection destroyed.

Wonderful strides have been made in wireless since its discovery, and yet it is still in its infancy, and we can only vaguely surmise what the future may have in store.

### Wireless of the Future

Within the few years since wireless telegraphy first became of commercial value many thousand stations have come into existence. These are scattered over the earth almost from pole to pole and in every land and climate.

Distant Alaska and the torrid tropics are in touch with each other through a myriad of wireless stations which readily relay messages from one place to another when the distance is too great to cover direct.

The stations at Washington will embrace a radius of communication reaching from the equator to Greenland, and from the Azores to the Pacific. A station at San Francisco can send its messages as far east as the Bermudas and as far west as Hawaii, while Sitka and Panama can be brought into communication north and south.

At Guam and the Philippines the stations have a range covering a large portion of the Pacific and Indian Oceans, and messages may be sent and received from Japan, Australia, and India. From India other stations carry their

MAP SHOWING RADIUS OF GOVERNMENT HIGH-PRESSURE WIRELESS STATIONS

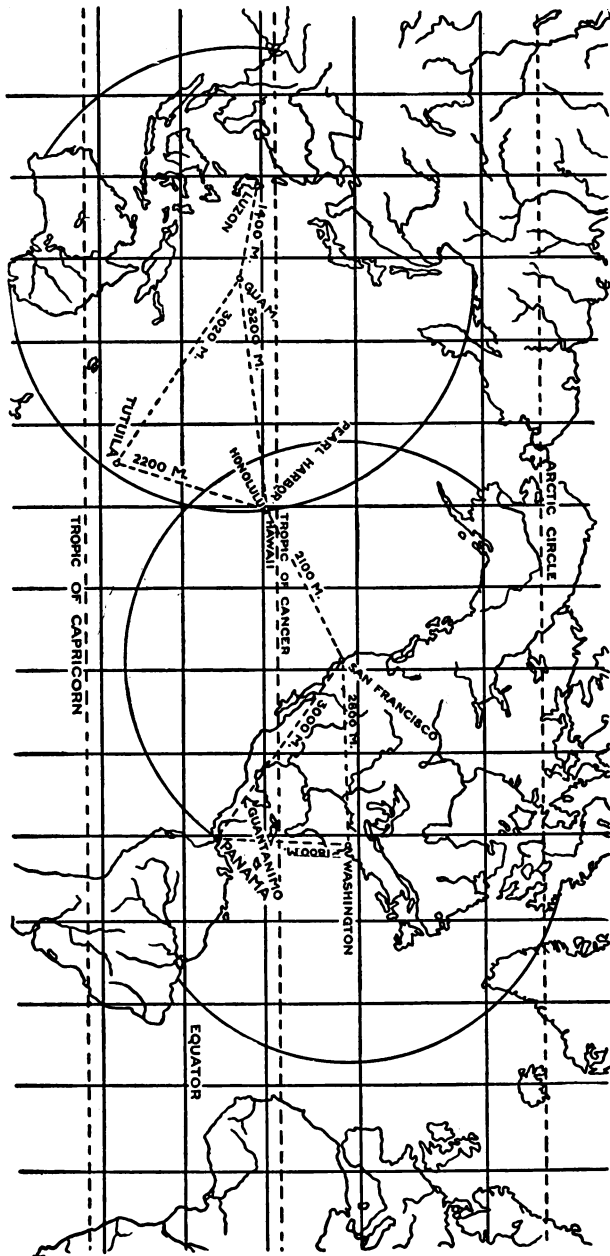



## HARPER'S WIRELESS BOOK

range far into Europe and Africa, and from Europe it is possible to communicate with our eastern coast. Thus the entire world is constantly in touch by wireless, and daily time-signals, weather reports, storm warnings, and general news is flashed back and forth around the globe.

Throughout the day and even during the silent midnight hours the great daily papers are gathering the news of the world, navies are being mobilized, and vessels in distress are calling for aid through the marvelous invisible medium of electrical waves; and yet, while distant countries and nations may be thus instantly linked by unseen means, the wonderful instruments and apparatus required to make possible the marvel are so simple and so readily mastered that a fourteen-year-old boy can make them with his own hands, and may listen to some ship or city hundreds of miles away.

Wireless telegraphy is now part and parcel of the busy commercial world, and yet it is only in its infancy, and the wildest dreams of the future possibilities of wireless progress would probably fall far short of the actuality.

So far wireless has been confined to the use of oscillating currents, which quickly die out in their passage. Wonderful as are the results produced by these weak currents, imagine what may yet be achieved if we can produce waves which do not decrease with distance.

The stupendous results which might develop from the use of such waves are almost beyond human comprehension.

At first it seems impossible to believe that any electrical current can ever be produced which will travel thousands of miles with undiminished force, but it is in a way perfectly simple and feasible. The term distance is merely relative, after all, for the greatest distance we can conceive of is a mere trifle as compared with the vast distances of space.

## WIRELESS OF THE PAST AND FUTURE

Recent discoveries in astronomy have proved that what were formerly considered single far-distant stars are in reality groups of thousands of stars—in fact, whole stellar systems—so enormously far away that even through our largest telescopes they appear as single points of light.

Although apparently close together, there is no doubt that each of the stars composing these groups is separated from its fellows by thousands or even millions of miles, and for aught we know other systems and other stars may exist billions of miles beyond these, and utterly beyond the visual radius of any instrument devised by man.

Even from these inconceivably distant bodies light penetrates to our earth, and in order to consider the electrical phenomena we must throw aside all our ordinary ideas of distance.

A non-conductor the size of a pea will prove a far greater impediment to the free passage of an electrical current than the whole circumference of the earth, which is a fairly perfect conductor of electricity. If the earth in one spot is caused to vibrate, as by an earthquake shock, the entire sphere transmits the vibrations like a huge bell, the period of vibration being measured by hours.

When disturbed electrically the charge oscillates about twelve times in a second, and by subjecting the earth to waves of certain lengths, properly proportioned to the earth's diameter, the sphere may be thrown into resonant vibration.

When man masters the means of producing the proper waves it will be possible to measure every terrestrial distance by simple electrical devices. By such means it would be possible to navigate a vessel at any time without compass or chronometer, to determine the latitude and longitude without sextant or quadrant, to know the hour of the day or night without a timepiece, and even to determine the

## HARPER'S WIRELESS BOOK

distance from any point and the speed and direction at any moment.

When such waves are at last produced and controllable a wave may be so proportioned in intensity and velocity as to produce an electrical effect at any selected spot and without appreciable loss of power or force.

### Transmission of Power by Wireless

Many experiments have been made with a view to transmit mechanical power by the Hertzian or electromagnetic waves.

If this could be successfully accomplished vast sums of money would be saved yearly, and enormous tracts of land and wide stretches of country could be transformed from waste places to busy industrial and manufacturing centers.

The falls of Niagara, of Zambesi, of Victoria, and the innumerable mighty cataracts in South and Central America, Asia, and Africa daily waste power enough to perform every mechanical task in the whole world.

Could wireless power transmission be perfected to the state now attained by wireless telegraphy, the waterfalls of Africa or Venezuela could be made to run the subway-trains, the mills and railways, auto-trucks, and other machines in New York or London. Smokeless, steamless, swift-moving liners would sail across the seven seas by the power generated in South American jungles, while express-trains might easily travel across the continent impelled by the power from some unseen and almost unknown cataract in the wilds of Alaska or Mexico.

At the present time such things are but a dream, although the dream is founded on scientific facts, and the accomplishment of such wonderful results would be no more remark-

## WIRELESS OF THE PAST AND FUTURE

able than the ordinary wireless telegraph or telephone would have been considered a score of years ago. Only a few years ago wireless, the submarine, the aeroplane, and even the automobile were unthought of save in fiction, and yet to-day they are all important and practically indispensable adjuncts of our life.

In view of our rapid progress along mechanical lines, and especially in the realm of electricity, no one can possibly state what will and what will not be accomplished in the near future. Even the greatest living authorities on electricity really know but little in regard to it, for it is a mysterious and wonderful power, and we have merely begun to realize its possibilities and the methods of making use of it.

### Tesla's Oscillatory Currents

It is not at all unlikely that the most wonderful and important developments of electricity—and especially wireless—will be along the lines of Tesla's "high-potential magnifying transmitters" and the mysterious and wonderful "oscillatory currents."

Such currents leave their conductors behind, produce sparks twenty-five feet or more in length, and defy all ordinary laws. These remarkable currents will melt great masses of metal with almost explosive force, and yet they will readily pass through the human body without the least indication of their presence.

The natural path of oscillatory currents is the immeasurable ether of the universe, and their confinement by wires or ordinary conductors appears impossible. With no visible means of production, these miraculous electrical discharges will instantly produce results two thousand miles from their source, and when better understood and under man's con-

## HARPER'S WIRELESS BOOK

trol the possibilities of the oscillatory currents of the Tesla transformers may work undreamed-of wonders in the transmission of wireless power, and may even make possible the long-sought-for process of transmitting a visual image over vast distances.

### Wireless in the Arctic

Wireless is also playing a very important part in exploration, especially in the Arctic and Antarctic. Of course, during a great deal of the time such expeditions are beyond the range of other stations, but a base station can keep the outside world informed of the progress, success, or failures of the explorers.

This very autumn, 1913, the first wireless station ever established in the true Arctic has been set up by the Crocker Land Expedition at Etah, on the northwestern coast of Greenland, which was Peary's old base. This expedition, which is led by Donald B. MacMillan, who accompanied Peary in his successful quest for the Pole, was organized by the American Museum of Natural History, the American Geographical Society, and the University of Illinois. It carries a complete wireless outfit, which will be operated by Jerome Lee Allen. Lieut. Fitzhugh Green, U.S.N., the engineer and physicist of the expedition, who has given special attention to wireless, is in charge of this among other departments of the expedition. If this expedition, which will remain in the north for three years, reaches the "unknown continent" called Crocker Land, the first news will be signaled to the world from this "farthest north" wireless station.

The ethnologist and explorer, Mr. Vilhjálmur Stefánsson, who has been so much associated with "White Esquimaux"

## WIRELESS OF THE PAST AND FUTURE

in the popular mind, has also appreciated the value and use of wireless in the far north, and when he was equipping his elaborate expedition which left Esquimalt, B. C., in June, 1913, he expected to include a wireless outfit. But circumstances prevented.

A recent Antarctic expedition carried a wireless outfit, and has been using it in the field.

## Chapter XV

### SOME ELECTRICAL TERMS EXPLAINED

**E**VERY boy who experiments with wireless or with any other electrical device or apparatus will constantly meet with terms that he cannot clearly understand.

Thus he will often hear the terms "volts," "amperes," "ohms," "series," "series-multiple," "magneto," "dynamo," etc., and although he may know in a general way that amperes, ohms, and volts mean certain "powers" or "forces" of electrical energy, and that "series" and "series-multiple" mean certain methods of wiring batteries, yet their true meaning and a simple understanding of such terms is seldom grasped by boys who have not studied electricity deeply.

#### Amperes, Ohms, and Volts

Although we speak of electricity as "flowing through" certain substances or articles, such as metallic wires, etc., yet the exact manner in which the force, or energy, travels is not definitely known. Any material over which electricity readily travels is known as a "conductor," while substances which bar the path of the current are "non-conductors." Practically all metals, water, many minerals, and other substances are conductors, while wood, stone, porcelain, paper, wax, glass, and many other materials are non-conductors. Many of these non-conductors become excellent conductors when wet or damp, and every boy

## SOME ELECTRICAL TERMS EXPLAINED

electrician should bear this fact in mind. Authorities now generally agree that an electrical current does not actually flow *through* a conductor, but that it mainly follows the surface or flows *over* the conductor.

For the purpose of simply explaining the terms of measurement used by electricians it is, however, easier and simpler to consider the current as actually flowing through the wire.

In this way we may compare a current of electricity to a stream of water flowing through a pipe, and by this comparison the terms and their meanings may be more readily understood.

We all know that any liquid flowing through a pipe is said to be under a certain *pressure*, which causes it to move, the pressure being due to a difference in level between the source and the outlet, or else caused by some artificial means, such as a pump.

In the same way an electrical current has pressure caused by a difference in what is known as *potential* between the source and the outlet. To electricians this pressure is known as *voltage*.

Thus the term *volt* is the unit of pressure which is dependent upon the difference in *potential*.

If you remember that the *voltage* of a current is practically equivalent to the *pressure* in a current of water, you will have no trouble in understanding just what the term "voltage" really means.

A stream of water passing a given point during a certain period of time has a certain "rate of flow," usually considered in so many gallons per minute.

In a similar way the current of electricity has a rate of flow, which is measured by a unit known as an *ampere*, which represents *quantity*, just as in a water-pipe the quantity of water is reckoned by gallons.



## HARPER'S WIRELESS BOOK

The quantity of water flowing through the pipe is dependent upon the *pressure* used to force it along, and also upon the resistance, or friction, of the pipe, which tends to prevent it from flowing rapidly and freely.

In the same way the number of *amperes* in an electrical current depends upon the voltage, or pressure, and upon the resistance to the passage through the conductor.

You can easily remember that an *ampere* is a unit to denote the *rate of flow*, and is equivalent to the rate of flow of water, which is measured in *gallons per minute*.

As the flow of water is retarded by friction and resistance and is increased by pressure, so electricity's flow is decreased by resistance and increased by *voltage*.

A small water-pipe will not carry as many gallons per minute with the same pressure as a large one, but if the pressure is increased sufficiently the same quantity will be *forced* through a small pipe as through a large one with less pressure.

In the same way a small wire or a poor conductor will not carry as great *amperage* of electricity with the same *voltage* as a large wire or a good conductor, but by increasing the voltage the amperage will be increased. In both cases power is wasted, and it is economy to always use the best conductors and the largest-sized wires possible.

The resistance to water flowing through a pipe is called *friction*, and the amount of friction depends upon the size, shape, and length of the pipe, and whether it is straight or crooked, smooth or rough.

In electricity the resistance is measured by *ohms*, and is dependent upon the diameter, length, and temperature, as well as material of the wires or other conductors.

The terms *series* and *series-multiple* apply to certain methods of wiring, and as the life of dry batteries and the

## SOME ELECTRICAL TERMS EXPLAINED

current obtainable from them is largely dependent upon the method of wiring up, it is important that the difference between the two methods should be clearly understood.

Series wiring consists in wiring the zinc terminal of one cell to the carbon of another and carrying the wires to the instruments from the carbon of the final battery on one side and from the zinc terminal on the final battery on the other end.

This method is clearly shown in Fig. 1, where five dry



Fig. 1

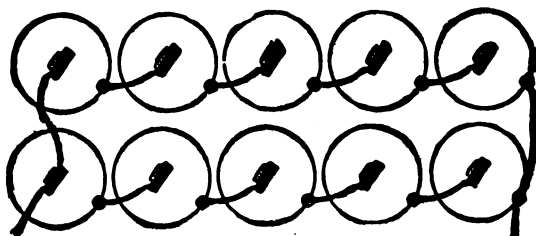

Fig. 2

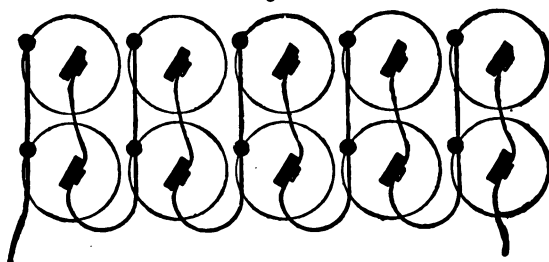

Fig. 3

batteries are connected in *series*. The voltage of these five cells would be about  $7\frac{1}{2}$ , with an amperage of about 20.

Series-multiple wiring consists in wiring two sets of bat-

## HARPER'S WIRELESS BOOK

teries in *series* and connecting the last battery of each set together by the carbons on one end, and by the zincs on the other, as shown in Fig. 2. Thus the ten batteries wired in series-multiple will produce about  $7\frac{1}{2}$  volts, with 40 amperes.

Still another method is to wire the two carbons of adjoining batteries to the two zincs of the next two, as shown in Fig. 3. This gives the same voltage and amperage as the multiple-series shown in Fig. 2; but in either of these methods the batteries will last almost twice as long, and will give a much greater flow of current than by plain series wiring.

### Sources of Current

Most amateurs use dry batteries to furnish the current for their instruments. These are cheap, they answer well, and they are very convenient and easily managed, but for more powerful long-distance work a dynamo or magneto or a storage battery should be used.

Storage batteries *do not* produce any current, but merely hold or store the electricity produced by mechanical means, and give it off when the terminals are connected.

Magnetos and dynamos, however, actually produce electricity, and, although they must be driven by some power, such as a water-motor, a gas-motor, a windmill, or an engine, yet their current is so much stronger and more regular than that of batteries that they are far better.

In addition a magneto or dynamo current is always available, for as long as the instrument is in working order the current may be produced. In other words, they are never exhausted, while batteries are soon used up and must be replaced by new ones at considerable expense.

Dynamos and magnetos are very simple things, and a

## SOME ELECTRICAL TERMS EXPLAINED

simple form of an ordinary magneto is shown in Fig. 4. In this cut A and B represent the two arms of a soft-iron magnet, between which there is an electrical or magnetic field.

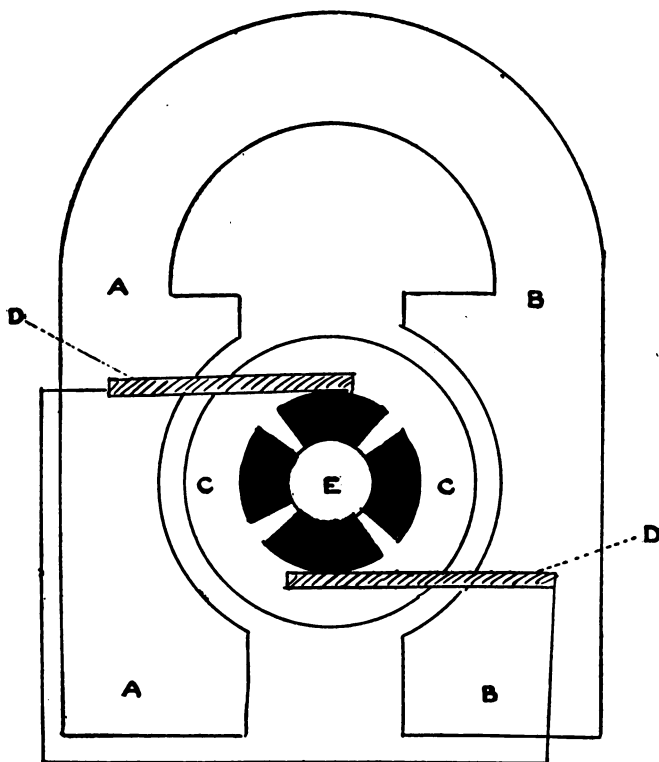

Fig. 4

In this field between the ends, or poles, of the magnets there is a revolving armature (C), which with its wire windings cuts through the lines of magnetic force as it revolves, and by this action currents of electricity are generated in the wires. As the rotation of the armature induces currents flowing in *opposite* directions, some means must be found

## HARPER'S WIRELESS BOOK

for gathering them up and turning them all in one direction to flow through the outside wires to the instruments.

To accomplish this, small pieces of carbon or other materials known as "brushes" (D) are used. These brushes rub against small segments of copper known as a "commutator" (E), attached to the ends of the armature, and to which are fastened the ends of the wires used in winding the latter. The brushes are placed so that they touch the commutator in such a way that the current is gathered up and flows out in one direction only.

A dynamo is very similar to a magneto as regards armatures, brushes, commutators, etc., but it differs in one very important point.

In the magneto the magnets are *permanent*; that is, they are magnetized iron pieces, whereas in the dynamo the magnets are *electromagnets*, or, in simple terms, they are merely iron bars which become magnetic when a current of electricity is passed around them through a coil of wire.

A simple dynamo is shown diagrammatically in Fig. 5. In this drawing the electromagnets (A, B) are pieces of iron which are magnetized by means of a small current known as a *shunt* (S), made to pass around them as shown.

This shunt-current is really a small portion of the current produced by the dynamo itself. The armature (C) revolves in a magnetic field, and is provided with brushes, commutator, etc., exactly as in the magneto.

The strength of the current generated by a dynamo or magneto depends upon the size of wire, the strength of the magnets, and the speed at which the armature rotates, as well as upon the number of windings of wire on the armature.

For these reasons the current of a dynamo increases very rapidly as the speed of the rotation increases, thereby in-

## SOME ELECTRICAL TERMS EXPLAINED

creasing the magnetism in the electromagnets and the field so that the strength of this type of machine varies more with its speed than does that of a magneto, in which the permanent magnets do not increase in power with the

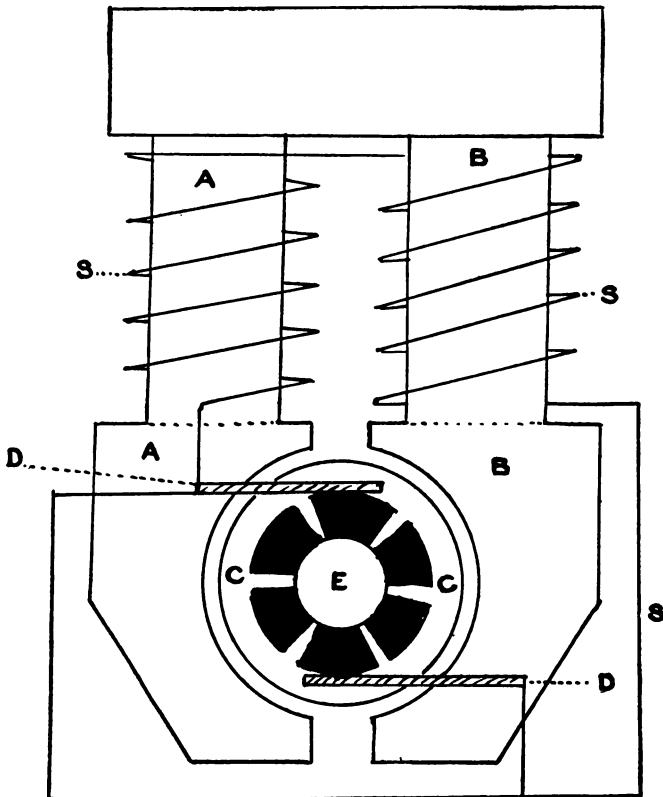

*Fig. 5*

speed. Unless the magneto or dynamo is operated at a fixed speed the current will be very irregular, and for this reason most dynamos and magnetos are equipped with governors, which regulate the speed at which the armature

revolves, regardless of the speed of the motor or engine that operates it.

A very small magneto will produce more and stronger current than a dozen dry cells, and it may be used in their place with far better results.

Magnetos and dynamos are divided into two classes, *high tension* and *low tension*. The latter take the place of dry or wet batteries, and produce a direct primary current, whereas the high-tension machines have two windings on the armatures which produce an intense alternating current.

As coils are almost invariably used in wireless operation the low-tension magneto is preferable, and, fortunately, this type of machine is the simplest, most durable, and the cheapest.

#### Spark-Coils

By passing a current of electricity through a coil of wire around a core of soft iron the intensity, or voltage, is greatly increased, and the core becomes magnetized. Such a contrivance is known as a *primary coil*, and the core is known as an *electromagnet*.

If a second coil of much finer wire is wound outside of the primary coil, but not connected in any way with it, an even more powerful current will be created in the outer winding. This phenomena is known as *inductance*, and a coil of this kind is known commonly as an *induction-coil*.

In wireless, where a powerful current with a large spark is essential, a coil of this sort is used to increase the voltage and produce a large spark.

Secondary or induction coils are of two classes, non-vibrating and vibrating coils.

Both kinds are used in wireless work, but the vibrating form is in many ways superior.

## SOME ELECTRICAL TERMS EXPLAINED

The operation of a vibrator-coil is very simple, once its principle is mastered, and a detailed section showing the construction and operation is shown in Fig. 6.

In this cut, A is the core of soft iron; B the inner, or primary, winding; C the vibrator; D the vibrator-spring;

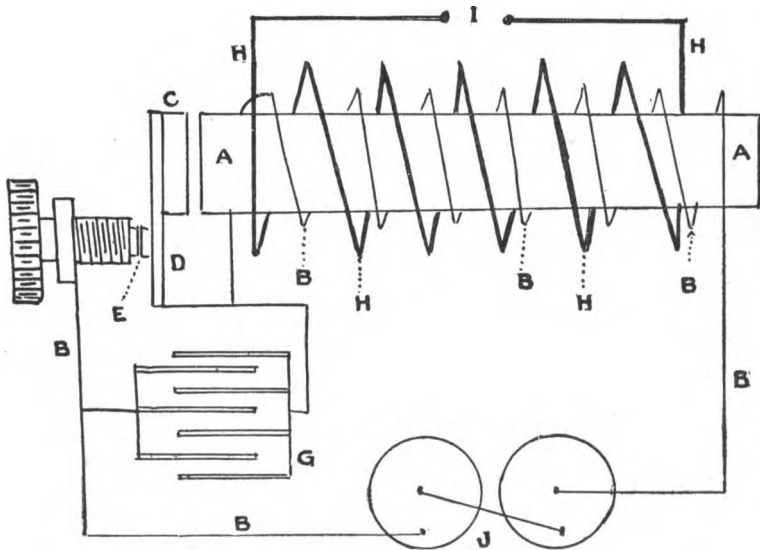

*Fig. 6*

E the contact-points; F the adjustment-screw; G the condenser; H the secondary winding; I the spark-gap; and J the battery or magneto.

As the current generated by the batteries passes through the primary winding (B) the core (A) is magnetized. The magnetism of the core attracts the piece of iron C at the end of the spring D. As soon as this piece is drawn away from the contact-point E the current flowing through the wire B to the primary winding is shut off.

This causes the core to lose its magnetism and allows the



spring D to fly back and again establish the circuit through the primary wire. This operation is repeated over and over again with extreme rapidity, and each time that the circuit rushes through the primary winding a powerful current is induced in the secondary (H). This current rushes through the wires toward I, and has power enough to leap or jump across the space between the ends of the wires. For this reason this type of coil is often known as a "jump-spark coil." A very important portion of such a coil is the condenser (G). This consists of alternate layers of tin-foil separated by mica or waxed paper. The sheets of foil are connected alternately, and the connecting wires are brought across the vibrator of the coil as indicated. The condenser is usually placed in the coil-box out of sight, and, as the wires and connections are all hidden, there is no external indication of the condenser's existence, and many users of coils are entirely ignorant of its presence or use.

The function of the condenser is to reduce the spark at the vibrator-points, for without it this spark would be larger than that produced at the secondary spark-gap. This is brought about by the capacity of the condenser being just great enough to neutralize the self-inductance of the primary current by temporarily absorbing the impulse at the moment it is broken by the vibrator. Almost instantly, however, there is a reverse action, and the stored energy of the condenser flows back with extreme rapidity and adds its charge to produce a larger secondary spark.

The vibrator is also very important, for upon its adjustment depends the amount of current consumed in operating the coil, as well as the size and intensity of the spark produced.

By turning the adjusting-screw (F) up or down the points at E may be brought closer together or farther apart, and the spark made stronger or weaker.

## SOME ELECTRICAL TERMS EXPLAINED

If too close together an excess amount of current will be consumed, and the screw should be adjusted until the maximum spark with the least current is obtained. This may be ascertained by placing a pocket ammeter between the battery and coil, and adjusting the latter until the minimum current is flowing without a decrease in the size of the spark.

The sparking or vibrator points on a coil are of platinum or some similar material, and after using for some time they will frequently become pitted, uneven, or burned, and will stick together and fail to vibrate.

This may be remedied by carefully smoothing them off with a fine, flat file; but by changing the wires from the batteries, so that the current flows in the opposite direction, from time to time, the trouble may be avoided.

If the wires have been connected so that the carbon side led to one connection of the coil, with the zinc to the other, shift them so that the carbon leads to the terminal formerly connected with the zinc, and vice versa.

### Batteries

Batteries are of several different types and a great variety of brands, but they may all be classed in three principal divisions—namely, wet batteries, dry batteries, and storage batteries. Wet and dry batteries actually generate an electrical current, whereas storage batteries merely absorb electricity from a magneto or dynamo and give forth the current as desired.

The most widely used form of wet battery consists of a glass or porcelain jar filled with a saturate solution of sal-ammoniac, and with two elements—carbon and zinc—immersed in the solution, and fitted with terminals at their protruding ends.

## HARPER'S WIRELESS BOOK

A battery of this form is illustrated in Fig. 7. The top of the jar is covered with a hard-rubber cap, through which the zinc passes, with a porcelain bushing around it to prevent short-circuiting. To avoid any possibility of the lower end of the zinc coming into contact with the carbon a soft-rubber ring is provided as shown. This type of wet battery is very cheap; it is long-lived, and the charge of salts

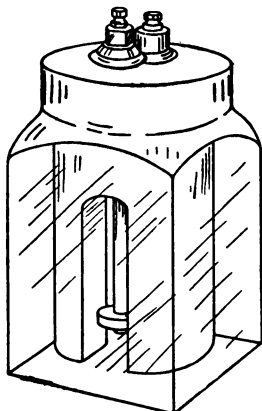

*Fig. 7*

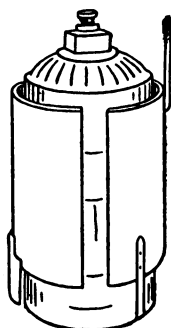
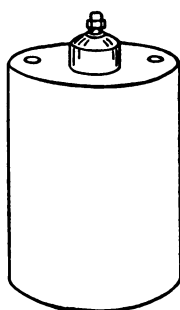

*Fig. 8*



*Fig. 9*



B

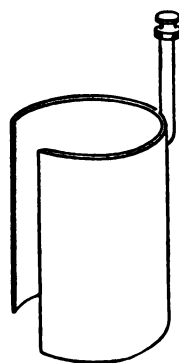

*Fig. 10*

## SOME ELECTRICAL TERMS EXPLAINED

may be readily renewed and new zincs substituted for a few cents. It is important that the terminals be kept clean and bright, and that the upper end of the carbon, as well as the cap, should be coated with paraffin for about two inches to prevent the salt solution from creeping up and crystallizing.

When the zinc becomes corroded or eaten away it should be renewed; and if the battery shows signs of weakening the solution should be thrown out, the jar and carbon washed thoroughly, and a fresh solution placed in the battery.

The "Sampson" battery, shown in Fig. 8, also employs carbon and zinc elements, but in this type the carbon is in the form of a fluted cylinder around which is a linen bag filled with manganese dioxide. The zinc is a heavy cylinder, and the two are placed in a jar, which is then filled with sal-ammoniac and the top sealed. When it is desired to use this battery water is poured in through an aperture in the top. This is known as a semi-dry battery, and is a very efficient form.

A wet battery which is very widely used is the Le Clanche, shown in Fig. 9. In this battery a flat carbon is placed within a porous earthenware jar and packed with manganese dioxide, the top sealed, and two openings left. The porous cup is then placed in a jar, and the latter filled to within an inch or two of the top with a sal-ammoniac solution. A common round zinc bar is then placed between the porous cup and the jar, and the cup filled with water.

Another form of Le Clanche cell is shown in Fig. 10. In this form the porous cup is replaced by a hollow carbon cylinder (B) filled with manganese dioxide. A heavy sheet-zinc cylinder is placed around the carbon, and the usual sal-ammoniac solution added.

In the well-known "Gonda" cell (Fig. 11) the manganese is in the form of compressed prisms, one being placed on

## HARPER'S WIRELESS BOOK

either side of the flat carbon, and the three are then held together by rubber bands. The zinc is placed in one corner of the jar, in a special opening provided for the purpose.

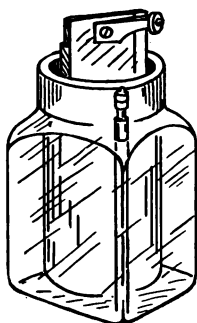

*Fig. 11*

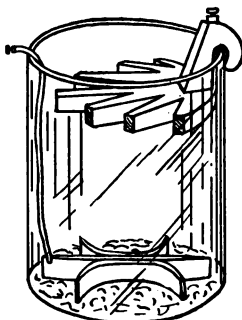

*Fig. 12*

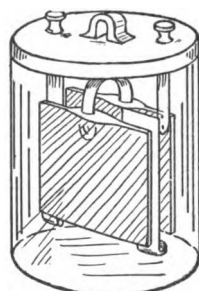

*Fig. 13*

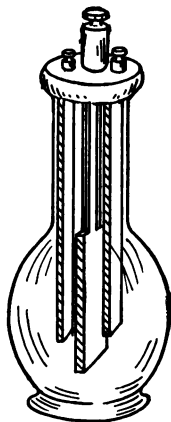

*Fig. 14*

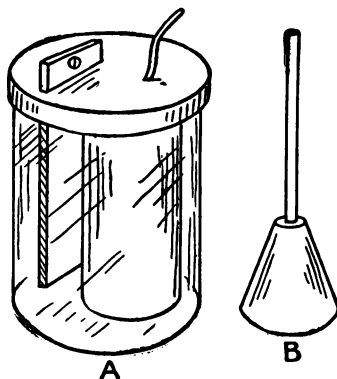

*Fig. 15*

A very different type of wet cell is that shown in Fig. 12, and known as the "Daniel" or "Crowfoot" battery. In this the elements consist of copper and zinc, while the electrolyte is a saturate solution of copper sulphate or blue vitriol.

## SOME ELECTRICAL TERMS EXPLAINED

This chemical acts upon both the zinc "crowfoot" and the copper plates at the bottom, and liberates copper sulphate from one and zinc sulphate from the other. The copper sulphate, being heavier, remains at the bottom, while the zinc sulphate remains near the top. Thus the two liquids are separated by gravity, and for this reason this kind of battery is also known as a "gravity" cell. Such cells are widely used where low amperage is required, as in ordinary telegraphic stations, etc. Another cell which works on the same principle uses a porous cup to surround the zinc, and this prevents the two liquids from mixing.

An efficient form of wet battery which is very long-lived and gives a good current is the Edison (Fig. 13). The elements employed are two zinc plates and one of copper oxide immersed in a solution of caustic potash or potassium hydrate. When the copper-oxide plate is fresh it is black, but as it becomes exhausted it turns red, so that by scraping it with a knife the amount of black or "live" oxide remaining may be determined at any time. When the oxide plate is entirely red throughout, it is exhausted and may be discarded.

The well-known bichromate battery is still another form of wet battery which gives a very powerful current, but which becomes rapidly exhausted if kept in constant use. In this type (Fig. 14) there are two carbon plates between which a zinc bar is placed, which may be raised or lowered in the solution of potassium bichromate and sulphuric acid. When not in use the zinc should always be raised from the fluid.

The "Fuller" cell uses the same elements as the last, with the same solution; but in addition there is a porous cup containing the zinc in the form of a small cone (Fig. 15, B). Enough mercury to cover the zinc is placed in the porous cup, and amalgamation is thus assured. This cell gives a very high amperage for short periods.

## HARPER'S WIRELESS BOOK

Dry batteries have now almost entirely replaced wet batteries for wireless and other commercial uses, as they are very cheap, are long-lived, and are clean and neat. Moreover, they are far smaller and more compact than any wet batteries, and have great recuperative powers. In the ordinary dry battery the case itself is composed of zinc (Fig. 16, A). This is filled with a chemical compound which varies in exact composition with various makers, but which is largely sal-ammoniac and manganese oxide. In the center of this the carbon is placed (Fig. 16, B, C). Dry batteries are so low in price that it hardly pays to bother with them when exhausted, but if no new batteries are available old ones may be used temporarily by punching holes in the zinc and immersing in a dish or jar filled with sal-ammoniac solution to within an inch of the top of the zinc.

Aside from your wireless work you will find a great many interesting things can be done with batteries, coils, wires, magnetos, etc.

You can install buzzers and bells, fire and burglar alarms, gas-lighters and door-openers, and by the use of the tiny candelabra and miniature tungsten lamps you can light your den, your table, or your instruments by electricity.

In a thousand and one ways an ingenious and intelligent boy will find electricity a means of keeping hand and mind busy, and while so employed he cannot fail to learn much of value in regard to the wonderful properties of the remarkable and little-understood power which we call electricity.

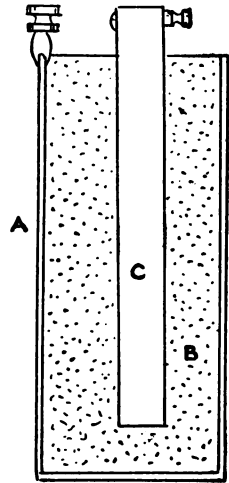

*Fig. 16*

## Chapter XVI

### A WORD ABOUT TOOLS

**I**N making instruments for wireless telegraphy or telephony comparatively few tools are required, and the various instruments may be made and set up with the ordinary tools to be found in almost any house.

Far better results will be obtained and better work may be accomplished, however, if you provide yourself with tools adapted to electrical work.

The most important tools and the ones which you should secure first are as follows:

Claw-hammer	Small screw-driver	$\frac{1}{4}$ " gimlet
Hand-saw	Large screw-driver	Bit-brace
Hack-saw	Brad-awl	Bits and augers
Round-nosed pliers	Plane	Mortising-chisels
Mallet	Cutting-pliers	Flat-nosed pliers
Bicycle wrench	Small Stilson wrench	Soldering-irons

The claw-hammer should be a fairly light one, but of good steel and not a cast-iron hammer, such as sold in the five-and-ten-cent stores. While a small and a large screw-driver will answer all ordinary purposes, the best kind is one with several blades which may be used in one handle, for sometimes you will require a long blade, at other times a short one, and for various sizes of screws you will find that blades of the proper widths will be easier to use and will be less liable to injure the screws than blades a trifle too large or too small.



## HARPER'S WIRELESS BOOK

The gimlet will prove useful in numerous ways, and wherever a screw or nail is to be driven the gimlet will serve as well as a bit, and is much handier.

The hand-saw that will be most useful is a fairly fine-toothed panel saw, but a rip-saw will save lots of time and trouble if you have occasion to saw boards or planks lengthwise, and as saws are always very useful tools to have in the home, you will do well to secure both a cross-cut saw and a rip-saw.

The hack-saw should be of the adjustable kind, and a package of assorted blades should be provided. Eight-inch blades are probably the handiest size.

Round-nosed, flat-nosed, and cutting pliers are very essential wherever wire is used, and a pair of each kind should be in your tool-kit.

You will have but little occasion to use wrenches, but in setting up terminals, in using lag-screws, and in connecting pipe you will find a "Coe" or bicycle monkey-wrench and a small "Stilson" or pipe wrench very handy.

For starting small nails or for making fine holes for wires a brad-awl should be used, while for larger holes the bits and augers with the brace must be employed.

A plain brace with bits from  $1/4''$  to  $1''$  diameter will be all that are needed, and, like the saws and hammers, these tools should be always on hand. If you do any carpentering or wood-working at all you will find chisels, mallets, planes, and gouges very useful, and you can scarcely expect to fit up a station without doing some carpentering.

A  $1/4''$ ,  $1/2''$ , and  $1''$  chisel are the best sizes, and a small iron smoothing-plane will probably answer all your requirements.

Whenever a joint in a wire is made it is a good plan to solder it, and, although the easily melted prepared solders

## A WORD ABOUT TOOLS

will often work well, a great many occasions will arise where a good soldered joint must be made with a soldering-iron and real solder.

If additional tools are required you may add various files, a hand-drill, taps and dies, wire and screw gauges, etc.

Whether you use many or few tools, you will always require a bench and a vise of some sort. The bench may be easily made from a few old boards or planks, as illustrated in Fig. 1, and the vise may be from two to five inches across the jaws, according to the size and amount of work you do and the price you are willing to pay for the vise.

As a rule vises less than three inches across are too light, and a four-inch vise will be found the best all-round vise.

The bench should be firm, strong, and in a good light, with the vise fastened to the right-hand corner (Fig. 2). Many people place the vise on the left-hand end, but you will find that the right-hand will be much more convenient, especially if long pieces of crooked material are used. If the vise is at the left you will be obliged to work left-handed, or else have the edge of the bench in the way when using long material.

An old flatiron, or some similar piece of iron or steel, should be set in the bench top to use as a small anvil. You will be greatly surprised to find how extremely useful this will prove when straightening nails, bits of metal, etc.

Another item which should not be overlooked is a whetstone for sharpening tools, for there is no greater abomination to a good workman than a dull tool, and there is no excuse for ever having one.

### Care and Use of Tools

A good mechanic takes good care of his tools, and you will find your work far easier and the results far more satis-

## HARPER'S WIRELESS BOOK

factory if you use care in keeping your tools in good condition and free from dirt and rust. You may keep the tools either in a chest, in drawers, or on racks over the bench, and if you have a room of your own the latter method is

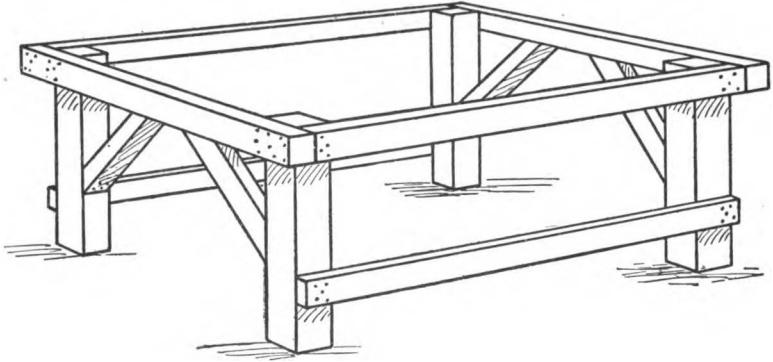

*Fig. 1*

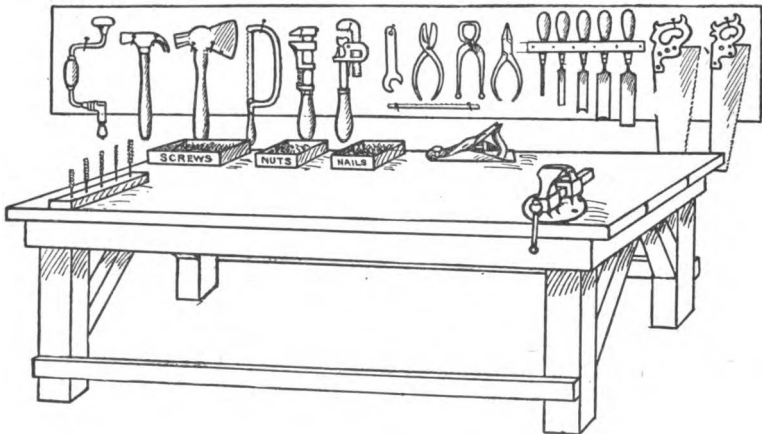

*Fig. 2*

preferable. If a board is nailed along just back of the bench and a little above it, all the tools may be hung thereon, and they will then be always in sight and readily found when required (Fig. 2).

## A WORD ABOUT TOOLS

Wrenches should be arranged together, all the pliers side by side, and, in fact, each class of tools should be kept by itself to avoid confusion. To arrange the racks for the tools it is only necessary to place the tool against the board, mark around it with a chalk or paint, and drive nails into the board for the tool to rest on. In this way you will always know just where each tool should hang, and if a tool is missing or mislaid you will know it at once.

If tools are kept rubbed off with a rag dampened with "Three-in-One" oil, or some other good machine-oil, they will seldom become rusty; but if rust does attack them it should be polished off with fine emery-paper and wiped with the oily rag.

A drawer under the bench, or even cigar-boxes on the bench, should be provided for holding nails, tacks, screws, odds and ends, etc., and each particular class of objects should occupy a box or compartment in the drawer by itself. A hodge-podge of miscellaneous odds and ends, rubbish, junk, nails, screws, etc., is a nuisance, and you will waste more time picking over a mixed lot of stuff like this to find what you want than you will spend in assorting your small objects and keeping them neatly.

Tools nowadays are very cheap compared to what they were a few years ago, and the boy with a mechanical mind can secure splendid tools at a very small expense. Taps and dies for cutting screw-threads are extremely useful, and these beautiful tools are very cheap. The smaller sizes are the most useful for electrical work, and every boy interested in mechanical work should strive to obtain a few good taps and dies of standard sizes, say, No. 8-32, 10-24, 12-24, 1/4-20, etc. These four sizes are the ones most often used, but a No. 4 and a 5/16" will prove handy at times.

In addition to tools you should have rolls of several sizes

## HARPER'S WIRELESS BOOK

of copper wire, assorted wood-screws, nails, brads, tacks, etc., and some good adhesive bicycle tape.

Wherever a wire is bared for making a connection it should be wound with this tape, and in a thousand and one places you will find the tape very useful.

For soldering you should have some half-and-half solder and some soldering-flux, as well as the soldering-iron, or copper; and, as a great deal of the success in soldering depends upon the flux, you should be sure to obtain a good flux. There are both pastes and fluids sold for this purpose, but the best all-round material is pure chloride-of-zinc solution with a little sal-ammoniac added.

In soldering be sure to keep your soldering-iron bright and clean and well "tinned," and you will have little trouble.

To "tin" an iron (or rather a copper) heat the copper in a charcoal fire, or over a gas-flame, until hot enough to melt solder readily when placed against it. File the four sides of the iron, where it runs to a point, until bright, dip it into the flux and rub it around and around in the solder. The solder will adhere to the copper and give a bright coating of tin. If the iron is rubbed against a piece of woolen cloth each time it is taken from the flame it will stay bright and well tinned, but if overheated or "burnt" it must be retinned in the same way.

A knowledge of soldering will prove very useful in electrical work, and you will find it lots of fun to solder all sorts of things once you get the "knack" of it.

### Various Useful Hints

There are a great many short cuts and easy ways of doing things once you know how, and a person will frequently

## A WORD ABOUT TOOLS

waste a great deal of time and trouble in accomplishing a certain task when it might have been done just as well in half the time by some other method.

The shortest and easiest means of doing things are usually discovered by practical experience, and every mechanic or electrician has certain individual "tricks of the trade" that he has invented himself. Some of these "kinks" are so universal and so well known that every boy should become familiar with them, and you will be surprised to find how much time and trouble they will save you.

In electrical work you will always use a great deal of wire, and wire of every size has a most disagreeable habit of kinking and snarling unless handled very carefully. No matter how much care you use, you will find it necessary to straighten wire frequently, and this is easily done in the following ways.

To straighten fine wire attach one end to a strong nail, screw, or other object, twist the other end around a short bar or stick and pull steadily until you feel the wire "give" slightly. It will then be found perfectly straight.

Larger wire may be straightened by laying it on a flat surface and rolling it back and forth beneath a board, or it may be rendered almost perfectly straight by "whipping" it down against a smooth floor or bench. If too long for either of these methods, it may be straightened by stretching like the smaller sizes.

### Boring Metals, Glass, Etc.

You will often need to bore small holes in hard metals, or even in glass, and this is easily done with a twist-drill and the proper lubricant. For drilling brass, lead, copper, and other soft metals, use machine-oil or lard-oil. For

## HARPER'S WIRELESS BOOK

hard steel use turpentine and oil, and for glass use camphor dissolved in turpentine.

When boring in hard wood a little kitchen soap rubbed on the drill or auger will make the boring easier, and screws will drive much easier if well soaped beforehand.

### Using Files

When files are used on soft metals such as lead, brass, copper, aluminum, etc., they will become filled with bits of metal, and will soon cease to cut. This may be prevented by rubbing the file with chalk before using. Another method of cleaning files is to immerse them in a dilute solution of acid. If filled with wood-dust or grease, use sulphuric acid; if lead, zinc, brass, tin, or solder, use muriatic acid. The acid will dissolve or loosen the foreign particles and slightly cut the steel. The file should then be rinsed in fresh water, immersed in a strong soda solution, dried by heat, and rubbed with an oiled rag.

### Emergency Pipe-Wrenches

If you have occasion to turn a pipe or round rod and have no pipe-wrench or Stilson on hand, an emergency wrench may be made by placing a three-cornered file in a monkey-wrench (Fig. 3). Another method is to wrap the pipe, in the direction it is to be turned, with a small rope or strong cord doubled. A stick or bar is placed in the loop at the end and used as a lever. One hand should be used to hold the cord in position, and the other used to turn the handle. If the rope slips dampen it with water (Fig. 4).

## A WORD ABOUT TOOLS

### Holding a Rod or a Pipe in a Vise

Ordinary vises will seldom hold a round rod or pipe securely without injuring it. A rod or pipe of any size may be held firmly and without marring or bending it by the following method. Bore a hole slightly smaller in diameter than the rod or pipe through a block of wood and saw

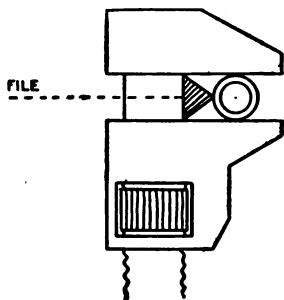

*Fig. 3*

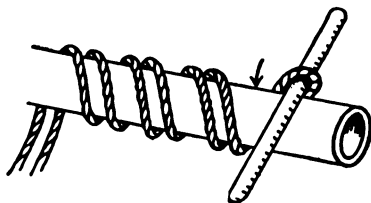

*Fig. 4*

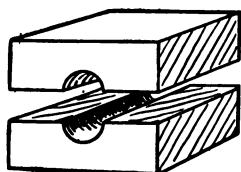

*Fig. 5*

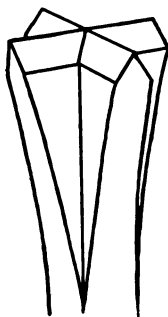

*Fig. 6*

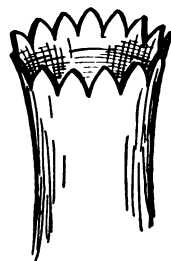

*Fig. 7*

the block in two through the center of the hole (Fig. 5). By placing the rod between the two halves and clamping firmly in the vise there will be no trouble with it slipping.

### Cutting Rubber

In electrical work you will have occasion to use more or less rubber, and, unless you know how, you will find great



## HARPER'S WIRELESS BOOK

difficulty in cutting it smoothly and evenly. To cut rubber use a very sharp knife and draw it back and forth like a saw, meanwhile keeping it lubricated with cold water. In this way even solid block rubber may be cut like cheese. It is often advisable to cut rubber under water.

### Drilling Brick

In running wires through walls, etc., you may have to bore a hole through bricks or mortar. This may be done with a cold-chisel or a mason's drill, but it can be accomplished far easier and a neater hole obtained by using a "star" drill. This drill has a cutting-blade in the form of a cross or star (Fig. 6). Such drills are not expensive, but a very good substitute may be made from a piece of iron pipe or steel tube by filing teeth or notches around the edge. After the notches are filed they should be "upset" or spread by driving a wedge, or tapered rod, into the pipe (Fig. 7). After the teeth are spread heat the end of the rod to a cherry red and plunge in cold water to temper it. This drill will cut rapidly, but will soon become dull, but it may be easily sharpened with a three-cornered file.

## Chapter XVII

### A BOY'S SUCCESSFUL STATION

**M**ANY boys may imagine that even with their best efforts to equip a wireless station they will be unable to receive or send messages for any great distance, and for this reason they may lose their interest in wireless.

Such is not the case, for, while boys who must by force of circumstances depend upon batteries as a source of current cannot send for any great distance, yet they may easily receive messages from immense distances, for a current is not required for receiving. There is a great deal of satisfaction in being able to listen to conversations carried on at places thousands of miles away, and, while this may seem beyond the reach of a boy's instruments, yet many amateurs have actually received and read messages from stations three thousand miles distant.

As a rule, however, such long-distance records are "freaks" due to some peculiar atmospheric condition. Such "freaks" are recognizable by their peculiar sound; they are heard, first as faint, far-away sounds which become gradually louder and louder and then die away. The most favorable time for receiving long-distance messages is during the winter months, when there is little "static" present in the atmosphere, and at such times many boys have made truly remarkable records in receiving radiograms.

As an example of what a boy may actually accomplish

## HARPER'S WIRELESS BOOK

in the way of receiving and sending messages, it may be of interest to describe the instruments used and the results obtained by a boy acquaintance of the author. This amateur has been interested in wireless for four years, and has gradually increased and perfected his station to a high state of efficiency, and has acquired a proficiency equal to most professionals. The current used in this station is the city lighting current, which in this case is an alternating current.

### The Boy's Sending-Apparatus

The sending-outfit is very complete and very efficient, but at the same time very simple and inexpensive, as most of the instruments are home-made. The outfit comprises a 1/2-kilowatt transformer, an electrolytic interrupter, a fixed condenser, a single helix coil with spark-gap, an ordinary telegraph key with platinum points, and a flat-topped loop aerial of six wires.

### The Interrupter

The electrolytic interrupter used and made by this boy is a very simple, efficient, and ingenious device. It consists of an ordinary glass fruit-jar with the cover pierced in the center. Through this hole a glass tube is inserted, with a fine platinum wire within it. The lower end of the tube is drawn out and fused about the wire, and is immersed in a dilute solution of sulphuric acid. At one side of the jar is a lead plate, and the plate and platinum wire are connected to terminals on the top of the jar (Fig. 1). When the current passes through the wire a bubble forms at the end of the wire and protects it from contact with the liquid, thus for an instant interrupting the current. This bubble

## A BOY'S SUCCESSFUL STATION

is almost instantly broken, however, and the current rushes through the liquid for a brief fraction of a second until a new bubble is formed. This occurs over and over again so rapidly that there seems to be an almost constant discharge at the terminals, and, in fact, the frequency of the interruptions in this apparatus is often as high as one thousand per second.

### The Fixed Condenser

The fixed condenser used by this young operator is composed of four panes of ordinary window-glass, each 14" x 18", with a sheet of tin-foil attached to each. This makes a very powerful and cheap condenser, and while the sending apparatus is in operation a beautiful discharge of deep amethyst flames, or sparks, may be seen playing back and forth along the edges of the condenser plates.

### The Helix

The helix used in this station is a very simple home-made affair, but of wonderful efficiency. It consists of two circular pieces of wood 15" in diameter, and connected by short uprights, which are wound with five turns of 1/4" copper tube, to which the wires are clipped as described in a previous chapter. Through the upper and lower ends of the helix the main wires pass to a spark-gap in the middle of the helix, and these wires are adjustable by means of a thumb-nut on the upper wire (Fig. 2). The lower terminal of the spark-gap is shielded by a rubber cone—the mouth-piece of an old speaking-trumpet.

When setting up and testing the helix and condenser a wave-meter was used. This was a simple device consisting of a glass tube containing a fine wire (Fig. 3), with a capil-

## HARPER'S WIRELESS BOOK

lary tube drawn out at one side. In this capillary tube a drop of alcohol was placed. The tester was attached in circuit with the aerial, and the current passing through the wire heated it, and the consequent expansion of the wire slightly compressed the air in the tube and forced the drop of alcohol farther up in the capillary tube. By varying the adjustment of the helix and the number and position of plates in the condenser until the drop assumed its most distant position, the best possible adjustment and longest wave-lengths were obtained. With its final adjustment the spark-gap shows a spark about  $1/4'' \times 3/8''$ , with a dazzling blue color when the aerials are connected. Without the condenser the spark shows as a clear flame of much greater size.

### The Receiving-Apparatus

The receiving-set comprises two double-slide tuning-coils, a potentiometer, a galena detector, a paper and tin-foil condenser, the telephone receivers, and the usual switches.

The tuning-coils were made at home, and are formed of cylinders of wood wound with enameled copper wire, which was wound on very smoothly and evenly by placing the wood in a lathe. The sliders are merely bits of spring-brass attached to square brass slides operating along square brass rods fastened to the two end pieces of wood (Fig. 4).

### The Detector

This boy's detector is the simplest affair of the entire outfit, and can be made in a few minutes from odds and ends. It consists of a plain wooden base on which two pieces of spring-brass are fastened and bent in the form shown in Fig. 5. Between the upper ends of these clips a bit of

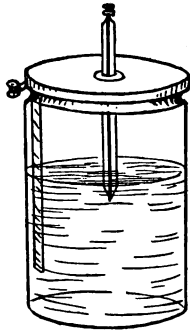

*Fig. 1*

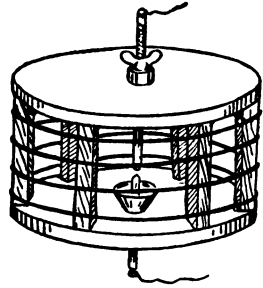

*Fig. 2*

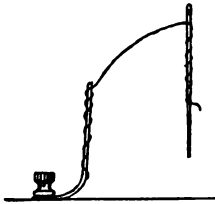

*Fig. 6*

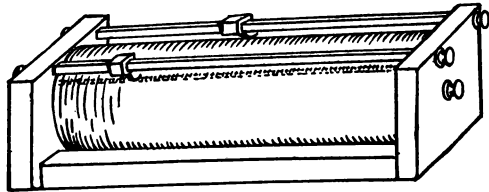

*Fig. 4*

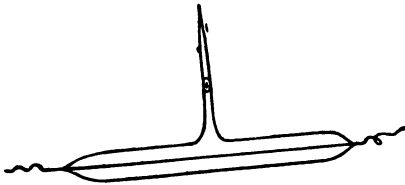

*Fig. 3*

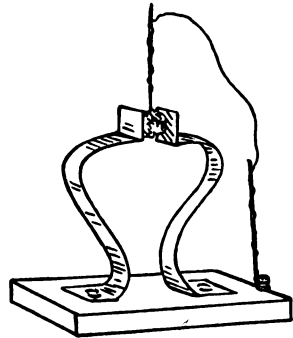

*Fig. 5*

## HARPER'S WIRELESS BOOK

galena crystal is placed. Above the galena, and touching it lightly, an ordinary sewing-needle is suspended by a fine copper wire wound about the needle, and with the other end fastened to a fairly stiff wire attached to the base (Fig. 6). By the slightest touch this needle may be vibrated or moved from point to point on the galena, until the most sensitive spot is discovered. It is not every piece of galena that will serve well as a detector, and usually two or three pounds of the mineral will not afford more than a few ounces of really good pieces, and from these you may obtain only a single tiny piece that is highly sensitive.

### The Aerial

The ordinary aerial used by this youth is a flat-topped, loop affair stretched from a tree 60 feet above the earth to the roof of the house, 35 feet above ground. The loop consists of six bare No. 16 copper wires, each 90 feet in length, giving a total wire length of 540 feet. For long-distance work two additional wires are used, each one 200 feet long and stretching to another tree, thus adding 400 feet of wire, and affording a total wire surface of 940 feet.

### What This Boy Has Accomplished

With the instruments described this boy has obtained some most interesting and truly remarkable results. He can send regularly for a radius of one hundred miles, and converses nightly with steamers passing through Long Island Sound, with operators all over his state (Connecticut), with New York City, and other points within his range. It is in receiving, however, that he has had the best results, and he has had many an exciting and interesting experience.

He can regularly receive and jot down the weather re-

## A BOY'S SUCCESSFUL STATION

ports and time sent from the station at Arlington, Virginia, and gets the latitude and longitude of incoming and outgoing ships two or three days out at sea.

Cape Hatteras sounds as loud and clear in his receivers as the New York stations, and even Bermuda is often audible. During the winter months Key West, Tampa, Porto Rico, the Gulf ports, and even far-distant Colon and Central American ports are heard and read; and sitting at his instruments, this boy in New Haven, Connecticut, can get the news of the world over his aerials hours before it appears in the morning papers.

During the summer this young wireless expert camps in the Maine woods far from civilization and railways, and while thus cut off from the news of the world he finds his wireless outfit of the greatest value and benefit. The receiving-outfit is set up exactly as in his home station; but the sending-apparatus is modified so as to use a battery current, for, of course, no powerful city circuit is available in the woods. For an aerial light aluminum wires are used, and these are stretched between trees. With this arrangement messages may be sent for a few miles, but the important matter is to receive, and with his portable outfit and large surface aerial the boy receives the time, weather reports, and other news from the government stations at Long Island, Arlington, Virginia, Halifax, etc., and in addition has all the daily news from commercial stations throughout New England, and even knows the various baseball scores before they reach the public in the large cities.

### The "Titanic" Disaster

Probably the most exciting and interesting experience of this boy's career as a wireless operator was that of the



## HARPER'S WIRELESS BOOK

*Titanic* disaster. He was one of the first amateurs to receive messages stating that the great liner was wrecked, and he sat day and night at his receivers catching the confused and varying messages relating to the wreck and jotting them down on paper as he read them. These original sheets of "copy" are very interesting, for they were written just as the dots and dashes were received, and no time was wasted trying to correct and straighten out the mistakes and undecipherable words and letters.

As every one knows, there was an immense amount of confusion among the messages received at this time, for a number of vessels, such as the cruiser *Salem*, the *Carpathia*, the *Virginia*, etc., were sending messages continually, while every commercial station and every amateur that could do so was dashing off questions and sending replies. The result was that any one attempting to receive the messages relating to the *Titanic* heard a great many other messages and portions of messages when other operators "cut in." In addition to this a number of messages were sent out at this time in private and government codes, and these, coming in between legible words, made the messages at times appear as a mere hodge-podge of meaningless sentences, words, and letters.

This is often the case when a number of messages are being sent at the same moment, and to eliminate those not wanted and make sense out of the words relating to the particular subject that interests you calls for considerable skill and experience. It was largely due to the delay and trouble caused by unauthorized people "cutting in" at the time of the *Titanic* disaster which caused the government to pass the strict laws in regard to wireless stations which are now in force.

## A BOY'S SUCCESSFUL STATION

### A Message About the Wreck

Just to show boy operators how garbled and confused the *Titanic* messages were a page of the "copy" is reproduced as it was received, and without any corrections. After reading this you can hardly blame the newspapers for their varying and confused accounts, or wonder that for days after the wreck no accurate and consistent story could be obtained. Some of the copy received was better than the one here reproduced, but other sheets were far worse, and the following is a fair sample:

Boats and embarked about six hundred persons then the cry up that the ship was sinking and a frenzderout beg ly gore the settled into the sea it is said that many boats were smashed to pieces in davits. Some swamped in launching thers went down with ship. The water soon reached engine force wireless flee. as gufre this was in which North Dakota to Tompkinsville about Cape Race 15 are lost says more for morning no passengers on Virginia and they are getting busy here so morning nrz ohz nrz ok soon leave do you know at where get a list bt alist of a list of passengers sent to the ancho carpathia good.

Yes they have passengers some accounted for by names g u f their name in following received forwashington via yed phila more from nah no 8 ck 47.

You can come to the yard this forenoon by starting from tompkinsville about 1 half-hour after the Florida going out give yours will have tugs myers fc yes all lost but eight hundred sisty eight mn bi dbi hr no 1 ok psd k 10 dh wireless br 16 Lucas bs bs under present conditions will dock about 8.30 A.M. nal be we gn nd ok nd nal out to portsmouth.

From this you will see that amateurs were not the only ones that "cut in" and interrupted the messages that the whole world were awaiting, for several of the interruptions which occurred at the most critical points in the story of the disaster were from government operators and officials themselves. Of course, this was in a way unavoidable, for the movements of naval vessels and orders to officers cannot

## HARPER'S WIRELESS BOOK

be held up awaiting news, even when that news is of world-wide interest and treats of the greatest marine disaster we have known.

Translated, the copy reproduced above gives but little news of the *Titanic*, and reads as follows:

Boats and embarked about six hundred persons, then the cry went up that the ship was sinking and a frenzied rout began. (Words missing probably should read) Ship settled into the sea, and it is said that many boats were smashed to pieces in davits. Some were swamped in launching, others went down with the ship. The water soon reached engine, forcing wireless to flee as (probably misspelled word should be "useless"). Cape Race says 15 are lost (probably refers to boats), says more will be forthcoming in the morning. There are no passengers on *Virginia*, and as they are getting busy here will wait till morning (code letters referring to government ship) will soon leave, do you know where to get a list of passengers to be sent to the anchor liner *Carpathia*?

Yes they have passengers, some accounted for by names (letters confused, refers to certain people), their names in following list received from Washington via "Philadelphia." More from (letters referring to some ship or steamship office).

(Message from naval authorities to ships:) Yes, all are lost but 868.

Such messages as this are most interesting and fill the operator with excitement as he receives them, but as a rule the messages caught on the aerials are rather dull and prosaic and of a strictly business nature.

A few years ago, when there were comparatively few stations and the busy commercial world had not awakened to the possibilities of wireless, each operator spent his time gossiping with his fellows, and the amateur, listening at his instruments, heard lots of interesting news, conversation, and advice. To-day all this is changed and the instruments are kept busy for revenue only, and few operators have time to spare in which to carry on friendly conversations, for between stock quotations, baseball scores, news of the world, private messages, time signals, and movements of steamships the aerials and instruments are busy day and night.

## Chapter XVIII

### SOME GENERAL CONSIDERATIONS

**W**HENEVER you are receiving at a wireless station, and the messages are interrupted by peculiar, scratchy, rumbling noises, you may be sure that "static" is in evidence, and that in all probability a thunder-storm is in the vicinity.

#### Static

This condition is much more in evidence in some sections of the country than in others and at certain periods of the day or year, and it is caused by electricity in the atmosphere. More or less atmospheric electricity is always present, but usually there is not enough to interfere with wireless operation.

The commonest and most familiar evidence of the presence of atmospheric electricity is lightning. This common and well-known phenomenon is in reality nothing but atmospheric electricity "jumping" just as the spark of your wireless jumps across the spark-gap. As lightning jumping produces very powerful waves in the ether, you can readily understand that aerials at a long distance from the discharge will be affected.

Although lightning has long been recognized as atmospheric electricity jumping over intervening space, yet there have been countless theories advanced as to the exact causes and conditions which produce it.

## HARPER'S WIRELESS BOOK

The most plausible and generally accepted theory is that lightning is an accumulation of electricity in the clouds, and that the minute drops of water or vapor forming the clouds carry the electricity on their surfaces. As the clouds grow heavier and the minute vapor-drops become united, preparatory to descending as rain, the electrical charges become stronger. This is the natural result of the increase in volume of the drops without a proportionate increase in surface area, so that the electricity upon the surface is forced to occupy a smaller space and is thereby condensed or intensified. Thus on a drop of rain composed of a great number of other smaller drops, the electrical charge is of much higher "potential" than it was on each of the small original drops. Although the amount of electricity on each drop is excessively small, yet the aggregate on the countless thousands or millions of drops is very great, and as this becomes concentrated by the enlargement of the drops the cloud soon becomes charged with a vast amount of high-potential electricity.

The phenomenon called "induction" has already been described in the explanation of the principles of the spark-coil, and this induction plays a most important part in the production of lightning. When a cloud heavily charged with electricity passes near another cloud or near the earth, an "induced" charge is produced in the other object, and the two charges strive to break across the intervening space and neutralize each other. Whenever two clouds pass close enough together, or the potential of the electricity becomes sufficiently great to overcome the resistance of the air between, the electricity "jumps" from one to the other, and a flash of lightning ensues. As the lightning rushes through the air the atmosphere in its path becomes heated and expands with terrific force, but instantly cool outside air rushes

## SOME GENERAL CONSIDERATIONS

into the space to fill the partial vacuum formed by the passage of the lightning. This sudden inrush of air produces enormous atmospheric waves, and these waves, striking the human ear, produce the sounds we know as thunder.

### Telling Time by Wireless

In America there are various stations which flash the hour of noon or midnight across the country by wireless. One of these is at Arlington, Virginia, another is at Fire Island, New York, and others are situated at various points throughout the United States.

More far-reaching in its scope is the wireless station on the Eiffel Tower, at Paris, which gives the standard Greenwich time to Europe, Asia, and Africa.

By the international code of signals this powerful station tells the time by wireless for 3,000 miles. Far off from land the officers of ships wait for the signals and set their clocks and correct their chronometers, and in every town in Europe—at Berlin, London, St. Petersburg, Rome, Barcelona, Madrid, and Cairo—clocks are set by the dots and dashes emanating from the lofty Paris station. As the wireless waves travel at a speed of 186,330 miles a second, no correction need be made, for the time consumed between the sending of the signal and its receipt for such a trivial distance as 3,000 miles would mean about  $1/63$  of a second.

The time messages are sent out at 10 A.M., 11.30 P.M., 11.45 P.M., and at midnight. From 11.30 to 11.33 at night a "tap" for each second is sent, thus giving 180 taps for the three minutes. At 11.44 to 11.49 a more complete message is sent, and this is followed by a weather report. Commencing at 11.57 the international midnight signal is sent out. Receiving-operators are prepared for the final dash

## HARPER'S WIRELESS BOOK

which announces midnight by three separate calls, each lasting one minute, as indicated in the illustration (Fig. 1). By means of relay stations these time messages are sent across Asia and over Africa, so that the most remote and isolated

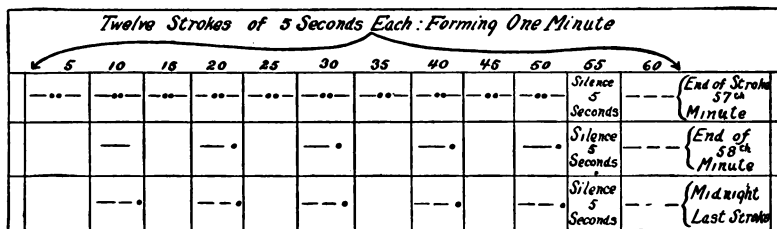

*Fig. 1*

settlements in the African jungles or on the Siberian plains receive the correct Greenwich time at the same instant that it is known in Paris, London, or Berlin.

### Does Wireless Pay?

A great many boys do not have the time, inclination, or opportunity to experiment with wireless or establish stations unless it is likely to be of real benefit to them. Whether or not there are opportunities for securing paying positions for boys interested in wireless work is a question frequently asked.

Wireless operation is a vocation not as yet overcrowded, and there is no reason why any steady, reliable boy should not secure a good position if he is a competent wireless operator.

Aside from the great number of private, commercial, and news stations now established throughout the world, there are thousands of positions to be filled aboard ships.

Unfortunately, the pay of a wireless operator on ship-

## SOME GENERAL CONSIDERATIONS

board is very low, \$45 to \$50 a month being usual; but, on the other hand, the operator may save practically all of his salary, as his board and meals cost nothing, and he cannot spend much money between ports.

While in port the operator has practically his entire time to spend as he chooses, and a great deal of the time aboard ship may be spent outside of the wireless-room.

There is little difficulty experienced in securing a position on a steamship, and it is not unusual for boys and young men who are competent operators to spend their vacations as operators on steamships, and thus obtain a great deal of fun, free transportation to foreign lands, and a fairly good salary all at the same time.

One acquaintance of the author's has spent the last five summers as an operator on a trans-Atlantic liner, and has had an opportunity to see the greater part of Europe during the time his ship was in port.

Wishing to visit Panama and the canal, this young man secured a position on a ship sailing to Colon, and in the same way he has visited South America, our southern ports, the West Indies, and various other places.

Another young man built and equipped a wireless station, became a self-taught competent operator, and at the age of seventeen secured a very good position on one of the Brazilian lines.

Of course, the boy who takes up wireless with the determination to make it a source of livelihood will succeed far better than the boy who wishes to secure a position merely for a vacation or for a short time; but any boy who is a good operator and has studied the principles and construction of wireless apparatus can pass the examination for a license, and, having secured a license, there will be little difficulty in obtaining a position.



## HARPER'S WIRELESS BOOK

The wireless class in a boys' club or in a night or day school often offers great advantages to boys who are unable to take up wireless themselves, for in the class you have the use of the instruments, the knowledge of the instructor, and the other members of the class to help you along and create an interest. Moreover, in these classes the most important points to be covered in securing a license are taught, and after a course in any good class of this sort any boy should be able to secure a license.

In the class at the Bancroft Foote Boys' Club in New Haven, Connecticut, both wireless telegraphy and wireless telephony are taught. The boys of this club have done excellent work, especially in wireless telephony, and many have obtained licenses and secured excellent positions.

Out of six members of the class who entered the Navy Yard examination last year five secured first-class operators' licenses, and the sixth member—who had been in the class for only a month—obtained a second-class license.

These boys ranged in age from fourteen to nineteen, and were no smarter or more intelligent than any other group of boys of the same age. In fact, several of the boys had been handicapped by lack of educational advantages and were employed in shops during the day.

This serves merely as an example of how simple it is to master wireless, the opportunities presented, and the constant demand that exists for competent wireless operators.

Nevertheless, unless an applicant has thoroughly familiarized himself with the theory and practice of wireless, and has thoroughly mastered the Continental-Morse code, he has little chance of securing a first-grade operator's license. The examination is severe, and no careless, inefficient, or lazy boys need expect to pass. The first requirement is to be able to send and receive at least twenty words

## SOME GENERAL CONSIDERATIONS

a minute, counting five letters to the word. Moreover, a single wrong letter ruins the applicant's chance of obtaining a license, and many inspectors require the applicant to receive or send in some foreign language, in order to insure absolute accuracy in reading the code. The next requirement is to pass a written test in regard to the theory, adjustment, care, and repair of instruments, and a knowledge of the Berlin Convention and Radio Acts of Congress. In this examination the questions asked are often puzzlers, and require replies to such queries as "How would you repair or erect and insulate an aerial if yours was damaged or destroyed?" or "If the starting-box of a motor-generator burned out what would you do to replace it?" The final test is in the adjustment for various wave-lengths and corrections of faults.

To obtain a second-grade license the applicant must have a knowledge of theory and apparatus, and must be able to send and receive twelve words a minute. Holders of a second-grade license are usually employed as assistants, and may obtain a first-grade license as soon as they are competent to pass the examination, and the experience obtained while acting as an assistant with a second-grade license is worth far more than a much longer time spent in study and practice in a class or by yourself.

Moreover, wireless presents wonderful opportunities for boys of an inventive mind. It is so new, so little understood, and so far from perfection that improvements are constantly being made, and each and every operator who is familiar with the construction and principles of his instruments should be continually striving to so arrange and adjust them as to increase their radius and efficiency.

One never knows when some slight alteration or some new and untried attachment or device may bring undreamed of

## HARPER'S WIRELESS BOOK

results, and any one who discovers or invents anything which will materially increase the utility and scope of wireless may be confident of reaping a rich reward.

Throughout the world thousands of amateurs are constantly building and experimenting with wireless instruments, and from the experiences and efforts of these serious and enthusiastic workers valuable data and results will be obtained and step by step the perfect wireless of the future will become an accomplished fact.

# APPENDIX

## USEFUL TABLES AND STANDARDS

### TO FIND SURFACE AND VOLUME

Area of rectangle = length x breadth.

Area of triangle = base x 1/2 height.

Diam. of circle = radius x 2.

Circumference of circle = diam. x 3.1416.

Area of circle = square of diam. x .7854.

Area of sector of circle = area of circle x degrees in arc ÷ 360.

Area of surface of cylinder = circumference x length, plus area of both ends.

Volume of cylinders = area of section in sq. inches x length in inches, and divide by 1728 to find cubic feet.

Diam. of circle with given area = divide area by .7854 and extract square root.

Surface of sphere = square of diameter x 3.1416.

Volume of sphere = cube of diameter x .5236.

Side of inscribed cube = radius of sphere x 1.1547

Volume of cone or pyramid, either round, square, or triangular = area of base x 1/3 the height.

A gallon of water = 231 cubic inches and weighs 8-1/3 lbs. (U. S. Standard).

### COMPARATIVE TABLE OF FRACTIONAL AND DECIMAL PARTS OF AN INCH

1/64 = .015625	3/32 = .093750	11/64 = .171875
1/32 = .031250	7/64 = .109375	3/16 = .187500
3/64 = .046875	1/8 = .125000	13/64 = .203125
1/16 = .062500	9/64 = .110625	7/32 = .218750
5/64 = .078125	5/32 = .156250	15/64 = .234375
1/4 = .250000	11/32 = .343750	7/16 = .437500
17/64 = .265625	23/64 = .359375	29/64 = .453125
9/32 = .281250	3/8 = .375000	15/32 = .468750
19/64 = .296875	25/64 = .390625	31/64 = .484375
5/16 = .312500	13/32 = .406250	1/2 = .500000
21/64 = .328125	27/64 = .421875	

# HARPER'S WIRELESS BOOK

## WIRE SIZES

(American B. & S. Gauges.)

NO. OF WIRE	SIZE IN.	NO. OF WIRE	SIZE IN.
0000	.46	19	.03589
000	.40964	20	.031961
00	.3948	21	.028462
00	.32486	22	.025347
1	.2893	23	.022571
2	.25768	24	.0201
3	.22942	25	.0179
4	.20431	26	.01594
5	.18194	27	.014195
6	.16202	28	.012641
7	.14428	29	.011257
8	.12849	30	.010025
9	.11443	31	.008928
10	.10189	32	.00795
11	.090742	33	.00708
12	.080808	34	.006304
13	.071961	35	.005614
14	.064084	36	.005
15	.057068	37	.004453
16	.05082	38	.003965
17	.045257	39	.003531
18	.040303	40	.003144

## METRIC WEIGHTS AND MEASURES

*Length*

10 millimeters = 1 centimeter  
 100 centimeters = 1 meter  
 1000 meters = 1 kilometer

*Weights*

1000 grams = 1 kilogram  
 1000 kilograms = 1 metric ton

## VOLUME

1000 cubic centimeters = 1 liter      100 liters = 1 hectoliter

## COMPARATIVE METRIC AND ENGLISH WEIGHTS AND MEASURES

1 kilogram = 2.2046 lbs. avoirdupois.

1 lb. troy = 0.37324 kilogram.

1 lb. avoirdupois = 0.45359 kilogram.

1 millimeter = 0.03937 inch.

1 inch = 25.3995 millimeters.

1 meter = 3.280899 feet.

1 foot = 0.30479 meter.

1 mile = 1609.31 meters.

1 cubic centimeter = 0.061027  
cubic inch.

1 cubic inch = 16.386 cubic cen-  
timeters.

1 cubic centimeter = 0.03519  
fluid ounce.

1 fluid ounce = 28.41 cubic  
centimeters.

1 liter = 1.76 pints.

1 gallon = 4.543 liters.

1 liter = 0.2201 gallon.

## INDEX

### A

- A boy's experience with wireless, 84.
- A boy's successful station, 163.
- Aerials, 6, 8.
- Aerial switches, 27.
- Aeroplane outfits, 82.
- Alternating currents, 7, 17.
- A message from the wreck, 171.
- Ammeters, 29, 43.
- Amperage, 138.
- Amperes, 136.
- Anchor-gap, 27.
- Antennæ, 8, 52.
- Appendix, 181.
- Arcking, 23, 25.
- Audion, 112.
- Automobile outfits, 81.
- A word about tools, 153.

### B

- Batteries, 147.
- Bell microphone, 115.
- Benches, 155.
- Berlini system, 46.
- Bichromate battery, 151.
- Boring glass, 160.
- Boring metal, 159.
- Braun system, 46.

### C

- Carbon detector, 36.
- Carborundum detector, 32.
- Care of tools, 155.
- Closed core transformers, 22.

- Close-coupled helix, 24.
- Codes, 66.
- Condenser, 21, 23.
- Conductors, 6.
- Connecting a loose-coupled coil, 39.
- Constructing aerials, 52.
- Continental code, 67.
- Coupling, 24.
- Crowfoot battery, 150.
- Cutting rubber, 161.
- Cycle, 18.

### D

- Daniell cell, 150.
- Detectors, 7, 29, 30.
- Dielectric, 6.
- Direct current, 7, 18.
- Directive aerials, 13.
- Directive transmission, 44.
- Does wireless pay, 176.
- Drilling brick, 162.
- Dry batteries, 152.
- Dynamos, 141.

### E

- Earthing, 16.
- Edison batteries, 151.
- Electrical energy, 4.
- Electrical terms explained, 136.
- Electromagnets, 141, 143.
- Electromagnetic waves, 4.
- Electrolytic detectors, 31.
- Electrolytic interrupter, 21.
- Emergency wrenches, 160.
- Establishing a station, 51.

## HARPER'S WIRELESS BOOK

Ether, 4.  
 Ethereal waves, 5.  
 Experiences of a wireless operator,  
 118.  
 Experimenting with sound, 97.

### F

Fan aerial, 12.  
 Flat-topped aerial, 10.  
 Fuller cell, 151.

### G

Gonda cell, 149.  
 Gravity cell, 150.  
 Grid aerial, 12.  
 Ground, 6, 58.  
 Grounding, 16.

### H

Helix, 24.  
 Hertz's discovery, 127.  
 High-frequency oscillations, 5.  
 High-tension magnetos, 144.  
 How to make instruments, 61.

### I

Inductance, 24, 144.  
 Induction-coil, 6, 17, 19, 144.  
 Instruments for receiving, 29.  
 Instruments for sending, 17.  
 Instruments used in wireless tel-  
 ephony, 111.  
 Insulating, 14, 55.  
 Insulators, 14, 55.  
 International rules, 76.  
 Interrupters, 20.  
 Introduction, v.  
 Inverted-pyramid aerials, 12.  
 Ionized, 10.

### J

Jump, 21.

### K

Keys, 27.

### L

L-aerial, 12.  
 Laminations, 22.  
 Laws governing wireless, 73.  
 Lead in, 15.  
 Le Clanche cell, 149.  
 Leyden jar, 5.  
 Lightning switch, 59.  
 Loop aerial, 13.  
 Loose-coupled helix, 24.  
 Low-tension magnetos, 144.  
 Low voltage, 6.  
 Luminiferous ether, 4.

### M

Magnetic fields, 19.  
 Magnetos, 141.  
 Majorana transmitter, 111.  
 Making sound visible, 98, 101.  
 Materials for aerials, 14.  
 Metric weights and measures, 182.  
 Mineral detectors, 37.  
 Moretti apparatus, 114.  
 Morse code, 67.

### N

Navy code, 67.  
 Non-conductors, 6.

### O

Ohms, 136.  
 Oil-immersed condenser, 24.  
 Open-circuit transformers, 22.  
 Outfits of greater scope, 65.

### P

Perikon detector, 31.  
 Permanent magnets, 142.  
 Photophones, 104.  
 Potential, 137.  
 Potentiometers, 29, 32, 38.  
 Poulsen's method, 110.  
 Pressure, 137.

## INDEX

Primary, 6.  
 Primary coil, 144.  
 Principles of induction-coil, 19.  
 Pyramid aerial, 10.

### Q

Quenched gap, 25.

### R

Rat-tail, 15.  
 Reaction-coil, 23.  
 Receivers, 8.  
 Receiving, 70.  
 Rotary condenser, 34.  
 Rotary gap, 26.

### S

Sampson cell, 149.  
 Secondary, 6.  
 Selecting a site, 51.  
 Selenium, 104.  
 Series, 138.  
 Series multiple, 138.  
 Shunt current, 142.  
 Sliding-plate condenser, 34.  
 Soldering, 158.  
 Some general considerations, 173.  
 Sound, 96.  
 Sounds and sound-waves, 95.  
 Sound-waves, 98.  
 Sources of current, 140.  
 Spark-coil, 6, 144.  
 Spark-gap, 24.  
 Speaking-arc, 105.  
 Star-drills, 162.  
 Static, 10, 173.  
 Steinhall's experiments, 127.  
 Straightaway aerial, 13.  
 Straightening wires, 159.  
 Surface and volume, 181.  
 Switches, 27.

### T

T-aerial, 13, 55.  
 Talking by wireless, 69.  
 Talking through the air, 107.  
 Telegraphic codes, 67.

Telephones, 102.  
 Telephone receivers, 29, 103.  
 Telling time by wireless, 175.  
 Tesla's oscillatory currents, 133.  
 Test buzzers, 29.  
 Theory and principles of sound, 95.  
 The *Titanic* disaster, 169.  
 Tools, 153.  
 Tosi system, 46.  
 Transformers, 6, 17, 22.  
 Transmission of power by wireless, 132.  
 Transmitters, 8.  
 Transmitting, 67.  
 Tubular condenser, 24.  
 Tuning, 32, 41.  
 Tuning-coils, 33.  
 Tuning-devices, 29.

### U

U-aerial, 13.  
 Umbrella aerial, 10.  
 Use of tools, 155.  
 Useful hints, 158.  
 Useful tables and standards, 181.  
 Using files, 160.

### V

V-aerials, 12.  
 Value and uses of wireless, 80.  
 Vanni method, 113.  
 Variable condensers, 29.  
 Variometers, 29.  
 Various types of aerials, 10.  
 Various useful hints, 158.  
 Vises, 155.  
 Vertical aerial, 11.  
 Vibrators, 20.  
 Voltage, 137.  
 Volts, 138.

### W

Ways and means, 8.  
 Why wireless works, 3.  
 Wire gauges, 182.  
 Wireless in the Arctic, 134.  
 Wireless of the past and future, 127.  
 Wireless telephony, 94.  
 Wrenches, 157.

APR 1 1919