

THERMIONIC VALVES
IN MODERN
RADIO RECEIVERS

WITTS

W48

TECHNISCHE UNIVERSITEIT EINDHOVEN

Bibliotheek TU/e

Verwijderd uit de collectie

THERMIONIC VALVES
IN MODERN
RADIO RECEIVERS

Published by
PITMAN

RADIO UPKEEP AND REPAIRS

By ALFRED T. WITTS, A.M.I.E.E. Enables the average radio receiver owner to diagnose for himself the ordinary troubles of his wireless set and to remedy them successfully.

THE SUPERHETERODYNE RECEIVER

By ALFRED T. WITTS, A.M.I.E.E. Provides the essential working knowledge required by every keen amateur constructor, radio student, and service engineer. 5s. net.

RADIO RECEIVER CIRCUITS HANDBOOK

By E. M. SQUIRE. A useful guide to circuits for up-to-date members of the radio industry. 5s. net.

INTRODUCING RADIO RECEIVER SERVICING

By E. M. SQUIRE. A good sound book about first principles and practice. 6s. net.

WORKED RADIO CALCULATIONS

Graded Practical Examples

By ALFRED T. WITTS. Invaluable to the student of radio as well as to the practical service engineer and wireless operator. 6s. 6d. net.

CLASSIFIED RADIO RECEIVER DIAGRAMS

By E. M. SQUIRE. An analysis of modern radio receivers presented in diagrams. 10s. 6d. net.

*Send for Pitman's complete
list of Radio Books, post
free from 39 Parker Street,
Kingsway, W.C.2*

THERMIONIC VALVES IN MODERN RADIO RECEIVERS

A HANDBOOK ON
THEORY AND PRACTICE

BY
ALFRED T. WITTS

A.M.I.E.E.

SECOND EDITION

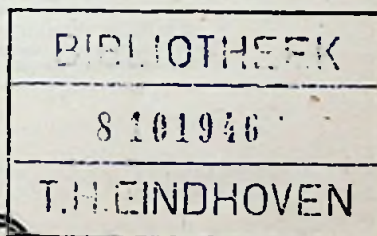

LONDON
SIR ISAAC PITMAN & SONS, LTD.

1945

Reprinted January, 1942

Reprinted August, 1942

Reprinted April, 1945

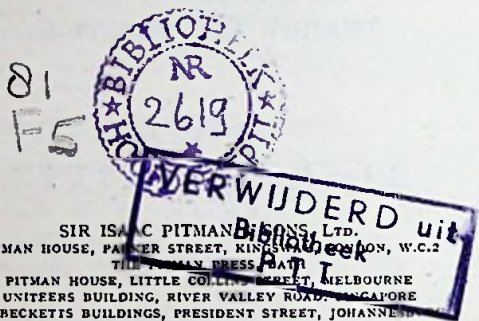

SIR ISAAC PITMAN & SONS, LTD.
PITMAN HOUSE, PALMER STREET, KING'S CROSS, LONDON, W.C.2
THE PITMAN PRESS, BATH
PITMAN HOUSE, LITTLE COLLING STREET, MELBOURNE
UNITEERS BUILDING, RIVER VALLEY ROAD, SINGAPORE
27 BECKETT'S BUILDINGS, PRESIDENT STREET, JOHANNESBURG

ASSOCIATED COMPANIES

PITMAN PUBLISHING CORPORATION

2 WEST 45TH STREET, NEW YORK

205 WEST MONROE STREET, CHICAGO

SIR ISAAC PITMAN & SONS (CANADA), LTD.
(INCORPORATING THE COMMERCIAL TEXT BOOK COMPANY)
PITMAN HOUSE, 381-383 CHURCH STREET, TORONTO



THE PAPER AND BINDING OF
THIS BOOK CONFORM TO THE
AUTHORIZED ECONOMY STANDARDS

MADE IN GREAT BRITAIN AT THE PITMAN PRESS, BATH
D5-(T.75)

PREFACE

THIS book is for the purpose of presenting an outline of the theory and practice of the application of thermionic valves to modern radio receivers. The subject dealt with has changed so much in recent years that it is considered that a book dealing with modern practice is required by students, service engineers, and keen radio amateurs. Many aspects of the subject have been dealt with so that the book will be of interest to those engaged in commercial wireless fields as well as in broadcast reception.

The writer has avoided reference to out-of-date phenomena and circuits, and to theoretical arrangements that are not actually employed in present-day receiver designs.

Acknowledgment is gratefully made to Mr. W. H. Nottage, B.Sc., M.I.E.E., F.Inst.P., who checked the manuscript and was very helpful in its preparation.

A. T. W.

LONDON,

September, 1936.

PREFACE TO SECOND EDITION

IN this second edition notes have been added on a large number of subjects, such as the use of aligned grids, output tetrodes, negative feedback and phase splitters for push-pull amplifiers, and the text has, in general, been revised and brought up to date.

A new chapter on Mains Rectifier Valves and Equipment has been added.

A. T. W.

PITMAN'S WIRELESS BOOKS

A SELECTION

SHORT-WAVE RADIO

By J. H. REYNER.

An invaluable companion volume to *Modern Radio Communication*, and is recommended to all students of radio engineering as a reliable textbook on modern developments in the use of the short, ultra-short, and micro-waves.

Illustrated

10s. 6d. net

186 pp.

RADIO SIMPLIFIED

By JOHN CLARRICOATS.

Provides a useful background of fundamental radio knowledge. The minimum of space has been devoted to purely theoretical considerations consistent with a sound basis of knowledge. There are fifty-one clear, interesting diagrams and many chapters dealing with such subjects as Series and Parallel, the Measurement of Current, Voltage and Resistance, the Magnetic Effect of an Electric Current, etc.

Cloth

4s. 6d. net

94 pp.

CATHODE-RAY OSCILLOGRAPHS

By J. H. REYNER, B.Sc. (Hons.).

Covers types of oscillograph tube, the oscillograph in use, waveform examination, deflection amplifiers, frequency response curves, etc.

Cloth

5s. 6d. net

188 pp.

RADIO RECEIVER SERVICING AND MAINTENANCE

By E. J. G. LEWIS.

A practical manual specially written to give the radio dealer, salesman, and the service man up-to-date and reliable assistance in the technical details of their work. A handy fault-finding summary, combined with the index, is a feature of the book.

Cloth gilt

8s. 6d. net

253 pp.

PROBLEMS IN RADIO ENGINEERING

By E. T. A. RAPSON, A.C.G.I., D.I.C., A.M.I.E.E.

A classified collection of examination questions set from time to time by some of the more important examining bodies in Radio Communication, together with some useful notes and formulae bearing on the different groups of questions and answers to those questions which are capable of a numerical solution.

In crown 8vo

5s. net

150 pp.

PITMAN

CONTENTS

CHAP.		PAGE
	PREFACE	v
	SYMBOLS AND ABBREVIATIONS	ix
I.	ELECTRON EMISSION	1
II.	FUNDAMENTAL VALVE CHARACTERISTICS	21
III.	DETECTORS	48
IV.	HIGH-FREQUENCY AMPLIFIERS	74
V.	LOW-FREQUENCY AMPLIFIERS	97
VI.	THE OUTPUT STAGE	115
VII.	PUSH-PULL OUTPUT STAGES	138
VIII.	FREQUENCY CHANGER VALVES	165
IX.	EMPLOYMENT OF VALVES FOR AUTOMATIC VOLUME CONTROL	183
X.	MAINS RECTIFIER VALVES AND EQUIPMENT	203
	INDEX	215

PITMAN'S WIRELESS BOOKS

A SELECTION

INTRODUCING RADIO RECEIVER SERVICING

By E. M. SQUIRE.

This book provides a concise introductory guide to the practical operation of a radio receiver, so that new radio service engineers, testers, and dealers may be able to obtain a working knowledge of receivers and servicing equipment in the briefest time.

In crown 8vo

6s. net

Cloth

RADIO RECEIVER CIRCUITS HANDBOOK

Containing Practical Notes on the Operation of Basic Modern Circuits.

By E. M. SQUIRE.

A useful guide to circuits for members of the radio industry, and radio amateurs. The text is liberally illustrated with circuit drawings and diagrams.

In crown 8vo

5s. net

104 pp.

EXPERIMENTAL RADIO ENGINEERING

By E. T. A. RAPSON. Assisted by E. G. ACKERMANN.

Sets out a number of experiments and methods of measurement suitable for a three or four years' course in radio engineering at a technical college. The majority of them may be carried out with standard laboratory equipment.

In crown 8vo

8s. 6d. net

Cloth

ELEMENTARY HANDBOOK FOR WIRELESS OPERATORS

By W. E. CROOK, A.M.I.E.E., A.F.R.Ae.S.

This book cannot be ignored by any future aircraft radio operator. It is precisely what he needs to assist him during his training, to supplement his official instruction, and will provide a firm groundwork on which to build his knowledge.

In demy 8vo

4s. net

102 pp.

ELEMENTARY MATHEMATICS FOR WIRELESS OPERATORS

By W. E. CROOK.

A thoroughly practical book designed to give only the mathematics required for the purpose and no more. It enables everybody to get a quick and immediate grasp of essentials. Invaluable to all wireless operators.

In demy 8vo

3s. 6d. net

63 pp.

PITMAN

LIST OF SYMBOLS AND ABBREVIATIONS

A	.	.	effective amplification
a.c.	.	.	alternating current
a.v.c.	.	.	automatic volume control
C	.	.	capacitance
$C_{in\ p}$.	.	input capacitance
cyc.	.	.	cycles per sec.
d.c.	.	.	direct current
f	.	.	frequency, cycles per sec.
g_m	.	.	valve mutual conductance
h.f.	.	.	high frequency
h.f.c.	.	.	high frequency choke
h.t.	.	.	high tension
i_a	.	.	anode current
i_{a0}	.	.	steady value of anode current
i_{a2}	.	.	peak value of alternating anode current
i.f.	.	.	intermediate frequency
i_g	.	.	grid current
i_{g0}	.	.	steady value of grid current
kc.	.	.	kilocycles per sec. = thousands of cycles per sec.
k Ω .	.	.	kilo-ohm = one thousand ohms
L	.	.	inductance
l.f.	.	.	low frequency
l.s.	.	.	loudspeaker
micro-	.	.	one millionth (Symbol: μ)
milli-	.	.	one thousandth (Symbol: m)
mA.	.	.	milliampere
mW.	.	.	milliwatt

LIST OF SYMBOLS AND ABBREVIATIONS

$M\Omega$.	.	megohm = one million ohms
$n_1 : n_2$.	.	turns ratio of transformer
R	.	:	resistance
R_a	.	.	valve anode a.c. resistance
R_o	.	.	load (external) resistance
r.m.s.	.	.	root mean square value = 0.707 peak value
SC	.	.	speech coil of loudspeaker
T	.	.	transformer
V_a	.	.	anode voltage
V_{ax}	.	.	peak value of alternating anode voltage
V_g	.	.	grid voltage
V_{HF}	.	.	high frequency voltage
ω	.	.	$2\pi \times$ frequency in cycles per sec.
W_{in}	.	.	power input, watts
W_o	.	.	power output, watts
μ	.	.	amplification factor
$\mu F.$.	.	microfarad
μmho	.	.	micromhos
Z_o	.	.	load (external) impedance
Z_{sc}	.	.	speech coil impedance

THERMIONIC VALVES IN MODERN RADIO RECEIVERS

CHAPTER I

ELECTRON EMISSION

IN the present state of physical knowledge, it is assumed that an electric current consists of a flow of electrons. These electrons are normally present in a conductor as discrete particles, a certain number of which are "free," i.e. they can be moved along the conductor by the application of an electric force. It is the movement of these "free" electrons that provides the electric current. The general convention of this arrangement is that the electrons are negative in sign.

Physicists have proved that the electron has a certain mass.* The terms *electron flow* and *electron stream* do not imply the movement of material particles, however. They do, nevertheless, indicate the passage of a number of particles, each with a small negative charge. Since these electrons are negative in sign, it follows that the body on which they finally rest must be negative in potential with respect to the body from which they emanated. This is to say that the addition of electrons makes a conductor negative while the subtraction of electrons makes it positive.

In the normal state of a conductor, i.e. before an electric force is applied to it, the electrons exist as a large number of groups, each revolving round a central nucleus. Of the electrons revolving round the nucleus, the velocity of the free electrons can be increased to such an extent that they leave the conductor of which the nucleus forms a part, and are then free to be attracted to the nearest positive body separated in space from the conductor.

* The mass of an electron is 9×10^{-28} gramme.

There are various ways whereby this critical velocity can be imparted to the electron. Electrons are liberated from some substances when light rays impinge on them. This is known as the *photo-electric* method. Then there is electronic bombardment which releases electrons. Later on (see page 12) this process will be examined in greater detail. If a conductor is exposed to an extremely intense electric field, electrons will be pulled out, as it were, and attracted to the source of the electric field. In X-ray apparatus great use is made of this process. A fourth method of releasing electrons, and the one used almost exclusively in radio thermionic valves, is to heat the conductor to such a temperature that the electrons fly out from it.

Effect of Heating a Conductor: As the temperature of a tungsten wire is raised to the point of incandescence, the electrons within it are given an increasing velocity until at last they shoot out from it into space. Until the electrons attain a certain velocity they cannot leave the surface of the conductor owing to the potential barrier. It has already been seen that as soon as an electron leaves a body, the latter becomes positive. Since the electrons are negative, they will be attracted back by the positive substance they have just left. Unless, therefore, the electrons have a greater velocity than that required to just leave the conductor, they cannot go very far away from the latter.

Work Function. Clearly each electron has to overcome a force tending to keep it within the conductor (potential barrier), and in doing so has to expend a certain amount of power. The power required for an electron to leave the surface varies with the different types of conductors. If electrons can leave body *A* when they have attained a high velocity, and body *B* when they are at a low velocity, it is apparent, since velocity is a function of temperature, that at a given temperature there will be a greater number of electrons enabled to leave body *B* than *A*. In other words, the facility with which electrons are allowed to leave a material (i.e. its *emissivity*) is inversely proportional to the velocity they must attain in order to do so. The term used in thermionics to express a measure of the velocity necessary for an electron to leave a body is *work function*. This is equal to the volts necessary to

raise from rest an electron in any particular substance to the required velocity that will give it the desired kinetic energy ($\frac{1}{2}$ mass \times velocity²). This term enables a comparison to be made of the relative units of the various cathode substances. If ϕ is the potential difference through which an electron is moved, e the charge on the electron, and A the work done on an electron, then

$$\phi = A/e$$

The factor ϕ is known as the electron affinity of the substance and is numerically equal to the work function.

The conductor with the lowest work function is the one from which electrons are released in the greatest number or with the greatest ease. As the power used by an electron in emerging from a cathode is a loss, as far as its utilization outside the conductor is concerned, the material with the lowest work function, other things being equal, will be most suitable for radio thermionic valve cathodes. It may be of interest to mention here that the work function in volts of tungsten is 4.52, platinum 4.4, thorium 3.35, and calcium 3.4. From these figures it can be seen that tungsten is the least prolific emitter of electrons. For this reason, tungsten has long been discarded as a cathode for radio receiving valves, although it is still used to a large extent in transmitter valves owing to its robustness and reliability.

Basic Emission Formula. The magnitude of the electronic emission from a hot conductor was worked out in 1901 by an early experimenter in thermionics, Dr. O. W. Richardson, to be

$$I = a(\sqrt{\tau})\epsilon^{-b/\tau}$$

where I is the electronic emission per square centimetre of cathode surface, τ is the absolute temperature, ϵ is the base of Napierian logarithms (2.718) and a and b are constants, the latter being proportional to the work function of the cathode emitting substance. Further research indicated that Richardson's formula required slight modification, and Dushman showed in 1923 (see *Physical Review*, Vol. 21, No. 6) that a more accurate expression is

$$I = a\tau^2\epsilon^{-b/\tau}$$

It is clear from this formula that an increase in temperature will bring about a more than proportionate increase in emission of electrons. Also that as b is proportional to the work function of the cathode material and in the formula is a negative power, the emission is inversely proportional to the work function.

The total emission is obviously dependent upon the area of the emitting body, because the emission formula is for the *intensity* of the emission, i.e. the emission per unit area. The greater the number of unit areas taking part in the emission, the greater must be the total emission from the entire cathode, other conditions being similar.

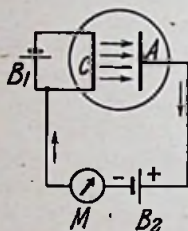

FIG. 1. CIRCUIT TO DEMONSTRATE THE EDISON EFFECT

The Edison Effect. Edison, as early as 1884, found that if a metallic plate with a positive potential applied to it was placed near a filament heated to incandescence in an evacuated bulb, an electric current was indicated in a meter joined in the wires connecting the filament with the positive plate. This arrangement is shown in Fig. 1. A wire C is heated by current from battery B_1 and emits electrons. These pass across the intervening vacuum to plate A , which is held at a positive potential by battery B_2 , through the meter M and back to the heated wire. Edison also noticed that when the connexions to the two electrodes in the bulb were reversed, no current was indicated. The device was thus conductive in one direction only, i.e. when the plate A was positive. On this simple experiment was founded modern thermionic practice.

Plate A is called the *anode*, because it is at positive polarity, and the heated conductor C is known as the *cathode* or *negative electrode*. These polarities, it must be noted, are in relation to the external battery B_2 .

The arrangement seen in Fig. 1 is an elementary circuit for the radio *diode* or two-electrode valve. Fleming's famous diode of 1904 was, in fact, a development of Edison's unilaterally conducting device. Fleming's invention consisted in adapting a two-electrode system for reception of wireless signals.

Now consider the effect of placing the positively charged metal plate in the vicinity of the electron emitter. As the temperature of the cathode is increased and the velocity of the electrons becomes greater, more and more electrons are enabled to leave the cathode. The positive anode throws out an electric field which attracts the negative electrons towards the anode. When an electron leaves the cathode, however, it is immediately attracted back owing to its release causing the cathode to become positive at that particular spot. Another influence tending to send the electron back to the cathode is the cloud of electrons that have already been liberated and have remained very close to the cathode. This negatively charged cloud (called the *space charge*) will tend to repel any further electrons emerging from the cathode, since these will be of the same sign.

There are, therefore, two opposing forces acting on the emergent electron, one due to the electric field of the anode tending to draw the electron towards the anode plate, and the other force consisting of (a) the repellent force of the negative space charge and (b) the attractive force of the cathode that the electron has just left, which tends to keep it very close to the cathode. At some point between the cathode and anode these two opposing forces must be equal and, if the electron possesses sufficient velocity to pass this point, it will come within the region where the anode force predominates and will be attracted to the anode plate. Unless, however, the electron has the velocity needed to reach the point where the resultant force is zero, it will be forced back on to the cathode again. It will be noted that once the electron has passed the neutral point it will be urged on by the cloud of electrons which will then be behind it.

In a diode, such as is now being considered, the neutral point for all electrons emitted by the cathode will lie in a surface parallel to the cathode. The actual position of this surface with respect to the cathode will vary with the voltage applied to the anode. As the electric field from the anode has to overcome the ability of the space charge to repel electrons back to the cathode, the higher the voltage applied to the anode, the more completely will it overcome the influence of the space charge and the neutral plane will be moved nearer to the cathode. In the extreme case, when a

very high voltage is applied to the anode, all the electrons emitted by the cathode will be drawn to the anode. This state is known as *saturation* and the current is said to be temperature limited. Up to the saturation condition the current is drawn from the space charge which acts as a virtual cathode, the operating conditions then being known as space charge limited. This space charge limited current is, of course, smaller than the saturation current.

Three Halves Power Law. The total quantity of electrons reaching the anode per unit time form the anode current that deflects the meter needle. This anode current has been shown by Child (*Physical Review*, vol. 32, p. 498) to be proportional to the $3/2$ power of the anode voltage and inversely proportional to the square of the distance between anode and cathode. Child's formula is

$$i_a = K(E^{3/2}/x^2)$$

where i_a is the anode current, E the anode voltage, x the distance between anode and cathode, and K a constant. Actually this applies to two plates. In the practical case of a radio diode where the cathode consists of a filament of diameter small in comparison with that of the anode, the formula is slightly modified to

$$i_a = K(E^{3/2}/r)$$

where r is the radius of the cylindrical anode. In this instance the anode current is inversely proportional to the radius of the anode, although still following the $3/2$ power law in respect of anode voltage.

The theoretical and the practical curves relating to anode current and voltage of a simple diode are seen in Fig. 2. One curve shows how the anode current would vary if it followed the $3/2$ power law of anode voltage; i.e. the current would increase with the applied voltage to a saturation value S_1 after which it would be unaffected by any augmentation of anode voltage. For the attainment of the anode current—anode voltage relations indicated by this curve, however, several important requisites are not realized in practice. Child's three halves power law presupposes the following conditions which are very difficult to produce in a manufactured diode—

- (1) A perfect vacuum. Most thermionic valve envelopes

are exhausted to a pressure of 10^{-5} mm. of mercury. With the use of gettering (see page 16), this pressure is reduced to about 10^{-7} mm. of mercury.

(2) Uniform temperature all over the cathode surface.

(3) An equipotential cathode surface, i.e. a cathode surface on which every point is at the same potential.

The last two conditions are not fulfilled for the following reasons.

When a filament is heated, the ends are always cooler than the centre owing to the reduction in temperature caused by the comparatively cold filament supports and by heat radiation. Consequently the emission from the ends is always less than from the centre. The ends emit their maximum number of electrons before the centre, because the maximum emission, as already shown, is dependent upon the temperature of the emitting body. The saturation point is therefore reached first by the ends and then moves along the filament to the centre, producing the gradual approach to complete saturation seen in the curve S_2 .

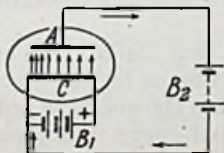

FIG. 3. ILLUSTRATION OF THE EFFECT OF A CATHODE FILAMENT BATTERY ON EMISSION

With battery-heated valves, an equipotential cathode is not obtained owing to the voltage drop down the filament produced by its ohmic resistance. As seen in Fig. 3, the drop down a filament, supplied directly by a battery, is equal to the voltage of the latter. The positive end of C heated by a 6-volt battery B_1 will therefore be 6 volts positive with respect to the negative end and, as the anode battery B_2 is connected to the negative cathode end, will be 6 volts less negative with respect to the anode voltage. In other words, at the positive side of the cathode the anode voltage is nullified to the extent of the

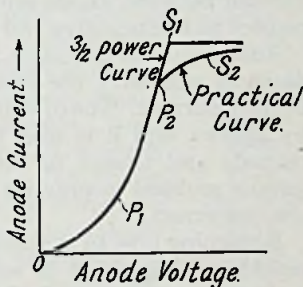

FIG. 2. FUNDAMENTAL CURVES SHOWING THE CURRENT-VOLTAGE RELATION IN A TWO-ELECTRODE THERMIONIC VALVE

voltage of the cathode battery B_1 . Since the anode current depends on the difference between the cathode and anode voltages, the saturation point of the positive end of the cathode will be reached before that of the negative end, and saturation point will begin at the positive end and move along the cathode thus tending to even out the point S_1 in the theoretical curve of Fig. 2. In practice, the difference in voltage between anode and cathode is always reckoned with respect to the negative end of the cathode.

Another point to notice from Fig. 3 is that one half of the filament will carry the total anode current in addition to its heating current. The direction of the anode current is indicated by arrows, and it is seen to flow to the negative end of the cathode and thence to the anode. This, however, is not a serious problem in practice so far as broadcast receiver valves are concerned.

Returning now to the anode voltage—anode current characteristic of Fig. 2, it is seen that both the theoretical and practical curves are similar up to the point P_2 . Point P_1 is practically at the higher end of the bottom bend. As far as P_2 the practical diode curve can be said to follow the $3/2$ power law of thermionics. From P_1 up to point P_2 , the curve is fairly straight. This is the part of the curve most useful to radio receivers. In practice there is a small current flow at zero anode volts, and at this point the practical curve deviates from the theoretical curve. In detection this flow of anode current at zero voltage is important and will be described later.

In the practical curve, it will be noted that the maximum point S_2 , known as the *saturation point* because no further electrons emitted by the cathode are attracted to the anode, is not nearly so clearly defined as the theoretical curve indicates. The saturation point is, indeed, approached quite gradually and gives the curve a top bend or knee. It will be noticed that after point S_2 of the operating characteristic has been reached, any further increase in anode voltage causes only a very small increase in anode current. The causes of a gradual approach to saturation instead of a sudden approach are similar to those that produce a deviation of the practical from the theoretical curve at the lower portions.

The practical significance of the various parts of the curve will be described in subsequent chapters.

Cathode Heated Indirectly. So far only cathodes heated by a flow of electric current along it have been considered. There is no actual necessity for this current flow along the cathode; in fact there are certain disadvantages in the flow of heating current. The electric field set up by the cathode-heating current tends to repel the emergent electrons back to the cathode surface and so make it more difficult for them to leave. Unequal heating of the cathode and voltage drop along it have already been mentioned.

In the indirectly heated cathodes, these drawbacks are largely overcome and a much more efficient emitter is obtained. The heater consists of a wire made of a highly refractory substance, i.e. a substance that will not readily evaporate when raised to a high temperature. This wire is threaded through a refractory insulator in a manner dependent upon the particular voltage which is to be applied to it, and over the insulator is closely fitted the cathode sleeve. The formation of a typical indirectly heated cathode is illustrated in Fig. 4,

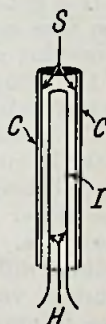

FIG. 4
ONE TYPE OF
INDIRECTLY
HEATED
-CATHODE

where *H* is the heater wire, *I* is the insulator, and *C* the cathode material coated to a metallic sheath *S*. It will be noted that *C* is not affected by the polarity of *H* since it is heated only by the heat passing through the insulator *I*. Such a cathode is at the same potential all over, i.e. it is equipotential. Consequently an arrangement of this kind is very suitable for connecting to alternating current mains, so long as the frequency of the current fluctuations is high enough to maintain *C* at a substantially constant temperature.

The indirectly heated cathode produces its own particular problems, of course, and is not a complete solution of the difficulties already enumerated. To begin with, the cathode will not be entirely at a uniform temperature owing to the cooling effect of radiation at the open end and to conduction by the heater supports. These supports must be far more massive than in the case of filamentary cathodes because the

weight to be supported (heater, insulator, and cathode tube) is so much greater, and the amount of heat lost by conduction through them is in many instances quite appreciable. The temperature at the end of the cathode nearer the supports will, therefore, be less than at the other parts. A similar effect is noticeable if the end of the cathode remote from the supports is open, although in this case it is due to heat radiation only. This defect is usually overcome by closing the cathode cylinder at that end.

It is not so easy to arrange an indirectly heated cathode in the true centre of the surrounding electrodes as a cathode consisting merely of a length of thin wire. Accurate centring of the cathode is essential if the valve is to operate according to a predetermined characteristic curve.

The refractory insulating material separating heater from cathode must be so chosen that no chemical reactions take place between it and the heater at any temperature to which the heater may be brought during the normal operation of the valve. This insulator must also be able to withstand the voltage difference existing between cathode and heater, yet must be very thin so as to absorb as little heat as possible. The thinner this insulator is, the shorter will be the time required for the cathode to be heated to the requisite temperature after the heater has been supplied with power.

Two requirements for the metal cylinder which carries the electronic emissive substance are—

- (1) It must be capable of retaining the emission layer when heated to a high temperature; and
- (2) It must not absorb much of the heat supplied by the heating element.

In practice it is found that copper or nickel meet these demands satisfactorily, and no trouble is experienced. The material used as heater is usually tungsten or nickel.

Effect of Varying Cathode Temperature. In Fig. 5 are seen a number of curves showing the effect of varying the heat applied to the cathode of a valve. Actually the voltage applied to the directly heated filamentary cathode is varied, but since the current flow through the filament is proportional to the voltage across it, the heating current will vary with the voltage applied. These curves are representative of what may

be expected from a filament designed to work from a 2-volt supply. When only 1.5 volts are applied across the ends of the filament the emission rises to the point S_1 . As the full 1.5 volts are across the filament, this means that the maximum electron flow is taking place and that as the anode voltage is increased the number of electrons attracted to the anode increases until, at S_1 , saturation sets in and the point is reached where any further increase in anode voltage results in but very slight increase in anode current.

When the filament volts are increased to 1.75, an immediate increase in anode current is noticeable. The saturation point

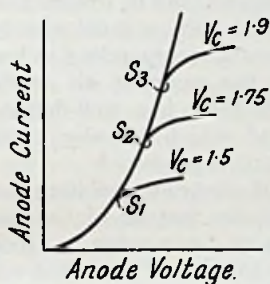

FIG. 5. SHOWING THE EFFECT OF INCREASING CATHODE HEATING VOLTAGE

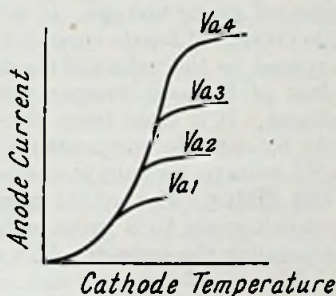

FIG. 6. ILLUSTRATING THE EFFECT OF RAISING THE ANODE VOLTAGE (V_a)

has now jumped from S_1 to S_2 , only a very slight increase in anode voltage being necessary to reach the saturation point. It should be noted, however, that up to S_1 the anode current for the two values of filament voltage is identical for the same anode voltage and that to reap the benefit of the increase in emission a higher anode voltage is needed. At 1.9 filament volts, a still further increase in anode current is obtainable, saturation point now being at S_3 ; and when the full 2 volts are applied the anode current increases rapidly with the anode voltage. Saturation point is not shown in the latter case because in practice with modern receiver valves it is rarely reached, the filament itself being usually damaged first. For this reason, the applied anode voltage must not be increased unduly.

Effect of Varying Anode Voltage. The dependence of anode current on the anode voltage is shown by the curves of Fig. 6. These are for different values of anode voltage designated V_{a1} , V_{a2} , etc., the lowest voltage being V_{a1} and the highest V_{a4} . As the temperature of the filament is increased from zero, the anode current increases until saturation sets in. With the lowest value of anode voltage, V_{a1} , the saturation point is soon reached in terms of filament temperature. As the anode voltage is increased, however, to V_{a2} , V_{a3} , and V_{a4} the saturation point is taken higher up the anode current scale thus showing that a higher anode current is obtainable with increased anode voltage. It will be noted that to obtain this higher value of anode current the anode voltage must also be increased, as the values of anode current corresponding to low values of filament temperature are the same at all anode voltages. It is clear from Fig. 6 that there is a well-defined limit to cathode temperature beyond which, at any given anode voltage, no gain in anode current is produced.

Gas Filling. The actual number of electrons reaching the anode depends to a great extent on the nature of the gas surrounding the cathode. In a *soft* valve, i.e. a valve in which a high vacuum does not exist, a large number of electrons will be produced by collision between the electrons leaving the cathode and gas molecules that happen to be in their path to the anode. The actual number of electrons knocked off these gas molecules will depend upon the velocity of the emitted electron at the instant of impact. All such electrons liberated by collision will be attracted by the positive anode and join the electrons emitted by the cathode. Soft valves are not used in modern broadcast receivers, and will not be considered further. The nature of their operation is fundamentally different to that of a *hard* valve; i.e. a valve that is operated in a vacuum of a very high order, usually at a pressure of about 10^{-7} mm. of mercury.

Secondary Emission. Another source of electrons is the secondary emission. When a primary electron (i.e. an electron emitted from the cathode) reaches the anode it possesses a velocity that bears a certain relation to the potential of the anode. If a high potential is applied to the anode, it is easily understandable that some electrons will be dislodged when

the primary electrons travelling at a very high velocity from the cathode strike the anode. The number of electrons so liberated can be as high as ten per impinging electron, and they are known as *secondary* electrons. Collectively, the secondary electrons are called the *secondary emission*, and in certain types of valves, such as the dynatron, this secondary emission is made great use of. In other types of valve, for instance, screen-grid valves, secondary emission is for most purposes not an advantage, and steps are taken to eliminate it. These points will be discussed later on.

Secondary electrons do not have any particular direction or velocity. If a positive body is close to the element from which they have been dislodged, they will, of course, be attracted towards this body; but otherwise the secondary electrons leave the anode in all directions and, as in the case of primary electrons emitted by the cathode at low velocity, will be forced back on to their original element. The number of secondary electrons emitted depends to a large extent upon the velocity of the primary electron at the instant of impact with the anode, but is also influenced by the nature of the surface of this electrode and by any particles that happen to be on it.

Shot Effect. Although the electron flow through the valve has a steady *average* value, there are instantaneous fluctuations which are due to the discrete nature of the electrons forming the current. The electrons are emitted from the cathode at random, and each electron represents a charge which, on striking the anode, causes a disturbance there among the other electrons. The net result of this is an excitation of the anode circuit and the development of a disturbing voltage—a “noise” voltage. This phenomenon is known as the shot effect, and the noise generated as the shot noise.

Flicker Effect. This is a fluctuation in current observable in the anode circuit of a thermionic valve and differs from the shot effect in that it is dependent in magnitude upon the nature of the emitting surface. The flicker effect in a valve employing a pure tungsten filament, for example, will not be nearly so great as in one with an oxide-coated cathode. The value of the electronic current flow will also affect the amount of fluctuation due to this effect.

In broadcast receivers the shot and flicker effects do not present serious problems except in high gain receivers where they set a limit to the permissible amplification. The combined effect of these two causes is commonly referred to as *valve noise*.

Bright and Dull Emitters. Bright emitter valves, or valves in which the cathode is heated to a bright heat, usually have tungsten as the cathode material. Tungsten is very robust in operation and can be heated to a very high temperature without noticeable evaporation, but suffers from the serious drawback, so far as broadcast receiver valves are concerned, of having a high work function (4.52 volts) and consequent low emissivity. In order to obtain a satisfactory emission from a tungsten cathode, the temperature has to be raised so high that a heavy drain is made on the source of supply, such as an accumulator. This was, indeed, one of the serious drawbacks to the early broadcast receivers. Valves often consumed just under one ampere of current each, as against many a modern battery valve's consumption of only about one-tenth of that figure.

Dull emitter valves, or valves that are operated with the cathode at a dull red heat, have cathodes made of a substance of low work function. There are two main types of dull emitter cathodes, namely, thoriated and oxide-coated.

Thoriated Cathodes. Thoriated cathodes are composed of an alloy of thorium (work function 3.35 volts) and tungsten. It is found that although the fusing point of pure thorium is $2\ 118^{\circ}\text{K.}$,* if a small amount, say 1.5 per cent by weight, is mixed with tungsten, it can be worked at temperatures up to $2\ 250^{\circ}\text{K.}$ without harmful effects. At temperatures as low as $1\ 500^{\circ}\text{K.}$ this thoriated tungsten cathode will give sufficient emission to operate a valve satisfactorily. The emission of a thorium-tungsten cathode at $2\ 000^{\circ}\text{K.}$ is one thousand times that of a tungsten filament at the same temperature and is as much at $1\ 380^{\circ}\text{K.}$ as that of a tungsten filament at $2\ 000^{\circ}\text{K.}$ At a normal operating temperature of $1\ 850^{\circ}\text{K.}$ thorium-tungsten has an emissivity of 700 mA. per cm.^2 of cathode surface. It can thus be seen how much more economical in cathode

* K. indicates degrees Kelvin, i.e. degrees centigrade beginning at $- 273^{\circ}$ approximately.

heating power it is to use thoriated cathodes instead of tungsten.

In operation, when the cathode is heated, atoms of thorium are pushed out from the core to the surface of the wire. There they form a layer one atom thick of pure thorium, and from this layer a profuse emission of electrons takes place. Evaporation of atoms at the surface of the cathode is instantly made good by further atoms coming out from the centre of the cathode. This process of evaporation and replacement of atoms goes on in orderly manner for several thousands of hours so long as the cathode is not heated to too high a temperature. If overheating takes place, the evaporation of thorium atoms is accelerated to such an extent that the atoms are not permitted to remain on the surface and emit electrons but are immediately evaporated. Under these conditions the cathode is in effect a tungsten wire and as such will be a comparatively poor emitter. It is very harmful to the life of a thoriated cathode, therefore, to raise its temperature too high.

Oxide-coated Filament. This is a very old type of cathode, and was used in one form as early as 1904 by Wehnelt. It comprises a layer of the oxides of the alkaline earth metals, such as barium and strontium, on a core of refractory metal. No gain in emissivity is effected by mixing these oxides, which have a similar value of work function (2.3 volts), but it is found that the adhesion of barium to the core material, when applied as a paste, is greatly improved if strontium is added to it. Furthermore, longer cathode life is given by a mixture of these two oxides than by barium alone. In practice the mixture consists usually of three parts of barium to two of strontium, and will give an emission equal to that of tungsten at an expenditure of only one-tenth the heating power.

There are various methods of forming the oxide coating on the core. One process is to cause, in a vacuum, a deposit to be formed on the oxidized metal core from vapour of barium, and in another method of manufacture the oxides are applied to the core in the form of a number of thin layers of paraffin paste containing the compound, each layer being separately baked on. In each case, the object aimed at is to produce an even layer that will give similar results in different valves. The operation of an oxide-coated filament is seriously affected

by even small irregularities in the coating, and it is important that the cohesion of the coating be good enough to prevent small pieces breaking off.

The emissivity of a barium oxide cathode produced by the vapour process, when operated at a temperature of $1\ 000^{\circ}$ K. is 500 to 600 mA. per cm.^2 , and of a barium-strontium paste cathode operated at 850° K., 500 mA. per cm.^2 . It will be noted that the paste type of cathode supplies the required emission at a lower temperature than one produced by the vapour process.

A wide application for this type of cathode is seen in the indirectly heated valve commonly used in mains receivers. Here the cathode is not in the form of a filament but is a cylinder, closed at one end, of very small diameter (see Fig. 4). This lends itself more easily to the formation of an oxide coating than does a filament of wire. The thoriated tungsten cathode would be very difficult to form on an indirectly heated cylinder owing to the nature of the thorium surface layer.

Gettering. For satisfactory operation of thoriated tungsten and oxide-coated cathodes, a high vacuum is necessary. This is because any residual gases, notably water vapour, nitrogen and oxygen, will seriously limit the emission by spoiling the surface layer. This disadvantage is largely overcome by the process known as *gettering*, in which a highly oxidizable substance is volatilized inside the exhausted bulb and absorbs the residual gases, after every precaution has been taken to produce a good vacuum during the manufacturing process.

It is an unfortunate fact that no matter what precautions are taken to ensure a gas-free enclosure for the valve electrode system, there will always be a certain quantity of gas liberated during the operation of the valve. Gas molecules are invariably occluded by the metal parts within the envelope and do not come out until these parts are heated during operation of the valve. In addition to this, the glass bulb itself gives off gases, mostly water vapour, as its temperature is raised. The amount of gas liberated by the bulb is influenced by the temperature it reaches. Although heated to a certain temperature and held at that level until no further liberation of gases takes place, more gas will be released by the bulb if the temperature is raised to a higher level.

For the successful operation of a getter it is thus necessary first to—

(1) Remove gases from the electrodes by a cleaning process and subsequent heating; and

(2) Drive out the gases from the glass envelope by heating to a temperature higher than that likely to be reached by the envelope during the normal operation of the valve.

These processes are, in fact, performed before the *getter*, as the substance used for gettering is called, is volatilized. The envelope is baked in an oven and the electrode system is heated by the application of a high-frequency magnetic field. The principle of heating in this way is the same as that of a high-frequency furnace. When the heat induced into the electrode system has reached a predetermined level, the getter substance is "flashed" and evaporates and is thus deposited on to the inside of the bulb. Here it forms an impervious layer to any further gas that is released by the envelope. At the same time any residual gas in the space surrounding the electrodes will be absorbed by the getter vapour. So long as the gases released during the operation of the valve are not excessive they will continue to be absorbed by the getter film on the inner wall of the glass bulb.

In practice the substance used for gettering takes the form of a pellet and is placed either on a separate small plate supported by a wire from the stem of the valve, or is fixed temporarily on the outermost electrode, usually the anode. A large number of substances are suitable for gettering, including barium, strontium, and magnesium.

The layer on the glass envelope due to the getter action is usually a poor radiator of heat. If, therefore, the bulb were completely covered by the getter material, the glass would tend to heat up unduly when the valve happened to be handling a heavy load and the anode became very hot. This would tend to neutralize the advantage of having a getter, for the gas given off by the glass bulb when heated to an abnormally high temperature would not all be absorbed by the getter material. Furthermore, some valves have an electrode connected by a lead to the top of the bulb. Indiscriminate gettering would couple this lead to others in the envelope and so set up serious interaction.

Introduction of Control Grid. It has been shown that the effect of the space charge on electrons emerging from the cathode is to repel them in a direction towards the cathode. The retarding influence of the space charge was seen to be effective until the electrons reached the "neutral zone" where the resultant of the opposing forces due to space charge and anode electric field was zero. It is clear, then, that if some means were available to neutralize the retarding effect of the space charge, a much greater number of electrons would reach the anode. Since the space charge is negative in sign, such a neutralizing means must be positive.

The means adopted to control the effect of the space charge in thermionic valves is to insert a grid electrode between the cathode and anode. The most favourable position for this controlling grid will be as close to the source of electron current as possible, for the electron density is greatest at a point infinitely close to the cathode surface. If the third electrode is made positive in polarity, say by means of a bias battery, the electrons emerging from the cathode will be attracted by it, and, if the formation of the grid is such that the electrons can continue their journey to the anode, these will be accelerated. The large number of electrons that normally leave the cathode and do not possess sufficient velocity to reach the anode, will, if the positive grid is suitably arranged, be given an impulse in velocity and thereby enabled to reach the anode. It is thus seen that the use of a positive grid close to the cathode is to increase greatly the anode current of a thermionic valve.

A grid for the purpose described above, known as a *space charge* grid, will have to be perforated sufficiently to allow the electrons to pass through to the anode. Spirals of wire make effective and convenient grid electrodes, and the pitch of the spiral (i.e. the distance between consecutive turns) will determine its effectiveness on the cathode emission. Space charge grid valves are not used in radio reception, but are mentioned here to lead up to the description of the working of a normal control grid in thermionic technique.

Since a positive grid, situated in close proximity to the electron emitter, will accelerate the electrons in their passage towards the anode, it follows that the converse must also

apply; i.e. that a negative grid will retard the electrons and reduce the net number of electrons reaching the anode. Further, if this grid is made first positive and then negative, it will alternately accelerate and retard the electron flow and thus produce an increase and then a decrease in anode current flow. In other words, the actual electron current will be dependent upon the polarity of the grid. Such a grid is therefore termed a *control grid*, for it controls the amount of anode current.

When the control grid is negative it will screen the cathode from the effect of the electric field sent out by the highly positive anode. The degree of screening effected by the grid at a given negative voltage will be dependent upon the pitch, if the grid is a spiral of wire, or upon the mesh if it is in the form of a wire netting.

For general receiver valves a spiral of wire is used as the grid, and for transmitter valves a wire netting. If the grid has its constituent wires close together and is given a high negative bias, it will stop all electrons from flowing to the anode and will thus completely screen the cathode from the anode field. The effect of screening exercised by the grid of a given pitch or mesh is clearly dependent upon the negative voltage or bias applied to it, and the anode current will decrease as the grid bias is increased.

Curves that are typical of the control effected by a grid in a triode are shown in Fig. 7, where the abscissae represent grid voltage and the ordinates anode current. This kind of curve is known as the *grid voltage-anode current* characteristic. Starting at the bottom horizontal line representing zero anode current on the smallest curve, the anode current is seen to increase rather gradually at first as the grid bias is reduced. At point P_1 the anode current begins to increase more rapidly with reduced grid bias and after this point is passed the anode current increases rapidly and linearly with the reduction in

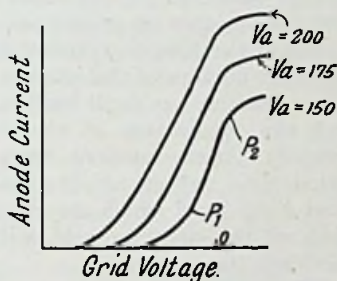

FIG. 7. TYPICAL ANODE CURRENT-GRID VOLTAGE CHARACTERISTICS OF A TRIODE

grid negative voltage. When P_2 has been reached the increase in anode current with decrease in grid bias slows down until saturation occurs as in the case of the diode.

The particular point of the characteristic curve at which a valve is required to be worked, known as the *representative* or *working* point, is determined solely by the circuit arrangement in which the valve is used. For one kind of detection, the grid is biased to P_1 , for another kind of detection the valve is worked at zero or even positive grid voltage, and for some types of amplification the working point is at the centre of the straight portion of the characteristic between P_1 and P_2 . All these matters are dealt with in the respective chapters outlining the application of thermionic valves to radio receiver circuits. At the moment, the point to be emphasized is that a triode grid voltage-anode current characteristic has a bottom and a top bend which are often referred to as the *foot* and the *knee* of the characteristic, with a straight portion extending between these bends.

The additional curves seen in Fig. 7 illustrate the effect of increasing the anode voltage. As this voltage is made higher, the characteristic curve is moved to the left almost in its entirety, and its knee is shifted farther away from the foot. This means, in effect, that as the anode voltage of a triode is increased (up to the maximum stated by the manufacturers, of course) the anode current at a given grid bias is increased and at the same time the linear portion of the curve is lengthened. This latter point is of particular importance for amplifier valves, in which the straight portion is required to be as long as possible.

A number of ratios can be worked out from the curves of Fig. 7. The actual values of these ratios have a profound influence on the working of any particular valve, and upon them depends the suitability of a valve for any given circuit or function. These are described in the next chapter.

CHAPTER II

FUNDAMENTAL VALVE CHARACTERISTICS

In this chapter are described typical characteristic curves relating to the working of the most commonly used types of thermionic valve. Such curves are not intended to convey a complete explanation of the working of the valves, but only the basic idea underlying the particular application referred to herein. The actual operation of the valves and the practical significance of these curves are outlined later.

Triode. An outline of the effect of inserting a grid between the cathode and anode has already been given, and it remains now to examine more exactly the influence of this grid on the working of the triode or three electrode valve.

In Fig. 8 are seen a family of anode current-grid voltage curves relating to the Cossor 210 DET receiving valve. These curves of characteristics are not extended into the regions of positive grid current because, in practical radio reception, the valve is never worked under such conditions for reasons that

will be considered a little later. Were these curves extended up to the saturation point, the shapes would be similar to those of the curves given in Fig. 7. In most modern valves, however, the cathode emitting surface is damaged before the saturation point of the anode current-grid voltage characteristic is reached.

Each of the curves in Fig. 8 has a bottom bend and a rectilinear portion. When only 75 volts are applied to the anode, the straight part of the curve (up to zero grid volts) is quite short. As the anode voltage is increased, this straight portion increases in length until, at 150 anode volts, it extends over approximately 7 mA. of anode current variation. So long

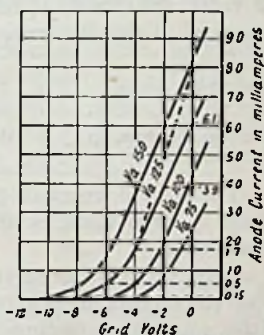

FIG. 8. ACTUAL CURVES OF A TRIODE, SHOWING METHOD OF CALCULATING MUTUAL CONDUCTANCE

as the grid voltage is such that the straight part of the curve is not departed from, therefore, the anode current will increase in direct proportion to the anode voltage, and the relation between anode voltage and current is linear as in ordinary direct current circuits obeying Ohm's law. It should be noted that the straight parts of all the curves are parallel, indicating that the conditions governing the flow of anode current are similar under all conditions of anode voltage.

Mutual Conductance. Consider now the precise effect of varying the grid voltage. With 125 volts on the anode, as the negative grid bias is reduced from 8 volts to zero in steps of 2 volts, the anode current increases in the following way, as marked in the illustration—

Grid bias, volts	- 8	- 6	- 4	- 2	0
Anode Current, mA.	0.15	0.5	1.7	3.9	6.1

The anode current variation as the grid bias is reduced from 4 to 0 volts is linear, but between 8 and 4 volts it is non-linear.

The point to be particularly noticed is that the voltage on one electrode (the grid) controls the current flowing to another (the anode) according to a definite relation over a certain voltage (- 4 to 0 volts). During this current variation (1.7 to 6.1 mA.) the anode voltage is constant. There is, therefore, a mutual relationship between grid voltage and anode current, whereby the conductance—or the capability to conduct electric current—of the anode is controlled. This mutual relation is known as the *mutual conductance* of the valve, which is defined as the ratio of the change in current in the anode circuit to the change in grid voltage producing it. Mutual conductance is measured in milliamperes of change in anode current per unit change in grid voltage, or more briefly milliamperes per volt (mA./V.). A smaller unit is the *micromho*, one micromho being a mutual conductance of one-millionth of an ampere per volt (the symbol being $\mu\text{A./V.}$). From the figures already given, the mutual conductance is seen to vary along the characteristic curve, being constant along the linear portion but varying along the curvilinear part.

The symbol for mutual conductance is g and, expressed as an equation,

$$g_m = di_a/dV_g \text{ with } V_a \text{ constant}$$

where d means "small change of," i_a is the anode current, V_g is grid voltage and V_a is anode voltage. As the curves in Fig. 8 represent all three factors determining the mutual conductance, it is possible to find this out from the characteristic curves supplied by manufacturers of radio valves. The procedure is as follows: along one curve take two values of anode current, note the corresponding values of grid bias at which the anode current values were taken, subtract the lower from the higher in both cases and then divide the anode current by the grid voltage.

An example of doing this can be worked out from the figure. The two anode currents to be taken are on the $V_a = 125$ curve at the points corresponding to 6.1 and 1.7 mA., while the corresponding grid-bias voltages are at -4 and 0 volts. Mutual conductance in milliamperes per volt is, therefore, given by

$$g_m = \frac{i_{a1} - i_{a2}}{V_{g2} - V_{g1}} = \frac{6.1 - 1.7}{4 - 0} = \frac{4.4}{4} = 1.1$$

This means that a variation of one volt applied to the grid produces an alteration of 1.1 mA. of anode current. If any other of the family of curves is chosen for deducing the mutual conductance of the valve represented by the characteristics of Fig. 8, the result will be always the same so long as the measurements are confined to the linear part of the curves.

Now suppose the curves had a steeper slope with respect to the grid voltage axis and were of form shown with a dotted line. The equation for mutual conductance would then be

$$g_m = \frac{i_{a1} - i_{a2}}{V_{g2} - V_{g1}} = \frac{8.0 - 1.7}{4 - 0} = \frac{6.3}{4} = 1.575 \text{ mA./V.}$$

It is thus evident that the steeper the slope of the i_a/V_g characteristic now being considered, the higher will be the mutual conductance. This is of very great importance in valve technique. Modern valves show an improvement over the older types, and this is most marked in regard to the slope of the i_a/V_g curve. Obviously, the higher the mutual conductance

of a valve, the greater will be the variation in anode current for any given signal voltage impressed upon the grid controlling it. In other words, the steeper the slope of the i_a/V_g characteristic, the greater is the amplification obtainable with the valve concerned.

This characteristic is frequently referred to as the *mutual conductance characteristic*.

Amplification Factor. An examination of the curves in Fig. 9, which are the same as those of Fig. 8, will show that a change of anode current can be effected by altering either the anode voltage or the grid voltage. For example, if the valve is working with 150 volts applied to the anode and 2 volts negative potential on the grid, the working point on the characteristic will be P_1 and 5.9 mA. of anode current will flow. If only 3.9 mA. of current are re-

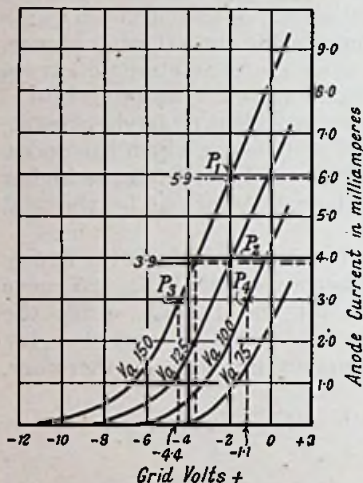

FIG. 9. ILLUSTRATING THE METHOD OF CALCULATING AMPLIFICATION FACTOR

quired, there are two ways of bringing about the necessary reduction. Either the grid bias may be increased to 3.6 volts negative as indicated by the broken line, the full 150 volts still being applied to the anode; or the grid bias may be maintained at 2 volts negative while the anode voltage is reduced to 125 volts. In the latter case, the next lower curve to the one corresponding to 150 anode volts will be worked upon at the point marked P_2 , which corresponds to an anode current flow of 3.9 mA. as required.

There is an amplifying effect produced by the change in grid volts, for an alteration of 1.6 grid volts (i.e. from -2 to -3.6 volts) produces exactly the same variation in anode current as an alteration of 25 anode volts (i.e. from 150 to 125 volts). This effect is termed the *amplification factor* of the

valve, the measure of this being the ratio of the change in anode voltage to the change in grid voltage to effect a given alteration in anode current, and may be expressed as

$$\mu = dV_a/dV_g \text{ for a given } di_a,$$

where μ is the amplification factor, d means "small change of," V_a is anode voltage, V_g is grid voltage and i_a is anode current.

Another way to express the amplification factor is, using the same symbols as above,

$$\mu = dV_a/dV_g \text{ at constant } i_a.$$

In this expression the anode current is assumed constant, and the ratio of anode voltage variations to grid voltage variations while maintaining this constant anode current is the amplification factor. This gives exactly the same result as taking the ratio of alteration in anode voltage to the change in grid voltage necessary to effect a given variation in anode current, but it is expressed in a more scientific manner.

In the example already mentioned, where the anode current was reduced from 5.9 mA. to 3.9 mA. by—

- (1) reducing the anode potential from 150 to 125 volts,
- (2) increasing the grid bias from -2 to -3.6 volts,

the amplification factor is

$$\mu = \frac{dV_a}{dV_g} \text{ for given } di_a = \frac{150 - 125}{3.6 - 2} = \frac{25}{1.6} = 15.$$

Now following out the procedure indicated by the second expression for amplification factor, i.e. maintaining a constant current through a variation of anode voltage with a compensating alteration in grid bias, we have the data given below.

Let the required constant current be 3 mA. This current can be obtained by operating the valve on the point P_3 of the 150-volt characteristic, in which case the grid bias is 4.4 volts. The same anode current (3 mA.) can also be produced by working on the 100 anode volts characteristic at the point P_4 with -1.1 grid voltage. Under these conditions the amplification factor is

$$\mu = \frac{V_{a1} - V_{a2}}{V_{g1} - V_{g2}} = \frac{150 - 100}{4.4 - 1.1} = \frac{50}{3.3} = 15$$

which is the same as given by the previous example. Any

other points on the *linear* portion of the curves can be chosen for finding the amplification factor, of course. Still considering the 3 mA. of anode current, for example, the 125 anode voltage curve can be taken, operated at the point corresponding to — 2.8 volts on the grid. This gives

$$\mu = \frac{V_{a1} - V_{a2}}{V_{g1} - V_{g2}} = \frac{150 - 125}{4.4 - 2.8} = \frac{25}{1.6} = 15$$

as before.

The amplification factor of any particular type of valve depends upon the geometrical arrangement of the electrodes. With a cylindrical arrangement of electrodes and where the grid wires have a diameter that is small in comparison to the spacing, which is usually so in practice

$$\mu = \frac{2 n \cdot s}{\log \left(\frac{1}{2} n \cdot r \right)}$$

where n is the number of grid wires per centimetre (length), s is the anode-grid distance in centimetres and r is the radius of the grid in centimetres. It is clear from this expression that the amplification factor increases with the number of grid wires per unit length and also as the distance between anode and grid is increased. The amplification factor is, however, inversely proportional to the radius of the grid.

Anode A.C. Resistance. A change in anode current has been shown to result from a change in the anode voltage. Some valve manufacturers use the term impedance to describe this relation, but this is not entirely satisfactory because impedance as generally used is dependent upon frequency. A better term is anode a.c. resistance, because the relation is obtained under static conditions. The anode a.c. resistance of a valve is equal to a small change in anode voltage divided by the resultant change in anode current, the grid voltage being kept constant. It should be noted that although the anode a.c. resistance is measured under static operating conditions, it is the *change* in anode voltage and current that determine this constant of the valve. This should be distinguished from the d.c. resistance offered by the valve to the source of h.t. supply, which is equal to the anode d.c. voltage divided by the anode d.c. current and does not always correspond to the anode a.c. resistance.

According to Ohm's law, resistance is equal to the voltage divided by the current. This implies a linear function. It has already been observed that part of the i_a/V_a characteristic is linear in form, and it is therefore reasonable to suppose that along this part of the curve Ohm's law will be obeyed. This is, in fact, the case, and it only remains to show how the anode a.c. resistance may be deduced from the usual family of curves applicable to the radio triode.

The curves relating to this particular valve are again reproduced in Fig. 10. As the a.c. resistance of the valve is a function of anode current and anode voltage, the grid voltage has to be maintained constant in this calculation. To find the anode a.c. resistance of the valve, take two values of anode voltage and the two corresponding values of anode current at one value of grid bias. Divide the difference of anode voltage by the difference of anode current in milliamperes $\times 1000$ and the quotient will be the

resistance of the valve in ohms. For example, in Fig. 10, two values of anode voltage are marked P_1 and P_2 on the 150 volts and the 100 volts curves respectively, both points being on that part of the curves corresponding to -2 volts grid bias. The anode currents indicated at these points are 5.9 mA. and 1.9 mA. respectively. From these figures we obtain

$$\begin{aligned} R_a &= \frac{dV_a}{di_a} = \frac{V_{a1} - V_{a2}}{i_{a1} - i_{a2}} \\ &= \frac{150 - 100}{(5.9 - 1.9)/1000} = \frac{50 \times 1000}{4} = 12500 \text{ ohms} \end{aligned}$$

ere R_a is the anode a.c. resistance.

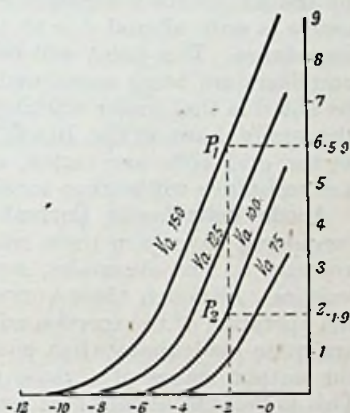

FIG. 10. SHOWING THE METHOD OF CALCULATING THE ANODE A.C. RESISTANCE

It is important to notice that the anode a.c. resistance or R_a has been calculated at a constant value of grid voltage. In point of fact, the grid voltage will be a continuously varying one when the valve is being used in radio reception, under which conditions the incoming signal voltage is applied to the grid. The anode resistance, therefore, varies considerably under working conditions, when the anode voltage supplied by the h.t. source is constant and the voltage actually on the anode is only altered due to the drop along the anode load impedance. This point will be examined more closely when amplifiers are being considered. At the moment, the fact to be noted is that under working conditions, one curve only of the family shown in Fig. 10 will be operated on. Consequently, as the grid volts are varied, say from 0 to -2 , the anode a.c. resistance will change considerably.

Anode Volts-Anode Current Curves. The curves so far considered have been those relating to the triode with static voltages on the electrodes, and are known as *static characteristics*. Although these curves are very useful in enabling the operation of the corresponding valves to be assessed, they are quite inadequate when power valves of the type used in the output stages of a radio receiver are being considered. This is because under these conditions the main requirement is power in the anode circuit, as distinct from voltage amplification.

Under operating conditions, the voltages on the electrodes are not static but are dynamic. Owing to the fluctuating signal voltages impressed on the grid, the electron current flowing to the anode will vary. The circuit connected to the anode has a certain amount of resistance, and, since a current flow along a resistance produces a voltage drop, the potential actually on the anode at any instant must be equal to the voltage of the high-tension supply less the voltage drop down the anode circuit resistance. The fluctuating anode current caused by the signal voltages applied to the grid therefore produces similar fluctuations in anode potential.

One consequence of the variations in anode potential is that the grid voltage fluctuations will not bring about the changes in anode current indicated by the grid voltage-anode current curves. Although the departure from these curves is not

serious in many cases—in high-frequency valves, for example—in the case of output power valves these curves have been discarded by the valve manufacturers as being of little value. In their place, curves representing anode voltage and anode current at given values of grid voltage are published. By means of these curves it is possible to obtain a much clearer idea of the working of any particular valve, and also to be able to work out the best load resistance for minimum distortion.

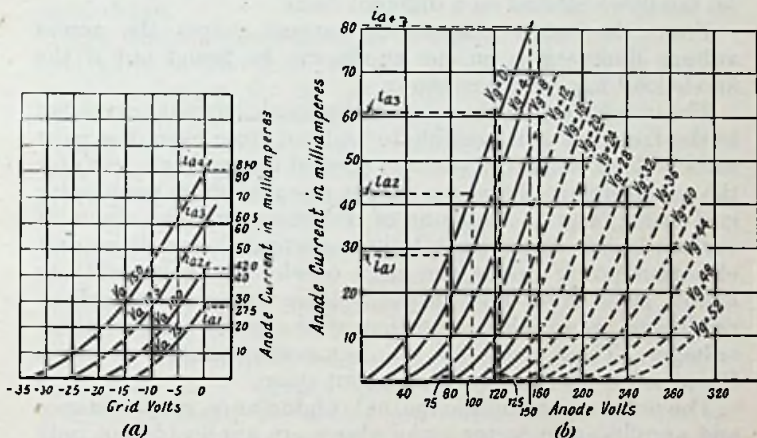

FIG. 11. COMPARISON OF TWO SETS OF VALVE CHARACTERISTICS

The anode voltage-anode current characteristics can be easily plotted from the grid voltage-anode current family of curves. In Fig. 11, for example, both families of curves relating to a small power valve are plotted for comparison. Taking first of all the grid volts-anode current curve at zero grid bias, it is seen from the (a) family, that the zero grid voltage ordinate cuts the curves corresponding to 75, 100, 125 and 150 volts at the points marked i_{a1} , i_{a2} , i_{a3} , i_{a4} representing anode currents of approximately 27.5, 42.0, 60.5, and 81 mA. respectively.

Now referring to the anode voltage-anode current curve for zero grid volts, the corresponding anode currents at 75, 100, 125, and 150 anode volts are marked i_{a1} , i_{a2} , i_{a3} , and i_{a4}

respectively, and these values are seen to be the same as the values of anode current at which the (a) family of curves cut the zero grid voltage line. In a similar way, the anode currents corresponding to the points at which the -4 volt ordinate cuts the 75, 100, 125, and 150 volt grid voltage-anode current curves, are seen to lie on the anode volts-anode current curve for -4 grid volts at the corresponding points. It is thus evident that the (b) family of curves is in reality the (a) family re-plotted on a different basis.

From the anode volts-anode current curves the actual voltage fluctuations on the anode can be found out if the anode load impedance is known.

The importance of the anode volts-anode current curves lies in the fact that it is possible to find out from them the most suitable load resistance (usually termed the *optimum load*) for the anode circuit, the power output, the maximum permissible grid swing, and the amount of distortion brought about at various loads. These are vitally important factors in respect of output power valves, the merit of which is their ability to handle large input and output voltage fluctuations without producing appreciable distortion of the wave form of these voltages. These questions are discussed in greater detail in Chapter VI, dealing with the output stage.

The notes regarding the mutual conductance, a.c. resistance and amplification factor given above are applicable not only to the triode, but also to the multi-electrode valves discussed below.

Screen-grid Valve. The screen-grid valve or *tetrode* has, in addition to the three electrodes of the triode, a grid between the control grid and anode. This extra grid is maintained at a positive potential that is high relative to the cathode. As the screen grid is either a helical wire of small pitch or is composed of a comparatively fine mesh wire netting, it has the effect of shielding the grid from the electrostatic field of the anode. It thus reduces the capacitance normally existing between the control grid and anode of a triode. The tetrode was, in fact, developed for the express purpose of eliminating the serious effects of the inherent capacitance between control grid and anode which imposed a narrow limit on the permissible high-frequency amplification with triode valves. In

average triode h.f. valves the grid-anode capacitance is $5 \mu\mu\text{F.}$, whereas in tetrodes this is reduced to the small value of about $0.001 \mu\mu\text{F.}$

Other very desirable features for radio receiver valves are obtained by inserting the shielding grid. These are, greatly increased anode a.c. resistance and amplification factor. In the chapter on high frequency amplification, these features of the screen-grid valve are examined in some detail.

The electrode formation of a screen-grid valve is seen from Fig. 12. Owing to the necessity for the screen grid to allow electrons to pass, it cannot be a perfect electrostatic screen. At the same time, its interposition between control grid and anode prevents the positive voltage on the latter from having much influence on the electron stream emerging from the cathode. The actual space current is, in fact, determined mainly by the steady voltage of the screen grid which in this respect acts similarly to the anode of a triode. Owing to its positive potential, the screen grid collects electrons from the stream passing through on its way to the anode. As this electron stream is modulated by the control grid, the electrons collected by the screen grid will produce an alternating current similar in wave form to that set up in the anode circuit. In order that the screen grid shall play its part as an electrostatic screen, therefore, it is essential in r.f. and i.f. amplifiers that this current be given a low impedance path back to earth or cathode so that the screen is maintained at earth or cathode a.c. potential. This is effected by joining a non-inductive condenser of suitable capacitance (say $0.1 \mu\text{F.}$ to $0.5 \mu\text{F.}$ for broadcast carrier frequencies) between screen grid and cathode. For the satisfactory operation of the screen-grid valve, this condenser, known as the *screen-grid decoupling* condenser, should be situated as close to the screen grid and cathode terminals as possible. Owing to this by-passing of part of the modulated space current, i.e. the signal current, the mutual

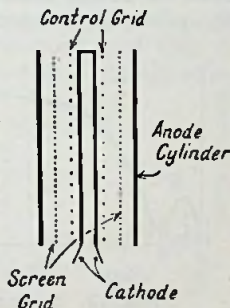

FIG. 12. ELECTRODE FORMATION OF SCREEN-GRID VALVE

conductance of the screen-grid valve is less than that of a comparable triode, although by careful design the difference may be made small—say 10 per cent.

The anode voltage-anode current curve of a screen-grid valve is very dissimilar to that of a triode, as can be seen from Fig. 13. This is due to the proximity of the highly positive screen grid to the anode, the screen grid acting as a collector of the secondary electrons knocked off the anode by the primary electrons shooting through the screen grid and striking the anode at high velocity.

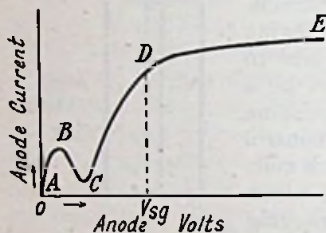

FIG. 13. TYPICAL CHARACTERISTIC CURVE OF A SCREEN-GRID VALVE

It should be noted that as the screen grid-anode space is some distance from the cathode there will be a negligible space charge there, and nothing to retard the passage of the electrons on their way to the anode. Once the secondary electrons have been liberated by the impact of the primary electrons they will go to the most positive body within easy reach. If, therefore, the screen grid happens to be at any particular time more positive than the anode itself, these secondary electrons will be attracted towards it and the anode will be deprived of its electrons. If, however, the anode is at a sufficiently high positive voltage, any secondary electrons that are released from it will be immediately attracted back and will not be influenced by the field of the screen grid.

As the anode voltage is increased from zero the current in the anode circuit rises first from A to B in the curve of Fig. 13. Up to this point the attractive force of the anode on the primary electrons is not sufficiently great to give them a velocity high enough to enable them to dislodge secondary electrons. The anode attains this attractive power at the voltage corresponding to the bend in the curve at B. As the anode potential is still further increased, therefore, the primary electrons are attracted to the anode with greater force and their velocity becomes high enough to liberate secondary electrons. A number of these secondary electrons

are attracted to the positive screen grid which is held at the d.c. potential indicated at V_{sg} . The net effect is a reduction in electrons on the anode, and thus a falling characteristic represents the action at the anode. At C a point is reached where, as the anode voltage approaches that of the screen grid, its attractive force on the secondary electrons is noticeable by a reduced negative slope until, as the anode potential is raised, the curve begins once more to move upwards. This indicates that the anode is attracting more electrons than it is losing. Up to point D the slope is very steep, and then it bends over and runs almost parallel with the anode voltage axis.

When the screen-grid valve is worked on that part of its characteristic curve lying between B and C the anode circuit offers a negative resistance, i.e. an increase in voltage produces a decrease in current. This means that the valve will generate oscillations. In radio receivers, the screen-grid valve is not used for this purpose. It is generally employed as a high-frequency amplifier and is operated on that portion of its characteristic between D and E . Later in this chapter the output tetrode, which is a modified screen grid valve, is described for use in a.f. amplifiers and output stages. From the foregoing it will be seen that the internal resistance of the screen-grid valve will decrease as the anode voltage approaches that of the screen grid, falling rapidly at the point where the i_a/V_a characteristic begins to slope away from the straight portion. This is shown by the curves in Fig. 14, which are in respect of different values of control grid voltage. All these curves show a low resistance at the anode voltage that equals the screen-grid voltage. It will also be noted that as the control grid bias increases, so does the internal resistance of the valve, and that the curve in respect of the maximum grid bias (-3.0 volts) with this particular specimen is far steeper than the curves corresponding to lower values of bias voltage.

Another family of curves relating to the screen-grid valve is

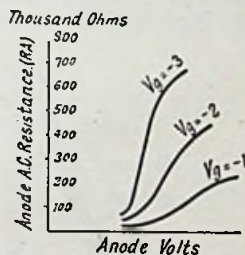

FIG. 14. ANODE A.C. RESISTANCE CURVES OF A SCREEN-GRID VALVE

shown in Fig. 15. These characteristics represent the relation between anode current and control grid voltage—the factors that control the mutual conductance. The three curves given in the figure are very similar in shape to those relating to a triode and indicate that the mutual conductance is controlled by the voltage on the control grid just as in the case of the triode. An important point to note in regard to these curves, however, is the small effect the alteration in anode voltage has on the position of the corresponding curve in comparison to a similar alteration applied to a triode. A variation in potential of from 150 volts to 200 volts on the anode displaces the characteristic curve only slightly to the left. This indicates the high anode a.c. resistance of the valve. Calculating the resistance from the expression

$$R_a = \frac{V_{a1} - V_{a2}}{i_{a1} - i_{a2}}$$

in respect of points p_1 and p_2 , we get

$$R_a = \frac{200 - 100}{\frac{3 - 2.5}{1000}} = 200\,000 \text{ ohms.}$$

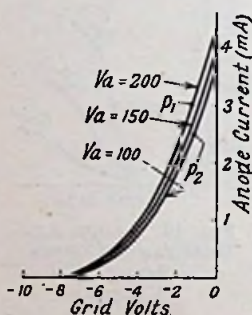

FIG. 15. MUTUAL CONDUCTANCE CURVES OF SCREEN-GRID VALVE

The very high resistance possessed by the screen-grid valve is caused by the shielding effect of the auxiliary grid. Owing to this shielding, the anode voltage has only a slight influence on the electron stream. In fact,

at the cathode itself, the anode field has little or no influence, the deciding factors on the emitted electron stream being the screen-grid voltage and the control grid voltage. The more perfect the shielding due to the screen grid, the less is the effect of the anode on the electron stream and consequently the higher is the anode a.c. resistance of the valve.

Relation of Screen Grid and Anode Currents. It has been shown that when the anode of a screen-grid valve is at a lower potential than the screen grid, secondary emission takes place from anode to screen grid. In addition to the secondary emission that is attracted to the screen grid, a certain number

of primary electrons will be drawn from their cathode-anode path and finally impinge on the screen grid. This is easily understandable since both anode and screen grid are at a high positive potential relative to the cathode, and each contends for its share of the available electron stream.

The net result of having two electrodes that are highly positive with respect to the cathode is that the total electron current is divided between these two electrodes. The cathode emission is substantially constant and the number of electrons reaching the plane of the screen grid depends greatly on the screen-grid potential. As the current to the anode decreases, therefore, the current to the screen grid must increase in almost the same proportion. This state of affairs is illustrated by the curves seen in Fig. 16,

which represent the conditions taking place in a typical screen-grid valve suitable for a.c. mains. The constant potential applied to the screen grid was 60 volts and the control grid bias was -1 volt. Commencing at zero anode volts, the respective screen-grid and anode currents are seen to vary in

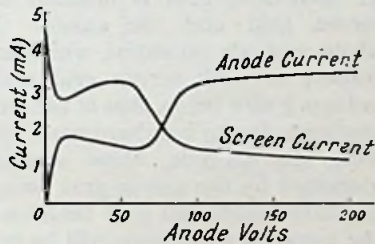

FIG. 16. SHOWING THE RELATION BETWEEN SCREEN-GRID AND ANODE CURRENTS

almost exactly inverse proportion throughout the whole of the scale shown and the total of the two currents remains sensibly constant.

The fact that the screen-grid current increases at the expense of the anode current is not a serious disadvantage so long as the linear part of the curve (i.e. the part of the anode current curve to the right of, say, 100 anode volts) is not departed from during the operation of the valve. Steps will have to be taken to ensure that the anode voltage during operation does not fluctuate too greatly, and, in so doing, depart from the linear part of the curve.

The Pentode. In some high-frequency amplifier stages, the limitation in anode voltage fluctuation that is imposed by the bend in the characteristic curve of Fig. 13, which has been

seen to be due to secondary emission by the anode, is not of serious consequence. This is because the valve is not called upon to handle input voltages high enough to produce the anode voltage variations sufficiently large to operate on the curved part of the characteristic. The output stages, however, have to handle large voltages, and in these stages the bend in the anode voltage-anode current characteristic is a serious limitation to the input voltage that can be applied to the screen-grid valve. If arrangements could be made whereby the kink from *B* to *D* were removed, a considerable increase in the output voltage swing available from the valve would then be obtained.

For the purpose of removing the kink mentioned above, an additional grid is inserted into the valve between the screen grid and the anode. This grid is maintained at about cathode potential, which is considerably negative with respect to both screen grid and anode. When the anode voltage is now below that of the screen grid and emits secondary electrons due to bombardment by the electron stream coming from the cathode, these secondary electrons will not be attracted by the screen grid owing to the interposition of the negative additional grid between it and the anode. In fact, the secondary electrons will be repelled back to the anode by the negative electrode. The loss of electrons from the anode that takes place in a screen-grid valve when the anode voltage falls below that of the screen grid is, therefore, prevented and the kink in the characteristic is removed. The additional grid is called the *suppressor* or *priming* grid.

In Fig. 17 is given a curve showing the relation of the anode voltage and anode current of a pentode, the corresponding curve of a screen-grid valve being given in a dotted line. It is seen that the anode voltage may now fluctuate between *A* and *B* volts without moving off the linear part of the characteristic, whereas with the screen-grid valve, an anode voltage fluctuation between *C* and *B* only is possible. At the same time the low slope of the screen-grid valve curve—indicating a high a. c. resistance—is retained. A similar mutual conductance to the screen-grid valve is also possessed by the pentode, so that in reality the pentode has the advantages of the screen-grid valve without the disadvantages.

The electrode arrangement of an output pentode is seen in Fig. 18. It will be noticed that the pitch of the screen grid is much larger than that for a screen-grid valve, although this would not be the case for a high-frequency pentode in which a high degree of screening is necessary. For the output stage, however, a large electron flow is necessary, and so there has to be plenty of space between individual turns of the grid helix. This point applies with equal force, of course, to the control grid. Both R_a and μ of a power pentode are therefore

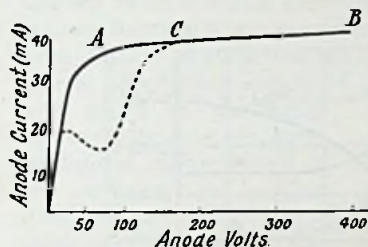

FIG. 17. A PENTODE CHARACTERISTIC (FULL LINE) COMPARED WITH A SCREEN GRID CHARACTERISTIC (BROKEN LINE)

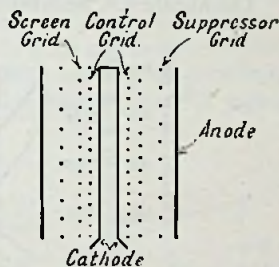

FIG. 18. FORMATION OF ELECTRODES IN A POWER PENTODE

lower than that of an r.f. screen-grid valve. Common values are, for R_a , 10 000 to 80 000 ohms and μ , 80 to 220.

Although the pentode was originally developed for the purpose of providing a sensitive low-frequency power valve, it was soon found to be of value in the radio frequency stages. Owing to its higher anode a.c. resistance than the screen-grid valve, greater selectivity and more amplification can be obtained per stage if a highly efficient tuned circuit is connected in the pentode anode circuit. This is an important additional advantage to the greater signal handling capability. Furthermore, a high-frequency pentode is more stable than a screen-grid valve, and for receivers employing two stages of high-frequency amplification this improved stability facilitates the design. For superheterodyne reception, the pentode was widely used as combined oscillator and first detector until the advent of the modern frequency changers outlined

in Chapter IX. It is employed in some modern super-heterodynes as mixer, with a separate oscillator valve. pentode is also frequently used as a sensitive detector.

The pentode is thus seen to be a valve of great adaptability, and in the chapters that follow the practical considerations regarding its use will be examined.

In Fig. 19 are seen three curves showing how the valve factors in a pentode are affected by alterations of control grid voltage.

The anode a.c. resistance R_a falls rapidly from about 160 000

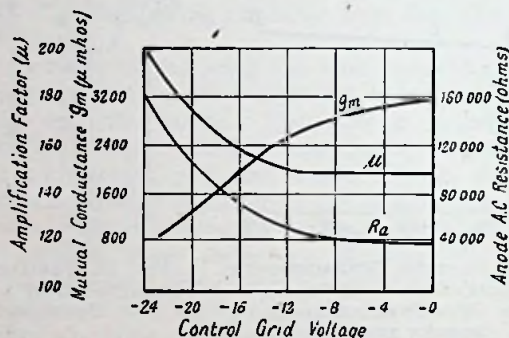

FIG. 19. CURVES RELATING TO A POWER PENTODE

ohms to 50 000 ohms as the grid voltage varies from - 24 volts to - 12 volts, and then falls much more gradually as the grid voltage becomes less negative. The amplification factor μ keeps fairly constant at grid voltages between zero and - 12 volts, while the mutual conductance g_m rises in inverse relation to the anode resistance. These curves relate to a typical output pentode.

Other curves to illustrate the working of a pentode are given in Fig. 20, these being applicable to an h.f. pentode. The plate resistance is much higher in the present case, and is seen to fall from 1.5 M Ω to 0.4 M Ω as the screen-grid voltage is raised from 50 to 150 volts. This is an important point to bear in mind in connexion with the operation of h.f. amplifiers, for it is most desirable that pentodes employed as such should have a high anode a.c. resistance. The curve shows that an

excessive screen voltage is very detrimental in this respect. Mutual conductance is seen to rise with increase of screen voltage, and the amplification factor falls slightly.

Variable- μ Valves. Until a few years ago, radio receiver designers were faced with two serious problems. One was how to devise a volume control that did not distort the incoming signals yet enabled a very wide variation in amplification to be obtained, and the other was how to prevent, or overcome the effects of, modulation distortion. The need for a non-distorting volume control became more apparent as the transmitting radio stations increased their radiation power, for it became necessary in a sensitive receiver to cut down reception from distant stations as well as from nearby transmitters. Unless an efficient means of reducing these powerful signals was fitted in the early stages of the receiver, overloading of either or all of the detector and low-frequency amplifier stages invariably resulted. The usual volume control employed in those times did not bring about the desired reduction in signal voltage, or, if this reduction was effected, distortion in some degree was almost certainly produced.

Cross modulation is a phenomenon that is due to a rectification effect caused

by the curve in the anode current-grid voltage characteristic of valves. This is examined in greater detail in the chapter dealing with h.f. amplification. For the moment it is sufficient to state that with straight, i.e. not variable μ , screen-grid valves, the grid bias can only be increased up to a limited extent, usually not higher than 7 volts and seldom higher than 10 volts. After this bias has been applied, zero current will be approached in the anode circuit. This means that if the incoming signal causes the grid voltage to fluctuate

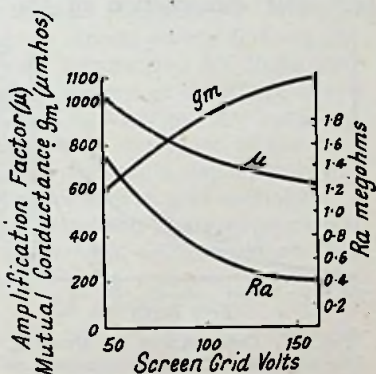

FIG. 20. CURVES RELATIVE TO AN H.F. PENTODE

more than 7, or at the most, 10 volts, no corresponding variation will be produced in the anode current and distortion is thus brought about. The difficulty is one result of not having a satisfactory volume control in the input circuit for if this were fitted and the grid voltage excursions were kept within the permissible grid swing of the valve, no cross modulation would take place.

The valve that was designed to overcome the above drawbacks to the use of sensitive receivers is known as the *variable μ* (or *mu*) valve. This valve is so-called because the effective amplification it provides is variable over a wide range. During such variation in effective amplification, which is brought about by altering the grid-bias voltage and thereby the mutual conductance, no serious distortion is produced owing to the particular construction of the valve that enables a very

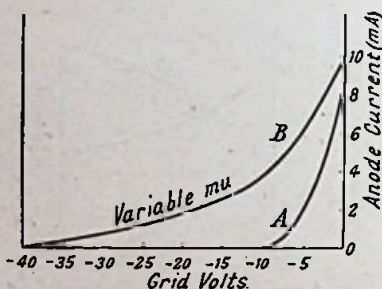

FIG. 21. COMPARISON OF MUTUAL CONDUCTANCE CHARACTERISTICS OF A VARIABLE-MU VALVE AND A STRAIGHT SCREEN-GRID VALVE

gradual cut-off of anode current to be obtained instead of a sharp one as with other valves.

Characteristic curves of a typical screen-grid valve without the variable- μ construction and one with it, are shown in Fig. 21. Curve A is similar to those already considered in connexion with triode and screen-grid valves. Anode current cut-off is seen to take place at 10 volts negative grid bias. This means

that the maximum permissible grid swing is 10 volts—5 volts for each half-cycle—and this will be easily surpassed by a strong signal. On the other curve, the anode current is reduced very gradually, enabling the input-grid to handle up to 40 volts before anode current cut-off is effected. The grid swing is not only more than trebled, but the comparatively sharp bottom bend in the characteristic is replaced by a rounded bend of large curvature. It is thus clear that effective volume control over a wide range is obtainable with

variable- μ valves and the cause of cross modulation is largely removed.

The greatly improved characteristic (from the particular points of view being discussed here) is due to the simple expedient of varying the pitch of the controlling grid along the length of the cathode. It has already been seen that the degree of control over the anode current exercised by a grid situated close to the cathode is influenced very considerably by the pitch of the wires forming the grid helix, or the mesh if a wire netting is used as grid element. The closer the grid wires are placed together, the greater will be the control exercised by the grid, and with this, the mutual conductance of the valve. If, therefore, one section of the wires forming the grid were spaced differently to those of another part, the degree of control and thus the mutual conductance would be different on the portions of cathode stream emerging from the respective lengths of the cathode surrounded by these two grid sections. The resultant anode current-grid voltage curve would therefore be a combination of two curves, one less steep than the other. The exact extent that the slope of the two parts of the resultant curve would vary would depend entirely upon the relative closeness of the respective grid sections.

If, for example, a gap were left between two grid portions, no control over the electron flow to the anode through this gap would be exercised at low grid-bias voltages. After the grid bias had been increased to the point of anode current cut-off in the case of a uniformly pitched grid (10 volts on curve *A* in Fig. 21), although no current will flow through the grid wires, the area of cathode not surrounded by the grid will still contribute its quota of anode current, comparatively unrestricted by the negative grid. As the grid bias is still further increased, however, the electric field of the grid helix is extended and limits the electron flow through the gap in it, until at last the respective electric fields from both grid portions meet and the electron flow is cut off across the entire gap. This state corresponds to -40 volts on curve *B*.

Perhaps the best way to see the practical result of spacing the grid wires irregularly along the cathode length is to examine certain of the curves given in the patent specification covering the variable- μ valve construction (British Patent

Specification No. 382 945). The particular curves referred to are reproduced in Fig. 22, and represent the resultant mutual conductance in a screen-grid valve which has had one and two turns respectively removed from the centre of the control grid. Curve *A* is the characteristic of a screen-grid valve with a normal grid of uniform pitch, showing the sharp cut-off of anode current at limited grid bias. Curve *B* shows the effect of taking out one turn from the middle of the control grid of the same type of valve, and curve *C* is for the valve with two turns removed. It is immediately apparent that the anode current cut-off has been extended by reducing the effective

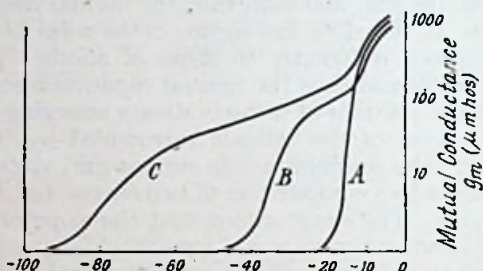

FIG. 22. ILLUSTRATING HOW THE VARIABLE-MU CHARACTERISTIC IS OBTAINED

mutual conductance in the centre of the grid. Even in the case of curve *B*, a marked increase in maximum grid swing from 17 volts (for the normal valve) to 40 volts is obtained, while with curve *C* the grid swing has jumped to about 90 volts.

This variable-mu feature is employed on a large variety of valves, e.g. screen-grid valve, pentode, hexode, and heptode and, as will be seen later, is very desirable for the satisfactory operation of the automatic volume control systems employed in most broadcast receivers.

Aligned Grids. It will readily be appreciated that the electron current flow to the screen grid or grids represents so much lost energy so far as the operation of the valve is concerned. A further disadvantage, and a more important one so far as radio frequency amplifiers are concerned, is the noise in the output that results from the use of a screen grid. The ratio of signal to noise with a screen-grid valve amplifier

is not nearly so good as with a triode. This is due to the random fluctuations in the electron stream. It can be shown experimentally that when a positive screen grid is used, the variations in the screen and anode currents is greater than the variations in anode current if the screen grid is not present. Apart from variations in the electron stream, there are also variations in the respective proportions of the total electron current taken by the screen grid and anode.

At first it would appear that the problem could be tackled by aligning the screen grid with the control grid so that it was situated in the control grid's shadow in the electron stream. To be effective, however, such an arrangement requires the screen grid to be so close to the control grid that the screen grid-control grid capacitance is increased to such an extent that the valve's operating efficiency as an r.f. amplifier is impaired. Furthermore, the best pitch for the control grid as required by the particular valve characteristic is often quite different from the most satisfactory pitch for an effective r.f. screen grid.

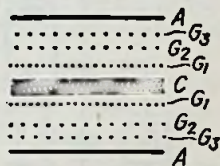

FIG. 23. ALIGNED GRID ARRANGEMENT

In some modern receiver valves the difficulty is overcome by using an auxiliary grid situated between the control grid and the screen grid. This additional grid is held at a low or earth potential and the screen grid is aligned behind it. The general arrangement is shown in Fig. 23, where the central cathode C is surrounded by the control grid G_1 , then the additional grid G_2 , with which is aligned the screen grid G_3 in front of the anode A . Because of its purpose, the auxiliary grid is known as the "low noise" grid. Owing to the low potential of the low noise grid G_2 electrons arriving from the cathode are deflected away from the grid wires and are forced to traverse the interstices. In so doing, they pass towards the anode and largely miss the screen grid G_3 which, therefore, does not collect so high a current as it would do if the low noise grid were not present.

A typical circuit arrangement for a low noise hexode is shown in Fig. 24. The input circuit IN is connected between the first grid (control grid) and cathode; second (low noise)

grid is joined to cathode; third (screen) grid to $HT +$; fourth (suppressor grid) to cathode; while the output circuit is, as usual, connected to the anode.

Output Tetrode. In the case of the output valve, screen-grid current is a serious drawback, for in many pentodes it is as much as 20 per cent or more of the anode current.

Such a large screen-grid current is due to the position of some of the screen-grid wires being situated between the

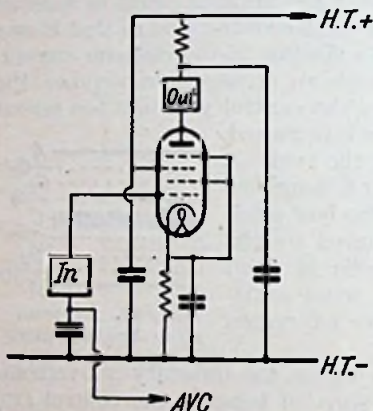

FIG. 24. LOW NOISE HEXODE
CIRCUIT

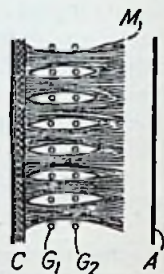

FIG. 25.
BEAM VALVE
ARRANGEMENT

interstices of the control grid. As the electrons are attracted by the high positive voltage of the screen grid, any wires so positioned will collect a large proportion of the electron flow at the particular positions they are located. Where the screen grid wire happens to be behind the control grid wire, it will receive only a small number of electrons.

In the beam output tetrode, the control grid is aligned with the screen grid. The formation of the electron flow to the anode is then as shown in Fig. 25. As the control grid G_1 is operated at a negative potential, the electrons from the cathode are compressed by the repulsion of G_1 , and the position of the screen grid G_2 is arranged to be within the electron shadow due to G_1 . It will be clear that the actual

degree of concentration or focusing of electrons is dependent upon the potential of G_1 , but the design of beam tetrodes is such that over the rated control grid swing, the beam formation of electrons is maintained. Alignment of control grid and screen grid is practicable with output valves because the shielding effect of the screen grid is not so important as for a valve amplifying r.f. voltages. Although the inter-electrode capacitance is increased, this is not considered to be a disadvantage in view of the important benefits derived from increased efficiency.

In Fig. 25 the electron beams broaden out to a plane M . At this plane is the potential minimum in the space between screen grid and anode, the properties of which are outlined below. At this juncture it should be noted that owing to the aligned grids a potential minimum is formed parallel to the anode.

Space Charge Suppression of Secondary Emission. It has been seen that the kink in the screen-grid valve's characteristic due to secondary emission from the anode places a definite limit to the output voltage for distortionless amplification, and that the use of an auxiliary grid (suppressor grid) between the screen grid and anode overcomes the difficulty.

An alternative method of suppressing the secondary emission from the anode is to so design and operate the valve that a space charge is formed between the screen grid and anode to repel the secondary electrons back to the anode. The normal potential gradient existing between the screen grid and anode without a space charge is represented by a straight line. The requirement for secondary emission suppression is that there be a potential dip or minimum in this gradient sufficient to repel the secondary electrons back to the anode. Such a potential dip is produced by the space charge at M , Fig. 25. Owing to the low velocity of most of the secondary electrons emitted by the anode, a space charge suppression is found in practice to be quite satisfactory.

Output tetrodes, which make use of the phenomenon mentioned above, may be constructed so that the electron stream is in the form of an intense beam—hence the title of beam valves. A beam is employed so as to increase the electron density and thereby create a space charge sufficiently

large to depress the potential below that of the anode. It may be formed by aligning control grid and screen grid as described already, and in addition by using auxiliary metal plates connected to the cathode so as to be maintained at cathode potential. These plates are situated parallel with the cathode and between this and the anode plates. The cathode electron emission will be repelled by the low potential of the

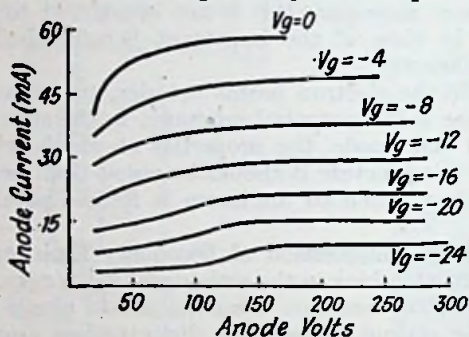

FIG. 26. OUTPUT TETRODE CHARACTERISTICS

auxiliary plates and so forced to take the path from cathode to anode between these plates.

The anode is separated by a larger distance than normal from the screen grid. For a given potential difference between anode and screen grid, the potential gradient will clearly be steeper as the two electrodes become closer. Conversely, as the distance between these electrodes increases the potential gradient becomes lower and a minimum is much easier to produce, owing to there being a larger number of electrons in the longer distance between screen grid and anode. There is a certain minimum distance—sometimes referred to as the critical distance—at which the required value of potential minimum is provided by the space charge. Not only is the potential gradient lowered by suitably spacing the screen grid and anode, but in addition the distribution of the electrons in the beam is made much more uniform. In this way the influence of the electron shadows close to the screen-grid wires in the direction of the anode is overcome, as shown in Fig. 25.

In order further to assist in the suppression of the secondary emission, the anodes are often ribbed in the direction of the screen grid. As these ribs are at anode potential, some of the secondaries emitted in random directions will be trapped by them and others will be attracted.

Typical curves of anode volts and anode current for an output tetrode are given in Fig. 26. These are seen to differ from the relevant pentode curves mainly at the low anode voltage portions of the higher bias curves (- 16 to - 24 volts). This does not influence the operation of the valve, however, because the load line lies clear of those parts of the curves.

CHAPTER III

DETECTORS

General Considerations. Before considering the actual process of detection, it will be of advantage to examine the constitution of the incoming signal. It is necessary to be very clear about the nature of the received signal for a complete understanding of the various problems associated with detection.

In Fig. 27 is shown a diagram of a modulated carrier wave, which is typical of a signal received by a radio receiver. During the time represented by the distance AB , the carrier wave peaks are of constant amplitude, the carrier being unmodulated, i.e. no signal has been impressed on it by the modulating apparatus at the transmitter. From B to C the amplitude of the carrier rises, then falls to D , rises again to E and finally falls to zero at F . The fluctuations shown at $BCDE$ and $B'C'D'E'F$ are due to the l.f. signal that has been impressed on the carrier wave at the transmitter, and the line joining them is known as the modulation envelope. The object of the detector is to extract this l.f. signal portion from the carrier wave.

It is seen that the carrier amplitude at D is greater than at F . This is because the degree or percentage of modulation at D is not so great as at F . The deeper the modulation the lower will the minimum amplitude fall, as at D and F , whereas during periods of light modulation the carrier wave amplitude will vary but slightly from its unmodulated condition. The percentage of modulation of a carrier wave is

$$m = \frac{i_x - i_o}{i_o} \times 100$$

where i_x = peak values of modulated carrier, and i_o = unmodulated amplitude of carrier. These values are indicated in Fig. 27. At C , for example, the modulation is

$$(3 - 2)/2 \times 100 = 50 \text{ per cent}$$

and at E it is

$$(4 - 2)/2 \times 100 = 100 \text{ per cent}$$

The modulation can never be greater than 100 per cent, for during periods of complete modulation, the carrier wave amplitude fluctuates between $2i_0$ and zero as seen at E and F in the figure. There is the greatest variation in carrier amplitude during periods of deepest modulation, therefore, and any device at the receiver that is operated by carrier wave amplitude fluctuations will give its maximum response during these periods, and a correspondingly reduced response during periods

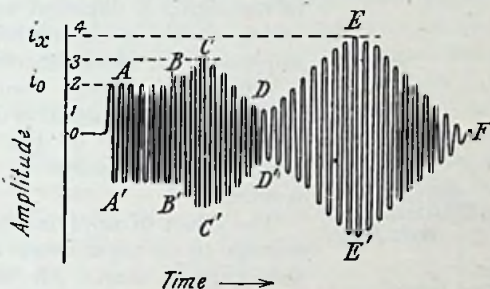

FIG. 27. REPRESENTATION OF A MODULATED CARRIER WAVE

of less deep modulation. It is clear, therefore, that the degree of modulation must play an important part in the actual response, i.e. the loudness of the reproduced signal, at the receiver.

The Need for Detection. It is seen in Fig. 27 that the carrier wave fluctuations on both sides of the modulation envelope are similar. They are, in fact, precisely equal. If the incoming signal were merely amplified and applied to the loudspeaker or other reproducer of a like nature, there would be no response because such an instrument is operated by a *change* in average current. In the signal being considered there is no change in average value, for the negative values of carrier amplitude are exactly equal to the positive values.

A detector renders the fluctuations of carrier amplitude into unidirectional impulses. In so doing, it brings about a change in average value of l.f. signal current and enables the reproducer to respond to the fluctuations on one side only of the carrier wave and thus to reproduce the original sound that

produced the signal. As this process is opposite in effect to that of modulation, it is often called demodulation.

The Ideal Detector. In order to render the incoming signal into a series of unidirectional impulses, the detector cuts off one-half of the carrier wave. This transforms the other half-wave into a series of individual impulses the amplitude of which depends upon the modulation depth at corresponding points in the incoming signal. The process of cutting off half of the signal is depicted in Fig. 28, which shows a modulated carrier applied to an ideal detector. Such a detector has zero conductivity to current in the negative direction, while to current in the positive direction it possesses a constant resistance.

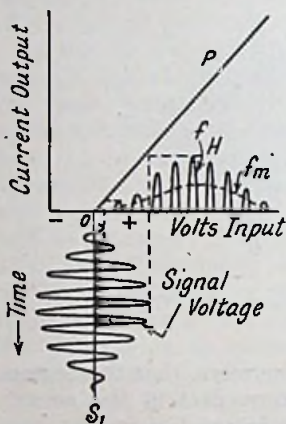

FIG. 28. SHOWING THE ACTION OF THE IDEAL DETECTOR

The effect of applying the signal voltage to an asymmetric device of this type is seen. All the signal voltages to the left of the line OS_1 are cut off, as the detector will not conduct in this direction, while the signal voltages on the right side of the line OS_1 are passed by the detector and appear in a similar form to that of the original signal. As the peak value of the signal voltages is proportional to the strength of

the signal, the line OP must be sufficiently long to accommodate as high a signal voltage input as will be applied to the detector, otherwise the form of the unidirectional impulses will be altered and distortion will result.

The average value of the impulses is shown as a broken line and the reproducer will respond accordingly. It is seen that the modulated carrier wave has been transformed into groups of half-waves. These groups correspond to the low-frequency modulation, representing the actual signal. A reproducer, for example a loudspeaker or an l.f. amplifier, will respond to the average value of current in each group as indicated in broken lines, and the required audible signal is obtained.

In practical detector circuits, the aim is to provide a curve m that is a perfect copy of the modulation impressed on the carrier applied to the input to the detector, over as large a range of input signal voltages as can be passed to the detector by the previous stages. Distortion of one kind or another is inevitable, as will be seen later, and steps have to be taken to operate the detector so that the actual distortion is the minimum possible.

It will be noted from Fig. 28 that two widely different frequencies of currents have to be dealt with by the detector. There is the carrier frequency f_H and the modulation frequency f_m . Now the object of detection is to extract f_m from the complex wave form applied to the detector, and to reject f_H . The detector, by itself, is incapable of rejecting f_H and so this has to be done by the circuit arrangement to which the detector is connected. If the output circuit of the detector, in which both f_H and f_m appear, is made to have a high impedance for low frequencies but a low impedance by-pass for high frequencies, then, since voltage equals current times impedance for a particular frequency, the modulation frequency will provide a much higher voltage for subsequent amplification than the carrier frequency f_H . This is the principle on which all detector circuits are designed. The simplest way to supply a low impedance by-pass for f_H is to connect a condenser, which need be only of fairly small capacity, across the load impedance that applies the detected voltage to the following amplifier. This condenser acts as a low impedance shunt path for f_H and thus by-passes currents of this frequency from the load impedance. In respect of f_m , however, the by-pass condenser presents a high impedance if its capacity is correctly chosen, and will, therefore, not shunt away any current of this frequency.

As the component f_H is the same frequency as the carrier voltage applied to the detector input circuit, it follows that if, in any type of amplifying detector—e.g. grid detector or anode detector—this component is fed back to the input circuit in the correct phase, it will augment the carrier-frequency signal voltage there. This not merely raises the voltage of f_H , but, since the modulation is impressed upon f_H , the resultant amplitude of f_m is also correspondingly increased. This process,

termed *reaction*, can only be carried out to a limited degree before the system breaks into oscillation and the selection of f_m , in the case of telephonic reception, becomes impossible. Up to this point, however, reaction increases the total signal voltage in the output circuit, and although the use of too much reaction causes distortion, it is frequently employed in low gain receivers and receivers with poor inherent selectivity owing to the great improvement in these respects that is thereby provided. The point being stressed at the moment is that the presence of the carrier frequency component f_{Π} can be regarded either as an evil, such as when considering the process of detection by itself, or as an advantage in view of the possibility of its use for reaction and other auxiliary purposes.

Diode Detectors. The diode is the simplest form of thermionic detector at present used in broadcast receivers. Its characteristic curve, given in Fig. 29, departs from the ideal already considered, at the bottom end, and it is at this part that a certain amount of distortion is produced during detection. Diode detectors are used almost universally in superheterodyne receivers owing to their ability to handle the large signal voltage provided at the output of the intermediate frequency amplifier without distortion. When the signal is applied to the diode, the anode is driven negative to an extent dependent upon the signal amplitude. With favourable circuit constants, this negative potential is almost equal to the peak signal input voltage, and for this reason the diode detector is sometimes referred to as a peak detector.

For straightforward detection the diode is connected in circuit as shown by the diagram just above the characteristic; i.e. a circuit tuned to the incoming signal carrier frequency is joined directly to the anode at one side and to the cathode at the other side through a load resistance R shunted by a condenser C to by-pass the h.f. component. The tuned input circuit is thus the voltage generator supplying the diode. When no signals are being received the anode may be assumed to be, for the present consideration, at zero potential, corresponding to point P on the characteristic.

The process of diode detection can be seen from Fig. 29. A typical anode current-anode voltage curve is shown

starting from the zero current and zero voltage point P . Although the diode curve is the theoretical one following the three-halves power law starting at zero potential at point P , in practice the contact potential between cathode and anode is sufficient to cause a certain flow of current through the load resistance R which sets the anode slightly negative to the cathode. For this discussion, however, it is assumed that

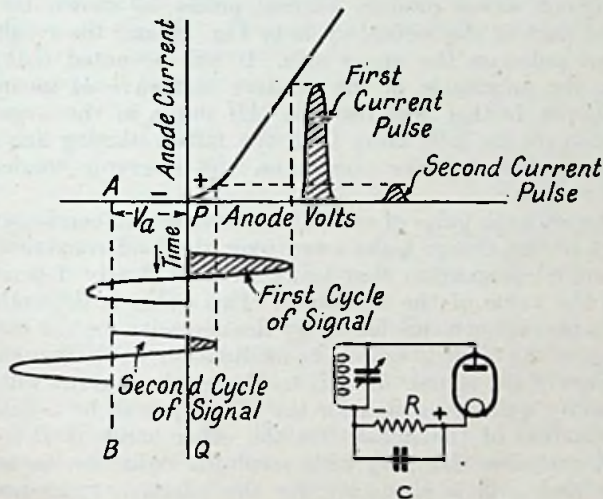

FIG. 29. DIODE DETECTION

initially there is no current flow and that the origin of the characteristic curve is at point P .

When the signal voltage is applied to the diode, the first positive signal half-wave makes the diode anode positive, depending upon the signal amplitude, and causes a rush of current from cathode to anode and round the external circuit, including the load resistance R . The positive signal half-wave and the resultant current pulse are shaded in Fig. 29. This current pulse charges up the condenser C (known as the reservoir condenser) which thereby acquires a negative charge. However, owing to the negative charge given to the reservoir condenser C , the anode is biased correspondingly

negative, with the result that by the time the following positive half-wave is applied to the diode, the anode is already biased negatively. The second cycle of signal voltage begins, therefore, not at the original point P but at a certain negative point A as shown. Owing to the diode not passing current until the anode is positive to cathode, the effect of the first cycle driving the anode negative is that only the tip of the next and subsequent waves produce current pulses, as shown by the shaded part of the second cycle in Fig. 29 and the resultant current pulse on the upper axis. It will be noted that the larger the amplitude of the positive half-wave of incoming signal, the further will the line AB move in the negative direction (to the left) away from the initial starting line PQ , owing to the negative charge on the reservoir condenser being greater.

Between each pulse of anode current flow into condenser C , a part of the charge leaks away over the load resistance R . The actual proportion that leaks away is clearly dependent upon the value of the resistance. This value is determined, with a maximum value for C , by the necessity for the output voltage of the diode to follow the modulation (audio-frequency) envelope of the signal. If R is too large, the current will not leak away quickly enough for the l.f. output to be a faithful reproduction of the signal. On the other hand, if R is too small, excessive damping with resultant reduction in selectivity and gain is produced, for the effective resistance of the diode on the tuned input circuit as shown in Fig. 29 is about $R/2$.

The maximum value of reservoir condenser mentioned in the previous paragraph is due to the high note cut-off if C is made too large. We have seen in the first part of this chapter that C should have a low impedance to the r.f. carrier wave. But too large a value of capacitance for C provides a short circuit across the load resistance R for the higher audio-frequency components. In broadcast receivers, a capacitance of $0.0001 \mu\text{F.}$ is found to be satisfactory when the normal intermediate frequencies (up to about 470 kc.) are used.

Given the value for the reservoir condenser, the load resistance is readily determined approximately by the time

constant CR that will enable the circuit to follow the audio-frequency envelope. For good quality reproduction, l.f. frequencies up to quite 10 000 cyc. should be passed by the detector, and for this CR should be 0.0001 second. The value for R so derived with the given capacitance of 0.0001 μF . for C is 1 megohm. Common values for R in broadcast receivers are 0.5 to 1.0 megohm.

An alternative circuit, known as the parallel connexion, is shown in Fig. 30. The general principles outlined above apply to this circuit also, with the difference that the damping of the diode on the input circuit is greater, the effective resistance now being approximately $R/3$. The parallel diode circuit is not so commonly used in broadcast receivers as the series circuit.

A point worth noting from the curve in Fig. 29 is the effect of applying a negative bias to the anode of the diode. Suppose that 3 volts negative bias is given to the valve. Since practically no current flows until the anode has attained a positive voltage, the effect of the bias must be to retard the rectifying action of the diode until a signal powerful enough to annul the negative bias is applied to the input circuit. All signals, therefore, whose positive peak value is less than 3 volts will not produce a current flow and no signal voltage will be provided along the load resistance.

In effect, therefore, the negative bias on the diode anode delays the action of the valve until a powerful signal arrives. This is made great use of in automatic volume control systems where the volume control diode is not desired to respond to signal voltage below a certain value.

Owing to various factors, including contact potential between cathode and anode, an electron current i_{a0} will flow round the circuit connecting diode anode to cathode when no signal voltage is applied to it. This provides a certain bias for the anode—which bias is, of course, negative—depending upon the value of the load resistance along which the direct current flows. In this way, therefore, the diode sets itself

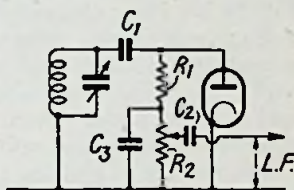

FIG. 30. DIODE DETECTOR,
PARALLEL FEED

automatically at a certain voltage. The precise value of this bias may be found by drawing a load resistance curve across the i_a/V_a characteristic of the diode. This is the automatic bias applied by the diode to itself that determines the operating point the valve is worked on its characteristic. The current cut-off point may be more than volt negative. Different values of load resistance will provide alternative bias voltages.

Dynamic Characteristics. The diode characteristic curve of Fig. 29 is a static characteristic, i.e. it is plotted under constant voltage conditions. When the diode is operating in a radio circuit the voltage and current are fluctuating at a very rapid rate. Hence, a characteristic that represents the voltage and current under actual operating conditions, known as a *dynamic characteristic*, will be of more practical value.

The method of plotting the dynamic characteristics of diodes is to apply a constant a.c. voltage to the input and then to vary the negative voltage (d.c.) bias on the anode and note the changes in output current. The significance of the variation in negative bias on the anode is as follows. During reception of a modulated carrier wave—say an ordinary broadcast signal—the rectified voltage drop along R , Fig. 29, is proportional to the degree of modulation. During periods of deep modulation this voltage drop is greater than during periods of light modulation and so, if the bias voltage applied to the anode is varied while the input carrier is maintained constant, the resultant effect for testing purposes is the same as when the input carrier is varying and producing various voltage drops along R , i.e. as if the degree of modulation was fluctuating as it does in the actual signal. It is important to note that the anode of a diode is always at a negative potential with respect to its cathode unless it is especially biased otherwise, for the negative electrons leave the cathode and, therefore, make this positive with respect to the anode that receives them. For this reason, the bias applied to the anode while dynamic curves are being plotted must be negative.

In Fig. 31 is seen a family of dynamic curves relative to the operation of a modern diode. These curves are not dissimilar to the dynamic curves of a triode considered in connexion with Fig. 11, and their significance is the same as

regards the load. Three load lines have been drawn across, R_1 being in respect of 500 000 ohms, R_2 200 000 ohms, and R_3 100 000 ohms. It is seen that the higher values of load resistance provide a larger anode voltage swing for a given h.f. voltage input (V_{HF}). A larger load resistance has the added advantage that it applies less damping to the tuned circuit feeding the diode.

The Practical Diode Circuit. A common circuit for use with a diode detector is shown in Fig. 32. Here L_1C_1 is the usual tuned circuit that applies the signal voltages to the diode electrodes. In order that as low an impedance as possible be offered to the carrier component of the rectified voltages, R_1 is by-passed by a condenser C_2 . It is thus seen that the i.f. voltages appear across the diode load resistance R_1 while

the h.f. component passes to the cathode via C_2 . Usual values of R_1 and C_2 are 500 000 ohms and 0.0001 micro-farad respectively. The actual rectification circuit is therefore comprised of diode cathode, diode anode, tuned circuit L_1C_1 , and R_1C_2 .

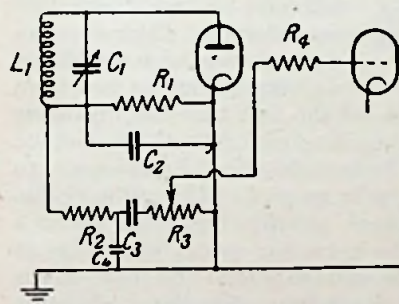

FIG. 32. PRACTICAL DIODE DETECTOR CIRCUIT

of the subsequent amplifier by $R_2C_3R_3$. The resistance R_2 generally goes by the name of *h.f. stopper*, as its purpose is to limit in conjunction with C_4 the residual h.f. or i.f. component in the rectified voltages, and its value is 50 000 to 100 000

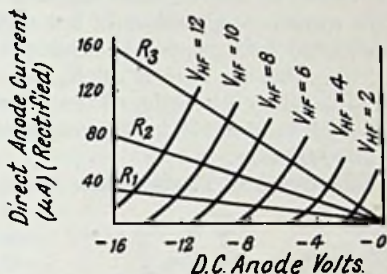

FIG. 31. DYNAMIC CURVES OF A DIODE DETECTOR

ohms. Condenser C_3 is the i.f. coupling condenser, and has a value of about 0.05 microfarad. Resistance R_3 , which is the grid leak of the i.f. amplifier, acts as manual volume control by virtue of the variable tapping with which it is provided. This resistance is seldom of less value than 500 000 ohms. An additional h.f. stopper is often fitted in the grid lead of the i.f. amplifier as shown at R_4 , especially in superheterodyne circuits where filtration of the i.f. component is difficult when a low i.f. (about 110 kc.) is employed. A common value for R_4 is 100 000 ohms.

Effective A.C. Diode Load. It is seen from Fig. 32 that there

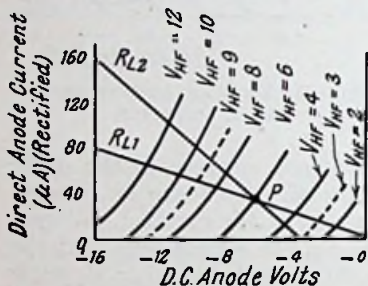

FIG. 33. SHOWING THE EFFECT OF HAVING A LOW A.C. DIODE LOAD

is across the d.c. diode load resistance R_1 a shunt path that is used by the i.f. component, this path consisting of $R_2C_3R_3$. As regards the d.c. in the diode circuit this shunt is of no importance owing to the blocking by C_3 . For alternating currents, however, it represents a shunt that may reduce the effective load resistance very considerably. This reduction in load resistance would not be very serious, as seen from

the load lines in Fig. 31, but for the fact that the operating point on the dynamic curves is determined by the d.c. diode load. These conditions can be best described by reference to Fig. 33. Here, load line R_{L1} is in respect of the ordinary d.c. load resistance of 200 000 ohms, say R_1 of Fig. 32. With a carrier input of 6 volts, the operating point would be at point P , and the d.c. anode voltage would fluctuate along the load line to an extent depending upon the modulation depth, in the usual way. Owing to the presence of the a.c. shunt path ($R_2C_3R_3$ in Fig. 32), the effective a.c. load resistance is reduced to, say, 100 000 ohms. The load line representing this resistance must pass through the operating point P , and is given as R_{L2} . This load line cuts the zero anode current line at the point corresponding to $V_{HF} = 3$,

and, therefore, limits the voltage fluctuations in the a.c. shunt circuit to this value. The result is that if the carrier (at $V_{HF} = 6$ volts) is modulated 50 per cent, the anode current will fluctuate between zero and the value where R_{L2} cuts the curve of $V_{HF} = 9$. If a higher modulation than 50 per cent occurs in the signal, the input voltage will fluctuate to a lower value than $V_{HF} = 3$, but, as the anode current cannot follow these fluctuations owing to the cut off at $V_{HF} = 3$, distortion is produced. It is evident, therefore, that the a.c. load resistance employed for feeding the i.f. signal voltage to the subsequent amplifier must not be too low in value. The permissible depth of modulation in a strong signal for a given amount of distortion is determined to a large extent by the value of the a.c. load, and it can be shown that for high fidelity this modulation is proportional to the ratio of the a.c. load to the d.c. load.

There are other ways of operating diode detectors. For example, a double diode is sometimes used in a push-pull arrangement

as shown in Fig. 34. In this circuit the tuned inductance is tapped at its electrical centre and connected to the diode load resistance. The diode anodes are now excited in opposite phase by the incoming signals and the respective electron currents take the paths indicated by the arrows. It should be noted, however, that the current from only one diode flows at any instant. When the anode *A*, for example, is made positive by the signal voltages, the anode *B* is made correspondingly negative. Thus the electron current flows from *A* through the upper half of *L* and along the diode load *R* back to cathode. During this positive period at *A*, the diode *B* will not pass current owing to the negative potential applied to its anode. However, when the incoming signal voltage makes *B* positive, the electron current passes from *B* along the lower half of *L* and through *R* to cathode. In the latter period, *A* will, of course, be inoperative. It is clear,

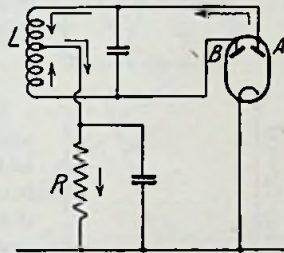

FIG. 34. PUSH-PULL DIODE DETECTOR CIRCUIT

therefore, that full-wave rectification is provided by this circuit, the actual current flow from *each* valve along *R* being as indicated by the arrows in Fig. 34.

One disadvantage of this arrangement is that owing to the centre tapping of the input coil, each diode has applied to it only one-half the total input voltage available at the terminals of the tuned circuit. A more serious drawback to its employment is the necessity for tapping the tuned coil *L* in the exact electrical centre. Owing to the stray capacitances and couplings, it is found extremely difficult in practice to get a sufficiently true centre tap to operate a pair of diodes in push-pull.

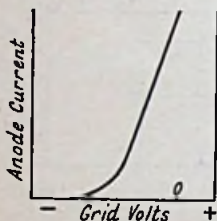
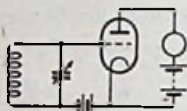

FIG. 35. CURVE AND
CIRCUIT OF THE
ANODE DETECTOR

ANODE DETECTION

Detection by a valve working on its anode current-grid voltage characteristic is known by various terms. *Anode bend detection*, *anode* or *anode circuit detection*, *plate* or *plate circuit detection* are terms which are used to describe this method. Throughout this book, anode detection is the relevant term employed.

The anode current-grid voltage curve consists of a long linear portion and a lower curved part that approaches the point of anode current cut-off. Detection is effected by working on the bend of the curve as can be seen from Fig. 35.

It will be noted that during anode detection the average value of anode current due to the asymmetry of the detecting characteristic is increased, whereas in grid detection the anode current is reduced. As the bend in the i_a/V_g curve usually occurs at low values of anode current flow there is much less current in the anode circuit than during grid circuit detection. This is because detection usually takes place at zero or slightly positive grid potential during grid detection, while for anode detection the grid has to be given a negative bias in order to take the working point to the most suitable part of the curve.

Dynamic Characteristics. The characteristic given in Fig. 35

is the usual static curve for the i_a/V_a relations, in which there is no external resistance in the anode circuit. In practice there will always be a load impedance in the anode circuit in order to couple the l.f. impulses to an amplifier, and this makes the working characteristic less steep. A very useful set of curves that show the voltage variations under working conditions can be obtained by giving the detector valve a normal bias to make it work on its lower bend, and then injecting into the grid circuit an h.f. voltage at various

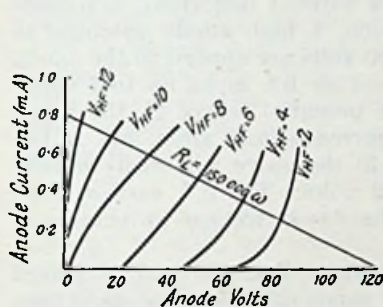

FIG. 36. DYNAMIC CURVES OF THE ANODE DETECTOR

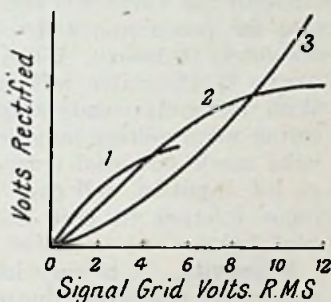

FIG. 37. TYPICAL ANODE DETECTION CHARACTERISTICS

amplitudes to represent signals at various strengths. If the anode voltage is then varied, a number of i_a/V_a curves will be obtained similar in significance to the dynamic curves given in Chapter II.

A family of anode detector dynamic characteristics is given in Fig. 36 and a suitable load line is drawn across them. The curve for $V_{HF} = 2$ (i.e. the r.m.s. value of the injected h.f. carrier wave is 2 volts) is very similar to the static i_a/V_a curve. As the carrier amplitude is increased, however, the curves become straighter until, at $V_{HF} = 12$, the curve is almost vertical. To find the voltage fluctuations in the output resistance for any given carrier strength and degree of modulation the same method as outlined in connexion with the diode detector is employed.

If the actual rectified voltage, as found from the dynamic curves by the method given above, be plotted against the

input carrier wave voltage, a true picture will be obtained of the process of detection. Such a curve, called a *detection characteristic*, is shown in Fig. 37. Characteristics are reproduced in respect of three values of static anode voltage and grid bias. The curve with the steepest slope is the one corresponding to lowest anode potential. The difference in the steepness of the slopes, however, is only slight, the principal difference between the three curves being the length of the linear portion. As this determines the maximum signal strength the valve will detect without distortion, it follows that for power anode detection, a high anode potential is absolutely necessary. When 60 volts are applied to the anode (curve 1), the valve will detect an h.f. input up to 4 volts. With 100 volts steady anode potential (curve 2), the input carrier wave voltage may be increased to 9 volts, and at 150 volts anode potential (curve 3) the valve will easily handle an h.f. input of well over 12 volts. The h.f. carrier wave input referred to here is the r.m.s. voltage at maximum modulation.

Selectivity. It is very important that the grid be biased sufficiently negatively during anode detection, for, as is seen in the circuit diagram of Fig. 35, the grid-cathode path of the detector valve is in shunt to the input tuned circuit. The grid bias required to work the valve on the bottom bend of its characteristic ensures a high cathode-grid impedance. Since the selectivity of the input circuit is dependent upon its having a high value of dynamic resistance, the high input impedance of the anode detector is very valuable when sharp selectivity is required owing to the very small damping it produces.

Sensitivity. Although the shape of the anode detector characteristic is similar to that of the grid detector, the bend on which detection is effected is much longer. Moreover, the anode detector curve is not so steep as the grid detector curve. These factors have been seen to be of great importance in detection. The length of curvilinear characteristic determines the minimum strength of signal that is necessary to produce efficient detection, the shorter the curved portion the less being the signal strength required. The anode detector is obviously insensitive to weak signals owing to the comparatively long curve. Upon the length of the curved part of the

characteristic also depends the amount of second harmonic and amplitude distortion that appears in the output circuit.

Distortion. As anode detection takes place on a curve which follows a square law, harmonic distortion is a serious disadvantage. The harmonic distortion that is produced is proportional to the modulation. In fact, the per cent second harmonic distortion is equal to $\frac{1}{4} M$, where M is the per cent modulation. A signal that is modulated 50 per cent, for example, will produce $12\frac{1}{2}$ per cent second harmonic distortion, and a 100 per cent modulated signal will set up 25 per cent distortion. In addition, there is intermodulation between the various musical frequencies constituting the signal and this produces distortion which is even more disturbing to the ear than that due to the second harmonics. Owing to this distortion, anode detectors are seldom used in modern radio receivers.

GRID DETECTION

In Chapter II it was seen that when the grid of a triode became positive, or sometimes when it was at only a slight negative potential, current would flow to the grid electrode due to the electrons from the cathode striking the grid wires during their passage to the anode. As the grid potential became more positive, the grid current increased.

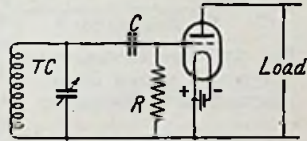

FIG. 38. GRID DETECTION CIRCUIT

Grid detection utilizes the flow of grid current to control the potential on the grid in such a way that detection of the modulated high-frequency currents applied to it is effected. The circuit arrangement is given in Fig. 38, where C is the grid condenser and R the grid leak. Incoming signals are applied to a circuit TC tuned to the carrier frequency in the usual way and the voltages set up in this tuned circuit are fed to the grid over the condenser C .

Now consider what happens when the valve is connected into circuit. As the cathode heats up, electrons emerge from the cathode and are attracted towards the anode. On their way they pass the grid, which, it will be noticed from Fig. 38, is connected to the positive side of the heating battery

and is therefore at a positive potential with respect to the greater proportion of the cathode. Some electrons strike the grid, others are attracted to it and so a grid current is produced which leaks back to the cathode along the high resistance R . The current cannot go back through the low resistance tuned circuit owing to the blocking of C . The value of R is so high, however, that the grid current does not have an easy passage back to the cathode and so the positive potential is to some extent annulled by the arrival of the electrons from the space charge. A state of equilibrium is soon reached in which the grid acquires a certain negative potential with respect to the positive part of the cathode and the current flowing to the anode has a steady value.

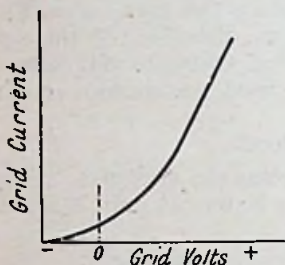

FIG. 39. THE CHARACTERISTIC ON WHICH GRID DETECTION IS EFFECTED

When a high-frequency signal is applied to the input tuned circuit TC , a voltage is passed to the grid via the grid condenser C and makes it alternately more positive and negative in the rhythm of the signal voltage. The small initial negative bias applied to the grid by the flow of grid current along R determines the actual point on the grid current-grid voltage curve, Fig. 39, that the valve is operated upon. The higher the value of leak resistance, therefore, the greater will be the initial bias the valve applies to itself since the $V = iR$ drop will be larger. It is thereby possible to adjust the bias so that the valve is operated on the most sensitive part of the i_g/V_g curve of Fig. 39.

In modern broadcast receivers, however, this aspect of grid detection is of secondary importance, as most detectors have to handle a large voltage input. The problem is how to detect loud signals without distortion, and in this book this point of view will be taken as being the principal one with which practical modern radio reception is concerned.

The series of events that takes place in a triode during grid detection is set out diagrammatically in Fig. 40. Curve a represents the modulated carrier wave that has to be

detected. At curve b_1 , the steady grid current flow at i_{g0} is that which passes to the grid and along the grid leak under the static operating conditions of the valve. This sets up a voltage which makes the grid negative with respect to cathode as shown in curve c at V_{g0} . Thus, before the arrival of the signal the grid is negatively biased V_{g0} and passes the anode current i_{a0} of curve d .

When the signal voltage is impressed by the tuned input circuit on to the grid of the detector valve, the positive half-cycles cause grid current to flow to an extent depending upon their individual amplitudes and thus charge the grid condenser. A series of grid current impulses are thereby set up in the grid condenser, as seen at b . As the grid current impulses due to the positive signal half-cycles build up the charge on the grid condenser, the mean voltage of the grid becomes more negative, although the instantaneous grid voltage will fluctuate in accordance with the modulation envelope of the received signal as seen at curve c . At point P_1 in

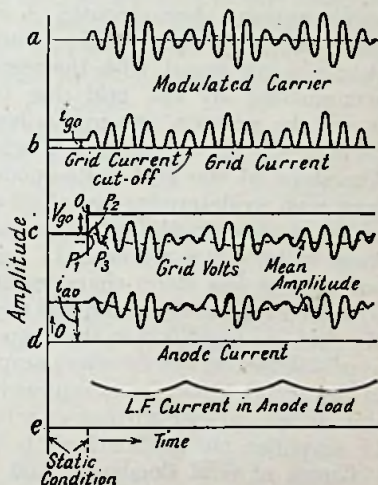

FIG. 40. CURVES SHOWING THE WORKING OF THE GRID DETECTOR

curve c the voltage on the grid commences to become more positive owing to the influence of the signal voltage, and rises in phase with the latter to a peak at P_2 . By this time, the grid has accumulated a charge of electrons (negative in sign) which cannot leak away readily. The signal voltage then falls to zero and passes through a negative half-cycle. Due to the accumulated negative charge resulting from the positive half-cycle; the potential of the grid at point P_3 in the negative half-cycle is more negative than it would be if the charge had leaked away, and the corresponding reduction in anode current

is the greater. At the next positive half-cycle the grid will again attract electrons and acquire a further negative charge.

The net result is that the anode current is varied in the same sense as the grid potential fluctuations, but that the average value of anode current is decreased. This is shown by curve *d*. The actual extent to which the average value of anode current is reduced from its steady value i_{a_0} is dependent upon the strength of the incoming signal and the slope of the grid volts-anode current characteristic. A strong signal will obviously make the grid more positive during the positive half-cycles than a weak signal, with the result that the negative charge accumulated by the grid due to the flow of electrons to it will be greater, causing a heavier drop in mean anode current, the l.f. component of which is indicated by curve *e*. The slope of the grid volts-anode current curve has already been seen to determine the effect of any grid voltage changes on the anode current flow. Consequently, a valve with a steeper slope will produce a greater l.f. output for a given input than one with a less steep characteristic. It will be noticed that with this type of detection the rectified voltages appearing on the grid are amplified in the output circuit. Valves employed as grid detectors are therefore amplifiers as well. The operation of the grid detector is, as can readily be seen from the description above, similar to that of a combined diode detector and l.f. amplifier, the grid-cathode being the diode detector.

Choice of Grid Condenser and Resistance Values. Until a few years ago, grid detection was regarded as very inferior to anode detection owing to the severe distortion that became apparent as soon as any but a weak signal voltage was applied to the grid detector. This distortion was due to the anode detection that took place simultaneously with grid detection and which counteracted the effect of the latter. Investigation showed that grid detection could be made far more distortionless than anode detection, and that the cause of the earlier unsatisfactory results was the incorrect choice of values for the grid condenser, grid leak, and anode voltage.

Detector Sensitivity. Sensitivity of the detector may be defined as the change in grid voltage due to an impressed signal

of a given voltage. Consider the equivalent circuit of the grid detector, given in Fig. 41. Here, the source of high frequency voltage (the tuned grid circuit) TC is connected to condenser C (grid condenser), and then, all in parallel, are resistance R (grid leak), condenser C_{gc} (the effective inter-electrode capacitance between grid and cathode), and R_{gc} (the effective resistance between grid and cathode). If the impedance consisting of C , R , C_{gc} , and R_{gc} is not high in comparison with that of TC , the voltage applied to the grid will be seriously reduced. Since the detector action depends on the magnitude of the voltage supplied by TC , the net effect of reducing the total impedance across it must be to diminish the efficiency of detection. C_{gc} and R_{gc} are inherent in the valve and are beyond the control of the user. In detector valves they are invariably small, C_{gc} usually being from 50 to 100 $\mu\mu\text{F.}$ and R_{gc} from 50 000–100 000 ohms. We are still left with C and R however. Since the reactance of a condenser $1/\omega C$ at any given frequency varies inversely as its capacitance, C must be as large as possible for it is in series with C_{gc} . It is seen that the voltage applied to the grid is proportional to $C/(C + C_{gc})$ neglecting for the moment the presence of R and R_{gc} . Consequently, as the capacitance of C is increased in relation to C_{gc} , the higher will be the voltage at the grid. For maximum gain the grid condenser should therefore have a capacitance several times greater than that of the grid-cathode capacitance of the valve if maximum sensitivity is required.

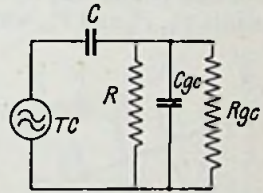

FIG. 41. EQUIVALENT CIRCUIT OF GRID DETECTOR

Effect of Grid Leak Resistance on Efficiency. It has already been mentioned that the value of R has an important influence on the efficiency or sensitivity of the grid detector. In order to see exactly how this is brought about it will be worth while examining the dynamic curves of the grid current and voltage in respect of various values of grid leak resistance.

The series of dynamic curves given in Fig. 42 have the same significance as the dynamic curves of the plate circuit (i.e. i_a/V_a characteristics) considered in Chapter II. They represent,

of course, the actual current and voltage values during the operation of the valve. In plotting these curves a high-frequency voltage input, unmodulated, was applied to the detector. If this input is considered as a carrier wave, the actual grid voltage fluctuations can be found from the curves, if the degree of modulation is known.

Load lines are drawn from zero grid volts to the grid current axis so as to represent the desired values of resistance. In the diagram, OC represents $0.25 \text{ M}\Omega$, OB represents $0.5 \text{ M}\Omega$, and OA represents $1 \text{ M}\Omega$.

Assume now that an input signal of carrier amplitude 6 volts, modulated 66.6 per cent, is applied to the detector. The working points will be on the $V_{HF} = 6$ curve as shown at the points P_1 , P_2 and P_3 , while the actual grid voltage fluctuations

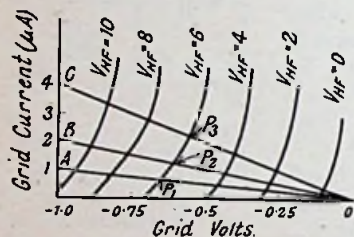

FIG. 42. DYNAMIC CURVES OF A GRID DETECTOR

will be $V_{HF} \times m = 6 \times 0.66 = 4$ volts on each side of the working point. That is to say, the grid voltage excursions will be between the curves $V_{HF} = 10$ and $V_{HF} = 2$, along any of the load lines OA , OB , or OC . These voltage variations can be read off the abscissa.

It is thus seen that as the value of grid-leak resistance is reduced, the grid swing for a given input signal voltage is diminished, so for maximum sensitivity the highest resistance is the best. This is neglecting the shunting effect of the grid leak on the input circuit, which is serious with low values of leak resistance.

It can be shown that the input impedance of the grid detector is usually equal to slightly over half the grid leak resistance. From this it follows that with a low value of R (Fig. 38) the input impedance is so low that sensitivity suffers considerably due to the shunting effect on the tuned circuit TC , whereas for high values of R , sensitivity is much greater. Measurements show that with a grid leak value $2 \text{ M}\Omega$ the rectified voltage from a given signal may be as much as three times greater than when $0.5 \text{ M}\Omega$ is used as leak resistance.

Distortion. One result of not employing the most suitable

values of grid condenser and leak is to bring about a serious distortion of the input signals that has the result of suppressing certain frequencies. This is known as *frequency distortion*.

It has been seen that after the grid condenser has been charged by an incoming signal impulse, it must discharge through the grid leak before the next modulation impulse arrives. The time taken for a charge to leak away from the condenser is proportional to CR , this being known as the *time constant*. It can be shown that in the time represented by CR there will be a leakage of approximately 63 per cent of the total charge, and that to afford a satisfactory leakage action, time CR should be smaller than the time between any two successive modulation peaks. Unless this is so, the leakage will not be effected at the rate of the modulation in the signal envelope. Professor Terman has shown (*Proc. Institute of Radio Engineers*, 1930, page 2160) that if X = effective reactance of grid condenser consisting of $C + C_{gc}$, R = resistance of grid leak, and m = degree of modulation, then frequency distortion will not be produced so long as

$$X/R > m/\sqrt{1 - m^2}$$

(the sign $>$ stands for "is greater than or equals"). As the impedance of C varies inversely as the capacitance, the conditions for high values of the ratio X/R are small C and small R . A curve drawn according to this equation is seen in Fig. 43, in which the ordinates represent X/R and the abscissae represent percentages of modulation. The curve thus represents the limiting values of C and R for distortionless reception at various degrees of modulation, and it is noted that as the modulation is increased the required value of X/R rises. There is, in fact, a clearly defined value of X/R to any particular percentage of modulation. For 60 per cent modulation a much higher value of X/R is necessary than for 20 per cent

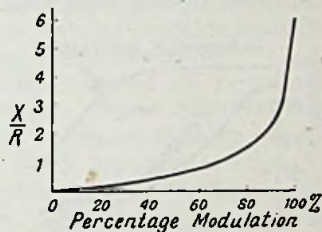

FIG. 43. CURVE SHOWING THE RELATION BETWEEN THE RATIO X/R AND PERMISSIBLE PERCENTAGE OF MODULATION

modulation, and for 100 per cent modulation the ratio X/R must be a great deal higher still. This means that for distortionless reception C and R must both be small.

It should be noted that the curve of Fig. 43 is for one modulation frequency only, since the rate of variation in the modulated carrier wave is a function of modulation percentage and modulation frequency. As the modulation frequency is decreased, the reactance offered by C is increased, and therefore X/R becomes greater and a higher degree of modulation is permissible. To each modulation frequency, therefore, there is a particular ratio of X/R and, correspondingly, a maximum percentage of modulation for distortionless reception.

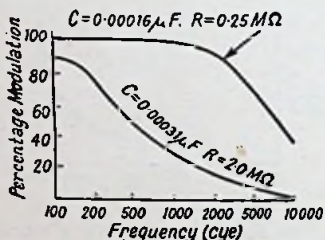

FIG. 44. SHOWING THE EFFECT OF DIFFERENT VALUES OF GRID CONDENSER AND LEAK

The actual value of CR has to be chosen with a view to producing a sensitive and selective detector as already mentioned, and a compromise between the various claims as to size has to be found. Usually, a grid condenser of $0.0001 \mu\text{F}$. is found to be a satisfactory value. The grid-leak resistance

which is found to be sufficiently low is usually $\frac{1}{4}$ to $\frac{1}{2} \text{ M}\Omega$.

In Terman's paper already mentioned, curves are given to show the effect of employing larger values of CR . These curves are reproduced in Fig. 44. The ordinates represent the percentage of modulation and the abscissae represent the modulation frequency in the signal. The values of grid condenser are the effective values, i.e. $C + C_{gc}$, the latter value in the valve to which the curves apply being $60 \mu\mu\text{F}$., so that the grid condenser has a capacitance of $0.0001 \mu\text{F}$. for the top curve and $0.00025 \mu\text{F}$. for the lower curve.

The curves of Fig. 44 are very interesting in the way they illustrate the fundamental difference between sensitive grid detection (for which $0.00025 \mu\text{F}$. and $2 \text{ M}\Omega$ are used for C and R) and power grid detection (for which the values are usually $0.0001 \mu\text{F}$. and $\frac{1}{4} \text{ M}\Omega$). In the case of sensitive grid detection the permissible modulation before distortion takes

place is quite small, and considerable discrimination against the higher modulation frequencies is shown. On the other hand, with power grid detection nearly 100 per cent modulation is allowable over most of the frequency scale, and even at 10 000 cye. the maximum modulation permissible before distortion takes place is 40 per cent. In the earlier days of broadcasting the percentage modulation employed at most transmitters was very small—about 20 per cent—so that the frequency discrimination of the grid detector was not so evident. Later, however, when the modulation was increased to as much as 100 per cent for loud passages in the transmission, the frequency distortion became very noticeable with the older method of employing the grid detector.

Pentode Detector. Quite a large number of broadcast receivers include a pentode detector. These receivers are invariably of the three-valve type, either straight or super-heterodyne, where the high sensitivity and high anode a.c. resistance of the pentode are required to increase the overall gain and selectivity of the receiver. Nevertheless, the pentode used as a detector is liable to introduce harmonic distortion (see page 123) and for good quality of reproduction it is not to be recommended for this stage.

A pentode detector is usually of the grid detector type. This is very similar to that of the more usual triode grid detector, as will readily be seen from Fig. 45. It will be noticed that reaction is employed by coupling reaction coil L_2 to tuned coil L_1 , and using the variable condenser C_2 for reaction control. Although the h.f. pentode was originally designed to avoid undesired self-oscillation, there is no reason why it should not be used with a reaction arrangement, and, in fact, the circuit shown in Fig. 45 is quite satisfactory. The values of the components are the same as for the triode circuit with the exception of the anode resistances. In the present case, the anode resistance R_2 is $\frac{1}{4}$ M Ω and the decoupling resistance R_3 is 75 000 ohms. These values are higher than those usually employed with a triode and are necessary owing to the much higher anode a.c. resistance of the pentode.

Rectified voltages developed along the detector load resistance R_2 are coupled via C_7 to the subsequent amplifier, which is also a pentode. Anode by-pass condenser C_5 is for

the purpose of providing a low impedance path for the carrier frequency component (f_H in Fig. 28) as described on page 51. An alternative path for the carrier frequency component is through L_2 and reaction condenser C_2 to earth. For effective reaction, therefore, by-pass condenser C_5 should not be too great, say not greater than $0.0005 \mu\text{F}$. If no reaction is employed with the detector valve, C_5 may be increased to

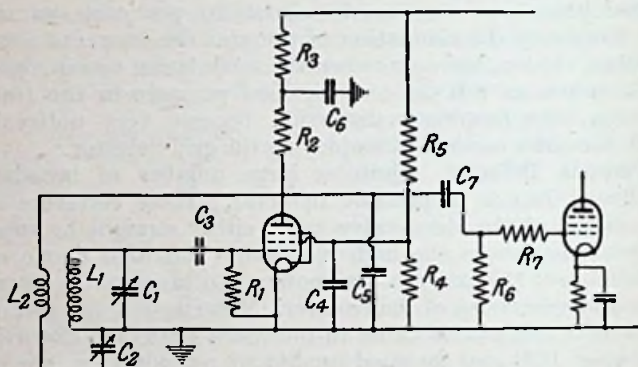

FIG. 45. PENTODE DETECTOR CIRCUIT

$0.002 \mu\text{F}$. with advantage to the quality of reproduction. A high frequency choke may be connected between the detector anode and R_2 to block this path against the carrier frequency component, but this choke is not always necessary if C_5 is chosen properly.

When a pentode is employed as a grid detector it is not advisable to apply a high voltage to the anode. The fairly high resistances in the anode circuit provide a large voltage drop and thus ensure that excessive anode current is not passed by the valve. In the circuit given in Fig. 45, the following operating conditions may be expected under average conditions—

Anode volts	.	.	45
Anode current (mA.)	.	.	0.5
Screen volts	.	.	45 to 60
Screen current (mA.)	.	.	0.2 to 0.3

It is seen, therefore, that the operating conditions for a pentode as a detector are totally different from those when the valve is employed as an amplifier. A high value of grid leak is generally used—from one to two megohms.

Screen-grid Valve Detector. Screen-grid valves are not used very much as detector valves in this country. They are employed with a circuit similar to that of the pentode, Fig. 45, and with low anode and screen-grid voltages (as low as 20 volts each). When a sensitive detector is needed, such as in small receivers, a pentode is generally employed.

CHAPTER IV

HIGH-FREQUENCY AMPLIFIERS

The Need for H.F. Amplification. In the previous chapter it was shown why a detector valve—whether of the power grid, anode, or diode type—should be supplied with a large voltage input in order that it may function with the minimum of distortion. Such a voltage, however, is not obtainable directly from an aerial circuit, and so the voltage received has to be amplified if reproduction of high fidelity is desired. This is one important reason for high-frequency amplification.

High-frequency amplifiers also enable a much greater degree of selectivity to be effected in the receiver owing to the larger number of tuned circuits that may thereby be used. The

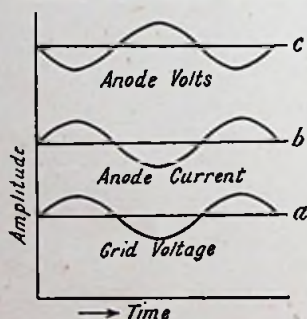

FIG. 46. CURRENT AND VOLTAGE RELATIONS IN THE GRID AND ANODE OF A VALVE

larger the number of circuits tuned to a signal, the easier is it to select the desired signal clear from interfering ones. It is thus seen that quite apart from the advantage of being able to receive the more distant stations at louder reproduced volume, the employment of h.f. amplifiers gives enhanced quality and selectivity.

Phase Relation of Currents and Voltages. Before an alternating voltage is impressed on the control grid of a valve, a certain value of direct current flows in the anode circuit as a result of

the application of the operating voltages supplied to the valve electrodes. When the voltage on the grid is altered, say by the signal, the anode current changes in phase with the grid voltage. This is shown in the curves in Fig. 46, where the alternating component of anode current (curve *b*) is seen to rise with the increase in grid voltage (curve *a*) and vice versa. Now in the anode circuit there is a load impedance

of some kind across which a voltage is produced by this change in anode current, and it follows that the larger the change in current the higher will be the voltage across the terminals of the load impedance and correspondingly less will be the voltage at the anode of the valve. This variation is shown by curve *c* in Fig. 46 where the anode voltage is seen to be of opposite phase to the anode current and grid voltage. It is important in the discussion that follows that the phase relations of the voltages at grid and anode should be borne in mind.

Amplification. A typical amplifier arrangement is shown in Fig. 47, where V_g is the alternating input signal voltage and R_e is the load resistance. V_g may be produced by any form of tuned circuit or even aperiodic (untuned) circuit, and R_e may be in the form of a pure resistance, tuned circuit, choke or transformer winding. These latter forms of load will be considered more particularly later on.

In any examination of the working of the screen-grid valve or pentode as a high-frequency amplifier it is important that the screen grid be at earth potential with respect to the voltages being amplified, so that it acts as an effective electrostatic screen, as explained on page 31. To fulfil this condition, condenser C , Fig. 47, must offer a very small impedance to the signal frequency; i.e. the capacitance of C must be large, say $0.05 \mu\text{F.}$ to $0.2 \mu\text{F.}$ and it must be of the non-inductive type. Under these circumstances, the screen grid functions effectively as a screen between anode and control grid, and any alternating currents set up in it by the electron stream inside the valve will be passed back to the cathode through condenser C without doing any harm. The screen grid is thus tied to earth potential for a.c.

It should also be emphasized that the equivalent amplifier circuit of Fig. 47 and the following discussion are equally applicable to triodes, screen-grid valves and pentodes, whether employed for h.f. or l.f. voltages. Each type of amplifier is considered separately in this book and its peculiarities

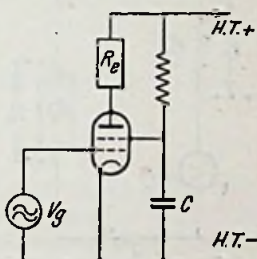

FIG. 47. BASIO H.F. AMPLIFIER CIRCUIT

outlined, but the basic principles of amplification are the same in all cases.

The equivalent circuit of Fig. 47 is given in Fig. 48, the significance of which is as follows. In the anode circuit there may be considered to be injected a voltage equal to the voltage applied to the grid of the valve multiplied by its amplification factor, i.e. μV_g . This generator voltage, so to speak, is distributed along the total resistance inserted in the circuit between the terminals of the generator G according to the usual laws of electro-technics. In the case under examination,

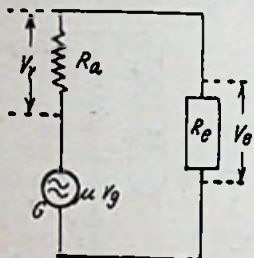

FIG. 48. EQUIVALENT CIRCUIT OF FIG. 47

the circuit resistance is comprised of two main parts: R_a , the anode a.c. resistance of the valve, and R_e the load impedance. The actual ratio of the voltages appearing across these resistances depends entirely upon their relative values. Since the voltage V_o across the valve resistance is wasted from the point of view of amplification it is clear that the value of R_e should be as high as possible consistent with other factors to be examined more fully later, because the higher the value of R_e the greater must be V_o and the effective voltage passed to the succeeding valve.

The actual value of the amplification effected by the valve is generally termed the *effective amplification* or *voltage amplification*, and is the ratio of the voltage developed across the load resistance to that applied to the grid of the valve. In Fig. 48 this is equal to V_o/V_g . Now the voltage across the load resistance (V_o) is equal to $\mu \cdot V_g \times R_e/(R_a + R_e)$. The voltage amplification is therefore

$$A = \frac{V_o}{V_g} = \frac{\mu \cdot V_g \times R_e/(R_a + R_e)}{V_g} = \frac{\mu \cdot R_e}{R_a + R_e}$$

This fundamental equation is applicable to all amplifiers. The actual value and means of providing R_e vary in the different types of amplifier circuits and the designer's problem in high-frequency circuits is to get the utmost impedance into R_e so that A may be as high as the limiting factors of stability

and selectivity will allow. It should be noticed that in high-frequency amplifiers we are concerned with voltage amplification as distinct from the production of power. A different set of factors have to be considered when power is required, and these are examined in Chapter VI dealing with the output stage that handles power.

It is seen from the formula above that voltage amplification is proportional to the amplification factor of the valve and the load resistance. Now consider voltage amplification in respect of the mutual conductance of the valve. We have

$$A = \frac{\mu \cdot R_e}{R_a + R_e}$$

and since $g_m = \mu/R_a$, or $\mu = g_m \cdot R_a$

we have finally $A = g_m \frac{R_a \cdot R_e}{R_a + R_e}$

where g_m is expressed in mhos and R_e and R_a in ohms. This shows that the amplification is also proportional to the mutual conductance. The expressions given above are basic formulae for voltage amplification, but they need modification, of course, when the anode load is an impedance instead of an ohmic resistance, as will be seen later.

Practical Application of Formulae and Amplification. Consider now how the formulae for amplification can be applied to practical radio receivers. In Fig. 49 is seen a circuit diagram of a typical high-frequency amplifier stage in which an h.f. pentode is employed with a tuned anode circuit. The load circuit is indicated by Z_e , as a tuned circuit is usually regarded as an impedance (Z) instead of a resistance. This makes no difference to the application of the formulae, however, because at resonance, the tuned circuit presents a pure resistance, i.e. its dynamic resistance, to the high-frequency currents.

The formulae for amplification show that the higher the impedance of Z_e , the greater will be the effective amplification. If Z_e could be made equal to infinity, the effective amplification would equal the amplification factor of the valve. As this condition can never be attained in practice, the actual amplification provided must always be less than the amplification factor. Z_e can be made high by using a good design

of coil in the tuned circuit—a coil in which such factors as ratio of diameter to length of winding, dielectric losses, screen, etc. losses, and type of wire have been carefully considered. The quality of a coil is governed by the ratio of its reactance to high-frequency resistance, i.e. $\omega L/R$. Another important factor in providing a high Z_e is the ratio L/C of the tuned circuit. The higher this ratio is, the higher is the dynamic resistance the circuit presents and, accordingly, the higher is the effective amplification of the stage.

Since L/C is only constant at one particular point of the tuning range, it is clear that with a tuned anode circuit the amplification will vary as the effective capacitance of the tuning condenser is varied to tune the receiver to the different wavelengths, being highest when a station on the shortest wavelength (highest frequency) is tuned in and the minimum capacitance is connected across the coil.

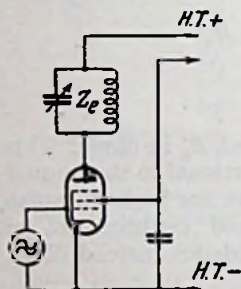

FIG. 49. TUNED ANODE H.F. AMPLIFIER CIRCUIT

Now examine the case where a given coil and condenser are provided in a receiver with a stage as shown in Fig. 49. From the formula given it is evident that the effective amplification will be proportional to the amplification factor μ . This is the real significance of the amplification factor, which is a somewhat misleading coefficient unless

it is thoroughly understood. Some h.f. pentodes, for instance, have amplification factors of 1 500 or more. It would be absurd to expect an actual amplification of 1 500 from these valves. As already seen, the effective amplification would be

$$1\,500 \times R_e / (R_a + R_e)$$

and would probably be in the neighbourhood of 150. Nevertheless, under the conditions now being considered, i.e. with a given load impedance, a valve with a μ of 400 and a given R_a will give approximately double the amplification provided by a valve with a μ of 200 and the same R_a , always assuming that other factors such as instability do not interfere and that the valves are both operated at correct supply voltages.

The third factor in the amplification formula is the anode a.c. resistance of the valve, R_a . It is seen that the effective amplification is inversely proportional to R_a . In a circuit having a given value of load impedance, therefore, the valve with a low R_a will provide higher amplification than one with a larger R_a if both valves have the same μ . This can readily be proved by inserting figures in the formula. Assume, for example, that R_a of three different valves is (1) 200 000 ohms, (2) 500 000 ohms, and (3) 1 000 000 ohms; the anode circuit has an impedance of 200 000 ohms (quite a normal figure), and that each valve has an amplification factor of 300. Actually a valve with an R_a of 1 000 000 ohms would probably have a μ of about 800, but we will disregard that for the moment. The respective effective amplifications provided by the three valves will be—

$$\text{Valve (1)} \quad A = \frac{300 \times 200\,000}{200\,000 + 200\,000} = 150;$$

$$\text{Valve (2)} \quad A = \frac{300 \times 200\,000}{500\,000 + 200\,000} = 86;$$

$$\text{Valve (3)} \quad A = \frac{300 \times 200\,000}{1\,000\,000 + 200\,000} = 50.$$

These figures demonstrate very clearly that there is not much advantage in using a valve of high impedance unless the circuit connected to its anode is of good quality. In fact, with most screen-grid valves and h.f. pentodes the effective amplification is determined by the quality of the impedance connected in the anode circuit. This is emphasized by the figures above, where, for instance, a valve with a μ of 300 and R_a of 1 000 000 ohms provides an amplification of only 50 when $R_c = 200\,000$ ohms. The higher the a.c. resistance of a valve, the more difficult will it be to obtain an effective amplification that is even a reasonable fraction of the amplification factor. When it is remembered that the average commercial radio frequency coil provides an impedance of about 100 000 ohms, it will be realized that under normal operating conditions the amplification of a screen grid or h.f. pentode valve can only be a small fraction of the theoretical μ of the

valve. So far as broadcast receivers are concerned, the effective amplification obtainable from one of these valves is proportional to the load impedance and the mutual conductance. An approximate figure will be given by

$$A = R_e \times g_m$$

where R_e is in ohms and g_m in mhos. It is thus seen that the mutual conductance g_m is of very great importance in respect of the amplification to be obtained from these high impedance valves; more so, in fact, than the amplification factor μ .

Selectivity. Typical selectivity curves are given in Fig. 50, curve 1 being in respect of a more selective circuit than curve 2.

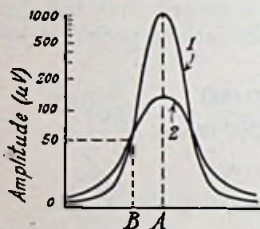

FIG. 50. TYPICAL SELECTIVITY CHARACTERISTICS

When both circuits are tuned to the carrier frequency A , the voltage of resonant frequency at the terminals of circuit 1 is $1000 \mu\text{V}$. An interfering voltage due to a signal on an adjacent channel at carrier frequency B sets up a voltage in circuit 1 of $50 \mu\text{V}$. The ratio of desired to interfering voltage is thus $20/1$ which is quite satisfactory for one circuit. In the case of circuit 2, however, the corresponding voltages are $150/50$, giving a ratio of only $3/1$ and thereby

enabling the disturbing voltage to produce a considerable amount of interference in the receiver. It is, therefore, of paramount importance that steps should be taken in the design of the receiver to ensure that the ratio of desired to interfering signal voltage is a maximum.

Any factor that introduces damping or resistance into a tuned circuit will tend to diminish the peak value of the selectivity curve as given in Fig. 50, and thereby reduce the selectivity. Now there are two known ways in which a valve can introduce damping into a tuned circuit. As seen from Fig. 49, the control grid-cathode path is in shunt to the input tuned circuit, and the anode a.c. resistance of the valve is in shunt to the anode circuit. If anything is done to bring the resistance of the grid-cathode path or R_a of the valve to values that are comparable with the respective impedances of these

tuned circuits, therefore, a shunting effect will result, this being equivalent to introducing a series resistance into the tuned circuit and thereby damping it. Conversely, of course, the higher the shunt resistances are, the less is the damping they will have on the tuned circuits and the greater will be the resulting selectivity.

To ensure that the input resistance across the control grid-cathode is high, it is necessary that the grid should be always at a negative voltage with respect to the cathode. If the grid bias is too low, or becomes positive, the input impedance becomes rather low as was seen in Fig. 19. This is especially so when grid current flows. In practice it is a fairly simple matter to maintain the grid negative, and selectivity seldom suffers through difficulties in this respect.

A valve with high R_a will be less of a shunt to the anode circuit than a valve with low R_a . On the other hand, the actual valve resistance has already (see page 27) been shown to be dependent upon the operating voltages, and these should be correct for satisfactory selectivity. For example, it is quite practicable to increase the anode a.c. resistance of an h.f. pentode from 0.25 M Ω . to 0.75 M Ω . by raising the anode potential from 100 volts to 250 volts, the screen voltage being constant.

Inter-electrode Capacitances. Owing to the proximity of the valve electrodes to each other inside the valve envelope, a certain amount of capacitance exists between them. In addition to this capacitance there are others due to the closeness of the leads-in, as these pass through the pinch of the valve, and also to the mounting of the pins on the base and their position in the valveholder. The net result of all these capacitances is indicated by the dotted line in Fig. 51. Capacitance C_{gc} is that between grid and cathode, C_{ga} that between control grid and anode, and C_{ca} that between cathode and anode.

A common value for C_{gc} with a screen-grid or h.f. pentode valve is 9 $\mu\mu\text{F}$. It is seen from Fig. 51 that this capacitance is effectively across the tuned input circuit, and therefore increases the minimum capacitance across the tuning coil by that amount. Unfortunately, C_{ga} is parallel with C_{gc} , and this makes the problem considerably more serious than would at first appear.

Now although C_{gc} and C_{ga} are effectively in parallel, they are not charged to the same potential, for it has already been shown that if V_g is the alternating grid voltage, μV_g is the alternating voltage in the anode circuit, and the respective capacitances will be charged to these voltages. If A represents the stage gain, the actual a.c. voltage across the load impedance will be $A \cdot V_g$. Furthermore, since the anode voltage is in opposite phase to the grid voltage, the actual voltage available at the terminals of C_{ga} , relative to the cathode, must be $(A + 1)V_g$. Suppose, for example, the grid voltage rises by 0.1 volt, and the effective stage gain A of a screen-grid valve is 100. Then compared with the static conditions $V_g = +0.1$ and $V_a = -10.0$. The difference between V_g and V_a has, therefore, altered by 10.1 volts, which is equal to $(A + 1)V_g$. It is thus seen that the effective capacitance across the input circuit is

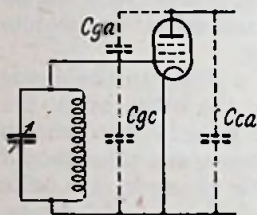

FIG. 51. EQUIVALENT CIRCUIT OF FIG. 49

$$C_{eff} = C_{gc} + (A + 1)C_{ga}.$$

This is the fundamental law of inter-electrode capacitances. The significant point about it, from the aspect of high-frequency amplification, is the influence of A —the *effective* stage gain, as distinct from the theoretical amplification factor of the valve. It is seen that, in addition to the grid-cathode capacitance, an additional capacitance is “reflected” into the input circuit numerically equal to the stage gain plus one times the static grid-anode capacitance. If, therefore, the gain is made very high—such as by employing highly efficient tuned circuits—then the effective input capacitance will be increased correspondingly. This fact should be remembered when considering the operation of screen-grid valves and h.f. pentodes. Although the control grid-anode capacitance of these valves is only a very small fraction of that present in a triode, they are not entirely free from the harmful effects of interelectrode capacitance owing to the much greater gain provided.

As regards the capacitance reflected into the input circuit, this will tend to throw out of alignment any ganging

arrangement of tuned circuits involved, if this capacitance has not been calculated and allowed for, or if it should be different to that reflected while the ganging process was being carried out. This also explains why a change of valve usually involves re-ganging the circuits for most satisfactory results.

Feed-back. In addition to reflecting a capacitance into the input circuit, the control grid-anode capacitance has the much more harmful effect of providing a means of enabling a voltage to be fed-back to the grid from the anode circuit. If this voltage is in phase with that already at the grid or has a component that is in phase, it will augment the voltage already there and, if the fed-back voltage is of sufficient magnitude, the h.f. resistance of the input circuit will be cancelled out and the amplifier valve will be set into oscillation. Such a state of affairs is, of course, fatal to the working of the amplifier, and it is this tendency to oscillate, or instability, that handicaps the triode for high-frequency amplification.

The feed-back of voltage from anode to grid is equivalent to introducing a resistance into the input circuit that is negative or positive according as the voltage is in phase or out of phase with the signal grid voltage. Now the phase of the feed-back voltage, relative to the grid voltage, is largely governed by the type of impedance in the anode circuit. When the anode circuit is *exactly* in tune to the input voltage, for example, it represents a pure resistance, but as the circuit is detuned it becomes either inductive at a frequency lower than resonance, and capacitative at a frequency higher than resonance. The most harmful condition with respect to stability is an inductive anode load, for over a certain range of load impedance a negative resistance is then reflected into the input circuit, in addition to the capacitance already mentioned, and tends to throw the system into oscillations. This negative resistance is brought about by the change in phase of the anode voltage, whereby the voltage fed-back to the grid increases that already there. In this connexion it should be noted that if the ganging of the grid and anode circuits is slightly inaccurate, resulting in the capacitance across the anode coil being insufficient for resonance, the conditions for instability are fulfilled and trouble due to this may be experienced.

Although when the anode circuit is *exactly* in tune it represents a pure resistance and there is not the same tendency towards self-oscillation, the difficulty still occurs that a resistance is reflected into the input circuit. In this case the resistance is positive and will not set up oscillations. As it appears across the input tuned circuit, however, it may seriously diminish the effective selectivity of the receiver by increasing the damping of this circuit. With screen-grid valves and h.f. pentode valves with high amplification factors and good quality tuning coils in the anode circuit, it frequently happens that the effective impedance across the input circuit approaches that of the tuned input circuit itself. This introduces a serious damping into the tuned grid circuit and the selectivity and gain of the stage are diminished.

A good quality tuned circuit in the anode circuit will also increase the instability owing to its high dynamic resistance (i.e. load impedance) providing a larger effective amplification, thereby increasing the voltage available for the feed-back.

Clearly, then, it is of vital importance for the satisfactory amplification of high-frequency signals to employ valves with the smallest possible control grid-anode capacitance. With triode valves suitable for high-frequency amplification, the grid-anode capacitance varied among the different types from $4 \mu\mu\text{F.}$ to $8 \mu\mu\text{F.}$ In screen-grid valves and h.f. pentodes the corresponding capacitance is usually some value between $0.001 \mu\mu\text{F.}$ to $0.035 \mu\mu\text{F.}$, the most common value being about $0.003 \mu\mu\text{F.}$ It is thus seen that the harmful capacitance has been reduced to less than one-thousandth that usually present in triode valves, and a corresponding improvement in stability, selectivity and gain (due to less damping being introduced into the input circuit) is provided by these valves.

When a highly efficient design of amplifier is employed with a triode h.f. stage, a gain of 20 to 30 is possible. Without nearly so much care in design or operation of an h.f. pentode valve a stage gain of 100 is obtainable and gains of several hundred are possible. These are the reasons that led to the decline of the triode valve as a high-frequency valve.

Precautions are still necessary in the use of screen-grid valves and h.f. pentodes. For example, unless care is taken to ensure that the anode and control grid circuits are not

coupled externally of the valve itself, i.e. in the receiver wiring or components, the benefit of the screen grid will be lost. A few micromicrofarads of capacitance are very easily provided by inefficient screening or wiring, and strict attention must be paid to this point.

Neutralizing Grid-anode Capacitance. Although this book is concerned only with modern radio receiver valve technique, mention of the method employed for neutralizing the effect of the grid-anode capacitance is outlined here because it is a principle of fundamental importance. This principle has been used, in fact, quite recently in connexion with h.f. pentode frequency changers and hexode valves, and cannot be considered as belonging to a past era.

To compensate the voltage fed back by C_{ga} to the grid, some means has to be devised for producing at the grid a voltage of equal magnitude but opposite in phase to that fed back.

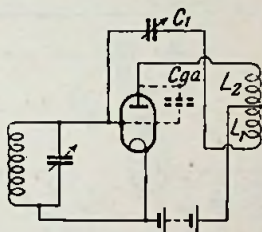

FIG. 52. NEUTRALIZED H.F. TRIODE CIRCUIT

There are many methods of neutralizing the effect of the internal grid-anode capacitance, but probably the commonest circuit employed was that shown in Fig. 52. The anode h.t. voltage is connected to the mid-point of the primary of a high-frequency transformer coupling the anode circuit of the h.f. amplifier to the subsequent amplifier or detector. A neutralizing condenser C_1 of very small capacitance is joined between one end of the transformer primary and the grid. The circuit consisting of L_1 L_2 C_1 C_{ga} is, in effect, a bridge circuit, of which the arms are L_1 C_1 and L_2 C_{ga} . If, therefore, L_1 is made equal to L_2 , and C_1 is the same value as C_{ga} , a balance is obtained and no reactive effect due to C_{ga} will take place. This system worked reasonably well in practice, although balance could only be obtained over a limited range of wavelengths. If the valve was changed, the value of the neutralizing condenser had to be readjusted to suit the different value of C_{ga} . Multi-stage amplifiers employing three neutralized valve circuits designed on these lines were successfully marketed, but extreme care had to be taken in ensuring a

very thorough screening of the circuits. Even so, it has been found to be no easy task to obtain a satisfactory balance, particularly when valves of fairly high amplification factor were employed.

H.F. Amplifier Circuits. If a tuned circuit is connected between the h.t. voltage supply source and the anode, an h.f. voltage will be produced across the tuned circuit terminals in the manner already examined, and this voltage may be coupled to the following amplifier or detector by means of a

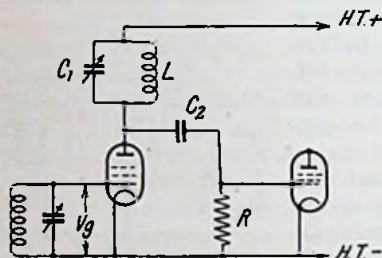

FIG. 53. SHOWING METHOD OF COUPLING TUNED ANODE AMPLIFIER TO SUBSEQUENT VALVE

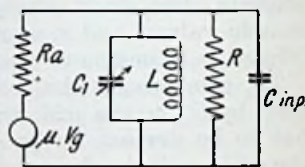

FIG. 54. EQUIVALENT CIRCUIT OF FIG. 53

fixed condenser. This arrangement is shown in Fig. 53, where LC_1 is the tuned circuit and C_2 is the coupling condenser. The dynamic resistance of LC_1 corresponds, therefore, to R_d in the amplification formula. Now we know that when a circuit is tuned it represents a resistance, called its dynamic resistance, to a current having the frequency of resonance. With the tuned anode circuit, it is the dynamic resistance (R_d) of the anode circuit that constitutes the load impedance R_d . The dynamic resistance of a circuit $= \frac{L}{CR}$, R being the high frequency resistance of the circuit, so the basic amplification formula now becomes

$$A = \frac{\mu \frac{L}{CR}}{R_a + \frac{L}{CR}}$$

where L , C , R , are in respect of the tuned anode circuit.

The equivalent circuit is given in Fig. 54. Coupling condenser C_2 does not appear in the equivalent circuit as it is assumed to have negligible reactance. This assumption can readily be seen to be justified by imagining C_2 to be situated between the top of LC_1 and C_{inp} (the effective control grid-cathode capacitance) shunted by R (the effective input resistance of the following valve). C_2 is actually in series with R , and since the latter is usually of a high order, the reactance of C_2 , even if several thousand ohms, will be negligible. A usual value of C_2 is 0.0001 $\mu\text{F.}$ to 0.0003 $\mu\text{F.}$,

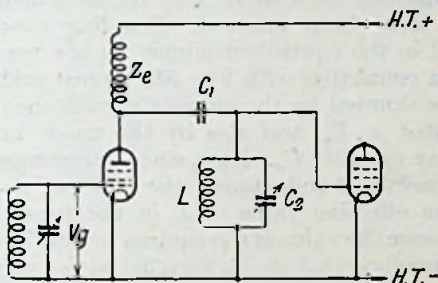

FIG. 55. CIRCUIT OF CHOKE COUPLED AMPLIFIER

so that its reactance $1/\omega C$ will frequently be only hundreds of ohms during broadcast reception.

The circuit of Fig. 54 shows that the tuned anode circuit is shunted on the one side by the valve impedance in series with the generator μV_g , and on the other side by the effective input capacitance C_{inp} in parallel with R . Consequently, for satisfactory amplification and selectivity, neither of these shunts must be allowed to have a resistance that approaches the numerical value of the dynamic resistance of LC_1 . This means that the valve should have a high R_a and that the grid leak of the subsequent valve should not be lower than one megohm—preferably two megohms.

The effect of the input capacitance of the following valve is to increase the capacitance connected across the tuning coil L and thus to diminish the amount of tuning condenser required to tune L to resonance. As this extra capacitance is usually several micromicrofarads, no serious

results are thereby produced if this additional capacitance is allowed for.

Impedance or Choke Coupled Amplifier. In this circuit, the tuned anode circuit of Fig. 53 is replaced by a high-frequency choke, and the grid leak of the next valve gives way to a tuned circuit. The new circuit is shown in Fig. 51 where Z_e is the anode impedance or h.f. choke, C_1 the coupling condenser, LC_2 the tuned grid circuit of the second valve, which may be either an amplifier or detector.

The equivalent circuit works out very similarly to the previous example, as seen in Fig. 56, in which the ohmic resistances have been omitted. Coupling condenser C_1 is not inserted in the equivalent circuit for the reasons already explained in connexion with Fig. 54. Tuned grid circuit LC_2 is seen to be shunted by the anode a.c. resistance R_a in series with generator $\mu \cdot V_g$, and also by the anode impedance Z_e with its stray capacity C_z . Now, since inductances in parallel reduce the resultant inductance, the effect of Z_e must be to diminish the effective value of L in the tuned circuit and thereby increase the value of C_2 required to tune it to resonance. It is seen, therefore, that the choke must have a value of inductance many times higher than L , partly so as not to throw out the tuning of LC_2 and partly so as not to shunt any serious proportion of signal voltage away from LC_2 . This implies that the reactance of Z_e must be high compared with the dynamic resistance of LC_2 .

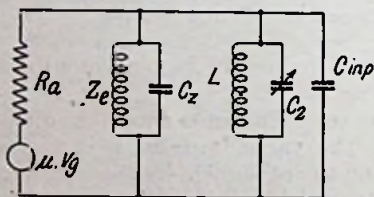

FIG. 56. EQUIVALENT CIRCUIT OF FIG. 55

The input capacitance of the second valve is indicated C_{inp} , and the stray capacitance of the choke by C_z . The latter is unavoidable owing to the necessity of providing a high reactance, entailing a very large number of turns of wire. Both C_z and C_{inp} are connected across the tuned circuit and thereby increase the effective tuning capacitance C_2 . It will be noted that this is the reverse of the influence of the shunting effect of the choke reactance. These two "effects" in choke-coupled

amplifiers tend to neutralize each other, therefore, although the degree of cancellation will depend upon the design of h.f. choke employed. An ordinarily good choke has a stray capacitance of $2 \mu\mu\text{F}$., whereas a poor one may have a capacitance of $10 \mu\mu\text{F}$. In neither case is the operation of the amplifier impaired if this stray capacitance has been allowed for.

A far more serious defect in the choke from the point of view of the efficiency of the tuned circuit LC_2 is its total resistance to high-frequency currents. This resistance is composed not merely of the d.c. copper resistance of the wire but also the h.f. resistance due to the former and insulation round

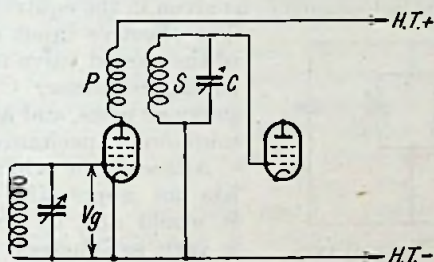

FIG. 57. TUNED TRANSFORMER COUPLED H.F. AMPLIFIER CIRCUIT

the wire, and is influenced considerably by the position of the terminals. It is important that this resistance be kept to the lowest possible figure, for it will reduce the dynamic resistance of the combined choke and tuned circuit, and thus diminishes gain and selectivity. With an ordinarily well-designed choke, having a high L/R ratio, the loss due to this is very small. The most serious disadvantage with choke coupling is the resonance that occurs in the circuit consisting of the choke and the stray capacitance. This resonant frequency should be lower than the lowest frequency to be received so as to avoid peaky reception over the waveband.

Tuned Transformer Coupling. In this circuit a high-frequency transformer is used, the primary being connected in the anode circuit and may be untuned. The secondary

may be tuned by a variable condenser and joined between control grid and cathode of the succeeding valve, as shown in Fig. 57. The transformer need not have a step-up ratio, but may be merely two inductance windings with the same number of turns, coupled together.

The equivalent circuit is given in Fig. 58 and is seen to be extremely simple. In practice, the two transformer windings act almost as though they were one as described below, with the result that as the secondary is tuned by C the effect is almost the same as if the primary were being tuned by C . That is to say, the primary P and secondary S act as though they were one inductance L , as given in the equivalent circuit.

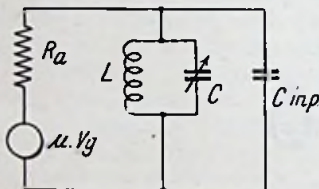

FIG. 58. EQUIVALENT CIRCUIT OF FIG. 57

The effective input capacitance of the second valve is across the tuning condenser C as in the previous cases, and increases the minimum capacitance of C .

Although the primary winding has an appreciable reactance, it would not, by itself, enable a very satisfactory gain to be obtained from the valve to whose anode it is connected. The

influence of the tuned secondary winding, however, is to inject a resistance into the primary winding which is additive to that already there. The resistance of the primary now being referred to is the high-frequency resistance (usually a few ohms only) and not the reactance (ωL). Resistance is only injected into the primary by the secondary by virtue of the latter being tuned to some frequency by means of C , and through the medium of the mutual inductance that exists between the two windings. From this it follows that the greater the mutual inductance M , the higher will be the resistance injected R_{inj} , and since M is proportional to the coupling for a given pair of coils, it is plain that the closer the primary and secondary windings are arranged together, the higher will be R_{inj} .

The relation between these can be expressed as

$$R_{inj} = \omega^2 M^2 / R_s \text{ ohms}$$

where M indicates mutual inductance in henries, R_{in} is the

resistance injected, ω is the usual $2\pi f$, and R_s is the high-frequency resistance of the secondary winding at the particular resonant frequency being considered. Now R_{inj} is, for all practical purposes, the load impedance of the valve. From the expression given above, therefore, the effective amplification, which has previously been shown to be proportional to the load impedance, must vary with the tuning of the transformer secondary, for under these circumstances the load impedance (R_{inj}) is seen to vary as the square of the frequency.

When both the primary and the secondary windings are tuned, they act as a filter. The coupling is then very critical, for not only is the effective amplification influenced by the coupling, but also the degree of selectivity. When the coupling is tight, the gain is increased but the arrangement is unselective. On the other hand, when the coupling is weak the amplification is reduced but at the same time the circuit is made much more selective. Tuned windings are generally employed in intermediate frequency transformers of superheterodyne receivers, and for varying the selectivity a mechanical device is frequently fitted to enable the relative proximity of the windings to be varied and so bring about an alteration in coupling and thereby the band-width passed.

Distortion in H.F. Amplifiers. In the operation of h.f. amplifiers various types of distortion are produced unless steps are taken to avoid them. In recent years the construction of an h.f. amplifier that is substantially distortion-free has been greatly facilitated by the introduction of special types of valve, but care is still needed in the practical design and operation of the amplifier. The provision of an effective non-distorting control of amplification in this stage was one of the greatest difficulties, but this was overcome by the introduction of the variable-mu valve as described in Chapter II.

SIDEBAND CUTTING. When the high-frequency circuits are made highly selective, the total frequency band passed by them is correspondingly reduced. This is evident from Fig. 50, where curve 1 is seen to be much narrower than curve 2, resulting in the extreme frequencies at *B* being partly suppressed. In the musical scale, the notes reproduced by the receiver loudspeaker corresponding to point *A* are the lowest while, as the distance from *A* to any point *B* is increased, the

corresponding musical note represented is higher. In the case of a highly selective circuit, the actual curve would be even narrower than curve 1 and thus distortion of the high notes is produced. This distortion is often referred to as *sideband cutting*. When much sideband cutting is taking place, the reproduction sounds low-pitched and lifeless. Some receivers are so selective that all frequencies over 3 000 are seriously diminished in amplitude.

The remedy for sideband cutting is the fitting of band-pass filters. These bring about a flattening of the top of the curves

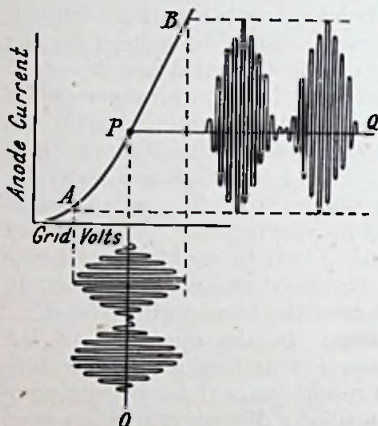

FIG. 59. SHOWING HOW MODULATION DISTORTION IS PRODUCED

shown in Fig. 50 and a straightening of the sides. The width of the filter is adjusted to the required degree for satisfactory musical reproduction. In many receivers the width is adjustable by hand, so that it may be wide for local reception and high fidelity, and narrower for the foreign stations that are more difficult to receive through interference.

MODULATION DISTORTION. This type of distortion is produced by the unequal amplification of the positive and negative

half-cycles of a modulated carrier wave due to the bend in the grid voltage-anode current characteristic. The net result is that the modulation degree is increased on the positive half-cycles and for this reason the type of distortion now being considered is sometimes referred to as *modulation rise*.

The actual process whereby modulation distortion is produced in a high-frequency amplifier is seen from Fig. 59. A normal modulated carrier wave is applied to the control grid of a high-frequency valve which is biased to operate at point P of its grid voltage-anode current characteristic. In the anode circuit there take place current fluctuations about a value

AB. It is seen, however, that the positive half-cycles of the modulation envelope are much greater in amplitude than the negative half-cycles, whereas in the original signal as applied to the grid, seen fluctuating about *PO*, the positive and negative half-cycles are of equal amplitude. The wave form of the modulation envelope has clearly been distorted.

It will be noticed that the operating point *P* is near a curved part of the amplifying valve's characteristic. Due to this, the asymmetric amplification shown along *AB* is brought about owing to the greater amplification at point *B*, for example, than at point *A*. If the operating point is moved further up the characteristic so that the points *APB* are on a linear portion of it, then the amplified signal will be a faithful copy of the input signal. The condition for undistorted amplification is, of course, that the distance *AP* equals *PB*. Under these circumstances the positive half-cycles of modulation envelope are equal to the negative half-cycles.

From Fig. 59 it can be seen that, even if the valve is worked on the bend of its curve, weak signal voltages will not be distorted, since the closer *A* and *B* are situated to *P* the more nearly equal do they become. It is also evident that the higher the signal voltage on the grid, the greater will be the modulation distortion owing to the reduced slope of the curve (and therefore the reduced amplification of the negative half-cycles of modulation) as the point of anode current cut-off is approached. Modulation distortion, in fact, is proportional to the square of the signal voltage applied to the grid.

In practice, an h.f. amplifier valve will not be worked at point *P* except under special circumstances. During reception of a signal of average intensity, the operating point is chosen to be well up on the linear part of the characteristic. With screen-grid valves that have no variable- μ characteristic, the permissible grid swing is small. Consequently, when it is desired to receive a strong signal, the valve will be seriously overloaded unless some form of volume control is employed. If the volume control affects the position of the operating point on the characteristic, then for reception of the strong signal, the point *P* will have to be moved towards the bend in the curve to an extent depending upon the strength of the incoming signal so as to avoid grid current. As the point of

anode current cut-off is approached, however, modulation distortion is bound to take place in the manner already outlined. This was one of the most serious drawbacks to the use of screen-grid valves before the advent of the variable-mu valve.

As the value of grid bias applicable to the straight screen-grid valve is very limited it is necessary to employ some kind of input circuit volume control of the type that limits the signal voltage applied to the control grid of the amplifier valve. The volume control most commonly employed is a variable resistance connected across the aerial-earth terminals of the receiver. For reception of a strong signal the amount of resistance in circuit across the aerial-earth terminals is reduced, thus short-circuiting a proportion of the signal voltage and enabling the amplifier valve to operate without departing from linear amplification.

When variable-mu valves are employed, modulation distortion is greatly reduced, if not eliminated entirely, owing to the shape of the grid voltage-anode current characteristic. The curve in Fig. 21 shows that the bend in this characteristic is not nearly so sharp as in that of the valve without variable-mu properties, and that the approach to anode current cut-off is very gradual. Consequently, the wave form is distorted far less, giving rise to a greatly diminished amount of modulation distortion.

CROSS MODULATION. This is a type of distortion due to the simultaneous reception of two signals, voltages due to which are additive at the control grid in such a manner that the desired signal carrier wave is modulated—*cross modulated*—by the audio-frequency variations taking place on the interfering signal carrier wave. Such an interfering station need not be the next adjacent station in respect of carrier frequency. In extreme cases it may be separated by several broadcast channel widths. The only essential feature for an interfering station to produce cross modulation is that it shall set up at the control grid of the high-frequency amplifier valve voltages of such a magnitude that they, added to the voltages produced by the desired signal (to which the circuits are tuned) swing the grid past the linear portion of the grid voltage-anode current characteristic.

When both the desired and interfering signals are modulated carrier waves, the two signals will be reproduced together. Should the modulation of the desired signal cease, however, the modulation of the interfering signal will be impressed on the desired signal carrier wave and will be heard in the reproducer. As soon as the desired station stops transmitting, however, the interfering station is not heard for there is then no carrier to cross modulate. The amount of cross modulation is practically independent of the desired carrier wave amplitude.

The principal cause of cross modulation is the non-linearity of the amplifier valve's mutual conductance characteristic. A variable μ valve has a characteristic, as seen in Fig. 21 which, although permitting a very wide range in effective amplification, is not perfectly linear about the central portion. When signals operate the valve over the non-linear part, cross modulation is likely to occur if there is present in the input circuit a strong signal on an adjacent channel to that tuned by the receiver. So long as the signal voltage does not swing past the linear portions of the curve or into the region of grid current, cross modulation does not occur. Should the interfering signal voltage be sufficient it will cause the valve to operate over the non-linear part of the curve, although the weaker desired signal has not the amplitude necessary to do so, and in this case also cross modulation takes place.

The use of automatic volume control in a receiver tends to increase the possibility of cross modulation in the following way. It will be seen from Chapter IX that the a.v.c. voltage is obtained from a part of the receiver that is much more selective than the radio frequency tuned circuit. Consequently the input to the a.v.c. valve is unlikely to contain an interference signal of sufficient amplitude to have an appreciable influence on the d.c. control voltage provided for biasing the previous amplifier stages. Thus, a weak desired signal produces a low a.v.c. voltage and the amplifier valves are accordingly biased by the a.v.c. line with a small negative voltage. The amplifier valves, under such conditions, are operated on the steep linear part of the characteristic (see Fig. 21) corresponding to low bias. If a voltage from an interfering station on an adjacent channel is developed in the r.f. circuits, this may be sufficient to increase the voltage at

the grid and swing the grid voltage over the non-linear portion or into the grid current region and so produce cross modulation.

The selectivity of the input circuit is clearly of paramount importance for the elimination of cross modulation, for if the voltages impressed on the aerial by the interfering signal are prevented from passing through the circuit coupling it to the h.f. valve, then no disturbing voltage can be set up on the grid. Fortunately for the effectiveness of preventive measures, the intensity of cross modulation varies as the square of the voltage produced by the interfering signal over a wide range of frequencies. One result of this proportionality is that any steps that are effective in reducing the interfering voltage by, say, one-half, will diminish the intensity of cross modulation by three-quarters. In practice it is found that an efficient band-pass filter coupling between aerial and valve grid is satisfactory as a means of preventing cross modulation. The actual degree of freedom obtained depends on the frequency difference between the desired and the interfering signal—the greater this difference is the more completely will the trouble be overcome. Should the gain in selectivity due to the employment of a band-pass filter instead of a single-tuned circuit as aerial coupling be as five is to one (i.e. the voltage of the interfering signal is reduced to one-fifth) then the intensity of the cross modulation will be diminished to one twenty-fifth. No influence will be effected on the cross modulation by the circuits in stages succeeding the first h.f. amplifier, because the process of cross modulation usually takes place in the aerial coupling circuit and first valve, and once the two signal voltages have become mixed, no subsequent measures will be able to separate them.

CHAPTER V

LOW-FREQUENCY AMPLIFIERS

THE low-frequency signal voltage delivered by a detector is too small for practical sound reproduction. Although in the case of grid detection the rectified voltage is amplified by the detector valve, the actual power available is not great enough to work a loudspeaker or other utilization device satisfactorily. Some means must therefore be provided for amplifying the signal voltage provided by the detector, and this is the object of the low-frequency amplifier stage.

An additional need for low-frequency amplification is the fitting of a gramophone pick-up. Although it is practicable to connect a pick-up directly to a sensitive output pentode, such as the Mazda AC2/Pen, it is preferable to employ a stage of low frequency amplification in addition to the output stage. The latter arrangement is usually employed in broadcast receivers.

RESISTANCE-CAPACITANCE AMPLIFIERS

The standard arrangement for a resistance-capacitance coupled amplifier is shown in Fig. 60, the actual amplifier stage consisting of V_1 , R_1 , C and R_2 . In operation, the anode current fluctuations of V_1 that are set up by the low-frequency voltage applied to the input electrodes of that valve, produce along R_1 voltage variations by the usual relation iR . These alternating voltages in R_1 are applied to the grid of the following amplifier valve V_2 by the coupling condenser C . The resistance R_2 plays an important part, but will be examined later on. Neglecting for the moment the effect of any stray capacitances, the equivalent circuit of Fig. 60 is given in Fig. 61. Here R_a is the anode a.c. resistance of V_1 , and the other circuit elements are indicated by similar letters to Fig. 60. It is seen that R_1 is in shunt to the coupling condenser C and grid leak R_2 of V_2 . As regards the voltage available at R_1 , however, C and R_2 do not present a serious load, as R_2 is usually several times larger than R_1 .

Considering first the possible amplified voltage available at R_1 for transfer across C , it is evident that the value of load resistance R_1 is of great importance, for if it is increased in an attempt to produce a high a.c. voltage drop, the h.t. voltage at the anode of V_1 will be reduced. In other words, the value of R_1 is limited by the h.t. supply provided. The most satisfactory way of operating a resistance amplifier, however, is to use a high anode supply voltage to compensate in some way for the d.c. voltage drop in R_1 . In this case, the higher R_1 is, the greater will be the possible amplification until,

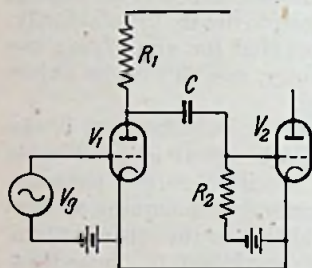

FIG. 60. BASIC RESISTANCE-CAPACITANCE COUPLED AMPLIFIER

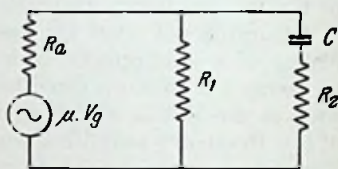

FIG. 61. EQUIVALENT CIRCUIT OF FIG. 60

if R_1 is infinitely large, the actual amplification is made equal to the amplification factor of the valve.

Considering only the alternating current i_a in the load resistance R_1 , this is equal to the amplified voltage available divided by the total resistance in the anode circuit consisting of R_1 and the anode a.c. resistance of the valve in series. Expressed as an equation, this is

$$i_a = \frac{\mu \cdot V_g}{R_1 + R_a}$$

Now the alternating voltage drop in R_1 must be equal to the product of the resistance by the alternating current, i.e. $V_a = i_a R_1$. Substituting for i_a in this equation the value given above, we get

$$V_a = \frac{\mu \cdot V_g \cdot R_1}{R_a + R_1}$$

and from this

$$\frac{V_a}{V_g} = \frac{\mu \cdot R_1}{R_a + R_1}$$

which is the same as saying that the amplification of voltage in a resistance-capacitance coupled amplifier valve is

$$A = \mu R_1 / (R_1 + R_a)$$

It should be noted that the voltage so far considered is that actually available from the anode resistance. If it is assumed that the coupling arrangement to the next valve is not productive of any voltage loss, then the stage gain is also that stated above. In many cases, this assumption is reasonably accurate, but it needs examination before being accepted in a particular case. In any event, the theoretical gain in a resistance-capacitance coupled amplifier is that given above. This explains the statement already made that as R_1 is increased the amplification is also raised to the limits imposed by the

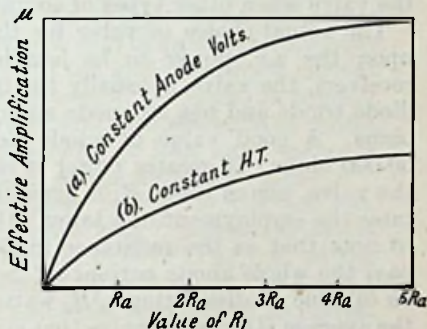

FIG. 62. SHOWING THE EFFECT OF DIFFERENT OPERATING CONDITIONS FOR AN R-C AMPLIFIER

h.t. supply available. It should be always remembered that as the value of R_1 is raised the h.t. available for V_1 is reduced.

In practice, the optimum value of R_1 is very easily found, as will be readily apparent from a perusal of the curves given in Fig. 62. These show the amplification in a resistance-capacitance amplifier stage under the respective conditions of constant anode volts and constant h.t. voltage supply. The effective amplification is seen to rise rapidly as R_1 is increased to twice R_a , and then the curve bends round. Any further increase in R_1 does not bring a corresponding improvement in amplification. In fact, there would appear to be little object in having R_1 greater than about $3R_a$. The advantage

of employing an ample h.t. voltage is apparent from a comparison of the curves in Fig. 62. Curve (a) is in respect of the valve when operated with a constant voltage at the anode; i.e. as the value of R_1 was increased, the h.t. voltage was raised to compensate for the higher voltage drop down R_1 . The conditions of the valve for curve (b), however, were such that as R_1 increased, the voltage at the amplifier valve anode diminished and, with it, the effective amplification as compared with the operating conditions relative to curve (a). These results demonstrate very clearly that satisfactory amplification with resistance capacitance amplifiers requires a higher h.t. voltage than would normally be required by the valve when other types of coupling are used.

The actual choice of valve for the R-C stage will depend upon the a.c. power to be handled by it. In broadcast receivers, the valve is usually the triode portion of a double diode triode and has an anode a.c. resistance of about 18 000 ohms. A good value of anode load resistance R_1 is thus 50 000 ohms. If greater power is required to be handled by the valve, one of lower R_a is generally used, and this necessitates the employment of a lower value of R_1 . It is important to note that as the resistance in the anode circuit R_1 must pass the whole anode current of the amplifier valve, it must be capable of dissipating $i_a^2 R_1$ watts. In the employment of the average HL type of valve that is usual for an R-C amplifier stage in a broadcast receiver, one watt resistances are suitable.

The Coupling Condenser. Alternating voltages produced in R_1 have to be transferred to the subsequent amplifier with the minimum of loss in voltage. To connect the following amplifier valve grid directly to the anode of the R-C valve would not be of any use, for the grid would then have applied to it the full h.t. voltage, with disastrous results to the valve. It is necessary, therefore, to block the d.c. path from the resistance-capacitance amplifier to the subsequent stage by means of a condenser—shown as C in Fig. 60.

Now the insertion of this blocking condenser—or *coupling condenser*, as it is generally termed—has a great influence on the working of the complete resistance-capacitance coupled stage. To begin with, the condenser has a reactance that varies inversely as the frequency ($X = 1/\omega C$) and so it will

present a different reactance to the high frequencies to be amplified as compared with that offered to the lower frequency voltages. Another factor is the negative charge built up in the condenser by the electrons collected by the grid.

Considering first the second point given above, it will be remembered that, during the examination of the grid detector, an outline was given of how the electrons, striking the grid, accumulate a negative charge in the grid condenser, which, for the satisfactory operation of the detector, had to be allowed a leakage path so as not to block the flow of electrons from cathode to anode. In the resistance-capacitance amplifier, a somewhat similar phenomenon may take place. If grid current flows the grid acquires a negative charge, and if no means are provided to dissipate this charge, the anode current will be reduced and, in the extreme case of an excessively large positive impulse being applied to the grid, the anode current may be cut off entirely. It is necessary, therefore, to connect a leak resistance between the grid and cathode, so as to enable the charge on the coupling condenser to leak away before it can interfere with the operation of the amplifier valve.

Correct Value of Leak Resistance. In Fig. 60, the grid-leak resistance R_2 is seen to be in series with C across the anode resistance R_1 . So long as the impedance of C and R_2 at the particular frequency being amplified is large in comparison to R_1 , no serious reduction in amplified voltage will be noticeable. There is another factor that enters the problem now, however, in the form of the grid-cathode impedance of the second valve across which R_2 is connected. The effective input resistance is really that of the leak resistance and the grid-cathode impedance in parallel. Clearly then, the leak must not be of too low a value or it will have a short-circuiting effect on the grid-cathode path inside the valve. On the other hand, it should not be too large, for this would increase the time constant (CR) of the circuit to such an extent that a negative charge on the coupling condenser would not leak away quickly enough. The value of R_2 employed will be governed by the capacitance of C for a given time constant, and if the grid-cathode impedance is high, demanding a high value of R_2 , then C must be reduced correspondingly.

Another limitation to the size of R is the presence of gas

in the valve V_2 . If an excessive amount of gas is present, the impact of electrons with the gas molecules liberates positive ions which are attracted by the negative grid, and thus form a positive ion current. A high value of grid leak R will produce a higher iR drop due to this current than a low resistance. A high value of grid leak will also accentuate the effect of leakage across insulators within the valve and grid emission. By limiting the value of grid leak used with the valve V_2 , these difficulties are guarded against. Most valve manufacturers state the maximum value of grid leak that should be used with their valves, and this resistance should not be exceeded. In practical receiver circuits, the

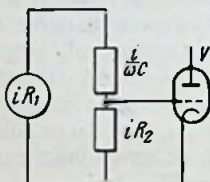

FIG. 63. THE POTENTIAL DIVISION IN THE COUPLING OF AN R-C AMPLIFIER

grid resistance used has various values from $\frac{1}{4}$ M Ω to 2 M Ω , depending on the valve and circuit constants as outlined above. The capacitance of C may be between 0.001 μ F. and 0.1 μ F. When the larger values of C are employed there is a tendency to instability in the amplifier, and for this reason the lower capacitance values are preferred. For a typical output valve (i.e. V_2 in Fig. 60) suitable values for C and R_2 are 0.01 μ F. and $\frac{1}{2}$ M Ω respectively.

Impedance of the Coupling Condenser. Referring to Fig. 63, it is seen that C , being in series with R_2 , will determine to a certain degree the alternating voltage applied to the grid of V which corresponds to V_2 of Fig. 60. If V_s is the applied voltage, the signal voltage developed across R_2 is

$$V_s \times \frac{R_2}{\sqrt{R_2^2 + X_c^2}}$$

where X_c is the reactance of C . If, for example, the reactance of C at any particular frequency is equal to the resistance of R_2 , the voltage developed across R_2 will be 0.707 of the signal input voltage and this will be applied to the grid of V_2 . This means that the stage gain is only 0.707 of what it would be if the reactance of C were small in comparison with the resistance R_2 ; and nearly the whole of the alternating voltage available at R_1 were transferred to the grid of V_2 .

It is, therefore, of the utmost importance for the effective gain of the complete stage, that the reactance of C be small compared with R_2 . This requires that the capacitance of C shall not be below a certain minimum determined by R_2 . As, however, the reactance of C varies inversely as the frequency, the actual value of the capacitance will determine to a large extent the quality of the amplified signals. For example, suppose that R_2 is 250 000 ohms and C is $0.01 \mu\text{F}$. The reactance of this capacitance at 100 cyc. is

$$\frac{1 \times 10^6}{6.28 \times 100 \times 0.01} = 159\,000 \text{ ohms.}$$

If a signal voltage of 4 volts is available at R_1 , 0.8 volt will therefore be lost in C and 3.2 volts applied to the grid of V_2 , at 100 cyc. For a 1 000 cyc. signal the reactance of C is 15 900 ohms. In this case, the voltage dropped in the coupling condenser is negligible. It is thus apparent that if a resistance-capacitance amplifier is to amplify the large range of frequencies employed in broadcast work, the choice of the coupling condenser must be such that at the lowest frequency to be received, this condenser has a reactance that is small in comparison to the effective impedance of the grid leak and the grid-cathode impedance in parallel. This impedance may be considered for practical purposes in low-frequency amplifiers as being equal to the leak resistance. If a low value of leak resistance is employed, therefore, the coupling capacitance should be increased. The limit to this increase has already been seen to be the point of instability in the stage.

In practice, the various limitations imposed on the size of C and R_2 are quite easily complied with in radio receiver design. For quite good fidelity in reproduction, the lowest frequency desired to be amplified is 50 cyc., and if a coupling condenser of $0.03 \mu\text{F}$. is used in conjunction with a 500 000 ohms or $1 \text{ M}\Omega$ grid leak, satisfactory reproduction will result.

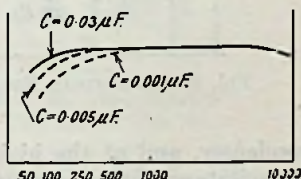

FIG. 64. EFFECT OF ALTERING THE VALUE OF COUPLING CONDENSER

In Fig. 64 are given a number of curves showing the effect of varying C in a resistance-capacitance stage. It is seen that with $C = 0.03 \mu\text{F}$. the amplification is remarkably level from 100 cyc. to 8 000 cyc. but that it falls at frequencies lower than 100 cyc. The reduced amplification at the lower frequencies is due to the increased reactance of the coupling

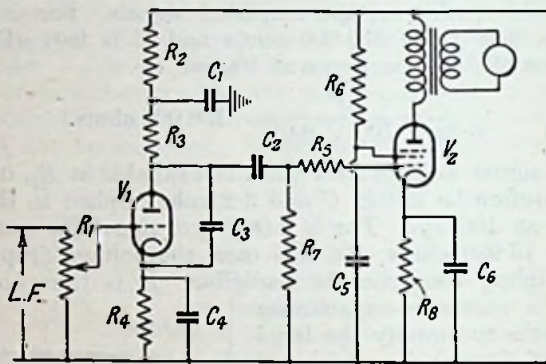

FIG. 65. PRACTICAL RESISTANCE-CAPACITANCE AMPLIFIER CIRCUIT

condenser, and at the high frequencies to the stray (shunt) capacitances of the circuit components and valveholders.

In Fig. 65 is given the circuit of the low-frequency amplifier stages of a modern broadcast receiver. The arrangement is typical of the circuits employed after a diode detector in a superheterodyne receiver. Grid leak R_1 (500 000 ohms) is made to act as volume control by providing a variable tapping as shown by the arrow. The resistance-capacitance coupled amplifier valve V_1 is of the HL class, of medium impedance, and is automatically biased by R_4 with shunt condenser C_4 ($25 \mu\text{F}$). In the anode circuit of this valve, R_2 (20 000 ohms) is for decoupling purposes and acts in conjunction with C_1 ($2.0 \mu\text{F}$) to prevent the setting up of spurious low frequency voltages in the amplifier circuit. The coupling resistance proper is R_3 (100 000 ohms) and the coupling condenser is C_2 ($0.05 \mu\text{F}$). In order that any residual i.f. component may be shunted away from the amplifier circuit, C_3 ($0.0001 \mu\text{F}$) is

connected directly across the valve between anode and cathode, and offers a low impedance to currents of that frequency. In series with the control grid of the output valve V_2 is h.f. stopper resistance R_s (100 000 ohms) that damps out any stray h.f. currents in this part of the circuit and makes the stage more stable. A common value for grid leak R_g is $\frac{1}{2}$ M Ω .

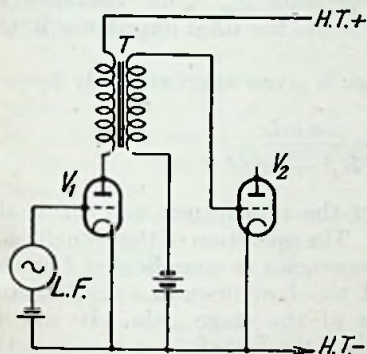

FIG. 66. BASIC TRANSFORMER COUPLED AMPLIFIER CIRCUIT

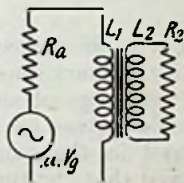

FIG. 67. EQUIVALENT CIRCUIT OF FIG. 66

R_s (not always necessary) is for the purpose of dropping the full h.t. voltage down to that required by the screen grid, and C_s is to decouple the screen grid.

TRANSFORMER COUPLING

When transformer coupling is employed for transferring the i.f. voltages in one anode circuit to the grid circuit of a subsequent amplifier valve, a circuit arrangement similar to that shown in Fig. 66 is used. In broadcast receivers, V_1 is either the i.f. amplifier or the detector valve and V_2 is usually the output valve. The audio-frequency currents in the anode circuit of V_1 produce a magnetic field round the primary winding of T . Both primary and secondary windings are wound on an iron core, with the result that as the magnetic flux varies with the magnitude of the anode current fluctuations of V_1 , the secondary winding of T is cut and has induced into it a corresponding voltage. If the coupling transformer

has been correctly designed, the voltages applied to the grid of V_2 are similar in wave form to those originally in the anode circuit of V_1 , and the coupling will, therefore, be distortionless.

In its simplest form, the equivalent circuit of Fig. 66 is given in Fig. 67. The theoretical voltage $\mu \cdot V_0$ available in the anode circuit is applied to the transformer primary L_1 , in series with the valve impedance R_a . The resistance R_2 across the secondary L_2 represents the total impedance in the input circuit of V_2 .

The actual gain of the stage is given approximately by

$$A = \frac{\mu n \omega L}{\sqrt{R_a^2 + \omega^2 L^2}}$$

where n is the turns-ratio of the transformer and ωL is the effective primary impedance. The operation of the transformer over the range of audio frequencies is complicated but this expression gives an idea of the fundamental considerations involved in the calculation of the stage gain. It will be observed that the turns ratio of the transformer increases the total amplification of the stage, and the formula assumes there is no leakage or stray capacitances in the transformer. The increased gain due to the transformer ratio is helpful, especially in low gain receivers, where a ratio of 4:1 or more may be employed.

The primary of T constitutes an inductive load on V_1 , which varies with the frequency. This means to say that at low frequencies, when the reactance ($X = \omega L$) of the primary is lowest, V_1 will provide least amplification, for then the effective load impedance ωL in the amplification formula is lowest. A good l.f. transformer has a high effective primary impedance so that even at the low audio frequencies a satisfactory gain is provided. For example, suppose the Varley Nicore II is being employed as T . The primary inductance of this transformer is 80 henries, and the reactance at 50 cyc. is therefore

$$6.28 \times 50 \times 80 = 25\,120 \text{ ohms}$$

If V_1 is a Mullard PM1HL—a suitable valve for small receivers—with an a.c. resistance of 20 000 ohms and an

amplification factor of 28, then the stage gain, neglecting for the moment the transformer ratio, will be

$$\frac{28 \times 25}{\sqrt{20^2 + 25^2}} = \frac{700}{\sqrt{1025}} = 22 \text{ times.}$$

Now take a frequency of 500 cyc. The reactance of the primary is 250 000 ohms approximately and the stage gain is practically equal to the μ of the valve, i.e. 28 times.

If the gain is now calculated for the amplifier using the same valve but connected to a transformer with an effective primary inductance of 40 henries it will be found that a gain of under 15 times is provided at 50 cyc., although at 500 cyc. the amplification is almost equal to μ . This shows very clearly the importance of using a transformer having a high effective primary inductance if satisfactory reproduction of the lower audio-frequency is desired.

Most satisfactory results are obviously obtained when V_1 and L_1 are suitably chosen. The primary inductance should have a reactance at 50 cyc., that is about twice the impedance of the valve. For instance, an 80-henry primary inductance has been shown to produce a reactance of 25 120 ohms at 50 cycles. If V_1 has an impedance of about 12 000 ohms, it will be quite suitable, but a valve with an impedance of 28 000 ohms will not give such good results, since amplification at 50 cyc. will be less and the reproduction will be deficient in bass response.

In practice, the amplification soon approaches the μ of the valve due to the quadrature addition of R_a and ωL , as can be seen from the previous calculations of gain. There are also present other reactive elements in the transformer that have a considerable influence on its operation to currents of higher audio frequencies. One is the effective capacitance in the transformer, but there are also eddy current losses in the core and leakage inductance. Capacitative reactance is produced by the presence of large masses of copper wire constituting the respective windings, causing capacitance to exist between: (1) primary and secondary windings; (2) the turns of each winding; and (3), in the case of a sectionally wound transformer, each winding and the core. In Fig. 68 the

capacitances are indicated by C_1 to C_5 . The net result of these capacitances is a shunt capacitance across the transformer primary.

The leakage inductance of the transformer is due to the imperfect coupling of the primary with the secondary. It is impossible to make a transformer so that every single magnetic line of force produced by the current flowing in the

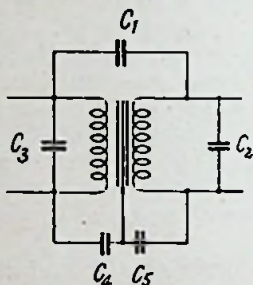

FIG. 68. SHOWING THE EQUIVALENT INTER-WINDING AND WINDING-TO-CORE CAPACITANCES

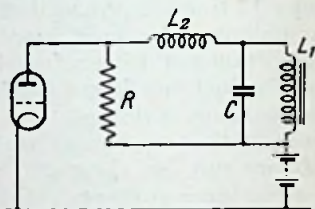

FIG. 69. EQUIVALENT L.F. TRANSFORMER CIRCUIT

primary cuts the secondary. This, however, is the condition necessary to avoid the presence of leakage inductance. The equivalent circuit representative of leakage inductance is an inductance in series with the primary winding.

Core losses produced by the setting up of eddy currents in the laminations may be represented by a shunt resistance. Thus the equivalent circuit of an input transformer primary is as seen in Fig. 69, where L_1 is the inductance of the transformer primary winding, C is the lumped stray capacitance, L_2 the leakage inductance, R the iron losses. In a well-constructed transformer, L_1 is very high and L_2 and C are low. A mathematical discussion of this circuit by Dr. Dye, was published in *Experimental Wireless* for September, October, and November, 1924.

The circuit of Fig. 69 must obviously have a resonant frequency. The action of the circuit over the range of frequencies required to be amplified in the l.f. amplifier is complex,

but in general terms it can be stated that if the primary should have a sufficiently large inductance to ensure satisfactory amplification at the lower end of the audio-frequency range, say at 50 cyc., the remainder of the frequency spectrum will be reproduced in the secondary winding at sufficient amplitude to produce a good overall amplification. It is for this reason that modern l.f. transformers have a high primary inductance—usually not less than 50 henries. At the higher frequencies, generally over 6 000 cyc., the stray transformer capacitances have an increasing effect, resulting in a reduction in effective step-up at these frequencies. There is often, however, a pronounced hump in the amplification curve at the resonant frequency of the leakage inductance L_2 and the stray capacitance C . This hump may be used to increase the upper frequency range of the transformer, but if it is too great distortion is produced. The resonant frequency usually occurs between 5 000 and 10 000 cyc.

It is thus apparent that the two major requirements for an intervalve l.f. transformer, i.e. high primary inductance and high step-up ratio, are not reconcilable; for the large number of turns necessary to provide a high primary inductance precludes the secondary from having more than a few times more turns owing to the self-capacitance that is produced by the windings. In practice, quality transformers are available with step-up ratios of 4:1, and this ratio seems to give very satisfactory results.

From Fig. 66 it will be seen that the type of valve to which the secondary of the transformer is connected has a great influence on the working of the previous stage. For example, the grid-cathode capacitance is parallel to the transformer capacitance and is thus added to the latter and increases the high note cut-off. This effect is not usually very harmful in practice, but it should not be overlooked that the total capacitance shunting the secondary winding includes not only that due to the input electrodes of the valve, but also any capacitances due to the input circuit wiring and the valve-holder. In bad cases, this may be appreciable.

A further factor affecting the operation of the transformer is the input impedance of the valve to which the secondary is connected (V_2 of Fig. 66). The actual voltage available

at the secondary is obviously diminished if a low resistance load is applied to it, and to obtain the best results from transformer coupling it is important that the input impedance of V_2 be as high as possible. This is ensured by working the valve with sufficient grid bias to prevent the grid ever becoming positive, or nearly so, during amplification of loud signals. The flow of grid current will not only reduce the amplification in the manner outlined above, but will also distort the positive halves of the wave form.

The last paragraph would indicate that the fairly common practice of connecting a resistance across the transformer secondary is harmful. As a matter of fact, the shunt resistance, if not too low in value, is definitely beneficial for, as Dye has shown, it limits the resonant peak voltages and helps to provide a flatter amplification characteristic. No serious diminution in amplification results so long as the shunt resistance is equal to $0.2n^2 M\Omega$, where n is the turns ratio. A shunt resistance across the secondary also serves the useful purpose of reducing the tendency of an inductive anode load to produce regeneration and thereby instability.

The amplification curve of a well-designed l.f. transformer is given in Fig. 70. It is seen that the amplification falls away at the lower and also at the upper frequencies. The reduced amplification at the lower frequencies is brought about by the reduction in the impedance of the transformer primary winding which has already been explained. When this impedance becomes lower than that of the amplifying valve, the voltage developed across the primary diminishes greatly as the valve is not then being operated under its optimum conditions of load. The upper falling off in amplification at frequencies above 6 000 is due both to the effect of the stray capacitances, which tends to by-pass these higher frequencies from the windings, and also to the leakage inductance.

It should be noted that the curve of Fig. 70 does not give any idea of the amount of harmonics present due to distortion of the wave form. A transformer that has been designed according to scientific principles will produce only a small harmonic content. An inferior transformer will, however, produce serious alteration in the shape of the wave form, which introduces harmonic distortion very badly, although

the amplification curve of the type given in the figure may be reasonably level.

Practical Circuit Considerations. In order to produce a transformer with a large primary inductance it is usual for manufacturers to utilize the highly magnetic properties of nickel-iron and various proprietary brands of highly permeable metals. The employment of these types of core material enables the makers to market transformers that are much smaller than would be the case if ordinary transformer iron-core laminations were used to give the same primary inductance. In operation, however, these transformers with special cores lose their high primary inductance if a steady current

is allowed to pass through one of the windings, for the effect of such a current flow is to reduce the effective inductance of the windings owing to the magnetization of the core. A low primary inductance has already been shown to be the cause of a poor amplification of the lower audio frequencies. Most manufacturers state the value

of the maximum permissible current flow in the primary winding, and this figure should never be exceeded. It varies in the different types of transformer from 1 to 10 mA. A practical circuit arrangement must, therefore, be one in which the steady anode current from the valve, in the anode circuit of which the primary is connected, is separated in some way from the transformer.

There are various ways of doing this, but most of them couple the transformer primary to the anode by a condenser. This condenser blocks the path for the d.c. component and only passes the a.c.

A commonly used circuit for *parallel feed*, as this type of coupling is called, is given in Fig. 71. The h.t. voltage is applied to the anode through R , and the l.f. currents pass round C and L if the value of resistance used at R is suitably chosen. In selecting R it should be remembered that there

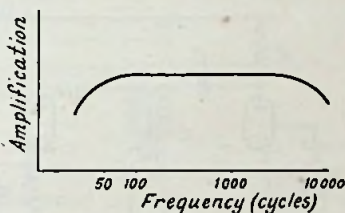

FIG. 70. AMPLIFICATION CURVE OF A GOOD TYPE OF AN L.F. TRANSFORMER

are two paths for the l.f. currents. One is from anode through R and power supply to cathode, and the other is via C and L , both these being in parallel as shown in Fig. 72. If, therefore, R is too small, most of the l.f. impulses will find their way back to cathode along the R route, whereas, if it is too large, the d.c. voltage drop due to the steady anode current flow will be so great that the h.t. voltage available at the anode will be too small to operate the valve satisfactorily.

It is seen from Fig. 71 that the parallel feed is in reality a combined resistance and transformer coupling, since the voltage fluctuations along R are transferred via C to the transformer primary. The value of R should be about twice or three times

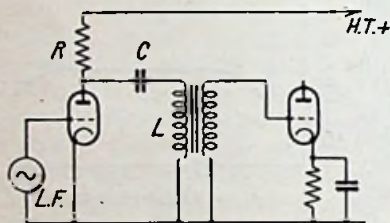

FIG. 71. PARALLEL FEED CIRCUIT FOR TRANSFORMER COUPLING

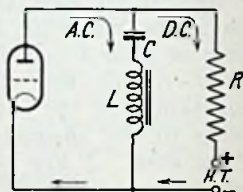

FIG. 72. SHOWING CURRENT PATHS IN PARALLEL FEED CIRCUIT

the value of the impedance of the valve, but, if there is a sufficient supply of h.t., it may be varied over a wide range without detrimental results to the amplifier. It is usual to choose a coupling condenser C of such a capacitance that it resonates with L at a low frequency where, normally, the amplification falls off.

It is clear from Fig. 72 that the path through the resistance also passes through the h.t. supply. For this reason it is usual to decouple the resistance path, and the insertion of the decoupling resistance diminishes still further the voltage actually at the anode.

Instead of employing R , a choke may be substituted, the rest of the circuit remaining as shown. In this arrangement, the amplifier valve acts as a combined impedance and transformer coupled stage. This circuit is very seldom used, however, as resistance-fed transformer coupled stages are found

to be more stable in operation, and there is less risk of undesired resonances which appear when impedance fed transformer stages are employed.

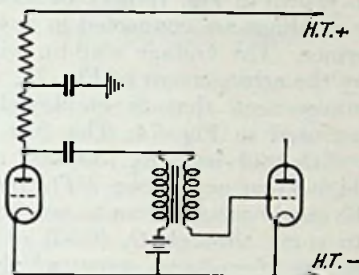

FIG. 73. AN ALTERNATIVE METHOD OF CONNECTING A PARALLEL FED TRANSFORMER

When the circuit shown in Fig. 71 is used, the voltage step-up of the transformer is utilized in a similar manner to that of the ordinary straightforward connexion. As only the

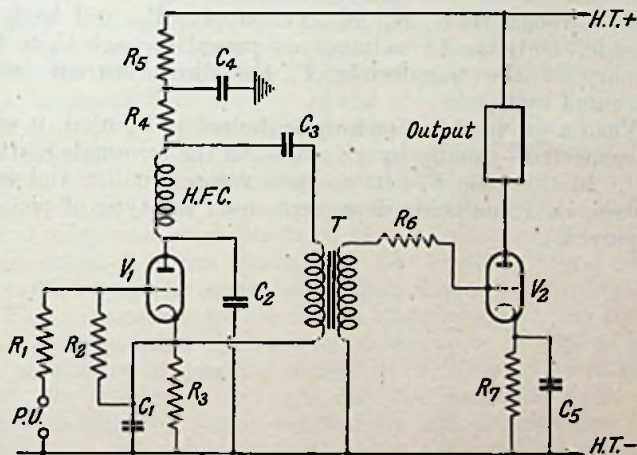

FIG. 74. COMMONLY USED PARALLEL FEED CIRCUIT IN COMMERCIAL RECEIVERS

a.c. component in the anode circuit is handled by the transformer, it is possible to connect it in a variety of ways, to obtain different effective voltage step-up ratios. For example, the arrangement shown in Fig. 73 may be used. In this case the transformer windings are connected in series and used as an auto-transformer. The voltage step-up will be less than that provided by the arrangement of Fig. 71.

A circuit arrangement that is employed in broadcast receivers is illustrated in Fig. 74. The first valve V_1 is a detector valve, with grid leak R_2 (500 000 ohms). In the anode circuit, high-frequency choke HFC prevents the h.f. component in the anode current from traversing the l.f. circuit by driving it to earth through C_2 (0.001 μ F.). R_4 acts as anode resistance, the l.f. voltages across which are impressed on the primary of the l.f. transformer T via C_3 (0.25 μ F.). Resistance R_5 (20 000 ohms) is for decoupling the anode circuit, and works in conjunction with C_4 (2 μ F.). The transformer secondary is connected to the control grid of the output valve V_2 through an h.f. stopper resistance R_6 (50 000 ohms).

In this circuit, the anode direct current flows from the anode through HFC , R_4 , R_5 , h.t. supply, R_3 , and back to cathode. Only the l.f. voltages are passed through C_3 to the primary of the transformer T , the direct current being prevented by C_3 .

When a gramophone pick-up is desired to be used, it may be connected—usually by a switch—to the terminals marked $P.U.$ In this case R_1 acts as both volume limiter and tone control, its value being dependent upon the type of pick-up employed.

CHAPTER VI

THE OUTPUT STAGE

AN output stage has a different purpose to that of a low-frequency amplifier stage, for it is concerned with the production of a.c. *power*, whereas the l.f. amplifier is for providing a high output *voltage*. The loudspeaker requires power to operate it and the output stage has to be connected and worked in such a way that this power is provided as efficiently as possible. As will be seen later on, the optimum conditions for voltage amplification are not necessarily those for producing the most satisfactory power output. In this chapter, push-pull output stages are not included as they are dealt with in a separate chapter. The methods of operating single valve output stages to provide the most satisfactory output power are considered here.

The simplest form of output stage is shown diagrammatically in Fig. 75. In response to an alternating voltage applied to the grid-cathode path of the output valve, current variations are produced in the anode circuit which, acting along the primary winding P of the output transformer T vary the magnetic field set up round the iron core to induce corresponding variations in current in the secondary winding S . This alternating current in the secondary flows round the speech coil SC of the loudspeaker and thus provides an a.c. magnetic field that interacts with the steady magnetic field of the loudspeaker and produces the required motion of the cone attached to the speech coil. The resulting vibrations of the cone set up air waves that produce the acoustical output.

This elementary review of the happenings in the output stages makes quite apparent the necessity to provide as large as possible an alternating current in SC for only by so doing will the interaction between the two magnetic fields and consequently the sound emitted by the loudspeaker be a maximum. On the other hand, the quality of the reproduced sound—i.e. its fidelity as a similarity of the original sound represented by the signal voltages at the input terminals of

the receiver—must not be marred in the attempt to obtain the highest possible output. When it is recalled that the output valve has to handle the voltages amplified by all the other amplifier valves in the receiver, it will be realized, in view of what has already been noted regarding the way in which distortion is produced, that the output valve has to be operated under stringent conditions if the quality is not to be impaired.

Choice of Valve. Although the primary object of the power valve is to produce a.c. power from the signal as efficiently as possible while at the same time reproducing the input wave form without distortion, it should not be supposed that the amplification of the valve is of little importance. Most receivers, and particularly the smaller ones, rely upon the output stage for quite a considerable stage gain, and this largely accounts for the popularity of the power pentode. Apart from the desired gain, however, the output valve should have as high a mutual conductance as possible,

consistent with a low anode a.c. resistance, for the power actually available in the anode circuit is dependent upon the square of the amplification factor. This can be seen from the following—

The alternating current in the load impedance Z_e is

$$i = \frac{\mu \cdot V_g}{R_a + Z_e}$$

$$\begin{aligned} \text{Power} &= i^2 R = \left(\frac{\mu \cdot V_g}{R_a + Z_e} \right)^2 \cdot Z_e \\ &= \frac{\mu^2 \cdot V_g^2 \cdot Z_e}{(R_a + Z_e)^2} \end{aligned}$$

The equation above also shows that the anode a.c. resistance R_a should be as small as possible for maximum power output.

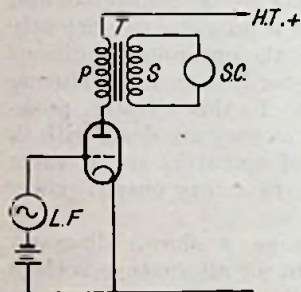

FIG. 75. BASIC OUTPUT STAGE CIRCUIT

The first two requirements for the output power valve are thus established, i.e. a low anode a.c. resistance and a high amplification factor.

In practice the anode a.c. resistance of a triode power valve may have any value from a few hundred ohms, as in the case

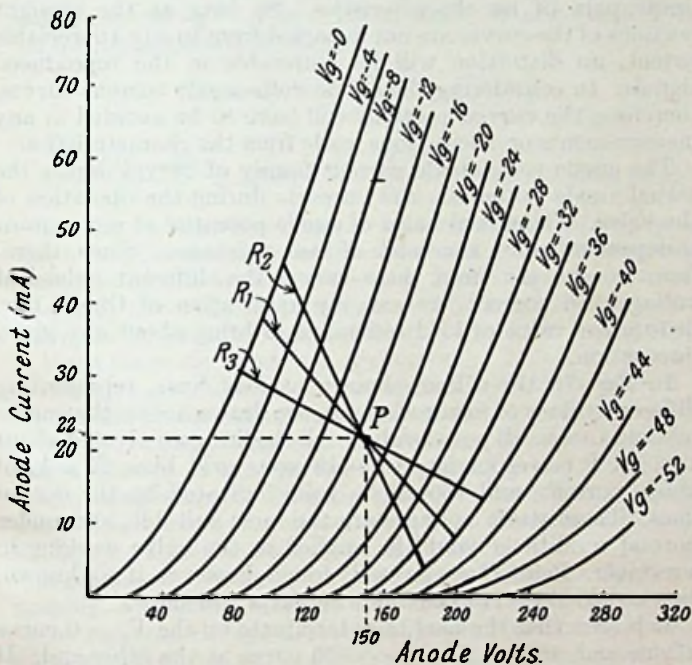

FIG. 76. ANODE CURRENT-ANODE VOLTAGE CHARACTERISTICS OF A TRIODE VALVE, SHOWING METHOD OF DRAWING LOAD LINES

of the large valves capable of handling many watts for public address equipment, to several thousand ohms as commonly used in small battery receivers. The latter class of valve is only called upon to handle the comparatively small power of a few hundred milliwatts.

The Optimum Load. The optimum load resistance of an output triode valve is that value of resistance load on the

valve that enables the maximum power output to be obtained from the anode circuit whilst at the same time limiting the second harmonic distortion to 5 per cent.

Harmonic distortion of the wave form of the signals passing through a valve is produced by operating the valve on a non-linear part of its characteristics. So long as the straight portions of the curves are not departed from to any appreciable extent, no distortion will be noticeable in the reproduced signals. In considering the anode volts-anode current curves, therefore, the curved portions will have to be avoided in any measurements or calculations made from the characteristics.

The anode volts-anode current family of curves depict the actual anode potentials and currents during the operation of the valve. The actual value of anode potential at any instant is dependent upon the value of load resistance. Since, therefore, we can see from these curves the different values of voltage and current, we can, by application of Ohm's law, deduce the value of load resistance to bring about any given fluctuation.

In Fig. 76 three lines, known as *load lines*, representing different values of load resistance, are drawn across the curves relating to a small power valve. All the lines are pivoted about a point P corresponding to \rightarrow 18 volts grid bias, 22 mA. of anode current, and 150 anode volts indicated by the dotted lines. These static voltages are the most suitable, and under normal conditions would be applied to the valve working in a receiver. Point P can be easily found, however, if not known, as a consideration of the following facts will show.

It is seen that the load lines terminate on the $V_g = 0$ curve at one end, and on the $V_g = -36$ curve at the other end. If the grid voltage fluctuated over a greater range, distortion would result owing to—

(1) The production of grid current during the periods that the grid was at a positive potential; and

(2) The curvilinear portions of the curves being worked upon.

The limits of the load lines are, therefore, first, the $V_g = 0$ curve at one end and, second, the non-linear part of the curve corresponding to double the static bias applied to the valve, since the voltage on the grid is fluctuated equally on both sides of the operating point P by the signals. The operating

bias at point P must, therefore, lie in a central position between the $V_g = 0$ curve and the curvilinear portions of the higher grid bias curves.

Referring to Fig. 76, load line R_1 is noticed to cut the $V_g = 0$ curve at a point corresponding to 90 volts and 39 mA., and to cut the $V_g = -36$ curve at 200 volts and 8 mA. Since the load resistance is equal to

$$R_1 = \frac{V}{i} = \frac{V_{a1} - V_{a2}}{i_{a2} - i_{a1}} \times 1\,000$$

we get

$$R_1 = \frac{200 - 90}{39 - 8} \times 1\,000 = \frac{110 \times 1\,000}{31} = 3\,500 \text{ ohms approx.}$$

This is, in fact, the value of load resistance stated by the valve manufacturers to be the optimum. As the anode a.c. resistance of this particular triode is 1 500 ohms, the optimum load is $2\frac{1}{3}$ times the valve resistance. With broadcast receiver valves in general, the optimum load for a triode is from twice to three times the anode a.c. resistance.

During operation, with the optimum load resistance in circuit, the anode voltage therefore varies between 90 and 200 as the grid voltage swings from zero to -36 volts, the actual anode voltage at any particular value of grid voltage being that corresponding to the point cut by the load line. Similarly, the anode current fluctuates from 8 to 39 mA. as the grid voltage is varied between -36 and zero.

Load line R_2 is seen to have a different slope to R_1 . Consequently, a different value of load resistance will be expected to be represented by it. In this instance the anode voltage fluctuates between 192 and 102, while the current varies from 5 to 45 mA. The load resistance is therefore

$$R_2 = \frac{192 - 102}{45 - 5} \times 1\,000 = \frac{90\,000}{40} = 2\,250 \text{ ohms.}$$

This is less than that of load resistance R_1 .

Applying the same method to calculate the resistance represented by load line R_3 , we get

$$R_3 = \frac{226 - 82}{31 - 14} \times 1\,000 = \frac{144\,000}{17} = 8\,500 \text{ ohms approx.}$$

this being greater than R_1 .

It is seen from this that the greater the slope of the load line with respect to the anode voltage axis the lower is the resistance value represented. In other words, the load resistance varies inversely as the slope of the load line.

Anode Dissipation. The power in an electrical circuit is, of course, the product of volts by current. In the present case there are two components of power in the anode circuit, one due to the static operating voltages, and the other produced by the signal voltages. The former of these is direct current power, while the latter is alternating current power and requires a different method of treatment.

When 150 volts are applied to the anode and — 18 volts to the grid, the anode current flow in the valve of Fig. 76 has already been seen to be 22 mA. As this mean anode current flows whether a signal voltage is applied to the grid or not, the amount of d.c. power actually at the anode is $22 \times 150 = 3\,300$ mW or 3.3 watts. This is known as the *anode dissipation* and should be distinguished from the a.c. power output. Valve manufacturers give a limiting value of anode dissipation for their respective power valves, and care should be taken that this power is not exceeded.

Anode dissipation, which is one of the limiting factors in the amount of power that an output valve can handle, is a measure of the heat generated in the anode by the multitudes of electrons striking it. Unless this heat can be radiated, or dissipated, as rapidly as it is produced, the anode temperature will be forced up excessively high and the valve will be destroyed. Before any serious damage is done to the electrodes, however, the vacuum will be spoilt by the liberation of gases in the manner outlined in the first chapter. For each particular design of valve electrode assembly there is, thus, a maximum temperature to which the anode can be raised, and therefore a maximum anode dissipation, beyond which the harmful effects noticed above will take place.

Most valve manufacturers give figures showing the maximum values of anode voltage and anode current to be used in the operation of the respective valves. The permissible anode dissipation is usually numerically equal to the product of the maximum anode volts by the maximum d.c. anode current. For example, the Mullard AC044 requires an h.t.

of 250 volts, at which voltage it passes a current of 48 mA., producing the anode dissipation of

$$250 \times \frac{48}{1000} = 12 \text{ watts.}$$

On the other hand, some valve manufacturers rate certain of their valves at a higher d.c. wattage than is indicated by the simple calculation given above. One example of this is the Mazda PP3/250, which, at $V_a = 250$ volts, $i_a = 40$ mA., giving an actual anode dissipation of 10 watts. The valve is rated, however, at 12 watts d.c. power.

Usually the maximum anode dissipation is drawn as a curve on the anode volts-anode current family and cuts the various curves at the points where the stated power dissipation is effected. The load lines must never be allowed to pierce the anode dissipation curve, or excessive heating of the electrodes and damage to the valve will ensue.

A.C. Power Circuit. The component of power in the anode circuit of a valve, with which radio receivers are more directly concerned, is the alternating current power, i.e. that power produced by the fluctuations in anode current in the load impedance caused by variations in signal voltage on the grid. So far, only the peak values have been considered. With regard to load line R_1 , for example, it was noted that the anode voltage varied from 90 to 200, while the anode current moved correspondingly from 39 to 8 mA. These are, of course, only instantaneous values, and in order to assess the a.c. power in the circuit, we shall have to use the ordinary a.c. calculations.

When the voltage passes from 90 to 200 it moves between its extreme upper and lower peak ranges. The effective or r.m.s. value is therefore

$$\frac{200 - 90}{2\sqrt{2}} = \frac{110}{2.828} \text{ volts.}$$

In a similar way, the extreme current range between opposite peaks is from 39 to 8 mA., and the corresponding r.m.s. value is $31/2.828$ mA. This gives the a.c. watts in the circuit as

$$\frac{110}{2.828} \times \frac{31}{2.828} = \frac{3410}{7.998} = 426 \text{ mW.}$$

This result can obviously be arrived at by merely taking the peak values of voltage and current as indicated by the load line, multiplying them together and dividing the product by 8. From the load line of R_2 , Fig. 76 (2 250 ohms), we get as the a.c. power output

$$\frac{90 \times 40}{8} = 450 \text{ mW.}$$

and from R_3 (8 500 ohms)

$$\frac{144 \times 17}{8} = 306 \text{ mW.}$$

It is seen from these figures that although R_1 of 3 500 ohms is stated to be the optimum load, actually R_2 of 2 250 ohms produces a slightly higher output.

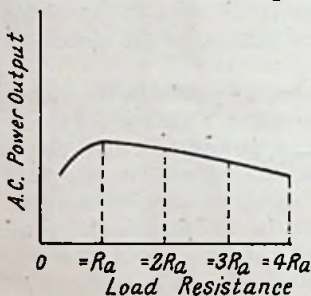

FIG. 77. THE ALTERATION IN POWER OUTPUT OF A TRIODE BY VARYING THE LOAD RESISTANCE

The general relation between the load resistance and a.c. power output of a triode is represented in Fig. 77. It is seen that, as the load resistance increases from zero to the value of the valve impedance, the output rises to a maximum. Thereafter the a.c. power output gradually falls off as the load resistance is increased. It will be noticed that the value of load resistance is not highly critical so long as it is not less than

the impedance of the valve and not more than about three times this value. In the case of the output pentode, a different set of conditions arises as described on page 127.

In practice, the utilization of the maximum power output of triodes or pentodes does not arise in radio reception, for other factors intervene to prevent this output being attainable if enjoyable reception is to be provided. This disturbing factor is the distortion of the a.c. wave form by the valve itself, which introduces additional audio frequencies that are multiples or harmonics of the fundamental frequencies, known as *harmonic distortion*.

Undistorted Power Output. Unless the anode voltage fluctuations on both sides of the operating point *P* (Fig. 76) are equal, harmonic distortion will be produced. A small amount of harmonic distortion will usually pass unnoticed by the average ear, and it is just this amount of permissible distortion that determines the maximum output of the valve. It will obviously vary according to individual musical education.

When an excessive amount of harmonic distortion is present, the reproduction is high pitched and "tinny" owing to the introduction of the undesired multiple frequencies that constitute the harmonics or overtones of the fundamental frequencies. As a certain amount of harmonic content in the output voltages is tolerable, for standardization of output power rating, the maximum a.c. power output of a triode is specified as that power provided by the valve operated at the voltages stated, at which 5 per cent second harmonic distortion occurs. The average ear will not detect the presence of 5 per cent second harmonic distortion. The harmonics that can be least tolerated by the musical ear are the odd ones, the higher harmonics being the most disturbing. Although 2.5 per cent of third harmonic distortion may pass unnoticed, 0.2 per cent of seventh harmonic will be easily perceived.

To many listeners, a more disturbing distortion is that due to intermodulation that occurs when harmonics are produced. When intermodulation takes place, a higher frequency is modulated by a lower frequency due to the valve being operated on a non-linear portion of its characteristics. For example, a 1 000 cyc. note may be modulated by a 50 cyc. note and set up frequencies of 950 and 1 050 cyc. In this manner, spurious frequencies are produced which tend to set up musical discords and deprive the reproduction from the loudspeaker of naturalness.

The most troublesome distortion in the operation of triode output valves is that due to the second harmonic. The fourth harmonic is also present to a noticeable extent under certain conditions. With pentode output valves, the odd harmonics are the most serious, principally the third. In considering the total effect of harmonics, it should be remembered that this

is equal to the square root of the sum of the squares of the individual components; i.e.

$$H_{tot} = \sqrt{(H_2^2 + H_3^2 + H_4^2 \dots)}$$

where H_{tot} is the total harmonic content and H_2, H_3 , etc., are the separate harmonic components.

The factors determining the degree of harmonic distortion are the relative lengths of the load line on the respective sides of point P (Fig. 76), the actual value being—

Per cent second harmonic distortion H_2

$$= \frac{\frac{1}{2}(i_{a \max} + i_{a \min}) - i_{a0}}{i_{a \max} - i_{a \min}} \times 100$$

where $i_{a \max}$ and $i_{a \min}$ are the high and low peak values respectively of the anode current, and i_{a0} is the steady anode current flow when the valve is biased to point P .

Applying this expression to the values indicated by the three load lines of Fig. 76, we get

$$R_1: \text{distortion} = \frac{\frac{1}{2}(39 + 8) - 22}{39 - 8} \times 100 = \frac{150}{31} \\ = 4.8 \text{ per cent.}$$

$$R_2: \text{distortion} = \frac{\frac{1}{2}(45 + 5) - 22}{45 - 5} \times 100 = \frac{300}{40} \\ = 7.5 \text{ per cent.}$$

$$R_3: \text{distortion} = \frac{\frac{1}{2}(31 + 14) - 22}{31 - 14} \times 100 = \frac{50}{17} \\ = 2.9 \text{ per cent.}$$

The distortion produced by R_3 is thus less than that brought about by the use of either R_2 or R_1 . In order to effect this improved fidelity in output—which in many cases will be quite unnoticed aurally—the power output has been reduced from 426 mW. to 306 mW. This is a severe restriction, and under the circumstances is quite unwarranted. It is, therefore, more advantageous to have 426 mW. output with 4.8 per cent distortion than 306 mW. with 2.9 per cent distortion.

On the other hand, R_2 of 2 250 ohms gives an output of 450 mW. with 7.5 per cent distortion. This means, in effect,

that in order to obtain an extra 24 mW. of power, which is not very appreciable, the distortion has been increased by 50 per cent. At 7.5 per cent the distortion will probably be detectable by the average ear. Consequently, the slightly increased power output has been bought at a cost in fidelity of reproduction.

The general relation between the load resistance and harmonic distortion with a triode is seen in Fig. 78. It is evident

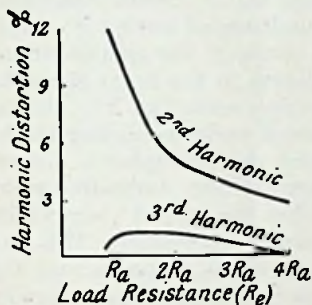

FIG. 78. HOW HARMONIC DISTORTION VARIES WITH THE LOAD RESISTANCE OF A TRIODE

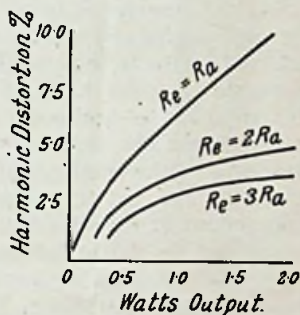

FIG. 79. RELATION BETWEEN HARMONIC DISTORTION AND POWER OUTPUT IN RESPECT OF THE LOAD RESISTANCE OF A TRIODE

that when $R_e = 2R_a$ the amount of second harmonic distortion is about 5 per cent. At the point where $R_e = R_a$, the distortion rises to 11 per cent, which is unpleasant in broadcast reception. As the load resistance increases, the second harmonic is seen to become lower. A certain amount of third harmonic distortion is also present, but is always very much smaller than the second. Under normal operating conditions, in fact, the third harmonic is seldom troublesome with a triode. From Fig. 78 it is seen that for minimum harmonic distortion a load resistance equal to several times the anode a.c. resistance of the triode is needed. This fact is emphasized by the curves in Fig. 79, which show typical curves in respect of output power, load resistance and harmonic distortion of a triode. A considerable drop in distortion is seen to take place as the load resistance is increased from the same value as the valve

impedance to twice this value. When the load resistance is increased still further, there is another, though smaller decrease in distortion. An important point that should be noted from Fig. 79 is that in all cases a reduction from the maximum output results in a large reduction in distortion. As the load resistance is increased, this reduction becomes less marked.

Practical Power Output. In actual broadcast reception, when the receiver is being operated under correct conditions for undistorted output, the rated undistorted output is seldom utilized. This is because the a.c. power in the output circuit depends upon the depth of modulation in the input signal to the receiver, as outlined in connexion with Fig. 27. During transmission the depth of modulation varies according to the loudness of the total sound reaching the microphone. Consequently, the instantaneous power in the audio-frequency component of the signal that reaches the output stage varies according to the instantaneous sound intensities. This can easily be seen by connecting an output meter across the loudspeaker transformer. The meter needle fluctuates rapidly backwards and forwards during reception of telephony. The significance of this is that if the output valve is made to provide its maximum output during reproduced passages of average amplitude, then it will be severely overloaded when a loud signal is being received. The difference in output wattage during *undistorted* reproduction of a loud passage and one of average intensity is frequently as 30 : 1.

It is thus necessary to employ an output valve capable of producing a large maximum output. For good quality reproduction on loud passages it is best to operate the valve so that at an average amplitude of output not more than about one-quarter of the maximum output is being utilized. This appears rather extravagant at first, but in practice it will be found to be very satisfactory. If a 5-watt valve is employed, for example, and worked with 1 watt at mean amplitude, the sound from the loudspeaker will be as much as most people desire in an average sized domestic room. During the loud passages, when the full 5 watts are used, there will be much less harshness than is commonly heard when a $2\frac{1}{2}$ -watt valve is operated with the same average output.

Harmonic Distortion of an Output Pentode. In Fig. 80 are given a number of curves showing the variation of harmonic distortion with the value of load resistance employed, taken from a very interesting paper by J. M. Glessner*. It does not follow that every pentode will produce harmonics in precisely the same manner as shown here, but the curves are

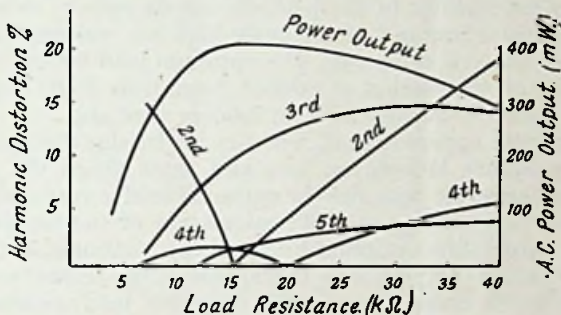

FIG. 80. THE EFFECT ON HARMONIC DISTORTION OF VARYING THE LOAD RESISTANCE IN A PENTODE CIRCUIT

fairly representative of what is to be expected from output pentodes as a whole.

Considering first the amount of second harmonic distortion, it is seen from Fig. 80 that as the load resistance is increased from 8 000 ohms to 15 000 ohms (which is the load for maximum output of this particular valve) this distortion falls from 15 per cent to zero. As the load resistance is further increased, the second harmonic content rises again to a fairly high percentage. The point at which the second harmonic disappears is that at which the load resistance is the optimum for undistorted output. The third harmonic distortion rises from a low value to about 15 per cent at $R_o = 30\ 000$ ohms and then remains fairly level with any further increase in load resistance. Both the fourth and fifth harmonics add their quota to the total harmonic content. In considering the harmonic distortion with a triode output valve, no fourth or fifth harmonic curves were given because the distortion due to these is usually negligible.

* *Proceedings I.R.E.*, 1931, page 1391.

From Fig. 80 it is apparent that the total amount of harmonic distortion present when a pentode output valve is employed is fairly considerable. A low value of load resistance will diminish the third and fifth, but will increase the second. A high load resistance increases both second and fourth harmonics. A high load resistance produces excessively high a.c. voltage fluctuations in the pentode output circuit, so on two scores—distortion and dangerously high a.c. voltage—a high load resistance is ruled out. The optimum load for the output pentodes on the market at present range from 2 500 ohms for mains valves to 25 000 ohms for battery pentodes.

It is quite apparent that, whereas for triodes the optimum load resistance is between two and three times the anode a.c. resistance, for pentodes the optimum load is very much less than the a.c. resistance. The calculation of the undistorted power output, the optimum load and the harmonic distortion is much more complex than in the case of the triode, and will not be given here. Usually the optimum load resistance is between one-tenth and one-quarter the value of anode a.c. resistance. The shape of the valve i_a/V_a characteristics is rather critical in this respect, and whereas one output pentode with an anode a.c. resistance of 40 000 ohms may require an optimum load of 8 000 ohms, another pentode with an anode a.c. resistance of 30 000 ohms may need the same value of load resistance.

Further curves showing the amount of harmonic content in the output of a power pentode are given in Figs. 81 and 82. These are general curves and are shown to illustrate the state of affairs that may usually be expected from output pentodes. In Fig. 81, is seen the relation between *total* harmonic content and load resistance when the valve is operated to provide the rated output. There is a clearly defined point in the curve (at $R_e = 8\ 000$ ohms) where the distortion is a minimum, i.e. 5 per cent. When a load resistance larger or smaller than this is used the harmonic content rises rather rapidly. In Fig. 82 is shown the variation of harmonic distortion with power output when the optimum load is employed. This curve is similar in shape to those representing a similar relation in connexion with the triode, and emphasizes what has already been mentioned about operating the output valve well within

its rated power output. For example, if a received carrier is modulated 20 per cent and the output pentode is operated so that it supplies 2 watts output power, only 4 per cent harmonic distortion is present. When the modulation is increased to say 80 per cent, however, as during a louder musical passage, the input voltage applied to the pentode will

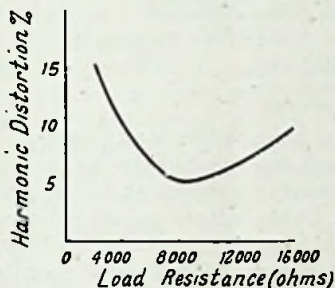

FIG. 81. SHOWING THE RELATION BETWEEN TOTAL HARMONIC CONTENT AND LOAD RESISTANCE OF A PENTODE

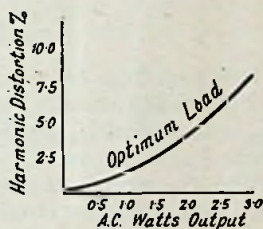

FIG. 82. ILLUSTRATING HOW DISTORTION INCREASES WITH THE POWER OUTPUT OF A PENTODE

be greatly increased and with it the power output, resulting in the production of a large amount of distortion.

Efficiency of Valve. In the operation of the output stage, one limiting factor has already been seen to be the anode dissipation. The merit of an output valve is, therefore, the amount of undistorted power output it will provide at the limit of anode dissipation. If two output valves are rated at the same maximum permissible anode dissipation but the first valve provides double the undistorted power output of the other, then the first valve will be double as efficient from the point of view of output as the second. The anode dissipation is the wattage at the anode when no signal is applied to the grid circuit. If this be called watts input, and represented by W_{in} , and the a.c. power output be represented by W_{op} , then

$$\text{Efficiency} = W_{op}/W_{in}$$

The d.c. wattage at the anode before the application of a signal voltage is equal to the product of the anode volts by

the d.c. anode current at the operating point, i.e. $V_{a0} \times i_{a0}$. The a.c. watts output is equal to the product of the r.m.s. value of the peak voltage and current in the anode circuit due to the signal. Let V_{ax} be the peak voltage at the anode and i_{ax} be the peak value of anode current, then, since r.m.s. values are equal to 0.707 of the peak values, we have

$$\begin{aligned} \text{Efficiency} &= \frac{0.707V_{ax} \times 0.707i_{ax}}{V_{a0} \times i_{a0}} \\ &= \frac{0.5V_{ax} \cdot i_{ax}}{V_{a0} \cdot i_{a0}}. \end{aligned}$$

It is seen from this expression that as the peak voltage V_{ax} and the peak current i_{ax} approach the value of the d.c. voltage V_{a0} and current i_{a0} , so the efficiency increases up to the point where $V_{ax} = V_{a0}$ and $i_{ax} = i_{a0}$. In the latter case the efficiency will be 50 per cent. It is evident, therefore, that the theoretical maximum efficiency obtainable from an output valve operated under conditions considered up till now is 50 per cent. In practice, the a.c. peak values fall well short of the d.c. anode voltage in a triode, as can be seen from the dynamic curves and load lines in Fig. 76, and the anode current peaks are also less than the maximum possible. A usual value of efficiency obtainable from triode output valves is about 23 per cent. With pentodes, the shape of the curve (see Fig. 17) is more favourable from the point of view of anode voltage swing, so that V_{ax} and i_{ax} approach more nearly the d.c. values V_{a0} and i_{a0} thus providing a higher efficiency—generally in the region of 35 per cent.

Matching Loudspeaker and Valve. Referring to Fig. 75, it is seen that the speech coil SC of the moving-coil loudspeaker is connected across the transformer secondary winding. The circuit shown in that diagram is not the only one possible, but it is the circuit commonly used by broadcast receiver manufacturers and will serve the purpose of the present outline of the method of matching the loudspeaker with the valve.

The impedance of a loudspeaker speech coil is much lower than the optimum load resistance of the output valve. It is, therefore, quite out of the question to connect the loudspeaker directly in the anode circuit of the valve, as was at one time the practice with moving armature loudspeakers, even if there

were no other obstacles to such a procedure. An output transformer is needed to ensure correct valve load. On the other hand, the impedance of the speech coil must be matched to the secondary winding of the output transformer T if maximum power is to be applied to it and thus the most efficient transformation of electrical to acoustical power effected. T is therefore a step-down transformer.

The connexion of the loudspeaker to the output valve is seen to involve, (1) matching speech coil to transformer secondary for maximum power output, and (2) matching transformer primary to the anode a.c. resistance of the valve. As the speech coil is an inductive reactance, its impedance varies with frequency; but for purposes of the approximate calculation of the most satisfactory turns ratio of the output transformer, it may be taken as being equal to twice the d.c. resistance of the coil.

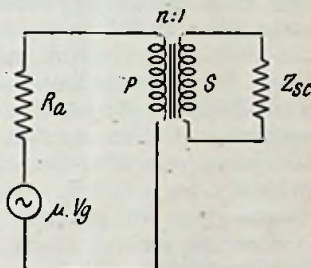

FIG. 83. EQUIVALENT CIRCUIT OF FIG. 75

The simple equivalent circuit of the output stage (Fig. 75) is given in Fig. 83, where the output transformer has a turns ratio $n : 1$ between primary P and secondary S and where Z_{sc} is the impedance of the speech coil that constitutes the load on the transformer. The effect of Z_{sc} across the secondary is to reflect an impedance equal to itself multiplied by the square of the turns ratio, i.e. $R_e = n^2 Z_{sc}$ where R_e is the reflected impedance in the primary P . For maximum undistorted output R_e must equal the optimum load. Now since

$$R_e = n^2 \cdot Z_{sc}$$

it follows that

$$n^2 = R_e / Z_{sc} \text{ or } n = \sqrt{(R_e / Z_{sc})}.$$

This is to say that the turns ratio of the output transformer should be equal to the square root of the optimum load resistance of the output valve divided by the impedance of the speech coil. For example, if the PX4 (optimum load

= 3 200 ohms) is to be used with a speech coil having a d.c. resistance of 3 ohms (or an approximate impedance of 6 ohms), the turns ratio of the output transformer ratio will be

$$n = \sqrt{(3\ 200/6)} = \sqrt{533} = 23 \text{ approximately.}$$

A transformer should, in this particular case, have a ratio as near to 23 : 1 as possible.

Operating the Output Stage. It is seen from the expression for output power on page 116 that the output power is proportional to the square of the input voltage. It follows from this that most satisfactory results will be provided by the output stage when sufficient input voltage is applied to it to utilize the available grid swing, without, at the same time, exceeding this. On the other hand, an output stage that only requires a small input voltage fully to load it is a much less expensive arrangement than one that requires a high input voltage. In the latter case a stage of low frequency amplification will probably be necessary, whereas in the former instance the output stage will probably be coupled to the detector. This is where the pentode scores, for, owing to the higher amplification it provides, a low-frequency amplifier is often not necessary except when diode detection is employed, and even then the detector is sometimes connected to a high slope pentode directly.

The anode supply voltage has a great influence on the operation of the output stage. Unless the anode voltage is the maximum permitted by the valve manufacturers, it is not possible to obtain either the rated power output or the required fidelity in reproduction. It is of the utmost importance, therefore, that the output valve should be chosen to suit the available anode supply voltage, after allowing for the voltage drops in the feed circuit. The voltage actually at the anodes should be the maximum.

As with the other stages, it is detrimental to the working of the output stage if grid current flows. The grid bias must be sufficient to prevent this, even at the peaks of input voltage. The numerical value of grid bias should, therefore, be equal to 1.414 times the maximum input signal r.m.s. value.

Triodes and Pentodes. The pros and cons of triodes and

pentodes as power output valves may be summarized as follows—

(1) Pentodes have a higher amplification factor and provide a higher stage gain. This usually enables a stage of low-frequency amplification to be dispensed with.

(2) Triodes provide an output more free from distortion than pentodes. Although a pentode can be operated to provide a low distortion factor, to do so the output power is seriously diminished and the principal advantage of the pentode (point 1) is lost.

(3) A triode requires a much more simple circuit to work satisfactorily. There is no need for screen-grid voltage dropping resistances or tone correcting devices.

(4) The efficiency of the average triode is about 23 per cent and that of the pentode about 35 per cent. By operating the pentode in such a way that the output power is increased, with a slightly larger harmonic content the efficiency may be as high as 40 per cent.

(5) The load resistance is more critical in the case of the pentode. This means that if the operating potentials fluctuate, the reproduction will suffer much sooner than when a triode is used as output stage. It is also at a disadvantage in respect of the damage that may be done to the pentode if the load resistance is too high.

Negative Feedback. The output pentode and tetrode have been shown to produce a fair amount of distortion when operated in normal conditions in a broadcast receiver. If a proportion of the output voltage is fed back to the input circuit from the output circuit and in opposite phase to the input voltage, part of the latter is thereby cancelled out and, as a result, the amplification *and distortion* is reduced. This type of feedback is negative. If feedback is in phase with the input voltage, it is, of course, positive as used in oscillators and reacting detector circuits.

Now the effect of using negative feedback in the output stage is to reduce harmonic and frequency distortion in the same proportion as the amplification. So long as the input voltage can be increased to compensate for the loss in amplification we shall gain by having greater fidelity in the output.

The process of negative feedback is as follows. Let the

signal voltage applied to the grid be V_g (see Fig. 84) and the amplification of the stage without feedback be A_o . In the output load impedance there is a signal voltage V_a . Thus

$$V_a = A_o V_g$$

If there is fed back to the input circuit a proportion β of the output voltage V_a in opposite phase to the input voltage at

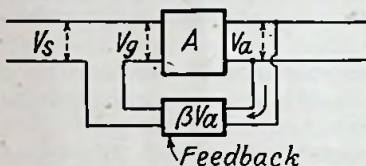

FIG. 84. BASIC FEEDBACK ARRANGEMENT

the grid, the actual feedback voltage is βV_a . The total signal input voltage to the amplifier is, say, V_s , so that we have with the negative feedback a net grid voltage

$$V_g = V_s - \beta V_a$$

Putting this value for V_g in the expression given above for V_a we get

$$V_a = A_o (V_s - \beta V_a) = A_o V_s - A_o \beta V_a = \frac{A_o V_s}{1 + \beta A_o}$$

The effective amplification with feedback is, therefore,

$$A = \frac{V_a}{V_s} = \frac{A_o}{1 + \beta A_o}$$

From the last expression it is clear that the amplification A_o before the use of feedback βV_a has been reduced by $(1 + \beta A_o)$ times. In order that full advantage can be obtained from negative feedback the proportion β fed back has to be such that βA_o is large compared with unity, βA_o being referred to as the feedback factor. When this is the case, the effective amplification A , as can be seen from the expression above, becomes practically $\frac{1}{\beta}$ and is then independent of the valve characteristics and operating voltage fluctuations.

An important point to note is that as the amplification is dependent on the feedback, it is possible to correct for any tone loss in the receiver by suitably modifying the frequency transmission efficiency of the feedback path. In practice, this is often done. To correct for loss of high notes in other parts of the receiver, for example, the feedback path should be so

designed that there is less feedback of the higher audio-frequencies and therefore less loss in amplification in respect of them as compared with the reduced amplification due to the feedback of the lower frequencies.

Distortion is reduced also to $\frac{1}{1 + \beta A_0}$ of its value before the application of negative feedback. This refers to all types of distortion that are produced in the valve or valves to which feedback is applied, including valve noise and hum. As most modern receivers can afford the loss in sensitivity consequent upon the use of negative feedback, this improvement in fidelity is a very great advantage.

Another effect of using negative feedback is to lower the effective anode a.c. resistance of the valve, which now becomes

$$R_{a \text{ eff}} = \frac{R_a}{1 + \beta \mu}$$

R_a and μ being the normal anode a.c. resistance and amplification factor respectively. The anode a.c. resistance R_a is

thus reduced to $\frac{1}{1 + \beta \mu}$ its value without negative feedback.

In a practical circuit this gives an effective R_a to the pentode which is similar to many output triodes. With triodes, the comparatively low anode a.c. resistance provides damping for the loudspeaker and thereby reduces the effect of loudspeaker resonances, the most disturbing resonance being at about 100 cyc. Owing to the much higher anode a.c. resistance of pentodes, there is very little damping due to the valve. By reducing the resistance of the pentode by means of negative voltage feedback, a beneficial damping is obtained, and this alone often improves very noticeably the reproduction from the loudspeaker.

There is a very large variety of circuits for applying negative feedback to valves. Two typical circuits are given in Figs. 85 and 86. In Fig. 85 the feedback takes place through C and R_1 to the grid resistance R_2 . Values of components will clearly depend upon the amount of feedback required, the degree of tone correction needed and the type of valve used. Condenser C blocks the path to the h.t. voltage at the anode and if this

is its sole purpose a value of about $0.1\mu\text{F}$. is suitable. The relation of R_1 and R_2 determines the amount of feedback, in this case being $\frac{R_2}{R_1 + R_2}$. The values selected for R_1 and R_2 should not be so low that they form a low resistance shunt

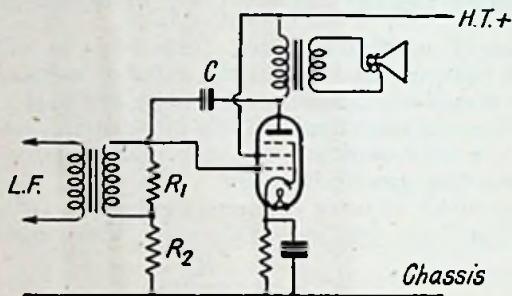

FIG. 85. PRACTICAL FEEDBACK CIRCUIT

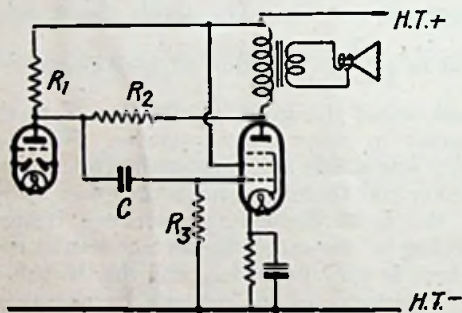

FIG. 86. ANOTHER FEEDBACK CIRCUIT

to the valve load impedance. A very useful ratio is 10:1, so if R_1 is 0.25 megohm and R_2 is 25 000 ohms a satisfactory arrangement will result with many modern output pentodes. In Fig. 86 the feedback is applied through R_2 . This very simple but effective connexion with many circuits may require a value of from 0.25 to 2 megohms.

Current Feedback. An alternative method of applying feedback is to utilize the output circuit current instead of the

voltage. The most common practice is to omit the cathode (grid bias) resistance by-pass condenser. This simple method results in an *increase* in anode a.c. resistance of the valve, and so does not improve the damping of the loudspeaker if used on the output valve. It is often employed with the phase inverter stage as described on page 162.

CHAPTER VII

PUSH-PULL OUTPUT STAGES

A PUSH-PULL amplifier is one in which the voltage input to two valves is in opposite phase and the outputs of these valves are additive in a common circuit.

Push-pull amplifiers are arranged in a large variety of ways, and are employed for many important purposes in both radio transmitters and receivers. In broadcast receivers their use is limited to the output stage, and the circuits in which they are used can be divided broadly as follows—

1. With normal amplifier bias applied to the control grids; i.e. *Class A Push-pull*.

2. With high grid bias applied, so that the anode current is reduced to nearly zero, but the valves are not allowed to run into grid current, i.e. *Quiescent Push-pull*.

3. With the valves operated well into the region of grid current—*Class B Push-pull with positive drive*.

CLASS A PUSH-PULL AMPLIFIERS

In this arrangement each valve is operated with a similar value of grid bias to that which would be applied to the same valve if connected to amplify in a straight amplifier; i.e. the operating bias is such that the working point is on the middle point of the grid voltage-anode current characteristic.

Consider the circuit shown in Fig. 87. Low-frequency signals in the l.f. transformer primary induce l.f. voltages in the transformer secondary winding. The common grid return is from the centre of the secondary winding, through the grid-bias battery to the two cathodes. When alternating voltages are applied to the secondary winding, therefore, points *B* and *C* will, at any given instant, be at opposite potentials with respect to *A* by an equal amount; that is to say, if the total voltage between *B* and *C* is 20 volts, and *B* is 10 volts positive with respect to *A*, then *C* is 10 volts negative with respect to *A*. The grids of the individual valves are, therefore, excited in opposite phase.

In the anode circuits there are, of course, the d.c. and the a.c. components. The direct electron current flows, in each case, from cathode to anode, through one half of the output transformer primary and the common h.t. battery back to cathode. The direction of the steady anode current from V_1 is from D to E as shown by the full line arrow, and that from V_2 is in the direction from F to E . Since the direct currents due to the respective valves flow in opposite directions along the primary winding, the effects on the common transformer core must be to cancel out their separate fields. The result of this balancing out of the anode currents is that the d.c.

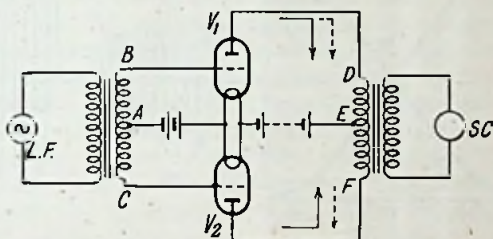

FIG. 87. BASIC PUSH-PULL AMPLIFIER CIRCUIT

component of the anode current has no effect on the performance of the transformer. As regards the a.c. components, however, these will always be in the same direction since the respective grid voltages are in opposite phase. For example, when B is so positive with respect to A that the anode current from V_1 is increased from its steady value by one-half, C will be at the same moment so negative that the anode current from V_2 is reduced by one-half from its steady value. The net results of these changes in currents are additive in the transformer primary, as indicated by the broken arrows in Fig. 87.

The actual operation of a push-pull stage with mid-point biasing can be described by reference to the grid voltage-anode current curves seen in Fig. 88. Here, the individual mutual conductance characteristics are shown superimposed on each other. It is assumed that the valve characteristics are perfectly matched—a desirable but not essential feature

for satisfactory push-pull operation—and that the valves are biased to the mid-point P . The input wave form is seen to swing the grid voltage of each valve over the linear part of the characteristic, producing changes in anode current as indicated by i_{a1} and i_{a2} , corresponding to the two individual valves V_1 and V_2 of Fig. 87. It is seen that the changes in anode current are in opposite phase; that is to say, as one

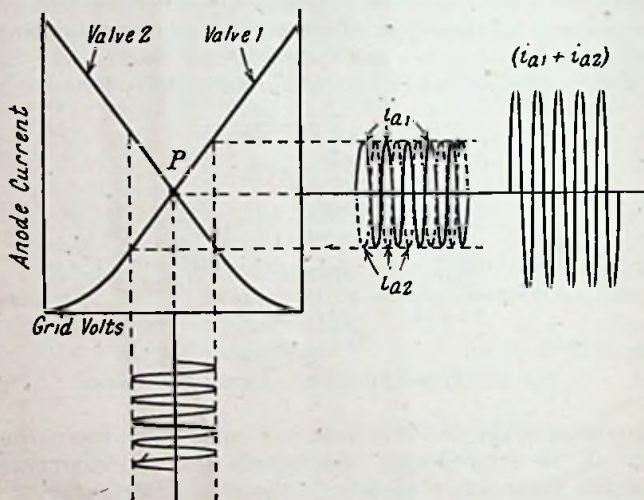

FIG. 88. ILLUSTRATING THE PROCESS OF PUSH-PULL AMPLIFICATION

increases the other decreases to an equal extent. The resultant of two currents in this form is zero, so some means has to be found for altering their phase by 180° so that as one current increases in one direction the other current also increases in that direction, thus giving a resultant that is the sum of the two individual currents. Referring again to Fig. 87, it is seen that the anode currents from the separate valves act on different parts of the output transformer primary, so that, in fact, the change in phase is brought about and the resultant effects as regards the a.c. component are additive. This arrangement of the anode circuits is called a *differential*

connexion. Owing to this differential connexion, the total current in the output transformer is that depicted by curve ($i_{a1} + i_{a2}$), which is seen to be equal to the sum of the individual anode currents.

It is seen from the above discussion that each valve is acting just like an ordinary amplifier biased to the mid-point of its i_a/V_g characteristic. That is to say, each valve amplifies both halves of the signal voltage wave.

Consider now the significance of this process in respect of a single A-amplifier valve. We have, in push-pull, two valves amplifying an input voltage, each valve output circuit consisting of anode, transformer primary, h.t. source, cathode. The conditions for optimum output in an output amplifier have already been found to be that $R_o = 2R_a$. These conditions must apply, therefore, to each valve in the push-pull stage, and the combined load impedance from the anode of one valve to the anode of the other is thus $4R_o$. Since the output of the valves is additive, the combined output is double that of one valve used as a Class A amplifier.

As regards the input circuit, it is evident from Fig. 87, that the total voltage across the secondary of the input transformer is divided between the two valves, owing to the centre tap connexion to the cathodes. The net result of this is that double the maximum input voltage applicable to a single A amplifier may be applied to the push-pull stage. Thus, although the push-pull stage provides twice the permissible grid swing of a single valve amplifier, each valve actually handles the same input voltage that it would in a straight A amplifier stage.

The advantage of this arrangement is that the push-pull stage handles twice the grid swing to produce twice the output, the efficiency remaining at about 23 per cent as in the single A amplifier. There is another point to consider besides input and output voltages. This is the distortion produced in the process of amplification, which will be examined later.

Although mid-point biasing is the ideal way of operating a Class A push-pull stage, it is not the most economical. In a single valve Class A amplifier, it has been seen to be necessary to select the operating point in the centre of the linear portion of the i_a/V_g characteristic so as to avoid working on

the curved part when handling large input voltages. If the latter occurred, even order harmonics were shown to be produced by the particular distortion produced in the amplified wave form. One advantage of using the push-pull A amplifier is that correct mid-point biasing is not now necessary owing to the cancelling out of the even order harmonic distortion in the differential output circuit.

In Fig. 89 are seen the two curves of Fig. 88, but the operating point P has now been shifted lower down the curves.

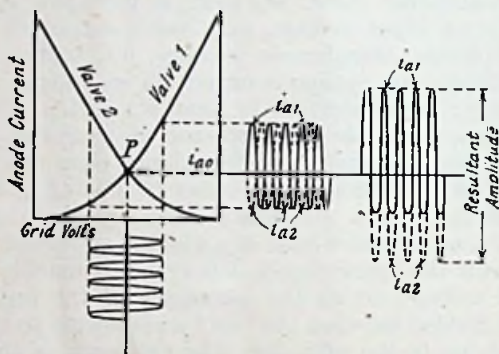

FIG. 89. SHOWING THE EFFECT OF INCREASING THE GRID BIAS APPLIED TO A PUSH-PULL AMPLIFIER

If one of these valves were used as a single Class A amplifier, serious harmonic distortion would be produced, and it would be quite impossible to obtain satisfactory reproduction from it. The individual curves of anode current are shown at i_{a1} and i_{a2} respectively, and are obviously very distorted reproductions of the input grid voltage. When these currents are displaced 180° as shown at i_{a1} and i_{a2} in the resultant amplitude curve, it is seen that during the half-wave that i_{a1} is distorted, the half-wave of i_{a2} that is added to it is faithfully amplified. In the following half-wave, however, i_{a1} is undistorted and i_{a2} is as badly distorted as i_{a1} was in the previous half-wave. The sum of the two distorted waves is shown in the resultant amplitude curve where the individual distortions are cancelled out to give a faithful amplified reproduction of the input voltage.

It should be noted that, by operating on a lower part of the characteristic, the steady anode current is reduced and therefore the anode dissipation is diminished. Furthermore, the permissible grid swing has been increased, for it is still equal to twice V_{00} . The extra grid swing is equal to twice the increased bias applied as compared with the bias required to operate the valves at the mid-point of their characteristic. For example, if 20 volts is the correct bias for true Class A amplification as in Fig. 88, but 25 volts are applied to work the valves in the manner indicated in Fig. 89, the increased grid swing will be 10 volts.

The practical significance of this cancelling out of the even order harmonics is that—

1. For a given grid swing, a push-pull amplifier will give less distortion than a single valve.
2. For a given percentage of second harmonic distortion, a greater grid bias can be applied to the valves, and consequently a larger input signal can be handled by each valve.

A push-pull amplifier with mid-point biasing is seen, therefore, to be a more faithful translator of electrical energy than a single valve amplifier, by virtue of the combination of the two valve characteristics. It is for this reason that push-pull is usually employed in *quality* or *high fidelity* amplifiers. Feature No. 2 above is the reason why public address systems, or any arrangement designed for a large output, employ push-pull; a larger total input voltage can be handled than twice that for a single valve and the arrangement is more economical because the anode dissipation on the power output valves is reduced by the application of a higher bias. In general terms, it may be stated that the a.c. output available from two valves in push-pull is about two and a half times that from one of these valves used as a straight amplifier. Quite apart from the double grid swing of the push-pull amplifier, this increase in output is of great importance in public address systems or any high power output stage.

Dynamic Conditions in Output Circuit. The usual methods of examining the dynamic operation of the output circuit of a single-power amplifier by means of the i_a/V_a characteristics needs modification when applied to a push-pull amplifier if a true picture is to be obtained of the actual conditions.

Although the normal treatment of this problem is applicable to the individual valves, it does not give correct results when the effective load, harmonic distortion, etc., actually existent in the anode to anode impedance, is considered. Since the a.c. voltage on the grid and anode of each valve is in opposite phase, the voltage variations on each valve take place in

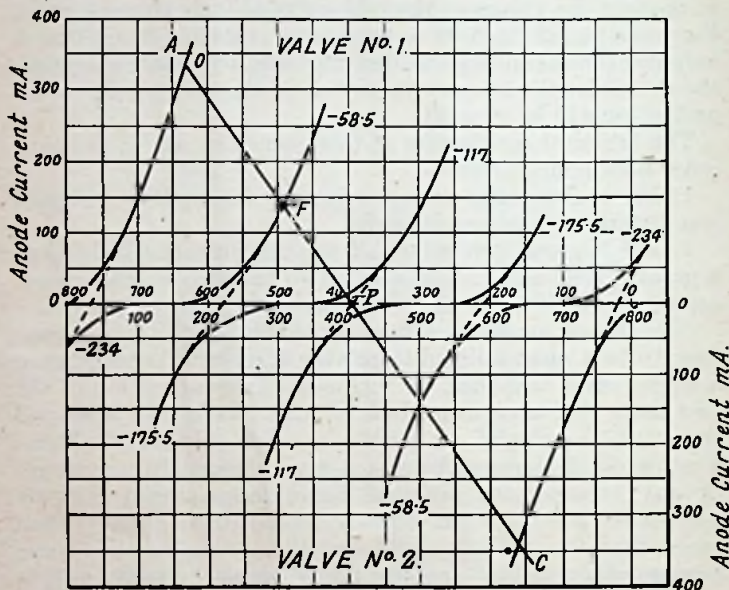

FIG. 90. PUSH-PULL POWER CURVES

opposite direction. For this reason, it is usual to combine the i_a/V_a characteristics of the two valves operated in push-pull, one set of curves being inverted, when examining the dynamic conditions of this type of amplifier.

A family of such curves is given in Fig. 90, these being relative to two Osram PX25A valves. The inverted curves are exactly similar to the upper set. This is the ideal push-pull condition, as already outlined, and presupposes a perfectly matched pair of valves and a coupling between the two halves of the output transformer primary equal to unity,

providing the composite characteristics as indicated by dotted lines.

If these curves are now considered in the light of the resultant current and voltage conditions already shown to be existent in the output circuit of the amplifier, they will be found to represent these conditions correctly. Both valves are operated with a grid bias of -117 volts, corresponding to point P on the resultant characteristic. The effective steady anode current has already been seen to be zero in the anode to anode impedance, and thus P is on the zero anode current line. A load line corresponding to one-quarter of the anode-to-anode impedance has been drawn across the characteristics. The instantaneous values of alternating current and voltage in the output circuit are obtained from the values given by the load line in the same way as is usually done with the normal output curves of a single amplifier. It will be noted that as the input grid voltage fluctuates, the representative point on the load line cuts the individual characteristics at the correct point. For example, when an a.c. voltage input of 58.5 volts peak value makes the grid of V_1 58.5 volts less negative (point F), the grid of V_2 is 58.5 volts more negative with respect to the operating point P .

A curve representing the relation between output power and load resistance is similar to that given in Fig. 77 in respect of a single triode output valve, i.e. the load resistance for maximum power output is not sharply critical for values above the optimum load, but for values below this the output power falls rather rapidly.

The power output of a Class A push-pull amplifier is

$$W_{on} = \left(\frac{2\mu V_g}{R_c + 2R_a} \right)^2 \cdot R_c$$

where R_c is the anode-to-anode impedance and R_a , μ and V_g are in respect of one valve. It is noted that the total anode a.c. resistance is $2R_a$, since the valves are effectively in series.

Before leaving this theoretical discussion on Class A push-pull, a note may be added about the efficiency of this system of amplification for weak and strong signals. It is apparent from Fig. 89 that with no signal voltage applied to the grid, there is dissipated at each anode, power equal to $i_{a0} \cdot V_{a0}$ where

i_{a0} is the steady d.c. flow and V_{a0} is the d.c. anode voltage. Now $i_{a0} \cdot V_{a0}$ must not exceed the maximum anode dissipation allowable for the valve in question, and it is quite a reasonable supposition that the valve is operated under conditions such that, with no signal voltage at the grid, $i_{a0} \cdot V_{a0}$ equals the rated anode dissipation of the valve. While a low signal voltage is being amplified, a small a.c. component is produced in the anode circuit of each valve, and the efficiency W_{op}/W_{inp} is low. As the signal voltage increases to the maximum permitted by the grid swing indicated by the characteristic, the anode a.c. component increases correspondingly. Since the d.c. power supplied by the h.t. source is constant, the efficiency increases as the signal voltage becomes greater and increases W_{op} in the anode circuit. To operate the stage at maximum efficiency, therefore, the grid voltage must swing to both limits of the i_a/V_a curves. Up to this point the efficiency increases as the square of the signal voltage on the grid, i.e. with half the maximum grid swing the efficiency is only a quarter of the maximum, notwithstanding that the power from the h.t. source remains the same. This is one disadvantage of a Class A push-pull amplifier as compared with the Class B stages outlined later in this chapter.

It is now possible to summarize the practical advantages of push-pull i.f. amplifiers over the single output valve or the same valves used in parallel—

1. A larger input voltage can be handled per valve without distortion owing to the cancelling out of even order harmonics in the anode circuit.

2. Less smoothing is needed in a.c. receivers owing to the cancelling out of the hum components in the output transformer.

3. There is less tendency to motor-boating, owing to the h.t. source being situated outside the circuit along which the alternating voltages pass, namely, from anode to anode.

4. Steady anode currents due to the valves are cancelled out in the output transformer, and this brings about an improvement in tone owing to the higher inductance of the primary winding thereby provided.

Against these advantages must be set the drawback that the effective gain is only half that obtainable if one valve is used owing to the available input voltage being divided

between the two valves. This point is not of much importance if the push-pull stage is fed by a high gain amplifier, but it emphasizes that push-pull A amplifiers are not suitable for small receivers or receivers supplied by dry batteries. In most practical cases, the diminished gain is considered of minor significance as compared with the extra signal voltage handling capabilities of the stage.

CLASS B AMPLIFICATION

It has been shown to be permissible to work a Class A push-pull amplifier with a higher grid bias than that required to operate each valve on the mid-point of its mutual conductance characteristic. The logical maximum grid bias voltage applicable to the valves is that at which anode current ceases to flow, for in that condition each valve will amplify alternate half-cycles of input voltage; i.e. during the half-cycle that one grid is made more positive by the incoming signal that valve will pass a current, but during the subsequent half-cycle when the grid is made more negative, no anode current will flow in that valve but does so in the other push-pull valve. In Class B amplification this state of affairs is approached. Actually, the valves are worked on the bottom bend of the characteristic, instead of at the anode current cut-off point, and it is found that this type of amplification gives certain advantages, which will be apparent from a further consideration of Class B amplification.

In Fig. 91 is seen the effect of operating two valves in push-pull with bottom bend biasing. The average line joining the individual curves of valves 1 and 2, which represents the sum of the two curve values at that region of grid voltage, is seen

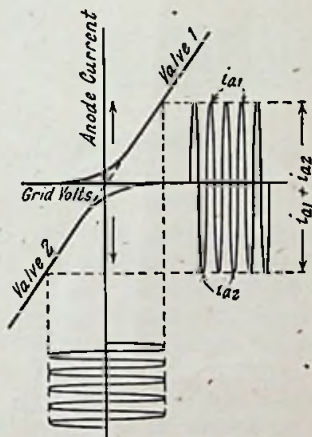

FIG. 91. ILLUSTRATING THE PROCESS OF CLASS B AMPLIFICATION

to be straight. It can be shown, in fact, that the sum of two parabolic curves is a straight line, and this is just what is required for a distortionless amplifier. Consequently, the effect of working the valves on the bottom bend of their mutual conductance characteristic does not entail distortion of the input voltage wave form as would be the case if a single valve were employed as amplifier in this way. It is apparent from Fig. 91 that the top half of the resultant wave form (i_{a1}) is reproduced by V_1 and the bottom half of the wave (i_{a2}) by V_2 in much the same manner as in ordinary anode bend rectification.

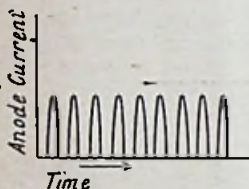

FIG. 92. CURRENT OUTPUT CURVES OF ONE VALVE IN THE CLASS B AMPLIFIER

Now consider carefully what is taking place in each valve. In Fig. 92 is given the anode current curve of one valve in respect of time when a voltage of sine wave form is applied to the grid, and it is seen that in the ideal case of absolute cut-off at zero grid voltage, the anode current of each valve consists of a series of

half sine waves. When no signal voltage is applied to the grid of the ideal Class B valve, no anode current flows and thus no load is placed on the valve. Even during amplification of a signal, the anode current only flows for half the duration of the signal. It is thus evident that the anode dissipation is kept very low and bears a direct relation to the actual signal applied to the grid. This is, of course, a very desirable feature in an output valve, since the anode dissipation has been shown to be the limiting factor in respect of the permissible signal handling capability of an output valve.

Efficiency of a Class B Stage. Owing to the very small anode current flow when a Class B valve is in the quiescent state (i.e. when it is not amplifying) the effective anode dissipation is produced almost entirely by the alternating power. This means that the major part of the input power W_{in} is constituted by the output power W_{out} . Accordingly it is to be expected that the efficiency of a Class B valve will be much higher than that of the Class A amplifier.

Consider the case where the maximum grid swing is applied to a Class B valve. The anode voltage swing at peak values

will approach that of the supply voltage, and V_{ax} may therefore be considered as equal to V_{a0} . As shown on page 130, the r.m.s. value of output wattage is

$$W_{op} = 0.5 i_{ax} V_{ax} = 0.5 i_{ax} V_{a0}.$$

In the ideal case where complete cut-off of anode current is effected in the quiescent state, the anode current only flows during the amplification of a signal voltage. Consequently, the input power W_{inp} in the anode circuit is the product of the mean value of the anode current by the operating voltage V_{a0} . As the mean anode current is $2/\pi$ times the peak value produced by the signal, the watts input

$$W_{inp} = (2/\pi) i_{ax} \times V_{a0}.$$

We therefore have for the Class B valve, as a theoretical maximum,

$$\begin{aligned} \text{Efficiency} &= \frac{W_{op}}{W_{inp}} = \frac{0.5 i_{ax} V_{a0}}{(2/\pi) i_{ax} V_{a0}} \times 100 = \\ &(0.5\pi/2) \times 100 = 78.5 \text{ per cent.} \end{aligned}$$

This figure of efficiency is much higher than that obtained from a Class A amplifier. In practice, the actual efficiency obtained need not fall very far short of the figure given if due care is given to the design of apparatus, and the correct operating conditions for the valve are complied with. The discussion is in respect of Class B amplifiers with positive grid drive, and for quiescent push-pull amplifiers, since the conditions as regards efficiency are similar. It should be noted that the efficiency figure given above is in respect of the maximum grid swing. If the grid swing is less than the maximum, the efficiency will not be so high for the obvious reason that the anode voltage excursions will be less than the h.t. voltage. The efficiency is in fact directly proportional to the grid swing, and this is another point of difference to a Class A amplifier in which the efficiency is proportional to the square of the grid voltage swing.

The high maximum efficiency of the Class B amplifier is one of its greatest advantages in broadcast receivers. Its practical significance can be realized from the following comparison of the a.c. output power provided by two valves, the

maximum anode dissipation of each being 5 watts. Now the maximum output power obtainable from a valve is

$$W_{op\ max} = \frac{\text{efficiency}}{W_x} \times W_d$$

where W_d is the maximum permissible anode dissipation and W_x is the maximum percentage of the h.t. power taken by the valve, which in a Class B valve is 32 per cent. Thus

$$W_{op\ max} = 78.5 \times 5/32 = 12.27 \text{ watts.}$$

In the case of the same valve operated as a Class A amplifier, it has been seen that the maximum output power is equal to the maximum allowable anode dissipation, so for the 5-watt valve, $W_{op\ max} = 2.5$ watts. This shows that for a given value of anode dissipation there is obtained from a Class B amplifier about five times the a.c. output of a Class A amplifier. In other words, it is possible to use Class B valves that are very much smaller—and therefore very much less expensive—than for a Class A amplifier.

Before carrying discussion further, it may be as well to summarize the main advantage of Class B amplification as compared with respect to Class A push-pull. They are—

1. Power derived from the h.t. source is proportional to the signal voltage actually being amplified. This is of great importance in receivers supplied by batteries.
2. Valves are operated at a much higher efficiency.
3. Smaller and less expensive valves may be employed.

Class B Distortion. The discussion up till now has only dealt with the case where the complementary characteristics of the two valves operated in the Class B amplifier have been perfectly similar. In practice it is not an easy matter to manufacture two sets of electrodes and mount them round a common cathode within a glass envelope, with such exactitude that the resultant combined characteristic is the straight line indicated in Fig. 91. There are factors inherent in the operation of a valve that are extremely difficult to predetermine, as was shown in the first chapter, and these factors make themselves apparent when the careful matching of valve characteristics that is desirable for the satisfactory operation of a Class B amplifier is attempted.

A prerequisite for the production of a straight line as the resultant characteristic of the two valves is that the algebraic sum of the ordinates be constant. Over the linear part of the curves this condition is usually satisfied, but, as the point of zero grid voltage is approached, the curves bend. Unless the curvilinear parts of the two curves are exactly alike, the resultant characteristic cannot be the desired straight line.

Owing to the difficulties alluded to above, the actual curve of a Class B valve is often distorted to a certain degree, even if small, as shown in Fig. 93. This is generally known as *Class B distortion*, and is the disadvantage attendant on the process of this type of amplification. It should be noted that this particular distortion is brought about by operating the valves on the bottom bend of their characteristics, and will not arise in a Class A push-pull amplifier as in this case the curved part of the characteristics is not normally used; or, if employed, the asymmetries in the resultant amplified wave form cancel out.

Reference to Fig. 93 will show the type of distortion usually produced. The wave form is flattened out as the point of zero anode current is approached. This introduces even order harmonics in the reproduced signal, tending to make the reproduction high pitched, causing "Class B shriek." Two different amplitudes of input signal voltage are shown to illustrate the fact that when a weak signal is being amplified, the distortion is greater in comparison to the output wattage than when a strong signal is amplified. In the case of the higher voltage input, just as much distorted characteristic is

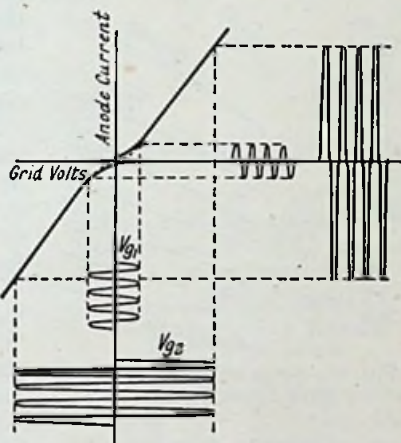

FIG. 93. ILLUSTRATING HOW CLASS B DISTORTION IS PRODUCED

worked on, but as the linear part of the characteristic is so much greater than the distorted portion, the *percentage* distortion is correspondingly less.

In practice, the amount of Class B distortion is generally very small when a fair output is being taken from the valve. It is advisable, however, to connect a correcting condenser across the output circuit to by-pass any excess of high note

reproduction. In the practical circuit given a little later on, it will be noticed that such a condenser is included.

Positive Grid Drive. The theoretical basis of Class B amplification outlined above needs some modification in actual practice. Consider, for example, the i_a/V_a curves of a typical Class B triode valve shown in Fig. 94. Owing to the curvature of the characteristics as zero anode voltage is approached—i.e. at maximum l.f. vol-

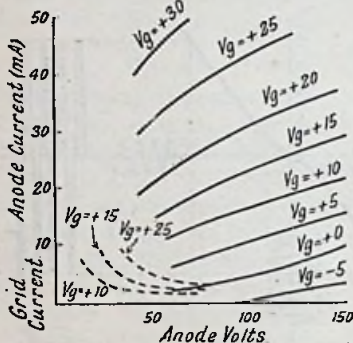

FIG. 94. CHARACTERISTIC CURVES OF A CLASS B VALVE

age amplitudes in the anode circuit—severe distortion is experienced if an attempt is made to obtain an l.f. voltage amplitude equal to the h.t. voltage. It is also apparent that, in order to obtain a high efficiency from the valve, the latter has to be operated well into the region of grid current. This is known as *positive grid drive*. Now it has been shown in earlier considerations of amplifiers of all types, that the presence of grid current is detrimental to the fidelity of the amplified wave form. With the type of valve now being discussed, however, special precautions are taken in order to overcome the effects of the grid current flow, and by this means it is possible to operate the valve with much greater efficiency, as will readily be seen from Fig. 94. It should be noted, nevertheless, that triode valves are now being considered. Pentodes have different characteristics and this case will be examined later. From Fig. 94 it is seen that it is possible to draw the load line as

far as the curve for $V_g = +25$ volts, but that thereafter the characteristics become too badly shaped to enable a reproduction to be obtained with a maximum of 5 per cent harmonic distortion.

It can be shown that if the load line is limited by the $V_g = 0$ curve, as is usual with Class A valves, the efficiency of a Class B amplifier is only 39 per cent when the triode valve is operated under conditions that provide the greatest output for the h.t. voltage employed.

In the design of a Class B amplifier with positive grid drive, means have to be provided to minimize the effect of the flow of grid current. If the grid to grid d.c. resistance is kept low, the actual power loss (i^2R) will not be serious. Consequently, the secondary winding of the input transformer must be of as low a resistance as possible. A common value for this is from 250 ohms to 500 ohms. Even so, there is a definite waste of power and in order to compensate for this, a driver valve is usually employed to supply the positive driven amplifier. It is thus seen that a Class B valve with positive drive involves the use of an additional stage of l.f. amplification, and satisfactory results are not obtained without this extra valve.

It is seen from Fig. 95 that the anode current amplitude is dependent on the voltage of the signal applied to the grids. This is of the utmost importance to receivers operated from dry batteries, for it means that during periods of no signal, there is little or no wastage of the very expensive h.t. current. Furthermore, a weak signal will produce only a small anode current flow, and if economy of h.t. current is necessary the receiver has merely to be operated in such a manner that comparatively small voltages are applied to the grid of the Class B stage. The popularity of Class B amplifiers is primarily due to this feature. There is, however, another side to this fact. Since the anode current amplitude is reduced with the

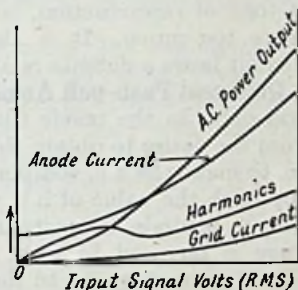

FIG. 95. THE OUTPUT RELATIONS IN A CLASS B AMPLIFIER STAGE

input voltage, so is also the anode dissipation. This is much more satisfactory than with Class A amplifiers, which have been shown to have an anode dissipation that *increases* as the signal voltage applied to the amplifier grids is diminished.

Fig. 95 also illustrates how the harmonic distortion rises to a maximum and then, as the input voltage increases, falls again. It is thus not advantageous, from the point of view of tone of reproduction, to reduce the input to the Class B valve too much. It is also seen that the amount of grid current bears a definite relation to input signal voltage.

Quiescent Push-pull Amplifiers. The need for using positive grid drive in the triode Class B amplifier arrangement arose from the desire to obtain the utmost efficiency from the valve, i.e. to make the a.c. component of voltage in the anode circuit approach the value of h.t. voltage. Examination of a typical output pentode characteristic as in Fig. 17 will show that there is no need to work this type of valve in the region of grid current owing to the possibility of obtaining an alternating voltage component in the anode circuit that approaches the theoretical maximum. For example, in Fig. 17, the anode voltage swing that cannot be actually utilized by the valve is only 30 volts out of 400 volts available. When pentodes are employed as Class B amplifiers, therefore, they are not allowed to run into grid current, but a grid bias of sufficient magnitude to enable the valve to be worked on a linear load line at the maximum input voltage is applied to the valve. This arrangement is known as *quiescent push-pull* and, throughout the remainder of this book, a Class B amplifier with positive grid drive will be referred to merely as a *Class B amplifier*, and a Class B amplifier using pentodes that are not allowed to be worked with a positive grid will be referred to as a *quiescent push-pull amplifier*. These are the usual terms employed in the radio industry for these two types of amplifiers.

Practical Class B Amplifier. In adapting a Class B amplifier to practical receiver design, several problems at once become apparent. In the first place, there is the rapidly fluctuating anode feed to be supplied by the h.t. source. The voltage provided by a mains supply unit varies with the load imposed upon it. That is to say, if a mains unit of ordinary

construction were employed to supply a Class B amplifier, the h.t. voltage would probably be, say, 150 volts during the no-signal periods but drop to about 120 volts during a signal peak. These conditions are quite impracticable and would result in serious distortion, for not only would the Class B stage be effected, but the previous amplifiers would also have their operating voltages changed. For this reason the use of Class B is confined to battery receivers in commercial radio receivers.

For public address systems, however, the employment of Class B amplifiers supplied from mains has various advantages, notably a lower initial cost and running expense, less weight and the need for a smaller mains unit than if the amplifier were Class A. In this case special mains supply apparatus is used, which has an exceedingly good regulation so that the output voltage remains substantially constant during the large current load fluctuations. The transformers and chokes, in particular, must be of very low resistance, so that during the periods of peak current flow, the voltage drop along them is not too large. Sometimes mercury vapour mains rectifier valves are employed in an endeavour to improve the regulation of the mains supply unit. It is obvious that grid-bias voltage cannot be provided by the usual bias resistance in the cathode lead, owing to the large variations in anode current that are produced.

In Fig. 96 is given a practical Class B amplifier circuit. The complete stage consists of the driver valve V_1 and the Class B valve V_2 consists of two triode elements in one envelope. A driver valve is necessary in order fully to load the output valve and also to supply the power that the Class B valve requires in its grid circuit during the periods of grid current. It is generally of the L type, with a medium impedance. The secondary winding of T_1 has to carry the grid current, which during periods of peak signal may be as much as twenty milliamperes. It is essential therefore, that the d.c. resistance of this winding be made as low as possible consistent with the required inductance. If the number of turns on the secondaries is made too low, however, V_2 will not be fully loaded at peak signal voltages. It should be remembered that there are, in effect, two secondary windings

to be wound round the same core as the primary, and this limits the size of wire and thereby the reduction in secondary resistance that can be attained. Resistances R_3 R_4 are sometimes joined across the respective secondary half windings to avoid resonances and spurious oscillation. They have a value of about 10 000 ohms. A grid h.f. stopper is usually employed in connexion with the driver valve, shown at R_1 .

The primary winding inductance of T_1 is governed principally by the necessity of having a large output impedance in the

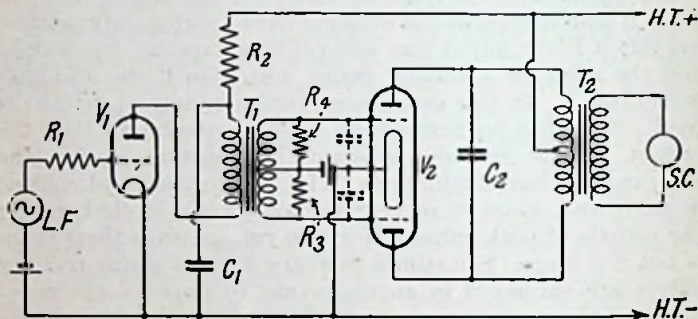

FIG. 96. PRACTICAL CLASS B AMPLIFIER CIRCUIT

anode circuit of the driver valve V_1 . Owing to the flow of grid current from the output valve V_2 , the load on the primary will vary considerably, and the effective impedance of the primary winding in the anode circuit of V_1 will fluctuate correspondingly. It has been shown, during the consideration of the operation of the output stage in a previous chapter, that it is important that the load impedance—in this case the primary winding of T_1 —should not be less than twice the triode valve impedance. During periods of high grid current flow, therefore, when the effective impedance in the anode circuit of the driver valve falls considerably, the amplification from the driver stage will be reduced correspondingly. The primary of T_1 must, therefore, have such an impedance that at the periods of peak grid current in V_2 its effective impedance is equal to at least twice the impedance of V_1 .

It is thus seen that T_1 must have a step down ratio between

V_1 and V_2 . In practice, the ratio varies from 2 : 1 to 5 : 1 depending upon the types of valves used for V_1 and V_2 .

Considerations governing the design of the anode circuit of V_2 are similar to those already discussed in connexion with the Class A push-pull amplifier. The inclusion of condenser C_2 is to improve the quality of reproduction by diminishing the high note response of the amplifier due to Class B distortion. A usual value for this condenser is $0.01 \mu\text{F}$. An alternative position for the tone correction condenser is across the grid circuits as shown in dotted lines, the value then being about $0.0005 \mu\text{F}$.

The Class B valve used in broadcast receivers consists of two L-type valves in one envelope. This arrangement has obvious advantages to receiver designers over the use of two separate valves: there is no need to match the valves, since this is done by the valve manufacturer; and it reduces the space taken up by the Class B stage, as only valve holder and one valve is employed.

It is seen from Fig. 96 that grid bias is applied to the Class B valve. This is usually done with low impedance valves, as more stable operation is usually obtained by so doing. Some valves on the market—such as the Mullard PM2B, do not need any grid bias. When bias is applied, its value should preferably be altered as the h.t. voltage falls, so as to avoid distortion and to maintain the anode impedance approximately constant. In cases where no grid bias is used, the optimum anode to anode impedance increases as the h.t. voltage is lowered.

Practical Quiescent Push-pull Circuit. It is generally more convenient to employ one valve with two sets of pentode electrodes as the q.p.p. valve than to use two separate valves for this purpose. A q.p.p. valve is therefore, comprised of two pentode valves. It is, nevertheless, just as feasible to work a receiver with two separate pentodes. In fact, this is not infrequently done, for by so doing, separate bias voltages are applicable to the respective valves and a means is thus provided for balancing out any small irregularities in the two valve characteristics. In the present instance, however, only the single q.p.p. valve will be considered, as this is the usual arrangement employed.

In Fig. 97 is seen the circuit for a q.p.p. amplifier. Owing to the high mutual conductance slope of the output pentodes they may sometimes be fed by the detector valve without the interposition of a driver. The comparatively small a.c. voltage in the anode circuit of the valve V_1 —usually a triode l.f. amplifier—makes it advisable to have an input transformer T_1 with a high step-up ratio so as fully to load the pentodes and take advantage of the large permissible grid swing that is available. A general value of the ratio of T_1 is 10 : 1. It is advisable to decouple the anode circuit of V_1 , and C_2 , R_1

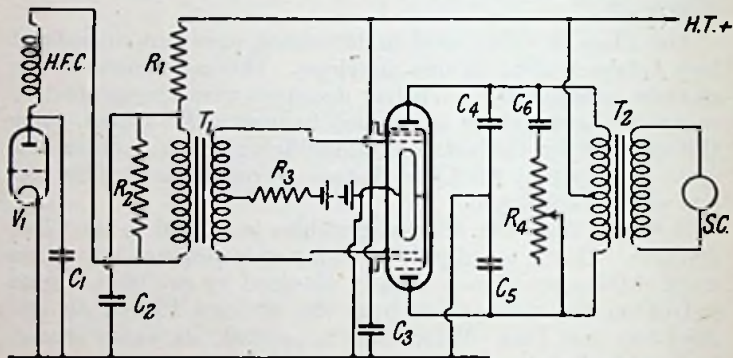

FIG. 97. PRACTICAL QUIESCENT PUSH-PULL AMPLIFIER CIRCUIT

are for this purpose. The anode current of V_1 will normally be quite small—less than 2 mA.—so the operation of T_1 will not be greatly affected thereby. If diode detection is used in the receiver, V_1 will be the triode l.f. amplifier, conveniently the triode section of a double-diode-triode valve. It is usual in this case, however, to use parallel feed coupling between V_1 and the q.p.p. valve owing to the appreciable anode current flow with series transformer coupling.

To the centre tapping on the secondary of T_1 is connected a resistance R_3 of from about 100 000 to 250 000 ohms for the purpose of preventing the outbreak of oscillations in the q.p.p. valve. In some cases this resistance is not needed, but it should certainly be used if the output stage is not stable.

The screen grids are joined together and decoupled in the

usual way by a $2\mu\text{F}$. condenser C_3 . Across the primary of the output transformer tone correcting condensers C_4 and C_5 of $0.001\mu\text{F}$. capacitance are connected. If desired, one condenser may be used as tone corrector by being joined from anode to anode in place of the tone control consisting of R_4 (30 000 ohms) and C_6 ($0.001\mu\text{F}$.). Output transformer T_2 has the matching ratio of turns (R_s being the speech coil impedance).

$$n_1/n_2 = \sqrt{(2R_c/R_s)}$$

R_c being in respect of one valve, of course.

As regards the actual operation of a q.p.p. stage, it is very important to maintain a high voltage on the anodes and screens, for as the h.t. falls, distortion increases rapidly. Valves with a rated maximum anode voltage of 150 will often give most unsatisfactory reproduction when the anode voltage has fallen to 110 volts, notwithstanding that the grid bias has been correspondingly decreased.

PARAPHASE PUSH-PULL

In the chapter dealing with l.f. amplifiers, it was shown that resistance-capacitance stages were capable of reproducing signal voltages with a high degree of fidelity. The push-pull circuits outlined up till now have all had iron-cored transformers in the input to bring about an opposition in phase of the signal voltage applied to the two valves of the push-pull stage. Any distortion produced by the behaviour of the input transformer will, therefore, be reproduced in the output circuit and passed to the loudspeaker. A paraphase push-pull amplifier is one in which resistance-capacitance coupling is used in an input stage to a push-pull amplifier to provide the requisite signal voltages in opposite phase.

The manner in which this is performed is as follows. In Fig. 98 are seen two resistance-capacitance coupled valves. L.f. signals are applied to the grid-cathode circuit in the usual way, and an amplified voltage appears in R_1 . Owing to the reversal in phase brought about by the valve itself (see Fig. 46), the alternating voltage in R_1 is opposite in phase to the input voltage, and a portion is tapped off R_1 and applied via coupling condenser C_1 to the grid of V_2 . The actual voltage applied to V_2 is arranged by means of the tapping along R_1 to be equal in

amplitude to the signal voltage on the grid of V_1 , and it is thus apparent that the i.f. voltages applied to both grids are equal in amplitude but opposite in phase. It is important to note that V_1 and V_2 are not functioning as a cascade amplifier arrangement, owing to the limited voltage applied to the grid of V_2 by the tapping along R_1 .

Since the input voltages applied to the valves in Fig. 98 are equal but in phase opposition, so also are the output voltages, although these will be amplified reproductions of

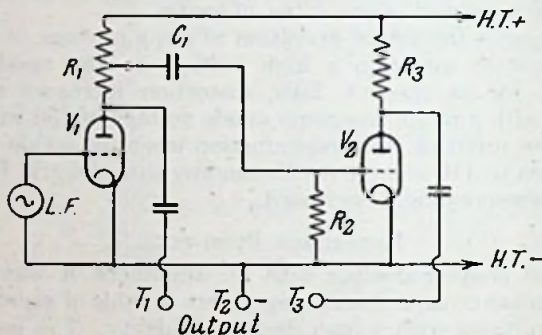

FIG. 98. BASIC PARAPHASE PUSH-PULL AMPLIFIER CIRCUIT

the respective input signals. All that is necessary for a push-pull stage to be fed from the circuit shown in Fig. 98 is, therefore, for connexions to be made to the push-pull valve grids from the anodes of V_1 and V_2 , the cathodes all being connected to earth. These connexions are taken to three terminals marked T_1 , T_2 , and T_3 , and it will be noticed that, in effect, the stage shown in this diagram is the equivalent to the input transformer of the previous types of push-pull amplifier stages. The amplification produced in the valves V_1 , V_2 , Fig. 98, will however be greater than that usually provided by the step-up ratio of a push-pull input transformer.

Application of Paraphase Push-pull to Receiver. Only a few designs of broadcast receiver take advantage of the paraphase push-pull amplifier. One drawback to its use is the cost of the two extra valves that are needed, this expense

precluding the fitting of this type of amplifier to any but the more ambitious receivers, or amplifiers of high fidelity.

In practice, the arrangement shown in Fig. 99 is found to be satisfactory. Here, V_1 and V_2 correspond to the same valves of similar designation in Fig. 98, i.e. they are the "paraphrasing" valves, while V_3 and V_4 constitute a push-pull amplifier stage. R_2 and C_2 are the grid bias resistance and

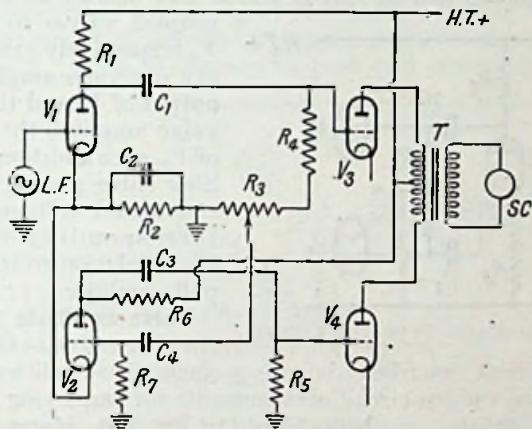

FIG. 99. PRACTICAL PARAPHASE PUSH-PULL AMPLIFIER CIRCUIT

by-pass condenser for both V_1 and V_2 , these valves being of the HL type and providing a fairly high amplification so as to load up the output stage.

The operation of the circuit in Fig. 99 is as follows. In response to the input signal voltages at the grid of V_1 , amplified voltages are applied by resistance-capacitance coupling constituted by R_1C_1 to the grid of V_3 . The grid leak of this valve comprises R_4 and R_3 , and from the latter a voltage is tapped by means of the variable connexion that is equal in amplitude to the original signal voltage at the grid of V_1 . This is fed to the grid of V_2 via condenser C_4 . R_7 is the usual grid leak of V_2 . Amplified a.c. voltages in the anode circuit of V_2 are coupled by a normal R-C arrangement consisting of R_6 and C_3 to the input electrode of V_4 , R_5 being the grid leak

of this valve. As already shown, the signal voltages actually applied to the respective grids of V_3 and V_4 will be opposite in phase, and the resultant a.c. voltages in the anode circuits of V_3 and V_4 are additive in the output transformer T in the secondary of which is the loudspeaker speech coil SC .

There are other ways of working a paraphase push-pull amplifier. For example, between V_1 and V_2 may be inserted an additional pair of valves, which may operate as two R-C

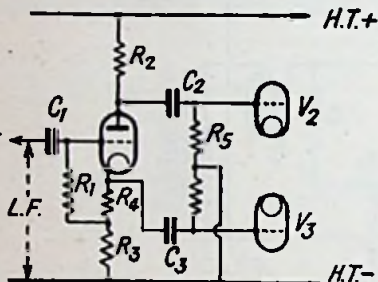

FIG. 100. PHASE INVERTER CIRCUIT

coupled valves to V_1 and V_2 respectively; that is to say, one valve amplifies the output of V_1 and the other valve amplifies the output of V_2 , each additional amplifier valve passing on the augmented voltage in the corresponding correct phase relation to the push-pull amplifier.

Valve as Phase Splitter.

An alternative to the paraphase circuit described above is a single phase splitter valve. There are various circuit arrangements for employing a valve as phase splitter, one being shown in Fig. 100. Instead of the load resistance being entirely between anode and h.t. + it is now divided into two equal parts, R_2 and R_3 , R_4 . One half, R_2 , is joined in the anode circuit between anode and h.t. + while the other half R_3 , R_4 is connected in the cathode lead so that they are effectively in series. So long as $R_2 = R_3 + R_4$, balance is obtained and the output voltages coupled by condensers C_2 , C_3 to the push-pull valves V_2 , V_3 will be of equal amplitude and opposite phase.

The manner in which opposition in phase is brought about is as follows: as the signal voltage on the grid of the phase splitter valve goes more negative, anode current falls, and with this the iR voltage drop along R_2 . As the iR drop becomes less due to the more negative signal, the anode voltage becomes *more* positive. At the same time, the reduced flow of anode current along cathode resistances R_3 , R_4 makes the cathode *less* positive to chassis. When the input signal to

the phase splitter becomes more positive, the reverse conditions at the anode and cathode take place. The net result is that the anode and cathode voltages are displaced in phase by 180° , and these are coupled by C_2 C_3 to the push-pull output stage as shown. Grid leaks are used for the output valves.

It will be noted that the l.f. signal is applied between the grid and earth in the circuit of Fig. 100, instead of the more usual connexion between grid and cathode. This results in a large amount of negative feedback, owing to the resistance R_3 and R_4 , which is common to both grid and anode circuits

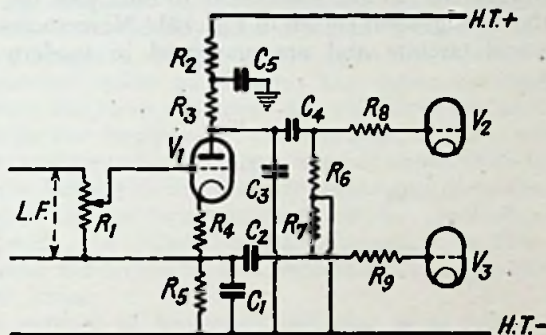

FIG. 101. ANOTHER PHASE INVERTER CIRCUIT

being equal to the anode resistance R_2 . The effective stage gain is, for this reason, slightly less than unity, but this is often not considered a disadvantage as compared with the two-valve paraphase circuit in view of the simplicity of matching the two halves of the total load resistance. In the paraphase circuit of Fig. 99, quite a small deterioration in the phase changer valve will spoil the balance.

In Fig. 101 is shown another phase splitter circuit. With this arrangement, the l.f. input is applied between the grid and cathode from R_1 , which may be in the diode a.c. load circuit. As in the previous circuit, the load resistance is divided in two halves, one being R_3 in the anode to h.t. + circuit and the other being R_5 in the cathode lead.

The great advantage of this circuit is the stage gain it provides, which is that of a normal resistance-capacitance

amplifier having a load resistance equal to $R_3 + R_5$. It is seen that the grid return goes to the high potential end of R_5 . The grid return will, therefore, be always at the full signal voltage developed across R_5 . Decoupling is used in the anode circuit at R_2 C_5 and intermediate frequency by-pass condensers (about 0.0002 μ F.) are shown at C_1 C_3 . The usual grid leaks are R_6 R_7 , and grid h.f. stoppers are connected at R_8 R_9 .

In both the circuits shown above, there is a rather high potential difference between the heater and cathode. This tends to make the circuits susceptible to hum pick-up, particularly the arrangement shown in Fig. 101. Nevertheless both are practical circuits and are employed in modern radio receivers.

CHAPTER VIII

FREQUENCY CHANGER VALVES

IN superheterodyne receivers, the process of changing the incoming signal carrier frequency to that of the intermediate frequency is usually carried out by a single valve. Some receivers, however, more particularly those designed for a high degree of fidelity and freedom from the limitations imposed by use of a single valve, employ one valve as oscillator and another valve as mixer. The latter arrangement is obviously the more expensive as two valves are used instead of one in the former case. In the past, triodes, screen-grid valves, and pentodes have been used as single-valve frequency changers, but in this chapter only those types of valves actually employed in modern superheterodyne receivers will be considered. For more detailed information on this subject, the reader is referred to *The Superheterodyne Receiver*, by the present writer.

The purpose of frequency changing is as follows. When efforts are made to amplify signals of a fairly high carrier frequency, say above 500 kc., difficulties are experienced, even with the modern h.f. pentode, in obtaining a high degree of amplification with, at the same time, complete stability in operation. This is because the feed-back from output to input circuits, already described in Chapter II, becomes troublesome, and, in order to overcome it, steps have to be taken which have the ultimate result of reducing the overall gain of the h.f. stages. Generally, not more than two h.f. stages are provided in a receiver for this reason. A straight receiver, i.e. a receiver employing h.f. stages, detection, and l.f. amplification, thus has a serious limitation in respect of the maximum permissible gain it can provide.

Another aspect of the reception problem that enters into the "straight versus superheterodyne" discussion is selectivity. The ability of a receiver to select the desired signal clear of interfering carrier frequencies, i.e. its selectivity, depends

among other factors, upon the ratio of the difference between the desired and the interfering carrier frequencies to the desired carrier frequency, as will be readily seen from the following example. Let the desired signal carrier have a frequency of 1 000 kc., and the interfering signal on the adjacent channel have a frequency of 1 010 kc. The difference between these two frequencies is 10 kc. and the ratio of 10 kc. to the desired signal carrier of 1 000 kc. is thus 1 : 100. Now the selective ability of an ordinary tuned circuit is such that a signal differing from the desired signal by only 1 per cent will, if its strength approaches that of the desired signal, be amplified with the desired signal and cause severe interference. An increase in the number of tuned circuits effects a marked improvement in selectivity, but here a practical limit is three variably tunable circuits. With three tuned circuits, a reasonable degree of freedom from interference on an adjacent channel differing by 1 per cent from the desired carrier frequency is attained under most conditions, but not if the interfering carrier is much stronger than the desired carrier. If, for instance, the interfering signal is from the local transmitter, there is every possibility that the adjacent channel on both sides of the local transmission would be unreceivable.

Now take the case of two signals, still on adjacent 10 kc. channels, but the desired carrier being 100 kc. and the interfering carrier of 110 kc. The ratio of the difference between the carrier frequencies to the desired signal carrier frequency is now 1 : 10 as compared with 1 : 100 in the previous case. The selectivity of the receiver for this signal will thereby have been increased by ten times as compared with the signal on the 1 000 kc. carrier. It is clearly, then, of great advantage if some means can be devised whereby the frequency of the 1 000 kc. signal is transformed down to 100 kc., for the selectivity of the receiver would thereby be automatically improved by ten times. The frequency changing process in a superheterodyne receiver has precisely this object, which it attains in the following way.

It is a demonstrable fact that if two h.f. voltages of frequencies f_1 and f_2 are combined in a single circuit, a voltage of beat frequency is set up after detection which has a

frequency equal to the difference between f_1 and f_2 . This beat frequency retains the characteristics of f_1 and f_2 . For instance, if one of the constituent h.f. voltages is modulated, the voltage of beat frequency, though much lower in frequency, has the modulation of the original signal in its envelope. Detection of the beat frequency produces voltages at two main frequencies, namely, $f_1 - f_2$ and $f_1 + f_2$. If a selective circuit is connected into the circuit and tuned to one of these frequency components, voltages of this particular frequency will be provided across its terminals. It is thus possible to reduce the effective signal carrier frequency from f_1 , as applied to the receiver input circuit, to $f_1 - f_2$ in the selective circuit in the output of the frequency changer.

In practical superheterodyne reception, the incoming signal frequency f_2 is combined with oscillations of frequency f_1 generated at the receiver itself. Usually f_1 is higher than f_2 and the resultant frequency is therefore $f_1 - f_2$. This produces the intermediate frequency of the superheterodyne receiver. In this way there is brought about a reduction in carrier frequency of the incoming signal, and the requirement for high selectivity is thus obtained. A common intermediate frequency in commercial superheterodyne receivers, for example, is about 125 kc. The receiver arrangement is such that *all* incoming signal carriers are changed to 125 kc. so that a much greater degree of selectivity is obtained than if the signal is amplified in circuits tuned to the original signal frequency. All-wave receivers use a higher intermediate frequency, usually about 460 kc., but for special reasons that do not enter into this outline of frequency changing.

It is thus seen that the frequency changer valve performs two most important duties—

1. It enables a much greater amplification to be obtained owing to the more stable amplification that is available at the reduced frequency; and

2. Selectivity of a higher order is produced owing to the inherently greater selective properties of tuned circuits at the lower frequencies, and because a much more efficient tuned circuit can be constructed when only *one* frequency—the intermediate frequency—is required to be tuned to.

It has been mentioned above that after rectification the

difference frequency ($f_1 - f_2$) is selected. Detection is the easiest term to explain the formation of the intermediate frequency signal. The actual process is not rectification as actual rectification in the sense that one-half of the waves are cut off does not now take place. Instead, the voltages of the respective frequencies f_1 and f_2 are applied to two separate grids in a common electron

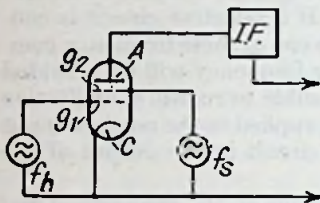

FIG. 102. BASIC MIXER CIRCUIT

stream in such a manner that as they go into and out of phase with respect to each other, the mutual conductance slope between the anode and one of the grids varies. Since the number of complete phase changes between the two frequencies (f_1 and f_2) will be equal to their difference ($f_1 - f_2$), we still obtain the desired difference frequency in the output of the frequency changer valve and this can be selected in the usual way to form the intermediate frequency.

A more exact examination of this process, known as *detection without direct rectification* or *multiplicative detection* will make it more clear. The simple circuit shown in Fig. 102 is applicable to the ideal case of a valve with two grids and with no inter-electrode capacitances of any kind. The external circuit is also assumed, for the present, to have no external coupling, either intentional or stray. Let the local oscillations or heterodyne f_h be applied to the grid g_1 nearer the cathode, and the incoming signal carrier f_s to the grid g_2 nearer the anode, as shown in Fig. 102. Under the ideal conditions now assumed, these two voltages influence the common electron stream emanating from the cathode C . The mutual conductance of g_2 with respect to A will be influenced directly by the instantaneous oscillatory voltage on g_1 , so that as the voltage on g_1 fluctuates at the oscillator frequency f_h , the slope of the mutual conductance between g_2 and A varies correspondingly. But this slope is also influenced by the oscillatory voltage f_s applied by the incoming signal to g_2 . Consequently these two voltages at frequencies f_h and f_s determine the resultant oscillatory anode current in the output circuit.

Primarily, the oscillatory anode current i_a is equal to the mutual conductance slope S times the voltage on g_2 , i.e.

$$i_a = S \cdot V_{o2}.$$

Since the slope is varied proportionately with the instantaneous local oscillator voltage applied to g_1 , we get

$$S = a \cdot V_{o1}$$

where a is a function depending upon the operating conditions of the valve. The final form of oscillatory anode current is

$$i_a = a \cdot V_{o1} \cdot V_{o2}.$$

Now V_{o1} and V_{o2} are voltages due to two sine waves of frequencies f_1 and f_2 , and it can be shown that in time t the product of these is

$$V_1 \cdot V_2 \cdot \frac{1}{2} [\cos (f_1 - f_2) t + \cos (f_1 + f_2) t]$$

the component $(f_1 - f_2)$ being the desired intermediate frequency which is selected by the tuned circuit connected to the anode. It is also noted from the expression that there is another component present equal to $(f_1 + f_2)$ in addition to the intermediate frequency. The frequency $(f_1 - f_2)$ is called the *difference frequency*, and $(f_1 + f_2)$ the *sum frequency*.

In practice the common electron stream is not influenced so perfectly as has been assumed in the above discussion. The inherent capacitances existing between the electrodes and the circuit components make the simple arrangement shown in Fig. 102 quite impracticable. The fundamental circuit shown, however, will be recognized in the practical frequency changer circuit diagrams described later on, the only modifications employed being those required to shield the signal frequency circuit from the local oscillator circuit, and to facilitate the generation by the valve of the required heterodyne voltage f_h . It should be noted that the outline given above of the process of frequency changing is unaffected by the insertion of auxiliary screening grids in the electron stream. These additional grids are essential to the practical operation of single-valve frequency changers.

Electron Coupling. When two or more circuits are coupled together through the medium of an electron stream, electron coupling is said to exist between them. An elementary example of electron coupling is seen in Fig. 102 and in several of

the circuits given later in this chapter. The use of electron coupling is advantageous in that there is less tendency for interaction to take place between the circuits being coupled, especially if screening electrodes are inserted in the electron stream between those electrodes to which the coupled circuits are connected. Electron coupling is not perfect in this respect, however, and on very high frequencies *pulling* or interaction between the circuits is experienced. One very important gain obtained by the use of electron coupling is that the element coupling the circuits is not affected by the tuning of the circuits. When inductive or capacitative coupling exists, for example, it is found that, as a receiver is tuned over its normal frequency range, the effective coupling between the circuits varies quite considerably. This is a problem that is difficult to solve by the usual circuit arrangements, but with electron coupling the amount of coupling is substantially constant over the tuning ranges of the receiver. On the other hand, it is essential that, if the most is to be made of the properties of electron coupling, steps should be taken to ensure that no stray coupling takes place between the external circuits joined to the respective grids. Any adventitious coupling will reduce the effectiveness of the electron coupling.

Conversion Conductance. In connexion with amplifier valves the mutual conductance between control grid and anode has been considered. With frequency changer valves, however, another term is required to express the efficiency of the valve as a frequency changer as distinct from an amplifier. Since the duty of a frequency changer is to produce the required intermediate frequency, the actual current in the anode circuit at that frequency for a given input voltage at the received signal frequency must determine the efficiency of the valve. The term that represents these conditions is the *conversion conductance*, which may be defined as the ratio of current at the intermediate frequency in the anode circuit to the signal voltage in the input circuit. Conversion conductance is usually expressed in micromhos or microamperes per volt; i.e. $\mu\text{A./V}$.

Conversion Gain. This is the effective voltage gain occurring in the frequency changer valve, and is numerically equal to the ratio of the intermediate frequency voltage in the output circuit to the radio frequency input signal voltage.

Hexode. The name hexode implies a valve with six electrodes. There are several combinations of valve electrodes to give a total of six, but these are not termed hexodes unless there are four grids between cathode and anode. One example of hexode construction is the combined triode-hexode, the operation of which is outlined later in this chapter. The hexode

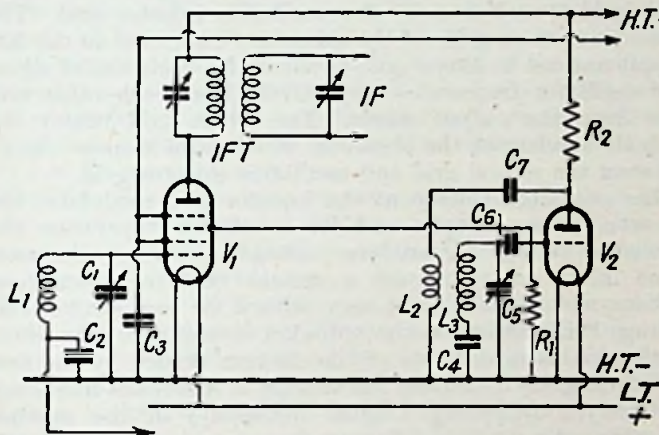

FIG. 103. TYPICAL FREQUENCY CHANGER CIRCUIT, HEXODE AS MIXER

is a straightforward example of a valve that effects multiplicative detection and couples circuits by means of an electron stream.

Hexode Mixer. One circuit arrangement using separate valves as oscillator and mixer is shown in Fig. 103. The mixer valve is the hexode V_1 , which has connected to its input electrodes the circuit $L_1 C_1$ tuned to the incoming signal. C_2 is the a.v.c. filter condenser. Oscillations at the heterodyne frequency are generated by triode V_2 at the frequency determined by the tuning of the grid circuit $L_3 C_5$ and C_4 . The oscillatory voltage is stabilized by grid condenser C_6 and grid leak R_1 , the latter providing an automatic bias which increases with the oscillatory current and thereby reduces the effect of changes in oscillation amplitude. A parallel fed oscillator circuit is shown, the anode feed

resistance being R_2 . Oscillator feedback is applied to the grid circuit *via* coupling condenser C_7 and reaction coil L_2 .

Oscillator voltage is applied to the injector electrode (grid 3) of the mixer valve from the grid of the triode. The electron stream emanating from the cathode of the mixer is thus seen to be modulated first by the voltage at the signal grid (grid 1) and then by the oscillation injector grid. The second and third grids of the mixer are connected to the h.t. supply and act as screen grids to shield the electrodes at signal and oscillator frequencies respectively from each other and also from the output anode. The screen grid nearer the cathode accelerates the electrons, which form a space charge between the second grid and oscillation injector grid.

The oscillator voltage at the injector grid modulates the electron stream deeply, and for satisfactory operation the oscillator voltage (heterodyne voltage) must be adequate. Most mixer valves require a certain value of heterodyne voltage which often is not very critical for best results, this voltage being known as the optimum heterodyne. The effect of the double modulation of the electron stream by the first and third grids is to form the voltage of difference frequency (heterodyne frequency - signal frequency) in the manner already outlined. This difference frequency is selected by the tuned intermediate frequency transformer *IFT* connected to the anode of the mixer valve from the many other frequencies present. These other frequencies include the original signal frequency, the oscillator frequency, and harmonics of these.

Ganging. It will be apparent from the above description that the oscillator tuned circuit must at all points of the tuning scale be resonant to a frequency which is equal to the signal frequency + the intermediate frequency. If the signal frequency range is 500-1 500 kc. and the i.f. is 450 kc., then the oscillator must tune over 950-1 950 kc. In the signal circuit the frequency ratio of highest to lowest frequencies to be covered by the variable condenser is thus 3:1, but in the oscillator circuit the ratio is only slightly over 2:1. It is for this reason impracticable to use standard tuning condensers for both signal and oscillator circuits unless some modification is made.

In order to limit the frequency range covered by the oscillator tuning condenser, a special type of variable condenser is sometimes used having shaped plates so designed that the required limited frequency band is suitably covered. A more usual method is to employ a condenser in series with the oscillator tuned circuit, known as the padding condenser. This is shown in Fig. 103 at C_4 . If the padding condenser is properly chosen it will, in conjunction with a suitable coil L_3 and trimmer condenser, enable the tuning of the oscillator circuit to be accurately ganged with the signal circuit over most of the frequency band. Although errors are unavoidable over certain portions of the tuning band, these can be kept very low by careful design.

Heptode. This valve has seven electrodes, five of which are grids, or at least allow the electron stream to pass through them on its way from cathode to anode. The American name for this valve is *pentagrid*.

The heptode is very popular as a frequency changer on account of its comparatively low cost and satisfactory operation on the broadcast wavelengths. It will operate as a frequency changer down to fairly short wavelengths, and for this reason is sometimes employed in all-wave receivers. On the other hand, there is a certain amount of interaction between the oscillator and signal frequency sections if the frequency is raised too high. This appears to limit the use of the heptode on the very short wavelengths.

A commonly used circuit is given in Fig. 104. The oscillator consists of grids G_1 and G_2 , the latter acting as oscillator anode. In physical construction G_2 may take one of several forms, but usually as rods, the important factor being that the electron stream is allowed to pass through it to the other electrodes further from the cathode. Coupling between L_3 and L_2 must be adjusted to provide sufficient reaction for producing and maintaining oscillations, which are tuned by $L_2 C_3$. The setting of C_3 thus determines the frequency of the oscillations produced by G_1 and G_2 , and the oscillatory voltage on the oscillator grid G_1 modulates the electron stream emerging from the cathode. This electron stream then passes through the oscillator anode G_2 and first screen grid G_3 , and is further modulated by the signal voltage applied to grid G_4 by

the signal tuned circuit $L_1 C_1$. These two separate modulations on the electron stream result in the production of the intermediate frequency by the process already outlined, and voltages of this frequency appear in the anode circuit to be tuned by the primary intermediate frequency circuit $L_4 C_5$. The intermediate frequency transformer T has a tuned secondary also, and in the usual practice the coupling between

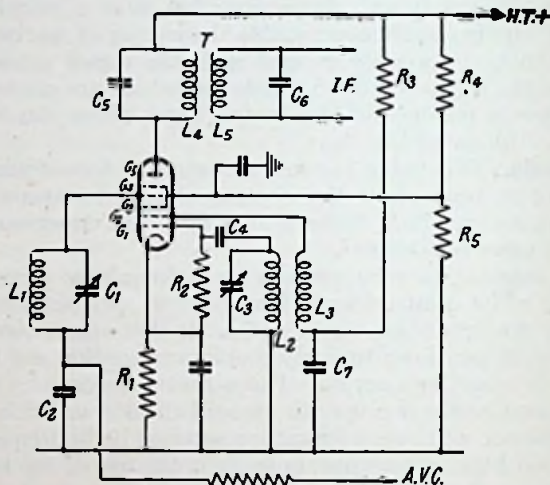

FIG. 104. A COMMONLY USED CIRCUIT FOR THE HEPTODE

L_4 and L_5 is adjusted to give a band-pass effect, with a fairly flat top characteristic. The tuned secondary circuit $L_5 C_6$ is connected to the grid and cathode electrodes of the subsequent intermediate frequency amplifier.

An oscillator grid leak and condenser are used for purposes of self-biasing the oscillator section of the valve and so maintaining the oscillator voltage fairly constant over the tuning range. In practice these components act very similarly to those used in grid detection. When the operating potentials are applied to the valve, a steady grid current flows from G_1 through the grid leak R_2 to cathode. This produces a negative bias voltage which is thus applied to G_1 , and when oscillations

take place, the voltage of G_1 oscillates on either side of this bias voltage. If the oscillatory voltage becomes higher, more grid current will flow and consequently the self grid bias at G_1 , brought about by the flow of grid current along R_2 increases, and this tends to reduce the feedback voltage from L_3 to L_2 , and thus bring about a compensation. The value of grid leak depends upon the type of valve employed, and the wave range it is required to work over, but is usually about 50 000 ohms with a grid condenser C_4 of about 0.0001 μF .

There are alternative ways of connecting the grid resistance and condenser to that shown in Fig. 104. For example, the resistance R_2 may be joined directly across C_4 in the position shown (for C_4). In this event, the oscillator grid G_1 is biased by the biasing resistance R_1 , in addition to the bias produced by the flow of grid current along R_2 . Grid resistance and condenser values are the same as those mentioned above.

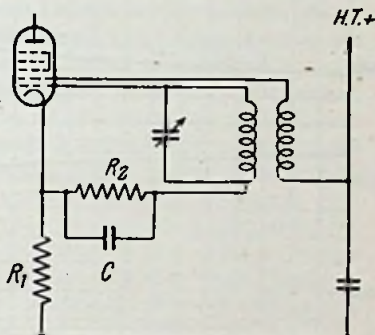

FIG. 105. AN ALTERNATIVE METHOD OF CONNECTING THE GRID CONDENSER AND LEAK OF A HEPTODE

Another position for the grid condenser and leak is at the low potential or earth end of the oscillator tuned circuit as illustrated in Fig. 105. In operation this arrangement is similar to connecting R_2 and C next to the grid, with the grid return wire taken directly to the cathode. The oscillator grid will not be at cathode potential owing to the flow of grid current along R_2 , and this self-biasing has the compensating effect on oscillator voltage already mentioned. It should be noticed that when a self-biasing arrangement of grid resistance is used, the oscillator grid is independent of fluctuations in main anode current. For example, if R_2 , Fig. 105, were connected to the earth line instead of to cathode, the oscillator grid would be biased by the flow of electron current consisting of oscillator anode current, screen-grid currents and main anode

current, along R_1 . Any fluctuations in this electron current in the operation of the valve would necessarily apply a different bias to the oscillator grid and might interfere with the satisfactory production of the oscillator voltage.

Characteristic curves of a Marconi heptode Type X30 are given in Fig. 106. The conversion conductance is seen to rise

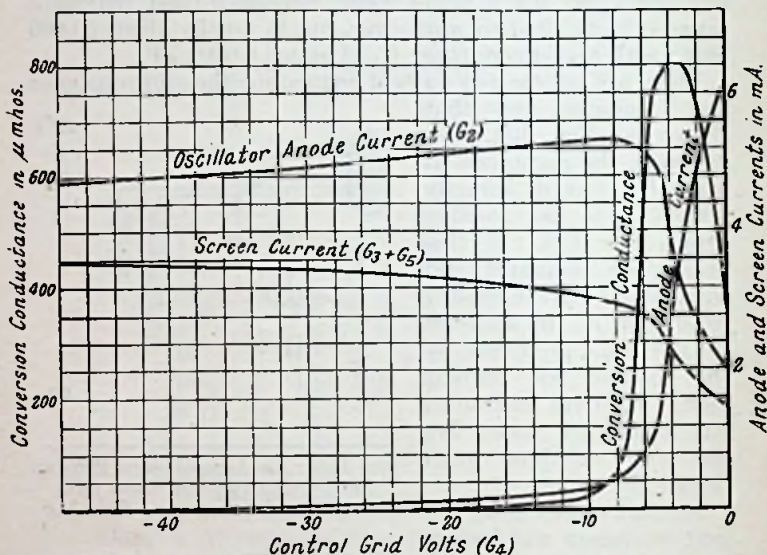

FIG. 106. CHARACTERISTIC CURVES OF THE MARCONI HEPTODE TYPE X30

to a maximum at about -3 volts on the signal control grid (G_4), thus indicating that for optimum gain a minimum bias of this value should be applied to the valve. The conversion conductance curve is similar to the mutual conductance characteristic of the variable- μ valve, and renders the heptode suitable for control by a.v.c. systems. A point that should be noted in respect of these curves is that at given h.t. voltages the total electron current to the various electrodes remains substantially constant over the large range of signal grid bias. Consequently, as the current at the main anode increases on

the approach to zero grid bias, the current at the screen grids (G_3 and G_5) and at the oscillator anode (G_2) decreases.

Space Charge Coupling. As the fourth grid (signal grid) of the heptode is biased negatively and is situated behind a positive screen grid, a space charge is formed between these two grids. Such a space charge is due to the electrons being attracted through the screen grid by the positive d.c. voltage at that electrode, but once past the screen grid they approach the negative field of the signal grid. This grid repels the electrons to a degree dependent, of course, on its negative potential and so forms the space charge or virtual cathode.

Now the space charge in front of the signal grid is an oscillating one, its frequency being that of the oscillator tuned circuit. We know from first principles that when movement of a charge takes place close to a conductor, a current is set up in that conductor. In the case being considered, the rapid fluctuations in the intensity of the space charge close to the signal (fourth) grid causes a current flow in the signal grid circuit. It should be noted that as this is a displacement current, it is produced independently of the voltage of the signal grid, which may, in fact, be so negative that electrons do not actually reach it. The electrical effect of this is the formation of a coupling between the oscillator grid and the signal grid, this being known as the space charge coupling.

The effect of space charge coupling is not appreciable until a receiver is tuned to the higher frequencies—1 500 kc. and higher. Its influence then becomes apparent by a voltage of oscillator frequency being induced on the signal grid. The actual voltage induced on the signal grid increases with the frequency.

In most receivers, the signal circuit is tuned to a lower frequency than the oscillator, and will, therefore, present a capacitative reactance to the oscillator voltage. The effective value of this reactance to the induced voltage will depend upon the similarity of the two frequencies. If a low intermediate frequency is employed, the impedance—and, of course, the voltage induced through the space charge coupling—will be much larger than if a high i.f. is employed, since in the latter case the signal and oscillator circuits are separated by a correspondingly larger frequency.

As the oscillator voltage induced into the signal circuit is in opposing phase to the oscillator voltage, a reduction in conversion conductance and stage gain results. This is one of the reasons that render the heptode type of frequency changer less efficient than other types of valve described in this chapter for reception on the higher frequencies. Space charge coupling can be neutralized—and often is—by means of a small condenser or a condenser and a resistance in series connected between the signal and oscillator grids.

Octode. This valve has six grid electrodes situated in the electron stream between cathode and anode. The electrode arrangement is similar to that of the heptode with the addition of a grid between the main anode and screen grid G_5 . This additional grid may be connected inside the valve to the cathode and it acts as a suppressor grid in a similar way to that of a pentode valve. One result of this is that the octode has a higher anode a.c. resistance than a heptode.

The circuit arrangement for use with an octode is the same as that for a heptode, and the values of grid leak and condenser are also similar.

Triode-hexode. This frequency changer valve consists of two sets of electrodes within one envelope. A triode is arranged to work as an oscillator and the hexode as mixer valve for the local oscillations and the incoming signal voltages. The employment of two separate valves to carry out these duties has certain advantages over the heptode circuit. For example, it is possible to construct the triode portion with a high value of mutual conductance and so to ensure the satisfactory production of oscillations at very high frequencies. With the single set of electrodes, e.g. heptode and octode, this construction is more difficult. Furthermore, the inter-electrode capacitance between oscillator and signal frequency circuits is greatly reduced by separating the electrode systems, and this also renders the valve very efficient at the higher frequencies. Other differences in operation will be evident from a perusal of the circuit arrangement given in Fig. 107.

Incoming signal voltages from the aerial or h.f. amplifier are applied to the circuit $L_1 C_1$ tuned to the desired carrier frequency. This circuit is connected to the first grid of the

hexode. Local oscillations are generated by virtue of the feed-back between the anode coil L_3 and the grid coil L_2 of the triode portion of the valve. The oscillator tuned circuit is $L_2 C_2$, and oscillatory voltages of the required frequency are applied to the triode grid across grid condenser C_3 . These voltages are fed to the third grid of the hexode by the connexion inside the valve envelope between the grid of the triode and the hexode's third grid. The electron stream passing between

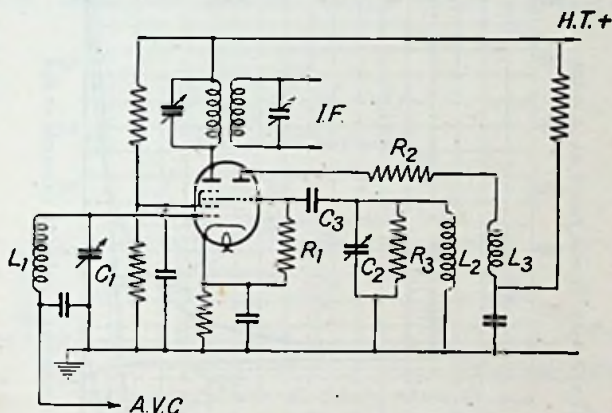

FIG. 107. CIRCUIT FOR THE TRIODE-HEXODE

hexode cathode and anode is thus modulated by the signal voltage on the first grid (counting from the cathode) and the oscillator voltage on the third grid. An intermediate frequency is thereby formed in the hexode anode circuit by the process of multiplicative detection outlined earlier in this chapter. This intermediate frequency voltage is selected by the tuned transformer shown connected in the hexode anode circuit and is passed to the subsequent amplifier.

At each side of the hexode grid that receives the oscillator voltage is a screen grid, these two screens being connected together inside the bulb and connected to a source of h.t. by means of the potentiometer arrangement shown. The effect of this double screen is to shield the signal frequency grid from the oscillator grid on one side and the oscillator grid

from the output anode on the other, and thus to prevent interaction between them. In this way the coupling is made as purely electronic as possible.

Oscillator grid condenser C_3 ($0.0001 \mu\text{F.}$) and grid leak R_1 ($50\,000$ ohms) help to maintain a constant value of oscillatory

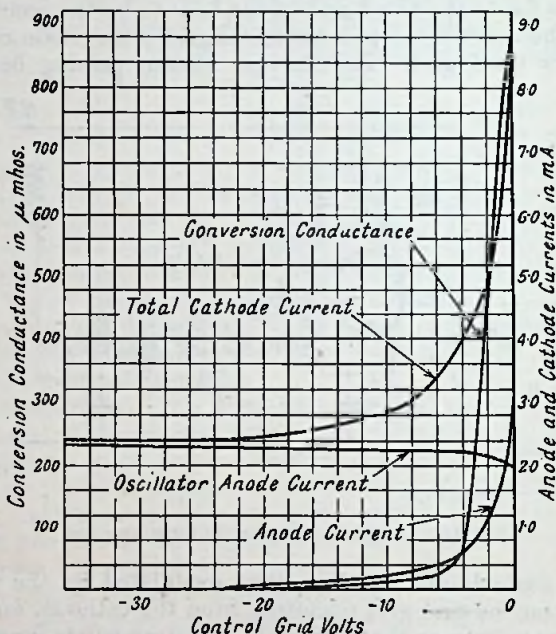

FIG. 108. CHARACTERISTIC CURVES OF THE OSRAM TRIODE-HEXODE TYPE X31

voltage at the mixer valve, and these components operate similarly to the manner described in connexion with the heptode. Resistance R_3 , which may have a value of about $40\,000$ ohms, further assists in stabilizing the oscillatory voltage generated over the various tuning ranges, by providing artificial damping at those portions of the frequency range where the oscillator works more efficiently. R_2 acts as a limiter to the oscillator voltage, and may have a value

between 100 ohms and 2000 ohms, depending upon the frequency band that $L_2 C_2$ is tuned over.

Characteristic curves of the Osram triode-hexode type X31 are given in Fig. 108. The oscillator anode current is seen to remain sensibly constant over the entire practical range of hexode control grid voltage. This is of considerable importance, and bears out the statement already made that the oscillator portion of the valve is independent of the mixer portion. When the automatic volume control is in operation

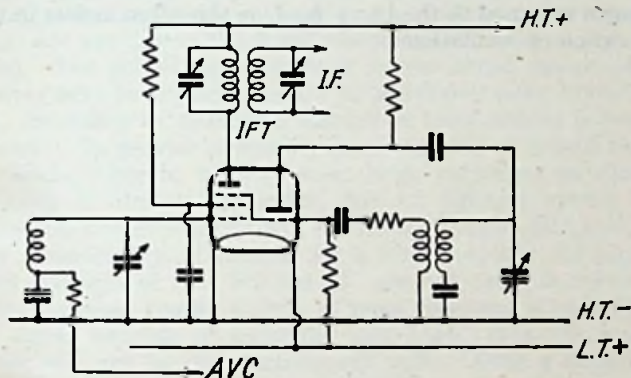

FIG. 109. TRIODE PENTODE CIRCUIT

there is thus no drift in the oscillator frequency due to interaction of oscillator anode current and mixer anode current. The curve of hexode anode current, indicated as "anode current," shows that as the hexode control (first) grid bias increases, this current decreases as in a pentode. This is different to the conditions in the heptode which were shown to be such that as the main anode current decreased, the oscillator anode and screen-grid currents increased. From the point of view of battery users, the current variation with control grid voltage of the hexode is an advantage in that during the reception of strong signals, when a large bias is applied to the control grid, the consumption of anode current from the h.t. battery is reduced. The conversion conductance curve has a gradual slope and enables a control voltage variation of about 20 volts to be applied before the point of virtual

anode current cut-off is reached, and thus allows the valve to be controlled by an a.v.c. system.

Triode-pentode. This valve consists of a triode oscillator and a pentode mixer within one envelope. The circuit arrangement is similar to that for the triode hexode, as can be seen from Fig. 109. The suppressor grid of the pentode acts as oscillation injector grid and is not screened, as in the hexode, from the anode. A parallel feed circuit is employed for the oscillator, with tuned anode circuit. The oscillator grid leak is shown returned to the l.t. + lead, as this often assists in the generation of oscillations.

CHAPTER IX

EMPLOYMENT OF VALVES FOR AUTOMATIC VOLUME CONTROL

AUTOMATIC volume control equipment is for the purpose of maintaining the output of a receiver fairly constant, notwithstanding variations in the strength of the signal or signals which are applied to the input circuit of the receiver by the aerial. The actual signal voltage in the aerial circuit of a receiver may be anything from 1 to 500 000 or even 1 000 000 μV ., according to whether a distant or local station is being received. To provide a sensibly constant level of output from the loudspeaker in spite of such large variations in signal intensity is almost impossible, but an efficient system of automatic volume control will reduce the output fluctuations very considerably. Demands for a level response for signal input voltages of 1 to 500 000 μV . are not usual in receiver design, because the sensitivity of most receivers is such that the signal capable of inducing only 1 μV . into the input circuit will not be of entertainment value. Even a sensitive receiver will require an input of 5 μV . to provide a satisfactory output for entertainment. Thus the voltage fluctuations over which the automatic volume control device is required to level the loudspeaker response becomes 5 to 500 000 μV . or as 1 is to 100 000. In practice, the a.v.c. system would be considered satisfactory if the actual variations in output, in this case, were 1 to 4. To enable a final evening-up of response, a manual volume control is provided in addition to the automatic system, so that the listener can bring the output level to that which his particular desire or the nature of the programme demands.

In the more simple systems for producing the a.v.c. voltage, the basic principle employed is to rectify part of the h.f., or in a superheterodyne receiver, the i.f. signals, and to utilize the d.c. voltage drop produced by the rectified impulses flowing along the rectifier load resistance for the purpose of applying a bias to one or, preferably, more valves in earlier

stages of the receiver. Owing to the fact that the h.f. or i.f. voltage applied to the rectifier will be dependent upon the intensity of the signal being received, the d.c. voltage produced along the rectifier load resistance will also vary correspondingly, and a means is thus provided for varying the bias applied to the previous amplifier valves according to the strength of received signal.

The diode is used almost universally for producing the a.v.c. voltage. This is because the diode may have a high voltage applied to it without overloading. Since up to about 30 volts

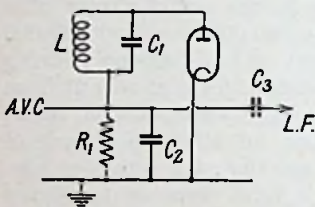

FIG. 110. BASIC DIODE
CIRCUIT FOR A.V.C.

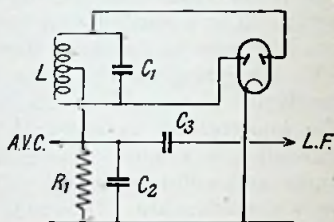

FIG. 111. PUSH-PULL DIODE
CIRCUIT FOR A.V.C.

is required for a.v.c. purposes, this property of the diode is important. The fundamental circuit of the diode when used for detection and a.v.c. is seen in Fig. 110. Signal voltages in $L C_1$ (which may be the intermediate frequency transformer secondary circuit of a superheterodyne or the tuned h.f. circuit of a straight receiver) are applied to the diode and rectified impulses pass along the diode load resistance R_1 . These impulses produce a d.c. voltage component and a low-frequency signal component. The d.c. voltage component, which makes the end of R_1 , connected to the tuned circuit negative in potential, is taken off directly and used as a.v.c. voltage for biasing the previous valves, while the l.f. component passes via coupling condenser C_3 to the l.f. amplifier. Condenser C_2 is the normal detector reservoir condenser. It is seen from this diagram that the actual voltage applied as a.v.c. is directly proportional to the signal input voltage to $L C_1$, since the electron current flowing through the diode and therefore through R_1 is dependent upon this signal voltage.

In Fig. 111 is shown a double diode circuit for detection and a.v.c. purposes. The letters have the same significance as those used in the previous diagram. A split input inductance is employed in this case, so that the signal voltages are applied to the respective diode anodes in opposite phase causing both halves of the voltages to be rectified. This arrangement enables more effective filtering of the residual signal voltage to be obtained owing to this component being of double the frequency of that resulting from half-wave rectification. This point is described more fully on page 59.

In Fig. 112 is seen another circuit using a double diode for a.v.c. Tuned circuit $L C_1$ applies signal voltages to the diode D_1 . This diode is the second detector of the receiver (or the detector in a straight receiver) and for this reason is known as the *signal diode*. Low-frequency voltages are tapped off the signal diode load resistance R_1 and applied to the i.f. stages in the usual manner via coupling condenser C_3 . Part of the i.f. voltage in the $L C_1$ circuit is also applied to the second or a.v.c. diode across C_2 , and rectified impulses flow down the load resistance R_2 . The actual d.c. negative potential at the diode D_2 will therefore be proportional to the signal voltage in $L C_1$, and this is employed for biasing the earlier valves. It will be noted that since no external voltage is applied to the anode of D_2 , this electrode will always be negative relative to the cathode whenever an electron (negative) current flows. This is, of course, the polarity required for biasing. Values of R_1 and R_2 vary from $\frac{1}{2}$ M Ω to 1 M Ω , and C_3 has a capacitance of about 0.01 μ F. In practice, C_2 may consist of two lengths of wire twisted together providing a capacitance of about 0.000065 μ F., although a fixed condenser of 0.0001 μ F. is more generally used.

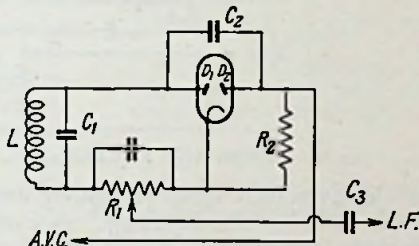

FIG. 112. PRACTICAL DOUBLE DIODE A.V.C. CIRCUIT

Delayed Volume Control. In the arrangements discussed so

far, the a.v.c. voltage produced has been proportional to the signal strength. This is not entirely satisfactory, however, for it has already been seen that a certain minimum value of signal strength is required before reception from a station has entertainment value. If this minimum signal input voltage is $25 \mu\text{V.}$, any reduction in output due to the operation

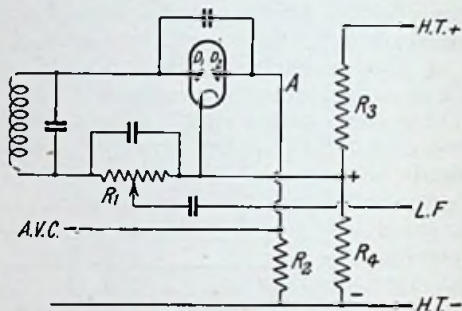

FIG. 113. DELAYED A.V.C. CIRCUIT

of the a.v.c. on a signal producing less than $25 \mu\text{V.}$ input will be a definite disadvantage. Accordingly, means must be provided for delaying the operation of the a.v.c. system until the minimum signal input voltage is received. Up to this point, therefore, the receiver will then behave as one without a.v.c. and for weak signals the output will be proportional to the received signal intensity.

In order to delay the operation of the a.v.c. system, a negative bias is applied to the a.v.c. diode anode. As the diode cannot pass current until the anode is positive to the cathode, it follows that no control voltage along its load resistance will be produced until the signal is sufficiently strong to overcome the negative bias. The actual bias applied will depend upon the design of receiver and may be made variable if desired. A convenient method of applying a negative potential to the diode is to connect the load resistance to earth and the cathode to a positive potential. One circuit for effecting delayed a.v.c. is shown in Fig. 113. This arrangement is the same as that shown in Fig. 112, with the addition of the potential divider $R_3 R_4$ connected across the h.t. supply. The value of R_3 will, of course, be very much greater than R_4 , so

that the actual positive potential of the cathode will only be about three volts. As the signal diode load R_1 is returned direct to the cathode, diode D_1 is not influenced by the positive voltage of the cathode. The a.v.c. diode load R_2 is joined to h.t.—and this makes the point A negative with respect to the cathode by the amount of voltage drop along R_4 . Under no-signal conditions, therefore, the a.v.c. line carries no negative bias to the controlled valves. The individual biases applied to these valves by their respective cathode resistances must, therefore, be the desired minimum bias for the correct operating conditions of those valves. When the signals are strong enough to produce sufficient

voltage to overcome the bias on D_2 , this valve becomes operative and passes a current to produce a d.c. voltage drop along R_2 and so to bias the controlled valves additionally to any minimum bias already applied to them.

These conditions of a.v.c. may be depicted graphically as seen in Fig. 114. The curve of the ideal a.v.c. system is RPQ : In this case, as soon as the signal voltage input reaches the threshold value (say $25 \mu V.$) and the output voltage is that indicated at P , any further increase in signal strength has no influence on the output voltage, and the curve from P to Q runs parallel with the input voltage axis. A more practical curve is RPS , where the output voltage variation is indicated by SQ . It is the aim of receiver designers, of course, to reduce SQ to the lowest possible value. The manual volume control, seen in the previous drawings in the form of a variable tapping along R_1 , enables the listener to bring the output level to the desired value. So long as SQ is reasonably short, one adjustment of the manual volume control is all that is necessary in listening to a station, even if this is subject to a considerable degree of fading. In practice, therefore, the imperfection of a.v.c. systems, as shown by Fig. 114, is not a serious disadvantage.

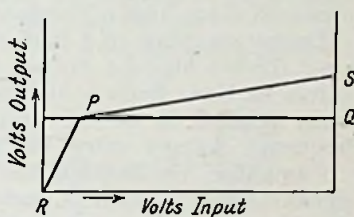

FIG. 114. DIAGRAMMATIC REPRESENTATION OF THE CONDITION FOR DELAYED A.V.C.

The signal voltage handled by each valve in the amplifier is, of course, different. An i.f. amplifier; for example, has applied to it a signal that has been amplified by the r.f. amplifier (if one) and the frequency changer. It has been seen that even the characteristic curve of the variable-mu valve is not perfect and that cross modulation and other distortion is produced if too high a bias is applied to the control grid.

During reception of a loud signal there is produced at the a.v.c. diode a high d.c. voltage for application to the amplifier valves as bias. Such a high bias may be quite satisfactory when applied to an r.f. amplifier, and sometimes to the frequency changer valve, but if the full bias is used for the i.f. amplifier, rectification and consequent distortion of the signal is likely to occur. Clearly, the best procedure is to split up the a.v.c. voltage so that less bias is applied to the i.f. amplifier, more to the frequency changer and, if an r.f. amplifier is used, the largest bias to that valve. This arrangement is commonly used in practice, and one circuit for doing so is shown in Fig. 115.

In Fig. 115 is seen a diagram of an arrangement that provides two different values of control bias. The principle of the working of this circuit is the same as that of Fig. 113, but the circuit has been adapted to meet the demands mentioned above. The a.v.c. diode load is constituted by R_1 , R_2 , and R_3 , which may have the values of $1\text{ M}\Omega$, $\frac{1}{2}\text{ M}\Omega$, and $\frac{1}{4}\text{ M}\Omega$ respectively. These values will depend on the type of frequency changer and i.f. valve to be controlled, of course, but the values quoted above are commonly used. By splitting the load resistance of the a.v.c. diode as shown, it is possible to obtain a large degree of latitude in the selection of the respective a.v.c. control bias voltages applied to the individual valves of the receiver, and so arrange that all the valves are suitably biased simultaneously. The voltage applied to the frequency changer valve is that produced along R_2 and R_3 , while the bias fed to the i.f. valve is that due to the drop down R_3 only. It will be noted that the cathodes of both the double-diode and the following valve are connected together and through R_4 and R_5 to h.t. —. This results in both cathodes being made positive by the amount of the voltage drop along these resistances produced by the flow of anode

current from the valve on the right. As the a.v.c. diode load resistances are returned to h.t. —, the double-diode cathode is positive with respect to the a.v.c. diode anode by the full voltage drop along R_4 and R_5 , and this voltage therefore provides the required delay. Automatic bias for the valve on the right is provided by R_4 only, as the grid of this valve is returned to the mid-point of R_4 and R_5 , and so the voltage drop along R_5 therefore does not influence this grid.

Valves Controlled by A.V.C. It has been seen, in a previous

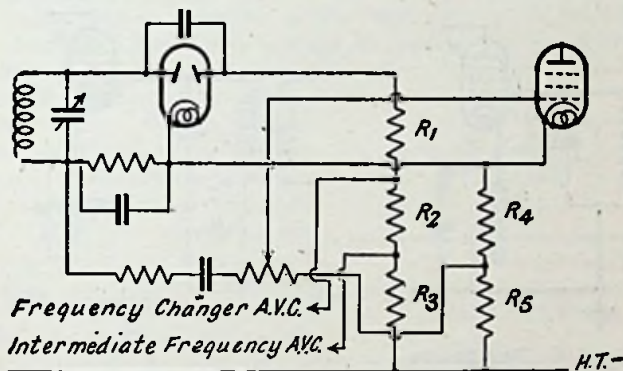

FIG. 115. PRACTICAL CIRCUIT FOR PRODUCING DELAYED A.V.C. VOLTAGES

chapter, that the variable- μ valve may be employed very satisfactorily for volume control purposes owing to the property of its characteristic that enables the valve to respond to a wide range of grid bias. It will be apparent, from this consideration, that the variable- μ valve is very suitable for employment as the controlled valve of an a.v.c. system.

In Fig. 116 is shown a diagram of the usual biasing arrangement for an indirectly heated variable- μ valve. In the cathode lead is connected a resistance R , the value of which is varied to bring about an alteration in bias according to the rule: $V = iR$. Receivers that do not incorporate a.v.c. have the bias resistance R in the form of a manual volume control, and the operator has to vary the amount of R in circuit according to the strength of the received signals. In the case

of distant reception, when fading is taking place, it may be necessary to alter R several times in the course of a few minutes if a level output of signal strength is desired.

When a.v.c. is used, the variation in R is rendered unnecessary. Instead of varying the grid bias by means of the cathode resistance, the variations in negative potential are applied from the source of a.v.c. voltage as already outlined, to the grid circuit directly. This arrangement is seen in Fig. 117, which shows the normal method of biasing a controlled

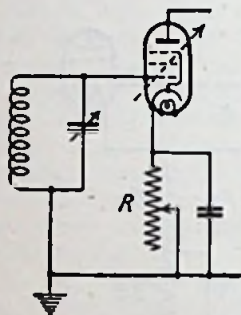

FIG. 116. THIS SHOWS THE USUAL BIASING ARRANGEMENTS OF A VARIABLE MU VALVE FOR MANUAL CONTROL

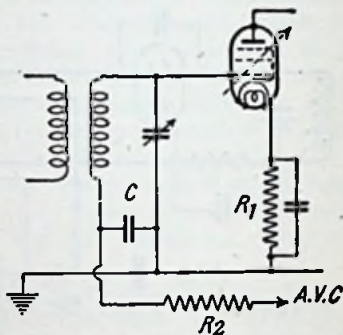

FIG. 117. CIRCUIT FOR APPLYING AUTOMATIC CONTROL VOLTAGE TO H.F. PENTODE

valve. R_1 is for providing a certain minimum fixed value of bias for the correct operation of the valve. Its usual value is from 100 to 500 ohms. Resistance R_2 carries the negative a.v.c. voltage from the a.v.c. diode load resistance, and this bias is applied to the low potential end of the grid tuning coil. Condenser C is for blocking the path of the d.c. bias voltage which otherwise would be short-circuited to earth instead of being applied to the grid, and for providing at the same time a low impedance path to earth for the r.f. or i.f. voltages. C also serves the purpose in conjunction with R_2 of assisting the filtration of any i.f. or l.f. components that happen to be present in the voltage applied by the a.v.c. diode load resistance. A filter is thus constituted by R_2C . Owing to C

being in series with the tuned circuit condenser, the effective value of the latter will be reduced, since the resultant of two capacitances C_1 and C_2 in series is $(C_1 \times C_2)/(C_1 + C_2)$. There is a minimum value usually about $0.05 \mu\text{F.}$ that C must have in order not to upset the tuning arrangements.

An alternative method, known as shunt feed, of applying the voltage is seen in Fig. 118. Here the blocking condenser C ($0.0001 \mu\text{F.}$) prevents the a.v.c. direct voltage from being short-circuited to chassis through the input circuit while at the same time it provides a low impedance path for r.f. or i.f. currents. The a.v.c. voltage is applied via resistance R which should have a value of about 1 megohm. It is seen that R is in parallel with the tuned input circuit. Consequently, if R is given too low a value it will damp the input circuit and reduce the gain and selectivity of the stage. In practice series feed as shown in Fig. 117 is more commonly used in broadcast receivers than shunt feed as in Fig. 118,

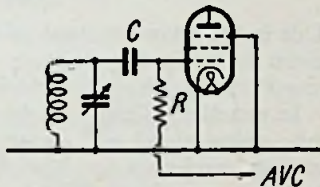

FIG. 118. A.V.C. CONTROLLED VALVE, SHUNT FEED

but in general the damping is not serious when a 1 megohm shunt feed resistance is used. An r.f. tuned circuit will be less damped by it than an i.f. tuned circuit because the latter has a higher dynamic resistance. In some receivers, the shunt feed is used on the r.f. circuits and series feed on the i.f. circuits.

Time Constant of the Circuit. From the outline of a.v.c. already given it might appear that the voltages produced by the a.v.c. valve are applied instantaneously to the controlled valve. Actually this is not so, owing to the presence of the decoupling condenser indicated at C in Fig. 117. What happens when an a.v.c. voltage is produced is that this condenser is charged through the filter resistance R_2 and when the condenser is charged the voltage thus available is applied to the control grid of the amplifier valve. Between the instant that the original a.v.c. voltage is produced at the diode anode and the moment of its application as bias to the controlled valve there elapses a period of time that is determined by the values of C , R_2 . This time period is shorter than the time taken

by the charge to leak away again, because C discharges over R_2 and the a.v.c. diode load resistance, which in Fig. 113 is R_2 . This slow increase and reduction in bias voltage has to be considered by the receiver designer.

The time required for a condenser to charge to 63 per cent of the applied voltage or to discharge 63 per cent of its peak charging voltage is expressed by $t = CR$, where t is in seconds, C is the capacitance in farads and R the total charging or discharging resistance in ohms. Taking usual values of $C = 0.1 \mu\text{F.}$ and $R = 1\,000\,000 \Omega$ we get,

$$t = \frac{0.1 \times 1\,000\,000}{1\,000\,000} = \frac{1}{10} \text{ sec.}$$

This is the time constant of the circuit, and the actual value given to it by the designer is dependent upon the type of reception for which the receiver is most suitable.

In practice, C may not be varied very much from the common value of $0.1 \mu\text{F.}$ owing to its position in series with the tuning condenser as already mentioned. R_2 of Fig. 117, however, may be varied over a fairly wide range so long as the effect for filtering out any a.c. components in the a.v.c. circuit is not impaired. The minimum values of diode load resistance and a.v.c. decoupling resistance are about $100\,000$ ohms and $500\,000$ ohms respectively. Resistances of these minimum dimensions would be used in receivers requiring a small time constant, such as car radio sets which must be designed for rapid fluctuations of input voltage brought about by the movement of the vehicle past screening objects, and short-wave receivers subject to rapid cycles of fading. When R is $600\,000$ the time constant with $C = 0.1 \mu\text{F.}$ is

$$\frac{0.1 \times 600\,000}{1\,000\,000} = \frac{1}{17} \text{ sec. approx.}$$

If the time constant is too small, the voltage at the filter condenser C will follow the low audio-frequency variations in the signal and so cause a reduction in bass response.

The result of having too large a time constant in the circuit is that there occur periods of weak signal reproduction. This is due to the large bias, applied by a strong signal, remaining on the controlled valves after the intensity of the signal has

diminished, so that, in effect the valves are over-biased and the gain of the receiver is reduced to a greater degree than the strength of signals warrants.

Practical Circuits with the Double-diode-triode. Owing to the diode being a rectifier valve only and not an amplifier, a receiver in which a diode is employed will have less overall gain, other things being equal, than when a triode is used for detection. This means that some extra amplification on the l.f. side is necessary for the same sensitivity. One convenient

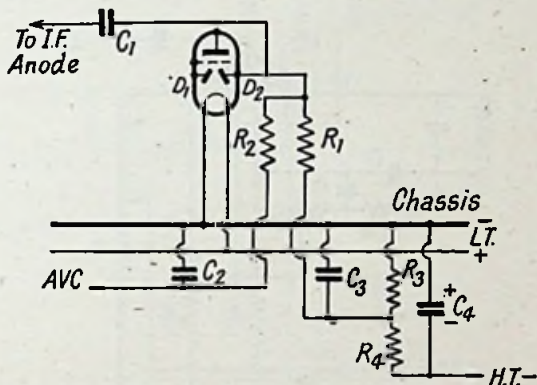

FIG. 119. DELAYED A.V.C. CIRCUIT FOR BATTERY RECEIVER

and commonly used method of obtaining the required additional sensitivity is to employ a double-diode-triode valve, which, as its name implies, comprises two diodes arranged to work in conjunction with a triode. The diodes and triode may be made to work in a diversity of ways, and the practical circuits described below are a selection of the most popular at present employed in broadcast receivers.

A type of circuit commonly used in battery broadcast receivers for delayed a.v.c. is shown in Fig. 119. The double-diode triode valve is connected for signal detection by D_1 , l.f. amplification by the triode section and production of a.v.c. voltage by diode D_2 . Only the relevant a.v.c. circuit is illustrated in Fig. 119.

Signal voltage is coupled by C_1 from the i.f. amplifier anode

to the a.v.c. diode anode D_2 . This anode is biased negatively by the voltage drop down R_3 in the main h.t. — line of the receiver. Automatic bias is thus produced along R_3 and R_4 , which are by-passed by electrolytic condenser C_4 ($25 \mu\text{F.}$). The full voltage drop along the two resistances may conveniently be used for the bias of the output valve. Negative bias for the a.v.c. diode is applied via the load resistance R_1 .

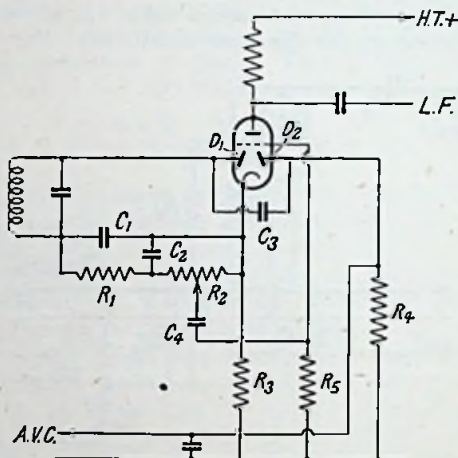

FIG. 120. COMMONLY USED DELAYED A.V.C. CIRCUIT

Rectified current from D_2 passes along R_1 and the voltage so developed is applied to the amplifier valves through R_2 , which with C_2 form the filter. It will be noted that with this arrangement, the delay bias is applied also to the controlled valves as grid bias, so that this circuit may provide the minimum bias for these valves.

In the circuit shown above, the a.v.c. diode is fed from the primary of the i.f. transformer. There are several advantages in this connexion as compared with feeding the diode from the transformer secondary. The input to the a.v.c. diode is increased because the primary voltage is larger than the secondary voltage, thus enabling a more effective control to be produced. The apparent selectivity of the receiver is improved, and the load on the i.f. transformers is equalized.

A somewhat similar arrangement to the one mentioned above, but modified to suit a mains valve, is shown in Fig. 120. Diode D_1 is again the signal rectifier, and the i.f. filter consists of $R_1 C_1 C_2$. The signal diode load resistance R_2 , which is returned direct to the cathode, is tapped for the purpose of volume control (manual) and the i.f. signals are applied via coupling condenser C_4 to the grid of the triode section of the

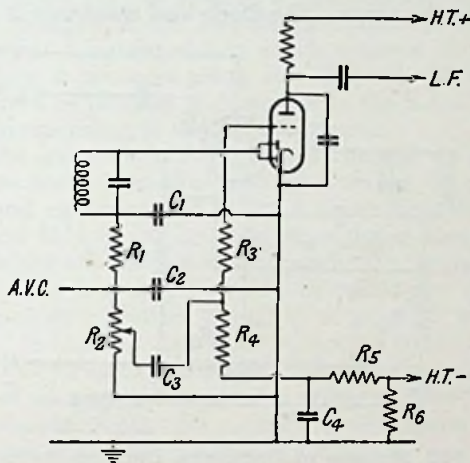

FIG. 121. A.V.C. CIRCUIT USING STRAPPED DIODE ANODES

valve, the grid leak being R_5 . Resistance coupling is generally employed with the triode, and amplified audio signals are fed to the following stage in the normal manner. A.v.c. diode D_2 is supplied with i.f. voltages by C_3 , and rectified impulses flow along the load resistance R_4 to the earth line. The d.c. voltages produced along R_4 are applied to the controlled valves, as a.v.c. Delay is effected by R_3 , through which the anode current of the triode section passes to set up a voltage that makes the cathode positive with respect to earth and D_2 . At the same time, R_3 acts as bias resistance of the triode.

In the circuit diagram of Fig. 121 is seen an arrangement that is used quite extensively. Although no delay voltage is

applied, the circuit works entirely satisfactorily. The diode anodes are strapped together and, since they are now in parallel, the impedance is halved. The diodes in parallel are used as combined signal rectifier and a.v.c. valve. $R_1 C_1 C_2$ form an i.f. filter network, while R_2 is the diode load resistance from which a.v.c. voltages are taken at the top, and i.f. voltages are tapped off by the manual volume control as indicated by the arrow. The diode load resistance is connected

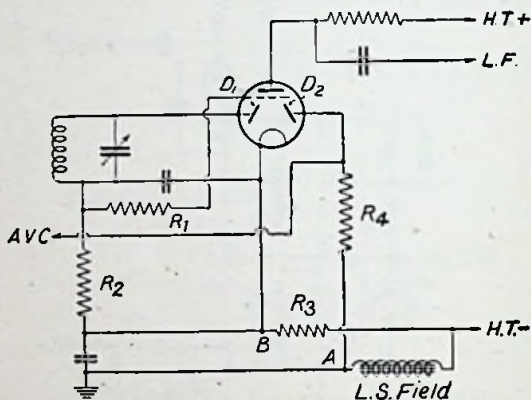

FIG. 122. METHOD OF OBTAINING DELAYED AMPLIFIED A.V.C.

to the cathode directly. Coupling condenser C_3 feeds l.f. signals to the grid of the triode via R_3 . Grid bias is applied to the triode by means of a connexion to the negative end of R_4 through which flows the anode current of the whole receiver. This method of biasing, it will be noticed, leaves the cathode joined direct to the earth line, as distinct from the arrangement shown in the preceding diagram and others in which bias is obtained from a resistance in the cathode lead to earth. The output circuit contains the usual resistance or transformer coupling elements.

Delayed Amplified A.V.C. In receivers that require a more effective system of a.v.c. than those already mentioned, an amplified a.v.c. arrangement is used. One example of this type of circuit is shown in Fig. 122.

The working of this commonly used circuit is as follows: voltages at the intermediate frequency are applied to the signal diode and rectified in the usual way, i.f. impulses passing along the signal diode load resistance R_2 . To the grid of the triode section are applied the i.f. voltages via R_1 , and also the d.c. potential developed along R_2 by the signals. Up to a point, therefore, the bias applied to the grid will be dependent upon the strength of the incoming signals, and likewise will be dependent also the triode anode current flow and the voltage drop it produces along R_3 . The voltages at point B will therefore be positive with respect to the h.t. — lead to an extent corresponding to the signal strength.

Now, the a.v.c. diode is connected through its load resistance R_4 to the loudspeaker field and thence to the h.t. —. As the total anode current of the receiver flows through the loudspeaker field, a voltage drop is produced along it that is not materially affected by alterations in the individual anode currents. This drop may therefore be considered as constant, and to produce a positive potential at point A with respect to h.t. —. It is noted that D_2 is connected to A (via R_4) and owing to this connexion it would, if R_3 were not in circuit, be maintained at a constant positive voltage. However, owing to the presence of R_3 , the cathode is also given a positive voltage, and unless the positive potential of D_2 , i.e. at point A , is greater than that of the cathode, i.e. at point B , no current can be passed by D_2 and no a.v.c. voltage is obtained from it. The net result of this arrangement is that the voltage of D_2 with respect to the cathode is dependent upon the relative voltage drops along R_3 and the loudspeaker field.

When a strong signal is being received, the anode current due to the triode section of the valve is reduced owing to the larger bias applied to the grid along R_1 . Consequently the voltage drop down R_3 is diminished, and with it the positive voltage of the cathode. This makes D_2 relatively positive owing to the voltage due to the current flow in the speaker field. When a weaker signal is received, the anode current flow along R_3 may not be reduced sufficiently to diminish the positive voltage at B to a lower value than that at point A , and in this case, since B will be more positive than A , D_2 is held at a negative voltage with respect to the cathode and no current is

passed by it. As soon as the required threshold value of signal voltage is impressed upon the grid, *B* becomes less positive than *A*, the a.v.c. diode becomes operative and draws current, and the negative voltage applied to the a.v.c. line will be approximately that which point *B* possesses relatively to point *A*.

It should be observed that in this arrangement, the a.v.c.

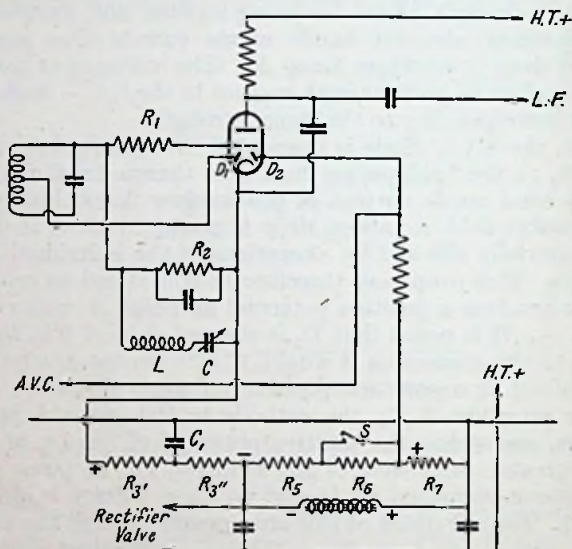

FIG. 123. A.V.C. ARRANGEMENT EMPLOYED IN THE G.E.C. SUPERHETERODYNE AVC5 RECEIVER

diode D_2 does not act as a rectifier valve as in the examples already shown in respect of other types of a.v.c. circuits, but more as a switching device that is operated automatically by the relation of the voltages at points *A* and *B*. The important feature about this circuit is that the actual voltage obtained for a.v.c. purposes is much greater than the d.c. bias voltage applied to the grid of the triode section of the valve. In other words, amplified a.v.c. is obtained.

An interesting modification of the circuit just considered is used in the G.E.C. Superheterodyne AVC5, and is shown

in Fig. 123. To simplify comparison with Fig. 122, the circuit elements in Fig. 123 are given similar designations if their purpose is the same. For example, R_3 of Fig. 122 is replaced by R_3' and R_3'' in Fig. 123, and so on. The actual working of the G.E.C. circuit is the same as that of Fig. 122, but the following additional features should be noted. An acceptor circuit, or low resistance filter, consisting of L and C tuned to the intermediate frequency, is joined across the signal diode load resistance R_2 to assist in the filtering of the i.f. component in the rectified signals. R_3 in Fig. 122 has been split up, in the present case, into two parts, R_3' and R_3'' (25 000 ohms each) which are decoupled by C_1 . Instead of using the voltage drop down the loudspeaker field directly for providing the delay voltage for D_2 , working in conjunction with the positive cathode due to R_3 , the circuit now being examined includes a potential divider across the loudspeaker field, consisting of R_5 , R_6 , and R_7 . A switch S is included in the circuit so as to short-circuit R_6 when closed. This arrangement works as follows: with S open, the voltage drop down R_3' and R_3'' is balanced against the potential along R_5 and R_6 to cause D_2 to operate in the manner discussed in connexion with Fig. 122. When S is closed, R_6 is short-circuited, the negative bias applied to D_2 is thereby diminished and the threshold value of signal strength at which the a.v.c. is brought into operation is lowered. The closing of S thus causes the receiver to be more sensitive; hence S is the sensitivity switch.

Inter-station Noise Suppression. A disadvantage of the a.v.c. systems so far described is that when a receiver is tuned to a point on the tuning scale midway between two stations, the receiver sensitivity is at its maximum and results in the reproduction of a great amount of background noise. In a powerful set, this inter-station noise is unpleasantly loud and means have to be provided to suppress it. The devices employed for this purpose are alternatively referred to as *interstation noise suppressors* or *quiet a.v.c.* (q.a.v.c.) systems.

One simple noise suppressor circuit that is employed in several types of receiver is illustrated in Fig. 124. Here, V_1 is the final intermediate frequency amplifier of a superheterodyne receiver. Detection of the signal voltages takes place in D_1 while D_2 supplies the normal a.v.c. voltages, in the

usual way. The noise suppression device consists of the connexion of the D_1 diode load R_2 to a tapping on R_3 instead of to cathode. It will be noticed that both the diode cathode and the i.f. amplifier cathode are made positive by R_4 .

Now it has already been shown that a diode cannot operate unless the anode is positive with respect to the cathode. In the present case, the double-diode cathode is normally positive

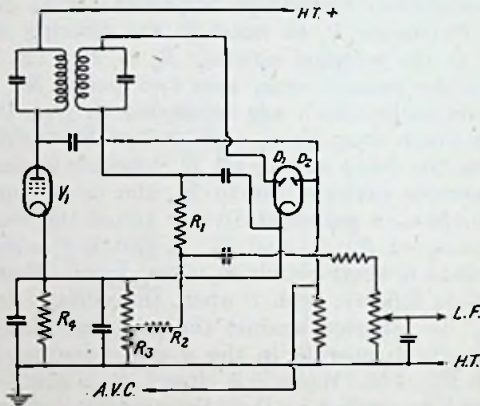

FIG. 124. A SIMPLE NOISE SUPPRESSION CIRCUIT

to the anodes owing to the positive bias applied to the cathode by the voltage drop down R_4 (about 4 000 ohms). This bias will vary according to the position of the tapping along R_3 (about 40 000 ohms) in shunt to R_4 , being maximum when this tapping is at the earth end of this resistance. As the tapping on R_3 is moved towards the earthed end the diode cathode becomes correspondingly more positive with respect to the anode, and, therefore, the anode is biased correspondingly negative. In other words, the signal voltage required to provide the reproduction from the loudspeaker must be greater as the tapping is moved along towards the earthed end of R_3 . All signals below the requisite strength will, therefore, be unable to operate the signal diode D_1 and will thus be suppressed. Potentiometer R_3 is seen to provide a manual control of noise suppression.

Whilst the circuit arrangement given in Fig. 124 provides a certain amount of noise suppression, it is not entirely satisfactory and various other noise suppression circuits have been developed. There is a large variety of these circuits, many of them being very complicated. One example is illustrated in Fig. 125. In this circuit, valve V_2 takes no part in the amplification but is for the sole purpose of rendering the

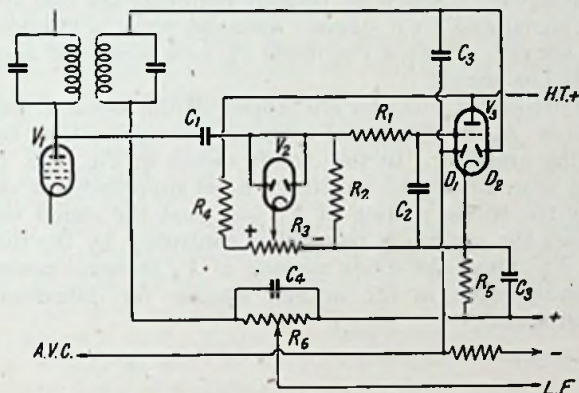

FIG. 125. AN EFFECTIVE CIRCUIT USED FOR INTER-STATION NOISE SUPPRESSION

signal diode D_2 operative only when the signal voltage applied to it is above the predetermined value for satisfactory reproduction. It should be noted that the release valve V_2 is fed directly from the i.f. amplifier V_1 via C_1 and is, therefore, independent of the actual voltage developed by the a.v.c. diode D_1 .

The operation of the circuit in Fig. 125 is as follows: In the no-signal condition, V_2 is inoperative by virtue of the positive bias applied to the cathode through the connexion of the latter to R_3 which forms, with R_4 and R_5 , a potentiometer across the mains. By means of the variable tapping along R_3 , the positive voltage to which the cathode of V_2 is returned may be altered over a wide range for adjusting the point at which muting begins. The resistance R_5 is such that the

cathode of V_3 is held sufficiently positive to render D_1 and D_2 inoperative in the absence of a signal of a certain intensity. When a strong signal is received, a voltage is applied to V_2 over C_1 and, after detection by that valve, overcomes the bias applied by the tapping along R_3 . The release valve V_2 thereon passes current along its load resistance R_4 , which automatically applies a negative bias to the grid of V_3 and reduces the anode current flowing through R_5 , thereby removing the bias applied to the signal and a.v.c. diodes. Delayed a.v.c. is provided by the connexion of the a.v.c. diode D_1 to a source of negative potential as shown.

Low-frequency voltages are tapped off the signal diode load resistance R_6 in the usual manner for application to the following amplifier. In the circuit shown in Fig. 125, therefore, it is seen that the muting or noise suppression is carried out by the triode portion of V_3 , and that the signal voltage at which the muting is released is controlled by the double-diode V_2 . Once the diode portion of V_3 becomes operative, the diodes work in the normal manner for detection and delayed a.v.c.

CHAPTER X

MAINS RECTIFIER VALVES AND EQUIPMENT

IN order that the receiver valves may operate, a supply of direct voltage has to be supplied to the anodes and screen grids. With direct current supply mains all that need be interposed between the mains and the receiver for this purpose is a circuit for smoothing out mains noise and voltage irregularities. But with alternating current supply, some means must be provided for converting the supply voltage to a steady value for anode and screen grid. The mains supply equipment as commonly used in radio receivers is for the purpose of providing this steady voltage—the h.t. supply—in addition to the cathode heater current and grid bias voltage, from the voltage available at the domestic supply mains. There are two distinct types of mains equipment: (1) for a.c. mains, (2) for either a.c. or d.c. mains. In both types a mains rectifier valve is employed, and the fundamental considerations from the point of view of rectification are similar.

The process of converting a.c. to d.c., known as rectification, can be carried out by either cutting off one half of the alternating current cycles, or by so arranging the circuit that both half-cycles produce a current flow in the same direction. The former is referred to as half-wave rectification, and the latter as full-wave rectification.

Half-wave Rectification. A circuit for half-wave rectification is shown in Fig. 126. A rectifier diode valve has its anode joined to one end of the mains transformer secondary winding the other end of which is connected to chassis or earth. The rectifier load circuit—which consists, of course, of the receiver valves—is represented by the resistance R . This is equal to the voltage output from the rectifier divided by the total current flow. A receiver taking 60 mA. at 300 volts thus represents a load resistance of $300/0.06 = 5\,000$ ohms.

When power is supplied to the circuit, alternate half-cycles of the supply voltage make the anode positive with respect to cathode and thereby enables a current to pass

from cathode to anode inside the valve and round the load circuit in the direction indicated by the arrows. During the remaining alternate half-cycles, the anode is made negative by the supply voltage, and as a consequence the valve is

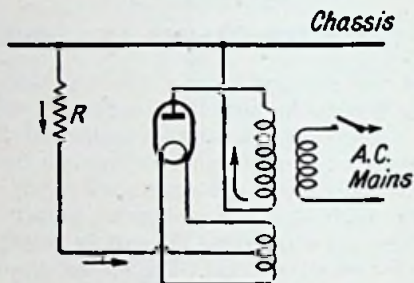

FIG. 126. HALF-WAVE RECTIFIER CIRCUIT

rendered non-conductive. There is thus produced at the output of the rectifier a series of current pulses corresponding to the alternate half-cycles, as shown above the line in Fig. 127.

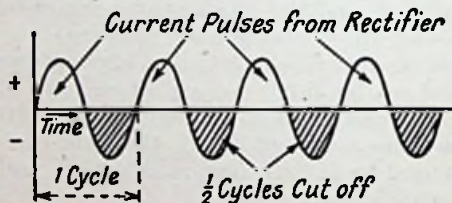

FIG. 127. HALF-WAVE RECTIFICATION

In practice, half-wave rectification is used for a.c./d.c. receivers, but for a.c. receivers the full-wave circuit is preferred because of the greater ease with which smoothing is carried out and for other reasons. This question will be discussed more fully later.

Full-wave Rectification. To rectify both halves of the a.c. supply a circuit as shown in Fig. 128 may be used. In this arrangement, the two anodes are joined to opposite ends of the high voltage secondary winding S_1 , the centre tap of

which is connected to the earth line or chassis. The total voltage across the high voltage secondary S_1 is now split up by the centre-tap connexion, half the voltage being applied to each anode. During one half-cycle the anode A_1 is positive

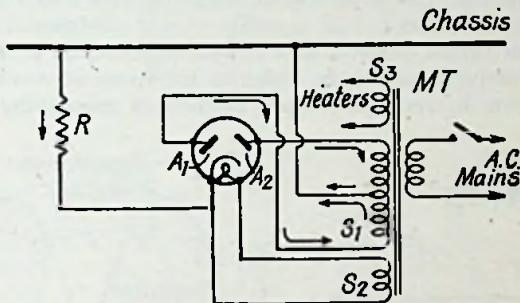

FIG. 128. FULL-WAVE RECTIFIER CIRCUIT

to cathode by half the total voltage across S_1 , and at the same time the anode A_2 is negative to the same extent. Current thereby passes from A_1 , through the lower half of S_1 , the centre-tap connexion to chassis and so through the load R back to cathode. In the following half-cycle, A_2 is

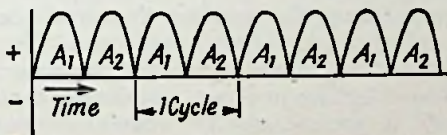

FIG. 129. CURRENT PULSES IN FULL-WAVE RECTIFICATION

positive and A_1 negative, so the current now passes from A_2 through the upper half of S_1 and the load circuit R to cathode. As a result of the full-wave rectifier connexion, current from the valve takes the form shown in Fig. 129.

It will be seen from Fig. 128 that current from the rectifier flows through the transformer secondary S_1 in opposite directions from the two anodes. This has the important effect of cancelling the magnetization of the transformer core by these currents. With half-wave rectification, the flow of

current from the rectifier valve always in the same direction produces magnetization of the core, and there is a tendency for distortion of the waveform.

Smoothing. The output from the rectifier with a resistive load as in Fig. 129 is clearly of little use to a radio receiver, for it consists merely of a series of uni-directional pulses, instead of direct current at a constant potential as required by the receiver valves. In order to level out, or smooth, the fluctuations in rectifier output current a smoothing circuit

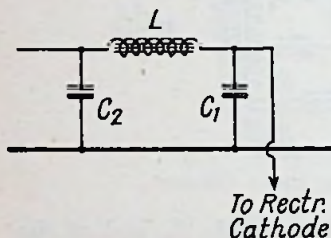

FIG. 130. SMOOTHING CIRCUIT

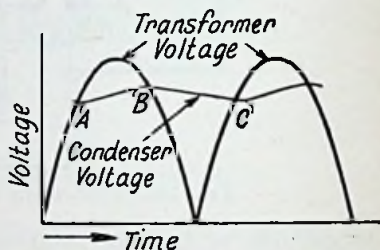

FIG. 131. VOLTAGE CURVES FOR FULL-WAVE RECTIFICATION

is employed, the most commonly used type for radio receivers being shown in Fig. 130.

Current pulses from the rectifier flow into the first condenser C_1 , called the reservoir condenser. The condenser thereby becomes charged and acts as the reservoir from which current is drawn by the receiver. Condenser C_1 is not sufficient by itself to smooth out the current fluctuations so a filter circuit consisting of C_1 , L and C_2 is used, L being the smoothing choke and C_2 the smoothing condenser.

In Fig. 131 are seen curves which show the influence of the reservoir condenser C_1 during the operation of the radio receiver. Once the condenser has acquired a charge from the rectifier, the current pulses from the mains rectifier valve do not increase this charge until its voltage (as applied by the transformer secondary) exceeds that across the condenser C_1 . In Fig. 131, for example, the condenser voltage is seen to increase from A to B during the time the rectifier voltage output is higher than that of the condenser. As soon as the

rectifier voltage drops below that on the condenser, the charging ceases. Between *B* and *C* the charge on the reservoir condenser has to supply the receiver alone and so the voltage falls as shown, until the following half-wave of rectifier voltage reaches a value higher than that at the condenser. It is apparent, therefore, that although the output from the rectifier, seen in the Fig. 129, for a resistance load is a series of half-waves, in practice, owing to the employment of the reservoir condenser, the output taken from the rectifier is a

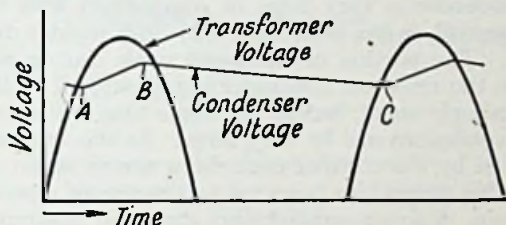

FIG. 132. VOLTAGE CURVES FOR HALF-WAVE RECTIFICATION

series of short pulses which replenish the charge on the reservoir condenser during the time represented by the distance *A* to *B* in Fig. 131.

The fall in voltage at condenser C_1 between each impulse received from the rectifier is inversely proportional to the load resistance, the capacitance of C_1 and the frequency of the pulses of current. A high load current (small load resistance) will clearly produce a larger drop from *B* to *C* than a light load current because during the time *BC* between two consecutive charging impulses a larger current will have been taken by the receiver. The drop in voltage between *BC* is emphasized when half-wave rectification is employed as can be seen from Fig. 132. Owing to the longer time *BC* between the current pulses, the reservoir condenser discharges to a lower voltage. The frequency of the current pulses, with a half-wave rectifier, is of course half that with a full-wave rectifier. As a consequence the ripple, which in Figs. 131 and 132 is represented by the irregularities in the condenser output voltage *ABC*, is greater than that provided from the full-wave circuit and the mean value or d.c. voltage output is

correspondingly lower. The smoothing circuit has to be correspondingly more efficient—and expensive. Further advantages of the full-wave circuit are its higher efficiency owing to the utilization of both half-waves of input current. The frequency of the ripple in the full-wave circuit is twice that of the supply voltage, but with a half-wave rectifier it is the same as the mains frequency.

The slope of the curve AB for a given load and supply frequency is determined by the size of reservoir condenser. If the condenser is very large in comparison with the load, the voltage will, as has been seen, only drop slightly during the time BC . The portion of the input cycle during which the charge on the reservoir condenser is replenished is, therefore, correspondingly small, but at the same time the current flow into the condenser will be very large. As this current has to be supplied by the rectifier cathode, a severe strain is placed on the valve unless this is suited to the size of reservoir condenser used. Valve manufacturers state the maximum value of reservoir condenser capacitance that should be used with their respective valves.

It is apparent from the shape of the curve ABC that the voltage from the reservoir condenser is still not suitable for operating the valves satisfactorily because the ripple voltage represented by the fluctuations ABC would produce excessive mains hum in the receiver. Further smoothing is provided by the smoothing choke L , for if this is of adequate inductance its inherent tendency to reduce fluctuations of current flowing through it will level out the ripple. As the effective inductance of an iron-cored choke coil falls as the current flowing through it increases, it is important that the smoothing choke shall have the required inductance—usually 20 henries—at the actual current passed through it in the receiver. Finally, the smoothing is completed by the condenser C_2 which levels out any remaining ripple in the current from the smoothing choke. The required capacitance of C_2 is dependent upon the effectiveness of C_1 and L in removing the ripple, but commonly used values are 8 $\mu\text{F.}$ to 32 $\mu\text{F.}$, the larger values providing, of course, the greater degree of smoothing.

An economic method of providing the requisite inductance for smoothing—and a commonly used one—is to use the

loudspeaker field winding. This winding is designed to have the required inductance for smoothing, and the flow of rectified current through it provides the necessary energization for operating the loudspeaker. Field windings of this type are wound with fine wire so as to form an adequate number of ampere-turns for the electro-magnet, and this results in a fairly high ohmic resistance being connected in series with the

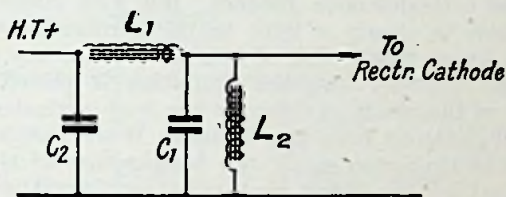

FIG. 133. PARALLEL ENERGIZATION OF LOUDSPEAKER FIELD WINDING L_2

rectifier, with consequent large voltage drop as compared with that when a low resistance smoothing choke is used.

Although with most a.c. receivers this is not a disadvantage owing to the latitude in design that is allowable by the use of a mains transformer, with a.c./d.c. receivers in which the available voltage is limited to that of the supply mains the loss of voltage is undesirable. A permanent magnet loudspeaker can, of course, be used to obviate the need for mains energization. When a mains-energized type is used, it is sometimes connected across the rectifier output as shown in Fig. 133 at L_2 . In this case, the smoothing choke L_1 may be designed to drop only a small voltage from the rectifier. The field winding L_2 has a high resistance, about 3 000 to 5 000 ohms.

Construction of Mains Rectifier Valve. It will be appreciated that as the charging current for the reservoir condenser starts at the rectifier valve cathode and passes across the valve to the anode, the cathode-anode path constitutes a series resistance in the d.c. supply source. It is of the utmost importance, therefore, that the rectifier should have a low impedance, otherwise an excessive voltage drop will occur across the valve and the regulation of the system become poor. By

regulation is meant the ratio of output at no load to that at full load. The lower the resistance of the valve and components which comprise the mains supply equipment, including the mains transformer windings, the better is the regulation, for the iR drop is proportionately less and consequently there is less voltage variation as the load alters.

One way to construct a valve with low impedance is to reduce the cathode-anode distance. But with mains rectifier valves there is clearly a limit to the permissible electrode closeness owing to the risk of a breakdown at the peaks of the supply voltage. Another limitation is placed by the necessity of the anode to dissipate the heat generated by the impact of electrons from the cathode. If the cathode-anode clearance is made too small, the temperature of the anode is increased by the direct heat radiation from the cathode itself, which, with indirectly heated valves, is considerable. One result of this is the risk of a reverse current from anode to cathode which damages the cathode and "softens" the valve.

An alternative means of reducing the impedance of the rectifier is to increase the length of cathode and anode for a given anode diameter. Owing to the construction of the indirectly heated cathode, it is not an easy task to produce an extended cathode that will give satisfactory results under practical working conditions. Filamentary cathodes (directly heated) can, however, be constructed to enable a valve of low impedance to be produced.

In modern radio receivers, both directly and indirectly heated valves are employed for mains rectification. Directly heated rectifiers heat up much quicker than indirectly heated valves. If, as usually is the case, the valves in the receiver are indirectly heated, the use of a directly heated rectifier results in this valve providing its output before the load circuit (receiver valves) is effectively connected. As a consequence, the rectifier is on no-load and a high voltage is produced across the circuit which may entail a risk of breakdown in insulation or condensers. When an indirectly heated rectifier is used with indirectly heated receiver valves, all the valves heat up in approximately the same time and the risk mentioned above is not present.

A.C./D.C. Equipment. When a receiver is designed to operate from either a.c. or d.c. mains, the rectifier valve is supplied directly from the mains. A transformer is of no use for connexion to d.c. mains as in this case there is no rapidly fluctuating input current to induce the required voltage in the secondary winding. The lack of an input transformer places the a.c./d.c. set at a disadvantage with respect to the purely

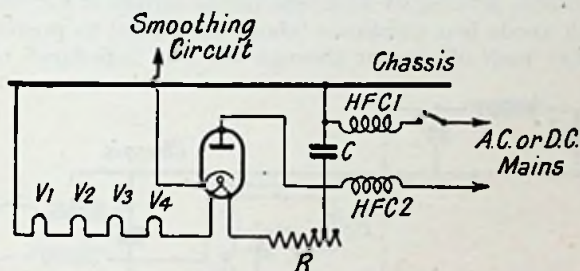

FIG. 134. A.C./D.C. SUPPLY CIRCUIT

a.c. receiver because the available h.t. voltage is less than the supply voltage. With modern valves this is not very serious, especially with the output tetrodes that provide a comparatively large output power with an h.t. supply of under 200 volts.

A typical circuit for a.c./d.c. equipment is given in Fig. 134. In this arrangement a half-wave rectifier valve is used, and it will be noticed that the cathode-anode path is directly in the h.t. + supply lead for d.c. mains. This causes a voltage drop and lowers the available supply. Connected directly to the mains is a filter consisting of high frequency chokes HFC_1 , HFC_2 and condenser C ($0.01 \mu F.$). This filter is designed to prevent the ingress of noises from the mains. When the equipment is connected to a.c. mains, the valve operates as a normal half-wave rectifier. The lead from the cathode is joined to the usual smoothing circuit.

The heaters of the receiver valves are connected in series across the mains. In Fig. 134 four valve heaters V_1 , V_2 , V_3 and V_4 are shown for the receiver in series with the rectifier heater and the voltage dropping resistance R . Heater

voltage for a.c./d.c. valves varies for the different types from 6.3 to 45 volts. The adjustment of R must be such that the total voltage required by the valves (being the sum of the respective heater voltages) plus the voltage drop down R equals the mains supply voltage.

A commonly used circuit is shown in Fig. 135. A double-diode valve is employed and this acts as half-wave rectifier with anodes in parallel when the mains supply is a.c. Joined to each anode is a resistance (about 100 ohms) to prevent an excessive rush of current through the low impedance of the

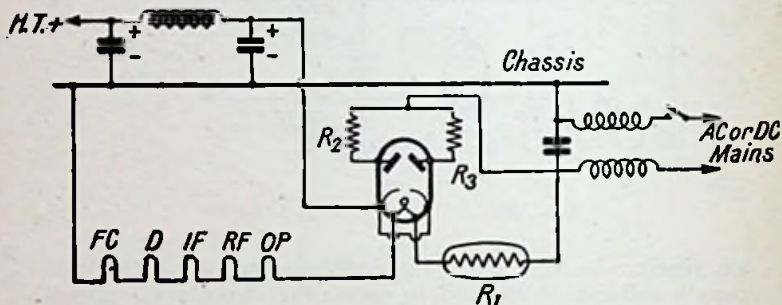

FIG. 135. ANOTHER A.C./D.C. SUPPLY CIRCUIT

paralleled valves during a voltage surge. Instead of using an adjustable resistance for dropping the mains voltage to that required by the valves, a current stabilizing resistance R is used. This is known as a barretter and usually consists of an iron resistance mounted in hydrogen within a glass envelope. The resistance of the barretter increases with the temperature and therefore with the current and thus serves to stabilize the current flow, which, of course, is arranged to coincide with the current demand of the valve heaters.

It will be noted from the heater circuits given above that, as the cathodes of the valves are joined to the earth line either directly or through a bias resistance, the cathode-heater potential is considerable in the valves nearer the rectifier. The design of valve heater must be such that the heater-cathode insulation can stand this high voltage. When a.c.

is supplied to such a heater circuit it is found that an excessive amount of hum is produced in the receiver unless special precautions are taken in the design of the cathode-heater elements. The usual step consists in fitting metal screening round the ends of the heater wire and joining this to the cathode. The introduction of hum is still further reduced by positioning the grid lead-in away from the heater wires.

PUBLISHED BY PITMAN

A FIRST COURSE IN WIRELESS

Being a Reprint in Book Form of a Series of Articles which appeared in *World Radio* under the title "The Radio Circle: for Beginners Only."

By "DECIBEL." In crown 8vo, cloth, 221 pp. 5s. net.

WIRELESS TERMS EXPLAINED

Based upon a series of articles which were published in *World Radio* under the title of "A Wireless Alphabet."

By "DECIBEL." In crown 8vo, cloth, 80 pp. 3s. net.

MODERN RADIO COMMUNICATION

By J. H. REYNER, B.Sc., A.C.G.I., A.M.I.E.E. In two volumes. Each in crown 8vo, cloth gilt, illustrated.

Vol. I. 330 pp. 7s. 6d. net.

Vol. II. 255 pp. 7s. 6d. net.

THE RADIO AND TELECOMMUNICATIONS ENGINEER'S DESIGN MANUAL

By R. E. BLAKEY, D.Sc.

In demy 8vo, cloth, 142 pp., illustrated. 15s. net.

ELECTRIC CIRCUITS AND WAVE FILTERS

By A. T. STARR, M.A., Ph.D., A.M.I.E.E., A.M.I.R.E.

In demy 8vo, cloth gilt, 476 pp. 25s. net.

WIRELESS TELEGRAPHY

Notes for Students.

Compiled by W. E. CROOK, A.M.I.E.E., A.F.R.Ac.S.

In demy 8vo, cloth, 185 pp. 7s. 6d. net.

DEFINITIONS AND FORMULAE FOR STUDENTS—RADIO AND TELEVISION ENGINEERING

By A. T. STARR, M.A., Ph.D.

In demy 16 mo., 49 pp. 8d.

Sir Isaac Pitman and Sons, Ltd., Parker St., Kingsway, W.C.2

INDEX

- A.C. power output, 121
 Aligned grids, 42
 Alkaline earth metals, 15
 Amplification factor, 24
 and h.f. amplification, 79
 formula for, 26
 Amplification, h.f. 74, l.f., 97
 voltage, 76
 Amplified, a.v.c., 196
 Anode, 4
 a.c. resistance, 26
 detection, 60
 dissipation, 130
 voltage, effect on emission,
 11
 Automatic volume control, 183
 controlled valves, 189
 delayed, 186
 delayed-amplified, 196
 diode, 183
 double-diode triode circuits, 192
 quiet, 199
 time constant of circuit, 191
- BARIUM**—
 as emitter, 15
 as getter, 17
- Beam valves, 45
 Bright emitters, 14
- CAPACITANCE**—
 inter-electrode, 81
 reflected, 82
- Cathode, 4
 equipotential, 9
 indirectly heated, 8, 16
 oxide coated, 15
 temperature, effect of varying, 10
 thoriated, 14
 tungsten, 14
- Characteristic curves—
 anode current-anode volts, 28
 anode current-grid voltage, 21
- Characteristic curves—(contd.)
 dynamic, 28
 static, 28
 variable-mu valves, 44
- Child's law of emission, 6
 Choke coupled h.f. amplifier,
 88
 Class B push-pull, see "Push-
 pull, Class B"
 Control grid, introduction of, 18,
 19
 Conversion—
 conductance, 170
 gain, 171
 Critical distance valves, 46
 Cross modulation, 94
- DELAYED amplified a.v.c., 196
 Delayed a.v.c., 185
 for battery valves, 193
 for mains valves, 194
 practical circuit, 198
 Detection characteristic, 62
 Detector—
 anode, 60
 diode, 52
 general considerations, 48
 grid, 63
 ideal, 50
 need for, 49
 pentode, 71
 screen-grid valve, 73
- Diode, 4
 detector, 52
 for a.v.c., 184
 push-pull detection, 59
 strapped for a.v.c., 195
- Double-diode detection, 59
 for a.v.c., 184
 Double-diode triode, practical
 circuits, 193
 Dull emitters, 14
 Dushman's Law, 3

- EDISON effect**, 4
Efficiency of valve, 129
Electron—
 affinity, 3
 coupling, 170
 flow, 1
 stream, 1
Emission—
 electronic, 1
 formula, 3
 law of, 3
 photo-electric, 2
 secondary, 12
 3/2 power law, 6
Equipotential cathode, 9
- FEED-BACK**, 83
 negative, 133
Filling, see "Gas filling"
Flashing, 17
Fleming's valve, 4
Flicker effect, 13
Free electrons, 1
Frequency changers, 165
 heptode, 173
 hexode, 171
 octode, 178
 triode hexode, 178
 — pentode, 183
Frequency changing process, 167
- GANGING**, 172
Gas filling, 12
Getter materials, 17
Gettering, 16
Grid—
 control, see "Control grid"
 low noise, 43
 screen, see "Screen grid"
 suppressor, see "suppressor grid"
Grid detection, 63
 choice of grid condenser, 67
 distortion, 70
 equivalent circuit, 67
 leak resistance, 69
 pentode, 71
 power, 71
 sensitivity, 67, 69
- HALF-WAVE rectification**, 203
Hard valve, 12
Harmonic distortion, 123
 in output pentode, 127
Heating conductor, effect of, 2
Heptode, 173
Hexode, 171
H.F. amplifiers, 74
 choke coupled, 88
 circuits, 86
 distortion, 91
 tuned anode, 86
 — transformer, 89
H.F. stopper, 57
- INDIRECTLY heated cathode**, 9
Inter-electrode capacitance, 81
Inter-station noise suppression, 199
- KELVIN**, degrees of temperature, 14
- LOAD lines**, 118
Loud-speaker smoothing, 209
Low frequency amplification, 97
 resistance-capacitance, 97
 transformer coupled, 105
- MAGNESIUM as getter**, 17
Mains supply equipment, 203
Matching loudspeaker and valve, 130
Micromho, 22
Modulation, 48
 distortion, 92
 rise, 92
Multiplication detection, 168
Mutual conductance, 22
Mutual conductance, characteristic, 24
 of screen-grid valve, 34
 of variable- μ valve, 44
- NEGATIVE**—
 electrode, 4
 feedback, 133
 meaning of, 1

- Neutral zone, 18
 Neutralizing grid-anode capacitance, 85
- OCTODE, 178
 Optimum load, 117, 126
 Output power—
 a.c., 121
 from Class A push-pull, 145
 practical, 126
 Output stage, 115
 choice of valve, 116
 Class A, 138
 load curves, 117
 operating triode, 132
 pentode, 133
 push-pull, 138
 tetrode, 44
 Oxide coated cathode, 13, 15
- PARALLEL feed for l.f. transformers, 111
 Paraphase push-pull, 159
 circuit, 160
 Pentagrid, 173
 Pentode, 35
 and triode, comparison, 132
 detector, 71
 h.f. amplifier, 77
 output stage, 127
 Phase relation of currents and voltages in valve, 74
 Phase splitter for push-pull, 162
 Photo-electric emission, 2
 Positive, meaning of, 1
 Power amplification, 115
 output, a.c., 121
 undistorted, 123
 Power grid detection, 71
 Primary electron, 12
 Push-pull, Class A, 138
 dynamic conditions, 143
 merits of, 146
 power output, 145
 Push-pull, Class B, 147
 distortion, 150
 efficiency, 148
 for public address, 155
 output curves, 153
 positive drive, 152
- Push-pull, paraphase, 159
 ———, quiescent, 154
- QUIESCENT push-pull, 154
 Quiet a.v.c., 199
- REACTION, 51
 Rectification, half-wave, 203
 ———, full-wave, 204
 Rectifier valve construction, 209
 Refractory substance, 9
 Resistance-capacitance l.f. amplifiers, 97
 impedance of coupling condenser, 102
 practical circuit, 100
 size of coupling condenser, 100
 value of grid leak, 101
 Richardson's law of emission, 3
- SATURATION, 7, 11, 12
 Schrotteffekt, 13
 Screen grid, 30
 current, 34
 decoupling condenser, 31
 valve, 30
 detector valve, 73
 Secondary—
 electron, 12
 emission, 12
 Selectivity, 80
 Shot effect, 13
 Sideband cutting, 91
 Smoothing, 206
 Soft valve, 12
 Space charge, 5
 coupling, 177
 grid, 18
 Static characteristics, 28
 Stopper, see "h.f. stopper"
 Strontium emitter, 15
 as getter, 17
 Superheterodyne reception, 165
 Suppressor grid, 36
- TETRODE, see "Screen grid valve"
 Thoriated cathodes, 14
 Three-halves power law of emission, 6

218 THERMIONIC VALVES IN MODERN RADIO RECEIVERS

- Time constant of a.v.c. circuit, 191
- Transformer coupled l.f. amplifier, 105
- amplification curve, 110
 - equivalent circuit, 107
 - parallel feed, 111
 - practical circuits 110
 - stage gain, 109
- Triode—
- characteristics, 21
 - hexode, 178
 - pentode, 182
 - v. pentode, 132
- Tuned anode circuit, 86
- transformer coupled amplifier, 89
- Tungston cathode, 14
- UNDISTORTED power output, 123
- VALVE noise, 14
- Variable- μ valve, 42
- operation, 189
- WEHNELT, 15
- Work function, 2
- of calcium, 3
 - of platinum, 3
 - of thorium, 3
 - of tungsten, 3
- Working point on curve, 20

