

*The*

RADIO

**ANTENNA**

**HANDBOOK**

THE  
**RADIO**  
**ANTENNA HANDBOOK**

BY  
**THE ENGINEERING STAFF  
OF "RADIO"**

*Under the direction of*  
**J. N. A. HAWKINS**

*Edited by*  
**W. W. SMITH**

Published and Copyrighted, 1936, by RADIO, Ltd., (Publishers of *Radio Magazine*),  
7460 Beverly Boulevard, Los Angeles, California, U.S.A.

SECOND PRINTING, SEPTEMBER, 1936

PRINTED IN U.S.A.

## PREFACE

The aim of *The "Radio" Antenna Handbook* is to present a comprehensive and practical outline of the whole antenna problem for the amateur and others using the high frequencies. It is not generally realized among amateurs that a given amount of time and money spent on increasing antenna efficiency will do more to increase the strength of the distant received signal than increasing the power output of the transmitter several times. Antenna data has been very incompletely presented in most common texts, and as the need exists for a more complete presentation of the subject, it is hoped that this work will prove a step in the right direction.

The matter presented is essentially practical rather than theoretical, although each function of the antenna and its associated feeder equipment is discussed in some detail.

Some of the data on directive arrays and some of that on harmonic antenna lengths, so far as is known, is available nowhere else at the present time.

Feeding power to the antenna is covered in some detail, as this subject is of the utmost importance.

A number of special wrinkles are offered which have proved valuable as time and money savers.

We wish to acknowledge the assistance of a great number of amateurs and engineers and particularly of Messrs. F. E. Terman, Lester Reukema, James Sharp, A. A. Collins, and R. S. Kruse in the preparation of this material. We wish also to thank *All Wave Radio* and the R.C.A. Manufacturing Co. for the use of certain illustrations used in this book.

*The Editors of* RADIO.

# CONTENTS

	PAGES
CHAPTER I	
ANTENNA FUNDAMENTALS	
Ground wave—Sky wave—Ionosphere—Skip distance—Selective fading—Antenna radiation—Angle of radiation—Frequency, wavelength, and antenna length—Radiation resistance and antenna impedance—Non-resonant lines—Antenna reactance .....	4-8
CHAPTER II	
CHOICE OF AN ANTENNA	
Advantages and disadvantages of various systems—Directive antenna arrays—Feeder systems .....	9-10
CHAPTER III	
METHODS OF FEEDING ANTENNAS	
End-fed antenna—Marconi antenna—Non-resonant lines and resonant feeders—Current and voltage feed—Zepp. antenna—Collins Multiband system—Linear transformer—Johnson Q antenna—Two-wire open line—Coaxial line—Twisted pair line—Coupling to the antenna—Y match—Delta match—Harmonic operation—Off-center feeding—Lecher wire matching—J antenna—T antenna—Capacity loaded—Dummy antennas.....	11-33
CHAPTER IV	
COUPLING TO THE TRANSMITTER	
Function of antenna coupler—Capacitive coupling methods—Inductive coupling methods—Inductive coupling—Pi section filter.....	34-38
CHAPTER V	
HARMONIC OPERATION	
Operating antennas on harmonics—Long wire antennas—Length formulas.....	39-41
CHAPTER VI	
DIRECTIVE ANTENNAS	
Directive properties of antennas—Antenna radiation characteristics—The "Vee" antenna—Rhombic antennas—Stacked dipole antennas—End-fire arrays—Broadside arrays—Feeding directional arrays—Folded type arrays.....	42-62
CHAPTER VII	
RECEIVING ANTENNAS	
All-wave receiving antennas—The double-doublet—Coupling transformers—Static shields—Ignition noise—Coupling to the receiver—Loading coils—Transmission lines—The "spiderweb" antenna.....	63-74
CHAPTER VIII	
SPECIAL ANTENNAS AND MISCELLANEOUS TABLES	
Reinartz rotary beam—Hawkins double vee—Miscellaneous tables—Field strength meters .....	75-77
CHAPTER IX	
SUPPORTING THE ANTENNA	
Guyed and guyless towers—Methods of construction and erection.....	78-80

## I. Antenna Fundamentals

Radio waves are electromagnetic waves which are transmitted through space from a radio transmitter to a suitable receiver.

Electromagnetic waves travel through space with the speed of light (186,000 miles or 300,000,000 meters per second). Radio waves include an electrostatic and an electromagnetic component. The electrostatic

ed by the sun. Therefore, radio waves act very differently at night.

The higher the frequency of the radio wave the more it penetrates the ionosphere, and the less it is bent back toward earth. 160 and 80 meter signals are bent so much by the layers of the ionosphere that they can almost be considered as reflected back; and thus if these low-frequency short waves are radiated almost straight up they will return back to earth (close to the transmitter). As the frequency goes up beyond about 5,000 kc., it is found that waves whose angle with the horizon exceed a certain critical angle never return to earth. Thus as the frequency goes up it is usually desirable to confine radiation to low angles, as the high-angle waves simply penetrate through the ionosphere and are lost.

Generally, it is found that signals above about 45,000 kc. are bent so slightly that they do not return to earth, although under exceptional circumstances radio waves of 75,000 kc. have been known to return to earth for very short periods of time.

Thus the sky wave does not give consistent communication at frequencies above 45,000 kc., and even above about 22,000 kc. the results are not good enough for commercial use.

### Skip Distance

The ground wave of a 7,000 kc. transmitter rarely can be heard over a hundred miles away. Also, the first bending of the sky wave rarely brings the sky wave back down to earth within three hundred miles from the 7,000 kc. transmitting antenna at night. Thus there is an area between 100 and 300 miles from the transmitter in which the signals cannot usually be heard. This area lies in what is termed the **skip distance**. Moving closer to or farther away from the transmitter allows the signals to be heard, but in the skip distance (or zone) no reception is possible.

The lower the angle of radiation of the wave, with respect to the horizon, the farther away will the wave return to earth and the greater the skip distance. The wave can be reflected back up into the ionosphere by the earth and then be reflected back down again, causing a second skip distance area. The drawing of figure 1 shows the multiple reflections possible. When the receiver receives signals which have traveled

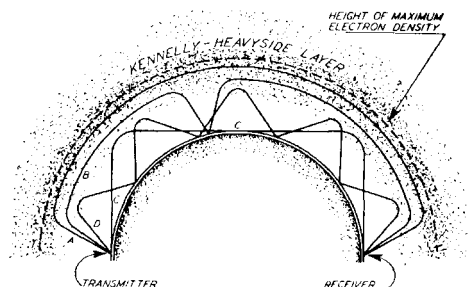


Figure 1

Showing some of the many possible paths of a high-frequency "skywave" signal.

component corresponds to the voltage of the wave and the electromagnetic component corresponds to the wave current.

High frequency waves travel along the surface of the earth in direct rays from transmitter to receiver but also can be radiated upward into the variable ionosphere to be bent downward in an indirect ray.

The energy radiated from the transmitting antenna divides into a ground wave and a sky wave. The **ground wave** travels along the surface of the earth and is rapidly attenuated so that it is practically useless for consistent communication for distances over 100 miles. The **sky wave** is a beam sent off at a tangent to the surface of the earth, or at an angle above the horizon, which is later returned to earth by the bending effect on the beam of the ionized particles in the various layers of the ionosphere.

The **ionosphere** consists of layers of ionized particles of gas located above the stratosphere and extending up to possibly 750 miles above the surface of the earth ("H Layer").

The amount of bending which the sky wave undergoes depends on the frequency of the wave and the amount of ionization in the ionosphere, which is in turn, dependent on ultra-violet radiation from the sun. The ionization is much greater in the daytime. Also, the height of the ionosphere is affect-

over more than one path between transmitter and receiver, note that the signal impulses will not all arrive at the same instant, as they do not all travel the same distance. When two or more signals arrive in the same phase at the receiving antenna the resulting signal in the receiver will be quite loud. On the other hand, if the signals arrive 180 degrees out of phase so that they tend to neutralize each other, the received signal will drop, perhaps to zero if perfect neutralization occurs. This explains why high frequency signals fade in and out.

### Selective Fading

Selective fading affects all modulated signals. Modulated signals are not a single frequency signal but consist of a narrow band of waves perhaps fifteen kc. wide. As the varying signal neutralization caused by multiple signal paths between transmitter and receiver is effective only for one frequency at a time it will be seen that the whole modulated signal band is not neutralized at any instant, but only part of it. This causes a peculiar and changing form of audio distortion at the receiver which suppresses some audio frequencies and emphasizes others. This constant change in the frequency response curve of the path between transmitter and receiver is known as selective fading.

### Antenna Radiation

When an alternating current is passed through a conductor, an alternating electromagnetic field extends around that conductor. Energy is alternately stored in the field and then returned to the conductor. As the frequency is raised it is found that more and more of the energy does not return to the conductor but is radiated off into space, in the form of electromagnetic waves which travel through space with the speed of light. Radiation from a conductor is materially increased wherever there is a sudden change in the electrical constants of the line. Such changes produce reflection, which places standing waves on the line.

For example, a wire in space to which is fed radio frequency energy whose wavelength is 2.08 times the length of the wire in meters, is said to **resonate** as a **dipole**, or half-wave antenna at that wavelength, or frequency. As both ends of the dipole are terminated in an infinite impedance (open circuit) there is a mismatch at each end, which produces reflection. This means that an incident radio frequency wave will travel to one end of the dipole and will be

reflected right back toward the center of the dipole. The returning waves which have been reflected meet the next incident wave and the voltage and current at any point along the antenna are the algebraic sum of the two waves. At the ends of the dipole the voltages add up while the currents in the two waves cancel, thus producing **high voltage and low current at the ends** of the

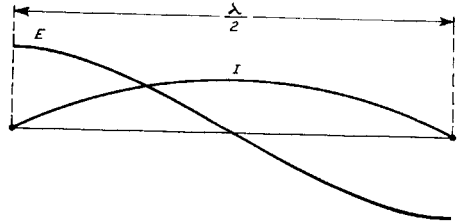


Figure 2  
Showing Voltage (E) and Current (I) Distribution on a Half-wave Antenna

dipole or half wave section of wire. In the same manner it is found that the currents add up while the voltages cancel at the center of the dipole. **Thus at the center there is high current but low voltage.** Note in figure 2 that the current in the dipole uniformly decreases as the measuring instrument is moved out from the center to either end, while the voltage uniformly increases (the polarities being opposite at the two ends, however). The curve of voltage or current represents a standing wave on the wire. If the voltage, or current, measured the same all along the wire it would indicate the absence of standing waves.

The points of maximum and minimum current and voltage are described as **loops** and **nodes**. A voltage or current loop in a wire or line is a point of maximum voltage or current. A voltage or current node is a point of minimum or zero voltage or current. In a wire or line containing standing waves it will always be found that a voltage node point in the line coincides with a current loop and a current node coincides with a voltage loop.

A non-radiating transmission line must be always terminated in its characteristic impedance in order to avoid reflection and standing waves. A Hertz antenna is an ideal example of a type of transmission line that is **not** terminated in its characteristic impedance at its ends. Thus standing waves are set up, and energy is literally snapped off the ends of the wire by a process somewhat similar to the "crack the whip" principle. (See page 67.)

A resonant line, such as "Zepp." feeders, may have high reflection losses and standing waves, but the effective radiation can be reduced by having the radiation from two adjacent wires in such amplitude and phase as to cancel out. In other words, the radiation from one wire is "absorbed" by the other wire, and vice-versa.

### Angle of Radiation

The reflection of low-frequency waves and the refraction of high-frequency waves from the ionosphere show that for any given distance and ionosphere height there is an ideal angle with the horizon which the radio wave should take. For long distance communication the angle of radiation should be low, while for short distance communication the angle of radiation should be considerably higher. Different types of antennas have different major angles of radiation as will be shown later.

### Frequency, Wave Length, and Antenna Length

All antennas used by amateurs are based on the fundamental Hertz type, which is any wire in space which is a half wavelength long electrically. The Marconi antenna is a special type of Hertz antenna used only when space considerations necessitate using something shorter than half of an electrical wavelength. The Marconi antenna always is grounded and is an odd number of quarter wavelengths long electrically. In other words, the ground acts as the missing half of the Hertz.

In any discussion of antennas the relationship between wavelength and frequency must be kept in mind. As the velocity of radio waves through space is constant at the speed of light, it will be seen that the more waves that pass a point per second (higher the frequency) the closer together the peaks of those waves must be (shorter the wavelength). Therefore, the higher the frequency the lower the wavelength. Frequency describes the number of wave peaks (in cycles or thousands of cycles per second) passing a point per second. Wavelength describes the distance in meters between adjacent peaks of a wave train. As a radio wave travels 300,000,000 meters a second (speed of light) a frequency of one cycle per second corresponds to a wavelength of 300,000,000 meters. As the frequency increases, the wavelength decreases; so if the frequency is multiplied by a million, the wavelength must be divided by a million in order to have them still refer to the same thing.

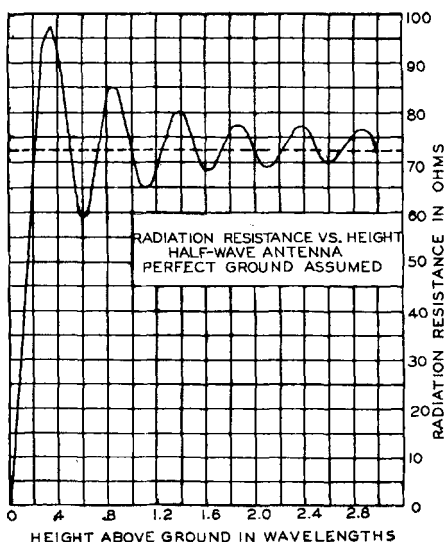


Figure 3  
Relationship of Height above Ground to Radiation Resistance for a Half-wave Antenna.

Thus a frequency of one million cycles per second (a thousand kilocycles) equals a wavelength of 300 meters. Multiplying frequency by ten and dividing wavelength by ten we get: a frequency of 10,000 kilocycles equals a wavelength of 30 meters. Multiplying by ten and dividing by ten again we get: a frequency of 100,000 kilocycles equals 3 meters wavelength. Therefore, remember when changing wavelength to frequency that **frequency in kilocycles equals 300,000 divided by wavelengths in meters**. Also, wavelength in meters equals 300,000 divided by frequency in kilocycles.

$$F_{kc} = \frac{300,000}{\lambda}$$

$$\lambda = \frac{300,000}{F_{kc}}$$

Note that when speaking of antenna lengths it is necessary to speak of **electrical length**. When speaking of a half-wave antenna we mean one whose electrical length is a half wave. Note that the velocity of a high frequency radio wave traveling along a conductor is not as high as it is in free space. Thus a half-wave antenna is slightly less than a half wave long physically, due to the "end effects".

At frequencies below 30,000 kilocycles this

effect is relatively constant, so that an electrical half wave is a fixed percentage shorter than a physical half wavelength. This percentage is approximately 5%; therefore most half wave antennas are really 95% of a half wave long. This is taken into consideration in the formula shown below. Thus a half wave antenna resonant at exactly 80 meters would be  $80 \times 1.56$ , or 124.8 feet.

Another way of saying the same thing is that a wire resonates at a wavelength of 2.1 times its length in meters.

$$\left. \begin{array}{l} \text{Wire length} \\ \text{of half wave} \\ \text{radiator, in feet} \end{array} \right\} = 1.56\lambda = \frac{467,400}{F_{kc}} = \frac{467.4}{F_{Mc}}$$

An antenna or wire in space resonates at more than one frequency. The **lowest** frequency at which it resonates is called its **fundamental** frequency, and at that frequency it is approximately a half wavelength long. A wire can have two, three, four, five or more standing waves on it and thus resonate at approximately the integral harmonics of its fundamental frequency. However, the higher harmonics are not exactly integral multiples of the lowest resonant frequency as "end effects" affect only the outer quarter waves.

Since the end effect comes in **only** at the ends, regardless of whether the antenna has its minimum resonant length or any of the longer resonant lengths, (harmonic resonance), the equivalent electrical length approaches the actual physical length more and more as the antenna length, measured in wavelengths, increases.

The following two formulas can be used to determine either the frequency or length of a wire with a given number of half waves on it. These formulas are accurate between 3000 and 30,000 kc.

$$L = \frac{492 (K-.05)}{F_{Mc}} \quad F_{Mc} = \frac{492 (K-.05)}{L}$$

Where F equals frequency in **megacycles**.  
L equals length in feet.  
K equals number of half waves on wire.

### Radiation Resistance and Antenna Impedance

A half-wave antenna is much like a tuned tank circuit. The main difference lies in the fact that the elements of inductance, capacity, and resistance are **lumped** in the tank circuit and are **distributed** throughout the

length of an antenna. The center of a half-wave radiator is effectively at ground potential, as far as r.f. voltage is concerned, although the current is highest at that point. See figure 2.

If the antenna is resonant, and it always should be for best results, the impedance at the center is a pure resistance and is termed the radiation resistance. Radiation resistance is a fictitious term used to express the power radiated by the antenna. It is the resistance which would dissipate the same amount of power that is being radiated by the antenna. The radiation resistance at the voltage node (current loop: in other words, minimum voltage and maximum current) depends on the length of the antenna and its proximity to nearby objects which either absorb or re-radiate power, such as the ground, other wires, etc.

The radiation resistance of a grounded quarter-wave antenna equals 36.57 ohms. A half-wave antenna, far from ground and other reflecting objects, has a radiation resistance at the center exactly twice as high, namely 73.14 ohms, since each half of the half-wave antenna carries the same current and radiates the same amount of energy for a given impressed voltage as does the grounded quarter-wave antenna.

As the power throughout the antenna is the same, the impedance of the antenna at any point along its length merely expresses the ratio between voltage and current at that point. Thus the lowest impedance occurs where the current is highest, namely at the center. The impedance rises uniformly toward each end. The impedance at the center of a resonant half-wave antenna is 73 ohms and at the ends, approximately 2400 ohms, **provided** the antenna is remote from ground.

When a vertical half-wave antenna is set up so that its lower end is at the ground level, the effect of the ground reflection is to increase the radiation resistance to approximately 100 ohms, instead of 73.14. When a horizontal half-wave antenna is used the radiation resistance (and of course the amount of energy radiated for a given antenna current) depends on the height of the antenna above ground, since the height determines the phase angle between the wave radiated directly in any direction and the wave which combines with it after reflection from the ground.

This variation of radiation resistance with height above ground, for a half-wave antenna, is shown in the curve of figure 3.



The radiation resistance of an antenna generally increases with length, although this increase varies up and down about a constantly increasing average. The peaks and dips are caused by the reactance of the antenna when its length does not allow it to resonate at the operating frequency.

All antennas have a certain loss resistance as well as a radiation resistance. The loss resistance defines the power lost in the antenna due to ohmic resistance of the wire, ground resistance, corona discharge, and insulator losses. The losses rarely amount to 5% of the power supplied to the antenna at the high frequencies. The losses usually go down as the frequency is raised.

All antennas should be resonated at the frequency of operation (except for certain special types of aperiodic directive arrays, such as the "diamond"). The radiation efficiency of a resonant wire is many times that of a wire which is not resonant. Thus an ungrounded antenna should always be an even multiple of a quarter wave long while a grounded antenna (Marconi) should always be an odd multiple of a quarter wave long. Note that length means **electrical** length, in this case. Short wires can be lengthened electrically by series inductive loading. Long wires can be "shortened" by about one-eighth wave length by means of a series condenser located at a voltage node.

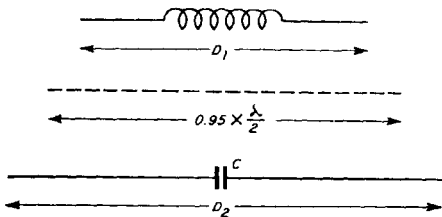


Figure 4  
Three Antennas, All Equal Electrically to One-Half Wavelength.

It is desirable to know the radiation resistance of an antenna when attempting to match a non-resonant transmission line to a resonant antenna. As the antenna end of the line must be terminated in its characteristic surge impedance in order to allow the line to operate without line radiation, it must be attached to the antenna at a point where the antenna impedance equals the line impedance.

#### Non-Resonant Line Explanation

Non-resonant transmission lines are really much simpler than might be thought from all the discussion about reflection, surge im-

pedance, velocity of propagation, etc. All it really amounts to is that, when an untuned transmission line is properly terminated, the load uses up the energy flowing down the line just as fast as it arrives at the termination. If the line were improperly terminated the load would not use up the energy as fast as it arrived, causing energy to pile up at the termination and allowing some of it to start back to the sending end of the line in the form of reflections (producing standing waves).

#### Antenna Reactance

As the voltage and the current vary uniformly in opposite directions along the length of an antenna, it is evident that there is a uniform variation in impedance to

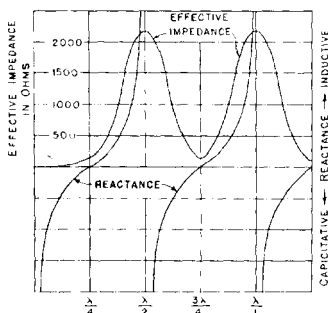


Figure 5

Effective impedance to ground from one end of a wire at a given frequency as the wire length is varied. Also showing whether reactance is capacitive or inductive for a given length.

ground along the antenna. Also, if the impedance to ground at one end of the antenna is measured as the length of the wire is varied, the result is the effective impedance curve of figure 5. As the reactance of an antenna, measured to ground at one end, varies from infinity capacitive at short antenna lengths, to zero at a length of a quarter wave, on up to infinity inductive just under a half wavelength, and infinity capacitive when the length is just slightly over the half wavelength, a feeder system must take into account both the resistance variation and the reactance variation. The curves of figure 5 show how these components vary as the length is varied from zero to one and a quarter waves. Note that the reactance curves may also be used on open-ended or resonant feeder circuits such as the zepp. feeder system.

## II. Choice of an Antenna

There are many different antenna and feeder systems possible for a given application. Some types are more desirable than others and a brief review of the underlying factors which affect the choice of an antenna for a particular purpose will be given in this chapter.

The most widely used antenna for all-around use is the simple, half-wave or dipole radiator mounted either horizontally or vertically. It can be fed in a number of ways. On the very low frequencies it may be physically impossible in some locations to erect a half-wave antenna, in which case a grounded quarter-wave or Marconi antenna can be used. The Marconi antenna also is advantageous on mobile vehicles, as its overall span is less than one-half the span required by a half-wave radiator. However, the grounded Marconi antenna is always materially less efficient than the half-wave type; so wherever possible the half-wave type should be used.

Vertical antennas are most desirable for ultra-high-frequency operation. They also are desirable for transmission at lower frequencies over extremely long distances (above 2500 miles or so). They are also preferable where a strong ground wave locally is desired.

For frequencies below 30 megacycles for long-distance general reception a horizontal antenna is more desirable than a vertical antenna. This is due to the fact that man-made noise generally creates relatively more interference in a vertical antenna, and also due to the fact that long distance signals usually arrive at the receiving antenna with horizontal polarization, regardless of the polarization of the transmitting antenna from which they were originally radiated. Thus a horizontal antenna can be expected to give somewhat better response to waves arriving with horizontal polarization. This applies only to signals which have been reflected or bent down by the ionosphere. Local signals are usually received best with an antenna whose polarization is the same as that of the transmitting antenna. However, only ultra-high-frequency signals are weak enough locally to require special polarization of the receiving antenna.

Remember that while half-wave antennas are slightly directional broadside to the wire, the directivity is quite small, so that no special precautions need be taken to aim the

antenna broadside to the direction of major reception.

Generally a horizontal half-wave antenna should be mounted a half wave above ground. Above or below this height the high-angle radiation goes up, which is undesirable for long distance work, but which may be desirable when working stations within 500 miles.

If a half-wave antenna is to be used on several higher frequency bands, it must be a compromise, as no length of wire resonates at the exact integral harmonics of its lowest resonant frequency. Thus, where possible, put up one antenna for each band. However, if one antenna is to be used on several bands, cut the antenna to formula for the highest frequency on which it is to be regularly used. For example, if one antenna is to work on 40, 20 and 10 meters, cut it as two full waves on 10 meters rather than as a half wave on 40 meters. The difference in length is approximately two feet, which is a much smaller proportionate error at 40 meters than it is at 10 meters.

### Directive Antenna Arrays

There are so many different factors affecting the choice of a directive antenna array, such as pole height, available ground space, feeder location, sharpness of the beam, reversibility, etc., that it is quite difficult to go into the required detail properly to tell the whole story.

Where the pole height is available, the broadside arrays give a lot of directivity without much ground space required. Where a lot of ground space is available but not much pole height, the "rhombic" or "diamond" antenna is very useful. The diamond is probably the most useful directive array on the basis of decibels improvement in received signal, per dollar of antenna investment. However, it does take up a lot of room. It should be noted that the gain of any directive antenna is almost directly proportional to the overall length of the antenna array.

The rather surprising gains claimed for some of the very simple amateur beam antennas must be considerably discounted. It takes a power gain of about four times to effect an improvement of one "R" in received signal and it is just not possible for two or even four half-waves to effect such a gain in power. The explanation will usually be found that the simple arrays usually have better matching of impedances through-

out the feeder system and also an improvement in the angle of vertical radiation in the favored direction may have resulted from a combination of radiators and guy wires, etc. Generally, if a simple, half-wave vertical antenna is mounted as high as possible and properly fed with a low-loss transmission line, equally good results would have been obtained in all directions.

### Feeder Systems

There is little to commend the "zepp." feeder system. For multiband use the Everitt single-wire-feeder system with the Jones modification of the tap-on point gives materially better results and is simpler than the zepp. to erect. The Collins "Multiband" system gives good results where the feeder system can be exactly the lengths specified by Collins, but the feeder system is heavy and relatively expensive, and must be rather carefully adjusted to specifications.

Where two-band operation is desired on 40 and 10, 80 and 20 or 160 and 40, either the "Double Vee" antenna or a third harmonic Johnson Q or twisted-pair-fed system allows somewhat lower transmission line losses than the single-wire-fed dipole. The single wire feed system requires a good ground connection to the final amplifier chassis as the return is through ground.

The two-wire spaced untuned line has somewhat lower losses than the twisted-pair type of line. This effect is more noticeable as the frequency is raised. Probably on 160 and 80 meters the difference between a spaced two-wire line and a twisted-pair line would be too small to be noticed, particularly if the line length were under 150 feet. However, on the higher frequencies

and for longer lines, try to use the two-wire line with an impedance-matching network between the line and the antenna.

The antenna impedance can be matched to the line impedance by many methods. There is the linear quarter-wave matching section (Q Bars), the J section, the T section, the Y match method, and the capacity-loaded antenna method. All are discussed in detail later on. Where the antenna must be fed at one end, the J matching system is about the only one that is recommended. Where the antenna can be fed at the center (high current point) any of the other matching systems give equally good results when properly operated. However, the simplest to put into operation is probably the Johnson Q or R.M.E. type of antenna, which uses the quarter-wave matching bars. This type of matching system is also widely used in commercial directive arrays.

There is nothing that the operator can do at the station end of a transmission line to remove standing waves or correct an impedance mismatch between the antenna and the line. This point is often overlooked. There is no such thing as an impedance mismatch at the station end between the line and the transmitter. A mismatch of impedances involves radiation loss. If the impedance transformation between the line and the plate circuit of the final amplifier is not right, there will be no radiation or dissipation of power at that point. The power simply will not be generated by the final amplifier unless the impedance into which the final amplifier tube "looks into" is right for the conditions under which that particular tube is operated.



### III. Methods of Feeding Antennas

#### The End-Fed Antenna

The end-fed antenna usually has no form of transmission line to couple the antenna to the transmitter, but brings the radiating portion of the antenna right down to the transmitter where some form of direct coupling is used to transfer energy to the antenna.

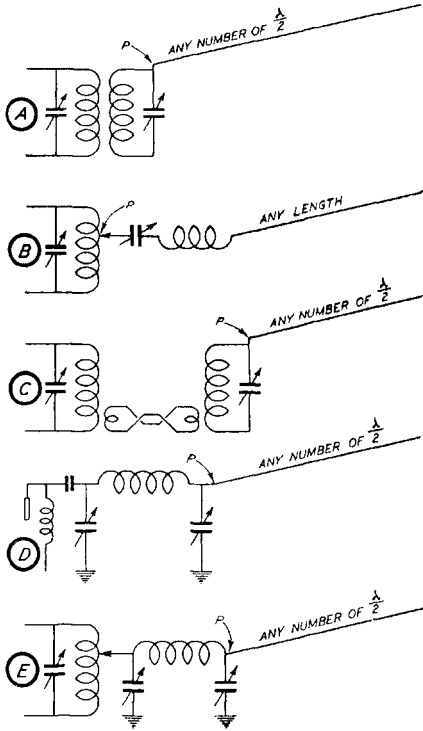


Figure 1  
Several Methods of End-Feeding an Antenna.

The end-fed Hertz antenna is always voltage fed and always consists of an even number of quarter wavelengths. There has been considerable reference to end fed, **current fed** Hertz antennas but it should be pointed out that they are neither end-fed nor Hertz antennas, being Marconi antennas fed somewhere above the ground end. Figure 1 shows several common methods of feeding the end-fed antenna.

This type of antenna has rather high losses unless the operating room is in a wooden building and is several stories above the street level. As there is high r.f. voltage at the point where the antenna enters the op-

erating room, the insulation at that point should be several times as effective as the insulation commonly used with low-voltage feeder systems. This antenna can be operated on all of its higher harmonics with equal efficiency as it can always be resonated to the exact transmitter frequency.

A neon bulb should be used to check the operation of this antenna by touching it to the antenna system at the point marked P. When the system is operating as an end-fed Hertz the neon bulb will always glow brightly showing high voltage at that point. If the neon bulb does not glow brightly the antenna is being current fed and is probably operating as a Marconi, or quarter-wave Hertz. The only disadvantage of operation as a Marconi antenna is that the losses are somewhat higher unless an exceptionally low resistance ground connection is used.

The antenna shown in figure 1 B is the best of the end-fed Hertz antennas as it can be any length and still be made to resonate. The most important point about tuning up the end-fed Hertz is that in the arrangements shown in figure 1 A, B, D, and E the plate tank must be tuned to resonance with the antenna disconnected. Then when the antenna is connected the tuning of the plate tank must not be changed. Always use the loosest amount of coupling to the load that allows the final amplifier to draw proper plate input.

#### The Marconi Antenna

The Marconi antenna, or grounded quarter-wave Hertz as it is more properly called, is widely used on the 160 meter band due to the fact that a half wave at that low frequency is around 260 feet long, which is out of the question for most city dwellers confined to an ordinary city lot. It is also widely used in mobile five meter applications. The use of the Marconi type of antenna allows the use of something less than half of the length of wire used for a half-wave Hertz radiator. The Marconi antenna is not as satisfactory for long distance communication as the Hertz type, and the antenna efficiency is never as great due to the losses in the ground connection.

The fundamental Marconi antenna is shown in figure 2, and all Marconi antennas differ from these only in the method of feeding energy to them. Antenna A in figure 3 is the fundamental vertical type.

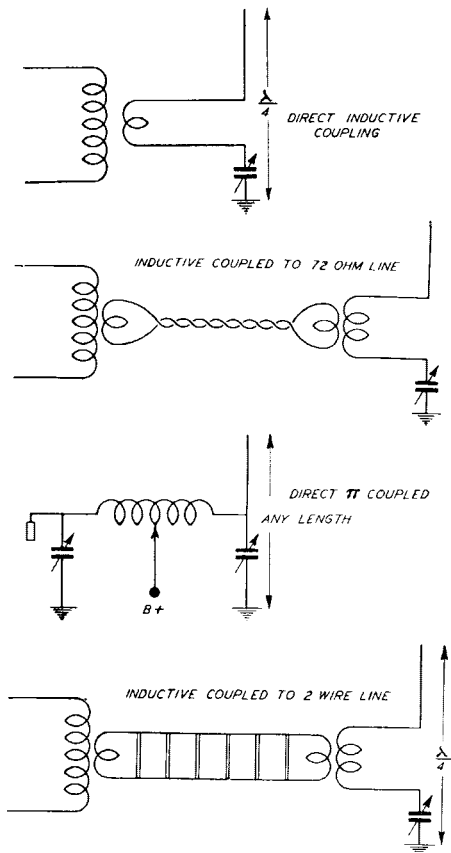


Figure 2  
Four Ways to Feed a Marconi Antenna (Grounded).

Type B is the "inverted L" type; type C is the "T type" with the two halves of the top portion of the T effectively in parallel. Type D is really the same as type B and is an inverted L type with a counterpoise acting as ground. Only about half of the length of the counterpoise acts as antenna length in type D. This point is seen more clearly in type E where the counterpoise adds practically no electrical length to the vertical wire, especially if the counterpoise is close to the ground. The lower the counterpoise the better. About eight feet is a good height as it is just high enough to clear the head of anyone walking under it in the dark. The counterpoise has very little r.f. voltage to ground but it should be insulated from ground. The more wires in the counterpoise the better, as the object of a good counterpoise is to have high capacity to ground.

The length of a Marconi antenna is not critical because the usual methods of feed-

ing power to it also tune it to resonance. The length of an unloaded Marconi antenna can be calculated by the following formulas:

$$L \text{ feet} = \frac{233}{F_{me}} = \frac{233,000}{F_{kc}} = 0.78 \times \text{Wave-length in meters}$$

Note that the length must include the ground connection, or about half of the counterpoise.

The Marconi antenna should be as **high as possible**, and too much attention cannot be paid to getting a **good ground**. Burying copper pipe or old washboilers as deep as possible in moistened soil helps a great deal. Driving six-foot pipes into the ground at several points on the edge of a 100 foot circle around the center of the antenna and connecting all the pipes to heavy, soldered ground wires brought back to the operating room is very much worth while.

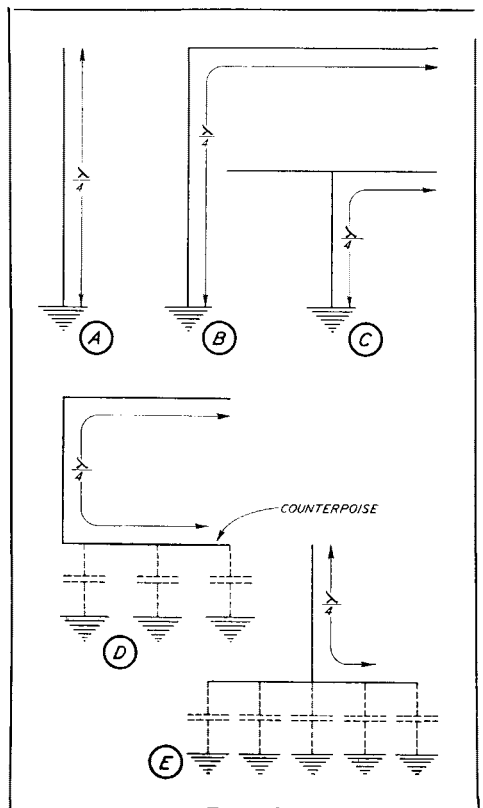
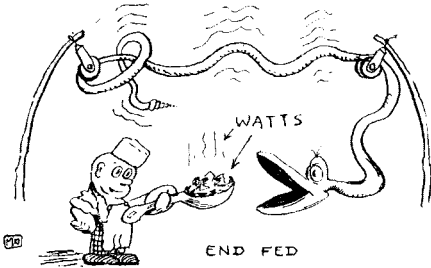


Figure 3  
Variations of the Marconi Type Antenna (Grounded and Capacity Grounded)

## Transmission Lines and Resonant Feeders

Any antenna may be fed directly by attaching it to the proper point or points on the plate tank of the final amplifier of the transmitter. This involves either bringing the antenna into the station or else mounting the transmitter up in the air. Usually it is more desirable to utilize some form of non-radiating transmission line to carry energy with as little loss as possible from the transmitter to the radiating portion of the antenna. There are many different kinds of transmission lines and generally speak-



ing practically any type of transmission line or feeder system can be used with any type of antenna.

Transmission lines are of two general types: resonant and non-resonant. Strictly speaking, the term **transmission line** should really only be applied to a **non-resonant** line. A **resonant** line should be termed a **feeder** system, such as Zepp. feeders, etc. A resonant line is really not a line at all but is merely part of the antenna folded back on itself so as to minimize undesired radiation.

The principal types of resonant feeders are Zepp. feeders and the Collins Multiband antenna feeders. The principal types of non-resonant transmission lines include the single-wire-feed, the two-wire matched impedance, the coaxial concentric feed line, and the four-wire matched impedance line.

### Current Feed and Voltage Feed

A half-wave Hertz antenna has high voltage and low current at each end, and it has low voltage and high current at its center. As any ungrounded resonant antenna consists merely of one or more half-wave antennas placed end to end, it will be seen that there will be points of high r.f. voltage every half-wave of length measured from either end of the antenna. Also there will be a point of high r.f. current half way between any two adjacent high voltage points. A voltage-fed antenna is any antenna which is excited at one of these high volt-

age points, or in other words, a point of high impedance. Likewise a current-fed antenna is one excited at a point along the antenna where the current is high and the voltage low, which corresponds to a point of low impedance.

## THE ZEPPEL ANTENNA SYSTEM

The Zepp. antenna system is very widely used due to the fact that it is rather easy to tune up and can be used on several bands by merely retuning the feeders. The overall efficiency of the Zepp. antenna system is probably not as high as some of the antenna systems which employ non-resonant transmission lines, but where space is limited and where operation on more than one band is desired, the Zepp. has some decided advantages. Zepp. feeders really consist of an additional length of antenna which is folded back on itself so that the radiation from the two halves cancels out. In figure 4 A is shown a simple Hertz antenna fed at the center by means of a pickup coil. Figure 4 B shows another half-wave radiator tied directly on one end of the radiator shown in figure 4 A. Figure 4 C is exactly the same thing except that the first half-wave rad-

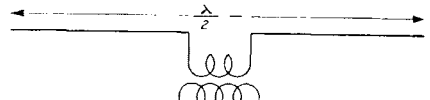


Figure 4 A  
Radiator One-Half Wave Long Electrically.

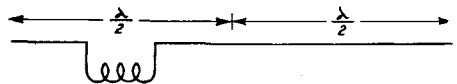


Figure 4 B  
Second Half Wave Added.

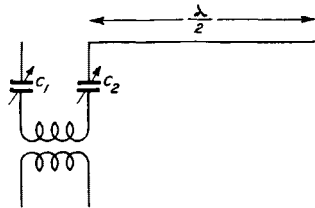


Figure 4 C  
First Half Wave Folded Back on Itself to Form a "Zepp" System,  $C_1$  and  $C_2$  Added for Tuning Adjustment.

iator in which is located the coupling coil has been folded back on itself, and therefore becomes a Zepp. feeder. Note that in this particular case each half of the folded part of the antenna is exactly a quarter-wave long electrically.

Naturally the addition of the coupling coil will lengthen the antenna, electrically, and thus in order to bring this portion of the antenna back to resonance we must electrically shorten it by means of the two series tuning condensers  $C_1$  and  $C_2$ . The two wires in the folded portion of the antenna system do not have to be exactly a quarter wave long physically, although the total electrical length of the folded portion plus the pickup coil and minus the tuning condensers, if series tuning is used, must be equal to one-half wavelength electrically.

If the total electrical length of the two feeder wires plus the coupling coil is slightly greater than any odd multiple of one half wave, then series condensers must be used to shorten the electrical length of the feeders sufficiently to establish resonance. If, on the other hand, the electrical length of the feeders and the coupling coil is slightly less than any odd multiple of one half wave, then parallel tuning must be used, wherein a condenser is shunted across the coupling

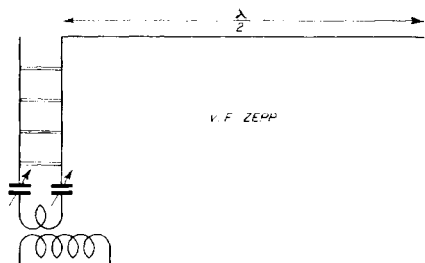


Figure 5  
The "Voltage-Fed" Zepp. (Compare Figure 6).

coil in order to increase the electrical length of the whole feeder system to a multiple of one-half wave length.

As the radiating portion of the Zepp. antenna system must always be some multiple of a half wave long, there is always high voltage present at the point where the live Zepp. feeder attaches to the end of the radiating portion of the antenna. See figure 5. Thus this type of Zepp. antenna system is often termed the **voltage-fed Zepp**. As the floating feeder is not attached to anything it is very difficult to balance properly this type of antenna. When this feeder system is adjusted for equal current in each feeder it is usually found that there is not exactly 180 degrees of phase shift between the two feeders. On the other hand, when the system is tuned for exactly 180 degrees of phase shift, it will then be usually found that the currents in the two feeders are not exactly equal.

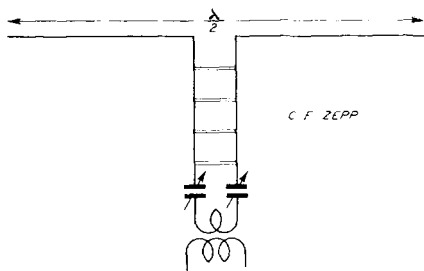


Figure 6  
The Center-Fed Zepp, Giving Better Balance. (Also Known as "Current-Fed").

### Center or Current-Fed Zepp.

This type of Zepp. antenna system is shown in figure 6. It is a current-fed system on the lowest frequency for which it will operate, but becomes a voltage fed system on all its even harmonics. See figure 7. Each half of the radiating portion of the antenna should be a quarter wave long at the lowest frequency of operation. Thus when operating on its lowest, or fundamental frequency, the feeders are attached to the radiating portion of the antenna at a point of high current, but low voltage. As it is desirable always to place the coupling coil in a Zepp. feeder system at a point of high current and minimum voltage in order to re-

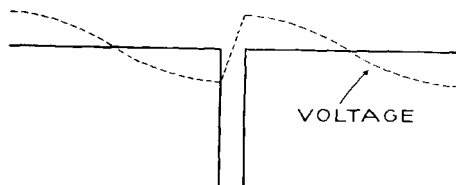


Figure 7  
Voltage Distribution of the "Double Zepp" Broadside Radiator (Two Half Waves in Phase) Shown in Figure 8.

duce radio frequency fields inside the operating room, certain precautions must be taken in operating a center-fed Zepp. system. When operating on its second, or higher, harmonics the feeder length and tuning arrangement are exactly the same as with the more common voltage (or "end") fed Zepp. shown above in figure 5.

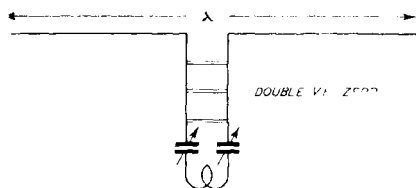


Figure 8  
The "Double Zepp." See Figure 7.

### Zepp. Feeder Table

Feeder Length	Voltage Fed	Current Fed
$\frac{\lambda}{8}$	Parallel	Series
$\frac{3\lambda}{8}$	Series	Parallel
$\frac{5\lambda}{8}$	Parallel	Series
$\frac{7\lambda}{8}$	Series	Parallel
$\frac{9\lambda}{8}$	Parallel	Series
$\frac{11\lambda}{8}$	Series	Parallel

The feeders can be shortened from the lengths shown up to about 10% of a half wave at the operating frequency without changing the tuning system. Feeder spacing is not critical, 6" being about average. Spacing may be decreased at the higher frequencies, and vice versa.

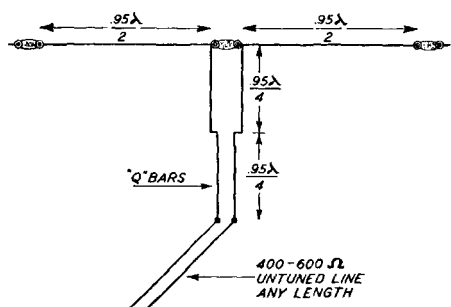


Figure 8 A  
Feeding the Double Zepp. with an Untuned Line by Means of "Q" Bars. (See page 18.)

### The Collins Multiband Antenna System

The Collins Multiband Antenna System is a special type of center-fed Zepp. using copper tubing as the resonant feeders in order to minimize the losses inherent in this type of feeder. The simplest type of multiband antenna, known as the Type A, consists of a half-wave radiator at the lowest desired frequency, plus two copper tubing feeders which are each exactly a quarter wave long. See figure 9. As the feeders are exactly the right length to make them resonant at the operating frequency and all its even harmonics, the station end of the feeders acts like a pure resistance (without any reactive components) and thus no loading coils or condensers are needed at

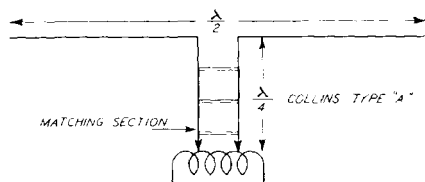


Figure 9  
The Type A "Multiband" Antenna System (Center-fed Zepp. with Special Feeders).

the station end to tune this system. The nominal input impedance is twelve hundred ohms on all bands. Thus there is high voltage at the station end which, though generally undesirable, is satisfactory in the Collins version of the center-fed Zepp. due to the special construction of the feeders. The main advantage of the Collins feeder system over the conventional center-fed Zepp. lies in the fact that the characteristic impedance of the feeders instead of being 600 ohms, as in the usual Zepp. antenna with 6 inch feeder spacing, is 300 ohms in the Collins version. This has a very marked advantage in that the input resistance of the feeders never goes above approximately 1200 ohms instead of the 5000 ohms it would become under certain conditions when using the conventional feeders with six inch spacing. The radiation resistance at the center of a half-wave Hertz antenna is 75 ohms on its fundamental frequency and approximately 1200 on all of its even harmonics. The geometric mean between 75 and 1200 ohms is 300 ohms, which is the ideal characteristic impedance of the feeders for a minimum of standing waves. The standing waves are not eliminated from the line due to the fact that there is always an impedance mismatch between the feeders and the antenna, but as the feeders are particularly designed for



low losses, the actual measured efficiency of the feeders runs about 97% for moderate lengths. The design formulas for the type A Collins multiband antenna are as follows:

$$\begin{aligned} \text{Antenna length} &= \frac{(K-.05) 492,000}{f_{kc}} \\ &\text{in feet} \\ \text{Feeder length} &= \frac{234,000 M}{f_{kc}} \\ &\text{in feet} \end{aligned}$$

Where

K = number of half wave lengths desired.

$f_{kc}$  = frequency in kilocycles.

M = number quarter wave lengths desired.

Several different models of such an antenna system are possible and Table I shows representative combinations designed for use on amateur bands. In each of the arrangements shown in Table I the length of the multiband transmission line is so chosen that the reactance at the transmitter end is negligible and the line can be coupled to the output tank circuit of the transmitter by a simple pickup coil. An impedance matching network need not be used provided the number of turns in the pickup coil is continuously adjustable. The feeders can be tapped on each side of a split plate tank through .002  $\mu\text{mf}$ . blocking condensers. Figures B, E, J, K, O, and Q on pages 35 and 36 show different methods of coupling the Collins feeders to various types of plate tanks.

In cases when it is not convenient to use a transmission line as long as is shown in Table I it is, of course, entirely practicable to reduce the length of the line to a convenient value and build out the equivalent electrical length by inserting an impedance matching network between the transmitter and the line. When such a network is used the line can be made any length, and then

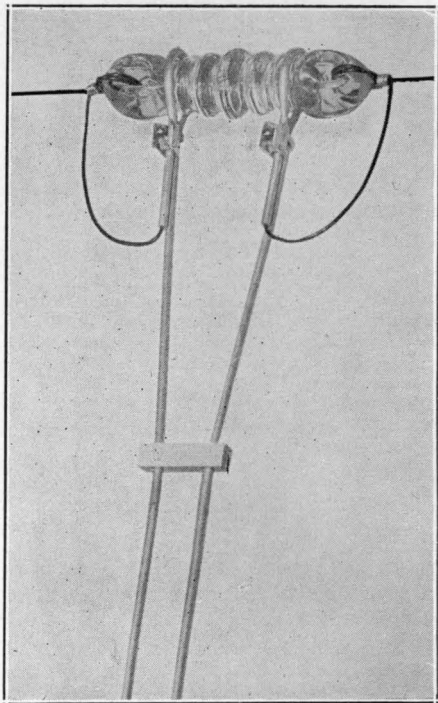


Figure 10  
Showing how the "Multiband" line is connected to the antenna.

the only important dimension is the antenna itself. The only precaution which must be observed is that the transmission line should not be  $\frac{1}{8}$ ,  $\frac{3}{8}$ ,  $\frac{5}{8}$ , etc. wave length long at any of the operating frequencies. If the line happens to be cut to a length equivalent to an odd number of  $\frac{1}{8}$  wave lengths, trouble may be encountered due to the network transmitting not only the fundamental fre-

TABLE I  
MULTIBAND ANTENNA SYSTEM DATA

Model	A	B	C	D	E	F	G
Antenna Length—Feet	136	136	275.5	250	67	67	103
Feeder Length—Feet	66	115	99	122	65	98	82.5
Frequency Range Mc.	3.5- 4.0 7.0- 7.3 14.0-14.4	3.7- 4.0 14.0-14.4	1.7- 2.0 3.5- 4.0 7.0- 7.3 14.0-14.4	1.7-2.0 3.7-4.0	7.0- 7.3 14.0-14.4 28.0-29.0	7.0- 7.3 14.0-14.4 28.0-29.0	3.7- 4.0 7.0- 7.3 14.0-14.4
Nominal Input Impedance	1200 ohms All Bands	75 ohms All Bands	1200 ohms 1.7, 3.5, 14 Mc. 75 ohms 7 Mc.	1200 ohms All Bands	75 ohms 7 Mc. 1200 ohms 14 Mc. 28 Mc.	1200 ohms All Bands	1200 ohms All Bands

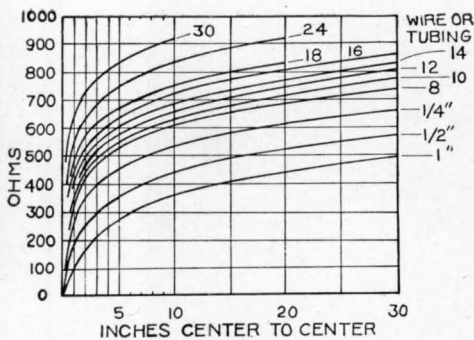


Figure 11

Conductor and Spacing Versus Line Impedance.

quency but also harmonic frequencies. This difficulty can be overcome by proper adjustment of the impedance matching network, but in general it is better to avoid these specific lengths.

Table I can be used directly for designing multiband antennas for amateur use. It will be noticed that the antenna lengths shown are an even number of one-quarter wave lengths long at the lowest and highest frequencies. In the case of antennas for 14,000 kc. and 4,000 kc. operation the frequencies are not harmonically related, but the lengths are chosen for the highest frequency, and they are also approximately right for the lower frequency where small variations in length do not represent very large percentages of a wave length.

In designing similar systems for other groups of frequencies, the antenna length should be  $(k-.05) 492,000/f$  ft. where  $f$  is the frequency in kilocycles and  $k$  is the number of half-wave lengths. Thus, for two or more frequencies integral values of  $k$  should be chosen to give approximately the same length and the exact length should be that for the highest frequency.

For example, consider a model A antenna. At 14,300 kc. and  $k=4$  (a two wave length antenna) the length is 136 feet. This length is also correct for  $f=7,050$  and  $k=2$  or  $f=3440$  and  $k=1$ . The frequency range of the amateur bands may be tolerated by this length even though the transmission line be terminated in an antenna impedance not a pure resistance.

The feeder length should be determined by the relation  $234,000/m/f$  feet where  $f$  is the frequency in kilocycles and  $m$  is the number of quarter wave lengths. That is, the 66 ft. feeder of model A antenna is one wave length at 14,200 kc., a half-wave length at 7,100 kc., and one-quarter at 3,550 kc.

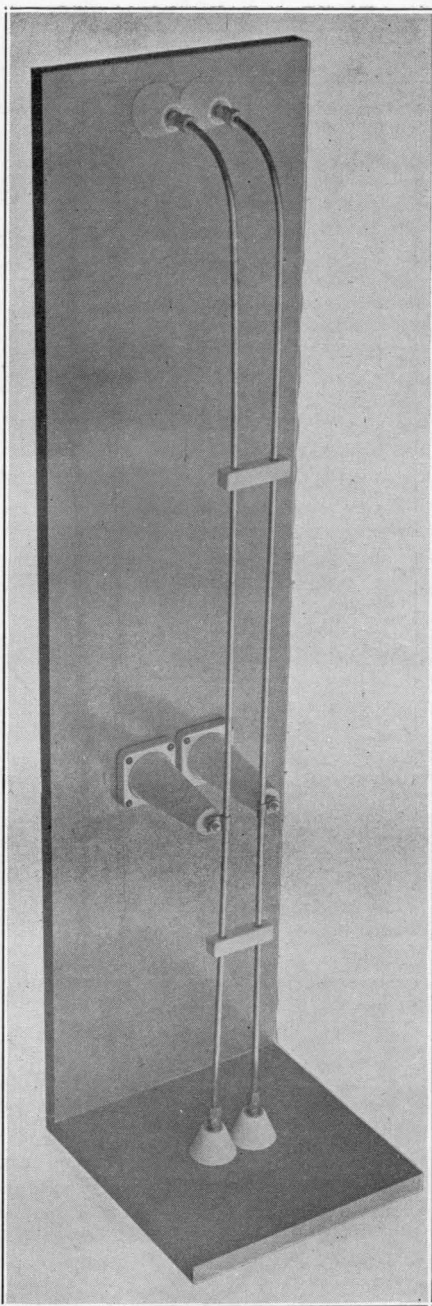
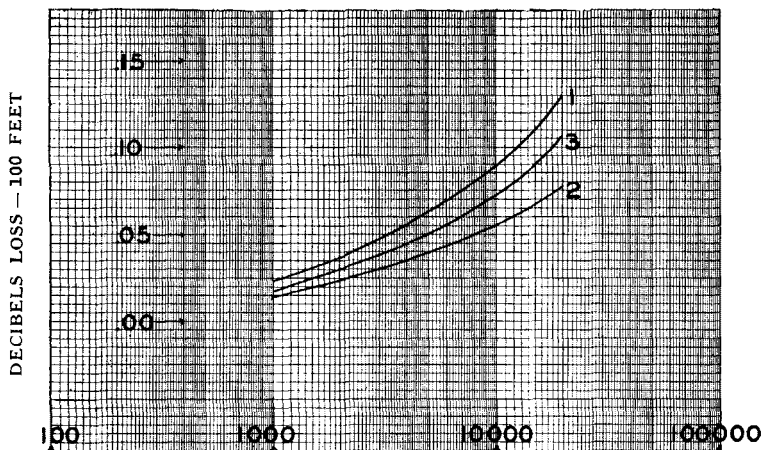


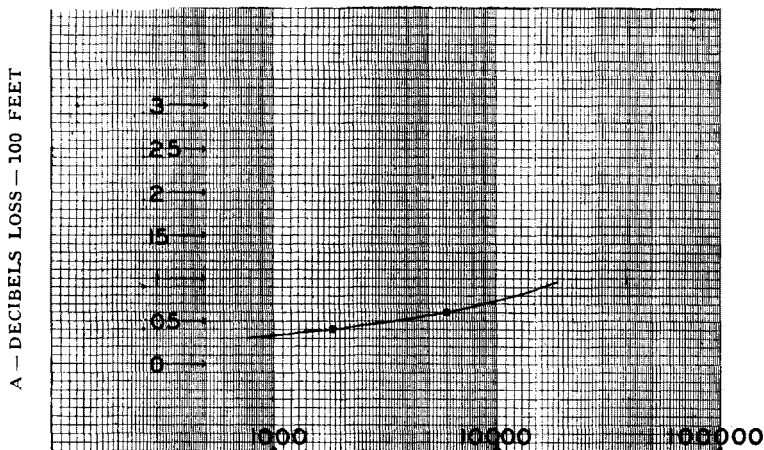
Figure 12

The constructional model illustrated above shows the manner of assembly. The spacers hold the  $1/4$  seamless copper tubing rigidly at  $1 1/2$  inch spacing. The stand-off insulators and feed-through insulators facilitate installation. Oil-impregnated wood spacers may be used in amateur multiband installations.



FREQUENCY — KILOCYCLES PER SECOND  
**LOSS VERSUS FREQUENCY (COMPUTED LOSS PLUS 50%)**

- 1—No. 12 hard drawn copper spaced 6" (Z equals 600)
- 2— $\frac{1}{4}$ " copper tubing spaced  $1\frac{1}{2}$ " (Z equals 300)
- 3— $\frac{1}{4}$ " aluminum tubing spaced  $1\frac{1}{2}$ " (Z equals 300)



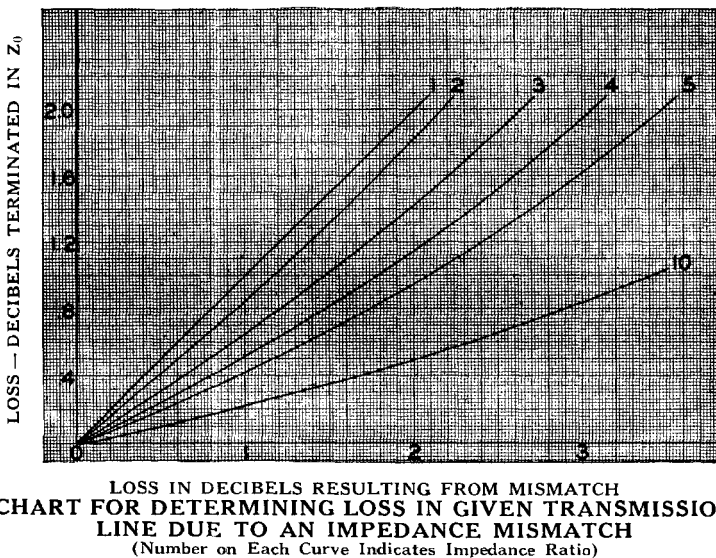
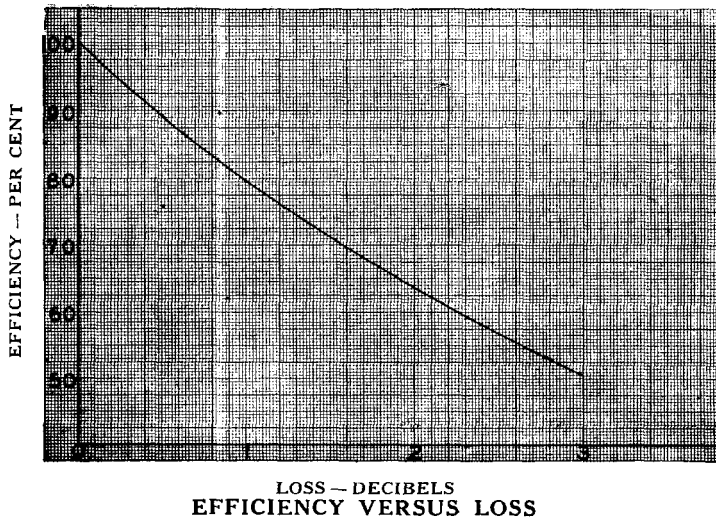
FREQUENCY — KILOCYCLES PER SECOND  
**LOSS VERSUS FREQUENCY**

- (Measured Loss)  
 $\frac{1}{4}$ " COPPER TUBING SPACED  $1\frac{1}{2}$ ". (Z EQUALS 300 OHMS)  
 Velocity of Propagation Equals 95% of Free Space  
 (Z = Surge Impedance of Line)

A slight variation from the above procedure is indicated in Model G. In this antenna the length of 103 feet is  $1\frac{1}{2}$  wave lengths at 14,100 kc. and approximately  $\frac{3}{4}$  and  $\frac{3}{8}$  wave lengths on the 40 and 80 meter bands. The feeder length of 82.5 feet is  $1\frac{1}{4}$  wave lengths at 14,200 kc. and approximately  $\frac{5}{8}$  and  $\frac{5}{16}$  wave lengths at the 40 and 80 meter bands. That is, on 40 and 80 meters the transmission line is terminated in an impedance largely reactive but is of such length that the impedance at the input to

the transmission line is approximately a pure resistance. The loss in the transmission line is slightly larger under this condition, but this antenna may be used successfully where space is a factor.

Many amateurs are using so-called "Zeppelin" antennas rather than antennas fed at the center because their transmitters happen to be located nearer the end than the center of the antenna and the transmission line is shorter if it is connected to the end of the radiator. The Zeppelin antenna is an



inherently unbalanced system (Zeppelin feeders balanced for equal currents are not balanced for equal phase and vice-versa) and a considerable portion of the energy is unavoidably radiated from the feeders, which radiation may or may not be useful for transmission. The multiband system just described should receive preference over the Zeppelin arrangement even if the transmitter is close to one end of the antenna, because the additional loss introduced by running the transmission line horizontally to a point under the center of the antenna, then vertically to the antenna itself will be

entirely negligible, and probably will be considerably less than the loss in Zeppelin feeders. The multiband feeders are readily supported from suitable stand-off insulators and can be carried around corners by making bends having a minimum radius of about 10 inches. It is entirely feasible to double back the line in trombone fashion, if desired, to obtain a length which will obviate the use of an impedance matching network.

The type B Collins two-band antenna (see table on page 12) is particularly interesting to the phone man due to the fact that the nominal input impedance of the feeders is

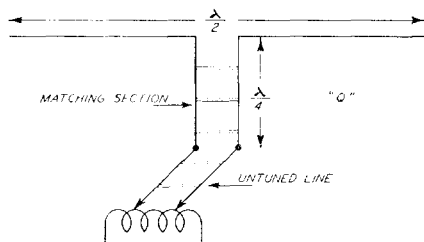
Frequency in kilocycles	Quarter wave feeder section	Half-wave radiator
3500	66' 10"	133' 7"
3600	64' 11"	129' 10"
3700	63' 2"	126' 4"
3800	61' 6"	123'
3900	59' 11"	119' 10"
3950	59' 2"	118' 4"
4000	58' 5"	116' 10"
7000	33' 5"	66' 9"
7050	33' 2"	66' 4"
7100	32' 11"	65' 10"
7150	32' 9"	65' 4"
7200	32' 6"	64' 11"
7250	32' 3"	64' 6"
7300	32'	64'
14,000	16' 9"	33' 5"
14,100	16' 7"	33' 2"
14,200	16' 5"	32' 11"
14,300	16' 4"	32' 9"
14,400	16' 3"	32' 6"
28,000	100'	16' 8.5"
28,500	98.4"	16' 5"
29,000	96.5"	16' 1.5"
29,500	94.8"	15' 10.5"
30,000	93"	15' 7.5"
56,000	50"	100"
57,000	49.2"	98.4"
58,000	48.3"	96.5"
59,000	47.4"	94.8"
60,000	46.5"	93"

**Length Versus Frequency Table for Johnson Q and Collins Multiband Antenna Systems.**

75 ohms on both bands. Thus, if it is not convenient to bring the lower end of the feeders directly in the operating room, a twisted pair transmission line can be attached to the lower end of the feeders and then run any reasonable distance back to the operating room. This particular application of the "Multiband" antenna brings out very strongly its resemblance to the "Johnson Q" antenna, except for the fact the "Q" antenna is useful only on one band.

### The Linear Transformer

Every quarter wave Zepp. feeder acts as an impedance matching transformer, and an understanding of this method of impedance transformation serves to explain the theory of operation of the Collins Multiband antenna and the Johnson Q antenna. It is possible to construct a wide variety of quarter-



**Figure 13**  
**The Johnson Q Antenna.**

wave Zepp. feeders all of which may be resonant to the same frequency but which differ in the wire size and the wire spacing used. Upon the wire size and the wire spacing depends what is known as the average, characteristic surge impedance of the particular resonant, quarter-wave matching section (matching transformer or Zepp. feeder; call it what you will). Let us take for example a quarter-wave Zepp. feeder consisting of no. 12 wire spaced six inches, which happens to have a surge impedance of 600 ohms. Let the far end be terminated with a pure resistance and let the near end be fed with radio frequency energy at the frequency for which each feeder is a quarter wavelength long. If an impedance measuring set is used to measure the impedance at the near end while the impedance at the far end is varied, an interesting relationship between the 600 ohm characteristic surge impedance of this particular quarter wave matching line and the impedance at the two ends will be discovered. When the impedance at the far end of the line is the same as the characteristic surge impedance in the line itself (600 ohms) the impedance measured at the near end of the quarter wave line will also be found to be 600 ohms.

Incidentally, the line, under these conditions, would not have any standing waves on it, due to the fact that it is terminated in its characteristic impedance. Now let the resistance at the far end of the line be doubled or changed to 1200 ohms. The impedance measured at the near end of the line will be found to have been cut in half and

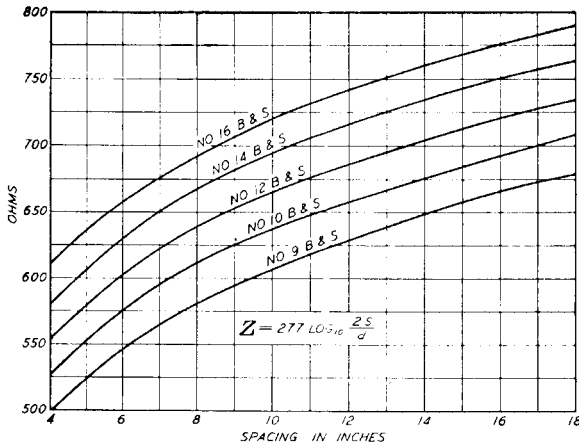


Figure 14  
 Characteristic Surge Impedance for Open Wire Lines of Various Spacings and Conductors. For Q Bars see Figure 11.

is now 300 ohms. If the resistance at the far end is made half the original value of 600 ohms, or 300 ohms, the impedance at the near end doubles the original value of 600 ohms and becomes 1200 ohms. Therefore as one resistance goes up the other goes down proportionately. It will always be found that the characteristic surge impedance of the quarter-wave matching line is the geometric mean between the impedances at both ends. This relationship is shown by the following formula:

$$Z_{MC} = \sqrt{Z_A Z_L}$$

where

$Z_{MC}$  = Impedance of matching section.

$Z_A$  = Antenna resistance.

$Z_L$  = Line impedance.

#### The Johnson Q Antenna

The above formula is used in determining the proper spacing for the quarter-wave tubes used in the Johnson Q antenna. When the Q is used as a half-wave Hertz antenna, the spacing of the aluminum tubes which comprise the quarter wave matching transformer should be such that the **characteristic surge impedance equals the geometric mean between the radiation resistance of the antenna and the characteristic surge impedance of the non-resonant line** which conveys r.f. energy from the transmitter to the station end of the quarter wave matching transformer.

The standard form of the Johnson "Q" is shown in figure 13.

Figures 11 and 14 show in graphical form the characteristic impedance of several com-

mon transmission lines or matching transformers. From these curves can be determined the characteristic impedance of the particular type of non-resonant line that is to be used between the station and the Johnson Q matching section. Then by putting this value of surge impedance and the radiation resistance in the formula shown above the geometric mean of these two values can be determined. This geometric mean is the required value of characteristic surge impedance for the quarter wave matching section and again, from the graph of figure 11 the proper spacing for the tubing used in the

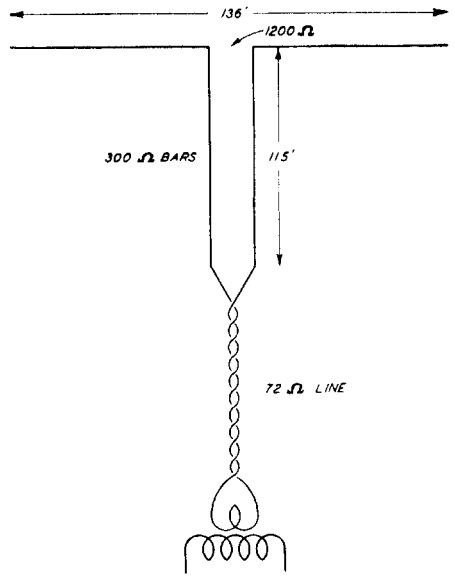


Figure 15  
 Collins Type B Multiband Antenna Fed with Twisted Pair (Any Length). Useful on Both 20 and 80 Meters. See Table 1, Page 12.

matching section can be determined. While it is generally assumed that the radiation resistance of a half wave antenna measured at its center is 72 ohms, this value assumes the presence of no nearby objects and that the antenna is either exactly a half wave high or is remote from the earth. As a practical matter the radiation resistance of an antenna can depart quite widely from its assumed value of 72 ohms for a half-wave Hertz, and there is no simple and accurate means of measuring the actual

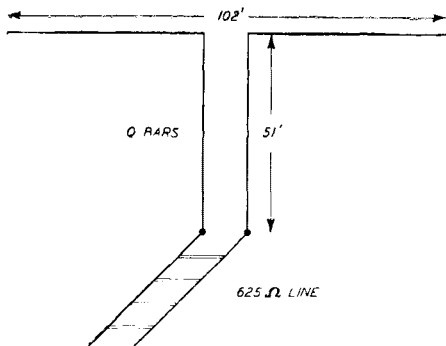


Figure 16  
Special Two-Band Q Antenna, 3.8 to 4.0  
Mc. and 14.0 to 14.4 Mc.

radiation resistance. Thus, from a theoretical standpoint, the Johnson Q and the Collins Multiband antennas are highly efficient, but as a matter of practice considerable cut and try variations from theory are necessary to obtain maximum performance from these antennas. However, 15% variation in spacing of the matching section causes little loss.

Another useful type of Q antenna is shown in figure 16. It operates on two bands, 3.8 to 4.0 Mc. and 14.0 to 14.4 Mc.

#### Non-Resonant or Untuned Transmission Lines

The tuned transmission lines used in Zepp antenna systems do not have an even distribution of voltage and current on them, due to the presence of standing waves. Thus in order to operate properly, the electrical length of a resonant transmission line is quite critical. In the non-resonant transmission line there is a smooth and even distribution of voltage and current along the line and the line length can be anything up to several thousand feet without material loss of energy. The only critical characteristic about the untuned line is its termination at the antenna end. It is the reflection from the antenna end which starts waves moving back toward the transmitter end. When waves moving in both directions along a conductor meet, standing waves are set up.

All transmission lines have distributed inductance, capacity and resistance. Neglecting the resistance, as it is of minor importance in short lines, it is found that the inductance and capacity per unit length determine the characteristic, or surge impedance of the line. When any transmission line is terminated in an impedance equal to its surge impedance, reflection of

energy does not occur and no standing waves are present. When the load termination is exactly the same as the line impedance it simply means that the load takes energy from the line just as fast as the line delivers it, no slower and no faster. Thus for proper operation (with standing waves and associated losses eliminated) some form of impedance-matching arrangement must be used between the transmission line and the antenna, so that the radiation resistance of the antenna is reflected back into the line as an impedance equal to the line impedance.

The use of a linear transformer in the Johnson Q and the Collins Multiband antennas, and the quarter-wave stub section in the J and T types of matched-impedance antennas act as the means of transforming the antenna resistance into the equivalent of the line impedance. Remember that the radiation resistance of a half-wave antenna varies from 73 to 2400 ohms, measuring out from the center to each end. As most commonly-used lines have a characteristic impedance of between 400 and 600 ohms (excepting the twisted pair and the concentric lines, which will be discussed later), matching a line to an antenna is not a simple matter. If the line is to be directly attached to the antenna, it must be attached at a point where the antenna impedance is the same as the line impedance.

#### The Two-Wire Open Line

As the impedance of a line depends on its distributed inductance and capacity,

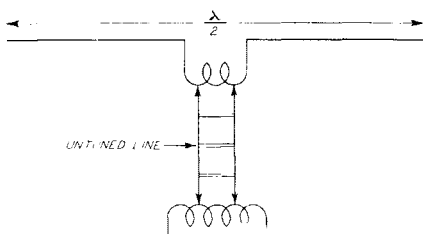


Figure 17  
One of Many Possible Methods of Coupling  
an Untuned, Open-Wire Line.

which are functions of the wire size and spacing, the impedance may be obtained directly from the following formula.

$$Z_s = 277 \log_{10} \frac{S}{R}$$

Where:  $Z_s$  is the characteristic impedance of the line,  $S$  is the wire spacing, and  $R$  is the radius of the wire (one half of the diameter of the wire). Note that  $R$  and  $S$  can be in any units as long as the same units



of measurement are used in both cases. What is required is the **ratio** between the two, not their actual absolute measurements.

The chart shown in figure 14 on page 21 shows line impedance against conductor spacing for several commonly used wire sizes. Figure 17 shows one way of using an untuned two-wire line to couple the transmitter to the antenna.

### The Coaxial (Concentric) Line

The characteristic impedance of a coaxial (concentric) line may be determined from the formula

$$Z_s = 138.5 \log \frac{R_o}{R_i}$$

Where:  $Z_s$  is the line impedance,  $R_o$  is the inside radius of the outer tube, and  $R_i$  is the outside radius of the inside tube.

Short lengths of concentric line may be constructed by stringing glass beads on no. 12 wire, crimping them into position, and threading through quarter-inch copper tubing.

### The Twisted Pair Untuned Line

The recent development of low-loss, low-impedance transmission cable for use at the high frequencies (such as EO1) allows a very flexible transmission line system to be used to convey energy to the antenna from the transmitter. The low-loss construction is largely due to the use of low-loss insulation plus a good grade of weatherproof covering. The older twisted flex cables used by amateurs had quite high losses and should be avoided. Generally avoid stranded cable at the high frequencies, as solid conductors usually have less r.f. resistance.

A twisted-pair line should always be used as an untuned line, as standing waves on the line will produce excessive losses and can easily break down the line insulation.

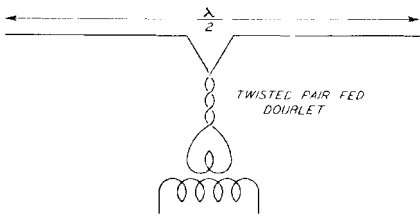


Figure 18

Half-Wave Doublet Fed with 72 Ohm Twisted Cable.

The radiation from twisted-pair lines, for a given slight amount of reflection loss, is much less than for a two-wire 600 ohm line with the same amount of reflection. However, the resistance and dielectric losses in the twisted-pair line run considerably higher

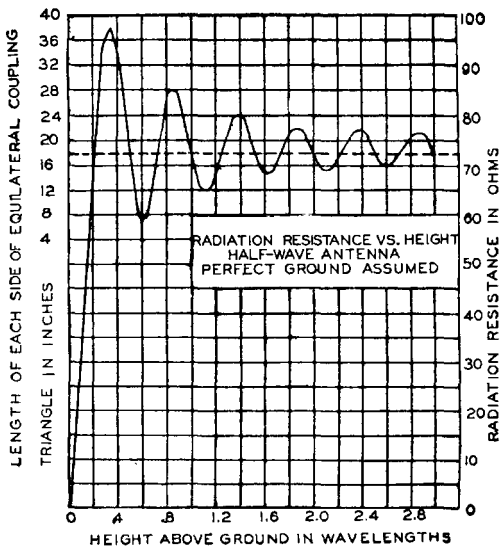


Figure 19  
Height of Radiator (Half Wave) Versus Radiation Resistance. Triangle Size Correct for 80 Meter (3.7 Mc.) Band. Divide by 2 for 40 Meters, 4 for 20 Meters, Etc.

than for the 600 ohm line. If the line is to turn many sharp corners, the twisted pair is far superior to the 600 ohm line.

The twisted pair line is particularly satisfactory in mobile applications where a transceiver might be mounted on the dashboard of a car and the antenna mounted on the rear or front bumper. See figure 27. For turning sharp corners and running close to large bodies of metal the twisted pair is almost as good as the coaxial (concentric) tubing line, whose cost unfortunately places it out of reach of the average amateur at the present time.

### Coupling to the Antenna

Coupling to the antenna deserves careful attention. In the following discussion the antennas are shown horizontally, though manifestly the half-wave types at least can be operated vertically if purely non-directional, low-angle transmission is desired.

The line should leave the antenna for some distance at right angles to the antenna wire, or at least at an angle of 45 degrees or more, to avoid standing waves along the line.

It has been said that a 72 ohm line matches the **average** impedance of a half-wave antenna, still assuming the antenna to be horizontal. However, as figure 19 shows only too clearly, we cannot simply let it go at 72 ohms, for the various heights of antennas may present us with the need of matching



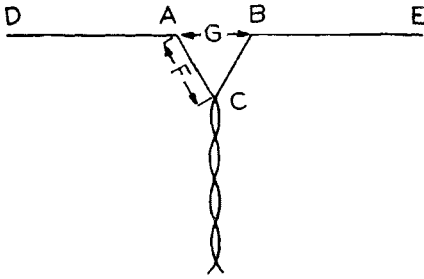


Figure 20  
Reference Schematic of the Doublet of Figure 18.

antennas with impedances all the way from 60 to 100 ohms. Figure 19, by the way, refers to "effective" height, but this is reasonably close to actual height over most soils. In some extreme locations tin roofs, trees, and houses reduce the effective height to a small fraction of the height above earth, but in a doubtful place one may first try  $\frac{3}{4}$  of the actual height, applying that to the curve of the figure 19 to get the impedance at the center of the antenna.

#### The "Y Match"

The "Y match" method of figure 20 is a common and simple means of adjusting the line impedance to the antenna impedance. A length "G" of the antenna-wire is removed and the line is "forked" for some distance back, shown as "F" in figure 20. It is convenient to make F and G the same length. These lengths are shown on the left edge of figure 19, and these figures are the important ones - those at the right be-

ing of academic, rather than practical, interest.

Because the impedance of the line changes at the point C, and at the points A and B, there are small voltage "bumps" at these points. Those at A and B are relatively unimportant, and add nothing to the job of the insulators used to tie A and B together. The story is different at C, and it is accordingly important that moisture be kept out of the crotch, especially as it might work in along the paper-wrap of the wire. Plenty of rubber tape and the electrical repairman's old reliable friend "P & B insulating paint" will do the trick. If "P & B" is strange to you, ordinary automobile top dressing will do nicely - not the thin stuff like "Duco", but the more "goocy" kind.

#### Delta Match

It is mechanically simpler to leave the antenna wire uncut, and to bridge the split line across a portion of the uncut antenna. This "delta" method of matching is not as flexible as to frequency, and for that reason, perhaps, is in little use among amateurs for low impedance lines. It is quite practical, though the triangle dimensions are not those given by figure 19.

#### Harmonic Operation

If a horizontal antenna is made  $\frac{3}{2}$ ,  $\frac{5}{2}$  or  $\frac{7}{2}$  wave long instead of  $\frac{1}{2}$  wave, we increase the horizontal directive effect. The total radiation is not changed materially, but more of it goes in particular directions. This is shown by figure 21. In the top di-

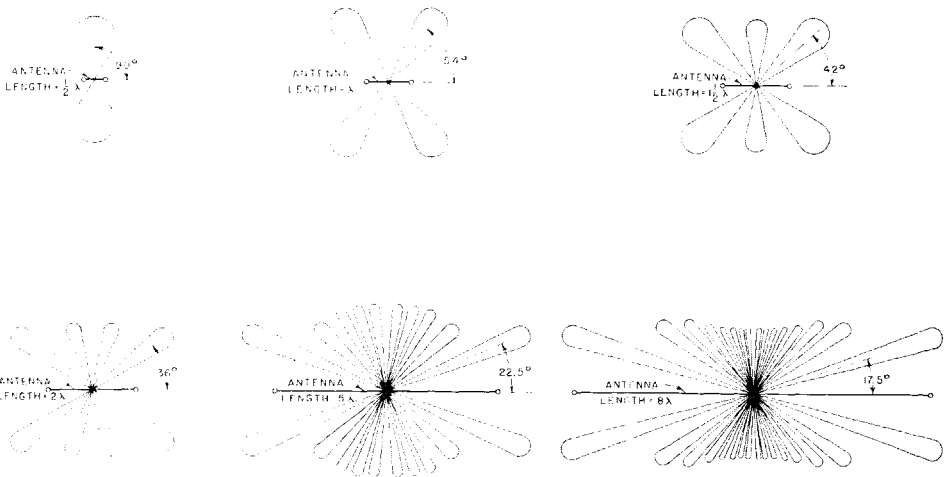


Figure 21

Approximate Field Pattern of Harmonically Operated Antennas, Showing Angles of Radiation Lobes (Looking Down on Antenna from Above).

agram of that figure we are supposed to be looking down on a  $\frac{1}{2}$  wave horizontal antenna. The solid "figure 8" shows the directional effect.

In the 2d diagram we look down on a  $\frac{3}{2}$  wave antenna, showing the pattern of transmission: four broad loops at 42 degrees to the antenna.

The  $\frac{5}{2}$  wave antenna gives sharper loops at 33 degrees, while  $\frac{7}{2}$  gives some nice beams at 28 degrees.

Several things are to be noted. As the antenna is made longer the major directional

**Table II**

Length of 72 ohm twisted-pair line (Type EO-1, with no. 12 wire, spaced 0.17" on centers) which produces 15% power loss.

Frequency	Wavelength (approx.)	Greatest permissible line length
1750 kc.	172 m.	650 feet
3500 "	85.5 "	325 "
7000 "	43 "	173 "
14,000 "	21.4 "	100 "
28,000 "	10.7 "	60 "
56,000 "	5.35 "	35 "

lobes become narrower and consequently longer—meaning stronger—but also there are growing up at the same time smaller lobes, intentionally shown in somewhat exaggerated size, which do produce signals in additional directions and may puzzle the operator of the antenna who does not expect transmission in those directions.

The impedance of these longer antennas, when "looked into" at their centers, is greater than that of a half-wave antenna, as

**Table III**

Impedance at the center of various horizontal antennas at great height. Practical antennas will vary 25% both ways from these figures.

Length of antenna	Impedance
$\frac{1}{2}$ wave	72 ohms
$\frac{3}{2}$ "	100 "
$\frac{5}{2}$ "	118 "
$\frac{7}{2}$ "	125 "

shown by table III. With this in mind, a larger coupling triangle has been used to operate successfully odd-half-wave antennas up to and including  $\frac{7}{2}$  wavelengths.

**The  $\frac{7}{2}$  Wave Antenna**

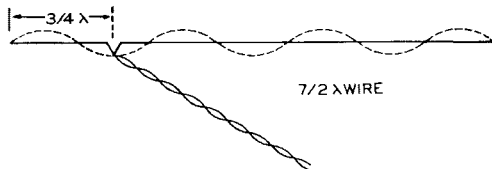
The  $\frac{7}{2}$  wave system is very useful, in that 2-band operation is most practical. If the  $\frac{7}{2}$  wave antenna is made for 14,000 kc., we find that it is a  $\frac{1}{2}$  wave antenna for 2000 kc. Similarly a  $\frac{7}{2}$  wave 10.7 meter (28,000 kc.) radiator is a  $\frac{1}{2}$  wave antenna for 75 meter (4000 kc.) phone.

A  $\frac{3}{2}$  wave section for 20 meters (99

feet), operating as shown in the third diagram of figure 21, is also a good actor. The four main lobes (alone) cover much territory, the two smaller ones filling in between.

While the losses in a long, twisted-pair line are higher than for a high, straight, 600 ohm two-wire line, they are lower than those of the average single wire feeder.

Table II shows the losses to be expected with 72 ohm line-wire such as was first referred to. Such a table would be very com-



**Figure 22**

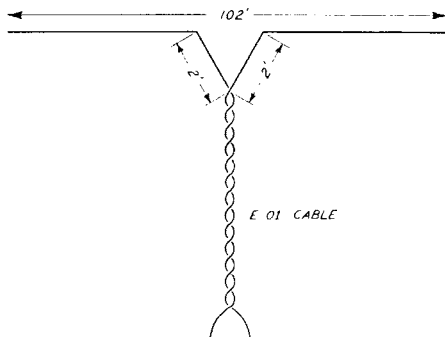
Method of Feeding a Harmonic Antenna with a Twisted Pair When It Is Physically Impossible to Center Feed It.

licated if all possible sorts of wire were to be included. Shorter feeders give a correspondingly lower loss.

**Off-Center Feeding**

Where it is not physically possible to feed the center of the antenna, an arrangement such as that of figure 22 may be used. Since the (radiation) load is no longer the same for the two line wires their currents will not be quite equal, but the radiation pattern remains substantially unchanged. The line attaches at a current maximum point; that is, at an odd number of quarter-waves from the end.

Unequal line currents may also be found



**Figure 23**

This 20-75 Meter "Compromise" Antenna Gives Excellent Results.

where one "half" of the antenna is not of the same length as the other "half". They may also be met where one end of the antenna is materially higher than the other, but in no case does much harm seem to result.

## Lecher-Wire Impedance Matching

The Y method of matching need not necessarily be used. It is quite possible to use Lecher-wires as the impedance-matching device. In figure 27 is shown ("J" antenna) a  $\frac{1}{4}$  wave section of this sort, used to "end feed" a  $\frac{1}{2}$  wave radiating section. This is nothing more than the familiar "Zeppelin"

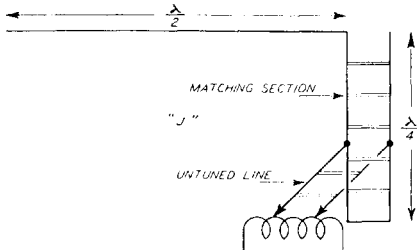


Figure 24  
The "J" Antenna System, Utilizing  
Lecher Wire Matching.

antenna with the 72 ohm line attached at such a point as to find a 72 ohm load. The radiator is  $\frac{1}{2}$  wave-length (electrically).

Lecher-wire sections may also be used to feed at other points along the antenna.

### The Matched Impedance "J" Antenna System

The "J" antenna system, shown in figure 25 A and B, is very similar to the voltage fed Zepp. in many respects. A folded, half-wave section of the antenna is used to transform the 2400 ohm impedance at the end of a Hertz radiator to the impedance of the non-resonant line, which is usually somewhere between 400 and 600 ohms. Twisted pair cable can be used in place of the two-wire spaced line shown, and the method of attaching the twisted pair to the J antenna is the same as for "Q" bars.

The length of the radiator  $L$  is determined as with any radiator, while the length  $N$  of each side of the matching portion of the J is obtained by the following formula: Length, in feet, equals 234 divided by the frequency in megacycles. The point  $P$  where the non-resonant line attaches to the resonant matching section varies with different wire size, height above ground, feeder spacing, etc. It is usually somewhere between one sixth and one third of the way up from the shorting bar.

The antenna system is tuned as follows: Disconnect the non-resonant line from the antenna entirely and excite the antenna from another one in the vicinity. Place a low

range r.f. ammeter in series with the shorting bar at the bottom of the J matching section. Slide the shorting bar up and down the feeders until resonance is established (where the meter current will be maximum). Solder the shorting bar in place and remove the meter. Now tap the non-resonant line about a third of the way up from the shorting bar. Apply low power to the transmitter and tap the r.f. meter across about two inches of wire in both the resonant and non-resonant feeders on each side of the point of junction. See figure 26 which shows the six points where the meter should be tapped in turn. If the currents at all six points are not equal, slide the non-resonant line up and down on the J matching section until they are the same. When the J-section impedance is the same as that of the line, identical currents will flow in both line and matching section.

Another way to determine experimentally the proper point of attachment is to place three meters in series with the non-resonant line at some convenient point where all three can be easily read. The three meters should be placed about one-sixth of a wavelength apart (see figure 26). The feed line is operating properly when all three meters read the same current. If there are standing waves on the non-resonant line,

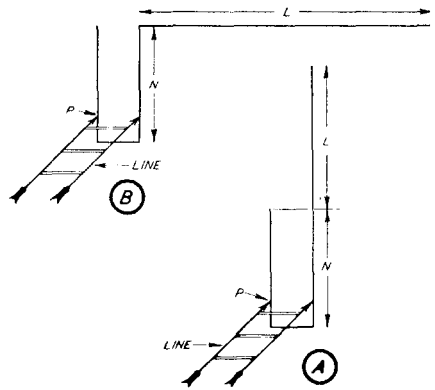


Figure 25  
The "J" Antenna System May Be Either  
Vertical or Horizontal.

they will be manifest by unequal currents in three meters. The point of attachment can be moved up and down until standing waves are eliminated from the non-resonant transmission line.

This type of antenna system is generally suitable only for one band. Matching sections are widely used to couple a concentric line to a vertical ultra high frequency rad-

## Dimensions for Matched Impedance J, T, Q, Single-Wire-Fed, and Collins Antennas

Frequency in Kilocycles	Quarter wave feeder section	Half wave Radiator	Dis. from end of radi- ator to feeder tap
	$\frac{234}{F_{mc}} \frac{.95\lambda}{4} = N$	$\frac{467.4}{F_{mc}} \frac{.95\lambda}{2} = L$	$D = \frac{169.2}{F_{mc}}$ (single wire feed)
3500	66' 10"	133' 7"	48' 4"
3600	64' 11"	129' 10"	46' 8"
3700	63' 2"	126' 4"	45' 7"
3800	61' 6"	123'	44' 6"
3900	59' 11"	119' 10"	43' 3"
3950	59' 2"	118' 4"	42' 8"
4000	58' 5"	116' 10"	42' 1"
7000	33' 5"	66' 9"	24' 2"
7050	33' 2"	66' 4"	23' 11"
7100	32' 11"	65' 10"	23' 9"
7150	32' 9"	65' 4'	23' 7"
7200	32' 6"	64' 11"	23' 4"
7250	32' 3"	64' 6"	23' 3"
7300	32'	64'	23' 2"
14,000	16' 9"	33' 5"	12' 1"
14,100	16' 7"	33' 2"	12'
14,200	16' 5"	32' 11"	11' 10.5"
14,300	16' 4"	32' 9"	11' 9"
14,400	16' 3"	32' 6"	11' 8"
28,000	100"	16' 8.5"	72"
28,500	98.4"	16' 5"	71"
29,000	96.5"	16' 1.5"	70"
29,500	94.8"	15' 10.5"	69"
30,000	93"	15' 7.5"	68"
56,000	50"	100"	36"
57,000	49.2"	98.4"	35.5"
58,000	48.3"	96.5"	35"
59,000	47.4"	94.8"	34.5"
60,000	46.5"	93"	34"

**TABLE IV**

Quick-reference guide for determining radiator and feeder (matching section) length for the J, T, Q, and Multiband antennas: Also for determining the proper point at which to attach a single-wire feeder for optimum results for one-band operation. For operation on more than one band, the flat top should be cut for the highest frequency band and the single-wire feeder tapped one-third of the way in from one end, disregarding the figures given in the right-hand column of the above chart. The antenna will then work equally well on several bands with but a slight reduction in efficiency.

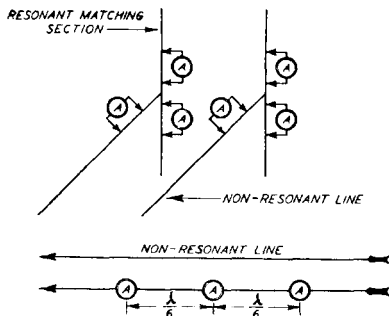


Figure 26  
Showing Points at Which to Check for Proper Operation of the "J" Antenna. All Readings Should Be Equal.

iator and sometimes are particularly desirable for 5 meter mobile applications. The five meter J antenna system shown in figure 27 gives very good results on that band and also allows the same antenna to serve for the broadcast receiver in the car. As the b.c.l. set is connected at a point of zero r.f. voltage on 5 meters, the ultra-high-frequency transmitter causes no interference to the broadcast receiver.

#### The Matched Impedance "T" Antenna System

In general the matched impedance T antenna system is very similar to the center fed Zepp. antenna system. The T system is also a close cousin to the J antenna system already described. The T system is usual-

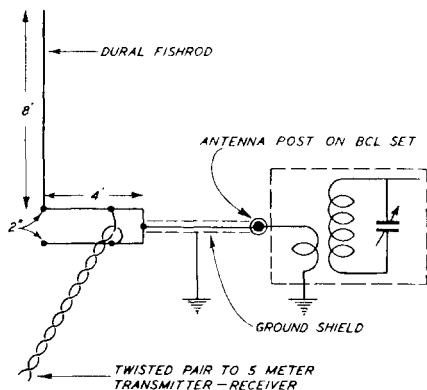


Figure 27  
Dual-Purpose "Fishrod" J Antenna for Mobile Use (56 Mc. and Broadcast).

ly somewhat more efficient than the J due to the fact that there is better current and phase balance in the resonant matching section or stub.

The length of the flat top of the T system is determined by the usual radiator formulas. If the flat top is an odd number of

half waves long there is high current at the center and the stub section must be left open at the bottom. See figure 28. If the radiating portion has an even number of half waves on it, there is high voltage at the center and the bottom end of the stub section must be short circuited. See figure 29. The length  $N$  of both stubs is the same and is determined from the formula: length in feet equals 234 divided by the frequency in megacycles.

The tuning procedure for the T antenna system is exactly the same as for the J system shown above. When the stub section is short circuited at the bottom the non-resonant line will be attached about a quarter of the way up from the bottom. When the stub is open-ended as in figure 28, the non-resonant line will attach about

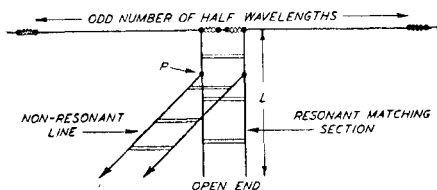


Figure 28  
The Matched Impedance "T" Antenna System. (See Also Figure 29).

a quarter of the way down from the top of the stub line. Remember that the non-resonant line is attached closer to the point of high current than high voltage.

This type of feeder system is commonly used to attach non-resonant lines to resonant directive antenna arrays. The T antenna and feeder system is primarily a one-band system and does not work well on its even harmonics.

#### The Matched Impedance "Y" Antenna System

The two-wire matched impedance "Y" antenna and non-resonant feeder system is quite widely used. Figure 30 shows this feeder system. The impedance of the transmission line is transformed gradually into a higher value by the fanned-out Y portion of the feeders, and the Y portion is tapped on the antenna at points where the antenna impedance equals the impedance at the ends of the Y.

The constants of the system are rather critical and the antenna must resonate at the operating frequency in order to get the standing waves off the line. Some slight re-adjustment of the taps on the antenna may be desirable, particularly on the lower frequencies, if noticeable standing waves per-

## Dimensions Table for Matched Impedance Y Antenna System

Frequency Kilocycles	$L = \frac{467.4}{F_{mc}} = \frac{.95\lambda}{2}$ feet	$D = \frac{175}{F_{mc}}$ feet	$E = \frac{147.6}{F_{mc}}$ feet
3500	133' 7"	50'	42' 2"
3600	129' 10"	48' 7"	41'
3700	126' 4"	47' 4"	39' 11"
3800	123'	46' 1"	38' 10"
3900	119' 10"	44' 9"	37' 11"
3950	118' 4"	44' 3"	37' 5"
4000	116' 10"	43' 9"	36' 11"
7000	66' 9"	25'	21' 1"
7050	66' 4"	24' 10"	20' 11"
7100	65' 10"	24' 8"	20' 9"
7150	65' 4"	24' 6"	20' 7.5"
7200	64' 11"	24' 4"	20' 6"
7250	64' 6"	24' 2"	20' 4.5"
7300	64'	24'	20' 3"
14,000	33' 5"	12' 6"	10' 6"
14,100	33' 2"	12' 5"	10' 5"
14,200	32' 11"	12' 4"	10' 4"
14,300	32' 9"	12' 3"	10' 3.5"
14,400	32' 6"	12' 2"	10' 3"
28,000	16' 8.5"	7.5"	6.3"
28,500	16' 5"	7.4"	6.2"
29,000	16' 1.5"	7.25"	6.1"
29,500	15' 10.5"	7.1"	6.0"
30,000	15' 7.5"	7.0"	5.9"
56,000	100"	37.5"	31.5"
57,000	98.4"	37"	31"
58,000	96.5"	36"	30.5"
59,000	94.8"	35.5"	30"
60,000	93"	35"	29.5"

TABLE V

The matched impedance "Y" antenna system is an old stand-by that has withstood the test of time. When properly adjusted the losses are as low as for any antenna system it is possible to construct, and lower than most of the ones in common use. The main drawback is that it is inherently a one-band affair. The dimensions L, D, and E refer to figure 30.

The dimensions are quite critical, and the values given above should be closely adhered to, then altered slightly if necessary for the particular installation until there is no trace of standing waves on the line (check as for the J antenna, figure 26).

sist in appearing on the line.

The constants are determined by the following formulas:

$$L_{feet} = \frac{467.4}{F \text{ megacycles}}$$

$$D_{feet} = \frac{175}{F \text{ megacycles}}$$

$$E_{feet} = \frac{147.6}{F \text{ megacycles}}$$

where L is antenna length; D is the distance in from each end at which the Y taps on; E is the height of the Y section.

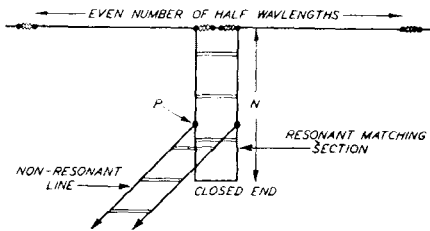


Figure 29  
"T" Antenna for Operation on Even Harmonics.

As these constants are correct only for a 600 ohm transmission line, the spacing S of the line must be approximately 75 times the diameter of the wire used in the transmission line. For no. 14 B & S wire the spacing will be slightly less than 5 inches. For no. 12 B & S the spacing should be 6 inches, and for no. 10 B & S wire the spacing should be 7½ inches to make the surge impedance of the line 600 ohms. Note that the distance D is quite close to three eighths (0.375) of the antenna length. This feeder system should never be used on either its even or odd harmonics, as entirely different constants are required when more than a single half wavelength appears on the radiating portion of the system.

### The Matched Impedance Capacity Loaded Antenna

The matched impedance capacity loaded antenna shown in figure 31 is designed to match a 600 ohm untuned transmission line directly without using any matching sections or linear transformers. The overall length of the antenna is about 26% longer than a half wave and is shortened to resonance by means of the loading condenser placed in

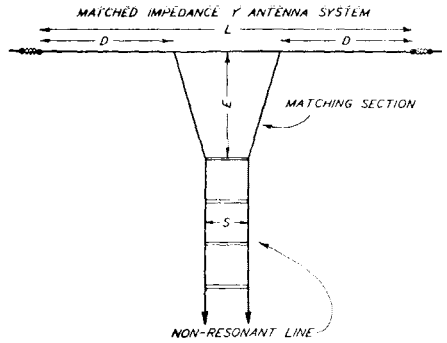


Figure 30  
The Matched-Impedance Y Antenna System.  
For Dimensions See Page 25.

the center of the antenna. The added length of the antenna and the value of the loading capacitance are chosen so that the impedance across the condenser is 600 ohms, which means that it acts as a resistive 600 ohm load on the conventional 600 ohm line connected across the loading condenser. This antenna system is useful only on any one band and does not operate on either its even or odd harmonics without bad mismatch. Where one-band operation of an antenna is desired this system is quite simple and has low losses.

Due to the fact that this antenna system has somewhat more wire in the air for a given frequency than conventional dipoles it has somewhat more radiation efficiency, although it takes a longer span between poles to resonate at any given frequency than the standard half-wave dipole.

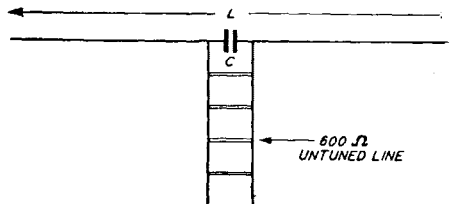


Figure 31  
The Matched-Impedance, Capacity Loaded Antenna, a One-Band Affair, But Highly Efficient. (See Table VI)

This antenna is "broad" enough to work over a frequency range of 5% above and below its resonant frequency without material loss. Thus it can be cut for the center of any amateur band and will work well over the whole band.

The following table of lengths and coupling capacitances covers the common bands. The fixed matching-condenser, C, should be housed in a moisture-proof container.

**TABLE VI**  
**Capacity-loaded 600 Ohm Matched Impedance Antenna**

Frequency in Kilocycles	Length in feet		Loading Capacity C
	L = $\frac{586.2}{F_{mc}}$		
3,500	167'	2"	700 $\mu$ fd.
3,600	162'	6"	
3,700	158'		
3,800	153'	10"	
3,900	150'	2"	
3,950	148'	2"	
4,000	146'	2"	370 $\mu$ fd.
7,000	83'	6"	
7,050	83'		
7,100	82'	4"	
7,150	81'	8"	
7,200	81'	2"	
7,250	80'	8"	
7,300	80'		
14,000	41'	10"	185 $\mu$ fd.
14,100	41'	6"	
14,200	41'	2"	
14,300	41'		
14,400	40'	8"	
28,000	20'	11"	90 $\mu$ fd.
28,500	20'	6"	
29,000	20'	2"	
29,500	19'	10"	
30,000	19'	7"	
56,000	125"		
57,000	122.8"		
58,000	121"		
59,000	118.6"		
60,000	116"		

*Constants are Correct only for a 600 Ohm Line.*

**The Single-Wire-Fed Antenna System**

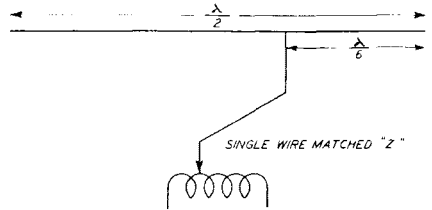
The matched impedance single-wire-fed antenna system is quite satisfactory where the length of the transmission line may be kept short. The losses are somewhat higher than for the two-wire types of transmission lines, but are lower than for the average Zepp. antenna.

The single-wire-fed antenna has one marked advantage over the two-wire fed types in that operation on the harmonics is possible without excessive losses. It should be noted that the single-wire line depends upon the earth as the return; so therefore, the transmitter must have a good, low-resistance ground connection to minimize losses.

Figure 32 shows a single-wire-fed Hertz

system. Due to the fact that the feeder must tap on to the antenna at a point where the antenna impedance equals the characteristic impedance of the single-wire feeder, the point of attachment is somewhat critical. As the antenna and line impedances both vary with wire size, height above ground, nearby objects, etc., no formula and table can give the **exact** distance from the end of the antenna at which the feeder should be tapped on. It is common practice to give single-wire feeder data as measured out from the center of the antenna. However, we feel that it will be much more convenient to indicate the distance from the end, or high voltage point, at which the feeder is tapped on.

The feeder will **usually** give close to a perfect match when tapped on a distance measured from either end of a half wave



**Figure 32**  
**The Simplest Feed System, the Popular Single-Wire-Fed Hertz.**

antenna equal to the antenna length multiplied by 0.362. This distance in from either end can be calculated for the frequency of operation by the following formula:

$$D = \frac{169.2}{F_{mc}}$$

where D equals distance in feet, and  $F_{mc}$  equals frequency of operation in megacycles. This formula holds accurately for no. 14 enamelled wire for frequencies between 3000 and 30,000 kc. for antennas and feeders well out in the clear and the antenna exactly a half wave above ground.

When operation on two or three bands is wanted it is desirable to cut the antenna and locate the feeder on the highest frequency to be used. The antenna length and feeder location will be off somewhat on the lower frequencies but the error there will be a smaller proportion of a half wave than if cut for the lowest frequency band.

Under certain conditions, cutting the antenna for the highest frequency and then locating the feeder exactly one third of the way in from either end gives good results. However, this antenna must always operate

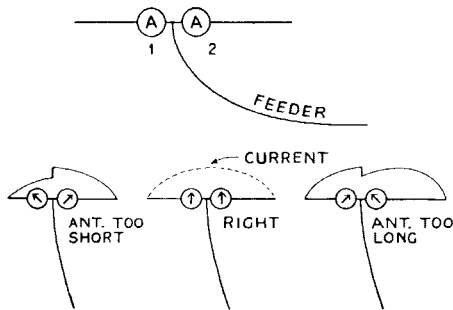


**TABLE VII**  
CHARACTERISTIC IMPEDANCE OF LONG WIRES

Wire Size B&S	Dia. inches	$Z_o$				
		3.5 Mc.	7.0 Mc.	14.0 Mc.	28.0 Mc.	56 Mc.
½" tubing		560	518	475	435	393
¼" tubing		600	560	518	475	435
No. 8	.128"	641	600	559	516	474
No. 10	.102"	654	613	572	530	490
No. 12	.080"	669	628	586	545	503
No. 14	.064"	684	643	600	560	517

$$Z_o = 138 \left( \log \frac{0.56\lambda}{2\pi r} \right)$$

where  $2\pi r =$  circumference of conductor



**Figure 33**  
Checking the Single-Wire-Fed Antenna.

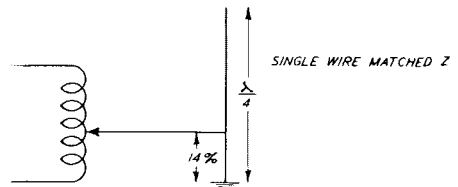
on one, two, four, eight, or sixteen times the lowest frequency for which it is to be used. In other words, avoid all the odd harmonics (except the first harmonic, or fundamental) and stick to the even ones.

When a single-wire-fed antenna is to be used on just one frequency, it is desirable to adjust the feeder by cut and try methods. Get the antenna length right for the operating frequency to be used. Then attach three similar neon bulbs to the feeder about one sixth of a half wave apart. Then move the feeder tap back and forth on the antenna until all three neon bulbs glow with the same brilliancy. This will indicate equal voltage along the line, showing that no standing waves are present. It is almost impossible to find a combination that will allow the standing waves to be entirely eliminated on two or more bands with this antenna, but tune it up for the higher fre-

quency band and it will give satisfactory results on the next lower frequency band.

The single-wire feeder can be clipped directly on to a single-ended plate tank circuit by means of a d.c. blocking condenser (.002  $\mu$ fds.) and moved up and down along the tank until the amplifier draws proper plate input. When the final amplifier is push-pull it is almost impossible to clip the single feeder on without disturbing neutralizing and tube loading. In this case it is better to use a separate antenna tank circuit link-coupled to the final amplifier. See figure 2P on page 36.

The single wire feeder should run at right angles to the antenna for a distance equal to about a sixth wavelength before turning toward the operating room. In other words, don't bring the feeder off so that it is more or less parallel with the antenna.



**Figure 34**  
Marconi with Single Wire Feed.

It is often desirable to feed a grounded Hertz, or Marconi antenna with a single wire feeder. Figure 34 shows such an arrangement. The feeder can be tapped about 14% of a **half wave** up from the

ground point. This type of antenna does not operate well on its harmonics and is principally used on 30, 60 and 120 megacycles.

Table VII on page 32 shows the characteristic impedance of long wires in space. The characteristic impedance of a single wire feeder can thus be found from this table. The presence of the ground and other nearby objects will affect the impedance slightly but the table is still quite useful where it is desired to calculate power in the feeder, etc.

### Dummy Antennas

When testing a transmitter it is always desirable to use some form of dummy antenna to minimize unnecessary interference.

The cheapest form of dummy antenna is an electric light globe coupled to the plate tank circuit by means of a two to four turn pick-up coil (or even clipped directly across a few turns of the tank coil). Another good form of dummy antenna that is relatively non-reactive is a short, thick bar

of carbon tapped across enough of the tank turns to load the amplifier properly. The "plaque" form of carbon resistors also are ideal for use as a dummy antenna load. In high power stations where it may be difficult to find a resistor or light globe with a high enough wattage rating a small tank full of water can be used as a load. The resistance of the load can be varied by pouring salt in the water to vary its conductivity. Enough water should always be used so that it does not come to a boil, as boiling water does not present a constant resistance to the flow of electricity. For the higher frequencies the only method that is satisfactory is to use compact, non-inductive resistors with very short leads.

If a lamp or lamps are chosen of such value that they light up to approximately normal brilliancy at normal transmitter input, the output may be determined with fair accuracy by comparing the brilliancy of the lamps with similar lamps connected to the 110 volt line.

TABLE VIII  
Conversion Chart for Quick Feeder Calculation

Length	160 M. 1750 KC.	80 M. 3500 KC.	40 M. 7000 KC.	20 M. 14,000 KC.	10 M. 28,000 KC.	5 M. 56,000 KC.	2½ M. 112,000 KC.
$\frac{\lambda}{8}$	67'	33'	16'	8'	4'	25"	13"
$\frac{\lambda}{4}$	134'	67'	33'	16'	8'	50"	25"
$\frac{3\lambda}{8}$	200'	100'	49'	24'	12'	75"	38"
$\frac{\lambda}{2}$	267'	134'	67'	33'	16'	100"	50"
$\frac{5\lambda}{8}$	334'	167'	83'	41'	20'	125"	63"
$\frac{3\lambda}{4}$	400'	200'	100'	49'	24'	150"	75"
$\frac{7\lambda}{8}$	467'	233'	116'	57'	28'	175"	88"
$\lambda$	534'	267'	134'	67'	33'	200"	100"

NOTE: The above lengths are approximate to the nearest unit and do not take end effects of harmonic wires into consideration. They are accurate enough for Zepp feeders but should not be applied to radiators and especially radiators more than a half wave long. Radiators should be cut to length where possible using one of the many length tables shown elsewhere in this book.

## IV. Coupling to the Transmitter

The choice of an antenna coupling method depends on the type of feeder used and also on whether the final amplifier utilizes a split or unsplit plate tank circuit. All push-pull and plate-neutralized amplifiers utilize some form of split tank circuit whereby the center of the plate tank is at ground potential as far as radio frequency voltage is concerned. The two ends of a split tank circuit are at high r.f. potential to ground. The unsplit plate tank circuit is becoming widely used. It is used in all single-ended pentode amplifiers, as well as with the single-ended, grid-neutralized triode amplifiers. In the unsplit tank circuit the end nearest the plate has high r.f. potential on it, while the end opposite from the plate is grounded through a condenser.

### Function of an Antenna Coupler

The function of an antenna coupler is not always clearly understood. It is known that the plate circuit of a vacuum tube operates most effectively into one particular value of plate load impedance for a given plate voltage and amount of grid excitation. If the load impedance into which the tubes "look" is too high, the plate current will be below normal and the tubes will not draw normal plate input. If the plate load impedance reflected back into the tube is too low, the tube will draw excessive plate current and the plate efficiency will decrease. The function of the output coupler therefore is to transform the impedance of the feed line, or the antenna, into that value of plate load impedance which will allow the final amplifier to operate most effectively. The antenna coupler is therefore primarily an impedance transformer. It may serve a secondary purpose in filtering out harmonics of the carrier frequency. It may also tune the antenna system to resonance. It should be noted that the antenna coupler has absolutely nothing to do with the presence or absence of standing waves on an untuned transmission line connected between the coupler and the antenna. There is no question involved in matching or mismatching impedances at the station end of a transmission line. Certain types of antenna couplers have been inaccurately termed impedance matching networks; a much better term would be **impedance transformer**.

Practically every known antenna coupler can be made to give good results when properly adjusted. Certain types are more

convenient to use than others, and the only general rule to follow in the choice of an antenna coupler is to use the simplest one that will serve your particular problem. The impedance transformation in the capacitively-coupled systems occurs by reason of auto-transformer action and the theory is the same as that of an impedance-coupled audio amplifier using a tapped audio choke to provide step-up or step-down of voltage. The inductively-coupled systems utilize the regular step-up or step-down function of the conventional transformer to obtain the transformation of antenna or transmission line impedance to optimum plate impedance.

The step-up or step-down of voltage is usually followed and analysed by starting with the voltage generator and ending up with the load in which the voltage is finally dissipated. In analysing the transformation or step-up and step-down of impedances the reverse procedure is followed. In other words, we start with the impedance of a load and work back toward the generator.

Thus a half-wave Hertz antenna under certain conditions has an impedance of 73 ohms at its center. Assume that it is fed by the Johnson Q system and that the non-resonant transmission line between the transmitter and the Johnson Q bars happens to have by reason of its wire size and spacing a characteristic surge impedance of 600 ohms. The only question of impedance matching in the whole system arises in the spacing of the Johnson Q bars. The transmission line must work into a load of 600 ohms if standing waves are to be eliminated from it. Therefore the Johnson Q bars, which are simply a special form of impedance transformer, must transform the 73 ohms impedance at the center of the antenna into 600 ohms at the lower end of the Q bars. As the transmission line is terminated in 600 ohms its input impedance must necessarily be 600 ohms as there are no standing waves on it. Assume a push-pull final amplifier. If the 600 ohm line is tapped on the ends of the plate tank circuit it should be obvious that the plate-to-plate load impedance into which the final amplifier tubes look will be 600 ohms, because the 600 ohm transmission line could be replaced with a non-inductive resistor of 600 ohms.

Most transmitting tubes operating class C would work inefficiently at a plate-to-plate load of 600 ohms. They would work, al-

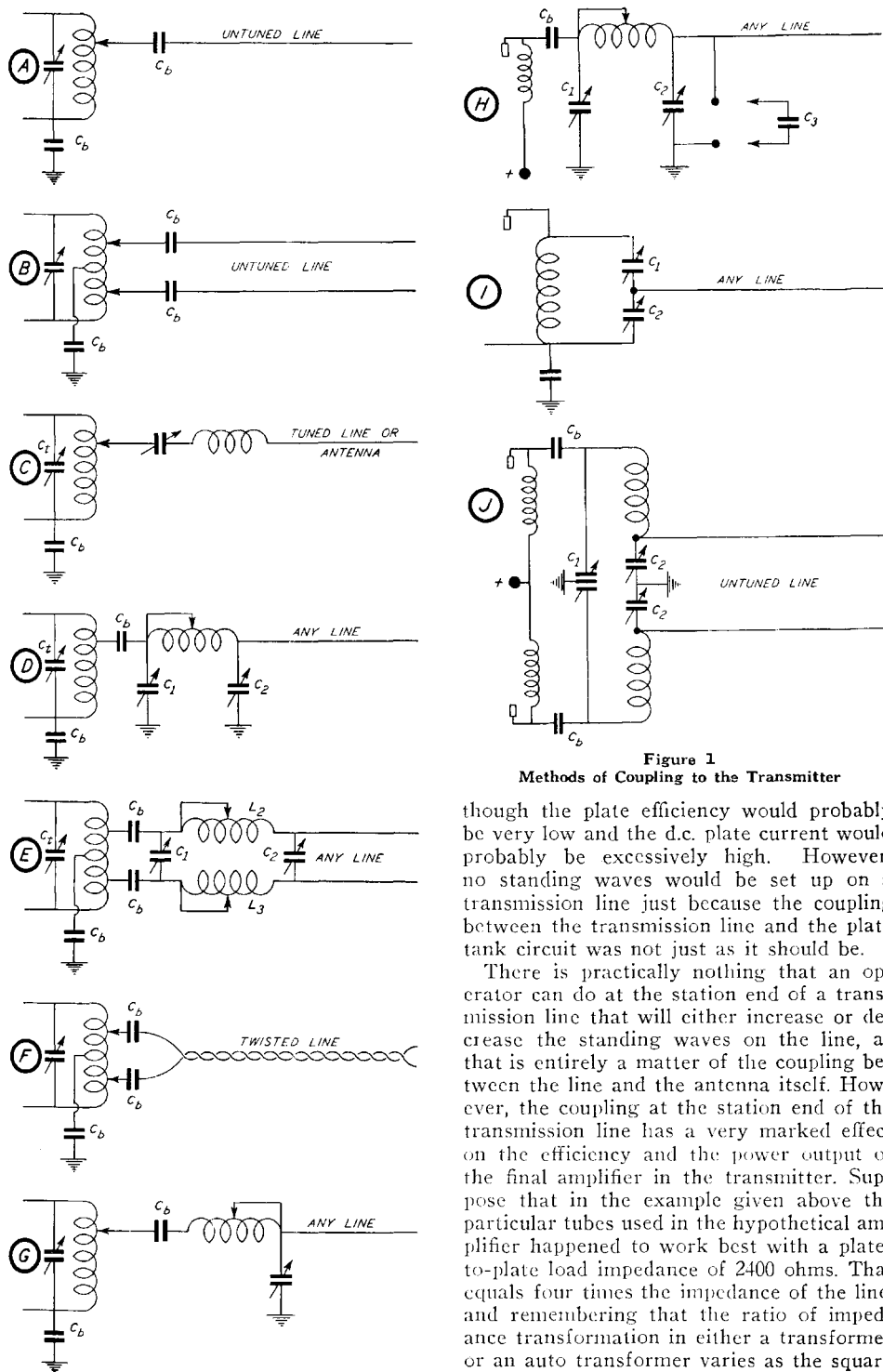


Figure 1  
Methods of Coupling to the Transmitter

though the plate efficiency would probably be very low and the d.c. plate current would probably be excessively high. However, no standing waves would be set up on a transmission line just because the coupling between the transmission line and the plate tank circuit was not just as it should be.

There is practically nothing that an operator can do at the station end of a transmission line that will either increase or decrease the standing waves on the line, as that is entirely a matter of the coupling between the line and the antenna itself. However, the coupling at the station end of the transmission line has a very marked effect on the efficiency and the power output of the final amplifier in the transmitter. Suppose that in the example given above the particular tubes used in the hypothetical amplifier happened to work best with a plate-to-plate load impedance of 2400 ohms. That equals four times the impedance of the line, and remembering that the ratio of impedance transformation in either a transformer or an auto transformer varies as the square

of the turns ratio, tapping the 600 ohm line across exactly half of the turns of the plate tank coil will reflect a plate load of the required value of 2400 ohms. Looking back from the line to the plates of the tubes, there is a step-up of two to one in turns ratio. Squaring the turns ratio gives us a four to one step-up in impedance. Whenever we adjust antenna coupling and thus vary the d.c. plate current on the final amplifier, all we do is vary the ratio of impedance transformation between the feed line and the plate (or plates) of the final amplifier tube (or tubes). All antenna couplers should be adjusted for the loosest amount of coupling that will allow the final amplifier either to draw rated plate current or dissipate rated plate loss, whichever occurs first.

When using tuned feeders, as in the Zepp. antenna system, it will also be necessary to keep re-tuning the antenna system to resonance as the coupling is varied.

### Capacitive Coupling Methods

Figure 1 A to G shows several of the most common methods of capacitive coupling between final amplifier and feed line.

Figure 1 A shows a simple method of coupling a single-wire non-resonant feeder to an unsplit plate tank. The coupling is increased by moving the tap up toward the plate end of the plate tank coil.

The system shown in figure 1 B shows a means of coupling an untuned two-wire line to a split plate tank. If it is desired to couple a two-wire untuned line to an unsplit plate tank it will be necessary to use some form of inductive coupling. See figure 2 K or O.

The circuit of figure 1 C shows how to couple a single-wire feeder or an end-fed antenna to an unsplit plate tank.

The circuit of figure 1 D shows the same thing except that a  $\pi$  section filter is used in place of the series-tuning shown in figure 1 C.

The circuit of figure 1 D gives better harmonic suppression than that of figure 1 C.

Figure 1 E shows the two-wire version of the Collins coupler, whereby a two wire line, tuned or untuned, may be coupled to a split tank circuit. This method gives somewhat better harmonic suppression than the circuits of figure 1 B, figure 2 L, or figure 2 Q.

Figure 1 F is a simple and effective means of coupling a twisted-pair untuned line to a split plate tank. If it is desired to couple a twisted-pair line to an unsplit plate tank

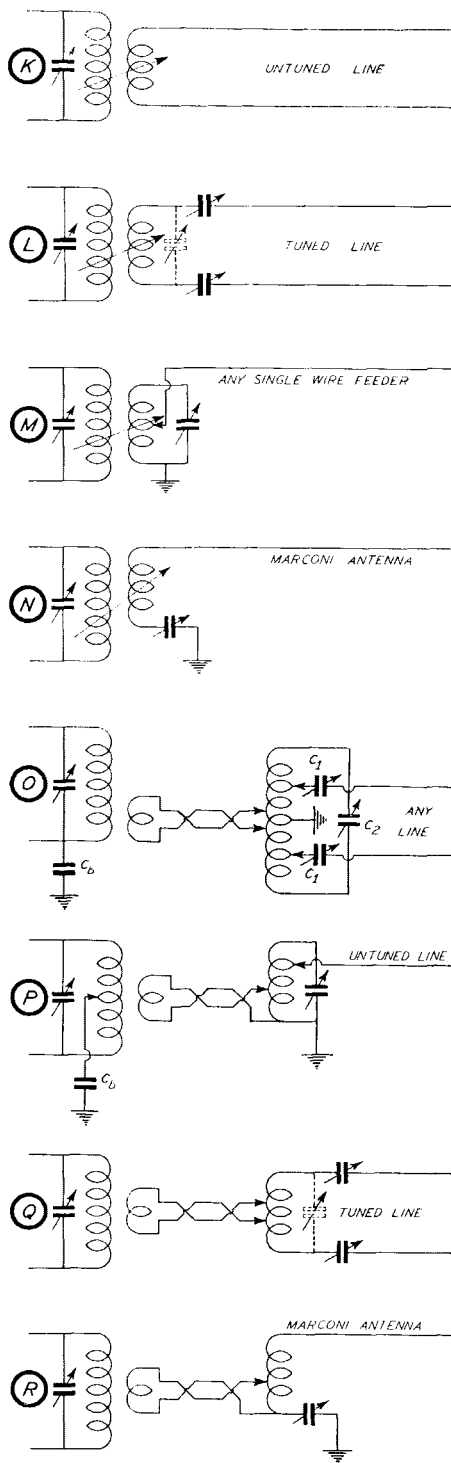


Figure 2

it will be necessary to use inductive coupling as in figure 3 S.

Figure 1 G closely resembles figure 1 D and its operation is quite similar. It uses an L section filter instead of a  $\pi$  section and is somewhat more difficult to adjust than that of figure 1 D.

Figure 1 H shows the Jones coupler, which is very similar to the Collins of figure 1 D except that the plate tank coil and condenser are eliminated. The  $\pi$  network effectively acts as a plate tank and antenna coupler at the same time. The more capacity at  $C_2$  and the less at  $C_1$ , the greater the impedance step-up between the line and the tube (and the looser the coupling). This holds true with all the  $\pi$  section couplers, such as figure 1 D; figure 1 E, H, and J.

The coupler shown in figure 1 I is very similar in operation to the coupler of figure 1 H. Its only advantage is that series feed can be used to the final amplifier, and its main disadvantage lies in the fact that an insulated shaft must be used on the rotor of condenser  $C_1$  in order to avoid hand capacity.

The circuit of figure 1 J is simply the push-pull version, for a two-wire line, of the coupler of figure 1 H.

### Inductive Coupling

Inductive coupling methods must be classified in two types: direct inductive coupling and link coupling. Direct inductive coupling has been very popular for years, but link coupling between the plate tank and the antenna coupler proper is usually more desirable, particularly when feeding a Zepp. antenna system. At the present time there has been no satisfactory means developed of using link coupling between a plate tank circuit and a  $\pi$  section antenna coupler. Thus if it is desired to use the  $\pi$  section coupler it will be necessary to use capacitive coupling, as even direct inductive coupling is quite difficult to adjust. At the present time there is no effective means of coupling a single wire feeder to a push-pull amplifier by means of the  $\pi$  section coupler.

The circuit of figure 2 K shows direct inductive coupling to an untuned two-wire line. This same arrangement can be used to couple from a split plate tank to a single-wire untuned feeder by grounding one side of antenna coil.

The circuit shown in figure 2 L is the conventional method of coupling a Zepp. or tuned feed line to a plate tank circuit, but

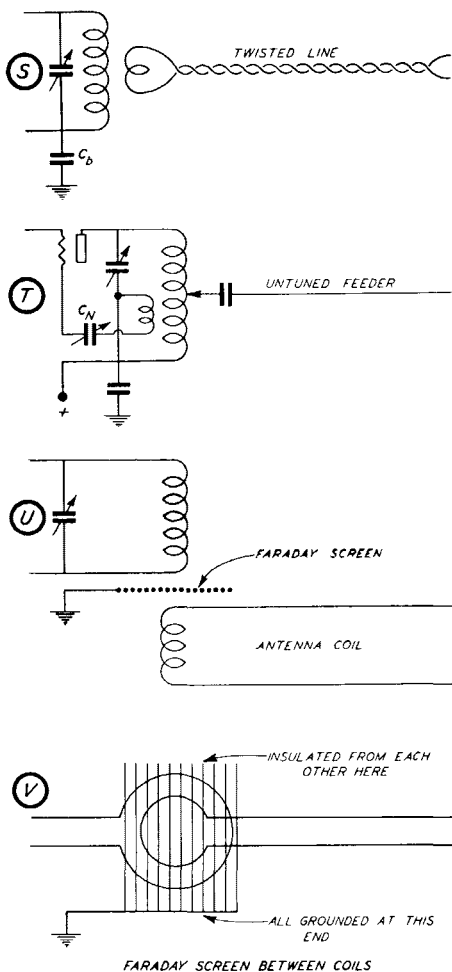


Figure 3

the arrangements shown in figure 2 O or figure 2 Q are easier to adjust.

The circuit shown in figure 2 M is for coupling a single-wire tuned or untuned feeder to either a split or unsplit plate tank circuit. The arrangement shown in figure 2 P is easier to adjust. The circuit shown in figure 2 N is the conventional means of coupling a Marconi or grounded quarter-wave Hertz to a plate tank circuit. But the circuit shown in figure 2 R is considered more desirable.

Figure 2 O shows link coupling between a plate tank and any two-wire line, tuned or untuned. If untuned, condensers  $C_1$  can be eliminated. As drawn the circuit shows an unsplit plate tank, but the same circuit can be used with a split plate tank pro-

viding the coupling link is coupled to the center of the tank coil instead of the lower end. All coupling links anywhere in a transmitter should be coupled at a point of low r.f. potential to avoid undesired capacitive coupling.

The arrangement of figure 2 P is used to couple an untuned single wire line to either a split or unsplit tank circuit. The diagram shows a split tank circuit, but the operation is the same in either case. The link must be moved down to the cold end of the plate coil if an unsplit tank is used.

The arrangement of figure 2 Q is used to couple a Zepp. or tune a two-wire line to either a split or unsplit plate tank circuit.

The circuit shown in figure 2 R illustrates the best means of coupling a Marconi antenna to either a split or unsplit plate tank circuit.

Figure 3 S illustrates a method of coupling a twisted-pair line to an unsplit plate tank. Figure 3 T shows a means of coupling an untuned single-wire feeder to a plate-neutralized amplifier. This sometimes leads to neutralizing difficulties due to the fact that the neutralizing coil is not part of the tuned circuit. Very close coupling must be used between the neutralizing coil and the tuned circuit and the neutralizing coil should have approximately two-thirds the turns of the tuned tank coil.

Figure 3 U shows how a Faraday screen can be placed between the plate tank coil and a direct, inductively coupled antenna coil in order to reduce capacitive coupling between the two circuits which otherwise would cause bad interlock in tuning. Figure 3 V shows how the Faraday screen is made. The screen can take the form of a piece of cardboard on which the screening wires are held by means of varnish or lacquer. Half-inch spacing between adjacent wires in the Faraday screen is usually satisfactory. Note that the wires must be connected together at just one point in order to avoid circulating current in the screen, with resultant losses. This screen is also very effective in reducing harmonic radiation, because most of the higher harmonics reach the antenna through capacitive rather than inductive coupling.

#### Tuning the Pi Section Filter

In order to get good results from the  $\pi$  section antenna coupler, certain precautions must be followed. The impedance transformation of this type of antenna coupler is best visualized by the circuit of figure 1 I. The feeder there is "tapped up and down"

the tank circuit by increasing the capacity of one condenser as the capacity of the other condenser is decreased. The effect is exactly the same as in figure 1 A, where the feeder is tapped up and down the coil instead of the condenser. The ratio of impedance transformation in the  $\pi$  networks, therefore, depends on the ratio in capacity of the two condensers  $C_2$  and  $C_1$ .

In the new system shown in figure 1 D and E, the first step in tuning is to disconnect the  $\pi$  section coupler from the plate tank entirely. Then apply low plate voltage and tune the tank condenser  $C_1$  to resonance. Remove the plate voltage and tap the  $\pi$  section connection or connections approximately half way between the cold point on the coil and the plate or plates. Adjust  $C_2$  to approximately half maximum capacity and apply plate voltage. Quickly adjust  $C_1$  to the point where the d.c. plate current dips, indicating resonance. At the minimum point in this plate current dip the plate current will either be higher or lower than normal for the final amplifier. If it is lower it indicates that the coupling is too loose; in other words, there is too high a ratio of impedance transformation. The plate current can be increased by **reducing** the capacity of  $C_2$  and then restoring resonance with condenser  $C_1$ . Note that at no time after the  $\pi$  section coupler is attached to the plate tank should the plate tuning condenser be touched. If the d.c. plate current with  $C_1$  tuned to resonance is too high it may be reduced by **increasing** the capacity of  $C_2$  in small steps, each time restoring resonance with condenser  $C_1$ .

If the plate current persists in being too high even with  $C_2$  at maximum capacity it indicates either that  $C_2$  has too low maximum capacity or that the  $\pi$  section filter input is tapped too close to the plate of the final amplifier. If the plate current can **not** be made to go high enough even with condenser  $C_2$  at minimum capacity, it indicates that the input of the  $\pi$  section is not tapped close enough to the plate end of the plate tank coil.

When the two-wire arrangement of figure 1 E is operating properly, the load on both tubes should be the same and there should be an equal spark (with a pencil) on each side of  $C_2$ . Likewise the arcs that can be drawn from each end of the plate tank coil should be the same. If they are not, it indicates an unsymmetrical condition of the push-pull stage or an unbalanced two-wire line.

## V. Harmonic Operation

### Operating an Antenna on Its Harmonics

The Zepp.-fed and direct-fed antennas have always been the most popular antennas for multi-band operation. This is due to the fact that practically all of the antennas that are fed by non-resonant transmission lines reflect a bad mismatch into the line when operated on two, four, or eight times the fundamental antenna frequency. Thus the twisted-pair doublet, the Johnson Q, the matched impedance J or T types all are unsuitable for even-harmonic operation. The single-wire-fed antenna can be used with fair success on two and sometimes three bands, but it operates **properly** on only one band.

The radiating portion of an antenna does not resonate on integral harmonics of its fundamental frequency. This point is not generally appreciated. It is a common assumption that a half-wave antenna cut, for example, for 3500 kc. (13377") resonates on all the integral harmonics of 3500 kc. and thus can be used on 7000, 14,000, 28,000 and 56,000 kc. Actually, a half wave antenna cut for 3500 kc. resonates at 7185, 14,550, 29,210 and 58,760 kc. These frequencies are related by the formula

$$F = \frac{(K-.05) 492,000}{L}$$

where F is the frequency in kilocycles, K is the number of half waves on the antenna, and L is the length of the antenna in feet.

Table I (see next page) shows the frequencies at which 24 different antenna lengths resonate at their second, fourth, eighth, and sixteenth harmonics. Note that there is no single antenna which will resonate inside both the 80 and 20 meter bands. However, resonance in an antenna is not sharply defined and all good antennas tune rather broadly.

In order to determine the harmonic frequencies at which a given antenna wire resonates, multiply by the factors shown below the frequency for which the antenna represents exactly a half wave.

	<i>multiply fundamental frequency by</i>
Fundamental or first harmonic	1.000
Second harmonic	2.052
Third harmonic	3.106
Fourth harmonic	4.158
Eighth harmonic	8.390
Sixteenth harmonic	16.677

Thus a wire which is a half wavelength long at 1,000 kilocycles resonates on its second harmonic at 2,052 kc.; third harmonic at 3,106 kc.; fourth at 4,158 kc.; eighth at 8,390 kc.; and the sixteenth harmonic at 16,677 kc.

When designing an antenna for operation on more than one band, note that it should be cut for harmonic resonance at its highest operating frequency. If it is to be operated off resonance on some band it is better to have it off resonance on a low frequency band, because any errors thus become a smaller percentage of a half wave. Thus if a given antenna is to work on both 20 and 40 meters it is best to cut the length of the radiator so that it is correct for operation on the 20 meter frequency to be used. When operating on forty meters at perhaps exactly half of the twenty meter frequency (one crystal) the antenna will be slightly too long but not enough to be bothersome. When trying to operate on three or four bands with one antenna it becomes quite difficult to establish a good compromise without having a pretty bad error on the lowest frequency. Thus if four band operation is to be obtained with one antenna, it is desirable to use either a Zepp. or end-fed antenna in order to be able to change the electrical length of the antenna by tuning as the frequency is changed, even though the losses in the Zepp. and the end-fed antennas are greater than in other types.

### Long Wire Antennas

Many amateurs who have the room available are using very long wires operated with as many as ten or fifteen half waves on them. Such an antenna should be resonant at the operating frequency. Remember that although 33 feet is a half wave at 20 meters a wire 330 feet long is not the equivalent of ten half waves. Ten half wavelengths on 14,200 kc. require a wire 345 feet long, which is about 15 feet longer than ten times one half-wave at the same frequency. The error is almost 50% of a half-wave, which would certainly upset any transmission line feeding this antenna, as an error of 50% of a half-wave puts high voltage where there should be high current and vice versa. Thus when cutting any long wire antenna such as a Vee beam or resonant diamond be sure to check lengths by the harmonic wire table (next page) or the formulas on page 37.



Length	$\frac{\lambda}{2}$	$\lambda$	$2\lambda$	$4\lambda$	$8\lambda$
133' 7"	3,500	7,185	14,550	29,210	58,760
129' 10"	3,600	7,390	14,970	30,130	60,450
126' 4"	3,700	7,595	15,390	31,010	62,135
123'	3,800	7,800	15,820	31,800	63,800
119' 10"	3,900	8,005	16,300	32,640	65,500
118' 4"	3,950	8,110	16,420	33,060	66,330
116' 10"	4,000	8,210	16,620	33,450	67,140
66' 9"	7,000	14,370	29,105	58,730	
66' 4"	7,050	14,470	29,305	58,990	
65' 10"	7,100	14,570	29,510	59,290	
65' 4"	7,150	14,670	29,710	59,800	
64' 11"	7,200	14,775	29,940	60,260	
64' 6"	7,250	14,880	30,130	60,640	
64'	7,300	14,985	30,365	61,110	
33' 5"	14,000	28,720	58,180		
33' 2"	14,100	28,950	58,640		
32' 11"	14,200	29,160	59,090		
32' 9"	14,300	29,290	59,340		
32' 6"	14,400	29,550	59,870		
16' 8½"	28,000	57,440			
16' 5"	28,500	58,500			
16' 1½"	29,000	59,595			
15' 10½"	29,500	60,710			
15' 7½"	30,000	61,500			
8' 4"	56,000				
8' 2⅜"	57,000				
8' ½"	58,000				
7' 10¾"	59,000				
7' 9"	60,000				

TABLE I.  
Resonant Harmonics for Various Wire Lengths

This matter of harmonic operation of antennas brings up the problem of operating on both 20 and 75 meter phone. The center of the 75 meter phone band is 3950 kc. and the center of the 20 meter phone band is 14,200 kc. It is rather common practice to use some form of half-wave 75 or 80 meter antenna and then work it on its fourth harmonic for 20 meter operation. The antenna will be off resonance on either 75 or 20 and it is better to have it resonant on 20 and slightly off on 75 because the percentage error on 75 with the antenna cut for harmonic operation on 20 is less than when a half-wave on 75 is operated on 20. Thus by ordinary practice one would cut the radiator 136 feet 10 inches so that it would have exactly four half-waves on 14,200 kc. As a half-wave for 3950 kc. is 118 feet 4 inches long, the antenna would be 16% long on 75 meters. While it is always desirable to operate antennas at resonance, the antenna efficiency does not drop off materially when it is 16% too long. However,

note that by cutting the radiator 102 feet long it resonates perfectly on 14,200 kc. on its **third** harmonic yet is only **13%** off (too short) for resonance at 3950 kc. Thus the 102 foot antenna is closer to resonance at 3950 kc. than the 136'10" radiator. Also note that there is high current at the center of this antenna on both bands, which is not the case with the 136'10" antenna. The latter has current at its center on 75 but high voltage there on 20 meters. Thus the third harmonic antenna could be fed with a twisted pair while the fourth harmonic antenna would require either a Zepp. or Collins resonant feed line, if center fed. There would be a slight mismatch between the twisted pair and the center of the 3d harmonic antenna as the radiation resistance on both 75 and 20 would approximate 100 ohms but the mismatch is slight. There would also be some reactance reflected into the twisted pair on 75 meters, but it is not enough to be bothersome and the losses would be materially less than with the average Zepp-

system. See figure 23 on page 21. This same 102 foot radiator can also be fed as a Johnson Q system. The Q matching section should be 49 feet 5 inches long. The proper spacing between the Q bars varies with the characteristics of the transmission line connected to it. One-inch spacing of 1/4 inch aluminum tubing worked out right for a transmission line made with no. 14 copper wire spaced 6 inches. The impedance at the input of this particular Q matching section is approximately 625 ohms on 14,200 and 3950 kc. See figure 16 on page 22.

### Length Formulas for Harmonic Antennas

Basic formula

$$L_{\text{feet}} = \frac{492 (K - .05)}{f_{\text{mc}}}$$

where K = no. of half waves on wire.

Half wave (K = 1)

$$L_{\text{feet}} = \frac{467.4}{f_{\text{mc}}}$$

Full wave (K = 2)

$$L_{\text{feet}} = \frac{959.4}{f_{\text{mc}}}$$

Three half waves (K = 3)

$$L_{\text{feet}} = \frac{1451.4}{f_{\text{mc}}}$$

Four half waves (K = 4)

$$L_{\text{feet}} = \frac{1943.4}{f_{\text{mc}}}$$

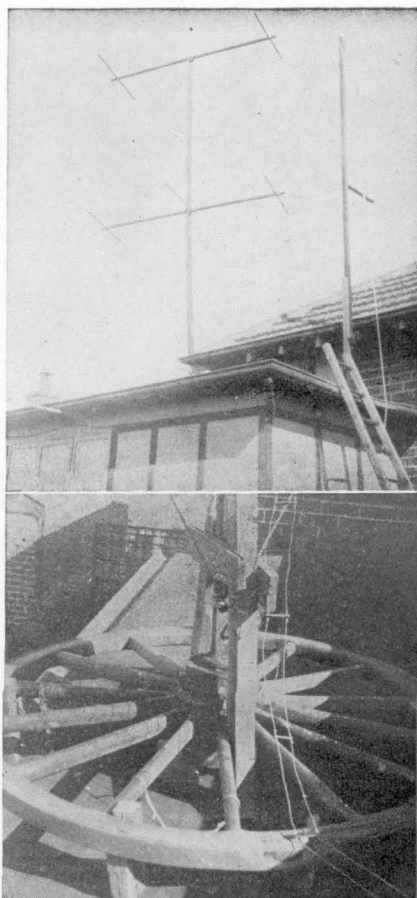
Eight half waves (K = 8)

$$L_{\text{feet}} = \frac{3911.4}{f_{\text{mc}}}$$

Sixteen half waves (K = 16)

$$L_{\text{feet}} = \frac{7847}{f_{\text{mc}}}$$

When calculating antenna lengths the answer almost always comes out in decimal parts of a foot. The following table provides a simple means of transposing between feet and inches. Fractional parts of an inch are not used as no common antenna need be cut to the fractional part of an inch. However, it sometimes is desirable to know the closest inch quite accurately. The table is used as follows: Suppose that an antenna for a given frequency works out to be 124.39 feet. We wish to know how many



Pictured here is an idea for a 56 mc. rotatable beam array. Its originator is Don Knock, VK2NO.

inches are .39 or thirty-nine hundredths of a foot. Glancing down the column we find that .39 appears between 0.375 and 0.458. Thus the closest inch is 5 inches.

Decimal Fraction of a Foot	Nearest Inch
0.000 to 0.042.....	0"
0.042 to 0.125.....	1"
0.125 to 0.208.....	2"
0.208 to 0.292.....	3"
0.292 to 0.375.....	4"
0.375 to 0.458.....	5"
0.458 to 0.541.....	6"
0.541 to 0.625.....	7"
0.625 to 0.708.....	8"
0.708 to 0.791.....	9"
0.791 to 0.875.....	10"
0.875 to 0.958.....	11"
0.958 to 1.000.....	12"

## VI. Directive Antennas

### Directive Properties of Antennas

No antenna radiates energy equally well in all directions. The directive properties of an antenna depend upon its length, its height above ground, and its slope. The relative field strengths in various directions about an antenna may best be shown by means of "polar diagrams" in which the dis-

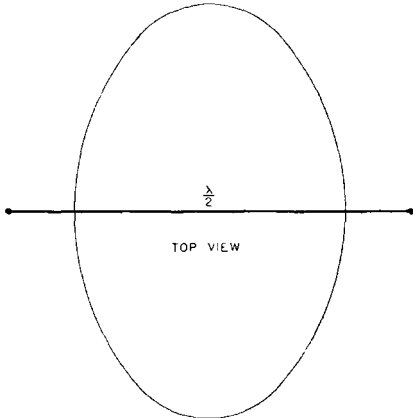


Figure 1  
Typical Polar Diagram of Horizontal Directivity of a Dipole in Free Space.

tance from the antenna out to the polar curve in any direction indicates the relative field strength set up in that direction. We can indicate most of the directive properties of any antenna with two "polar diagrams". The first type of polar diagram is that which indicates the horizontal directivity of an antenna, or represents looking down on the antenna from above. Figure 1 shows a typical polar diagram of horizontal directivity. In addition to directivity in the horizontal plane or in various directions around the horizon, we are also greatly interested in the directivity of an antenna in the vertical plane. The sky wave is of much more importance than the ground wave in long-distance, high-frequency communication, and the vertical directivity (the angle of radiation above the horizon) materially affects the skip distance.

### Antenna Radiation Characteristics

All antenna discussions start with the half-wave or dipole radiator. A half-wave doublet, Zepp., single wire fed, matched impedance, or Johnson "Q" antenna all have practically the same radiation pattern, when properly built and adjusted. They are all

dipoles, and the feeder system **should** have **no** effect on the radiation pattern.

The radiation pattern from a dipole can best be conceived as a fat doughnut with the antenna wire passing through the center of the hole. See figure 1. Thus if the wire is vertical, the doughnut of radiation extends outward in all directions in the horizontal plane. When the dipole is horizontal, radiation in the horizontal plane is least off the ends of the wire and greatest in a direction at right angles, or broadside to the wire. However, as the "doughnut" around a simple half-wave antenna is quite fat the actual difference between the power radiated broadside and the end fire power radiated is not very great. Nearby objects also minimize the directivity of a dipole radiator so

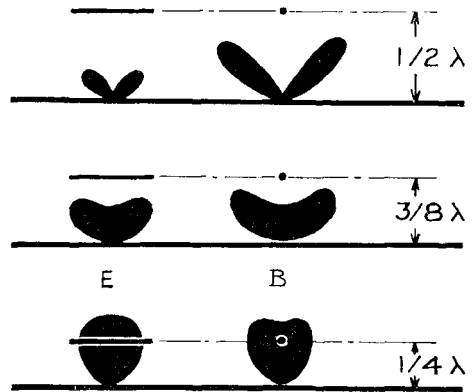


Figure 2  
Endwise and Broadside Directivity Obtained in Actual Practice With a Horizontal Dipole at Different Heights Above Earth.

that it hardly seems worth while to go to the trouble to rotate a simple half-wave dipole in an attempt to improve transmission and reception in any direction.

When the half-wave dipole is brought close to earth its radiation pattern changes somewhat due to reflection from the earth. If the dipole is mounted vertically the radiation is the same in all directions around the horizon, which means that its curve of horizontal directivity would be perfectly circular. As far as the vertical directivity or angle of major radiation is concerned, it does not go out directly at right angles to the antenna or parallel with the ground as might be expected, but instead, due to reflection from the ground, the wave is projected upward. The angle of radiation above

the horizon varies with the height above ground and is reduced as the height of the antenna goes up. In other words, the higher a vertical half-wave antenna the lower the angle of radiation.

The horizontal directivity of a horizontal dipole remains unchanged when viewed from above as the height of the dipole above ground is varied; thus figure 1, which is a top view of a horizontal dipole, is independent of height. The "angle of radiation" or the vertical directivity of the horizontal dipole varies with the height of the antenna above ground in a manner somewhat similar to that of a vertical dipole. Again the higher the antenna the lower the angle of radiation with respect to the horizon.

When a multiplicity of radiating dipoles are so located and phased as to reinforce

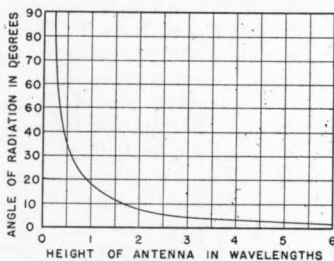
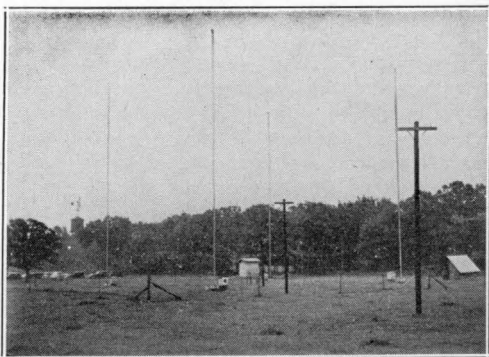


Figure 3  
**ANGLE OF RADIATION CHART**  
 Showing the angle of radiation above the horizon of the major low-angle lobe in a horizontal half-wave antenna.

the radiation in certain desired directions and to neutralize radiation in other undesired directions a directive antenna array is formed.

The function of a directive antenna when used for transmitting is to give an increase in signal strength in some direction at the expense of reduced signal in other directions. For reception one might find useful an antenna giving little or no gain in the direction from which it is desired to receive signals, if the antenna is able to discriminate against interfering signals and static arriving from other directions. A good directive transmitting antenna, however, can generally also be used to good advantage for reception. For communication with a distant locality, the maximum effectiveness of a directive system is obtained when the direction of the beam coincides with the great circle route to the distant point.

The great circle course between any two points on the surface of a sphere, such as the earth, is the shortest course between those two points. It is **not** a straight line



Above is shown the unusual 75 meter beam antenna of W9PZ. It is "aimed" merely by punching the proper push-button at the operating position inside the station. The vertical duraluminum poles are the  $\frac{1}{4}$  wave vertical antennas. The wood poles in the foreground support the transmission line and the control wires.

as drawn on the average flat or Mercator projection of the world. It can be determined by means of spherical trigonometry or by stretching a rubber band between the two points on a globe. The maps on pages 59, 60, and 61 show all great circle courses from the three key cities of Washington, D.C.; Topeka, Kansas; and San Francisco, California as straight lines to all parts of the world. By using the map which is keyed to the city nearest you, there will only be a minute error developed for distances under 9000 miles for any amateur living in the United States. Strictly speaking, the maps should be used only for the cities on which they are keyed, but errors of direction of as much as 5% or so are unimportant in radio work as the ionosphere causes some wave scattering anyway, making the direction of a received signal vary 5% or more. Also, even a highly-directional antenna covers several degrees with the "strong" part of its field-pattern lobe, further making small errors in direction calculation of little importance.

There are two kinds of antenna directivity: horizontal plane and vertical plane directivity. Directivity in the vertical plane affects the angle of radiation with respect to the horizon and affects the skip distance for any frequency. It has been pretty well determined that low angle radiation (7 to 20 degrees) is most useful for working locally and for very long distances, such as 4,000 miles or more. Higher angle radiation (20 to 50 degrees) is more useful for working out from 500 to 4,000 miles. The best angle for a given distance varies with the fre-

quency, time of day, season of the year, and the sunspot cycle.

If amateur stations were uniformly scattered around the horizon, horizontal directivity would be undesirable for the amateur who wishes to be able to work everyone else. However, a short study of an azimuth projection of the world (wherein all great circle courses from a given point are straight lines. See page 59) will show that the great majority of amateurs in the world are concentrated in from four to six great circle courses from a given point. In California two bi-directional antennas will effectively cover all continents but Europe, as North America and Africa are directly opposite Australia while South America is directly opposite the Orient. Europe is a little East of North from here and in the opposite direction the great circle course travels about halfway between Tasmania and Little America, which means that an antenna directive on Europe would not be particularly useful in the opposite direction.

Commercial practice in constructing large antenna arrays for transmitting is to obtain the gain chiefly by directivity in the horizontal plane and make use of only limited directivity in the vertical plane. There seems, thus, to be considerable faith in a great circle mode of transmission. For receiving, however, it has recently been found advantageous also to use high directivity in the vertical plane to select one of a group of downcoming waves from a distant station, in order to mitigate fading due to phase interference of several components of the group.

The effect of some amateur stations receiving considerably improved reports in the line of a beam and also slightly better reports in all other directions might be explained on the basis of a field pattern having the main lobe of radiation in the favored direction and also a cluster of smaller, narrow lobes of radiation in a number of other directions. If these small lobes happened to fall in the proper directions, one might not readily detect that there were directions of low signal (directions of minimum radiation) between, when relying solely on reports from distant stations.

There can be no question but that the use of one or more beam antennas is a good investment for the amateur who has available room for a beam near his home. Really tremendous gains in effective radiated power can be obtained with relatively inexpensive antenna arrays. For the amateur

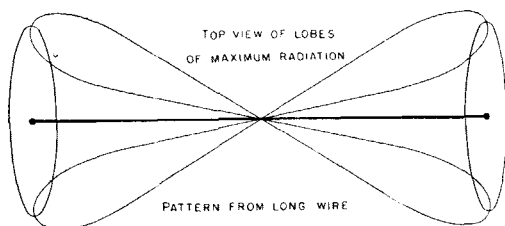


Figure 4

#### Horizontal Directivity of a Full-Wave Antenna.

who is already using the maximum legal input to his final amplifier, the directive antenna array provides a means of increasing "effective" power without stepping outside of the legal limit. One of the most complex and extensive beams now in existence gives a power gain of 23 decibels in one particular direction. 23 decibels represents a power gain of 200 times, and thus if the antenna array were fed 1,000 watts of r.f. power, the signal at all receiving stations within the aperture of the array would receive the equivalent of a 200,000 watt signal being radiated from a single half-wave vertical Hertz dipole. This particular antenna is undoubtedly too expensive and too hard to adjust for an amateur. In fact, the aperture of such an array is believed to be too narrow even for point to point communication between two fixed stations, due to the phenomenon known as apparent deviation from a great circle course. Most authorities agree that an antenna gain of 16 db. is about as high as practicable at the present time. Sixteen db represents a power gain of 40 times, and it takes quite an extensive array to obtain this amount of directivity. Probably the maximum amount of antenna gain economically feasible for amateurs is about thirteen db. This represents a power gain of 20, which means that a kilowatt transmitter lays down a 20 kw. signal in the favored direction. Several relatively simple antenna arrays that are easy to adjust are capable of gains exceeding 7 db, which is a power gain of five times.

The economics of directive antennas are interesting. A commercial radio telegraph transmitter can be built for about \$5.00 per watt of output. A commercial phone transmitter would cost about twice that, or about \$10.00 per watt of output. An amateur radio telegraph transmitter can be built for about \$1.00 per watt, while a phone transmitter of good design costs about \$2.50 per watt. Thus a 100 watt amateur phone transmitter would probably cost somewhere in the neighbor-

hood of \$250.00. Suppose that the owner of this hypothetical 100 watt transmitter wanted to lay down a 500 watt signal in a given direction. A 500 watt transmitter would cost him approximately \$1250.00, which is \$1000 more than the 100 watt transmitter. As telephone poles in many sections of the country are installed at 50-cents per foot of height and good steel core antenna wire is only about 1-cent per foot, think what a "fine business" directive antenna array could be erected for the thousand dollar difference in transmitter costs. Of course, he would sacrifice field strength in other than the favored direction, but \$1000 ought to build the average ham who has the room available, enough

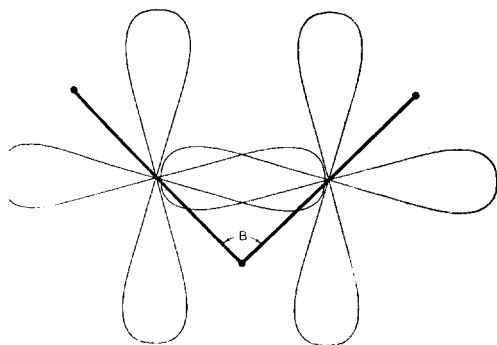


Figure 5

Showing How the Lobes of Two Full-Wave Antennas May Be Arranged to Add and Cancel, Thus Providing Increased Directivity (Vee Beam).

directive antenna arrays to work all continents and even give him the choice of the long way or the short way around.

Directive antennas can be classified into two general types: the long wire antennas and the stacked dipole arrays. Both types can be made to give very good results and each type has its advantages and disadvantages.

### Long Wire Antennas

The first and simplest step toward increased directivity is to use a long wire, which may be up to fifteen or twenty wave lengths long.

The single half-wave Hertz dipole is essentially a broadside radiator of energy, although the radiation pattern is quite broad. See figure 1.

As the length of the radiator is increased, in even multiples of a quarter wave length, the doughnut of radiation around the simple dipole changes into two cones located apex to apex. In other words, there is a

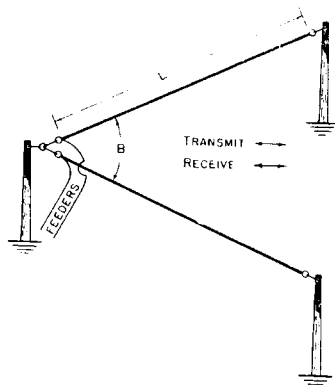
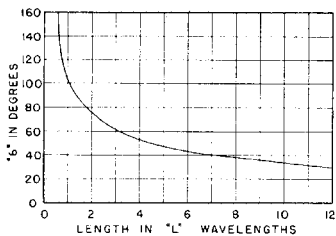


Figure 6

Typical "Vee Beam" Antenna.

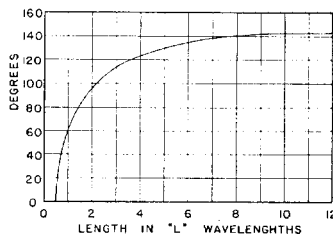
cone of radiation around each end of the wire. See figure 4. The angle that the cone makes with the wire gets smaller as the length of the wire is increased, so that as the length of an antenna is increased the antenna changes from a broadside radiator into an "end-fire" radiator. As all long wire antennas are necessarily horizontal, or parallel with the horizon, the portion of the radiating cones that shoot radiation upward into the sky and downward into the earth are useless and only those portions of the cones that shoot radiation outward more or less parallel to the surface of the earth are useful. It will be seen that a small part of each side of each cone usefully radiates, so that a long wire antenna radiates best in four directions. The longer the wire the smaller is the angle between the lobes of maximum radiation and the wire itself. If the wire had an infinite length and had no r.f. resistance the lobes of maximum radiation would shoot exactly off the ends of the antenna.

Note that if two long-wire antennas are built in a form of a "vee", it is possible to make two of the maximum lobes of one leg shoot in the same direction as two of the maximum lobes of the other leg of the vee. See figure 5. It is also possible to make the other two lobes of each leg of the vee neutralize and cancel each other. Thus a properly built vee antenna is bi-directional; in other words it radiates maximum power in two exactly opposite directions. A typical vee antenna can be six and three-quarters wavelengths on each leg. The angle between the two legs (which decreases as the length of each leg increases) should be approximately 40 degrees. Another useful vee antenna, though much less directional than



### VEE BEAM CURVE

Figure 7-A. Showing the included angle between the two legs of a Vee-beam antenna for various leg lengths.



### DIAMOND OR RHOMBIC BEAM CURVE

Figure 7-B. Showing the included angle at each side of the diamond. This is not the included angle at each end of the diamond. This included angle is twice the tilt angle of the array.

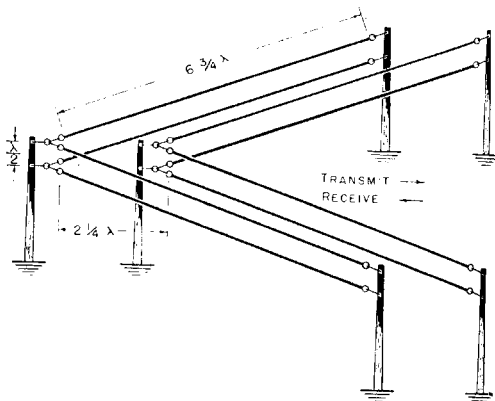


Figure 8  
Stacked "Vee" Antenna With Reflector.

antennas are adversely affected by the r.f. resistance of the wire. This resistance also affects the "Q" or selectivity of the long wire and as the length is increased the tuning of the antenna becomes quite broad.

TABLE I

### Radiation Resistance of Harmonic Antennas

No. of $\frac{\lambda}{2}$	Radiation resistance ohms	Angle of maximum radiation	Power in major lobe of radiation
1	72	90°	1
2	90	55°	1.15
3	100	46.5°	1.25
4	110	37°	1.35
5	115	34.5°	1.5
6	122	30.5°	1.7
7	125	28°	1.85
8	131	27°	2.1
9	135	25.5°	2.3
10	139	24°	2.55
11	142	22.5°	2.75
12	145	21°	3.1
13	148	20.5°	3.3
14	150	20°	3.65
15	152	19.5°	3.9
16	154	19°	4.25
17	156	18.5°	4.55
18	158	18°	4.9
19	160	17.5°	5.25
20	162	17°	5.65
21	163.5	16.5°	6.0
22	165	16°	6.3
23	166.5	15.5°	6.75
24	168	15°	7.2

the preceding one, is one and a half wave lengths long on each leg, in which case the angle between the legs is exactly 90 degrees or a right angle.

The vee antenna can have each leg either an even or an odd number of quarter waves long. If an even number of quarter waves long the antenna must be voltage fed at the apex of the vee, while if an odd number of quarter waves long current feed can be used. Figure 6 shows a typical vee antenna and figure 7 includes a curve showing the relationship between the length of each leg and the angle included between the two legs.

Building a reflector vee similar to the radiator, an odd number of quarter waves behind or in front of the antenna, concentrates all the radiation in one direction. Building a similar vee above or below the vee, and fed in phase, gives some vertical directivity and concentrates the radiation at a low angle with respect to the horizon. See figure 8.

The directivity of a long wire does not increase very much as the length is increased beyond about fifteen wavelengths. In fact the directivity does not go up in proportion to the additional cost of the long wire after about 8 wavelengths are used. This is due to the fact that all long wire

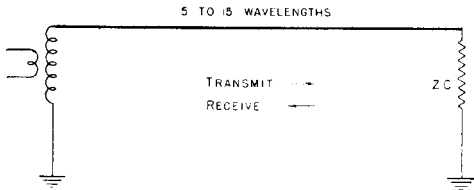


Figure 9

**Aperiodic, Unidirectional, Long-Wire Antenna.**

In fact, a long wire about 15 waves long is practically aperiodic and works almost equally well over a wide range of frequencies.

Terminating the far end of a long wire antenna in its characteristic impedance makes it even more aperiodic and, at the same time, tends to make it unidirectional. See figure 9. In other words it radiates only away from the transmitter out over the terminating resistance. The power that otherwise would be radiated out back in the opposite direction from the resistance-terminated end is dissipated in the resistance.

**The Rhombic Antenna**

This leads us to the diamond, or horizontal rhombic type of antenna. The diamond antenna is simply a vee antenna with another vee backed up against the first one. See figure 10. A properly built diamond antenna is always unidirectional. R.f. power is fed into one apex of the two vees and the apex of the other vee is terminated in its characteristic impedance with a resistor.

The directive gain of the diamond or Bruce rhombic antenna is dependent on the

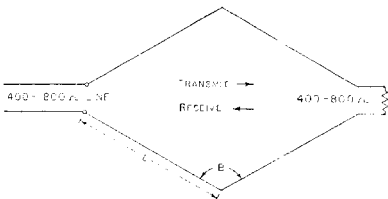


Figure 10

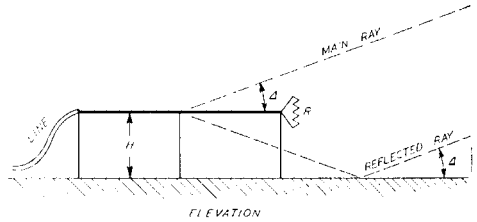
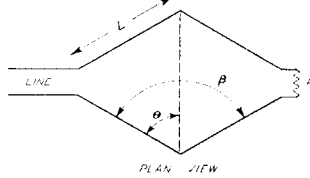
**The Rhombic (Diamond) Directive Antenna System Developed by Bruce and Widely Used in Commercial Applications.**

height above ground and the tilt angle as well as the overall length of each of the four radiating wires in the array. Therefore the gain is not easy to calculate.

One typical diamond that gives a gain in power in the favored direction of 25 times (14 db.) has each leg  $3\frac{1}{4}$  wavelengths long.

The included angle at the front and back is 64 degrees and the angle at the sides (twice the tilt angle) is 116 degrees. The

height above ground is a half wave and the vertical angle of radiation becomes approximately 13 degrees. This antenna will work over a range of almost four to one in frequency, although the directivity is greatest



**DESIGN FORMULA**

$$H = \frac{\lambda}{4 \text{ SINE } \Delta}$$

$$L = \frac{\lambda}{2 \text{ SINE}^2 \Delta}$$

$$\text{SINE } \theta = \text{COSINE } \Delta$$

$$\beta = 180 - 2\Delta$$

WHERE .

$\theta$  = TILT ANGLE

$\beta$  = INCLUDED ANGLE

$\Delta$  = VERTICAL ANGLE OF MAX RADIATION

H = HEIGHT ABOVE EARTH IN METERS

L = LENGTH OF ONE ELEMENT IN METERS

Figure 11

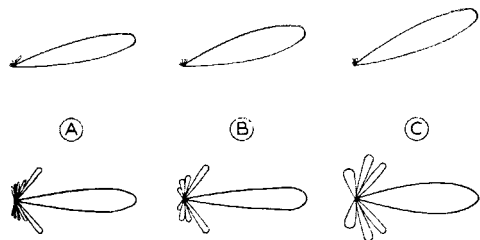
**Design Chart and Formulas for the Rhombic Antenna.**

at the frequency for which the dimensions are as given above.

Thus for operation on 7, 14 and 28 megacycles with a peak at 14 megacycles the dimensions are: length of each leg, 218 feet; height above ground, 33 feet; and the angles those given above.

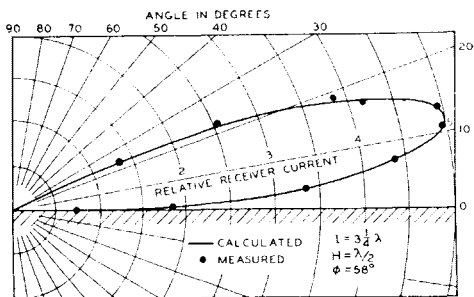
If the height is raised to 66 feet above ground, the directivity remains about the





**Figure 12**  
Radiation patterns of three rhombic antennas: vertical directivity above and horizontal directivity below. "A", pattern of rhombic antenna 4 waves on a side and one wavelength high. "B", 3 waves on a side and  $\frac{3}{4}$  wavelength high. "C", 2 waves on a side and a half wavelength high. Note that the above conditions hold for a single antenna, worked over a frequency range of 2/1, as well as for three different antennas at the same frequency.

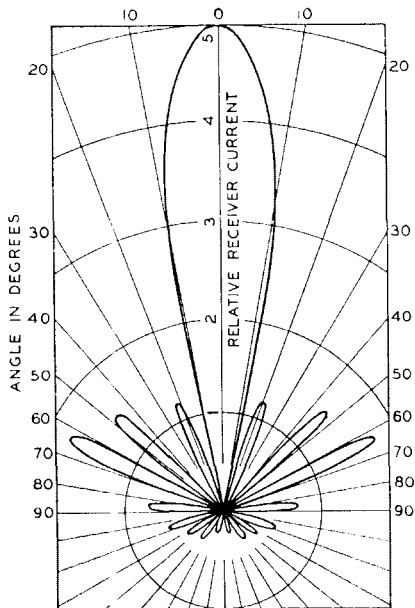
same, but the angle of vertical radiation goes down to about 9 degrees above the horizon, on 14 Mc. This amount of gain is truly remarkable for such a simple antenna, and as the diamond requires no critical adjustment for good results, its use is highly recommended for those who have the necessary room available. The terminating resistance at the front of the diamond will usually be between 400 and 1000 ohms, with 800 ohms a good average value. The input resistance of the diamond which is reflected into the transmission line that feeds it is always somewhat less than the terminating resistance and is around 750 ohms when the resistor is 800 ohms.



**Figure 13**  
Vertical directivity of the  $\frac{3}{4}$  wavelength rhombic antenna described in the text. The receiver current ratio of 5/1 at the tip of the lobe represents a power gain of 25 times, or 14 db.

The diamond loses a good deal of directivity when the terminating resistor is left off and it is operated as a resonant antenna. If it is desired to reverse the direction of maximum radiation it is much better practice to run feeders to both ends of the antenna and mount terminating re-

sistors also at both ends. Then with either mechanically or electrically controlled, remote controlled double-pole double-throw switches located at each end of the antenna it becomes possible to reverse quickly the array for transmission or reception to or from the opposite direction.



**Figure 14**  
Horizontal directivity of the rhombic of figure 13.

The diamond antenna should not be tilted in any plane. In other words the poles should be the same height and the plane of the antenna should be parallel with the ground. Tilting the antenna simply sacrifices about half the directivity due to the fact that the reflection from the ground does not combine with the incident wave in the desired phase unless the antenna is parallel with the ground.

It is highly desirable to use the antenna in swamp or marshy soil in order to get high ground conductivity. Perhaps the best location would be where the antenna is located over salt water, with the water extending at least a half mile in front of the antenna in the direction of the distant station. It is usually better to locate an antenna and particularly a directive antenna in swampy and marshy country rather than on top of a high mountain.

The diamond is generally unsuitable for general ultra-high-frequency use (5 meters, for instance) due to the fact that it radiates

horizontally polarized waves and also due to the fact that while it is a low angle radiator it still does not radiate any appreciable energy out at a zero vertical angle, which is desirable for ultra high frequency use.

The diamond antenna is very desirable for commercial use where unidirectional transmission and reception is essential to reduce static and interference. The ability of the diamond to work well on all frequencies over a range of two to one is also desirable for commercial use, as many commercial stations must change frequency three to four times a day and their frequencies are not harmonically related. However, not that the unidirectional characteristic of the diamond is **not** obtained by reflecting the radiation in the undesired direction back into the desired direction. Instead it merely absorbs and dissipates the undesired radiation in a big resistor. Thus about 35% of the r.f. power applied to the diamond is dissipated in heat.

### STACKED DIPOLE ANTENNAS

Earlier in this handbook the characteristics of a half-wave dipole were described. It will be remembered that maximum radiation from a simple dipole occurs in a plane perpendicular to the axis of the dipole. The electromagnetic field around the dipole extends out and induces energy in any object placed within its field, such as a distant receiving antenna. Every object in the field of the dipole absorbs some energy but the

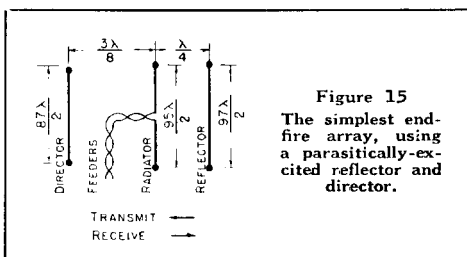


Figure 15  
The simplest end-fire array, using a parasitically-excited reflector and director.

absorption is quite small even only 20 wavelengths away. Up to one wavelength away the absorption in a nearby object can be quite large, but if the nearby object is capable of re-radiating the energy absorbed, there will be little waste of energy, though there will be a definite change in the shape of the field pattern.

### End-Fire Arrays

If the nearby object that causes the interference with the radiated wave consists of

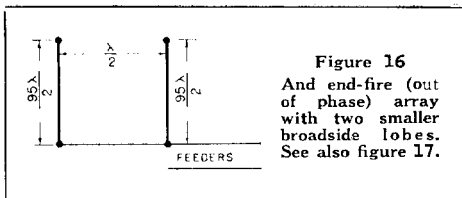


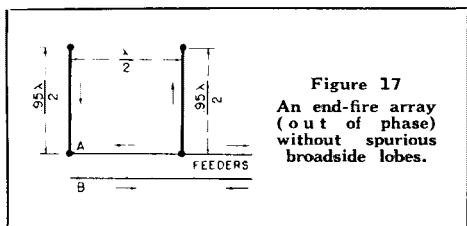
Figure 16  
And end-fire (out of phase) array with two smaller broadside lobes. See also figure 17.

another dipole tuned to a slightly lower frequency than the radiator, and is a quarter wave away and parallel with the radiating dipole, an interesting phenomenon occurs. As electromagnetic waves travel with the speed of light through space, the radiated wave arrives at the interfering dipole a quarter of a cycle after it leaves the radiator, as they are spaced a quarter wave apart. A current is induced in the interfering dipole which lags by a half-cycle of the electromagnetic flux which produces it. (By Lenz' law.) Thus the current in the interfering dipole lags the current in the radiating dipole by three quarters of a cycle, or 270 electrical degrees. The current flowing in the interfering dipole causes radiation from that dipole and this radiated wave arrives back at the radiating dipole after another quarter cycle, or 90 degrees, so that the wave from the interfering dipole arrives at the radiating dipole just 360 degrees after the originating wave started from the radiating dipole. Thus the wave from the interfering dipole arrives at the primary radiator just as the next wave starts from the primary radiator. The two waves are in phase so they combine into a wave twice as strong in a direction **away** from the interfering or reflecting dipole. Also note that as we move back to the reflecting dipole one wave **gains** 90 degrees while the other wave **loses** 90 degrees so that the two waves are 180 degrees out of phase in that direction and consequently neutralize each other. Thus the radiation in the direction of the reflector is canceled out. See figure 15.

Therefore, a dipole tuned to a frequency slightly below that of the primary radiator and spaced a quarter wave from the radiator acts as a **reflector** and the lobe of maximum radiation is in line with the two dipoles.

If the interfering dipole is slightly **shorter** than the radiator (tuned to a slightly **higher** frequency) it has the opposite effect, and acts as a **director**, the lobe of maximum radiation pointing toward the interfering dipole.

Whether the interfering dipole acts as a director or reflector depends on the **phase**



**Figure 17**  
An end-fire array  
(out of phase)  
without spurious  
broadside lobes.

of the interfering radiation relative to the phase of the original wave. When the interfering dipole offers an inductive reactance (dipole longer than half wave) to the voltage induced in it by the primary wave the phase of the secondary or interfering wave is such that the interfering dipole acts as a reflector. When the reactance is capacitive to the induced voltage (dipole less than a half wave) the interfering dipole acts as a director. See figure 15 and also figure 25. This is the simplest form of an end fire array using stacked dipoles.

### Feeding End-Fire Arrays

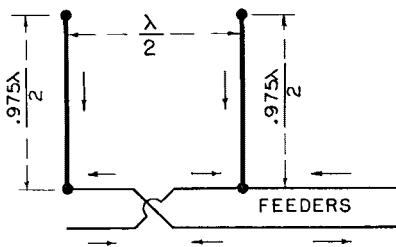
End-fire arrays can be directly fed from a transmission line as well as parasitically excited as was shown above. The length of the two-wire phasing section connecting the elements of an end-fire array should be the same as the physical spacing between the elements of the array. This simply means that the phase shift and the physical spacing should be the same in electrical degrees. An end-fire array may have any number of radiators in line but if more than three radiators in line are used each radiating element should be directly fed rather than dependent on parasitic excitation. When the radiating elements are directly fed from one or more transmission lines fed from the same transmitter, all the elements should be the same length. The length will depend upon how the elements are fed and also upon their spacing, but will usually be between .96 and .99 times a half wave.

All end-fire arrays are unidirectional as long as the spacing between elements is not exactly one-half wavelength, when the array becomes bi-directional. With spacings other than a half wavelength the array is directional toward the end in which the phase lags.

An unidirectional end-fire array may have its radiation reversed by adding or subtracting 180 degrees to the phase shift between elements. For example take an end-fire array with quarter-wave spacing between elements. Ordinarily the phase shift between such elements would be 90 degrees,

so that the direction of transmission would be towards the lag in current. However, if a half-wave phasing section be added to the original phasing section so that the total phase shift becomes 270 degrees, the direction of maximum radiation will be exactly reversed. 270 degrees of lag is the same as 90 degrees of lead so that, in effect, the radiator which originally had a 90 degree lag in current now has the same thing as a 90 degree lead. The extra 180 degrees of phase shift may be added by means of series inductance and/or parallel capacitance in the phasing line.

It might be asked which element spacing is the best to use. Quarter-wave and three-eighths-wave spacing give exactly the same directivity. One-eighth-wave spacing gives slightly less directivity and half-wave spacing gives considerably less directivity than the quarter- or three-eighths-wave spacing. This is for a given overall length of the array. Thus quarter-wave spacing is prob-



**Figure 18**  
A broadside array representing a simple  
change in phasing from the array of  
figure 17.

ably the best compromise. While it requires nearly 50% more wire for a given directivity, than the end-fire array using  $\frac{3}{8}$ -wavelength spacing between elements, no special adjustment of the transmission line interconnecting the elements is necessary and no loading between the elements is needed to establish proper phase shift.

The directivity of an end-fire array of stacked dipoles is almost directly proportional to the overall length of the array expressed in wavelengths.

For example, an end-fire array requires an overall length of 3 wavelengths to give a power gain of ten times over a half-wave vertical dipole antenna used as a reference standard. With quarter-wave spacing, 13 radiating elements are required, while with  $\frac{3}{8}$ -wave spacing only 8 radiating dipole elements are necessary to get the same directivity. For a power gain of 5 times an over-

all array length of one and a half wavelengths is required. With quarter-wave spacing, 7 elements are required, and with three-eighths-wave spacing, only 5 dipole elements are necessary.

End-fire arrays give about the same overall directivity as broadside arrays, although they give somewhat more vertical directivity and somewhat less horizontal directivity than a broadside array. It is also very hard to lay out an effective end-fire array without serious "tapering" of the current as it flows down the array. Thus it is hard actually to realize in practice the theoretical power gain noted above.

### Broadside Arrays

If the two dipoles are spaced a **half wave length** apart the current flowing in the parasitically-excited, interfering dipole will be 360 degrees, or a full wave behind the current in the radiator, and the two dipoles are said to be **in phase**. When this happens the two waves from the two dipoles meet at a point half way between the two (a quarter wave from each) and they are 180 degrees **out of phase** and thereby cancel. Thus there is minimum radiation in line, or end fire, but the radiation broadside is maximum.

If the interfering dipole in the simple broadside array (dipoles half wave apart)

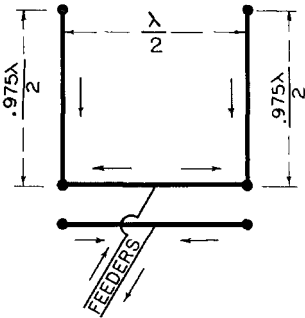


Figure 19

A broadside array with better current distribution than the array of figure 18.

were fed by a transmission line instead of parasitically by radiation from the other dipole, the result would be the same, as long as both dipoles were excited **in phase**. See figures 18 and 19. If the second dipole is fed 180 degrees **out** of phase the array becomes end fire. See figure 17.

Note the difference between figure 18 and figure 19. They both give exactly the same results but notice that in figure 18 the resonant half-wave line that couples the two radiators together is transposed once in order to provide proper phase shift, while in

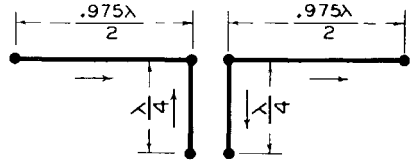


Figure 20

Simple, two-element Franklin or co-linear broadside array, showing use of quarter-wave matching section.

figure 19 the coupling line is **not** transposed. In fact, at first glance the coupling between the two broadside radiators of figure 19 looks exactly like the out-of-phase coupling for the two end fire radiators of figure 17. The difference lies in the fact that the feed line from the transmitter is connected to the center of the phasing line in figure 19 while it connects to one extremity of the line in figure 17. The presence of the resonant feeders makes the difference and causes the proper phase shift. The phase shift of the coupling lines in all the stacked dipole arrays is indicated by the small arrows adjacent to each resonant half-wave section. These arrows indicate the direction of current flow **at any given instant**. Note that current flows in opposite directions in any two half-wave sections that are connected together. These current-flow arrows enable any complex directive array to be analyzed quickly to determine whether it is a broadside or end fire array. If the arrows in two parallel half-wave radiators point in the same direction at any instant the array radiates broadside to the plane of the radiators. If the arrows point in opposite directions the array is either end fire or else unworkable.

Note that the arrays of figure 26 depend on the same unusual feeder and coupling line connection of figure 19. The arrays of figure 18 and figure 19 give about the same results, the difference being that the array of figure 18 is fed at a high voltage point while the array of figure 19 is fed at a high current point. Figure 19 gives better balance. Note that a rather simple switching arrangement can be used to change the end-fire array of figure 17 into the broadside array of figure 18. A single-pole double-throw switch is used to connect the lower end of the left hand radiator of figure 17 to either side of the phasing line at points A or B. When the radiator connects to feeder A the array is end fire. With the radiator connected to B the array becomes broadside. In either connection the array is bi-directional.

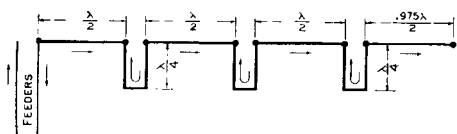


Figure 21  
Four Half Waves in Phase to Increase Broad-  
side Directivity; Zepp. Fed.

A broadside array of stacked dipole radiating elements consists of a number of dipoles, (vertical, for example) spaced at uniform distances along a horizontal line and excited in phase so that the current flows in the same direction in all the radiators at any given instant.

Such an array is capable of quite sharp horizontal directivity at right angles to the line of radiating dipole elements and the directivity depends upon the overall length of the array and is independent of the spacing between elements for all spacings under three quarters of a wavelength, at which spacing bad parasitic lobes appear. The directivity broadside is about the same for a given overall array length for  $\frac{5}{8}$ ,  $\frac{1}{2}$  and  $\frac{3}{4}$  wavelength spacing. Although half-wave spacing between elements requires the most antenna wire for a given directivity, this spacing is probably most desirable, as the transmission line or phasing line which feeds power to all the elements can simply be an ordinary two-wire line running down the array. With half-wave spacing the electrical phase shift between adjacent elements

is the same as the physical spacing. With spacings other than one-half wavelength, special loading must be used in the transmission line interconnecting the radiating elements in order to give 180 or 360 degree phase shift in  $\frac{5}{8}$  or  $\frac{3}{4}$  of a wavelength of physical space. The adjustment of such a folded or loaded phasing section becomes quite difficult, especially without a reference oscillator and a measuring bridge to measure both impedance and reactance. It is almost impossible to adjust a loaded phasing section by means of a field strength measuring set located out in front of the array.

For a gain of ten times, an overall length of about 4 wavelengths is required in the broadside array. With half-wave spacing this requires 9 dipole elements. With three-quarter wave spacing only six elements are necessary.

For a power gain of 5 times the overall length must be about 2 wavelengths, which requires 5 elements with half-wave spacing and three elements with three-quarter wave spacing.

#### The Franklin or Co-Linear Array

Another common type of bi-directional broadside antenna uses two half-waves in phase along a common axis, as shown in figure 20. This antenna is merely the old center-fed Zepp., worked on its second harmonic. In other words if each half of the flat top is 66 feet, the fundamental wave

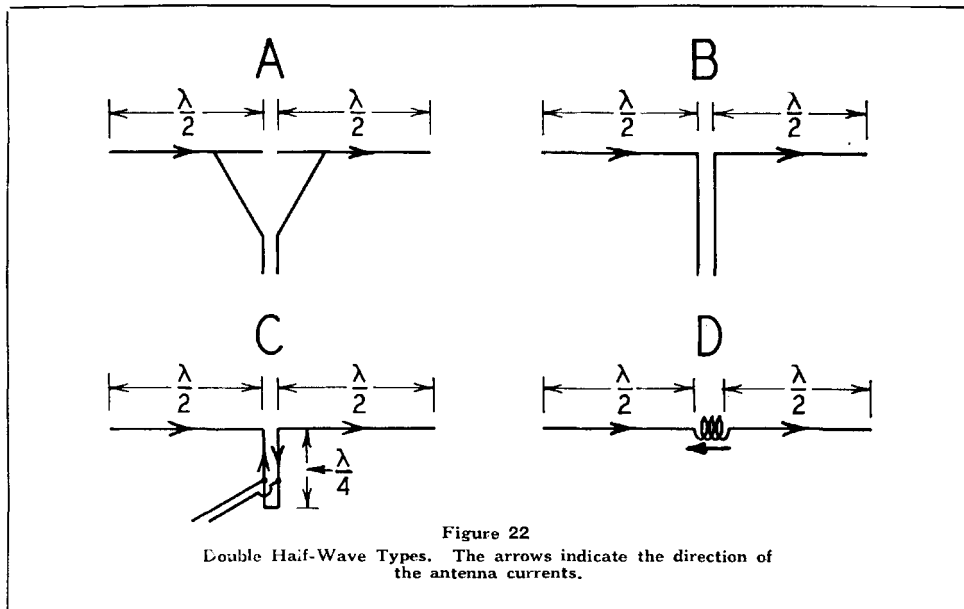
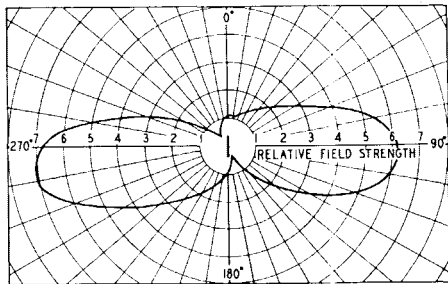


Figure 22  
Double Half-Wave Types. The arrows indicate the direction of  
the antenna currents.

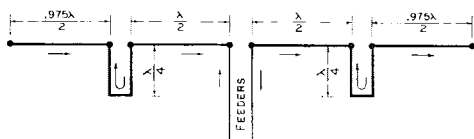


**Figure 23**  
Field Distribution Around a Horizontal Double Half-Wave Antenna. The position of the antenna is shown at the center.

length of the antenna is 80 meters, where it radiates as a simple half-wave dipole. However, on 40 meters the two half-waves in phase provide materially more broadside directivity than the antenna gives on 80.

The system in figure 22 A makes use of a two wire non-resonant feeder line, each wire being connected to one side of the center of a half-wave section as is customary in the off-center single-wire-fed Hertz antenna. The type B is the familiar double "Zepp," using a resonant feeder line. C is a variation using a quarter-wave matching transformer to connect to a matched impedance transmission line. In D the antenna coupling coil, which may be tuned with a condenser in parallel, is at the center of the antenna.

Figure 23 shows an experimental radiation pattern obtained from an antenna of this type (figure 22 D).



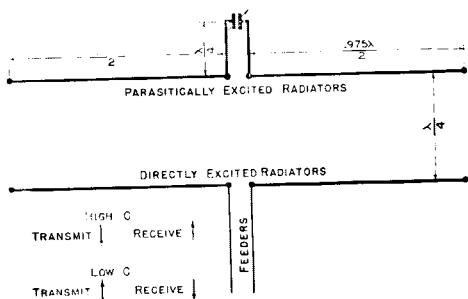
**Figure 24**  
Array Similar to Fig. 21, but Superior in Performance. Less Unbalance Caused by Feeder Connection, which is Now Connected to the Center of the Array Instead of the End.

The use of more than two half waves in phase to get still greater broadside directivity is shown in figure 21 and 24. The array of figure 21 is fed at high voltage point at one end. This is bad because the current that flows to the dipole radiator farthest away from the feeders has to flow through the loss and radiation resistance of all the other half-wave phasing and radiating sections. This causes a progressive phase shift which cannot be tuned out by adjusting the phasing sections and also

causes an uneven current distribution which makes the realized directivity less than it should be.

The arrangement of figure 24 is a big improvement over figure 21 as the feeders are connected to a high voltage point at the center of the array. However, a certain amount of phase shift and current unbalance still reduces the directivity.

The gain of the Franklin or co-linear broadside array is theoretically proportional to the overall length, in wavelengths, of the array. The length should be measured between the centers of the outside elements. However, the current distribution affects the gain and this type of array is particularly difficult to feed symmetrically.



**Figure 25**  
Novel, Reversible Unidirectional Array, Simple and Effective.

The gain of the Franklin array is less, for a given overall length, than either the broadside or end-fire array, due to the fact that the dipoles composing the array already have some directivity in the plane at right angles to the array, which reduces the improvement that can be obtained by stacking the dipoles.

The gain of this type of broadside array is about the same for any element spacing (measured between centers of adjacent dipoles) up to one wavelength. A total array length of 7 wavelengths is required for a power gain of ten times. Thus with half-wave spacing, 15 dipole elements are necessary, and with full-wave spacing between the centers of adjacent elements, 8 dipole elements are required for the 10 db gain noted above.

If a power gain of 5 times is satisfactory, an overall length of 3 wavelengths is enough. With half-wave spacing this requires 7 elements; with full-wave spacing 4 elements provide the required directivity. Note that for all practical purposes, in a Franklin broadside array with half-wave

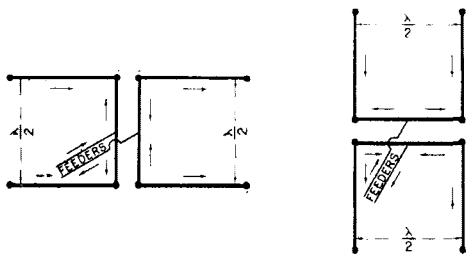


Figure 26

**Stacked Dipoles, Offering Considerable Vertical Directivity in Addition to Horizontal Directivity. They May Be Either Vertical or Horizontal with Equal Effectiveness. All Radiating Elements in the "H" Array Should Be Cut 0.975 of a Half Wave Long.**

spacing, every other radiating element could be left out without reducing the directivity more than about 5%.

The arrangements shown in figure 26 are much to be preferred although there is half as much horizontal directivity (theoretically) and twice as much vertical directivity as with the arrays of figures 21 and 24. Tests with both types indicate that the arrays of figure 26 have almost as much horizontal directivity as those of figures 21 and 24 and the added vertical directivity is usually quite welcome for long-distance high-frequency work. The arrays of figure 26 require one half as much distance between the supporting poles, but the poles should be somewhat higher. The arrays of figure 26 should have their center at least a full wave above ground for best results.

The best commercial arrays using stacked dipole radiators usually group the radiators into groups of four as in figure 26; then additional groups of four are added, each fed from a separate feed line so that all quads get exactly the same current. The difficulty in this method arises when they try to get current to all quads in exactly the same phase. As most amateurs lack the expensive measuring equipment necessary to balance up more than one resonant feed line, it is suggested that if more directivity is desired than given by the array of figure 26 some form of long-wire array be used.

### Feeding the H Type Array

The H type of directive array (stacked dipole) is usually fed by means of tuned (Zepp.) feeders. However, somewhat better results are obtained by using an untuned line and a Q matching section as shown in figure 27.

Note that each element is 97.5% of a half wave long when the array is between a half wave and a full wave from ground.

The impedances at various points in the array must be considered in order to avoid any mismatch and undesired radiation from the transmission line and the phasing section.

The impedance at each open end of the four dipoles is approximately 2400 ohms. The impedance at each end (see "A") of the half-wave phasing section is, therefore, one-half of 2400 ohms or 1200 ohms. Each half of the phasing section (see "B") may be considered as a quarter-wave or "Q" matching section with a characteristic surge impedance of 600 ohms. (A line of no. 12 wire spaced six inches has a characteristic impedance of close to 600 ohms.)

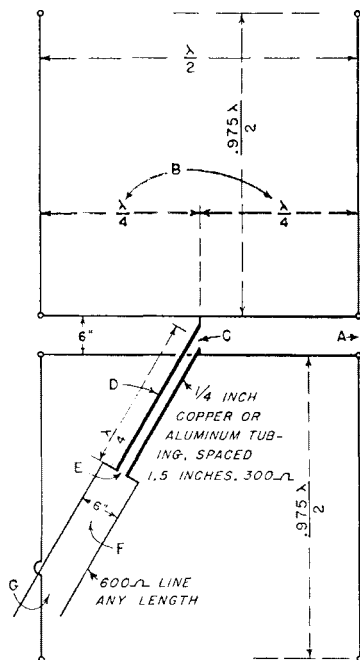


Figure 27

**Highly Efficient Method of Feeding an H Type Array.**

Due to the impedance transformation of the quarter-wave section, the 1200 ohm load at each end of the phasing section is transformed into two 300 ohm loads in parallel at the center of the phasing section, designated as point C in figure 27. The two 300 ohm loads in parallel act as a 150 ohm load on the 300 ohm matching section "D", which is composed of two quarter-inch copper or aluminum tubes spaced 1½ inches (center to center) and exactly a quarter wave long.

The matching section D transforms the 150 ohm load of point "C" into a 600 ohm load at point "E" where the untuned 600 ohm line "F" from the station is attached. As the 600 ohm load matches the 600 ohm line there should be no standing waves on the line and the line should reflect a non-reactive 600 ohm load into the transmitter at G.

Due to the mutual coupling between the four radiating dipoles, the impedances do not work out theoretically exactly as specified, but the two transformations of radiation resistance occurring at "B" and at "D" materially minimize any errors. For those who plan to add a reflector curtain a quarter wave to the rear of the radiator curtain and a director curtain  $\frac{3}{8}$  of a wave in front of the four main radiators, it should be noted that the measured impedance at point "C" becomes 120 ohms under such conditions. In order to match a 600 ohm line at point "E" the spacing of the matching section "D" should be  $1\frac{1}{4}$  inches instead of the  $1\frac{1}{2}$  inches provided for the array shown without reflectors or directors.

The H array of figure 27 shows a gain of 3 db for the two lower half-waves in phase. Another 2 db is added by stacking two more half-waves in phase along the axes of the first two half-waves. Thus the total gain is 5 db. Adding a reflector curtain a quarter wave to the rear adds 3 db, and adding a director curtain three-eighths of a wave in front of the array adds another 2 db. It should be noted that 90% of the useful radiation from any dipole comes from the center third of the dipole, where the current is highest. Thus the top and bottom of the H could be bent inwards without sacrificing much directivity. This allows the longest dimension of this particular array to be practically cut in half where space is at a premium.

The true gain of a directive antenna array cannot be accurately expressed in decibels gain as only a three dimensional space figure can truly depict the energy distribution around the array. A lot of horizontal directivity may be obtained without increasing the signal at a distant point unless the vertical component of the directivity leaves the antenna at the proper angle with respect to the horizon.

#### **Parasitically-Excited End-Fire Arrays**

The first step toward increasing the directivity of a broadside array is to hang a curtain of parasitically excited reflectors and directors a quarter wave behind and in

### **DIRECTIVE ANTENNA CHART**

#### **RADIATORS**

The dipole radiators in a broadside array should be exactly a half-wave apart. All primary, or directly excited radiators should be 95% of a half-wave long when center fed.

#### **REFLECTORS**

A dipole reflector should be 97% of a half-wave long and should be mounted exactly a quarter-wave behind the antenna.

#### **DIRECTORS**

A dipole director should be 87% of a half-wave long and should be mounted 75% of a half-wave in front of the antenna.

front of the antenna proper. See figure 15.

The "trick" antenna shown in figure 25 is offered as a simple and rather effective unidirectional array, whose direction can quickly be reversed. As was pointed out above, the only difference between a reflector and a director lies in whether the parasitically excited interfering dipole is longer or shorter (electrically) than a half wave at the frequency of operation. If longer, it acts as a reflector; if shorter it acts as a director. In the arrangement of figure 25 the directly excited portion of the array consists of two half waves in phase, and they can either be horizontal or vertical, depending on whether horizontal or vertical directivity is desired. A quarter wave away and in the same plane, are mounted two more half waves connected to a phasing stub, each leg of which is slightly more than a quarter wave length. The adjustment of the tuning condenser effectively changes **both** of the parasitically excited dipoles at the same time and a very small change in the capacity of the tuning condenser C effects the desired 180 degree shift in the directivity of the whole array. Incidentally, when tuning up the antenna, do not tune C for either maximum current in the reflector-director circuit or maximum loading of the transmitter. It will be necessary to adjust C while in contact with a station more than 500 miles away as field strength tests at closer distances are often badly affected by the ground wave. Once the two points have been determined, some permanent stops can be mounted on the frame of the tuning condenser C which will enable rapid and accurate change-over of the array.

One user of this array uses a relay to cut in a small locked variable condenser across the main locked variable condenser in order to change direction; his shack is several hundred feet away from the antenna.



## Feeding Directional Arrays

The directivity of any antenna array is largely a function of the physical space it takes up. Visualize an imaginary cylinder a quarter wavelength in diameter surrounding each dipole or half wavelength of wire in any given array. The directivity will be roughly proportional to the number of such cylinders in the array. However, in assessing the value of an array the current distribution must be taken into account. For example, a given number of "cylinders of directivity" fed at the center would not be nearly so effective as the same array fed at enough points so that the currents in each dipole, or half-wave section of the array, were equal. Due to radiation and losses there would be a tapering of current in an array fed at one point unless the array were symmetrically disposed about the point of feed.

Note that practically all directional arrays utilize resonance of a multiplicity of half-wave sections, excepting of course, the aperiodic arrays such as the terminated long wire types which few amateurs use, in spite of their simplicity and high directivity (rhombic type, for example).

Thus some form of resonant matching line is necessary to connect a non-resonant transmission line to the resonant arrays. As non-resonant lines usually have a characteristic surge-impedance between 60 and 600 ohms, a quarter-wave section will be necessary when feeding a high voltage point in the array in order to allow the non-resonant transmission line to connect to a high current (low impedance) load. If the array is fed at a high current point it will usually be necessary to provide a half-wave matching section. It should be noted that a quarter-wave matching line means a quarter wave **in each leg**. Thus the total length is really a half wave. Similarly, a half-wave matching line has a half-wave **in each leg**, making a total electrical length of a full wave.

In some cases it is possible to tap a low-impedance line directly on the array at a low impedance point. However, for practical reasons, it is usually best to isolate the transmission line so that resonances in the line will not unbalance the array.

All directional arrays should be tuned up with the transmission line disconnected. The antenna can be excited from a nearby half-wave antenna fed from a small transmitter.

DB	POWER RATIO
1	1.25
2	1.6
3	2.0
4	2.5
5	3.17
6	4.0
7	5.0
8	6.33
9	8.0
10	10.0
11	12.5
12	16
13	20
14	25
15	32
16	40
17	50
18	64
19	80
20	100
24	250
27	500
30	1000
40	10,000
50	100,000
60	1,000,000

### Decibel Conversion Table

The gain of a directive antenna is often expressed in decibels. The table shown above allows decibels or power ratios to be obtained directly, without computation. For example: A gain of 7 decibels means that a given antenna radiates 5 times as much power in the favored direction as a half-wave vertical reference antenna with the same power input.

Incidentally note that the stub can be practically any convenient length, just so it can be resonated with a suitable condenser "C" so that there is high voltage at the points where the stub connects to the two dipole reflector-directors. A line several full-waves long may be used to bring the condenser C right into the shack, but remember that resistance losses in the line detract from the directivity of the array.

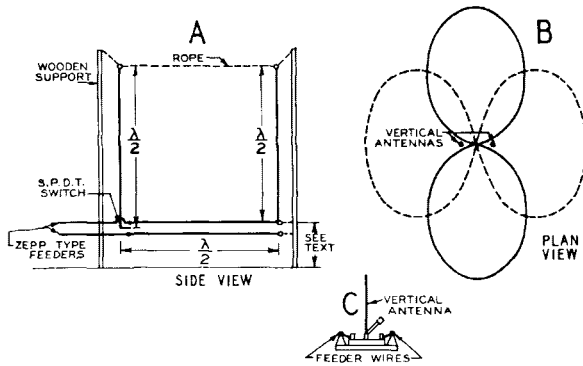


Figure 28

Two Position "Figure Eight" Beam. With the switch in A down the radiation is as shown by the solid curve in B and with the switch up it is as shown by the dashed curve.

Tune each element separately for maximum current and then start tying the elements together.

An antenna wire (free at each end) resonates when its length is about  $.475\lambda$ , or about 5% less than a half wave long. If this wire is in an array of antennas where the element spacing is close enough so that there is coupling between adjacent radiators, the lengths of the radiator wires must be increased if they are to stay in tune. When the radiators become as close as

$$\frac{\lambda}{8}$$

$$\frac{\lambda}{2}$$

the length of each wire becomes

$$\frac{\lambda}{2}$$

$$\frac{.95\lambda}{2}$$

Attaching a feeder or phasing section to either end of a dipole radiator practically eliminates the "end effect" or "radiant shortening" of the wire at that end. Thus a dipole radiator with a phasing section attached to each end becomes practically a half wave long instead of the

it would be if free at both ends.

If all the radiating and phasing sections are the proper length there should be no trouble in tying them together. However, remember that reflecting and directing dipoles must be tuned **off resonance** so that they can wait until the directly excited portion of the array is operating before they are adjusted. In fact, it is a good idea to detune completely all reflectors and directors while adjusting the primary radiators for length and resonance.

Note that the exact length of a reflector or director is quite hard to calculate, as

quite small variations from quarter-wave spacing of primary and secondary dipoles cause a noticeable change in the optimum length of the parasitically excited secondary radiators. Thus reflectors and directors are best adjusted by means of distant field strength reports.

### Two Position "Figure Eight" Beam

Figure 28 A shows an antenna arrangement with some very interesting possibilities. When the single-pole-double-throw switch is down the currents in the two vertical half-wave sections are in phase and the radiation is as shown by the solid curve of figure 28 B. With the switch up the currents in the two antennas are 180 degrees out of phase and the radiation pattern has been shifted through 90 degrees to look like the dashed curve of 28 B. The gain of this antenna over one vertical half wave is approximately 3 db. in the line of either beam. The radiation from an antenna of this type is at a rather low vertical angle. A convenient arrangement for the switch is given in figure 28 C. The lower ends of the antennas may be only a few feet off the ground.

### Folded Types

There are several types of folded antennas which can be conveniently supported by means of two poles. Figure 29 A shows such a type, which is known as a Bruce antenna array after Mr. Edmond Bruce of the Bell Telephone Laboratories. This antenna lends itself well to 14 mc. work as the overall height is only about 17 feet, and the overall length about 70 feet. The directions of the currents in this antenna are indicated by the arrows (figure 29 A). The center of each half-wave section (a point of maximum current) is located at the center of the vertical sections. The currents in the vertical wires

are all in phase at any instant, while the currents in each alternate one-eighth wave length of the horizontal sections are in opposite phase. The radiation is, thus, broadside in both directions to the system, vertically polarized, and at a fairly low angle.

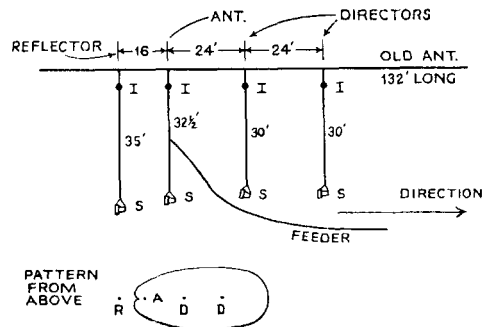
With somewhat more space available the Bruce antenna of figure 29 B might be used. The overall length for 14 mc. use is about 90 feet. Figure 29 C shows a Bruce antenna system which has been used at W8JK for some time. The antenna wire is four wave lengths long and there are eight vertical sections. The entire rope and wire assembly is supported by two poles of moderate height. The height of the lower end of the array is about 8 feet from the ground. The wire length of each quarter-wave section may be made equal to the length of the

wave in free space (i.e.,  $\frac{\lambda}{4} \times 3.28$  feet). It

is customary with straight wire antennas to make them about 5% shorter than this. The folding of a long wire antenna seems under certain conditions actually to **increase** the natural frequency, making a longer length necessary for a given frequency. The amount of this effect is different at different frequencies. The wires in the Bruce beam (figure 29 C) as originally erected at W8JK were shortened by the usual 5% and the curve of figure 30 was obtained with this arrangement. Lengthening the antenna, however, made the current distribution on the antenna more nearly ideal. Some "cut

and try" might be advisable with these antennas, although operation does not appear to be extremely critical to such small changes in wire length.

The array is fed at the center by means of a quarter-wave matching transformer. Since the antenna has a fairly low imped-



Fourth harmonic 20 meter single-wire-fed antenna changed over to end-fire array. Anchor the flower pots for windy weather.

ance at this point it was found best to connect it to the quarter-wave section at a point very near to where the non-resonant transmission line is connected. Typical dimensions and points of connection on the matching transformer are given in the detail in figure 29 C. These points of contact may well be adjusted for best results in each individual case, as indicated by the dotted positions for the antenna and shunt. Adjustments were made until an indicating device located at the center of one of the

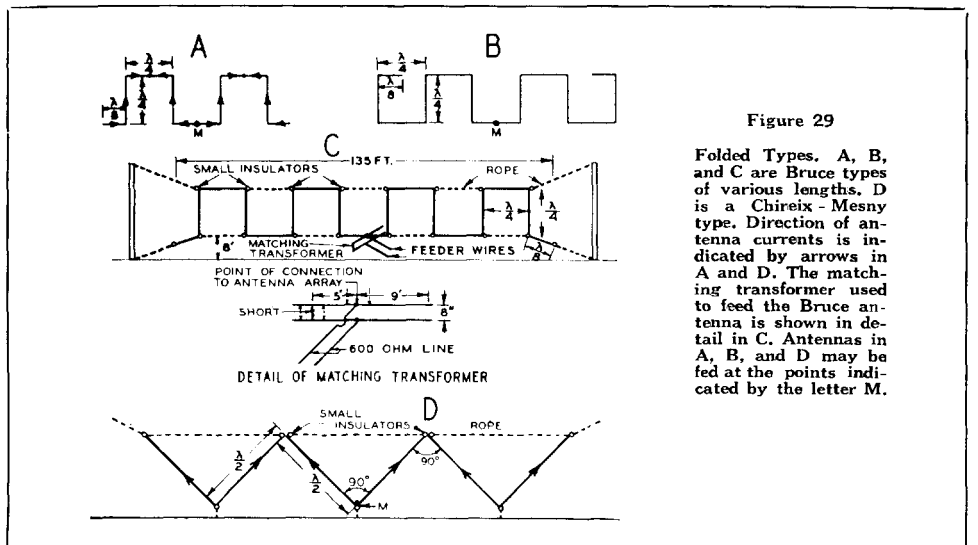
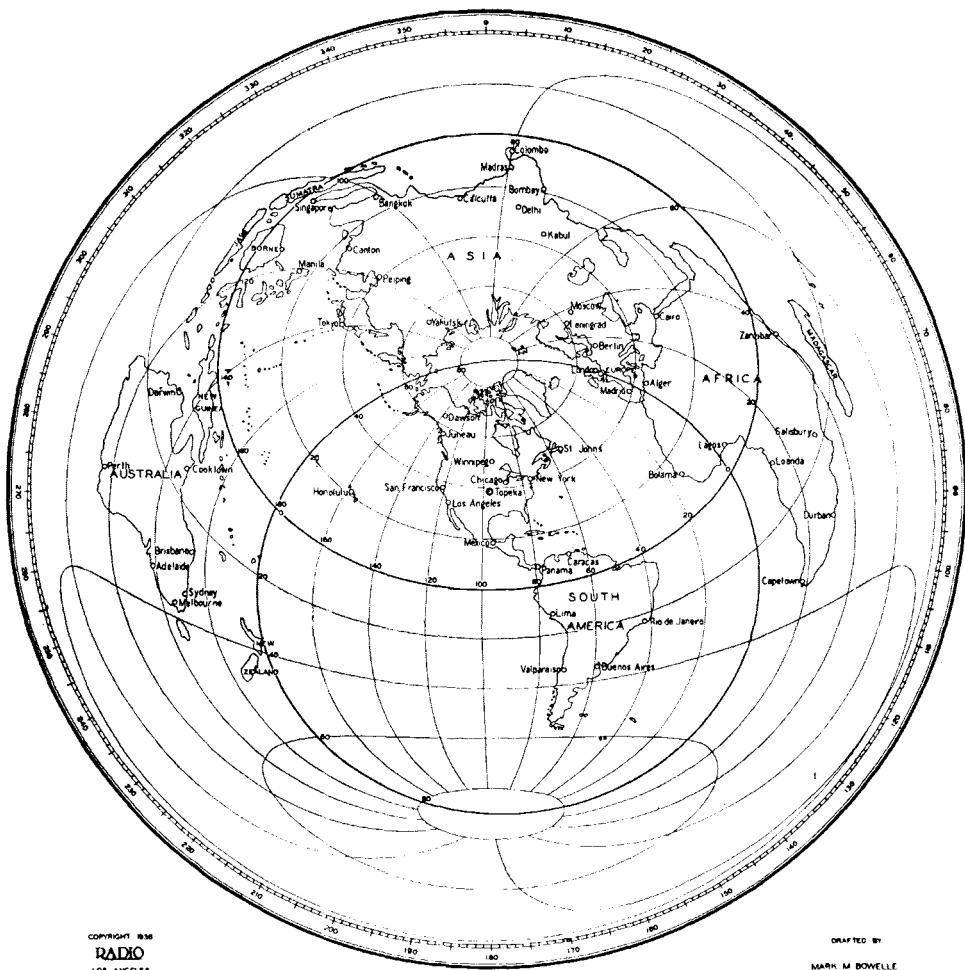


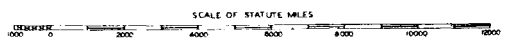
Figure 29

Folded Types, A, B, and C are Bruce types of various lengths. D is a Chireix - Mesny type. Direction of antenna currents is indicated by arrows in A and D. The matching transformer used to feed the Bruce antenna is shown in detail in C. Antennas in A, B, and D may be fed at the points indicated by the letter M.



COPYRIGHT 1938  
**RADIO**  
 LOS ANGELES

DRAFTED BY  
 MARK W. BOWELLE



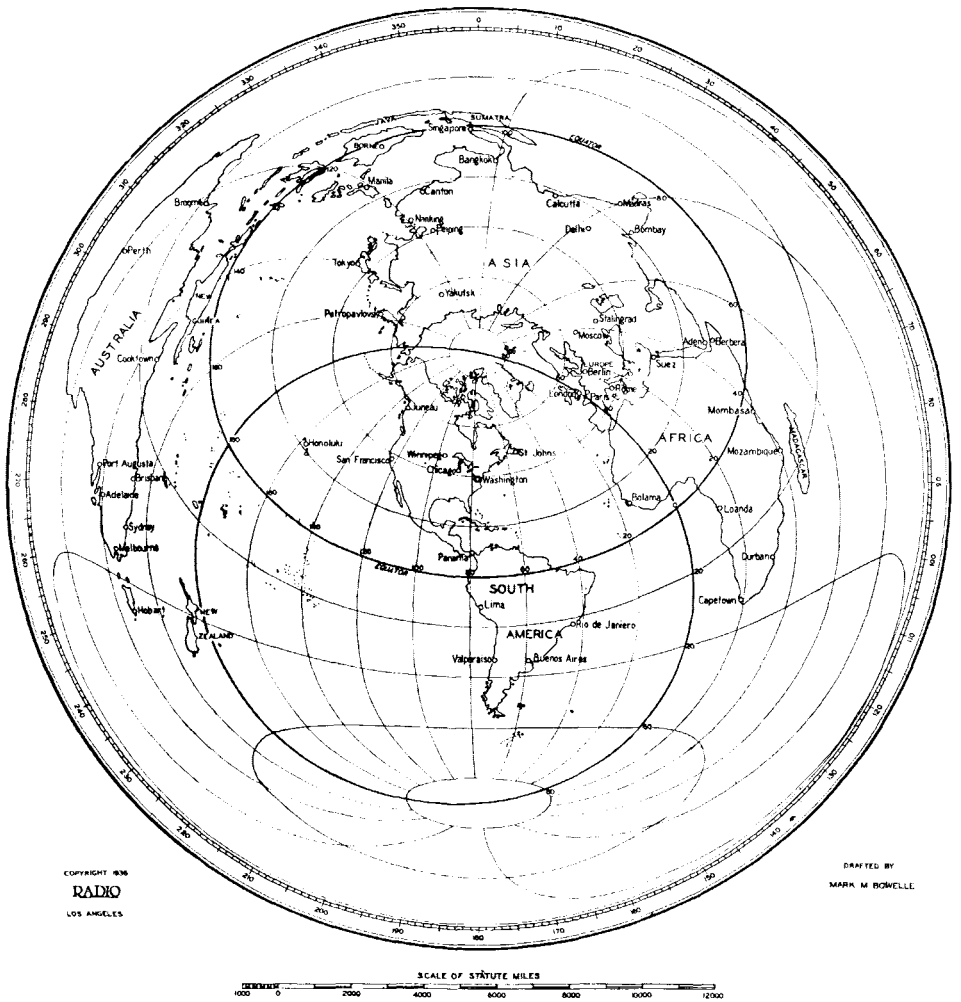
## GREAT CIRCLE MAP OF THE WORLD

### Centered on Topeka, Kansas

Radio signals to a distant point follow a great circle path. For that reason, it is important when putting up a directive antenna array to "aim" the array in the right direction. The direction from Topeka to any other point on the surface on the globe may be determined by laying a straightedge across the two points.

The point at which the straightedge crosses the numbered circle will give the direction. Thus Manila is  $40\frac{1}{2}$  degrees west of north from Topeka. Verify this on a globe if you doubt it.

The map may also be used for measuring direction and distance to distant points from other cities in the U.S.A., though there will be a slight error, especially in regards to direction of points over 9000 miles away. To determine distance in kilometers, multiply by 1.6. Similar maps on other cities in the United States appear from time to time in the magazine "Radio" and other radio periodicals.



## GREAT CIRCLE MAP OF THE WORLD

Centered on Washington, D. C.

(Refer to page 59 for Application)

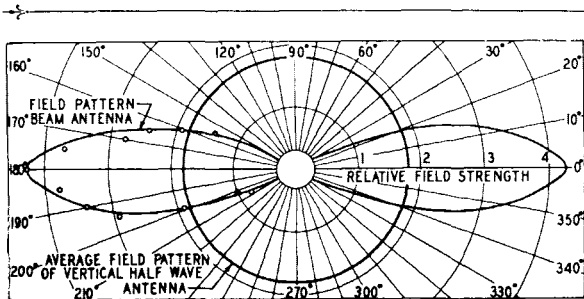
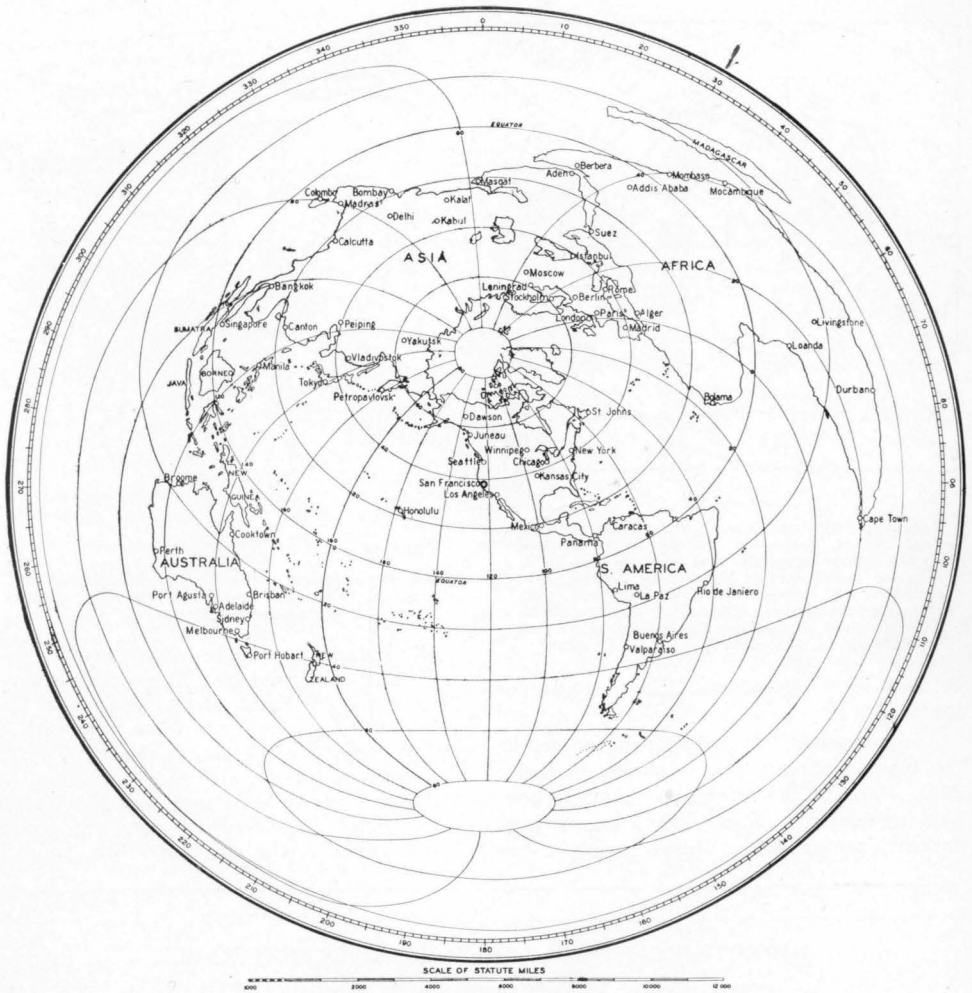


Figure 30

Field Strength Pattern of Four Wavelength Bruce Beam-Antenna Compared with Vertical Half-Wave Antenna Having Same Power Input. Both antennas used for 14 mc. operation. Small circles indicate experimental values measured at a distance of 550 feet (about 8 wavelengths). The beam gives a stronger signal than the vertical half-wave in two directions over an angle of about 40°.



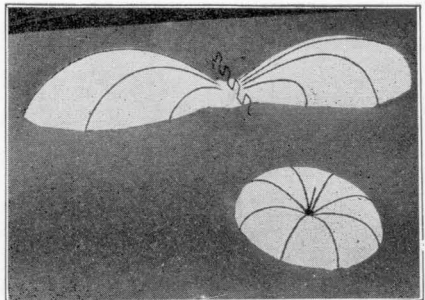
## GREAT CIRCLE MAP OF THE WORLD

Centered on San Francisco, Calif.

(Refer to page 59 for Application)

Figure 31

Approximate three-dimensional radiation model of antennas of figure 29C. Same power in each antenna. Relative position of the beam and vertical antennas as used at W8JK is the same as in the model. The vertical distribution assumes a perfectly conducting earth. The other figure shows the distribution around a half-wave vertical reference antenna.



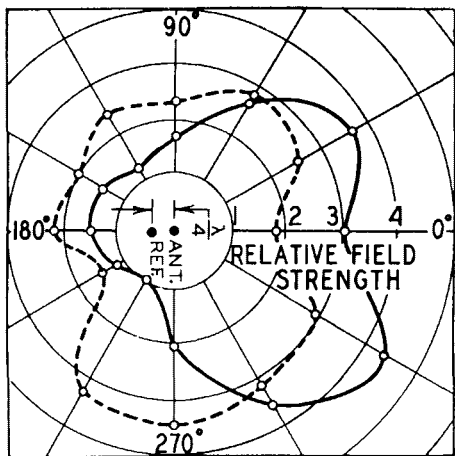


Figure 32

Parasitic Reflector Type. Field pattern for vertical 14 mc. half-wave antenna alone (dashed curve) compared with that for antenna with reflector (solid curve). Values are relative field strengths as obtained with a calibrated field strength meter at a distance of 25 feet. Both patterns show distortions due to conductors and buildings in the vicinity of the antennas.

vertical sections indicated a maximum of current.

Another kind of folded antenna known as the Chireix-Mesny type is shown in figure 29 D. Each of the straight sections is one-half wavelength long. The instantaneous currents are phased as shown giving a ver-

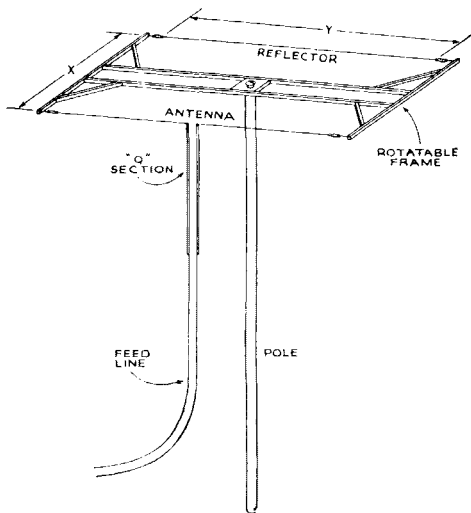


Figure 33

Idea for a simple, rotatable, 10-meter directive antenna. If 72 ohm feeder cable is used, the Q bars may be eliminated.

tically polarized wave broadside in both directions to the antenna. The antenna may be fed similarly to the Bruce antenna at the point M. An antenna of this type with 4 "V" sections (overall length about 200 feet) has been used for 14 mc. operation at W8JK. Both this antenna and the Bruce work quite satisfactorily over the wave length range of the amateur 14 mc. band.

## DIRECTIVE ANTENNA MATCHING-SECTION TABLE

Center-to-Center Spacing versus Surge Impedance in Ohms

	Radius in mils.	Center-to-center spacing												
		1"	1¼"	1½"	1¾"	2"	2½"	3"	3½"	4"	5"	6"	7"	8"
<b>Tubing</b>														
½" dia.	250.0	166	180	212	225	250	275	295	317	335	360	380		
¾" dia.	187.5	200	225	245	262	280	310	330	350	370	390	415		
1" dia.	125.0	250	277	298	318	333	353	375	395	415	442	460		
<b>Wire</b>														
No. 10	50.1	350	375	400	420	440	463	485	509	525	550	572	592	605
No. 12	40.4	375	400	430	450	467	492	520	533	550	572	596	622	637
No. 14	32.04	400	433	460	481	500	533	550	567	583	607	631	652	669
No. 16	25.41	433	466	500	520	542	561	580	600	624	650	670	691	710

## VII. Receiving Antennas

### All-Wave Receiving Antennas

Due to the fact that any length of free wire in space acts as an efficient radiator or interceptor of radio frequency energy at one fundamental frequency and the harmonics of that frequency, it is a difficult problem to make an antenna work well over a wide range of frequencies. Various meth-

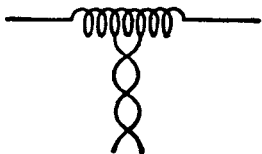


Figure 1  
Simplest method of connecting the transmission line to a type A doublet system

ods of combining different resonant points in one antenna system feeding one low impedance transmission line have been worked out and these systems are constantly being improved.

There are four general types of "all-wave" receiving antennas. The four types are termed types A, B, C, and D. Type D is the double-doublet type which also includes the spiderweb antenna system and which will be discussed in detail later.

Types A and B are essentially similar and consist of a doublet with a matching transformer between the doublet and the twisted transmission line. The type C antenna uses no matching transformer between the antenna and the transmission line but all types of all-wave antenna systems use a matching transformer between the transmission line and the receiver. (The new Philco antenna system might be considered to be an exception to this general rule but in the newer Philco all-wave receivers the matching between the transmission line and the set is done by a switching arrangement in the set itself, which is highly desirable. The same wave band switch that changes the coils also changes the antenna coupler.)

Figure 1 and figure 2 show two common arrangements used to couple the type A symmetrical all-wave doublet to the transmission line.

One of the best examples of the type A antenna system is the Stromberg Carlson type.

Types A and B all-wave antennas are alike in that they both use a method of matching of impedances between the an-

tenna and the line so that there are no standing waves on the line. The type C all-wave antenna uses no matching transformer between the doublet and the line but uses a matching transformer similar to the type B matching transformer between the line and receiver. The line length is quite critical in the type C system as it is in certain of the type D double-doublet systems.

The type A and B systems differ in that the type A system uses a symmetrical doublet, while the type B system uses a non-symmetrical doublet. At any frequency the type A closely resembles the simple doublet; the type B system more closely resembles the single-wire-fed (Everitt) antenna due to the fact that it deals with the signal at a higher impedance point in the antenna than does the type A system.

Both systems give good results. It is quite difficult directly to compare both systems. Type A systems will give better response at certain frequencies while the type B system will be better at other frequencies. The ad-

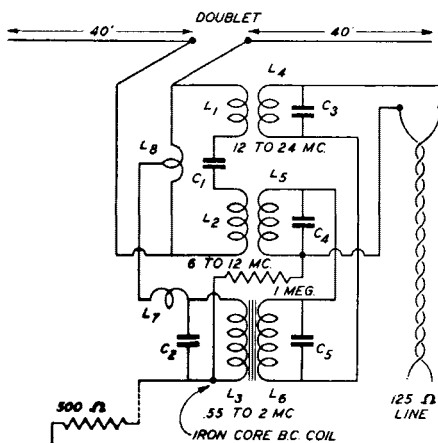
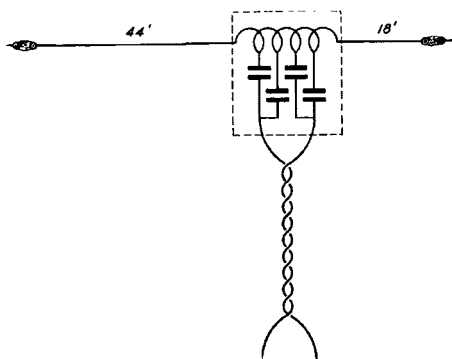


Figure 2  
Second method of connecting the twisted line to a type A symmetrical doublet

vocates of the type A system claim better balance to ground with somewhat better discrimination against local man-made noise, but the proponents of type B systems offset this by claiming enough more signal at the high frequencies to over-ride any slight increase in noise. Both systems give about the same results on the broadcast band (0.55 to 1.5 mc.). However, improvements in both types of all-wave antennas are coming so fast that no designer or manufacturer seems

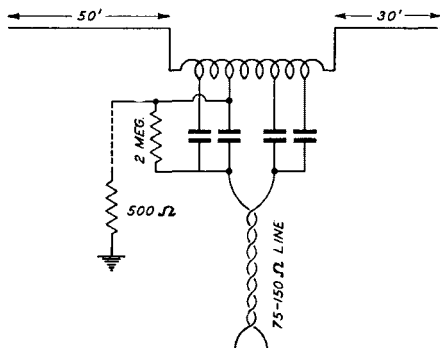




**Figure 3**  
Simplest form of type B coupler  
(asymmetrical doublet)

to be able to maintain any advantage for more than a few months.

The type B non-symmetrical all-wave doublet, good examples of which are the Philco and the Horn Stratosphere antenna systems, are quite similar to the type A systems except for the details of the antenna-to-line matching transformer. Figure 3 shows the simplest form of type B matching transformer. The somewhat more complex coupler shown in figure 4 gives somewhat better suppression of man-made noise than the simpler coupler. It is always desirable where possible to run a separate external ground connection to a neutral point in the antenna-to-line coupler, in order to improve the balance to ground of

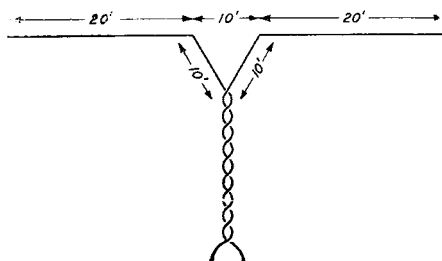


**Figure 4**  
Another form of type B coupler, giving better  
suppression of man-made noise than the simpler  
coupler of Figure 3.

the system. This applies to all types of antennas but can usually be applied most conveniently to the types A and B antenna systems. The ground connection should have a 500 ohm resistor in series to make the system aperiodic over the broadcast band.

The type C system often depends on the use of line resonance and thus standing waves on the line are common with this type of system. This allows the antenna-to-line coupler to be eliminated, which simplifies the system. Figure 5 shows the most common type C antenna, which is the General Electric Vee doublet. This system is one of the best all-wave antenna systems.

The Hawkins triple Vee receiving doublet is essentially similar and is shown in figure 6. The only advantage of the triple Vee doublet is that it requires only a 40-foot span instead of the 50-foot span required by the G.E. system—assuming lowest resonance at 6.1 megacycles for both antennas. For a more complete discussion of the triple Vee antenna see the data on the double Vee transmitting antenna on page 76.



**Figure 5**  
The G.E. "Vee Doublet" (type C)

All all-wave receiving antennas require a line-to-receiver matching transformer for best results. Three common types of such matching transformers are shown in figures 7, 8, and 9. They all are capable of about the same results and will all work with almost any type of all-wave antenna and transmission lines system. The theory on which all of them work is that only one portion of the transformer matches the transmission line at the frequency being received. The rest of the windings as well be disconnected but their presence causes no material loss in signal, due to the large mismatch between the line and the unwanted transformer windings. Usually, it will be found that the matching transformer is divided into at least three sets of interconnected transformers. One set usually covers a range from about 12 to 18 megacycles; a second set of windings covers from about 6 to 12 megacycles; and the third set usually is designed to cover the broadcast band from 550 to perhaps 1750 kc. For frequencies outside of these ranges the antenna system

usually works "in spite of" the matching couplers and not because of them. However, even at frequencies other than those favored by the couplers the system is usually at least as good as an ordinary single wire cut to a random length.

The best way to indicate the actual performance of an all-wave antenna system is to plot antenna response against frequency on a chart such as figure 10. This chart shows relative response of a typical, standard all-wave antenna system **above** the response induced by a standard signal in a reference antenna of the same effective height, at each frequency tested. The reference antenna was defined as aperiodic, or with a Q of 1. Thus the curve does not show actual response of the all-wave antenna but the **improvement** in signal over

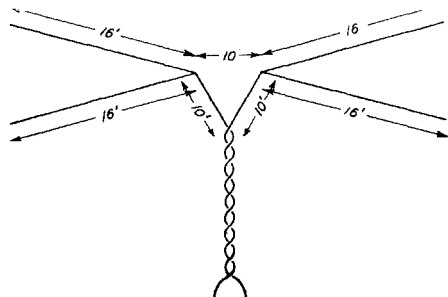


Figure 6  
The "Triple Vee" doublet takes up slightly less space than the one of Figure 5

the reference antenna.

It should be noted again that the all-wave antennas are definitely better than any single doublet **over a wide range of frequencies**, but for amateur use or where only one frequency is to be received the standard half-wave doublet gives a definitely better signal-to-noise ratio than any of the all-wave antenna systems. For use on several amateur bands perhaps the best single antenna system would be a modification of the R.C.A. spiderweb antenna (general type D), with each dipole cut for an amateur band.

### THE DOUBLE DOUBLET OR TYPE D ANTENNA SYSTEM

The first all-wave antenna placed on the market was the R.C.A. "Double Doublet".

#### Design of the Line

The only principle which has been successfully employed for the reduction of man-made static is to locate the antenna in a comparatively noise-free area and to employ a lead-in of such a type that pick-up on the lead-in is eliminated. To place the antenna

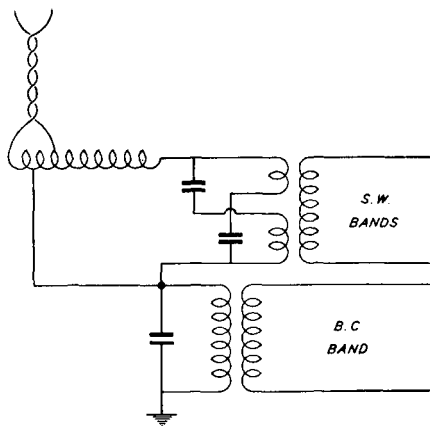


Figure 7  
Line-to-receiver matching system

in a noise-free location is a unique problem for each installation. However, the type of lead-in is an important design problem. There are two general types: the shielded lead-in and the balanced transposed line. The shielded line is unsuitable for high frequencies, because to be effective, the shielding must be grounded every few feet with short ground wires. This is obviously impossible in most installations.

The balanced line, however, is eminently suitable for many reasons. When used in conjunction with a well-designed transformer at the set, pick-up on the line is almost completely eliminated. No grounding is nec-

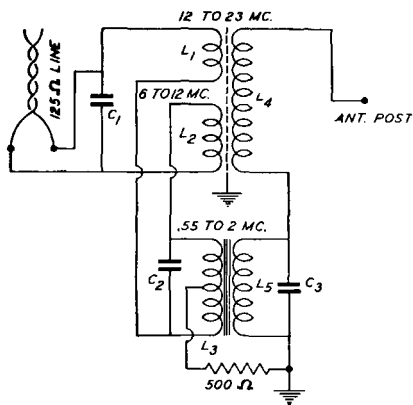


Figure 8  
Another common matching transformer

essary. Losses are lower than in a shielded line and are practically negligible if the design is right.

#### Line Carefully Chosen

In designing the line the space between the wires and the size of the wires are

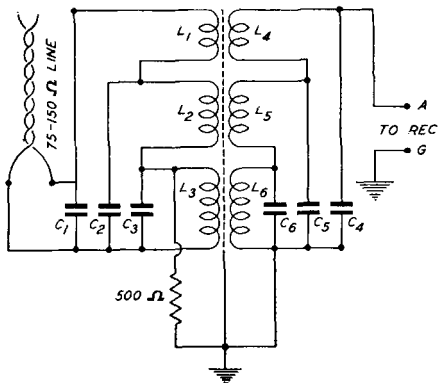


Figure 9  
A matching transformer commonly used with the type B system

important. The farther apart they are, and the smaller they are, the higher is the characteristic impedance of the line. If a line is terminated at each end with its characteristic impedance, its transmission is nearly constant at all frequencies. However, when the terminating impedances are widely different from the proper value, the transmission varies greatly with frequency, the curve passing through a series of peaks and valleys corresponding to resonance points in the line.

For the R.C.A. World-Wide Antenna System a line having 180 ohms impedance was chosen because this value is about the average input impedance of most short-wave receivers and because it is about the average

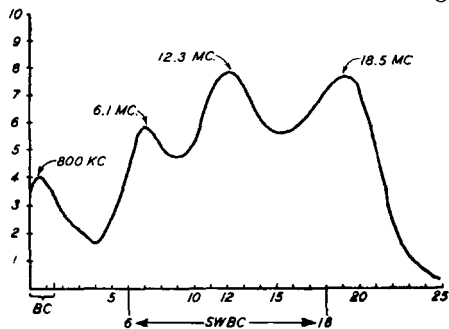


Figure 10  
Response of a typical, all-wave system over an aperiodic antenna

impedance of the "Double-Doublet" antenna over the short-wave frequency spectrum.

#### Line Peaked at S.W. Bands

Because the antenna does not represent an impedance exactly equal to the line impedance at all frequencies, the transmission curve does have a series of minor peaks and valleys, varying in efficiency two or

three-to-one. The line length was adjusted experimentally by throwing short lengths in and out of the circuit, until a length was found such that a transmission peak occurred at each of the important short-wave broadcasting bands.

Mechanically, the line consists of a rubber-covered twisted pair with stranded, tinned copper wire for each conductor. After exhaustive tests special submarine cable rubber was specified for insulation of the transmission line due to its low losses and high natural rubber content. The life of this transmission line is materially increased by the use of this high-quality rubber insulation and an outer covering of weather-proof braid.

In order to keep the losses low when the line is wet, it is important that no untreated

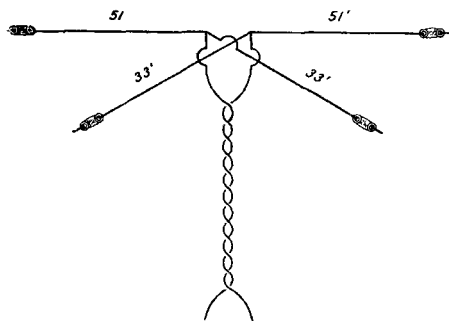


Figure 11  
The R.C.A. "Double Doublet" with dimensions altered for optimum response on the amateur bands

cotton be used as insulation. A cotton wrap must be well-impregnated, to prevent the impregnating material from evaporating away and moisture getting in, thereby increasing the line losses.

#### The "Double-Doublet" Antenna

It is well known that a half-wave doublet is a most efficient collector of short-wave signals. However, it is at its best only at or near its resonance point. Obviously, if two dissimilar doublets can be connected to the same transmission line without either harming the performance of the other, the overall performance of the combination will be good over a wider range of frequencies than that of a single doublet.

The secret is the much-discussed "cross-connection". That is, the left arm on the longer doublet connects to the same side of the transmission line as the right arm on the short doublet. The connection must be made in this way in order for the output of the short doublet to be additive to the output of the long doublet at a frequency

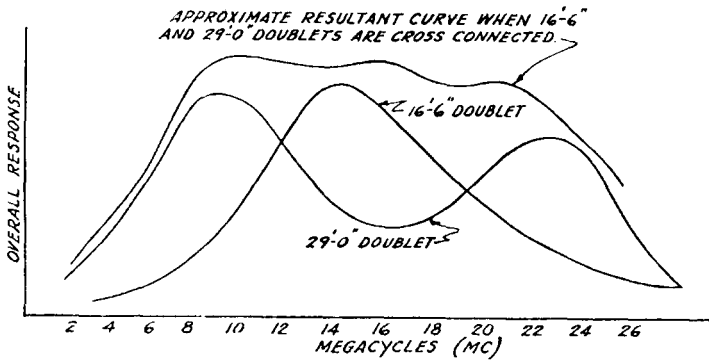


Figure 12  
Resultant response of the two doublet sections in a "Double Doublet"

midway between their resonance points.

In order to understand this apparent paradox, consider the fact that the long and short arms connected to a given side of the line form a single and nearly straight wire which is resonant in the half-wave mode at the frequency mentioned.

#### Antenna Impedance Considered

If the two sides of the line were connected near the center of these two straight wires, the antenna would form a low-impedance termination for the line. If the two-line connections were then moved out from the center in opposite directions, the impedance of the antenna would rise progressively, reaching a very high value when the ends of the wires were reached.

At the point actually used, the impedance of the antenna at this frequency is slightly higher than the line impedance.

At the frequency of resonance of either the long or the short doublet, the impedance of the antenna system is somewhat lower than the line impedance. Thus it can be seen that the line impedance chosen is a good compromise value. The performance of the "Double-Doublet" is compared to that of single doublets in the curves of figure 12.

The long doublet is resonant in the half-wave mode at about 8 mc. and in the 3/2 mode at 24 mc. The short doublet is resonant at about 14 mc. The response of the combination is relatively flat over the important part of the short-wave spectrum.

There is a popular misconception that to have a good short-wave antenna, one must use enamel wire. Bare wire has been specified because it is more practical. It has a better appearance and is easier to handle, besides being somewhat cheaper.

#### The Coupling Transformer

It is very important to note that the noise-

eliminating feature of the system depends entirely on the design of the transformer which couples the line to the set. The purpose of this transformer is to eliminate "in-phase" signals while transmitting "out-of-phase" signals. The expression "in-phase" means that the voltages of the two sides of the line go positive together and then go negative together. Obviously, this type of signal will produce no current in the primary of the transformer; it simply changes its potential. "Out-of-phase" signals are those which cause one side of the line to go negative when the other goes positive and then the reverse. This type of signal does produce primary current. The mere presence of a transformer does not eliminate the "in-phase" signals (or noise), because if there is capacity coupling, the noise will be transmitted to the set through that capacity.

#### Static Shield in Transformer

In the transformer under discussion a special and highly efficient static shield (see

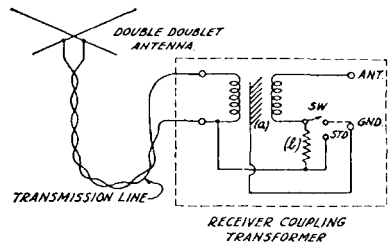


Figure 13  
Receiver coupling transformer used with the "Double Doublet"

"a", figure 13) is used, completely eliminating capacity coupling. As a result, the "in-phase" signals and noise picked up by the line are eliminated while the "out-of-phase" signals picked up by the antenna are transmitted to the receiver.

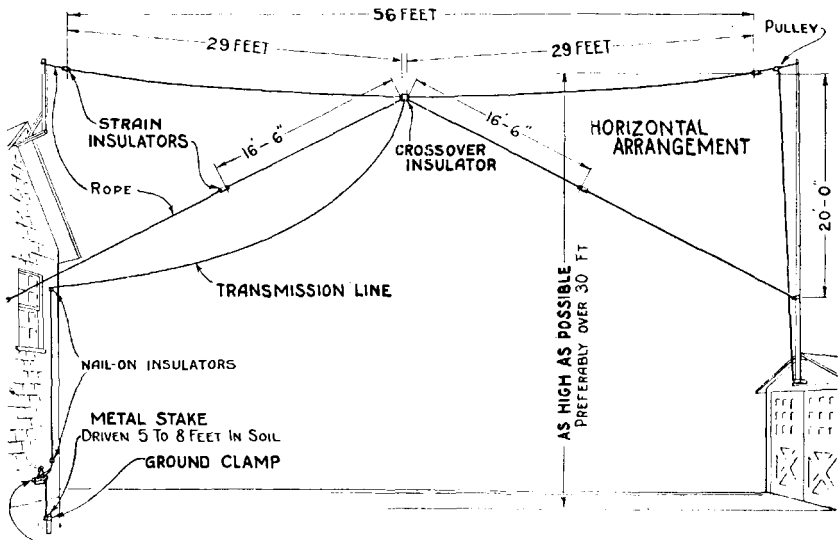


Figure 14  
Typical "Double Doublet" Installation

When the switch is on position marked "SW", operation is as described above. When the switch is on "STD" position the antenna and lead-in both act as antenna, that is, both "in-phase" and "out-of-phase" signals are transmitted together.

#### A Practical Test

A practical test may be made showing that the system does work in this way. When the switch on the transformer is thrown to the position marked "STD", both "in-phase" and "out-of-phase" signals are received. If the two sides of the line are shorted it makes very little difference for this connection. When the switch is thrown to the "SW" position the "in-phase" signals are eliminated, hence if the two sides of the line are shorted the result is almost complete silence.

A resistor (see "b", figure 13) is connected from one side of the primary to ground to prevent the antenna system from collecting a high static potential and sparking to ground, which would cause disturbing and periodic clicks in the receiver.

#### Conclusion

When choosing a noise-free area in which to locate the "Double-Doublet" antenna, it is well to keep in mind the generally accepted theory that the strength of noise interference varies inversely as the square of the distance from the source of noise. Since the signal strength of the received broadcast signal is usually considered to increase in a direct proportion to the height

above ground the reason for the recommendation to install the "Double-Doublet" antenna **as high as possible**, is readily seen. When installed, the signal-to-noise ratio for short-wave reception should be materially increased.

#### Nearby Stations on Ground Wave

On short-wave signals originating at relatively short distances from the receiver it is often found that greater signal strength is obtained with the "SW-STD" switch in the "STD" position. This is to be expected as the signal being received is probably the ground wave (that portion of the transmission vertically polarized) rather than the sky wave. The ground wave does not develop much signal voltage in the "Double-Doublet", but does develop a voltage on the transmission line. Thus since both "in-phase" and "out-of-phase" signals are transmitted with the "SW-STD" switch in the "STD" position, greater signal is received from the local short-wave broadcasting station at this "STD" position.

#### Ignition Noise Reduced

A puzzling feature of the performance of this system is the marked improvement shown on automobile ignition noise. Since this noise is generated at a distance from the antenna, it would seem reasonable that it should be picked up on the antenna and transmission line equally, in which case no improvement in signal-noise ratio would be expected by eliminating the line pick-up. Nevertheless, a distinct improvement does

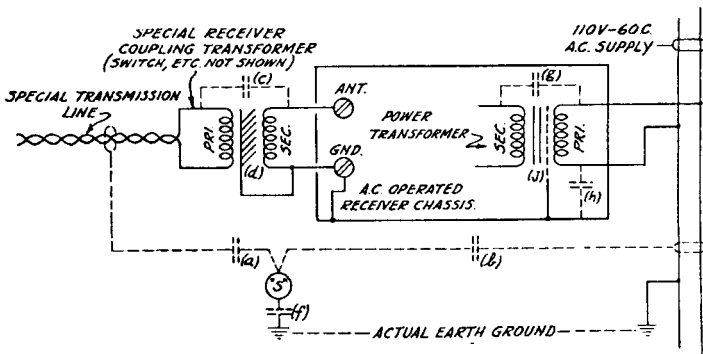


Figure 15  
Reference schematic showing noise elimination principle (see text)

result. There are two possible explanations of this unexpected fact. First, probably most of the auto-ignition radiation is vertically polarized and cannot be picked up efficiently by a horizontal doublet. Second, probably a good share of the automobile noise does not come in on the antenna at all, but is carried to the set by the power line.

The receiver coupling transformer of the system eliminates noise of this type completely. This can best be explained by the following paragraphs and illustrated by referring to figure 15.

"S" represents a signal generator such as a source of auto-ignition noise. (a) Represents the capacity coupling from "S" to the transmission line. (b) Represents the capacity coupling from "S" to the power supply line. (h) Represents the capacity coupling from one side of the power supply line to the metal chassis. (f) Represents the capacity coupling from "S" to actual earth ground.

#### Shield Stops Capacity Coupling

(A) The noise voltage that would be induced by capacity coupling (a) into the transmission line would correspond to an "in-phase" signal and therefore would be coupled or fed through to the secondary of the receiver coupling transformer by the capacity (c) if this capacity (c) were not eliminated by the special and highly efficient electrostatic shield (d). If it were not for shield (d) a noise voltage would be developed across "ANT" and "GND" of the receiver, due to a completed circuit from "GND" to chassis frame through "h" to the power supply line which is usually grounded on one side and thence back to "S" through (f).

(B) The noise voltage that would be induced by capacity coupling (b) causes cur-

rent to flow through the power transformer and develop a noise voltage from ground to the chassis through capacity (h). If no receiver coupling transformer was used this voltage would occur across "ANT" and "GND", the input terminals, of the receiver and hence cause noise. When the "World-Wide" antenna system is used, including the receiver coupling transformer, this voltage occurs between the primary and the electrostatic shield since capacity (c) has been eliminated. However, this does not produce primary current. Therefore this noise voltage does not induce a voltage in the transformer secondary.

(C) The electrostatic shield (j) provided with most power transformers serves to offset the capacity coupling (g) and thus prevents the introduction of r.f. noise voltage into the voltage supply of the receiver directly.

No doubt the above reasons (A) and (B) contribute to very real improvement in signal-to-noise ratio to be had with this system on auto-ignition interference.

The R.C.A. De Luxe System differs from the first and standard system in that a transformer has been designed for use at the antenna end of the transmission line, and in that a new transformer without the "SW-STD" switch has been designed for use at the receiver end of the transmission line. The same "Double-Doublet" antenna arrangement is used and the same type of transmission line. The latter has been changed to a length of 80 feet and of a different type of wire.

#### "De Luxe" System Explained

The fundamental development which made the De Luxe system design possible is the idea of using different transformers for different frequency bands and placing

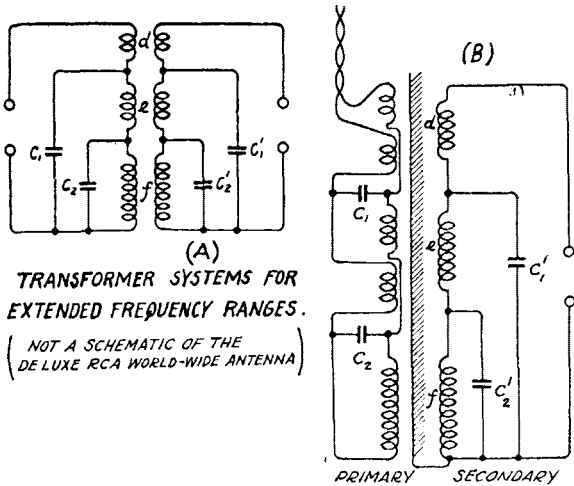


Figure 16  
Two coupling systems giving extended frequency ranges

the transformers in series to obtain transmission over the combined frequency ranges.

The circuit arrangement for doing this is shown in figure 16-A. The transformer (d), having the smaller inductance, transmits the highest frequency waves. These waves are by-passed around the other transformers (e) and (f) by condensers  $C_1$  and  $C_2$ .

Lower frequency waves are transmitted by the transformers (e) and (f). There is a certain intervening frequency at which the transformers (d) and (e) are equally effective in passing on the energy. At this frequency transformer (e) gives a double phase reversal due to the presence of the condensers  $C_1$  and  $C_2$  and the leakage reactance of the transformer. As a result the outputs of the two transformers (d) and (e) are additive, provided the signs of the mutual inductances of the transformers are the same.

In this manner any desired number of transformers may be connected in series and the frequency range extended almost without limit in either direction. The efficiency of transformation is high and practically constant over the extended frequency band.

In designing this transformer system the component transformers are designed separately for adjacent bands, providing a slight over-lap. These transformers are then connected together as shown.

### Feeding an All-Wave Receiver

In feeding an all-wave receiver from a balanced transmission line with this system, it is best to maintain primary symmetry by using the circuit as shown in figure 16-B.

The values of the inductances are the same as in figure 16-A, but the windings are split into two parts so that the stray capacities to ground are the same for each side of the line.

A transformer of the type of figure 16-B may be used in place of the single-shielded transformer as used with the original R.C.A. world-wide antenna system (as illustrated schematically in figure 13) and noise pick-up on the transmission line lead-in eliminated over the entire frequency band. Without further change, however, the pick-up is too weak for broadcast band (550 kc. to 1500 kc.) signals, since lead-in pick-up has been eliminated and only the "out-of-phase" signals from the two sides of the "Double-Doublet"

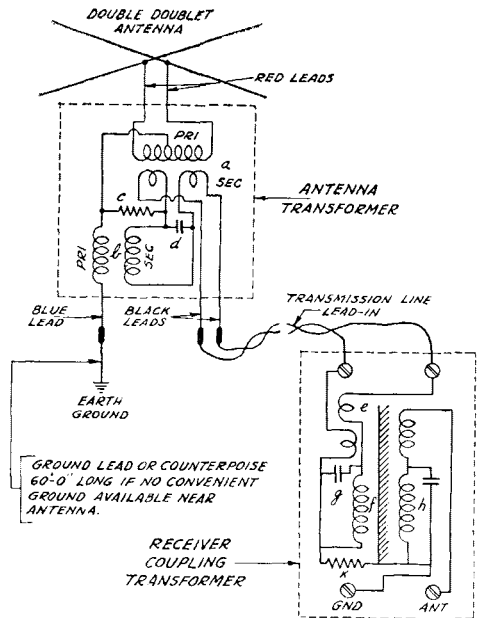


Figure 17  
"Double Doublet" system giving good broadcast-band response

are utilized.

To correct this a change must be made at the antenna end of the transmission line. One possibility is to add a third doublet of a suitable length to favor the broadcast band. This is ordinarily impractical because the required space is not available. (A doublet

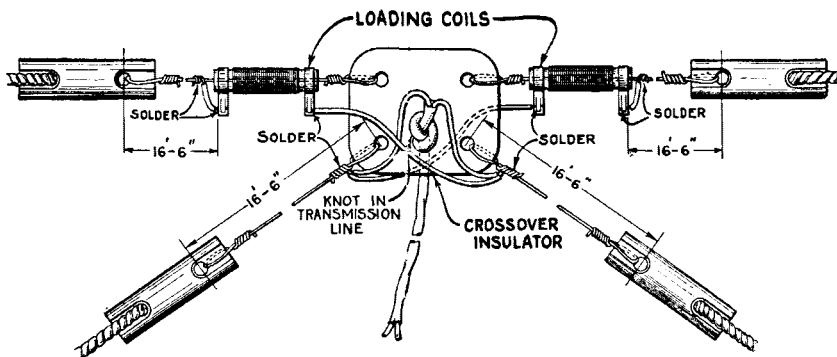


Figure 18  
 Illustrating cross-over connection and loading coils (latter permitting erection of a "double doublet" in restricted space)

to tune to 1000 kc. must have a span of 213.5 feet.)

The circuit of figure 17 shows the result of a new development to avoid erecting a third doublet, giving a good practical solution to the problem.

#### "Double-Doublet"

The "Double-Doublet" is connected to the transmission line lead-in through a special all-wave antenna doublet transformer. By referring to figure 17 it will be seen that both primary and secondary are divided into two parts. The center tap of the short-wave transformer (a) primary is connected to ground through the primary of the broadcast frequency (500-1500 kc.) transformer (b). The secondary of the broadcast frequency transformer is in series with the split short-wave transformer secondary. If a suitable ground is not available it may be replaced by a counterpoise about 60 feet long.

#### "T" Type on Standard Broadcast

It can be seen from figure 17 that the "Double-Doublet" becomes a "T" type receiver antenna for receiving standard broadcast frequencies (550 kc.-1500 kc.).

The antenna impedance is matched to the line impedance by means of the primary of broadcast transformer (b) through the secondary of the broadcast transformer (b) in series with the split secondary of the short-wave transformer (a).

The condenser (d) (see figure 17) by-passes the short-wave frequencies around the secondary of the broadcast transformer.

Similarly the "Double-Doublet" antenna impedance is matched to the transmission line impedance for short-wave frequencies by means of the short-wave transformer (a), the primary of the broadcast trans-

former acting as a high-impedance to ground for short-wave frequencies, and being connected to the center tap of the short-wave transformer primary, has relatively little effect on short-wave reception.

The receiver coupling transformer (see figure 17) is similar to the arrangements shown in figure 16 and should need no further explanation.

Resistors (c) and (k) (see figure 17) are used to prevent the system from collecting a high static potential and sparking to ground, which would cause disturbing and periodic clicks in the receiver.

#### Doublet Lengths

The length of each doublet may be derived by a very simple calculation:  $L = 0.95\lambda/4$ , where  $\lambda$  is equal to the wavelength in **meters**. The length (L) as determined from this formula is obviously in **meters** also but can be expressed in **feet** if preferred by multiplying by 3.28. If interest is centered in not more than two frequency **bands** (for instance, any two of the four "amateur" channels located respectively at 20, 40, 80 and 160 meters), best results will be obtained using lengths calculated by the above formula. However, if uniform results over a given **range** (say, between 20 and 40 meters) are more desirable, the doublet lengths will of necessity be somewhat different from the theoretical values in order to effect a suitable compromise. This will be understood readily by considering the doublet lengths furnished in the kit for general sale.

In that kit, the doublet lengths are 16½ feet and 29 feet which, from the above formula, are resonant at wavelengths of approximately 21 and 37 meters, respectively. Such lengths of course are not theoretically cor-



rect for any of the short wave broadcasting bands (at 16, 19, 25, 31 and 49 meters) but are **compromises** which have been found to serve equally well for all bands. Better results could be obtained in the 49 meter band if the 29-foot doublet were increased to 39 feet but reception at 31 meters would be very deficient. Likewise, better results at 16 meters could be obtained by cutting the 16½-foot doublet to 13 feet at the expense of poor reception in the 19 and 25-meter bands.

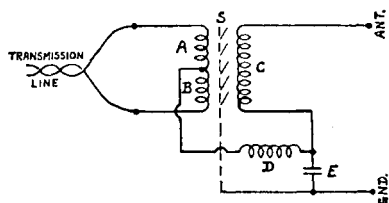


Figure 19  
Receiver coupler used with the "Spider-web" system (multiple doublet)

It should be obvious that compromise lengths for any other tuning range can be determined only by experiment. Laboratory tests tend to indicate that uniform performance cannot be obtained over a range greater than three to one.

#### Horizontal and Vertical Doublets

The double-doublet antenna system can be installed either horizontally or vertically. Preference should be given to the horizontal arrangement since it affords a better signal-to-noise ratio and is highly directional to local pickup. Interference radiated by power lines, street railways, passing automobiles, etc., can be eliminated most easily by erecting the doublets remote from the source of disturbance. In the case of a local radio transmitter, however, this resource is not possible and the directional effect of the horizontal antenna will be found very helpful. Least pickup of course will be obtained when the doublet parallel to earth points directly toward the source of interference. For other than local radiation, the directional effect is negligible since such signals are usually in a state of random polarization. Vertical doublets are non-directional but often can be employed to advantage when installation space is restricted.

#### Loading Coils

Loading coils are lumped inductances used in series with the doublets to change the resonance characteristics. Thus, in cases of limited installation space, short doublets

with loading coils can be used in place of the correct lengths. The actual amount of pick-up of course will be somewhat decreased but proper **matching** to the transposed lead-in (transmission line) will be maintained.

One form of loading coil is available as a standard accessory. It allows reduction of the 29-foot doublet to 16½ feet, thereby reducing the overall span from 56 feet to 30 feet. Two or more of these coils in series may be used to effect a greater reduction but the number required will be a matter of experimentation, bearing no direct relation to the length of the doublet. Probably, the best procedure would be to determine the approximate additional inductance required by observing results with various coils and then wind two single coils (one for each half-section) of the proper value.

#### Transmission Line

The transmission line or transposed lead-in is a weather-proof twisted-pair having a length of 80 feet. This length is not arbitrary but is that which affords correct impedance matching to the doublets used in this system. It is very close to an optimum value for each of the four principal short-wave broadcasting bands (at 19, 25, 31 and 49 meters) and introduces only a slight loss at 16 meters. The instructions supplied with that kit, therefore, strongly recommend against cutting off any portion of the transmission line. In the case of any other frequency range, however, improved results likely will be obtained with a different length.

From a theoretical standpoint, best matching to the doublets will be attained when the transmission line is one-half wavelength or integral multiples thereof. A 20-meter (65.6-foot) line would of course appear to be ½ wavelength for the 40-meter amateur channel, full wave for the 20-meter amateur channel, 3/2 wavelengths at 13.3 meters, double wave at 10 meters, etc. Since the line is insulated and twisted, however, the theoretical or electrical length is greater by a constant percentage than the required or physical length. For this particular transmission line, the required length will always be 56 per cent of the calculated length and, in the above example, would be  $20 \times 0.56 = 11.2$  meters or 36.7 feet. If it is necessary for practical reasons to use a length greater than computed in this manner, any integral multiple of that length will be satisfactory.

A further slight modification of the transmission-line length may be found necessary

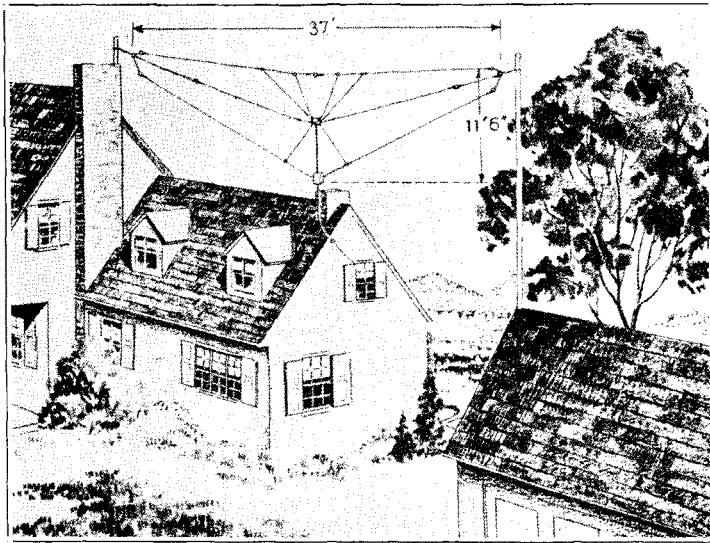


Figure 20  
Typical "spiderweb" installation

after the system is completely installed and in operation. The error has in all probability been incurred because of antenna reactance and the optimum length therefore can be determined only by experiment. Short lengths of line can easily be added or removed by means of a four-pole double-throw switch and with a few trials, the proper length will be quickly found.

#### THE R.C.A. "SPIDERWEB" ALL-WAVE ANTENNA

The new R.C.A. Spiderweb Antenna might be termed the "Quindublet" antenna due to the fact that five doublets are coupled to a common transmission line. The high-frequency range runs from 6,000 to 70,000 kc., in which range it acts as an antenna-transmission line system. It also gives good response in the range from 140 to 6000 kc., in which range it acts as a modified T antenna. The operation of the "Spiderweb" is based on the same theory of operation as the double-doublet except that the larger number of doublets or dipoles used brings the resonant peaks closer together in the range above 6,000 kc., thus giving a more constant response over the high frequency range than is possible with the simpler, all-wave doublets and double-doublets.

The Spiderweb requires a span of 38 feet and a vertical clearance of 12 feet below the line of the span. Due to the fact that

it can be supported at just two points it is somewhat simpler to install than the conventional double-doublets, which require four supports. The standard Spiderweb only goes up to 23,000 kc., but the addition of the ultra-high-frequency dipole assembly adds the 23 to 70 mc. range to the antenna.

#### Doublets Efficient Collectors

If several doublets of different lengths are connected to the same transmission line without any one harming the performance of the other, the resultant antenna will have good signal pickup in several bands of frequencies, namely the bands in which each of the doublets is resonant. If the doublets are selected so that the resonant frequencies of any pair are not too far apart the overlapping of their characteristics will hold up the in-between bands, thus giving uniform signal pickup over a much wider range of frequencies than could be obtained by a single doublet. Five such doublets are effectively utilized in the new R.C.A. Spiderweb antenna system. Figure no. 20 shows how this antenna appears when erected. The bottom wires "E" and "F" are resonant at 6 megacycles (49 meters), "A" and "B" at 12 megacycles (25 meters), "C" and "D" at 18 megacycles (16 meters), "G" and "K" at 35 megacycles (9 meters), and "L" and "H" at 60 megacycles (5 meters). "E" and "F" are closely coupled to the line through an auto transformer which lowers the resonance of this doublet to the desired

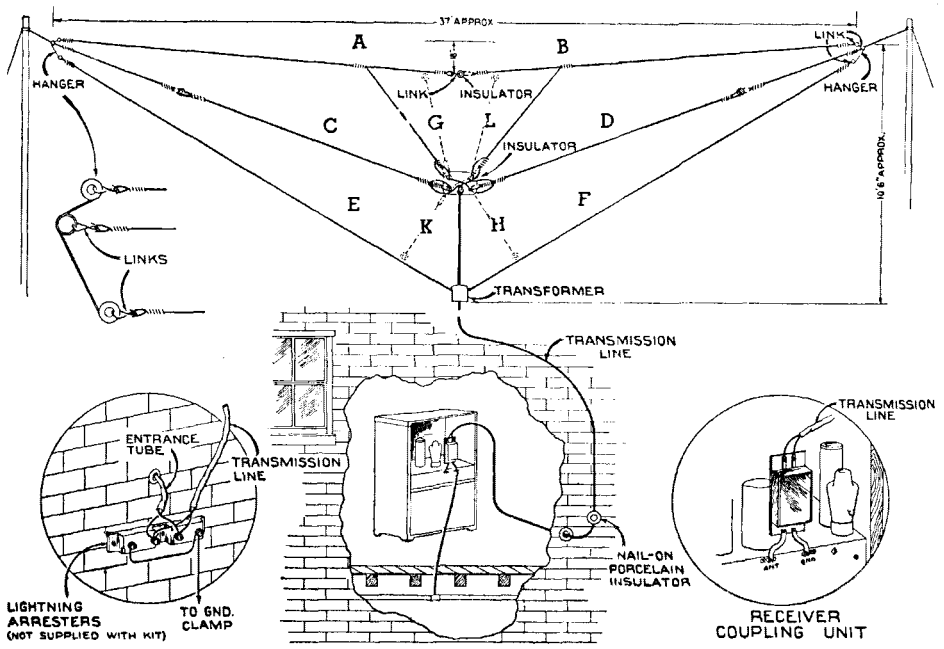


Figure 21  
Schematic diagram of the "spiderweb" antenna system

frequency, 6 megacycles. This transformer is enclosed in a moisture-proof container and is supported in the network by the 6 megacycle doublet (bottom wires) and the short transmission line directly below the crossover insulator.

**Loading Coils Used**

Loading coils are used in the 35 megacycle doublet "G" and "K" because satisfactory space for a longer vertical doublet is not available in the network.

The lengths of the doublets have been carefully chosen for the best utilization of the space and so that the overlapping of two adjacent dipoles will hold up the intermediate frequencies between bands, thus giving practically uniformly high performance over the entire range (5 to 70 megacycles) covered by the dipole antennae.

When receiving signals in the range of 140 to 5,000 kilocycles, the whole network functions as a single unit.

The main Spiderweb kit will effectively pass signals in the frequency range of 140 to 23,000 kilocycles. The two doublets, "G-K" equipped with loading coils and "L-H", shown dotted in figure 21, are furnished complete ready to assemble to the main network in the R.C.A. Spiderweb Accessory

Kit. With this pair of dipoles attached to the main network full coverage is obtained (140 to 70,000 kilocycles).

A feature of importance incorporated in this design is superior noise reduction on those bands affected mostly by man-made interference, namely the "C" and "D" bands (6,000 to 70,000 kilocycles). Within these bands the intercepted signals are usually quite weak and man-made interference is generally the strongest and most localized. The noise reduction is obtained by erecting the Spiderweb Multiple Dipole Antenna remotely to the source of greatest interference and coupling it to the receiver through a balanced non-pickup transmission line. Seventy-five feet of line is assembled to the network. In case additional line is required, 45-foot units are available, which may be added. These units must not be cut, as the line terminates at the receiver in a carefully designed transformer which is matched to the line impedance.

It should be emphasized that any of the all-wave systems described should be high and in the clear, to provide maximum signal and minimum noise pick-up; also the feeder cable should be of good quality so that the signal is not unduly attenuated before it reaches the receiver.

## VIII. Special Antennas and Miscellaneous Tables

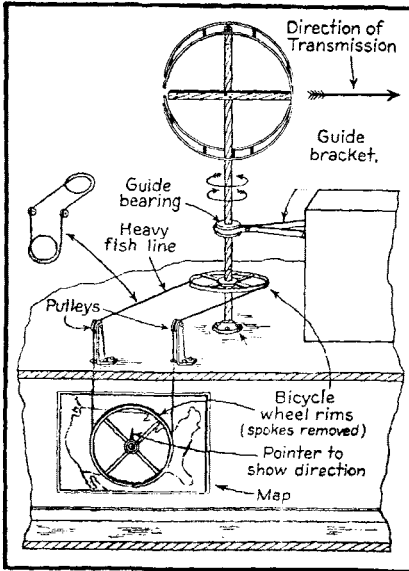


Figure 1  
Sketch of a complete Rotary Beam Aerial Installation.

### THE REINARTZ ROTARY BEAM

The Reinartz double loop rotary beam has been extremely successful on 30 and 60 megacycles. It is essentially uni-directional in a direction parallel to the plane of the loops and away from the open end of the two loops. See figure 1. This antenna is mainly advantageous for receiving. It gives only about 1 decibel gain in the favored direction but gives a loss of about 7 decibels to signals originating to the rear. The pattern is heart shaped. One loop gives about the same directive pattern as the two loops shown but it is difficult to obtain a balanced feed line from the antenna. Unless the feed line is well balanced it will pick up signals originating to the rear of the antenna and thus reduce the directive selectivity.

There are three commonly used methods of feeding the beam. Current feed from a twisted pair line each side of which connects to one of the radiators at a point

exactly opposite the open end (or, in other words, at the current loop) is one method. The beam can also be Zepp. fed at the open ends. However, the best method of feeding the beam is the arrangement shown in figure 3, where a 600 ohm, two-wire untuned line is tapped on each loop 20 inches from the open end each way for 5 meter operation. For ten meters the taps are 40 inches from the open ends, and for twenty meters the taps are 82 inches from the open ends.

Note that small differences in mechanical construction will materially affect the stray capacitances of the loop circuits, and thus the beam should be resonated experimentally, as no table of lengths can be very accurate at the higher frequencies.

There are many various ways of mount-

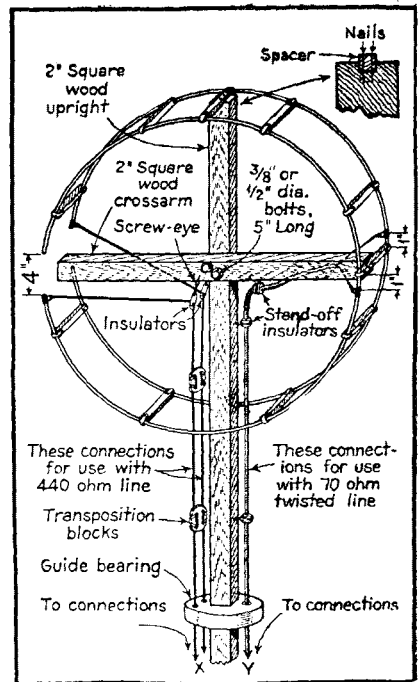
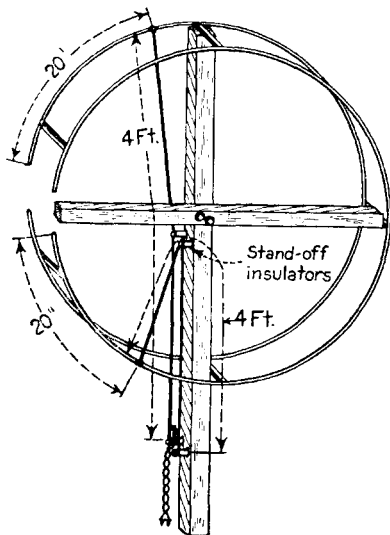


Figure 2  
Details of the aerial proper, and how the transmission lines are connected.

### Reinartz Rotary Beam

Frequency	Tube feet	Length inches	Loop Spacing	Loop Opening	Total Circumference	Diameter	600 ohm feeder Tap
14,150 kc.	33'	396"	24"	18"	414"	133"	82"
29,250 kc.	16'	192"	12"	8"	200"	64"	40"
58,500 kc.	8'	96"	6"	4"	100"	32"	20"

ing the beam so that it can be rotated. It should be kept in mind that the beam has quite a bit of wind resistance and must be well supported.



**Figure 3**  
This simplified version of the Reinartz Rotary Beam for five meters is now in use in many stations and is working out very satisfactorily.

### THE HAWKINS DOUBLE V ANTENNA

The use of the "double V" doublet is sometimes desirable when there is not sufficient room available to put up a conventional doublet or half-wave antenna. The double V requires about one-sixth less length of span for a given frequency than a resonant, half-wave single wire. For example, at 7 megacycles an ordinary half-wave dipole is about 67 feet long. A double V dipole resonant at the same frequency (7 mc.) is only about 54 feet long. Figure 4 shows the double vee system.

The following table shows approximate lengths for the double V and single wire dipoles at various frequencies:

Frequency	Length Double V Dipole	Length single wire dipole
2,000 kc.	189 feet	235 feet
3,500	108	134
4,000	95	118
7,000	54	67
14,000	27	33

The double V antenna is somewhat less directional than the single wire dipole and the overall efficiency of radiation is about the same. It has a lower "Q", so that it can be used over a wider band of frequencies than the single wire. However, due

to the large "end effect" it must be used on its harmonics with care. Check its length against its harmonic frequency carefully as there is considerable disparity between the resonant and other integral harmonics of its fundamental frequency. One ideal combination consists of a 95 foot double V antenna for 4 mc. phone use. It happens that the frequency for which the 95 foot double V antenna resonates as three half waves is 14.2 megacycles, which is the middle of the 20 meter phone band. Thus, this one antenna is correct for both 75 and 20 meter phone.

The length formula for the double V antenna is:

$$L = \frac{(K-0.23) 492}{F}$$

where L is length in feet, K is the number of half waves, and F is the frequency in megacycles. The formula for one half-wave is

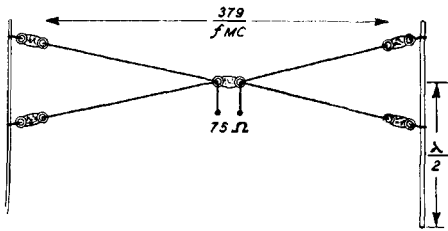
$$L = \frac{379}{F}$$

where L is length in feet and F is frequency in megacycles.

The spacing between the ends of each V should be about 10% of the length of the antenna. Thus at 7 mc. the ends of each V

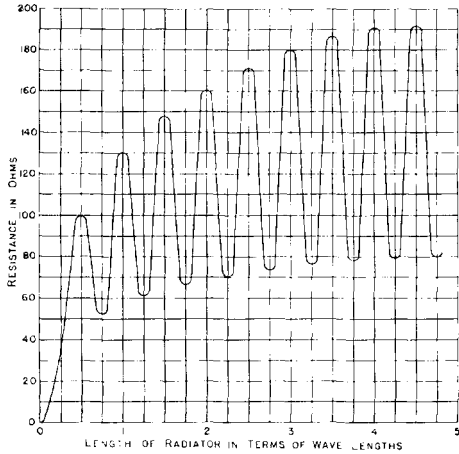
### DOUBLE VEE ANTENNA

Frequency	Length
3500	108' 2"
3600	105' 3"
3700	102' 5"
3800	99' 9"
3850	98' 5"
3900	97' 1"
3950	95' 10"
4000	94' 8"
7000	54' 1"
7050	53' 8"
7100	53' 4"
7150	52' 11"
7200	52' 6"
7250	52' 2"
7300	51' 11"
14,000	27' 1"
14,100	26' 10"
14,200	26' 8"
14,300	26' 6"
14,400	26' 4"
28,000	13' 6"
28,500	13' 3"
29,000	13' 1"
29,500	12' 10"
30,000	12' 7"



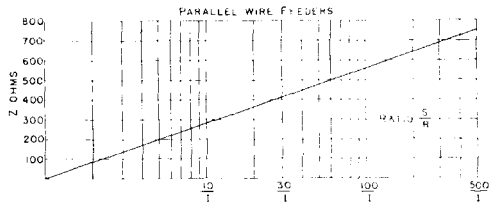
**Figure 4**  
The "Double Vee" Antenna takes up less room than a conventional doublet.

should be spaced about  $5\frac{1}{2}$  feet. As the impedance at the center of a double V dipole is approximately 75 ohms at its fundamental frequency, this antenna can be fed by any of the common methods of feeding a doublet, including twisted pair transmission line, Johnson Q feeders, etc. The Collins Multiband antenna system does not work well with this type of radiator except for possible two band operation, such as 160-40; 75-20; etc. Note that the ends of each V can be either horizontal or vertical.

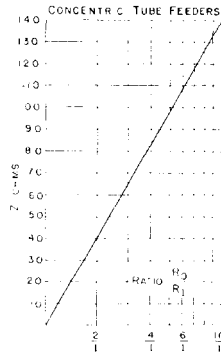


**Figure 5**  
Radiation resistance of a grounded vertical wire as measured at any current loop.

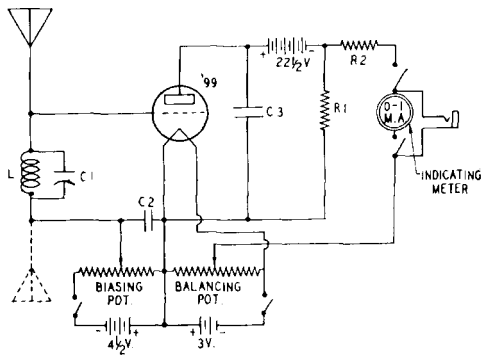
Sometimes it is desired to operate a Marconi or grounded antenna whose length is materially less than a quarter wave. Thus the antenna system requires considerable series inductive loading to make it resonate. Such antennas are common on small boats, aircraft, and motor cars. In such cases it is sometimes desirable to know the radiation resistance in order to match a feeder system to the antenna. The radiation resistance of a grounded antenna less than a quarter wave long is approximately  $L^2$  (520) where L is the length in wavelengths.



**Figure 6**  
The surge impedance of an untuned, two-wire line depends upon the ratio of the radius of the conductors to the spacing. From the above curve the impedance of any two-wire line may be determined at a glance. S equals the spacing and R the radius of the conductor in the same lineal units (inches, centimeters, etc.).



**Figure 7**  
The surge impedance of a coaxial (concentric) transmission line depends upon the ratio of the outside radius of the inner conductor to the inside radius of the outer conductor. The surge impedance may be determined after the ratio is known, by a glance at the above curve.



**Figure 8**  
A Simple Field Strength Meter  
L—18 d.c.c. on  $1\frac{1}{4}$ " diam. form to hit band  
C<sub>1</sub>—100 μfd. midget variable condenser  
C<sub>2</sub> and C<sub>3</sub>—0.001 μfd.  
Biasing potentiometer—2000 ohms  
Balancing potentiometer—200 ohms  
R<sub>1</sub>—5000 ohms  
R<sub>2</sub>—1000 ohms

## IX. Supporting the Antenna

Impossible to achieve, of course, but the ideal method of hanging an antenna would be to have it in position with no surrounding objects to absorb or otherwise distort the radiation pattern. Unfortunately, "sky hooks" remain legendary.

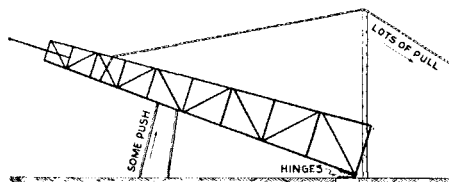


Figure 1

Raising a wood tower is not especially difficult when the above method is used. If the tower is to be guyed, no foundation need be used. If the tower is to be self-supporting, the hinged should be fastened to heavy stakes in the ground so placed that the base of the tower will "fall into place" on the foundation shown in figure 3 when the tower is raised. If the tower is to be well-guyed rather than self-supporting, somewhat lighter construction is permissible.

With masts or supports less than 40 feet or so in height, this is not much of a problem. With poles or spliced lengths of wood, little is needed in the way of guy wires or bracing.

However, with heights of 60 to 90 feet, the mast construction has to be such that utmost stiffness and light weight are had. The wind pressures encountered by an average installation of this sort are occasionally so heavy that means of bracing the tower and anchoring it to the ground assume the proportions of a problem. These considerations point to a design in which the mast consists of 3 or 4 vertical corner pieces tapering toward the top, and securely braced and strengthened by means of girders and cross braces. This design is used in many of the new broadcast towers and vertical radiators, both wood and metal.

When several antennas are used of the vertical and semi-vertical types, these have

in some cases been used as the guy wires by placing them at points where the strain comes.

In the tower shown, the cost has been kept to a minimum and materials used are such that they, or inexpensive substitutes, are available in most parts of the country. For the vertical runners, use straight-grained Oregon pine 2x2's or 1x3's in 20 or 22 foot lengths if available. If these are hard to get or too expensive, shorter lengths of some cheaper wood will be all right for a guyed tower if each piece is selected carefully and knots and other weakening factors are kept out as much as possible.

The cross braces and girders are made of "car strips", "tobacco lath" or even plaster lath, but the last mentioned is the least desirable. The others are stronger and cheaper. Get those with the "fuzzy" or rough finish, as the rough finish is cheaper and weathers better than finished wood. The same thing applies to the 2x2's; don't get surfaced ones.

The first thing to do in building a tower of this type is to lay out enough of the uprights to make up a tower length which is desired. These are spliced together by means of overlapping pieces two or three feet long of the same material. These may be bolted, screwed, or nailed, to the edges which will be on the inside of the finished tower. Of the afore-mentioned methods, the bolting is preferable, using big husky washers on each side in order to keep the head or nut from sinking into the wood.

Two spliced lengths are then placed side by side with the bottom ends separated by 3 to 6 feet, depending on guying, height, etc., and a cross girder nailed in position. The two lengths taper together toward the top to some 12 or 15 inches. With these in position and the sides straight, start nail-

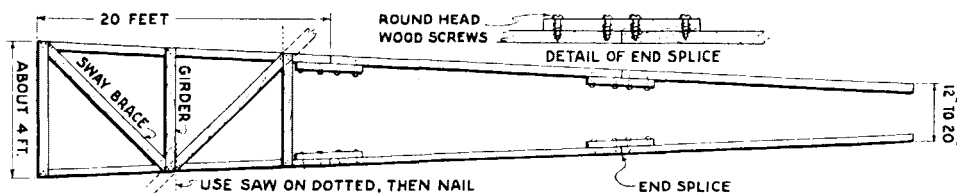


Figure 2

Above is shown in detail the construction of the "end splice". It makes a better-looking splice than an ordinary overlapping splice. Below it is shown construction of one of the two similar sides of the tower. To show constructional detail better, the illustration is not drawn to scale.

ing the girders across the two pieces. With even spacing of the girders, place each one across the two sides at a distance up the tower which is equal in length to the last girder nailed on. This will give a series of squares diminishing in size toward the top of the tower.

After this is completed start up with the cross braces, laying them in position, marking them and sawing them to fit the angle. With these nailed in properly, one side of the tower will be finished.

Make the second using the first as a sort of template, thereby securing a duplicate of the first. Stand these two sides on their edges, space them properly, and start nailing girders exactly as when making the first side. With the operation repeated on the fourth side, you will have a tower that has stiffened surprisingly when put together.

For permanently secure nailed joints, look around and see if you can get the type of box nails similar to shingle nails that are coated with a sort of cement. These when driven in "set" themselves and never do loosen up. If any trouble is had with splitting wood when nailing, soak the strips or lath in water for some time, or drill holes through them slightly smaller in diameter than the nails.

The painting may be done either before assembling the tower or afterwards. If done afterward, then while waiting for it to dry, go ahead and prepare the base for the

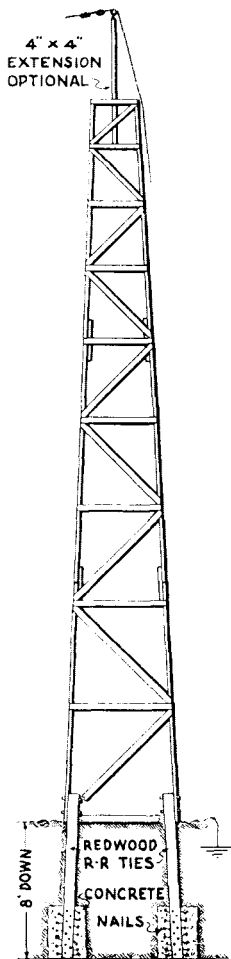


Figure 3  
The foundation used for a guyless tower (four redwood posts or railroad ties sticking out of the ground a ways) to which the base of the tower is anchored.

tower and assemble the things needed for raising it.

In the tower shown, the base was so securely anchored that no guy wires were needed. This was done by sinking some redwood railroad ties, which had been liberally studded with large spikes, into four spaced holes and then pouring in a rough mixture of cement with a good many rocks in it. The holes were around 8 feet deep and 18 inches in diameter.

The concrete mixture was put in to about a depth of 20 inches, and the rest of the hole filled with dirt after the mixture had set. If the ground is such that digging or blasting the holes is impractical make a base for the tower to keep it from "walking" and guy it well.

If holes are wanted in rock, and the tools for rock drilling are not readily available, get an old model-T axle and have the end shaped and hardened. Using this and an 8 lb. sledge hammer, drill holes in the rock and set therein some 1 inch pipe in concrete. This will hold about anything.

For raising the tower illustrated, some heavy posts were set temporarily in such a position that the tower would swing down nicely on the base which had been prepared for it. The bottom of the tower was hinged to these stakes and with the aid of a "gin-pole" and some rope the tower was raised. A borrowed ladder with a greased top rung makes an excellent gin-pole. If not too far from the base a couple of huskies can "walk" it into position if necessary.

The 4 x 4 extension shown in the drawings is of course optional. If installed, secure it by means of x-bracing across the inside of the tower. Also, this x-horizontal bracing should be put in at several points down the interior of the tower, as there is a tendency for the tower to try to fold up flatwise.

For halyards use tarred rope, either paraffined or well soaked with crankcase drainings, as this will make them last several times as long when exposed to the weather.

If the tower is not to be totally guyless, be sure to break up the guys at frequent intervals with "egg" type strain insulators. The adjoining wires are looped around each other and they will still hold even if the insulator breaks, which isn't likely, as when properly installed these insulators are subject only to compression and not to a pulling strain. Do not measure off the breakup lengths of the guy wires; make them assorted short lengths; then in case some par-



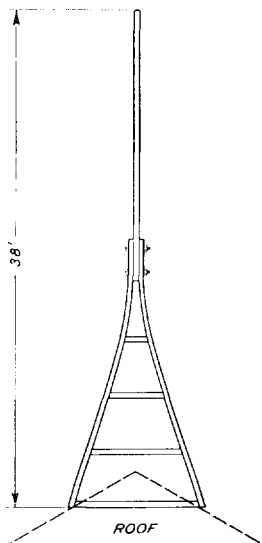


Figure 4  
The most practical antenna support for heights up to 40 feet and moderate pulls.

tical length of guy wire is "shock excited", there won't be a whole family of wires the same length causing trouble. Do not guy to the exact center of a pole or mast, especially if limber, as this will under some conditions produce a "full wave" oscillation which is liable either to bring down the mast or severely strain it.

When tying a guy wire to an insulator, bring it around the insulator and take four or five running turns around the main length of the wire before finishing off with several closely wrapped "buttons". The twist at the ends of a guy wire should be in opposite directions, as this avoids any tendency for the wire to untwist when a strain is put upon it.

One need not follow the layout of this particular tower. Some other methods of construction have also proven very suitable. Fine looking towers have been built following the general design of some of the b.c. station vertical radiators, with the largest diameter in the center and tapering off both ways down to about 6 x 6 inches. Due to lack of footing area these must be guyed and are best suited to uses where some of the antennas may also be used for guy wires.

Any kind of paint is ok for painting wood towers or poles, and if protection and cheapness are the paramount considerations, common asphalt paint is very good. If one wants color and at the lowest cost, get

some ground metallic and mix it up with second grade linseed oil. Due to lack of "dryer" this will take somewhat longer to dry, but has the virtue of cheapness and gives fine durability.

A triangular assembly of the sides instead of square has the advantage of reducing the amount of material and has less area exposed to the wind; but it is harder to make, as the long pieces have to be made triangular in cross section, at least where the girders and cross braces attach, and unless special metal plates are used at junction points it has not the strength of the one shown.

When heights over 40 feet are not needed and excessive strain is not placed on the antenna, a pole of the type shown in figure 4 is simple to build and is easy to place in location, being made of three, 20-foot 2 x 2's.

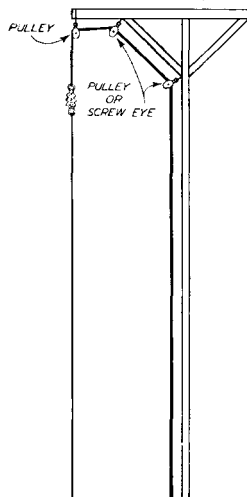


Figure 5  
The "gallows" type pole is ideal for 5 and 10 meter vertical radiators. By making the cross-arm long enough, a quarter-wave matching section may be supported from the vertical part of the pole and a two-wire open line run up the pole on standoff insulators.

A type especially suited for a vertical antenna is the simple "gallows" pole shown in figure 5. As it is mostly used on the higher frequencies, a single 20 foot length of 2 x 3 is generally sufficient. The cross arm at the top may be 4 to 6 feet long with braces sufficiently long to give good strengthening against the down pull. Of course this is perfectly practical in a taller arrangement, and was used extensively some years ago when the vertical antenna and "counterpoise" (in reality a current-fed bent half-wave) was in great favor on 40 meters.

NEW DEVELOPMENTS AND DISCOVERIES ARE BEING  
MADE EVERY DAY ON THE SUBJECT OF

# ANTENNAS

We can't publish an antenna book every day; so the best way for you to keep abreast of the times, and ahead of the ham down the street, is to subscribe to



## “RADIO”

*“The Worldwide Authority of Amateur, Shortwave,  
and Experimental Radio.”*

All the current developments are covered—completely—so that you can understand them. Every month† you get 100 or more pages of authoritative, technical and constructional information, printed on enamel coated paper with finer illustrations than ever before.

By the year, it costs you less than a penny a day to be up-to-the-minute. Send \$2.50 (or \$4.00 for 2 years) NOW—before you forget it.

WHAT MAKES IT WORK . . .

HOW TO MAKE IT WORK . . .

HOW TO BUILD IT WITH THE LEAST WORK . . .

### “RADIO” SUBSCRIPTION RATES

In the United States, Canada, Newfoundland, Cuba, and Mexico: current issue, 30c; 1 year, \$2.50; 2 years, \$4.00

All other *independent* American countries and Spain: current issue, 35c; 1 year, \$3.00; 2 years, \$5.00.

In the United Kingdom: current issue 1/8; 1 year, 14/6; 2 years 24/6.

Elsewhere: current issue, 40c; 1 year, \$3.50; 2 years, \$6.00.

†Except August and September; ten issues per year including enlarged special annual number

In Every Field of Human Endeavor  
One Factor Stands Supreme  
~~~~~ *In the radio magazine field its*

7460 Beverly Boulevard  
Los Angeles

# RADIO

ESTABLISHED 1917