

THE
JOHN DEERE
LIBRARY

Design of Modern Radio Receiving Sets

By M. B. SLEEPER

Showing the construction of instruments so simple that they can be assembled in the "kitchen table workshop," yet so designed that they give the appearance and results of commercial equipment.

Fourth Edition

Completely Revised

du

COPYRIGHT 1922
BY
M. B. SLEEPER

PUBLISHED BY
SLEEPER RADIO CORPORATION
88 PARK PLACE
NEW YORK

HAMMOND PRESS
W. B. CONKEY COMPANY
CHICAGO

TABLE OF CONTENTS

A LOOSE COUPLER THAT DOES WHAT IS EXPECTED OF IT

A design is given for a loose coupler with which primary and secondary windings can be used to give a wavelength range, with an ordinary 0.0003 mfd. antenna, of 169 to 1,066 meters or 179 to 2,665 meters.

Page 9

SINGLE CIRCUIT AUDION RECEIVER

Compact and convenient, this set is admirably adapted for general reception on wavelengths from 150 to 3,200 meters, tuning in amateur, phone, commercial, and time signal transmitters.

Page 13

A REAL RADIO RECEIVING EQUIPMENT

Of all apparatus described in RADIO AND MODEL ENGINEERING this 150 to 2,600-meter regenerative receiver has been, and still is, the most popular. Criticisms have been made that the tuning is somewhat broad, and that some loss of efficiency is experienced below 300 meters, but for phone reception and commercial stations up to time signals it is hardly surpassed by the most elaborate variometer sets.

Page 16

A REAL RADIO RECEIVING EQUIPMENT

The detector and 2-step amplifier described is primarily designed to be used with the 150 to 2,600 meter regenerative receiver, tho it is equally good for any type receiving set. In fact, it can be wired to a crystal receiver, such as the Areola, Jr., when loud signals are required.

Page 21

SIMPLE CRYSTAL RECEIVER FOR PHONE RECEPTION

Here is an excellent crystal receiver, costing less than five dollars to assemble, which, with a single wire antenna 100 ft. long and 30 ft. high, will receive phone broadcasts up to 15 or even 20 miles.

Page 26

RADIO FREQUENCY AMPLIFICATION AT 200 METERS

The simplest type of radio frequency amplifier is described, embodied in a set that gives astonishingly sharp tuning. Suitable for regular 200-meter traffic, the set offers interesting possibilities for experimenting. By slightly increasing the number of turns on the coils phone stations can be received.

Page 28

12,000 TO 20,000 METER RECEIVER

European stations come in with surprising strength when an audion detector is used in conjunction with this instrument. Simplicity of control, without sacrifice of efficiency, is a strong point in its favor. It is an interesting set to operate, and opens a new field for the man who has only worked on short waves.

Page 34

150 TO 600 METER REGENERATIVE RECEIVER

Another special success has been scored by this equipment. For relay work on 200 meters it is unexcelled, both in the matter of signal strength and tuning. The man who has experienced interference while receiving phone broadcasts or is troubled with weak signals can promise himself a new experience when operating this outfit.

Page 38

SOME COMMON RADIO PROBLEMS

A few answers and remedies are given for perplexities that are frequently met by the novice and experimenter.

Page 42

IDEAS FOR THE SHOP AND LABORATORY

Suggestions are given for an oscillating wavemeter, inductance standards, and a phone bob, handy pieces of apparatus for the man who is doing experimental work.

Page 43

LISTS OF PARTS AND PRICES

To describe the construction of an instrument for which parts cannot be obtained is only an aggravation. Consequently, complete lists of parts and prices are given for G. A. Standardized Supplies of which the equipment can be built.

Page 46

511738

PREFACE

So popular were the articles which appeared in **RADIO AND MODEL ENGINEERING** from the first issue, in May, 1921, to the last number of the year that, in response to a demand which has entirely exhausted the supply of back numbers, the material on receiving sets has been reprinted in book form.

The reason for this demand is probably the care and sincerity with which the articles were prepared. A feeling of confidence seems to be created by the manner in which the data is presented, and is justified by the results obtained when the work has been carried out carefully. Those who are not familiar with radio construction work may be reminded, however, that the best directions are not proof against faulty workmanship.

An unusual feature of this book is the list of parts and prices to accompany the instruments described, giving the experimenter a source of supply for parts required.

Assistance of great value was rendered, in the preparation of this data, by Mr. W. H. Bullock, whose experience in radio design contributed greatly toward simplifying mechanical and electrical construction.

M. B. SLEEPER

A Loose Coupler That Does What Is Expected Of It.

Homemade loose couplers seldom meet the expectations of the experimenter in the matter of wavelength range. Here are some ideas which cannot go away.

Loose Couplers and Wavelength.

MOST Experimenters are over the idea that the bigger the antenna the louder the signals. For all-round work a single wire 100 ft. long, averaging 30 ft. high, is the thing. Such an antenna is best suited for wavelengths from 200 to 2,500 meters.

The wavelength of any circuit depends on the amount of capacity and inductance in that circuit. Since the antenna provides the capacity of the primary circuit, the inductance of the primary must be of such a size as to give, with the antenna capacity, the wavelength range required.

The usual loose coupler, bought or homemade, has enough taps on the secondary, to look reasonable. But, usually, there is very little reason connected with it. Unless a condenser is used in the secondary circuit, sharp tuning cannot be obtained, and if a condenser is used, the taps should be so arranged, that, with a specified condenser, the wavelength with maximum capacity at one tap will be slightly higher than the wavelength at minimum capacity on the next tap. This provides an overlap.

The Panel Type Loose Coupler.

A PARTICULAR disadvantage of the ordinary loose coupler is that the controls are not of the rotary type, mounted on the panel. In the instrument illustrated in Fig. 1, however, the primary and secondary coils are mounted at right angles to give zero coupling. Coupling is provided by the primary coupling coil which rotates inside the secondary.

Two switches at the left control the primary inductance, one for small steps and one for large steps, and a single switch, on the right regulates the secondary coil. No primary condenser is needed, but a G. A. STD variable condenser, 0.0008 mfd., is required for fine tuning in the secondary circuit. Connections for this instrument are the same as for an ordinary loose coupler. Specifi-

cations are given for two sets of coils, one for 200 to 1,000 meters, and one set for 200 to 2,500 meters, according to the requirements of the builder.

Laying Out the Panel.

FIG. 2 shows the front panel, rear connection panel, primary coil at the left, and secondary coil at the right. The rear panel, of $6 \times 2\frac{1}{2} \times \frac{1}{8}$ -in. L.P.F., is secured to the front panel by two 1-in. lengths of angle brass. Dimensions can be scaled off from the drawing, as it is exactly one-half size.

The Inductances

FIG. 3 shows the long and short wave coils. The same size tubes, of the dimensions given in Fig. 2 are used for all the coils. For the secondary, either long or short wave, a considerable portion of the tube is not wound. This is done so that the screws which hold the coil mounting pillars to the panel will be out of sight under the coupling dial.

COUPLING COIL: The coupling coil for either wave length has 7 turns of No. 24 S.S.C. wire on each side of the ball, with leads soldered to the split shaft.

SHORT WAVE PRIMARY: The short wave primary coil is wound with No. 24 S. S. C. wire on a G-A-Lite tube $3\frac{1}{4}$ ins. long and $3\frac{1}{2}$ ins. in diameter. Starting $5/16$ ins. from the left hand end, taps are taken off at the following turns: 0, 2, 4, 6, 8, 10, 20, 30, 40, 50, 60, 70, 80, 90, 100 and 110. The first five are connected to the upper switch, and balance to the lower. An extra switch point is provided at each extremity so that the lever will not slip off. The full coil has an inductance of 1.0 millihenry which, with an antenna of 0.0003 mfd., gives a maximum wavelength of 1,032 meters.

SHORT WAVE SECONDARY: The same tube and wire are used for this coil.

Start the winding $\frac{1}{4}$ -in. above the center of the shaft hole, and take off taps at the 24th turn, and the 62nd, which is the end of the coil. The inductance with the first tap is 0.08 millihenry and 0.40 milli-

hand end, taking off taps from the following turns: 0, 6, 9, 12, 15, 18, 21, 39, 57, 75, 93, 111, 129, 147, 165, 183, 201, 219, 237, 255 and 273. The first six go to the upper switch, and the balance to the

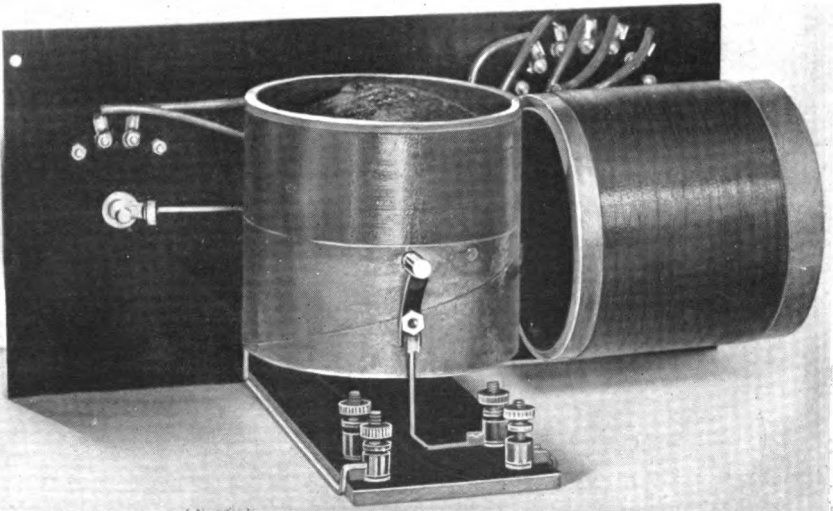
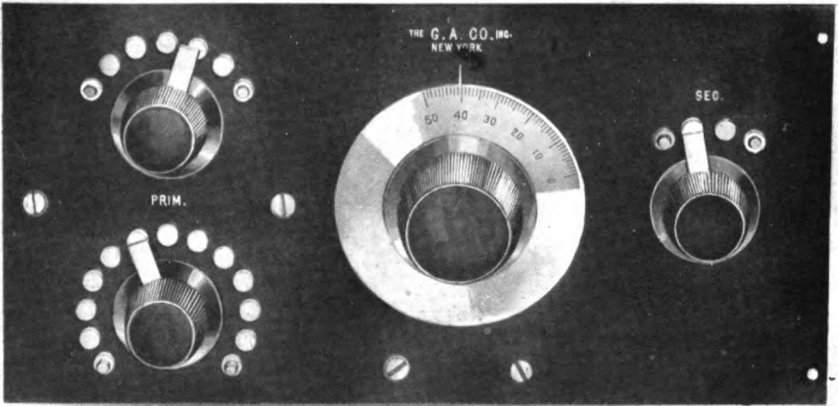

Fig. 1. Front and rear views of the panel control loose coupler with rotating ball coupling adjustment.

henry with the full coil. This gives a range with a 0.0008 mfd. condenser of 169 to 477 meters and 377 to 1,066 meters. **LONG WAVE PRIMARY:** Three banks of No. 24 S. S. C. wire are required for the long wave primary. Like the other, start the winding $\frac{5}{16}$ -in. from the left

lower. The full coil has an inductance of 6.0 millihenries, which, with a 0.0003 mfd. antenna gives a maximum wavelength of 2,529 meters.

LONG WAVE SECONDARY: Here again a $3\frac{1}{2}$ -in. tube $3\frac{1}{4}$ -in. long is wound with No. 24 S. S. C. wire in three

banks. Start the winding $\frac{1}{4}$ -in. above the rotor shaft hole, and take off taps at the 21st, 57th and 145th turn, which is the end of the coil. The inductances at these three points are 0.09, 0.50, 2.50 millihenries, and the wavelength ranges with

the regular winding. After the coil has been given a coat of Valspar and the varnish dried, cut the extra turns in the middle and twist the two parts together close to the coil. There is your tap. Do not twist the wire too tightly or it will

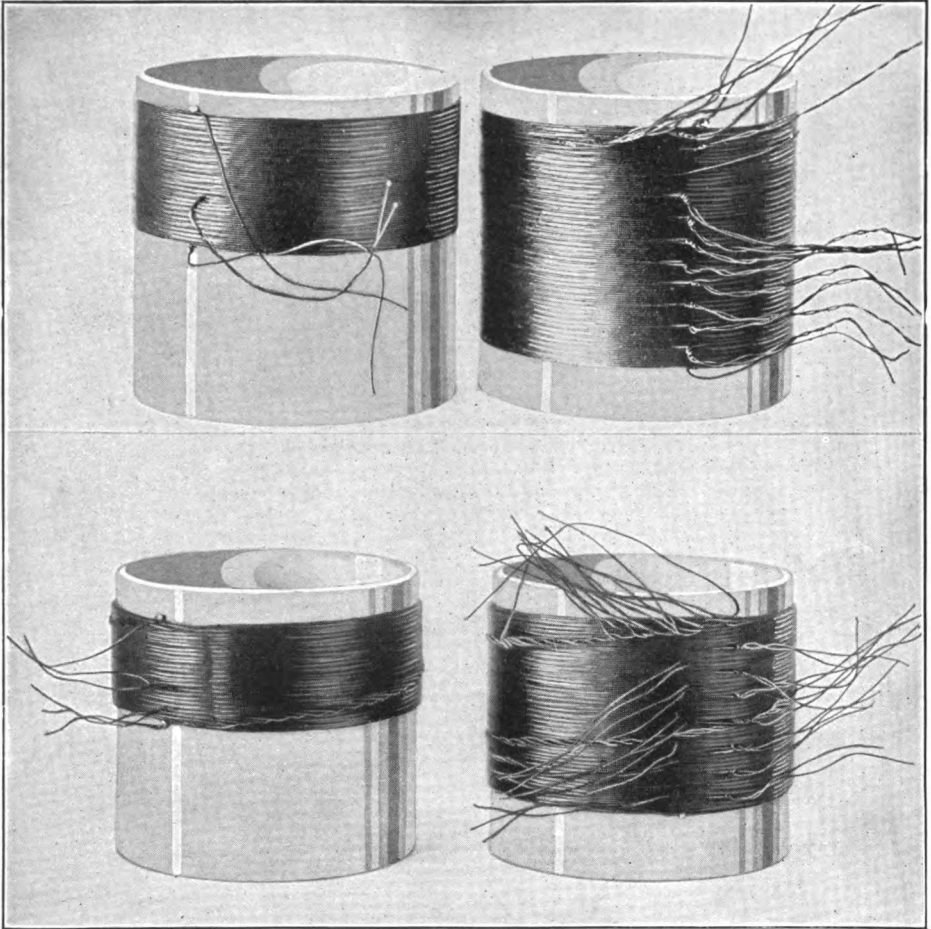

Fig. 3. Above coils for the short waves; below, the long wave primary and secondary.

a 0.0008 mfd. G. A. STD condenser 179 to 506, 421 to 1,192, and 942 to 2,665 meters respectively.

TAPPING THE COILS: There is a very easy way to take off taps on coils of this sort. When a tapping point is reached, instead of twisting or cutting the wire, merely bend the wire to one side and put one turn around the part already wound. End this extra turn just where it was begun, and carry on with

break. A tap not yet twisted is shown in Fig. 3, near the top of the upper right hand coil.

Operation of the Coupler.

THIS loose coupler, fitted with the long or short wave coils will receive spark, modulated undamped waves, voice or music when connected with a crystal or audion detector. A G. A. STD variable condenser, 0.0008 mfd., is needed for the secondary.

Single Circuit Audion Receiver

This set, operated by two controls, tunes from 150 to 3,200 meters.

Selection of Design.

THE experimenter who is making up his first audion detector set, and often the advanced student who builds a stand-by outfit, is usually perplexed by the multitude of designs possible. Starting with the circuit elements, he adds one thing and another until the set becomes too awkward or too expensive.

Here is a little outfit, designed for a standardized L.P.F. cabinet, 10x5x5 ins., that brings in the signals as well as a loose coupler outfit, and is equal in efficiency and appearance to panel sets running up to seventy-five dollars in price. The simplicity of the design and circuit assures the success of the builder, for there are no tricks or catches.

Laying Out the Panel.

FIGS. 1 and 2 show the views of the receiver, with half size scale drawings in Fig. 3. It will be seen that the rear panel, carrying the socket and binding posts, is secured to the front panel by two 1-in. lengths of angle brass. The smaller panel also acts as a support for the instrument.

Winding the Coil.

G-A-LITE tubing, 3 ins. in diameter, is used as a form for the coil. Altho condensite celleron is preferable, it is difficult to wind it with two banks. The details of the inductance and wavelength ranges are given below. These are based on the use of a G.A.STD. condenser of 0.0008 mfd.

First Tap—0.02 millihenries, 0.1 in., 7 turns
146 to 267 meters
Second Tap—0.05 millihenries, 0.21 in., 17 turns
231 to 421 meters
Third Tap—0.14 millihenries, 0.41 in., 33 turns
386 to 705 meters
Fourth Tap—0.40 millihenries, 0.72 in., 61 turns
653 to 1192 meters

Fifth Tap—1.20 millihenries, 1.45 ins., 121 turns
1132 to 2065 meters
Sixth Tap—3.00 millihenries, 2.8 in., 235 turns
1788 to 3264 meters

A hint about winding the coil will save much trouble. When the wire is brought from the tube up to the top layer, it should be brought over the previous top turn and then down on top of the lower turn. Throwing up the turns in this way gives the effect noticeable in Fig. 1.

Assembling the Parts.

THE coil is mounted on brass pillars 11/16 in. long, threaded 6-32 clear thru. Screws are put in from the inside of the coil, and screws thru the panel into the other ends secure the pillars and coil. Having the binding posts on the rear is a great advantage because it takes all the wires from the front. The tube socket is mounted with the positive filament and plate contacts toward the panel, and the terminals of the rheostat on the right, looking at the rear.

Operation of the Receiver.

A 22.5-VOLT B battery and 6-volt storage battery are needed to operate the tube. The antenna may be a single No. 14 copper wire 100 ft. long and 25 ft. high at each end, with a water pipe ground connection. However, such combinations as a gas pipe and water pipe can be substituted for the antenna and ground, or a wire soldered to a tin roof for the antenna. With the new Radiotron 200 tubes practically no resistance is needed when 6 volts are applied to the tube

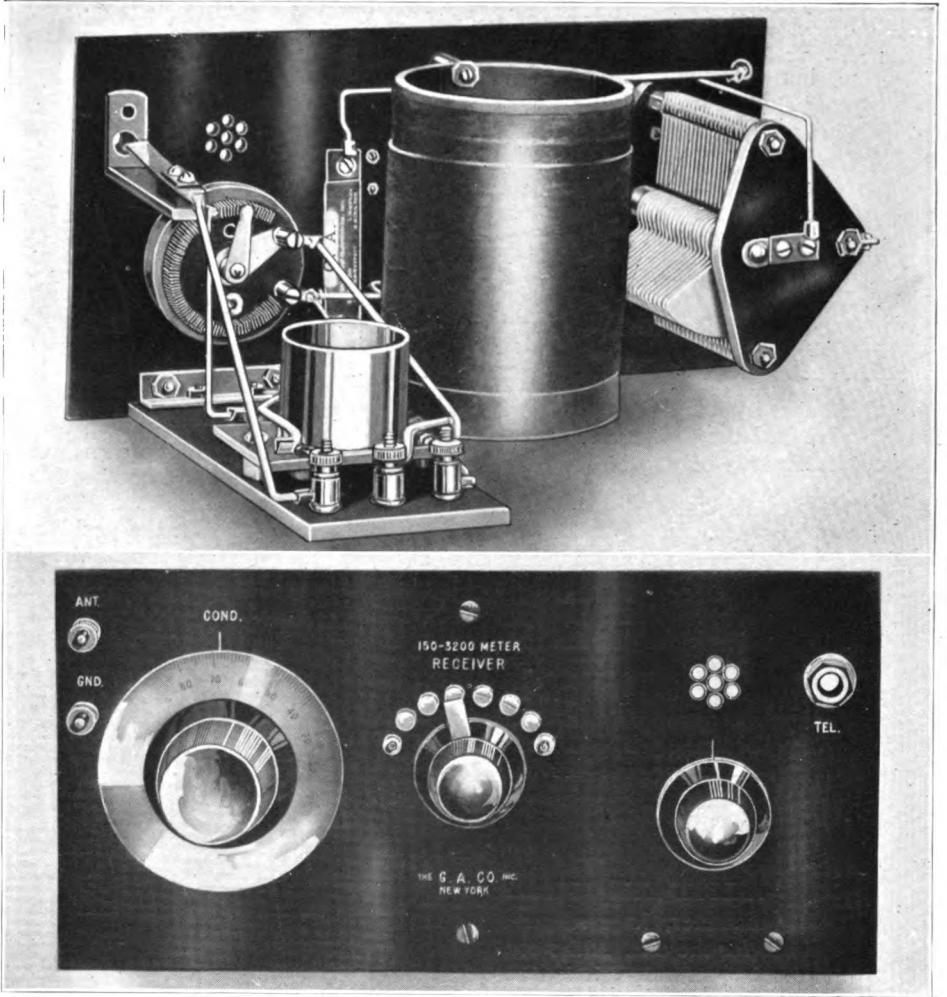

Figs. 1 and 2. Ready to receive over a range of 500 to 1,000 miles.

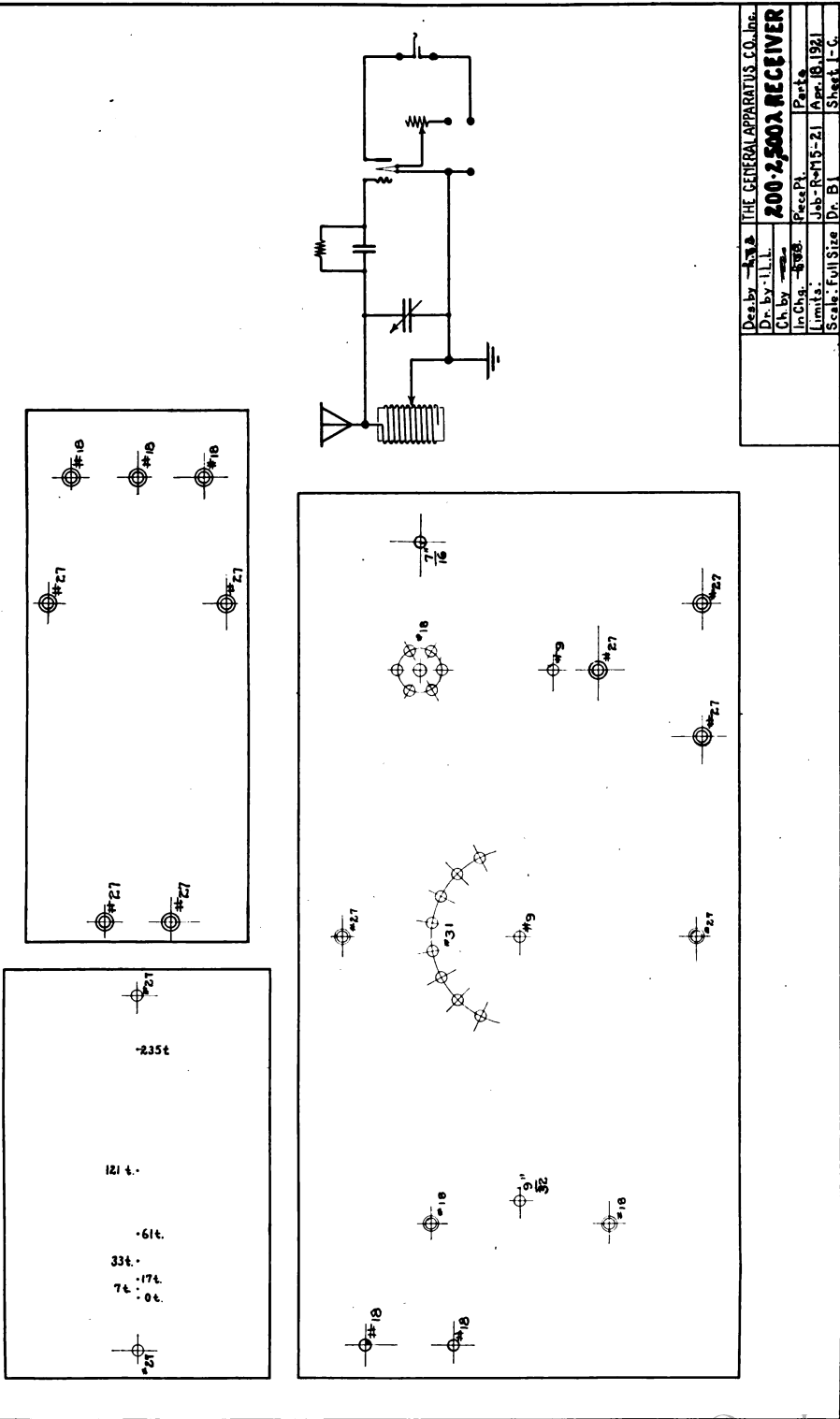

Fig. 3. Layout of the coil tube, connection panel, and front panel, shown at one-half scale so that dimensions can be taken directly from the drawings.

A Real Receiving Equipment

This set probably introduces a new era in experimental instruments; it is a regeneration tuner of astonishing sensitivity for 150 to 2,600 meters.

REGENERATIVE receivers, as many an experimenter knows, are not only difficult to handle but are quite expensive. Some of the variometer type sets have as many as nine control knobs, the minimum being five, exclusive of the audion circuits.

The time required to tune such sets multiplies rapidly with the number of controls, because of the extremely sharp tuning and the frequency variations due to the hands, with the result that short calls are often lost before they can be tuned in. Moreover, the wavelength range at best is 150 to 300 meters unless an air or mica condenser is added in the secondary.

When properly constructed, this set brings in signals louder than the very best variometer set, regenerates splendidly on the first half of the feed-back coil scale, and oscillates freely on the second half. In addition, it is excellent for receiving long waves to which a variometer outfit will not respond.

Both in operating qualities and cost it is a logical successor to the older receivers, which have so long held the interest of experimenters.

ANOTHER new feature is introduced in this article, namely, the panel supporting methods. At the G. A. Company we have actually built dozens of boxes and tried out many and varied schemes for supporting instrument panels, for the purpose of finding an inexpensive and at the same time good-looking method. The angle brass supports, shown in Fig. 1, is the outcome. These are easily made, furnish excellent bracing for the panel, permit instruments to be attached on top or at the sides, and carry the rear connection panel conveniently. All around, it is the best system for the man who does not want to put four or five dollars into a cabinet for each instrument.

The
Tuning
Circuit.

Panels
and
Supports.

FIG. 2 gives the layout of the front and rear panels and of the angle brass supports. These can be cut and drilled from regular stock. They are also sold completely made up, in which case the brass is nicked. Since all dimensions are one-half size, they can be readily scaled off from the drawings. If a sharply pointed scribe is used, light lines can be made on the front of the panel and later sanded off, when the holes have been drilled, with No. 0 sandpaper and oil. Do not rub dry sandpaper on L.P.F., for it quickly fills up. Plenty of oil, however, keeps the particles floating, and they do not coat over the sandpaper.

First
Assembly
Job.

AS soon as the front panel has been drilled, the three coil mounting pillars, the switch, and switch points should be put on. An extra switch point is allowed at each end of the row. The condenser may be mounted also, but none of the other parts, for they will be in the way.

Winding
the
Coil.

BANKED windings, hold a terror for many experimenters who have had experience with them, in almost every case because they did not go about it in the right way. A simple winding rig is needed, consisting of two round pieces to fit in the tubing, fastened to a 1/4-in. shaft fitted with a handle and supported on two sturdy uprights. It is difficult to tell an Experimenter how to wind the coil; he must learn by practice. For a three-bank coil, the process, briefly, is this:

Wind three complete turns around the tube, keeping the wire just as tight as possible. At the end of the third turn, bring the wire up between the second and third turns and wind once around. Then another turn between the first and second. At the end of the fifth turn,

jump up between the fourth and fifth and wind one turn. The result should be a pyramid of three layers of three turns, then two, then one.

When the sixth turn has been completed, bring the wire down onto the

take off the taps. This method keeps the winding tight and the taps out of the way.

A G-A-Lite tube, $3\frac{1}{2}$ ins. in diameter and $4\frac{1}{2}$ ins. long, carries the winding of No. 24 S.S.C. wire in three banks. Taps

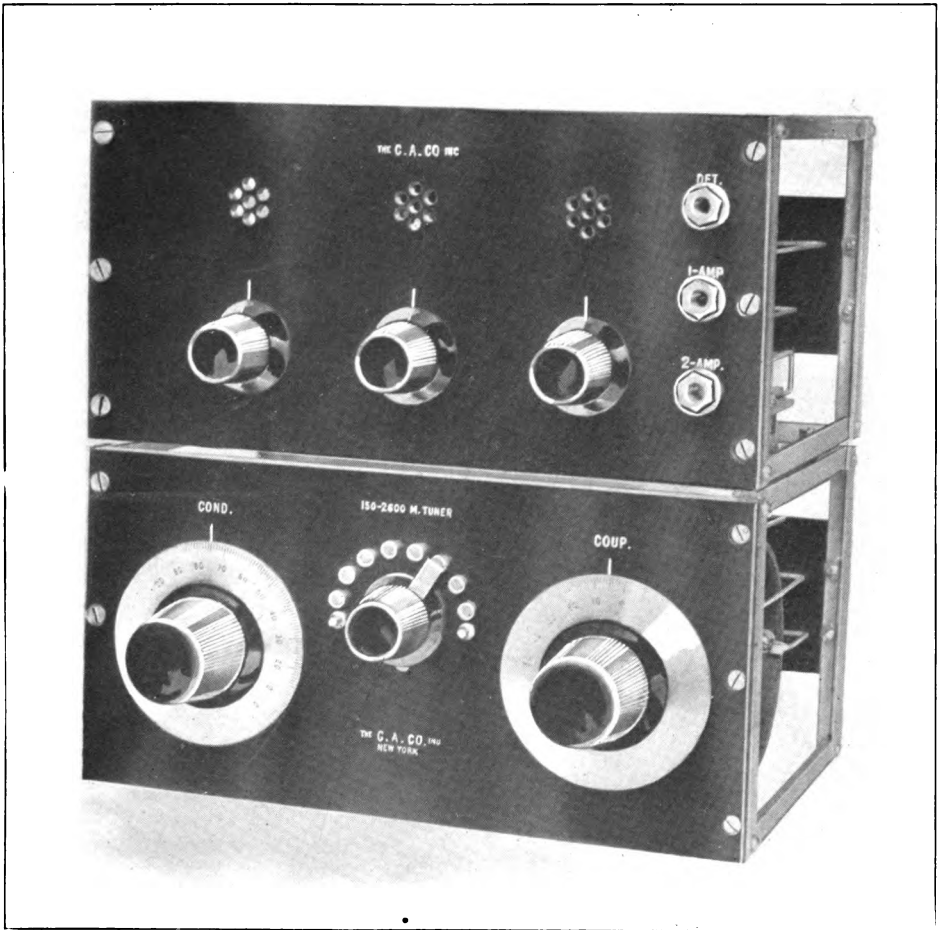
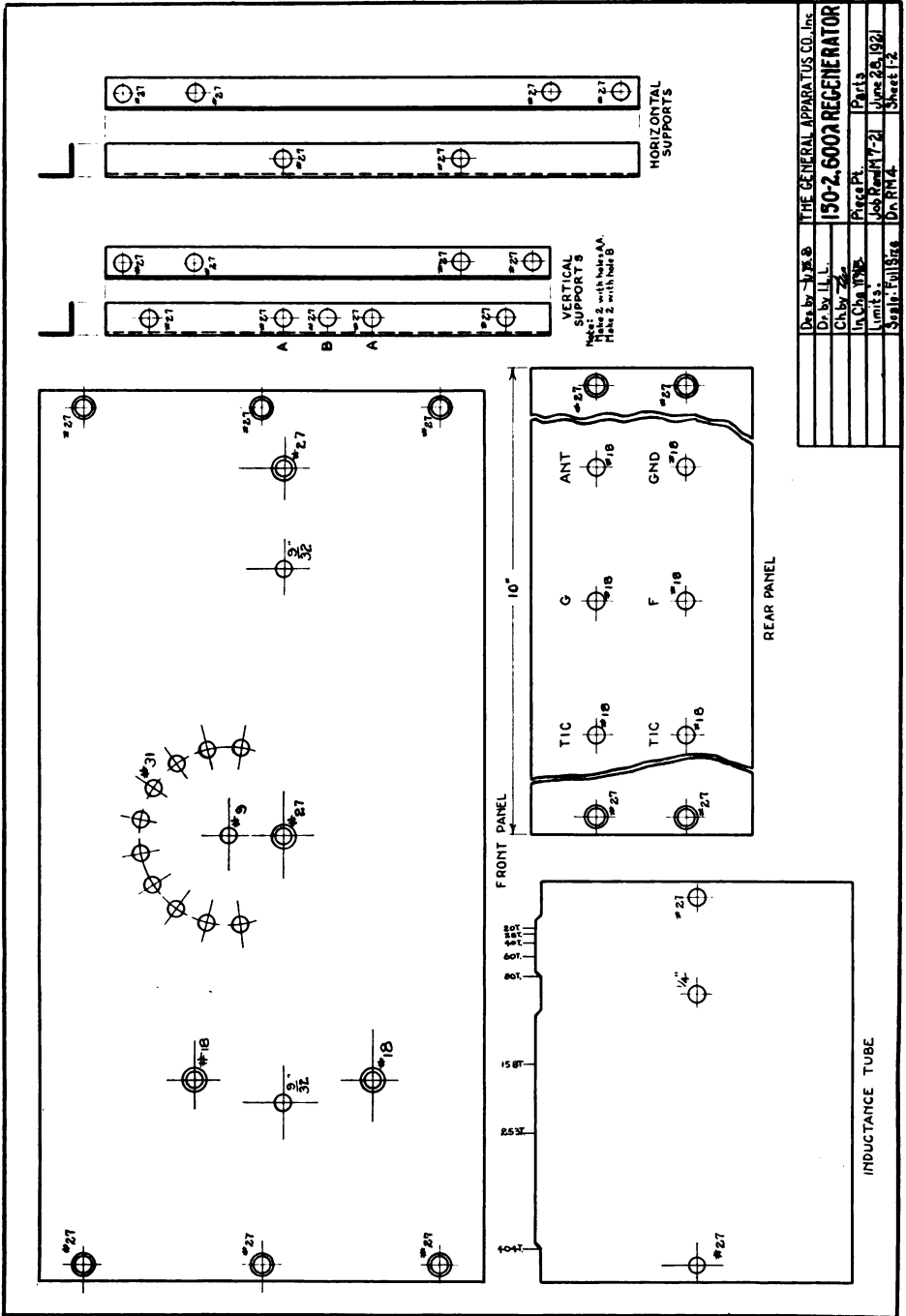

Fig. 1. The 150 to 2,600 meter regenerative set with a detector and two-step amplifier.

tube and put on the seventh turn, the eighth turn on the seventh, and the ninth turn on the eighth. Jump to the tube again, and repeat the process. To take off taps, when the tapping point is reached, bend the wire sharply to one side and wind a single turn around the part of the coil already wound. Bring the end of that turn back to where it was started and continue with the winding. After the coil has been completed and varnished, cut the tapping turns and

for this 150 to 2600-meter coil are taken off, as shown in Fig. 2. Remember that a $\frac{3}{8}$ -in. space is allowed after the fifth tap. The inductances and wavelength ranges with a 0.0008 mfd. series condenser and a 0.0003 mfd. antenna arc:

- Tap 1—0.09 millihenry
150 to 253 meters.
- Tap 2—0.16 millihenry
200 to 337 meters.
- Tap 3—0.30 millihenry
270 to 462 meters.



Des. by	J. W. G.	THE GENERAL APPARATUS CO. Inc.
Dr. by	H. L.	
Ch. by	Z.	150-2, 6002 RECEIVER
In. Ch.	W. B.	Piece #1
Units		June 28, 1921
Suppl. File No.	DR. R. 114	Sheet #2

Fig. 2. Mechanical details of the receiver

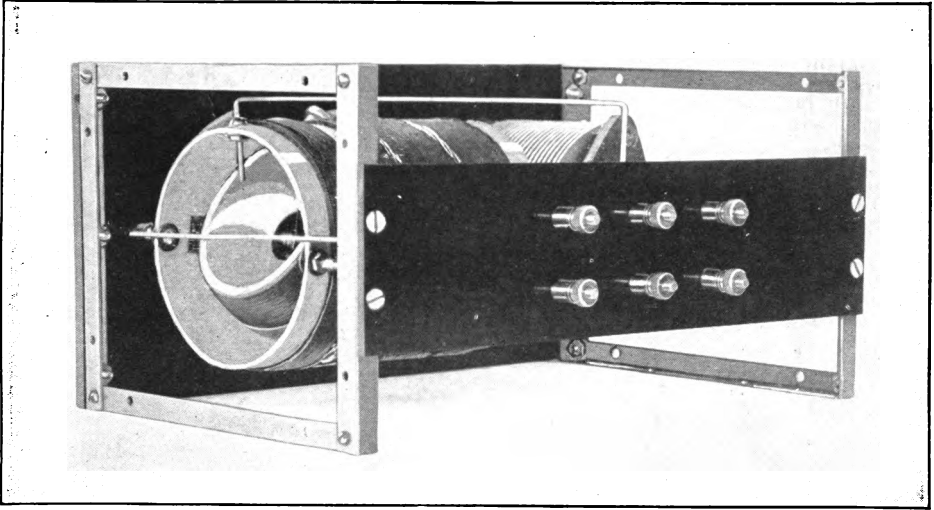

Fig. 3. End view, showing the tickler details and the connection panel.

Tap 4—0.60 millihenry
383 to 653 meters.
Tap 5—1.20 millihenries
546 to 923 meters.
Tap 6—2.50 millihenries
789 to 1,333 meters.

Tap 7—5.00 millihenries
1,066 to 1,885 meters.
Tap 8—10.00 millihenries
1,577 to 2,665 meters.

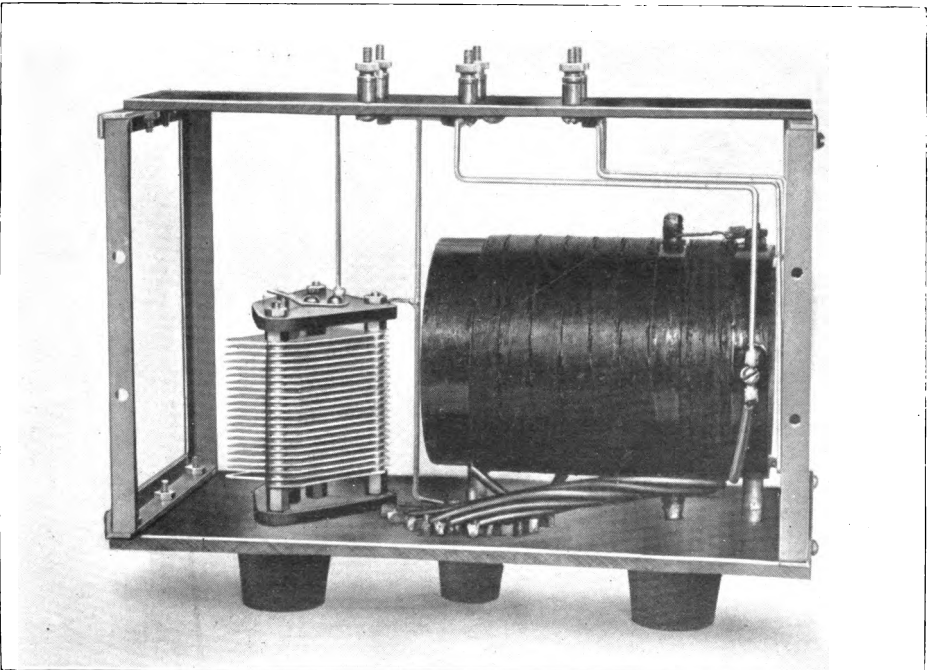

Fig. 4. Looking down on the condenser and inductance.

The Coupling Ball.

THE G-A-STD coupling ball is made of mahogany, turned out with a heavy center web. The material and construction make the ball free from the usual warping and shrinking experienced with thin-walled balls of other wood. Moreover, greater friction and support is given to the shaft, so it will not run out of true or become loose.

To obtain sufficient inductance to make the set oscillate over such a wide wavelength range, the ball is wound on each side with two layers of No. 24 S.S.C. wire. The winding is started at the outside, running up to the top, then, jumping down to the outside, the winding is run up again. This is repeated on the other side, winding in the opposite direction so that the two halves will actually be in the same direction. The adjacent ends of the two halves are soldered together and the outside ends run to the two parts of the split shaft.

Mounting the Coils.

THREE GA-STD coil mounting pillars are required, one at the right and two at the left, as shown in Fig. 2. Holes in the tube for the tickler shaft must be located carefully or the tickler dial will not turn true. The shafting is of 1/4-in. brass rod. Since the tickler ball is already drilled with a small guiding hole, it is only necessary to enlarge it with a 1/4-in. drill.

Before the tickler is put in place, two small pieces, 3/4 by 1 1/2 ins., should be cut from No. 24 spring brass sheet, and drilled with a 1/4-in. hole in their centers. They are for spacers between the ball and the inside of the inductance tube. When the coil has been mounted, the shaft, carrying the dial, is put in from the panel, a spacer fitted over it, and the shaft pushed into the ball. This is repeated from the rear. The wires from the tickler are then soldered to the ends of the shaft, Fig. 3, and pigtailed soldered on outside as in Fig. 4. Finally a 1-in. screw is put through the tube, Fig. 3, 3/16 in. from the end, to act as a stop for the tickler. This also serves as a terminal for the start of the winding, as may be seen in Fig. 4.

Connecting and Finishing.

WITH the taps, covered with Empire tubing, soldered to the points and the condenser in place, the next step is to assemble the panel supports and the connection panel.

Round head 4-36 machine screws hold the angle brass strips together. Holes

in the angle brass can be drilled more readily if a jig is made of 3/8 by 1/16th in. brass strip, bent over at one end. The holes are first laid out on this strip. Then, by hooking it on one end of the angle brass, the holes can be located quickly and exactly.

The binding posts should be put in place, with No. 6 soldering lugs, and tightened before the panel is fitted to the panel supports. Fig. 5 gives the connections, and they can be traced out in Fig. 4.

ONLY an audion detector and its accessories are required in addition to the receiver. A variable grid leak or grid condenser is not necessary; they should be fixed, of approximately 1 megohm and 0.0005 mfd. respectively.

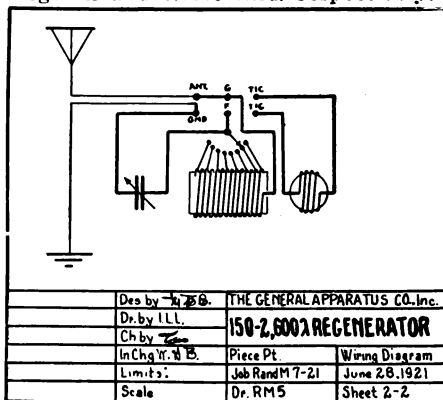

Fig. 5. Wiring diagram of the completed instrument.

If, at maximum tickler coupling, the set does not oscillate, as indicated by a plucking sound when the grid post is touched, the connections to the tickler should be reversed. Sometimes it is necessary to put a 0.001 mfd. phone condenser around the B battery and telephones. This is required when an amplifier is used. A little experimenting will show whether one, two or three are needed around the primary of the transformer.

To tune the set, the tickler is slightly advanced, and the switch and variable condenser adjusted until signals come in. Increasing the tickler brings up the signals to the point of oscillation, when they become mushy.

With the regeneration obtained signals come in loudly which, without the tickler, cannot be heard at all. It will be found that the more closely the set is tuned, the greater is the regenerative action.

A Real Receiving Equipment

Altho this detector and two-step amplifier is designed particularly for the 150- to 2,600-meter regenerative set, it will work admirably with any receiver

Notes on Amplifier Design.

THERE are so many different types of amplifiers on the market that one may gain the impression that any combination of sockets, rheostats, and transformers will give good results. Experimenters who have neither time nor

distance across the grid and filament of each tube. Leakage, either thru or over the surface of the material of which the base is composed, slight as it may be, reduces the tiny voltage applied to the grid by the incoming signal. The result of this loss, possibly not percepti-

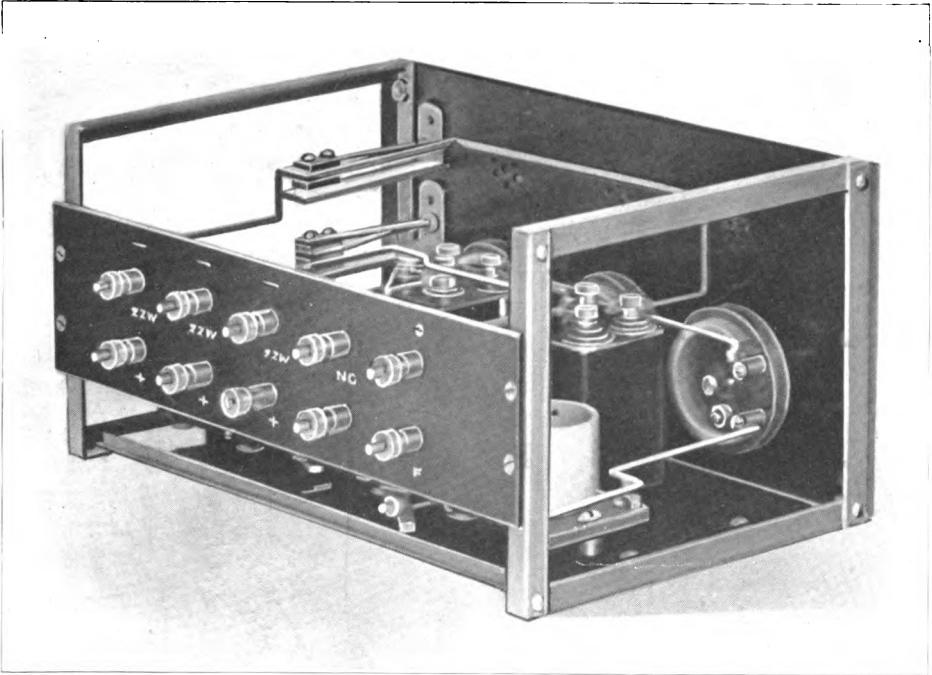

Fig. 2. A machine shop is not needed to turn out business-like radio apparatus if a correct design is chosen.

equipment to make comparative tests are particularly given to drawing conclusions not based on laboratory results but mere impressions, when, as a matter of fact, two stations with identical apparatus may show quite different operating characteristics.

Tube Socket Details.

THE sockets to be used may be taken up first. Experimenters cannot be impressed too forcibly with the necessity of maintaining a maximum re-

ble in the detector, is surprising when multiplied in successive stages of amplification.

It is for this reason that L.P.F. was chosen for the bases of the new GA-STD-A1 tube sockets. A very striking example of low resistances in the so-called perfect molded compositions is that of a grid leak mounting widely sold by one of the leading manufacturers. The leak is fitted between springs set in a molded base. Altho the only conductivity was supposed

to occur in the 1,000,000-ohm grid leak, a number of the mountings showed as low as 50,000 ohms across the terminals, rendering the grid leak worthless as a high resistance by-pass.

Another important feature is the tightness of the audion in the socket tube. If

Selection of Transformers IF the amplifier is to produce maximum signals the transformers must be of a design to conform with certain requirements. The ordinary square core transformer is not to be recommended in spite of its lower price. In the first place, this type is generally of too low

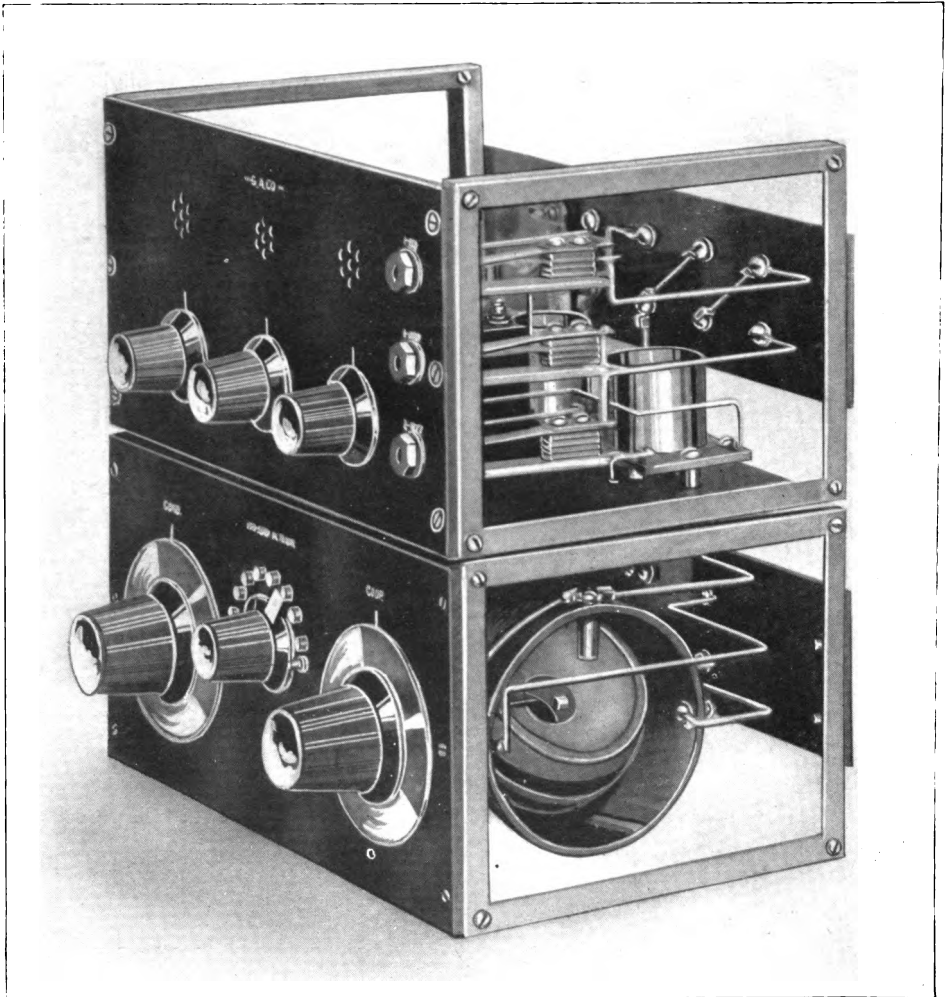

Fig. 1. A 150- to 2,600-meter receiving set which can be assembled with no other tools but a hand drill, screw driver, pliers, and soldering iron.

it is loose the springs will not make perfect contact and even slight vibration will cause a varying resistance between the contact springs and tube pins, giving a noise that is often supposed to be from the B batteries.

impedance to match the tubes. These transformers howl readily because of their large exterior magnetic field.

The shell type core, such as is employed on the G.A. transformers, permits the use of a very small winding yet it gives

A Real Receiving Equipment

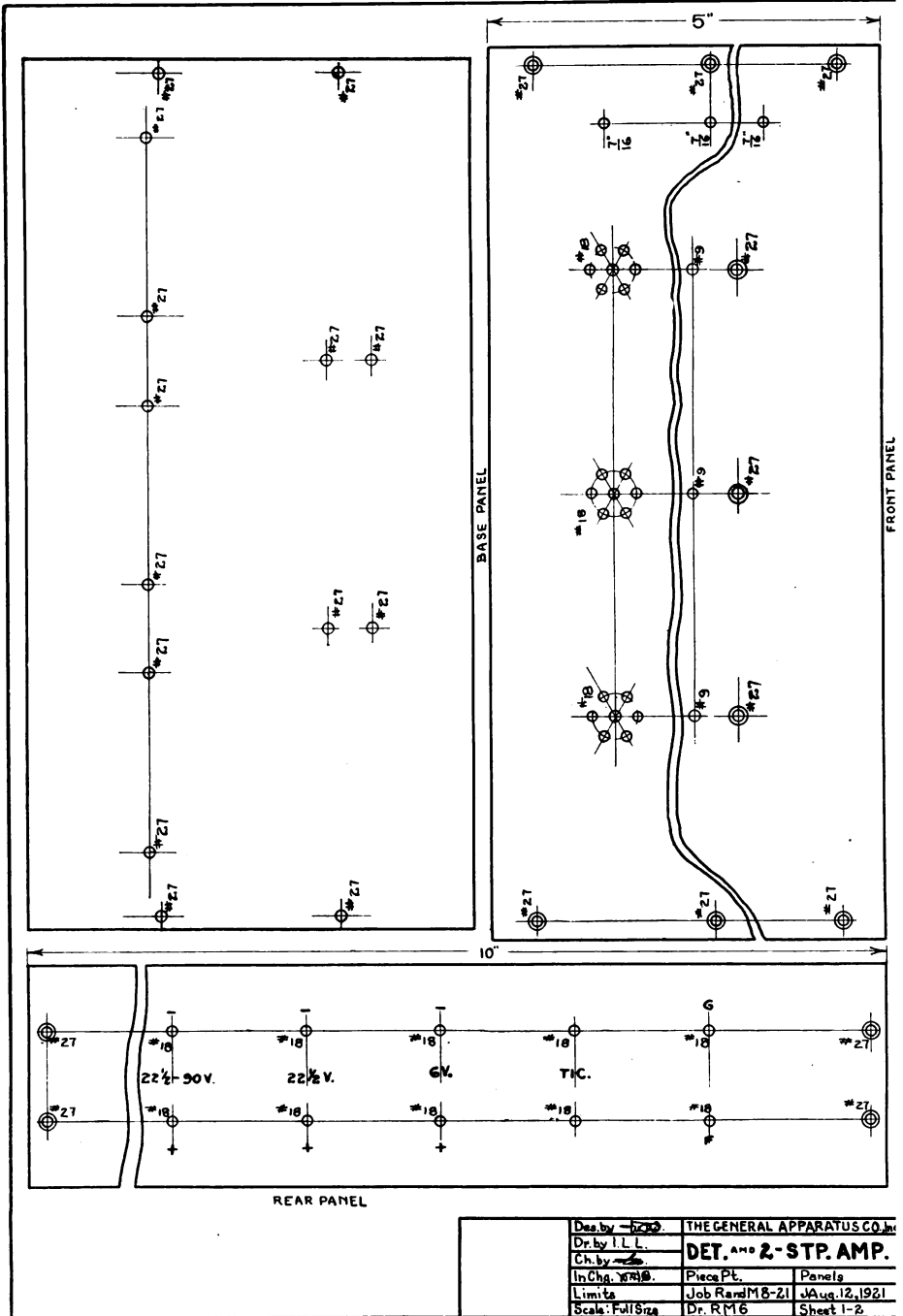

Des. by <i>h.c.p.</i>	THE GENERAL APPARATUS CO., INC.	
Dr. by I. L. L.	DET. AND 2-STP. AMP.	
Ch. by <i>h.c.p.</i>	Piece Pt.	Panels
In Chg. <i>h.c.p.</i>	Job Rand M8-21	JAUG. 12, 1921
Limits	Dr. R.M.6	Sheet 1-2
Scale: Full Size		

a high impedance. When wired properly these transformers can be placed close together without any interference from howling on account of their slight exterior field. While the shell type is strongly recommended in preference to the square core, the advantages are only found in types where the core laminations are at right angles to the turns on the coil. Some transformers have circular laminations in the same direction as the turns on the winding with the result that the magnetic field is perfectly short circuited. In addition to introducing serious

combination giving minimum inter-tube coupling and the shortest possible connections, both important features. In the first model the jacks were placed beneath the rheostats. This was altered, as can be seen in Fig. 1, for the telephone cord hung down over the receiving set. In any set it is better to keep the jacks at one side.

A special convenience is the angle brass supports for the panel. They make it possible to mount the detector and amplifier above the receiving set, or support

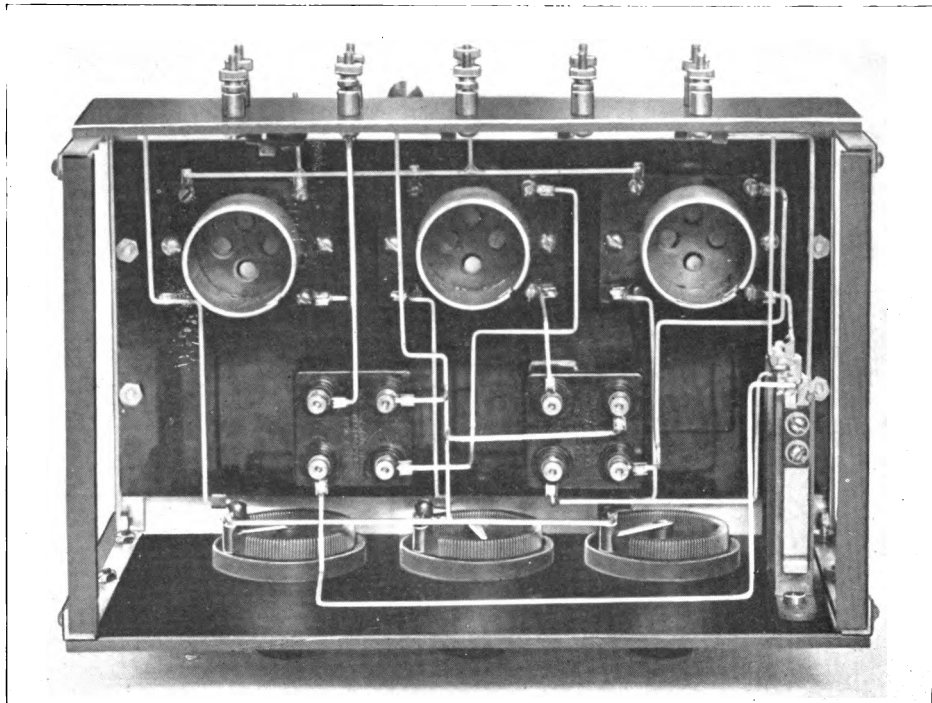

Fig. 5. Looking down on the amplifier, showing the effect of symmetrical arrangement.

losses it causes distortion in the reception of speech and music. Other special designs produce resonance effects for given audio frequencies. That is all right for spark reception, but bad for telephonic signals.

Mechanical Design Features.

ALL that is gained by careful selection of parts can be nullified by incorrect mechanical design. In the set shown in Fig. 1 a combination of efficient arrangement and convenience was attempted which proved quite successful in the completed instrument.

The arrangement of the parts is a modification of the GA-STD-A5 and -A6 detector and amplifiers, resulting in a com-

it directly on the table. The arrangement of the binding posts is such that only four connecting wires to the receiver are required at the back. All the wiring which, at best, does not add to the appearance of the outfit is out of sight, giving the front a clean cut appearance.

Figs. 2 and 3 show the layout of the parts. The holes are symmetrically lined up to make the location of their centers easy, and a minimum number of drill sizes employed. Since the original drawing in Fig. 3 has been reduced exactly one-half the dimensions can be quickly scaled off with dividers and transferred to the panels with a square and scribe. The angle brass supports are identical to those used for the receiving set, dimensions for which have been given already.

Assembling the Instrument.

ALL the panels and the supports should be drilled and sanded or polished before the assembly is started.

Put the transformers and sockets on the bottom panel first, making sure that they are set in the proper direction. Then come the rheostats and jacks on the front panel. The binding posts should be tightened firmly on the back panel because they are difficult to get at once the panels are assembled on the supports.

The greatest care must be exercised in wiring. Tinned square copper wire, coming in straightened lengths, makes this

heavy current drawn by three tubes the plates of the battery, if of a cheap make, are very liable to buckle, and for this reason a standard make, such as the Witherbee, is recommended. Two 22½-volt B batteries are also needed. When wired as indicated by the connection panel marking, 22½ volts are applied to the detector and 45 to the amplifiers.

The only connections to the receiving set are for the grid filament and the tickler coil. If the amplifier is used with a variometer type receiver the plate variometer should be joined to the posts marked P P. In the case of an ordinary

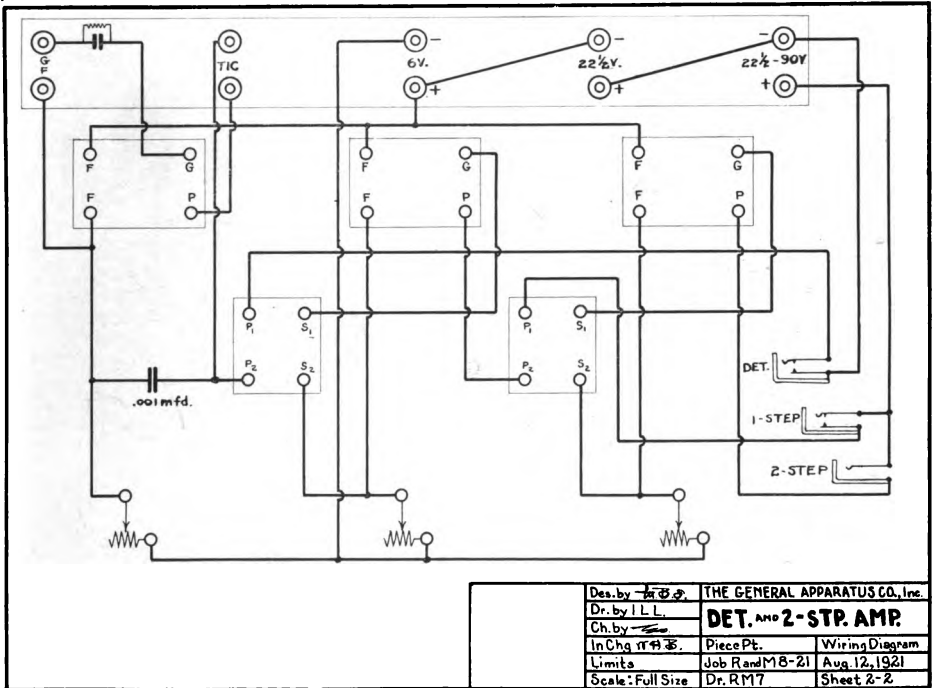

work much easier. What additional time is spent in fitting the wires is well repaid in the results and appearance. The greatest danger lies in excessive use of soldering paste. No tinning is needed on the wires if they are wiped off with a clean cloth, and the soldering lugs can be tinned before the parts are mounted. Then, in connecting up, no paste at all, or the tinnest bit, is needed.

Operating the Instrument.

THE first requisite for the successful operation of an amplifier is a good filament lighting battery. Tubes now available take almost the full 6 volts of the battery, and will not operate when this voltage drops appreciably. With the

non-oscillating set the P P posts should be short circuited to close the plate circuit.

Frequently a regenerative receiver will not oscillate, when connected with an amplifier, unless a fixed condenser of 0.001 or 0.002 mfd. is put across the primary of the first amplifying transformer. This is not shown in the wiring diagram because it is not always needed.

The completed instrument shown in the accompanying illustrations, tested against two other standard makes, gave appreciably louder signals, due to the careful attention given to each detail of this outfit. Those results can be readily duplicated by any experimenter who is equally conscientious about his work.

Simple Crystal Receiver for Phone Reception

The first receiving set. The beginner should start out with a receiver so simple that he will have no difficulty in making it work.

The First Problem

WHEN a man makes up his mind to install a radio set he generally asks a friend who has a station already for advice as to what he should buy. He is usually told to get an audion detector outfit, with a loose coupler, condensers, and so many other things, that if he does not lose heart immediately, he probably will before he learns to use the apparatus.

The proper start is with a set so simple that it cannot fail to work, yet designed to

signals very loudly, but with broader tuning than is obtained on a loosely coupled set.

On the front of the panel are the switch controlling the inductance and a crystal detector; at the rear the tuning coil and phone condenser. The switch is used in preference to a slider because the latter wears away the wire, leaving a copper dust to short circuit the winding. Galena is the most sensitive crystal for the detector, and, with a fine copper wire for the contact, will keep its adjustment.

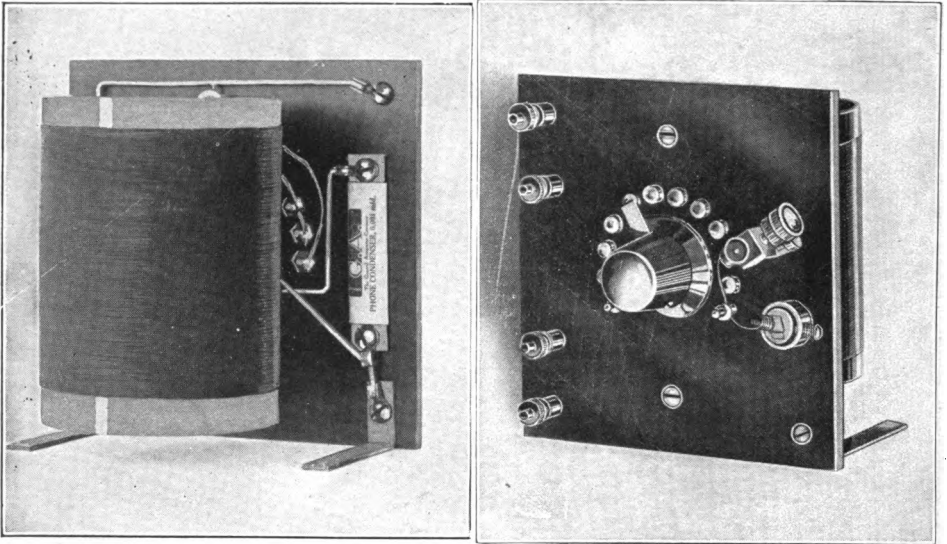

Fig. 1. Front and rear views of the beginner's receiver. Note the simplicity of the wiring and assembly.

conform with standard practice. In addition, the arrangement should be such that other instruments can be added to improve the operation as the beginner's experience is broadened. To get the most fun from the set it must be strictly home made.

A Beginner's Outfit.

A receiving set which conforms with the requirements just given is shown in Fig. 1. Built on a standard 5- by 5-in. panel, all the parts are conveniently located and so connected that there is no mystery about the circuit. This outfit is commonly known as a single-circuit receiver, a type that brings in

Putting the Parts Together.

FIG. 2 shows the holes in the 5- by 5- by 3/16-in. L.P.F. panel. This material can be drilled readily with an ordinary hand drill after the holes have been located with a center punch. A drawing is also given for the panel support brackets, cut from 3/8- by 1/16-in. brass strip.

The hardest work is on the coil. This is wound with No. 24 S.S.C. wire on a G. A.-Lite tube 3 ins. in diameter. To start the winding, put a pin into the tube 1/2 in. from one end, and twist the wire around it. Then wind to the first tap as

indicated in Fig. 2. At this point bend the wire toward the start of the coil and put one turn around the part already wound. Bring the end of this turn around to the place where it was started and wind on to the next tap. Secure the last turn with another pin. When the coil is finished, cut those extra turns, twist them together where they started, and bring them out for taps to the switch.

Before the coil is mounted, the detector parts, switch, switch points, fixed condenser, and binding posts should be put on. Then comes the coil, supported on the two mounting pillars. Great care must be taken in connecting the taps to the switch point, so that extra soldering

only way to insure perfect and permanent contact, and is well worth the additional work involved.

Operating the Receiver

THIS receiver is designed to operate on a single-wire antenna 100 to 150 ft. long and 30 to 50 ft. high, with the lead-in brought from any part of the antenna. One 3-in. HF insulator is needed at each end. The lead-in should be connected to the upper binding post on the panel, and a wire from a water pipe to the lower. The phones, preferably 2,000-ohm Murdocks, go to the center posts. A buzzer is needed to test the adjustment of the detector. It should be connected with a dry cell and push button,

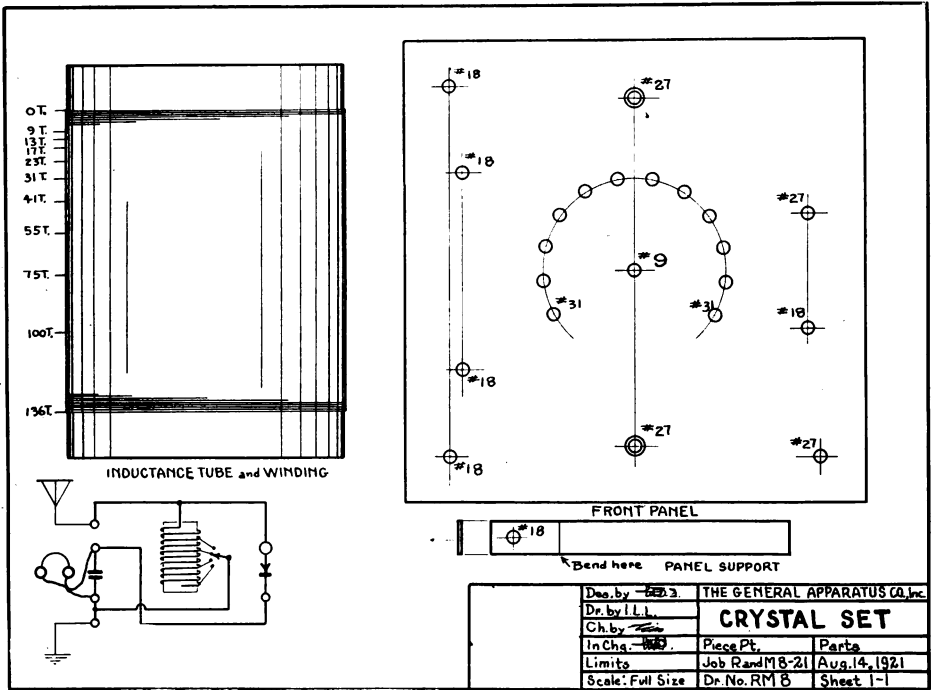

Fig. 2. Exactly one-half size. Showing the parts and the wiring of the completed outfit.

paste will not run over the panel. An old tooth brush is handy for cleaning out of the way places. The best practice is to increase controls by turning clockwise. Therefore the first tap should be brought to the left hand switch point, and so on until the last tap goes to the last right hand point.

Connections are given in Fig. 2. Made with square tinned copper wire, they can be easily fitted and soldered. That is the

with a wire running from one terminal of the buzzer to the ground lead. When the detector is in adjustment the buzzing can be heard in the telephone. To tune the set for incoming signals simply turn the switch back and forth until sounds are heard at maximum strength.

If this outfit is properly installed, it will tune from 200 to 1,000 meters and bring in the larger stations up to 500 miles away.

Radio Frequency Amplification at 200 Meters

This set, designed for reception on 150 to 250 meters, combines radio frequency amplification and regeneration in a receiver critically sharp in tuning and as easy to build as it is inexpensive

**New
Types of
Receivers**

THE urge for something new, which all radio men experience at frequent intervals, is probably responsible for the insurgent tendency to get away

In fact, many experimenters have been more successful with the familiar loosely coupled receiver and tickler coil, and they claim that no losses are apparent from the use of a small variable condenser

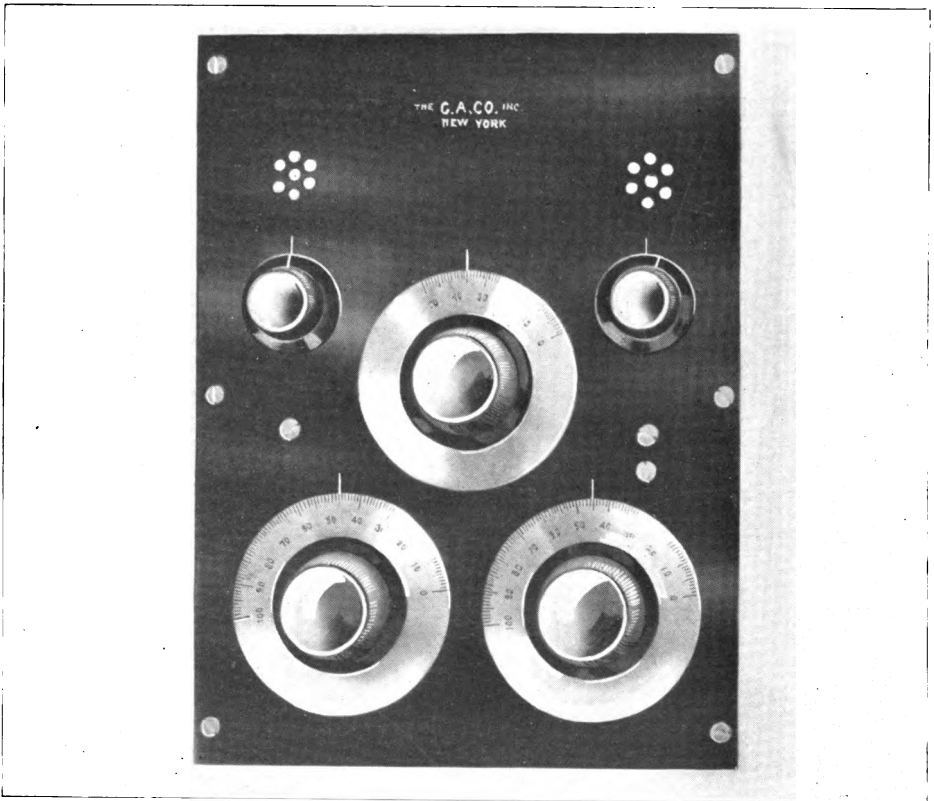

Fig. 1. A radio frequency amplifier and detector with tuning circuits for 150 to 350 meters. Addition audio frequency amplification can be used if desired.

from the old standby—the variometer receiver. The latter is being warmly defended from many quarters, and its strong points cannot be denied. However, it is not fair to experimenters for those who are personally interested in the continued use of the variometer sets to attempt the discouragement of development work along other lines, for it is entirely possible that something better can be worked out.

across the secondary circuit. Any variometer set that tunes over a range of more than 150 to 350 meters has mica condensers in the secondary.

At the G. A. we have tried out many different circuits, with varying results. Different characteristics often make a circuit good for particular requirements but not broadly adaptable. One circuit, however, has stood out from the rest, a circuit

familiar to some in Army or Navy research sections, but not generally known to experimenters. It is the tuned impedance radio frequency amplifier. While this circuit is not proposed as an open sesame to the door of optimum methods, it has several unique advantages which other circuits do not possess.

Radio Frequency Amplifier

character.

ANY radio frequency amplifier increases the amplitude of the incoming oscillations without affecting their character. A telephone in the output cir-

static as much as the audio frequency type, as will be explained later on.

With the methods now available, transformer coupling or similar systems cannot be employed on wavelengths below 600 meters. Reasons for this have been set forth by Armstrong in his paper on "A New System of Short Wave Amplification."¹

Tuned Impedance Coupling

TUNED impedance coupling, fortunately, offers a simple alternative method for one step. Two steps can be

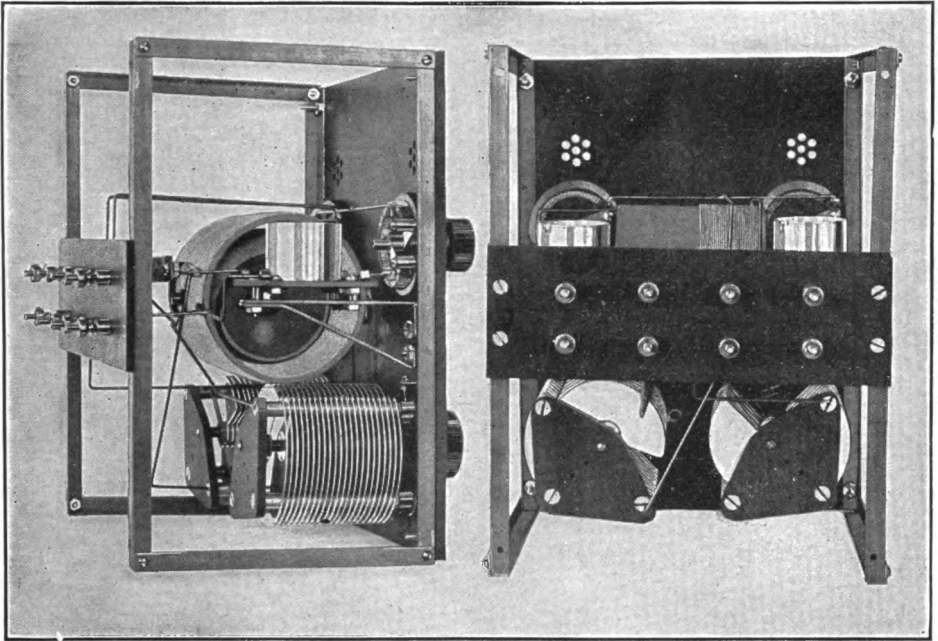

Fig. 2. Side and rear views of the receiver.

cuit of a radio frequency amplifier produces no sound, as the oscillations of the input circuit are not rectified until they are put thru a detector. If the incoming signals are strong enough to operate a detector, an audio frequency amplifier will amplify them, but a radio frequency amplifier produces the same effect as moving the receiving station nearer the transmitter because it amplifies any impulses without regard to their weakness. In fact, signals can be received when three or more stages of radio frequency amplification are required to bring them up to a strength sufficient to act upon a detector.

Another advantage of this type of amplification is that it does not amplify

employed, but the tuning with more steps becomes so extremely sharp as to constitute a disadvantage. Fig. 3 shows a simplified diagram of impedance coupled radio frequency amplifier. In the plate circuit of the first tube are a coil and condenser of such dimensions that they can be tuned to the frequency of the incoming waves. The direct current from the plate battery has a low resistance path thru the coil, but the tuned parallel circuit presents an infinite impedance, theoretically, to the incoming radio frequency, serving the same purpose as a resistance in a resistance coupled ampli-

¹Proceedings of The Institute of Radio Engineers, February, 1921. Sold by The Sleeper Radio Corporation, 88 Park Place, New York City, \$1.50 per copy.

fier. The second tube, with its grid condenser, acts as a detector, to which audio frequency amplifiers can be added if desired. Since there is no tuning to static disturbances, they tend to pass directly thru the impedance coil, producing only a slight effect upon the detector.

General Description of Set
THE receiver shown in the accompanying illustrations is a strictly 200-meter set, as the wavelength range, with an antenna of 0.0003 mfd., is only 150 to

pendance condenser. The radio frequency amplifier tube, on the left, and the detector, on the right, are adjusted by their respective rheostats below. Binding posts are carried on the rear connection panel mounted on an angle brass frame.

An idea of the simplicity of the circuit may be gained from the fact that there are only 14 separate wires used to join the instruments. If an audio frequency amplifier is employed, it can be wired to posts provided at the rear. Fig 3 shows

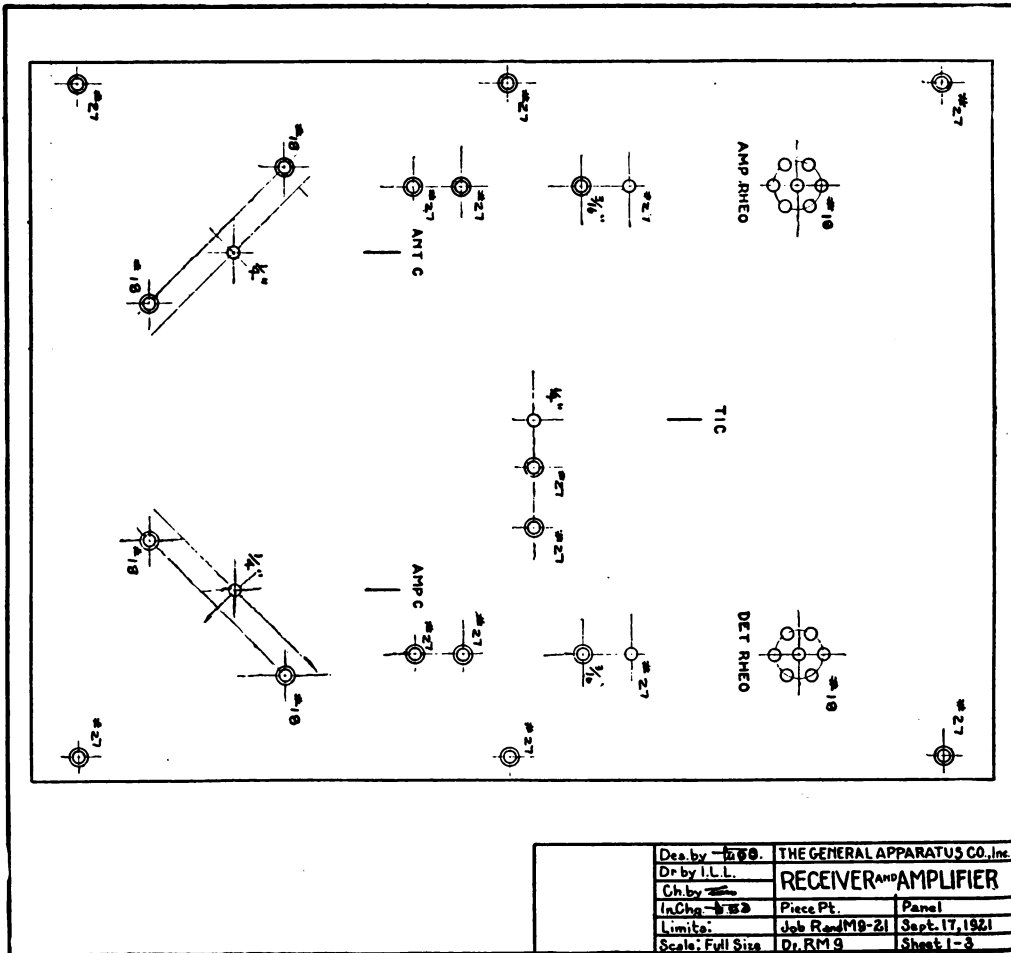

Fig. 4. One-half size. Scale drawing of the instrument panel.

350 meters. Tuning in the antenna circuit is accomplished by a fixed inductance mounted at the rear of the panel and a 0.0008 mfd. condenser at the lower left hand corner of the panel. The impedance inductance, also of a fixed value, is adjustably coupled to the antenna coil, its position being controlled by the center dial. On the right is a 0.0008 mfd. im-

the diagram.

The Parts Required

THIS receiver is made up of a front instrument panel, 10 by 7½ by 3-16 in. rear connection panel 7½ by 2½ by 1/8 in., cut from a standard sheet 10 by 2½ ins., angle brass frames, two 0.0008 mfd. condensers, two rheostats and

sockets, fixed inductance, tickler, and grid condenser. No switches are required.

Fig. 4 shows at one-half scale the layout of the panel. To take off the dimensions it is only necessary to measure on the drawing and double the distances. Drill sizes are indicated; two circles call for countersinking. Thru standardization of the parts, a minimum variety of drill sizes are needed.

A G-A-Lite tube, 3½ ins. in diameter

furnished with ¼-in. holes which give a tight fit on a ¼-in. rod.

The only other difficult work is in making the brackets for the sockets. They are cut from 3/8 by 1-16-in. strip, drilled and bent as in Fig. 3. To obtain a perfect adjustment of the sockets it may be necessary to file the rear holes of the lower brackets into the shape of slots. The sockets are furnished with short posts for mounting, threaded 8-32 and held by ¼-in. screws. These screws should be removed and 1-in. 8-32 screws

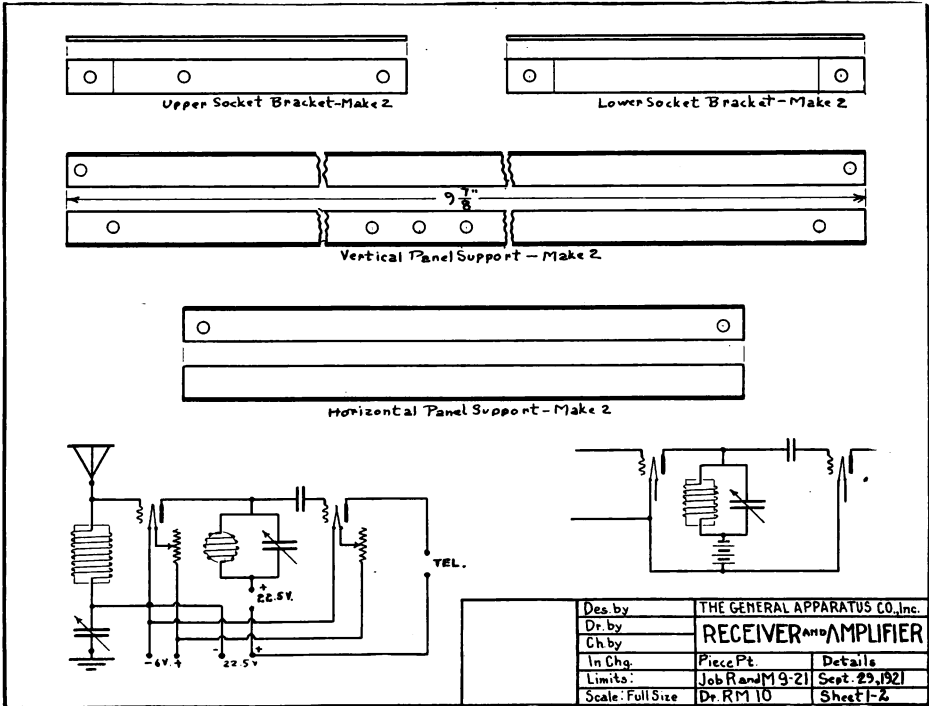

Fig. 3. One-half scale. Circuit details and scale drawings of the support frames.

by 3 ins. long, wound with 28 turns of No. 20 D.C.C. wire, is held by two supporting pillars at the right of the shaft. The screw heads are hidden by the tickler dial. A standard 3-in. tickler ball is mounted in the coil by a two section shaft. It has been found quite satisfactory to use holes drilled in the G-A-Lite tubing for shaft bearings. The tickler ball is wound with one layer of No. 20 D.C.C. wire, with the start of the coil soldered to one-half of the ¼-in. brass shaft, and the end to the other half. Pig-tail leads may be soldered to the shaft or friction bearings of spring brass fastened to the tube and pressing on the shaft are satisfactory. These balls are

put in their places to extend thru the brackets.

Eight binding posts are mounted on the rear panel. The two rows are 1 in. apart and the posts separated by 1½ ins.

Assembling the Receiver **W**HEN the parts are ready for assembling, the rheostats should be put on first, then the coil and tickler, after all leads have been soldered, next the condensers, and finally the angle brass frames without the rear panel. Because the rear panel is in the way during part of the soldering, all wires not running to binding posts should be fitted first. Instead

of running a wire from the ground side of the left hand condenser to the ground post, both these terminals are connected to the left frame. Other details of connections are given in Fig. 3.

Suggestions on Operating THIS receiver has a number of peculiarities which must be observed by actual operation, and the tuning is so sharp that the best results can be obtained only by the correct handling of the controls.

For best understanding, the left hand condenser may be considered as the pri-

mary control and the right hand condenser and tickler the secondary. This is because the tickler gives a wavelength control effect which makes it necessary to adjust the tickler and impedance circuit condenser simultaneously. It will be noted that a 180° dial is used on the tickler as it is sometimes put on one side or the other of zero coupling.

Spark, telephone, or undamped telegraph stations can be heard with this receiver clearly and without distortion. At the same time the receiving range is increased beyond that which can be covered with any number of audio frequency amplifiers.

12,000 to 20,000 Meter Receiver

Long Wave Reception Is Coming Back, Not Only Because It Is Interesting and Good Code Practice, But Because It Affords Opportunity For Much Experimental Work.

Suggestions on Long Wave Reception

BACK in the days when four-foot inductances gave a spectacular appearance to a receiving station and the controls were operated by yardsticks, long wave reception from foreign stations was quite popular, but it was dropped later as a temporary fad. Now, however, interest of a more permanent and serious character is reviving for several reasons. Long wave signals are the easiest to receive over great distances, so that the man with an indoor antenna or a small loop can get them. Stations are always transmitting, and at slow speed, giving better code practice than a practice machine whose records are soon learned.

For testing work long waves give a steady source of signals, comparatively free from erratic results obtained on short waves. Several stations can be heard at any time during the twenty-four hours.

The Set and Its Circuits

THREE views of a receiver for this purpose are given, showing the simplicity of the instrument and the wiring. To cut down the work and expense of the coils, a single circuit is employed, using a stationary coil of fixed inductance and a 0.0008 mfd. condenser in shunt in the antenna circuit, with a movable coil in the plate circuit. With an antenna of 0.0003 mfd. this receiver will tune from 12,000 to 20,000 m. In the first tests on the circuit, the conventional cross-wound concentrated coils were used, but, surprising as it may seem, signals were increased 50 to 75% when the layer-wound coils were substituted. One reason is that the D. C. resistance is much lower, and losses due to varnish are less because varnish is only applied to the outside layer.

The smooth and easy operation of the set and the fact that it picks up European stations on a single detector tube make it a real pleasure to operate.

Panel and Supports

FIG. 4 gives the details of the $7\frac{1}{2} \times 10 \times 3\frac{1}{16}$ -in. panel at one-half scale. The only hard part is the slot which is made by drilling a row of holes and filling. No dimensions for the angle brass supports are given, as it is of the conventional type

formerly described, measuring $7\frac{1}{2}$ by 6 ins. A regular 10- by $2\frac{1}{2}$ - by $\frac{1}{8}$ -in. panel, carrying six binding posts, is secured at the rear. At each end are $\frac{3}{8}$ - by $1\frac{1}{16}$ -in. strips carrying the tickler coil support rods. These should not be soldered to the frames, however, until the coils are completed.

Winding the Coils

IN Fig. 3 the coils are illustrated as they appear when ready to mount. A $3\frac{1}{2}$ -in. G-A-Lite tube, 6 ins. long, is used for the antenna coil. The winding is started $\frac{3}{8}$ in. from one end. First, 44 turns are wound on then the wire is brought up between the 43rd and 44th turns, and 43 turns are wound back over the first layer. This is continued, winding back and forth until 11 layers have been put on, giving 44, 43, 42, 41, 40, 39, 38, 37, 36, 35, 34 turns per layer, or a total of 429 turns per section. At the end of the section the process is repeated until, with three sections, an inductance of 124.00 millihenries is obtained. The end of the winding is brought to a screw and lug $\frac{1}{2}$ in. from the end of the tube.

A G-A-Lite tube 3 ins. long and $4\frac{1}{2}$ ins. in diameter is required for the tickler. The winding is started $\frac{1}{2}$ in. in, and made up in two sections of 7 layers, having 44, 43, 42, 41, 40, 39, 38 turns per layer. A light coat of Valspar varnish, baked in a gentle heat, will hold the wire permanently. Next come the angle pieces which slide on the $3\frac{1}{16}$ -in. rods and the $3\frac{1}{16}$ -in. rod by which the coil is moved, both of which are shown in Fig. 4. Flat head screws are used in all cases, with the heads inside the tube to give clearance over the antenna inductance.

It is necessary to set the antenna coil back from the panel quite a distance. Therefore, in addition to the regular GA-STD-14 coil mounting pillars, held to the tube by $\frac{1}{2}$ -in. 6-32 F.H. screws, two GA-STD-8 threaded posts are put over 1-in. 6-32 F.H. screws from the front of the panel, and the screws threaded into the coil mounting pillars.

Assembling and Wiring

WITH the parts ready, the supporting frames should be put on the panel, and the coils mounted, without cutting off the $3\frac{1}{16}$ -in. rods to length. Then

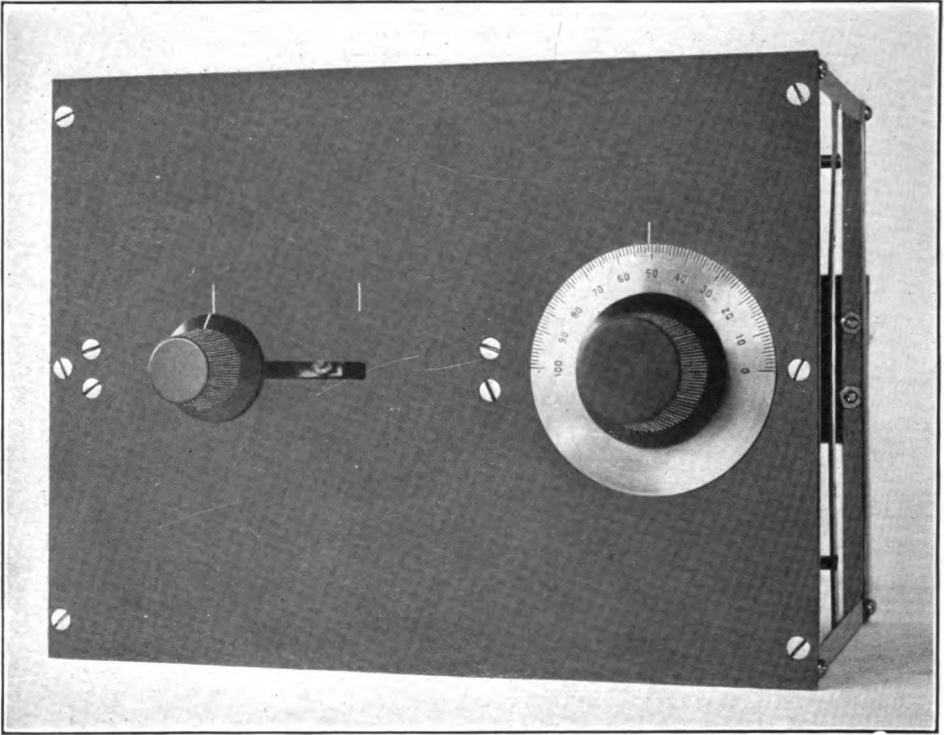

Fig. 1. Two controls only are used to tune from 12,000 to 26,000 meters, covering the range of Trans-Atlantic stations.

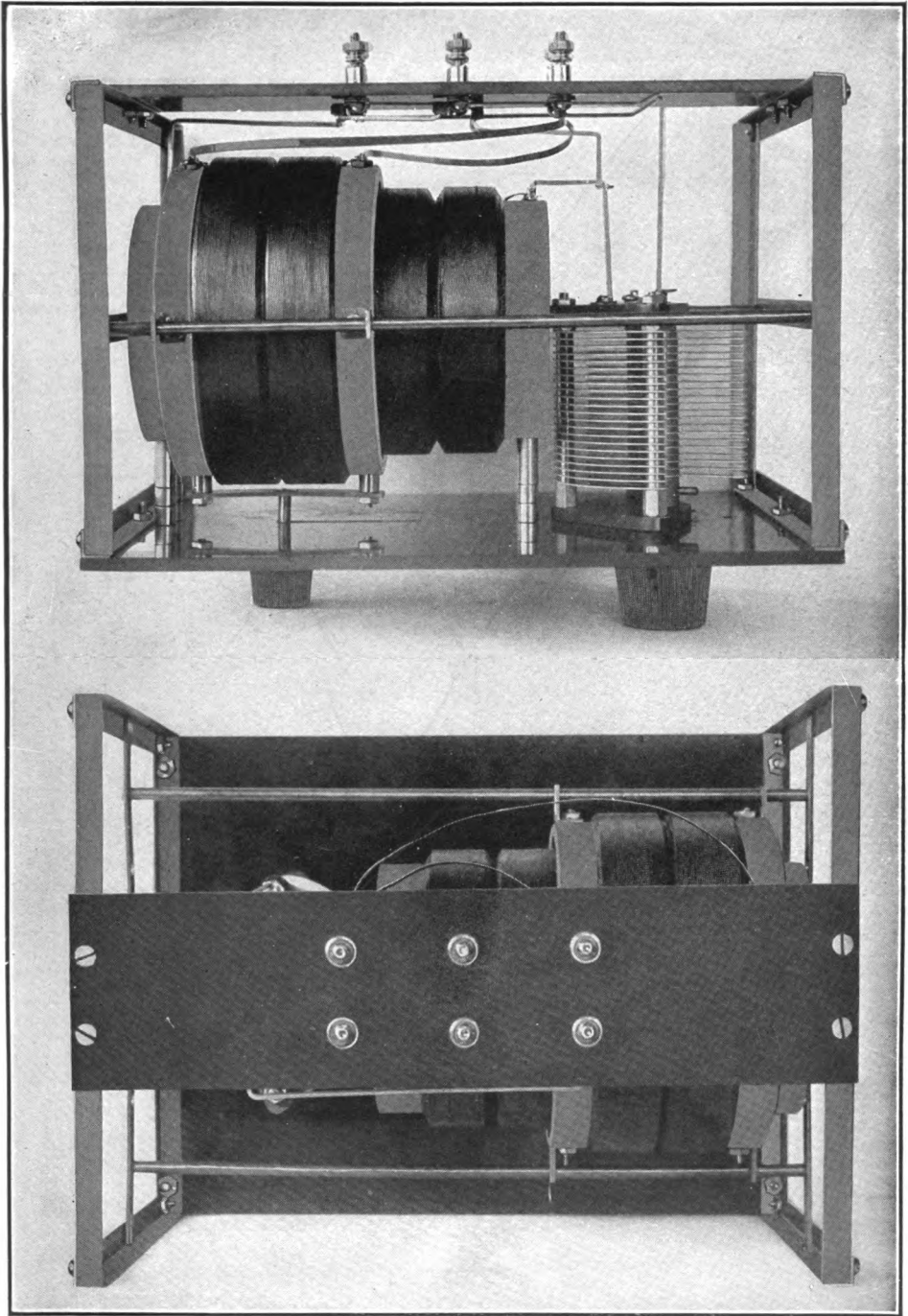

Fig. 2. Bottom and rear views of the long wave receiver, as fine a set as you ever operated. Suitable for general reception or experimenting.

comes the condenser, back panel with the binding posts already on, and the wiring. Two flexible leads of phosphor bronze strip are used between the tickler terminals and the corresponding binding posts. A diagram is given in Fig. 4.

**Hints
on
Operating**

TO wire up the receiver it is only necessary to attach the antenna and ground, run wires from the G and F posts to corresponding terminals on the detector, and to insert the tickler in the plate circuit. Reverse the tickler connections if the cir-

The terminals of the loop should be connected to the antenna and ground connections on the receiver. In addition a condenser such as the 0.0002 mfd. GA-STD-A15 is recommended.

The loop should be mounted so as to be swung easily on its axis in whatever direction signals are to be received. While a loop of this sort is not as efficient as a single wire antenna 30 ft. high and 200 to 300 ft. long, the size with which the set is expected to be used, long distance reception can be accomplished much more readily than on the short waves.

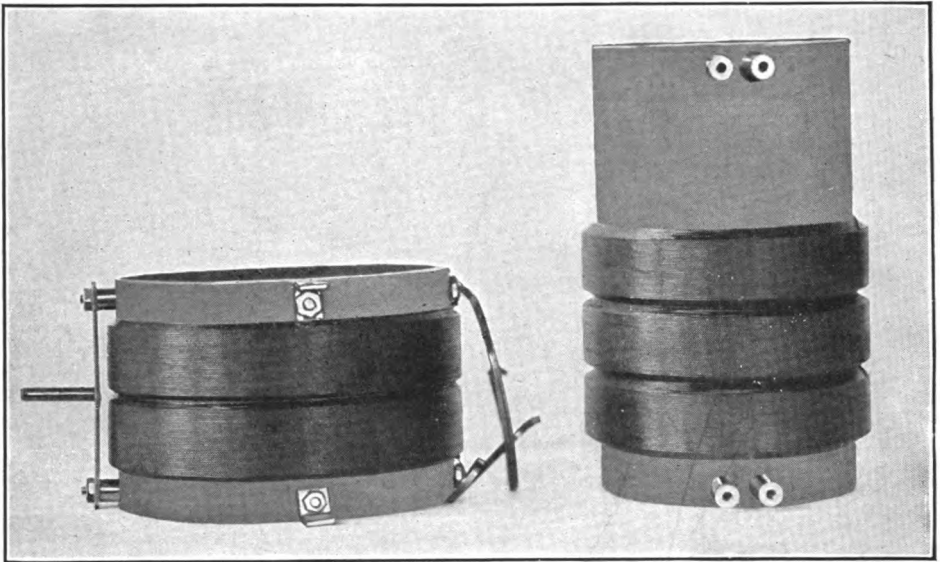
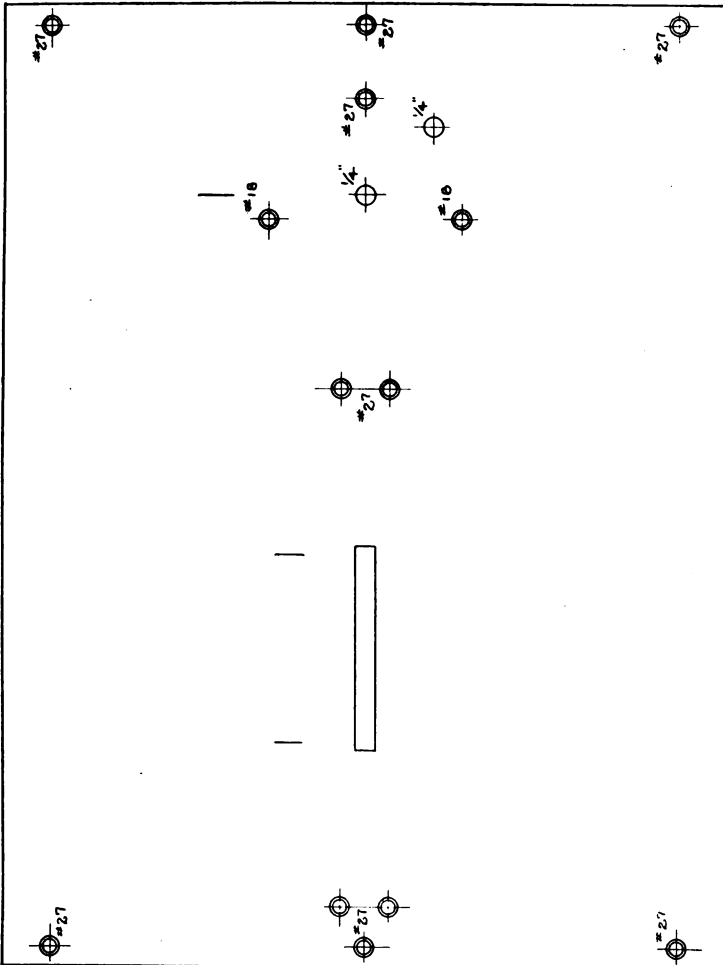

Fig. 3. Details of the completed coils, ready to mount on the panels, the tickler at the left and the antenna coil on the right.

cuit does not oscillate. When an amplifier is added, put a 0.001 mfd. phone condenser across the transformer and plate battery of the detector; otherwise the set will not oscillate properly. With two or three steps of amplification foreign stations come in with extreme loudness.

Many experimenters have had excellent results with indoor loop antennas working on long waves. To use with this receiver a frame is suggested with 40 turns of No. 20 D.C.C. wire spaced $\frac{1}{4}$ -in. apart.

Radio dealers can use the signals from long wave stations advantageously for demonstration purposes, attaching two or three stages of amplification and a loudspeaker to the receiver. This is better than depending upon the irregular short wave signals because the former transmit steadily, oftentimes hour after hour, a great advantage when the signals are depended upon to attract the attention of people passing by the store. A public code practice can also be furnished in this way.



FRONT PANEL

Des. by	4-33	THE GENERAL APPARATUS CO., Inc.
Dr. by	I.L.L.	12,000 - to 20,000 - M. REC'R
Ch. by		Details
In Chg.	59	Piece Pt.
Limits	Job Ref. M10-21	Oct. 10, 1921
Scale	Full Size	Dr. R.M. 11
		Sheet 1 C

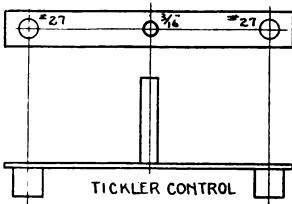
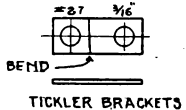
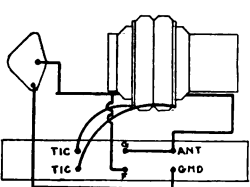

150 to 600 Meter Regenerative Set

The condenser-tuned secondary in this receiver has the advantage of a larger wavelength range than can be obtained with a grid variometer.

Use of This Set

THERE are now many users of short wave regenerative receivers beside the regular radio experimenters, for those who buy crystal sets for broadcast reception soon recognize the short-comings of those outfits, and find the need of a receiver that will cut out interference as well as bring in signals with greater strength.

For long distance or broadcast reception this outfit comes well recommended, for excellent

The Circuits Used

In this receiver there is an antenna inductance, controlled by small and large step switches, to which is coupled a ball carrying the entire secondary inductance. Only the variable condenser is used to tune the secondary circuit. The plate variometer gives the tuning necessary to make the set regenerate or oscillate. A detector is provided in this outfit, to which an amplifier can be attached by the binding posts on the right. When the detector only is in use, phones are plugged in at the jack.

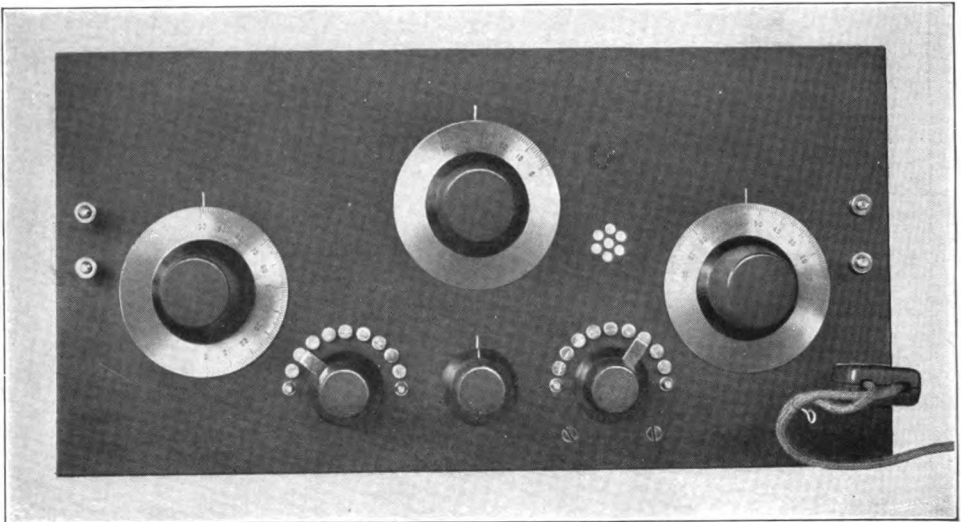
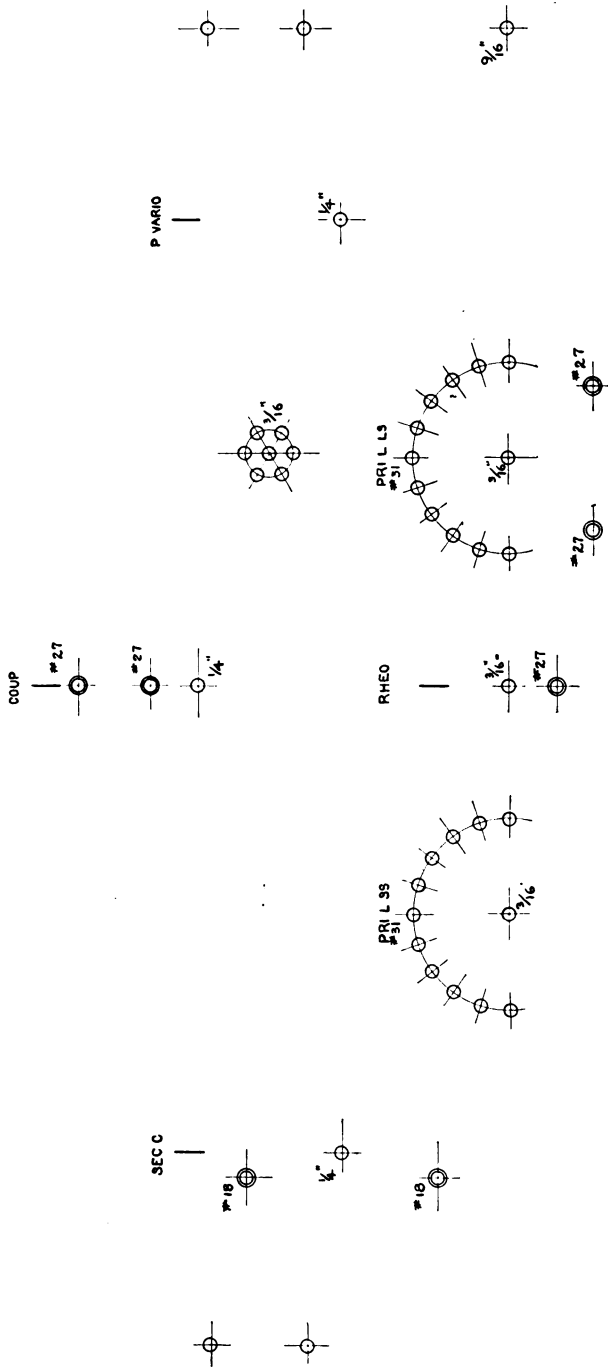

Fig. 1. In appearance and operation, a first class receiver

results have been obtained on 200 and 360 meters. With two steps of amplification, when copying Newark at the G. A. laboratory, a pair of Murdock receivers were overloaded so that the entire casing vibrated from the movement of the diaphragm. Dealers and experimenters who make up apparatus to sell will find this set sure and dependable, one on which they can guarantee maximum results. A few simple instructions are required, however, before the set is put in the hands of a beginner because of the extreme sharpness of the tuning. In practice, the least amount that the secondary condenser can be moved will bring phone signals in or out. Of special advantage is the shielding obtained by using the new german silver dials.

One of the new Federal plugs, which takes the phone tips, is illustrated.

Some experimenters will exclaim over the use of what appears to be a large capacity in the secondary, as compared with the variometer tuned circuit. Actually, however, a very small capacity is employed at the 200-meter setting, and the distributed capacity is low. With a variometer there is a comparatively high distributed capacity, not only between the windings of the variometer but in the shellac or varnish used. No grid variometer will tune over a range of more than 150 to 350 meters. For longer wavelengths the common practice is to shunt the secondary circuit with mica



Des. by	The GENERAL APPARATUS CO., Inc.
Dr. by	L. L.
Ch. by	W. S.
In. by	W. S.
Limits	Job Form III-Z
Scale: Full Size	Dr. RPT14
	Sheet 1-Z

Fig. 4. Scale drawing of the panel, reduced to one-half size.

condensers, bringing a heavy capacity into the circuit just the same.

Details of Construction

There is very little hand work to be done on the set, and what must be done is quite elementary, giving the experimenter the advantage of a splendid outfit at a small cost. The list of parts is helpful in getting together the material required. Fig. 4 gives a one-half scale drawing of the front panel, of L. P. F., $7\frac{1}{2}$ by 15 by $\frac{3}{16}$ in. Dimensions can be determined by the simple method of setting the dividers on the drawing and doubling the distances. Countersunk holes are shown by two circles.

The primary inductance is wound on an L.P.F. tube $3\frac{1}{2}$ ins. outside diameter and 5 ins. long, with a $\frac{1}{8}$ -in. wall. The first No. 27 hole for the coil mounting pillar is $\frac{1}{4}$ in. from the end of the tube, the second $\frac{3}{4}$ in. below, and the $\frac{1}{4}$ in. hole for the shaft another $\frac{1}{2}$ in. down. The winding, of No. 20 D. C. C. wire, B. and S. gauge, starts $\frac{1}{4}$ in. from the center of the shaft hole. Taps are taken off at the left, for the small steps switch, at 0, 1, 2, 3, 4, 5, 6, 7, and 8, and on the right, for the large steps switch, at 9, 18, 27, 36, 45, 54, 63, 72, and 81 turns.

Taps can be made by winding extra turns, as has been explained in previous articles, or by the

other side on the other outside hole, and both brought out through the center hole. Tap wires are less liable to break when taken off in this way.

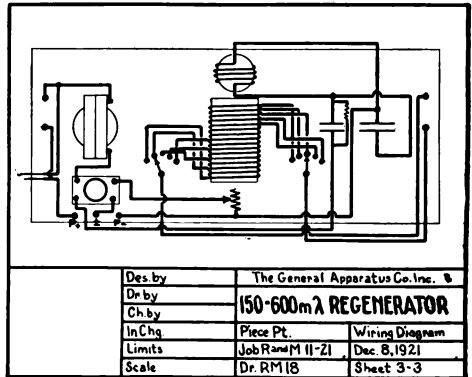

Fig. 3. Connections for the set

One side of the tap is cut off short, and soldered to the other, to make a single wire lead.

The secondary ball is of the 3-in. standard size, of mahogany, wound full with one layer of No. 20 D. C. C. wire, B. and S. gauge. A split

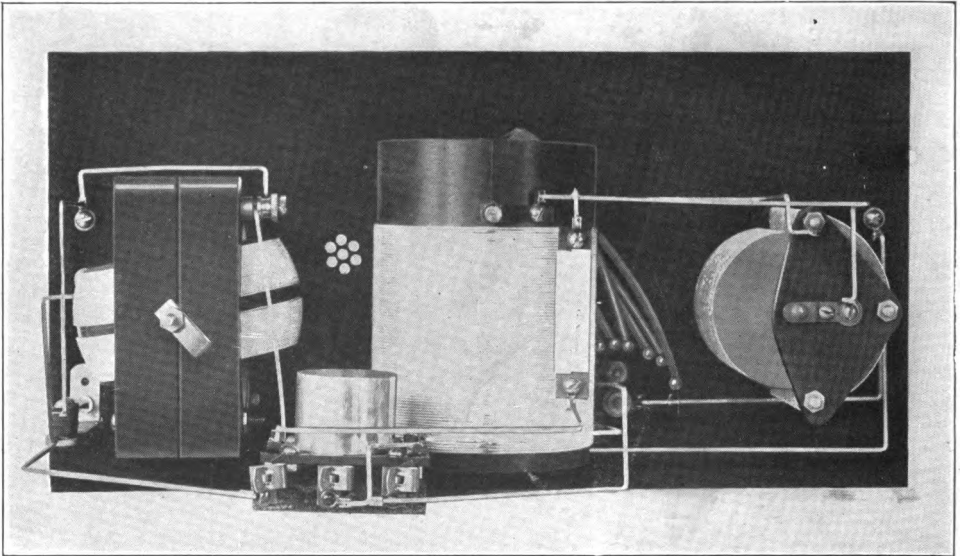

Fig. 2. Rear view, showing constructional features

three-hole method. This is more satisfactory for heavy wire. Before the tube is wound, a set of three holes, the holes of a set spaced $\frac{3}{16}$ in. apart, is made for each tap. The sets of holes should be staggered, and spaced down the tube on the basis of 24 turns per inch. One side of the tap is put in one outside hole, the

shaft serves as the terminals for the coil. Phosphor bronze springs, fastened by $\frac{1}{4}$ -in. 6-32 screws to the tube at one end, and bear on the shaft to make contact. Lugs are fitted to the screws to take the connections.

A wooden panel 6 by $2\frac{1}{2}$ by $\frac{3}{8}$ ins. carries the socket and battery terminals. This is

fastened to the front panel by 1-in. 6-32 F. H. screws. Two 3/8-in. holes are drilled in the base and 6-32 nuts put in for the screws.

Since no mounting device is provided for the Tuska variometer, four No. 27 holes are drilled and threaded 8-32 to take 1/2-in. 8-32 F. H. screws through the panel. They must be laid out carefully with a scribe and square.

**Assembly
of the
Parts.**

With the panel drilled, the coupler completed and the coil mounting pillars in place, the variometer drilled, and the tube base ready, the work of assembly begins. The switches and points are mounted, the switch points tinned and cleaned from paste, binding posts, tube base, rheostat, jack, and variometer put in place. Lugs should be put on the rheostat screws, also. It should be placed so that the screws will be toward the condenser end.

Finally, the coupler goes on the panel and the leads are soldered. Fig. 3 gives a diagram. It

will be noticed that on both switches and dial controls clockwise rotation gives an increase, in accordance with approved practice.

**Operation
of the
Receiver**

The proper use of the tuning controls must be learned through experience with the set, for the adjustments are so critical that, if not handled properly, the set will not produce maximum results. Adjustments should be made on the primary first, then the secondary condenser, the plate variometer, and, finally a slight regulation of the rheostat. Usually the secondary coupling is at zero.

If an amplifier is employed, make sure that a 0.001 mfd. phone condenser is connected across the primary of the first amplifying transformer. Do not expect good results with dry cells for filament lighting. Use a storage battery of 6 volts, 40 or 60 ampere-hours capacity.

Some Common Radio Problems

Troubles and questions that radio experimenters encounter.

The Set That Won't Oscillate

EVERY day experimenters write to the G. A. about things that won't work, often questions that are hard to answer even broadly because of lack of details given, but there are a few common ones which occur so often that it may be worth while to take a little space to discuss them.

The usual report is that a regenerative receiver doesn't regenerate or oscillate. In most cases the audion filament is supplied by dry cells. A Radiotron UV200 or 201 will not work on dry batteries unless there are at least two sets of five cells, with the cells of a set wired in series and the two sets put in parallel. At least two sets must be used for each tube.

When a circuit is oscillating the losses in the grid are supplied from the plate by the feedback coupling. Unless the filament is burning brightly, a UV200 takes practically the full 6 volts from a storage battery, the flow of current in the plate circuit is not great enough to supply the grid losses. Hence no oscillations. The plate circuit acts as a hammer hitting a pendulum just hard enough to keep it swinging steadily.

Of course there are Radiotrons which are not good oscillators, but in general they are thoroughly reliable. Remarks concerning the Radiotron apply equally to Cunningham tubes. As for other makes, some experimenters like them and some do not. The easiest way to settle the tube problem is to try it in another set which is working.

Very few tubes or circuits will oscillate when connected to an amplifier unless a condenser of 0.001 mfd. or more is connected across the primary of the first amplifying transformer.

Another thing—a UV200 tube should have 22.5 volts on the plate and 45 volts on the UV201. Voltages up to 110 can be applied to the latter type, however, when great amplification is required.

A variable gridleak or variable grid condenser is not needed for regeneration. Experimenters who have them, however, consider them necessary, not realizing that the adjustments obtained run to higher and to lower values than should be used. When the adjustments are properly set they will be found to be of about 1 megohm and 0.0005 mfd., the correct values for the gridleak and grid condenser.

Radio Phone Reception

A great many electrical stores are now selling radio receiving sets, and some of the statements made by uninformed clerks would be amusing if they did not cause so much trouble for the novice who is earnestly trying to put up a set to receive the telephone broad-

ers, for example, that a crystal receiver will bring in speech and music clearly at a distance of 100 miles. It won't and doesn't. A crystal set will not give clear speech from the stations now transmitting when more than 10 miles away. On a good non-regenerative audion set readable speech can be heard over 50 miles, and 75 to 100 miles on a regenerative receiver.

This is taking average results. As a matter of fact, Mr. L. M. Clement has received reports on the Western Electric $\frac{1}{2}$ K.W. phone station at New York from very nearly every State in the Union. Reception on a loud speaker was possible in California, but that cannot be done at every receiving station or from any other transmitting station now operating. The wavelength ordinarily used by that station is 450 meters.

Reception on Loud Speakers

Frequently a man buys a Vocaloud or similar loud speaker and complains that, altho the signals are clear in the telephones, he cannot hear them two feet from the loud speaker. Of course not. Signals must be very strong in the phones before a Vocaloud can be heard in a large room. One to three amplifiers, with, preferably, three 45-volt plate batteries on the last tube should be employed. Then the Vocaloud will make plenty of noise. These instruments are not meant to do the work of amplifiers.

Some Patent Queries

Then there are the questions about patents. Experimenters sometimes get the idea that they want to build and sell radio instruments, or regenerative receivers with one connection left off. Radio equipment and circuits are bound up in a net work of patents, some of which have been defended and some have not. The safest course for a man who is not fully informed as to conditions now existing and the changes that are constantly taking place is to take no chances, for he will not find the possible gain worth the risk involved. Neither is it safe to side-step responsibility by leaving out a connection or to employ similar methods. In the last six months many companies have been brought to account. In this connection it may be mentioned that suit has been brought against the Radio Service Company of Lynbrook, Long Island, for infringement of patents covering the familiar G. A. grid, phone, and gridleak condensers, though action is not taken in such cases frequently because the infringers are found to lack financial responsibility and have no assets against which claims can be made.

Ideas For the Radio Shop and Laboratory

Here are a few handy instruments, neatly made, which every experimenter needs but not so many have

Short Wave Laboratory Oscillator

HAVE you ever worked and worked to get a resonance point in making measurements with a wavemeter, giving up in the end or taking a chance that the readings you made were somewhere near correct? You won't have to do that with an oscillating wavemeter. The circuit is simple, and contains only the elements of an oscillating circuit, an inductance connected at one end to the grid of a tube, a center tap to the filament, and the other end running to the negative side of a plate battery, the positive battery lead to the telephones, and the phones to the tube plate. A variable condenser is connected across the ends of the coil. This is a laboratory oscillator which, when calibrated, becomes a wavemeter.

There are many uses to which the instrument can be put described in detail at the end of this article.

Construction of the Wavemeter

FIG. 1 shows the completed meter connected and ready for use on wavelengths from 180 to 600 meters. A GA-STD-A15 variable condenser, 0.0002 mfd. capacity, is mounted on a 5 by 5 by 3-16 in. panel fitted on a box 2½ ins. deep inside and 5 ins. square outside. Three special clamping posts are needed for connections, made to hold the coil connection lugs in the center and wires to the audion at the top. They are located 5/8 in. from the edge, the left hand post being 1 5-16 in. from the side of the panel, the next ½ in. to the right and the third 1 15-16 in. from the second.

The coil is 1 7-16 in. long, of 65 turns of No. 24 S.S.C. wire on G-A-Lite tube 3¾ ins. in diameter and 2¾ ins. long. Winding is started 1 in. from the left hand end, and a tap is taken off at the thirtieth turn. Next, 1-in. round head 8-32 screws are put thru the tube, spaced to line up with the binding posts and clamped with nuts. End and center leads from the coils are soldered to their respective screws. Finally large size soldering lugs are put in position on the binding posts and the screws on the coil soldered to them. Thus the screws provide support for the coil as well as connections. The outside binding posts are wired to the condenser terminals.

Connections to the audion have been described already. When a Laboratory Type Control is employed, as in Fig. 1, the right hand wavemeter post is joined to the upper left hand control post, the center post to the lower control post, negative plate battery lead to the left wavemeter post, and the positive lead to the regular positive plate battery connector at the rear of the control. The right control panel posts take the telephones.

Calibrating the Meter

TO calibrate this meter, connect it as directed and light the tube filament. If a UV200 is used, put 22.5 volts on the plate, or for more power a UV201 with 45 volts. Couple the coil to the inductance of the calibrated meter, and swing the condenser back and forth until clicks are heard in the phones. There will be a click on each side of the resonance point. Decrease the coupling until the clicks are very close together. The center point between the clicks gives the true reading. This method, tho it may seem rather uncertain from the description, works out very nicely in practice.

Measuring Other Circuits

BEFORE measuring the wavelength of a circuit disconnect any other circuit coupled to it or set the coupling at zero. Whether the circuit is for transmitting or receiving it is not necessary to excite it. Merely couple the wavemeter to it and listen for the clicks which indicate resonance.

If the wavemeter is set up near a telephone or undamped wave transmitter, beat notes will be heard on both sides of the resonance point.

Other Uses for the Wavemeter

THERE are many interesting uses for this instrument. It may be coupled to a non-oscillating audion or crystal circuit and used for heterodyning undamped wave signals. For experiments on impedance coupled radio frequency amplifiers the meter itself can be used as the impedance circuit. Again, it may be connected in the plate circuit of a non-oscillating detector, and it will cause the circuit to oscillate and regenerate.

Comparison Testing Switch

THE only way to compare tubes, amplifying transformers, receiving sets, and other devices is to connect one and then the other, keeping the con-

side instead of up and down. For simplicity, small wire was used for connections, insulated with Empire tubing.

The top and side clips should be given corresponding numbers to facilitate the

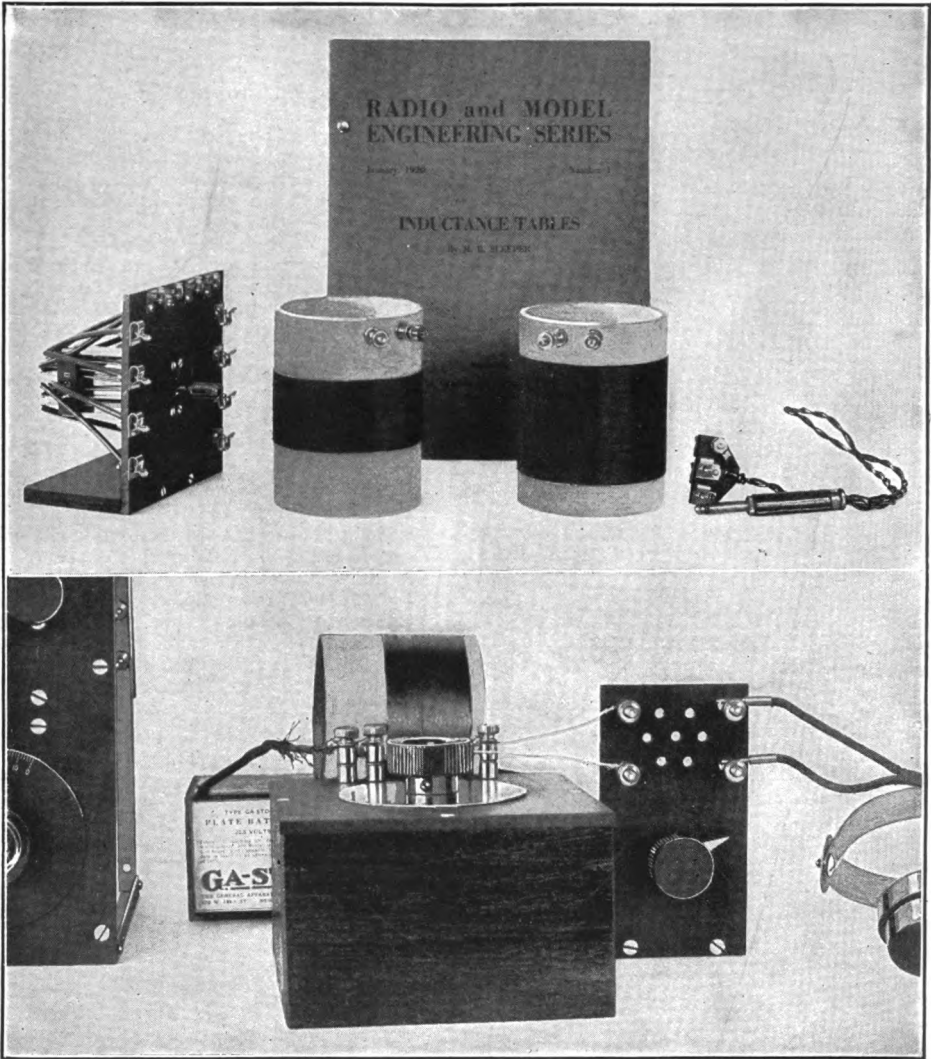

Fig. 1, below. The complete wavemeter set-up, coupled to a receiving set. Fig. 2, above. Testing switch, inductance standards, phone bob, and Inductance Tables, all useful things for the radio man.

ditions the same. A handy switch for this purpose is shown in Fig. 2, at the left.

It is a Federal anti-capacity switch mounted on an L.P.F. panel 5 by 5 by 3-16 in. The panel is supported on a wooden base. Fahnestock clips for the center contacts are mounted across the top of the panel, and the clips on the sides for the side contacts. It might have been better to have the handle thrown to the

wiring of instruments to be compared. Whatever devices are to be compared should be connected to the side clips, while the top clips go to the auxiliary apparatus.

Standard Inductance Coils

ALL kinds of experiments call for inductance standards. Every laboratory should have an assortment, running from 0.1 to 10.0 millihenries. (While these

are expensive in the forms in which they are usually manufactured, the coils in Fig. 2 can be wound up quickly, and to an accuracy of well within 5%.

**Two Phones
on One
Plug**

SO many times we have needed two pairs of phones on a set provided with only one jack that we now use a phone bob. It is just a little piece of L.P.F. cut from a $2\frac{1}{2}$ by 5 by $\frac{1}{8}$ in. panel, carrying four Fahnestock clips, with a cord running to the phone plug. A phone bob, as we call it, is shown at the left of Fig. 2. Its convenience has more than compensated for the time it took to make it.

The easiest way to determine the size of a coil to produce a given inductance is by means of "Inductance Tables." By means of these Tables the size of wire, diameter, length, or turns per inch required for a certain inductance can be found to an accuracy of 2% merely by a multiplication or division. Actually the Table consists of 2,900 separate calculations from Nagoaka's formula applied to coils from 0.1 to 10.0 ins. long and 3 to 10 ins. in diameter but without the turns per inch squared value. This is supplied in making the calculation. A glance at the directions which accompany the Tables show how easily the required contents can be determined.

G. A. STANDARDIZED PARTS FOR THE SINGLE CIRCUIT RECEIVER, TYPE 1000

1—L.P.F. panel 10x5x3 ¹ / ₄ in. for front...	\$1.31
1—L.P.F. panel 2 ¹ / ₂ x6x ¹ / ₄ in.39
6—Switch points, 4c ea.24
2—Stopping points, 5c ea.10
1—G.A. Gridleak condenser.50
1—G.A. knob and dial, 180 degrees.	1.25
8—STD nickel plated binding posts, 10c ea.80
1—G.A. audion socket.80
1—G.A. rheostat.	1.00
1—Closed circuit jack.85
1—GA-STD variable condenser, 0.001 mfd.	4.30
1—Package of small soldering lugs.25
2—Coil supporting pillars, 8c ea.16
1— ¹ / ₂ lb. spool No. 24 S.S.C. wire.	1.25
1—3 in. G.A. Lite tube 12 in. long.32
1—Pkg. 6-32 ¹ / ₂ in. R.H. brass screws.12
1—Pkg. 6-32 ¹ / ₂ in. F.H. nickeled screws.12
1—Pkg. 6-32 1 in. F.H. nickeled screws.14
3—24 in. lengths square tinned copper wire.	1.15
2—Angle brackets.20
Complete set of parts to construct this receiver as listed above, can be assembled with the simplest tools in a few hours.	13.99
Complete set of parts with coil wound and tapped, front and rear panels drilled and engraved, put up in attractive box.	18.47

AUXILIARY EQUIPMENT

Radiotron U.V. 200 detector tube.	\$5.00
Radiotron U.V. 201 amplifier tube.	6.50
Eveready B Battery, 22.5 V.	3.00
Wetherbee storage battery, 40 A.H. 6 V.	12.00
Telephone plug.	1.25

PARTS FOR 150 TO 1,000 AND 150 TO 2,500 METER LOOSE COUPLER, TYPES 1100 AND 1101

1—L.P.F. panel 5x10x ¹ / ₄ in. for front (1/2 lb.)	\$1.31
1—L.P.F. panel 2 ¹ / ₂ x6x ¹ / ₄ in. for rear.	(3 oz.) .39
3—Switches, 1 in. radius, 65c.	(2 oz.) 1.95
4—Pillars to mount coils, 8c ea.	(2 oz.) .32
1—G.A. 90 degree dial and knob.	(2 oz.) 1.25
28—Switch points, 4c ea.72
1— ¹ / ₄ in. brass rod, per 12 in. length.	(4 oz.) .15
1—3 in. mahogany variometer ball.	(3 oz.) .70
4—GA-STD nickel plated binding posts, 10c ea.	(2 oz.) .40
2—Square copper connection wire, 5c per 2-ft. length.10
1—Piece No. 24 spring sheet brass.	(3 oz.) .05
1—Short wave primary coil wound and tapped.	(8 oz.) 1.00
1—Short wave secondary coil wound and tapped.	(8 lbs.) .85
1—Long wave primary coil wound and tapped.	(1 lb.) 2.20
1—Long wave secondary coil wound and tapped.	(8 oz.) 1.35
1—Pkg. of 6-32 ¹ / ₂ in. R.H. nickel brass machine screws.	(1 oz.) .12
1—Pkg. 6-32 1 in. F.H. nickeled screws.	(2 oz.) .14
2—Angle brackets.	(2 oz.) .20
Complete set of parts for the 150 to 1,000 meter loose coupler as listed above, ready to assemble.	(3 lbs.) 9.48
Complete set of parts for the 150 to 2,500 meter coupler, as listed above, ready to assemble.	(4 lbs.) 10.90

AUXILIARY PARTS

¹ / ₂ lb. spool No. 24 single silk covered wire, 400 ft.	\$1.25
9-in. length G.A-Lite tubing, 3 ¹ / ₂ in. diameter.	(8 oz.) .38
GA-STD variable condenser 0.001 mfd.	(1 lb.) 4.30
L.P.F. panel 5x5x ¹ / ₄ in. for mounting condenser.	(oz.) .66
G.A. 180° dial and knob.	(2 oz.) 1.25

STANDARDIZED PARTS FOR THE 150 TO 2,600 METER REGENERATOR, TYPE 1200

1—L.P.F. panel 5x10x ¹ / ₄ in.	(12 oz.) \$1.31
1—L.P.F. rear panel 2 ¹ / ₂ x10x ¹ / ₄ in.	(4 oz.) .45
4—Lengths ³ / ₄ in. angle brass.	(3 oz.) .80
4A variable condenser 0.001 mfd.	(1 lb.) 4.30
1—180° dial and knob, ¹ / ₄ in. hole.	(2 oz.) 1.25
1—90° dial and knob, ¹ / ₄ in. hole.	(2 oz.) 1.25
1—Complete switch, 1 in. radius.	(2 oz.) .65
2—Stopping points.	(1 oz.) .10
3—Switch points.	(1 oz.) .32
1—L.P.F. tube 3 ¹ / ₂ in. diam.	(5 oz.) 1.48
1— ¹ / ₂ lb. spool No. 24 S.S.C. Wire.	(8 oz.) 1.25
2—Coil supporting pillars.	(2 oz.) .16
1—Length ¹ / ₄ in. brass rod.	(7 oz.) .15
2—ft. Empire tubing.	(2 oz.) .40
1—Pkg. 6-32 washers.	(1 oz.) .04
1—Pkg. ¹ / ₂ in. 6-32 R.H. nickeled screws.	(1 oz.) .12
2—Pkg. 6-32 nickeled nuts.	(1 oz.) .16
1—Pkg. ¹ / ₄ in. 6-32 R.H. nickeled screws.	(1 oz.) .11
4—Fibre washers.	(1 oz.) .16
1—Pkg. ¹ / ₂ in. 6-32 F.H. screws.	(1 oz.) .12
2—Contact springs.	(1 oz.) .08
6—GA-STD nickeled binding posts.	(3 oz.) .60
2—Lengths square tinned copper connection wire.	(2 oz.) .10
1—GA-STD mahogany variometer ball shaft hole drilled.	(3 oz.) .70
Complete set of parts to build the 150 to 2,600 meter regenerator.	(7 lbs.) 15.51
NOTE—This set, giving extremely loud signals on phone signals, costs less than two variometers alone.	
Complete supporting frames, nickeled, pair.	(6 oz.) \$1.25
Inductance wound and tapped.	4.00
Complete inductance unit with coupling coil, ready to mount on panel.	6.95
Front panel with condenser, coil, and tickler mounted, fitted with dials, switch, and switch points, practically finished, except for supports, connection panel and wiring.	17.92
Complete set of parts, including nickeled support frames, panels drilled and engraved and tuning unit completed.	22.28

STANDARDIZED PARTS FOR THE DETECTOR AND TWO-STEP AMPLIFIER, TYPE 1300

1—L.P.F. panel 5x9 ¹ / ₂ x ¹ / ₄ in.	(24 oz.) \$1.31
1—L.P.F. panel 5x10x ¹ / ₄ in.	(24 oz.) 1.31
1—L.P.F. rear panel 2 ¹ / ₂ x10x ¹ / ₄ in.	(4 oz.) .45
4—Lengths ³ / ₄ in. angle brass.	(8 oz.) .80
6—Lengths square tinned copper wire.	(4 oz.) .30
3—G.A. rheostats.	(16 oz.) 3.00
2—G.A. transformers.	(16 oz.) 10.00
2—G.A. closed circuit jacks.	(6 oz.) 1.70
1—G.A. open circuit jack.	(3 oz.) .70
3—GA-STD-A1 sockets.	(12 oz.) 2.40
10—GA-STD-A10 binding posts.	(5 oz.) 1.00
1—Pkg. small soldering lugs.	(1 oz.) .25
2—Pkg. F.H. 6-32 ¹ / ₂ in. nickeled screws.	(2 oz.) .24
1—Pkg. R.H. 6-32 ¹ / ₂ in. nickeled screws.	(1 oz.) .12
1—Pkg. R.H. 6-32 ¹ / ₄ in. nickeled screws.	(1 oz.) .11
3—Pkg. 6-32 nuts nickeled.	(2 oz.) .24
1—GA-STD-A4 Gridleak condenser.	(1 oz.) .50
1—GA-STD-A3 phone condenser.	(1 oz.) .35
Complete set of parts as listed above, ready to assemble in your own shop.	(7 lbs.) 24.82
Complete set of parts with the panels drilled and engraved and nickeled support frames.	(7 lbs.) 29.90

AUXILIARY PARTS

Eveready 45 V-tapped B battery.	(6 lbs.) \$5.50
Wetherbee 6-volts, 40-amp-hour storage battery.	(15 lbs.) 12.00
Radiotron detector tube UV 200.	(8 oz.) 5.00
Radiotron amplifier tube UV 201.	(8 oz.) 6.50
Telephone plug.	(4 oz.) 1.25

STANDARDIZED PARTS FOR THE SINGLE CIRCUIT CRYSTAL RECEIVER, TYPE 1400

1—L.P.F. panel 5x5x $\frac{3}{8}$ in.	(6 oz.)	\$0.66
1—L.P.F. tube 3-in. diam.	(5 oz.)	.76
1— $\frac{1}{4}$ lb. spool No. 24 S.S.C. wire.	(5 oz.)	.75
10—GA-STD-A13 switch points.	(1 oz.)	.40
1—Switch complete.	(2 oz.)	.65
2—Coil mounting pillars.	(3 oz.)	.16
1—Set of detector parts.	(3 oz.)	.75
1—Mounted galena crystal.	(1 oz.)	.30
4—GA-STD-A10 binding posts.	(4 oz.)	.40
1—Brass strip $\frac{3}{8}$ x $\frac{1}{8}$ in.	(3 oz.)	.13
2—Length sq. tinned cop. wire.	(2 oz.)	.10
1—Pkg. F.H. 6-32 $\frac{1}{2}$ in. nickeled screws	(1 oz.)	.12
1—Pkg. 6-32 $\frac{1}{4}$ in. nickeled screws.	(1 oz.)	.11
1—Pkg. 6-32 nuts nickeled.	(1 oz.)	.08
1—Pkg. No. 6 washers.	(1 oz.)	.04
1—GA-STD-A3 phone condenser.	(1 oz.)	.35
2—Stopping points.	(2 oz.)	.10

COMPLETE SET OF PARTS

As listed above, ready to assemble in your own shop. (4 lbs.) **\$5.76**

Complete set of parts with coil wound, panel drilled and engraved, put up in attractive box. (4 lbs.) **7.34**

AUXILIARY PARTS

Antenna wire, No. 14 bare copper, per 100 ft.	(2 lbs.)	\$6.80
3-in. HF insulators, 33,000 volts, 350 lbs.	(6 oz.)	.25
Deveau Go'd Seal 2 200 ohm phones	(1 $\frac{1}{2}$ lbs.)	8.00

STANDARDIZED PARTS FOR 200-METER RECEIVER WITH RADIO FREQUENCY AMPLIFIER, TYPE 1500

1—L.P.F. panel 10x7 $\frac{1}{2}$ x $\frac{3}{8}$ in.	(20 oz.)	\$1.97
1—L.P.F. rear panel 10x2 $\frac{1}{2}$ x $\frac{1}{2}$ in.	(4 oz.)	.45
6—Lengths $\frac{3}{8}$ in. angle brass.	(12 oz.)	1.20
4—Lengths tinned copper wire.	(3 oz.)	.10
2—G.A. rheostats	(8 oz.)	2.00
2—GA-STD-A1 sockets.	(8 oz.)	1.60
8—GA-STD-A10 binding posts.	(4 oz.)	.80
1—Pkg. small soldering lugs.	(1 oz.)	.25
2—GA-STD-A18 variable condensers. (2 lbs.)		8.60
1—GA-STD-A2 grid condenser.	(1 oz.)	.35
3—Knobs and dials, 180°	(6 oz.)	3.75
1—GA-STD-11 mahogany tickler ball	(3 oz.)	.70
1—GA-Lite tube, 3 $\frac{1}{2}$ in. diam.	(5 oz.)	.38
1— $\frac{1}{4}$ lb. spool No. 20 D.C.C. wire.	(10 oz.)	.80
1—Length $\frac{1}{4}$ in. brass rod.	(7 oz.)	.15
2—Lengths $\frac{3}{8}$ x $\frac{1}{8}$ in. brass strip.	(12 oz.)	.26
2—Pkg. $\frac{1}{2}$ in. 6-32 F.H. nickeled screws	(2 oz.)	.24
1—Pkg. $\frac{1}{2}$ in. 8-32 F.H. nickeled screws	(1 oz.)	.14
1—Pkg. $\frac{1}{4}$ in. 8-32 R.H. nickeled screws	(1 oz.)	.16
1—Pkg. $\frac{1}{4}$ in. 6-32 R.H. nickeled screws	(1 oz.)	.11
1—Pkg. $\frac{1}{2}$ in. 6-32 R.H. polished nickeled screws.	(1 oz.)	.12
2—Nickeled coil mounting pillars.	(2 oz.)	.16
4—Brass washers, $\frac{1}{4}$ in. hole.	(2 oz.)	.04
1—Pkg. No. 6 nickeled washers.	(1 oz.)	.04
2—Pkg. 6-32 nickeled nuts.	(1 oz.)	.16
1—Pkg. 8-32 nickeled nuts.	(1 oz.)	.09

COMPLETE SET OF PARTS

As listed above ready to assemble in your own shop. The cost of the complete set is less than that of two variometers and a variocoupler (8 lbs.) **\$24.39**

AUXILIARY PARTS

Eveready plate battery, 22 $\frac{1}{2}$ volts.	(3 lbs.)	\$3.00
Radiotron UV 200.	(8 oz.)	5.00
Witherbee 6-volt 40-ampere-hour storage battery	(15 lbs.)	12.00
GA-STD-A6 amplifier control.	(2 lbs.)	13.95
Radiotron UV 201.	(8 oz.)	6.50

STANDARDIZED PARTS FOR THE OSCILLATING WAVEMETER, TYPE 1600

1—L.P.F. panel 5x5x $\frac{3}{8}$ in.	(6 oz.)	\$0.66
1—Knob and dial.	(2 oz.)	1.25
3—GA-STD-A18 double base binding posts	(3 oz.)	.42
1—Length G-A-Lite tube, 3 $\frac{1}{2}$ in. diam.	(7 oz.)	.38
1— $\frac{1}{4}$ lb. spool No. 24 S.S.C. wire.	(6 oz.)	.70
1—Pkg. large soldering lugs.	(3 oz.)	.30
1—GA-STD-A15 0.00025 mfd. condenser	(10 oz.)	3.25
1—Pkg. 8-32 1 in. R.H. nickeled screws	(2 oz.)	.16
1—Pkg. 8-32 $\frac{1}{2}$ in. nickeled screws.	(1 oz.)	.14

STANDARDIZED PARTS FOR INDUCTANCE STANDARDS

Inductance tables, post paid.		\$0.25
G-A-Lite tubing 3 in. diam., 9 in. long	(5 oz.)	.32
G-A-Lite tubing 3 $\frac{1}{2}$ in. diam., 9 in. long	(7 oz.)	.38
G-A-Lite tubing 4 $\frac{1}{2}$ in. diam., 9 in. long	(9 oz.)	.48
No. 24 S.S.C. wire per $\frac{1}{4}$ lb. spool.	(6 oz.)	.70
No. 24 S.S.C. wire per 1 lb. spool.	(18 oz.)	2.25

STANDARDIZED PARTS FOR PHONE BOB, TYPE 1700

Phone plug	(5 oz.)	\$1.25
4—Nickeled Fahstock clips.	(1 oz.)	.12
L.P.F. panel 2 $\frac{1}{2}$ x5x $\frac{3}{8}$ in.	(3 oz.)	.33

STANDARDIZED PARTS FOR THE 12,000 TO 20,000 METER RECEIVER, TYPE 1800

1—L.P.F. panel 10x7 $\frac{1}{2}$ x $\frac{3}{8}$ in.	(1 lb.)	\$1.97
1—L.P.F. panel 10x2 $\frac{1}{2}$ x $\frac{1}{2}$ in.	(8 oz.)	.45
2—24 in. lengths square tinned copper wire	(2 oz.)	.10
6—12 in. lengths $\frac{3}{8}$ in. angle brass.	(12 oz.)	1.20
6—GA-STD-A10 binding posts.	(3 oz.)	.60
1—Pkg. of 20 small soldering lugs.	(1 oz.)	.25
1—GA-STD-A7 180° dial and knob.	(8 oz.)	1.25
3—Lb. No. 24 S.S.C. copper wire.	(3 lbs.)	6.75
1—GA-STD-13 indicating knob, $\frac{3}{8}$ in. hole	(2 oz.)	.40
2—12 in. lengths $\frac{3}{8}$ x $\frac{1}{8}$ in. brass strip	(12 oz.)	.26
2—12 in. lengths $\frac{3}{8}$ in. brass rod.	(8 oz.)	.18
10—GA-STD-8 threaded posts.	(6 oz.)	.40
4—GA-STD-14 coil mounting pillars.	(5 oz.)	.32
1—GA-STD-A17 variable condenser.	(1 lb.)	4.30
1—9 in. length 3 $\frac{1}{2}$ in. G-A-Lite tube	(6 oz.)	.38
1—9 in. length 4 $\frac{1}{2}$ in. G-A-Lite tube	(9 oz.)	.48
1—Pkg. of 10 screws 6-32 $\frac{1}{4}$ in. F.H.	(1 oz.)	.11
1—Pkg. of 10 screws 6-32 $\frac{1}{2}$ in. F.H.	(2 oz.)	.12
1—Pkg. of 10 screws 6-32 1 in. F.H.	(4 oz.)	.14
2—Pkg. of 10 nuts, 6-32	(2 oz.)	.16
1—Pkg. of 10 screws 6-32 $\frac{1}{4}$ in. R.H.	(1 oz.)	.11
1—Pkg. of 10 screws 8-32 $\frac{1}{2}$ in. F.H.	(3 oz.)	.14
2—12 in. length flexible conductor.	(1 oz.)	.08

COMPLETE SET OF PARTS FOR THE RECEIVER

As listed above, ready to assemble, more efficient and less expensive than concentrated coil receivers (8 lbs.) **\$19.89**

SEMI-FINISHED PARTS

Antenna inductance wound.	(3 lbs.)	\$5.00
Tickler inductance wound.	(2 lbs.)	4.50
Complete nickeled support frames, per pair	(12 oz.)	1.50
Complete set of parts, including nickeled support frames, all panels drilled and engraved, coils wound	(8 lbs.)	26.15

AUXILIARY APPARATUS

GA-STD-A5 Laboratory type detector control	(1 lb.)	\$5.95
--	---------	--------

GA-STD-A6 Laboratory type amplifier control (2 lbs.)	\$13.95	1—GA-STD-A4 Gridleak condenser. (2 oz.)	\$0.50
GA-STD-A3 Phone condenser 0.001 mfd. (2 oz.)	.35	2—Rotor shaft contact springs. (1 oz.)	.08
Radiotron UV200 detector tube. (8 oz.)	5.00	2—Fibre rotor spacing washers. (1 oz.)	.08
Radiotron UV201 amplifier tube. (8 oz.)	6.50	1—Pkg. of 10 ¼ in. 6-32 R.H. nickel- elected screws. (3 oz.)	.11
Eveready plate battery, 22½ volts. (3 lbs.)	3.00	½—Lb. No. 20 D.C.C. wire. (8 oz.)	.80
Eveready plate battery, 45 volts, 22½ volt tap (6 lbs.)	5.50	1—GA-STD-A1 audion socket. (5 oz.)	.80
Witherbee 6-volt, 40-ampere-hour storage battery, charged and ready to use (15 lbs.)	12.00	1—Pkg. of 10 6-32 nickeled nuts. (2 oz.)	.08
STANDARDIZED PARTS FOR THE 150 TO 600-METER REGENERATIVE RECEIVER, TYPE 1900		1—GA-STD-11 mahogany coupling ball (5 oz.)	.70
1—GA-STD-8P L.P.F. panel 15x 7½x¾ in. (1½ lbs.)	\$2.97	1—GA-STD-A17 0.001 mfd. variable condenser (1 lb.)	4.30
1—12 in. length ¼ in. brass rod. (7 oz.)	.15	1—GA variometer (2 lb.)	6.00
1—L.P.F. panel 2½x6x¾ in. (4 oz.)	.39	1—L.P.F. tube 5 in. long 3½ in. diam. ¼ in. wall. (6 oz.)	1.48
2—Angle brackets (2 oz.)	.20	4—2 ft. lengths square tinned copper wire (2 oz.)	.20
2—GA-STD-A7 100 division dial and knob, ¼ in. hole. (1¼ lbs.)	2.50	4—Stopping points. (2 oz.)	.20
1—GA-STD-A8 50 division dial and knob, ¼ in. hole. (9 oz.)	1.25	COMPLETE SET OF PARTS FOR RECEIVER	
2—GA-STD-A9 1 in. radius switches (10 oz.)	1.30	As listed above ready to assemble. (10 lbs.)	
1—G.A. rheostat (6 oz.)	1.00	SEMI-FINISHED PARTS	
18—GA-STD-A13 switch points. (2 oz.)	.72	Variocoupler wound and assembled (2 lbs.)	
7—GA-STD-A10 binding posts. (10 oz.)	.70	\$5.95	
1—G.A. open circuit jack. (6 oz.)	.70	Set of parts including wound variocoupler, panels drilled and engraved. (10 lbs.)	
2—2 ft. lengths Empire tubing. (2 oz.)	.80	33.99	
1—Pkg. of 20 small soldering lugs. (2 oz.)	.25	AUXILIARY PARTS	
2—Coil mounting pillars. (3 oz.)	.16	GA-STD-A6 Laboratory type amplifier (2 lbs.)	
1—Pkg. of 10 No. 6 nickeled washers (1 oz.)	.04	\$13.95	
1—Pkg. of 10 ½ in. 8-32 F.H. nickel- elected screws. (2 oz.)	.14	UV200 Radiotron detector tube. (8 oz.)	
		5.00	
		UV201 Radiotron amplifier tube. (8 oz.)	
		6.50	
		Deveau Gold Seal 2,200 ohm phones (1½ lbs.)	
		8.00	

These Construction Sets and standardized, interchangeable Construction Parts are manufactured and sold by the Sleeper Radio Corporation. They come in attractive cartons well packed with complete instructions enclosed. They may be purchased through any responsible dealer in radio supplies or, in territory not served by any dealer, they may be ordered direct from the Sleeper Radio Corporation. The Sleeper Radio Corporation used to be known as the General Apparatus Company, Inc., hence the trade mark GA and STD meaning "standardized." Both are now being superceded by the trade-mark "Sleeper."

Radio and Model Engineering

EDITED BY M. B. SLEEPER

RADIO AND MODEL ENGINEERING is a monthly magazine devoted exclusively to the construction of radio apparatus which can be built in the "kitchen table workshop" from parts readily obtainable.

You can get an idea of R. and M. from this book, the pages of which are reprinted from previous issues. You ought not to miss the coming numbers. A single article may be worth a year's subscription.

Put a dollar bill, with your name and address, in an envelope and send it to the G. A. Company. You will find it the best investment you ever made.

SLEEPER RADIO CORPORATION

88 Park Place, New York