

basic television

by A. SCHURE



VOLUMES

1 to 5

a RIDER publication

\$2.25

basic television

by Alexander Schure, Ph.D., Ed.D.

VOL. 1

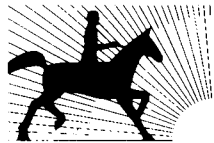

JOHN F. RIDER PUBLISHER, INC.
116 West 14th Street • New York 11, N. Y.

Copyright January 1958 by John F. Rider Publisher, Inc.

All rights reserved. This book or any parts thereof may not be reproduced in any form or in any language without permission of the publisher.

Library of Congress Catalog Card Number 57-13493

Printed in the United States of America

PREFACE

This five-volume course in the fundamental principles of television represents the end product of three years of research and experimentation in teaching methods and presentation at the New York Technical Institute. As a result of this experimentation in correspondence and resident courses approved by the New York State Department of Education, and following the recommendations of advising industrial groups, the highly pictorialized presentation used throughout this book was adopted. An illustration has been provided for each important concept and placed together with the explanatory text on the same page to pinpoint essential material. In addition, review pages spaced throughout each volume summarize the major points already presented.

This combination of the visual approach and idea-per-page technique makes **BASIC TELEVISION** readily understandable with or without an instructor. It is thus suitable for individual or correspondence use as well as for classroom study. Its coverage is complete from the creation of the television image in the studio to its appearance on the receiver screen, and presupposes only a knowledge of basic electronics and radio. Many topics not covered in the more traditional texts are treated here and fully explained for the first time.

The author wishes to acknowledge the assistance of his staff at the New York Technical Institute and that of Mr. Gilbert Gallego in the preparation of some of the illustrations. Special gratitude is due to the staff of John F. Rider Publisher and to Mr. Rider personally for his contributions to both the text and the picturization of this course.

New York, N. Y.
January 1958

ALEXANDER SCHURE

CONTENTS

VOL. I — BASIC TELEVISION

Introduction	1
The Television Camera	4
The Studio	13
Review	17
The Sound Signal	19
The Picture Signal	30
The Iconoscope	36
Review	41
The Image Orthicon	43
The Vidicon	54
The Electron Beam	56
Review	62
Scanning	63
The Video Signal	76
Blanking Pulses	82
Review	86
Synchronizing Pulses	87
The Picture System	96
Television Transmission	102
Review	109

INTRODUCTION

Television Broadcasting

The excitement of sports, the glamor of a musical spectacular, the romance of motion pictures, the impact of important news events; all these and more exist right in your home because of the magic of television! It is no wonder, then, that TV has attracted the greatest audience in history.

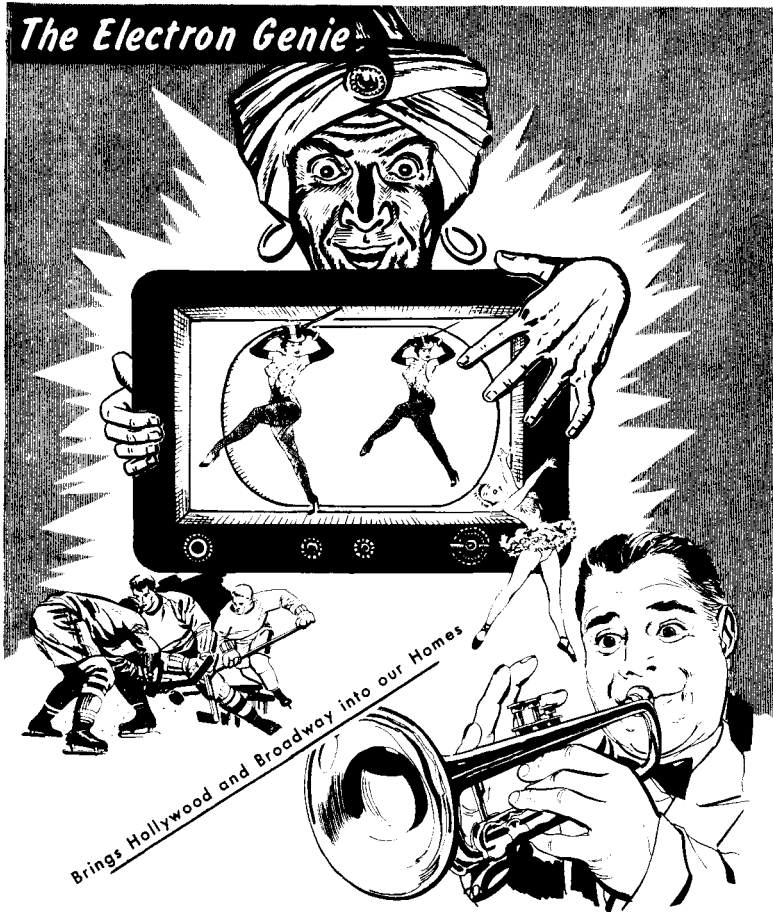

Television has become a way of life. The rural family now has intimate contact with happenings thousands of miles away. As a powerful educational medium, television is valuable to the youth, as well as the grownups, of all nations. It is unsurpassed as a means of generating understanding between peoples of the world. The day is arriving when television will span the oceans and unite the lands of the world, and on that day the peace that everyone is seeking might be a long step nearer to reality.

INTRODUCTION

The Television Team

To fully appreciate a television receiver you should have some knowledge of television broadcasting: what occurs on stage in a television studio, within the equipment, in the control room and in the chain of apparatus between the studio and the transmitting antenna.

There are tricks in every trade, and the electronic engineers affiliated with television broadcasting have developed many exciting and intriguing special effects. Have you wondered how two people located at different places can be shown on a single screen talking to each other; how a man can be shown walking up a wall; a giant taller than a mountain? We explain these now.

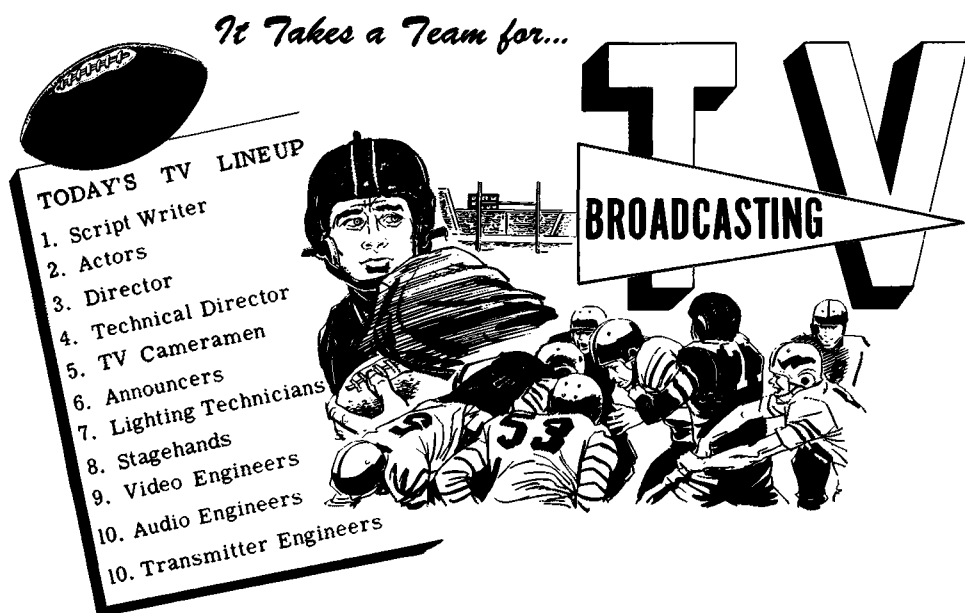

TV time is expensive. The sponsor wants his money's worth . . . the public in turn expects perfection. Television broadcasting not only requires the services of many people with all sorts of talents and all sorts of educational backgrounds, but it also requires teamwork and timing. To achieve this takes more than just rehearsals. From beginning to end the electronic equipment must function perfectly. The eye and the brain are fooled by television techniques, but only when everything is working perfectly. Defects in equipment along the transmitting chain are immediately recognizable and adversely affect the show as a whole.

We shall begin this course on Basic Television with a capsule review of the people, places, and things that, all fitted together, emerge as TV picture and sound signals.

INTRODUCTION

The Television Theater

With the show *on the air* there is no room for mistakes. A cue missed by a sound-effects man can easily destroy an illusion, a slip by a director can destroy days of careful rehearsal, a wrong twist of a dial in a control room can turn a suspense play into a comedy! There just isn't any margin for error. The wonder is how so many men and women work together so well and slip so infrequently. Let's see how they work out a TV production.



ON STAGE IN THE TELEVISION STUDIO

The work of the television show as a whole is guided by one man, the *director*. Not only does he utilize the services of engineers, technicians and cameramen, but he also directs their operations. A movie director can yell "Cut!" and remake a scene, but there can be no cuts for the TV director. Once the show starts it must continue. The first scene must be shot first and the rest in logical sequence. The cameras must continue their shooting no matter what an actor does with his lines. In fact, the director isn't even on stage while the show is in progress. He is sitting in the TV studio control room behind a glass partition through which he watches both the show and the camera outputs as shown on special monitor screens. It is from this control room that the director unveils his talent to the viewing audience.

THE TELEVISION CAMERA

The Television Camera

A televised scene begins in the television camera. In some outdoor scenes only one camera may be used but as a rule, especially at baseball games and in the studio, as many as three or four cameras may be in action at one time, each delivering a separate scene to the director in the control room.

THE TELEVISION CAMERA

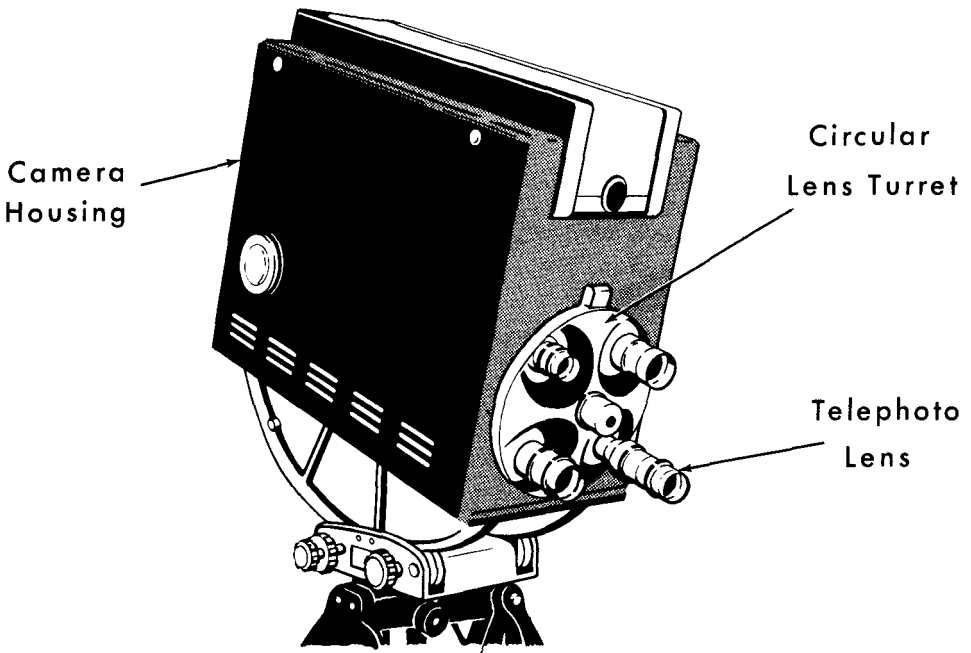

On the TV camera four different lenses may be mounted on a circular turret. The lenses gather the light from the scene and focus it as a small, sharply defined picture on a specially prepared surface inside the camera tube. Only one lens works at any one time. By rotating the lens turret the cameraman brings into action any one of the lenses. The long lens is a *telephoto* lens generally used for closeups. The other lenses permit the camera to get normal shots and closeups, depending on the distance to the subject.

The camera housing encloses the camera tube and the electronic equipment directly associated with it. The entire camera is mounted on a "dolly" which can be rolled along the floor as desired. The handle permits panning, that is, moving the camera both vertically and horizontally.

THE TELEVISION CAMERA

The Television Camera (contd.)

The television camera is much larger than the movie camera, otherwise they are somewhat alike in outward appearance. Differences between TV cameras arise from the kind of camera tube used. One type of camera uses the *iconoscope* camera tube. Although no longer popular for studio pickup, the "ike" was of major importance in the early days of television. In another type of camera the camera tube used is the *image orthicon*. In still another, but much smaller camera, the tube is known as the *vidicon*.

Essential Elements of the Television Camera

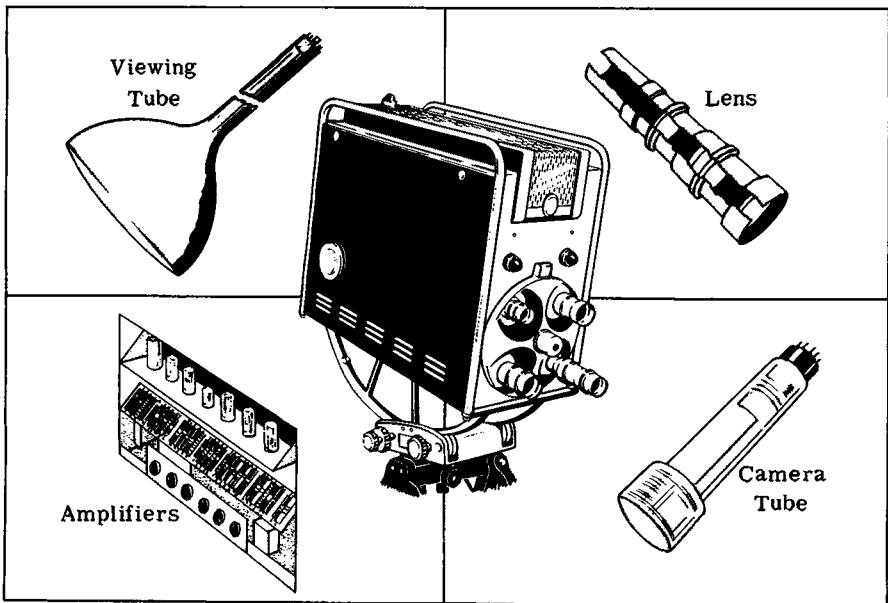

In general, a television camera consists of four major sections or systems. One of these is the optical system; a multiplicity of lenses (usually 3 or 4) that pick up the light reflected from the object, and project a sharply focused image onto the specially prepared surface of the camera tube. The second portion is the camera tube that translates light energy into electrical energy. Third are the amplifiers required for correct functioning of the camera tube and for amplification of the picture signal (video) output from the camera before it is delivered to other amplifiers outside the camera. The fourth portion of the studio-type camera is the viewing system which enables the operator to see the image picked up by his camera. It consists of a picture tube similar to, but smaller than, those used in the home, and its associated amplifiers.

THE TELEVISION CAMERA

Using the Camera

Let's examine a few tricks of the television broadcasting trade. They involve the television camera, manipulation of electronic circuits, and mechanical gimmicks. Many television techniques have been borrowed from the moving picture industry, including the manipulation of prisms in front of the camera lens for multiple-image effects. Many trick television images are accomplished by a change in the direction of electric currents which actuate certain portions of the camera.

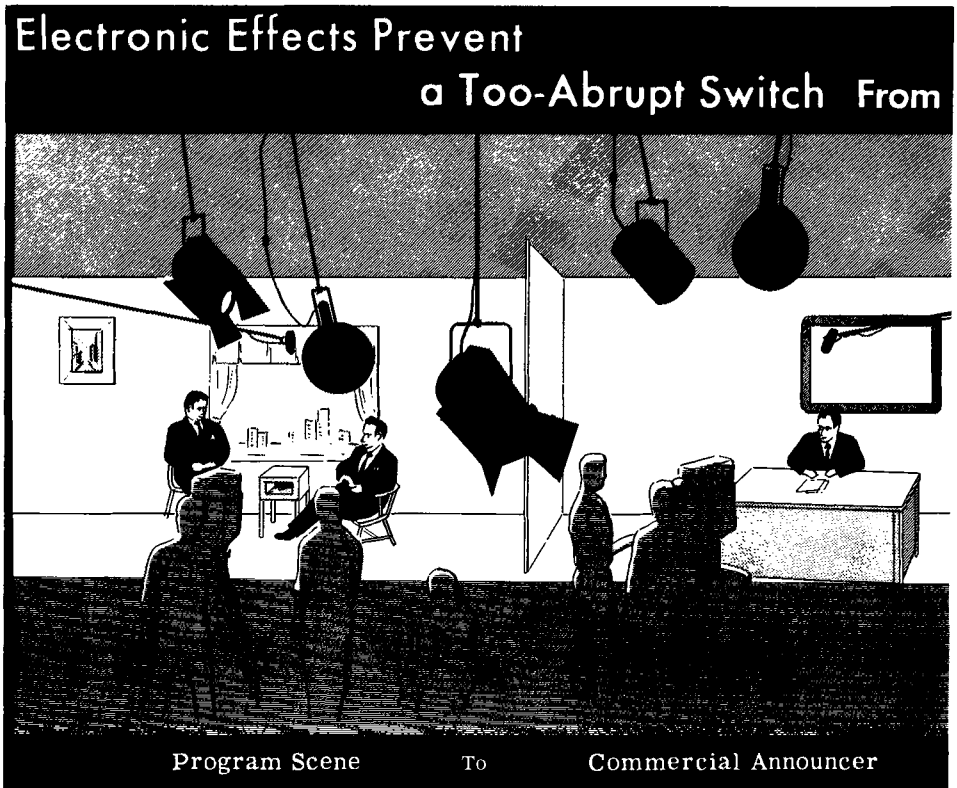

A stage-wise director demands many special effects from the camera. For example, he'll try to avoid an irritatingly abrupt switch from program scene to commercial. For a smooth transition he might use a fade—gradually fade the program scene into darkness and replace it slowly with the image of an announcer delivering his commercial. This procedure is at the command of the director, but is accomplished by a control operator. Both are stationed in the studio control room (which we shall describe later) from where the electronic behavior of the cameras is regulated.

THE TELEVISION CAMERA

Using the Camera (contd.)

The Lap Dissolve

Another trick, employing two television cameras, is the lap dissolve. In it one scene is slowly faded out while a second scene is gradually brought into view so that for a short while *the two pictures overlap*. This technique, which was borrowed from the movies, is used to indicate that only a short time has elapsed between the actions associated with the two scenes. The fading scene, for example, may show a man and woman seated in a railroad car. It is slowly replaced by a view of a hotel lobby, and after a moment a man and woman are seen walking into the lobby to the registration desk. The viewer at home immediately understands that the actions of leaving the train and going to the hotel have taken place.



For this effect the behind-the-scenes camera work is simple. With one camera trained on the railroad car set and a second trained on the adjacent hotel set, the director and monitoring engineers in the control room fade out the first picture and bring up the second, while the actors walk from the first set to the second.

THE TELEVISION CAMERA

Using the Camera (contd.)

The Montage

A bit of electronic sleight-of-hand can be interesting in a television show. Youngsters viewing at home are enthralled when they see a giant taller than a mountain. What the viewers don't know is: they are being deceived.

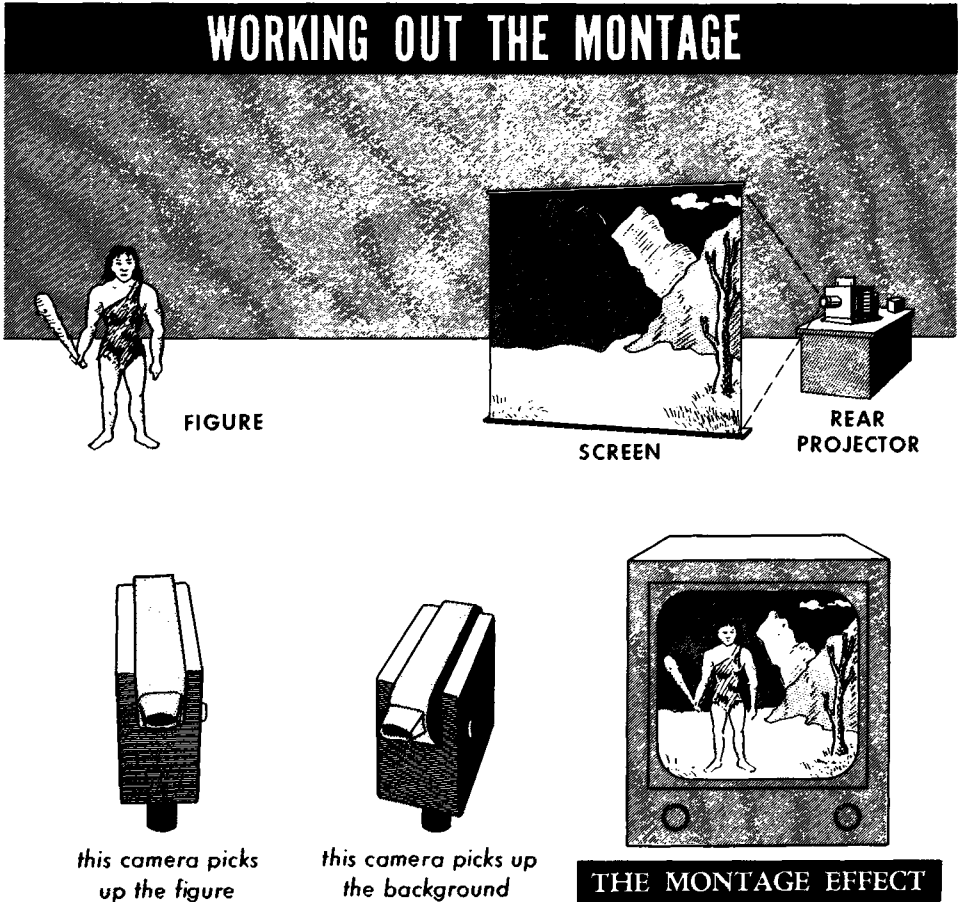

The mountain looks very realistic but it is actually a lantern slide whose image content is thrown onto a screen by rear projection. The man is real, dressed in a costume to suit the story. To perform this trick the outputs of two cameras are put on the air simultaneously; one camera picks up the lantern-slide scene and the other camera picks up an image of the man. The two views are combined into a composite signal and sent to the receivers. When viewed on the receiver the two pictures appear as one.

THE TELEVISION CAMERA

Using the Camera (contd.)

Multiple Images

There are times when the effect of multiple images is desired. A simple method of accomplishing this is by mounting on the camera lens a prism that can be rotated around an axis. Almost any number of images can be obtained by setting the proper prism in front of the lens. When the prism is rotated the images revolve about one another on the television screen.

A Multiple-Facet Prism

Attached to A Camera

And Rotated ...

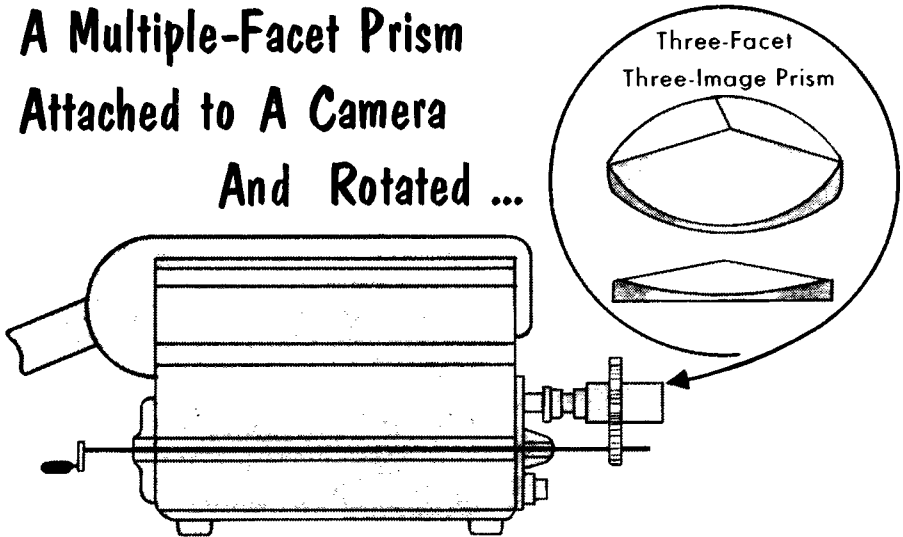

Gives Multiple Images

Which Revolve

Around

Each Other



The triple image shown in the illustration utilizes a triple-facet triple-image prism. If eight images are desired an eight-facet eight-image prism is used. The number of images is determined by the number of facets on the prism. The television director has a bag full of tricks, but we shall not describe any more of them, for now we want to probe the electronic details of the equipment.

THE TELEVISION CAMERA

Using the Camera (contd.)

Many of the illusions seen on the television receiver screen are created with mechanical aids. They are utilized not only by television but also by the moving picture industry.

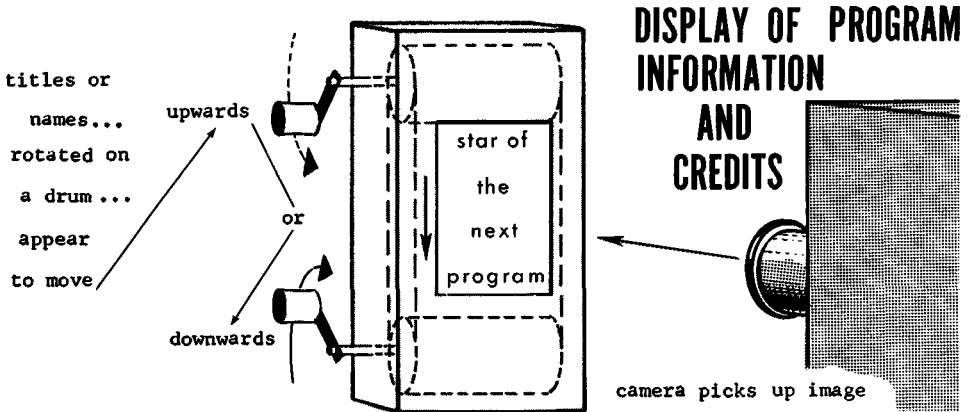

One special effect is produced by rotating a disc on which a spiral has been drawn. The rotation of this disc in a counterclockwise direction would make the spiral appear to run out of the receiver screen; rotating it clockwise would make it appear to be spiraling towards the center of the screen.

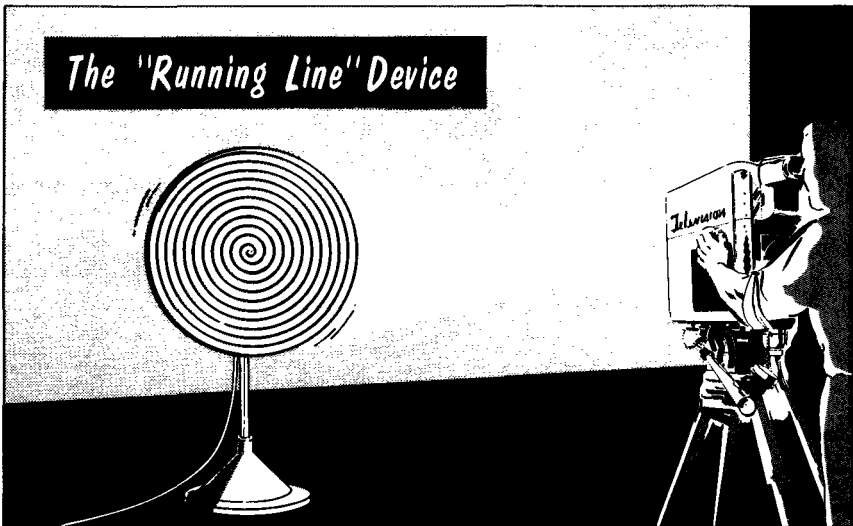

THE TELEVISION CAMERA

Inside the Television Camera

What is inside the housing of a television camera? Let us answer this question by examining two different kinds of cameras; the image orthicon monochrome (black-and-white) camera, and the vidicon camera.

Examining an exposed view of the image orthicon camera we see tubes, electronic components and a variety of controls—but no film. This is the feature which differentiates the TV from the movie camera.

In our illustration only one lens is shown, but imagine a turret with four different lenses mounted on it. A shaft through the camera permits the operator to rotate the turret, bringing into play whichever lens he chooses. The operator's viewing monitor, seen in the upper right-hand corner of the camera, is a standard picture tube that is the same, only smaller, as those used in home TV sets. The picture picked up by the lens and projected onto the light-sensitive surface of the image orthicon camera tube is reproduced on the monitor screen, so the operator sees what the camera picks up.

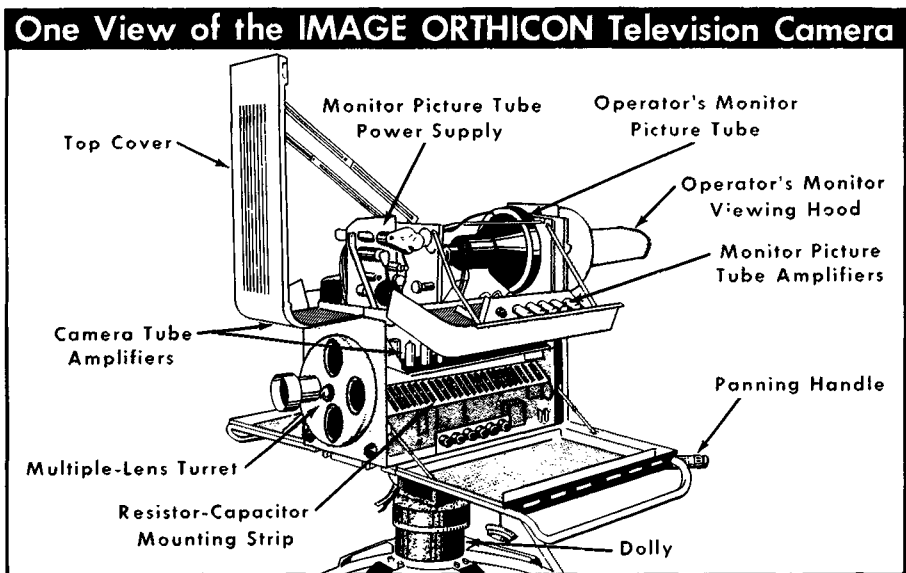

After RCA

The image orthicon camera tube is not visible in the drawing, but is behind the assembly of components which appear on the vertical band in line with the active lens. Operating voltages required for the functioning of the camera system and amplifier tubes are fed from outside the camera by special cables (not shown). A variety of amplifiers required for the operation of the camera tube, the viewing monitor picture tube, and the initial amplification of the camera-tube picture-signal output, are also part of the camera.

THE TELEVISION CAMERA

Inside the Television Camera (contd.)

The vidicon camera is very much smaller and very much simpler than the image orthicon. Although originally intended for industrial and closed-circuit TV, the refinements made in the vidicon camera have widened its utility. Its portability makes it popular for field pickup, and it is enjoying increasing use in the television studio.

Our illustration shows one version of the vidicon. A complete outline of the vidicon camera tube is not visible in the drawing but it can be visualized as a long and narrow glass envelope inside the tube marked "light barrel." The single lens attached to the housing projects the image onto the photo-sensitive surface of the vidicon. On other vidicon cameras a rotatable multiple-lens turret mounts three different lenses.

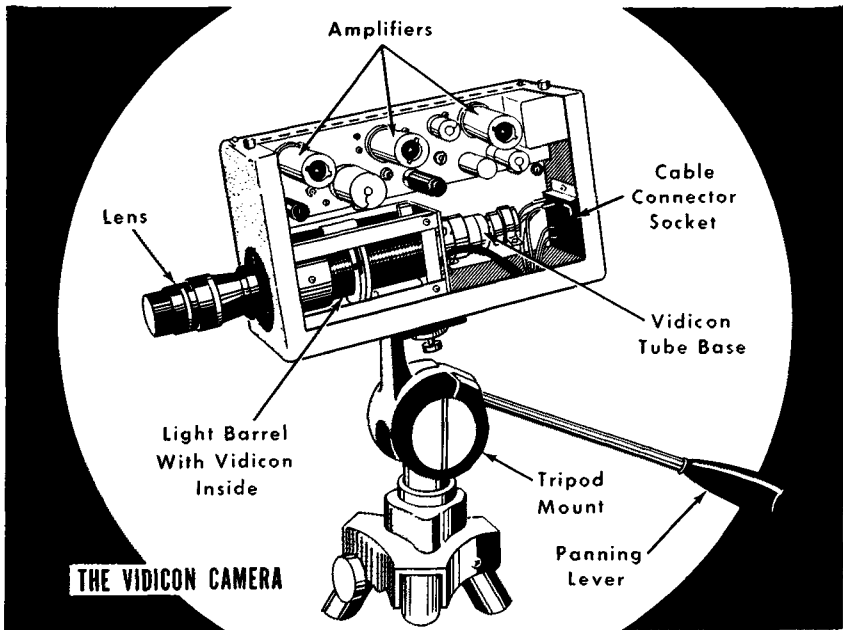

After RCA

The shielded tubes shown above the camera-tube portion of the camera are the video amplifiers. They amplify the video output before it is delivered to amplifiers outside the camera. The power supply which operates the camera tube is located in a separate unit not shown in the illustration. A cable connects the camera with the power supply and delivers the necessary operating voltages to the camera.

We have shown a manually controlled camera, as indicated by the panning lever attached to the upper tripod. Some cameras are hand-held. Also, some vidicon cameras can be remotely controlled.

THE STUDIO

The Studio

Have you ever been inside a television studio? Some are small, some large, and when they are large they are really big—75 to 100 feet long, 30 to 50 feet wide, with ceilings 30 or 40 feet overhead—large enough to put on a circus show and still not occupy the entire place.

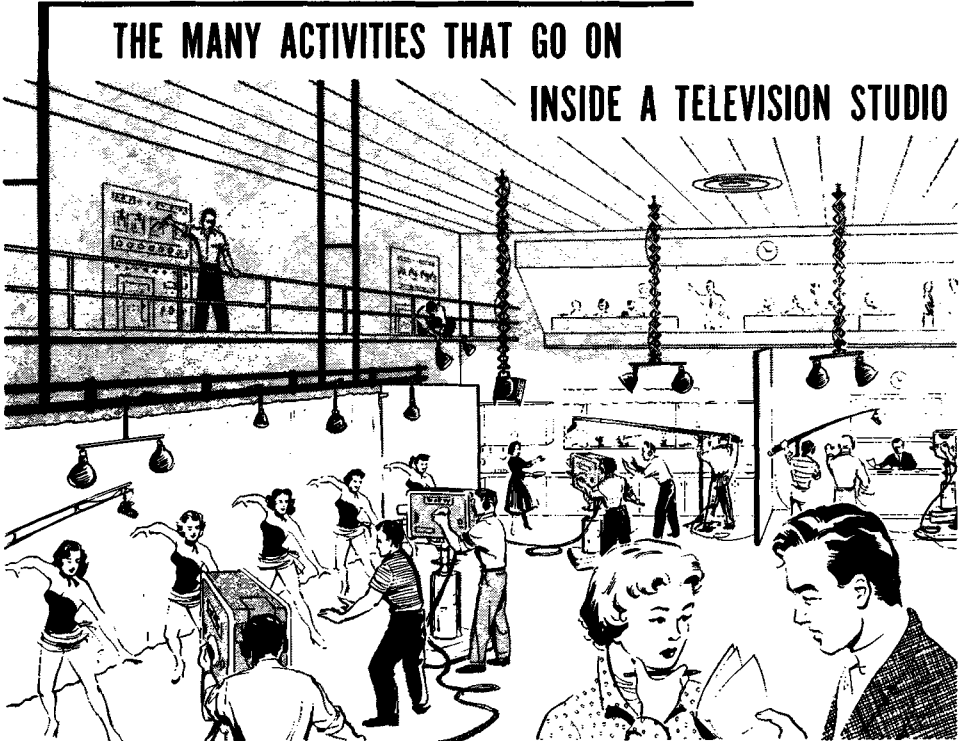

Around the sides of the room 15 to 20 feet above the floor is a catwalk with a railing all around it. A maze of pipes criss-cross on the ceiling. From it hangs an assortment of lights, some fixed in location, others movable. There is usually ample room to put up three, four or more sets for the same show or for shows that follow each other. Even then there is room available. Scattered around the studio are cameras and microphones. Cables from these devices sprawl all over the floor. Banks of lights illuminate one area and where they shine it is really hot. Every job is clearly planned, for the technique of broadcasting requires the most perfect timing. Any sound is picked up by the microphones while a show is on, so signals are given by means of printed signs, intercom microphones and head sets, and motions which comprise a sign language all of their own. Considering what goes on behind the scenes in the production of a television show, the degree of perfection of the programs one sees on a receiver screen is really astounding.

THE STUDIO

The Studio Control Room

The studio control room can rightfully be referred to as the command post of the television broadcasting activity of any one station. It is a room which usually overlooks the stage. It is here that the director works when the show is on the air. To master-mind the telecast the director sits among the studio control operators. In front of him is a master switching panel with which he can select from the camera pickups displayed on the camera monitors the one scene he wants to transmit.

OPERATORS IN THE STUDIO CONTROL ROOM

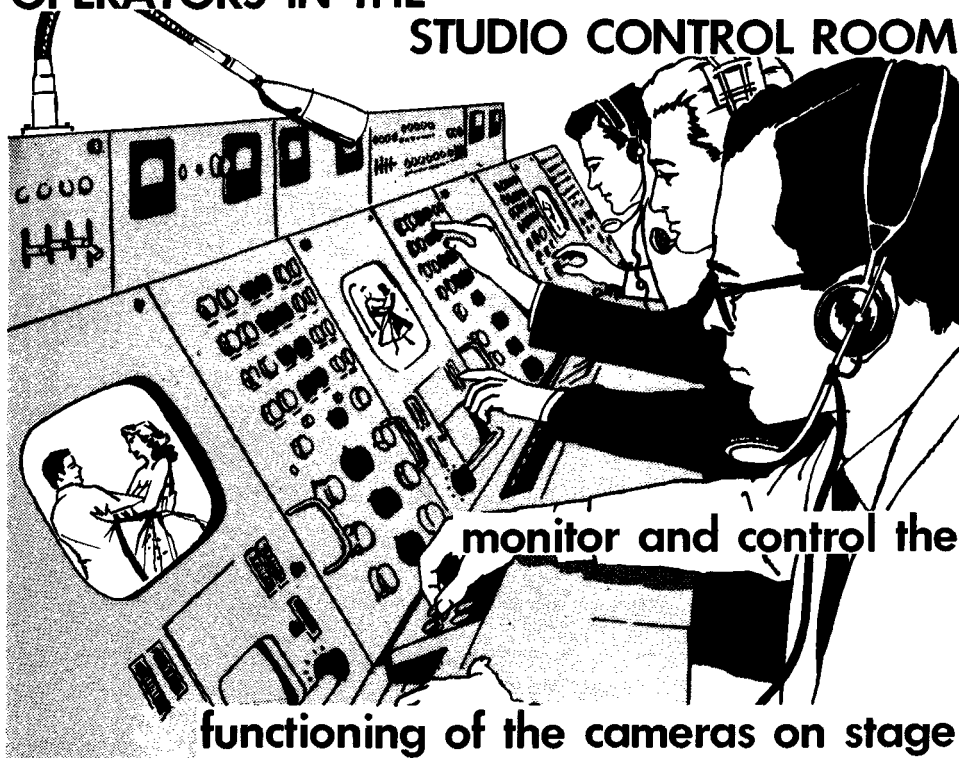

Each control operator has before him the monitor which displays the scene picked up by the studio camera that is his responsibility. Manipulation of the "live" camera on the stage is the responsibility of the cameraman; manipulation of the electronic system within the camera is the function of the studio control operator. The scene is fed from the camera to the monitor by a cable and a related video amplifier located in the control room. The view of the control room shown here is a typical one. The number of control operators and monitors depends upon the size of the installation.

THE STUDIO

The Studio Control Room (contd.)

Also located in the studio control room are the "air" and "preview" monitors, shown here in another studio control room. They are picture tube display systems to which picture signals are piped directly, rather than transmitted over the air. The air monitor displays the scene that the director has selected for transmission to the public. The preview monitor (or monitors) displays pictures that have been made ready to be put on the air; for example, a commercial, or some picture that is to be cut into the sequence of the video presentation. Of course, whatever sound must accompany the scene displayed on the preview monitor is transmitted when the preview monitor image is put on the air and appears on the air monitor.

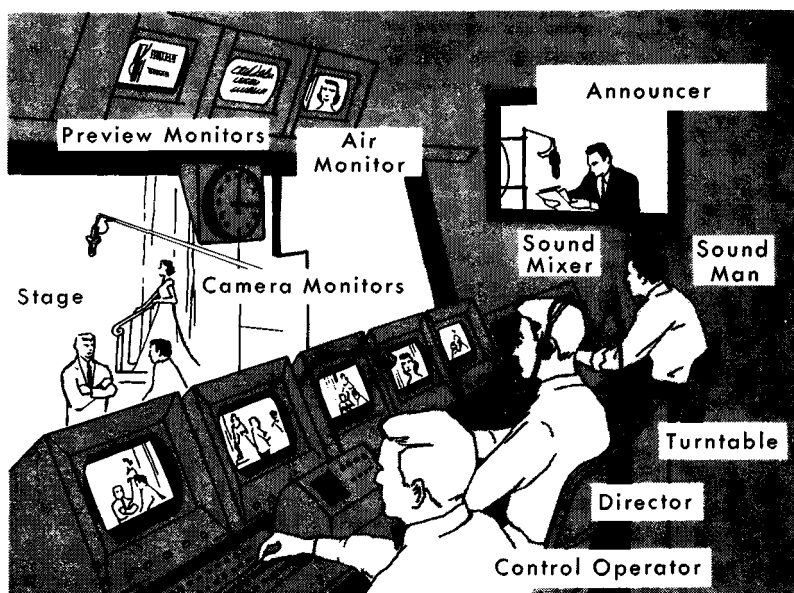

Another Studio Control Room

The studio control room also accommodates the *sound man*. He, too, takes his cues from the director. He monitors the sound that accompanies the action on stage, the announcer's comments, or whatever audio must be transmitted to the viewers. In front of the sound man is the sound mixer panel to which the cables are fed from the live microphones on the stage. The output from each microphone is controlled separately on the mixer panel, enabling the sound man to raise or lower the individual outputs as required, or to blend the sounds if necessary. When the sound accompaniment to a picture is delivered from several sources, it is made into a composite audio signal within the mixer, ready for delivery to other audio amplifiers and eventually to the transmitter.

THE STUDIO

The Studio Control Room Picture Chain

To clarify the relationship between the studio and the studio control room, wherein lie the duties of the director, we show a greatly simplified block diagram of the picture signal chain between these two parts of the television station. Many elements of equipment are omitted. They will appear later as part of the more detailed explanations.

In the diagram we have arbitrarily assigned certain duties to the three cameras on stage. Camera 1 is being used for full-length shots, camera 2 for closeups, camera 3 is mounted on an elevated dolly for overhead shots. These functions are indicated by the nature of the scenes being shot.

**Simplified Block Diagram
of the Camera and Control Room Monitors**

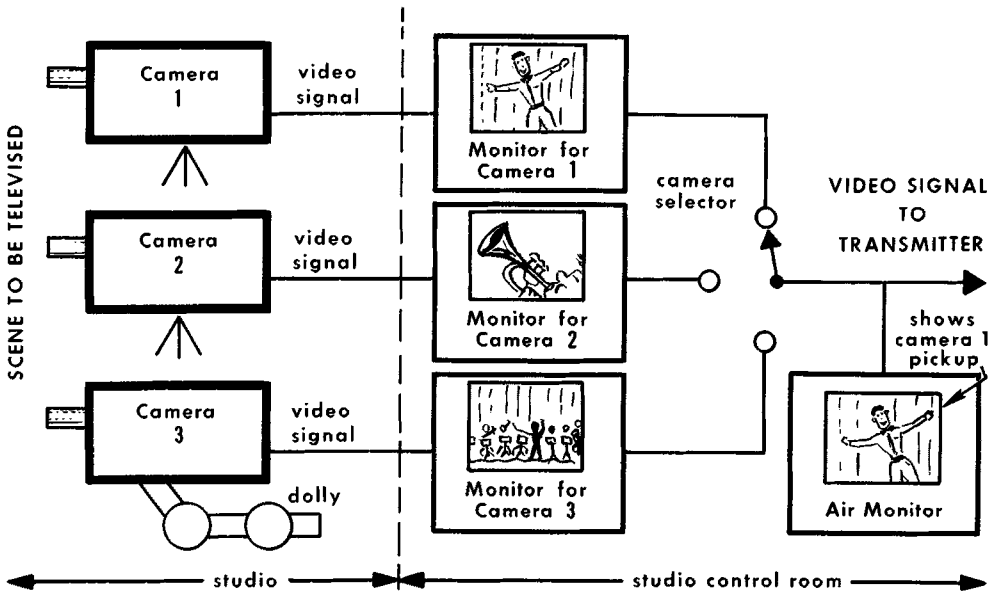

The three-position camera-selector switch is a simplification of the control with which the director selects the scene to be transmitted. We show only three positions because only three cameras are shown. A switching panel allows the director to issue instructions to the individual cameramen, microphone men, and the sound man in the studio. Cables that connect the director with the personnel on stage are not illustrated in the block diagram. The video cables which feed the picture signal from the cameras to their related monitors also contain conductors which supply the electrical energy to each camera. In addition, they permit voice communication between the men on the stage and in the studio control room.

REVIEW

1. *Production.* A television show can be successful only when all of the people and elements involved in the production are functioning with perfect coordination.

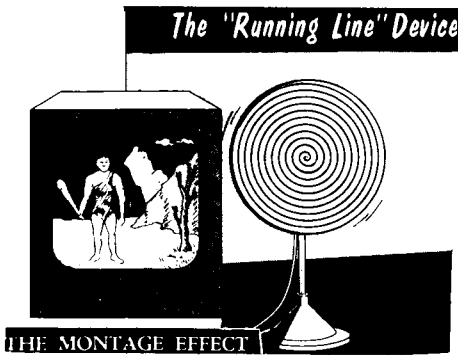
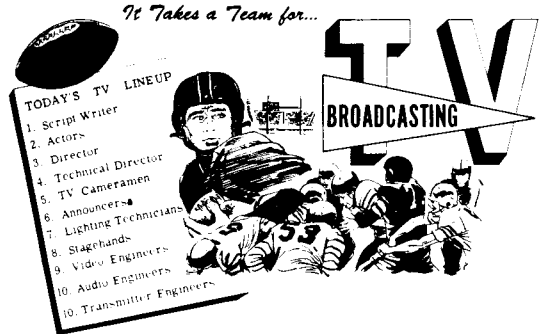

2. *Techniques.* Much of the effectiveness of television results from judicious use of electronic "tricks" worked with the camera and/or lenses, and "sleights of hand" involving mechanical aids.

3. *The Lens* is the beginning of the action of the camera, as the camera is the beginning of the televised scene. Many cameras are fitted with a four-lens turret, each valuable for a special purpose.

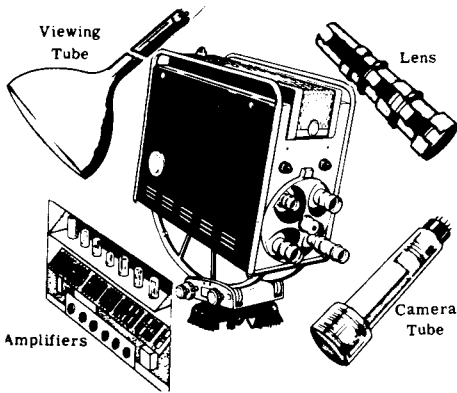
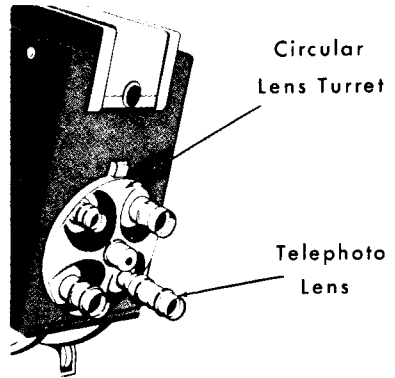

4. *Television Cameras* consist of four sections: lenses which pick up the image; the camera tube which converts light energy into electric energy; amplifiers; and the camera-man's viewing system.

REVIEW

5. *The Vidicon Camera* is the smallest and most versatile television camera. Originally developed for outdoor and portable uses, it is now being adapted for regular studio purposes.

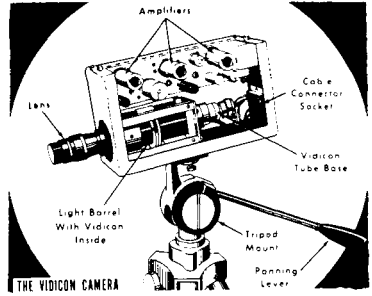

6. *The Television Studio* is unique for its vastness and complexity. Many sets are in operation simultaneously — one for a show on the air, others for shows in rehearsal.

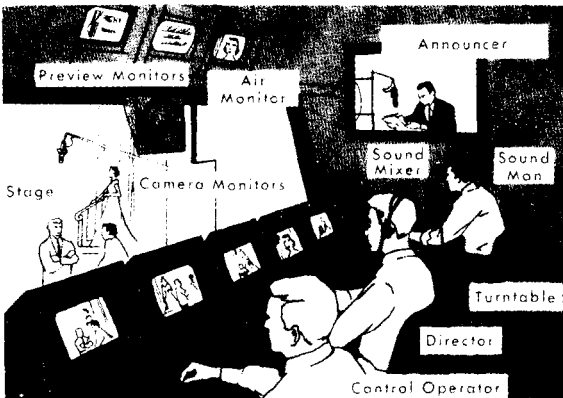

7. *The Director* carries the ultimate responsibility for the program. He works in the studio control room with control operators. Displayed in front of him is the output from each camera. He selects, via the master switching panel, the pickup he wants transmitted.

THE SOUND SIGNAL

Tracing the Sound Signal

Let us now begin to examine how the sound and picture signals advance from the studio to the transmitting antenna. We shall deal first with the sound signal.

Whenever possible, microphones are placed out of sight; behind flowers, desk equipment, the folds of a dress, statues or any available prop. Stage directors have been very successful in this attempt to maintain illusion and prevent distraction, without sacrificing the quality of sound pickup. Even the color of the microphones is given consideration; those worn by narrators or interviewers who walk about the stage during a program, or those visible on a desk, are colored to be as inconspicuous as possible.

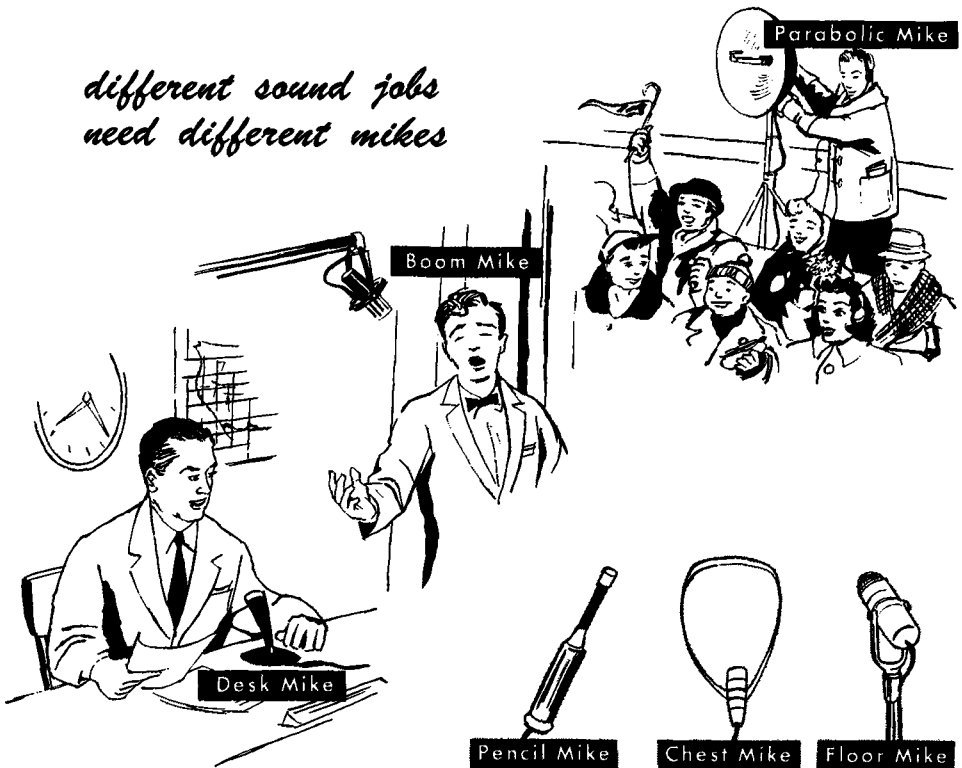

You may have wondered how the sound is picked up when the speaker is seen in a full-length shot with no microphone cables visible. The trick is the use of a miniature short-distance microphone-transmitter. The microphone pickup modulates the tiny transistorized transmitter, which in turn radiates a signal picked up outside camera range.

THE SOUND SIGNAL

Tracing the Sound Signal (contd.)

Now we will construct, step by step, the sound signal block diagram from studio to transmitting antenna.

The Beginning Of The SOUND TRANSMITTER Block Diagram

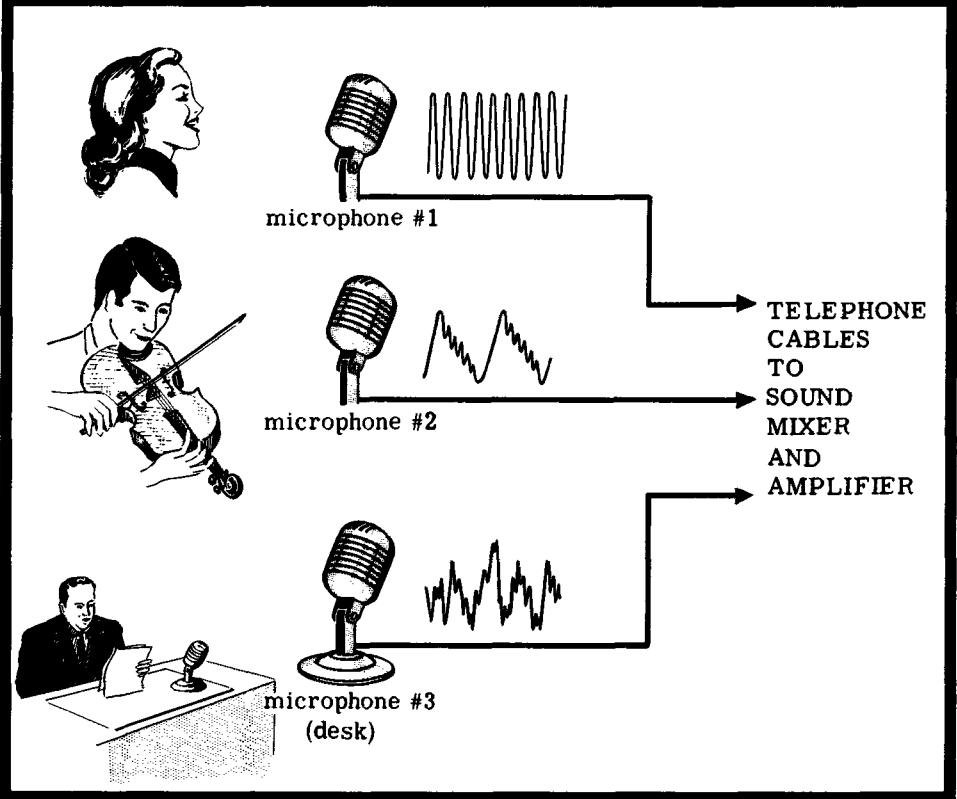

The microphones, waveforms and sources of sound indicated on the block diagram are only symbolic. The sound waves picked up by the microphones are translated into electrical voltages by these devices and fed into the control room through individual audio cables. We show only three microphones but there may be more or fewer in use at any one time. There is no elevated boom-type microphone in this picture, although it is a frequently used device.

THE SOUND SIGNAL

Adding the Sound-Mixer Amplifier

Microphones seldom pick up the required level of audio energy, and it becomes necessary to control the level of the microphone output. Provisions for raising or lowering the level to suit a particular situation are part of the audio amplification process—a function of the mixer-amplifier.

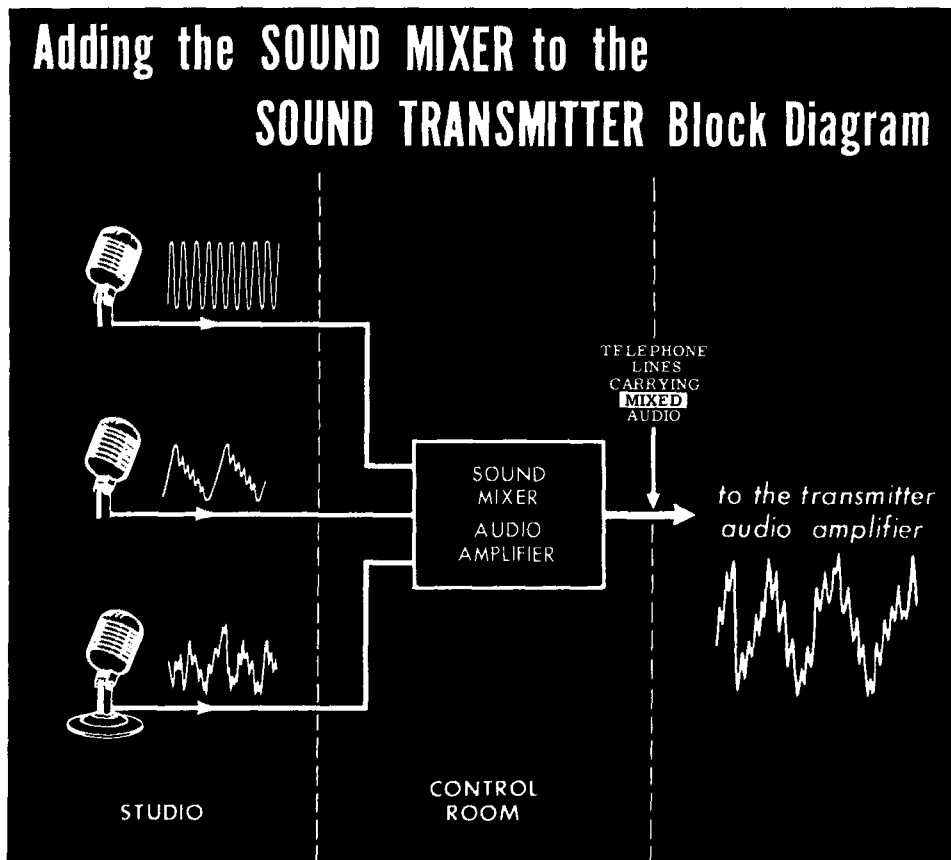

Still another function of the mixer is suggested by its name. Regardless of how many sources of sound are part of the televised scene, and how many microphones are used to pick up these sounds, it is a composite of *all* of them that becomes the audio voltage which modulates the carrier wave transmitted to the receiver. All the microphones feed into the mixer. There the input level of each microphone signal is individually controlled and fed into a common amplifier. The result is piped over telephone lines to the transmitter to be amplified more and applied to the f-m carrier.

THE SOUND SIGNAL

Producing the Frequency-Modulated Sound Carrier

Radio theory teaches that effective radiation of an audio-frequency signal is possible only by modulating the radio-frequency carrier with the audio signal, and then radiating the modulated carrier.

In standard radio broadcasting one method of combining the intelligence with the radiated carrier is *amplitude modulation*. The superimposition of the audio signal on the radio-frequency carrier results in a final carrier which is *constant in frequency* but *varies in amplitude* in accordance with the instantaneous variations of the audio-modulating voltage. This is described by saying that the *envelope* of the amplitude-modulated carrier has the same outline as the instantaneous variations of the audio voltage.

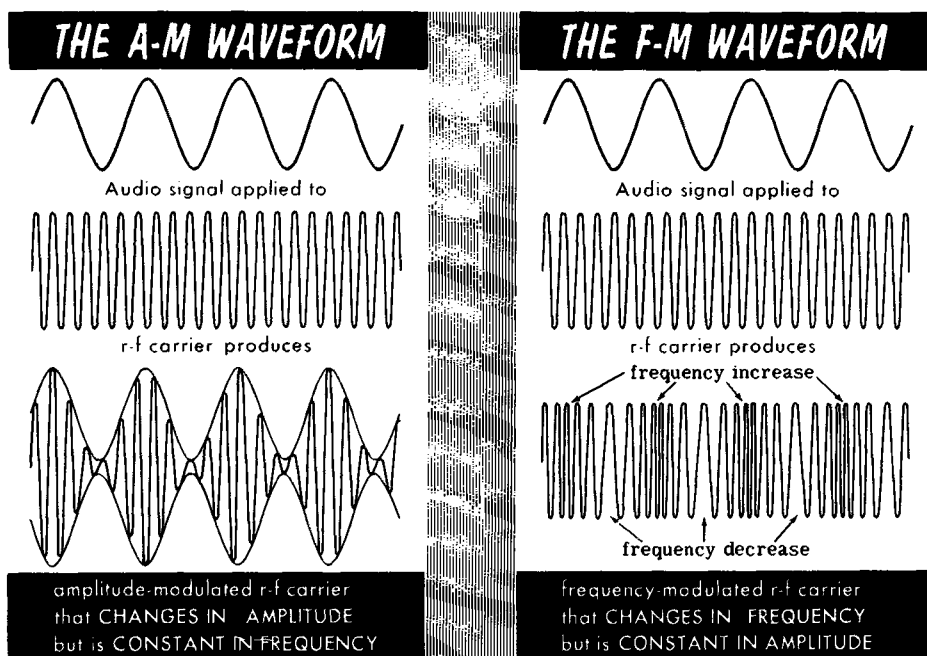

Another method of transmitting intelligence by electromagnetic waves is to convert the audio voltage that is to be transmitted into frequency variations of the radio-frequency radiated carrier. This process delivers the sound portion of the television broadcast to the viewer. Such modulation is called frequency modulation and produces a radio-frequency carrier which is *constant in amplitude* but *varies in frequency* within certain maximum limits determined by the system design. The increase and decrease in frequency is a function of the *loudness of sound*, (amplitude of the modulating voltage), whereas the *rate of change* of frequency is a function of the frequency of the *audio modulating voltage*.

THE SOUND SIGNAL

Producing the Frequency-Modulated Sound Carrier (contd.)

A very simple example will illustrate the special language that is related to frequency modulation. Assume a TV channel 5 signal. Its sound carrier frequency allocation is 81.75 mc. In the *absence of any modulation* this radiated sound carrier has the constant or "resting" frequency of 81.75 mc.

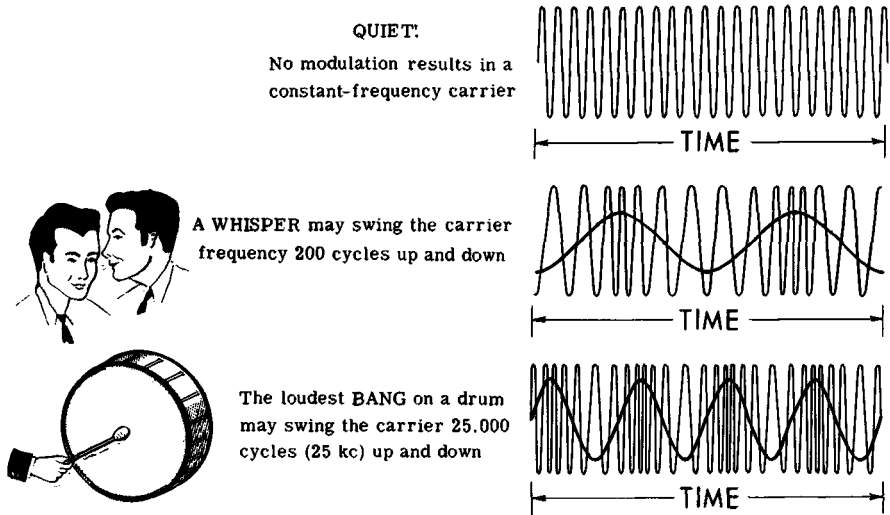

Frequency Modulation

The change in carrier frequency during frequency modulation is known as frequency deviation. When the frequency increases above the resting frequency it is known as positive deviation; when the frequency decreases below the resting frequency it is called negative deviation. The change in frequency is also called *swing*. If, for instance, a whisper at the input to the sound system results in a carrier frequency change of 200 cycles above and below the stated 81.75 mc, the frequency of the carrier swings 200 cycles in each direction, or has a total swing of 400 cycles from 81.7498 mc to 81.7502 mc.

On the other hand a sound loud enough to produce 100% modulation of the frequency-modulated carrier would, according to American standards, raise and lower the frequency by 25,000 cycles (25 kc)—an overall swing of 50 kc. The channel 5 sound carrier with a resting frequency of 81.75 mc would then have a low-frequency limit of $81.750 - .025$ mc or 81.725 mc and a high-frequency limit of $81.750 + .025$ mc or 81.775 mc.

THE SOUND SIGNAL

Producing the Frequency-Modulated Sound Carrier (contd.)

In the f-m sound carrier, the reactance modulator and the fundamental-frequency sound-carrier oscillator work as a pair. To explain their functioning, assume again the 81.75-mc f-m sound carrier for channel 5. The FCC requires that the high-frequency carriers used in TV be created by generation of a low-frequency signal (fundamental frequency).

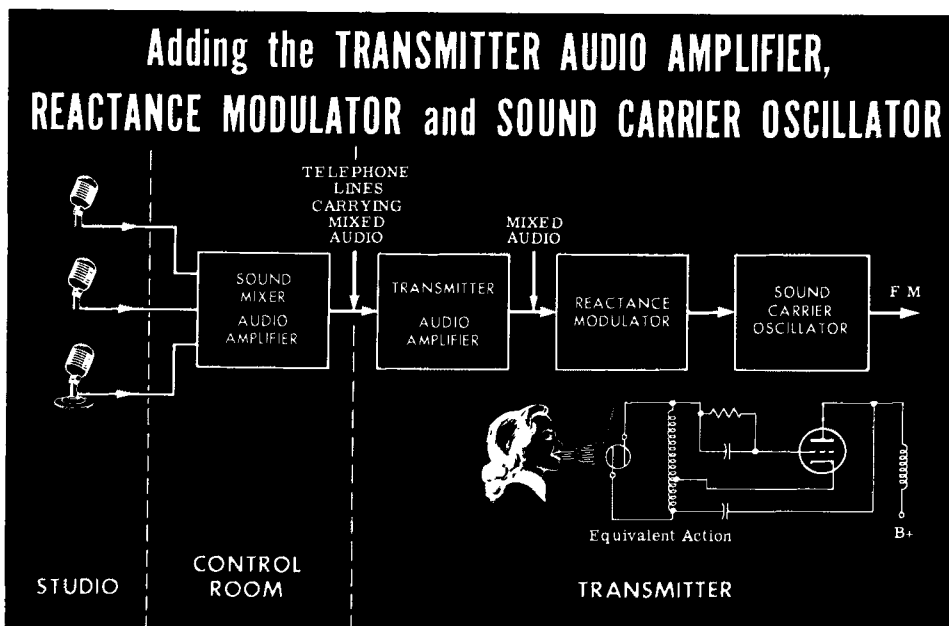

For example, a suitable fundamental frequency for the 81.75-mc sound carrier is 2.5547 mc. This signal is produced in the fundamental-frequency sound-carrier oscillator (called the sound-carrier oscillator). When multiplied 32 times, the required 81.75-mc signal is arrived at. The reactance modulator takes signals from the transmitter audio amplifier, translates the audio voltage variations into frequency changes and impresses them on the sound carrier. The action of the reactance-modulator may be considered as a vacuum tube system which behaves as an automatically variable tuning capacitance that is active in the sound-oscillator circuit. The variation in capacitance follows the audio-signal voltage changes and automatically varies the frequency of the sound-carrier oscillator. Hence the changes in carrier frequency correspond to the loudness of the audio signal, whereas the rate of change of the carrier frequency corresponds to the frequency of the audio voltages. The amount of swing allowed in the sound-carrier oscillator during frequency modulation takes into account the multiplication of frequency later on. This is explained in the pages which follow.

THE SOUND SIGNAL

Producing the Frequency-Modulated Sound Carrier (contd.)

Frequency-Multipliers

The proper frequency for the radiated carrier is arrived at by frequency-multiplication of the signal frequency of the sound-carrier oscillator.

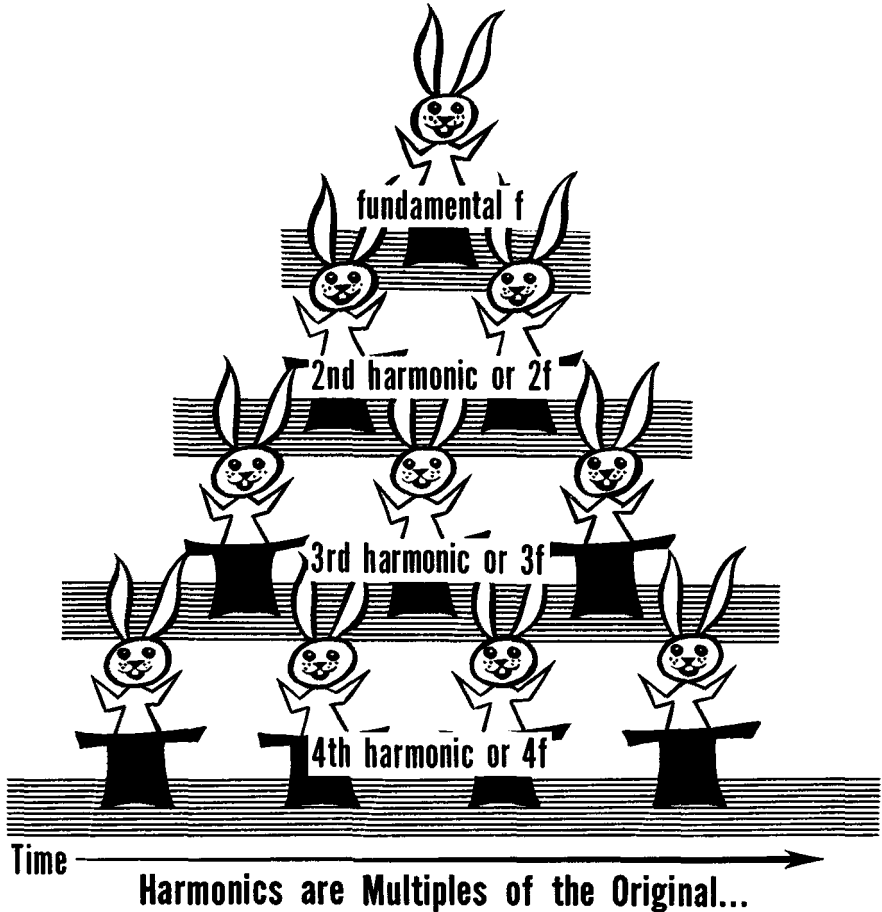

A conventional vacuum tube oscillator generates not only the fundamental-frequency voltage for which it is designed but also a host of other voltages at frequencies known as *harmonics* or *harmonic frequencies*. Harmonics are simply voltages whose frequencies are *whole number multiples* of the fundamental frequency. Assume for the moment a fundamental frequency (f) of 2.5 mc. The second harmonic or $2 \times f$ will have a frequency of 2×2.5 or 5 mc; the third harmonic or $3 \times f$ will have a frequency of 3×2.5 or 7.5 mc; the fourth harmonic or $4 f$ will have a frequency of 4×2.5 or 10 mc, etc. Depending on the equipment, harmonics up to the 200th may be useful.

THE SOUND SIGNAL

Producing the Frequency-Modulated Sound Carrier (contd.)

The fundamental-frequency oscillator is followed by an amplifier which accepts all the frequencies present in the oscillator output. But because it contains a tuned circuit in its plate circuit, resonant to the second harmonic of the fundamental, the amplification is effective only on the second harmonic. Such an amplifier functions as a frequency-doubler. Its output signal frequency is equal to twice the frequency fed to the input.

Amplifiers... when used

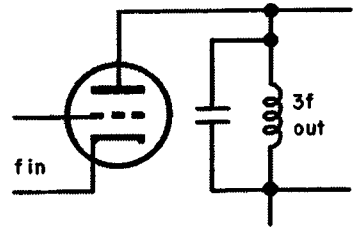
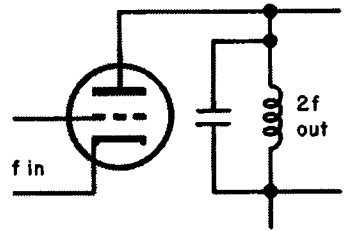
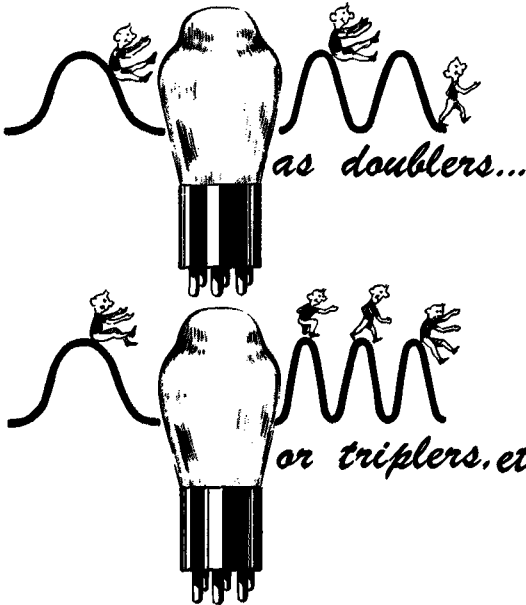

are Frequency Multipliers

In similar manner an amplifier may be arranged to amplify the third harmonic of an input frequency, in which case it is acting as a frequency-tripler, or it may select the fourth harmonic for amplification and then is a frequency-quadrupler. When referred to in broad terms such amplifiers are frequency-multipliers. Two, three, four or more frequency-multipliers may follow each other, thus affording an overall frequency-multiplication of whatever amount is needed. Each amplifier is arranged to accept whatever frequency is fed into it and to distort the signal, thus creating harmonics within the amplifier stage. The tuned plate circuit then selects the harmonic desired for transfer to the next frequency multiplier.

THE SOUND SIGNAL

Producing the Frequency-Modulated Sound Carrier (contd.)

A series of frequency multipliers raises the frequency-modulated sound-carrier oscillator output signal to the desired value (as determined by the FCC allocation of the sound-carrier frequency) to a television station. Assuming channel 5 as the station being discussed, the allocated sound-carrier frequency of 81.75 mc can be achieved by generating a 2.5547-mc fundamental frequency in the sound-carrier oscillator and multiplying this frequency 32 times; $2.5547 \times 32 = 81.7504$ mc, in round numbers 81.75 mc.

The 32-time multiplication can be accomplished in several ways: in three steps such as $2 \times 4 \times 4$ using a doubler and two quadruplers. The signal outputs would have frequencies of 2×2.5547 or 5.1094 mc, 4×5.1094 or 20.4376 mc and finally 4×20.4376 or 81.7504 mc. Or four frequency-multiplier stages such as $2 \times 4 \times 2 \times 2$, or $2 \times 2 \times 2 \times 4$ could be used.

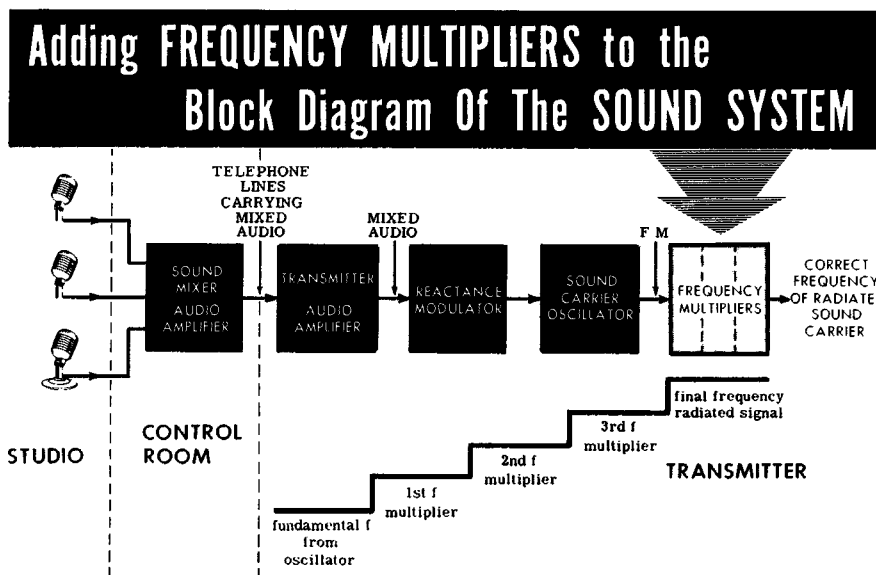

There is one very significant detail that relates the amount of frequency-multiplication applied to the fundamental sound-carrier frequency to the change in frequency corresponding to the frequency-modulated radiated sound carrier. Inasmuch as the maximum change in frequency of the radiated sound carrier is 25 kc in each direction for 100% modulation, 32-time multiplication of the fundamental frequency limits the frequency changing action by the reactance-modulator on the sound-carrier oscillator signal of 2.5547 mc to $1/32$ of 25 kc or 781 cycles. If the amount of frequency-multiplication is different, the frequency change corresponding to 100% modulation of the fundamental sound-carrier oscillator is modified.

THE SOUND SIGNAL

The F-M Sound Power Amplifier

There is just one more amplifier stage that the frequency-modulated sound carrier must pass through before it is "put on the air." This is the power amplifier. To make certain that the radiated signal has ample strength when it reaches the receiver, the amount of electrical energy fed to the transmitting antenna must be of a prescribed level. Achieving this is the function of the tuned power amplifier stage, which makes use of high-power tubes. Depending on the power output rating of the transmitting station, these power amplifiers may be rated from a few thousand watts to perhaps 25 to 50 kw.

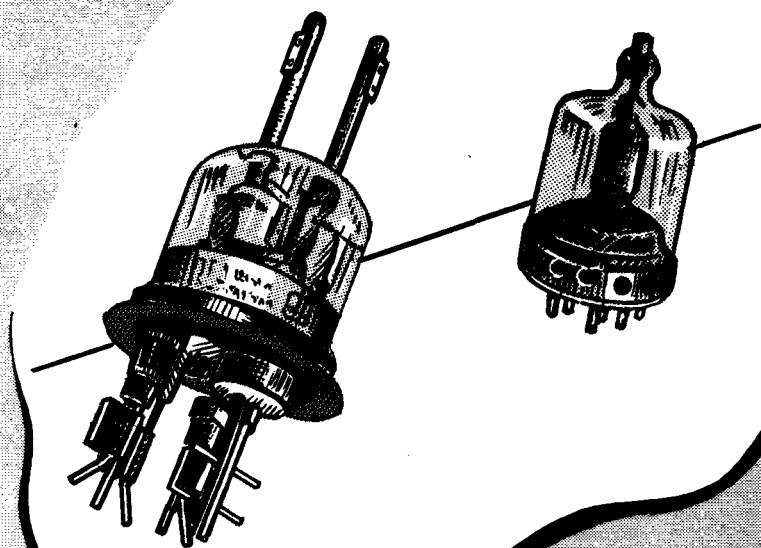

**POWER AMPLIFIER TUBES
of the TELEVISION TRANSMITTER**

(1-29)

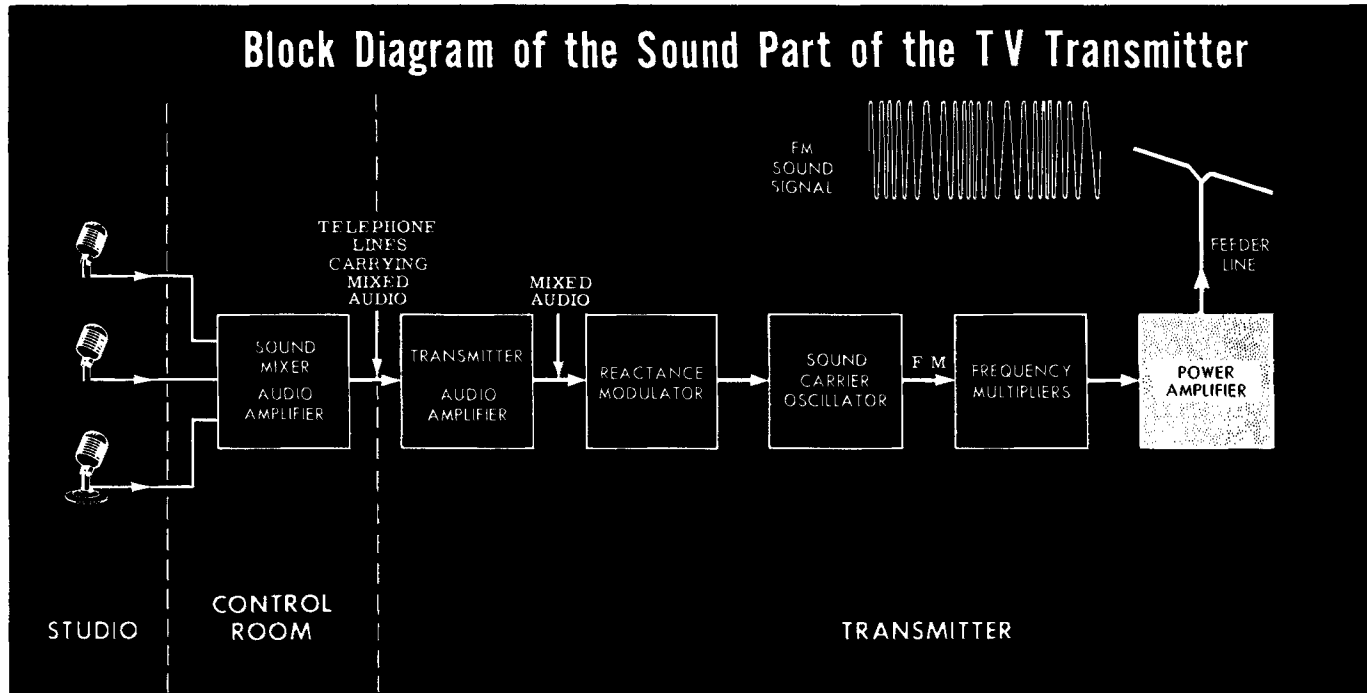

THE SOUND SIGNAL

Complete Sound System in TV Transmitter

This block diagram of the sound system in the television transmitter is more of a symbolization than an attempt to show exactly the amplifier stages. Some transmitters use a single antenna for radiating the sound and the picture carriers. Others use separate

antennas for putting the two signals on the air. The feed line between the power amplifier and the antenna is an r-f transmission line capable of carrying the required amount of r-f energy. Details about transmission lines are given later in the course.

THE PICTURE SIGNAL

The Picture System

The start of the picture system in the television transmitter is the camera. The heart of the camera is the camera tube. As our first step in the explanation of this tube we shall discuss the most fundamental type of tube which can convert light energy into electrical energy. This is the phototube.

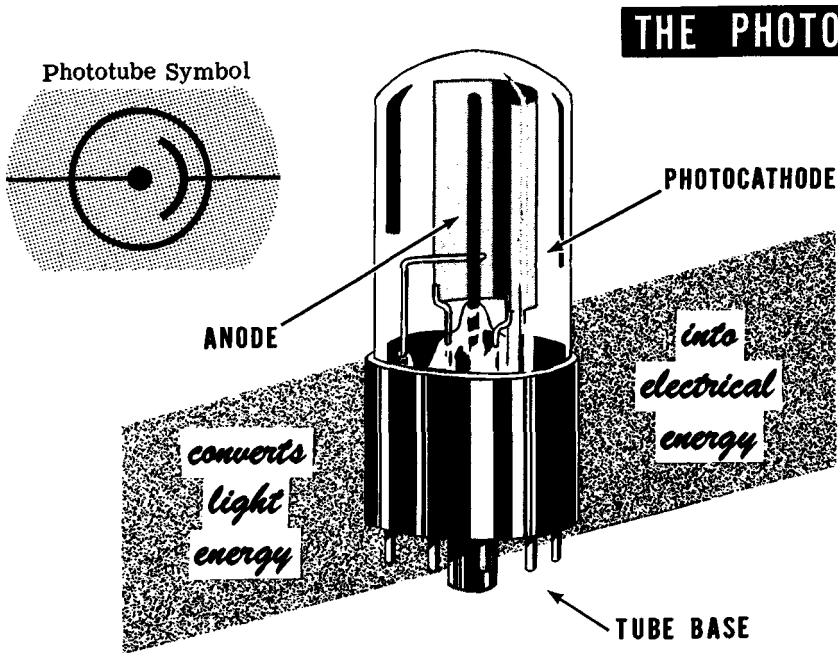

The phototube looks like a conventional radio receiving type of vacuum tube. The semicircular electrode inside the envelope is the photocathode. The upright metal electrode near the curve of the photocathode is the anode. The schematic representation of the tube bears a close resemblance to its physical structure as would be seen from a top view. Electrical connections to the electrodes is by means of conventional tube pins protruding from the tube base—in all respects like the conventional receiving tube base.

The derivation of the word photocathode is the following: "photo" from the Greek meaning light, and "cathode", the name for an emitter of electrons. A photocathode then is simply an electrode bearing a surface or coating which has the property of emitting electrons when struck by light. The anode, on the other hand, is a name assigned to an electrode that attracts electrons to itself by a positive voltage applied to it. In this case it attracts the electrons that are emitted by the photocathode. Thus, a *phototube is a device which converts light energy into electrical energy.*

THE PICTURE SIGNAL

Phototube Circuitry and Functioning

The basic phototube circuit consists of the tube, a load resistor and a source of d-c voltage. A source of light is of course required but it is not a part of the phototube circuit. When light shines on the inner surface of the photocathode the coating emits electrons. The positive d-c voltage derived from the power supply and applied to the anode causes the anode to attract the emitted electrons which flow through the circuit in the direction shown by the arrow. The brighter the light that shines on the photocathode the higher is the amount of current flowing in the circuit. In the absence of any light the phototube current is zero. Since the tube current flows through the load resistor (R) a voltage drop proportional to the tube current is developed across the load. The output voltage is the electrical energy equivalent of the light energy that strikes the photocathode. Hence, the tube is a converter of radiant (light) energy into electrical energy.

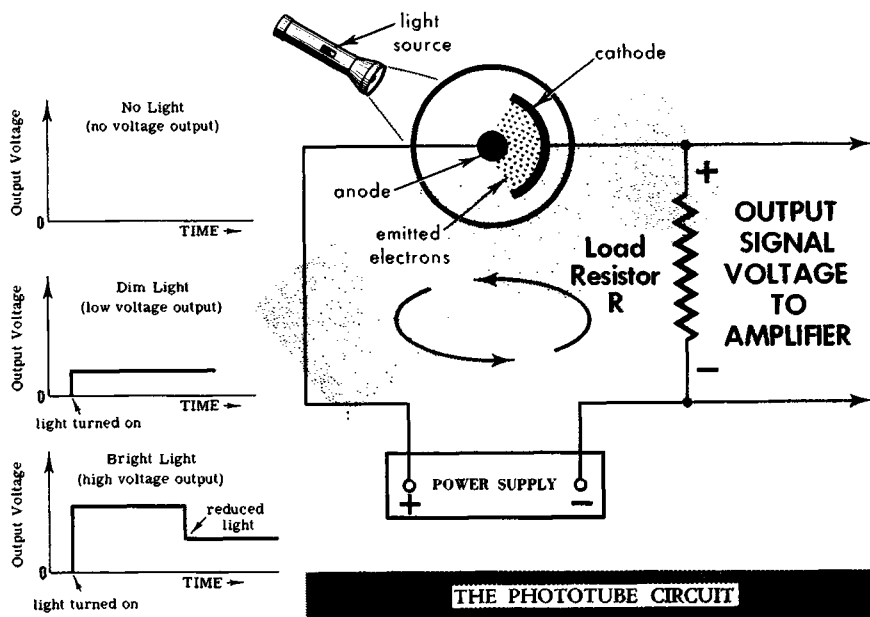

The output voltage graphs symbolize the behavior of the phototube under different conditions of incident light. It is seen that the output voltage is zero when incident light is zero. If the light is dim the output voltage is low; if the light is bright the output voltage is high. A sudden change in light intensity from bright to a lower level results in a corresponding instantaneous change in output voltage. Thus the phototube can produce an output signal voltage which instantaneously increases and decreases in amplitude in accordance with the changes in intensity that strike the photocathode.

THE PICTURE SIGNAL

A Primitive Image-To-Voltage Conversion System

A primitive system for converting the image of an object into video signal voltages will now be discussed. ("Video" is from the Latin, I see.) It is an impractical system, but useful to us as a foundation for understanding the action in the image pickup tube of a television camera.

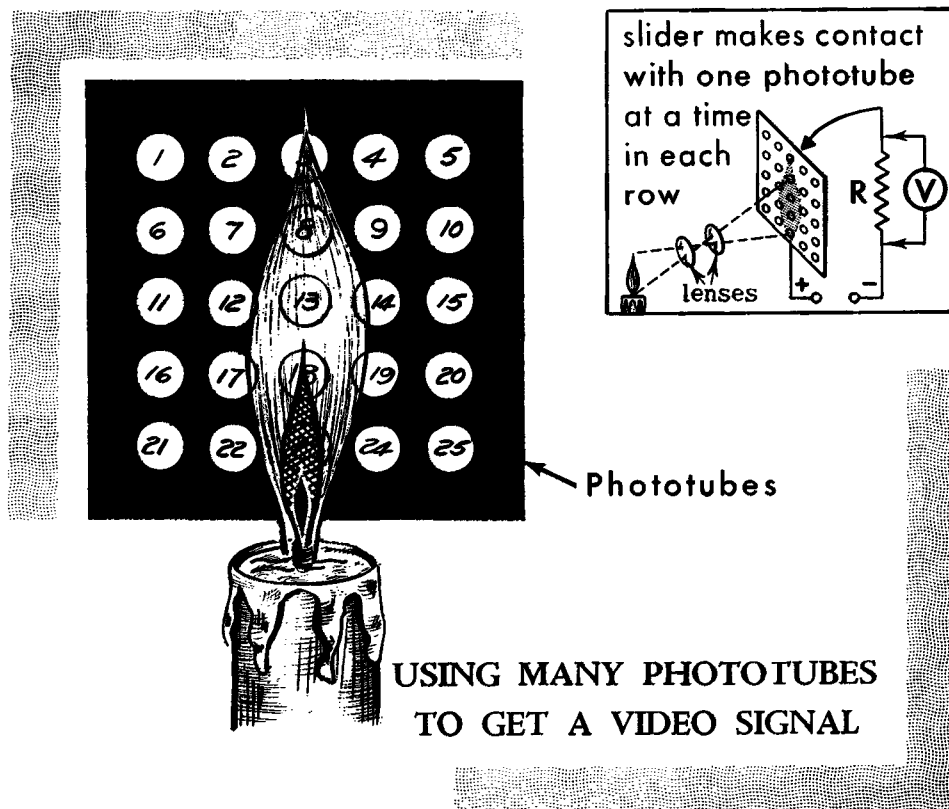

USING MANY PHOTOTUBES TO GET A VIDEO SIGNAL

Imagine 25 small phototubes assembled on a board located in back of a lens system. All the anodes are connected to the power supply, but the photocathodes (abridged to cathodes) end in separate terminals so that each tube cathode can be contacted individually by a mechanically driven slider. The slider moves along each horizontal row of cathode terminals, contacting one at a time and completing a tube current path. Having completed the top horizontal row it automatically and very rapidly positions to start the next lower row, and repeats the horizontal scan. This action is repeated for each horizontal row, one row at a time. A recording voltmeter (V) indicates the waveform of the voltage drop developed across the load resistor (R).

THE PICTURE SIGNAL

Primitive Image-to-Voltage System

The image that is projected onto our bank of phototubes is that of the flame of a candle. For identification in the discussion we have assigned arbitrary numbers to each of the phototubes. It is seen that the image of the flame covers some of the phototubes completely, others are unaffected, and still others bear only a portion of the image of the flame. This, plus the difference in brightness of the core of the flame, means that light varying in amount from zero to maximum impinges on the phototubes. Each phototube will produce a d-c voltage proportional to the light upon it.

THE VIDEO VOLTAGE GRAPH FOR THE TOP ROW OF PHOTOTUBES

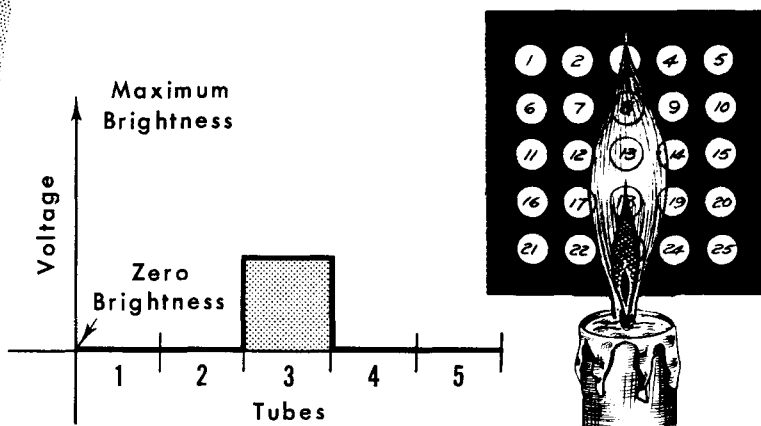

All portions of even the bright parts of the flame are not equally bright, but this elementary system of using a few phototubes cannot resolve segments of parts of the flame. Therefore the output video voltage from each phototube represents the average amount of illumination incident on the photocathode. This limitation in performance does not hinder our examination, for all that interests us at the moment is the development of the output video voltage, horizontal line by horizontal line. The video voltage graph for the top row shows zero voltage output for tubes 1, 2, 4, and 5, and an arbitrary value (less than maximum) for tube 3, which is subject to illumination from only the tip of the flame. The abrupt change of voltage from zero illumination (tube 2) to partial illumination (tube 3) and return to zero illumination (tube 4) results in a straight-line rise and fall of the output video voltage. The interval between phototubes is neglected in this voltage graph.

THE PICTURE SIGNAL

Primitive Image-to-Voltage System (contd.)

We scan each horizontal row of phototubes and develop a series of output video voltages, line by line. The amount of illumination incident on tube 8 (line 2) is greater than tube 3 (line 1). Therefore, the amplitude of the output voltage developed by the current from tube 8 is greater.

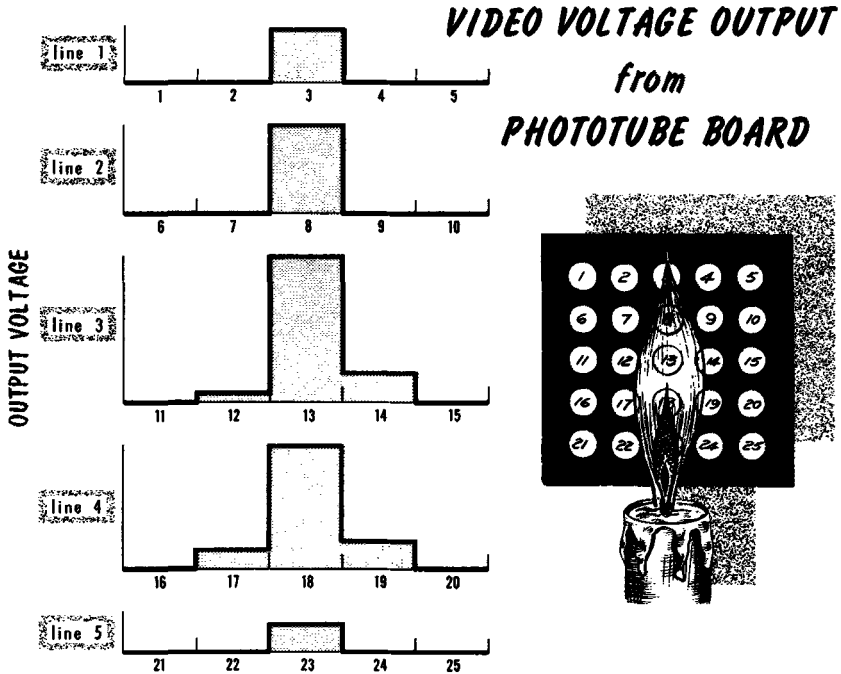

Looking at line 3, tube 12 is subject to just the fringe of the flame, therefore its output voltage is low. Tube 13 is brightly illuminated, therefore the output voltage is maximum. Tube 14 is illuminated less than tube 13 but more brightly than tube 12, so its output voltage is appreciably less than tube 13, but more than tube 12. In the fourth line tubes 17, 18, and 19 are illuminated, but to different amounts, hence the output voltages have different amplitudes. The illumination on tube 18 is partly from the core of the flame, hence the output voltage is less than the maximum, as for example from tube 13. On the other hand tube 17 is subject to more illumination than 12, so its voltage output is greater. The reverse is true of tubes 14 and 19.

Finally we scan line 5. Here only tube 23 is illuminated, and that not brightly, because it is the core of the flame. The output voltage is relatively low. It should be understood that the levels of the video voltages shown are strictly arbitrary and entirely illustrative.

THE PICTURE SIGNAL

Primitive Image-to-Voltage System (contd.)

Let us now elaborate on the primitive system we have shown by increasing the number of phototubes onto which the image is projected. What we shall end up with is not a duplicate of the commercial television camera tube systems, but it will approach the system closely enough to render the entire operation more understandable.

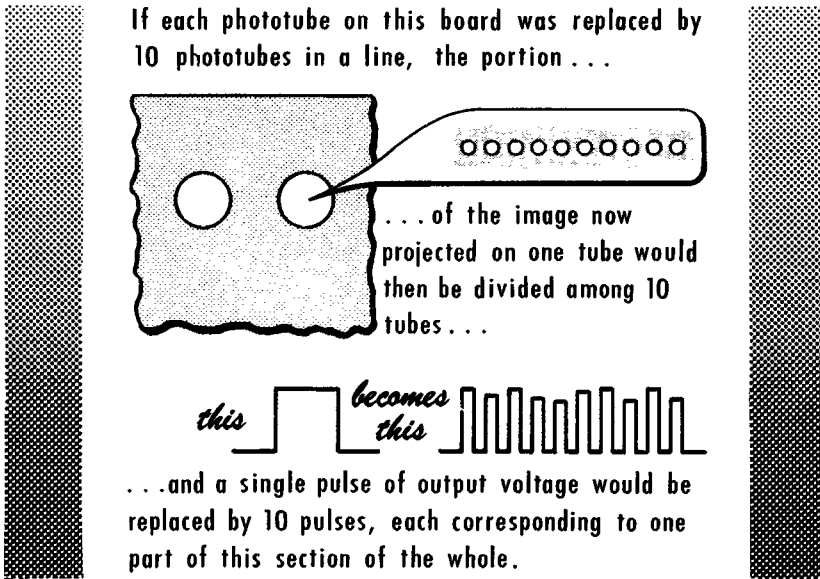

If, in the space previously occupied by one phototube we place 10 phototubes which are each separate from the other, the portion of the candle flame image previously projected onto one phototube now would illuminate 10 phototubes. The illumination on each of these tubes would be representative of a section of that part of the whole flame. Each tube then would produce an output voltage corresponding to a much smaller part of the whole image than when fewer but larger phototubes were used. Differences in brightness of parts of the flame would create voltage pulses of different amplitude, whereas when all of these 10 parts illuminate just one phototube the voltage pulse represents an average of the total illumination. In other words, the greater the number of parts onto which an image is divided the greater is the detail which is possible in the reproduction of the image because each part then produces its own voltage pulse. As will become evident the commercial version of the photocell pickup device as used in the television camera tube divides the image into a great many small elements, many thousands of times more numerous than shown even in this elaboration of the primitive system.

THE ICONOSCOPE

Zworykin's Iconoscope

Vladimir Zworykin, probably the most famous scientist in American television, devoted 10 years to the development of an electronic system that made the primitive phototube board into a practical device. Inside of an evacuated glass envelope Zworykin placed an assembly of components which formed a highly successful television camera tube. It has been modified since, but we show it here because it is the basis of all television camera tubes.

Zworykin gave the tube the name *iconoscope*, derived from "icon" meaning image and "scope," to observe. He called the phototube board the *mosaic*.

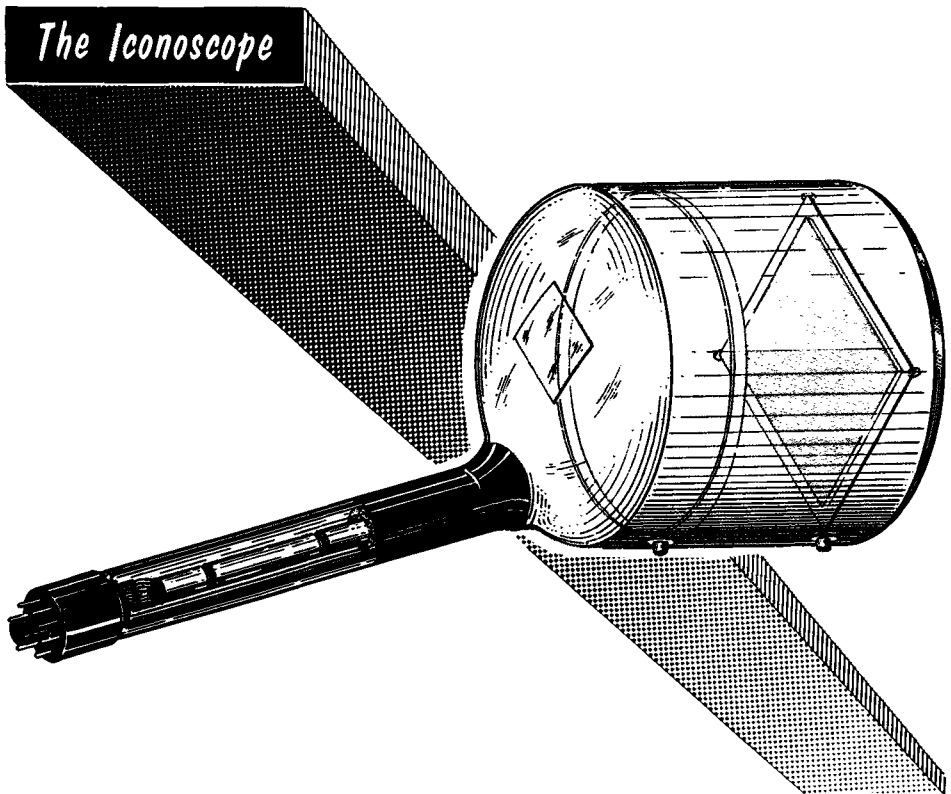

The Mosaic

Strange names such as mosaic are chosen in electronics because of their descriptive meanings. In the world of art, mosaic is the name for a pattern formed by inlaying small pieces of colored stone, glass, or other material.

THE ICONOSCOPE

The Iconoscope (contd.)

The mosaic in the iconoscope actually consists of millions of tiny drops of photosensitive compound deposited on one side of a thin sheet of mica. Each photodroplet is capable of emitting electrons when struck by light, so in effect we have millions of tiny phototubes arranged on the mica sheet. On the other side of the mica sheet is a thin coat of conducting graphite called the signal plate. The mosaic board resembles a sandwich, with light-sensitive cells on one side, the signal plate on the other side, and nonconducting mica in between. In every sense this arrangement is equivalent to a capacitor. In fact each photodroplet and the corresponding area of the signal plate does comprise a tiny capacitor. Thus the mosaic board is made up of millions of tiny photoemissive capacitors with one active surface of each capacitor, the signal plate, common to them all.

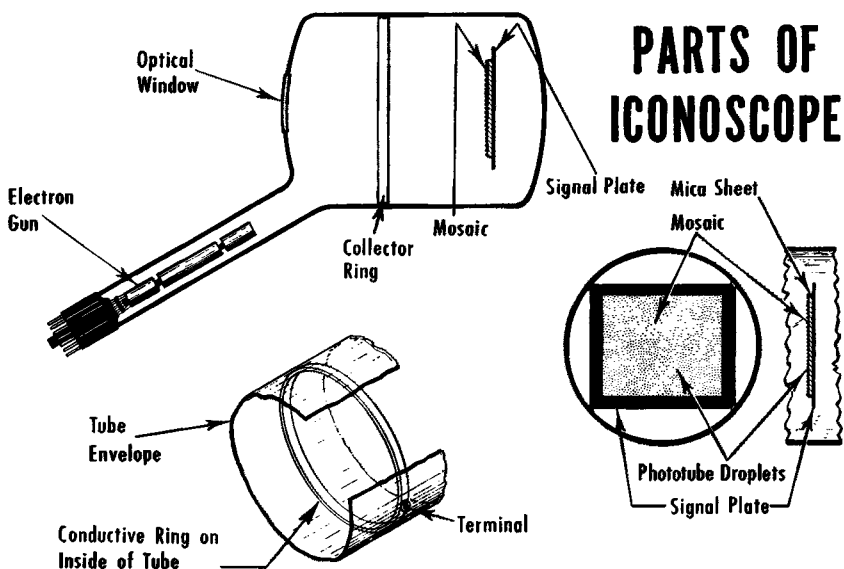

The Collector Ring

You will recall that every phototube has an electron-collecting electrode, the anode. A similar electron-collecting device common to all the photodroplets is part of the iconoscope, and called the collector ring. It is a metallic coating in the form of a narrow ring on the inside of the iconoscope envelope and is located a short distance from the mosaic. Each photodroplet, together with the collector ring, forms a tiny phototube in which the droplet is the photocathode and the collector ring is the anode. Zworykin's mosaic, with its millions of phototubes, is the professional version of the primitive phototube board. With so many picture element pickups, it is capable of developing a highly detailed picture.

THE ICONOSCOPE

The Iconoscope Circuit

In every way the iconoscope is more elaborate than a simple phototube, and its electrical system is far more complex. So that we may easily understand its functioning we shall divide the action of the iconoscope into two parts: the illumination of the mosaic by the scene, and the electron-beam scanning-action. The former is related to the storage of the image on the mosaic, the latter is related to the conversion of stored picture information into picture voltage pulses. Associated with these actions is the behavior of each photo-droplet and the signal plate as a tiny capacitor.

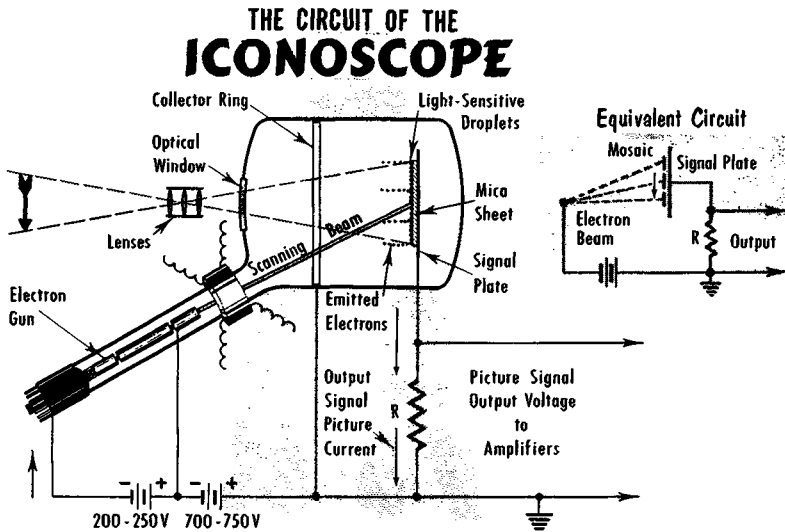

Assume that an image is projected onto the photodroplets. Each tiny phototube will emit electrons in proportion to the amount of light incident on it. The emitted electrons are attracted to the collector ring. At the same time there occurs a redistribution of electrons through the external circuit between each droplet and its corresponding facing area on the signal plate. In other words, each tiny capacitor becomes *charged*. The charge corresponds to storage of that portion (element) of the picture illumination which was incident in the droplet.

The electron gun in the iconoscope produces a very narrow pencil of electrons. It is aimed at the mosaic and by suitable means (deflection, to be explained later) the electron beam moves (scans) horizontally across the photodroplets, describing one very thin horizontal line at a time. The scanning electron beam replenishes the electrons lost by each photodroplet, that is, it suddenly discharges each photoemissive capacitor. The discharge current is the picture current that flows through the load resistor (R) and develops the picture signal output voltage applied to the amplifiers.

THE ICONOSCOPE

The Electron Gun

The electron gun is aptly described by its name; it is an assembly of components designed to create a thin, dense beam of electrons and to propel them at high velocity at the target. In this instance the target is the mosaic. Heated to a high temperature by an associated incandescent heater, the cathode emits electrons in abundant supply. The quantity of electrons which makes up the beam is determined by the control grid, an electrode lying in the path of the emitted electrons and located near the cathode. Having passed the control grid the electrons enter two cylindrically shaped electrodes, anode 1 and anode 2.

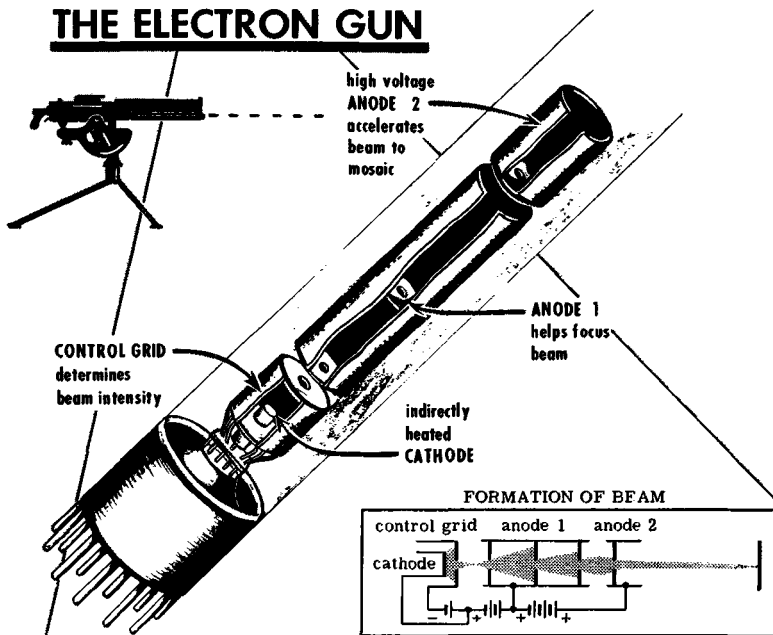

Both anodes are subject to d-c voltages, positive with respect to the cathode. They exert an attracting force on the electrons and propel them towards the mosaic. The voltage applied to anode 1 is much less than that applied to anode 2. Because of the shapes of these electrodes and the voltages applied, the electrons moving from anode 1 towards anode 2 become densely packed into a thin beam. The action is called focusing. It results in an electron beam that has a very narrow diameter (about .015 inch) at the point where it strikes the mosaic. In addition to aiding the focus, the high positive voltage applied to anode 2 causes electrons to advance towards the mosaic at a high speed. As indicated in the illustration, the complete electron gun assembly is located inside the neck of the tube.

THE ICONOSCOPE

The Deflection Yoke for the Iconoscope

The electron beam in the iconoscope releases picture information stored in the mosaic's photodroplet capacitors. It moves across the entire surface of the mosaic line by line, eventually discharging all the photodroplets. The beam motion is *to and fro horizontally* and *depressed vertically*. Each horizontal excursion and return is lower on the mosaic than the preceding one. Finally the electron beam reaches the bottom, and from there is returned to the top to start the next series of horizontal movements. Such motion of the electron beam across the surface of the mosaic is called *scanning the mosaic*. When the beam performs these movements it is said to be *deflected*.

THE BEAM

is returned a little lower
is returned a little lower
and so on

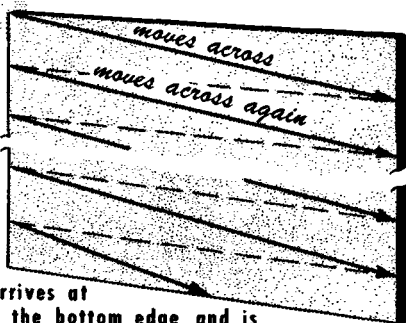

eventually it arrives at the bottom edge and is returned to the top to begin again

The magnetic effects of the deflecting currents push the beam across and back -- and down as well as up.

THE DEFLECTION YOKE

How It Looks

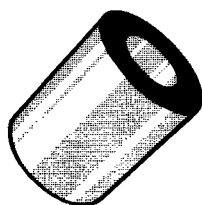

The Schematic

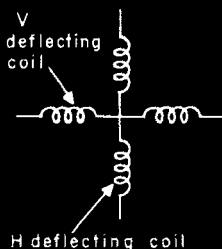

The Magnetic Fields

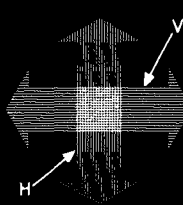

Location of Yoke on Neck of

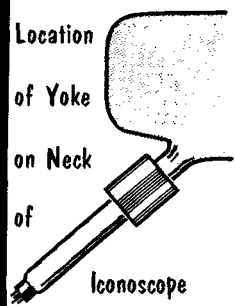

The forces which move the beam horizontally and vertically, (the deflecting forces), are produced by two externally produced magnetic fields arranged to penetrate the neck of the iconoscope and so interact with the magnetic lines of force that encircle the tube's electron beam. The two external magnetic fields originate in the horizontal and vertical deflecting coils which make up the *deflection yoke*. Each coil carries suitable deflection currents. The yoke as a whole is positioned around the neck of the iconoscope.

REVIEW

1. *The Audio System* originates with the microphone. Different types of sound (music, voice, sound effects) necessitate different microphones. After picking up sound waves and translating them into electrical voltages, the mike feeds the audio through a cable into the control room.

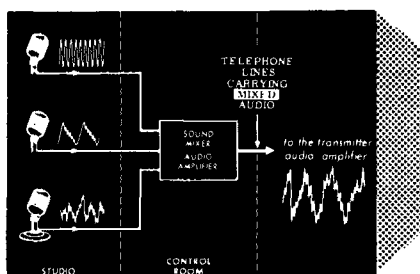
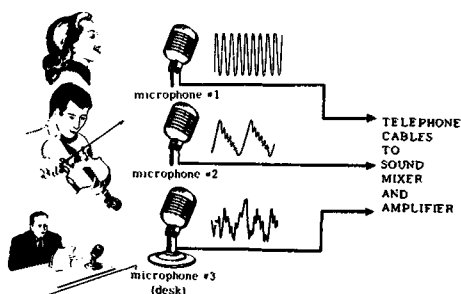

2. *Amplification.* The mixer-amplifier in the studio receives, then amplifies, the sound signal. It also blends several sound sources into one signal. From the mixer, the sound is piped through telephone lines into the transmitter.

3. *Frequency Modulation.* Television audio intelligence is transmitted by fm. With this method, audio voltages are converted into frequency variations of the r-f radiated carrier, which is constant in amplitude but variable in frequency.

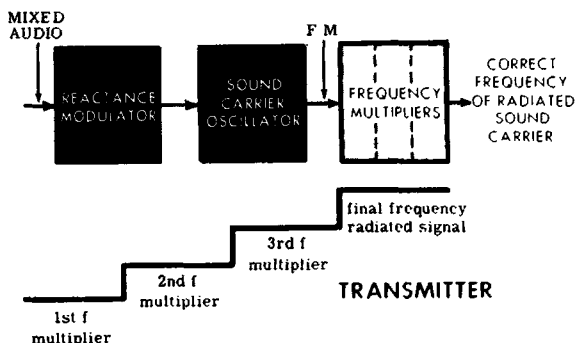
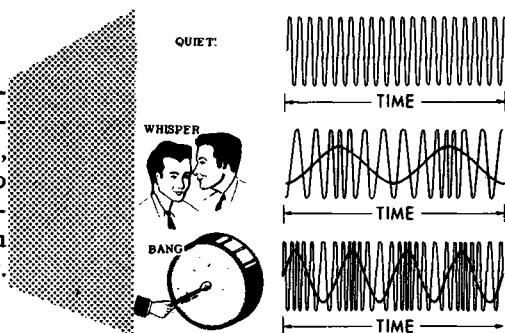

4. *Frequency Multiplication.* The sound-carrier oscillator generates both fundamental and harmonic frequencies. They are sent to a series of amplifiers, each of which is effective on only the harmonic fed to it. A tuned plate circuit selects the harmonic to be transferred to the next frequency multiplier.

REVIEW

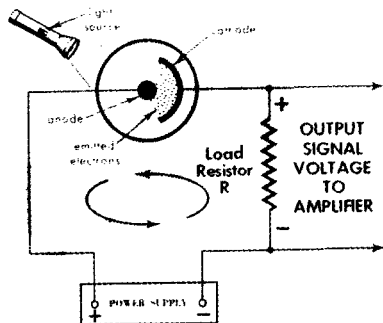

5. *Phototube Circuit.* The heart of the camera is the camera tube. The most basic type of camera tube is the phototube. When light shines on the photocathode, electrons are emitted which are attracted by the anode. The strength of the resultant flow varies with the strength of the original light.

7. *The Iconoscope* uses a *mosaic* — a sheet of mica covered with a photosensitive compound. In the iconoscope, the electron-attracting anode

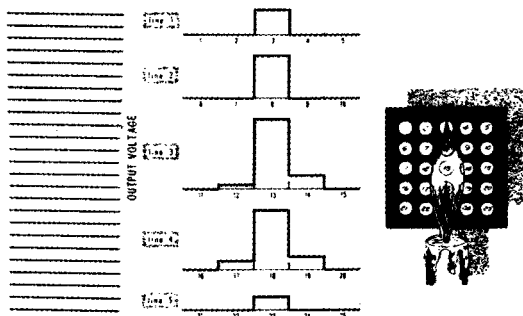

6. *On a Phototube Board* each tube is exposed to one section of the image. A slider is mechanically driven across the terminal of each tube, developing a series of video voltages.

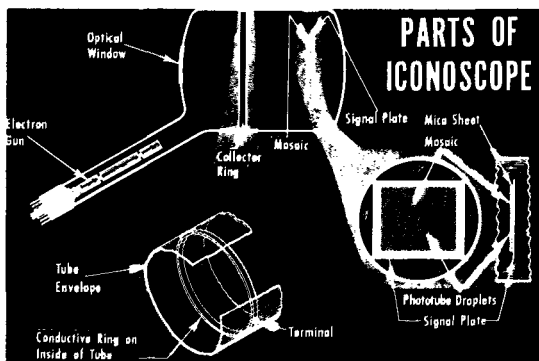

takes the form of a collector ring, a metallic coating inside the iconoscope envelope neck.

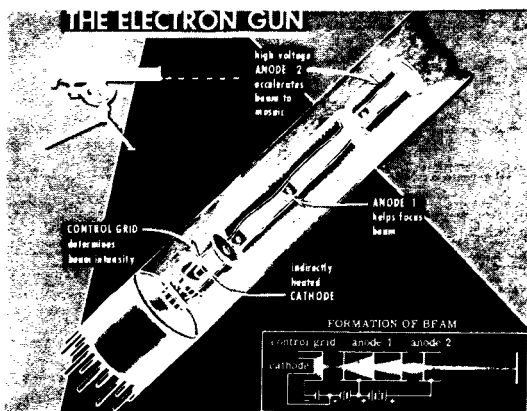

8. *The Electron Gun* directs a beam of electrons, emitted by the cathode, at the mosaic. The electrons pass two attracting anodes of unequal voltages which propel the electrons towards their target, and also cause them to become densely packed, aiding in focus.

THE IMAGE ORTHICON

The Image Orthicon

In many television station studios, iconoscopes are being replaced by another Zworykin development called the image orthicon. One important reason for the decline in popularity of the iconoscope is its lack of sensitivity and the consequent need for intense illumination of the scene. A second, more important reason is its tendency to generate false signals.

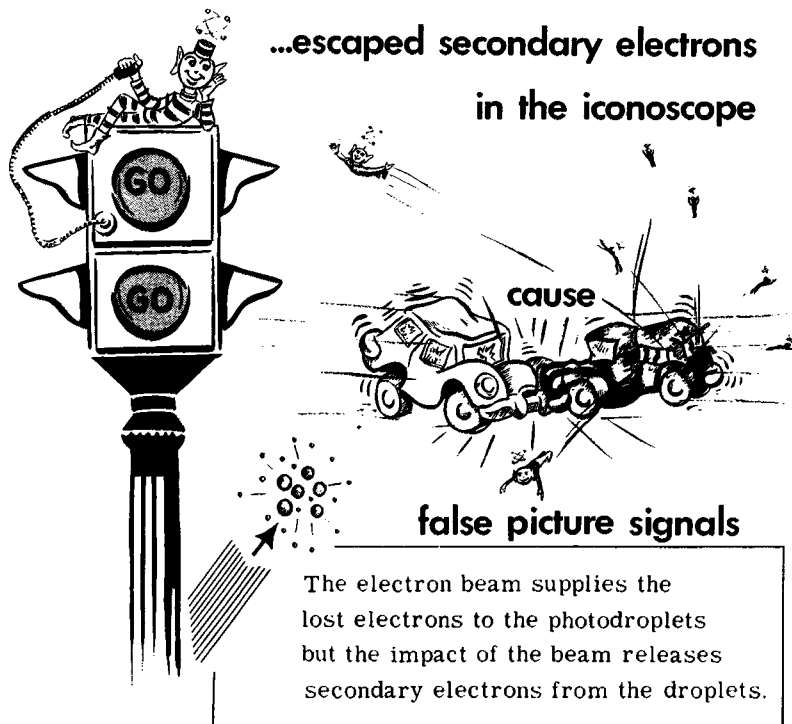

Secondary Emission

The false-signal phenomenon is caused by secondary emission of electrons from the photodroplets. The scanning beam supplies electrons to the photodroplets of the mosaic and so releases the picture information, but the impact of the beam when it strikes the droplets also has another effect. It causes the photosensitive material to emit secondary electrons. They scatter in all directions and fall on neighboring droplets which have not yet been scanned. The result is a charge which is not caused by the image. Thus the total charge on these droplets is not true picture information; when these droplets are discharged by the scanning beam, the result is current due to the image charge plus secondary electron charge.

THE IMAGE ORTHICON

The Image Orthicon (contd.)

Secondary emission that occurs when the scanning beam strikes the iconoscope mosaic is certainly unwanted. Yet there are occasions when secondary emission can be put to good use. In the image orthicon (the camera tube which succeeded the iconoscope) Zworykin used a low-speed scanning beam to avoid the creation of secondary emission. In another part of the tube he used an electron multiplier, an assembly of tube electrodes, which is useful *because* of the secondary emission of electrons. It utilizes secondary emission to amplify the picture information current and thus the image orthicon is a more useful and valuable camera tube than is the iconoscope.

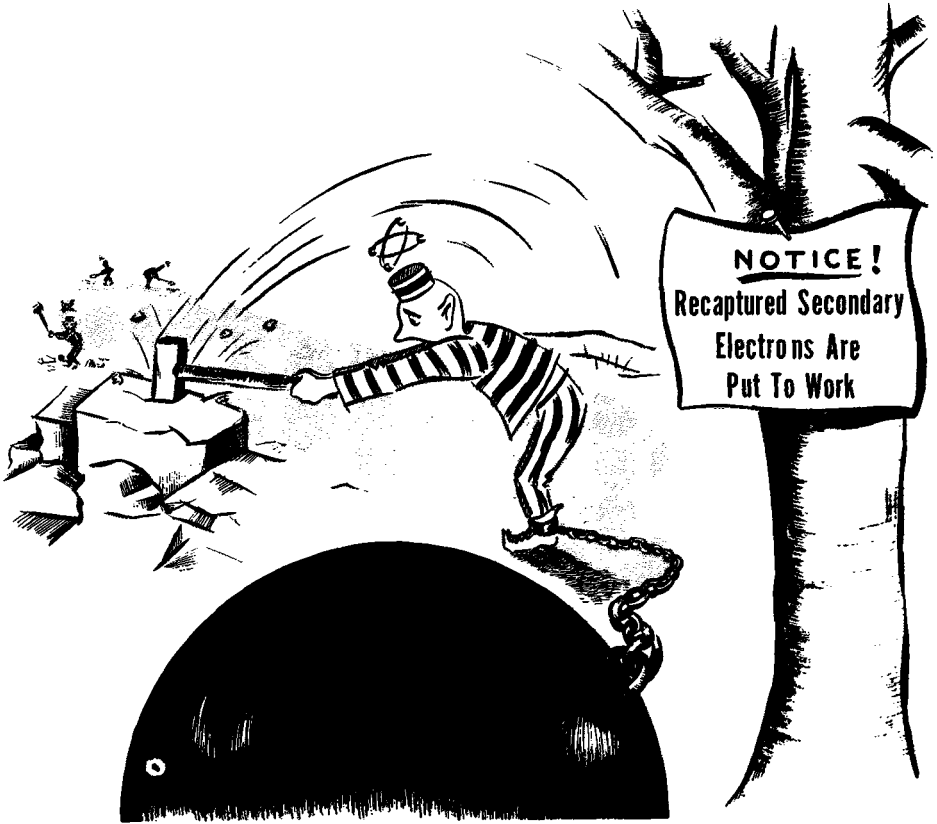

With like amounts of illumination from an image, the image orthicon affords a much greater picture current output than does the iconoscope. A sort of chain reaction situation is created wherein the secondary electrons that are emitted are captured and put to work to cause greater current output than input. This action, repeated several times, occurs in the electron multiplier. In addition to its high current output, the image orthicon is free of false signal output.

THE IMAGE ORTHICON

The Image Orthicon (contd.)

The image orthicon differs from the iconoscope in appearance and mode of operation, but there are some fundamental similarities between the two.

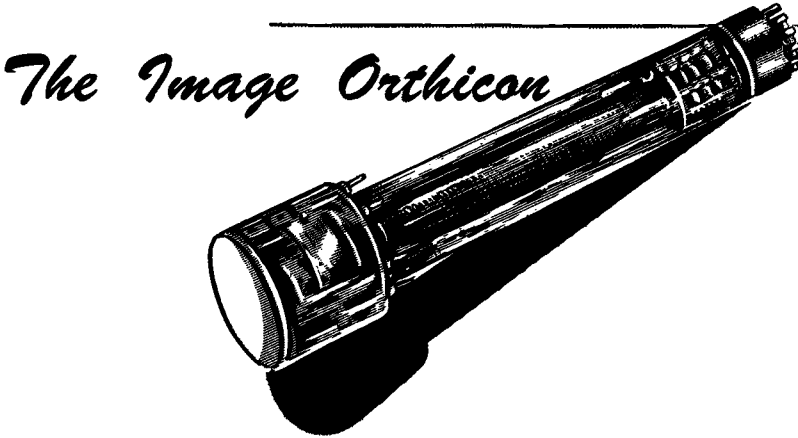

In the image orthicon the neck of the tube containing the electron gun lies along the long axis of the tube, with the electron gun at one end. On the other end is located the optical window through which the rays focused by the lens system are admitted to the tube. Between the two is located

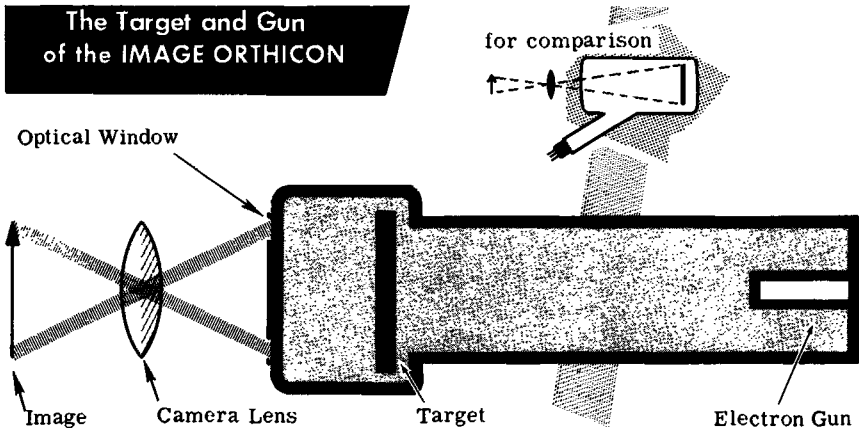

the target. The image is produced on one side of the target in a special manner soon to be described, and the scanning beam originating in the electron gun strikes the other side of the target.

THE IMAGE ORTHICON

Adding the Photocathode

The image orthicon *mosaic* is really two separate electrodes: the *target* that is scanned by the beam, and the *photocathode* which emits electrons when struck by light. The photocathode is a translucent surface located

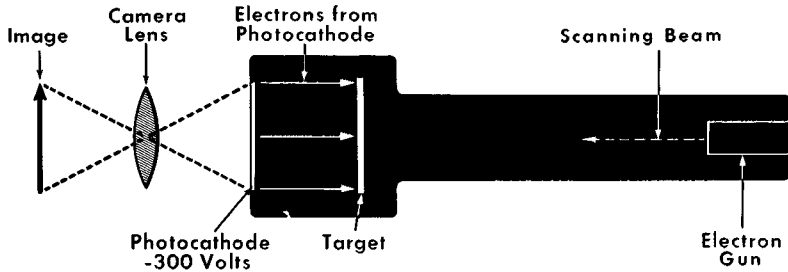

Adding the Photocathode

inside the tube envelope near and parallel to the optical window. The lens takes the light reflected from the object being televised and focuses it, as a sharply defined image, onto the photocathode. As the image falls on the front side of the photocathode the rear surface emits electrons in quantities proportional to the light striking the point. Because the photocathode is negative relative to the target, the electrons advance towards the target.

Adding the Focus Coil to the Tube

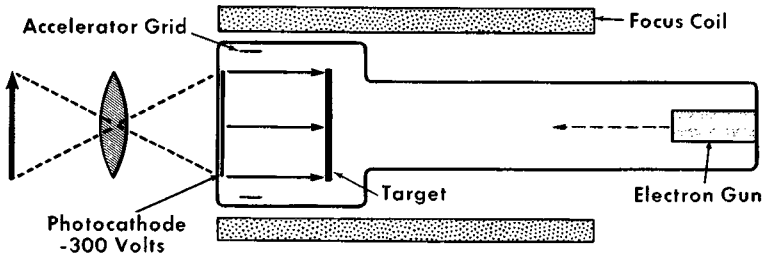

Adding the Focus Coil

The electrons emitted from the photocathode advance towards the target. Proper functioning of this camera tube requires that the electrons move in straight parallel lines. To accomplish this, the tube uses a d-c current-carrying focus coil. The magnetic field created by the current bends all the diverging electrons into the correct paths so they advance between the photocathode and the target in parallel paths.

THE IMAGE ORTHICON

Behavior of the Target

The target is a rectangular sheet of very thin glass, specially composed. Its *surface* resistance is very high in comparison to the resistance *through* the glass from one side to the other. The difference in conductivity along the surface and through the sheet is of great importance.

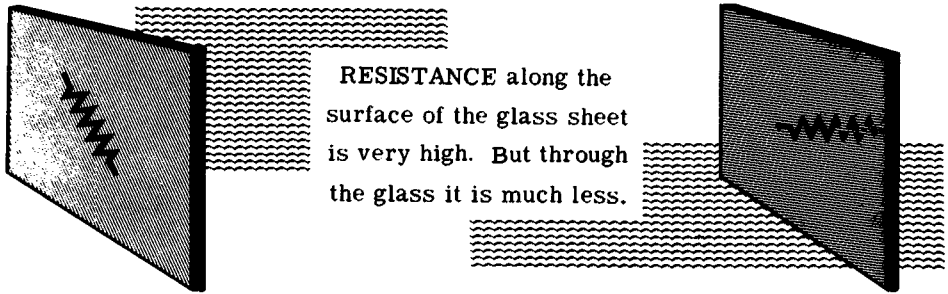

If a beam of electrons strikes a point on the surface of the glass it dislodges secondary electrons from that tiny area, causing a positive charge. Because of the high surface resistance the charged condition remains intact and will neither dissipate nor spread to adjacent areas along the surface. Thus if many individual rays of electrons strike the surface at the same time, there will be created many tiny charged areas, each isolated from the other.

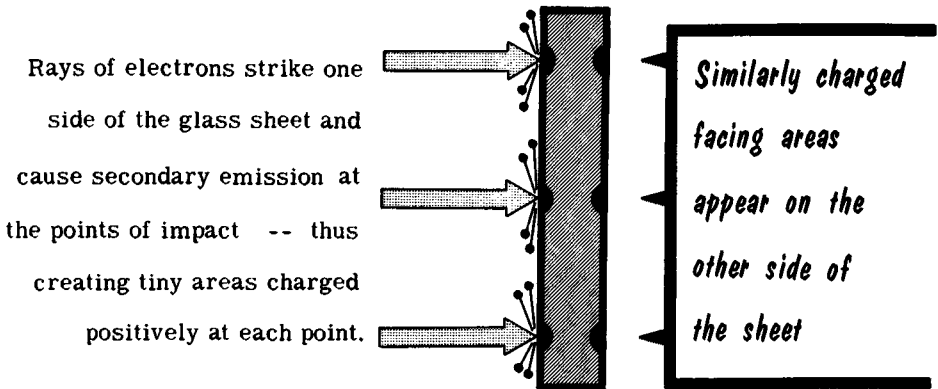

At the same time the thinness of the sheet and the conductivity through the glass causes the appearance of an equal number of similarly charged areas to appear on the other side of the sheet. Each charged area on one side of the sheet faces a charged area on the opposite side of the sheet. The magnitude of the positive charge created at each charged area is a function of the intensity of the electron ray that strikes the glass at each point. The greater the number of electrons in the bombarding ray, the greater the amount of positive charge created at corresponding points on each side.

THE IMAGE ORTHICON

Behavior of the Target (contd.)

The location of the image orthicon target causes it to be bombarded by rays of electrons emitted by the photocathode. The density of each of these rays is determined by the amount of illumination incident on the photocathode at each emitting point. By making the emitted electrons travel in parallel paths after they have left the photocathode, the advancing rays form an electron image of the pattern which is on the photocathode.

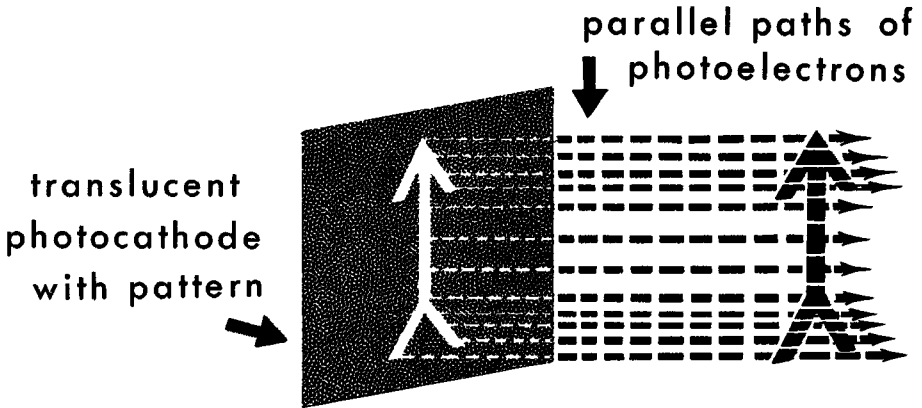

The Formation of the Electron Image

When the electron rays strike the target they form a charge image of whatever pattern is on the photocathode on *both* sides of the target. As we stated earlier the electrons strike the target on the photocathode side only, but the conductivity of the glass results in the reproduction of charge images on the other side of the target. So in a sense the target in the image orthicon is a two-sided mosaic. The reason for this is the removal of picture information by scanning of the mosaic with an electron beam.

The Formation of the Charge Pattern on the Target

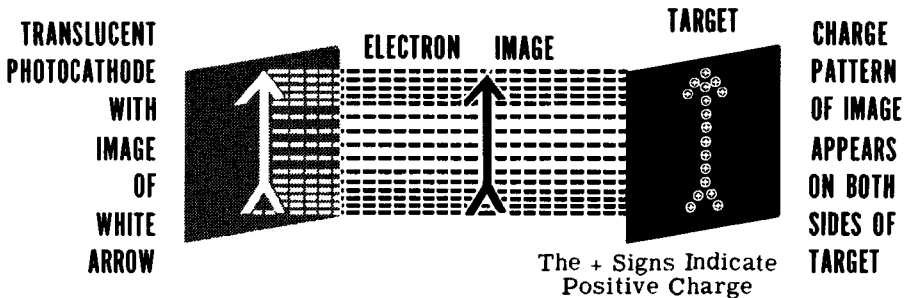

THE IMAGE ORTHICON

The Target Screen

The secondary electrons emitted from the target must be captured. This is done by a screen of very thin wire located near the target. A low voltage of positive polarity is applied to the screen. While the screen is effective in catching the secondary electrons from the target, it does not block the passage of electron rays coming to the target from the photocathode.

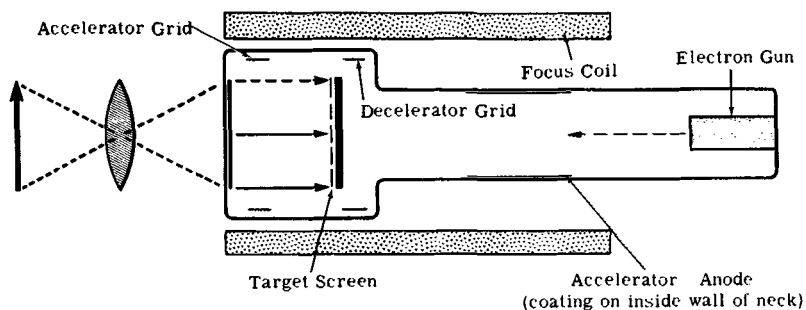

The Accelerator Anode

The iconoscope utilizes a scanning beam that is formed from the electrons emitted by the electron gun. To make the beam move to the target an accelerator anode is included as part of the tube assembly. It is a conductive coating of graphite on the inside wall of the tube neck. A relatively high positive voltage applied to this anode attracts the electrons and accelerates the beam as a whole towards the target.

The Decelerator Grid

Acting under the influence of the high positive voltage applied to the accelerator anode, and without any form of control, the electrons in the scanning beam would strike the target with impact sufficient to free secondary electrons and so defeat the aims of the tube design. To prevent this from occurring a decelerator grid (actually a coating on the inside wall of the tube) is located near the target. A relatively low positive voltage is applied to it. The electron beam leaving the high-intensity electrostatic field of the accelerating anode and entering the low-intensity electrostatic field of the decelerator ring is greatly reduced in acceleration. Thus it strikes the target with sufficiently low impact for the secondary electrons not to be emitted.

THE IMAGE ORTHICON

The Behavior of the Scanning Beam

Although the scanning beam in the image orthicon is produced by an electron gun similar to that used in the iconoscope, and it is moved back and forth across the target by a deflection yoke placed around the neck of the tube, its overall action is quite different from that of the iconoscope.

When the electrons emitted by the gun enter the neighborhood of the accelerating anode they are immediately speeded up. Coming into the field of the deflection yoke, the beam feels a pull (a deflecting force) due to the magnetic fields created by the horizontal and vertical deflecting coils inside the yoke, and it is bent out of its original path towards the target. When the beam enters the area of the decelerating grid it slows down under the influence of the lower-level electrostatic field in the vicinity of this grid, but it still continues on the way to the target. On approaching the target, of zero voltage relative to the cathode, the beam slows up even more.

The Path of the Image Orthicon Scanning Beam

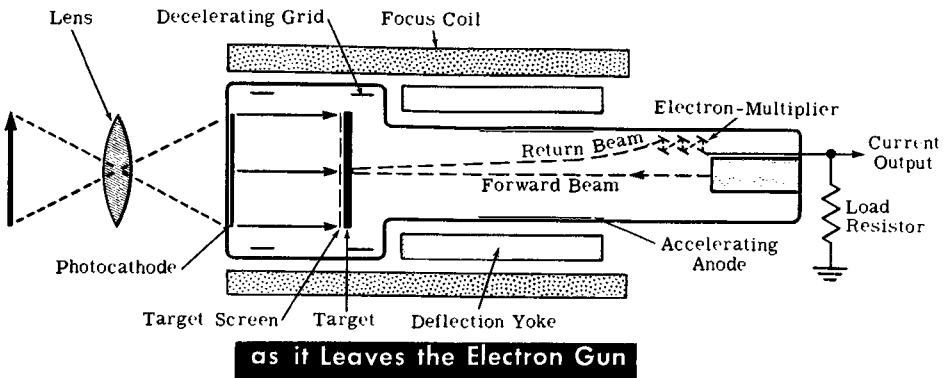

At this point let us divide the rest of the action into two parts. First we shall say simply that the beam strikes the target and in effect bounces off the target. Feeling the pull of the decelerating grid which is at a positive voltage, the beam reverses its direction and moves back towards its point of origin, but not along the same path. Passing the area of the decelerating grid, it feels the urge of the positive voltage applied to the accelerating anode and speeds up greatly, arriving at the collecting electrode. About this we say more later.

THE IMAGE ORTHICON

The Behavior of the Scanning Beam (contd.)

Let us now consider the second part of the action. The beam has arrived at the target at one particular tiny area (A) where a positive charge corresponding to the image exists. The beam gives up as many electrons as are required to neutralize the positive charge at the point of impact. The remaining beam electrons which struck the target leave and move back in the general direction of the electron gun, but not quite to it. This beam now has in it fewer electrons than it had before it struck the target. So at this instant the returning beam is less dense than it was when it began.

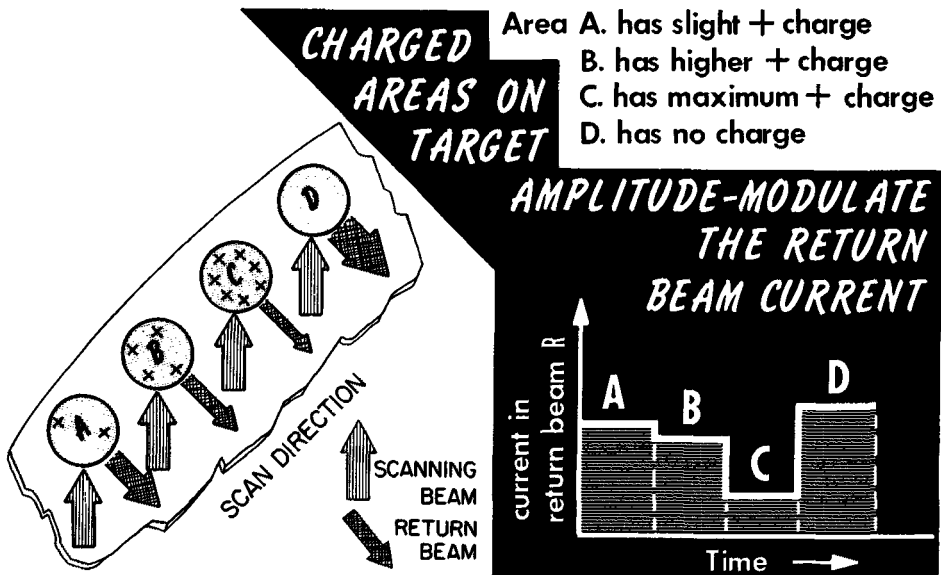

An instant later the beam arriving from the electron gun strikes another tiny area (B) on the target, a point where there is now a greater positive charge. The beam gives up more electrons than before because it requires more electrons to neutralize the greater positive charge. Hence, upon return, the beam contains fewer electrons. Considering only these two instances, and recognizing that the electron beam is a current flowing through space, it is clear that the two return beams represent different amounts of picture current which correspond to the picture content appearing as a *charge image* at the two areas on the target struck by the beam.

If we now visualize the beam moving across the target and striking many points on the target, we can see that the return electron beam will momentarily increase and decrease in density because of the changing amount of electrons it gave up to neutralize the different areas on the target. In effect it will be amplitude modulated by the differences in the charge pattern on the mosaic, which correspond to the light and dark areas of the image.

THE IMAGE ORTHICON

The Electron Multiplier in the Image Orthicon

We have said that one major advantage of the image orthicon over the iconoscope is its greater sensitivity, accounted for by the electron-multiplier portion of the tube assembly. This device is a current amplifier.

The current amplifier consists of a number of metallic surfaces (dynodes) each bearing an increasingly higher positive voltage, and each emitting secondary electrons in abundance when struck by primary electrons. The physical organization of the plates is such that a primary beam (the return beam current) striking one plate causes the emission of secondary electrons which advance to the next plate. There they cause secondary electrons to be emitted in greater quantity, etc. This action is repeated among a number of plates, until the final stream of electrons delivered to a collector plate constitutes a much higher current than the original primary beam current.

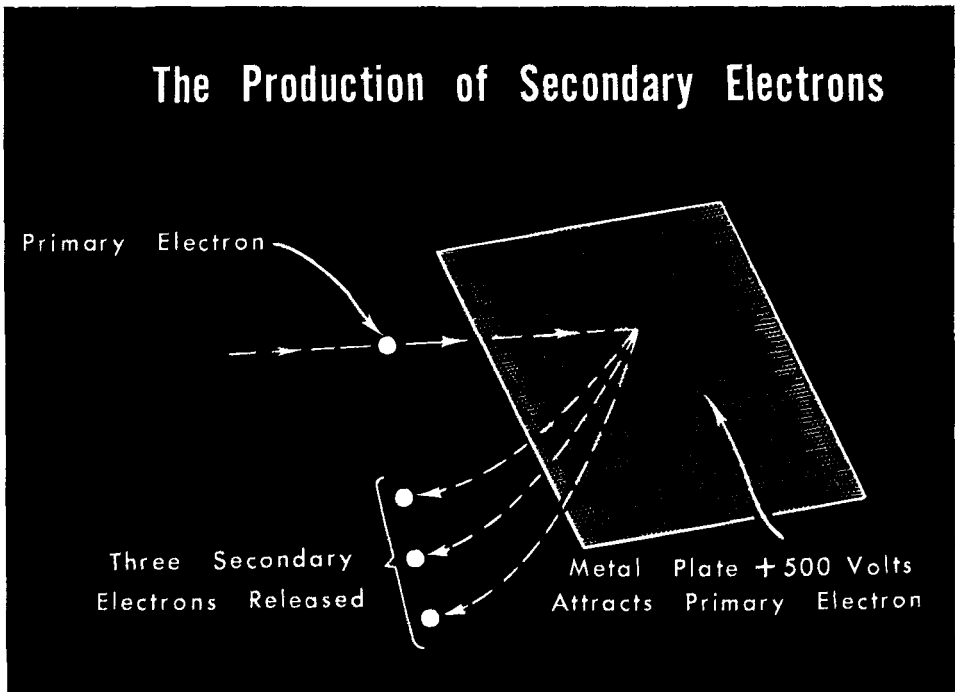

For an illustration, imagine a single electron traveling at high velocity towards a small metal plate. On impact with the metal plate the single electron knocks out three secondary electrons. If we can capture these three electrons, the current they constitute will be three times the primary current, and we will have a simple example of current amplification.

THE IMAGE ORTHICON

The Electron Multiplier in the Image Orthicon (contd.)

Now suppose that we put a second metal plate near the first one and apply a higher positive voltage to the second plate. The three secondary electrons knocked out of the first plate will move at high velocity to the second plate, where each one of them will in turn liberate three new electrons from the surface. Now we have nine electrons in place of three, or if we think back on the single primary electron we have multiplied the current nine times.

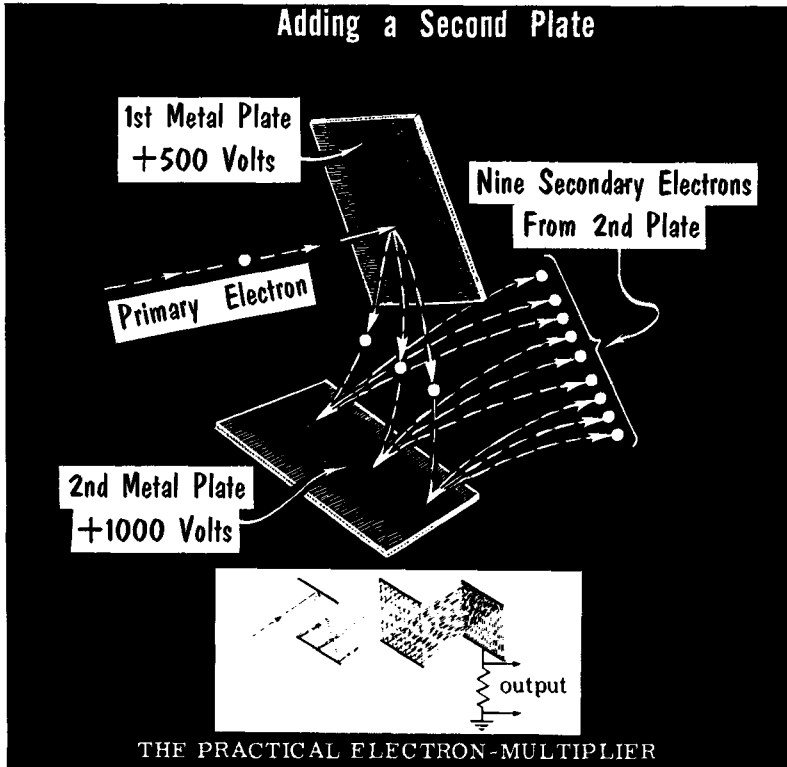

The commercial version of the electron multiplier may have as many as five stages, (stages meaning electrodes which emit secondary electrons). The technical name for each of these metallic emitters is dynode. Current amplification may be achieved as many as 500 times. The last electrode in the assembly is the collector plate which accepts the abundant supply of electrons from the last dynode and passes it out of the tube as picture signal current. It should be understood that whatever variations exist in the primary stream of electrons that strike the first dynode will be maintained in the beam current returning from the target. These variations are repeated in the action which occurs at each dynode, and appear at the collector plate.

THE VIDICON

The Vidicon Camera Tube

The vidicon, a recently developed camera tube, is substantially smaller than the image orthicon. It is highly adaptable to portable field and industrial applications in which the resolution requirements are less severe. This tube requires a scene illumination about eight times that of the image orthicon, but offers great promise where reduced resolution and greater brightness of illumination are not serious handicaps.

The Vidicon Tube and its Structure

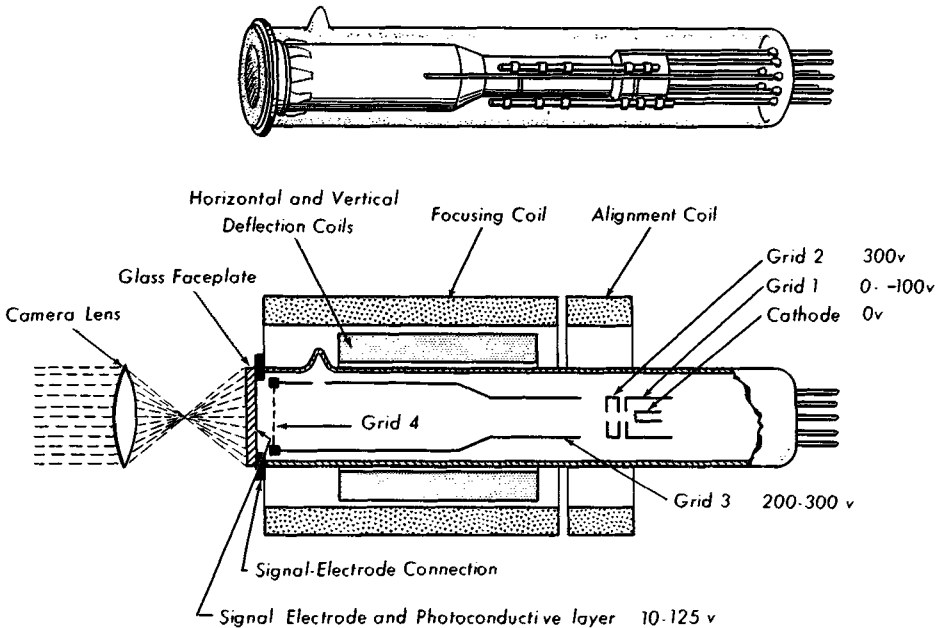

The front of the tube is comprised of three distinct layers going toward the electron gun: the glass faceplate, the signal electrode (which is a conductive film overlaying the inner surface of the faceplate), and a photoconductive layer deposited on the signal electrode.

The photoconductive layer consists of a mosaic of elements which are nonconductive in the dark but become electrically conductive when illuminated. The extent of their conductivity depends upon the intensity of illumination. As the image of the scene falls on the faceplate, the illuminated elements become more conductive and experience a change of voltage, coming closer to the charge on the signal plate. Since the signal plate is positive, a charge pattern develops on the signal plate which electrically duplicates the light image.

THE VIDICON

The Vidicon Camera (contd.)

The beam from the gun: the cathode, grid 1 (control grid), grid 2 (accelerating grid) is focused on the photoconductive layer by the long focusing electrode (grid 3) and the wire screen (grid 4) immediately in front of the inner surface of the faceplate. Scanning is accomplished by external deflection coils, and additional fine focusing by the focusing and alignment coils.

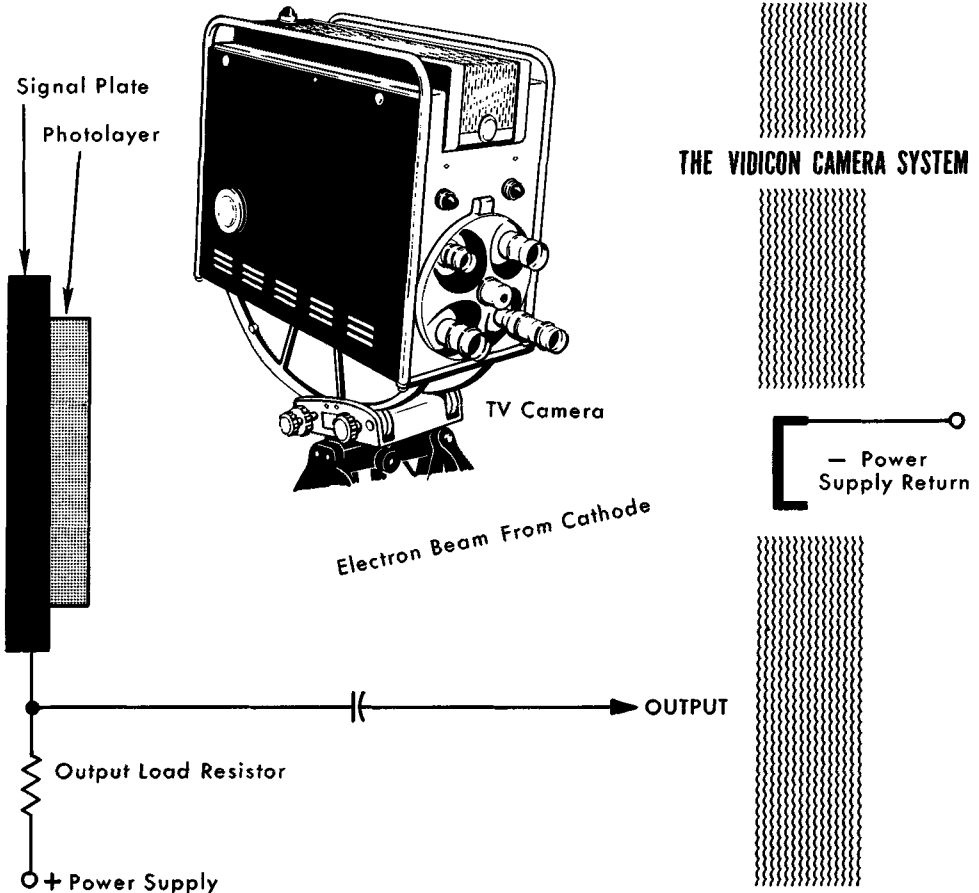

As beam electrons reach the photoconductive layer some are absorbed to neutralize the positive charges that reside there due to the image, and excess electrons are discarded. The varying amounts of electron-absorption produce a current in the load resistor of corresponding intensity. The signal voltage drop across this resistor then serves as the camera output voltage, which is transferred through the coupling capacitor to the succeeding video amplifiers.

THE ELECTRON BEAM

How A Magnetic Field Deflects an Electron Beam

The fact that magnetic fields can exert physical forces underlies the operation of many electrical devices.

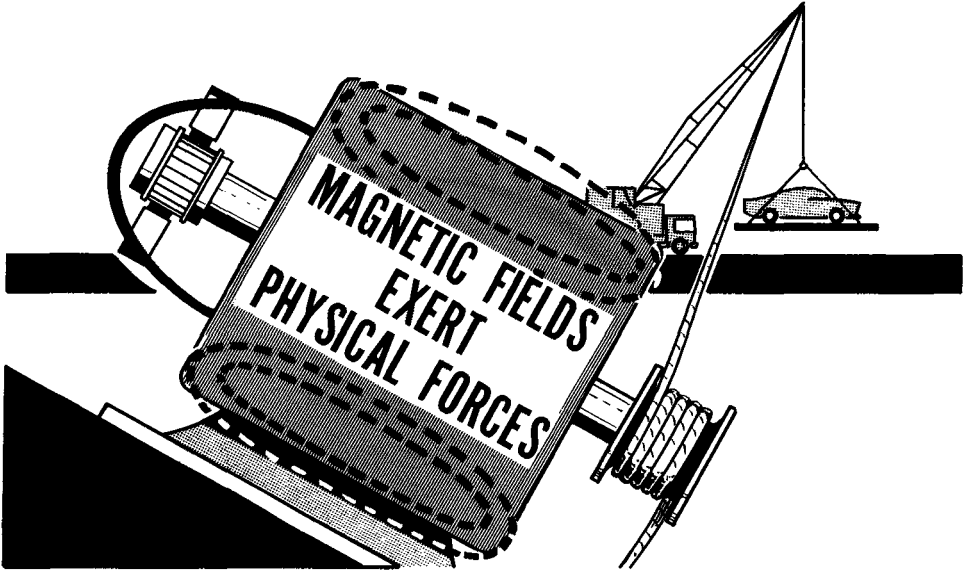

Basic electricity teaches that a wire carrying current is encircled by magnetic lines of force which have a direction determined by the direction of the current. (The direction of the magnetic field is based on the electron flow concept.) The same principal applies to the electron beam. The electron

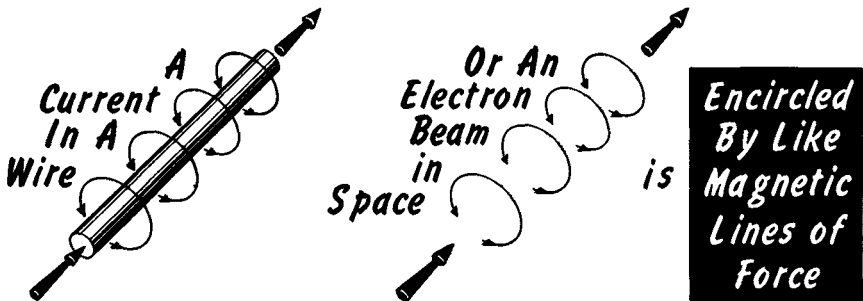

beam is an electric current traveling through space (the vacuum in the tube) rather than through a conductor. It too is encircled by magnetic lines of force whose direction is determined by the direction in which the beam is propelled, that is, the direction in which the current is moving.

THE ELECTRON BEAM

How A Magnetic Field Deflects an Electron Beam (contd.)

There is a direct similarity in behavior between a current-carrying conductor located in a magnetic field and the electron beam which is projected through a magnetic field. In both instances the electron current is at right angles to the direction of its own magnetic field and we assume that it is at right angles to the externally produced field. An example of the current-carrying conductor in a magnetic field is found in the electric motor. An electron beam in a magnetic field is found in the cathode-ray tube typified by the iconoscope, the image orthicon, and the conventional television receiver picture tube (kinescope).

In the case of the electric motor, the external magnetic field is produced by current passing through coils wound on a core made of magnetic material; in the case of the cathode-ray tube the external magnetic field is produced by suitable currents passing through the deflection coils, only one of which is shown here.

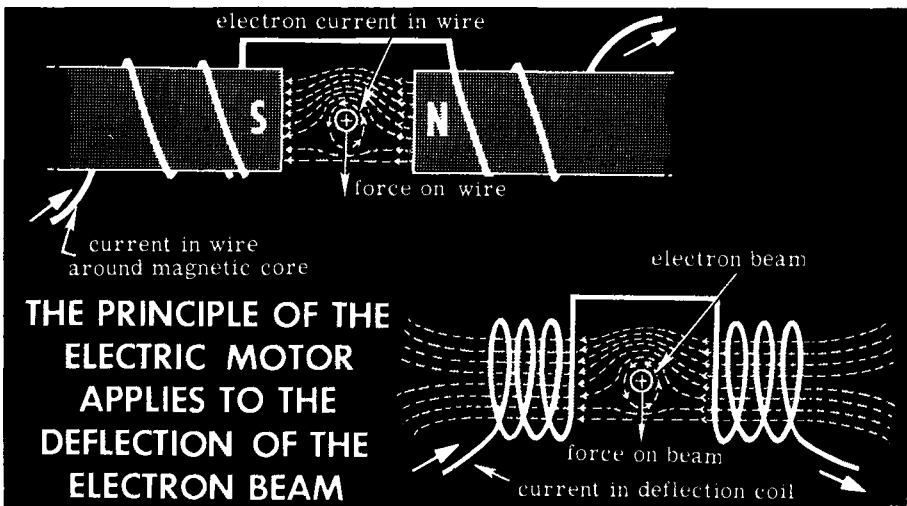

If you examine the directions of the lines of force of the two fields you will see that in each case they aid each other above the current and buck each other below the current. Where they aid each other the result is a strengthened field; where they buck each other below the field is weakened. Thus the stronger field is again above the current and the weaker field is below. When a current-carrying conductor or an electron beam is immersed in a nonuniform magnetic field, the field exerts a force which makes both the conductor and the beam from the area of the stronger field move toward the area of the weaker field. Hence both the conductor and the beam are pushed in the downward direction. The word "push," applied to the electron beam in a modern cathode-ray tube, means deflection of the beam.

THE ELECTRON BEAM

Deflecting the Beam in the Horizontal Direction

Deflection of the electron beam in the iconoscope, in the image orthicon, or in any magnetically deflected cathode-ray tube is the result of a force acting on the beam in the horizontal direction and another force acting in the vertical direction at the same instant. To make this action more understandable, we shall deal with each direction separately, then combine them.

Action of Horizontal Deflecting Coil

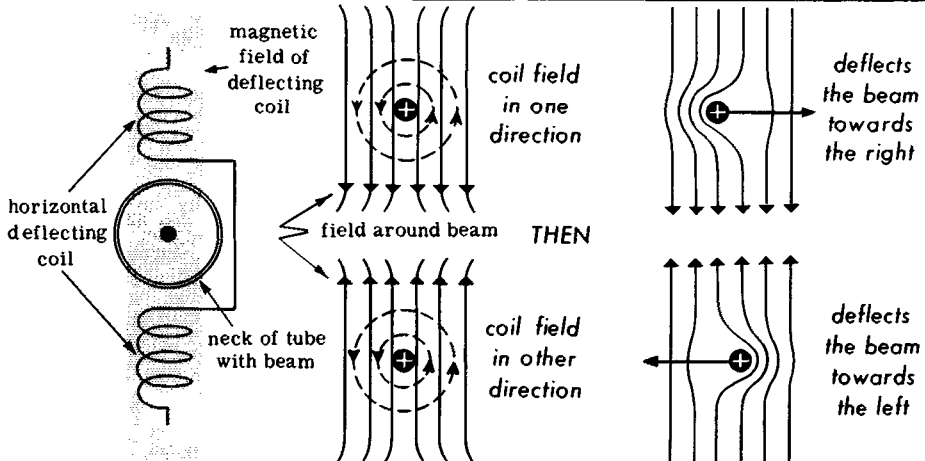

With Bidirectional Current and Bidirectional Field

Deflection in the horizontal direction means motion of the beam across the mosaic, target, or picture tube screen from left to right, and then in the *reverse* direction. For this to happen the horizontal deflecting coil must be positioned *vertically*, at 90° relative to the direction in which the beam is to be moved. This relationship is dictated by the fact that the lines of force of the magnetic field of the coil are at right angles to the direction of the windings' turns. Also a factor is the lines of force of the field which encircles the beam being at right angles to the direction of advance of the electrons in the beam. When the two magnetic fields are oriented in this relationship, they combine to produce a *stronger* field on *one side of the beam than on the other*. Acting under the force exerted by the combined field, the beam moves in the horizontal direction, towards the weaker field.

Whether the beam moves towards the right or the left is determined by the instantaneous direction of the current flowing in the deflecting coil. To produce motion alternating between right and left, the deflecting-coil current is caused to alternately reverse its direction. This is a function of the device which generates the deflection voltage that is applied to the deflecting coil.

THE ELECTRON BEAM

Deflecting the Beam in the Vertical Direction

The principle underlying the motion of the beam from side to side across the target also applies to the motion of the beam up and down along the surface of the target, except that the strengthened and weakened areas of the combined field now must be above or below the beam. For this to occur the orientation of the long axis of the vertical deflecting coil must be horizontal, at 90° relative to the direction in which the beam is to be moved. Then the lines of force from the coil current and the lines of force of the beam field will aid each other either above or below the beam, and the two fields will buck each other on the side opposite.

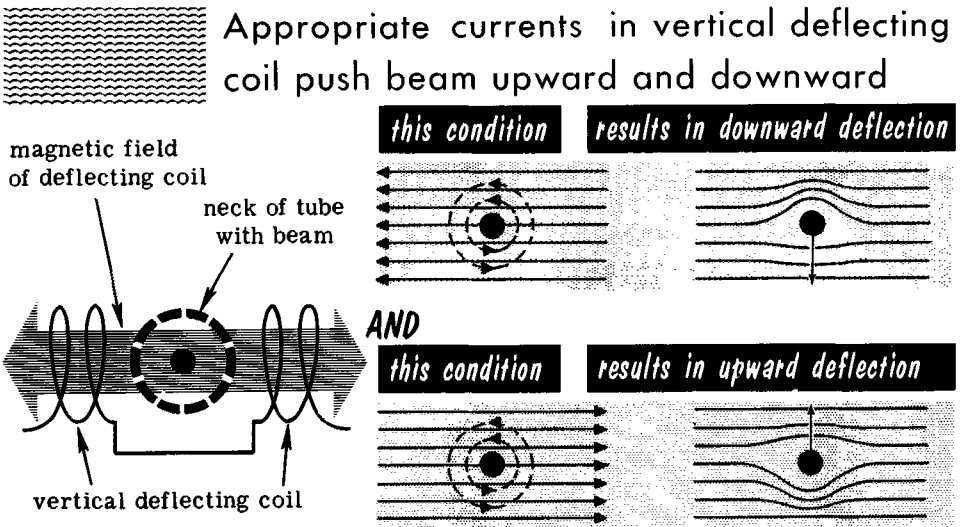

Whether the beam moves upwards or downwards depends on the direction of the current flowing in the vertical deflecting coil. The direction of the beam also is a factor, but we assume its direction to be constant (from the electron gun towards the target to be scanned). We realize that the *return* beam in the image orthicon travels from the target toward the electron multiplier, which is opposite to the direction of the scanning beam. We do not, however, concern ourselves with the return when explaining the process of deflection as part of the scanning action. Let it suffice to say that given any direction of the deflecting coil field and a direction of the beam field, to change the direction of advance of the beam means changing the direction of its field and reversing the direction of deflection. What was previously to the left, would now be towards the right; what was previously upward, would now be downward. To make the beam move up and down alternately, the vertical deflecting-coil current is reversed in direction alternately.

THE ELECTRON BEAM

Simultaneous Horizontal and Vertical Deflection

We have said that the actual scanning of the mosaic or of any target by the electron beam is motion that represents the result of two forces acting simultaneously, one in the horizontal direction and one in the vertical direction. Just as an object cannot be in two places at one time, it can not move in two directions at one time. But it *can* move in a manner determined by two influences acting at the same time. What we mean when we say that the electron beam is deflected horizontally and vertically at the same time is that there is a motion which is the result of two components of force—a horizontal component and a vertical component—active simultaneously.

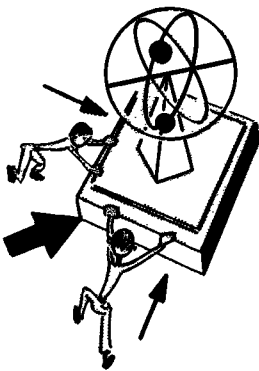

Two men pushing equally hard at right angles on a movable object will give the object forward motion in a **RESULTANT** direction

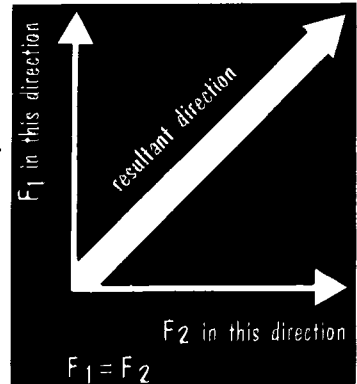

You may recall learning in high school physics that two men pushing equally hard at right angles on a movable object will cause it to move in a direction that is the resultant of the directions of the two applied forces. If one man pushes with more force than the other man, the object will move forward in a new direction, *towards the direction the greater force is applied.*

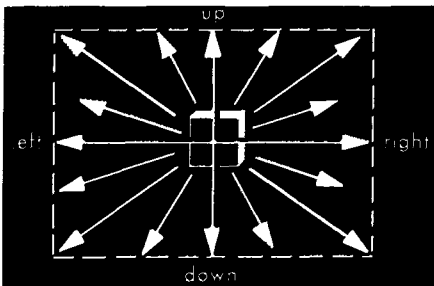

By controlling the direction and magnitude of the two component forces any given directional force can be achieved.

EVERY POINT ON THE RECTANGLE CAN BE COVERED.

The horizontal deflecting field and the vertical deflecting field are the equivalent of individual forces pushing the beam in two directions at right angles to each other.

THE ELECTRON BEAM

Simultaneous Horizontal and Vertical Deflection (contd.)

The behavior of two forces acting at right angles to each other, as explained on the preceding page, is directly comparable to the forces demonstrated by the horizontal and vertical deflecting fields acting together on the electron beam. The circular field around the beam, plus the horizontal and vertical deflecting coil fields, combine to aid or buck each other on two *adjacent sides* of the beam, rather than just on the left side, right side, above, or below when only one deflecting field is active.

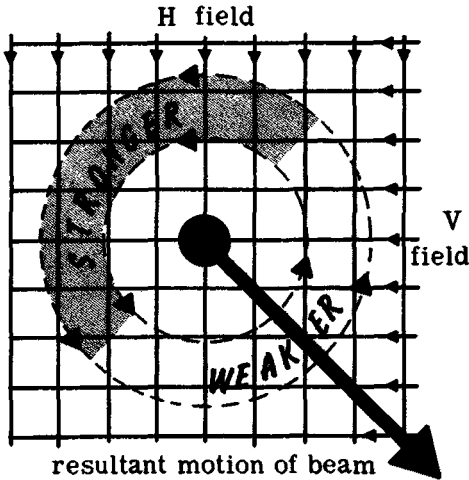

Combined H and V Fields

Deflect the Beam at an Angle

Assume the H and V fields have the instantaneous directions shown. The three fields combine to produce a distorted field which is stronger *above and to the left* of the beam, and weaker to the *right and below* the beam. The beam is deflected toward the weakened field, which now is at an angle relative to straight right or straight down.

Simultaneous H and V
deflection of the beam

will scan
the entire target

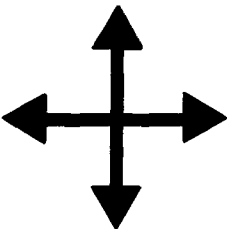

By changing the direction and instantaneous amplitude of the two deflecting currents we can control the direction and intensity of the resultant field, hence the direction in which the beam will move instant by instant, and also the distance that it will move. In this way we can deflect the beam so that it will touch every desired point on any target in a prescribed order.

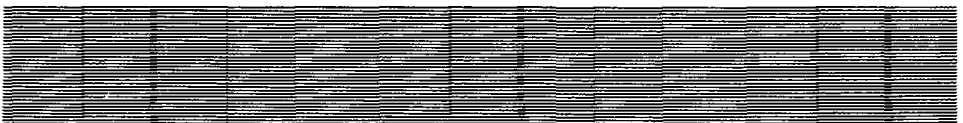

REVIEW

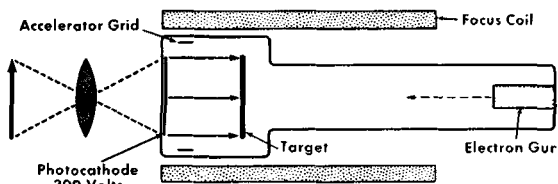

1. *The Image Orthicon* uses a low-speed scanning beam to increase its output by secondary emission. Electrons traveling from photocathode to target are kept in parallel paths by focusing coils which produce magnetic fields.

2. *The Target.* The side of the target facing the photocathode is struck by electrons. They are contained in isolated surface spots but are transmitted to the rear of the target so that the image appears there, ready to be scanned.

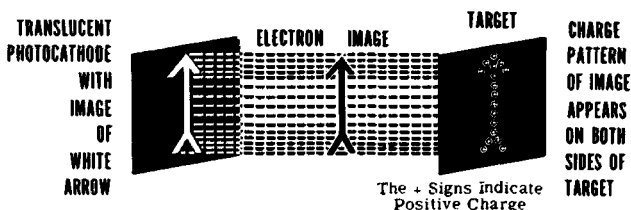

3. *The Electron Multiplier.* A series of dynodes (positive-voltage metallic surfaces) act as current amplifiers. The number of electrons they emit increases from dynode to dynode as each electron strikes and frees other electrons.

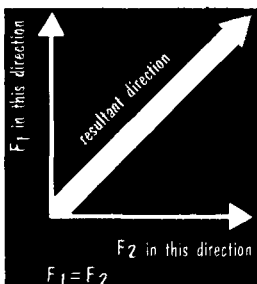
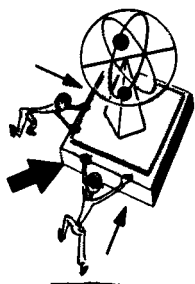
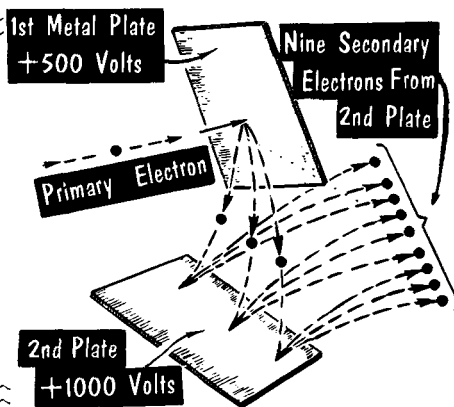

4. *Deflection.* An electron beam is deflected from a stronger to a weaker magnetic field. The final beam direction results from the combined horizontal and vertical deflections.

SCANNING

Scanning

The deflection process positions the electron beam on the surface to be scanned. It may be the mosaic in the iconoscope, the target in the image orthicon, or the screen of the television receiver picture tube. In any case the beam describes a particular pattern of motion called the *scanning pattern* across the surface. In line with standards of television broadcasting employed throughout the world, the pattern used is *interlaced scanning*. This name denotes the way in which the televised image is reconstructed on the receiver picture tube screen, a process reversing the image's division into parts in the television camera and its subsequent transmission to the receiver as an electrical signal. Let us examine interlaced scanning.

WHEN READING A PRINTED PAGE OUR EYES PERFORM PROGRESSIVE SCANNING

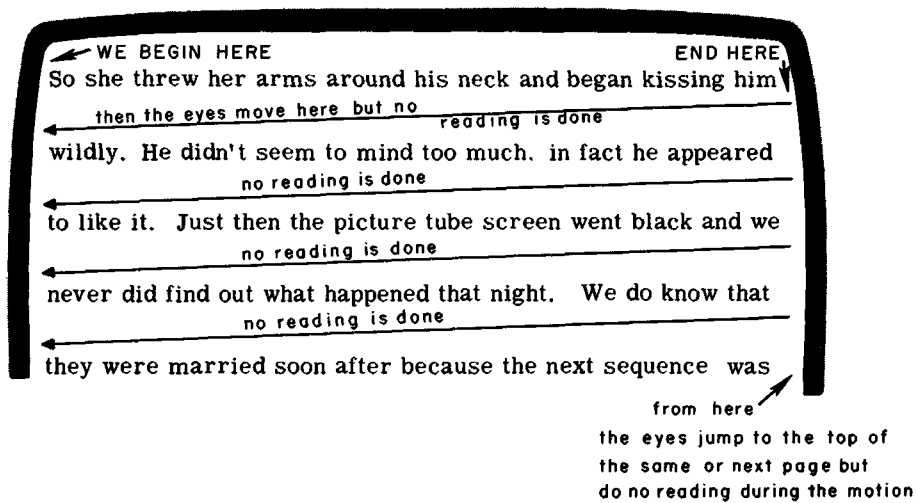

We can learn a great deal about the scanning process used in television by thinking of how we read a printed page. We read the printed page a line at a time, beginning at the left-hand edge of the page and moving towards the right. Having reached the end of the first line the eye sweeps to the beginning of the next line at the left side of the page, and the horizontal scan is repeated. Upon reaching the bottom of the page, the eye moves rapidly to the *left* edge of the *top* line of the *next* page.

What we have described is *progressive scanning*—reading one consecutive line after another. However, there are two intervals when no actual reading is done; while the eye is moving from the end of a line to the beginning of the next line, and while the eye is moving from the bottom of the page to the top of the next page. Bear these no-reading intervals in mind, because they occur in electronic scanning also.

SCANNING

How the Electron Beam Performs Interlaced Scanning

Progressive scanning is not used in television broadcasting. Interlaced scanning is used instead. Later on we shall show this phenomenon in detail, but for now all that is necessary for us to understand is the principle. The following example illustrates the idea of interlaced scanning.

The first page reads...



1	Once upon a time
2	There was a little girl
3	Named Red Riding Hood
4	Who lived with her grandmother
5	In a large forest

ORIGINAL IMAGE

Let us assume that we have opened to the first page of a child's book in which there are five lines of words, also that this page is imaged on the target (or mosaic) of the camera tube, and finally that the target is divided into five horizontal rows of picture information. We will further imagine that these five rows are numbered 1 through 5. We know that there is no such arrangement in the actual camera tube, but what we have described will serve as a means of explaining the action.

SCANNING

Interlaced Scanning (contd.) (The First Field)

The scanning beam in the camera tube starts moving across the target. Because of the design of the vertical and horizontal deflecting systems, and the voltages involved, the starting position of the beam is at the left-hand edge of the row of picture information. The first row corresponds to line 1 in our illustration. Because of the shape and the amplitude of the vertical deflecting voltage the horizontal excursions of the beam traverse rows 1, 3, and 5 of the image, skipping rows 2 and 4.

*The odd-numbered lines
are scanned*

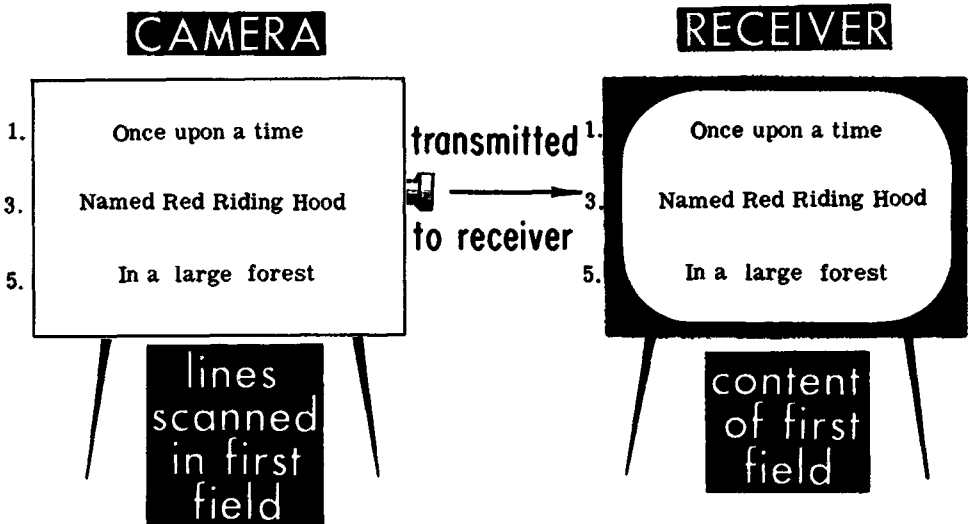

We have scanned the *odd-numbered* lines in the image and are now at the bottom edge of the target. The picture information as developed during the scanning of the odd-numbered rows is transmitted to the receivers bit by bit. Having completed the scanning of the odd-numbered lines in the image, the action is described as scanning a *field*, in this case the *odd field*. Also, having transmitted the picture information content of the odd-numbered lines to the monitor in the control room and to the receivers, we have transmitted the odd field to the receivers.

The picture information comprising the first or odd field appears on the screen of the receiver picture tube. How this occurs will be discussed later. In the meantime bear in mind that there is only a portion of the whole image at present on the camera tube mosaic.

SCANNING

Interlaced Scanning (contd.) (The Second Field)

After completing the first field, the scanning beam is returned to the top of the target on which the complete image exists. But now, because of the starting position of the scanning beam, the even-numbered rows, that is rows 2 and 4, are scanned for picture information, while rows 1, 3, and 5 are skipped.

Scanning all the even-numbered lines (only two of them are used in this simple example) completes the scanning of the second, or even field. As in the case of the first field, the information developed bit by bit is transmitted as a train of signals. With the second field transmitted, the picture seen on the monitor screen and in the homes of the viewers is the complete image of the page as originally presented on the camera-tube target.

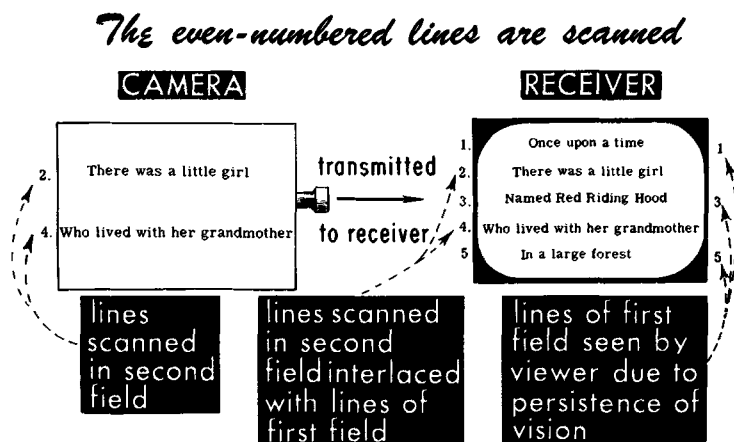

In the reconstruction of the picture (on the monitor or receiver picture tube screens) the even-numbered rows of the second field are interlaced between the odd-numbered rows which made up the first field. Space for the interlacing is provided for by the voltages present in the deflection system. The spaces skipped during the scanning of the first field are recreated on the receiving tube screens in between the odd-numbered lines of the picture that are reconstructed on the screen. The deflection voltages that move the beam during picture reconstruction have the same characteristics as the deflection voltages which account for the scanning in the camera tube, hence a row skipped during the scanning of the camera tube target results in a corresponding vacant row in the reconstructed image.

Observe that the scanning process does not disturb the location of the rows of picture information; it simply selects the odd-numbered rows for the first field and the even-numbered rows for the second field in the camera and places them in their correct relative positions on the receiver screen. It should be clear now, that the picture is sent in two parts.

SCANNING

Interlaced Scanning (contd.) (The Frame)

A complete picture is seen *only* when two consecutive fields appear, interlaced, on the picture tube screen. When two consecutive fields have been transmitted, a *frame* has been transmitted. The presentation of the individual field content in terms of rows of picture information is illustrated below.

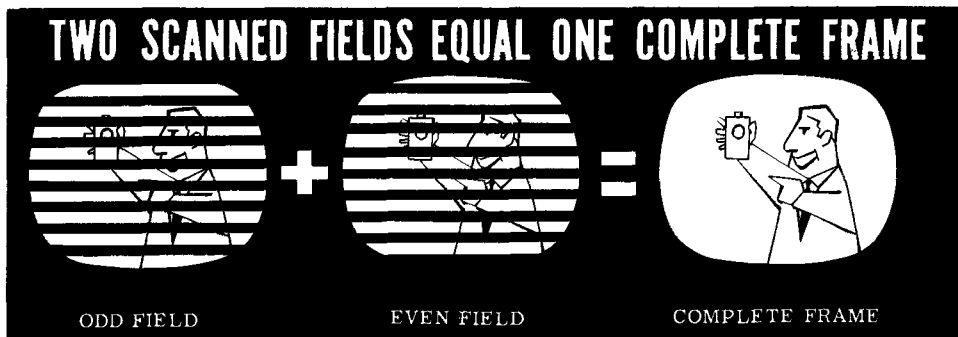

To scan a complete field consumes $1/60$ second. This is true in the camera tube and at the receiver picture tube. Because a frame consists of two fields, the total time lapse for a frame is $2 \times 1/60$ second, or $1/30$ second. These time intervals are very important for several reasons which are discussed later. In the meantime we should answer a question which no doubt has risen in your mind. If each field is transmitted separately how can the viewer see a complete picture corresponding to a frame? The answer is found in a characteristic of the human eye known as *persistence of vision*. The brain "memorizes" the first field, and because the two consecutive fields follow each other in such rapid sequence, the brain sees a complete frame or picture instead of two separate fields.

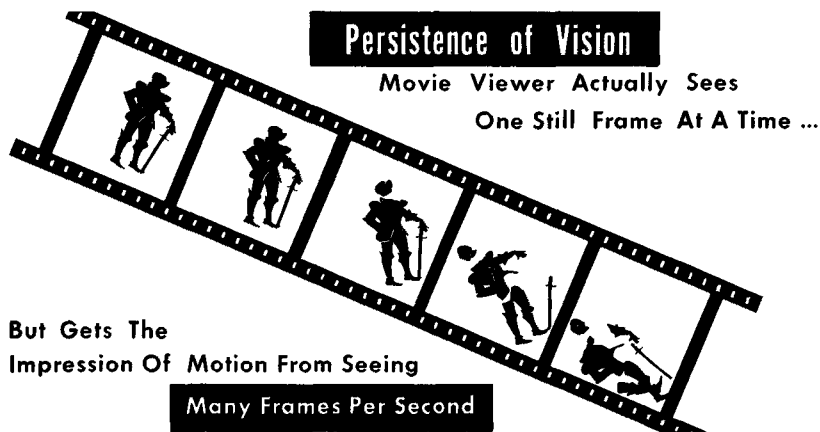

SCANNING

Technical Details of Interlaced Scanning

The concept of interlaced scanning illustrated by the child's book is easy to understand, but as we said before, only the principles described are technically accurate. The difference between the simplified explanation and the actual function is found in the number of rows of picture information that make up the picture, or more correctly the number of lines scanned in each field. Also, there are details relating to the motion of the scanning beam that have not yet been discussed.

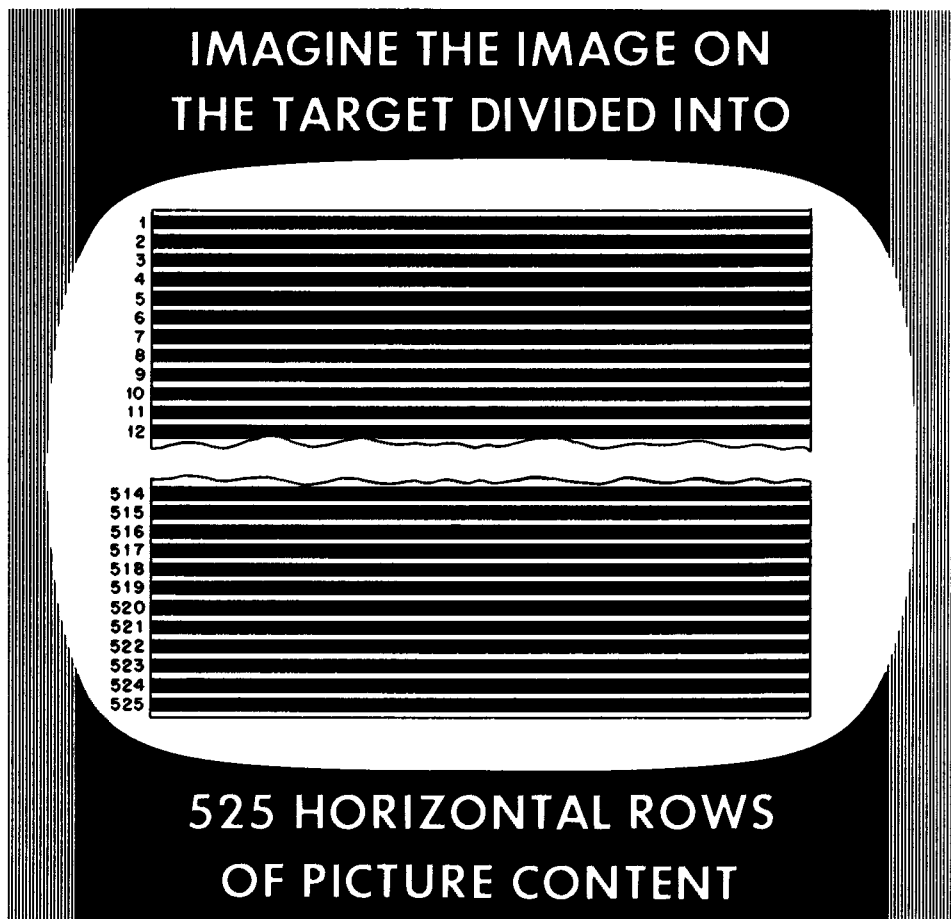

Whereas our original example of a printed page on the camera tube target was assumed to be scanned by only five horizontal excursions of the electron beam, the actual scanning of a camera tube target requires 525 horizontal excursions to complete a frame. The image on the target is divided into 525 rows of picture information.

SCANNING

Technical Details of Interlaced Scanning (contd.)

We said that each image was transmitted in two fields, also that the first contained only the odd-numbered lines and the second only the even-numbered lines of picture information. Under these circumstances, the image made up of 525 lines of picture information is divided into two fields of 262.5 lines each. The beam scans 262.5 odd-numbered lines beginning with 1 and continuing through 3, 5, 7 . . . 521, 523, 525 completing the first field. The 262.5 even-numbered lines theoretically beginning with line 2 and advancing through 4, 6, 8 . . . 520, 522, 524 are scanned by the beam completing the second field.

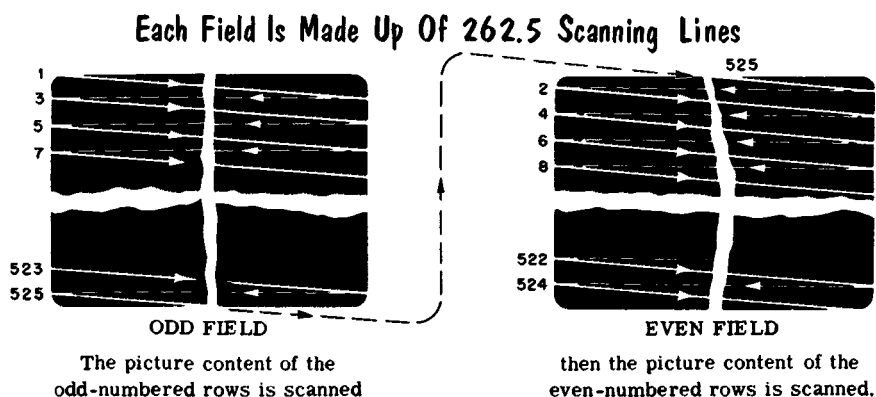

The interlacing is made possible by specific positioning of the starting point of the scan of each field. The first field scan begins at the upper left-hand corner of the target and ends at the center of the lower edge. The scan of the second field starts at the center of the upper edge of the screen and ends at the lower right-hand corner of the target. The last scan of the first field is only a half-line, the first half of the line 525. On the other hand the first scan of the second field is also a half-line which can be considered to be the completion of line 525, except that it is at the top of the target rather than at the bottom. The first full line of the second field begins at line 2 of the complete image.

The vertical deflecting voltage accounts for the distance between the horizontal scanning lines described by the beam. It is the same kind of voltage for both fields, and by beginning the second field at the center of the top edge of the target rather than at the top left edge, the scanning lines of the second field fall in between the scanning lines of the first field, that is, they interlace. The importance of the interlace action occurs in the reconstruction at the receiving end, but the configuration of the scanning lines of the two fields at the camera is no less important, for what happens there influences what happens at the receiver, as will be seen later.

SCANNING

Technical Details of Interlaced Scanning (contd.)

What does the interlaced pattern of scanning lines look like? We have shown two images produced by the interlaced scan of rows of picture information. However, neither one of these was really true to form. It is difficult to show the interlaced pattern of the scanning lines described by the beam while it is completing a frame because of the great number of lines involved. We can approach it by showing just some of the lines in their relative positions without showing any picture information. In other words only the pattern traced on the camera tube target (or on the picture tube screen) by the moving beam is illustrated. The solid lines show the left-

The Interlaced Scanning Pattern

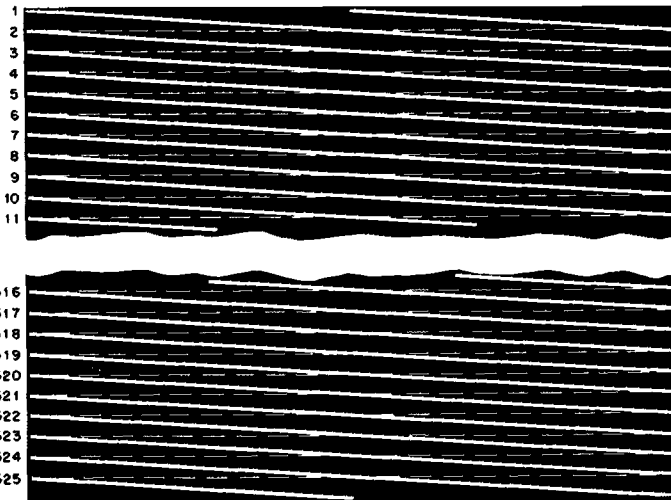

THE TWO FIELDS INTERLACED

Note: Instantaneous return from bottom to top of mosaic is assumed here.

to-right movement and the dashed lines show the right-to-left return of the beam. Note that the beam return from the right edge of odd-numbered lines is to the next odd-numbered line on the left. Also, the beam return from the right end of even-numbered lines is to the next even-numbered line on the left. The exceptions are the half-lines on the bottom and the top of the pattern. The dot-dash line showing the return of the beam from the bottom (at the end of the fields) to the top of the pattern makes horizontal excursions while advancing to the top. This is so because the horizontal deflecting voltage which accounts for the to and fro motion of the beam is always active. We will say more about this later.

SCANNING

Horizontal and Vertical Scanning Time and Frequencies

The horizontal motion of the scanning beam can be divided into two parts; the movement from the left edge to the right edge of the target (or screen), called the *horizontal forward trace* or simply *horizontal trace*, and the more rapid return from the right edge to the left edge. This is called the *horizontal retrace*. The horizontal trace time is 56 microseconds and the horizontal retrace time is 7 microseconds. The forward trace and the retrace action make up a horizontal cycle. The total time for the cycle is 63 microseconds which corresponds to a frequency of $1/0.000063$ or 15,750 cycles. The frequency of the horizontal deflecting voltage is therefore 15,750 cycles.

HORIZONTAL-VERTICAL SCANNING FREQUENCIES

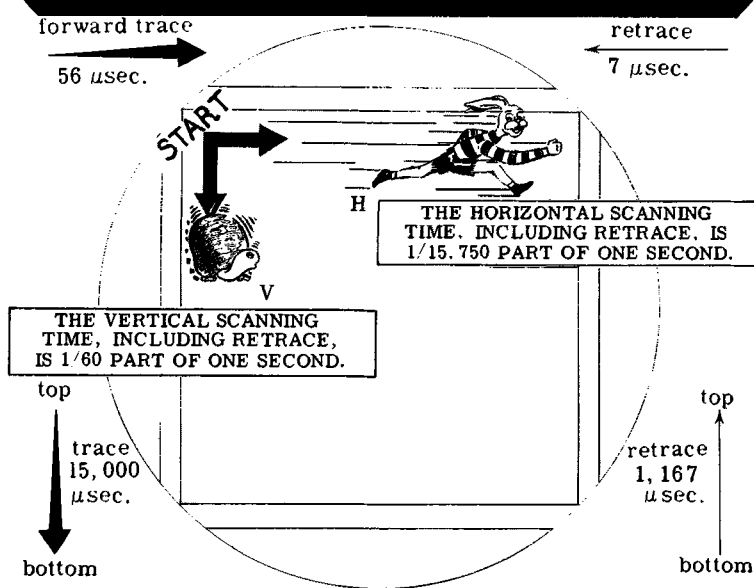

The vertical scanning action can be analyzed in the same manner. The downward action is the *vertical trace* whereas the return from the bottom edge to the top edge is the *vertical retrace*. The two motions complete a vertical scan cycle. The vertical trace time is 15,500 microseconds and the vertical retrace time is 1,167 microseconds (allowing for tolerances). The sum of these two time intervals is 16,667 microseconds, which corresponds to a frequency of $1/0.016667$ or 60 cycles. Dividing 15,750/60 gives the number of horizontal scanning lines that are completed during one vertical cycle, namely 262.5 lines. Because the frequency references are simpler than the microsecond references, it is customary to refer to the horizontal and vertical scanning actions in terms of frequency rather than time elapsed per cycle.

SCANNING

Control of the Scanning Beam

The master timing device for controlling the entire television system, both transmitter and receiver, is the *pulse generator*. It produces five different kinds of control-voltage pulses, each of which performs a specific task relative to the control of the scanning beam in the camera tube. Two kinds of accurate frequency-control pulses are delivered by the pulse generator to the horizontal-vertical deflection-voltage generator. One determines the instant when the beam begins its horizontal forward trace and its retrace; another determines the instant when the beam begins its vertical deflection action downward and retrace after having completed a field. These control pulses are the horizontal and vertical sync pulses.

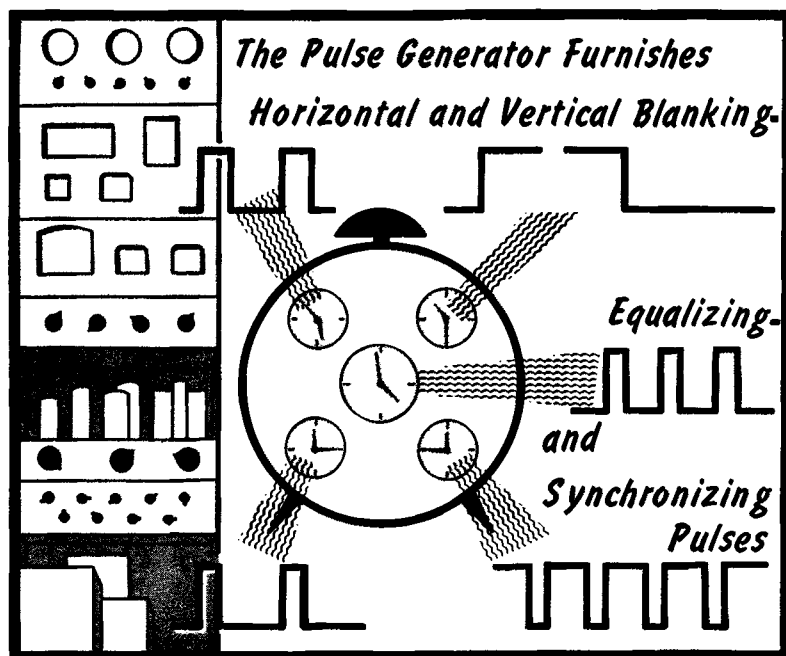

The two kinds of blanking pulses determine the beginning and the end of the periods when the camera tube ceases releasing picture information. The equalizing pulses are used to establish identical electrical conditions which enable the vertical sync pulse to initiate the vertical retrace at the correct moment in each field.

In addition to serving the camera tube, the pulses produced in the pulse generator are also delivered to the receiver for identically precise beam-control purposes in the receiver picture tube. To send each control pulse to the receiver, it is made part of the composite picture signal that eventually amplitude-modulates the carrier. The control pulses are added to the camera output signal in the control room and at the transmitter, as is explained later.

SCANNING

Horizontal and Vertical Blanking

When applied to an electron beam, "blanking" means beam cutoff which is similar to plate current cutoff in the conventional vacuum tube. In the camera tube or any other cathode-ray tube, beam cutoff prevents the electron beam from striking the mosaic, target, or screen whichever it may be. The beam is stopped at the control grid of the electron gun by a sufficiently high negative bias applied to this electrode, or a sufficiently high positive bias applied to the cathode. Actually, the beam is extinguished.

Blanking creates action in the camera tube similar to the no-reading action the eyes experience while they move to begin a new line after reading the previous one, or while they are moving between a completed page and the top of a new page. Similarly, the electron beam is blanked when it has completed the scan of one line and is being retraced to begin the next horizontal scan. It is blanked again when the beam has reached the bottom edge of the mosaic or target and is returned to the top edge to begin the scanning of the next field, that is during vertical retrace. Failure to blank the beam would result in the development of confusing picture information during the horizontal and vertical retrace intervals.

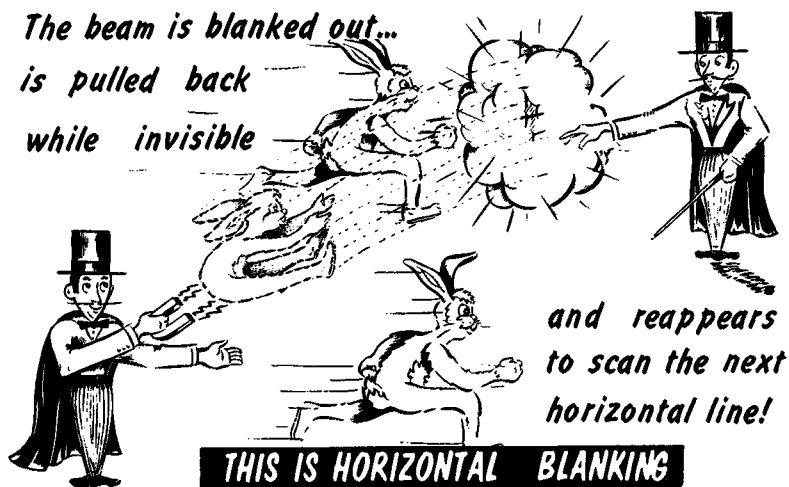

Horizontal blanking is accomplished by a blanking voltage pulse applied at a particular time in the sequence of horizontal scanning. It is a 10-microsecond pulse that recurs 63.5 microseconds apart, just shortly before the end of the scan of a horizontal line. It remains on for the 7-microsecond retrace and for about another 2 microseconds after the scanning of the next horizontal line has begun. Vertical blanking is the result of a blanking voltage that occurs once in every field. It lasts for about 1,250 microseconds and appears just about the time that the fourth from the bottom horizontal line scan begins, and lasts throughout the vertical retrace and over the period of the first 10 or 11 horizontal lines at the start of each field.

SCANNING

The Aspect Ratio

The dimensions of the TV picture were set by the standards of the movie industry. The ratio of width to height of the traditional motion picture film is 4 to 3. If it is 4 feet wide, for example, it will be 3 feet high; if it is 16 feet wide, it will be 12 feet high. The technical term for the relation of the width to the height is the *aspect ratio*.

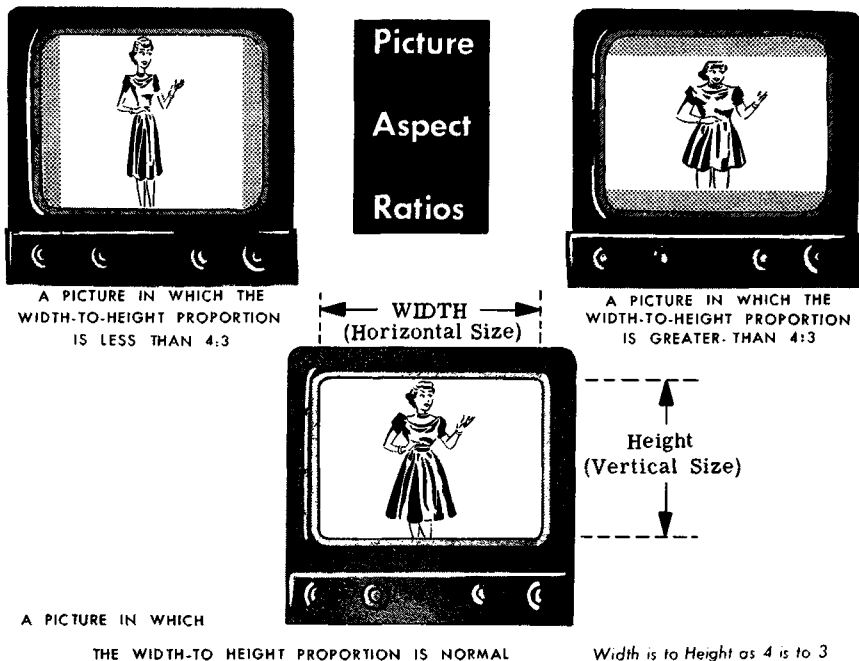

The Aspect Ratio for the Receiver

Television receivers now in use have viewing screens of all sizes. Projection screens for use in theatres are gigantic. Yet, regardless of the size of the final picture, its dimensions must have the 4 to 3 ratio. The penalty for disregarding this standard is a distorted picture, because the aspect ratio is set in the television camera, and it is 4 to 3—width to height.

Horizontal and Vertical Size Controls

Hand controls for setting the width and height of the picture are provided in receivers. They are the size controls; vertical for the height of the picture, and horizontal for the width of the picture. As a rule they are located at the rear of the chassis.

SCANNING

Adding the Pulse and Deflection Voltage Generators to the Picture Signal Chain

Now add the pulse and deflection-voltage generators to the block diagram of the picture-signal chain. When doing this we must also add several related amplifiers. They are the horizontal and vertical deflection amplifiers which raise the amplitude of the respective deflection voltages produced in the deflection generator to the level required by the deflecting coils of the camera.

CONTROL OF THE SCANNING BEAM

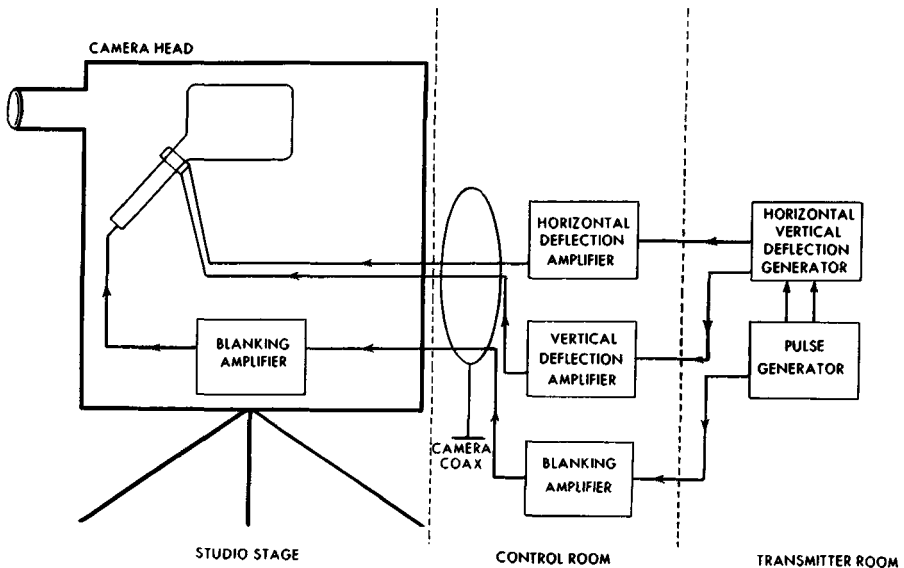

We also add the blanking amplifiers, one in the camera housing and one in the control room. The two amplifiers shape the blanking voltage pulses and raise their amplitudes to the required values. The pulse and deflection generators are in the transmitter room whereas the deflection amplifiers are in the control room. A coaxial (coax) cable containing the necessary conductors pipes the different control voltages to the camera tube. By properly locating the amplifiers and their controls in the control room it is easy for the control operators to comply with the desires of the director when he calls for special visual effects such as flop-over of an image or combining the output of two cameras into a single image. All of these effects relate to manipulation of the deflection voltages. The pulse generator is located where it can be under constant supervision by the engineers.

THE VIDEO SIGNAL

The Video Signal Amplifiers

In addition to the lines carrying the blanking and deflection voltages to each camera there are lines within the same coax cable which carry the picture information voltages from the cameras to the associated video amplifiers. We show only one camera and one video amplifier although usually there are three, four or even more. Each camera head contains its own video preamplifier to amplify the very weak video signal output of the camera close to the point of generation and minimize the introduction of electrical noise into the camera signal.

Adding the Video Amplifiers to the Block Diagram

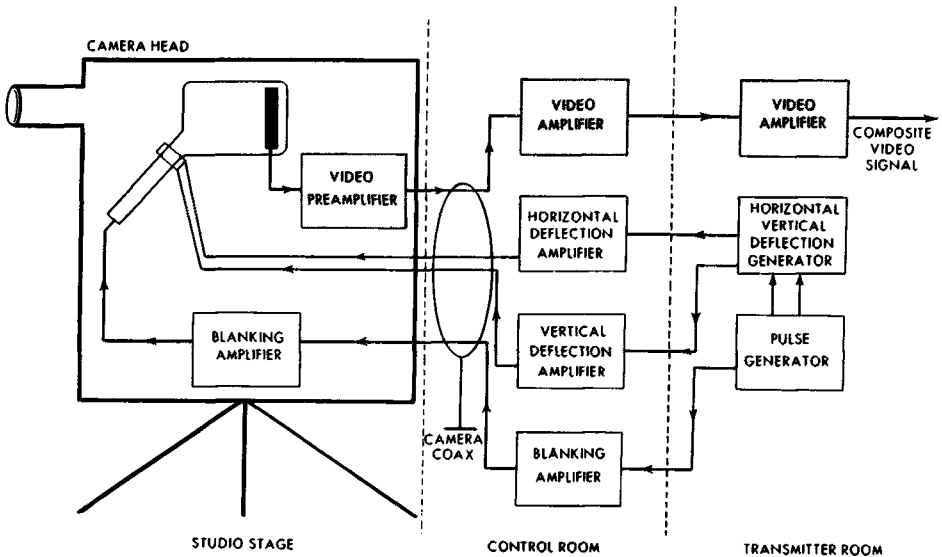

The video amplifiers in the control room are used to amplify the signals from the cameras and to feed signal voltages to the associated monitor picture tubes. The amplifiers also raise the picture signal amplitude to the desired level for delivery of the chosen picture to the transmitter. At the transmitter there is still another video amplifier which makes up for whatever loss in strength there occurred during transportation of the signal from the control room to the transmitter. It also acts to raise the picture-signal amplitude to the level required to amplitude-modulate the picture carrier. The output of the video amplifier in the transmitter room is the *composite video signal* containing picture and control elements, some of which are yet to be explained.

THE VIDEO SIGNAL

Adding the Monitors to the Video Chain

We have said that the output of each camera is displayed on an associated monitor in the control room for viewing by the director, allowing him to select the picture to be "put on the air." Let us add the monitor to the video chain. We show only one monitor with the one video amplifier in the control room. Many installations have four or five monitors and an equal number of video amplifiers.

ADDING THE MONITOR TO THE BLOCK DIAGRAM

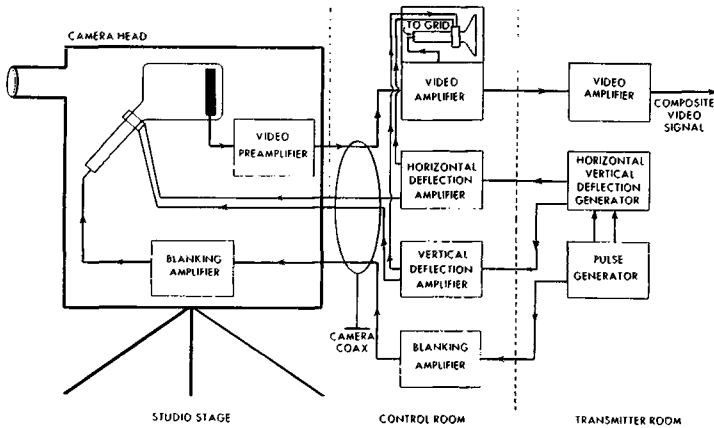

Each monitor is an assembly of a picture tube like one found in a home television receiver and components which enable it to function on the signal derived from its associated video amplifier. Each picture tube has its own electron gun for generating the electron beam, and horizontal as well as vertical deflecting coils to move the beam. The target for the beam is the inside surface of the glass envelope at the large end of the tube. This is the screen, with a surface coat of special material that glows or fluoresces when the beam strikes it. Whereas the camera tube beam acts to convert light energy into electrical energy (picture information voltages) the electron beam in the monitor tube receives its picture information voltages from the video amplifier and converts it into light energy. It "paints" the camera image on the screen, using tiny areas of light and dark spots caused by the beam striking the screen.

To make certain that the monitor beam moves in exact synchronism with the beam in the camera tube, the deflection voltages applied to the camera tube are also applied to the monitor-tube deflecting yoke windings.

THE VIDEO SIGNAL

The Video Signal from the Iconoscope Camera

Having assembled the vital elements of the picture channel in the transmitter, let us now examine the picture signal output from the camera. Since both the iconoscope and the image orthicon are still being used as television camera tubes we shall examine the action of each. (The block diagrams of the picture channel of the transmitter will continue showing the iconoscope.)

THE VIDEO SIGNAL PRODUCED BY SCANNING ONE LINE OF AN IMAGE IN THE ICONOSCOPE

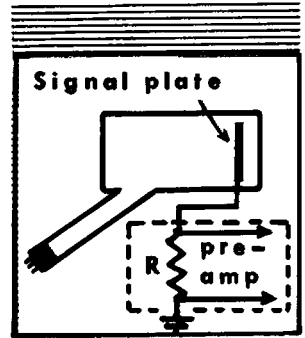
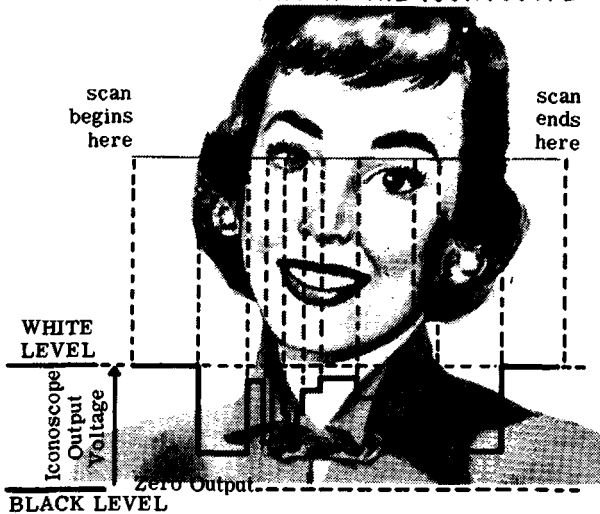

The iconoscope output current is fed into the camera tube preamplifier.

The Iconoscope

Our picture subject is a pretty girl. We know that the amplitude of the output signal is a function of the amount of illumination which has fallen on the photodroplets that make up the mosaic. What does the camera tube output signal look like? To find the answer let us scan a single horizontal line through the face of the subject. Maximum voltage output corresponds to white in the image; minimum voltage corresponds to black in the image; zero reflectance, or jet black, which produces zero output voltage, apparently is not present in the line scanned. Values of gray, between white and black, result in output voltage amplitudes between maximum and minimum. The abrupt changes in output voltage shown by the steep sides of the voltage wave are based on abrupt changes in the light and dark areas along the line being scanned. More gradual changes in shading would result in less abrupt fluctuations in output voltage. We should mention here that the usual method of illustrating line by line picture voltages derived from a camera tube is more often symbolic than realistic. We are using a representational drawing here only to facilitate our understanding.

THE VIDEO SIGNAL

The Video Signal from the Iconoscope Camera (contd.)

The voltage equivalent of any horizontal line that is scanned begins where the beam starts scanning the image horizontally and ends where the scanning finishes and the horizontal retrace blanking begins. If we assume that the scanning action continues line after line, as happens in television transmission, we find we have delivered to the video preamplifier (in the camera) a *train* of picture voltages with intervals of blanking between.

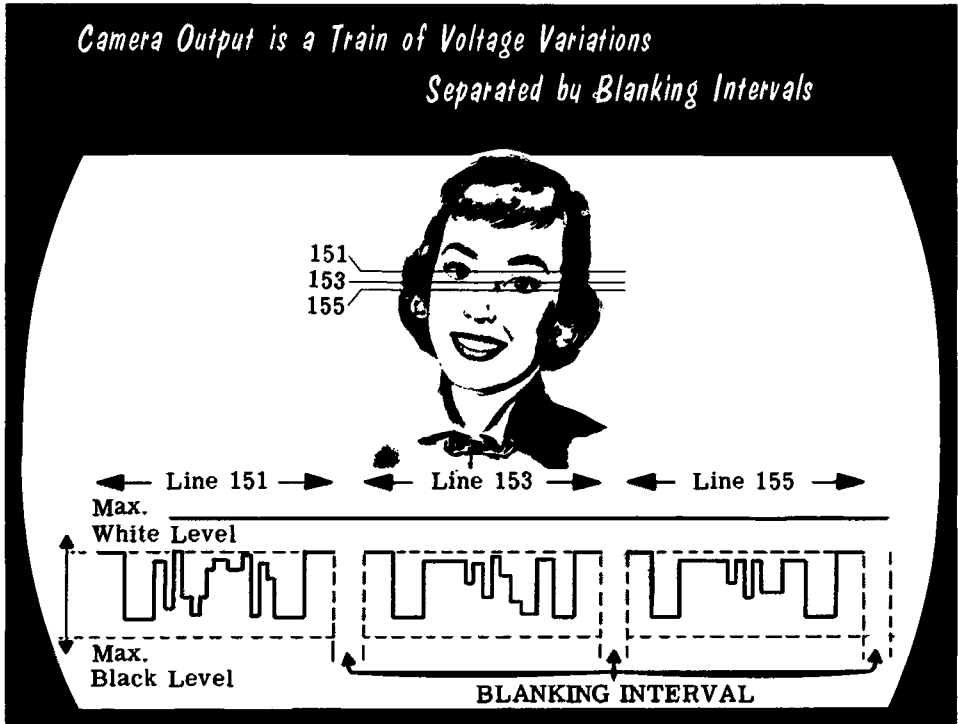

Our illustration shows the video output for only three consecutive odd-numbered lines that were scanned in a field, say lines 151, 153 and 155, but several important conditions relating to the entire image were brought to light by these three lines. Although the lines scanned are positioned one below the other, the voltage representation of these lines is a *train* of fluctuations, one following the other, along a time base. A blanking voltage is applied to the camera tube to extinguish the beam during horizontal retrace, although the signal output from the camera is zero during the blanking interval. In other words the blanking signal fed to the electron gun of the camera tube does not appear in the camera tube video output. The picture voltage representation of every line scanned is separated from the next by the blanking interval.

THE VIDEO SIGNAL

The Video Signal from the Iconoscope Camera (contd.)

We have shown that the picture signal output from the iconoscope increases in amplitude as the image changes from black to white, and that white in the image produces the stronger signal. But this is not the way the signal is processed. The American standard of television transmission utilizes negative video polarity. This means that the conditions of operation call for white in the image to produce the theoretically zero signal and black in the image to produce the theoretically maximum picture signal.

HOW ICONOSCOPE SIGNAL OUTPUT IS GIVEN NEGATIVE VIDEO POLARITY

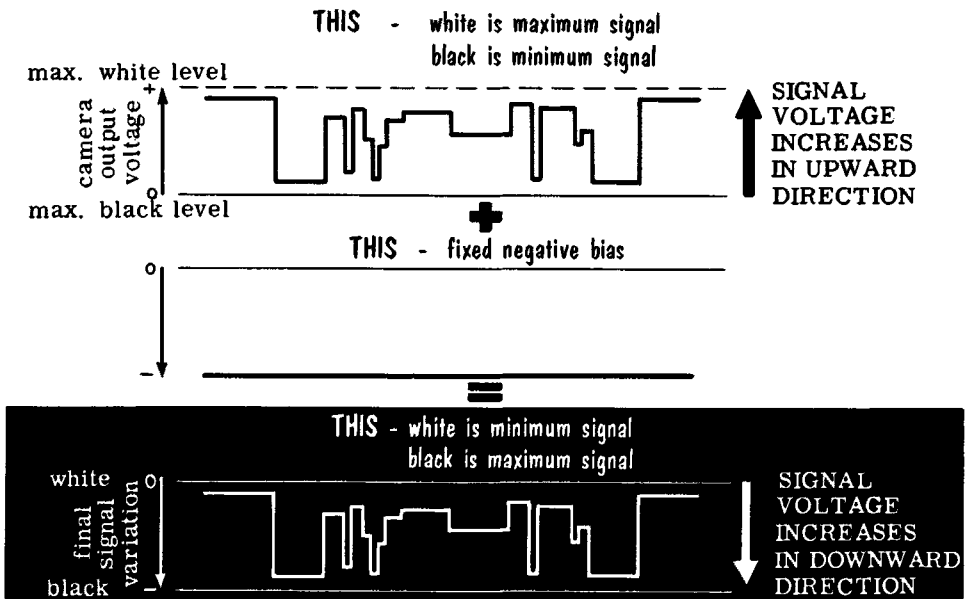

This requirement can be satisfied using the iconoscope camera by simply applying the camera output signal to a negative clamping circuit. Then the entire camera signal appears below the zero-voltage base line and is entirely in the zone of negative polarity voltages. When the fixed negative bias is added to the positive-polarity camera signal the result is a signal-voltage variation wherein white in the image becomes the least negative voltage and black in the image becomes the most negative voltage. This is readily understandable if we use a few simple figures as examples. Assume that the camera output for white in the image is $+1.9$ volts and that black in the image produces an output voltage of $+0.1$ volt.

If we add these voltages to a fixed negative bias of 2 volts, then the final fluctuation in signal voltage is between -0.1 volt (white in the image) and -1.9 volts (black in the image). Thus black is the higher signal voltage.

THE VIDEO SIGNAL

The Video Signal from the Image Orthicon

The picture signal output from the iconoscope has been described as maximum for white areas in the image and minimum for black areas. How does this compare with the signal output from the image orthicon? Let us assume that the image and the line being scanned are the same as before. The charge pattern developed on the target has the *maximum* charge for the white areas and *minimum* charge (theoretically zero) for the black areas in the image. Relating these conditions to the return beam, we find it contains fewer electrons (less current) when returning from a white-area charge on the target and the normal amount of electrons (maximum current) when returning from a black-area charge on the target. Converting these currents into voltage under normal circumstances, white in the image produces minimum output voltage and black in the image produces maximum output voltage. The result is a negative-polarity video signal from the image orthicon.

THE VIDEO SIGNAL PRODUCED BY SCANNING ONE LINE IN THE IMAGE ORTHICON

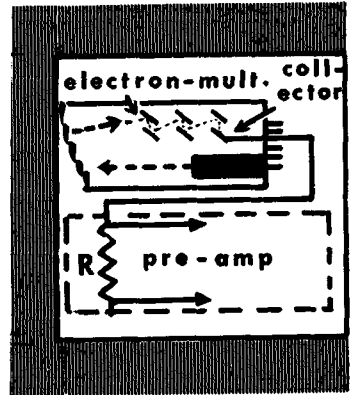
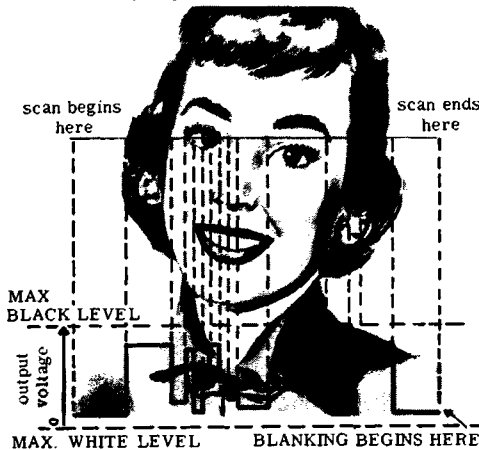

The return beam current after amplification in the electron multiplier flows through the camera tube load resistor.

The difference in behavior of the iconoscope and the image orthicon is for us only of academic interest. We are concerned mainly with the control of the scanning beam in each camera tube and with the content of the television picture signal that is radiated to the receiver. Like the signal output of the iconoscope, the image orthicon signal is picture information only; blanking as well as the other control voltage pulses must be added to the picture information in correct time sequence.

BLANKING PULSES

Adding the Blanking Pulses to the Picture Signal

To display the picture on the monitor screen and eventually on the receiver tube screen without showing the horizontal and vertical retrace motions of the beam, horizontal and vertical blanking voltages must be added to the picture signal. These pulses must appear in the same time sequence as the horizontal and vertical retraces during scanning. To assure perfect timing, blanking voltages are supplied from the pulse generator through the blanking amplifier in the control room, the same source which supplied blanking voltages to the camera tube. A cable connection between the blanking amplifier and the video amplifier in the control room feeds the blanking pulses from one to the other.

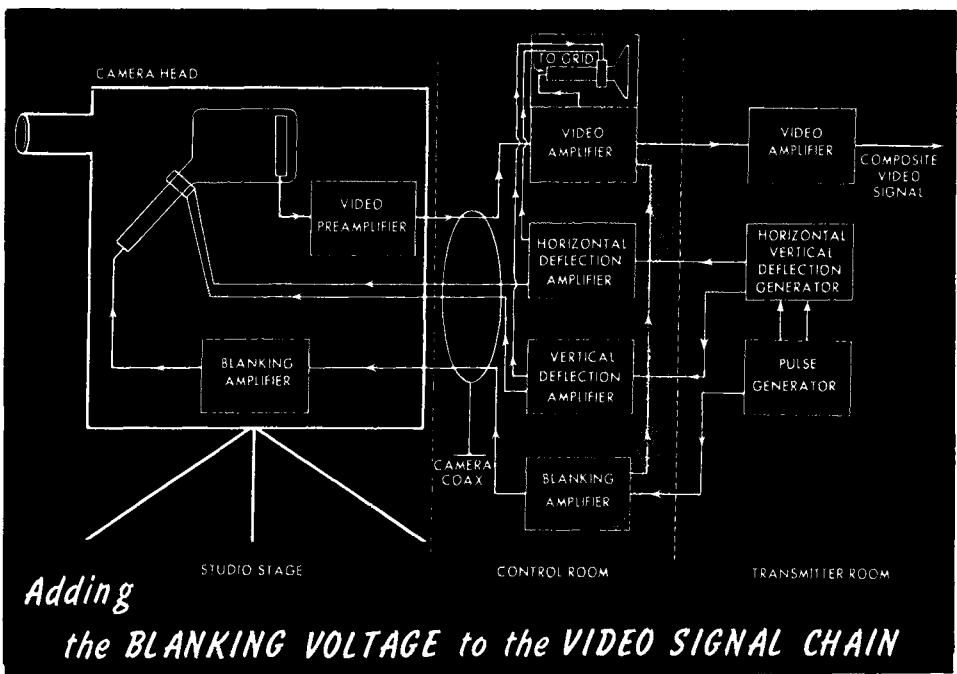

The picture signal and the blanking voltages are combined into a train of signals in the video amplifier. Then the combination signal containing picture and blanking information is fed to the monitor tube. The same combination signal is also available for delivery to the video amplifier at the transmitter. Whether or not it is sent there for additional processing (as will be described later) is determined by the director who selects the picture that is put on the air. As we stated earlier, each studio camera in use on the stage delivers a picture signal to its video amplifier and related monitor in the control room, thus allowing the director to select the angle shot he chooses.

BLANKING PULSES

Adding the Blanking Pulses to the Picture Signal (contd.)

The blanking pulses are of negative polarity. Their amplitude varies between zero and a suitable peak value which exceeds the peak amplitude of the signal corresponding to black in the image. Also, they are of two different durations: the horizontal blanking pulses have a duration period that is only a small fraction of that of the vertical blanking pulses. The pulses are generated as a continuous train and follow each other in the same sequence that patterns the beam retrace intervals during scanning. Since there are many more horizontal than vertical blanking intervals in a field, there are many more horizontal than vertical blanking pulses in the train. In this regard we should clarify a point. Horizontal blanking in a field begins after the first 7 to perhaps 12 horizontal lines have been scanned, and ends when about 2 to 4 horizontal lines remain to be scanned. The reason for the delay in starting the horizontal blanking and for ending it before the field is completed is the vertical blanking pulse. Because of its time duration it starts before the beam is at the bottom of the camera tube mosaic (or target). That is when about 2 to 4 horizontal lines remain to be scanned in each field. It is active during the entire vertical retrace and remains active during the scanning of the first 7 to 12 lines of the next field. Starting early and ending late is insurance that the much slower vertical retrace will not be visible on the picture tube screen. We should emphasize that the action of the vertical blanking pulse during the period just described blanks the two groups of horizontal lines as well as the vertical retrace. Picture information is not delivered by the camera tube while vertical blanking is active.

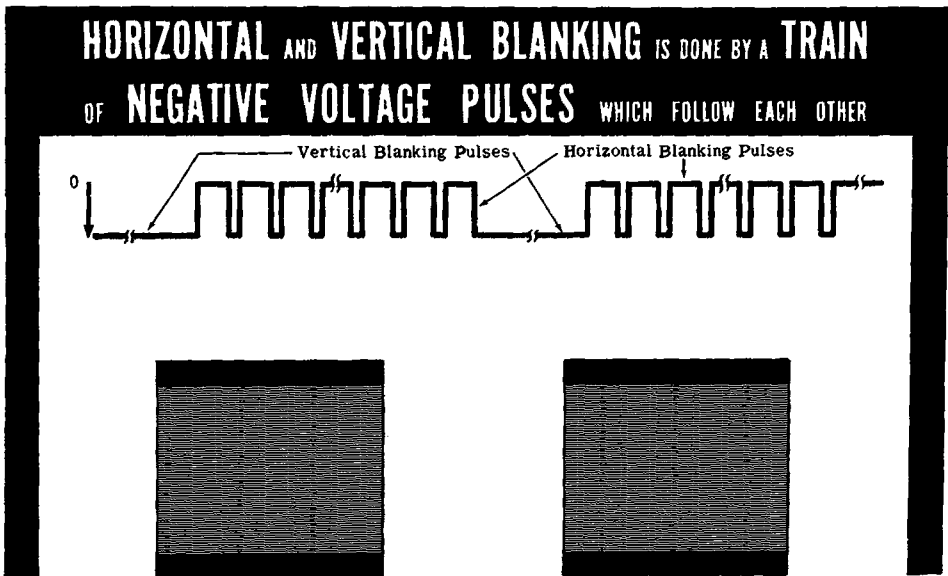

BLANKING PULSES

Adding the Blanking Pulses to the Picture Signal (contd.)

Adding the blanking voltage pulses to the picture signal fills the gap, labeled earlier the no-picture-signal-interval, between the end of one horizontal line of picture information and the beginning of the next line. We

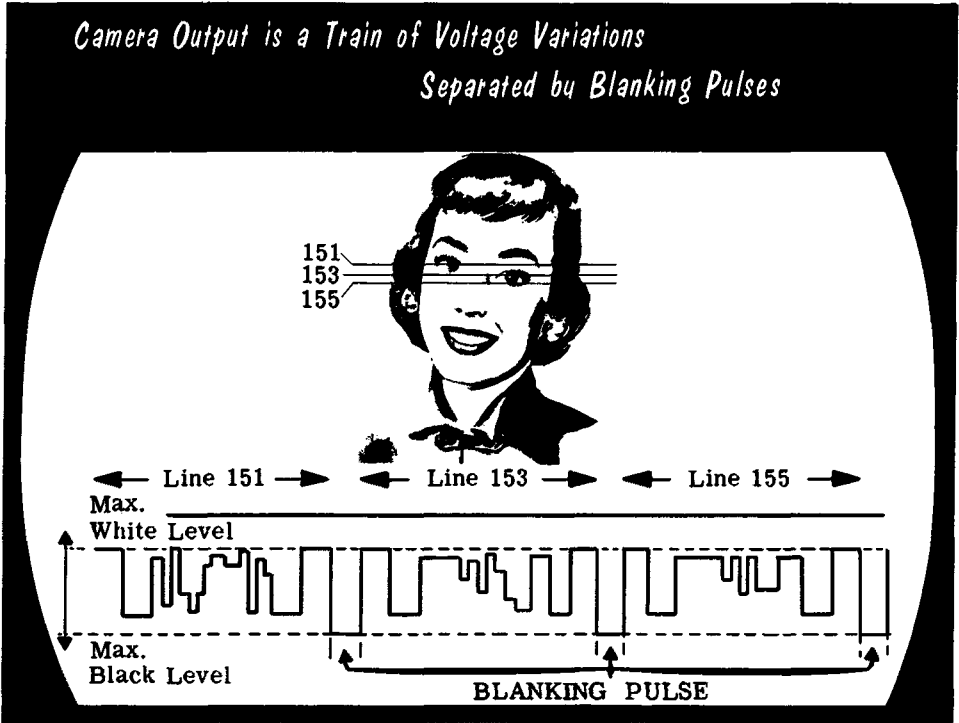

illustrated the results of only three lines of picture information. Here we show the same three lines with the blanking pulses added. Continuous scanning of field after field results in a signal consisting of an unending series of picture information voltages followed by blanking voltage.

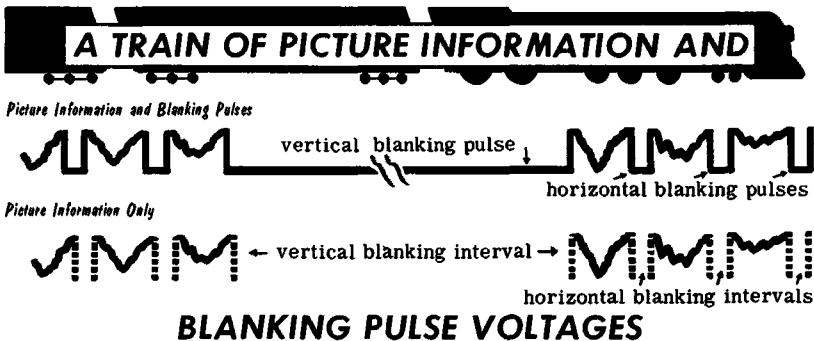

BLANKING PULSES

Details of Horizontal Blanking Pulses

Before concluding the discussion of blanking pulses, it might be well to detail the constants and action of the horizontal blanking pulse. The conditions of its use are of special interest, and are not evident simply by observation of the scanning lines that make up the fields.

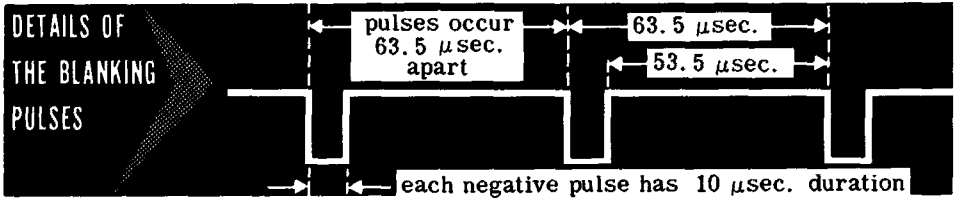

In line with the constants shown above the distribution of the horizontal blanking time is the following:

DISTRIBUTION OF HORIZONTAL BLANKING TIME

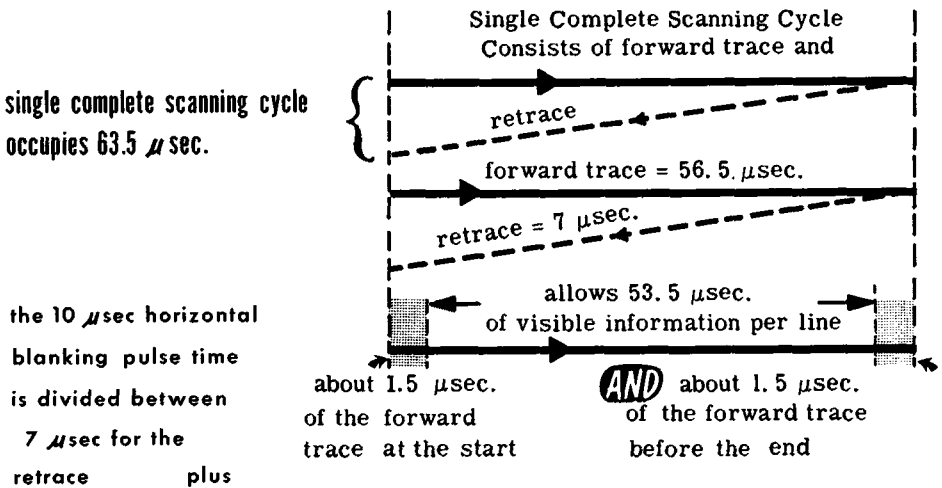

The blanking of the horizontal scan for the short intervals after it begins and before it ends is not the same in the camera tube as in the monitor and receiver picture tubes. The horizontal blanking pulse delivered to the camera tube is slightly shorter in duration than that which is combined with the signal. This is a safety measure to assure that the beam is in the proper position before the delivery of picture information begins. The slight loss in picture content because of the extended horizontal blanking time is inconsequential, as is the picture content lost by the complete blanking of a number of horizontal scanning lines.

REVIEW



1. *Interlaced Scanning.* All odd-numbered lines are scanned as a group (a field), then all even-numbered lines. The first and last lines of each field are only half-rows; interlacing begins here. The complete interlaced scan of two consecutive fields (the first held in the viewer's eye by persistence of vision) produces an intelligible picture.

2. *Output Voltages in the Iconoscope* are determined by the degree of illumination on the mosaic. The voltages from a series of scanned lines are broken by the blanking pulses.

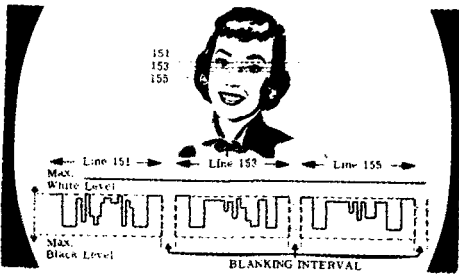

SCANNING ONE LINE IN THE IMAGE ORTHICON



3. *Comparative Video Signals.* The strength of iconoscope voltages increase as the image becomes whiter. In the image orthicon, an applied negative bias causes the voltages to appear in such a manner that black produces the maximum voltage.

4. *Blanking Voltages* are supplied from the pulse generator and, together with the picture signal, pass to the video amplifier. There are separate horizontal and vertical blanking pulses. While they are active, no picture information is transmitted.

Picture Information and Blanking Pulses

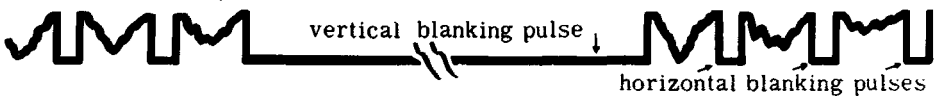

Picture Information Only

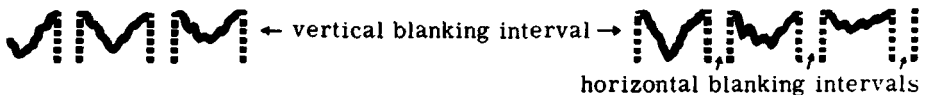

SYNCHRONIZING PULSES

Adding the Sync Pulses to the Video Signal

Reconstruction of a television scene on the screen of a monitor or receiver picture tube requires that the electron beam in this tube describes exactly the same horizontal and vertical motions as does the electron beam in the camera tube. It is not enough for the two beams to move under the influence of deflecting currents of identical frequency; the current variations must be perfectly in step with each other.

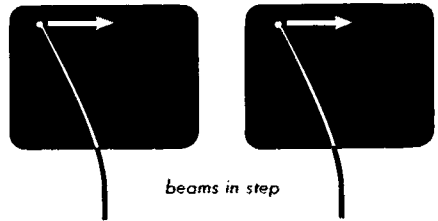
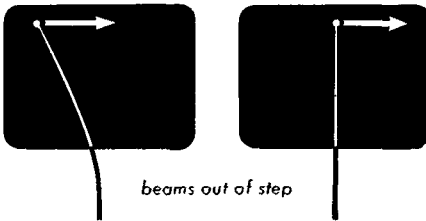
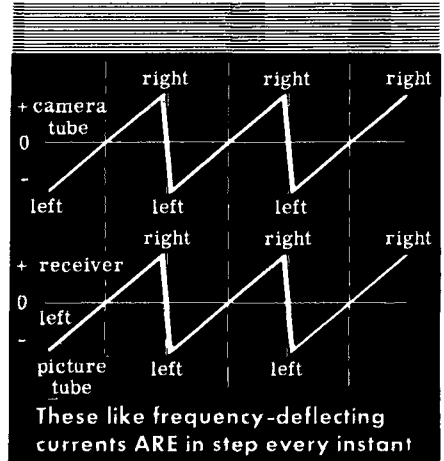
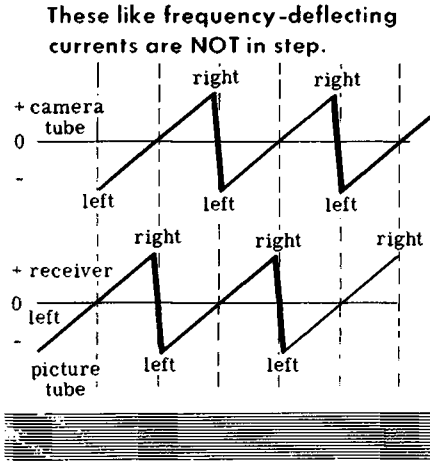

BEAM MOTIONS IN CAMERA AND PICTURE TUBES

The two beams must change direction at the same instant, and must reach their minimum and maximum values in step with each other. If the two beams do not move in synchronism an unintelligible picture will be reconstructed. To assure perfect reconstruction of the televised scene, the vacuum tube generators that supply the horizontal and vertical deflection voltages to the deflecting coils in the camera, and those in the receiver which produce the deflection voltages for the deflecting coils of the picture tube, are synchronized by voltage pulses derived from the same source—the pulse generator at the transmitter.

SYNCHRONIZING PULSES

Adding the Sync Pulses to the Video Signal (contd.)

The horizontal and vertical deflection voltages which cause the corresponding deflecting currents in the camera tube deflecting coils originate in the deflection generators. The deflecting voltages generated in the receiver and fed to the deflecting coils which serve the receiver picture tube must be not only of the same frequency as those active in the camera tube, but must also vary in step moment by moment. To assure this, deflecting voltage

Adding Sync Pulses To The Video Signal

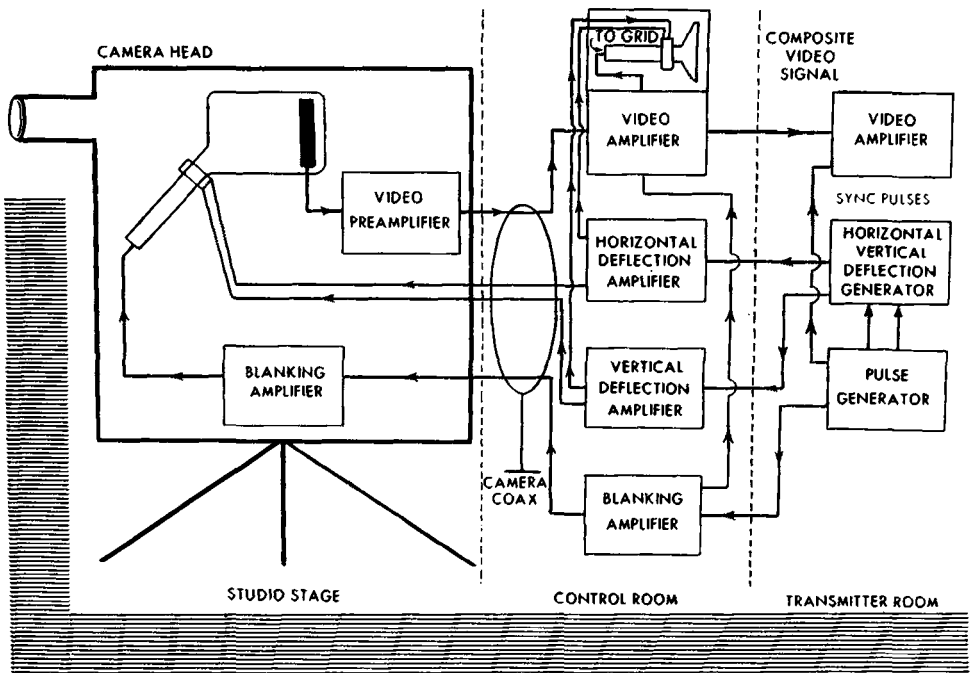

sources in the receiver are placed under the control of the pulse generator in the transmitter. The timing or synchronizing pulses which control the deflection voltage generators are made a part of the picture signal that is sent to the receiver. A cable from the pulse generator feeds horizontal and vertical sync pulses to the video amplifier at the transmitter. It is in this amplifier that the sync pulses are added to the picture signal which now also contains the blanking voltage pulses.

SYNCHRONIZING PULSES

Adding the Horizontal Sync Pulse

Sync pulses are of two kinds, horizontal and vertical. At this time we shall discuss only the synchronizing pulse that is related to the horizontal movement of the beam.

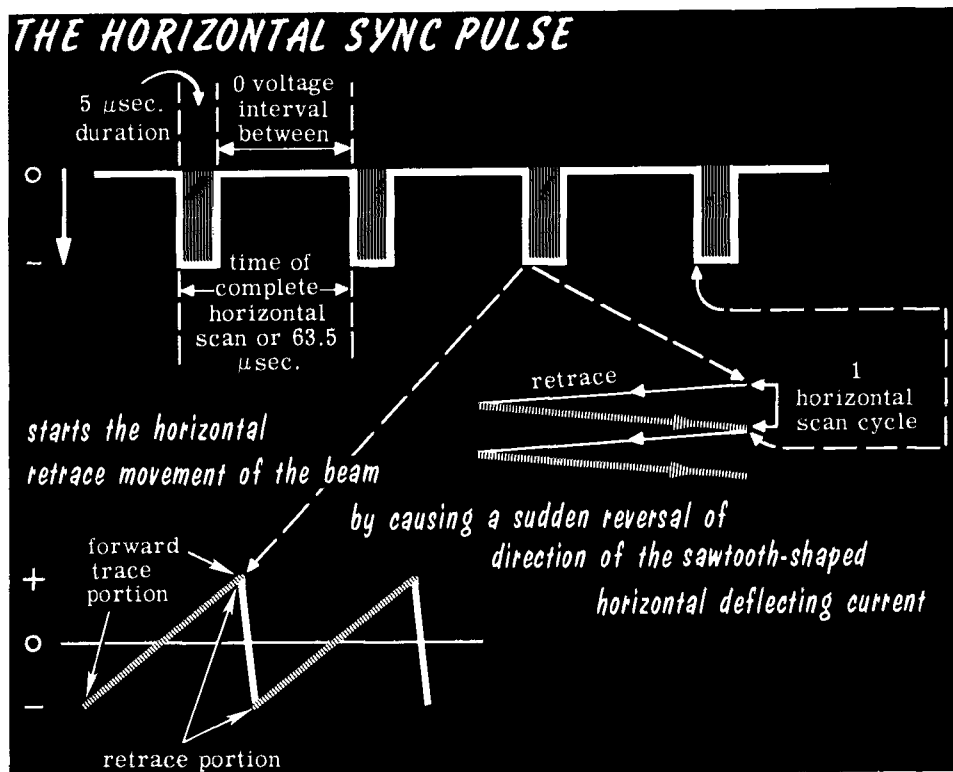

The horizontal sync pulse is very narrow; it lasts for only 5 microseconds. Its polarity is the same as that of the horizontal blanking pulse, for as will be seen shortly, the sync pulse rides on the blanking pulse enabling its separation from the picture signal in the receiver. The pulse is timed to appear coincidentally with the arrival of the beam at the end of its horizontal excursion towards the right. It triggers the horizontal deflection generating system to initiate the retrace portion of the horizontal scanning cycle. In other words the horizontal sync pulse appears at the end of each horizontal scan. In this way the electron beam in the receiver picture tube is positioned at the proper point on the screen to accept the picture information being developed in the camera tube, whose beam also is in the identical position on the mosaic (or target). We should emphasize that the destination of the horizontal sync pulse after delivery to the receiver as a part of the picture signal is the horizontal deflection-current generator system.

SYNCHRONIZING PULSES

Adding the Horizontal Sync Pulse (contd.)

Each horizontal sync pulse is timed to appear just slightly after the start of the 10-microsecond horizontal blanking pulse which appears at the end of each horizontal scan. Having a duration of only 5 microseconds, the sync pulse ends before the blanking pulse. Therefore, the sync pulse occurs within the duration period of the blanking pulse. By making the peak

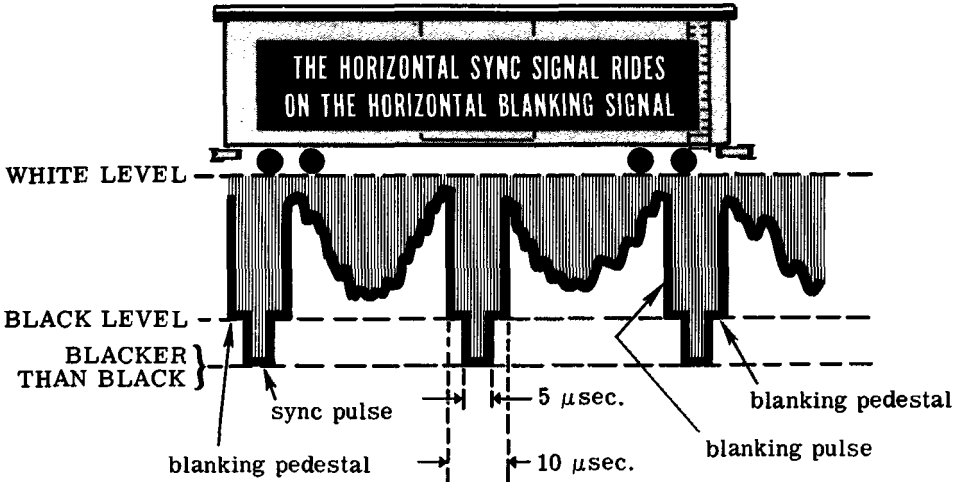

amplitude of the sync pulse greater than that of the blanking pulse, the sync pulse extends beyond the blanking pulse pedestal when the two are seen together. This makes it possible to "clip" the sync pulse off the blanking pulse pedestal in the receiver and to use it as a timing signal. Also, because the sync pulse extends beyond the black level set by the blanking signal pedestal height, the sync pulse signal is said to be located in the "blacker than black" region of the picture signal.

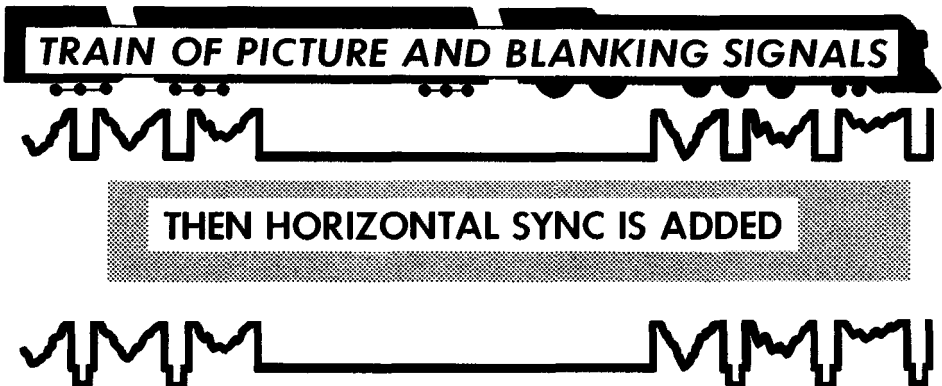

SYNCHRONIZING PULSES

Adding the Vertical Sync Pulse

It is not enough that the receiver picture tube beam move from side to side in synchronism with the camera tube beam. The two beams must also move in step in the vertical direction. To make this happen is the function of the vertical sync pulse, which, like its horizontal counterpart, is used in the transmitter, and is received as part of the picture signal. In both the transmitter and the receiver the vertical sync pulse is applied to the vertical deflection generator where it triggers the sudden reversal of direction of the vertical deflection current. In so doing it starts the scanning beam moving upward at a particular moment in relation to the overall scanning.

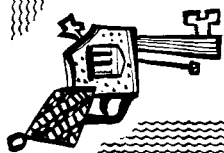
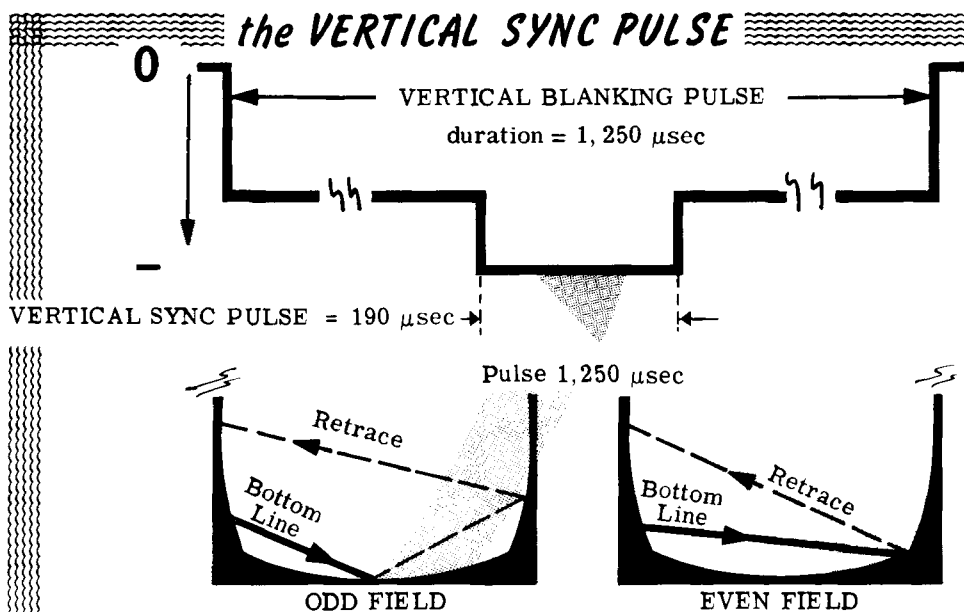

STARTS

the VERTICAL RETRACE in EACH FIELD

The vertical retrace action of the scanning beam occurs once in each field; when the beam, having scanned the bottom horizontal line, is ready to move to the top of the scanned surface and begin scanning the next field. The vertical sync pulse appears every 1/60 sec or 60 times per second. The pulse interval is 190 microseconds. This makes it a long-duration pulse in comparison with the 5-microsecond horizontal pulse.

SYNCHRONIZING PULSES

Adding the Vertical Sync Pulse (contd.)

The beam moves upward, but not straight up; it zig-zags from side to side because of the action of the horizontal deflecting field which is ever present in both the camera tube and in the receiver picture tube. This movement must occur if the beam is to start scanning horizontally the moment the vertical retrace is completed. In this connection, each beam must be at its correct location—the camera tube beam ready to start the development of the picture information for transmission and the receiver tube beam ready to reconstruct the picture. For both the camera tube and the receiver picture tube, the moment *when* retrace begins in each field is extremely important. Each must begin at one precise instant if correct interlace of the two fields is to be accomplished. For this reason, and also to make certain that the horizontal syncing is continuous, the vertical sync pulse is notched or serrated; another train of pulses called the equalizing pulses is added ahead of and after the vertical sync pulse.

The Vertical Retrace

Moves

From

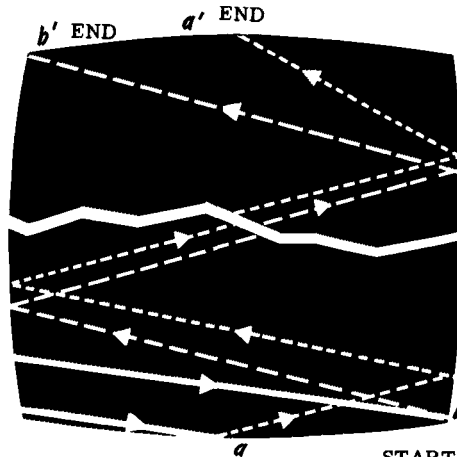

a and a' are at the center
b and b' are at the corners

START OF ODD
FIELD RETRACE MUST BE PRECISE

START OF EVEN
FIELD RETRACE
MUST BE PRECISE

Side to Side As The Beam Climbs Upward

You will recall the statement that there are 262.5 horizontal lines in each field. The simplified presentation of the odd and even fields showed the odd lines numbered from 1 through 525 and the even lines numbered from 2 through 524. Obviously the vertical retrace period of each field must consume some of these lines. This happens, but it is not necessary to again present the organization of the lines in each field. We simply accept the fact that about 20 lines per field are inactive because of vertical blanking.

SYNCHRONIZING PULSES

The Serrated Vertical Sync Pulse

When thinking about synchronizing the vertical deflecting system of the receiver and the camera tube, we should not lose sight of a similar need for synchronization in the horizontal deflecting system. The simplified version of the vertical retrace shows it as an instantaneous movement from the bottom edge to the top edge of the mosaic, screen, or target. Actually it does not retrace this way.

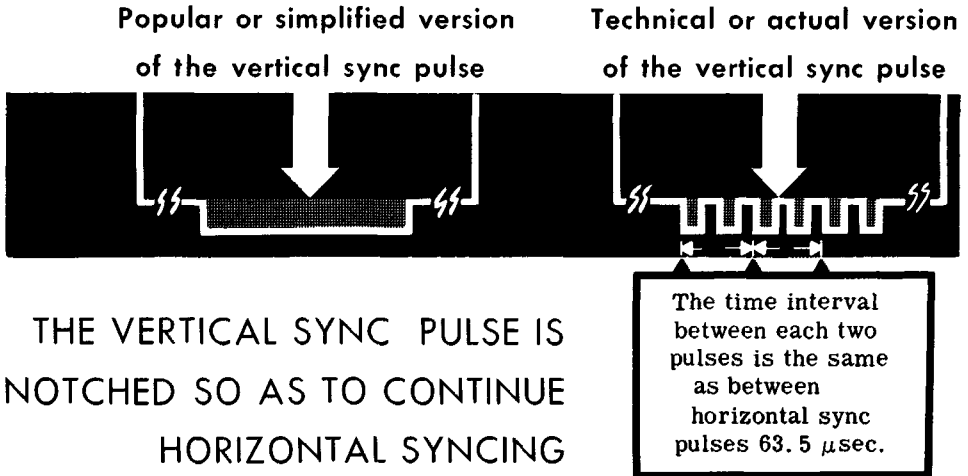

To maintain horizontal sync during the presence of the vertical sync pulse in each field, the pulse is notched or serrated. This reforms the single long pulse that we illustrated into six like pulses of comparatively long duration with short intervals of no sync voltage between. The serrations are positioned so that the time interval between the leading edges of each two adjacent notches is the same as between two adjacent horizontal sync pulses. In this way the horizontal deflection generator is subjected to three horizontal sync impulses during the time when the vertical sync pulse is active in each field.

The vertical sync pulse on the vertical deflection generator is not impaired by the short intervals when the sync voltage falls to zero (the notches). Vertical syncing behaves as a constant amplitude pulse. As will be shown later in the course, the receiver system distinguishes between the horizontal and the vertical sync pulses due to the difference in duration and voltage intervals between these pulses. (You can see this difference for yourself if you compare the above notched vertical sync pulse with previous illustrations which show the horizontal sync pulses.)

Serrating the vertical sync pulse does not in any way change its relationship to the blanking pulse on which it rides as illustrated in the preceding drawing. Everything said before still applies.

SYNCHRONIZING PULSES

Completing the Vertical Sync Action (Equalizing Pulses)

The description of the vertical sync action is completed when we add the *equalizing pulses*. They appear as two trains of six pulses each in each field; one train timed to appear just before the vertical sync-pulse interval and one train immediately after. They have the same polarity as the vertical sync pulse, but are unlike the latter in that they are short duration pulses. They, too, are formed so that the interval between two adjacent pulses corresponds to a horizontal scanning cycle, thus providing the equivalent of three horizontal sync pulses immediately before the vertical retrace appears, and three horizontal sync pulses immediately after the vertical sync pulse. In this way they keep the horizontal deflection generator on frequency during the period when the vertical deflection generator is being made ready for the reversal of the direction of the deflection current. This is the initiation of the vertical retrace.

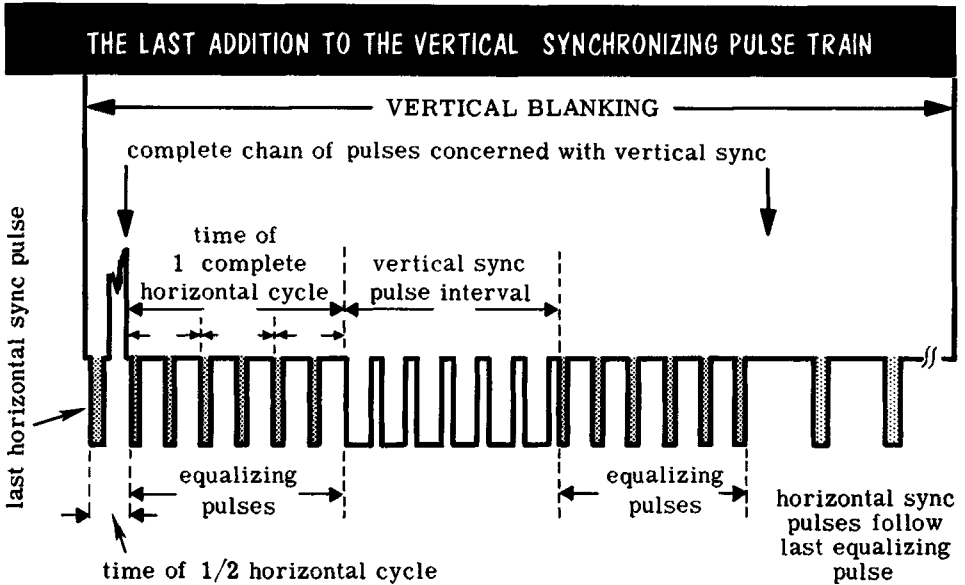

Note. these are the equalizing pulses for one field only - the odd line field

The "get ready" interval is required because each field contains a half-line. The instant of triggering of the vertical retrace action of the odd line and the even line fields differs by a half horizontal line. The last horizontal line in the odd field ends at the center of the bottom edge of the surface being scanned, completing the last horizontal line of the even field which ends at the right corner of the bottom edge. The equalizing pulses in each field take care of this time difference and trigger the vertical retrace of the successive fields at the proper moments so that correct interlace of the horizontal scanning lines takes place.

SYNCHRONIZING PULSES

The Composite Video Signal

The addition of the horizontal and vertical blanking pulses, the vertical sync pulses, and the two trains of equalizing pulses to the picture signal produces what is called the *composite video signal*. This is the signal output from the video amplifier at the transmitter, and is used to amplitude-modulate the picture carrier. Since the process of composite signal transmission is continuous as long as the transmitter is on the air, any single train of signals may represent a short period of transmission without regard to the field, or portion of the field, that is being transmitted, unless the contrary is specifically indicated. We should also mention that it is customary to symbolize the waveform of the picture content between horizontal blanking pulses by the use of jagged lines.

COMPOSITE VIDEO SIGNAL is made up of

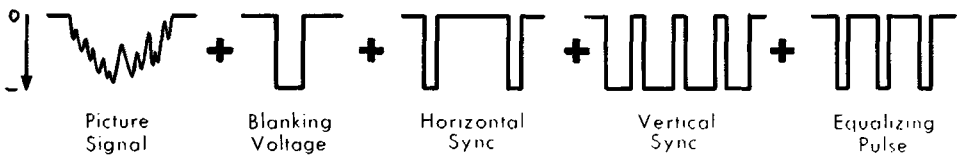

and
may
be
shown
as a
NEGATIVE
or
POSITIVE
POLARITY
SIGNAL

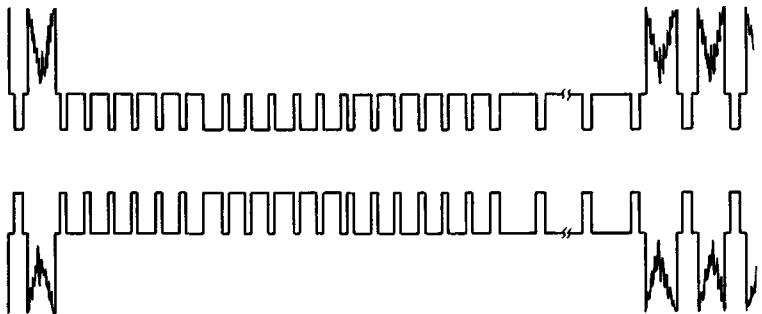

Another point which should be mentioned is the polarity of the composite video signal. Our discussion so far has been concerned with negative polarity signals although the illustration of the composite signal is more often one of positive polarity. The sync pulse peaks are the highest signal levels and the white content of the picture is the lowest signal level. However, the lowest peak signal level is not equal to the zero level of the signal used for modulation. The FCC and industry standards set the whitest signal at 5% to 10% higher than the camera's white output.

THE PICTURE SYSTEM

The Generation of the Picture Carrier

The composite video signal has numerous high-frequency components but it cannot be sent to the transmitter antenna and radiated from there. It must first be applied to a *carrier* as amplitude-modulation; then the amplitude-modulated carrier is radiated to the host of television receivers. This carrier is the *picture carrier* of the transmitting station.

Partial Block Diagram of

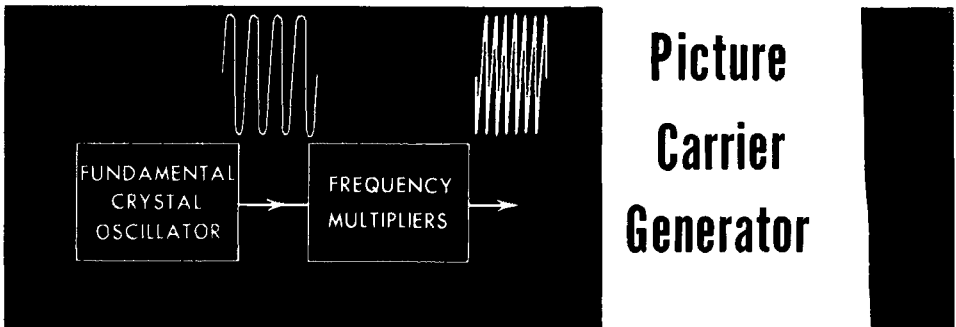

Like the sound carrier described earlier, the picture carrier is either in the very high frequency (VHF) or in the ultra high frequency (UHF) region of the electromagnetic spectrum, as determined by the operating picture carrier frequency allocated to the television station by the Federal Communications Commission. Also, as in the case of the sound carrier, the allocated picture carrier frequency cannot be generated directly.

The required degree of accuracy would be difficult to reach. An accurately controlled signal that has a much lower frequency than the final picture carrier frequency, but is a submultiple of the final carrier frequency, is generated. Then by a series of frequency-multipliers the signal frequency is raised to the required figure, at which time the amplitude-modulation is applied. We have described the process of frequency-multiplication in connection with the sound carrier, and shall not repeat it here. However we must emphasize that the picture carrier is amplitude-modulated, therefore there is no frequency-modulation present at either the stage where the basic frequency signal is produced or anywhere along the chain of frequency-multipliers. The modulated carrier varies in amplitude in accordance with the instantaneous changes in the amplitude of the modulating signal, which is the composite video signal.

THE PICTURE SYSTEM

The Generation of the Picture Carrier (contd.)

With the multiplier stages performing the task of raising the frequency of the picture carrier to the final figure, a number of stages of amplification are needed to raise the amplitude of the carrier to the proper level for modulation. This is performed in a series of radio frequency amplifiers.

Adding R-F Amplifiers to the Picture Carrier Block Diagram

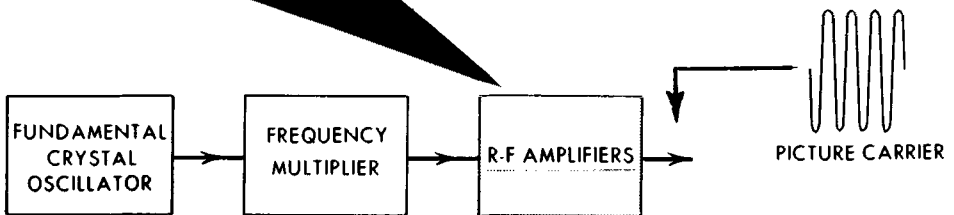

The composite video signal must be combined with the r-f picture carrier. This combining occurs in the modulator stage. It is an r-f amplifier to which are fed the carrier signal from the r-f amplifiers and the composite video signal from the video amplifier at the transmitter. The output of the modulator is an r-f signal whose carrier-cycle amplitudes vary in accordance with the amplitude variations of the composite video signal. It has an upper

Adding the Modulating Stage to the Block Diagram

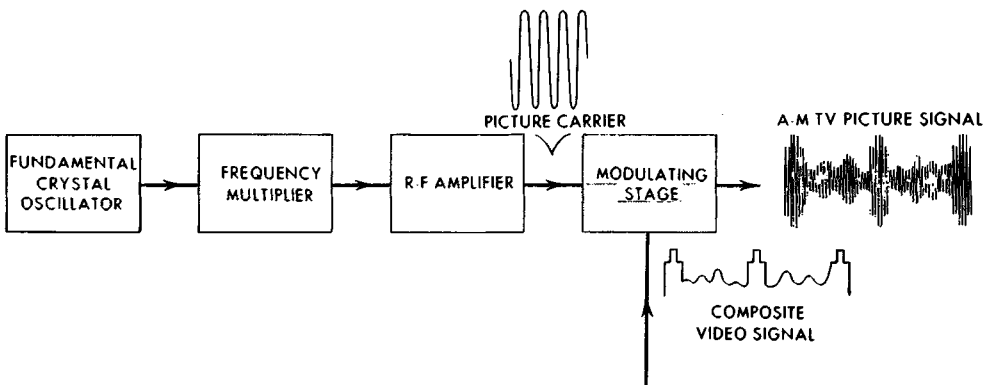

and a lower sideband just as any amplitude-modulated carrier has. Now the modulated signal has a frequency band width which is equal to twice the highest frequency present in the composite video signal.

THE PICTURE SYSTEM

The Power Amplifier

The amplitude-modulated r-f carrier signal is fed into a number of power amplifiers, which in turn feed the signal to the transmitting antenna for radiation to the receivers. These amplifiers perform a dual function in many transmitters. In all cases they raise the level of the modulated carrier to the amount required for transfer to the antenna and the attainment of the desired radiated power. The effective radiated power rating of a television transmitter is a function of the energy level obtained from the power amplifiers and also of the power gain achieved in the antenna. The meaning of power gain is explained elsewhere in this course.

The Block Diagram

of the Picture Part of the TV Transmitter

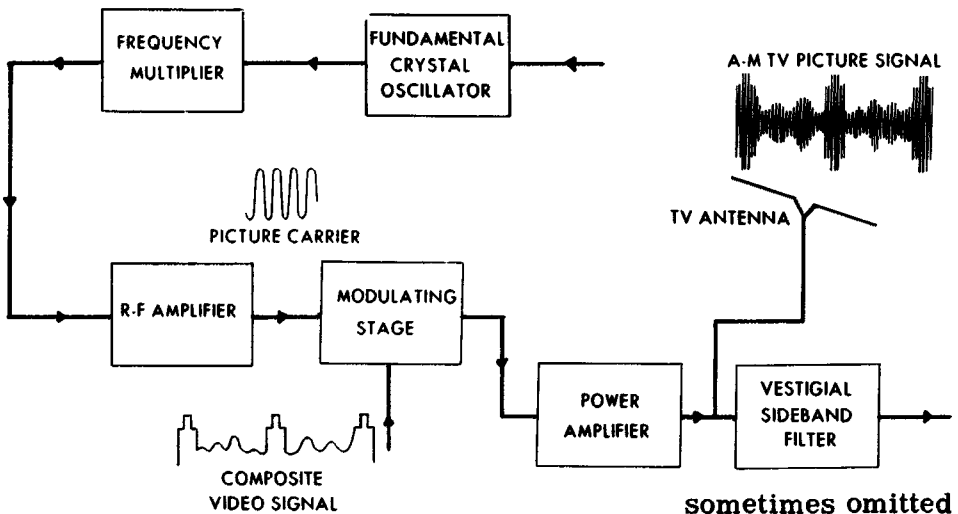

The second function performed by the power amplifiers in some transmitters is to limit the extent to which the lower sideband of the modulated picture carrier is transmitted. The amplifiers are operated somewhat off-tune. This allows the carrier and the entire upper sideband, but only about 1.25 mc below the carrier frequency of the lower sideband, to be fed to the antenna. In some transmitters the power amplifier output contains the full upper and lower sidebands, but the lower sideband frequencies beyond 1.25 mc are removed in special filter circuits that are interposed between the output of the power amplifiers and the antenna. They are known as *vestigial* sideband filters. This picture-carrier treatment conforms with vestigial sideband or partially attenuated sideband form of transmission.

THE PICTURE SYSTEM

The TV Picture Signal Sidebands

The usual amplitude-modulated radio signal is described as having a carrier, an upper and a lower sideband. The intelligence is transmitted in the sidebands, never in the carrier. The two sidebands are alike in bandwidth, the maximum bandwidth determined by the highest frequency component of the modulating signal. For instance, if the highest frequency component of the modulating signal is 7.5 kc, then the overall bandwidth of the amplitude-modulated signal is 15 kc or twice the highest frequency component of the modulating signal. If the carrier is 600 kc, the upper sideband signal frequency limit is $f_c + f_m$ or $600 + 7.5$ or 607.5 kc. The lower sideband signal frequency limit is $f_c - f_m$ or $600 - 7.5$ or 592.5 kc.

BANDWIDTH of the TELEVISION PICTURE SIGNAL BEFORE CORRECTION

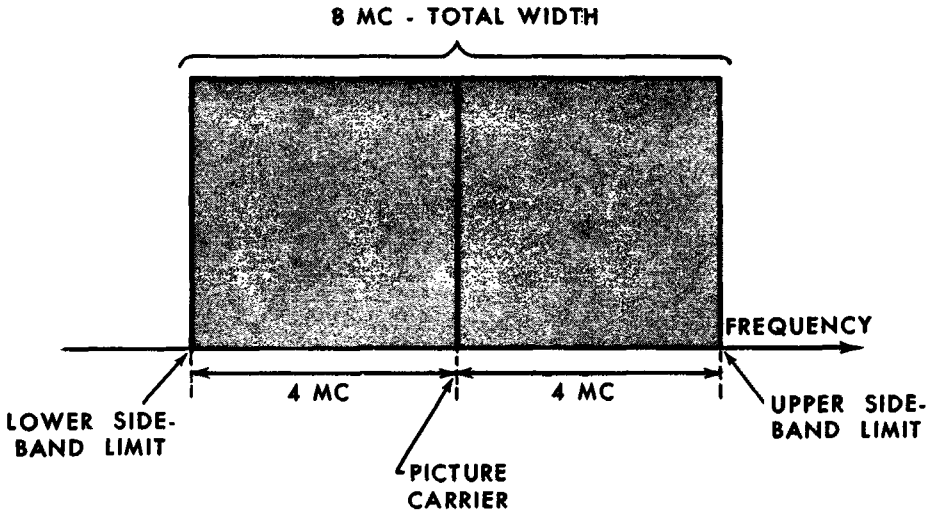

Except for the numerics involved, the above description fits the amplitude-modulated television picture carrier at the output of the modulator in television station transmitters, and at the output of the power amplifier in some instances. American standards of television transmission set the highest frequency component of the composite video signal at 4 mc. Under the circumstances the amplitude-modulated picture carrier has two sidebands, each 4 mc wide, or a total signal bandwidth of 8 mc. However there is insufficient space in the frequency spectrum to permit each station to occupy the full 8 mc band for its picture signal transmission, hence the signal bandwidth is narrowed. In fact the FCC allows a total channel width of only 6 mc for both picture and sound signals. How is this done?

THE PICTURE SYSTEM

Vestigial Sideband Transmission

The inclusion of both the picture and the sound carriers with their modulation components within a total channel bandwidth of 6 mc is made possible by using *vestigial sideband transmission* techniques. This technical phrase is defined as transmission in which one sideband is partially suppressed while the other is transmitted unaltered.

Authorized Bandwidth of the Transmitted Picture Signal

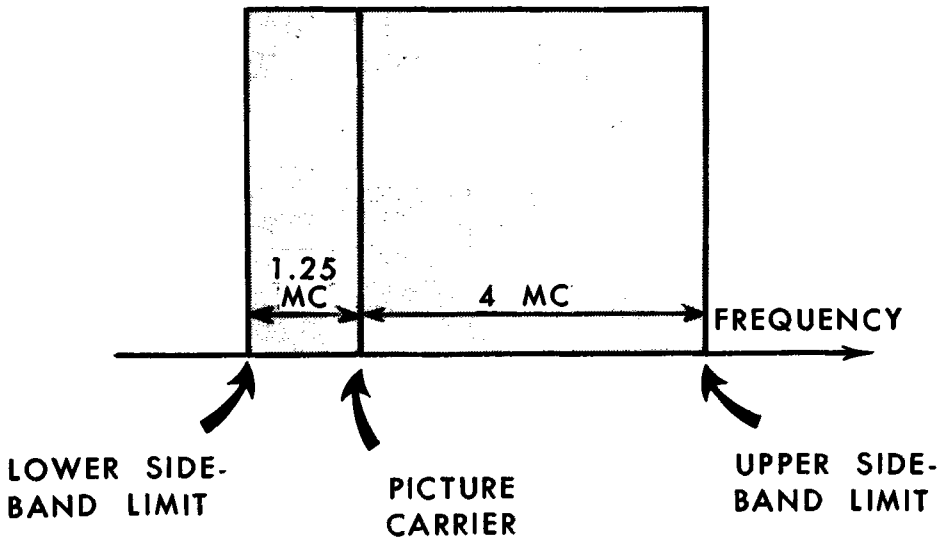

The completed upper sideband of 4 mc is transmitted, but the lower sideband is transmitted at maximum amplitude over a relatively narrow frequency band of .75 mc. From there, the progressively higher frequency components are gradually attenuated, reaching complete attenuation or zero signal level at 1.25 mc. Thus all frequency components up to .75 mc in the composite video signal are transmitted as double sideband; all frequency components between .75 mc and 1.25 mc become more and more upper sideband, and above 1.25 mc are only upper sideband. This correction is the function of the vestigial sideband filter (which we show in the complete transmitter block diagram on the next page), or, in some instances, is accomplished in the power amplifiers by operating them off-tune. Thus the required picture-modulation components are confined to a total bandwidth of 5.25 mc. This permits the picture and sound signal radiations from a transmitter to be within an overall signal bandwidth of 6 mc.

(1-101)

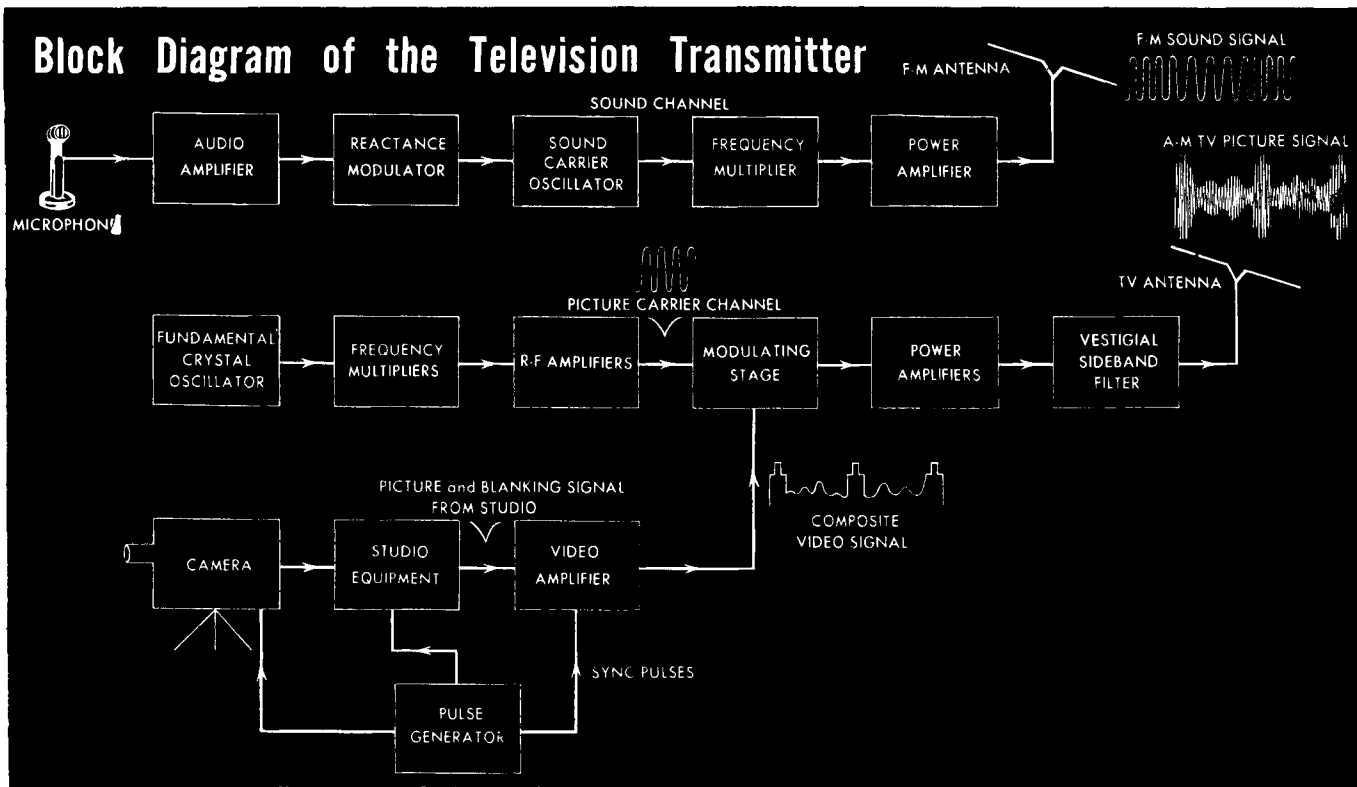

THE PICTURE SYSTEM

The Complete Television Transmitter

This description of a black and white television transmitter is a generalization, rather than the block diagram of any one particular transmitter. Numerous

elements relating to control have been omitted. Only those details integral to the formation of the sound and video signals in the transmitter are illustrated.

TELEVISION TRANSMISSION

Transmission Lines and Filters

The transmission line is the final link between the audio-video transmitters and the television antenna. Basically the transmission line is nothing more than a pair of wires or a cable that delivers to the antenna the power generated by the transmitters. The most common type of transmission line is the coaxial cable. It may consist of concentric conductors—a center wire passing through an outer cylindrically shaped wire braid, and a low-loss

The TV Transmission Line

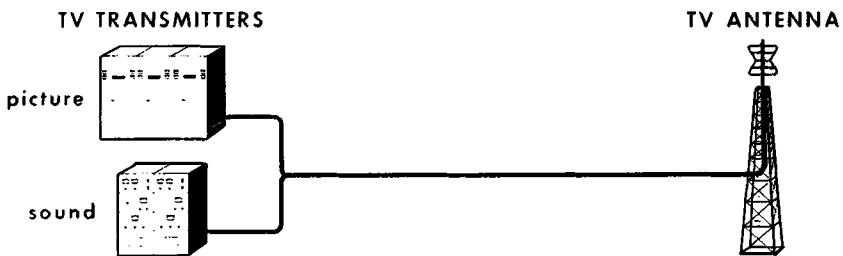

transfers power from the PICTURE and SOUND TRANSMITTERS to the TV Antenna

Vestigial-Sideband Filter

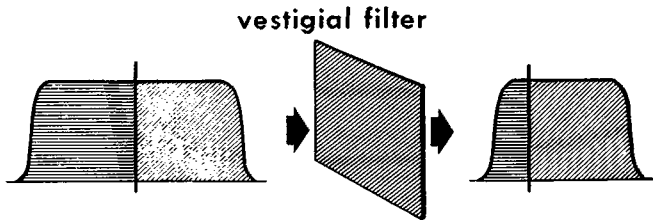

removes portion of LOWER SIDEBAND of TV SIGNAL

insulator keeping the wires correctly spaced. A more efficient line used in many high-power installations is a coaxial cable consisting of two coaxial cylindrical conductors insulated from each other by low-loss spacers. In this case the dielectric between the conductors can, for all practical purposes, be considered as air. In some instances, the space between the conductors is filled with an inert gas such as xenon, under pressure, to keep moisture out of the line and prevent oxidation.

TELEVISION TRANSMISSION

Transmission Lines and Filters (contd.)

Since it is common practice to transmit both sound and picture carriers from the same antenna, a special circuit called a *diplexer* is used. Into this unit is fed the r-f signals from the sound and the picture transmitters. They are mixed and then fed to a common antenna from where they are radiated.

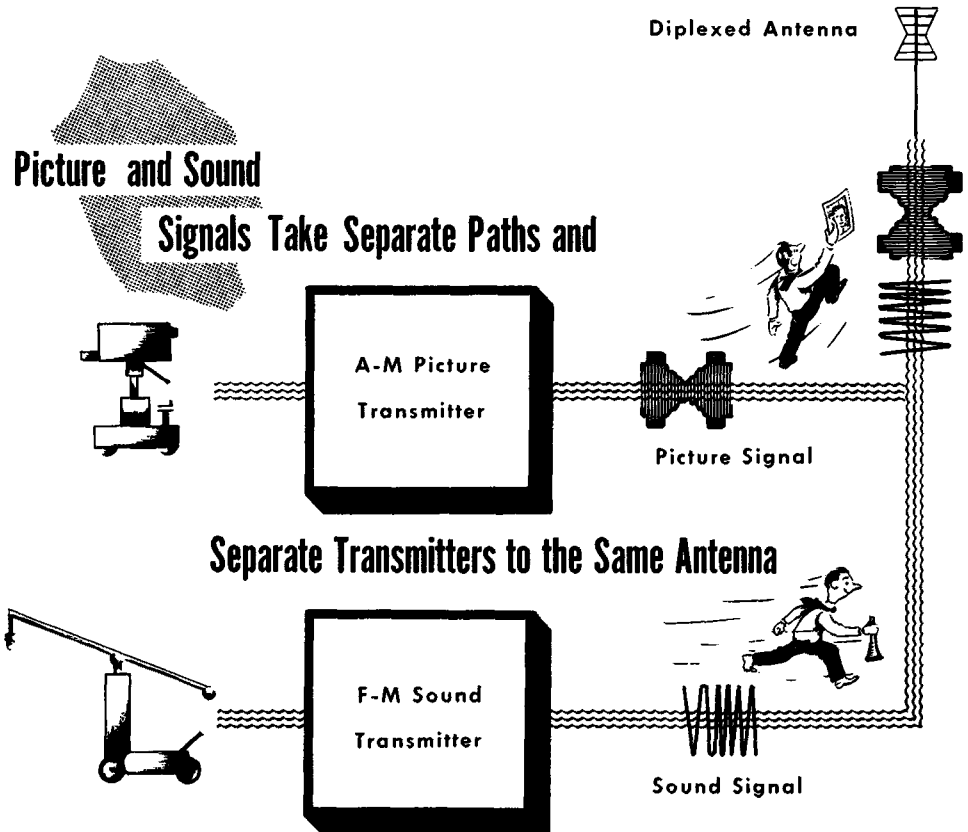

As will be discussed later in this course, a vestigial type of transmission is used in television broadcasting wherein a portion of the lower sideband or the transmitted signal is removed. Since essentially the same information is contained in both the upper and lower sidebands, considerable broadcasting spectrum space can be saved by using only one of the sidebands.

The circuit used to attenuate one of the sidebands is called a vestigial-sideband filter. It consists basically of a highly selective circuit tuned in the region of the unwanted sidebands. This filter can be placed in the final stage of the picture transmitter, or in the transmission line between the transmitter and the broadcast antenna.

TELEVISION TRANSMISSION

Television Transmitting Antennas

The final step in the transmission of television signals is the radiation of the picture and sound carriers from the broadcast antenna. To send these signals the greatest possible distance, the transmitting antenna is usually

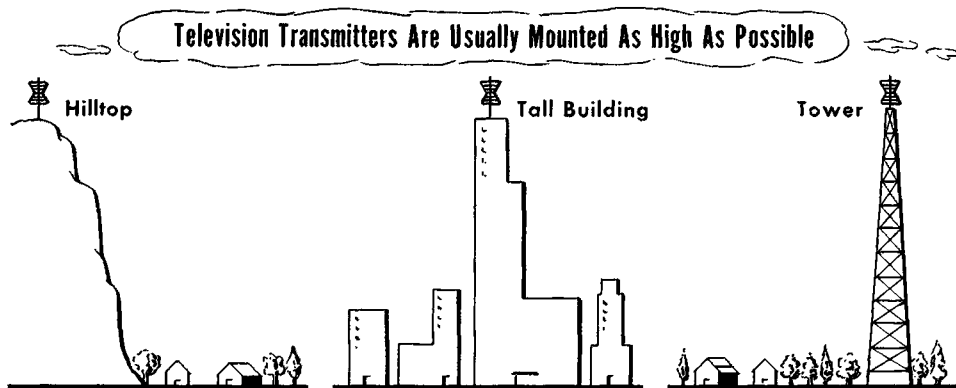

located at the highest possible point in an area. Electromagnetic energy radiated from this antenna is directed toward the greatest concentration of television receivers. In some locations, the antenna is made omnidirectional (designed to radiate equally well in all directions).

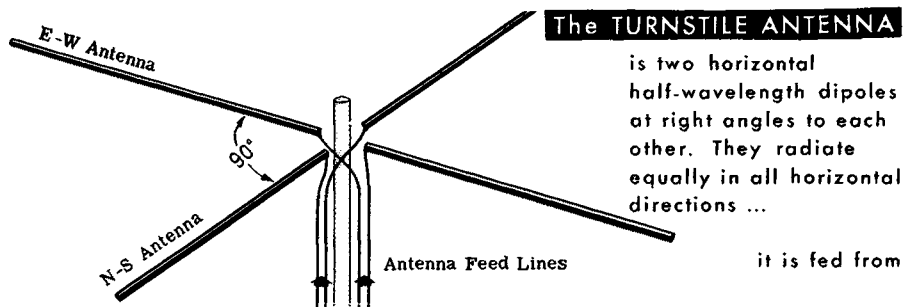

the transmitter with signals phased by a



To obtain this uniform signal distribution a *turnstile* antenna is used. To further concentrate the radiated picture and sound carriers in a horizontal plane about the broadcast antenna, the *supertturnstile* antenna is used.

TELEVISION TRANSMISSION

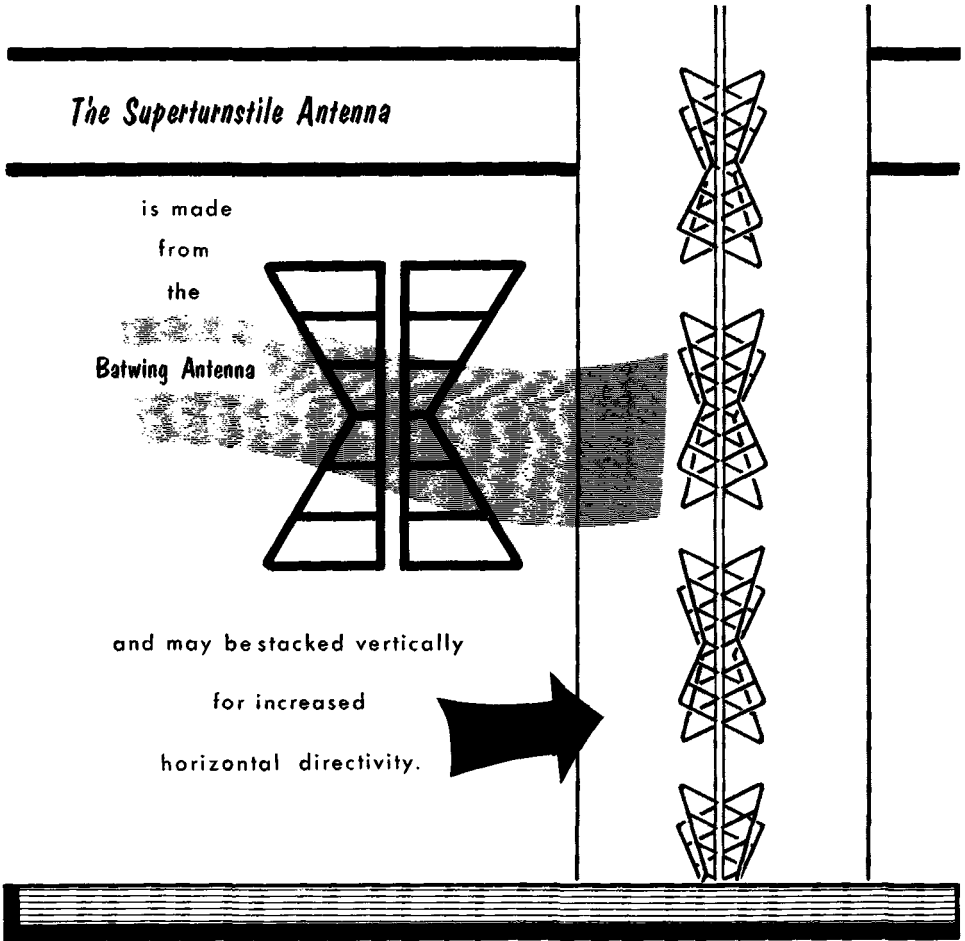

Television Transmitting Antennas (contd.) The peak output power of a television broadcast antenna may be as high as 50 kilowatts in a typical high-power installation. However, depending upon the efficiency of the antenna, the effective radiated power (erp) may be many times greater.

This antenna is produced by the vertical stacking of *batwing* turnstiles. Each batwing unit consists of a series of horizontal elements or rods. The center rod is the shortest, giving the antenna the appearance of a batwing. This device may be considered as an extremely broad dipole antenna, useful for extending the frequency range of the broadcast antenna.

Other antennas such as the *super-gain* and the *helical* are also used in television transmission, but have not achieved the popularity of the superturnstile.

TELEVISION TRANSMISSION

Television Standards in Other Parts of the World

The American television standards result in what has been generally agreed upon to be an acceptable picture. Notwithstanding, engineers in other countries have set their own standards substantially different from ours.

Two respects in which they are the same are the interlace of the two-field transmissions, and the aspect ratio of 4:3. It might be mentioned that a number of years ago the British standard was a 5:4 aspect ratio.

Because of the differences in the number of lines per field and per frame used in other systems, the horizontal and vertical sync as well as blanking intervals differ somewhat, although not necessarily too greatly, from our American standard.

It is possible to separate all of the other standards into three groups; European, British and French. All of the European countries do not necessarily use the European system; some use the British and some use the French. The European system involves the transmission of 625 lines per frame and 50 fields or 25 frames per second. The horizontal scanning frequency is 15,625 cycles per second. Whereas the American system allows from 483 to 499 active or unblanked horizontal scanning lines, the European system allows from 563 minimum to 589 maximum active or unblanked lines.

The British system is based on 405 lines per frame and 50 fields, or 25 frames per second. The horizontal scanning frequency is 10,125 cycles per second and calls for 377 active or unblanked lines per frame.

The French system involves 819 lines per frame and also 50 fields or 25 frames per second. Because of the greater number of lines per frame the horizontal frequency is naturally higher being 20,475 lines per second. The number of unblanked lines is 737.

While the sound portion of the television signal is frequency modulated in all of North and South America, this by no means holds true for the rest of the world. Many countries in Europe and Africa use amplitude modulation. Some areas, e.g. Vatican City, use amplitude modulation for one system and frequency modulation for another. In the American system of frequency modulation the maximum frequency deviation of the carrier is plus or minus 25 kilocycles; the European system makes use of a 50-kilocycle deviation corresponding to 100% modulation.

Another item of considerable variation is the television channel width. Here again all television broadcasting in North and South America use a channel width of 6 megacycles. The French system using 819 lines per frame requires a channel width of 14 megacycles, while the other systems make use of channel widths of 6, 7, 8, and 9 megacycles.

TELEVISION TRANSMISSION

Television Standards In Other Parts of The the World



With the exception of Argentina and Venezuela, all nations in this hemisphere which enjoy television broadcasts use the same standards of operation as does the United States.

France and her colonies use two systems; 441 and 819 lines per frame, 25 and 50 frames per second. A-M for audio transmission. Fourteen-mc bandwidth for each television channel.

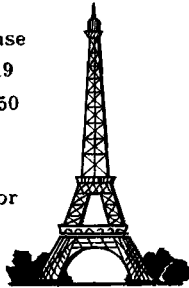

Great Britain uses 405 lines per frame, 25 frames per second. A-M for transmission. Five-mc bandwidth per channel.



The European System used in many countries is 625 lines per frame, 25 frames per second. A-M and f-m for audio transmission. According to standards in the individual countries, 5, 7, 8 and 14-mc channel bandwidth.

Japan and the Phillipines use American standards ; other countries use either the European or the French Systems.



TELEVISION TRANSMISSION

Television Transmission

In some instances additional work is required in the distribution of the television signal. Some sparsely populated areas cannot provide financial support for a local television station, therefore a TV signal must be brought to them from some distant point. In other areas there may be only one station, and the large networks not represented in these areas must "bring in" their signals.

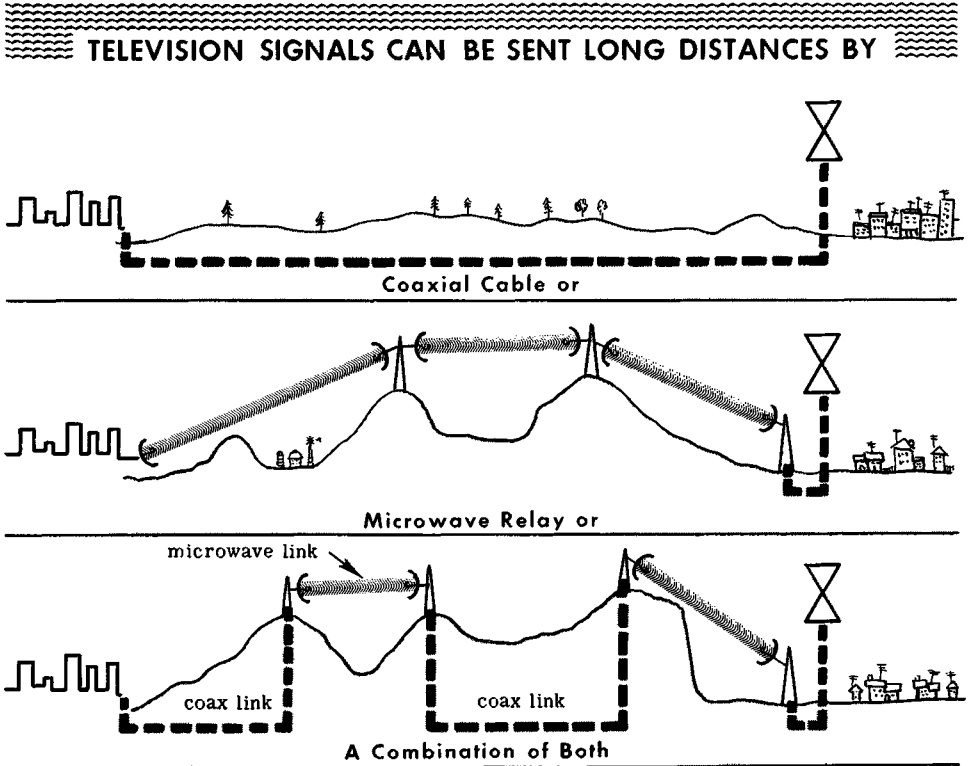

Two methods are used for *intercity transmission* of television signals. One is the use of long *coaxial cable transmission* lines that stretch for hundreds of miles. These lines, which are buried in the ground or strung along poles, contain amplifiers that periodically boost the signal along the line. The other popular method is *microwave transmission*, in which a series of microwave repeaters or relays are set 40 to 50 miles apart. Each relay receives the television signal and retransmits it. The radiation is in the form of a very narrow beam, and is *focused* by parabolic reflectors. When the signal reaches its final destination, its carrier-wave frequency is reduced to the required channel frequency and broadcast to the local community.

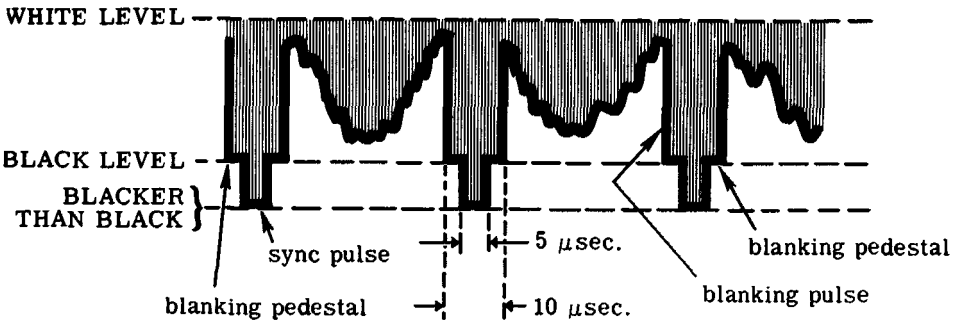

1. *Horizontal Sync Pulses* ride on horizontal blanking pulses, but being of shorter interval are easily "clipped" from the blanking pulses. Sync pulses appear at the end of each horizontal scan, synchronizing the information on the receiver screen with that on the camera tube.

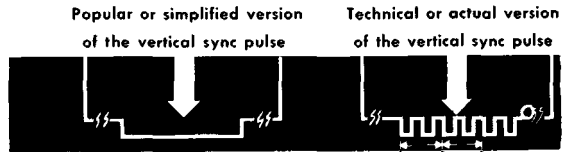

2. *The Vertical Sync Pulses* coincide with horizontal deflection generation. This allows horizontal syncing to be continuous, also regulates interlacing to begin at the proper moment.

The time interval between each two pulses is the same as between horizontal sync pulses 63.5 μsec.

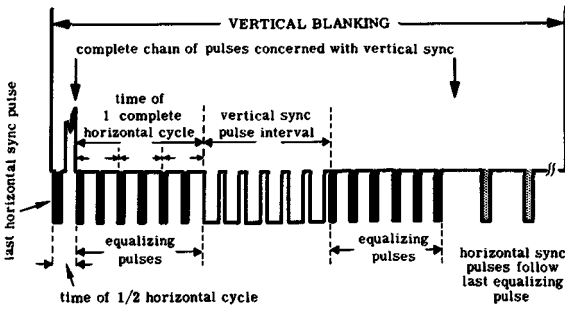

Note: these are the equalizing pulses for one field only the odd line field

3. *Equalizing Pulses* appear in groups of six before and after each vertical sync pulse. They equalize the time difference created by the half-lines of each field, and trigger the vertical retrace so that correct interlacing takes place.

4. *Picture-Carrier Generation.* Picture-carrier frequencies are submultiples of the final carrier frequency. The signal is raised by a series of frequency multipliers, is passed through a number of amplifier stages, and then, in the modulator stage, is combined with the r-f picture carrier.

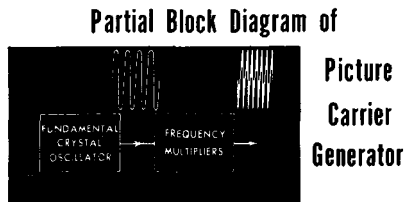

REVIEW

Vestigial-Sideband Filter

vestigial filter

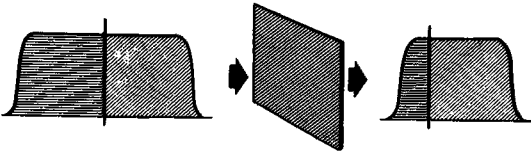

removes portion of LOWER SIDEBAND of TV SIGNAL

6. *Picture Signal Sidebands* transmit TV intelligence. American standards require a total bandwidth of 8 mc, but the FCC allows a total channel width of only 6 mc. Therefore one sideband is partially suppressed either by a vestigial sideband filter or by the power amplifiers operating off tune.

5. *Power Amplifiers* raise the modulated carrier to the level required for transfer to the antenna and the desired radiated power; they also limit the transmission of the modulated picture-carrier lower sidebands.

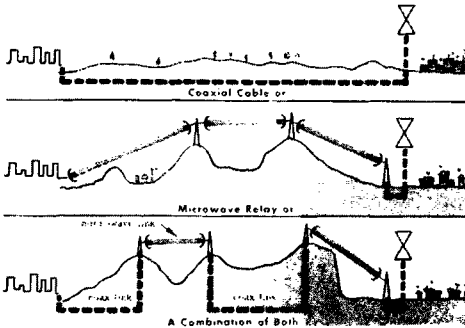
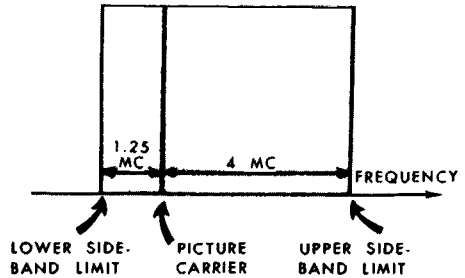

7. *Television Transmitting Antennas* which radiate picture and sound carries of the television signals are of several types; one is the turnstile antenna which provides uniform signal distribution, another is the superturnstile which concentrates the radiated carriers in a horizontal plane about the broadcast antenna.

8. *Television Transmission.* TV signals can be received from distant points by one of two methods: the use of hundreds-of-miles-long coaxial cable transmission lines, or a series of microwave repeaters or relays set 40 to 50 miles apart.

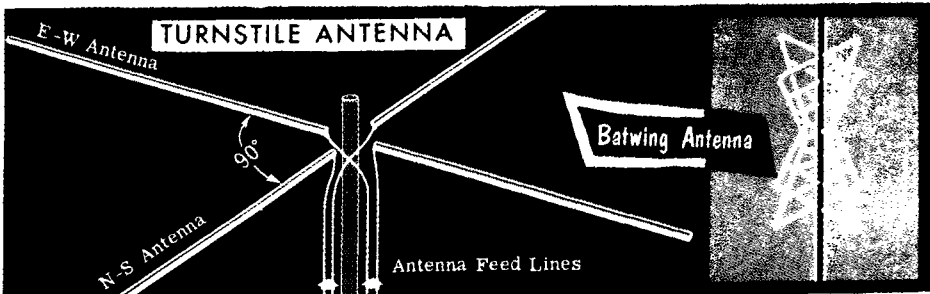

INDEX TO VOL. I

(Note: A cumulative index covering all five volumes in this series will be found at the end of Volume V.)

- Accelerator anode, 1-49
- Amplitude modulation, 1-22
- Amplitude-modulated carrier envelope, 1-22
- Antenna, 1-104, 105
- Aspect ratio, 1-74

- Batwing turnstiles, 1-105
- Blacker-than-black, 1-90
- Blanking:
 - horizontal, 1-73
 - horizontal pulses, details of, 1-85
 - pulse pedestal, 1-90
 - signal, 1-79
 - vertical, 1-73, 92
 - voltages, 1-82-84
- British television system, 1-106

- Camera tube, 1-30
 - image orthicon, 1-5, 11, 43-53
 - iconoscope, 1-5, 36-42, 78
- Camera usage, 1-6-11
- Charge image, 1-51
- Coaxial cable, 1-75, 76, 82, 83, 102, 108
- Collector ring, 1-37
- Composite video signal, 1-8, 76, 95, 96, 97
- Control operator, 1-14

- Decelerator grid, 1-49, 50
- Deflection:
 - horizontal, 1-58
 - simultaneous, 1-59-61
- Deflection coil:
 - horizontal, 1-40, 58, 60, 61
 - vertical, 1-40, 59, 60, 61
- Deflection voltage generators, 1-75, 88
- Deflection yoke, 1-50
- Deviation:
 - positive, 1-23, 95
 - negative, 1-23
- Diplexer, 1-103
- Director, 1-3, 6, 14, 16, 82
- Dolly, 1-4
- Dynodes, 1-52, 53

- Effective radiated power, 1-105
- Electron gun, 1-39, 45
- Electron multiplier, 1-44, 52, 53

- Equalizing pulses, 1-94
- European television systems, 1-106

- Field pickup, 1-12
- Focus coil, 1-46
- Frame, 1-67
- Frequency-doubler, 1-26
- French television system, 1-106
- Frequency modulation, 1-21, 22
 - power amplifier, 1-28
 - sound carrier, production of, 1-22-27, 96
- Frequency-multipliers, 1-24, 25, 26, 27
- Frequency-quadrupler, 1-26
- Frequency-tripler, 1-26
- Fundamental frequency sound-carrier oscillator, 1-24, 26, 27

- Harmonic frequencies, 1-25
- Horizontal forward trace, 1-71, 72

- Iconoscope:
 - circuit, 1-38
 - defects of, 1-43
 - deflection yoke, 1-40
 - electron gun, 1-38, 39
- Image orthicon, 1-11
- Image-to-voltage conversion system, 1-32-35
- Interlaced scanning, 1-63-70
 - first field, 1-65
 - frame, 1-67
 - second field, 1-66
 - technical details, 1-68-70

- Lap dissolve, 1-7
- Lens:
 - telephoto, 1-4
 - turret, 1-11, 12

- Mechanical aids, 1-10
- Microphones, 1-13, 19, 20, 21
 - output level, 1-21
 - transmitter, 1-19
- Microwave repeaters, 1-108
- Microwave transmission, 1-108
- Mixer-amplifier, 1-21
- Modulator, 1-97

INDEX

- Monitors, 1-77
 - air, 1-15
 - preview, 1-15
- Montage, 1-8
- Mosaic, 1-36, 37, 46, 52, 58, 83
- Multiple Images, 1-9

- No-picture-signal interval, 1-84

- Odd field, 1-65
- Optical window, 1-45

- Panning, 1-4
- Panning lever, 1-12
- Parabolic reflectors, 1-108
- Persistence of vision, 1-67
- Photocathode, 1-30, 46, 48
- Photocell pickup device, 1-35
- Phototube circuitry, 1-31
- Photodroplet, 1-37, 38, 40, 78
- Photoelectric cell, 1-30
- Phototube, 1-30
- Picture-carrier generation, 1-96, 97
- Picture-signal chain, block diagram of, 1-16
- Picture system, 1-30
- Picture tube assembly, 1-77
- Power amplifier, 1-98
- Prisms, 1-9
- Pulse generator, 1-72, 75, 88

- Radio-frequency amplifier, 1-97
- Radio-frequency carrier, 1-22
- Reactance modulator, 1-24
- Resting frequency, 1-23
- Resultant force, 1-60, 61
- Retrace:
 - horizontal, 1-71, 72
 - vertical, 1-71, 92, 94
- Review, 1-17, 18, 41, 42, 62, 86, 109, 110

- Scanning, 1-63
 - beam, 1-45, 50, 51, 72
 - pattern, 1-63
 - progressive, 1-63, 64
 - the mosaic, 1-40
 - time and frequencies, H and V, 1-71
- Secondary emission, 1-43, 44
- Size control:
 - horizontal, 1-74
 - vertical, 1-74
- Special effects, 1-10

- Sound man, 1-15
- Sound mixer:
 - amplifier, 1-21
 - panel, 1-15
- Sound signal:
 - block diagram, 1-20
 - tracing the, 1-19
- Studio control room, 1-6, 14, 15, 16
- Superturnstile antenna, 1-105
- Swing, 1-23
- Sync Pulses:
 - added to video signal, 1-87-92
 - clipping of, 1-90
 - vertical, addition of, 1-91, 92-94
 - vertical, serrated, 1-93

- Target, 1-45, 51, 81
 - behavior of, 1-47, 48
 - screen, 1-49
 - surface resistance of, 1-47
- Television:
 - broadcasting, 1-1
 - cameraman, 1-14
 - studio, 1-2, 13
 - techniques, 1-6
 - theater, 1-3
 - tricks, 1-2, 6
- Television camera, 1-4, 5, 11, 12
 - manually controlled, 1-12
- Timing signal, 1-90
- Transistorized transmitter, 1-19
- Transmission, 1-108
 - vestigial sideband, 1-98, 100, 103
- Transmission filters, 1-102, 103
- Transmission lines, 1-102, 103
- Transmitter, sound system, 1-29
- Transmitting antenna, 1-104, 105

- Video polarity:
 - positive, 1-80
 - negative, 1-80, 81, 95
- Video signal:
 - adding sync pulses to, 1-87, 92
 - amplifier, 1-76
 - in iconoscope, 1-78, 80
 - in image orthicon, 1-81
- Vertical trace, 1-71, 94
- Vestigial sideband filter, 1-103
- Video preamplifier, 1-79
- Viewing monitor, 1-11
- Vidicon camera, 1-5, 11, 12, 54, 55
 - resolution requirements of, 1-54

- Zworykin, Vladimir, 1-36

\$2.25

basic television

by Alexander Schure, Ph.D., Ed.D.

VOL. 2

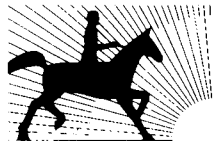

JOHN F. RIDER PUBLISHER, INC.
116 West 14th Street • New York 11, N. Y.

Copyright January 1958 by John F. Rider Publisher, Inc.

All rights reserved. This book or any parts thereof may not be reproduced in any form or in any language without permission of the publisher.

Library of Congress Catalog Card Number 57-13493

Printed in the United States of America

PREFACE

This five-volume course in the fundamental principles of television represents the end product of three years of research and experimentation in teaching methods and presentation at the New York Technical Institute. As a result of this experimentation in correspondence and resident courses approved by the New York State Department of Education, and following the recommendations of advising industrial groups, the highly pictorialized presentation used throughout this book was adopted. An illustration has been provided for each important concept and placed together with the explanatory text on the same page to pinpoint essential material. In addition, review pages spaced throughout each volume summarize the major points already presented.

This combination of the visual approach and idea-per-page technique makes **BASIC TELEVISION** readily understandable with or without an instructor. It is thus suitable for individual or correspondence use as well as for classroom study. Its coverage is complete from the creation of the television image in the studio to its appearance on the receiver screen, and presupposes only a knowledge of basic electronics and radio. Many topics not covered in the more traditional texts are treated here and fully explained for the first time.

The author wishes to acknowledge the assistance of his staff at the New York Technical Institute and that of Mr. Gilbert Gallego in the preparation of some of the illustrations. Special gratitude is due to the staff of John F. Rider Publisher and to Mr. Rider personally for his contributions to both the text and the picturization of this course.

New York, N. Y.
January 1958

ALEXANDER SCHURE

CONTENTS

VOL. II — BASIC TELEVISION

The Television Receiver	1
The Tuner Frequencies	3
Intermediate Frequencies	11
The Tuner I-F Stages	15
The Video Detector	18
Automatic Gain Control	22
The Video Amplifier	24
The Sound Channel	26
Achieving Picture Contrast	29
Review	30
The Synchronizing Circuits	32
The Vertical Sweep Circuits	36
The Horizontal Sweep Circuits	40
Receiver Power Supplies	45
The Split-Sound Receiver	47
UHF Reception	48
Review	50
The Television Antenna	53
Propagation	55
The Radiated Wave	61
The Basic Dipole Antenna	80
Dipole Behavior	67
Review	76
Dipole Antenna Response	82
Antenna Resistance	91
Frequency Response of a Dipole	99
Other Dipole Antennas	103
Review	109
Adding Antenna Elements	111
UHF and VHF Antennas	117
Television Transmission Lines	123
Special Techniques	138
Review	141

THE TELEVISION RECEIVER

The TV Receiver

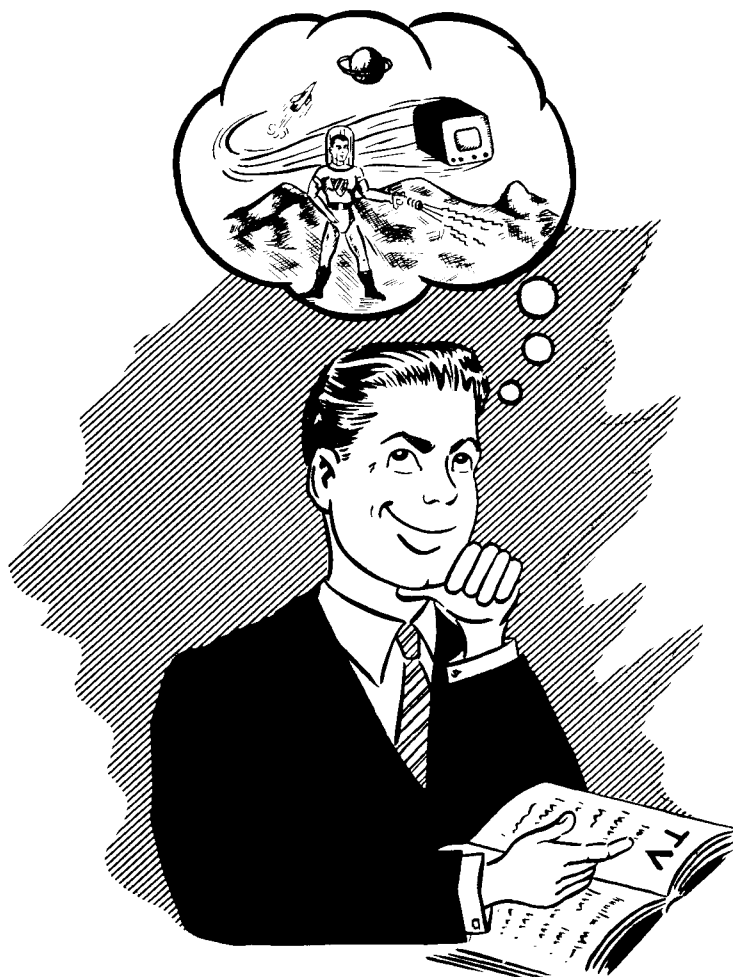

ONCE TV WAS CLASSSED WITH SPACE SHIPS

Before World War II, the man in the street thought of television—if he thought about it at all—as a sort of Buck Rogersish device in a class with atomic disintegrators and interplanetary travel. Occasional reports filtering out of experimental laboratories indicated that television was on its way, but details of the new system were hazy and promised to be complicated. When television receivers finally appeared, they were breathtaking—a source of entertainment that rivaled the drawing power of the movies, and the public rushed to buy. Much has happened since then, all of which has led to television becoming a part of our lives.

THE TELEVISION RECEIVER

The TV Receiver (contd.)

The general layout of a television receiver is much like that of the ordinary radio receiver. Both are superheterodynes. Even the circuits in the television receiver with unfamiliar names—e.g., the *video amplifier*, *sync clipper*, and *blocking oscillator*—are not unknown arrangements, even though they have not been part of radio receivers. Television, after all, is a direct descendant of radio, and the two have a distinct family resemblance. Of course, the television receiver is much more elaborate in organization and design than a conventional radio receiver, but all the principles underlying radio receivers known to you will be found applicable to television receivers. In fact, the block diagram organization of the television receiver discussed in this section will be found to be like that of a radio receiver in many respects.

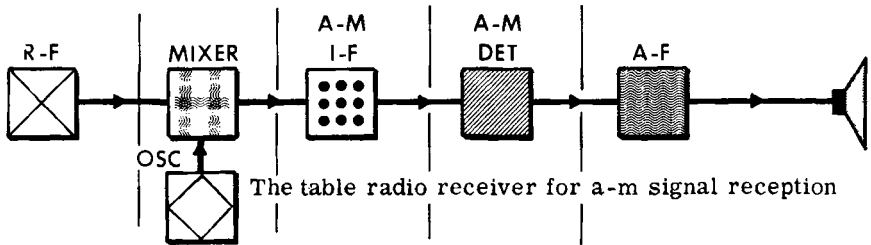

The table radio receiver for a-m signal reception

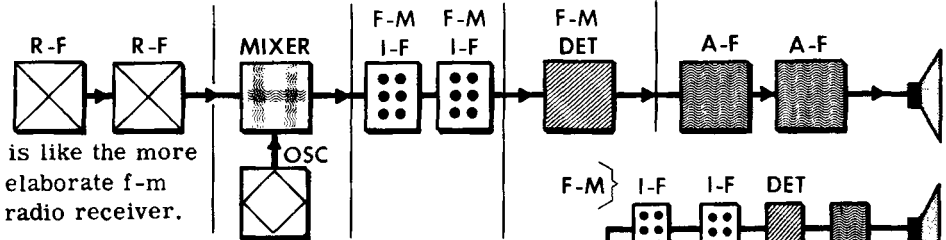

is like the more elaborate f-m radio receiver.

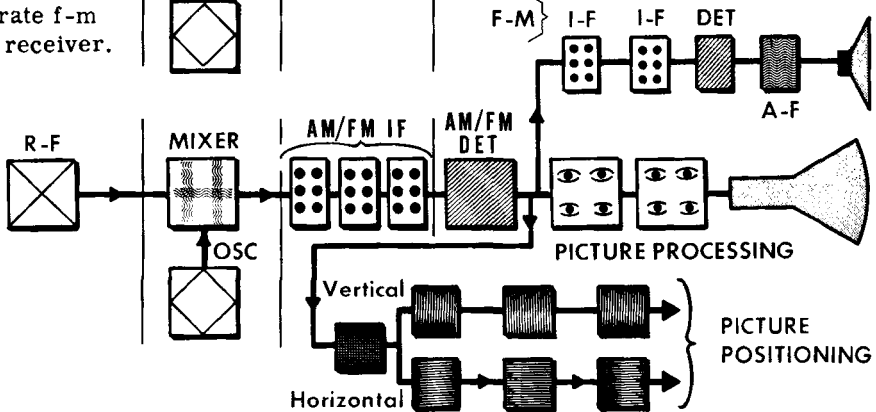

The television receiver has more tubes than either the f-m or a-m radio, since it processes a-m and f-m signals at the same time and also contains tubes that position the picture on the picture tube screen.

THE TUNER FREQUENCIES

The R-F Amplifier

The radio receiver has an antenna to intercept the signal energy radiated by the transmitter; the television receiver has a device for the same purpose. Television antennas are, however, a broad subject requiring separate treatment. (This is given in the next section.)

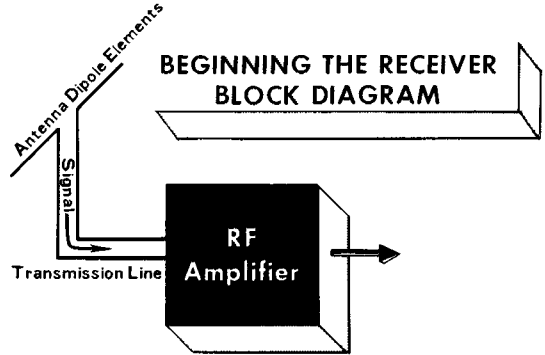

The Function of the R-F Amplifier

The first stage in the superheterodyne radio receiver is generally an r-f amplifier. This is also true of the television receiver. Every such receiver has an r-f amplifier stage. The r-f amplifier in the television receiver performs the same function as it does in the radio receiver. The antenna picks up a variety of television signals from several television transmitters. Usually, the carrier strength is too weak for direct application to the mixer stage. One function of the r-f amplifier is to build up the television carrier.

Amplification, however, is only part of its job. It has another equally important function. The television antenna picks up not only the signal of one transmitter, but also the signals from transmitters operating on adjacent channels. If the signals of more than one station were processed simultaneously in the receiver and displayed on the picture tube, the resulting picture would be hopelessly confusing. The r-f amplifier contains the *tuning* device that helps to select the picture and sound carriers of *just one* channel.

The Amplifier *Selects* and *Builds Up* the Channel Carriers

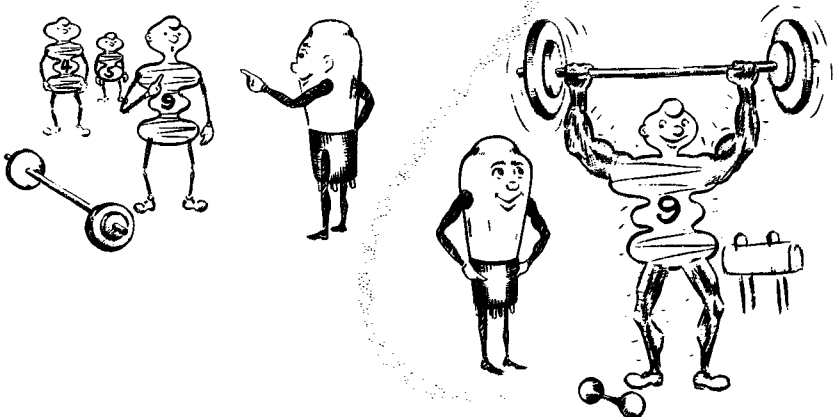

THE TUNER FREQUENCIES

The TV Channel

VHF		UHF		UHF	
Channel	Frequency limits	Channel	Frequency limits	Channel	Frequency limits
2	54-60	35	596-602	73	824-830
3	60-66	36	602-608	74	830-836
4	66-72	37	608-614	75	836-842
5	76-82	38	614-620	76	842-848
6	82-88	39	620-626	77	848-854
7	174-180	40	626-632	78	854-860
8	180-186	41	632-638	79	860-866
9	186-192	42	638-644	80	866-872
10	192-198	43	644-650	81	872-878
11	198-204	44	650-656	82	878-884
12	204-210	45	656-662	83	884-890
13	210-216	46	662-668		
		47	668-674		
		48	674-680		
		49	680-686		
		50	686-692		
		51	692-698		
		52	698-704		
		53	704-710		
		54	710-716		
		55	716-722		
		56	722-728		
		57	728-734		
		58	734-740		
		59	740-746		
		60	746-752		
		61	752-758		
		62	758-764		
		63	764-770		
		64	770-776		
		65	776-782		
		66	782-788		
		67	788-794		
		68	794-800		
		69	800-806		
		70	806-812		
		71	812-818		
		72	818-824		

UHF	
Channel	Frequency limits
14	470-476
15	476-482
16	482-488
17	488-494
18	494-500
19	500-506
20	506-512
21	512-518
22	518-524
23	524-530
24	530-536
25	536-542
26	542-548
27	548-554
28	554-560
29	560-566
30	566-572
31	572-578
32	578-584
33	584-590
34	590-596



List of
Television
Channel
Frequencies

The *station selector* knob of the television receiver is a device that bears numbers indicating the different TV channel positions that are assigned to television stations by the Federal Communications Commission. In New York City, for example, channels 2, 4, 5, 7, 9, 11, and 13 are assigned to different transmitting stations. If the station selector knob on a receiver in that city should be switched to channel 11 for example, the picture viewed would be that of station WPIX, and the music or speech from the speaker would be that broadcast from the WPIX studios.

THE TUNER FREQUENCIES

The 6-mc Channel Bandwidth

A television "channel", containing the video carrier frequency and its associated video information (sidebands), and the audio carrier frequency and its sidebands, is 6 mc wide. This bandwidth is standard in the United States and several other countries. In transmitting video information amplitude modulation is used; for audio, frequency modulation is used. Note that this is *narrow-band* fm with deviation of only plus or minus 25 kilocycles either side of the sound carrier frequency.

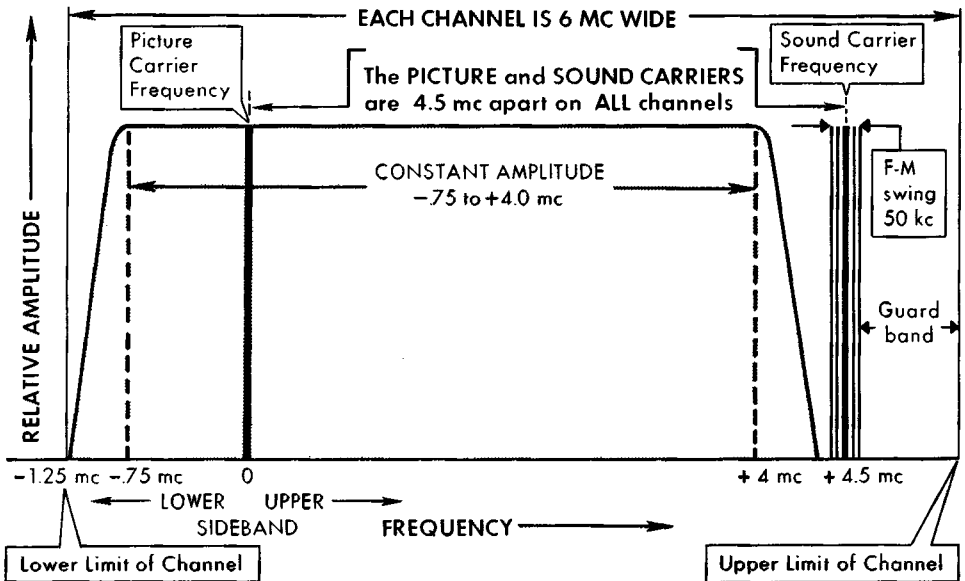

The arch-like curve with its flat top represents the picture (video) signal carrier and its sideband frequencies. If we consider the picture carrier as our reference or zero frequency, the sideband frequencies increase in either direction away from the carrier frequency.

In conventional amplitude modulation both the upper and lower sidebands are transmitted. However, to conserve bandwidth, a system of *vestigial* sideband transmission is used in which a large portion of one sideband is removed or attenuated. (In the United States, it is the lower sideband that is attenuated.) Of the lower sideband frequencies transmitted, from 0 to 0.75 mc are radiated at maximum amplitude, with frequencies from 0.75 mc to 1.25 mc sharply attenuated.

The upper sideband frequencies, starting at the video carrier at 0, extend upwards to approximately 4.5 mc. In this band, frequencies from 0 to about 4 mc are transmitted at maximum amplitude, with frequencies above 4 mc generally transmitted at progressively decreasing amplitude.

THE TUNER FREQUENCIES

The Sound Carrier

As to the radiated f-m sound carrier, frequency space is allocated to permit 100% modulation. This places the low-frequency limit near the high end of the upper sideband of the picture carrier—but still above it. The sound carrier frequency allocated to a television station by the FCC is the resting frequency (unmodulated) of the signal. Frequency modulation applied to this signal “swings” the frequency up and down around the resting frequency. The maximum allowable swing is 25 kc each side of the resting frequency, the remainder of the band being left clear for harmonics and to provide a vacant space between the top of the picture channel and the bottom of the sound channel.

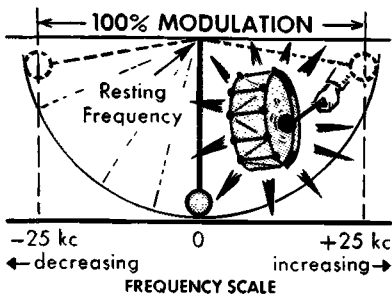

WHEN THE CARRIER IS FREQUENCY MODULATED,

the loudest sound processed in the studio produces an upward swing in frequency to 25 kc higher than the resting frequency and a downward swing to 25 kc lower than the resting frequency.

THIS IS A TOTAL SWING OF 50 KC FOR
MAXIMUM LOUDNESS OR 100% MODULATION

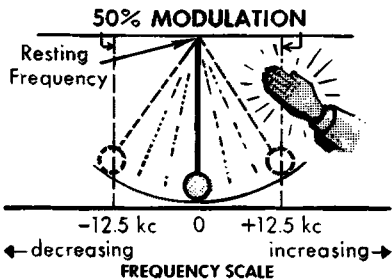

A sound of less than maximum loudness processed in the studio produces an upward swing to less than 25 kc higher than the resting frequency and a downward swing to less than 25 kc lower than the resting frequency, or

A VARIABLE SWING OF LESS THAN
50 KC ACCORDING TO LOUDNESS.

The upper frequency limit of the sound carrier does not mark the end of the television channel band. Beyond it, there is a small “no man’s land” of frequencies known as the *guard band*. This is the space between the upper limit of the sound carrier sidebands of one television channel and the lower limit of the video carrier sideband of the next higher channel. It is used to prevent possible interference due to overmodulation of the f-m sound carrier of a channel interfering with the picture being transmitted on the channel above it.

THE TUNER FREQUENCIES

R-F Amplifier Response

The IDEAL r-f amplifier tuned circuit would allow all frequencies in the 6-mc wide signal to pass equally well and would reject all others.

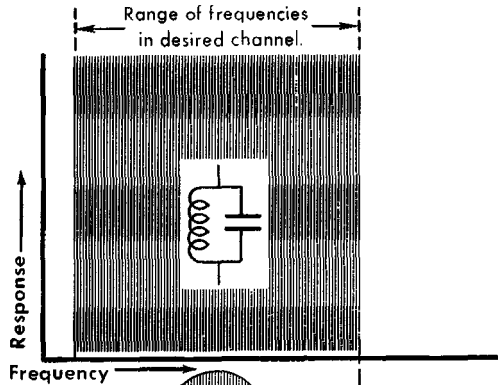

but

a PRACTICAL tuned circuit does not do this. All frequency components are not equally strong at the output.

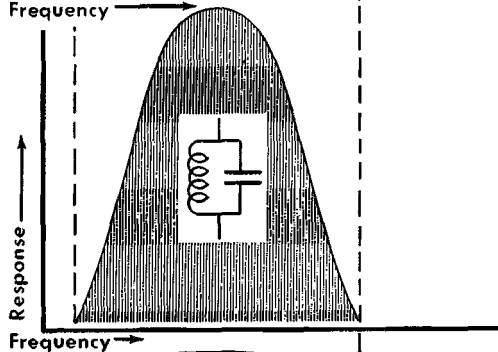

so

the tuned r-f circuit in a TV receiver is designed to accept more frequencies than are desired. The wanted ones are equally strong at the output and the unwanted ones are rejected later.

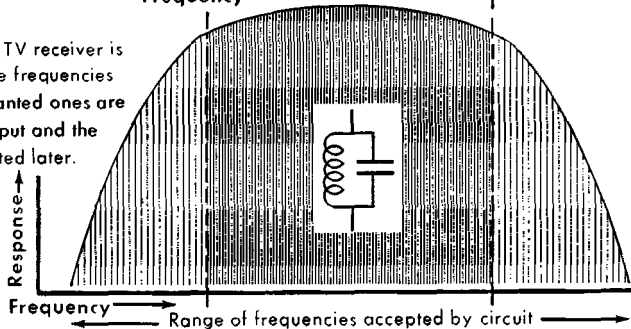

The ideal r-f amplifier in a television receiver would limit response to the 6-mc channel bandwidth of a channel and provide all frequencies within that channel with equal amplification. This does not occur in practice because such amplifiers are very expensive to produce. The usual r-f amplifier passes signals over about a 12-mc frequency band and accepts equally all frequencies about 3 mc each side of the frequency to which the circuit is tuned—that is, a 6 mc band. Further processing in the receiver eliminates the undesired signals passed through the r-f amplifier.

THE TUNER FREQUENCIES

The Mixer and the Oscillator in Radio Receivers

IN A RADIO RECEIVER,

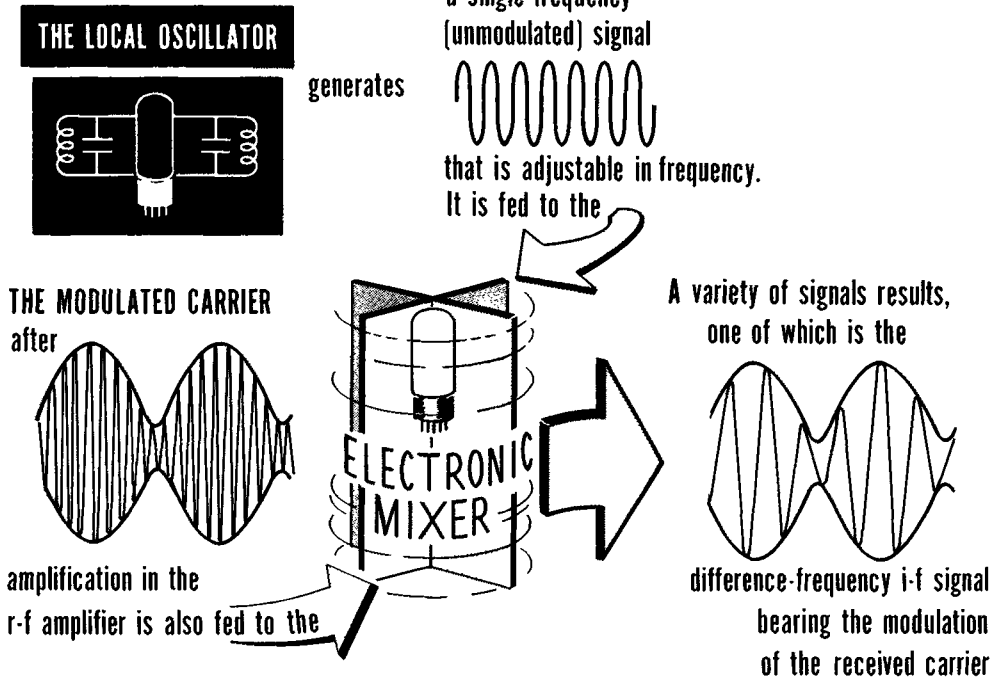

The principle underlying the operation of the superheterodyne receiver is the production within the receiver of a relatively low-frequency counterpart of the incoming carrier signal. This lower-frequency signal is called the intermediate frequency or i-f signal. The foremost advantages gained by this principle are increased sensitivity and selectivity.

Increased sensitivity is obtained as a result of the i-f amplifier processing fixed band of frequencies. The i-f amplifier circuitry can be designed for optimum performance at these frequencies. Excellent selectivity can be attained since the i-f amplifier can be *aligned* for a desired bandwidth.

Two circuits play important parts in the heterodyne principle—the *local oscillator* and the *mixer*. The oscillator generates an unmodulated r-f signal whose frequency can be varied over a wide range to suit the range of carrier frequencies accepted by the receiver. The mixer accepts the amplified version of the carrier from the r-f amplifier and the signal from the local oscillator. It combines or "mixes" these signals and produces a variety of signals in its output. Each bears the modulation of the r-f carrier, but the frequency of one of them is equal to the difference between the r-f carrier and the local oscillator frequency. *This is the i-f signal processed in the receiver.*

THE TUNER FREQUENCIES

The Mixer and the Oscillator in Television Receivers

The mixer and the oscillator in the television receiver function in similar fashion with one major exception. The television transmitter radiates a picture and a sound carrier, therefore *two* signals are processed by the r-f amplifier and *two* signals are fed to the mixer. The local oscillator signal is mixed with these two carrier signals and the mixer stage output contains, among other signals, the two difference-frequency i-f signals used.

In connection with this action, remember that the radiated picture carrier is amplitude modulated, whereas the sound signal is frequency modulated.

IN A TELEVISION RECEIVER, WHEN

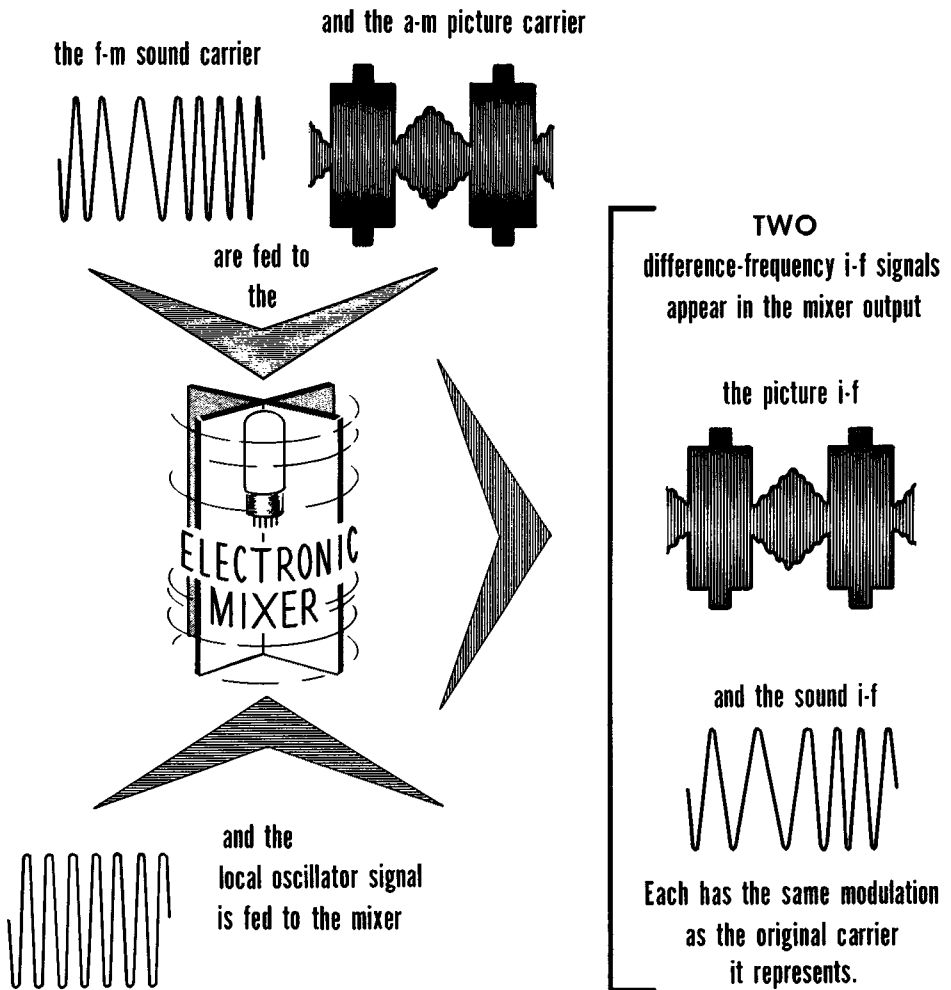

THE TUNER FREQUENCIES

The Frequency of the Local Oscillator

The mixing process in the mixer stage does not depend on the frequency of the signals fed into it. Theoretically, the frequency of the signal generated by the local oscillator can be higher or lower than the r-f picture and sound carriers derived from the r-f amplifier. In either case, two difference-frequency i-f signals (one the equivalent of the received picture carrier and the other the equivalent of the received sound carrier) are produced in the plate circuit of the mixer stage. Both the sound and picture i-f signals contain the original modulation of their carrier waves.

Design of the television receiver is made easier if the local oscillator frequency is higher than the received picture and sound carriers.

More important than the relative position of the local oscillator, with respect to the received carriers, is the precise frequency difference between the local oscillator and the incoming r-f carriers. This frequency difference represents the i-f frequency and must be constant on every TV channel to be received. Since the tuning of the i-f amplifier following the mixer is fixed at intermediate frequency, the frequency separation between the local oscillator and r-f carrier, if more or less than the i-f, will deteriorate picture quality considerably.

Incorrect oscillator output frequency can result from a number of conditions. Slight changes in the values of the oscillator circuit components due to temperature variation can result in incorrect frequency output; changes in temperature as the oscillator is warming up can cause frequency drift. To compensate for these effects, many television receivers are equipped with a *fine tuning control*, located on the panel.

The Fine Tuning Control Compensates For Oscillator Drift

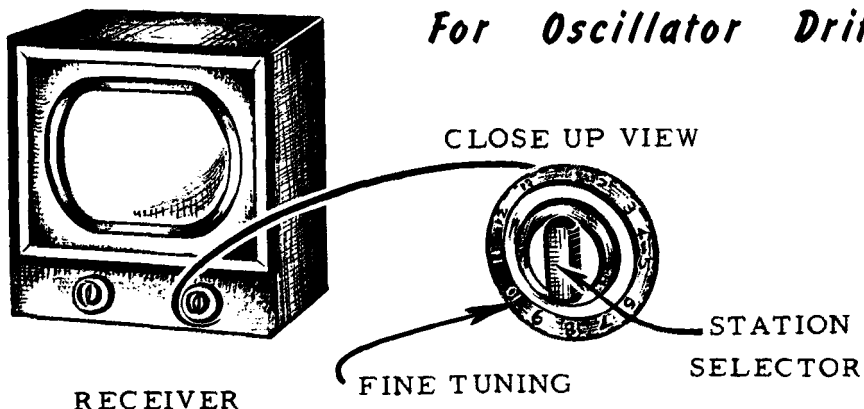

INTERMEDIATE FREQUENCIES

The Picture I-F Signal

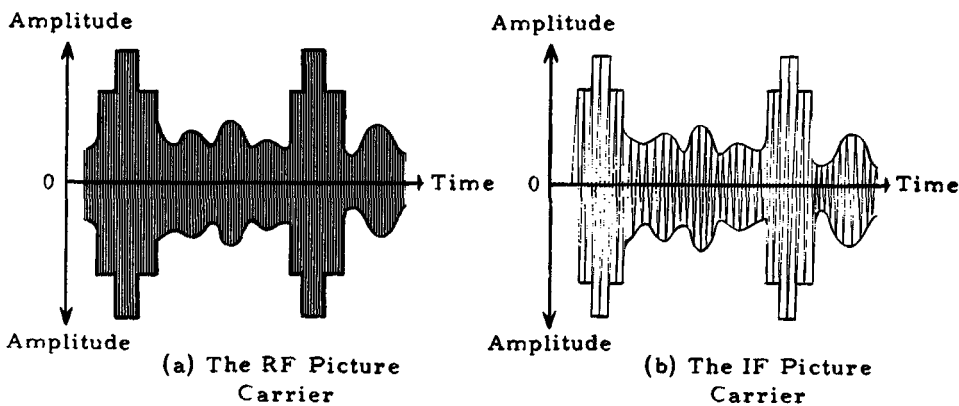
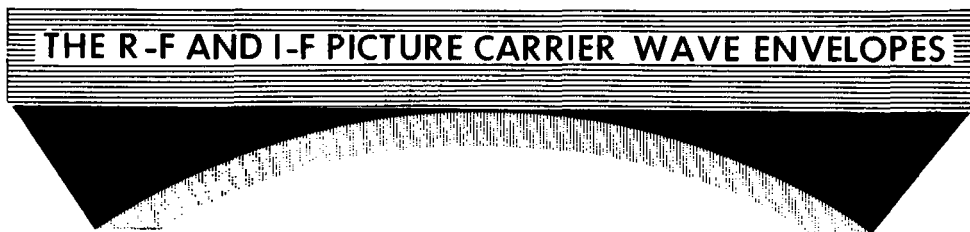

**ARE EXACTLY THE SAME AND CONTAIN
IDENTICAL PICTURE INFORMATION**

The picture (video) i-f output from the mixer carries the same modulation sidebands as the original received r-f picture carrier, consequently it has the same outline or *envelope*. The only basic way in which the i-f and r-f signals differ is in the lower frequency of the i-f as compared to the received picture carrier. The frequency conversion process in the mixer accounts for this. The sideband frequencies, representative of picture information added to the transmitted picture carrier as modulation, exist unchanged in the picture i-f signal. They do not undergo any frequency conversion. Hence we say that the amplitude-modulation components of the transmitted picture carrier are repeated in the picture i-f.

In (A) the r-f carrier is indicated by the line within the envelope. Although the upper and lower envelopes of the i-f (B) are shaped identically with those of (A), the carrier-signal cycles of the i-f are shown farther apart and fewer in number. This is a symbolization that the i-f frequency is lower. Both illustrations, by the way, are exaggerations; the frequencies are much higher than the illustrations indicate.

INTERMEDIATE FREQUENCIES

The Sound I-F Signal

In the same manner as it produces a picture i-f that is the counterpart of the received modulated picture carrier, the mixer also produces a sound i-f signal that is the counterpart of the received frequency-modulated sound carrier. The sound carrier and i-f signals are alike in all respects except for the numerical value of the center or resting frequency.

The sound i-f is really a newly created carrier that is frequency-modulated exactly as the original sound carrier from the transmitter. Thus, if the loudest sound signal processed at the television studio raises and lowers the sound carrier frequency 25 kc in both directions, the sound i-f appears as signals that are 25 kc higher and lower, respectively, than the sound i-f. For instance, if the radiated sound carrier for channel 2 is 59.75 mc and the loudest sound in the studio raises and lowers this carrier or resting frequency by 25 kc, to 59.775 mc and 59.725 mc, respectively, a sound i-f of 21.25 mc would be frequency modulated to 21.275 mc and 21.225 mc.

The symbolization of a frequency-modulated carrier is a series of sine waves non-uniformly distributed along a time axis. Where the cycles are closer together than normal, it indicates an increase in frequency; where the cycles are farther apart than normal, it indicates a decrease in frequency. The so-called normal distribution corresponds to zero modulation or the resting frequency. The fewer cycles per unit length along the time base for zero modulation in the i-f representation, as compared to the r-f representation, indicates that the resting frequency of the i-f signal is lower than the resting frequency of the r-f signal.

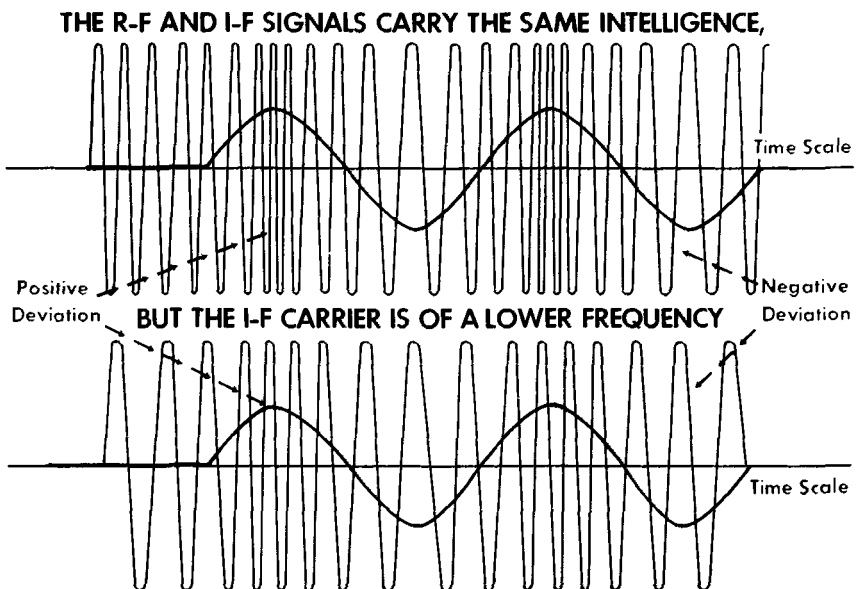

INTERMEDIATE FREQUENCIES

The Frequencies of the Picture and Sound I-F Carriers

Television receivers produced during 1946 and the years following were designed for a picture i-f of 25.75 mc and a sound i-f of 21.25 mc. The past several years of receiver manufacture have witnessed a change in design wherein the picture and sound i-f carrier frequencies were raised to be within the so-called 40-mc range. Specifically, the picture i-f carrier frequency is in the vicinity of 45.75 mc and the sound i-f carrier frequency is in the vicinity of 41.25 mc. Whatever the actual frequencies, the picture and sound i-f frequencies are *always* 4.5 mc apart.

Given any Difference-Frequency I.F.,

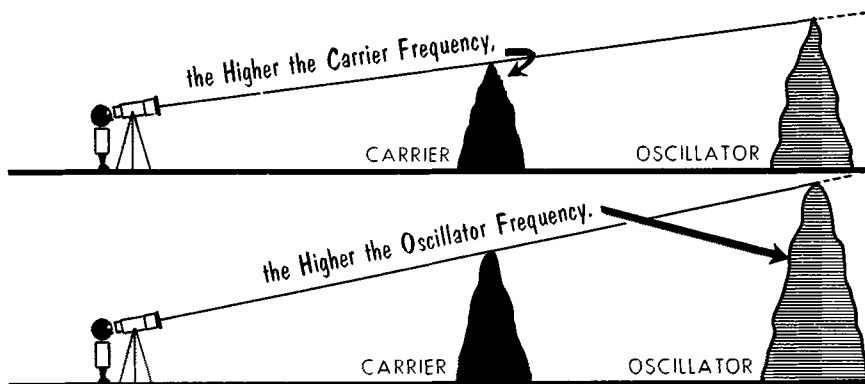

The changeover to the higher intermediate frequencies was made to meet practical needs. The lower i-f's afforded more amplification and greater receiver stability, but the higher i-f's afforded greater freedom from interference such as image frequencies.

Virtually all television receivers function with the local oscillator frequency higher than received picture and sound carriers. For example, let us assume a receiver designed for a 41.25-mc sound i-f and a 45.75-mc picture i-f. Let us assume further that the receiver channel selector is set to channel 7 (174 mc to 180 mc). The picture carrier then is 175.25 mc and the sound carrier frequency is 179.75 mc. To develop a sound i-f of 41.25 mc the local oscillator frequency must be $179.75 + 41.25$ or 221 mc.

By similar reasoning, the 45.75-mc picture i-f carrier is the result of the frequency difference between 221 mc and 175.25 mc, or $221 - 175.25$ mc equals 45.75 mc. For any given difference-frequency i-f, the higher the received carrier the higher must be the local oscillator frequency. Conversely, the lower the received carrier frequency the lower is the local oscillator frequency. The change in frequency of the local oscillator to suit the changes in carrier frequencies is done automatically within the receiver as the station selector is set to the different channels.

INTERMEDIATE FREQUENCIES

The Frequencies of the Picture and Sound I-F (contd.)

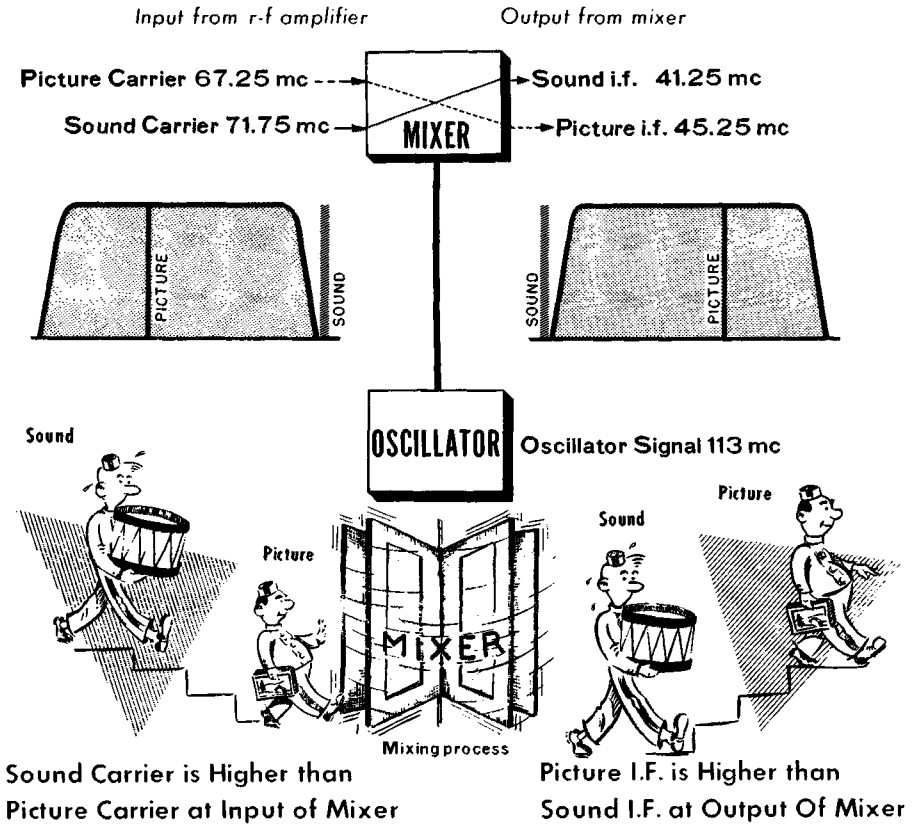

THE TRANSPOSITION OF THE CARRIERS AND I.F.'S

The relationship between the radiated picture and sound carriers for every television channel has the sound carrier higher on the frequency scale than the picture carrier. In the case of channel 4, the picture carrier frequency is 67.25 mc whereas the associated sound carrier is 71.75 mc — 4.5 mc higher. This is the frequency relationship when the signal is amplified in the r-f amplifier and when it is fed into the mixer. But after the mixer action the two intermediate-frequency counterparts of the received carriers *change places* frequency-wise. The picture i-f is now 4.5 mc *higher* than the sound i-f. This change in frequency relationship occurs because the oscillator frequency is higher than the two received carriers, hence the difference between the oscillator frequency and the picture carrier ($113 - 67.25 = 45.75$ mc) is greater than between the oscillator frequency and the sound carrier frequency ($113 - 71.75 = 41.25$ mc). All received carriers undergo this transposition of their i-f counterparts.

THE TUNER I-F STAGES

The Front End or Tuner

Having discussed the general functions of the r-f amplifier, mixer, and oscillator, we have in fact examined the organization of the stages that comprise the *front end* of the television receiver. Hence, we can add these stages to the original r-f amplifier block. (The arrows show direction of signal flow.)

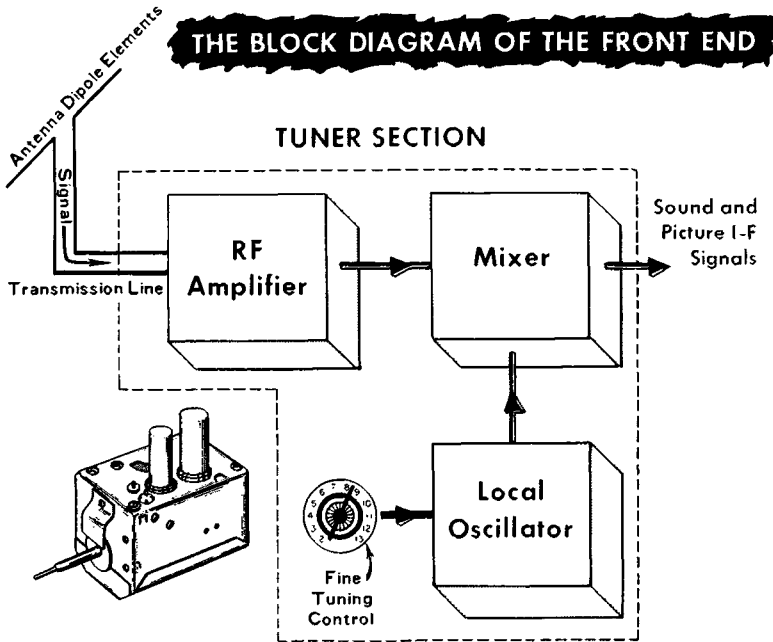

In most current television receivers, the front end is an individual entity. The r-f amplifier, mixer, and oscillator make up a separate group on the main chassis. The front end subchassis is mounted on the chassis slightly apart from the rest of the receiver. The whole section is known as the *receiver front end* or *tuner*. Contained in the tuner are the resonant circuits (coils, capacitors, and resistors) for each of the channels and the means for selecting the circuitry for each channel. The apparent use of two tubes in the illustration of the tuner and the three blocks in the front-end block diagram is not a contradiction; most tuners use a dual-section tube in a single envelope to perform the mixer and oscillator functions. As is shown later in this course, some tuners make use of two stages for the r-f amplifier, and two stages for the mixer-oscillator. Even then, only two tube envelopes are in evidence, because each pair of tube functions is performed by dual tubes in a single envelope.

The tuner shown here is just one example of many physical forms that are to be found in television receivers. It was selected because it typifies the most frequently used variety.

THE TUNER I-F STAGES

I-F Amplifiers in Television Receivers

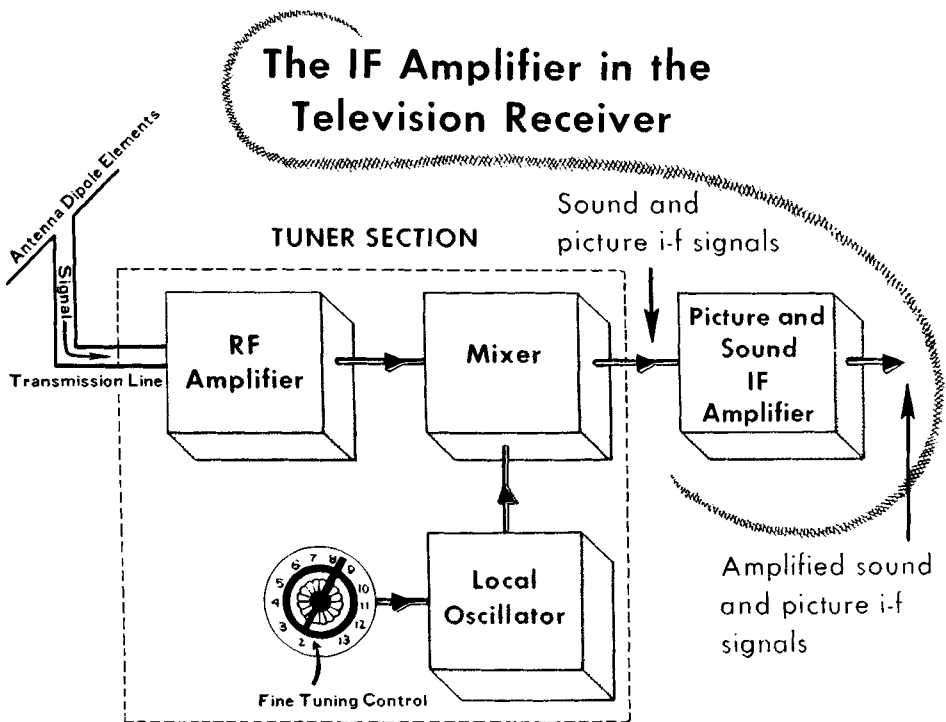

The intermediate-frequency signals derived from the mixer are too weak to be of much use and must be amplified. As has been shown, television receivers differ from conventional radio receivers in that two different i-f signals are delivered by the mixer. Both of them—the picture i-f and the sound i-f signal—are amplified simultaneously in a multistage i-f amplifier. The amplifier circuits tune broadly so as to accommodate the 4.5-mc separation between the picture and sound i-f's and in so doing, the circuits accept the modulation components of both i-f signals. The single i-f amplifier block can represent from 2 to 4 stages of i-f signal amplification.

The picture i-f carrier is amplitude-modulated by the picture information as well as by the control and synchronizing voltages, whereas the sound i-f carrier is frequency-modulated by the accompanying sound. Because the two signals differ in character, they are subject to different forms of processing in the receiver to produce the visible picture on the picture tube screen and the audible sound from the speaker. Unlike the r-f amplifier where the aim is to amplify each frequency component of a signal by a like amount, the dual-signal i-f amplifier is adjusted to *limit* amplification of the lower video modulation frequencies.

THE TUNER I-F STAGES

I-F Amplifiers in Television Receivers (contd.)

As an amplifier of the picture and sound intermediate frequencies, the i-f amplifier system has the additional task of providing more gain for some picture i-f sidebands than for others. In this process an "i-f response curve" is formed that is extremely important in determining the operation and alignment of the television receiver.

To provide equal amplification for the picture i-f and its modulation sidebands, the i-f response curve is shaped so that it slopes downward from maximum amplification 0.75 mc below the picture i-f, shown as zero frequency. At the picture i-f the gain of the i-f amplifier has fallen to approximately 50% of maximum value. From zero frequency the gain continues to fall, effectively reaching zero at 0.75 mc above the picture carrier. Thus, when the responses to the lower sideband -0.75 mc to 0, and the upper sideband 0 to $+0.75$ mc are combined, the lower i-f sideband from 0 to beyond 4 mc is of equal amplitude. This assures equal quality of the low-frequency background and the high-frequency detail.

Another form of frequency correction occurs over the range of the sound i-f band. The amount of amplification provided the f-m sound i-f is only about 10% of the maximum amplitude of the picture i-f. This is done to facilitate the separation between the picture and sound i-f's later in the receiver.

The Response of the picture -sound amplifier is different for picture and sound signals

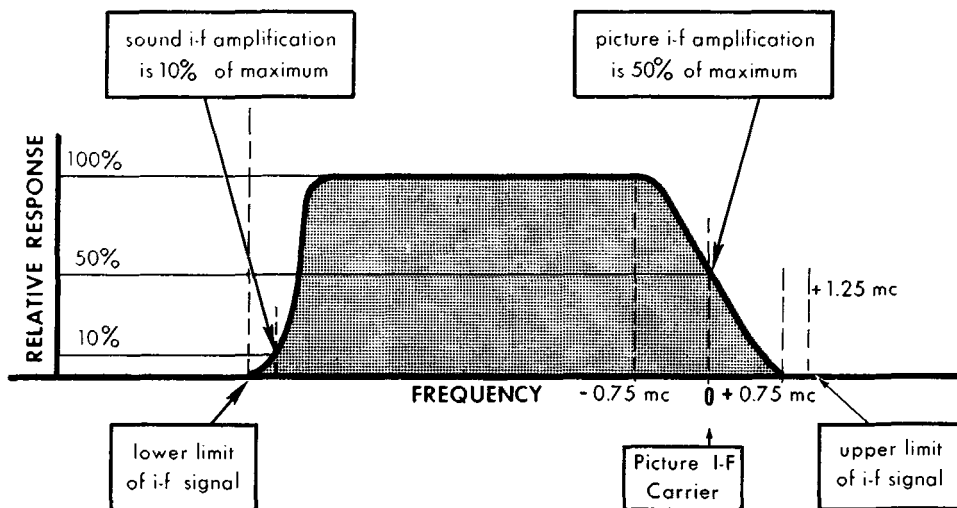

THE VIDEO DETECTOR

The Video Detector

Assuming that the picture and sound i-f signals have been amplified to a usable level (the level required by the video detector) in the picture-sound i-f amplifier, the next step in the evolution of the receiving chain is the addition of the video detector.

The video detector in the television receiver performs the same function as the *second detector* in the conventional superheterodyne radio receiver. It extracts the *intelligence* from the modulated i-f carrier. (This is known as *demodulation* or *detection*. The detector may be a vacuum tube or a crystal diode.)

In the television receiver the video intelligence is the picture information voltage, the blanking pulse voltage, and the synchronizing pulse voltage. As will be explained later, the picture and blanking voltages follow one path to the picture tube, while the synchronizing voltages are channeled to another path where they contribute to achieving synchronization (coincidence) between the motion of the picture-tube electron beam on the picture-tube screen with the movement of the electron beam in the camera tube as it scans the camera tube mosaic at the studio.

The video detector performs still another function in current television receivers. Although explained in detail later in this course, we should mention here that the video detector also behaves as a *mixer*, mixing the two modulated i-f carriers that are fed into it from the picture-sound i-f amplifier. Among the numerous signals resulting from the mixing process is one whose frequency is the difference between the picture i-f and the sound i-f frequencies. Hence, the mixing process in the video detector produces an output signal of 4.5 mc that contains primarily the frequency-modulation characteristics of the sound i-f signal.

ADDING THE VIDEO DETECTOR TO THE INTERCARRIER RECEIVER

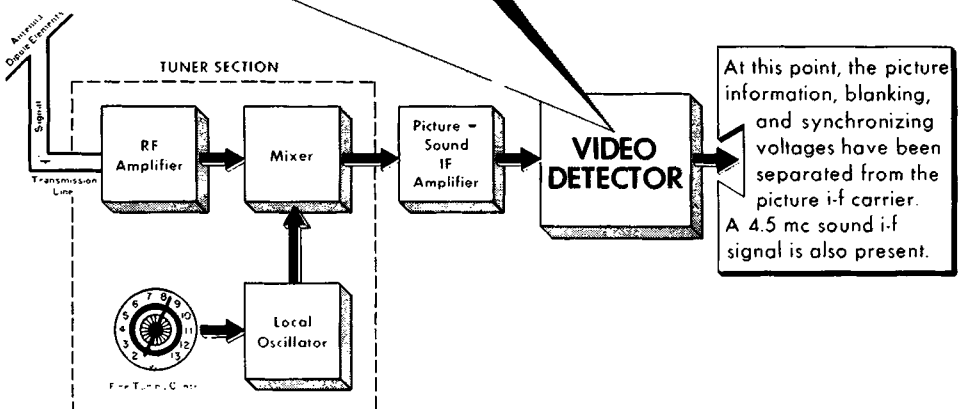

THE VIDEO DETECTOR

The Video Detector as a Picture I-F Signal Demodulator

In the action of demodulation, the video detector translates the instantaneous variations in the peak amplitudes of the picture i-f into a unidirectional voltage of either positive or negative polarity, depending on the kind of circuit used in the detector. In the process of demodulation either the negative or the positive alternations of the input signal are removed. Such behavior is, to all intents and purposes, rectification of the modulated picture i-f signal. Since the sound i-f signal is also present at the input of the video detector, it too is rectified because the video detector cannot distinguish between sound and picture i-f signals.

Assuming one type of video detector, the rectifying action removes the negative alternations of the input signal, whereas the positive alternations cause a composite video output voltage, which although changing in value, remains positive relative to a zero-voltage reference line. This voltage contains all the frequency components originally superimposed on the picture carrier at the transmitter during the process of modulation. These components are the picture information, the blanking pulses and the synchronizing pulses.

A composite video voltage with blanking pulses pointing upwards has been identified as a *positive-going, positive-polarity, or negative-phase* voltage. If this kind of signal voltage is fed to the control grid of the receiver picture tube, the picture will have the appearance of a photographic negative—the light and dark areas will be reversed. This happens because the more positive the instantaneous voltage applied to the control grid of the picture tube, the denser the electron beam and the brighter the spot that it makes on the picture tube screen. To enable such a signal voltage to produce a normal picture on a picture tube screen, it must be applied to the *cathode* of the picture tube.

ONE WAY IN WHICH THE VIDEO DETECTOR WORKS

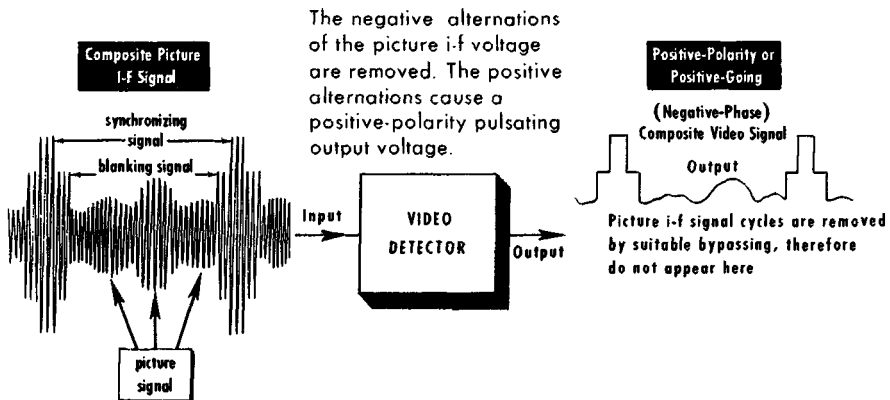

THE VIDEO DETECTOR

The Video Detector as a Picture I-F Signal Demodulator (contd.)



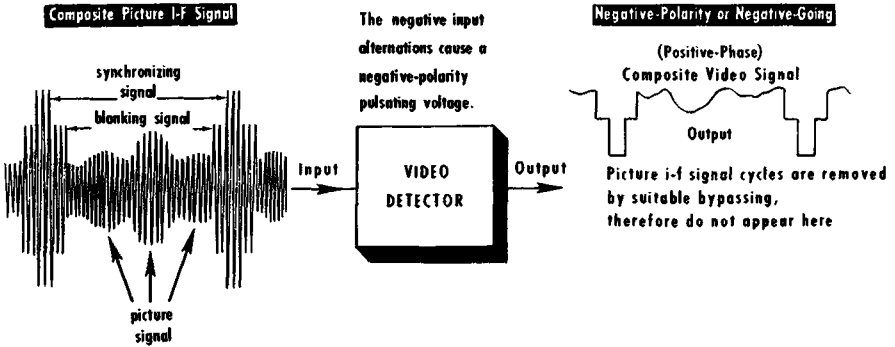

ANOTHER WAY IN WHICH THE VIDEO DETECTOR CAN WORK



If the connections in the video detector are reversed, the positive alterations of the input picture i-f signal voltage are removed, resulting in an output voltage that is negative relative to zero. It is identified as a *negative-polarity* or *positive-phase* video voltage.

If this voltage is applied to the control grid of the television receiver picture tube a proper kind of image results. But if a positive phase voltage is applied to the cathode of the picture tube, a negative image results—the black and white areas are reversed because the more negative the cathode relative to the control grid, the denser the electron beam and the brighter the resultant spot on the screen.

The designer of the receiver has the option of feeding the composite video voltage to either the control grid or to the cathode of the picture tube. Moreover, the opportunity of changing the phase of the composite video voltage exists in the video amplifier stages that follow the video detector. (These stages will be discussed after the intercarrier principle.)

<u>Polarity of Voltage</u>	<u>Phase of Voltage</u>	<u>Applied To</u>	<u>Kind of Image</u>	
<u>Positive</u>	<u>Negative</u>	<u>Control Grid</u>	<u>Reversed</u>	
<u>Positive</u>	<u>Negative</u>	<u>Cathode</u>	<u>Correct</u>	
<u>Negative</u>	<u>Positive</u>	<u>Control Grid</u>	<u>Correct</u>	
<u>Negative</u>	<u>Positive</u>	<u>Cathode</u>	<u>Reversed</u>	

THE VIDEO DETECTOR

The Inter-carrier Principle

All current television receivers, as well as most manufactured since 1949, are identified as *inter-carrier sound* (simplified to "inter-carrier") receivers. This design differs from the *split-sound* type of receiver which is no longer manufactured, although many are still in use. We shall describe split-sound sets briefly after we have completed the description of the inter-carrier type.

The basic idea in the inter-carrier receiver design is the generation of a low-frequency (4.5-mc) frequency-modulated sound i-f signal within the video detector stage by mixing the picture and sound i-f signals that are supplied to the video detector from the picture-sound i-f amplifier. If, for example, the picture i-f in the picture-sound amplifier is 45.75 mc and the sound i-f is 41.25 mc, the two signals when mixed in the video detector develop a difference-frequency equal to $45.75 - 41.25$ or 4.5 mc. This signal is the inter-carrier sound i-f for eventual translation into audible sound. Although it is the result of mixing an amplitude-modulated signal with a frequency-modulated signal, the 4.5-mc i-f voltage is essentially frequency-modulated. This situation stems from the fact that of the two i-f signals fed from the picture-sound i-f amplifier to the video detector, the frequency-modulated sound i-f signal is by far the weaker, and it is a characteristic of the mixing process that the resultant signal bears a preponderance of the modulation characteristics of the weaker of the two signals that are mixed. You will recall the deliberate shaping of the response curve of the picture-sound i-f amplifier to amplify the sound i-f only about 10% of the amount that most of the frequency components of the picture i-f signal were amplified.

Mixing In The Inter-carrier Receiver

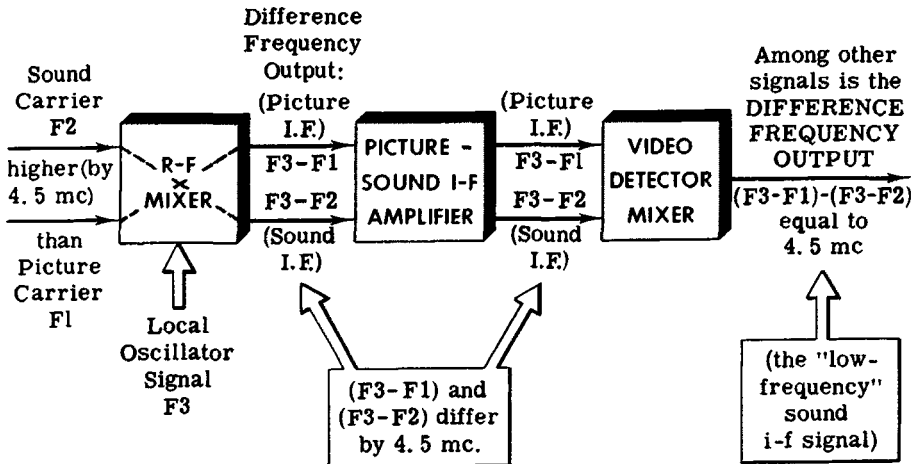

AUTOMATIC GAIN CONTROL

Automatic Gain Control (AGC)

AVC KEEPS THE OUTPUT CONSTANT DESPITE VARIATIONS IN SIGNAL STRENGTH

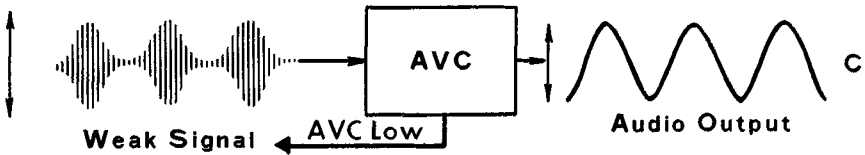
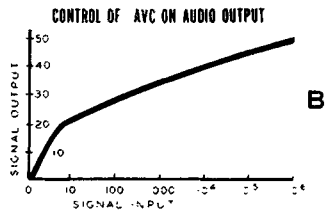
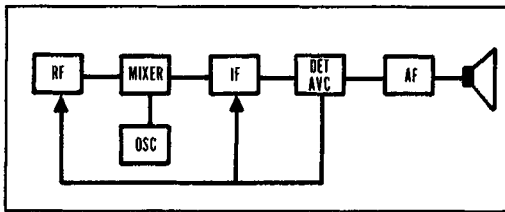
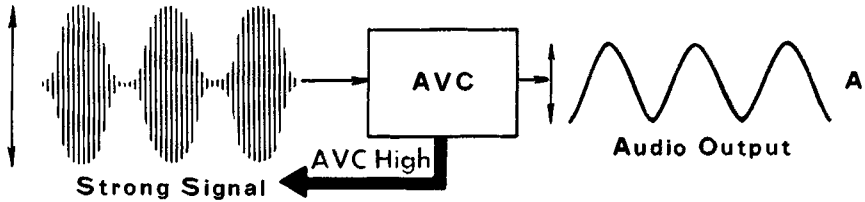

The audio output of the everyday superheterodyne radio receiver is held fairly constant regardless of changes in the strength of the received signal carrier by the use of avc (an abbreviation of *automatic volume control*). The i-f signal is rectified in the second detector. A portion of the rectified voltage, of negative polarity, is filtered so as to be free of signal fluctuations. It is then applied as a negative d-c control grid bias to the r-f and i-f amplifying tubes. The negative bias so developed varies in proportion to the amplitude level of the i-f carrier, which is the same as varying in proportion to the received signal carrier. When applied to the controlled amplifying stages, it behaves as an automatically-varying grid bias, increasing and decreasing the amount of amplification available from each stage. As the received signal level increases, the control bias automatically increases, thus reducing the amount of amplifier gain; as the signal level decreases, the amount of control bias decreases, hence the amplification increases. In this way a balance between amplifier gain and signal output from the detector is maintained, resulting in a substantially constant-level audio output.

AUTOMATIC GAIN CONTROL

Automatic Gain Control (contd.)

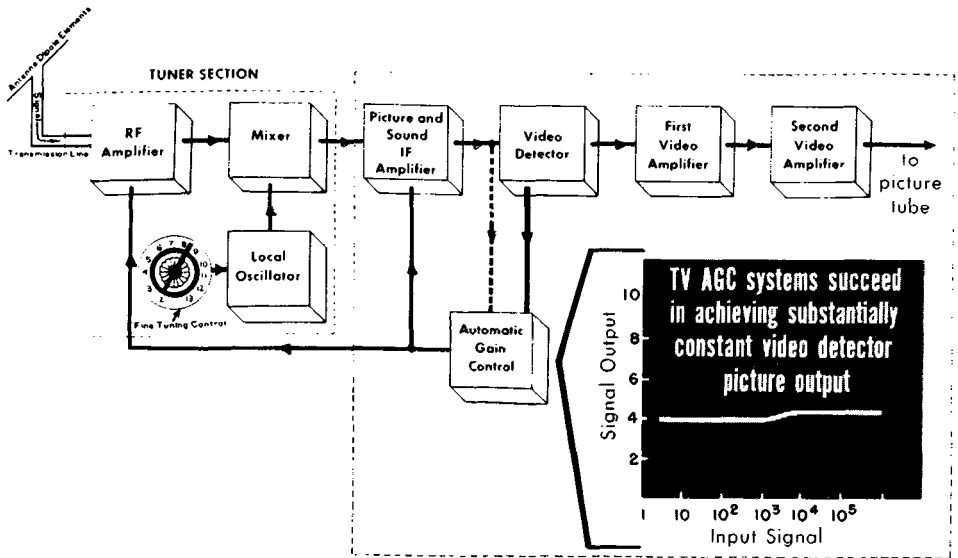

Automatic Gain Control in the Intercarrier Receiver Block Diagram

A similar form of amplification control is used in television receivers except that its purpose is to maintain constant picture signal level at the video detector, regardless of changes in received picture signal strength. Under the circumstances, the signal control system in the television receiver cannot rightfully be called an automatic volume control since it has relatively no effect on the audio output level. Instead it is called *agc* or automatic *gain* control inasmuch as it automatically varies the gain or the amount of amplification in the r-f and i-f paths of the picture signal.

This control is achieved by applying an automatically varying negative d-c bias voltage (derived by rectification of the picture i-f signal) to the r-f and i-f amplifying tubes. Several different methods of securing this bias voltage are used. Circuit details are given later in this course during the discussion of component organization and function. In the meantime, a simple arrangement is shown above. The automatic gain control block is a single tube acting as a rectifier of the picture i-f signal derived from the picture-sound i-f amplifier. The remainder of the picture i-f signal is fed to the video detector for regular processing.

In basic principle, the agc system in a television receiver is similar to avc systems in radio receivers—it provides a constant-amplitude signal.

THE VIDEO AMPLIFIER

The Intercarrier Video Amplifier

The composite video voltage output of the video detector is not high enough to drive the picture tube directly. It is necessary to use one or two stages of video amplification between the video detector and the picture tube element that receives the composite video signal. In addition to amplifying the video voltage, the blanking voltage and the synchronizing voltage (although the latter serves no function when applied to the picture tube), the video amplifier sometimes amplifies the 4.5-mc frequency-modulated sound i-f signal. Amplification of this signal in the video amplifier affords economies in the number of tubes required in the system that eventually processes the 4.5-mc intercarrier sound signal into audible sound. We shall deal with the sound system separately later; but for the moment let it be said that somewhere along the video amplifier chain the "takeoff" point for the 4.5-mc sound i-f signal is located.

The composite video signal represents a wide band of frequencies substantially everything that makes up the picture carrier sidebands. Certainly the frequencies that correspond to the picture information taken off the camera tube mosaic are vital to the reproduction of the detail in the picture. There are others, as will be discussed later, but dealing with these alone is sufficient to indicate that the video amplifier must pass a certain band of frequencies. If the take-off point for the 4.5-mc sound i-f signal is between the first and second video amplifier stages, the frequency response of the amplifier is from about zero to 4.5 mc up to the sound i-f takeoff point. After that it is limited to around 3.5 mc in order to keep the 4.5 mc sound signal out of the picture tube cathode or control grid circuits. If it reaches these circuits, broad horizontal stripes called *sound bars* appear in the picture.

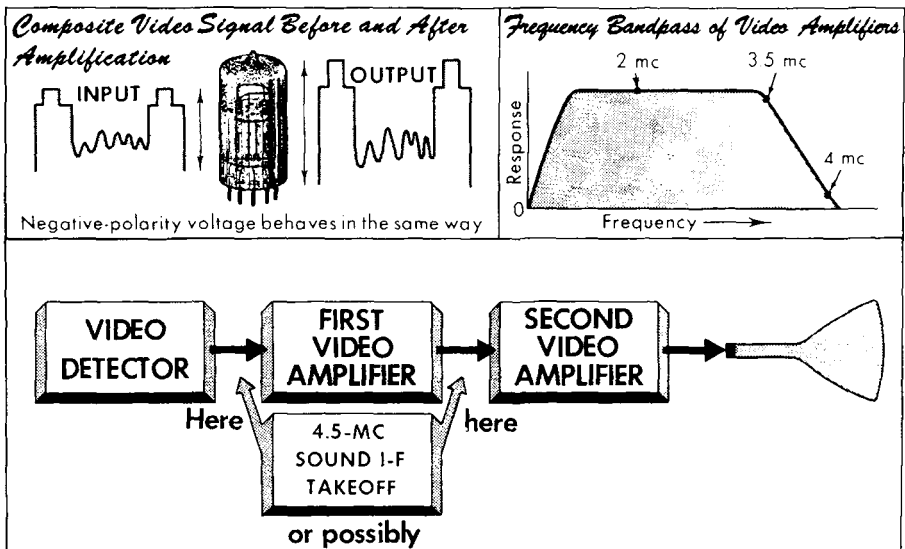

THE VIDEO AMPLIFIER

The Video Amplifier (contd.)

Related to the amplifying function of the video amplifier is the phase of the composite video signal required at the picture tube. The video detector can be arranged to provide a negative phase or a positive phase output signal, whichever may be required. But as was said earlier, the video detector output is too weak to drive the picture tube directly. The video amplifier is therefore responsible not only for raising the level of the video signal, but also for delivering the video voltage in correct phase to the cathode or control grid of the picture tube. These requirements determine whether one or two stages of video amplification are used. In this regard the important point to remember is that a single stage of video amplification inverts the phase of the video signal between input and output.

If a negative phase (positive polarity) signal is delivered by the video detector, the one stage of video amplification will furnish a positive-phase (negative polarity) voltage to the picture tube. If the voltage input to the amplifier is of a negative phase, the output will be of positive phase.

A SINGLE STAGE OF AMPLIFICATION INVERTS THE PHASE

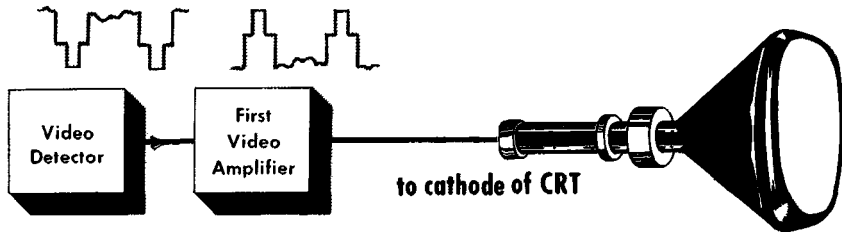

If a two-stage video amplifier is used, the phase of the output voltage is the same as the phase of the input voltage. An amplifier with an even number of stages repeats the phase of the input signal at its output. Each of the amplifying stages inverts the phase in that stage, but the occurrence of two consecutive inversions results in the same phase at the input and output.

TWO STAGES OF AMPLIFICATION REPEAT INPUT PHASE

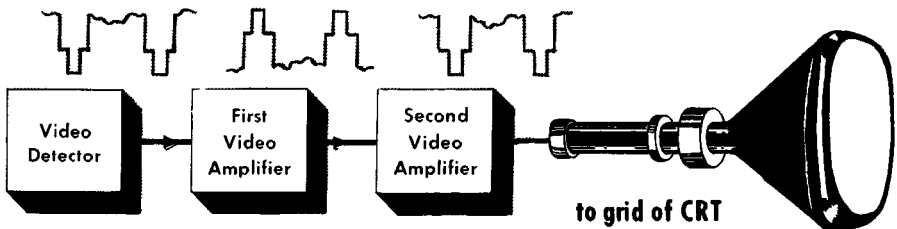

THE SOUND CHANNEL

The FM Sound Channel

The f-m sound channel in the intercarrier television receiver is organized very much like a portion of the everyday f-m radio receiver—the section between the last i-f stage and the loudspeaker. It consists of one or possibly two stages of i-f amplification at a 4.5-mc center frequency; possibly a single limiter stage; an f-m discriminator or ratio detector (whichever is used to translate the changes in signal frequency into audio voltages); one or more stages of audio amplification; and the loudspeaker.

THE BLOCK DIAGRAM OF THE SOUND AND VIDEO SYSTEM IN THE INTERCARRIER RECEIVER

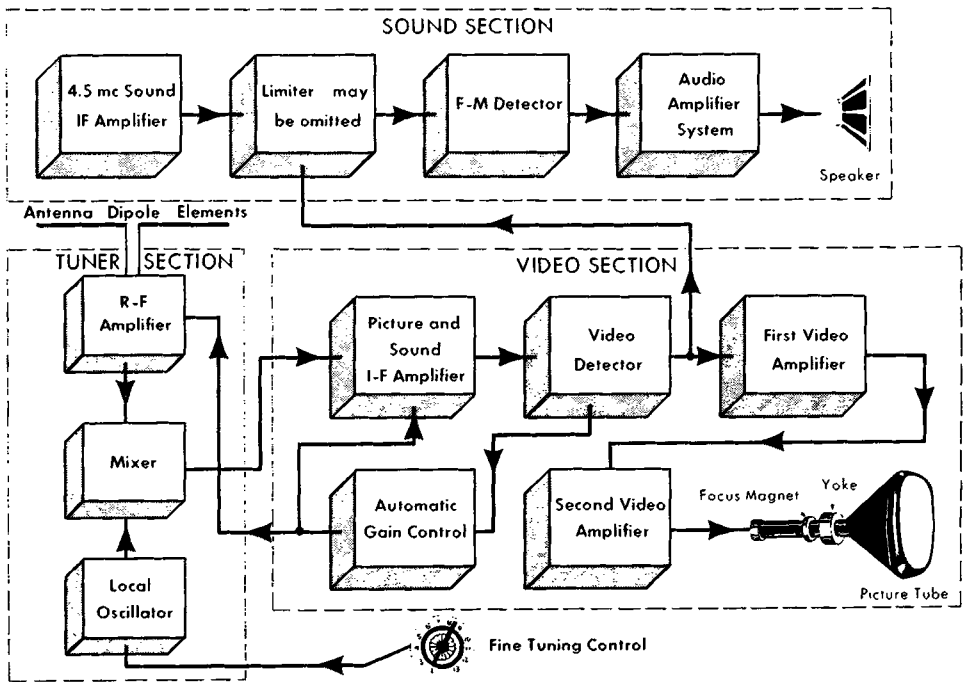

In the television receiver system shown here, the intercarrier f-m sound signal developed in the video detector is passed through one stage of amplification in the video amplifier and then fed to the 4.5-mc intercarrier sound amplifier in the sound channel. In this case a single stage of amplification (in the sound channel) is sufficient because the stage of video amplification aids in building the signal strength to the level required. (In some television receivers the 4.5-mc sound signal takeoff point is immediately after the video detector, as indicated by the dashed line; sometimes it comes directly from the video detector, in which case two stages of 4.5-mc amplification may be used in the sound channel.)

THE SOUND CHANNEL

The Limiter

THE LIMITER IS AN ELECTRONIC GRINDER THAT REMOVES HEIGHT VARIATIONS IN A VOLTAGE WAVE

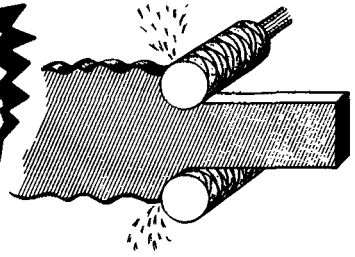

input voltage with noise pulses and varying amplitude

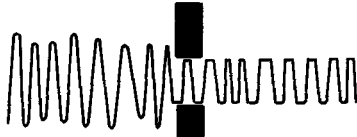

output voltage with noise peaks removed and constant amplitude

LIMITER STAGE

The limiter block following the 4.5-mc amplifier is sometimes omitted from the sound channel when the limiting action is effectively performed by the f-m detector. The action of limiting is really clipping the positive and negative peaks of the f-m signal. The normal f-m signal is of constant amplitude, but it is possible that noise signal voltages originating at a variety of sources may find their way into the f-m circuits and will ride on the f-m carrier, thus amplitude-modulating it. The limiter stage removes these noise voltages by limiting the peak amplitude changes of the f-m carrier. Inasmuch as the audio modulation appears as changes in carrier frequency and not as changes in carrier amplitude, reduction of the peak-to-peak amplitude of the carrier does not impair the effectiveness of the frequency-modulated signal.

The F-M Discriminator

The next block in the sound channel chain is the f-m discriminator or f-m detector. Both are translators of variations in frequency into audio voltages.

The audio amplifier follows the detector in the sound channel. Its function is to raise the audio voltage to a usable level. Although we show only a single stage of audio amplification in our typical sound channel, some receivers use two or more stages.

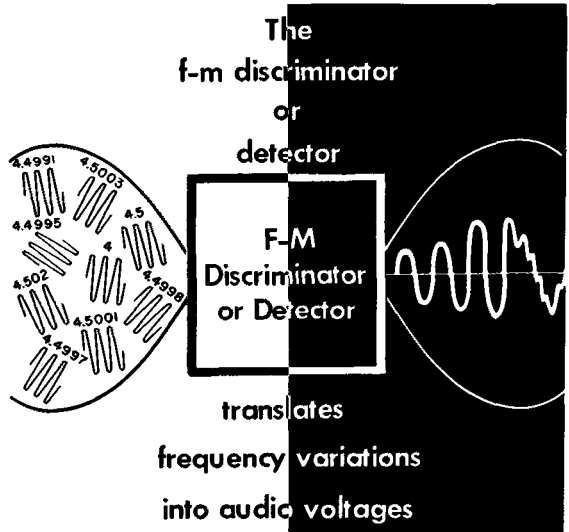

CONTRAST CONTROL
THE BRIGHTNESS CONTROL IN THE RECEIVER BLOCK DIAGRAM
D-C RESTORER

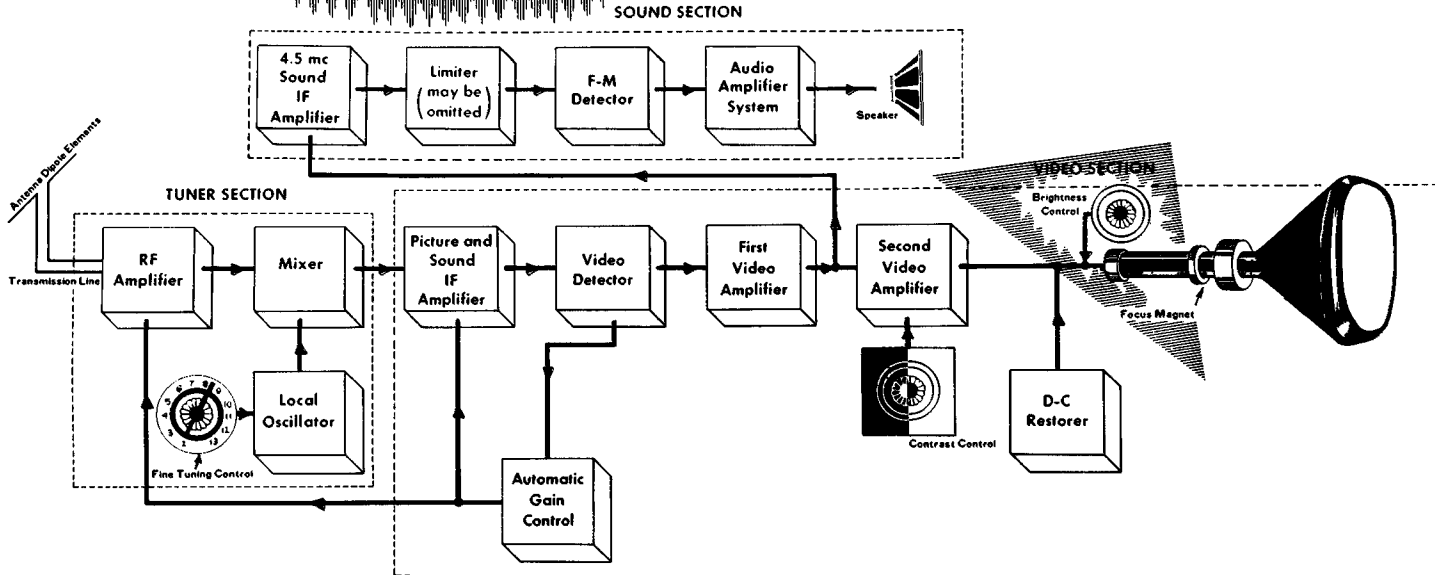

Two variable receiver panel controls and one block complete the picture-information processing channel: the **CONTRAST** control, the **BRIGHTNESS** control, and the **D-C RESTORER**. The d-c restorer is still to be found in many television receivers. although more recent designs have eliminated the need for d-c restoration. The contrast and brightness controls are standard in all television receivers.

ACHIEVING PICTURE CONTRAST

Contrast, Brightness, and D-C Restoration

When the black areas of a reproduced image have the proper blackness and the white areas are really white, it is said the *contrast* is good. The contrast control function in modern receivers is one of amplification control in the video amplifier. Contrast depends on the amplitude of the video or picture-information signal; that is, the difference in video voltage corresponding to black and white. The greater the amplitude of the signal, the greater is the change in voltage between that corresponding to white and that corresponding to black. Early-design television receivers located the contrast control in the circuits that were processing the picture i-f signal. Later designs changed the location to the video amplifier. The actual circuitry of the contrast control is shown and explained later as a part of the circuit discussions.

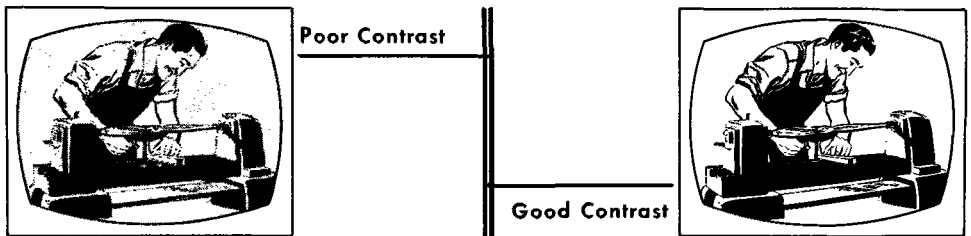

The brightness control is related to contrast control although the two are located in different parts of the video amplifier chain. Every scene that is televised has an average brightness. It is with respect to this average brightness that some parts of the scene are black and others are white with shades of gray in between. If a scene does not have the correct amount of brightness, it appears dark and detail is lost; if the brightness is excessive the image appears washed out and the parts that are supposed to be black take on a grayish appearance. How brightness is controlled is explained later in the course. For the present we can say that the brightness control determines an average voltage level around which the picture voltage varies (in one direction to produce black and in the other direction to produce white in the image.) Adjustment of the contrast and brightness controls is required to produce the most pleasing image on the picture tube screen.

D-C restoration was necessary in the early-design television receivers because the capacitive coupling used between the video detector and the picture tube removed the d-c component of the picture information signal. In the absence of d-c in the video signal fed to the picture tube, control of the brightness of the reproduced image was impossible.

The d-c restorer stage served to put a d-c component back into the video signal. Where used, the d-c restorer is a rectifier that removes a portion of the video signal derived from the video amplifier and inserts it into the picture tube circuit.

REVIEW

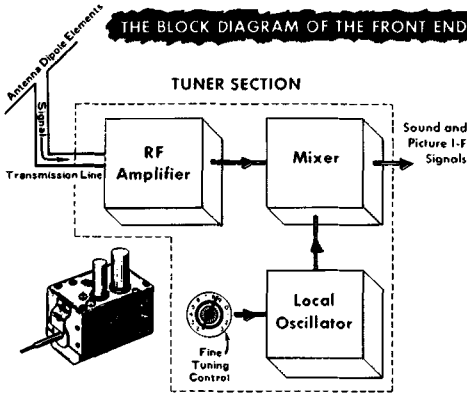

1. *The Tuner*, or front end, is responsible for channel selection. Amplification of the incoming a-m video and f-m sound signals, and their conversion to the intermediate-frequency signals required by the i-f amplifier is also accomplished in the tuner.

2. *The I-F Amplifier* is used to amplify the weak picture and sound i-f signals from the tuner, thus bringing them up to a usable level for processing in the video detector.

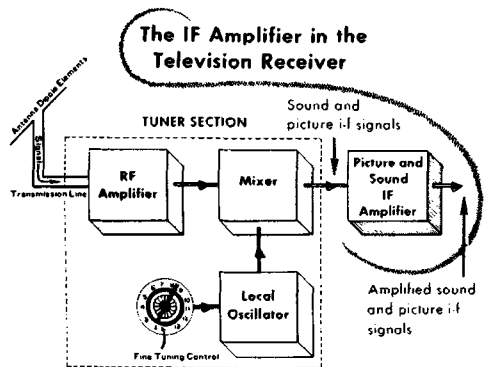

ONE WAY IN WHICH THE VIDEO DETECTOR WORKS

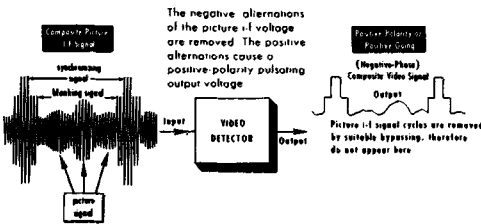

3. *The Video Detector* extracts the intelligence from (demodulates) the picture i-f signal, thus providing a composite video signal for the video amplifier system. It also functions as a mixer to produce a 4.5-mc sound signal, eventually to be amplified and demodulated in the intercarrier sound stages.

4. *The Intercarrier Principle* is the generation of a low-frequency (4.5-mc) f-m sound signal within the video detector stage, by mixing the picture and sound i-f signals, which have been amplified in the i-f amplifier. 4.5 mc is the difference-frequency equal to the picture i-f carrier minus the sound i-f carrier frequencies.

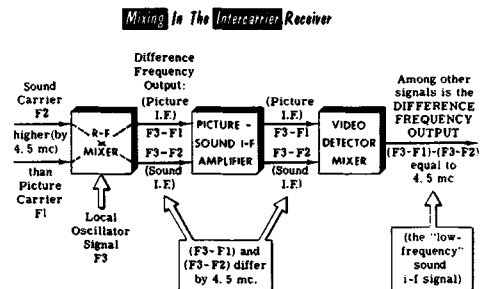

REVIEW

5. *The Automatic Gain Control (AGC) system* maintains a substantially constant video detector picture output by applying an automatically varying negative d-c bias voltage to the r-f and some i-f amplifying tubes. In basic principle, the agc system in a TV receiver is similar to avc systems in radio receivers—it provides a constant-amplitude signal.

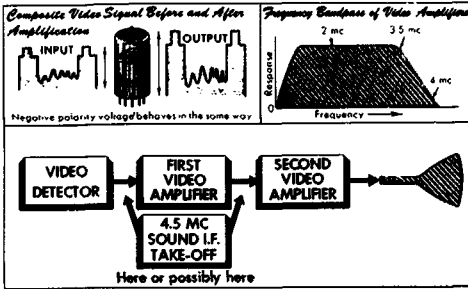

6. *The Video Amplifier* builds up the weak composite video signal from the video detector to a level usable by the picture tube. It is sometimes used to amplify the 4.5-mc sound i-f signal as well.

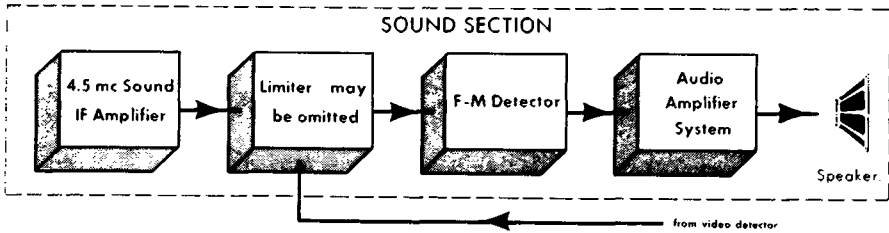

7. *The F-M Sound Channel*, consisting of an i-f amplifier, a limiter (possibly), and an f-m demodulator, amplifies the 4.5-mc f-m sound signal in the i-f amplifier. The limiter removes the noise voltages by limiting the peak amplitude changes of the f-m carrier. The discriminator translates the frequency variations into audio voltages, to be amplified in the audio system.

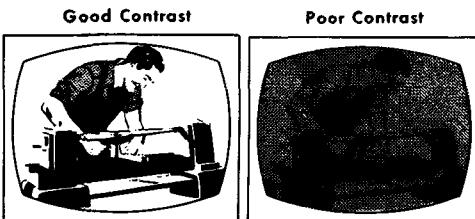

8. *The Contrast and Brightness Controls* are used to produce the most pleasing image on the picture tube screen. The contrast control varies the amplitude of the video signal. The brightness control varies the average illumination level of the screen.

THE SYNCHRONIZING CIRCUITS

The Synchronizing System

End view of the yoke coils.



Downward
Tilt and Spacing
Controlled by
Vertical Sweep Action

They look like this on the CRT

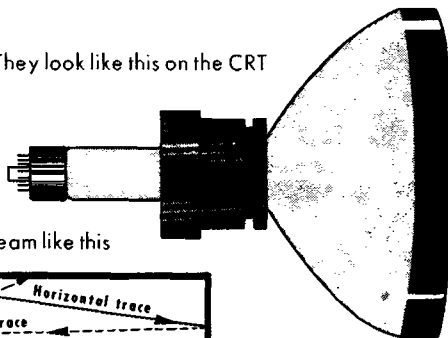

and sweep the beam like this

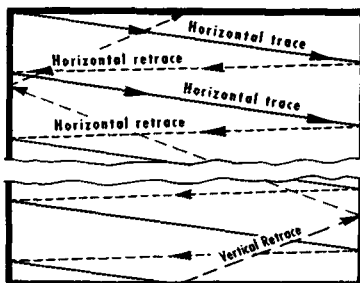

Let us examine what we have discussed so far. The sound and picture processing channels up to the picture tube are complete, and the composite video signal is being fed to the picture tube. However if the beam is to "draw" the picture on the screen, it must sweep both horizontally and vertically across the picture tube screen.

The component responsible for sweeping the electron beam is the deflecting *yoke*, consisting of horizontal and vertical deflecting coils. The yoke fits over the neck of the picture tube, usually as far forward as the flare of the tube permits. Vertical and horizontal deflection current is fed to the yoke, with the vertical-deflecting-coil current causing the electron beam to sweep from the top of the screen to the bottom, and return to the top, 60 times per second. The downward sweep is relatively slow, while the return or *retrace* is considerably faster.

The horizontal-deflecting-coil current causes the electron beam to sweep across the screen from left to right, and return to the left, 15,750 times per second. As with the vertical sweep, the trace is relatively slow, while the right-to-left retrace is considerably faster.

The sweep currents in the horizontal and vertical deflecting coils are produced by special circuits in the receiver called the horizontal and vertical sweep systems. Each system contains an oscillator circuit, the vertical oscillator operating at 60 cycles and the horizontal oscillator operating at the much higher frequency of 15,750 cycles (15.75 kc). In addition, each system contains a power output tube that provides the power necessary for driving the deflecting coils.

THE SYNCHRONIZING CIRCUITS

Synchronization

It is essential that the Transmitter's Camera Tube Scanning Beam

and the Receiver's

Picture Tube

Scanning Beam

move precisely in step

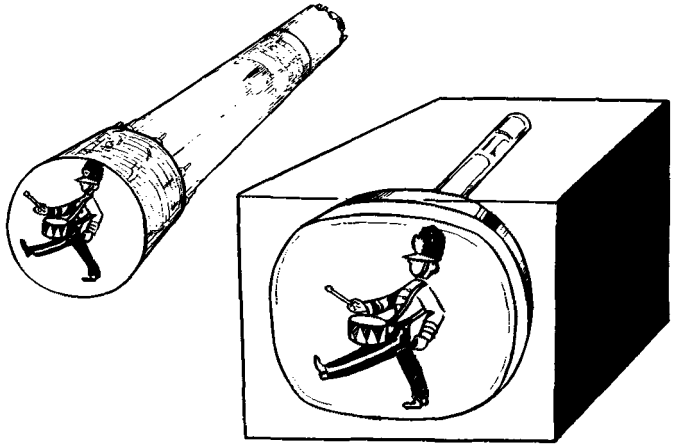

We learned that the scanning beam in the picture tube must move precisely in step with the scanning beam in the camera tube. The sweep oscillators in the receiver develop sweep voltages that can move the receiver picture-tube electron beam at *approximately* the correct rate in each direction. But *approximately* is not good enough! The beams in the receiver picture tube and in the transmitter camera tube must move *exactly* in step. To achieve this, the picture tube beam movement is placed under the control of the transmitting scanning system. The control is maintained by triggering or synchronizing pulses which are received from the transmitter. One is the *horizontal synchronizing* or *sync pulse*; the other is the *vertical sync pulse*. There are also *equalizing pulses*. They are all part of the modulation that is superimposed on the picture carrier at the transmitter and they appear in the signal output of the video detector.

The horizontal sync pulses time the operation of the horizontal sweep oscillator, and keep it on frequency (15,750 cycles). The vertical sync pulses time the operation of the vertical sweep oscillator and keep it on frequency

(60 cycles). Most ordinary lighting circuits in the home furnish a 60-cycle voltage, but this frequency may vary, hence it cannot be used as the vertical sweep voltage or for timing purposes, where a high degree of accuracy is required.

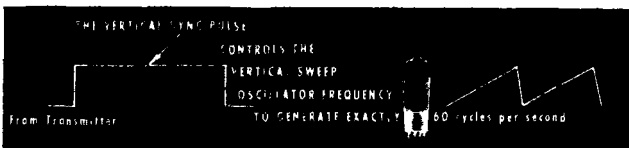
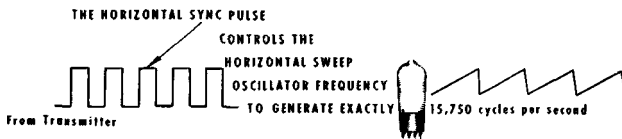

THE SYNCHRONIZING CIRCUITS

Synchronizing Pulse Separation

We have established that the synchronizing pulses which control the horizontal and vertical oscillators are part of the modulation that makes up the composite video signal sent to the receiver. These pulses ride on top of blanking pulses. If they are to control the horizontal and vertical sweep oscillators in the receiver, the sync pulses and the blanking pulses as well as the picture information voltages must be separated.

The separation mentioned above is done in the first of the stages which make up the *sync section* of the *beam positioning* portion of the receiver. Different names have been assigned to this stage, as for example *pulse clipper*, *pulse separator*, *sync clipper* and *sync separator*. We shall use the last name mentioned.

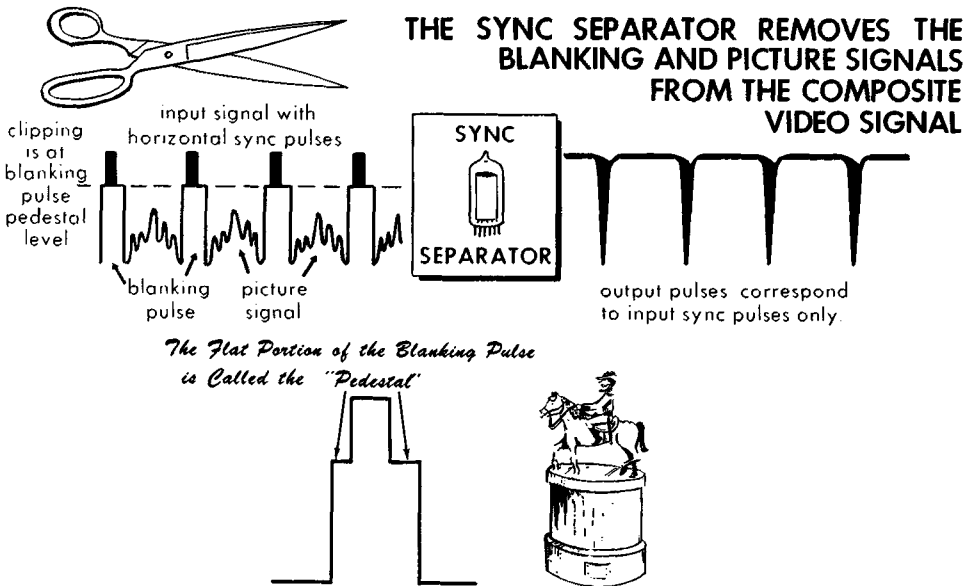

The composite video voltage is derived from the video amplifier after amplification. It is fed into an amplifier which is biased so that only the sync pulses cause plate current to flow. Input signal voltages up to the level of the blanking voltage pedestal have no effect on the plate current. The result is a series of output pulses which correspond to the sync pulses in the input composite video signal. Whatever may be the shape or sequence of the sync pulses that ride on the blanking voltage pedestal, the sync separator output will contain replicas of these pulses. It will be seen later that although three different kinds of pulses—horizontal, vertical, and equalizing—make up the synchronizing group, and they have different shapes relative to their time of duration and the time interval between, all have a time relationship to the horizontal sync pulses.

THE SYNCHRONIZING CIRCUITS

Adding The Sync Separator and Sync Amplifier

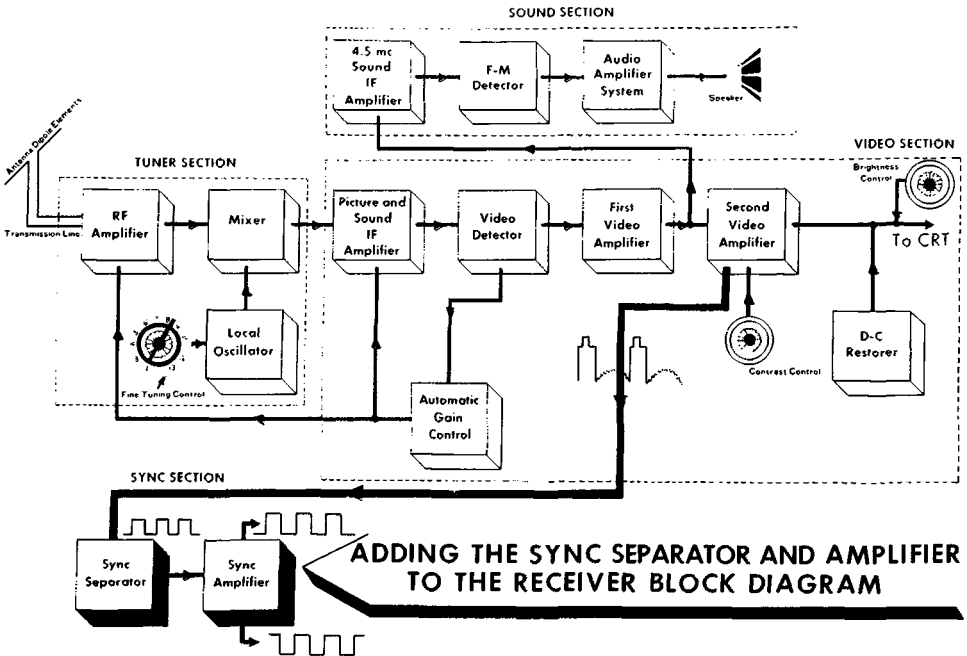

The output pulses available from the sync separator are fed into another amplifier stage (*the sync amplifier*), which performs several functions. It is an amplifier with two output circuits, each of which affords the same signal—amplified versions of the train of pulses fed into it. The reason for the two outputs is to furnish synchronizing signals to two channels, the vertical oscillator path and the horizontal oscillator path. It is very important to bear in mind that there is no distinction between the synchronizing pulses at the output of the sync amplifier. The vertical oscillator path and the horizontal oscillator path receive the same train of pulses from the sync amplifier. Because of the manner in which the two outputs are derived in the sync amplifier, they differ in phase by 180° . That is, one is inverted in polarity relative to the other. Because of this action this stage is often called a *phase splitter*.

The separation of horizontal sync pulses from the vertical and equalizing sync pulses takes place in the two sweep oscillator paths. Here, circuitry made up of resistors and capacitors distinguishes between the higher-frequency (15.750-kc) short-duration horizontal sync pulses and the longer-duration lower-frequency (60-cycle) vertical sync pulses, accepting one and rejecting the other. This makes available only vertical sync pulses to the vertical oscillator and only horizontal sync pulses to the horizontal oscillator.

THE VERTICAL SWEEP CIRCUITS

The Vertical Sweep Circuit

The pulses fed into the vertical oscillator channel from the sync amplifier become vertical sync pulses as the result of the action of the "integrator," a resistor-capacitor combination that lies in the path of the pulses. It is part of the vertical sweep oscillator assembly, although we show it separately for clarity. The "how" of this action is explained later. For the present, suffice it to say that a series of pulses of approximately 15 microseconds duration and occurring 60 times per second issues from the integrator and is applied to the vertical sweep oscillator.

The vertical oscillator frequency must not only be precisely that used at the transmitter for vertical deflection (60 cycles), but also must change in direction and value, instant by instant, in exact synchronization with the vertical sweep voltage active on the camera tube beam. To accomplish the vertical sweep at the constant rate, the waveform of the voltage is like a "sawtooth," in which the long-duration portion (15,500 microseconds) accounts for the downward sweep of the beam from the top of the picture screen to the bottom, and the relatively short duration portion (1,167 microseconds) accounts for the rapid return or *retrace* of the beam from the bottom of the screen to the top. (The full cycle of vertical sweep voltage consumes 16,667 microseconds.) The vertical sync voltage triggers the retrace. It is a recurring reminder to the oscillator to stay on frequency and thereby gives correct vertical positioning of the beam.

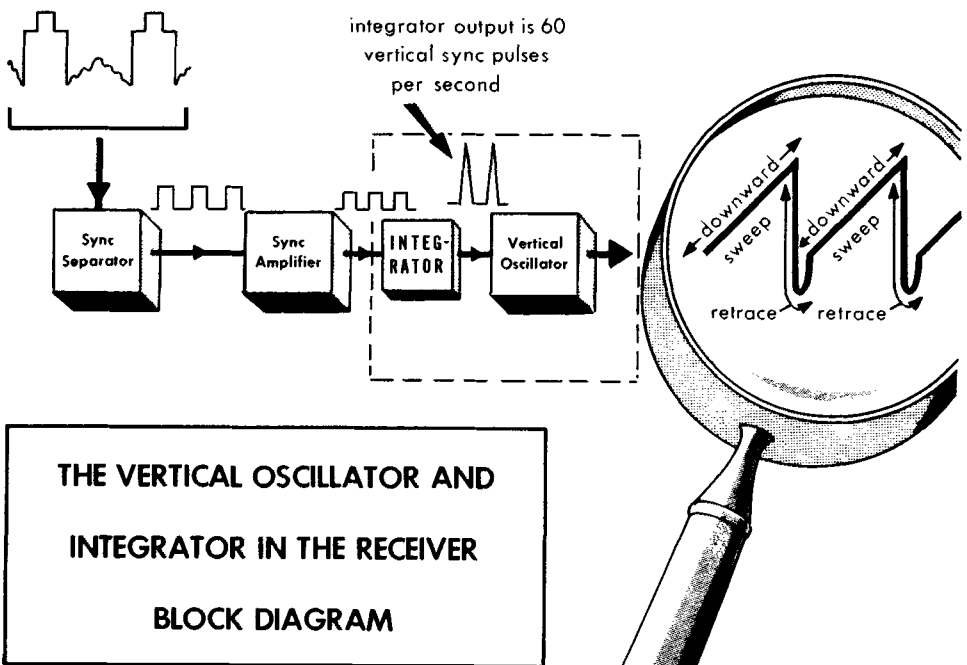

THE VERTICAL SWEEP CIRCUITS

The Vertical Hold and Height Controls

If you have a television receiver at home, you have no doubt experienced pictures that slip upward or downward. The fact that the picture is moving up or down indicates that the vertical oscillator is out of synchronization with the vertical oscillator supplying the vertical sweep signal to the camera tube in the television studio. Most television manufacturers provide an adjustment known as the *vertical hold control* by which the vertical oscillator frequency can be varied until the picture becomes stationary—that is, until it is vertically synced. In some receivers, this control is mounted at the rear of the set, in others it is a front-panel control.

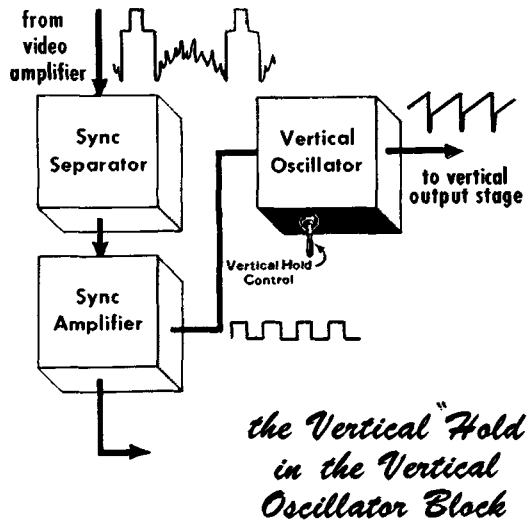

Every receiver is provided with an adjustment whereby the height of the picture can be changed. It is called the height or *vertical size control*. This adjustment varies the *amplitude* of the voltage output from the vertical oscillator—thus the amount of vertical deflection current in the vertical deflecting coil. Increasing the output increases the height of the picture; decreasing the output reduces the height of the picture.

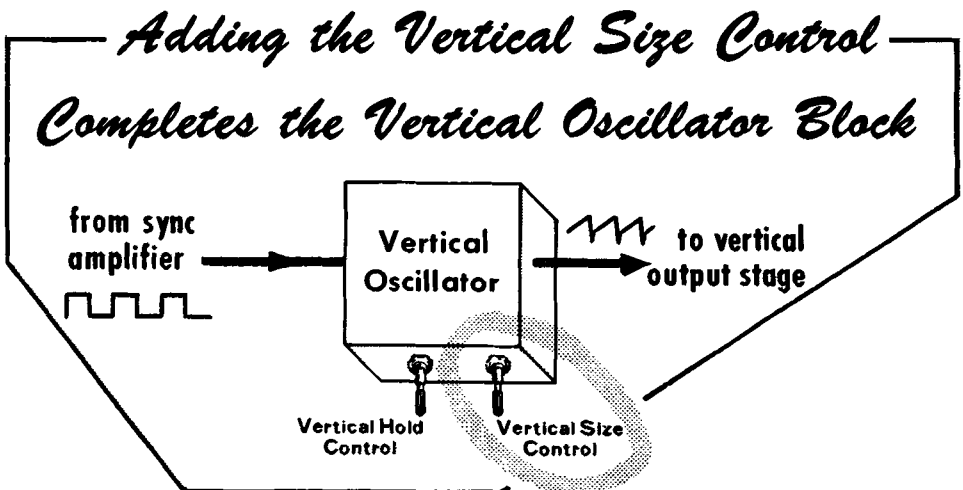

THE VERTICAL SWEEP CIRCUITS

The Vertical Output Stage and Vertical Linearity Control

The output from the vertical oscillator is insufficient to drive the vertical deflection (or deflecting) coils properly. Therefore an amplifying stage (the vertical output tube) is added between the vertical oscillator and the vertical deflection coils. It is primarily an amplifier, but as will be seen, it serves another function as well.

Reference has been made to the need for a constant rate of change in the movement of the electron beam while under the influence of the vertical deflecting force. The amount that the vertical deflecting force depresses the beam as it is describing its horizontal motion is the same for every like interval of time until it reaches the bottom. When this happens adjacent horizontal lines are equidistant. Any condition that prevents this from happening will distort the picture, either compressing it or expanding it vertically. Such a condition may be present in the waveform received from the vertical oscillator. To overcome it, receiver manufacturers provide a linearity control in the vertical output stage that changes the amplifying characteristic of the vertical output tube so that a certain amount of distortion is deliberately introduced. This distortion is somewhat opposite to that present in the sweep input to the vertical output tube. One offsets the other and a substantially distortion-free voltage is delivered to the vertical deflecting coil. The linearity control is variable to permit adjustment.

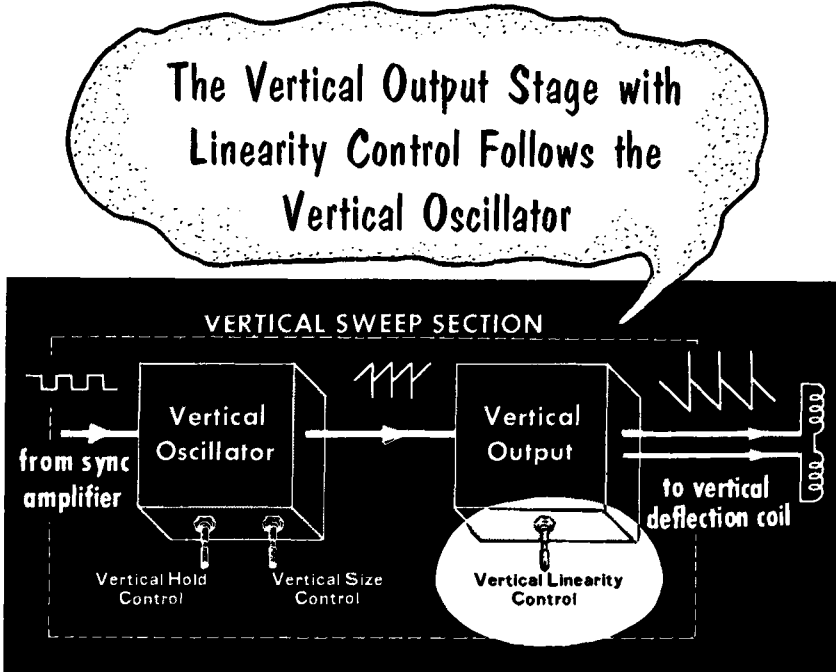

THE VERTICAL SWEEP CIRCUITS

THE ADDITION OF THE VERTICAL OUTPUT STAGE COMPLETES THE VERTICAL SWEEP SECTION

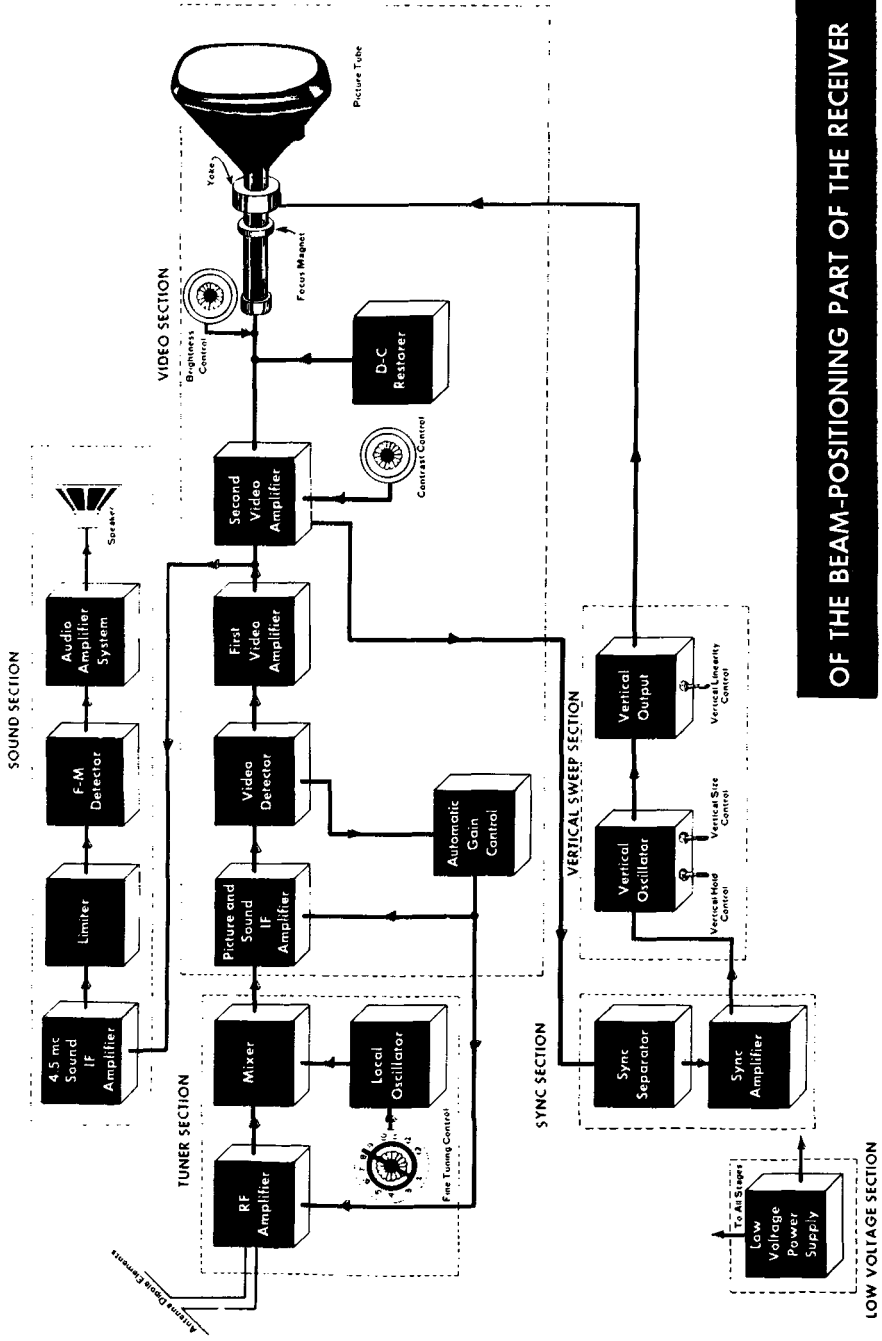

OF THE BEAM-POSITIONING PART OF THE RECEIVER

THE HORIZONTAL SWEEP CIRCUITS

Horizontal Sweep Section and AFC

Now that we have completed our general discussion of the vertical sweep section, we will go back to the sync amplifier and pick up the trail of the composite sync pulses previously indicated as being intended for the horizontal sweep section of the receiver.

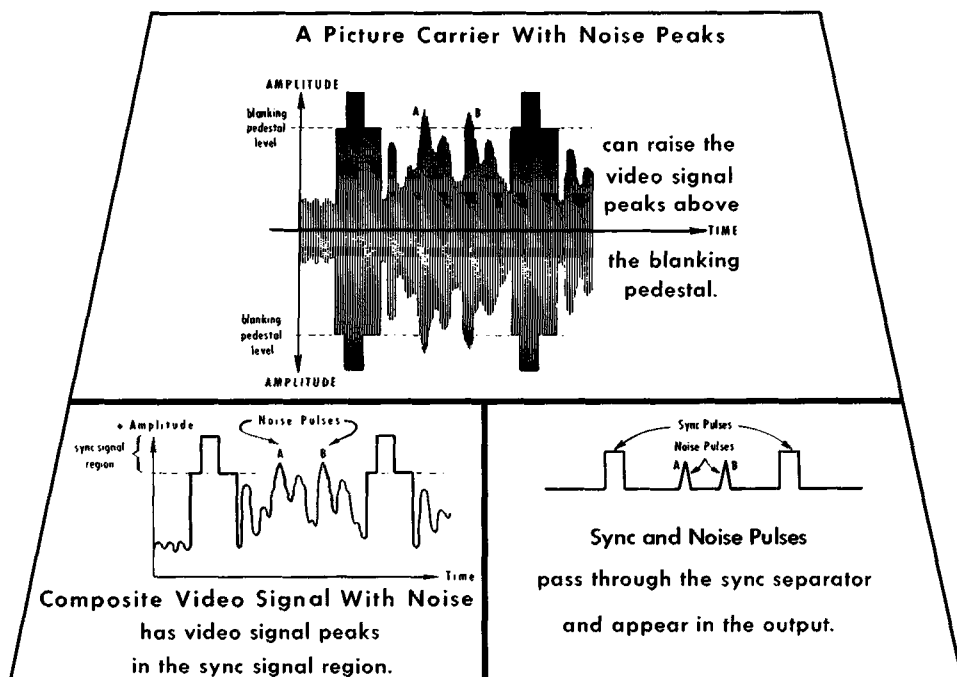

In its general form, the horizontal sweep section follows the pattern of the vertical sweep section. But there are important differences between the two, and because of these we shall find several blocks in the horizontal sweep section that we did not find in the vertical sweep section.

Electrical noise voltages that become part of an amplitude-modulated signal modify the envelope by elevating the peaks. Noise on the picture portion did at one time prove troublesome in television receivers; it caused "tearing" of the picture as well as "jitter."

If we demodulate a picture carrier containing noise of high amplitude we can very easily find noise peaks which extend beyond the blanking voltage pedestal, and are consequently in the sync signal region. When such a signal is fed into a sync separator, that circuit recognizes no difference between the normal sync voltages and noise peaks (shown as A and B in the illustrations). The signal output of the sync separator and that of the sync amplifier contain spurious pulses in addition to regular pulses.

THE HORIZONTAL SWEEP CIRCUITS

The Horizontal AFC Circuit

ONE TYPE OF

HORIZONTAL A-F-C CIRCUIT

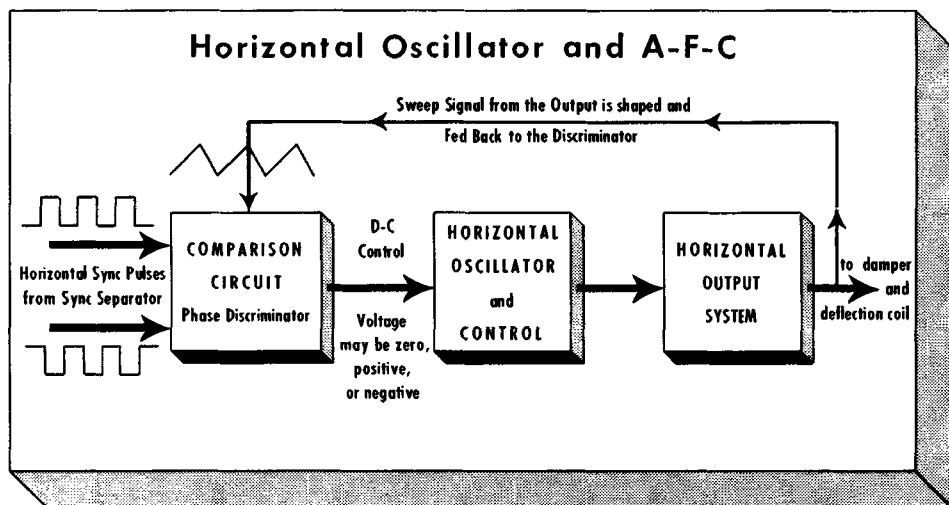

Noise pulses applied to the horizontal oscillator in addition to the horizontal sync pulses could destroy synchronization between the horizontal motion of the electron beams in the picture tube and the camera tube, with consequent horizontal tearing of the picture. In the example shown, four sync pulses (two normal and two spurious) would be experienced in the time interval when only two sync pulses should occur. The result of spurious triggering of the horizontal sweep oscillator raises the frequency of the oscillator output waveform.

Designers of current television receivers have gone a long way toward beating the spurious triggering problem by applying automatic frequency control (afc) to the horizontal sweep section. Several types of horizontal circuits exist, but as far as general organization and function is concerned they are all similar. Here we deal with only one system as typical. Later on, we shall discuss all the popular types. The technique used in the horizontal afc system under consideration is to *compare* the timing of the received horizontal sync pulses with the horizontal sweep voltage that is applied to the horizontal deflecting coils. It should be realized that the horizontal sweep voltage for the horizontal deflecting coil has its origin in the horizontal oscillator. The result of the comparison is the production of a d-c control voltage that is applied to the horizontal oscillator, raising or lowering its frequency to restore horizontal synchronization.

THE HORIZONTAL SWEEP CIRCUITS

Horizontal Output Stage and Hold Control

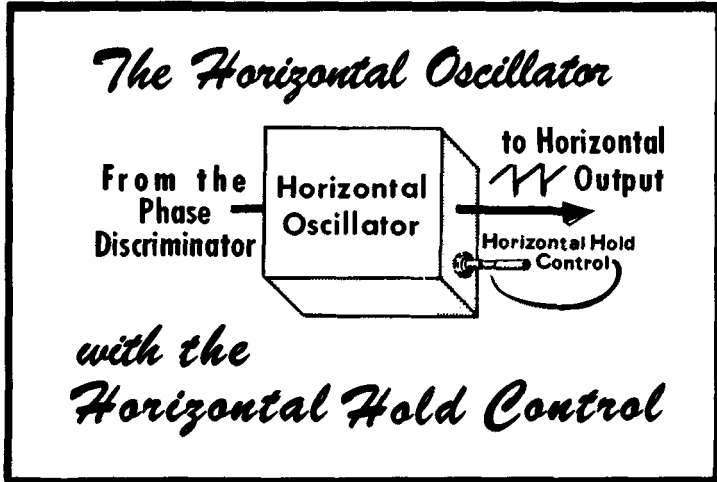

The horizontal sweep voltage to the horizontal deflecting coil has its source in the horizontal oscillator. The oscillator is so designed that its "free-running" output approximates 15,750 cycles, but after afc action it is accurate.

The corrected frequency signal from the horizontal oscillator is fed to the *horizontal output stage*. This stage is primarily a power amplifier intended to raise the horizontal output to a level suitable for further processing. Among these processing operations is the creation of a specially shaped *sawtooth* current required for the horizontal deflecting coil. This occurs in the system associated with the damper tube that follows the output stage. The output stage usually contains a variable control known as the *horizontal drive* that determines the amplitude of the horizontal sweep voltage fed into the output stage. Insufficient "drive" to the horizontal output stage results in insufficient width of the picture on the screen. Another function of the horizontal output stage is to furnish the voltage that eventually is converted to dc by a rectifier and used as high voltage for the picture tube.

Adding the Horizontal Output Stage With the Drive Controls

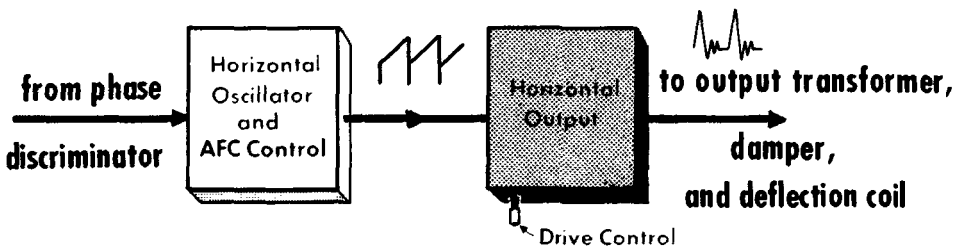

THE HORIZONTAL SWEEP CIRCUITS

Horizontal Output Transformer—Damper—Width—Linearity

The horizontal output tube plate circuit contains a transformer (T), which we show as an entity only because it plays a very important part in the development of the final sweep voltage that is delivered to the horizontal deflecting coil, and to the high voltage delivered to the high-voltage power supply rectifier.

The horizontal output system between the output tube and the horizontal deflection coils is fairly complex. We can only give a brief description of this system here; a more complete discussion appears as part of the discussion on circuitry.

The Complete Horizontal Sweep Section

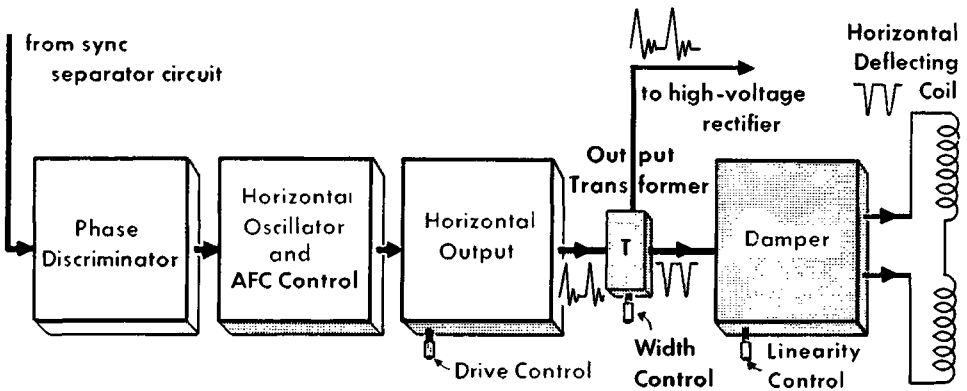

The plate current cutoff behavior of the horizontal output tube is such that when the horizontal sweep voltage is delivered to the horizontal deflecting coil via the horizontal output transformer, relatively high-frequency oscillations appear in the output-transformer deflecting-coil system. As is explained later, these oscillations contribute to the formation of the sawtooth deflection current in the horizontal deflection winding; but to produce it, some of these oscillations must be damped out. During this process, use is made of the damper tube and also of a *linearity* circuit with a variable control. The function of the linearity circuit is to assure horizontal tracing by the electron beam at a constant rate, thus preventing horizontal stretch or compression of the picture.

The output system also contains a *width* control. The width control is related directly to the output transformer and its purpose is to afford a means of increasing or decreasing the horizontal dimension of the image on the picture tube screen. It is to be remembered, however, that inadequate width as well as nonlinearity are related to the drive control which is part of the horizontal output stage.

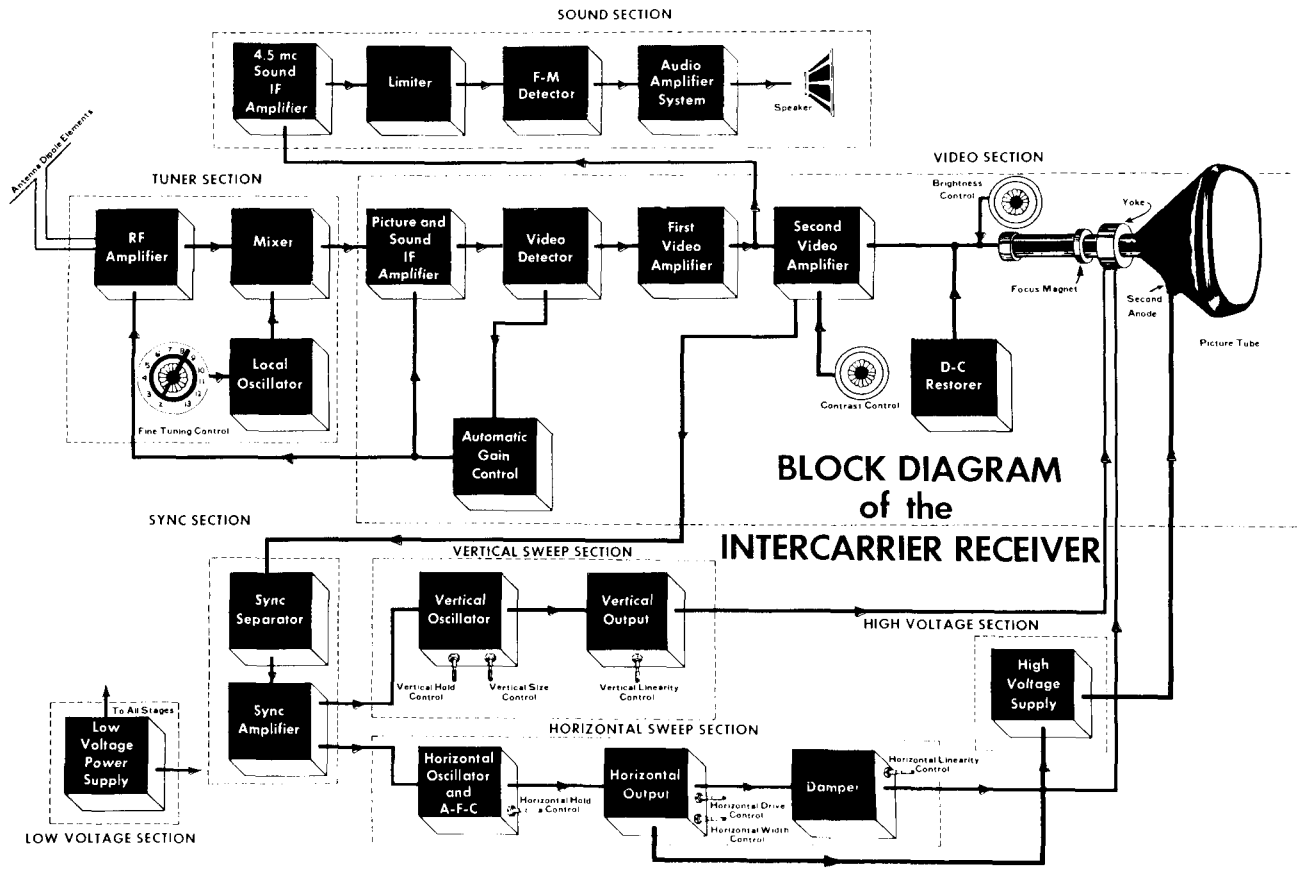

RECEIVER POWER SUPPLIES

High-Voltage Power Supply

The high-voltage power supply in most television receivers resembles the conventional half-wave power supply in most respects. It functions with a 15,750-cycle a-c pulse input voltage of between 10,000 and 20,000 volts. This is a departure from the rectifier arrangement found in most radio equipment, in which the input voltage frequency is usually 60 cycles. The filtering is done by a resistance-capacitance filter, which is adequate because the ripple frequency in the rectified voltage is relatively high. R-F power supplies also have been used in television receivers. They will be discussed separately in connection with the explanation of power-supply circuitry. The rectified d-c output of the high-voltage power supply is applied to the *second anode* or high-voltage anode of the picture tube. Interestingly enough, the output capacitor in the R-C filter of the power supply is often part of the picture tube itself, being formed by the high-voltage Aquadag inner coating and the outer grounded coating of the picture tube envelope.

Low-Voltage Power Supply

All the tubes in the television receiver require a variety of "low" voltages for their operation. The range of voltage values begins at whatever the heater voltage is (usually 6.3 volts ac) and extends upwards to from 200 to perhaps 600 volts dc for screen, plate, voltages and bias voltages. The low-voltage power supply usually is a conventional full-wave vacuum-tube or metallic-rectifier system, although in some instances two rectifier systems may be tied together to function as a single power supply. There are no unusual features associated with these units (but this does not lessen their importance in the overall functioning of the receiver).

The Picture Tube

The picture tube is discussed in detail elsewhere in this course. Hence, for the present, a brief summary of its operation will suffice. The electron beam that produces the image on the screen is generated wholly within the tube and is controlled by a variety of signal and operating voltages that are applied to the tube. The signal voltages derived from the video amplifier *intensity-modulate* the beam, varying its intensity between zero (corresponding to black in the image) and maximum (corresponding to white in the image). The voltages derived from the high-voltage and low-voltage power supplies relate to the development of the beam, and they advance from the cathode to the anodes, and in some cases to the focusing of the beam so that it will produce a sharply defined image on the screen. The deflection coil voltages derived from the horizontal and vertical sweep output systems position the beam on the picture-tube screen so that the location of the elements of the reproduced picture conforms with their location on the camera tube mosaic.

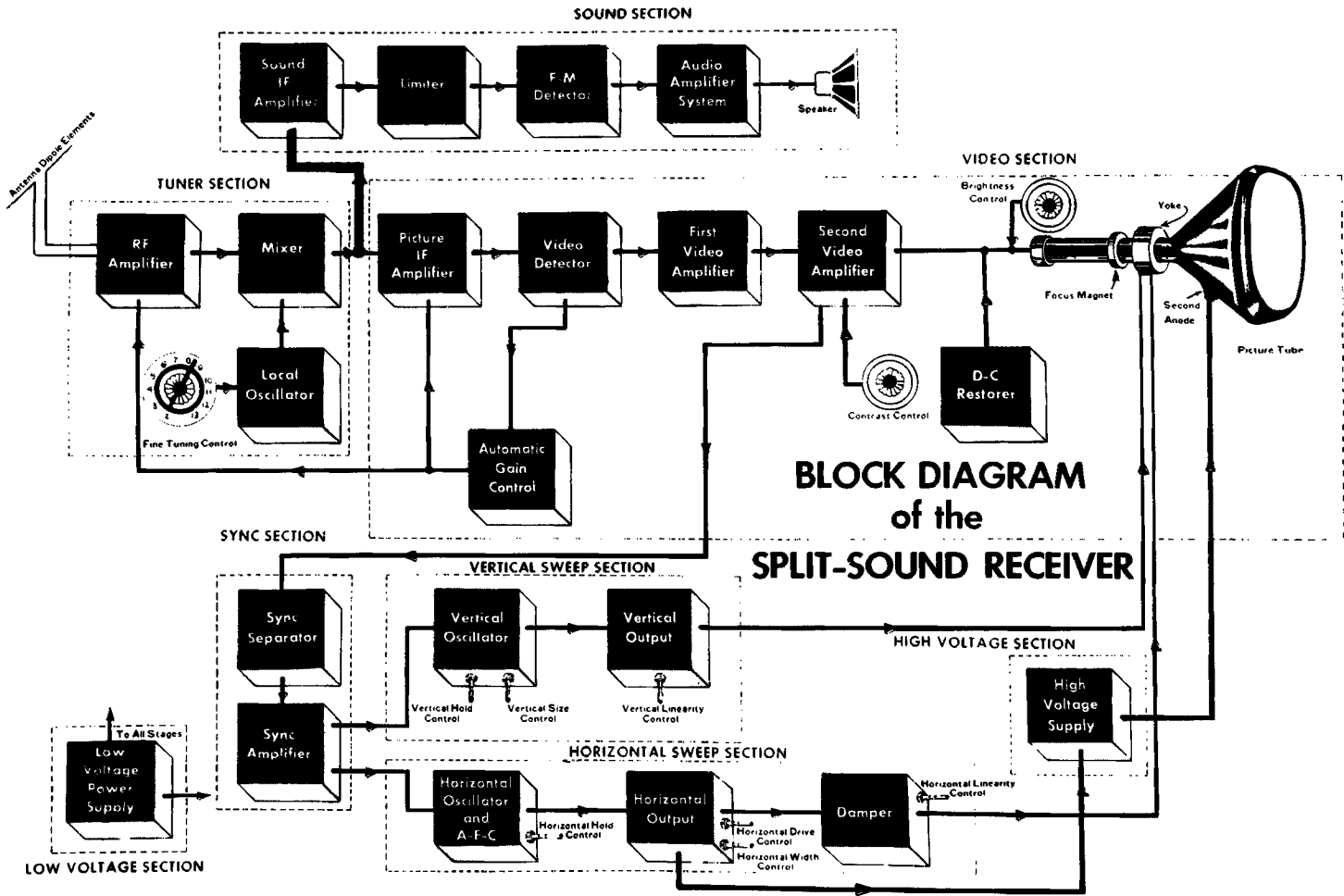

THE SPLIT-SOUND TV RECEIVER

The Split-Sound Receiver

Now that we have described the organization of the intercarrier type of television receiver it is time to refer to another type identified as *split-sound*. Although split-sound sets are no longer being manufactured, several million were made, and, doubtless, many are still in use.

The split-sound receiver differs from the intercarrier type in one major respect. The sound i-f signal and the picture i-f signal are fed into separate paths for processing. It is this sound i-f signal that is translated into audio voltages without any further mixing. If, for example the difference-frequency between the received r-f sound carrier and the local oscillator is 21.25 mc at the output of the mixer, the sound i-f amplifier system processes this 21.25-mc signal and the sound demodulator translates it into its audio equivalent. The sound i-f signal takeoff point is located at one of two places; either at the output of the mixer, or after one stage of i-f amplification that is common to both the sound and the picture i-f signals.

In all other respects the split-sound receiver organization is like the intercarrier type. Operating frequencies are the same and destinations of the blanking and synchronizing voltages are alike in both types of receivers. The processing of the sync signal is also the same in both types of receivers, although it might be said that the general run of split-sound receivers utilized more tubes than are usual in the intercarrier type because more single-function types were used.

The vertical and horizontal sweep systems in the split-sound receiver correspond closely to the intercarrier system, although a greater variety of afc circuits are found in intercarrier receivers. The damper, low-voltage, high-voltage and deflection systems are substantially identical in both kinds of receivers. We can summarize by saying that the organization of the split-sound receiver is the same as the intercarrier except for the takeoff point of the sound i-f signal and the operating frequency of the sound i-f amplifier. No split-sound receivers were made with 41-mc i-f systems, whereas in the intercarrier design both 21- and 41-mc i-f systems were used.

It might be well to mention that the demise of the split-sound receiver can be attributed to the economies in design that were effected by the intercarrier approach, as well as by the greater ease of tuning.

Critical tuning was an inherent characteristic of the split-sound receiver because of oscillator drift. Since any change in oscillator frequency produces a change in the sound and picture i-f, it was extremely important that the oscillator frequency be stable. In this respect, the relatively narrow-band sound signal was much more easily lost than the wide-band picture signal. With the intercarrier receiver, the sound signal is locked 4.5 mc away from the picture signal. Oscillator drift causes a decrease in amplitude of the picture and sound signals, but the chance of losing the sound signal entirely has become far less probable.

UHF RECEPTION

UHF Station Reception

Since both uhf and vhf transmitters may serve an area, receiving systems must of necessity be capable of accepting both frequency ranges. Numerous methods have been devised to permit uhf reception using a vhf receiver. Two methods are shown here: in one the vhf tuner in the receiver has been modified so that it can also be used to tune to uhf signals. The second method uses an external uhf tuner or converter that can be connected to the antenna input terminals of the vhf receiver. In converting the uhf signal to a lower frequency, two methods are used: (1) single conversion, where the uhf signal is heterodyned down directly to an intermediate frequency; and (2) double conversion where the uhf signal is heterodyned down to a vhf signal, then down to the intermediate frequency.

Single-Conversion UHF Reception

The uhf tuner is a frequency converter that is part of the uhf-vhf receiver, and consists of a mixer stage and an oscillator. For uhf reception it is switched into the circuit; for vhf reception it is switched out of the circuit. The frequency of the uhf oscillator is such that the difference-frequency picture i-f output from the uhf converter is a modulated 45.75-mc signal, and the sound i-f output from the uhf converter is 41.25 mc. Instead of being fed directly into the receiver i-f amplifier, these two i-f signals are first amplified by the r-f amplifier and mixer stages. These are modified (by appropriate switching) to behave as addition picture-sound i-f amplifiers. The switching system automatically connects while it disables the vhf oscillator. (This is position "13" in the conventional 12-position tuner.)

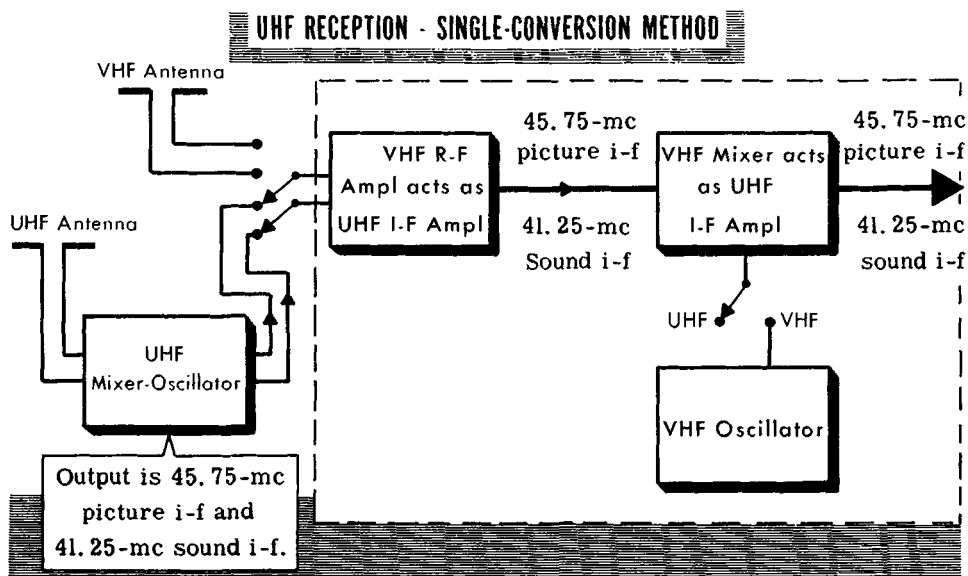

UHF RECEPTION

Double-Conversion UHF Reception

UHF RECEPTION - DOUBLE-CONVERSION METHOD

Assume a UHF Channel 20 signal being received and the VHF Front End set to Channel 6

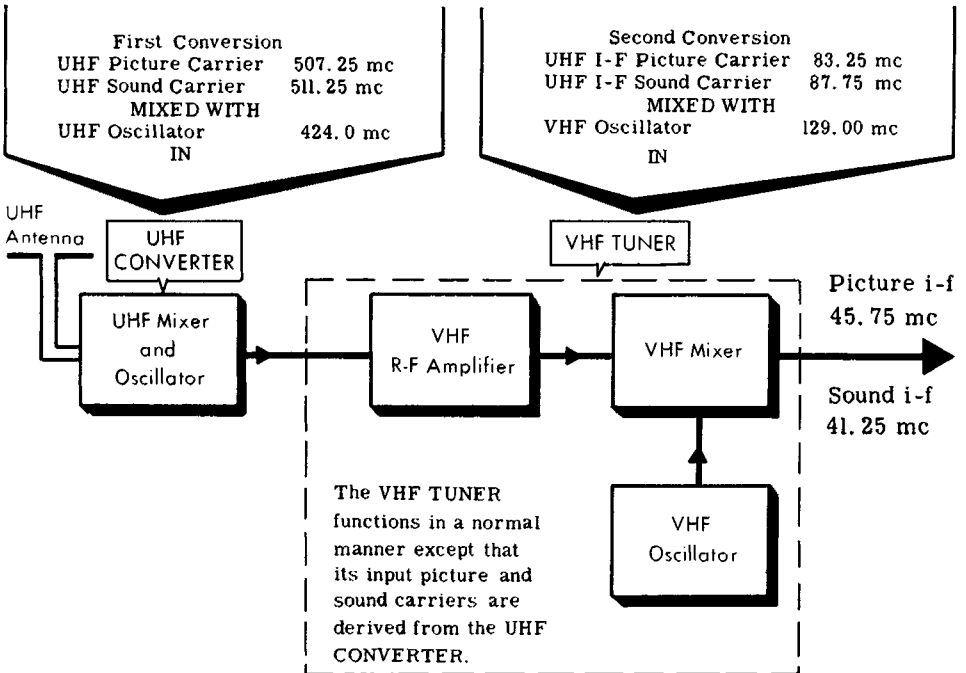

The second method of uhf reception with a vhf television receiver makes use of a uhf converter as an external accessory to the receiver. The converter consists of a uhf mixer and oscillator. It accepts the uhf picture and sound carriers of a given uhf channel and delivers at its output two *difference-frequency* signals that are the equivalent of the uhf picture and sound carriers but are of a lower frequency. By virtue of the design of the uhf oscillator, the output signals from the uhf converter most commonly fall within the frequency band for channels 5 or 6 of the vhf band. Inasmuch as these two vhf channels are never allocated for the same area, one of them is always an unused position on the vhf tuner. The uhf converter output signals are processed by the vhf front-end just as if they were vhf signals received from a vhf transmitter. To position the sound carrier higher in frequency than the picture carrier at the input of the vhf front-end, the uhf oscillator generates a frequency which is lower than the received uhf sound and picture carriers. The numerics shown in the illustration show the double frequency conversion which takes place in the system.

REVIEW

It is essential that the Transmitter's

Camera Tube Scanning Beam

and the Receiver's

Picture Tube

Scanning Beam

move precisely in step

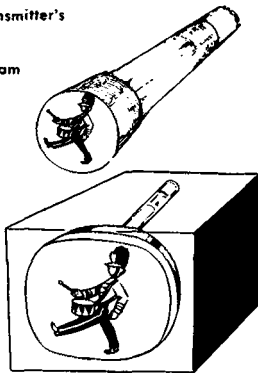

1. *Synchronization* is required to keep the scanning beam in the picture tube precisely in step with the scanning beam in the camera tube. Horizontal sync, vertical sync, and equalizing pulses, which are all a part of the composite video signal, are used for synchronization.

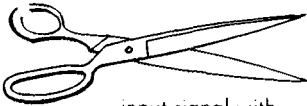

THE SYNC SEPARATOR REMOVES THE BLANKING AND PICTURE SIGNALS FROM THE COMPOSITE VIDEO SIGNAL

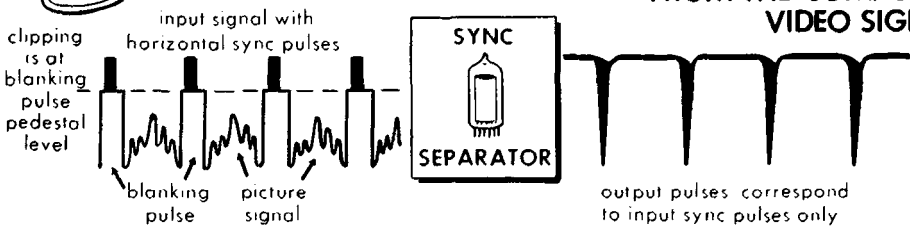

2. *The Sync Separator* removes the horizontal sync pulse (15,750 cycles), the equalizing pulses, and the vertical sync pulses (60 cycles) from the composite video signal.

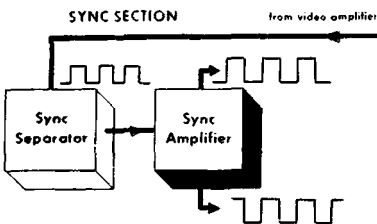

3. *The Sync Amplifier, or phase splitter* amplifies the pulses from the sync separator. The amplified pulse train is made available at two outputs which differ in phase by 180° . This provides two separate paths—one to the horizontal, and one to the vertical sweep oscillator circuits.

4. Except for the 180° phase difference, the pulse trains available at both outputs of the sync amplifier are identical. Separation of horizontal sync, vertical sync and equalizing pulses takes place in the two sweep oscillator paths. Here, resistor and capacitor circuitry distinguishes between the horizontal (15,750-cycle) and vertical (60-cycle) sync pulses, rejecting one and accepting the other. This makes available only vertical sync pulses to the vertical oscillator and only horizontal sync pulses to the horizontal oscillator.

REVIEW

1. *The Vertical Oscillator* generates the 60-cycle vertical sweep voltage whose waveform is shaped like a sawtooth. The 60-cycle vertical sync pulses from the integrator keep the output voltage precisely in step with the vertical sweep voltage active on the camera tube beam.

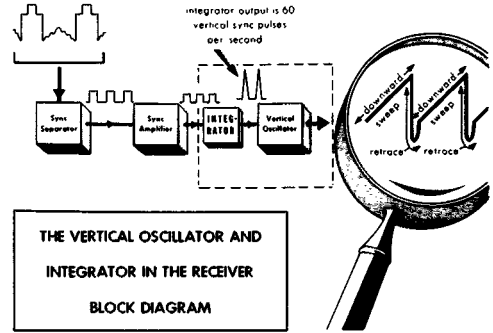

The Vertical Output Stage with Linearity Control Follows the Vertical Oscillator

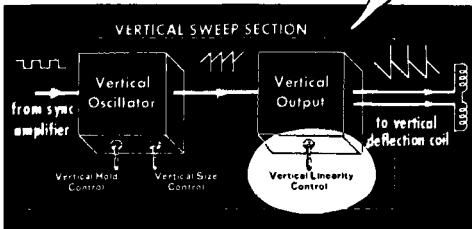

3. *The Horizontal AFC Circuit* compares the timing of the received horizontal sync pulses with the sweep voltage applied to the horizontal deflecting coils to produce a d-c control voltage that is applied to the horizontal oscillator.

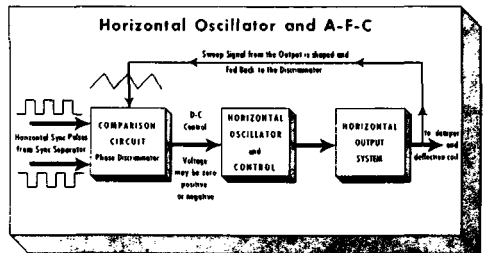

Adding the Horizontal Output Stage With the Drive Controls

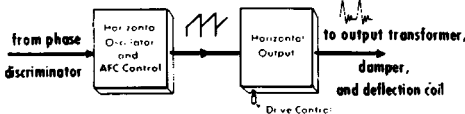

4. *The Horizontal Output Stage* is primarily a power amplifier which raises the signal from the horizontal oscillator to an output level suitable for further processing. The horizontal drive control determines the amplitude of the horizontal sweep voltage fed into this stage.

Insufficient drive results in insufficient width of the picture. Among the processing operations is the creation of a specially shaped sawtooth current required for the horizontal deflecting coil. Another function is to furnish the voltage that eventually is converted to dc by a rectifier and used as high voltage for the picture tube.

REVIEW

The Complete Horizontal Sweep Section

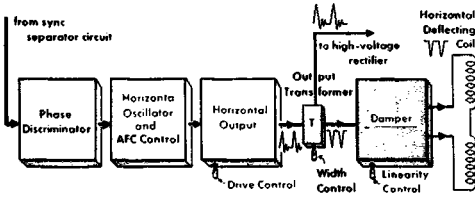

5. The *Horizontal Output Transformer* is in the horizontal output tube plate circuit. In conjunction with the *width control*, *dumper*, and the *linearity* circuit, it develops the final sweep voltage delivered to the horizontal deflecting coil. It also develops the high voltage delivered to the high-voltage power supply rectifier.

6. The *High-Voltage Power Supply* furnishes the high voltage for the high-voltage anode of the picture tube. A 15,750-cycle a-c input voltage of between 10,000 and 20,000 volts supplied by the horizontal output transformer is converted to dc by a half-wave rectifier. This high d-c voltage is filtered by a resistance-capacitance filter before it is fed to the high-voltage anode of the picture tube.

7. In the *Split-Sound Receiver* the sound i-f signal and the picture i-f signal are fed to separate paths for processing.

8. For *Single-Conversion UHF Reception* the uhf signal is heterodyned down directly to an intermediate frequency. The uhf tuner is a frequency converter that is part of the uhf-vhf receiver, and consists of a mixer stage and an oscillator. The switching system automatically connects it while it disables the vhf oscillator.

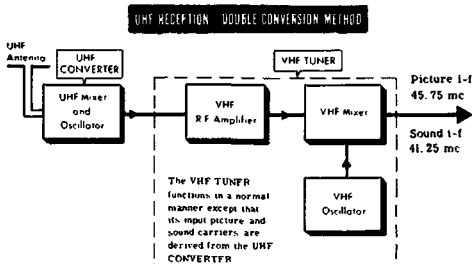
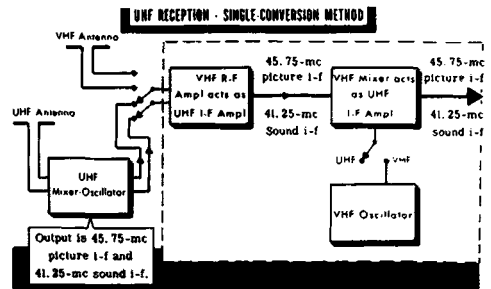

9. For *Double-Conversion UHF Reception* the uhf signal is heterodyned down to a vhf signal, then down to the intermediate frequency. The uhf converter is an external accessory to the receiver. The uhf converter output signals are processed by the vhf front end just as if they were signals received from a vhf transmitter.

THE TELEVISION ANTENNA

The TV Receiver Antenna

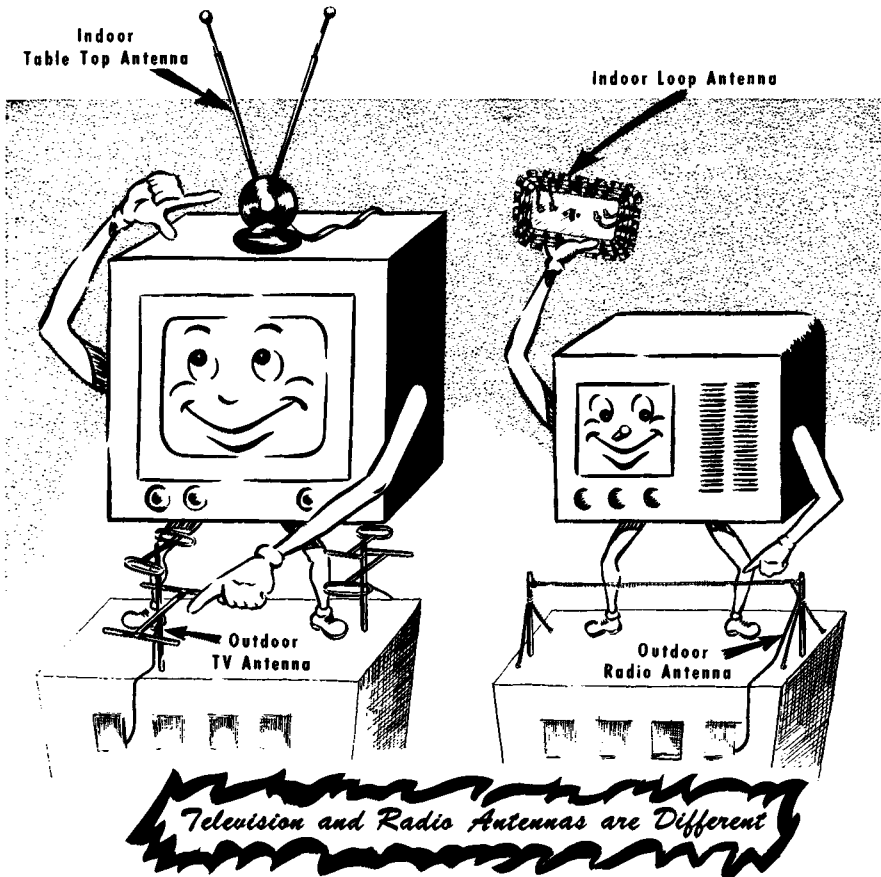

Radio receivers require an antenna to intercept energy radiated from the transmitter. The television receiver needs a similar device. One glance at almost any roof top, however, is enough to establish that the antenna used for television reception differs greatly from the conventional home radio receiving antenna.

An outdoor elevated wire 40 to 60 feet long suspended between two insulators was the standard radio antenna for many years. Today over a hundred million table model radio receivers function with self-contained antennas — a ferrite loopstick, or a loop 6 to 10 inches on a side, made of several turns of wire mounted on a fiber or plastic frame, and housed within the receiver cabinet. Sometimes, in areas close to a transmitter, a small piece of wire is satisfactory antenna for intercepting television signals. This is however, the exception rather than the rule.

THE TELEVISION ANTENNA

The TV Receiver Antenna (contd.)

The directional relationship between the *television* receiving and transmitting antennas is more critical than in home broadcast reception. Moreover, the high-frequency television signals can be blocked off by, or reflected from surfaces or obstacles that might be in their path of advance, just as light rays are blocked by opaque objects or reflected by a shiny surface. This behavior of the radiated television signal dictates the necessity for positioning the television receiving antenna so that it is in the path of the advancing signal. For best reception the receiving antenna should not be hidden from the "line of sight" of the transmitting antenna. When the receiving antenna is "out of sight" of the transmitting antenna, the reception of television signals requires that the receiving antenna be so located as to take advantage of the reflection phenomenon, that is, pick up the "bounce" of the radiated signal from a suitable surface such as an adjacent building, water tower, or gas tank.

Because the frequency of the television signal is high, the physical length of the receiving antenna becomes critical. This is especially so since the receiving antenna is made to behave as a *tuned* signal-pickup device.

The received television signal eventually produces a picture on the picture tube screen. For this picture to have the proper quality, it is necessary that the received signal not be modified or distorted. The first point where changes in signal construction could take place is the antenna. Therefore, it is important that the antenna accept all the frequencies present in the signal. This problem seldom, if ever, arises in broadcast radio reception.

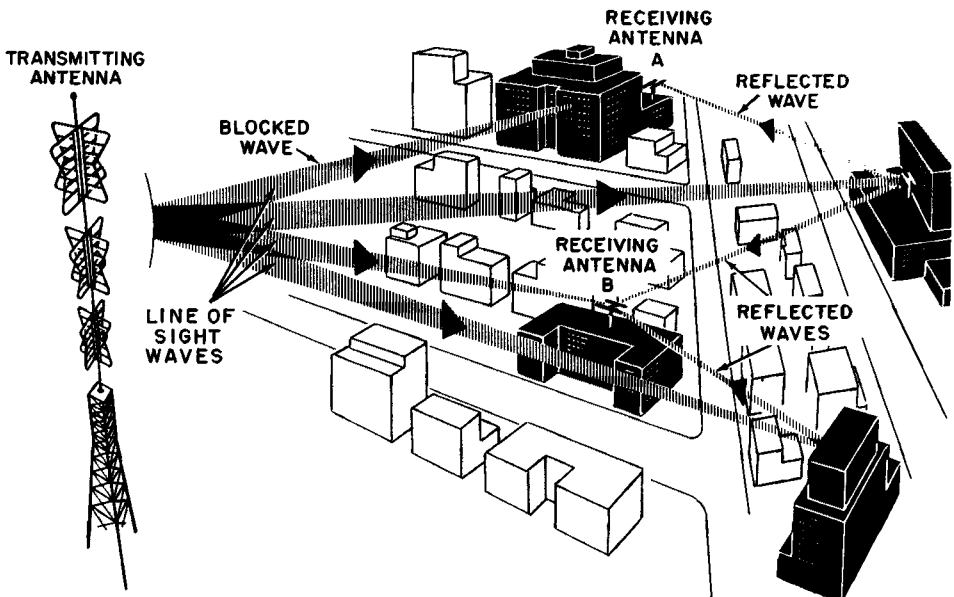

PROPAGATION

Propagation of Television Signals

The word *propagation* refers to the way electromagnetic energy, representative of television signals, travels from the transmitting antenna to the receiver antenna.

The frequency (or wavelength) of a radiated signal determines the path that is effective in causing the signal to reach the receiver. The frequencies used for home television broadcasting begin at about 54 mc and extend upwards to about 890 mc. Within this frequency range are found a number of other communication services, transmitting a-m and f-m radio rather than television signals. They, as well as the television broadcasting stations, make use of the same propagation phenomena.

Television signal radiations can reach a receiver by advancing along one or more of three signal paths. One of these is the *skywave* path. Skywave signals leave the antenna at an angle that directs them upward from the earth. Electromagnetic energy advancing along this path is generally wasted at the present time because there are no television receivers high above the earth and little use is made of skywaves. To minimize the waste of signal energy in this direction, television transmitting antennas are designed to concentrate their radiations in directions towards the earth's surface.

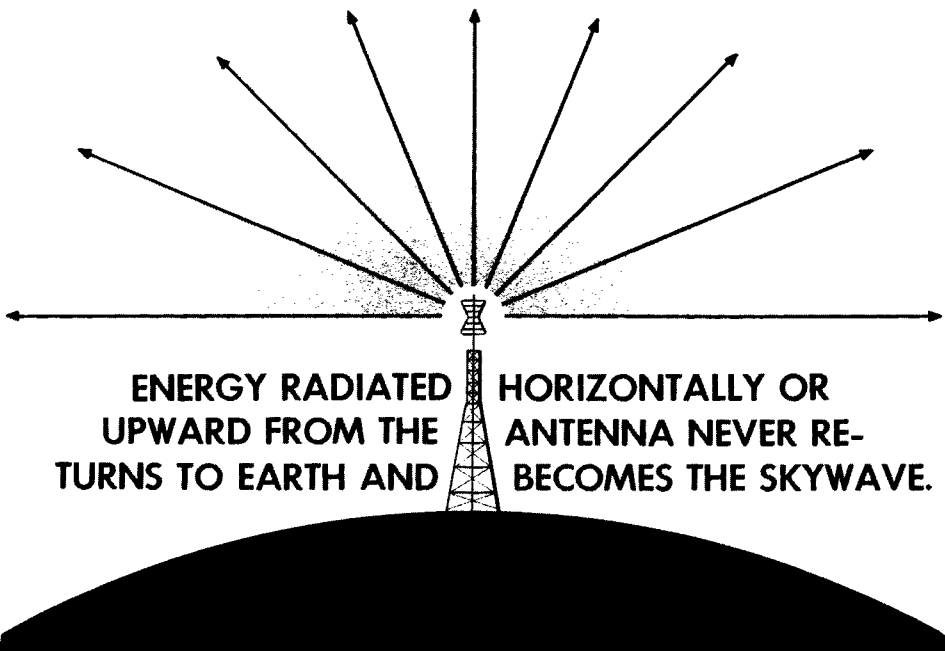

PROPAGATION

The Propagation of Television Signals (contd.)

The second path is the *direct-wave* path. The direct-wave radiations leave the transmitting antenna substantially parallel to the surface of the earth and travel to the receiver in a straight line. It is assumed that this is an unobstructed path free of all intervening obstacles. This is the most useful radiation for television reception, although it does not account for the total signal at the receiver. Also contributing to the received signal is the radiation that follows the *ground-reflected path*.

A portion of the energy released by the transmitting antenna is directed towards the surface of the earth, from which it is reflected, at the same angle at which it struck the earth's surface. The smaller the angle at which the energy from the transmitting antenna strikes the earth or other reflecting surface the more efficient the reflection process (the greater the relative amount of energy that is reflected).

Accompanying the process of reflection is another phenomenon that is important: *flip-over*, or inversion of the signal at the point of reflection. The phase of the signal may be changed almost 180° . For example, a negative-going signal at the instant of arrival at the reflecting surface, can be changed to a positive-going signal after reflection, and vice-versa.

The direct wave signal goes directly to the receiver, whereas the ground-reflected wave reaches it after bouncing off the earth's surface or a rooftop.

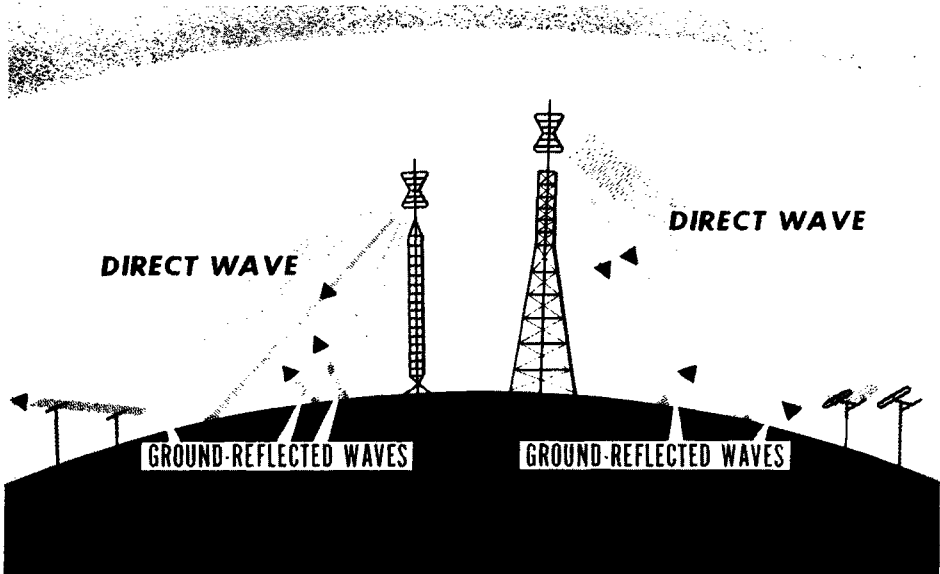

PROPAGATION

The Propagation of Television Signals (contd.)

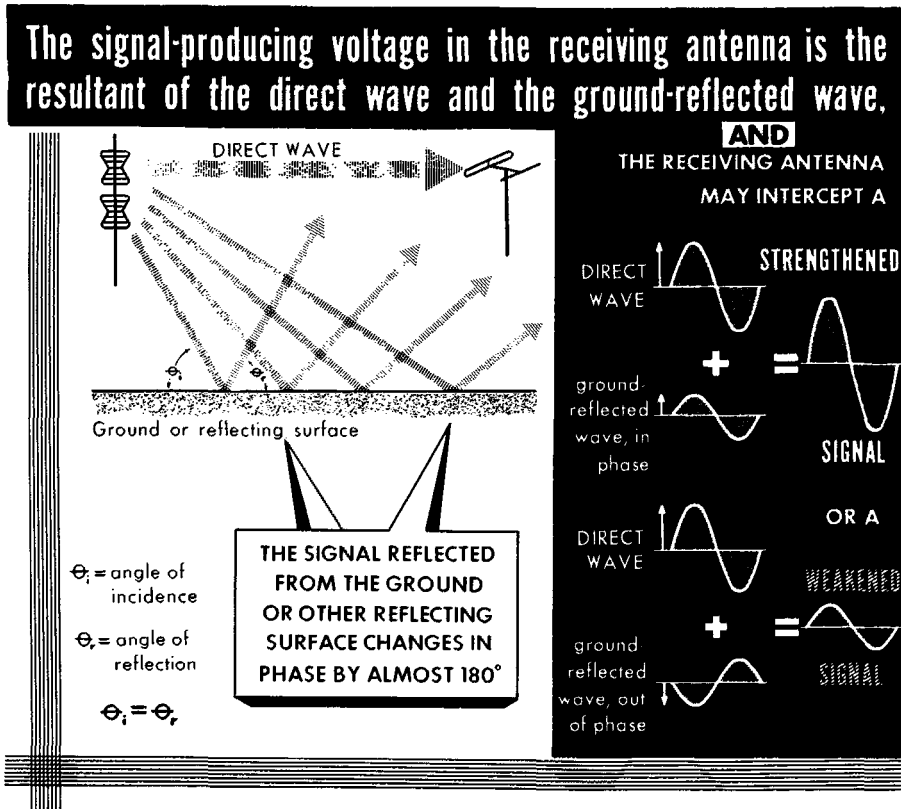

Whether the combination of the direct-wave and ground-reflected signals arriving at the receiving antenna is stronger or weaker than the direct-wave signal alone, depends on whether the two signals aid or oppose each other at the instant of arrival at the receiving antenna. Aiding or bucking is a function of the timing of the two signals that traveled the two paths. The two signals had the same instantaneous phase when they left the transmitting antenna, but if they arrive out of phase at the receiving antenna the resultant or combined signal will be minimum. (Complete cancellation cannot take place.) If the two signals arrive in phase with each other the resultant signal will be a maximum.

The instantaneous phase of the signals that arrive at a receiving antenna after following two signal paths depends on the height of the receiving antenna above the reflecting surface. Interpreting these factors into practice means that increasing the height of a television receiving antenna will not necessarily produce a stronger signal — there will be heights where the signal strength is minimum and others where it is maximum.

PROPAGATION

The Propagation of Television Signals (contd.)

'GROUND REFLECTION' CAN MEAN

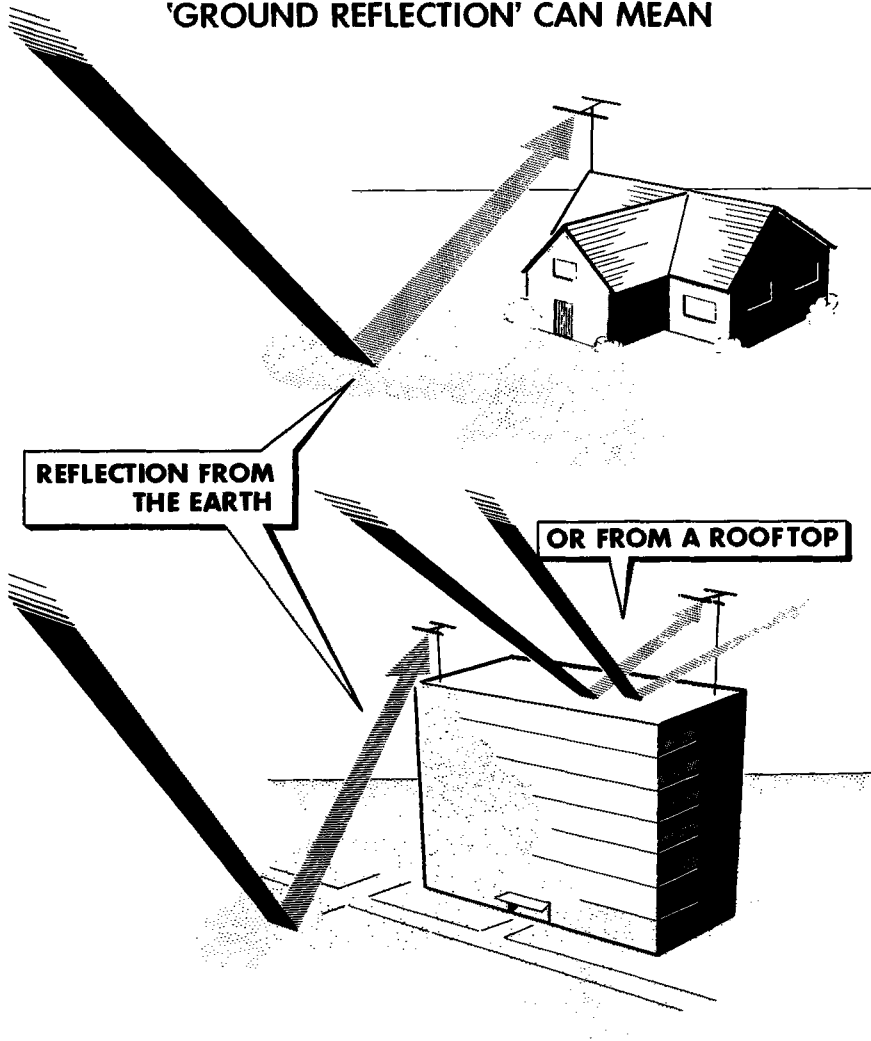

“Ground-reflected path” has several meanings. It can be the path involving reflection from the earth’s surface (the ground itself), or reflection from whatever surface is present below the antenna. An antenna located on a mast mounted above the roof of a private dwelling would, in addition to the direct-ray signal, be subject to a signal reflected from the ground or possibly the roof. An antenna atop an apartment house might receive a reflected signal from the earth or from beneath the tar paper and gravel that is usually used for roofing.

PROPAGATION

Line-of-Sight Transmission

Arrival of the signal energy at the receiving antenna along the direct-wave path is usually referred to as *line-of-sight* propagation. It implies that the maximum distance between transmitter and receiver antennas for useful transmission and reception is determined by the ability to "see" the receiving antenna from the transmitting antenna. The maximum distance that can be "seen" from the television transmitter antenna is called the optical horizon.

An approximation of the useful horizontal range of a television antenna for line-of-sight transmission may be determined from the equation

$$\text{distance in miles} = 1.41 \times \sqrt{\text{transmitter antenna height (in feet)} + \text{receiver antenna height (in feet)}}$$

Assume that the transmitting antenna is located at a height of 900 feet above ground and the receiving antenna is located 50 feet above the ground; what is the maximum useful transmission distance?

$$\begin{aligned} \text{distance} &= 1.41 \times \sqrt{\text{transmitter antenna height (in feet)} + \text{receiver antenna height (in feet)}} \\ &= 1.41 \times \sqrt{900} + \sqrt{50} \\ &= 1.41 \times \sqrt{30} + \sqrt{7.07} = 1.41 \times 37.07 \\ &= 52.3 \text{ miles} \end{aligned}$$

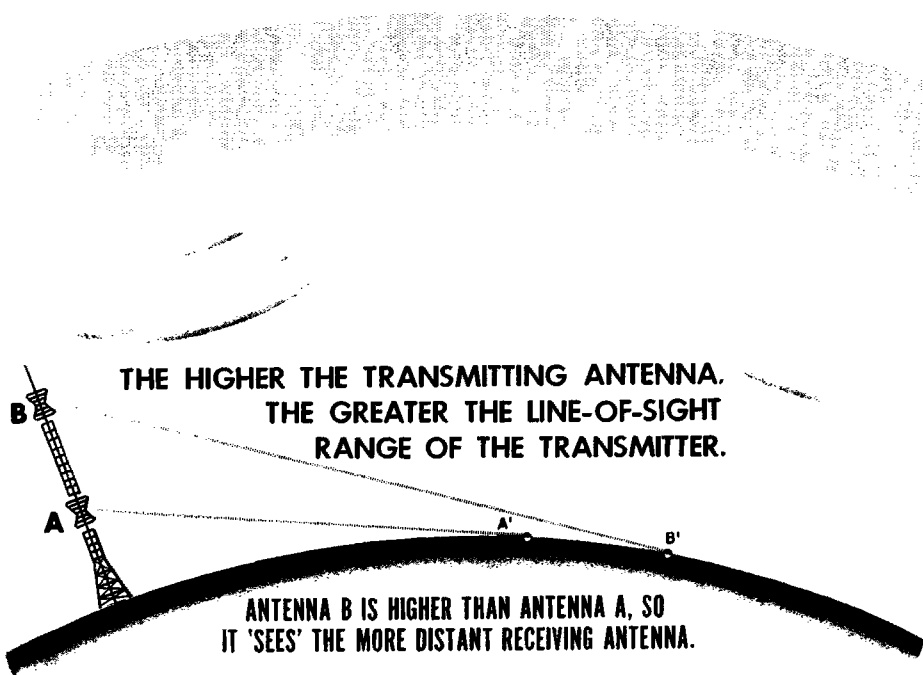

PROPAGATION

Long-Distance Television Reception

On occasion, television reception over many times the normal range is experienced. (This distance may be as great as 500 to 1000 miles, or more.) This is attributed to a phenomenon known as *temperature inversion*. At definite intervals during the year (usually in the spring and fall, sometimes in the summer, and rarely in the winter) layers of hot dry air and cool moist air may exist above the earth. Normally, the higher the altitude, the lower the temperature of the air. But sometimes these conditions are reversed, and a discontinuous change in temperature and humidity prevails in the atmosphere.

When the hot dry air is present above the cool moist air, radio energy entering the region is bent downward because the upper part of the wave (which is in the hot dry air) travels more rapidly than the lower part (which is in the cool moist air). As a result, radiation that normally would pass over antennas near the ground is bent back to the earth, striking receiving antennas far beyond the optical horizon of the transmitting antenna.

THE EFFECT OF TEMPERATURE INVERSION

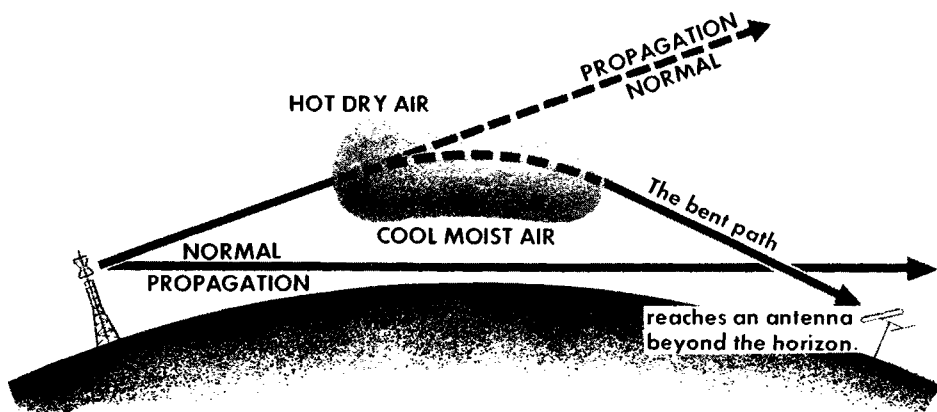
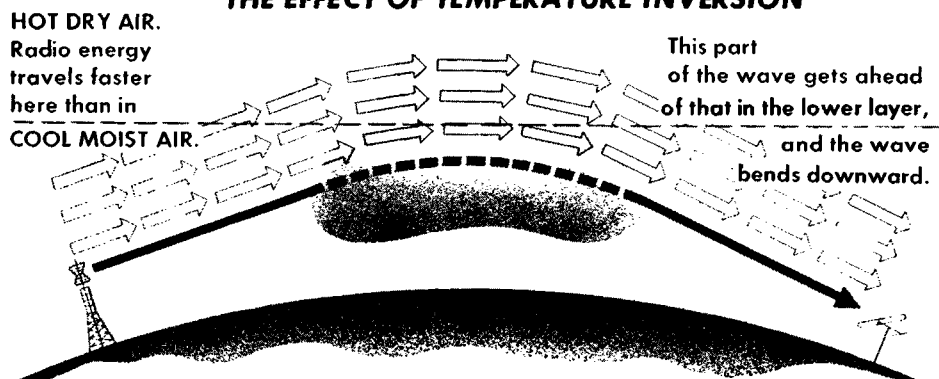

THE RADIATED WAVE

Reflection of Television Waves

The phenomenon of reflection can be a means of receiving a television signal which otherwise would be unavailable because the antenna is located in a "blocked-off" area, as has been illustrated. Reception of reflected signals in a location where direct radiation exists can subject the receiving antenna to two identical signals, one arriving slightly later than the other. The directly received signal will produce a picture on the picture tube screen, and the reflected signal, arriving slightly later, will produce another complete picture displaced to the right of the first. Such secondary signal pictures are called "ghosts" or "lagging ghosts". The existence of line-of-sight conditions is not necessarily productive of "clean" pictures. In areas not too far distant from a television transmitter, a direct-wave signal can find its way into the receiver without benefit of "gain" from a receiver antenna and produce a weak picture on the screen. An identical signal finds its way into the same receiver via the antenna, and produces a second image on the picture tube screen. The signal that enters the receiver without benefit of the antenna system appears ahead (to the left) of the other on the screen because its path into the receiver is the shorter of the two. This signal produces a "leading ghost."

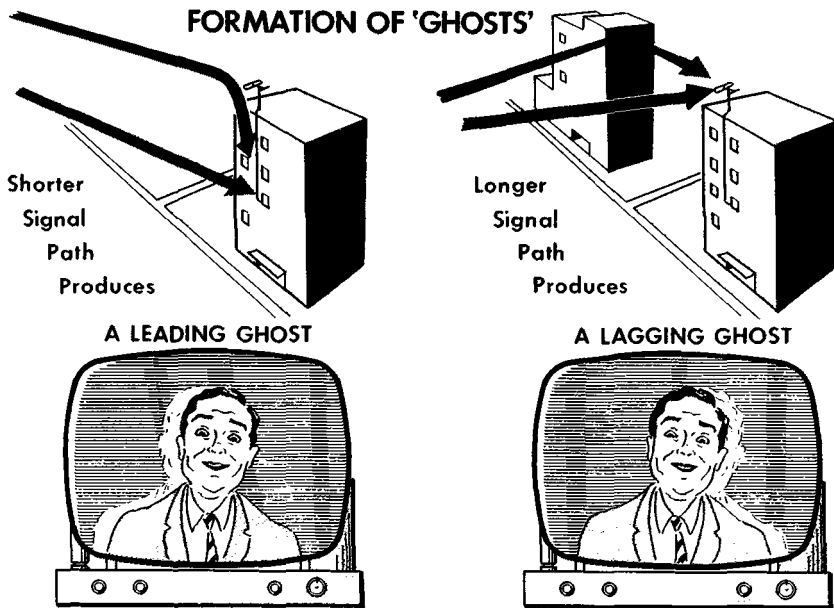

The most logical answer to the reflection problem is to experiment in locating the antenna to minimize these effects, and to select the antenna design that is most directional in its receiving characteristics. Elimination of a leading ghost requires improved shielding of the r-f portion of the receiver, including the small length of transmission line that connects the r-f amplifier of the television receiver to the antenna input terminals.

THE RADIATED WAVE

The Electromagnetic Wave

The energy fed to the transmitting antenna is liberated into space by a process called "radiation." The energy travels in the form of an electromagnetic wave that consists of electric energy corresponding to the voltage distribution on the antenna and magnetic energy corresponding to the current in the antenna. Each of these portions contains half of the radiated energy. Because only the electric part of the wave will be mentioned in our discussion of receiving antennas, we break the wave into its components at this point, rather than considering it as a whole.

THE PHENOMENON OF RADIATION

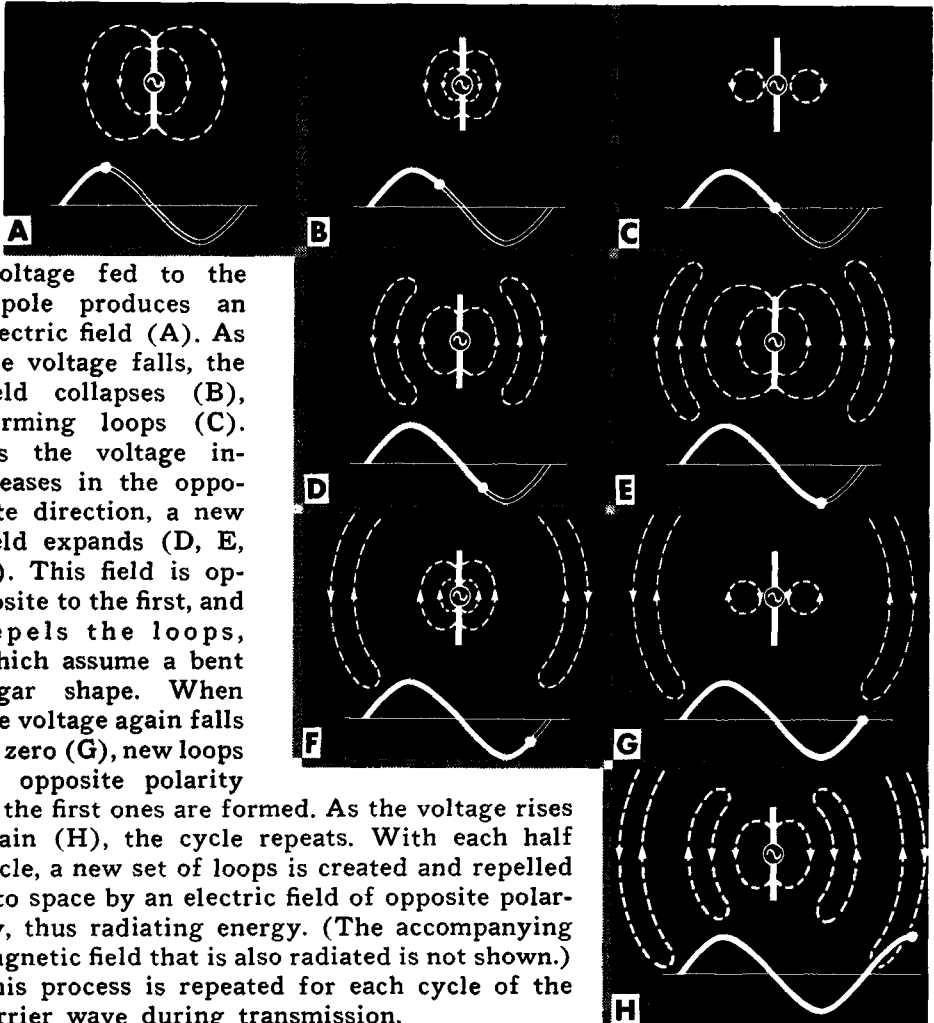

Voltage fed to the dipole produces an electric field (A). As the voltage falls, the field collapses (B), forming loops (C). As the voltage increases in the opposite direction, a new field expands (D, E, F). This field is opposite to the first, and repels the loops, which assume a bent cigar shape. When the voltage again falls to zero (G), new loops of opposite polarity to the first ones are formed. As the voltage rises again (H), the cycle repeats. With each half cycle, a new set of loops is created and repelled into space by an electric field of opposite polarity, thus radiating energy. (The accompanying magnetic field that is also radiated is not shown.) This process is repeated for each cycle of the carrier wave during transmission.

THE RADIATED WAVE

Directional Antennas

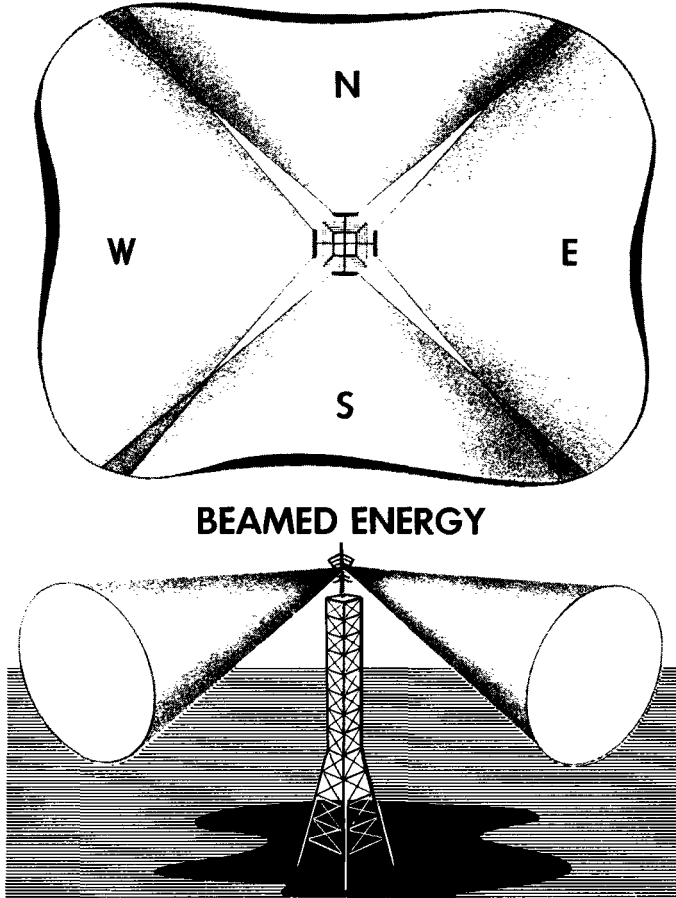

If we assume the transmitting antenna to be a theoretical point source located in space, the liberated energy spreads out from it as an ever-expanding sphere with the energy lying on the surface of the sphere. The sphere of energy expands at the velocity of light (approximately 300,000,000 meters per second), which in round numbers is 186,000 miles per second.

The practical television transmitting antenna is not a point source of radiation. Rather, it is a directional type that concentrates the radiated energy into a beam—somewhat like the beam of a searchlight—so that the signal can be directed as required to serve best the receiver population. The “front” of the beamed energy is the equivalent of a sheet of energy that moves with the speed of light just as in the case of the expanding sphere of energy. By arranging four directional antennas on a tower, one antenna facing north, another south, a third east and a fourth west, beamed radiation can be obtained in all four directions with greatest effectiveness.

THE RADIATED WAVE

The "Field" Concept

Energy is the ability to do work. Unfortunately it cannot readily be pictured. Instead, we use a method of illustration that shows the direction in which electric (or magnetic) energy present in a region will perform work. This is the "field" idea, wherein lines or arrows represent "lines of force" that occupy the region where energy is present. A line of force is an imaginary entity, but it is nevertheless a very convenient way of showing the existence of energy and the direction along which the electric or magnetic energy present in an electromagnetic wave (or field) will do work.

Although we shall deal mainly with the electric energy, that is, with the *electric field* component of the wave, we must nevertheless illustrate it and the magnetic field component at the beginning of the discussion. Both fields are shown by a series of parallel lines positioned at right angles to each other. As a means of identification the electric field lines are called "E" lines, and the magnetic field lines are called "H" lines. Arrowheads on the lines of force indicate the direction in which the fields will do work on free electrons that come within their influence.

If the position of radiating elements is horizontal relative to the earth's surface (assumed to be flat between the transmitter and the receiver) the plane of action of the electric field portion of the radiated signal will likewise be horizontal relative to the earth's surface. The position of the long axis of the antenna rods determines the plane of action of the electric field because the signal voltage fed to the transmitting antenna elements always generates an electric field whose lines run parallel to the long axis of the antenna elements. (This was shown in connection with radiation.)

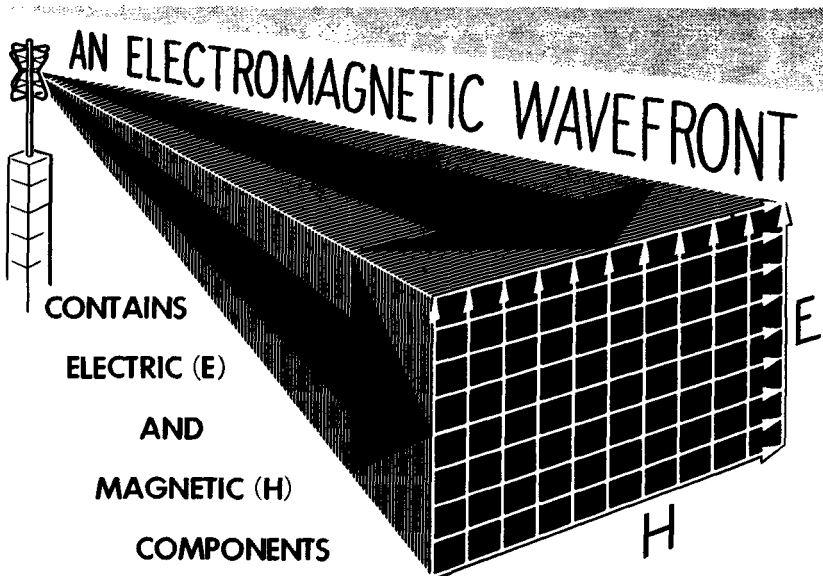

THE RADIATED WAVE

The Field Concept (contd.)

Electric and Magnetic Fields

of Horizontally Polarized Antennas

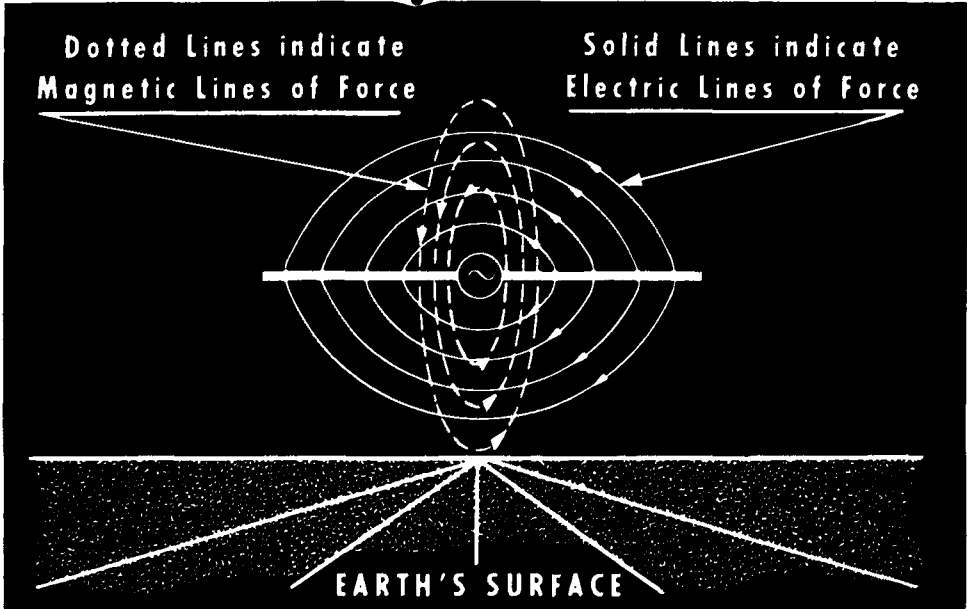

The magnetic energy contained in this radiated wave is shown by magnetic field lines that are positioned at right angles to the electric field lines. This angular relationship stems from the fact that the signal current in the transmitting antenna elements causes magnetic lines of force to surround the antenna conductors. Since the electric field is parallel to the conductors, the magnetic field lines are at right angles to the electric field lines. This relationship repeats itself in the electric and magnetic field components of the radiated wave. The directions in which the electric and magnetic field components of the radiated wave act are at right angles to each other and to the direction in which the wave is propagated. This relationship never changes.

When the transmitting antenna radiates an electromagnetic wave in which the electric field lines are positioned parallel to the earth's surface, the wave or signal is said to be *horizontally polarized*. To receive horizontally polarized signals most effectively the receiving antenna conductors also must be positioned horizontally.

THE RADIATED WAVE

Polarized Radiation

Antenna positioning is important in TV reception

REQUIREMENT #1

If the transmitting antenna is positioned vertically to the earth's surface



The receiving antenna must be positioned vertically to the earth's surface



EARTH'S SURFACE



If the transmitting antenna is positioned parallel to the earth's surface



The receiving antenna must be positioned parallel to the earth's surface



EARTH'S SURFACE

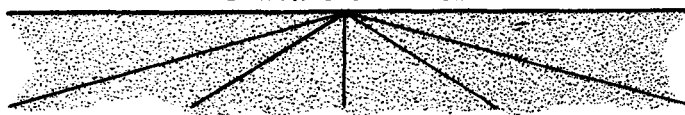

All television receivers used for broadcasting to the public are positioned horizontally relative to the earth's surface.

Television broadcasting in America is never done by transmitting antennas positioned vertically relative to the earth's surface. Transmitting antennas positioned vertically radiate *vertically polarized* waves. The electric field component acts perpendicularly to the earth's surface, and the associated magnetic field energy acts horizontally. The receiving antenna used to intercept vertically polarized radiations must be positioned vertically relative to the earth's surface to make it parallel to the transmitting antenna. Horizontally polarized radiation minimizes pickup of vertically polarized noise voltages generated in the vicinity of receiving antennas. In addition, many of the communication services that function in the frequency vicinity of television stations, or generate harmonics that may fall within the boundaries of the television channels, radiate vertically polarized waves. The use of horizontally polarized antennas minimizes interference from these sources.

THE BASIC DIPOLE ANTENNA

The Simple Dipole TV Antenna

The simplest type of television receiving antenna is the half-wave or half-wavelength dipole. It is the "basic" television antenna from which all other types are derived.

By definition, "a dipole antenna is a symmetrical antenna in which the two ends are at opposite potential relative to the midpoint." The dipole antenna is a metal rod that has a physical length approximating one half-wavelength in free space at the frequency of operation. This frequency is considered to be the resonant frequency of the antenna. The reason for stipulating that the physical length is one half-wavelength at the operating frequency is that a metal rod of this length is the shortest possible conductor that can be made to demonstrate all the characteristics of a resonant (tuned) circuit.

**The Simple Dipole
is a Rod of Continuous Material**

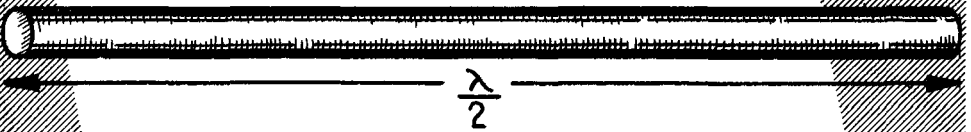

**or
it is Split at the Center**

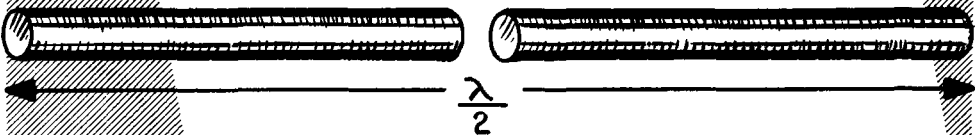

THE BASIC DIPOLE ANTENNA

Finding the Half-Wavelength Dimension

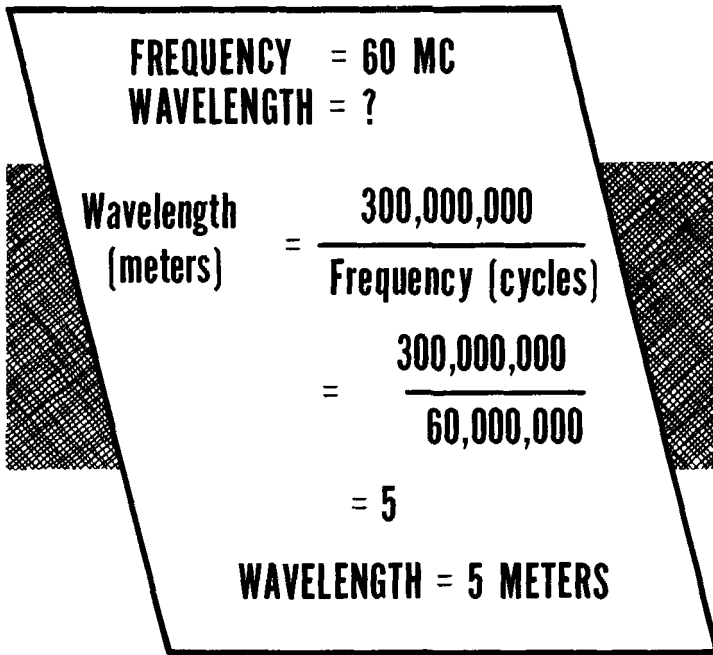

FREQUENCY = 60 MC
WAVELENGTH = ?

$$\begin{aligned} \text{Wavelength (meters)} &= \frac{300,000,000}{\text{Frequency (cycles)}} \\ &= \frac{300,000,000}{60,000,000} \\ &= 5 \\ \text{WAVELENGTH} &= 5 \text{ METERS} \end{aligned}$$

The wavelength (λ , lambda) of any signal *in free space* is given by

$$\begin{aligned} \text{wavelength (in meters)} &= \frac{\text{velocity of electromagnetic propagation (in meters per sec)}}{\text{frequency of signal (in cycles)}} \\ &= \frac{300,000,000}{f \text{ (in cycles)}} \end{aligned}$$

Since most work with television antennas involves frequencies measured in megacycles and antenna lengths measured in feet or inches, it is valuable to convert the fundamental formula given above to a more useful form that permits direct use of these practical values. Substitution of the following equivalents gives us the desired form of the equation:

$$1 \text{ meter} = 39.37 \text{ inches}$$

$$1 \text{ megacycle} = 1,000,000 \text{ cycles}$$

$$\text{Wavelength (in inches)} = \frac{300,000,000 \times 39.37}{1,000,000 \times f \text{ (in cycles)}} = \frac{300 \times 39.37}{f \text{ (in mc)}} = \frac{11,810}{f \text{ (in mc)}}$$

A half-wavelength is one half of this value or

$$\frac{\lambda}{2} \text{ (in inches)} = \frac{5905}{f \text{ (in mc)}}$$

THE BASIC DIPOLE ANTENNA

The Half-Wavelength Dimension (contd.)

WAVELENGTH = 5 METERS
FREQUENCY = ?

$$\text{Frequency (cycles)} = \frac{300,000,000}{\text{Wavelength (meters)}}$$

$$= \frac{300,000,000}{5}$$

$$= 60,000,000$$

FREQUENCY = 60,000,000 CYCLES
OR 60 MC

If it is desired to find $\lambda/2$ in feet we need only divide by 12:

$$\frac{\lambda}{2} \text{ (in feet)} = \frac{492}{f \text{ (in mc)}}$$

If a particular television signal has a frequency of 60 mc, a half-wavelength in free space is

$$\frac{5905}{60} = 98.4 \text{ inches} \quad \text{or} \quad \frac{492}{60} = 8.2 \text{ feet}$$

Practical antennas made of thin metal rods and used for television reception (or for any other kind of signal) allow electromagnetic energy to move along them at only about 95% of its velocity in free space. Therefore the equation for the wavelength dimension in free space is modified by the multiplying (velocity) factor 0.95, then

$$\begin{aligned} \text{half-wavelength in feet} &= \frac{492 \times 0.95}{f \text{ (mc)}} \quad \text{or} \quad \text{half-wavelength in inches} = \frac{5905 \times 0.95}{f \text{ (mc)}} \\ &= \frac{468}{f \text{ (mc)}} && = \frac{5616}{f \text{ (mc)}} \end{aligned}$$

Using the corrected equation, the half-wavelength antenna dimension for a 60-mc signal becomes 93.5 inches or 7.79 feet.

THE BASIC DIPOLE ANTENNA

Basic Half-Wave Dipole Forms

The basic half-wave dipole antenna appears in two forms; as a continuous rod (shown earlier), and as a rod that is split at the center, that is, consisting of two equal parts, each part being slightly shorter than one quarter-wavelength. The latter type is called the *split* or *center-fed* dipole, the name being derived from the point of connection of the transmission line to the antenna, as will be explained later. The overall physical length of the split-type dipole for any one half-wavelength includes the separation between the inner ends of the two rods, therefore this type has the same dimension for a half-wavelength as the continuous rod. The usual separation between the inner ends of the two portions of the split dipole is approximately 1 to 1.5 inches.

The Center-Fed Split Dipole Antenna

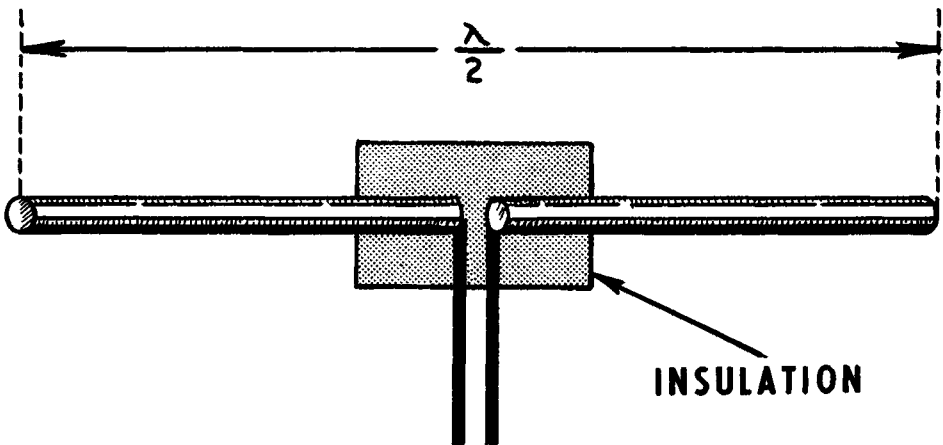

The continuous half-wave dipole and the split half-wave dipole are the equivalent of each other. Both can be used to extract energy from the passing wave and deliver the energy to a receiver via a transmission line. The split dipole antenna is used more often because it is easier to connect to the transmission line. On the other hand, the continuous dipole has applications for which the split dipole is not conveniently suitable. One of these is to extract energy from a passing electromagnetic wave and to re-radiate the energy in a controlled manner to aid the performance of an associated center-fed dipole that is connected to a receiver. This action is explained in detail elsewhere in the course. In the meantime, we shall explain the behavior of the basic half-wave dipole antenna in terms of the split or center-fed rod.

THE BASIC DIPOLE ANTENNA

The Transmission Line

The Transmission Line Feeds Energy

From the Antenna

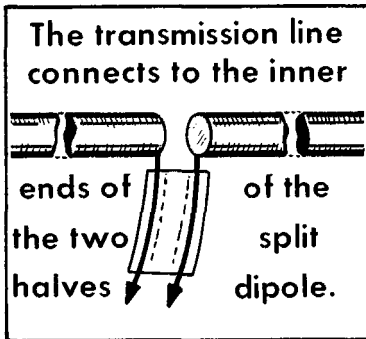

To the Receiver
Antenna Input Terminals

The function of the transmission line is to carry the received signal energy from the antenna to the television receiver. As will be seen later, transmission lines are of many different varieties. Here we show just one kind, but whatever may be the specific type, it is made up of two conductors or leads insulated from each other. The two leads at one end of the transmission line are connected to the dipole antenna, and the two leads at the other end of the line are connected to the antenna terminals of the receiver. The length of the transmission line is such as to conveniently span the distance between the antenna and the receiver, allowing for all mounting requirements.

THE BASIC DIPOLE ANTENNA

The Zero-DB-Gain Rating of the Basic Half-Wave Dipole

The basic half-wavelength dipole—continuous or split at the middle—bears still another identification which is very pertinent. It is called a *zero-db-gain* antenna. This is an artificial term that has become standard and expresses that the portion of energy which such an antenna can capture from a passing electromagnetic wave under standard conditions of use is fixed. Therefore the half-wave dipole can be used as a reference for comparison with the signal-capture capabilities of other type antennas.

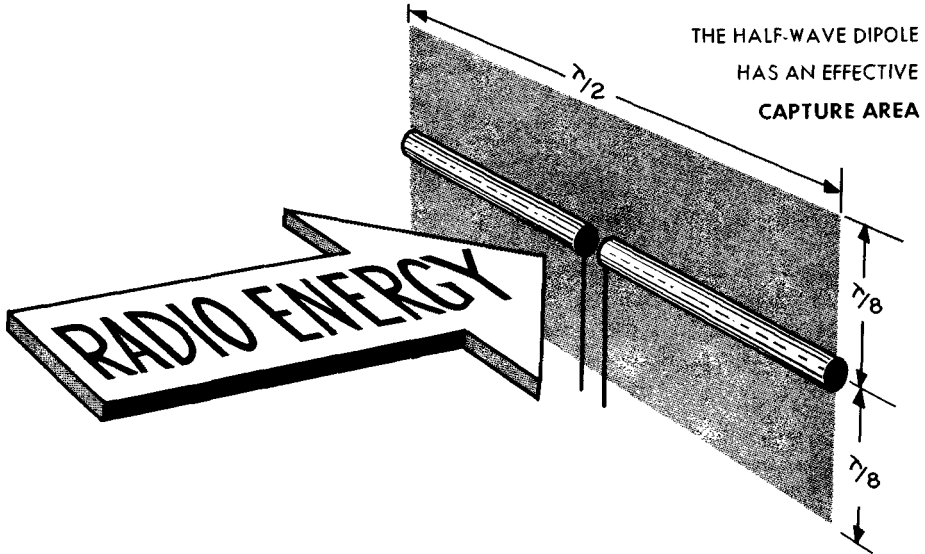

For example, it is assumed on a theoretical basis that the basic half-wave dipole will capture energy from a passing electromagnetic wave over an area that is one half-wavelength along the antenna and $\frac{1}{8}$ -wavelength above and below the antenna. This corresponds to zero-db-gain performance by the antenna. If, by modifying the antenna, it is made capable of capturing more than this normal portion of energy from the wave, the antenna with improved performance is described as having *gain*. Many elaborate antennas are capable of capturing from 2 to 7 times as much energy from a passing electromagnetic wave as the basic half-wave rod. That is, the amount of power extracted from the wave is from 2 to 7 times greater. Such antennas are said to have a *power gain* of from 2 to 7 times over the standard zero-db-gain half-wave dipole. By converting the power gain values to more conveniently usable *db* or *decibel* figures, the antenna with a power gain of 2 times is then described as having a gain of 3 db; the antenna with a power gain of 5 times has a gain of 7 db, and so on.

Comparison of antennas on the basis of gain is commonplace. Of course other bases of comparison are also used, but gain is very important.

THE BASIC DIPOLE ANTENNA

The Zero-DB-Gain Rating of the Basic Half-Wave Dipole (contd.)

THE STANDARD OF COMPARISON
FOR ANTENNA GAIN
IS THE

BASIC DIPOLE



(A ZERO-DB-GAIN ANTENNA)



$$\text{Gain of ANTENNA X (IN DB)} = 10 \log_{10} \frac{P_2 \text{ (Power output of antenna X)}}{P_1 \text{ (Power output of Basic Dipole)}}$$



DECIBEL TABLE

DB GAIN	POWER RATIO (P2/P1)
1	1.26
2	1.59
3	2.00
4	2.51
5	3.16
6	3.98
7	5.01
8	6.31
9	7.94
10	10.00
15	31.62
20	100.00

THE BASIC DIPOLE ANTENNA

Forms of the Basic Half-Wave Dipole Antenna

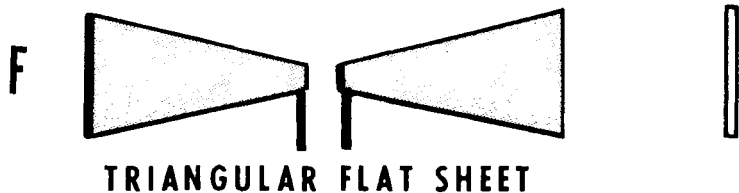
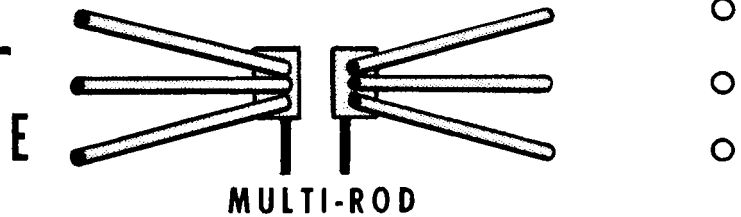
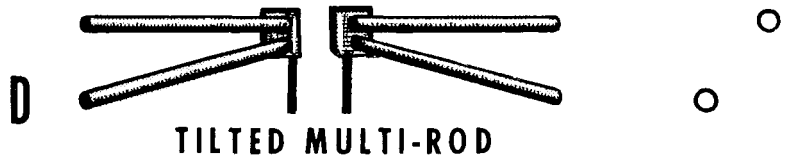
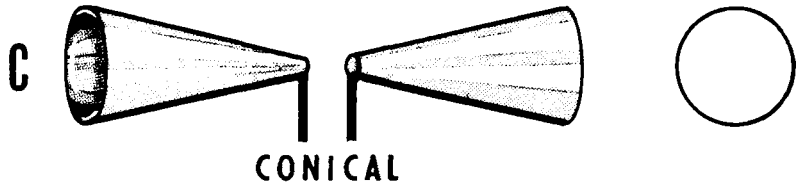
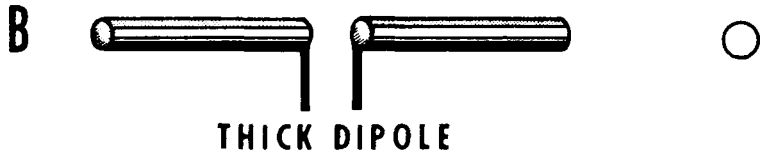
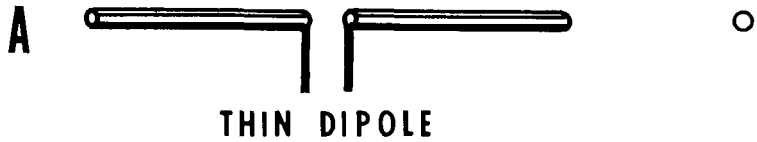

*There
Are
Various
Types
of
Half-Wave
Zero-db-
Gain
Dipole
Antennas*

THE BASIC DIPOLE ANTENNA

Forms of the Basic Half-Wave Dipole Antenna (contd.)

Basic half-wave dipole antennas are of many physical forms. Each offers something in electrical behavior (characteristics) or physical structure that the other types do not have. All of them are rated at zero-db gain.

Practical antennas in daily use are almost all elaborations of the basic versions, and the study of television antennas must begin with the study of basic forms.

The center-fed half-wave dipole is usually made of a small-diameter ($\frac{1}{4}$ - or $\frac{1}{2}$ -inch) rod (A). Sometimes it is made of tubing of substantially wide diameter, say from 2 to 4 inches (B). Much more popular type of half-wave antennas are variations of the conical form (C). Because the complete cone offers too much physical resistance to wind, its equivalent is created by the use of multiple thin rods that fan outwards from the point of support. Sometimes the rods are all in line and project straight outwards from the point of support (D), and sometimes they are arranged to tilt towards the front (E), forming a horizontally positioned "V" pointing towards the arriving signal. Another basic type is made of flat sheet aluminum of triangular form (F). This is known as the "bat-wing", and is very popular at the ultra-high frequencies (UHF). The end view of each of these basic antennas is shown adjacent to the front or broadside view.

Although the basic half-wave dipole television antennas are shown "split" at the center, these antennas are not restricted to this form. The use of multiple rods to produce the equivalent of the conical form is simply a means of achieving the wide electrical "surface" that the cone presents to an approaching television wave without the disadvantage of the solid surface of the complete cone. The use of three rods instead of two, four, five or six to simulate each quarter-wave section of the cone-shape antenna is a compromise.

Whatever may be the number of thin rods making up each quarter-wave section, they act together as one, and the two halves make up a single *element*. This also is true of the solid-sheet bat-wing when it is simulated by the thin rod bent into a triangle.

Every half-wave dipole antenna displays the properties of resonant circuits, namely inductance, capacitance, and resistance. Resonant circuits tune sharply or broadly, depending on their design, and this action occurs with dipole antennas as well. This is important from the viewpoint of how the antenna will respond to the signals from one or more television stations that serve an area. The thin half-wave dipole antenna (A) tunes much more sharply than the dipole made of a large-diameter rod (B). The conical antenna (C) or its equivalents (D) and (E) will, by virtue of their greater surface, tune as broadly as (B), but also afford other electrical operating conditions that antenna (B) does not offer. The bat-wing (F) also tunes broadly and demonstrates electrical behavior corresponding to that of (C), (D), and (E).

DIPOLE BEHAVIOR

Resonance in a Half-Wave Dipole Antenna

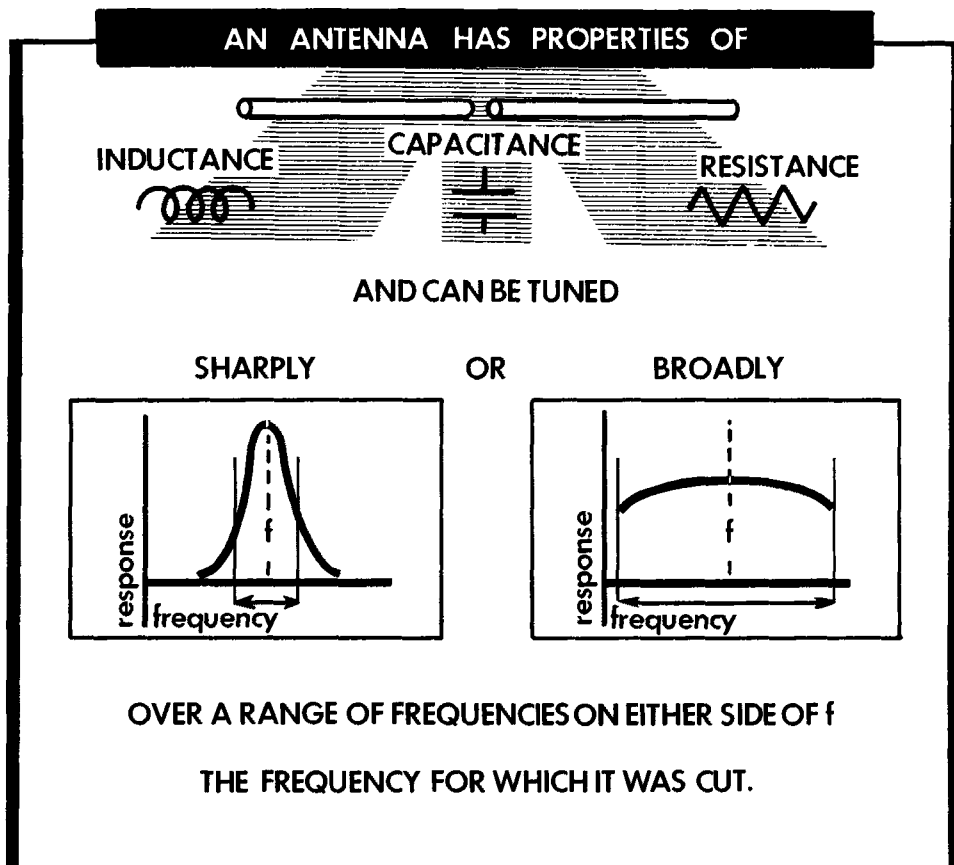

Thus we see that the diameter or surface area of an antenna is an extremely important factor in determining how sharply an antenna tunes. The various configurations shown are all dipole antennas, differing principally in their sharpness of tuning.

This variation in sharpness of tuning makes one type of antenna better suited to the reception of signals from several stations serving an area than another. The more broadly an antenna tunes, the wider is the band of frequencies that it will accept. In addition to frequency response, there exists still another very important consideration. It is referred to as *antenna resistance*. With more details to follow, this operating electrical constant is determined by the current and voltage distribution in the antenna produced by the television signal that the antenna intercepts—that is, the E/I relationship. This electrical constant in turn determines the kind of transmission line that can be used to couple the antenna to the receiver.

DIPOLE BEHAVIOR

Signal Interception by the Basic Dipole Antenna

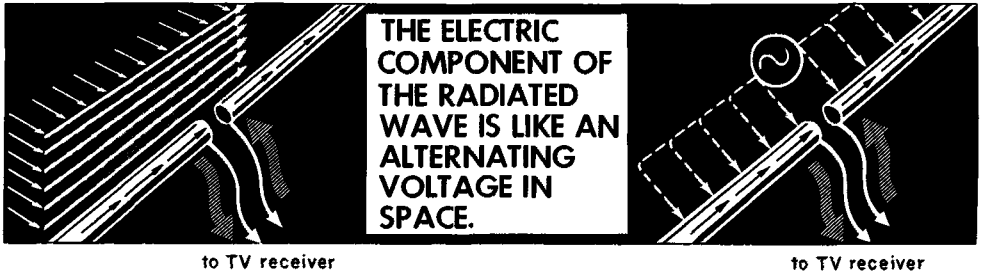

When an electromagnetic wave strikes a half-wave metal rod that is positioned parallel to the electric field lines of the incident wave, the electric energy in the wave induces a difference of potential between points along the surface of the rod.

The action might be visualized in terms of many alternating-voltage sources aiding each other connected across points along the rod. Therefore it is possible to say that the electric field of an electromagnetic wave is the equivalent of an *alternating voltage in space*.

When a voltage is induced along the metal rod, current will flow between the points of different potential along the surface of the rod. This is the signal current. By virtue of the presence of voltage and current in the intercepting antenna, the action is the equivalent of transferring electrical energy from the passing wave to the metal antenna.

For the half-wave rod to extract the greatest amount of electrical power from the passing wave its half-wave dimension must satisfy the frequency of the passing wave. Also, its orientation towards the arriving wavefront must be broadside (parallel). This enables the passing electric field to act "simultaneously" on the full length of the rod.

IF THE HORIZONTAL RECEIVING ANTENNA IS TO PERFORM MOST EFFECTIVELY

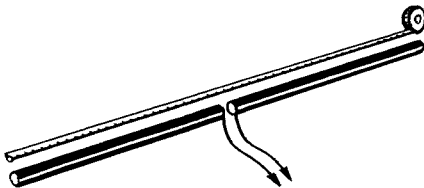

The half-wave dimension should equal the half-wave equivalent of the arriving signal frequency.

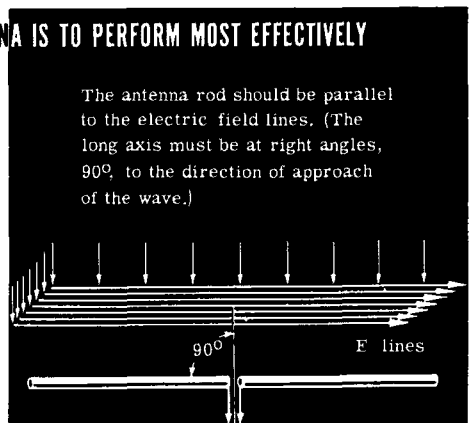

DIPOLE BEHAVIOR

Re-radiation of the Receiving Dipole

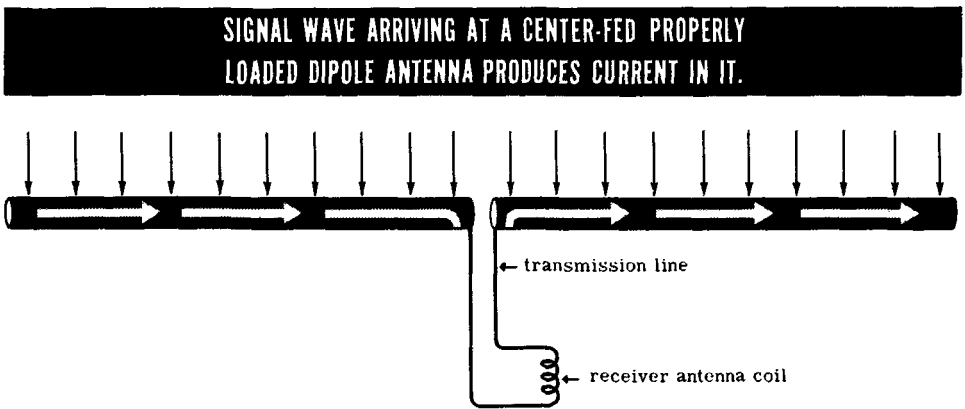

THEN

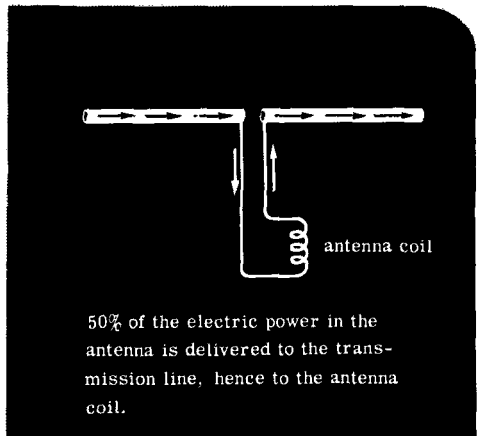
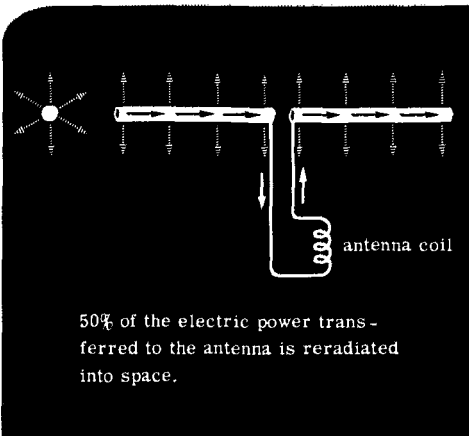

What happens to the electrical energy that is delivered to the receiving antenna? Assume for the moment that the antenna is a split or center-fed dipole with the proper transmission line connected from it to a receiver.

When current flows along the receiving antenna rod, signal energy is delivered to the receiver, but something else also occurs. Current in a transmitting antenna rod results in *radiation*. The same phenomenon occurs in the receiving antenna rod. In other words, the receiving antenna rod not only functions as a means of *extracting* energy from the passing television signal wave, but it also *re-radiates*, or liberates into space, some of the energy that it has extracted from the wave.

DIPOLE BEHAVIOR

Re-radiation From a Continuous Rod

Although the primary function of the antenna is to behave as an intercepting or receiving device, it cannot perform its function without also behaving as a transmitting antenna.

Suppose that the intercepting antenna is a continuous rod instead of a split dipole and there is no transmission line connected to the rod. What happens then?

The movement of electrons along the conductor will make the rod perform as a radiator, just as in the case of the split dipole. However, in the absence of the transmission line connection to the continuous rod, none of the energy transferred to the rod by the passing signal wave is extracted; therefore, the rod *re-radiates virtually all of the energy that it intercepts*. In effect, such a rod takes energy out of a passing signal wave and then sends the energy out into space again, so that its behavior is like that of a transmitting antenna far removed from the actual point of transmission.

This action may appear useless. Actually, it is very important in the operation of the antennas in daily use. It might be well at this time to mention that the signal interception and re-radiation actions of the split and the continuous-rod and half-wave dipole antennas also occur when the element has some other shape—a wide diameter rod, conical (or its equivalent), bat-wing, etc.

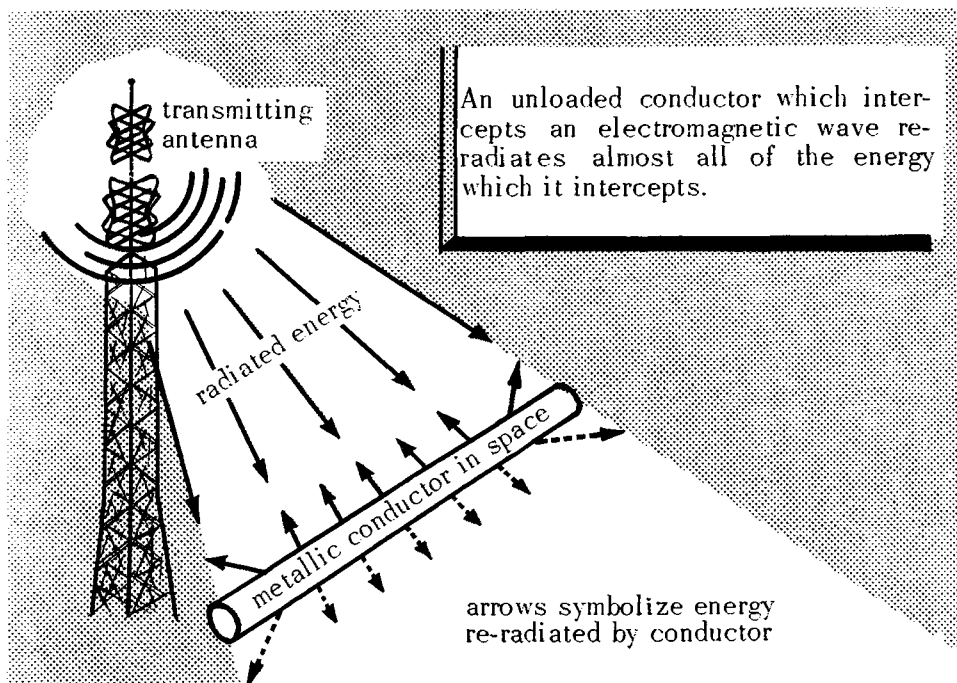

REVIEW

The signal-producing voltage in the receiving antenna is the resultant of the direct wave and the ground-reflected wave.

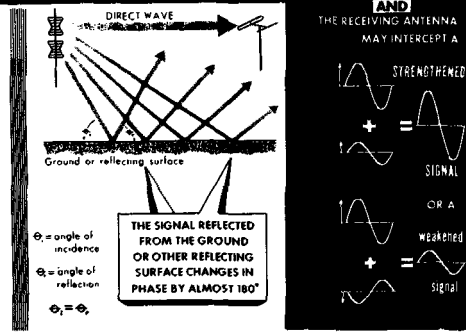

1. *Propagation of Television Signals.* The combination of the direct-wave and ground-reflected signal is stronger or weaker than the direct wave alone, depending on whether or not the two signals aid or oppose each other at the instant of arrival at the receiving antenna.

2. *The Field Concept.* The energy contained in the radiated wave is shown by magnetic field lines positioned at right angles to the electric field lines. The signal is horizontally polarized (i.e., the electric field lines are parallel to the earth's surface).

Electric and Magnetic Fields

of Horizontally Polarized Antennas

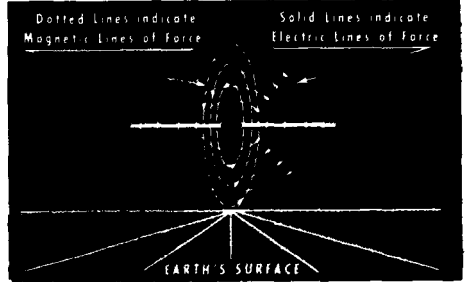

Antenna positioning is important in TV reception

REQUIREMENT #1

If the transmitting antenna is positioned vertically to the earth's surface

The receiving antenna must be positioned vertically to the earth's surface



If the transmitting antenna is positioned parallel to the earth's surface

The receiving antenna must be positioned parallel to the earth's surface



All television receivers used for broadcasting to the public are positioned horizontally relative to the earth's surface.

3. *The Radiated Wave.* All television receivers used for broadcasting to the public are positioned horizontally relative to the earth's surface. Horizontally polarized radiation minimizes pickup from vertically polarized voltages.

4. *The Zero-DB-Gain Rating of the Basic Half-Wave Dipole.* The basic half-wavelength dipole, continuous or split at the middle, is also called a zero-db-gain antenna, which means that the portion of energy that it can capture from an electromagnetic wave is used as a standard of comparison.

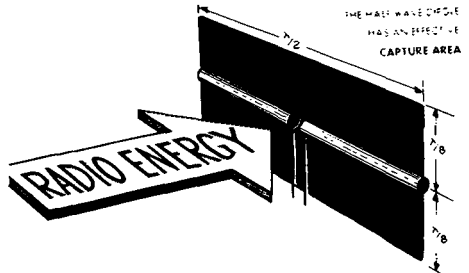

REVIEW

5. *Forms of the Basic Half-Wave Dipole Antenna.* The basic half-wave dipole antenna takes many forms. Each shape has its own physical and electrical characteristics. These antennas are not restricted to the "split-in-the-center" form. Whatever the number of thin rods making up each quarter-wave section, they act together as one, and the two half-sections make up a single dipole element.

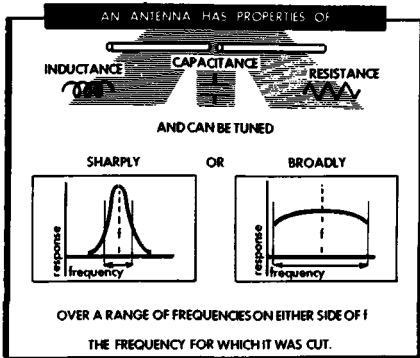

7. *Signal Interception by the Basic Dipole Antenna* is maximum when its half-wave dimension satisfies the frequency of the passing wave, and when it is orientated parallel to the arriving wavefront.

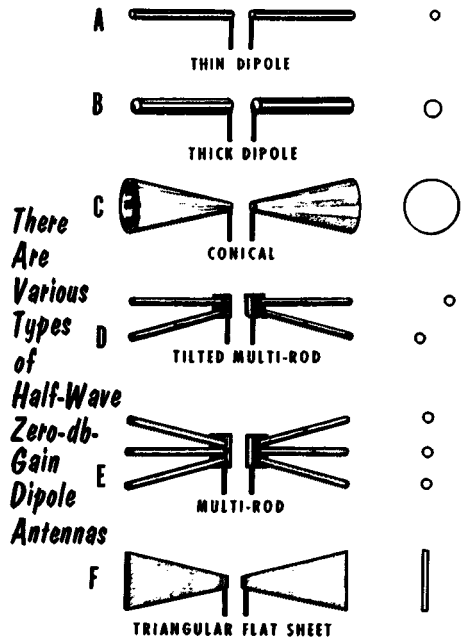
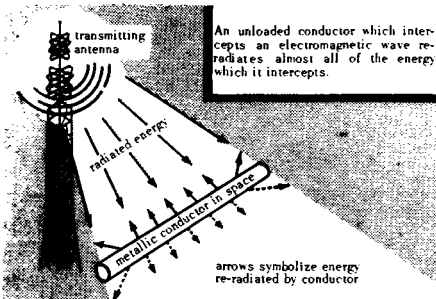

6. *Resonance in a Half-Wave Dipole Antenna.* The diameter or surface area of an antenna is an extremely important factor in determining how sharply an antenna tunes. The various configurations shown are all dipole antennas, differing principally in their sharpness of tuning.

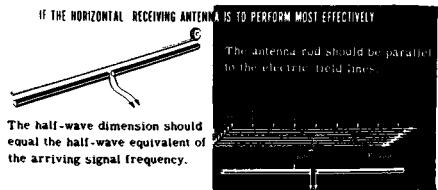

8. *Re-radiation from a Continuous Rod.* When current flows along the receiving antenna rod, signal energy is delivered to the receiver. Current in a receiving antenna rod results in re-radiation of some of the energy extracted from the wave.

DIPOLE ANTENNA RESPONSE

Broadside Positions of the Receiving Dipole

The term *broadside* as used here means *parallel*. For any two surfaces to lie in parallel planes does not require that they be at equal heights. The receiving dipole can be broadside to a radiated wavefront when the transmitting antenna is higher than the receiving dipole, on the same level, or below it. Given any horizontal receiving dipole, the transmitting dipole can also be broadside when it is facing either the front surface or the rear surface of the receiving rod.

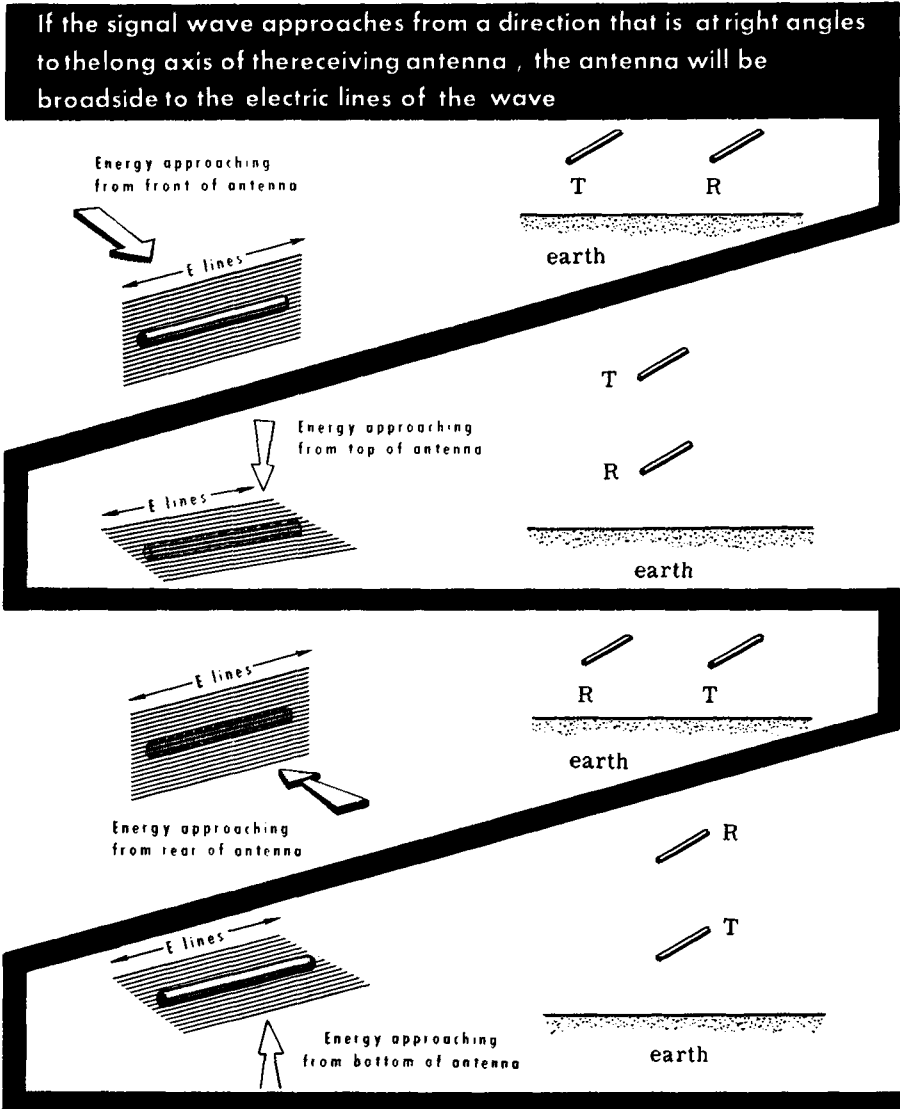

DIPOLE ANTENNA RESPONSE

Directional Response

An extremely important item of television antenna behavior is the manner in which it responds to signals that arrive from different directions. This characteristic is termed the *directional response* of an antenna or its directivity.

Understanding this action makes it possible to "point" the antenna so that best reception of the desired stations (with minimum interference from the undesired stations) results, especially when receiving points are midway between transmitting stations located in different directions relative to the receiving point. Also, it provides one of the reasons why there are different types of antennas. Directional response is very important in areas where signals are received from many angles.

The different

Horizontal Orientations

of a receiving antenna

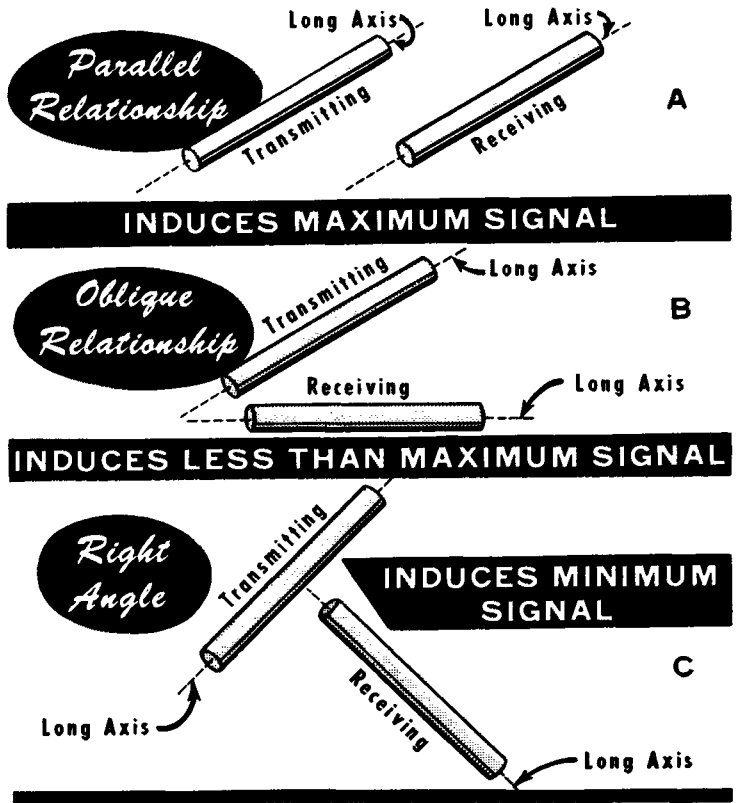

We have said that when the receiving dipole is broadside to the transmitting dipole (which is the same as saying its long axis is parallel to the electric field lines in the approaching television signal wave), maximum signal voltage will be induced in the antenna. What happens if this broadside relationship does not exist?

DIPOLE ANTENNA RESPONSE

Demonstration of Receiving Antenna Dipole Positioning Effects

Let us perform a simple experiment to determine how the signal pickup by a horizontal dipole of correct physical length changes as antenna orientation to an approaching horizontally polarized wave is varied. The demonstration frequency is 600 mc, permitting the use of a small-sized antenna. The experiment is conducted in an area where the signal picked up by the receiving antenna arrives only from the direction of the transmitting antenna. (The ground-reflected signal is neglected.) The transmitting and receiving antennas are at the same height.

The receiving dipole is mounted on a pivot so that it can be revolved through a flat circle of 360°. A scale attached to the antenna upright indicates the angle through which it has been turned relative to its starting position. A suitable rectifier system and an indicating meter connected to the receiving dipole indicate the relative strength of the signal voltage induced in the antenna at each position.

The results of rotation are plotted on the graph. When the two antennas are broadside to each other (positions A-E and E-A), maximum signal voltage is induced in the receiving antenna. In this position the receiving antenna is parallel to the electric field lines of the wave that it intercepts. When the ends of the receiving antenna are pointing straight at the transmitting antenna (positions C-G and G-C), minimum signal voltage is induced in the receiving antenna. (The voltage is never zero because even the tiniest antenna has some cross section, therefore constituting a horizontal surface that can be acted on by the horizontal electric field lines of the approaching wave.)

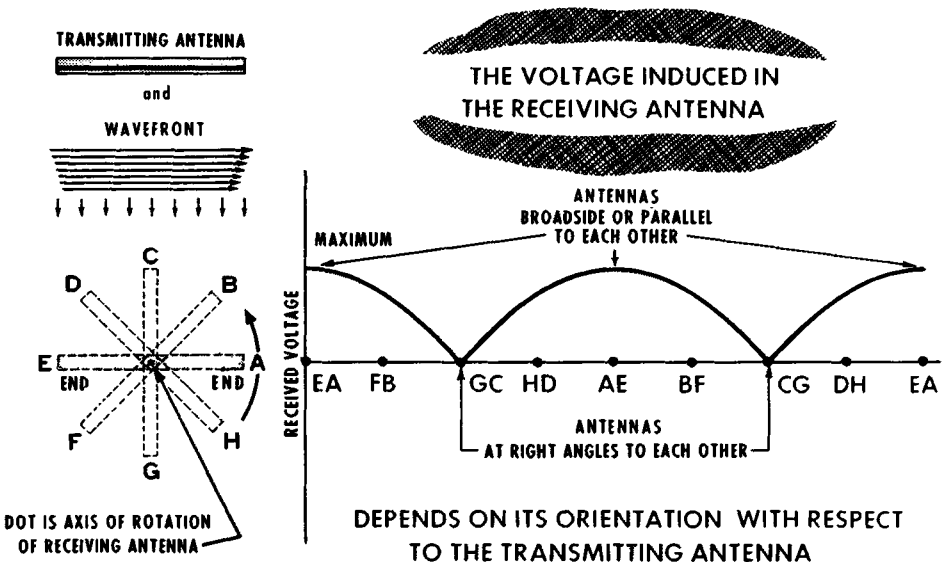

DIPOLE ANTENNA RESPONSE

Dipole Positioning Effects (contd.)

Positioning the receiving antenna between broadside and right angles to the approaching electric field affords different amounts of induced signal voltage. The amount of signal energy contained in the wave that arrives at the receiving antenna always is the same, whereas the amount of signal voltage induced in the receiving antenna differs according to its orientation. Thus, we can attribute the variation in the amount of energy transferred from the wave to the receiving antenna to the behavior of the antenna. How do we explain this? The illustration shows the following:

SOURCE

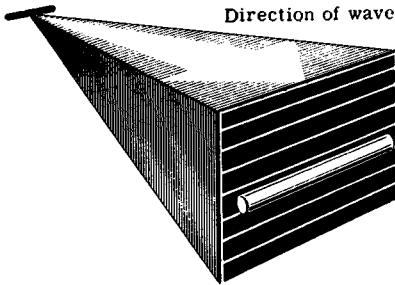

When the receiving dipole is parallel to the approaching wavefront, the electric field "sees" the entire antenna and acts on the entire antenna.—Result is the strongest signal.

SOURCE

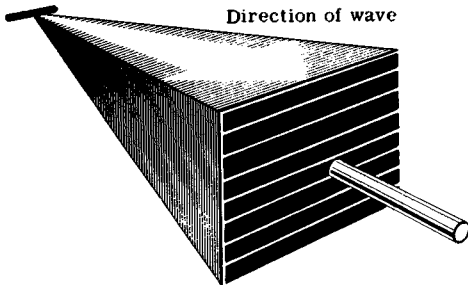

When the receiving dipole is at right angles to the approaching wavefront, the electric field "sees" only a tiny antenna, the cross section of the rod.—Result is theoretically zero signal.

SOURCE

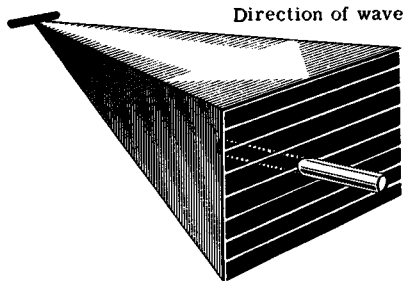

When the receiving dipole is oriented between parallel and right angles to the approaching wavefront, the electric field "sees" only a reduced portion of the rod at any one time.—Result is reduced signal strength.

For intermediate positions of orientation of the receiving antenna, between broadside and right angles, the electric portion of the approaching wave "sees" different amounts of the antenna conductor.

DIPOLE ANTENNA RESPONSE

Directional Response of a Half-Wave Dipole

We have seen that changing the orientation of a horizontal dipole relative to a fixed-position source radiating a horizontally polarized signal changes the amount of signal voltage induced in the antenna. Let us now examine how the same dipole behaves when the horizontally polarized signal approaches from different directions.

To do this we place a half-wave receiving dipole at a fixed point. Attached to it is a suitable rectifier and a meter to indicate the strength of the signal voltage induced in the antenna under different conditions. We arrange to move a transmitter and its antenna in a circle around the fixed receiving dipole. The frequency (600 mc) of the transmitter corresponds to the half-wave dimensions of the receiving and transmitting antennas.

The starting position has the transmitter and receiver dipoles broadside to each other. This point is designated as the 0° (start) and 360° (finish) position. The signal voltage induced in the receiving dipole is measured and noted in conjunction with its angular position, 0° . Then the transmitter is moved through 10° and a second measurement of the signal pickup by the receiving dipole is made and noted.

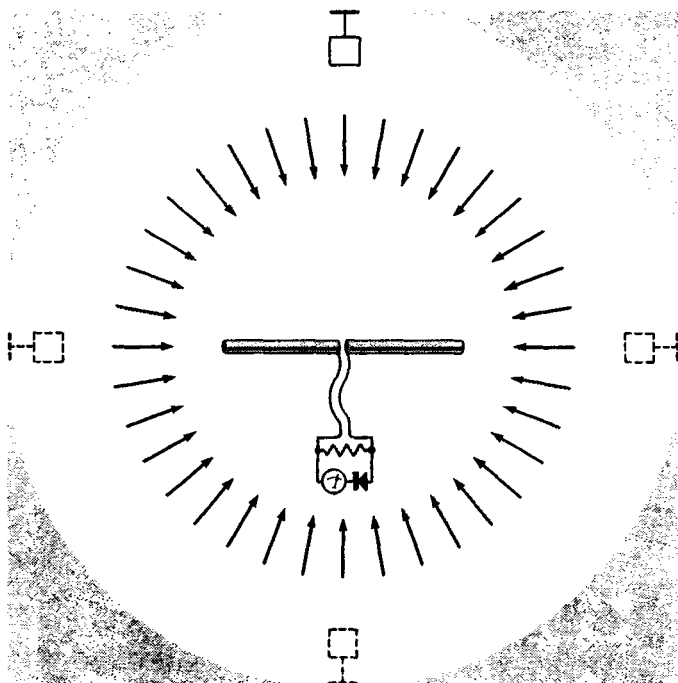

The wavefront of a radiated wave can approach the receiving antenna from a variety of angles

This procedure is repeated every 10° of the circle until the full 360° has been covered. Now we will transfer this information to *polar coordinate* graph paper. This paper is made up of a series of concentric circles, beginning with a dot at the center, and uniformly spaced radii fanning outward from the center. Each radius corresponds to a particular angle relative to 0° , and the response, plotted on the radii gives the response pattern.

DIPOLE ANTENNA RESPONSE

Directional Response of a Half-Wave Dipole (contd.)

DATA FOR THE RESPONSE PATTERN

Angle from Broadside (degrees)	Signal Strength Units	Angle from Broadside (degrees)	Signal Strength Units
0	100	190	97
10	97	200	92
20	92	210	83
30	83	220	70
40	70	230	57
50	57	240	42
60	42	250	30
70	30	260	10
80	10	270	1
90	1	280	10
100	10	290	30
110	30	300	57
120	42	310	70
130	57	320	83
140	70	330	92
150	83	340	97
160	92	350	97
170	97	360	100
180	100		

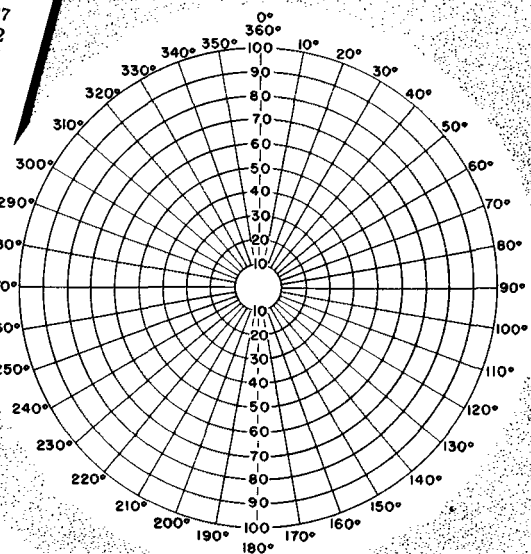

The signal voltage measurements made during the demonstration had a low value of 1 unit and a maximum value of 100 units. We will select the radii at 0° and 180° and use them for the signal response scales. We have 10 uniformly spaced circles intersecting these radii. Each is used to represent a signal voltage level 10 units higher than the preceding one, working outwards from the center, which has a level of 0. The circles joining these points represent voltage levels as shown on the voltage scale. The first (innermost) circle represents 10 units of signal strength; the second one, 20 units; the third one, 30 units, and so on to the outermost circle, which represents 100 units of signal pickup. We draw a short horizontal line through 0 signal level to represent the antenna.

DIPOLE ANTENNA RESPONSE

Directional Response Pattern of a Half-Wave Dipole (contd.)

To transfer the tabulation of signal pickup values to the corresponding points on the polar coordinates, we place a dot at the appropriate level of signal pickup along the radii corresponding to the angular positions of the transmitting antenna where measurements were made. Then we join these points and the result is a *figure 8* pattern.

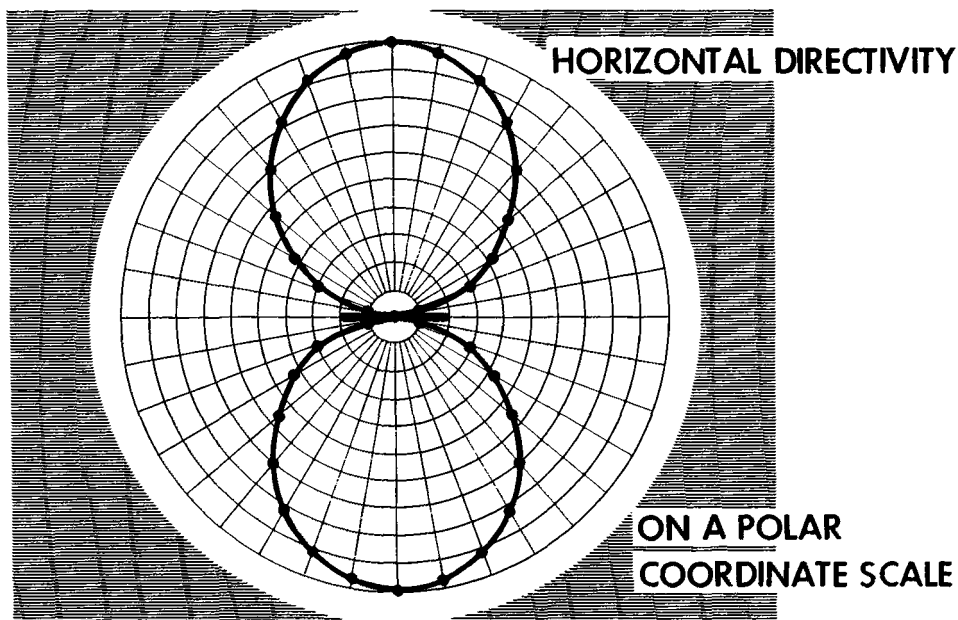

The antenna is seen to be bidirectional; that is, it accepts signals equally well from two directions, the front and the rear. This form of behavior is independent of the transmitter signal output because it is a characteristic of the antenna itself. It does, however, require that the frequency of the signal received be that for which the antenna length equals a half-wavelength. This is the *fundamental* frequency of the antenna. If operation is not on the fundamental frequency the behavior of the antenna no longer is equally bidirectional. It differs substantially as we shall describe later.

The pattern also shows that signals from directions that differ from the broadside positions by equal angular amounts, say 30° and 330° , or 70° and 290° (and are of the correct frequency), will induce like voltages in the receiving antenna, regardless of whether they arrive from the front or from the rear of the antenna. Minimum (theoretically zero) pickup results when the signals arrive from the side of the antenna. This was shown earlier when we rotated the receiving antenna in a flat circle relative to a fixed-position transmitting antenna so that the ends of the receiving antenna were pointing towards the transmitting antenna.

DIPOLE ANTENNA RESPONSE

Directional Response Pattern of a Half-Wave Dipole (contd.)

The response pattern on each side of the antenna is called a *lobe*. Each lobe shows the receptivity of the antenna to signals of the correct frequency originating in directions that are encompassed by the lobe. Each response lobe shows the direction of best and poorest signal pickup by the antenna.

Although it is true that a rotatable antenna can be positioned so as to provide the best signal in the receiver, it is nevertheless valuable to know about antenna directivity. When several stations operating at different frequencies and located in different directions from the receiving site are being received on a single antenna, knowledge concerning the horizontal directivity response makes it easier to position the antenna. The direction of the radiated energy from an undesirable station should be between response lobes or in a direction that minimizes pickup by striking the antenna at a low response point on a lobe.

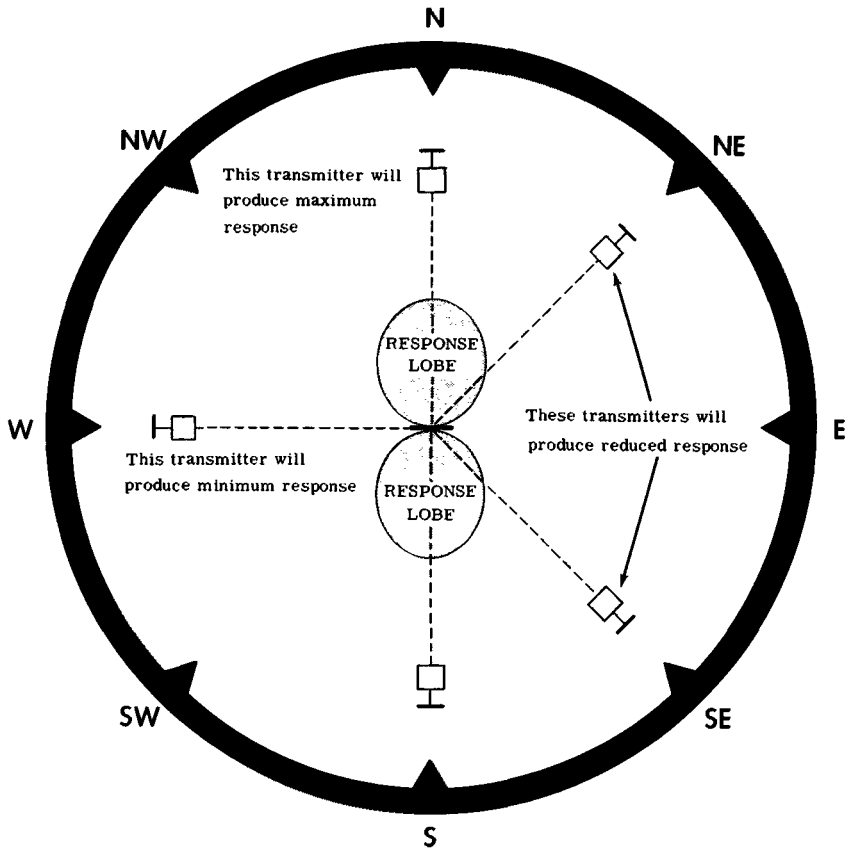

DIPOLE ANTENNA RESPONSE

Directional Response of a Half-Wave Dipole to Nonresonant Frequencies

What happens to the horizontal directional response if an antenna intercepts signals of higher than its resonant frequency? When the frequency of a signal is twice the resonant frequency of an antenna, the original half-wave antenna length becomes a full-wavelength long relative to the arriving signal. Maximum response is no longer broadside to the front and rear. What was maximum response broadside to the front and rear is now minimum response.

The main signal pickup directions are at four different angles to the long axis of the antenna. To achieve maximum pickup it would be necessary to turn the receiving antenna so that a line drawn through the long axis of any one of the lobes would be at right angles to the wavefront.

The usual method of using television antennas does not involve orientation on the basis of the theoretical response lobes. In most cases the positioning is a practical compromise that affords the best signals from the different TV stations which serve an area. Nevertheless you should be familiar with changes in directional response caused by differences between the frequency of the received signal and the resonant frequency of the half-wave antenna. Suppose the signal frequencies are not whole number multiples of the resonant frequency of the simple half-wave dipole antenna. Assume a signal frequency of 195 mc (channel 10) and a half-wave antenna cut for 79 mc (channel 5), a ratio of about $2\frac{1}{2}:1$ in frequency. The half-wave antenna at resonance (79 mc) is $1\frac{1}{4}$ wavelengths long at 195 mc.

If an antenna is cut to be a half-wavelength at 63 mc (channel 3), it is $1\frac{1}{2}$ wavelengths long at 189 mc (channel 9)—a ratio of three times.

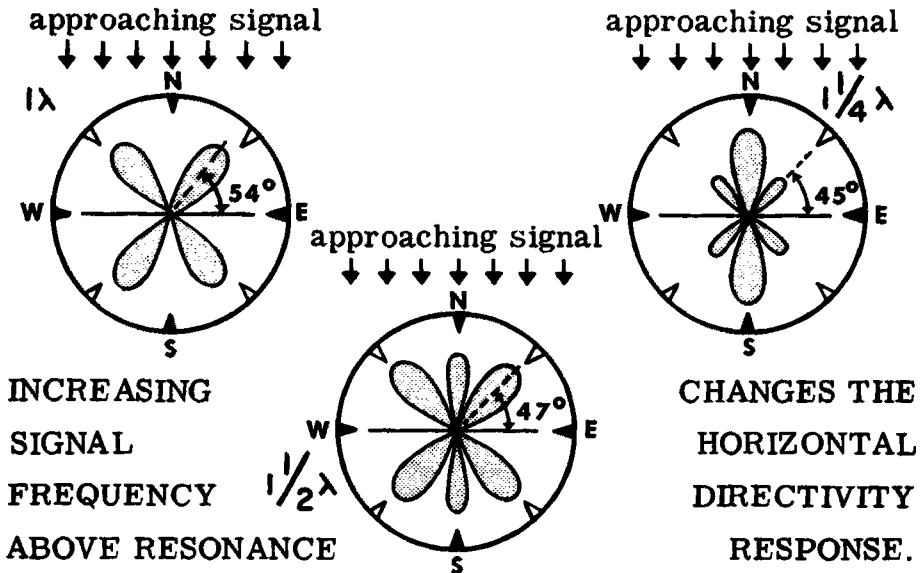

ANTENNA RESISTANCE

Voltage and Current for a Half-Wave Dipole at Resonance

For the sake of explanation, let us assume a radiated signal of a single frequency. When the passing wave induces a voltage (and corresponding current) in a half-wave dipole functioning at the resonant frequency, a special form of voltage and current distribution takes place. This occurs in the continuous-rod half-wave dipole as well as in the split half-wave dipole. The two extreme ends of the half-wave rod assume potentials that are maximum and of opposite polarity, and the voltage decreases to a minimum (not zero) at the center of the rod.

Similarly, the distribution of current caused to flow in the rod by the induced signal voltage is nonuniform. The current is minimum (not zero) at the ends of the rod and is maximum at the center of the rod.

The current and voltage pattern is not influenced by how much signal voltage is induced in the antenna. The passing electromagnetic wave may be strong, from a local station, or weak, from a distant station, thus inducing either a high or a low voltage. In any case, the voltage and current distribution pattern is the same.

The values of voltage and current are not too important from the practical standpoint. What matters more is that for any value of induced voltage there is a finite value of current at every point along the antenna. If we now look at the current and voltage distribution pattern it is evident that some characteristic—inherent in the antenna—is responsible for the amount of current that flows under the influence of the induced voltage. We can regard this as being some form of inherent antenna resistance which we label R_a . It is much greater than conductor resistance, which we neglect.

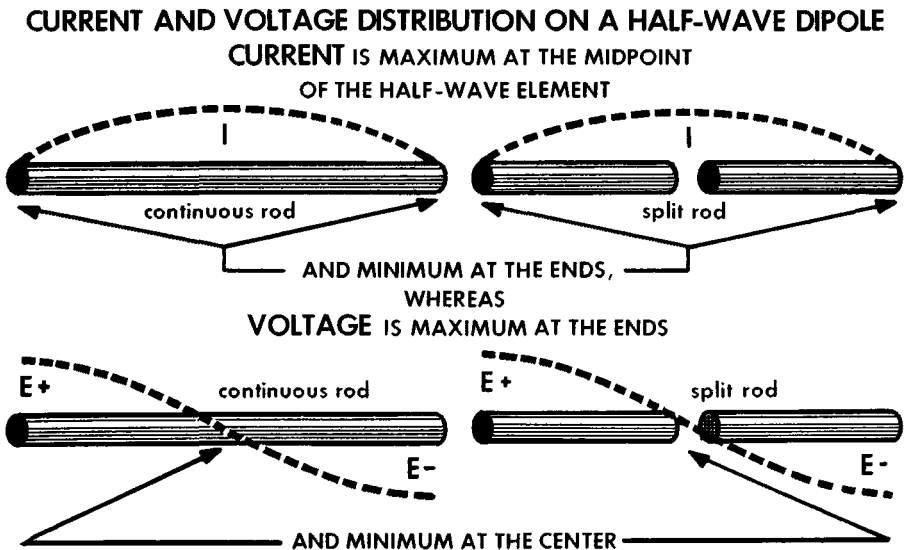

ANTENNA RESISTANCE

Antenna Resistance of Half-Wave Antenna

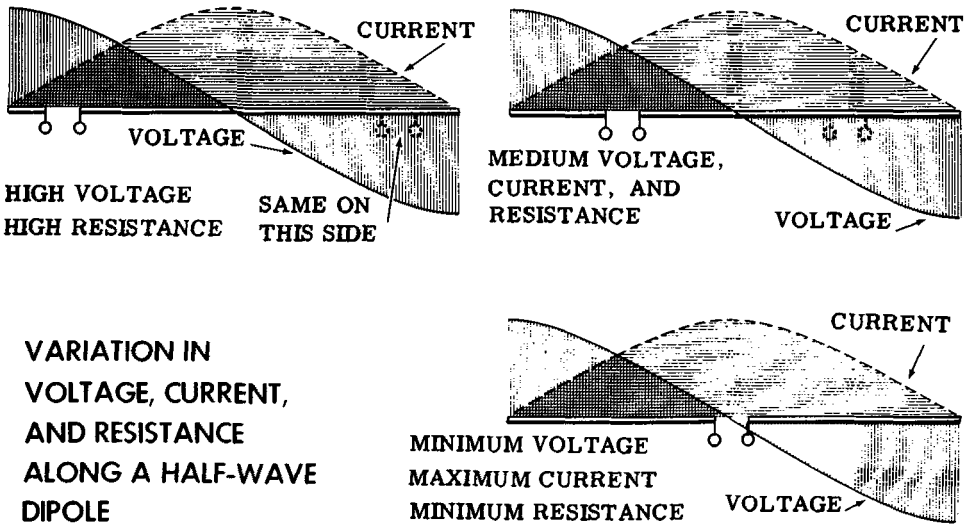

VARIATION IN
VOLTAGE, CURRENT,
AND RESISTANCE
ALONG A HALF-WAVE
DIPOLE

The ratio E/I between the induced voltage and resultant current is, however, not constant along the antenna length. If we view the E/I ratio as being an indicator of antenna resistance (R_a), then

1. the resistance is least at the midpoint of the antenna, as indicated by the fact that minimum induced voltage results in maximum current;
2. the resistance increases as we move away from the midpoint of the rod, as indicated by the fact that as the voltage increases the resultant current decreases;
3. the resistance increases in similar fashion both sides of the midpoint of the dipole, as indicated by the fact that current changes are similar each side of the dipole midpoint and voltage changes are similar each side of the dipole midpoint;
4. the resistance is greatest at the ends where, although the voltage is maximum, the current is minimum.

Measurement and calculation have shown that the antenna resistance at the midpoint of an infinitely thin, straight half-wave dipole operated at its resonant frequency would be about 72 ohms. The resistance between the ends of such an antenna would be about 2500 ohms. Of these two values it is the center or midpoint resistance that interests us. It is generally considered that any straight, half-wave rod having a diameter up to about $\frac{1}{2}$ inch demonstrates an acceptable approximation of this midpoint resistance of 72 ohms. As shown later, increasing the diameter of the dipole rods or tubes lowers the midpoint resistance substantially.

ANTENNA RESISTANCE

Antenna Resistance of a Nonresonant Half-Wave Antenna

Operation at the fundamental frequency has been discussed. The condition of resonance influences the distribution of the induced voltage and resultant current along the length of the rod and therefore the antenna resistance (R_a) of the antenna. In most instances, television receiving antennas are not resonant to the signals they intercept, and the center impedance is more than 72 ohms. This is not an accident, but rather a deliberate condition created in antenna design to raise the midpoint resistance to satisfy the "generator-to-load" impedance relationship for optimum power transfer. (We will explain this in more detail later.)

THE ANTENNA RESISTANCE OF A HALF-WAVE DIPOLE AT RESONANCE IS LOWEST AT THE CENTER AND INCREASES SYMMETRICALLY ON EACH SIDE OF THE CENTER.

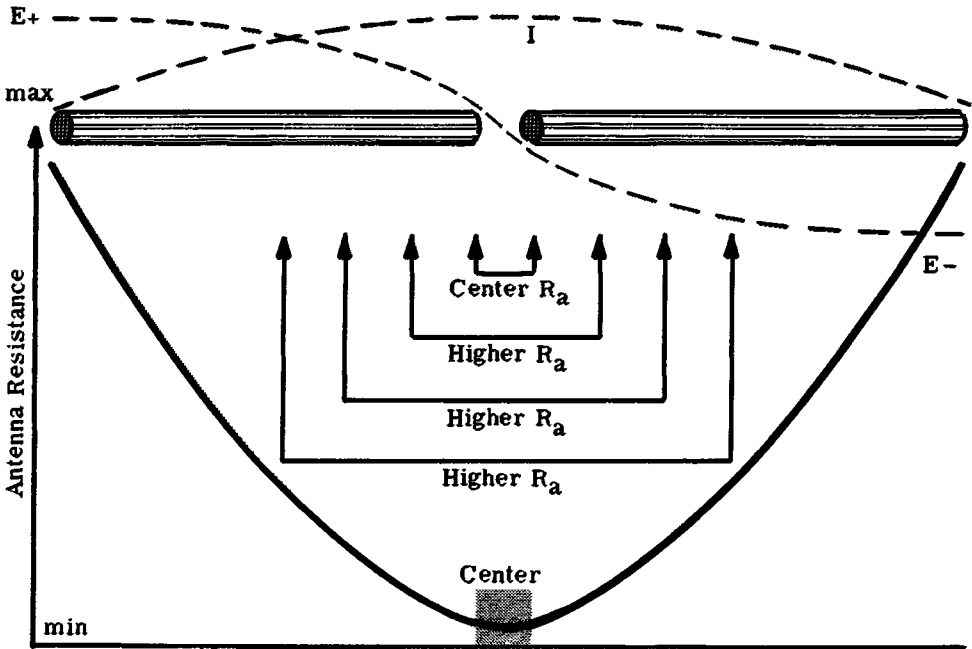

Most modern day television receivers are intended to be used with transmission lines rated at 300 ohms. Therefore, antennas must be arranged to feed signal energy efficiently into a 300-ohm line (load), when intercepting the signals from different television stations. Inasmuch as this value of resistance is obtained only under certain specific conditions, which cannot be realized in practice during multistation reception with a single antenna, we must examine antenna behavior under so-called *nonresonant* conditions.

Television antennas often operate at signal frequencies which differ from that for which the antenna was "cut" to be a half-wavelength long.

ANTENNA RESISTANCE

Antenna Resistance of a Nonresonant Half-Wave Antenna (contd.)

It is easily possible that the received signal frequency is such as to make the half-wavelength dimension of the antenna a fractional or a whole-number multiple relative to the received signal frequency. For instance, if an antenna is a half-wavelength at 63 mc (channel 3), it is $1\frac{1}{2}$ wavelengths long at 189 mc (channel 9), but the same antenna is only a fractional multiple of a half-wavelength for a signal of 85 mc (channel 6). What effect does such operation have on the antenna midpoint resistance? Stated briefly, it raises the antenna resistance at the midpoint. In fact, antenna resistance rises and falls (as the operating frequency relative to the resonant frequency of the antenna changes), but it never falls to the value corresponding to resonant operations at the half-wavelength.

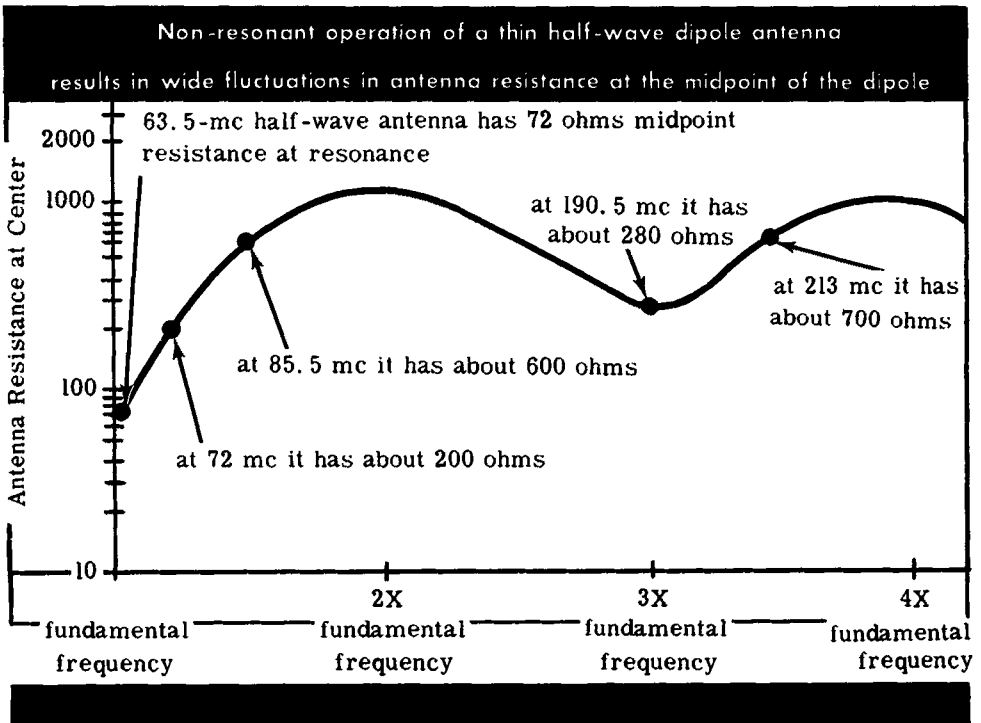

Operation of the simple straight-rod half-wave dipole at some frequency higher than that for which it was cut results in a midpoint resistance higher than at fundamental resonance. Whether the midpoint resistance is *very much* higher or merely higher, depends on the relationship between the antenna length and the arriving signal frequency. Controlling antenna resonance (length) is one means of achieving almost any desired midpoint resistance. Another method is to change the diameter of the antenna conductor or the shape of the antenna.

ANTENNA RESISTANCE

The Antenna Feedpoint or Loadpoint

If we wish to extract energy from the receiving antenna we must connect a *load* to the antenna. Such a load is the transmission line that conducts the energy from the antenna to the antenna-input coil of the receiver. The point along the antenna where the transmission line is connected is called the *feedpoint* or the *loadpoint*.

The word feedpoint arises from the language of transmitting antennas and expresses the place along the antenna where the energy is delivered. The loadpoint is receiving practice language, being the place along the antenna where the signal energy is removed and fed to the receiver. So, feedpoint and loadpoint are one and the same position along the antenna.

In all applications of television receiving half-wave dipoles, the loadpoint is in the vicinity of the midpoint of the antenna. This is so for the continuous-rod dipole and for the split dipole. It affords a balanced antenna structure and also is the most convenient point for attaching the transmission line because the voltage is lowest and the resistance is lowest.

Apropos of the "resistance at the midpoint" of the half-wave dipole, we refer to it as being of a value (say, 72 ohms for the thin-rod half-wave resonant dipole). In practice, this midpoint resistance is considered as being effective over a region of $\frac{1}{2}$ to $\frac{3}{4}$ inch each side of the midpoint of the overall length of the rod. In other words, we assume an acceptable approximation of the rated midpoint resistance (here, 72 ohms) when the transmission line connections to the thin, straight dipole are made at points about $\frac{1}{2}$ to $\frac{3}{4}$ inch each side of the midpoint. This may be considered true for antennas of different conductor thicknesses or shapes and for antennas rated at more or less than 72 ohms midpoint resistance.

THE CENTER OR MIDPOINT
of a split dipole



is its FEED POINT in all
television receiving applications
and is the point



where the
TRANSMISSION
LINE is
connected.



The midpoint of a continuous
half-wave dipole is actually about
1.5 INCHES WIDE.



A transmission line connection to a
continuous rod is not a short circuit
because antenna resistance exists
between all points along the rod.



ANTENNA RESISTANCE

Power Transfer from a Half-Wave Antenna

Basic electricity teaches that maximum electrical power can be delivered from a generator to a load only when the impedance of the load is equal to the internal impedance of the source (generator). Let us examine this situation from a simple d-c viewpoint, even though in practice we are concerned with alternating voltage and current. The d-c example is applicable to a-c conditions, provided that we consider d-c resistance as being replaced by a-c circuit impedance in the control of current.

Assume that the d-c generator is rated at 100 volts, with an internal d-c resistance of 100 ohms, and is connected to loads of 50 ohms, 100 ohms, and, finally, 150 ohms.

E = 100 volts

100 ohms
internal
resistance
of generator

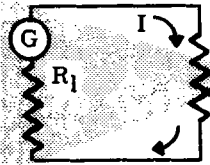

R₂
= 50
ohms

$$I = \frac{E}{R_1 + R_2} = \frac{100}{150} = 0.66 \text{ amp}$$

$$P = I^2 R = 0.66^2 \cdot 50 = 0.44 \cdot 50 = 22 \text{ watts}$$

E = 100 volts

100 ohms
internal
resistance
of generator

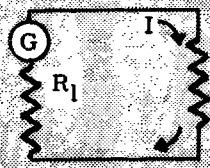

R₂
= 100
ohms

$$I = \frac{E}{R_1 + R_2} = \frac{100}{200} = 0.5 \text{ amp}$$

$$P = I^2 R = 0.5^2 \cdot 100 = 0.25 \cdot 100 = 25 \text{ watts}$$

E = 100 volts

100 ohms
internal
resistance
of generator

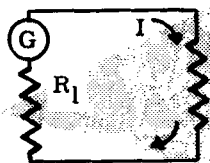

R₂
= 150
ohms

$$I = \frac{E}{R_1 + R_2} = \frac{100}{250} = 0.4 \text{ amp}$$

$$P = I^2 R = 0.4^2 \cdot 150 = 0.16 \cdot 150 = 24 \text{ watts}$$

Examining these simple calculations we note two significant facts. Maximum power is delivered to the load only when the load resistance is equal to the internal resistance of the generator. In this case, as much power is delivered to the load as is wasted in the generator. Such operation occurs with the correct resistance (impedance) *matching*. If the load resistance is either greater or smaller than the generator resistance, less than the maximum amount of power that can be delivered to the load is transferred to it. We can relate these findings to a receiving antenna and say that under ideal conditions of matching—that is, when the transmission line impedance (load resistance) equals the midpoint resistance of the antenna—the antenna (generator) will deliver 50% of its energy to the load.

ANTENNA RESISTANCE

Why the Antenna Loadpoint Resistance Is Important

We have explained that maximum power transfer takes place between a generator and its load when the load resistance is equal to the generator resistance. Applying this principle to a television receiving system, the antenna is the generator and the antenna input transformer in the receiver is the load.

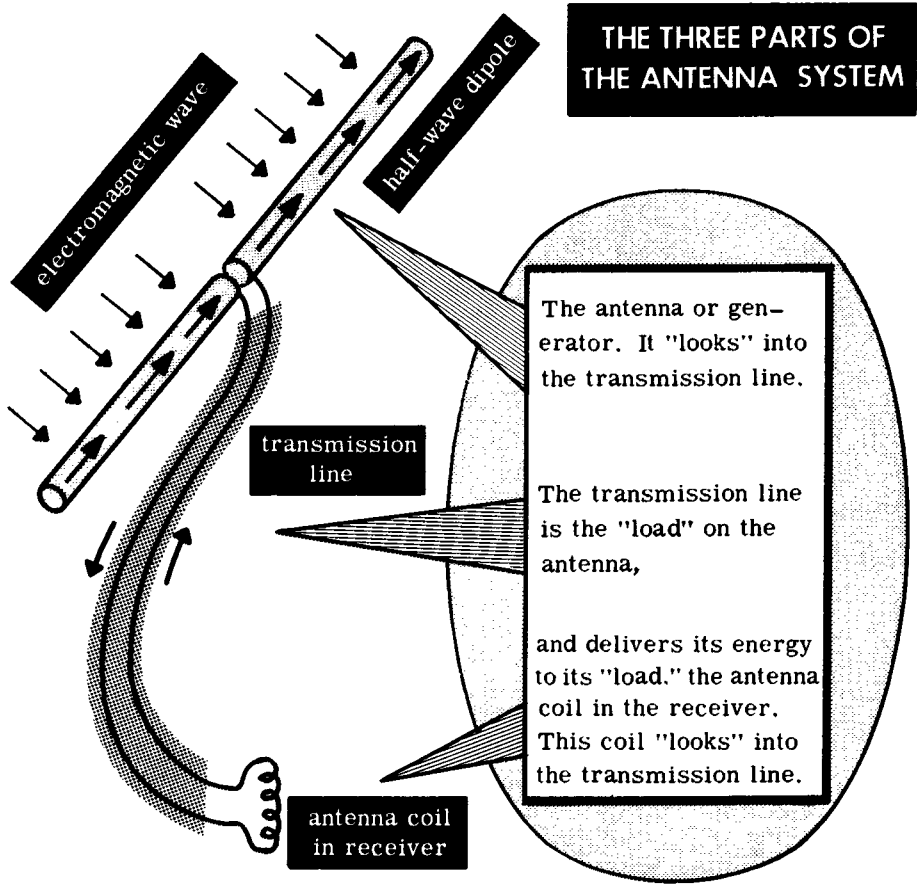

The transmission line impedance, therefore, must satisfy both the antenna loadpoint resistance and the antenna transformer input impedance. Treating each of these individually, the first determining factor for maximum power transfer between the antenna and the transmission line requires that the transmission line impedance equal the antenna loadpoint resistance. Thus the loadpoint resistance of the antenna is one of the determining factors in deciding the impedance of the transmission line. An improper match means a waste of power in the antenna.

ANTENNA RESISTANCE

The Input Impedance of the Antenna Input Transformer

Conditions of impedance match for best transmission of energy from antenna to receiver

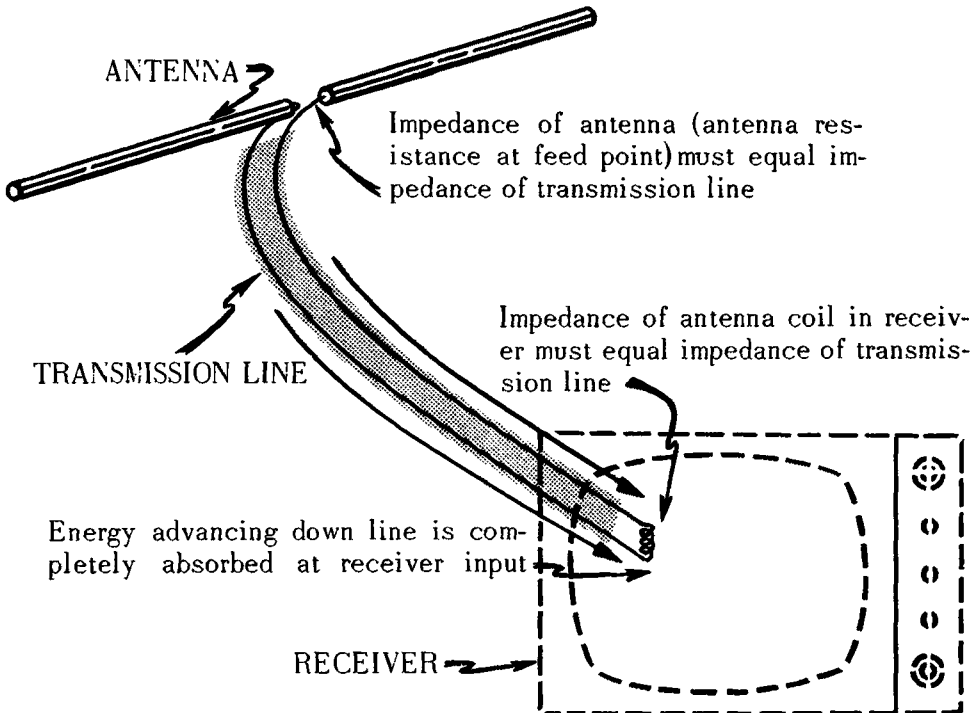

The second determining factor relative to the transmission line impedance is the input impedance of the antenna input transformer. Under ideal conditions this value should equal the loadpoint resistance of the antenna. In that event, the transmission line that matches the antenna loadpoint resistance, automatically matches the antenna input transformer, and maximum signal power is delivered to the receiver.

Appraising the importance of the two determining factors, the input impedance of the antenna input transformer is the more important of the two in deciding the impedance of the transmission line which must be used.

In years past, antenna input transformers in television receivers were rated at 72 ohms, 95 ohms, 150 ohms, and 300 ohms impedance. Therefore, a variety of transmission lines were used to link the antenna with the receiver. Today, the most frequently used type of line is one rated nominally at 300 ohms impedance. Hence, antenna designs are manipulated to make the loadpoint resistance of the antenna approximate 300 ohms.

FREQUENCY RESPONSE OF A DIPOLE

Frequency Response of a Thin Half-Wave Dipole Antenna

The simple thin half-wave dipole (as well as every other type) displays all the properties of a resonant circuit. It has inductance (L), capacitance (C), and resistance (R).

The inductance appears in the antenna element itself, just as it would in any length of conducting material. The capacitance appears between sections of the antenna, between the antenna elements and neighboring structures, and between the antenna elements and ground. The resistance stems from the manner of functioning of the device.

Proper dimensioning of the antenna produces the desired resonant condition. The shape and dipole diameter control the sharp or broad tuning behavior of the antenna.

So far as successful television picture reproduction is concerned, adequate signal strength in an antenna is just one of the requirements. In addition, the response of the antenna must be fairly uniform over the range of signal frequencies present because each frequency component requires equal processing.

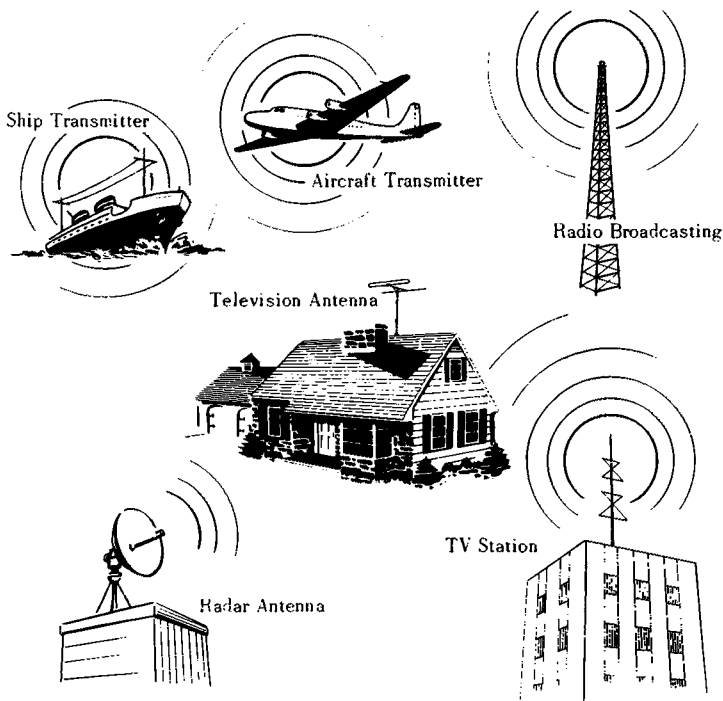

The television antenna receives radiations from all transmitters - and voltages are induced - but most of them are not of usable magnitude

FREQUENCY RESPONSE OF A DIPOLE

Center Frequency

SYMBOLIZATION OF FREQUENCY RESPONSE OF CONVENTIONAL HALF-WAVE DIPOLE RELATIVE TO CENTER FREQUENCY

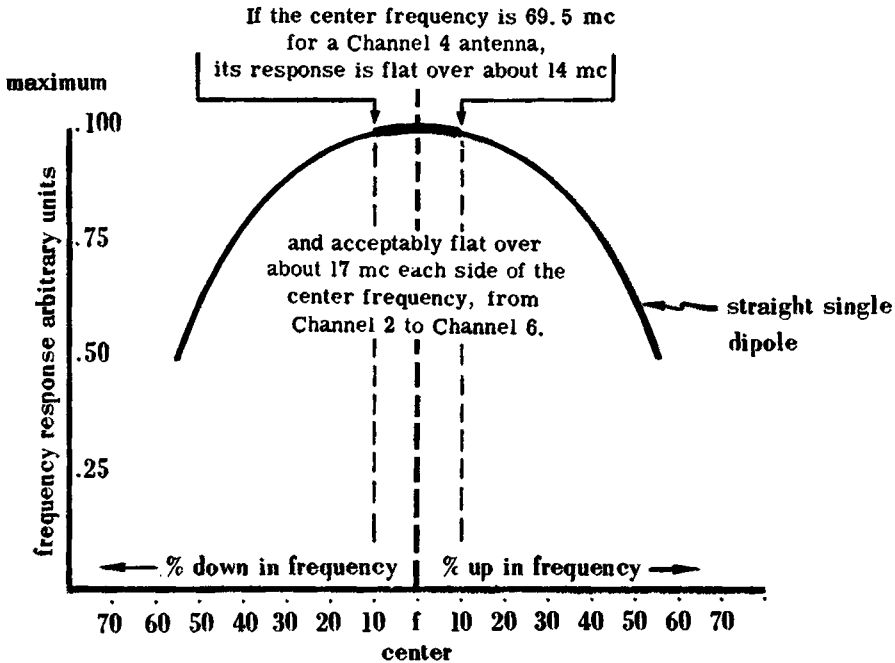

As a tuned circuit, the half-wave dipole responds best to that signal frequency for which it is a half-wavelength long. But even at best, it tunes more broadly than the conventional L-C circuit resonant to the same frequency. When an antenna is cut for a frequency that is at the center of a band of frequencies which it is supposed to cover, the resonant frequency is called the *center frequency*. If a dipole antenna is intended to function on channel 4 only (66–72 mc), it would be cut so that its half-wavelength dimension would correspond to the geometric midfrequency (69.5 mc) of this band. In this way fairly uniform response to the channel signal frequencies (picture and sound) is obtained. The response embraces 14 mc—7 mc each side of the 69.5-mc resonant point—with reduced response at the other frequencies.

It is conceivable that an antenna may be fairly “flat” in its frequency response over a 30- to 40-mc band, but it would still have a *center* frequency because it has a fixed length.

FREQUENCY RESPONSE OF A DIPOLE

Bandwidth of an Antenna

The conventional thin, single half-wavelength dipole affords frequency response over a number of television channels, in addition to the one for which it was cut. But whether or not it is adequate depends on the received signal strength. Given adequate signal strength, the decrease in response over a frequency region each side of the midfrequency may mean very little, in which case even the simplest of antennas may be a four- or five-channel antenna, provided that all other requirements are also satisfied.

For instance, if the center frequency of such an antenna is 195 mc, or the arithmetical center of channel 10, a frequency change of 12.5% is 24.4 mc below 195 mc and 24.4 mc above 195 mc. This places the low limit below the low-frequency limit of channel 7 (54 mc to 60 mc), and the high limit above the high-frequency limit of channel 13 (210 mc to 216 mc). It is therefore reasonable to expect that an antenna which behaves in this manner frequency-wise and which is suitably oriented will handle adequately the signals for stations within the high-frequency band of the vhf group.

Before we can accept such performance capabilities as valid reasons for using this type of antenna for this purpose, it is necessary to consider signal

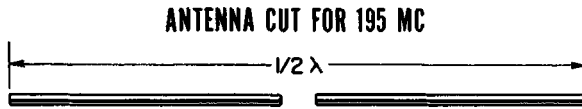

A 12.5% CHANGE EITHER SIDE OF THE CENTER FREQUENCY PROVIDES COVERAGE OF CHANNELS 7 TO 13

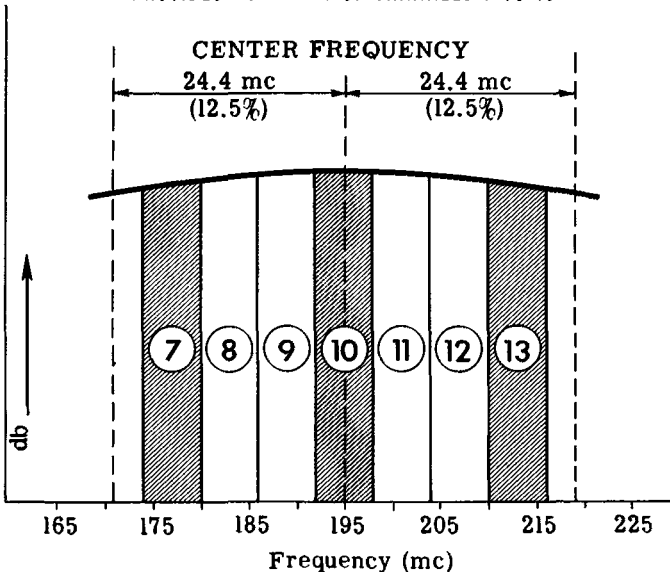

strength at the low-response region and the feedpoint resistance of the dipole. The nominal 72-ohm feedpoint resistance of this type of antenna at resonance makes it difficult to attain a proper match with the receiver antenna input transformer, usually rated at an impedance of 300 ohms. Hence, the general use of antennas of some other type which provide the required frequency response as well as the proper feedpoint resistance for correct matching to the receiver. (Resistance frequently dictates the choice of a design.)

FREQUENCY RESPONSE OF A DIPOLE

Determination of Center Frequency

The determination of the center frequency of a band can be made in two ways. One is the simpler of the two and results in a fair approach to the actual value. Simply, it is the arithmetical mean (average) of the sum of the upper and lower frequency limits of the band involved. For example, the center frequency of the low-frequency band of vhf television channels (54-88 mc) arrived at in this fashion is:

$$\frac{\text{high frequency} + \text{lowest frequency}}{2}$$

$$\frac{54 \text{ mc} + 88 \text{ mc}}{2}$$

$$71 \text{ mc}$$

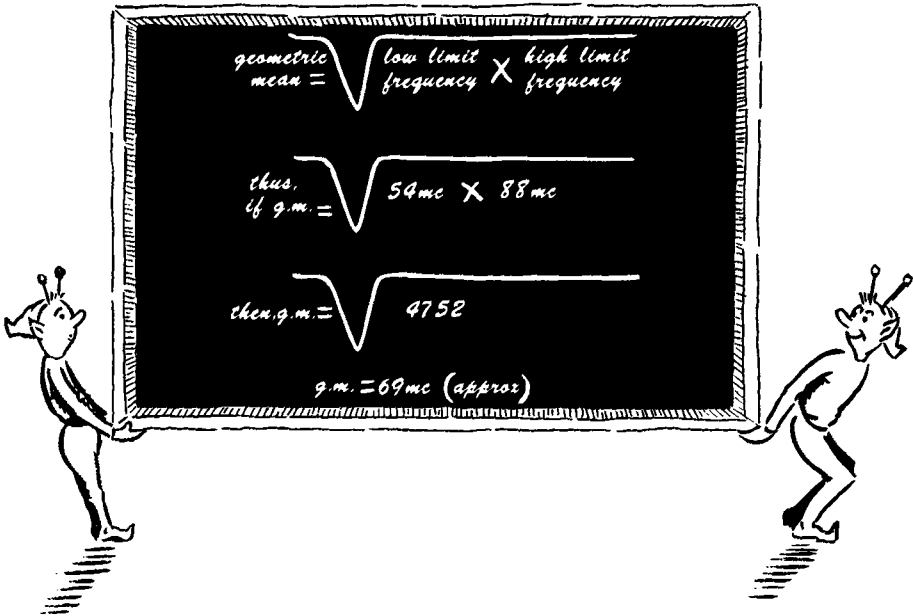

The second method is by determining the *geometric mean*. This is equal to the square root of the product of the low-frequency limit and the high-frequency limit of the band involved. Using the previously mentioned upper and lower frequency limits, the geometric mean frequency is just under 69 mc—in round numbers, 69 mc. For the high-frequency band of the vhf group the arithmetic mean is $(174 + 216) / 2$ or 195 mc. The geometric mean frequency is just under 194 mc.

For general purposes the determination of the center frequency by simple arithmetic means is entirely satisfactory.

OTHER DIPOLE ANTENNAS

Other Zero-DB-Gain Antenna Types and Characteristics

We have said that variations of the single-element, thin-rod half-wave dipole afford a variety of electrical characteristics and behavior that differ from the thin-rod version. The characteristics of interest to us, from the viewpoint of practical application, are antenna feedpoint resistance and frequency response.

Half-wave dipole antennas made of a relatively large-cross-section conductor (2 to perhaps 5 to 6 inches) display some of the characteristics of the thin-cross-section antenna, but exhibit one or more properties that are different. Increasing the cross section of the element shortens the physical length corresponding to a half-wavelength at any frequency. Thus, large-diameter-rod antennas may require velocity correction factors varying between 0.75 and 0.85, rather than 0.95, for rods or tubes up to 0.5 inch in diameter.

There is still another difference. Whereas the thin-rod half-wave dipole has a nominal feedpoint resistance of 72 ohms at resonance, a half-wave dipole made of 2.5- to 5-inch diameter tubing cut for and operated at the same frequency would have a greatly reduced feedpoint resistance—between 35 and 45 ohms. Also, the larger the diameter of the antenna conductor the less drastic the changes in antenna feedpoint resistance as the received signal frequency differs from the antenna resonant frequency.

Accompanying this effect is *flatter* response over a wide frequency range, making the large-cross-section-rod antenna more suitable for the reception of a number of television channels than the small-diameter antenna.

The large-cross-section antenna appears to offer a number of advantages as a receiving dipole. But it has three disadvantages—the low feedpoint resistance, the large wind surface, and the electrical disadvantage which develops at the feedpoint from trying to pass electrical energy from a large cross-section tube to a comparatively thin-wire transmission line. It is like passing water from a large opening into a small one without a funnel.

INCREASING the antenna-conductor diameter

REDUCES the length corresponding to a half wavelength. For example,

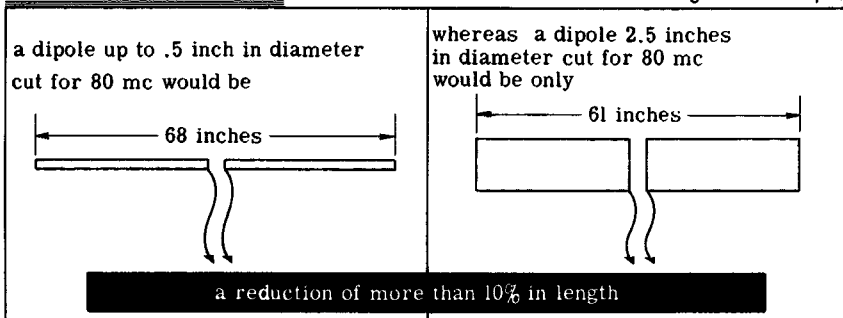

OTHER DIPOLE ANTENNAS

The Conical Family of Zero-DB-Gain Half-Wave Dipole Antennas

The cone-shaped antenna generally referred to as *biconical* consists of two cone-shaped sections lying along a common axis. It is a fundamental type that is simulated in many ways for use as a practical television receiving antenna. It is the equivalent of a large-cross-section-rod antenna, even though it does not have a uniformly large cross section throughout. In the practical version each section is made up of two or more rods or tubes, usually about 0.5 inch in diameter, fanning outwards from the feedpoint and tilted somewhat towards the approaching wave.

THE BICONICAL FORM ANTENNA FINDS ITS

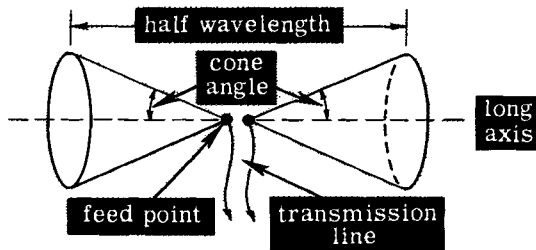

EQUIVALENTS FOR TELEVISION RECEPTION IN

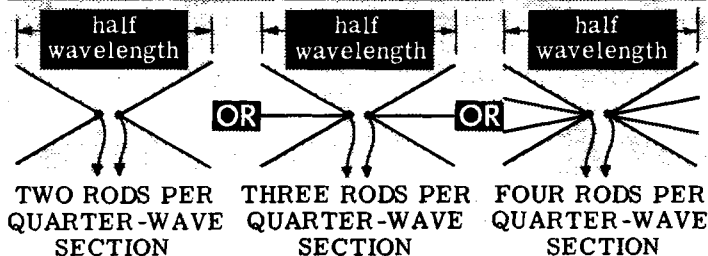

It is unnecessary to analyze each version individually because the general behavior of the conical-shaped equivalents is, in essence, applicable to all variations. All are zero-db gain at resonance. All are single-element antennas with no improvement in the ability to extract energy from a passing wave over that of the simple half-wave dipole. (In this respect we specifically exclude the "V" antenna.)

OTHER DIPOLE ANTENNAS

Conical Antennas (contd.)

The conical form, as depicted by a variety of configurations of multiple rods in each section, is a broadly tuned antenna. Therefore, it is used when reception of several television stations is desired. It can accept all vhf stations, but not both vhf and uhf. The antenna resistance at the feedpoint is a function of the number of rods per section, the angle at which the rods fan outward from the feedpoint, and the degree of tilt in the forward stations, but not both vhf and uhf. The antenna resistance at the feedpoint does not vary as drastically with changes in signal frequency as the thin or even medium-thick straight-rod dipole. This feature, used in a special manner as described later in this lesson, accounts for the popularity of this antenna design.

In this regard, we should mention that different lengths of each section, different numbers of rods per section fanning outward at different angles and with different amounts of tilt, as well as different cross section of the individual rods can be combined in different ways to form antennas with similar electrical characteristics.

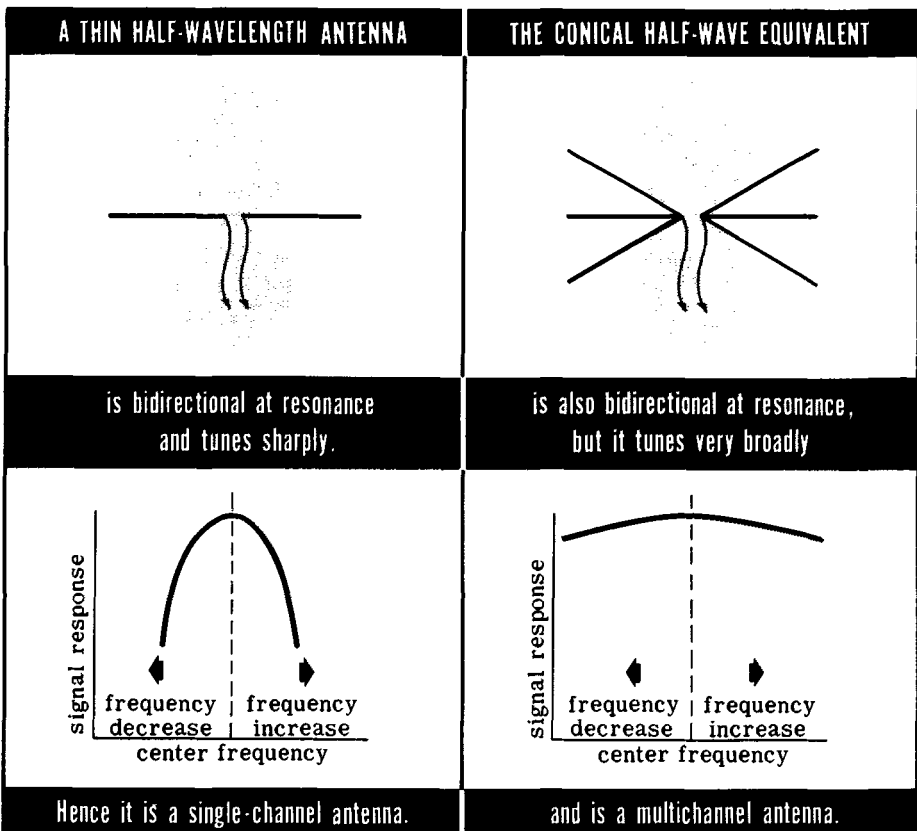

OTHER DIPOLE ANTENNAS

The V Antenna

The V or Vee antenna is a half-wave dipole formed from two medium-thick quarter-wave sections tilted towards each other. Although it is classed a zero-db-gain antenna at the resonant frequency (for which its overall length equals a half-wavelength), certain differences in behavior warrant comment. The V antenna allows reception over a very wide band of television frequencies, oftentimes being used to cover the vhf as well as the uhf stations that serve an area. The V antenna rods are tilted inward between 30° and 40° .

As the frequency of the received signal increases (the corresponding wavelength decreases) the antenna departs from being a half-wavelength structure. Each leg gradually becomes a multiwavelength relative to the frequency of the arriving signal. For instance, an antenna cut for channel 2 (54–60 mc) will accommodate $\frac{3}{4}$ wavelength in each leg at about 180 mc; almost $2\frac{1}{2}$ wavelengths in each leg at 600 mc, and $3\frac{1}{2}$ wavelengths in each leg at about 840 mc. The greater the number of wavelengths accommodated by each leg, the better the antenna performance.

Because of the forward *tilt*, the electric field of a low-frequency signal will not “see” as much of the antenna length as if the two quarter-wave sections were “in line.” Hence, at the low vhf frequencies (perhaps the lowest) the V antenna shows substantially less signal pickup than the conventional straight-rod antenna—actually a little less than the conventional half-wave dipole. But if the frequency of the signal is high (wavelength of the signal is short relative to the wavelength of each leg of the V antenna), the opening between the ends of the V accommodates quite a few half-wavelengths of the approaching wavefront. The currents induced in each leg as the wavefront advances along the antenna aid each other and the antenna shows *gain*. In effect, its signal-extraction capabilities are greatly improved; the response remains bidirectional, but each response lobe becomes narrow. In other words, the antenna as a whole becomes highly directional. This is no problem if all the transmitting antennas serving an area are located in a line intersecting the V.

A V ANTENNA CUT FOR THE LOW VHF BAND

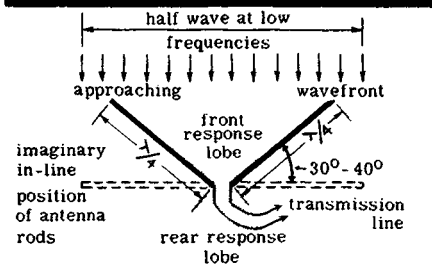

is bidirectional with reduced efficiency at low frequencies. BUT

is very efficient at wavelengths a small fraction of the antenna rod's length.

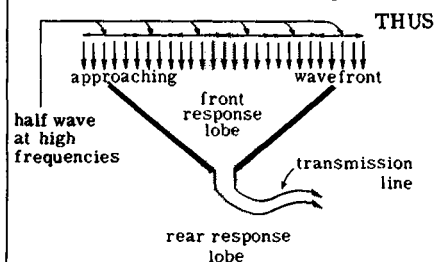

THE V ANTENNA IS EFFICIENT IN MULTI-FREQUENCY HARMONIC APPLICATIONS.

OTHER DIPOLE ANTENNAS

The Bat Wing Antenna

The *bat wing* antenna behaves in a manner similar to the conical group. It is used mostly for the reception of uhf channel television stations as a part of a multielement antenna. Therefore, we shall discuss it when dealing with such wave-intercepting devices.

The Folded Dipole Antenna

THE FOLDED DIPOLE

IS ZERO-DB GAIN,

IS BIDIRECTIONAL,

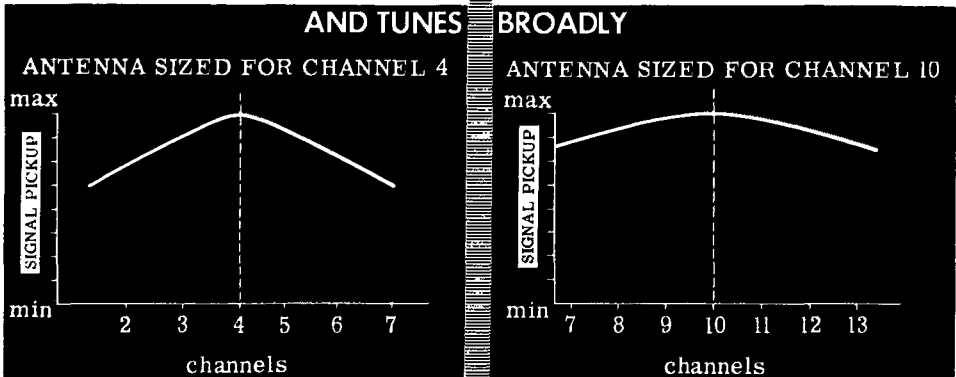
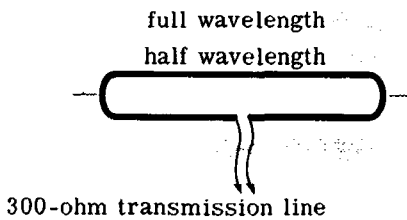

One of the most popular variations of the basic single-element half-wave dipole is the *folded* dipole. It derives its name from its physical structure. It may be viewed as a continuous-rod dipole connected in parallel with a split dipole. The two active parts of the antenna are separated by possibly 5 to 10 times the diameter of the antenna conductors. The overall length of the antenna conductor, inclusive of the separation at the feedpoint, is a full wavelength at the frequency for which the antenna is cut. Since the antenna conductor is folded upon itself, the horizontal length equals a half-wavelength at the resonant frequency. The folded dipole is a zero-db-gain antenna, tunes more broadly than the thin-rod half-wave dipole, and is bidirectional in its horizontal directivity.

OTHER DIPOLE ANTENNAS

The Folded Dipole (contd.)

The principal advantage of a folded dipole is its relatively high feedpoint resistance. When the antenna conductor is of uniform diameter throughout, the feedpoint resistance is 288 ohms at resonance. It is therefore a good match for a 300-ohm transmission line.

IF THE CONTINUOUS ROD HAS TWICE THE
DIAMETER OF THE SPLIT ROD,

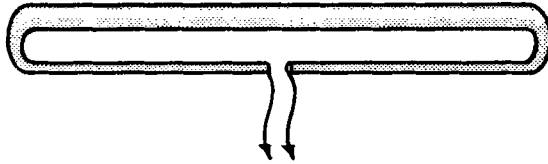

THE FEEDPOINT RESISTANCE IS 648 OHMS.

The folded dipole displays a peculiar characteristic when the signal frequency is such that the horizontal length of the antenna equals a full wavelength, or an even multiple of a full wavelength. In these cases the feedpoint resistance falls to a very low value and results in an extremely bad match with a 300-ohm transmission line. For instance, a folded dipole cut for channel 4, or 69 mc, will display a very low feedpoint resistance at 138 mc or 276 mc, and other even-number multiples of 69 mc. Fortunately this is no problem in television reception because a folded dipole cut for the vhf band will not be subject to television signals which will make it operate in this fashion. The same is true for uhf antennas cut for the low end of the uhf band. Moreover, a folded dipole intended for the vhf band is generally not used for the reception of uhf stations. At frequencies other than the above, and when the horizontal length is not an exact wavelength, the feedpoint resistance fluctuates but does not go below the nominal 300 ohms.

Folded dipole made from 300-ohm twin lead

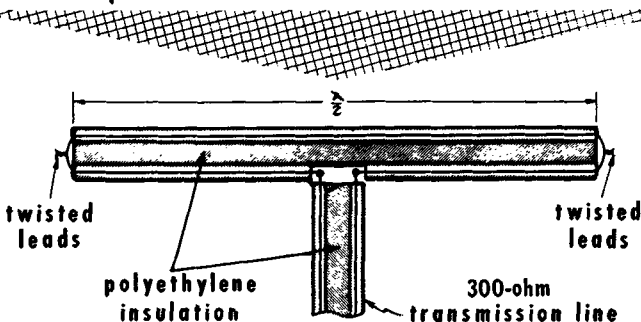

REVIEW

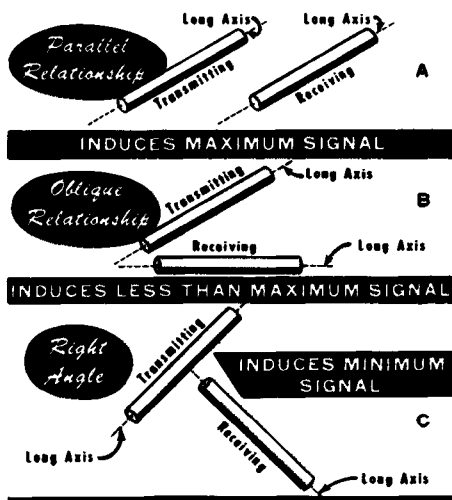

2. **Directional Response Pattern of a Half-Wave Dipole.** The response pattern on each side of the antenna is called a lobe. The direction of the radiated energy from an unwanted station should be between response lobes or striking the antenna at a low response point on the lobe.

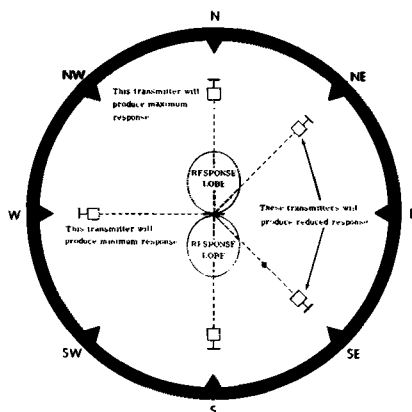

CURRENT AND VOLTAGE DISTRIBUTION ON A HALF-WAVE DIPOLE
 CURRENT IS MAXIMUM AT THE MIDPOINT OF THE HALF-WAVE ELEMENT

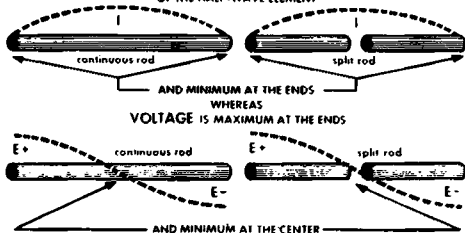

1. **Directional Response.** The manner in which an antenna responds to signals that arrive from different directions is termed its directional response or the directivity. Directional response is very important in areas where signals are received from many different directions.

3. **Voltage and Current for a Half-Wave Dipole at Resonance.** When the passing wave induces a voltage and a current in a half-wave dipole functioning at its resonant frequency, a special form of voltage and current distribution takes place.

Conditions of impedance match for best transmission of energy from antenna to receiver

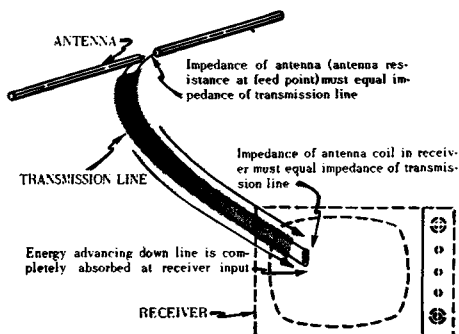

4. **The Input Impedance of the Antenna Input Transformer.** The transmission line impedance must satisfy both the antenna loadpoint resistance and the antenna transformer input impedance. An improper match means a waste of power in the antenna.

REVIEW

ANTENNA CUT FOR 195 MC
A 12.5% CHANGE EITHER SIDE OF THE CENTER FREQUENCY
PROVIDES COVERAGE OF CHANNELS 7 TO 13

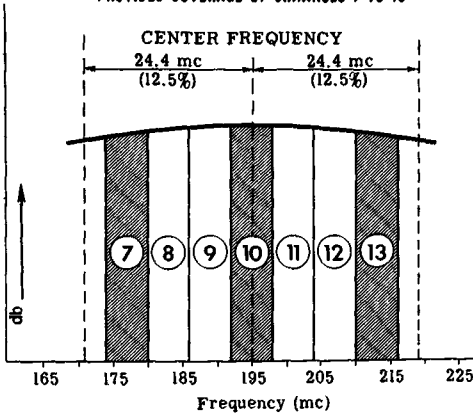

6. *The Conical Family of Half-Wave Dipoles*, generally referred to as biconical, consists of two cone-shaped sections lying along a common axis. It is simulated in many ways for use as a practical television receiving antenna.

5. *Bandwidth of an Antenna*. The conventional thin single half-wave-length dipole affords frequency response over a number of television channels in addition to the one for which it was cut. Whether or not this response is adequate depends on the received signal strength.

THE BICONICAL FORM ANTENNA FINDS ITS

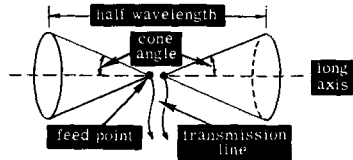

EQUIVALENTS FOR TELEVISION RECEPTION IN

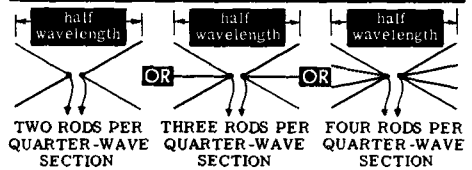

7. *The V or Vee Antenna* is a half-wave dipole formed from two medium-thick quarter-wave sections tilted towards each other. The V antenna allows reception over a very wide band of television frequencies, often-times being used to cover the vhf as well as the uhf stations that serve an area.

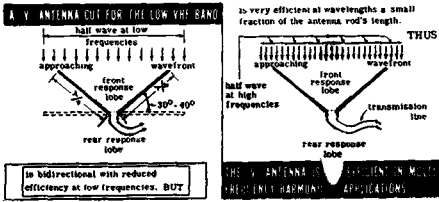

8. *The Folded Dipole Antenna* may be viewed as a continuous-rod dipole connected in parallel with a split dipole. The two active parts of the antenna are separated by possibly 5 to 10 times the diameter of the antenna conductors.

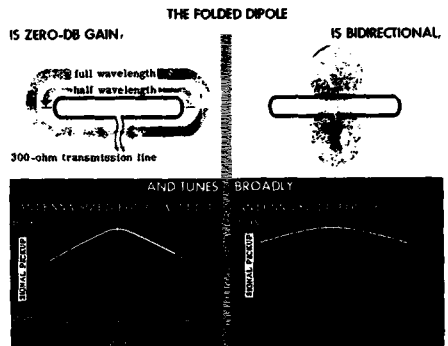

ADDING ANTENNA ELEMENTS

Multiple-Element Antennas

By far the most frequently used television antennas are not simple single-element dipoles or folded dipoles. They are multiple-element antennas, usually consisting of one element that is connected to the receiver, and another element that behaves as a *parasitic* (the meaning of which shall be explained soon). In some installations the antenna is made up of more than two elements. One is connected to the receiver and the remainder contribute to the effectiveness of the system as a single pickup device. The element connected to the receiver can be any one of the numerous varieties we have indicated as being single-element, zero-db-gain half-wave dipoles. The aiding (parasitic) element or elements usually are straight continuous rods, but in some instances, they have the same shape as the element which is connected to the receiver.

The multiple-element antenna generally picks up signals from the front much better than from the rear. It behaves as if it captures more energy from the passing wave that it intercepts than does the single-element dipole. Therefore it has gain. Finally, it tunes more sharply and can thus be made highly selective so that it will respond principally to a single television station.

Based on these capabilities the multiple-element antenna is used when increased signal pickup is desired, when signals arriving from the rear (such as reflections from buildings) are to be minimized, and when maximum signal pickup is desired from a single station.

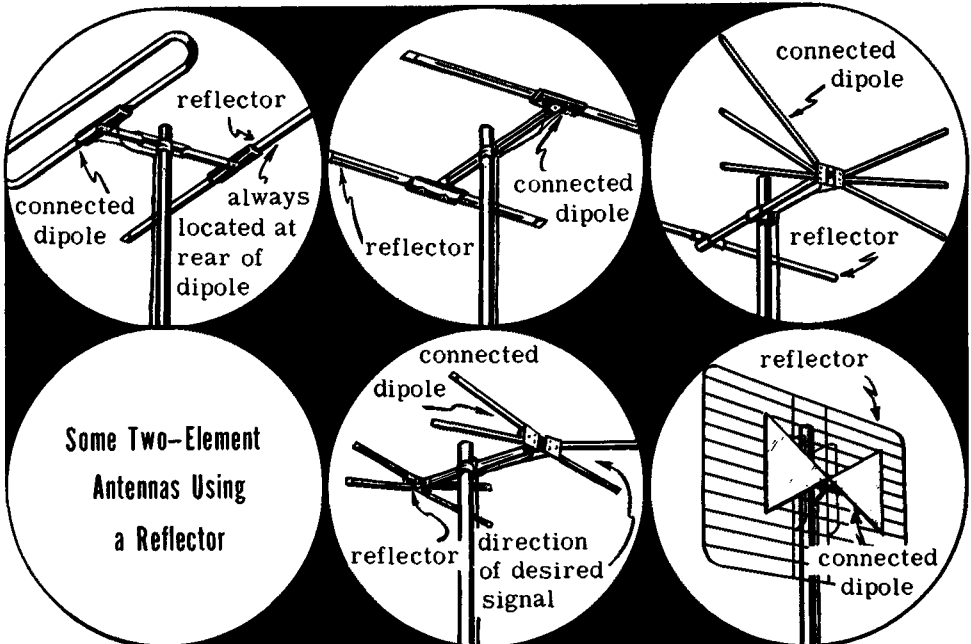

ADDING ANTENNA ELEMENTS

The Operation Of Multiple-Element Antennas

It will be recalled that a receiving antenna connected to a receiver transmits only a portion of the energy that it intercepts to the receiver; the rest is re-radiated. If, however, the dipole is not connected to a receiver or some other load, it re-radiates virtually all of the energy that it captures. If the unconnected rod (*parasitic element*) is cut to be resonant at the received frequency, a 180° phase inversion takes place in the process of re-radiation. (This action is analogous to the reflection of the electromagnetic waves discussed earlier, and an unconnected rod of this kind placed behind the connected element is called a *reflector*.)

Let us examine the action of a dipole-reflector combination on an approaching wavefront. If a wave arrives from the front, part of it is intercepted by the connected dipole, while the rest passes on toward the reflector, which captures additional energy from it. If the reflector is placed a quarter-wavelength behind the connected element, the reflector is excited a quarter-cycle (90°) later than the connected element. The energy is immediately re-radiated with a 180° phase shift, and part of it arrives back at the connected element 90° later. The total of the phase equivalent of the transit times (180°) and the actual phase shift (180°) is equivalent to a full cycle; hence the energy sent back to the connected element from the reflector arrives in phase with the oncoming signal from the front.

A signal that approaches from the back of the combination reaches the connected element 90° after a part of it has been intercepted by the reflector. In this case, the reflector again re-radiates the energy 180° out of phase, and a part of this energy also arrives at the connected element 90° later. The two signals are 180° out of phase at the connected element, hence the re-radiated signal from the reflector cancels part of the signal arriving directly at the connected element. This results in reduced response to signals received from behind.

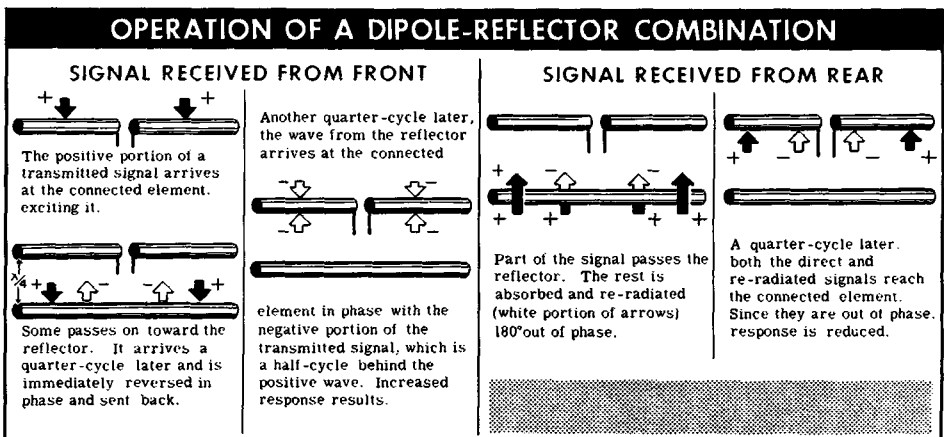

ADDING ANTENNA ELEMENTS

Response of a Dipole-Reflector Combination

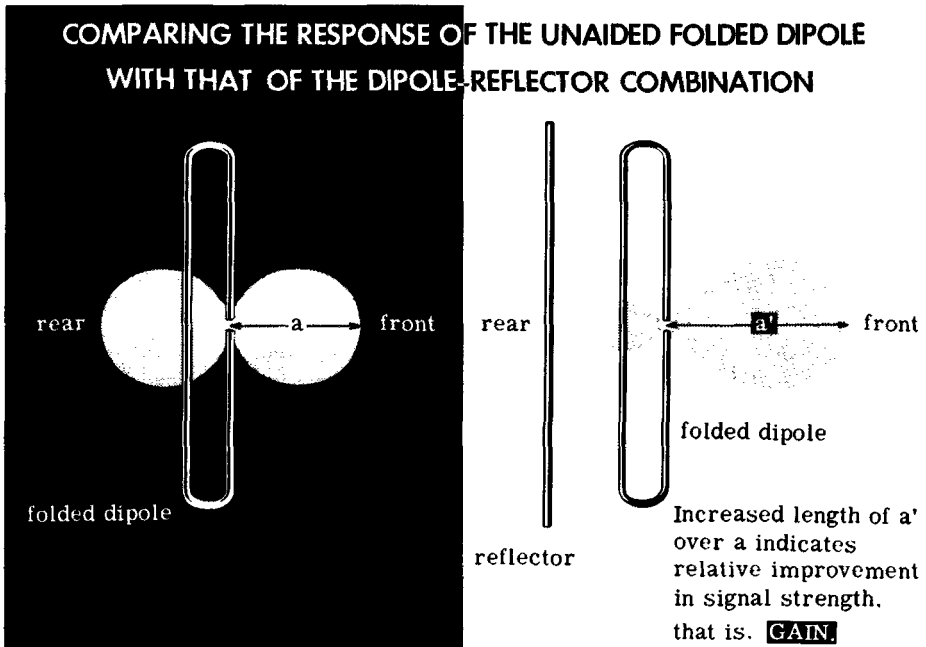

The preceding discussion is greatly simplified. In practice, reflectors are made about 5% longer than the connected element, which results in a phase shift greater than 180° . They are therefore placed closer to the connected element than a quarter-wavelength. In addition, part of the energy intercepted by the connected dipole is re-radiated toward the reflector and returned by it. This energy may not be in phase with the directly received signal and experimentation with reflector length and position is required to get the best compromise result.

It can be seen that the signal available for transfer to the receiver in the connected dipole is more than was actually extracted from the passing wave by that element. The signal intercepted by the reflector makes its contribution by re-radiating some of the energy to the connected element. A dipole-reflector combination will show a *power gain* of about 5 db. This means that the antenna behaves as if the power in the arriving wave had been increased about 3.5 times over that in a single-element half-wave dipole antenna.

The narrower response lobes show the antenna to be more restrictive in its horizontal directivity. Response to signals that approach it from the rear is less than for the conventional single-element dipole. On the other hand, its response is much greater than with the single dipole only, when the signal approaches the antenna from the front.

ADDING ANTENNA ELEMENTS

Other Characteristics of a Dipole-Reflector Combination

The folded-dipole/reflector combination tunes more sharply than the folded dipole alone. (The addition of a reflector will sharpen the tuning of any connected element.) The frequency bandwidth accepted by the antenna remains adequate for reception of either vhf or uhf stations.

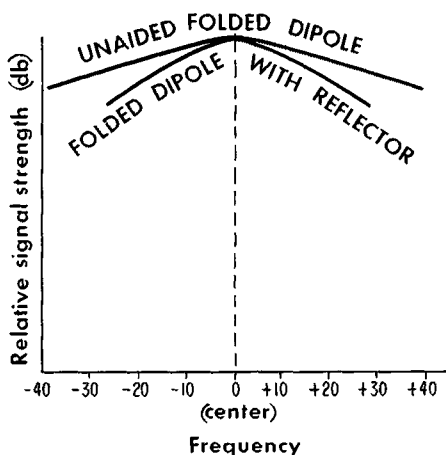

Two other electrical characteristics must be noted. Current in the connected dipole is higher when the reflector is present than when it is absent. This can be interpreted as a decrease in the antenna feed-point resistance. The straight-rod, half-wave dipole-reflector combination will show about 25–30 ohms feedpoint resistance at resonance, contrasted with 72 ohms when the reflector is absent. A folded dipole-reflector combination operated at half-wave resonance will show between 100–110 ohms feedpoint resistance, contrasted with 300 ohms when the reflector is absent. Dipoles of other shapes used with reflectors demonstrate similar reduction in feedpoint resistance. The initial high feedpoint resistance of the folded dipole accounts for its great popularity as the connected element in dipole-reflector type antennas. Operating the antenna off-resonance on the various TV channels raises the feedpoint resistance to a usable value even with the reflector present.

The second significant change in electrical performance brought about by the addition of the reflector is the reduction in the antenna's response bandwidth.

ADDING ANTENNA ELEMENTS

Connected Element with Reflector and Director

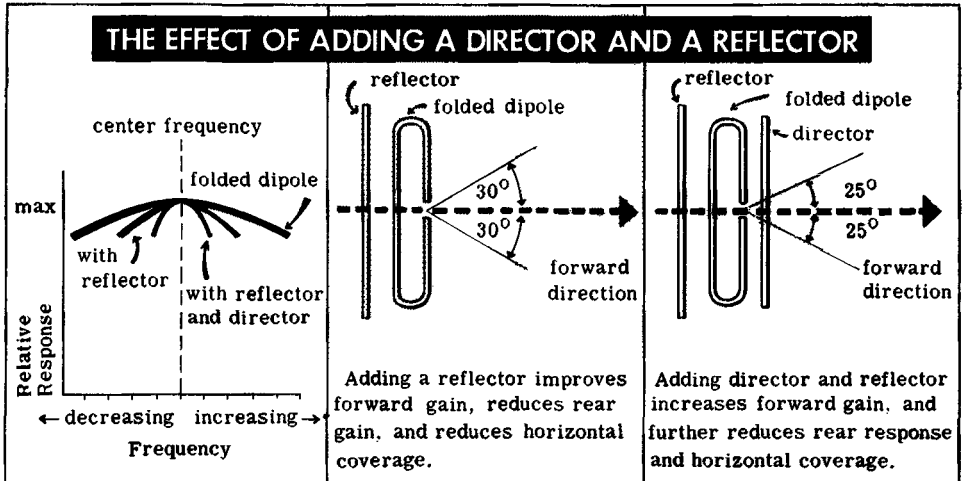

The use of a reflector has been seen to improve forward response and minimize the response from the rear. It is possible to increase forward pickup even more, at the same time sharpening horizontal directivity, and still further reducing the response from the rear. This is done by adding another parasitic element, a *director*. The director is placed in front of the connected element, being separated from it by from 0.1 to 0.2 wavelength for the frequency at which the antenna is sized. The contribution to the antenna behavior by the director is predicated on re-radiation by the director after excitation from the approaching wave. Thus the addition of a properly proportioned director improves the signal pickup of the antenna as a whole. The addition of a director to a connected-element-reflector combination normally sharpens the tuning of the system, limiting the number of channels that can be received with the antenna. However, by departing somewhat from resonating all the antenna elements to the same frequency it is possible, in receiving antennas, to broaden the frequency response and still derive some of the advantages of multiple elements. This is a practical compromise that works.

It must be realized that theoretical considerations do not always result in readily evident improvements in practice. This depends upon the individual set of circumstances. However, that which presents an advantage in theory cannot give poor results in practice, if that which is offered by the theory is what is sought. It might be mentioned that variations in behavior in terms of diameters of elements, as described in connection with an ordinary dipole are also applied, but not too often, to multiple element antennas consisting of connected element, reflector and director. The aim here is to provide the broadest possible frequency response to oncoming signals without sacrificing gain.

ADDING ANTENNA ELEMENTS

The Yagi Antenna

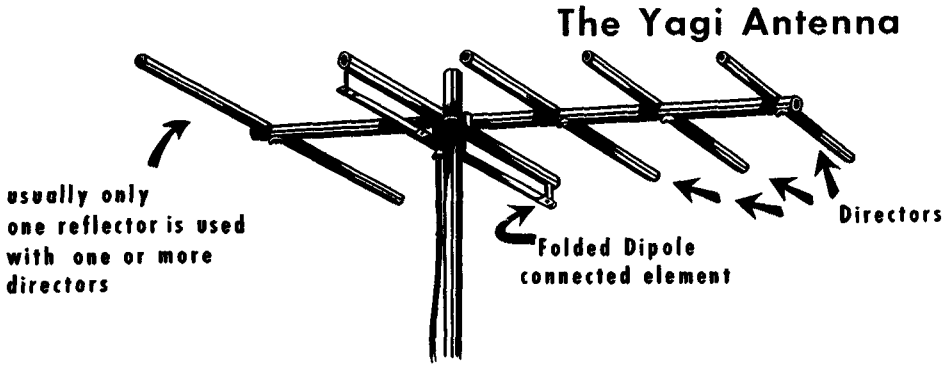

A type of multielement antenna that finds use in many fringe areas has a number of directors, one or more folded-dipole connected elements, and a single reflector. These are called Yagi antennas. The standard Yagi has only one connected element. Because the multiple parasitic elements reduce the feedpoint resistance drastically, the folded-dipole-connected elements are of such design as would result in a very high feedpoint resistance. These would be unlike-diameter conductors, or perhaps three-conductor folded dipoles. The conventional Yagi is intended for single-channel reception because it tunes relatively sharply. The Yagi can demonstrate power gains, depending upon design, of from 9 to 11 db over a conventional half-wave dipole.

Commercial antenna designs have produced *broadband* Yagis which are intended, again depending upon design, to cover from three to perhaps six or seven adjacent television channels. In these compromise designs two differently-sized folded dipoles behave as the connected elements, and the director elements as well as the reflector are adjusted in length so as to function best. They are the result of experimental determination which does not in any way detract from their operating effectiveness.

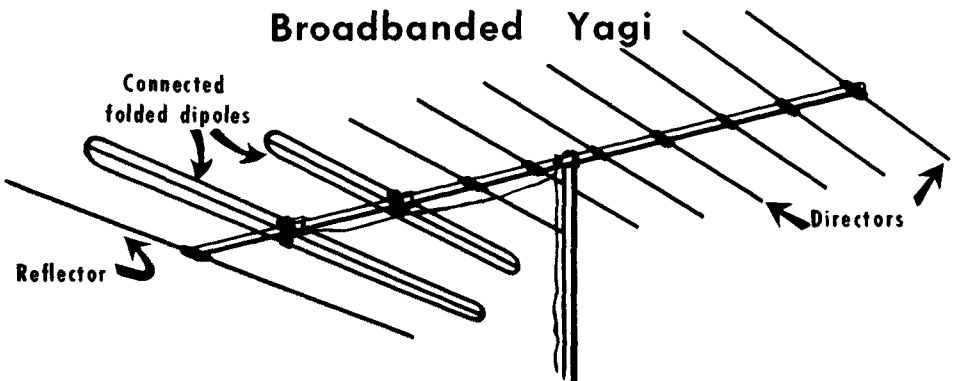

UHF AND VHF ANTENNAS

Antennas for Ultra-High-Frequency (UHF) Reception

THE BILLBOARD ANTENNA

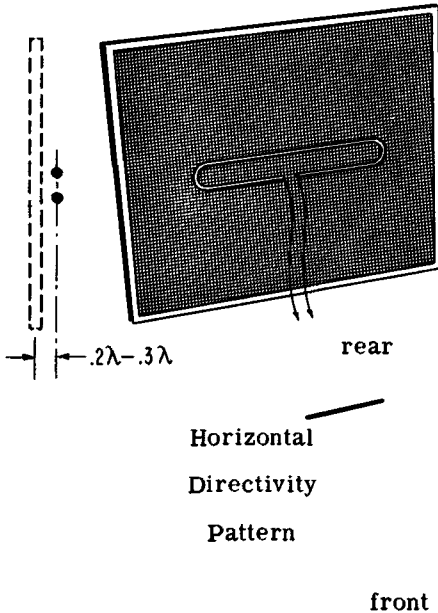

consists of a half-wave dipole mounted in front of a square metal screen that is about half again as long as the connected element. The dipole is mounted about 0.2 or 0.3 wavelength of the selected frequency in front of the screen.

When the connected element is a folded dipole, the feedpoint resistance may vary between 250 and 400 ohms, so that a match to a 300-ohm line is practicable. If the connected element is a conventional dipole, the feedpoint resistance falls to about one quarter of these values.

Antennas designed for the reception of television stations in the uhf band usually are made of the connected element (dipole) and a reflector. In this case, the reflector is somewhat different from that used with vhf antennas. The smaller physical dimensions of the uhf antenna allow the use of wave-reflecting surfaces made of metal, which are very much more effective than the dipole rods of the vhf structures.

The connected elements of the uhf antennas have the same shape as the vhf versions. The dimensional considerations stemming from the frequency-wavelength relationship also are the same, as is the behavior of the connected dipoles when being acted on by the approaching signal wavefront. The points of difference are related to the reflectors used with the uhf dipoles. In the case of the uhf antennas the reflector usually consists of a screen, and increases in effectiveness with increase in overall size. It has a minimum dimension which is determined by the horizontal length of the connected element used with it. Beyond this, its maximum size is a compromise between effective performance and cost. UHF antennas are substantially unidirectional.

UHF AND VHF ANTENNAS

UHF Antennas (contd.)

The *bow-tie* antenna used with a corner reflector is another version that is popular in uhf television areas. In the example shown, the connected dipole is bent into a horizontally positioned V. Its sides then are parallel to the sides of the corner reflector so that maximum energy is returned from the reflector to the dipole. Here too, the larger the reflector (within reason, of course) the more effective its action. By shaping the dipole and the reflector in this manner, wave energy that strikes the reflector bounces off and is intercepted by the connected element. A 90° corner reflector with the bow-tie dipole mounted about 0.3 wavelength (at the chosen frequency) in front of it will provide approximately a 9- to 10-db power gain.

The connected element sometimes is a folded dipole rather than a bow-tie, in which case the feedpoint resistance approximates 250 to 400 ohms, depending upon the condition of resonance. When the connected element is a bow-tie or a large-diameter dipole, the feedpoint resistance is lower. But by operating off-resonance an acceptable match to a 300-ohm transmission line is made. Compromise operation relative to resonance is customary.

The dimensions of the corner reflector are large relative to the half-wavelength dimension of the connected element. Usually, the length of the sides of the reflector approximate several wavelengths at the selected frequency. The horizontal dimension of the reflector sides is perhaps 25 to 100% longer than the horizontal length of the dipole. The antenna is unidirectional, being responsive to the front only.

THE BOW-TIE ANTENNA WITH CORNER REFLECTOR

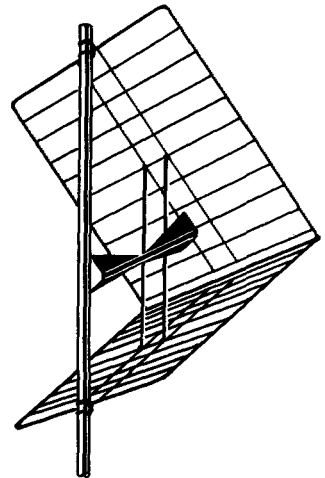
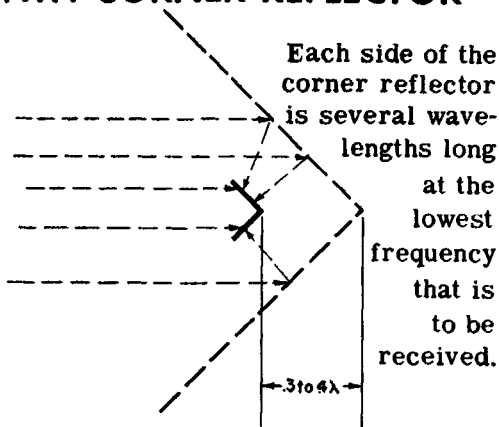

HORIZONTAL DIRECTIVITY PATTERN



UHF AND VHF ANTENNAS

Combination Low- and High-Band VHF Antennas

The division of the vhf channels into the *low-frequency band* (channels 2 through 6 covering 54 to 88 mc) and the *high-frequency band* (channels 7 through 13 covering 174 to 216 mc) has led to the use of various antenna arrangements. In some cases individual antennas are used for each of these bands; in others, a single antenna is designed to be broadband and cover them all. In the case of individual antennas for each band, the installation is relatively simple. The high-band antenna is positioned above the low-band antenna. The vertical separation between the two assemblies usually approximates a half-wavelength corresponding to the geometric mean of the frequencies for which the two antennas were cut. Thus, if the *lo*-band antenna is dimensioned for approximately 69 mc and the *hi*-band antenna is dimensioned for approximately 190 mc, the geometric mean frequency is approximately 115 mc. The vertical separation then would be equal to a half-wavelength corresponding to 115 mc. The points of reference usually are the connecting terminals on the antenna.

Commercially manufactured antennas, which are intended to be used in pairs so as to cover all vhf channels, invariably furnish instructions concerning the vertical separation between the component elements, and these instructions rather than the theoretical considerations should be used. The reason for this is that manufacturers elect their own basis of dimensioning antennas relative to the frequency which may be selected as mid-frequency for the *lo* and *hi* bands.

COMBINATION LOW-BAND AND HIGH-BAND VHF ANTENNA

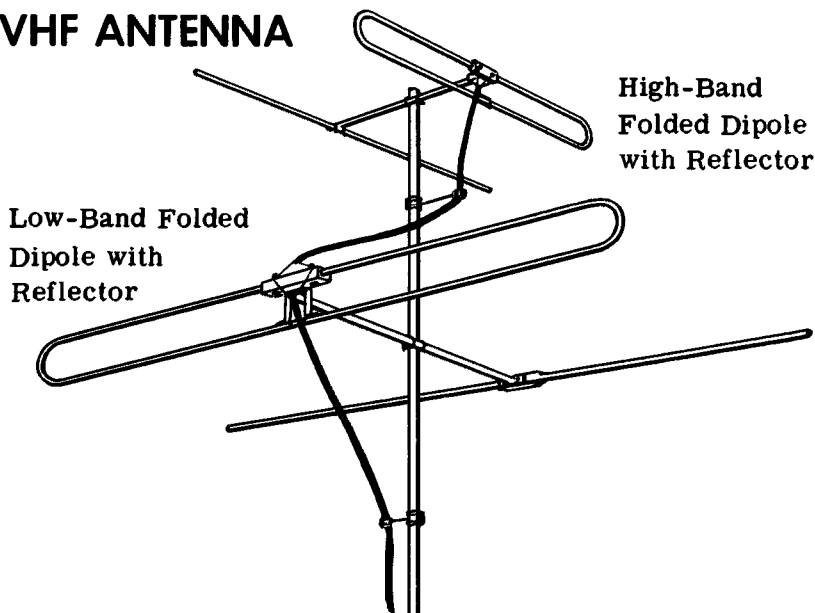

UHF AND VHF ANTENNAS

Combination VHF and UHF Antenna Arrays

ALL-CHANNEL UHF-VHF ANTENNAS

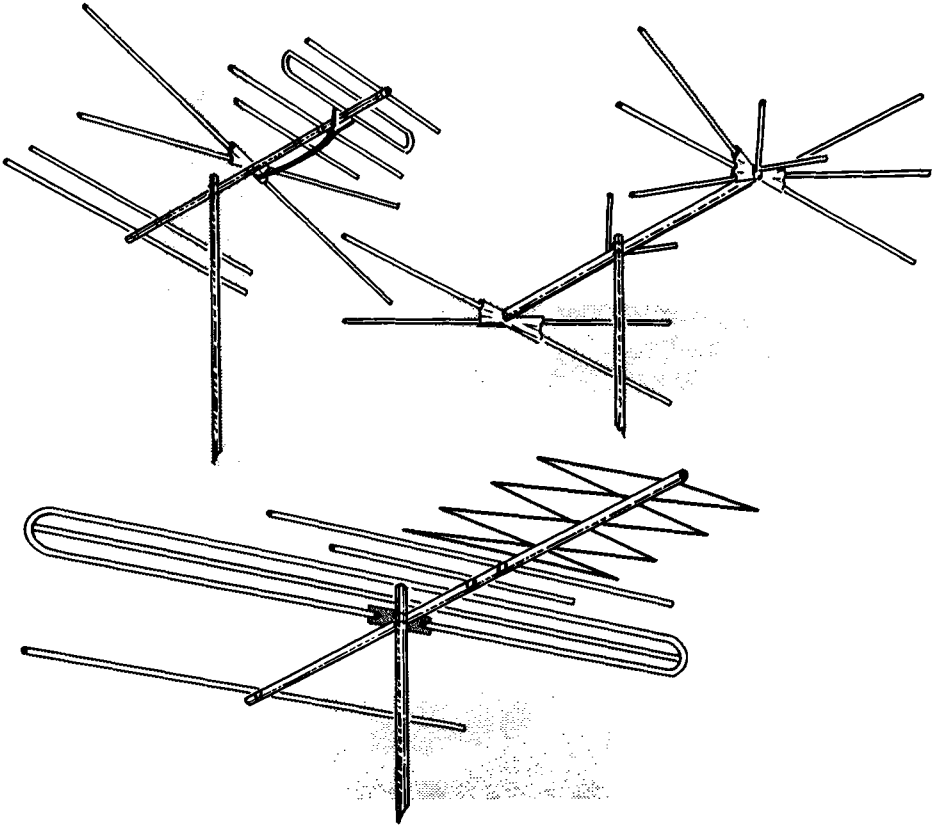

Quite a few receiving locations are served by both vhf and uhf television transmitters. To satisfy this need, antenna manufacturers have produced combinations of vhf and uhf antennas that mount on a single mast and which feed energy to the receiver via a single transmission line. Three examples of quite a few types available are shown here. One of them is a combination of the conical equivalent and the *rhombic* (the rhombic antenna is explained later in this course). The rhombic antenna is used for the uhf channels, whereas the conical equivalent is adjusted for the vhf channels.

The second type consists of a conical equivalent for the vhf channels, which is modified also to behave as a V antenna for the uhf channels. This is done by adding a V element to the conical-equivalent connected dipole, and another V element, which is used as the reflector.

UHF AND VHF ANTENNAS

Combination VHF and UHF Antenna Arrays (contd.)

The third type is a combination of a three-section folded dipole as the connected element for the vhf channels functioning in conjunction with directors and reflector. The three-conductor folded dipole operated at resonance or slightly off resonance affords a high feedpoint resistance, which when paralleled by the feedpoint resistance of the uhf antennas, results in the final value of 300 ohms feedpoint resistance to match a 300-ohm transmission line.

For the uhf channels a specially shaped helix antenna is the pickup device. Strangely enough, antenna manufacturers have conceived many unusual combinations and shapes of antennas which differ from theoretically conceived designs. Many of these are the result of experiments and juggling of constants until a usable antenna is developed. This makes the explanation of the applicable theory quite complex. The objectives are a suitable match to a 300-ohm transmission line and a functioning antenna. Whatever departures from theory must be made to achieve results, are made. As a rule, the vhf-uhf antennas are used in pairs or *bays*, that is, they are *stacked* so as to achieve still greater improvements in signal pickup than are possible from the use of a simple dipole-and-reflector combination. Stacking is explained in connection with transmission lines elsewhere in this course.

UHF-VHF

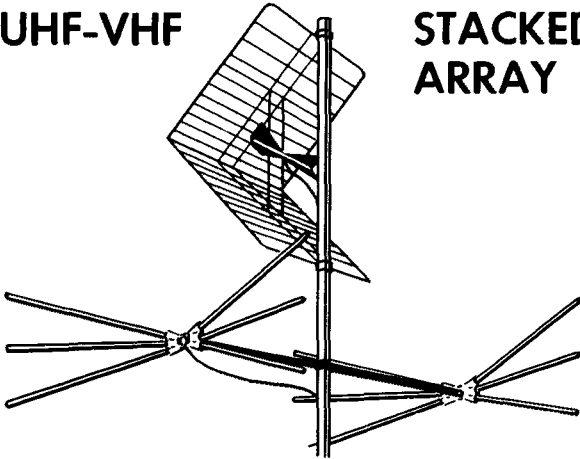

STACKED
ARRAY

There are other varieties in addition to those shown. We cannot overlook the popular and effective simple combination of a conventional conical-equivalent connected-element with reflector, and bow-tie dipole used with a corner reflector, mounted one above the other on a common mast. This arrangement owes much of its popularity to its relatively low cost and its ease of construction and installation.

In fact, the latter version is the more frequent when the directions of approach of the signals from the vhf and uhf stations are unlike, and each antenna must be oriented separately. Each antenna is oriented to suit the receiving conditions. This is in contrast to the specially designed single-unit combination uhf and vhf antenna. Most of these require that the direction of approach of the uhf and vhf signals be substantially the same. By virtue of the mechanical arrangement, orientation of the vhf antenna automatically orients the uhf antenna in the same direction.

UHF AND VHF ANTENNAS

The Rhombic Antenna

This is a very efficient antenna of great frequency capabilities. Its original function was as a communication antenna for directional transmission and reception. Although it has been used for television signal receiving on the vhf band, its dimensional requirements for effective operation have restricted its use over the 54-to-216-mc band. But it has found wide application for uhf reception. The high frequencies permit antennas of practical length to be mounted on antenna masts.

In a sense, the rhombic antenna is an extension of the V type. It might be considered as a diamond-shaped affair lying in the horizontal plane, terminated at one end in a resistance of 600–700 ohms and fed at the other end through a 600-ohm line. This feedpoint resistance permits paralleling this antenna with another 600-ohm antenna to produce a required match to both of 300 ohms. If each leg is several wavelengths long at the frequency of operation, and if the angle θ at the apex is 50° – 70° , the antenna will have a power gain of from 8 to perhaps 12 db over the basic dipole. The antenna is substantially unidirectional in the direction of the terminated end, and has a very narrow principal response lobe; therefore, it is highly directional. It is an excellent antenna for operation over a very wide band of frequencies, especially if the leg lengths are several (about 5 or 6) wavelengths long at the lowest frequency of operation.

Its high order of horizontal directivity stems from the development of two principal response lobes in each leg, and from the condition that one lobe in each leg cancels a corresponding lobe in the other leg. This is four lobes pointing in the same direction. These are additive, and result in a single lobe in the forward direction.

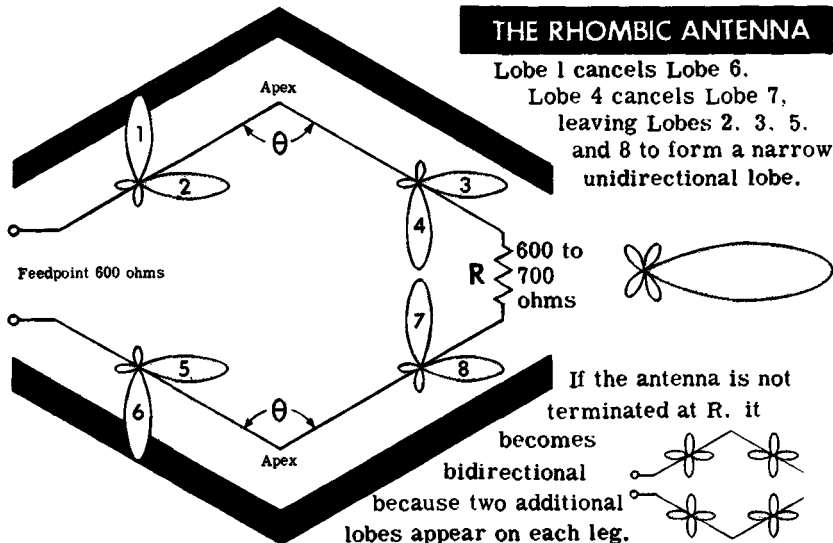

TELEVISION TRANSMISSION LINES

Transmission Lines

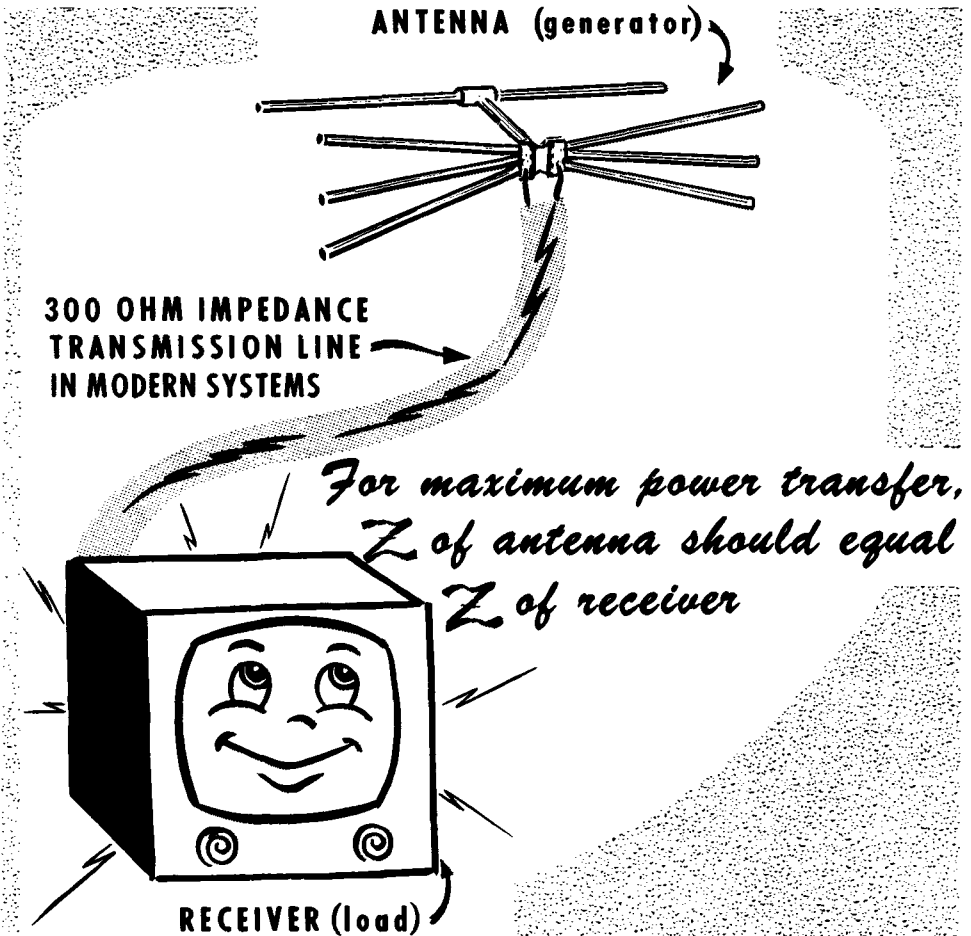

The transmission line is the path over which the signal energy is conducted from the antenna to the television receiver. Its counterpart in the early days of radio broadcast reception was the *lead-in*. But unlike the lead-in wire of old, the television transmission line cannot be just any two wires. On the contrary, it must be selected to electrically “suit” the antenna and receiver constants—specifically, the impedance at each end. We referred to this earlier as matching.

The feedpoint resistance of the antenna also is referred to as *antenna impedance*, with impedance being symbolized by the letter *Z*. Hence, it is said that the transmission line must match the impedance of the antenna to the input impedance of the receiver. The input impedance of the receiver is the input impedance of its antenna coil.

TELEVISION TRANSMISSION LINES

Transmission-Line Reflection

Among the other desired conditions achieved when a proper impedance match exists between an antenna and a receiver, via a transmission line, is freedom from transmission-line *reflections* that produce transmission-line ghosts. Such ghosts are multiple images on the receiver picture tube screen.

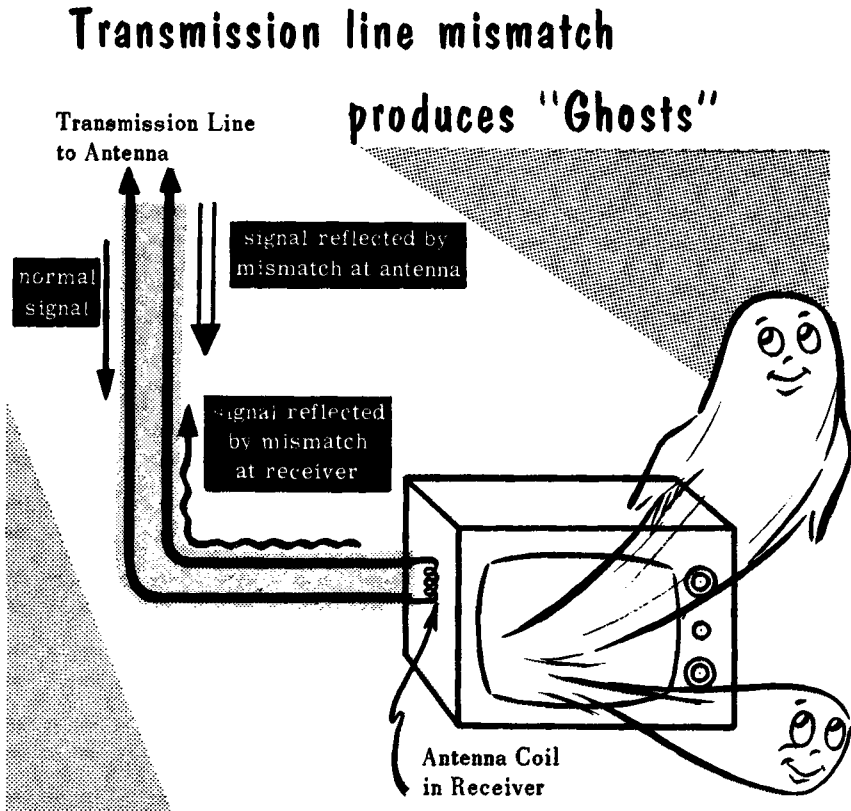

If an impedance mismatch exists between transmission line and antenna input transformer on any channel (or on all channels), all of the signal energy sent down the line is not absorbed by the antenna input coil. Some of it (depending on the amount of mismatch), is sent back up the line towards the antenna. If a mismatch also exists between the transmission line and the antenna, some of the signal energy reflected from the receiver antenna coil is re-reflected at the antenna and sent down the line to the receiver just as if it were a repeat of the original signal. If the transmission line is of substantial length, the re-reflected signal appears as a second image on the picture tube, displaced somewhat to the right. The reflection and re-reflection process can produce several ghost images, depending on how many round trips are made by the reflected signal.

TELEVISION TRANSMISSION LINES

Types of Transmission Lines

Types of transmission lines

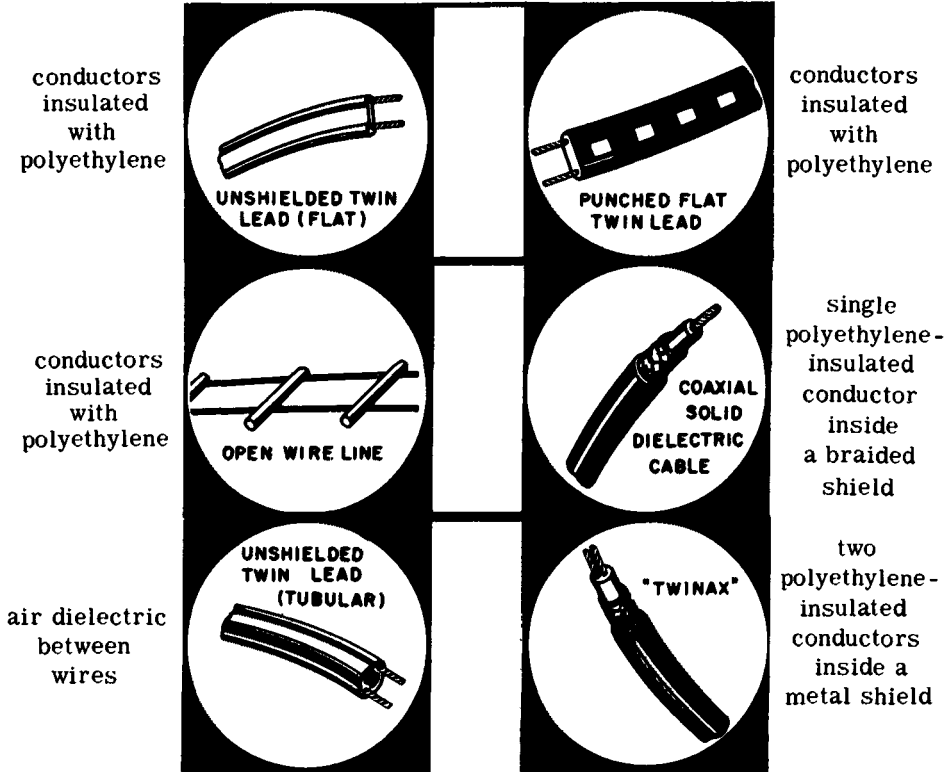

The transmission line used in television receiving systems is a special type of two-conductor cable. It differs from conventional two-wire conductor, such as lamp cord, in many ways. Foremost is the construction; the conductor diameter is constant throughout the length as is the physical separation between the conductors. Also, the material used for keeping the conductors apart and as insulation around the conductors, is *low-loss* material at television frequencies. Although we are concerned with the application of these r-f energy paths to television receiving systems, transmission lines are used over a very wide band of frequencies—far below and above the television broadcasting band.

As to the constructional features, the illustration shows the physical appearance and highlights the constructional details. The types illustrated are those peculiar to television receiving installations. They are only a few of the many varieties that are commercially available for general application as transmission lines in both transmitting and receiving systems.

TELEVISION TRANSMISSION LINES

The Impedance of Transmission Lines

Earlier in this lesson we related the *impedance* of a transmission line to the transfer of energy from an antenna to a receiver. We said that to achieve optimum operation the transmission line must match the feedpoint resistance of the antenna to the impedance of the antenna input transformer.

The impedance (Z) of a transmission line is an abridgement of characteristic impedance (Z_0). It is one of the important electrical constants of a transmission line as well as being a major form of identification relative to application. The impedance rating of the line is the basis of selecting the transmission line which will most suitably link the antenna with the receiver.

Characteristic impedance (Z_0) or simply impedance (Z) is expressed in ohms. In a sense it is comparable to resistance (R) in the conventional d-c circuit or very-low-frequency a-c circuit, although the two are not alike. Circuit resistance (R) expresses the ratio between the voltage E and the current I , or E/I , taking the entire circuit into account. For any given value of d-c voltage E , I is a function of total R . The same is true in a low frequency a-c circuit when the length of the circuit is insignificant relative to a wavelength of the a-c voltage. A wavelength at 60 cycles spans about 3100 miles.

Characteristic impedance similarly expresses the ratio between the voltage E and the current I , or E/I . But instead of dealing with the circuit as a whole, it deals with each point along the transmission line, that is, with instantaneous values of E and I at each point. Also, unlike circuit resistance, which is a function of the conductor material, cross section, and length, Z_0 is a function of the physical construction of the line.

THE CIRCUIT RESISTANCE R

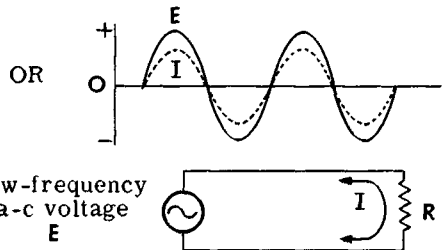
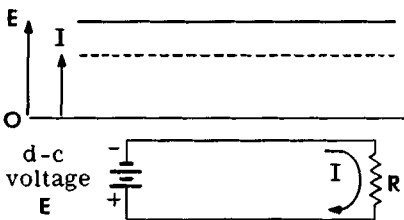

in a d-c circuit or in a low-frequency a-c circuit expresses the ratio between voltage E and current I in the circuit as a whole.

THE CHARACTERISTIC IMPEDANCE Z_0

of a theoretically infinitely long transmission line expresses the ratio between E and I at each point in the circuit, rather than in the circuit as a whole.

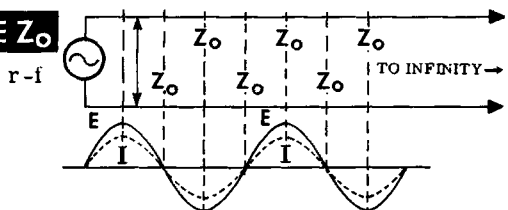

TELEVISION TRANSMISSION LINES

Inductance and Capacitance in Transmission Lines

When a d-c voltage or a low-frequency a-c voltage is applied to a two-conductor cable to which some sort of a load is connected, we concern ourselves mainly with the resistance of the conductors. But when r-f voltage is applied to such a cable we must concern ourselves more with the inductance and capacitance of the cable than with its resistance. Their effects on the current can be very great when the resistance is low. The inductance per foot may be as little as $0.1 \mu\text{h}$ or it may be much more, and the capacitance may be as small as $2 \mu\mu\text{f}$ per foot. There is of course also resistance in each conductor as well as leakage through the dielectric between the conductors. But for the present we neglect them here.

BASIC ELECTRICITY TEACHES THAT

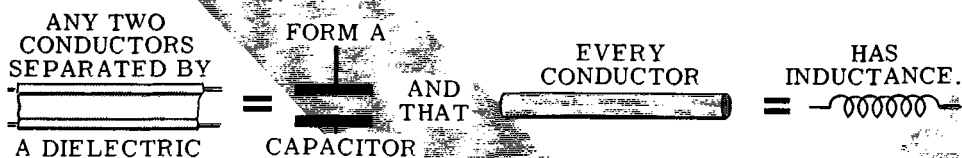

THEREFORE

A TRANSMISSION LINE CAN BE VIEWED AS BEING

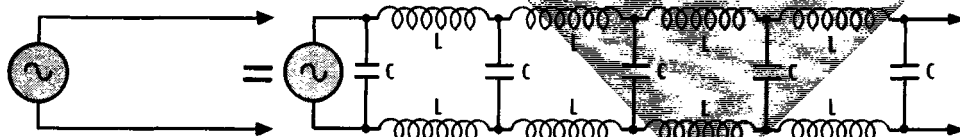

AN INFINITE NUMBER OF DISTRIBUTED SHUNT CAPACITORS AND SERIES INDUCTORS.

The importance of the inductance and capacitance per section of the line (arbitrarily set here as being 1 foot) arises from the way we look at the behavior of a transmission line. We view it as being made up of a great many sections, each of which presents the same fixed amounts of series inductance (L) and the same fixed amount of shunt capacitance (C). When r-f signal energy is applied at the input end of an infinitely long line, it moves down the line past each section at a fixed velocity determined by the design of the line. At each point in its travel the wave encounters an impedance due to the series L and shunt C , and the resultant current at each point is determined by the impedance existing there. In other words, the current is not governed by the whole circuit resistance. Rather, it is governed only by the impedance at the point where the voltage exists.

TELEVISION TRANSMISSION LINES

Characteristic Impedance

THE INFINITELY LONG TRANSMISSION LINE.

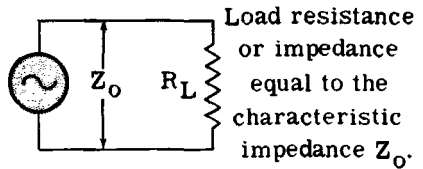
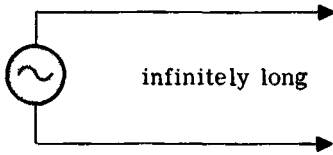

THE PROPERLY TERMINATED LINE OF FINITE LENGTH.

In view of this, the voltage-current ratio is the same everywhere, regardless of the instantaneous value of the voltage. For instance, if the voltage is 1 volt at one point and the current is .0033 ampere at the same point, the ratio $1/.0033$ equals 300 (ohms); if at another point in the same line the voltage is .03 volt and the current is .0001 ampere, the ratio $.03/.0001$ remains 300 (ohms). This ratio is known as the characteristic impedance or, simply the impedance of the line. It is a characteristic of the line construction.

When the characteristic impedance of a transmission line is given, it is assumed that the line is "infinitely" long. The use of an infinitely long transmission line in this discussion is simply a matter of convenience while explaining the action. Obviously a transmission line cannot be endless and still be practical. The conditions which exist with the infinitely long transmission line are achieved by terminating the practical transmission line with a resistance or impedance which is equal to the characteristic impedance of the line. When this is done all the energy sent down the line from the generator is absorbed by the load.

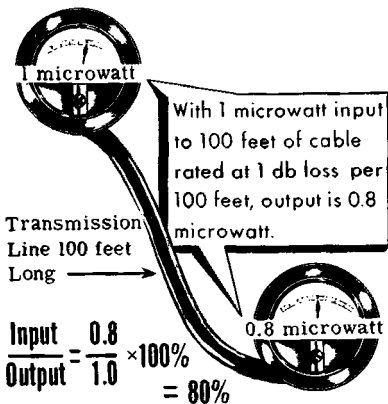

Some loss of energy does occur in the transmission line. It is referred to as *attenuation*. It arises from the resistance of the conductors, from heat losses in the dielectric, and from leakage through the shunt capacitance. Every kind of transmission line suffers some power loss; some types more than others. The amount of signal power loss is expressed in decibels or *db*, usually at 100 mc and for lengths of 100 feet and multiples thereof. For example, conventional flat two-lead wire is rated at a power loss of 1.2 db at 100 mc per 100 feet when dry, and 7.3 db when wet.

TELEVISION TRANSMISSION LINES

Velocity of Propagation Constant of Transmission Lines

You will recall an earlier statement that electromagnetic energy travels fastest (at the speed of light or roughly 300,000,000 meters per second) in free space and is slowed down in physical paths. It requires the application of a correction factor (0.95) when determining the half-wavelength dimension of a thin-rod dipole as compared to a half-wavelength for the same frequency in free space. The same thing happens in transmission lines. In fact, even to a greater degree.

The velocity of a signal moving along a transmission line relative to its velocity in free space is known as the *velocity of propagation constant*, or simply *propagation constant*. It is symbolized by the letters *VP*. Assuming the velocity in free space to be equal to unity or 1, the propagation constant is a percentage of 1. Thus when the manufacturer of a transmission line rates the line at a VP of 0.82 it means that the signal will travel through it at a velocity equal to 82 percent of its velocity in free space. For some other transmission line design the propagation velocity may be only 66 percent of that in free space. These figures are, of course, only approximations. The VP may vary by two or three percent for lines of the same type produced by different makers. The VP figure is not an indication of quality.

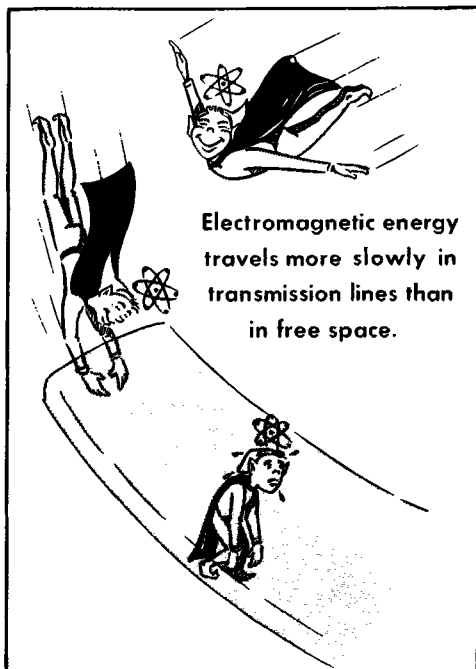

Different kinds of transmission lines bear different propagation-constant ratings. For example, transmission lines spoken of as *open* lines, using air as the dielectric, are rated at a VP of about 0.98. The ribbon type of lead like that which bears the Amphenol trademark Twin-Lead has a VP of 0.83 and the general run of solid dielectric coaxial cables bears a VP of 0.66. Although only three types of transmission lines are shown here, each is representative of a category or type, and therefore can be considered as applying to all versions.

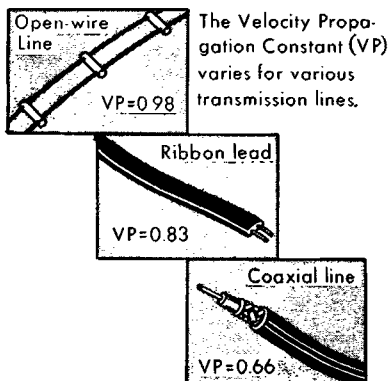

TELEVISION TRANSMISSION LINES

Effect of Velocity of Propagation on Wavelength

It will be remembered that wavelength is a function of frequency when the velocity is constant. If the velocity is changed because the medium through which the wave is moving differs from free space, the wavelength corresponding to a frequency also is changed. For instance, a wavelength corresponding to 85 mc in free space is

$$\begin{array}{l} \text{wavelength} \\ \text{in meters} \end{array} = \frac{300,000,000}{85,000,000} = 3.35 \text{ meters} = 136 \text{ inches}$$

What is the dimension of a wavelength for 85 mc if the energy is being conducted by a transmission line having a propagation constant of 0.83? Having determined the wavelength dimension in free space to be 136 inches, we multiply this figure by 0.83, the propagation constant, and derive the answer— 136×0.83 or about 113 inches. This represents wavelength in this new medium. A half-wavelength then would be $113/2$ or 56.5 inches. If the propagation constant of a medium is 0.66, a wavelength corresponding to 85 mc is 89.7 inches or roughly 90 inches.

THE WAVELENGTH WILL VARY WITH THE PROPAGATION CONSTANT

1 Wavelength of an 85-mc Signal equals

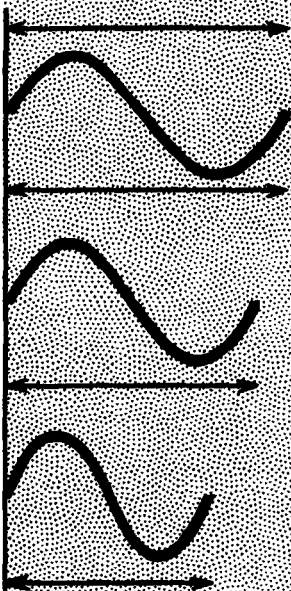

136 inches
in Free Space

112.8 inches
in a material
with VP of 82%

87.1 inches
in a material
with VP of 66%

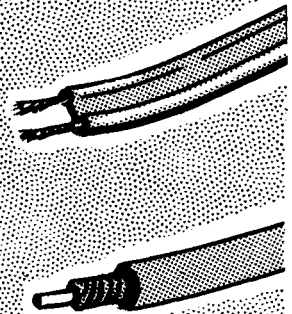

TELEVISION TRANSMISSION LINES

Current and Voltage Distribution in Transmission Lines

WHEN A PROPERLY TERMINATED LINE

of any length is subject to a wave of energy, all points along it are subject to all values of voltage and current

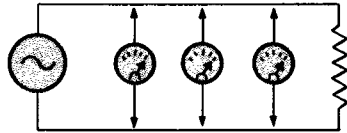
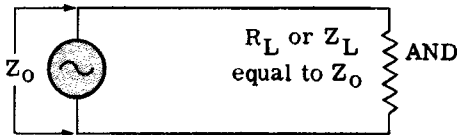

the line behaves as if a constant-amplitude voltage was applied to it.

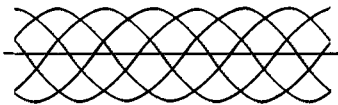

When a transmission line is terminated in a resistance (impedance) equal to its characteristic impedance the energy fed into the line moves from the input to the output, where the energy is absorbed. The input voltage and resultant current pass through cyclic variations between zero and maximum amplitude. The changes occur at every point along the line as the energy advances down the line. Therefore, there are no fixed points along the line at which the voltage or current always are maximum, zero, or any intermediate value between.

A voltmeter connected anywhere along the line will show the same value of voltage; an ammeter inserted anywhere in the line will show the same value of current, ignoring losses. Viewing the voltage and the current as being constant all along a properly terminated transmission line tends to mask a very useful situation. A reversal of phase of 180° occurs every half-wavelength along the line. This condition permits the use of a properly terminated transmission line of suitable length as a means of either changing the phase of the voltage and current by 180° , or tying together two points where the voltage (and current) differ in phase by 180° .

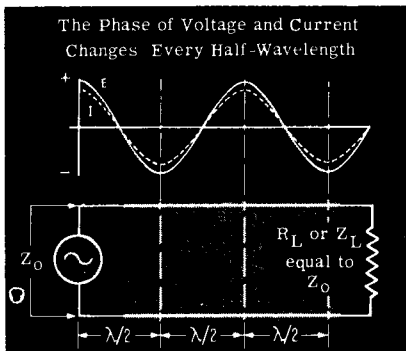

THEREFORE

the phase of the voltage at the input to a half-wavelength line is inverted 180° at the output.

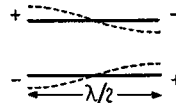

AND

the phase of the input to a full-wave line is duplicated at the output.

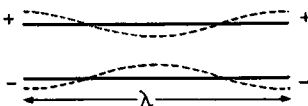

TELEVISION TRANSMISSION LINES

Mismatched Lines

Let us now consider the transmission line which is terminated by a resistance which differs substantially from the characteristic impedance of the line. The load resistance may be higher or lower than the characteristic impedance. In either case a mismatch exists. What happens now? The energy sent down the line from the generator (the antenna, for example) is not absorbed; some of it is reflected at the point of mismatch and sent back along the line. The generator continues supplying energy that goes down the line and the mismatch behaves like a generator that sends energy back up the line. Voltage and current move in both directions. The greater the amount of mismatch the greater is the percentage of energy sent down the line which is reflected back along the line.

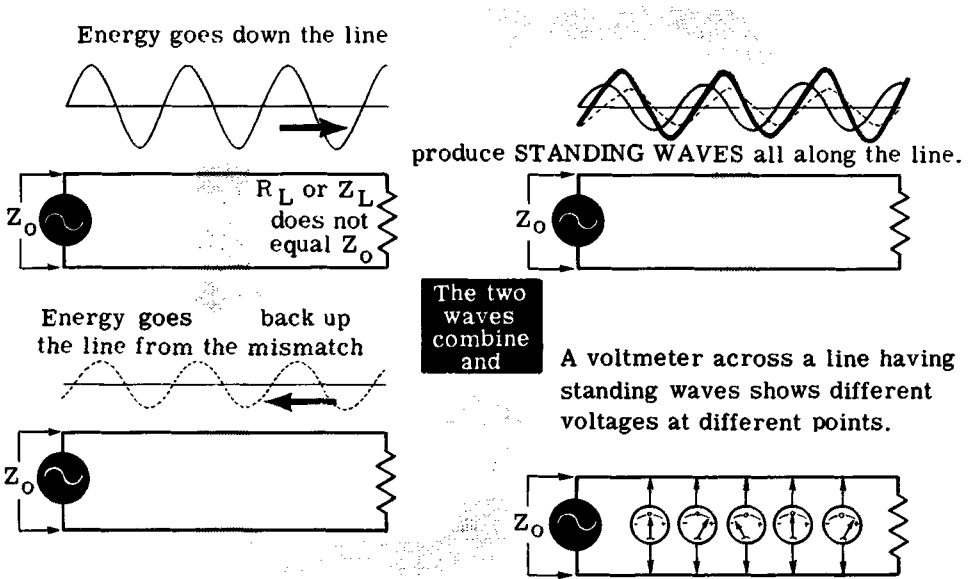

The voltages and resultant currents moving along the line in the two directions combine and produce a new (resultant) pattern of voltage and current all along the line which *remains fixed in position*. They are known as *standing waves* and appear as fixed points of minimum and maximum voltage and current along the line. Let us deal only with the voltage. Corresponding values of voltage would appear a half-wavelength apart relative to the point of mismatch.

As to the practical importance of standing waves on the transmission line between the antenna and the receiver, it means that less than the maximum amount of signal is being delivered to the receiver. Also, it means that the line is sensitive to positioning or handling; motion can result in changes in the appearance of the picture on the picture tube screen.

TELEVISION TRANSMISSION LINES

Open-Circuited Transmission Lines

Let us consider a case of extreme mismatch—the transmission line without a load. Imagine any transmission line open-circuited at the load end. Reflection takes place because of the mismatch, hence standing waves exist on the line. It results in a pattern of voltage and current distribution which leads to special applications.

CHARACTERISTICS OF OPEN-END LINES

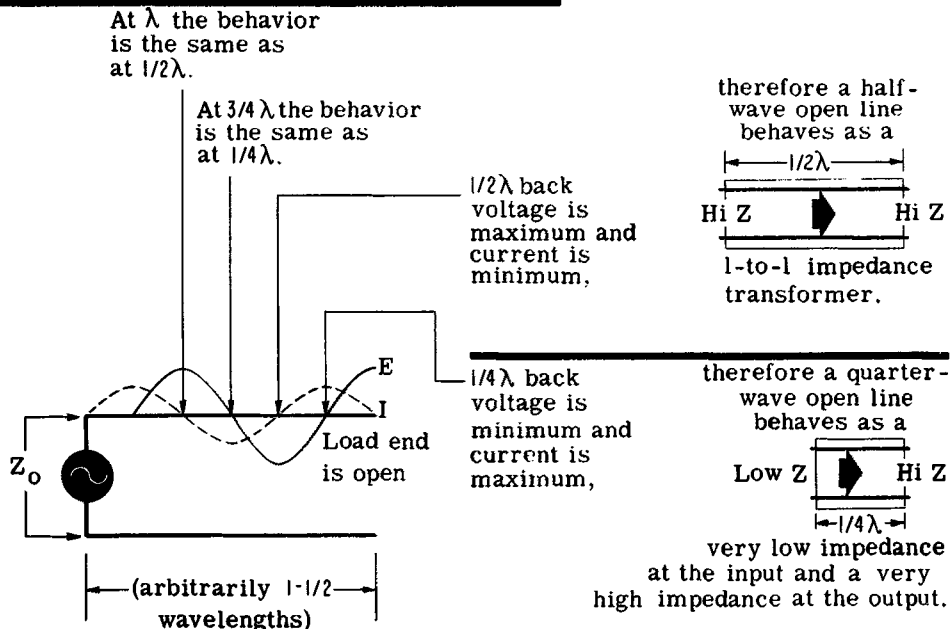

The point of reference for examination is the point of mismatch—the open-circuited end. This is where the reflection originates. Starting at the open end, we say that an open circuit is the equivalent of an infinite impedance or resistance, hence zero current and maximum voltage. One quarter-wavelength back from this point the current is maximum and the voltage is zero. Another way of looking at this is to say that where the voltage is minimum and the current is maximum the transmission line *behaves* as if the impedance is minimum or a short circuit exists. Another quarter-wavelength back along the line we note zero current and maximum voltage; the same conditions as at the open load end. In other words, a half-wave section of open line presents a high impedance at both ends. Moving back another quarter-wavelength, we note maximum current and zero voltage again. Thus the $3/4$ -wavelength line duplicates the conditions of a $1/4$ -wavelength line, and so on. The summary of the behavior is illustrated.

TELEVISION TRANSMISSION LINES

Use of Open-Circuited Transmission Lines

source of signals

connected end

open end

$1/4\lambda$

A quarter-wave line behaves like a series resonant circuit.

If a quarter-wavelength open line is connected across any source of signals, the source will "see" a very low impedance at the frequency for which the line was dimensioned.

A quarter-wave open line connected to an antenna will "short circuit" the antenna over a narrow band of frequencies around the frequency for which the line was dimensioned.

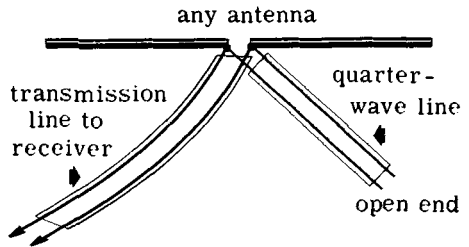

transmission line to antenna

RECEIVER

quarter-wave line

open end

A quarter-wave open line cut for an interfering signal frequency and connected to the antenna terminals of a receiver will act as a short circuit (trap) over a narrow band of frequencies around the interfering frequency.

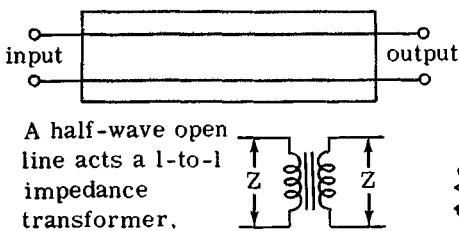

and a half-wave line terminated in a resistance or impedance Z will display the same impedance at the input, accompanied by a 180° phase inversion.



How do we make use of such behavior? If we connect a $1/4$ -wavelength section of an open transmission line across a signal source, the source will "see" very low impedance (a short circuit) at that frequency for which the line is electrically $1/4$ -wavelength long or any *odd multiple* of $1/4$ -wavelength. In this respect it behaves as a series-resonant circuit at resonance.

TELEVISION TRANSMISSION LINES

Use of Open-Circuited Transmission Lines (contd.)

There is still another way of using the $\frac{1}{4}$ -wave open line—as an impedance transformer. The impedance transformer action works in both directions. It would work equally well to match a 300-ohm line to a 72-ohm antenna, or a 72-ohm line to a 300-ohm antenna input transformer.

The half-wave open line is often used as the connecting link between two V antennas positioned in the horizontal plane. The two antennas are separated by a half-wavelength and both behave as connected elements. The approaching wavefront excites the front element and a half cycle later excites the rear element. The lapse in time (half cycle) equals 180° , hence the rear antenna is 180° out of phase with the front antenna. We have said that a half-wave line inverts the voltage by 180° . Therefore the half-wave-length line between the rear and the front antennas shifts the signal voltage by another 180° , making it in phase with the voltage developed in the front antenna.

THE PROBLEM

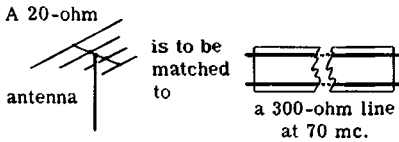

THE SCHEMATIC

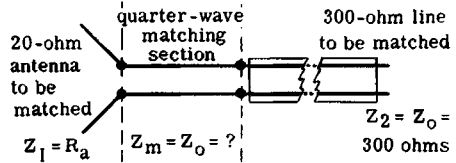

THE EQUATION

$$Z_m = \sqrt{Z_1 \times Z_2}$$

THE SOLUTION

$$Z_m = \sqrt{20 \times 300} = \sqrt{6000} = 78 \text{ ohms}$$

A quarter-wave line with $Z_o = 75$ ohms is satisfactory. The length of the line

$$\text{in inches} = \frac{2952}{70} \times 0.83 = 35 \text{ inches}$$

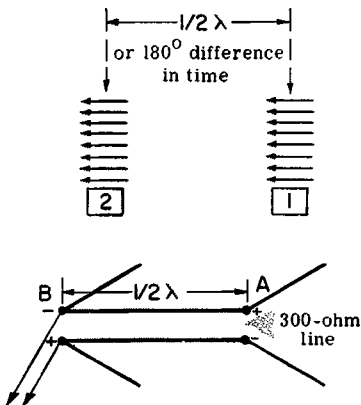

A wave at position 1 excites antenna A and at position 2 excites antenna B (180° later). Therefore, the polarity is reversed at antenna B. A half-wave length transmission line connected from B to A inverts the voltage from antenna A so that it arrives at B in phase with the voltage generated in it by the passing wave.

TELEVISION TRANSMISSION LINES

Short-Circuited Transmission Lines

At the full-wavelength point, behavior is like that at the half-wavelength point.

At a half wavelength back from the shorted end, voltage is minimum and current is maximum

At the three-quarter-wavelength point, behavior is like that at the quarter-wavelength point.

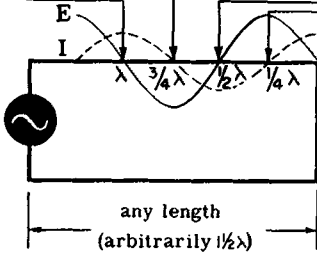

At a quarter-wavelength back from the shorted end, voltage is maximum and current is minimum.

a half-wave shorted line behaves as a very low impedance at input



a quarter-wavelength shorted line

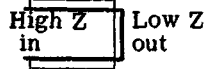

behaves as a very high impedance at the input;

Let us consider another extreme in mismatch—the shorted transmission line. Reflection takes place at the point of mismatch and standing waves appear on the line. The current at the shorted end is maximum and the voltage is minimum—impedance is minimum. Working back from the point of mismatch, the shorted-load end, we note a variety of minimum and maximum impedance points every $\frac{1}{4}$ -wavelength, as summarized in the illustration.

Among many other uses, a shorted $\frac{1}{4}$ -wave line connected across two points where a variety of signals exist will behave as a very low impedance—a virtual short circuit—to all frequencies other than a very narrow band around the one for which it is a $\frac{1}{4}$ -wavelength long. In other words it will select a very narrow band of frequencies and short out the rest. If the shorted line is $\frac{1}{2}$ -wavelength long, it will short circuit a very narrow band of frequencies and pass the rest.

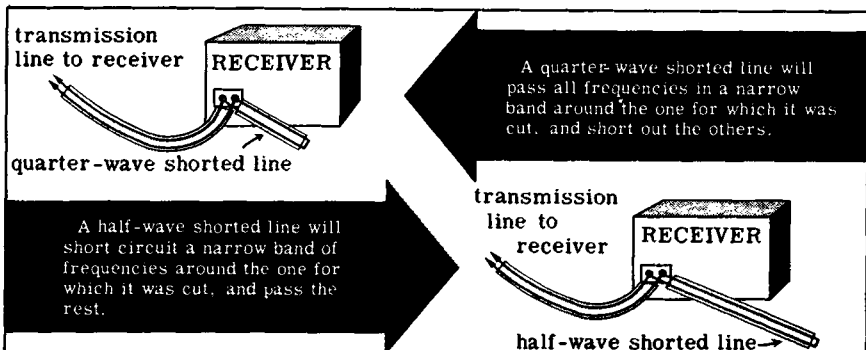

TELEVISION TRANSMISSION LINES

Antennas and 300-Ohm Transmission Lines

It has become standard practice to design television receivers for use with 300-ohm transmission line. To permit the use of these lines antenna manufacturers resort to different means of achieving a suitable approximation of 300 ohms feedpoint resistance. Because of the high signal level which prevails in highly populated areas, feedpoint resistance between 200 and 400 ohms has been found tolerable. The loss in signal strength is not too important in most cases.

A frequent practice followed in antenna design is to operate off-resonance. This does not defeat the fundamental theory as described in these lessons. In fact the reverse is true; it shows the practical application of the change in feedpoint resistance of a dipole antenna cut for a certain frequency as the frequency changes. By making the antenna length somewhat shorter or longer than the half-wave resonant length, the feedpoint resistance is raised so as to become a suitable match for a 300-ohm line. Also, the use of a folded dipole as the connected element is frequent. It is made slightly off-resonant for the connected-element-reflector combination, and when several directors and a reflector are used the folded dipole is designed for feedpoint resistance of two or three times the nominal 300 ohms.

Achieving the Usable Feedpoint Resistance

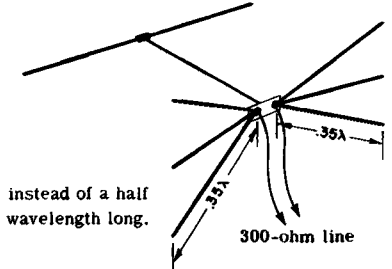
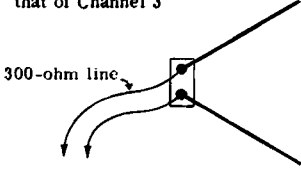
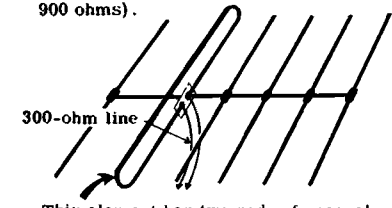
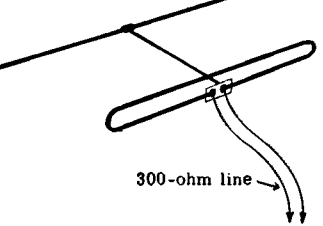
<p>The conical antenna may be 0.7 to 0.75 wavelengths in overall length at its center frequency</p>  <p>instead of a half wavelength long.</p> <p>300-ohm line</p>	<p>The V antenna intended for vhf coverage is cut for a frequency some what below that of Channel 4 and above that of Channel 3</p>  <p>300-ohm line</p> <p>and will function over both vhf and uhf channels.</p>
<p>Usually, Yagi antennas are intended for single channels. It has a folded dipole connected element (R_a 600 to 900 ohms).</p>  <p>300-ohm line</p> <p>This element has two rods of unequal diameter or three rods of the same diameter.</p>	<p>The folded -dipole/reflector antenna can be cut slightly longer than a half</p>  <p>300-ohm line</p> <p>wavelength at the center frequency.</p>

SPECIAL TECHNIQUES

Stacked Antennas

It is possible to arrange antennas physically so as to take advantage of the signal distribution along the vertical dimension of the wavefront of an approaching wave and so extract an increased amount of energy. It is done by placing the antennas one above the other, separated by a half-wavelength. Such antennas are stacked vertically. Horizontal stacking also is possible.

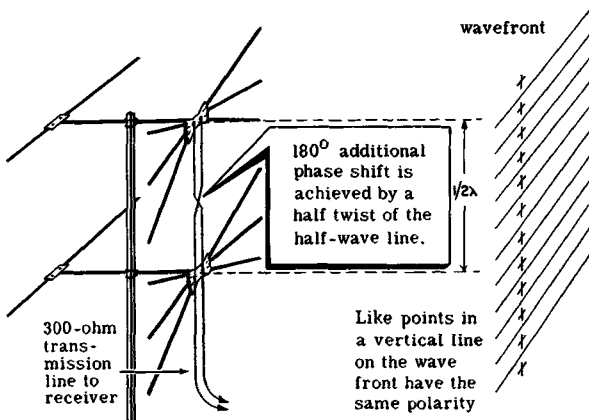

The approaching wavefront strikes both antennas at the same time and induces a like voltage in each of them.

The 180° phase shift imparted by the half-wave line is increased to 360° by giving the line a half twist.

Currents from the antennas are thus in phase, and maximum signal is delivered via the transmission line to the receiver.

All varieties of dipole antennas can be stacked vertically. But for the sake of simplicity we illustrate the discussion using two conical equivalents with reflectors. The horizontal directional properties of the stacked antenna remain the same as for either one of the antennas alone, the principal advantage of vertical stacking being an approximate two-fold increase in the amount of power extracted from the passing wave. Vertical stacking of two antennas affords a 3-db power gain over one antenna. As a rule, antennas stacked vertically are of an even number such as 2, 4, 6 and so on.

All points in the vertical plane along a wavefront have identical polarity. Hence, each antenna is acted on at the same instant by a voltage of like polarity, and the currents in the two antennas flow in the same direction. In order that the signals in the two antennas be fed to a common transmission line, a half-wave line (of any characteristic impedance) connects the two feedpoints, and the line to the receiver joins the feedpoints of the lower antenna. It will be remembered that a half-wavelength transmission line inverts the polarity of the voltage by 180° between the input and the output. To offset this action and to make the two antennas behave as one relative to signal polarity, the half-wave line connecting the two antenna feedpoints is given a mechanical half twist so that the instantaneous *plus* lead on the top antenna joins the instantaneous *plus* point on the lower antenna. In this way the signals fed to the common transmission line are in phase all the time.

SPECIAL TECHNIQUES

Location of the Transmission Line Takeoff Point

Locating the takeoff point for the main transmission line to the receiver at one of the antenna feedpoints is a compromise based on convenience. It works satisfactorily because of the high antenna resistance at the feedpoints and because some loss of signal can usually be tolerated. Technically speaking, the resistance at the feedpoint under such circumstances is no longer the feedpoint resistance; actually two antenna feedpoint resistances are in parallel and the takeoff resistance now is one-half of what it was when they were unconnected.

Oftentimes the takeoff point for the main transmission line to the receiver is half-way along the transmission-line section that connects the two antennas. In that event, the resistance (impedance) at the takeoff point is equal to half the feedpoint resistance value. Assuming truly 300-ohm antennas, the takeoff point resistance is 150 ohms and would require a transmission line rated at this value. 300-ohm lines have been used in such cases. It is not a good match but it has been found acceptable. In the event that the antenna feedpoint resistance is substantially higher than 300 ohms because of nonresonant operation, the 300-ohm transmission line connected to the takeoff point is entirely satisfactory.

Connection of the transmission line to a stacked array.

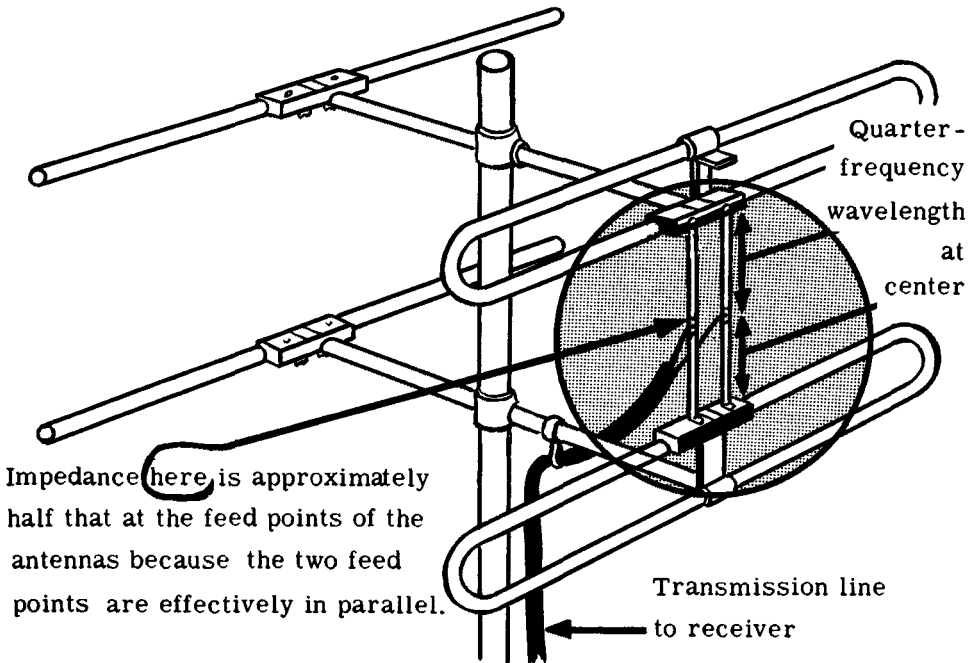

SPECIAL TECHNIQUES

Matching Transformers and Indoor Antennas

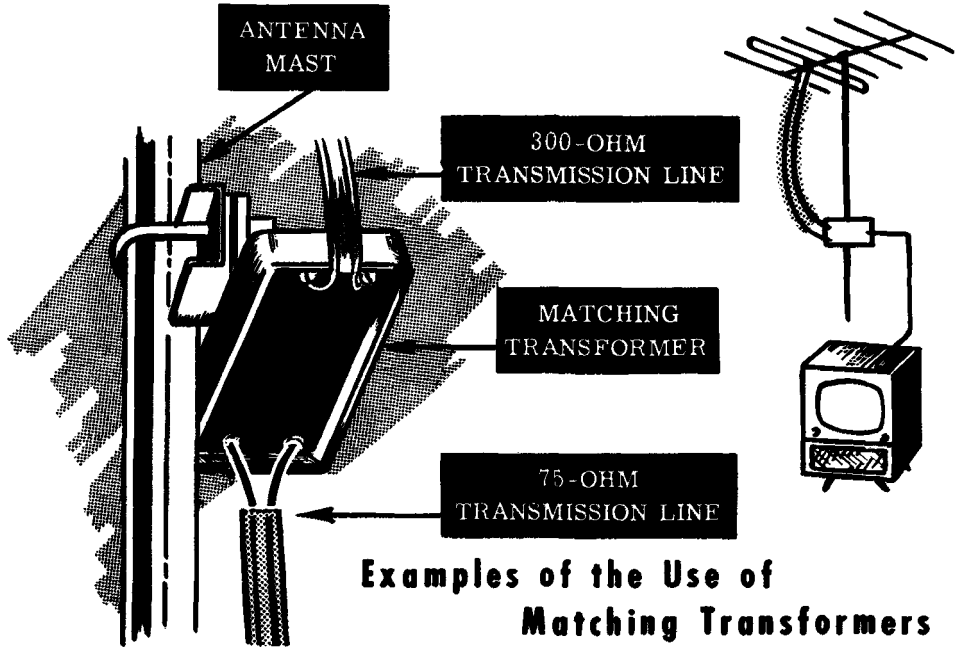

Many types of antennas are available. The modern installations are designed for 300-ohm transmission lines, but many others in use were designed with feedpoint resistance values which required 72 to 75-ohm lines or 300-ohm lines. To accommodate these different types of antenna designs for receivers rated at 72–75 or 300 ohms input impedance, matching transformers (*baluns*) were conceived. Sometimes they are called elevator transformers. Their function is to match these antenna feedpoint resistance values to the receiver. In essence, matching transformers of this kind are coiled transmission lines which can be connected in parallel or in series as required by the impedance match requirements.

The indoor antenna takes many shapes, most popular of which is the upright V also called *rabbit ears*. The arms are adjustable in length, being adjusted to the best response as seen on the picture tube screen. Although used with a 300-ohm transmission line, it is in the main the equivalent of an ordinary center-fed dipole of adjustable length. Operation off-resonance accounts for whatever feed-point resistance match is made. As a rule, the rabbit ears provides relatively poor performance when compared to conventional antennas. It is used only where an outdoor type cannot be installed.

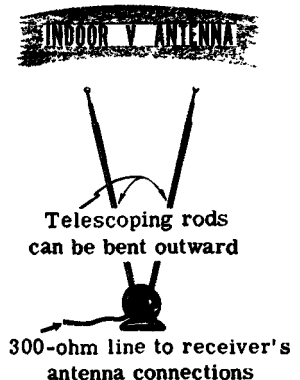

REVIEW

1. *Response of a Dipole-Reflector Combination.* The signal available for transfer to the receiver in the connected dipole is more than was actually extracted from the passing wave by that element. The signal intercepted by the reflector makes its contribution by re-radiating some of the energy to the connected element.

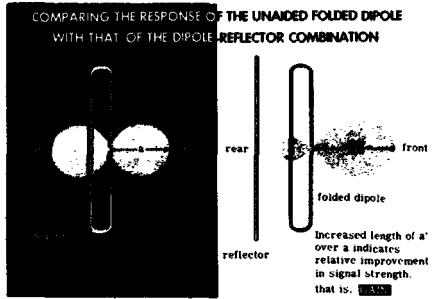

THE BOW-TIE ANTENNA WITH CORNER REFLECTOR

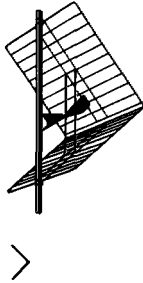
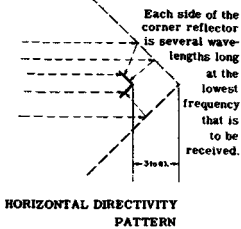

2. *UHF Antennas.* In the bow-tie antenna used with a corner reflector, the connected dipole is bent into a horizontally positioned V. Its sides are then parallel to the sides of the corner reflector so that maximum energy is returned from the reflector to the dipole.

3. *Combination Low- and High-Band VHF Antennas.* The high-band antenna is positioned above the low-band antenna. The vertical separation between the two assemblies usually approximates a half-wavelength corresponding to the geometric mean of the frequencies for which the two antennas were cut.

COMBINATION LOW-BAND AND HIGH-BAND VHF ANTENNA

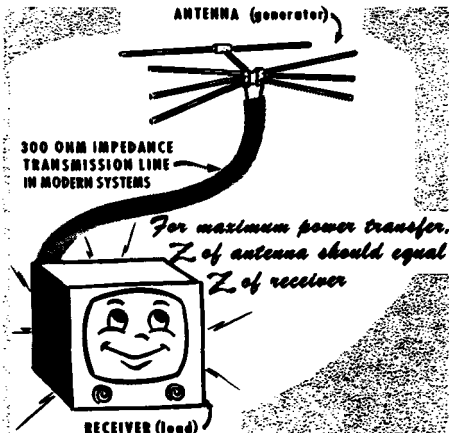
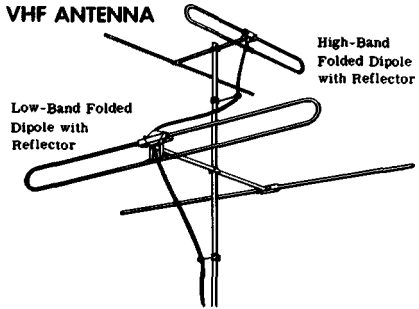

4. *Transmission Lines.* The transmission line is the path over which the signal energy is conducted from the antenna to the receiver. It must be selected to "match" electrically the antenna and the receiver impedances, which are made equal in value.

REVIEW

Types of transmission lines

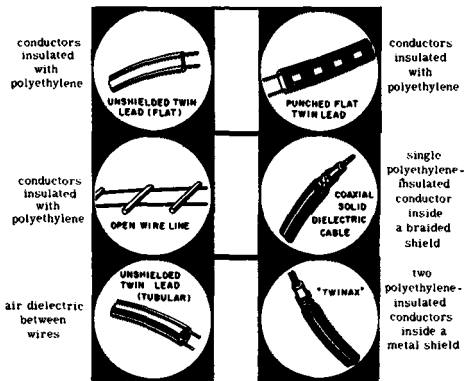

6. *The Velocity of Propagation* of a signal moving along a transmission line relative to its velocity in free space is known as the velocity of propagation constant, or simply propagation constant. Assuming the velocity in free space to be equal to unity, or 1, the propagation constant is some percentage of 1.

5. *Types of Transmission Lines.* The transmission line used in television receiving systems is a special type of two-conductor cable. The conductor diameter is constant, as in the physical separation between conductors. The dielectric that separates the conductors is low-loss material at television frequencies.

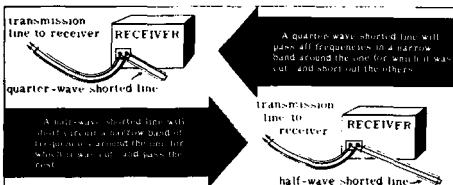
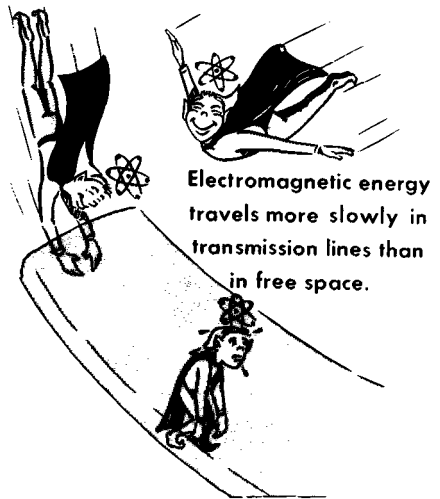

7. *Short-Circuited Transmission Line* $\frac{1}{4}$ -wave long will behave as a virtual short circuit to all frequencies other than a very narrow band around the one for which it was cut. If the shorted line is $\frac{1}{2}$ -wavelength long, it will short circuit a very narrow band of frequencies and pass the rest.

8. *Indoor Antennas.* The most popular indoor antenna is the upright V, also called *rabbit ears*. The arms are adjustable in length, being adjusted to the best response as seen on the picture tube screen. Because of its relatively low gain, it is used only when an outdoor type cannot be installed.

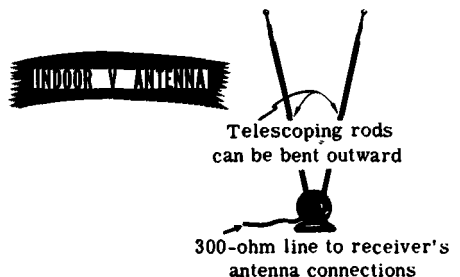

INDEX TO VOL. II

(Note: A cumulative index covering all five volumes in this series will be found at the end of Volume V.)

- AFC, 2-40, 41
- AGC, 2-22, 23
- Amphenol, 2-129
- Antennas:
 - bandwidth, 2-101
 - basic dipole, 2-67-77
 - computations of, 2-68, 69
 - forms of, 2-74, 75
 - resonance in, 2-76
 - signal interception by, 2-77
 - batwing, 2-107
 - biconical, 2-104
 - bow-tie, 2-118
 - broadband yagi, 2-116
 - center frequency, determination of, 2-102
 - combination lo-band and hi-band vhf, 2-119
 - combination vhf and uhf arrays, 2-120, 121
 - conical, 2-105
 - connected element with reflector and director, 2-115
 - continuous rod, re-radiation from, 2-79
 - corner reflector, 2-118
 - corner reflector, equivalent, 2-120
 - dipole:
 - behavior, 2-76-79
 - center frequency, 2-100
 - response, 2-82-90, 99-102
 - broadside positions, 2-82
 - parallel positions, 2-82
 - types of, 2-103-108
 - dipole-reflector combination, 2-113, 114
 - power gain of, 2-113, 114
 - directional response, 2-63, 83
 - directivity, 2-83
 - elements, addition of, 2-113-116
 - feedpoint, 2-95
 - folded dipole, 2-107, 108, 114, 118
 - half-wave dipole:
 - directional response, 2-86-90
 - E and I, at resonance, 2-91
 - nonresonant, resistance of, 2-93, 94
 - power transfer from, 2-96
 - resistance of, 2-92
 - thin, frequency response of, 2-99
 - zero-db rating of, 2-72, 73
 - impedance, 2-123
 - input transformer, 2-98
 - large cross-section, 2-103
 - loadpoint, 2-95
 - loadpoint resistance, 2-97
 - multiple element, 2-111
 - operation of, 2-112
 - parasitic elements, 2-111, 112, 114, 116
 - rabbit ears, 2-140
 - receiving dipole:
 - broadside positions of, 2-82
 - positioning effects, 2-84, 85
 - reflector, 2-112, 115, 117, 120
 - re-radiation:
 - continuous rod, 2-79
 - receiving dipole, 2-78
 - resistance, 2-92-98
 - half-wave, antenna, 2-92
 - nonresonant half-wave antenna, 2-93, 94
 - rhombic, 2-122
 - special techniques, 2-138-140
 - stacked, 2-138
 - TV receiver, general, 2-53, 54
 - uhf, 2-117-122
 - vhf, 2-117-122
 - V, 2-106, 120, 140
 - Yagi, 2-116
- Automatic frequency control, 2-22, 23
- Automatic gain control, 2-22, 23

- Brightness, 2-29

- Characteristic impedance, 2-128
- Contrast, 2-29

- D-C restoration, 2-29
- Deflecting yoke, 2-32
- Delayed avc, 2-22,
- Demodulation, 2-18, 19, 21
- Detector, f-m, 2-27
- Discriminator, f-m, 2-27
- Double-conversion uhf reception, 2-49

INDEX

- Electromagnetic wave theory, 2-62
- Field concept, 2-64, 65
- Fine tuning control, 2-10
- Frequency-conversion process, 2-11-14
- Ghosts, 2-124
- Guard band, 2-6
- Horizontal:
 - afc circuit, 2-40, 41
 - damper, 2-43
 - linearity control, 2-43
 - hold control, 2-42
 - output stage, 2-42
 - output transformer, 2-43
 - sweep circuits, 2-40-43
 - sweep section, 2-40
 - width control, 2-43
- Impedance mismatch, 2-124
- Incorrect oscillator output
 - frequency, causes of, 2-10
- Indoor antennas, 2-140
- Infinitely long line, 2-128
- Intercarrier principle, 2-21
- Intercarrier video amplifier, 2-24, 25
- Intermediate frequencies, 2-11-14
- Lead-in, 2-123
- Limiter, f-m, 2-27
- Line-of-sight transmission, 2-59
- Local oscillator:
 - frequency, 2-10
 - relative position of, 2-10
- Long-distance television reception, 2-60
- Matching transformers, 2-140
- Mixer function, radio receiver, 2-8
- Negative-phase voltage, 2-19, 25
- Oscillator, function radio receiver, 2-8
- Picture i-f:
 - carriers, frequencies of, 2-13, 14, 16, 17
 - i-f signal, 2-11
- Picture tube, 2-45
- Polarized radiation, 2-65, 66
- Positive-polarity voltage, 2-19, 25
- Power supplies, 2-45
- Propagation, 2-55-60
 - constant, 2-129
- Pulse:
 - clipper, 2-34
 - separator, 2-34
 - types, introduction to, 2-33
- Radiated wave, 2-61, 66
- Reflection of TV waves, 2-61
- Resting frequency, 2-6
- Review, 2-30, 31, 50, 51, 52, 80, 81, 109, 110, 141, 142
- R-F amplifier:
 - functions of, 2-3
 - response, 2-7
- Sidebands, 2-5, 11
- Single-conversion uhf reception, 2-48
- Six-mc channel bandwidth, 2-5
- Soundbars, 2-24
- Sound:
 - carrier, 2-6
 - channel. fm. 2-26, 27
 - i-f carrier, frequencies of, 2-12, 13, 14, 16, 17
- Standing waves, 2-132
- Station selector, 2-4
- Superheterodyne receiver, 2-8
- Sync:
 - amplifier, 2-35
 - clipper, 2-34
 - pulse separation, 2-34
 - separator, 2-34, 35
- Synchronization, 2-33
 - circuits, 2-32-35
- Television:
 - channel, 2-4, 5
 - receiver:
 - front end, 2-15
 - general layout of, 2-1, 2
 - i-f amplifiers in, 2-16, 17
 - mixer and oscillator function, 2-9
 - relation to radio receiver, 2-2
 - split-sound, 2-47
 - signals, propagation of, 2-55-58
 - transmission lines, 2-71, 123-137

INDEX

Transmission lines:

- attenuation, 2-128
- E and I distinction in, 2-131, 132
- impedance, 2-126
- L and C in, 2-127
- open-circuited, 2-134, 135
- reflection, 2-124
- short-circuited, 2-136
- takeoff point, 2-139
- 300-ohm, 2-137

Tuner:

- frequencies, 2-3-10
- i-f stages, 2-15-17

Tuning function, 2-3

UHF reception, 2-48, 49

Vertical:

- height control, 2-37
- hold control, 2-37
- linearity control, 2-38
- output stage, 2-38
- sweep circuits, 2-36-38

VP, 2-129

Vestigial-sideband transmission, 2-5

Video:

- amplifier, 2-24, 25
- detector, 2-18-21

Wavelength, formula for signal in

- free space, 2-68
- sample computation, 2-130

\$2.25

basic television

by Alexander Schure, Ph.D., Ed.D.

VOL. 3

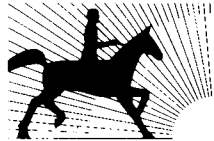

JOHN F. RIDER PUBLISHER, INC.
116 West 14th Street • New York 11, N. Y.

Copyright January 1958 by John F. Rider Publisher, Inc.

All rights reserved. This book or any parts thereof may not be reproduced in any form or in any language without permission of the publisher.

Library of Congress Catalog Card Number 57-13493

Printed in the United States of America

PREFACE

This five-volume course in the fundamental principles of television represents the end product of three years of research and experimentation in teaching methods and presentation at the New York Technical Institute. As a result of this experimentation in correspondence and resident courses approved by the New York State Department of Education, and following the recommendations of advising industrial groups, the highly pictorialized presentation used throughout this book was adopted. An illustration has been provided for each important concept and placed together with the explanatory text on the same page to pinpoint essential material. In addition, review pages spaced throughout each volume summarize the major points already presented.

This combination of the visual approach and idea-per-page technique makes **BASIC TELEVISION** readily understandable with or without an instructor. It is thus suitable for individual or correspondence use as well as for classroom study. Its coverage is complete from the creation of the television image in the studio to its appearance on the receiver screen, and presupposes only a knowledge of basic electronics and radio. Many topics not covered in the more traditional texts are treated here and fully explained for the first time.

The author wishes to acknowledge the assistance of his staff at the New York Technical Institute and that of Mr. Gilbert Gallego in the preparation of some of the illustrations. Special gratitude is due to the staff of John F. Rider Publisher and to Mr. Rider personally for his contributions to both the text and the picturization of this course.

New York, N. Y.
January 1958

ALEXANDER SCHURE

CONTENTS

VOL. III—BASIC TELEVISION

The Front End	1
Tuner Circuitry	14
Cascode Tuners	23
Review	29
Tuning Arrangements	31
Traps and Coupling Methods.....	39
UHF Converters	50
Tuner Response	56
Review	63
The I-F Amplifier.....	65
Review	91
The Video Detector.....	93
The Sound Signal.....	104
Automatic Gain Control.....	107
Review	113
The Video Amplifier.....	115
Review	133

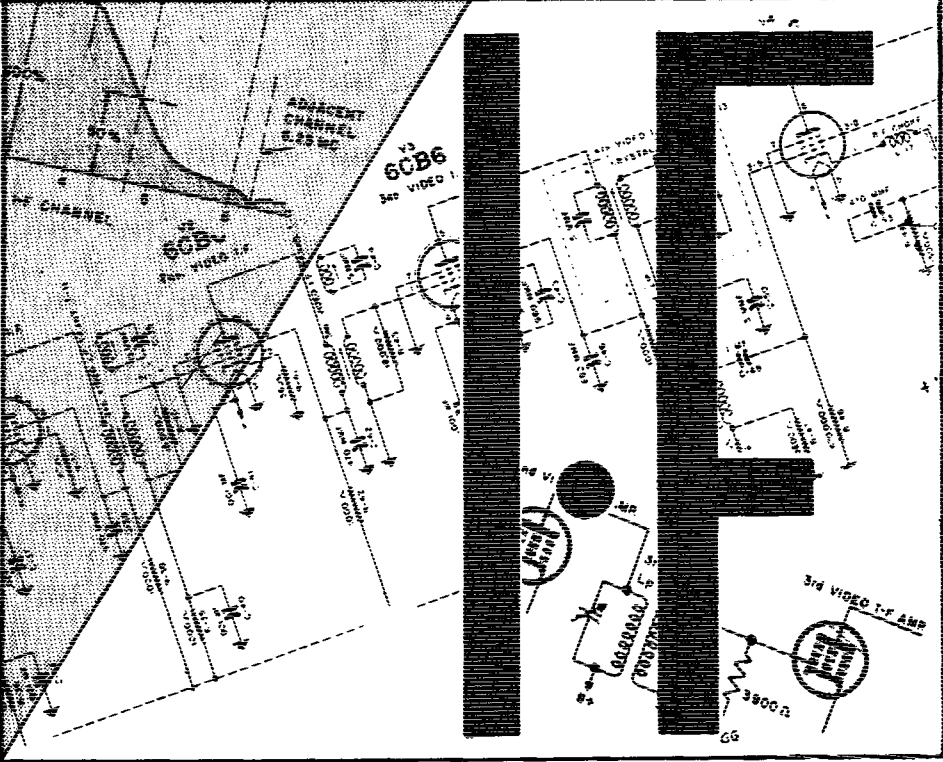
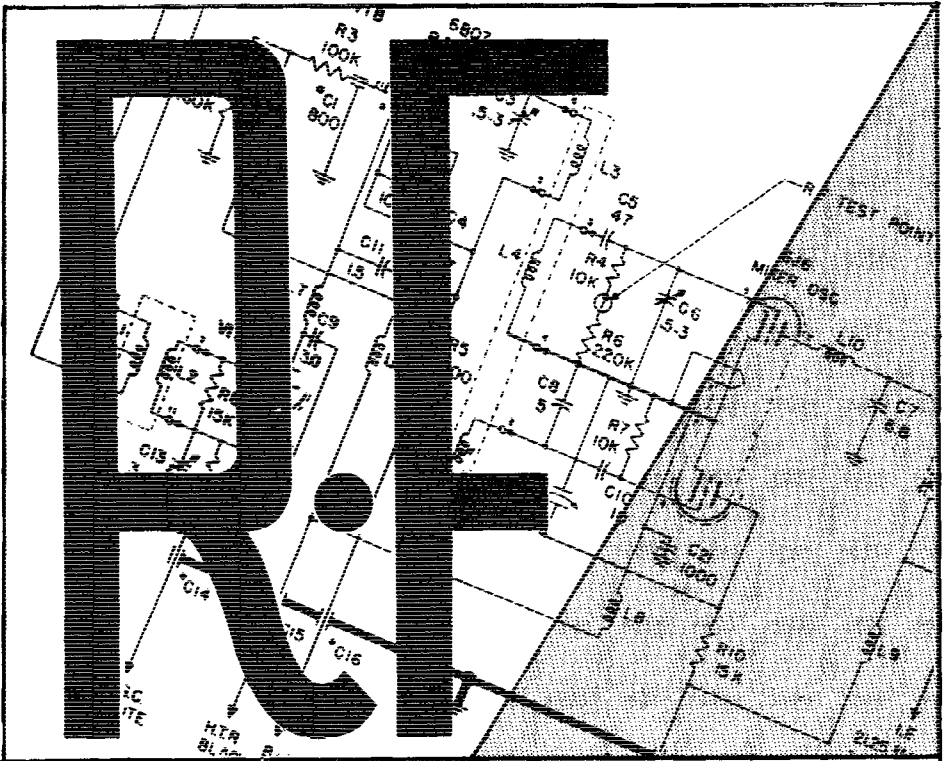

THE FRONT END

VHF and UHF Television

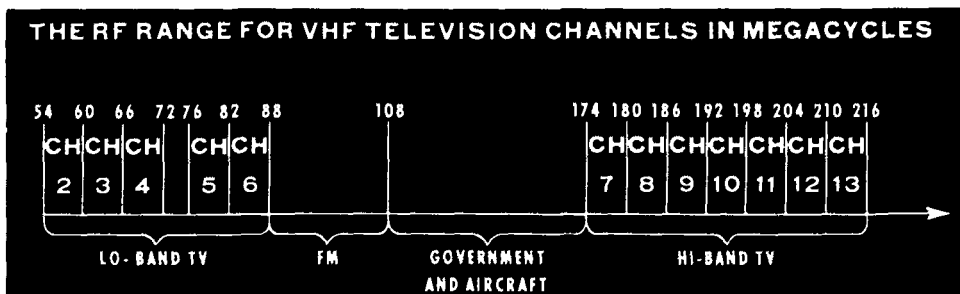

The frequency range of *rf* in home television broadcasting begins with 54 mc, the lower frequency limit of the vhf group of TV channels. In both radio and television, the meaning of *rf* is the same; it refers to the frequency of the carrier waves that are radiated from the transmitter to the receiver. The *low band* of television stations occupies the frequency range from 54 to 88 mc, with a small gap of 4 mc between channels 4 and 5. (This band—from 72 to 76 mc—is used by other services.) Between the low-band and the high-band stations there is a frequency space (88 to 174 mc) that is occupied by f-m broadcasting and government and aircraft communications services. The high-band stations occupy the range from 174 to 216 mc. The entire low- and high-band range is called the vhf portion of the television frequency spectrum.

Ever since the beginning of television broadcasting, there has been a great demand for additional channels. Most localities in the nation are limited to three different television stations; in New York City and Los Angeles, however, seven channels are available to television viewers. With all the frequency space in the vhf band occupied, the demand for new television frequencies was met by entering the uhf region.



Channel 14, the first of the uhf channels, occupies the band from 470 to 476 mc, channel 15 from 476 to 482 mc, channel 16 from 482 to 488 mc, and so on, all the way up to 890 mc. Within this band from 470 to 890 mc (a total of 420 mc) 70 television channels are accommodated. Like the vhf allocations, each uhf television channel is 6 mc wide.

THE FRONT END

Unbalanced and Balanced R-F Input Systems

The part of the receiver that the modulated r-f picture and sound carrier waves sent out by the transmitter pass through (the r-f amplifier) is similar, whether the signals are in the vhf or uhf band. The point where the antenna is connected to the r-f amplifier is its input. A number of considerations relating to the r-f input will now be examined; its output will be treated separately.

The r-f amplifiers used in television receivers are of several types but the antenna input systems of these amplifiers can be placed in two major groups *unbalanced* and *balanced*. Although use of the balanced system has been virtually standard practice in all television receivers manufactured during the past six or seven years, we must deal with unbalanced input as well.

The distinction between the unbalanced and balanced input systems lies in the absence or presence of electrical symmetry relative to ground or chassis, in the antenna, the transmission line, and in the antenna input transformer primary windings. The unbalanced system employs the usual television antenna and the conventional two-wire transmission line, but the primary winding of the antenna input transformer to which the transmission line is connected is a two-terminal coil, one end of which is grounded.

One lead of the transmission line connects to one of the antenna terminals on the antenna terminal strip; this terminal is internally connected to the "high" side of the antenna transformer primary winding. The other lead of the transmission line connects to the other antenna terminal on the terminal strip, which is internally connected to the "low" or grounded side of the primary winding. Such a system is electrically "unbalanced" relative to ground or chassis, since one leg of the transmission line is grounded while the other is not grounded.

Noise voltages induced in the transmission line cause currents to flow in the same direction in both legs of the line, whereas the currents due to desired signal pickup by the antenna, flow in opposite directions.

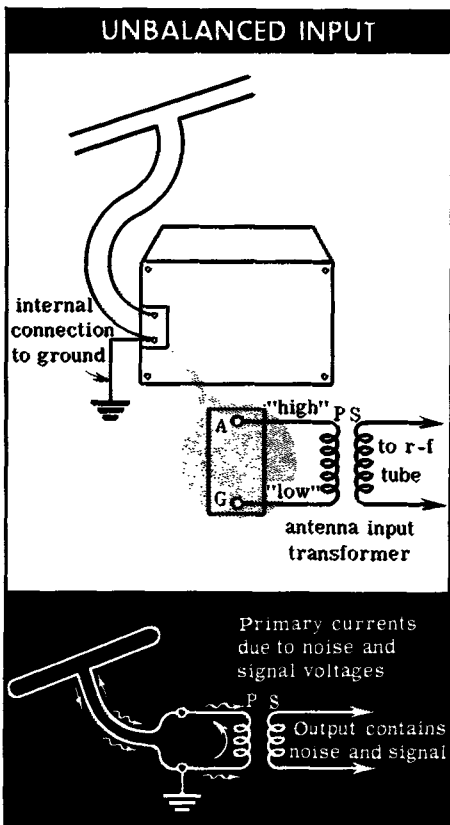

THE FRONT END

Unbalanced and Balanced Input Systems (contd.)

Both currents flow to the antenna input transformer primary winding. The noise currents do not cancel each other in the unbalanced input, hence voltages corresponding to both noise and the desired signal are induced in the secondary of the transformer and are fed into the r-f amplifier. The electrical unbalance also tends to have a bad effect on receiver and picture stability.

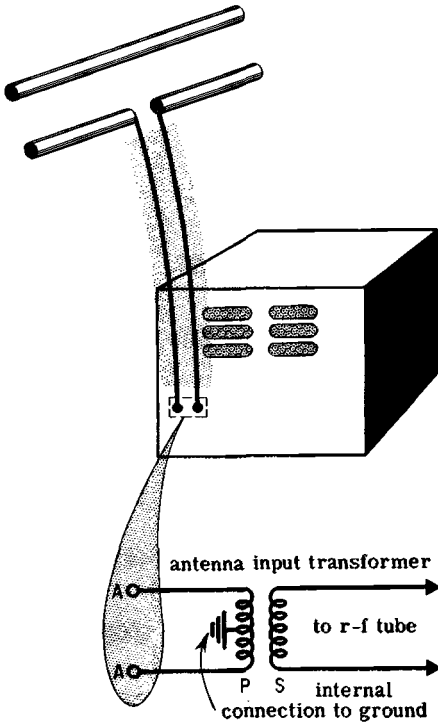

BALANCED INPUT

ANTENNA AND TRANSMISSION LINES BALANCED TO GROUND

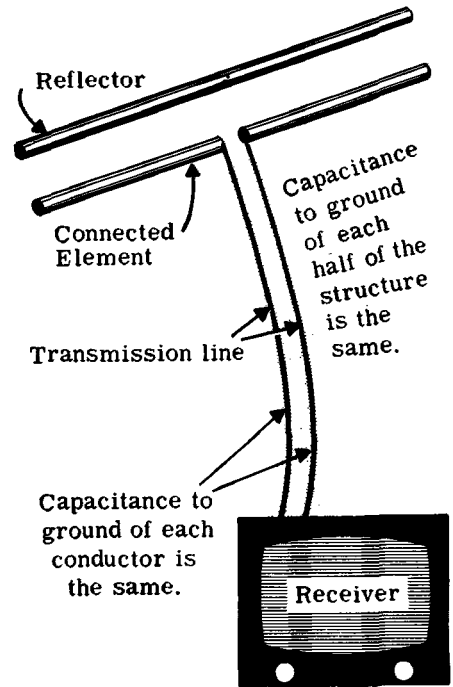

The balanced input system differs only slightly in design from the unbalanced system, but contributes a great deal to minimizing noise interference and improving receiver stability. The principal difference between the balanced and unbalanced input system is in the use of a 3-terminal primary winding in the antenna input transformer with the center tap grounded. The legs of the transmission line are connected to the ends of the primary of the antenna coil. With the center tap connected to ground, corresponding points on each half of the primary winding, on the two legs of the transmission line, and on the antenna itself are at the same potential relative to ground.

THE FRONT END

Unbalanced and Balanced Input Systems (contd.)

Operationwise, signals picked up by the antenna cause currents to flow in opposite directions in the transmission line and in the same direction in the primary winding. The voltages induced across each half of the primary winding therefore aid each other, and result in the maximum signal voltage across the secondary of the transformer.

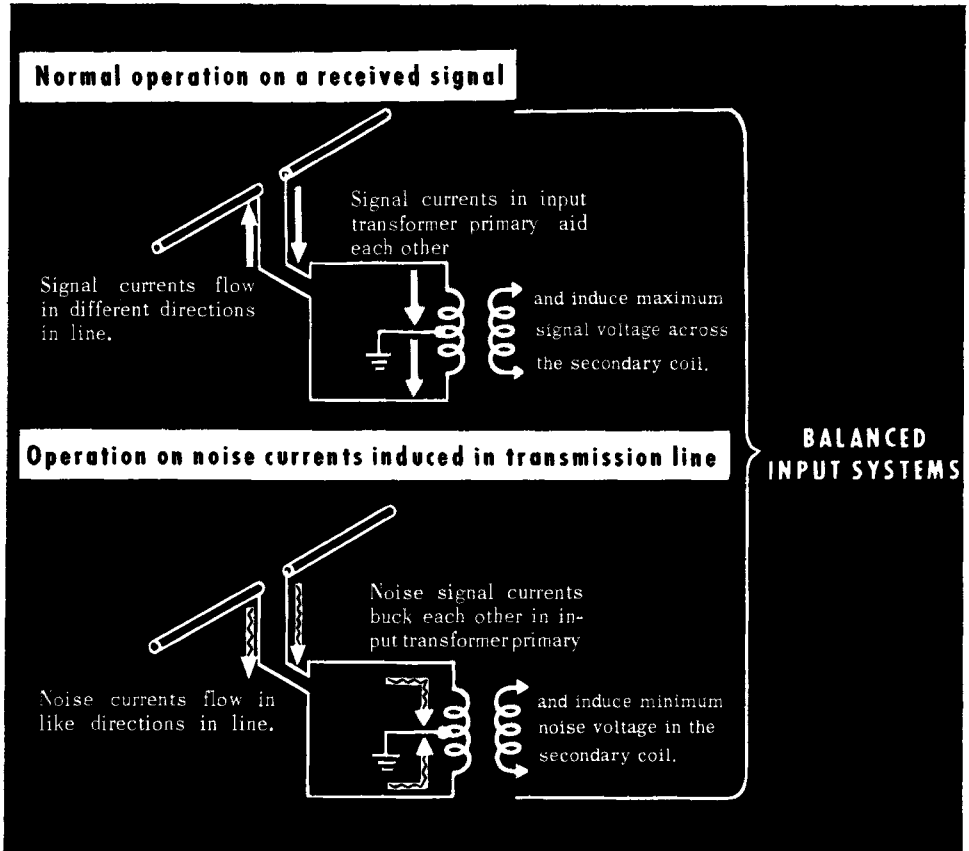

Noise voltages picked up by the transmission line cause equal currents to flow in the same direction through both legs of the transmission line and in opposite directions through the transformer primary. Noise voltages generated across one half of the winding are equal in amplitude but opposite in polarity to the noise voltages induced across the other half of the primary winding. These voltages (theoretically) cancel each other and no noise voltage appears across the secondary winding. For this reason, the balanced system affords a much greater signal-to-noise ratio than the unbalanced system, which is one of its principal advantages.

THE FRONT END

Balanced Transmission Lines

Transmission Lines For Balanced Antenna Systems

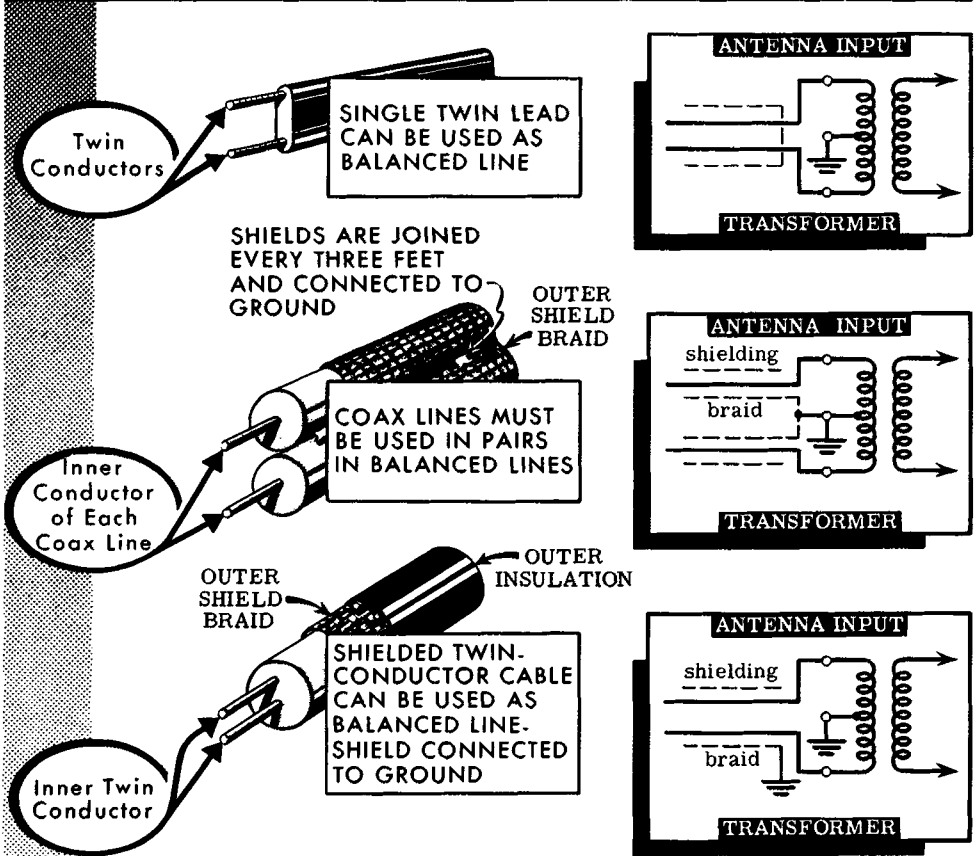

The balanced antenna-input system requires a balanced transmission line. Such lines are two-conductor cables that are manufactured with and without shielding around the conductors. To help minimize noise-voltage pickup by the transmission lines in areas in which noise is a problem, some receiver installations use shielded transmission lines. The shield is a woven metal braid that surrounds each conductor or both conductors together. (Usually, the shield is connected to ground.) The use of shielding poses a problem, however, because shielded lines are usually rated at relatively low impedance values—far lower than the rating of the antenna-input systems of some receivers. To use shielded transmission lines with such receivers requires the application of special *matching* techniques that are discussed in detail in a later lesson.

THE FRONT END

The TV Receiver Front End (Tuner)

The *front end* of the TV receiver is a complete entity. It contains the r-f amplifier, the local oscillator, and the mixer, assembled into one unit. It contains the tubes and circuit elements for these stages as well as a mechanical system that permits the tuner to respond to the desired TV channel. Although there are many front-end designs, they all have the function of selecting the desired TV channel and the generation of the sound and picture i-f signal voltages.

The selection of a vhf channel is accomplished in various ways, four of which will be discussed here. The first method to be considered uses three sets of tapped inductors, one set for the r-f amplifier, another for the oscillator, and the third for the mixer. Each set of inductors consists of 12 series-connected coils. These assemblies are mounted on separate decks of a stacked wafer switch, so that rotation of the channel selector knob simultaneously changes the position of shorting contacts on each of them. These contacts touch taps that are positioned along the inductors at intervals that permit the inductance in each of the three circuits to be correct for the channel chosen. As the knob is turned from a lower channel to a higher one, progressively more inductance is shorted out of the circuits. Resonance is achieved by use of the distributed capacitance of the coils, stray circuit capacitance, and trimmer capacitors.

THE SWITCHES

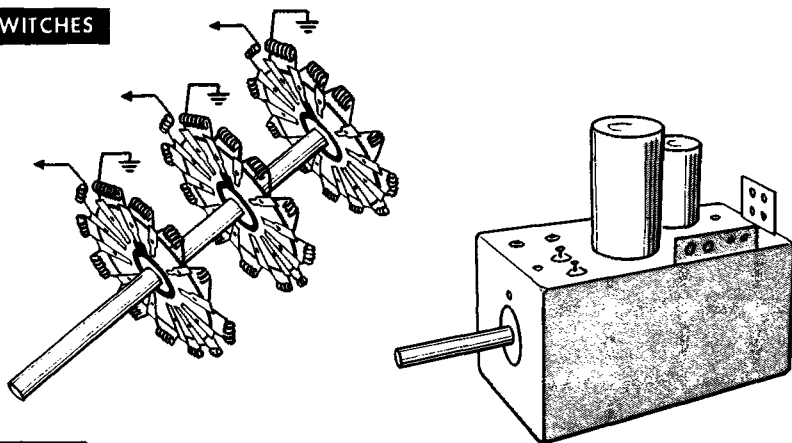

THE ACTION

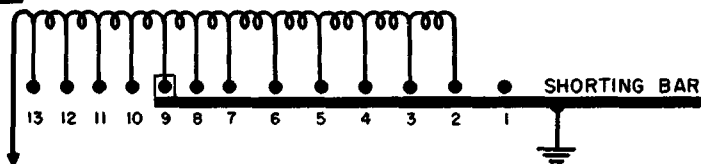

The turns between contacts 9 and 2 are inactive; the active inductance is between the end and contact 9 on the switch.

THE FRONT END

The Rotating Turret Arrangement

THE TURRET

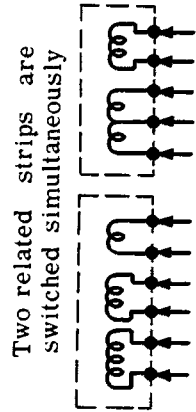
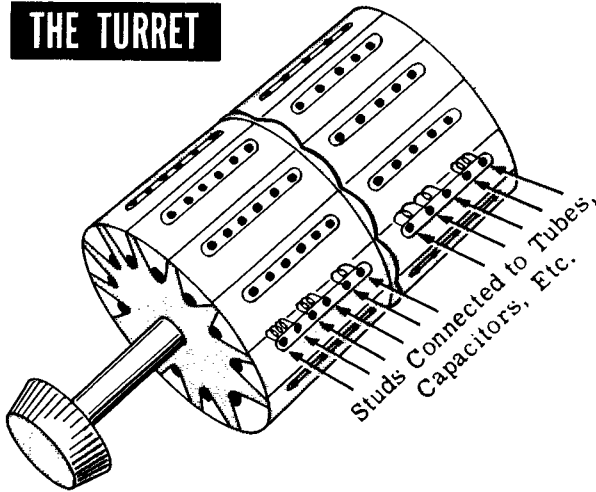

a typical coil strip

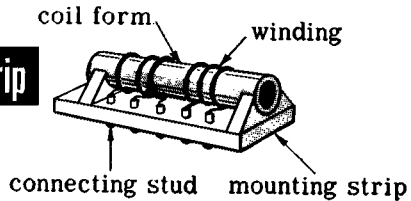

The rotating turret arrangement (sometimes referred to as "strip tuner") is perhaps the most popular. Twenty-four separate removable coil strips carry the twelve sets of coils required to cover the twelve television channels. The antenna coil and r-f amplifier grid winding comprise the antenna input transformer strip. There are twelve of them, one for each television channel. The r-f amplifier plate coil, the mixer grid coil and the oscillator coil for the same channel are mounted on the other strip in the set. There are also twelve of these strips, one for each television channel, thus totaling 24 strips. Each coil on each strip terminates in connecting studs that protrude through the outside of the strip.

A rotatable mechanical support known as the "turret" allows each strip to be snapped into place between a pair of tension springs. The turret carries all 24 strips. The r-f amplifier, mixer and oscillator tubes are mounted atop the turret housing whereas the capacitors and resistors used with the coils are inside the housing. This circuitry terminates in connecting studs mounted on frames attached to the turret housing. When the coil strips are rotated, the studs on the desired strips make contact with the circuit studs, thus completing the tube circuits. Operating voltages are derived from an external source.

THE FRONT END

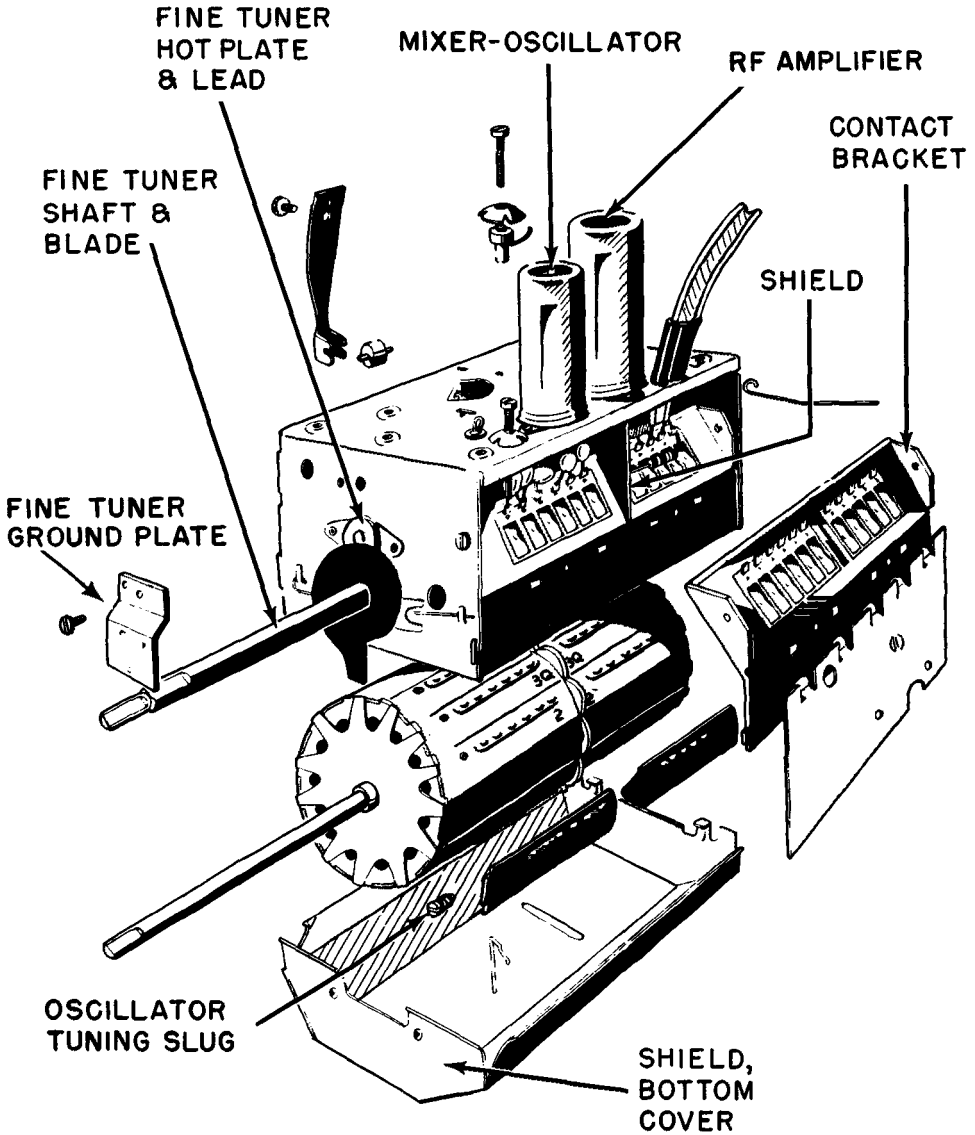

Mechanical details of the

Standard Coil turret tuner

THE FRONT END

The Continuous Tuner (Mallory Inductuner)

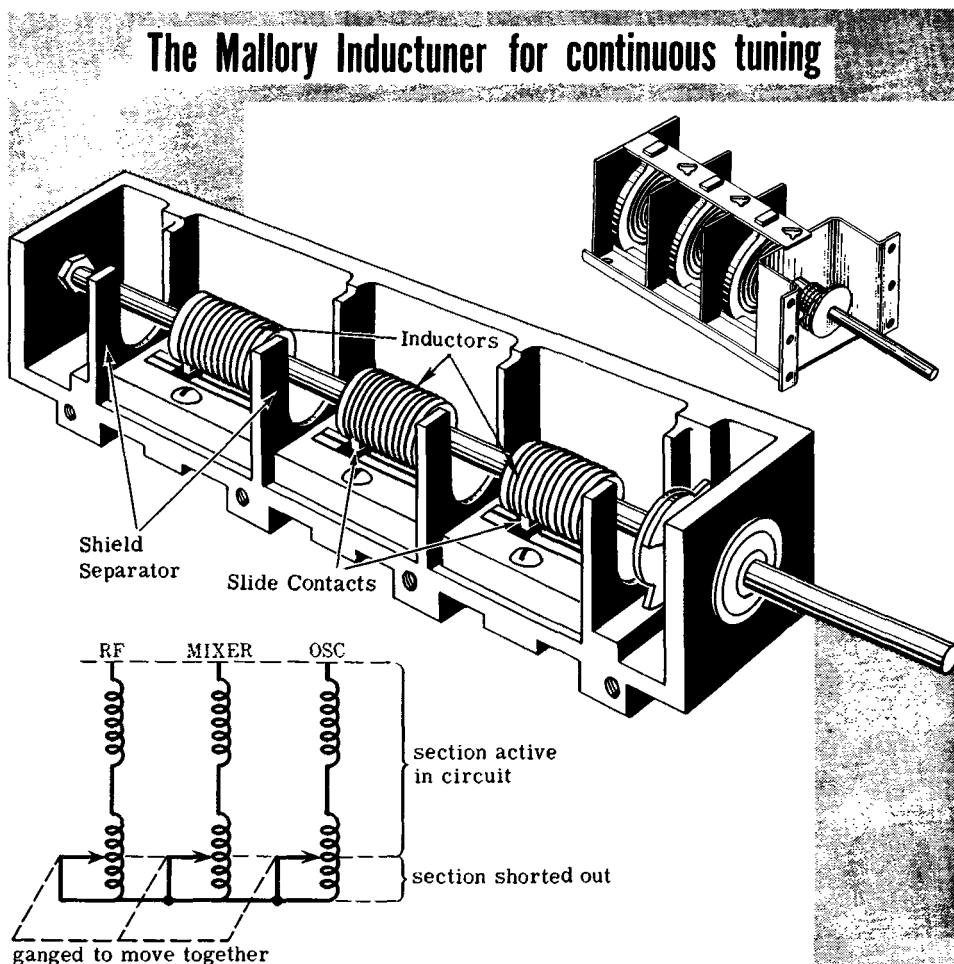

In the third arrangement, the inductances in the r-f amplifier, mixer and oscillator stages are continuously variable over the entire VHF television band by ganged sliding contacts which ride along the surface of the turns of three coils. As the tuning knob is rotated, the sliding contacts ride on the coiled inductors. The r-f amplifier, mixer, and oscillator function with separate coils. The position of the sliders on the wires determines the amount of inductance that is shorted out of the circuits, therefore determining how much remains active in them. By providing for continuous tuning between the low-frequency limit of the VHF television band (54 mc) and the high-frequency limit (216 mc) coverage is automatically given over the f-m band of 108 mc to 176 mc.

THE FRONT END

Continuous Permeability Tuning and Hi-Lo Switching

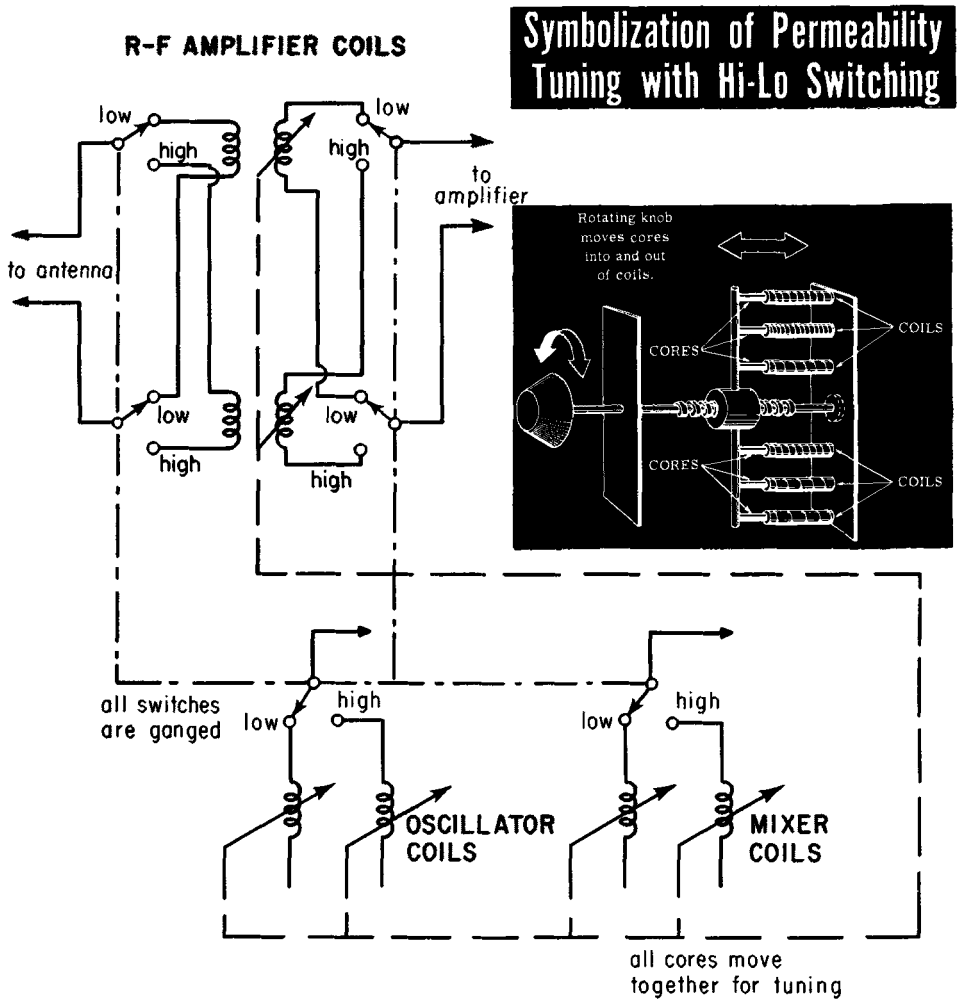

The fourth method of channel selection is a combination of switching and continuous tuning. The switching system is a conventional coil-switching arrangement that permits selection of either the low-band or high-band coils in the r-f amplifier, oscillator, and mixer circuits. Continuous tuning through the selected band is by means of sliding powdered-iron cores that are mounted inside the coils by the rotation of the tuning control. The change in the position of the cores changes the inductance of the coils that surround them, which in turn changes the resonant frequency of the circuits of which the coils are elements. Variable capacitors are connected across the coils for trimming purposes.

THE FRONT END

Front-End Circuitry

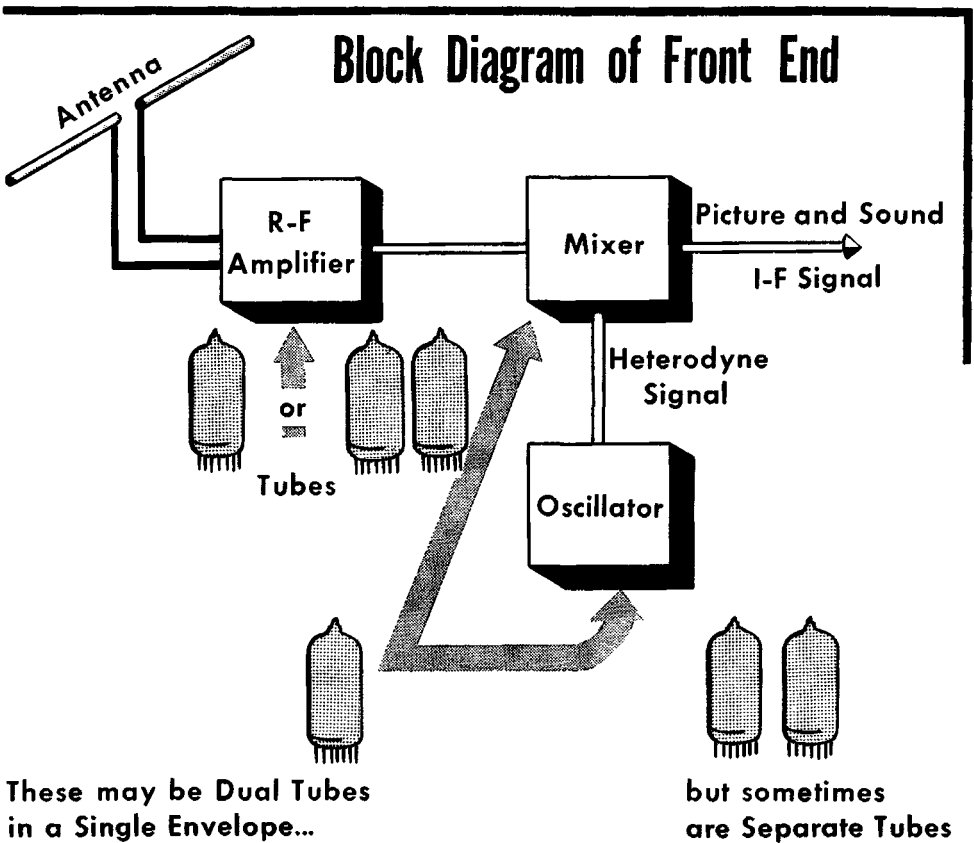

To explain each of the circuit arrangements used in these different kinds of tuners as well as in the variations of these basic types would take far more space than would be warranted in a book of this scope. The many years of television-receiver production have seen many differing tuner designs, all of which aim for the same results. All the tuners perform the same functions, even though the exact means of doing so vary widely. Most vhf tuners use three or four tubes. (Sometimes two of them are contained within a single envelope.) The organization of all television tuners involves an r-f amplifier, an oscillator, and a mixer stage, however, the circuitry used between these sections differs from one manufacturer to another (except, of course, when the same tuner appears in several brands of receiver). Similar external appearance does not necessarily mean identical circuit-component organization.

THE FRONT END

R-F-Amplifier and Mixer-Oscillator Tubes

The r-f amplifier receives an extremely wide range of signal voltages from the antenna circuit. In fringe areas signal strength may be as low as 100 microvolts, whereas in strong-signal areas the signal strength may be as great as several hundred millivolts. Because the r-f amplifier may have to handle very small signal voltages, the tube must have very little inherent noise and a high transconductance. For low noise, the triode would be ideal; however, the comparatively low gain of triodes made it necessary to use low-noise pentodes instead.

R-F AMPLIFIER TUBES

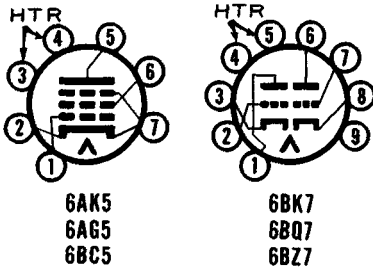

MIXER-OSCILLATOR TUBES

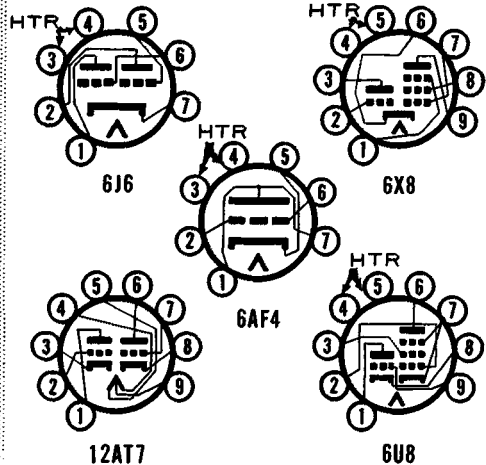

The first tubes used as r-f amplifiers were the 6AK5 and 6AG5 sharp-cutoff pentodes. They were later superseded by the 6BC5, which has a higher trans-conductance and improved high-frequency characteristics. The cascode amplifier (which uses a twin triode) was developed to give the high gain of a pentode, while providing a triode's low noise. The 6BK7, 6BQ7, and 6BZ7 (medium-mu units designed for vhf television tuners) have virtually dominated this field.

The 6J6 (a medium-mu twin triode that can be used as an oscillator at frequencies as high as 600 mc) is the dominant mixer-oscillator tube for vhf tuners, with one triode section used for each function. A recent trend, however, is toward such triode-pentode tubes as the 6X8 and 6U8. (The pentode section is used as the mixer.) In uhf operation, the 6AF4 oscillator has been a virtual standard in the 470- to 890-mc band.

THE FRONT END

The Standard Coil "1000 Series" Tuners

These and similar turret tuners switch strip-mounted coils used in the r-f amplifier, mixer and oscillator stages for each vhf channel. The 12 vhf channels employ 12 sets of coils. A set consists of 5 coils, two of which form the antenna-input-r-f-amplifier grid transformer, the third is the r-f amplifier plate winding, the fourth the mixer input coil, and the fifth the oscillator coil assembly. How they are used will become evident as we explore the circuitry.

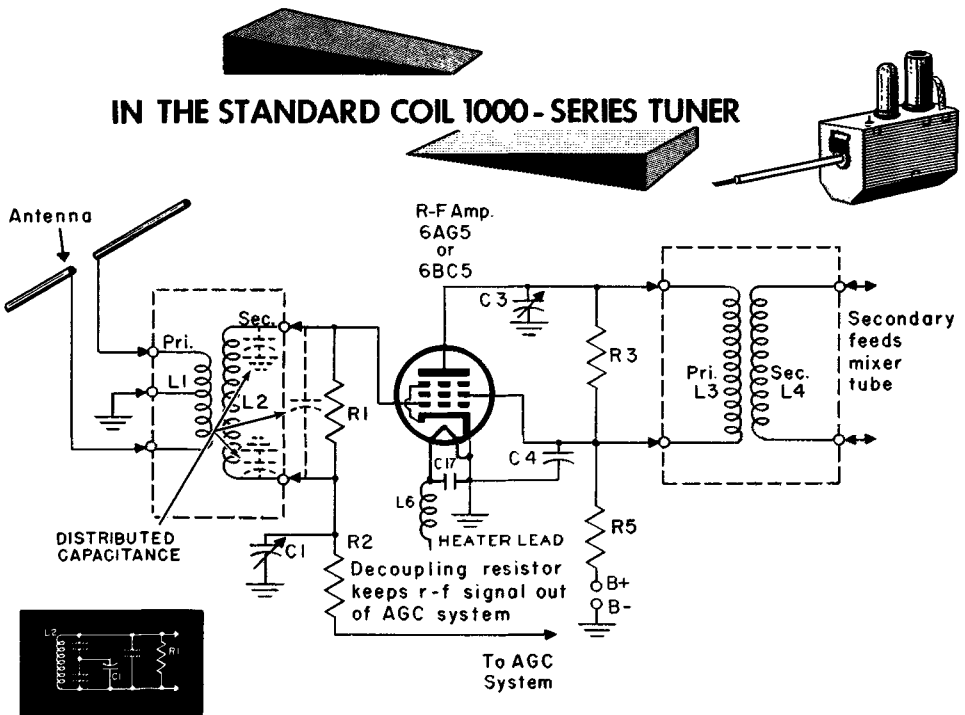

The arrangement of the distributed capacitances and C1 active in tuning L2

These coils are changed each time the viewer selects a new channel

The r-f-amplifier-input or antenna-grid-circuit coils are L1, L2 and L3. L1 is the antenna transformer primary coil wound for balanced input, with its center tap connected to chassis ground. The r-f signal voltage that is delivered to L1 by the transmission line induces a voltage across L2, and is applied to the grid-cathode circuit of the pentode r-f amplifier. C1 completes the r-f path to the cathode. Distributed capacitance (shown by the dashed-line capacitors) and C1 resonate L2 to the desired television channel frequency.

TUNER CIRCUITRY

The "1000 Series" R-F Amplifier

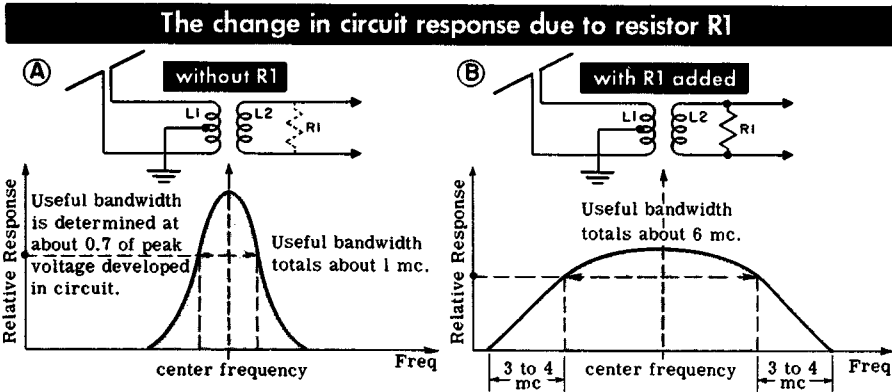

Each TV channel to which the r-f stage is tuned covers a band 6 megacycles wide, therefore the bandpass of all tuned circuits passing the received signals must be wide enough to include all of the frequency components in the 6-mc channel. Resistor R1 broadens the L1-L2 circuit frequency response. A resistor connected in parallel with a resonant circuit (as R1 is) increases the losses in the circuit, and broadens the band of frequencies to which the circuit will respond. The bandpass curve shown in A is that of a resonant circuit without a "loading" resistance added, whereas curve B shows the effect of the loading resistance. The useful circuit bandwidth usually is considered at 70% of the peak response. Comparing curves A and B and remembering the 6-mc bandwidth of a TV channel, it is clear the 1-mc wide response of circuit A is inadequate for the processing of the television signal, whereas response B is adequate.

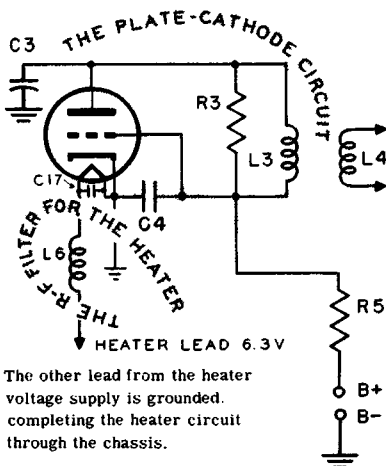

The plate circuit of the r-f tube contains L3, with C3 used as the alignment trimmer for tuning L3-L4 to the center frequency. R3 is the loading resistor that broadens the bandpass. (It serves the same function as R1 for L2.) R5 and C4 prevent r-f voltage variations from getting back into other circuits through the power supply. R5 also serves as the dropping resistor for both the screen and plate voltages. The heater circuit contains C17 and L6. This r-f filter prevents signal fluctuations that may develop in the heater circuit of the r-f amplifier tube from getting into the heater voltage supply and thus appearing in the other heater systems of the front end.

TUNER CIRCUITRY

The Local Oscillator in the "1000 Series" Tuner

In the Standard Coil tuner that we are discussing (as well as in other tuners) the oscillator section is built around one of the triodes in a 6J6 twin-triode tube. (The other triode in the tube envelope is the mixer, which will be discussed later.) The oscillator circuit is the *ultraudion*, one of the oldest oscillator circuits in the history of radio. The modern version is the *Colpitts* oscillator.

The circuit as shown on television schematics is not too easily read, therefore we show a rearranged version that is more readable than the usual schematic, which is also shown. The circled letters indicate corresponding points on the two diagrams.

The customary Ultraudion Schematic

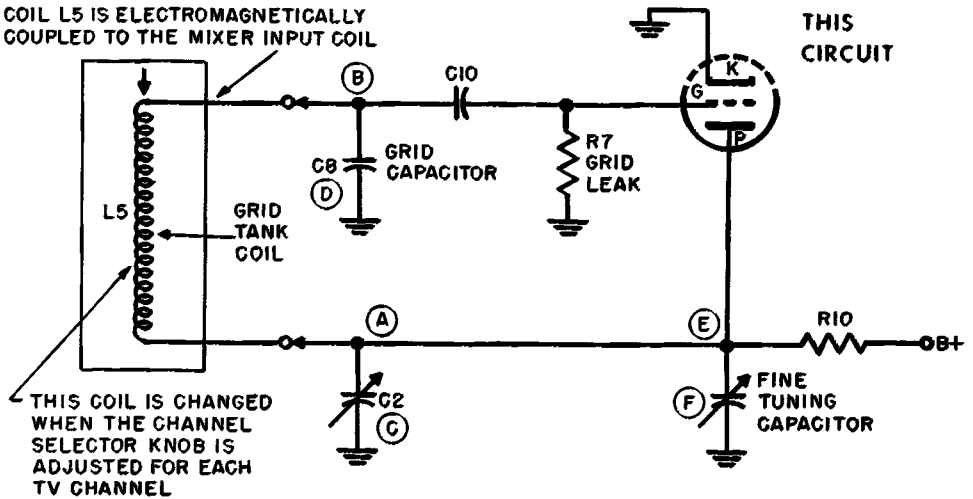

this redrawn diagram is the same as

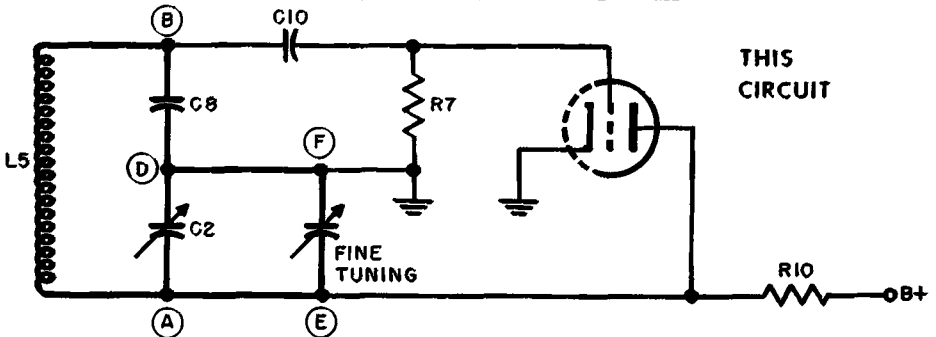

TUNER CIRCUITRY

The Local Oscillator (contd.)

Every amplifier can act as an oscillator if sufficient signal is fed back from the plate to the grid, and if the signal voltage fed back is in phase with the original signal voltage at the control grid. Normally, the signal voltages at the control grid and the plate are 180° apart as shown in A. Somehow the feedback path must invert the signal fed back from the plate to the grid by 180° . In the Colpitts oscillator (B) often used in television receivers, feedback occurs in the following way.

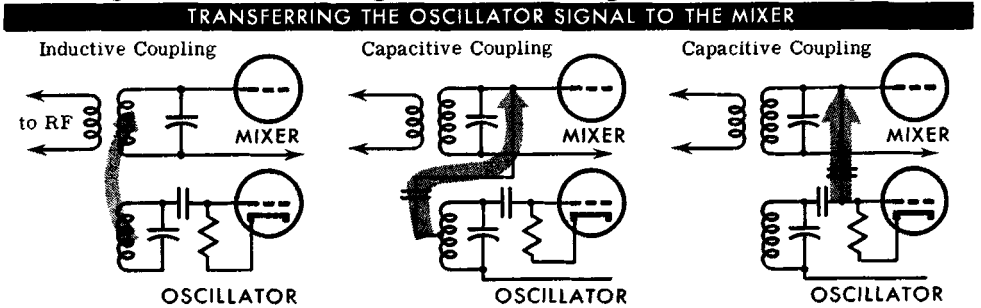
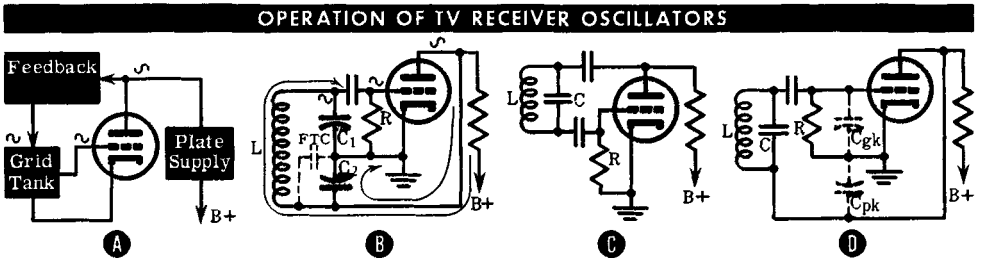

The r-f plate currents get to the cathode through two paths—through C_2 and through L and C_1 . Thus one signal voltage is developed across C_2 and another through C_1 , but because of the presence of L in the L - C_1 path, the feedback voltage developed across C_1 is 180° out of phase with that at the plate and is in phase with the original signal voltage at the control grid, causing the tube to oscillate. (The capacitor shown in dotted lines and labeled FTC is the fine tuning control.) Note that this circuit is like the oscillator circuit used in the tuner that we are discussing. Another popular oscillator circuit used in television receivers is called the ultraudion. Circuitwise (C), it does not look like the Colpitts, but it functions in a similar manner as is clear from the redrawn circuit D. Instead of using two lumped capacitors as the feedback capacitor divider, use is made of the grid-cathode (C_{gk}) and plate-cathode (C_{pk}) tube interelectrode capacitances. With these added to the circuit it now resembles the Colpitts, and functions like it.

Coupling of the heterodyning signal from the oscillator to the mixer is accomplished in numerous ways. Three popular methods are shown.

TUNER CIRCUITRY

The Mixer

Signals in the Mixer System

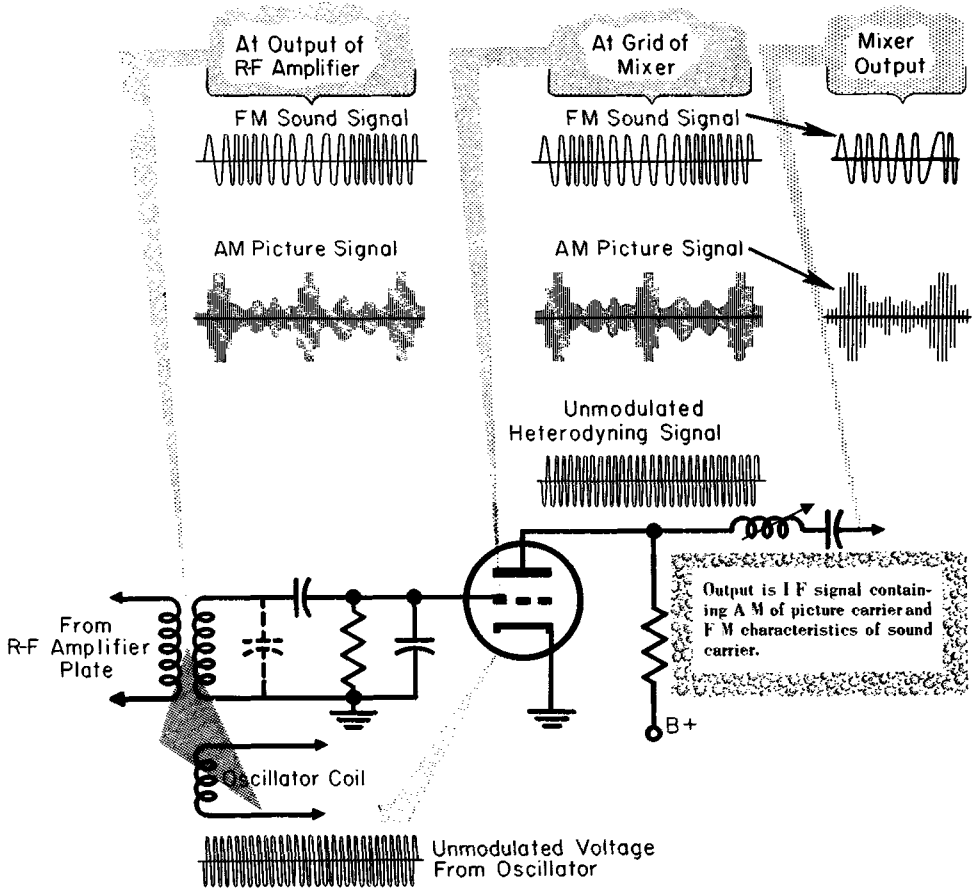

After amplification in the r-f amplifier, the sound and picture r-f carriers are fed to the mixer tube. The unmodulated heterodyne signal generated in the oscillator also is fed to the mixer tube. Thus, three signals are supplied to the mixer tube, whereas only two are taken out, the sound and picture i-f voltages.

Mixing requires that the tube display the same characteristics as a detector. Under such conditions, the mixing device produces a variety of combinations of the signals that have been supplied to it. These constitute the output of the mixer, but only two of them are selected for use as the sound and picture i-f signals.

TUNER CIRCUITRY

The Mixer (contd.)

If the r-f picture carrier is called f_p , the r-f sound carrier f_s , and the heterodyning signal from the local oscillator f_h , the output of the mixer will contain among other signals $f_p + f_h$, $f_h - f_p$, $f_s + f_h$, and $f_h - f_s$. These are called *sum* and *difference* frequencies respectively. Harmonics of all these signals in various combinations also exist in the mixer output and they, too, produce sum- and difference-frequency signals, but we do not work with them. Receiver designers build their current models so as to use the fundamental difference-frequency signals only, ignoring the sum frequencies as well as any harmonics.

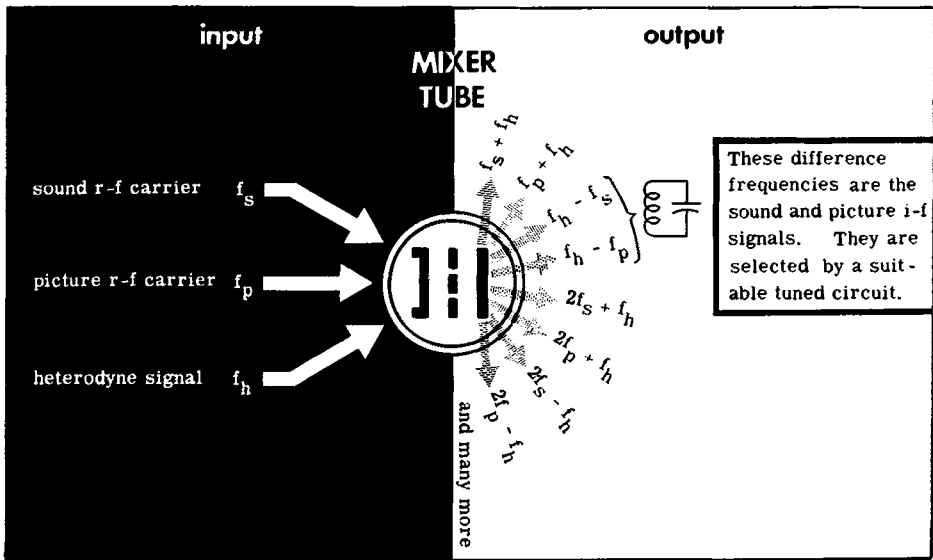

If for the moment we assume a picture r-f carrier (f_p) of 55.25 mc and a sound r-f carrier (f_s) of 59.75 mc (these are the r-f carriers for TV channel 2) and a heterodyne oscillator frequency (f_h) of 101 mc, two *sum* frequencies in the mixer output will be $f_p + f_h$ equal to 156.25 mc and $f_s + f_h$ equal to 160.75 mc, and two difference frequencies in the mixer output will be $f_h - f_p$ equal to 45.75 mc and $f_h - f_s$ equal to 41.25 mc. Other popular difference-frequency i-f signal frequencies used in older receivers are 25.75 mc for the picture i-f and 21.25 mc for the sound i-f. The difference-frequency signals, 45.75 mc and 41.25 mc, are selected by suitably tuned circuits in the mixer output circuit and used as the picture and sound i-f signals respectively. Each of these i-f signals contains exactly the same modulation as the original r-f carrier of which it is the equivalent. All that we have done in the mixing process is to lower the "carrier" frequencies. This action is duplicated in every superheterodyne receiver except that we deal with two i-f signals in the television receiver.

TUNER CIRCUITRY

The Mixer Input System

The mixer tube is usually the second half of the 6J6 double-triode. (As stated earlier, the first triode in this envelope is used for the oscillator.) Sometimes separate tubes are used for the mixer and for the oscillator.

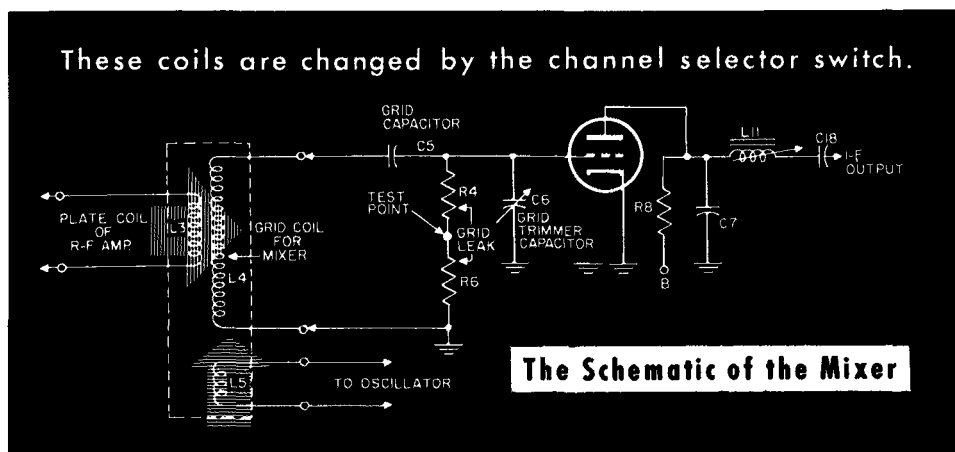

The amplified r-f sound and picture signals that appear across the plate coil L3 are inductively coupled to the mixer grid coil L4 and appear across the grid-cathode circuit of the mixer tube. At the same time, the oscillator tank coil L5 is inductively coupled to the mixer grid coil L4, therefore, the heterodyning signal also appears across the grid-cathode circuit of the mixer. Coils L3, L4, and L5 are located on the same strip in the turret tuner. The resonant circuit in the mixer input system consists of L4, C6 and C5, plus the stray capacitance of the stage input. C6 is *variable* to permit tuning the mixer input circuit to the correct frequency as an alignment adjustment. The distributed capacitance associated with L4 as well as the mixer input wiring is not shown, but it is a part of the total capacitance that tunes L4 to the correct frequency. The factory that produces the front-end adjusts the turns of the L4 winding, with the coil in place, thereby taking the distributed capacitance into account.

The mixer *test point* located along the series chain R4-R6 permits testing the operation of the r-f amplifier and permits easy determination of whether the oscillator is supplying the heterodyning signal to the mixer. It is accessible from the outside of the tuner shield housing. The d-c potential developed across the mixer grid leak R4-R6 by the mixer-tube grid current on the positive cycles of the input signals can be measured and used as an indication of circuit performance. It also serves as the point of connection to an oscilloscope indicator device when tuning (alignment) adjustments are made in the r-f oscillator and mixer circuits. (Such adjustments are the province of a service technician.)

TUNER CIRCUITRY

The Mixer Output

The output circuit of the typical mixer is relatively simple. In the tuner shown, resistor R8 is the plate load resistor, which also determines the plate and screen voltages applied to the mixer tube. Capacitor C7 is present to act as a bypass for the frequencies higher than the desired sound and picture i-fs.

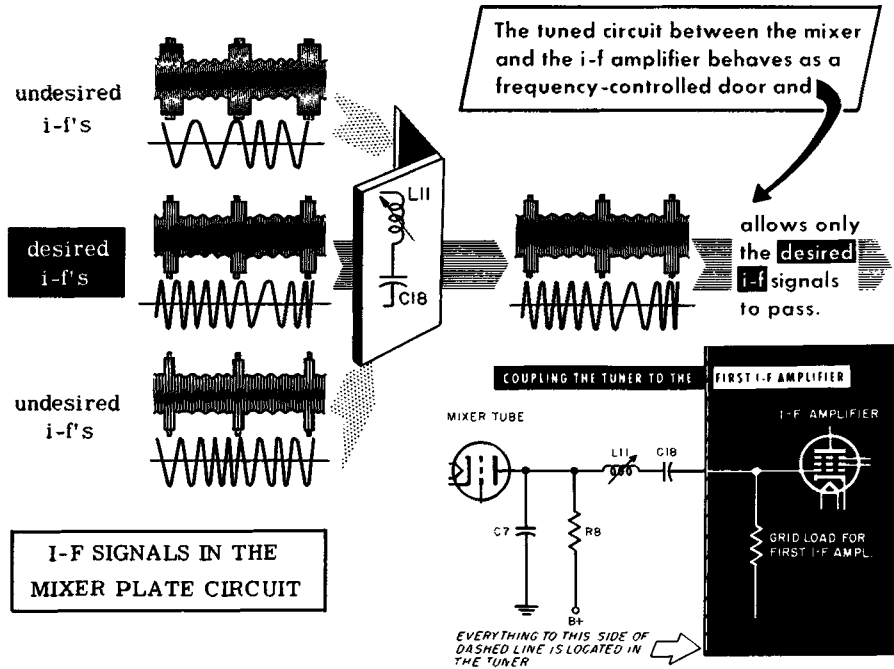

The variable inductor L11 and the capacitor C18 form a series-resonant circuit that is tuned to the band of frequencies that correspond to the *desired* picture and sound i-f signals. It will select these signals and reject the other signals present in the mixer output. Thus, if the desired sound i-f signal frequency is 41.25 mc and the picture i-f signal frequency is 45.75 mc, the L11-C18 circuit will accept all signals from perhaps 38 to 47 mc, a bandwidth of about 9 mc. All other i-f currents that are present in the mixer plate circuit are (theoretically) prevented from passing into the i-f amplifier.

L11 and C18 in the output circuit of the mixer, are part of the first i-f stage, but as a means of gaining most efficiency in performance, they are physically located in the tuner. The signals passed through this series combination appear as the sound and picture i-f signal voltages across the grid load of the first i-f stage. After amplification in this stage, the sound and picture i-f signals are ready for further processing.

TUNER CIRCUITRY

The Standard Coil "1000 Series" Tuner Circuit

The three circuits we have studied (the r-f amplifier, the local oscillator, and the mixer) comprise one version of the pentode-triode Standard Coil front end. When we combine these elements into a working schematic it is

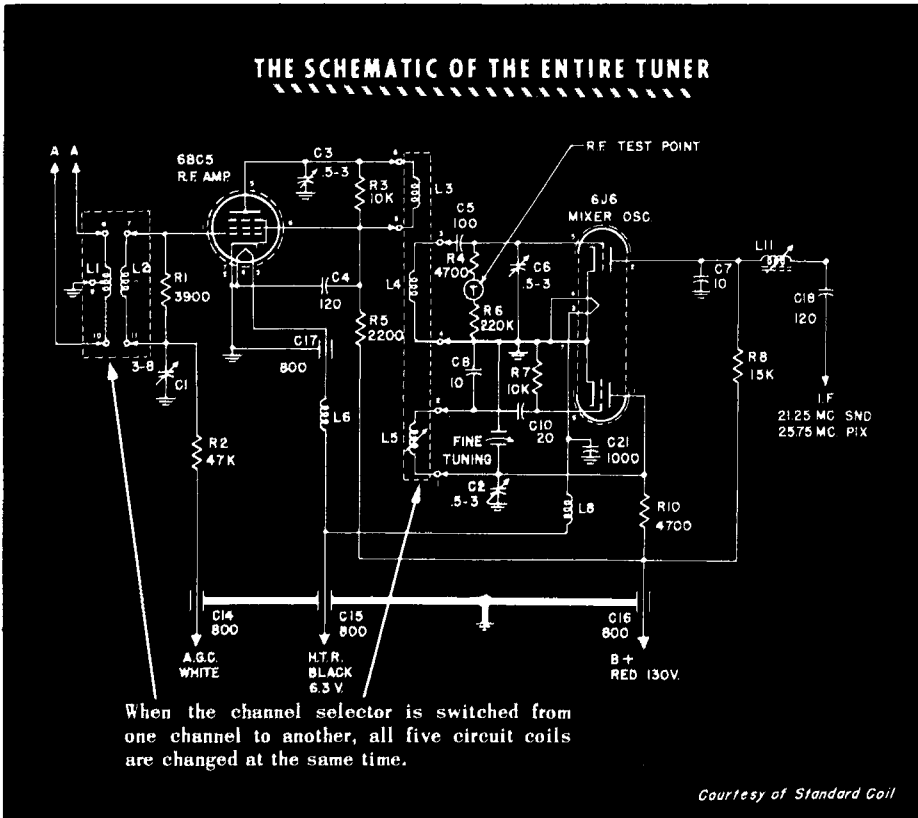

C14, C15 and C16 are feed-through r-f bypass capacitors. C14 bypasses the automatic gain control (agc) lead that supplies the automatically varying r-f amplifier grid bias. C15 is the bypass for the heater lead that brings 6.3-volts ac to all the heaters of the vacuum tubes in the front end. C16 is the r-f bypass capacitor for the B+ lead. Although each of these voltage-supply circuits has its own bypass capacitor at its source, it has been found advisable to locate additional signal bypass capacitors where the voltage-supply leads enter the chassis. This keeps r-f signals out of the voltage-supply leads and minimizes interaction between the different currents in the front end, permitting realization of the full amplification available in the r-f amplifier and mixer. (The schematic does not show the channel selector, but it does show the electrical parts of the circuit controlled by it.)

TUNER CIRCUITRY

Mechanical Details of the Standard Coil "1000 Series" Tuner

A great many of these pentode tuners are found in television receivers. Some are exactly as described in the schematic, some contain circuit variations, but in the main the physical appearance is like

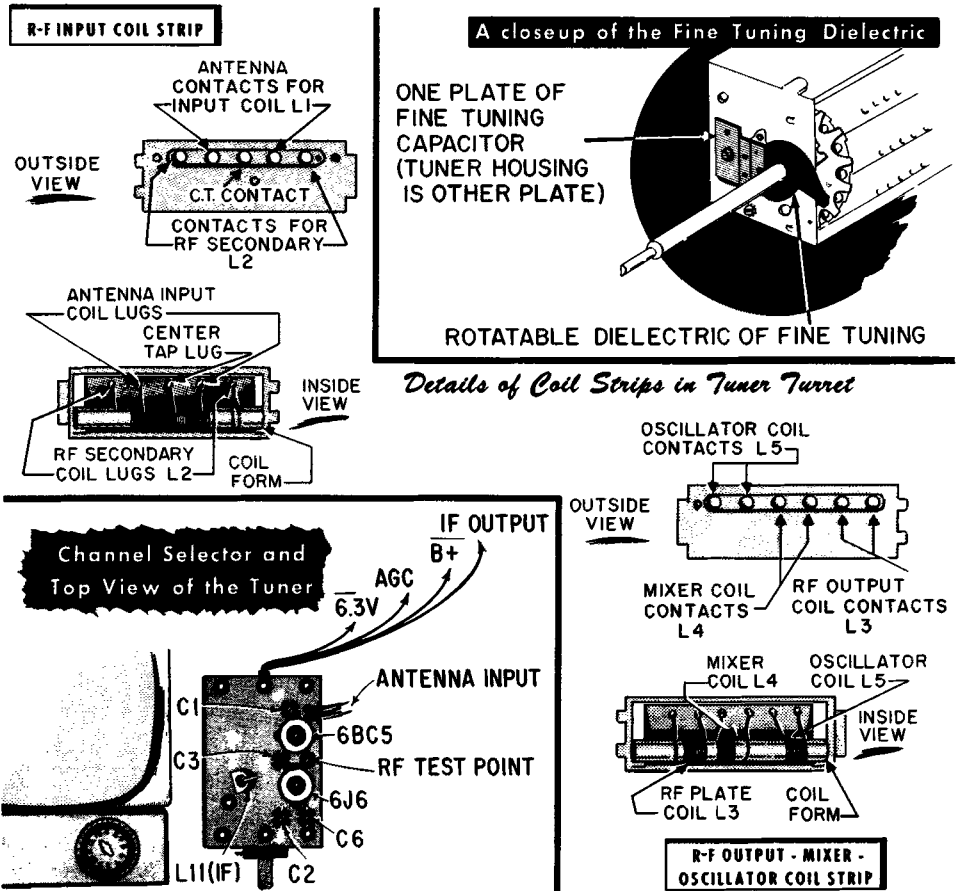

Several cables connected to different points on the receiver chassis enter the tuner housing. One is a section of 300-ohm ribbon lead that connects the antenna terminals of the receiver to the balanced input circuit of the tuner. Another is a single lead that supplies the heaters of the 6J6 mixer and the 6BC5 r-f amplifier tubes with the 6.3-volt a-c supply. (The other side of the heater circuit is completed through the grounded chassis.) Another wire conducts the i-f signal to the i-f amplifiers. Still another wire is the lead for the agc voltage supply for the control grid of the r-f amplifier. The remaining lead carries the B+ voltage from the low-voltage rectifier.

CASCADE TUNERS

The Standard Coil Cascade Tuner

The "Cascode" series tuner is another important design. Although we introduce it in a particular brand of tuner, the cascode idea is almost standard among all television receiver manufacturers and is to be found in many different brands of tuners. The principal difference between this type and the pentode r-f amplifier is in the r-f amplifier circuitry. The cascode circuit utilizes twin triodes in the r-f amplifier; the mixer-oscillator also uses twin triodes in a single envelope. These changes give a tuner with greater amplification capabilities (higher gain) and less inherent noise than the earlier designs. One of the more modern cascode tuner circuits is

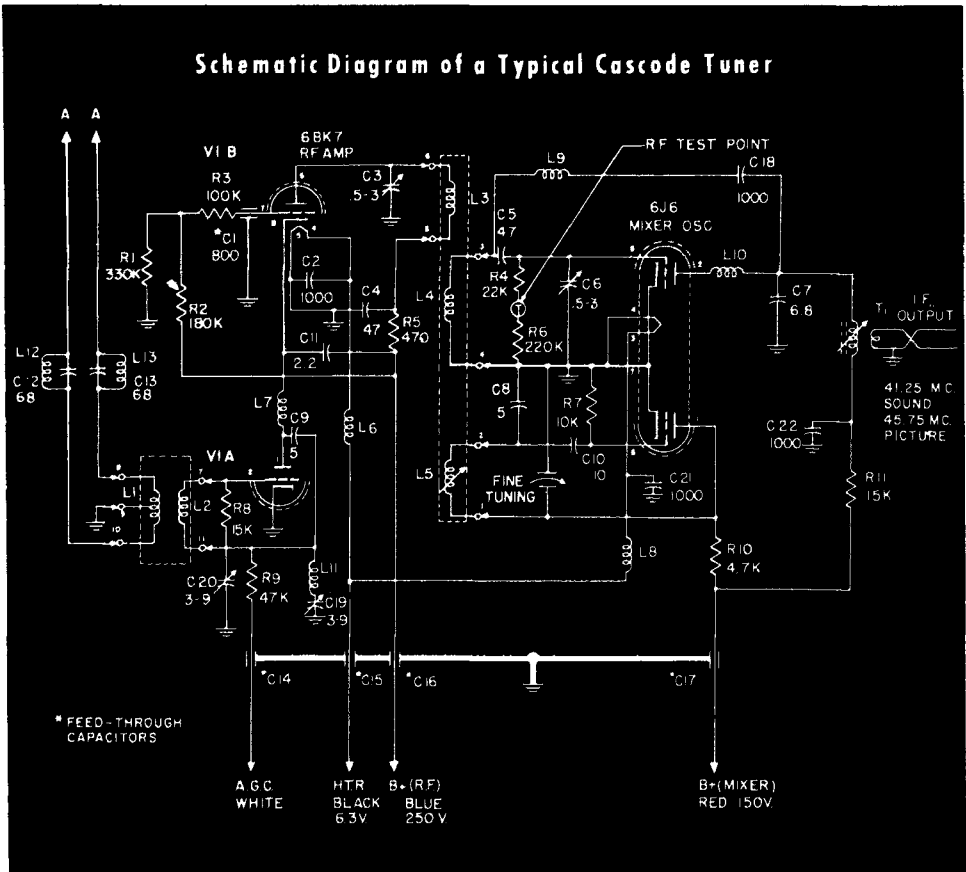

Fundamentally, this tuner contains two important features: The cascode radio-frequency amplifier stage to provide high gain while introducing very little noise into the signal and turret or "strip" tuning, with a separate set of coils for each channel, as a means of channel selection.

CASCODE TUNERS

The Cascode R-F Amplifier Input System

An understanding of the operation of this tuner is most readily obtained by tracing the signal through the tube circuits. Let us consider each part of the tuner separately. L12-C12 and L13-C13 in the transmission line are two parallel-resonant i-f traps, tuned between 40 and 46 mc. This band of frequencies encompasses the desired intermediate frequencies derived from the mixer. Located in each leg of the transmission line between the antenna and the tuner input, each trap presents a high impedance to the passage of all signals that approximate its resonant frequency. The traps prevent interfering signals that approximate the receiver intermediate frequency (sound and picture) from entering the tuner and getting through the mixer to the picture i-f amplifier. Such signals can issue from many sources that operate their transmitters within this frequency range.

The received signals that pass through the traps are transferred inductively from the antenna transformer primary (L1) to the grid winding (L2) of tube V1-A (one half of the r-f amplifier). The grid load resistor (R8) across L2 serves to broaden the bandpass of the antenna transformer so that it will pass all the frequency components of the TV channel. V1-A acts as a conventional r-f amplifier and L2 is tuned by its own distributed capacitance, the associated circuit capacitance (not shown), and C20.

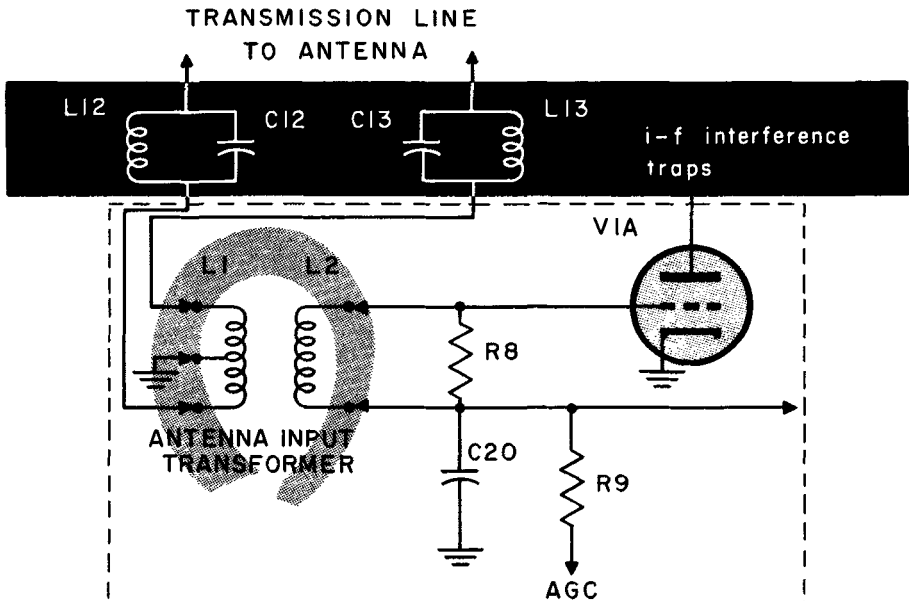

The antenna input transformer and r-f tuning arrangement are the same as in the pentode tuner.

CASCADE TUNERS

The Cascode System: Voltage Distribution

The word *cascode* is derived from the *cascaded cathode-driven* amplifier and refers to the series relationship between V1-A and V1-B. In this circuit, the plate of V1-A is connected directly to the cathode of V1-B. The d-c plate voltage distribution in this circuit can be noted by considering the two tubes as a simple series circuit. With the plate resistance of V1-A equal to that of V1-B, the total B+ supply voltage of 250 volts divides approximately evenly between them. This places the cathode of V1-B at the same potential relative to ground as the plate of V1-A. The d-c resistance of the coupling coil L7 is very low; hence, the d-c voltage drop across is negligible. The voltage divider R1-R2 across the 250-volt plate supply provides a fixed d-c voltage for the control grid of V1-B. This voltage is fed through isolating resistor R3.

With zero signal input, the bias of each tube is approximately equal, with the resultant voltage drop across each tube equal. With the arrival of an incoming signal, *agc* voltage is applied to the control grid of V1-A. This increases the plate resistance of V1-A, thereby raising its plate voltage. Since this plate is connected to the cathode of V1-B, the incoming signal also raises the cathode voltage of V1-B making the cathode more positive than its control grid, thus applying negative grid bias to the tube.

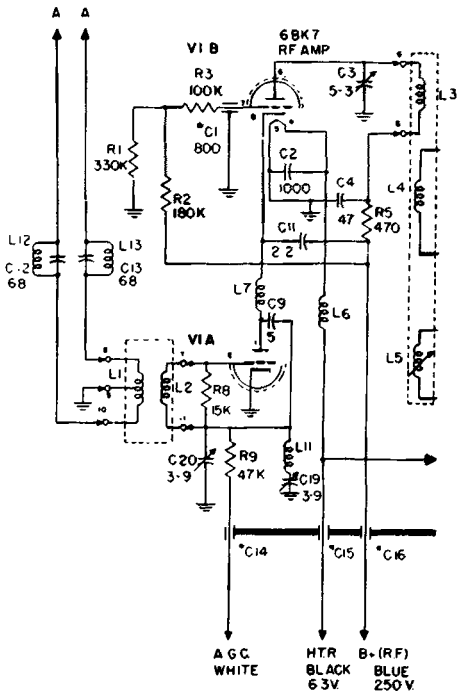

The ACTUAL R-F AMPLIFIER

K of V1-B is more positive than G of V1-B, thus making G negative relative to K.

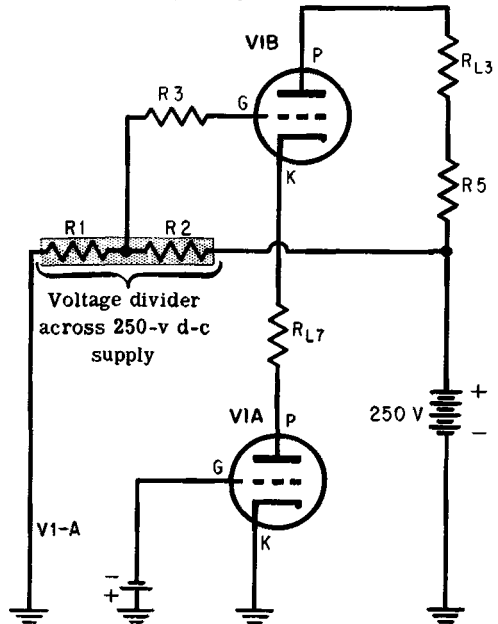

becomes THIS FOR D-C VOLTAGES

CASCODE TUNERS

The Series-Connected Amplifier

Let us now examine the behavior of the circuitry when processing a received signal. How does the signal get from tube V1-A to tube V1-B? To show this most easily we replace the circuits that process the received signal with the symbol for an a-c generator.

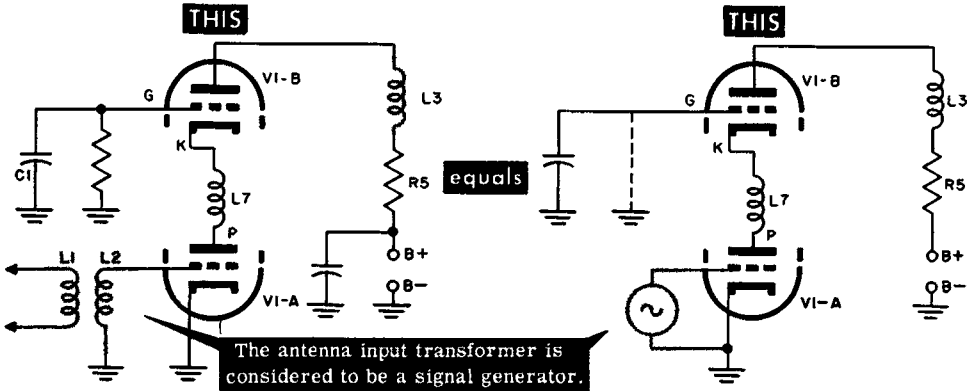

The transformer L1-L2 is considered to be a generator located between the control grid and the cathode of V1-A. Since C1 connected between the control grid and ground of V1-B is the equivalent of a short circuit to r-f signals, this grid is grounded for r-f currents as shown by the dashed line.

Consider V1-A, as a whole, the generator of the signal that it actually receives via the antenna. When we show it in this way, it is easy to see that whatever signal variations appear in the output of V1-A also appear between the cathode (K) of tube V1-B and ground. Since the control grid of V1-B is effectively at ground potential for r-f signals, the signal voltage variations between K, of V1-B and ground, appear between K and G. Thus the signal fed into V1-A is transferred to V1-B, where it is amplified, and appears across the primary of the mixer input transformer L-3.

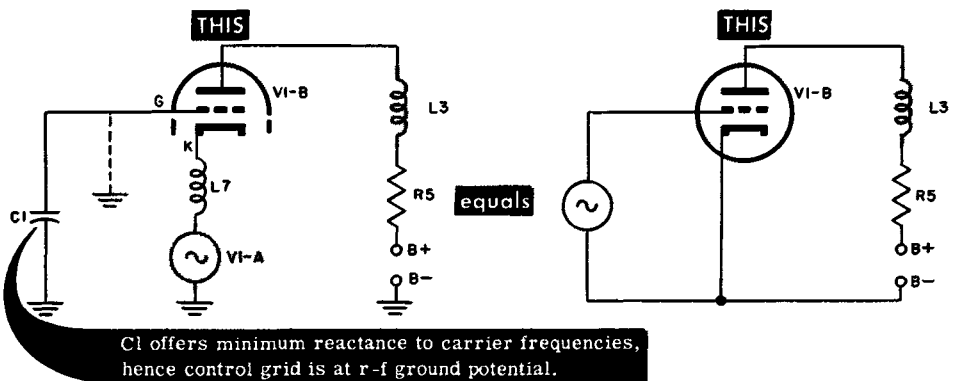

CASCODE TUNERS

The Series-Connected Amplifier (contd.)

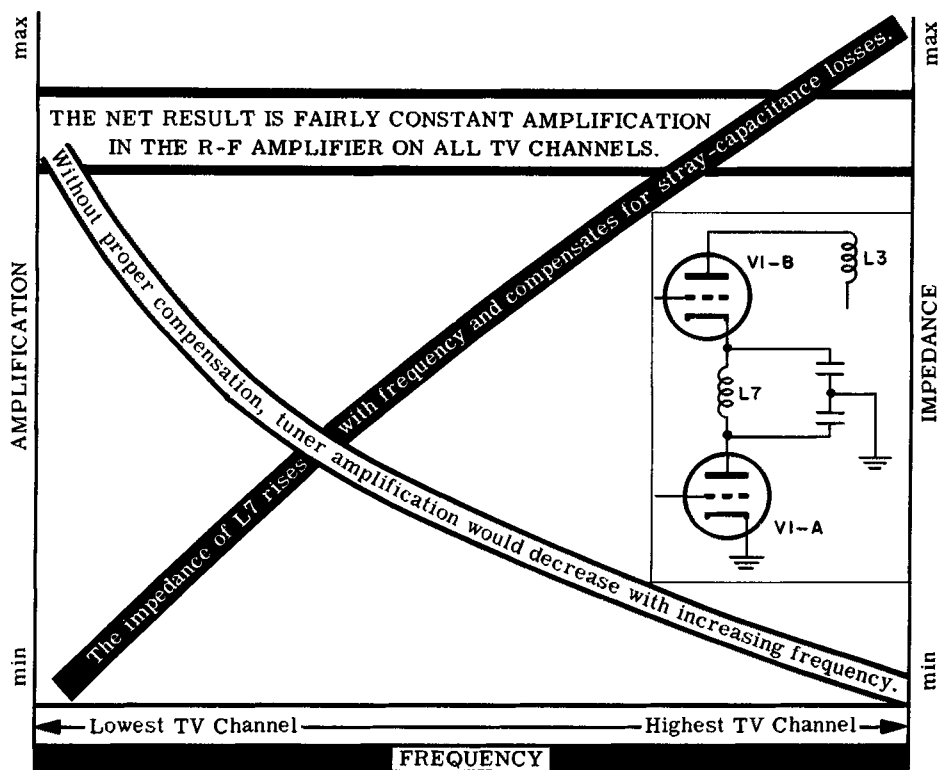

Inductor L7 connected between the plate of V1-A and the cathode of V1-B serves two distinct purposes. Together with the plate-to-ground capacitance of V1-A and the cathode-to-ground capacitance of V1-B, it forms a circuit that resonates at a frequency somewhat higher than Channel 13 (that is, above 216 mc). As the receiver is set to TV channels of higher numbers, the frequency of the received signal rises, hence the combination of L7 and the associated capacitances presents an increasing plate load impedance to tube V1-A, thus extracting the greatest amount of signal from it. The overall action compensates for the detrimental effects of stray capacitances at high signal frequencies. The second function of L7 is to couple the amplified energy from the plate of V1-A to the cathode of V1-B. Signal voltage fluctuations at the end of L7 closer to the plate of V1-A also appear at the end of L7 closer to the cathode of V1-B.

The cascode idea is fundamental; similar circuitry is to be found in many different brands of tv tuners. The electrical constants may differ somewhat in different makes of tuners, but the organization of the circuit is substantially the same.

CASCODE TUNERS

The Mixer-Oscillator in the Cascode Turret Tuner

THE MIXER-OSCILLATOR IN THE CASCODE TURRET TUNER

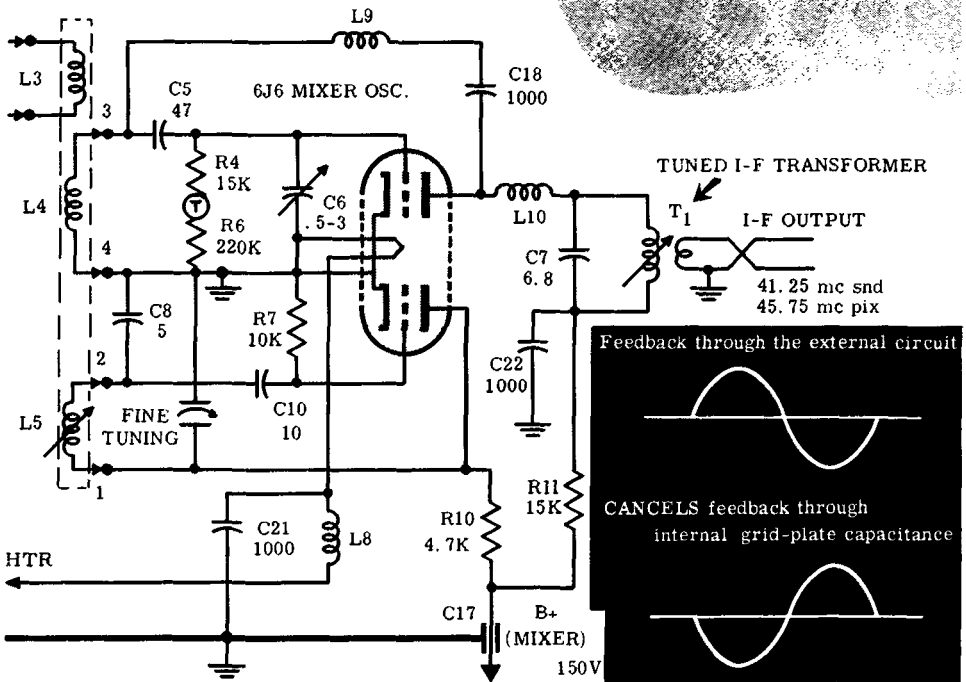

The mixer-oscillator circuit in this front end differs in a few respects from that used in the pentode tuner. For example, the series combination of L9 and C18 connected between the control grid and the plate of the mixer is used as an external feedback control. It counteracts the feedback between the plate and grid via interelectrode capacitance. L9 changes the phase of the feedback signal so that it opposes that in the capacitive internal path.

Another variation is the tuned transformer T1 in the mixer plate circuit. The primary of T1 is permeability-tuned to the desired difference-frequency picture and sound i-f signals that are part of the mixer output. The secondary is a low-impedance winding consisting of relatively few turns, making the connection between the mixer output and the first i-f stage a low-impedance link. The low impedance minimizes any signal voltages that may be induced in the circuit by the horizontal and vertical sweep oscillators and the horizontal output system. (The presence of these signals in the i-f system would impair the picture.) L10 and C7 resonate at a frequency that tends to keep the impedance of the mixer plate circuit high over the desired i-f signal band.

REVIEW

1. **VHF and UHF Television.** Because of the limited vhf range available for television broadcasting, the demand for new channels required use of the uhf band, which gives space for an additional 70 channels.

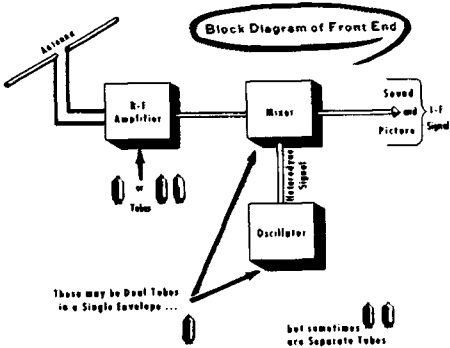
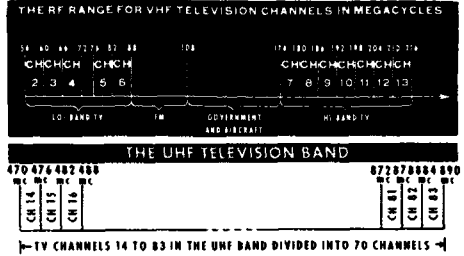

2. **The Tuner or Front End** of a TV receiver consists of three main parts—the *r-f amplifier* into which the signal from the antenna is fed, the *oscillator* that produces an unmodulated signal, and the *mixer*, in which the oscillator signal “beats” with the received carriers to produce the sound and picture i-f signals.

3. **Balanced and Unbalanced Input Systems.** The input from the antenna to the antenna input transformer may be symmetrical with respect to ground (balanced system) or one leg of the transmission line may be grounded (unbalanced system). The balanced system provides the advantage of minimized noise pickup, because noise voltages in the transmission line are cancelled in the input transformer.

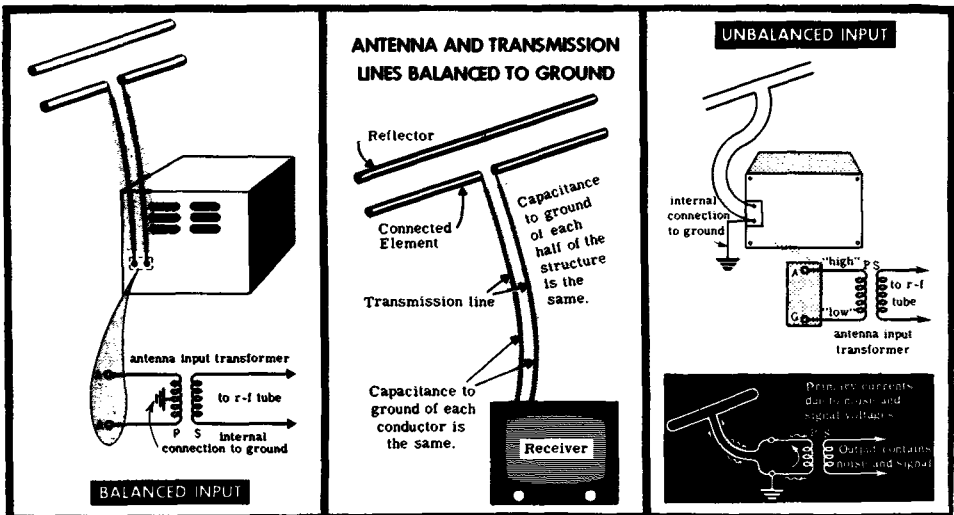

REVIEW

THE TURRET

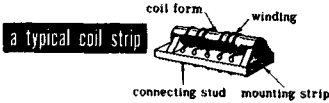
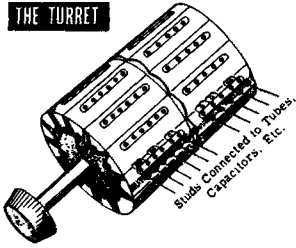

4. *The Turret or Strip Tuner.* One of the most common tuning arrangements uses a rotatable turret that carries separate strips for each channel. The strips carry the coils that provide the correct inductance for tuning the r-f amplifier, mixer, and oscillator circuits to the desired channel frequency.

5. *R-F Amplifier and Mixer-Oscillator Tubes* used in TV receivers are usually special types designed for the purpose. Low-noise pentodes and twin-triodes are used as r-f amplifiers, and twin-triodes or triode-pentodes are commonly used as mixer-oscillators, with one section used for each function.

R-F AMPLIFIER TUBES

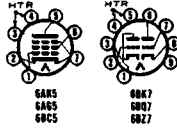

MIXER-OSCILLATOR TUBES

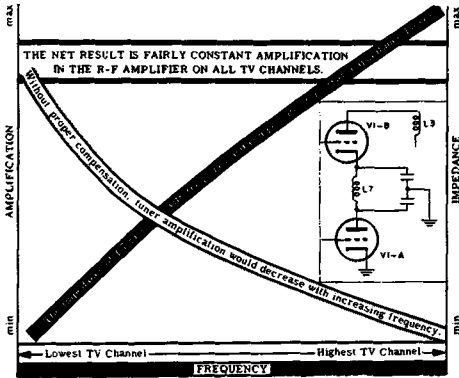
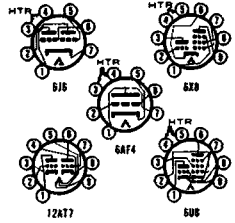

6. *The Output of the R-F Amplifier* must be of constant value over a wide band of frequencies if the picture and sound signals processed in the receiver are to contain all their original modulation content. This constant frequency response is achieved by the use of an inductor that compensates for the normal drop in output level at the high-frequency end.

7. *The Mixer* functions to produce i-f carriers that bear the modulation components of the received r-f carriers. This is accomplished by feeding the oscillator and the r-f signals into the mixer tube and selecting (by means of a tuned circuit) the two difference-frequency signals desired from the output at the plate.

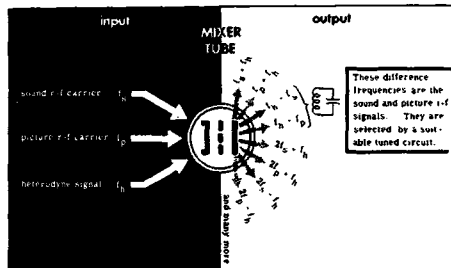

TUNING ARRANGEMENTS

Wafer-Switch Tuners: Tuned Impedances

The transfer of radio energy from one circuit to another by transformer coupling (as used in turret tuners) is one basis of circuit design. Many brands of front ends utilize transformer coupling, but many employ other techniques. A determining factor in the selection of coupling methods is the means used for switching from one television channel to another.

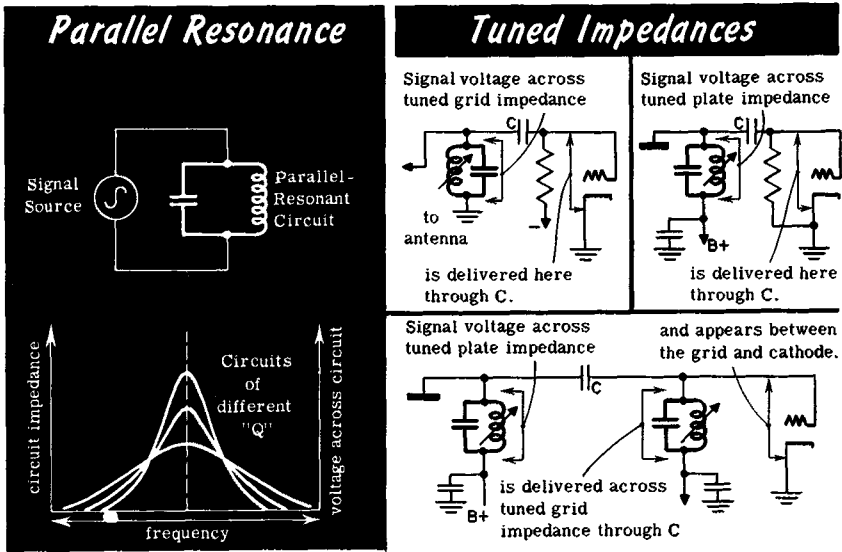

One of the most common methods employs the multiple-deck wafer switch. If a device of this type is to perform effectively at television carrier frequencies, the coils must be mounted directly at the points where switching takes place. Such construction minimizes distributed capacitance, although it makes it difficult to use transformers to link the stages. One substitute for transformer coupling is *tuned-impedance* coupling. The signal voltage delivered to a tube or extracted from a tube is that developed across a single parallel-tuned coil, rather than that developed across a primary or secondary winding.

A parallel-resonant circuit presents maximum impedance at resonance. If the tuned circuit is located in the grid circuit of the tube, it will deliver maximum signal voltage between the control grid and cathode at the resonant frequency, either directly or through a coupling capacitor. If the tuned circuit is located in the plate circuit of an amplifier, it will extract maximum signal from the tube at the resonant frequency, because the circuit impedance is then highest relative to the plate resistance of the tube, and the maximum possible signal-voltage drop occurs across it. The signal taken from a tube in this manner can be delivered to the next stage by a coupling capacitor.

TUNING ARRANGEMENTS

Wafer-Switch Tuners: Coils

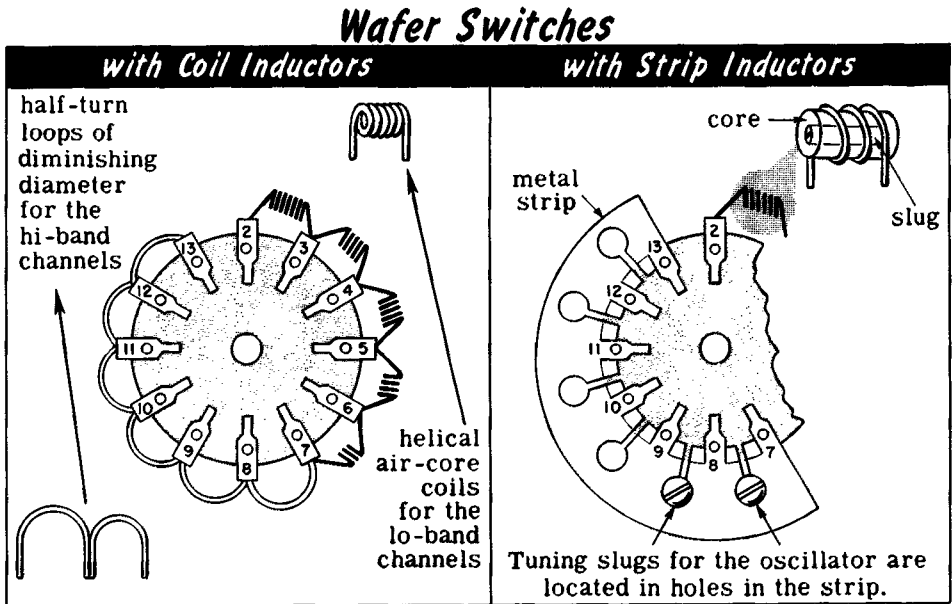

Stray circuit capacitance and (frequently) trimmer capacitors tune the coils in vhf wafer-switch tuners. The variable quantity in the different resonant circuits is the inductance. Air-core inductors in wafer-switch tuners are of several types. One kind is helically wound (for channels 2-6); another is half-turn loops of decreasing diameter (for channels 7-13). When adjustment is necessary to achieve tracking between two or more circuits, the coils are "knifed." (The turns are pushed together to increase the inductance or spread apart to decrease it, using a thin blade like a very dull-edged knife.) The inductance of the half-turn loops is changed by bending them toward or away from the tuner chassis. To facilitate adjustment of the inductors used in oscillator circuits, the coils are wound on forms that accept a slotted-head threaded slug of brass or powdered iron that can be moved into and out of the coil, thus varying its inductance. Some tuners have inductors for channels 7-12 formed from a thin strip of copper into which slots of different shapes are cut. The metal between the tongues (which are attached to the switch terminals) acts as the different amounts of inductance required for the different channels. (Remember that every conductor has inductance.) Forming the strip in this manner gives the necessary inductances in the most convenient and economical fashion, and gives series connection at the same time. Inductors of this type used in oscillator circuits must be variable. This is accomplished by the use of threaded brass slugs that move inside threaded holes cut into the strip.

TUNING ARRANGEMENTS

Wafer-Switch Tuners: Coils (contd.)

WAFER- TYPE SWITCH

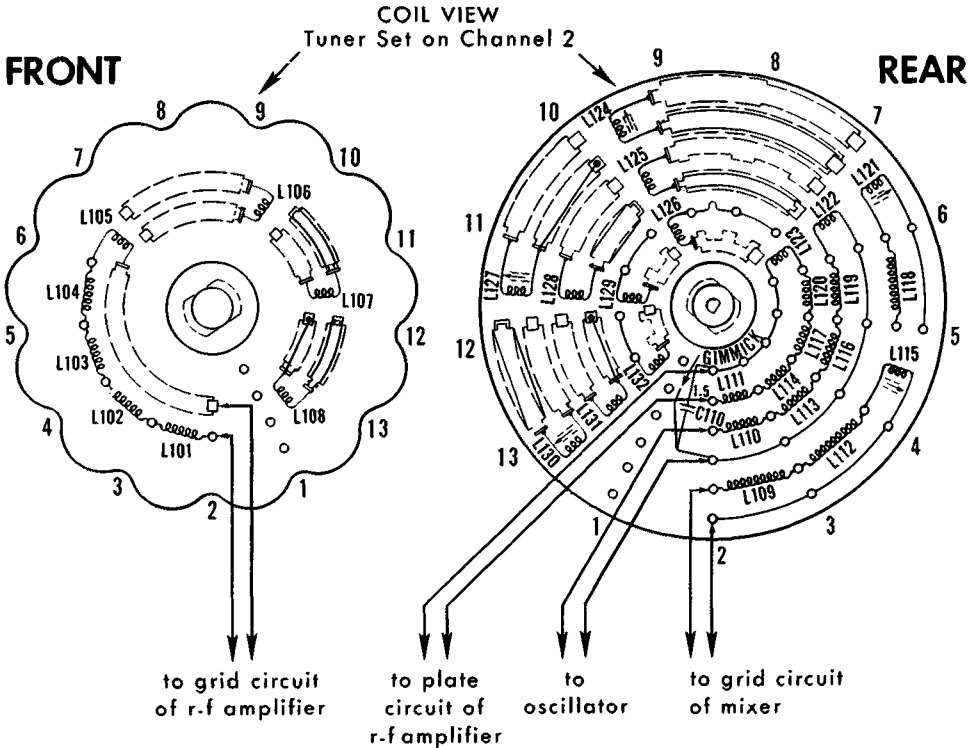

A singular departure from the conventional wafer-switch arrangement of inductor mounting is shown above and used in some Admiral receivers. The inductors are helical coils and metal strips. Unlike the usual arrangement, in which the inductors associated with circuits of the tuner are mounted on individual decks of the wafer switch, this arrangement mounts three of the four sets of tuned inductors on one disk, and the other set of inductors on a second disk. Another departure is in the manner in which the inductors are organized. Channels 2 through 6 use inductors connected in series, one of which is a metal strap. Channels 7, 8, and 9 employ a separate set of straps and a coil, and are completely dissociated from the rest of the inductors. Similarly, channels 10 and 11 have their own coils and straps, as do channels 12 and 13. The illustration shows the inductors for the grid circuit of the pentode r-f stage mounted on one disk, with those for its plate circuit, those for the mixer grid circuit, and those for the oscillator mounted on a separate disk.

TUNING ARRANGEMENTS

Wafer-Switch Tuners: Wafer Switches

A wafer switch is not a device that is readily disassembled and reassembled. When trouble develops in a wafer switch, the easiest and best solution is replacement. It is, however, advantageous to be able to read a wafer-switch symbol, because this makes wafer-switch-controlled circuitry more understandable. Although there are many varieties of wafer switches, the study of only two types will help to clarify the subject.

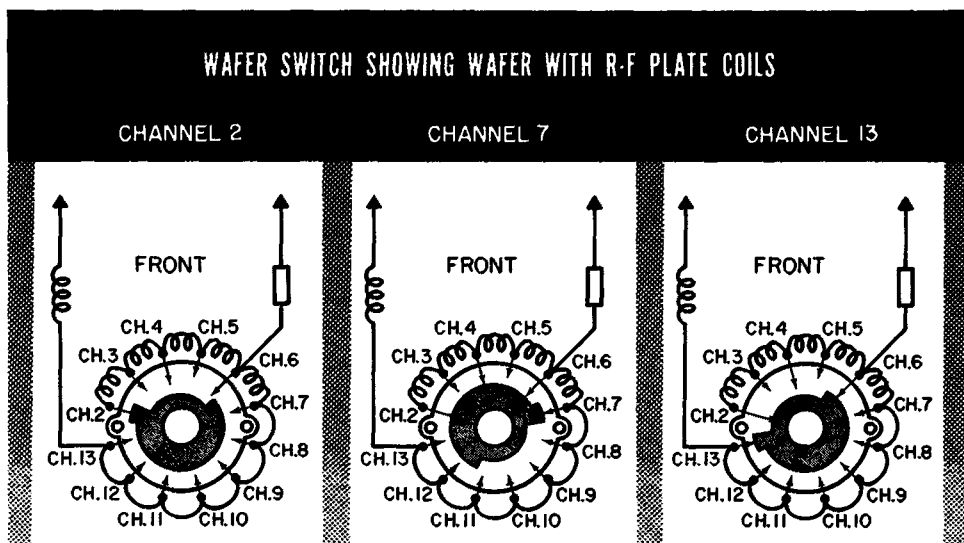

We show here a 12-position wafer switch that uses only the front deck as the active element. (A receiver could conceivably use several such wafers.) The label "Front" next to the switch symbol on the schematic indicates that the front is the active side of the deck. The mechanism that rotates as the switch is manipulated (the *rotor*) is a metal contact attached to the movable center of the deck. It can be a complete ring as shown here, or a partial ring as will be shown later. The stationary terminals on the deck (to which the circuit elements that are to be controlled are attached) are indicated by the heavy dots and the arrows placed in a circular pattern around the symbol. (Arrows in contact with the rotor indicate electrical connection.) By shaping the rotor (that is, by having a tongue or narrow and wide portions on it), single or multiple connections can be made as the rotor turns. In television tuners, one of the fixed terminals always makes contact with the rotor and is used as one side of the complete circuit. The diagrams show the progressive change in the number of inductors active in the circuit as the switch is manipulated, changing the position of the rotor. Note that the switch mounts inductors for channels 2 through 12, only; in accordance with common practice, the inductor for channel 13 is separately wired into the circuit.

TUNING ARRANGEMENTS

Wafer-Switch Tuners: Wafer Switches (contd.)

TYPICAL WAFER SWITCH CIRCUITRY

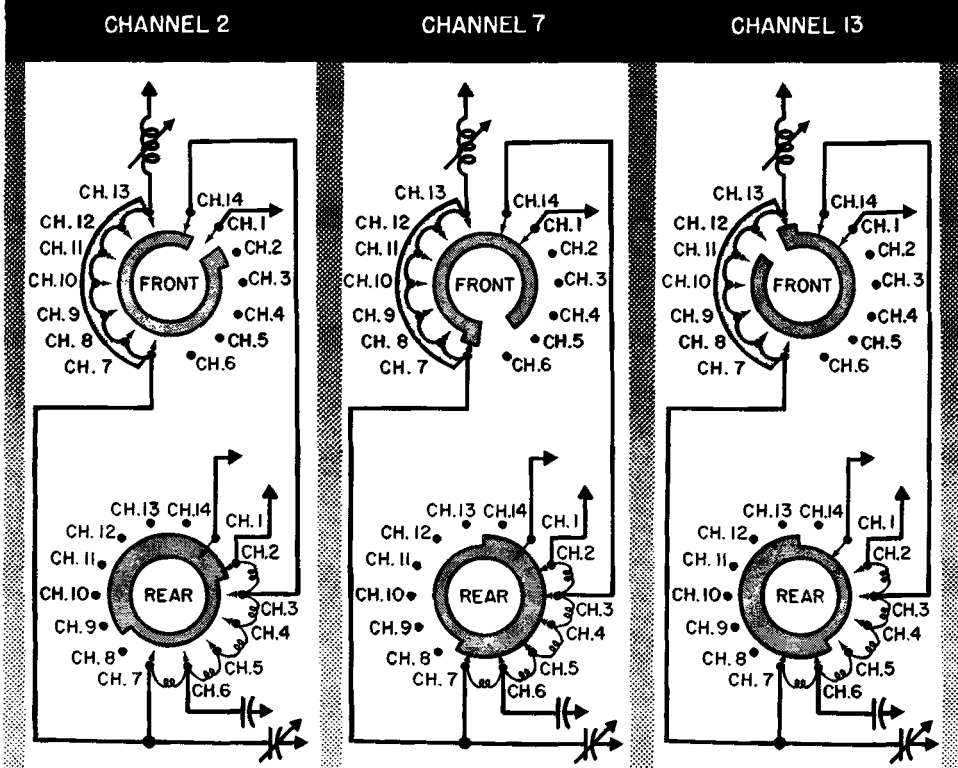

A 14-contact wafer that has a front and a rear deck is shown here. (Three or four such wafers could comprise the channel-selector switch in a receiver.) The rear deck mounts the inductors for channels 7 through 12. (The inductor for channel 13 is part of the circuit but is not switch-controlled.) Although it is customary to use 12-terminal wafers, the use of a 14-terminal wafer is only a matter of special design to accommodate more than the usual number of circuit elements that must be switched into and out of the various circuits in the process of channel selection. The rotor on the rear deck is differently shaped from that on the front, to permit the rotors to perform different functions. As the switch is moved from channel 2 to channel 13 one step at a time, the rear rotor shorts out the lo-band conductors one at a time; only when all of them are shorted out does the front rotor begin to short out the high band inductors one at a time. The illustrations show the change in circuitry as the switch is manipulated.

TUNING ARRANGEMENTS

Wafer-Switch Tuner Circuits

Although they differ in specific circuitry, wafer-switch tuner circuits are alike in their general design because they have similar objectives. For example, the use of tuned impedances instead of transformers is virtually standard, yet there is only limited consistency in the circuits used in different brands of tuners using a like number of tubes. Most cascode wafer-switch tuners have wafer-switch-controlled tuned circuits in the grid circuit of the r-f amplifier input in the plate circuit of the grounded-grid amplifier, in the grid circuit of the mixer, and in the oscillator. However, the method of coupling the antenna to the r-f amplifier differs between brands of tuners, as do the coupling methods applied between the r-f amplifier plate circuit and the mixer. Variations in circuitry also arise from the different means used to achieve the stability required in the tuner. Certain basic circuit elements are however standard, as shown in the simplified schematic.

Basic Cascode Wafer-Switch Tuner Circuit

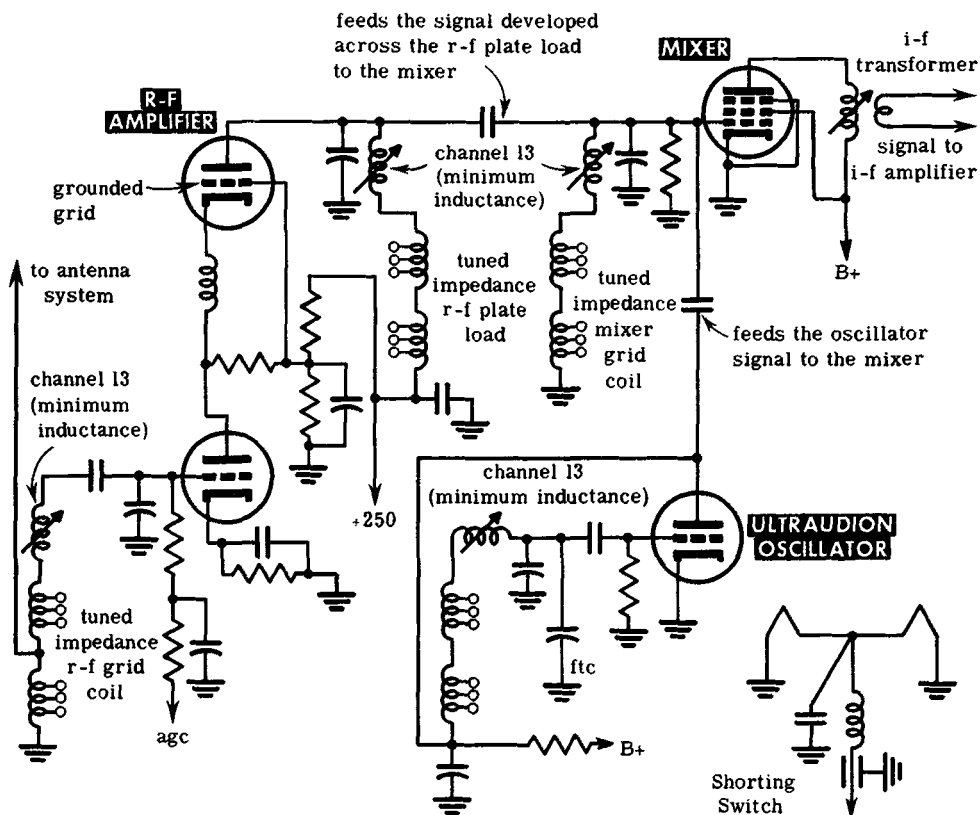

TUNING ARRANGEMENTS

The Continuously Variable Tuner Circuit

The continuously variable inductance tuner is like the wafer-switch tuner except that the inductance in the tuned circuits is varied by sliders moving along the bare wires of the coils instead of switching inductors in and out of the circuits.

Continuously Variable Tuner Circuit

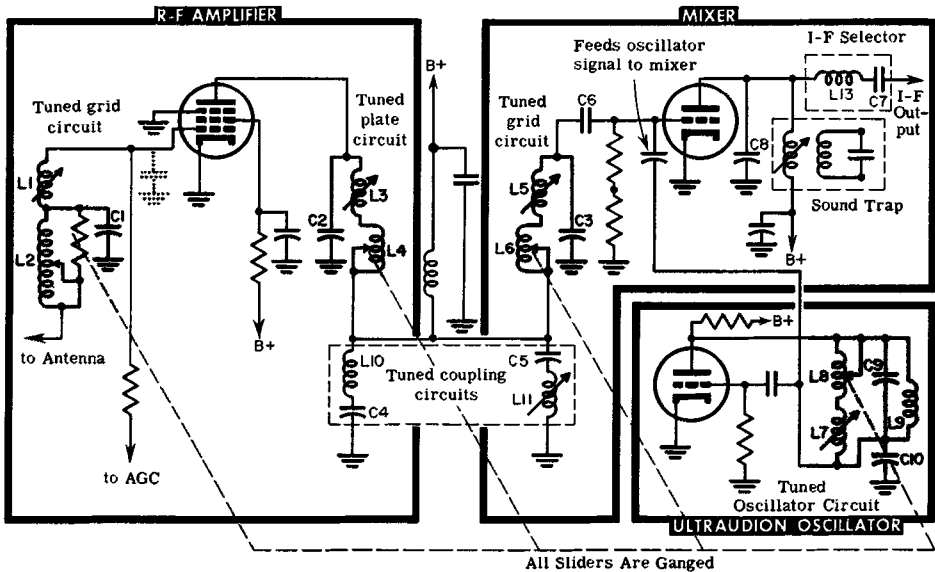

The basic elements of a four-circuit continuously variable inductance tuner (Inductuner or Inputuner) are shown in the schematic. The location of the four tuned circuits is shown by the shaded boxes. (The chassis ground is the common path that completes the circuits.) L1, L3, L5, and L7 are separately adjustable inductors used to control the performance of the circuits at the high-frequency end. (Inductors used in the same manner are found in all wafer-switch tuners.) Note L10, C4, C5, and L11; these components function as the common coupling link between the tuned r-f plate circuit and the tuned mixer grid circuits. Signal currents from the r-f plate circuit pass through these coupling circuits, which, being common to both tuned circuits, feed the signal from the r-f plate to the mixer grid over the frequency band from 54 to 216 mc. (This action is described in more detail later.) L12 keeps the junction of L4 and L6 above r-f ground, which permits the coupling circuits to function.

TUNING ARRANGEMENTS

The Permeability-Tuned Tuner

The lo-hi-band continuously variable permeability-tuned tuner bears a resemblance to both the wafer-switch and the continuously variable front ends. The variation in inductance for the lo- or hi-band tuned circuits is accomplished by the positions of the powdered-iron slugs used as the cores of the coils. Because the inductance of a coil depends on the material of which its core is made, and because iron is a better path than air for the magnetic lines of force produced when the coil carries current, the position of the iron core determines the inductance of the coil. The inductance is increased when the core is inserted into the coil and reduced when it is removed. The permeability-tuned tuner makes use of this phenomenon, varying the coil inductances to change circuit resonant frequencies. (As discussed earlier, the capacitance that causes the circuits to resonate may be considered to be fixed.)

The schematic is that of a three-circuit permeability-tuned tuner set to either the lo- or the hi-band channels. Either one may be assumed because the circuit elements used in both are similar, and the range of tuning is set by switching one of two sets of coils into the circuits. The resonant circuits are shown by the heavy lines.

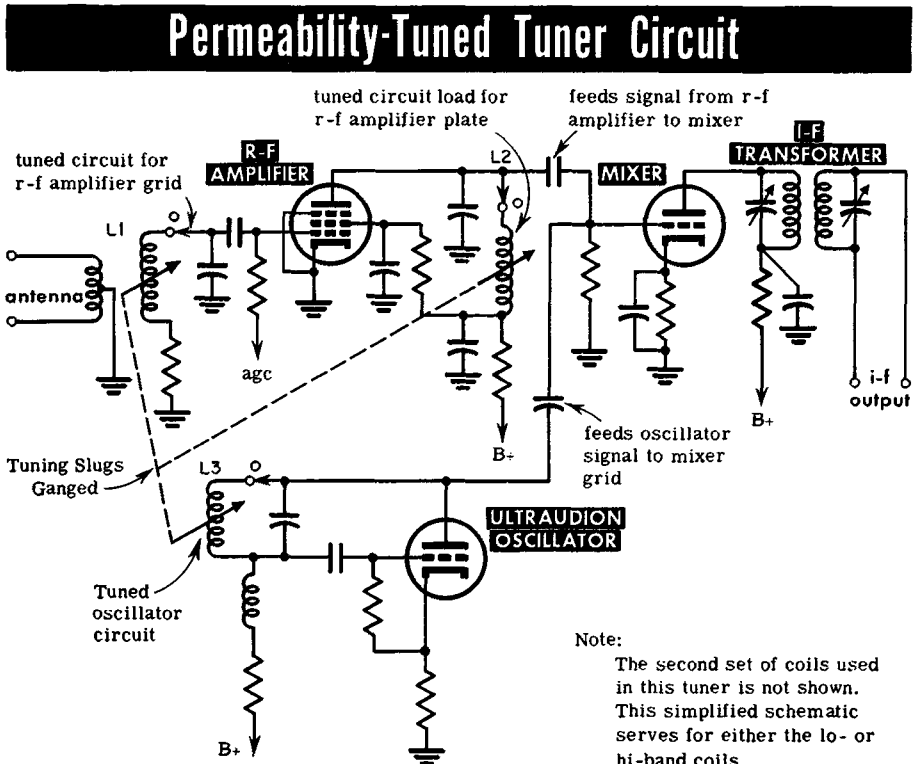

TRAPS AND COUPLING METHODS

Cathode-Fed R-F Input Circuits

The r-f amplifiers in the tuners that we discussed represent only a small cross section of the many that are used. Here is an example of r-f signal feed into the cathode circuit of a grounded-grid amplifier. We repeat that application of a signal to the cathode of a grounded-grid system is the equivalent of applying the signal between the control grid and the cathode. It should be noted that every grounded-grid amplifier is not necessarily part of the cascade amplifier. The circuit shown here is one such example. The received signal is applied across switch-selected parallel-tuned circuits located between cathode and ground. These circuits act as the load on the antenna transformer. Different combinations of L and C are made active as the channel is changed. The upper deck of the wafer switch controls the selection of the tuned circuits for channels 7-13, whereas the lower deck cuts in the components required for channels 2-6. The sectionalized schematics show the circuits formed for the different channels as the wafer switch is rotated. The change made is shown in heavy lines. Elements L3-C3 form a series resonant i-f trap active on the lo-band channels. Its action is described in more detail elsewhere in this section. The cathode bias current flows through the antenna transformer secondary and the bias resistor R.

Grounded-Grid R-F Amplifier

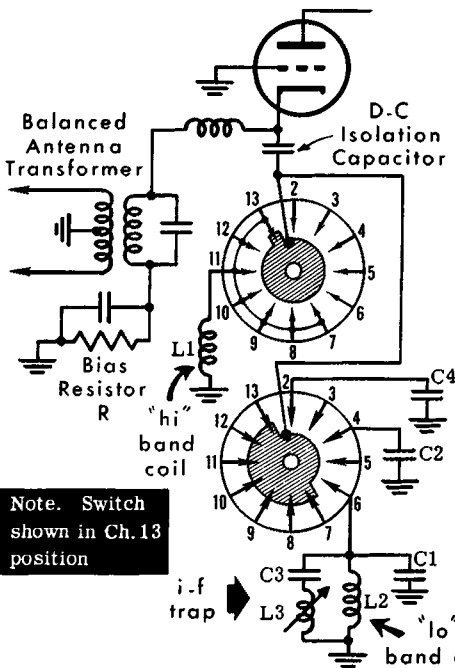

Equivalent Cathode Circuits

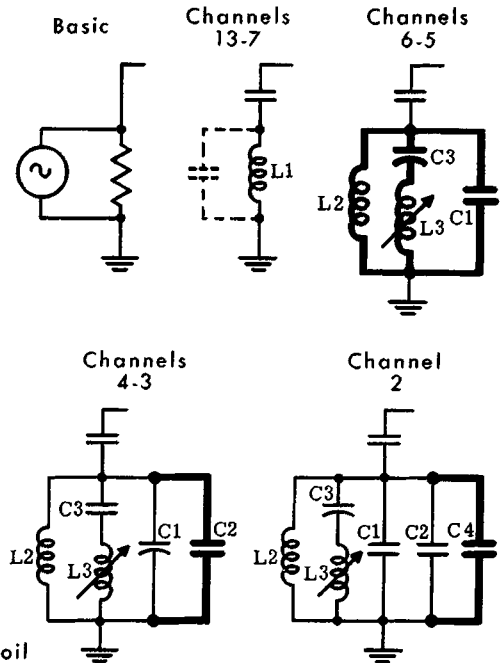

TRAPS AND COUPLING METHODS

Cathode-Fed R-F Input Circuits (contd.)

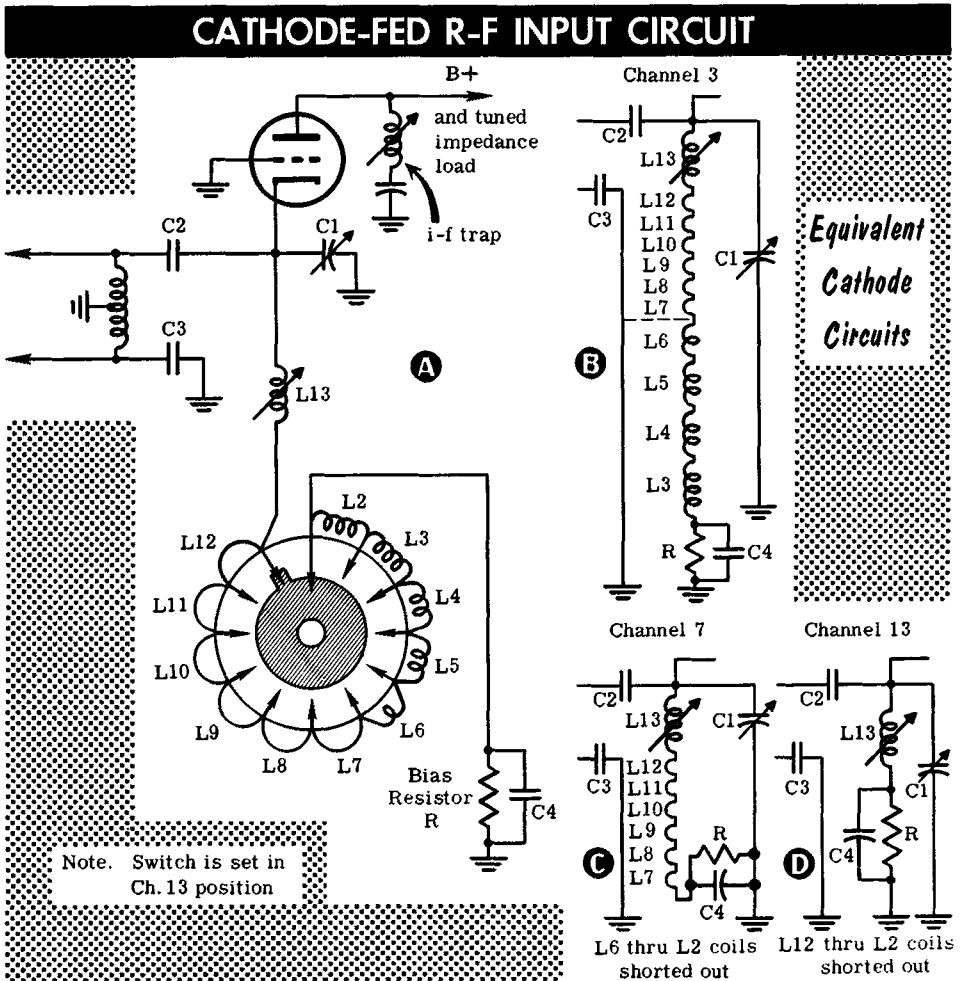

Another example of a signal feed across a tuned circuit connected between cathode and ground is shown above. The antenna transformer output (via C2-C3) is applied across the tuned signal circuit that is formed by the tuning capacitor C1 and the wafer-switch-controlled inductors L2-L13. The design of the switch is such as to add coils in series while shorting out the inactive coils. This is shown in the three sectional schematics.

In some cases, a signal from the antenna transformer is applied across a portion of the parallel-tuned circuit when most of the inductors are active, and across the entire circuit when it is set for the high-band channels. This arrangement is shown by the dotted-line connection in circuit B.

TRAPS AND COUPLING METHODS

Series-Resonant Trap Circuits in Tuners

THE SERIES-RESONANT CIRCUIT

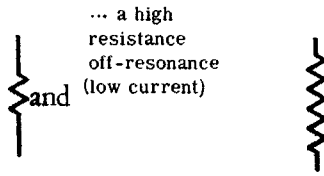
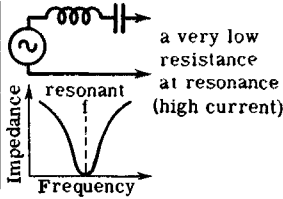

THE PARALLEL-RESONANT CIRCUIT

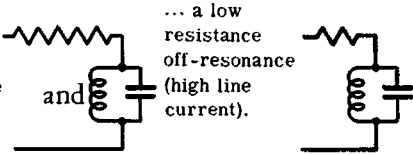
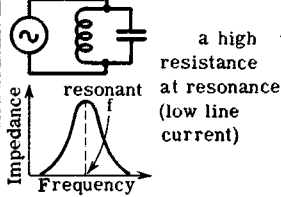

Television receivers are subject to interference signals. Television channel frequencies and operating frequencies assigned to other services are intermixed. Any signal (image) that differs in frequency from the heterodyne oscillator frequency by the receiver's i-f will, if it gets into the mixer, be processed by the receiver. Any signal that has a frequency within the passband of the i-f system of the receiver, will, if it gets into the i-f system, be processed through the receiver. Thus, Television receiver design must prevent the entry into the front end of a wide variety of interference signals. This is done by means of series and parallel resonant trap circuits. Later on you will see the application of traps in another important part of the receiver.

Although identified with a particular *resonant* frequency, each kind of trap circuit functions over a relatively narrow band of frequencies. The width of the bandpass is a function of the circuit "Q." The smaller the resistance of the circuit the more sharply it tunes, and the narrower its bandpass will be.

How Series-Resonant Traps Are Used In Tuners

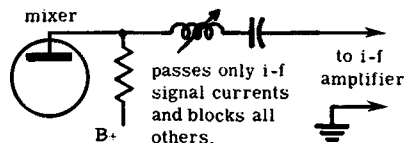
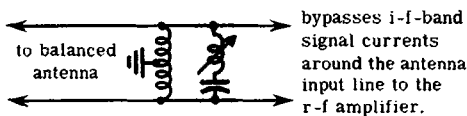
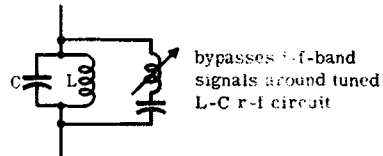
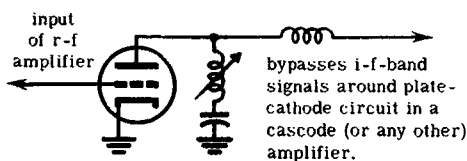

TRAPS AND COUPLING METHODS

Parallel-Resonant Trap Circuits in Tuners

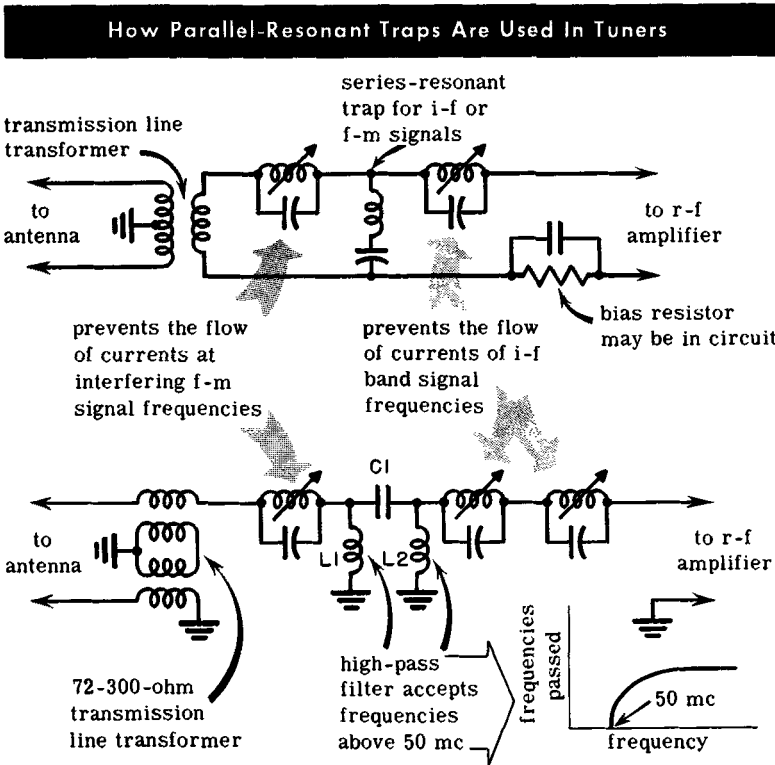

We discussed the parallel-resonant circuit as a tuned-impedance signal load in the plate and grid circuits of amplifiers and mixers. Now we show a similar L-C combination used for a different purpose, as a means of preventing the flow of undesired signal currents. When using a parallel-resonant circuit as a signal trap, we take advantage of the high impedance that the circuit presents to the flow of currents at the resonant frequency *in the line* in which the circuit is connected. The circuit also presents a high impedance when it is used as a load, but then we *transfer* the signal voltage built up across the resonant circuit to the next stage. In the case of the trap application, the energy represented by the voltage buildup across the circuit is not used; rather we allow it to be dissipated in the circuit. In the trap application of the parallel-resonant circuit we reduce the undesired currents in the line as much as possible, thus developing the lowest possible undesired signal voltage across whatever load may be on the line. The inductor present in one leg of the parallel resonant circuit permits its insertion in d-c paths. Elements L1, L2, and C1 in Circuit B act as a high-pass filter, that is, act to short circuit (or at least greatly attenuate) all frequencies below the lowest television channel frequency.

TRAPS AND COUPLING METHODS

Transmission-Line Input Systems

Some vhf tuners apply the received r-f picture and sound carrier signals between the control grid and ground of the r-f amplifier; others apply it between the cathode and ground. In both cases the system is unbalanced, inasmuch as both ends of the input system are not at the same potential relative to ground.

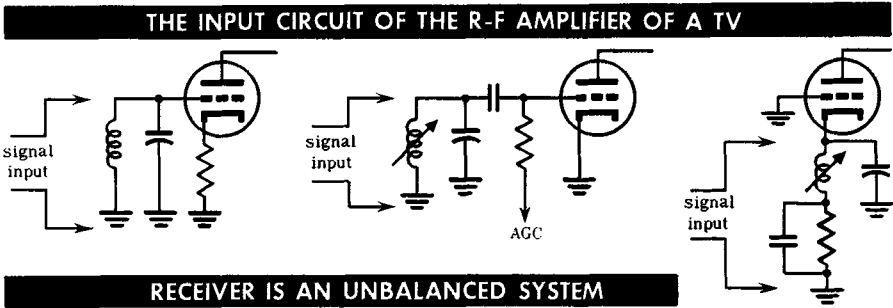

Most transmission lines in use have a nominal impedance of 300 ohms and are balanced, although unbalanced lines of lower impedance are sometimes used. Any line must be "matched" to the r-f amplifier. Design engineers have different ways of accomplishing this result, so it is not surprising that there are quite a few transmission line input systems in different receivers. They differ in the means employed to accomplish the proper loading on the line, thus avoiding reflections due to impedance mismatch and attaining delivery of maximum signal to the receiver.

Matching Transmission Line To R-F Amplifier

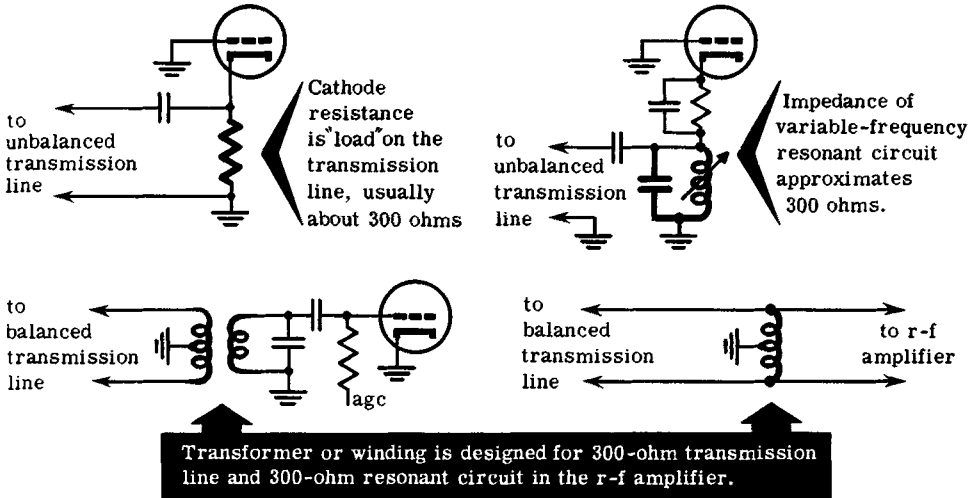

TRAPS AND COUPLING METHODS

Transmission-Line Input Systems (contd.)

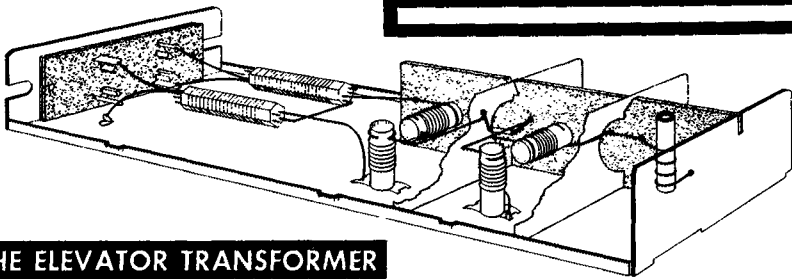

THE ELEVATOR TRANSFORMER

Many brands of television receivers are equipped with a transmission-line input device that will accept either a 75-ohm unbalanced transmission line or a 300-ohm balanced line at one end and deliver a 300-ohm unbalanced output at the other. In action it is an impedance transformer or *balun* (derived from *balanced* to *unbalanced*) that works in both directions, although it is used in only one direction in television receivers.

The transformer consists of the equivalent of two 150-ohm twin conductor balanced transmission lines. Each line is formed from two bifilar-wound coils, each winding of which is the equivalent of one of the conductors of the equivalent line. (A bifilar winding is made up of two conductors, wound side by side on the frame.) The two pairs of bifilar windings are therefore the equivalent of two twin-conductor transmission lines.

BIFILAR COILS AND TRANSMISSION LINES

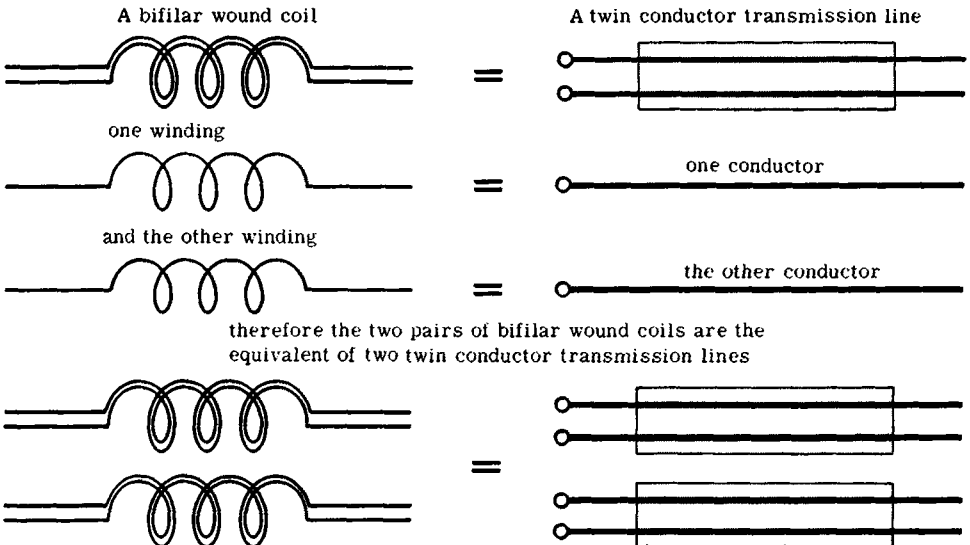

TRAPS AND COUPLING METHODS

Transmission-Line Input Systems (contd.)

300-ohm to 300-ohm Baluns

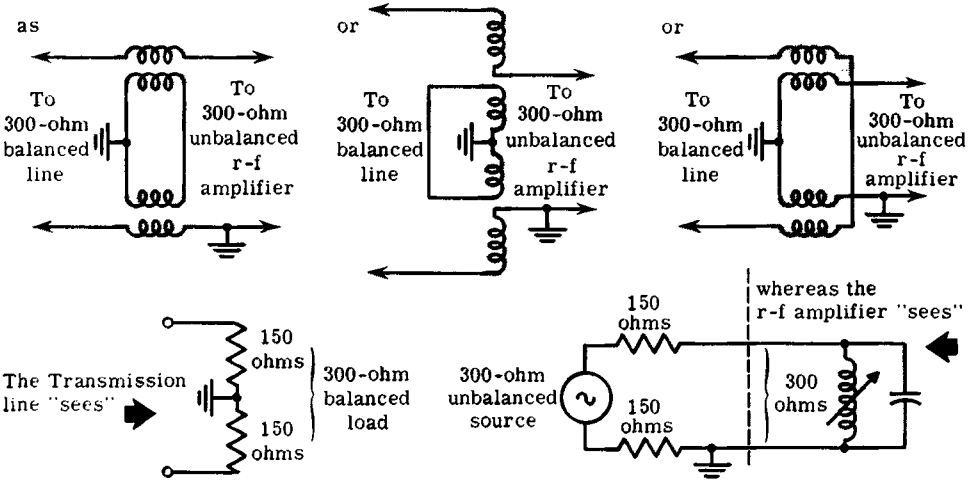

The very tight coupling between the windings that make up each line enables the unit when connected for a 300-ohm line to behave in a fashion which makes a 300-ohm balanced line "see" a grounded center-tapped (balanced) load made up of two 150-ohm impedances in series; similarly, the r-f amplifier "sees" a 300-ohm source made up of the two 150-ohm impedances in series, one in each leg. A variety of circuit arrangements are used when the unit is connected between a 300-ohm balanced antenna and delivers a 300-ohm unbalanced output.

The same device, when connected differently, accepts the 75-ohm unbalanced line and delivers 300-ohm unbalanced output. To accommodate the lower impedance input, the two transmission-line equivalents are connected in parallel at the input side and remain individual lines acting in series at the output side.

75-ohm to 300-ohm Balun

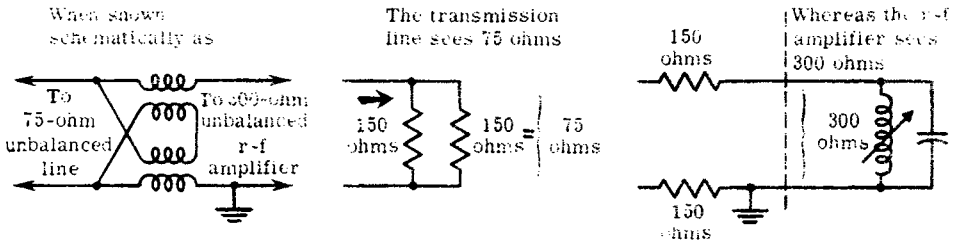

TRAPS AND COUPLING METHODS

Broadband Signal-Transfer Methods: Stagger Tuning

Certain portions of a television receiver process two carriers simultaneously—the transmitted r-f picture and sound carriers or their i-f counterparts. In both instances the two carriers are 4.5 mc apart, hence broadband circuits must be used to couple these signals from one point to another in the receiver. Several methods are used to give the necessary bandpass.

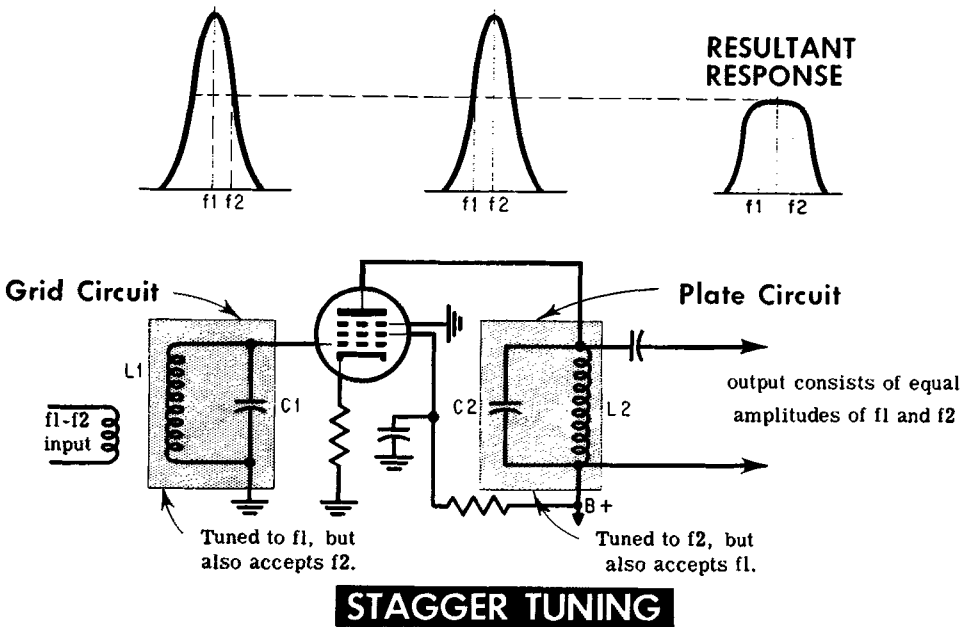

One method takes advantage of the fact that the response of resonant circuits exists on either side of the resonant frequency. If two signals of frequencies f_1 and f_2 are fed into a resonant grid circuit L_1-C_1 , which although tuned to f_1 also accepts f_2 to some measure, both frequencies will be present across the circuit. (Voltage f_2 will, of course, have lower amplitude than f_1 .) If another tuned circuit L_2-C_2 resonated to f_2 , but broad enough in response to accept f_1 to some degree, is located in the plate circuit of the same amplifier, the f_1 and f_2 grid voltage variations will cause plate current variations; the voltages at f_1 and f_2 will be developed across L_2-C_2 . The amplifier as a whole functions as a double-tuned or broadband amplifier and this method of broadbanding is called *stagger tuning*. The frequency response of such a system (measured between the input to L_1-C_1 and the output L_2-C_2) is shown by a double-peaked curve that sometimes approaches a flat-topped character. The method is not limited to two tuned circuits and a single amplifier stage as in a tuner; three and four resonant circuits often are stagger tuned, as in the picture i-f amplifier of the television receiver, which we shall discuss shortly.

TRAPS AND COUPLING METHODS

Broadband Signal-Transfer Methods: Capacitive Overcoupling

Assume a resonant circuit L_1-C_1 in the plate circuit of an amplifier, and another similar circuit L_2-C_2 in the grid circuit of the succeeding stage. Both circuits are tuned to the same frequency. There is no inductive coupling between L_1 and L_2 , and the two circuits are connected only by capacitor C_3 .

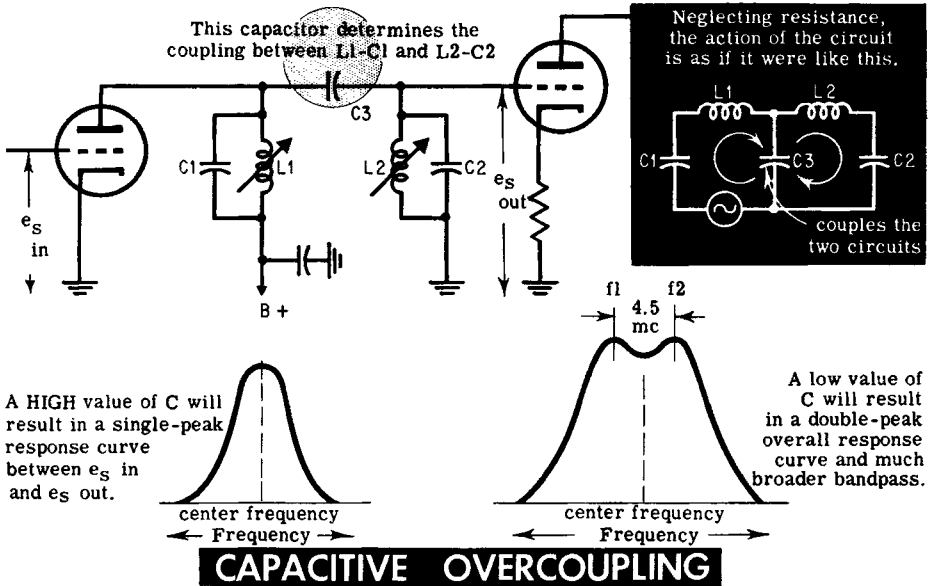

It may appear that the function of C_3 is to couple signal energy from the plate circuit to the grid circuit; however, its action is not as simple as this. A changing voltage across L_1-C_1 produces a varying voltage across C_3 , hence C_3 acts as the source of signal voltage for L_2-C_2 . In addition, a varying signal voltage across L_2-C_2 develops a varying signal voltage across C_3 , and C_3 now acts as a voltage source for L_1-C_1 . This behavior of C_3 is the equivalent to that of a coupling impedance common to both circuits. The *higher* the value of C_3 , the lower its reactance at the signal frequencies and the *looser* the coupling because the voltage developed across C_3 is smaller; conversely, the lower the value of C_3 , the higher its reactance, hence the higher the voltage across it and the tighter the coupling. Given sufficient interaction, the response of the two circuits to a single frequency gives way to response over a much wider band with new resonant peaks at two frequencies, one lower and one higher than the resonant frequency to which the circuits were originally tuned. This gives a double-peaked broadband-tuned system: An arrangement of this kind can very easily pass two signals f_1 and f_2 , 4.5 mc apart, hence it may be used between the r-f amplifier and mixer in tuners.

TRAPS AND COUPLING METHODS

Broadband Signal-Transfer Methods: Inductive Overcoupling

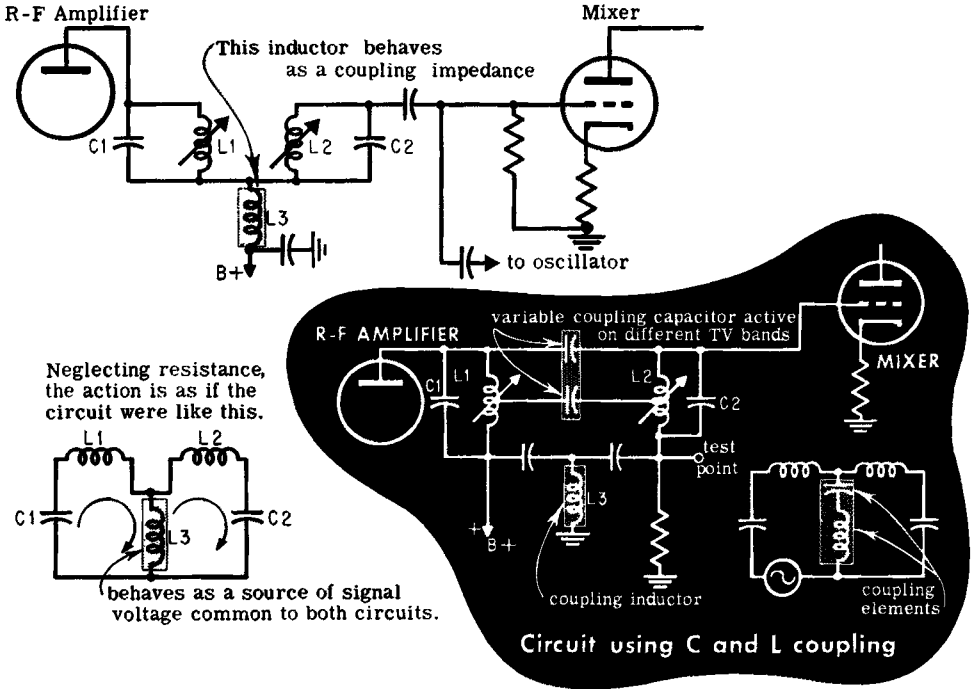

INDUCTIVE OVERCOUPLING

Another broadband signal transfer method utilizes inductance rather than capacitance as the coupling impedance that links the two independently tuned circuits. Because the coupling link is located at the "low" end of the circuit this method is called *bottom coupling*. The two circuits L1-C1 and L2-C2 are tuned to the same frequency and again there is no magnetic coupling between them.

The inductor L3 behaves as a common voltage source for the two tuned circuits, just as the capacitor does in capacitive coupling. However, when *direct* inductive coupling is used, the amount of coupling increases with an increase in inductance, because an increase in inductive reactance causes an increase in the voltage developed across the coupling link. When used in television tuners such inductive coupling links are small coils or even a small strip of metal.

In some television tuners, the coupling is capacitive as well as inductive, utilizing one or more capacitors and the inductor. The use of several coupling capacitors is the answer to changes that occur in coupling as the inductors are switched into the circuit to change channels.

TRAPS AND COUPLING METHODS

Broadband Signal-Transfer Methods: Transformer Overcoupling

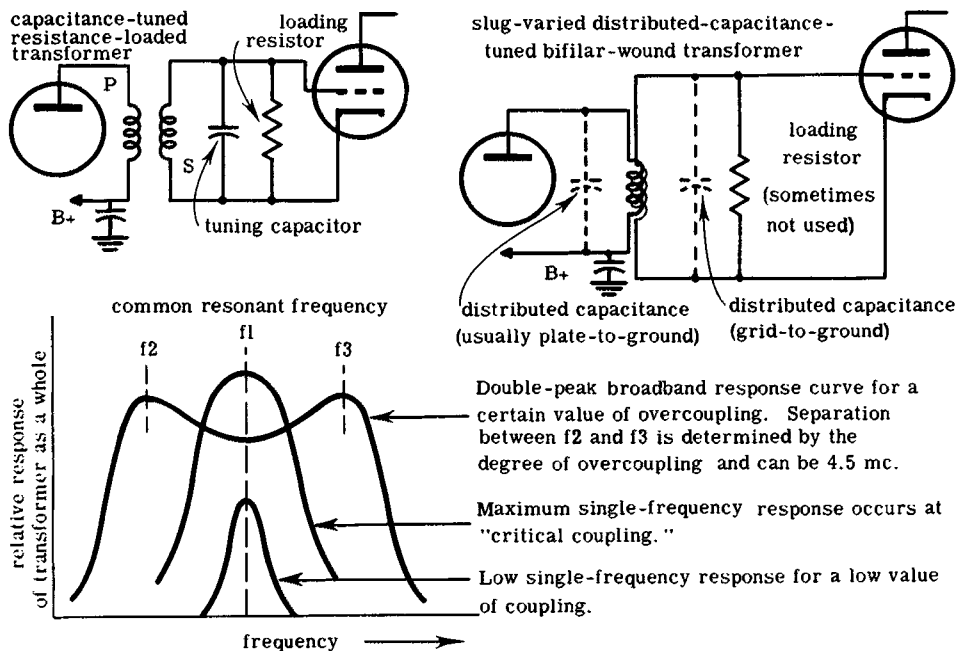

TRANSFORMER OVERCOUPLING

The most popular method of broadband signal transfer is the tuned transformer. It is used in television tuners and i-f amplifiers. There are numerous possible arrangements but those in use can be placed into two main groups: the capacitance-tuned and resistance-load types, and the bifilar-wound type. In both instances, the primary and secondary windings are (if independently tuned) resonated to the same frequency. Were it not for the overcoupling, the unit as a whole would display a single-peak response curve. The condition of overcoupling does, however, modify the frequency response. The signal current in the primary develops a magnetic field that cuts the secondary turns and develops a voltage across these turns. But the secondary voltage causes a secondary current, which in turn develops a magnetic field that cuts the primary turns and induces a voltage across the primary. (Here the magnetic field is the common coupling impedance.) When the coupling is greater than "critical" (which results in the greatest single-frequency response), the interaction between the two circuits creates two new resonant peaks, one above the original resonant peak and one below it, thus making the overall frequency response double-peaked or broadband. The amount of overcoupling determines the frequency separation between the peaks, and resistance loading is used to flatten the peaks.

UHF CONVERTERS

UHF Converters: Strip Tuner

DOUBLE-CONVERSION UHF STRIP CONVERTER

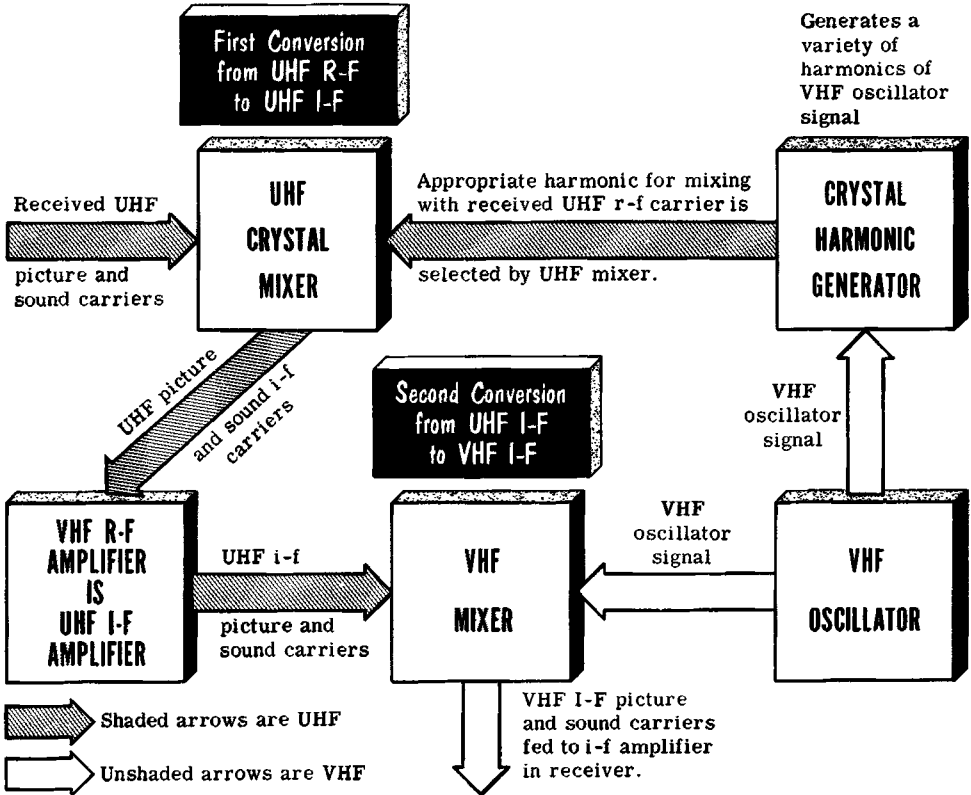

The uhf strip converter is used with vhf front ends that have a turret bearing strip-mounted coils for vhf reception. Since no receiving location makes use of every one of the 12 channel positions covered by a vhf strip tuner, several vhf strips can be removed and replaced by the uhf strips that are appropriate for the channels available at a receiving location. When the uhf strips are used in place of the vhf strips, all circuit modifications are made automatically. The uhf strip converts the vhf front-end to a double-conversion system, in which a crystal mounted on the strip acts as the first mixer, and the regular vhf mixer tube performs the second mixing. When the front end is used in this manner, its vhf r-f amplifier is modified by the uhf strip to behave as the uhf i-f amplifier. The vhf oscillator serves in its original capacity, in addition to which, it also generates the basic signal harmonics, of which one is used in the first mixer to heterodyne against the received uhf picture and sound carriers.

UHF CONVERTERS

UHF Converters: Strip Tuner (contd.)

To understand the frequency conversion process, consider the following case. Assume that the receiver is designed for a 45.75 mc picture i-f and a 41.25 mc sound i-f. UHF channel 33 (584-590 mc) is to be received. Its picture and sound carrier frequencies are 585.25 mc and 589.75 mc, respectively. After passing through preselection circuits these two signals are fed to the uhf crystal mixer (the first mixer). The vhf oscillator generates a 157.75-mc signal, the frequency being determined by the circuitry of the channel-33 uhf strip. The 157.75-mc signal then is fed into two paths—to the harmonic generator and to the vhf mixer. The harmonic generator is a crystal rectifier in which the rectification of the oscillator signal produces an output signal voltage that contains many harmonics of the signal from the vhf oscillator signal. This host of signals is fed to the uhf mixer, where, by virtue of its resonance, the circuitry picks out the third harmonic (whose frequency is 3×157.75 or 473.25 mc) for mixing with the two received uhf carriers. When the 585.25-mc picture carrier is mixed with the 473.25-mc heterodyning signal, the difference-frequency (585.25—473.25) picture i-f signal of 112 mc is produced. Similarly a difference-frequency sound i-f of 116.5 mc is produced.

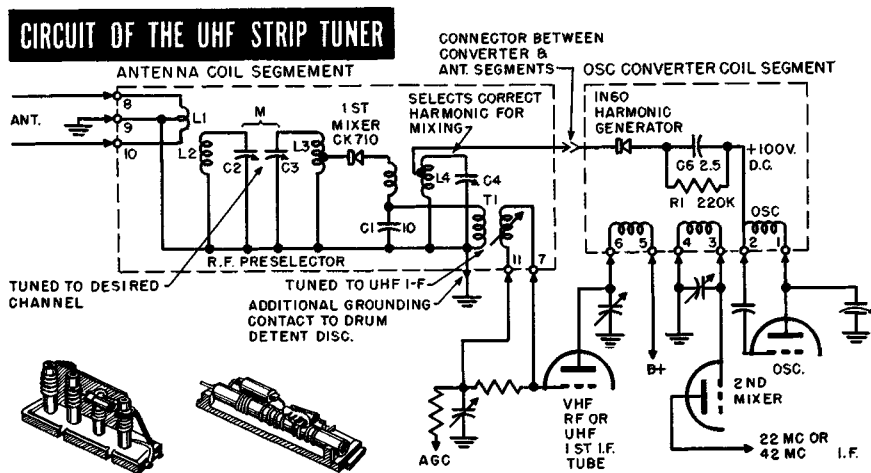

The two i-f carriers produced by the first mixer are fed to the uhf r-f amplifier. (This stage, when used for vhf reception is the vhf r-f amplifier.) The output of the uhf i-f amplifier is fed to the vhf (second) mixer. It accepts the 112-mc and 116.50-mc signals because the uhf strip tunes the mixer circuit. This mixer receives a 157.75-mc signal from the uhf oscillator. Mixing takes place and two conventional difference-frequency vhf signals are produced, these being the 45.75-mc picture i-f and the 41.75-mc sound i-f signal carriers. Both are fed to the receiver i-f amplifier for normal processing.

UHF CONVERTERS

UHF Converters: Strip Tuner (contd.)

SINGLE-CONVERSION UHF AND VHF STRIP TUNER

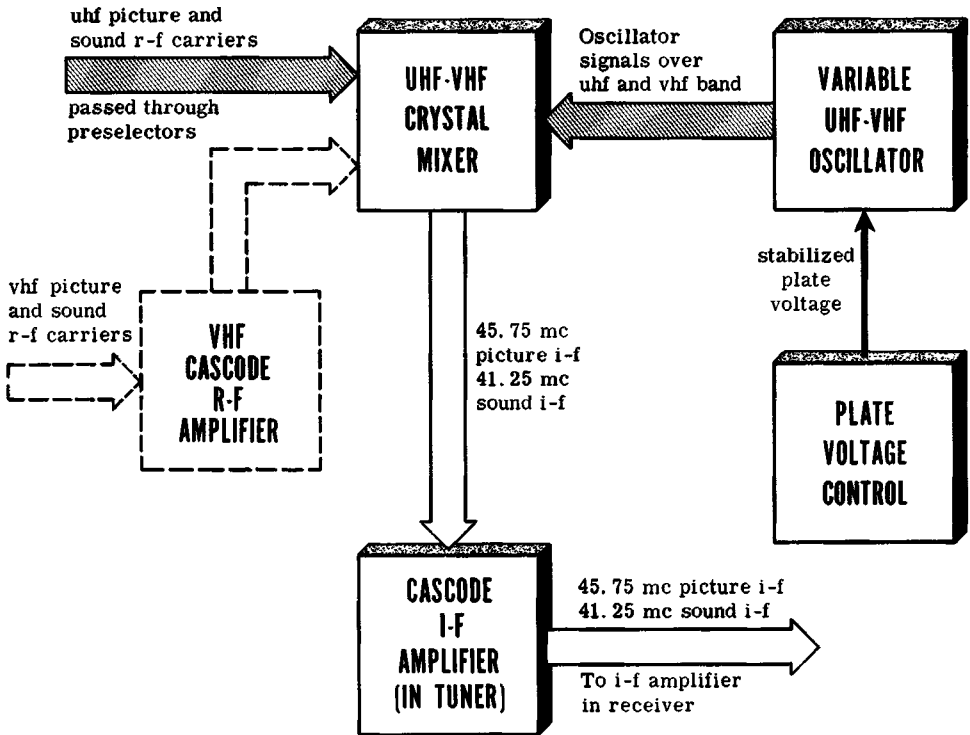

The block diagram of a single-conversion combination uhf and vhf strip tuner is shown below. It differs from the preceding tuner in a number of respects. Inspecting the uhf portion first, the uhf picture and sound r-f carriers pass through two stages of pre-selection after which they are fed to the crystal mixer. A plate-voltage-stabilized local oscillator generates fundamental frequencies that are high enough to heterodyne directly against the received uhf carriers in the mixer to produce the desired picture and sound i-f carriers without any additional conversion. If, for example, uhf channel 20 (506-512 mc) is being received, the local oscillator generates a 553-mc signal that heterodynes with the 507.25-mc picture r-f carrier and with the 511.75-mc sound carrier to produce the difference-frequency i-f carriers of 45.75 mc (picture) and 41.25 mc (sound). Before being applied to the i-f amplifier in the receiver, the picture and sound i-f signal output from the mixer is subjected to pre-amplification in a cascode i-f amplifier in the tuner. For vhf reception, a cascode r-f amplifier is cut into the circuit between the antenna and the mixer.

UHF CONVERTERS

UHF Converters: Tuned-Line Type

Tuned circuits used in uhf converters are usually formed from specially constructed transmission lines called *tuned lines*. They are preferred to conventional coils and capacitors because they are higher "Q" circuits that are more efficient at uhf as well as at vhf frequencies. As a rule, the line approximates an electrical quarter-wavelength at the operating frequency. It is shorted at one end and therefore presents a high impedance at the other. (This form of behavior corresponds to that of a parallel resonant circuit.)

OPEN QUARTER-WAVE LINE IS TUNED BY CHANGING L OR C

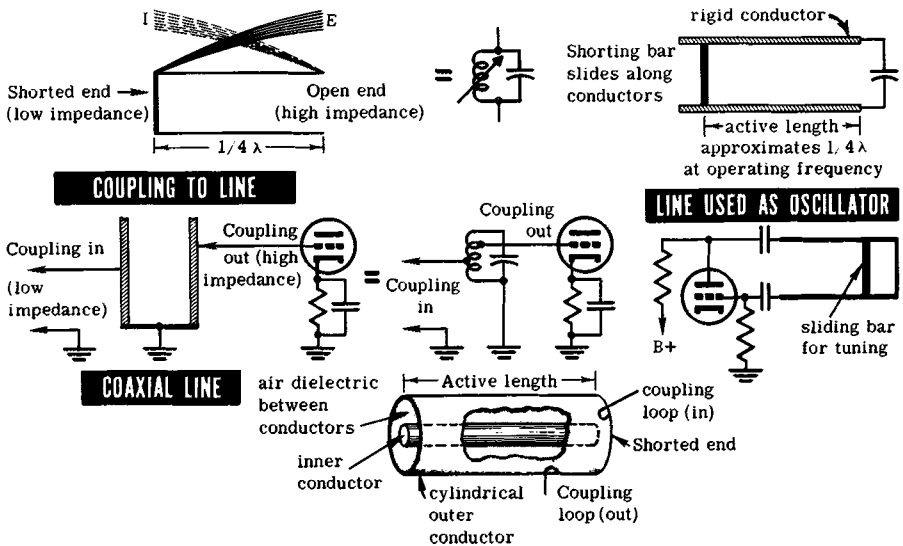

One variety of line is made from rigid conductors separated by air. Coupling to the line is effected by direct contact with the conductors. Different points along the conductor afford different impedance ratings between minimum at the shorted end to maximum at the open end. Another variety of tuned line is coaxial. A cylindrical tube acts as the outer conductor, and a centrally located metallic rod within the tube is the inner conductor. Air separates the two conductors, and the signal energy exists in the space between them. Coupling to and from the line is achieved by means of loops placed within this signal field. The open conductor and the coaxial line are tuned by changing their inductance (with a shorting bar that slides along the length of the conductor, reducing its active length). The lines may also be tuned by capacitors connected between the conductors, or capacitance vanes that are introduced into the field space to increase its dielectric constant, thus increasing the total capacitance of the circuit.

UHF CONVERTERS

UHF Converters: Tuned-Line Type (contd.)

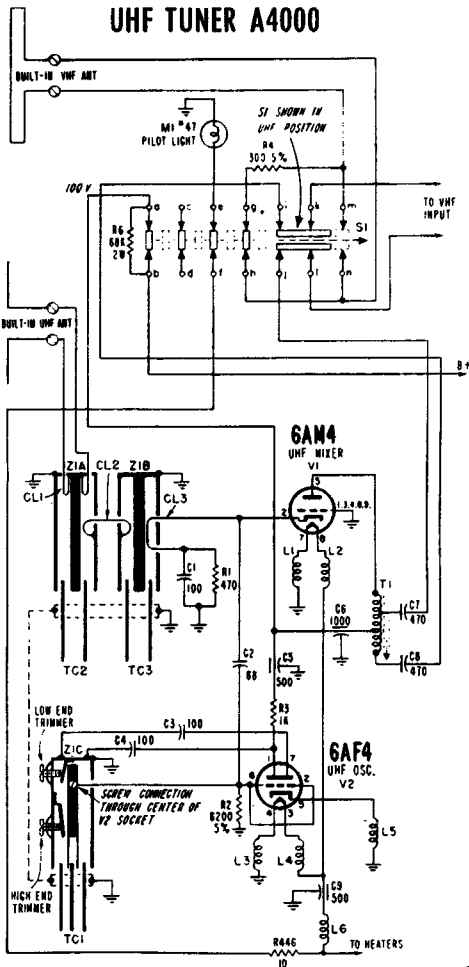

The schematic of a uhf converter that functions in conjunction with a vhf tuner set to either channel 5 or 6 is shown here. The output of the uhf mixer is a uhf i-f picture carrier and a uhf i-f sound carrier that correspond in frequency to the carriers of vhf channel 5 or 6, whichever is not allocated in the area. (Only the uhf portion is shown here because we have already discussed a variety of vhf tuner circuits.) The uhf portion consists of a vacuum-tube or crystal mixer and an oscillator, the circuits of which use tuned lines and are variable in frequency over the entire uhf band. The output frequency of the oscillator (a Colpitts circuit) is below that of the received uhf carriers. As a result of this relationship, the picture carrier in the output of the uhf mixer is lower in frequency than its associated sound carrier.

For vhf reception, the switching mechanism selects the vhf antenna and cuts out the uhf converter. For uhf reception, the mechanism connects the output of the uhf mixer to the input of the vhf tuner.

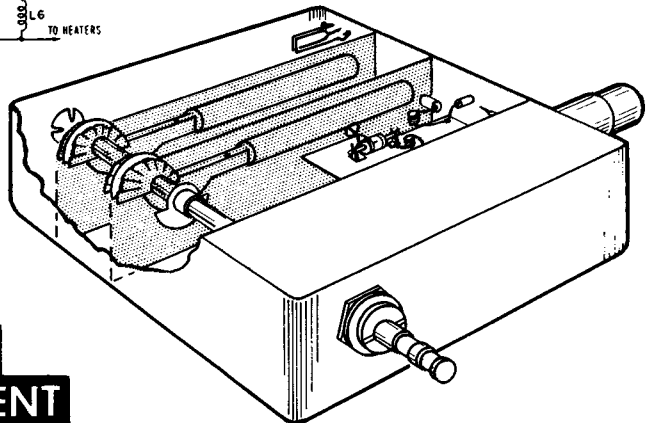

**THE
TUNED-LINE
ARRANGEMENT**

UHF CONVERTERS

UHF Converters: Tuned-Line Type (contd.)

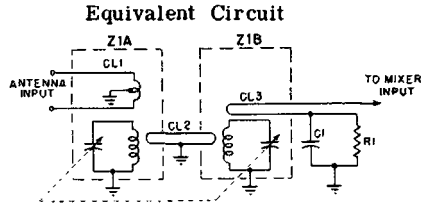
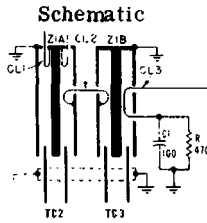
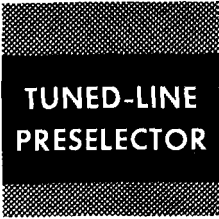

The tuned-line schematic and the equivalent circuit of the preselector bear like component identifications. Portions Z1A and Z1B are individual quarter-wave tuned lines of the coaxial type. The balanced transmission-line input is provided by the centertap-grounded loops CL1. Holes in the grounded metal base of the coaxial line allow the coupling loops to be placed within the space between the active conductors. The tuning capacitance for the input section of the preselector is TC2, which consists of segmented metal leaves that move between the active parts of the tuned line, changing its capacitance. When the leaves are completely meshed, the line is resonant to channel 14. Coupling between the first and second sections is accomplished by the link loops labeled CL2. They enter each coaxial line through holes in the outer conductor. The tuning capacitance for the output section (Z1B) is TC3. Coupling to the mixer from the second section of the preselector is via loop CL3 in the field area of Z1B.

TUNED-LINE OSCILLATOR

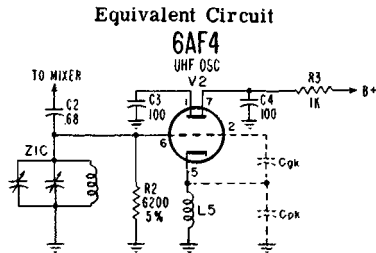
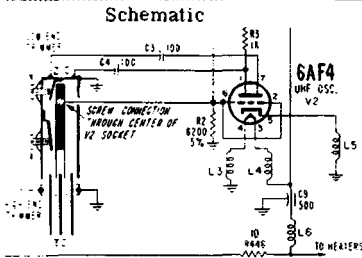

The tuned-line schematic and the equivalent circuit of the oscillator also bear like component identifications. The circuit is a Colpitts, with the plate grounded for r-f through C3 and C4. Two capacitors are used to reduce lead inductance and thus maintain oscillation at the high end of the uhf band. Feedback is provided through the cathode circuit, as well as through the interelectrode capacitances C_{pk} (between control grid and cathode), and C_{pk} (between plate and cathode). The coil L5 keeps the cathode above ground at r-f. The tuned circuit is the tuned line Z1C. The tuning capacitance TC1 is ganged with TC2 and TC3, thus tracking the mixer and oscillator circuits.

TUNER RESPONSE

TV Tuner R-F Response Curves

The overall performance of a television receiver is to a great extent determined by the response curve of the tuner; this is true for both uhf and vhf tuners. In addition to the function of station selection, the front end also serves to amplify the received signal. It is in this connection that the response curve of the tuner assumes importance. Only those frequency components of the received signal that are delivered by the tuner to the i-f amplifier can be processed by the receiver. Whatever signals are lost in the tuner cannot be recovered elsewhere.

R-F AMPLIFIER RESPONSE CURVES

The IDEAL response

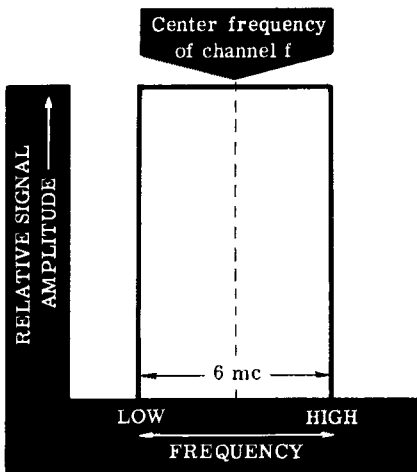

The COMPROMISE response that achieves the 6-mc flat top.

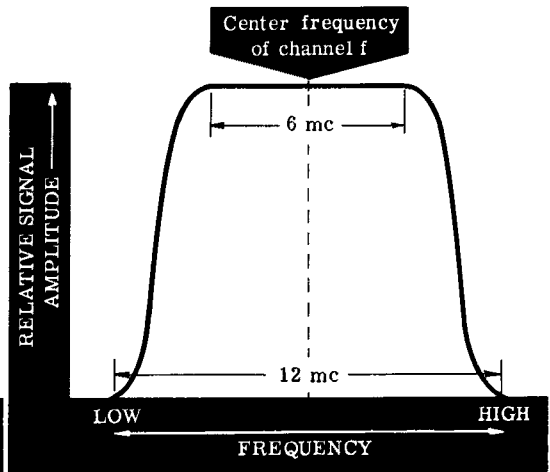

With the picture and sound carrier of each channel separated by 4.5 mc and with the picture signal sidebands also present, substantially uniform amplification must extend over the 6-mc bandwidth of the channel. The ideal response for each channel (uniform amplification over a 6-mc band to the exclusion of all other frequencies) is not possible in practice. A suitable compromise is response over a band of about 12 mc overall, with substantially uniform amplification over the 6-mc bandwidth of the channel. The section of the front end that determines r-f response is everything between the antenna input and the test point in the grid circuit of the mixer. If the front end also contains a uhf converter, the antenna input referred to is that of the uhf converter instead of that for the vhf tuner. The vhf mixer plate circuit and the vhf oscillator are not associated with r-f response but are concerned with i-f response, a phase of tuner performance that will be discussed separately.

TUNER RESPONSE

TV Tuner R-F Response Curves (contd.)

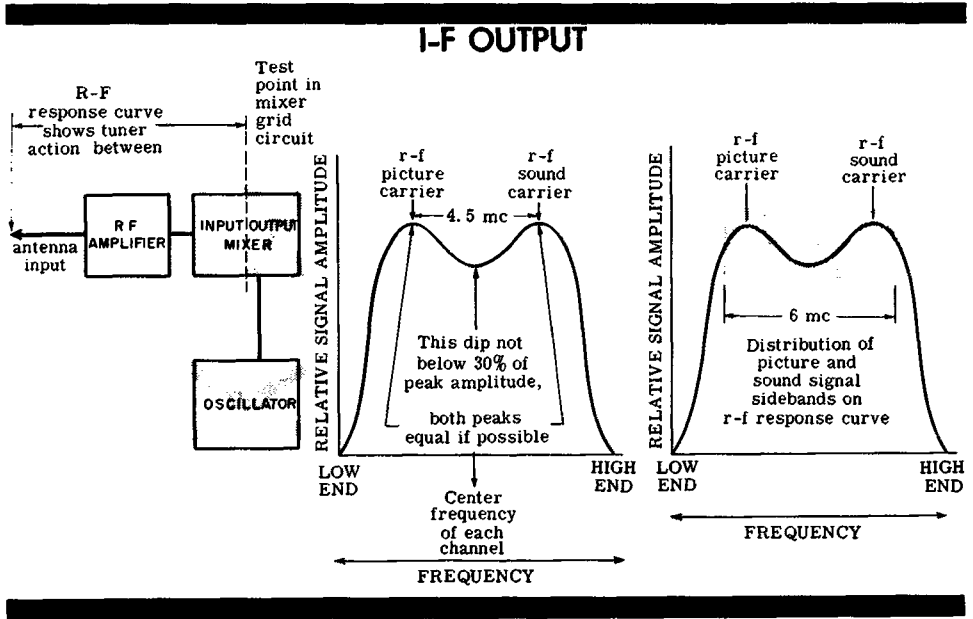

All vhf tuners and most uhf converters contain the circuit elements (inductors and capacitors) that control the overall bandpass of the device and create the 6-mc-wide plateau. As a rule, the manufacturer of the equipment supplies specific instructions concerning the adjustments required for creation of the correct r-f response. Such adjustments are called for on several of the vhf channels in order to cover the entire band. The usual labels are "low-end" and "high-end" adjustment. The entire operation is called *alignment*, and involves the use of special signal generators. The operation should be performed only by skilled technicians. In the case of vhf tuners that have frequency-selective circuits in the grid and plate circuits of the r-f amplifier, flat-topping and bandpass are usually achieved by tuning the grid circuit to the picture carrier assigned to the channel on which the adjustment is being made and tuning the plate circuit to the sound carrier.

When the tuner contains frequency-selective circuits in the plate circuit of the r-f stage and in the grid circuit of the mixer stage, both are tuned to the center frequency of the channel. Coupling adjustments are provided for the purpose of controlling the amount of bandpass and degree of flat-topping of the response curve. The final curve does not really have a flat top, but shows two peaks, one for the r-f picture carrier and the other for the r-f sound carrier, with a shallow dip in between. Each of the peaks is equidistant from the center frequency.

TUNER RESPONSE

TV Front-End Performance: Tuner I-F Output

Every television receiver is planned to function with prescribed picture and sound i-fs. Most makes of receivers designed for 20–27-mc intermediate frequency use 25.75 mc as the picture i-f and 21.25 mc as the sound i-f. In the case of the 40–47-mc receiver, most of them use a 45.75-mc picture i-f and a 41.25-mc sound i-f. Slight departures from these frequencies occur in some makes and models of receivers, but the fundamental conditions discussed here remain unaltered.

OSCILLATOR ADJUSTMENT

FRONT OF TUNER SHOWING

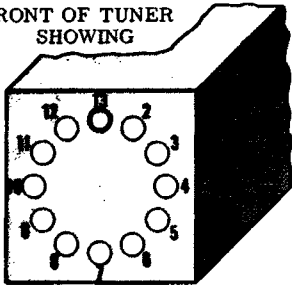

individual channel oscillator adjustment holes and possible effects of oscillator adjustments

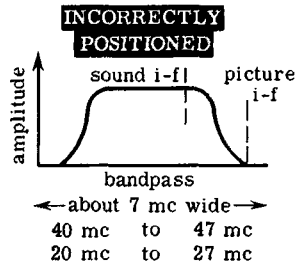
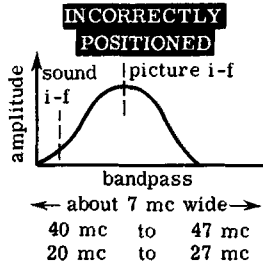
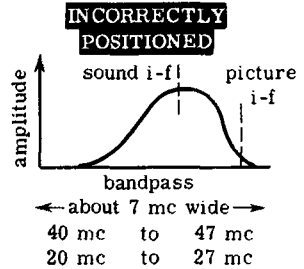
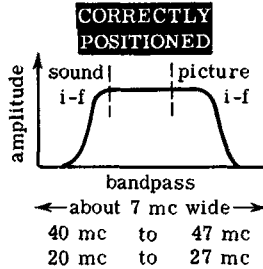
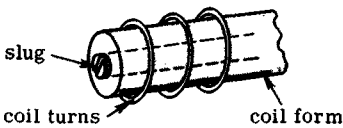

The source of the picture and sound i-f signals is the mixer in the front end. The control of the specific intermediate frequencies derived from the mixer lies in the frequency adjustment of the heterodyning oscillator. If the heterodyning oscillator is off frequency, a deteriorated picture, loss of picture, or loss of sound may result. Because the f-m signal that is processed into audio is the product of mixing the picture and sound i-f signals in the video detector, the loss of the picture i-f signal at the mixer output automatically means a loss of sound. On the other hand, the loss of the sound i-f signal at the mixer output does not mean a loss of the picture. All front ends have a provision for adjustment of the frequency of the heterodyne oscillator for each channel. Access to this adjustment is through holes in the front of the front-end housing. Proper adjustment must be made so that the fine tuning control can perform correctly. (Normally it varies the frequency of the heterodyne oscillator about 2 mc, but this amount of variation is useful only if the oscillator frequency is very nearly correct at the outset.)

TUNER RESPONSE

TV Front-End Performance: Tuner I-F Output (contd.)

Although the r-f circuits in the front end provide a bandpass of about 12 mc for each channel, the i-f circuit in the mixer plate system provides a bandpass of about 9 mc. It is determined by the design of the tuned i-f transformer or the series-resonant circuit that selects the correct picture and sound i-f signals available from the mixer. The frequency limits of the i-f bandpass are about 39–48 mc in a receiver that uses the 45.75-mc picture i-f and the 41.25-mc sound i-f, and about 19–28 mc in sets that use a 25.75-mc picture i-f and the 21.25-mc sound i-f. These frequency limits are available when the circuits are tuned to the center frequency of these bands, 43.5 mc and 23.5 mc, respectively.

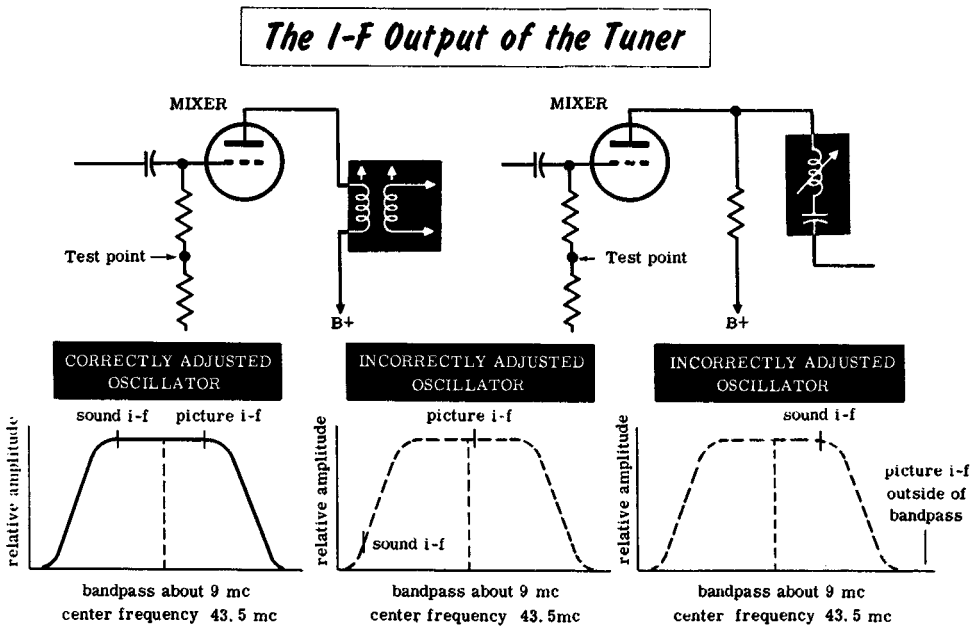

Assuming a 39–48-mc transformer that is tuned to 43.5 mc, *correct* frequency adjustment of the heterodyning oscillator on each channel locates the 45.75-mc picture i-f and 41.25-mc sound i-f signals equidistant from the center frequency (on or near the plateau of the bandpass curve). This is where they should be in order to supply the full range of i-f carrier modulation components to the i-f amplifier for processing. Incorrect frequency adjustment of the heterodyning oscillator can produce picture and sound i-f signals whose frequencies are appreciably higher or lower than desired, in which cases one or the other may be on the slope of the bandpass curve, or even outside the limits of the curve. Both conditions are undesirable. The fine tuning control is capable of some compensation, but it may not be enough to achieve the desired result.

TUNER RESPONSE

Tuner Alignment Techniques

The precise procedure and the frequencies involved in the alignment of the tuner of a television receiver should follow the information given by the set manufacturer. Because of the various physical constructions found where almost identical circuitry is used, different distributed capacitances come into play, and only the manufacturer — who has labored developing an optimum alignment technique for his set — can supply the exact information.

To Align Front End of TV Receiver

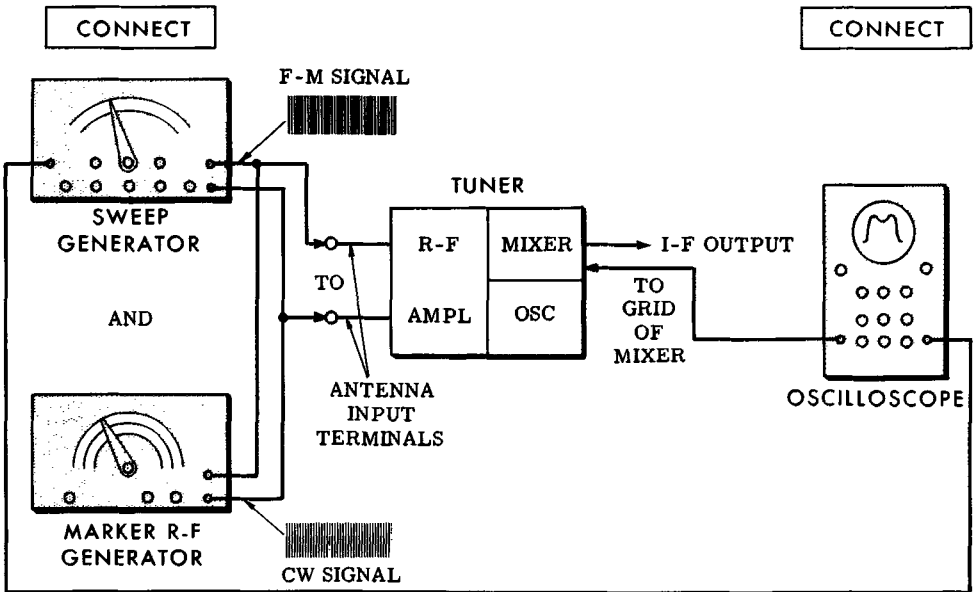

This does not, however, prevent us from understanding the basic procedure. Fundamentally, a signal that simulates the incoming broadcast signal is fed into the antenna input terminals of the TV receiver. This signal is processed by the r-f amplifier and is fed to the grid or input circuit of the mixer tube. At this point an oscilloscope is connected to observe the waveform. (Because the signal on the mixer grid is in the vhf or uhf range, a detector probe must be used in conjunction with the scope.) Following the manufacturers' instructions, various adjustments are made in the tuner until the desired waveform is obtained. To identify the various points on the waveform, a marker generator is used. This is merely an r-f generator that produces an unmodulated signal that *beats* with the sweep signal and produces beats or "pips" on the waveform. The sweep generator must tune through the desired vhf or uhf range, and have a sweep width of at least 10 mc.

TUNER RESPONSE

Tuner Alignment Techniques (contd.)

CIRCUIT CONNECTIONS FOR TUNER ALIGNMENT

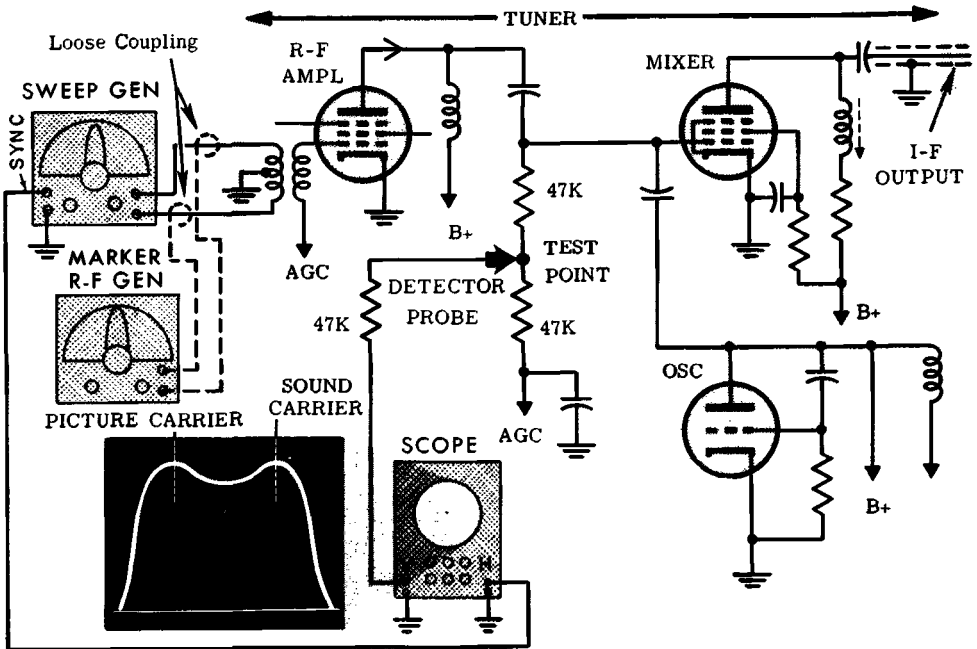

Sweep generators used for alignment often have a marker generator built into their circuitry. This is highly desirable because it avoids the coupling problem between the two generators. Where a separate marker generator is used, it should be loosely coupled to the antenna input terminals. The generator usually sweeps at a frequency of 60 cycles. To synchronize the oscilloscope horizontal sweep with that of the sweep generator, a synchronizing voltage from the sweep generator is fed to the horizontal input of the oscilloscope. The vertical input to the scope is fed from the grid of the mixer. This is usually called the *test point*, and is clearly labeled on most schematics.

In observing the waveform at the test point, a detector probe is used. This probe rectifies the r-f signal so that only the outline or envelope of the waveform can be seen. The waveform will usually change slightly from channel to channel, so manufacturers' service notes should be used to check the desired waveform on each channel. Most tuners contain traps such as f-m and i-f traps, and, using the same alignment procedure, these circuits can also be tuned. The marker generator should be highly accurate because the "pips" on the waveform are the only method of determining frequency at a particular point.

TUNER RESPONSE

Troubles In TV Front Ends

The principles of operation of the television receiver front end that we have discussed point up the contribution of this part of the receiver to the final picture and sound. Performance that is contrary to the theoretical requirements usually spells trouble of one kind or another, to say the least. However, a variety of difficulties with which theory has only a remote association can develop; in either case, the result is the same—unsatisfactory performance. We detail here those troubles that occur most frequently.

Perhaps the most common is general tube failure (short-circuited or open electrodes, or just deterioration as a result of continued use). A very common problem has been discussed from the theoretical viewpoint—incorrect frequency output from the oscillator, most often attributable to improper positioning of the oscillator tuning slug. Still others are shown pictorially.

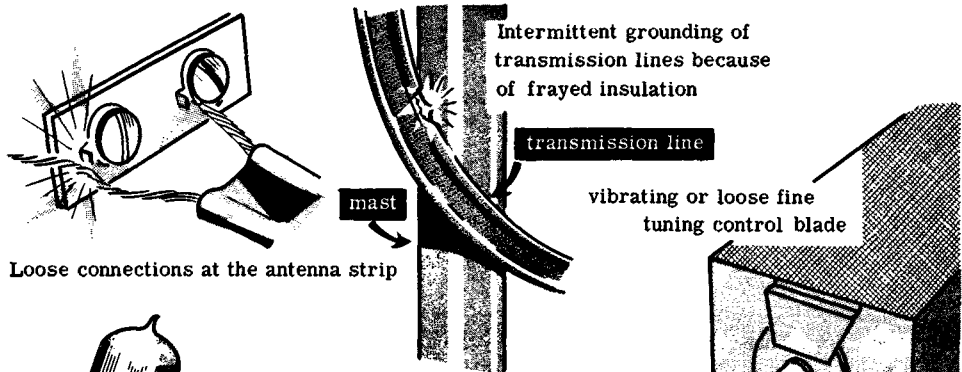

UNSTABLE PICTURES and NOISE

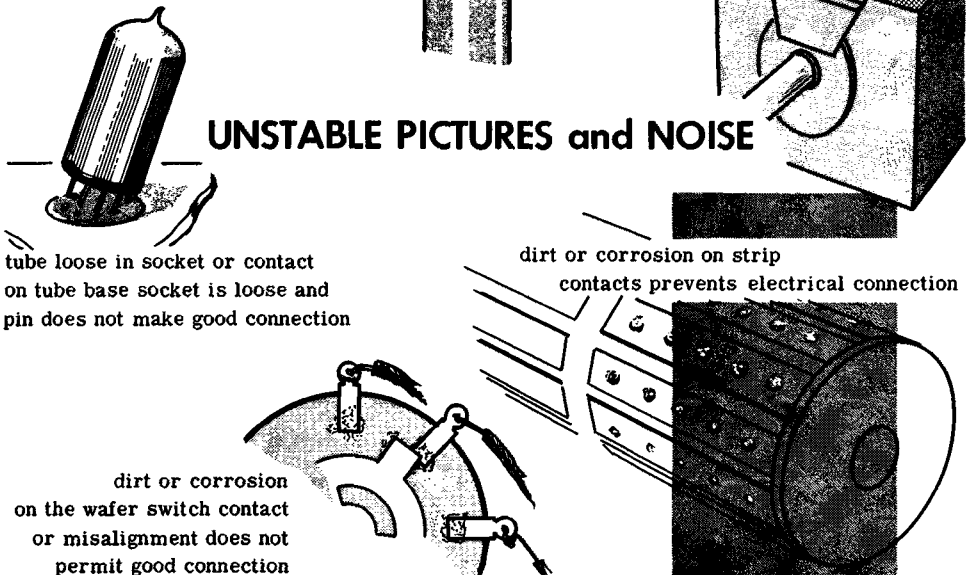

REVIEW

1. **Wafer Switches.** A Popular method of selecting television channels is the use of portions of an inductor. The inductor has a number of taps, each tap representing a different amount of inductance. For the lowest channel the full inductor is used. The entire inductor is frequently mounted on a wafer switch, and the shorting is accomplished by movement of a rotating contact.

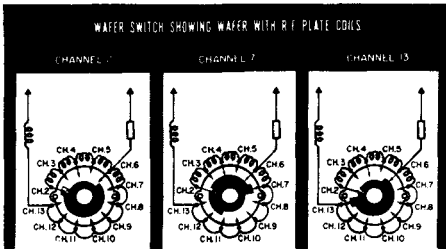
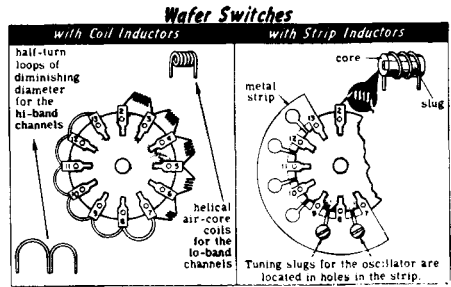

2. **The Inductance Between Taps** varies so that minimum inductance is present when a television receiver is tuned to channel 13. Manipulation of the switch cuts in increasing amounts of inductance for the lower channels.

3. **Resonant Circuits** are the basis of tuning, coupling, and traps. Fundamentally, series resonance means high current and low impedance; parallel resonance means low line current and high impedance.

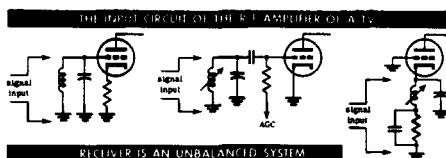
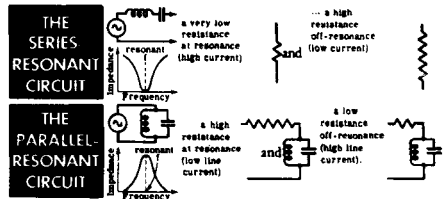

4. **The R-F Amplifier** in a television receiver is an unbalanced system because the signal input is usually fed between the control grid and ground or between cathode and ground in the basic grounded-grid r-f amplifier circuit.

REVIEW

Matching Transmission Line To R-F Amplifier

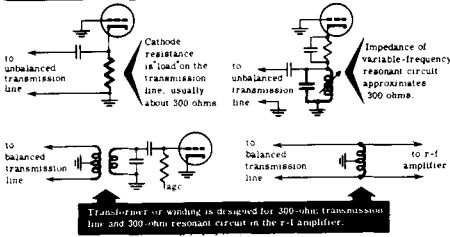

5. *The Impedance of the Transmission Line* must be equal to the input impedance of the r-f amplifier for maximum efficiency. All the methods shown accomplish this purpose.

6. *Stagger Tuning* is a method used to obtain the broad bandpass required by the television signal. By tuning two or more circuits to slightly different frequencies, a resultant response is obtained that is broader than for either circuit alone and can pass a wide band of frequencies.

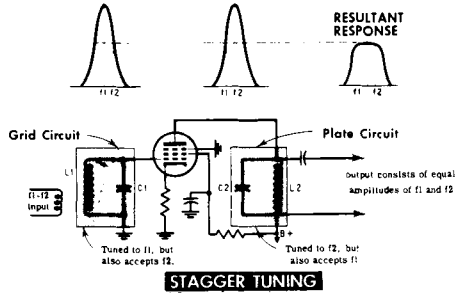

DOUBLE-CONVERSION UHF STRIP CONVERTER

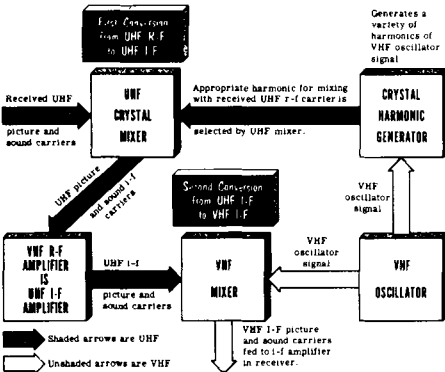

7. *Double-Conversion UHF Reception* involves the reduction of the uhf carrier signal to some frequency in the vhf band. This signal is then treated like any other vhf signal and is fed to the mixer, where it is converted to an i-f carrier.

8. In *Single Conversion Reception*, the incoming ultra-high-frequency signal is mixed in a crystal mixer and converted directly down to the receiver's intermediate frequency. This method is common with receivers using an i-f in the 40-mc range.

SINGLE-CONVERSION UHF AND VHF STRIP TUNER

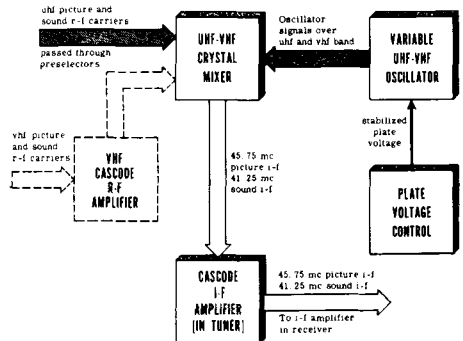

THE I-F AMPLIFIER

The Picture I-F Amplifier

The "picture i-f amplifier" follows the mixer in the television receiver chain. The names "picture i-f amplifier" as well as "video i-f amplifier" are used interchangeably, but both are misnomers because this section processes several i-f signals, not just the picture i-f signal. However, the name indicating a single function is used nonetheless. The amplifier processes the picture i-f and related sound i-f signals, while it attempts to minimize all adjacent-channel signals. Because the conditions of operation are not the same for all these signal voltages, we shall examine each of them individually.

THE I-F AMPLIFIER IN A RADIO RECEIVER

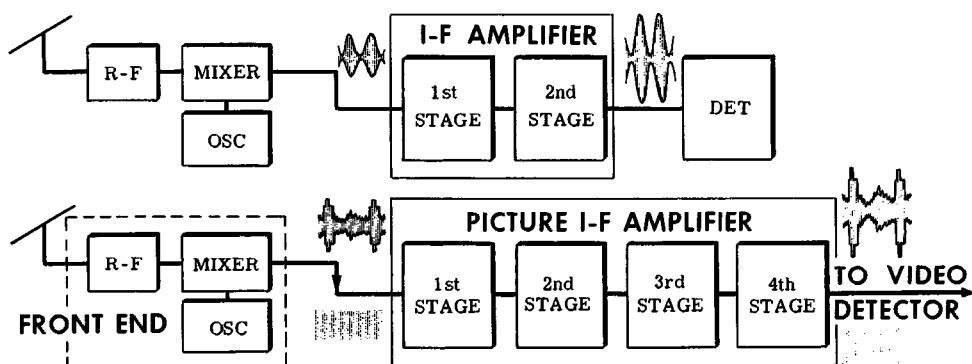

IS THE PICTURE I-F AMPLIFIER IN THE TELEVISION RECEIVER

The picture i-f amplifier is a multistage tuned amplifier comparable in many respects to the i-f amplifier in the conventional superheterodyne radio receiver. Of course it is more complex, because it must do many more things. The amplifier usually consists of three or four stages with adjustable tuned interstage coupling circuits. These circuits are made responsive to a varying degree to the desired channel picture and sound i-f carriers, and are arranged to reject the adjacent channel carriers. The input connects to the mixer and the amplifier output terminates in the video detector. Each stage is intended to amplify the desired picture i-f signal from 8 to perhaps 15 times, hence the amplifier can be said to be capable of overall amplification amounting to from 2500 to perhaps 10,000 times, depending on its design. Its objective is to raise the picture i-f signal from the level of approximately 1 millivolt or slightly more at the mixer output to between 3 and 5 volts peak video signal at the video detector output. The tubes used as amplifiers are pentodes such as the 6AG5, 6AU6, 6CF6 and 6DE6 as well as their equivalents in the 3-volt series.

THE I-F AMPLIFIER

The Desired and the Adjacent-Channel Signals

An understanding of the organization as well as the behavior of the picture i-f amplifier requires familiarity with the nature of the signals that the amplifier has to process. The listing of vhf and uhf picture and sound carrier frequencies shows that with only two exceptions consecutive channel picture carriers are separated by 6 mc, as are all consecutive channel f-m sound carriers. (The separation between channels 4 and 5 and that between channels 6 and 7 is greater than 6 mc.) This means that, with the exception of the channels mentioned, the picture carrier of each channel is only 1.5 mc away from the next lower channel sound carrier.

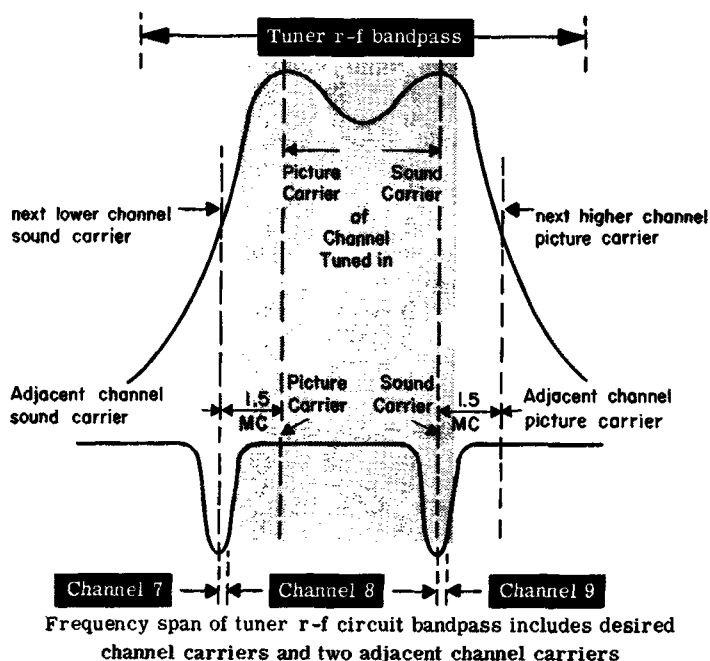

Adjacent-channel signals are accepted by the tuner bandpass and passed on to the mixer.

If we relate these frequency separations to the 12-mc bandpass of the r-f section of the front end, it becomes evident that when we tune to say, channel 8, the front-end r-f system will accept the two carriers of this channel, and in addition, the f-m sound carrier of channel 7 as well as the a-m picture carrier of channel 9 (providing that the receiving location permits the adjacent-channel carriers to be present). The total frequency span of these four carriers is $1.5 + 4.5 + 1.5$ or 7.5 mc, completely within the 12 mc bandpass. Normally adjacent channels are not assigned to the stations that serve a given area, but many receiving localities are between stations located at a distance and they may be assigned adjacent channels. Adjacent-channel interference is common at night when propagation conditions are favorable for long-distance reception.

THE I-F AMPLIFIER

Desired and Adjacent-Channel Signals (contd.)

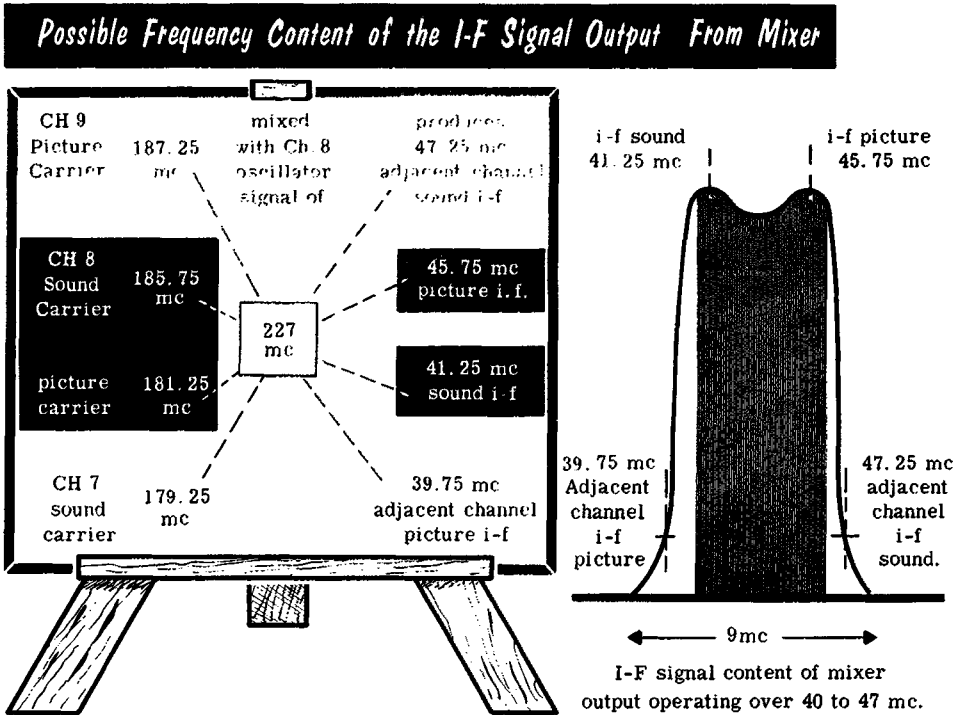

The heterodyning process in the mixer does not differentiate between signals that originate at the desired station and those that originate at adjacent-channel stations. Whatever r-f carrier gets through the front-end to the mixer will be heterodyned by the local oscillator and will appear in the mixer output. When the frequency separation between the desired and undesired i-f carriers is as small as 1.5 mc there is no doubt about both being present. In other words, the 9-mc bandpass of the mixer i-f-output system will very readily accept the four i-f carriers that are within the overall span of 7.5 mc. It is easy to see that the i-f signals that might have to be handled by the picture i-f amplifier include the two adjacent-channel signals as well as the picture and sound i-f carriers of the desired channel.

The narrower bandpass of the i-f circuits in the mixer output tends to attenuate the adjacent-channel signals relative to the amplitude of the desired channel i-f carriers, and it is one function of the picture i-f amplifier to eliminate them. Of the two undesired adjacent-channel i-f carriers the sound i-f carrier from the next lower channel is the more important one. If it is not eliminated at the picture i-f amplifier, it causes moving sound bars to appear in the picture display. Of course, the adjacent-channel picture i-f carrier must be also reduced to zero amplitude.

THE I-F AMPLIFIER

The Normal Double-Sideband Picture Signal

Earlier in this course we remarked that television stations the world over utilize vestigial-sideband transmission techniques for the amplitude-modulated picture carrier. The American and European standards call for partial suppression of the lower sideband whereas the British and French standards suppress the upper sideband. Let us now examine the American system in more detail.

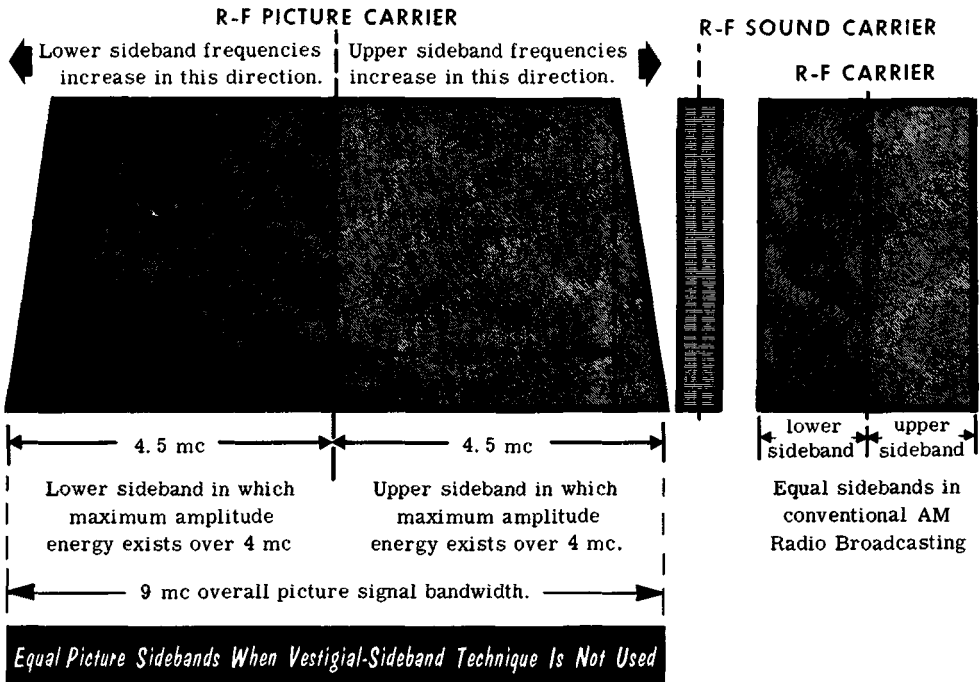

In the absence of vestigial sideband transmission, the normal process of transmission of an amplitude-modulated picture carrier would result in a picture signal that would have equal upper and lower sidebands. (This is what happens during the transmission of conventional amplitude-modulated radio broadcasting.) In the case of the television picture signal the process of generating the modulation-frequency components leads to modulation frequencies that commence at 0 frequency and extend up to about 4.5 mc. The normal process of transmitting double sidebands would therefore produce a television signal about 9 mc wide, consisting of 0 to 4.5-mc upper and lower sidebands. However, the limited amount of space in the frequency spectrum allowed for television broadcasting does not permit the luxury of equal sidebands; hence the need for a technique that permits the transmission of the required intelligence while conserving space in the frequency spectrum. This technique is vestigial-sideband transmission.

THE I-F AMPLIFIER

Vestigial-Sideband Transmission

The same signal transmitted using the American system of vestigial sideband technique undergoes a change in the distribution of its modulation-frequency components. The upper sideband retains all of its frequency components as before, but the lower sideband is much cut.

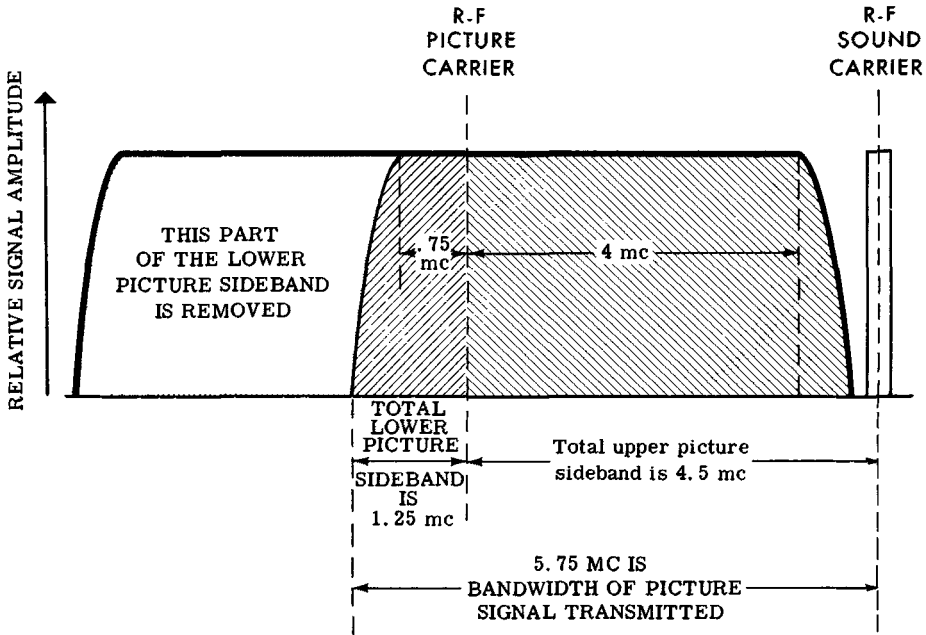

The Result of Vestigial Sideband Transmission on Frequency Content of Picture Signal

Modulation frequencies between 0 and 0.75 mc in the lower sideband are retained in full and at the same maximum level as the upper sideband frequencies. However, all modulation frequencies higher than 1.25 mc are excluded from the lower sideband that is transmitted. Thus the two sidebands of the transmitted picture signal are unlike in frequency content and bandwidth. The lower sideband is only 1.25 mc wide at its widest. In fact, it may be viewed as being only 0.75 mc wide, because the contribution made by the components between 0.75 mc and 1.25 mc is small. The same can be said for components between 4 mc and 4.5 mc in the upper sideband, hence the effective upper sideband can be viewed as being only 4 mc wide. It is impossible to "chop off" the sidebands abruptly, but a fairly rapid attenuation is employed.

THE I-F AMPLIFIER

Vestigial-Sideband Transmission (contd.)

Basic radio teaches that the intelligence as well as the power in an amplitude-modulated signal is in the sidebands. There is twice as much intelligence power in two sidebands as there is in a single sideband. Such being the case, the transmitted picture signal has unequal distribution of power in its sidebands for the modulation frequencies between 0 and 0.75 mc relative to those higher than 0.75 mc.

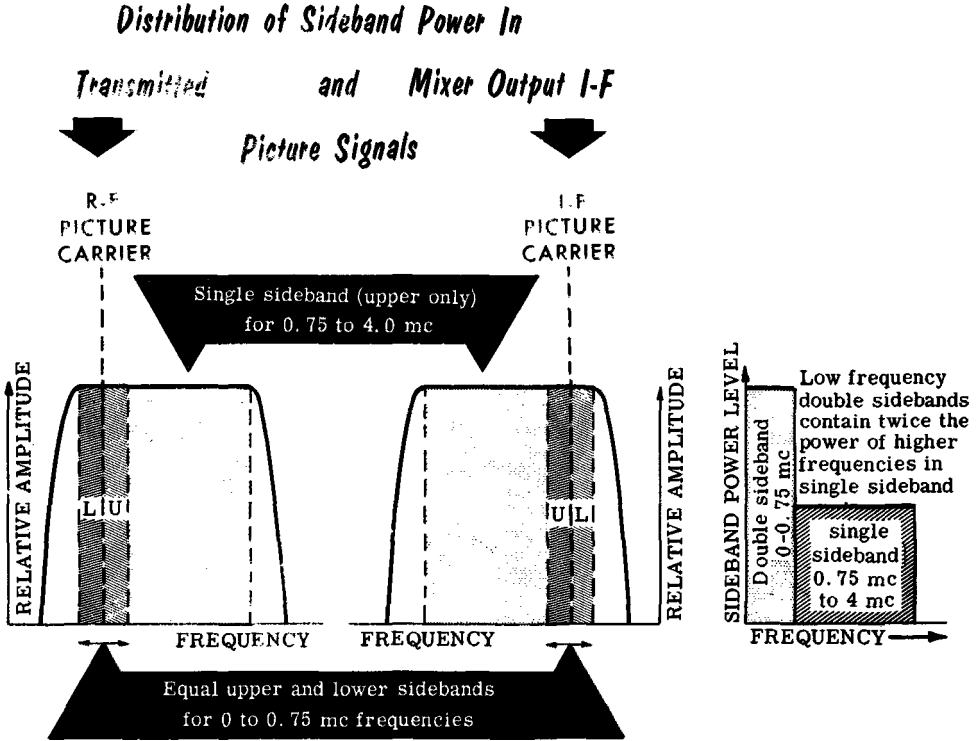

Examining the sideband content we note that the modulation frequencies between 0 and 0.75 mc appear in *equal* amounts in the lower (L) sideband and in the upper (U) sideband, whereas the higher frequency components from 0.75 mc to 4 mc, are present only in the upper sideband. (We ignore the frequencies between 0.75 mc and 1.25 mc in the lower sideband, and those between 4 mc and 4.5 mc in the upper sideband.) If we process the signal as transmitted, or as delivered by the mixer (both of which are shown), the picture on the screen would be poor because of the undue emphasis given to the low-frequency modulation components. Background and large object detail would mask the fine detail in the picture. The problem has a solution—a special pattern of amplification of the frequencies that make up the picture signal,

THE I-F AMPLIFIER

Compensating for the Unequal Sideband Power Distribution

The unequally distributed sideband power in the picture i-f signal derived from the mixer output is compensated for in the video i-f amplifier by amplification on a frequency-selective basis. The tuned circuits in the amplifier are adjusted to afford broadband response at maximum level over a frequency range commencing at about 0.75 mc higher than the picture i-f carrier frequency, and ending about 4 mc higher than the picture i-f carrier frequency. (This satisfies the needs of the high-frequency components of the picture i-f signal.) The amplifier response then falls quite rapidly to about 5 percent of maximum at the sound i-f carrier frequency. As to the low-frequency picture signal components of the upper and lower sidebands, the amplifier is adjusted to afford amplification equal to 50 percent of the maximum given to signals at the picture i-f carrier frequency. All modulation components between 0 and 0.75 mc in the lower sideband are amplified by progressively *decreasing* amounts as the frequency increases, whereas all modulation components between 0 and 0.75 mc in the upper sideband are amplified by progressively *increasing* amounts as the frequency increases.

Being treated in this fashion, any two low-frequency modulation components equidistant frequency-wise from the picture carrier will have an *aggregate* energy level that is constant and equal to the level of the high-frequency components. As an example, assume that maximum response over the high frequencies corresponds to an arbitrary energy level of 15 units. If the 0.25-mc component in the lower sideband is raised to an energy level of 5 units whereas the same component in the upper sideband is raised to an energy level of 10 units, the sum of the two energy levels is 15 units, the same as for the high frequencies. In the case of the 0.75-mc component in the lower sideband, its energy level is theoretically zero whereas the same frequency component in the upper sideband has an energy level of 15 units. Similar treatment is accorded the low-frequency components between those that we have mentioned.

RESPONSE CURVE SHOWING FREQUENCY SELECTIVE MEANS OF CORRECTING UNEQUAL SIDEBAND POWER DISTRIBUTION

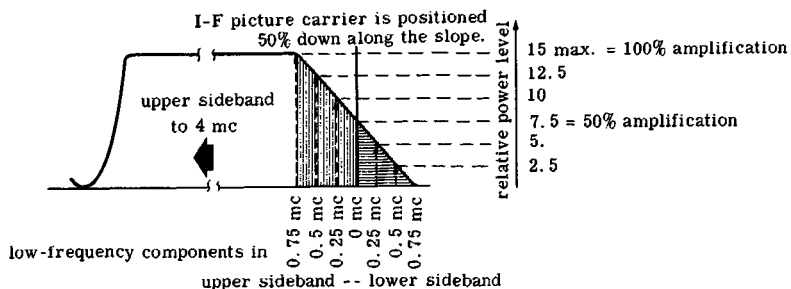

THE I-F AMPLIFIER

The Desired Frequency Response of the Picture I-F Amplifier

Now that we know the variety of signals that may get into the picture i-f amplifier and the kind of correction that is necessary for the unequal distribution of the low-frequency sideband power of the picture i-f signal, we can picture the overall performance requirements of the amplifier. We illustrated it in the preceding volume and repeat it here with further explanation. We call this presentation the *frequency response curve*, which is another way of referring to the "amplification-vs.-frequency" behavior of the amplifier.

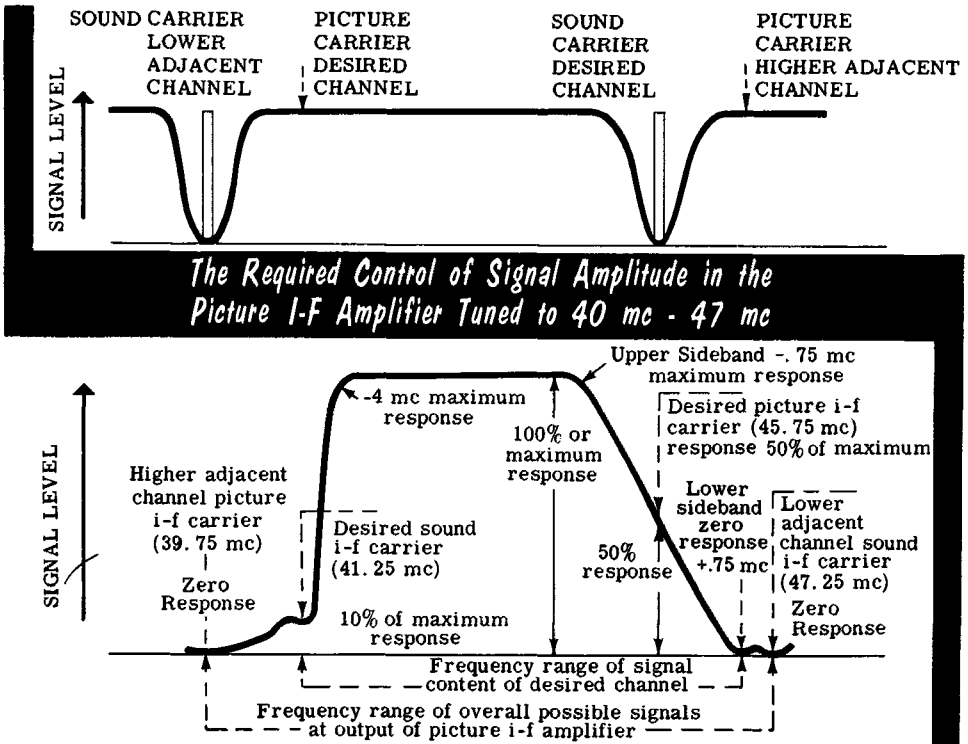

The curve shows the performance over a bandpass of slightly more than 7 mc overall. It includes the two carriers of the desired channel; the next lower adjacent-channel sound i-f carrier as well as the next higher adjacent-channel picture i-f carrier. It may be seen that both of the adjacent-channel signals are to be kept at the minimum level, preferably at zero level. It is also seen that the desired picture i-f carrier reference location corresponds to 50 percent of maximum amplification. Finally, the amplitude of the desired channel sound i-f carrier signal is held down to 5 or possibly 10 percent of the maximum amplitude of the high frequency components of the related picture i-f signal.

THE I-F AMPLIFIER

The Picture I-F Amplifier Stage

Having shown the frequency-vs.-amplitude relationship desired in the picture i-f amplifier, we now are ready to examine how it is achieved. The circuit of the i-f amplifier stage follows conventional lines, resembling in many respects the r-f or i-f amplifier in a superheterodyne radio receiver. Regardless of the kind of coupling used between stages, the plate and screen voltages, as well as the automatic grid bias or the cathode bias, are such that the stage functions as a linear amplifier. Grid current never flows, whereas plate current flows during the entire cycle of input voltage.

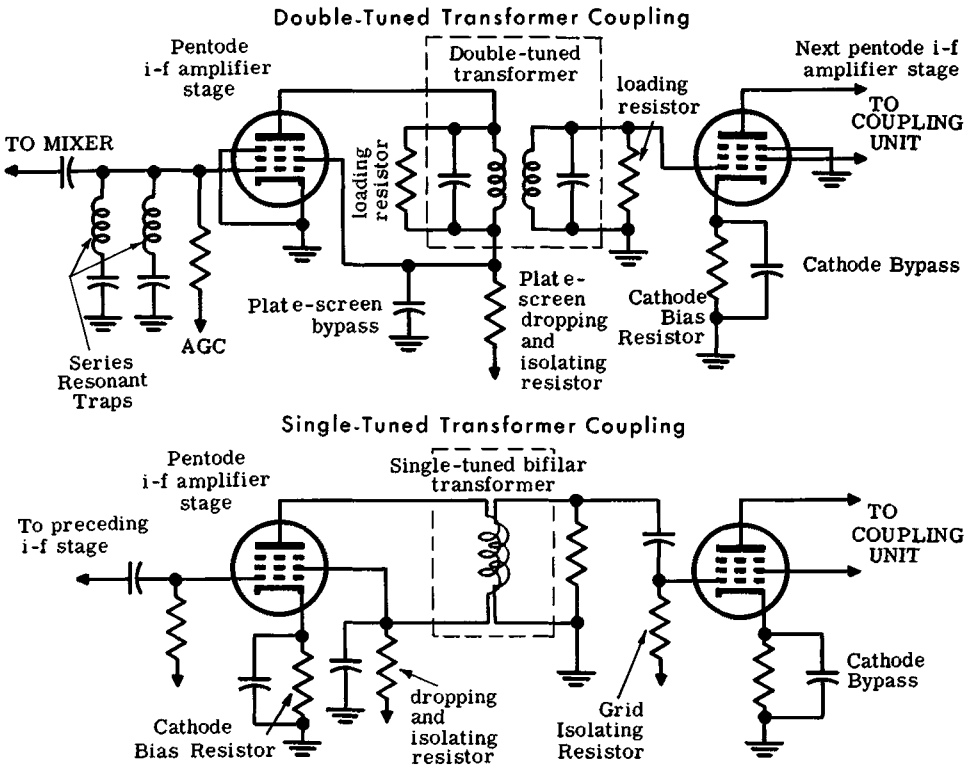

The function of bypass capacitors and grid isolating resistors is exactly the same as in the conventional i-f amplifier in a radio receiver. The high end of the cathode circuits, as well as the B+ supply points of plate and screen circuits are bypassed to ground, thus creating conditions of maximum gain consistent with maximum stability. Suppressor grids are joined to grounded cathodes or are grounded directly when the cathode circuit contains a bias resistor. The frequency response of the individual amplifying stages varies in different makes and models of receivers, according to their design. Examples of this appear later in this lesson.

THE I-F AMPLIFIER

Coupling and Traps

PICTURE I-F AMPLIFIER STAGES DEMONSTRATE SINGLE OR DOUBLE PEAK FREQUENCY RESPONSE

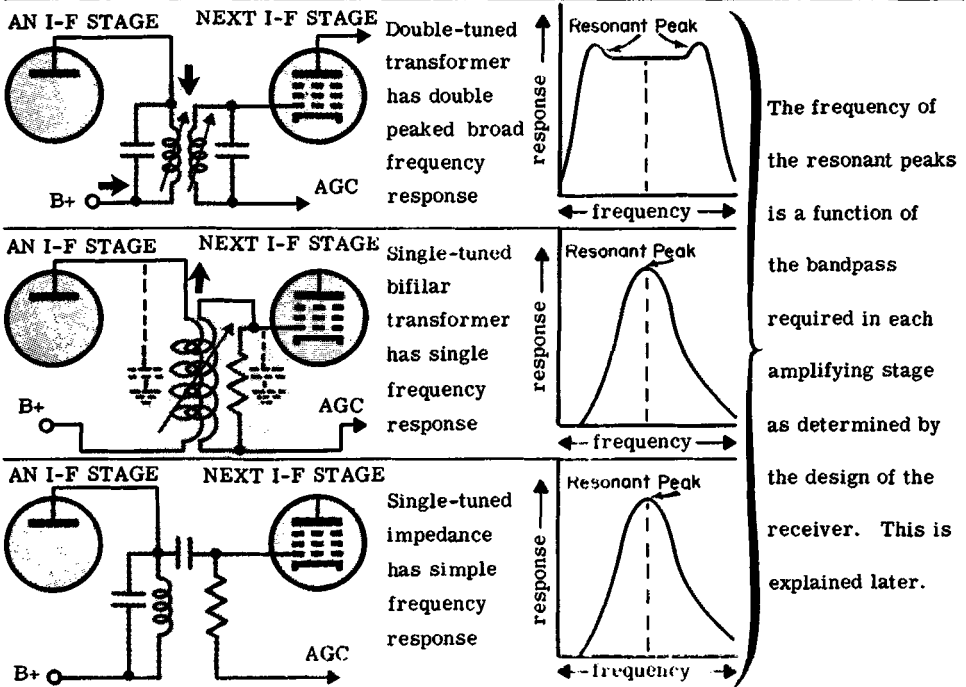

Two general types of resonated coupling systems are used. One is the tuned transformer and the other is the tuned-impedance plate load with resistance-capacitance (RC) coupling to the next grid. Tuned transformers are of two types—double-tuned and single-tuned. Both have a primary and a secondary winding, but the double-tuned variety has individual powdered-iron tuning slugs to change the inductance of each winding, whereas the single-tuned type uses a single tuning slug that moves inside the core of a bifilar-wound primary and secondary. Either lumped or the associated distributed capacitance helps create resonance. A major difference between these two transformer-type interstage coupling methods is that the double-tuned unit demonstrates double-peak frequency response, whereas the single-tuned transformer demonstrates single-frequency response. (The tuned-impedance system is comparable in response to the single-tuned transformer because it, too, demonstrates single-frequency response.) Several stages of any one type or possibly mixed types make up a picture i-f amplifier. Each stage is individually tuned to have a prescribed bandpass with different frequency peaks, which in aggregate achieve the required overall amplifying characteristic.

THE I-F AMPLIFIER

Coupling and Traps (contd.)

I-F coupling transformers often contain a third winding. It is tuned to a signal frequency that is present in the primary that it is desired to remove or to attenuate severely. In other words it is a *trap circuit*, usually of the absorption type. (In some instances, not shown here, it is a series-resonant circuit.) The trap may be tuned to the adjacent-channel sound or picture i-f carrier, neither of which is wanted in the amplifier, or it can be tuned to the desired sound i-f carrier, in order to attenuate the signal to perhaps 5 to 10 percent of maximum. By the use of several three-winding transformers, all of these objectives can be accomplished.

EFFECT OF THIRD WINDING IN I-F TRANSFORMER

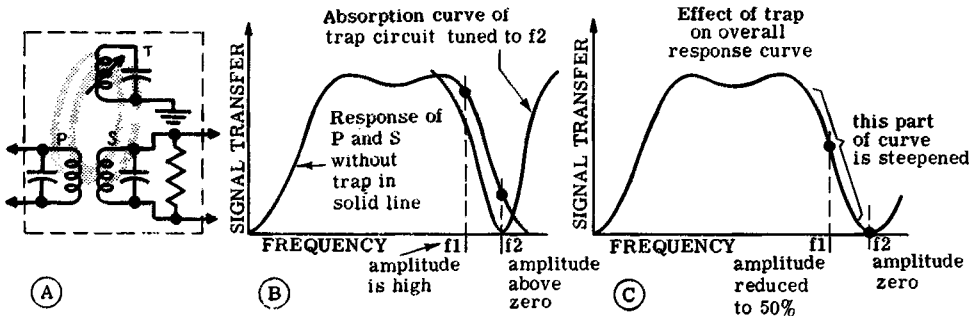

The effect that the trap has on the frequency bandpass of the transformer plays an important part in producing the desired overall amplifier characteristic. The primary and secondary windings will pass a band of frequencies, and the absorbing trap will remove some of these frequencies. The two actions occurring together create a resultant bandpass in each stage that is different than for either action alone. By aggregating the individual stage bandpasses we produce the final desired overall amplifier response curve. For instance, in curves B and C we symbolize the action taking place in a double-tuned transformer with trap. In B the bandpass of the primary P and secondary S windings and that of the trap T are shown separately. The P-S bandpass affords almost maximum response to f1 (the desired picture i-f carrier of 45.75 mc) and much lower response to f2, the adjacent-channel sound i-f carrier of 47.25 mc. The trap (T) is tuned to f2 (47.25 mc), its function being to remove this signal. Like all resonant circuits, however, the trap is effective at frequencies on each side of its resonant frequency. Hence its absorption action will occur over a limited band of frequencies passed by the primary and secondary windings. The combined action is shown in C. The overall bandpass has been narrowed; the right-hand slope of the response curve has been steepened. In so doing, the amplification of f1 is reduced from almost maximum to 50 percent, and amplitude of f2 is reduced to zero. Such action at different predetermined frequencies is used to give the response curve the desired shape.

THE I-F AMPLIFIER

Coupling and Traps (contd.)

Several other examples of traps used in picture i-f amplifiers are shown on this page. The four-stage strip given in abridged form in A shows single-tuned transformers, each with its own absorption trap. Traps T1 and T3 are tuned to the adjacent picture and sound i-f signals, respectively. (These frequencies are 39.75 mc and 47.25 mc.) Trap T2, on the other hand, is tuned to the desired sound i-f carrier of 41.25 mc. T1 and T3 are tuned to eliminate the resonant-frequency signals, whereas the T2 trap is intended merely to attenuate the signal. The other frequency figures indicate the resonant frequency to which the primary and secondary windings are tuned. The use of unlike frequencies here indicates that the system as a whole is *stagger tuned*, a subject that we have touched upon earlier, but which will be detailed later.

Schematic B shows series-resonant trap circuits in the input of the first picture i-f amplifier stage, where the signals are weakest and attenuation is easiest. The remainder of the amplifier is made up of single-tuned transformers without traps. The frequency identifications for the other input resonant circuits and the interstage transformers are the frequencies to which the circuits are tuned to achieve the desired overall bandpass characteristics.

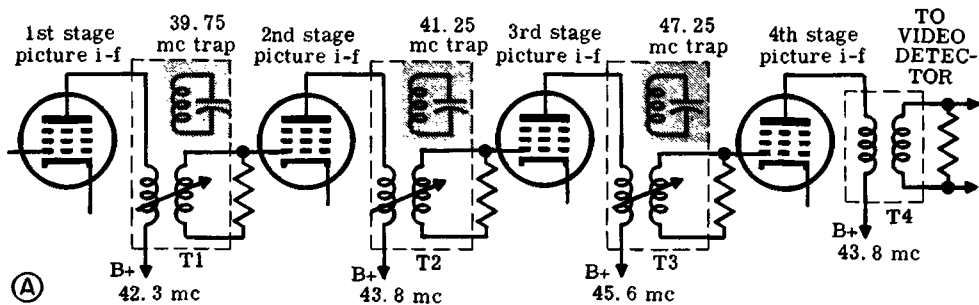

A FOUR-STAGE PICTURE I-F STRIP WITH THREE ABSORPTION TRAPS

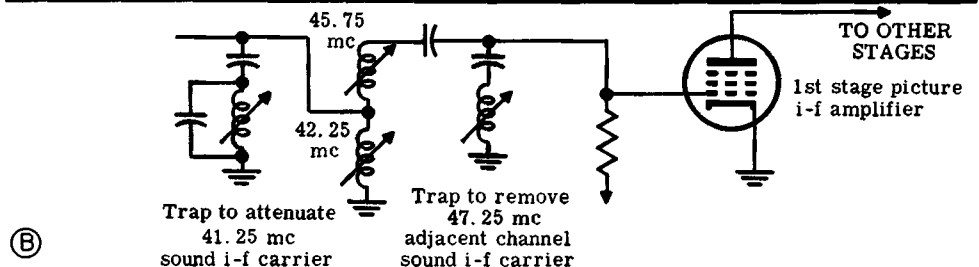

A PICTURE I-F STAGE WITH THE TRAPS IN THE INPUT

THE I-F AMPLIFIER

Cathode-Circuit Traps

Cathode Traps Cause Degeneration On A Frequency-Selective Basis

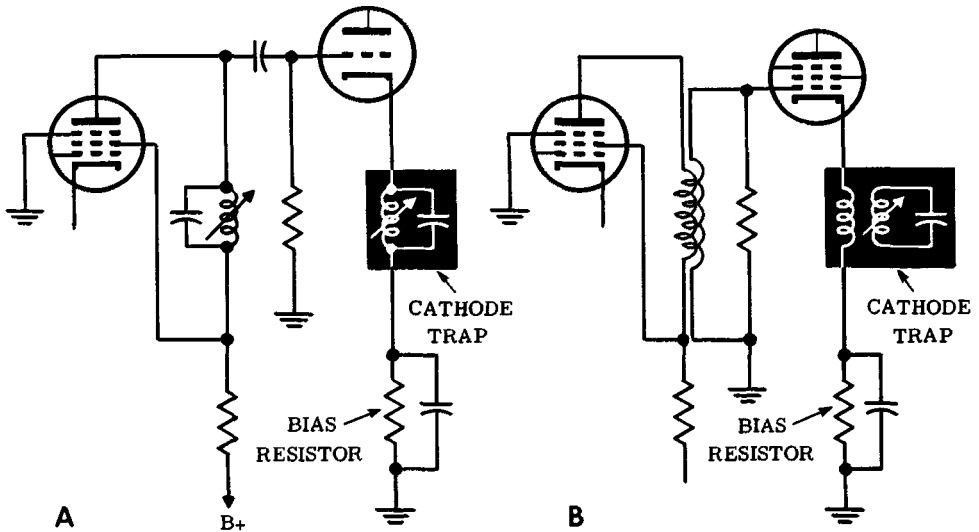

Signal-attenuating traps also are found in the cathode circuits of some picture i-f amplifier stages. In A, a parallel-resonant trap is connected directly into the cathode circuit, whereas in B the trap is inductively coupled to the cathode circuit. In both instances, the resonant circuit introduces an impedance into the cathode circuit on a frequency-selective basis. Maximum impedance appears at the resonant frequency of the trap, with decreasing impedance each side of resonance. When the signal frequency is sufficiently far from the resonant frequency, the impedance falls to zero.

The circuit impedance acts in addition to the fixed value of cathode bias resistance, and serves to develop a bias voltage that is a function of the frequency of the input signal. Maximum bias (hence the greatest degeneration and least amplification) occurs at the resonant frequency of the trap because that is the frequency at which the trap is intended to attenuate the signal most severely. Some attenuation occurs on both sides of resonance because the circuit cannot be made responsive to only one frequency.

Circuits such as these are used to reduce the amplitude of the desired sound i-f carrier, or by using cathode traps in two or more stages, to remove the undesired adjacent-channel sound or picture i-f signal. The coupled circuit (B) is usually sharper in its tuning than the directly connected circuit (A). Cathode traps also help shape the overall amplifier response curve.

THE I-F AMPLIFIER

The Response of Coupled Circuits

The picture i-f amplifier accomplishes its purpose by virtue of amplification in the tubes as well as by variable frequency response in the tuned circuits. This combination produces the desired overall picture i-f response curve. In order to explain why the technique of stagger tuning is used (why the circuits are tuned to different frequencies) let us examine briefly the behavior of tuned circuits.

Assume two identical tuned circuits resonant to the same frequency. (Each is an imaginary interstage coupling device used between amplifying tubes.) Neglecting the amplification available in the tubes, we can describe the behavior of each tuned circuit by showing its response curve. (We do this with arbitrarily selected performance characteristics that will nonetheless serve our purpose.) Each circuit is seen to have peak response at 43 mc, and the reference signal level (that at the resonant frequency) is assumed to be one volt. Inasmuch as each circuit has single-peak response, all other frequencies are accepted to a lesser degree. The table below indicates arbitrary relative response; frequency versus voltage, and bandwidth at the different voltage levels.

Frequency	Relative Response Voltage	Frequency	Bandwidth
39.50 mc	0.1	46.50 mc	7.0 mc
41.00 mc	0.3	45.00 mc	4.0 mc
41.60 mc	0.5	44.40 mc	2.8 mc
42.10 mc	0.7	43.90 mc	1.8 mc
42.25 mc	0.8	43.75 mc	1.5 mc
42.50 mc	0.9	43.75 mc	1.0 mc
43.00 mc	1.0	—	—

Engineering practice says that the usable bandpass of a circuit is that which exists at approximately 0.7 of peak response. In this case it is seen to be 1.8 mc.

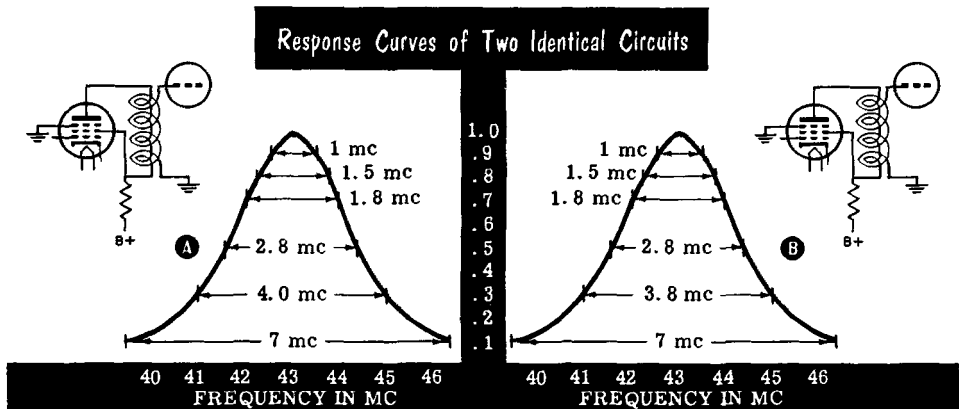

THE I-F AMPLIFIER

The Response of Coupled Circuits (contd.)

Let us now imagine that the two amplifying tubes and the tuned circuits are connected in cascade so that one feeds the signal to the other. Response is measured between the input to the first amplifier tube (e_{in}) and the output of the second tuned circuit (e_{out}).

By assuming 100-percent transfer of the signal through the tubes, we can establish the behavior of the tuned circuits alone. Since both circuits are tuned to the same frequency (43 mc), maximum response will occur at this frequency. Again we arbitrarily say that it is one volt. What response will the other frequencies generate in the complete system? The answer to this question is simple. The *overall* response (including both tuned circuits) will be equal to the *product* of the response of each circuit to the same frequency, as shown in the table.

Frequency	Response in Circuit A	Response in Circuit B	Product of Both Responses
39.50 mc and 46.50 mc	0.1 Volt	0.1 Volt	$0.1 \times 0.1 = 0.01$ Volt
41.00 mc 45.00 mc	0.3 Volt	0.3 Volt	$0.3 \times 0.3 = 0.09$ Volt
41.60 mc 44.40 mc	0.5 Volt	0.5 Volt	$0.5 \times 0.5 = 0.25$ Volt
42.10 mc 43.90 mc	0.7 Volt	0.7 Volt	$0.7 \times 0.7 = 0.49$ Volt
42.25 mc 43.75 mc	0.8 Volt	0.8 Volt	$0.8 \times 0.8 = 0.64$ Volt
42.50 mc 43.50 mc	0.9 Volt	0.9 Volt	$0.9 \times 0.9 = 0.81$ Volt
43.00 mc	1.0 Volt	1.0 Volt	$1.0 \times 1.0 = 1.00$ Volt

If we plot the product of both responses, the result is a much *narrower* resonance curve than either circuit acting alone. The frequencies at which response is 0.7 of peak are 42.3 mc and 43.7 mc, giving a bandpass of 1.4 mc, compared to 1.8 mc for either circuit alone. At the 0.3-volt level it is 2.5 mc compared to 4 mc. Obviously cascaded tuned circuits resonated to the same frequency reduce bandpass rather than increasing it.

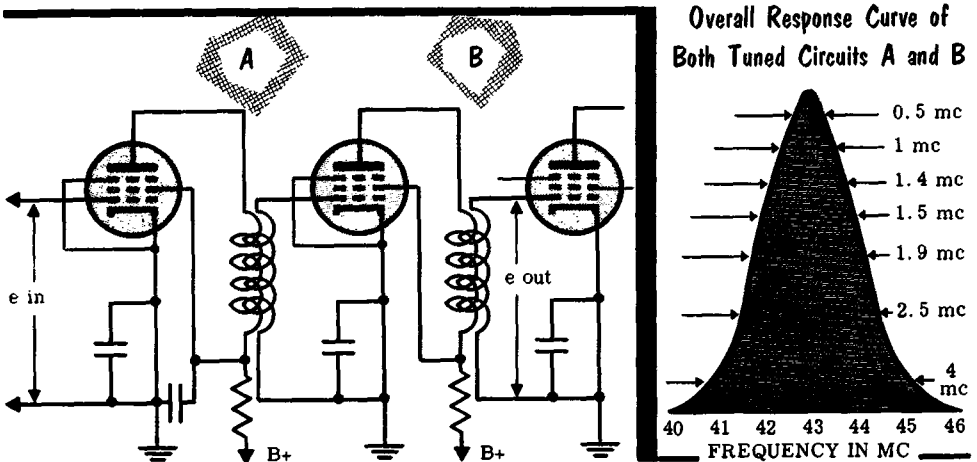

THE I-F AMPLIFIER

Stagger Tuning

The broad bandpass needed in the picture i-f amplifier is produced by stagger tuning of cascaded tuned circuits. Picture i-f amplifiers in commercial television receivers often use 4 or 5 tuned circuits, but we can illustrate the principle of stagger tuning with only two circuits. Let us assume two single-frequency response interstage i-f transformers, tuned to different frequencies—A to 43 mc and B to 44 mc. What will the final response curve look like? We neglect the tubes and deal only with the transformers. Once more, the overall response at any frequency is equal to the product of the response of each circuit to this frequency. Maximum response in each circuit is assumed to be 1 volt. If you multiply the response in each of the circuits to the same frequency, you will arrive at the resultant response curve shown by the shaded area. For example, both circuits show 0.675 of peak response at 43.5 mc. The resultant then is 0.675×0.675 or 0.455 volt. At 42 mc circuit A has 52 percent of maximum response, whereas circuit B's response is 0.3 volt. The product is 0.156 volt, and so on. It is seen that the resultant response is very much broader than the response of either circuit alone. The loss in gain that accompanies stagger tuning of tuned circuits is compensated for by the amplification in the vacuum tubes so that ample signal level over a broad band is available from the amplifier as a whole. The boxed representation symbolizes how stagger tuning of five circuits plus a number of traps achieves the desired overall picture i-f amplifier response curve.

By suitable selection of resonant frequencies as well as differently shaped response curves (because of differences in Q) for the circuits involved, almost any kind of resultant response curve can be achieved.

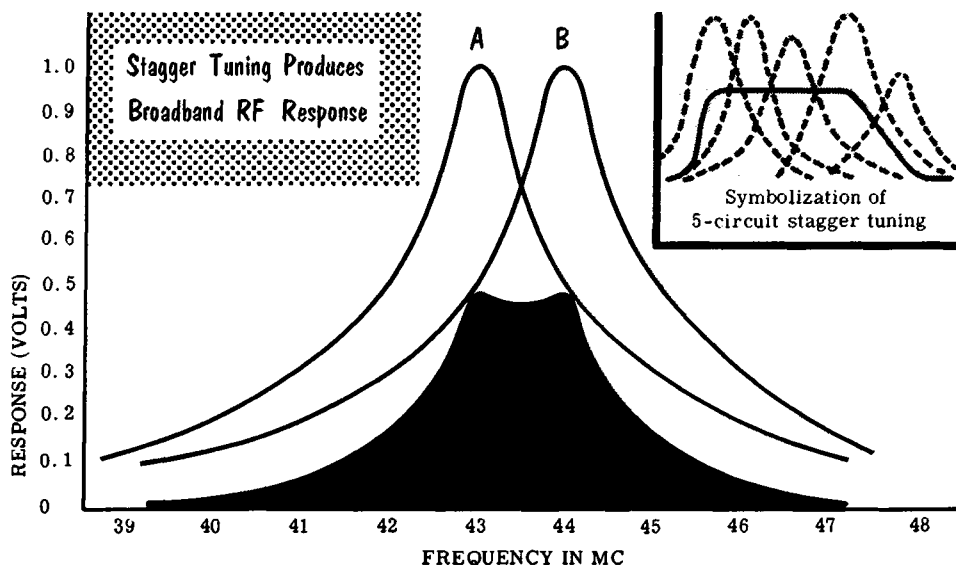

THE I-F AMPLIFIER

Stagger Tuning (contd.)

THE STAGGER-TUNED I-F AMPLIFIER

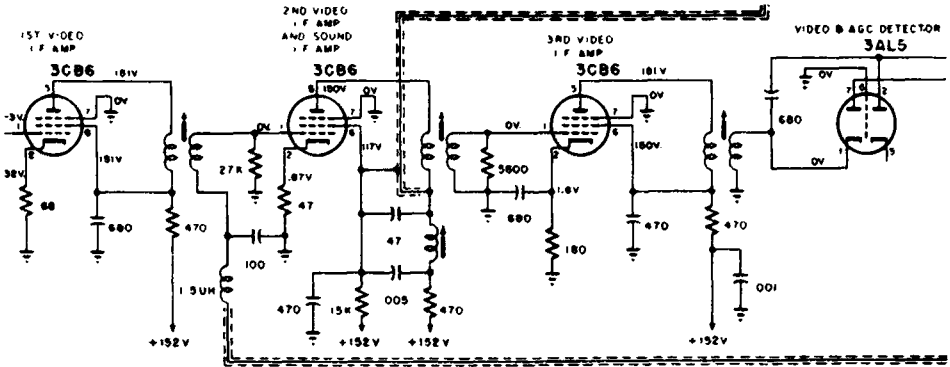

A

Transformer Coupling

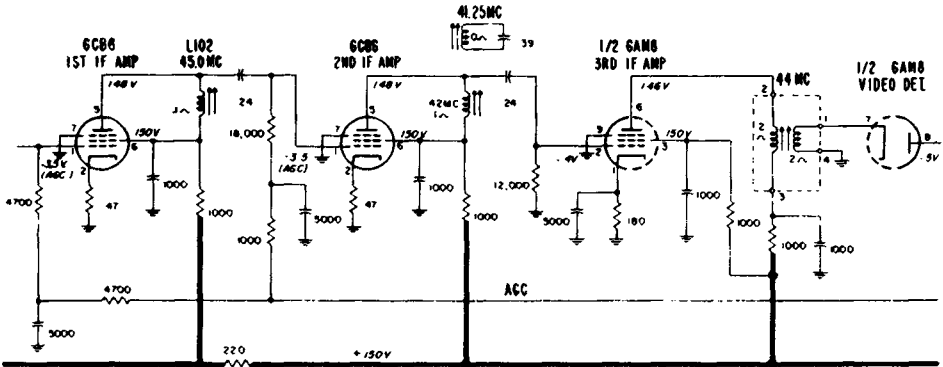

B

Tuned Impedance with R-C Coupling

Two typical stagger-tuned picture i-f amplifiers with single resonance interstage transformers A or tuned impedances B are shown on this page. (The values associated with the components are the electrical constants of the circuits.) It is seen that except for the coupling methods, the two amplifiers are very much alike. Sometimes both kinds of interstage coupling methods are found in the same receiver. The loading resistors in parallel with the tuned circuits tend to broaden the response of the circuit, but in so doing they do not defeat the use of the stagger tuning techniques as the means of attaining the broadband response.

THE I-F AMPLIFIER

Sound I-F Separation

SOUND I-F SIGNAL TAKEOFF IN SPLIT-SOUND RECEIVERS

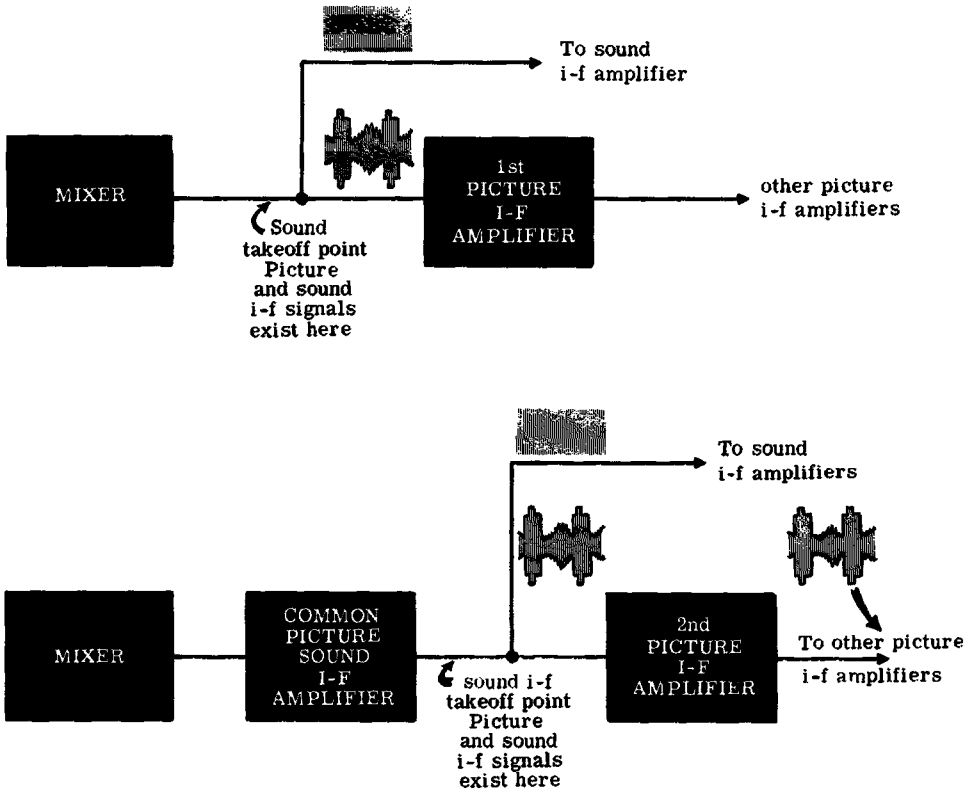

We have mentioned that television receivers produced for the public were of two types—the split-sound design and the intercarrier design. All of the picture i-f amplifiers shown in the preceding pages represent those under the intercarrier design. Although the split-sound design is obsolete, it is nevertheless necessary to present a capsule review of the picture i-f amplifier used in the split-sound system. As we mentioned earlier, it differs from the intercarrier design in several respects. In some sets, the desired sound i-f signal was separated from the picture i-f signal at the output of the front-end mixer and both signals were fed into individual channels (amplifiers) for processing. In other designs, the first picture i-f amplifier (and sometimes the second stage as well) acted as a common amplifier for both sound and picture i-f signals, after which the two signals followed separate paths.

THE I-F AMPLIFIER

Sound I-F Separation (contd.)

PICTURE I-F – SOUND I-F SIGNAL SEPARATION IN SPLIT-SOUND RECEIVERS

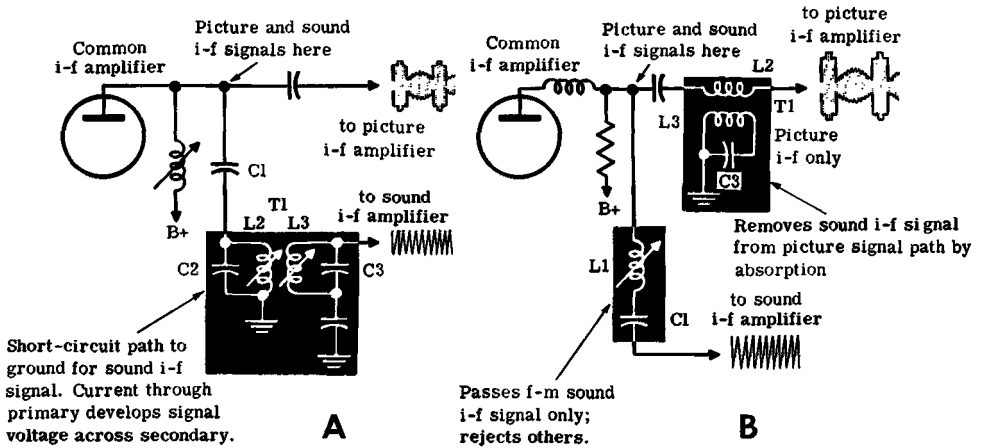

A variety of circuits were used in split-sound receivers to separate the picture and sound i-f signals. We show two methods. In each case we assume the use of a single common stage of i-f amplification that amplifies the sound and picture i-f voltages prior to their separation. In A, the primary of the transformer T1, acting in conjunction with the capacitor C1, presents a low-impedance series-resonant path to ground for the sound i-f currents, thus siphoning these signals from the picture i-f path. The resonant currents in the primary winding L2 induce voltages of corresponding frequency in the tuned secondary L3-C3, which are then applied to the sound i-f amplifier. This leaves the remaining picture i-f amplifier stages with only the picture i-f signal to process.

In system B a series-resonant circuit L1-C1 offers a low-impedance path for the sound i-f currents. The voltage developed across this circuit is applied to the sound i-f amplifier. At the same time (to still further minimize the presence of the sound i-f signal in the picture i-f signal circuit) the primary winding L2 of transformer T1 carries the currents of both the picture and sound i-f signals, but induces a voltage at the sound i-f frequency, only, across the tuned trap circuit L3-C3. Grounding this circuit effectively removes whatever remains of the sound i-f signal in the picture i-f path. The remaining picture i-f signal is processed in the picture i-f amplifier. Correction for the unequal distribution of low-frequency-sideband power due to vestigial-sideband transmission was performed in the picture i-f amplifier of the split-sound receiver in the same way as in the intercarrier receiver.

THE I-F AMPLIFIER

Printed Circuits

A PRINTED-CIRCUIT PANEL

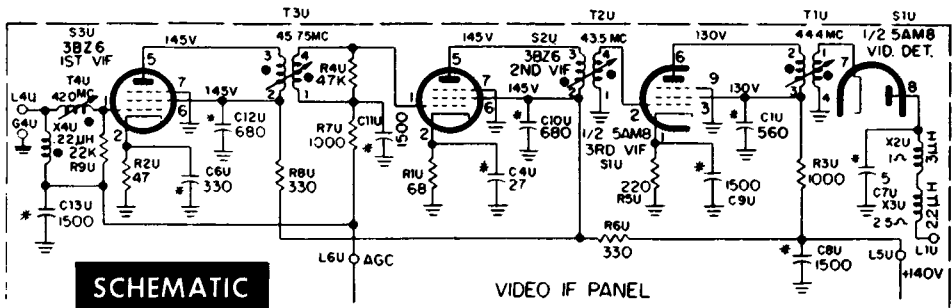

**ACTUAL
APPEARANCE**

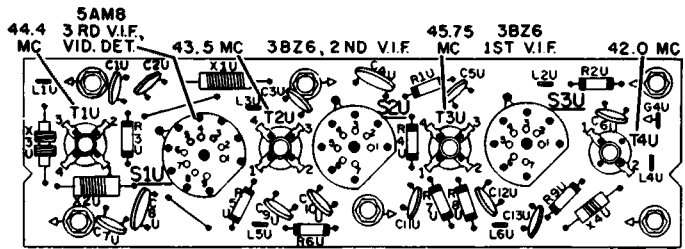

The drastic change created in the appearance and representation of the bottom view of the picture i-f amplifier in intercarrier receivers that use printed wiring dictates this brief description. Current receivers still interconnect components with copper wire, but they also use printed wiring in numerous sections of the receiver, one example of which is shown here. The components are mounted on top of the chassis "board" that is pre-fabricated in many respects prior to the mounting of the parts. The location of all of the components is pre-planned, hence one of the pre-fabrication processes is the punching of all the mounting holes, as well as the holes that will allow the leads from the components to penetrate the board and be accessible on the underside. Inasmuch as the intended location of the leads from the components on the underside of the board is known, a second step in the pre-fabrication is to "etch" the interconnecting wiring in copper foil on the underside of the board before the components are mounted. After the parts are mounted, the leads connected to them are brought through the holes and placed in contact with the printed wiring. The underside of the board is then dipped in a bath of molten solder, causing all the components to be soldered to the wiring in a single operation.

THE I-F AMPLIFIER

I-F Alignment Techniques

As we stated when demonstrating tuner alignment, our discussion must be limited to the basic technique because each manufacturer has his own specific procedure. This is a result of the different intermediate frequencies and the different distributed capacitances resulting from various physical arrangements in the individual sets.

ALIGNING THE I-F AMPLIFIER

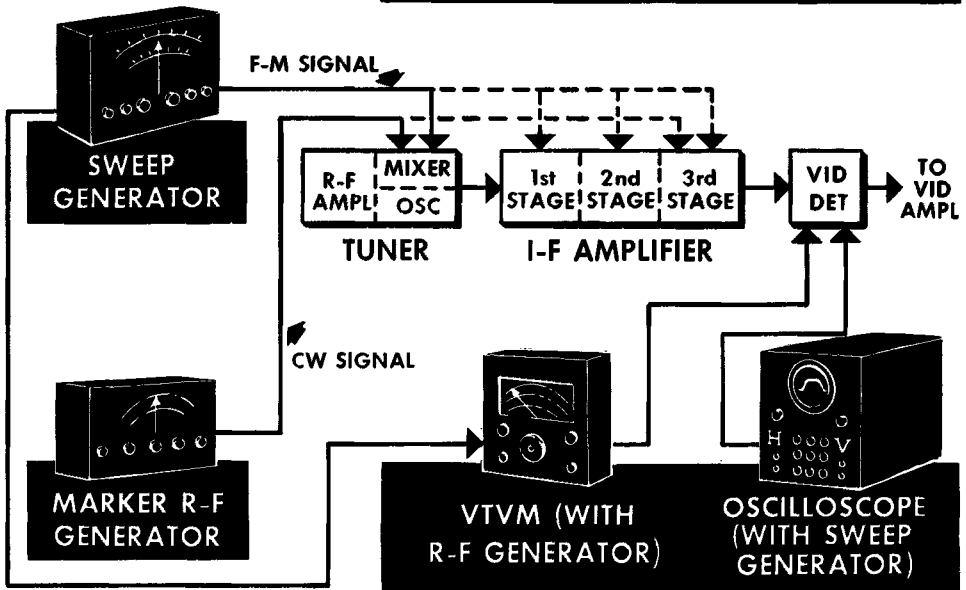

The same basic equipment can be used here as was used in the tuner alignment, the only changes being in the points of circuit connections. The sweep generator output feeds into the grid circuit of the mixer tube in the tuner. The marker generator also feeds into this point, however, it can be fed into the last i-f amplifier, since its purpose is to supply markers on the waveform that appears across the video detector load resistor. In a stage-by-stage alignment (usually the preferred method), the sweep generator initially feeds the last i-f stage. When this circuit is aligned, the sweep generator output is fed into the next-to-last i-f stage, and so on. Feeding to the mixer grid provides an overall view of the i-f amplifier response.

The oscilloscope is connected across the video detector load resistor. When a standard r-f signal generator replaces the sweep generator, the vtvm instead of the scope can be used to measure the voltage across the video load resistor.

THE I-F AMPLIFIER

I-F Alignment Techniques (contd.)

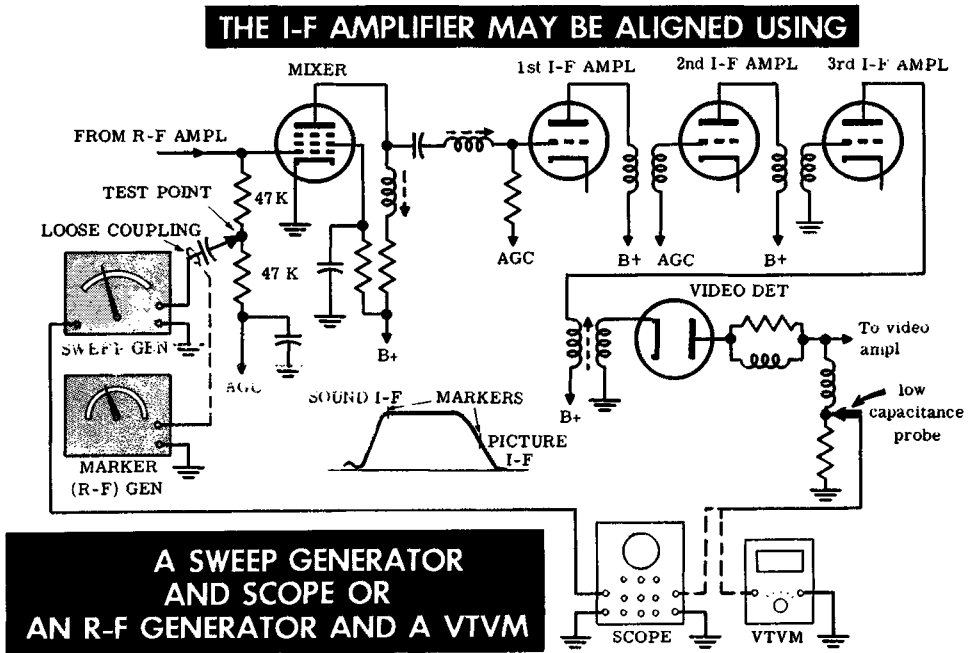

The input is to the test point at the grid of the mixer tube, whether a sweep generator or an r-f generator is used as the source of signal frequencies. The generator input should be connected through a capacitor of about $.001 \mu\text{f}$, for isolation purposes. A sweep width of approximately 7 mc should be set up when using the sweep generator. When using an r-f generator, a pattern of the i-f amplifier response can be obtained in the following manner: Set the signal generator at some frequency a few megacycles below the sound i-f; measure the output voltage on the vtm; then, keeping the same output level on the signal generator change the generator frequency to one-half megacycle higher, and again note the voltage on the vtm; continue this process, measuring the vtm voltage every half megacycle until the video i-f is reached and continue for a couple of megacycles beyond this. All the voltages measured are then plotted on graph paper to produce the i-f response curve as measured every half megacycle. The sweep generator and oscilloscope method is, of course, preferable, because the entire waveform is seen instantaneously, and changes can be noted as the circuits are adjusted.

For an overall r-f-i-f response, the sweep- and marker-generator signals may be fed into the antenna input terminals, as in the tuner alignment, and the waveform observed on the oscilloscope connected across the video detector load resistor.

THE I-F AMPLIFIER

Troubles In Picture I-F Amplifiers

In the broad sense, every component and every connection found in a picture i-f amplifier is a possible source of trouble, but experience has shown that some components are more prone to failure than others. It is these components that we shall discuss.

COMMON FAULTS IN PICTURE I-F AMPLIFIERS

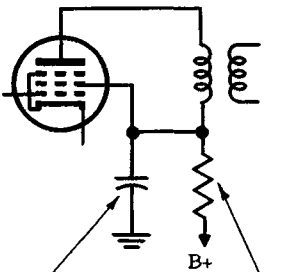

When the screen bypass capacitor short circuits to ground it also causes the failure of the plate circuit resistor.

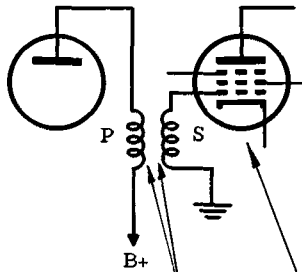

Leakage between primary and secondary windings causes overload and sometimes damages this tube.

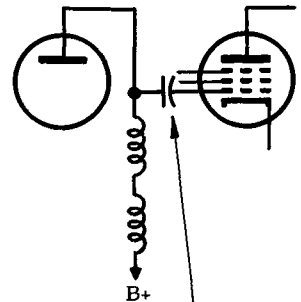

Coupling or blocking capacitors become "leaky."

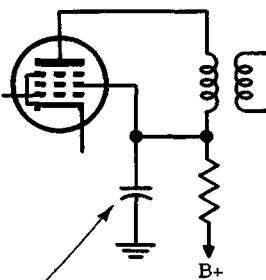

The screen bypass capacitor may open and cause oscillation in the picture i-f stage.

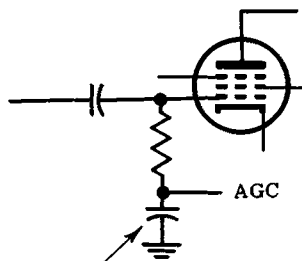

The agc bypass capacitor may short to ground, removing the bias and thus cause overloading.



Tube failures (open and shorted electrodes) are quite common.

One might expect that in view of the emphasis devoted to the adjustment of the tuned circuits, that misalignment would be a common problem. Strangely enough, this is not the case. Given good components, the transformer and tuned-impedance units will hold their tuning adjustments for a long time. In other words, if the set has been properly aligned, alignment troubles are infrequent. The other difficulties shown in the illustration occur much more frequently.

THE I-F AMPLIFIER

Component Identification

The matter of video i-f amplifier component identification warrants attention. Of principle interest are the symbolizations of plate load assemblies (tuned impedances, traps, and interstage coupling units). The manner of showing the component on the schematic gives the symbol special meaning. These pertinent facts are detailed here.

A single arrow indicates that a single adjustment accounts for the variation of the inductance of the winding or windings. If the arrow is shown above the coil, it indicates that the adjustment is accessible from the top of the unit; if the arrow is shown below the coil, it indicates that the adjustment is accessible from the bottom of the unit.

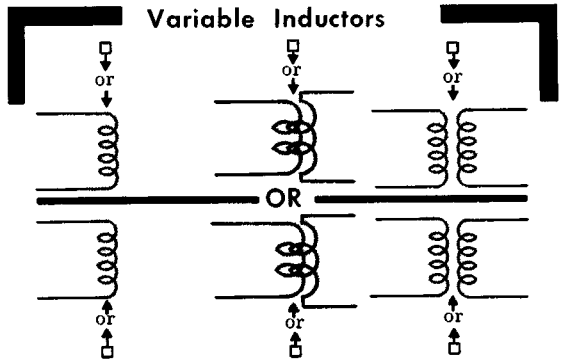

adjustment for L2

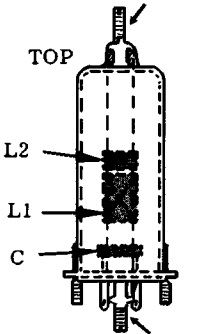

A dotted or dashed-line square surrounding the symbol or symbols indicates that the entire unit is a single assembly, and the housing is a shield that can house all the components shown inside the border. Openings in the metal housing on top or bottom or both, allow access to the adjustable component.

Single Assembly

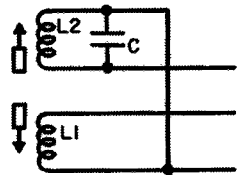

Mutual Coupling Inductors

The SCHEMATIC

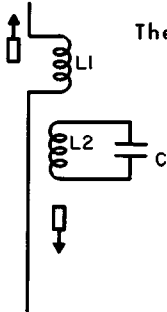

The COMPONENT

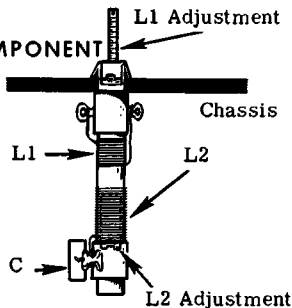

Inductors that are coupled to each other are not necessarily contained in shield cans. Early receivers used shield cans to house the tuned inductors used in the picture i-f amplifier, but the practice is not always followed in the more modern units.

THE I-F AMPLIFIER

Component Identification (contd.)

VIDEO I-F TRANSFORMER

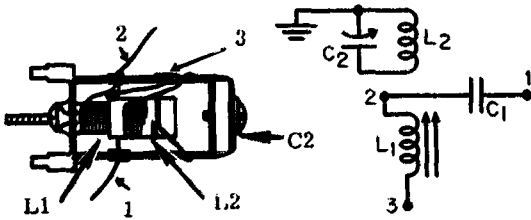

Variable capacitors are often used to tune adjacent-channel or sound traps. The schematic wiring diagram may indicate that the variable capacitor is housed in the shield can, but what it does not show is that the capacitor is built into the can as its top or bottom cover.

Virtually all schematic diagrams indicate the electrical constants of the components, but this information does not facilitate recognition of the actual units, especially in differentiating between tubular ceramic capacitors and low-power-rated tubular resistors. Tubular ceramic capacitors are hollow, although this may not be evident if the coating material has closed the open ends. The capacitor may be recognized in one of two ways: by the location of the connecting pigtaills, which may issue from lumps on the side of the unit, instead of from the ends as in resistors; or, when the capacitor has axial leads, by the use of capacitor-color-coding dots painted on the body of the unit, rather than the colored coding rings used on the body of a resistor.

Resistors and Tubular Ceramic Capacitors

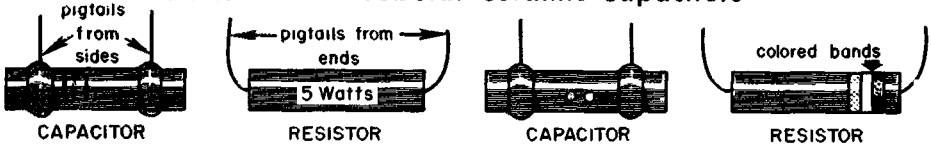

Many capacitors used in video i-f amplifiers and elsewhere in the receiver are of the disc ceramic type. (They are quite common as bypass capacitors.) Often, two capacitors utilized to bypass adjacent circuits are part of the same physical unit. The capacitor is a dual unit, in which the center lead is common to both capacitors. These units come in two shapes as shown.

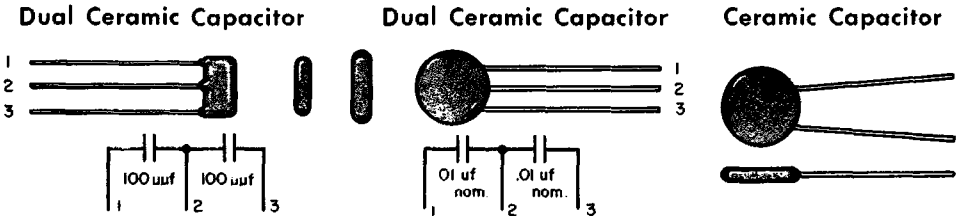

REVIEW

1. **Traps.** The Broad Bandpass required in the front end of a television receiver permits the passage signals from adjacent channels. The adjacent-channel sound signal from the lower channel and the adjacent-channel video from the upper channel are particularly troublesome. Special traps are used to remove these unwanted signals.

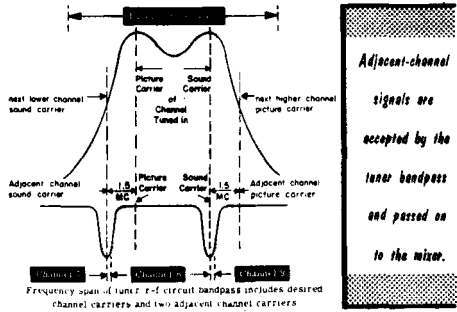

Cathode Traps Cause Degeneration On A Frequency Selective Basis

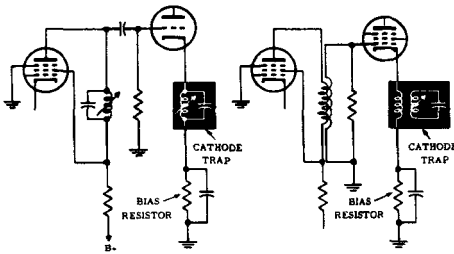

2. **Cathode Traps** are used to attenuate unwanted signals. On either side of resonance, they present a very low impedance; at resonance, however, they present a high impedance that "loads down" the cathode circuit and reduces the gain of the amplifier at that frequency. This means that a cathode trap causes degeneration at its resonant frequency.

3. **In Radio Broadcasting**, the vestigial-sideband system is not used, and the upper and lower picture sidebands are identical. They contain the same power and the same modulation components (intelligence).

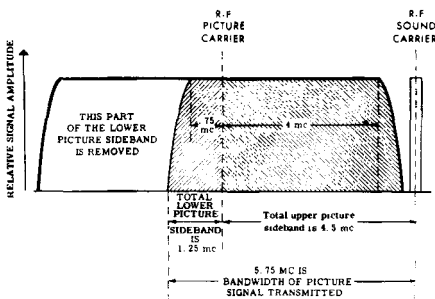
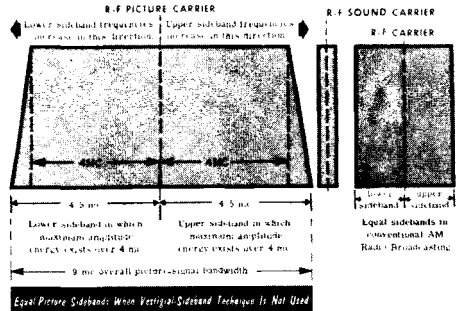

The Result of Vestigial Sideband Transmission on Frequency Content of Picture Signal

4. **The Television Signal** carries modulation components up to 4.5 mc above the carrier frequency. If the sidebands were of equal width the transmitted signal would be 9 mc wide. To permit more television channels on the air it is necessary to reduce the bandwidth of the television signal as much as possible. This is done by vestigial sideband transmission in which a part of the lower sideband is removed. This enables a television station to contain its signal in a 6-mc band.

REVIEW

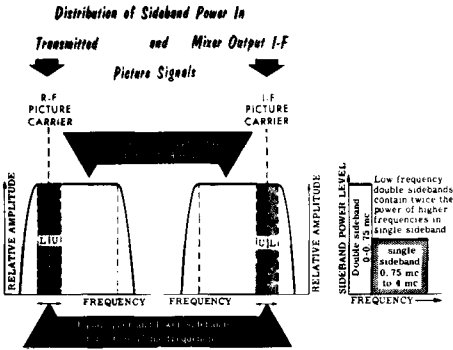

6. A Single- or Double-Peak Response can be obtained by using the proper type of interstage coupling. A double-tuned transformer can produce a broad double-peaked response, whereas the other coupling methods produce a single-peaked response.

5. Vestigial Sideband Transmission. This removal of part of the lower sideband leaves portion is close to the picture carrier that consists of lower-frequency components. The transmitted signal, therefore, contains more low-frequency power than high-frequency power. This would cause masking of fine detail in the picture, if the picture i-f amplifier did not compensate for it.

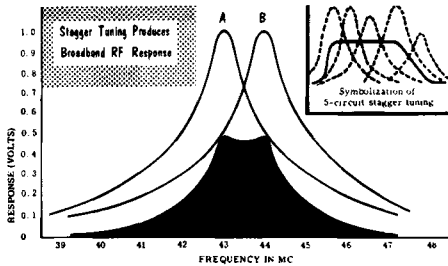
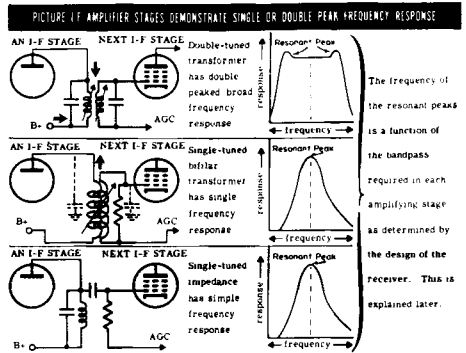

7. Broadband R-F Response can be obtained by stagger tuning. In this process the signal passes through successive stages that are tuned to slightly different frequencies. The net effect of this is to produce a broad bandpass for the signal so that very little of the sidebands are lost or attenuated.

8. In Split-Sound Receivers the sound signal can be removed by inductive coupling through a sound-takeoff coil or through a series resonant circuit that will offer a high impedance to all frequencies except the sound intermediate frequency. The takeoff point may be at the output of the mixer or after one or more i-f amplifier stages.

PICTURE I-F—SOUND I-F SIGNAL SEPARATION IN SPLIT-SOUND RECEIVERS

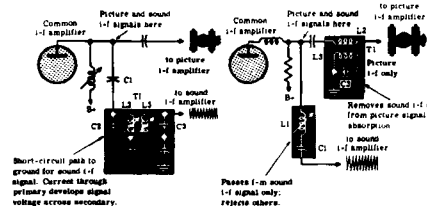

THE VIDEO DETECTOR

Functions of the Video Detector

The purpose of the video detector in the intercarrier receiver

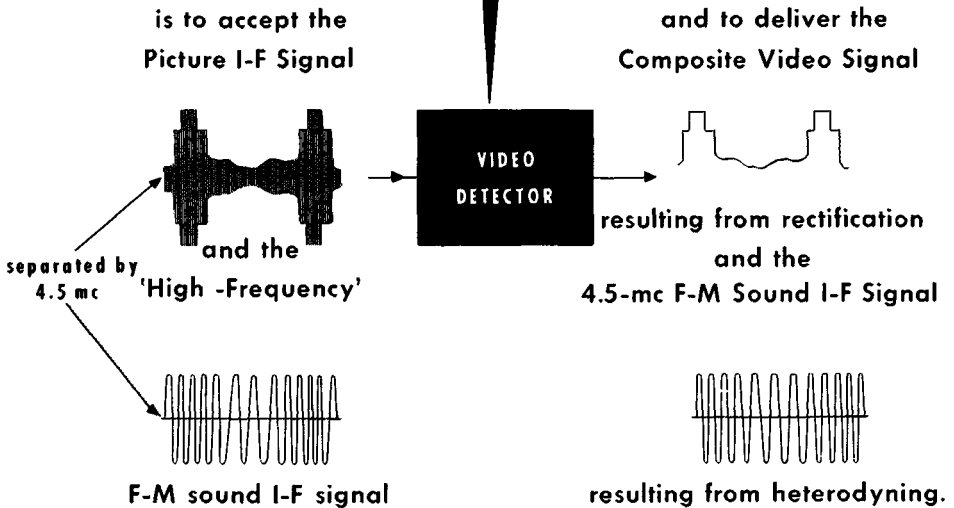

The functions of the video detector in a television receiver were mentioned earlier. Now we shall become more specific and examine its circuitry and action. In the intercarrier type of television receiver, the video detector:

1. Accepts the picture i-f signal as well as the f-m sound signal, and by a process of rectification delivers the *composite video signal*. (This signal contains all of the picture information; the horizontal and vertical blanking pulses, the horizontal and vertical synchronizing pulses, and the equalizing pulses.)
2. The video detector makes available a 4.5-mc f-m sound i-f signal that results from the mixing of the picture and sound i-f signals from the picture i-f amplifier. (Strictly for clarity, we say that the video detector changes the "high-frequency" f-m sound i-f signal into a "low-frequency" f-m sound i-f signal.)

The output of the video detector eventually follows three paths: to the picture tube control grid or cathode, depending on circuit design; to the synchronizing system where the synchronizing pulses are extracted and delivered to the beam-positioning (sweep) circuits; and to the "low-frequency" sound i-f system. (This path receives the 4.5-mc f-m sound i-f signal produced by mixing.)

THE VIDEO DETECTOR

The Detector in Radio Receivers

The action of the video detector in the television receiver and that of the second detector in the conventional superheterodyne radio receiver are substantially the same. The two detectors do, however, differ in output circuitry (as explained later) because of the frequency content of their signals.

The Detector Used in Radio Receivers

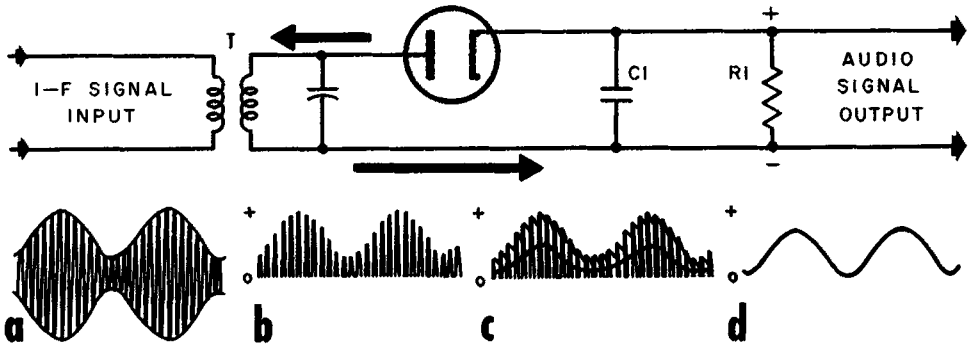

A diode radio detector is shown. (A crystal can replace the tube and an example of its use as the video detector appears later.) The i-f transformer, T, feeds the i-f signal to the detector. The signal is seen to have equal positive and negative alternations (A). Connected as shown, the positive alternations of the modulated i-f carrier make the diode plate positive relative to its cathode, and current (B) flows through the diode and through the load resistor R1 in the direction shown by the arrows. The negative signal alternations are removed because the diode does not conduct when its plate is negative with respect to its cathode.

A current corresponding to the *instantaneous* variations of the input signal *carrier* cycles of the positive alternations flows into the capacitor C1 and charges the capacitor to almost the peak value of input positive carrier cycles (C). Resistor R1 prevents the capacitor from discharging after each rectified pulse before the arrival of the next pulse. The average of the charging current appearing across R1 has an outline that is like the envelope of the positive alternations of the input i-f signal. This is the detector output signal (D). Because of the circuit used (the plate of the diode being made positive by the positive half of the input signal) the rectified current flows as shown. This produces positive-polarity output signals across the diode load R1. When the rectified output is fed through a capacitor, the d-c component is removed and the signal assumes an a-c character.

THE VIDEO DETECTOR

The Video Detector Circuit

The Two Video Detector Circuits

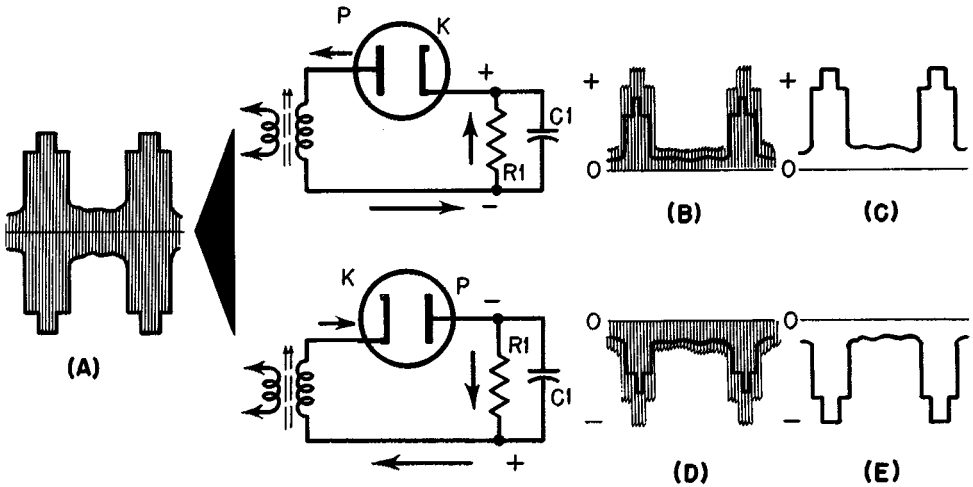

Let us now examine the action of the diode video-detector circuit. The i-f transformer delivers the picture and sound i-f signals to the detector. Examining the picture i-f signal (A), we note that it has like positive and negative alternations. If, for the moment, we overlook the simplicity of the R-C load applied to the diode and its adverse effect on the waveform of the output voltage, we note that the rectifying action is like that which would take place if the input i-f signal were simply sine-wave modulated. The rectified current appears in pulses, one pulse for each i-f carrier cycle (B and D), and these pulses of current charge the load capacitor C1. The average value of the charging current pulses has the same waveform as the input i-f signal envelope. The voltage built up across the resistor R1 has the waveform (C and E) corresponding to the input voltage. (This waveform would not be observed with the simple load circuit shown; a much more elaborate system is required as is shown on the pages that follow.)

The direction of the current pulses through R1, hence the polarity of the voltage built up across it is determined by the connection of the diode. Two possible arrangements are shown. One circuit connection affords positive-polarity (negative-phase) output voltage, whereas the other affords negative-polarity (positive-phase) output voltage. Which one is used is determined by the receiver design, specifically, the number of video amplifying stages and whether the composite video signal fed to the picture tube is applied to the cathode or the control grid. These subjects will be discussed individually.

THE VIDEO DETECTOR

Frequency Response

Basic radio teaches that the process of demodulation (detection) of an amplitude-modulated carrier removes from the carrier the intelligence that was added to it during modulation in the transmitter. If this is done properly, the rectified output of the video detector (a composite video signal of either positive or negative phases) should have the same waveform as the envelope of the modulated i-f carrier fed to the detector. For this to occur, it is essential that all of the frequency components present in the input signal also be present in the rectified output, and that they be present in correct proportions. This is not difficult to attain when the components are in a limited frequency range, but, as we have stated, the picture i-f signal is made up of numerous parts. Each of these parts is associated with a frequency band as indicated on the pages that follow.

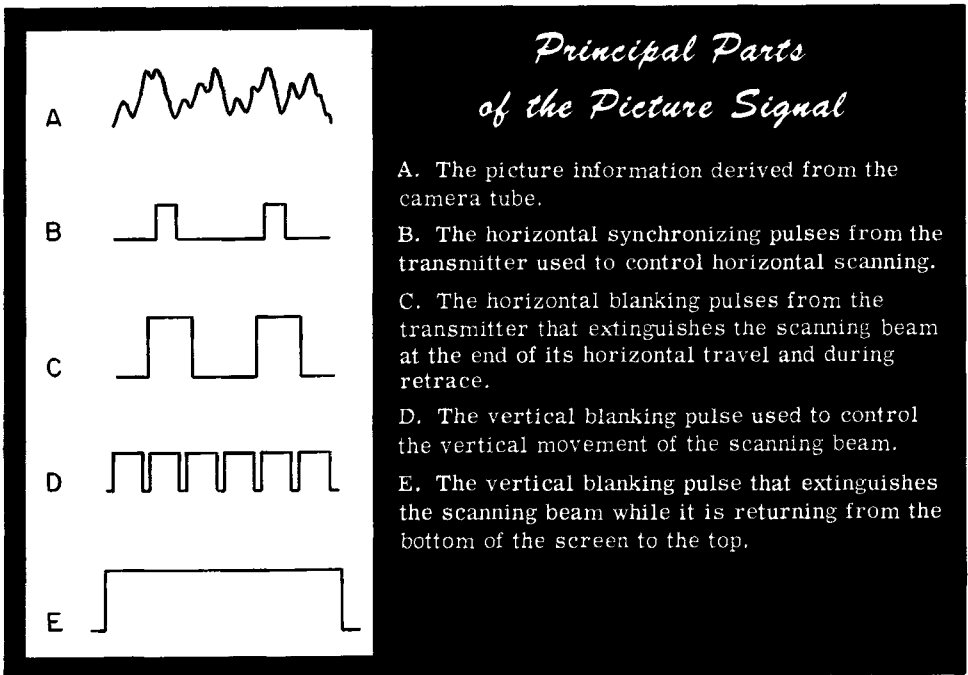

Treated as a whole, we say that the picture signal represents a frequency span of from 0 to 4 mc. This band must be processed by the video detector output circuit. In addition, the video detector must deliver a 4.5-mc f-m sound i-f signal. This means that the detector output circuit must accept this 4.5-mc signal. In practice, if the designer plans for a 4-mc top frequency, the output circuit will pass the 4.5-mc signal to an adequate extent. Similarly, if the low limit is set at 30 cycles instead of 0 frequency, the output circuit will accept frequencies considerably below 30 cycles.

THE VIDEO DETECTOR

Frequency Response (contd.)

Several causes underly the emphasis given to the frequency response of the video detector. The frequency content of the signal delivered to the video amplifier is that of the rectified output of the detector. If the detector output is deficient in frequency content, the frequencies lost cannot be added in the circuits that later process this signal. Incorrect signal output at the video detector can impair the quality of the picture and the stability of the display. The larger the screen, the more important is the presence of all the frequency components in correct relative amplitudes.

FREQUENCIES AND PRACTICAL RECEIVER BANDWIDTHS

Horizontal Sync Pulse		Fundamental frequency $1 / .0000635 = 15,750$ cycles Practical bandwidth required = 4 kc to 3 mc
Horizontal Blanking Pulse		Fundamental frequency = 15,750 cycles Practical bandwidth required = 4 kc to 3 mc
Vertical Sync Pulse		Fundamental frequency $1 / .016666 = 60$ cycles Practical bandwidth required = 10 cycles to 3 mc
Vertical Blanking Pulse		Fundamental frequency = $1 / .016666 = 60$ cycles Practical bandwidth required = 10 cycles to 3 mc
Scanning		Fundamental frequency = $1 / .0000635 = 15,750$ cycles Practical bandwidth required = 4 kc to 4.5 mc
Equalizing Pulses		Fundamental frequency = 15,750 cycles Practical bandwidth required = 10 cycles to 4 mc

The quality of the picture display is primarily determined by the timing action of the synchronizing, blanking, and equalizing pulses. This timing, in turn, is determined by the shape (waveform) of these pulses. Under ideal conditions they have vertical rising and falling sides (leading and lagging edges). We cannot achieve this ideal, but it is essential to approach it as closely as possible. To develop these shapes at the video detector output and to retain them in the video amplifier, the full range of frequencies associated with each pulse must be present, and their relative amplitudes must be correct. Abrupt changes in picture content from white to black or from black to white correspond to voltages that rise and fall steeply. These rapid changes are equivalent to high-frequency signals, which again demand broad response.

THE VIDEO DETECTOR

Frequency Response (contd.)

To show the association between frequency response and the shape of the signal waveform a usable (A) and a badly distorted (B) picture signal voltage waveform are shown on this page. The distortion is attributable to inadequate frequency content. The waveform shows picture information from parts of two horizontal scanning lines, a horizontal blanking pulse and a horizontal sync pulse. Corresponding points on the two waveforms are indicated by similarly numbered arrows. The two waveforms are drawn on the same time scale but with individual amplitude scales. Although we show only a limited part of the picture signal, much important information can be developed.

The Effect of Poor Video Detector Output Response

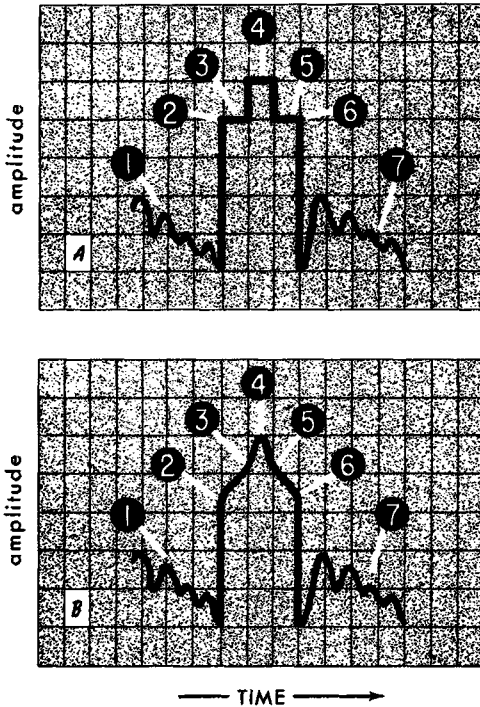

Using the time scale as reference, it is evident that the blanking action of B begins later than for A. This is indicated by the increase in time required for the voltage in B to reach the blanking level. The sync pulse in B rises at a much slower rate than in A, which would affect the timing of the beam movement in the picture tube and the presentation of the picture. In fact, the interlacing of the two fields could be completely destroyed. Lessons to follow will show why it is important for the synchronizing voltage to have substantial periods of constant amplitude. In B these plateaus are almost completely lacking. The sharp rise of the blanking pulse can be obtained only where the high-frequency response of a circuit is such that the odd harmonics of the fundamental frequency are passed without any appreciable distortion.

The picture-information waveforms are also adversely affected. As they appear in A and B, they are only symbolizations; nonetheless the distortion shown has meaning. The loss of low- and high-frequency components causes changes in both amplitude and waveform, as will be shown later in this volume. These changes can account for major troubles: *blurriness* that cannot be corrected with the focus control, *smear*ed pictures that cannot be sharpened by tuning adjustments, and apparent transparency of parts of the picture display—the X-ray effect.

THE VIDEO DETECTOR

Frequency Response (contd.)

The circuit that acts as the load on the video detector for the rectified picture i-f signal is more elaborate than the parallel resistor-capacitor combination that is used in the conventional radio receiver. The need is for a fairly constant load impedance over a range from 30 cycles to about 4 mc. To make the thoughts behind the need most understandable, consider a video detector with a load circuit like that used with a radio-receiver detector.

The Simple R-C Load Affords Poor Video-Frequency Response

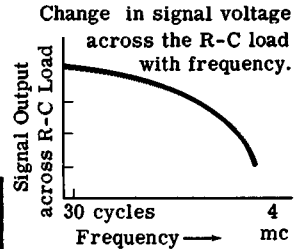
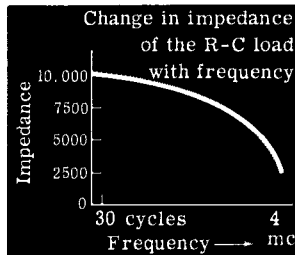
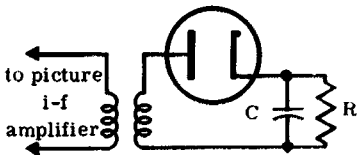

If we set 30 cycles as the low-frequency limit of the passband for the frequencies the value of this capacitor would be between 4 and perhaps 25 μmf . Let us assume it to be 10 μmf . Arbitrarily, we make R equal to 10,000 ohms. If we set 30 cycles as the low-frequency limit of the passband for the frequencies present in the picture i-f signal, C has a capacitive reactance (X_c) of 530,000,000 ohms. At the 4-mc end of the passband X_c is about 4000 ohms. R and C in parallel present an impedance (Z) which may be found from the equation

$$Z = \frac{X_c \times R}{\sqrt{X_c^2 + R^2}} \quad \text{For example, at 30 cycles } Z = \frac{530,000,000 \times 10,000}{\sqrt{530,000,000^2 + 10,000^2}}$$

Solving this formula at 30 cycles, Z is about 10,000 ohms, whereas at 4 mc it is about 3700 ohms. The change in detector load impedance from a high of 10,000 ohms to a low of 3700 ohms results in wide variation in amplitude of the high- and low-frequency components in the rectified signal, a condition that is not favorable to good picture quality or to receiver stability. Suppose that we make R equal to 1000 ohms. At 30 cycles Z is about 1000 ohms and at 4 mc it is about 970 ohms. On the surface, this appears to solve the problem. Actually it is not a solution because the voltage drop across this small load impedance is insufficient for signal transfer to the next stage. For this reason, a higher value of load impedance is indicated, without, however, wide fluctuations in value over the frequency range involved. This is achieved by using a more elaborate load circuit.

THE VIDEO DETECTOR

The Video Detector Output Circuit

The frequency-compensated output circuit (A) offers a suitably high, yet reasonably constant load impedance over the full range of modulation frequencies present in the rectified composite video signal. (The f-m sound i-f takeoff circuit has been omitted.) The value of R (shunted by C) sets the low limit of impedance for the low-frequency components, because the shunt capacitance has limited affect over that range. The load impedance for the high frequency components is determined by coils L1 and L2.

The Video Detector Output Circuit

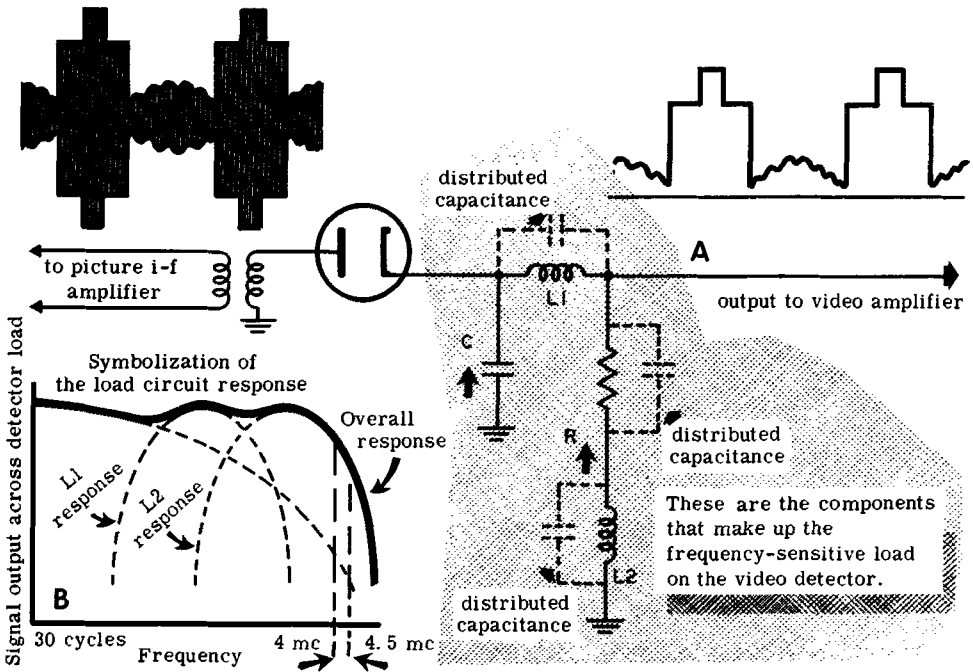

These coils behave as parallel resonant circuits resonated by their associated distributed capacitances and (in some instances) by capacitor C as well. One coil resonates broadly near the midpoint of the band of modulation frequency components, whereas the other resonates broadly higher up in the band as shown by the resonance curves of drawing B. Sometimes the peaks are flattened by the use of resistors connected in shunt with these *peaking coils*. The series circuit of L1, R, and L2 presents a reasonably constant value of load impedance that is sufficiently high over the entire video frequency band to afford a suitable signal output from the detector. At the high-frequency end the rise in impedance of the coils compensates for the decreasing reactance of the capacitor C.

THE VIDEO DETECTOR

I-F Filtering

Filtering the I-F from the Video Detector Output

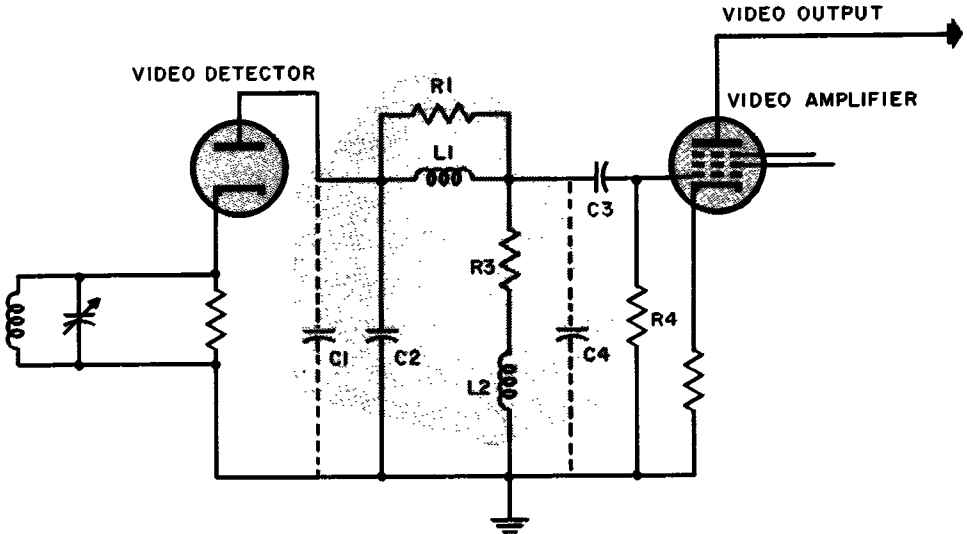

The picture signal output desired from a video detector is a d-c voltage that varies in amplitude according to the envelope of the input picture i-f signal. We have, however, learned that this voltage is the result of instantaneous pulses of charging current, one such pulse for each i-f carrier cycle. Thus it would appear that the i-f carrier signal in the form of half cycles also would be present across the detector load circuit and would be passed on to the video amplifier. This does not occur. The various distributed capacitances (C1 and C4) associated with the circuit elements that comprise the load on the video detector and capacitor C2 present a very low-impedance path to the i-f carrier cycles thus preventing the build-up of a signal voltage representative of them. The peaking systems established in the detector load circuit thus act as a lowpass filter, passing everything up to, say, 4.5 mc, and attenuating all higher frequencies. This prevents the transfer of the i-f carrier voltage.

Even with a 1:5 ratio between the highest modulating frequency, roughly 4.5 mc, and the lowest i-f frequency, approximating 20 mc, the capacitances previously identified filter the i-f carrier voltage very adequately while they allow the modulating-frequency components to be passed through with very little attenuation. The filtering was improved further by the change in intermediate frequency from the 20-27-mc band to the 40-47-mc band,

THE VIDEO DETECTOR

Crystal Diodes

In the early days of radio, the *galena crystal* and the *cat's whisker* (made of very thin wire) were used as the detector in radio receivers. Later, the crystal detector became obsolete because vacuum tubes did a better job. Today in radio, television and numerous other communications devices that require rectification of modulated voltages, the crystal detector is once more a respected member of the community of electronic components. However it is no longer made of galena; it is now generally made of a metal called *germanium*.

CRYSTAL DETECTOR...

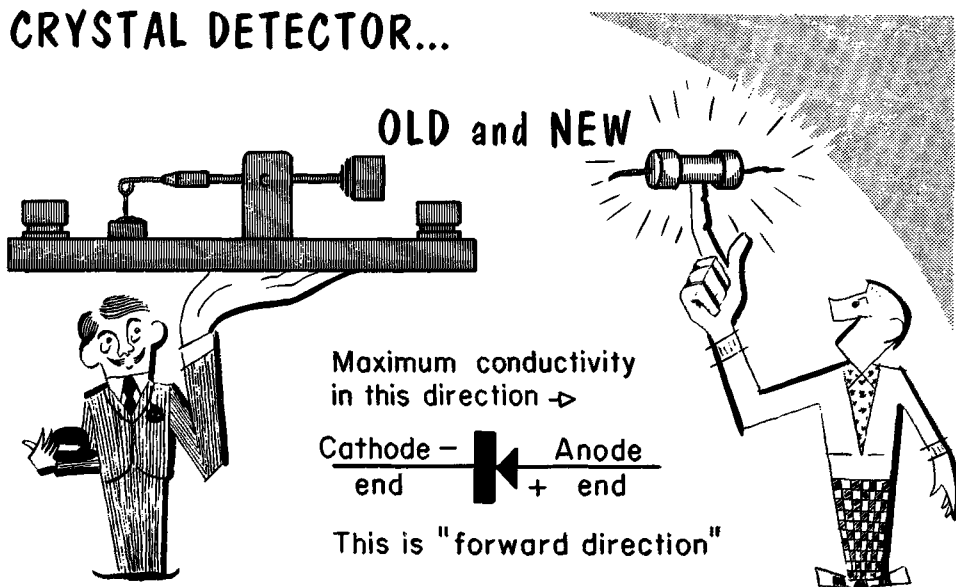

Germanium crystals conduct electricity better in one direction than another, a characteristic that makes them suitable as rectifying detectors and mixers. Another way of referring to this property is *unidirectional conductivity*. Electric current in such a crystal encounters little opposition to the flow in one direction (*forward resistance*) and very high opposition to the flow in the opposite direction (*back resistance*). The ratio of forward to back resistance usually is in the neighborhood of 100:1 in germanium crystals.

As a substitute for the vacuum tube, the germanium crystal (diode) is meeting with increased favor. It does not require a heater, hence no power is expended when using it. In addition, a germanium diode is very small, thus conserving space.

THE VIDEO DETECTOR

Crystal Diode Circuits

Crystal Detector Circuits

for Negative and Positive Signal Outputs

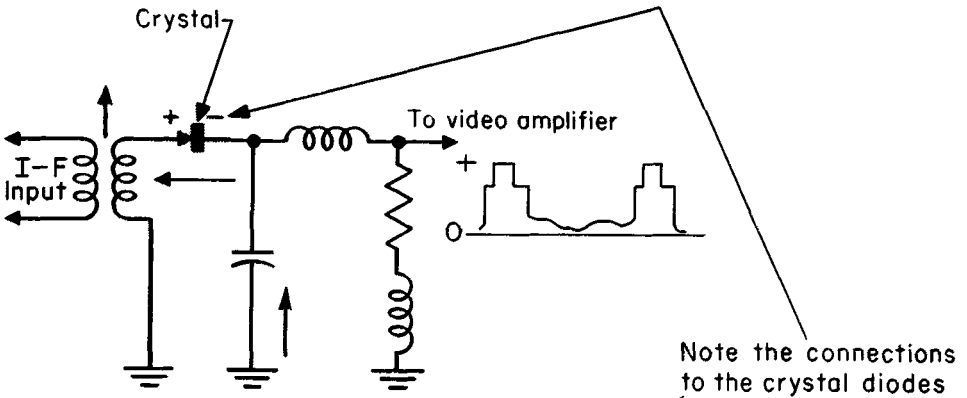

(a) Negative phase detector

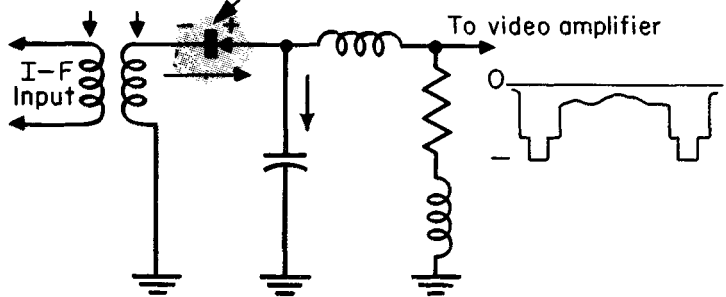

(b) Positive phase detector

It is an easy matter to arrange the crystal-diode video detector for producing either negative- or positive-phase signals. In every respect the circuit is conventional except that the vacuum-tube diode is replaced by the crystal. The polarity of the crystal (indicated by + and -) is determined by the phase of the output signal desired.

THE SOUND SIGNAL

The 4.5-mc F-M Sound I-F Signal

Up to this point we have concerned ourselves with the composite video signal output of the video detector. We mentioned (but did not discuss in detail) the 4.5-mc f-m sound i-f signal that is produced by mixing the picture i-f signal and the sound i-f signal in the video detector. These two signals are separated by 4.5 mc and, when fed into a non-linear element (any rectifier), will produce a difference-frequency signal that bears the modulation characteristics of the *weaker* of the two signals. This is why the tuned circuits in the picture i-f amplifier are adjusted to produce a very low-level sound i-f signal.

The separation of the 4.5-mc f-m sound i-f signal from the composite video signal output of the detector can be accomplished at the detector output or after one stage of amplification in the video amplifier. Both methods are used in commercial receivers, however the second permits the use of one less amplifying stage in the 4.5 mc i-f amplifier. When separation occurs at the detector output, the circuit is somewhat more elaborate than that we showed earlier. We show here one method of picking off the 4.5 mc sound i-f signal at the output of the video detector. The notations explain the functions of the circuit elements.

Typical Intercarrier Video Detector Circuit

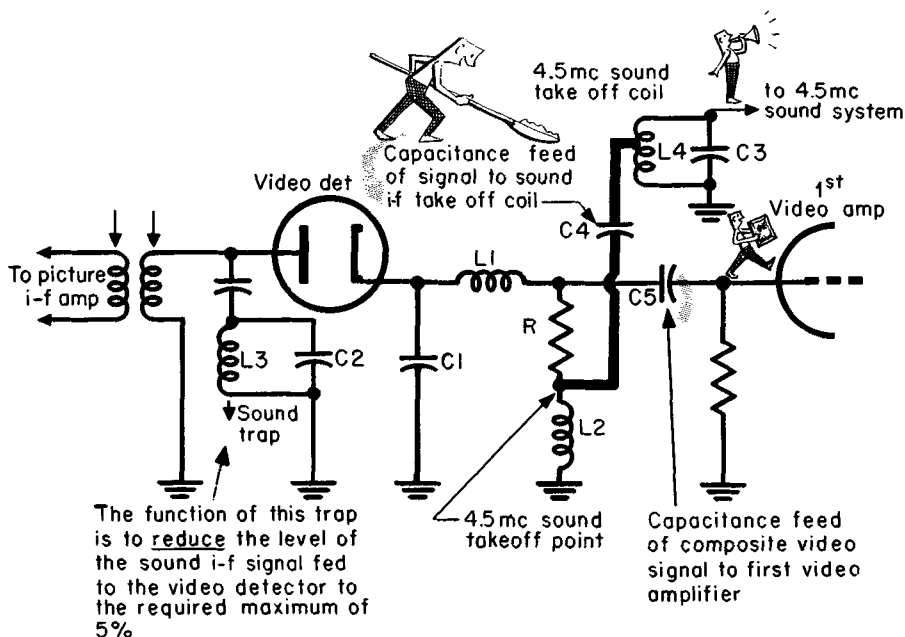

THE SOUND SIGNAL

4.5-mc F-M Sound I-F Signal Takeoff

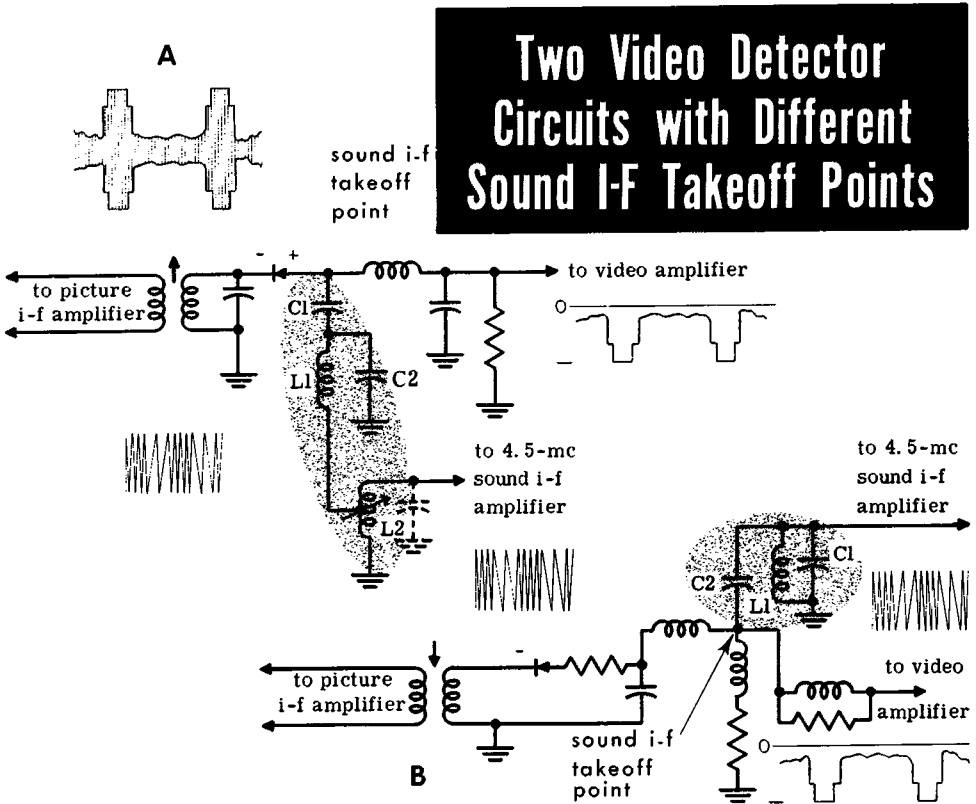

Two more examples of takeoff of the 4.5-mc sound i-f signal at the detector are shown on this page. In both instances the detector is a crystal diode, but it could just as readily be a vacuum tube diode. In circuit A, C1, L1, C2 and tapped inductor L2 comprise the sound signal takeoff circuit. Elements C1, L1 and one part of L2 form a 4.5-mc series-resonant circuit that is shunted across the detector load, affording an easy path for sound i-f signal currents. L2 as a whole is also resonated to 4.5 mc by its distributed capacitance, and it, too, behaves as a resonant circuit. With a portion of L2 acting as a part of the series-resonant system, some of the 4.5-mc signal current flows through it, and the coil as a whole behaves as a tuned auto-transformer that steps up the sound signal voltage, which is applied to the first 4.5-mc sound i-f amplifier tube.

In circuit B the 4.5-mc sound takeoff system is the parallel-resonant circuit L1-C1, which is connected in shunt with a part of the detector load through coupling capacitor C2. The voltage built up across L1-C1 is applied to the first stage of the sound i-f amplifier.

THE SOUND SIGNAL

4.5-mc F-M Sound I-F Signal Takeoff (contd.)

We may be slightly premature in showing the 4.5-mc sound i-f takeoff in the video amplifier at this point, because we have not yet discussed the amplifier itself. However, because we are dealing with the sound i-f signal and the takeoff point usually is at the output of the first stage, it is felt proper to take this much license with the organization of this lesson.

The techniques used are relatively simple in most cases. The composite video signal as well as the 4.5-mc sound i-f signal are fed to the first stage of the video amplifier. Both signals are amplified in a normal fashion, after which the signals are divided into two paths at the video amplifier plate in various simple ways. In circuit A, the 4.5-mc sound i-f signal is removed from the composite video signal path by means of a tuned transformer that is connected in the plate circuit of the first video amplifier stage. The primary is subject to both signal currents from which the secondary, inductively and capacitively coupled to the primary and tuned to 4.5 mc, removes this component. The voltage built up across L2-C2 is delivered to the first stage of the 4.5-mc sound i-f amplifier.

Sound I-F Takeoff in the Video Amplifier

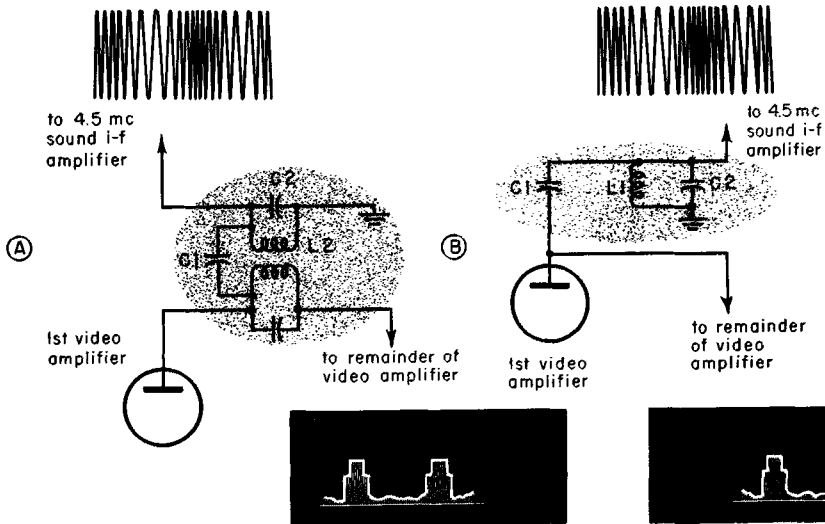

Circuit B shows a different approach. The parallel-tuned circuit C2-L1 resonated to 4.5 mc is capacitively coupled through C1 to the plate of the first video amplifier tube. The 4.5-mc signal built up across this circuit is fed to the control grid of the first 4.5-mc sound i-f amplifier stage. The other branch circuit connected to the plate of the video amplifier feeds the video signal to the circuit elements of the remainder of the video amplifier.

AUTOMATIC GAIN CONTROL

Automatic Gain Control (AGC)

Relationship Between AGC Action and Received Signal Strength

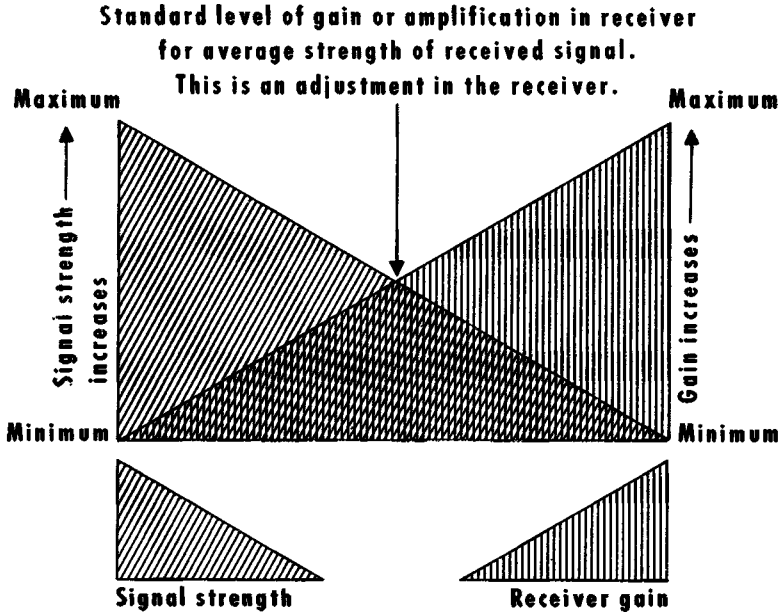

When received signal strength goes up,
gain or amplification in receiver goes down

Earlier (when we discussed the tuner and the picture i-f amplifier), we made reference to automatic gain control of the r-f stage and several picture i-f amplifier stages. We remarked that the bias was automatically varied so as to control the amplification or "gain" of the controlled stages. Automatic gain control or "agc" is to the television receiver what automatic volume control or "avc" is to the conventional radio receiver. Just as it is annoying to tune from one radio station to another and have the audio weak in one case and excessively loud in the next, it is equally annoying to experience major changes in *contrast* when changing from one television channel to another. The agc system must strengthen the weak signals and attenuate the strong ones. It does this by varying the amplification ahead of the video detector to provide constant-level video from the video detector.

AUTOMATIC GAIN CONTROL

How the AGC System Works

How is the agc system to sense when the i-f signal is strong and when it is weak? One way is by making the agc system responsive to the i-f signal level. We have, however, seen that the level of picture i-f signal (or at that of least its picture content) changes from moment to moment. How then can we compare the picture i-f signal received from one station with that received from another?

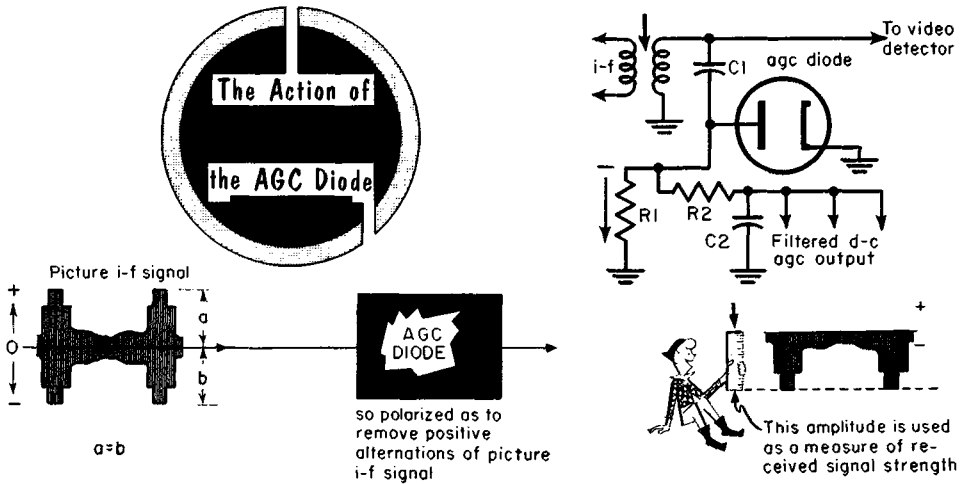

The method selected by the television industry was comparison of the *synchronizing-pulse levels*. Whereas the picture information signal is an unknown quantity (because its average amplitude is strictly a function of the content of the scene being televised), the blanking and sync-pulse amplitudes always bear fixed relationships to the level of the radiated *carrier*. (The blanking pulse pedestal has been standardized at 75 percent of the carrier level, and the sync pulse peaks have been standardized as being equal to 100 percent of the picture carrier level.) It is possible, therefore, to use the sync-pulse amplitudes as a means of gaging the level of the received carrier, because the amplitudes of this portion of the signal remain constant during the transmissions from any one station, and are in no way affected by the picture content.

However, both alternations of the picture i-f carrier are the same, hence simultaneous measurement of the amplitudes of both negative and positive sync pulses in the signal would produce a net result of zero regardless of the carrier amplitude. The selection of either the positive or the negative pulses as a measure of received signal strength is therefore necessary. Usually, agc circuit designs polarize the rectifier so that the positive input alternations are removed. The rectified current is applied to a filter system to derive a negative d-c output.

AUTOMATIC GAIN CONTROL

Typical AVC (Radio) and AGC (Television) Circuits

The organization of the avc circuit used in the radio receiver (A) is very much like the agc circuit used in television receivers (B). Both systems polarize the rectifier so that the top end of the load resistor (R1) is negative relative to the ground, as shown by the arrows.

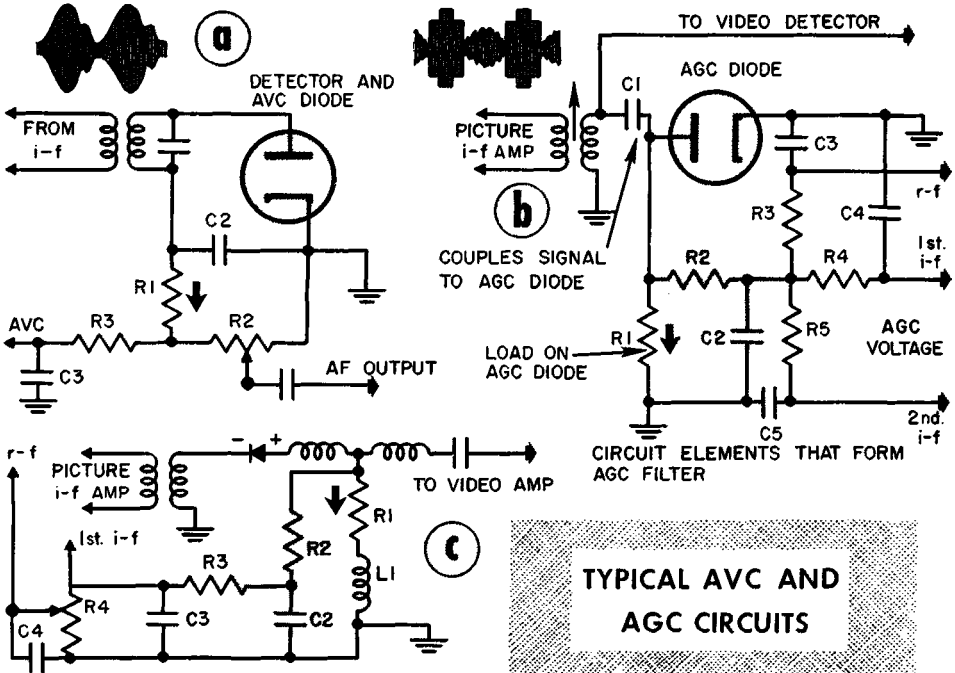

The load circuit applied to the agc diode in circuit B is not frequency compensated. Frequency compensation is not required, because the rectified currents at the fundamental frequency (15,750 cycles) can charge the load capacitor C1 to the peak value. The charge applied to C1 is prevented from leaking off to any great extent during the interval between input signal pulses by the high value of R1 and R2. A value of about 0.5 megohm for each of these resistors and a capacitance of about 0.2 μf for C1 produces a long time constant with resulting long charging and discharging times. This prevents rapid changes in grid bias values, a disadvantage of the system that makes it insensitive to abrupt changes in signal level. Further isolation of the agc source from the circuit of the controlled tube is accomplished by R3, R4 and R5 as well as by their associated capacitors C3, C4 and C5. In circuit C, the agc circuit is associated with the video detector. The rectified video voltage present across R1-L1 is used to charge C2 through R2 (1.5 Meg.). Additional filtering and isolation is given by R3, C3, R4, and C4.

AUTOMATIC GAIN CONTROL

Delayed AGC and Local-Distance AGC

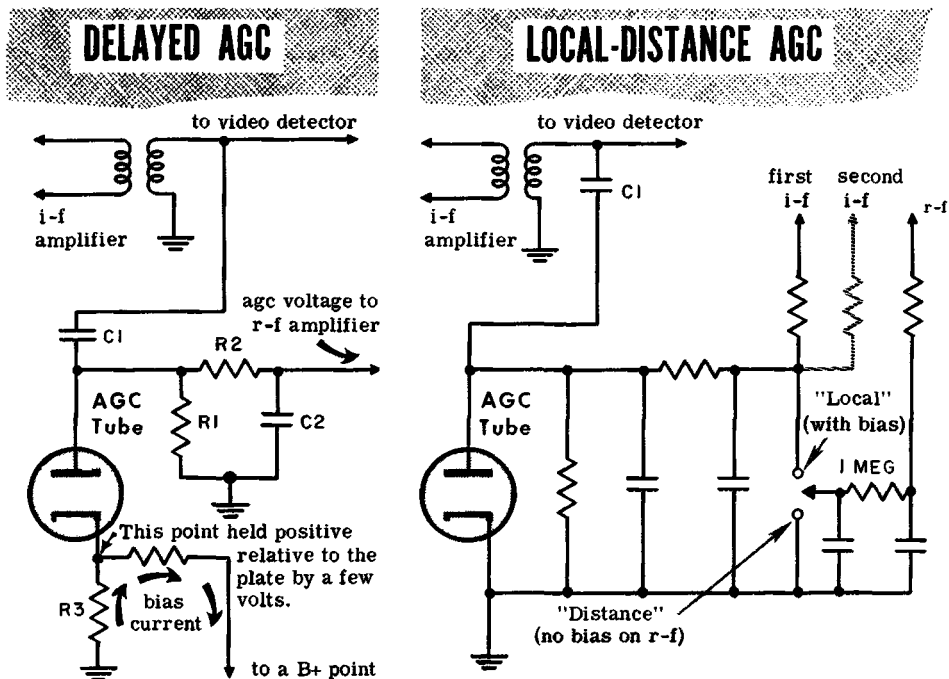

The agc circuits that we have shown will develop control bias even if the received signal is quite weak. This reduces the usefulness of the automatic bias system, because maximum r-f amplifier gain is required when weak signals are being received. The problem is solved in two ways; by delaying the action of the agc system until the received signal amplitude exceeds a prescribed minimum level (A), or by the use of a manual switch that removes the automatic bias from the r-f amplifier (B). The delay action is caused by applying a fixed positive bias to the cathode of the agc tube, thus preventing conduction until the bias voltage is exceeded by the i-f signal level at the plate. The delay bias results from connection of the cathode of the agc tube to the B+ supply via voltage divider R3-R4. The direction of bias-current flow through the divider makes the cathode positive relative to ground, and to the plate.

The local-distance manual switch arrangement (B) is simple. For "local" (strong signal) reception the controlled i-f and r-f bias supply busses are connected in parallel, and automatic bias is supplied via these two paths. For "distance" (weak signal) reception, the manually operated selector switch disconnects the r-f tube bus from the agc line and connects it to ground, thus permitting the r-f tube to function wide open, affording maximum gain.

AUTOMATIC GAIN CONTROL

Keyed AGC

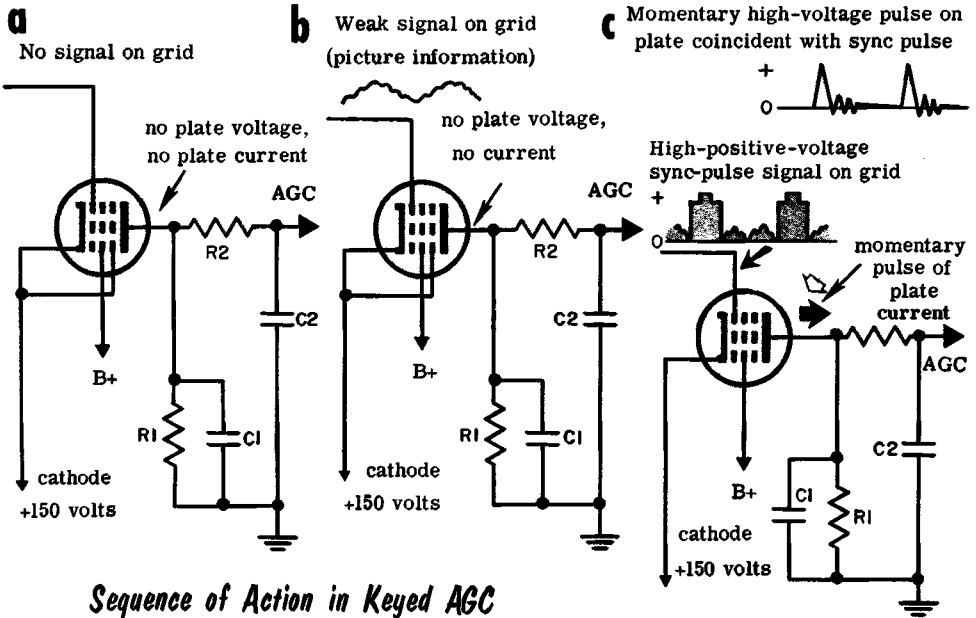

Sequence of Action in Keyed AGC

The simple and the delayed agc systems are useful, but they do not take care of some undesired situations that occur. If an airplane flies along the signal path between the transmitter and the receiver, the signal is reflected and combines with the direct and ground-reflected signals, causing rapid changes in the resultant signal level at the receiving antenna. These rapid changes cannot be followed by the automatic bias, because the high values of capacitance and resistance in the agc load and filter circuits do not allow the capacitors to charge and discharge sufficiently rapidly. In addition, noise pulses riding on the signal can develop unduly high bias voltages, entirely out of proportion to the true signal level, thus causing an excessive reduction in gain. The solution to these problems is *keyed agc*.

Keyed agc is a system that uses coincidental actions to determine the moments when the control bias is developed. The sequence of action with no signal, weak signal, and strong signal is shown in A, B, and C. This precise timing reduces the period when noise pulses can determine control-grid bias. The circuit has a lower time constant because capacitors C1 and C2 and resistors R1 and R2 in the load and filter circuits are lower in value than in simple agc circuits. For this reason, the bias changes can occur more rapidly. As a whole, the keyed agc system is a gated amplifier tube that is made conductive on a momentary basis by the appearance of a high-amplitude positive voltage pulse on the plate, *simultaneously* with the appearance of a positive-polarity sync pulse on the control grid.

AUTOMATIC GAIN CONTROL

Keyed AGC (contd.)

Simplified Diagram of a typical Keyed AGC System

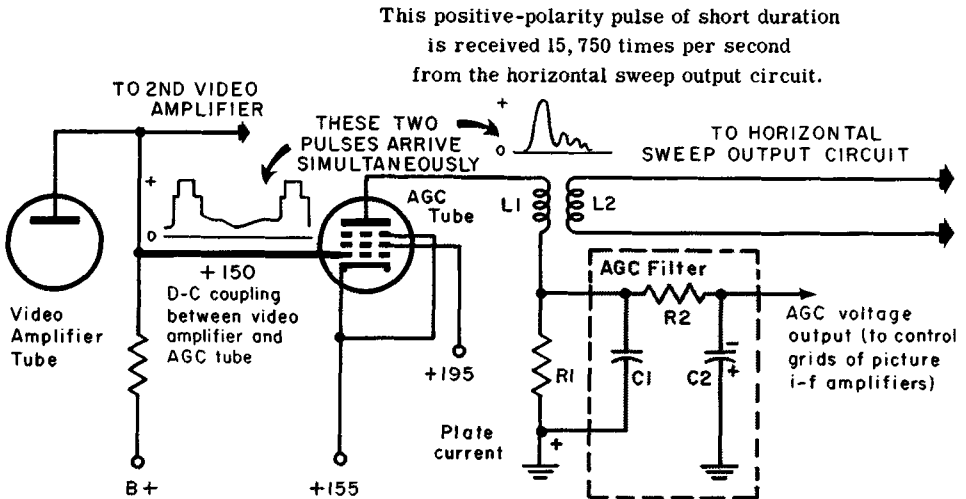

Note. Voltage values shown may differ in different receivers.

An abridged version of a keyed agc system using a pentode amplifier tube is shown here. Let us examine the different signals involved. The control grid receives a positive-polarity composite video signal from the first video amplifier stage. Direct coupling between the video amplifier plate and the agc tube control grid applies a positive-polarity voltage on the grid. (The amplitude of this voltage varies with the received signal strength.) The cathode of the agc tube is held at a positive d-c voltage that is slightly higher than the maximum level of the positive grid voltage. The plate of the agc tube is subject to a momentary *keying* or *triggering* plate voltage pulse of from 200 to 500 volts, 15,750 times per second. (It receives this voltage from the horizontal sweep system via the transformer L1-L2.)

Although a positive-polarity voltage is applied to the control grid of the agc tube, the high positive voltage at the cathode plus the *absence* of plate voltage prevents the flow of plate current, and the tube is nonconducting. When the receiver is correctly adjusted, the horizontal sweep system delivers a voltage pulse of positive polarity to the plate of the agc tube at the *same instant* that the control grid of the tube receives the sync pulse. Because the plate voltage is so much more positive than the cathode voltage, conduction occurs in the tube, and a momentary pulse of plate current flows through R1, charging C2 with the polarity indicated. Variations in the level of the received signal cause changes in the amount of the plate current, producing variations in the bias-voltage output of the system.

REVIEW

1. *The Video Detector* in the intercarrier receiver serves two purposes. It rectifies the picture i-f signal for processing by the video amplifier, and it produces the 4.5-mc intercarrier sound signal, by heterodyning of the picture and sound i-fs.

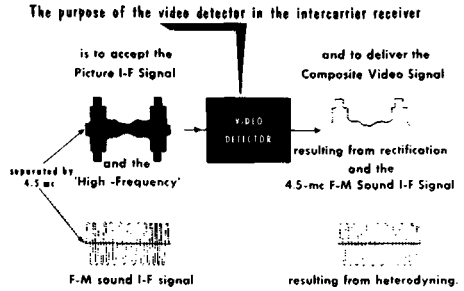

The Two Video Detector Circuits

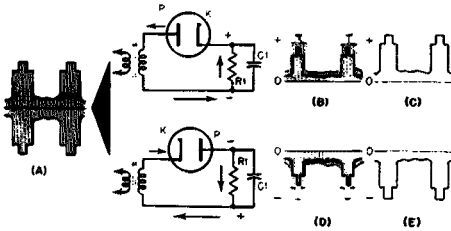

2. *The Video Detector* can be connected so as to produce either a negative-going or a positive-going output signal. Either polarity works equally well, and the choice depends upon the number of video amplifier stages used in the receiver and whether the picture tube is cathode-driven or grid-driven.

3. *A Conventional R-C Load* on the video detector as is used in radio receivers does not provide the necessary frequency response for video processing. The frequency response is adequate at the low frequencies, but falls off badly at the higher frequencies. This causes loss of detail in the picture display.

The Simple R-C Load Affords Poor Video-Frequency Response

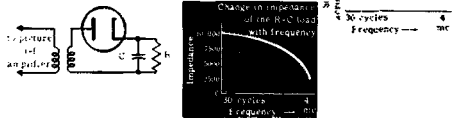

The Video Detector Output Circuit

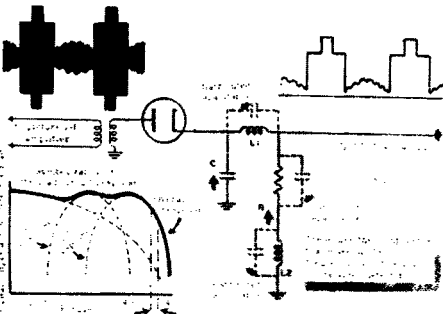

4. *The Output Circuit of the Video Detector* is a specially designed network containing resistance, inductance, and capacitance that acts to boost the higher video frequencies. This action is known as peaking, and is accomplished by using special values of L, C, and R.

REVIEW

Sound I-f Takeoff in the Video Amplifier

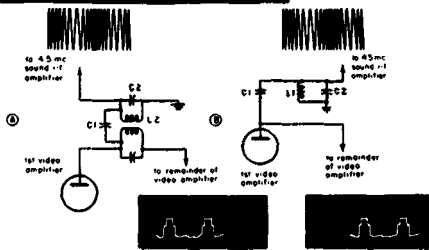

5. **Sound Takeoff** from the video amplifier or video detector may be accomplished inductively, capacitively, or a combination of both. Basically, what happens is that the 4.5-mc inter-carrier sound signal developed in the video detector is removed from the video path and fed to the input circuit of the sound i-f amplifier.

6. **Automatic Gain Control** in television is the equivalent of automatic volume control in radio receivers. A diode rectifies the incoming video signal and develops a negative voltage that is used to control the gain of r-f and i-f amplifiers. The agc voltage is filtered to produce a smooth d-c output.

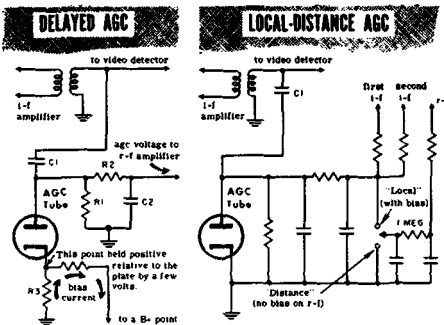
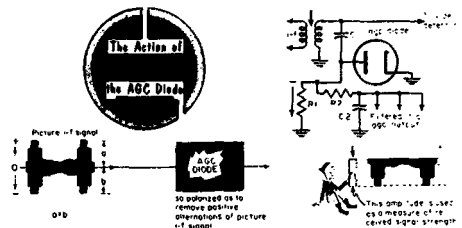

7. **Automatic Gain Control** may be of the simple variety or more complex such as delayed agc or local-distance agc. In the delayed type, no agc voltage is developed until the input signal reaches a predetermined level. With a local-distance switch, a means is provided to remove bias from the r-f amplifier permitting it to operate with maximum gain.

8. **Keyed AGC** provides a more dependable method of controlling the gain of the r-f and i-f stages. Two signals are fed to the agc tube—the video signal from the video amplifier, and a high-voltage pulse from the flyback transformer or from the horizontal sweep circuit. When both arrive, plate current flows and agc voltage is produced.

Simplified Diagram of a typical Keyed AGC System

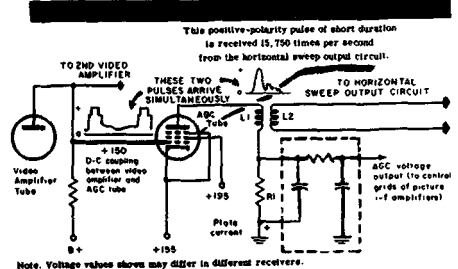

THE VIDEO AMPLIFIER

The Video Amplifier

The video amplifier raises the level of the composite video signal at the output of the video detector to that required at the picture tube grid or cathode. This level varies from 25 to perhaps 45 or 50 volts peak to peak, and is determined by the design of the receiver. Some receivers achieve the gain in one stage of video amplification, others require two stages. Each stage inverts the polarity of the signal voltage. The tubes used as video amplifiers are such pentodes as the 6AH6, 6AQ5, 6AU6, 6AW8, 6CL6, and 12BY7.

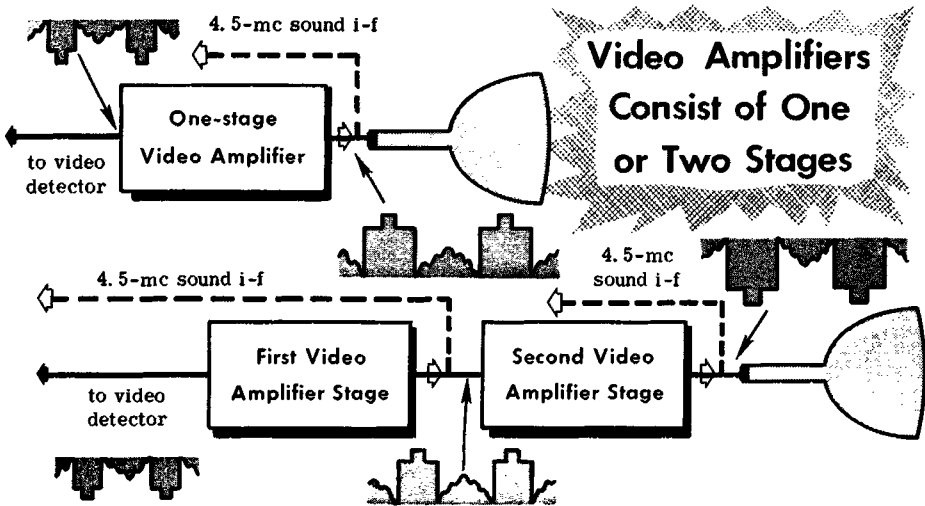

We have already shown the broad frequency content of the picture signal and the need for passing this wide band of frequencies through the r-f system, i-f system, and the video detector. The same requirements exist in the video amplifier; here, however, theory dictates one set of electrical requirements, whereas practice demands another. What should be the frequency passband of the video amplifier—4 mc or 4.5 mc? We have established that the 4.5-mc sound i-f signal can cause trouble (sound bars) if it gets into the input circuit of the picture tube, thus the top limit of passband for the video amplifier should be 4 mc. However, we have also shown that the sound i-f signal takeoff point often is in the video amplifier and that a circuit that accepts 4 mc reasonably well will not reject 4.5 mc. Design engineers solved the problem by limiting the video amplifier bandpass to slightly *below* 4 mc, knowing that even a 3.5-mc passband will allow passage of sufficient 4.5-mc intercarrier sound signal to serve the takeoff needs. If the sound-signal takeoff point is at the video detector output, the video amplifier passband is often even less than 3.5 mc wide—3 mc is not uncommon. Fine detail suffers, but not to an extent that bothers the viewer; sound bars in the picture would annoy him much more.

THE VIDEO AMPLIFIER

Ideal and Practical Video Response

Let us translate the video amplifier performance that we have discussed into graphic form. The curve in part A can be considered the ideal response curve. Note the low limit of 10 cycles that is required in order to allow the proper reproduction of the low-frequency (60-cycle) voltage waveforms. However, this passband cannot be achieved in practice. We accept much less, as shown by curves 1, 2, and 3 in part B of the illustration.

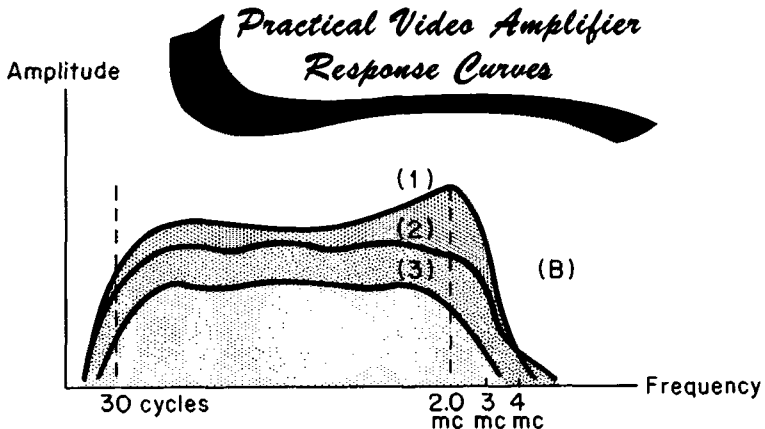
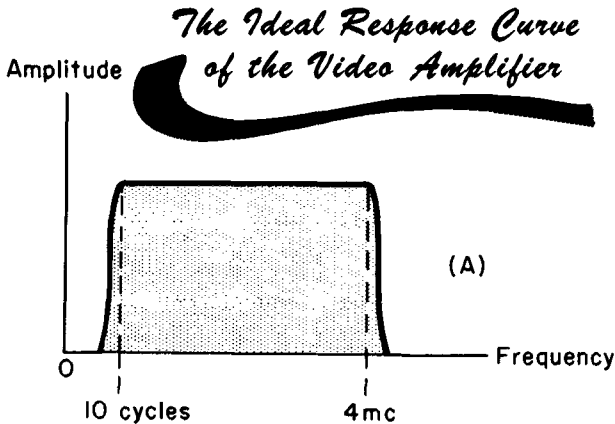

Both the bottom and top frequency limits are modified so that the overall passband is reduced. The kinks in the curves arise from the resonant conditions deliberately created in the amplifier so as to get the required passband, and from uncontrollable actions of the inductance and capacitance present in the amplifier.

THE VIDEO AMPLIFIER

Gain in the Video Amplifier: The Effect of Distributed Capacitance

Obtaining uniform amplification over the 30-cycles to 4-mc range in the video amplifier involves the application of several interesting techniques. The video amplifier resembles the conventional R-C-coupled audio amplifier, but it is more complex.

SHUNT CAPACITANCE ATTENUATES THE HIGH FREQUENCIES

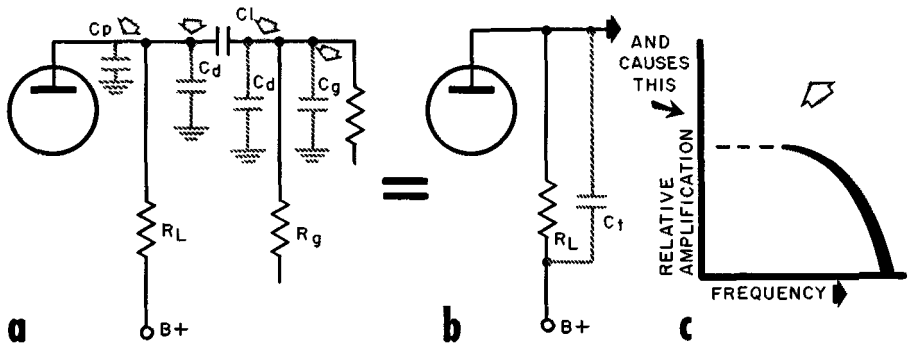

Every amplifier contains distributed capacitance between the components and wiring to ground (or chassis). They are shown as C_p , C_d , and C_g in illustration A. In effect, all are in shunt with the plate load resistance R_L . The aggregate value of these capacitances presents a total capacitance shown as C_t in illustration B. Since the reactance of C_t is in shunt with R_L , it reduces the effective value of the plate load impedance presented to the tube. If we assume that C_t amounts to $24 \mu\text{f}$, its reactance at 30 cycles will be $X_{C_t} = 1/6.28 \times 30 \times 24 \times 10^{-12} = 220,000,000$ ohms. (The equation shown is the usual one for capacitive reactance, $X_c = 1/6.28 \times f \times C$.)

At 1 mc, the capacitive reactance becomes approximately 6600 ohms, which falls to about 1600 ohms at 4 mc. If, for the moment, we assume R_L to be 4000 ohms, it is easy to see that the shunt capacitive reactance will have no effect on the effective plate load resistance at 30 cycles, but at 1 mc, the load impedance falls to 2480 ohms, and at 4 mc to about 1140 ohms. The higher the signal frequency the lower the shunt reactance and the greater the reduction of the effective plate load resistance. If we relate these figures to the amplification available in the tube (amplification = transconductance in micromhos \times plate load resistance in megohms), a tube rated at 2400 micromhos transconductance will afford amplification equal to $2400 \times .004$ or 9.6 at 30 cycles, only $2400 \times .00248$ or 5.9 at 1 mc, and $2400 \times .00114$ or only 2.7 at 4 mc. This variation in high-frequency signal amplitude is symbolized in part C, from which it is evident that the amplification is nonuniform. The need for correction is indicated.

THE VIDEO AMPLIFIER

Gain in the Video Amplifier: Shunt Peaking

Let us look into the means of correcting nonuniform high-frequency response. One method involves the addition of a parallel-resonant peaking coil that is wired in series with the resistive load R_L . The coil is indicated as L_p in circuit (A). The inductance is parallel-tuned to the *correction frequency* (f_c) by the distributed capacitance C_t . (The *correction frequency* is that high-frequency limit to which the amplifier is desired to be flat in response.) Usually the correction frequency is 4 mc, although it is frequently lower.

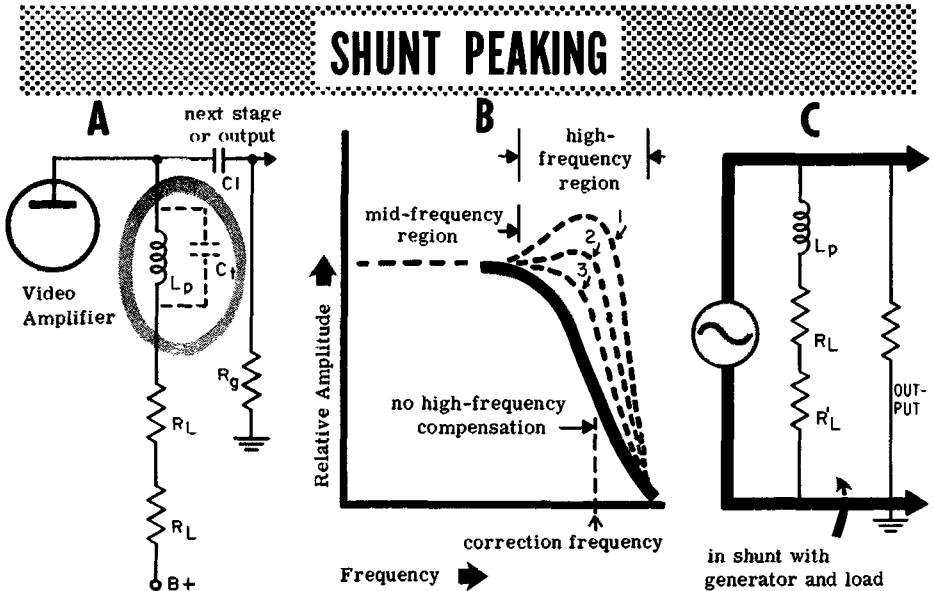

Utilizing a tuned circuit in this manner accomplishes a three-fold purpose; it compensates for the shunted distributed capacitance; it affords increased amplification in the vicinity of the resonant frequency; and the increased amplification straightens out the frequency-vs.-amplification characteristic of the response curve at the high-frequency end. The results of high-frequency correction by different values of L_p are shown in (B) by the dashed curves numbered 1, 2, and 3. Curve 3 indicates over-correction caused by an excessive amount of inductance; curve 1 shows under-correction because of insufficient inductance; and curve 2 shows correct conditions. The uncompensated behavior is indicated by the thick curve. High-frequency compensation of this variety is called *shunt peaking*. The designation arises from the fact that the peaking coil is part of a circuit that is connected in *parallel* with the tube (acting as a generator), as indicated in (C). C_t is omitted here because it has no effect on the action at the high frequencies.

THE VIDEO AMPLIFIER

Gain in the Video Amplifier: Shunt Peaking (contd.)

What is the basis for determining the plate load resistance R_L in a high-frequency-compensated video amplifier such as the one that we are discussing? One might think that R_L should be as high as possible because the internal plate resistance of the pentode tube is very high (1 megohm or more). This is not the case. Experimental determination has proven the effectiveness of making R_L equal to the reactance of C_t at f_c . When this is done and the inductance of L_p is of the correct value (as shown later), the resultant impedance of the plate circuit network at f_c becomes equal to R_L . This is important because R_L constitutes the impedance of the plate circuit over the mid-frequency range of the amplifier. The shunt peaking system is not active over this range, thus the amplification available from the tube ($A = g_m \times R_L$) is constant over the entire passband of up to f_c .

Knowing the required value of R_L makes it easy to establish the correct value of L_p . Again experimental determination has given the formula that leads to the inductance of the shunt peaking coil. The calculations are shown here, assuming $24 \mu\mu\text{f}$ of shunt distributed capacitance for C_t and f_c equal to 4 mc. The value of L_p found here is typical for commercial receivers.

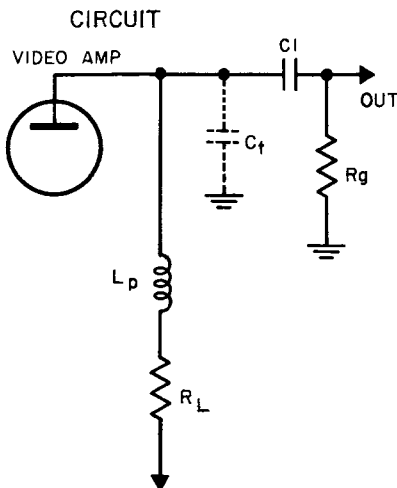

$$R_L = X_{ct} \text{ AT } 4 \text{ mc.} \quad f_c = 4 \text{ mc.}$$

$$\begin{aligned} R_L &= \frac{1}{2 \pi f_c C_t} \\ &= \frac{1}{6.28 \times 4 \times 10^6 \times 24 \times 10^{-12}} \\ &= \frac{1}{6.28 \times 96 \times 10^{-6}} \\ &= 1600 \text{ OHMS (APPROX)} \end{aligned}$$

KNOWING R_L WE CAN DETERMINE L_p BY

$$\begin{aligned} L_p &= \frac{0.5 R_L}{2 \pi \times f_c} \\ &= \frac{0.5 \times 1600}{6.28 \times 4 \times 10^6} \\ &= .000031 \text{ HENRY (APPROX)} \\ &= 31 \text{ MICROHENRIES (APPROX)} \end{aligned}$$

THE VIDEO AMPLIFIER

Gain in the Video Amplifier: Series Peaking

Another method of accomplishing high-frequency compensation is known as *series peaking*. It, too, makes use of a resonated coil that *peaks* the high-frequency end, but this time the coil is located in *series* with the signal path between the source of the signal and the load to which it is delivered. The circuit is shown in A, with the series peaking inductance labeled L_s . Locating the coil in this position modifies the shunt distributed capacitance that is responsible for the use of shunt or series peaking.

SERIES PEAKING SYSTEMS

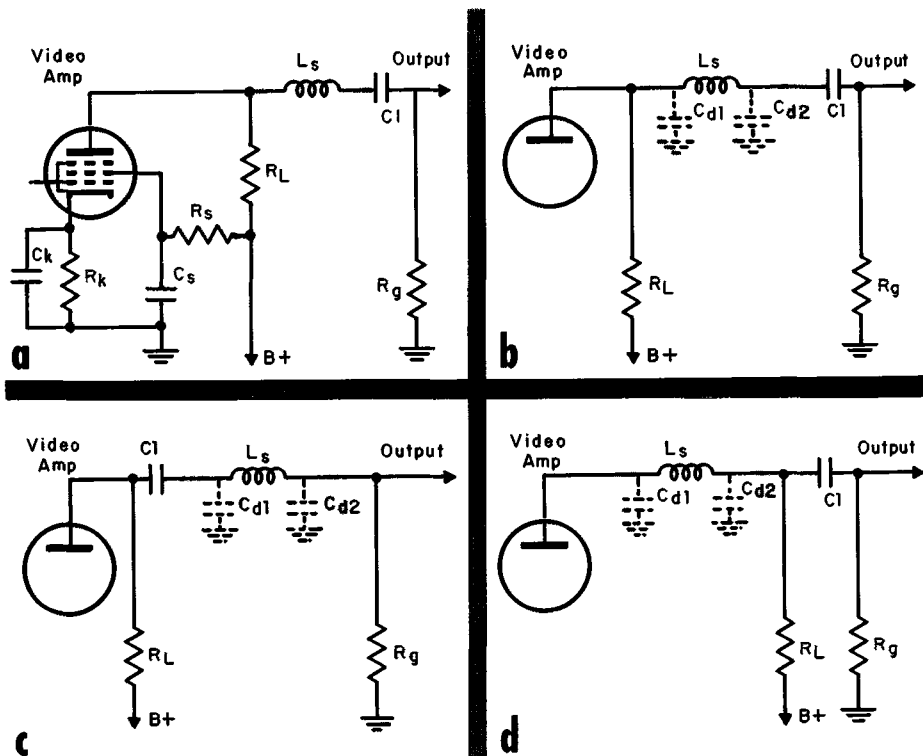

The distributed capacitance is present, but it is separated into two parts, C_{d1} and C_{d2} , the division resulting from isolation by the coil, as shown in B. Some of the capacitance is associated with the circuitry to the right of the coil and the rest with the circuitry to the left of it. A similar situation develops when the position of the peaking coil is changed as shown in C and D. (Circuits C and D are merely variations of A, and the action is the same in each case.) The variations divide the distributed capacitance in ratio that best suit the purposes of the designer.

THE VIDEO AMPLIFIER

Gain in the Video Amplifier: Series Peaking (contd.)

Let us re-examine the basic series peaking circuit to determine how it accomplishes its purpose. (The circuit is shown again in part A of the illustration.) Note that the isolated distributed capacitance C_{d1} alone is in parallel with the amplifier plate resistance R_L . Recalling that C_{d1} is less than the total distributed capacitance in the amplifier circuit, the value of R_L can be made higher than that of the plate load in the shunt-peaked system because the shunting effect of this smaller reactance is smaller. Making R_L greater increases the amplification over the entire frequency range. This is one reason for the popularity of series peaking.

How Series Peaking Works

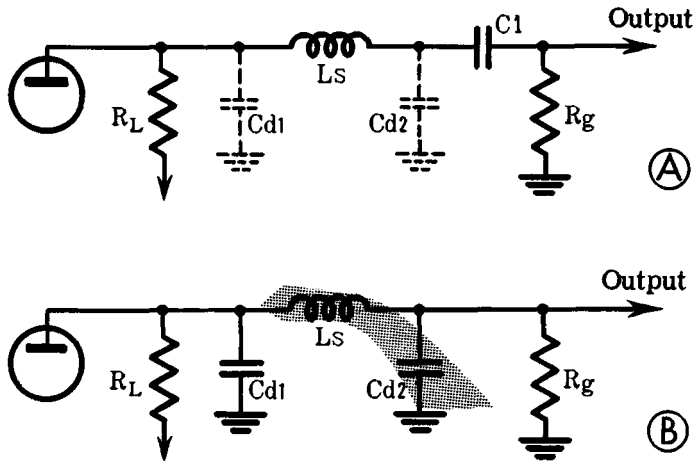

Before considering how frequency correction is accomplished with series peaking, let us first eliminate the circuit elements that have no bearing on high-frequency response. For example, the coupling capacitor C_1 has a sufficiently high capacitance (and low reactance) that it is effectively a short circuit at high frequencies. In addition, the resistance of the grid resistor R_g is sufficiently high so that it, too, does not affect high-frequency response. This leaves C_{d1} , L_s , and C_{d2} to be considered. Removing C_1 and dissociating C_{d1} and C_{d2} for greater clarity, the circuit appears as shown in part B of the illustration. L_s and C_{d2} form a series-resonant circuit, and the signal voltage is taken off across the capacitor.

Basic electricity teaches that the current in a series circuit is maximum at resonance, when the inductive and capacitive reactances are equal. It also teaches us that a voltage step-up can occur across each element of the circuit. This increase in voltage drop occurs across C_{d2} , and a boosted voltage at the correction frequency (f_c) appears across it, which is applied across R_g and output circuit. Sometimes the resonant frequency of the series peaking circuit is made higher or lower than that of the shunt peaking circuit, which broadens the frequency band that is boosted.

THE VIDEO AMPLIFIER

Gain in the Video Amplifier: Low-Frequency Compensation

The low frequencies can be a problem in R-C-coupled amplifiers when uniform amplification over a broad frequency band is desired. The difficulty stems from the action of the coupling (or blocking) capacitor and its related grid resistor. We have labeled these components C1 and R_g in part A of the illustration.

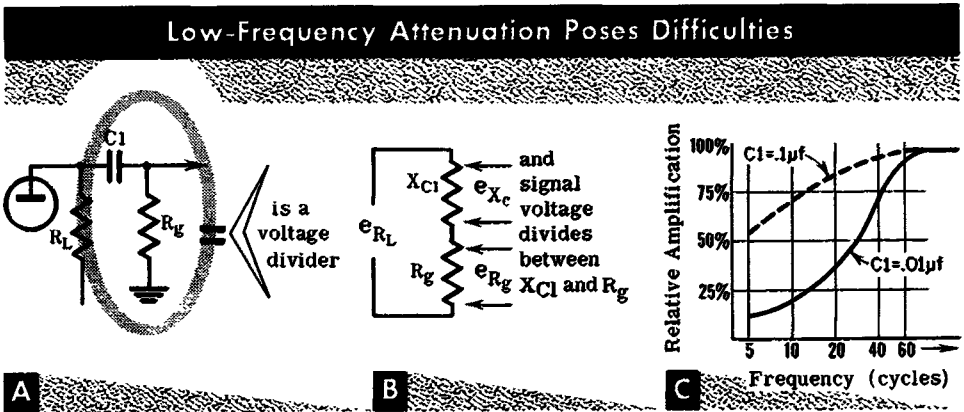

The combination of C1 and R_g forms a voltage divider across the signal source R_L as shown in part B of the illustration. The division of the signal-voltage drop between C1 and R_g is determined by the value of these elements and the signal frequency. What is desired is uniform signal voltage output over the amplifier passband, at least within reasonable limits—preferably not more than a 10-to-15-percent variation. It is over the low-frequency range that the reactance of C1 may assume a value relative to the resistance of R_g that results in a very nonuniform output. This is shown in the table below, where R_g is assumed to be 0.45 megohm and two values of C1—0.01 μf and 0.1 μf—are considered. Part C of the illustration shows the conditions corresponding to these figures.

Frequency	X _{C1}	X _{C1}	R _g	Signal across R _g	
	(C1=0.1 μf)	(C1=0.01 μf)		(C1=0.1 μf)	(C1=0.01 μf)
5 cycles	308,000 ohms	3,080,000 ohms	0.45 Meg	60 percent	16 percent
10 cycles	154,000 ohms	1,540,000 ohms	0.45 Meg	74 percent	23 percent
20 cycles	77,000 ohms	770,000 ohms	0.45 Meg	85 percent	37 percent
40 cycles	38,500 ohms	385,000 ohms	0.45 Meg	92 percent	54 percent
60 cycles	25,600 ohms	256,000 ohms	0.45 Meg	95 percent	74 percent

It would seem that satisfactory results down to 20 cycles are obtainable with the 0.1 μf capacitor and that the problem is solved. Some manufacturers get the same results with C1=0.05 μf and R_g=1 megohm. This is the case in some modern receivers, although earlier receivers applied a different technique as shown on the next page.

THE VIDEO AMPLIFIER

Gain in the Video Amplifier: Low-Frequency Compensation (contd.)

Let us examine one kind of modification that is applied to an R-C amplifier (A) to overcome the attenuation of the low frequencies. The original circuit is shown in part A of the illustration, and the part of the circuit responsible for the improvement is indicated by the heavy lines in part B of the illustration.

Low-Frequency Compensation

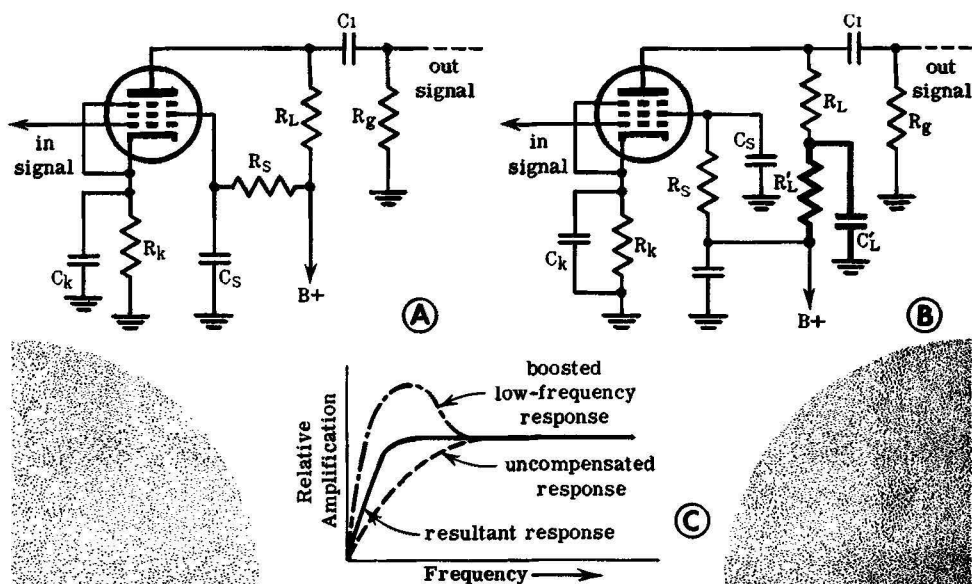

It would seem that R'_L and C'_L are decoupling elements. Their actual function, however, is that of a frequency-sensitive impedance. R_L and R'_L are in series, therefore the total resistance of the plate load at the lowest frequency is several times higher than if R_L alone were in the circuit. This increase in total plate load resistance produces greater amplification. The reactance of C'_L is less than that of R'_L at the lowest frequency, but when the signal frequency starts increasing (still in the low-frequency region), the reactance of C'_L decreases and (because it is connected across R'_L) it gradually decreases the contribution of R'_L to the total plate load resistance. Reduction of amplification follows. In effect we have given some of the low frequencies a "boost" that is enough to offset the attenuation due to the voltage divider action of C_1 and R_g . This is shown in part C of the illustration. The values chosen for R'_L and C'_L produce the same time constant as for C_1 and R_g . The longer the time constant, the lower the lowest frequency accepted by the amplifier. Usually the resistance of R'_L is from 2 to 4 times that of R_L .

THE VIDEO AMPLIFIER

Gain in the Video Amplifier: The Middle-Frequency Band

What happens over the middle-frequency region of the passband of the video amplifier? Although there are no set boundaries for this range of frequencies, it can be said to extend from a low-frequency limit of about 200 to 400 cycles up to perhaps 100 or 200 kilocycles as the high-frequency limit. The low limit is set by the highest frequency (neglecting low-frequency boost) at which the coupling capacitor C_1 and the grid resistor R_g cause more than very slight attenuation. The high-frequency limit is the lowest frequency (neglecting high-frequency boost) at which the distributed capacitance reduces the plate load impedance and the amplification to a major extent. Between these limits the amplification remains substantially constant.

The signal amplitude over the middle-frequency range is the reference level for all signal frequencies passed through the amplifier. It is this amplitude that must be equaled by the extended range of frequencies at the high-frequency end. Similarly, it sets the level to which the low-frequency boost circuits must raise the low-frequency signals.

The Middle-Frequency Band of the Video Amplifier

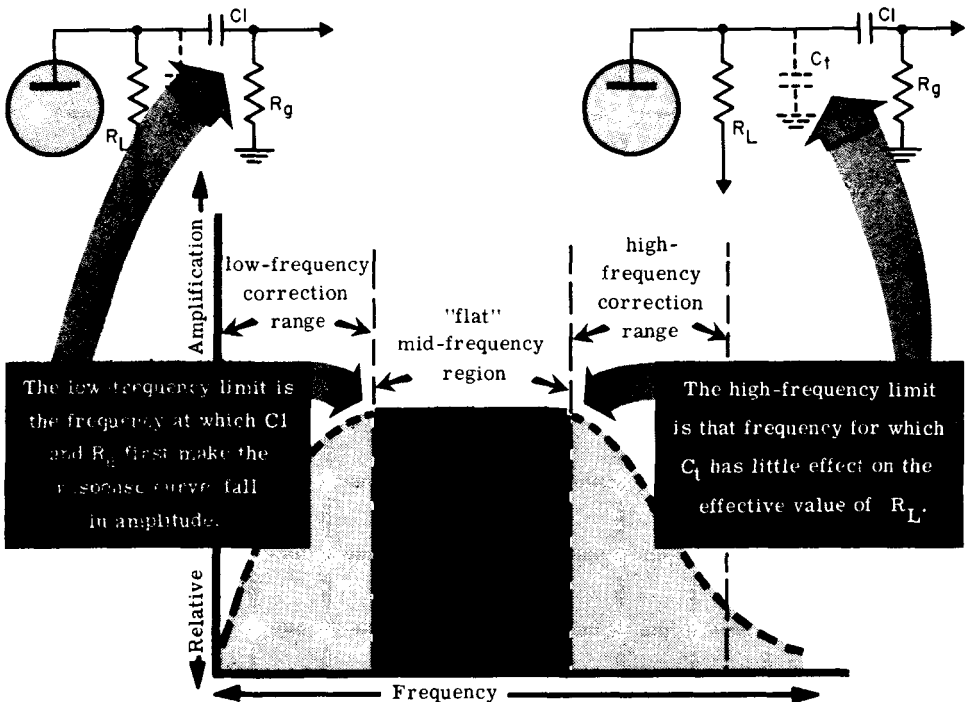

THE VIDEO AMPLIFIER

Phase Distortion

To make the meaning of phase distortion most understandable, consider a pattern on the camera tube mosaic that is made up of alternate black and white vertical areas as in part A of the illustration. The picture signal derived from scanning a line through this pattern is a train of square-wave voltage cycles, each of which has steeply rising and falling sides corresponding to the rapid changes from black to white and white to black.

LOW-FREQUENCY PHASE DISTORTION CAUSES SMEAR

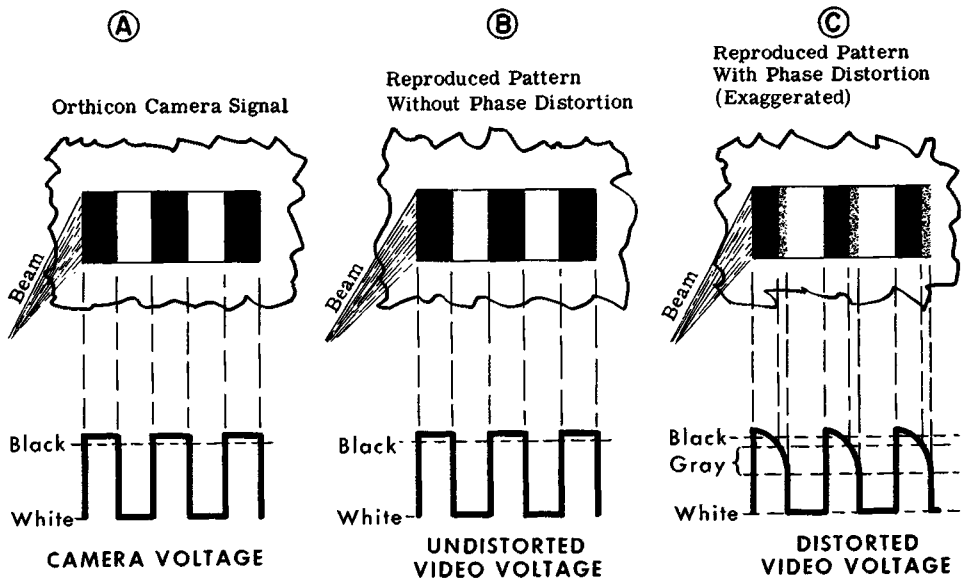

To reproduce such a pattern on the picture tube screen requires that similarly shaped voltages (B) be applied to the moving electron beam in the picture tube. The changes in video voltage from the black level to the white level (or white level to black level) must occur as rapidly in the receiver as in the camera-tube output. Such a signal voltage can be derived only from a video amplifier that does not suffer from phase distortion (one that affords flat response over the required frequency band, say from 30 cycles to 4 mc).

Phase distortion over the low-frequency range will produce the results shown in part C of the illustration. The rising and falling sides of the voltage are made less steep; the rate of change from the black level to the white level is reduced; and the boundary between black and white no longer is sharp—a tone of gray appears in between. In other words, *smear* has developed.

THE VIDEO AMPLIFIER

Phase Distortion (contd.)

Phase distortion is a form of distortion that affects voltages containing two or more related frequency components. Picture-information and pulse signals are examples of such voltages. The frequency components involved are a fundamental and many harmonics. Phase distortion is a change in the time relationship or *phase* of the harmonic components relative to the fundamental. A simplified case is shown in parts A and B of the illustration.

Phase Distortion Is Unequal Time Delay

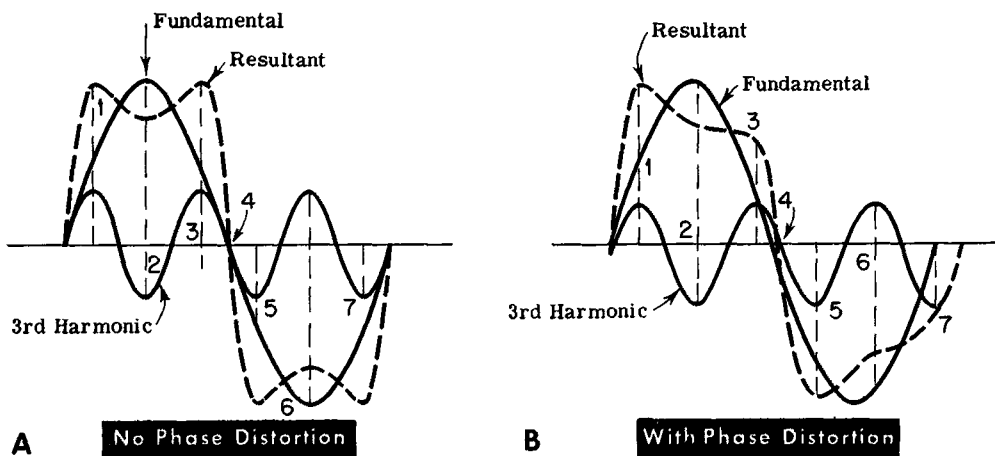

The signal voltage fed into the video amplifier (A) consists of a fundamental frequency with its third harmonic in phase with it. Note that the third harmonic passes through its peak and zero points at certain intervals relative to the amplitude of the fundamental. These points are shown by the dashed lines numbered 1, 2, 3, 4, 5, 6, and 7. The resultant voltage is shown by the dashed curve.

Waveform B shows the voltage after it has passed through a video amplifier that causes some phase distortion. Note that the peaks and the zero points of the harmonic component now occur later relative to the fundamental than before. (The harmonic component has been delayed relative to the fundamental during transit through the amplifier.) Delay occurs to varying degrees when there are numerous harmonics, causing waveform distortion such as that shown on the preceding page, which produces smear. Phase distortion exists principally in amplifiers that do not provide equal amplification of all frequencies within the required passband. A video amplifier that has proper frequency compensation and flat response does not suffer from phase distortion. If circuit component values change during use, causing nonuniform amplification, phase distortion will appear, with smear around parts of the picture display.

THE VIDEO AMPLIFIER

The Peaking-Coil Damping Resistor

Location of the Peaking-Coil Resistors

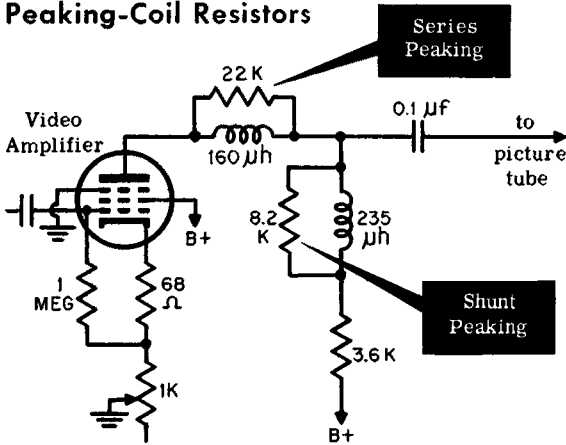

The Physical Appearance of the Peaking Coil

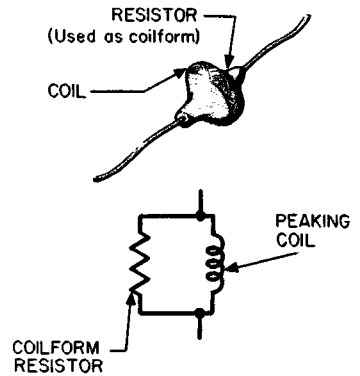

The resonated peaking coil used for high-frequency compensation in most cases has a resistor connected across it. The schematic diagram shows shunt and series peaking using a damping resistor.

Commonly, the peaking coil and the damping resistor are one assembly, with the coil wound on the resistor. The function of the resistor is to damp any transient oscillations that may appear in the resonant peaking circuit as a result of an abrupt change in signal voltage. Such transient oscillations (also known as *ringing*) cause *overshoot* in a square or rectangular waveform. When ringing occurs because of an open damping resistor or excessive peaking in a video amplifier, it usually causes trailing black lines following white lines or white lines following black lines on the picture. (They may be outlines of a letter or an area, and are always the reverse of the original.) Sometimes ringing causes ripples running vertically through the picture.

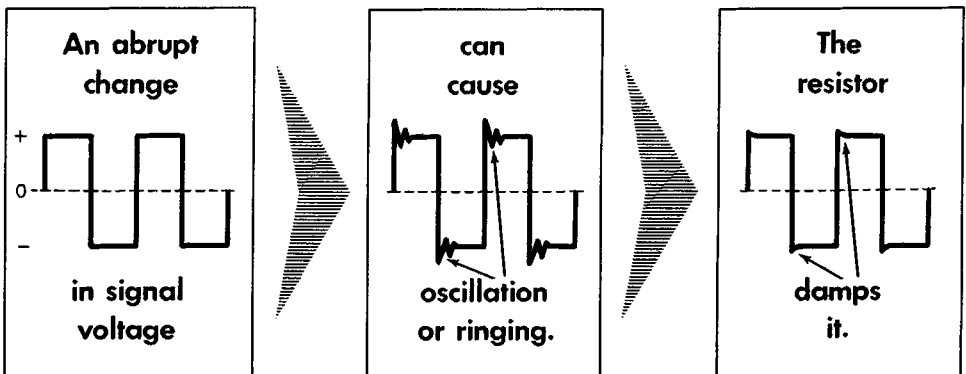

THE VIDEO AMPLIFIER

The Contrast Control

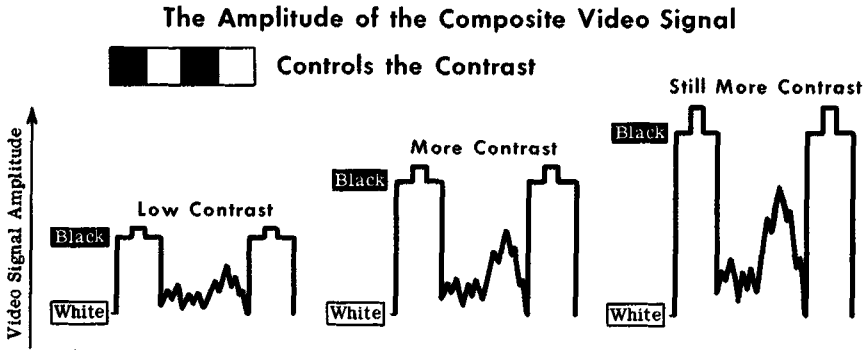

Every television receiver has a manually operated contrast control. Regardless of its location in the receiver circuit, the function of the control is to vary the amplitude of the composite video signal that arrives at the picture tube. This is accomplished by controlling the amount of amplification in the video amplifier or by picking off a fraction of the total signal amplitude by means of a voltage divider. As far as the viewer is concerned, the contrast control varies the blackness of the black relative to the whiteness of the white in the picture on the screen.

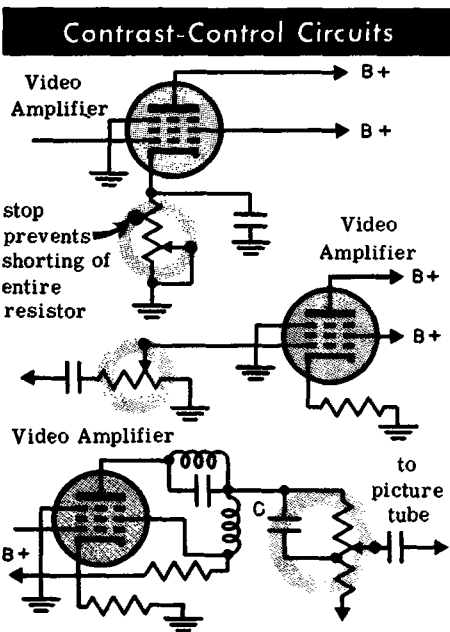

The most common method of contrast control is variation of the cathode bias in the first video amplifier stage. Increasing the amount of resistance decreases the amplification of the stage, thus reducing the contrast in the picture.

Another method of contrast control is the variation of the amplitude of the composite video signal applied to the video amplifier from the video detector. The control itself is a potentiometer located in the video detector output circuit.

Still another method of contrast control varies the amplitude of the video signal fed to the picture tube from the video amplifier. This variation is accomplished by means of a potentiometer located in the output circuit of the video amplifier.

THE VIDEO AMPLIFIER

Brightness Control and D-C Restoration

Bias Determines Brightness

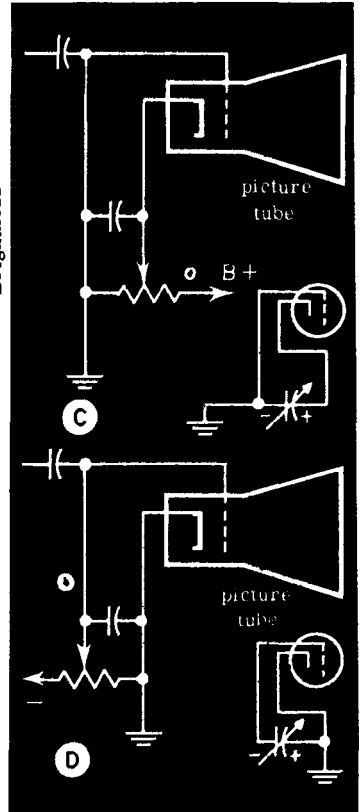
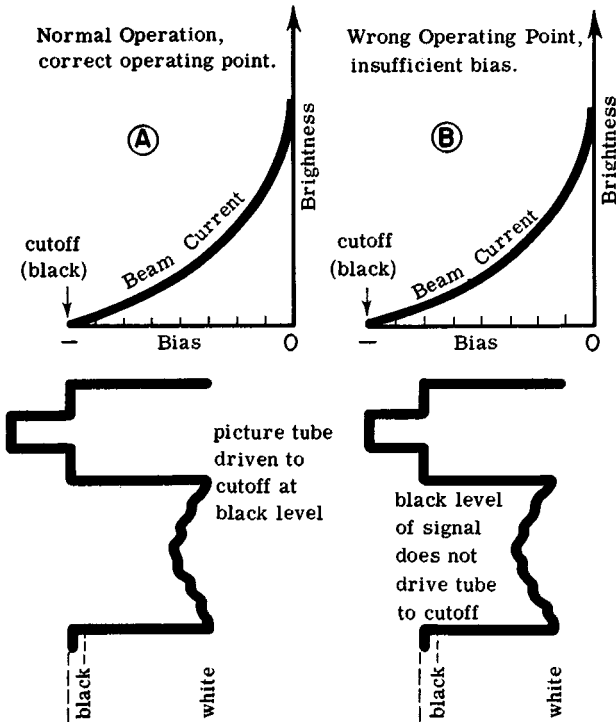

Every television receiver is equipped with a manually operated brightness control. It is the viewer's means of adjusting the overall illumination of the scene to suit his personal taste. The brightness control sets the operating bias active between control grid and cathode of the picture tube. It is around this bias (and another discussed on the next page) that the picture information voltage fluctuates. Normal conditions are indicated in part A of the illustration. When the overall picture is too bright and objects that should be black appear gray, it simply means that insufficient bias has been applied, as in B. (Excessive brightness in some older receivers makes the vertical retrace lines visible, because the vertical blanking voltage does not drive the picture tube to cutoff.) When objects that should be gray or white appear black or gray, it means that too much bias is applied. The source of the bias voltage (the brightness voltage) is a voltage divider that is connected between B+ and ground. A positive d-c voltage is applied to the cathode of the picture tube (C) or a negative voltage is applied to the control grid (D).

THE VIDEO AMPLIFIER

Brightness Control and D-C Restorer (contd.)

The manual brightness control is often supplemented by an automatic control, the *d-c restorer*. The signal derived from the camera tube has a d-c component corresponding to the average illumination on the scene, and a fluctuating a-c component, the video information. Both components appear in the output of the video detector. If amplified in a direct-coupled amplifying system and fed directly to the picture tube, the d-c component reaches the picture tube and automatically varies the operating bias in direct relation to the average illumination of the televised scene (A). This action is separate from that of the brightness control. If, however, the amplifier is a-c coupled anywhere after the video detector, the coupling (blocking) capacitor removes the d-c component as in (B). The automatically changing bias no longer exists between cathode and grid of the picture tube and the only means of varying illumination is by the brightness control.

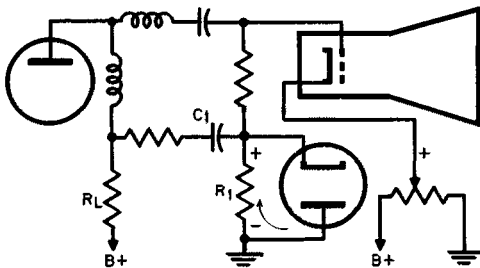
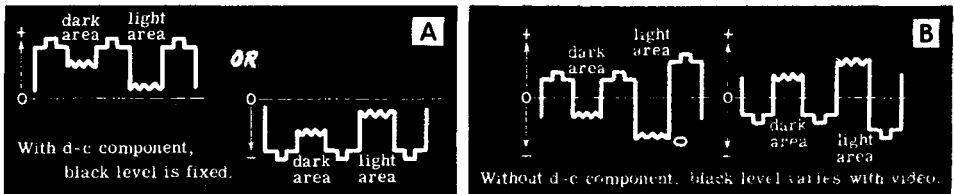

A-C signal with negative sync pulse peaks is rectified by the diode, causing current to flow in R_1 as shown.

This makes the top of R_1 positive, and adds the d-c component to the signal.

The *d-c restorer* is a diode rectifier that corrects this condition by adding a d-c voltage to the composite video signal fed to the picture tube. This voltage is proportional to the peak amplitude of the sync pulses, therefore to the pedestal of the blanking pulses. The composite video signal rectified by the d-c restorer (C) charges capacitor C_1 (0.047 to 0.1 μf) to the peak value of the sync pulses. Because of a-c coupling these pulses (and the blanking pulses) no longer are at a constant fixed level, but vary in proportion to the average level of picture information. C_1 is part of a long-time-constant (40,000 to 100,000 μsec) circuit, and retains its charge sufficiently long between sync pulses to act as a source of reasonably constant d-c voltage. The polarity of this voltage is determined by the polarity of the composite video signal and the connection of the diode rectifier. The output changes only when a sustained reduction in the illumination of the scene reduces the peak-to-peak amplitude of the composite video signal.

THE VIDEO AMPLIFIER

Typical Video Amplifier Circuits

DIRECT-COUPLED VIDEO AMPLIFIER

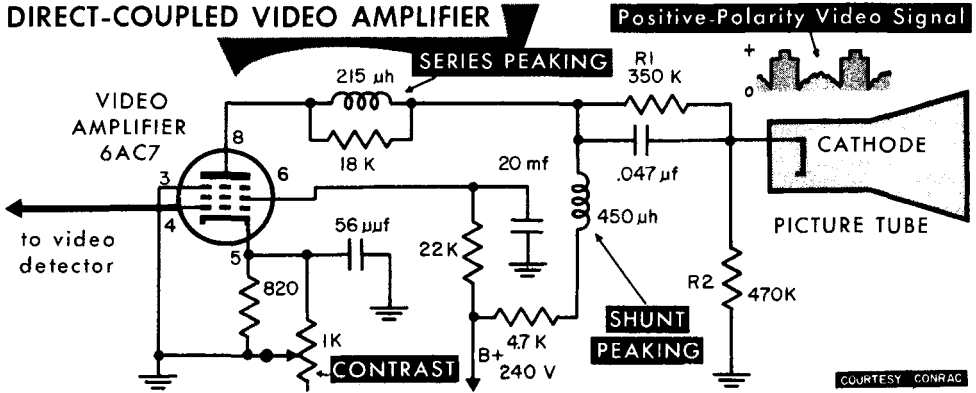

The direct-coupled (d-c) video amplifier shown above in almost all respects utilizes the design theory that we have presented. The system is distinctive because it does not use coupling capacitors at any point in the amplifier, therefore the d-c component present in the signal output of the video detector is present in the signal fed to the picture tube. This obviates the necessity for low-frequency compensation, because the amplifier will process d-c (that is, signals whose frequency is zero cycles). High-frequency compensation is, however, required. There is no need for a separate brightness control. The 0.047- μf capacitor connected across the 350,000-ohm section of the voltage divider R1-R2 that feeds the picture tube is a low-reactance path to the cathode for a-c components of the signal.

A two-stage video amplifier using a-c coupling is shown in the circuit below. A brightness control circuit is used. It applies a variable positive-polarity voltage to the cathode of the picture tube in a conventional manner. Note the use of high-value (0.1- μf) coupling capacitors.

A-C-COUPLED VIDEO AMPLIFIER

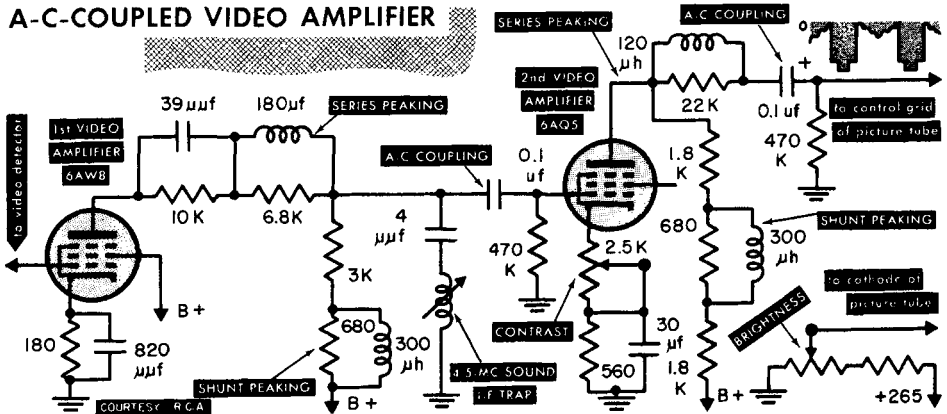

THE VIDEO AMPLIFIER

Troubles in Video Amplifiers

The discussion of the theory underlying the circuitry of the video amplifier contained references to visible symptoms demonstrated by several different types of troubles. Understandably, when concerned with defective performance of a system, every component and connection including the amplifier tubes is a possible source of trouble. Inasmuch as we assume that you have a background in the fundamentals of radio, we have not dealt with radio amplifier details, other than showing how the same principles are used in television. We take for granted that you understand the effects of improper operating voltages applied to vacuum tubes, and that you recall the three possible defects that may occur in capacitors and resistors—open circuit, short circuit, and change in value with use. As an aid to the correlation of possible troubles with video amplifier components, we show a typical two-stage video amplifier schematic on which trouble symptoms visible on the picture tube are labeled.

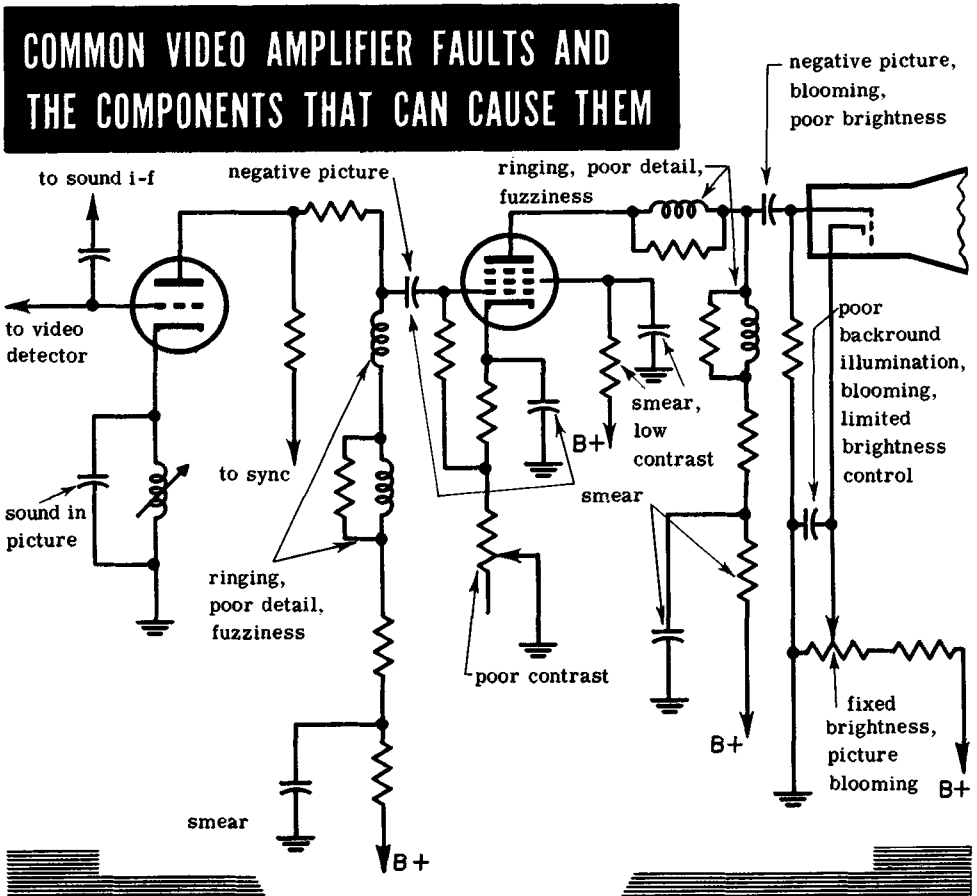

REVIEW

1. *The Video Amplifier* follows the video detector and may consist of one or two stages. Each stage inverts the input signal fed to it, and amplifies it. If the intercarrier sound signal is taken off after one of the video amplifier stages, that stage must be capable of passing a 4.5-mc signal.

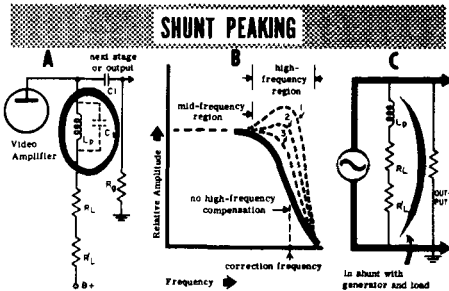
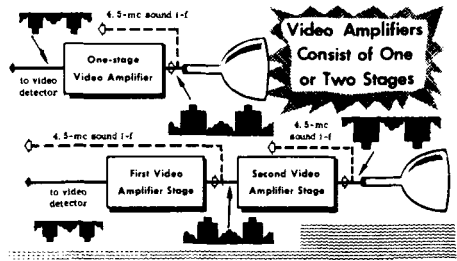

2. *Shunt Peaking* provides a means of boosting the high-frequency response of the video amplifier. Without this frequency compensation the fine detail in the picture would be lost. As in the video detector, peaking is provided by selecting proper values of L , C , and R for the plate circuit components.

3. *Series Peaking* is an alternate method of boosting the high-frequency response of a video amplifier. In this method, the grid circuit of the following stage is virtually isolated from the plate circuit of the video amplifier. In many instances a combination of series and shunt peaking is used.

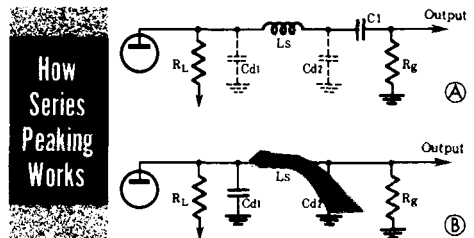

The Middle-Frequency Band of the Video Amplifier

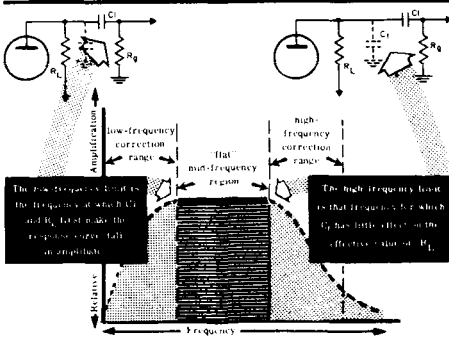

4. *The Middle-Frequency Band* of the video amplifier is that flat portion used as a reference level by which the high- and low-frequency response is judged. No "correction" components are use for this range.

REVIEW

LOW-FREQUENCY PHASE DISTORTION CAUSES SMEAR

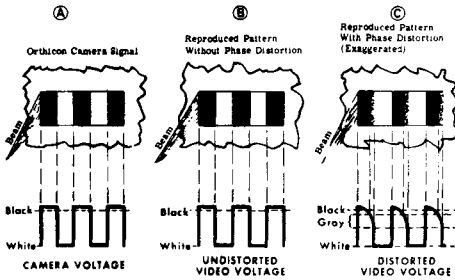

5. *Smear is the Result of Low-Frequency Phase Distortion.* When moving from a black to white area the video waveform takes on a square-wave character. If this pulse is distorted, the picture will show a gray area following the black portion. Such distortion is caused by an unequal delay of the low- and high-frequency components of the signal.

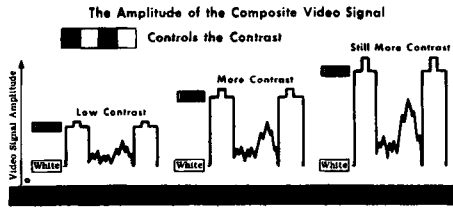

7. *Contrast* in a television receiver is the equivalent of volume in a radio receiver. The greater the contrast, the whiter the whites and the blacker the blacks. Thus, the contrast control varies the peak-to-peak amplitude of the video signal that is applied to the picture tube and permits adjustment for the most pleasant appearance to the viewer.

6. An abrupt change in signal voltage, such as in a square wave, is the equivalent of a very high frequency. As a result, the "inertia" of a circuit may cause ringing or oscillation. A resistor lowers the Q of the circuit and minimizes the ringing.

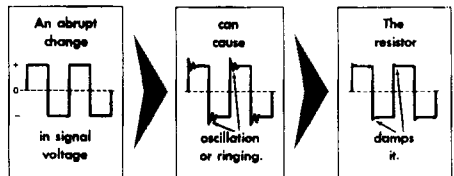

8. *The Brightness Control* does nothing more than establish the bias or operating point of the picture tube. It should be adjusted so that the blanking level is sufficient to cut off the tube. If the bias point is not set properly, the blanking level may not cut off the tube and retrace line will be visible.

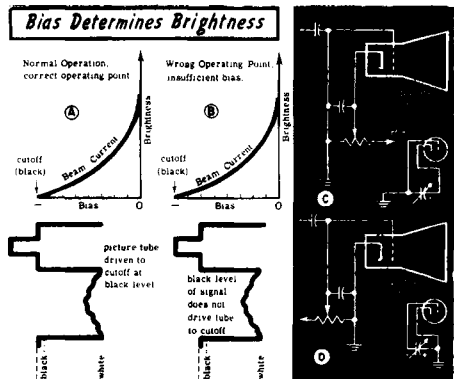

INDEX TO VOL. III

(Note: A cumulative index covering all five volumes in this series will be found at the end of Volume V.)

- Absorption trap, 3-75
- Adjacent-channel:
 - picture, 3-71
 - signals, 3-66, 67
 - sound, 3-71
- Automatic gain control, 3-107-112
 - diode, 3-109
 - circuits, 3-109
 - keyed, 3-111
- Alignment, 3-57, 60, 61, 86, 87
- Amplification, amount of, 3-128
- Antenna coil, 3-7
- Automatic volume control, 3-107
 - circuits, 3-109

- Back resistance, 3-102
- Balanced:
 - r-f input systems, 3-2, 3, 4
 - transmission lines, 3-55
- Bandpass:
 - curve slope, 3-59
 - tuned circuits, 3-14
- Bifilar-wound coils, 3-44
- Brightness, 3-130
- Broadband:
 - amplifier, 3-46
 - circuits, 3-46
 - response, 3-71
 - signal-transfer methods, 3-46
- Bottom coupling, 3-48

- Capacitive overcoupling, 3-47
- Cascaded tuned circuits, 3-78
- Cascode:
 - r-f amplifier, 3-24
 - tuners, 3-21-27
- Cathode-circuit traps, 3-77
- Cathode-fed r-f input circuits, 3-39-40
- Cats' whisker, 3-102
- Coaxial line, 3-55
 - tuned, 3-53
- Coils, 3-33
- Colpitts oscillator, 3-15
- Component identification, 3-89, 90
- Continuous tuner, 3-9, 10
- Contrast:
 - changes, 3-107
 - control, 3-128

- Converters, tuned-line, 3-53
- Copper foil, 3-85
- Coupled inductor, 3-89
- Coupling, 3-74-76
 - impedance, 3-48
 - link, 3-48
- Crystal diode, 3-102
 - circuits, 3-103

- D-C restoration, 3-126
- Decoupling elements, 3-123
- Delayed agc, 3-110
- Detector, 3-17
 - in radio receivers, 3-94
- Diode:
 - radio detector, 3-94
 - video-detector circuit, 3-95
- Disk ceramic capacitor, 3-90
- Distributed capacitance, 3-13, 101, 117
- Double-sideband picture signal, 3-68
- Double-peaked broadband-tuned system, 3-47

- Electrical quarter-wavelength, 3-53
- Electrical unbalance, 3-3

- Fine tuning, 3-58
- Fixed positive bias, 3-110
- F-M:
 - band, 3-9
 - sound i-f signal, 3-104
 - takeoff, 3-105-106
- Forward resistance, 3-102
- Frequency:
 - conversion, 3-51
 - correction, 3-118-119, 121
 - passband, 3-115
 - response, 3-96-99
- Frequency-selective circuits, 3-57
- Front end, 3-1-13
 - circuitry, 3-11

- Galena crystal, 3-102
- Ganged sliding contacts, 3-9
- Gated amplifier, 3-111
- Germanium diode, 3-102

INDEX

- Harmonic generator, 3-51
- Harmonics, 3-18
- Helical coils, 3-33
- Heterodyne:
 - oscillator, 3-58
 - signal, 3-17
- High-band stations, 3-1
- High-frequency compensation, 3-131
 - signals, 3-97
- Hi-lo switching, 3-10

- I-F:
 - alignment techniques, 3-86-87
 - amplifier, 3-65-84, 86-87
 - carrier modulation, 3-59
 - filtering, 3-101
 - signal frequencies, 3-18
- Inductive overcoupling, 3-48
- Intercarrier design, 3-83
- Interstage coupling methods, 3-81

- Keyed agc, 3-111

- Linear amplifier, 3-73
- Load impedance, 3-99-117
- Loading resistance, 3-14, 81
- Local-distance manual switch, 3-110
- Local oscillator, 3-15
- Low band, 3-1
- Low-frequency:
 - boost, 3-124
 - compensation, 3-122, 131
 - loss, 3-126
 - modulation, 3-71
 - sideband power, 3-84
- Low-level sound i-f signal, 3-104

- Marker generator, 3-86
- Mixer:
 - grid coil, 3-7
 - input system, 3-19
 - output, 3-20
 - test point, 3-19
 - tubes, 3-12
- Modulated r-f picture carrier, 3-2
- Multiple images, 3-62

- Negative d-c output, 3-108
- Negative-phase output stage, 3-95
- Negative-polarity output voltage, 3-95
- Noise currents, 3-3
- Noise voltages, 3-2-4

- Oscilloscope, 3-86-87
- Over-correction, 3-118
- Overcoupled interstage transformers, 3-82
- Overshoot, 3-127

- Parallel-resonant:
 - circuit, 3-105
 - i-f traps, 3-24
 - tuning circuit, 3-106
- Peaking-coil damping resistor, 3-127
- Peaking system, 3-101
- Phase:
 - distortion, 3-125
 - shift, 3-126
- Picture i-f amplifier, 3-65-73
 - troubles in, 3-88
- Plate load resistance, 3-123
- Positive-phase output stage, 3-95
- Positive-polarity output voltage, 3-95
- Positive voltage pulse, 3-111
- Powdered iron core, 3-10
- Preselector, 3-55
- Printed circuits, 3-85

- Quarter-wave tuned lines, 3-55

- Receiver, split-sound, 3-84
 - intercarrier, 3-93
- Rectified video signal, 3-100
- Relative amplitudes, 3-97
- Resistance loading, 3-49
- Resonant frequency, 3-121
- Response, double peaked, 3-49
 - coupled circuit, 3-78-79
- Review, 3-29, 30, 63, 64, 91, 92, 113, 114, 133, 134

- R-F:
 - amplifier, 3-2, 12
 - grid winding, 3-7
 - plate coil, 3-7
 - input, 3-2
 - response curves, 3-56, 57
 - signal generator, 3-86
- Rotating turret arrangement, 3-7

- Series-connected amplifier, 3-26, 27
- Series-resonant circuit, 3-20, 105
- Shielded attenuator, 3-62
- Shunt capacitive reactance, 3-117
- Shunting effect, 3-121
- Sideband compensation, 3-71
- Signal division, 3-106
- Signal generators, 3-57

INDEX

- Signal-to-noise ratio, 3-4
- Sound:
 - carrier, 3-2
 - i-f separation, 3-82
 - signal, 3-104, 106
 - traps, 3-90
- Split-sound design, 3-83
- Stagger tuning, 3-46, 80-82
 - process, 3-82
- Standard Coil "1000-Series"
 - tuners, 3-13-22
- Station selection, 3-56
- Stray circuit capacitance, 3-7
- Strip tuner, 3-50, 51, 52
- Sum and difference frequencies, 3-18
- Sweep generator, 3-86, 87
- Synchronizing-pulse levels, 3-108

- Tapped inductors, 3-7
- Television stations, 3-1
- Time delay, 3-126
- Tracking the mixer and oscillator circuits, 3-55
- Transformer overcoupling, 3-49
- Transformers, single-resonance, 3-81
- Transmission line, balanced, 3-7, 44
 - impedance of, 300 ohm, 3-43
 - impedance mismatch, 3-43
 - input systems, 3-43, 44, 45
 - shielded, 3-7
 - two-wire, 3-2
 - unbalanced, 75-ohm, 3-44
- Trap circuit, 3-75
 - parallel-resonant, 3-42
 - series-resonant, 3-41
- Traps, 3-74, 75, 76
 - coupling methods, 3-40-49
- Triggering plate voltage, 3-112
- Trimmer capacitors, 3-7
- Tubular ceramic capacitors, 3-90
- Tuned impedance, 3-74, 81
 - coupling, 3-31
- Tuned interstage coupling circuits,
 - 3-49, 65, 74, 106

- Tuner:
 - circuitry, 3-14-19
 - continuously variable, 3-37
 - permeability-tuned, 3-38
 - response, 3-56, 62
 - wafer-switch, 3-36
- Tuning arrangements, 3-31-38

- UHF:
 - channels, 3-1
 - converters, 3-50, 51, 52, 55, 57
 - crystal mixer, 3-51
 - i-f amplifier, 3-51
- Ultraudion oscillator, 3-16
- Unbalanced r-f input systems, 3-2, 3, 4
- Unequal sideband power, 3-71
- Unidirectional conductivity, 3-102
- Unstable pictures, 3-62
- Upper sideband, 3-69

- Vestigial-sideband transmission,
 - 3-68, 69, 84
- VHF:
 - channels, 3-7
 - oscillator, 3-50
 - tuners, 3-57
- Video amplifier, 3-115
 - circuits, 3-131
 - gain, 3-117, 118, 122, 123, 124
 - series peaking, 3-120, 121
 - troubles, 3-132
- Video detector, 3-93, 95, 102
 - function of, 3-97
 - output circuit, 3-100
- Video i-f amplifier, 3-65
- Video response, 3-116
- Voltage divider, 3-122

- X-ray effect, 3-98

- Wafer-switch tuners, 3-31, 34

\$2.25

basic television

by Alexander Schure, Ph.D., Ed.D.

VOL. 4

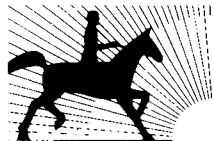

JOHN F. RIDER PUBLISHER, INC.
116 West 14th Street • New York 11, N. Y.

Copyright January 1958 by John F. Rider Publisher, Inc.

All rights reserved. This book or any parts thereof may not be reproduced in any form or in any language without permission of the publisher.

Library of Congress Catalog Card Number 57-13493

Printed in the United States of America

PREFACE

This five-volume course in the fundamental principles of television represents the end product of three years of research and experimentation in teaching methods and presentation at the New York Technical Institute. As a result of this experimentation in correspondence and resident courses approved by the New York State Department of Education, and following the recommendations of advising industrial groups, the highly pictorialized presentation used throughout this book was adopted. An illustration has been provided for each important concept and placed together with the explanatory text on the same page to pinpoint essential material. In addition, review pages spaced throughout each volume summarize the major points already presented.

This combination of the visual approach and idea-per-page technique makes **BASIC TELEVISION** readily understandable with or without an instructor. It is thus suitable for individual or correspondence use as well as for classroom study. Its coverage is complete from the creation of the television image in the studio to its appearance on the receiver screen, and presupposes only a knowledge of basic electronics and radio. Many topics not covered in the more traditional texts are treated here and fully explained for the first time.

The author wishes to acknowledge the assistance of his staff at the New York Technical Institute and that of Mr. Gilbert Gallego in the preparation of some of the illustrations. Special gratitude is due to the staff of John F. Rider Publisher and to Mr. Rider personally for his contributions to both the text and the picturization of this course.

New York, N. Y.
January 1958

ALEXANDER SCHURE

CONTENTS

VOL. IV — BASIC TELEVISION

Synchronization — Vertical and Horizontal	1
The Vertical Sync Pulse	3
Horizontal and Equalizing Pulses	12
Review	19
The Sync Clipper	21
The Sync Amplifier	29
The Integrator	31
The Multivibrator	34
Review	46
The Cathode-Coupled Multivibrator	48
The Blocking Oscillator	50
Wave Shaping	56
The Vertical Output System	60
Review	66
The Horizontal Sweep Circuit	67
The Differentiator	68
Horizontal AFC	75
Review	93
Horizontal Drive	95
Horizontal Output Circuits	99
Horizontal Output Transformers	115
Review	119
Index	121

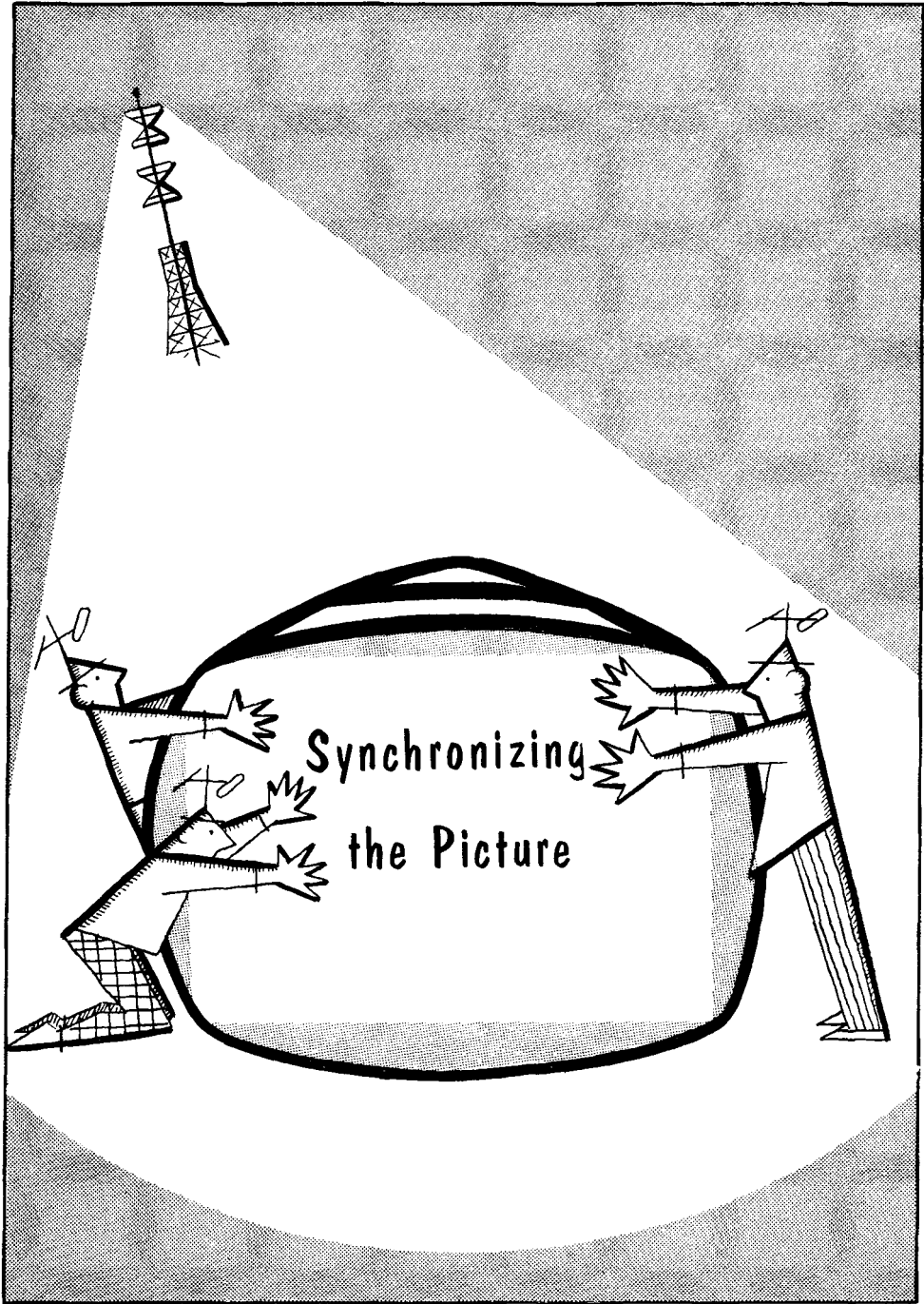

SYNCHRONIZATION—VERTICAL AND HORIZONTAL

Synchronizing the Picture

We have already discussed the system which controls the frequency of the horizontal sweep oscillator. We might mention that the horizontal sweep oscillator is the source of the voltage which eventually results in the horizontal deflection currents that flow in the horizontal deflection winding of the deflection yoke.

We also related the horizontal scanning lines developed on the picture tube screen to the frequency of the horizontal sweep oscillator. The horizontal sweep oscillator functions at 15,750 cycles, and is kept on this frequency by the horizontal synchronizing signal from the transmitter. These pulses appear within the horizontal blanking intervals and are compared with the signal generated by the horizontal sweep oscillator. The result of the comparison is a frequency-controlling voltage which fixes the frequency of the horizontal sweep oscillator.

Control of the horizontal sweep oscillator is only one of the operations necessary for the reproduction of a televised image on the screen of a receiver picture tube. It is necessary to control the vertical movement of the electron beam in the picture tube with equal accuracy. This is accomplished by a special 60-cycle voltage generated in the receiver.

Control of the frequency of the currents that flow in the horizontal and vertical deflection windings of the deflection yoke (the currents which move the beam of the picture tube vertically and horizontally) is very important indeed. But this is not the whole story. The beam in the picture tube must move across the screen surface in perfect step with the beam in the camera tube at the studio. Moment by moment the relative positions of these two beams on the picture tube screen and on the camera tube mosaic, respectively, must be the same.

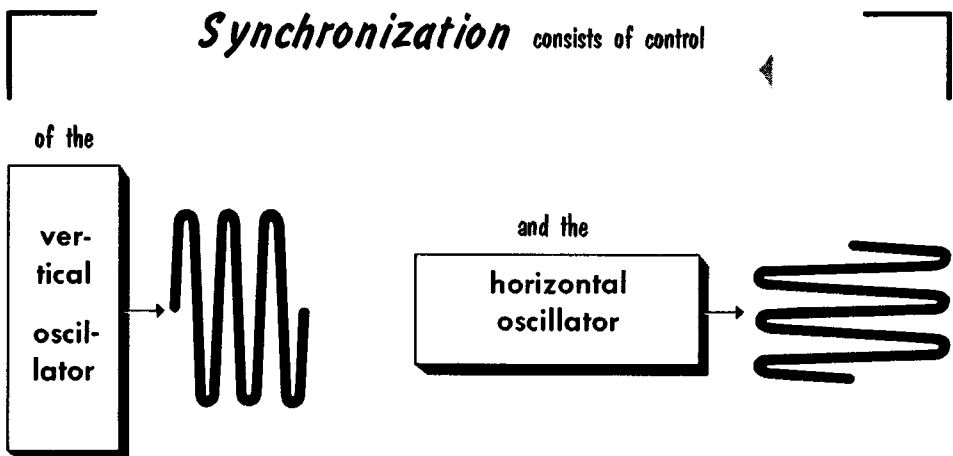

SYNCHRONIZATION—VERTICAL AND HORIZONTAL

Synchronizing the Picture (contd.)

Synchronization of the picture, therefore, involves not just the accurate control of the horizontal and vertical sweep oscillators, or the two blanking actions, but also the correct timing between the start of the horizontal sweep and retrace—and the start of the vertical sweep and retrace—in the picture tube and in the camera tube.

If these two actions are not synchronized, the reproduced image of the televised scene becomes unintelligible. Here are several examples of the results of incorrect picture synchronization. When both horizontal and vertical sweep oscillators are off frequency, the picture is virtually unrecognizable. Even when only one of the two sweep oscillators is unsynchronized, although the other is synchronized, the picture remains virtually useless.

All the imperfectly synchronized examples have one thing in common—the positioning of the electron beam on the picture tube screen does not conform with the positioning of the scanning beam on the camera tube mosaic moment by moment. To position this beam, the sweep oscillators in the receiver must be placed under the control of the horizontal and vertical sync pulses generated in the transmitter and radiated to the receiver as a part of the television signal.

Vertical Sync

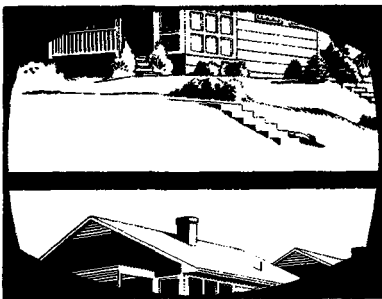

Horizontal Sync

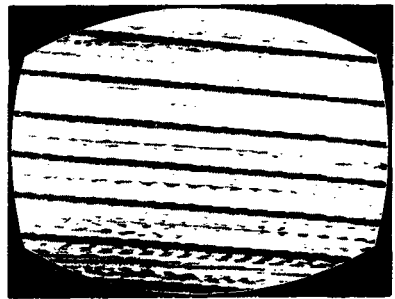

LOSS
OF
SYNC

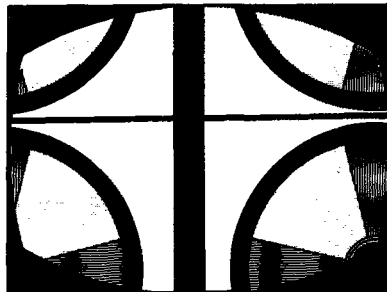

Horizontal
and
Vertical Sync

VERTICAL SYNC PULSE

Vertical Deflection Control Signals



The control of the vertical motion of the picture tube beam—the scan from the top of the tube screen to the bottom, and the vertical retrace which returns the beam to the top—is just as critical as the horizontal motion. The downward motion of the beam must start at a precise moment relative to the horizontal motion. The full excursion of the picture tube beam in the downward direction for a field must be completed within a prescribed time interval, specifically in 15,500 μsec (microseconds). The retrace action must take place in 1,167 μsec .

If we allowed the beam to form luminous lines on the screen while the vertical retrace was active it would impair the picture. Hence vertical blanking is required during the retrace. This action too must begin at a certain moment and end at a certain moment, with about 1,250 μsec being allowed for its duration.

The mere statement that the vertical sweep frequency is 60 cycles, and that a vertical sweep cycle is completed in $1/60$ second does not really tell what happens in this time interval.

As a matter of fact, if we re-examine the organization of the two fields which form a frame, we note several details that are very pertinent to the timing relationship between the vertical and the horizontal sweep actions. We are referring to the dissimilarity at the beginning and the ends of the two fields. In one case the field *starts* with a whole horizontal line, with its beginning point at the left top of the screen, and *ends* with a horizontal half line at the bottom of the screen.

The next field *starts* with a horizontal half line, with its beginning at the middle of the top and *ends* with a whole line at the right bottom of the screen.

While it is true that each field consists of 262.5 lines, the starting points for the vertical and horizontal beam deflection at the top of the screen are unlike in the two fields, as are the completion points of the deflection action for the two fields.

VERTICAL SYNC PULSE

Vertical Deflection Control Signals (contd.)

There is, therefore, present in each field an actual difference in the moment when the horizontal sweep oscillator trace comes out of blanking and reappears on the screen. It is triggered 525 times every two fields, each time producing a whole horizontal line which corresponds to a frequency of 15,750 cycles. Once in each field it must produce a half line, and the time occupied by this half line on the screen is $63.5/2 \mu\text{sec}$.

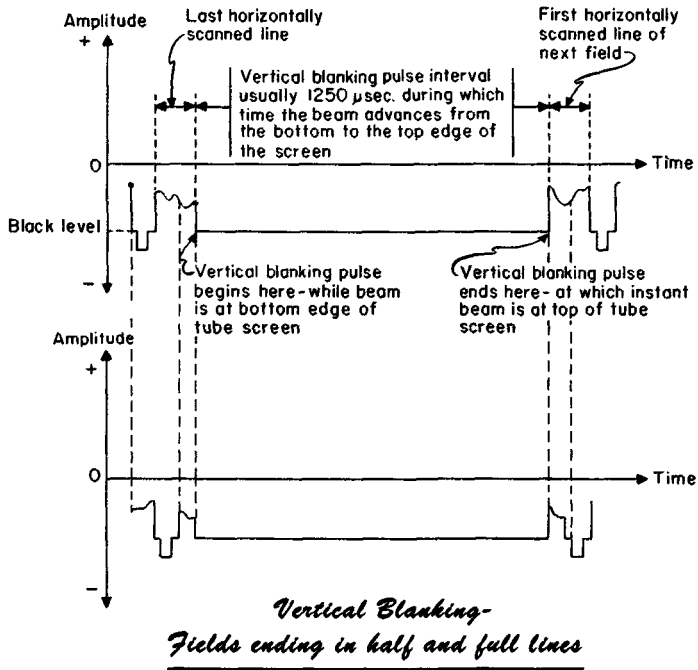

In addition, it is necessary that the horizontal lines of each field in a frame be correctly *interlaced* throughout the entire frame. Therefore, the triggering of the horizontal and the vertical sweep oscillators must occur at just the moments (relative to the vertical deflection) that the odd and even lines of the two frame fields are equally spaced despite the difference in the starting and ending points of each field of the frame. All of this is taken care of by special sync pulses to be described later.

Thus, the pulses related to the control of the beam's vertical motion are called the *vertical sync* pulses, derived from the received signal. The blanking of the electron beam during vertical retrace is the function of the *vertical blanking* pulse, also derived from the received signal. The equalization of the difference in timing created by the half lines in each field is taken care of by *equalizing* pulses. All of these control pulses will now be explained.

VERTICAL SYNC PULSE

The Vertical Blanking Pulse

We have learned that at the completion of a horizontal scanning line, there occurs a horizontal blanking interval during which the tube is "blacked out." The horizontal retrace occurs during this period. Hence, it does not appear as a visible line on the screen.

Horizontal Blanking With Time Intervals

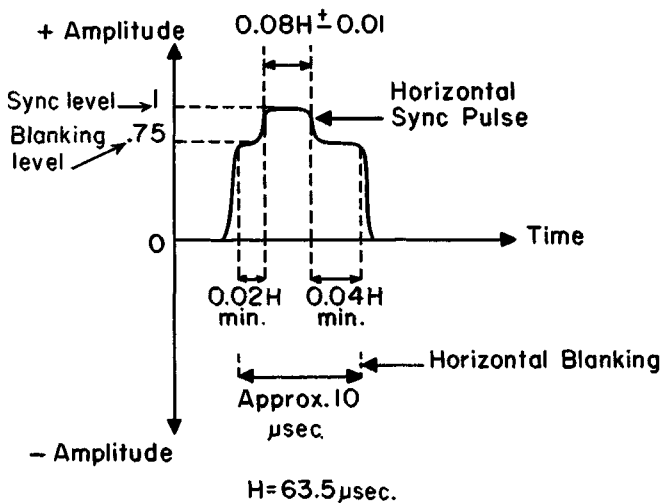

To be entirely correct in our statement, we show the duration of the horizontal blanking period as it really exists. It blanks the beam just before it reaches the limit of its travel under the influence of the horizontal deflection field, and also blanks the beam for a period at the start of the next horizontal line. This accounts for the fact that the visible portion of the horizontal scanning line is only 53.5 μ sec, whereas the actual *horizontal line interval* is 63.5 μ sec. Picture information is transmitted only during the time period of 53.5 μ sec. As may be seen, 10 μ sec of the full horizontal scanning time are taken up by the horizontal blanking.

The same action occurs with the vertical trace and retrace. Theoretically, when the last horizontal line of a field has been scanned, and the vertical retrace is supposed to start, the beam is blanked out by the vertical blanking pulse. This gives the beam the opportunity to return to the top of the tube screen without producing visible retrace lines.

VERTICAL SYNC PULSE

Vertical Blanking Pulse (contd.)

One of the factors we learned was that the last scanned line in a field may be a whole line or a half line. To explain the action taking place under the influence of the vertical sweep control voltages, we may select either of these fields as an example. Arbitrarily, we choose the field which ends in a whole horizontal line. Here is the waveform representation of this condition.

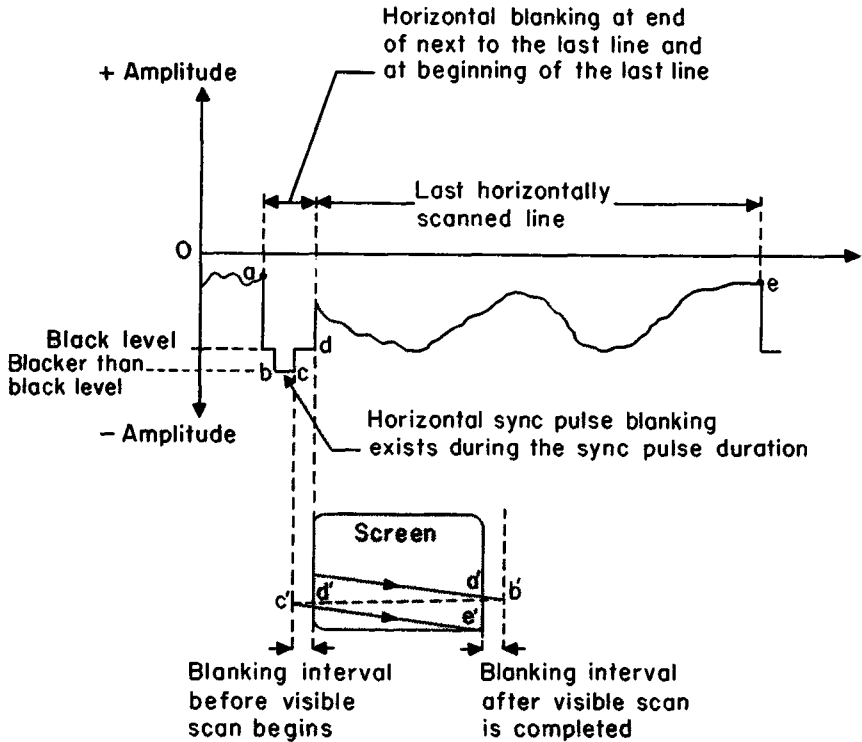

The last full line in a field

Point *a* is the beginning of the horizontal blanking pulse for the next to the last line scanned. Points *b-c* represent the horizontal sync pulse and *d* is the end of the horizontal blanking period. Picture information is transmitted until point *e*. This point corresponds to the end of the field, and can be considered as the starting point for the vertical blanking pulse for the field in question.

VERTICAL SYNC PULSE

Vertical Blanking Pulse (contd.)

Actually, point *e* is the start of the vertical retrace period, and the vertical blanking interval may start earlier than the completion of the last horizontal line. For the moment we may consider that the start of vertical blanking coincides with the end of the last line.

If we show the presence of the vertical blanking pulse in relation to the end of one field and the beginning of the next—that is, the completion of the bottom line of one field and the first line of the next field—we have this:

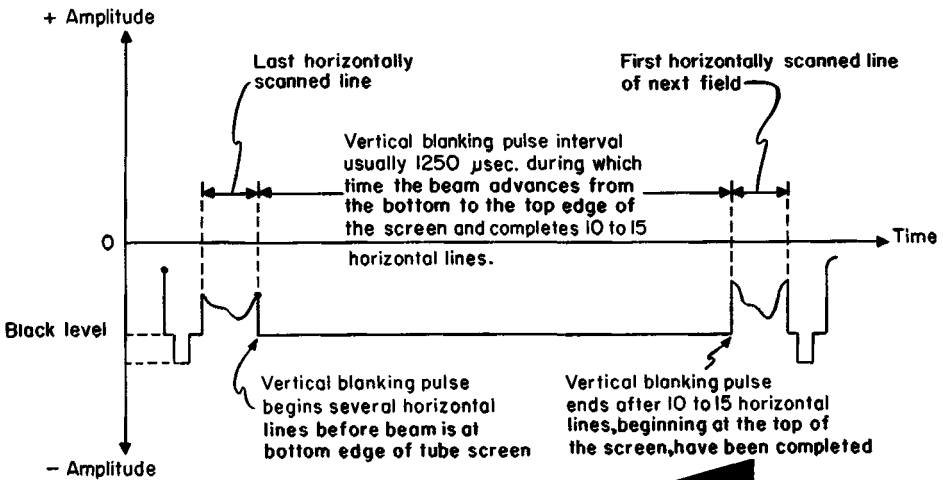

The Vertical Blanking Pulse Between Fields

The blanking pulse interval allowed by FCC regulations can be from a low of 833 μ sec to a maximum of 1,330 μ sec. The tolerance is allowed because all signal generating equipment must be permitted some frequency variation. Although we speak here in terms of time duration, this term has its equivalent in frequency. An average period for the vertical pulse is about 1,250 μ sec. The shorter the pulse duration (within the limits stated), the greater the coincidence between its starting time and the end of the last horizontal line. Likewise, its “unblanking” approaches coincidence more closely with the start of the first horizontal line in the next field.

The amplitude of the vertical blanking pulse is the same as that of the horizontal blanking pulse. Hence, the tube is driven into the “black” region and the screen does not show the beam motion.

VERTICAL SYNC PULSE

Vertical Retrace

It might be well to repeat that the motion of the beam during vertical retrace within the vertical blanking time is *not* a single surge upward in a straight line.

The beam starts upward, but the horizontal deflection voltages force the beam to describe a side-to-side motion between the left and right edges of the screen. In most modern receivers this motion cannot be followed on the screen because of the effective vertical retrace blanking. But in some of the older receivers the vertical retrace lines become visible if the brightness control is advanced too far.

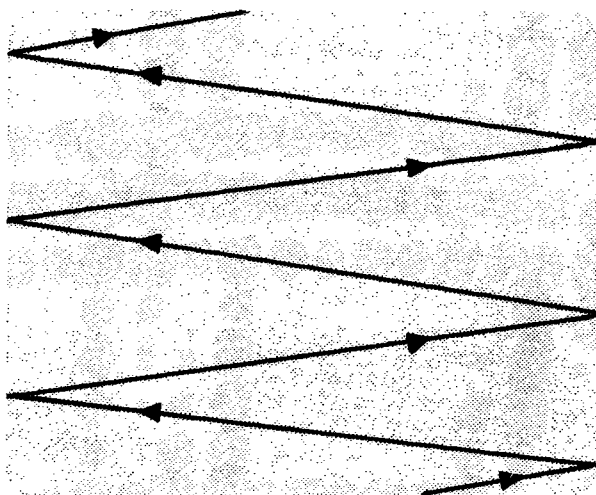

Motion of Beam During Vertical Retrace

The production of vertical retrace lines is the result of improper grid bias on the picture tube. Normally, the retrace lines are invisible since they occur during the vertical blanking period. Since this represents the so-called black area of the picture tube, the retrace lines occur during the time that the picture tube is cut off. However, it frequently happens that the bias on the picture tube is not large enough. This can be caused by some component in the grid-cathode circuit becoming defective or by having the brightness control on the television receiver set for excessive brightness. In either case the retrace lines can become visible and the familiar back and forth motion of the picture tube beam can be seen as it moves from the bottom of the picture to the top. As explained later, special circuits have been designed to eliminate this sometimes annoying effect.

VERTICAL SYNC PULSE

The Vertical Sync Pulse

The vertical sync pulse uses the vertical blanking pulse for its pedestal, just as the horizontal sync pulse rides on top of the horizontal blanking pulse. Once during every field the vertical sweep oscillator is fed a series of six successive triggering pulses which have the effect of a single 190- μ sec pulse. The level of these pulses is the same as the blacker-than-black horizontal sync pulses.

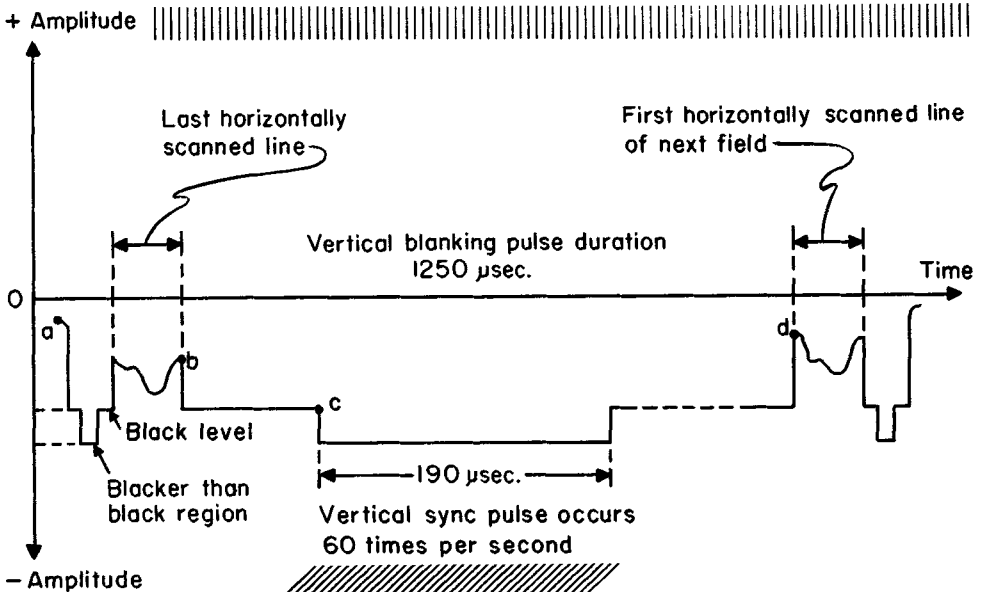

Adding the Vertical Sync Pulse to the Vertical Blanking Pulse.

This illustration shows the overall duration rather than the technical representation of the pulse; the discrepancy will be dealt with later. We might mention, however, that it is the omission of the pulses required to maintain horizontal synchronization during the vertical sync pulse interval.

Another point of interest is the location of the leading edge *c* of the sync pulse relative to the leading edge *b* of the blanking pulse. It is shown as appearing some time after the start of the blanking pulse. Bearing in mind that the blanking pulse duration may vary somewhat, it is important to remember that the moment of triggering the vertical sweep oscillator remains fixed at the transmitter, regardless of the duration of the vertical blanking pulse. This is true for both fields of each frame.

VERTICAL SYNC PULSE

The Serrations in the Vertical Sync Pulse

Continuous horizontal synchronization during the vertical sweep interval requires that the shape of the vertical sync pulse be modified. Its overall time-duration is held at 190 μsec , but to provide synchronizing pulses for

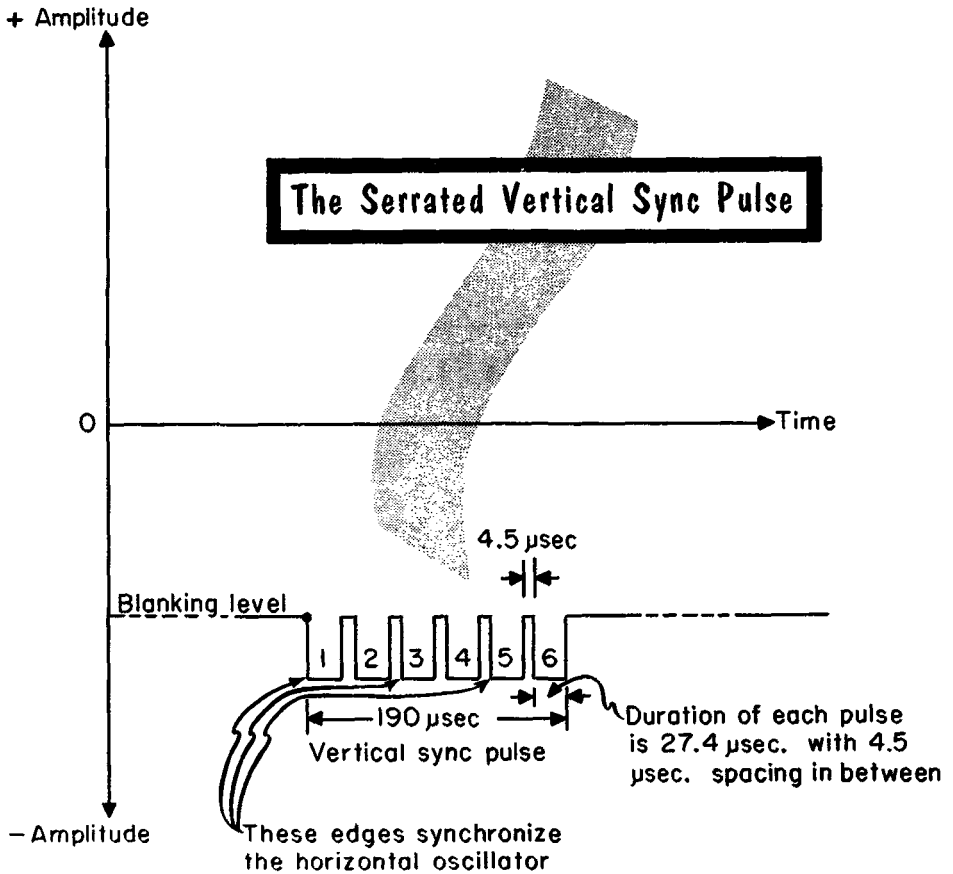

the horizontal sweep oscillator the vertical pulse is divided into six equal pulses, each slightly more than 27 μsec in duration. A better way to describe this modification of the vertical sync pulse is to say that it is *serrated*.

These notches or serrations serve two functions. As six pulses which follow each other in comparatively rapid succession, they ultimately act on the vertical sweep oscillator as a single triggering pulse. This comes about as the result of another action called "integration" which will be explained shortly.

VERTICAL SYNC PULSE

The Serrations in the Vertical Sync Pulse (contd.)

These same serrations provide alternate pulses which control the horizontal sweep oscillator frequency. The alternate pulses are produced when the vertical pulse is divided into 6 equal parts each having a time duration equal

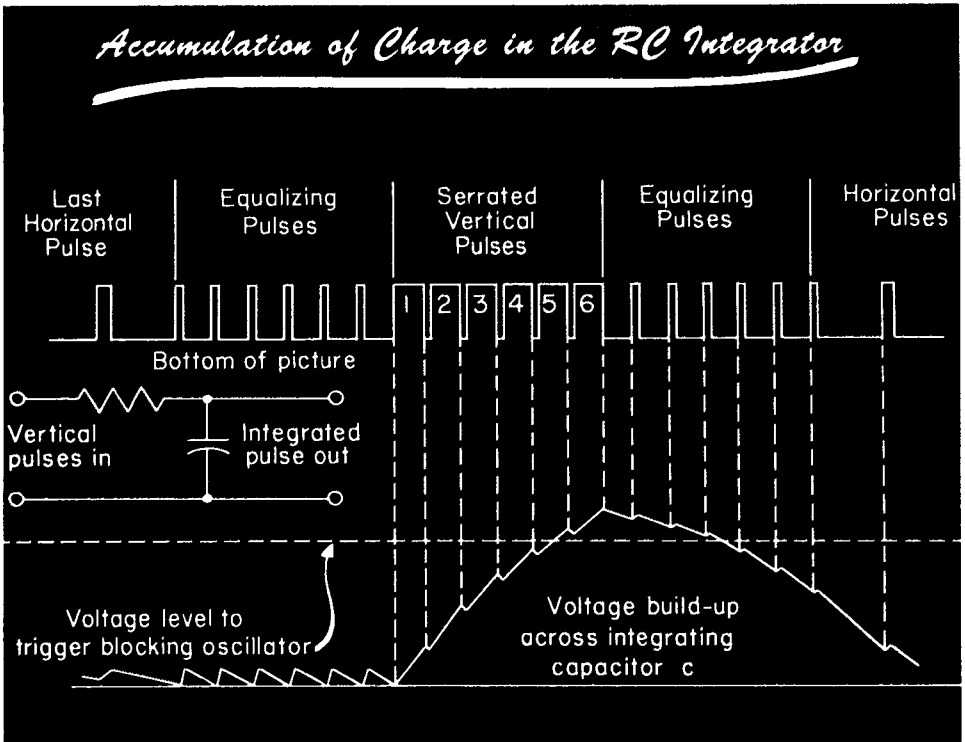

to half a horizontal line. The leading edges of pulses 1, 3 and 5 synchronize the horizontal oscillator during the vertical retrace period when the field ends in a complete horizontal line. With each serrated pulse having a duration of $27.4 \mu\text{sec}$, and with the spacing between serrations being $4.44 \mu\text{sec}$, each pair of pulses corresponds to the time of a horizontal line, i.e., $(2 \times 27.4) + (2 \times 4.44)$, approximately $63.5 \mu\text{sec}$.

In view of what follows later in this book, it is well to call attention to certain conditions which may not have been indicated by the time intervals of the vertical sync pulse serrations. Note that the duration of the individual pulses is long compared with the interval between them.

It will be seen later that this permits the use of these pulses to accumulate a charge in a capacitor until it reaches the level required to trigger the vertical sweep oscillator.

HORIZONTAL AND EQUALIZING PULSES

The Equalizing Pulses

Although we have seen how the vertical sync pulse is serrated to provide signals for horizontal synchronization during the vertical sync pulse interval, we must still consider the remainder of the time embraced by the vertical blanking interval. Somehow horizontal synchronization must be maintained during the entire vertical blanking interval for each field.

To achieve this synchronization, two sets of six pulses each are added, one set of six appearing before the start of the vertical sync pulse, and one set of six appearing after the conclusion of the vertical sync pulse interval. Later on we will show additional pulses, but for the present we will speak about these two sets of six pulses each.

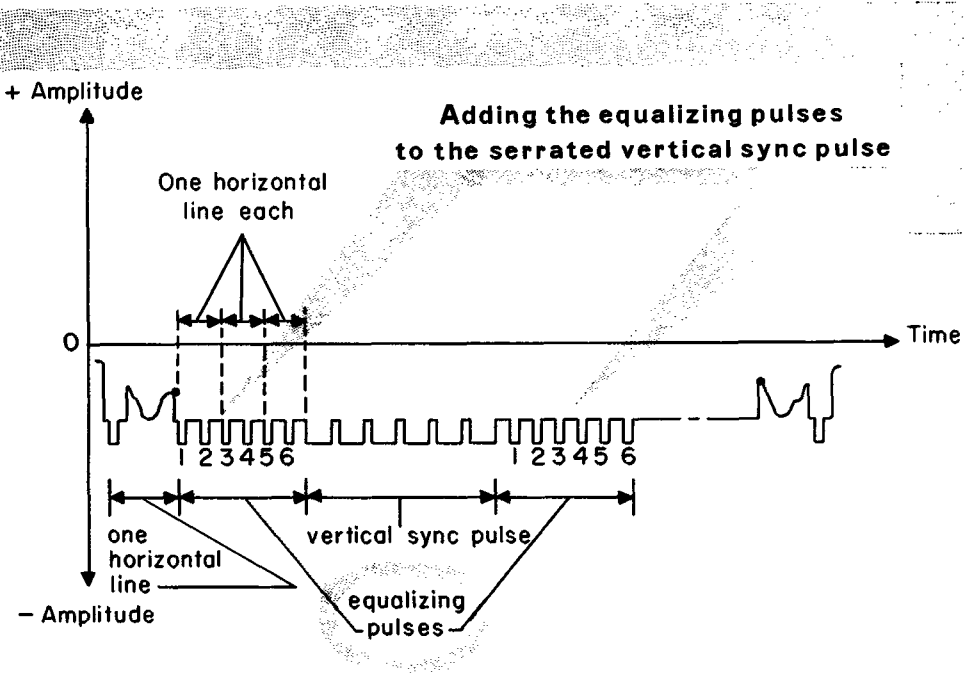

These pulses are called *equalizing* pulses. Although they are shown for the one field which ends in a whole horizontal line, their accurate picturization would be only slightly different for the other field. Therefore, the following general comments are applicable to the equalizing pulses used for both the fields of a frame.

Still one other point must be made. While the equalizing pulses appear among the signal waveforms embraced by the vertical retrace interval, they also are applied to the horizontal synchronizing system during the vertical retrace period.

HORIZONTAL AND EQUALIZING PULSES

The Equalizing Pulses (contd.)

Six equalizing pulses appear between the start of the vertical blanking period and the start of the vertical sync pulse, and six more follow the vertical sync pulse. But unlike the serrations of the vertical sync pulse, the equalizing pulses are of short duration and have comparatively long intervals between them.

Each equalizing pulse has a duration of slightly more than $2.5 \mu\text{sec}$ and an interval between of slightly more than $29 \mu\text{sec}$. From the leading edge of one pulse to the other the interval is substantially $31.5 \mu\text{sec}$ or equal to a half horizontal line. Therefore, two such pulses amount in time to a whole horizontal line.

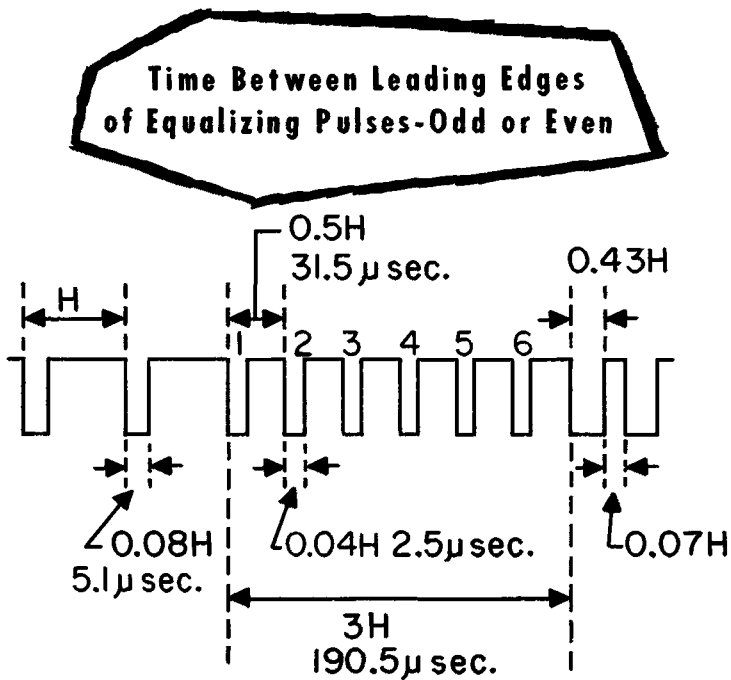

Whether we start with the leading edge of pulse 1 and measure time to the leading edge of pulse 3, or similar points between pulses 3 and 5, and from 5 to the leading edge of the first vertical serration, or between pulses 2 and 4, 4 and 6, the time lapse always corresponds to approximately the $63.5 \mu\text{sec}$ of a whole horizontal line. In this respect the time represented by these pulses is like the time represented by the serrations of the vertical sync pulse. This point is being made to show that if the equalizing pulses get to the horizontal synchronizing system—which they do—the leading edges of the appropriate pulses can help keep the horizontal sweep oscillator on frequency (in sync).

HORIZONTAL AND EQUALIZING PULSES

Functions of the Equalizing Pulses

Two functions can be ascribed to the equalizing pulses. First of all, they perform horizontal synchronization during that portion of the vertical blanking interval occupied by the equalizing pulses.

In the case of the field that ends with the whole horizontal line, the horizontal synchronization is done by the leading edges of the odd numbered equalizing and vertical sync pulse serrations, whereas in the field which ends with a half horizontal line, the leading edges of the even-numbered equalizing and vertical sync pulses perform the horizontal synchronization.

The equalizing pulses also trigger the vertical sweep oscillator at the same instant for each field. This is done by having the equalizing pulses "prepare" the *integrator*, which serves the vertical sweep oscillator. The integrator accumulates the charges fed to it in the form of the serrated vertical sync pulses until they reach the level which triggers the vertical sweep oscillator. The triggering level must be reached at a certain time, and "preparing" the integrator means setting up conditions so that the charge accumulated on the integrating capacitor is due to the vertical sync pulses only, and to no other pulses which may reach the integrator. The full meaning of this will be clear when we explain the vertical integrator.

EQUALIZING PULSES

aid horizontal sync at beginning and end of vertical blanking

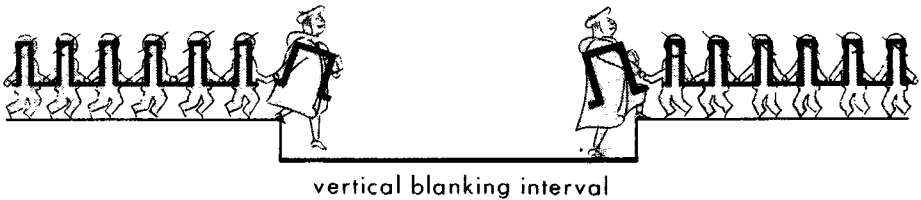

AND

trigger vertical sweep oscillator

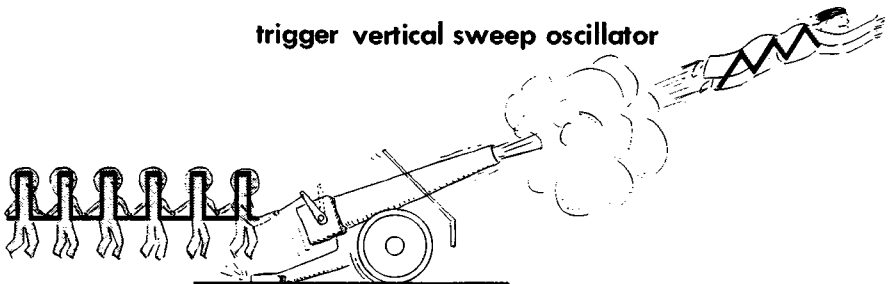

HORIZONTAL AND EQUALIZING PULSES

The Horizontal Sync Pulses During Vertical Retrace

The time interval embraced by the six equalizing pulses *ahead* of the vertical sync pulse, and the six equalizing pulses *after* the sync pulse amounts to approximately $3 \times 190 \mu\text{sec}$ or $570 \mu\text{sec}$. With $63.5 \mu\text{sec}$ required for each horizontal line this time-lapse totals about 9 lines. But we know that the vertical retrace interval in practice amounts to about $1,160 \mu\text{sec}$. This leaves about 9.5 horizontal lines of time within the vertical retrace interval for which we have not shown any means for horizontal synchronization.

Horizontal synchronization is available in the form of a train of regular horizontal sync pulses which follow the second set of equalizing pulses. The number of these horizontal sync pulses which fill out the vertical retrace

Horizontal Lines Blanked

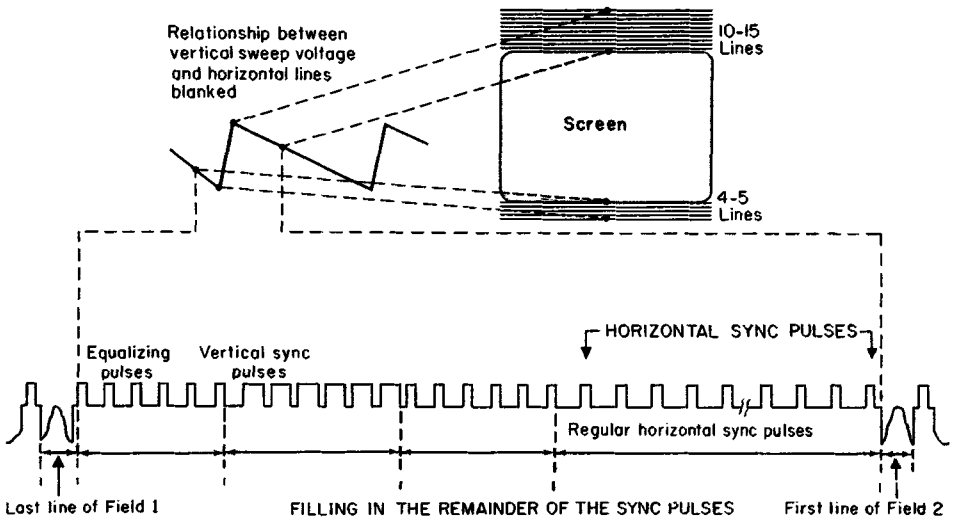

interval depends on the time allowed for the latter. Because of the tolerance allowed in the system, there may be as few as 9 such pulses, and there may be as many as 13. The exact figure is unimportant, as long as we understand that these pulses continue keeping the horizontal sweep oscillator on frequency while the beam is climbing its zig-zag path towards the top of the tube screen.

It is interesting to note that, in practice, the vertical blanking interval is sufficiently long so that it blanks out about 10–15 horizontal lines at the top of the screen and about 4–5 lines at the bottom of the screen. Even so, the vertical and horizontal synchronization is essential to proper interlacing, maximum resolution, and high stability.

HORIZONTAL AND EQUALIZING PULSES

A Simple Experiment

The explanation we have just given of the events occurring during the vertical blanking interval suggests an interesting, simple experiment.

In many receivers, one of the front panel knobs is a *vertical hold* control. By turning this knob slightly from its regular setting, the picture can be made to roll *slowly* upwards—or downwards—so that the lower and upper half of the picture, separated by a horizontal bar can be seen and stopped momentarily.

The upper part is the lower half of the image, and what lies below the dark horizontal bar is actually the upper half of the image.

If we turn up the brightness control we can see that the horizontal bar between the picture halves is not uniformly dark, but contains a definite pattern. The vertical blanking level shows up as a dingy gray. The sync peak level, being more negative, shows up black. The sharper the focus the easier is to see the blanking-bar pattern.

The vertical blanking interval begins after the last horizontal line of the visible picture has been scanned, and is darker than the darkest part of the image background. The equalizing pulses' signal level extends into the blacker-than-black region and so appears blackest on the screen.

The result of a slight re-adjustment of the vertical hold control

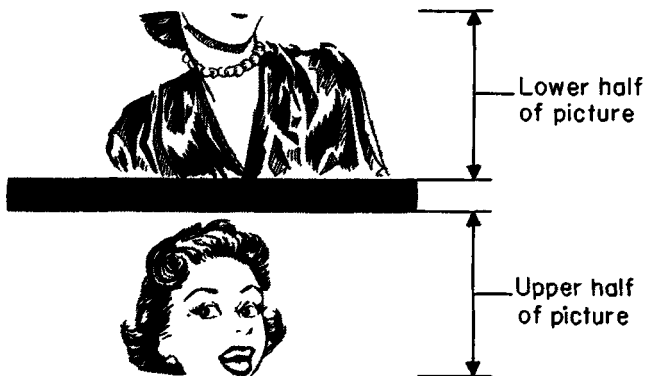

Since there are six equalizing pulses before the arrival of the serrated vertical sync pulse, the distance down from the top of the "hammer" represents the depth of three horizontal lines. Since the equalizing pulses occur at half-line intervals, the six equalizing pulses tick off three horizontal sweeps of the scanning beam.

HORIZONTAL AND EQUALIZING PULSES

A Simple Experiment (contd.)

Since the width of each serration in the vertical sync pulse is greater than the width of each equalizing pulse, the blackening effect of these serrations occupies a greater width. As a matter of fact, each of these serrations occupies almost the entire width of half a line, with just a small break where

SYNC PULSES . . .

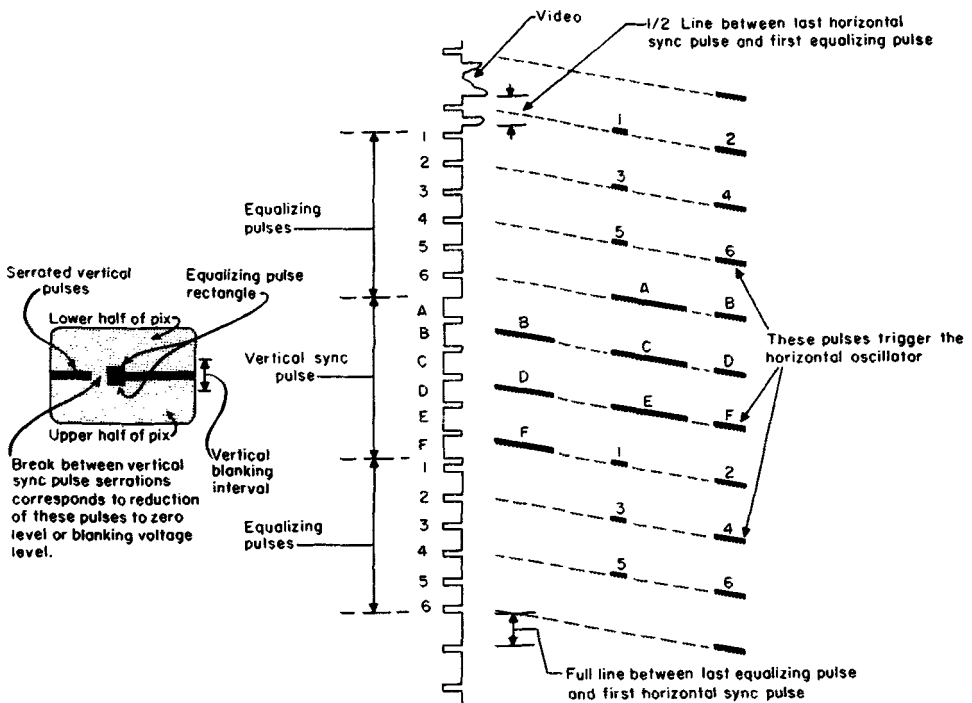

. . . as seen on the picture tube screen

the signal moves to the blanking level. The brighter effect of this small break is shown in the diagram. With the arrival of the next serration, the remainder of the horizontal line after the break is again black, and extends to the right-hand end of the screen.

When the last of the vertical serrations has passed, a second set of equalizing pulses follows. We should then expect the small black rectangle to appear underneath the broken horizontal bar of the serrations, as indeed it does.

HORIZONTAL AND EQUALIZING PULSES

Processing the Sync Signals

We already know the picture tube converts the *picture part* of the composite video signal into light and dark tones on the face of its screen. The blanking signals between picture information intervals, both horizontal and vertical, drive the picture tube to cutoff and make the retrace lines invisible. We can say, then, that even though the entire composite video signal—picture signal, blanking pulses, sync pulses and all—are fed to the picture tube, only the *picture signal* is seen on the screen.

The composite video signal is *also* fed to the sync circuits. Which part of the entire composite video signal will they use? We know that the horizontal and the vertical oscillators, acting through the deflection yoke, cause the picture tube beam to scan over the face of the tube.

We know also that the two sweep oscillators, although capable of functioning by themselves, cannot act in *synchronism* with the transmitting station's camera unless they are triggered by the sync pulses contained in the composite video signal. Since the oscillators require only the sync pulses for control, there is no need for the rest of the composite video signal to appear in the sync circuits at all.

The Sync Clipper

removes sync pulses from composite video signal

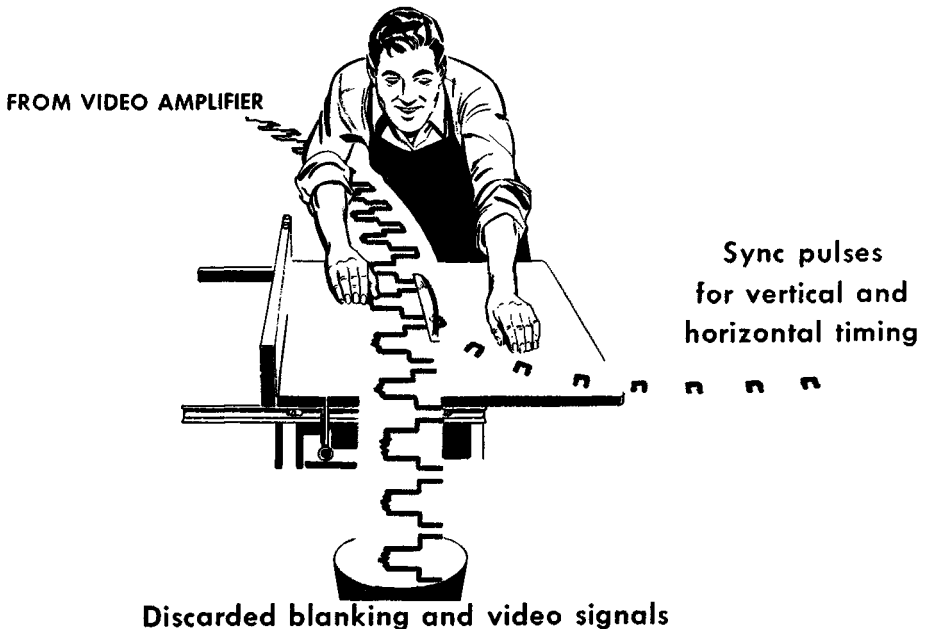

REVIEW

1. *Synchronization of the Picture* involves the accurate control of the horizontal and vertical sweep oscillators, the two blanking actions, and the correct timing between the start of the horizontal sweep and retrace. It also involves the start of the vertical sweep and retrace in the picture tube and the camera tube.

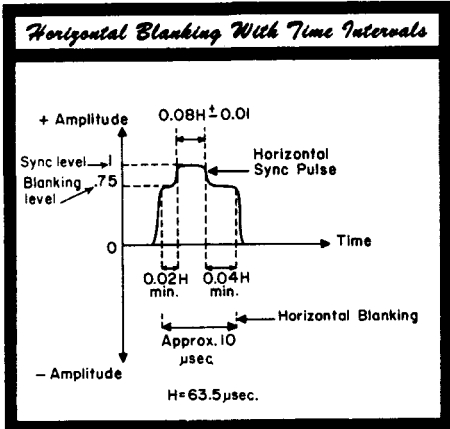
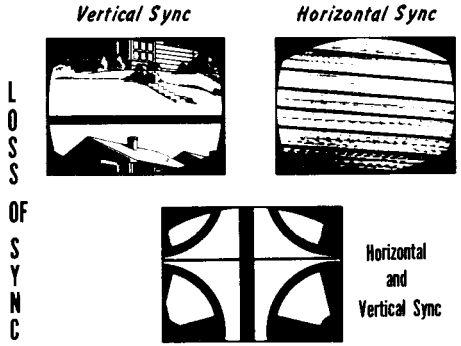

2. *The Horizontal Retrace* occurs during the horizontal blanking interval. The horizontal blanking period blanks the beam. 10 μsec of the full horizontal scanning time is taken up by the horizontal blanking. This accounts for the fact that the visible portion of the horizontal scanning line is only 53 μsec .

3. *The Vertical Blanking Pulse.* An average period for the vertical pulse is about 1250 μsec . The shorter the pulse duration, the greater the coincidence between its starting time and the end of the last horizontal line.

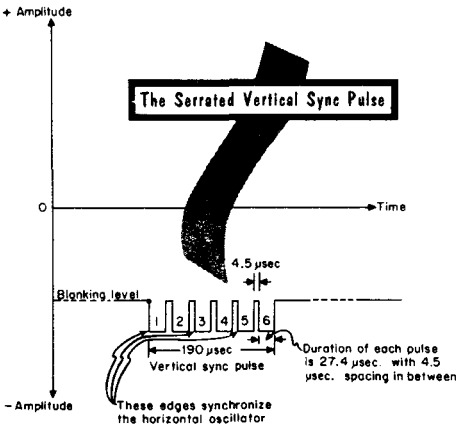
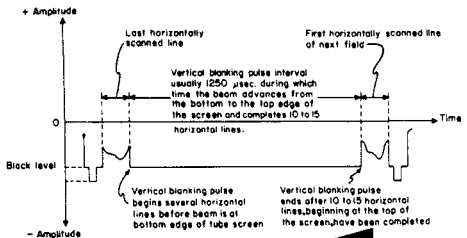

The Vertical Blanking Pulse Between Fields

4. *The Serrations in the Vertical Sync Pulse.* The overall time-duration of the vertical sync pulse is held at 190 μsec . To provide sync pulses for the horizontal sweep oscillator the vertical pulse is divided into six equal pulses each slightly more than 27 μsec in duration. We say that the vertical pulse is serrated.

REVIEW

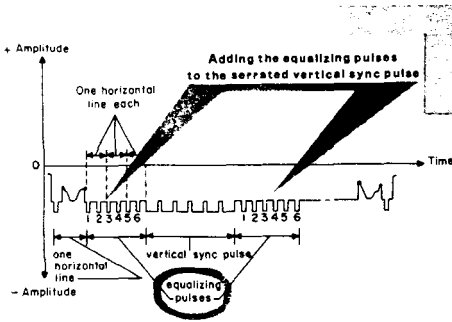

6. Functions of the Equalizing Pulses. The equalizing pulses perform horizontal synchronization during the portion of the vertical blanking interval occupied by the equalizing pulses. The equalizing pulses also trigger the vertical sweep oscillator at the same instant for each field.

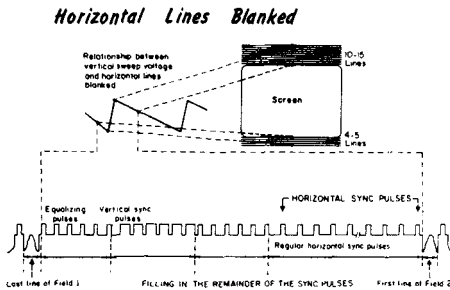
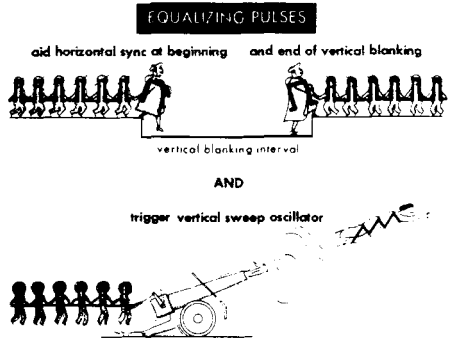

7. The Horizontal Sync Pulses during Vertical Retrace. Horizontal synchronization is available in the form of a train of regular horizontal sync pulses which follow the second set of equalizing pulses. The number of these horizontal sync pulses which fill out the vertical retrace interval depends on the time allowed to the latter.

8. A Simple Experiment. In many receivers, one of the front panel knobs is a vertical hold control. By turning this knob slightly from its regular setting, the picture can be made to roll slowly upward—or downward. The upper part is the lower half of the image, and what lies below the dark horizontal bar is actually the upper half of the image.

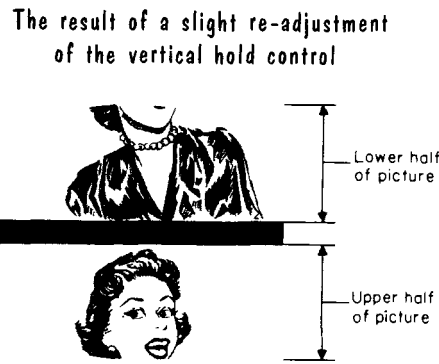

SYNC CLIPPER

The Sync Clipper — or Separator

If only the sync pulses are needed in the sync circuits, there must be some arrangement which removes the *sync pulses* from the composite video signal, and discards the remainder of the signal. Such action is called sync clipping or sync separation.

The stage which performs this function is called the *sync clipper* or *sync separator* and the block diagram shows what its output signals look like for a typical input. The output signal is made up of the same sync pulses that

The function of the Sync Clipper

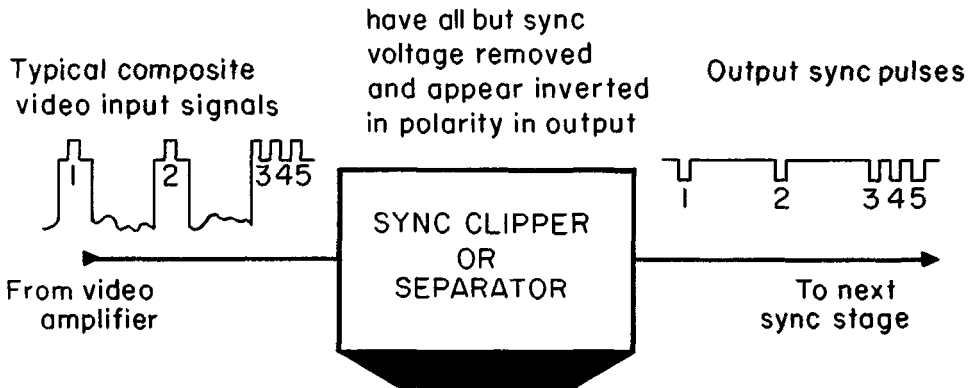

Numbers assigned to input and output signals are arbitrary for identification purposes only

were sitting on top of the pedestals of the input signal, but the pulses appearing in the output signal are *inverted*. This, of course, is the familiar *phase inversion* behavior of a single stage of amplification. The sync clipper also serves as an amplifier.

The sync clipper clips the sync peaks off the composite video signal in somewhat the same way as a gardener might clip the tops of a hedge. He establishes a line that he visualizes as the "clipping level," and clips down to that line but no further. We get all the sync pulses at the *same level* by establishing a "clipping level" in the stage. Coupling is usually arranged between the output circuit of the video amplifier and the input to the sync clipper.

SYNC CLIPPER

Loss of D-C Component

A voltage (made up of composite video plus dc) is developed across the load resistor of the video amplifier and it is this voltage which is to be coupled to the sync clipper through an R-C coupling network. We have already seen in our discussion of the d-c restorer the complications introduced by the use of a coupling capacitor when the signal contains dc. The d-c component of the composite video signal is lost, and the sync and blanking pulses in the signal are not maintained at the same level.

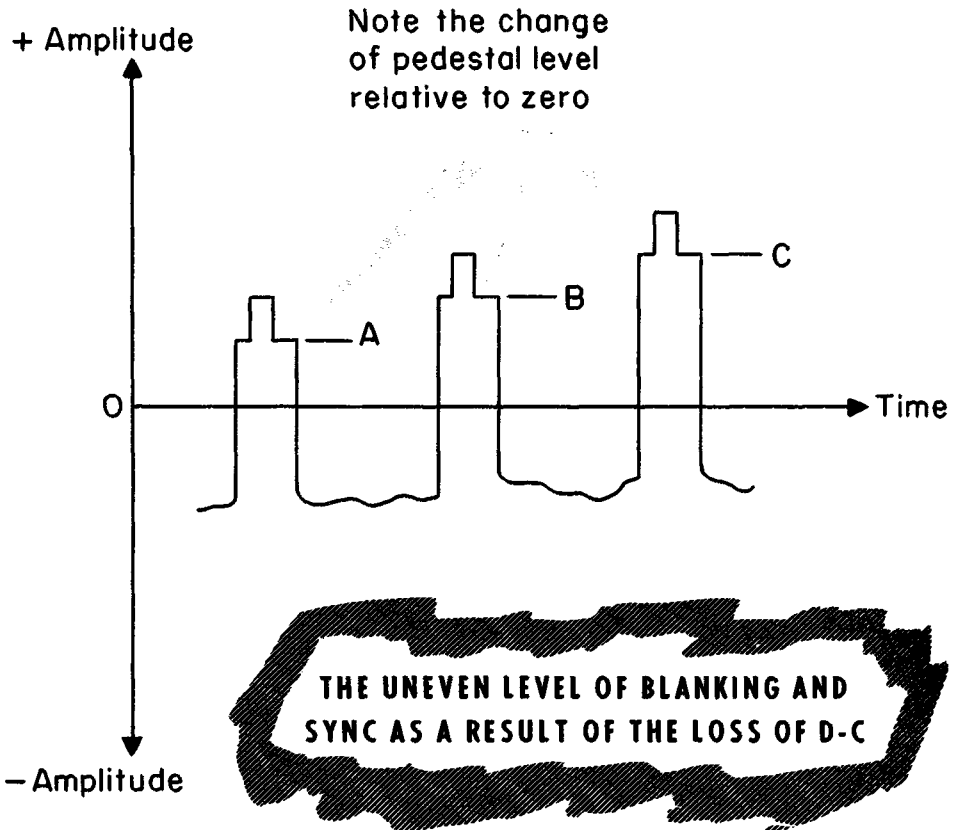

If a signal like this were fed to the clipper, the latter would not be able to determine the proper clipping level. For the first pulse, we would have to set the clipper so that it will remove the sync pulse above level A. For the second pulse we would have to set it at level B, and so on. The solution to the whole problem is to use some circuit to *restore the d-c component* to the signal and so get all of the sync pulses at the *same level*. We don't have to go very far to find such a circuit. It is the diode clamper.

SYNC CLIPPER

The Diode Clamper

When the plate of the diode clamper is grounded, the result is called positive clamping. If the plate is made positive with respect to cathode or the cathode negative with respect to plate, current will flow through the diode. Thus in the grounded-plate diode clamper shown, the diode will act as an open circuit during the positive alternations of the input signal. The negative alternations will cause diode current to flow. At maximum negative alternation there will be maximum current flow through the diode and the tube will act as a virtual short circuit. Thus, the maximum negative swing of the input signal is effectively placed at ground potential. We can see from this that with the input signal shown, the output waveform will vary from ground to some positive value.

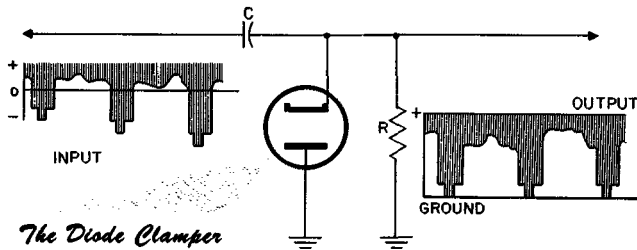

Now we can reverse the diode clamper by grounding the cathode. In the diagram shown the output waveform will vary between some negative value and ground. This is caused by the fact that the maximum positive alternation of the input signal will cause heavy conduction and thus place the plate at ground potential. For all negative alternations, the tube acts as an open circuit and the output will be negative with respect to ground. The overall effect of these circuits is to place the sync peaks at a constant level so they can be processed by the sync clipper.

REVERSING THE DIODE CLAMPER

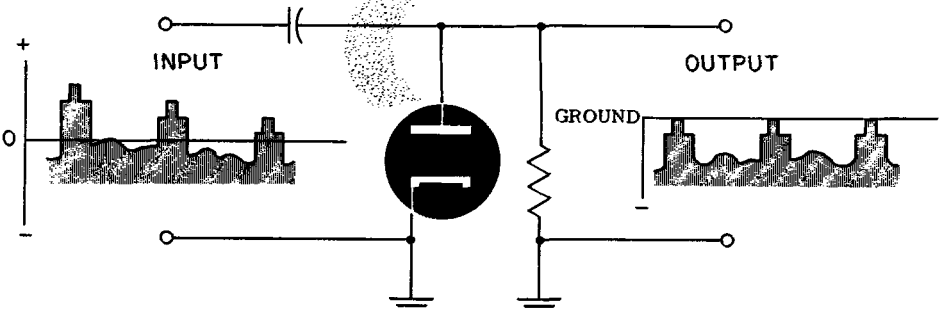

SYNC CLIPPER

Developing the Clipper Circuit

From what we know about the behavior of a tube with one or more grids, we can say that the combination of control grid and cathode of such a tube could be used as a diode. If the signal applied to the control grid swings positive with respect to cathode, the grid draws current; when the signal swings negative, no current is drawn. This is exactly the way the diode works. What we can do, then, is to use the cathode and control grid of a triode or pentode as the diode for our clamper circuit.

If this schematic is compared to that of Reversing the Diode Clamper, the two are found to be exactly the same, the only difference being the type of tube involved. It follows, then, that the voltage across R in this illustration will also be a composite video signal whose sync pulses will all be at the same level.

USING THE CONTROL GRID AND CATHODE OF A TUBE AS A DIODE CLAMPER

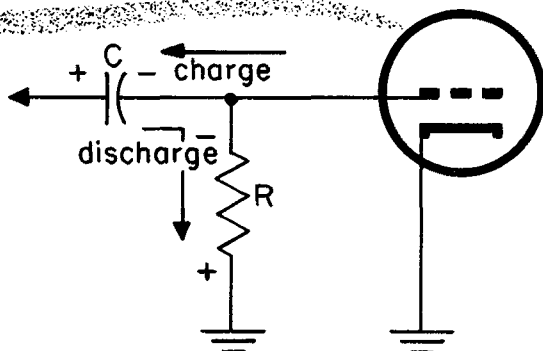

Fundamentally, this circuit operates on two separate operations. Initially, when any signal that is positive with respect to cathode is applied to the grid, the grid will draw current. As current is drawn by the grid, capacitor C acts as a short circuit to the charging current, and will charge approximately to the peak value of the applied voltage. After the applied voltage has passed its peak and begins to decline, the voltage necessary to keep the capacitor charged is no longer present and the capacitor begins to discharge through resistor R, developing a voltage on the grid side of the resistor that is negative with respect to ground. Since the discharge path is a higher resistance than the charge path, the discharge is slow, and there will still be some charge remaining when a new voltage pulse arrives, again driving the tube into conduction, and the cycle starts again. The overall result is to maintain a relatively stable d-c bias voltage on the grid.

SYNC CLIPPER

Completing the Sync Clipper

Now that we have seen how the combination of a tube's control grid and its cathode works, suppose we fill in the rest of the tube and its circuit.

If R1 (the same resistor as R in the schematic of the diode clamper) has a rather high value of resistance, the d-c voltage across it will be correspondingly high, and the bias on the tube's control grid may be even more negative

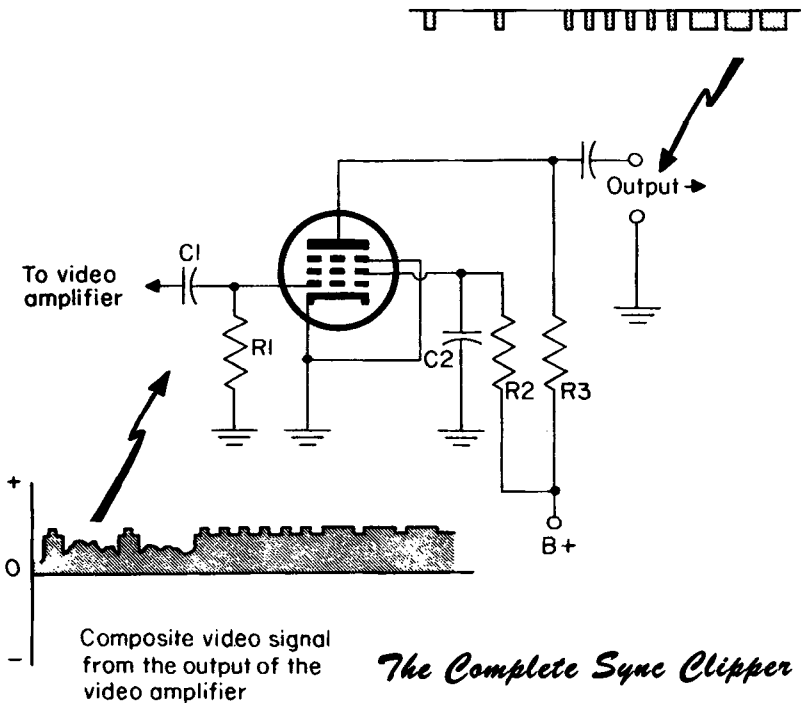

than cutoff. Assuming that this condition prevails, the plate current that flows through output load resistor R3 will have the waveshape illustrated on the next page.

Here we see how the I_p - E_g characteristic of the pentode can be used to show the waveform of the plate current in the sync clipper. The vertical dotted line is the bias voltage on the control grid, and since it is the average value of the composite video signal, the signal is shown varying around it. Because the bias voltage is more negative than cutoff, the dashed line is drawn to the left of the cutoff point.

SYNC CLIPPER

Completing the Sync Clipper (contd.)

We know that any part of the varying control grid signal which is *more negative* than cutoff will produce no plate current. In the diagram above, therefore, nothing to the left of the cutoff point appears as plate current, but the parts of the composite video signal to the right of cutoff do permit plate current flow.

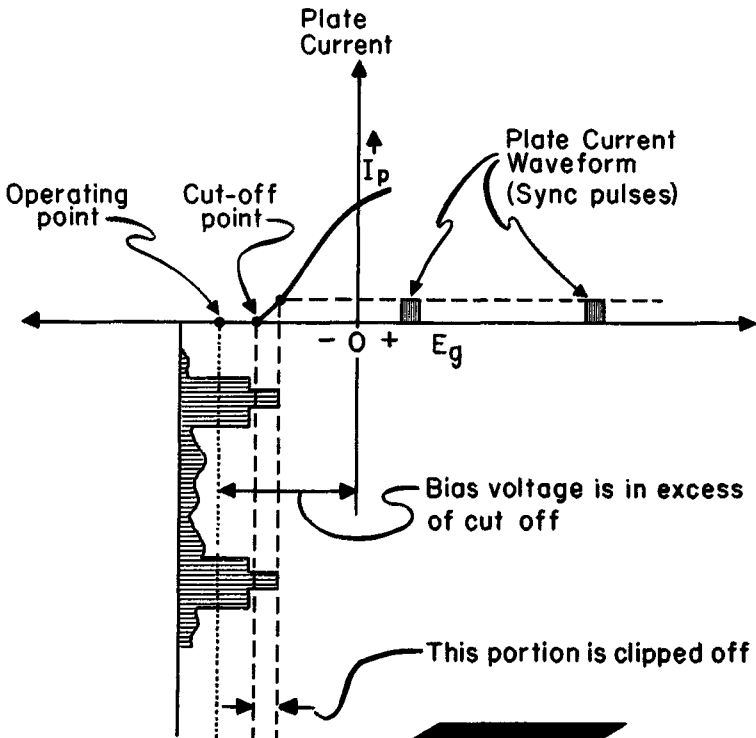

The behavior of the plate current of the clipper

Note that only the *sync pulses* appear to the right of cutoff, so that the plate current waveform is made up of sync pulses only.

When plate current flows through plate resistor R3 in the schematic, the top of the resistor is *negative* with respect to the bottom end of the resistor. We can see, then, that the sync pulse peaks which were put on the grid as positive-going voltages become *negative-going* voltages across the load resistor R3.

SYNC CLIPPER

Sync Clipper and Noise Limiter

A circuit growing increasingly popular is the sync clipper and noise limiter, using a pentagrid tube such as the 6BY6 or the 6CS6. Two video signals are fed to this tube: a strong positive-going signal from the video amplifier and a considerably weaker negative-going signal from the video detector. The signal from the video amplifier is processed in the conventional clipper manner, with grid 3 acting as the plate of a diode in conjunction with the cathode. As a result, a train of negative-going sync pulses appears in the output.

SYNC CLIPPER AND NOISE LIMITER

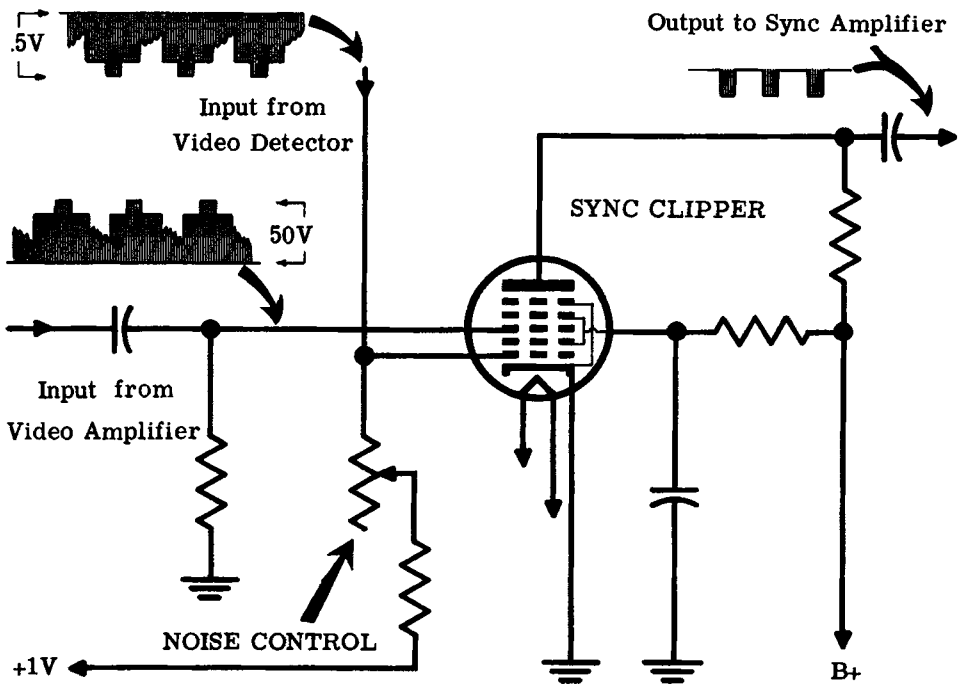

The signal from the video detector is fed to grid 1 which is normally held at a slight positive bias. The signal from the video detector is too weak to drive grid 1 into cutoff. However, should a strong noise pulse appear, grid 1 is driven into cutoff and plate current in the tube ceases. Of course, the sync pulse is lost during this time, but this loss is usually not noticeable and the output is noise free. A noise control potentiometer is often provided so that the small bias voltage of grid one can be varied. This control is important because in weak signal areas the signal may be so small that noise pulses will not cut off grid 1, and hence they will appear in the output.

SYNC CLIPPER

Pulse Shape

How a Badly Shaped Pulse May Cause Poor Syncing

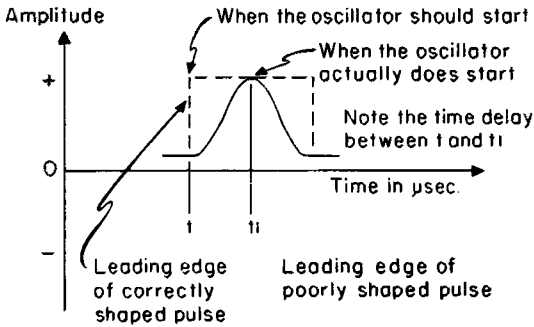

Above is shown a properly shaped and a very badly shaped horizontal sync pulse. Most oscillators are triggered on the *leading edge* of the sync pulse. For the square pulse, the oscillator triggers at time t , as shown in the figure. But the poorly shaped pulse does not get the oscillator going until time t_1 . Since time is advancing to the right in this illustration, we can see that the distorted pulse triggers the horizontal oscillator *later* than it is normally supposed to. The result is a picture that will *tear*.

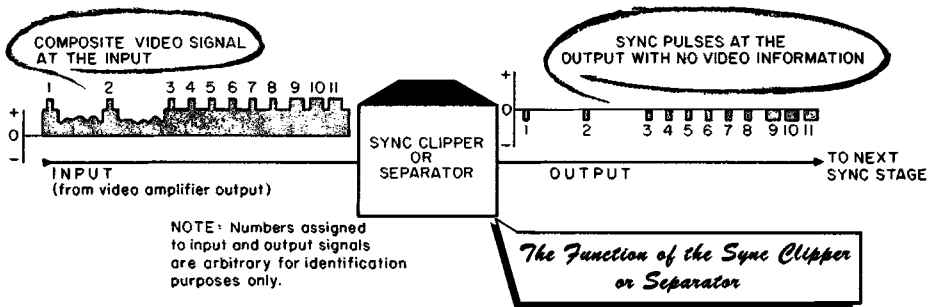

In the study of the sync clipper or separator circuit, we have seen that its effect is to strip the sync pulses from the composite video signal.

Let us assume that we have sync separator action as shown above. There is a whole string of sync pulses. They are the several horizontal sync pulses that occur at the end of each horizontal line, the six closely packed equalizing pulses and three vertical serrated sync pulses.

But these horizontal and vertical sync pulses are not yet ready to be applied to their respective oscillators—they are too weak. This can be corrected by putting the sync pulses through a *sync amplifier*.

SYNC AMPLIFIER

The Sync Amplifier

Putting the sync pulses through a sync amplifier not only strengthens the signal applied to its control grid, but also *clips* any irregularities (such as noise) that may appear on top of the sync pulses fed to it, and so makes *certain* that it is really square.

The sync amplifier that follows the regular sync clipper may be either a triode or a pentode. For simplicity's sake, let us imagine that the tube is a triode.

Whether a pentode or a triode, the general organization of the sync amplifier circuit is the same. The cathode of the tube usually is grounded, which

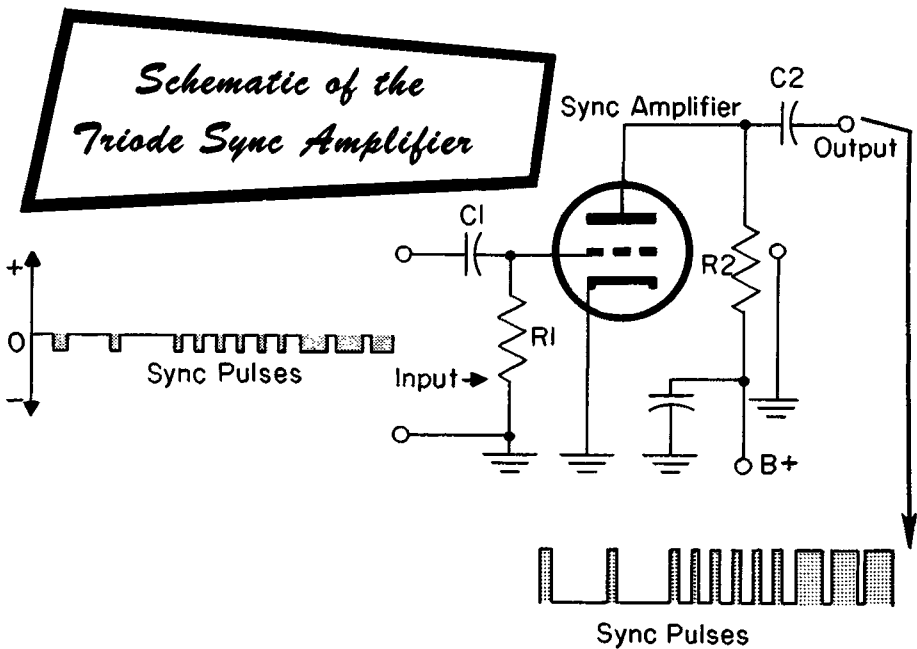

means that the signal applied to the tube will swing the grid positive. When the grid becomes positive with respect to cathode, it will, of course, draw current. That current will flow down the resistance R1, the grid leak, in the direction of the arrow placing the top of the resistor (and the grid) at a negative potential with respect to cathode. The capacitor C1 charges and holds the negative voltage fairly constant, the grid of the tube is thus given a negative bias.

Like the bias for the sync separator, the negative bias is more negative than cutoff. The illustration shows what the plate current looks like when the negative polarity sync pulses are applied to the tube grid.

SYNC AMPLIFIER

The Sync Amplifier (contd.)

The incoming sync pulses are shown with their peaks no longer square. We assume that noise or some other factor has caused them to lose their square shape. Since these ragged peaks are well beyond the cutoff point, they cannot influence the plate current. The plate current wave that flows in load resistor R2 therefore has sharp corners, and the sync pulses still point downwards. For every sync pulse voltage peak applied to the grid of the tube, the corresponding plate current is zero. As the plate current stops flowing through load resistor R2, the voltage drop across the resistor is zero, which means that the output voltage E_{R2} with respect to chassis is maximum (positive).

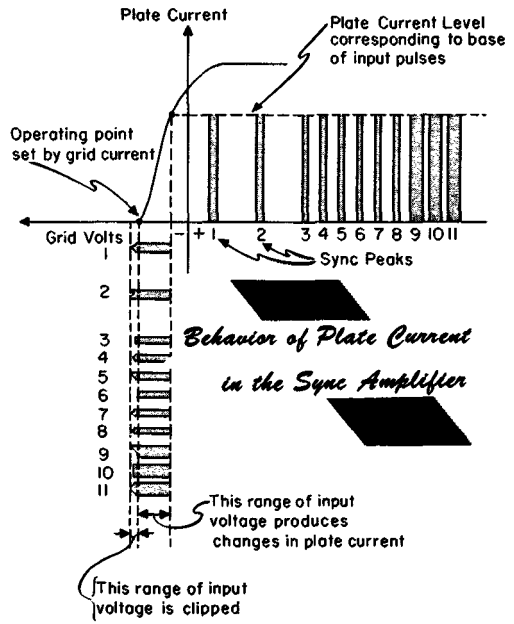

The current during the interval between the sync pulses is at maximum level, which means that the voltage drop across the load resistor is maximum. This means that output voltage E_{R2} is minimum. Such is the phase inversion action between input and output signal voltages.

The Sync Amplifier Reverses the Phase of the Sync Pulse

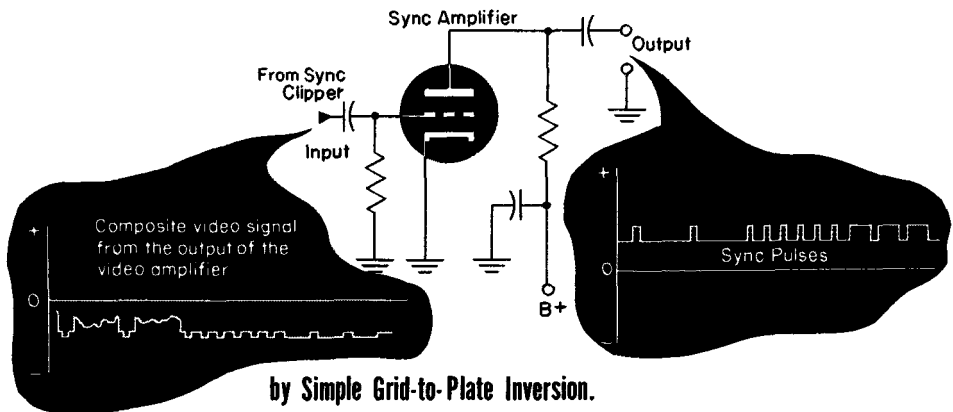

THE INTEGRATOR

Separating the Pulses, The Integrating Circuit

When the sync pulses—horizontal, equalizing, and vertical—have been built up to a good level of strength, they are ready for *separation*. The sync pulse which arrives at the end of every scanned *horizontal* line must be fed to the *horizontal* oscillator to trigger it into action at the right moment, and the *vertical* pulse arriving at the end of each scanned field must be fed to the *vertical* oscillator. *Separating* these two types of sync pulses so that each will take its designated path is the job of special circuits.

The vital circuit in sync separation—the circuit which actually works to separate the vertical from the horizontal pulses—is the *integrating circuit*.

The Integrating Circuit

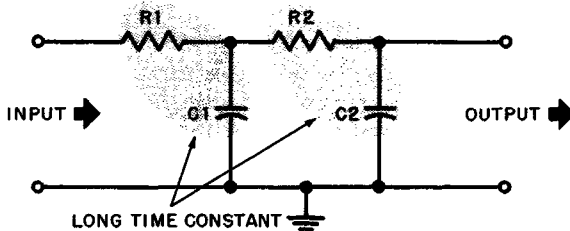

Makes Use of the Vertical Pulses Only

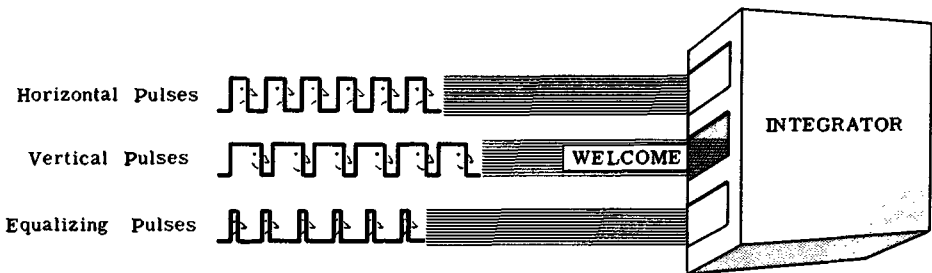

We can best begin our explanation of the integrator by saying that it is made up of resistors and capacitors, as shown. The output is taken off the last capacitor.

By definition, an integrator is a device which sums up instantaneous values. The output voltage is a function of the *duration* of the input voltage and also of its amplitude. In the television receiver the vertical integrator distinguishes between vertical and horizontal sync as well as equalizing pulses, and permits the vertical sync pulses to build up to a voltage level suitable for triggering the vertical sweep oscillator.

THE INTEGRATOR

Integrating Action

Let us assume a series of sync pulses, all of the same height, but of different widths. First we have the horizontal sync pulses, (1-2) of short duration with substantial time in between. At the end of a field, the equalizing pulses 3-4-5-6-7-8 come along; these too are of short duration. After the first set of equalizing pulses comes the broad serrated vertical sync pulse. In the six serrated vertical sync pulses, we encounter a different shape—each of the serrations is a wide pulse, wider than either horizontal or equalizing pulses. Furthermore, the interval between pulses is so short, that the integrator capacitors do not have time to *discharge* too much before the next pulse comes along. Each vertical sync pulse provides additional charge.

How
the Integrator Reacts to

Horizontal, Equalizing and Vertical Sync Pulses

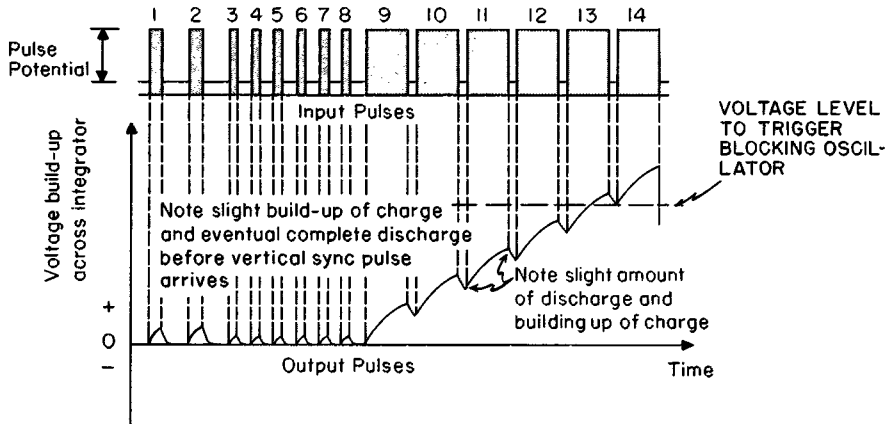

Pulse number 1, at the top of the diagram, is the horizontal sync pulse arriving at the end of the next-to-last line in a field. The moment the leading edge of this pulse arrives at the integrating circuit, the capacitors in the circuit accumulating the charge contained in that pulse, as shown in the lower section of the drawing. Because the first pulse lasts for only a short time, the charge accumulated is small. Furthermore, there is a fairly long interval between pulse number 1 and pulse number 2.

By the time pulse 2 arrives, then, the charge in the integrating capacitors has leaked off. For pulse 2, a new charge is built up, but it is dissipated before the next pulse in the procession comes along. For each of the thin horizontal and equalizing pulses, then, the charge built up by the integrator circuit is small and is fully dissipated before the first vertical sync pulse comes along.

THE INTEGRATOR

Integrating Action (contd.)

Now the serrated vertical sync pulses are applied to the integrator. These serrations are all wider than the horizontal or equalizing pulses, the charge each contains is greater, and the charge accumulated in the integrator circuit is greater. Pulse number 9 is the first of these pulses to reach the integrator circuit. It builds up a charge as shown. But the time interval between the trailing edge of 9 and the leading edge of 10 is so short, that before the

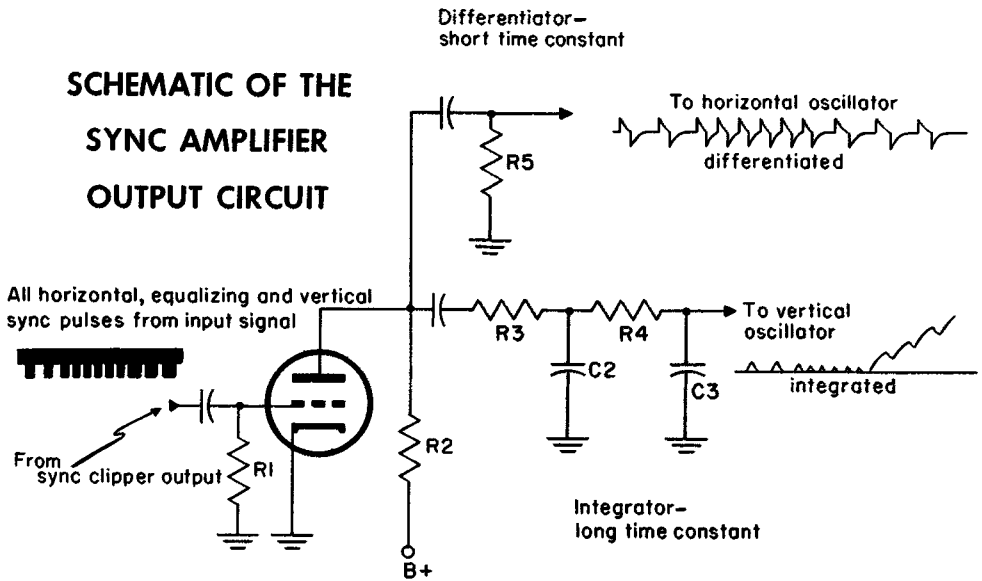

charge built up by 9 has a chance to leak off very much, the arrival of pulse 10 *adds* to it. The effect of the whole train of serrations in the *vertical* sync pulse is to build up quite a high charge at the integrator output.

What we have just said indicates that the integrator builds *only* the serrated vertical sync pulse up to the triggering voltage. The horizontal and equalizing pulse charges have no effect. The very narrow equalizing pulses help dissipate any residual charge remaining from the horizontal pulses. This permits the build-up of voltage due to the six vertical sync pulses to be the *same* for each field time-wise, and so trigger the vertical oscillator at the same time for each field.

Across plate load resistor R2 appears a signal voltage made up of more or less squared, horizontal, equalizing, and vertical sync pulses. Part of this signal voltage is fed into the integrating circuit. The remainder of this same output signal voltage developed across R2 is fed into the horizontal sweep system which will be discussed later.

THE MULTIVIBRATOR

The Vertical Oscillator

Now we know that the integrator circuit builds the vertical sync pulse into an "effective force." But, why? There must be a reason behind this building up the vertical sync pulse. Remember what has been said about

The Vertical Oscillator or Multivibrator Provides a

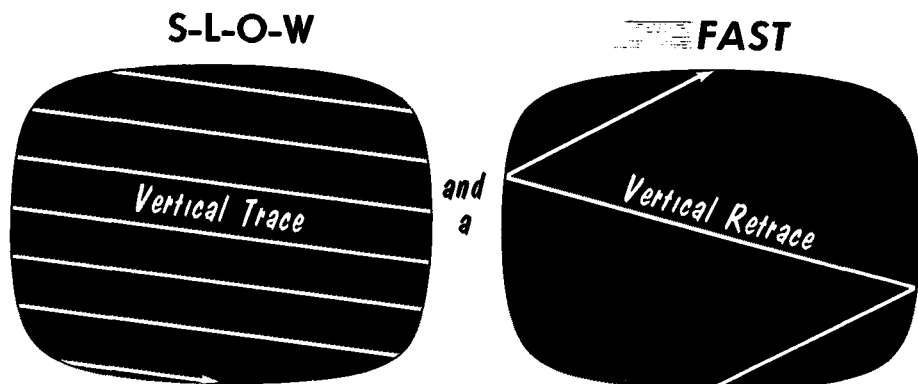

these sync pulses and the reason is clear. The vertical sync pulse *triggers* the vertical oscillator into pulling the scanning beam up and down over the face of the picture tube in *synchronism* with the camera scanning beam at the transmitting station. The swollen vertical pulse coming out of the integrator circuit, then, is to be applied to the vertical oscillator.

Our next step in the investigation of the vertical sync circuits of television receivers is to see what a vertical oscillator circuit looks like, and to find out just how it works.

If we don't as yet know how the vertical oscillator circuit is set up, we have some idea how it works from Volume II. The oscillator can be compared to an insect trying to climb up the slime-covered wall of a well. Trapped in this way, the insect is likely to be persistent. He journeys steadily upwards until, almost within reach of daylight, he slips dizzily back to where he started; he repeats the slow grind towards the top and once more slides swiftly back.

THE MULTIVIBRATOR

The Multivibrator

There are two general types of relaxation oscillators which are used in the vertical sweep system of television receivers:

The Multivibrator

The Blocking Oscillator

Although the multivibrator is a stranger to the person familiar only with radio receiver circuits, it actually consists of two very familiar circuit types put together. It is the resistance-capacitance amplifier, two stages of which are shown below.

The two stages are identical. Tube A is like tube B. C2 corresponds to C1, R3 to R1, and R4 to R2.

Two Resistance-Coupled Stages In Cascade

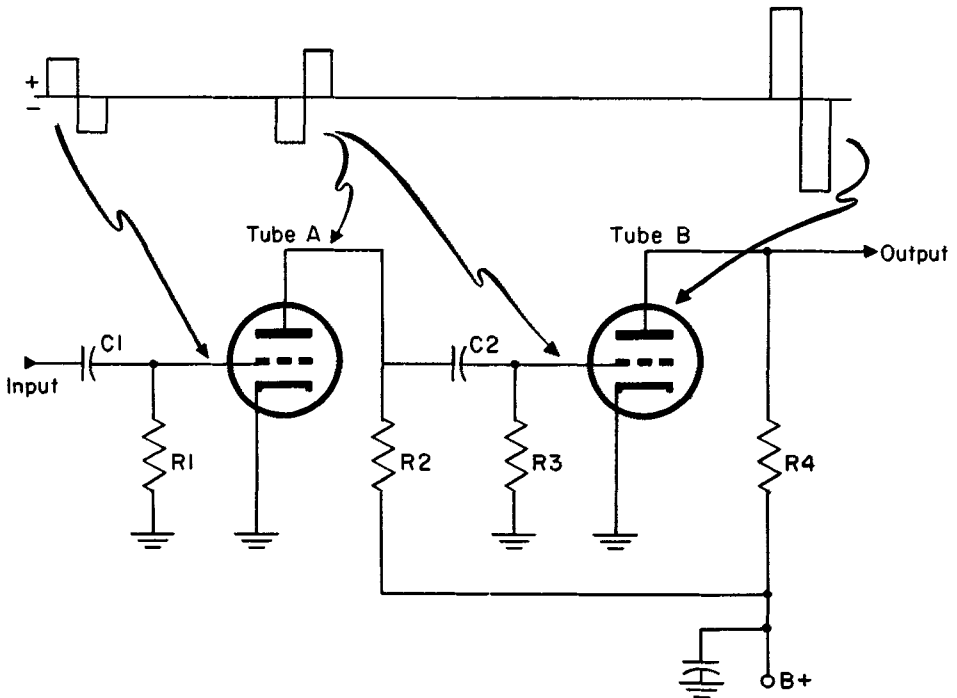

THE MULTIVIBRATOR

The Multivibrator (contd.)

If the grid of the tube A receives a positive-going voltage, the top of plate resistor R2 becomes negative-going. This negative-going voltage is passed on to the grid of tube B through C2. With a negative-going voltage on the grid of tube B the top of R4 is positive-going. We can say then that the presence of two stages repeats the input phase at the output, that is, the output is *in phase* with the input.

Let us now couple the lead labeled "output" back to the *input*. Connecting a wire from the top end of R4 to capacitor C1 links the output of this two-stage amplifier with its input; that is to say, we feed back an in-phase signal from the output of the system to its input. The expression

Feedback in the Multivibrator Circuit

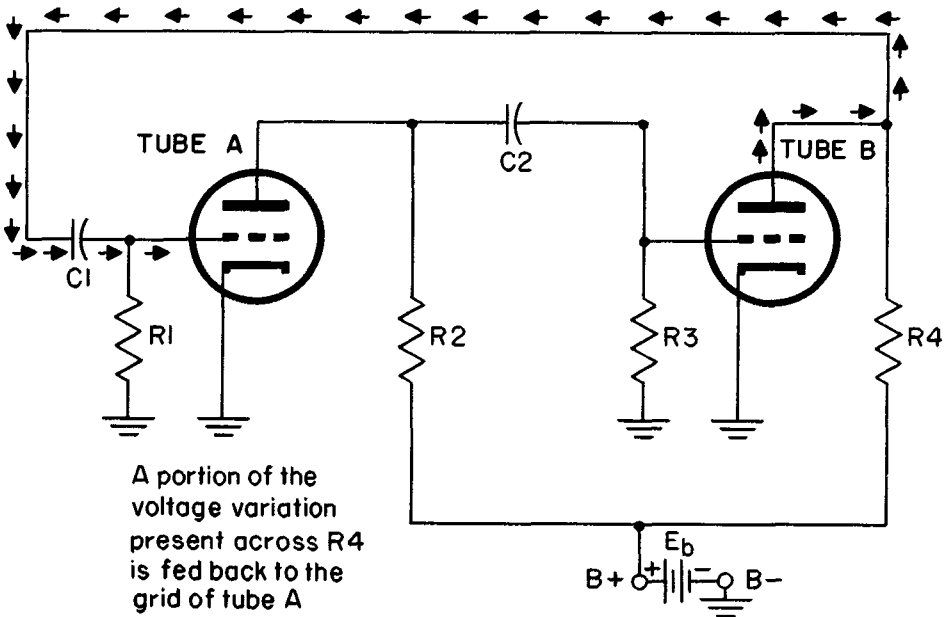

"feedback" should ring a bell as it is a radio technical term used in connection with oscillators. As a matter of fact, the circuit can oscillate without receiving any energy from an outside source!

Fundamentally, the circuit is an amplifier. If we take some of the voltage from the output and feed it to the grid of the first tube, *in phase* with the input grid voltage, then the voltage on that first tube's grid will be *strengthened*. If the grid voltage is raised sufficiently it can compensate for the losses in the circuit and will act as an oscillator.

THE MULTIVIBRATOR

Electrical Action in the Multivibrator

What is the order of electrical events that takes place in the circuit and what sort of oscillations does the circuit produce? To better analyze the circuit, suppose we correlate the circuit of the multivibrator with the action.

Let us assume a momentary impulse created in the circuit by closing the B+ supply circuit. Current begins flowing through R2 causing a varying voltage across R2. Let us say that it is negative-going. This negative-going voltage is applied to the grid of tube B through coupling capacitor C2. As a result of phase inversion in the second stage, the voltage variation at the top of R4 is positive-going. This rise in voltage at the plate of tube B is fed back to the grid of the tube A, increasing its plate current.

Now, if the plate current in A is increased, the voltage at the top of R2 is driven even further lower, the voltage at the top of R4 becomes more positive, and in turn the grid of tube A is made still more positive. All of this action takes place much more rapidly than we can describe. The voltage of tube A's grid rises very rapidly. At the same time, the voltage at the top of R2 is *dropping* at an equally rapid rate, and the grid of tube B is speedily driven more and more negative.

The rapid rise in voltage on grid A and the fall in voltage on grid B does not continue without reversal. After a short period, grid B is driven to its cutoff point and even beyond it; plate current in tube B ceases, and the voltage fed back to the grid of A no longer rises. For a moment, then, the action of the circuit is at a standstill, with the grid of A retaining its highly positive voltage, and the grid of B being very negative.

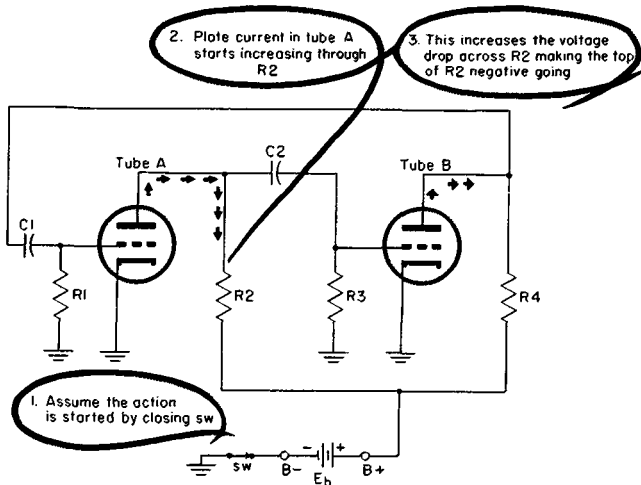

The Start of Action in the Basic Multivibrator

THE MULTIVIBRATOR

Electrical Action in the Multivibrator (contd.)

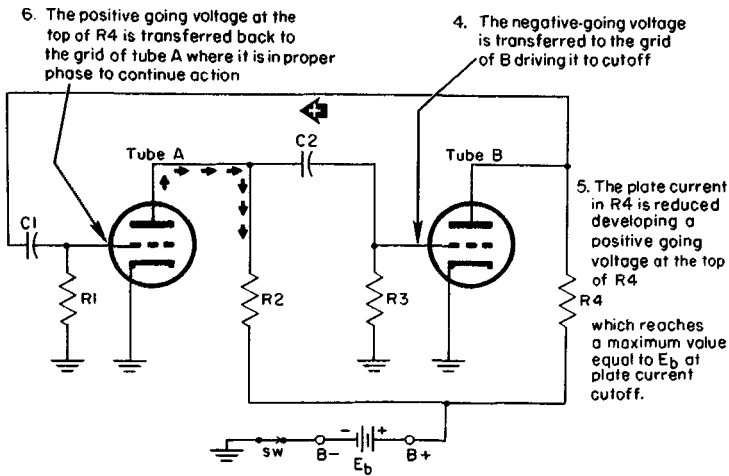

While all this is going on, C2 is accumulating a charge. With the action of the circuit temporarily stopped, C2 is able to discharge. It discharges through R3, but it can only do so slowly, since the resistor prevents an instantaneous discharge. As C2 discharges, the voltage of grid B becomes less and less negative, until finally it is less negative than cutoff, and plate current in tube B begins to rise. With the plate current of B on the increase, the voltage at the top of R4 starts falling. This voltage decrease is fed back to the grid of tube A through C1.

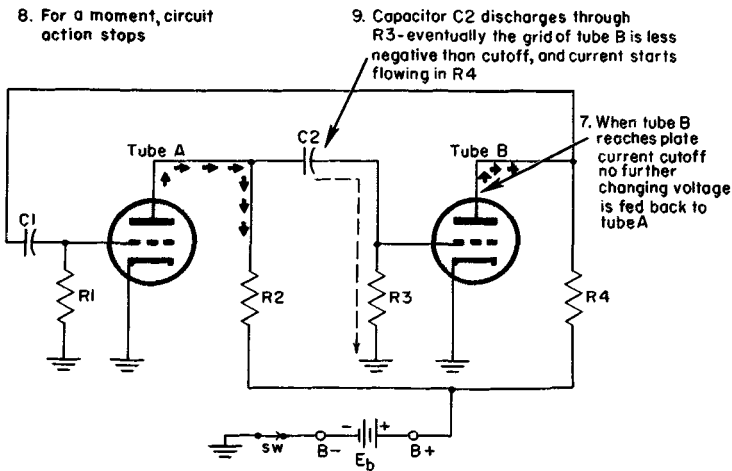

THE MULTIVIBRATOR

Electrical Action in the Multivibrator (contd.)

The voltage on the grid of A rapidly becomes increasingly negative, eventually going past the cutoff value. At cutoff the plate current in A ceases altogether, and once more the system is at a standstill, with the grid of A highly negative. During this quiet period, C1 discharges through resistor R1.

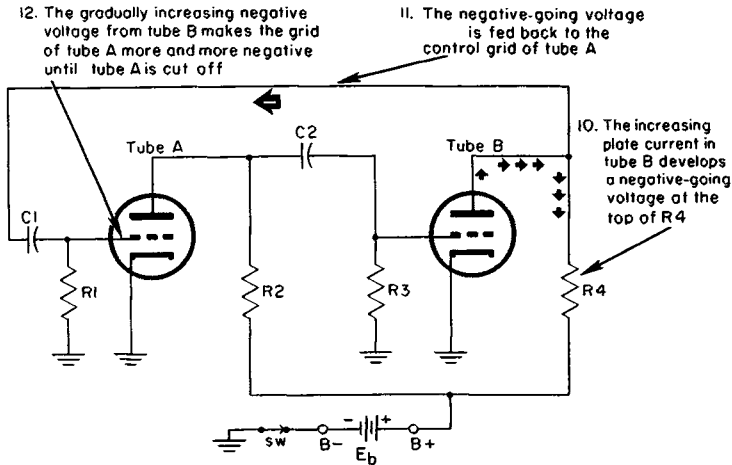

With the resistance of R1 opposing the flow of current, the capacitor discharge is achieved at a relatively slow rate, and the voltage on grid A slowly becomes less negative. Once more plate current begins flowing in tube A, and a repetition of the whole cycle we have described takes place.

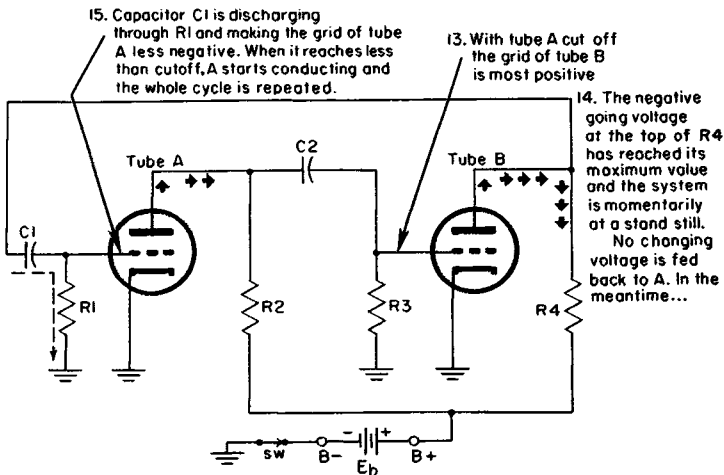

THE MULTIVIBRATOR

Wave Shapes in the Multivibrator

The word description of the multivibrator action that we have given is all very well, but a *picture* of what happens would be much better. Since our story revolves around the grid of tube B for the most part, suppose we take a close look at the action there first.

The graph below shows us what is happening at the grid of tube B in the multivibrator schematic. At zero time—the time which marks the beginning

Wave Shape Voltage at the Grid of Tube B

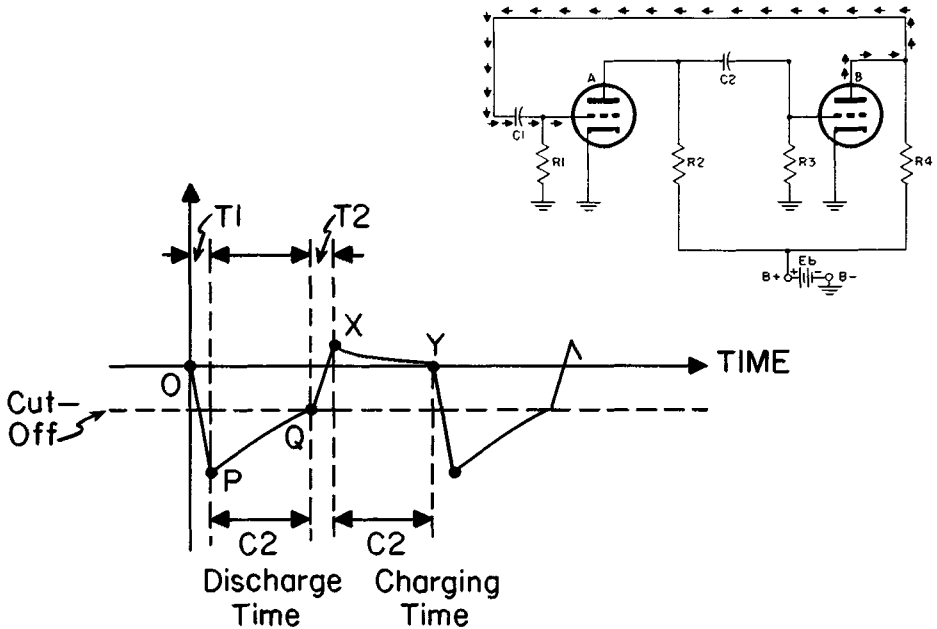

of our explanation—the grid voltage is zero. Then, as we explained, the grid voltage falls very rapidly in the negative direction, with point P being the most negative value. Since time is measured horizontally the horizontal distance between O and P, designated by T_1 , represents the *interval of time* in which the grid voltage drops from zero to its most negative value. The plate current cutoff voltage, as a negative voltage, is represented by the horizontal dotted line. As shown in the diagram point P is far more negative than cutoff.

THE MULTIVIBRATOR

Wave Shapes in the Multivibrator (contd.)

At point P, capacitor C2 is discharging through resistor R3. The grid voltage rises relatively slowly from P until it reaches the cutoff value at Q. At the instant the grid becomes slightly less negative than cutoff, plate current begins flowing in tube B, the grid of tube A starts going negative, and the grid voltage of tube B rises very rapidly in the positive direction to point X. The time represented by the distance between X and Y is one of those "standstill periods" we spoke of earlier. It is during this time interval that C2 charges up again. After Y, of course, the whole action repeats itself.

If we wanted to show the waveform of the voltage on the grid of tube A we could do so very easily remembering that, because of the phase-inversion action of a single stage, the grid of tube A is in its positive phase while the grid of B is in its negative phase. The grid of tube B is in its negative phase from O to just an instant after Q. It is during this same time that grid A is in its positive phase.

Wave Shape Voltage at the Grid of Tube A

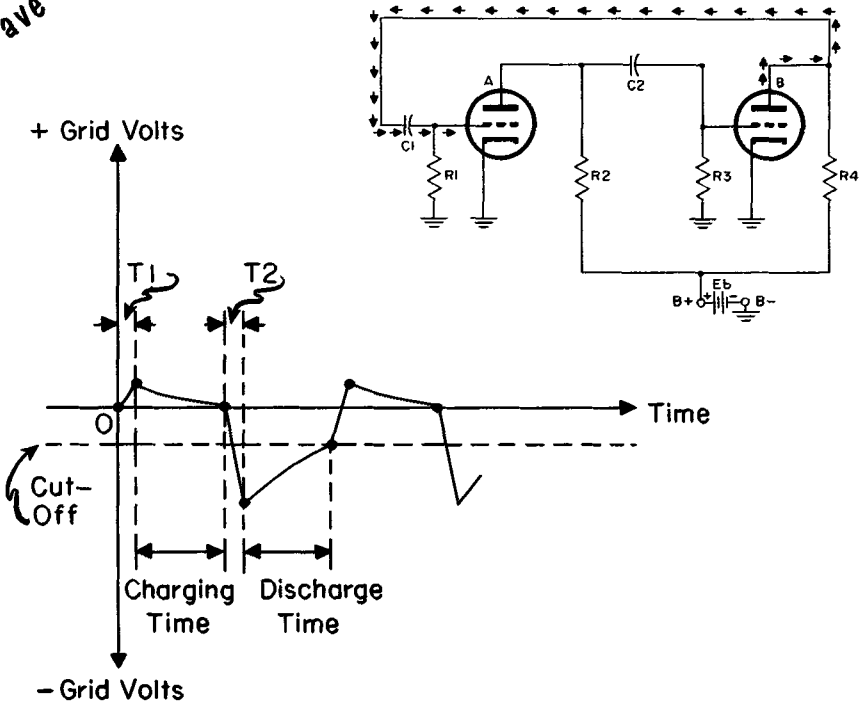

THE MULTIVIBRATOR

Frequency of the Multivibrator Wave

The waveforms illustrated have been exaggerated to show details. If they were drawn strictly to scale, the horizontal distances T_1 and T_2 would be practically zero compared, for example, to the much longer charging and discharging intervals of the capacitors C_1 and C_2 . The two waves, then, would look like this illustration.

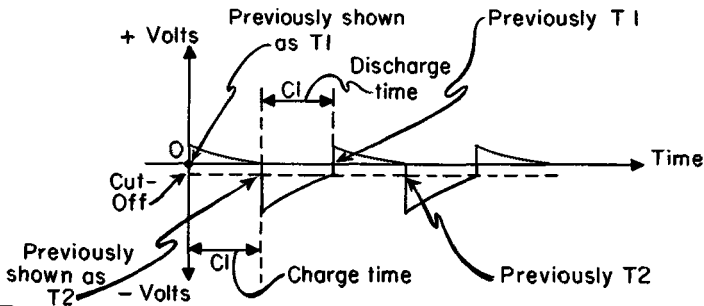

(A) GRID OF TUBE A

WAVE SHAPES OF VOLTAGES AT BOTH GRIDS

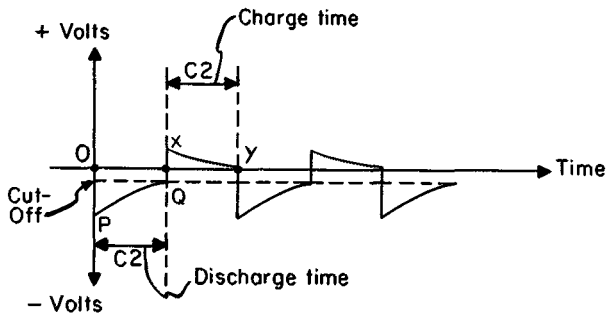

(B) GRID OF TUBE B

Suppose we look for a moment at drawing of tube B which shows that, at the start of the action of the multivibrator, the grid voltage of tube B drops very sharply, then rises slowly as C_2 discharges, and so on. At point Y, the whole sequence of events begins over again, for Y marks the beginning of a second drop of the grid voltage followed by the slow discharge of C_2 . We can then say that the multivibrator has completed *one cycle* of oscillation when the grid voltage goes through a variation from O to Y. The horizontal distance from O to Y is the time during which one cycle is completed, and this time interval is defined as the *period* of oscillation or frequency of the oscillator.

THE MULTIVIBRATOR

Frequency of the Multivibrator Wave (contd.)

Is there any way we can vary the period of oscillation of the multivibrator? The time for the first half-cycle—the horizontal distance from O to Q—is occupied by the discharge of capacitor C2. Similarly, the time for the second half of the cycle, the distance from Q to Y is taken up by the charge of C2.

If we reduce the time C2 needs to charge or discharge, then the period of the oscillation will be shortened and the frequency will be raised. We do this by lowering the capacitance of C2.

C2 charges and discharges through R3. Hence the resistance of R3 determines the length of time the capacitor takes to charge or discharge. By making R3 variable we can vary the period of oscillation of the multivibrator.

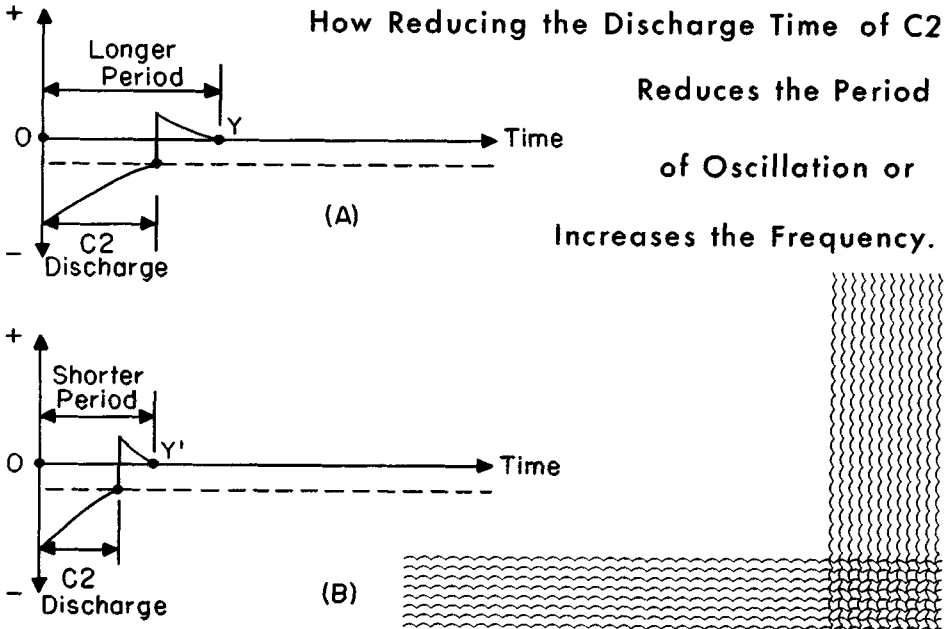

This illustration shows how the period of oscillation of the multivibrator can be changed by varying the amount of resistance through which C2 must discharge. In (A), the resistance is fairly large, and the capacitor takes a fairly long time to discharge; in (B) however, the size of the resistance has been reduced, and the time for the discharge of C2 has been similarly reduced. The period is shortened.

Shortening the period of the oscillator's electrical cycle has the effect of increasing the oscillator's frequency. If the time taken for a single cycle is shortened, more cycles can occur in 1 second.

THE MULTIVIBRATOR

Amplitude of the Multivibrator Wave

Although we have managed to change the frequency of the multivibrator oscillation, the *amplitude* of the two waves is still the same. This is not surprising; it is strictly in accord with the theory of oscillators. The amplitude and frequency of a wave are two different quantities, and it is entirely possible to change one without affecting the other. By another arrangement, we can change the *amplitude* of the multivibrator's wave.

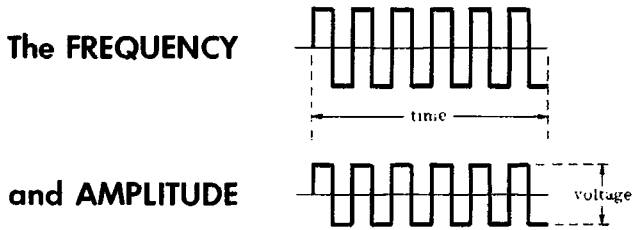

of the Multivibrator wave are independent.

-BUT-

Increasing the Amplitude of Plate and Grid Voltage

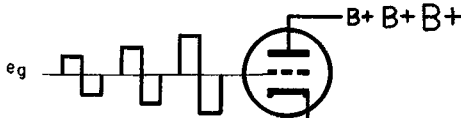

Increases the Amplitude of the Plate Current

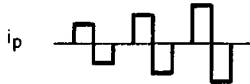

From what we know about the behavior of tubes, it should be easy to figure out a way to change the amplitude of the wave. The current that flows in either of the two multivibrator tubes depends on the strength of the positive voltage that is furnished the plates of those tubes by the power supply. If we increase the plate voltage of tube B, for example, the current flowing in the tube will be larger, and the voltage it feeds back to the grid of tube A will also be greater. Obviously, then, the amplitude—or strength—of the multivibrator signal can be varied by changing the *plate voltage* on one of the tubes.

It is true, as we have just stated, that the plate current of a tube depends on the voltage applied to the plate by the power supply. But it is also true that the plate current of a tube depends on the varying signal applied to the tube's grid. Given the voltage which appears on the grids of tubes A and B of the multivibrator, we can see what the plate current form in either tube looks like. Suppose we examine tube B.

THE MULTIVIBRATOR

Plate Current and Plate Voltage Waveforms

The grid voltage at tube B begins at zero, and drops to point P which is more negative than cutoff. Since the plate current decreases as the grid voltage becomes more negative, at point E of the grid voltage waveform the plate current is zero, since E marks cutoff voltage on the grid. As long as the grid voltage is at cutoff or is more negative than cutoff, the plate current will remain at zero. Any negative voltage greater than E will have no effect on the zero plate current.

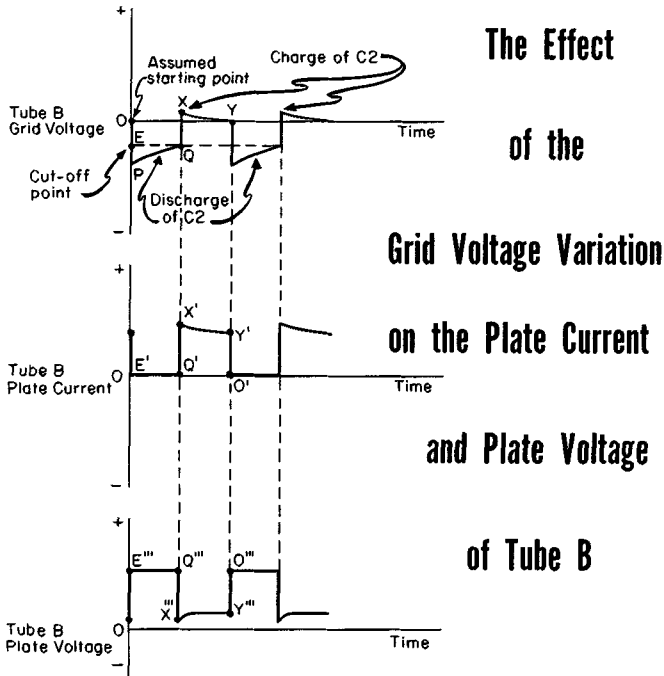

From P to Q, the grid voltage rises slowly. But all during that time, the grid is still more negative than cutoff. For the P' to Q' time interval, then, the plate current remains at zero. But point Q is at the cutoff level. Any rise in grid voltage above Q will produce a corresponding rise in plate current. From Q to X, where the grid voltage rises very sharply, there will be an equally sharp rise in the plate current. (Q' to X'). From X to Y the voltage falls off rather slowly, but never during that fall does it get as far negative as cutoff. The plate current, therefore, varies accordingly.

If we construct the plate current of tube A in the multivibrator in the same way, we will find that it is an inverted image of the plate current curve of tube B. Both these plate current pictures are very nearly square waves. We shall see later just how important such square waves of plate current are.

REVIEW

The function of the Sync Clipper

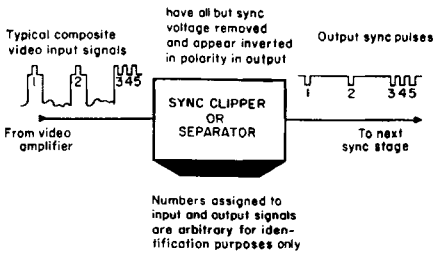

2. **The Sync Clipper and Noise Limiter.** In this highly effective circuit a positive signal is fed to grid 3. A negative signal is fed to grid 1. By having grid 1 act as a switch to remove noise pulses, the output waveform is virtually free from noise. Grid 3 action is conventional.

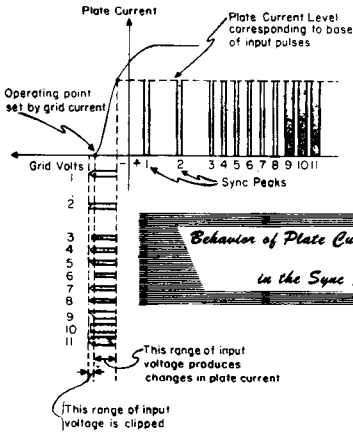

SYNC CLIPPER AND NOISE LIMITER

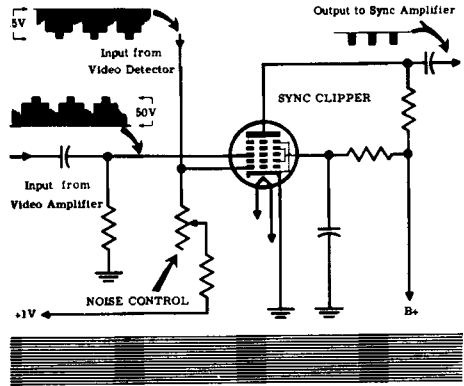

3. **The Sync Amplifier.** The incoming sync pulses are shown with their peaks no longer square. Since the ragged peaks are well beyond the cut-off point, they cannot influence the plate current. The plate current wave therefore has sharp corners.

4. **The Integrating Circuit** consists essentially of series-resistance and shunt-capacitance, the output being taken off the last capacitor. The output voltage is a function of the duration and amplitude of the input voltage. The vertical integrator distinguishes between vertical and horizontal sync as well as equalizing pulses.

The Integrating Circuit

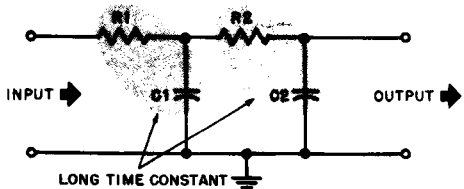

REVIEW

5. *Integrating Action.* The serrated vertical sync pulses are applied to the integrator. These serrations are all wider than the horizontal or equalizing pulses. The charge accumulated in the integrator circuit increases with each serration. The integrator builds only the serrated vertical sync pulse up to the triggering voltage. The horizontal and equalizing pulse charges have no effect. The very narrow equalizing pulses help dissipate any residual charge remaining from the horizontal pulses. The buildup of voltage due to the six vertical sync pulses is the same for each field time-wise, and so trigger the vertical oscillator at the same time for each field. Across the plate load resistor R2 appears a signal voltage made up of more or less squared, horizontal, equalizing, and vertical sync pulses. Part of this signal voltage is fed into the integrating circuit. The remainder of this same output signal voltage developed across R2 is fed into the horizontal sweep system.

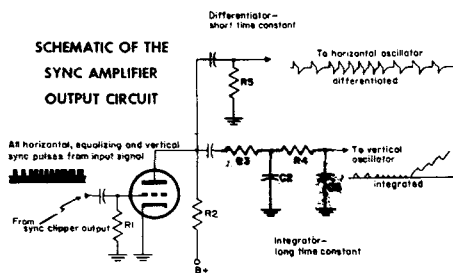

Two Resistance-Coupled Stages In Cascade

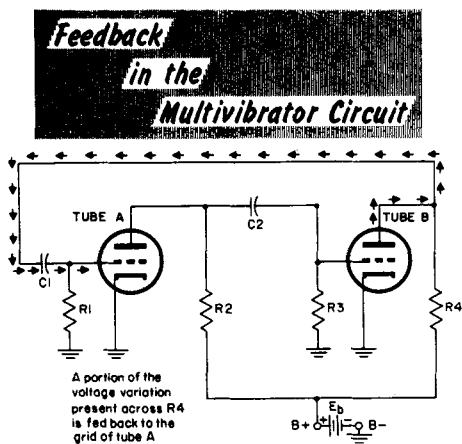
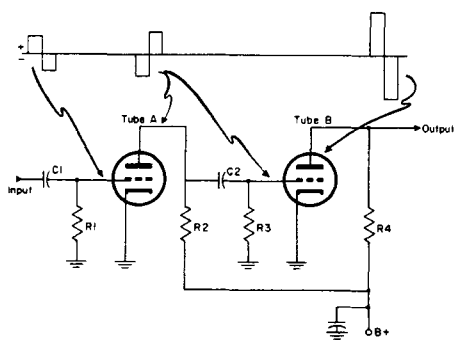

6. *The Multivibrator.* Consider the two-stage resistance-capacitance coupled amplifier. If the grid of tube A received a positive-going voltage, the top of plate resistor R2 becomes negative-going and this voltage is passed to the grid of tube B and the top of R4 is positive going. We can say that the output is in phase with the input. Let us now connect the lead labeled output to the input. We feed back an in-phase signal from the output of the system to its input. If the grid voltage of the first tube is raised sufficiently, the circuit losses are compensated. The circuit will act as an oscillator.

THE CATHODE-COUPLED MULTIVIBRATOR

The Cathode-Coupled Multivibrator

Another type of multivibrator, made up in a slightly different way, is even more popular with television receiver manufacturers.

This type of multivibrator, known as the *cathode-coupled* multivibrator, is a close cousin to the basic multivibrator. We retain the resistance coupling between the first and second stages, also the phase inversion of

The Cathode Coupled Multivibrator

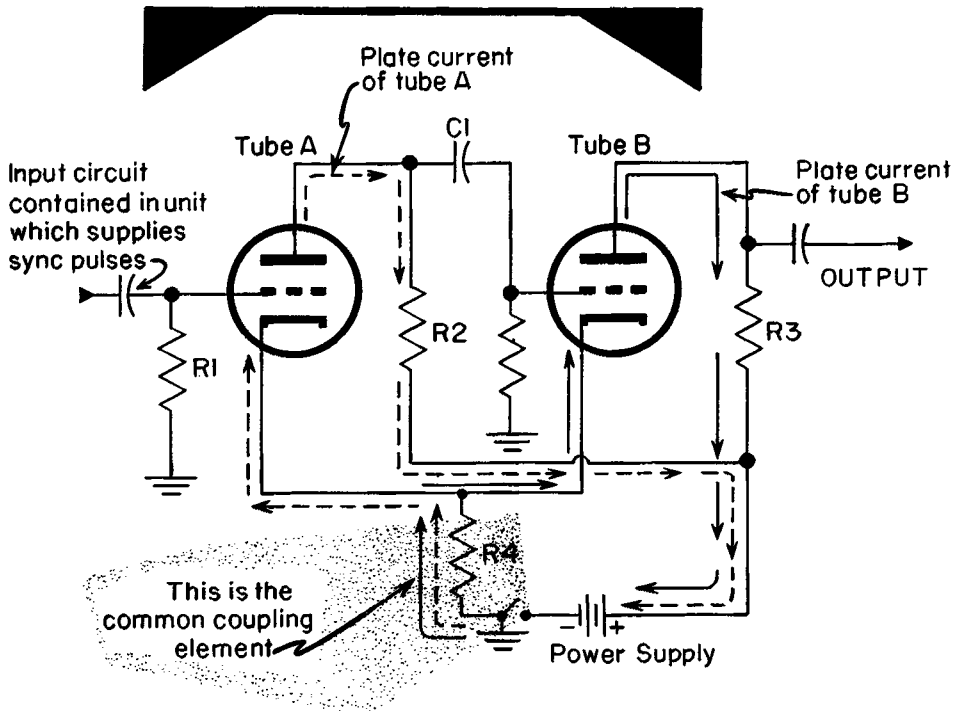

signal between the grid of the first tube and the grid of the second. But what seems to be missing in this circuit is the feedback arrangement by which the signal at the output of tube B is fed back to the grid of tube A.

The feedback arrangement is in the circuit, but does not have the same form as in the basic multivibrator. Coupling between tube B and tube A occurs through resistor R4. Both cathodes have this resistor as a common plate current path. Plate current in tube B must pass through R4 on its way back to the cathode of tube B. Since this same resistor is in the cathode circuit of tube A, the signal developed across R4 as a result of the rise and fall of tube B plate current will be fed back to the grid of tube A.

THE CATHODE-COUPLED MULTIVIBRATOR

The Practical Cathode-Coupled Multivibrator Circuit

The two triodes, tubes A and B, are within the single envelope of a duotriode. Note the capacitor C1, between the plate of tube A and the grid of tube B, and the cathode-coupling resistor, R4; both were in the previous circuit. But why two variable resistors, R5 and R7? What functions do R6 and C2 serve?

Although we have not seen these resistors before, it is easy to explain their purpose. R5 varies the total resistance between the grid of tube B and chassis, thereby determining the rate of discharge of C1—hence the frequency of the oscillator. Earlier we explained how varying the resistance between the grid of tube B and the chassis of the basic multivibrator has the effect of changing the *frequency* of the oscillator. We can go still further. You might recall from an early lesson that the “hold” control in the vertical oscillator is the device by means of which the frequency of the vertical oscillator is regulated—R5 is the *vertical hold control*.

Varying the resistance of R7 controls the total resistance between the plate of tube B and the positive terminal of the B supply. If this resistance is *increased*, the voltage at the plate of tube B decreases. A variation of the plate voltage on tube B results in a change in the *amplitude* of the multivibrator output. R7 is the *vertical size control*.

As the diagram shows, the grid of tube A is connected to the vertical integrator circuit. The idea behind this connection is that the large vertical sync pulse developed by the integrator may keep the oscillations of the multivibrator under control. Notice also that a resistor and capacitor in series—R6 and C2—are wired from the plate of tube B to chassis.

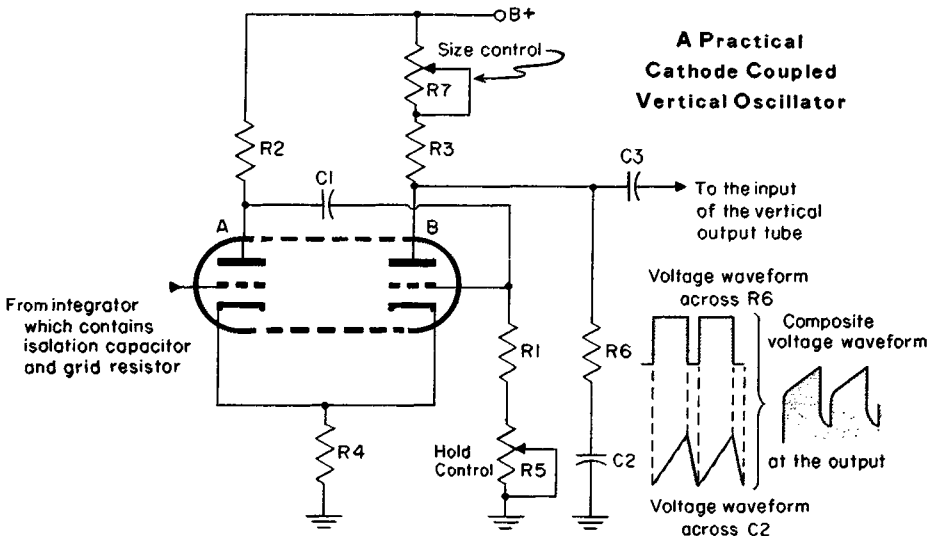

THE BLOCKING OSCILLATOR

The Blocking Oscillator

Assume that a small positive voltage is applied to the tube grid. Thus electrons flow from cathode to plate and through L2, R3, and part of R4, to B+.

Because of the voltage drop across these resistors, the voltage at the plate swings downward (negative-going). With L1 and L2 wound around the same iron core, the two windings are coupled. By virtue of this coupling, the drop in plate voltage is *reversed in phase* to a positive rise in voltage. This feedback positive-going voltage swings the originally slightly positive grid *even more strongly positive*.

This further increases the plate current so that the plate voltage swings downward even more. The phase-reversed feedback voltage increases the positive potential on the grid and the plate current continues to rise rapidly. But plate current cannot rise indefinitely because *saturation* soon occurs.

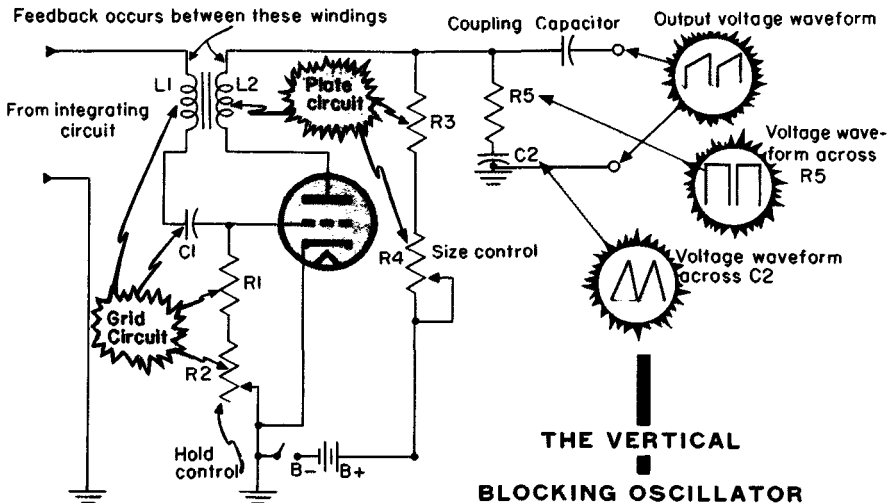

Since the feedback voltage to the grid depends on changes in plate current, the failure of the plate current to rise any further means that the transfer of positive voltage to the grid ceases. Without the feedback to sustain it, the plate current starts to fall. With *falling* plate current, the voltage drop across the resistor in the plate circuit is reduced and the plate voltage becomes positive-going. The voltage fed back to the grid now is *negative*. With negative voltages applied to the grid, plate current in the tube drops rapidly, making the plate even more positive. Eventually the grid is driven so far negative that the tube is cut off.

With the grid more negative than cutoff, plate current ceases completely. Now we have an "inactive" period as in the multivibrator. During this inactive period C1 discharges, raising the grid voltage slowly in the positive direction. When it is slightly above cutoff, current flows once again.

THE BLOCKING OSCILLATOR

Controls in the Blocking Oscillator

Just as we did with the multivibrator, we can vary the *frequency* of the blocking oscillator by varying the time of discharge of the capacitor in the grid circuit. Since that capacitor—C1 in the schematic—discharges through the grid resistors, we can vary the time of the discharge by varying R2. As we shall find, any tendency of the picture on the screen to roll in a vertical direction can be corrected by adjusting the frequency of the vertical oscillator. Because proper setting of R2 can hold the picture steady, it is known as the *vertical hold control*.

===== THE BLOCKING OSCILLATOR CONTAINS CONTROLS FOR... =====

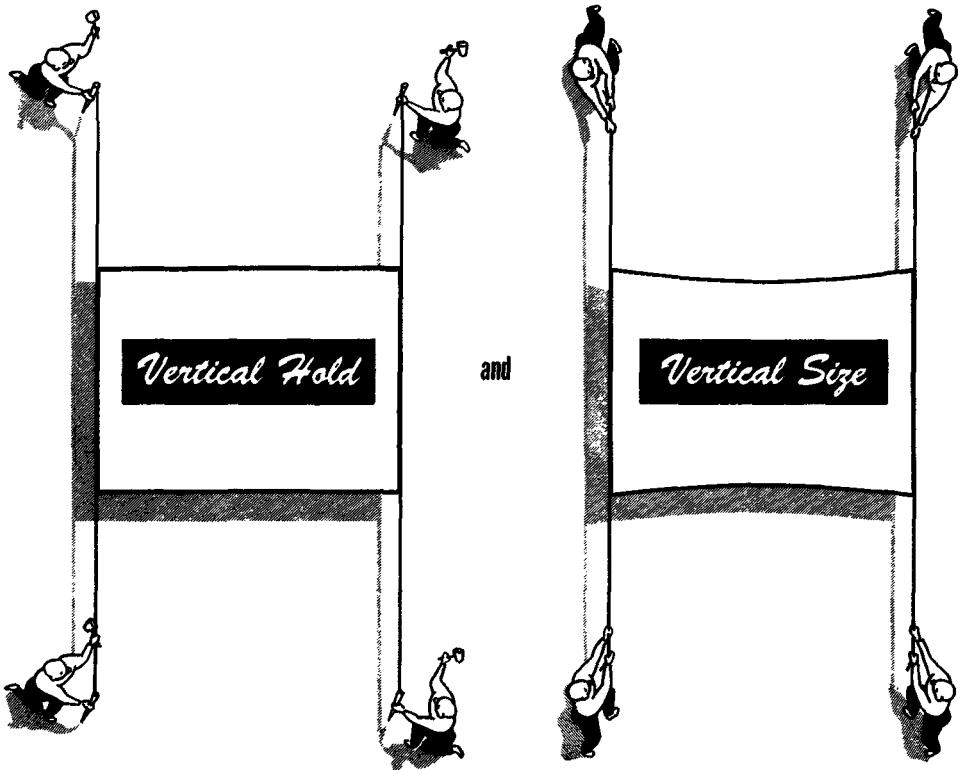

Changing the resistance of R4 can change the *amplitude* of the oscillator's output waveform. Since the amplitude of the vertical oscillator's output controls the height of the picture, R4 is called the *vertical size control*. In most receivers, the vertical size control is on the back of the chassis for the service technician's use. The *hold* control, on the other hand, is usually placed on the front panel for the set-owner's convenience if the picture should slip either up or down.

THE BLOCKING OSCILLATOR

Waveforms in the Blocking Oscillator

From the description we have just given, we should be able to construct the waveform of the blocking oscillator grid voltage. The whole cycle of action begins with the grid voltage going slightly positive from a zero value. Both plate current and grid voltage rise rapidly together. Then, when saturation is reached, the grid voltage drops just as rapidly until it becomes even more negative than cutoff. Just this part of the cycle is illustrated.

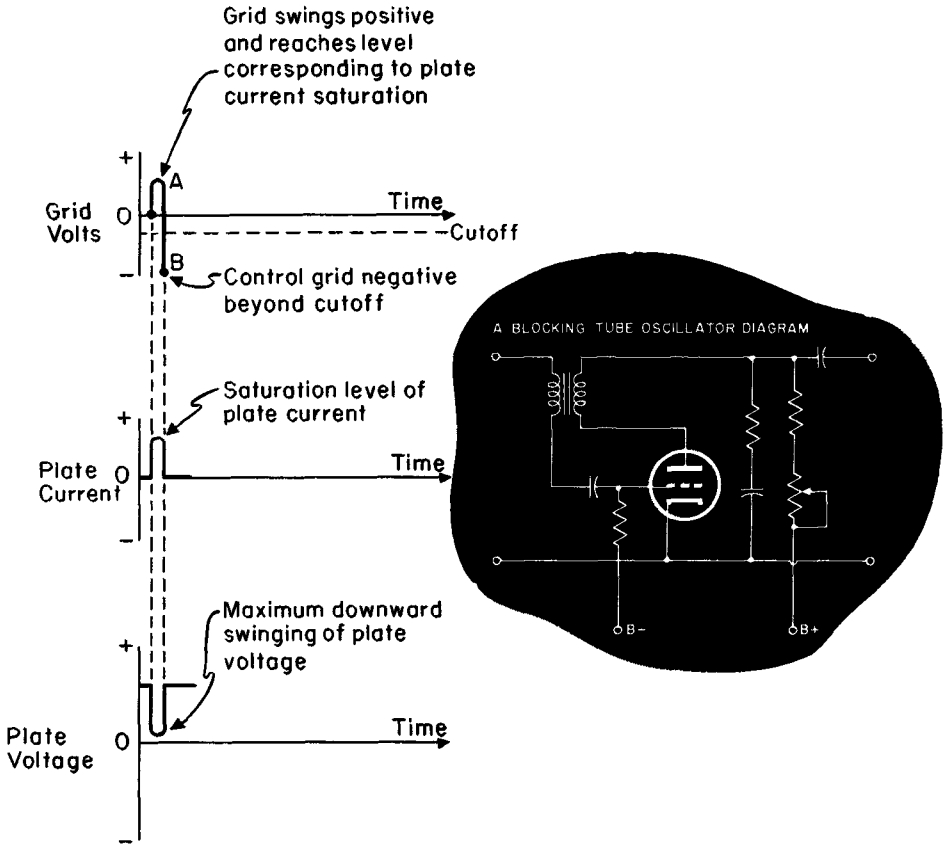

Blocking Oscillator Grid Voltage Waveform

The grid voltage is shown rising very quickly to a maximum at A, then dropping just as sharply to point B, which is far more negative than cutoff. B, now, is just the beginning of the quiet period during which the capacitor C1 discharges.

THE BLOCKING OSCILLATOR

Waveforms in the Blocking Oscillator (contd.)

The next phase is the quiet period, with the grid voltage rising slowly, along with the capacitor discharge, until cutoff is reached.

Once the cutoff point is reached, the very rapid rise in grid voltage takes place again, and the cycle is complete at point P.

The Next Phase of the Grid Voltage Variation

*A Complete Cycle of the
Grid Voltage Variation*

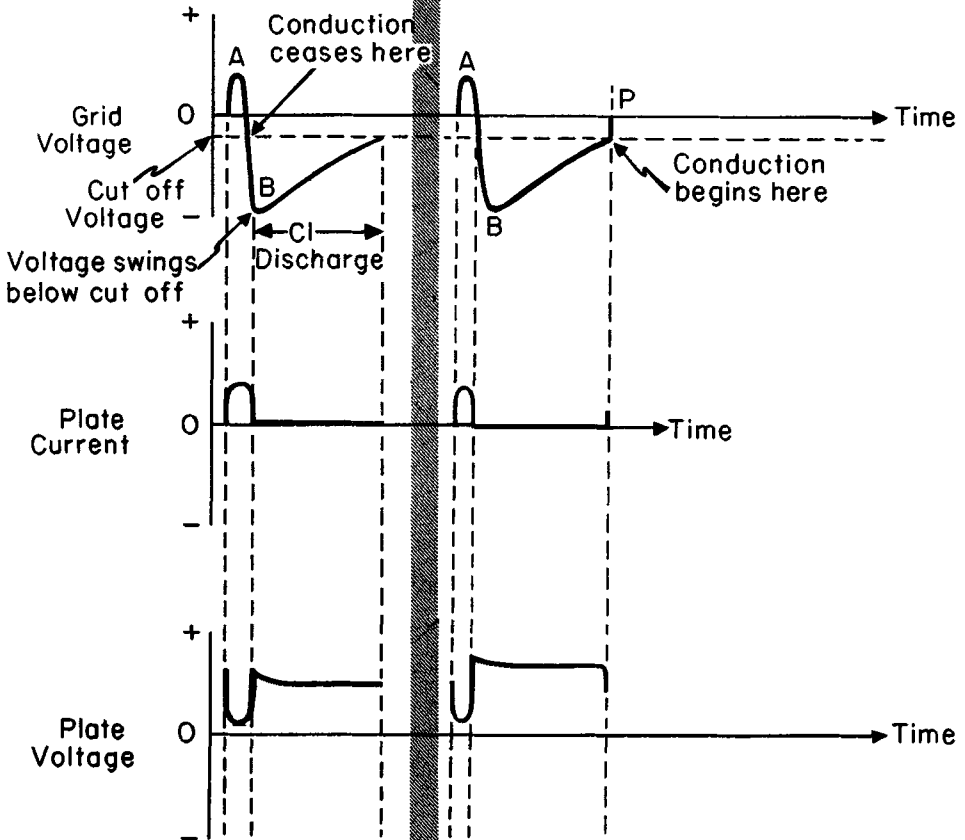

Of course, the grid voltage does not stop at P; it keeps rising until it hits a peak at the same level as point A, and goes through exactly the same motions as it did before.

THE BLOCKING OSCILLATOR

Waveforms in the Blocking Oscillator (contd.)

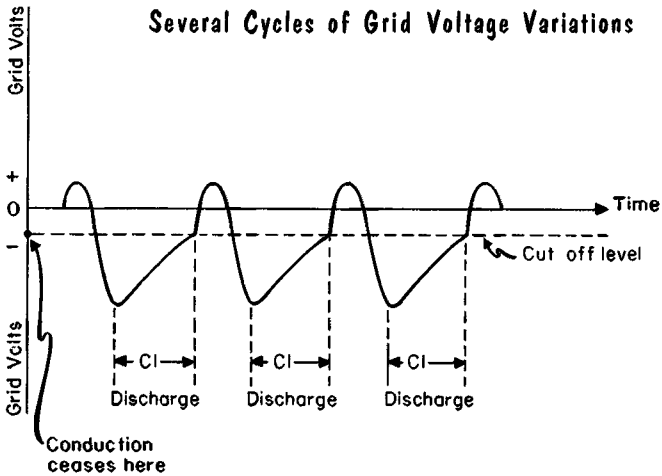

With the aid of the figure, we can see how the plate current in the blocking oscillator tube varies. Remembering the rule that the plate current waveform corresponds to the grid voltage *except* where the grid voltage becomes *more negative* than the cutoff value or more positive than the saturation value, we are able to draw the plate current in the tube.

The Plate Current

in the
Blocking
Oscillator

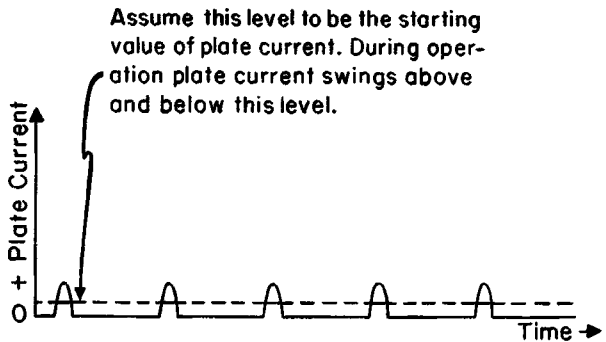

The plate current curve does not show the complete capacitor discharge action since that takes place at voltages more negative than cutoff. All during the capacitor discharge time, the plate current remains at zero.

Looking at the curve we can see that this plate current waveform is somewhat like a *square wave*, just as the plate current waveform in the multi-vibrator was close to a square wave. In fact, that is one of the requirements of the relaxation oscillator used in the sync circuit of a television receiver—its ability to produce a square-waved plate current.

THE BLOCKING OSCILLATOR

Syncing the Vertical Blocking Oscillator

We have seen how the integrator circuit adds the vertical sync pulse serrations into one pulse while ignoring the other sync peaks. The vertical sync pulse at the integrator output is fed to the blocking oscillator to force it to operate at the vertical frequency—that is, 60 cycles. The vertical oscillator is designed to run free at *approximately* that rate. Applying the integrated vertical sync pulse to the grid of the vertical oscillator “drives” it at this frequency.

Remember that the output of the integrator consists of pulses of *positive* polarity. *Positive* pulses, when applied to the grid of the blocking oscillator, can raise the grid above its cutoff value, and so force it to start conducting sooner than it normally would. By applying pulses of the correct frequency we can force the oscillator to conduct at the precise instant necessary for correct functioning frequency-wise (synchronization).

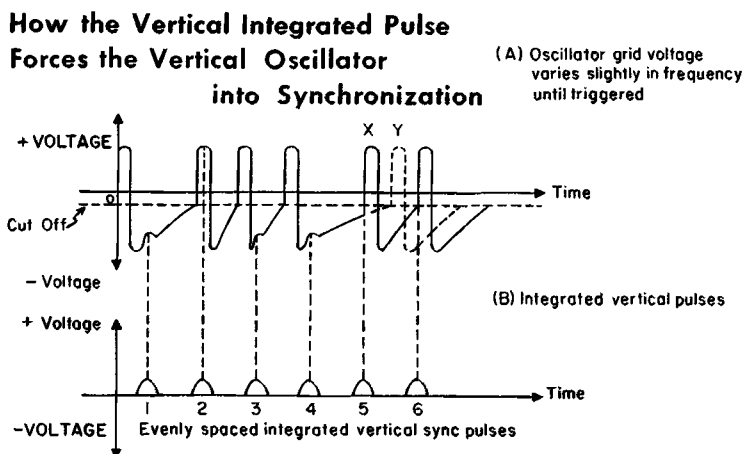

In (A) is shown the grid voltage of the blocking oscillator, and just below it, in (B), are the integrated vertical pulses. Pulse 1 is just above the point where the grid voltage is at its most negative. At this point, the sync pulse is powerless to affect the oscillator frequency since it is not positive enough to bring the tube out of cutoff. Pulse 2 can do no better, because it arrives at a time when the grid voltage is positive anyway.

Pulses 3 and 4 are in the same category as pulse 1. But pulse 5 appears on the scene when the grid voltage of the oscillator is approaching the point where the tube is ready to “fire.” Pulse 5 adds just enough positive voltage to trigger the blocking oscillator into conduction at X. The broken line illustrates what the timing (Y) of the oscillator *would have been* had the triggering pulse not come along. From this moment on, the integrator pulses keep the blocking oscillator synchronized.

WAVE SHAPING

The Sawtooth Shaping

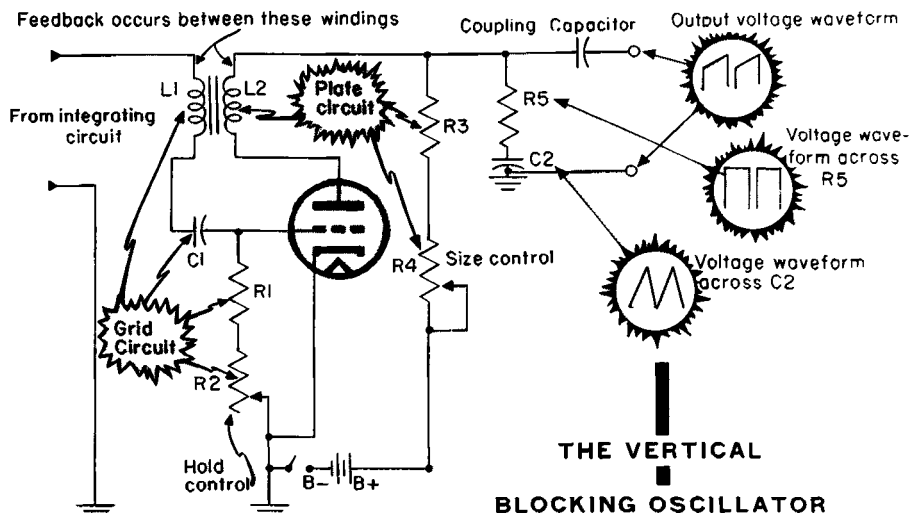

Note C2 and R5. This circuit produces a specially shaped voltage which is used ultimately for vertical deflection in the picture tube.

To explain the production of this special waveform, let us examine the schematic diagram of the blocking oscillator, paying particular attention to the series circuit that consists of R4, R3, R5, and C2. This circuit may be considered to be connected across the d-c source since it finally returns to ground at the bottom of C2.

When the system is first turned on, C2 is charged from the d-c source, obtaining its voltage through all of the series components mentioned above. This might be considered to take place while the blocking oscillator triode is just warming up and has not yet begun to oscillate.

Now consider what happens when the tube begins to conduct during its first cycle of blocking oscillation:

not only will the normal plate current flow freely through the tube, but capacitor C2 will also be able to discharge through it. The discharge current will flow through the tube, L2 and R5. None of these parts represents really high resistance, so C2 discharges very quickly.

We say the *time constant* of the C2-R5-L2 tube combination is quite low. This permits C2 to lose a large portion of its charge in a very short time.

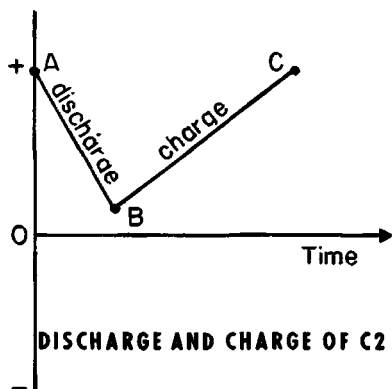

WAVE SHAPING

The Sawtooth Shaping (contd.)

As we have said, we are starting with a charged capacitor. This is at point A in the figure. When the tube conducts, C2 discharges through a relatively low resistance. This is the line from A to B, representing fast decrease of voltage from some positive value at A to much lower positive value at B.

Before C2 can discharge completely, however, the tube stops conducting, its plate current stops flowing, and it now looks like an open circuit to the capacitor discharge path. This occurs during that part of the blocking oscillator cycle when the grid is driven beyond cutoff by the action of the feedback circuit, as previously described. Cutoff is marked by point B in the drawing above. Now C2 again begins to charge from the d-c source. In this case, the charging current must flow through a high-resistance path including R5, R3, and R4 so that the rate of charge is very slow. Thus, the voltage across C2, in going from point B to point C, rises much more slowly than it fell.

When point C is reached, the tube again conducts and quickly discharges C2. One cycle of this charge and discharge action is thus completed when the voltage goes from A to B to C. The new cycle begins with the discharge starting at point C.

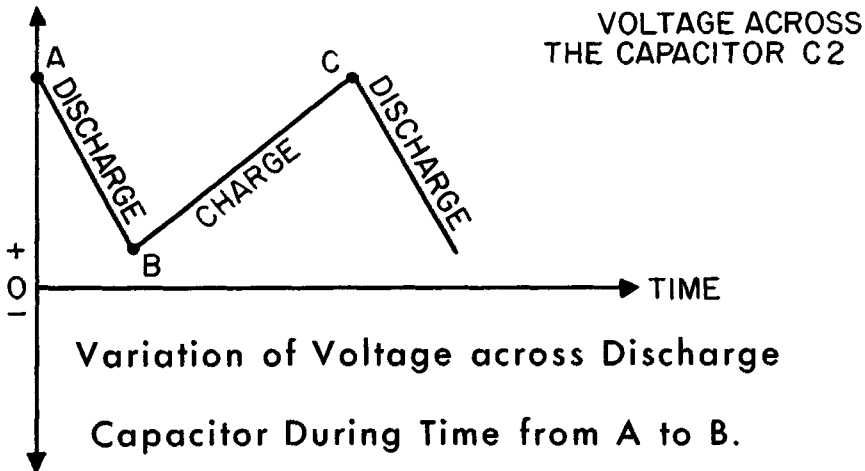

The voltage changes during charge and discharge follow straight lines, as the drawing shows, and for this reason are said to be *linear*. This linearity is very important in producing an undistorted television picture and a great deal of care must be taken in designing the discharge circuit to obtain it. The time constants must be just right otherwise the voltage may follow curved lines, producing short squat bodies and long narrow faces on the screen. The problem of linearity and its adjustment will be discussed in more detail later on.

WAVE SHAPING

The Sawtooth Shaping (contd).

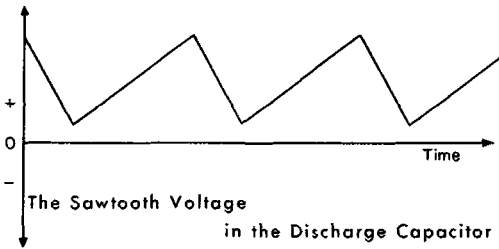

As the discharge capacitor C2 completes cycle after cycle, the voltage across its terminals forms a sawtooth wave. The voltage drop across R5 depends upon the current that flows through it. So think in terms of the charge and discharge current before translating these into voltages.

The circuit constants are adjusted so that C2 charges and discharges *linearly*. To obtain a linear effect, the current that flows into the capacitor during the charging process must do so at a constant rate throughout this part of the cycle. So, while the capacitor is slowly charging, a small but steady current must flow through R5, causing a similar steady voltage drop across it (the voltage from B to C).

The Voltage Across the Resistor in the Discharge Circuit

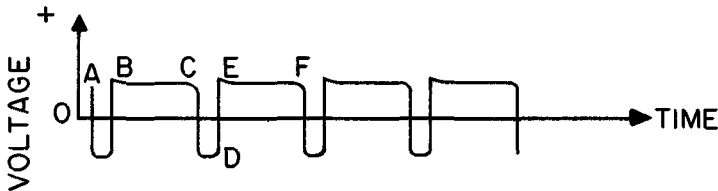

As soon as the blocking oscillator tube conducts, C2 discharges quickly through R5. Now the current is in the reverse direction through the resistor as compared with the charge portion of the cycle. Hence, the voltage drop across R5 suddenly reverses and drops almost instantaneously into the negative region—from C to D. At this point conduction stops, the steady current begins to flow *into* C2 again, once more giving rise to a steady positive voltage drop across R5 (points E to F).

The waveform of repeated cycles of this voltage drop across R5 is that of a square-wave in contrast to the sawtooth wave of voltage developed across C2 in series with it.

The voltage across *both* in series should be the sum of the two voltages. That is, the voltage across the whole discharge circuit of resistor and capacitor is a combination of sawtooth and square wave.

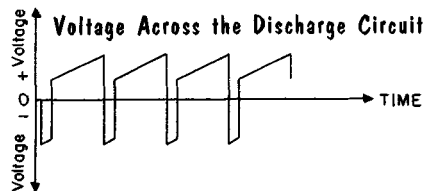

WAVE SHAPING

Feeding the Vertical Deflection Coils

At this point it is natural to ask why we should want a summed-up voltage having this so-called *trapezoidal* waveform. The underlying reason is this: modern television receivers use electromagnetic deflection to sweep the electron beam up and down the face of the picture tube. This deflection is produced by the vertical deflection coils which are large, specially shaped inductors. To obtain the linear sweep so necessary for an undistorted picture, the *current* (not voltage!) through the inductors must have a sawtooth waveform. Now the question resolves itself into: "What kind of voltage is required to cause a sawtooth current to flow through an inductor?"

It is well known that voltage having a square-wave form will cause a sawtooth current to flow through a *pure* inductance having absolutely no resistance. But practical deflection coils *do* have resistance. As we know from

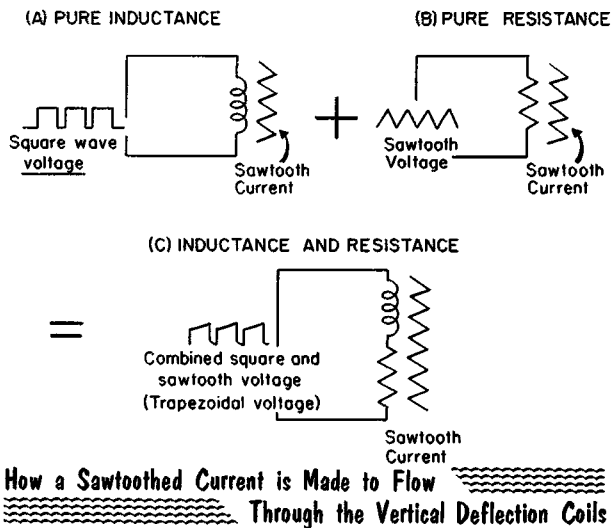

d-c theory, the current through a resistor always has the same form or shape as the applied voltage. From this we can conclude that a sawtooth current will flow through a pure resistance only if a sawtooth voltage is applied across it.

Let us now combine these two ideas in the manner suggested by the above figure. A trapezoidal voltage—comprising a combined square-wave and sawtooth voltage—applied across the terminals of a practical deflection coil having both inductance and resistance, should result in a sawtooth current through the combination. The fact that it does is borne out in practice. Hence, we should stow away in our minds the fact that a trapezoidal voltage produces a sawtooth deflection current in a practical vertical deflection coil.

VERTICAL OUTPUT SYSTEM

The Vertical Output System

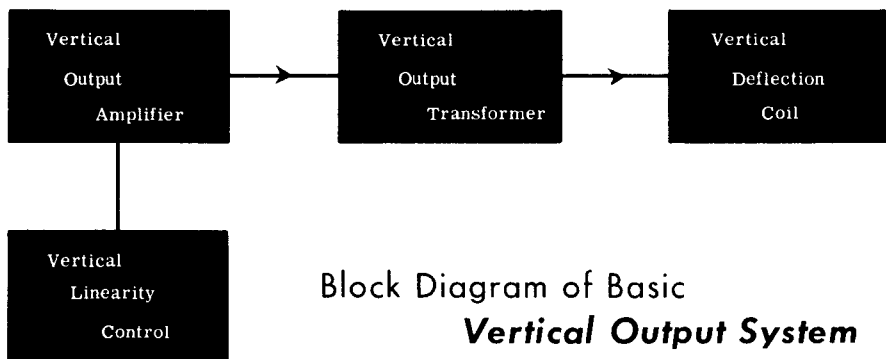

The voltage that appears at the plate of the vertical oscillator is of the correct waveform to produce a sawtooth current in an inductor; but, unfortunately, it does not have the required strength. This calls for further amplification—a job that is handled by the *vertical output amplifier*. This amplifier, together with its associated resistors and capacitors, plus the *vertical output transformer*, the *vertical deflection coil*, and the *linearity control* comprise the vertical output system.

The vertical output tube is usually a vacuum tube of the power pentode or power triode variety such as the 6AQ5, 6K6, 6AU5, 6S4, or 6AV5. Often the blocking oscillator used for producing the vertical deflection voltages is one triode section of a twin-triode (like the 6SN7) while the output tube is the other section.

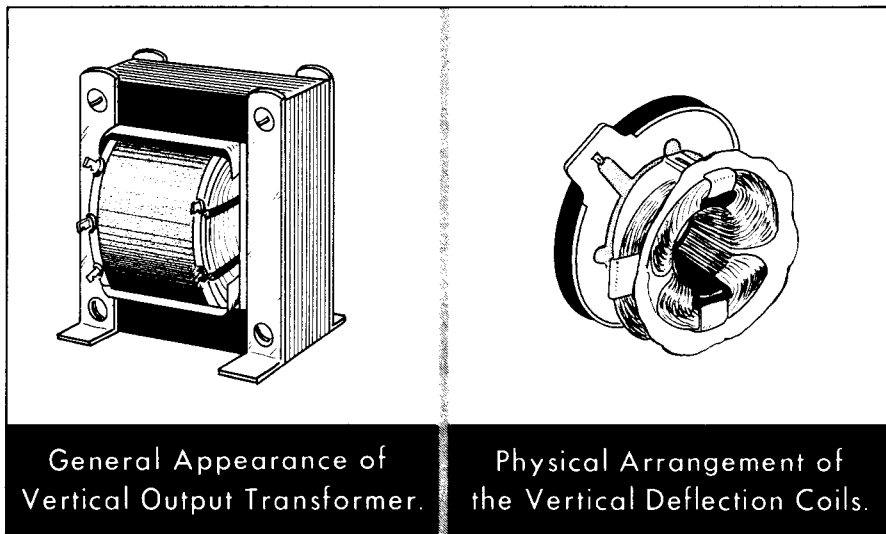

VERTICAL OUTPUT SYSTEM

How the Vertical Output System Works

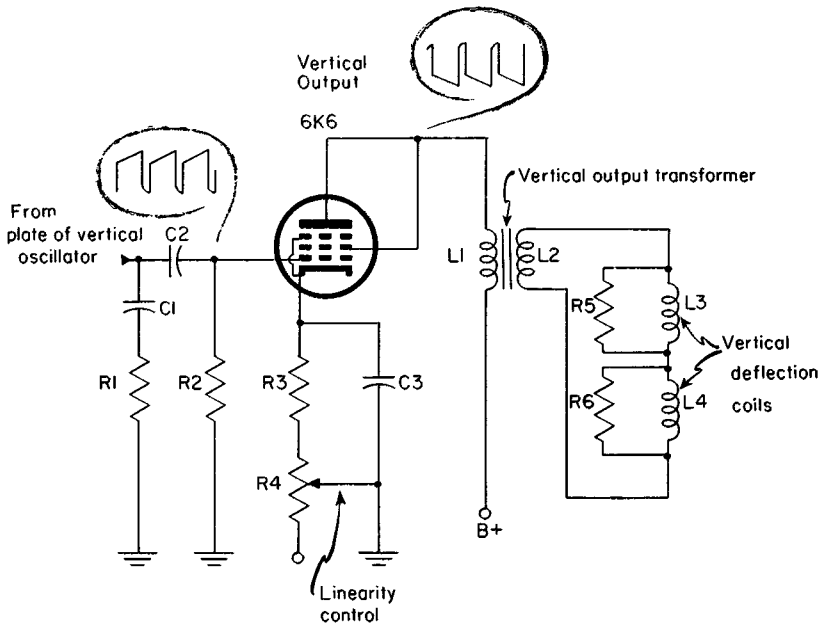

The Vertical Output System Schematic

We start the schematic at the left side with the familiar components of the discharge circuit, discussed in the previous paragraphs, C1 and R1. C2 couples the trapezoidal voltages from the blocking oscillator to the grid of the vertical output tube while at the same time blocking the dc which appears at the plate of the oscillator from reaching the grid of the 6K6 vertical output amplifier. R2 is the grid return resistor we have found in all amplifiers before this; it permits the grid to be held at ground potential with reference to the d-c level of the whole receiver. We shall discuss R3 and R4 later in this lesson.

The trapezoidal voltage appears in inverted and greatly amplified form at the plate of the 6K6. This means that the voltage applied across the primary winding (L1) of the vertical output transformer has the same shape and is transferred inductively by transformer action to the secondary winding L2. The fact that the voltage is inverted at the 6K6 plate makes no difference at all since we can control the final output phase by reversing the leads to either winding of the transformer.

Thus, the trapezoidal sweep voltage is applied to the vertical deflection coils with L2 acting as the new source of sweep. These coils are formed into a *yoke* which fits around the neck of the picture tube. The same yoke also contains the horizontal deflection coils, as we shall discuss later.

VERTICAL OUTPUT SYSTEM

Vertical Output Transformer

Fundamentally, the vertical output transformer in the vertical output stage performs a function similar to the familiar output transformer in a radio receiver. Instead of providing an impedance match for a loudspeaker, the vertical output transformer matches the impedance of the plate circuit of the vertical output tube with the impedance of the vertical deflecting coils. This is necessary since the plate circuit impedance of the output tube is much higher than the impedance of the vertical deflecting coils. A proper impedance match assures a maximum transfer of power.

The diagram shows an output transformer having isolated primary and secondary windings. This is not necessarily a requisite, and many modern television receivers use an autotransformer in the plate circuit of the vertical output tube. Here, the entire transformer winding is in the plate circuit of the output tube while a small portion of the winding is used to feed the vertical deflecting coils.

The Vertical Output Transformer May Be

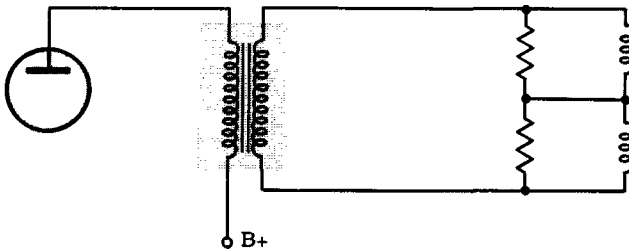

An Isolated-Secondary Type or

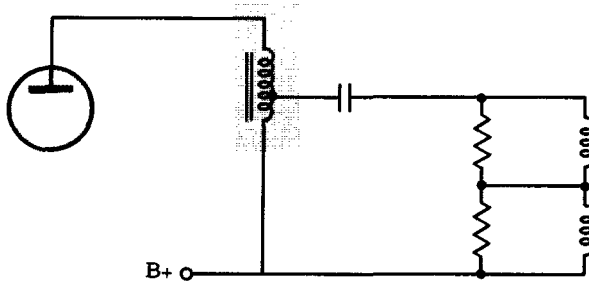

an Autotransformer

VERTICAL OUTPUT SYSTEM

Linearity Control

The linearity control is an interesting and important part of the vertical output system. Being a part of the cathode circuit of the tube, it controls the grid-cathode bias and hence permits the user to change the point of operation on the tube's characteristic curve. This curve, you will remember, has a linear and a nonlinear portion. Normally, one would expect the bias to be selected for linear operation because, under these conditions, the tube serves as a distortionless amplifier. On the other hand, although we have pictured the top of the trapezoidal voltage as a perfectly straight line in all our drawings, this condition is usually not true: there is always some curvature in the charge curve of a capacitor. By placing the vertical output amplifier tube on a slightly curved part of its characteristic, it is possible to balance out the opposite curvature introduced by the discharge circuit. In effect, we balance out one distortion by introducing another distortion of an opposite type.

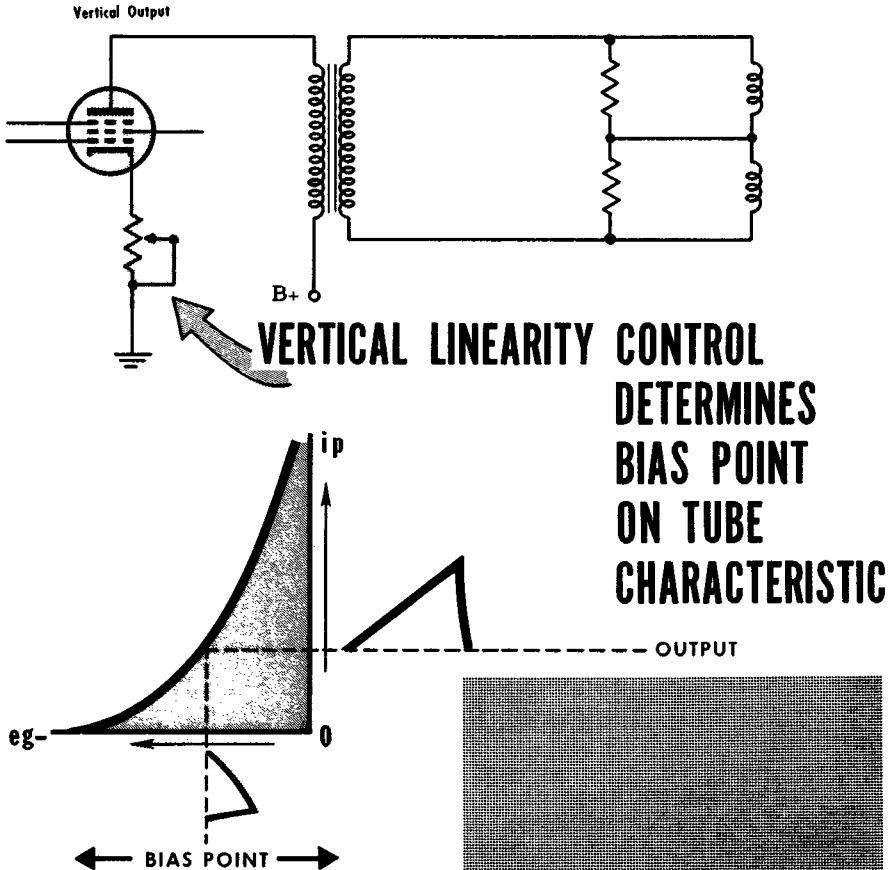

VERTICAL OUTPUT SYSTEM

Damping Resistors

Resistors R5 and R6 are connected directly across the vertical deflection windings. In this position the resistors lower the Q of the vertical deflecting circuit and *dampen* or reduce any tendency toward oscillation in this circuit. Hence, they are given the name *damping* resistors.

The cutting off of the vertical output tube during retrace causes the magnetic field around the vertical deflecting coils to collapse. This induces a sharp pulse which could shock-excite the deflection circuit into oscillation. However the damping resistors introduce losses in the circuit that quickly attenuate the oscillations. If one of the damping resistors were to open, the effect would be a train of oscillations in the deflecting circuit that would interfere with the normal vertical sweep and cause a distorted picture on the screen. The distortion would occur, of course, only if the oscillations were to continue into the trace portion of the sweep.

In addition to the above function, the damping resistors also serve to dampen voltage pulses induced into the vertical windings from the horizontal deflection coils that are mounted within the same yoke. These pulses are undesirable, but sometimes almost unavoidable due to the closeness of the two windings.

Damping Resistors

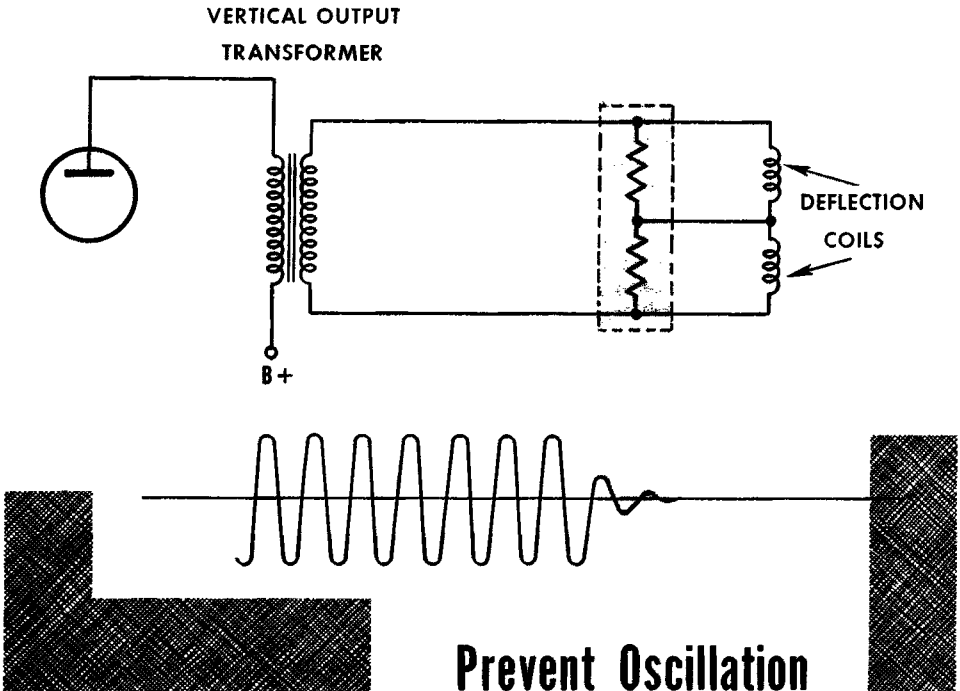

VERTICAL OUTPUT SYSTEM

Vertical Retrace Blanking

To remove the annoying vertical retrace lines visible when the brightness control is turned up, most manufacturers include in their chassis a vertical retrace blanking circuit. Fundamentally, the theory behind this circuit is to blank out or darken the picture tube screen during vertical retrace.

The general approach to this blanking is to cut off the picture tube during the time that the vertical retrace lines would normally appear. This can be done by applying a large negative pulse voltage to the control grid of the picture tube or by applying a positive pulse voltage to the cathode—each has the same effect relative to the other. Generally, it is a good idea to apply the retrace-elimination pulse to the element not used for the video input.

The logical place to obtain this blanking pulse is from the vertical oscillator or output circuit, with the most common takeoff point being from the vertical output transformer circuit.

THE VERTICAL RETRACE BLANKING PULSE may be

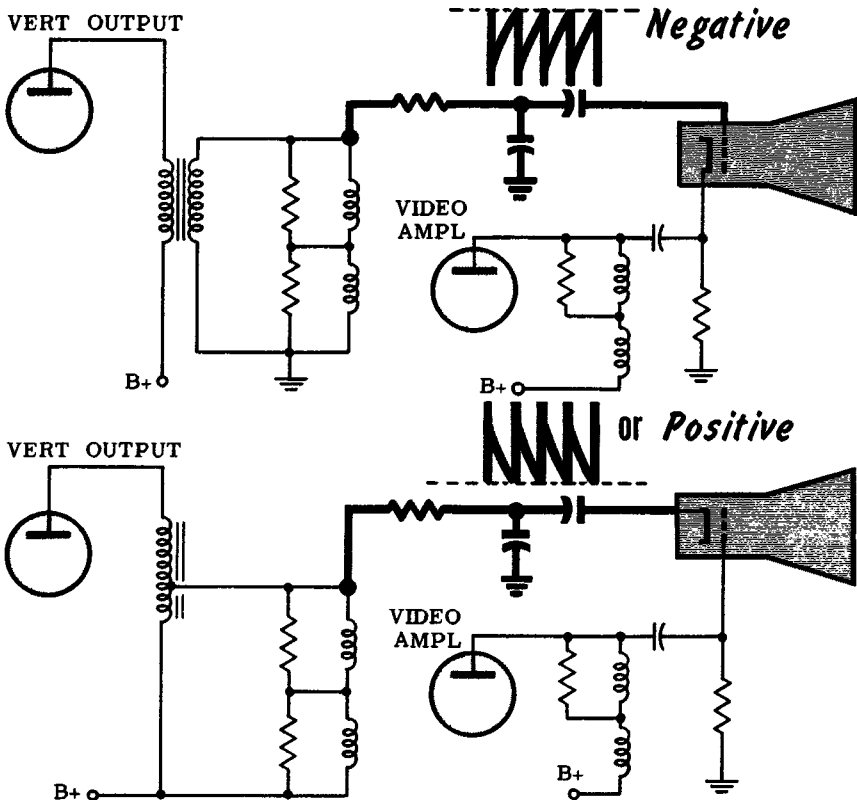

REVIEW

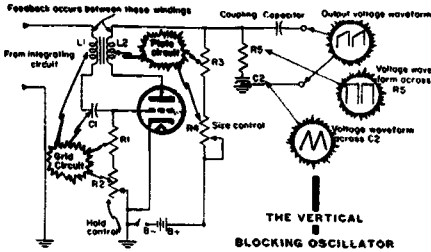

1. *The Blocking Oscillator.* In modern television receivers, the blocking oscillator is used as a synchronizing oscillator. Feedback from plate to grid is accomplished with a transformer. Any change in plate current will induce a voltage in the grid circuit which will act to aid this change.

2. *The Vertical Output System.* The voltage that appears at the plate of the vertical oscillator is of the correct waveform, but it does not have the required strength. A vertical amplifier, together with its associated resistors and capacitors, plus the vertical output transformers, the vertical deflection coil, and the linearity control comprise the vertical output system.

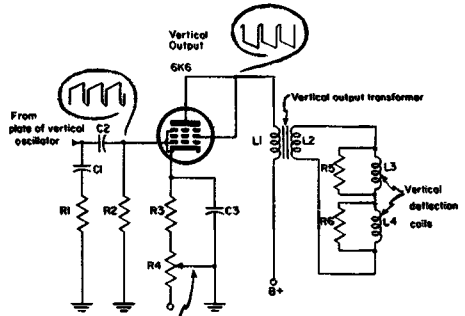

The Vertical Output System Schematic

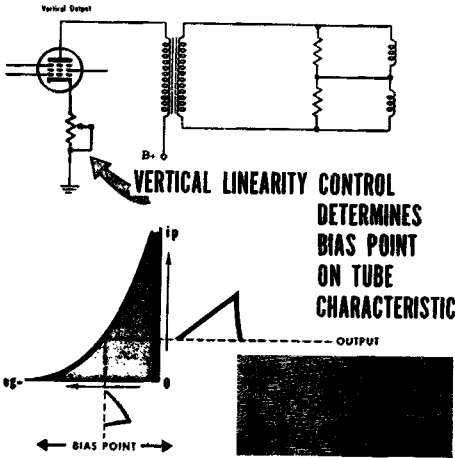

3. *The Linearity Control* is an important part of the vertical output system. By placing the vertical output amplifier tube on a slightly curved part of its characteristic, it is possible to balance out the opposite curvature introduced by the discharge circuit.

4. *Vertical Retrace Blanking.* The general approach to this blanking is to cut off the picture tube during the time that the vertical retrace lines would normally appear. We do this either by applying a large negative pulse to the control grid of a positive pulse to the cathode of the picture tube.

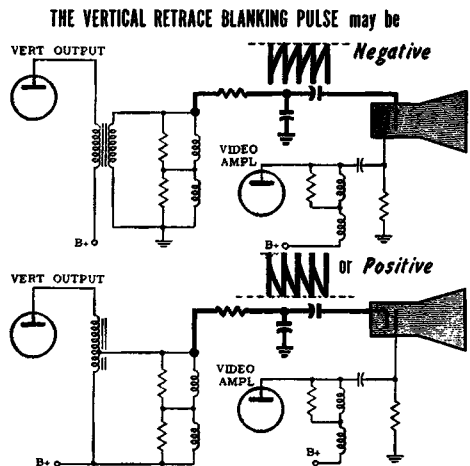

HORIZONTAL SWEEP CIRCUIT

The Horizontal Sweep Circuit Action

We have shown the action of the vertical sweep oscillator, and how the vertical sync pulse controls the performance of the vertical sweep oscillator. When we traced the progress of the vertical and horizontal sync signals in the preceding lesson we noted that they were divided into two paths—the vertical sweep circuit and the horizontal sweep circuit.

Block Diagram of Sync Circuits Which Feed the Sweep Circuits

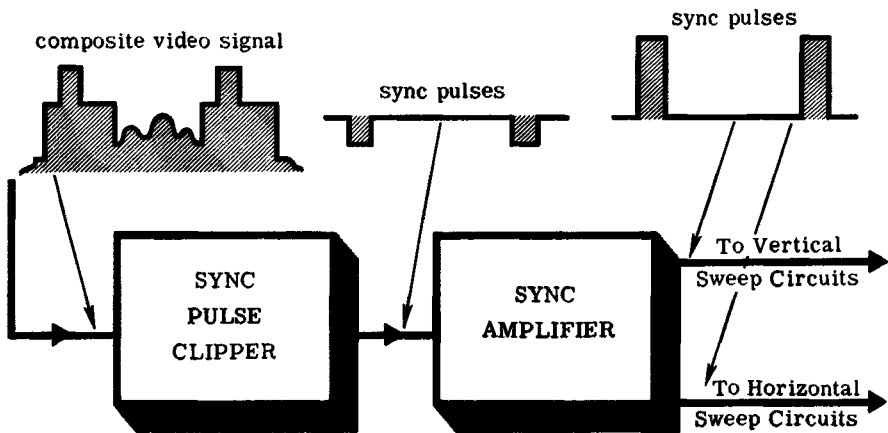

The sync separator-amplifier furnishes two outputs: One which contains the vertical sync signal is fed to the vertical integrator; the other, which may be considered to be the horizontal sync signal, is fed to the horizontal sweep oscillator.

Both of these synchronizing signals have substantially the same characteristics, but the *input* systems to the vertical and horizontal sweep circuits distinguish between the pulses required by the vertical sweep oscillator and the pulses required for the horizontal sweep system. The integrator for the vertical sweep system selects the serrated vertical sync pulses, changes their shape, feeds them to the vertical oscillator, and makes the horizontal sync pulses ineffective.

On the other hand, the horizontal and vertical sync pulses are both fed to the input of the horizontal sweep system. The serrated vertical sync pulses, the equalizing pulses, and the horizontal sync pulses all contribute to the control of the horizontal oscillator. Its timing must be under control *all the while the receiver is functioning*.

The appropriate timing pulses are chosen by the input systems of the horizontal sweep circuits from the train of vertical, equalizing and horizontal sync pulses that come from the sync separator-amplifier tube.

THE DIFFERENTIATOR

The Differentiator

The electrical "doorway" to the horizontal sweep system is a circuit known as the *differentiator*. It is located in the output system of the sync circuits.

A differentiator is a simple combination of resistance and capacitance having values such that a square or rectangular pulse fed into the system will result in a *sharply peaked* output pulse. The differentiator circuit is a series combination of a capacitor and a resistor, with the input voltage fed across the combination.

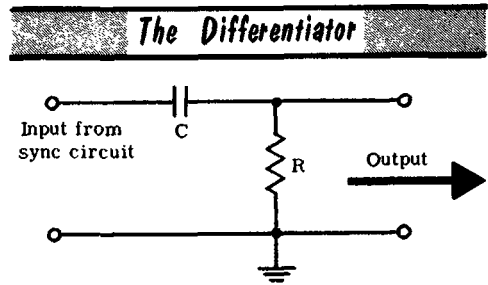

The output voltage is taken off across the resistor only as illustrated in the schematic. By definition a differentiator is a circuit whose *output is proportional to the rate of change of the input voltage*. The time constant of a differentiator is short compared to the cycle period of the input voltage; that is, the capacitor in the system can be charged and discharged more rapidly than the input signal can change polarity.

The diagram shows an actual and ideal square-wave pulse, the ideal having sides that are perfectly straight. Straight sides correspond to *zero rise time*; that is, zero time for the rise in amplitude to maximum. While such a pulse cannot be obtained in practice, it lends itself well to simplified explanations. The pulse is shown as a positive waveform to indicate that all its changes occur in the positive region.

At point P the pulse amplitude is zero, and it is assumed to rise to Q, its maximum value in zero time. After Q has been reached the voltage of the pulse remains constant for period t represented by the horizontal distance Q-X. Then the voltage falls rapidly to zero or point Y. The time interval X-Y corresponds to the fall time and this, too, is assumed to be zero.

ACTUAL and IDEAL PULSE SHAPES

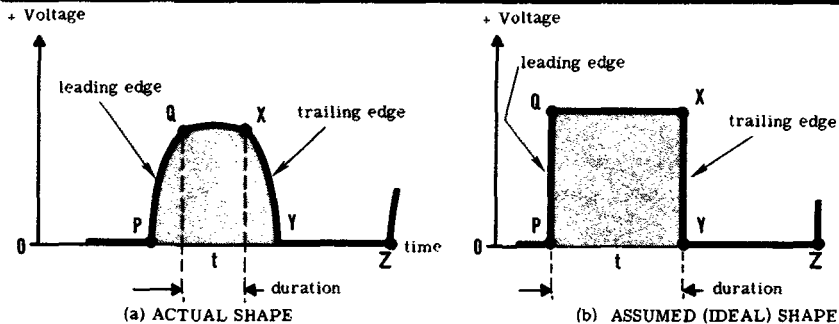

THE DIFFERENTIATOR

R-C Time Constant

The time constant of an R-C circuit is defined as the product of the capacitance in farads and the resistance in ohms. Basic electricity teaches that when voltage is applied to a capacitor a definite time must pass before the voltage built up across the capacitor by the charging current equals the applied voltage. The higher the resistance in the circuit (and the larger the capacitance), the longer will be this period of voltage build-up. In a similar manner, the higher the resistance (and the larger the capacitance), the greater will be the time required for the capacitor to discharge. By definition the time constant is the time required for the voltage to build up to approximately 63% of the applied voltage.

Charge and Discharge Curves

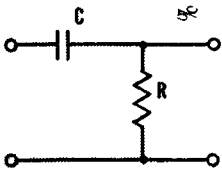
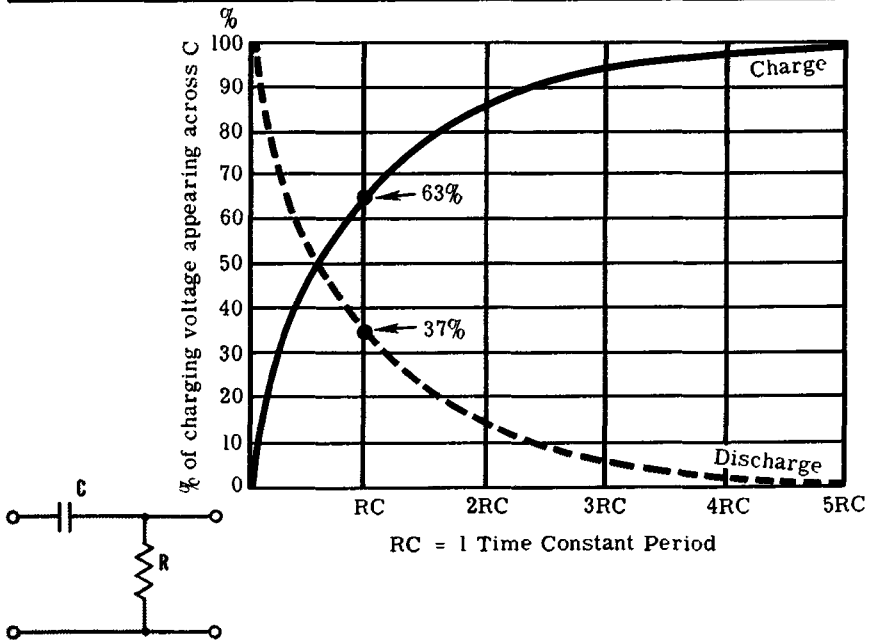

If the capacitance of an R-C differentiator is $.002 \mu\text{f}$ (.00000002 farad) and the resistor has a value of 10,000 ohms, the time constant in seconds is $.00000002 \times 10,000$ or .00002 second. This time period is equal to the time needed to complete 1 cycle of a 50-kc signal or $1/.00002 = 50,000$ cycles. Hence such a circuit would be a *short-time-constant* differentiator for frequencies of 10,000 cycles or less, and a *long-time-constant* circuit for frequencies of 50,000 cycles or higher. By juggling the value of C and R it is possible to arrange short- or long-time-constant differentiators for voltages of any frequency.

THE DIFFERENTIATOR

Action of Differentiator

What happens when a square-wave voltage pulse is applied to a short-time-constant differentiator? Suppose we assume the ideal pulse illustrated before. The sharply rising leading edge (P-Q) corresponds to a very rapidly changing voltage. This produces a sudden rush of charging current through R and C. With R of low resistance and C of small capacitance, the capacitor charges rapidly to the peak value. The charging current being high, a large voltage-drop appears across R while the current is flowing.

The voltage across the capacitor reaches its maximum value rapidly, hence the charging current ceases. With no further change in input voltage, the capacitor charging current falls to zero. With diminishing current-flow through R, the voltage-drop across R gradually falls to zero. Thus the sudden charging of the capacitor causes a very sharply peaked pulse to appear across R.

With the voltage drop across R having fallen to zero while the input voltage to the differentiator circuit was constant (at its maximum value), and no further current flows through R, the voltage across R remains zero for most of time t.

Then the applied square-wave voltage suddenly falls to zero. The charged capacitor discharges in the differentiator circuit and a sudden rush of discharge current takes place in the *opposite* direction through R. This develops a large voltage drop across R with a polarity *opposite* to that which prevailed before. As the discharge current decreases, the voltage across R also decreases. Hence, a negative pulse appears during the time interval X-Y-Z. This pulse, like the previous one reaches zero shortly after the applied voltage reaches its zero value, and remains at zero until the next rise in applied voltage. At point Z, the next P-Q rise is about to begin, thus repeating the process.

So it is that a differentiating circuit produces a pulse for each abrupt *change* in voltage applied to the circuit. Because the constants of R and C are small and the change in applied voltage is very abrupt, the differentiated peak is very pointed and of very short duration.

Note that the peak-to-peak value of the differentiated pulse amounts to twice the peak value of the applied input voltage. This arises from the condition that the amplitude of the positive differentiated pulse is the result of the maximum charging current, and the amplitude of the negative differentiated pulse is the result of the maximum discharging current—both charging and discharging currents having similar peak values.

Although both the positive or the negative peaks of the differentiated voltage can be used, they seldom are. Usually one or the other is clipped, to suit the particular circuit needs. In our case only the positive peaks are used, as shown in the illustration opposite

The Three Steps of the Differentiation Process

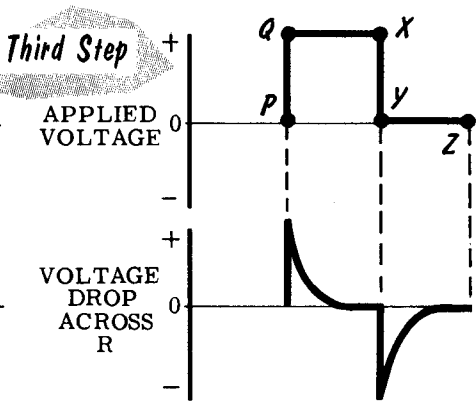
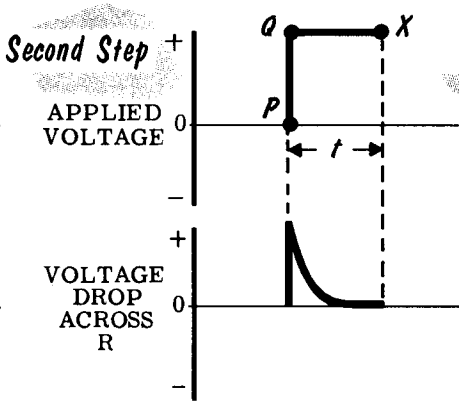
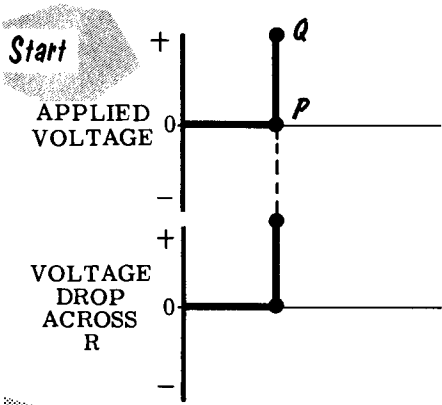

Output of a Differentiator
Having Negative Peaks Clipped

VOLTAGE OUTPUT ACROSS R OF DIFFERENTIATOR

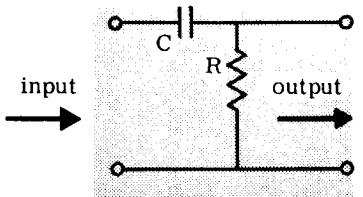
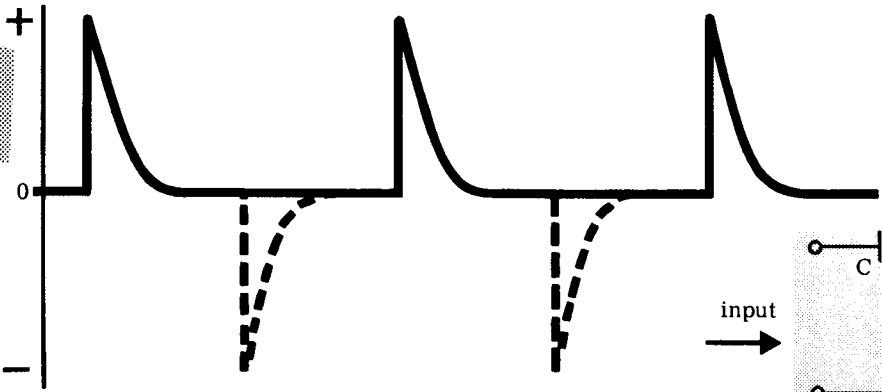

THE DIFFERENTIATOR

The Effect of the Input Pulse Shape on the Differentiated Output

We have shown the short-time-constant differentiated output for a square-wave input voltage. Suppose that the input voltage pulse is of relatively long duration with short zero voltage intervals between.

The differentiating action does not change. The negative pulse of the differentiated output for the trailing edge of the input voltage is very close to the positive differentiated pulse due to the leading edge of the adjacent input voltage pulse. The time relationship, however, between the leading edges of the input voltage pulses and the positive differentiated pulses has not changed, nor has it changed between the trailing edges of the input voltage pulse and the negative differentiated pulses.

HOW THE DIFFERENTIATOR REACTS

TO THE VERTICAL SERRATED PULSE.

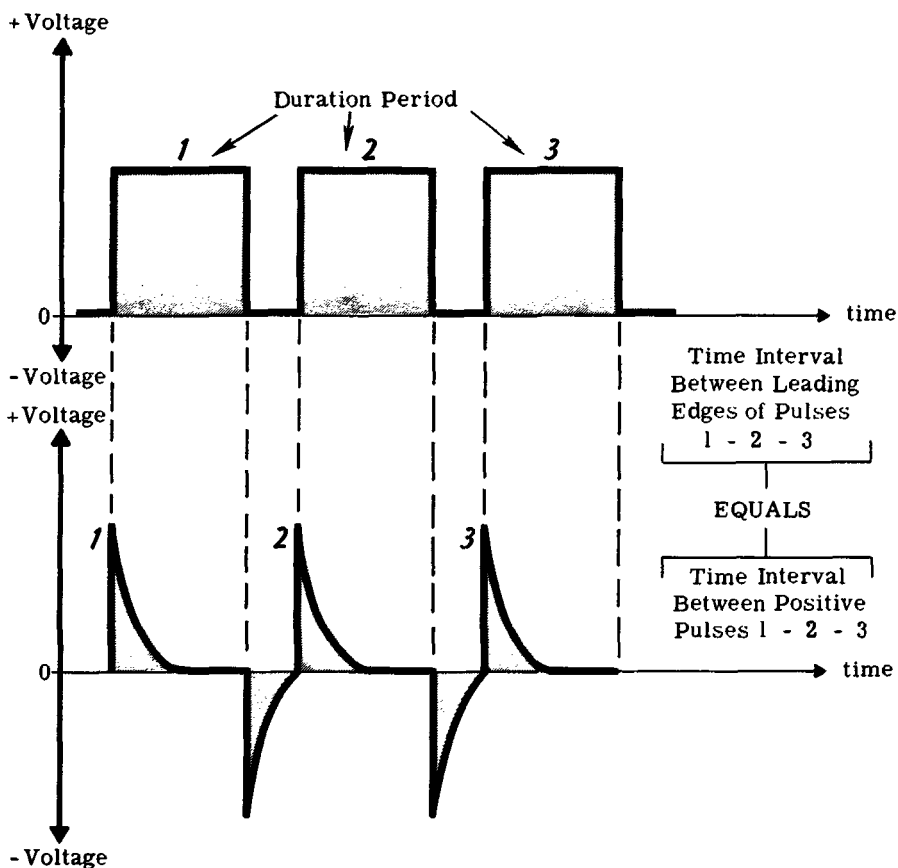

THE DIFFERENTIATOR

Input and Output Voltage in the Differentiator

Let us now apply a variety of voltage pulses to a differentiating network, as for example equalizing, vertical sync and horizontal sync pulses. Three kinds of pulses are shown here. All are rectangular but some differ from the others in duration. The equalizing and the vertical sync pulses have adjacent leading edges which are only one-half horizontal line apart; that is, they have a frequency of 31,500 cycles. However *alternate leading edges* correspond to full horizontal line separation or a frequency of 15,750 cycles. The horizontal sync pulses have adjacent leading edges that are timed for 15,750 cycles; that is, they are a full line apart so that they will trigger the horizontal oscillator once every 63 μSEC (the time for the picture tube beam to complete its excursion to the right-hand edge of the tube and return to the left-hand side).

Input and Output PULSE Voltage in the Differentiator

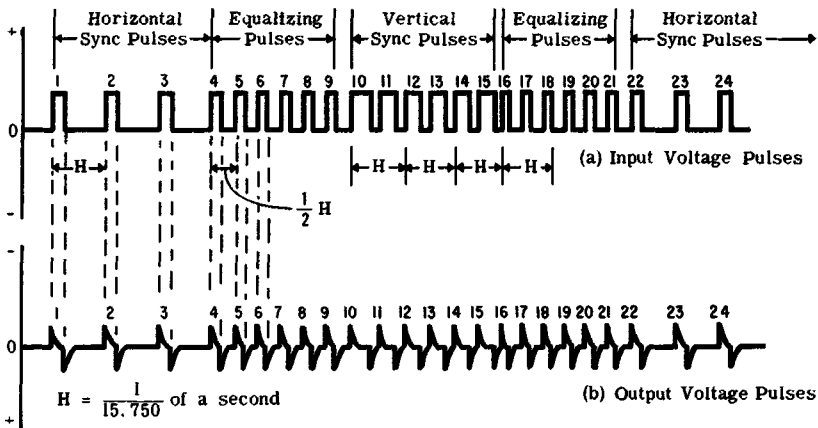

The differentiating system develops a positive pulse for every leading edge of the input voltage pulses, and a negative pulse for each trailing edge. The spacing between the positive pulses of the differentiated voltage is constant over a substantial region; but the spacing of the negative differentiated peaks changes relatively often.

If the *positive differentiated* pulses are arranged to *trigger* the horizontal sweep oscillator, the variations in timing of the negative differentiated pulses become unimportant. The six equalizing pulses before the six vertical sync pulses and the six equalizing pulses which follow it are as acceptable to the differentiator as horizontal sync pulses, and contribute to the timing of the horizontal oscillator in the same manner as the differentiated horizontal sync pulses. The only difference is that the differentiated pulses (produced by the *alternate leading edges* of the equalizing and vertical sync pulses) trigger the horizontal sweep oscillator.

THE DIFFERENTIATOR

Triggering Action

If the differentiated pulse corresponding to the leading edge of horizontal sync pulse 1 triggers the horizontal oscillator, then the differentiated pulses for leading edges of equalizing pulses 4, 6 and 8, the leading edges of vertical sync pulses numbered 10, 12, and 14 and the leading edges of equalizing pulses numbered 16, 18, and 20 will trigger the oscillator, after which time the horizontal sync pulses again take over.

The fact that the equalizing and the vertical sync pulses produce positive-polarity differentiated pulses at half-line intervals also (pulses 3, 5, 7, etc.) does not result in improper triggering of the horizontal oscillator because the circuit conditions in the oscillator are such as not to respond to these positive pulses from the differentiator.

Triggering in a Multivibrator

showing lack of response to half-line triggering pulses.

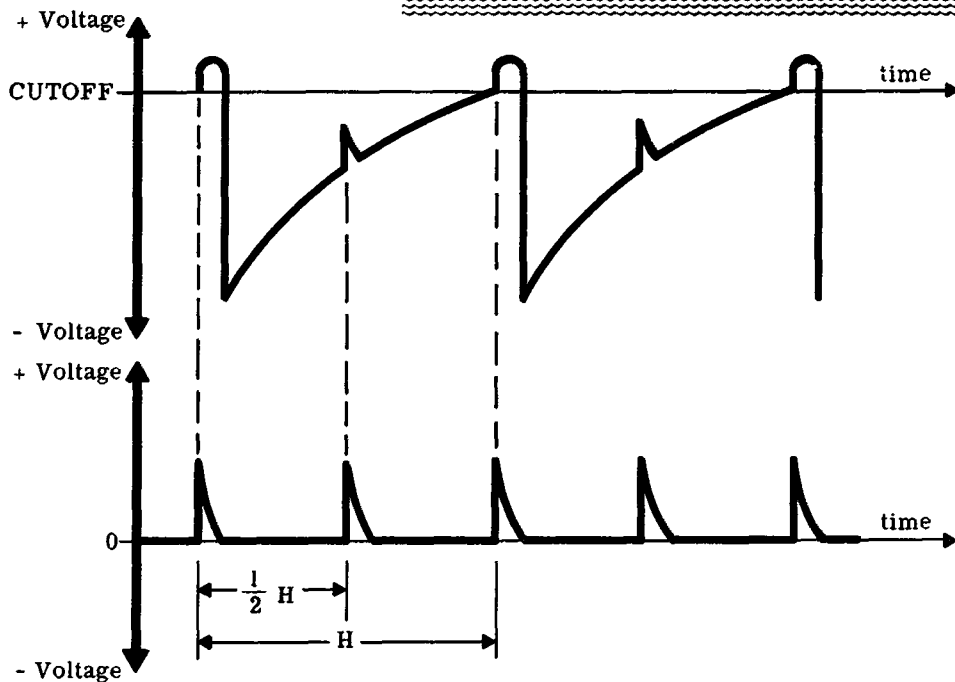

Although most modern day television receivers do not use direct triggering of the horizontal sweep oscillator by the differentiated voltage received from the sync circuits, it is important to understand this action.

HORIZONTAL AFC

Horizontal AFC

The control of the horizontal sweep oscillator frequency by direct application of differentiated pulses would be successful if it were not for the random noise pulses that are present in the sync signals. These noise pulses often cause untimely triggering of the oscillator.

Inasmuch as the sweep oscillator cannot distinguish between various voltages applied to it for synchronizing purposes, undesired signals of this variety can make the picture-tube electron beam move out of step with the electron beam in the television camera. The result is a very unsteady picture; in fact, a picture of this kind cannot be deciphered at all.

NOISE Signals in the Sync Pulses

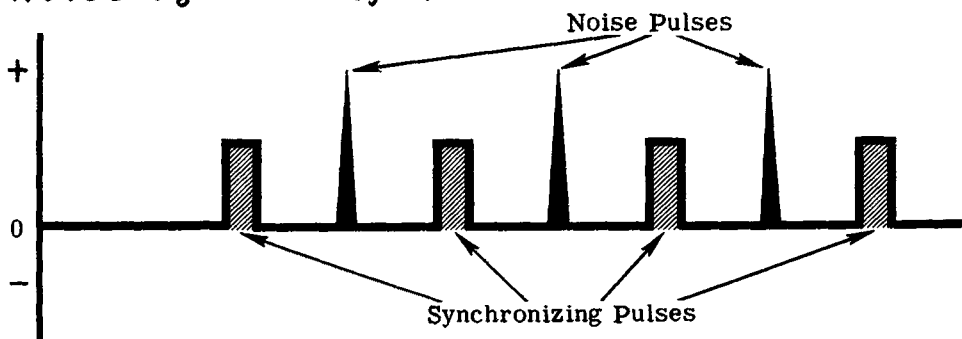

To avoid this possibility, horizontal *afc* or *automatic frequency control* was developed. Such systems are standard in all modern television receivers. In *afc* systems the sync pulses are used strictly for reference purposes; that is, they are *compared* electronically with either the voltage generated by the horizontal sweep oscillator, or with the sweep voltage which actually moves the electron beam in the horizontal direction across the picture tube screen.

If the horizontal sweep oscillator output is not timed correctly (frequency and phase) with the reference sync pulses, a d-c *correction* voltage is generated in a *comparator* circuit. This voltage either raises or lowers the frequency of the sweep oscillator, as necessary. If the two voltages are correctly timed, the comparison circuit "idles," causing no change in conditions.

The change in frequency of the sweep oscillator is accomplished by a *reactance modulator*, mentioned earlier in connection with f-m operation. The reactance modulator receives its control voltage from the comparison circuit and it is determined by the *polarity* and *magnitude* of the control voltage developed in the comparison circuit, whether it raises or lowers the operating frequency of the horizontal sweep oscillator, or allows it to operate unchanged.

HORIZONTAL AFC

Block Diagram of One Type of Horizontal AFC System

The horizontal afc system is designed to keep the horizontal oscillator "on frequency." The first section of the system is a device which *detects changes* in the frequency of the oscillator output—a circuit called an f-m detector or *discriminator*.

The discriminator can react to changes in frequency *below* the normal frequency by developing a *positive* d-c output voltage. It can react to variations in frequency *above* normal by producing a *negative* d-c voltage. It answers to a *normal* frequency input by a *zero* output voltage. By feeding the output of the horizontal oscillator into a discriminator, we can observe the changes taking place in the frequency of the oscillator.

1st Step in Setting Up the Block Diagram of the HORIZONTAL AFC SYSTEM

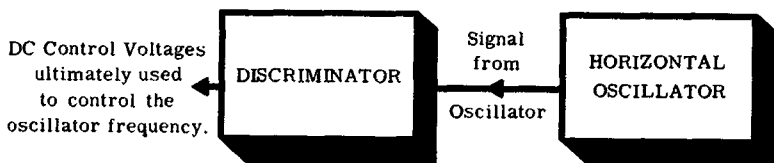

It is now entirely possible to translate these d-c output voltages from the discriminator into oscillator frequency changes which cancel the original oscillator "errors." For example, suppose that the oscillator frequency is lower than it should be; by suitable circuitry, we can arrange for the resultant positive d-c output voltage from the discriminator to raise the oscillator's frequency enough to cancel the original deviation. Similarly, we can arrange to have the discriminator output d-c voltage lower the oscillator frequency when the latter deviates above its normal frequency. This job is handled by the reactance modulator, a circuit which can act as a variable inductance when the grid of its tube is subjected to different bias voltages.

Adding the REACTANCE MODULATOR to the HORIZONTAL AFC Block Diagram (Incomplete Circuit)

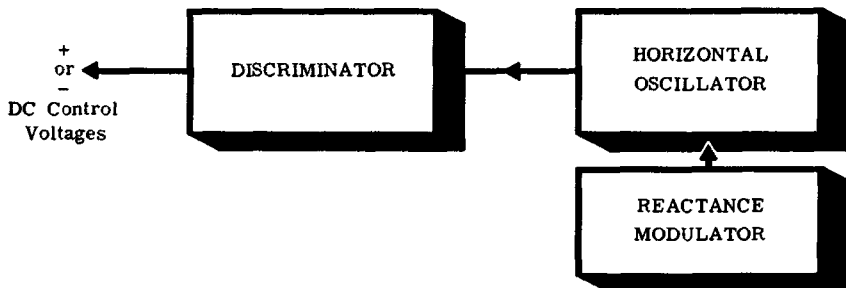

HORIZONTAL AFC

One Type of Horizontal AFC System (contd.)

The reactance modulator is connected to the tank circuit of the horizontal oscillator and its inductance is made a part of the inductance which governs the oscillator frequency.

Where does the reactance modulator derive the grid-bias voltages that cause it to pull the horizontal oscillator back to its normal frequency?

Bias voltages of the right nature are available from the output section of the discriminator, as explained above. Hence, if the control voltages developed in this stage are applied to the reactance modulator as bias, the horizontal automatic-frequency-control (afc) system is complete.

The SYNCHROLOCK HORIZONTAL AFC SYSTEM

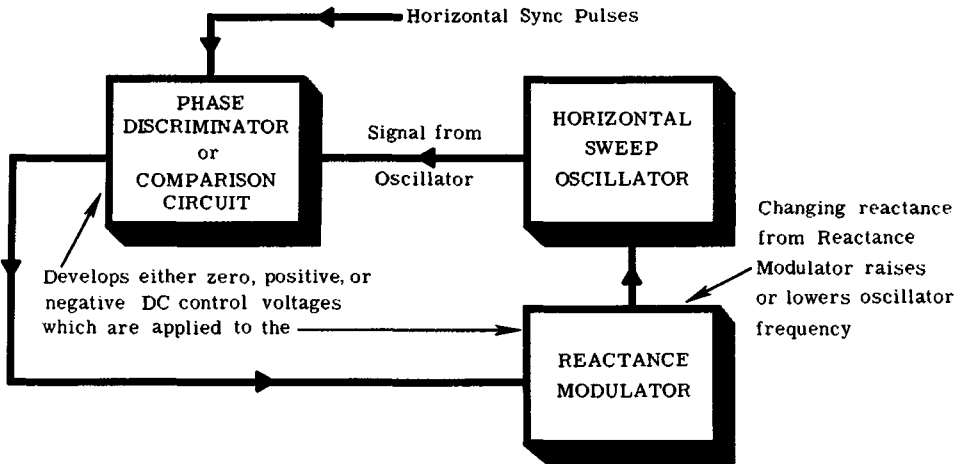

Suppose, for example, that the horizontal oscillator should rise in frequency above 15,750 cycles. The discriminator senses the change and develops a negative d-c voltage at its output terminals which voltage is applied to the grid of the reactance modulator tube. This circuit then behaves as a larger-than-normal inductance added to the tuning inductance of the oscillator. With more inductance than before, the frequency of the horizontal oscillator then goes down.

The system works in the opposite manner if the oscillator frequency falls *below* 15,750 cycles. For a reduced frequency, the discriminator output is a positive d-c voltage; this positive voltage is then applied to the reactance modulator grid causing the reactance modulator to behave as a *smaller* inductance. The total tuning inductance of the horizontal oscillator is thus lowered, *increasing* the output frequency.

HORIZONTAL AFC

The Importance of the Sync Pulses in Horizontal AFC Systems

In the foregoing explanation of the horizontal afc system, we said that the discriminator develops an output voltage when the oscillator drifts away from its normal frequency. The question now arises: How does the oscillator "know" what the normal frequency is?

There is a standard for the horizontal oscillator frequency. This is the rate at which the horizontal sync pulses arrive. The television receiver can set no standards of its own—it obeys the signals sent to it from the transmitter.

Thus, the horizontal sync pulses are transmitted to the receiver to keep the horizontal oscillator in step with the horizontal-sweep rate at the transmitting station. The action of these sync pulses establishes the *normal* frequency of the receiver's horizontal oscillator.

Complete Block Diagram of HORIZONTAL AFC SYSTEM

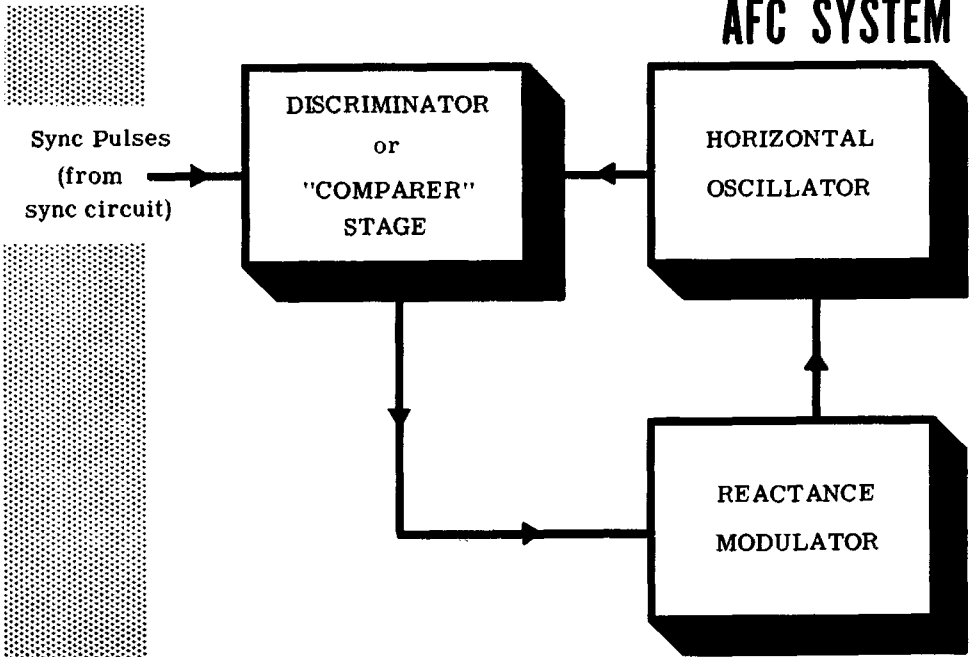

To make the block diagram complete, we must show sync pulses arriving at the input to the discriminator of the horizontal afc system from the sync circuit. Now, the discriminator can *compare* the sync-pulse frequency with the horizontal oscillator frequency.

HORIZONTAL AFC

A Typical Horizontal AFC Circuit—Synchrolock

This horizontal afc circuit first appeared in commercial television receivers in 1946. Despite the passage of years, it remains an outstanding example of excellent engineering and exceptionally stable performance. Although it has been supplanted by newer, more economical systems, we study the Synchrolock horizontal afc circuit here because it is the most straightforward approach to the problem of automatic frequency control.

One Type of HORIZONTAL AFC SYSTEM — *Synchrolock*

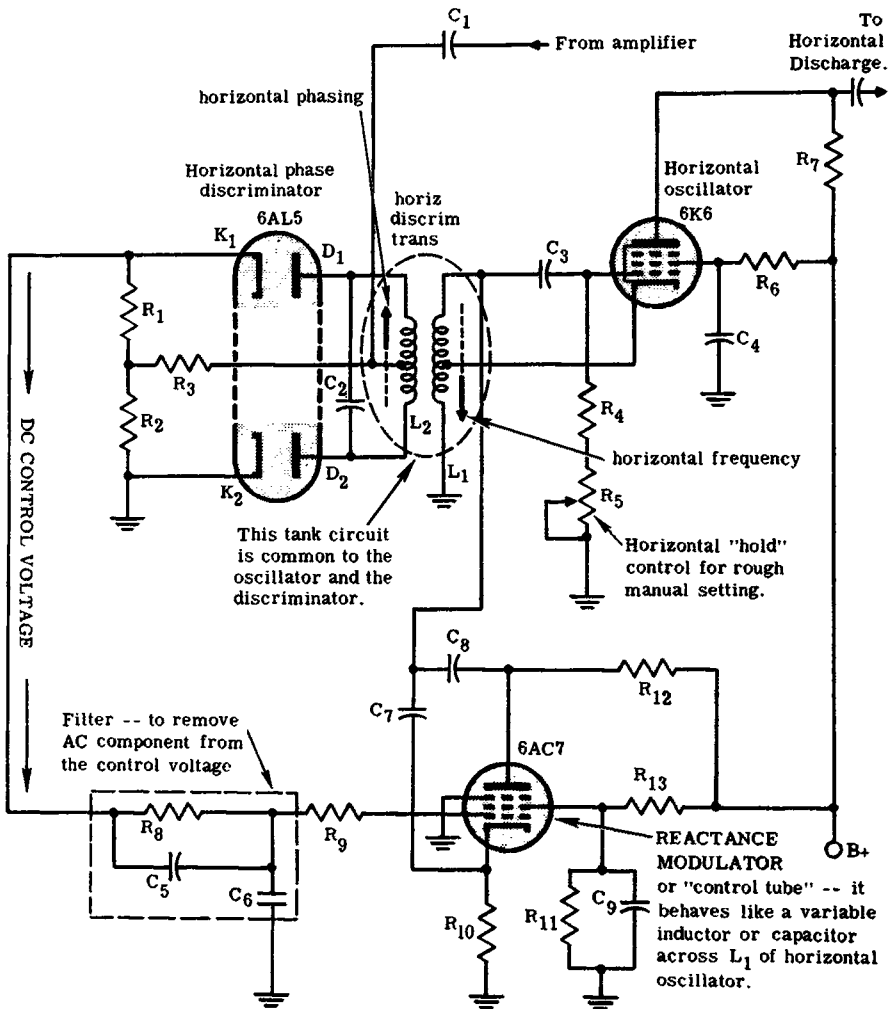

HORIZONTAL AFC

Synchrolock AFC (contd.)

According to the block diagram, two signals are fed to the discriminator. One of these is the output of the horizontal oscillator—a sine-wave voltage; the other consists of the sync pulses coming from the sync amplifier. The sync pulses from the sync amplifier are coupled into the discriminator via capacitor C1. The 6K6 tube is the horizontal oscillator; its signal appears as a voltage across L1. Since coils L1 and L2 are wound on the same core they form a transformer in which the voltage across the primary winding L1 is coupled to the secondary L2 by electromagnetic induction.

Now we see that while the sync pulses are fed to the discriminator at the center-tap of L2, the horizontal oscillator voltage is applied across all of L2. This places *equal-amplitude* but *unlike-polarity* oscillator voltages on the two diode plates. Simultaneously, applied through C1, are the sync voltages which, as a result of the type and point of feed, place *equal-amplitude* and

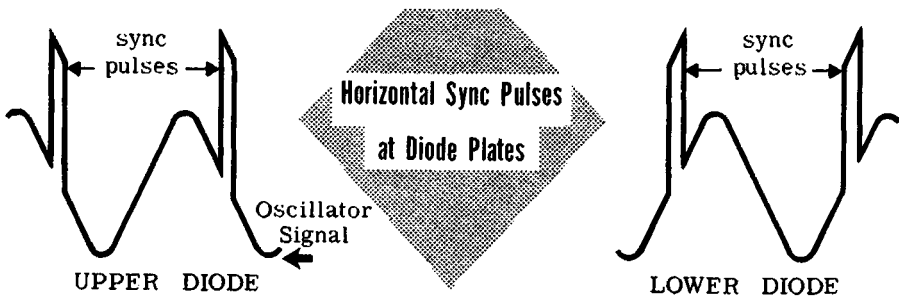

identical-polarity signals on the same diode plates. These voltages are additive when they arrive in perfect synchronization. In other words, when the frequency of the horizontal oscillator in the receiver is exactly the same as the frequency of the sync pulses, these waveforms appear on the diode plates.

Notice how the voltage of the incoming sync pulses adds to the sine waveform of the horizontal oscillator. But notice more particularly that at this point synchronization is perfect—the sync pulses combine with the sine waves at equal voltage points. The sync pulse in the upper diode is riding about half-way down the side of the descending portion of the sine wave, while in the lower diode, the sync pulse has an equivalent position half-way up the ascending side of the sine wave. The net result is that the d-c control voltage which appears across resistors R1 and R2 is zero and the reactance tube idles, leaving the horizontal frequency where it is, without change.

Assume now that the frequency of the horizontal oscillator decreases for some reason (i.e., change in line voltage). From a relative point of view, the sync pulses appear on the sine-waves sooner than before, producing waveforms like those on the next page.

HORIZONTAL AFC

Synchrolock AFC (contd.)

In the upper diode, the sync pulse is now riding higher up on the sine wave producing a *greater* net voltage output than in the previous case. In contrast, the sync pulse in the lower diode has slid further down the sine wave toward the trough of the wave, yielding a *lower* voltage output than in the perfectly synchronized condition. This state of unbalance—higher voltage from one diode than the other—results in a change from zero to a *positive* control voltage. A positive control voltage applied to the grid of the reactance tube produces a *rise* in horizontal oscillator frequency as we have explained before. This cancels the tendency of the horizontal oscillator to slow down, bringing it back to 15,750 cycles.

Should the horizontal oscillator speed up for some reason, this is what happens: the horizontal-oscillator sine waves get slightly *ahead* of the sync pulses causing the effect shown. Now, the upper diode develops a smaller net voltage than the lower diode, the voltage across R1 and R2 goes negative, the control (reactance) tube grid goes negative, its inductance increases, and the frequency of the horizontal oscillator drops. This lowered frequency exactly compensates for the increases which started the process, and the horizontal oscillator returns once again to 15,750 cycles.

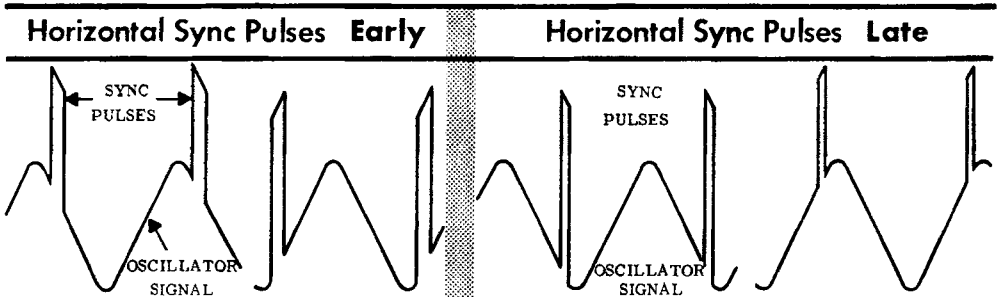

A few other points about the afc circuit should be mentioned at this time. Since the reactance tube operates by virtue of d-c control voltages, a filter is required to remove a-c components from the control signal. This is accomplished by the filter consisting of R8, R9, C5, and C6. The grid return circuit for the reactance tube may be traced through R9, R8, R1 and R2 to ground. The transformer is really a double tank circuit, one portion resonating the discriminator and the other side tuning the horizontal oscillator. The resistor R5 is the horizontal hold control which permits rough manual adjustment of the horizontal oscillator frequency. When this afc circuit is operating properly, R5 may be rotated from one side to the other without destroying the synchronization. As the components age, the hold control may be used to restore synchronization lost due to slightly changed tube characteristics or small variations in resistances or capacitances. The core of the transformer is also adjustable. It controls the basic oscillator frequency and is much more effective in making large frequency alterations.

HORIZONTAL AFC

The Discriminator Transformer

Aside from the hold control, the afc circuit we have just described may be adjusted by moving the core slugs (represented by the dotted arrows in the schematic) of the transformer. While the horizontal hold control is usually located within easy reach of the viewer, the slug adjustments for the transformer are generally found behind or on top of the chassis. The setting of slug L2 has a very decided effect upon the horizontal synchronization of the picture. If L2 is not at its correct setting, the right and left halves of the picture, separated by a vertical black bar, may show on the screen of the receiver.

Result of Misalignment

of the horizontal
AFC Transformer

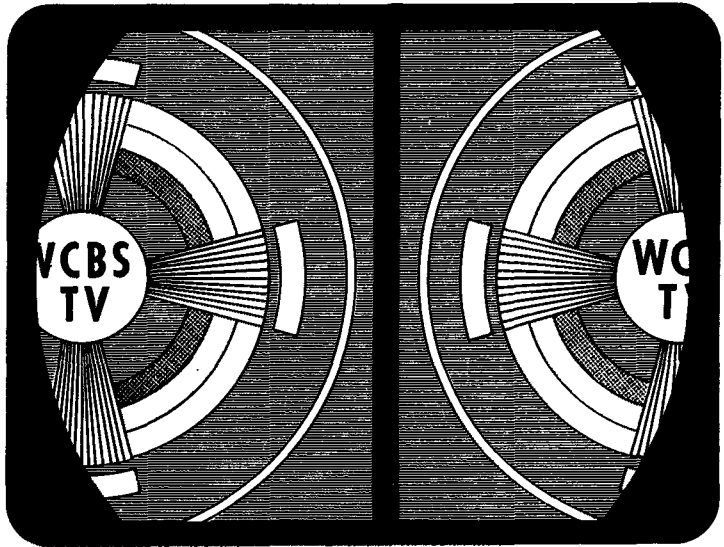

The portion to the left of the vertical black bar is the right-hand portion of the picture while the part to the right of the black bar is the left-hand portion. The black bar is the result of the horizontal blanking pulse that arrives at the end of every horizontally scanned line. The message this abnormal picture carries to the informed technician is that the horizontal oscillator is functioning at the correct frequency of 15,750 cycles but is not *in step* with the incoming sync pulses. The afc circuit is holding the oscillator frequency so well that it is actually preventing it from falling into step with the sync pulses. It is perfectly possible for the horizontal oscillator to be functioning at the same frequency as the rate of arrival of the horizontal sync pulses and still be out of step with the pulses. This is known as an *out-of-phase* condition. Readjustment of the discriminator transformer can re-establish horizontal phasing and so correct "picture splitting." Because of this function, slug L2 is often called the horizontal phase adjust.

HORIZONTAL AFC

Another Horizontal AFC System—Phase Discriminator

A Second Type of HORIZONTAL AFC SYSTEM

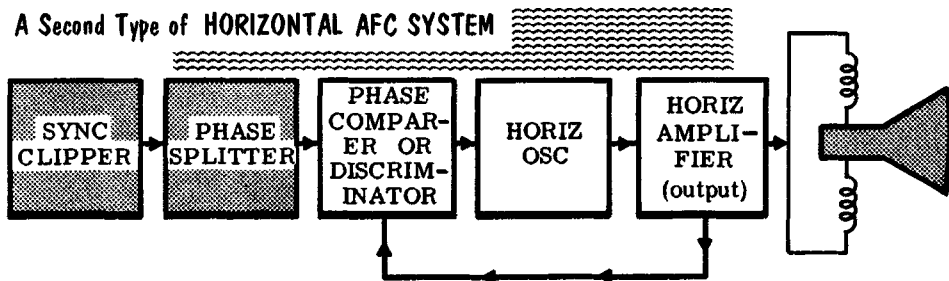

Another type of horizontal afc system, arranged almost the same as the one we have already seen, manages to do without the horizontal-discriminator transformer. The three basic stages shown previously in the block diagram are still present in this system, but they are arranged differently.

First, let us analyze the operation of the horizontal oscillator and its frequency control.

A CATHODE-COUPLED MULTIVIBRATOR

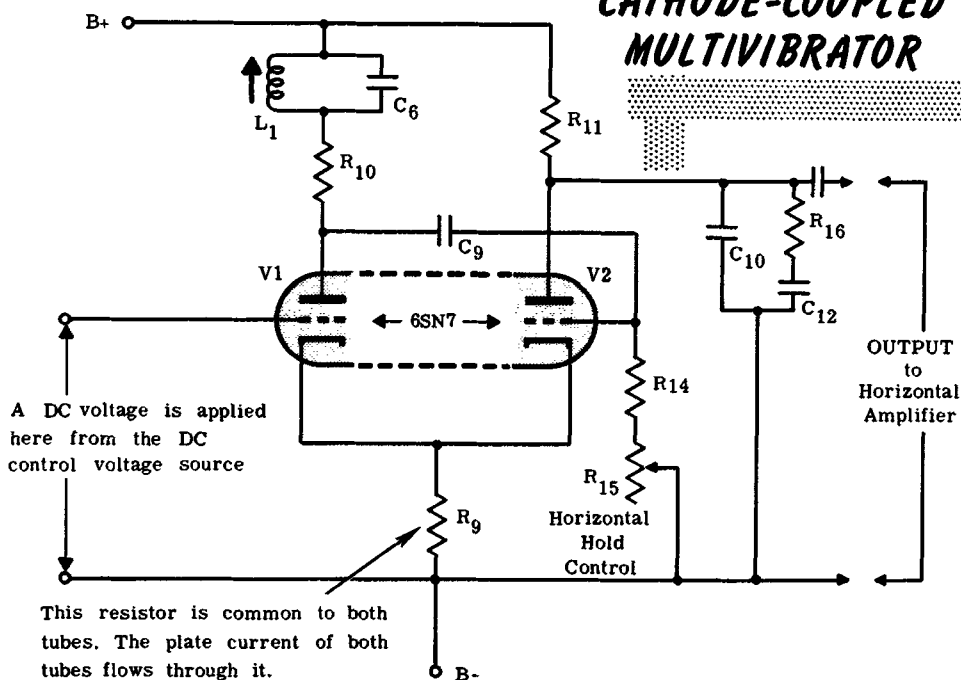

HORIZONTAL AFC

Phase Discriminator AFC (contd.)

The oscillator is an ordinary cathode-coupled multivibrator with one additional feature. The presence of L1 in the plate circuit of one of the triodes allows a certain amount of phasing adjustment, as will be indicated later. Otherwise, the circuit is perfectly straightforward. With the horizontal hold-control potentiometer in its proper position, the output frequency of the multivibrator is approximately 15,750 cycles. Now we shall see how a positive or negative d-c control voltage applied to the grid of the controlled triode governs the frequency of the multivibrator between limits.

When a multivibrator functions without outside "interference" from a controlling stage it produces a waveform something like this:

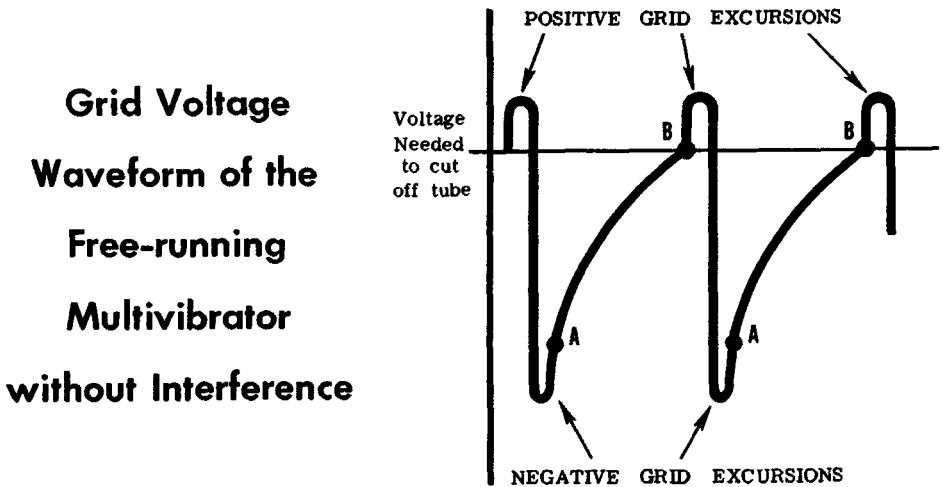

In normal oscillation, the grid of the multivibrator tube is driven far down into the region below cutoff. The time interval which must elapse before the next positive pulse is obtained from the multivibrator is governed by the length of time needed for the grid voltage to decay back to cutoff (over the path A to B, in the diagram). Thus, the frequency of the multivibrator—which we want to be exactly 15,750 cycles—depends to a great extent upon this decay time.

While the circuitry of multivibrators may vary slightly, the decay time is usually determined by the action of a resistor and capacitor in series. Thus, in effect, the time constant of an R-C network is involved. If the value of R and C is relatively small, the decay will be rapid, and it will take only a short period of time for the voltage swing to climb to the cutoff level. If the R-C value is large, the decay time will be slow, and the time taken for the voltage to reach cutoff level will be long.

HORIZONTAL AFC

Action of the Control Voltage

Consider now that a negative potential of a few volts is applied to the grid of the left-hand triode section, V1, of the 6SN7. This causes a decrease of the plate current of V1 which in turn reduces the voltage drop across the common cathode resistor R9; that is, the top of R9 becomes less positive with respect to B- than it had been before the application of the new minus voltage on the grid of V1. Now we turn our attention to V2. Since its cathode is connected to the top of R9, the voltage at this point becomes slightly less positive than it was previously. When a cathode becomes less positive this is the same thing as having the grid of the same tube go *positive*. Hence, we see that a negative voltage applied to the grid of V1 causes a corresponding positive voltage to appear at the grid of V2.

Action of Control Voltage at the grid of the Multivibrator

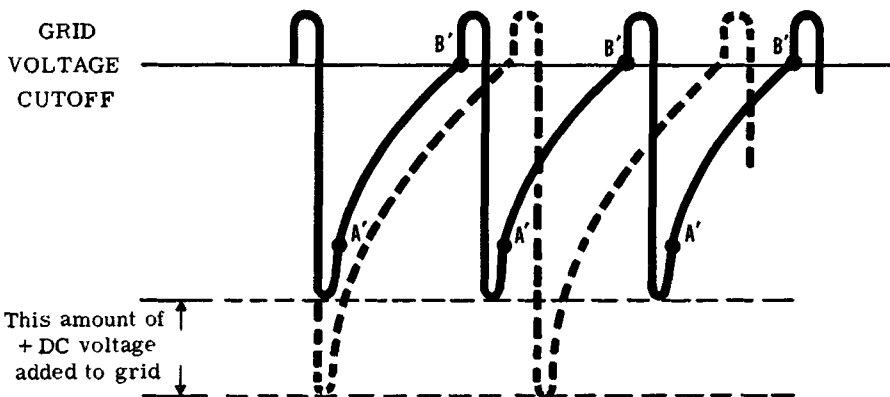

With this voltage present the grid of V2 cannot be driven as far negative during the cycle of the multivibrator oscillation as it was before. The waveform under these changed conditions appears as a solid line in the illustration above, in contrast to the waveform obtained without the control voltage (broken line). Now that the positive d-c voltage prevents the negative grid excursion from being as great as it was before, the time required for the grid voltage to decay back to cutoff is smaller (A' to B') so that the next multivibrator cycle begins substantially earlier. In this way, *the frequency of the horizontal oscillator is increased by applying a negative control voltage to the grid of V1.*

Should the control voltage be positive in polarity, the opposite effect occurs. The grid of the right-hand triode, V2, may now be driven further below cutoff and the time needed for its grid to come back to conduction again is extended. Hence, fewer cycles are obtained per second and *the frequency is lowered when the d-c control voltage is positive.*

HORIZONTAL AFC

The Phase Detector

Now let us study the *phase splitter* and *phase comparer* (or detector) section. Sharp negative synchronizing pulses from the preceding sync clipper stage are fed to the grid of the triode phase-splitter. Each time a negative pulse arrives at the grid of the triode, its plate current decreases sharply and causes a positive voltage pulse in its plate circuit. This positive sync pulse is fed through coupling capacitor C2 to the plate P1 of the duo-diode (6AL5). With a positive voltage pulse on P1, electrons flow from the plate in the direction of solid-line arrows, down R5, out at the tap between R5 and R6, through R7, and back to the cathode through R12.

Complete Diagram of the Second Type of AFC SYSTEM - Phase Discriminator

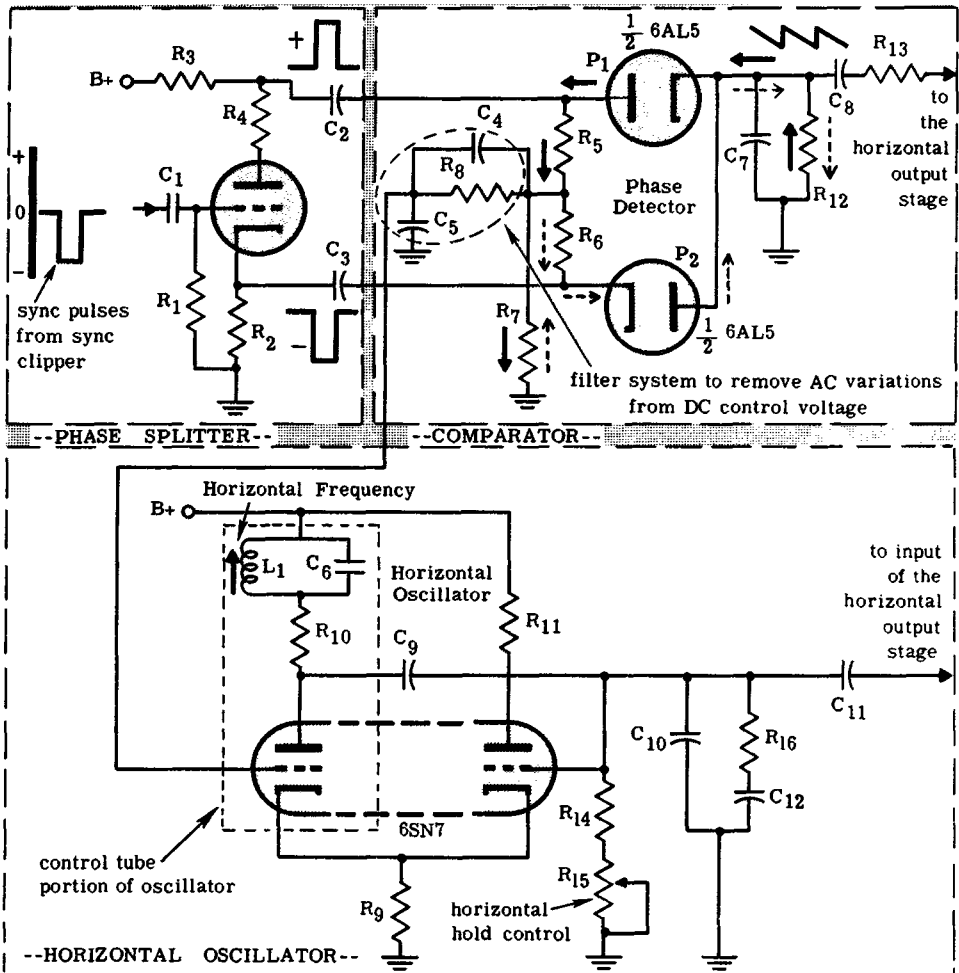

HORIZONTAL AFC

Phase Detector (contd.)

In a similar way we can trace the action in the lower diode of the 6AL5. What is the polarity of the pulse fed to lower diode? This pulse comes from the top of R2 in the cathode circuit of the phase-splitter. Remember that the voltage drop across a cathode resistor always differs in phase by 180° from the voltage drop across the plate resistor of a triode. Hence, the voltage pulse fed to the lower diode must be *negative*. As is seen from the schematic diagram, this negative pulse is fed to the cathode of the lower diode through coupling capacitor C3. When a negative pulse is applied to the cathode of any tube, the cathode becomes negative with respect to the plate or (what amounts to the same thing) the plate becomes positive with respect to the cathode, and plate current increases. This plate current follows the path of the dashed arrows in the diagram.

Analyzing a Section of an AFC System

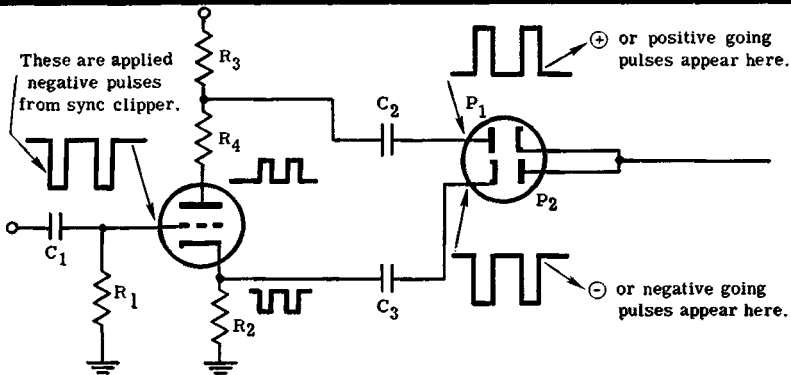

Notice, now, that the direction of the dashed arrows is opposite to the direction of the solid-line arrows for the top diode. The path consists of R12, R7, R6, then back to the cathode. It is important to note at this point that the voltage drop across R7 is zero if the two diode currents are exactly the same. Since two equal currents flowing in opposite directions through a resistor give a *net zero current*, there can be no voltage drop.

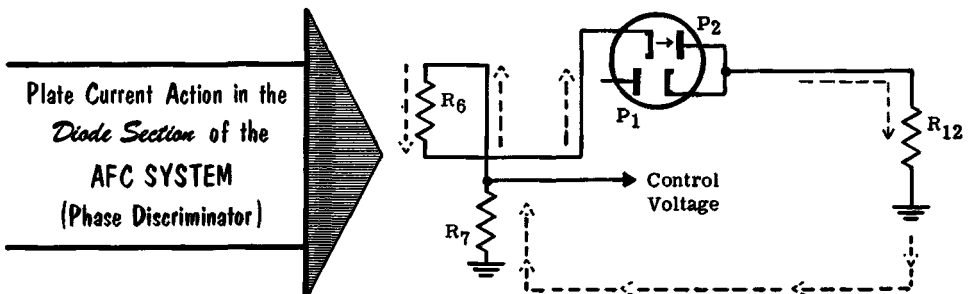

HORIZONTAL AFC

Phase Detector (contd.)

Assume first that there is no horizontal-sweep voltage applied to the diodes from the horizontal output stage. Under these conditions, the two out-of-phase voltages across R7 cancel each other leaving a net voltage of zero.

Now imagine that a sawtooth voltage from the horizontal output stage is applied to the cathode of the upper diode and the plate of the lower diode through coupling capacitor C8. If this voltage is so timed that the sawtooth is intersecting the zero voltage axis at the same instant that the sync pulses are being applied to the upper and lower diodes, the effect is *the same as though there were no sawtooth voltage at all*.

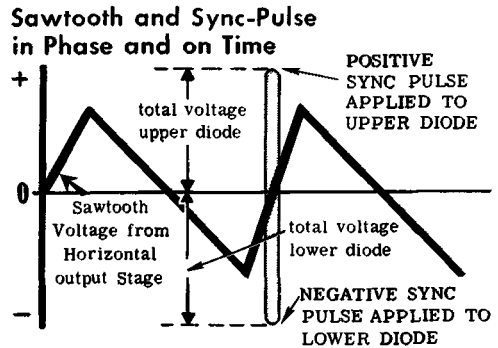

It can be seen from the figure that this perfect coincidence of sawtooth voltage and sync voltage does not permit the sawtooth to *add* or *subtract* from the sync peaks. Thus, the two diodes still draw equal plate currents in opposite directions through R7, the net voltage across this resistor is zero, and there is no control voltage fed to the multivibrator. This is a balanced condition in which the oscillator frequency is *just right*.

Now consider what happens to the superimposed waveforms when the multivibrator frequency is *too high*. In the light of timing or phasing, the horizontal sawtooth cycles occur too soon as compared with the arrival of the sync pulses.

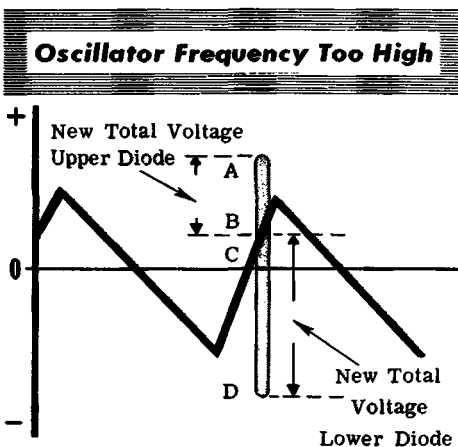

The arrival of the incorrectly timed sawtooth gives rise to this condition: at the instant when a positive pulse (a-c) from the sync system appears at the plate of the upper diode (P1), a somewhat smaller positive voltage (B to C) is applied to the cathode of the same tube by the sawtooth. These voltages are subtractive and the net voltage on the upper diode is thus *reduced* as compared to the correctly timed case as described above.

HORIZONTAL AFC

Phase Detector (contd.)

At the same instant that a negative sync pulse is applied to the cathode of the lower diode (C to D), the sawtooth feeds a small positive voltage to the plate (P2) of this diode. This voltage direction is additive so that the net voltage is *increased* above the properly timed value.

This change of voltage on both diodes causes the current indicated by the dashed lines to *increase* (due to the raised voltage on the lower diode) and the solid-line current to decrease (due to the reduced voltage on the upper diode) so that we have a picture something like this across R7:

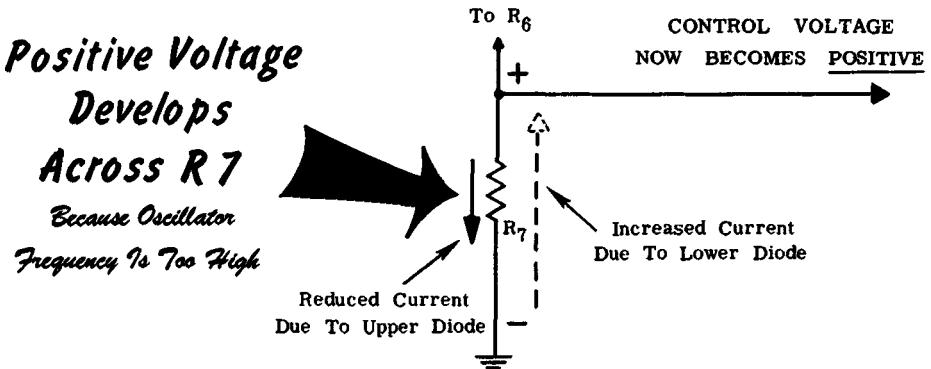

The net current in R7 is no longer zero. Now, a definite current flows upward from ground through R7, causing a voltage drop of the polarity shown in the drawing. The control voltage fed to the multivibrator is, therefore, *positive* at this instant.

If we recall that this positive voltage is produced because the multivibrator frequency is too high, we arrive at this conclusion: *a horizontal oscillator operating at too high a frequency produces a positive control voltage.*

When both these results are "joined end-to-end," we see that we have a self-controlling system following this pattern:

If — horizontal frequency is too **HIGH**

Then — a positive control voltage is produced and applied to the grid of V1 of the horizontal oscillator.

This causes — the horizontal frequency to decrease until it is in step with the incoming pulses, at which point the control voltage drops to zero and the oscillator is synchronized.

Likewise:

If — horizontal frequency is too **LOW**

Then — a negative control voltage appears at the grid of V1.

This causes — the horizontal frequency to increase until synchronized with the horizontal sync pulses.

HORIZONTAL AFC

A Third Type of Horizontal AFC System—Pulse-Width or Synchroguide

This extremely popular afc system dispenses completely with discriminators, discriminator transformers, and phase or frequency comparers. It is more economical initially and requires fewer tubes, the horizontal oscillator and control tube usually being contained in a single dual-triode envelope. The horizontal oscillator is customarily a blocking type rather than a multi-vibrator because this circuit is more responsive to small d-c control voltage variations and because only one tube (rather than two) is needed for the oscillator section.

A simplified circuit of a pulse-width system is drawn out on the facing page. Two sets of waveforms are fed to the control grid of V1, the control tube: one of these provides standard incoming sync pulse voltages while the other is a *parabolic waveform* obtained by combining a part of the horizontal output system sweep voltage with varying plate voltages from the blocking oscillator. The parabolic wave is shown emerging from the block labeled "horizontal deflection system in the diagram.

The cathode biasing resistor for V1 is sufficiently large so that the incoming parabolic waveform just drives the grid voltage to the point before conduction begins; that is, the tube is biased slightly below cutoff for the peaks of the parabolic waves. If there were no additional pulse voltages applied to the grid of V1, no plate current would flow.

As the sync pulses arrive, they combine with the parabolic wave. If the system is perfectly synchronized, the peaks of the parabolic waveform join the sync pulses at the coincidence time shown in *A*. Here it may be seen that the sync pulse combines partly with the gradually rising leading edge of the parabola and partly with the trailing edge. At the leading edge, the tube is driven into conduction for an interval represented by the horizontal portion of the pulse above the cutoff line.

Hence plate current flows in V1 during the interval shown in *A* and, on its way through cathode resistor R2, produces a voltage drop such that a small positive voltage is applied to the grid of blocking oscillator V2. It is assumed that now the horizontal oscillator has an output of 15,750 cycles and is perfectly phased with the sync pulses. In other words, this small control voltage keeps the blocking oscillator on frequency.

Suppose that the horizontal oscillator now tends to speed up. As a result, the parabola will reach its peak sooner than it should; but the transmitted sync pulse still will arrive at the same time. This moves the pulse closer to the trailing edge of the parabola and kicks the control tube into the conducting region for a shorter time than before, as shown in *B*.

This causes the average plate current of V1 to decrease. In consequence, the voltage drop across R2 also decreases and the control voltage at the grid of V2 becomes less positive than before. Applying a *less positive* voltage to the grid of a blocking oscillator causes its frequency to *decrease*. Thus, the control voltage brings the blocking oscillator back to 15,750 cycles.

A THIRD Type of HORIZONTAL AFC SYSTEM (Pulse Width or Synchroguide)

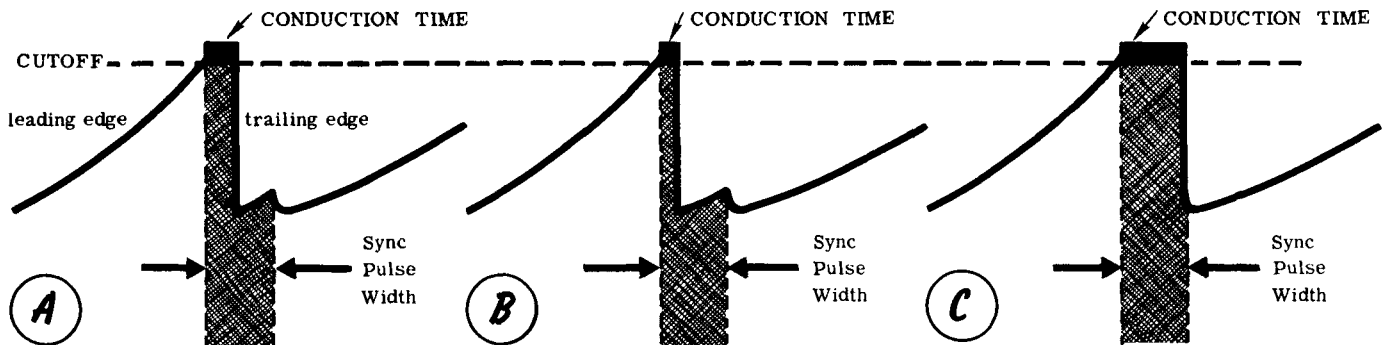
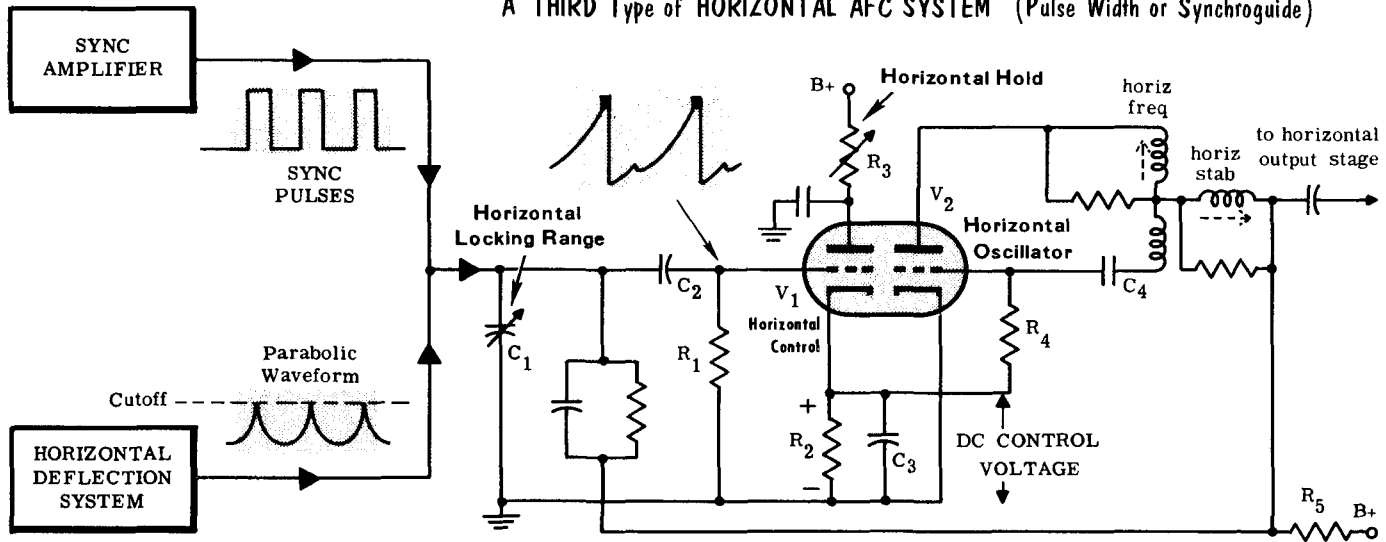

HORIZONTAL AFC

Pulse-Width or Synchroguide AFC (contd.)

When the horizontal oscillator slows down due to some voltage or circuit change, the condition shown in *C* is encountered. Here, the parabola arrives late with respect to the sync pulse and *V1* is driven into conduction for a longer interval. The net effect of this is to increase the average plate current of *V1*, make the control voltage more positive, and cause *V2* to speed up—or to return to 15,750 cycles. Like a system of checks and balances, a wavering horizontal oscillator is gently prodded from side to side by the control voltage each time it attempts to wander.

The control voltage is an *average* value obtained by the integrating action of capacitor *C3*. The final potential used for control is built up over a few cycles of oscillator operation since *C3* does not charge instantaneously to the peak voltage. A few synchronization pulses must be received before *C3* reaches its stable state for perfect synchronization. This is an advantage because it makes the system immune to short, sharp noise pulses. Such interference could trigger the horizontal oscillator if the afc system were one in which synchronization took place cycle by cycle. The averaging action of the cathode bypass capacitor and resistor is such that the d-c control voltage fed to the grid of *V2* changes gradually, hence it does not respond to single, isolated pulses resulting from noise voltages.

AFC Controls

In most receivers two controls are provided for this afc system: the *horizontal hold* is a potentiometer in series with the *B+* supply lead which establishes the correct basic oscillator frequency of 15,750 cycles. It is then the job of the afc system to prevent this from drifting, even slightly. The second control is generally labeled “horizontal locking range” and consists of a smaller trimmer capacitor in the grid circuit of the control tube (*V1*). This capacitor helps to phase the pair of incoming waveforms so that the sync pulse falls on the correct part of the parabolic waveform when the oscillator frequency is exactly 15,750 cycles.

THE SYNCHROGUIDE AFC CIRCUIT contains controls

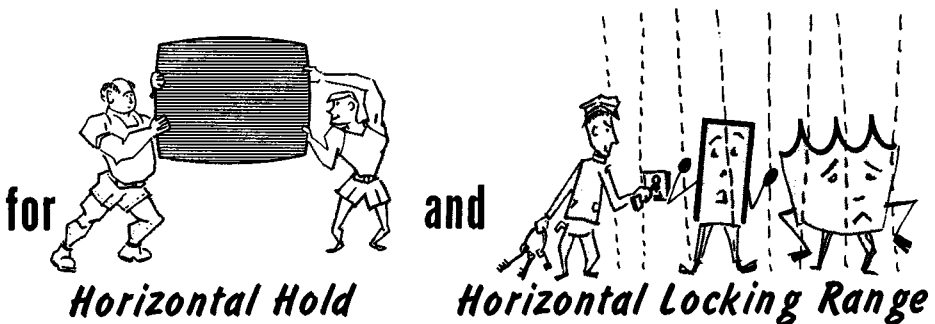

REVIEW

1. *The Horizontal Sweep Circuit Action.* The sync separator-amplifier furnishes two outputs: One which contains the vertical sync signal is fed to the vertical integrator, the other which may be considered to be the horizontal sync signal, is fed to the horizontal sweep oscillator.

Block Diagram of Sync Circuits Which Feed the Sweep Circuits

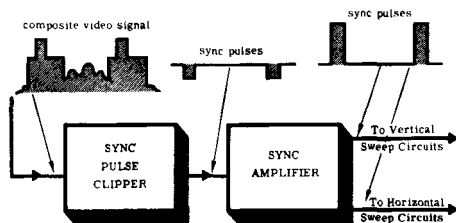

The Differentiator

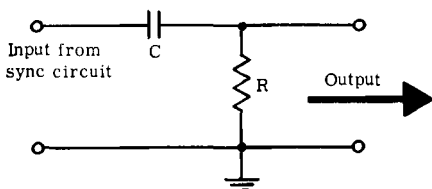

2. *The Differentiator* is located in the output system of the sync circuits. It consists of a simple combination of resistance and capacitance having values such that a square or rectangular pulse fed into the system will result in a sharply peaked output pulse.

3. *The R-C Time Constant of an R-C circuit* is defined as the product of the capacitance in farads and the resistance in ohms. By definition the time constant is the time required for the voltage to build up to approximately 63% of the applied voltage.

Charge and Discharge Curves

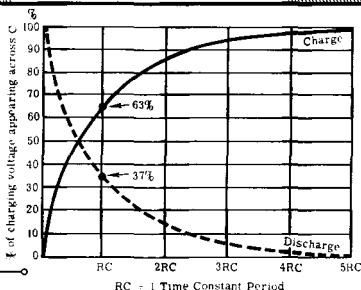

HOW THE DIFFERENTIATOR REACTS

TO THE VERTICAL SERRATED PULSE.

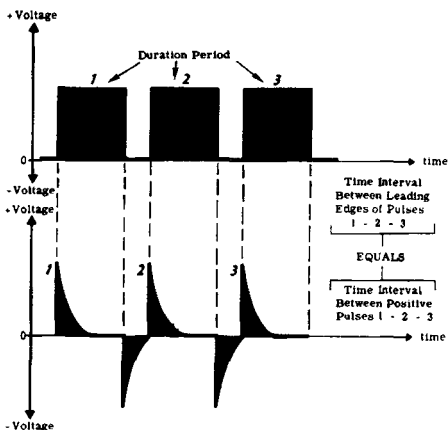

4. *The Effect of the Input Pulse Shape on the Differentiated Output.* If the input voltage pulse is of relatively long duration with short zero voltage intervals between, the negative pulse of the differentiated output for the trailing edge of the input voltage is very close to the positive differentiated pulse due to the leading edge of the adjacent input voltage pulse.

REVIEW

NOISE Signals in the Sync Pulses

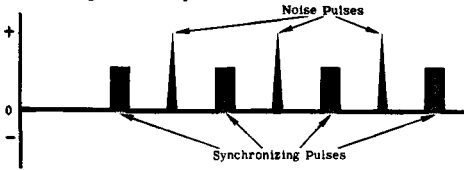

6. One Type of Horizontal AFC System. The reactance modulator is connected to the tank circuit of the horizontal oscillator and its inductance is made part of the inductance which governs the oscillator frequency. Bias voltages of the right nature are available from the output section of the discriminator, and are applied to the reactance modulator as such, completing the horizontal automatic-frequency-control (afc) system.

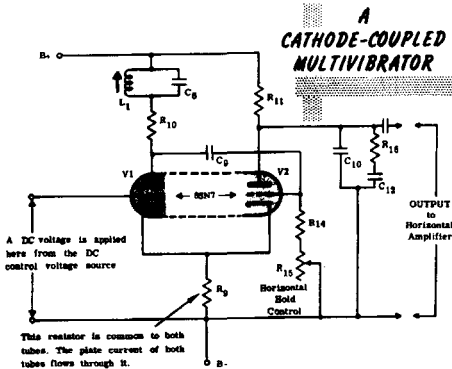
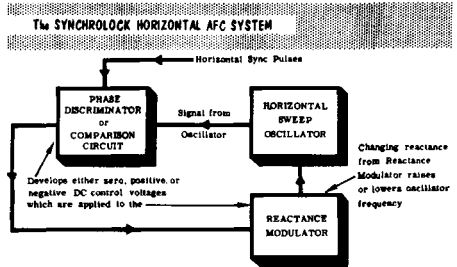

7. Another Horizontal AFC System—Phase Discriminator. The horizontal oscillator is a cathode-coupled multivibrator with an additional coil L1 in the plate circuit of one of the triodes to allow a certain amount of phasing adjustment. With the horizontal hold control potentiometer in its proper position, the output frequency of the multivibrator is about 15,750 cycles.

8. Phase Discriminator. In normal oscillation, the grid of the multivibrator tube is driven far down into the region below cutoff. The time interval which must elapse before the next positive pulse is obtained from the multivibrator is governed by the length of time needed for the grid voltage to decay back to cutoff over the path A to B on the diagram.

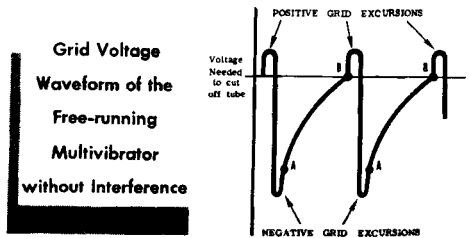

HORIZONTAL DRIVE

The Horizontal Sweep Circuit

The horizontal sweep circuit in many ways resembles the vertical sweep circuit previously discussed, as we can see in this block diagram.

Block Diagram of HORIZONTAL SWEEP CIRCUIT

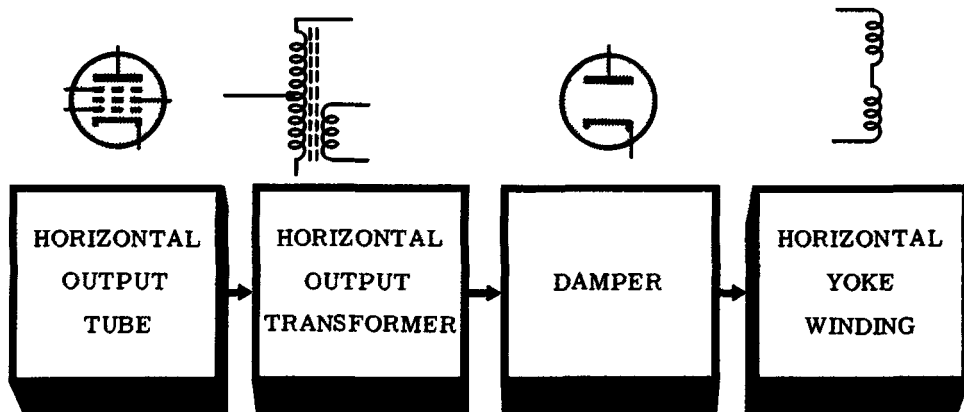

The final function of this system is to provide the necessary current waveforms to the horizontal winding in the picture-tube yoke for the purpose of sweeping the electron beam across the screen. The horizontal sweep action produces the scanning lines of which the image is composed. In addition, the horizontal output system supplies the high-voltage power supply with driving voltage, boosts the B+ from the low-voltage power supply to increase the efficiency of the horizontal output tube itself, and provides the pulses needed for the afc system, automatic gain control arrangements, and the video blanking pulses.

As we shall see, the horizontal sweep section of the television receiver is unusual in that so many parts depend on other functions for their own proper operation. The horizontal output stage must receive a sweep voltage of the proper frequency and amplitude and shape, from the horizontal oscillator or discharge circuit. This sweep voltage is then fed to the horizontal output tube which provides horizontal sweep power to the deflection coils. To match the impedance of the deflection coils to the horizontal output tube we make use of the horizontal output transformer. The illustration shows also a damper section. This consists of a diode tube and associated circuitry that aids in the wave formation of the horizontal deflection currents in the deflection coils. During the operation of all this circuitry a high-voltage pulse is developed across the horizontal output transformer that is used in obtaining high voltage for the picture tube. All this circuitry works together in a smoothly integrated network.

HORIZONTAL DRIVE

The Horizontal Discharge Circuit

In discussing the vertical output system, we noted that an arrangement called the *discharge circuit* is used in connection with the vertical oscillator to produce a voltage having the required waveform; that is, the waveform needed to cause a sawtooth *current* to flow through the vertical deflection coils in the yoke. The same goes for the horizontal output system.

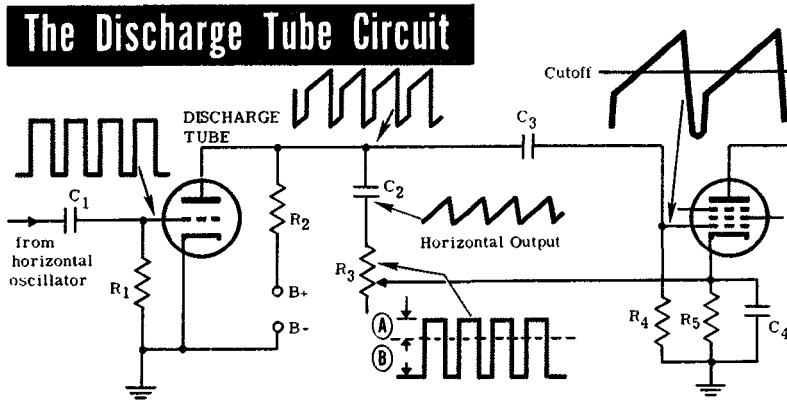

There are two general methods in use to produce the correct discharge waveform. The simplest of these uses a resistor and capacitor in the same arrangement as the discharge circuit discussed in connection with the vertical oscillator. In the diagram describing the second afc circuit on previous pages, R₁₆ and C₁₂ make up a network which produces the sawtooth waveform. In some receivers, however, a separate tube is used in combination with an R-C network to form the output pulses into the desired shape. The resistance of R₃ is low compared to that of R₂. Capacitor C₂ charges relatively slowly through the path formed by the sequence of B+ to R₂ to C₂ to R₃ to R₅ to ground or B-. Since the charging current is low and the resistance of R₃ is relatively small, very little voltage drop appears across this resistor during the time that C₂ is charging; this small voltage is shown at A in the waveform. When a heavy positive pulse from the horizontal oscillator appears at the grid of the discharge tube, the tube conducts suddenly and quickly discharges C₂, the discharge current flowing through R₃ and R₅, too, since these resistors are part of the discharge circuit. This time a large negative voltage develops across R₃, as shown at B of the resistor waveform. Thus, the charge-discharge cycle of capacitor C₂ produces a *peaked* or square-wave voltage across R₃ while, at the same time, giving rise to a sawtooth voltage across C₂. The sum of these two voltages is, as we have seen in the case of the vertical output stage, a *trapezoidal* waveform. This is the voltage waveform needed to drive a *sawtooth* current through an inductive winding such as the horizontal deflection coil of the yoke.

HORIZONTAL DRIVE

Horizontal Drive Control

Since the trapezoidal voltage developed across the discharge circuit is the sum of a sawtooth and square wave, its final shape depends upon how much of each of these voltages is being combined with the other. Clearly, if R3 is made larger, the trapezoid will contain more square wave than sawtooth; if R3 is reduced in size, the reverse will be true. In any event, R3 governs the overall amplitude of the trapezoidal voltage fed to the

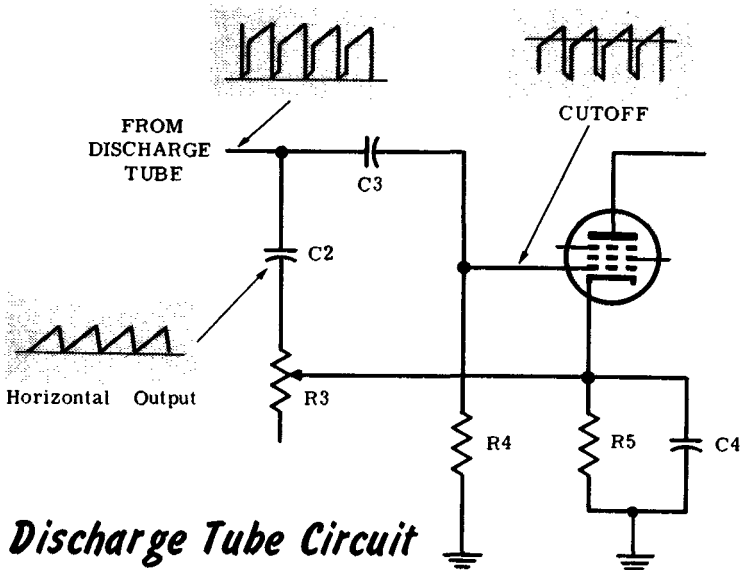

Discharge Tube Circuit

grid of the horizontal output tube and, to some extent, controls the *width* or *horizontal size* of the picture. But it does more than this. A portion of the trapezoidal voltage must appear across R5, the cathode bias resistor of the horizontal output tube. C4, like any cathode bypass capacitor, removes or bypasses the a-c component of the trapezoid leaving a d-c voltage across the resistor. The size of the d-c voltage depends upon the amplitude of the trapezoidal voltage originally developed across R5.

Appearing across the cathode resistor as it does, this d-c voltage constitutes bias for the horizontal output tube and, as such, partially determines the operating point of the tube. As we saw in the case of the vertical sweep system, a change of operating point affects the linearity of response of the output tube so that an adjustment of R3 must cause a difference in the linearity as well as horizontal picture size.

Thus, R3 does two things; actually it is neither a linearity control nor a width control; rather, it makes small but significant adjustments on *both*. It is called the *horizontal drive control*.

HORIZONTAL DRIVE

Another Way to Control Horizontal Drive

Capacitors C_1 and C_2 , connected across the grid input circuit of the horizontal output tube, form a capacitive voltage divider in which the applied sweep signal is divided into two parts according to the relative sizes of the capacitors. This is the same process that occurs in resistive voltage dividers. The voltage appearing across the drive control depends upon how large C_2 is compared to C_1 . C_2 is intentionally made smaller in capacitance than C_1 ; this makes its capacitive reactance larger so that the portion of the total voltage that appears across it is larger than across C_1 . If the capacitance of the drive control is now *increased*, its reactance *decreases*, and the voltage that appears across it is reduced. Thus, less trapezoidal driving voltage is fed to the grid of the horizontal output tube and the width of the picture decreases. Excessive drive voltage also affects linearity by causing the picture to stretch on the left side. In some receivers, excessive drive also causes a white bar to appear near the center of the picture, while in others the center of the picture may exhibit a wrinkling type of distortion.

The Horizontal Drive Control

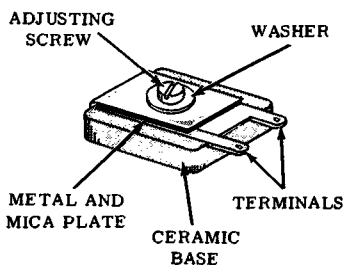
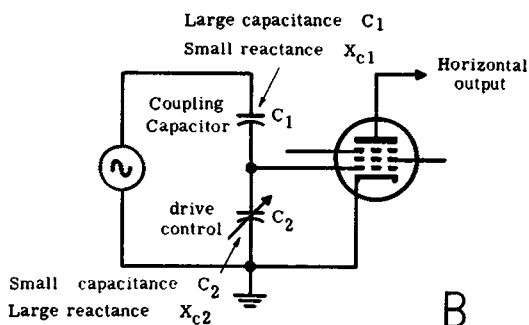
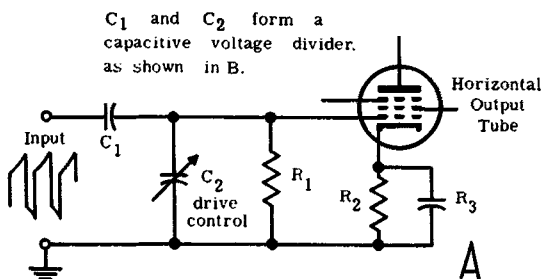

Mica-Compression Type Trimmer

SINCE
 $E = IX_c$
 AND SINCE
 I is the same in C_1 and C_2
 (series circuit)
 THEN
 Large X_c means Large E
 and small X_c means small E

In modern receivers, the horizontal drive control capacitor is usually a mica-compression or ceramic type trimmer.

HORIZONTAL OUTPUT CIRCUITS

The Horizontal Output Stage

The horizontal output stage in today's television receiver invariably consists of a high-efficiency type of power or beam pentode, an output (flyback) transformer, and associated small components. The other parts of the horizontal output *system*, in distinction to the output stage, may be listed as: the horizontal deflection coil in the yoke, the damper circuit, the high-voltage power supply, the B+ boost circuit, the linearity control and the width control. Let us analyze each of these in turn, starting with the horizontal output stage.

As we have seen, the grid input to this stage consists of trapezoidal voltage pulses from the discharge circuit which follows the horizontal oscillator. Consider a simplified output circuit like this:

The Horizontal Output Stage

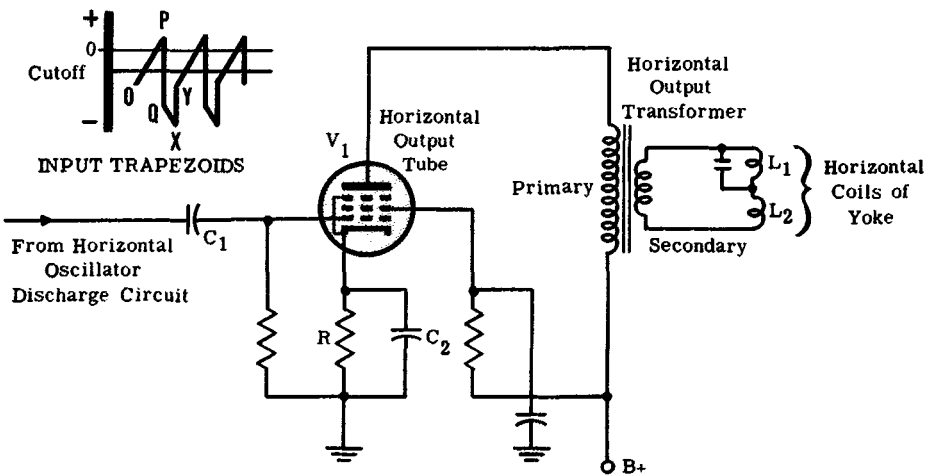

Trace and Retrace Time

The voltage applied to the grid of the output tube rises at a steady rate from O to P. When it reaches P it takes a sharp drop in the negative direction to Q. Then there is a short interval while the voltage goes from Q to X, after which it rises suddenly to Y and starts a new cycle. The period from O to P represents *trace time* and the time from Q to X *retrace time*.

As the drawing shows, the *trace time* is the period during which the electron beam of the picture tube is being deflected uniformly, at a *relatively* slow rate across the face of the tube, leaving behind a flowing line which ultimately forms a part of the picture.

HORIZONTAL OUTPUT CIRCUITS

Horizontal Output Stage (contd.)

The Trace and Retrace Time

This slow rise in voltage moves the beam from left to right --- the forward trace.

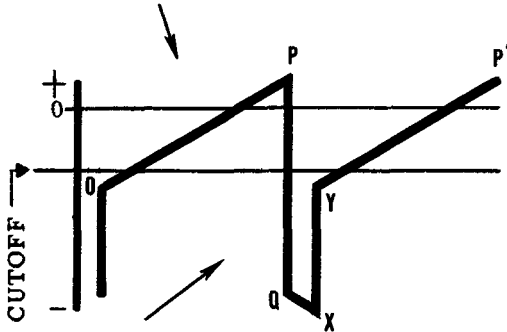

During This Interval, RETRACE Occurs.

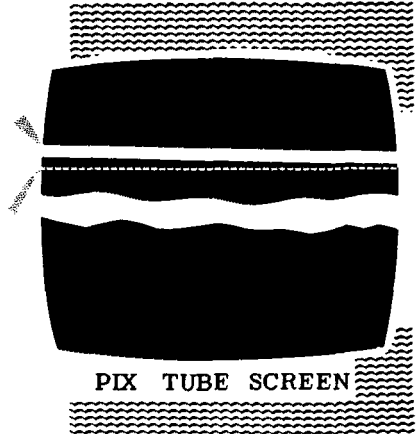

During *retrace* or *flyback*, the electron beam is blanked out. (That explains why we show the retrace line as a dashed line in the drawing.) It returns to the left side of the screen to begin sketching the next line of the picture.

The Plate Current Waveform at the Output Tube

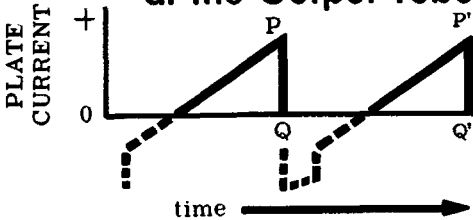

At the same time, the plate current of the output tube tends to follow a pattern like this illustration. Since plate current cannot flow when a tube is cut off, the dashed section of the plate current waveform shows that portion of the grid voltage-input beyond cutoff. During this time, plate current is zero.

Essentially, the waveform is the same as that of the voltage applied to the grid of the output tube. It is all in the positive region, of course, since plate current cannot flow backward in a vacuum tube. Note the very sharp decline of current each cycle from P to Q. *It is this very sudden drop in plate current which makes possible the generation of the high voltage needed for operating the picture tube.*

You will recall from your work in basic ac that the magnitude of an electromagnetically induced emf depends, among other things, upon the *rate of change of current flowing in a coil*. If the current strength changes *rapidly*, the induced emf is *large*. Certainly, a greater rate of change of current than that which occurs from P to Q could hardly be realized anywhere. Hence, use may be made of this waveform in producing the extremely high voltages needed for the second anode of the picture tube.

HORIZONTAL OUTPUT CIRCUITS

The High-Voltage Flyback Transformer

As the schematic diagram of the simple horizontal output stage shows, there is a coil in the plate circuit of the tube. As we shall show later, this coil is the primary of a transformer which is needed to provide the correct impedance match for the yoke winding L_1 and L_2 . In practice, the transformer primary winding is modified by adding to its turns and extending the winding on the same core, in this fashion:

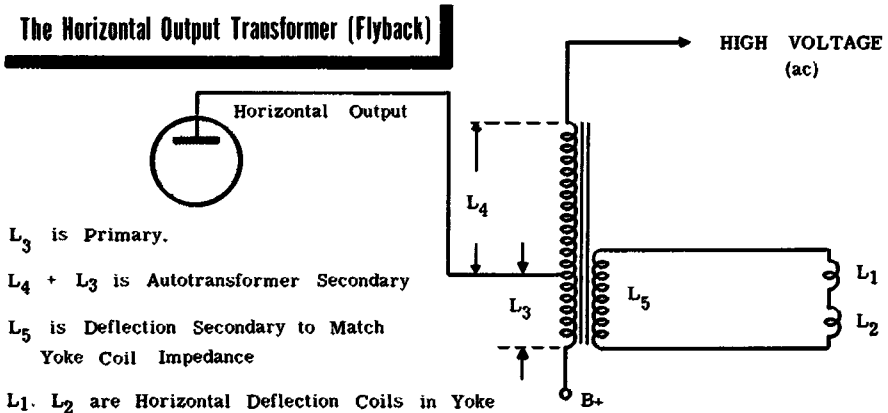

L_3 and L_4 together make up an *autotransformer*. The operation of this type of transformer follows the same pattern as that of an ordinary transformer. It may provide voltage step-up or step-down, depending upon its construction and connections, the voltage ratios being determined by the same simple rules which apply to the two-winding types. For example, the voltages that might be obtained from a typical autotransformer are compared with a similar two-winding transformer in this diagram.

The TRANSFORMER and the AUTOTRANSFORMER

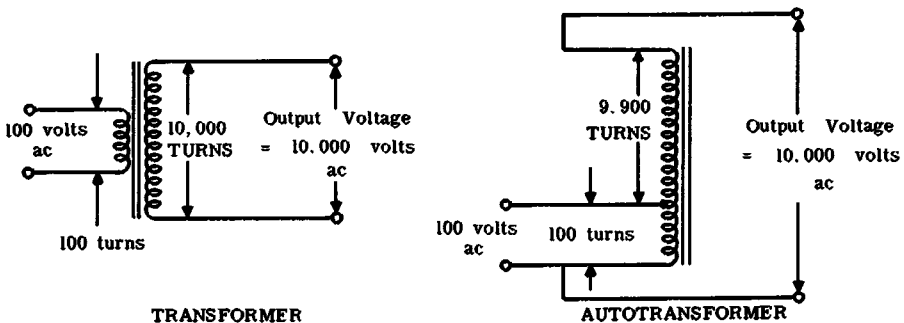

HORIZONTAL OUTPUT CIRCUITS

Two Types of Flyback Transformer

Returning to our output system, when the time for the flyback of the scanning beam arrives, the sharp drop in current flowing through L3 induces a very high voltage across this portion of the winding. This in turn induces an *extremely* high voltage across the whole winding L4, since L4 contains many more turns than L3. If this high voltage is now rectified, we will have the d-c voltage that the picture tube requires.

The horizontal deflection voltage appears across the secondary winding L5 by regular transformer action. Since L5 is matched to the impedance of the horizontal deflection coils L1 and L2, a large current having the waveform essential to proper sweep of the picture tube electron beam will flow in these coils. Later, we shall discuss this at greater length.

The horizontal output transformer is called the *flyback transformer* because the high voltage just discussed is developed during the *flyback* interval of the scanning voltage. Two types of horizontal output transformer have been widely used.

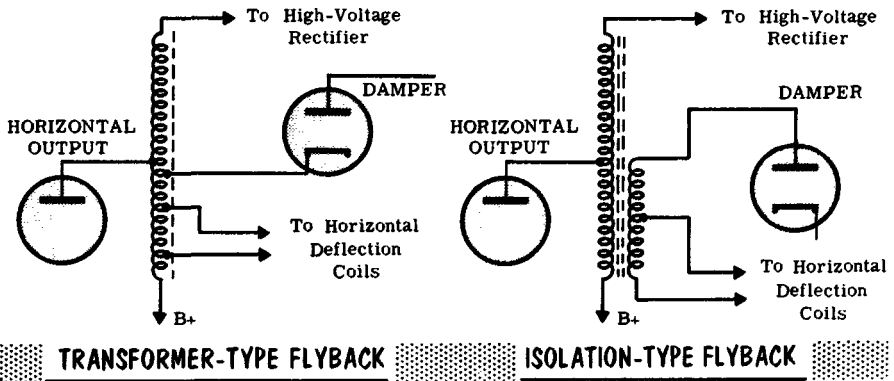

The two-winding or "isolation" type flyback transformer was used mostly in the early days of television. The autotransformer flyback has since gained in popularity and is used widely in modern television receivers. In the autotransformer type flyback there is just one continuous winding, with taps for the high-voltage rectifier, horizontal output tube, damper, horizontal deflection coils, and B+. The only important difference between the two types is that the voltages fed to the damper and horizontal deflection coils will be inverted in one with respect to the other. This is the result of the separate secondary in one and not in the other.

In the diagrams of the output circuit, there is a small capacitor across one of the horizontal deflection coil windings. This is called a balancing capacitor and is used to prevent coupling between the vertical and horizontal deflection coil windings in the yoke. For proper balancing it is connected across the "high" side of the horizontal deflection coil.

HORIZONTAL OUTPUT CIRCUITS

The High-Voltage Power Supply

The output voltage at the top of the flyback transformer has a very high a-c potential with reference to ground. The second anode of the picture tube requires dc, however, so the flyback output must be rectified and filtered.

To the previous circuit we have added a high-voltage rectifier tube (1B3, 1X2, or similar), a filter resistor R_1 , and a filter capacitor C_1 . One of the most interesting features of the circuit is the method whereby the high-voltage rectifier obtains its filament power. One or two loose turns, well sheathed in high-voltage insulating tubing, are usually placed near L_5 around the same core. Since a 1B3 or 1X2 requires 1.5 volts across its filament, enough voltage is induced in these turns to do the job.

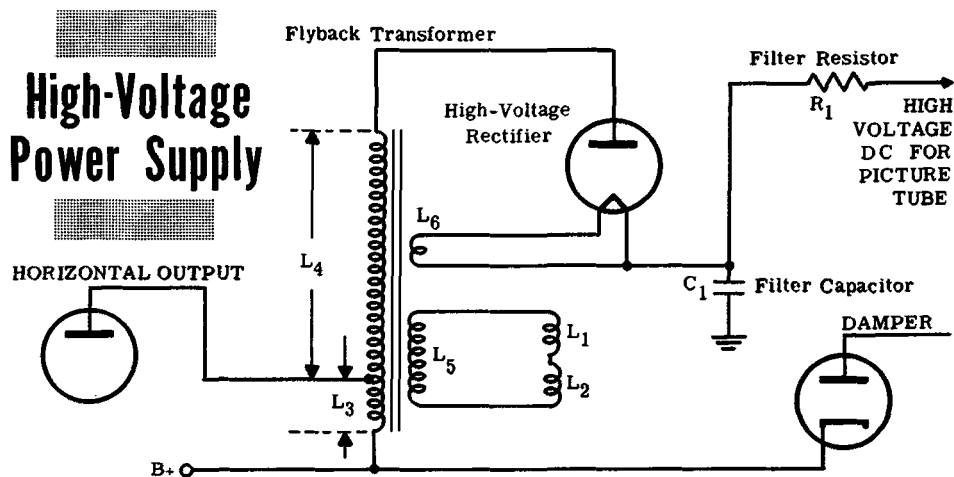

The high-voltage rectifier is connected in a simple half-wave rectifier circuit. Each time the plate is made positive by the voltage pulse in the flyback transformer, current flows from filament to plate, through L_4 and L_3 , through the low-voltage power supply to ground and back to the filter capacitor C_1 . Thus, C_1 charges to the peak voltage of the high-voltage ac—often as much as 20,000 volts in modern 21-inch receivers. This voltage is then applied directly to the second anode of the picture tube.

The filter capacitor must have a very high voltage rating, of course; otherwise it may break down and destroy itself. Fortunately, its capacitance does not have to be very high so that the capacitor can be quite small. Even with small capacitances, filter capacitors can provide adequate filtering action, as long as the a-c voltage applied to the rectifier is high in frequency. Certainly, this is the case here. The frequency is 15,750 cycles—the frequency of the horizontal oscillator that supplies the pulses required by the flyback transformer. The usual capacitance of C_1 is 500 micro-microfarads ($500\mu\mu\text{f}$).

HORIZONTAL OUTPUT CIRCUITS

The Damping Circuit

In the vertical output system, a pair of damping resistors connected across the vertical deflection coils was sufficient to prevent the effects of ringing or shock oscillation in the coils. However, due to the high scanning frequencies involved in the horizontal deflection system, damping resistors cannot do the job adequately.

These waveforms show the effect of the changing output tube grid voltage upon the deflection coil current and voltage.

When the voltage at the grid of the horizontal output tube drops suddenly from P to Q, the plate current of the tube cuts off suddenly. The secondary circuit of the stage contains a great deal of inductance in the form of secondary winding L5 and deflection coils L1 and L2. The sharp cutoff

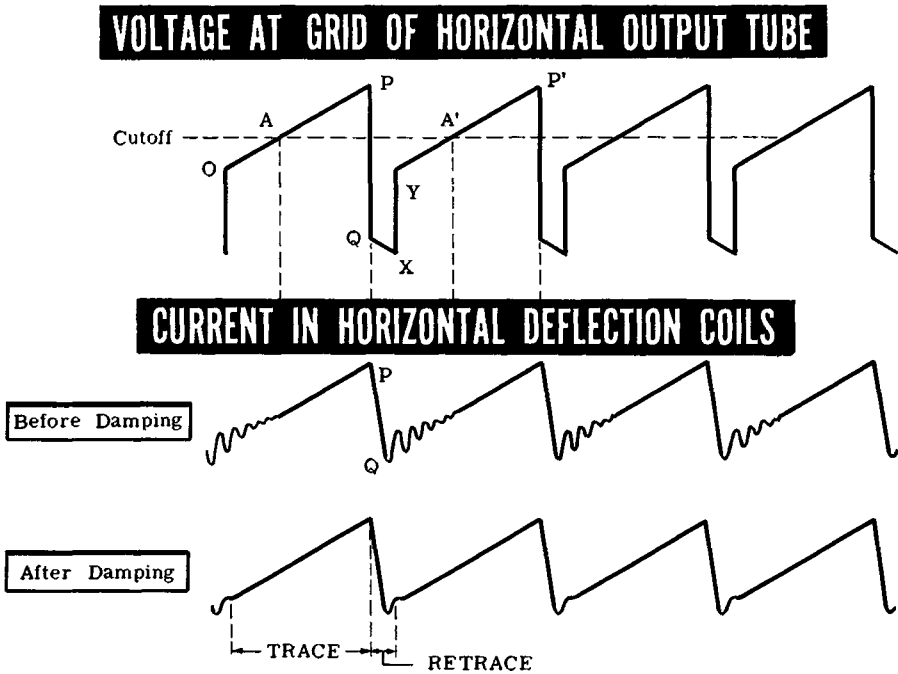

of current causes the magnetic field around L1 and L2 to collapse suddenly and induce a very high voltage across L1 and L2 in the form of a counter emf. This shocks the whole system into self-oscillation. All the inductance in the circuit plus the stray capacitances that are present form a tuned circuit which resonates in the vicinity of 70 to 80 kc. These oscillations, as pictured in the waveform diagram, continue for a large part of the cycle before being dissipated in the low resistance of the coils and, if permitted to occur unhampered, would completely destroy the picture quality.

HORIZONTAL OUTPUT CIRCUITS

The Damping Circuit (contd.)

However, there is a need for a definite portion of this shock oscillation: should no oscillation occur, the energy stored in the yoke as a result of the sharp current change in the tube would be dissipated very slowly. This would result in a slow decay of the sawtooth current in the deflection winding. A lingering decline of this nature is very detrimental because the flyback (retrace) is not completed before the next scanning line appears. This produces an effect called horizontal foldover, where the picture folds back over on itself.

The 70–80-kc oscillation permits a heavy inductance to exhibit a *fast* decay; that is, the first half-cycle of the shock oscillation (P to Q) speeds the decline of the yoke current for rapid retrace. Since oscillation of this

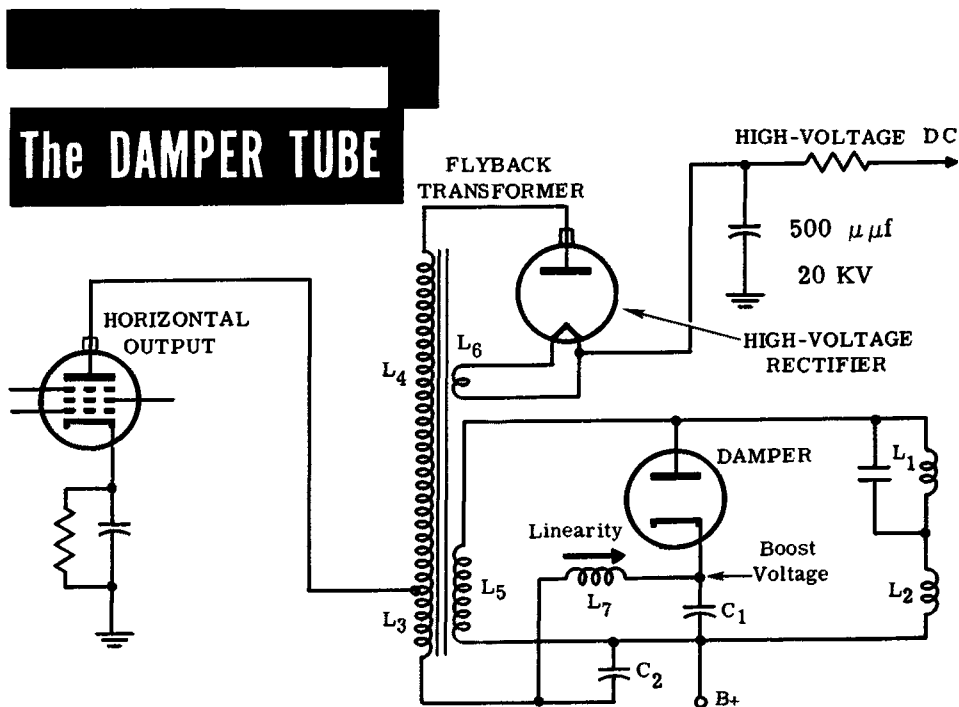

frequency has a *period* of approximately 14 μsec, the first half-cycle is completed in about 7 μsec. The horizontal blanking time of the video signal is close to 10 μsec, so that the beam has more than enough time to return to the left side of the screen before the next line begins. *This could not happen without the help of the shock oscillation.* After the first half-cycle is completed, however, further oscillation would be intolerable. Its removal is accomplished by the *dampner tube* and its associated circuit.

HORIZONTAL OUTPUT CIRCUITS

The Damping Circuit (contd.)

As you examine the circuits, you note the following:

1. The damper tube is a diode which is connected in parallel with the horizontal deflection coils L1 and L2. The capacitance of C1 is chosen so that its reactance at 15,750 cycles is negligible.
2. The B+ voltage supply to the plate of the horizontal output tube now follows a path through the damper tube, through L7 (the linearity coil which will be discussed shortly) and finally through L3 to the plate.

During the interval A-P of the forward trace the horizontal output tube is conducting. Throughout this period, current flows up from ground through the cathode resistor, the output tube, down through L3, through L7 and the diode, to B+. No shock oscillation can possibly occur under these conditions because the horizontal output tube is acting as the damper—that is, it “loads down” the deflection coils.

At the completion of the line-scanning interval, the current in the yoke drops sharply (P to Q). The voltage across L1 and L2, produced by the collapsing magnetic field, reverses, making the plate of the damper diode negative with respect to its cathode. In this condition, it becomes an open circuit and the half-cycle of oscillation (P to Q) takes place unhampered. You will recall that this half-cycle is essential for fast retrace.

At the completion of the half-cycle (point Q), the yoke current reverses, attempting to continue the damped oscillation. As it does so, the plate of the diode becomes positive with respect to its cathode due to the reversed voltage drop, the diode conducts, and causes the yoke current to fall slowly and linearly toward zero. Contrast this low, even decay with the oscillatory decay shown below.

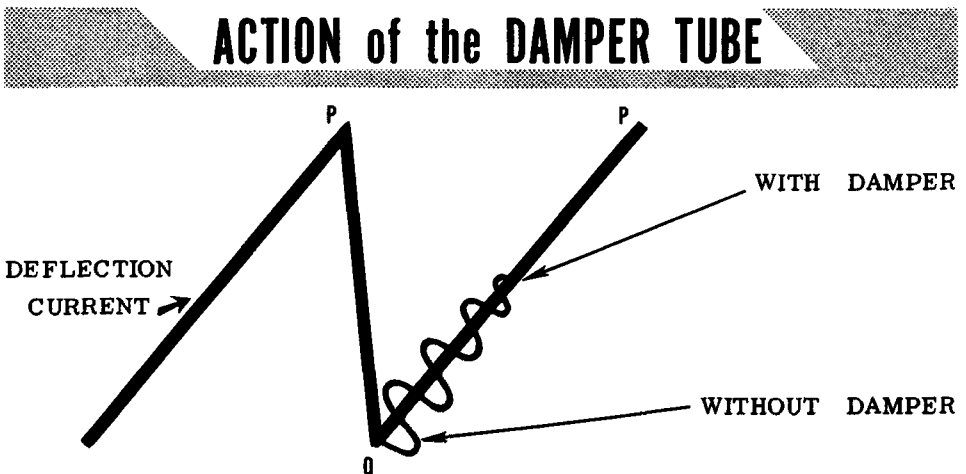

HORIZONTAL OUTPUT CIRCUITS

The Damping Circuit (contd.)

Once the yoke current decays to zero, the output tube conduction cycle again takes over, maintaining a uniform, linear rise of yoke current as required for proper sweep.

Until now it was assumed that yoke current flowed during the entire linear rise in horizontal output tube grid voltage. While this is true, it is not all the result of grid voltage. Recall that approximately one-third of the grid waveform occurred while the horizontal output tube was cut off. Thus, plate current flow in this tube accounts for only two-thirds of the yoke sweep current waveform.

The diagram shows how plate current flows at point A and continues for about two-thirds of the yoke current waveform. When the grid voltage drops suddenly into cutoff, the magnetic field around the horizontal deflection coils collapses, shock-exciting the horizontal output system, as de-

SWEEP CURRENT IN YOKE IS MADE UP OF...

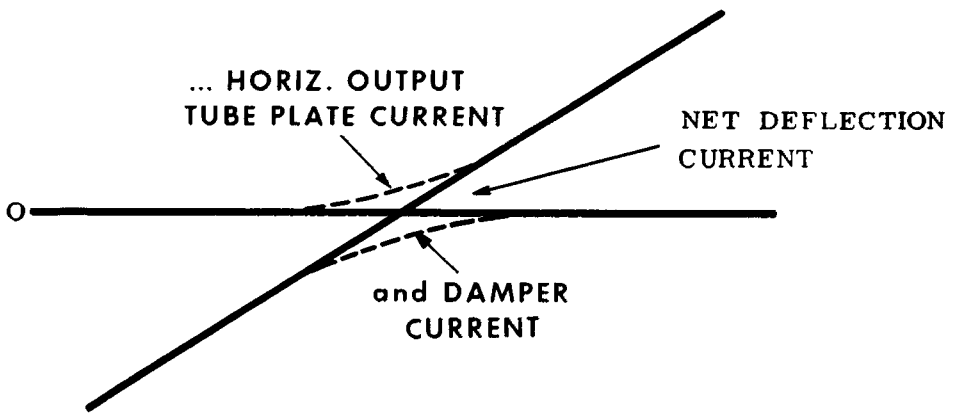

scribed, moving the beam from right to left (retrace). When the beam has completed its retrace and is at the left side of the screen, the damper begins to conduct (B), and places a heavy load across the deflection coils. This damps the oscillations and provides the sweep current for the first one-third of the deflection-coil current waveform.

As the rate of energy decay becomes nonlinear, the horizontal output tube, which has been in cutoff during retrace and the first one-third of the horizontal sweep, begins to conduct. With proper adjustment of the linearity coil, the damper decay and the start of horizontal-output tube conduction are arranged so as to increase and give the current waveform in the deflection coils an even rise.

HORIZONTAL OUTPUT CIRCUITS

The Auxiliary Low Voltage Supply—Boost Voltage

During the time that the damper diode conducts, to stop yoke oscillation, the flyback voltage developed across the deflection coils L_1 and L_2 is in such a direction as to make the plate of the diode positive with respect to its cathode. Hence, current flows and charges C_1 *positively with respect to $B+$* . If we now trace the plate voltage supply path for the horizontal output tube back through L_3 , L_7 , and C_1 to $B+$, it is apparent that C_1

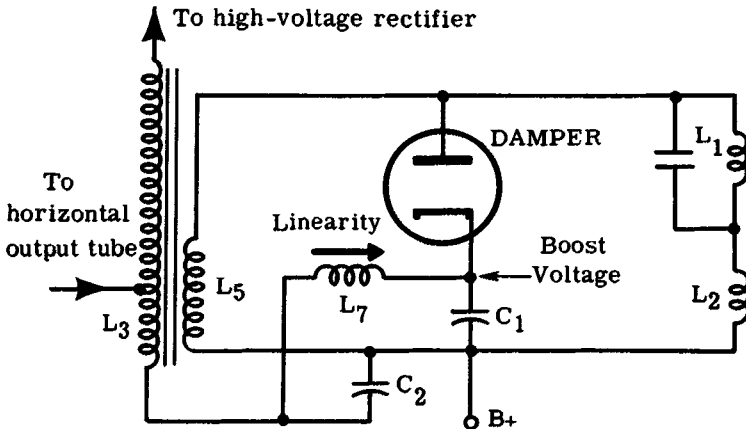

The DAMPER TUBE

is in series with the voltage applied to the output tube plate. Therefore, whatever charge appears on C_1 (due to the self-induced voltage in the yoke coils) is added to the normal low-voltage supply. This "boost" permits the set designer to get better efficiency and output from the horizontal output tube circuit and is an important function of the damper tube circuit. The additional voltage thus obtained often ranges as high as 200 volts or more above that of the regular $B+$ voltage.

The boost voltage developed is sometimes called the "bootstrap" voltage and is often indicated on schematic diagrams as $B++$. Many receivers make considerable use of this higher voltage, using it to supply plate voltage for the vertical output tube, picture tube elements, and the horizontal oscillator tube. In this respect, failure of the boost circuit can cause television troubles that may at first be deceiving. For example, boost voltage failure or trouble in a receiver may cause loss of vertical deflection, or loss of horizontal synchronization. It could even cause a loss of high voltage by reducing the output from the horizontal oscillator. When applied to the picture tube, low boost voltage could cause a loss of brightness or poor focusing.

HORIZONTAL OUTPUT CIRCUITS

The Linearity Control

The boost voltage obtained from C1 is in the form of pulsations occurring at the horizontal scanning rate of 15,750 cycles, since the damper tube conducts once in every horizontal output cycle, charging the capacitor at this repetition rate. In a sense, the circuit comprising C1, C2, and L7 forms a filter network in which the ripples (caused by horizontal output tube and damper current crossover) are reduced before the voltage is passed on to the plate of the horizontal output tube.

At the same time, there does remain a slight ripple in the final plate supply voltage to this tube. A change in position of the iron core of L7 can affect the phasing of the ripple by changing the inductance of the coil. On the other hand, the sawtooth plate current flowing through L7 is not dependent upon the setting of the core.

As L7 is adjusted, the ripple voltage can therefore add to the plate supply voltage in several different ways. It can produce a convex "bump" in the sawtooth, a concave "hole," or a "jiggle," depending upon the phasing between the ripple and sawtooth current flowing through L7. Such modification in the sawtooth waveform changes the *linearity* of the sweep.

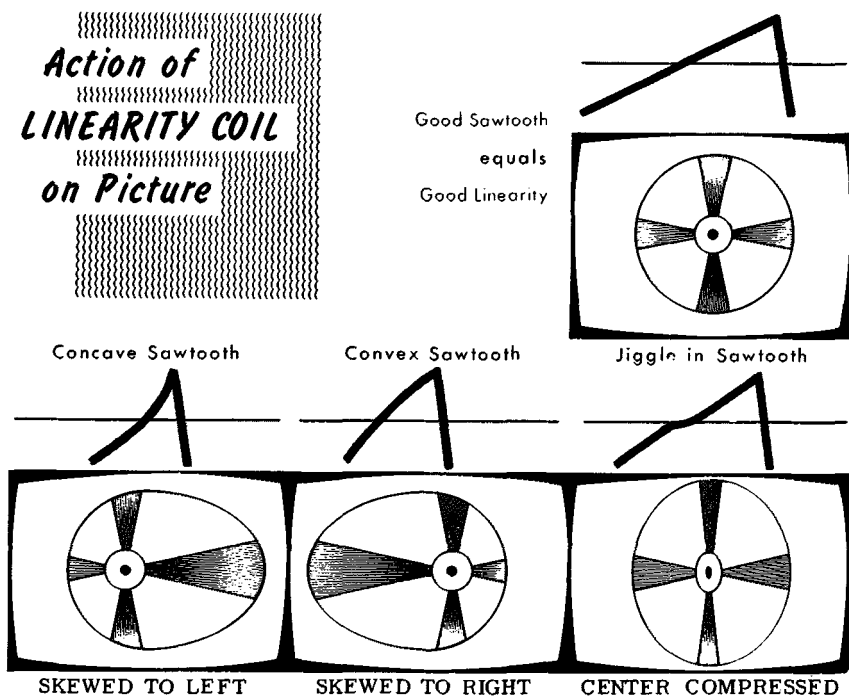

When L7 is adjusted correctly, the rising portion of the sawtooth current is quite linear and the reproduced picture is free of distortion.

HORIZONTAL OUTPUT CIRCUITS

The Horizontal Size or Width Control

A television picture is transmitted with an *aspect ratio* (ratio of width to height) of 4:3. Unless this ratio is maintained in the receiver, all the objects in the televised scene will be uncomfortably distorted; figures will appear taller and thinner, or shorter and broader than they should be. As we saw in the discussion of the vertical output system, there is a vertical *height* control which permits the service technician to fill the screen area in this direction. After the height of the picture is correctly set, the *width* of the picture must be adjusted. This adjustment is made by the *width control* or *horizontal size control*.

In many receivers, the width control takes the form of a slug-adjusted coil connected across a part of the horizontal output transformer secondary winding.

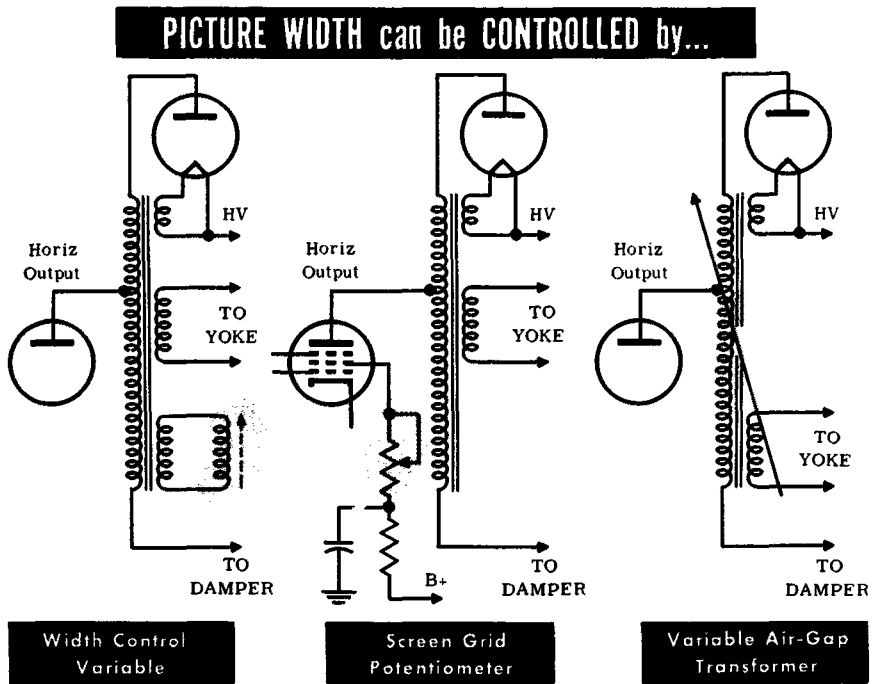

With the slug inserted all the way into the width coil, the inductance of this unit is high, its inductive reactance is large, and its loading effect is small. In this position the width coil removes very little sweep-frequency energy from the horizontal output transformer, and behaves more or less like an open circuit. Thus, picture width is *maximum* with the slug fully inserted in the coil. As the iron core is gradually removed, the shunting inductive reactance decreases and absorbs power so that less and less sweep power is fed to the deflection coils. This action reduces the picture width.

HORIZONTAL OUTPUT CIRCUITS

Other Forms of Horizontal Output Circuits

Some manufacturers prefer the autotransformer type of output system in which there is only one winding on the horizontal output transformer. As explained in a preceding section, a transformer need not have separate primary and secondary windings to perform stepup or stepdown action. A single winding tapped at the proper points can be designed to do the same job. Such a system is illustrated below. Note that the connections are very

Horizontal Sweep System Using an Autotransformer

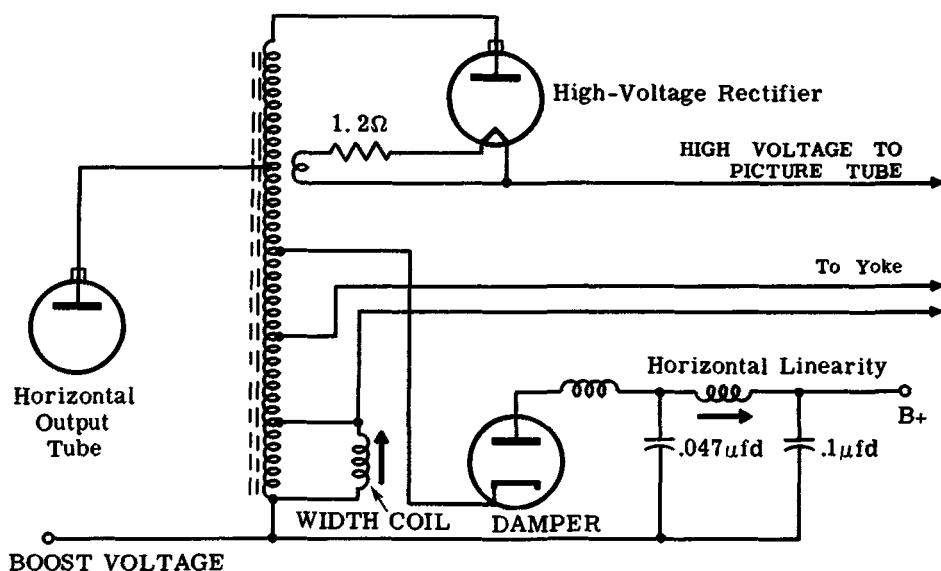

similar to the two-winding transformer and that a one- or two-turn coil is still used to pick up filament voltage for the high voltage rectifier. A circuit of this type provides for damping, high-voltage output, and horizontal deflection, and is somewhat more economical in construction.

The current trend in television receivers is very much toward the use of autotransformers in the high-voltage deflection system. Fundamentally, the only real difference the autotransformer introduces, as compared to the conventional transformer, is in the polarity of the damper elements. In the diagram above, the cathode of the damper is connected at a point high up on the transformer winding. This is opposite to the connection found in conventional transformers. The phase reversal is due to the fact that the usual primary-secondary phase inversion is missing in the autotransformer.

HORIZONTAL OUTPUT CIRCUITS

Horizontal Output Circuits (contd.)

In still other receivers, a directly driven output system is employed. Note the comparative simplicity of this circuit as contrasted with the others.

A DIRECT-DRIVE HORIZONTAL OUTPUT CIRCUIT

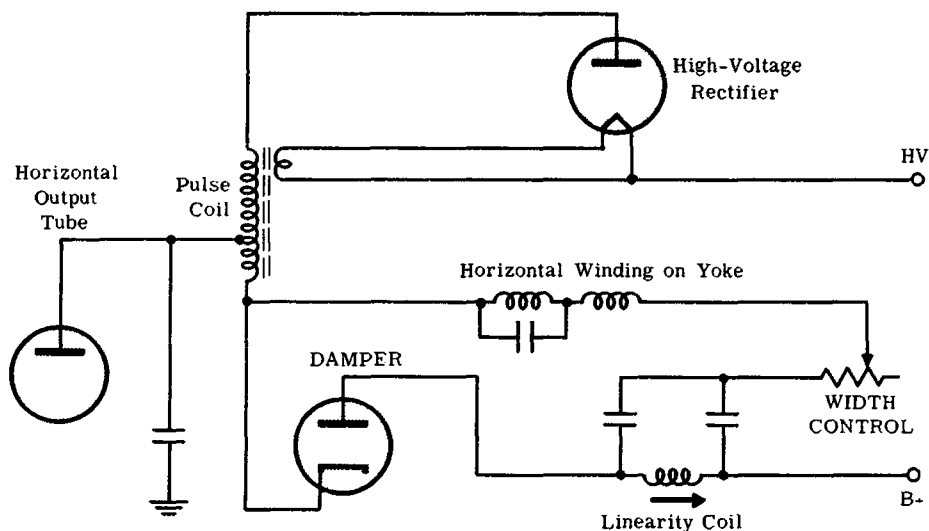

The horizontal output transformer is replaced by the pulse coil and aside from the loosely coupled one- or two-turn filament winding, there is no normal transformer action in passing on the sweep output to the deflection coils in the yoke. Autotransformer step-up is obtained, however, since the entire pulse coil winding behaves as the secondary while only the portion of the pulse coil between the tap and the damper cathode serves as the primary. The damper tube forms part of a series circuit consisting of the linearity coil, the width control—a variable resistor rather than a coil in this circuit—and the horizontal deflection coil.

The horizontal deflection coil used in the direct drive system must have a *higher impedance* than the type associated with transformer-drive arrangements. Damper action and the first half-cycle of shock-excited oscillation account for the fast flyback time in this system in exactly the same manner as discussed in the more conventional systems. The width control operates by virtue of the resistance loss it inserts in the series circuit of which it forms a part. This control is generally of the 2-watt variety because of the relatively heavy currents which flow in this deflection circuit.

HORIZONTAL OUTPUT CIRCUITS

Other Varieties of Width Controls

An ideal width control governs the horizontal size of the picture without affecting either the linearity or magnitude of the high voltage. So far, we have seen two types of width controls: in one, some of the sweep voltage that appears across the secondary of the flyback transformer is shunted away from the deflection coils by a width coil; the other introduces a resistance loss in series with the horizontal yoke winding. This diagram shows how width coils may be connected in other arrangements.

The Tapped Width Coil

Has two parts. one slug adjusted, the other fixed.

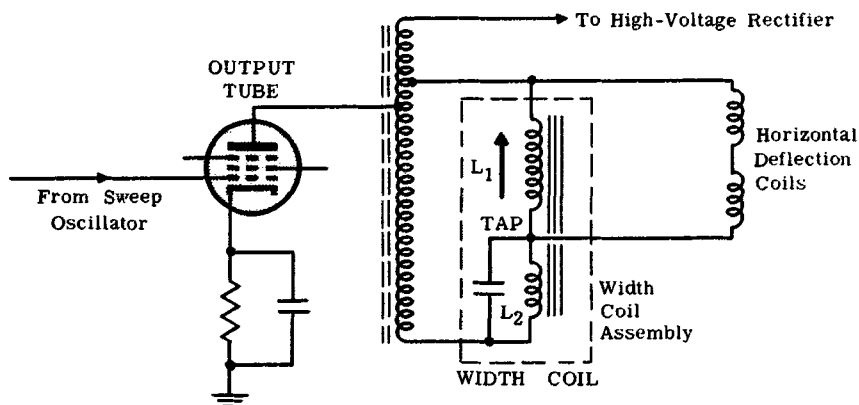

This is a combination shunt and series connection for the width coil relative to the horizontal deflection coils in the yoke. The adjustable portion of the width coil, L_1 , is in shunt with the yoke winding while the fixed section, L_2 , is in series with it. The combination of L_1 and L_2 are in parallel with the entire low-voltage secondary of the flyback transformer.

As the inductance of L_1 is varied by moving its slug in or out of the coil, the ratio of inductance between L_1 and L_2 is caused to change. This effectively alters the electrical position of the *tap* between the two sections and is intended to provide a greater range of width control than the simple shunting type described before. In most receivers, this aim is achieved without noticeable change in the linearity or high voltage. It has been found, however, that the distributed capacitance (capacitance between turns) of this large width coil, connected as it is across the entire low-voltage secondary winding, tends to lengthen the time for beam retrace. Thus, if this control is "overadjusted," the new line may start before retrace is complete, spoiling the left side of the picture.

HORIZONTAL OUTPUT CIRCUITS

Control by α Potentiometer

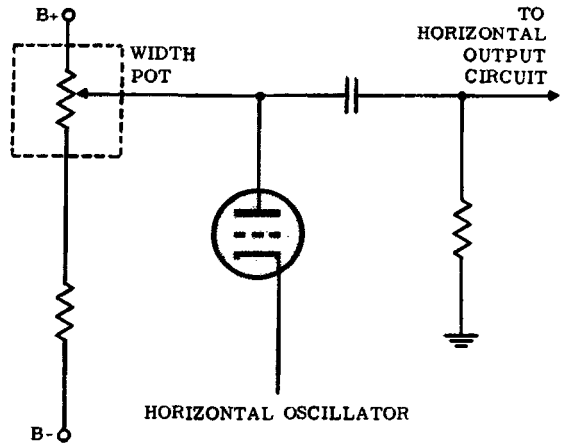
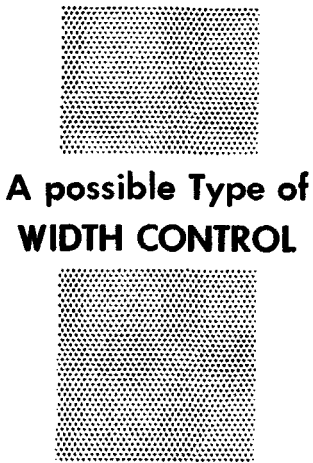

As indicated before, picture width may also be controlled by an adjustable resistance or potentiometer. In this circuit, for example, the plate voltage of the horizontal oscillator is controllable. The potentiometer, therefore, governs the oscillator output over an appreciable range, thereby controlling the drive to the output tube. It should be noted, however, that any time the horizontal drive is varied, the high voltage will also change somewhat. There is one exception to this rule that is often tolerated. A popular and common type of width control is the variation of screen grid resistance of the horizontal output tube. This varies the screen grid voltage and thus the gain of the tube. When properly designed this control can give substantial width control while having only a slight effect on high voltage.

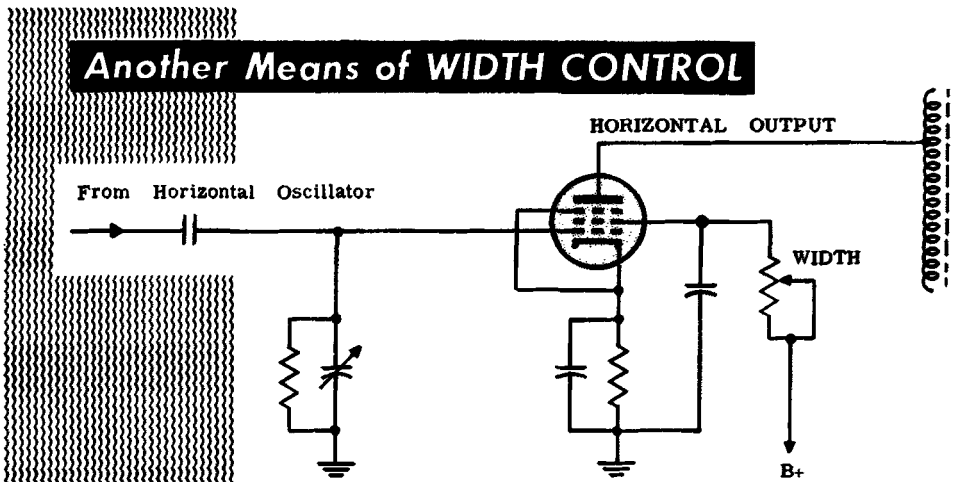

HORIZONTAL OUTPUT TRANSFORMER

Variable Air-Gap Transformer

Variable Air-Gap Type of Transformer

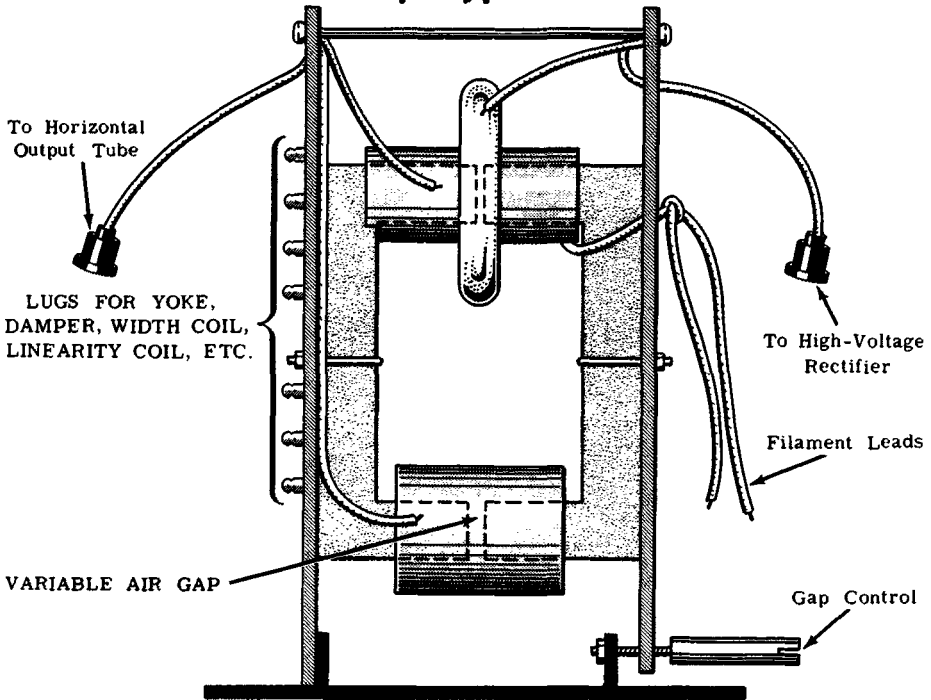

Still another method of width control is finding favor among manufacturers. Examination of this diagram reveals that rotation of the tapped shaft at the bottom right side of the transformer causes the entire side panel to move carrying with it half of the core. As the air gap widens, the *reluctance* of the magnetic path increases causing a reduction of the induced signal voltage in the secondary winding. Thus, the width of the picture decreases. Although this affects the high voltage as well as the picture width, the change in high voltage is not as serious as it is in the case of potentiometer controls.

Constructional Features of Horizontal Output Transformers

The presence of very high pulse voltages in output transformers make it essential to design these units along entirely different lines than ordinary power transformers. In addition to the need for precautions against high-voltage arcing and *corona*—a term we shall explain shortly—the design of the horizontal output transformer must be aimed at high Q to realize the best efficiency.

HORIZONTAL OUTPUT TRANSFORMER

Constructional Features of Horizontal Output Transformers (contd.)

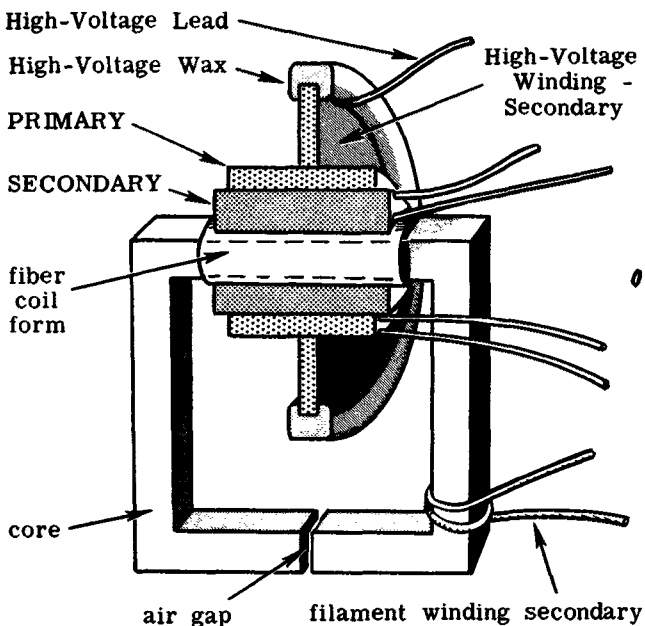

*Winding Construction
of a Horizontal Output
Transformer*

These demands necessitate a completely different approach to the problem of construction.

The diagrams and photos we have seen illustrated the essential features of a typical transformer. Let us examine these by tracing the fabrication starting with the iron core.

The Iron Core: This section of the transformer is the frame which supports the windings and provides the required rigidity. It may be made of ferrite, flaked iron, or thin laminations of high grade transformer steel. The air gap, an important part of the core, has the function of preventing magnetic saturation of the iron due to the direct current that flows in the primary winding. It will be recalled that the horizontal output tube plate current flows through a portion of the primary and that this current is quite high. Unless the magnetic flux path is broken by a gap, saturation would occur quickly and the transformer losses would rise to intolerable figures.

Sweep Output Secondary: A fiber strip, encircling the top of the core, is used as the base upon which the sweep output secondary winding which feeds the yoke is wound. This coil carries the heavy yoke currents, hence must be wound with relatively thick wire. To obtain the necessary inductance with wire of this size, the sweep secondary must be wound over a great enough length of the core. Thus, it is the longest winding of the transformer. Its ends and any taps it may have are brought out to terminal lugs on Bakelite panels fastened to the core.

HORIZONTAL OUTPUT TRANSFORMER

Horizontal Output Transformers (contd.)

Primary: This winding is of finer wire and is wound on several layers of insulating tape which cover the outside of the sweep secondary. The presence of high voltages on the primary leads necessitate the use of high-voltage *dope* and other measures intended to prevent arcing. The primary winding is larger in diameter than the sweep secondary but not as wide, as may be seen from the illustration.

High-Voltage Winding: This is wound directly over the primary; it is a very flat, wide coil—a form of construction which encourages high *Q*—being fabricated of very fine wire. The current it must carry is only in the order of a few milliamperes so that heavy wire would be unnecessarily costly and bulky.

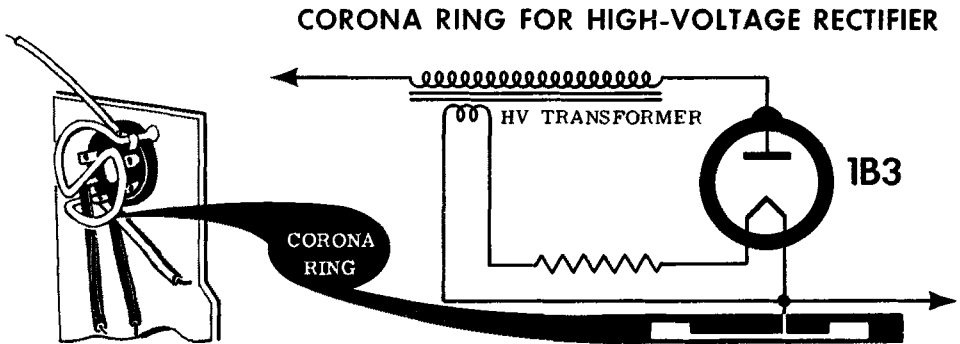

The Corona: Corona is the name applied to bluish sparks which shoot from any sharp-pointed conductor carrying high-frequency, high-voltage electricity. The high concentration of electrons found on such points cause the surrounding air to ionize and become slightly conductive, permitting energy-wasting sparks to appear around the point. Corona is prevented by doing away with all sharp edges and corners by careful soldering at the terminals and in other ways. The corona ring, a ring of thick metal about 1 inch in diameter sometimes found under the high-voltage rectifier, prevents corona by distributing the high potentials around a large, smooth surface. Wax impregnation is used on the entire transformer assembly to present a smooth surface to the air for corona prevention. A wax "tire" is secured to the outer edge of the high-voltage winding for the same purpose.

The Filament Wires: Potential for the filament of the high voltage rectifier is obtained from a few turns of well insulated wire loosely coupled to the transformer core. Often, a low-value fixed resistor is used in series with the filament turns and the filament of the rectifier. This maintains the filament voltage at its proper value for the particular transformer type and arrangement of filament wire loops.

HORIZONTAL OUTPUT TRANSFORMER

Voltage Doublers

THE VOLTAGE DOUBLER

High Voltage Supply

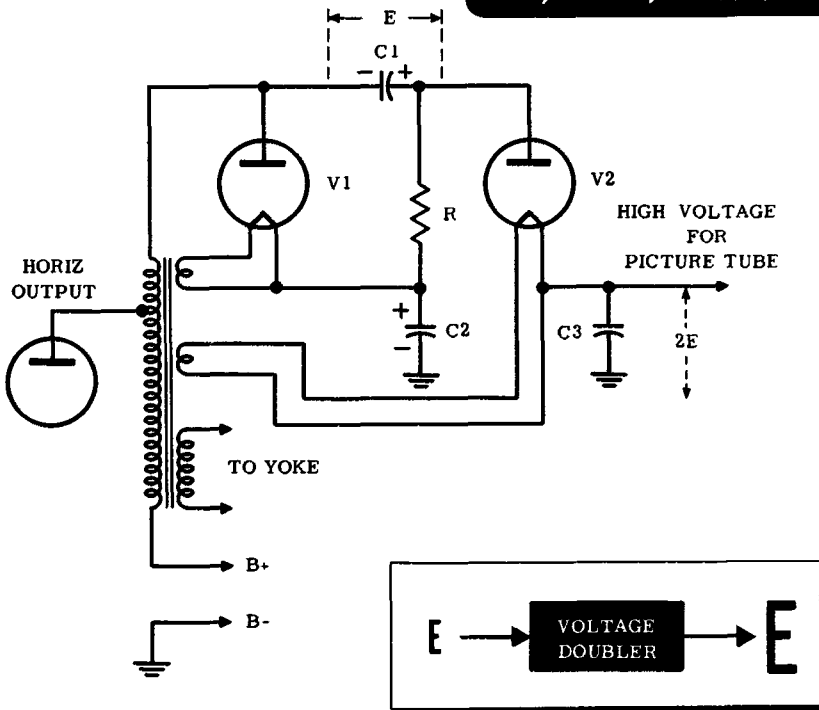

In many television circuits the voltage doubler is used as a convenient method to obtain the high voltage necessary for the second anode.

When a positive high-voltage pulse is applied to the plate of rectifier V1, the tube conducts and places a charge of approximately E on C2. Between pulses, C2 discharges through the flyback transformer, C1 and R. With R having a resistance of 1 megohm or more, the discharge time is slow and some of the C2 charge is built up across C1. After a number of pulses the voltage across C1 increases to approximately E . Thus, the voltage on the plate of V2 is also equal to E . However, when a new pulse is applied to V1, the voltage on the plate V2 is equal to the new pulse E in series with E across C1—a total of $2E$ or double the voltage applied to the plate of V1.

When V2 conducts, C3 charges to approximately the plate voltage of V2, or $2E$, and this voltage is applied to the second anode of the picture tube. When V2 conducts, the current flow discharges C1. This, however, is a temporary condition as C1 recharges with the following pulses.

REVIEW

1. The Horizontal Sweep Circuit.

The sweep voltage is fed to the horizontal output tube which provides horizontal sweep power to the deflection coils. To match the impedance of the deflection coils to the horizontal output tube we make use of the horizontal output transformer. A damper tube is inserted between the transformer and the deflection coils.

Block Diagram of HORIZONTAL SWEEP CIRCUIT

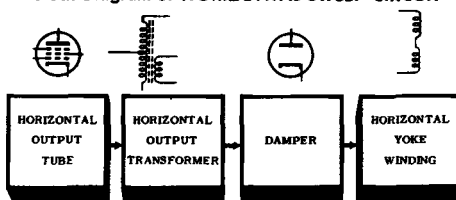

2. The Horizontal Output Stage invariably consists of a high-efficiency type of power or beam pentode, an output (flyback) transformer, and associated small components. The grid input to this stage consists of trapezoidal voltage pulses from the discharge circuit which follow the horizontal oscillator.

The Horizontal Output Stage

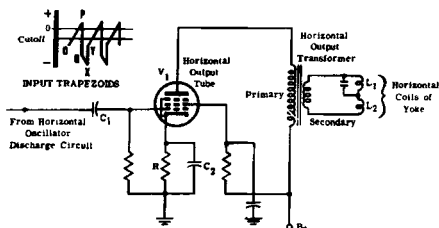

3. The High-Voltage Flyback Transformer. The transformer primary winding of the horizontal output stage is modified by adding to its turns. L3 and L4 together make up an auto-transformer. The operation of this type of transformer follows the same pattern as that of an ordinary transformer.

The Horizontal Output Transformer (Flyback)

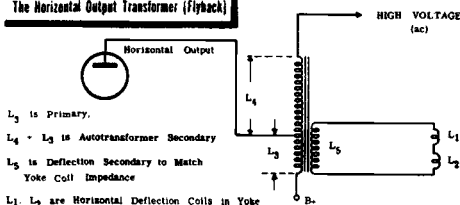

4. Two Types of Flyback Transformer. Two types of horizontal output transformers have been widely used. The two-winding or isolation type flyback transformer was used mostly in the early days of television. In the autotransformer type flyback, there is just one continuous winding, with taps for the high voltage rectifier, horizontal output tube, damper and horizontal deflection coils, and B+.

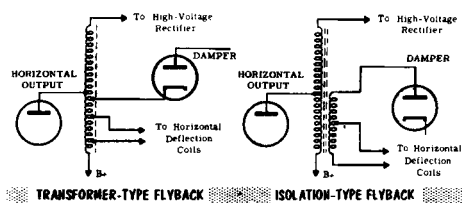

REVIEW

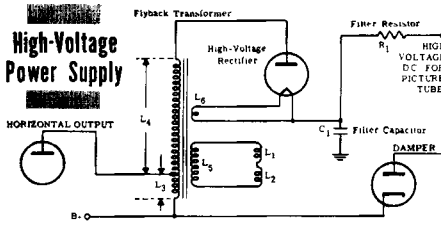

5. The High-Voltage Power Supply. The very high a-c potential at the top of the flyback transformer must be rectified and filtered before it can be applied to the second anode of the picture tube. A high-voltage rectifier tube, filter resistor and filter capacitor are added to the previous circuit.

6. The Damping Circuit. As you examine the circuits, you note the following: The damper tube is a diode which is connected in parallel with the horizontal deflection coils L1 and L2. The capacitance of C1 is chosen so that its reactance at 15,750 cycles is negligible.

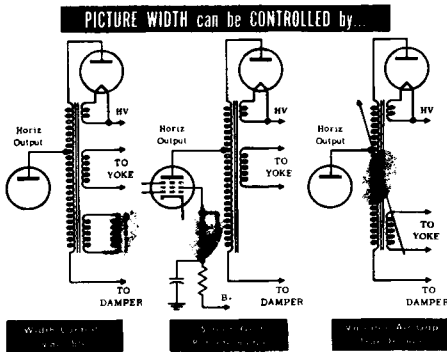
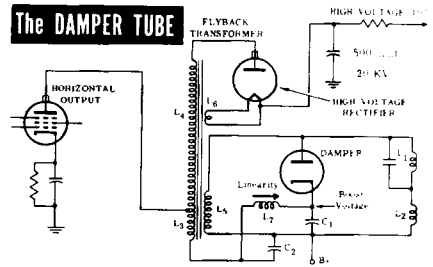

7. The Horizontal Size or Width Control. After the height of the picture is correctly set, the width of the picture is adjusted with the width control or horizontal size control. In many receivers the width control takes the form of a slug-adjusted coil connected across a part of the horizontal output transformer secondary winding.

8. Voltage Doublers. When a positive high-voltage pulse is applied to the plate of rectifier V1, the tube conducts and places a charge of approximately E on C2. After a number of pulses the voltage across C1 also becomes equal to E. With a new pulse applied to V1 the voltage on the plate V2 is equal to E in series with E across C1 or a total of 2E or double the voltage applied to V1.

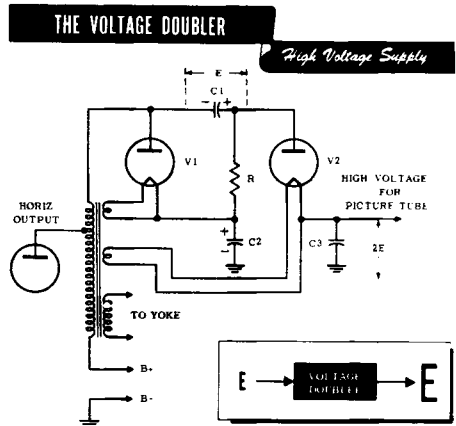

INDEX TO VOL. IV

(Note: A cumulative index covering all five volumes in this series will be found at the end of Volume V.)

- AFC controls, 4-92
- Automatic frequency control, definition of, 4-75
- Autotransformer, 4-101

- Blanking pulse interval, 4-7
- Blocking oscillator, 4-35, 50-55
 - controls in, 4-51
 - syncing in, 4-55
 - waveforms in, 4-52, 53, 54
- Boost voltage, 4-108, 109

- Cathode-coupled multivibrator, 4-48, 49
- Clipper circuit, 4-23, 26, 27
- Comparator circuit, 4-75
- Control,
 - linearity, 4-63, 109
 - size, 4-110
 - width, 4-110, 113, 114
- Corona, 4-115, 117

- Damping circuit, 4-104-107
- Damping resistors, 4-64
- Differentiated output, effect of input pulse shape on, 4-72
- Differentiator, 4-68-74
 - action of, 4-70
 - definition of, 4-68
 - input and output voltage in, 4-73
- Diode clamper, 4-23
- Discriminator transformer, 4-82

- Equalizing pulses, 4-12-17
 - function of, 4-14

- Flyback transformer,
 - high voltage, 4-101-103
 - types of, 4-102

- Horizontal AFC, 4-75-93
 - definition of, 4-75

- Horizontal AFC system,
 - block diagram of, 4-76, 77
 - phase discriminator, 4-83, 84
 - pulse-width or synchroguide, 4-90-92
 - sync pulses in, 4-78
 - synchrolock, 4-79-81
- Horizontal and equalizing pulses, 4-12-18
- Horizontal synchronization, 4-67-120
 - discharge circuit, 4-96
 - drive, 4-95-98
 - drive control, 4-97, 98
 - line interval, 4-5
 - linearity control, 4-109
 - output circuits, 4-99-114
 - output stage, 4-99, 110
 - output transformers, 4-115-118
 - construction of, 4-115-117
 - size control, 4-110
 - sweep circuit, 4-67, 95
 - sweep circuit action, 4-67
 - sync pulse, 4-15
 - width control, 4-110, 113, 114

- Integrating action, 4-32, 33
- Integrating circuit, 4-31
- Integrator, 4-14, 31, 33
 - definitions of, 4-31
 - pulse separation in, 4-31
- Low voltage supply, 4-108

- Multivibrator, 4-34-45
 - electrical action in, 4-37, 38, 39
 - plate current waveforms, 4-45
 - plate voltage waveforms, 4-45
 - wave frequency of, 4-42, 43
 - wave shapes in, 4-40
- Multivibrator wave, amplitudes of, 4-44

- Noise Limiter, 4-27

- Pedestal, 4-9

INDEX

- Phase comparer, 4-86-89
- Phase detector, 4-86-89
- Phase discriminator, 4-83, 84
- Phase discriminator,
 - control voltage, 4-85
- Phase splitter, 4-86-89
- Picture synchronization, 4-1-2
- Power supply, high voltage, 4-103-107
- Pulse separation, 4-31

- R-C time constant, 4-69
- Reactance modulator, 4-76, 77
- Relaxation oscillator, 4-35
- Retrace action, 4-3, 8
- Retrace time, 4-99, 100
- Review, 4-19-20, 46-47, 66, 93-94, 119-120

- Sawtooth shaping, 4-56, 57, 58
- Serrations in the vertical sync
 - pulse, 4-10, 11, 17
- Sync amplifier, 4-29, 30
- Sync clipper, 4-21-28
 - diode clamper, 4-23
 - loss of d-c component, 4-22
 - noise limiter, 4-27
- Sync pulses, horizontal AFC
 - systems, 4-78
- Sync separator, 4-21-28
- Sync separator-amplifier outputs, 4-67
- Sync signals, processing of, 4-18

- Synchrolock, 4-79-81
- Synchronization, fundamentals of
 - vertical and horizontal, 4-1, 2, 15

- Trace time, 4-99, 100
- Triggering action, 4-74

- Variable air-gap transformer, 4-115
- Vertical synchronization, 4-3-66
 - blanking, 4-3
 - blanking interval, 4-12, 16
 - blanking pulse, 4-5, 6, 7
 - deflection control signals, 4-3, 4
 - deflection coil feed, 4-59
 - oscillator, 4-34
 - output system, 4-60-65
 - amplifier, 4-60
 - explanation of operation, 4-61
 - linearity control, 4-63
 - output transformer, 4-62
 - retrace, 4-8, 12, 15
 - blanking, 4-65
 - horizontal sync pulse during, 4-15
 - sync pulse, 4-3-11
 - serrations in, 4-10-11
- Voltage doublers, 4-118

- Wave shaping, 4-56-60

\$2.25

basic television

by Alexander Schure, Ph.D., Ed.D.

VOL. 5

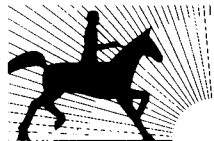

JOHN F. RIDER PUBLISHER, INC.
116 West 14th Street • New York 11, N. Y.

Copyright January 1958 by John F. Rider Publisher, Inc.

All rights reserved. This book or any parts thereof may not be reproduced in any form or in any language without permission of the publisher.

Library of Congress Catalog Card Number 57-13493

Printed in the United States of America

PREFACE

This five-volume course in the fundamental principles of television represents the end product of three years of research and experimentation in teaching methods and presentation at the New York Technical Institute. As a result of this experimentation in correspondence and resident courses approved by the New York State Department of Education, and following the recommendations of advising industrial groups, the highly pictorialized presentation used throughout this book was adopted. An illustration has been provided for each important concept and placed together with the explanatory text on the same page to pinpoint essential material. In addition, review pages spaced throughout each volume summarize the major points already presented.

This combination of the visual approach and idea-per-page technique makes **BASIC TELEVISION** readily understandable with or without an instructor. It is thus suitable for individual or correspondence use as well as for classroom study. Its coverage is complete from the creation of the television image in the studio to its appearance on the receiver screen, and presupposes only a knowledge of basic electronics and radio. Many topics not covered in the more traditional texts are treated here and fully explained for the first time.

The author wishes to acknowledge the assistance of his staff at the New York Technical Institute and that of Mr. Gilbert Gallego in the preparation of some of the illustrations. Special gratitude is due to the staff of John F. Rider Publisher and to Mr. Rider personally for his contributions to both the text and the picturization of this course.

New York, N. Y.
January 1958

ALEXANDER SCHURE

CONTENTS

VOL. V — BASIC TELEVISION

The Television Picture Tube	1
Magnetic Fields	10
Focusing	15
Review	30
Deflection	31
The Deflection Yoke	47
The Ion Trap	54
Picture Tube Characteristics	61
Review	68
Television Sound System	70
Review	83
Low-Voltage Power Supply	84
Review	97
Closed Circuit Television	98
Review	124
Index	125
Cumulative Index	127

THE TELEVISION PICTURE TUBE

The Picture Tube

Introduction: To the eye of the viewer, the picture tube is the most critical part of the television receiver. Those of us who work with television daily are aware that there is no such thing as the "most critical part"; that every component in a complex instrument, like the individual organs of the body, plays an essential role; and that the final performance depends upon the close cooperation between all the circuits in the set.

As we have found, special efforts are made to control and shape the received signal in a television system. Much relatively complex circuitry is incorporated in a television receiver to provide correct timing and synchronization. All this is necessary because the picture tube demands very definite input voltages for proper display of the final scene.

The comments we have made thus far about the picture tube have been general. In this Volume we shall deal with special features of its construction and operation which will lead to a better understanding of its behavior, and we must therefore become concerned with the elements that act upon the picture tube externally as well as those that are enclosed in the tube envelope. We have seen such a block diagram before, but it is worth looking at again.

The first of the signals entering the picture tube is the *composite video* signal amplified by the video amplifier and fed to the grid or cathode. Under the influence of this varying voltage, the grid or cathode increases or diminishes the intensity of the scanning electron beam. In this way, the light and dark tones of the picture are made to match the image seen by the camera tube at the studio.

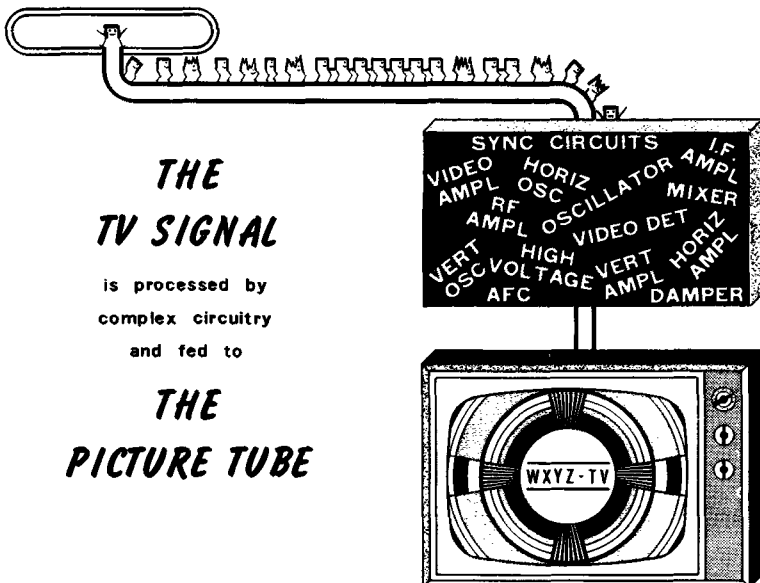

THE TELEVISION PICTURE TUBE

The Picture Tube (contd.)

Even as it is being modulated by the video voltage, the scanning beam must be moved across the screen of the picture tube. We know that the scanning motion of the beam follows horizontal lines that are shifted downward at the same time. Both vertical and horizontal forces act upon the beam to produce this two-fold motion. These forces are generated by magnetic fields produced by the horizontal and vertical deflection coils in the yoke that surrounds the neck of the picture tube. In turn, the magnetic fields in both sets of coils result from different sawtooth currents flowing through them.

The horizontal sawtooth current is the end result of the wave-shaping process performed on the output of the horizontal oscillator; similarly, the vertical oscillator signal is shaped by the vertical sweep system to form the vertical sawtooth current. Thus, from each sweep system emerge the voltages which act upon the deflection yoke to drive the scanning beam across the face of the picture tube screen.

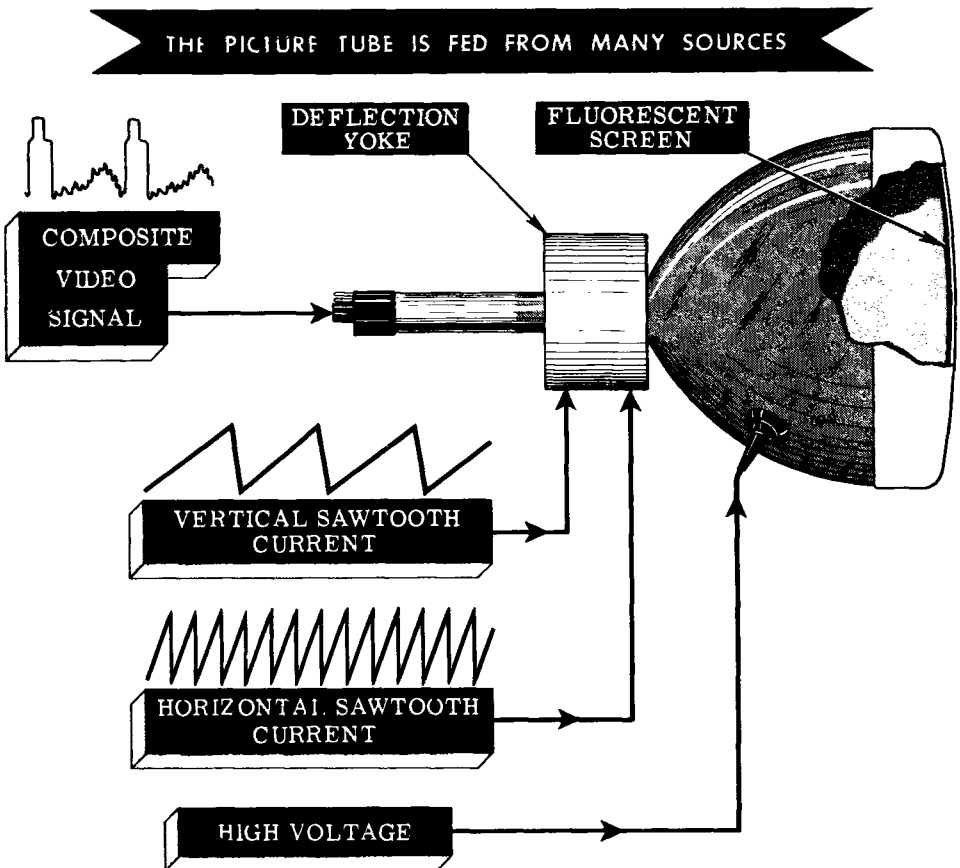

THE TELEVISION PICTURE TUBE

The Cathode-Ray Tube

The cathode-ray tube is a large glass structure from which as much air has been removed as possible. Although it is not possible to produce a *perfect* vacuum with pumps currently available, the envelope of the cathode-ray tube is very highly evacuated; this evacuation is essential for good picture tube performance.

HEART OF THE CATHODE-RAY TUBE IS **THE ELECTRON GUN**

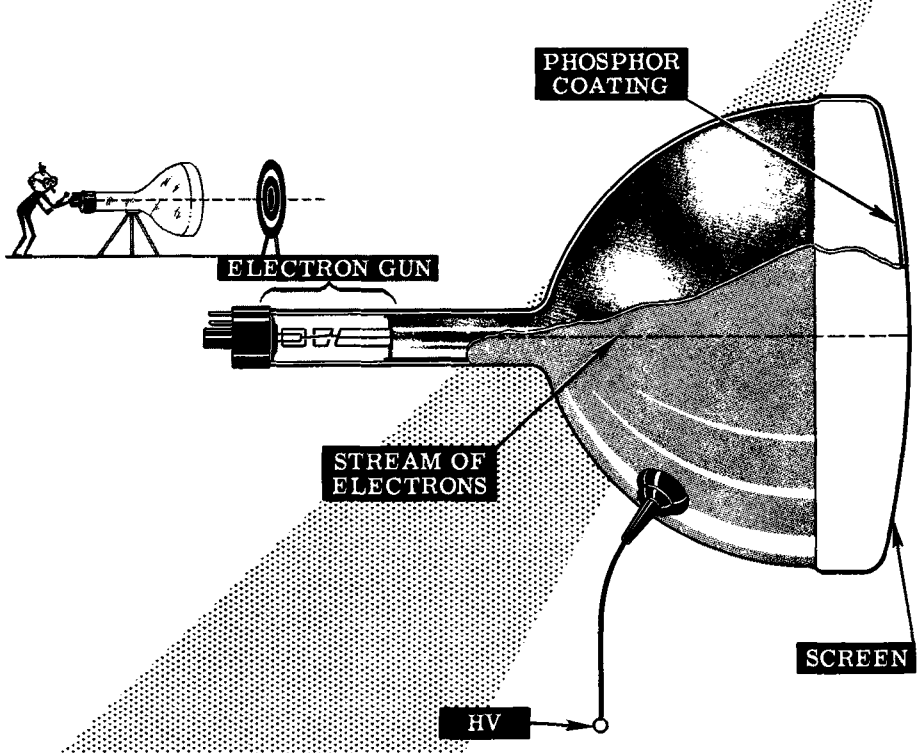

At the narrow end (the "neck") of the tube is an assembly known as the *electron gun*. This comprises the elements which emit and control the electron beam just as a machine gun shoots and controls the direction of a stream of bullets.

The wide end of the tube may be either round or rectangular in shape. A thin coating of *fluorescent* material called a phosphor, deposited on the inside surface of the face, is responsible for the glowing lines which paint the television picture. When a high-speed beam fired from the electron gun strikes the phosphor, the face of the tube shows a tiny disc of light at the point of impact. Thus, the screen converts the energy of the moving electrons into light energy.

THE TELEVISION PICTURE TUBE

Components Of The Electron Gun

COMPARING SOURCES OF ELECTRON EMISSION

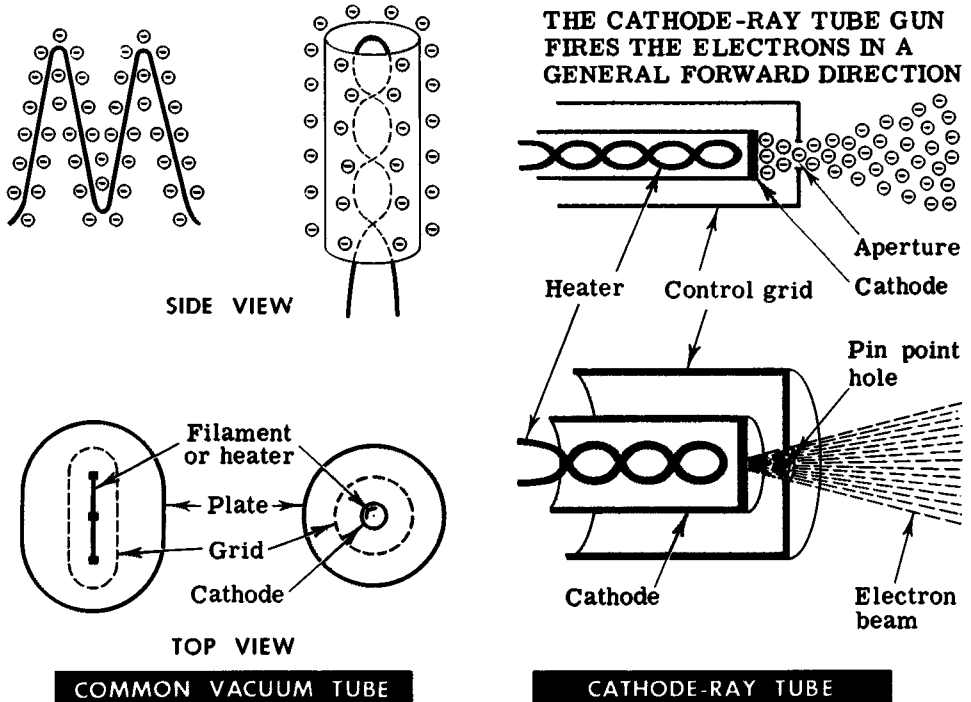

You will recall that electrons are liberated from the filament or cathode of an ordinary vacuum tube and that it is the stream of these electrons that constitutes the plate current of the tube. Electrons, released in exactly the same manner in the cathode-ray tube, form the television picture.

The cathode or electron-emitter is a small metal cylinder which is covered by an oxide coating. When the cathode is heated to a dull red by a heater wire located inside the cathode mounting, electrons are emitted by the cathode in large quantities.

This drawing shows the differences between the heater-cathode construction in a common vacuum tube and in a cathode-ray tube. The significant difference in operation is apparent: the electrons discharged from the cathode of an ordinary tube move off in all directions while those coming from the cathode of the cathode-ray tube are emitted in a general *forward* direction.

In the enlarged view of a portion of the neck of the picture tube, one may see the cathode assembly, part of which has been cut away to show the heater element inside the cathode.

THE TELEVISION PICTURE TUBE

The Grid Of The Picture Tube

The element that governs the intensity of the electron stream moving through the picture tube is the *control grid*. Unlike the element of the same name in the common vacuum tube, it is cylindrical in shape and resembles a metal cap rather than a wire screen.

The small hole at the forward end of the cathode forces the electrons to *spray out* into the open space of the tube; the beam is formed later.

GRID BIAS CONTROLS ELECTRON STREAM

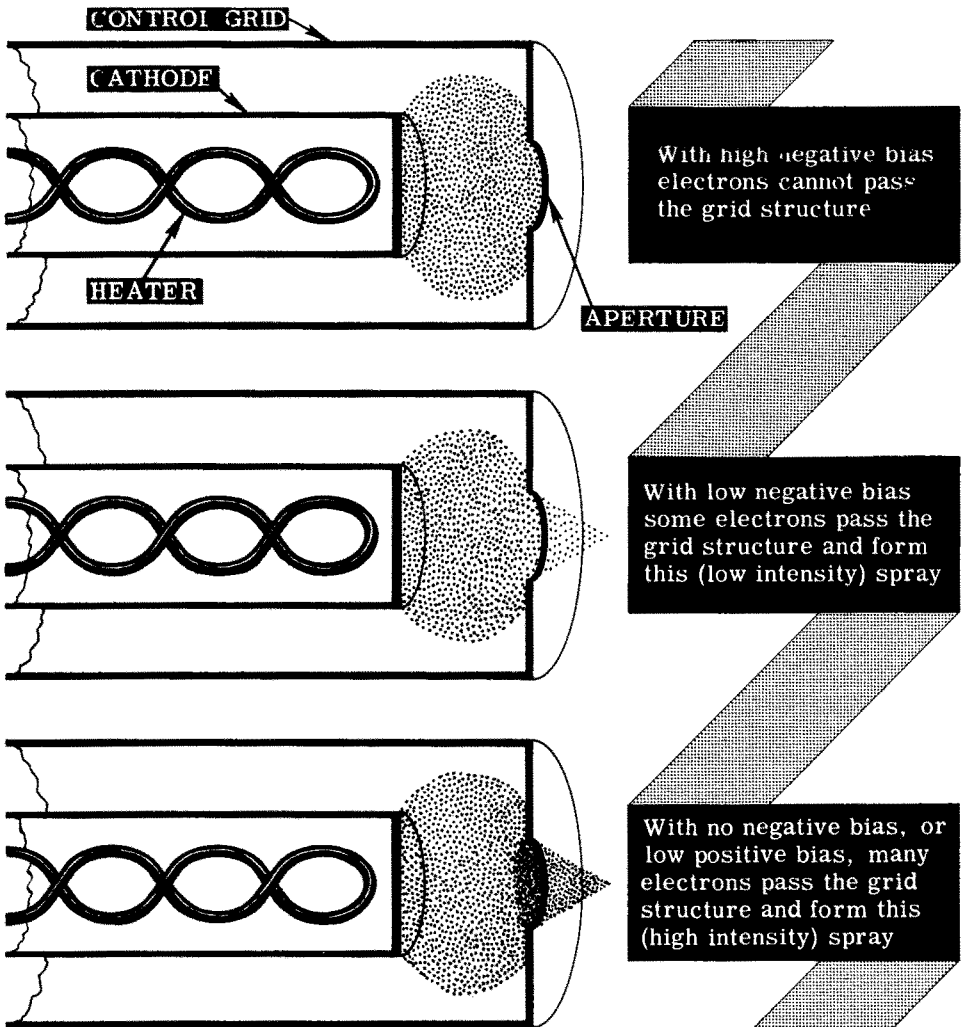

THE TELEVISION PICTURE TUBE

The Grid Of The Picture Tube (contd.)

From these illustrations it is seen that the control grid of the cathode-ray tube influences the density of the electron spray that emerges from the grid's pinhole aperture. From what you already know of picture tube action, it is clear that this spray must now be formed into a thin, sharp beam of sufficiently high velocity to strike the phosphor on the screen with considerable force.

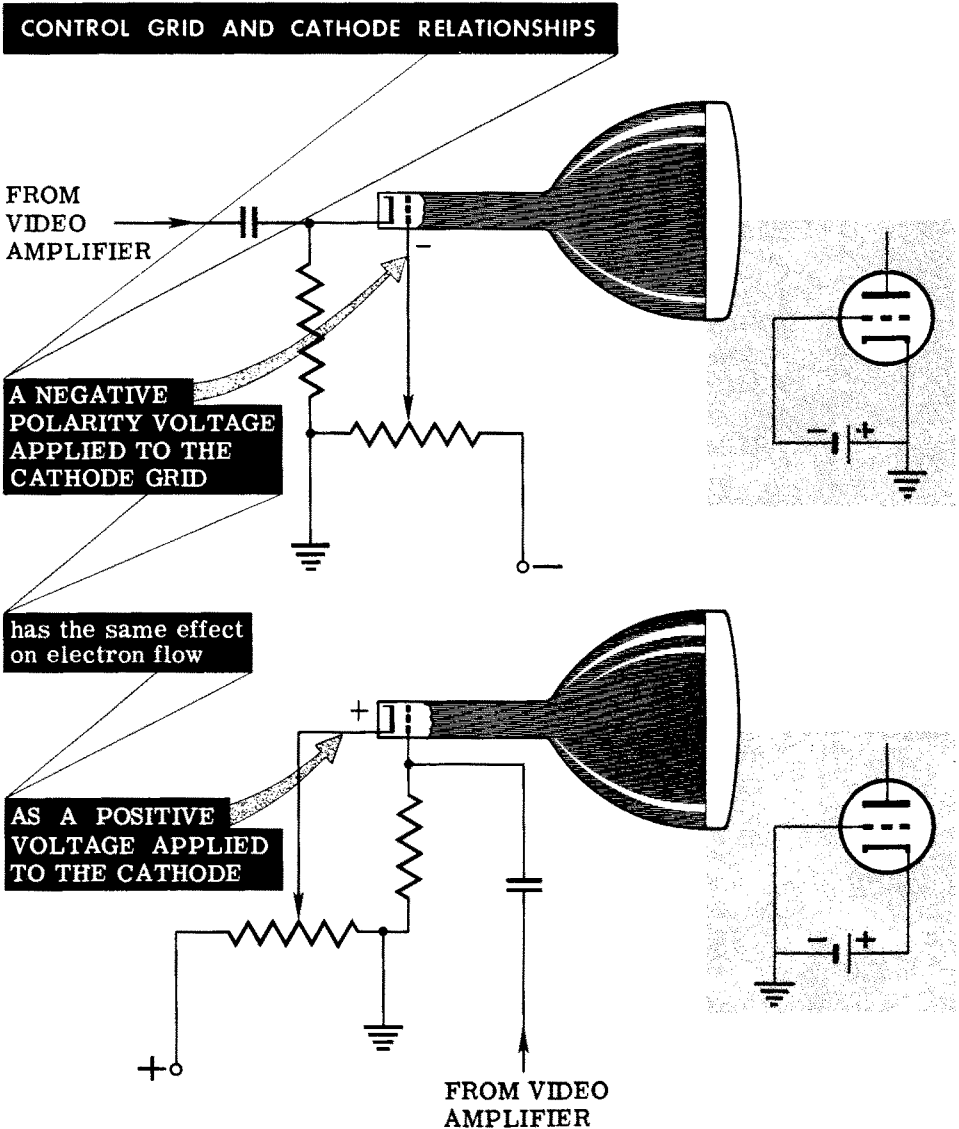

THE TELEVISION PICTURE TUBE

The First Anode Or Second Grid

Most modern picture tubes have a second cylindrical structure placed immediately adjacent to the control grid as shown here.

The principle function of the first anode is that of accelerating the electrons which emerge from the pinhole in the control grid structure. This accelerating action also causes some degree of *beam-forming*, since the electrons are caused to increase speed as they pass through the apertures in the first anode. It should be noted that the potential applied to the first anode is in the vicinity of 300 to 400 volts. The position of this element is such that it causes the electrons coming from the grid to accelerate as a result of the electrostatic attraction between the negative electrons and its own positive potential.

It should be mentioned here that some picture tubes do not have a first anode or *accelerating grid*, as it is sometimes called. In these tubes, acceleration is accomplished by high voltages applied to an element which we shall discuss as the *second anode* in the more standard picture tube we examine.

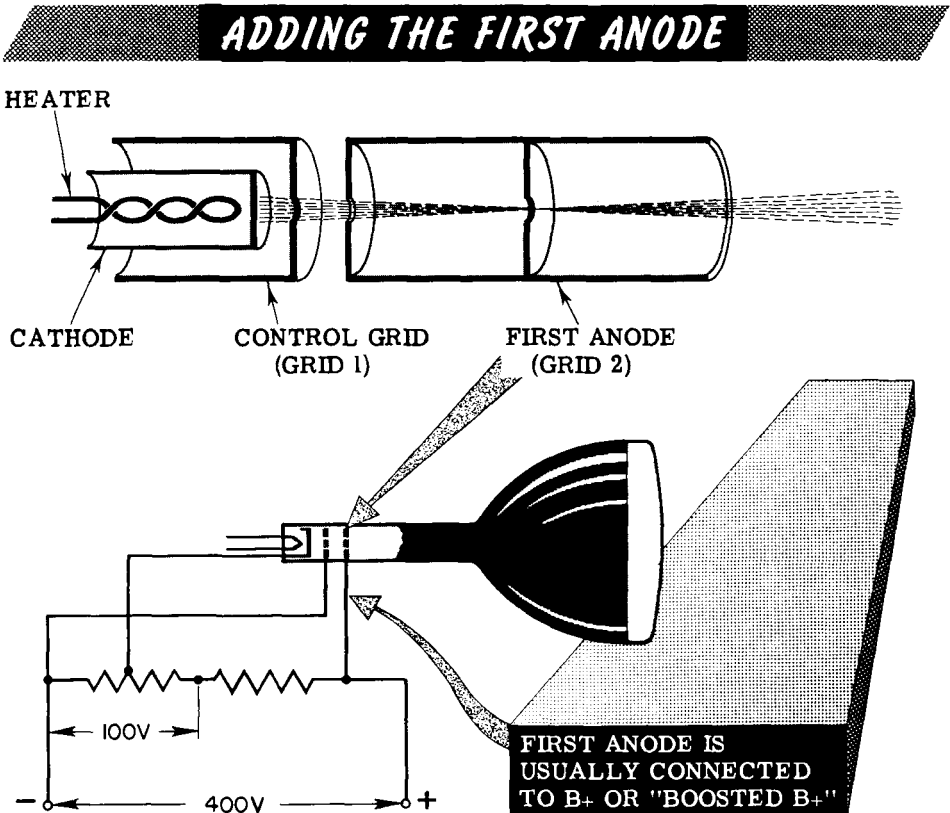

THE TELEVISION PICTURE TUBE

The Second Anode

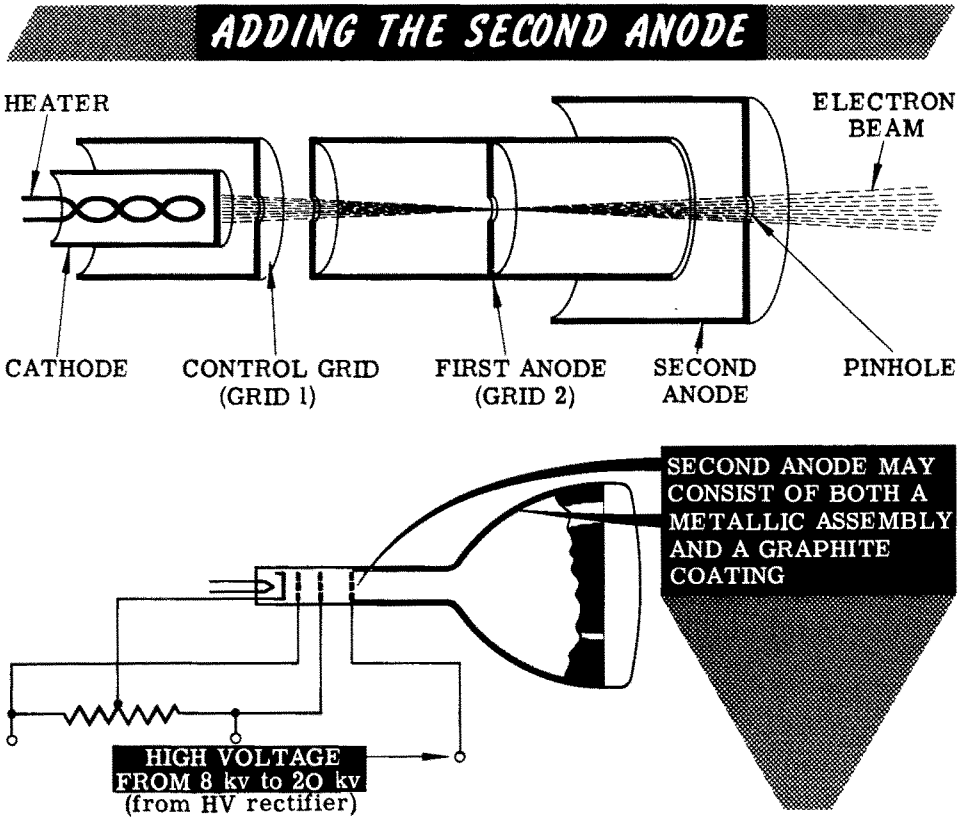

The accelerating grid or first anode does not cause sufficient acceleration of the electron beam to produce a satisfactory picture. To obtain the required electron velocities, a second positive electrode is added to the electron gun structure; this element usually carries anywhere from 8,000 volts to 20,000 volts (positive) depending upon the type of picture tube.

The *second anode* may consist of two distinct parts: (1) a cylindrical metallic structure adjacent to and following the first anode and (2) a conductive coating inside the glass envelope which covers almost the entire area of the glass bell. In some tubes, the conductive coating is omitted.

The conductive coating which forms a large part of the second anode is a colloidal graphite deposit called *Aquadag*. Aside from its accelerating action, the *Aquadag* coating plays a part in maintaining the electron stream in the form of a thin beam and assists, as we shall see, in filtering the ripples from the high-voltage supply.

THE TELEVISION PICTURE TUBE

The Capacitor Action of the Aquadag Coating

A glass picture tube sometimes has an inner conductive coating which forms part of the second anode, and an outer coating of the same material that covers about the same area on the glass surface. This electrical "sandwich" consisting of a nonconductor—the glass envelope—separating two conducting layers, forms a capacitor. Although its capacitance is not very great (approximately $500 \mu\mu\text{f}$), it is large enough to serve as a filter capacitor for the high-voltage supply.

The outer Aquadag coating is connected to the chassis (ground) of the receiver. The inner coating is joined to the second anode and is connected to the high-voltage terminal inside the receiver. Thus, this capacitor is connected across the high-voltage supply which provides the potential needed for the second anode.

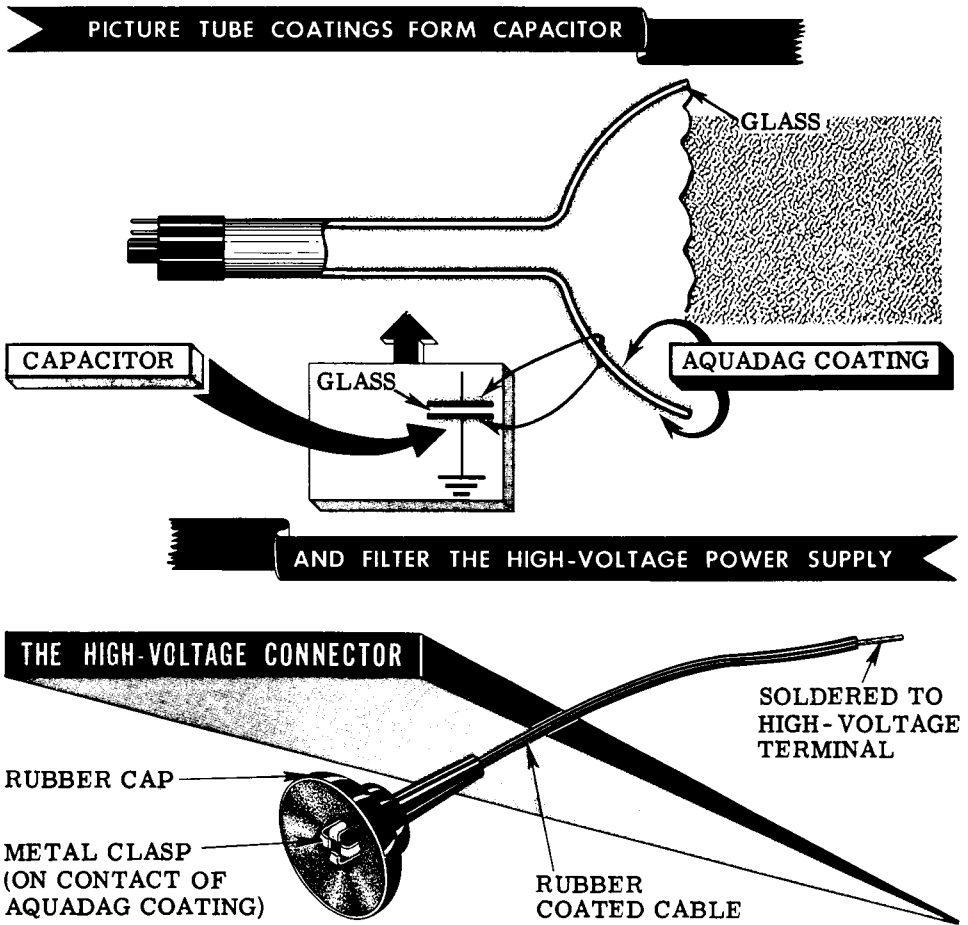

MAGNETIC FIELDS

Review Of Fundamentals Relating To Magnets And Fields

The electron beam in the television picture tube consists of a stream of electrons which advances in a predetermined direction from the cathode structure to the screen. In doing so it moves through the tube without benefit of a metallic conducting path. This is in contrast to the use of wires which normally conduct electrons in an ordinary circuit. Thus, a major difference between current in a picture tube and current advancing through a wire is the type of path; in the first case it is *space* and in the second it is *metallic*.

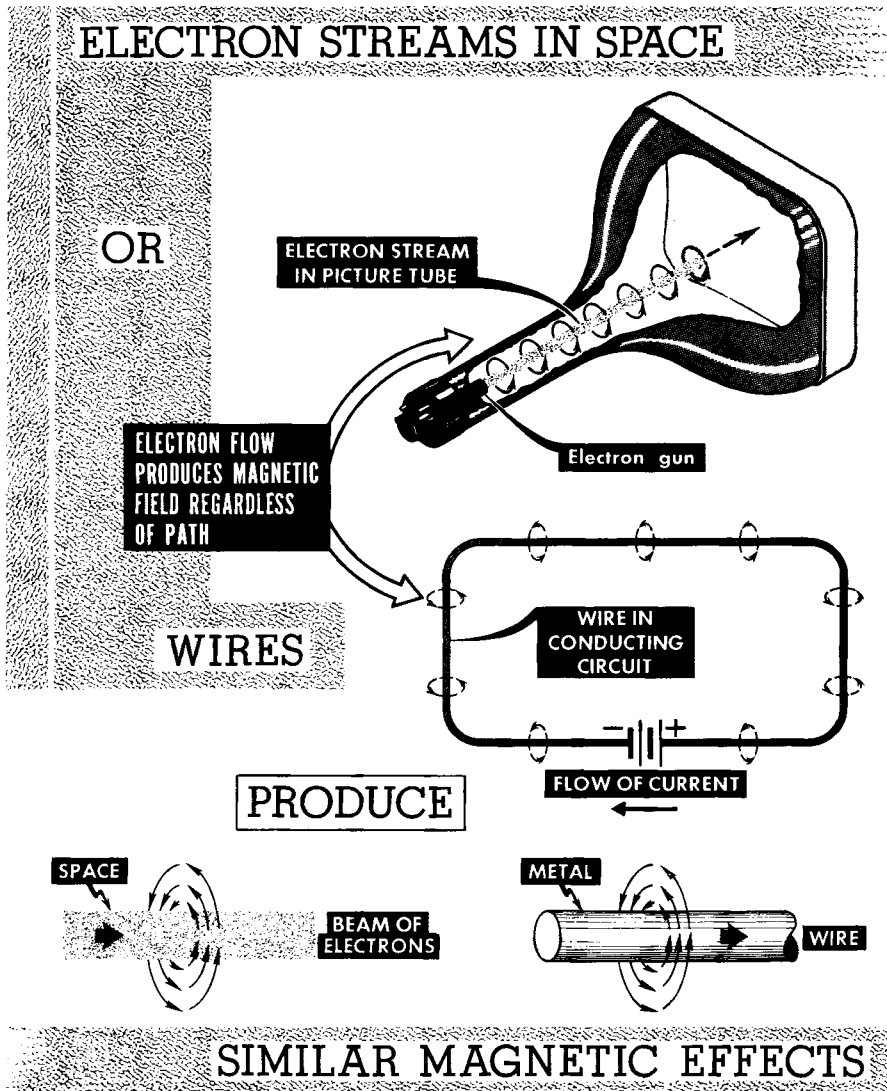

MAGNETIC FIELDS

Review Of Fundamentals Relating To Magnets And Fields (contd.)

Basic electricity teaches that if a wire carrying a current is placed in a magnetic field produced by some other means, the lines of force surrounding the current-carrying wire and the lines of force of the magnetic field will interact. Such interaction of fields produces forces which can cause motion if the resistance against this motion is not too great.

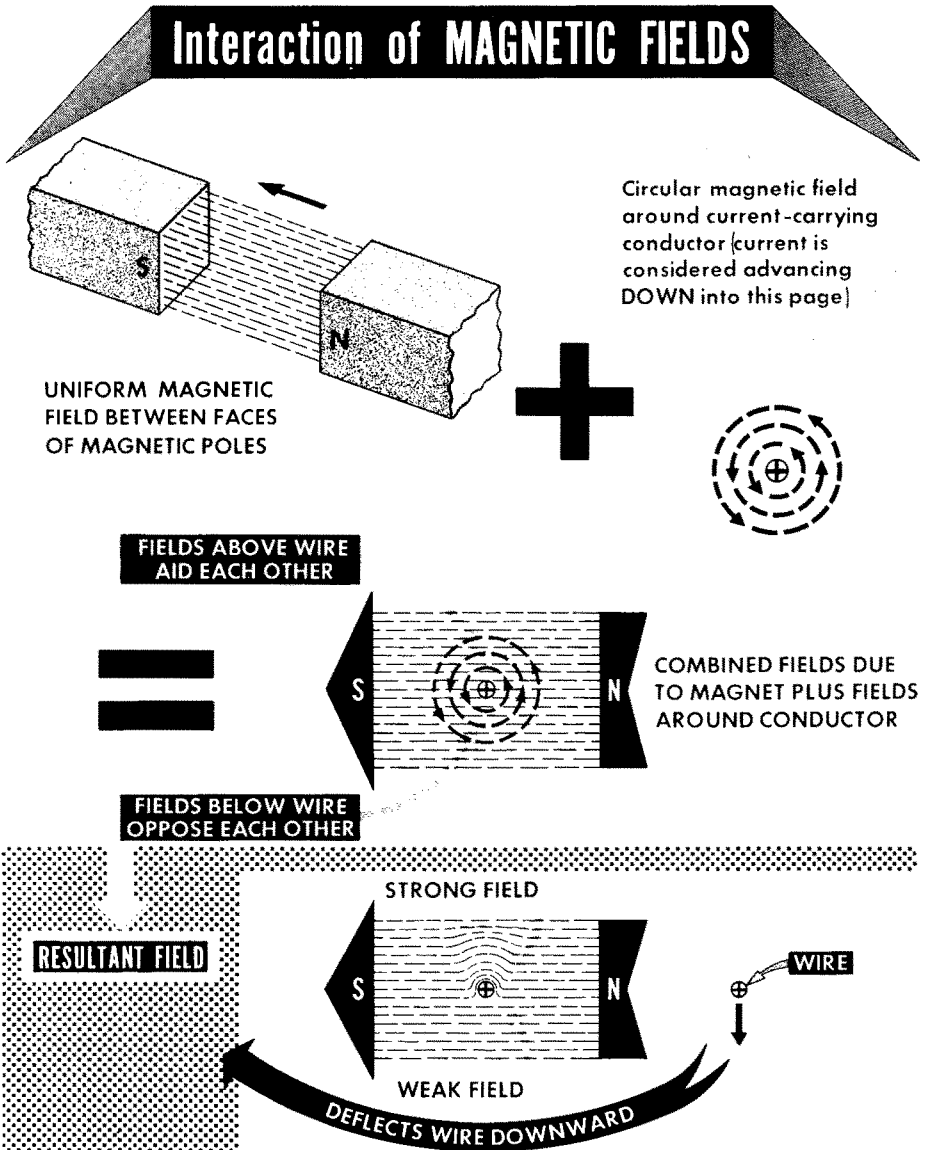

MAGNETIC FIELDS

Review Of Fundamentals Relating To Magnets And Fields (contd.)

In the case of a wire carrying a current, motion of the wire might result if the wire were not taut or were free to move. When two or more magnetic fields are present simultaneously, the interaction between them gives rise to a *resultant* force whose direction depends upon the way in which the fields reinforce or cancel each other.

The movement of the wire arises from the condition that the interaction of the two magnetic fields causes the resultant field to be stronger on one side of the wire than on the other, hence the wire moves in the direction of the *weaker* field.

changing THE DIRECTION OF THE PERMANENT MAGNET FIELD changes THE DIRECTION OF WIRE MOTION

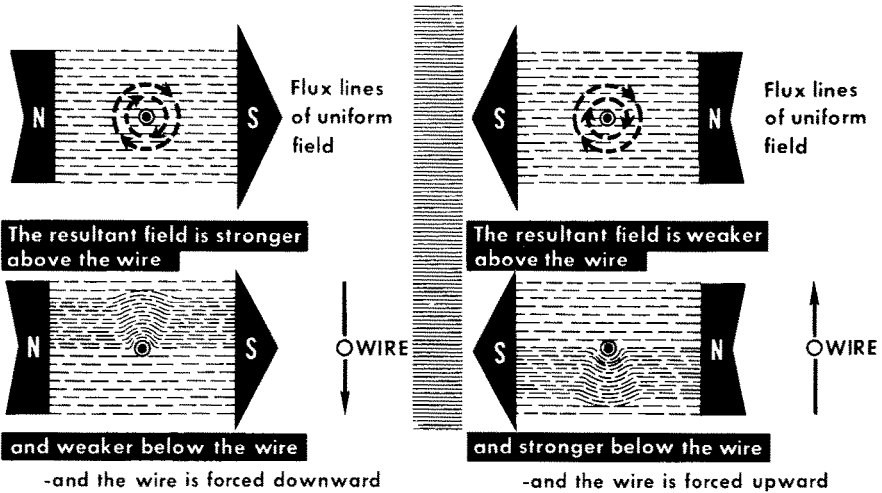

REORIENT THE STEADY FIELD AND THE DIRECTION OF MOTION OF THE CURRENT-CARRYING WIRE CHANGES

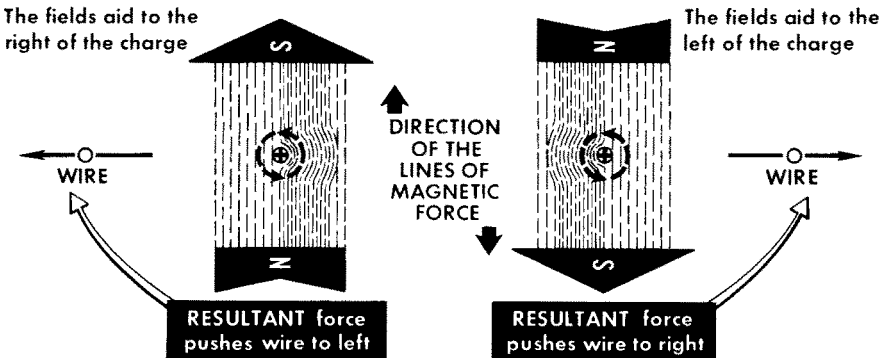

MAGNETIC FIELDS

Review Of Fundamentals Relating To Magnets And Fields (contd.)

The direction of motion is determined by the relative direction of the current through the wire (hence the direction of the field surrounding the wire) and the direction of the lines of force of the other field.

It is possible, therefore, to *control* the direction of the motion of the wire by (1) controlling the *direction* of the lines of force of the external magnetic field and (2) by changing the direction of the current in the wire. Actually, these two methods of control are closely related and have the same basis. Reversing the north and south poles of a permanent magnet merely changes the direction of the magnetic lines of force by 180° . By changing the direction of current flow in a conductor, the flow of the magnetic field surrounding the wire changes from, for example, clockwise to counterclockwise. Thus, regarding the interacting fields of the permanent magnet and the current-carrying conductor, they combine for a net effect.

Changing THE DIRECTION OF CURRENT IN THE WIRE changes THE DIRECTION OF WIRE MOTION

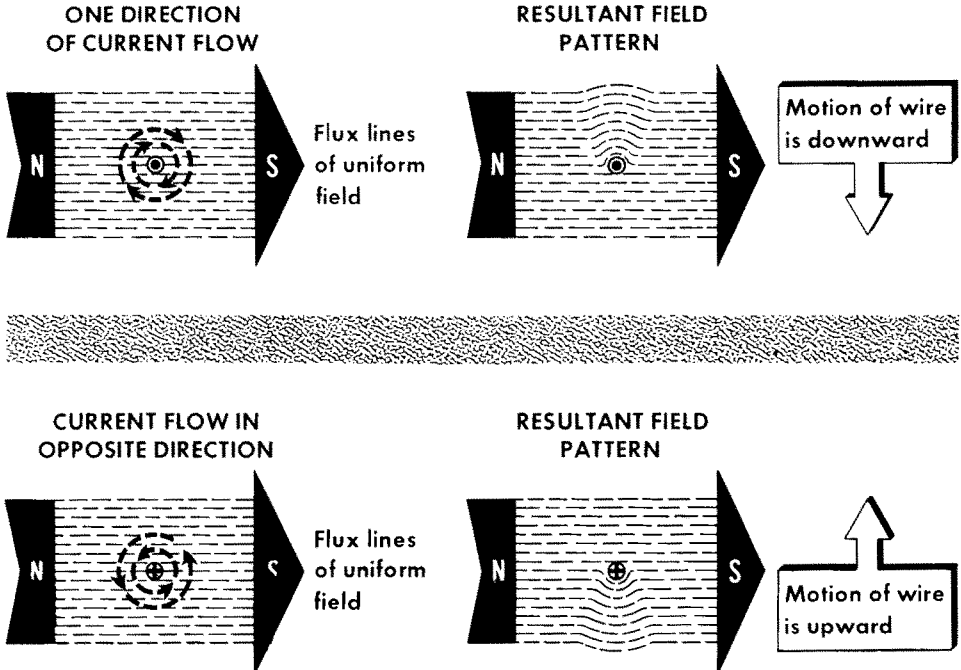

MAGNETIC FIELDS

Effects Of Magnetic Field On An Electron Stream

Inasmuch as we are interested in the similarity of behavior of a current-carrying wire and the electron beam in the picture tube, let us for the moment think only of the direction of the external lines of force. The direction of motion of the electron beam is fixed—from cathode toward screen; so if there is to be any control of electron beam motion, it must be done by changing the direction of the external field.

Let us now imagine a magnet placed around the neck of a picture tube in which an electron beam is advancing from the cathode to the picture screen. The resultant of the interaction is a force that *deflects* the beam at right angles to the direction of advance of the electron beam *and* at right angles to the lines of force between the pole pieces. Whether the beam moves upward or downward depends upon the direction of the flux lines between the pole pieces of the magnet. In either case, it is evident that the electron beam in the picture tube *may be moved at will* by an external magnetic field developed especially for this purpose.

In practice, interaction between this external field and the beam field makes possible *magnetic focusing* and *deflection*. In many television receivers, focusing is the job of a permanent magnet while in others the focusing device is an electromagnet. On the other hand, deflection is accomplished by *electromagnetically* established fields in virtually all modern American receivers.

The focusing and deflection functions are carried on independently of each other. Let us examine each of these briefly.

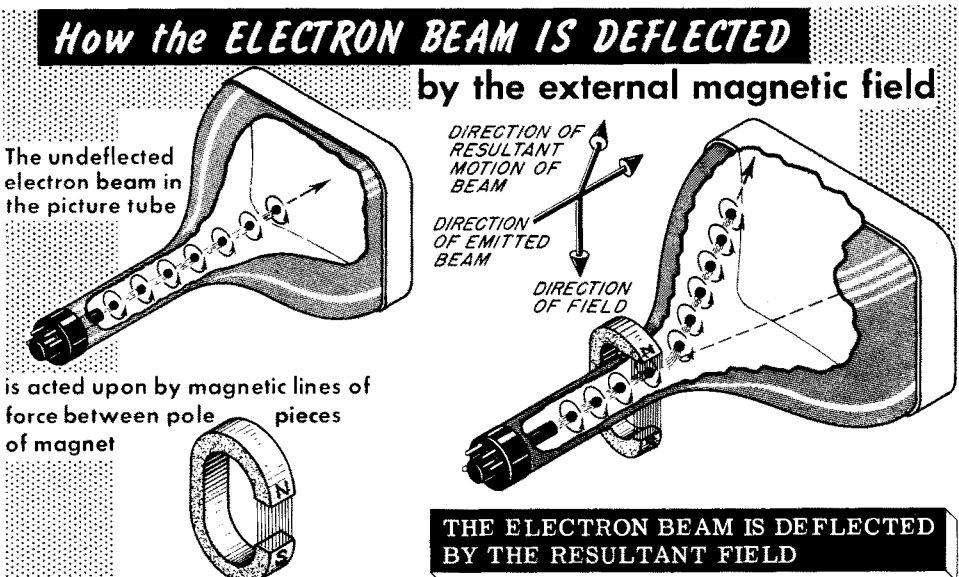

FOCUSING

Focusing

Although the electrons emerge from the opening in the second anode in the form of a pencil-like beam, a satisfactory picture cannot be reproduced until the beam is *focused*, or converged so that it covers the smallest possible area at the instant it reaches the screen. In the earliest picture tubes, focusing was handled by elements within the tube neck; with advances in tube design came a swing toward focusing by *electromagnetic fields* produced by devices on the outside of the tube. Now, new developments have tended toward the increased use of low-voltage electrostatic focus picture tubes in which proper convergence is produced *electrostatically*. Since most television receivers are still equipped with the magnetically focused tubes, this type will be discussed first.

ELECTRON FOCUSING

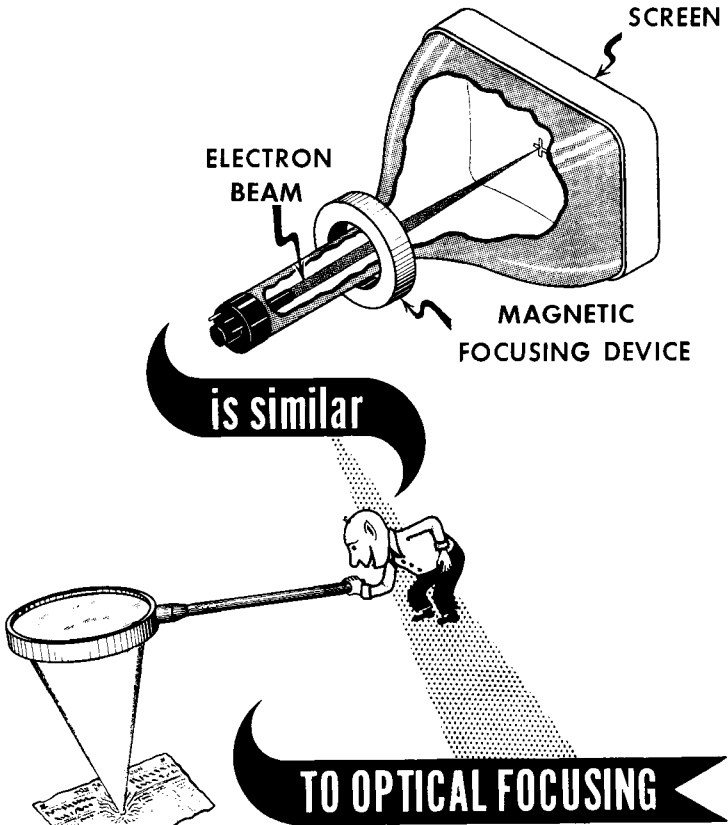

FOCUSING

Magnetic Focusing

A Typical

A beam of electrons such as that coming from the electron gun in a picture tube may be brought to a focus by an externally applied magnetic field of *fixed* intensity. For this reason, it is possible to bring the beam to a point with the help of either an adjustable *permanent magnet* or a *focus coil* through which a constant current (dc) flows. Older receivers favored the focus coil arrangement since control of focusing current then became a function of a single potentiometer mounted in some easily available spot on the chassis apron. Since focus current may reach appreciable figures (100 ma or more), provision had to be made for a huskier low-voltage power supply and bleeder system. An adjustable permanent magnet does just as good a job when properly set but the adjustment is a mechanical one and is somewhat more difficult to handle. Almost all modern television receivers have come to rely upon the permanent magnet arrangement in the interests of economy and simplicity.

A *focus coil* has no iron core of any kind; it merely fits around the neck of the picture tube. The intensity of the magnetic field it applies to the picture tube is adjusted by controlling the current flowing in the coil.

PERMANENT MAGNET FOCUS DEVICE

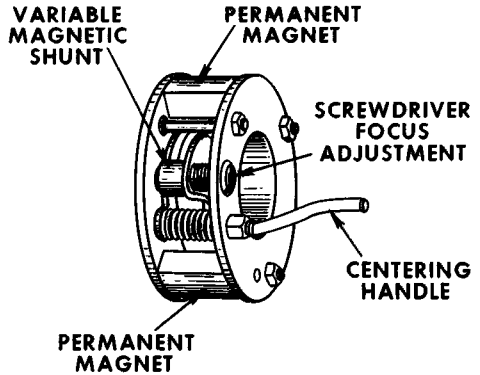

FOCUS COIL

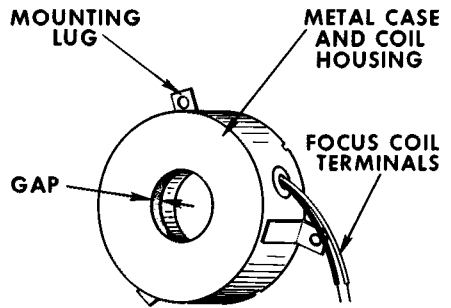

in a Typical Circuit

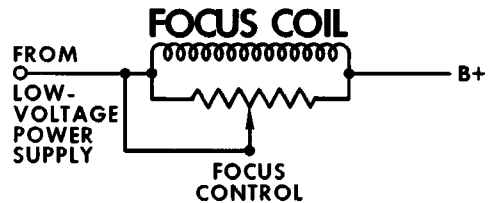

FOCUSING

Magnetic Focusing (contd.)

Now let us investigate the method whereby a magnetic field may be used to shape the beam so that it covers as small an area as possible when it strikes the picture tube screen.

The focus coil is a relatively narrow multilayer solenoid of many turns positioned around the neck of the tube so that the electron beam passes through its center. The strong uniform magnetic field produced by the current in the coil penetrates the glass of the neck and interacts with the passing electron stream.

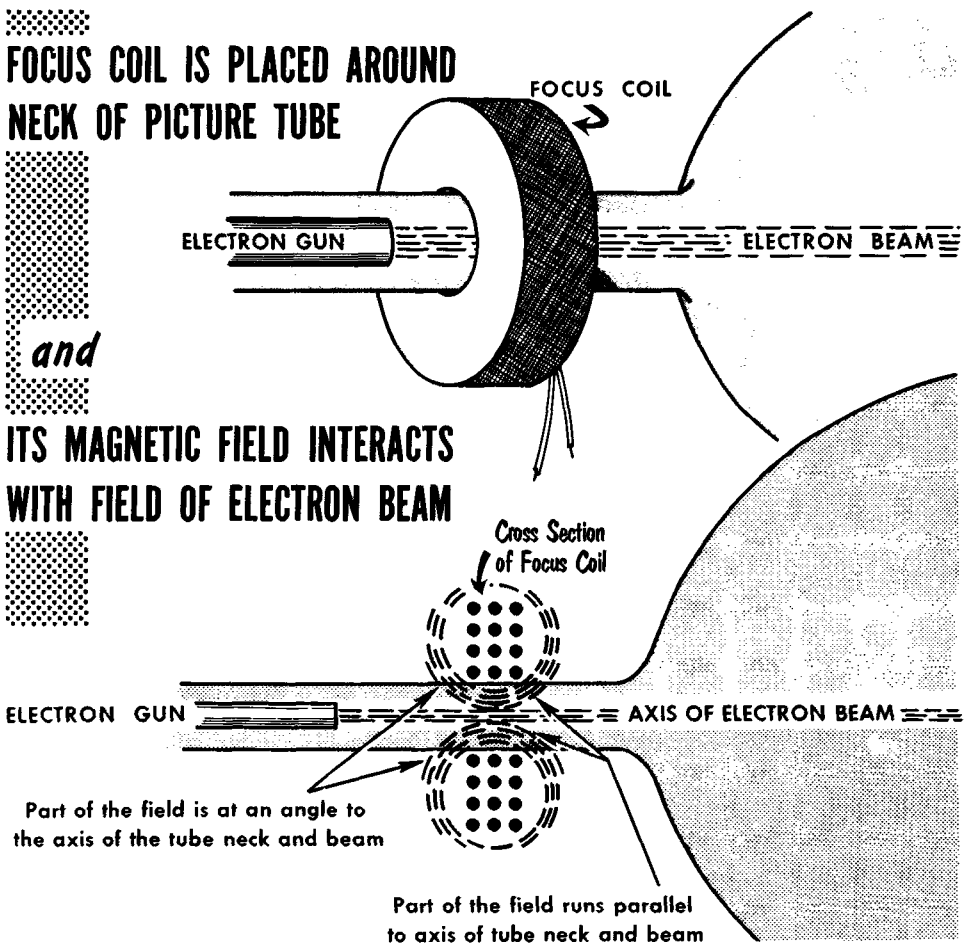

FOCUSING

Magnetic Focusing (contd.)

As explained previously, electrons in the stream emerging from the grid and anode apertures come out in the form of a diverging spray. Some electrons such as *A*, advance into the *middle* of the field and travel a path along the axis X-Y; others enter the field at various angles as, for example, electrons *B* and *C*. While only two such diverging electrons are illustrated in the interests of simplicity, a very large number of these pass through the field at many different angles. Only electrons that enter the field at the exact center, along the path X-Y or the axis of the tube, travel parallel to the direction of the external field lines and remain unaffected.

Effect of EXTERNAL MAGNETIC FIELD on ELECTRON STREAM

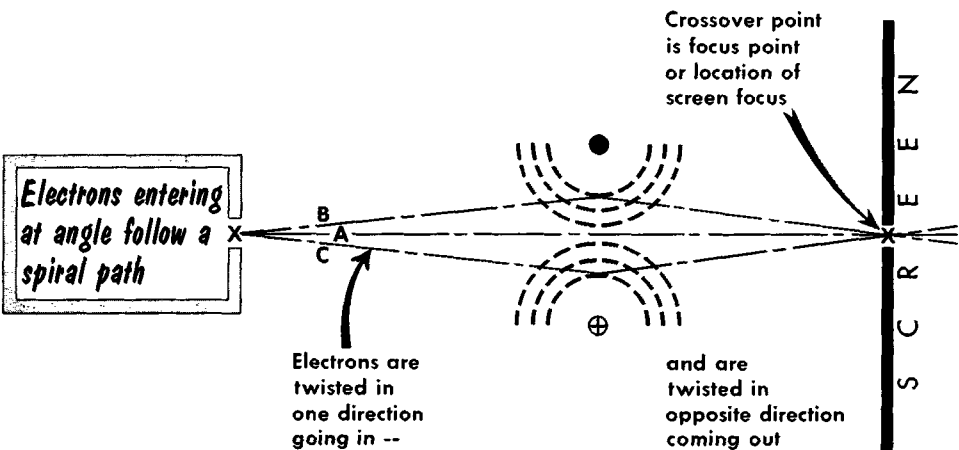
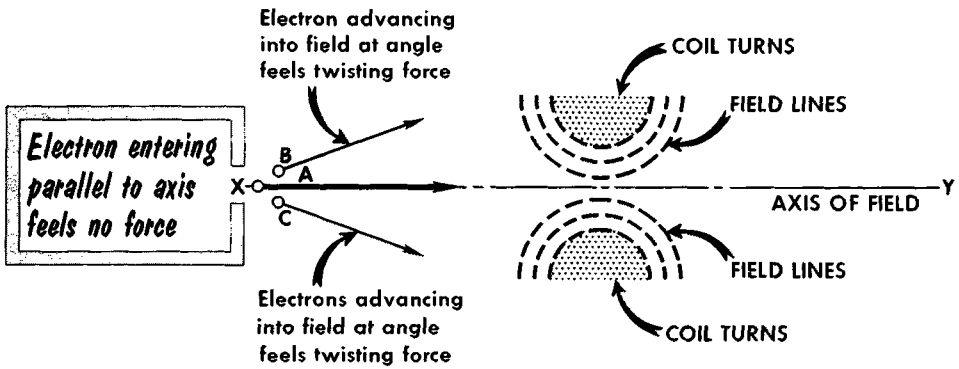

FOCUSING

Magnetic Focusing (contd.)

Image Formation on Picture Tube Screen

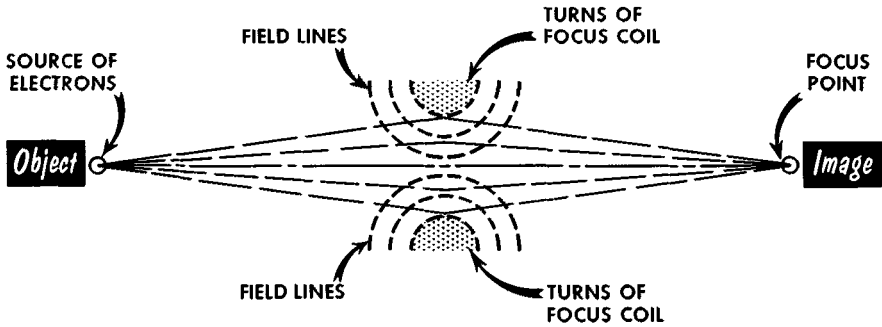

EQUIVALENT OPTICAL SYSTEM using converging lens

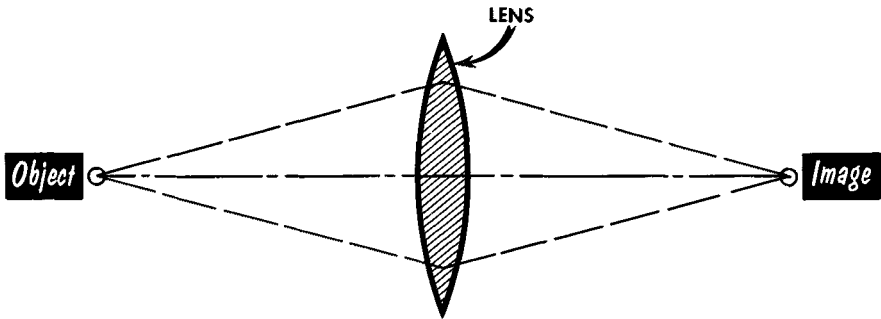

The focusing action stems from the behavior of electrons which enter a magnetic field. If they pass into the field parallel to the direction of the field lines, they undergo *no directional change*. But if they enter the field at an angle to the lines of force—as *B* and *C*—they are twisted in their path in a spiral fashion. The dimensions of the spiral paths are such that all the electrons converge at a point outside the field and so meet those which passed through without deviation.

The point of electron convergence is located at a fixed distance from the external magnetic field, this distance being determined by the strength of the flux passing through the neck of the tube and the acceleration of the electron beam.

The extent of the twist given the advancing electron stream depends upon the angle at which the electrons enter the field, in addition to the strength of the field itself.

FOCUSING

Magnetic Focusing (contd.)

To understand why electrons entering the magnetic field at an angle follow a spiral path, it must be remembered that an electron in motion is essentially an electric current and therefore possesses a magnetic field of its own. As an electron enters an external field, therefore, a force is exerted on it just as it would be if the electron were flowing in a wire.

As is shown here, the force acting on an electron as it enters a field, is at *right angles*. The direction of the force is always perpendicular to both the original direction of motion of the electron and to the direction of the magnetic field. *This does not mean that the electron immediately moves off at 90° to its original path.* The new direction it adopts is determined partly by its original velocity and partly by the strength of the field acting on it, hence it will follow a line intermediate between the two, such as path *AB*, during the very first instant of entry into the field. As soon as it is on its way on *AB*, however, it again experiences a perpendicular push, this time at right angles to path *AB*. This forces it to take a new direction, *BC*. During each infinitesimal period of time that it remains in the magnetic field, the electron feels a perpendicular force that alters its direction.

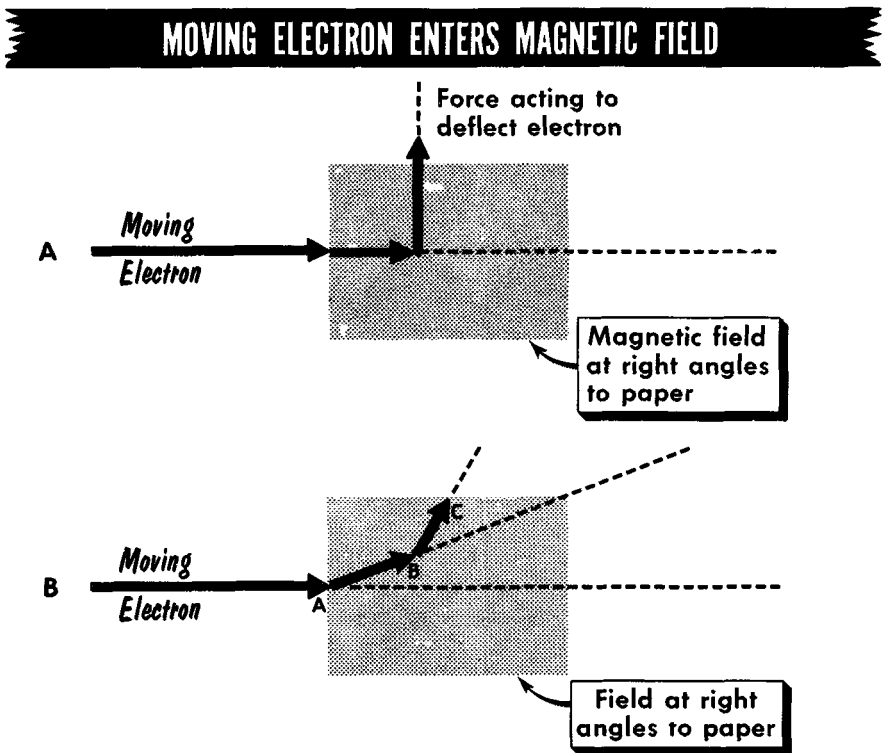

FOCUSING

Magnetic Focusing (contd.)

Of course, this movement is a smooth action rather than a segmented one, as the electron crosses lines of force from the external field during every moment of its transit. The actual path, therefore, is a smooth curve.

Now consider what takes place when an electron enters a magnetic field at some angle between 0° and 90° as many do in a TV picture tube. The motion that results is a composite one, partly circular and partly straight. The combined motion is similar to a corkscrew; it is spiral or helical, with the electron finally converging, together with others, at the same point on the screen. In designing picture tubes, all efforts are directed to adjust the combination of anode voltage and the location and strength of the focusing magnet in such a way as to cause each electron to complete approximately a one-turn helical path on its way to the screen.

Fundamentally, this action may be described as *focusing* because the separated electrons are forced to form an *image* of the source—that is, the *point* or *area* of emission on the cathode. When the system is properly designed and operating correctly, the image is at the surface of the screen. In effect, electromagnetic focusing is the same as optical focusing.

ACTION OF MAGNETIC FIELD ON MOVING ELECTRON

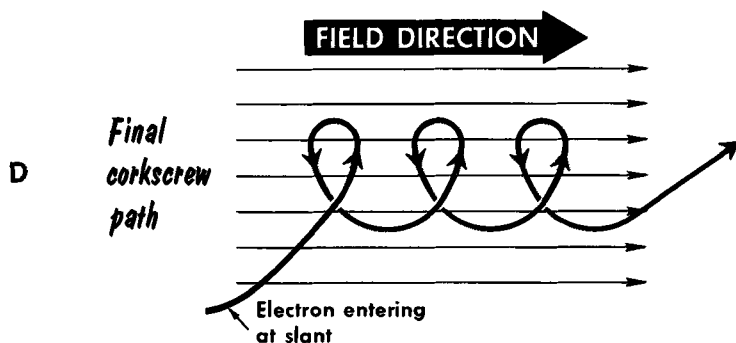
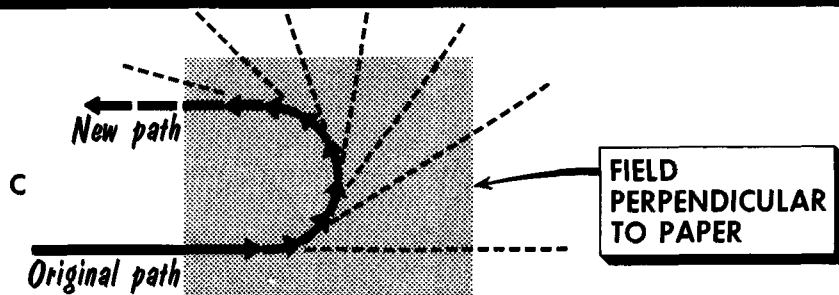

FOCUSING

Electrostatic Focusing

We have seen how the electron beam can be focused by properly oriented magnetic fields that originate in either a focus coil or a permanent magnet focus device. Although magnetic focusing is highly successful, it does have the disadvantage that external, adjustable elements are required. In the case of the focus coil, provision must be made for supplying power to the unit. With the permanent magnet arrangement, the focus device must be placed and rotated on the tube neck by experienced hands if optimum results are to be obtained.

There is another way to obtain electron beam focus: metallic elements built into the electron gun may be made to act on the electron stream by *electrostatic* rather than electromagnetic fields. This method is known as *electrostatic focusing*.

Electrostatic Fields. When two oppositely charged, flat metal plates are brought near each other, an *electrostatic field* capable of exerting forces on charged particles is formed between them.

To facilitate analysis, a direction is *assigned* to the electrostatic field on the basis of some arbitrary assumption. In this case the lines are assumed to have the same direction as that which an electron (or a negative ion) would follow if it were placed in the field.

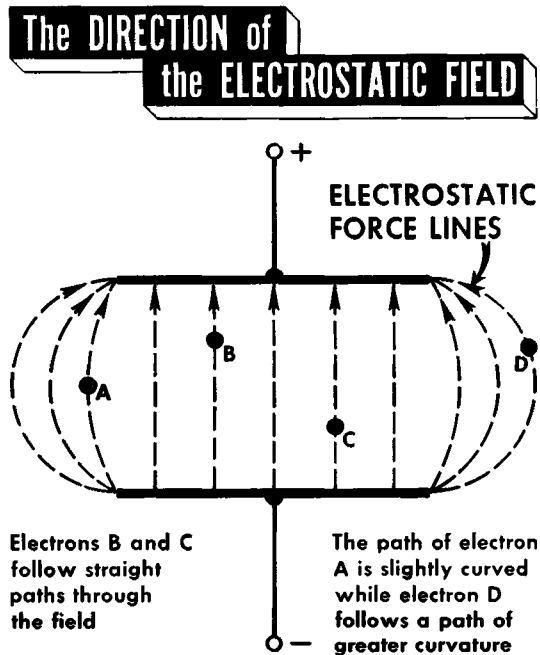
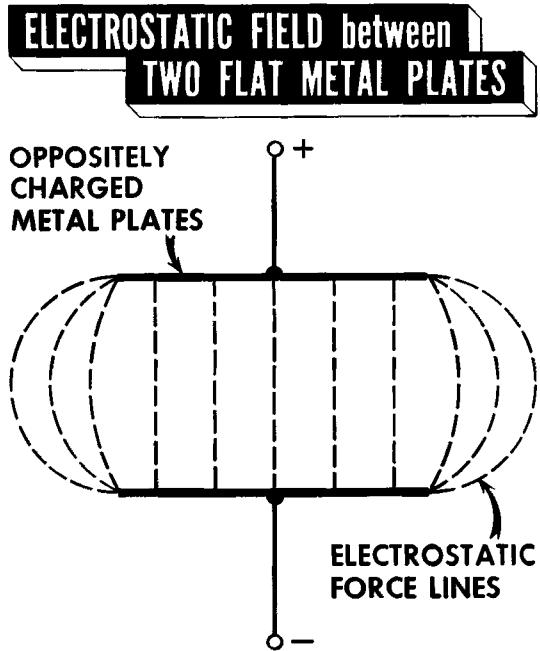

FOCUSING

Electrostatic Focusing (contd.)

Let us now draw a series of lines across the electrostatic field in such a way that these new lines cross the force lines everywhere at right angles. Such a group of lines are *equipotentials*. They are useful in clarifying the action of an electrostatic field on moving electrons and negative ions.

A very important conclusion may be drawn from these structures: since electrons always travel along electrostatic lines of force, and since equipotential lines are constructed at right angles to electrostatic lines of force, then electrons in moving through an electrostatic field *always cross equipotential lines at right angles* provided no other forces act upon them.

By changing the shape of charged electrodes it is possible to generate almost any desired pattern of electrostatic lines of force and consequently any desired pattern of equipotential lines.

Equipotential lines CROSS the ELECTROSTATIC FIELD at RIGHT ANGLES

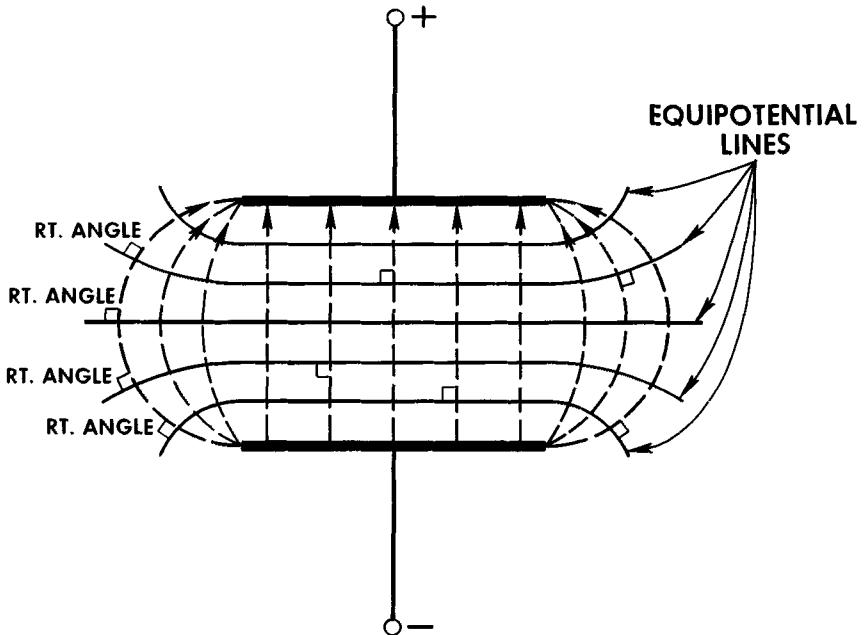

There is always ONE equipotential line that crosses ALL field lines without bending.

FOCUSING

Electrostatic Focusing (contd.)

In the electron gun of a picture tube, the aperture plates of the control grid and the first anode lie adjacent to each other like this:

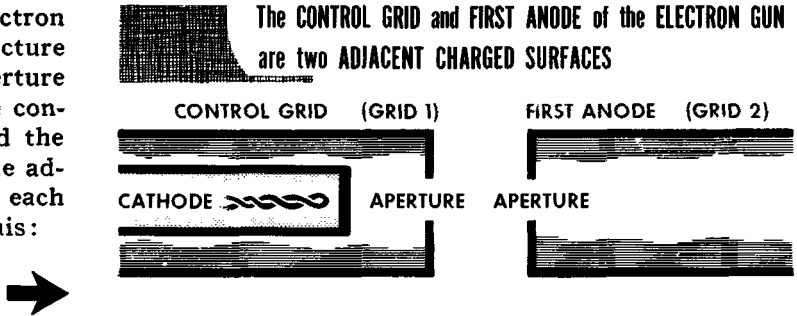

This configuration of charged plates establishes a pattern of equipotential lines which appears somewhat like this:

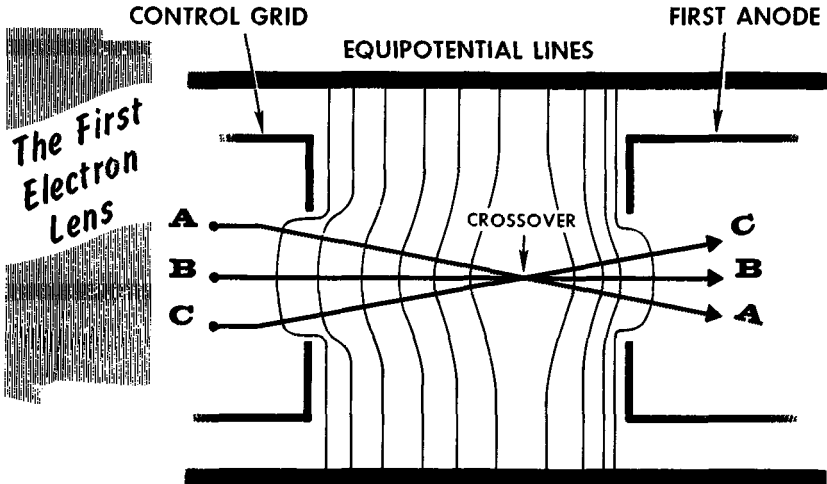

◇ To cross the equipotential lines at right angles:

- ▶ Electron A must swerve downward
- ▶ Electron B goes straight through and is said to LIE ON THE AXIS OF SYMMETRY
- ▶ Electron C must swerve upward
- ▶ This establishes a CROSSOVER POINT between the two electrodes.

The manner in which the electrons must cross the equipotential lines to form right angles explains why a *crossover* of paths must occur between the two electrodes. This joint system, consisting of the control grid and first anode, is often called the *first electron lens*. It is interesting to note that even electromagnetic focus tubes are equipped with the same first electron lens, but differ from electrostatic focus types in the next step in the focusing process.

FOCUSING

Electrostatic Focusing (contd.)

As the stream of electrons leaves the crossover point, it again becomes divergent but before it has the opportunity to strike the insides of the cylindrical elements it is acted upon by the so-called *focus* electrode (grid 4). This element is roughly cylindrical in shape but is so proportioned and positioned as to produce a pattern of equipotential lines of this nature:

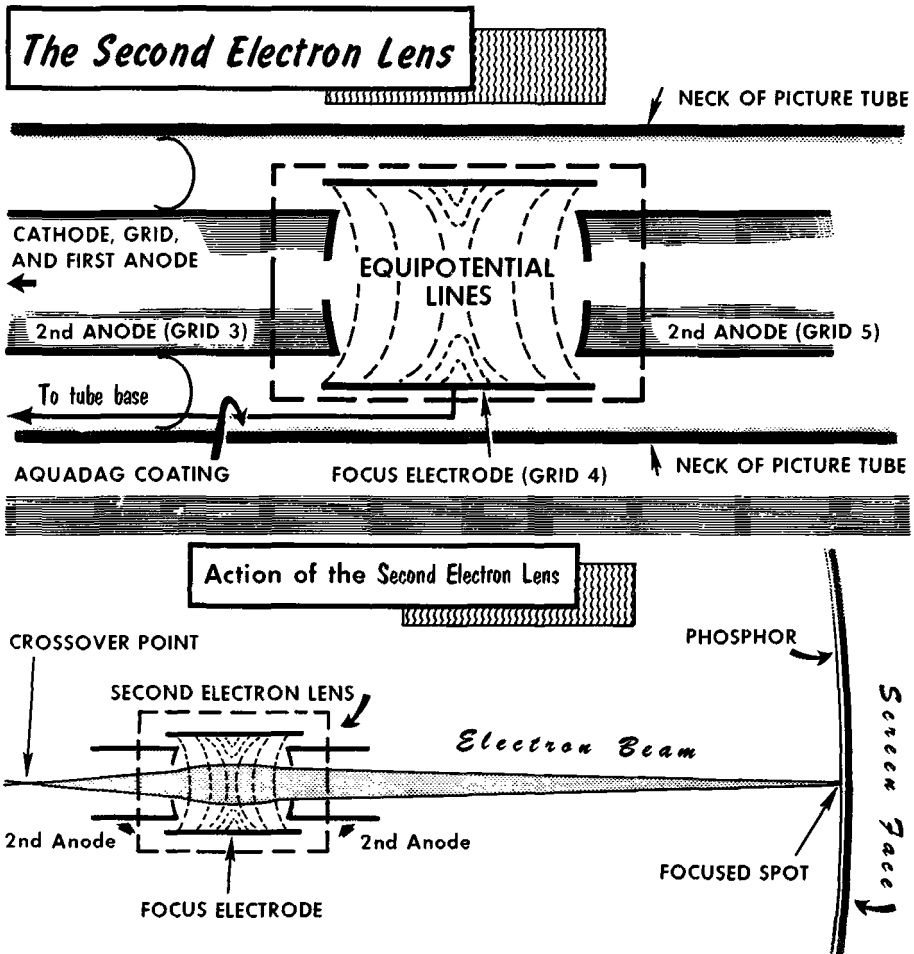

The focus electrode overlaps the edges of a split second anode, and is connected electrically to the base of the tube (usually pin 6). Dimensions and voltages are calculated to produce this equipotential pattern. As the diverging electron beam passes into this field, following the law of perpendicular crossing at all equipotential lines, it is made to converge once again and is brought to a focus on the screen.

FOCUSING

Electrostatic Focus Tubes

The voltage required for low-voltage electrostatic focus elements will vary from set to set, from tube to tube. In fact, some manufacturers provide a potentiometer which varies the voltage supplied to the focus electrode (usually pin 6) from zero or ground potential, up to as much as 400 volts. The correct voltage must be determined experimentally, by varying the focus voltage while observing the picture on the screen.

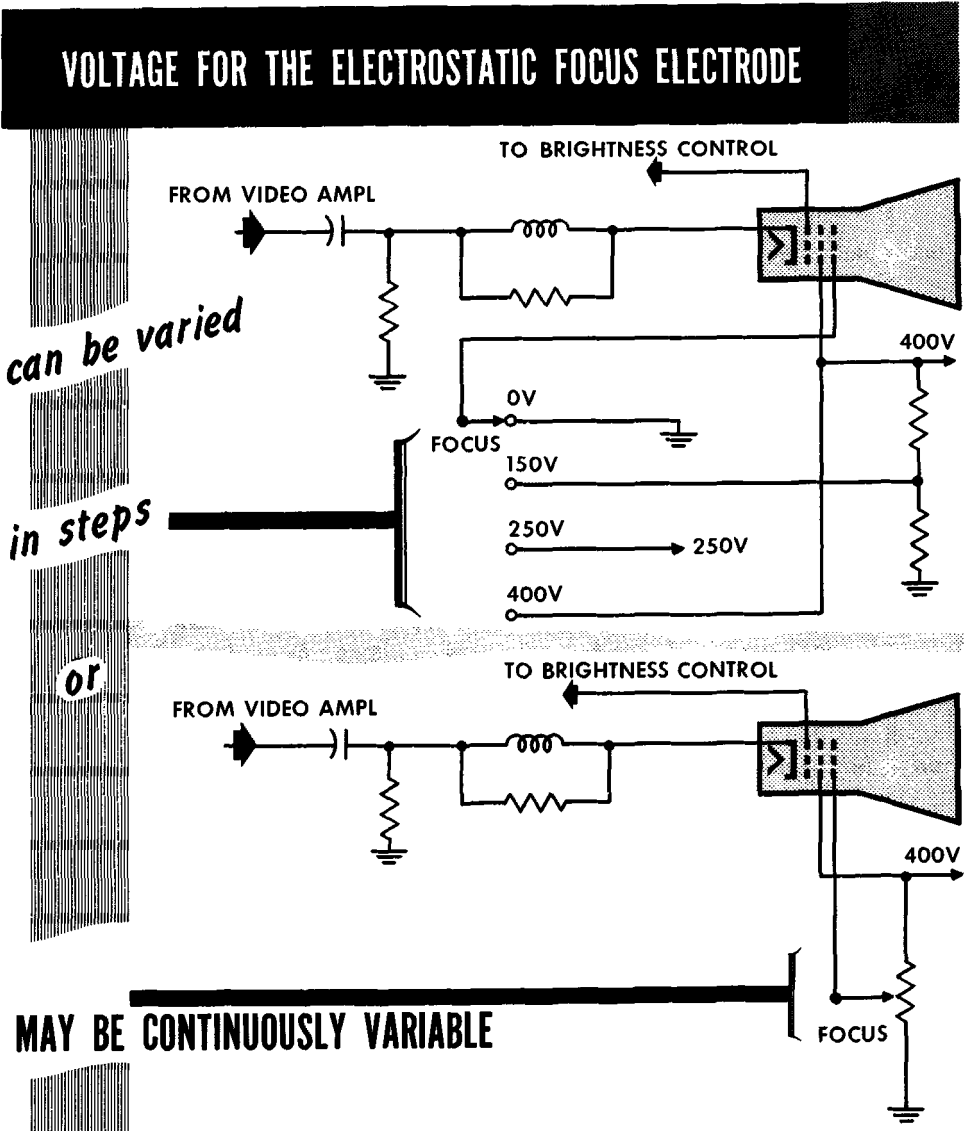

FOCUSING

Electrostatic Focus Tubes (contd.)

The low-voltage electrostatic focus tube is by no means the only tube using this type of focusing method. While never achieving real prominence, the self-focus or automatic focus electrostatic tube has been made by several cathode-ray tube manufacturers. This tube is very similar to the low-voltage electrostatic focus tube, differing primarily in that the focusing electrode is connected internally to the cathode of the picture tube through a resistor of about 1 megohm. This tube has the obvious advantage of requiring no external circuitry and drawing no additional power. By the same token it has the disadvantage that once the tube is manufactured, there is virtually nothing that can be done should the focusing be somewhat less than desirable.

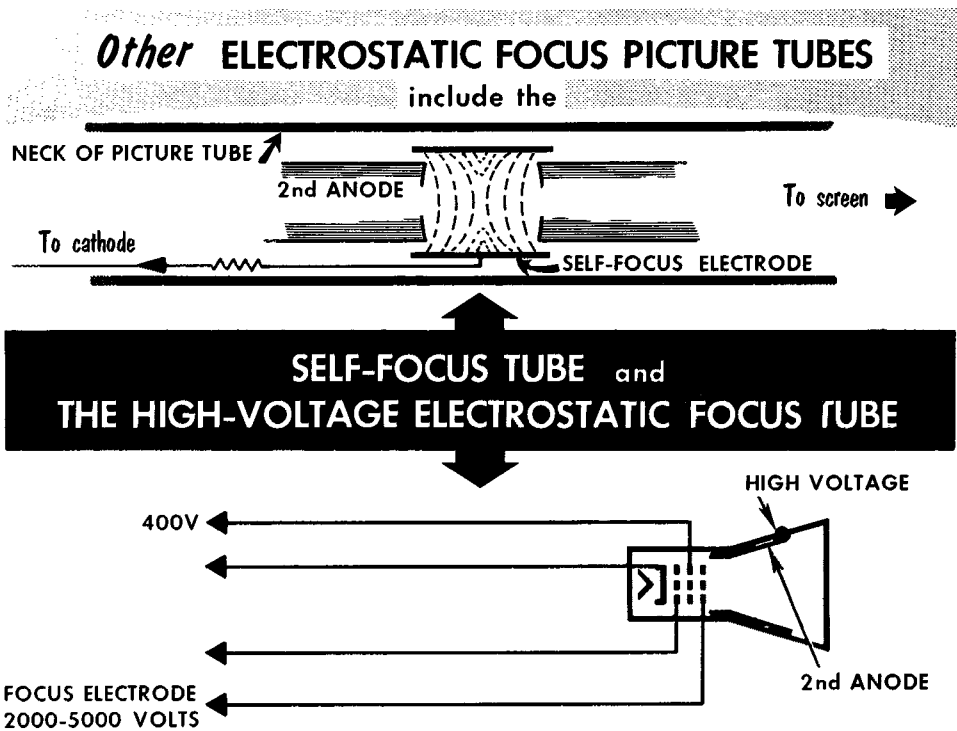

In some early picture tubes a method that might be described as high-voltage electrostatic focus, was used. The high voltages applied to the focus element produced large current drains from the power supply, and fluctuations in line voltage interfered with focusing and made frequent readjustments of the focus control necessary. Redesign of the electron gun and focus section brought about the use of focus elements having an insignificant current drain, and requiring comparatively low voltage.

FOCUSING

The Focusing Coil

Located just behind the deflection yoke, on the side toward the base of the picture tube, is the focus coil. In early television receivers the focus coil was standard equipment with 247-ohm 200-ma, 470-ohm 140-ma, and 360-ohm 150-ma types used most frequently. These coils gave way to the less complicated permanent-magnet focus devices, though many millions were placed into use.

The focus coil is placed over the neck of the picture tube so that its axis coincides with the axis of the deflection yoke. It should be placed approximately $\frac{3}{8}$ inch behind the deflection yoke but this distance will vary slightly, depending upon magnet strength and the individual picture tube. If the coil is placed too close to the deflection yoke there will be interaction between the magnetic fields of the focus coil and the deflection yoke.

The FOCUS COIL is located close to the deflection yoke

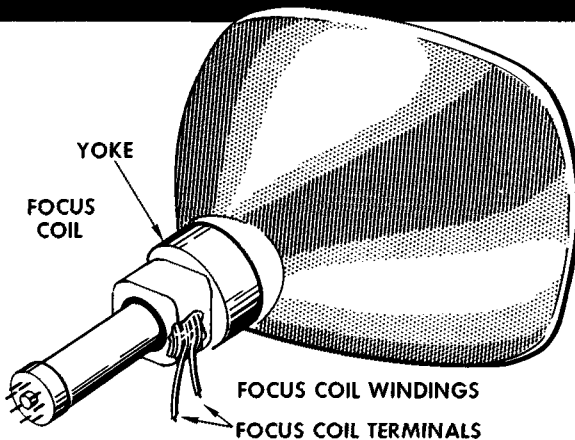

and ACTS on the ELECTRON BEAM

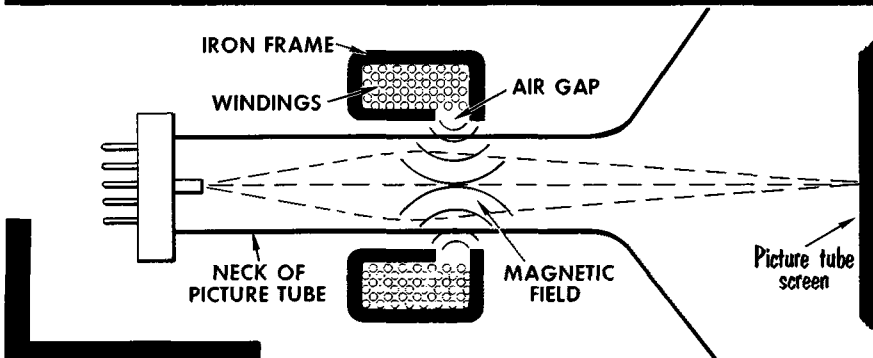

FOCUSING

Adjusting The Focus Coil

In some receivers, an improperly centered picture may be re-positioned by adjusting potentiometers usually mounted on the rear apron of the chassis. These variable resistors control d-c voltages supplied to the deflection coils as explained earlier.

Where there are no electronic controls, picture centering is a matter of loosening the nuts holding the focus coil to its bracket around the picture tube neck and tilting the coil housing until centering is accomplished. The

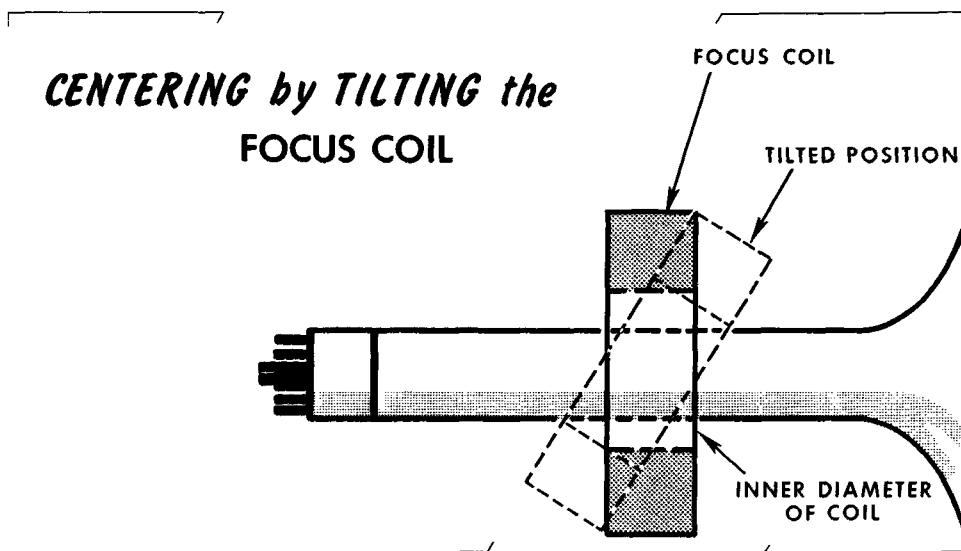

hole in the center of the housing is generally somewhat larger in diameter than the neck of the tube, permitting the plane of the coil to be tilted with respect to the tube axis.

The amount of tilt is somewhat exaggerated but it does show how the coil may be manipulated to move the picture on the screen. It is worthwhile noting that the process of tilting the focus coil can put a strain on the neck of the tube and, if forced, may even break it. This is not only costly but is also very dangerous!

An improperly aligned focus coil may also be responsible for neck shadow. When its magnetic field is lined up in the wrong direction with respect to the beam axis electrons in the beam may be directed against the neck of the tube. The distance between the deflection yoke and the focus coil is a matter of individual receiver specifications. In some cases, the focus coil may actually touch the deflection yoke; in others, a distance of $\frac{1}{2}$ to $\frac{3}{4}$ of an inch may separate the two.

REVIEW

HEART OF THE CATHODE-RAY TUBE IS **THE ELECTRON GUN**

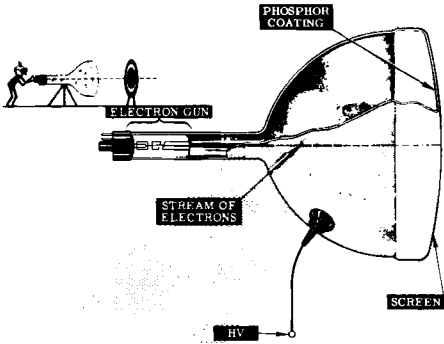

How the **ELECTRON BEAM** IS DEFLECTED

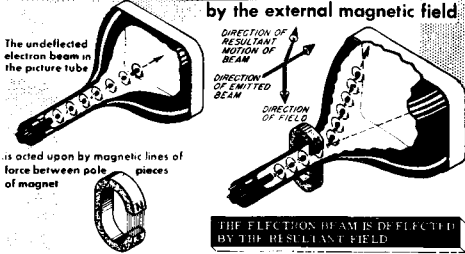

MOVING ELECTRON ENTERS MAGNETIC FIELD

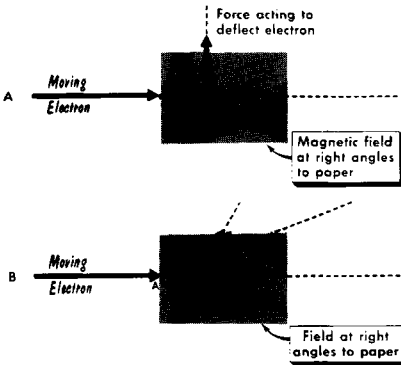

4. *Electrostatic Focus Tubes.* The voltage required for low-voltage electrostatic focus elements will vary from set to set, from tube to tube. The correct voltage must be determined experimentally, by varying the focus voltage while observing the picture on the screen.

1. *The Cathode-Ray Tube.* The cathode-ray tube is a large glass structure from which as much air as possible has been removed. A thin coating of fluorescent material called a phosphor, deposited on the inside of the face is responsible for the glowing lines that paint the television picture.

2. *Effects of Magnetic Field On An Electron Stream.* Interaction between the external field and the beam field makes possible magnetic focusing and deflection. Deflection is accomplished by electromagnetically established fields in virtually all modern American receivers.

3. *Magnetic Focusing.* The force acting on the electron as it enters a field, is at right angles. The direction of the force is always perpendicular to both the original direction of motion of the electron and to the direction of the magnetic field.

VOLTAGE FOR THE ELECTROSTATIC FOCUS ELECTRODE

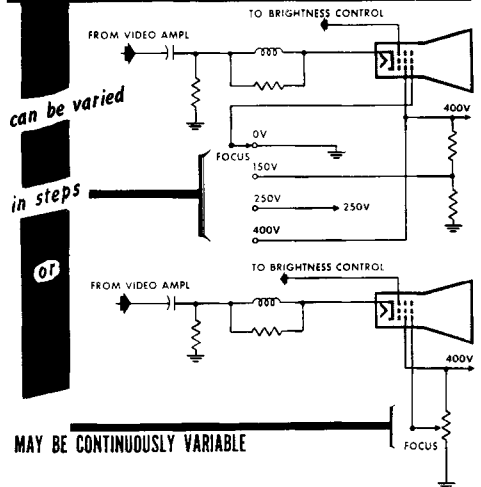

DEFLECTION

Electromagnetic Deflection

The mechanism of electromagnetic deflection is essentially equivalent to that of focusing: the forces resulting from the interaction between the magnetic field surrounding the moving charge and a separately generated field produces a deviation of the electron stream. This deviation is sidewise for the horizontal deflection system and up-and-down for the vertical system.

Deflection of Electron Stream Toward Weaker Field

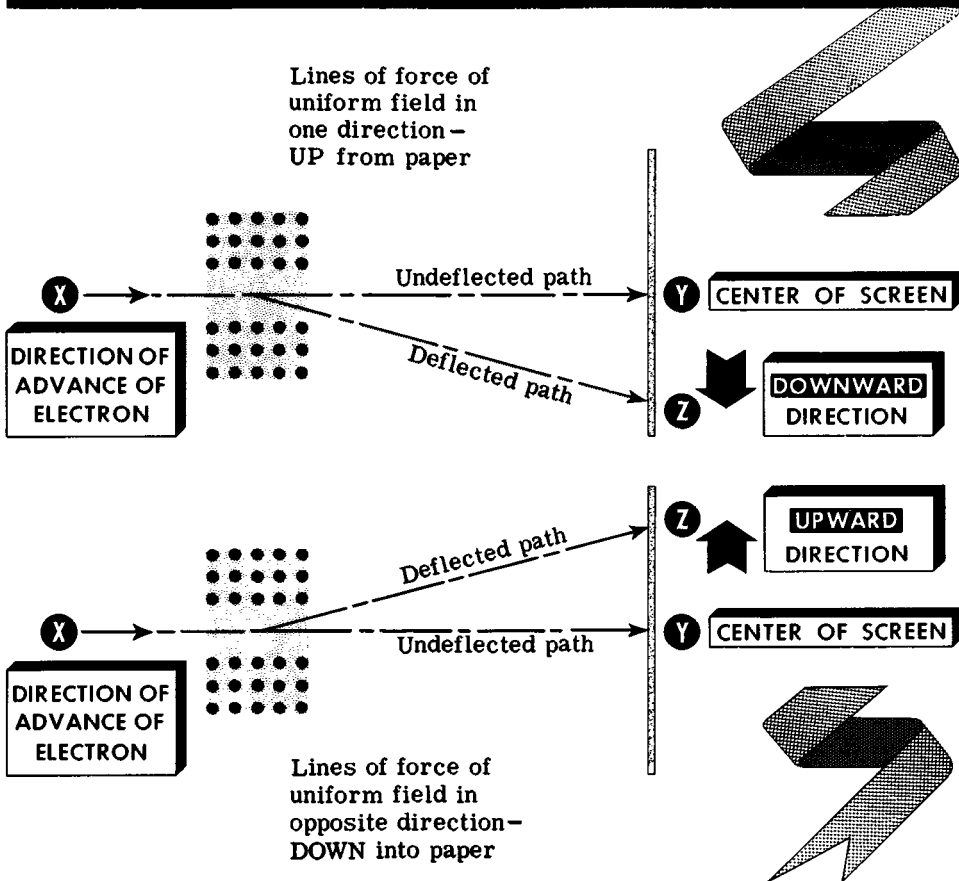

The resultant of the two fields is stronger on one side of the charges than on the other, hence the charge is deflected from its "normal" path. The direction of deflection is always toward the weaker of the two fields.

DEFLECTION

Electromagnetic Deflection (contd.)

Deflection fields are generally made narrow along the axis of the picture tube. Thus, the electrons leave the field shortly after entering it, but their new path of advance differs from the original path along which they entered as shown by the undeflected path Y and the deflected path Z.

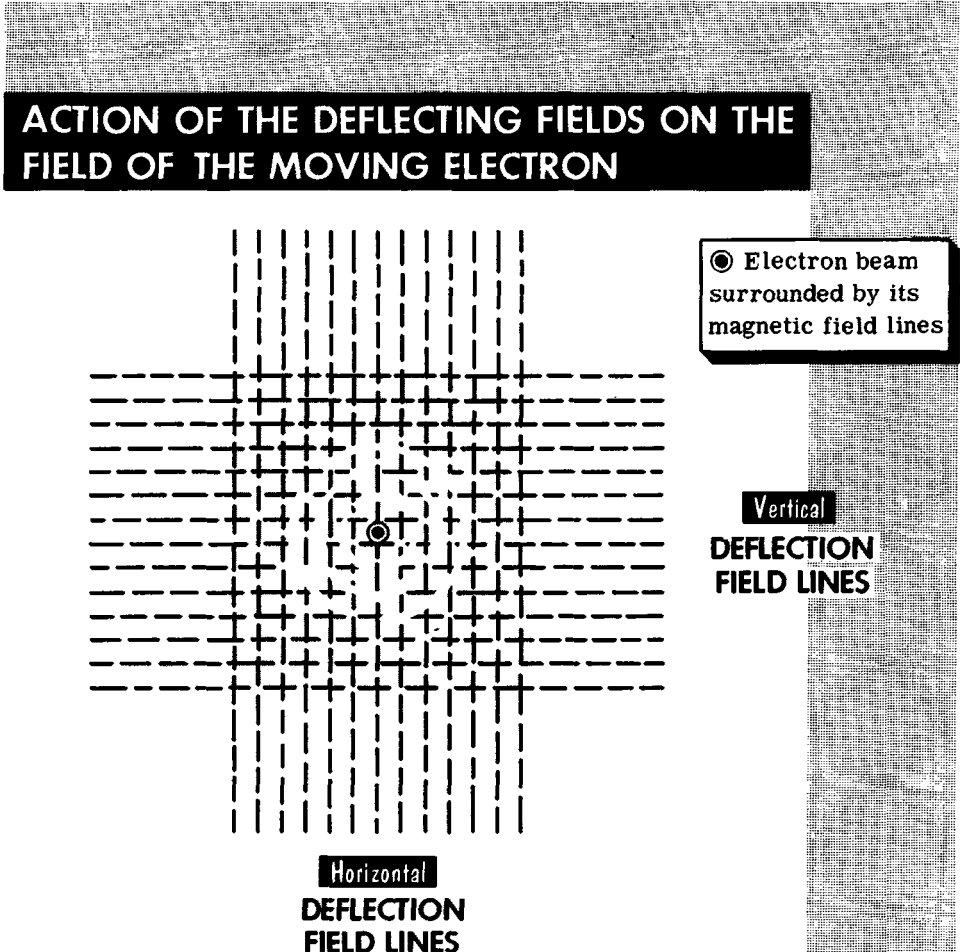

As mentioned above, electromagnetic deflection as used in television involves two simultaneous deflecting fields—one which moves the electron stream vertically while the other acts upon the stream horizontally. During this period, the stream moves forward inside the tube from cathode to screen.

DEFLECTION

Electromagnetic Deflection (contd.)

As shown, there are three fields in constant interaction: the field produced by the moving charge, the vertical deflecting field, and the horizontal deflecting field.

The amount of deflection (the extent to which the path of entry and the path of departure from the field differ) is a function of several factors. One of these is the intensity of each of the deflecting fields; the stronger they are, the greater is the degree of deflection. This effect is visible on the picture tube screen as an increase in distance covered by the moving spot of light which, in turn, governs the picture width and height.

A second controlling factor is the high voltage applied to the second anode of the picture tube. If this voltage is very high, the beam-advance velocity is very high. The momentum of the moving particles is so great under these conditions that they tend to continue in a straight line and are deflected with more difficulty than when their velocity is low. For this reason, a high voltage on the second anode produces what is often called a "stiff" beam which deflects less than a "soft" beam for a given deflecting field.

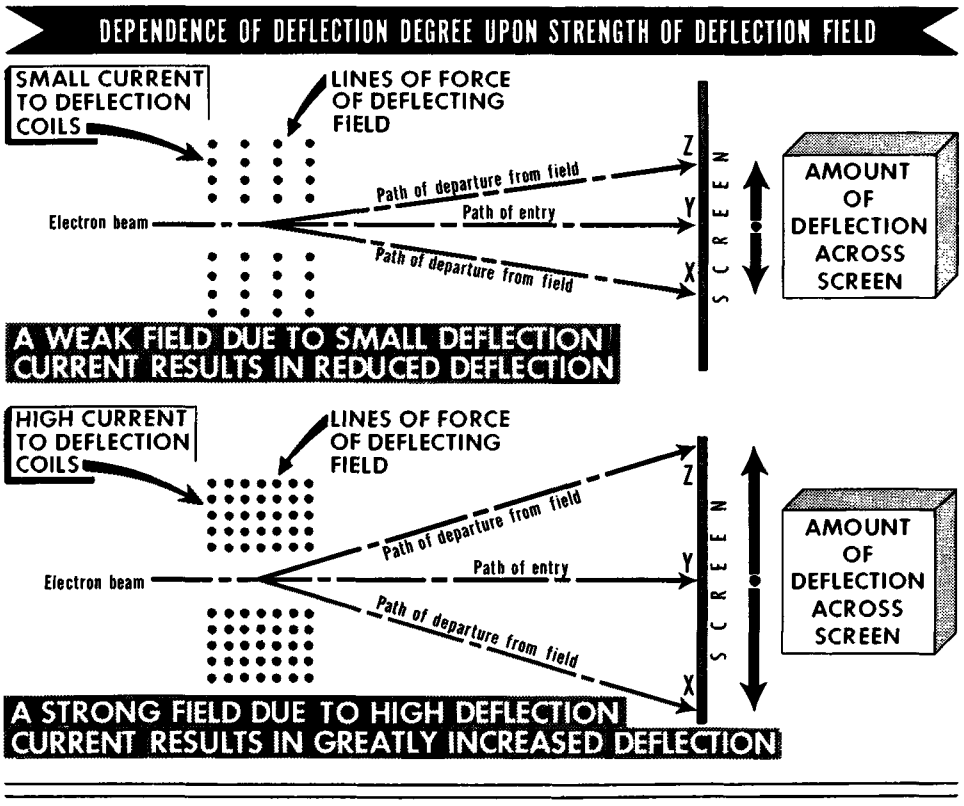

DEFLECTION

Electromagnetic Deflection (contd.)

To simplify our analysis of the deflection process, we can ignore the field due to the motion of the electrons in the beam and concentrate our attention on the deflecting fields. When both the vertical and horizontal fields act on the beam, the direction and degree of deflection is a function of the relative intensities and directions of these fields.

Scanning or deflection may also be accomplished by electrostatic means, but by and large, the television industry has found electromagnetic deflection to be most satisfactory. You will recall frequent references made to the *yoke* in a previous volume; it is the yoke which carries the horizontal and vertical deflection coils.

EFFECT OF DEFLECTING FIELDS on High and Low Velocity Electron Beams

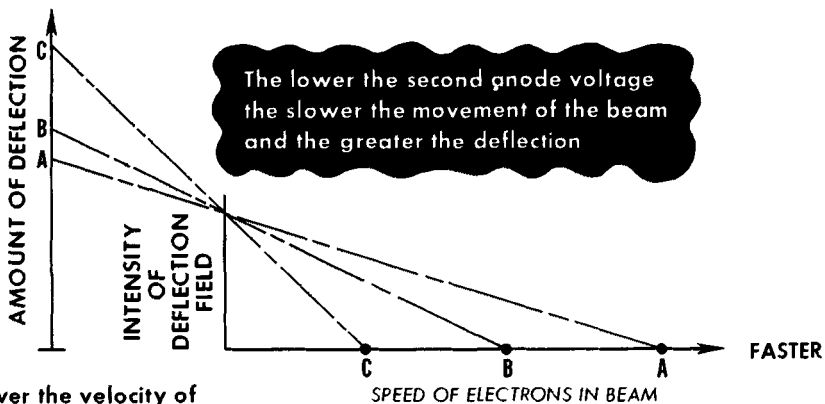

The lower the velocity of an object (electron)

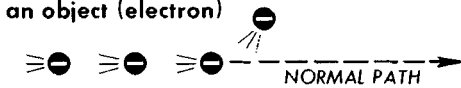

the more easily it is deflected from its path
(**GREATER DEFLECTION**)

THE SLOWER MOVING ELECTRON SPENDS MORE TIME IN THE DEFLECTING FIELD

The higher the velocity of an object (electron)

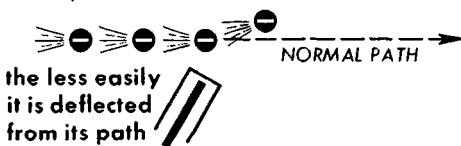

the less easily it is deflected from its path

THE FASTER MOVING ELECTRON SPENDS LESS TIME IN THE DEFLECTING FIELD

DEFLECTION

Vertical Deflection Action

POSITION OF THE BEAM with zero vertical and horizontal deflection currents

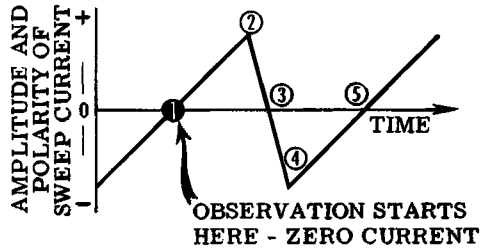
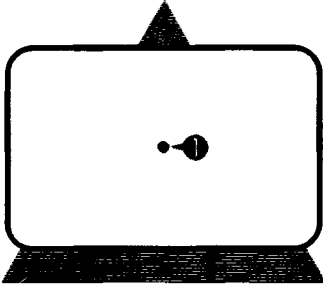

When several actions occur simultaneously, it is helpful to isolate each one and study them individually. To examine the action of the vertical deflection system alone we shall assume that sawtooth sweep currents exist *only* in the vertical deflection coils and that no horizontal sweep currents are present in the horizontal deflection coils.

Let us assume further that the vertical deflecting current is at its instantaneous zero value at the moment we start our observations. At this time therefore, there are neither vertical nor horizontal deflection fields in existence, hence the electron beam strikes the geometric center of the screen.

Movement of the Beam TOWARD THE BOTTOM OF THE SCREEN

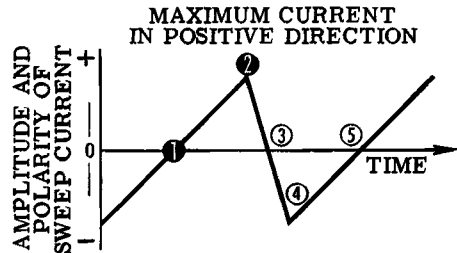
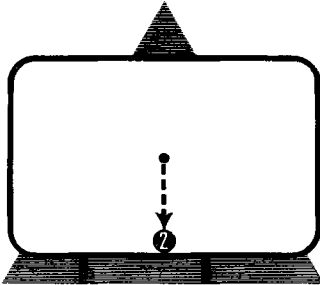

Having passed through its instantaneous zero value, the current in the vertical deflection coil starts increasing in a linear fashion. This means that the current grows equal amounts in equal times in the positive direction. This results in a steady, even motion of the beam toward the bottom of the screen. At the moment that the vertical sweep current reaches its maximum positive value, the beam reaches the bottom of the screen (point 2 on the sawtooth curve and the screen in the illustration). Immediately after maximum is reached, the vertical sweep current drops very rapidly. The fall to point 3 takes a fraction of a second; then direction of the sawtooth current reverses and it rapidly rises to a negative maximum (point 4).

DEFLECTION

Vertical Deflection Action (contd.)

THE BEAM RETRACE OCCURS VERY FAST

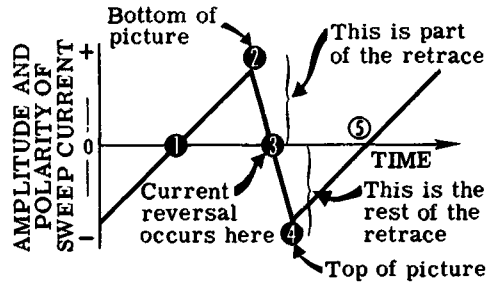
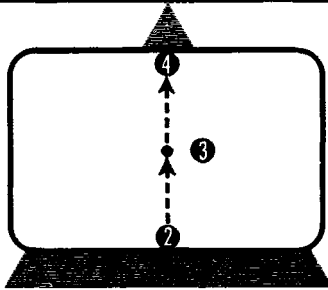

The portion of the sweep current cycle from point 2 to point 4 is called the *retrace*. It should be noted carefully that the beam is brought from the bottom of the screen all the way back to the top of the screen during the very short time required for the sweep current to go from point 2 to point 4. The return of the beam from point 2 to point 3 occurs when the sweep current drops from its positive maximum to zero; the movement to point 4 accompanies the rise in sweep current from zero to maximum negative.

RETURN OF THE BEAM to its starting point

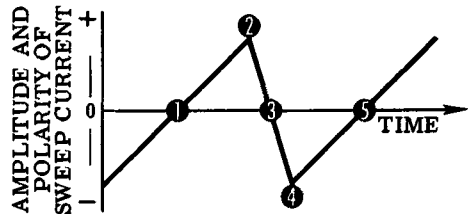
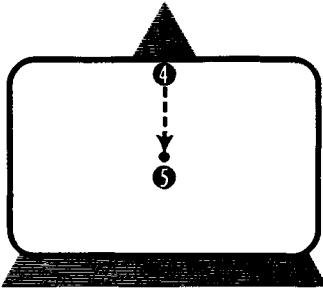

When the retrace is complete, the sweep current begins decreasing in value at a slower, constant rate from the maximum negative point. This causes the beam to progress at a uniform speed downward from the top edge of the screen to the center. It reaches center-screen (point 5) at the instant that the vertical sweep voltage passes through zero on its way up.

Thus, in the absence of horizontal deflection currents, the beam sweeps downward and retraces upward on the screen as long as vertical sweep current flows in the vertical deflection coils. One cycle of the vertical sweep current in a television receiver requires $1/60$ second (16,667 microseconds) for completion. The actual "picture-producing" sweep downward from the top to the bottom edge of the tube screen occupies 15,500 microseconds while the retrace takes 1167 microseconds.

DEFLECTION

Horizontal Sweep Action

To isolate the horizontal sweep action we shall again make a simplifying assumption: there is no vertical deflection current flowing in the vertical coils and the electron beam in the picture tube is influenced only by the varying magnetic field produced by the horizontal deflection current. Since linear motion of the beam across the screen is required—this time in a horizontal path—the horizontal sweep current in the deflection coils of the yoke must again be a sawtooth.

The horizontal sweep current, like its vertical counterpart, varies between a maximum negative value, changing from one to the other at a relatively slow rate. At about the center of its variation it must pass through zero. Once during each cycle the sawtooth current changes very rapidly from the maximum positive to the maximum negative value. The time over which the fast change occurs is the *retrace* portion of the sweep cycle (7 microseconds). The part of the cycle in which the change from maximum negative to maximum positive occurs at a slower rate is the *sweep* time (56 microseconds). Thus, the total horizontal sweep current cycle requires 63 microseconds.

We again assume that our examination of the action begins at the instant when the horizontal sweep current is at its instantaneous zero value (point 1) during the sweep portion of the cycle. With

POSITION OF HORIZONTALLY SWEEPED BEAM IN THE ABSENCE OF VERTICAL DEFLECTION

DIRECTION OF MOTION FOR HORIZONTAL DEFLECTION

In the absence of vertical deflection horizontal sweep results in a single line across the screen. The beam traces the same path all the time.

Electron Spot with no Deflection

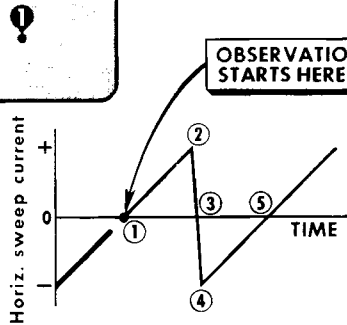

Beam Reaches the Right Edge

of the picture tube screen

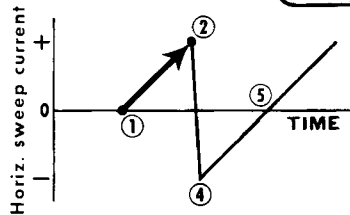

DEFLECTION

Horizontal Sweep Action (contd.)

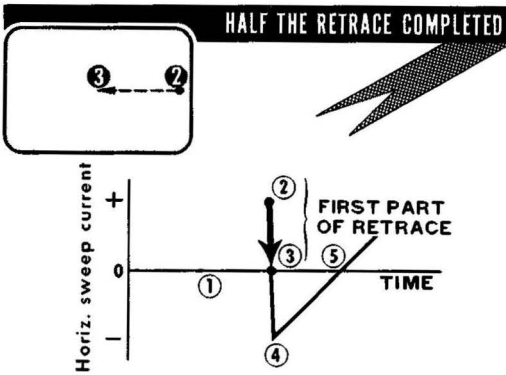

neither vertical nor horizontal deflection currents in the yoke windings, the beam is at the geometric center of the screen. The sweep current starts rising toward its positive maximum (point 2); this causes the beam to be deflected progressively toward the right edge of the screen. It reaches the edge coincidentally with the positive peak value of the sweep current.

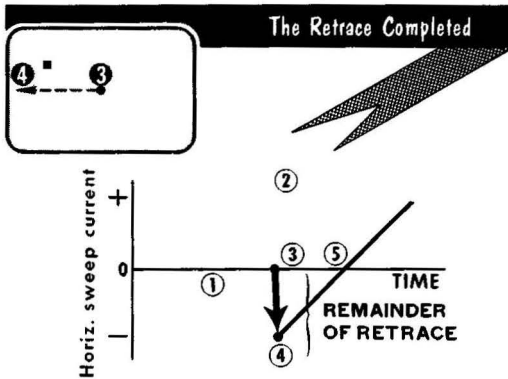

At the instant the retrace part of the horizontal sweep cycle begins the beam is returned very quickly to the center of the screen.

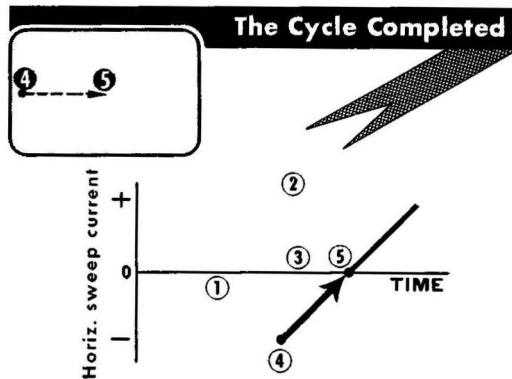

This position coincides with the zero value of the horizontal sweep current (point 3). Here the current reverses and very rapidly increases to maximum negative, thus forcing the beam to the left edge of the screen. This completes the retrace (point 4). As the sweep current starts to fall from the negative maximum toward zero, the beam begins its return to the center of the screen. The beam motion from the left edge of the screen toward the center corresponds to progressively diminishing negative deflection with zero horizontal deflection being reached at the moment (point 5) when the horizontal sweep current falls to its zero value. Thus, the deflection produced by the horizontal sweep current in the yoke moves the beam laterally across the face of the screen. In the absence of vertical deflection currents, the horizontal path is always the same; result: a single horizontal line across the screen center.

DEFLECTION

Simultaneous Horizontal and Vertical Deflection

During normal operation of a television receiver, sweep currents are present in both deflection coils of the yoke. They produce magnetic fields that act simultaneously on the beam. For a fundamental understanding of the action it is necessary to deal with the actual sweep currents since our interest lies in the *deflecting forces*. Any force, in fact any quantity having size and direction, may be represented by an arrow which we call a *vector*.

A VECTOR IS AN ARROW used to describe the magnitude and direction of a physical quantity

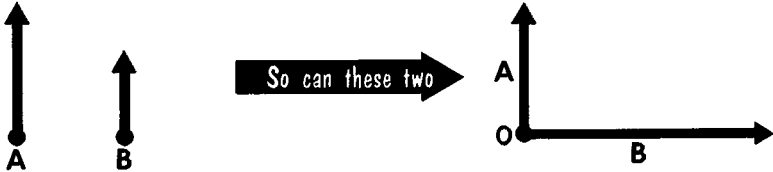

These two arrows can indicate two quantities of different amounts and like polarity, direction of action, or phase.

Direction of action of B is shown to be at right angles to A. They are related by originating from the same reference point O.

We learned in basic electricity that magnetic lines of force never cross each other; that while two sources may generate two sets of magnetic lines of force (or two magnetic fields) these fields do not act independently of each other. When two fields act simultaneously on a given point, they combine to produce a *resultant field*. But when the combined action is studied, we must still recognize the identity of each of the component fields. To put this into practice, let us assume the existence of a vertical and horizontal deflection field each having some arbitrary but known value. Assign the letter V to the vectors which represent the vertical deflection force and the letter H to the horizontal vectors.

The vectors indicate that the two fields and their forces act at right angles to each other; this relationship stems from the definition of “vertical” and “horizontal”. Furthermore, since the zero-deflection point is at the center of the screen, the vectors originate from a common point. This point corresponds to zero of whatever quantity—forces, fields, currents, etc.—is being shown by the vectors.

Vertical and Horizontal Deflecting Forces

represented by vectors

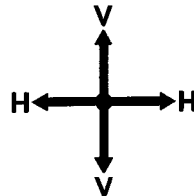

DEFLECTION

Simultaneous Horizontal and Vertical Deflection (contd.)

RELATIONSHIP OF SWEEP CURRENTS TO VECTORS OF DEFLECTING FORCES

NOTE: Arrows represent intensities

Maximum intensity of HORIZONTAL sweep field in NEGATIVE direction

Maximum intensity of VERTICAL sweep field in NEGATIVE direction

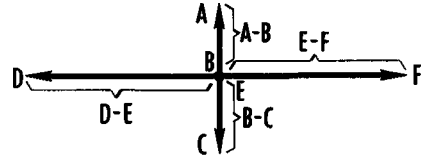

Maximum intensity of HORIZONTAL sweep field in POSITIVE direction

Maximum intensity of VERTICAL sweep field in POSITIVE direction

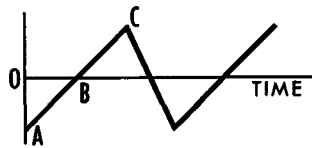

VERTICAL SWEEP CURRENT

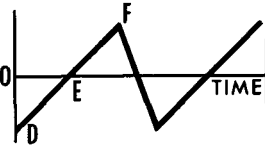

HORIZONTAL SWEEP CURRENT

We must now correlate the two sweep current representations with the vectors corresponding to the two deflection forces. (The retrace portions of the sweep current cycles are not significant at the moment.) The extreme left end of the horizontal vector corresponds to the maximum negative voltage attained by the horizontal sweep current, while the right end represents the maximum positive voltage of the same current.

When two forces act simultaneously on a single point of a movable object, the *resultant* action is a function of the size and direction of the *component* (or original) forces. For instance, let us visualize two people pulling at right angles on a heavy block.

At first glance it may appear as though the forces are working against each other. Actually they will move the block in a direction that is a compromise between the two—a compromise determined by the direction and pull of each of the original forces. Assuming that each man exerts an equal pull, as indicated by the equal lengths of vectors F_a and F_b , the block will move in the direction illustrated.

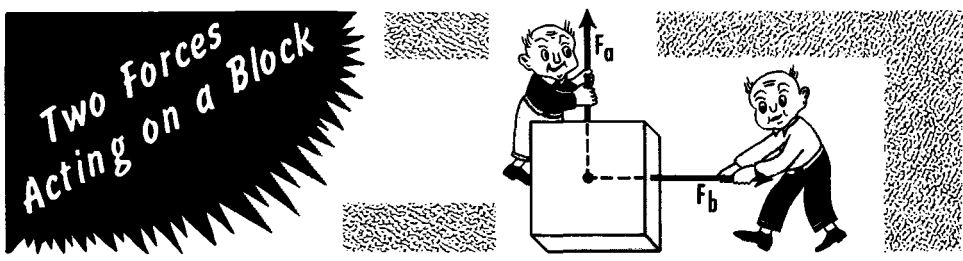

DEFLECTION

Simultaneous Horizontal and Vertical Deflection (contd.)

The direction of the resultant of two forces F_y and F_x acting at right angles to each other may be determined by simply drawing a *force parallelogram*, using the two known sides ab and ad as the reference sides. Side bc is parallel to ad and of like length; side cd is parallel and equal to side ba . The diagonal of the parallelogram, which originates at the point of application of the two forces (point a), represents the resultant force. This diagonal is labeled F_z in the drawing. Its length shows the size of the force and its direction illustrates the direction of action of the resultant force.

If force F_y is twice as great as force F_x , the magnitude and direction of the resultant force is altered as shown.



Thus, by changing the direction and magnitude of the component forces, the resultant force can be changed at will as illustrated in these drawings. The behavior of the deflection fields on the electron beam in the picture tube may be likened to the results observed in the example of the two men exerting pull on the heavy block. The simultaneous action of the two deflection fields makes the instantaneous position of the beam a function of the individual deflection force magnitudes.

IF TWO FORCES ARE EQUAL

the resultant force takes a direction midway between the components

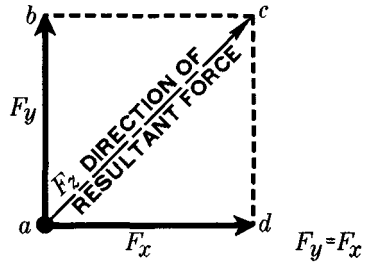

WITH FORCES OF UNEQUAL

size, the resultant direction is different but is again determinable as the resultant of the force parallelogram

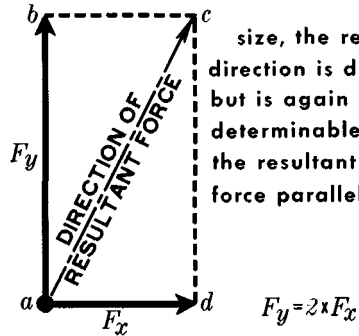

EXAMPLES OF VARIOUS COMPONENTS AND THEIR CORRESPONDING RESULTANTS

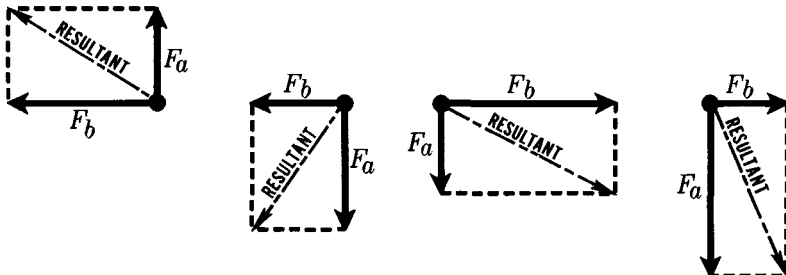

The effect of simultaneously applied Vertical and Horizontal Deflection Forces on the position of the Electron Spot.

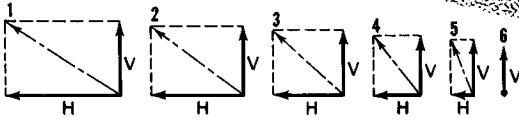

Decreasing horizontal deflection from maximum negative to zero, while vertical deflection decreases (at a much slower rate) from maximum negative to zero describes half of first line.

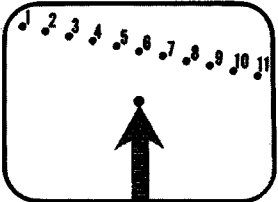

CENTER OF SCREEN

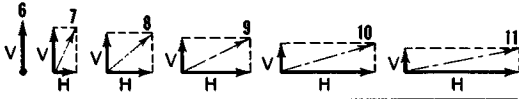
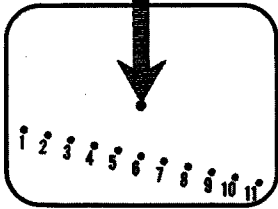

Increasing horizontal deflection from zero to maximum positive while vertical deflection continues decreasing from maximum negative to zero, completes first line.

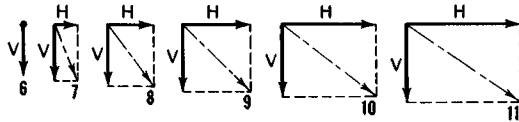
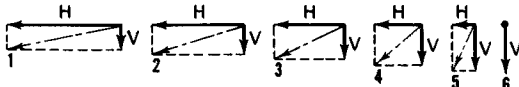

FORCE DIAGRAM FOR THE LOWER HALF OF THE SCREEN

DEFLECTION

Simultaneous Horizontal and Vertical Deflection (contd.)

These drawings show, in somewhat exaggerated form, how the vertical and horizontal deflection fields acting at right angles to each other shift the position of the beam to trace one line on the upper portion of the screen. Each instantaneous position is the resultant of two forces acting at a given time. The length of the V line in each force diagram indicates the instantaneous intensity of that deflection field; the same is true of the H line relative to that field. The amount of change in the lengths of each of the lines is purely arbitrary. Six different values of vertical and horizontal deflection are shown depressing the beam and moving it from the extreme left to the center of the screen while tracing the left half of the line. Five values are illustrated moving the beam from the center to the right end. It should be remembered that the progress of the line from left to right is a *smooth continuous process* rather than one which occurs in leaps and bounds as the explanatory diagram seems to imply, and that the complete line—including retrace—requires about 57 microseconds to complete.

The change in amplitude of the vertical deflection field takes place much more slowly than illustrated. The complete downward swing of the beam occupies 262.5×63.5 microseconds since there are 262.5 horizontal lines in each field. An illustration scaled to the true time dimensions, however, would not demonstrate the process clearly.

A similar set of force diagrams with the vertical deflection field intensity line pointing downward, rather than upward, explains the action over the lower half of the screen.



Nonlinear Deflection. Horizontal and vertical deflection for a particular channel is controlled at the station, and information for receiver synchronization is transmitted with the television signal in the form of sync pulses. It should be remembered that these synchronizing pulses merely *trigger* the horizontal and vertical oscillator circuits, but have no control over them once the television receiver sweep action has started. The rate or linearity of the retrace and trace portions of the sweep is determined wholly by the receiver sweep circuits themselves, and not by the television studio.

On the past few pages we have discussed how the movement of the electron beam is the resultant of vertical and horizontal forces acting on it. In many instances, unfortunately, the waveforms of the horizontal and vertical deflecting currents in the yoke are of such shape that the resultant force on the electron beam makes it move horizontally or vertically in a nonlinear fashion. When this occurs one portion of the picture appears stretched and another portion compressed. To correct this trouble, where there are no serious circuit defects, there are linearity controls. In the horizontal sweep circuit the linearity control must be adjusted in conjunction with the drive control and sometimes the width control.

DEFLECTION

Deflection in the TV Picture Tube

To help us visualize the action of the deflection fields, let us imagine that we are standing directly in front of the picture tube screen looking *through* the screen material toward the electron gun. The beam, formed in the gun, therefore travels toward us in a straight line if it is not being deflected. Since we have seen that deflection is accomplished by means of coils, we might ask how the magnetic fields of these coils are oriented to cause vertical and horizontal deflection.

This illustration shows the position of the *vertical* deflection field. If the approach of the beam is at right angles to the plane of the paper—that is, out of the paper towards the reader, and if the beam is to be moved vertically the *magnetic field* must be so directed that its lines of force are *horizontal*. Since the electron beam is deflected at right angles to *both* the direction of its motion and the line of the magnetic field, the only motion that satisfies this condition is a *vertical* one.

MAGNETIC CIRCUIT OF VERTICAL DEFLECTION COIL

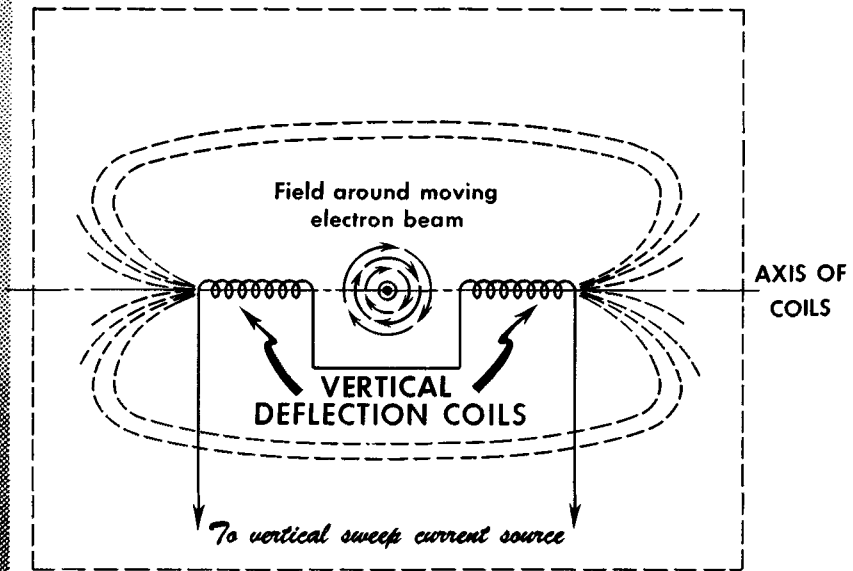

DEFLECTION

Deflection in the TV Picture Tube (contd.)

How must the vertical deflection coils be placed to produce a horizontal field? We have found that the magnetic field due to a coil is always directed along the axes of the core. Thus, to realize a horizontal magnetic field, the core axis of the deflection coils must be positioned horizontally as shown in the illustration. The normal vertical deflection coil contains two windings connected in series so that their magnetic fields collaborate in producing the beam motion. Since glass has no effect on magnetic lines of force, these coils are located outside the envelope of the neck of the tube and make their effect felt through the glass.

In view of the foregoing explanation, it is reasonable to assume that the *horizontal* deflection coils are oriented with their core axes *vertical*. In this way, the magnetic flux lines from these coils are vertical relative to the horizontal center line of the tube screen. Similarly, they are placed at right angles to the axis of the beam as the diagram shows.

MAGNETIC CIRCUIT OF HORIZONTAL DEFLECTION COIL

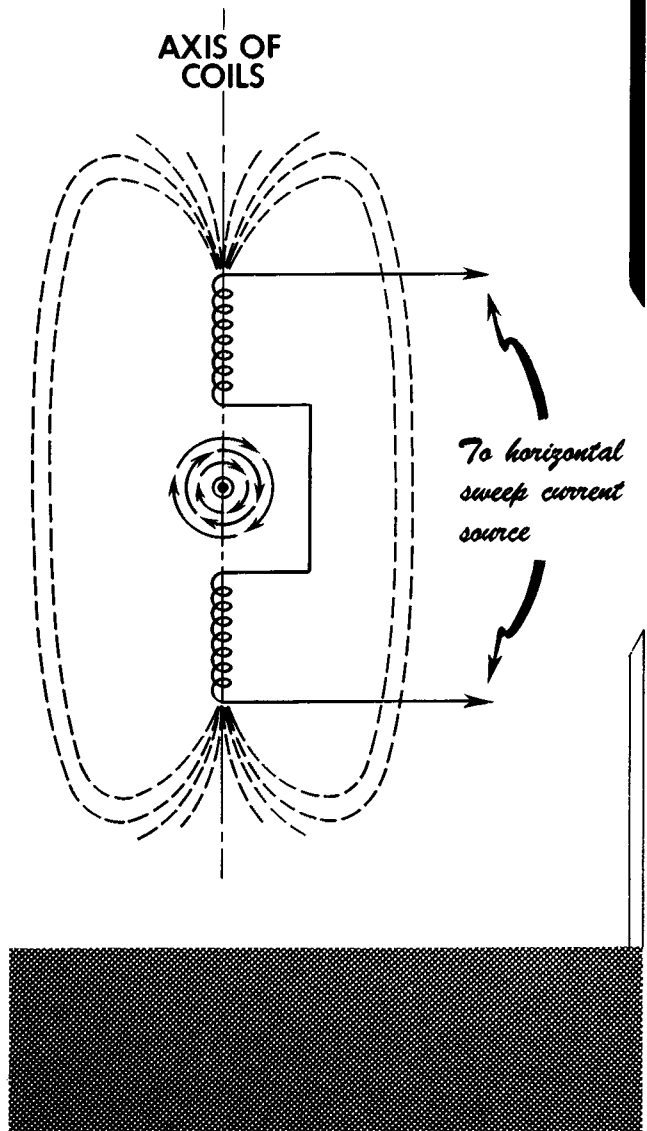

DEFLECTION

Deflection Sensitivity

Deflection sensitivity is defined as the amount of linear screen deflection, measured in inches or centimeters, obtained when one unit of field strength is applied to the electron beam. For our purposes we may consider that the number of ampere-turns in a given deflection coil is a measure of field strength. For example, a deflection sensitivity of 0.1 inch per ampere-turn means that the beam will be swept linearly over the screen a distance of 1 inch for every 10 ampere-turns in the deflection coil. Aside from the deflection field, second-anode voltage independently contributes to the deflection sensitivity of any picture tube. When the second-anode voltage is high, the beam is said to be "stiff" because the electrons move toward the screen at a very high velocity. High-speed electrons are more difficult to deflect from a straight path than slow-speed electrons. Thus, if a given field strength will produce a certain deflection angle when the second-anode voltage is 16 kv, then the same field strength will deflect the beam over a *wider* angle if the second-anode voltage drops to 12 kv.

IMPROVED DEFLECTION SENSITIVITY in the *110° Picture Tube*

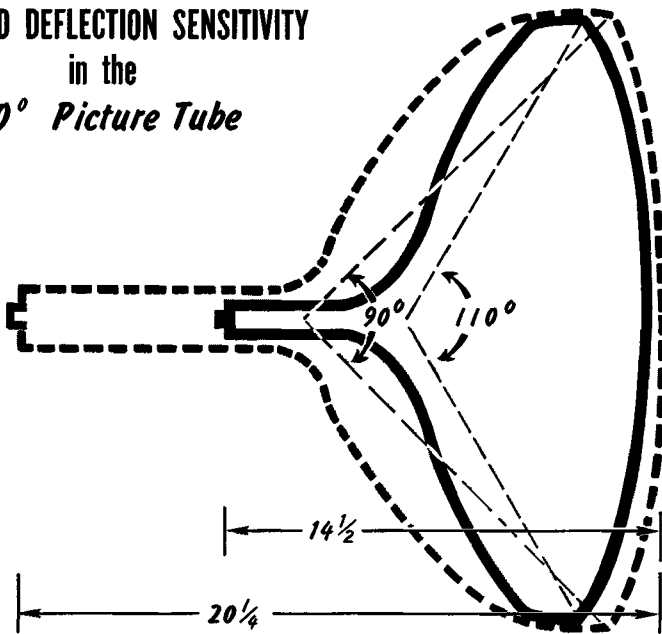

Deflection sensitivity is also a function of tube length: the longer the tube, the greater the linear deflection for a given deflection angle as we have previously explained. The diameter of the neck also enters the problem; in the new 110° deflection angle tubes mentioned before, the neck is manufactured with a smaller diameter than heretofore. This permits the magnetic deflection field from the yoke to approach the axis of the tube more closely, which, in turn, improves the deflection sensitivity.

THE DEFLECTION YOKE

The Deflection Yoke

Deflection Yoke Dismounted

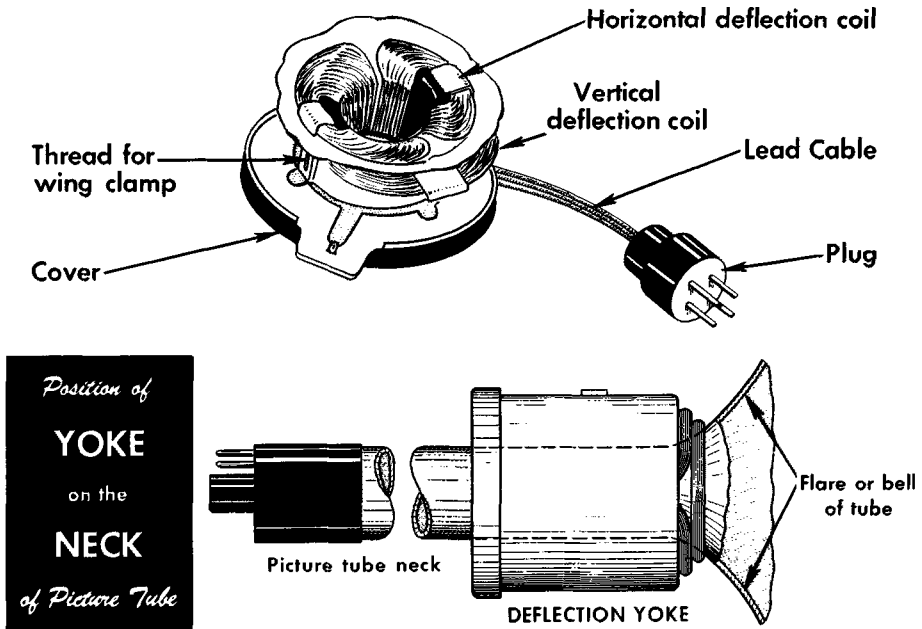

In practice, the two pairs of deflection coils shown schematically in the preceding figures are combined in a single unit known as the *deflection yoke*. When the yoke is in its normal position around the tube neck, its coils cannot be seen because the windings are inside an insulating cover.

Although the yoke coils are wound around a core whose axis is at right angles to the neck of the picture tube, they are not wound in the fashion suggested in the schematic drawings. The coil configuration is more like that of a pancake which is warped to fit closely the curvature of the cylindrical neck of the picture tube.

The yoke slides over the neck of the picture tube and is fixed in position by a wing nut or screw that fastens to a mounting plate. Loosening the holding hardware permits a limited backward and forward motion. Provision is also made to allow some rotation of the yoke around an axis which coincides with the beam axis. As a rule, the yoke is slid as far forward as possible so that its front edge is up against the flare or bell of the picture tube envelope.

Four wire leads come from the yoke: two of these are the terminals of the vertical coils and the other two feed the horizontal coils.

THE DEFLECTION YOKE

Neck Shadow

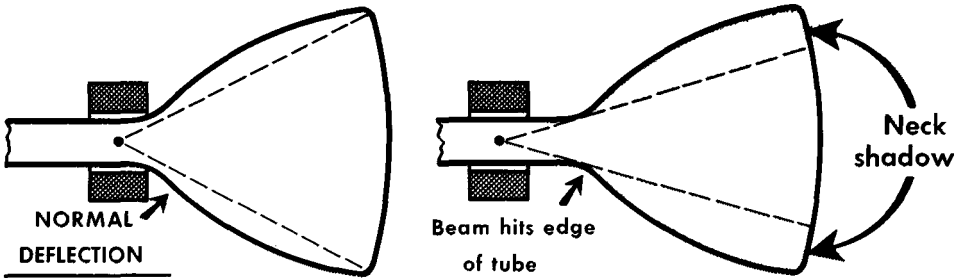
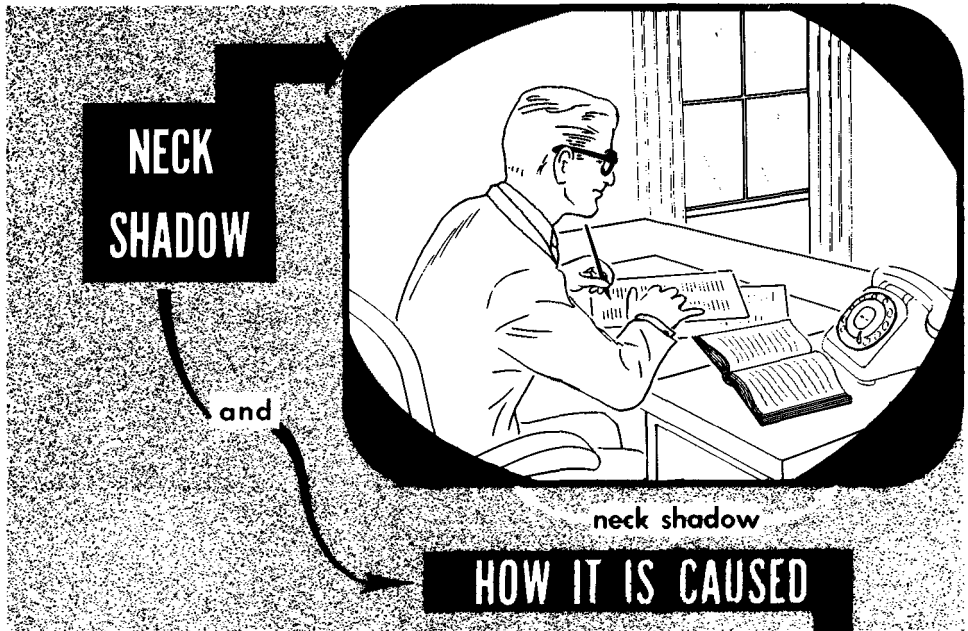

A movement of the yoke along the neck of the tube causes the size of the picture to change. Moving the yoke back from its correct position may "enlarge" the picture. Actually, although it may enlarge the elements in the viewed scene, it cannot make the overall picture dimensions any larger than the limits of the tube face. Pulling the yoke back from its normal setting on the neck of the tube, however, can cause an annoying black circular area known as *neck shadow* around the picture.

When the yoke is properly placed just back of the flare of the tube, the limits of the electron beam sweep over the tube face as well within the curve of the tube's "bell". As the yoke is displaced further toward the picture tube socket, away from the flare, the deflection starts sooner than it does normally. The neck of the tube gets in the way of the beam.

THE DEFLECTION YOKE

Grounding Strips on the Yoke

In the discussion of the Aquadag coating on the picture tube, mention was made of metal grounding strips that are fastened to the deflection yoke. These press against the outer coating, forming a solid spring contact. Since the case of the yoke is grounded to the chassis of the television receiver, this contact grounds the outer Aquadag coating which, with the inner coating, forms a capacitor which aids the high-voltage filtering action.

Filtering action of the

DOUBLE AQUADAG COATING

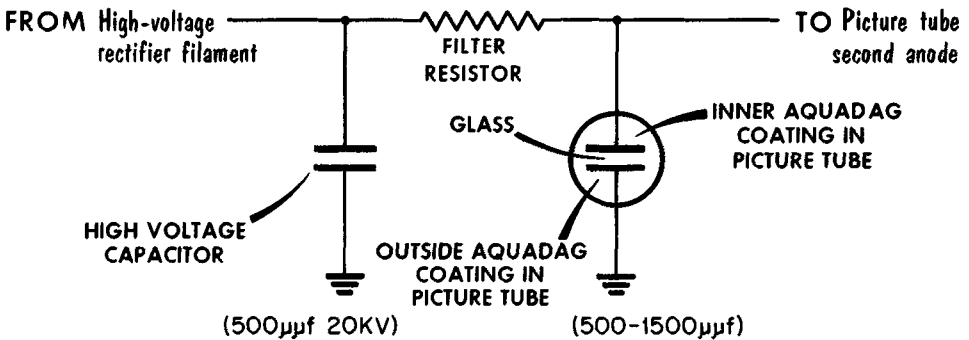
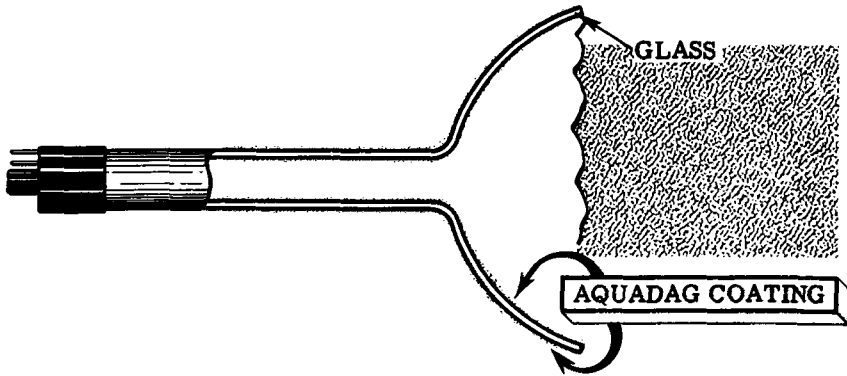

THE DEFLECTION YOKE

Rotating the Yoke

Consider the orientation of the *horizontal* deflecting coils: with the magnetic field of these coils in a vertical line, the beam in the picture tube is deflected horizontally causing a horizontal line to appear on the screen. Now suppose that the yoke is rotated around the tube neck over a small angle. Since the path of the scanning beam must always adopt a position at right angles to the direction of the magnetic field, the traced line will be rotated relative to the horizontal by the same angle.

THE EFFECT OF YOKE ROTATION on a HORIZONTAL TRACE

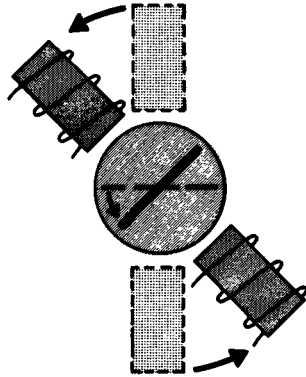

Remembering that both horizontal and vertical deflection coils are fixed in their relative positions inside the yoke case, it can be seen that rotating the yoke from its correct position will tilt the entire picture like this:

THE EFFECT OF YOKE ROTATION on the WHOLE PICTURE

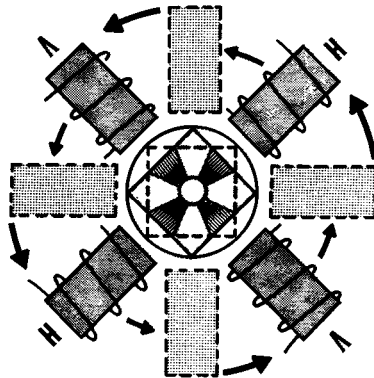

THE DEFLECTION YOKE

Cosine Deflection Yokes

The advent of wide-deflection-angle tubes and electrostatic focusing introduced accessories not normally encountered in older receivers. Among them are the cosine deflection yoke, anti-pincushioning magnets, and centering magnets, all of which we shall look at now.

As the deflection angle of a picture tube is increased, it becomes more difficult to keep the picture in perfect focus all over the screen, particularly at the edges. A conventional deflection yoke having windings of uniform thickness unfortunately produces a nonuniform magnetic field. The effect of this is to defocus an otherwise perfect picture at the edges of the screen. This defect is almost entirely overcome by winding the deflection coils so that the turns near the inside of the winding—that is, those closest to the window or axis of the coil—form a thin layer. As the turns proceed outward the layer becomes thicker and thicker.

The drawings clearly indicate the winding thickness progression and the overlapping of the vertical and horizontal coils.

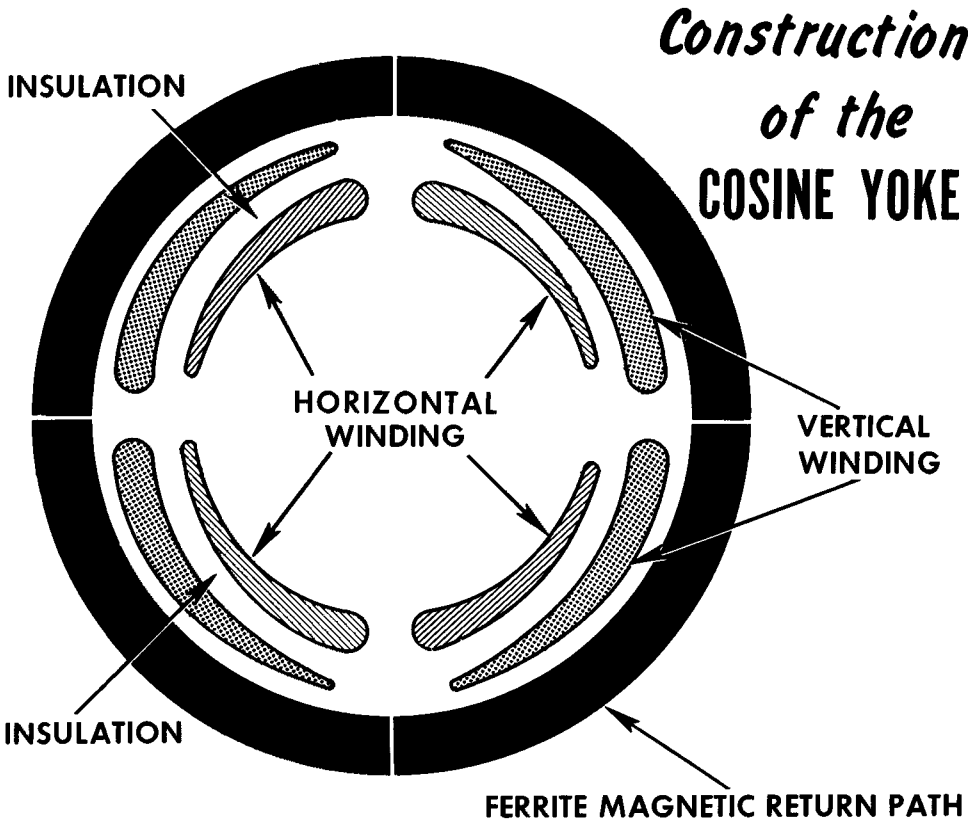

THE DEFLECTION YOKE

Anti-pincushioning Magnets

PINCUSHIONING AND KEYSTONING are commonly encountered in **LARGE PICTURE TUBES**

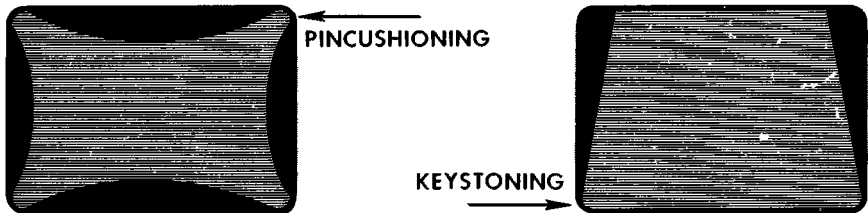

Pictures that suffer from *pincushioning* or *keystoning* are easily recognized. Although not particularly common in small-screen television receivers, these defects are often encountered when the screen size is large and where cosine yokes are used to avoid defocusing action. These forms of distortion may be caused by so many variable factors that it is impracticable to attempt to redesign the deflection yoke for each individual case. Rather than attempt yoke corrections, small permanent raster-correction magnets—in some cases two, in other cases four—are attached to a nonmagnetic frame near the flare of the picture tube. The position of these magnets is adjustable either by mounting them on flexible metal arms or by fastening them to wing-nut mounts which permit side-to-side and rotary motion.

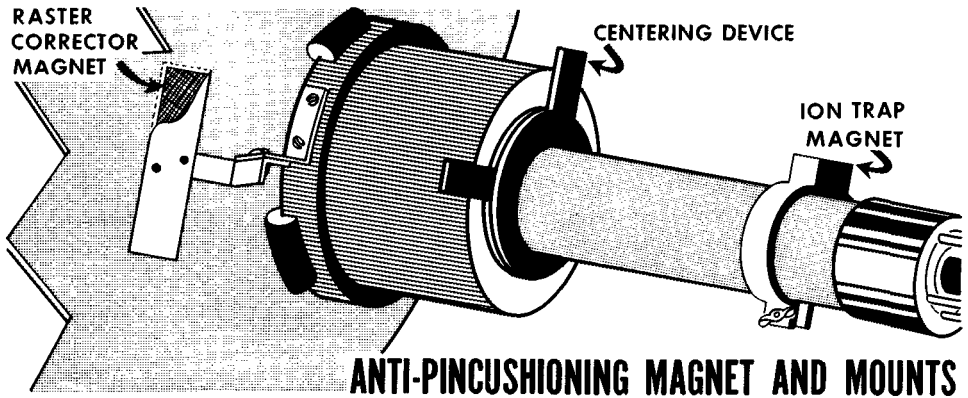

When these magnets are adjusted and positioned correctly, they pull and stretch the raster in the right places to compensate for the original distortion. In some receivers, anti-pincushioning magnets are also recommended as linearity adjusting devices. Normally these magnets are adjusted and oriented at the factory and need not be touched thereafter unless they are jarred out of place or the picture tube is replaced.

THE DEFLECTION YOKE

Centering Magnets

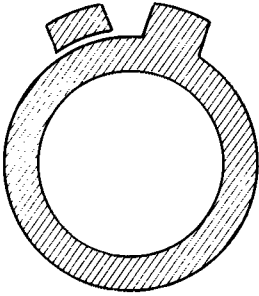

Various methods have been used to center the raster on the television screen. In many early sets centering was done by varying potentiometers marked horizontal and vertical centering, to produce changes in the amount of dc that flowed through the vertical and horizontal winding, thus affecting vertical and horizontal positioning.

Centering Magnets

fit over the neck of the *picture tube*

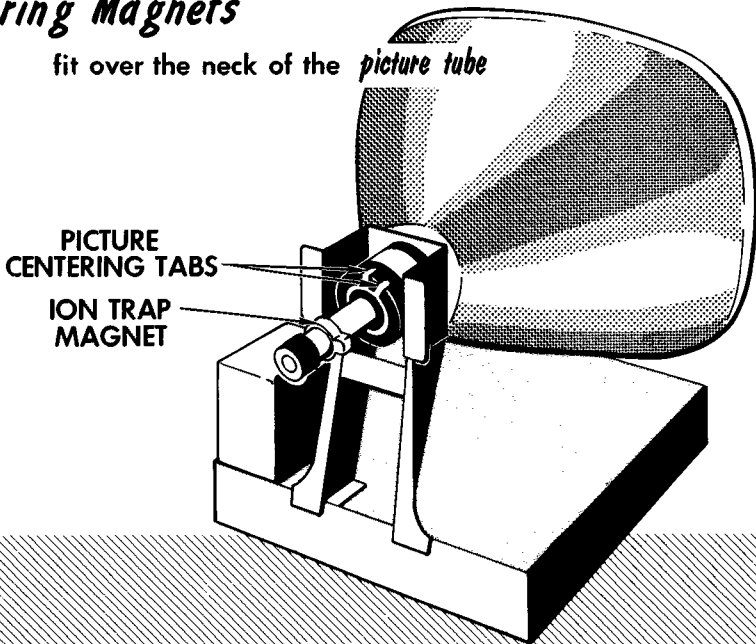

Another system widely used involved moving the focus coil or focus magnet on the neck of the picture tube. Tilting the focus device around a horizontal axis moves the picture up and down, while horizontal motion is obtained by twisting it around a vertical axis.

With the trend toward the use of electrostatic focus tubes, centering had to be done by means other than the focus coil or magnet. The device used consists of two centering magnets. These units are thin, flat, circular rings that fit over the neck of the picture tube and are placed close to the deflection yoke. The centering magnets have tabs, and in making the picture centering adjustment the tabs are rotated around the neck of the tube.

THE ION TRAP

The Function of the Ion Trap

To understand the construction and functioning of the ion trap we must return briefly to atomic theory.

In the light of recent advances in this field, the atom can no longer be pictured as a miniature solar system with a central sun and orbiting planets. For explanatory purposes, however, it is still permissible to simplify the concept of an atom by considering that it contains a positively charged nucleus and revolving electrons bearing negative charges. In the normal atom, the total number of negative charges (electrons) is equal to the total number of positive charges (the protons in the nucleus). Such an atom is electrically neutral because it has no *net* positive or negative charge. Suppose, however, that an electrically neutral atom should in some way lose or capture an electron. Since an electron carries a negative charge, an atom with an excess electron will have more negative charges than positive charges, or a *net negative charge*. This is a *negative ion*. On the other hand, an atom that is short of one or more electrons bears a *net positive charge* and is called a *positive ion*.

— ATOMS AND IONS —

A normal helium atom contains two nuclear protons and two neutrons. The neutrons do not carry a charge, thus do not affect the electrical balance. Two orbital electrons cancel the proton charges.

If a helium atom loses one or more electrons, it becomes a *positive ion* of helium like this, bearing a net + charge.

If the atom gains an electron by capture, it forms a *negative ion* like this.

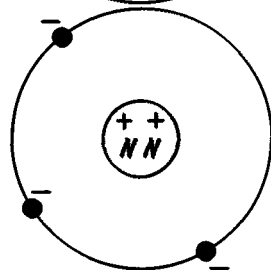
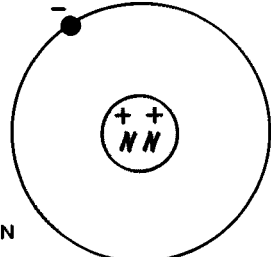
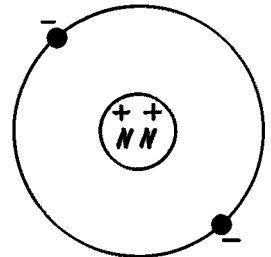

THE ION TRAP

The Function of the Ion Trap (contd.)

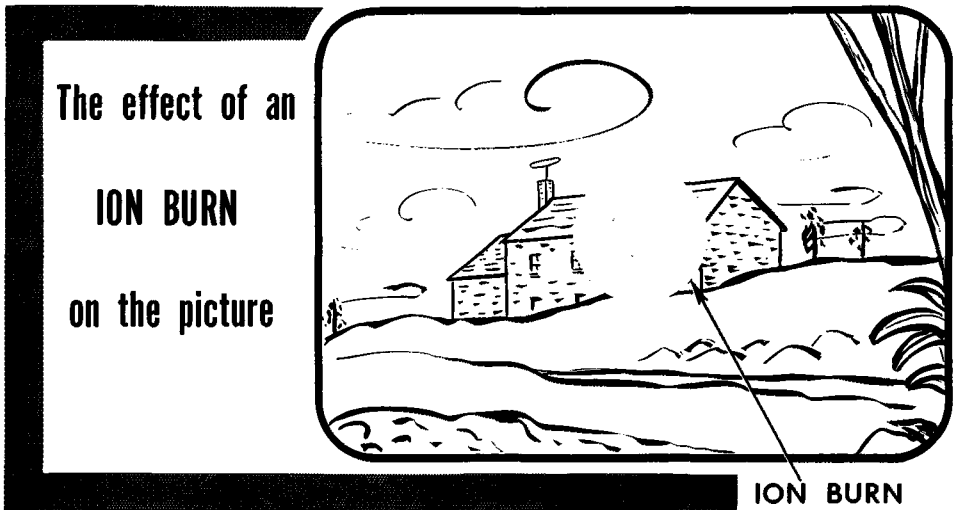

The cathode of the picture tube is predominantly an electron emitter, but some ions are torn off its surface at the same time. In addition to this source of ions, there is another reservoir present in the form of residual gases in the tube envelope. These gases remain in the tube even after exacting evacuation and their atoms are subject to high-speed collision with the advancing electron beam.

In many cases, gas atoms suffer the loss of one or more orbital electrons as a result of these collisions, thus forming free positive ions. These cause no harm because they are immediately attracted to the cathode. But many negative ions are formed as well—some right at the cathode and others in the space near it. These join the electron stream and would strike the picture tube screen if nothing were done to prevent it.

This is a very undesirable condition. A glance at the sketches of atoms and ions shows that whereas an electron has very little mass, an ion is much, much heavier since it contains the nucleus with its massive protons and neutrons. While the deflection yoke is capable of sweeping the electrons in the picture tube beam easily over the whole surface of the tube face, its field is much too weak to affect the extremely heavy ions.

Thus, while the electrons in the beam are continually on the move over the screen, never lingering for any length of time at any point, the massive ions are able to bombard one spot on the screen for prolonged periods. After a time, this spot becomes brown and "burned." An *ion burn* on a tube forms part of every scene and is very annoying. To prevent these negative ions from reaching the screen and causing an ion burn, tube and set manufacturers have come up with several methods of side-tracking them.

THE ION TRAP

Details of a Typical Electron Gun and Ion Trap

As most of the damaging negative ions originate in and around the electron gun, this is the best place to stop them. One method is to alter the construction of the electron gun like this:

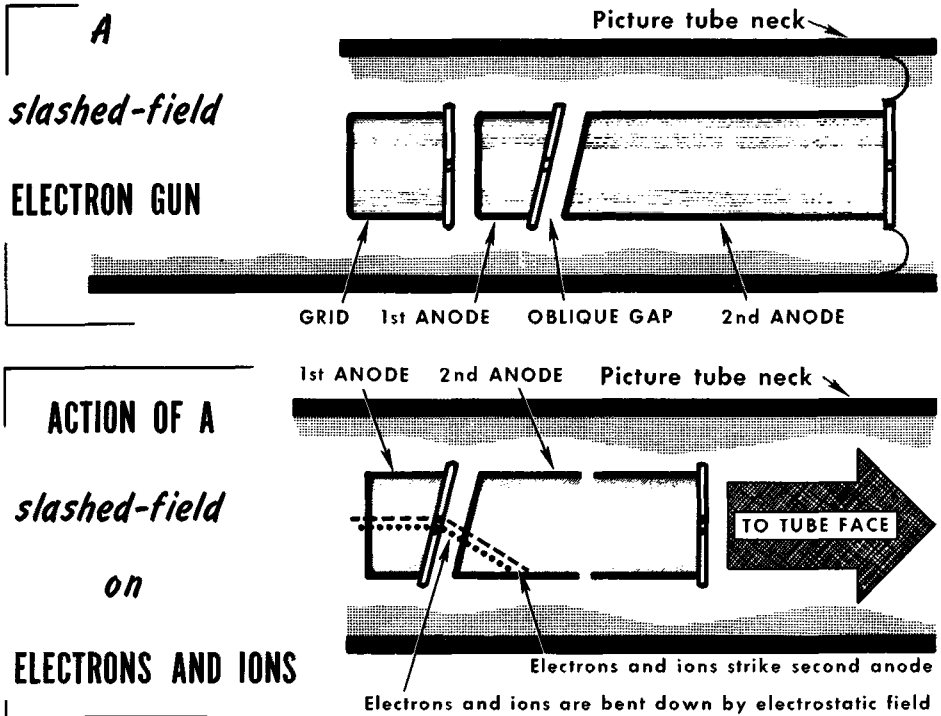

In this particular construction there are two anodes, each of which is cut at an angle to their axes so that the gap between them is oblique with respect to the tube axis. In passing from the first to the second anode, both electrons and ions are acted upon by a strong, slanted electrostatic field and are deflected downward toward the neck of the picture tube.

The second anode is highly positive. Its normal voltage is far higher than that of the first anode, and consequently attracts negative charges. Thus, both electrons and negative ions are drawn toward the second anode following a path which would carry both types of particles into the neck of the picture tube if the second anode were not there.

The next step is to bend the electron path back into the tube axis again without effecting the ions. If the latter are permitted to continue on their way they will strike the second anode and become neutralized, thus being rendered harmless.

THE ION TRAP

The Ion Trap Magnet Beam Bender

A magnetic field is capable of changing the flow-path of a stream of electrons easily but has little effect on the direction of heavy ions. Such a field may be produced by a permanent magnet which forms a part of a device called the ion-trap magnet or *beam bender*.

For the type of electron gun just discussed, the beam bender consists of two permanent magnets one of which is stronger than the other.

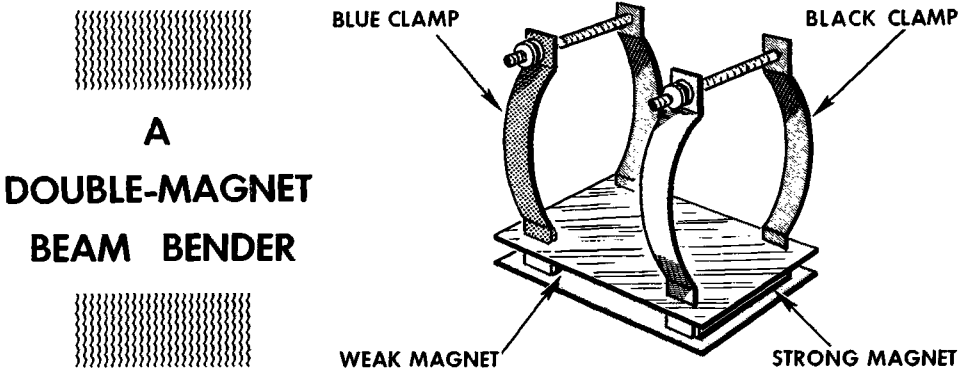

This type of beam bender is designed to fit over the neck of the picture tube near its base. The stronger magnet is always located closer to the picture tube socket than the weaker one. When the beam bender is adjusted correctly, the electrons in the swept beam are first bent *upward* by the stronger magnet and then bent *downward* by the weaker magnet. This double bending levels off the electron beam so that it travels along the axis of the tube once it gets past the beam bender's field. The ions in the beam are unaffected by the weak magnetic field and are thus trapped in the second anode structure of the electron gun.

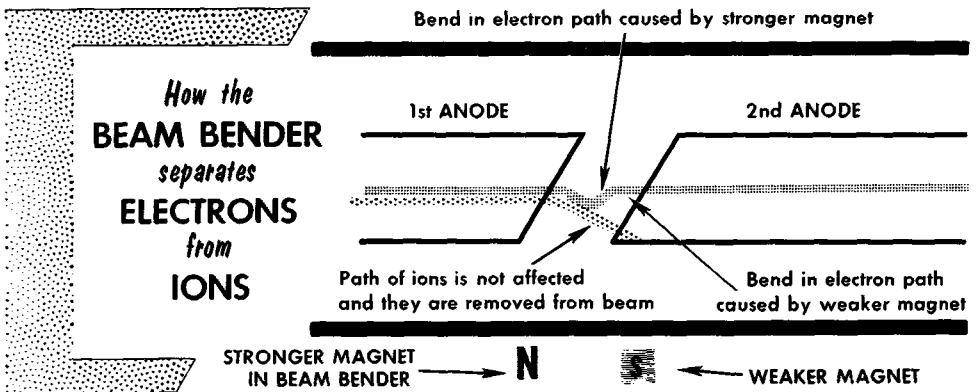

THE ION TRAP

A Second Type of Ion-Trap System

The next diagram illustrates another successful way of tackling the ion-trapping problem.

The whole electron gun is bent, in this case, and the beam bender is a *single* magnet. Electrons and ions leave the cathode along a path indicated by the dashes—a path that would carry the stream of both particles directly into the side of the second anode if it were not for the beam bender. Owing to the field of the beam bender, however, the electrons swerve upward and take the direction shown by the solid-line arrow along the axis of the tube. The massive ions, unaffected by the relatively weak magnetic field, continue on their original path and are trapped in the anode.

A beam-bending magnet cannot be placed around the neck of the picture tube in a random position. For best results it must be adjusted carefully. Unless care is taken, two undesirable effects may occur: the picture on the face of the tube may be cut off by a darkened area which resembles neck shadow, or the tube itself may be damaged if a prolonged maladjustment is allowed to exist.

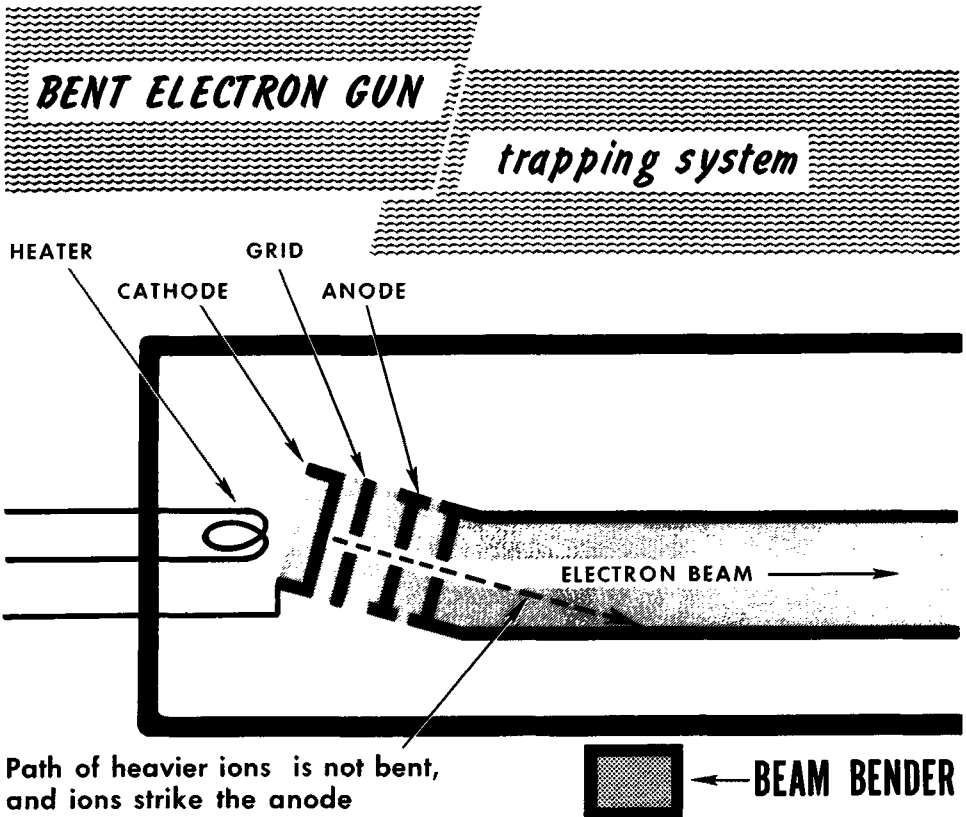

THE ION TRAP

Effects of an Improperly Positioned Ion-Trap Magnet

Consider what may happen if the bender is improperly adjusted so that the electron stream is bent upward *too much*. In this event the stream strikes the upper portion of the cylindrical anode. The charge content of the electron beam is quite large so that a very heavy second anode current may flow under these conditions. The resultant heat is sometimes sufficient to fuse the second anode material at the point of impact!

You may be surprised to learn that a misplaced beam bender can also damage the picture tube screen by producing an *ion burn*. The negative ions emitted by the picture tube cathode are trapped in the electron gun as described in previous passages, but there is another source of ions in the tube, the second anode itself. If the off-center electron beam resulting from a misplaced beam bender strikes this element at high velocity, the anode may become very hot. Under certain conditions, this may result in the "tearing-off" of heavy negative ions from the metal of this element. As there is no trap between the second anode and the tube screen, these heavy ions can travel along an undeflected path to the fluorescent material and in time, produce a serious ion burn.

Many ring type beam benders carry a printed or engraved arrow on the metal sleeve. While the receiver is turned off, the beam bender is slipped over the neck of the picture tube so that the arrow points approximately at the high-voltage terminal on the tube bell. In this position the thick ring containing the stronger magnet will be in back of the thin ring. For the clamp type of beam bender the weaker magnet is under the blue clamp and the stronger magnet under the black clamp. Thus, the beam bender is facing the right way when the blue clamp is nearer the tube flare. When in doubt, place the stronger magnet closer to the base of the tube.

~~~~~  
**How the SECOND ANODE  
can be  
DAMAGED by an IMPROPERLY  
ADJUSTED BEAM BENDER**  
~~~~~

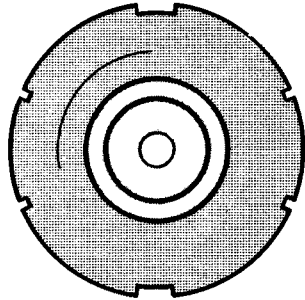

NORMAL FACE

(Inside face of second anode looking toward picture tube screen)

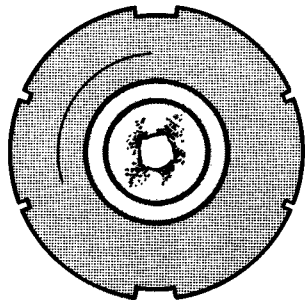

PITTED FACE

(Inside face of second anode looking toward picture tube screen)

THE ION TRAP

Final Adjustment of the Ion-Trap Magnet

Locating the ion-trap magnet or "beam bender" is an extremely important adjustment. Improper positioning can easily ruin the picture tube within as little as 30 seconds. When a bent-gun picture tube is used a single-field ion-trap magnet is generally placed over the neck of the picture tube at a point near the gap between the control grid and first anode in the electron gun. A double-field ion-trap magnet is frequently used with the slashed-gun type of picture tube, and is placed over a pair of internal pole pieces called "flags" in the electron gun. When the double-field magnet is used, the stronger of the two fields is located closer to the base of the picture tube. Ion-trap magnets are usually made of alnico.

While adjustment procedure varies among manufacturers, it is usually a good idea to keep the brightness low until a raster can be seen. Then move the ion-trap magnet forward and backward, at the same time rotating it slightly in both directions for maximum brightness. If corner shadows appear with maximum brightness, they should be removed by adjustment of the deflection yoke or focusing device. The ion-trap magnet should never be used to center the raster or eliminate corner shadow if, in so doing, the screen brightness is reduced.

Because there is a certain amount of interaction between the ion-trap magnet, deflection coils, and focus magnet, the picture should be refocused after the ion-trap magnet has been adjusted.

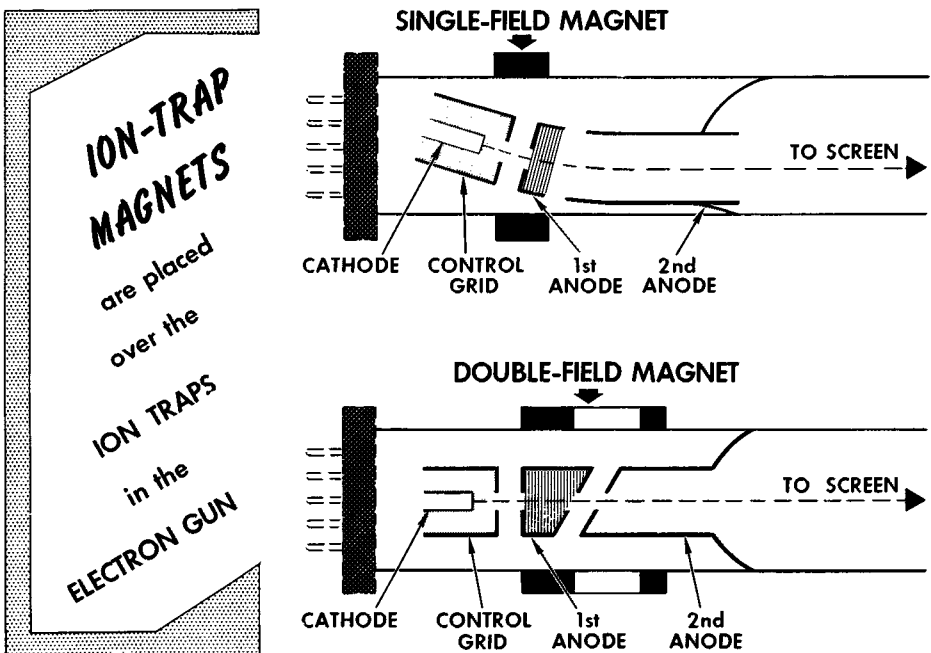

PICTURE TUBE CHARACTERISTICS

Picture Tube: Effect on Screen Shape

Round Screens WASTE FACE OR PICTURE AREA

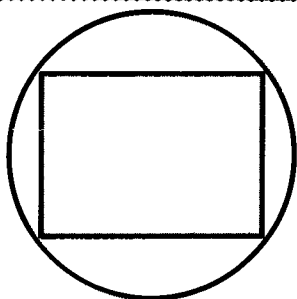

A

ROUND TUBE - 25% Waste screen

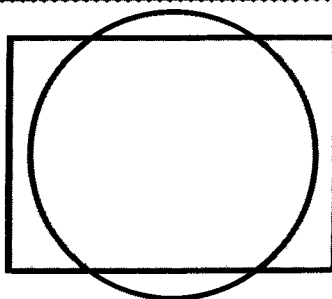

B

ROUND TUBE - 14% Waste picture

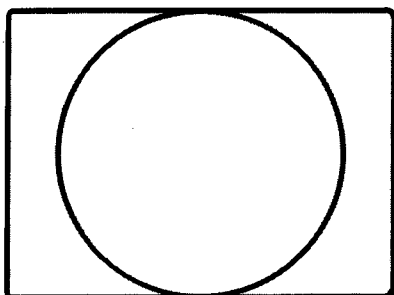

C

ROUND TUBE - 38% Waste

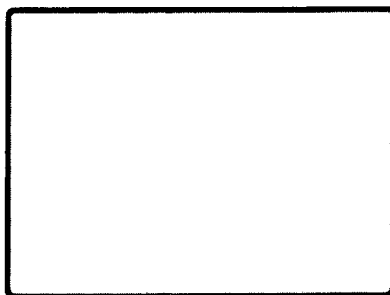

D

RECTANGULAR TUBE - No waste

When the novice in television is confronted with a listing of picture tube types he is apt to feel hopelessly bewildered. As a point of fact, the gradual growth and development of television display techniques has caused many minor differences between tube types which permit them to be directly interchanged, or interchanged with minor modifications in the receiver. Thus, there are far fewer real differences in picture tube structure than one would at first imagine. Many excellent handbooks are available if one is interested in specific dimensions and characteristics of a particular picture tube. We are concerned, however, not with specific tubes but rather with those characteristics which make certain tubes totally different from others.

Screen Shape. All early television picture tubes had round screens. Since the TV picture is transmitted as a rectangle having an aspect ratio of 4:3, there was much wasted space, or much wasted picture if an attempt was made to use the entire tube screen width. Virtually all modern receivers utilize rectangular-faced tubes.

PICTURE TUBE CHARACTERISTICS

Picture Tube: Dimensions

The television picture tube has undergone tremendous changes both in screen face area and in tube length. Two shapes have dominated picture tube screens—the circle and the rectangle. The most popular of the early tubes was the 10BP4, a tube having a round screen approximately 10½ inches in diameter. Virtually all 10- and 12-inch tubes are round. Starting with the 14-inch tubes many rectangular shapes appeared. The largest of the round tubes is the seldom used 30-inch 30BP4, with most 17- to 27-inch picture tubes having rectangular screens.

SCREEN SIZE IS DETERMINED by the

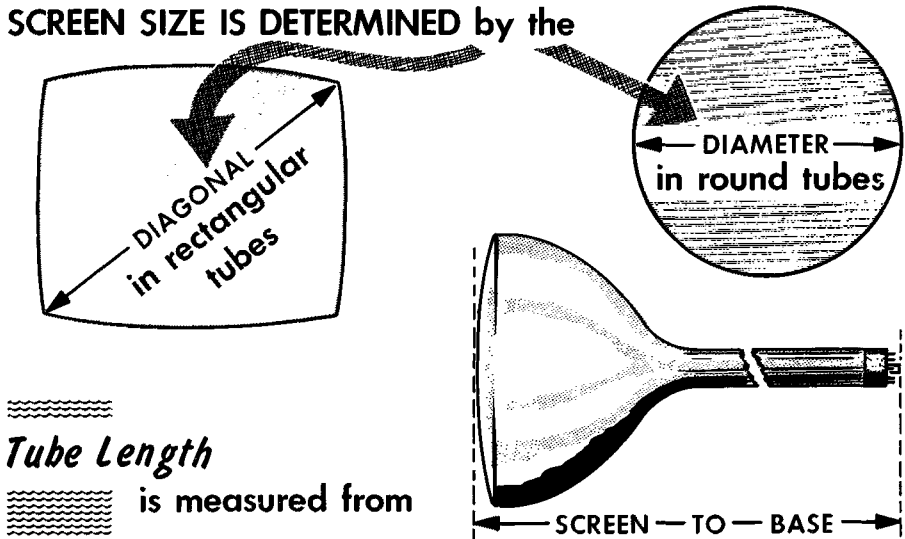

While it has been accepted that the size of a round screen is equal to its diameter, there has been some controversy as to how to measure a rectangular screen. This is now established as by measuring the diagonal.

Tube lengths have also changed with changes in screen size and with changes in deflection angle. As the screen was made larger, to maintain the same deflection angle it was necessary to make the tube longer. Since this became clumsy and dangerous with respect to breakage, wider deflection angles were used with an attendant shortening of the tube length.

The early 10BP4 had a 10-inch screen and a deflection angle of 50°. The length of this tube is approximately 17½ inches. The 16 LP4 with a deflection angle of 52° was 22¼ inches long. By going to a 70° deflection angle the 21AP4 was only 22½ inches long. Using a wide 90° deflection angle, the 27-inch 27AP4 is only about 12½ inches long. Finally, the design of a 110° deflection angle tube such as the 24-inch 24AHP4 produced a tube length of slightly less than 16 inches. The future holds prospects for still shorter tubes.

PICTURE TUBE CHARACTERISTICS

Picture Tube: Deflection Angle

The deflection angle is defined as the angle in degrees covered by an electron beam as it swings diagonally across the screen.

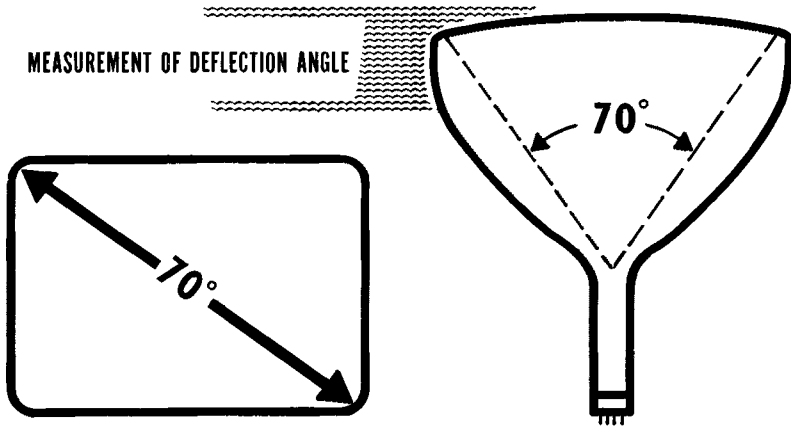

For example this tube is seen to have a required deflection angle of 70° . Tubes designed to work with wide deflection angles are substantially shorter than those with small angles of sweep. This in turn means that the design of a yoke for a wide-angle tube is different from that used for small-deflection-angle tubes. In most cases a wide deflection angle also necessitates more deflection driving power from the receiver's sweep output system.

The deflection angle actually obtained with a given yoke depends to a very great extent upon the ampere-turns of the deflection winding under consideration. If a 50° yoke is used with a tube having a 70° deflection angle, a large portion of the screen will be dark. Conversely, a 70° yoke used with a 50° tube will cause sweep overshoot that will waste an appreciable part of the picture.

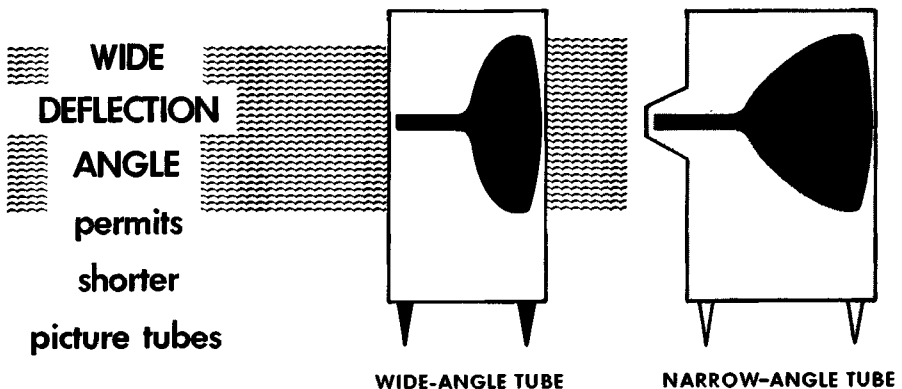

PICTURE TUBE CHARACTERISTICS

Picture Tube: Deflection Angle (contd.)

Through the years, deflection angles have increased to conform with the public demand for cabinets having less depth. Hence shorter picture tubes. Early 20-inch round tubes, for instance, were designed with deflection angles of about 54° . Later, deflection angles were increased to 70° and 90° in more recent 21-inch types. Currently in production is a 21-inch type which has a deflection angle of 110° , thus making it possible to reduce the overall length of this popular size by approximately 5 inches.

A Short Tube must have **A WIDE DEFLECTION ANGLE**



For the same screen size,
a short length picture tube
requires a larger deflection
angle than a long picture tube.

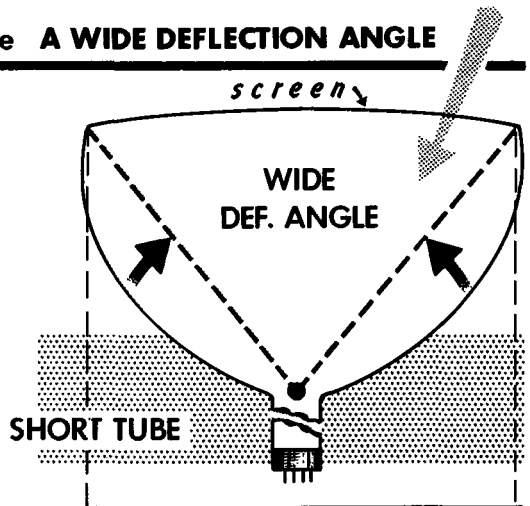

Different deflection angles
require different yokes
and deflection driving power.

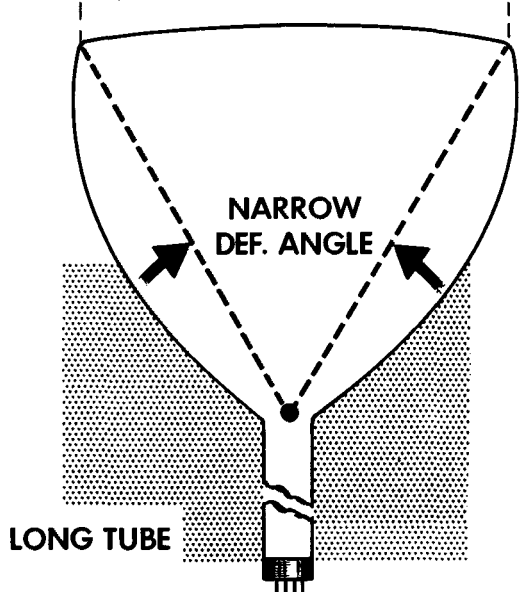

PICTURE TUBE CHARACTERISTICS

Picture Tube: Screen Material

Phosphor materials differ from each other in *display color* and *persistence of trace*. In addition, one picture tube screen having a phosphor identical to another may differ from it in the treatment of the glass itself: there are clear glass screens, gray glass finishes—the so-called “black” tubes—and frosted glass screens.

Virtually all television picture tubes are now finished with a medium-persistence, white-fluorescing phosphor identified as a “P4” material.

High-Voltage Connections. All glass picture tubes are equipped with either a *cavity* or a *ball* type connection. The terminal of the high-voltage lead must, of course, match the tube connection. Metal-cone picture tubes are provided with a rim flange or *cone lip*. Here again, the high-voltage lead must carry a matching connector.

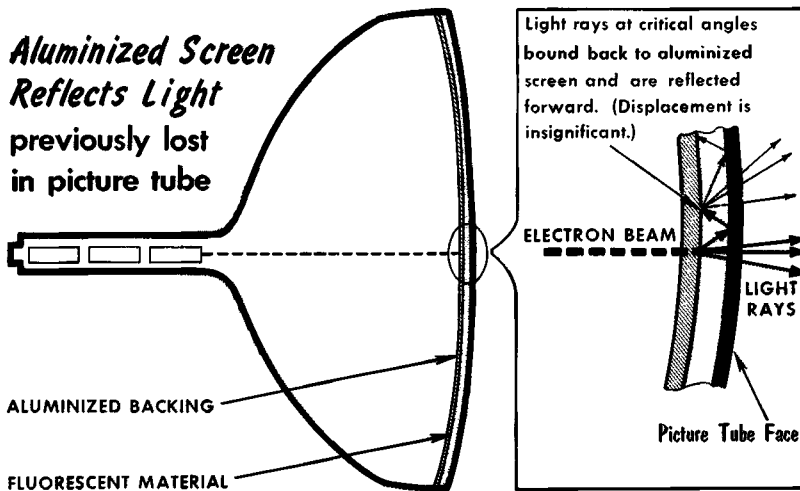

The screens of many modern tubes are also “aluminized.” A thin coating of pure metallic aluminum applied to the inner surface of the picture tube faceplate improves picture brightness and contrast by preventing backward reflection of light toward the cathode. While a plain glass face tends to bounce much of the light back toward the electron gun instead of allowing it to come through to the viewer, aluminization minimizes this effect.

Aluminization, incidentally, performs another useful function. The thin metallic coating, while permitting relatively easy passage of electrons through it, impedes the movement of ions. Thus, even if some ions escape the trap in the electron gun they can do little harm when they reach the faceplate because the aluminized layer protects the phosphor material from their bombardment. Indeed, in some picture tubes the aluminization is so effective in this regard that there is no need for an ion trap at all.

TYPICAL PICTURE TUBE CHARACTERISTICS

TYPE No.	HEATER		BULB						DEFLECTION METHOD		FOCUSING METHOD		TYPICAL OPERATION		
	Volts	Amperes	Nominal Face Dimensions Inches	Nominal Length Inches	Construction	Anode Terminal	Face Plate	Deflection Angle Degrees	Ion Trap Required	RETMA BIASING	Filter Capacitance Provided by Bulb Coating $\mu\text{f.}$	Anode Volts	Accelerator Grid Volts		
10BP4	6.3	0.6	10 $\frac{1}{2}$ Diam.	17 $\frac{5}{8}$	Glass	Recessed Small Cavity	Clear	50	Double	12N	500 Min., 2500 Max.	Magnetic	Magnetic	9,000	250
10BP4A							Gray								
12LP4	6.3	0.6	12 $\frac{7}{16}$ Diam.	18 $\frac{3}{4}$	Glass	Recessed Small Cavity	Clear	54	Double	12N	750 Min., 3000 Max.	Magnetic	Magnetic	11,000	250
12LP4A							Gray								
12LP4C							GA								
16EP4	6.3	0.6	15 $\frac{7}{8}$ Diam.	19 $\frac{5}{8}$	Metal	Cone Lip	Clear	60	Double	12D	None	Magnetic	Magnetic	12,000	300
16EP4A							Gray								
17QP4	6.3	0.6	15 $\frac{3}{8}$ x 12 $\frac{1}{4}$	19 $\frac{5}{8}$	Glass	Recessed Small Cavity	Gray Cyl.	70	Single	12N	750 Min., 1500 Max.	Magnetic	Magnetic	14,000	300
17QP4A							GA Cyl.								
19AP4	6.3	0.6	18 $\frac{5}{8}$ Diam.	21 $\frac{1}{2}$	Metal	Cone Lip	Clear	66	Single	12D	None	Magnetic	Magnetic	13,000	250
19AP4A							Gray								
20HP4	6.3	0.6	18 $\frac{1}{4}$ x 14 $\frac{1}{2}$	21 $\frac{3}{4}$	Glass	Recessed Small Cavity	Gray	70	Single	12M	None	Magnetic	Electrostatic	14,000	300
20HP4A							Gray			12L	750 Min., 1500 Max.				
20HP4B							GF			12M	None				
20HP4C							GA			12M	None				
20HP4D							GA			12L	750 Min., 1500 Max.				
21ACP4	6.3	0.6	20 $\frac{1}{4}$ x 16 $\frac{3}{8}$	20	Glass	Recessed Small Cavity	Gray	90	Single	12N	500 Min., 750 Max.	Magnetic	Magnetic	16,000	300
21ACP4A							GA								
21CEP4	6.3	0.6	20 $\frac{1}{4}$ x 16 $\frac{3}{8}$	14 $\frac{7}{16}$	Glass	Recessed Small Cavity	Gray A	110	None	8HR	2000 Min., 2500 Max.	Magnetic	Electrostatic	16,000	500
24CP4	6.3	0.6	22 $\frac{1}{4}$ x 18 $\frac{7}{16}$	21 $\frac{1}{8}$	Glass	Recessed Small Cavity	Gray	90	Single	12N	500 Min., 750 Max.	Magnetic	Magnetic	18,000	300
24CP4A							GA								
27LP4	6.3	0.6	25 $\frac{3}{32}$ x 20 $\frac{7}{32}$	24 $\frac{23}{32}$	Glass	Recessed Small Cavity	GA	90	Single	12N	250 Min., 400 Max.	Magnetic	Magnetic	20,000	300

A RETMA basing system is used in picture tube cataloging. There is also a RETMA system for receiving tubes, but it is seldom used by the technician.

PICTURE TUBE CHARACTERISTICS

Picture Tube Manuals

Tube manuals for picture tubes are much the same as the familiar manuals used for receiving tube types. Tubes are listed in order of their first two digits which stand for the picture tube screen size. Thus, the 10BP4 has a screen size of 10 inches, while the 27LP4 indicates a 27-inch screen. Note that each tube type number ends with a "P4". This indicates the fact that the picture on the screen is of a white color with medium persistence.

Since the early days of television, the 6.3-volt, 0.6-ma heater has been a standard. The table also indicates the size of the picture tube face and tells whether it is round or rectangular; nominal lengths are usually given and information as to whether the tube is of glass or metal construction. The type of anode terminal is shown as well as the type of face plate, which may be clear, aluminized or frosted, spherical or cylindrical. One of the more important pieces of information, the deflection angle, is always given, as well as the type of ion trap required, the basing information, and the filter capacitance provided by the bulb coating. Also provided is the method of deflection and focusing.

Different manufacturers provide various amounts of information under "typical operation." Generally the most important information is the high voltage or anode voltage and the accelerator grid voltage. With the above information it is possible, using a picture tube manual, to replace picture tubes and to check picture tube voltages for normal operation.

BASE DIAGRAM SYMBOLS

- | | |
|----------------------|---------------|
| A Anode | G4 Grid No. 4 |
| G1 Grid No. 1 | H Heater |
| G2 Grid No. 2 | K Cathode |
| C Conductive Coating | |

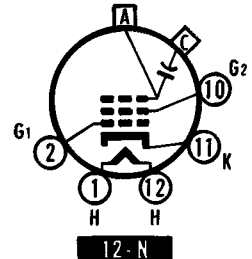
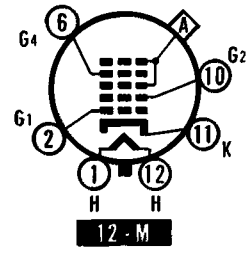
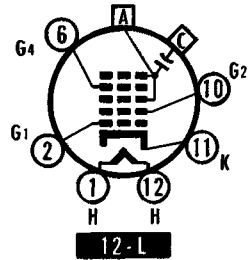
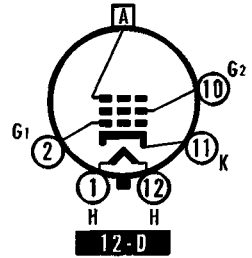
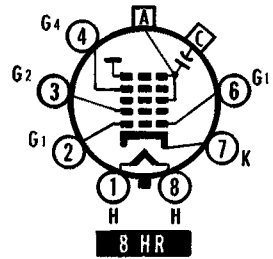

REVIEW

MAGNETIC CIRCUIT OF VERTICAL DEFLECTION COIL

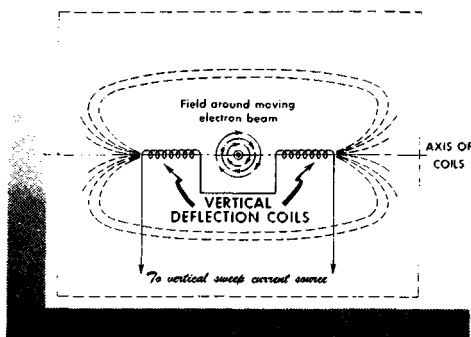

Deflection Yoke Dismounted

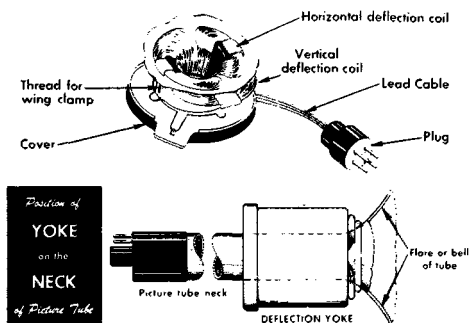

3. *Grounding Strips on the Yoke.* Metal grounding strips fastened to the deflection yoke press against the outer Aquadag coating, and form a solid spring contact. The outer and the inner coatings form a capacitor that aids the high-voltage filtering action.

4. *Cosine Deflection Yokes.* Defocusing of an otherwise perfect picture at the edges of the screen is almost entirely overcome by winding the deflection coils so that the turns near the inside of the winding—those closest to the window or axis of the coil—form a thin layer. As the turns proceed outward the layer thickens progressively.

1. *Deflection in the TV Picture Tube.* Vertical deflection coils are oriented with their core axes horizontal. Magnetic flux lines from these coils are horizontal relative to the vertical center line of the tube screen.

2. *The Deflection Yoke.* Two pairs of deflection coils are combined in a single unit called the deflection yoke. Four wire leads come from the yoke. In many receivers these four leads are cabled together and terminated in a four-prong or octal plug that fits a matching receptacle in the television chassis.

Filtering action of the DOUBLE AQUADAG COATING

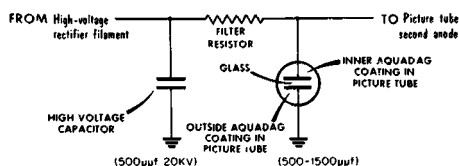
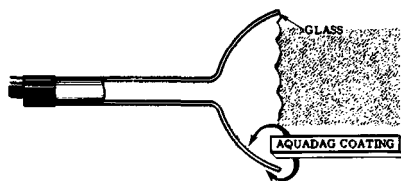

Construction of the COSINE YOKE

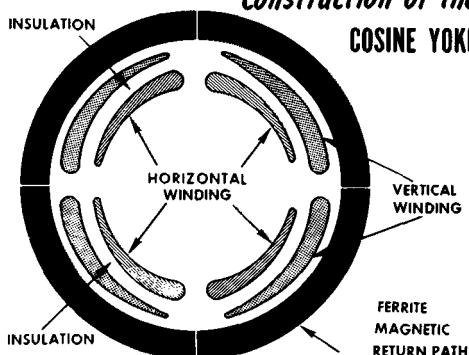

REVIEW

5. *Effect of an Ion Burn on the Picture.* An ion burn on a tube forms part of every scene and is very annoying. To prevent the negative ions from reaching the screen, several methods called ion traps have been devised to side-track them.

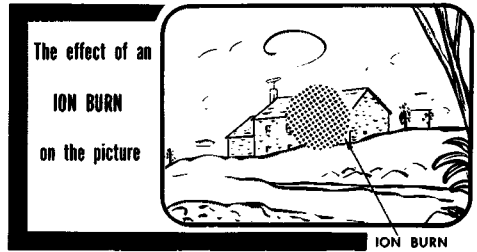

6. *A Second Type of Ion-Trap System.* The electron gun is bent, in this case, and the beam bender is a single magnet. Electrons and ions leave the cathode along a path that would carry the stream of both particles directly into the side of the second anode if it were not for the beam bender.

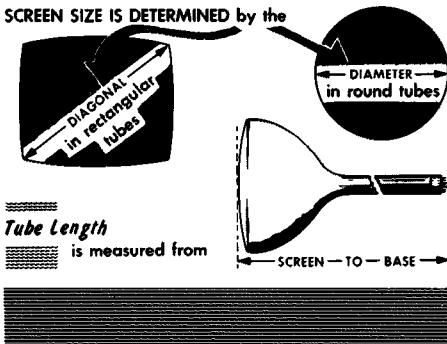
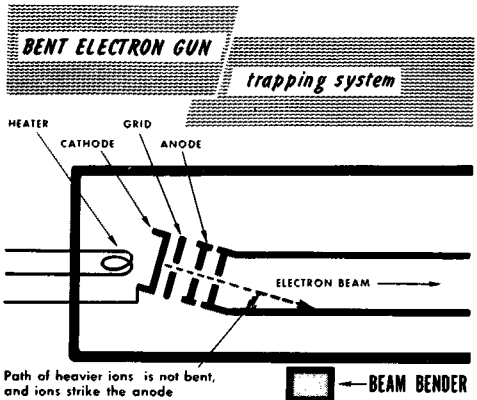

7. *Picture Tube: Dimensions.* The size of a round screen is equal to its diameter. To obtain the size of a rectangular screen, measure the diagonal. Tube length is measured from screen to base. Tube lengths have also changed with changes in screen size and deflection angle.

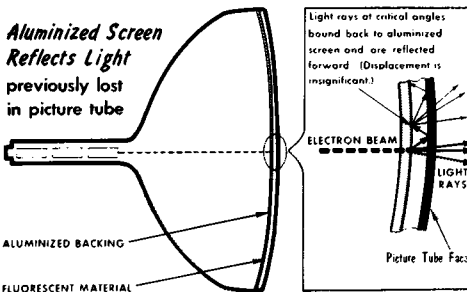

8. *Aluminization.* Screens of many tubes are aluminized. A thin coating of pure metallic aluminum on the inner surface of the tube face plate improves picture brightness and contrast by preventing backward reflection of light into the picture tube. The metallic coating also usefully permits the passage of electrons but impedes the movement of ions.

TELEVISION SOUND SYSTEM

The Television Sound System

The TV Sound System consists of

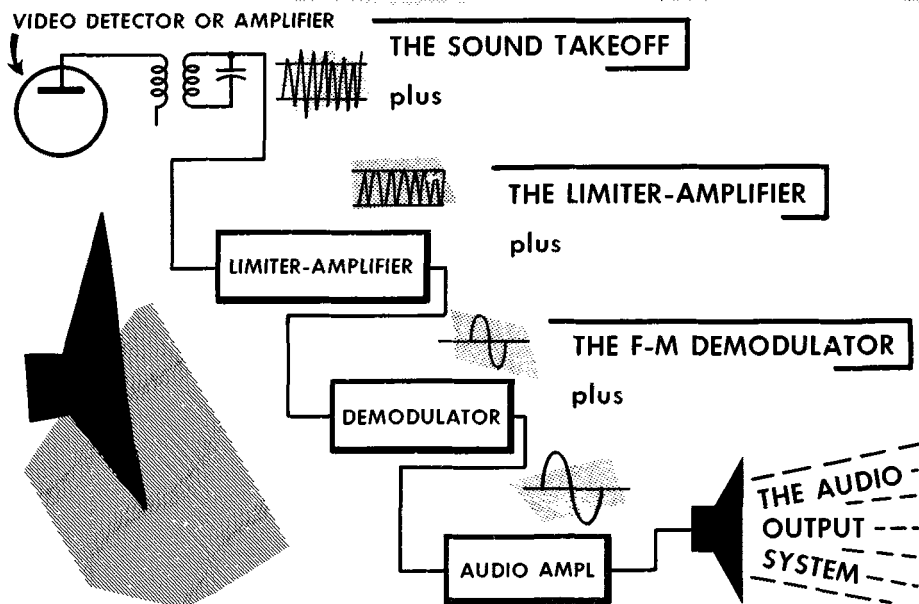

The television receiver provides us with both a picture and a sound signal. So far we have concerned ourselves primarily with the picture portion of the television signal, stating merely that the sound signal is separated from the video signal at the output of the video detector or video amplifier.

It is at either of these points that we may consider the *sound system* as beginning. From the sound takeoff point the sound signal is fed into one or more limiter or amplifier stages, and from there it is processed by an f-m demodulator that converts the frequency variations in the 4.5-mc inter-carrier sound signal into audio variations. Now we will discuss the three principal demodulators used in television receivers: the Foster-Seeley discriminator, used in many early television receivers but seldom used in modern sets; the ratio detector, by far the most popular circuit, and an almost absolute standard for many years; and the gated-beam discriminator, growing increasingly popular in recent years.

The output of the f-m demodulator stage feeds the audio signal, through a *de-emphasis network*, into the audio amplifier stage. From this point most receivers feed the signal into a conventional audio output stage and then to the loudspeaker. In some receivers the audio system may be more elaborate, having a push-pull output fed by a phase-inverter driver stage and containing some inverse feedback for higher fidelity.

TELEVISION SOUND SYSTEM

The Sound Takeoff

In the intercarrier television receiver the i-f amplifier stages process the sound and picture i-f signals, feeding them both into the video detector stage. These i-f signals are exactly 4.5-mc apart, and are mixed or heterodyned in the video detector. The mixing of the amplitude-modulated video signal and the frequency-modulated sound signal produces a 4.5-mc component. Since this 4.5-mc beat signal contains primarily the modulation of the weaker signal, the frequency response of the intercarrier receiver is so adjusted that the amplitude of the sound i-f is approximately 10% of the maximum amplitude of the video i-f signal.

The actual sound takeoff can be made through capacitive coupling, or by magnetic coupling, to a 4.5-mc sound takeoff circuit. When a sound takeoff coil is used, the signal is then fed to the first 4.5-mc sound amplifier. When sound takeoff is through a coupling capacitor, the signal is usually fed to the first sound amplifier by way of a 4.5-mc trap. This is a parallel L-C circuit from grid to ground that presents a high impedance to 4.5 mc, but shunts higher- and lower-frequency signals to ground. The coupling capacitor must be large enough to pass the 4.5 mc with little attenuation, but small enough to attenuate much of the lower video sideband frequencies. When the 4.5-mc signal is taken from the video amplifier circuit, the coupling between the video detector and video amplifier must be capable of passing the 4.5-mc signal so as not to attenuate the sound signal.

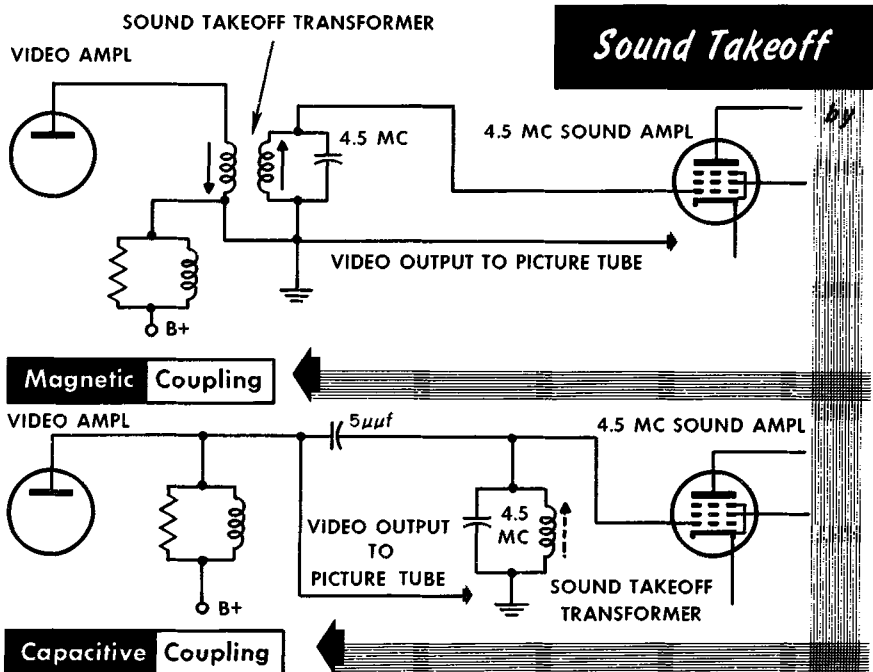

TELEVISION SOUND SYSTEM

The Limiter-Amplifier

We have stated that the 4.5-mc f-m signal is picked up by the sound takeoff coil. The following basic operation to perform on the signal is demodulation. However, the intercarrier sound signal is relatively weak at the point of sound takeoff, and a certain amount of amplification is necessary for optimum processing of the sound signal. Thus, before the 4.5-mc signal is demodulated, it passes through a stage of amplification.

The circuitry of this amplifier depends considerably on the type of demodulator used. For example, the Foster-Seeley discriminator is sensitive to amplitude variations as well as frequency variations, and its preceding stage must perform a *limiting* action. When the ratio detector is used, a limiter is usually not necessary as the ratio detector is relatively insensitive to amplitude variations. Instead, the stage preceding it is generally a conventional amplifier for the 4.5-mc signal.

The limiter stage is fundamentally a class-C amplifier, using grid-leak bias and having very low screen grid and plate voltages. A sharp-cutoff pentode is often used, with the tube easily driven into saturation on the positive peak of the input voltage, and into cutoff on the negative peaks. The net result of this arrangement is to provide an output f-m signal that is free from amplitude variations which are often the result of noise, and so permit the maintenance of a noise-free f-m signal.

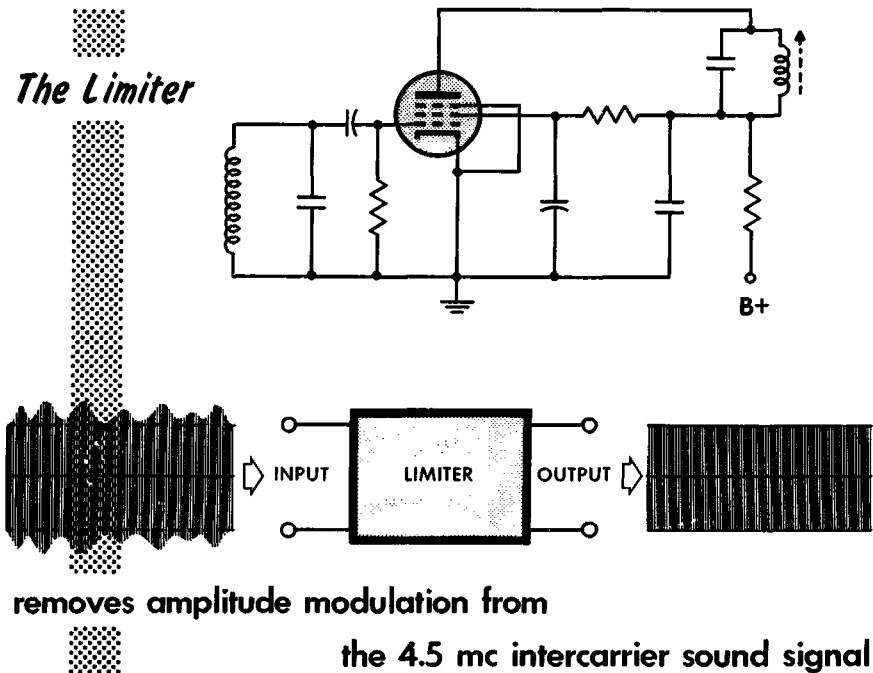

TELEVISION SOUND SYSTEM

Foster-Seeley Discriminator

This circuit, sometimes called the *phase-shift* discriminator, was quite popular in the very early television receivers, but has since lost out to the ratio detector. The Foster-Seeley discriminator has a tuned input circuit, tuned to 4.5 mc.

When the input signal to this circuit is unmodulated, that is, at exactly 4.5 mc, the voltages applied to each diode are equal, and the rectified output voltages across resistors R1 and R2 are equal. However, these voltages are opposite in polarity, and the net output voltage is zero. When the input frequency varies above and below the 4.5-mc carrier frequency, the voltages developed across resistors R1 and R2 are no longer equal, and a varying audio output voltage appears as the net voltage across R1 and R2.

Important in the operation of this circuit is the coupling arrangement between the limiter and discriminator stages. It is this arrangement that provides the varying voltages applied to the diodes, as the f-m signal varies above and below its center value. Coupling is performed in two ways simultaneously—by simple induction from L1 to L2, and by capacitive coupling through C1. The inductive coupling feeds a push-pull signal to the input circuit of the discriminator, and the capacitor feeds its signal in parallel to the two diodes. Thus, the output represents the resultant sum of these voltages and provides the response curve shown.

THE FOSTER-SEELEY Discriminator

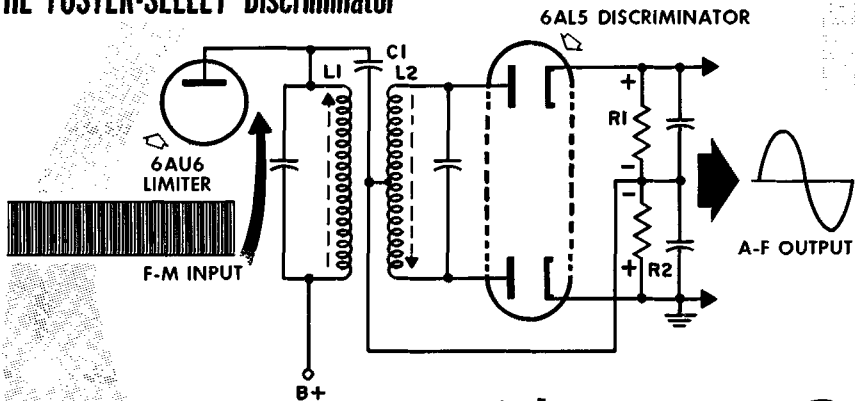

and its Response Curve

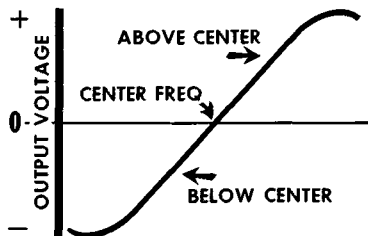

TELEVISION SOUND SYSTEM

The Ratio Detector

This circuit represents an interesting comparison of variation and consistency at the same time. The ratio detector has virtually dominated the field of f-m demodulators since the early days of television, and has given way only slightly to the relatively new gated-beam detector. While being the dominant circuit for f-m demodulation, the ratio detector has, at the same time, undergone numerous circuit variations. One of its principal features is that this circuit is virtually immune to amplitude variations. Since noise generally appears as variations in amplitude rather than variations in frequency, the ratio detector provides a means of f-m demodulation with no need for prior limiting.

While variations exist in ratio detector circuitry, certain arrangements are the same. For example, all circuits contain a third or tertiary winding in addition to the primary and secondary windings between the ratio detector and the preceding amplifier stage. This is necessary because low-value load resistors are used in this circuit, and the third winding helps match the impedance of the driver stage to that of the ratio detector. In essence, the ratio detector actually converts the incoming f-m signal into what might be called a form of amplitude modulation. This is then detected by the two diodes.

Note that the diodes are connected in one direction, or in series. Current flows through the load resistance, across which is connected a large filter capacitor. This capacitor charges to the peak voltages developed across the load resistance. The parallel combination of resistors and capacitor gives automatic bias to the diodes, varying with average signal strength.

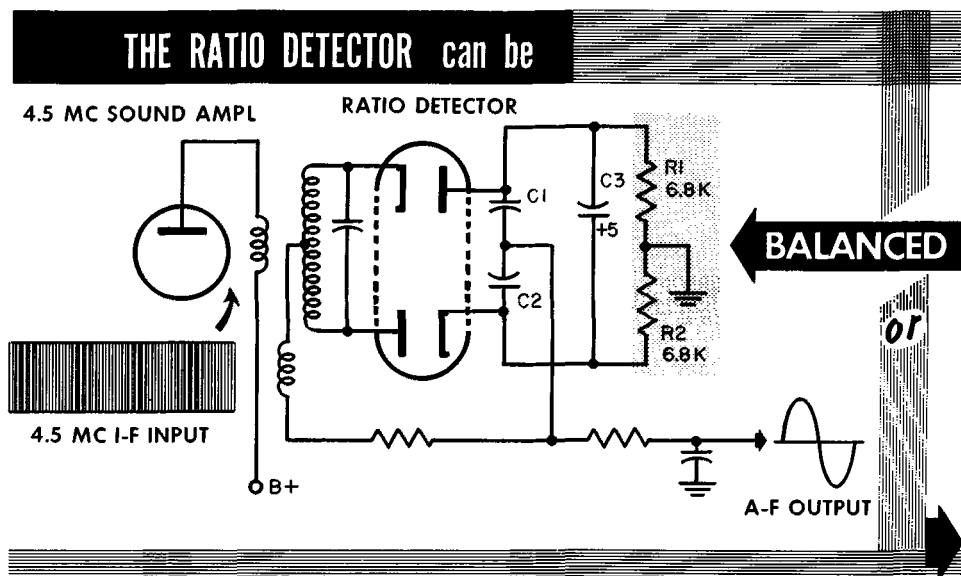

TELEVISION SOUND SYSTEM

Ratio Detector (contd.)

An important point is that this circuit does not respond to noise pulses, there being no current fluctuations as the result of these pulses.

By centertapping the secondary, voltages induced in L3 are fed in parallel to the diodes, while the induced voltage is fed in push-pull. The f-m variations cause the phase angle to shift between the two voltages as in the discriminator. This produces voltage variations in the signals applied to the diodes. However, since the diodes are in series, the total voltage developed across the load resistance is constant. With the sound takeoff in a balanced detector, one half of the total voltage is taken off the load and fed to the following audio amplifier stages. This voltage is determined by the ratio of the voltages across C1 and C2. The voltage across stabilizing capacitor C3 minimizes noise voltage fluctuations. The ratio detector obtains its name from the fact that the voltage across R1 and R2 is constant, but that the ratio of the voltage drop across the resistors varies with the audio modulation.

Of increasing popularity is the unbalanced ratio detector arrangement using the entire audio voltage developed across the stabilizing capacitor.

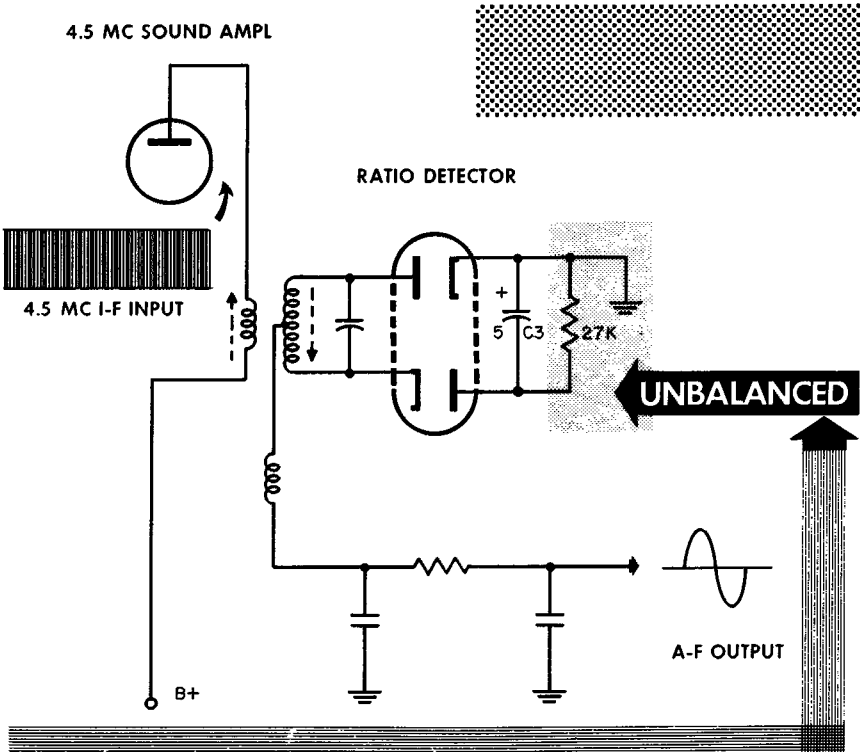

TELEVISION SOUND SYSTEM

Pre-emphasis and De-emphasis

The audio signal used in connection with the television signal is frequency modulated, with the modulation or sideband frequencies often extending outward to as much as 15,000 cycles. This provides a much broader audio range than is usually found in conventional amplitude-modulation broadcasting. The higher audio frequencies produced at the studio are generally weaker than the lower frequencies, and thus produce a smaller frequency deviation in the transmitted carrier. In the normal transmitting process a certain amount of interference is encountered, such as atmospherics, which have little effect on the large-amplitude low-frequency signals. However, with regard to the weak high-frequency signals, the signal-to-noise ratio is low. To correct this condition the Federal Communications Commission (FCC) standards call for a pre-emphasis network. This consists of a high-pass filter having a time constant of 75 microseconds.

The pre-emphasis at the f-m transmitter provides for an audio gain of 1 at 50 cycles, to a gain of 7 at 15,000 cycles. From 50 to 500 cycles the rise is very slight, but from there it increases rapidly. Thus, the net effect of this procedure is to increase the signal-to-noise ratio at the higher audio frequencies.

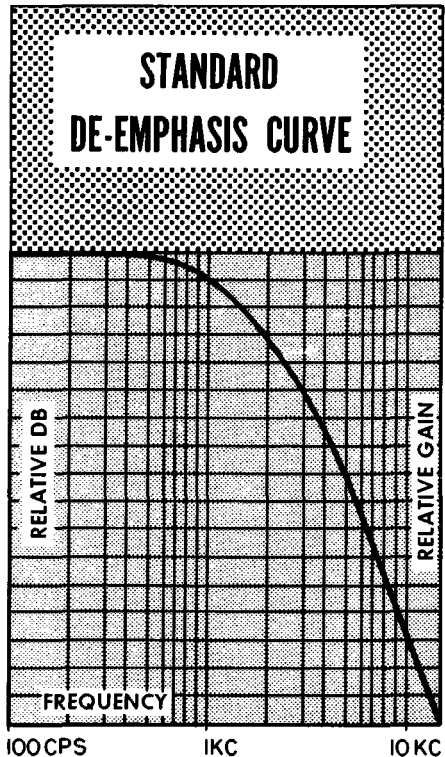
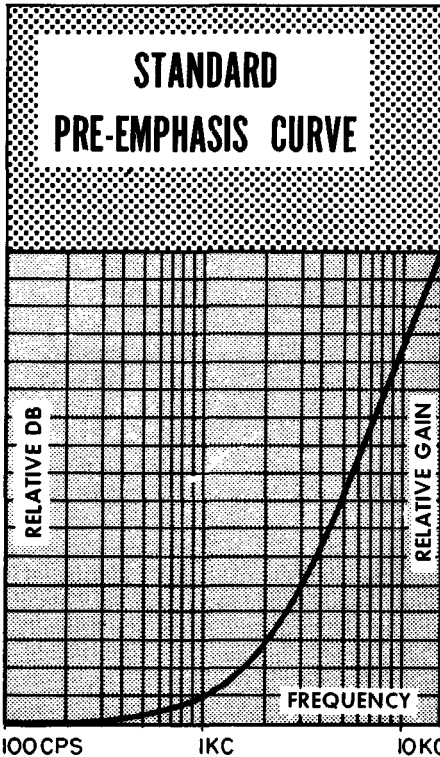

TELEVISION SOUND SYSTEM

Pre-Emphasis and De-emphasis (contd.)

If the pre-emphasis were not corrected at the receiver, the sound signal would have a heavy treble effect. To compensate for this, the f-m receiver contains a de-emphasis network—a low-pass filter. As in the case of the high-pass filter, the de-emphasis network also has a 75 microsecond time constant.

The de-emphasis network can be placed in any one of several places in the f-m receiver, but practice finds it located at the output of the f-m detector circuit. It is an R-C filter that shunts the higher audio frequencies to ground while affecting the lower frequencies to a lesser extent. The overall effect of the pre-emphasis de-emphasis maneuver is to provide a noise-free signal at the output of the f-m receiver that is a replica of the sound signal at the studio.

In designing a de-emphasis network, engineers take into consideration the distributed capacitances. Thus, the “lumped” R-C time constant may not be precisely equal to 75 microseconds.

DE-EMPHASIS NETWORKS

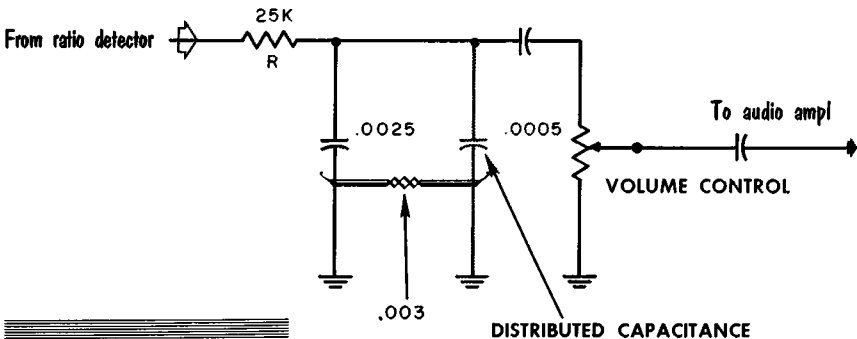
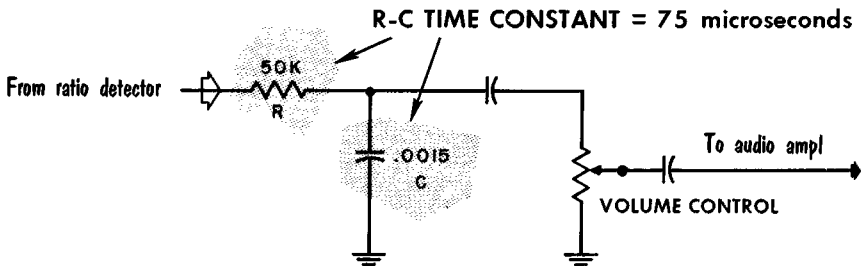

TELEVISION SOUND SYSTEM

The Gated-Beam Detector

A most unusual receiving type tube development was that of the 6BN6, a tube which lends itself to circuitry that can be made to operate as a limiter, f-m detector, and audio amplifier, simultaneously. The 6BN6's operation is based on electron-optical principles.

The focus electrode surrounding the rectangular cathode, in conjunction with the lower slot in the accelerator, forms a compact sheet-like beam of electrons that is projected against the limiter (first control) grid.

The Gated-Beam Tube

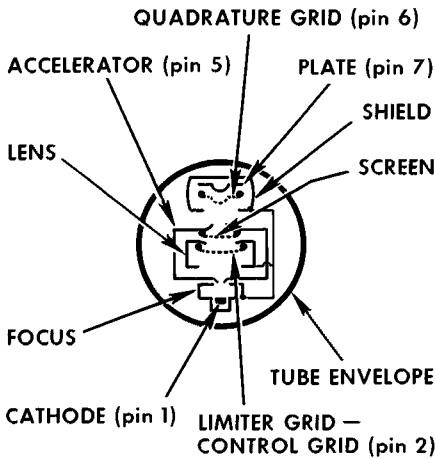

physical appearance

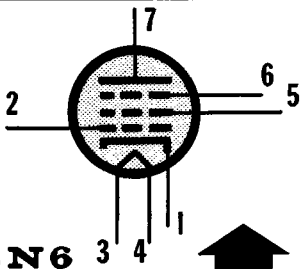

6BN6

schematic appearance

The slot in the lens, together with the screen and the upper slot in the accelerator, act as a convergent lens system and refocus the beam and project it onto the second control or quadrature grid. The quadrature grid and the anode are enclosed within a shield.

The important characteristic of the 6BN6 is its ability to cut off sharply, and maintain a constant plate current with wide variations in grid voltage. The limiter grid acts like a gate. At approximately -2 volts on the grid the tube is cut off. When any voltage more positive than this is applied to the limiter grid, the plate current rises rapidly from zero to some sharply defined value—a maximum which occurs at about 2 volts. Thereafter, no matter how far positive the grid is driven, there will be no increase in plate current. Thus, with wide variations in amplitude of the input signal, the plate-current swing from minimum to maximum will be constant, eliminating a-m interference. This tube characteristic provides excellent limiting action.

The quadrature grid also has a characteristic that governs the level to which the plate current will rise. Either grid, the limiter or the quadrature, acting as a voltage-controlled gate, can cut off plate current. Plate current will not flow unless both grids are positive at the same time.

TELEVISION SOUND SYSTEM

The Gated-Beam Detector (contd.)

The gated-beam detector is an extremely simple f-m demodulator, using no discriminator transformer, and depending upon tube design for limiting and demodulation. If a sine-wave signal of 2 volts or so is applied to the limiter grid, the tube alternately conducts and cuts off, producing a plate-current signal of square-wave form. Thus, limiting action takes place immediately at the first or limiter grid; then the beam passes through the upper accelerator slot and on to the quadrature grid.

The quadrature grid is connected to a high-Q circuit that is tuned to 4.5 mc, which resonates because of the space-charge coupling within the tube. When the f-m signal applied to the limiter grid is unmodulated, the 4.5-mc voltage on the quadrature grid lags the applied voltage by 90° . However, when the incoming signal at the limiter grid increases in frequency, the phase difference between these two voltages is more than 90° . A swing below 4.5 mc produces a phase difference of less than 90° . Thus, the phase difference between the limiter grid and quadrature grid voltages varies with the audio modulation of the 4.5-mc sound signal. This changing phase is then converted into the original audio modulating voltage.

We have stated that plate current flows in this tube only when both the limiter and quadrature grids are positive, simultaneously. As the 4.5-mc signal varies in frequency as a result of the modulating voltage, positive voltages appear on both these grids for varying periods of time. This causes plate current to flow for changing periods of time, depending upon the modulating frequencies. Thus, plate current flows in a series of pulses of varying width. The plate voltage pulses are integrated by capacitor C1 to develop an average voltage across the plate-load resistor. This voltage is the demodulated audio signal.

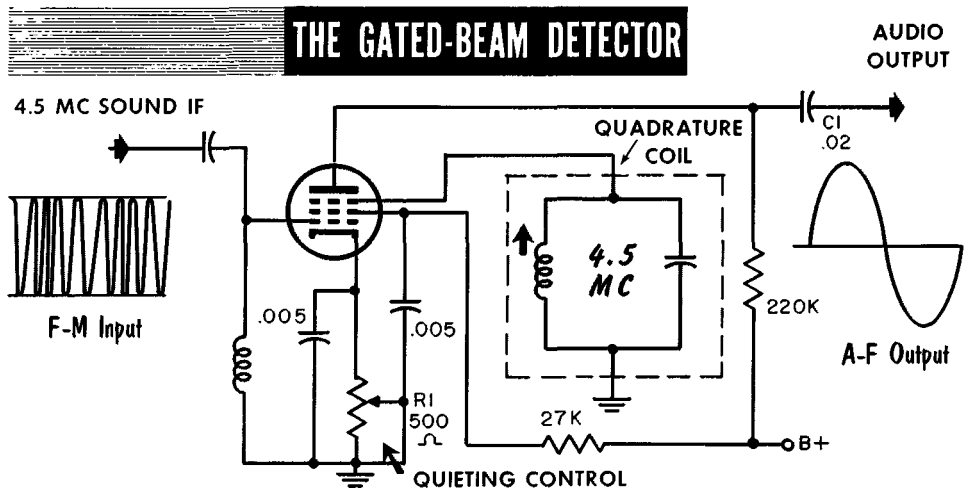

TELEVISION SOUND SYSTEM

The Gated-Beam Detector (contd.)

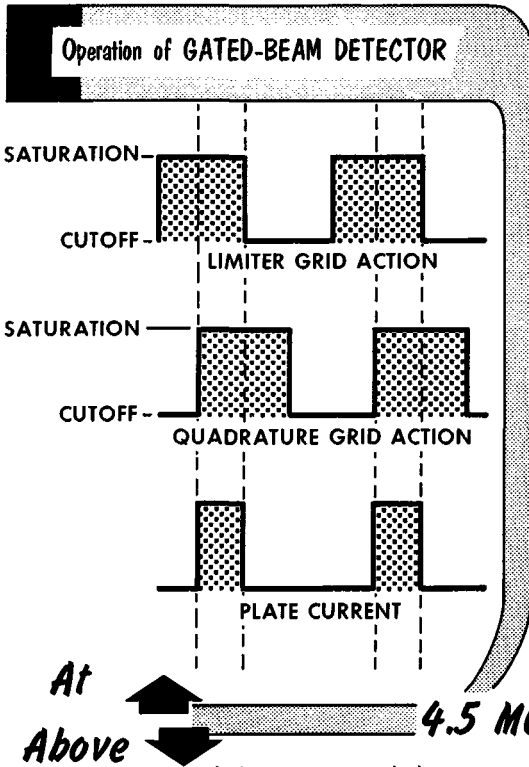

Though not always necessary under normal conditions, the 6BN6 is generally preceded by a separate 4.5-mc limiter stage for good limiting action in fringe areas. This stage feeds the gated-beam detector.

The buzz or quieting control sets the operating point of the 6BN6 to eliminate the 60-cycle vertical pulse from the plate circuit. The quadrature coil and buzz control should be adjusted for cleanest sound and minimum buzz.

The audio output level of this circuit is usually of sufficient amplitude to drive the power output stage directly, eliminating the tube and components of an audio amplifier stage.

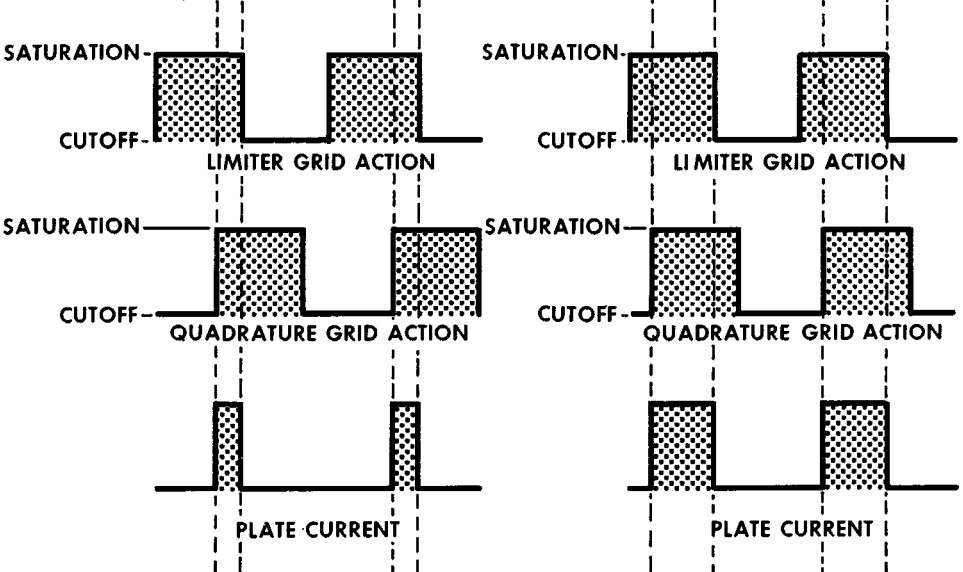

TELEVISION SOUND SYSTEM

Audio Output System

The output of the sound demodulator must be fed to an audio amplifier so that the output signal can be strengthened to the proper amplitude to drive the loudspeaker. The circuitry of the audio amplifier is generally quite conventional, with television sets usually providing only the bare essentials for audio reproduction. In many sets the audio output system consists of a simple audio amplifier with volume control, an audio output stage, and a small 5-inch loudspeaker. In some sets the audio system is fairly complex, consisting of an audio amplifier stage with volume, bass, and treble controls, followed by a phase-inverter driver stage and a push-pull audio output stage. A set such as this may have a high-quality 12-inch loudspeaker or possibly two or more speakers covering different portions of the audio range (woofer and tweeter), and a comprehensive feedback arrangement.

The quality of the audio system is also governed by whether or not the TV set is made as part of a combination together with a phonograph and an f-m and a-m radio receiver. To obtain maximum quality from the f-m output, some TV receivers provide a sound takeoff point at the output of the de-emphasis network so that the audio can be fed into the input of a high-fidelity amplifier.

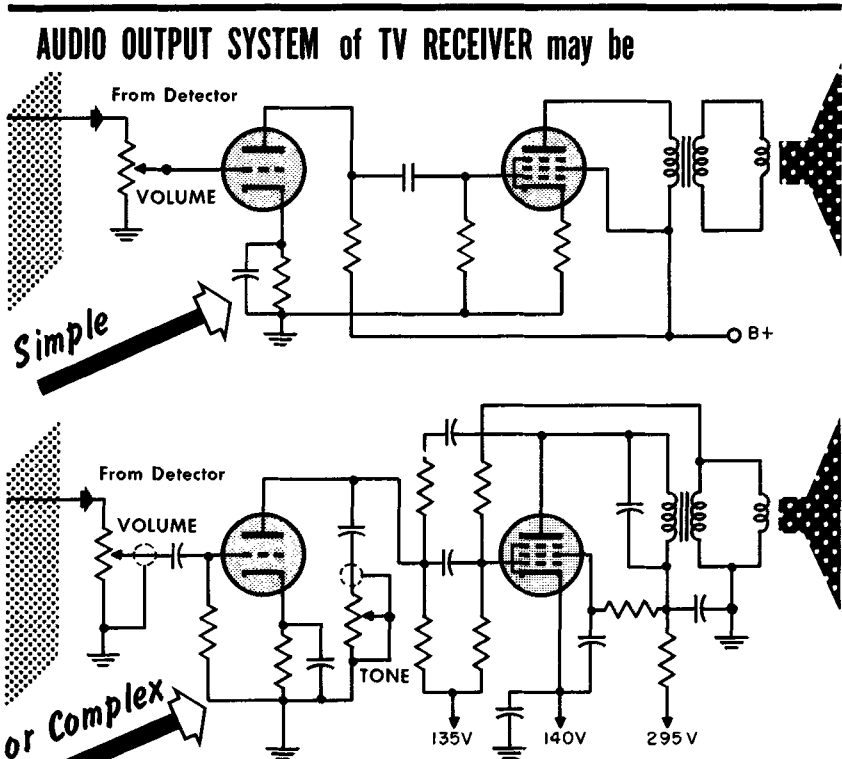

TELEVISION SOUND SYSTEM

The Complete Sound System

Trends in TV Sound Systems

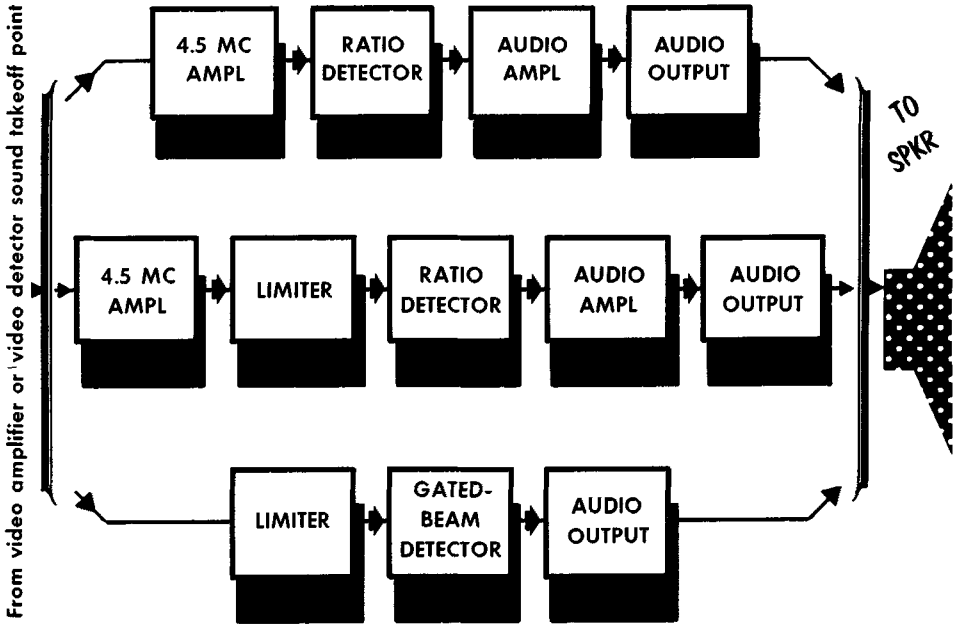

Through the years of television circuitry development a certain pattern has emerged regarding the makeup of the television sound system. By far the most popular is the system where the sound takeoff is fed into an amplifier and then to the ratio detector. From this point the demodulated signal is fed to an audio amplifier where the audio voltage is strengthened. Finally, the audio signal is fed to a power stage where the audio driving power for the loudspeaker is developed.

In some cases the above system is used with one exception—a limiter stage is inserted between the intercarrier sound amplifier and the ratio detector. This provides additional limiting action and is done to improve performance rather than out of basic necessity. Where a manufacturer is looking to produce a TV receiver as economically as possible, he will generally not include a limiter stage at this point.

Emerging as the result of the increasingly popular gated-beam tubes, is the arrangement in which a limiter stage feeds a gated-beam detector. The output of this tube is rather high, and is fed into the audio output stage directly, without passing through a stage of audio voltage amplification. While not done very often, some sets have appeared using the gated-beam detector without a preceding limiter stage.

LOW-VOLTAGE POWER SUPPLY

Power: Past, Present and Future

Radio and television circuits have many common features. Among other things, both systems demand ac and dc voltages and currents of widely varying magnitudes. An overwhelming majority of TV receivers in this and other countries must operate from a single power source—either 120-volt or 220-volt ac available from the residential power receptacle—so that we must use one or more *power supplies* in the receiver. The current practice in this regard is the same as it has been since the earliest days of television: each receiver has two power supplies—one to provide low-voltage dc and ac for tube elements and the other to produce very high voltages for the second anode of the picture tube.

At the beginning, all low-voltage power supplies had at least two things in common: vacuum tubes were used as rectifiers and all tube heaters were connected in parallel. With the passage of time television manufacturers, chiefly in the interests of economy, began to use semiconductor rectifiers to an increasing extent. During the same period series-parallel heater arrangements making use of 6.3-volt and 12.6-volt tubes in the same receiver made an appearance. The trend now seems to be toward selenium and silicon crystal rectifiers as well as straight series heater circuits. Completely new lines of tubes are now available having characteristics expressly designed for series heater hookups. Semiconductor rectifiers have been improved to the point where they now offer promise of substantially longer life than vacuum tube rectifiers with no sacrifice in performance or economy; fusible resistors and resistors having large temperature coefficients now appear in heater circuits as protective elements; and finally, voltage multipliers, so common in radio receivers, are becoming just as common in TV sets. In this section we shall discuss all these recent advances.

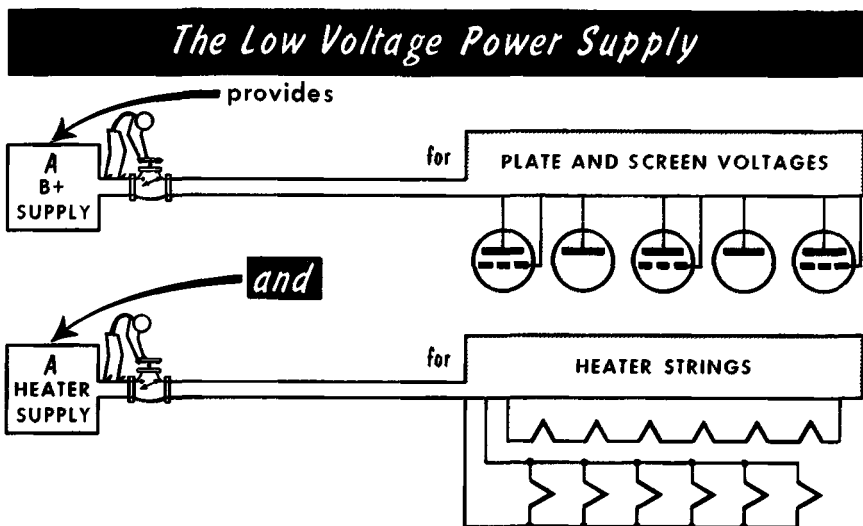

LOW-VOLTAGE POWER SUPPLY

Basic Vacuum Tube Power Supply

A Complete Low-voltage Power Supply for a *TELEVISION RECEIVER*

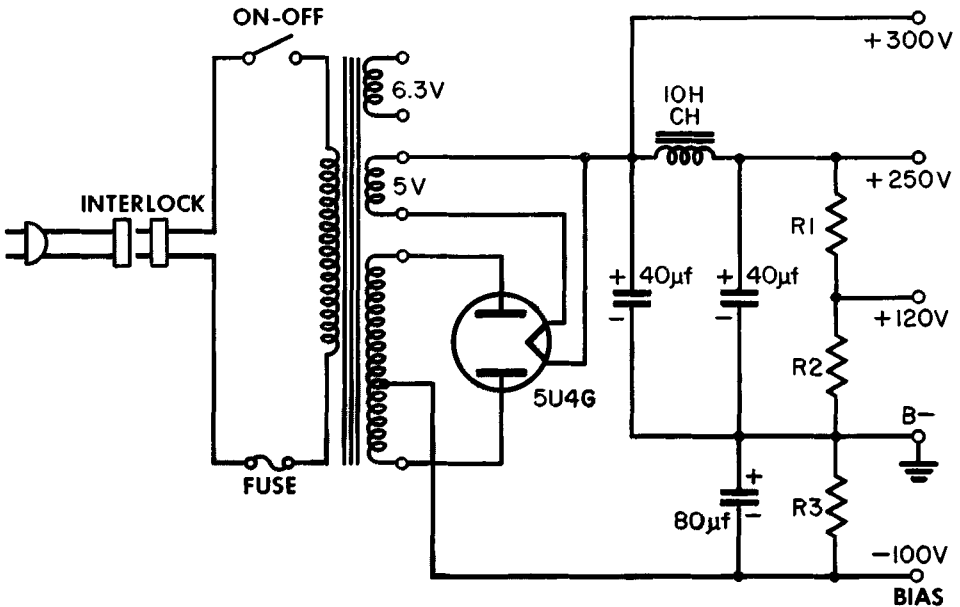
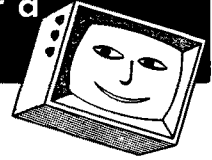

This power supply is essentially the same as any transformer type of supply used for operating radio receivers. It differs from its predecessors only in its "bleeder" system—R1, R2, and R3. The 5U4-G is a straightforward full-wave rectifier used in conjunction with a centertapped power transformer. The filter network consisting of two $40\text{-}\mu\text{f}$ capacitors and a 10-henry iron-core choke is quite standard. Ground (common) is connected to the junction of R2 and R3, and the $80\text{-}\mu\text{f}$ capacitor connected across R3 filters ripples out of this section of the bleeder.

Since the ground return of the system is brought to a point having a more positive potential than the centertap of the transformer, the low end of R3 then becomes a source of negative bias.

LOW-VOLTAGE POWER SUPPLY

Basic Vacuum Tube Power Supply (contd.)

The current drain of the tubes and voltage divider systems of television receivers is considerably higher than that of radio sets due to the greater number of tubes used. To supply currents of the order of 250 ma or more continuously, rectifier tubes are often used in parallel. For example, the maximum continuous dc current available from a 5U4-G, one of the largest receiving-type rectifiers, is only 225 ma. When the current demand is greater than this, two tubes are connected this way:

Obtaining BIAS VOLTAGE from the POWER SUPPLY

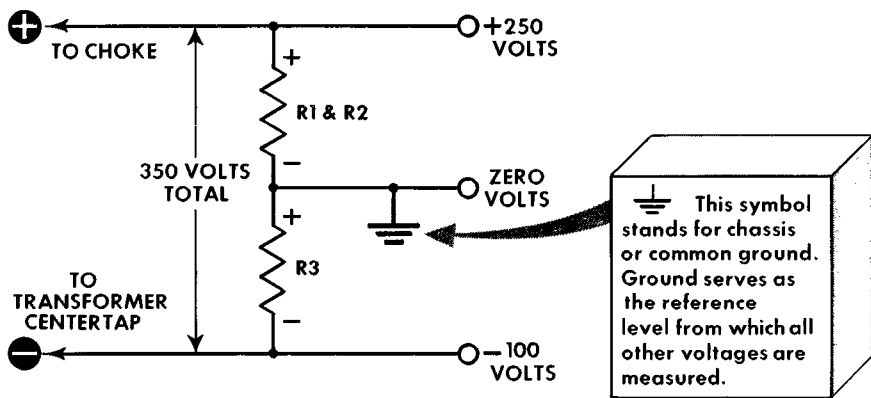

USE OF TWO 5U4-G RECTIFIERS IN PARALLEL TO SUPPLY MORE THAN 225 ma WITHOUT OVERHEATING

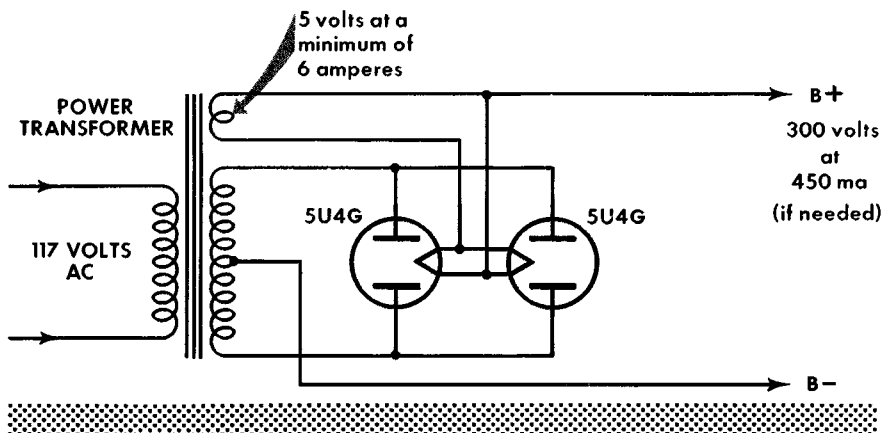

LOW-VOLTAGE POWER SUPPLY

Selenium Rectifier Power Supplies

A Basic Half-wave Selenium Rectifier Power Supply

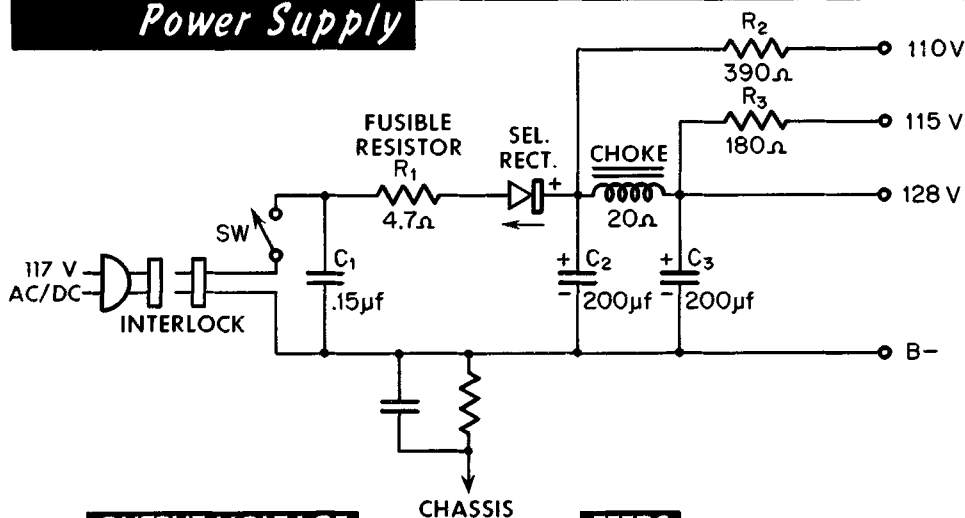

OUTPUT VOLTAGE

110 volts

115 volts

128 volts

CHASSIS

FEEDS

Audio output tube

All video and audio tubes except vertical and horizontal output.

Horizontal and vertical output

Many of today's television receivers feature "transformerless" power supplies. This word refers to the elimination of the *power transformer* only, as audio, sweep output, and high voltage transformers are still present. A transformerless power supply boasts two distinct advantages: lower cost and the possibility of using the TV receiver on dc rather than ac if desired.

For ac-dc applications, half-wave rectifier systems are utilized.

The selenium rectifier has very good conductivity in the forward direction as indicated by the arrow under the rectifier symbol, but presents a high resistance to current attempting to flow in the opposite direction. Thus, on every alternate half-cycle of the applied ac, current flows through C2 and C3 charging them. Capacitor C2 charges to approximately peak line voltage (about 165 volts) while C3 charges to a lower potential (about 135 volts) due to the voltage drop in the filter choke.

Three different output voltages are obtained. R2 connects to the system at the highest voltage point, but due to the drain on the filter capacitor C2, and the voltage drop in R2, the operating output voltage is approximately 110 volts.

LOW-VOLTAGE POWER SUPPLY

Selenium Rectifier Power Supplies (contd.)

The Fusible Resistor

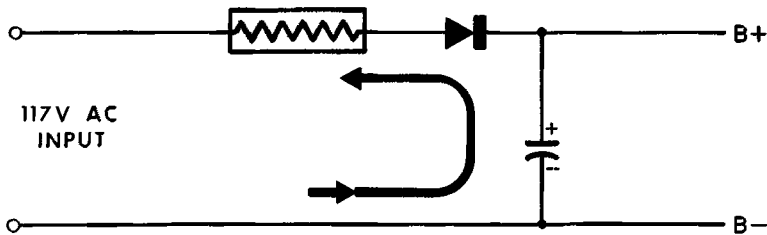

limits charging current through rectifier

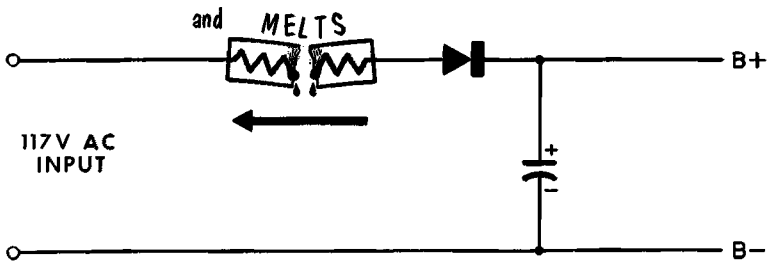

when current through rectifier is excessive

A selenium rectifier must always be protected from surge overload by a series resistor of low value such as R1. An overload may come about as follows: suppose that the ac cycle is approaching its peak at the instant that the on-off switch is turned on, and suppose further, that its polarity is such as to permit current to flow in the forward direction through the selenium rectifier, thus causing C2 to charge. Without R1 in the circuit the resistance in series with C2 is very low so that this capacitor charges *almost instantaneously*. To bring a capacitor of this size—200 μ f—up to full charge in a tiny fraction of a second requires an extremely heavy current, all of which flows through the selenium rectifier. A current of this magnitude flowing through the selenium rectifier even for a short time is very likely to destroy it. The introduction of R1 into the circuit limits the current to a safe value by increasing the time required to charge the capacitor. Modern receivers utilize *fusible resistors*, thus including two protective measures in one component.

LOW-VOLTAGE POWER SUPPLY

Selenium Rectifier Power Supplies (contd.)

While television circuitry can be designed around a wide range of B+ voltages, there are limitations to picture quality if the circuits must work from relatively low voltages. It has thus become necessary in many receivers for the circuit designer to make use of a voltage doubler when slightly higher B+ voltages are wanted. A frequently used circuit is shown in the diagram.

We can see how this circuit operates by assuming that line voltage E is applied to the circuit with point X being negative with respect to point Y. This would cause current to flow through the switch, resistor $R1$, capacitor $C1$, and selenium rectifier $SR1$, back to point Y. In the process, capacitor $C1$ would charge approximately to the value of E , as shown. Thus point A on the diagram would be at E volts with respect to point X. On the next half cycle point X would be E volts positive with respect to point Y, or ground. Thus, since point X is E volts positive with respect to ground, and point A is E volts positive with respect to point X, then point A is $2E$ volts positive with respect to point Y or ground. It is at this time that capacitor $C2$ can charge up to the full value of point A through selenium rectifier $SR2$. With this voltage doubler arrangement, then, the difference in potential between B+ and B- is equal to approximately twice that of the input line voltage.

A VOLTAGE DOUBLER SELENIUM RECTIFIER POWER SUPPLY

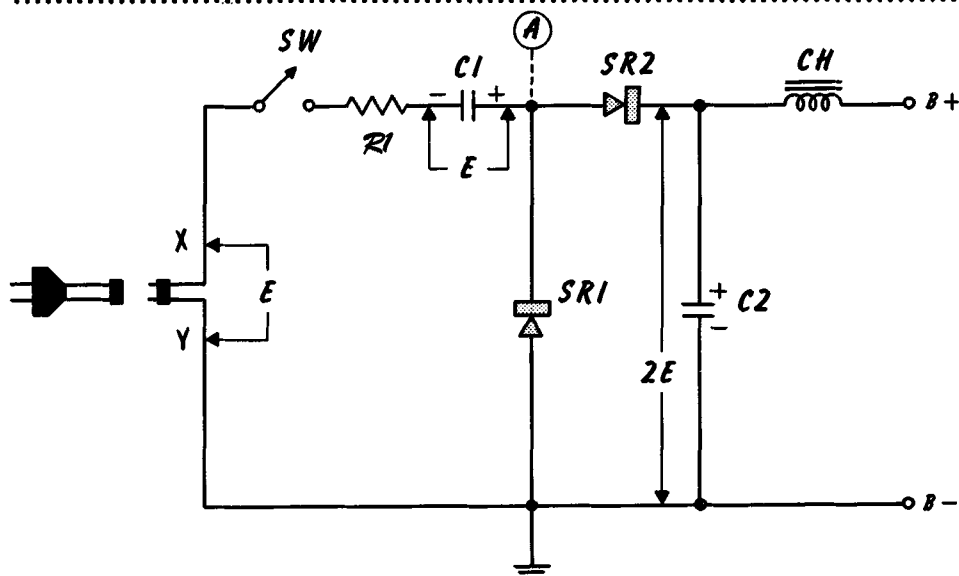

LOW-VOLTAGE POWER SUPPLY

Selenium Rectifier Power Supplies (contd.)

How a Cascade Type of

HALF-WAVE VOLTAGE DOUBLER works

FIRST STEP:

Polarity of AC is represented by battery; C1 charges through SR1.

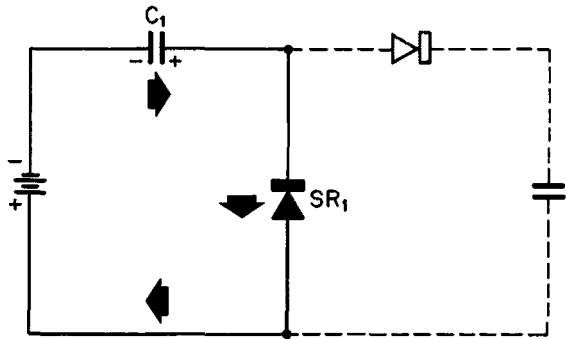

SECOND STEP:

A-C polarity reverses. C1 charge now in series with applied AC so that double the line voltage is applied to C2 causing it to charge to $2E$ ($E + E = 2E$).

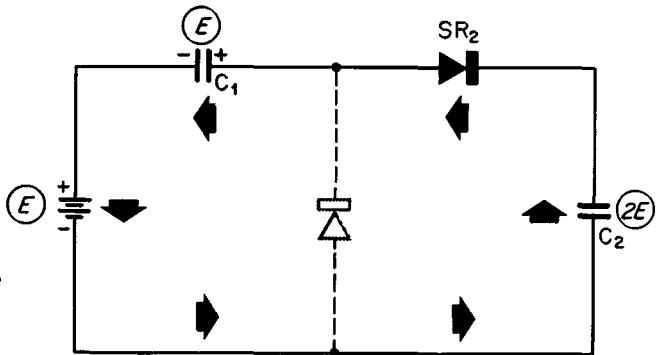

We can start the explanation of this circuit by assuming that the applied ac has just taken on a polarity which makes SR1 conduct, causing C1 to charge almost to peak line voltage just as it does in the basic half-wave system. When the polarity of the line reverses, SR1 stops conducting, and C1 attempts to discharge. It cannot discharge through SR1 because this rectifier presents a high resistance to this direction of current flow. But it can discharge in series with the source, thereby applying *twice the peak line voltage* to C2 through SR2.

This is a half-wave voltage doubler power supply system. It has the great advantage of allowing one side of the line to act as a common ground for both the input and output circuits.

LOW-VOLTAGE POWER SUPPLY

Selenium Rectifier Power Supplies (contd.)

Two selenium units may also be connected in a full-wave voltage doubler circuit like this:

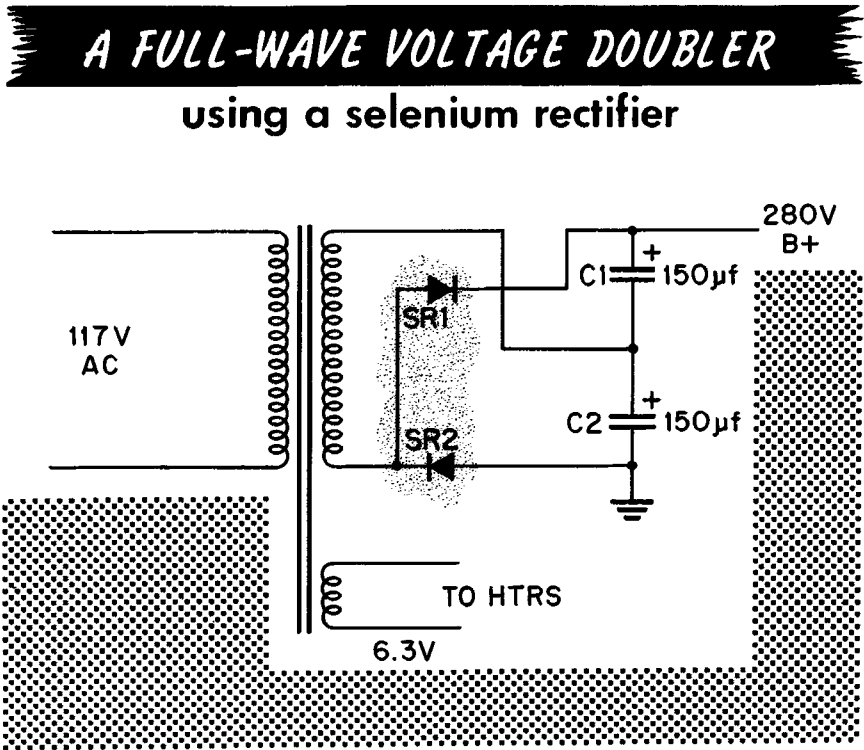

Here again each rectifier conducts on an alternate half-cycle of the input ac. When SR1 conducts, C1 becomes charged to a figure approximating peak line voltage. On the next half-cycle, while C1 is holding the charge it just received, SR2 conducts charging C2 nearly to peak line voltage. The two capacitors, effectively connected in series across the output line, add their voltages to supply the load with a potential which approaches twice the peak line voltage (2E). The ripple frequency of this power supply is 120 cycles (if the input ac frequency is 60 cycles per second as shown) since each rectifier supplies energy to each capacitor on every half-cycle. Full-wave systems are not as popular as half-wave voltage doublers because it is not possible to have a single common ground connection between output and input circuits. For this reason, it is sometimes difficult to eliminate hum voltages which may cause annoying hum bars in the television picture. This circuit can be used with one side grounded when connected through a power transformer.

LOW-VOLTAGE POWER SUPPLY

Parallel Heater Circuits

When a television receiver has a power transformer, the tube heaters are almost invariably connected in parallel since this method of connection is the simplest. The addition of a heater winding of adequate current capacity does not significantly increase the price of the power transformer. In some receivers, two heater windings are provided to distribute the heater load where the receiver has many tubes, and to isolate circuits. In most of the recent receivers of the straight ac type, a single heater winding is used to supply all the tube heaters including the picture tube and damper. The high-voltage rectifier is the only exception; you will recall that it derives its filament power from one or two turns on the flyback transformer. Here is a modern parallel heater string:

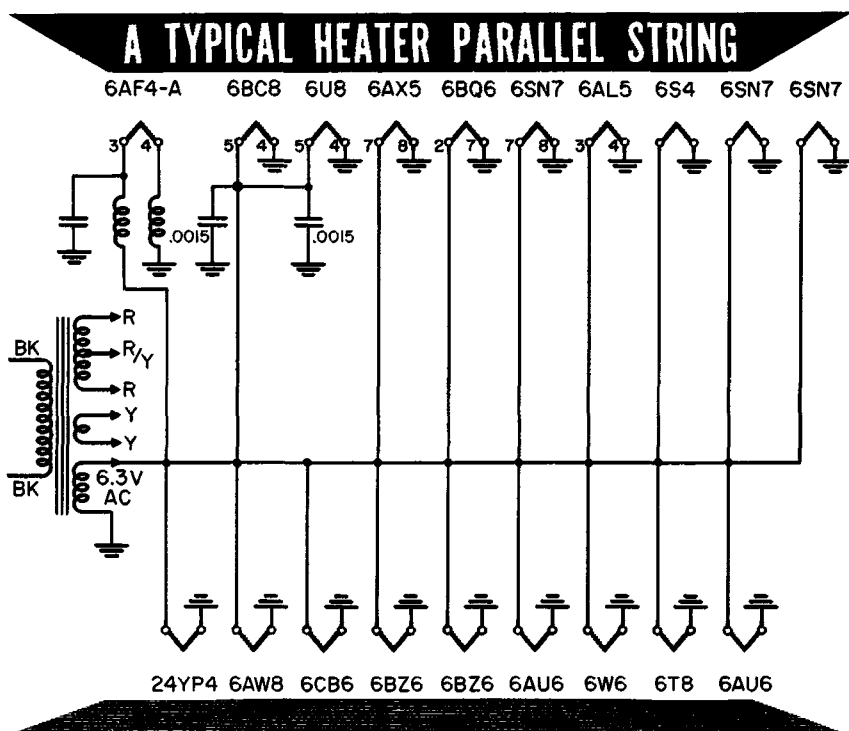

Many types of variations of the basic parallel heater system have been used, but in every case the equivalent 60-cycle circuit can be reduced to a simple parallel arrangement. As the diagram shows, wherever there is danger of feedback or interaction between high-gain tubes via the filament circuit, small isolation chokes and bypass capacitors are employed. These have no effect whatsoever on the 60-cycle operation but do prevent undesirable r-f voltages from being transferred from tube to tube.

LOW-VOLTAGE POWER SUPPLY

Series Heater Strings

The heater-voltage problem imposed by the absence of a power transformer in most modern receivers is easily solved by connecting the heaters in series strings. Prior to the introduction of new tube types expressly designed for series connection, manufacturers who wished to use series heaters were forced to make compensations for the different requirements of the then available types.

Since the current in a series circuit is everywhere the same, the only tubes that can be wired in straightforward series connection are those having *identical heater current ratings*. Study this series string:

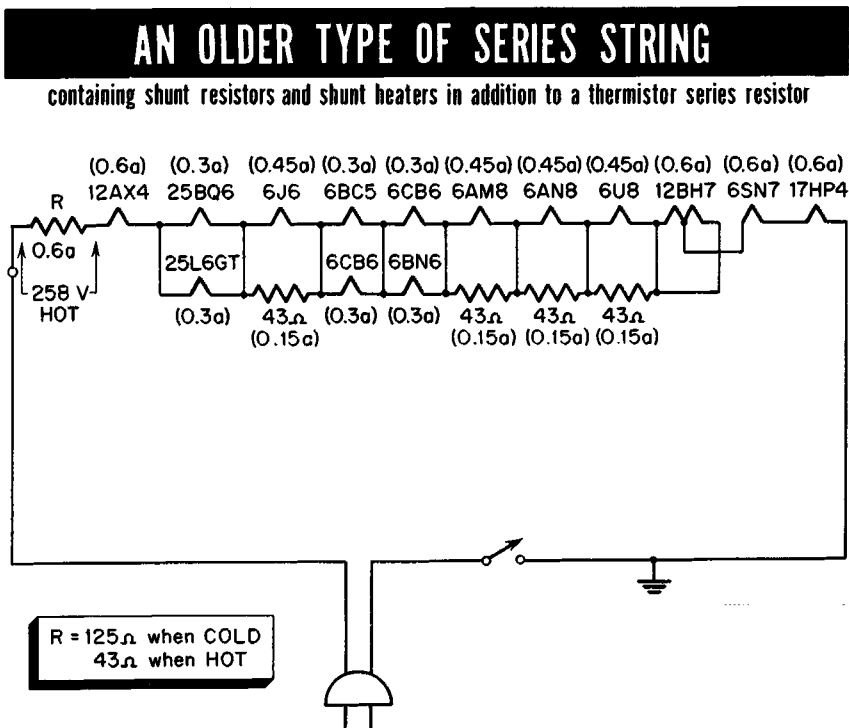

The basic series current is 0.6 ampere. In every case, where the resistance of the tube heater is not designed to pass this current at the rated voltage of the heater, either a shunt resistor takes up a part of the load or another tube heater is used for this purpose. The 6AM8, 6AN8, and 6U8 heaters, for instance, are designed to operate at 0.45 ampere rather than 0.6; a 43-ohm shunt resistor passes the other 0.15 ampere needed to keep the total string current 0.6 ampere. On the other hand, the 6CB6, 6BC5, and 6BN6 are all 0.3-ampere tubes so that they may be paired in parallel to permit 0.6 ampere to flow through the joint branches.

LOW-VOLTAGE POWER SUPPLY

Series Heater Strings (contd.)

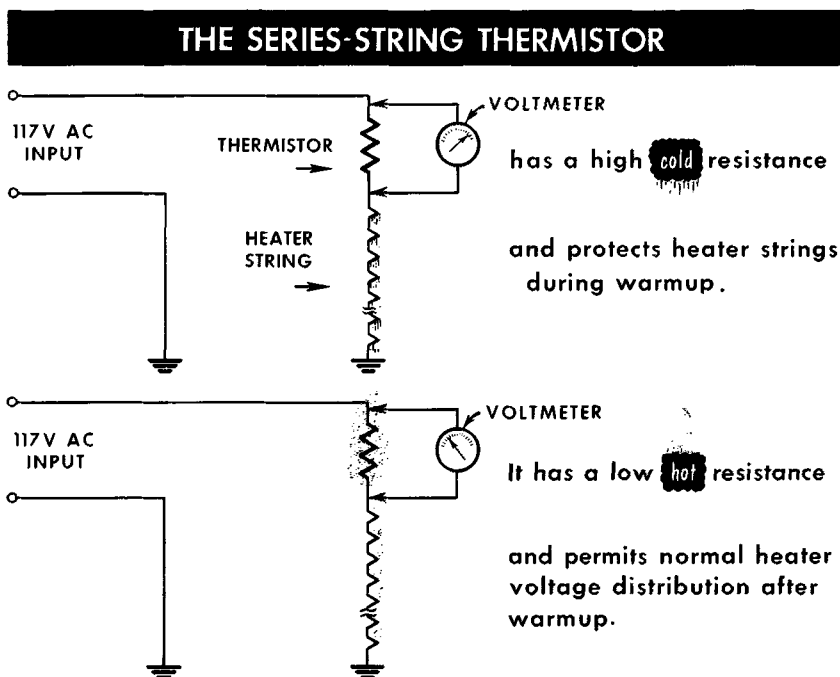

Resistor R is a real tube saver. The metals used in making tube heaters have *positive temperature coefficients*. That is, they have lower resistance when cold than when hot. Thus, even though the "hot-resistance" of all the tube combinations add up to the proper value to maintain the total series current at 0.6 ampere this overall resistance is *much lower when the set is first turned on ("cold")*. This situation leads to excessively large surge currents through the heaters when the tubes are cold, a condition which measurably shortens their lives. Resistor R, known as a *thermistor*, has a compensating *negative temperature coefficient*, or a resistance that is much higher when cold than when hot (125 ohms cold, 43 ohms hot). Hence, as the series string heats up, the tube heaters increase in resistance while the thermistor decreases at approximately the same rate. This keeps the current in the circuit at or about 0.6 ampere at all times.

Modern series strings utilize the so-called "600" tube series. The tubes in this group are intended for operation at various heater voltages, as indicated by the first number or numbers of the type designation. But *all of them* are designed for 0.6 ampere heater current.

In checking any series heater string, two essential facts must be determined:

- (1) is every element of the string intended for the same current drain? and,
- (2) do the specified component voltages total the applied voltage?

LOW-VOLTAGE POWER SUPPLY

Series Heater Strings (contd.)

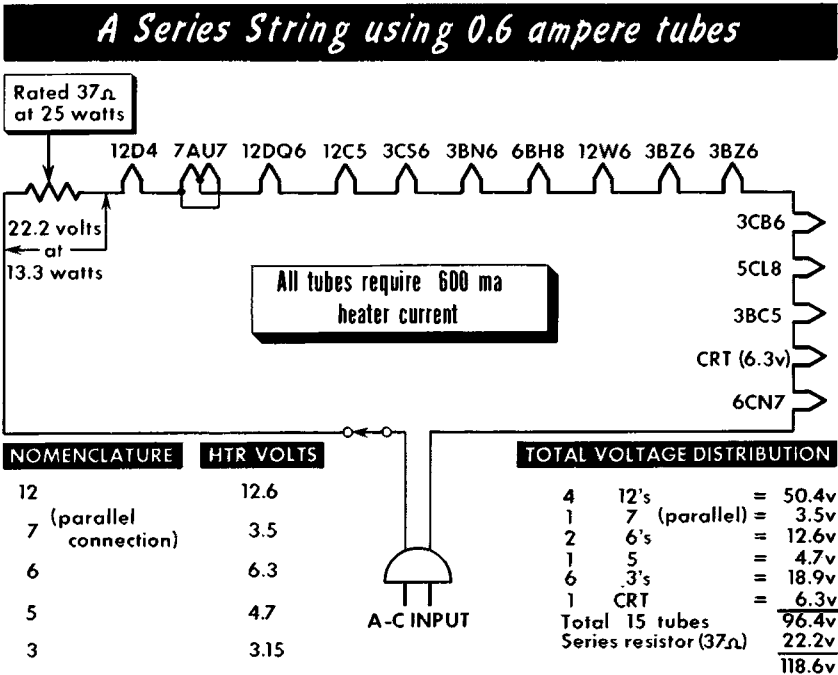

The method whereby these questions are approached is clearly shown in the legend that accompanies this diagram of the 0.6-ampere heater string.

All tubes used in this string are rated at 0.6 ampere heater current. Since these are not shunt resistors or paralleled heaters, question (1) is satisfactorily answered. Using the nominal voltage ratings as given by the tube manufacturer for each of the tubes according to tube type prefix number (e.g., 12D4 = 12.6 volts, 3BZ6 = 3.15 volts, 5CL8 = 5.7 volts, etc.), all the voltage drops are added. In this example, the voltage distribution for the tube heaters comes to 96.4 volts. Hence, a series dropping resistor of 37 ohms is employed. The voltage drop across this unit is 22.2 volts which, added to 96.4 volts, totals 118.6 volts. This figure is well within the nominal line voltage range of 117 volts as used in the United States. As a last check, we see that a 15-watt series resistor has been chosen. Since the current is 0.6 ampere and the voltage drop is 22.2 volts, the anticipated dissipation is: $P = EI = 22.2 \times 0.6 = 13.3$ watts. Thus, a 25-watt resistor provides a safety factor of almost 100% in normal operation.

There is still another heater trend in evidence: tube manufacturers have introduced a line of 450-ma heater tubes such as the 8AW8-A, the 8CG7, and the 8CM7. These would be used in circuits similar in design to the one just described.

REVIEW

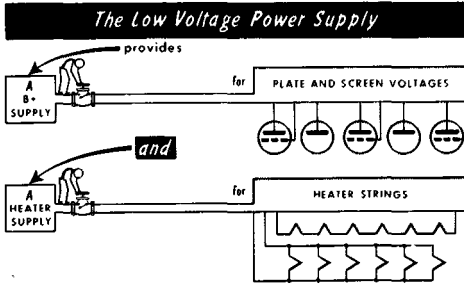

2. **Basic Vacuum Tube Power Supply.** This power supply is essentially the same as any transformer type of supply used for radio receivers. It features an additional bleeder system consisting of resistors R1, R2, and R3. Since the top of R3 is grounded, the low end becomes a tap for negative bias.

3. **Selenium Rectifier Power Supplies.** The selenium rectifier conducts in the forward direction but presents a high resistance to current attempting to flow in the opposite direction. Three different d-c output voltages can be obtained: 110 volts for the plates of the audio output tube, 115 volts for all video and audio tubes except the vertical and horizontal output, and 128 volts d-c for the vertical and horizontal output tubes.

A VOLTAGE DOUBLER SELENIUM RECTIFIER POWER SUPPLY

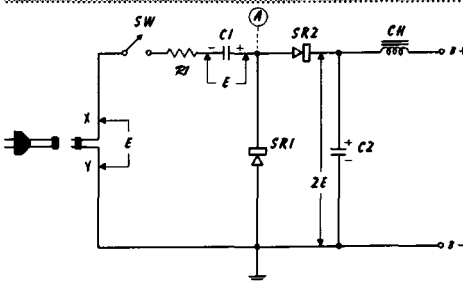

1. **Power: Past, Present and Future.** The current practice for the overwhelming majority of TV receivers is to use two power supplies—one to provide low-voltage d-c and a-c for tube elements, and the other to produce very high voltages for the second anode of the picture tube.

A Complete Low-voltage Power Supply for a TELEVISION RECEIVER

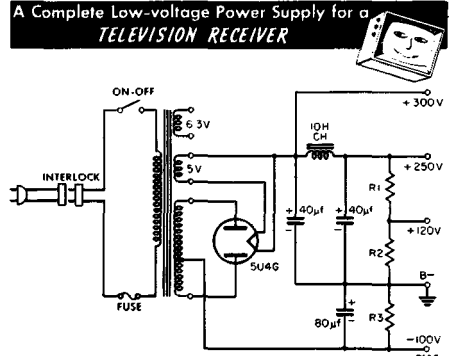

A Basic Half-wave Selenium Rectifier Power Supply

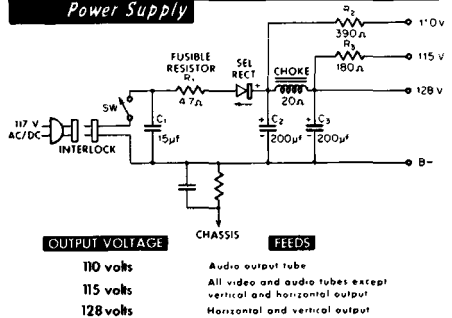

4. **Voltage Doubler Circuit.** Circuit designers make use of a voltage doubler circuit when slightly higher B+ voltages are needed. With the voltage doubler, the difference potential between B+ and B- is approximately twice that of the input line voltage.

CLOSED CIRCUIT TELEVISION

Closed Circuit Television: What It Is

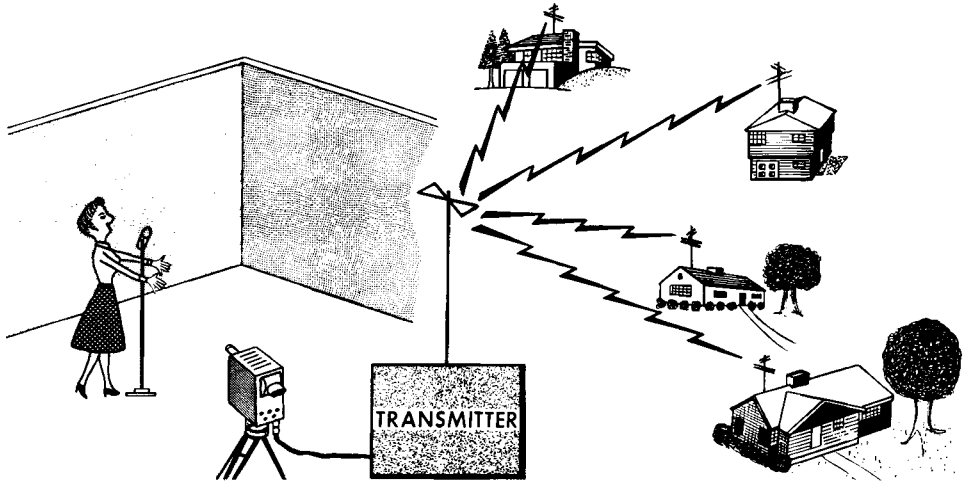

Basic TV Arrangement

as compared to

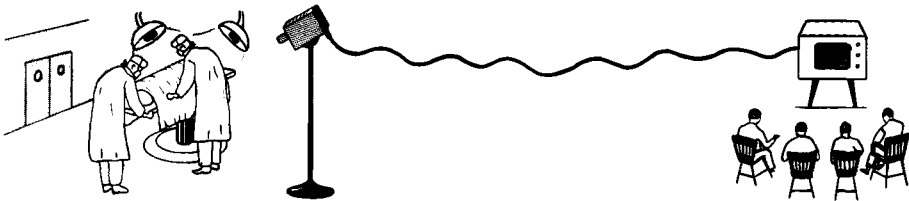

CLOSED CIRCUIT TV

Closed circuit television differs from standard television broadcasting in that the closed circuit system makes it possible to transmit picture and sound to a preselected audience. A singer on the stage of popular commercial television broadcasting stations may be viewed by millions of people simultaneously. Who these people are, where they are located, what kind of television receivers they have, and the quality of their reception are relatively unknown quantities in normal television broadcasting. The director of a closed circuit telecast, however, not only knows all these things but also has them under his control every moment of the program. His audience may be limited to a single viewer at a single television receiver, or expanded to thousands of people watching a dozen or more screens.

CLOSED CIRCUIT TELEVISION

Closed Circuit Television: What It Is (contd.)

Closed circuit television is a wired system in which either one of two general conveyance methods may be used. In the inexpensive installations used for small manufacturing plants in which a group of apprentices may watch a delicate mechanical operation at a distance from the scene, for department store floor advertising, or for similar small-audience display, the signal may be carried from camera to viewer by video voltages only. More elaborate systems are best handled by modulated r-f carrier conveyance. In this case, the video signal is used to modulate a radio-frequency carrier as in commercial telecasting, but the signal is carried to the receiver by wires so that its route and destination may be fully controlled. The economy and simplicity of the video-conveyance arrangement immediately recommends it for small operations of the one-shot type, for remote monitoring, and for communication to small groups. It is relatively easy to install and maintain. In fact, its cost may be brought down to a figure low enough to entice merchandisers to use it for stunt advertising.

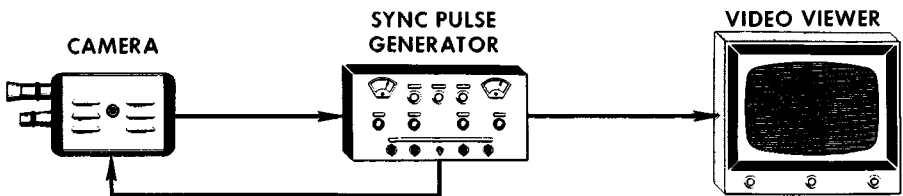

A wired VIDEO-CONVEYANCE CLOSED CIRCUIT TV SYSTEM

A wired R-F CARRIER CONVEYANCE CLOSED CIRCUIT TV SYSTEM

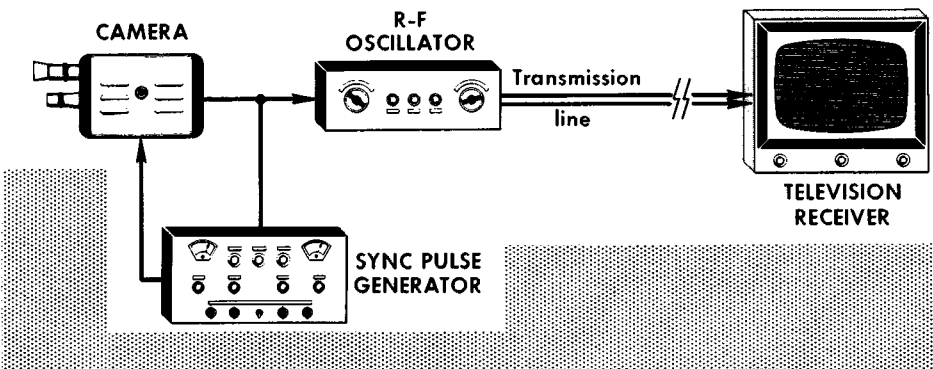

CLOSED CIRCUIT TELEVISION

Closed Circuit Television: What It Is (contd.)

In general, the television camera used in a system of this type is small and portable, as is the sync pulse generator. The viewer may be a standard television receiver that has been modified to accept a video signal directly. It need not have an r-f tuner, i-f amplifiers, or a detector, as only the video amplifiers, the low-voltage power supply, the picture tube, and the picture tube accessories are required.

The r-f carrier-conveyance method has several important advantages. An *unmodified* television receiver is used as the viewer so that the signal may be fed directly to its antenna terminals. Transmission frequency may be any unused commercial channel. In this way, the television receiver may be used for both broadcast reception and closed circuit purposes. An r-f distribution arrangement also has the distinct advantage that it permits the user to operate several cameras at the same time with an equal number of receivers tuned to preselected channels. A block diagram of a multiple system of this kind may be drawn like this:

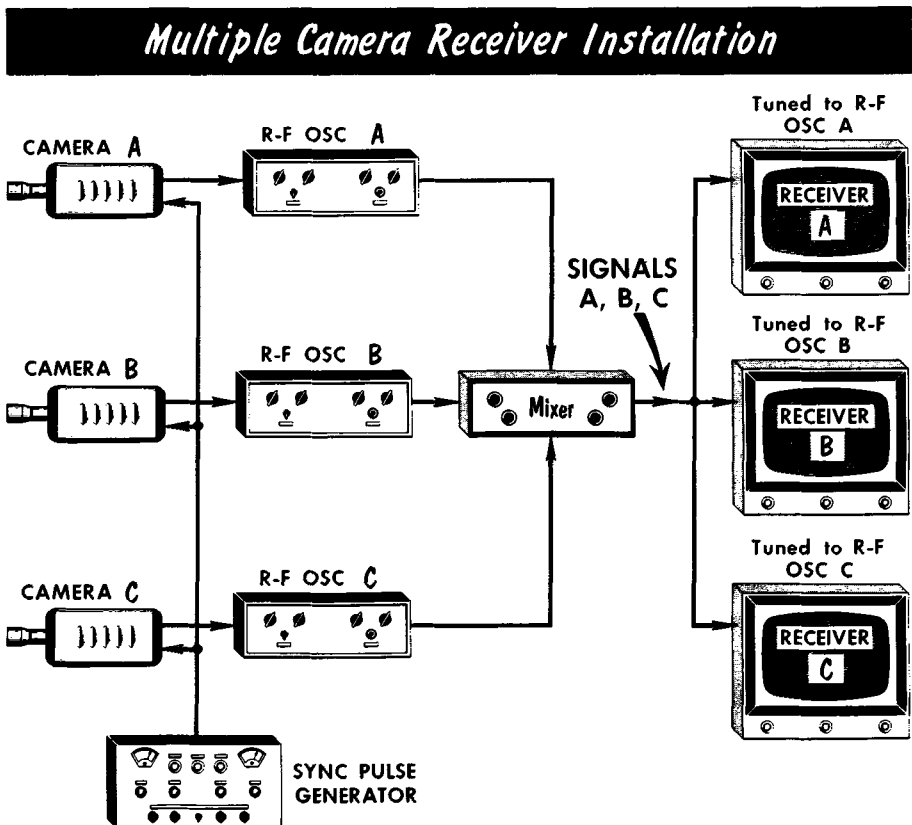

CLOSED CIRCUIT TELEVISION

Scanning Standards

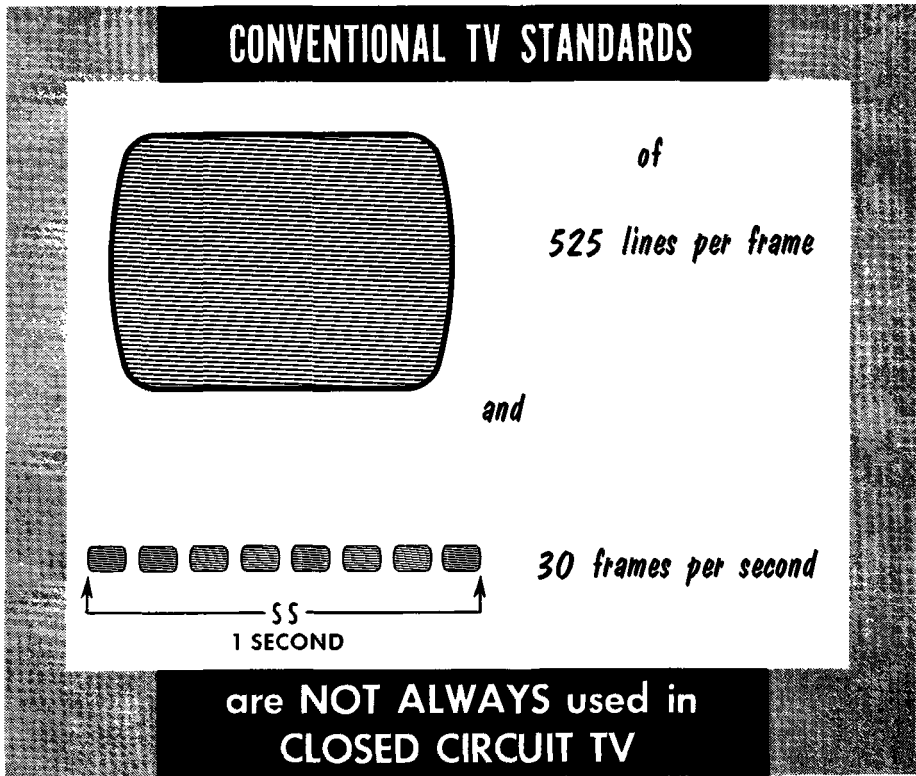

The television broadcast system in the United States, as we have studied, is based upon a scanning standard of 525 lines per frame, 30 frames per second, each frame having two fields interlaced with each other. To generate 525 lines per frame at a frame frequency of 30 per second, the pulse that initiates each scanning line must have a frequency of repetition of 525×30 or 15,750 cycles per second. This is the relationship that connects scanning standards with the frequency of the synchronization pulses.

It is possible to cut equipment costs by lowering the scanning standards. Although procedures of this kind have been attempted, most closed circuit television manufacturers and users are aware of the advantages inherent in the broadcast standards. Aside from the convenience of using standard television sets as viewers, adhering to broadcast scanning conventions makes possible the use of common equipment and components, and enhances the value of the viewer since it may be used for commercial broadcasts as well as closed-circuit display.

Nevertheless, some systems in current use have altered the scanning standards to simplify the equipment and reduce the initial cost of the installation.

CLOSED CIRCUIT TELEVISION

Random Interlace

One change is that of random interlace. This modification is specifically intended to simplify the problem of synchronizing the transmitter and the receiver or industrial monitor. In the normal composite television signal used in broadcasting we find blanking pulses, horizontal synchronizing pulses, vertical synchronizing pulses and equalizing pulses. The generation and timing of this combination of signals is a costly and difficult procedure but is essential for the reception of stable pictures under even adverse conditions. The same precision is not required for many closed circuit television applications. In the random interlace method, only two pulses accompany the video information: horizontal and vertical blanking pulses. These have sufficient amplitude to serve as the horizontal and vertical sync pulses as well.

The major difference between random interlace and commercial broadcast interlacing is that in the random system it is possible for lines of the second field to fall on top of lines from the preceding field. Both systems use $262\frac{1}{2}$ lines per field and a field frequency of 60 per second. In the less expensive arrangement, the laws of chance determine the quality of the interlacing. Those who have viewed random interlacing are aware of the inferiority of the scanning precision, yet the loss of detail and flicker are not bad enough to warrant more costly installations.

SIMPLIFIED WAVEFORM FOR TV SIGNAL

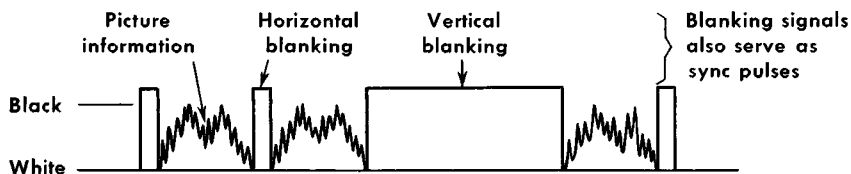
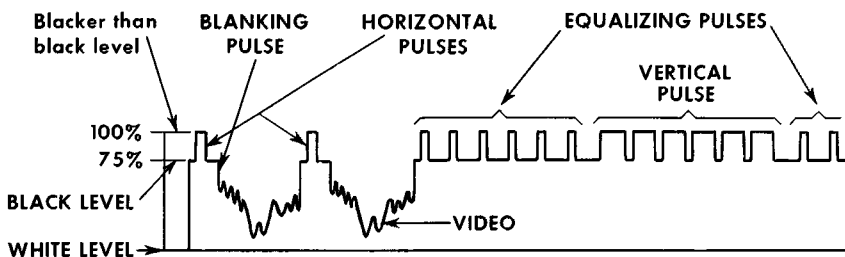

VIDEO AND BLANKING SIGNALS IN A RANDOM INTERLACE INDUSTRIAL SYSTEM

CLOSED CIRCUIT TELEVISION

Non-Interlaced Scanning

COMMERCIAL INTERLACE

Note even spacing between lines of alternate fields.

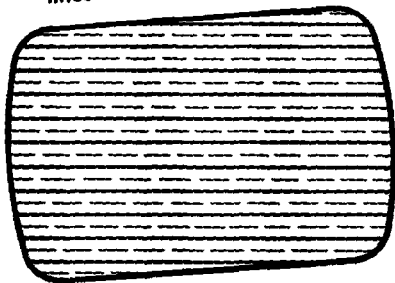

FIELD 1 ——— FIELD 2 - - - -

RANDOM INTERLACE

Note random spacing between lines of alternate fields.

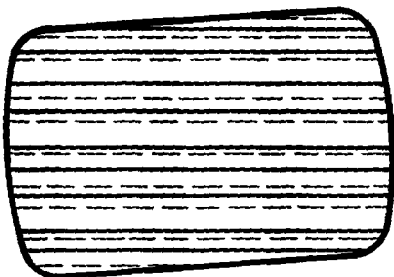

FIELD 1 ——— FIELD 2 - - - -

NON-INTERLACE

Even spacing between scanned lines, but only one field per frame.

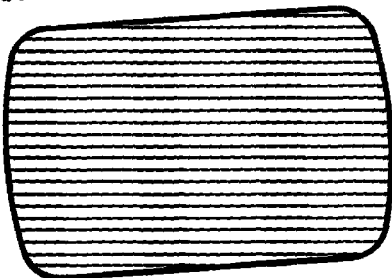

ONE FIELD PER FRAME

It will be recalled that the process of interlacing is introduced for the purpose of reducing flicker. If 30 fields per second are used rather than 60 fields per second, as with our present commercial system, the normal eye can perceive the switch from field to field as an annoying flicker. This is especially noticeable when the picture brightness is high. The use of non-interlaced scanning does not, however, reduce the resolution capability of the system. Resolution depends upon receiver or monitor bandpass, and upon the total number of lines used per field or frame.

Since non-interlaced scanning requires fewer tubes and much more economical camera and receiver design, this system is often favored under low-brightness conditions.

Slow scanning. Further economies in camera and receiving equipment can be realized by using a slow scanning process for transmitting pictures of stationary or slow-moving objects. One such system utilizes a 400-line picture reproduced at a 2- to 7-second frame rate. Obviously, a slow repetition rate like this requires a picture tube having long-persistence or storage characteristics. The major advantage of slow-scan systems is the reduced requirement with respect to bandwidth. When pictures are to be transmitted over television lines having a bandwidth of only 7 to 8 kc instead of the commercial telecasting bandwidth of 3 to 6 mc, a slow-scan system is required.

CLOSED CIRCUIT TELEVISION

High-Resolution Scanning

There are a substantial number of closed circuit television applications in which better resolution than that afforded by the normal 525-line system is needed. Among these applications are high-quality film recording and the viewing of X-ray pictures at remote points. To obtain resolution of the required order, it is necessary to increase the bandwidth of the connecting cables to 8 mc or better, and to use a greater number of scanning lines.

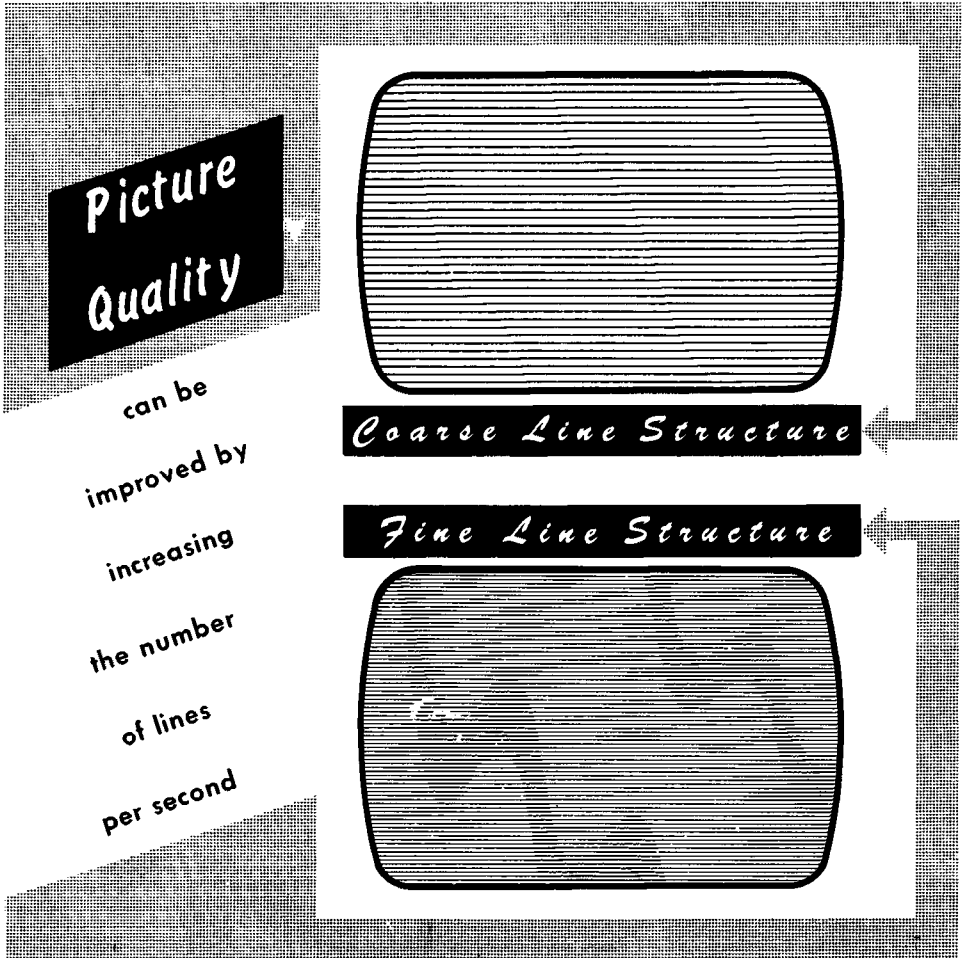

One such high-resolution system employs 1000 lines per frame, 24 frames per second, and no interlace. Another is based upon 1029 lines per frame. The resolution and detail available in systems such as these closely approximates that of a fine movie.

CLOSED CIRCUIT TELEVISION

Spiral Scanning

Timing of the U.S. standard Television Signal

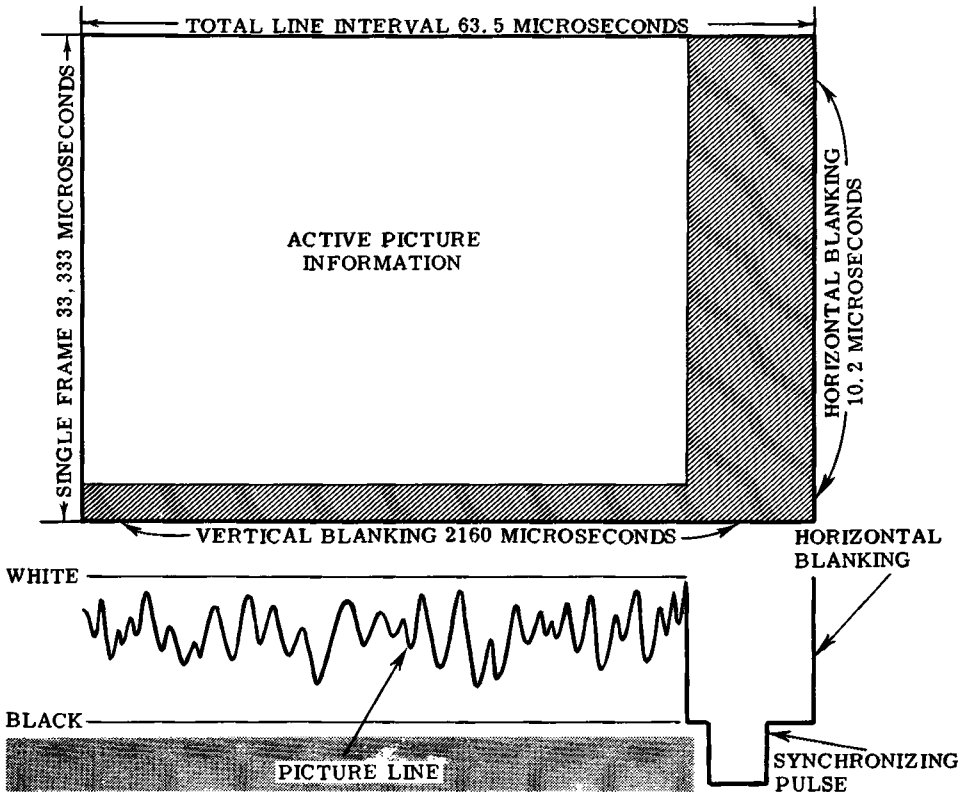

Horizontal linear scanning of the television subject as used in the United States has several disadvantages, not the least of which is the loss of usable picture area to horizontal and vertical blanking time. This inefficiency is very evident in this diagram of information and timing intervals.

It should be remembered that the principal reason for this loss of active-information picture time lies in the need for blanking out the electron spot at the end of every horizontal line and at the end of each scanned field.

The total loss of picture time is approximately 22%. This means that a 22% improvement in picture resolution could be obtained with the same standards of scanning, if blanking time could be reduced to zero. This is an obvious impossibility with horizontal scanning.

CLOSED CIRCUIT TELEVISION

Spiral Scanning (contd.)

In the spiral-scan system, however, a total blanking time loss of only 3% is considered feasible. This is a substantial improvement. The electron beam starts its scan from the center of the screen, spiralling outward in gradually increasing sweeps. The movement of the electron beam is controlled by a pair of sine-wave currents or voltages that grow in amplitude under the influence of a sawtooth wave properly applied to the sine-wave generator.

Normal Spiral Scan

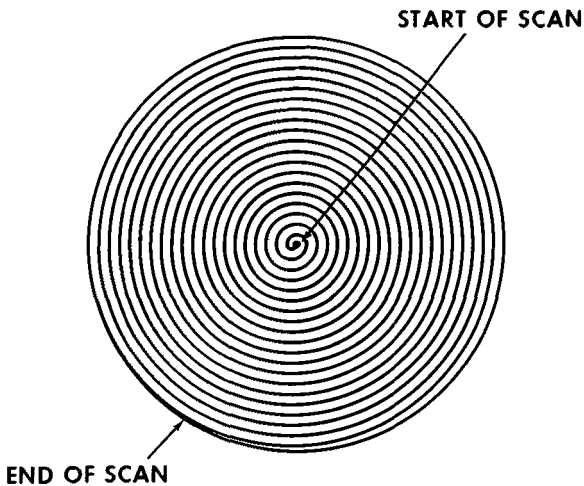

Two equal sine waves applied to the picture tube deflection system at a phase angle of exactly 90° will trace a perfect circle. If, while the circle is being traced, a sawtooth waveform causes the amplitudes of both sine waves to increase at the same pace, the spiral trace shown in this figure will result.

Each succeeding near-circle of the forming spiral is completed in exactly the same interval of time. This follows from the fact that the time required to complete one near-circular sweep depends only upon the frequency of the sine waves.

Each succeeding near-circle however, has a larger radius and hence a larger circumference than the one before. Thus, the electron spot must travel further on each revolution in the same period of time. If no correction were inserted, the outer portions of the spiral would become dimmer and dimmer as the dwell-time of the electron spot decreased.

Correction is quite simple, however. The same sawtooth voltage used for increasing the sine-wave sweep voltage (or current) amplitude, may also be applied as a positive voltage of increasing magnitude to the grid of the picture tube. By proper balancing, this voltage can be made to neutralize the brightness drop-off.

The important advantage of spiral scanning is the greatly increased efficiency—that is, increased information time and reduced blanking and retrace time. The spiral trace need be blanked out only once in each frame, as it returns from the outer curve of the spiral back to the center.

The percentages given above for spiral scanning apply only for a circular picture mask. The fraction lost increases with a 4:3 rectangular mask.

CLOSED CIRCUIT TELEVISION

Suitable Camera Tubes

The camera or pickup tube in a television system is the device which accepts an image of the scene to be televised from an optical system, and converts the image to electrical signals which carry the picture information. The *image orthicon*, certainly the most advanced type of tube made today, is used almost exclusively for broadcast purposes because of its superior sensitivity and reproduction quality. This tube has been thoroughly discussed in Volume 1 of this series, but certain electrical characteristics which have not been emphasized before—particularly as applied to closed circuit television—will be reviewed. The *vidicon* camera tube has also been described. This tiny pickup type will be contrasted with the image orthicon so that the reader may make comparisons. Finally, the *image dissector* tube, although not suitable for commercial telecasting, has been widely used in industrial television and deserves detailed description.



Royal Family of Closed Circuit TV

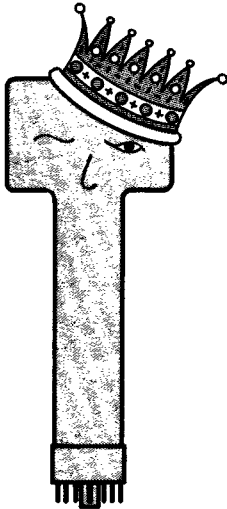

**IMAGE
ORTHICON**

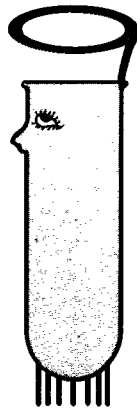

VIDICON

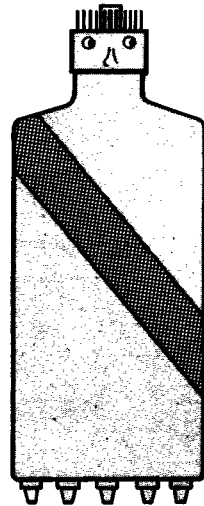

**IMAGE
DISSECTOR**

CLOSED CIRCUIT TELEVISION

The Image Orthicon

The reader will recall that the image orthicon is a pickup tube that utilizes the principle of photo-emission. Light falling on a photo-sensitive surface causes the emission of electrons. The emitted electrons are directed toward a target which is then scanned by an electron beam from the tube's electron gun. The beam that returns from the target varies in intensity in accordance with the charge pattern present on the target.

A typical modern image orthicon has these interesting electrical characteristics:

Resolution: When properly adjusted and aligned, a standard orthicon can resolve or discriminate between 600 lines at the center of the picture. This is high resolution, and is one of the characteristics that accounts for this tube's popularity with commercial television engineers.

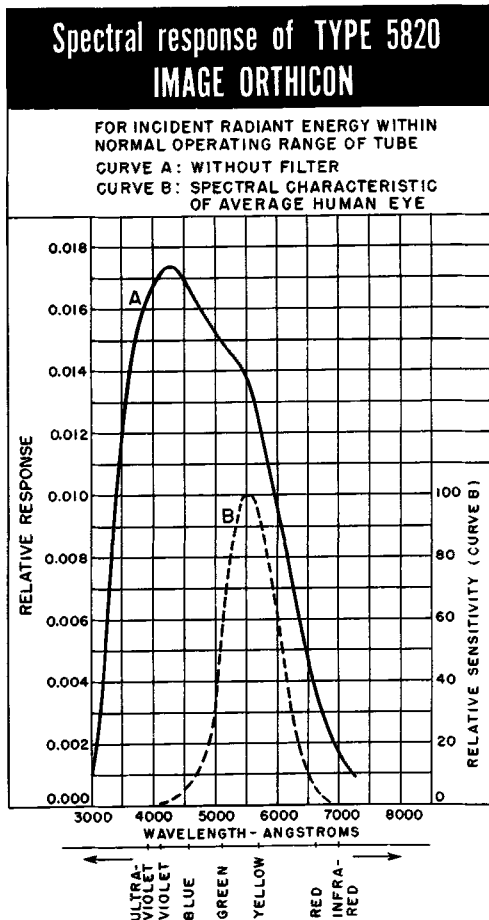

Sensitivity: The sensitivity of a pickup tube is a function of the amount of illumination required on its face for adequate picture reproduction. In normal use and without any special adjustments or tricks, the image orthicon will provide excellent results when the total scene illumination is only 15 foot-candles.

Color Response: An image orthicon is sensitive to the entire visible spectrum. It covers a range of light frequencies considerably in excess of the normal human eye.

Power Needs: The power supply requirements of a pickup tube are always important considerations in selecting one for industrial use. The image orthicon calls for 1500 volts for the multiplier section, —500 volts for the image section, 330 volts for the scanning system, and 6.3 volts for the heaters.

Cost: A new image orthicon costs in the vicinity of \$1200.

CLOSED CIRCUIT TELEVISION

The Vidicon

The Vidicon Tube and its Structure

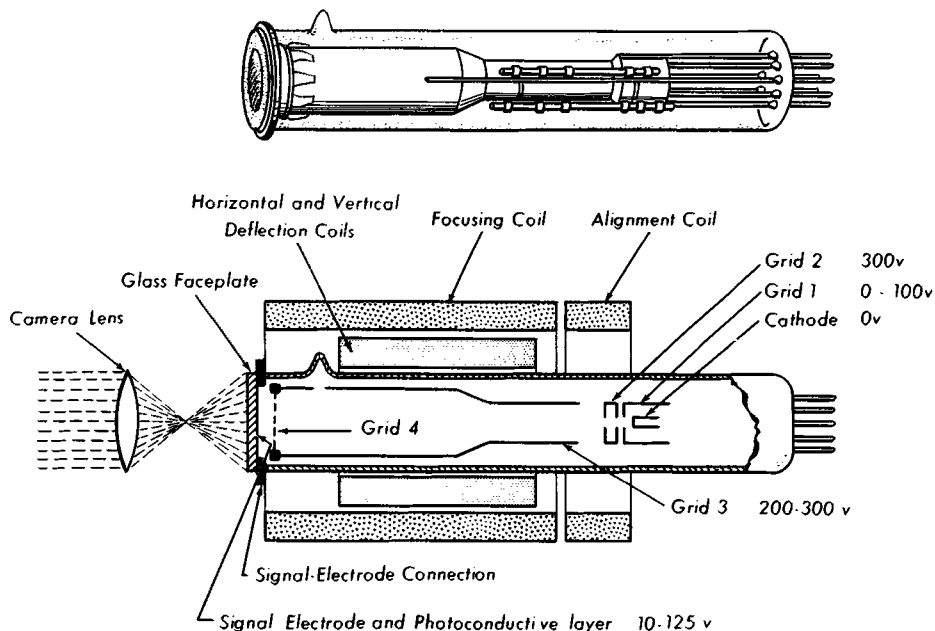

This pickup tube has found much favor in industrial and military television applications because of its small size. Despite miniaturization, the vidicon retains the properties of good resolution and satisfactory sensitivity. It is a much simpler device than the image orthicon as may be guessed from its schematic diagram.

It would be useful to review the vidicon's operation briefly. The screen on which the lens system casts an image is a transparent conducting plate on which a uniform layer of photoconductive material has been deposited. The electron beam for scanning is generated and shaped by a conventional electron gun and a set of auxiliary electrodes; deflection is accomplished by external coils.

The image is focused sharply on the faceplate. Each element of the photoconductive surface then becomes more or less conductive depending upon the intensity of the light reaching it. A constant positive voltage is applied to the faceplate. As an elemental area of photoconductive layer becomes reduced in resistance due to the light striking it, the opposite side—the side of the layer facing the electron gun—takes on an increased positive potential. When the scanning beam passes over these positively charged areas, it supplies electrons to the element, causing the charge to be neutralized.

CLOSED CIRCUIT TELEVISION

The Vidicon (contd.)

Thus the removal of electrons from the scanning beam in varying proportions, that is according to the amount of illumination on each element, produces a varying current which forms the video signal.

Compare the electrical characteristics of the vidicon with those of the image orthicon. While doing so, bear in mind that the orthicon is about 15 inches long and more than $3\frac{1}{2}$ inches in diameter at the faceplate. The vidicon is only 6 inches long, and about 1 inch in diameter at its widest point.

Resolution: Equal to the orthicon; about 600 lines at center of picture.

Sensitivity: For good reproduction of an average scene, an illumination of about 100 foot-candles is required. Thus, the vidicon is about one-seventh as sensitive as the orthicon. On the other hand, usable pictures for industrial purposes have been obtained with as little as 5 foot-candles of illumination. These would not be suitable for telecasting, but can serve definite purposes in some industrial applications.

Color Response: Somewhat more extended than the response of the normal human eye as shown in these curves.

Power Needs: The vidicon requires only 300 volts for its electrodes and external coils, -100 volts for the control grid, and 6.3 volts for the heaters.

Cost: Approximately \$225.

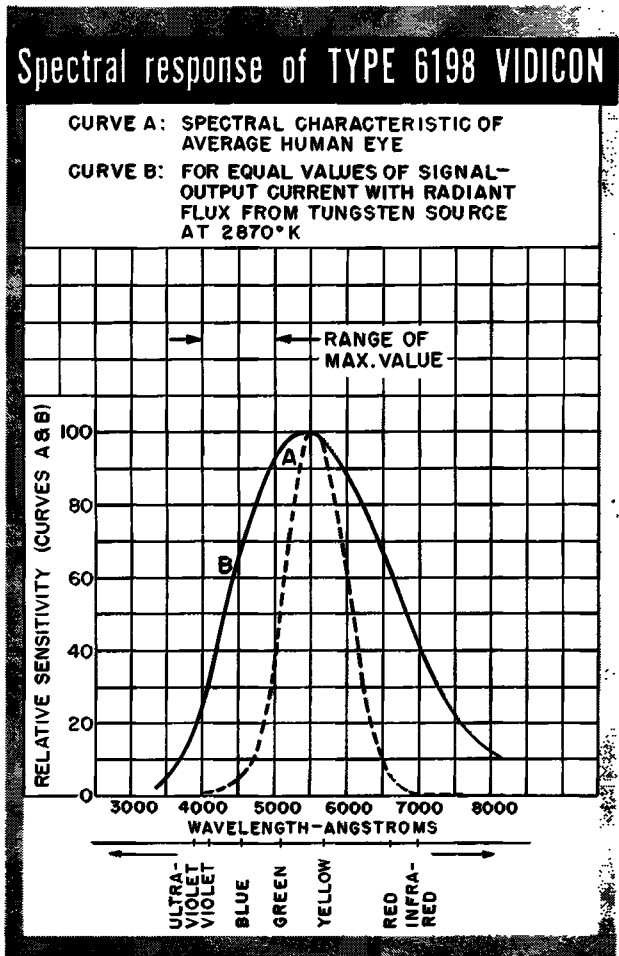

CLOSED CIRCUIT TELEVISION

The Image Dissector

The image dissector pickup tube differs from the orthicon and vidicon in that it is a *non-storage* type of tube. Both of the other, more sensitive types depend partially upon the fact that the light from the scene being televised acts continuously on the light-sensitive surface so that the resulting electrical charge continues to build up between fields. This action results in an improved sensitivity to low-level illumination and makes the

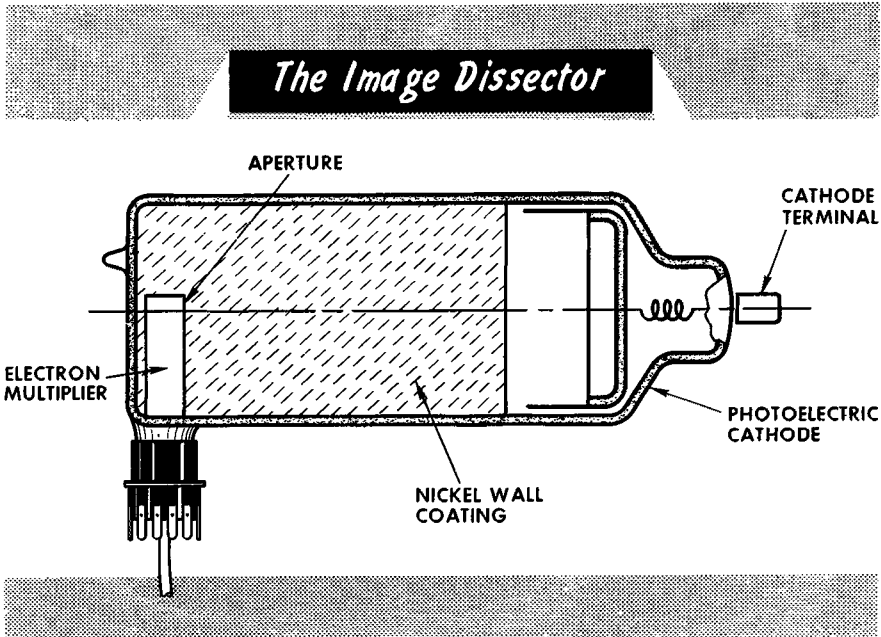

orthicon and vidicon more popular than the image dissector for general broadcast purposes.

Despite the lower sensitivity of the image dissector tube, it has nevertheless found much application in closed circuit television systems. One form of image dissector pickup tube may be illustrated as the diagram shows.

Light from the subject is sharply focused on the front of the photocathode. This element is of translucent material so that the light passes through from the screen to the photosensitive surface at the rear of the cathode. Electrons are emitted from the surface of the element into the tube cavity. Close to the photocathode are three accelerating rings which are positively charged. The charge distribution is such that the photoelectrons move in the direction of the anode in essentially parallel lines. The external focus coil is adjusted so that the image arrives at the anode in the form of electrons, the image area being very closely the same as the original light image on the photocathode.

CLOSED CIRCUIT TELEVISION

The Image Dissector (contd.)

To produce usable output, however, the arriving electrons must pass through a relatively small aperture. When they do so, they fall upon an 11-stage photomultiplier. The resulting video current is amplified a million times or more by this series of multiplier dynodes. The aperture is made sufficiently small so that only those electrons from a tiny part of the photocathode manage to pass through to the dynodes. Scanning is accomplished by sweeping the whole electron image horizontally and vertically across the aperture. As the image moves past the aperture, electrons representing the light intensity of each picture element at a given instant pass on to the dynode multiplier.

It should be observed that only those electrons emitted from the photocathode during a very small part of the picture time are collected by the multiplier stage. All the others emitted from remoter portions of the scene represent lost energy because the image dissector makes no provision for storage. Thus, this pickup device is comparatively insensitive.

It might be thought that increasing the aperture size might improve the sensitivity, as more electrons will pass through a larger opening resulting in a larger dynode current. This is true, but unfortunately any gain of sensitivity realized by increasing the aperture size also results in a loss of resolution. If the photomultiplier is fed an electron stream from a larger group of picture elements simultaneously—as would occur if the aperture were opened further—the resulting output current would contain an unresolved mixture of several picture element currents. This effect may be likened to scanning the orthicon target with a broad rather than a fine electron beam.

The aperture size varies from manufacturer to manufacturer. One industrial image dissector has an aperture of square shape measuring .03 inch on a side. This is the equivalent of about 300 picture lines.

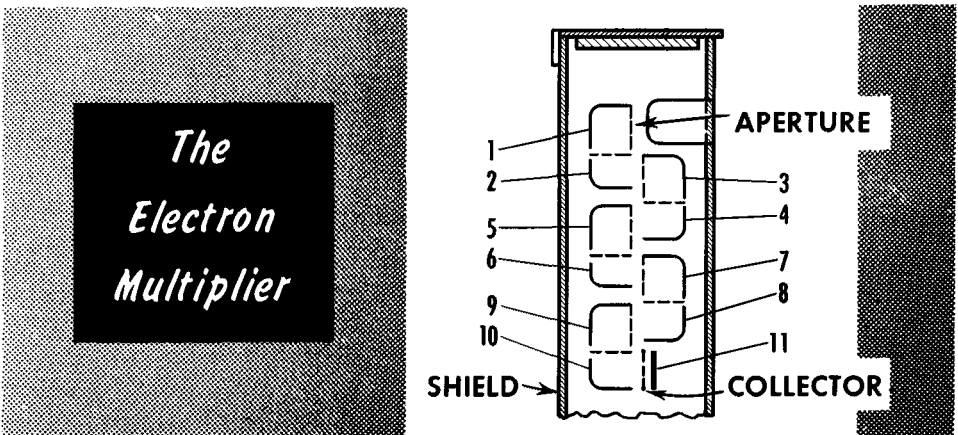

CLOSED CIRCUIT TELEVISION

The Image Dissector (contd.)

Comparative characteristics of the image dissector against other tubes are:

Resolution: In the order of 300 lines. Thus, the image orthicon and vidicon surpass the image dissector by at least a factor of 2.

Sensitivity: Approximately 300 foot-candles for a wide-open lens of commercial quality. Contrast this with the scene illumination required for an image orthicon—15 foot-candles.

Color Response: Two types of photocathode materials are available, neither of which has a response that approximates that of the human eye as in the case of the orthicon and vidicon. One of these materials peaks in the infrared region of the spectrum and the other in the ultraviolet region. As the curves show, the visible spectrum produces a response in both photocathodes, but the slopes of the curves are very different from the curve for the human eye.

Power Needs: About —2500 volts and less for the tube elements, normal B+ supply for the external coils.

Cost: Approximately \$600.

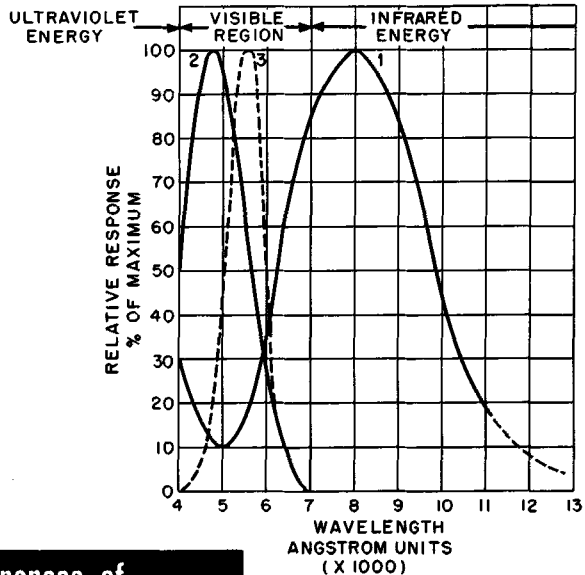

Spectral responses of
Image Dissector and Utilicon
photocathodes

1. SILVER-OXYGEN-CESIUM, S-1 (RED)
2. ANTIMONY-OXYGEN-CESIUM, S-4 (BLUE)
3. HUMAN EYE

CLOSED CIRCUIT TELEVISION

Special Display Tubes

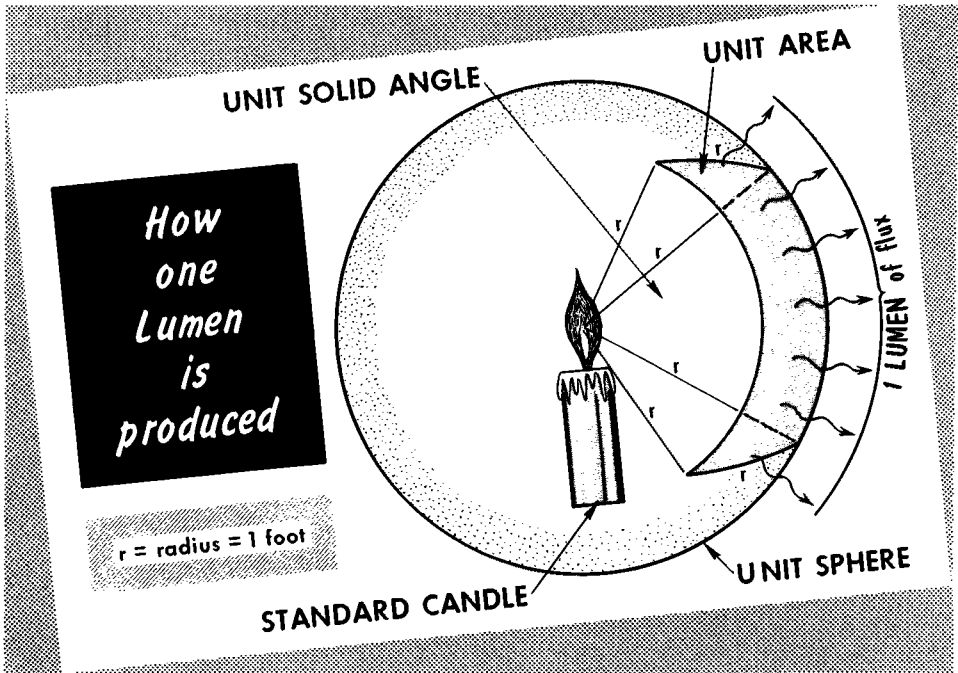

You are already familiar with standard picture tubes used for commercial television reception. Picture tubes in general—aside from their physical size and mechanical construction—have several important characteristics. Among these are normal highlight brightness, and persistence of fluorescence. For example, the familiar 21-inch rectangular picture tube operating with a second anode voltage in the order of 15 kv, has a highlight brightness of about 100 foot-lamberts. To give you an idea of the light-value of this brightness, let us investigate briefly the meaning of a foot-lambert. If a standard candle is placed in the center of a sphere having a radius of one foot, the light which falls upon one square foot of the inside surface of the sphere is called a *lumen*. A foot-lambert is defined as one lumen per square foot. Thus, if a square foot of illuminated surface has a brightness of one lumen, the illumination is said to be one foot-lambert. If, again, an area of half a square foot shines with a brightness of one lumen, then the intensity is said to be 2 foot-lamberts; or if the intensity of light coming from an area of 2 square feet is only one lumen, then the brightness is 0.5 foot-lambert.

The persistence of fluorescence of a 21-inch television tube using a standard P-4 phosphor is approximately .005 second. A short persistence time such as this is necessary for televising rapid motion to avoid after images superimposed on successive frames.

CLOSED CIRCUIT TELEVISION

Special Display Tubes (contd.)

In closed circuit television, it often is necessary to obtain higher brightness figures or longer persistence times. Special storage types of tubes have been developed for this purpose. Study this diagram.

This type of display tube has two electron guns: one is called the "writing gun" and the other the "reading gun". The writing gun emits a single beam of electrons which scans the storage grid in the conventional manner at the standard scanning rate. Instead of producing a picture on the phosphor, the video intelligence carried by the modulated writing beam is stored on the storage grid in the form of charge elements. The reading gun whose emission consists of a broad cone or "flood" of electrons may then be energized. As the flood of electrons passes the storage grid, the electron distribution pattern is altered in accord with the stored information and the reproduced picture appears on the phosphor screen. The picture may be highly intensified in brightness with a typical highlight value in the vicinity of 2000 foot-lamberts. In addition, stored information can be displayed for periods of time up to and exceeding a full minute after the scanning has stopped.

At the time of writing, display tubes for color television fall into two general groups: (a) dot-sequential type using a triple electron gun and a shadow mask as in conventional color television receivers; and (b) a conventional tube and rotating color drum patterned after the original CBS line-sequential system display method.

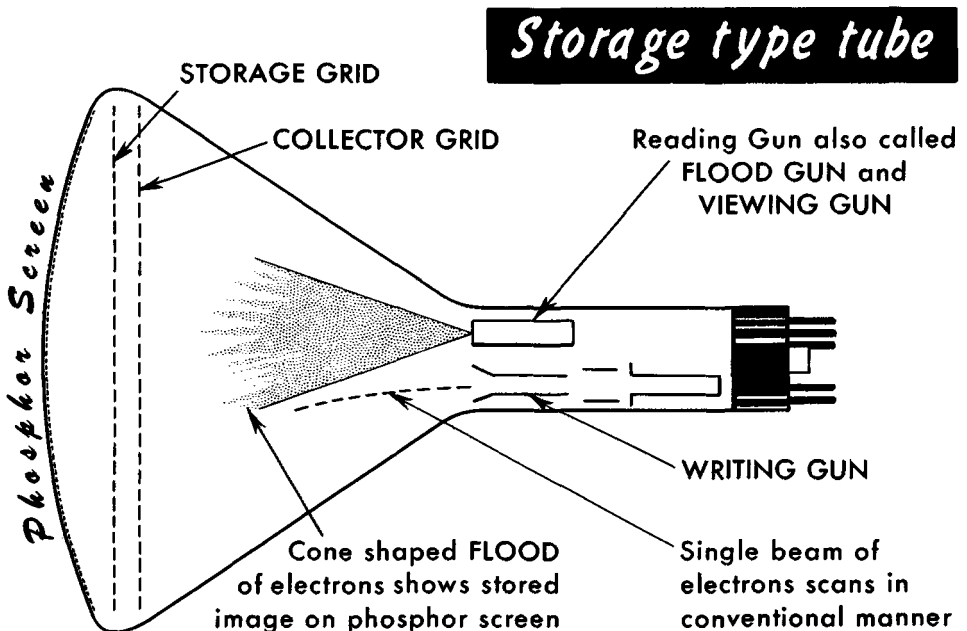

CLOSED CIRCUIT TELEVISION

Use of Film in Closed Circuit TV

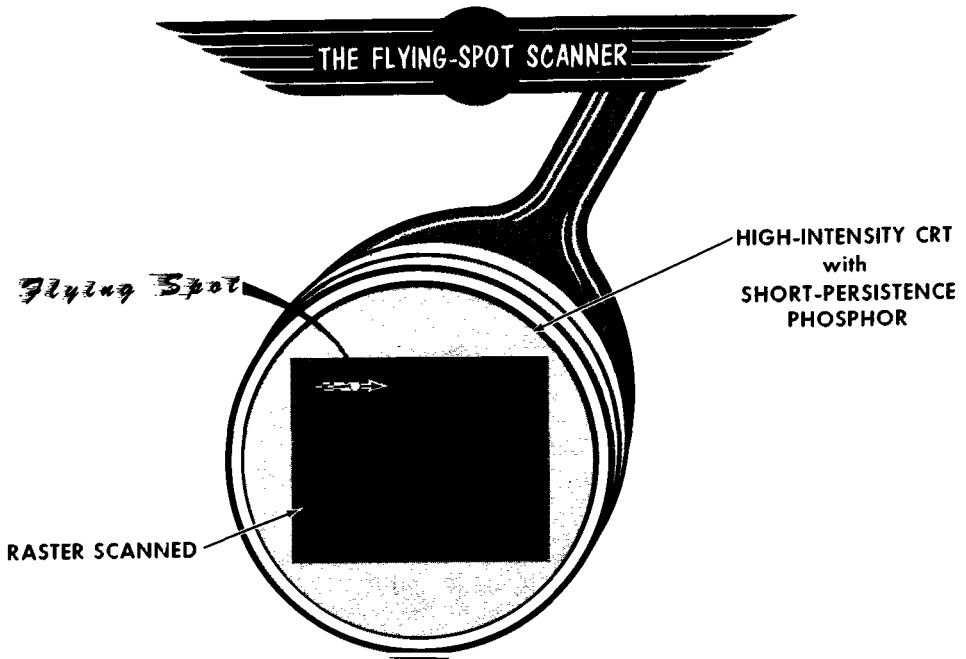

produces a beam of light that is focused on the scene to be reproduced

A large portion of current commercial telecasting consists of the transmission of motion pictures for commercials and entertainment. Although the use of pre-recorded movies, slides, diagrams, and other art work finds only occasional application in closed circuit television, this type of transmission, if made convenient and easy to use at a moment's notice by proper planning, offers a valuable supplement to normal "live" programs. Certainly, this is particularly true of sales meetings, on-the-job training, and other educational efforts. To encourage the use of movies, still slides, and pictures projected by opaque projectors, industrial television manufacturers attempt to reduce the cost of the operation in several different ways. Either a vidicon pickup unit or a *flying-spot scanner* (to be discussed shortly) is used for the sake of economy. In addition, optical *multiplexers* are set up to permit the utilization of a single television camera for films, slides, or opaque projections without moving any of the projectors or the camera when the projection system is changed. Before discussing optical multiplexing, let us first see how the flying-spot scanner operates.

CLOSED CIRCUIT TELEVISION

Use of Film (contd.)

Starting with an ordinary cathode-ray tube having very high intensity and small spot size (i.e., sharply focused on the screen phosphor), a raster is produced on the face of the tube. The raster is composed of 485 active lines like that of any picture tube. The difference is merely one of much greater fluorescent intensity and much finer line structure. The flying spot producing the raster acts as a point source of light which is directed through a transparent film or slide by an optical system, as shown. After passing

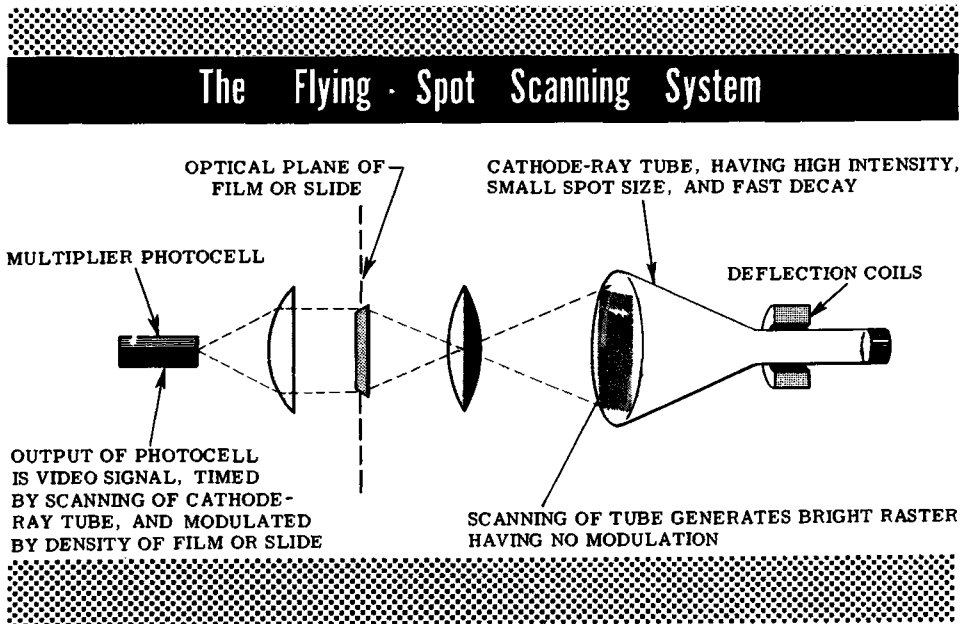

through the film, the light is picked up by a sensitive but inexpensive photocell whose output constitutes the video current. Since the raster is unmodulated, the light that reaches each portion of the film during the scanning process is of unchanging intensity. As it passes through the lights and darks of the film, the intensity of the light varies in accord with the changing density of the transparency and is therefore modulated. Each picture element is "examined" sequentially by the flying spot so that the video current carries modulation that corresponds with the information on the film.

A similar method of scanning an opaque picture by a flying spot may be used for televising printed photographs or written matter. In this case, the light from the flying spot is reflected from the surface of the opaque material and is modulated by the changing *reflectance* of the printed information.

CLOSED CIRCUIT TELEVISION

Use of Film (contd.)

Motion picture projectors used for television differ considerably from those found in theaters. Aside from the modifications in optical systems, provision must be made to match the standard television field repetition rate of 60 fields per second, to films commercially photographed at 24 picture frames per second.

One successful method for doing this consists of scanning alternate film frames twice and three times respectively. In this way, 12 of the 24 frames per second are scanned twice to yield a total of 24 doubly-scanned frames per second. The other 12 are scanned three times each for a triple-scanned total of 36 frames per second. Thus, the grand total of scanned frames per second is 60 ($24 + 36$) which corresponds with the television scanning standard. The projector motor is usually synchronized with the generator that produces the timing pulses for the scanning process, to maintain a perfectly timed match between the scanning beam and the individual frames of the film.

THE CLOSED CIRCUIT TV PROJECTOR

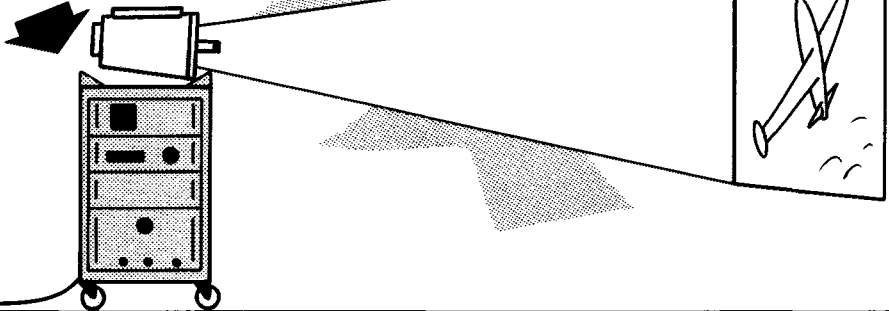

is fashioned after the THEATER PROJECTOR

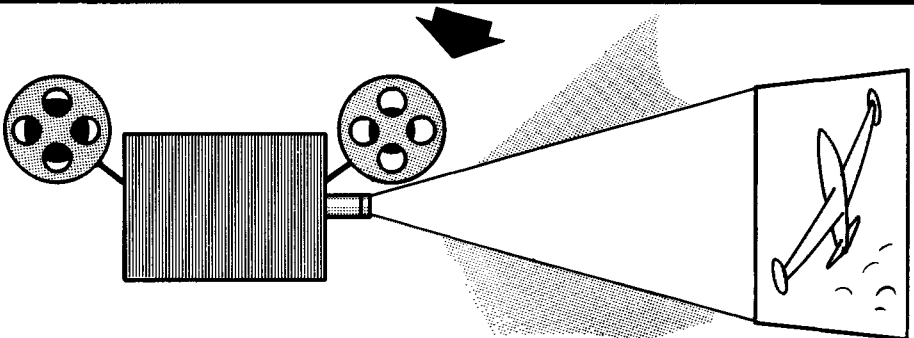

CLOSED CIRCUIT TELEVISION

Optical Multiplexing

Multiplexing FOUR PICTURE SOURCES on ONE *Vidicon* TV CAMERA

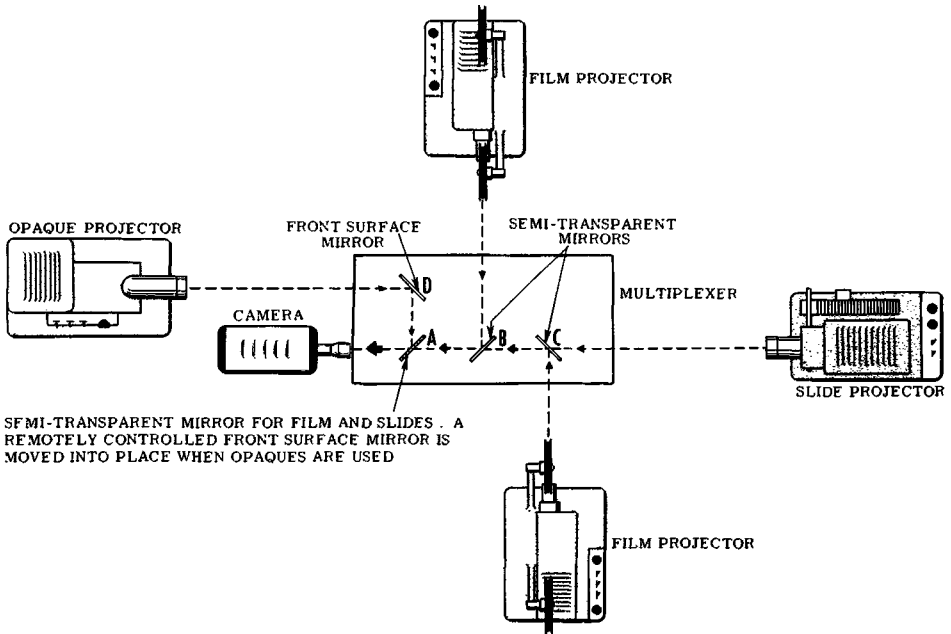

As well as making for convenience of operation, optical multiplexing offers a means of smooth transition from one picture source to another. Note that only one camera is used for reproducing projections from either motion film projector, the slide projector, or the opaque projector.

Mirrors A, B, and C are semi-transparent or lightly silvered so that fixed percentages of the incident light are transmitted and reflected. To use the upper film projector, for example, all other sources would be darkened and the camera would then receive the information from the film by reflection from mirror B, and transmission through mirror A. The lower film projector passes its picture to the camera by reflection from mirror C and transmission through both mirror B and mirror A. The slide projector at the right is arranged so that its light reaches the camera by transmission through all three semi-transparent mirrors. Mirror D is a front-surface, full reflecting type of mirror.

The image from the opaque projector, when this is in service, reaches the camera by regular reflection from mirror D and partial reflection from mirror A. An arrangement like this makes it possible for a single operator to run an entire program, especially if the projectors are equipped with remote control mechanisms as most of them are.

CLOSED CIRCUIT TELEVISION

Remote Control of Industrial Cameras

Very few industrial installations for closed circuit television make provision for manned-camera operation. In some cases, manned operation is impossible because of the hazards involved at the camera position. This would be true of cameras used for observing the operation of blast furnaces and smelters at close range, or nuclear reactions where the radiation level might be beyond human tolerance. In other situations, the presence of an operator might be undesirable or inconvenient, as in the operating theater of a hospital. For the majority of industrial applications, the camera is left at a fixed position for occasional or repetitive televising of a given scene at a given location. Here, the cost of an operator's time and physical presence might be prohibitive in the circumstances.

Modern remote control systems solve all of these problems. It is convenient to divide remote control mechanisms into two classes: (a) those used to control electrical characteristics such as beam current in the orthicon or vidicon, beam focus, voltages, and amplification; and (b) those that govern mechanical functions such as camera aperture opening or closing, optical focus, lens turreting, camera movements, and lens zooming.

Electrical quantities are easily varied by controls at the monitor panel, being connected to the camera by cables up to 1000 feet in length. Mechanical functions, however, require auxiliary drive mechanisms such as solenoid controls and servo motors by means of which various types of motion may be accomplished.

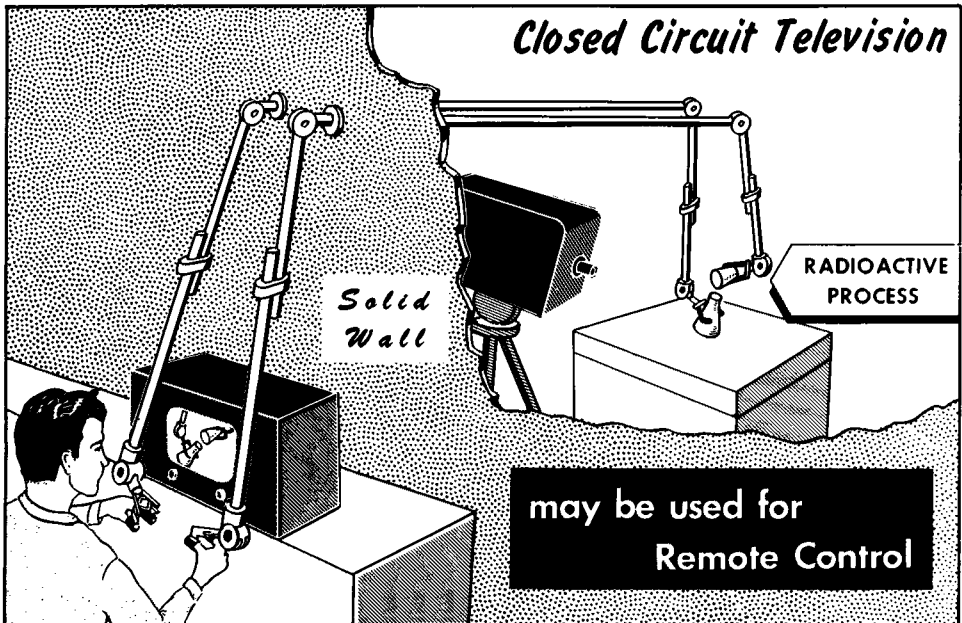

CLOSED CIRCUIT TELEVISION

Applications of Closed Circuit TV: Military

An interesting application of closed circuit TV is in the military field. Important information can be picked up from a number of sources, such as aircraft, jeeps on patrol, and trucks stationed in strategic positions. Microwave transmission is generally used in sending the picture information back to the command van, and this might be considered beyond the meaning of "closed circuit" TV. However, in using specially coded signals and restricted frequencies we may include this arrangement as being closed circuit.

Closed Circuit TV using Radio Relay

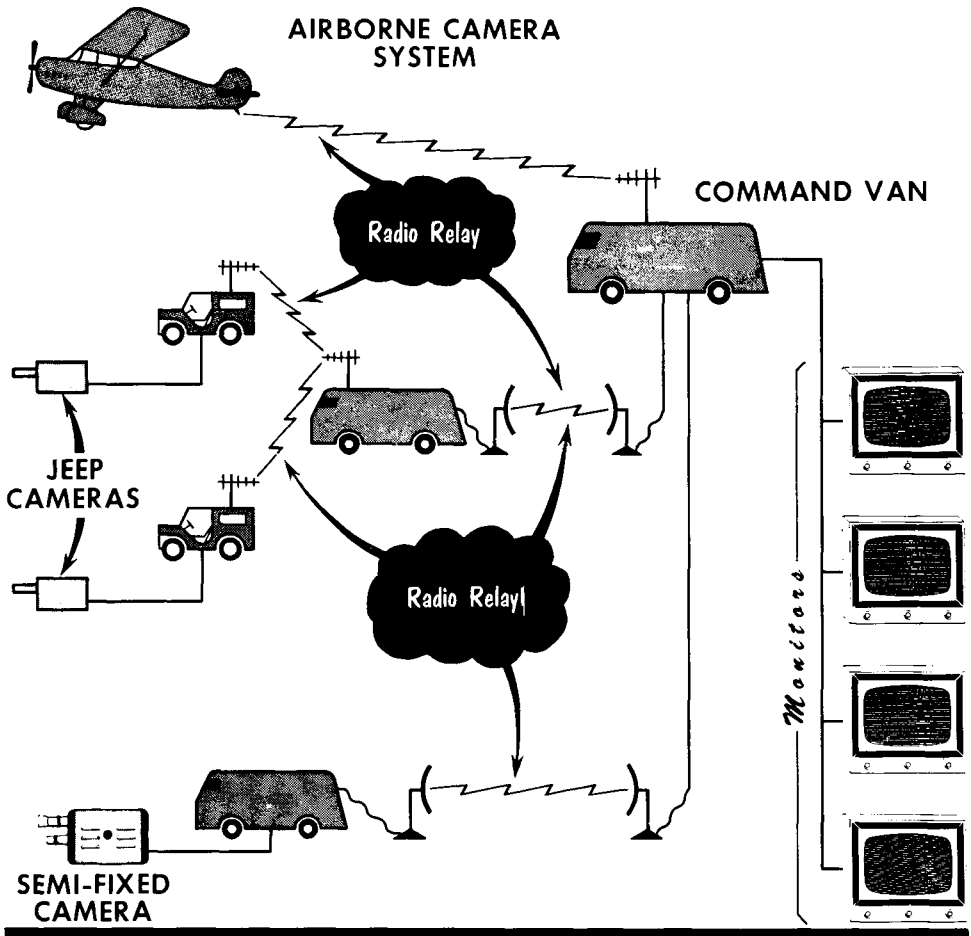

CLOSED CIRCUIT TELEVISION

Applications (contd.): Surveillance

The use of several cameras located in positions where they can survey areas of importance makes a closed circuit TV system ideal for "watchdog" work. A single guard situated in a booth containing a monitor and switching arrangement to control the various cameras, can do the work of several people. Working silently, each camera keeps a constant vigil on a selected area. The system can be further improved by including microphones. While shown in a warehouse, the closed circuit setup is equally applicable for use in department stores, self-service stores, and the like.

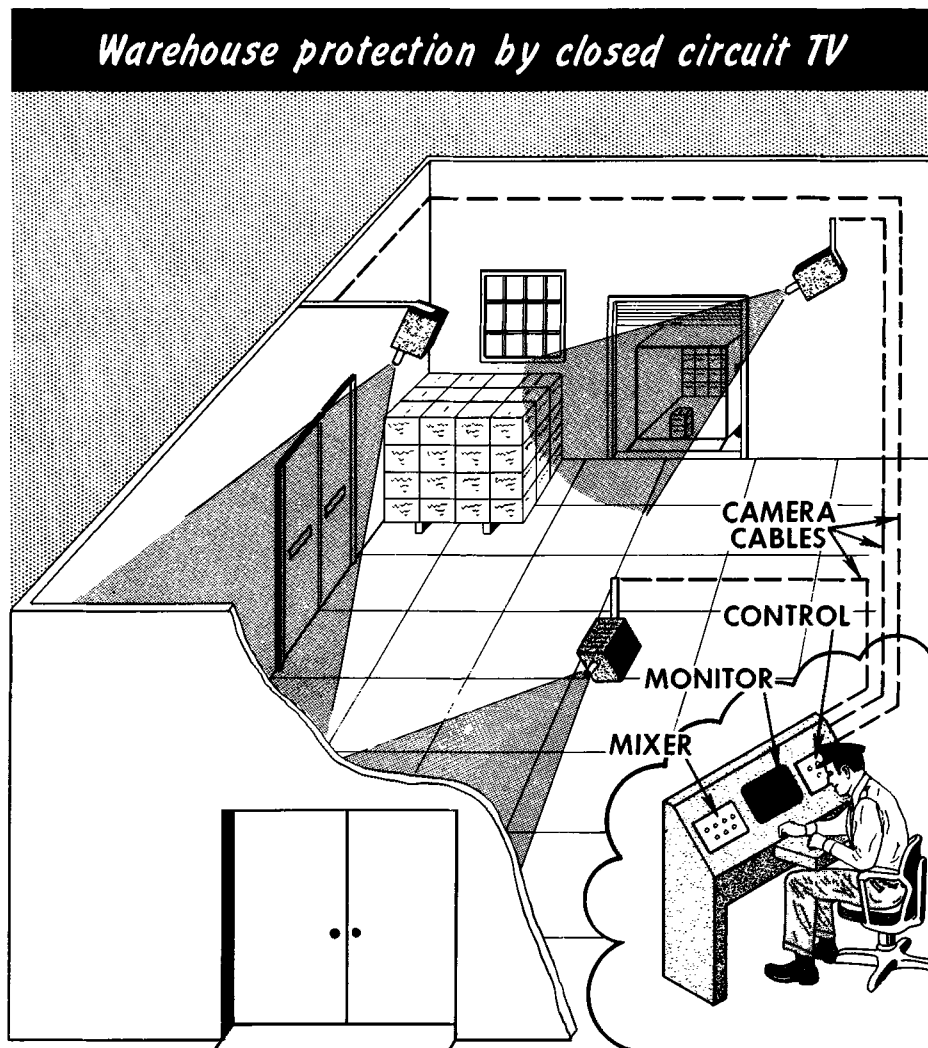

CLOSED CIRCUIT TELEVISION

Applications (contd.): Education and Sales

TV Camera picks up the microscope slide image

and enlarges it on the *Classroom Screen*

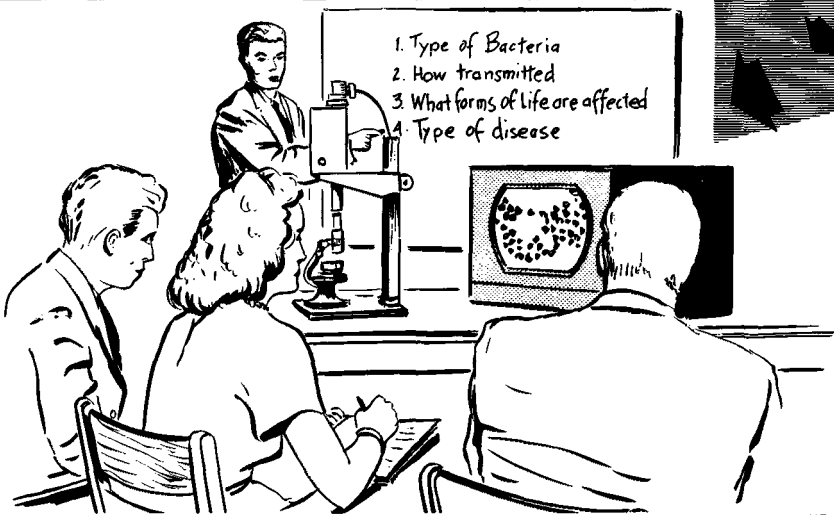

Salesmen all over America can sit in visually on

new model pep-talks from *Head Office*

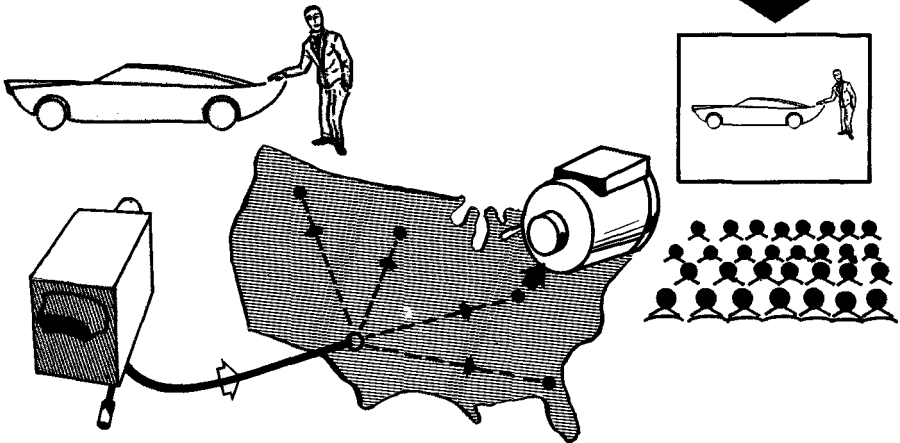

From CLOSED CIRCUIT TV SYSTEM PLANNING. *Mayers and Chipp.*

REVIEW

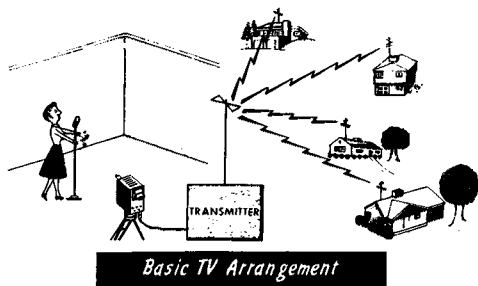

Basic TV Arrangement

as compared to

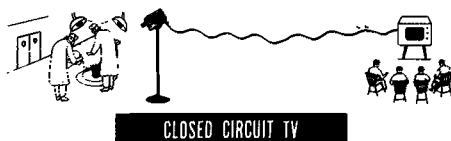

CLOSED CIRCUIT TV

2. *Random Interlace* simplifies the problem of synchronizing the transmitter and the receiver where absolute precision and the reception of stable pictures is not entirely necessary. In this method only two pulses — horizontal and vertical — accompany the video information.

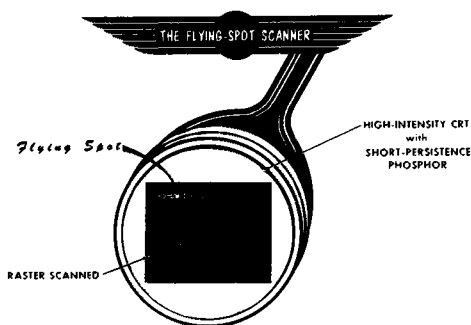

produces a beam of light that is focused on the scene to be reproduced

4. *Closed Circuit TV* and two-way audio offer an effective means of private communication between top management and field personnel on matters of policy, sales promotion, arbitration, launching of new products, etc.

1. *Closed Circuit Television* differs from standard TV broadcasting in that the closed circuit system makes it possible to privately transmit picture and sound to a pre-selected audience within a building, a city, or from coast to coast, for reception on one TV receiver or a dozen or more screens.

SIMPLIFIED WAVEFORM FOR TV SIGNAL

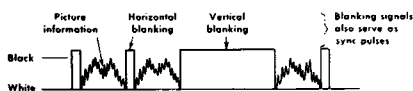
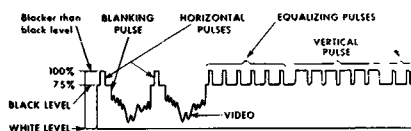

VIDEO AND BLANKING SIGNALS IN A RANDOM INTERLACE INDUSTRIAL SYSTEM

3. *The Flying-Spot* produces a raster of improved fluorescent intensity and finer line structure. It also acts as a point source of light that is directed through transparent film by an optical system to be picked up by a sensitive, inexpensive photocell, the output of which constitutes the video information.

Salesmen all over America can sit in visually on new model pep-talks from Head Office

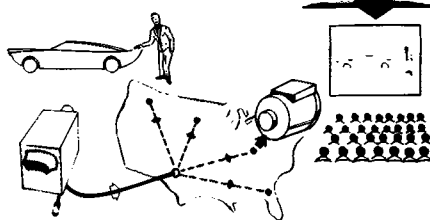

From CLOSED CIRCUIT TV SYSTEM PLANNING.

Mayers and Chipp.

INDEX TO VOL. V

(Note: A cumulative index covering all five volumes in this series is included at the end of this index.)

- Accelerating grid, 5-7, 8
- Aluminization, 5-65
- Ampere-turns, 5-46
- Anti-pincushioning magnets, 5-52
- Aperture plates, 5-24
- Applications,
 - closed circuit TV, 5-121-123
- Aquadag, 5-8, 9, 49
- Audio output system, 5-81

- Beam bender, 5-57, 58, 59, 60
- Beam forming, 5-7
- Bleeder system, 5-16
- Buzz control, 5-80

- Camera tubes, 5-107-115
- Capacitor action, Aquadag coating, 5-9
- Cathode-ray tube, 5-3-9
- Centering magnets, 5-53
- Closed circuit television:
 - what it is, 5-98-100
 - applications, 5-121-123
- Coil window, 5-51
- Commercial broadcast interlacing, 5-102
- Composite video signal, 5-1
- Conductive coating, 5-8
- Control grid structure, 5-7
- Convergence, 5-15, 19
- Core axis, 5-45
- Cosine deflection yoke, 5-51, 52

- De-emphasis network, 5-70, 76, 77, 81
- Deflection,
 - degree of, 5-33, 46, 62, 63, 64, 66
 - fields, 5-32, 33, 41
 - sensitivity, 5-46
 - simultaneous, 5-39-43
- Dynode multipliers, 5-112

- Electromagnetic deflection, 5-31-34
 - fields, 5-10-13, 15
- Electron beam focus, 5-22
 - beam motion, 5-14
 - convergence, 5-15, 19
 - gun, 5-3, 4, 22, 24, 56
 - spiral path, 5-19
 - spray, 5-18
 - stream, 5-10
- Electrostatic field, 5-22, 23
 - focusing, 5-15, 22-25, 51
 - focus tubes, 5-26-27
- Equipotential lines, 5-23

- Fields, interaction of, 5-11, 13
- Film, use of, 5-116, 117, 118
- First anode, 5-7, 8, 9
- First electron lens, 5-24
- Flags, 5-60
- Flicker, 5-103
- Flux lines, 5-14
- Flying-spot scanners, 5-116-117
- Focusing, 5-15-21
 - action, 5-19
 - current, 5-16
 - coil, 5-16, 17, 22, 29, 53
 - electrode, 5-25, 27
 - element, 5-27
- Force parallelogram, 5-41
- Foster-Seeley discriminator, 5-70, 72, 73
- Full-wave voltage doubler, 5-91
- Fusible resistors, 5-84, 88

- Gated-Beam detector, 5-78, 80, 92
- Gated-beam discriminator, 5-70

- Half-wave power supply, 5-87-90
- Half-wave voltage doublers, 5-89-91
- High-resolution scanning, 5-104
- High-voltage electrostatic focus, 5-27
- High-voltage power supply, 5-2, 8, 9
- Horizontal
 - deflection coils, 5-2, 3, 4, 35, 44, 45, 49
 - deflection system, 5-31, 33, 44
 - oscillator, 5-2, 43
 - sawtooth current, 5-2, 35, 38
 - sweep action, 5-37, 38, 39

- Image dissector, 5-107, 111, 112, 113
- Image orthicon, 5-107-108
- Industrial cameras,
 - remote control of, 5-120
- Ion, 5-22
- Ion trap, function, 5-54, 56
 - magnet, 5-57, 58
 - final adjustment of, 5-60
 - improperly positioned, 5-59

INDEX

- Keystoning, 5-52
- Limiter-amplifier, 5-72
- Linearity controls, 5-43
- Linear screen deflection, 5-46
- Lines of force, 5-11-14
- Low-voltage electrostatic
 - focus elements, 5-26
 - electrostatic focus tube, 5-27
 - power supply, 5-16, 84, 85, 86
- Magnetic deflection, 5-14
- Magnetic field, 5-2
 - effect on electron stream, 5-14
 - fields, review of, 5-10-13
 - focusing, 5-14, 16-21
- Multilayer solenoid, 5-17

- Neck shadow, 5-48
- Non-interlaced scanning, 5-103

- Optical multiplexers, 5-116, 119

- Parallel heater circuits, 5-92
- Permanent magnet, adjustable, 5-16
 - focus device, 5-22
- Picture tube: characteristics,
 - table of, 5-66
 - deflection angle, 5-63, 64
 - deflection in, 5-44, 45
 - dimensions, 5-62
 - effect on screen shape, 5-61
 - grid of, 5-5, 6, 7, 8
 - high-voltage connections, 5-65
 - introduction to, 5-1, 2
 - manuals, 5-62
 - screen material, 5-65
- Phosphor materials, 5-65
- Pincushioning 5-52
- Power supplies, 5-84
- Pre-emphasis network, 5-76, 77
- Projectors, 5-118

- Quadrature coil, 5-80
 - grid, 5-78

- Random interlace, 5-102
- Raster-correction magnets, 5-52
- Ratio detector, 5-70, 72, 74, 75
- R-C time constant, 5-77
- Resultant action, 5-40
 - field, 5-12, 39
 - force, 5-12

- RETMA basing system, 5-62
- Retrace, 5-36, 37, 38
- Review 5-30-68, 69, 83, 97, 124

- Sawtooth sweep currents, 5-36, 37, 106
- Scanning, 5-101-106
 - beam, 5-2
 - standards, 5-101
- Second anode, 5-7, 8, 9, 46, 56
- Second grid, 5-7, 8, 9
- Selenium rectifier
 - power supplies, 5-87, 91
- Semiconductor rectifiers, 5-84
- Series heater circuits, 5-84, 93-95
- Series parallel heaters, 5-84
- Sideband frequencies, 5-76
- Slow scanning, 5-103
- Soft beam, 5-33
- Sound takeoff, 5-71
- Special display tubes, 5-114
- Spiral scanning, 5-104-106
- Split second anode, 5-25
- Stiff beam, 5-33, 46
- Surge currents, 5-94
 - overload, 5-88
- Sweep time, 5-37

- Television sound system, 5-70, 82
- Tertiary winding, 5-74
- Thermistor, 5-94
- Transformerless power supplies, 5-87-91
- Tweeter, 5-81

- Vectors, 5-39
- Vertical deflection action, 5-35, 36, 37
 - deflection coil, 5-2, 34, 35, 38, 45, 49
 - deflection system, 5-31, 33, 37, 44
 - sawtooth current, 5-2, 34, 35
 - sweep system, 5-2, 35-38
- Vidicon, 5-107, 109, 110
- Voltage doubler, 5-89-91
- Voltage multipliers, 5-84
- Voltage stabilization, 5-96

- Waveforms, 5-2
- Wire, direction of motion, 5-13, 14
- Woofers, 5-81

- Yoke, cosine, deflection, 5-51, 52
 - deflection, 5-2, 28, 34, 38, 39, 47, 63
 - grounding strips, 5-49
 - rotation, 5-50
 - windings, 5-38

CUMULATIVE INDEX

NOTE: The first number of each entry identifies the Volume in which the information is to be found; the second number identifies the page.

- Absorption trap, 3-75
- Accelerating grid, 5-7, 8
- Accelerator anode, 1-49
- Adjacent-channel picture, 3-71
 - signals, 3-66, 67
 - sound, 3-71
- AFC, 2-40, 41; 4-92
- AGC, 2-22, 23
 - diode, 3-109
 - circuits, 3-57
- Alignment, 3-57, 60, 61, 86, 87
- Aluminization, 5-65
- Ampere-turns, 5-46
- Amphenol, 2-129
- Amplification, amount of, 3-123
- Amplitude modulation, 1-22
- Amplitude-modulated carrier envelope, 1-22
- Antenna, 1-104, 105
- Antenna coil, 3-7
- Antennas:
 - bandwidth, 2-101
 - basic dipole, 2-67-77
 - computations of, 2-68, 69
 - forms of, 2-74
 - resonance in, 2-76
 - signal interception by, 2-77
 - batwing, 2-107
 - biconical, 2-104
 - bow-tie, 2-118
 - broadband Yagi, 2-116
 - center frequency, determination of, 2-102
 - combination low-band and high-band vhf, 2-119
 - combination vhf and uhf arrays, 2-120, 121
 - conical, 2-105
 - connected element with reflector and director, 2-115
 - continuous rod, re-radiation from, 2-79
 - corner reflector, 2-118
 - equivalent, 2-120
 - dipole:
 - behavior, 2-76-79
 - broadside position, 2-82
 - center frequency, 2-100
 - parallel positions, 2-82
 - power gain of, 2-113, 114
 - response, 2-82-90, 99-102
 - directional response, 2-63, 83
 - directivity, 2-83
 - elements, addition of, 2-113-116
 - feedpoint, 2-95
 - folded dipole, 2-107, 108, 114, 118
 - half-wave dipole:
 - directional response, 2-86-90
 - E and I, at resonance, 2-91
 - nonresonant, resistance of, 2-91, 94
 - power transfer from, 2-96
 - resistance of, 2-92
 - thin, frequency response of, 2-99
 - zero-db rating of, 2-72, 73
 - impedance, 2-123
 - input transformer, 2-98
 - large cross-section, 2-103
 - loadpoint resistance, 2-97
 - multiple element, 2-111
 - operation of, 2-112
 - parasitic elements, 2-111, 112, 114, 116
 - rabbit ears, 2-140
 - receiving dipole:
 - broadside positions of, 2-82
 - positioning effects, 2-84, 85
 - reflector, 2-112, 115, 117, 120
 - re-radiation:
 - continuous rod, 2-79
 - receiving dipole, 2-78
 - resistance, 2-92-98
 - half-wave, antenna, 2-92
 - nonresonant half-wave antenna, 2-93, 94
 - rhombic, 2-122
 - special techniques, 2-138-140
 - stacked, 2-138
 - TV receiver, general, 2-53, 54
 - uhf, 2-117-122
 - vhf, 2-117-122
 - V, 2-106, 120, 140
 - Yagi, 2-116
- Anti-pincushioning magnets, 5-52
- Aperture plates, 5-24
- Applications, closed circuit TV, 5-121-123
- Aquadag, 5-8, 9, 49
- Aspect ratio, 1-74
- Audio output system, 5-81
- Automatic frequency control, 2-22, 23
- Automatic gain control, 2-40, 41; 3-107-112
- Autotransformer, 4-101
- AVC circuits, 3-109

CUMULATIVE INDEX

- Back resistance, 3-102
- Balanced r-f input systems, 3-2, 3, 4
- Balanced transmission-quarter-wave tuned lines, 3-55
- Bandpass curve slope, 3-59
- Bandpass, tuned circuits, 3-14
- Batwing turnstiles, 1-105
- Beam bender, 5-57, 58, 59, 60
(See also ion trap)
- Beam forming, 5-7
- Bifilar wound coils, 3-44
- Blacker-than-black, 1-90
- Blanking:
 - horizontal, 1-73
 - horizontal pulses, details of, 1-85
 - pulse interval, 4-7
 - pulse pedestal, 1-90
 - signal, 1-79
 - vertical, 1-73, 92
 - voltages, 1-82, 84
- Bleeder system, 5-16
- Blocking oscillator, 4-35, 50-55
 - controls in, 4-51
 - syncing in, 4-55
 - waveforms in, 4-52, 53, 54
- Boost voltage, 4-108, 109
- Brightness, 2-29; 3-130
- British television system, 1-106
- Broadband amplifier, 3-46
- Broadband circuit, 3-46,
- Broadband response, 3-71
- Broadband signal-transfer methods, 3-46
- Buzz control, 5-80

- Camera tubes, 1-30; 5-3-9, 107-115
 - cathode-ray, 5-3-9
 - image dissector, 5-111-113
 - image orthicon, 1-5, 11, 43-53; 5-108
 - iconoscope, 1-5, 36-42, 78
 - vidicon, 5-109-110
- Camera usage, 1-6-11
- Capacitive overcoupling, 3-47
- Capacitor action, Aquadag coating, 5-9
- Cascaded tuned circuits, 3-78
- Cascode r-f amplifier, 3-24
- Cascode tuners, 3-21-27
- Cathode-coupled multivibrator, 4-48, 49
- Cathode-fed r-f input circuits, 3-29, 40
- Cathode-ray tube, 5-3-9
- Cat's whisker, 3-102
- Centering magnets, 5-53
- Characteristic impedance, 2-128
- Charge image, 1-51
- Clipper circuit, 4-23, 26, 27

- Closed circuit television:
 - what it is, 5-98-100
 - applications, 5-121-123
- Coaxial cable, 1-75, 76, 82, 83, 102-108
- Coaxial line, 3-55
- Coaxial tuned line, 3-53
- Co-channel interference, 3-57
- Coil window, 5-51
- Coils, 3-33
- Collector ring, 1-37
- Colpitts oscillator, 3-15
- Commercial broadcast interlacing, 5-102
- Comparator circuit, 4-75
- Component identification, 3-89, 90
- Composite video signal, 1-8, 76, 95, 96; 5-1
- Conductive coating, 5-8
- Continuous permeability tuning, 3-10
- Continuous tuner, 3-9
- Contrast, 2-29
 - changes, 3-107
 - control, 3-128
- Control:
 - linearity, 4-63, 109
 - size, 4-110
 - width, 4-110, 113, 114
- Control grid structure, 5-7
- Control operator, 1-14
- Convergence, 5-15, 19
- Copper foil, 3-85
- Core axis, 5-45
- Corona, 4-115, 117
- Cosine deflection yoke, 5-51, 52
- Coupled inductor, 3-89
- Coupling, 3-48, 74, 75, 76
- Coupling impedance, 3-48
- Crystal diode circuits, 3-102-103

- Damping circuit, 4-104, 107
- Damping resistors, 4-64
- DC restoration, 2-29; 3-126
- Decelerator grid, 1-49, 50
- Decoupling elements, 3-123
- De-emphasis network, 5-70, 76, 77, 81
- Deflection:
 - degree of, 5-33, 46, 62, 63, 64, 66
 - fields, 5-32, 33, 41
 - horizontal, 1-58
 - sensitivity, 5-46
 - simultaneous, 1-59, 61; 5-39, 43
- Deflection coil:
 - horizontal, 1-40, 58, 60, 61
 - vertical, 1-40, 59, 60, 61

CUMULATIVE INDEX

- Deflection voltage generators, 1-75, 88
- Deflection yoke, 1-50; 2-32
- Delayed AGC, 3-110
- Delayed AVC, 2-22
- Demodulation, 2-18, 19, 21
- Detector, 3-17
 - f-m, 2-27
 - in radio receivers, 3-94
- Deviation:
 - positive, 1-23, 95
 - negative, 1-23
- Differentiated output, effect of input pulse shape on, 4-72
- Differentiator, 4-68, 74
 - action of, 4-70
 - definition of, 4-68
 - input and output voltage in, 4-73
- Diode clamper, 4-23
- Diode radio detector, 3-94
- Diode video-detector circuit, 3-95
- Diplexer, 1-103
- Director, 1-3, 6, 14, 16, 82
- Disc ceramic capacitor, 3-90
- Discriminator, f-m, 2-27
- Discriminator transformer, 4-82
- Distributed capacitance, 3-13, 101-117
- Dolly, 1-4
- Double-conversion uhf reception, 2-49
- Double-peaked broadband-tuned system, 3-47
- Double-sideband picture signal, 3-68
- Dynode multipliers, 5-112
- Dynodes, 1-52, 53

- Effective radiated power, 1-105
- Electrical quarter-wavelength, 3-53
- Electrical unbalance, 3-3
- Electromagnetic deflection, 5-31-34
 - fields, 5-10-13, 15
- Electromagnetic wave theory, 2-62
- Electron beam focus, 5-22
 - beam motion, 5-14
 - convergence, 5-15, 19
 - gun, 1-39, 45; 5-3, 4, 22, 24, 56
 - spiral path, 5-19
 - spray, 5-18
 - stream, 5-10
- Electron multiplier, 1-44, 52, 53
- Electrostatic field, 5-22, 23
 - focusing, 5-15, 22, 23, 51
 - focus tubes, 5-26-27
- Equalizing pulses, 1-94; 4-12-17
 - function of, 4-14
- Equipotential lines, 5-23
- European television systems, 1-106
- Field, concept, 2-64, 65
- Field, pickup, 1-12
- Fields, interaction of, 5-11, 13
- Film, use of, 5-116, 117, 118
- Fine tuning, 3-58
- Fine tuning control, 2-10
- First anode, 5-7, 8, 9
- First electron lens, 5-24
- Fixed positive bias, 3-110
- Flags, 5-60
- Flicker, 5-103
- Flux lines, 5-14
- Flyback transformer:
 - high voltage, 4-101-103
 - types of, 4-102
- Flying-spot scanners, 5-116-117
- F-M band, 3-9
- F-M sound i-f signal, 3-104
- F-M sound i-f signal takeoff, 3-105-106
- Focus coil, 1-46
- Focusing, 5-15-21
 - action, 5-19
 - coil, 5-16, 17, 22, 29, 53
 - current, 5-16
 - electrode, 5-25, 27
 - element, 5-27
- Force parallelogram, 5-41
- Forward resistance, 3-102
- Foster-Seeley discriminator, 5-70, 72, 73
- French television system, 1-106
- Frequency:
 - conversion, 3-51
 - correction, 3-118-119, 121
 - modulation, 1-21, 22
 - passband, 3-115
 - power amplifier, 1-28
 - response, 3-96, 97, 98, 99
 - selective circuits, 3-57
 - sound carrier, production of, 1-22-27, 96
- Frequency-doubler, 1-26
- Frequency-multipliers, 1-24, 25, 26, 27
- Frequency-quadrupler, 1-26
- Frequency-tripler, 1-26
- Front end, 3-1-13
- Front-end circuitry, 3-11
 - troubles, 3-62
- Full-wave voltage doubler, 5-91
- Fundamental frequency sound carrier oscillator, 1-24, 26, 27

- Galena crystal, 3-102
- Ganged sliding contacts, 3-9
- Gated amplifier, 3-111
- Gated-beam discriminator, 5-70
 - buzz, 5-80

CUMULATIVE INDEX

- Germanium diode, 3-102
- Ghost, 2-61, 2-124
- Guard band, 2-6

- Half-wave power supply, 5-87-90
- Half-wave voltage doublers, 5-89-91
- Harmonic frequencies, 1-25
- Harmonic generator, 3-51
- Harmonics, 3-18
- Helical coils, 3-33
- Heterodyne signal, 3-17
- Heterodyning oscillator, 3-58
- High-band stations, 3-1
- High-frequency compensation, 3-131
- High-frequency signals, 3-97
- High-low switching, 3-10
- High-resolution scanning, 5-104
- High-voltage electrostatic focus, 5-27
- High-voltage power supply 5-2, 8, 9,
- Horizontal:
 - afc circuit, 2-40, 41
 - damper, 2-43
 - deflection coils, 5-2, 3, 4, 35, 44, 45, 49
 - deflection system, 5-31, 33, 34
 - forward trace, 1-71, 72
 - hold control, 2-42
 - linearity control, 2-43
 - oscillator, 5-2, 43
 - output stage, 2-42
 - output transformer, 2-43
 - sawtooth current, 5-2, 35, 38
 - sweep action, 5-37, 38, 39
 - sweep circuits, 2-40-43
 - sweep section, 2-40
 - width control, 2-43
- Horizontal AFC, 4-75-93
 - definition of, 4-75
- Horizontal AFC system:
 - block diagram of, 4-76, 77
 - phase discriminator, 4-83, 84
 - pulse-width or synchroguide, 4-90-92
 - sync pulses in, 4-78
 - Synchrolock, 4-79-81
- Horizontal and equalizing pulses, 4-12-18
- Horizontal synchronization, 4-67-120
 - construction of, 4-115-117
 - discharge circuit, 4-96
 - drive, 4-95-98
 - drive control, 4-97, 98
 - line interval, 4-5
 - linearity control, 4-109
 - output circuits, 4-99-114
 - output stage, 4-99, 110
 - output transformers, 4-115-118
 - size control, 4-110
 - sweep circuit, 4-67, 95
 - sweep circuit action, 4-67
 - sync pulse, 4-15
 - width control, 4-110, 113, 114

- Iconoscope:
 - circuit, 1-38
 - defects of, 1-43
 - deflection yoke, 1-40
 - electron gun, 1-38, 39
- I-F alignment techniques, 3-86-97
- I-F amplifier, 3-65-84, 86-87
- I-F carrier modulation, 3-59
- I-F filtering, 3-101
- I-F signal frequencies, 3-18
- Image dissector, 5-107, 111, 112, 113
- Image orthicon, 1-11; 5-107-108
- Image-to-voltage conversion system, 1-32-35
- Impedance mismatch, 2-124
- Incorrect oscillator output frequencies, causes of, 2-10
- Indoor antennas, 2-140
- Inductive overcoupling, 3-48
- Industrial cameras, remote control of, 5-120
- Infinitely long line, 2-128
- Integrating action, 4-32, 33
- Integrating circuit, 4-31
- Integrator, 4-14, 31, 33
 - definitions of, 4-31
 - separation in, 4-31
- Intercarrier design, 3-83
 - principle, 2-21
 - video amplifier, 2-24, 25
- Interlaced scanning, 1-63-70
 - first field, 1-65
 - frame, 1-67
 - second field, 1-66
 - technical details, 1-68-70
- Intermediate frequencies, 2-11-14
- Interstage coupling methods, 3-81
- Ion, 5-22
- Ion burn, 5-59
- Ion trap, function, 5-54, 56
 - magnet, 5-57, 58
 - final adjustment of, 5-60
 - improperly positioned, 5-59

- Keyed AGC, 3-111
- Keystoning, 5-52

- Lap dissolve, 1-7
- Lead-in, 2-123

CUMULATIVE INDEX

Lens:

- telephoto, 1-4
- turret, 1-11, 12
- Limiters-amplifier, 5-72
- Limiters, f-m, 2-27
- Linear amplifier, 3-73
- Linear screen deflection, 5-46
- Linearity controls, 4-109; 5-43
- Line-of-sight transmission, 2-59
- Lines of force, 5-11-14
- Load impedance, 3-99-117
- Loading resistance, 3-14
- Loading resistors, 3-81
- Local-distance manual switch, 3-110
- Local oscillator, 3-15
 - frequency, 2-10
 - relative position of, 2-10
- Long-distance TV reception, 2-60
- Lowband, 3-1
- Low-frequency boost, 3-124
 - compensation, 3-122
 - loss, 3-126
 - modulation, 3-71
 - sideband power, 3-84
- Low-level sound i-f signal, 3-104
- Low-voltage electrostatic focus elements, 5-26
 - electrostatic focus tube, 5-27
 - power supply, 5-16, 84, 85, 86
- Low-voltage supply, 4-108

Magnetic deflection, 5-14

- Magnetic field, 5-2
 - effect on electron stream, 5-14
 - fields, review of, 5-10-13
 - focusing, 5-14, 16-21
- Marker generator, 3-86
- Matching transformers, 2-140
- Mechanical aids, 1-10
- Microphones, 1-13, 19, 20, 21
 - output level, 1-21
 - transmitter, 1-19
- Microwave repeaters, 1-108
- Microwave transmission, 1-108
- Mixer-amplifier, 1-21
- Mixer function, radio receiver, 2-8
- Mixer grid coil, 3-7
- Mixer input system, 3-19
- Mixer oscillator tubes, 3-12
- Mixer output, 3-20
- Mixer test point, 3-19
- Modulated r-f picture carrier, 3-2
- Modulator, 1-97
- Monitors, 1-77
 - air, 1-15
 - preview, 1-15

Montage, 1-8

- Mosaic, 1-36, 37, 46, 52, 58, 83
- Multilayer solenoid, 5-17
- Multiple images, 1-9, 3-62
- Multivibrator, 4-34-45
 - electrical action in, 4-37, 38, 39
 - plate current waveforms, 4-45
 - plate voltage waveforms, 4-45
 - wave frequency of, 4-42, 43
 - wave shapes, 4-40
- Multivibrator wave, amplitude of, 4-44

Neck shadow, 5-48

- Negative d-c output, 3-108
- Negative-phase output stage, 3-95
- Negative-phase voltage, 2-19, 25
- Negative-polarity output voltage, 3-95
- Noise currents, 3-3
- Noise voltages, 3-2-4
- Non-interlaced scanning, 5-103
- Nonlinearity, 5-43
- No-picture-signal interval, 1-84

Odd field, 1-65

- Optical multiplexers, 5-116, 119
- Optical window, 1-45
- Oscillator, function radio receiver, 2-8
- Oscilloscope, 3-86-87
- Over-correction, 3-118
- Overcoupled interstage transformers, 3-82
- Overshoot, 3-127

Panning, 1-4

- Panning lever, 1-12
- Parabolic reflectors, 1-108
- Parallel heater circuits, 5-92
- Parallel-resonant circuit, 3-105
- Parallel-resonant i-f traps, 3-24
- Parallel tuning circuit, 3-106
- Peaking-coil damping resistor, 3-127
- Peaking system, 3-101
- Pedestal, 4-9
- Permanent magnet, adjustable, 5-16
 - focus device, 5-22
- Persistence of vision, 1-67
- Phase comparer, 4-86-89
- Phase detector, 4-86-89
- Phase discriminator, 4-83, 84
 - control voltage, 4-85
- Phase distortion, 3-125
- Phase shift, 3-126
- Phase splitter, 4-86-89

CUMULATIVE INDEX

- Phosphor materials, 5-65
- Photocathode, 1-30, 46, 48
- Photocell pickup device, 1-35
- Photodroplet, 1-37, 38, 40, 78
- Photoelectric cell, 1-30
- Phototube, 1-30
- Phototube circuitry, 1-31
- Picture-carrier generation, 1-96, 97
- Picture i-f:
 - amplifier, 3-65-73
 - troubles in, 3-88
 - carrier, frequencies of, 2-13, 14, 16, 17
 - signal, 2-11
- Picture-signal chain, block diagram of, 1-16
- Picture splitter, 4-86-89
 - splitting, 4-82
- Picture stretch, 4-98
- Picture synchronization, 4-1-2
- Picture tilt, 5-50
- Picture tube, 2-45
 - assembly, 1-77
 - characteristics, table of, 5-66
 - deflection angle, 5-63, 64
 - deflection in, 5-44, 45
 - dimensions, 5-62
 - effect on screen shape, 5-65
 - grid of, 5-5, 6, 7, 8
 - high-voltage connections, 5-65
 - introduction to, 5-1, 2
 - manuals, 5-62
 - screen material, 5-65
- Pincushioning, 5-52
- Plate load resistance, 3-123
- Polarized radiation, 2-65, 66
- Positive-phase output stage, 3-95
- Positive-polarity output voltage, 3-95
- Positive-polarity voltage, 2-19, 25
- Positive voltage pulse, 3-111
- Powdered iron core, 3-10
- Power amplifier, 1-98
- Power supply, high voltage, 4-103-107
- Power supplies, 2-45; 5-84
- Pre-emphasis network, 5-76, 77
- Preselector, 3-55
- Printed circuits, 3-85
- Prisms, 1-9
- Projectors, 5-118
- Propagation, 2-129
- Pulse:
 - clipper, 2-34
 - generator, 1-72, 75, 88
 - separator, 2-34
 - types, introduction to, 2-33
- Pulse separation, 4-31
- Quadratic coil, 5-80
 - grid, 5-78
- Quarter-wave tuned lines, 3-55
- Radiated wave, 2-61, 66
- Radio-frequency amplifier, 1-97
- Radio-frequency carrier, 1-22
- Radio receivers, detector, 3-94
- Random interlace, 5-102
- Raster-correction magnets, 5-52
- Ratio detector, 5-70, 72, 74, 75
- R-C time constant, 4-69 - 5-77
- Reactance modulator, 1-24, 4-76, 77
- Receiver, split sound, 3-84
- Rectified video signal, 3-100
- Reflection of TV waves, 2-61
- Relative amplitudes, 3-97
- Relaxation oscillator, 4-35
- Resistance loading, 3-49
- Resonant frequency, 3-121
- Response, double peaked, 3-49
- Resting frequency, 1-23, 2-6
- Resultant action, 5-40
 - field, 5-12, 39
 - force, 1-60, 61; 5-12
- RETMA basing system, 5-62
- Retrace, 5-36, 37, 38
 - action, 4-3, 8
 - horizontal, 1-71, 72
 - time, 4-99, 100
 - vertical, 1-71, 92, 94
- Review, 1-17, 18, 41, 42, 62, 86, 109, 110
 - 2-30, 31, 50, 51, 80, 81, 109, 110, 141, 142
 - 3-29, 30, 63, 64, 91, 92
 - 4-19, 20, 46, 47, 66, 93, 94, 119, 120
 - 5-30, 68, 69, 83, 97, 124
- R-F amplifier, 3-2, 12
 - functions of, 2-3
 - response, 2-7
 - grid winding, 3-7
 - plate coil, 3-7
- R-F input, 3-2
- R-F response curves, 3-56, 57
- R-F signal generator, 3-86
- Ringling, in picture, 3-127
 - in raster, 4-104
- Rotating turret arrangement, 3-7
- Sawtooth shaping, 4-56, 57, 58
- Sawtooth sweep currents, 5-36, 37, 106

CUMULATIVE INDEX

- Scanning, 1-63
 - beam, 1-45, 50, 51, 72; 5-2
 - mosaic, 1-40
 - pattern, 1-63
 - progressive, 1-63, 64
 - standards, 5-101
 - time and frequencies, H and V, 1-71
- Second anode, 5-7, 8, 9, 46, 56
- Second grid, 5-7, 8, 9
- Secondary emission, 1-43, 44
- Selenium rectifier, power supplies, 5-87, 91
- Semiconductor rectifiers, 5-84
- Series connected amplifier, 3-26, 27
- Series heater circuits, 5-84, 93-95
- Series parallel heaters, 5-84
- Series resonant circuit, 3-20-105
- Serrations in the vertical sync pulse, 4-10, 11, 17
- Shielded attenuator, 3-62
- Shunt capacitive reactance, 3-117
- Shunting effect, 3-121
- Sideband frequencies, 5-76
- Sideband power distribution, compensation in, 3-71
- Sidebands, 2-5, 11
- Signal division, 3-106
- Signal generators, 3-57
- Signal-to-noise ratio, 3-4
- Single-conversion uhf reception, 2-48
- Six-mc channel bandwidth, 2-5
- Size control:
 - horizontal, 1-74
 - vertical, 1-74
- Slow scanning, 5-103
- Soft beam, 5-33
- Sound:
 - carrier, 2-6; 3-2
 - channel, f-m 2-26, 27
 - i-f carrier frequencies of, 2-12, 13, 14, 16, 17
- Sound i-f separation, 3-82
 - signal, 3-104, 106
 - takeoff, 5-71
- Soundbars, 2-24, 3-67
- Sound man, 1-15
- Sound mixer:
 - amplifier, 1-21
 - panel, 1-15
- Sound signal:
 - block diagram, 1-20
 - tracing, 1-19
- Special display tubes, 5-114
- Special effects, 1-10
- Spiral scanning, 5-104-106
- Split second anode, 5-25
- Split-sound design, 3-83
- Stagger tuning, 3-46, 80, 81, 82
 - process, 3-82
- Standard coil "1000 series" tuners, 3-13
- Standing waves, 2-132
- Station selection, 3-56
- Station selector, 2-4
- Stiff beam, 5-33, 46
- Stray circuit capacitance, 3-7
- Strip tuner, 3-50, 51, 52
- Studio control room, 1-6, 14, 15, 16
- Sum and difference frequencies, 3-18
- Superheterodyne receiver, 2-8
- Superturnstile antenna, 1-105
- Surge currents, 5-94
 - overload, 5-88
- Sweep generator, 3-86, 87
- Sweep time, 5-37
- Swing, 1-23
- Sync:
 - amplifier, 2-35; 4-29, 30
 - clipper, 2-34; 4-21-28
 - diode clamper, 4-23
 - loss of d-c component, 4-22
 - noise limiter, 4-27
 - pulse separation, 2-34
 - separator, 2-34, 35
- Sync pulses:
 - added to video signal, 1-87-92
 - clipping of, 1-90
 - horizontal AFC system, 4-78
 - vertical, addition of, 1-91, 92-94
 - vertical, serrated, 1-93
- Sync separator, 4-21-28
- Sync separator-amplifier outputs, 4-67
- Sync signals, processing of, 4-18
- Synchrolock, 4-79-81
- Synchronization, 2-33; 4-67-120
 - circuits, 2-32-35
- Synchronization, fundamentals of
 - vertical and horizontal, 4-1, 2, 15
- Synchronizing pulse levels, 3-108
- Tapped inductors, 3-7
- Target, 1-45, 51, 81
 - behavior of, 1-47, 48
 - screen, 1-49
 - surface resistance of, 1-47
- Tearing, 2-40; 4-28
- Television:
 - broadcasting, 1-1
 - cameraman, 1-14
 - channel, 2-4, 5
 - receiver:

CUMULATIVE INDEX

- front end, 2-15
 - general layout of, 2-1, 2
 - i-f amplifiers in, 2-16, 17
 - intercarrier type, 3-93
 - mixer and oscillator function, 2-9
 - relation to radio receiver, 2-2
 - split-sound, 2-47
- signals, propagation of, 2-55, 58
- studio, 1-2, 13
- techniques, 1-6
- theater, 1-3
- transmission lines, 2-71, 123-137
- tricks, 1-2, 6
- Television camera, 1-4, 5, 11, 12
 - sound system, 5-70, 82
 - stations, 3-1
- Tertiary winding, 5-74
- Thermistor, 5-94
- Time delay, 3-126
- Timing signal, 1-90
- Trace time, 4-99, 100
- Tracking mixer and oscillator circuits, 3-55
- Transformerless power supplies, 5-81-91
- Transformer overcoupling, 3-49
- Transformers, single resonance, 3-81
- Transistorized transmitter, 1-19
- Transmission, 1-108
 - vestigial sidebands, 1-98, 100, 103
- Transmission filters, 1-102, 103
- Transmission line, impedance of, 300 ohm, 3-43
 - impedance mismatch, 3-43
 - input system, 3-43, 44, 45
- Transmission lines, 1-102, 103
 - attenuation, 2-128
 - balanced, 3-7, 3-44
 - E and I distinction in, 2-131, 132
 - impedance, 2-126
 - L and C in, 2-127
 - open circuited, 2-127
 - reflection, 2-124
 - shielded, 3-7
 - short circuited, 2-136
 - takeoff point, 2-139
 - two-wire, 3-2
 - 300-ohm, 2-137
 - unbalanced, 75-ohm, 3-44
- Transmitters sound system, 1-29
- Transmitting antenna, 1-104, 105
- Trap circuit, 3-75
- Trap circuits parallel resonant, 3-42
 - series-resonant, 3-41
- Traps, 3-74, 75, 76
- Traps and coupling methods, 3-40, 49
- Triggering action, 4-74
 - plate voltage, 3-112
- Trimmer capacitors, 3-90
- Tubular ceramic capacitors, 3-90
- Tuned impedance, 3-74, 81
- Tuned-impedance coupling, 3-31
- Tuned interstage coupling circuits, 3-65
- Tuned transformer, 3-49, 74, 106
- Tuner:
 - frequencies, 2-3-10
 - i-f stages, 2-15-17
 - circuit continuously variable, 3-37
 - circuitry, 3-14, 19
 - circuits, wafer-switch, 3-36
 - permeability-tuned, 3-38
 - response, 3-56, 62
- Tuning arrangements, 3-31, 38
 - function, 2-3
- Tweeter, 5-81

- UHF channels, 3-1
- UHF i-f amplifier, 3-51
- UHF converters, 3-50, 51, 52, 55, 57
- UHF crystal mixer, 3-51
- UHF reception, 2-48, 49
- Ultraudion, 3-16
- Unbalanced r-f input systems, 3-2, 3, 4
- Unequal sideband power, 3-71
- Unidirectional conductivity, 3-102
- Unstable pictures, 3-62
- Upper sideband, 3-69

- Variable air-gap transformer, 4-115
- Vectors, 5-39
- Vertical:
 - height control, 2-37
 - hold control, 2-37
 - linearity control, 2-38
 - output stage, 2-38
 - sweep circuits, 2-36-38
- Vertical deflection action, 5-35, 36-37
 - deflection coil, 5-2, 34, 35, 38, 45, 49
 - deflection system, 5-3, 33, 37, 44
 - sawtooth current, 5-2, 34, 35
 - sweep system, 5-2, 35-38
- Vertical synchronization, 4-3-66
 - blanking, 4-3
 - blanking interval, 4-12, 16
 - blanking pulse, 4-5, 6, 7
 - deflection coil feed, 4-39
 - deflection control signals, 4-3, 4
 - oscillator, 4-34
 - output system, 4-60-65
 - amplifier, 4-60
 - explanation of operation, 4-61
 - linearity control, 4-63

CUMULATIVE INDEX

- output transformer, 4-62
- retrace, 4-8, 12, 15
 - blanking, 4-65
 - horizontal sync pulse during, 4-15
 - sync pulse, 4-3-11
 - serrations in, 4-10, 11
- Vertical roll, 4-5
- Vertical trace, 1-71, 94
- Vestigial-sideband filter, 1-103
- Vestigial-sideband transmission, 2-5;
3-68, 69, 84
- VHF channels, 3-7
- VHF oscillator, 3-50
- VHF tuners, 3-57
- Video amplifier, 2-24, 25; 3-115
 - circuits, 3-131
 - gain, 3-117, 118, 122-124
 - series peaking, 3-120, 121
 - troubles, 3-132
- Video detector, 2-18, 21; 3-93, 95, 102
 - function of, 3-97
 - output circuit, 3-100
- Video i-f amplifier, 3-65
- Video polarity:
 - negative, 1-80
 - positive, 1-80
- Video preamplifier, 1-79
- Video response, 3-116
- Video signal:
 - adding sync pulses to, 1-87, 92
 - amplifier, 1-76
 - in iconoscope, 1-78, 80
 - in image orthicon, 1-81
- Vidicon, 5-109, 110
- Vidicon camera, 1-5, 11, 12, 54, 55
 - resolution requirements of, 1-54;
5-110
- Viewing monitor, 1-11
- Voltage divider, 3-122
- Voltage doublers, 4-118; 5-89-91
- Voltage multipliers, 5-84
- Voltage stabilization, 5-96
- Wafer switch tuners, 3-31, 34
- Waveforms, 5-2
- Wavelength, formula for signal in
free space, 2-68
 - sample computation, 2-130
- Wave shaping, 4-56-60
- Wire, direction of motion, 5-13, 14
- Woofers, 5-81

- X-ray effect, 3-98

- Yoke:
 - adjustment, 5-47
 - cosine, deflection, 5-51, 52
 - deflection, 5-2, 28, 34, 38, 39, 47, 63
 - grounding strips, 5-49
 - rotation, 5-50
 - windings, 5-38

- Zworykin, Vladimir, 1-36