

# A-C CALCULATION CHARTS

by  
R. LORENZEN



JOHN F. RIDER PUBLISHER, INC.  
404 Fourth Avenue New York City

COPYRIGHT, 1942, BY JOHN F. RIDER

Printed in the United States of America

DEDICATED TO

JOHN F. RIDER

*whose aid and cooperation enabled  
this book to see the light of day*



## TABLE OF CONTENTS

INTRODUCTION . . . . .	9
ARRANGEMENT OF CHARTS . . . . .	9
HISTORY OF THE CHARTS . . . . .	9
THEORY UNDERLYING THE CHARTS . . . . .	10
BIBLIOGRAPHY . . . . .	10
INDUCTIVE REACTANCE . . . . .	11
INDUCTIVE SUSCEPTANCE . . . . .	11
CAPACITIVE REACTANCE . . . . .	11
CAPACITIVE SUSCEPTANCE . . . . .	11
SERIES RESONANCE . . . . .	12
PARALLEL RESONANCE AND ANTIRESONANCE . . . . .	12
SERIES CIRCUITS . . . . .	12
PARALLEL CIRCUITS . . . . .	13
SERIES-PARALLEL CIRCUITS . . . . .	14
MESH CIRCUITS . . . . .	15
MISCELLANEOUS APPLICATIONS:	
RESISTANCE-CAPACITANCE TUNED OSCILLATOR . . . . .	17
CONDUCTANCE . . . . .	17
RESISTORS IN PARALLEL . . . . .	17
CHARTS:	
INDEX PAGES . . . . .	18, 19
REACTANCE—IMPEDANCE . . . . .	Plates 1- 72
SUSCEPTANCE—ADMITTANCE . . . . .	Plates 73-144
Q . . . . .	Plate 145
PHASE ANGLE . . . . .	Plate 146



# INTRODUCTION

The series of charts contained in this book are intended for the purpose of making alternating-current circuit calculations with a greater speed than has hitherto been attainable. The charts and the supplementary scales accompanying them were designed with the object of reducing the time consumed in making electric circuit computations to a minimum.

Although special types of reactance charts and improved scales on slide rules had reduced the laboriousness of a-c computations to some extent, it nevertheless remained true that the former were lacking in precision while the speed of computation of the latter was still unsatisfactory.

Accordingly, it was felt that some combination of the reactance-frequency chart and the slide rule, which retained the advantages of both while eliminating their shortcomings, would provide a useful tool for the engineer in the solution of electrical networks.

## Arrangement of Charts

The first two charts are intended to serve as an index and the enormous ranges covered by the charts in this book may be seen by an examination of these index charts. They enable the determination of the Plate which should be used in making a given computation. If any two of the four quantities (frequency, inductance, capacitance, and reactance or susceptance) are known, the point of intersection of the two lines corresponding to these two known quantities will lie in the numbered square which is to be utilized in making the computation. However, after becoming more familiar with the charts, this step may frequently be omitted, and the proper Plate may be located by rapidly glancing through them.

Following the two index charts are the impedance and admittance plates. The first 72 plates are used to compute reactance or impedance, while the next 72 plates are employed to calculate susceptance or admittance. These charts are arranged in groups of nine, each group having the same frequency range but with ascending values of reactance or susceptance. Because of this arrangement it is usually unnecessary to consult the index charts in order to determine which numbered plate should be used, for a glance at the edges of the charts gives this information. Since the reactance or susceptance charts alone would not enable the determination of impedances or admittances, supplementary scales are printed on each page to permit such computations to be made.

In order to facilitate the location of points on the charts, they have been printed in two colors, the frequency-resistance logarithmic co-ordinate system is

printed in green, while the inductance-capacitance logarithmic co-ordinate system is printed in red. The inductance values appear on the right and left, and the capacitance values appear on the top and bottom. It will be noted that the inductance and capacitance lines are interchanged on the susceptance charts.

The A, D, C, and CI scales, which are found below the charts are similar to those found on a slide rule and serve the same purpose, namely, to evaluate squares, square roots, and reciprocals. It will be found, however, that these scales are correlated with the charts which they accompany, so that for a given circuit it is rarely necessary to turn to another plate in order to complete the computation.

Although the Q chart may be employed to perform the operations of multiplication or division, its main purpose is to enable the determination of the ratio of the reactance to the resistance or the ratio of the susceptance to the conductance. This is the only chart in the book which is not direct reading, but this is of no great importance since the range of the  $X/R$  or  $B/G$  ratio is so limited that the location of the decimal point is easily determined by inspection.

The phase angle chart is useful when it is necessary to know the phase angle in addition to the absolute value of the impedance or admittance of the circuit.

## History of the Charts

The reactance-frequency chart was originally designed by T. Slonczewski in about 1928 and described by him in the *Bell Laboratories Record* of November 1931. This chart covered a wide range of frequency and reactance, but was accurate to only one significant figure. Despite the limited precision, the chart was of great value in rapidly determining the reactance of an inductance or capacitance, or the resonant frequency of a combination of inductance and capacitance. This chart was not, however, suitable for the determination of impedance except when the circuit resistance could be neglected.

Although the applicability of this chart for finding susceptance was mentioned in passing by Slonczewski, its practical determination was first described by J. R. Tolmie in the September 1933 issue of the *Proceedings of the Institute of Radio Engineers*. Tolmie suggested the juxtaposition of an inverted ordinate scale adjacent to the present ordinate scale. Susceptances could then be read on this inverted scale. This modified chart was not suitable for the determination of admittance, except for the case when the conductance was negligible in comparison to the susceptance. In addition, the close proximity of

the logarithmic and inverse logarithmic scale at the left margin made for some difficulty in obtaining a reading.

The major disadvantage of the two preceding charts was their lack of precision, so that, in general, a slide rule computation was frequently found to be necessary. In addition, these charts did not permit the computation of impedance and admittance. For this, it was necessary to resort to the slide rule, and although modern slide rules of the log log vector type enabled a-c circuit problems to be more rapidly computed than had been the case in the past, it was felt that this increase in speed was still inadequate. Furthermore, the fact that a slide rule is not direct reading introduces a possible source of error due to the incorrect location of the decimal point.

The present series of charts are an attempt to incorporate the advantages of the original frequency-reactance chart and those of the slide rule, while at the same time eliminating their disadvantages.

### Theory Underlying the Charts

Since it was desired to have the reactance as the ordinate and the frequency as abscissa, the equation for inductive reactance was written as

$$X_L = (2\pi L) f$$

Taking the logarithm

$$\log X_L = 1 \log f + \log 2\pi L$$

Since this is of the form  $y = mx + b$ , the equation represents a family of lines having a slope of 1, namely, the lines slope upward to the right making an angle of  $45^\circ$  with the horizontal axis. The intercept on the left axis is given by  $\log 2\pi L$ , with reference to an origin of 1 cycle and 1 ohm.

Similarly, the equation for the capacitive reactance may be written

$$X_C = \left(\frac{1}{2\pi C}\right) \cdot \frac{1}{f}$$

Then

$$\log X_C = -1 \log f - \log 2\pi C$$

The slope is  $-1$ , so that the capacitance lines are at right angles to the inductance lines, and slope upwards to the left making an angle of  $45^\circ$  with the horizontal axis. The intercept on the left axis is given by  $-\log 2\pi C$ , with reference to an origin of 1 cycle and 1 ohm.

Since the inductive susceptance is given by

$$B_L = -\left(\frac{1}{2\pi L}\right) \cdot \frac{1}{f}$$

and the capacitive susceptance is given by

$$B_C = (2\pi C) f$$

it will be seen that on the susceptance charts the inductance and capacitance lines are interchanged with respect to their position on the reactance charts.

The supplementary scales giving squares or square root are similar to the D and A scales on a slide rule and, similarly, the supplementary scales giving reciprocals are also similar to the C and CI scales of a slide rule.

### Bibliography

- Slonezewski, T., A Versatile Nomogram for Circuit Problems, *Bell Laboratories Record*, Vol. 10, No. 3, November, 1931, page 71.
- Tolmie, J. R., Note on a Modified Reactance-Frequency Chart, *Proceedings of the Institute of Radio Engineers*, Vol. 21, No. 9, Sept. 1933, p. 1364.
- Anonymous, Inductance—Capacity—Frequency—Impedance Chart, *General Radio Experimenter*, Vol. 3, No. 1, June 1928.
- Anonymous, A New Type of Inductance-Capacity Reactance Chart, *Aerovox Research Worker*, Vol. 5, No. 1, Dec. 1931—January 1932.
- Anderson, H. W., A Capacity, Inductance and Impedance Conversion Chart, *Radio Engineering*, Vol. 11, No. 6, June 1931, p. 32.



# A-C CALCULATION CHARTS

## INDUCTIVE REACTANCE

The inductive reactance of a coil is given by the expression

$$X_L = 2\pi fL$$

where  $X_L$  is the inductive reactance in ohms,  $f$  is the frequency in cycles per second, and  $L$  is the inductance in henrys.

The determination of the inductive reactance of a given inductance is rapidly obtained for any frequency by means of the charts. Given frequency and inductance, to find the inductive reactance: Start from the inductance scales at the right or left margin, and follow the red slanting inductance line and also follow the green vertical frequency line upwards. From the point of intersection of these two lines move leftwards horizontally to the left margin, and read the inductive reactance in ohms. Thus, from Plate 14, it is seen that 0.2 henry at 300 cycles has an inductive reactance of 377 ohms. Similarly, from Plate 50, an inductance of 25  $\mu$ H at 3.5 megacycles is seen to have an inductive reactance of 550 ohms.

Given frequency and reactance, to find the inductance: Follow the green frequency line upwards. From the given reactance value in the left margin, move horizontally to the right. The intersection of these two lines will lie on the slanting red line which gives the inductance that has the desired reactance at the specified frequency.

Given inductance and reactance to determine the frequency: Follow the slanting red inductance line until it intersects the horizontal green reactance line. From this point drop down to the bottom margin and read the frequency at which the given inductance possesses the specified reactance.

## INDUCTIVE SUSCEPTANCE

For a *pure* inductance the inductive susceptance  $B_L$  of a coil is the negative reciprocal of the inductive reactance  $X_L$ , namely,

$$B_L = -\frac{1}{X_L} = -\frac{1}{2\pi fL}$$

For an inductance the inductive susceptance is negative, and is usually expressed in mhos, or micromhos (1 mho =  $10^6$  micromhos). There are two methods of finding inductive susceptance by means of the charts, one requiring a single step, the other necessitating two operations.

In the single-step method, the admittance-susceptance charts are employed. The red slanting inductance line intersects with the green vertical frequency line, and the susceptance is read directly at the left margin. Thus, from

Plate 85, an inductance of 0.32 henry at 740 cycles will have an inductive susceptance of  $-670 \mu$  mhos.

The two-step method utilizes the impedance-reactance charts. The reactance is first determined in the usual manner from the chart. The red logarithmic scales at the lower part of the page is then used, and opposite the reactance on the C-scale will be found the susceptance on the CI scale. In the case of the example just given, from Plate 15 the inductance of 0.32 henrys at 740 cycles has a reactance of 1490 ohms. Opposite 1490 ohms on the C-scale will be seen  $-670 \mu$  mhos on the CI-scale.

## CAPACITIVE REACTANCE

The capacitive reactance  $X_C$  (in ohms) of a condenser is given by the expression

$$X_C = -\frac{1}{2\pi fC}$$

where  $f$  is the frequency in cycles, and  $C$  is the capacitance in farads.

The method of obtaining capacitive reactance by means of the impedance-reactance charts is similar to that used in determining inductive reactance. It will be noticed, however, that the capacitance lines slope in a direction which is perpendicular to that of the inductance lines.

Given the capacitance and the frequency to find the capacitive reactance: Follow the red slanting capacitance line until it intersects the green vertical frequency line. Move horizontally to the left margin and read the capacitive reactance. A condenser of 3.8 microfarads capacitance will have a reactance of 168 ohms at 250 cycles, as determined from Plate 14.

In a similar manner, if any two of the three quantities are known, the third may be found.

## CAPACITIVE SUSCEPTANCE

For a *pure* capacitance the capacitive susceptance  $B_C$  of a condenser is the reciprocal of the capacitive reactance  $X_C$ , namely,

$$B_C = \frac{1}{X_C} = 2\pi fC$$

Capacitive susceptance is positive and is usually expressed in mhos or micromhos. There are two methods of determining capacitive susceptance by means of charts, one utilizing the admittance-susceptance charts, the other employing the impedance-reactance charts.

Using the admittance-susceptance charts, the intersection of the red slanting capacitance line with the green

vertical frequency line indicates the magnitude of the susceptance, which will be read in the left margin. For example, from Plate 112, a capacitance of 480  $\mu\text{f}$  at 240 kc will have a susceptance of 723  $\mu$  mhos.

This result could also have been found, but more laboriously, if the impedance-reactance charts were employed. First, the reactance of the condenser is determined by the intersection of the red slanting capacitance line with the green vertical frequency line. Then, opposite this reactance on the C-scale the susceptance will be found on the CI-scale. In the case of the above example, from Plate 42 the reactance is found to be 1380 ohms and its reciprocal is then seen to be 723  $\mu$  mhos.

### SERIES RESONANCE

Series resonance is defined as the condition for which the total reactance of the circuit is zero. For this condition the inductive reactance is equal to the capacitive reactance, and the charts therefore enable the rapid determination of the resonant frequency.

The point of intersection of an inductance line with a capacitance line determine a point for which the inductive reactance is equal to the capacitive reactance. The resonant frequency of the combination may then be read on the bottom margin. Thus, given an inductance of 0.012 henry and a capacitance of 0.054 microfarad, the point of intersection of these two lines determines the resonant frequency as 6250 cycles, as determined from Plate 23.

On the other hand, had there been given the frequency at which a given inductance was to be resonated, the point of intersection of the inductance line and the frequency line would determine the capacitance line which would bring about the required condition of resonance. Suppose, for example, that it was desired to resonate a 30 microhenry coil at 5 megacycles. An examination of Plate 50 indicates that the intersection of the red 30 microhenry inductance line with the green 5 megacycle frequency line determines the red 33.8 micromicrofarad capacitance line.

Given

- $R = 110$  ohms
- $L = 0.24$  henry
- $C = 3.6$   $\mu\text{f}$
- $f = 220$  cycles

Find  $Z$

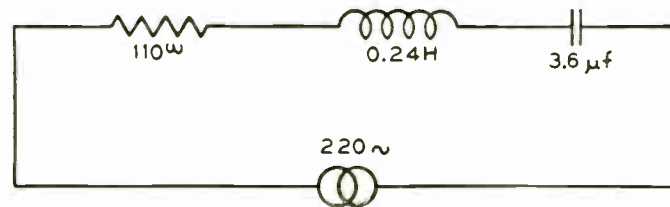
*Solution*

$$R^2 = 12,100$$

$$\omega L = 331$$

$$\frac{1}{\omega C} = 201$$

$$\omega L - \frac{1}{\omega C} = 130$$



Opposite 110 on the D-scale read 12,100 on the A-scale.

Read directly from reactance chart.

Read directly from reactance chart.

By simple subtraction.

### PARALLEL RESONANCE AND ANTI-RESONANCE

Parallel resonance is defined as the condition for which the total susceptance or reactance of the circuit is equal to zero, namely, the condition of unity power factor. Since for this condition the inductive susceptance is equal to the capacitive susceptance, and also the inductive reactance equals the capacitive reactance, either the susceptance charts or the reactance charts may be employed to determine parallel resonance in exactly the same manner as was done for series resonance.

Since antiresonance, namely the condition which results in the circuit having a maximum impedance or a minimum line current, generally differs only slightly from the condition of parallel resonance, the charts may usually be employed for determining this condition also.

### IMPEDANCE OF SERIES CIRCUIT

One of the many important advantages of the charts resides in the fact that the impedance of a series circuit comprised of resistance, inductance, and capacitance, or any combination of them, can be rapidly solved.

Consider the general case in which a resistance, an inductance, and a capacitance are connected in series. The impedance  $Z$  for this circuit is given by the expression

$$Z = R + jX = R + j(X_L - X_C) = \sqrt{R^2 + \left(\omega L - \frac{1}{\omega C}\right)^2}$$

where,  $Z$  is the impedance in ohms,  $R$  the resistance in ohms, and  $\omega$  is  $2\pi f$ , where  $f$  is the frequency in cycles,  $L$  is the inductance in henrys, and  $C$  is the capacitance in farads. The phase angle  $\theta_z$  is given by the relation

$$\theta_z = \arctan \frac{X}{R}$$

In order to show the ease with which the impedance of such a circuit can be computed, an actual example will be taken. Assume the resistance to be 110 ohms, the inductance 0.24 H, the capacitance 3.6 microfarads, and the frequency 220 cycles. The following steps are then performed using Plate 14.

$$\left(\omega L - \frac{1}{\omega C}\right)^2 = 16,900$$

$$R^2 + \left(\omega L - \frac{1}{\omega C}\right)^2 = 29,000$$

$$Z = \sqrt{R^2 + \left(\omega L - \frac{1}{\omega C}\right)^2} = 170$$

$$\theta_z = \arctan \frac{130}{110}$$

$$\theta_z = \arctan 1.18$$

$$\theta_z = 49.7^\circ$$

Opposite 130 on the D-scale read 16,900 on the A-scale.

By simple addition.

Opposite 29,000 on the A-scale read 170 on the D-scale.

$$\theta_z = \arctan \frac{X}{R}$$

Read from Q chart and locate decimal point.

Read directly from phase angle chart.

### PARALLEL CIRCUITS HAVING PURE ELEMENTS

The general case for a parallel circuit having a single pure parameter in each branch would consist of a resistance, an inductance, and a capacitance in parallel. For this condition

$$Y = G + jB = \sqrt{G^2 + \left(\omega C - \frac{1}{\omega L}\right)^2}$$

$$\text{where } B = \left(\omega C - \frac{1}{\omega L}\right)$$

Or, more simply,

$$G = \frac{1}{R} \quad B_c = \omega C \quad B_L = \frac{-1}{\omega L}$$

The case where one or more of the parallel branches is comprised of two or more of the circuit parameters is more involved and the above relations do not then apply.

Then

$$G = \frac{1}{R} = 556 \times 10^{-6} \text{ mhos}$$

$$G^2 = 309000 \times 10^{-12}$$

$$\omega C = 598 \times 10^{-6} \text{ mhos}$$

$$\frac{1}{\omega L} = 135 \times 10^{-6} \text{ mhos}$$

$$B = \left(\omega C - \frac{1}{\omega L}\right) = 463 \times 10^{-6} \text{ mhos}$$

$$B^2 = 215000 \times 10^{-12}$$

$$G^2 + B^2 = 524000 \times 10^{-12}$$

$$Y = \sqrt{G^2 + B^2} = 724 \times 10^{-6} \text{ mhos}$$

$$\frac{B}{G} = 0.832$$

$$\theta_x = \arctan \frac{B}{G} = 39.8^\circ$$

$$Z = \frac{1}{724 \times 10^{-6}}$$

$$Z = 1380 \text{ ohms}$$

$$\theta_z = -39.8^\circ$$

Opposite 1800 on the C-scale read 556  $\mu$  mhos on the CI-scale, namely  $556 \times 10^{-6}$  mhos.

Opposite 556 on the D-scale read 309000 on the A-scale, and multiply by square of the 10 factor.

Read 598  $\mu$  mhos directly from susceptance chart, and convert to mhos.

Read 135  $\mu$  mhos directly from susceptance chart, and convert to mhos.

By simple subtraction.

Opposite 463 on the D-scale read 215000 on the A-scale, and multiply by square of the 10 factor.

By simple addition.

Opposite 524000 on the A-scale read 724 on the D-scale, and multiply by square root of the 10 factor.

Read significant figures from Q-chart and point off decimal point.

Read directly from phase angle chart.

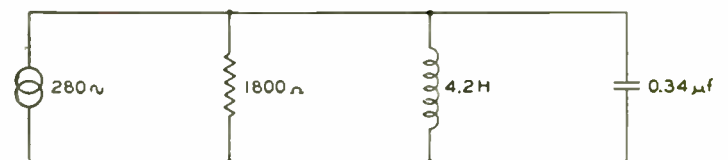
$$\text{Since } Z = \frac{1}{Y}$$

Opposite 724  $\mu$  mhos on CI-scale read 1380 on C scale.

Since  $\theta_z = -\theta_x$

This more complicated type of circuit is discussed later.

Employment of the charts enable admittance to be rapidly computed. Consider the parallel circuit shown, in which the resistance is 1800 ohms, the inductance is 4.2 henrys, and the capacitance is 0.34 microfarad.



The following steps are then performed with the aid of Plate 85, except where otherwise noted.

Given

$$R = 1800 \text{ ohms}$$

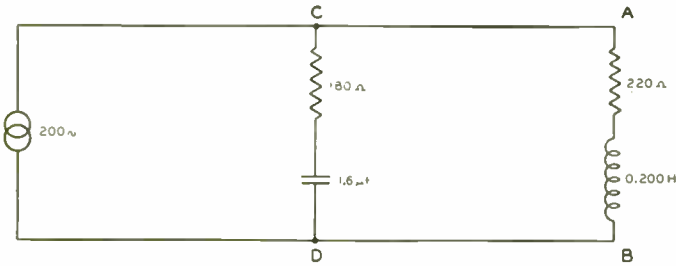
$$C = 0.34 \mu\text{f}$$

$$L = 4.2 \text{ H}$$

$$f = 280 \text{ cycles}$$

## SERIES-PARALLEL CIRCUITS

When the parallel circuit is comprised of circuits in which the separate parallel branches consist of series connections of the circuit parameters, the computations become somewhat more involved. As an illustrative case the circuit shown will be considered.



Before examining this circuit it will be well to state the various formulas which will be employed in its solution.

The relation  $Y = \frac{1}{Z}$  is general in its application, not only for pure parallel circuits, but also for series-parallel circuits.

The various steps in obtaining the solution of a series-parallel circuit are generally made in the following sequence:

- (1) The impedance  $Z$  of each of the series branches is determined, and the admittance  $Y$  of each series branch by the relation  $Y = \frac{1}{Z}$ .
- (2) The real and imaginary components of the admittance function  $Y = G + jB$  are found by the relations

$$G = \frac{R}{R^2 + X^2} = \frac{R}{Z^2}$$

$$B = \frac{-X}{R^2 + X^2} = \frac{-X}{Z^2}$$

It will be observed that these formulas reduce to  $G = \frac{1}{R}$  when the reactance of a branch is zero, and to  $B = \frac{-1}{X}$  when the resistance of a branch is zero, as would be the case in a pure parallel circuit.

(3) The real components  $G_1, G_2, G_3$ , etc. of the admittance functions of the various branches are added algebraically to obtain the real component of the total admittance function, namely,

$$G = G_1 + G_2 + G_3 + \dots$$

Similarly, the imaginary components  $B_1, B_2, B_3$ , etc., of the admittance functions of the various branches are added algebraically to obtain the imaginary component of the total admittance function, namely,

$$B = B_1 + B_2 + B_3 + \dots$$

The total admittance function  $Y$  is therefore

$$Y = G + jB = (G_1 + G_2 + G_3 + \dots) + j(B_1 + B_2 + B_3 + \dots)$$

(4) The total impedance  $Z$  of the circuit is then obtained by the relation  $Z = \frac{1}{Y}$ .

(5) The phase angle  $\theta_z$  of each of the various branches may be obtained either from the relation  $\theta_z = \arctan \frac{X}{R}$  or from the relation  $\theta_r = \arctan \frac{B}{G}$ . It will be observed that  $\theta_z = -\theta_r$ . The phase angle of the total circuit is found in a similar manner.

A-B circuit (Plate 14)

$$\begin{aligned} R &= 220 \text{ ohms} \\ X_L &= 251 \text{ ohms} \\ R^2 &= 48400 \\ X_L^2 &= 63100 \\ Z^2 &= R^2 + X_L^2 = 112,000 \\ G_{AB} &= \frac{R}{Z^2} = 1960 \mu \text{ mhos} \\ B_{AB} &= \frac{-X_L}{Z^2} = -2240 \mu \text{ mhos} \end{aligned}$$

Given.  
Read directly from chart.  
Opposite 220 on D-scale read 48400 on A-scale.  
Opposite 251 on D-scale read 63100 on A-scale.  
By addition.  
By division.  
By division.

C-D circuit (Plate 14)

$$\begin{aligned} R &= 180 \\ X_C &= -498 \\ R^2 &= 32400 \\ X_C^2 &= 248000 \\ Z^2 &= R^2 + X_C^2 = 280000 \\ G_{CD} &= \frac{R}{Z^2} = 643 \mu \text{ mhos} \\ B_{CD} &= \frac{-X_C}{Z^2} = 1780 \mu \text{ mhos} \end{aligned}$$

Given.  
Read directly from chart.  
Opposite 180 on D-scale read 32400 on A-scale.  
Opposite 498 on D-scale, read 248000 in A-scale.  
By addition.  
By division.  
By division.

A-B and C-D circuit in parallel

$$G = 1960 + 643 = 2600 \mu \text{ mhos}$$

$$= 2600 \times 10^{-6} \text{ mhos}$$

$$B = -2240 + 1780 = -460 \mu \text{ mhos}$$

$$= -460 \times 10^{-6} \text{ mhos}$$

$$G^2 = 6.76 \times 10^{-6}$$

$$B^2 = 212000 = 0.212 \times 10^{-6}$$

$$G^2 + B^2 = 6.97 \times 10^{-6}$$

$$Y = \sqrt{G^2 + B^2} = 2640 \mu \text{ mhos}$$

$$Z = \frac{1}{Y} = \frac{1}{2650 \times 10^{-6}} = 377 \text{ ohms}$$

$$\theta_Y = \arctan \frac{-460}{2600}$$

$$\theta_Y = -\arctan \frac{460}{2600}$$

$$\theta_Y = -\arctan 0.180$$

$$\theta_Y = -10.2^\circ$$

$$\theta_Z = 10.2^\circ$$

$$G = G_{AB} + G_{CD}$$

$$B = B_{AB} + B_{CD}$$

Opposite 2600 on D-scale, read  $6.76 \times 10^6$  on A-scale of Plate 6, and multiply by  $10^{-12}$ .

Opposite 460 on D-scale, read 212000 on A-scale of Plate 5, and multiply by  $10^{-12}$ .

By addition.

Opposite 6.97 on A-scale, read 2.65 on D-scale of Plate 3, and convert to micromhos.

By division.

$$\theta_Y = \arctan \frac{B}{G}$$

$$\arctan (-X) = -\arctan X.$$

Read from Q chart, and locate decimal point.

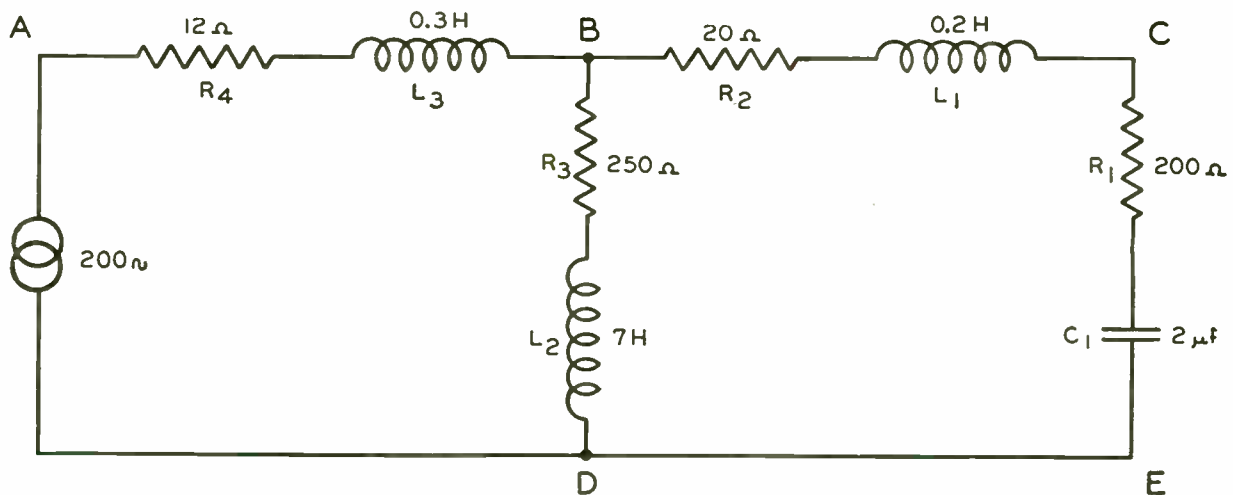
Read directly from phase angle chart.

$$\theta_Z = -\theta_Y.$$

## MESH CIRCUITS

More complicated circuits than the foregoing series-parallel type are frequently encountered, so that it will be well to show the application of the charts to such mesh circuits.

In the two-mesh circuit shown below it is desired that the circuit impedance as viewed from the source be known.



BCE is a series circuit in parallel with circuit BD, so we shall find the BE admittance.

BE circuit (Plate 14)

$$R_{BE} = 200 + 20 = 220 \text{ ohms}$$

$$X_{L1} = 251 \text{ ohms}$$

$$X_{C1} = -398 \text{ ohms}$$

$$X_{BE} = X_{L1} - X_{C1} = -147 \text{ ohms}$$

$$R_{BE}^2 = 48400$$

$$X_{BE}^2 = 21600$$

$$Z_{BE}^2 = R_{BE}^2 + X_{BE}^2 = 70000$$

$$G_{BE} = \frac{220}{70000} = 3140 \mu \text{ mhos}$$

$$R_{BE} = R_1 + R_2.$$

Read directly from Plate 14.

Read directly from Plate 14.

By subtraction.

Opposite 220 on D-scale, read 48400 on A-scale.

Opposite 147 on D-scale, read 21600 on A-scale.

By addition.

$$G_{BE} = \frac{R_{BE}}{Z_{BE}^2}$$

$$B_{BE} = \frac{147}{70000} = 2100 \mu \text{ mhos}$$

$$Y_{BE} = 3140 + j 2100 \mu \text{ mhos}$$

*BD circuit (Plates 14, 15)*

$$R_{BD} = 250 \text{ ohms}$$

$$X_{L2} = 8820 \text{ ohms}$$

$$R_{BD}^2 = 62500$$

$$X_{L2}^2 = 7.78 \times 10^7$$

$$Z_{BD}^2 = R_{BD}^2 + X_{L2}^2 = 7790 \times 10^4$$

$$G_{BD} = \frac{250}{77.9 \times 10^6} = 3.21 \times 10^{-6} \text{ mhos}$$

$$B_{BD} = \frac{-8820}{7790 \times 10^4} = -113 \times 10^{-6} \text{ mhos}$$

$$Y_{BD} = 3.21 - j 113 \mu \text{ mhos}$$

*BE—BD circuit in parallel*

$$Y_{BE-BD} = (3140 + 3.21) + j(2100 - 113) \mu \text{ mhos}$$

$$= 3140 + j 1990 \mu \text{ mhos}$$

$$G = 3140 \times 10^{-6}$$

$$B = 1990 \times 10^{-6}$$

$$G^2 = 9.87 \times 10^{-6}$$

$$B^2 = 3.98 \times 10^{-6}$$

$$Y^2 = G^2 + B^2 = 13.9 \times 10^{-6}$$

$$R_{BE-BD} = \frac{3140 \times 10^{-6}}{13.9 \times 10^{-6}} = 226 \text{ ohms}$$

$$X_{BE-BD} = \frac{-1990 \times 10^{-6}}{13.9 \times 10^{-6}} = -143 \text{ ohms}$$

$$Z_{BE-BD} = 226 - j 143 \text{ ohms}$$

*AB circuit (Plate 14)*

$$R_{AB} = 12 \text{ ohms}$$

$$X_{AB} = 378 \text{ ohms}$$

$$Z_{AB} = 12 + j 378 \text{ ohms}$$

*AB and BE—BD circuits in series (Plate 14)*

$$Z = (12 + 226) + j(378 - 143) \text{ ohms}$$

$$= 238 + j 235 \text{ ohms}$$

If absolute value of  $Z$  is desired, then

$$Z^2 = (238)^2 + (235)^2$$

$$= 56600 + 55100$$

$$= 112000$$

$$Z = \sqrt{11.2 \times 10^4} = 335 \text{ ohms}$$

$$\theta_z = \text{arc tan } \frac{235}{238}$$

$$= \text{arc tan } 0.987$$

$$= 44.6^\circ$$

$$B_{BE} = \frac{-X}{Z^2}$$

$$Y = G + jB.$$

Given.

Read directly from Plate 15.

Opposite 250 on D-scale of Plate 14, read 62500 on A-scale.

Opposite 8820 on D-scale, read  $7.78 \times 10^7$  on A-scale.

By addition.

$$G_{BD} = \frac{R_{BD}}{Z_{BD}^2}$$

$$B_{BD} = \frac{-X_{L2}}{Z_{BD}^2}$$

$$Y = G + jB.$$

$$Y_{BE-BD} = Y_{BE} + Y_{BD}.$$

From equation for  $Y$ .

From equation for  $Y$ .

Opposite  $3140 \times 10^{-6}$  on D-scale, read  $9.87 \times 10^{-6}$  on A-scale.

Opposite  $1990 \times 10^{-6}$  on D-scale, read  $3.98 \times 10^{-6}$  on A-scale.

By addition.

$$R = \frac{G}{Y^2}$$

$$X = \frac{-B}{Y^2}$$

Given.

Read directly from Plate 14.

$$Z = R + jX.$$

$$Z = (R_{AB} + R_{BE-BD}) + j(X_{AB} + X_{BE-BD})$$

$$Z^2 = R^2 + X^2$$

Opposite 238 on D-scale, read 56600 on A-scale, and opposite 235 on D-scale, read 55100 on A-scale.

By addition.

Opposite 112000 on A-scale, read 335 on D-scale.

$$\theta_z = \text{arc tan } \frac{X}{R}$$

Read from chart and locate decimal point.

Read directly from chart.

## RESISTANCE-CAPACITANCE TUNED OSCILLATOR

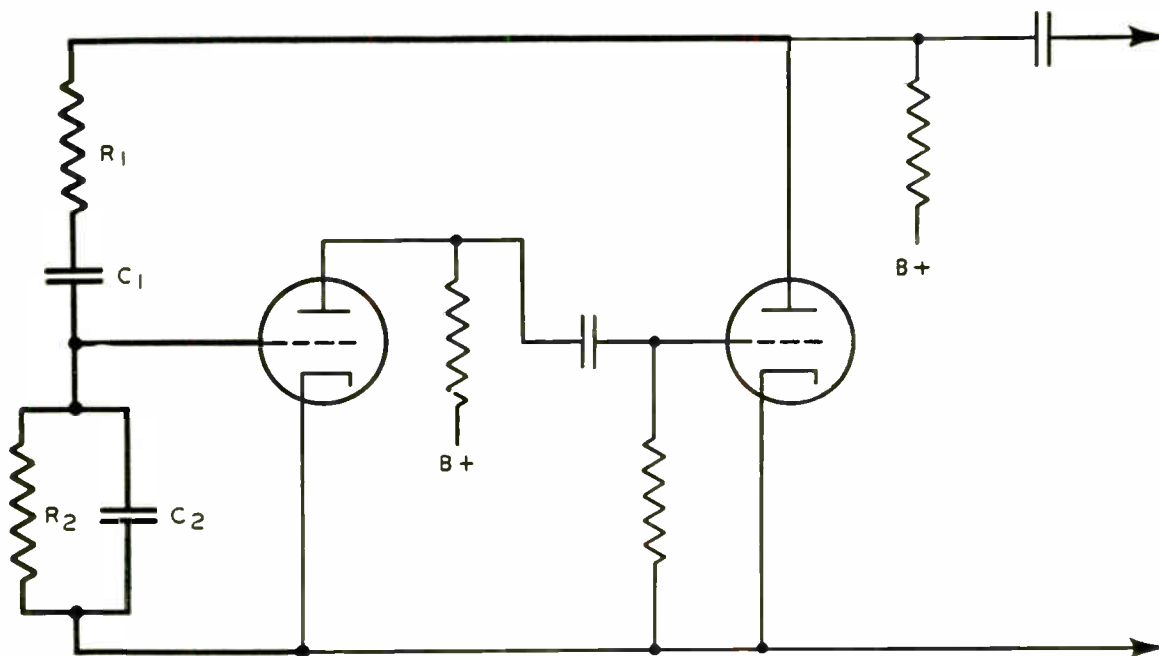
The charts may be used for computing the values of resistance and capacitance in resistance-tuned or capacitance-tuned oscillators. A typical circuit of this type is shown in the figure, where one or more of the elements  $R_1$ ,  $R_2$ ,  $C_1$ ,  $C_2$  may be varied. The frequency of oscillation, assuming that the amplifier has zero phase shift, is given by

$$f = \frac{1}{2\pi \sqrt{R_1 R_2 C_1 C_2}}$$

When the resistors are equal and the capacitors are equal, that is, when  $R = R_1 = R_2$  and  $C = C_1 = C_2$ , the oscillation frequency is

$$f = \frac{1}{2\pi R C}$$

For this condition, if any two of the three quantities, frequency, resistance, or capacitance, are known, the other may be found directly from the chart.



Thus, to determine the value of the resistance which should be used in conjunction with an  $800 \mu\mu\text{f}$  condenser in order to obtain a frequency of 40 cycles, on Plate 9, the green 40-cycle line is followed upward until it strikes the red sloping  $800 \mu\mu\text{f}$  line. The point of intersection indicates that a resistance of 4.97 megohms be employed.

Similarly, at 15,000 cycles an  $800 \mu\mu\text{f}$  condenser would require a resistance of 13,300 ohms, as determined from Plate 34.

### CONDUCTANCE

The conductance  $G$  (where  $G = \frac{1}{R}$ ) of a resistor is measured in mhos, or in some multiple thereof, as micromhos ( $\mu$  mhos), where  $1 \text{ mho} = 1,000,000 \mu \text{ mho} = 10^6 \mu \text{ mho}$ .

The conductance of a resistor is obtained by referring to the direct-reading C and CI scales which will be found at the bottom of each page. Opposite the resistance on the C-scale will be found the conductance on the CI-scale. Thus, a resistor having a resistance of 200 ohms (C-scale) has a conductance of 0.005 mho (CI-scale). Similarly, a resistance of 4270 ohms is equivalent to a conductance of  $234 \mu$  mhos.

Conversely, if the conductance is known the corresponding resistance may be obtained, since opposite the conductance on the CI-scale will be found the resistance on the C-scale. A conductance of 0.00345 mho (CI-scale) therefore corresponds to a resistance of 290 ohms.

### RESISTORS IN PARALLEL

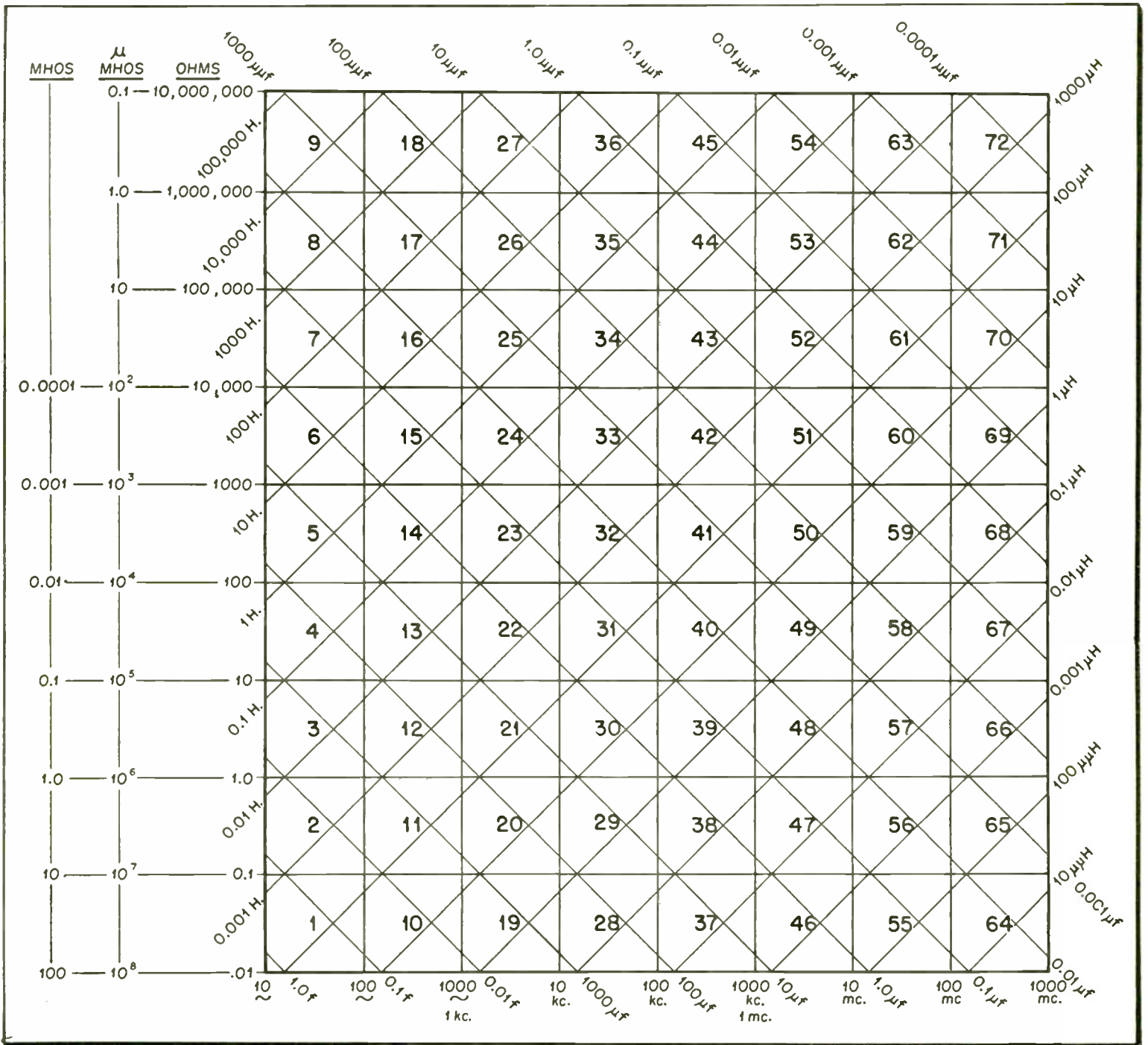
The total conductance  $G$  of resistors in parallel is equal to the algebraic sum of the individual conductances, namely,  $G = g_1 + g_2 + g_3 + \dots$ , where  $g_1$ ,  $g_2$ ,  $g_3$ , etc., are the individual conductances.

The total resistance  $R$  of a number of resistors in parallel is equal to the reciprocal of the sum of their separate conductances, namely,

$$R = \frac{1}{g_1 + g_2 + g_3 + \dots}$$

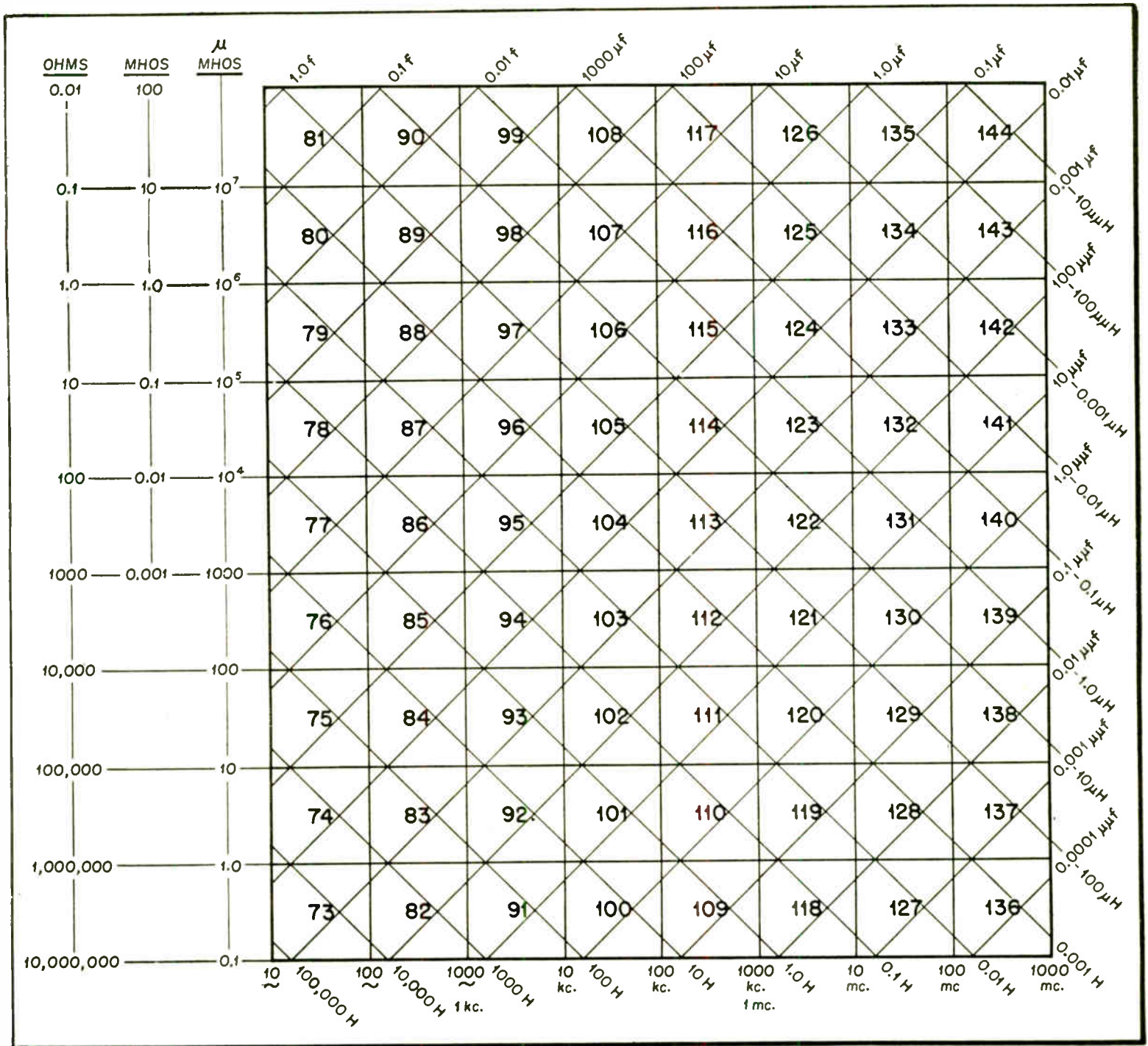
For example, let us assume that we have three resistors having resistances of 200, 300, and 400 ohms respectively. By the use of the C-scale and CI-scale we obtain conductances of 0.00500, 0.00333, and 0.00250 mhos respectively. The sum of these conductances is 0.0108 mho, and opposite this value on another CI-scale, we obtain the total resistance of 92.6 ohms on the C-scale:

# REACTANCE — IMPEDANCE INDEX CHART





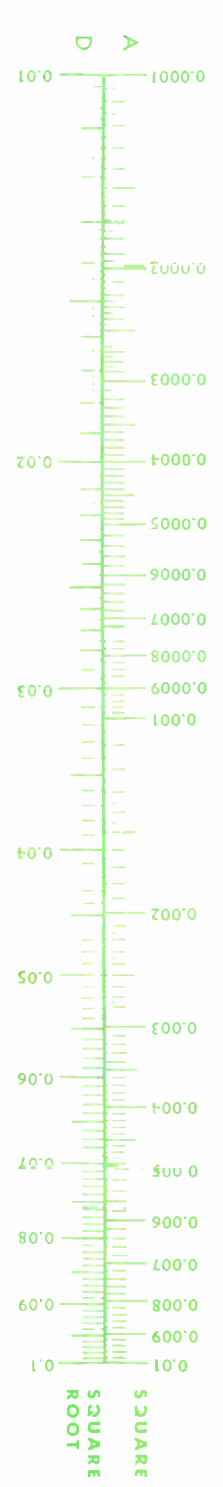
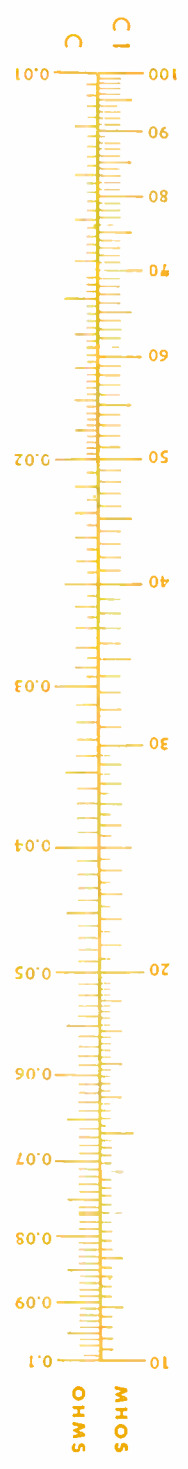
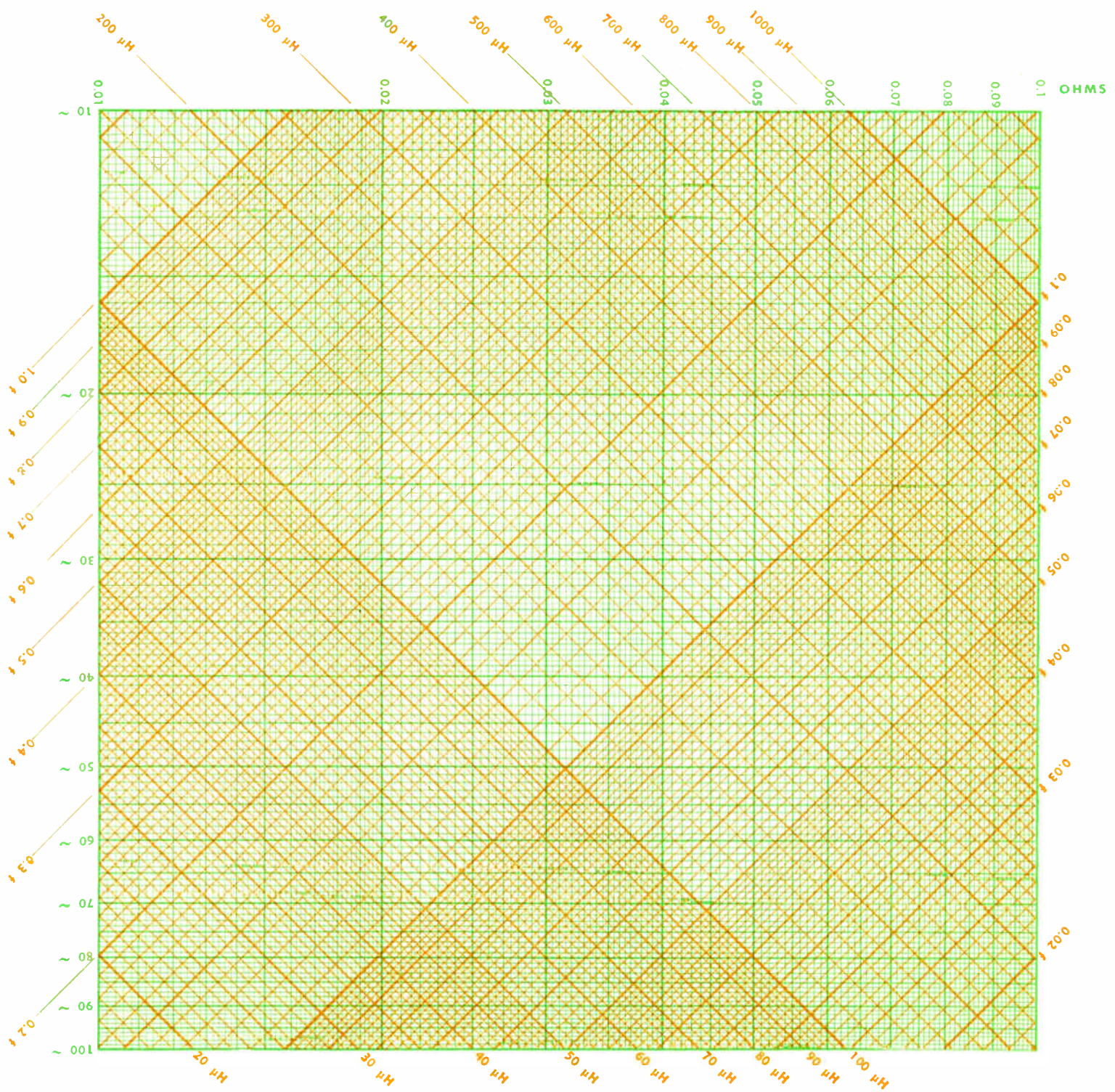
# SUSCEPTANCE — ADMITTANCE INDEX CHART





# A-C CALCULATION CHARTS





# PLATE 2

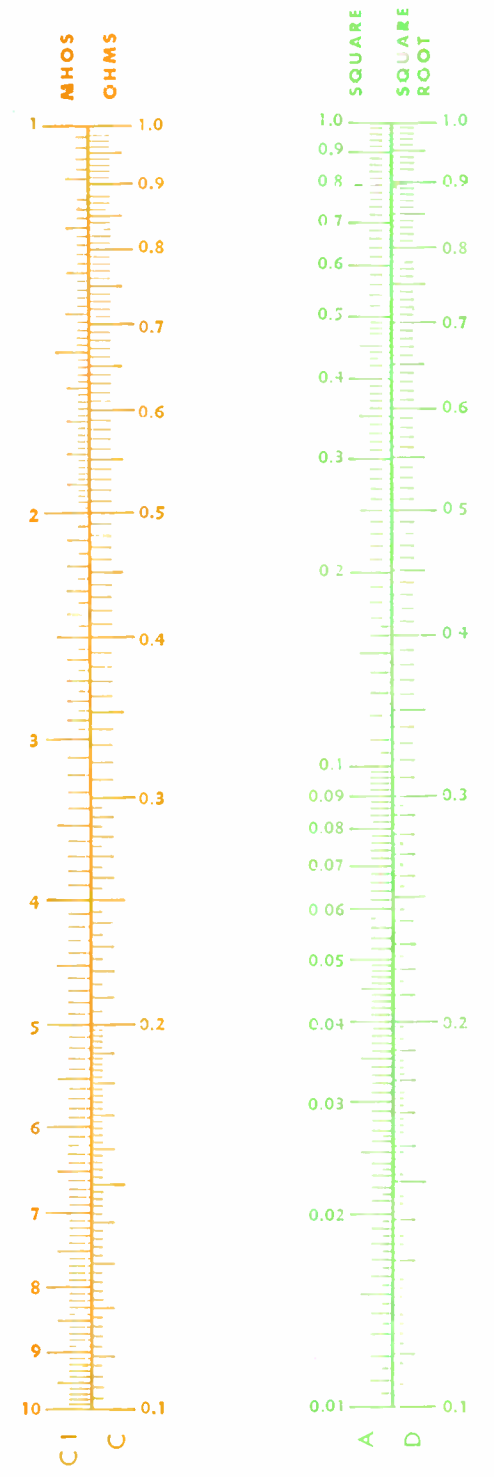
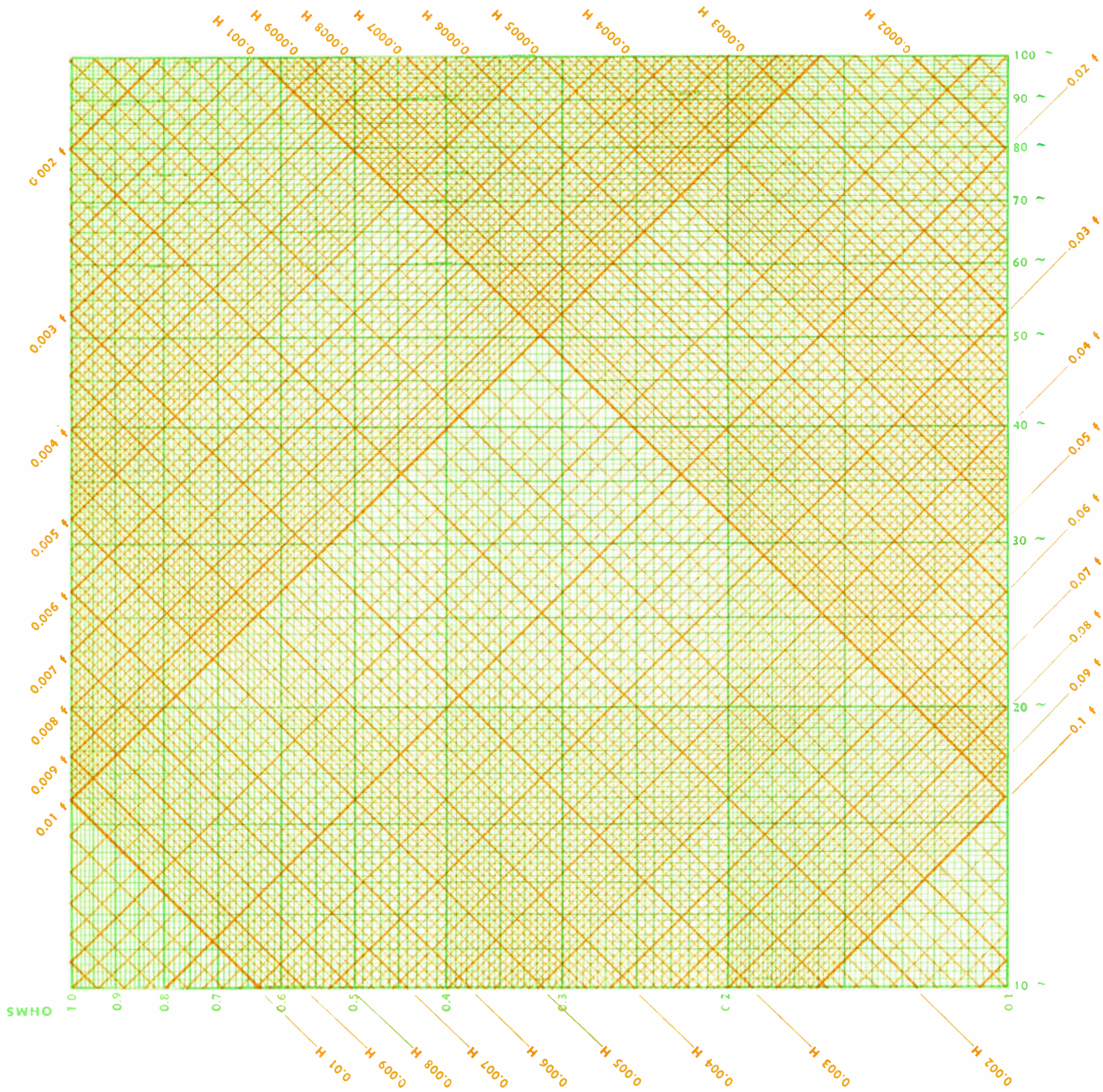
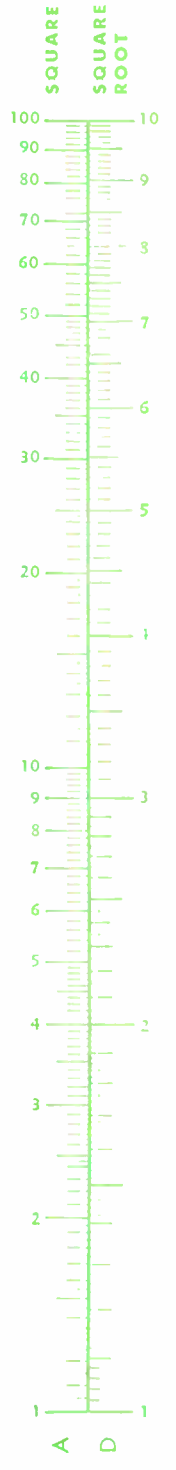
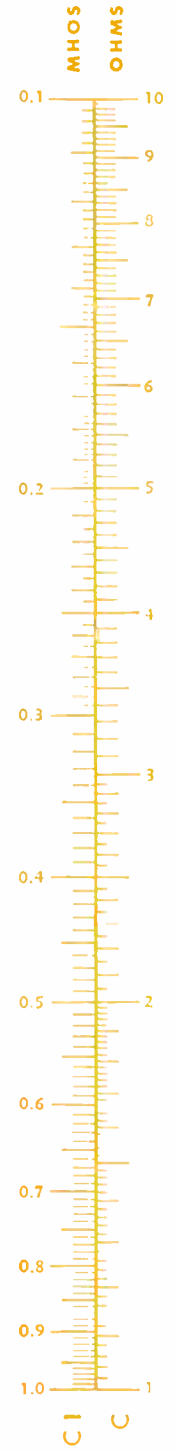
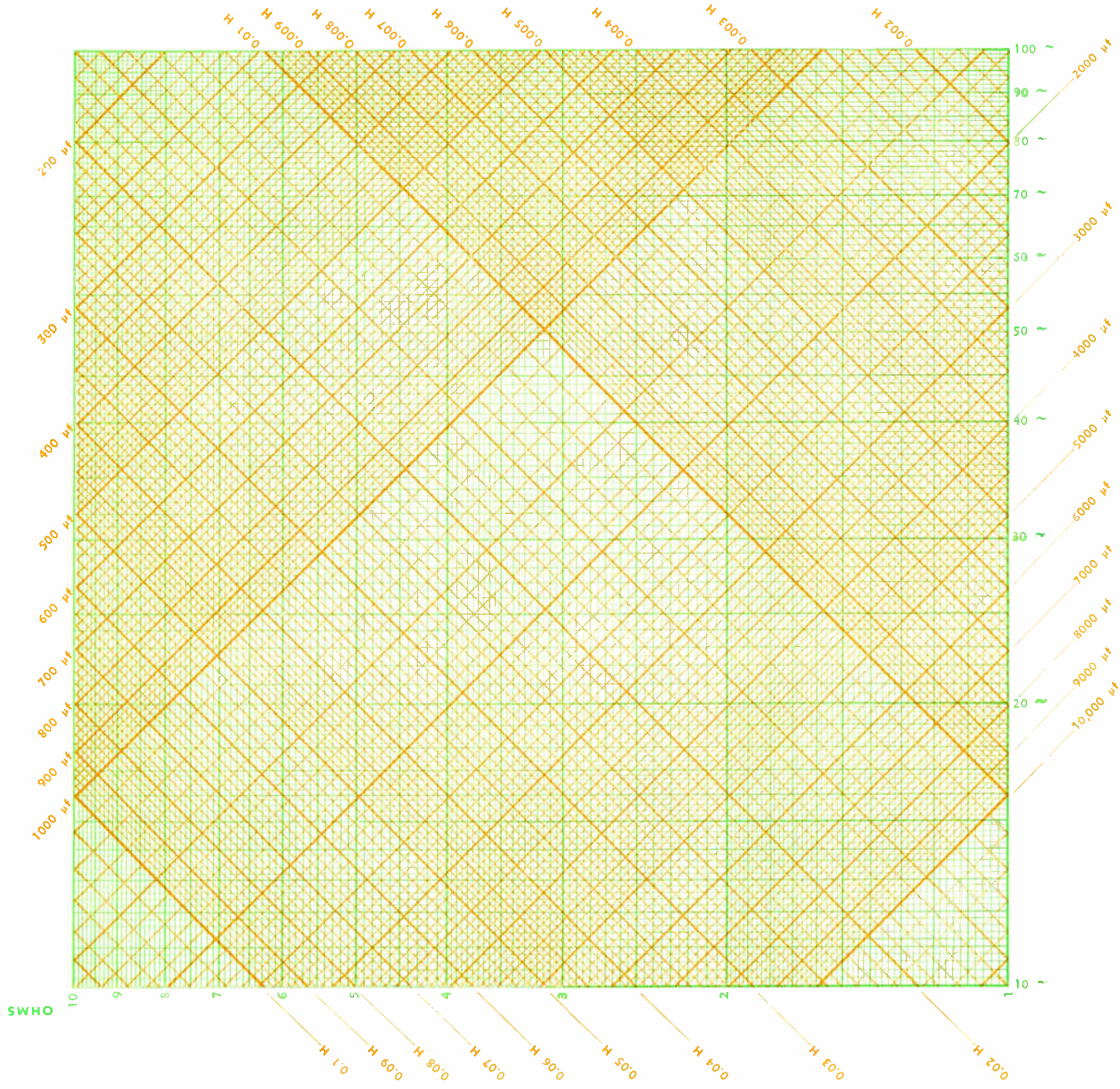
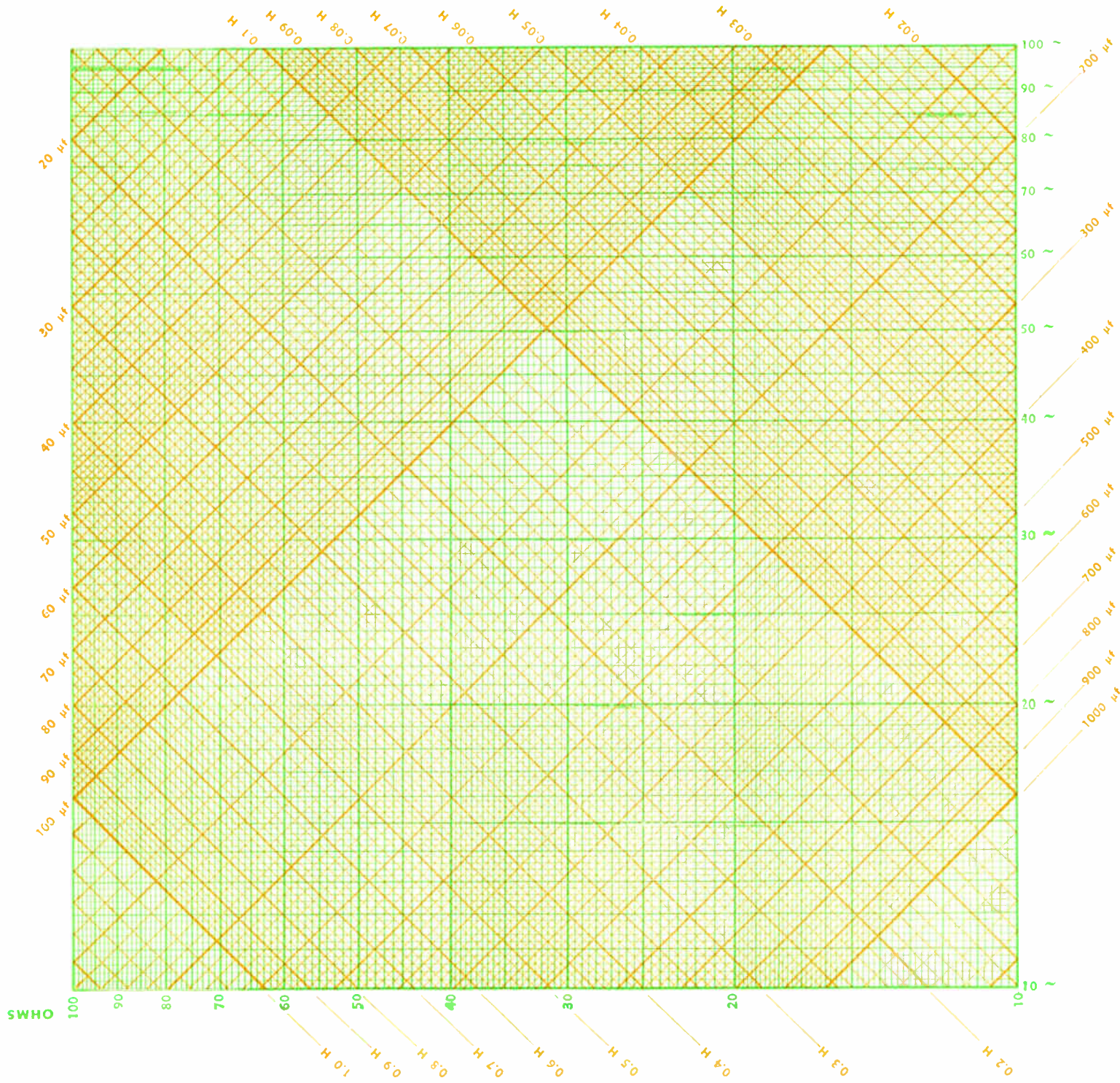


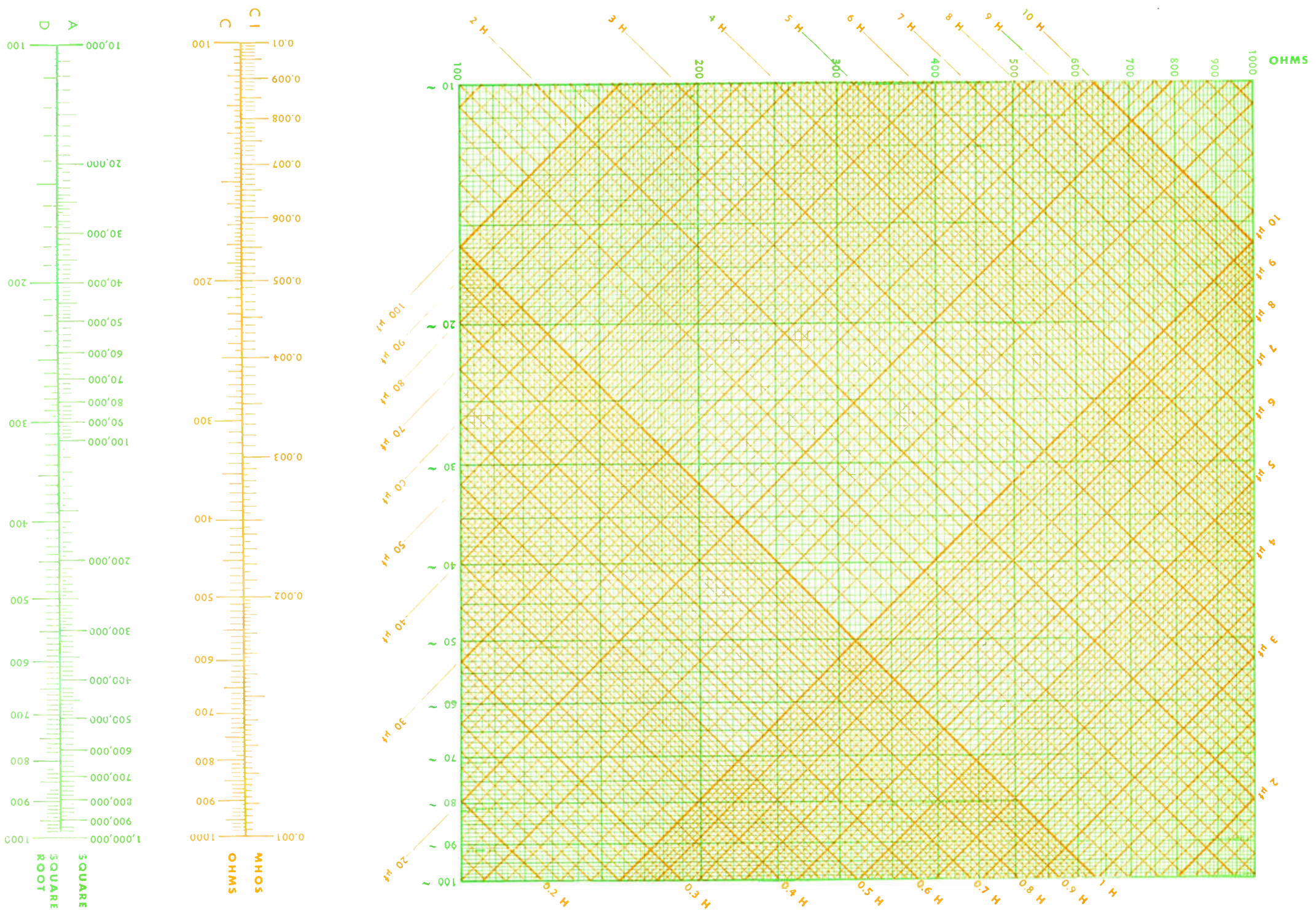
PLATE 3

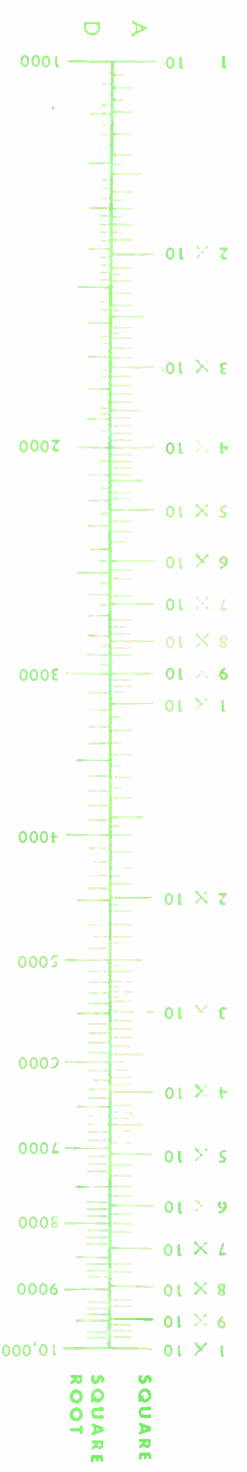
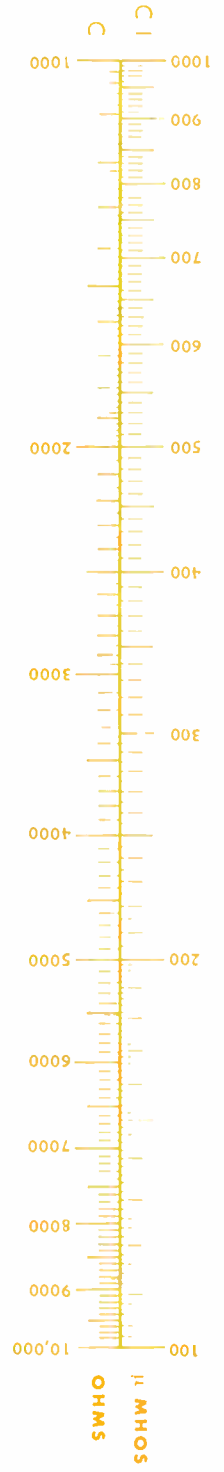
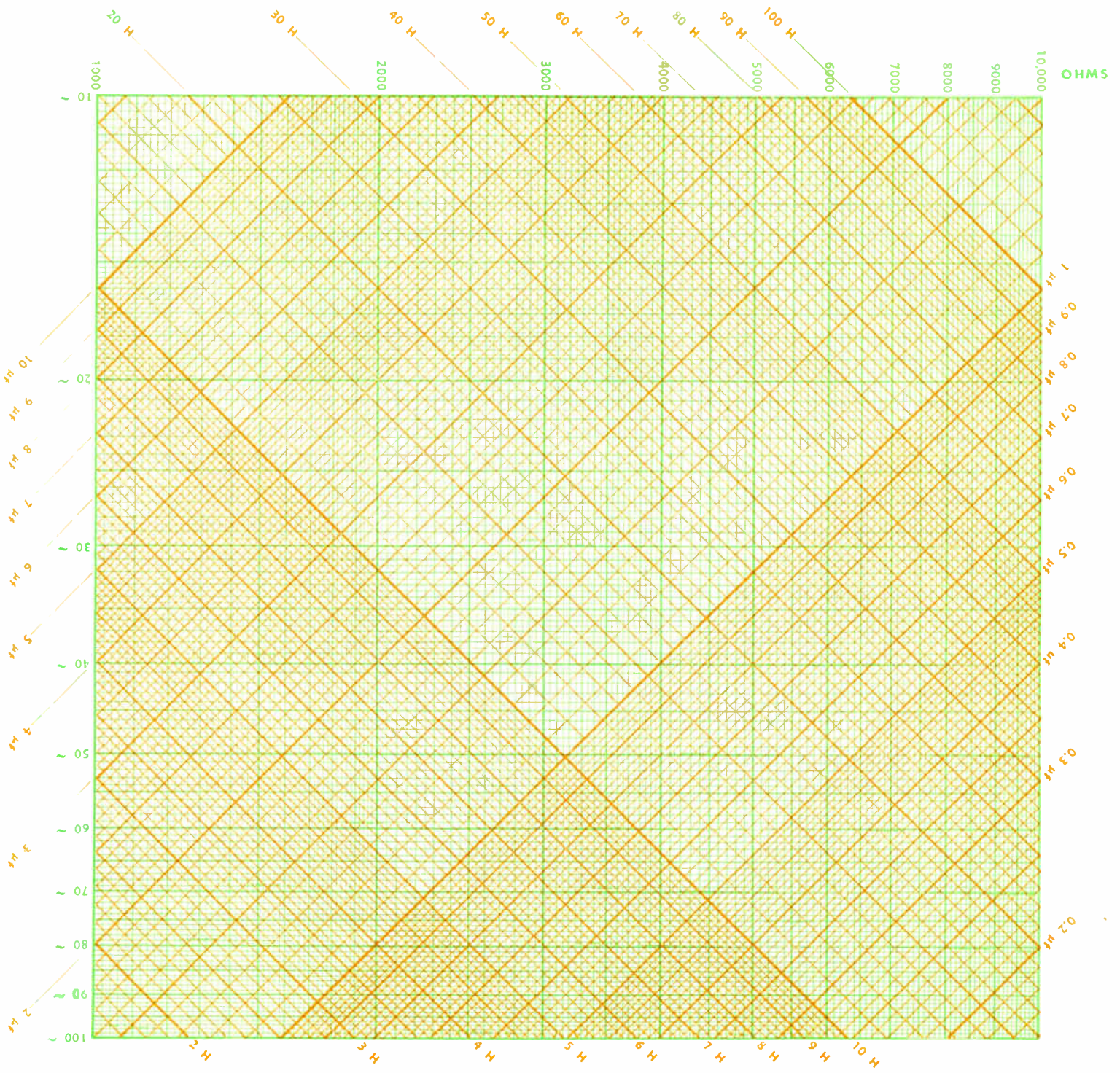


# PLATE 4









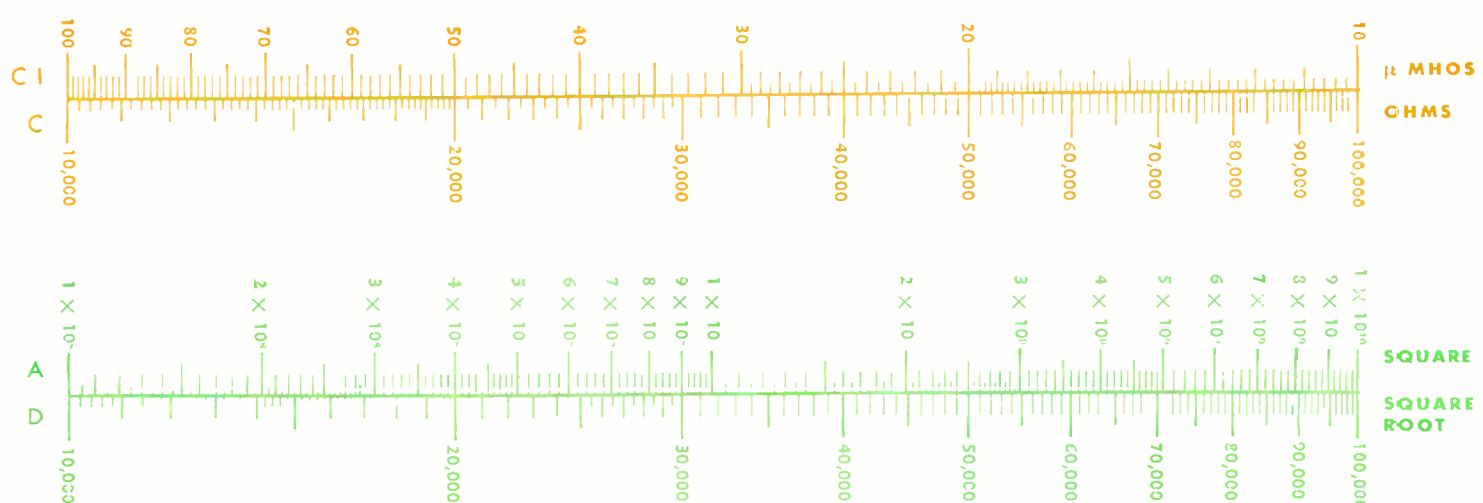
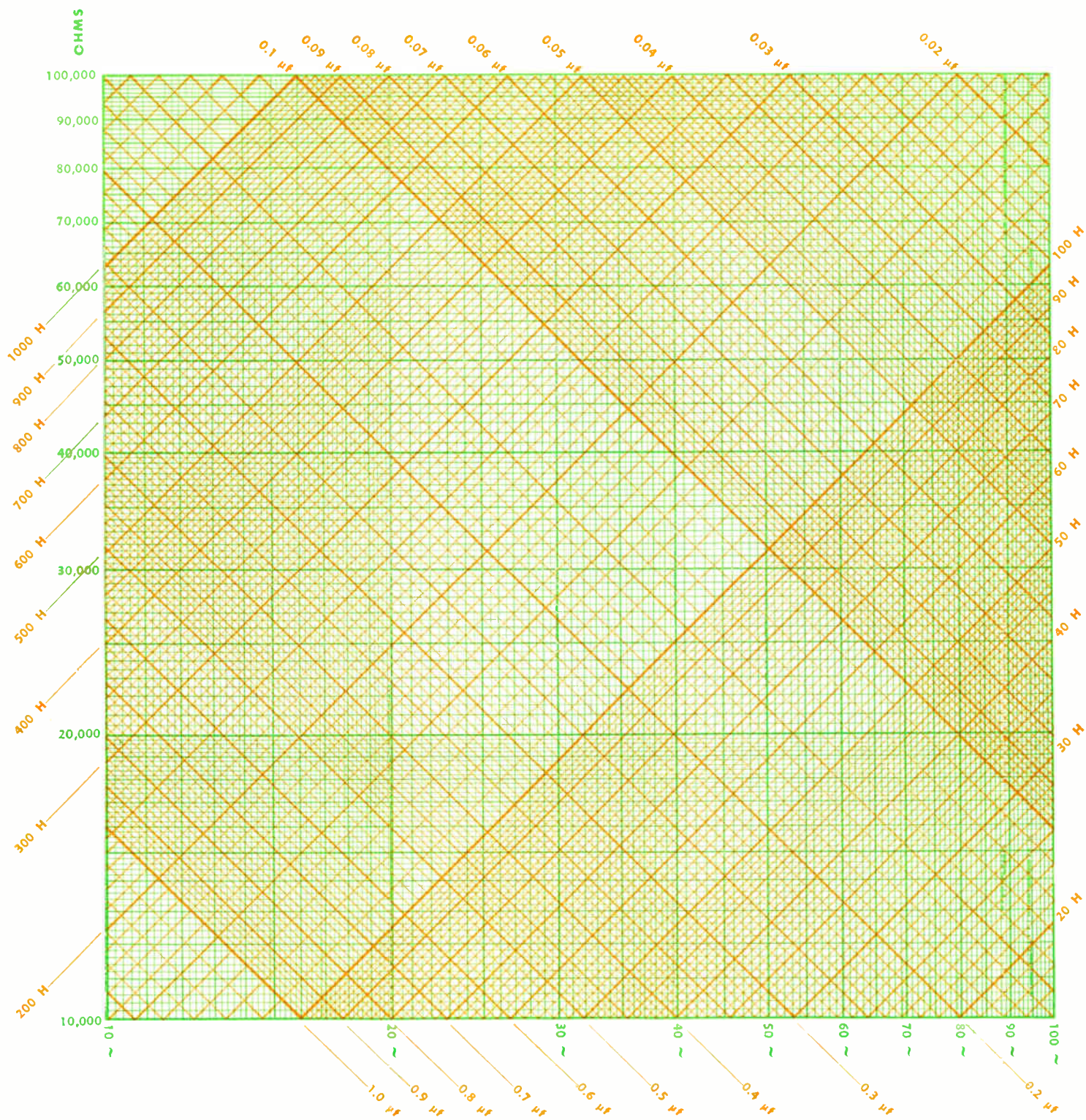
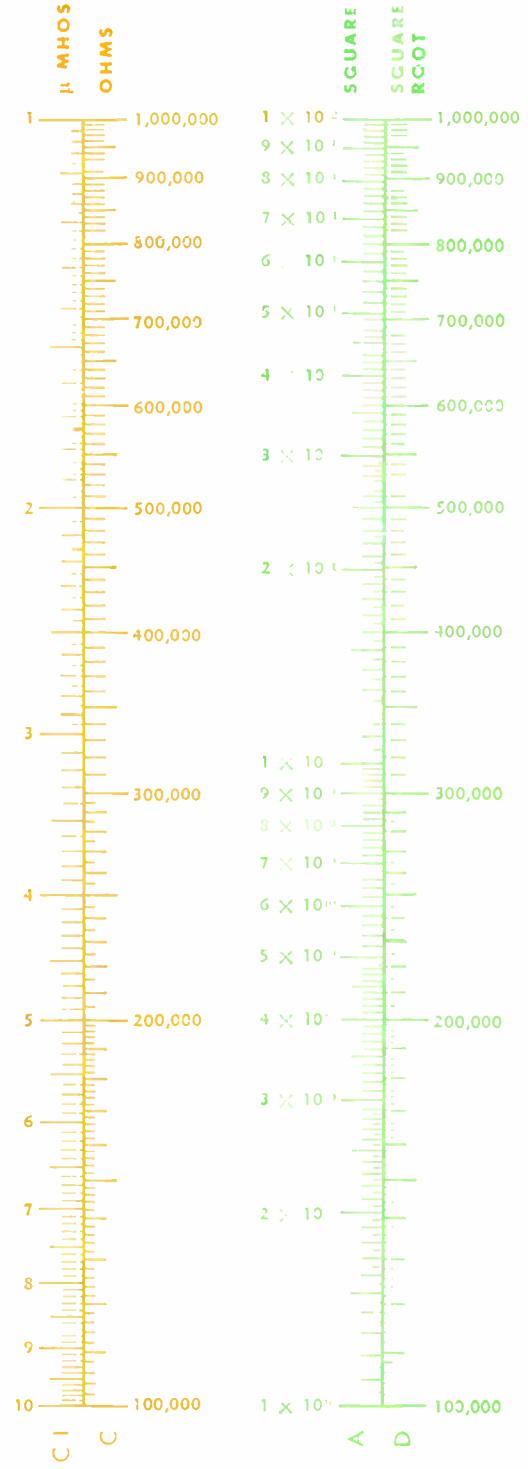
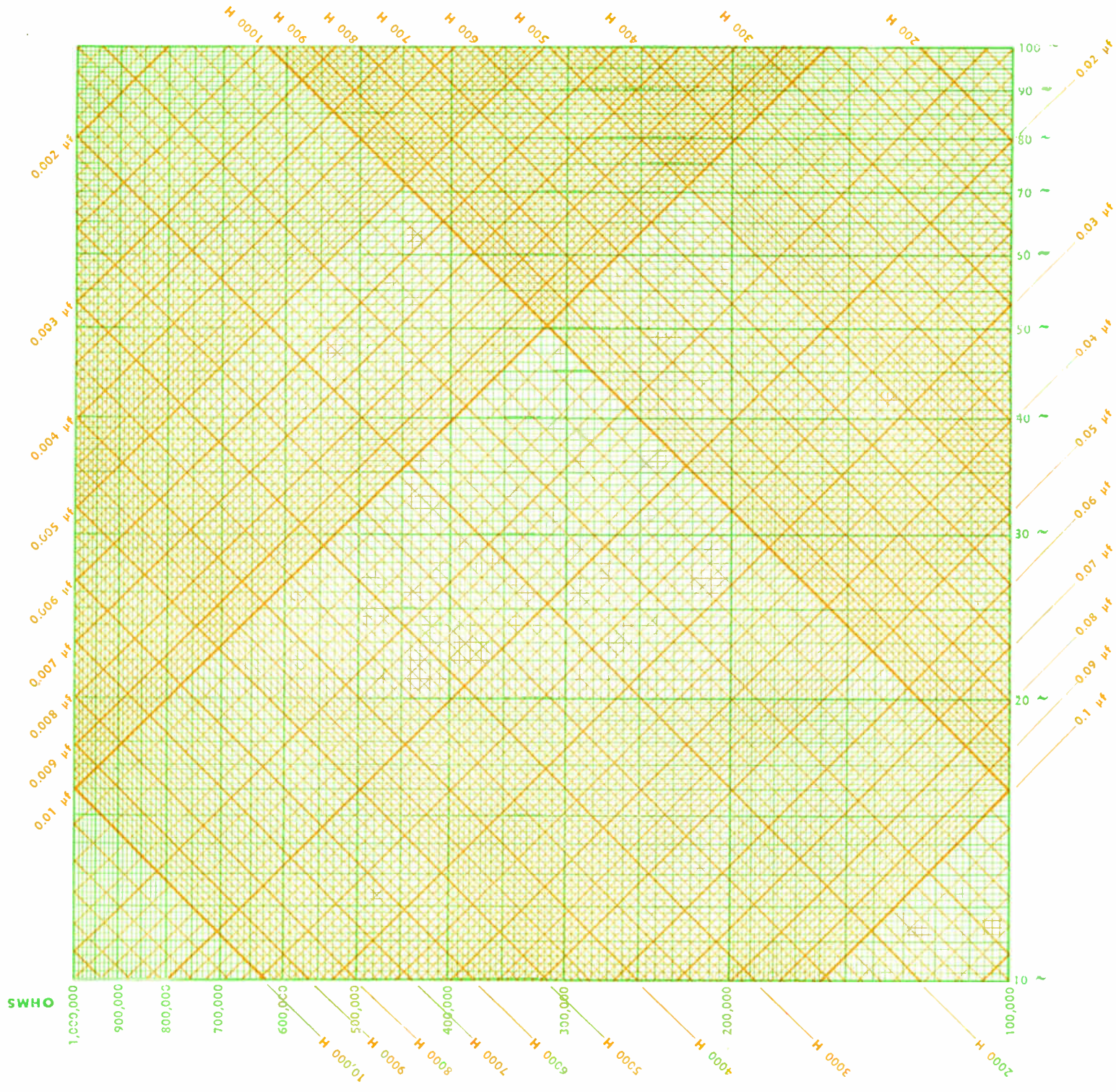
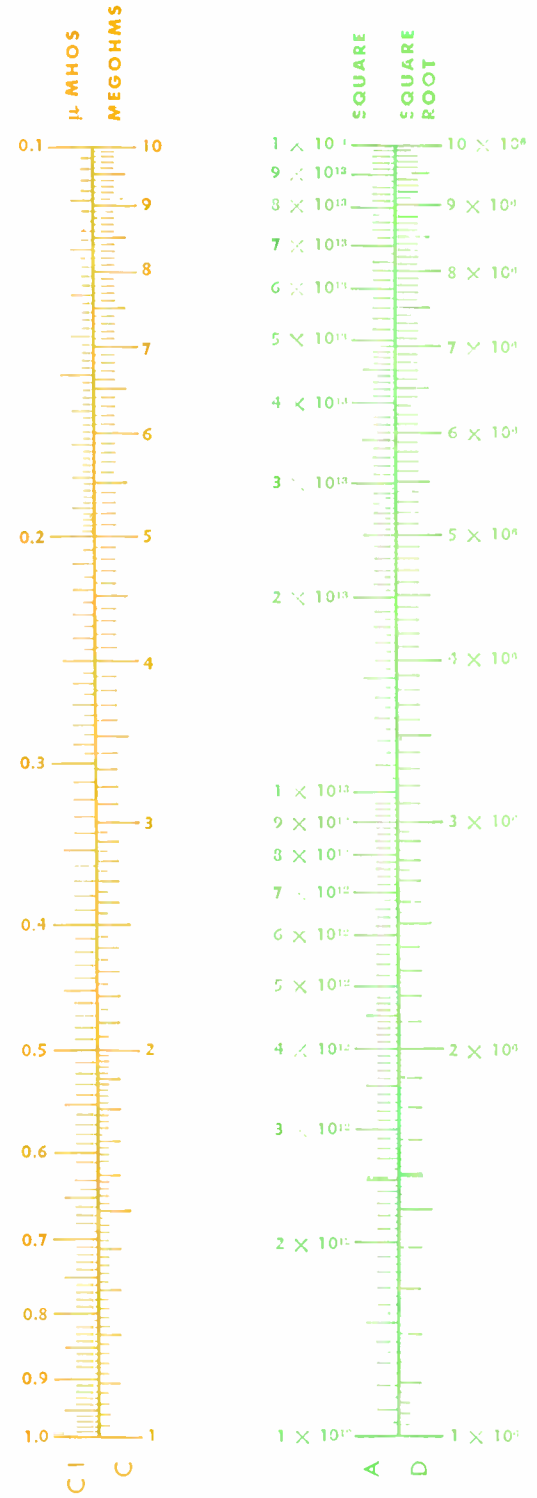
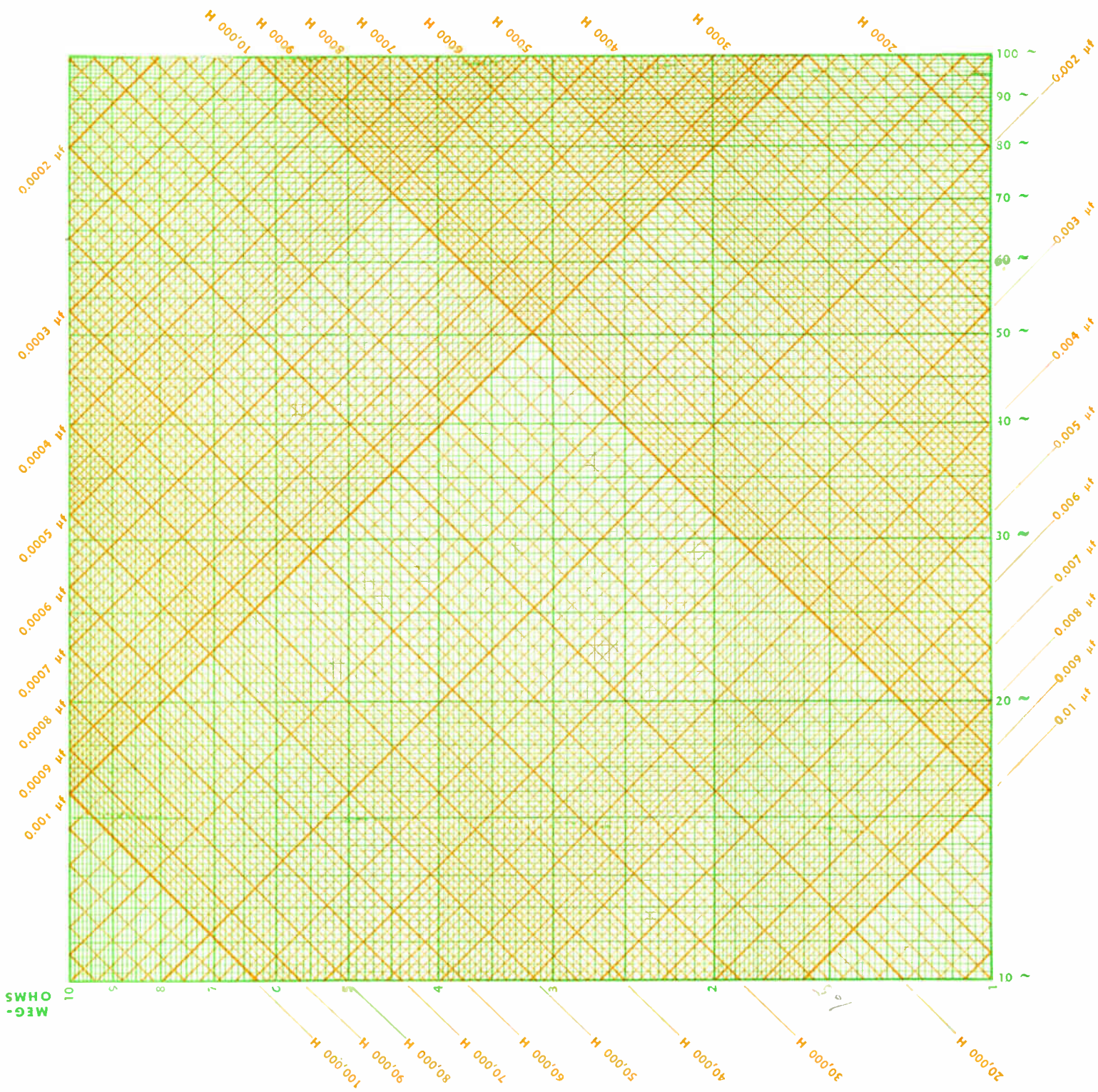


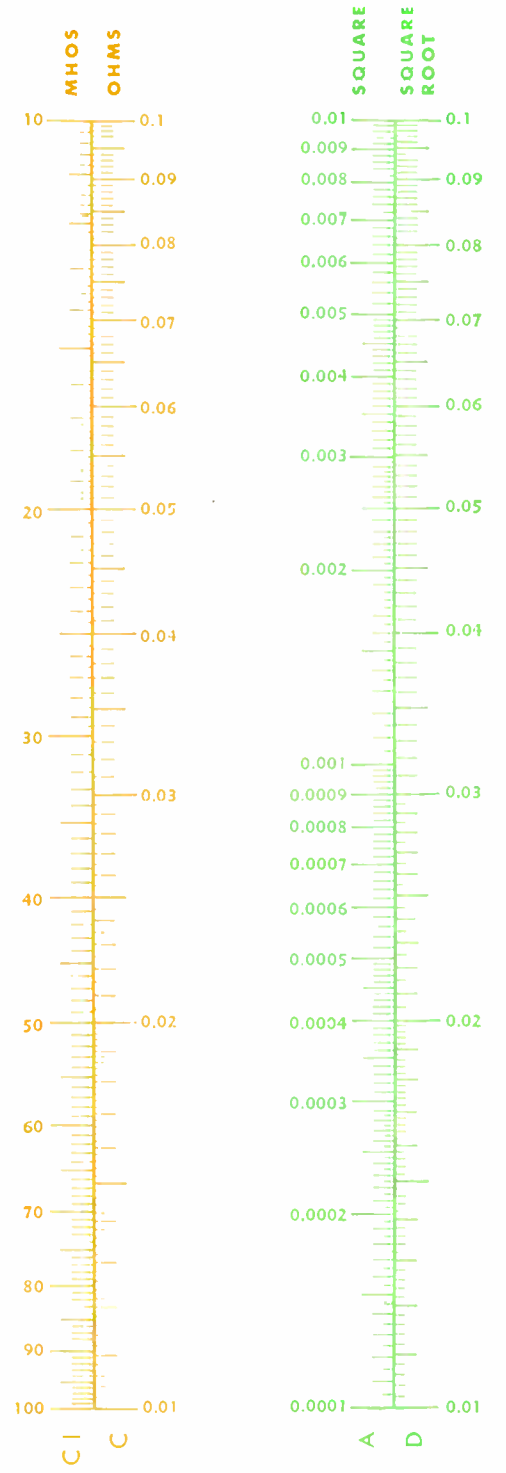
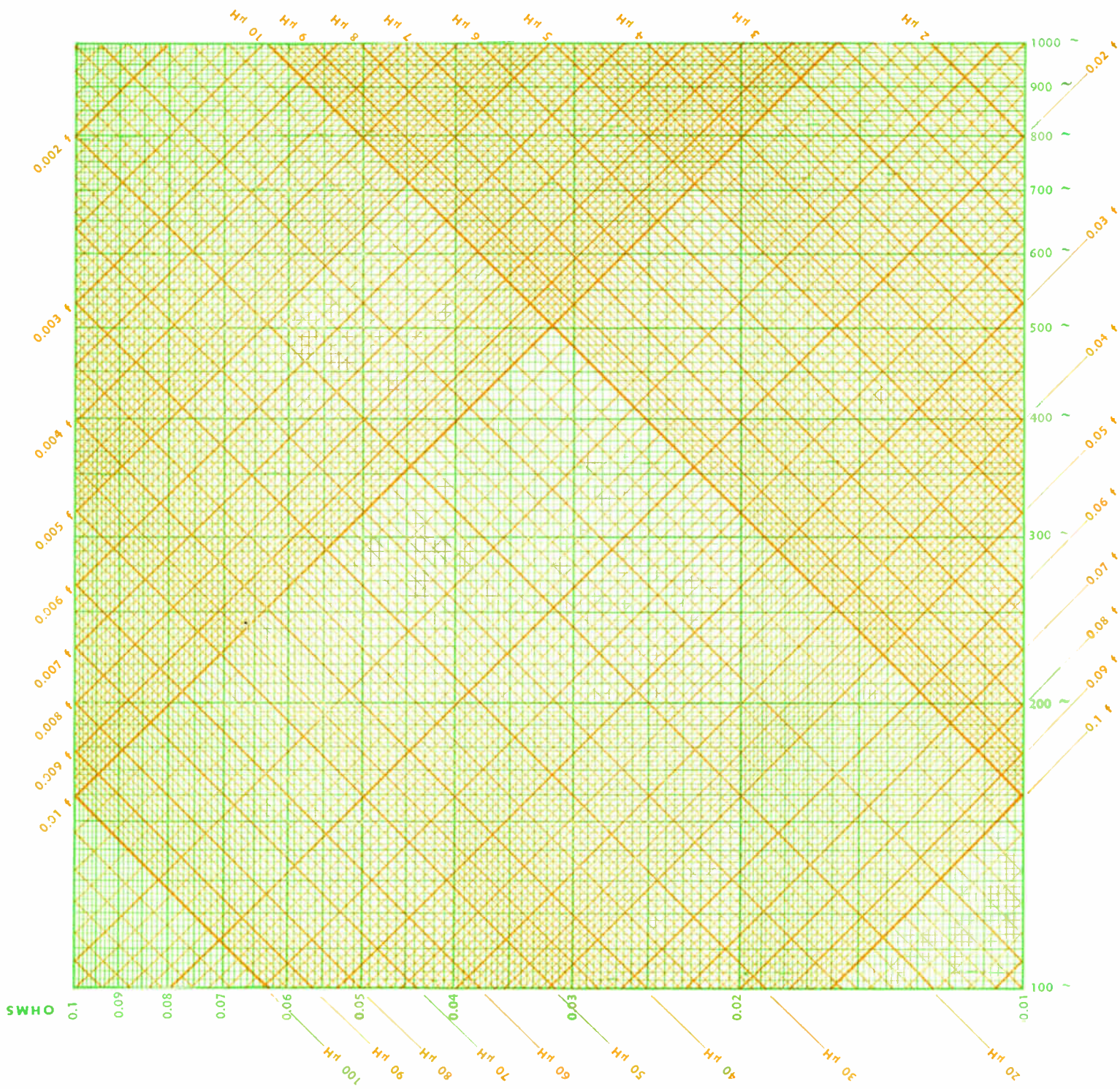
PLATE 8

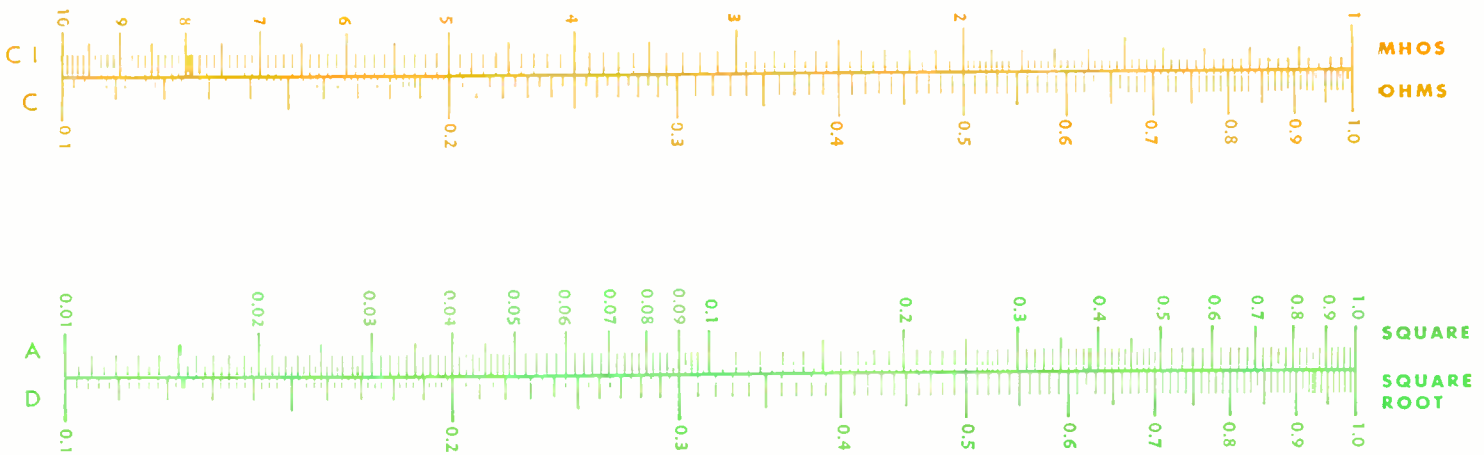
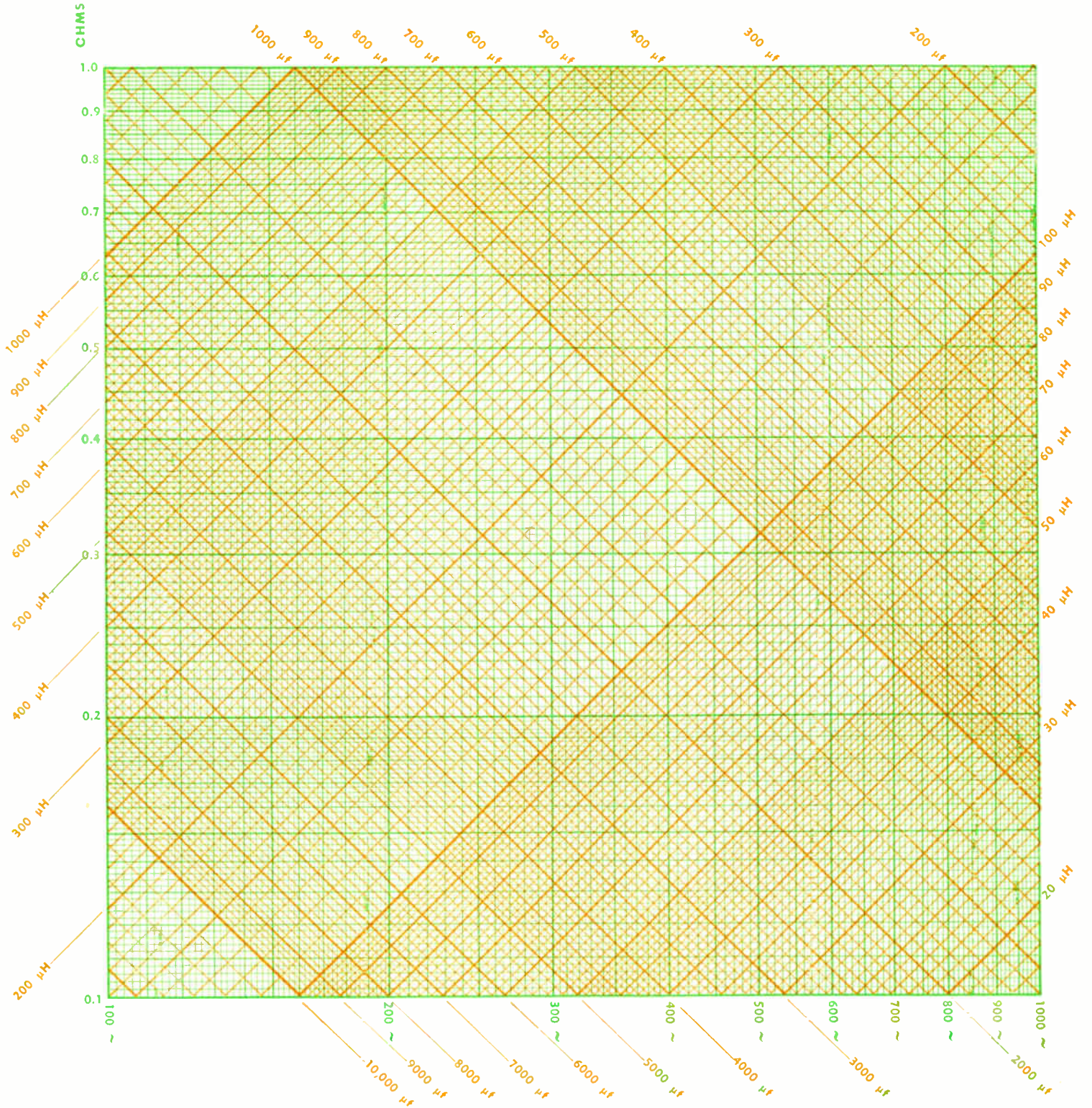


# PLATE 9

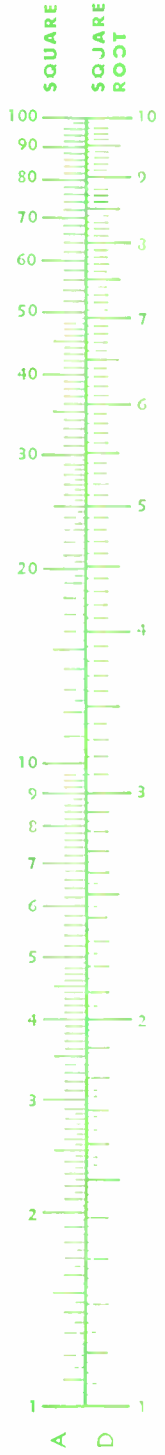
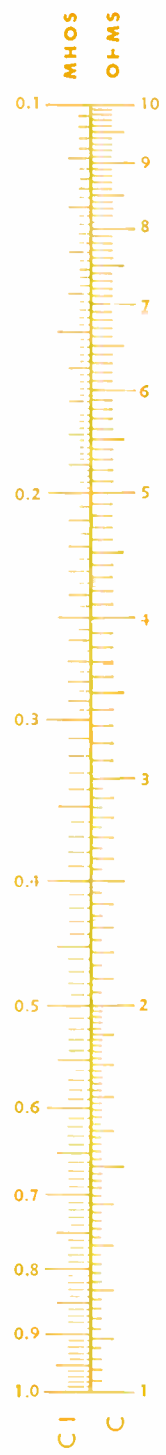
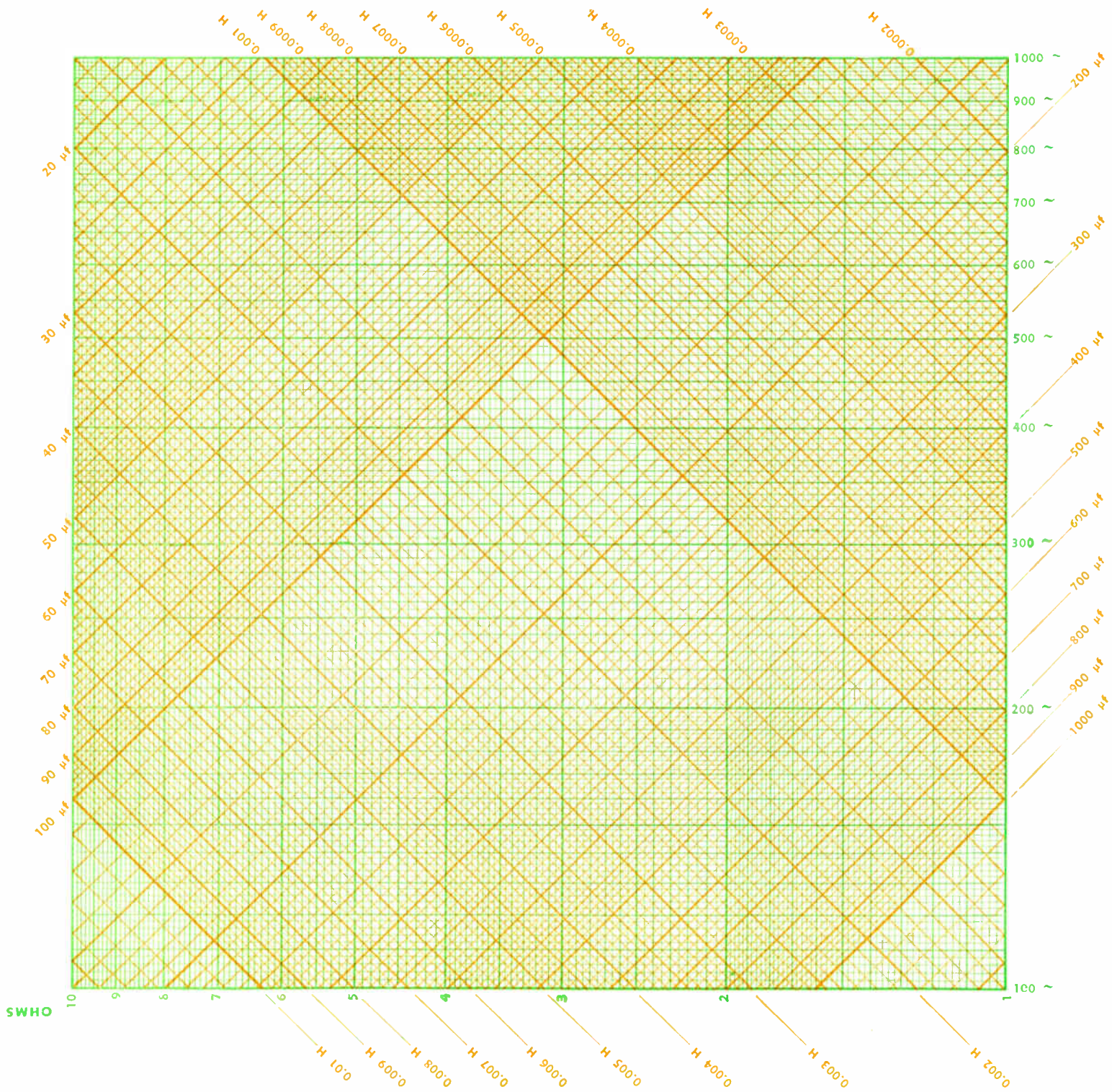


# PLATE 10





# PLATE 12





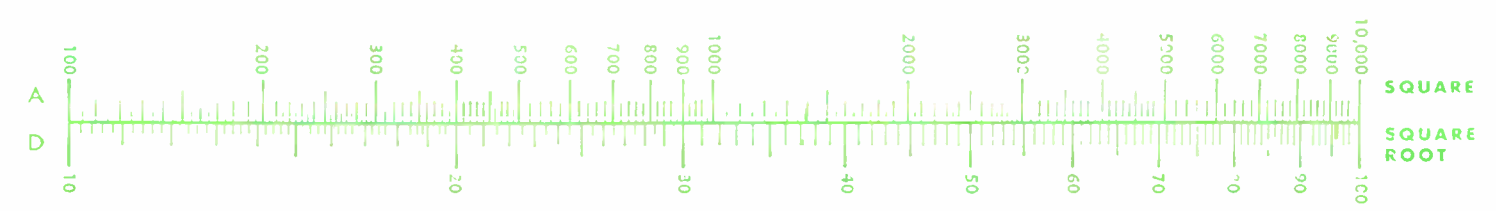
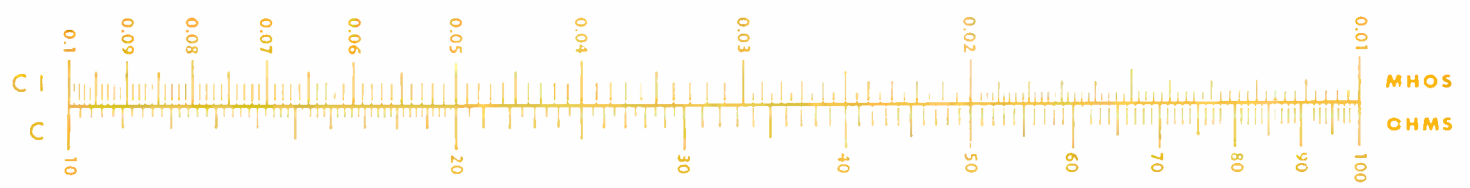
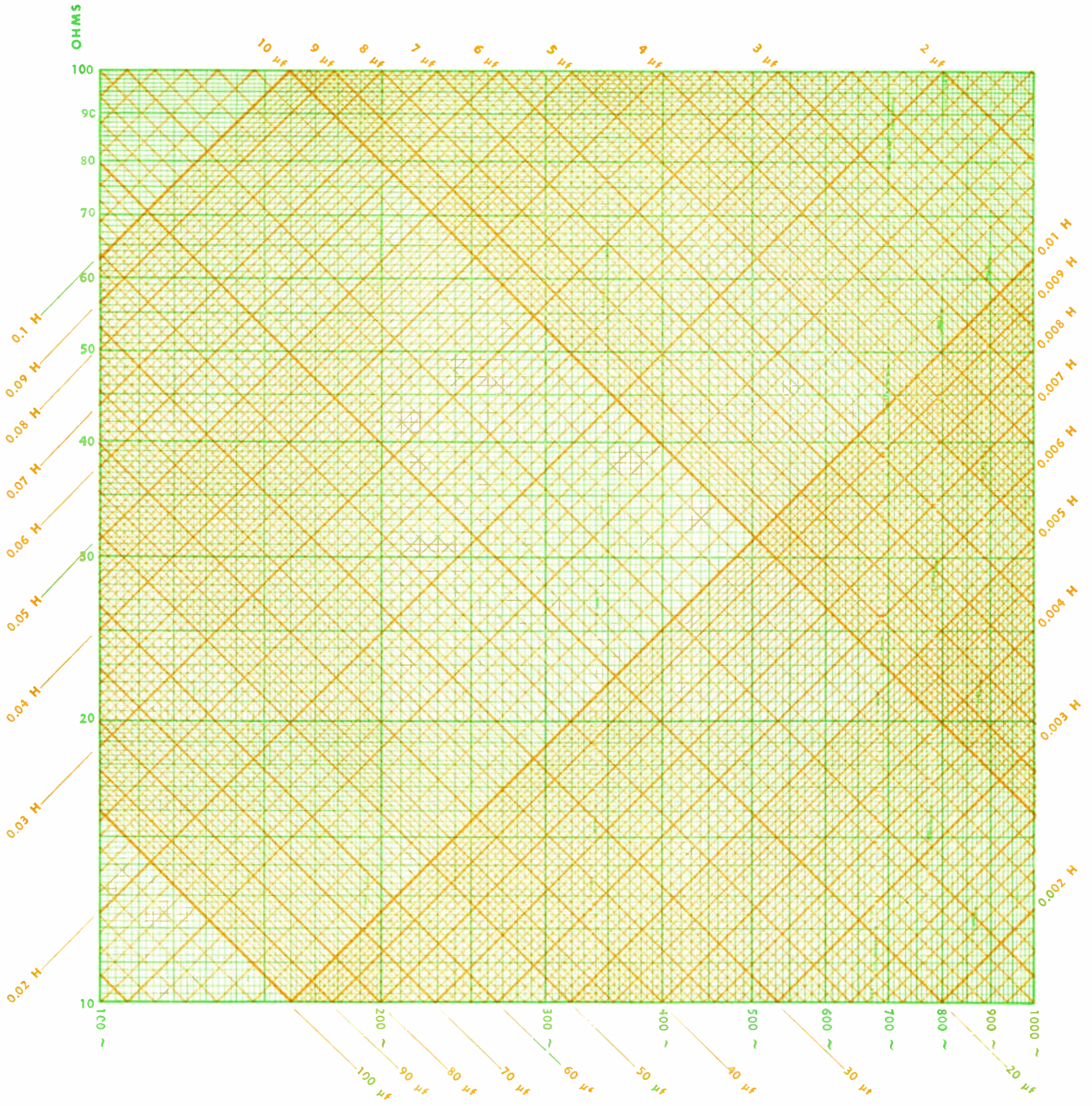
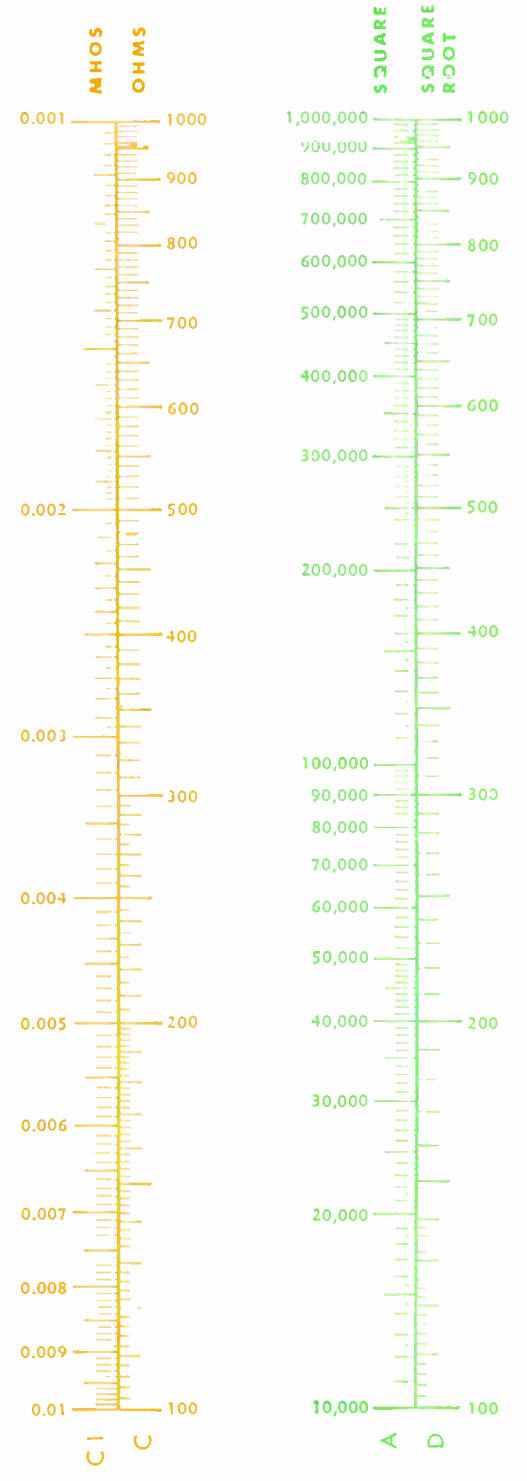
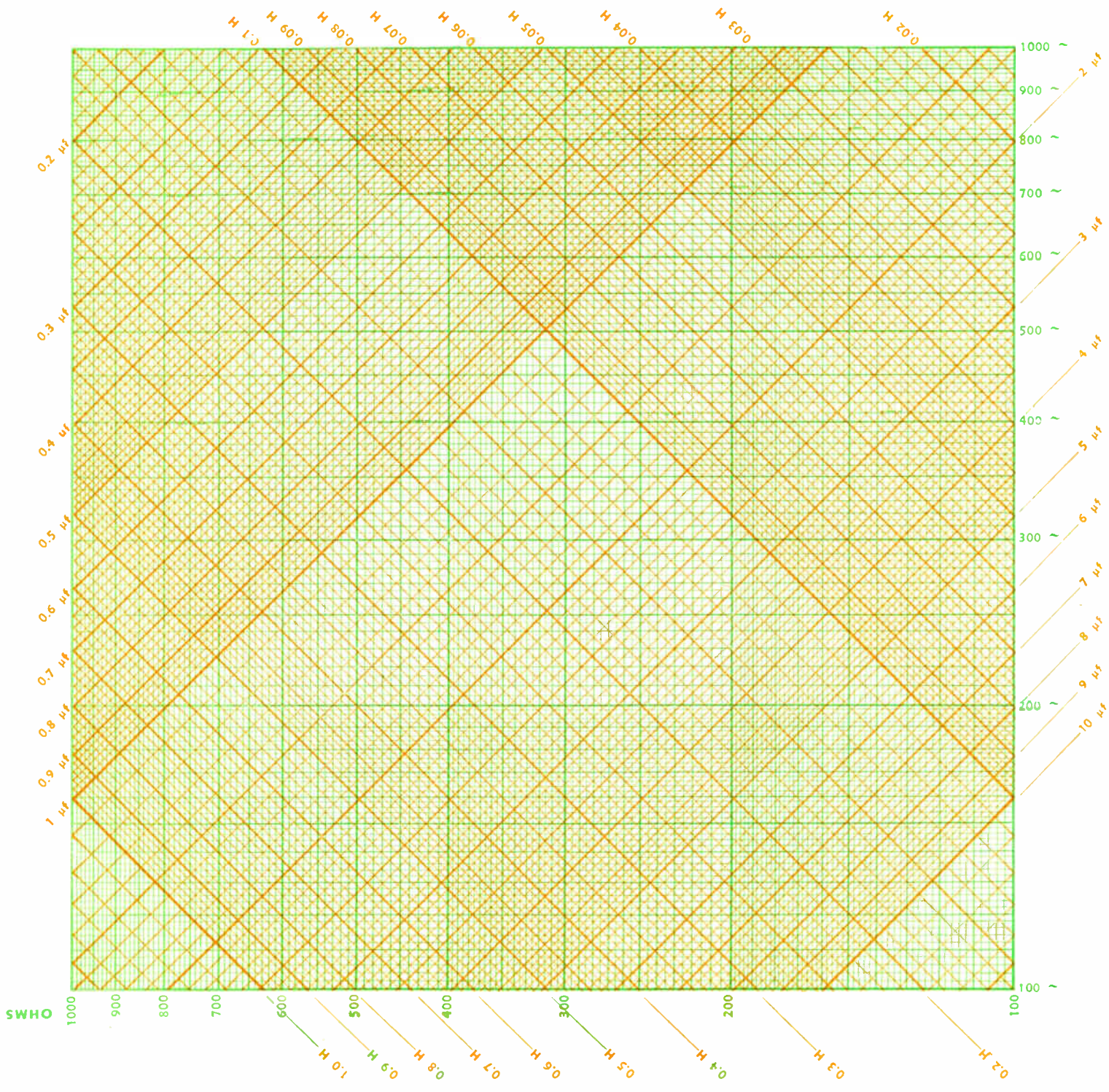
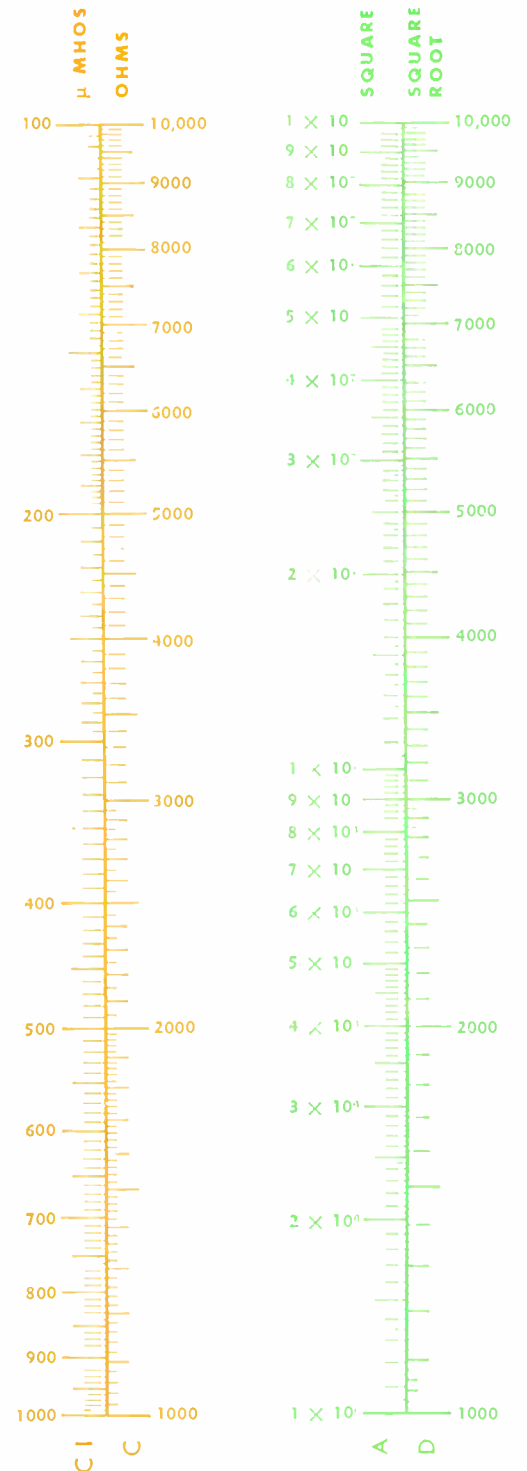
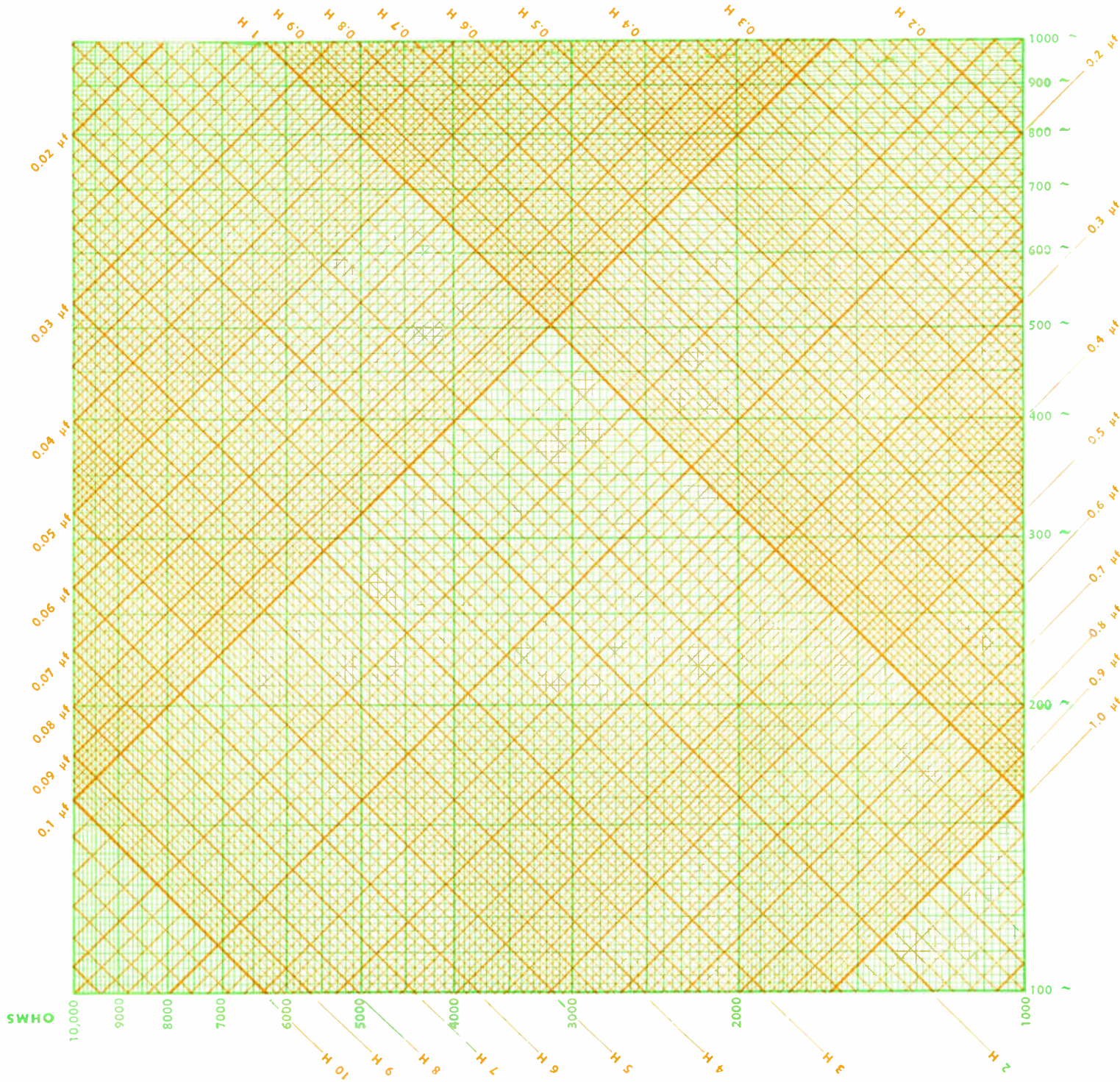
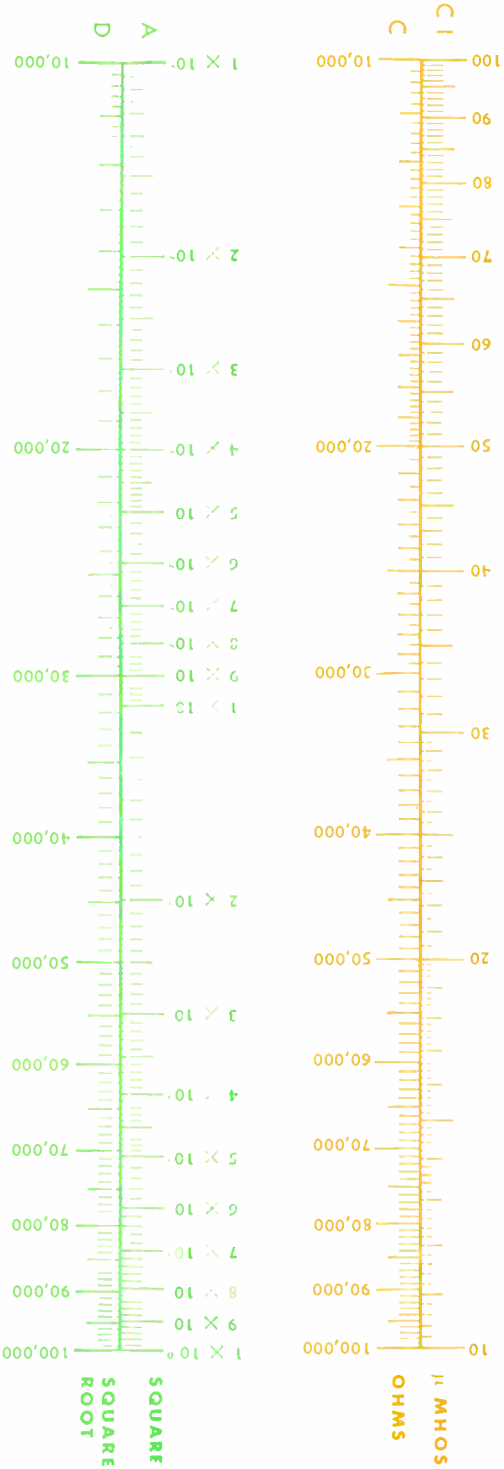
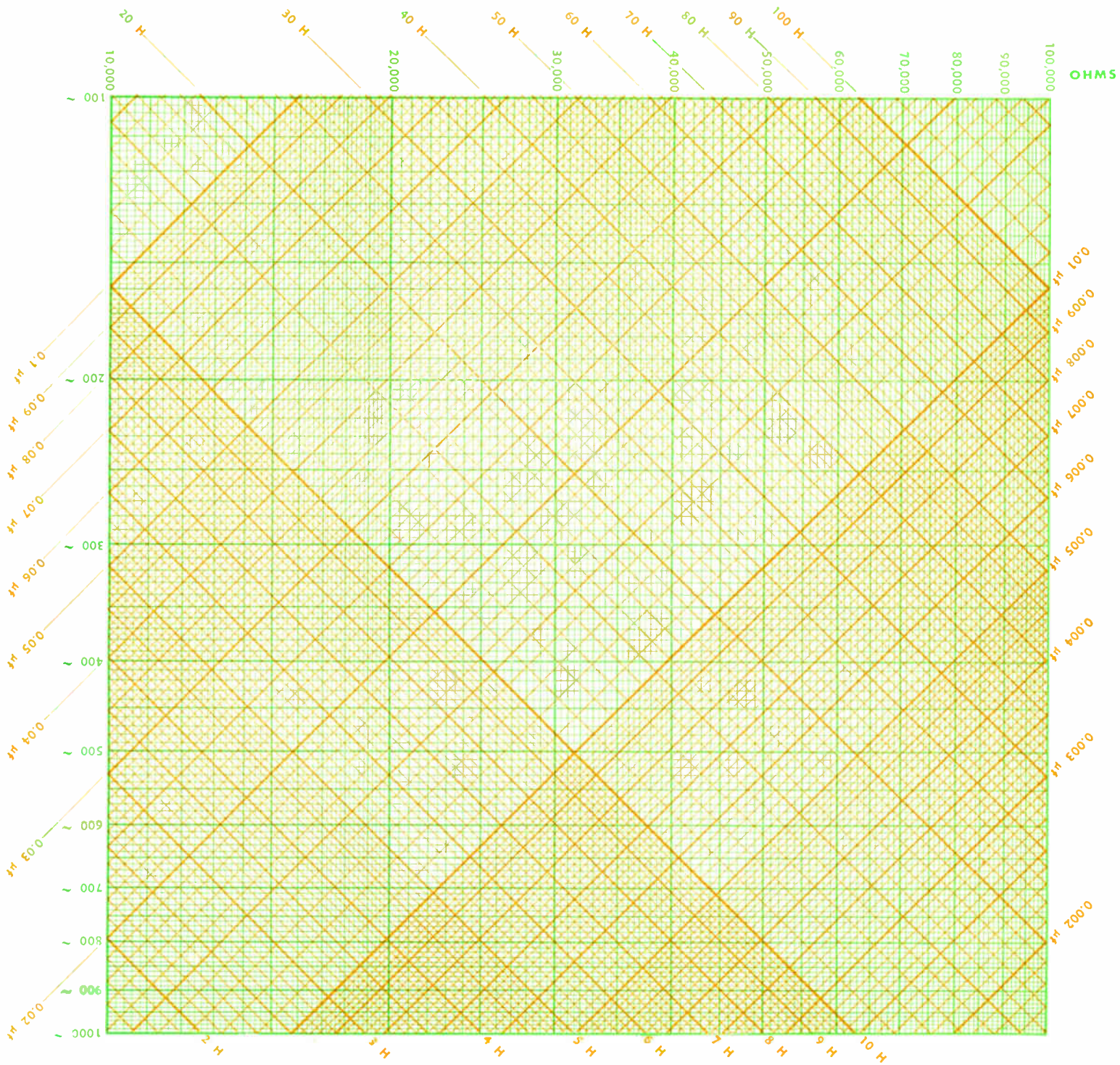


PLATE 14



# PLATE 15





# PLATE 17

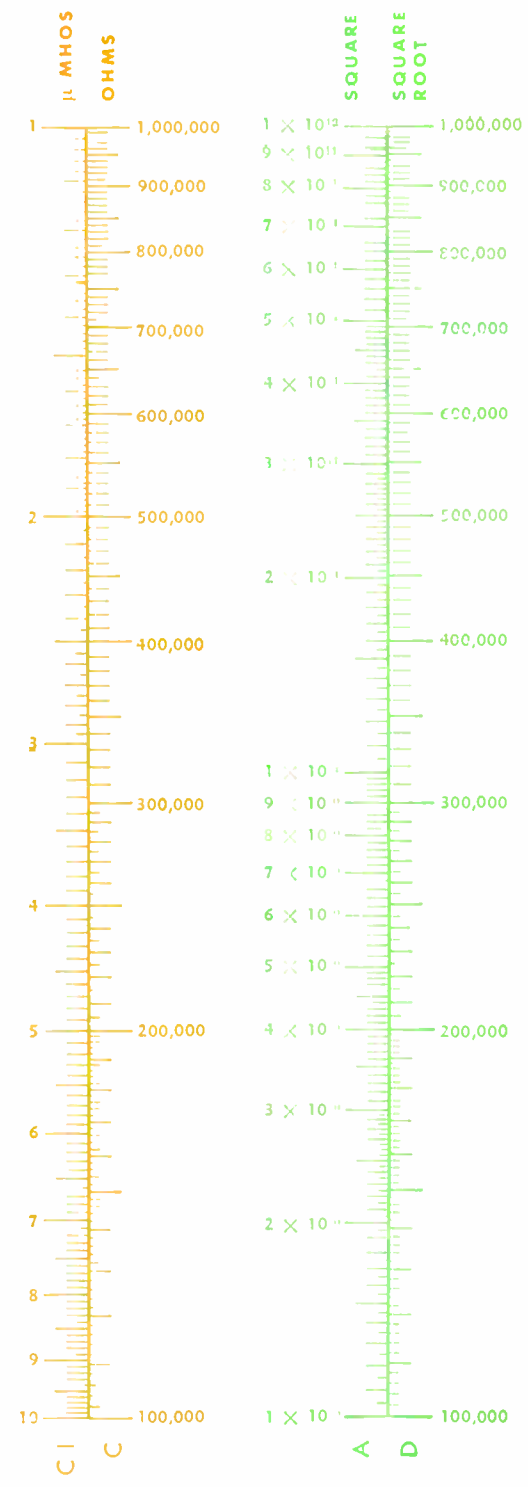
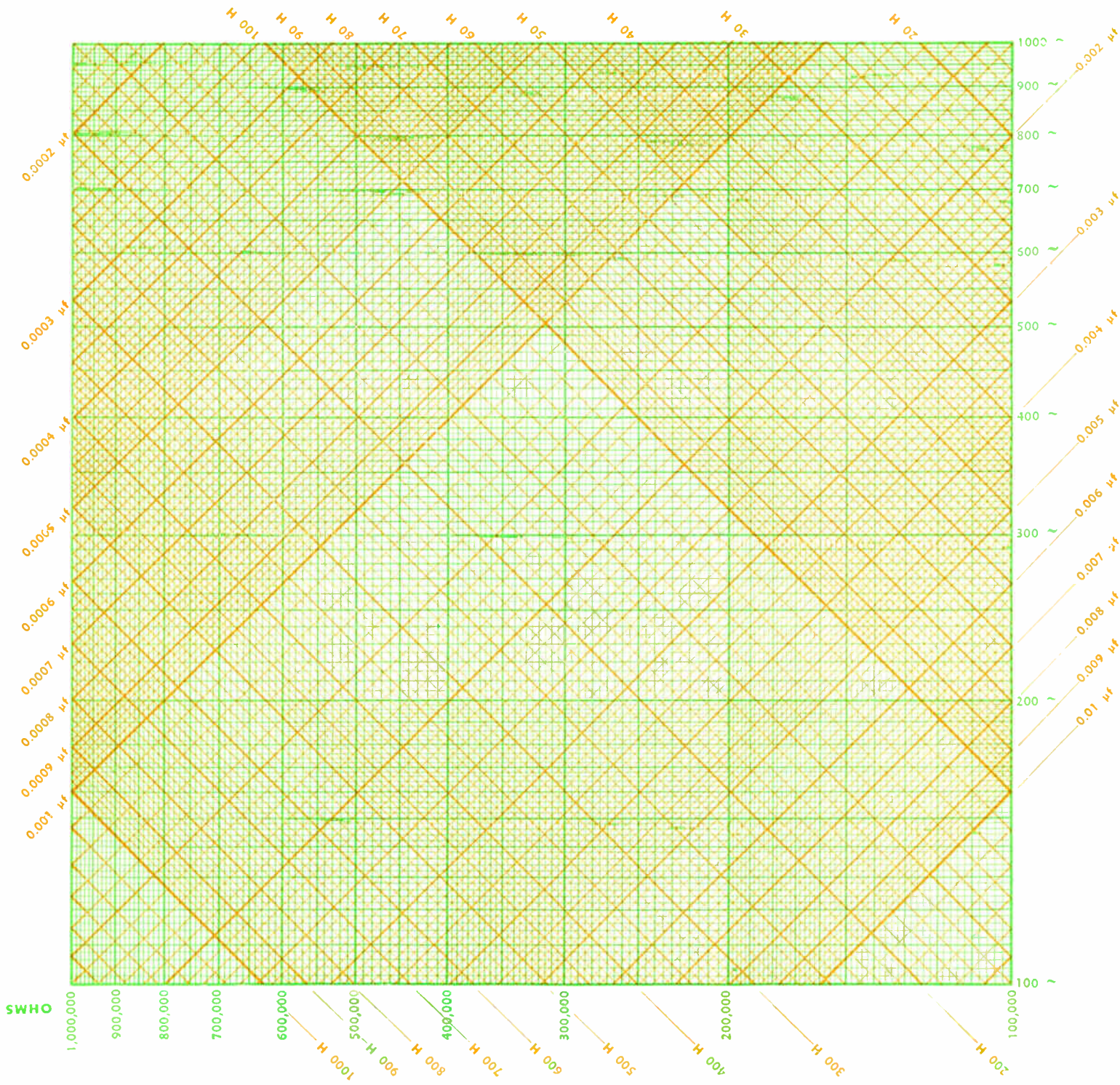
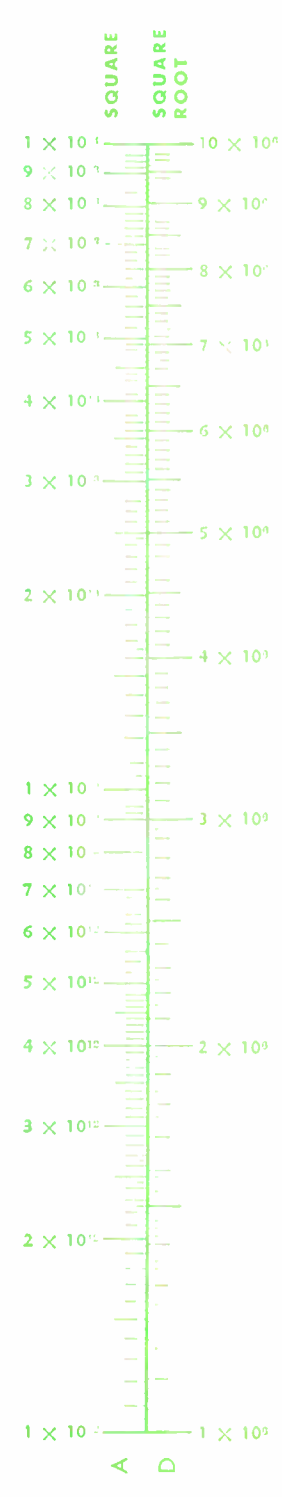
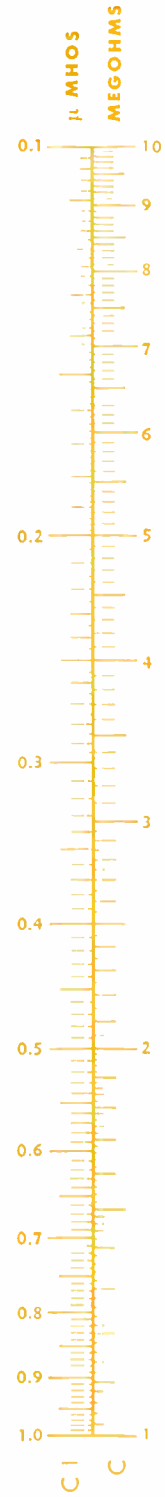
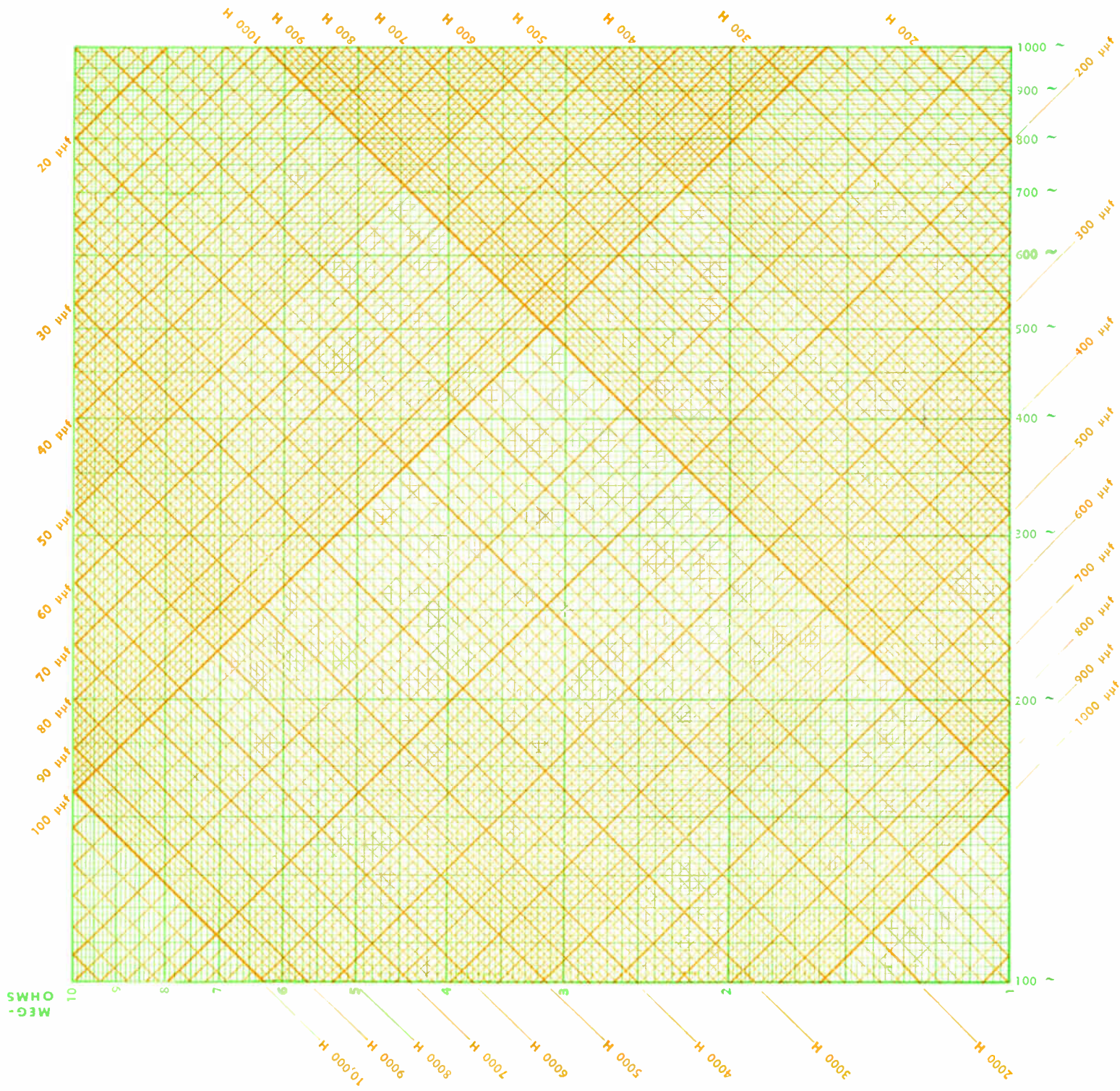
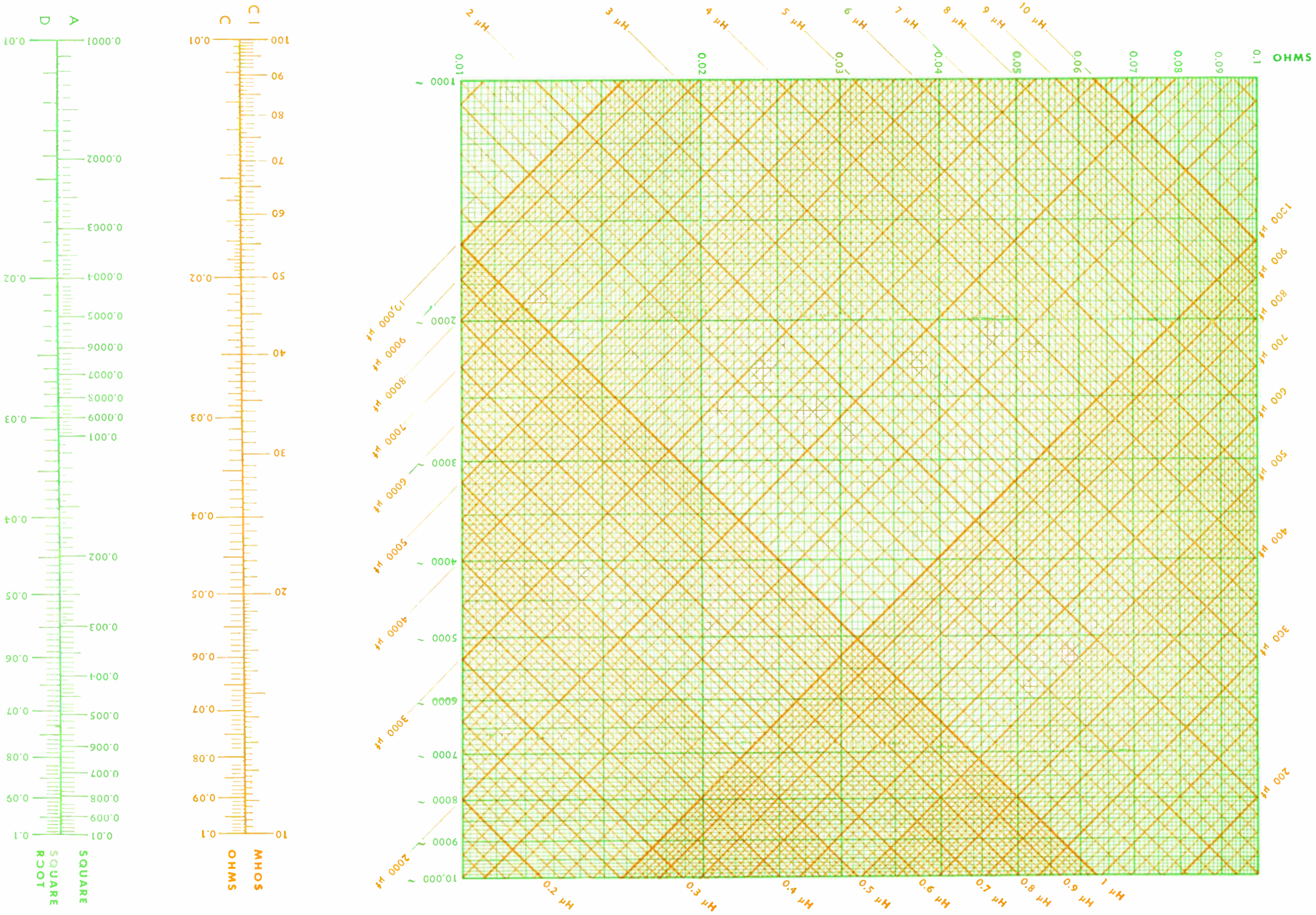
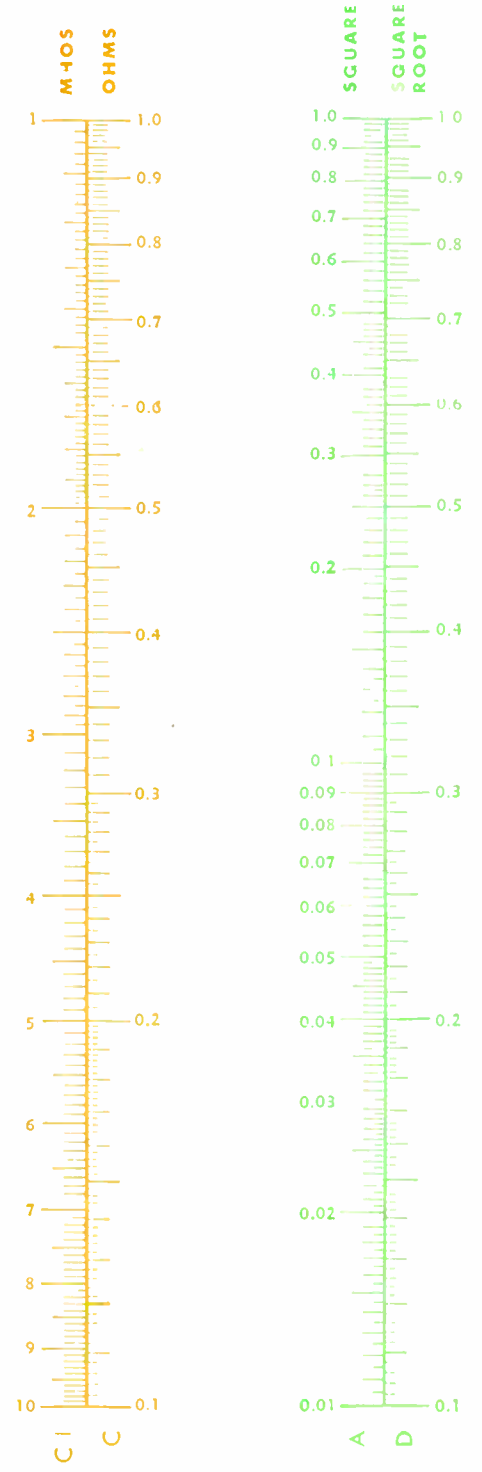
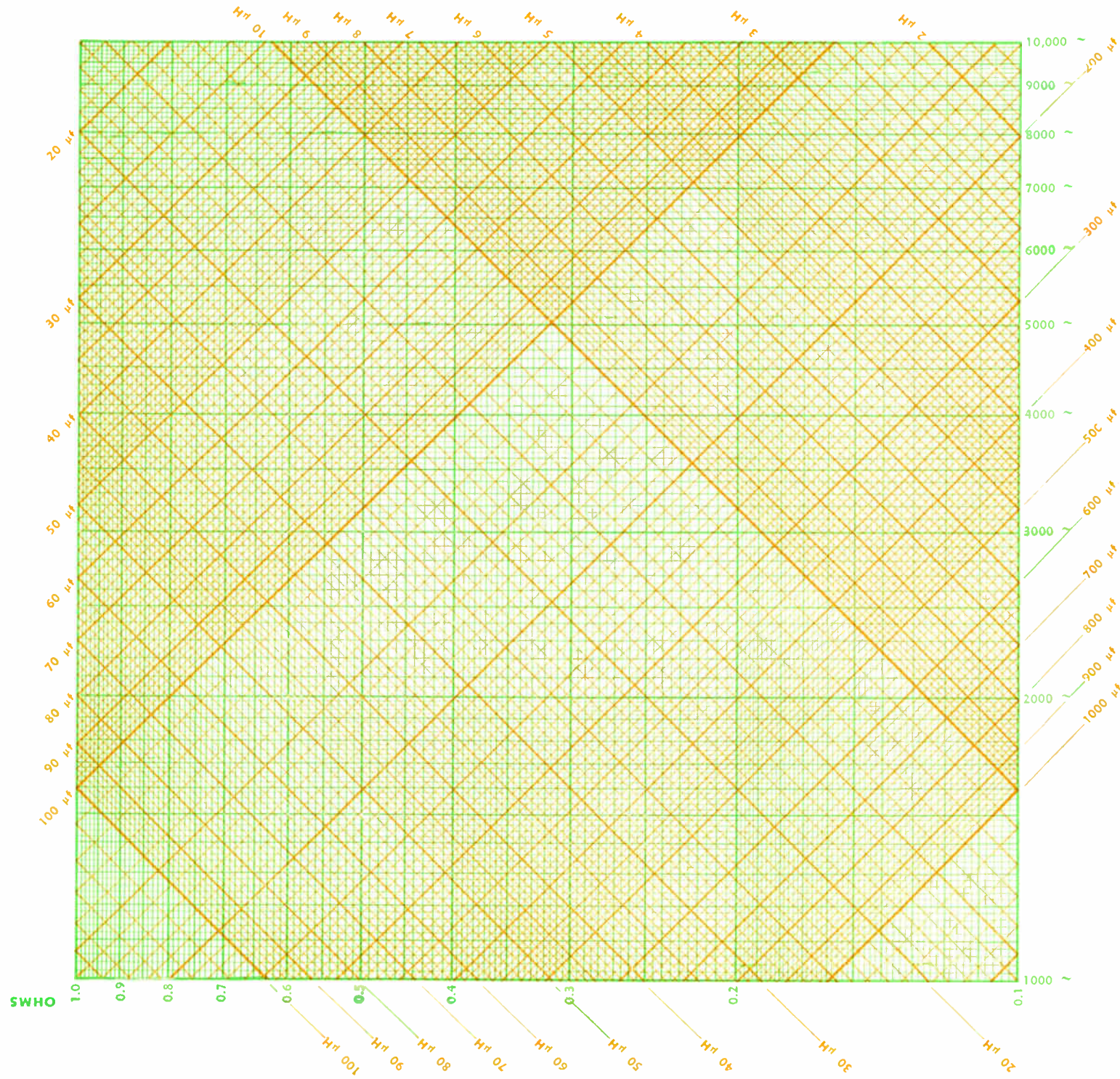


PLATE 18





# PLATE 20





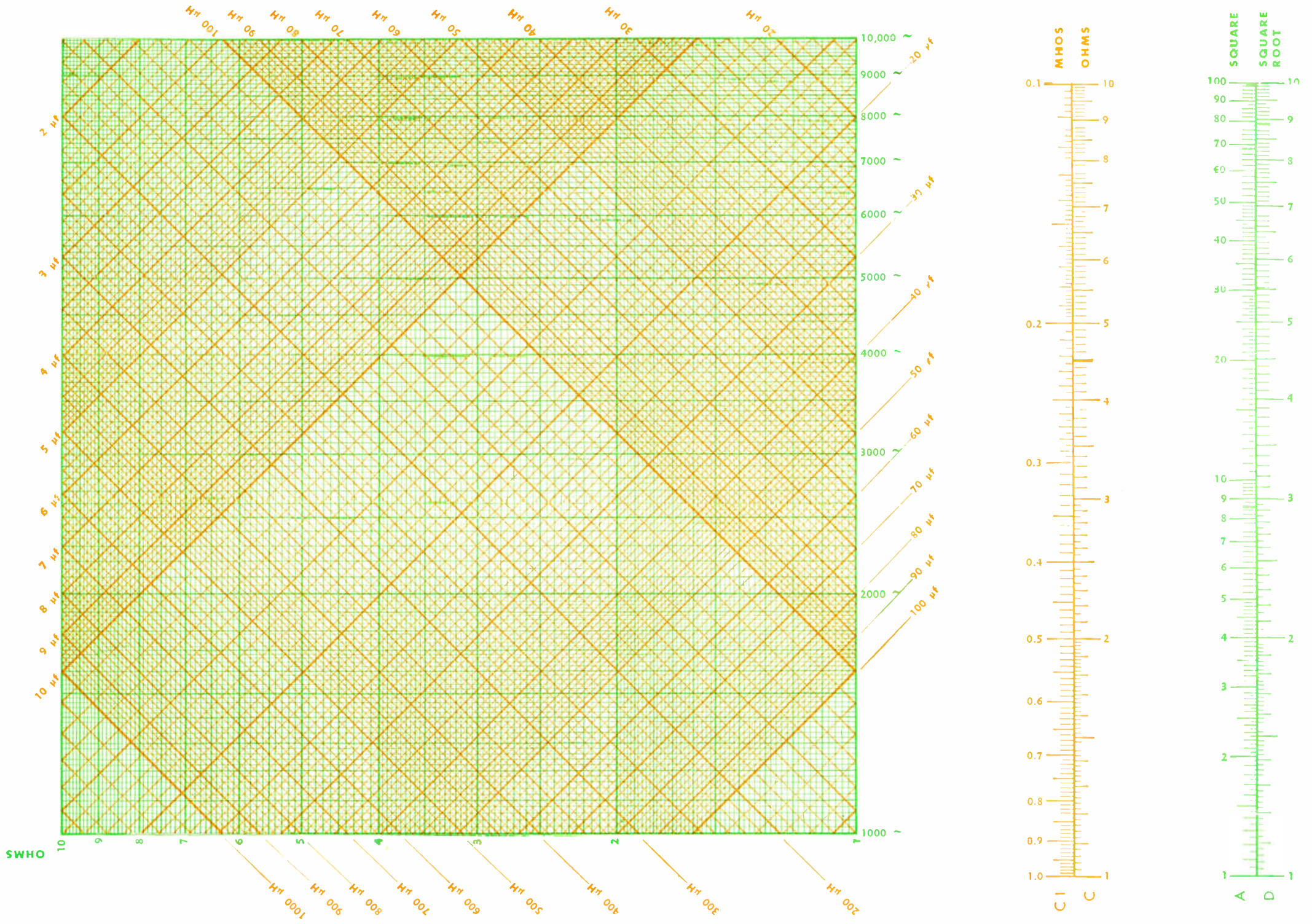
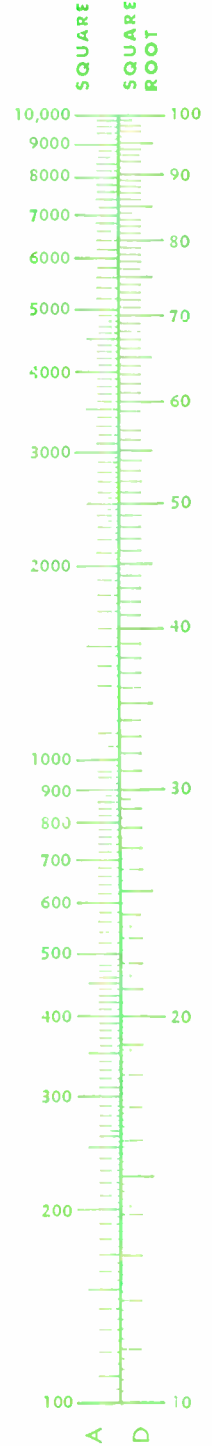
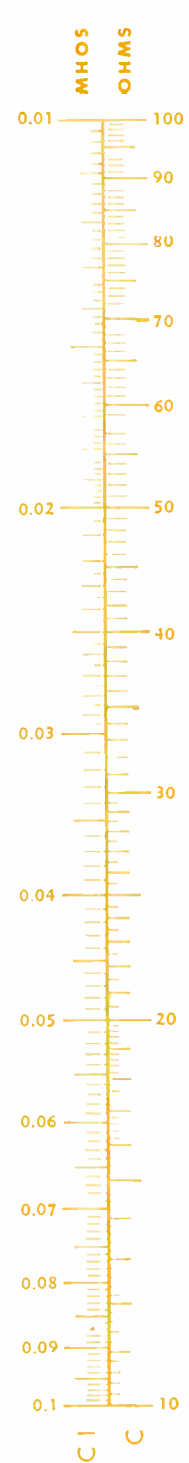
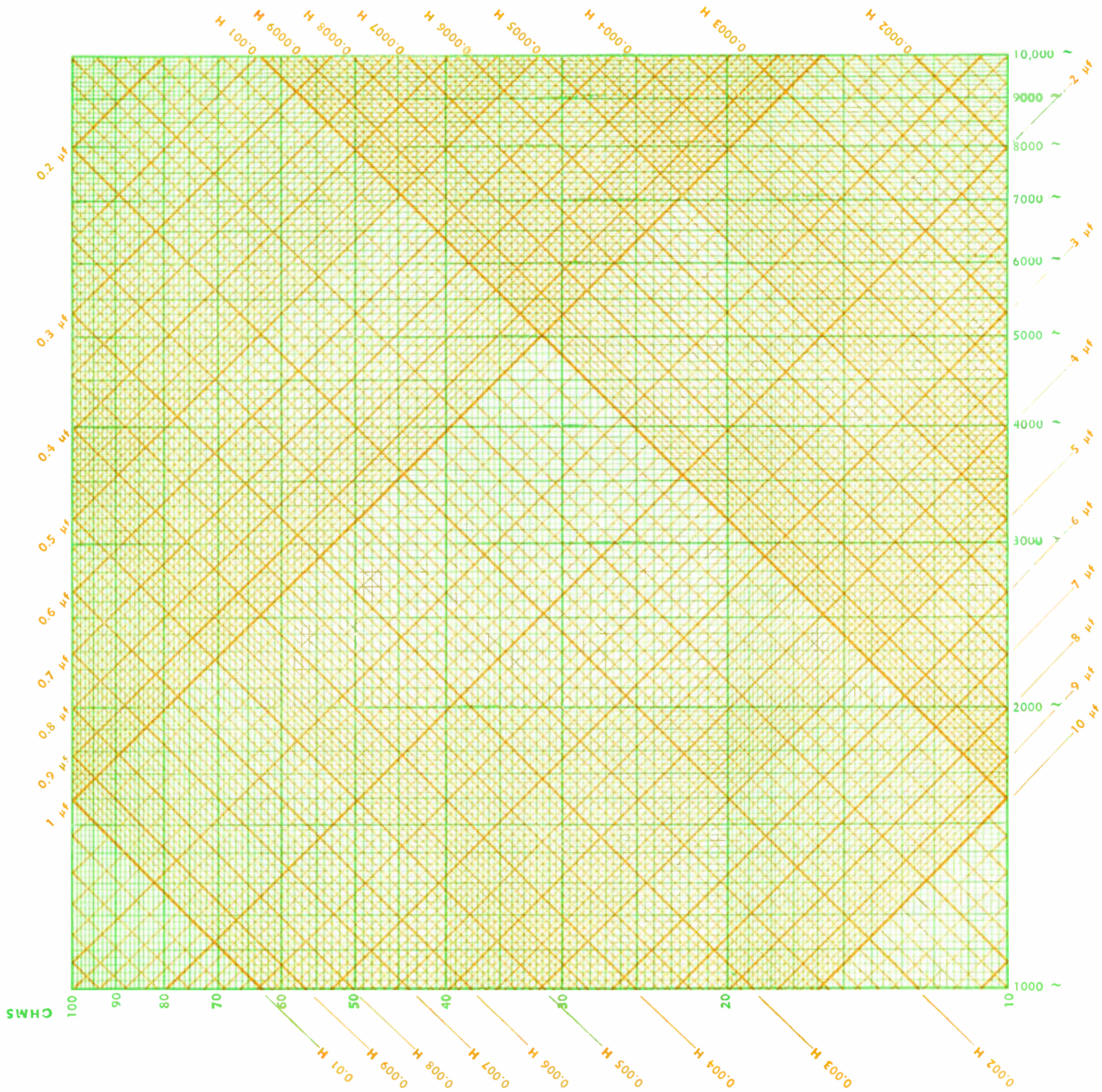
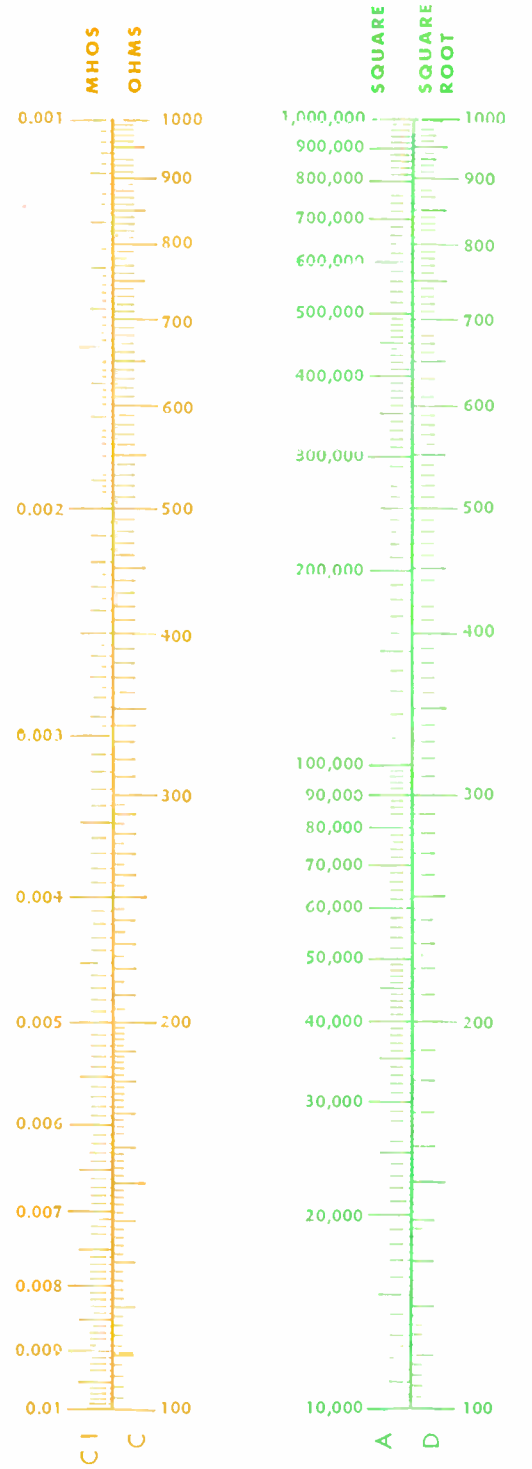
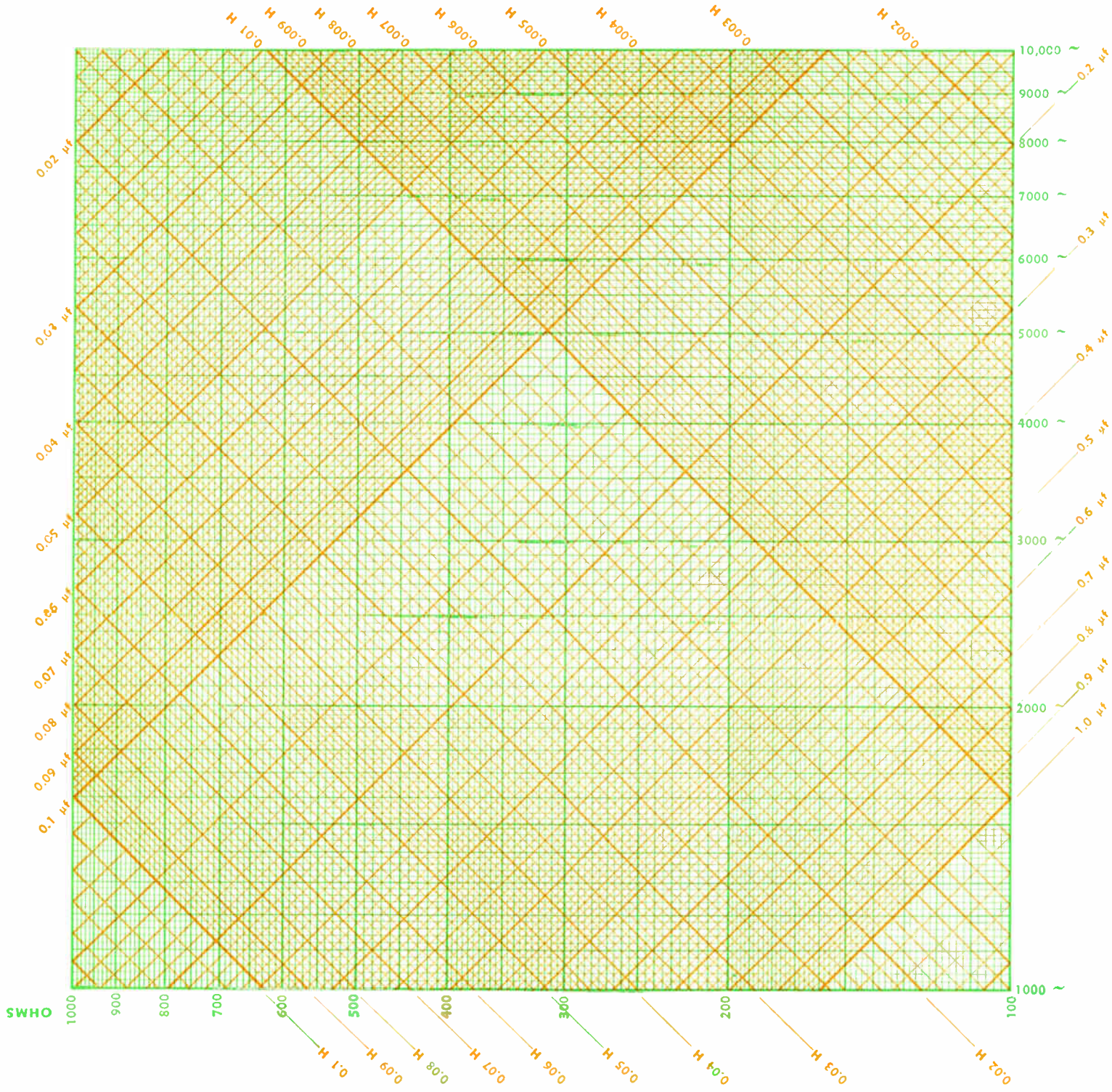
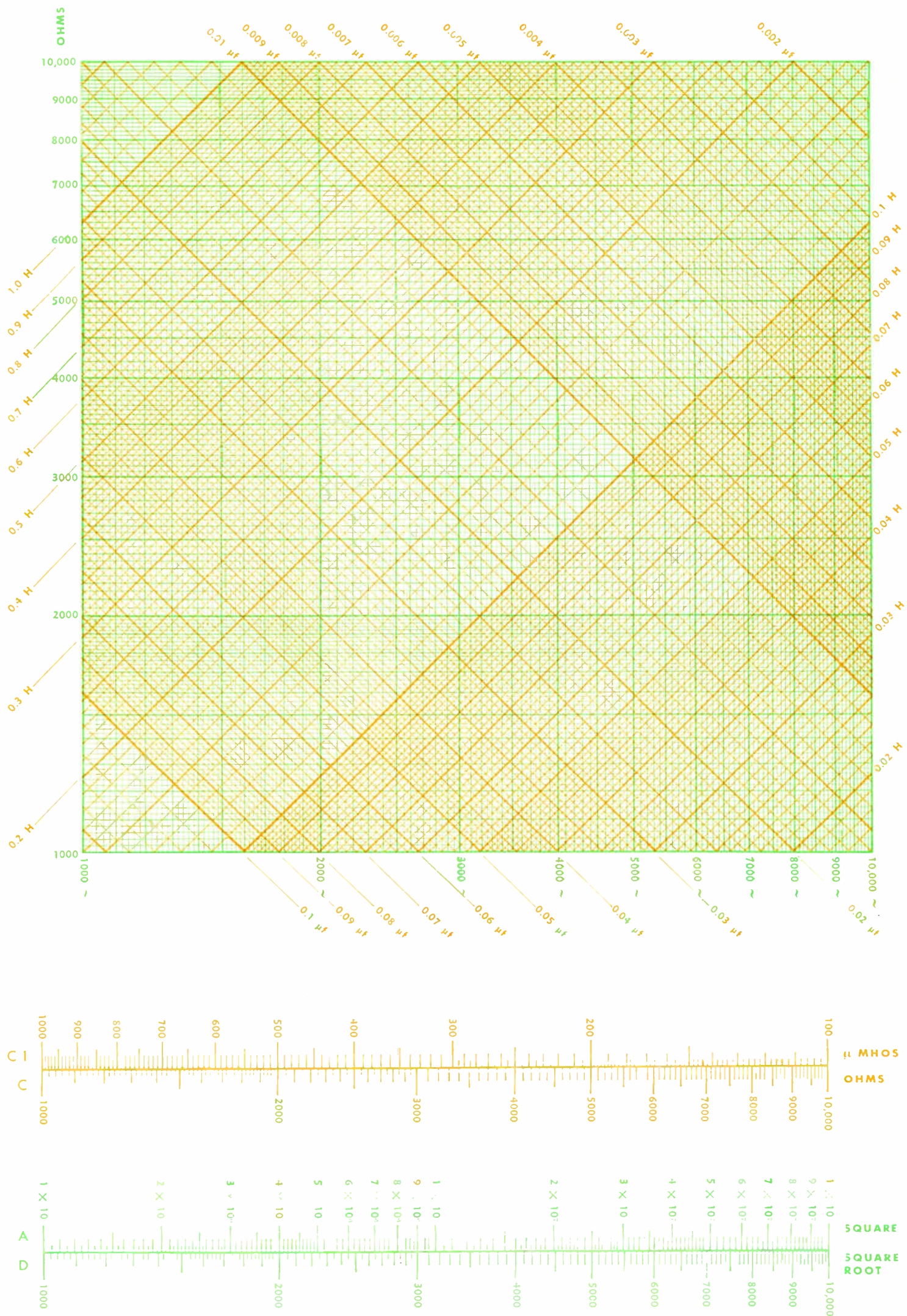


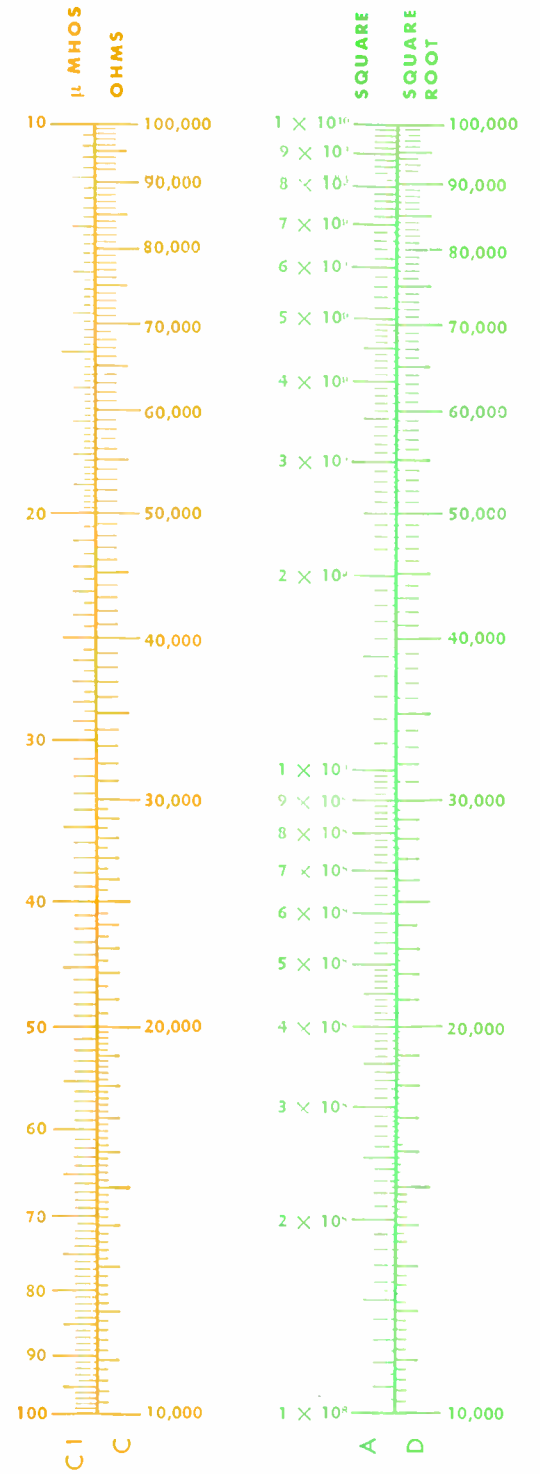
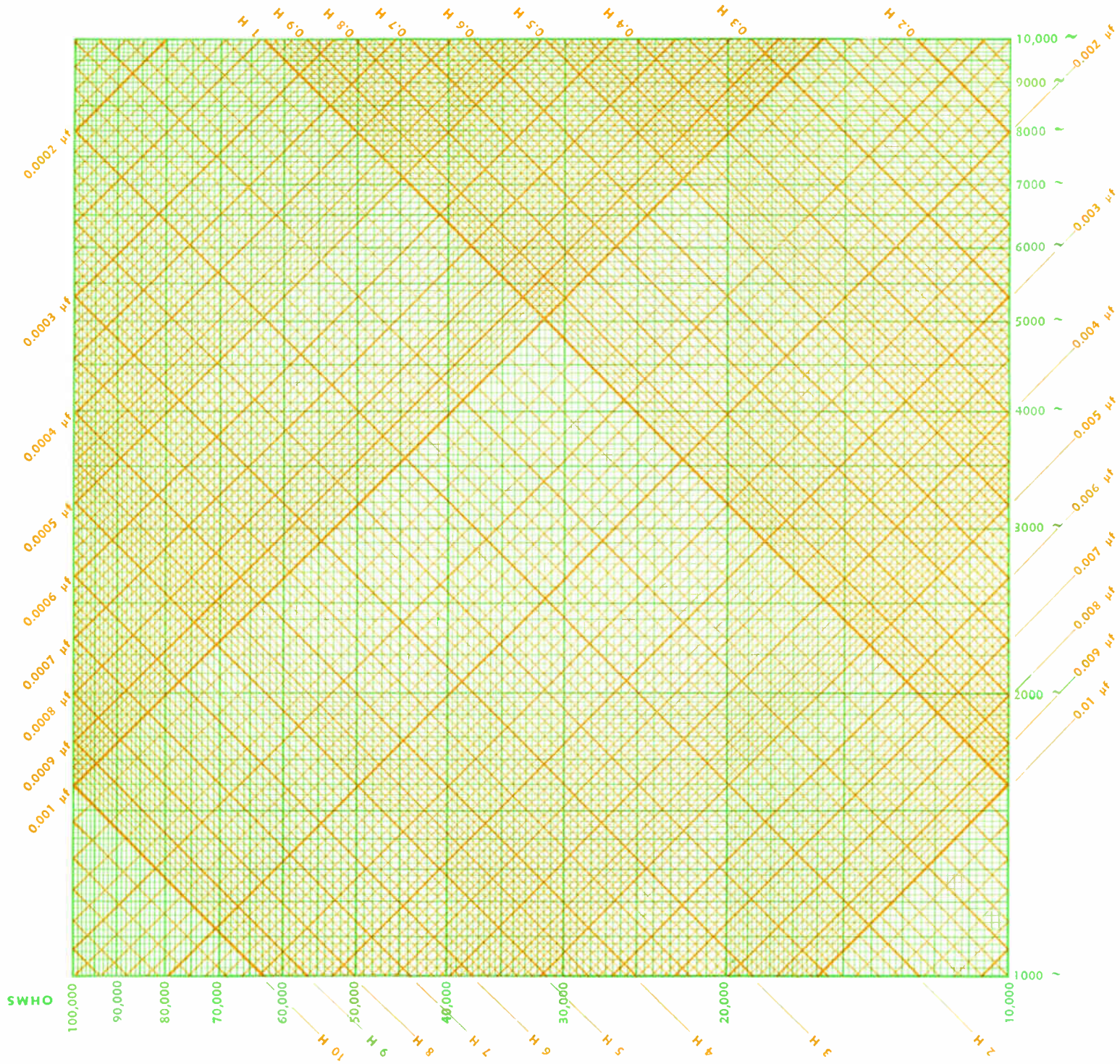
PLATE 22





# PLATE 24





# PLATE 26

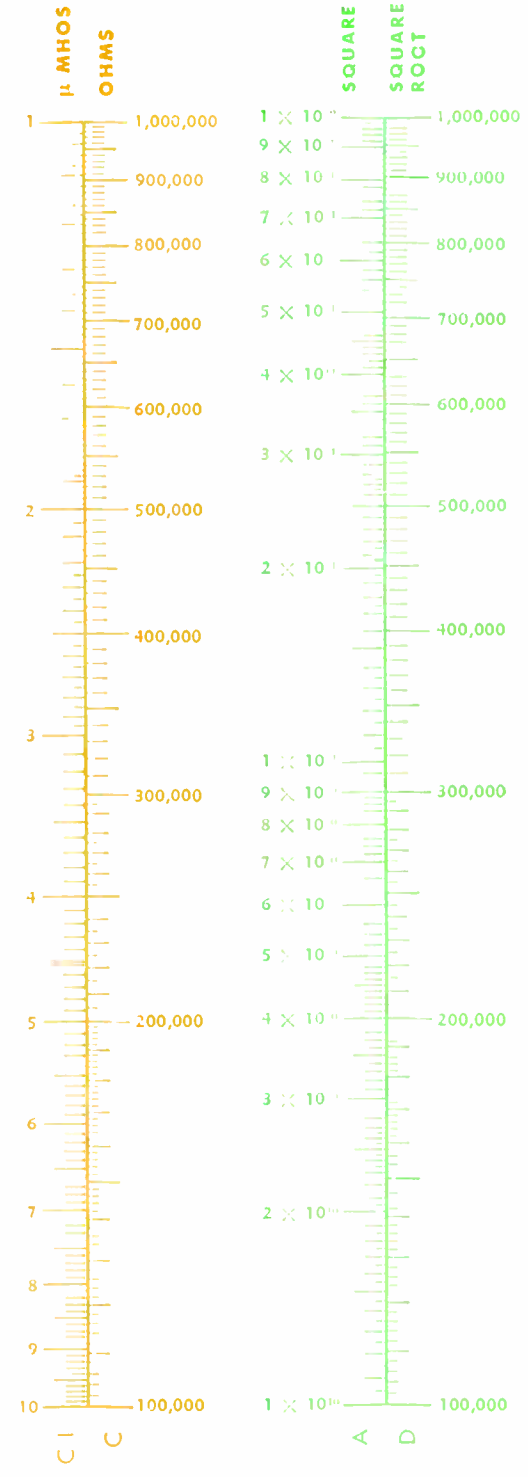
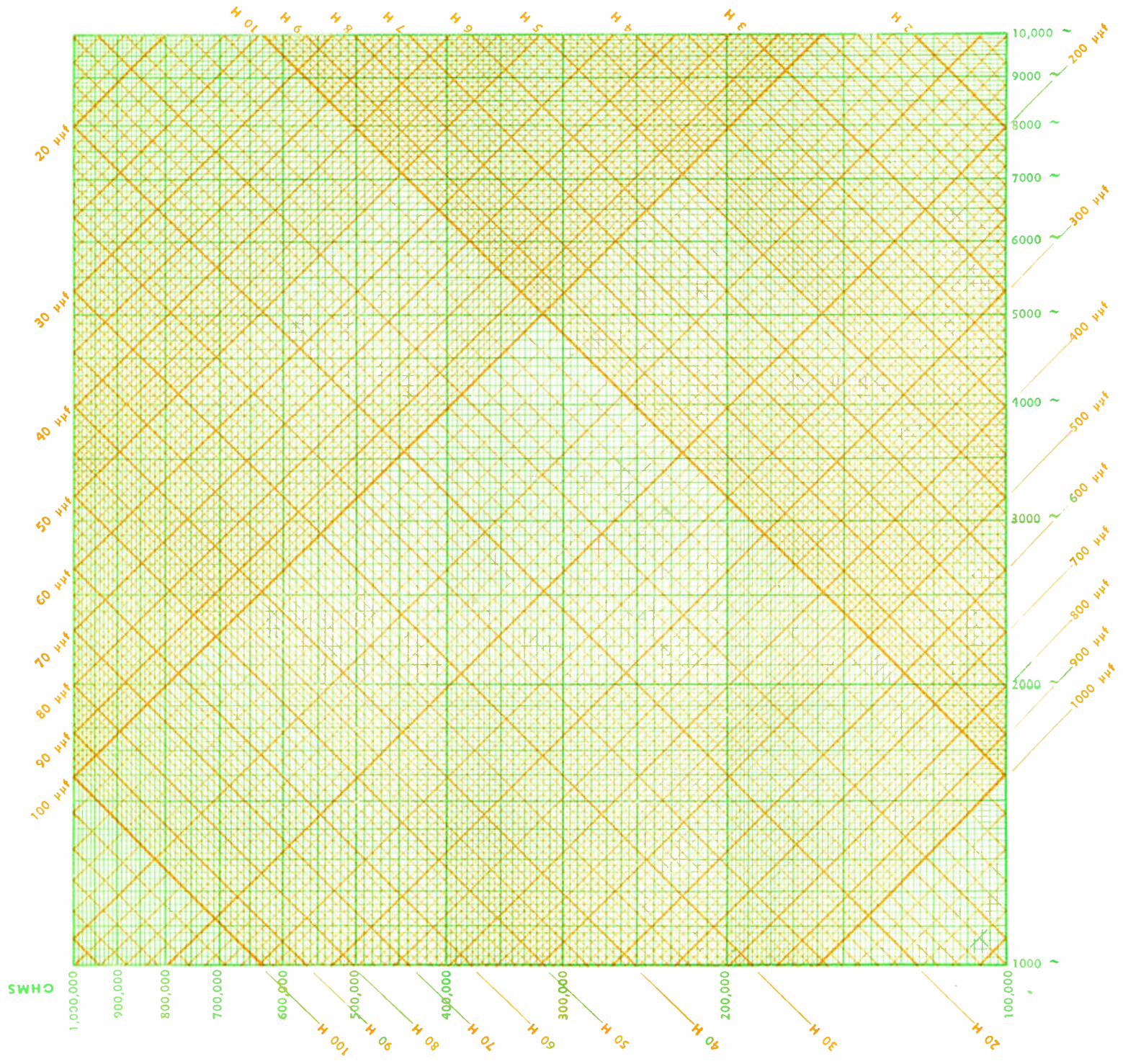
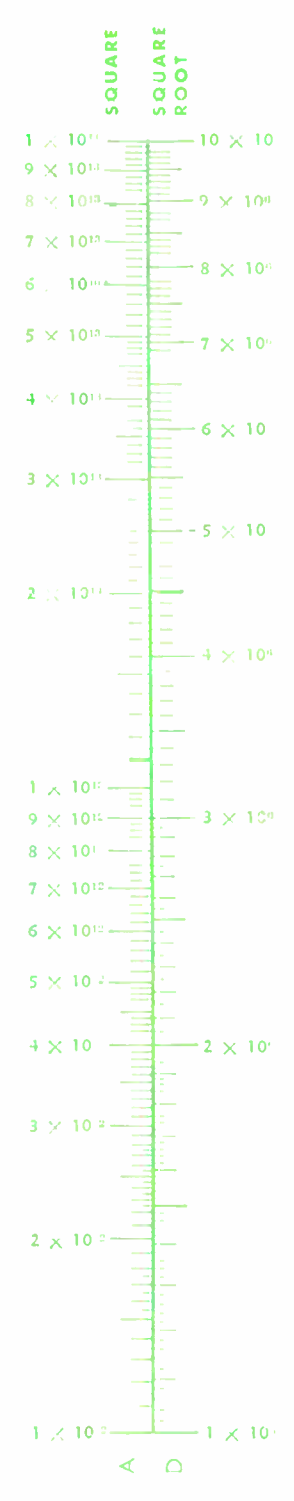
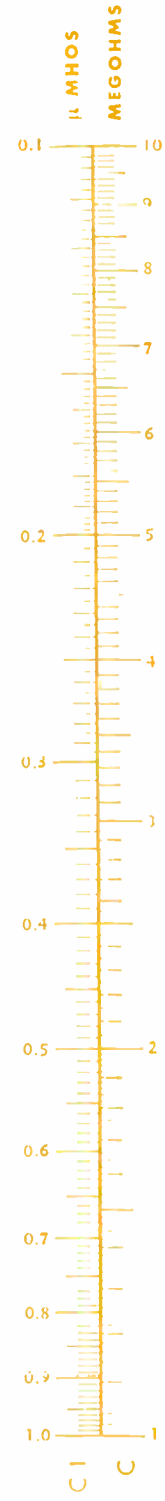
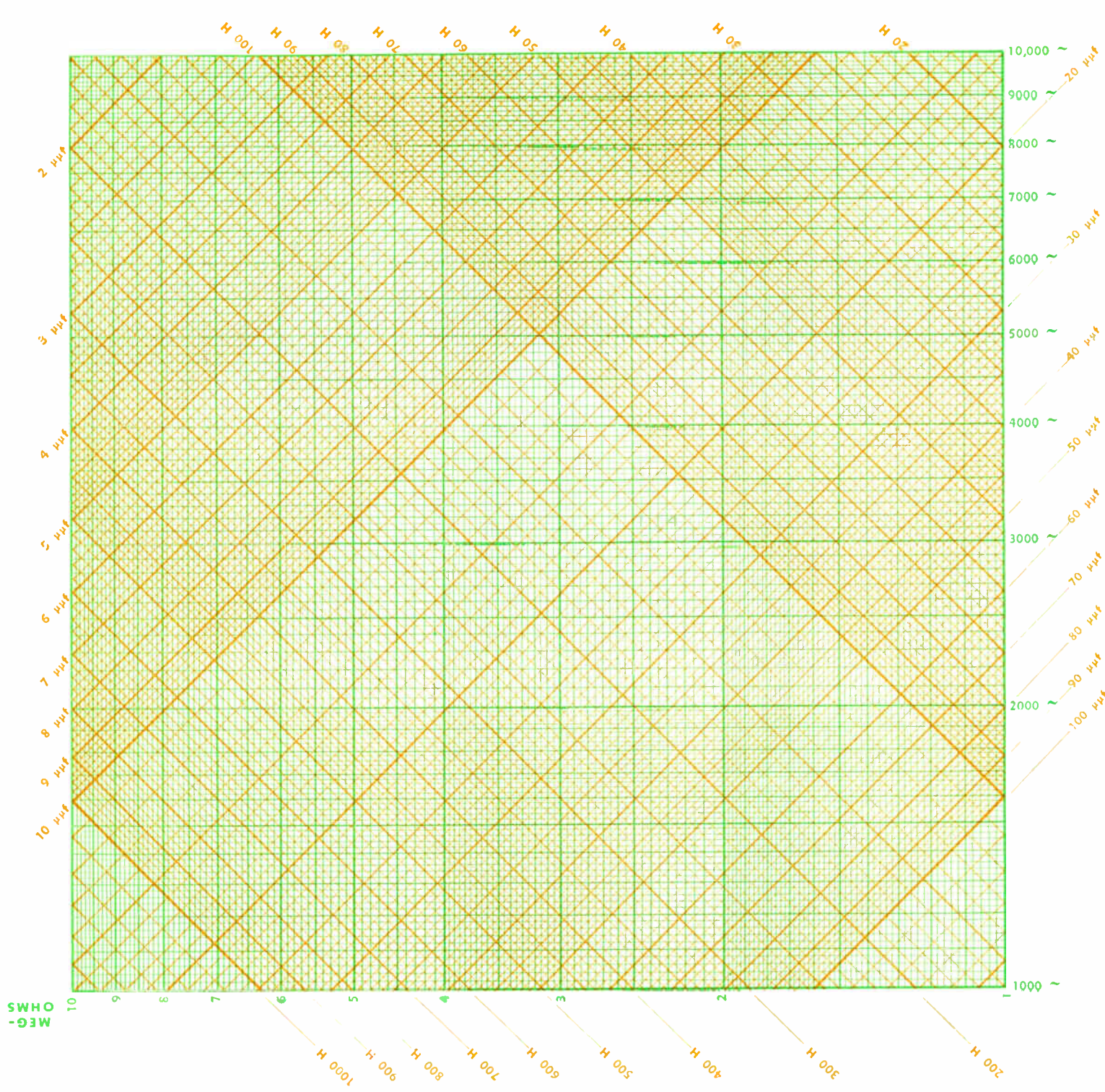


PLATE 27



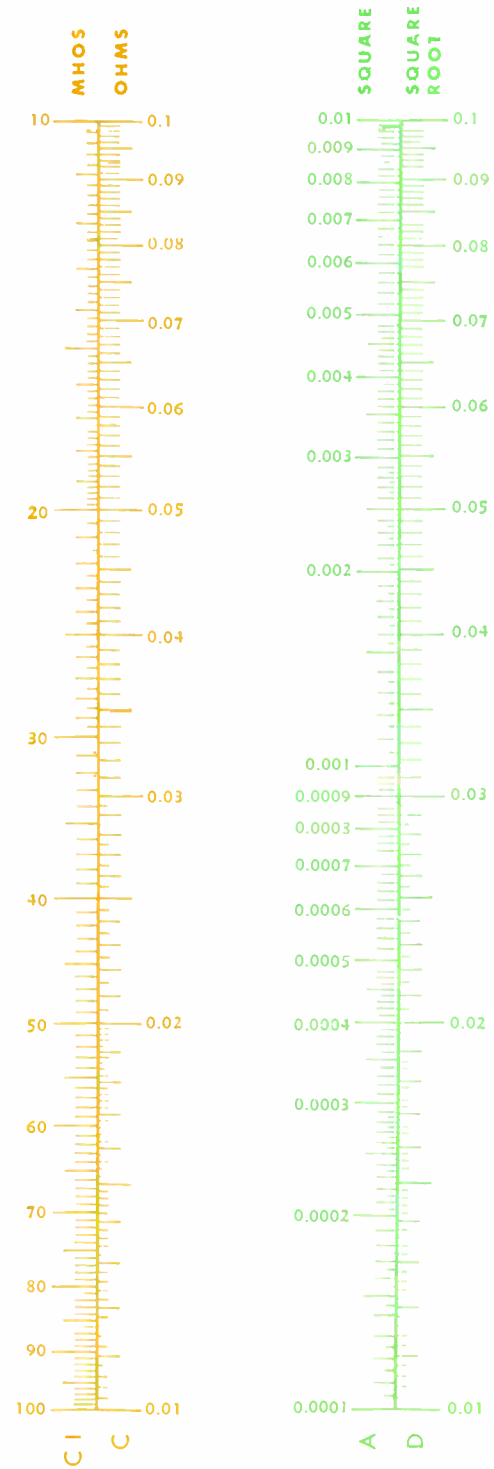
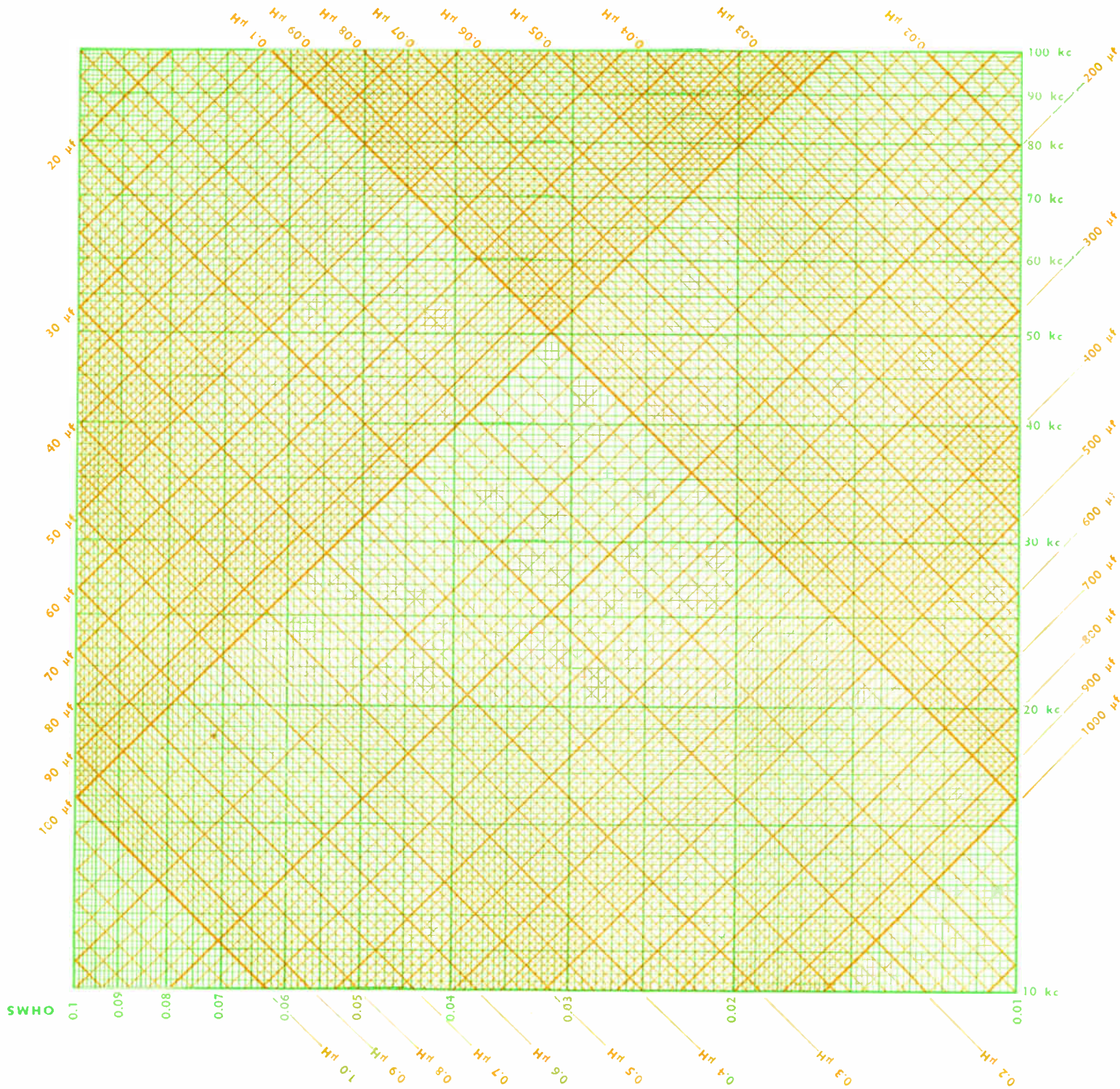




PLATE 29

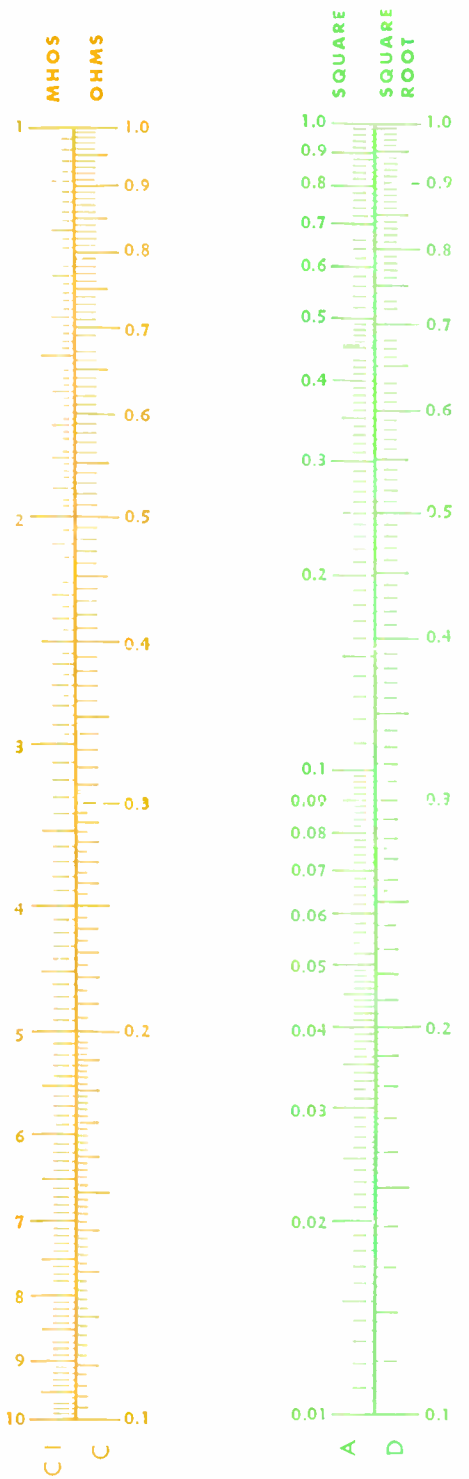
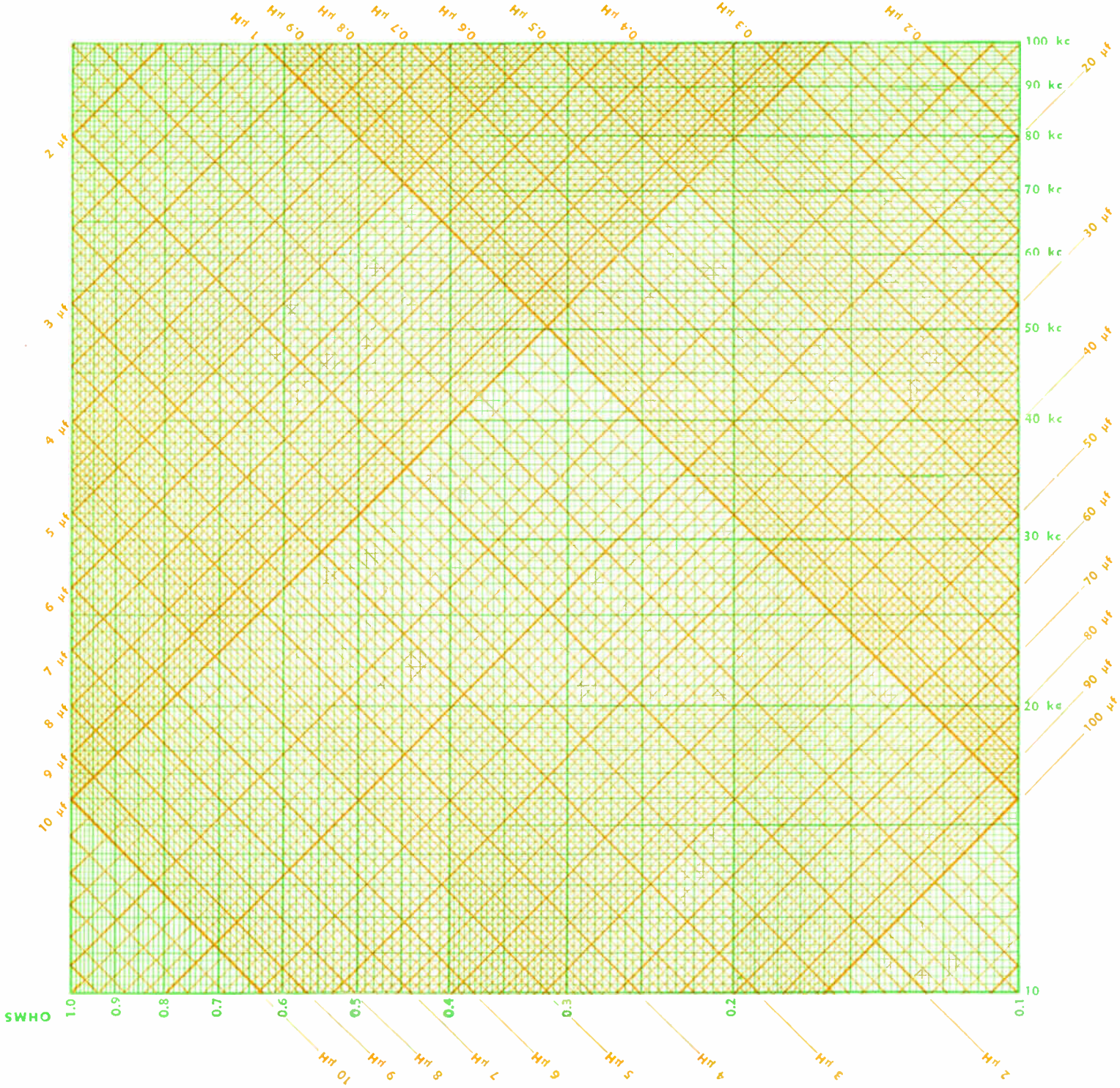


PLATE 30

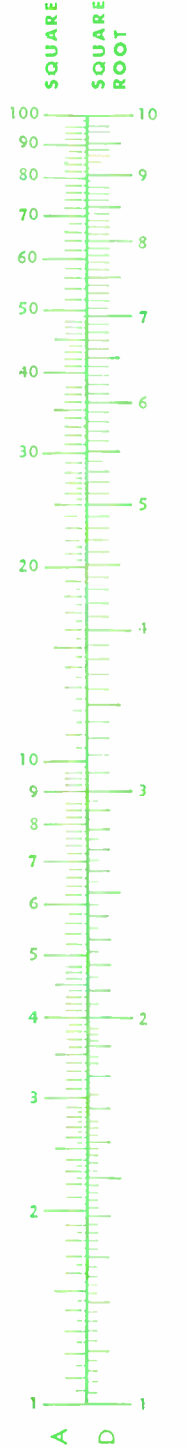
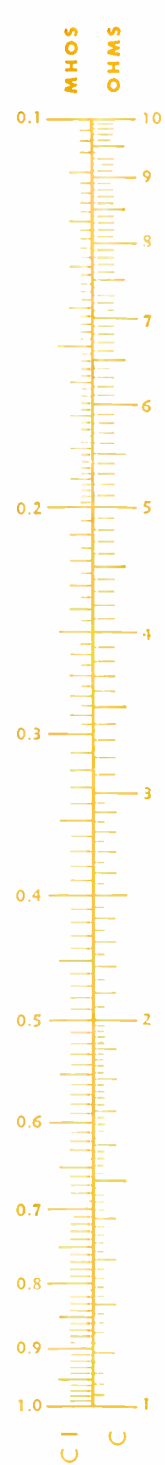
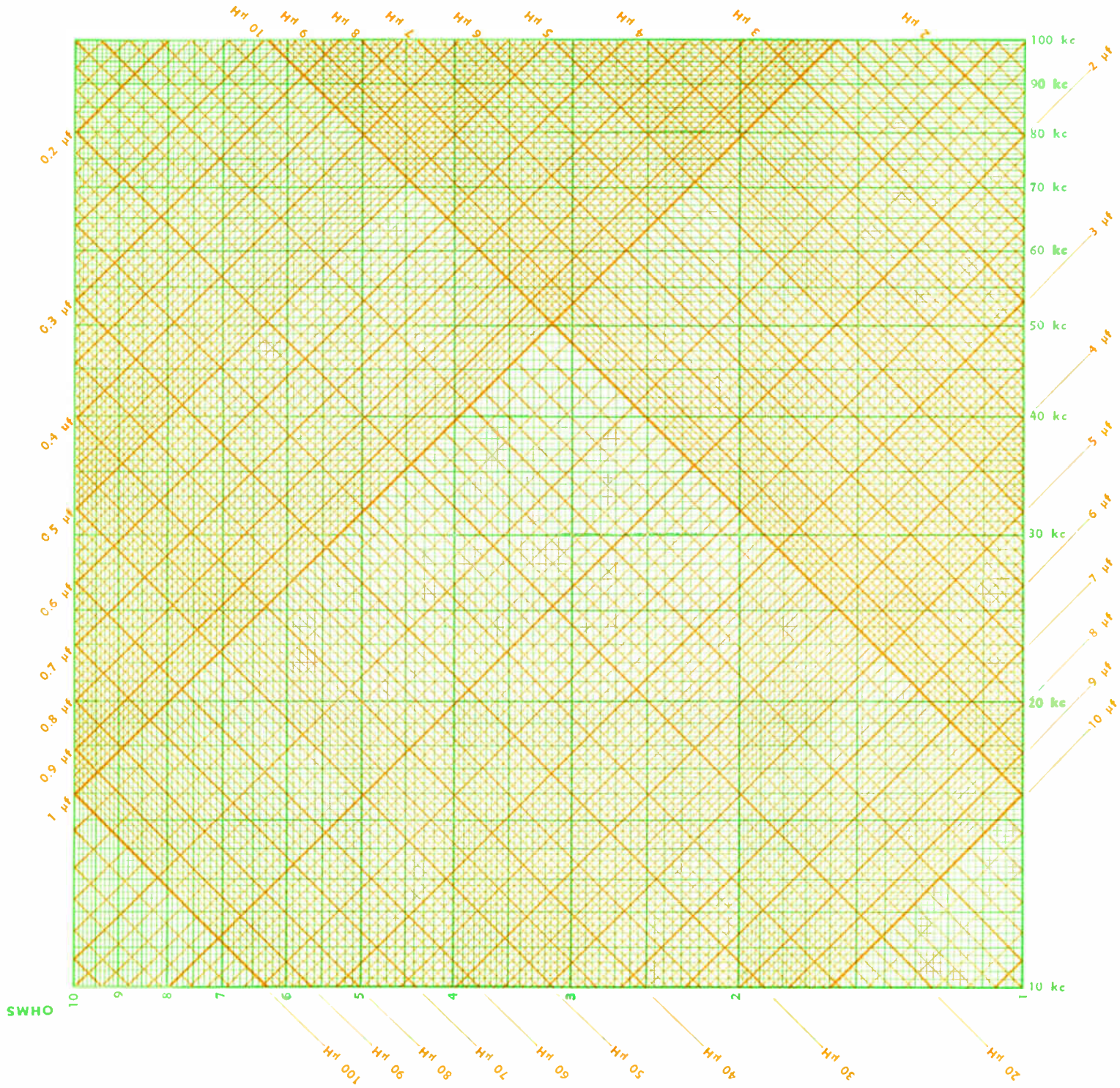


PLATE 31

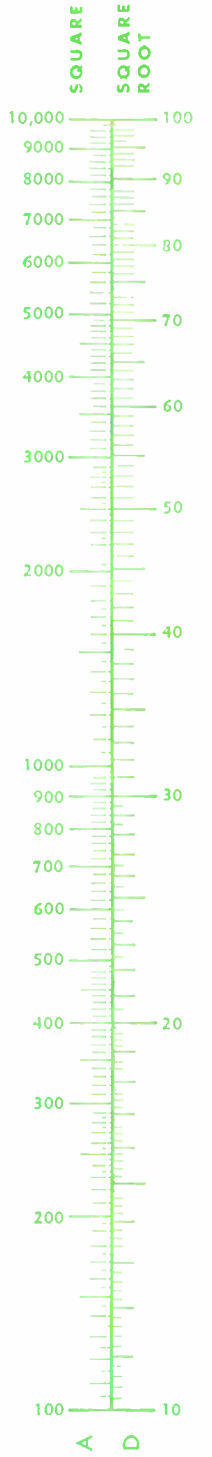
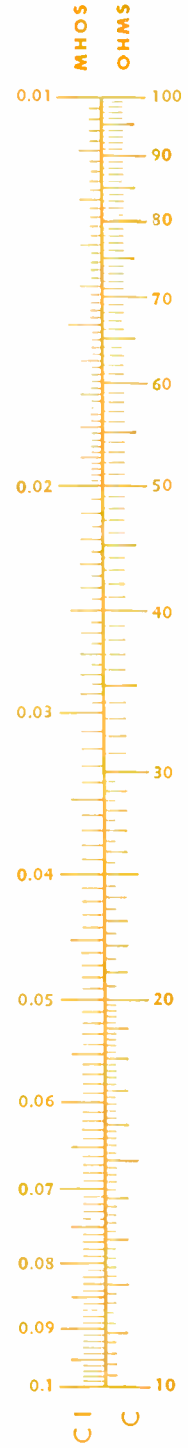
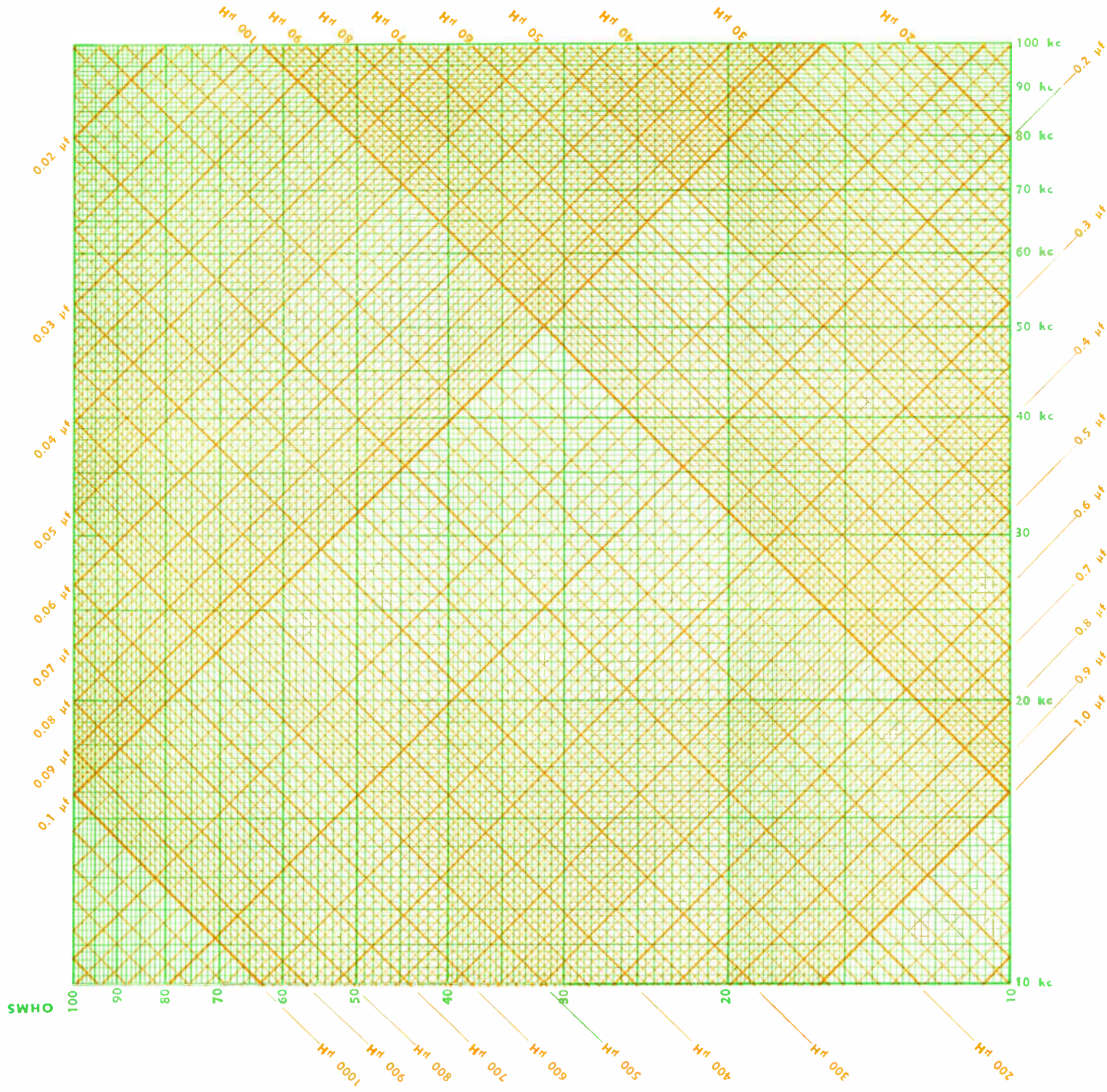
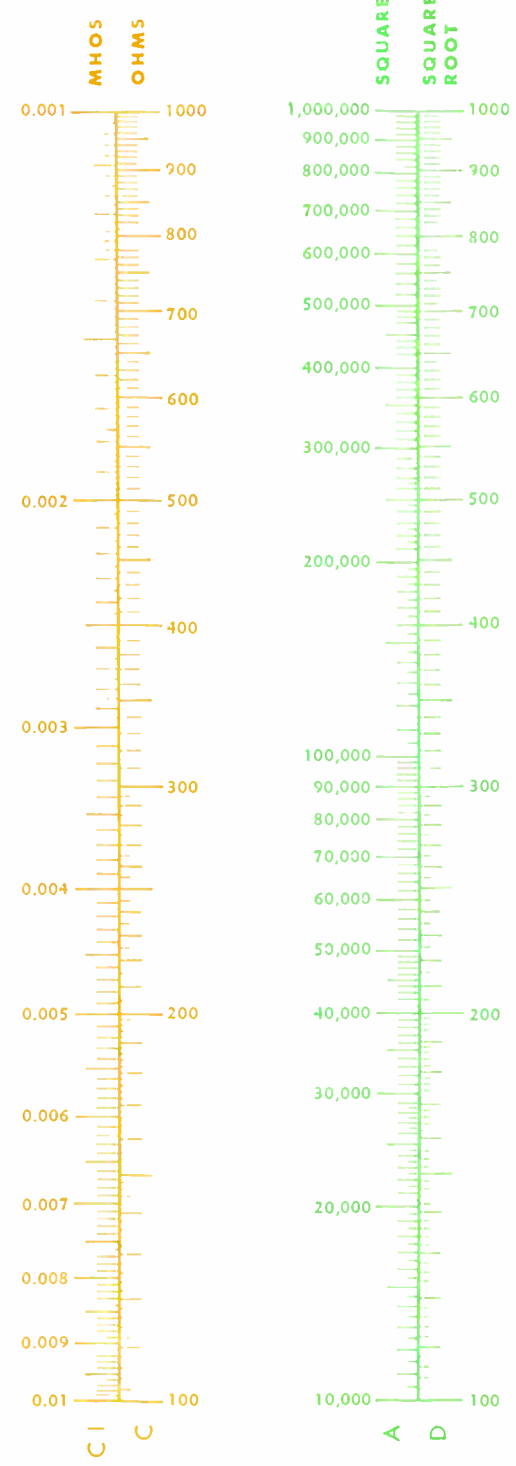
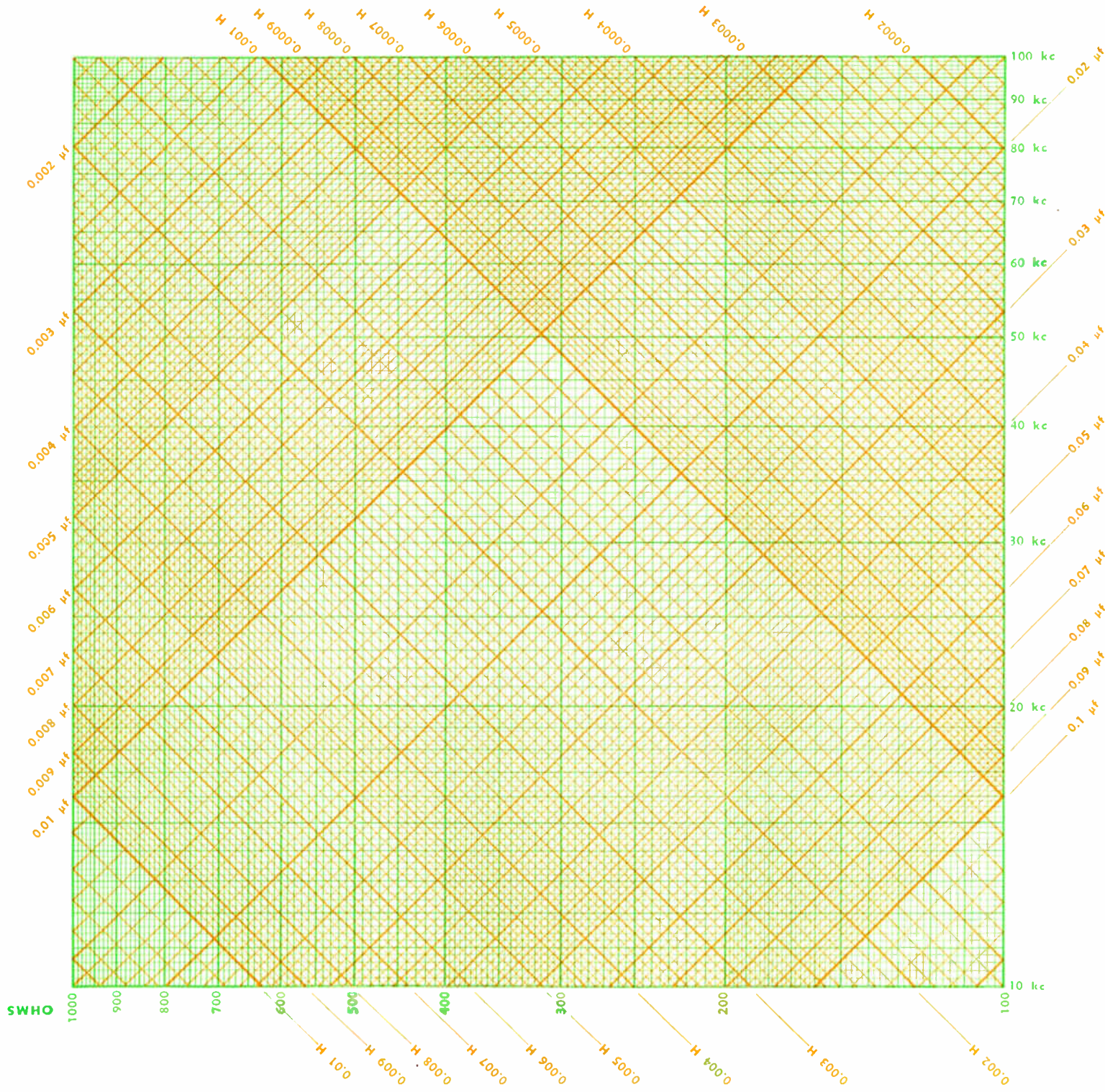
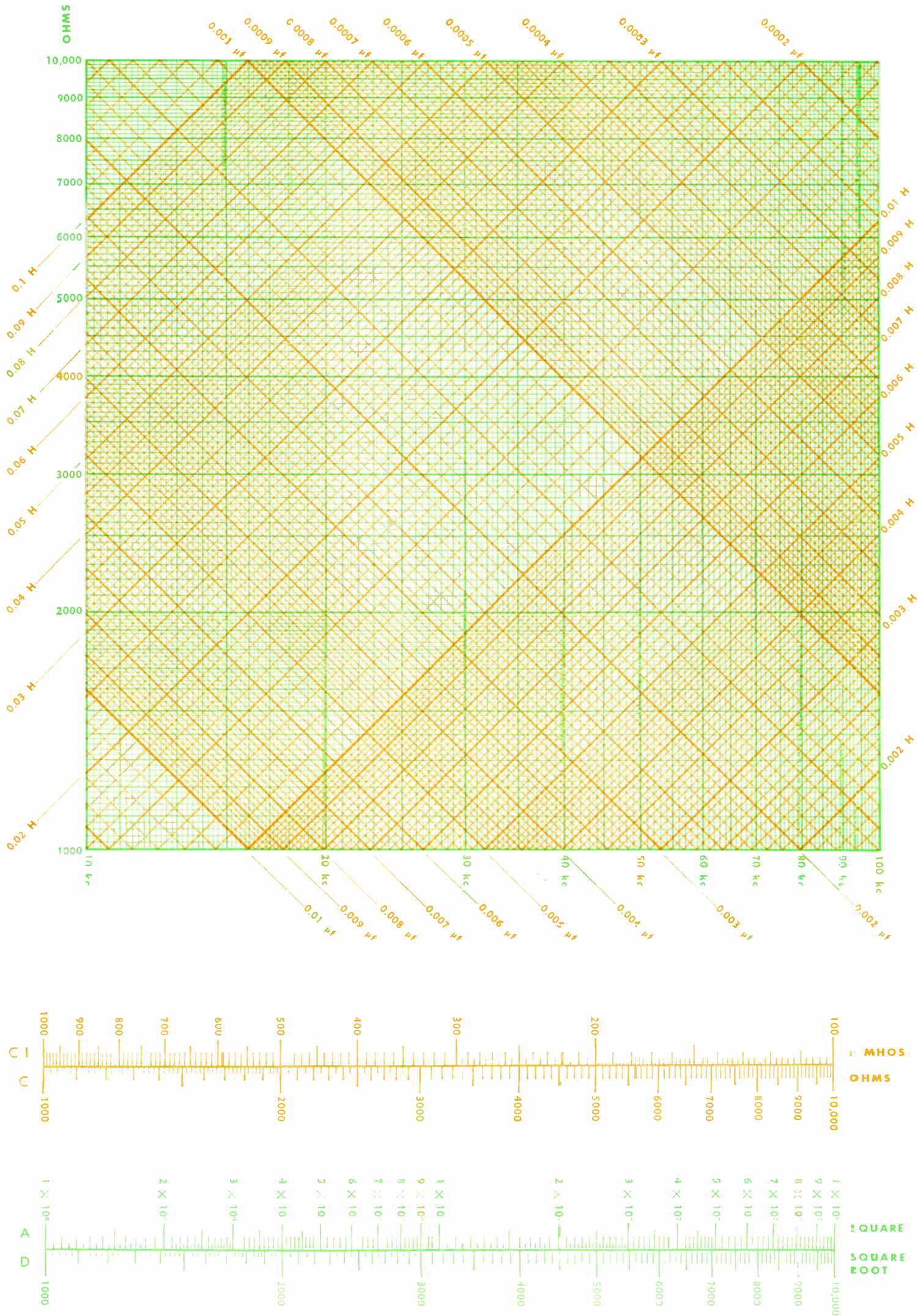
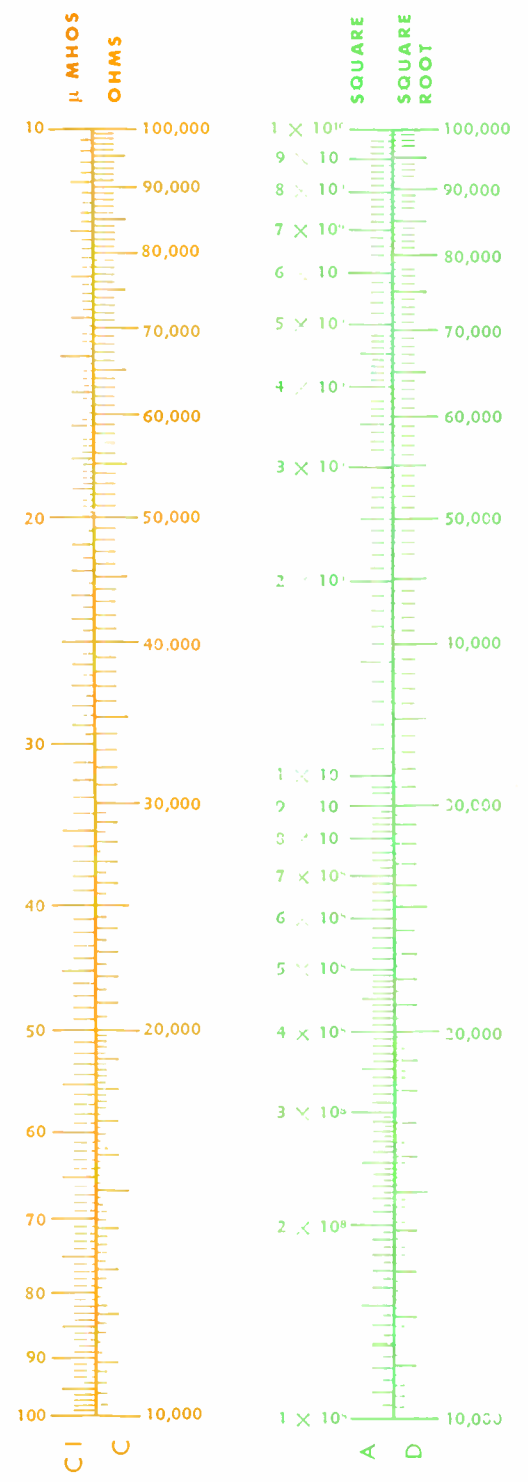
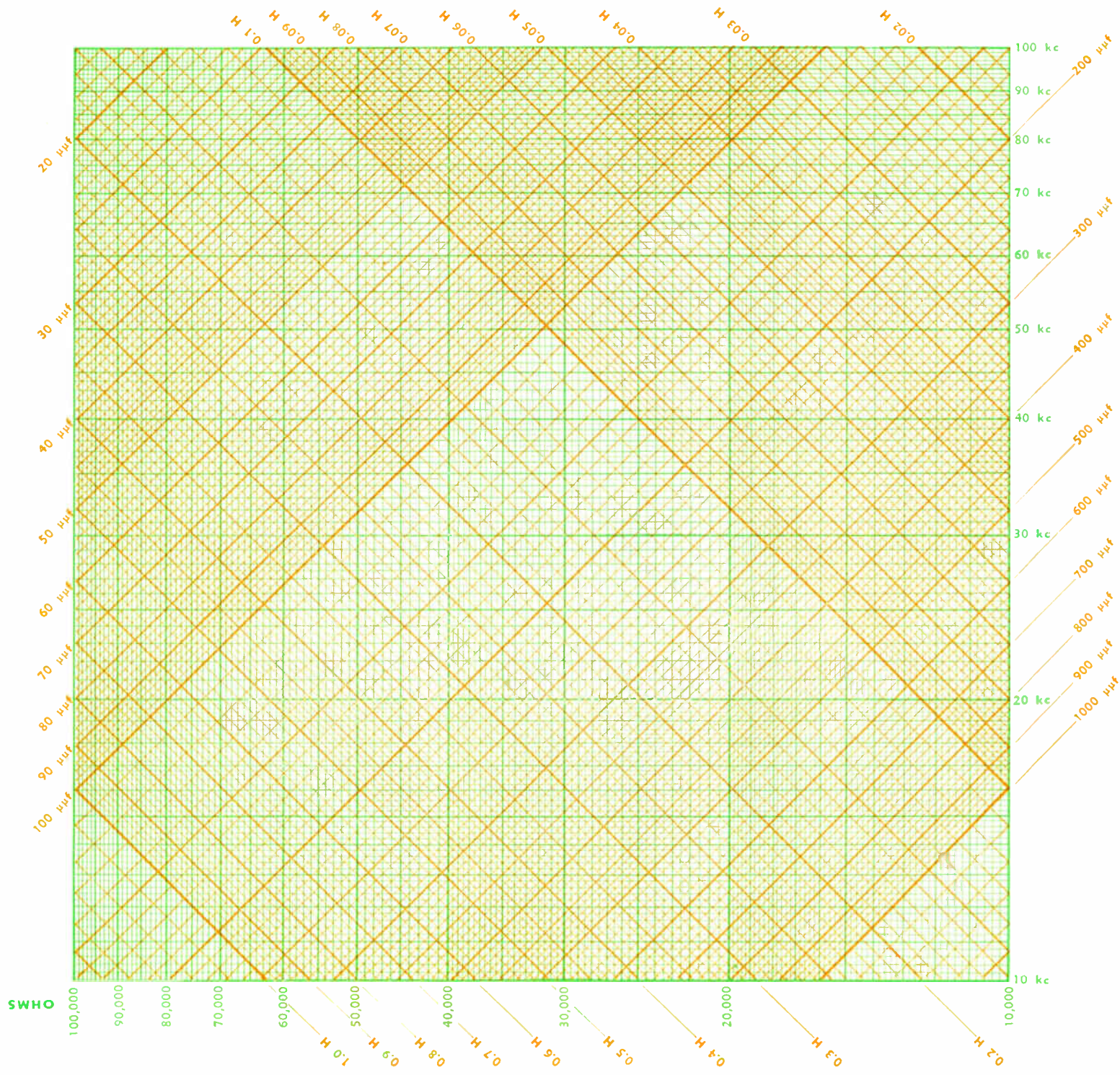


PLATE 32





# PLATE 34



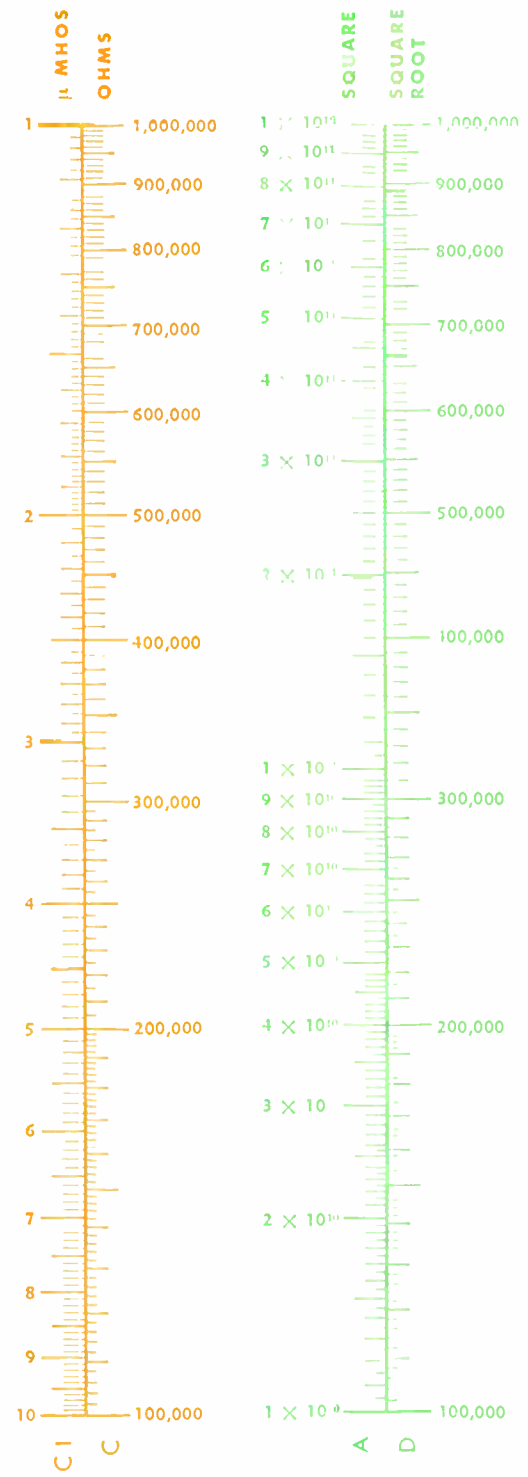
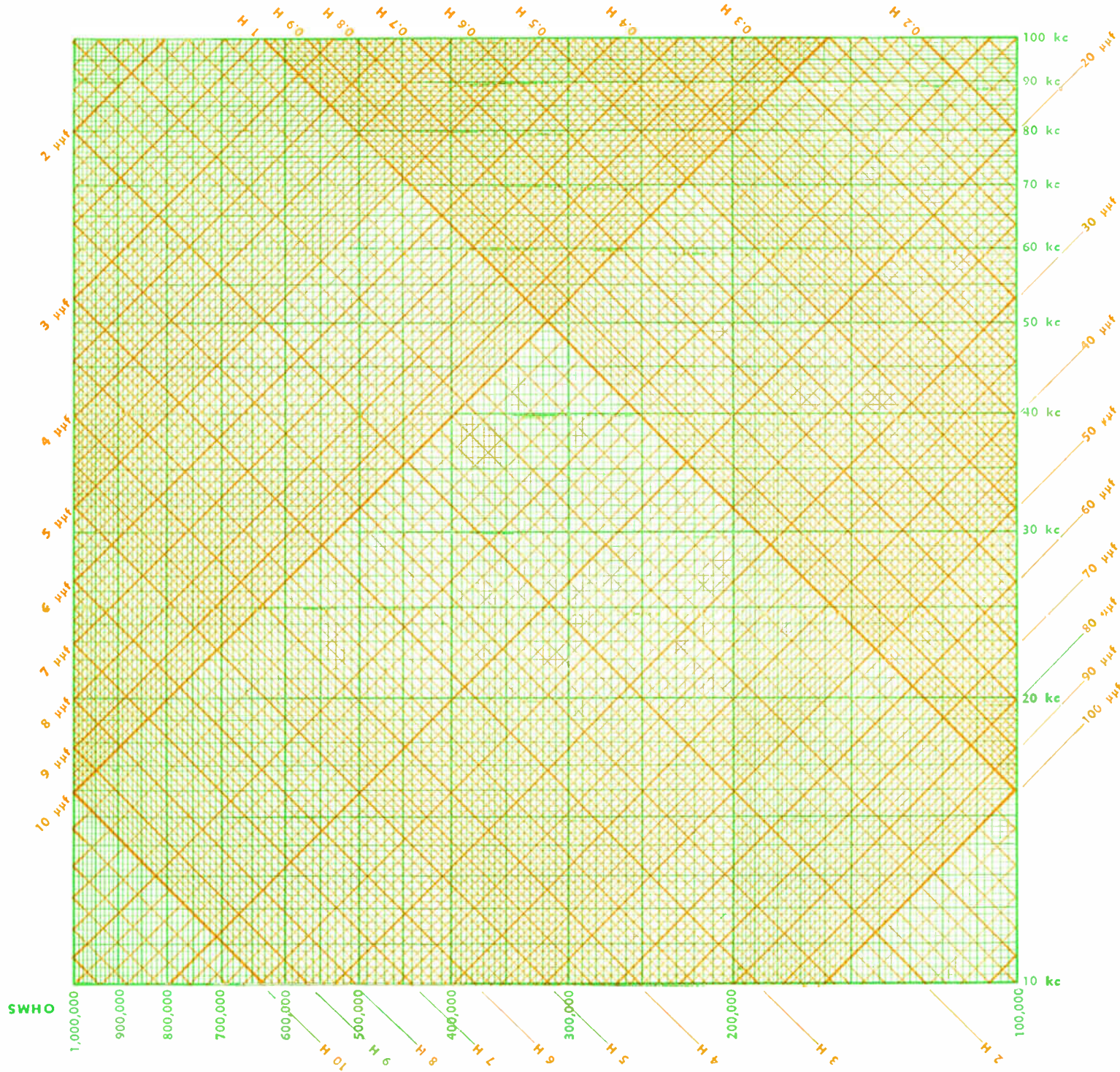
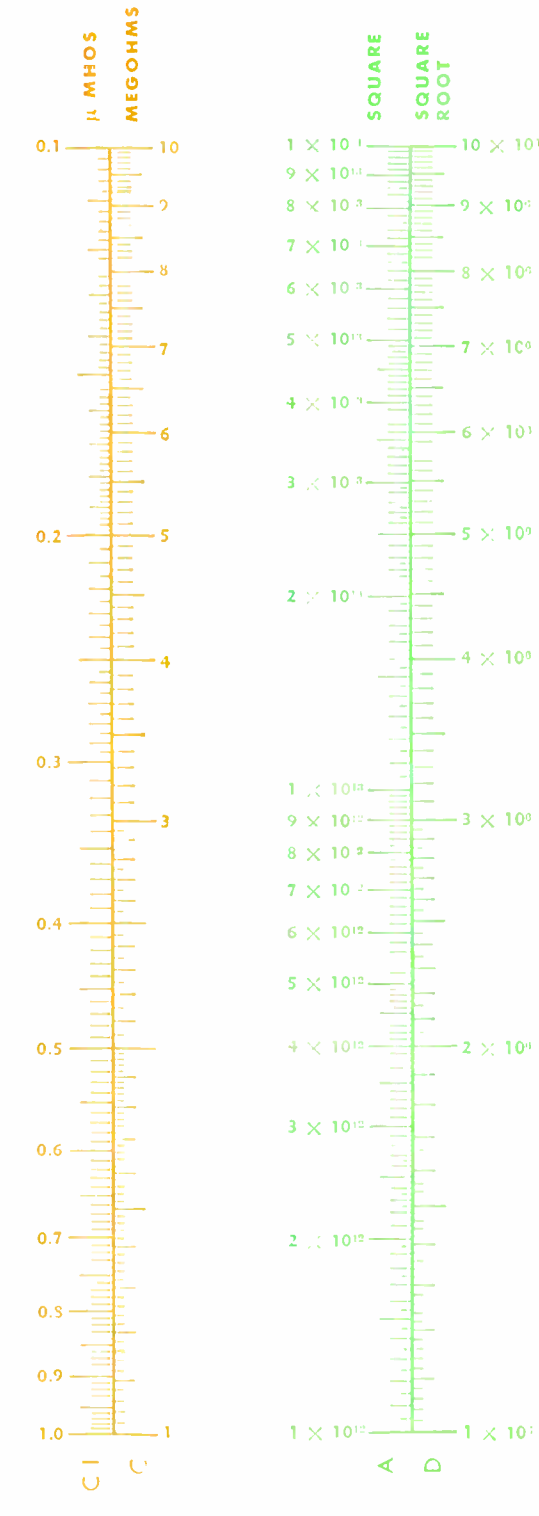
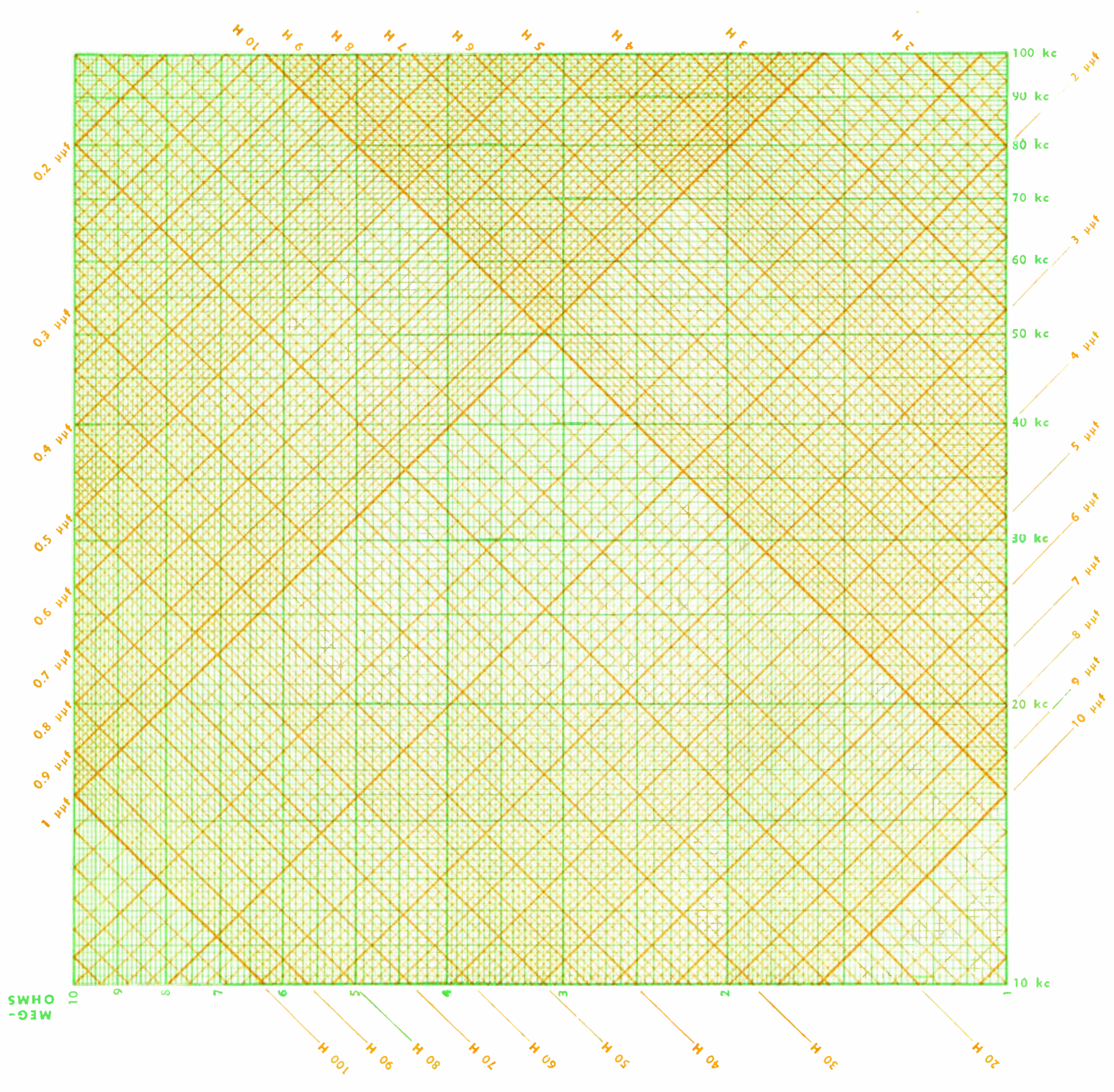


PLATE 36





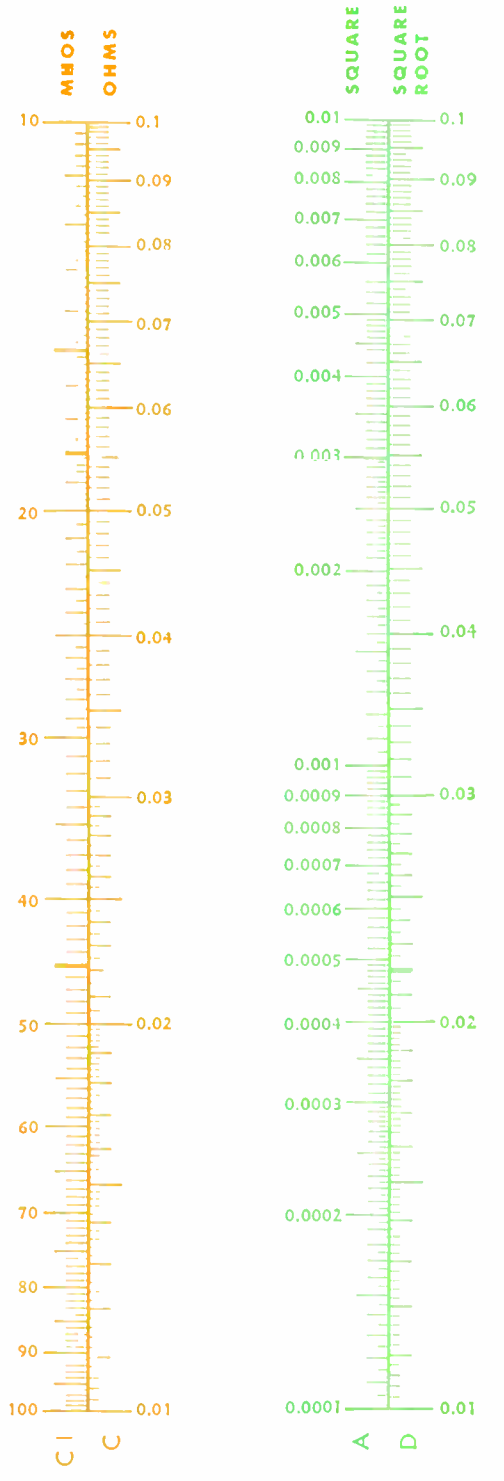
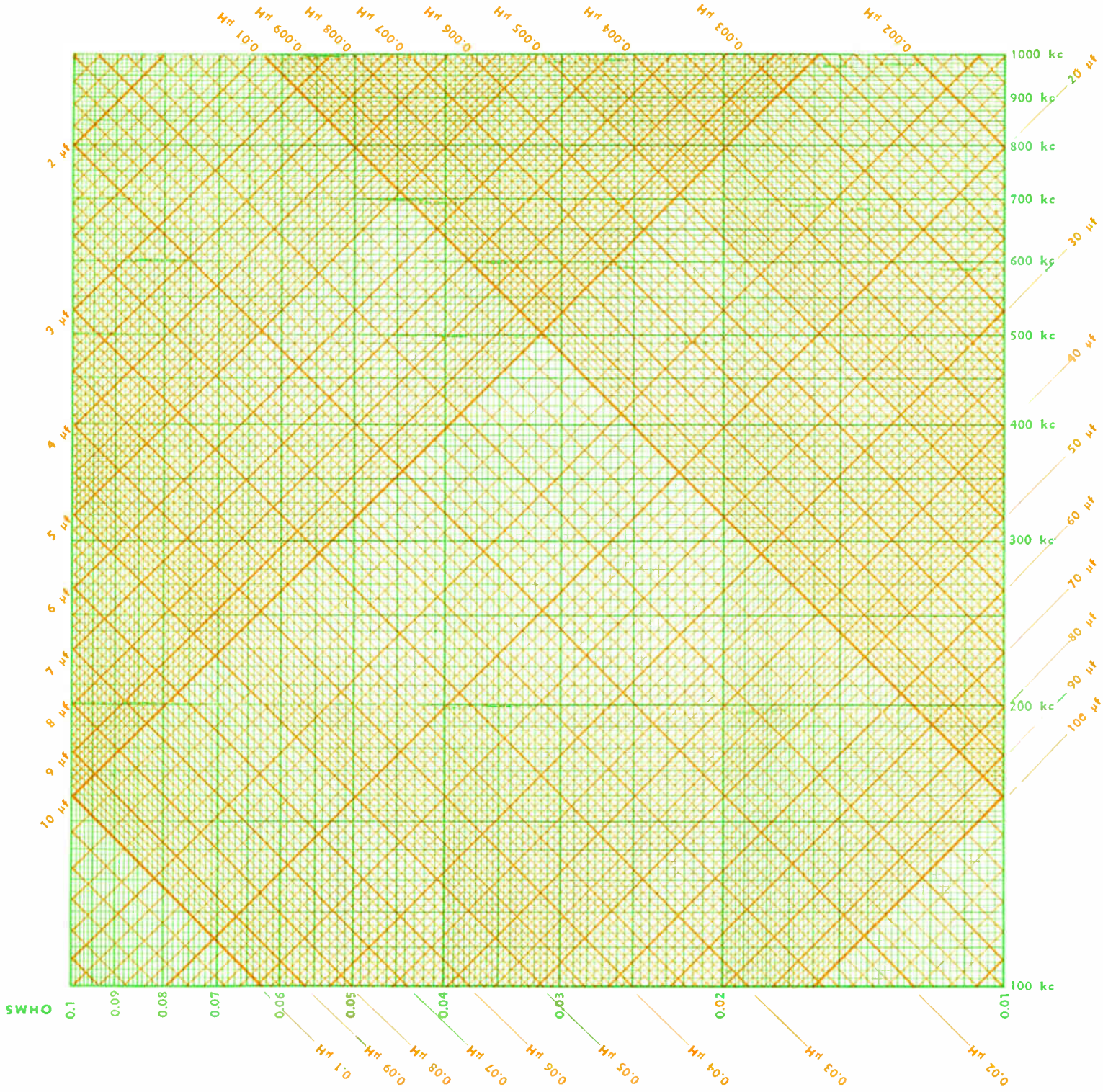
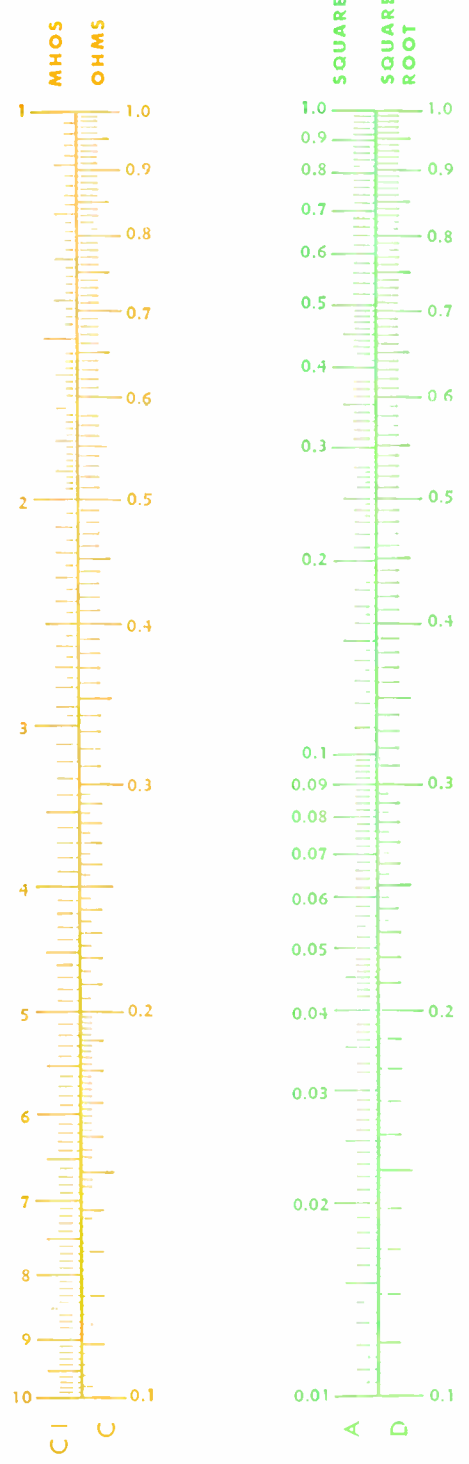
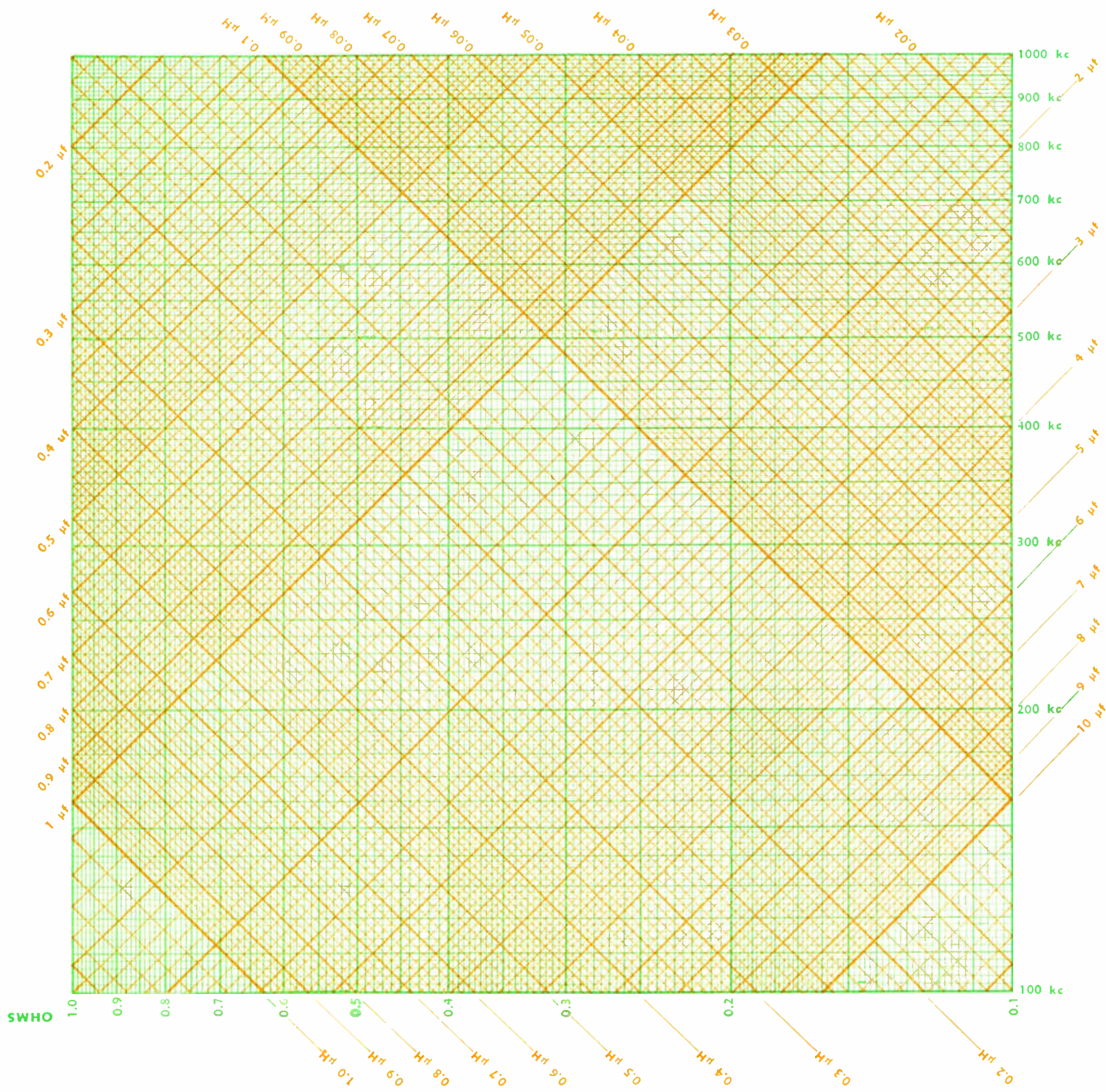


PLATE 38



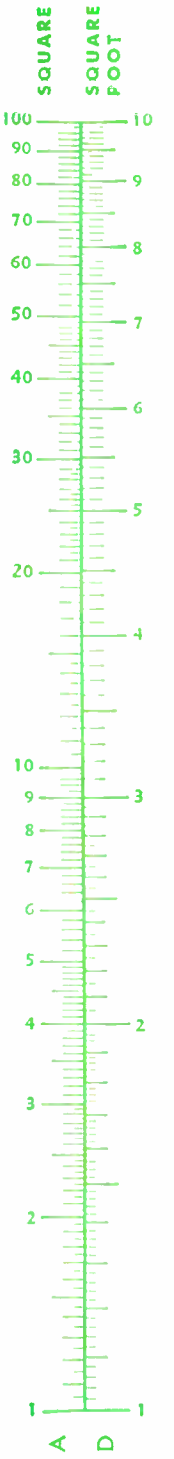
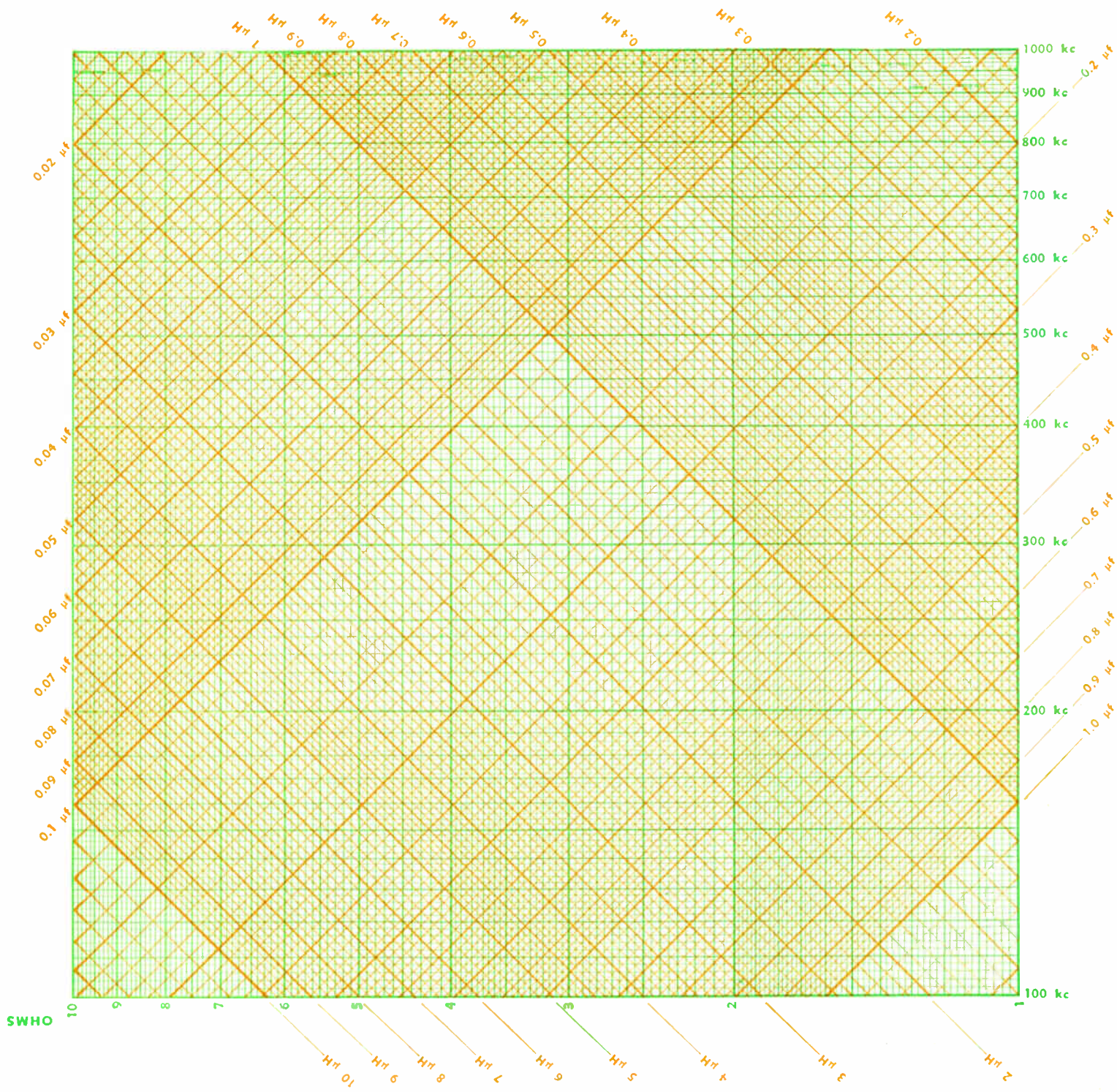
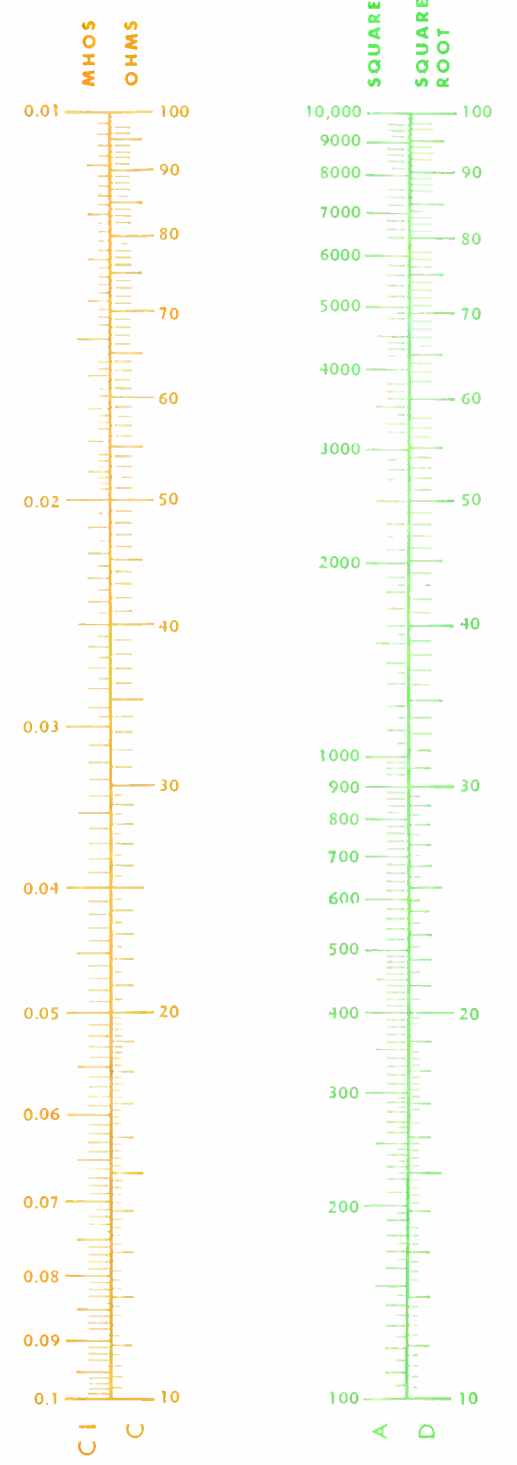
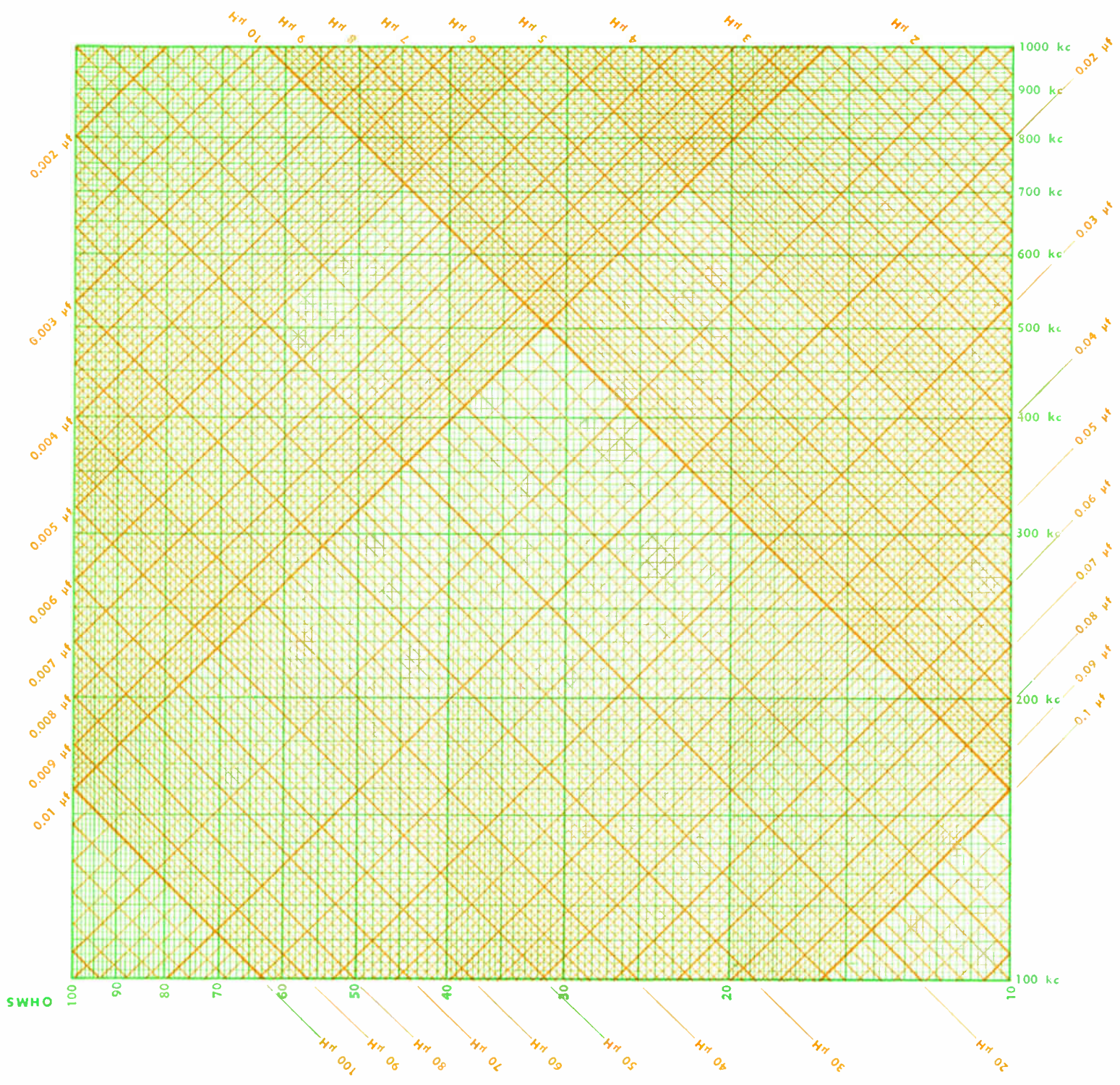
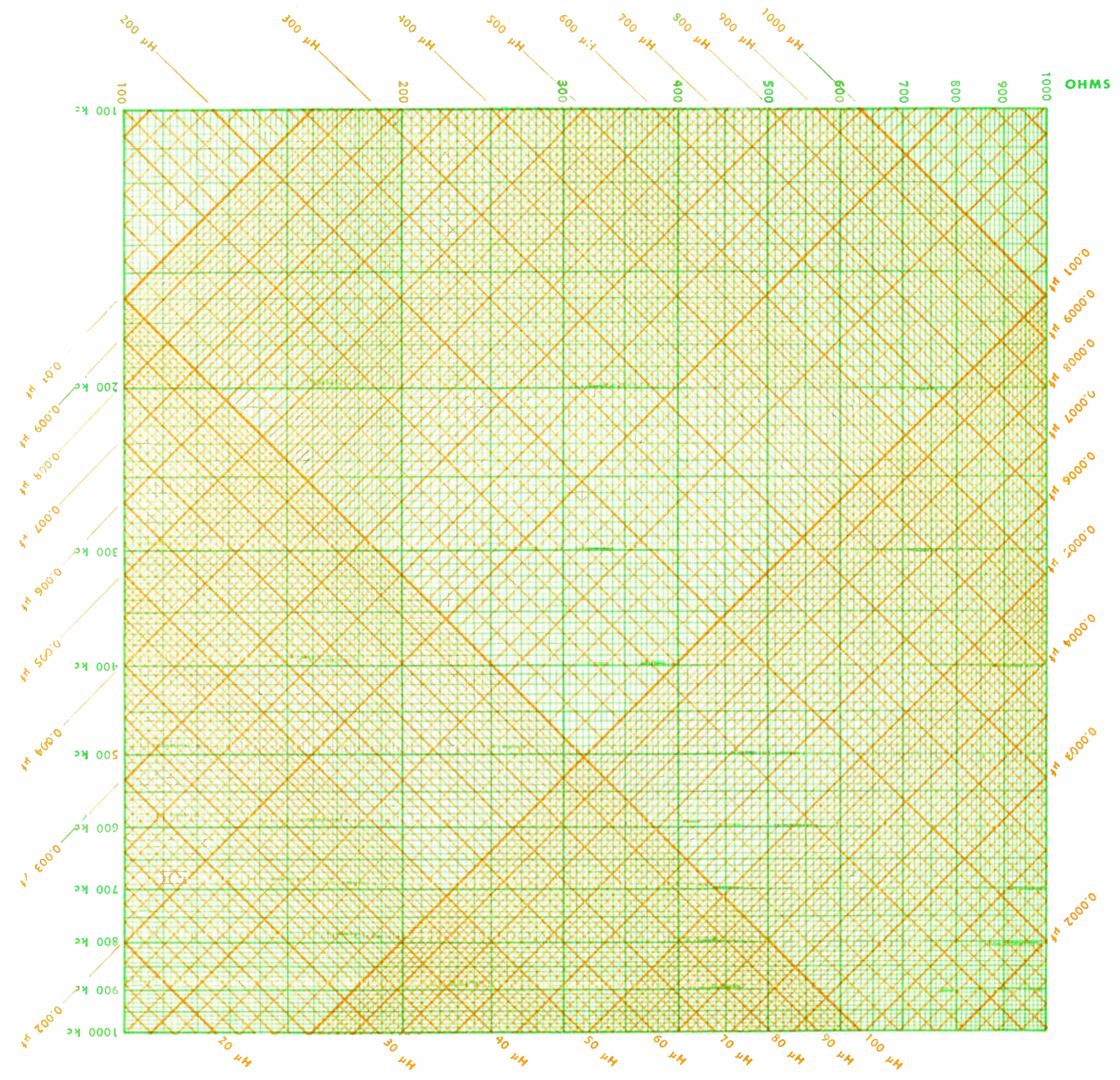
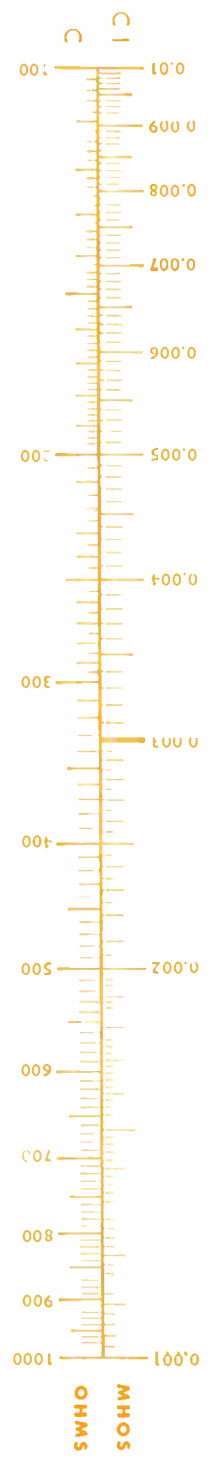
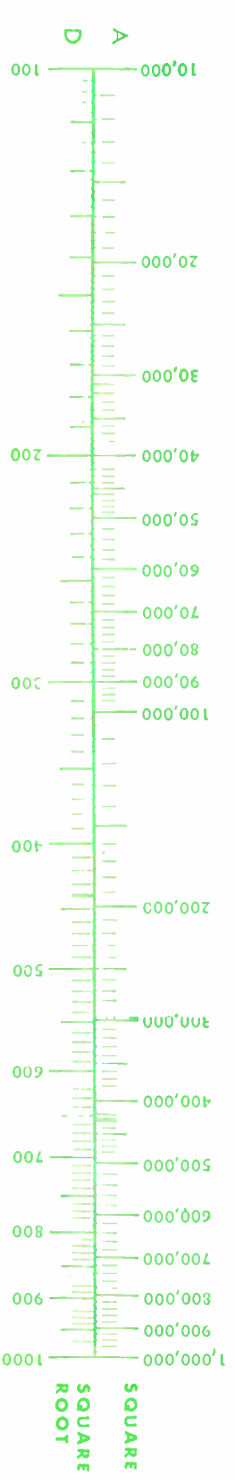
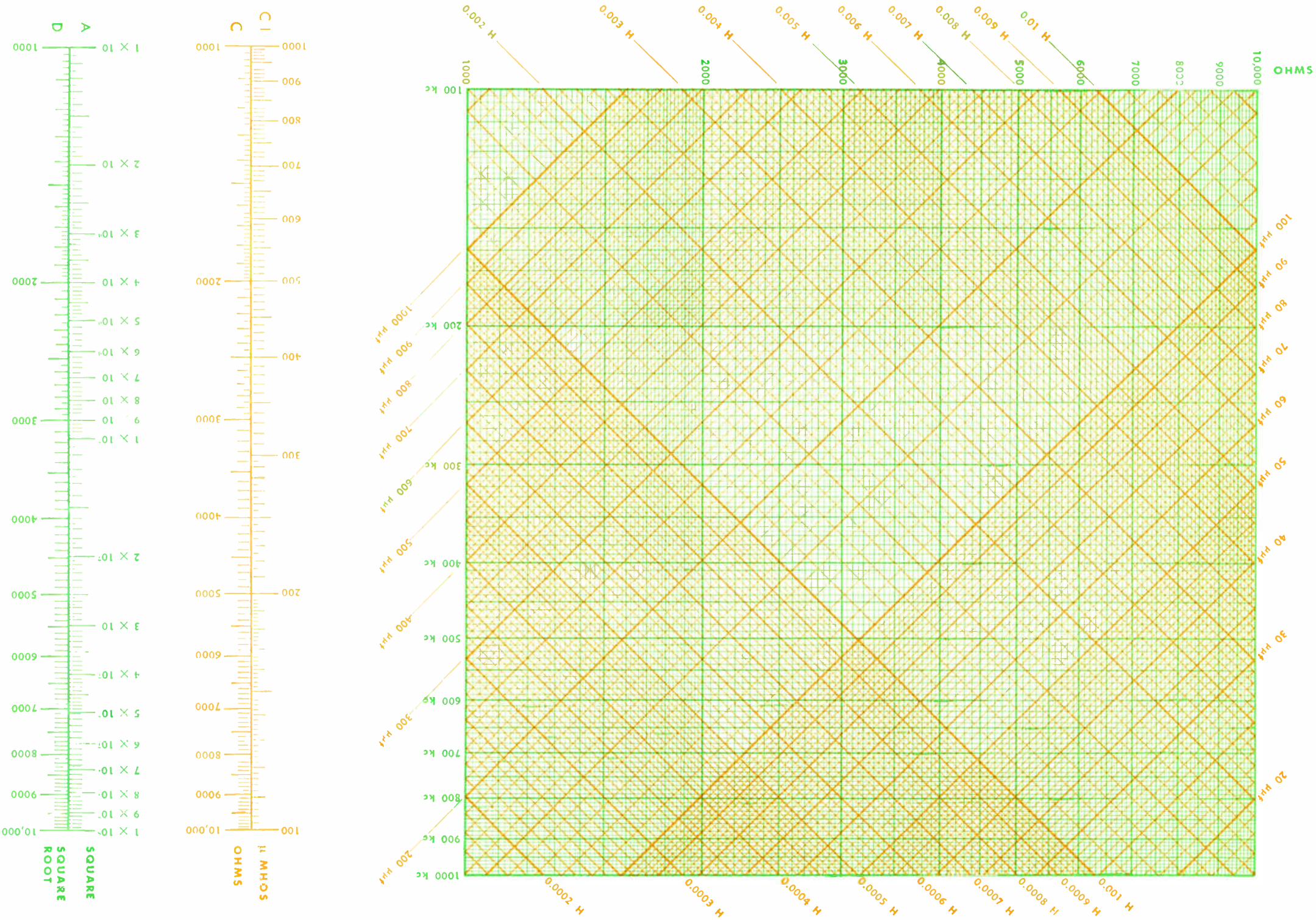
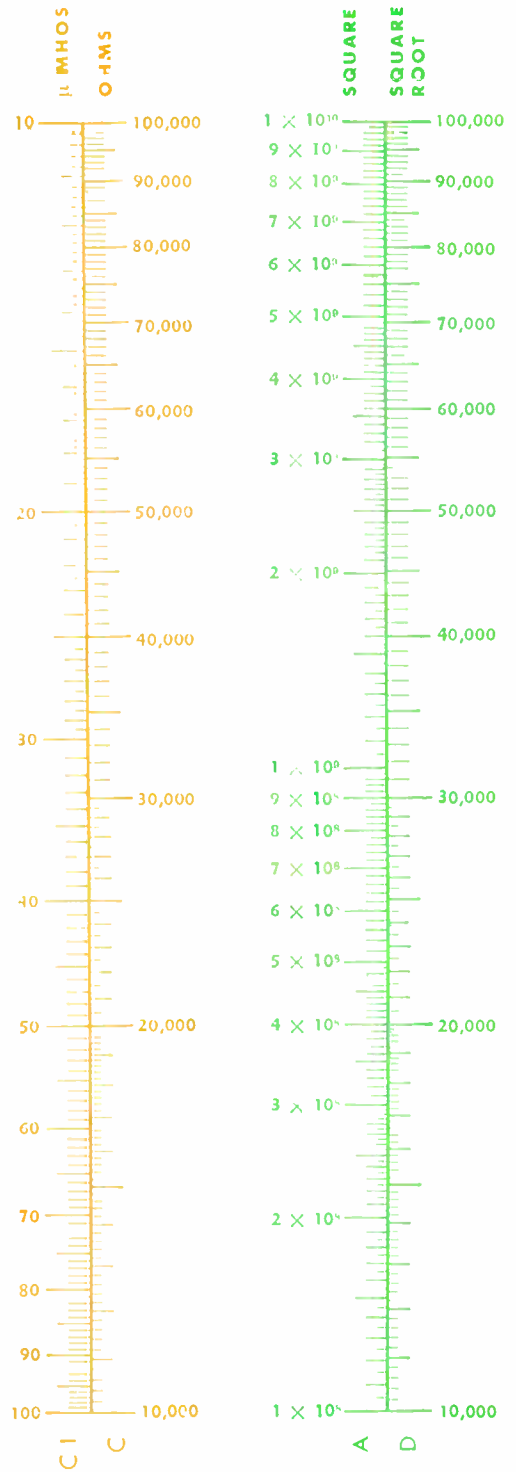
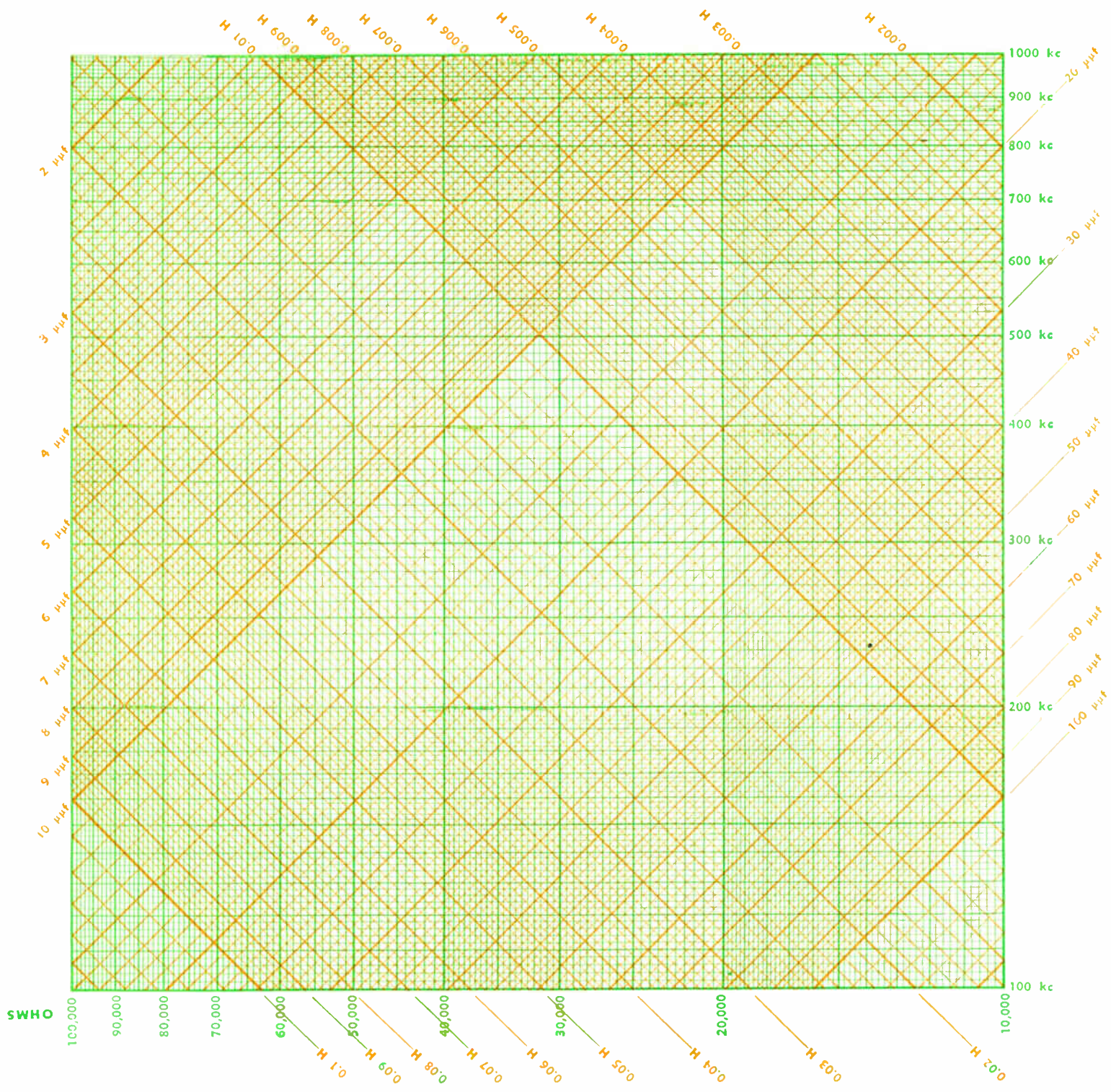


PLATE 40

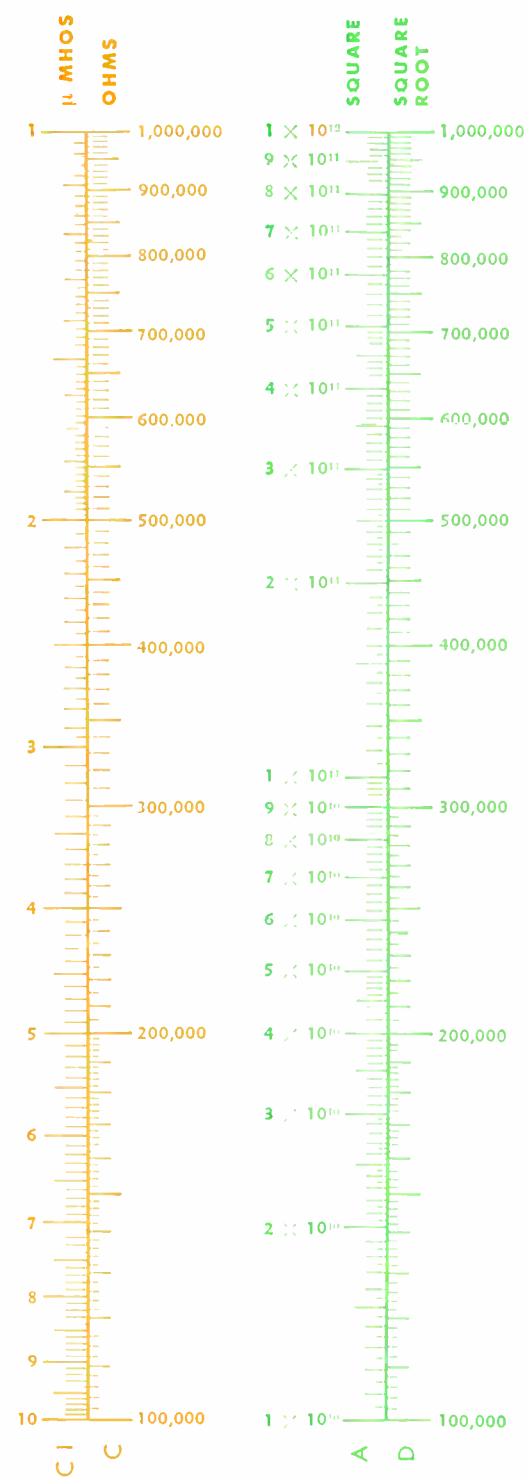
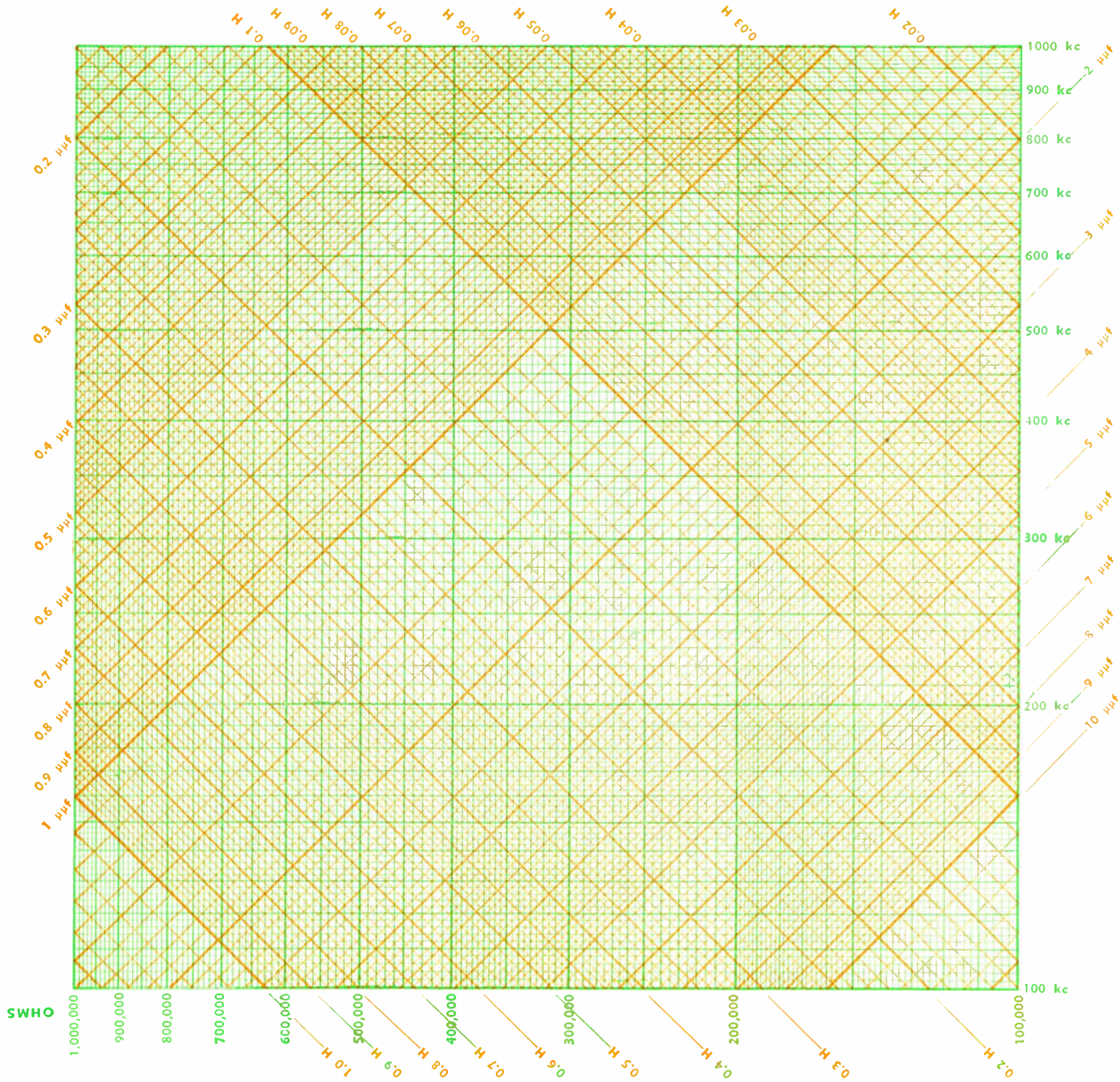




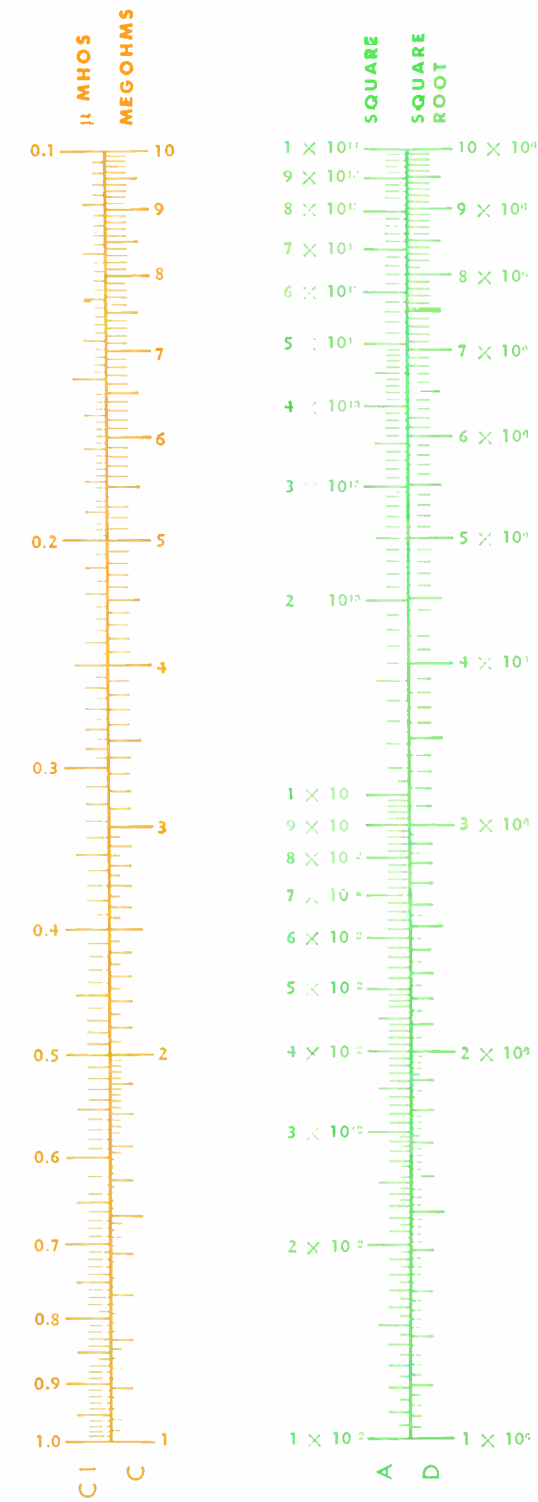
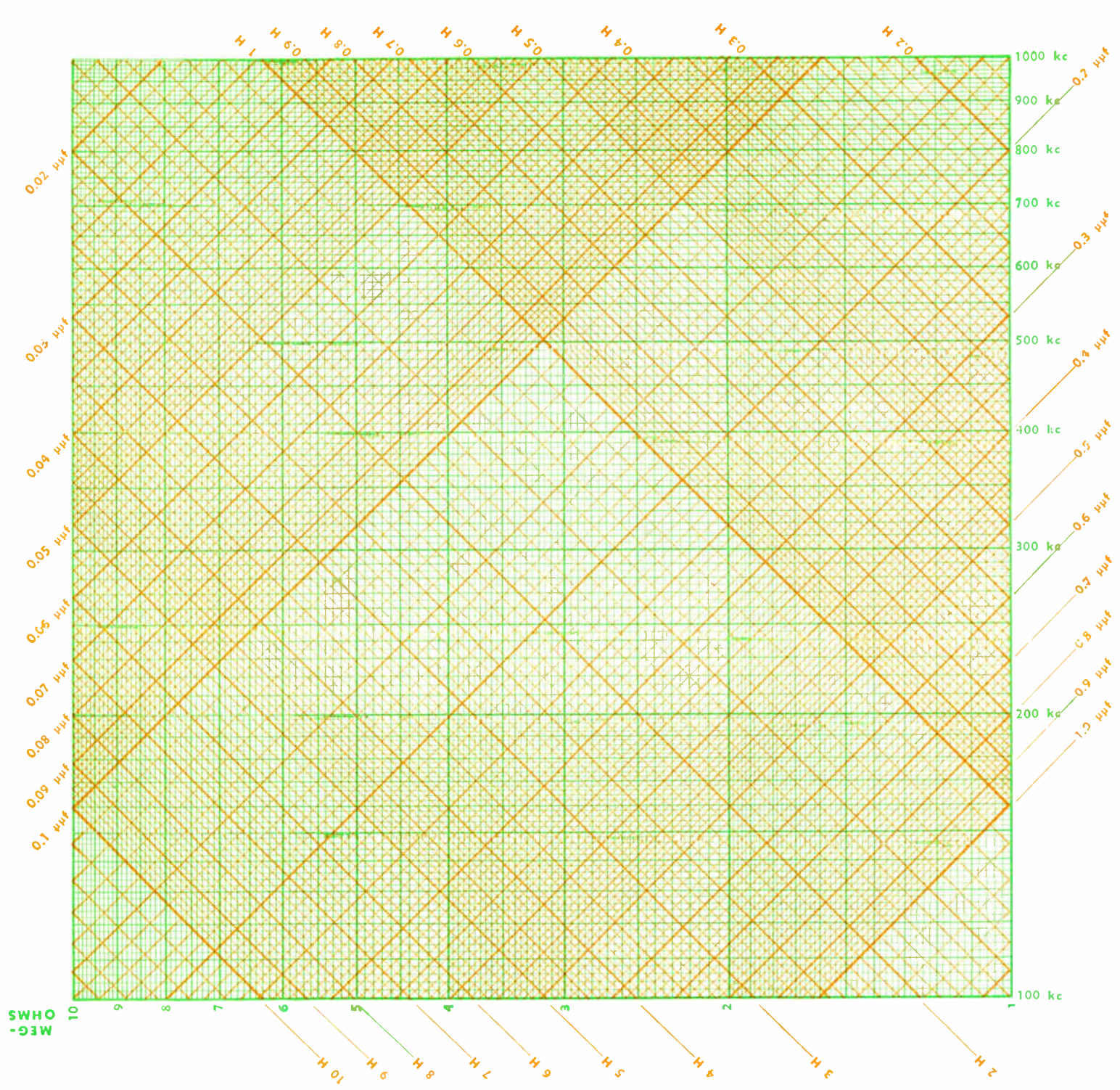


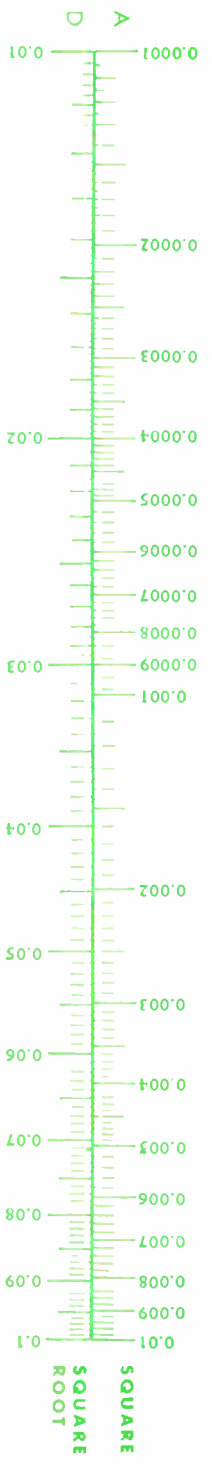
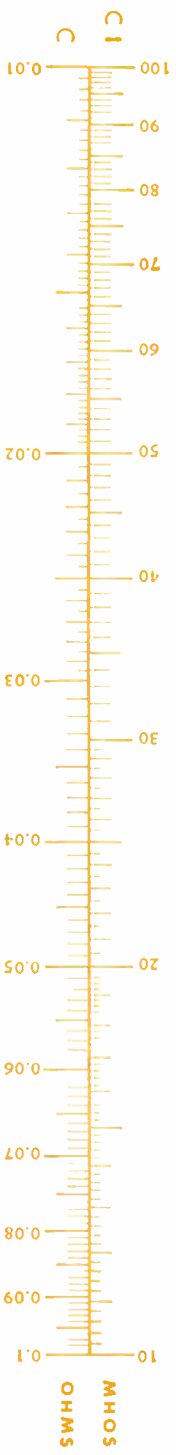
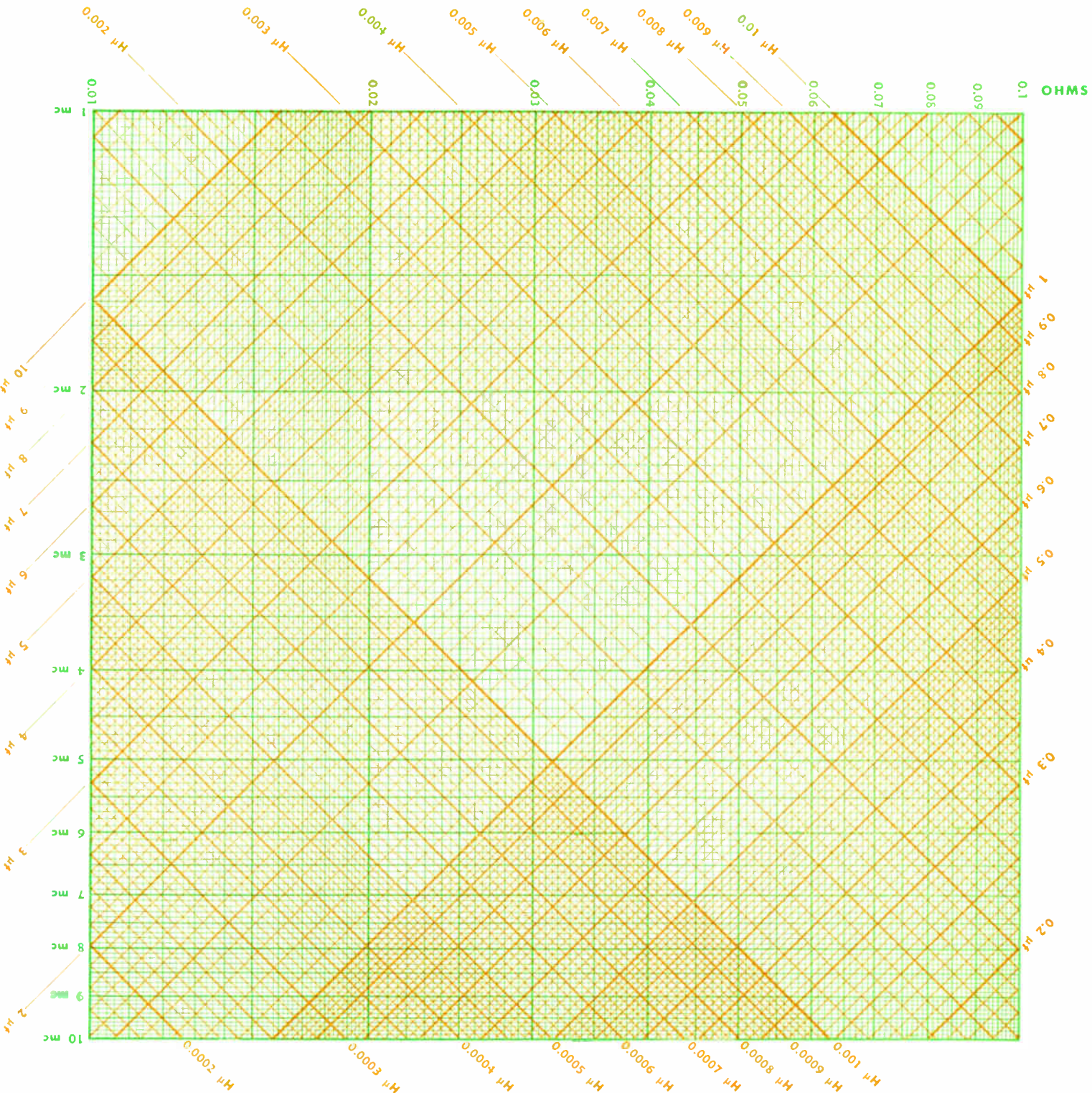


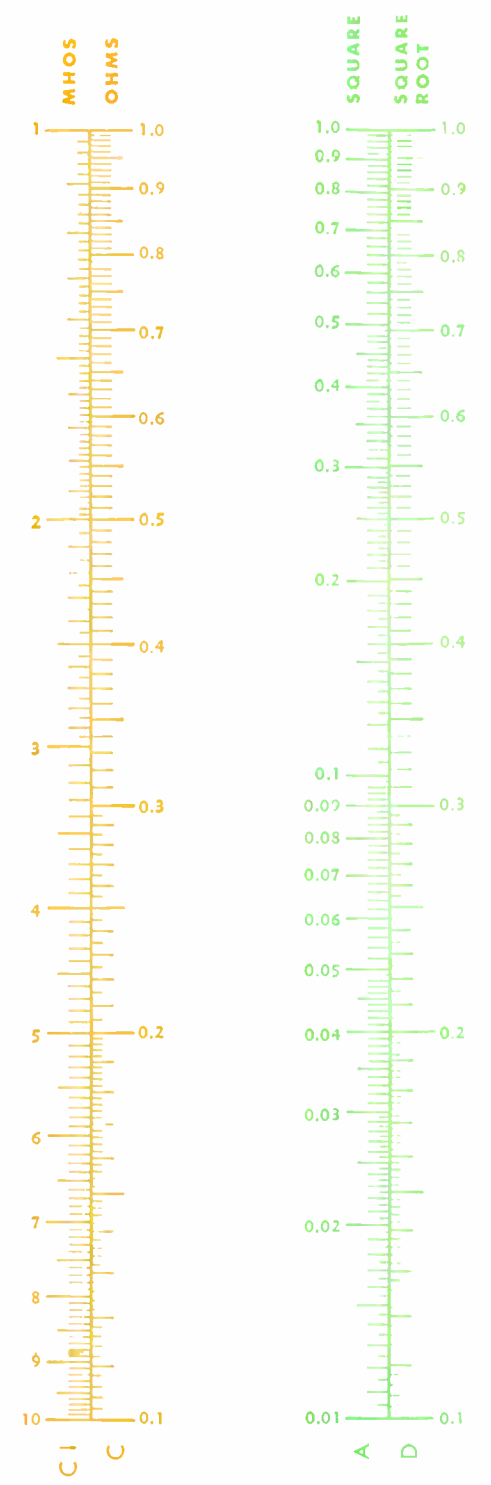
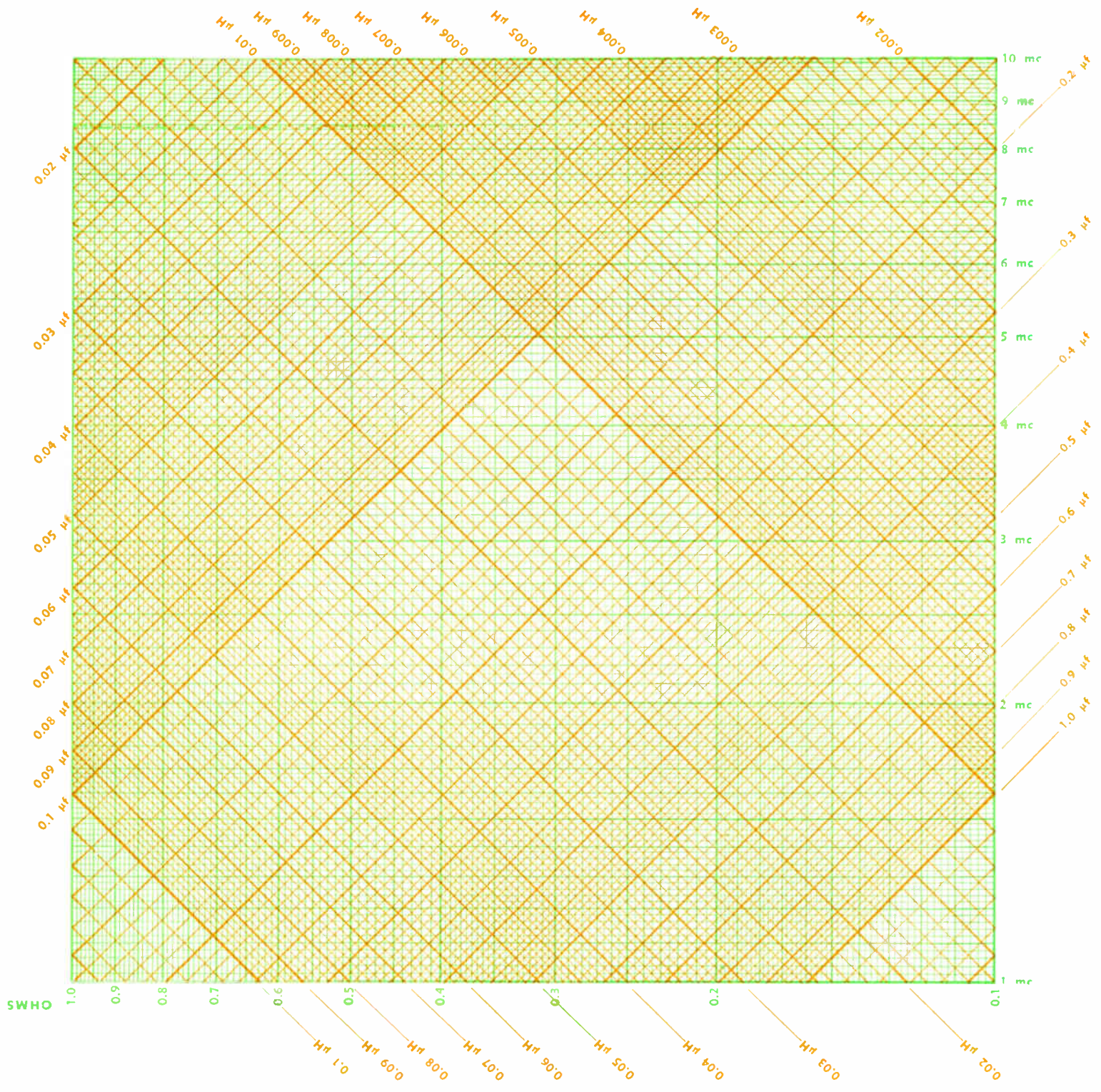
**PLATE 44**

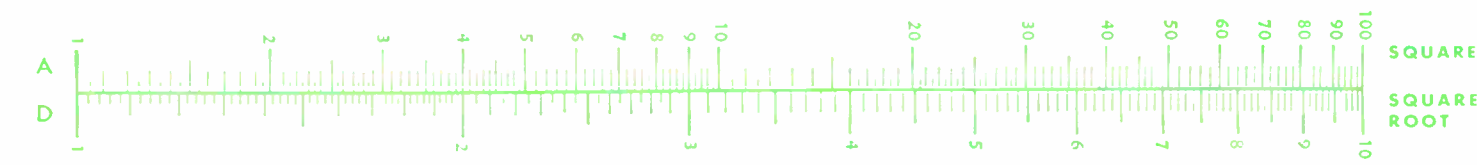
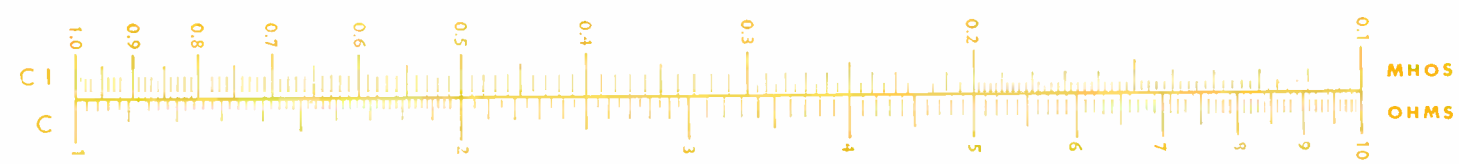
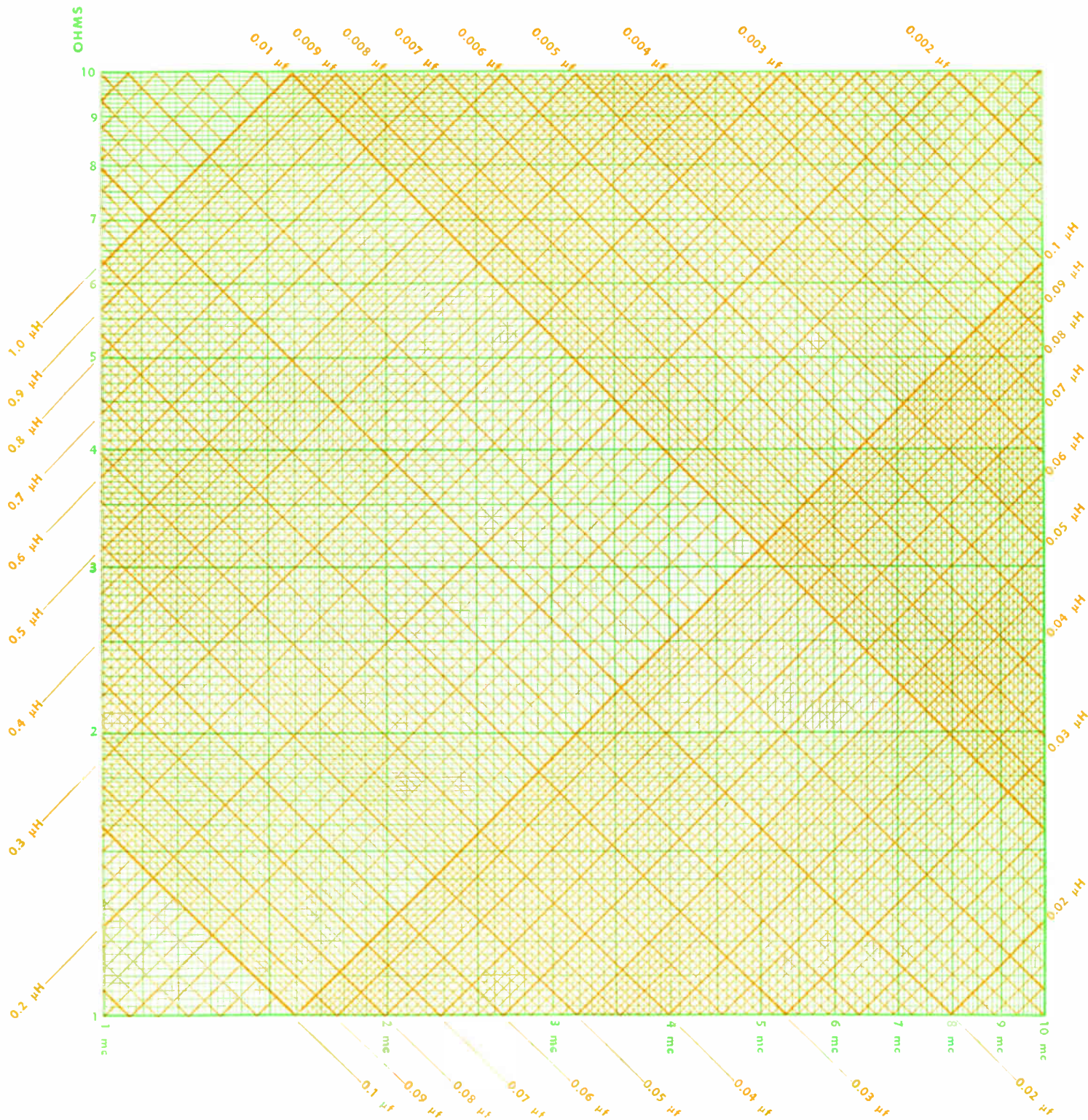


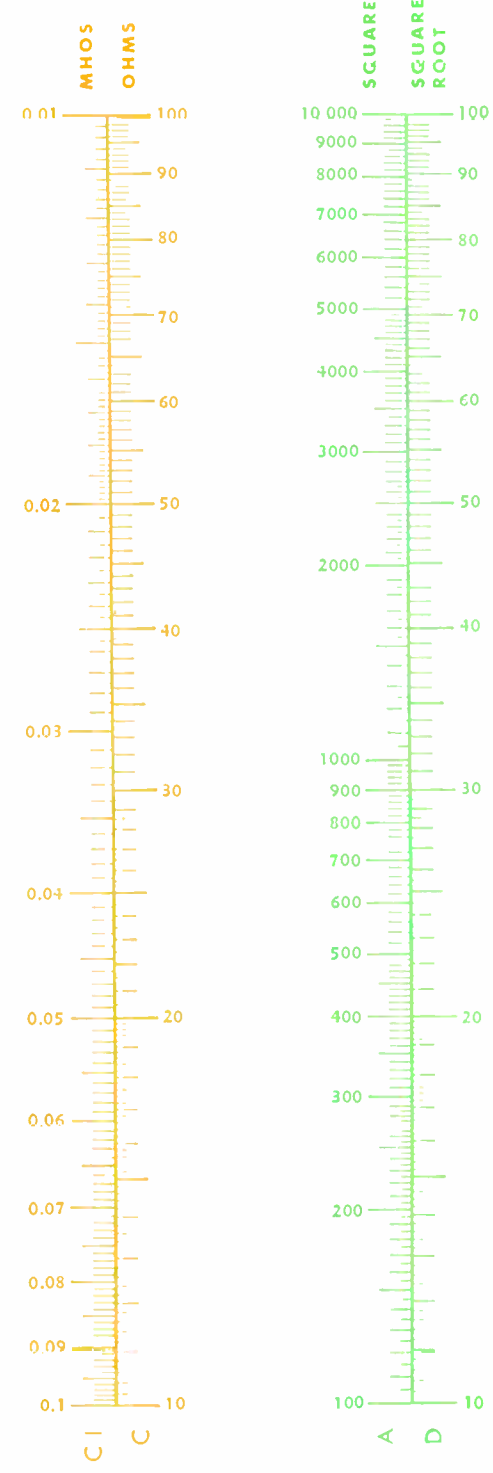
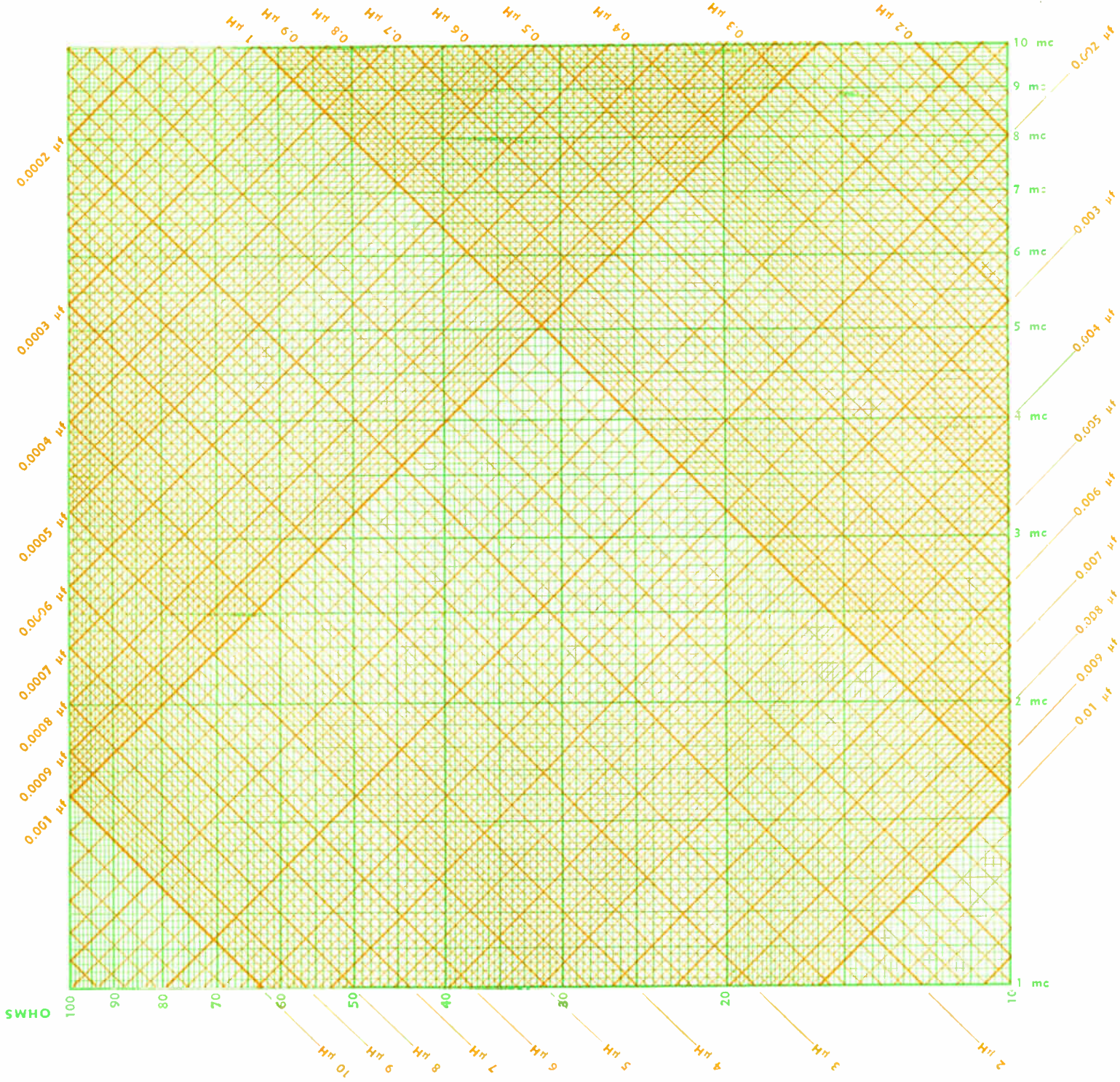




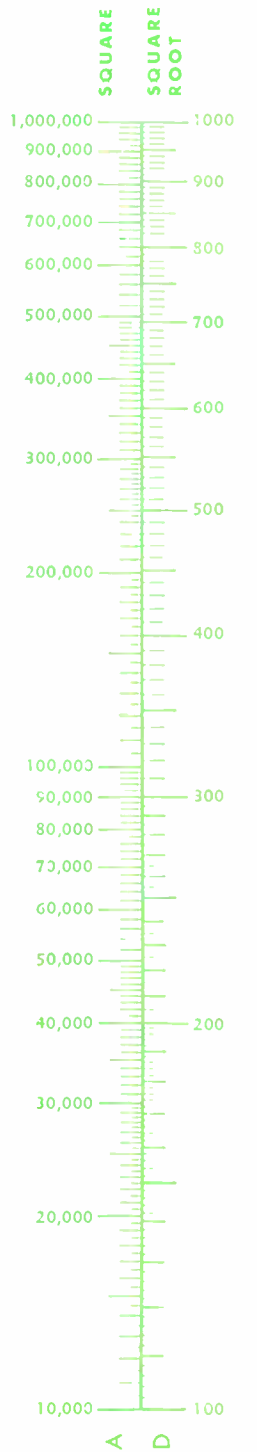
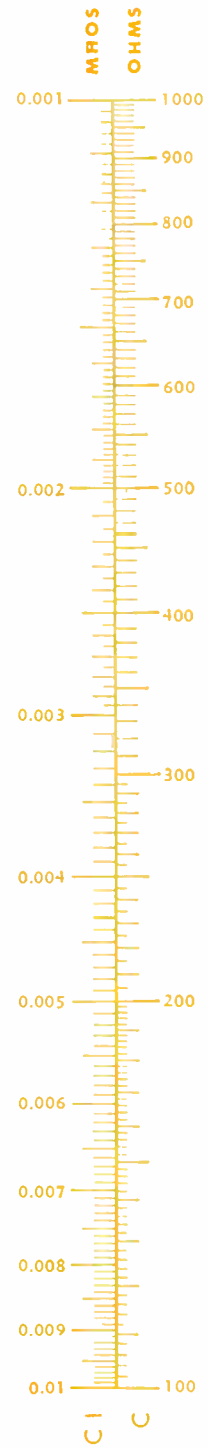
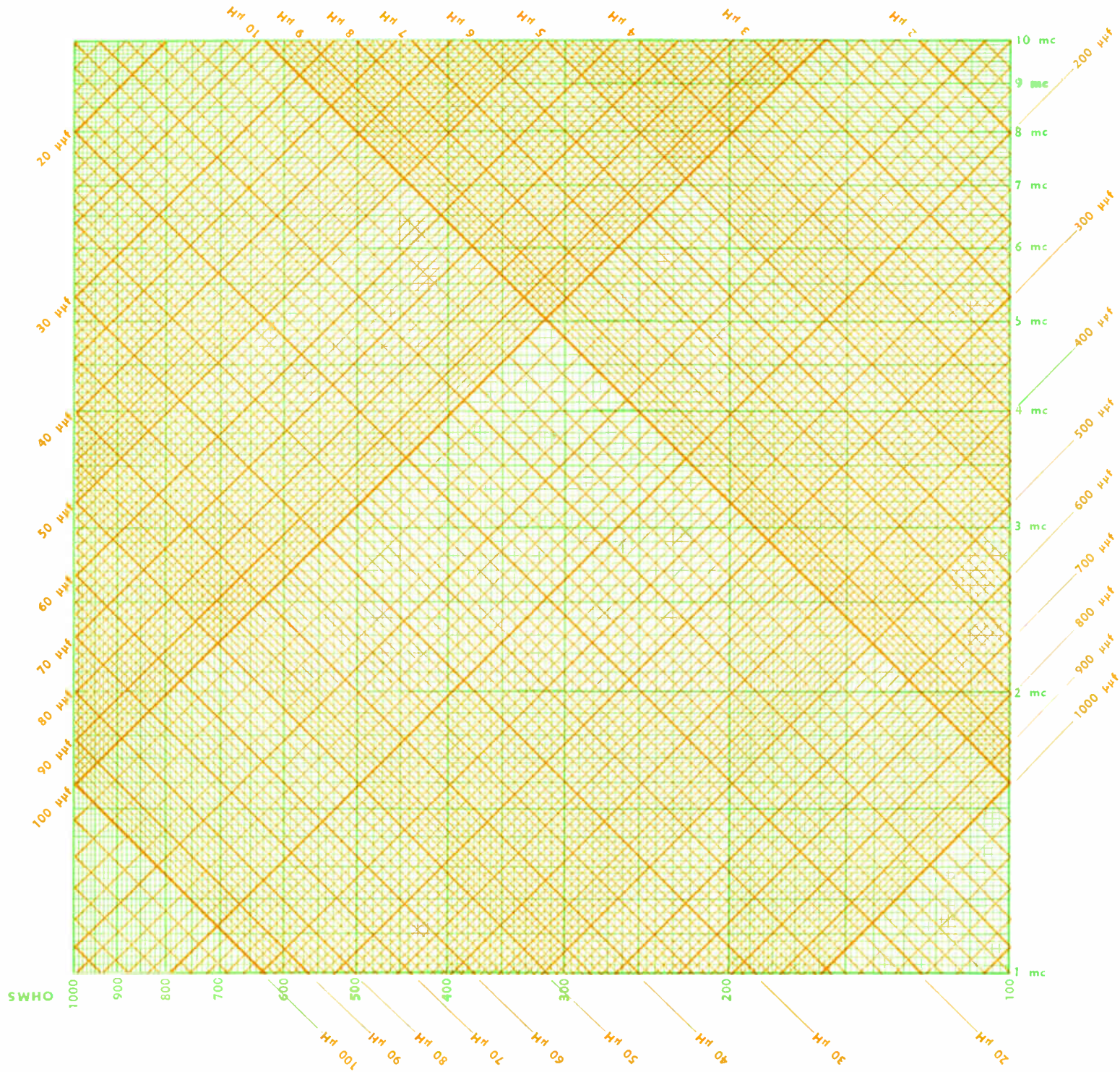


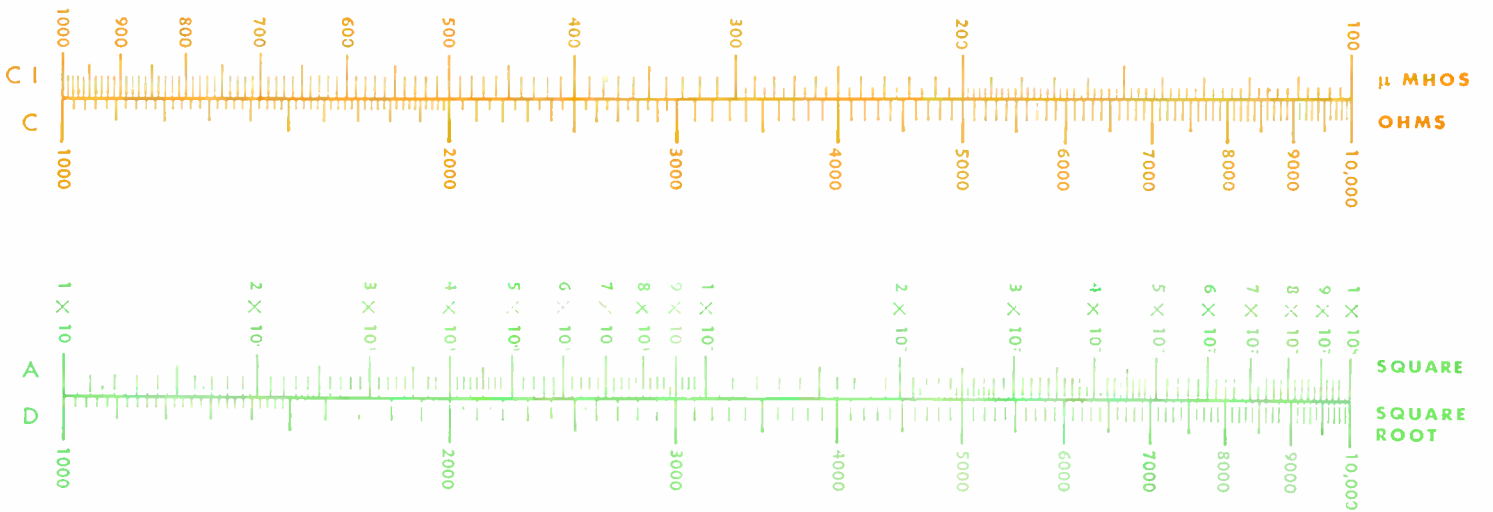
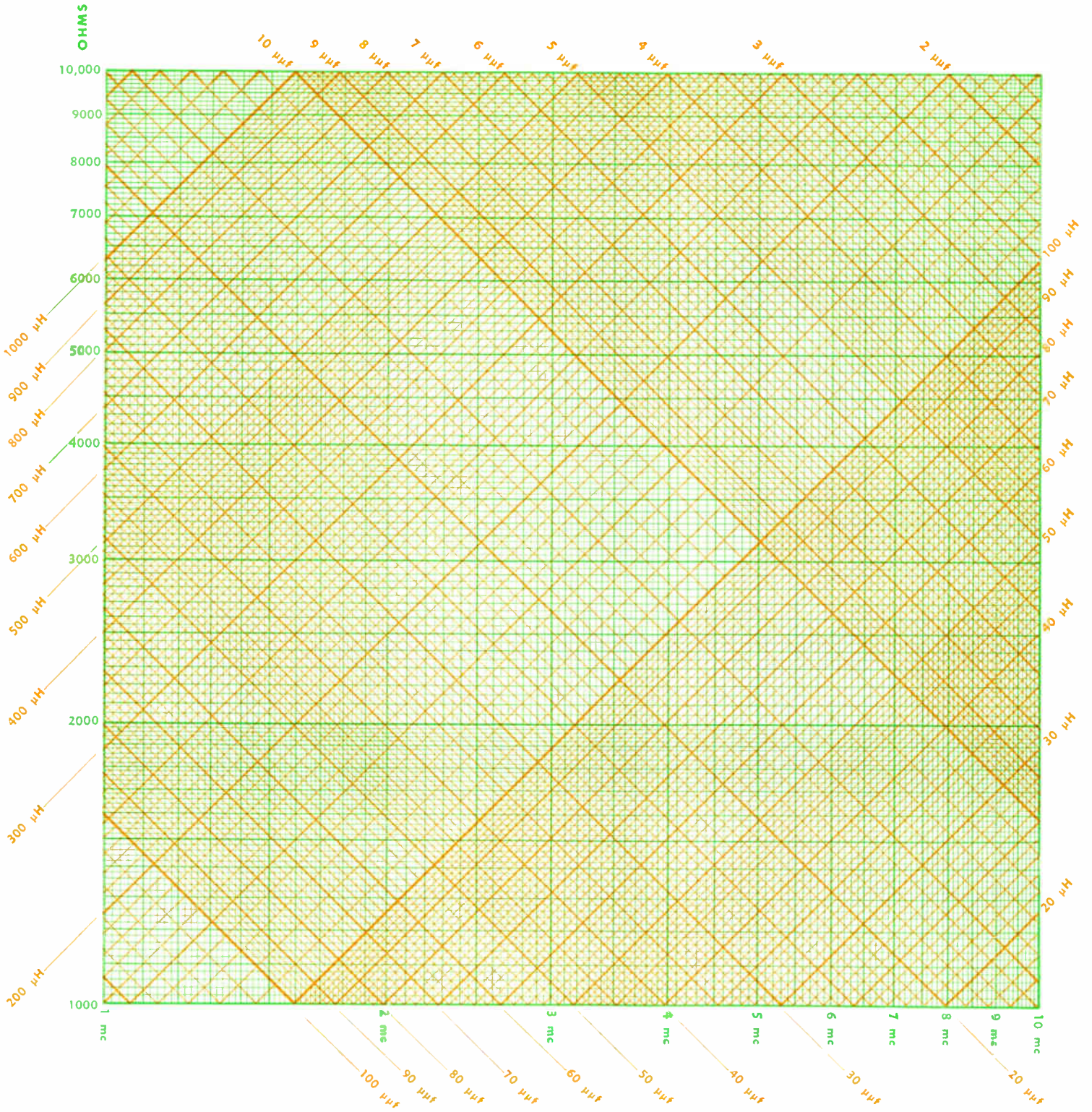




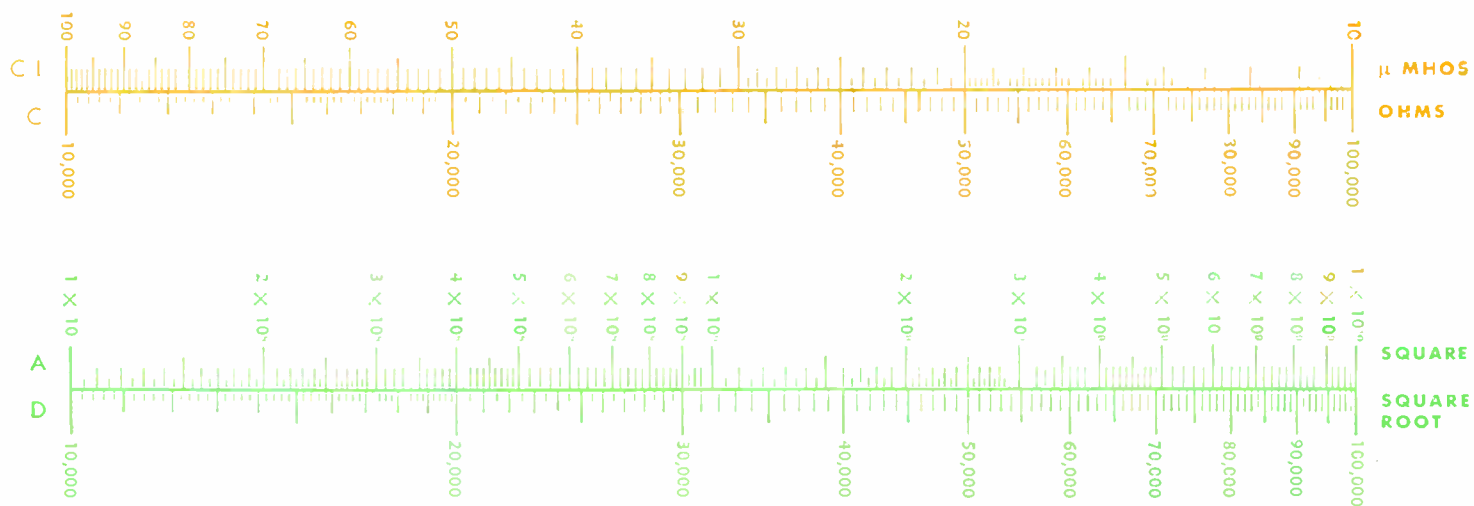
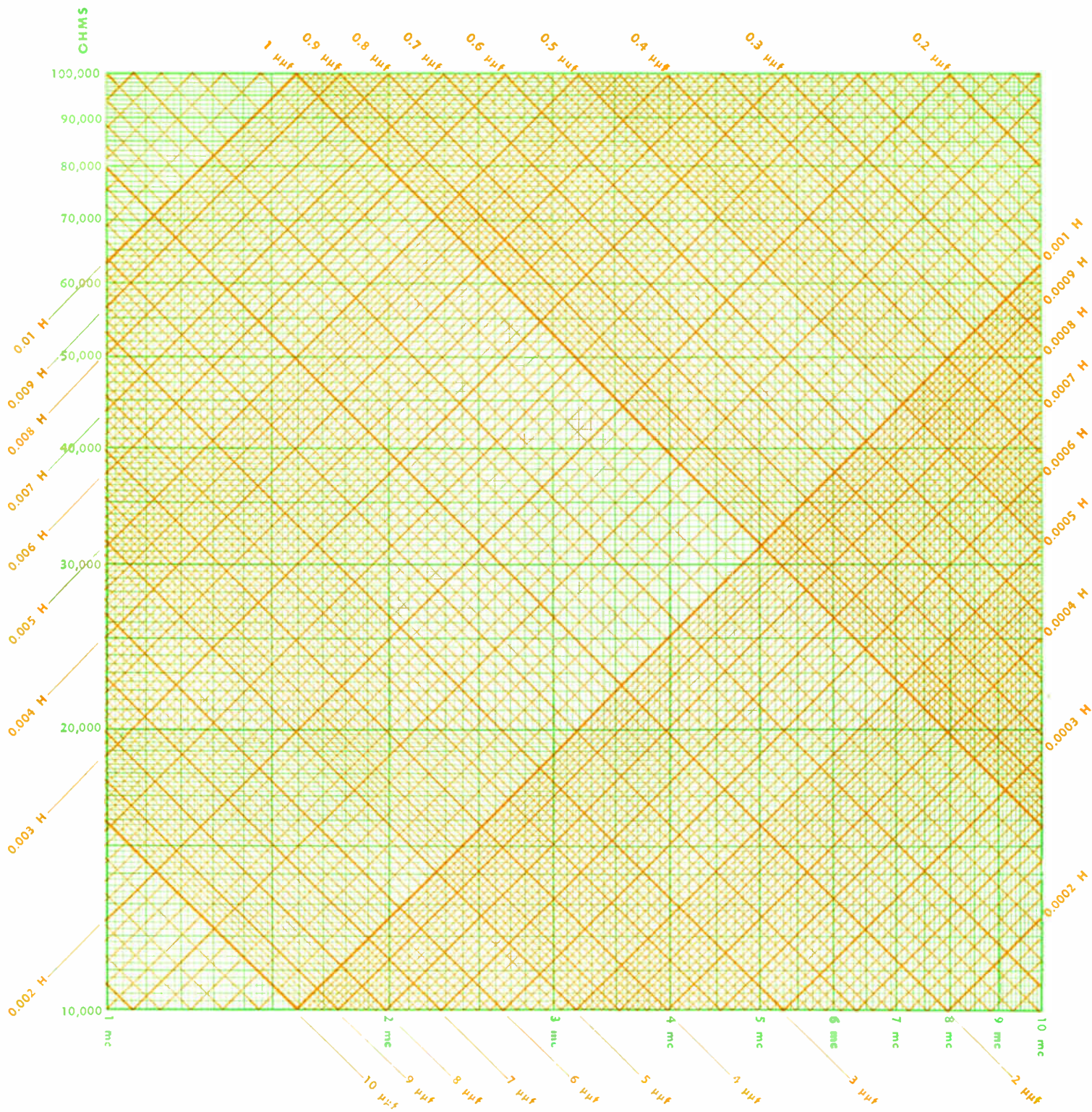


# PLATE 50

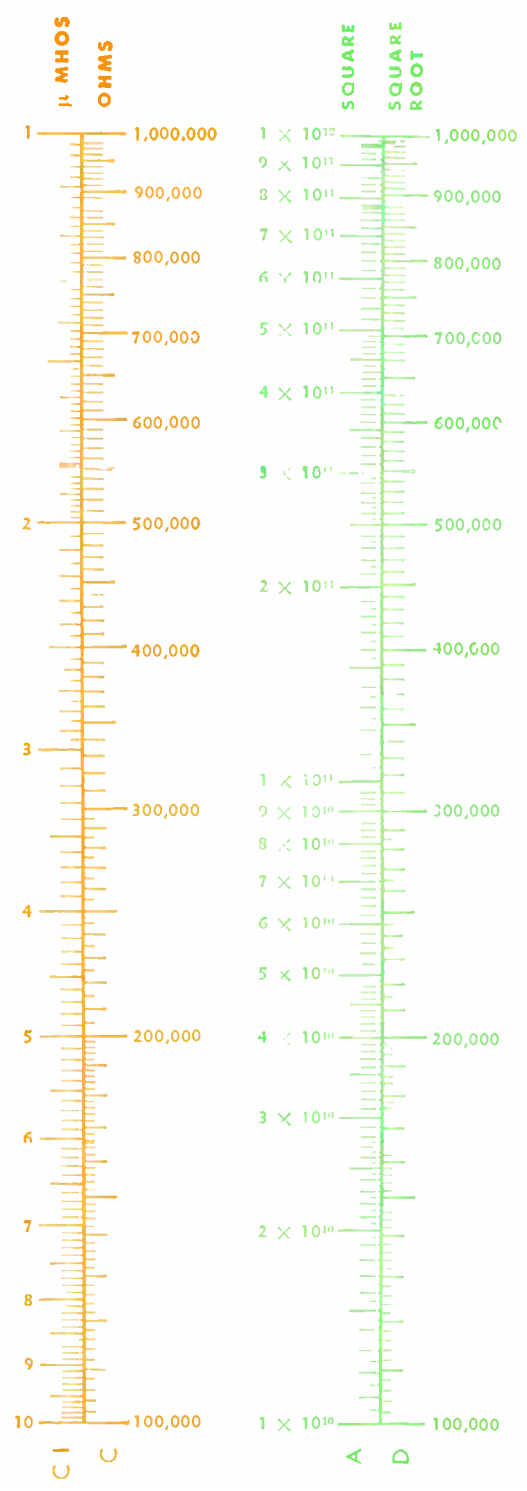
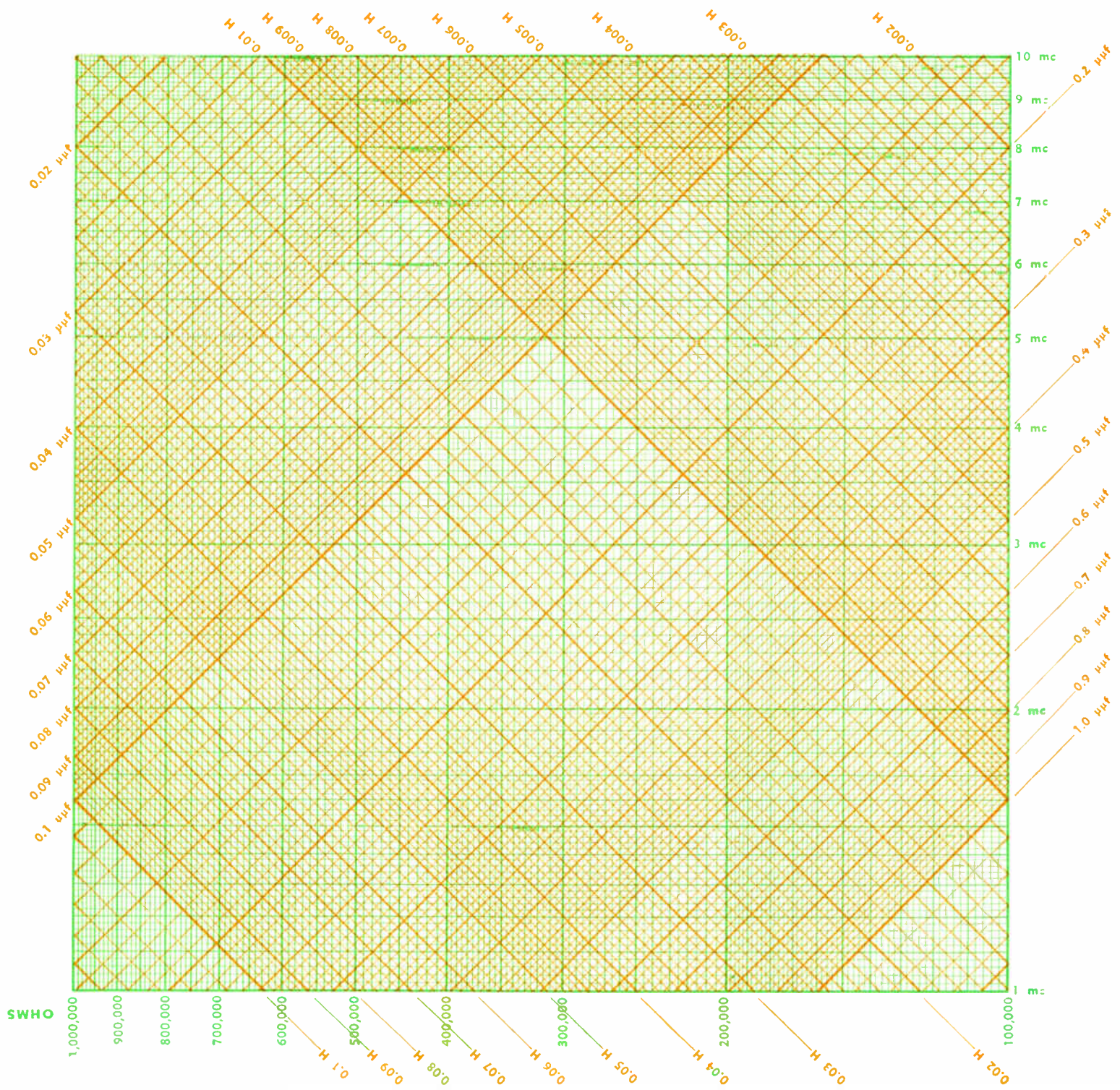


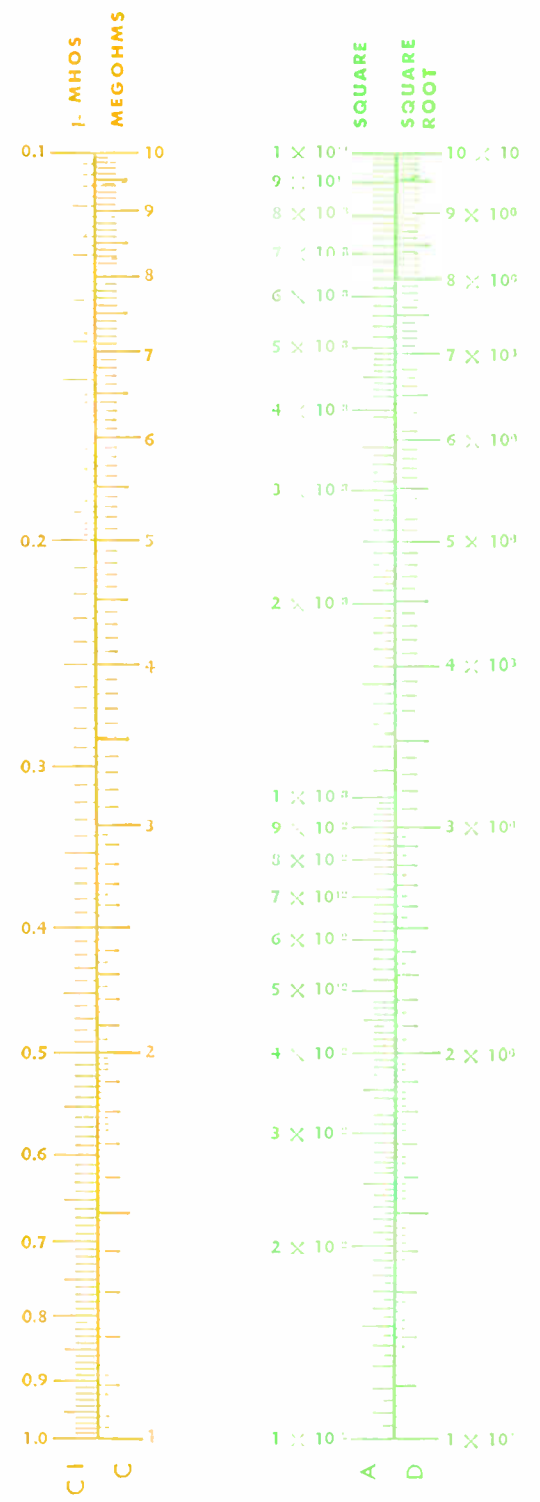
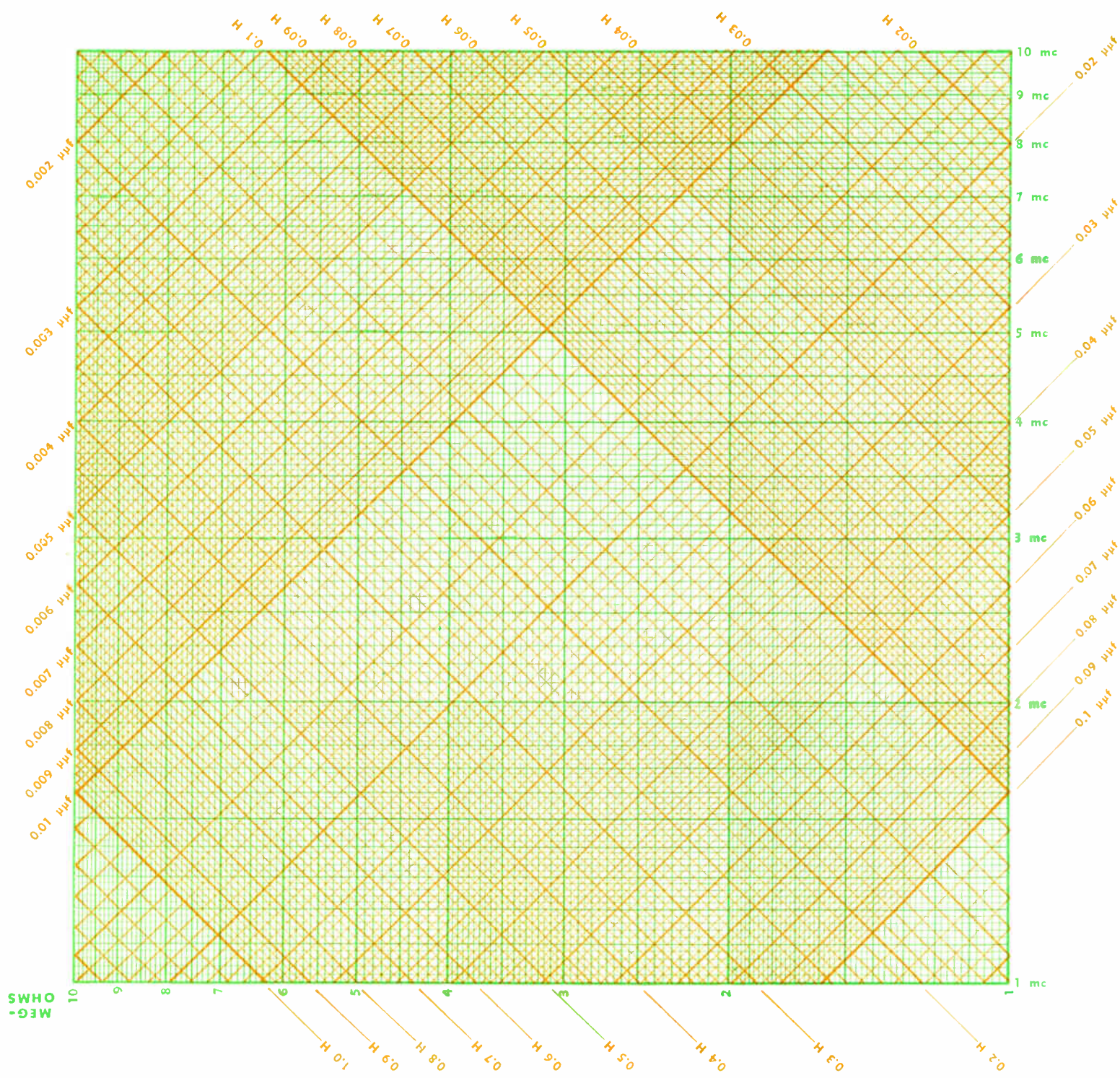


# PLATE 52









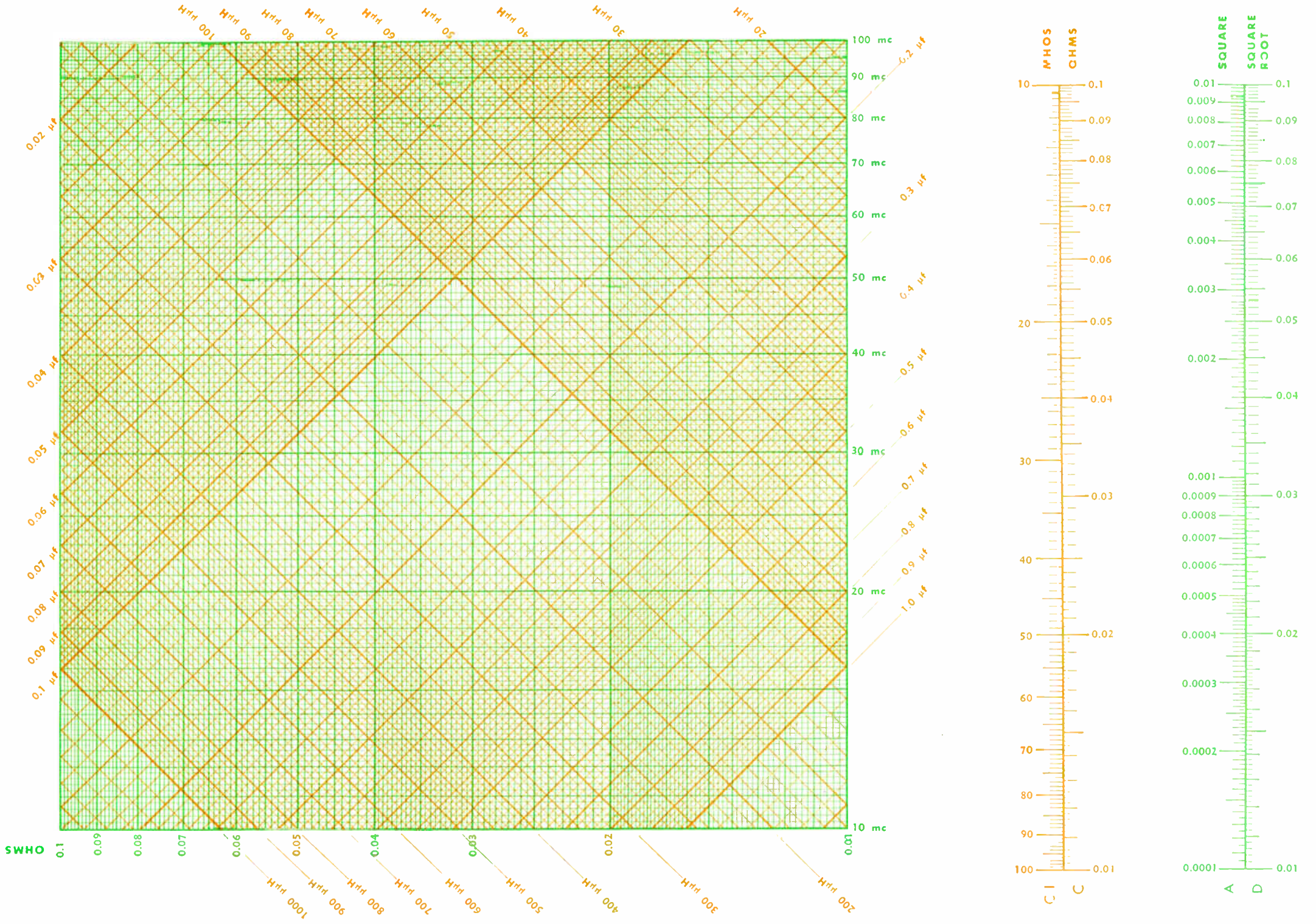
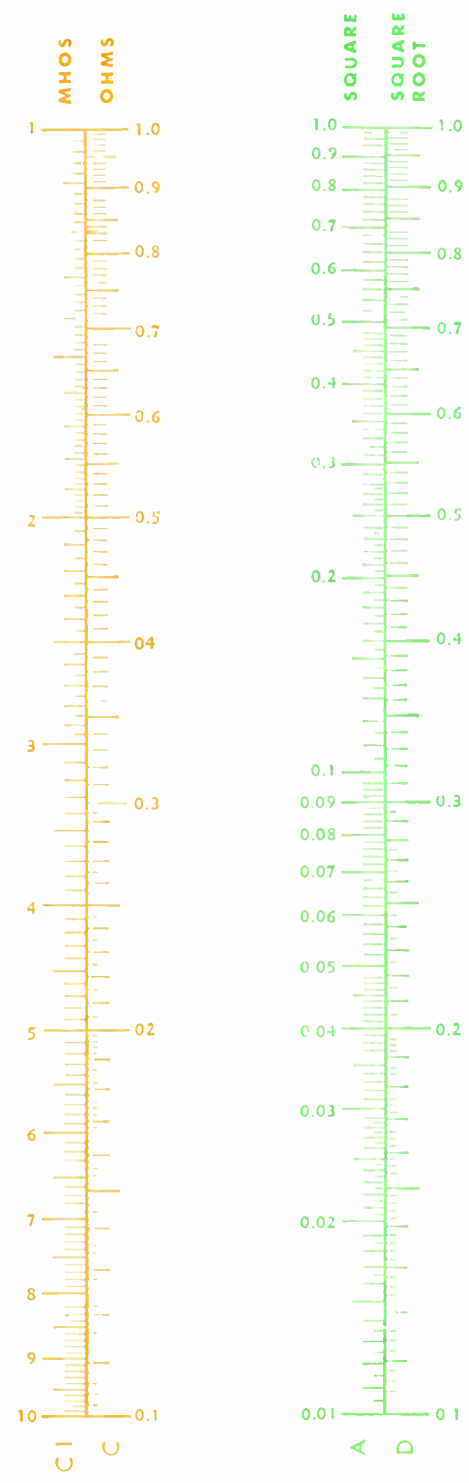
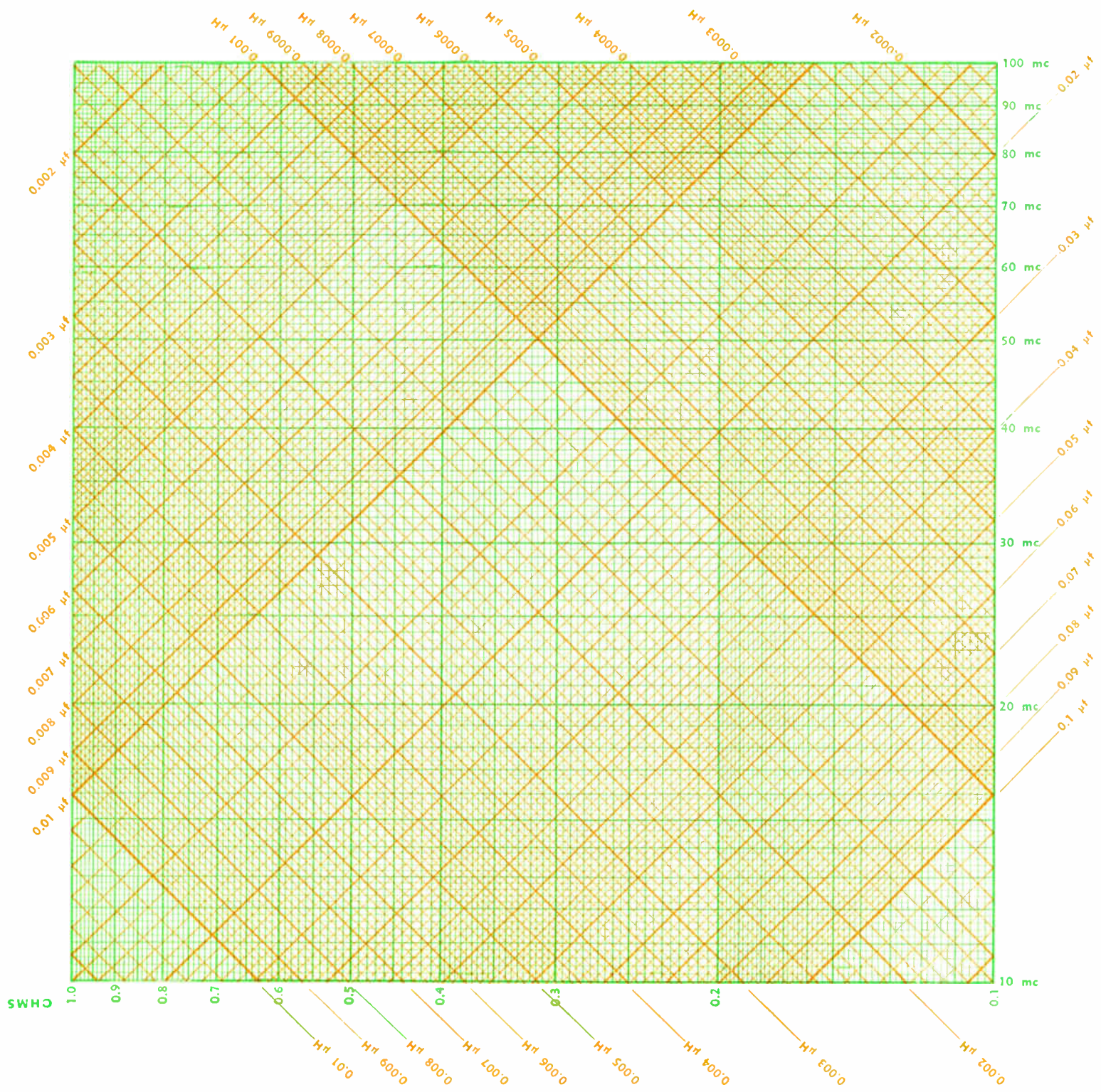


PLATE 56



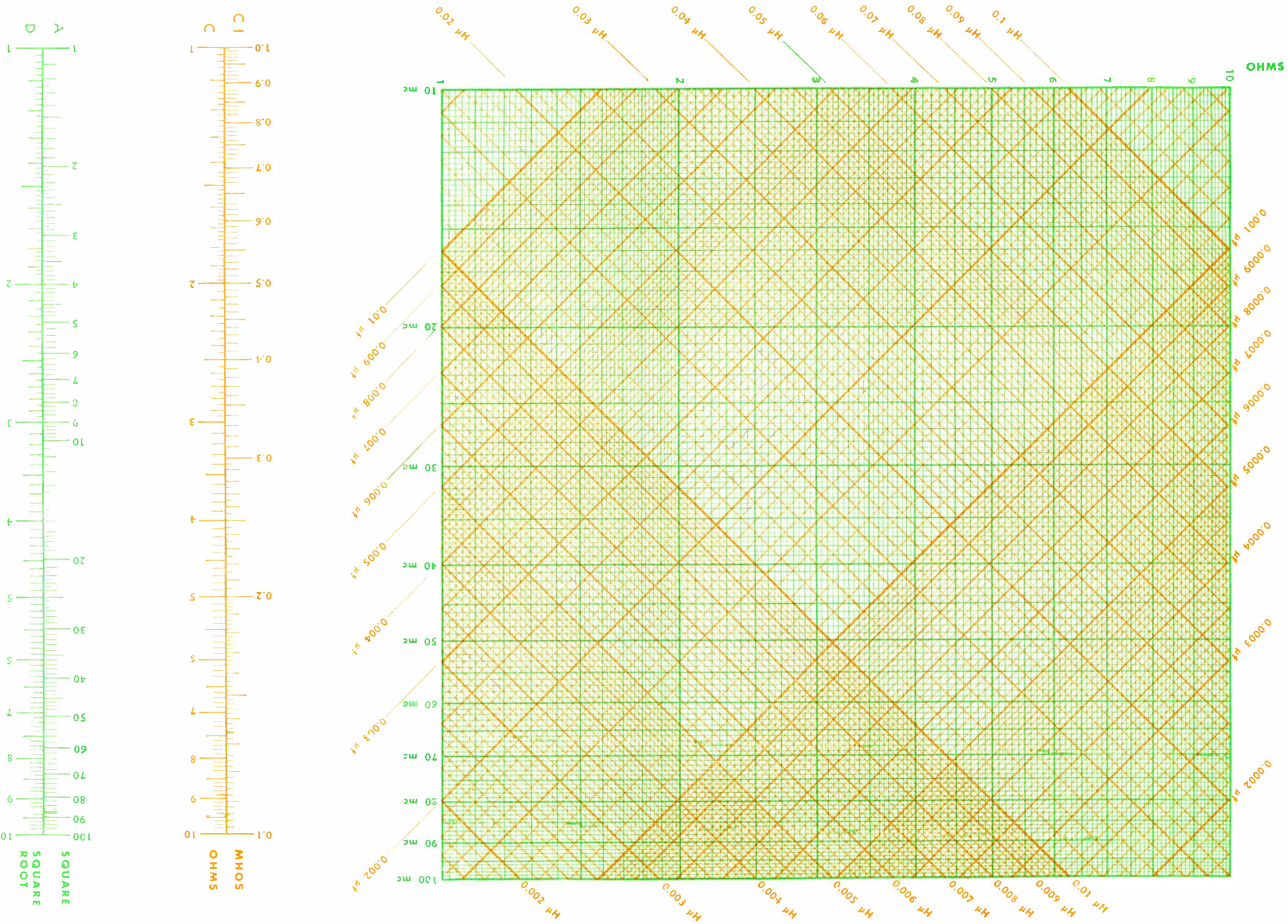
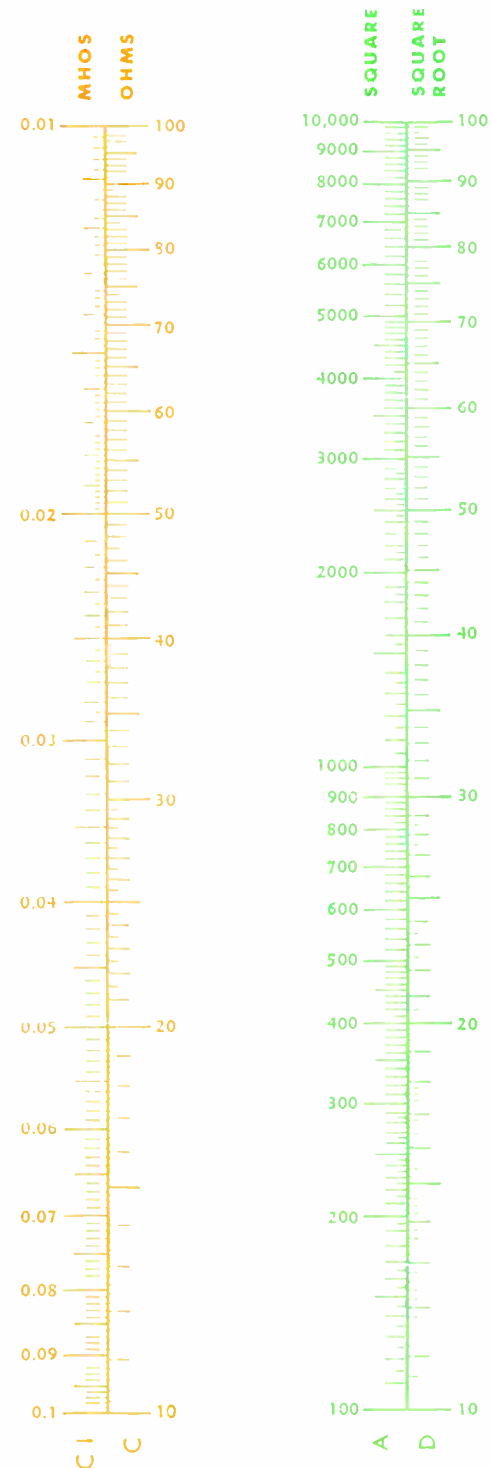
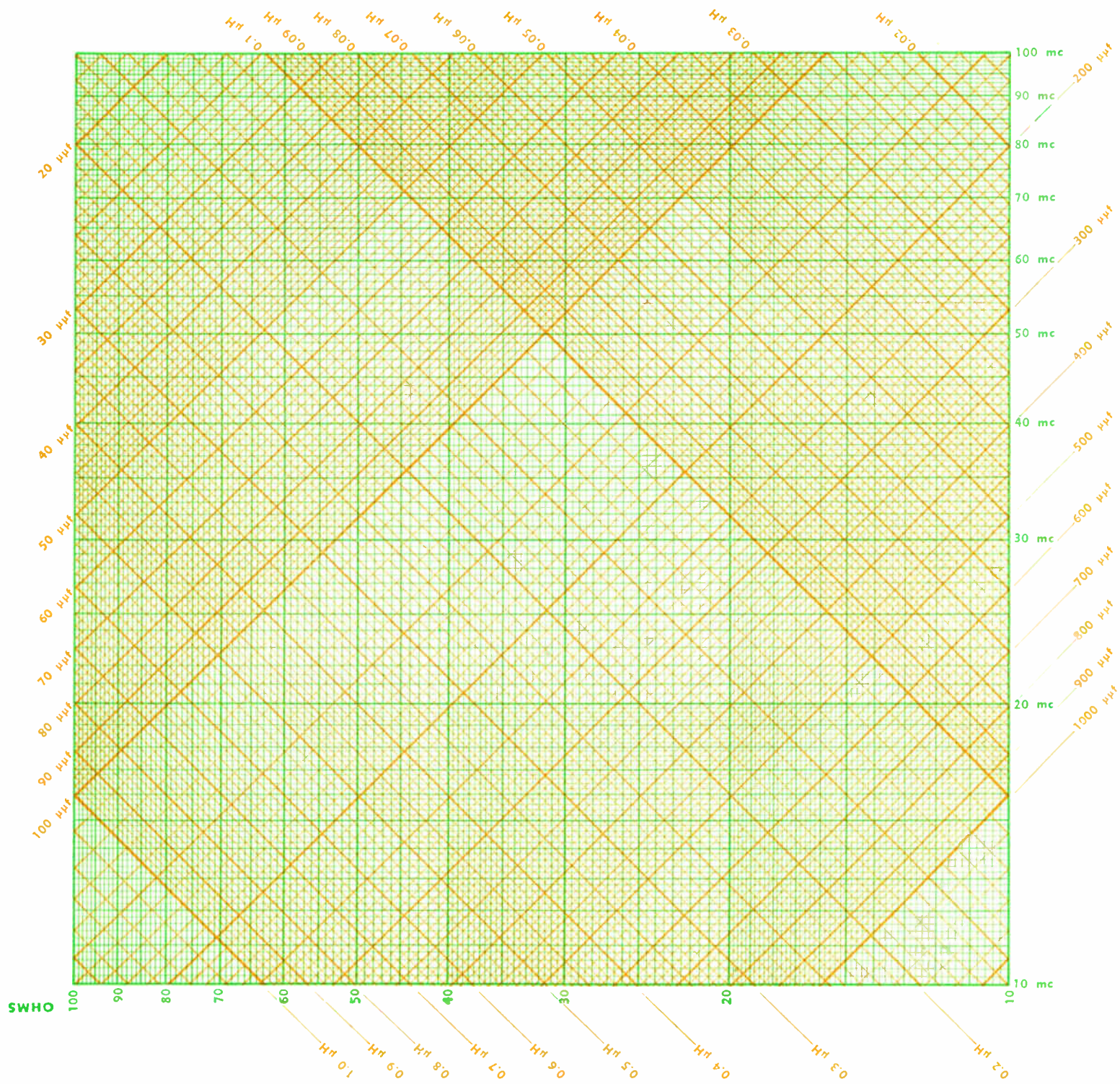


PLATE 58



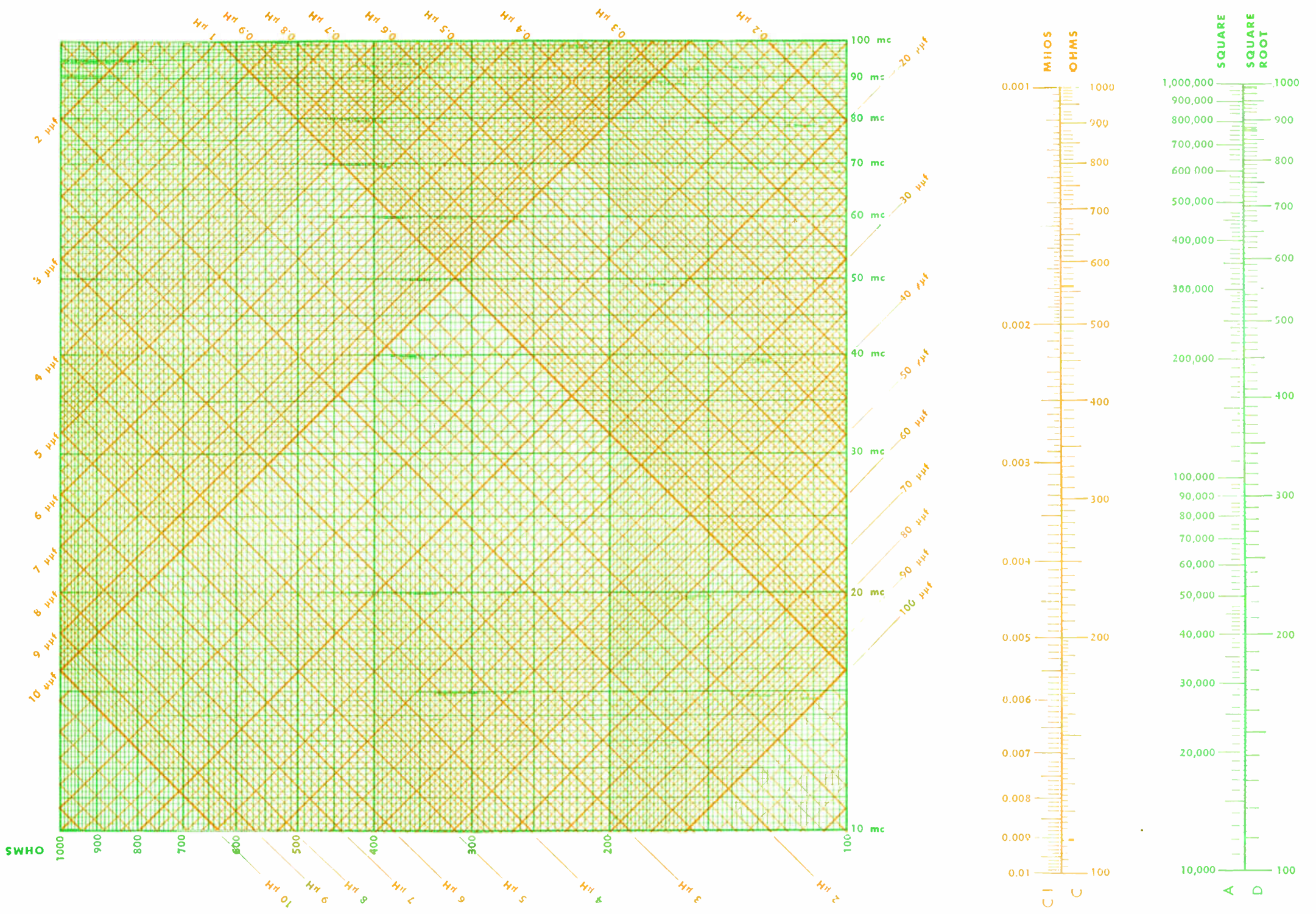


PLATE 60

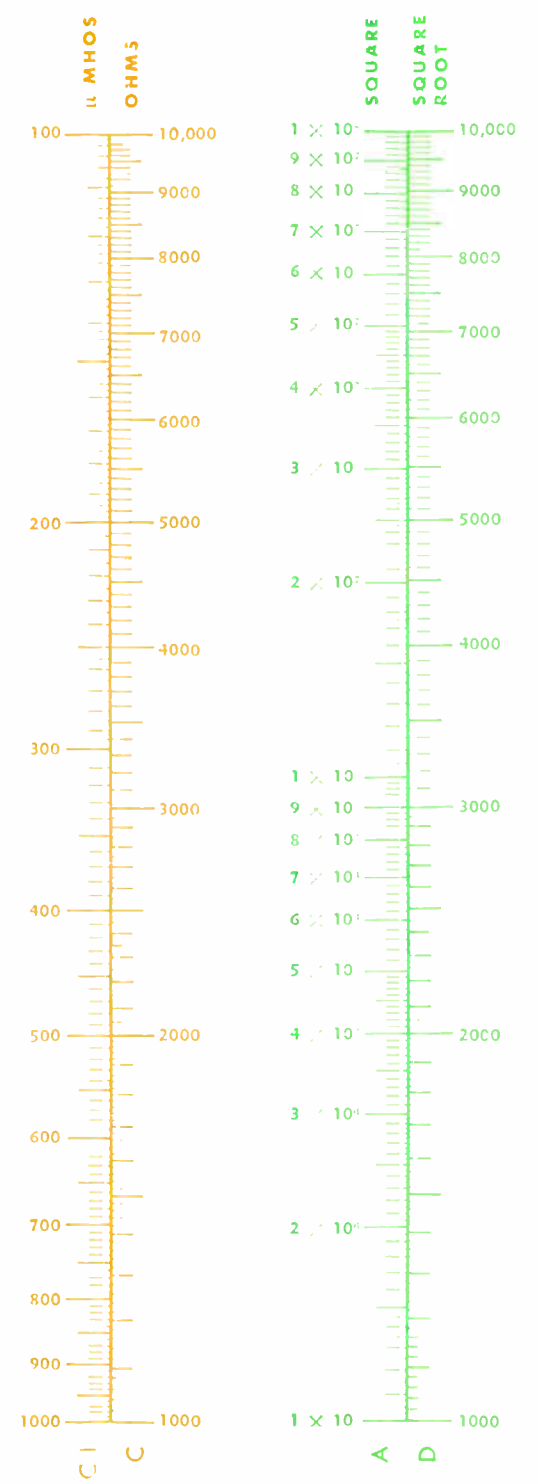
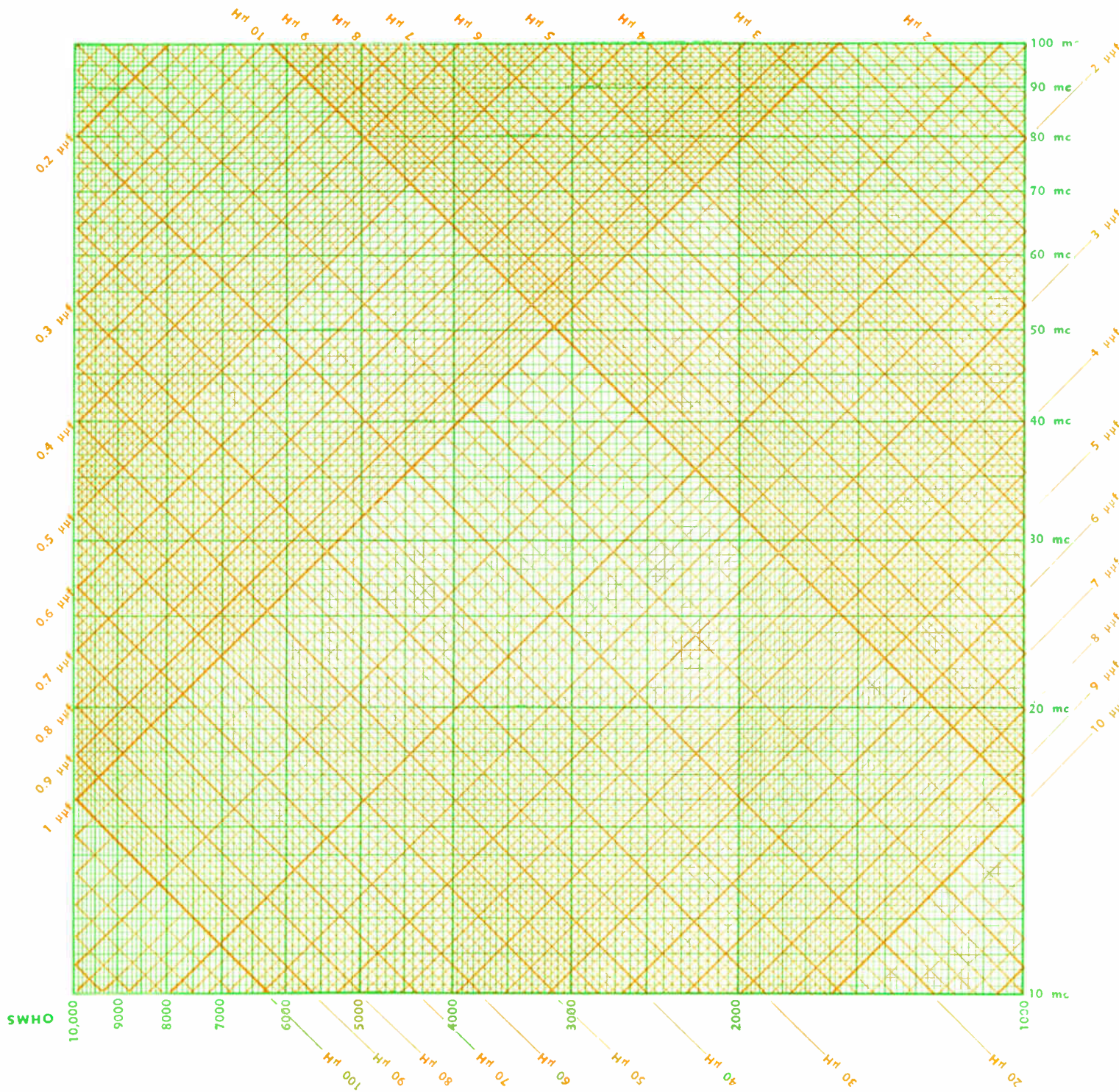
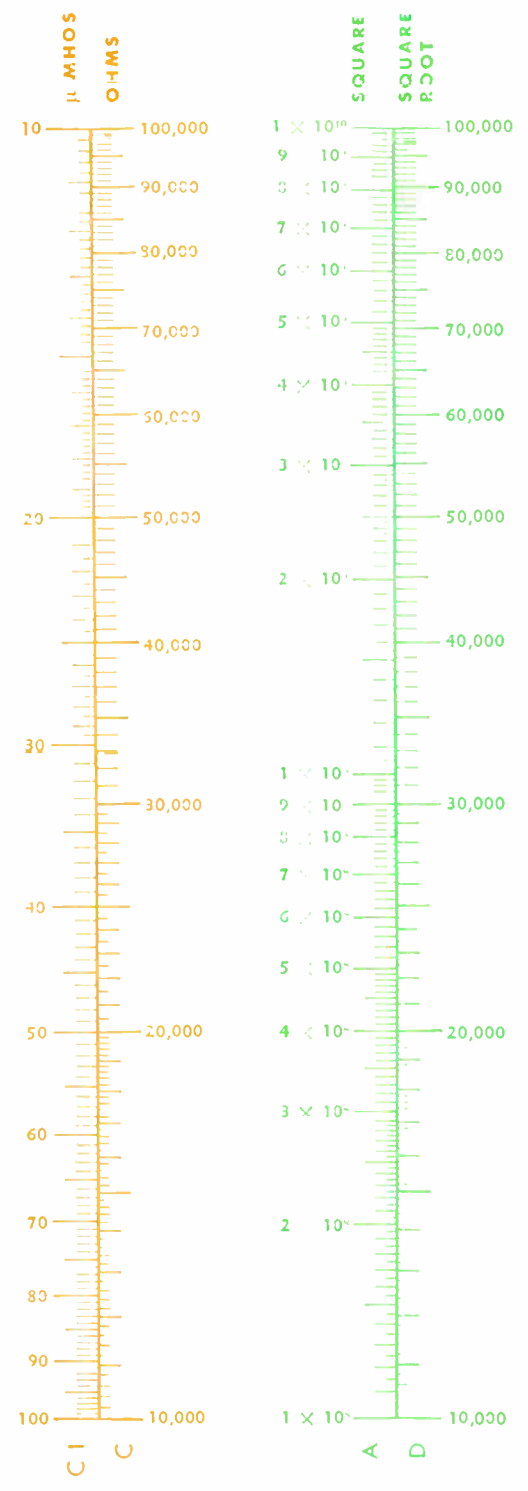
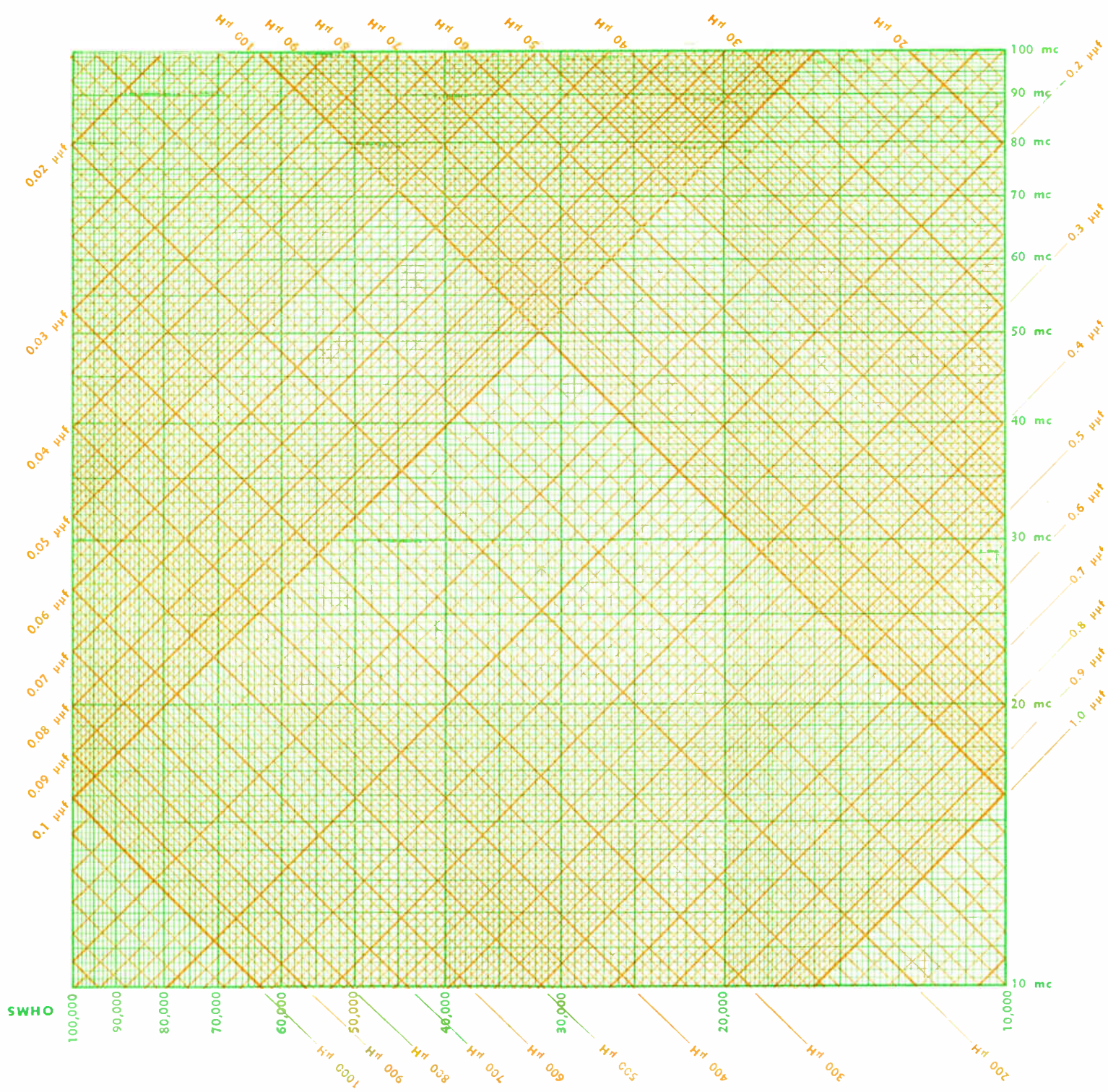
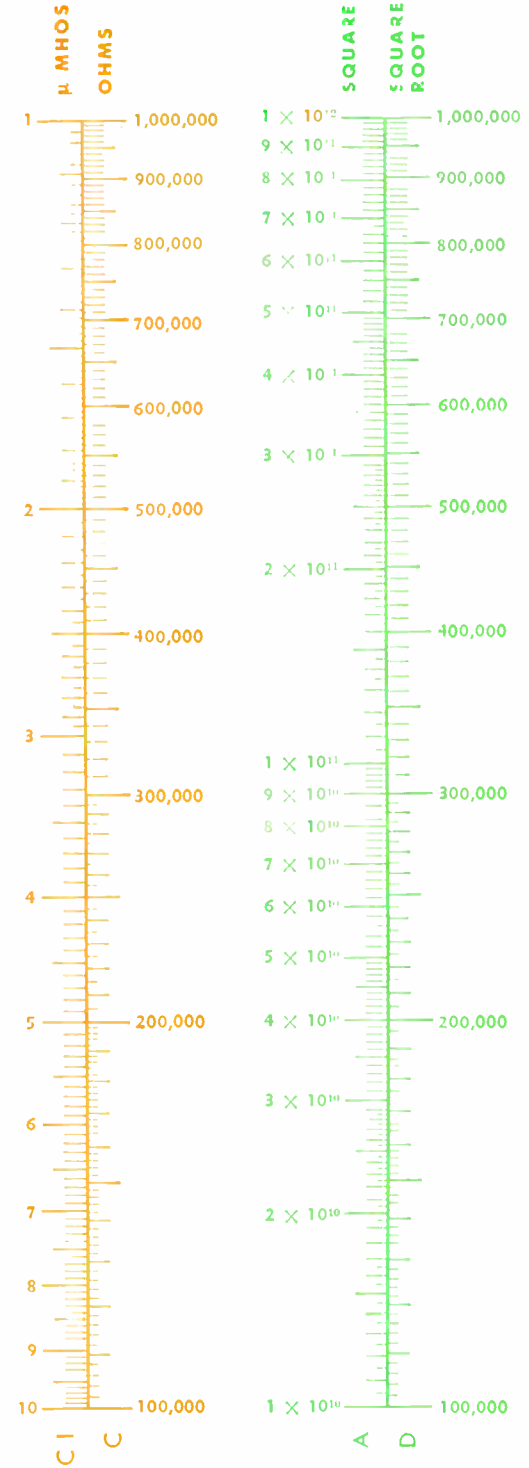
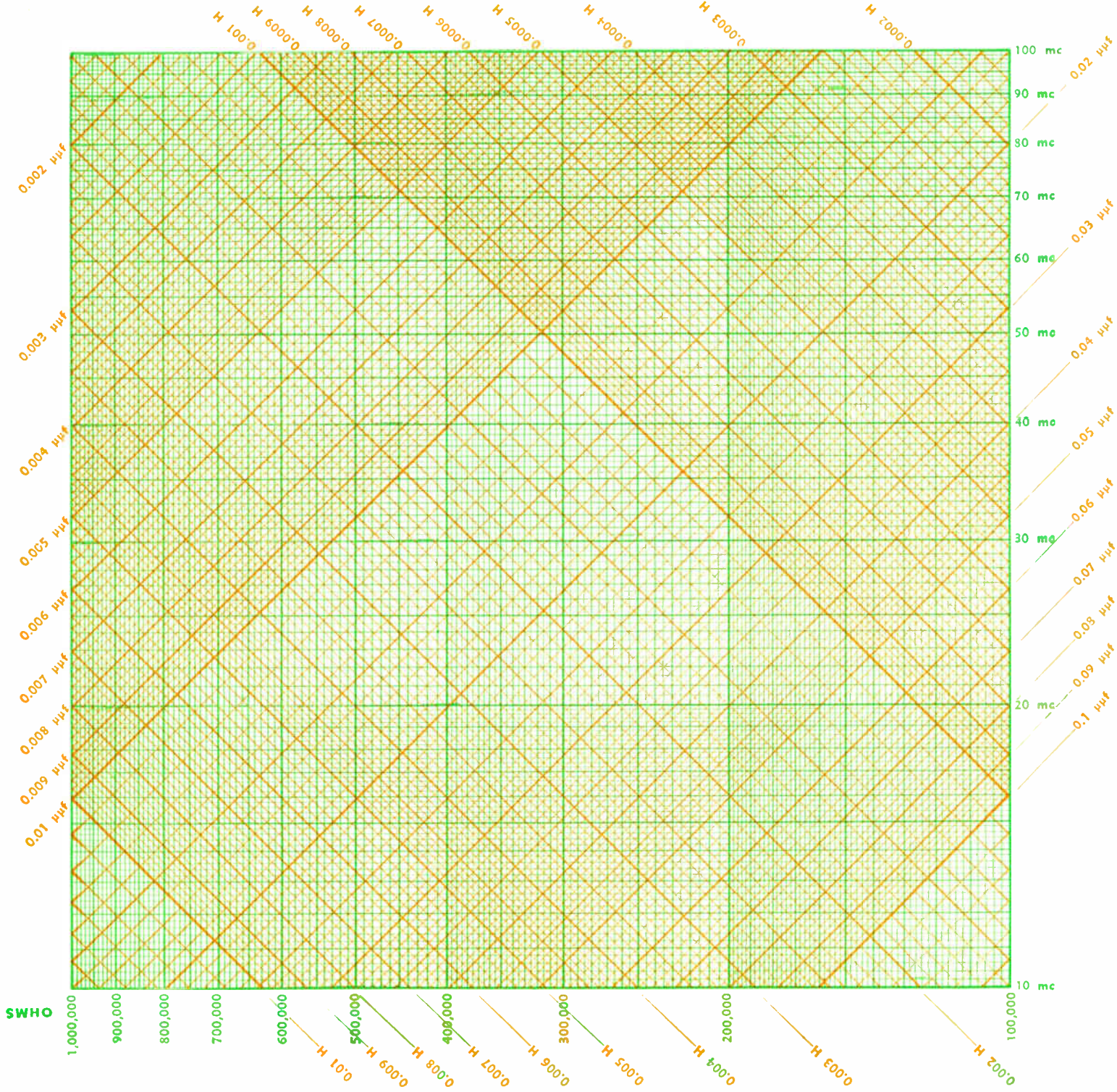




PLATE 61



# PLATE 62



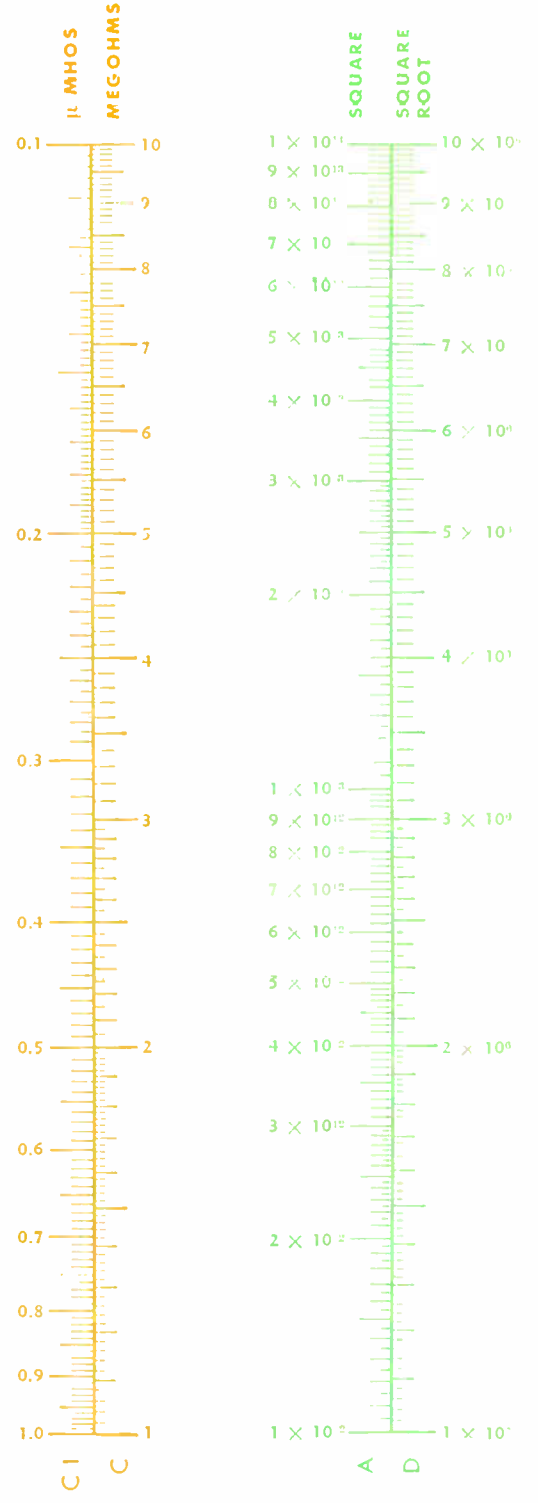
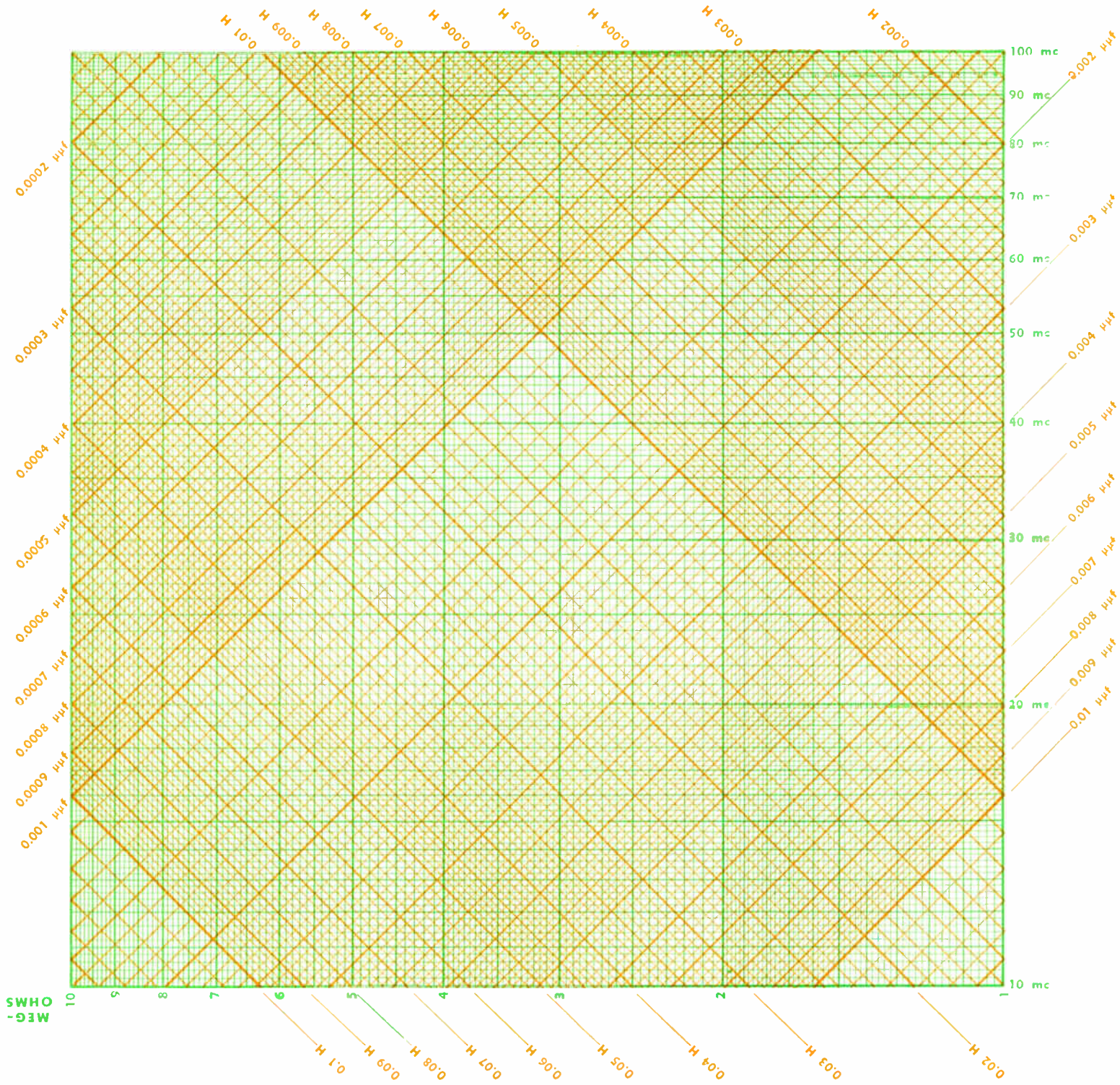
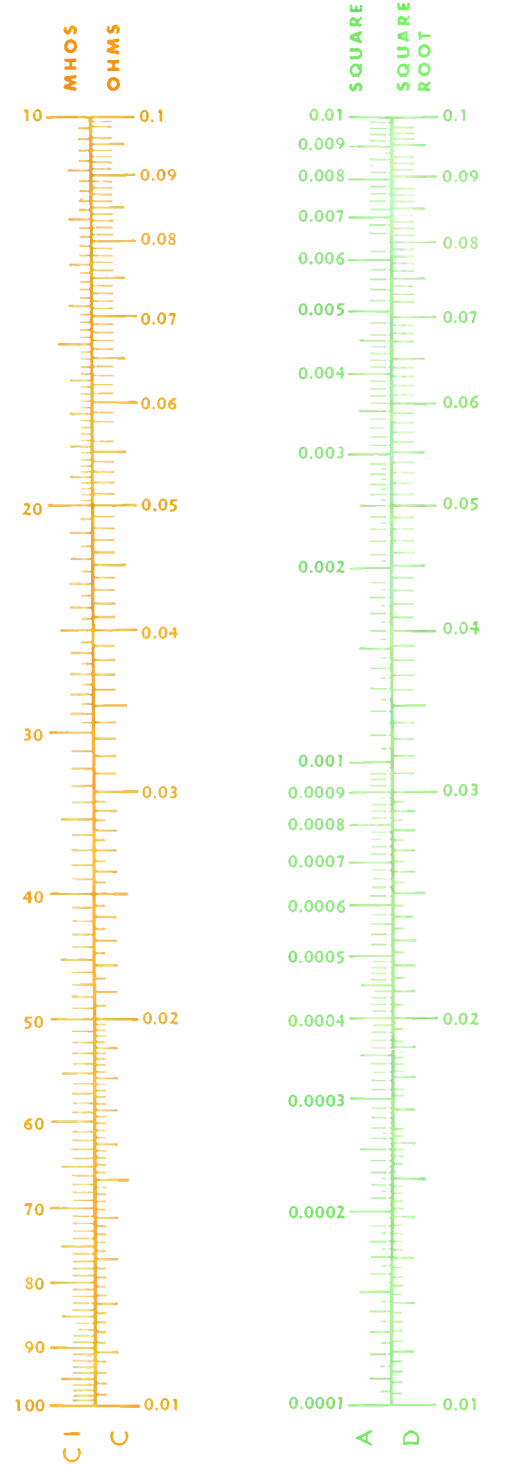
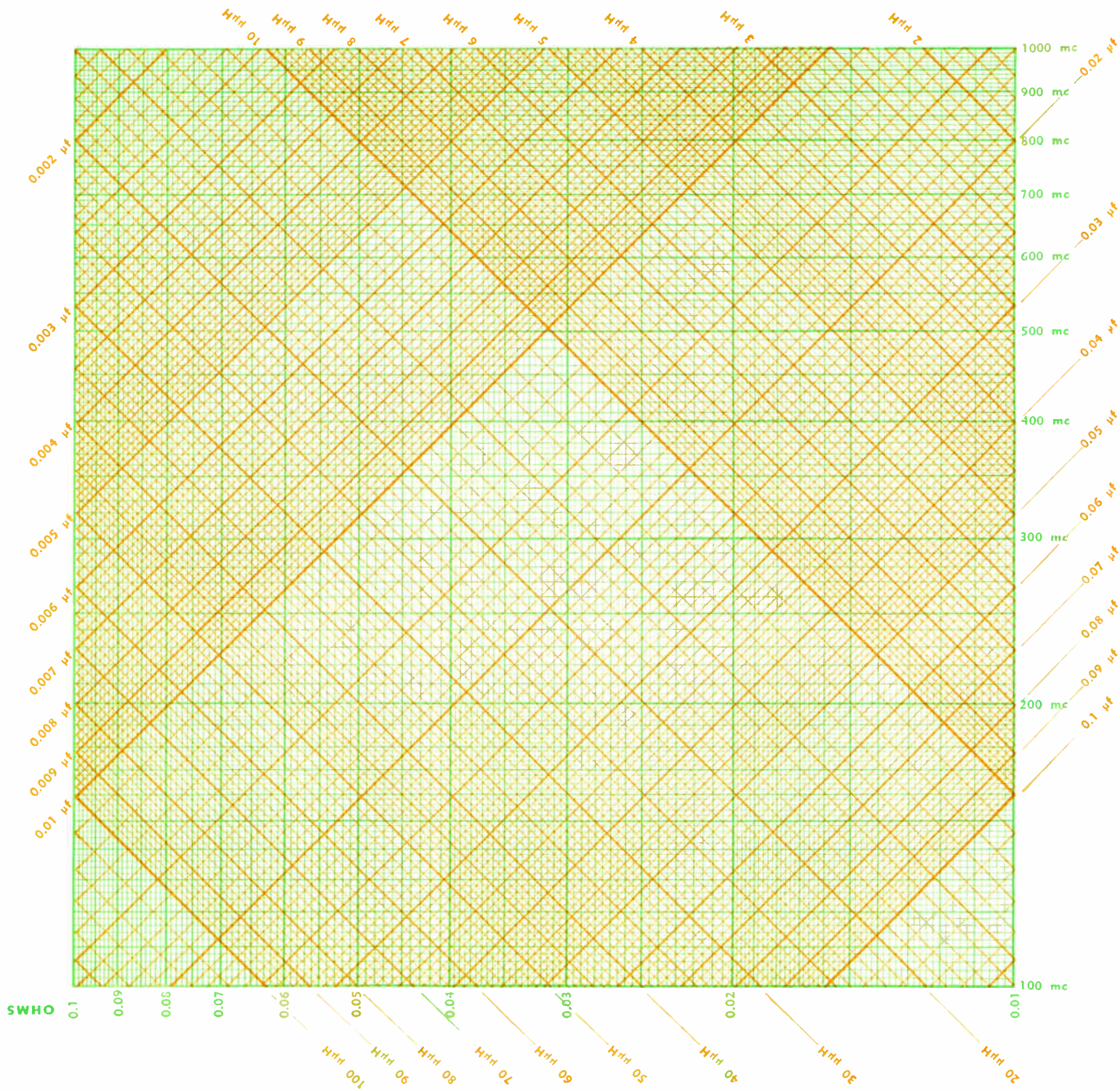


PLATE 64



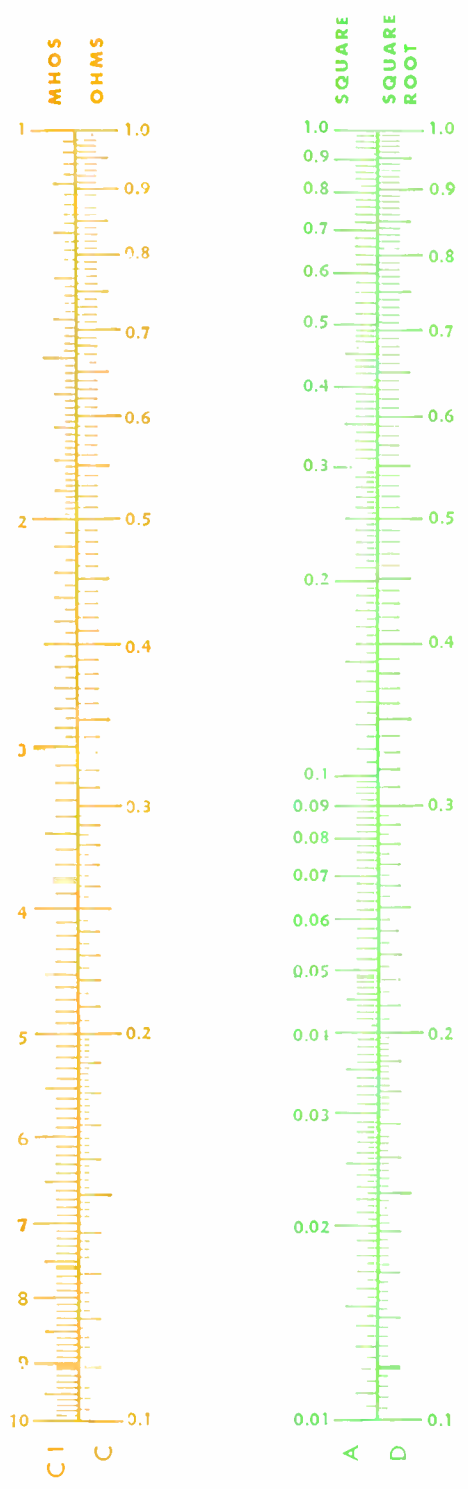
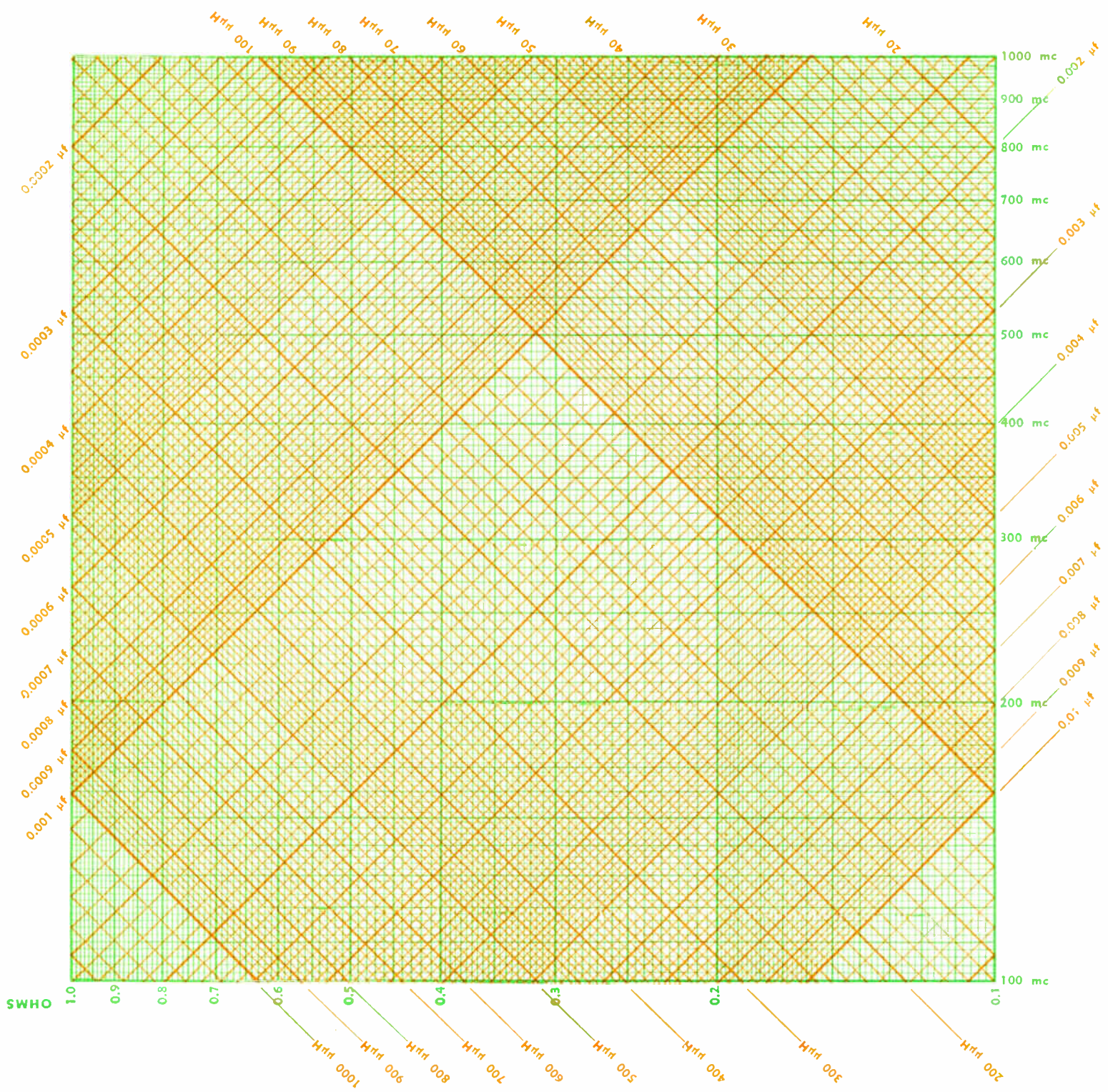
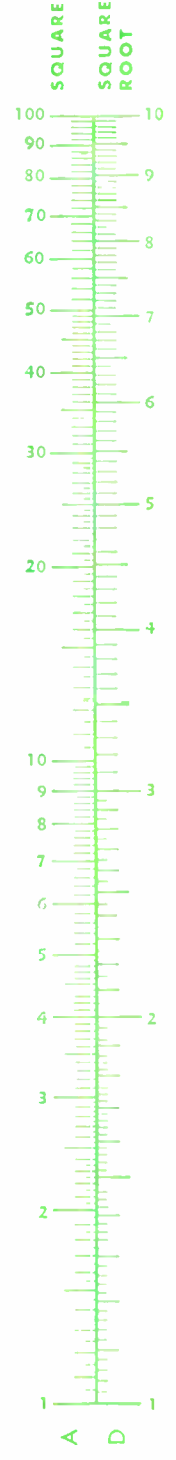
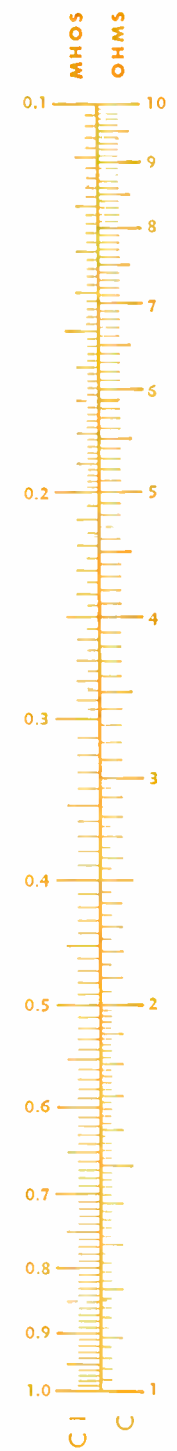
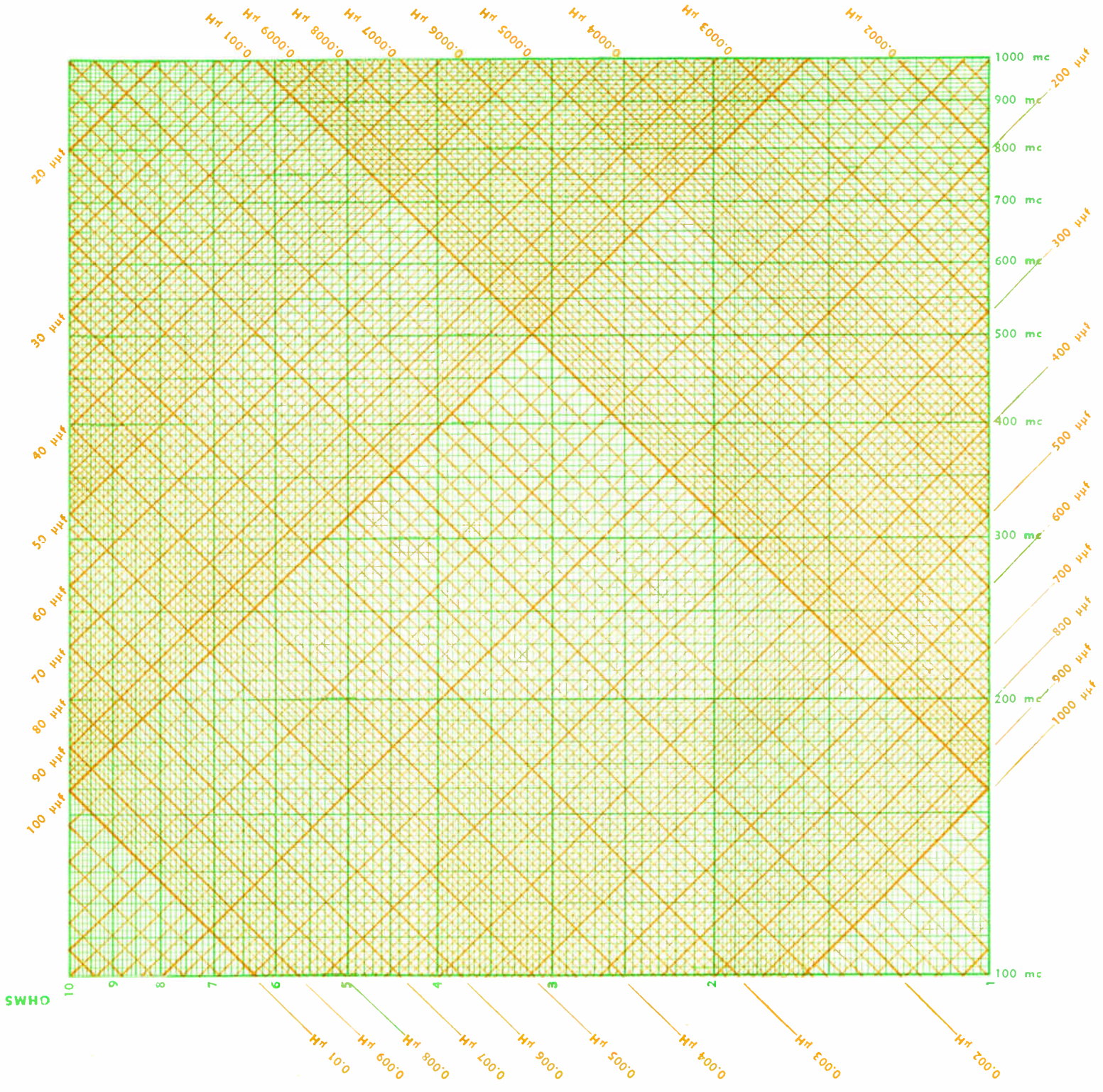
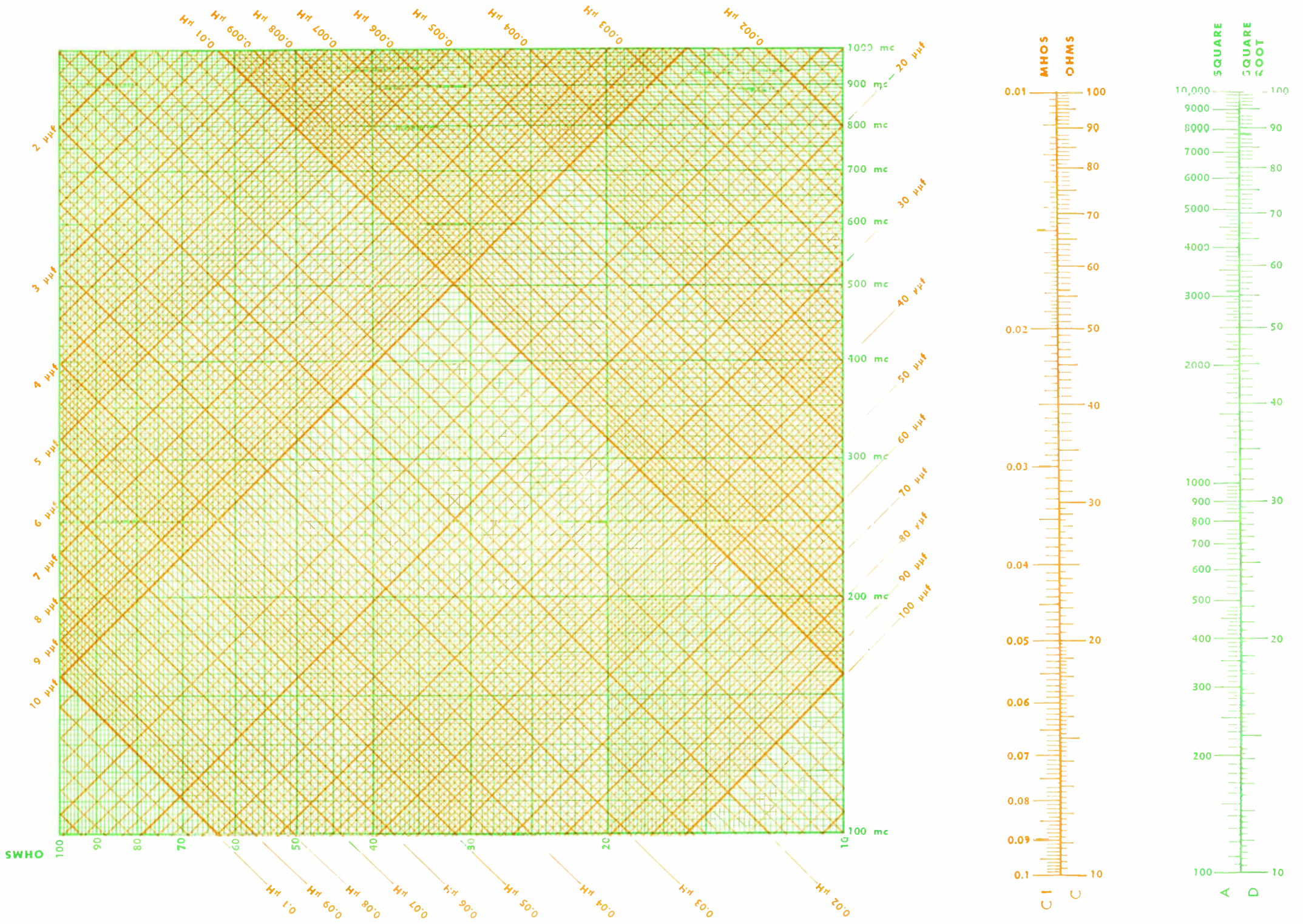
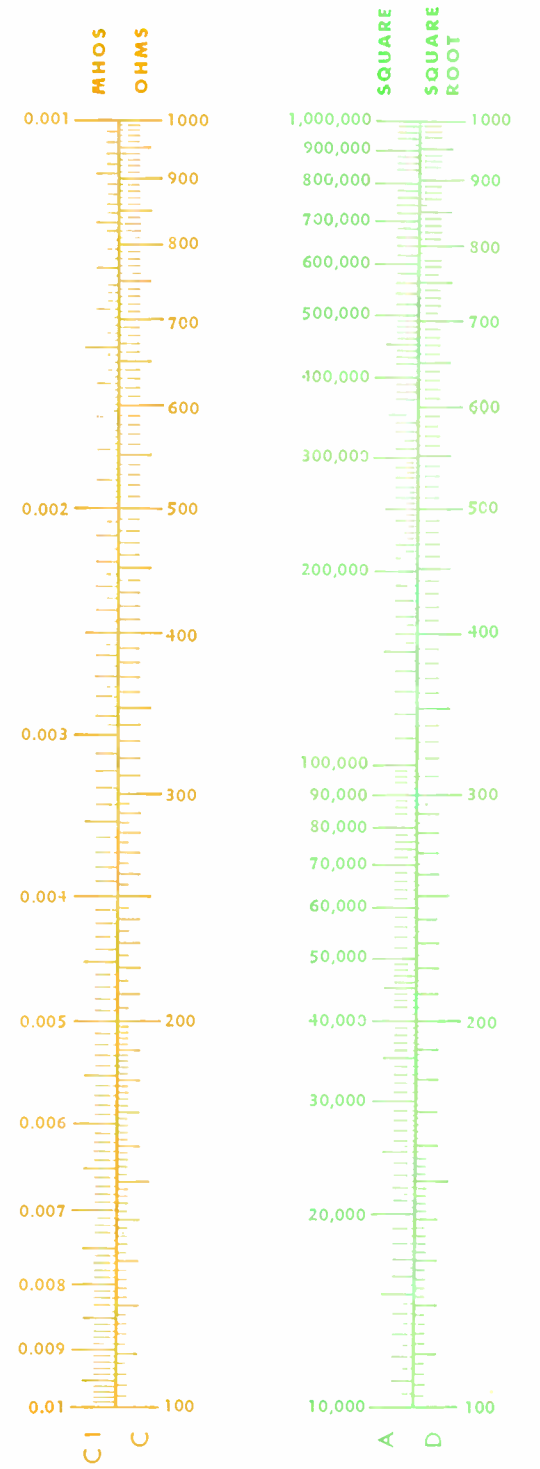
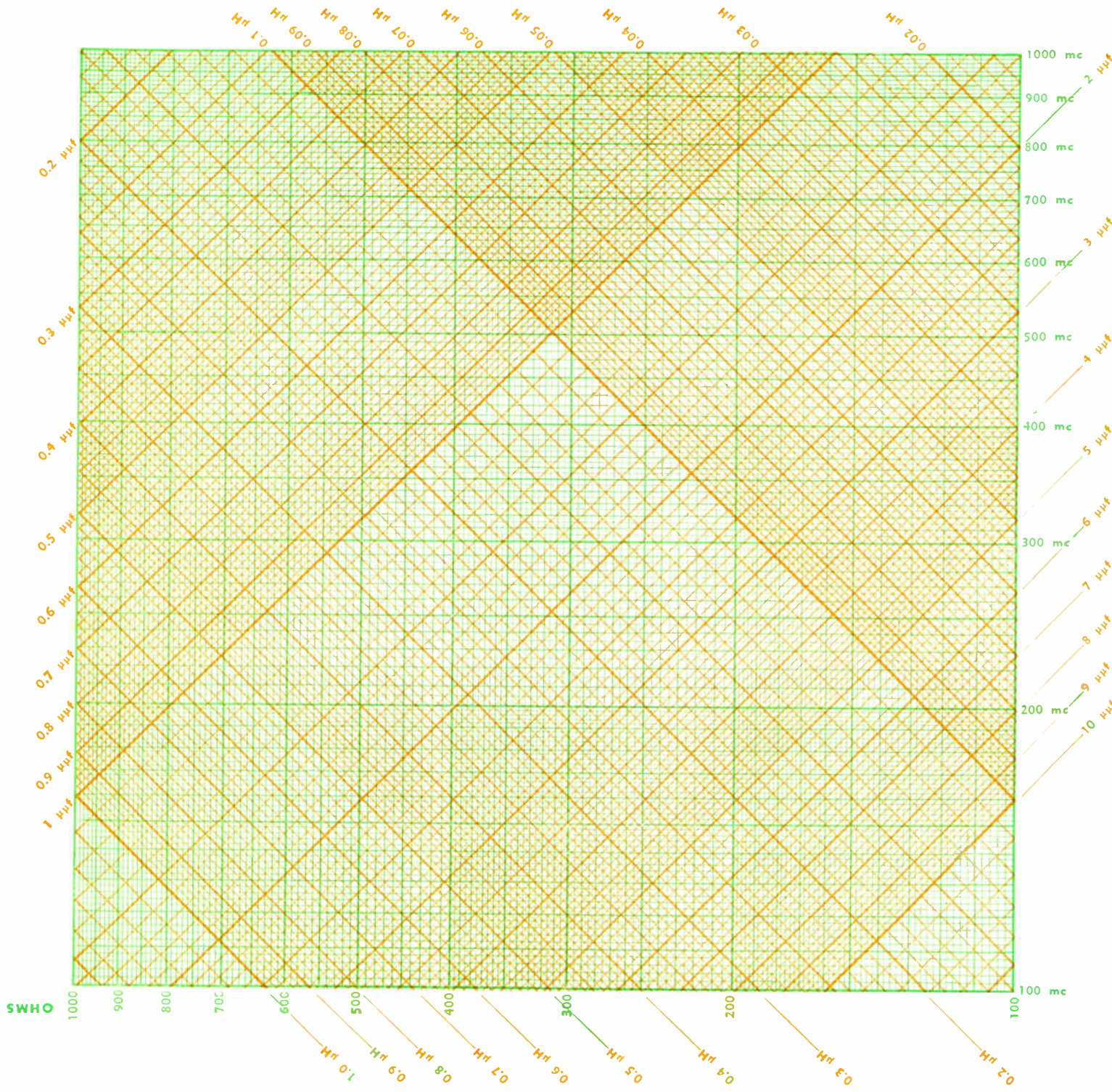


PLATE 66





# PLATE 68





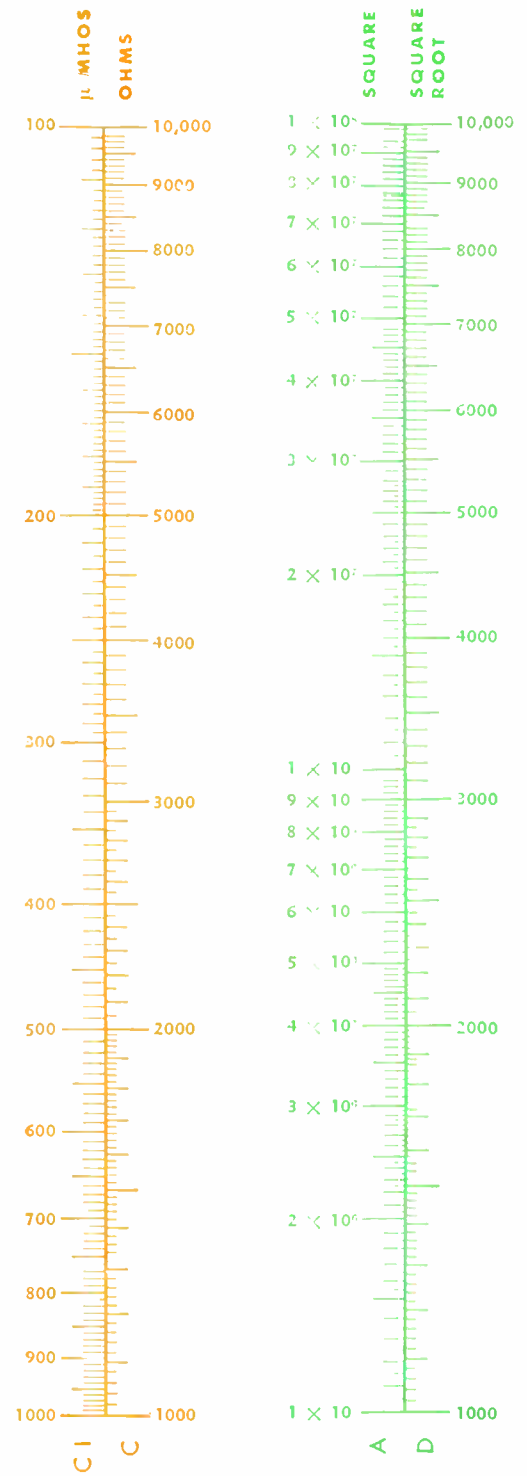
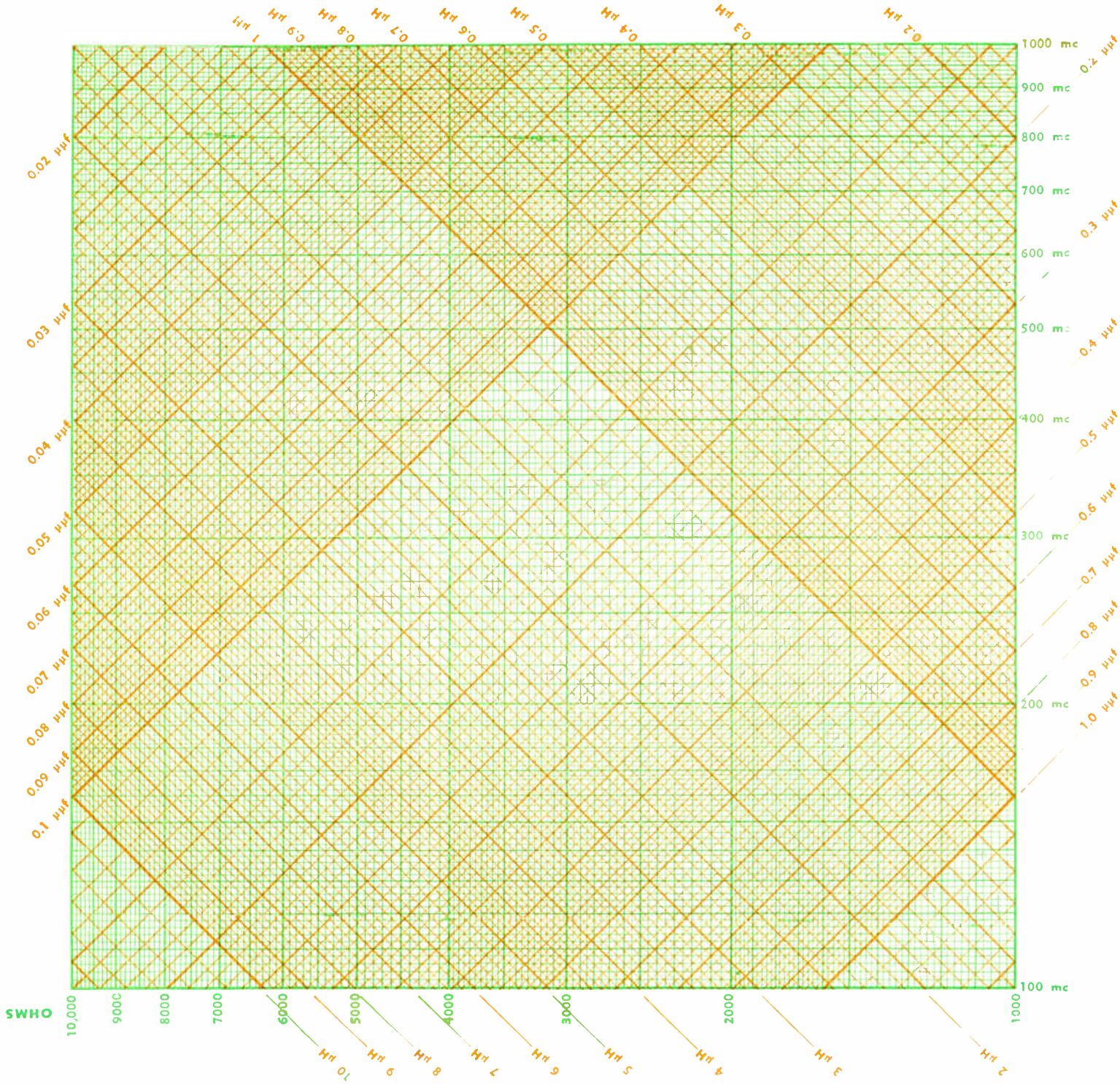
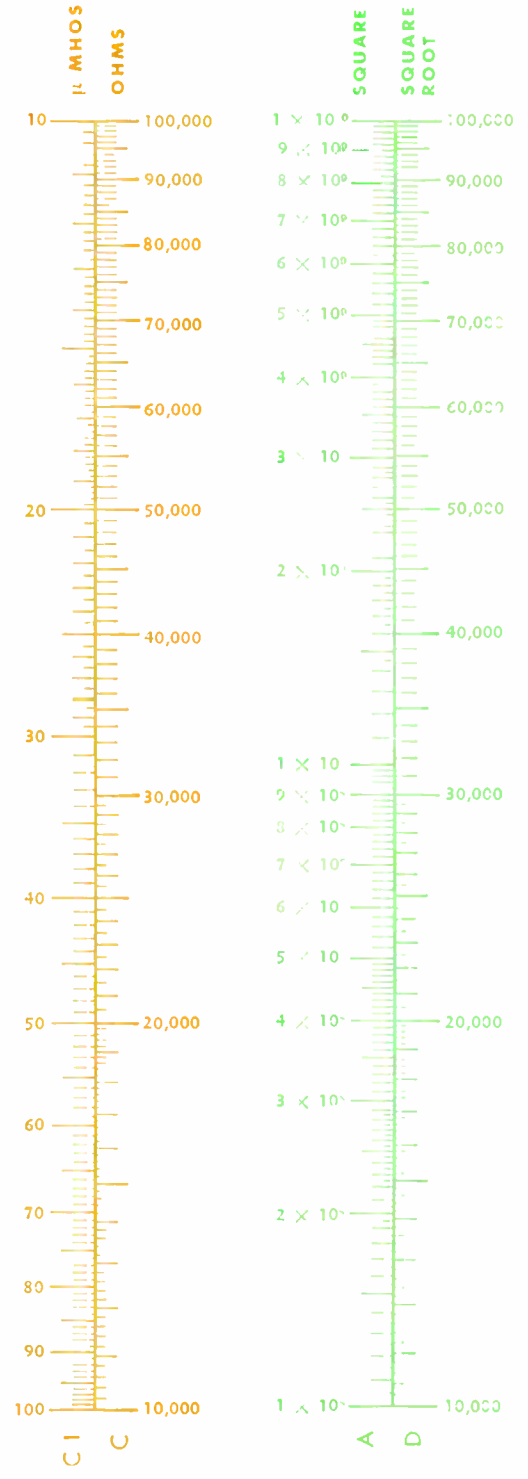
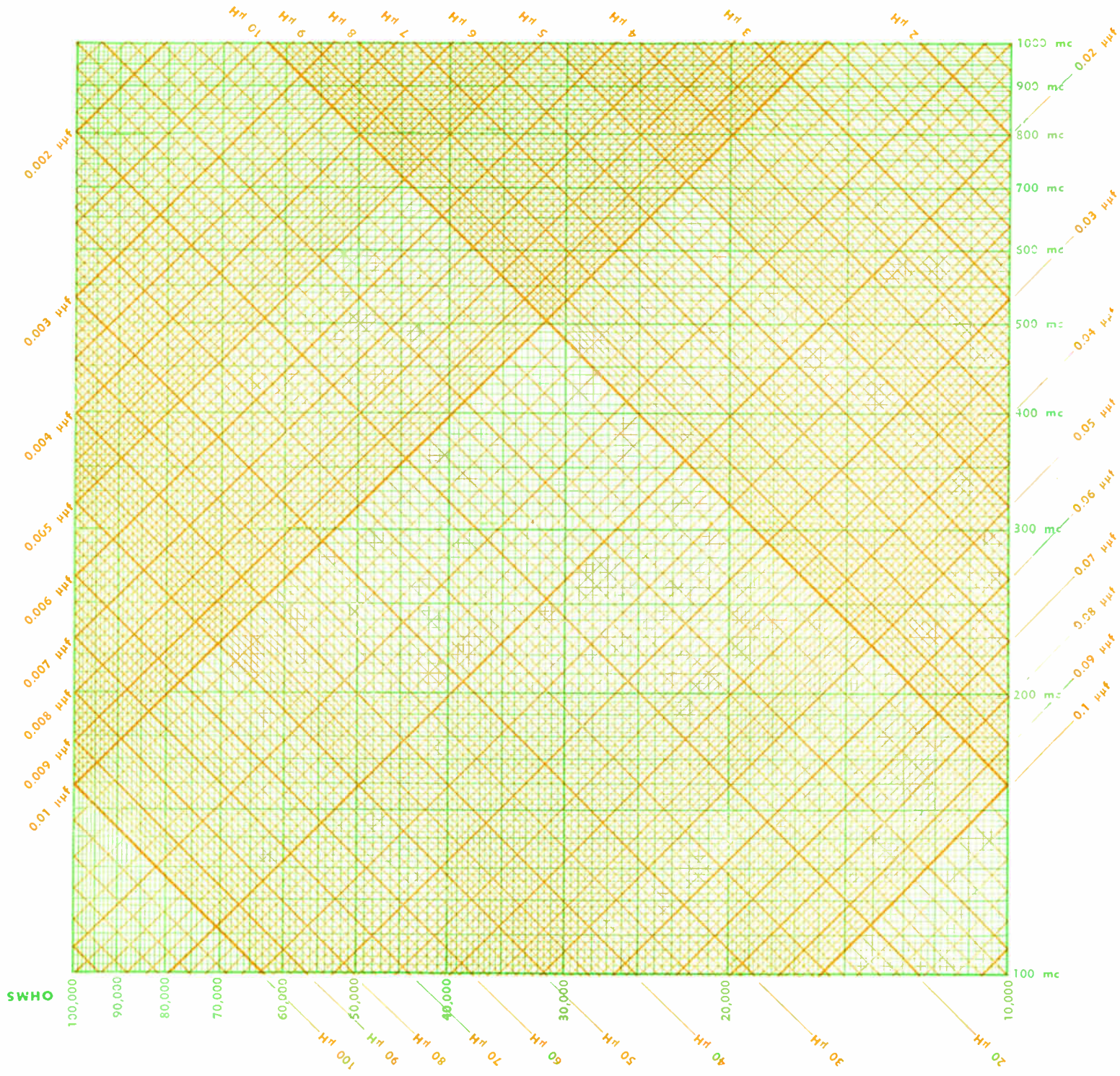
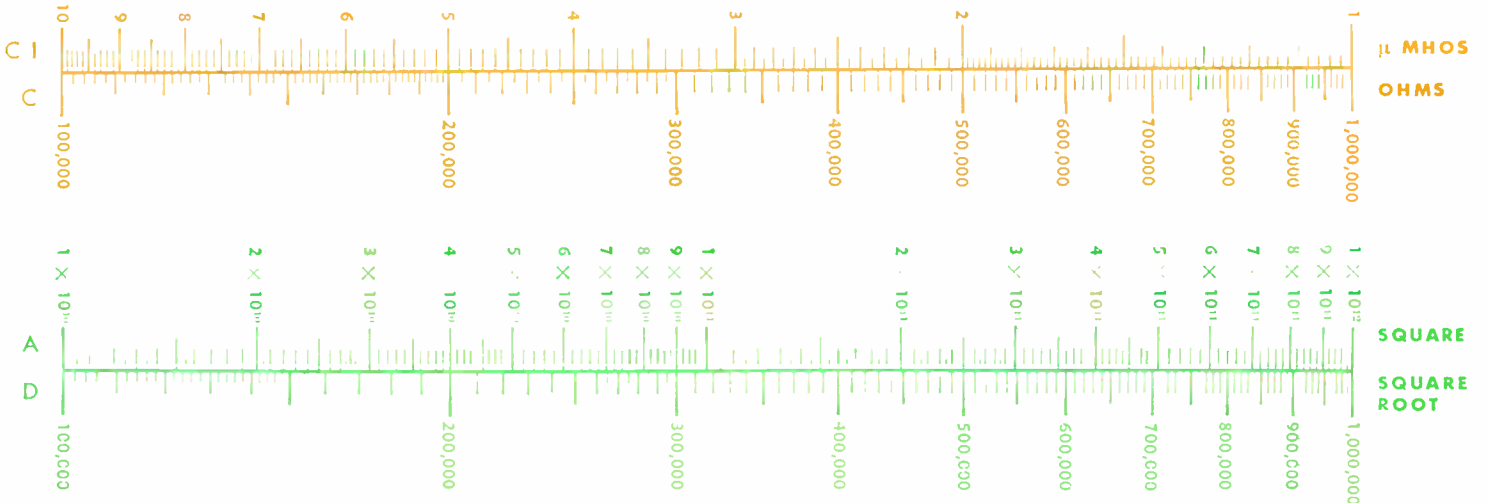
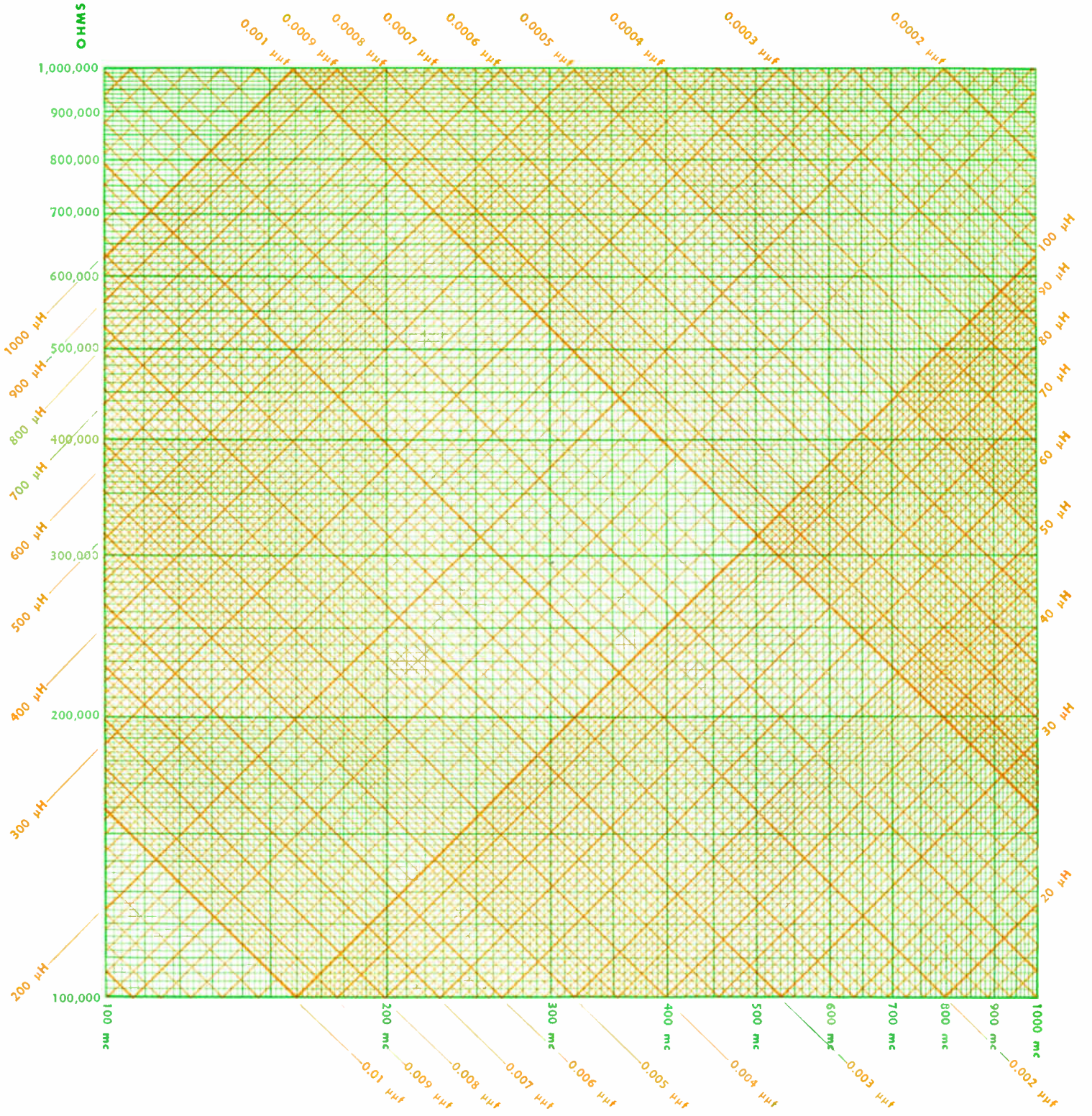
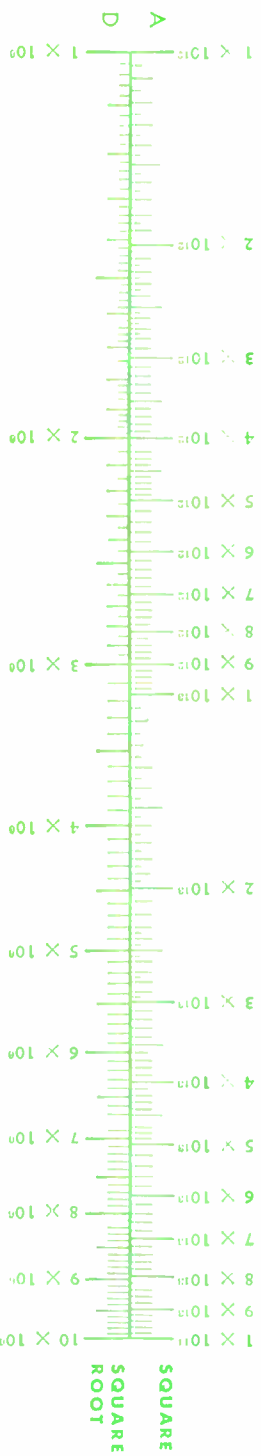
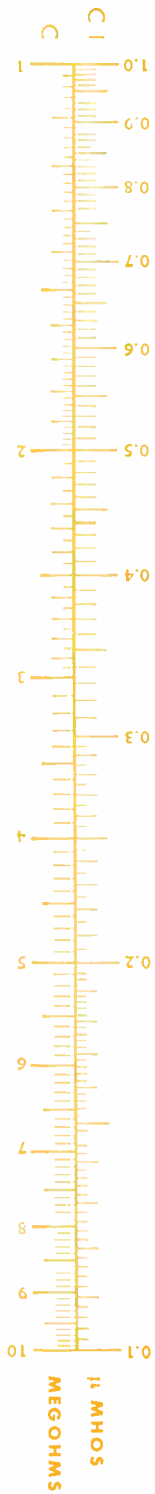
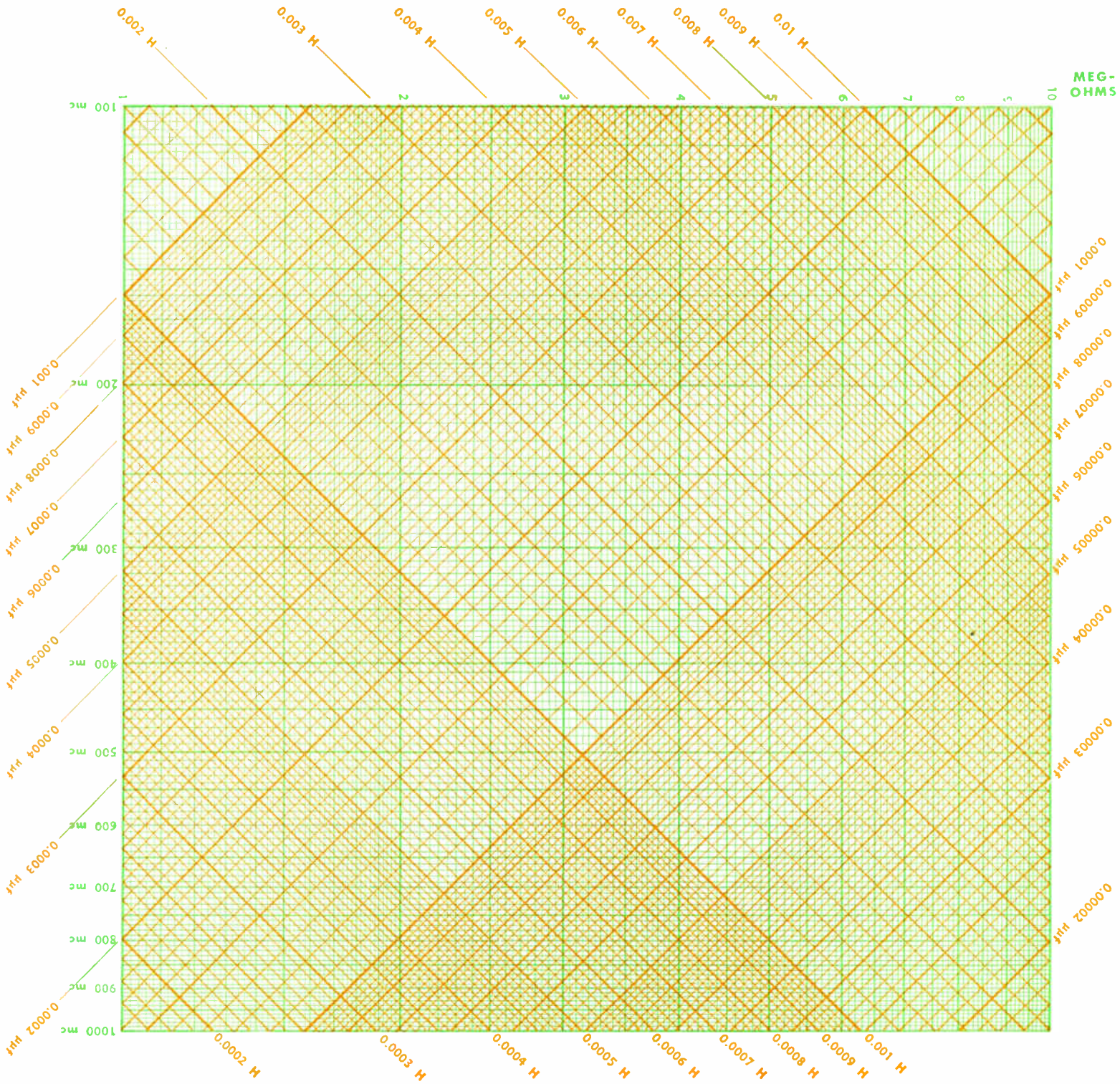
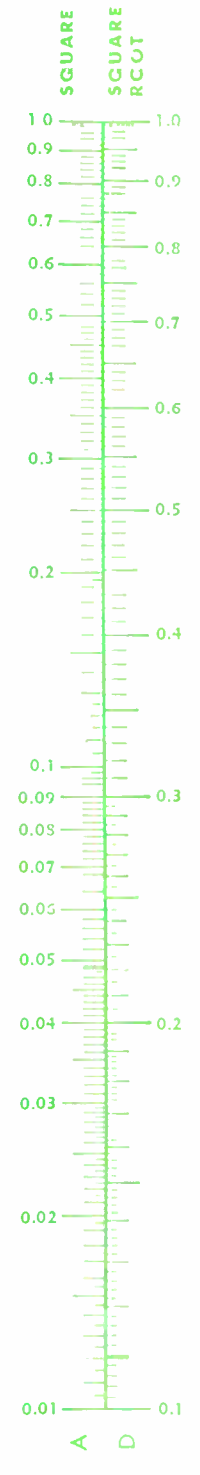
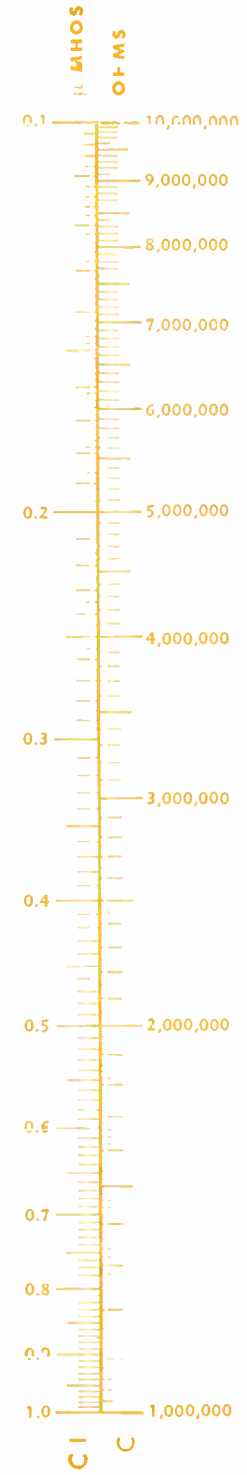
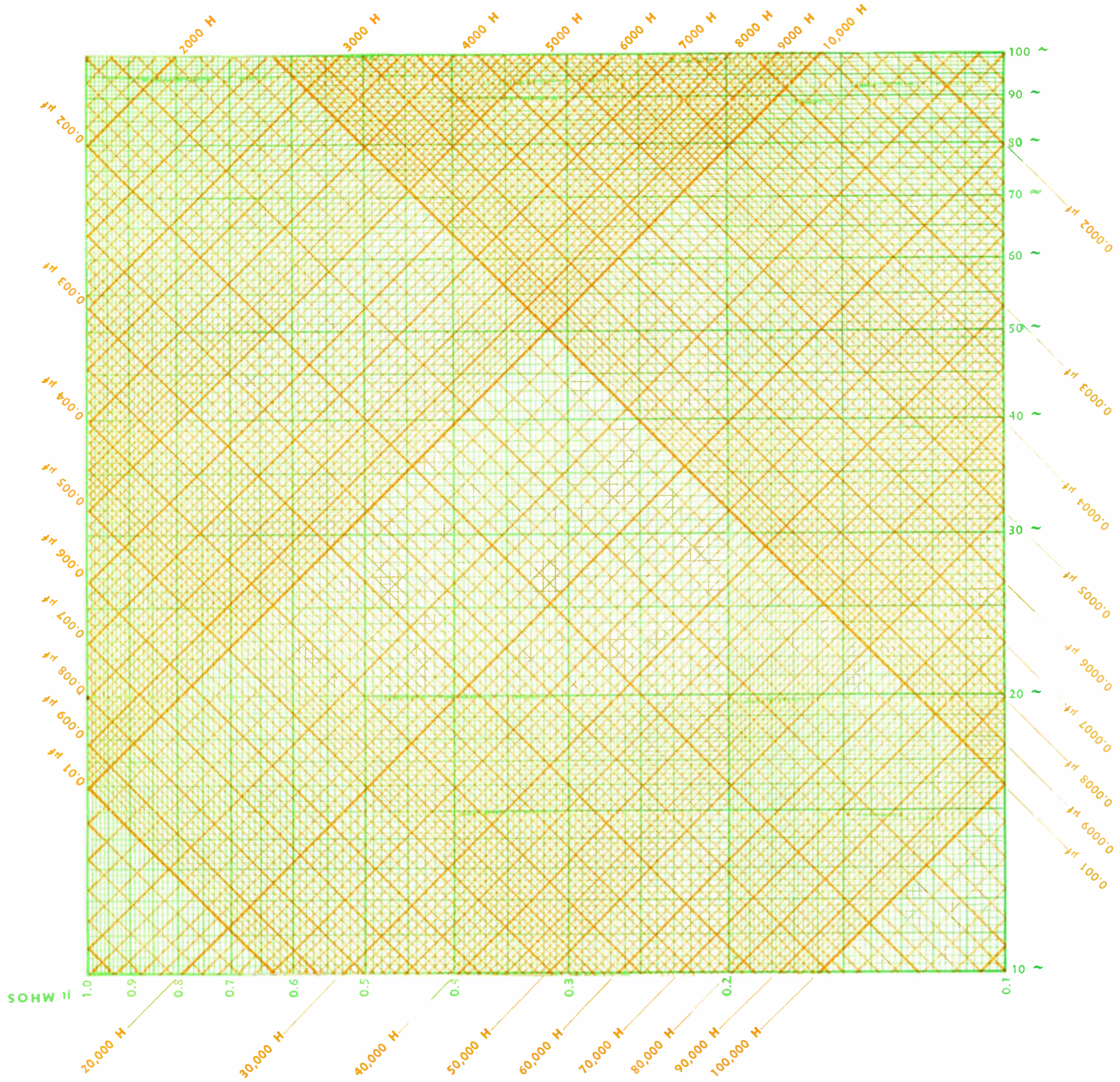


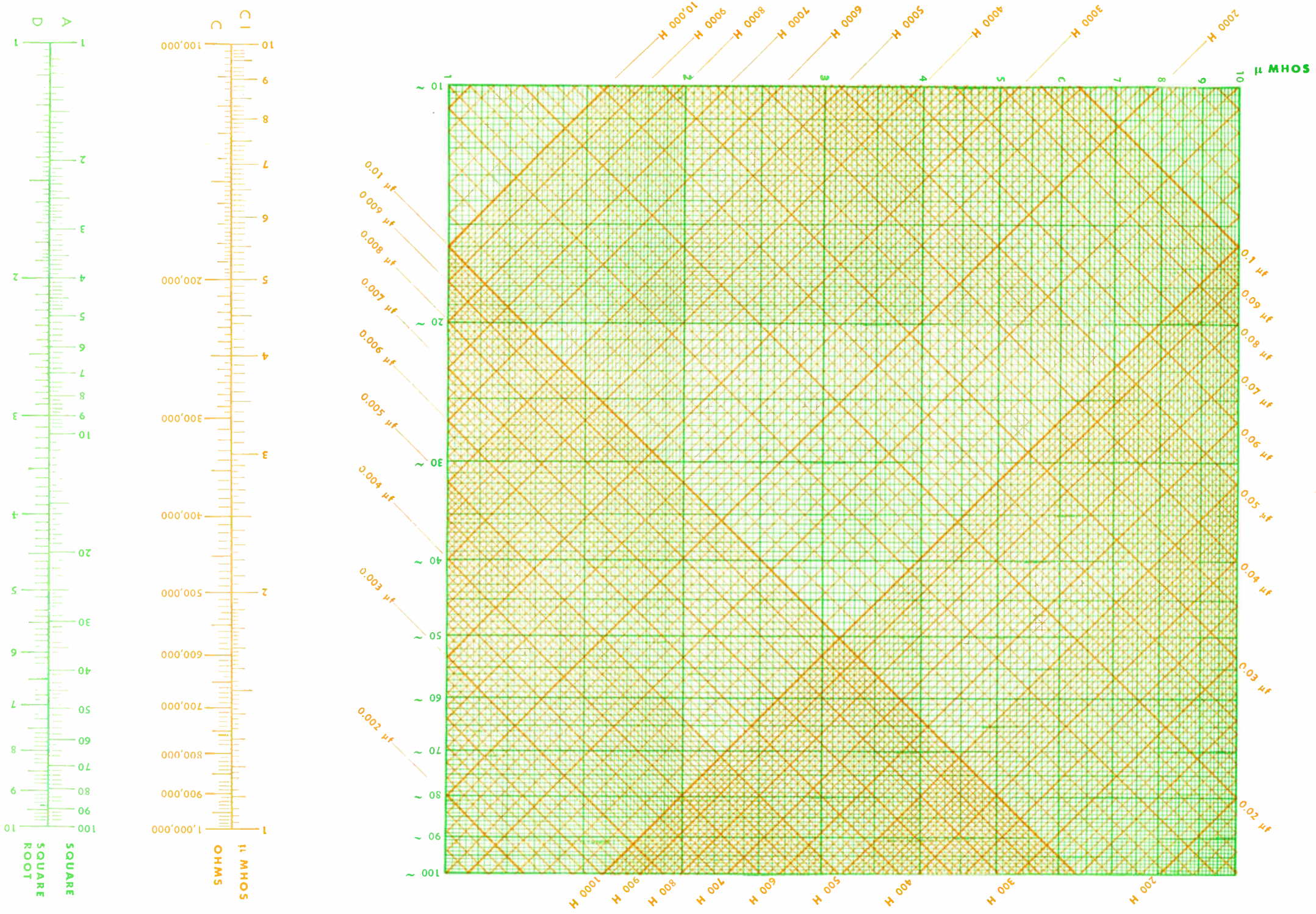
PLATE 70



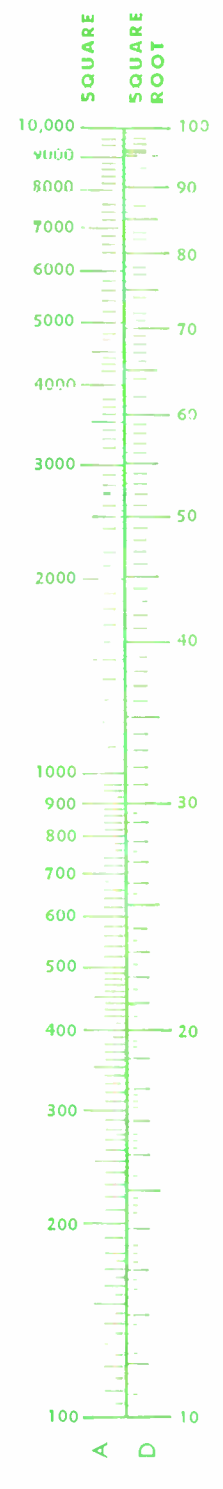
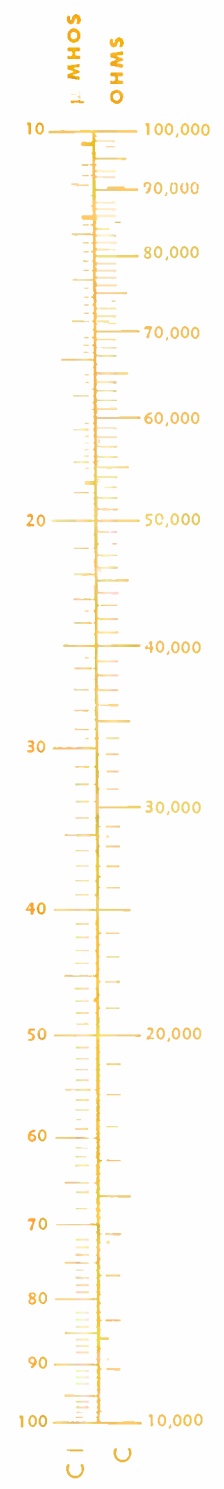
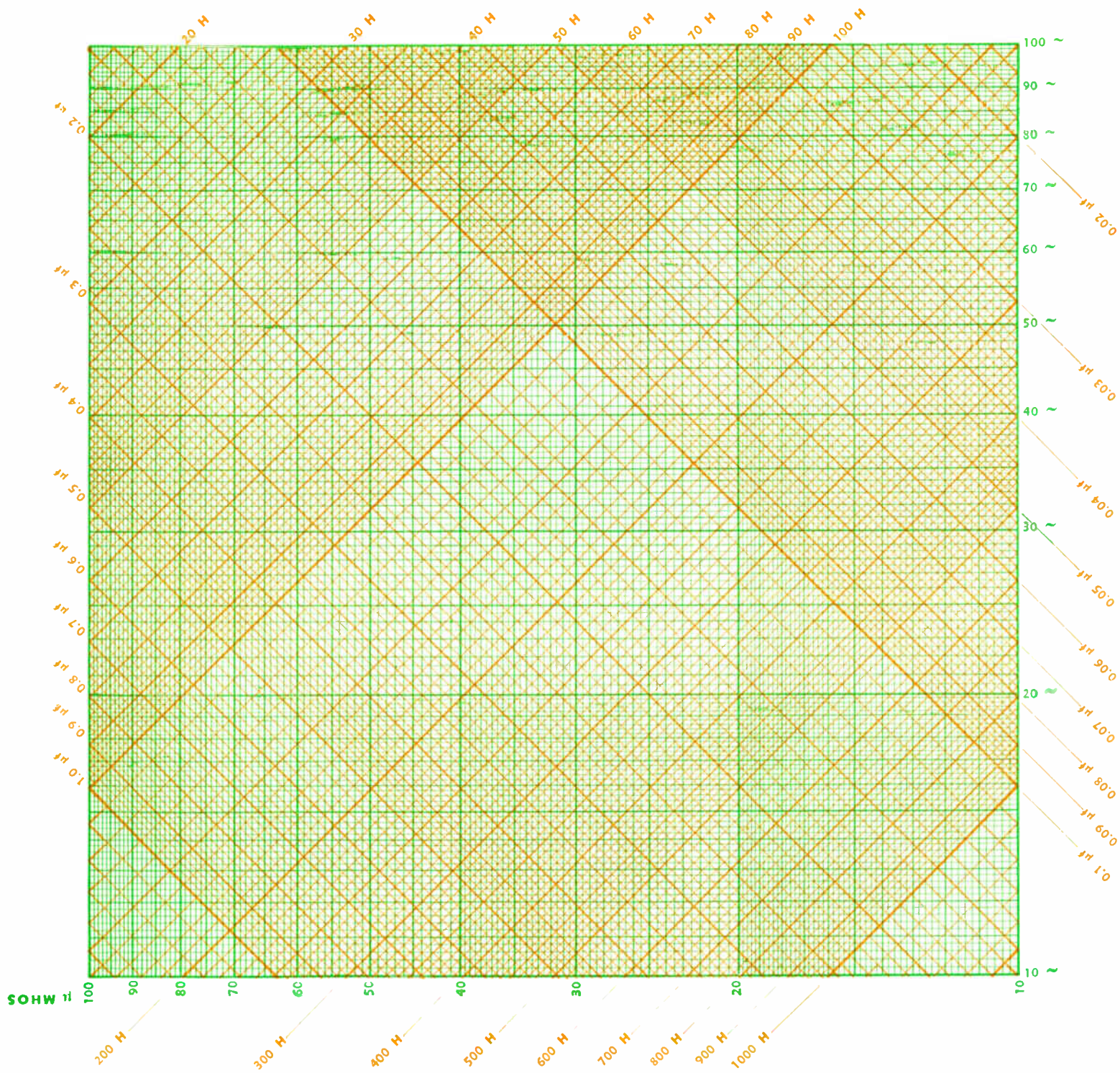




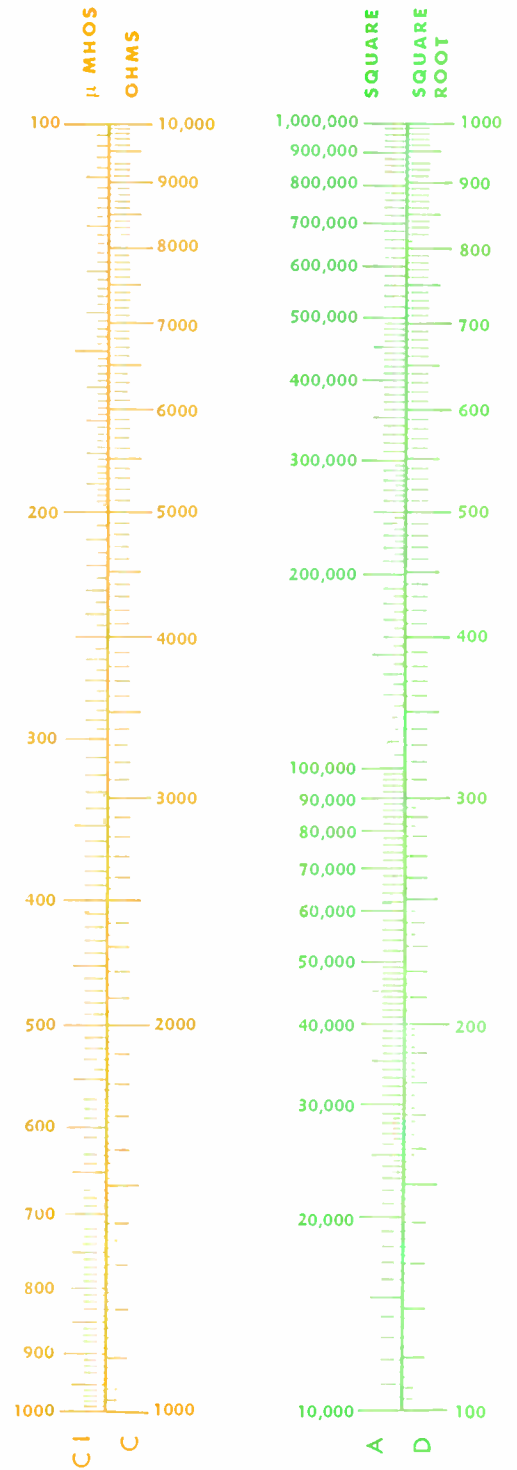
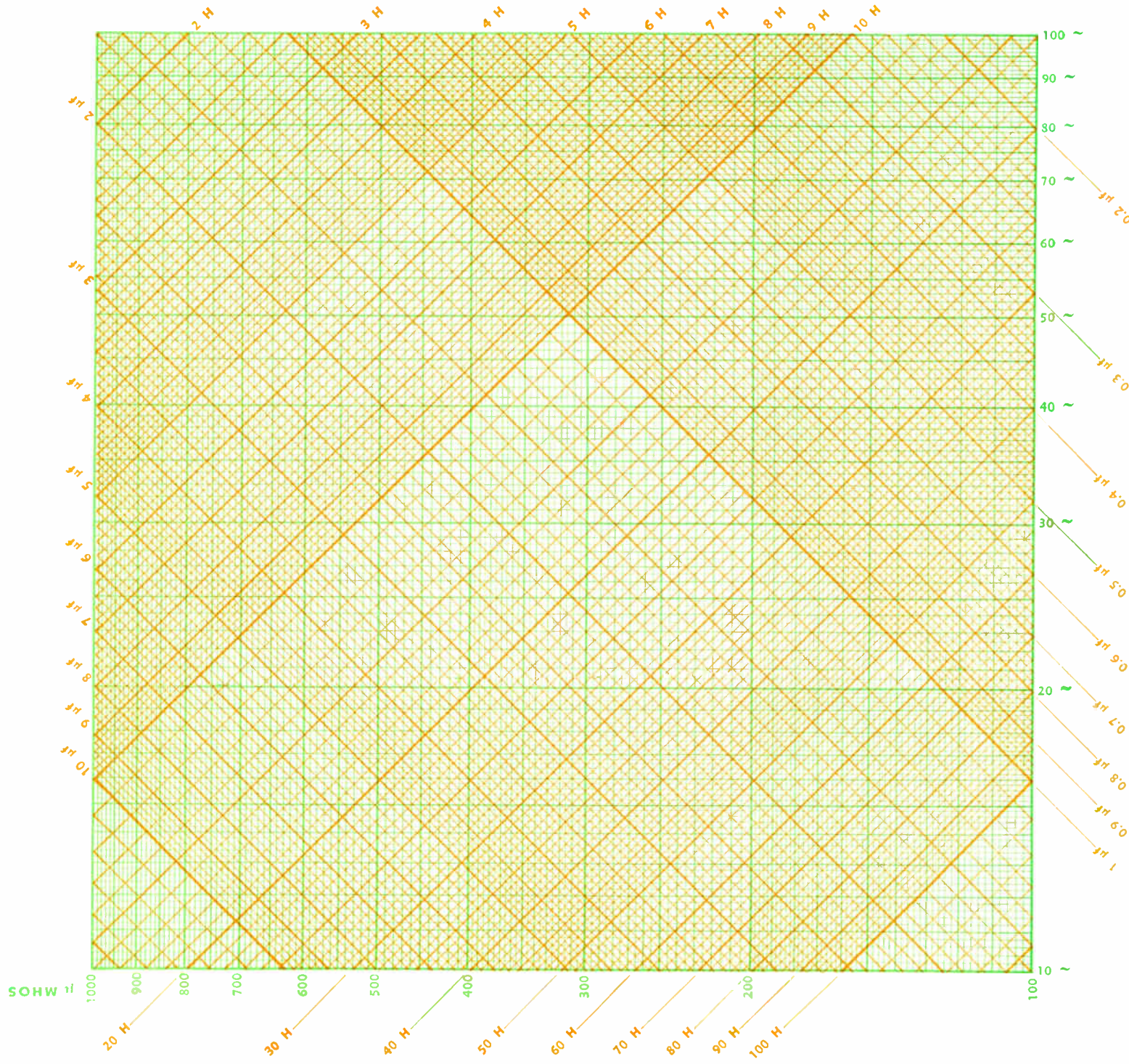




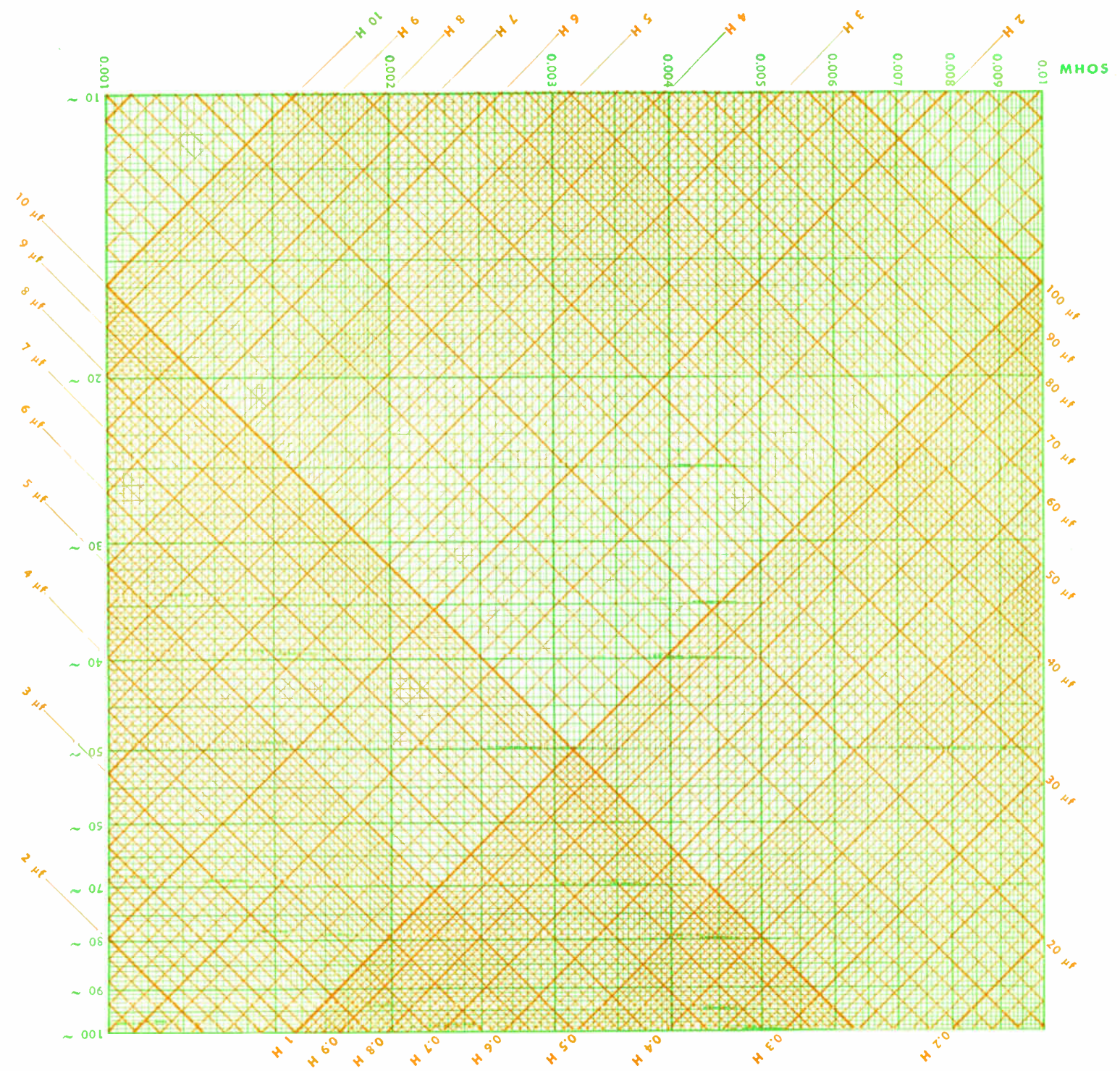
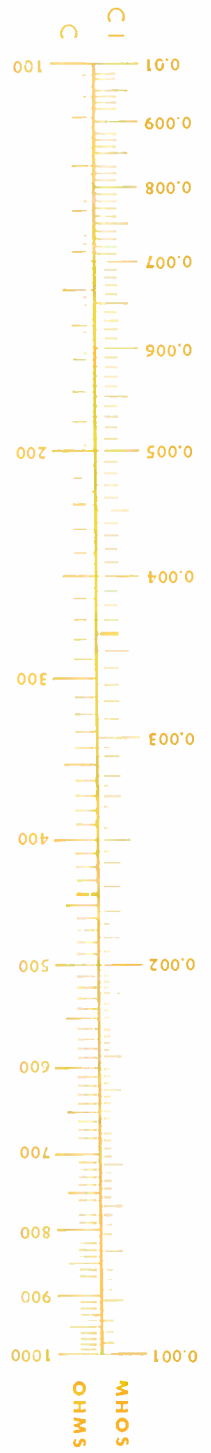
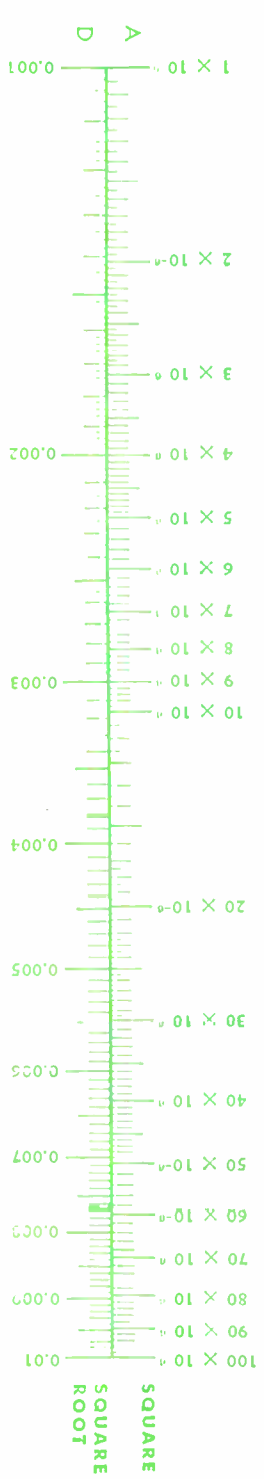
# PLATE 75



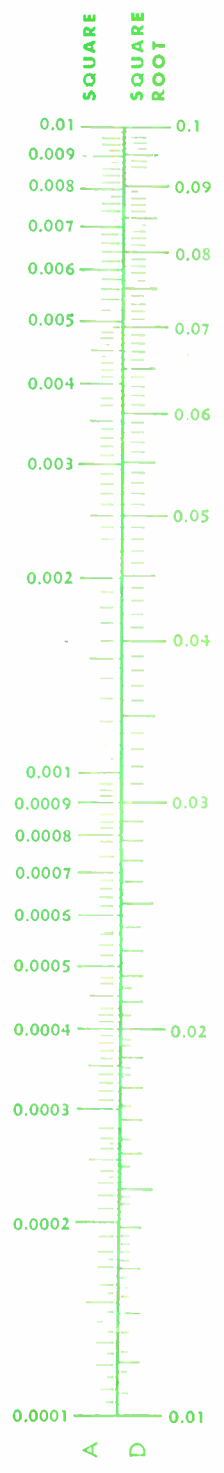
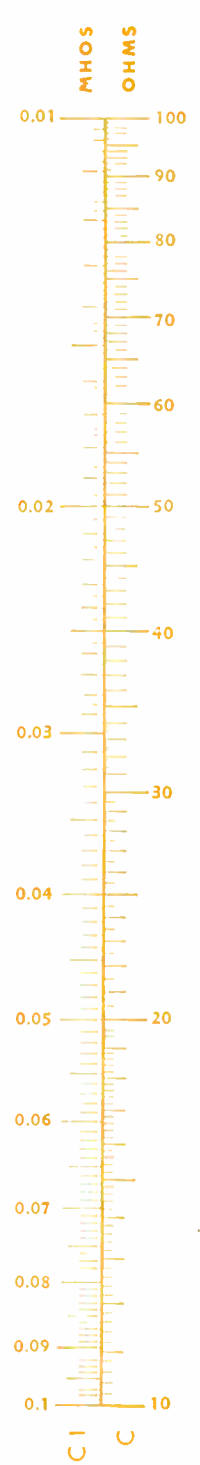
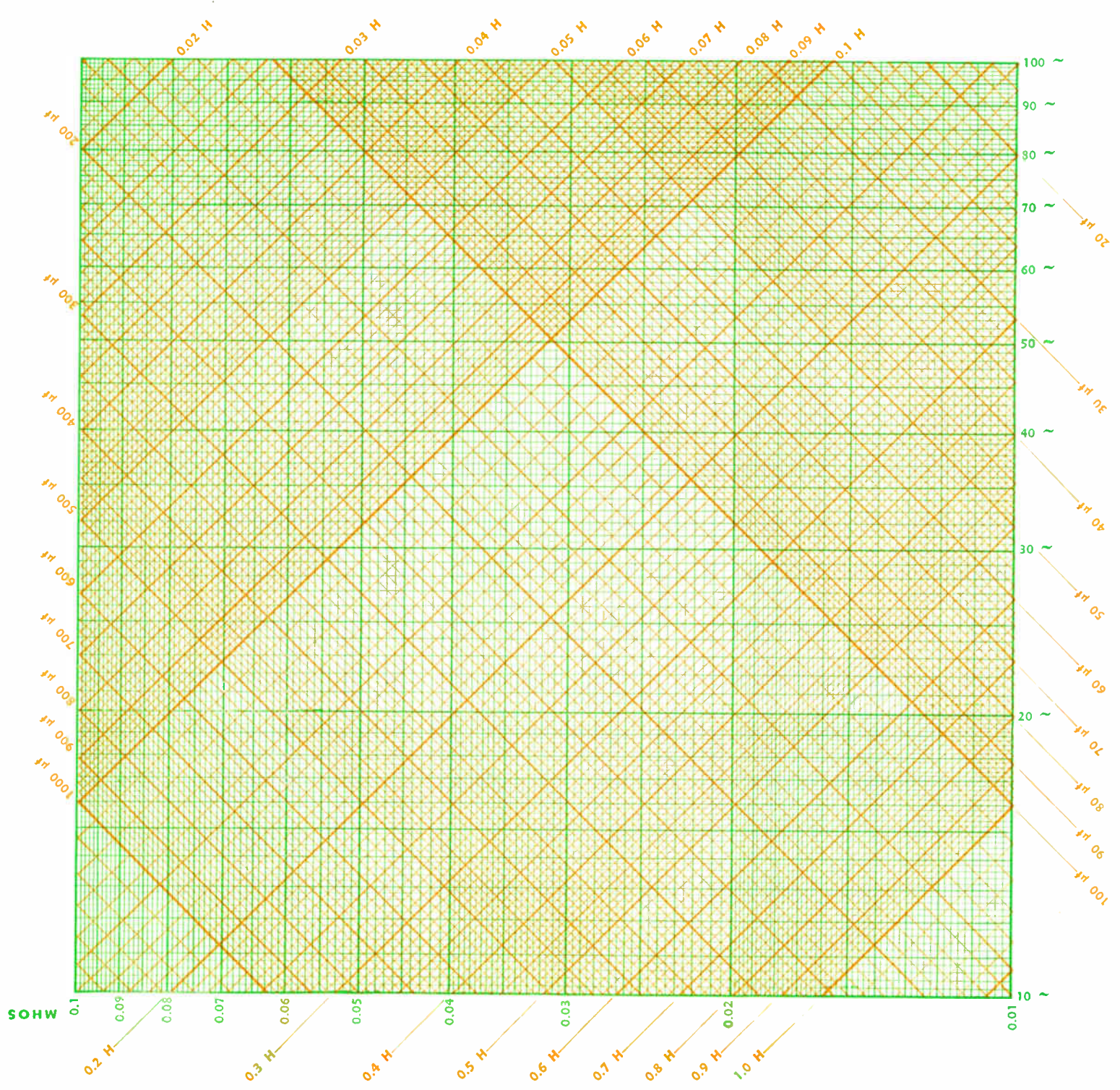
# PLATE 76







**PLATE 78**



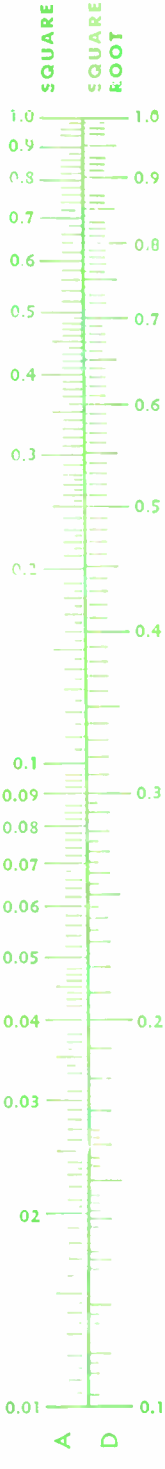
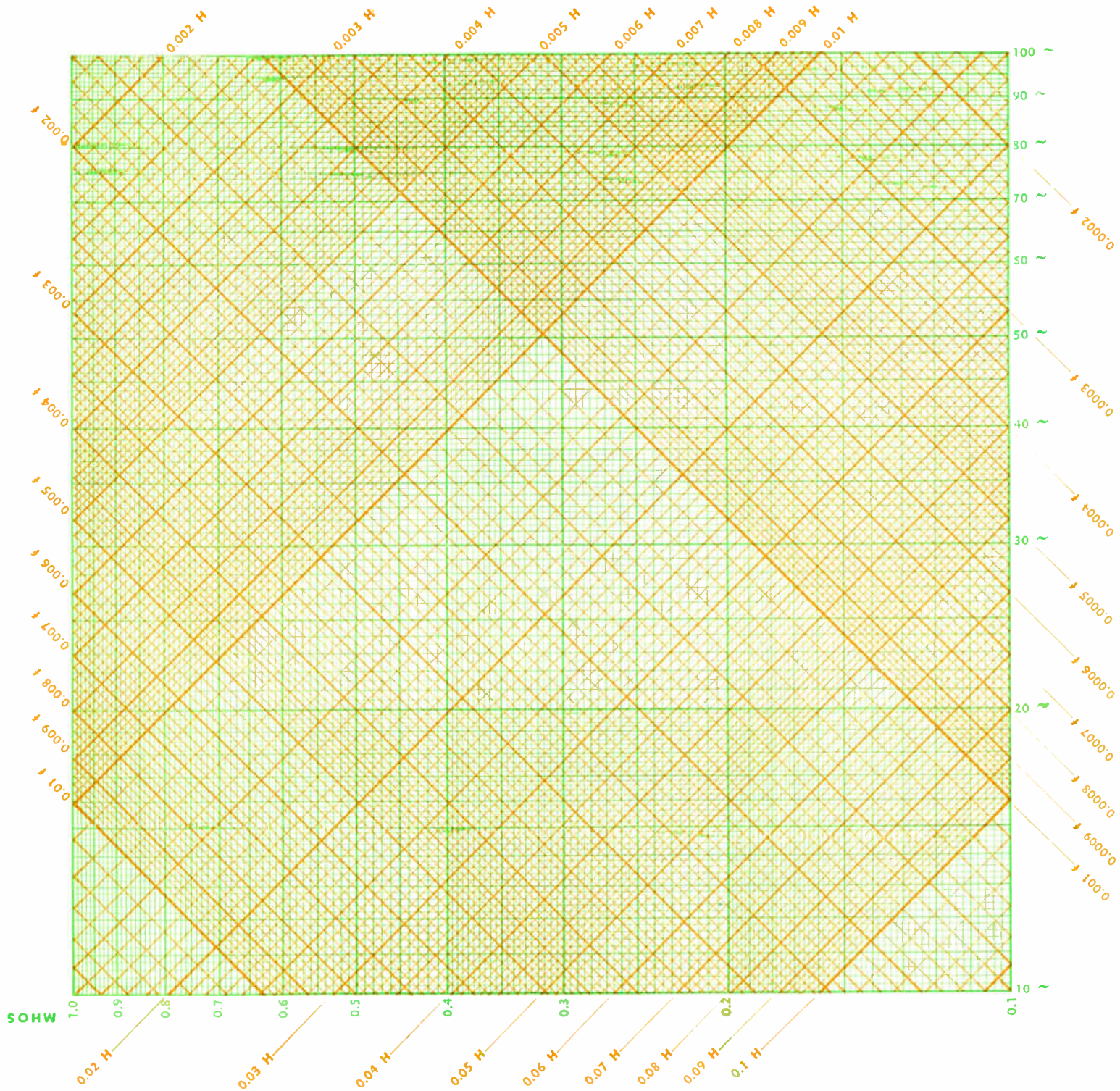
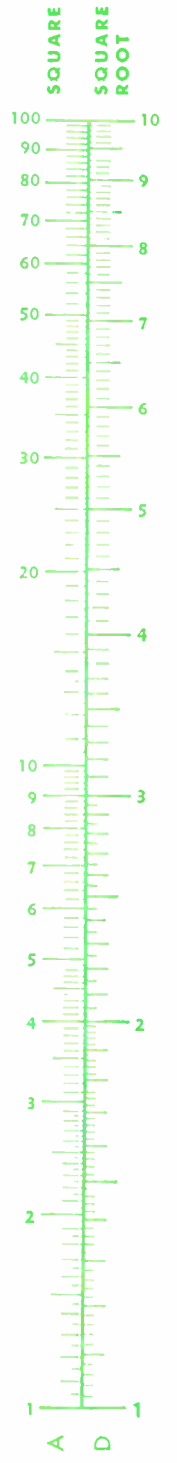
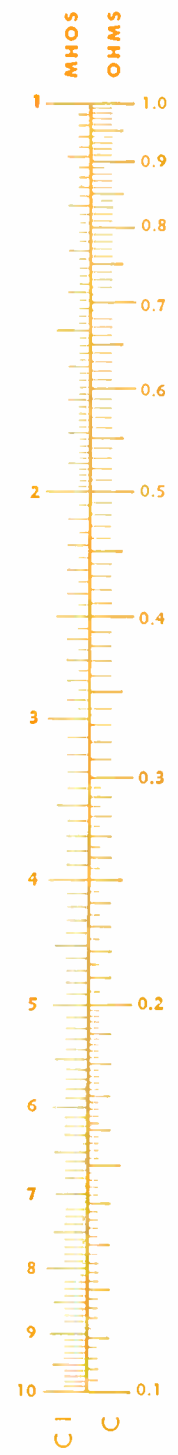
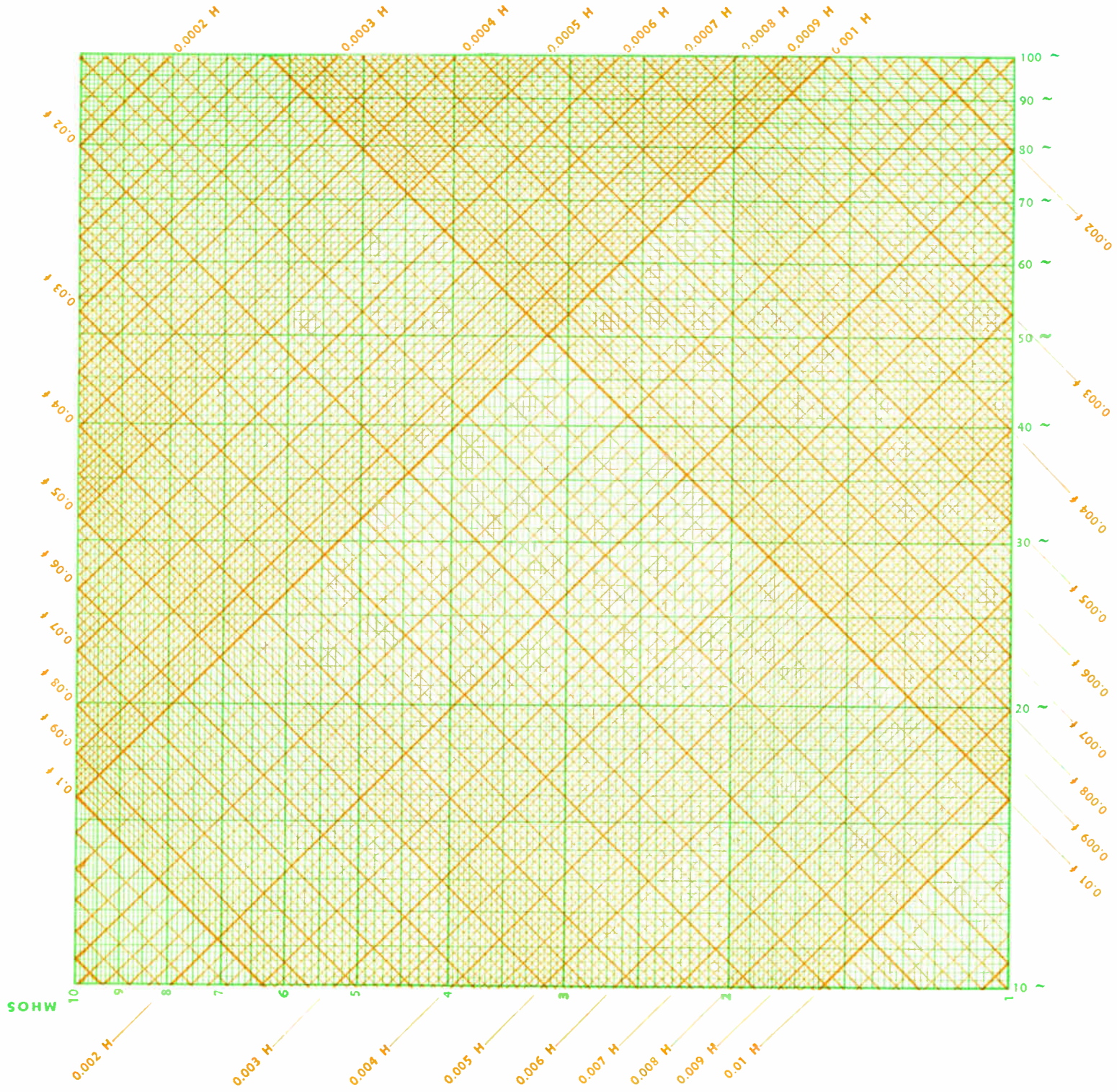
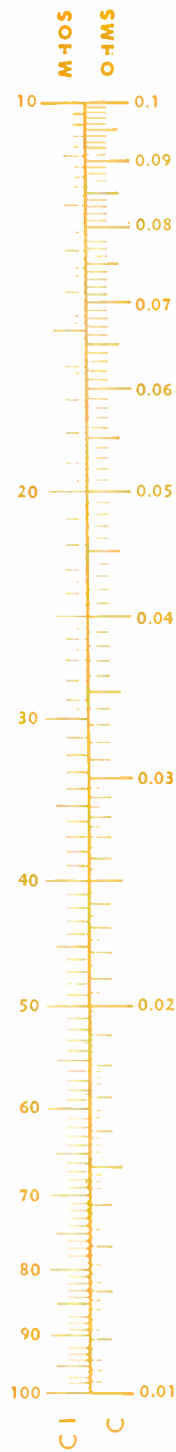
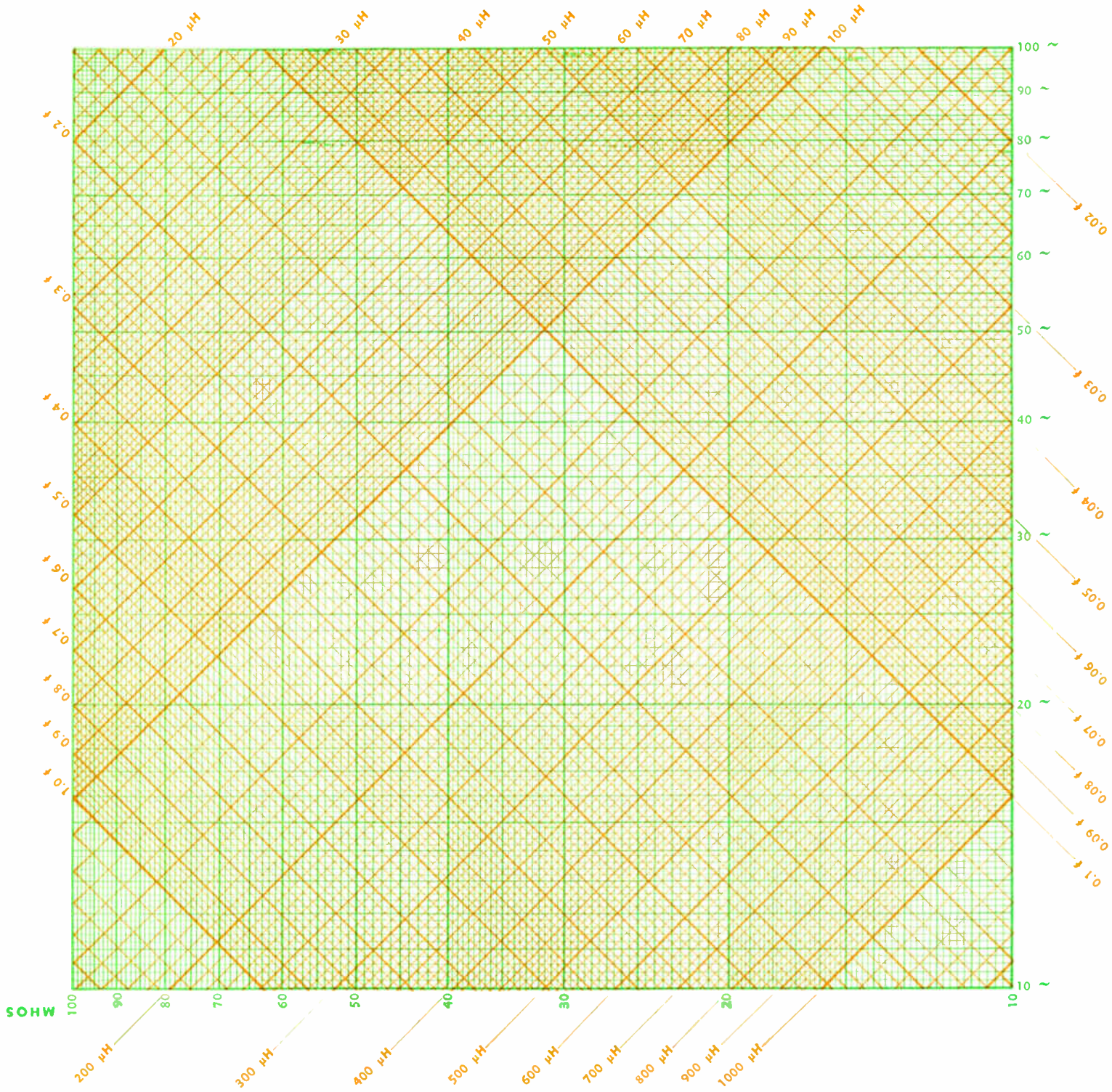
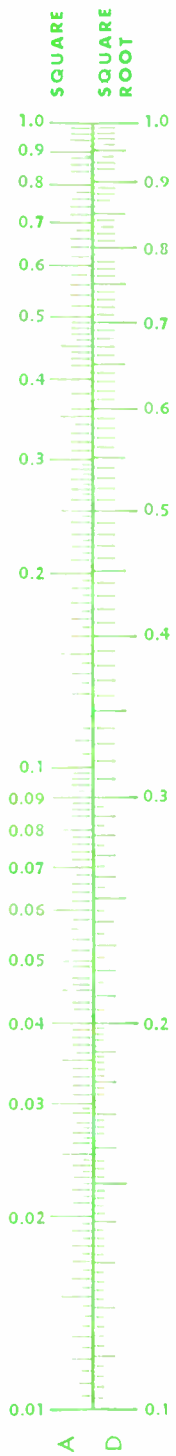
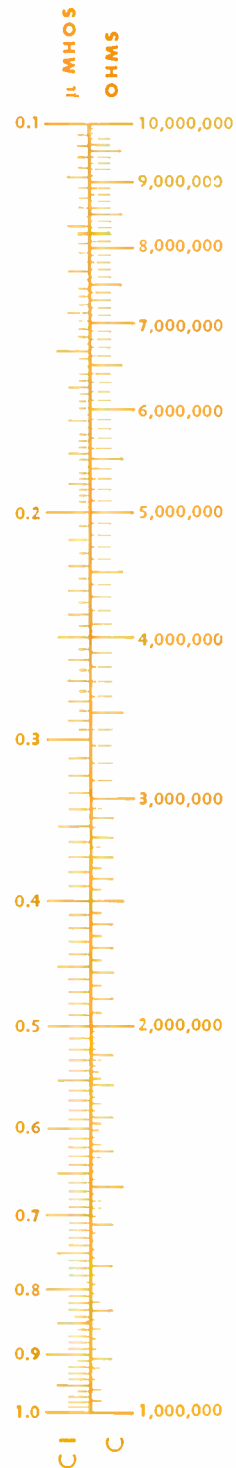
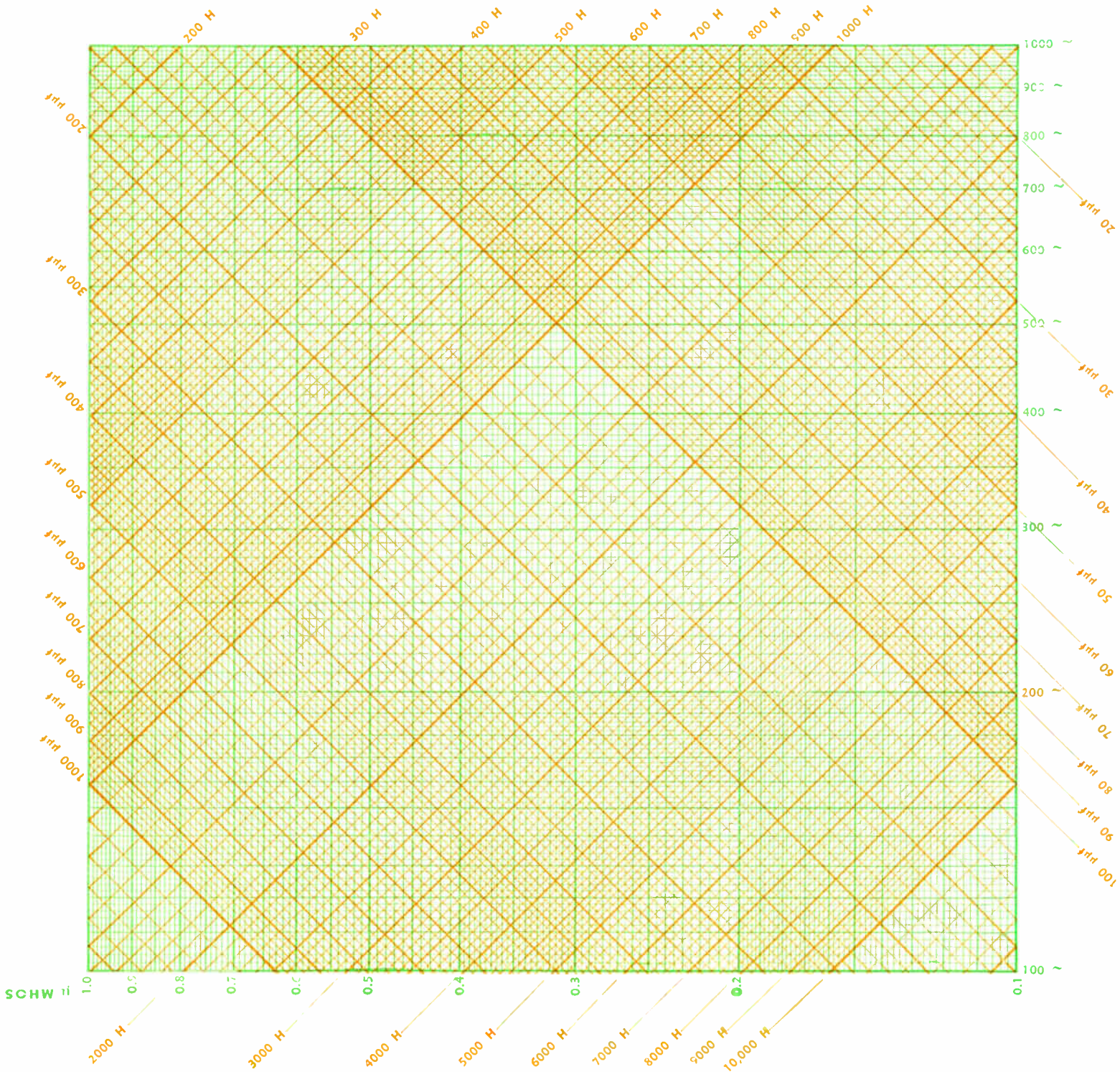


PLATE 80





# PLATE 82



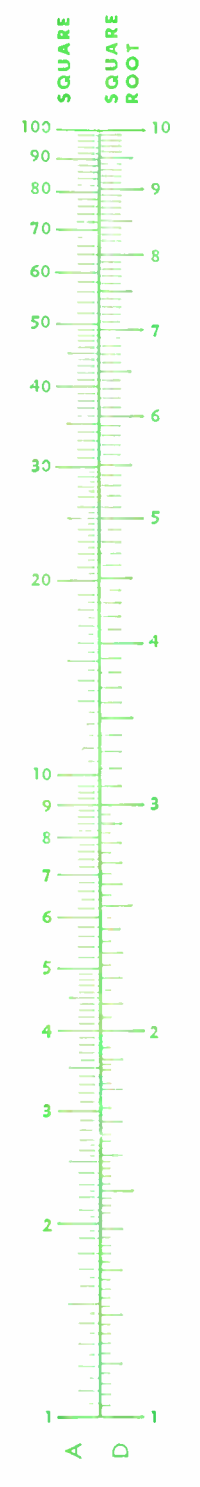
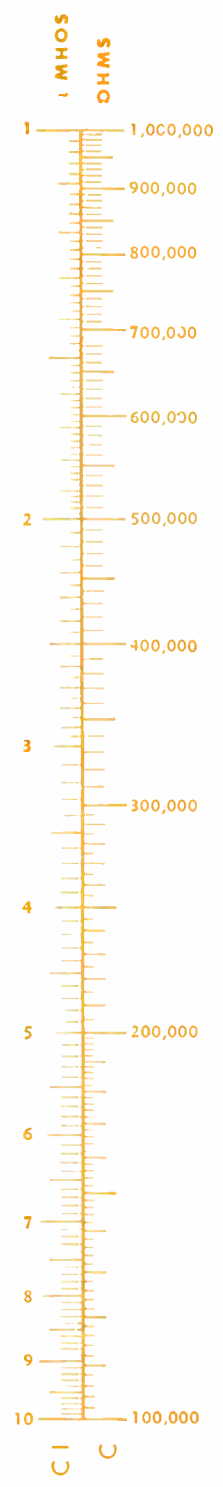
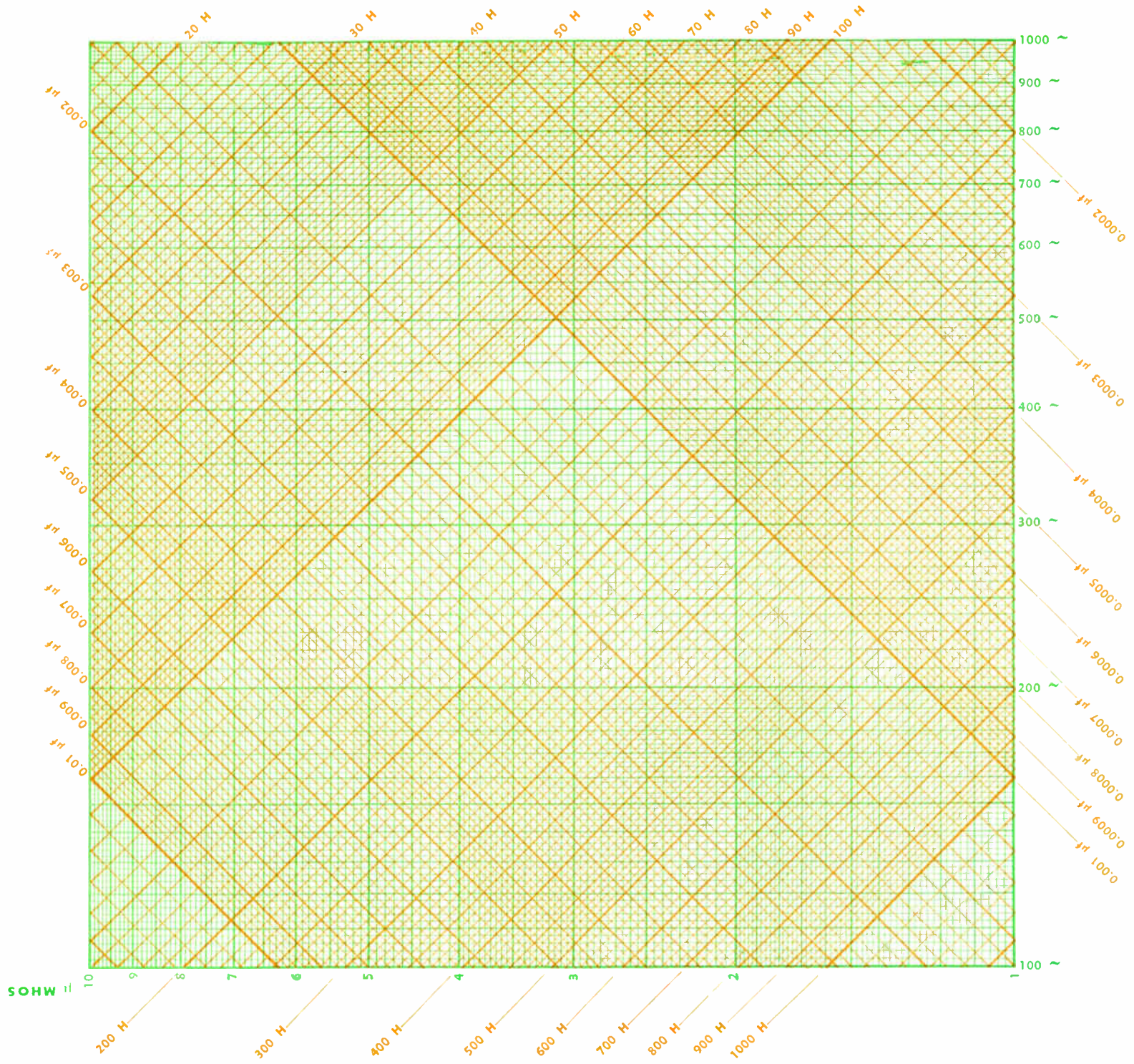
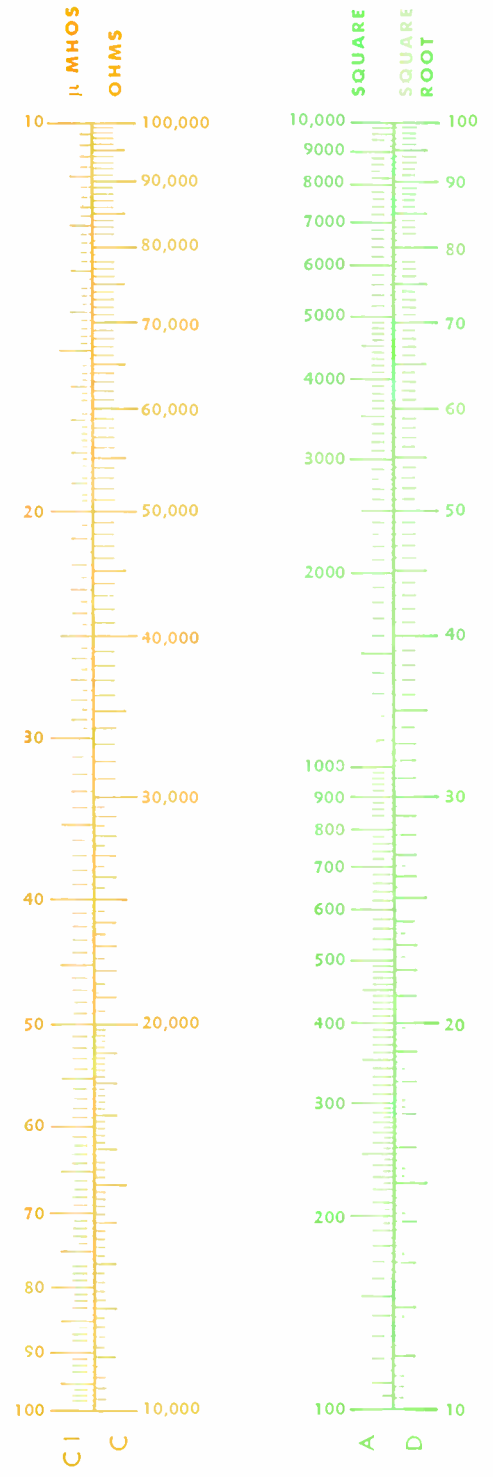
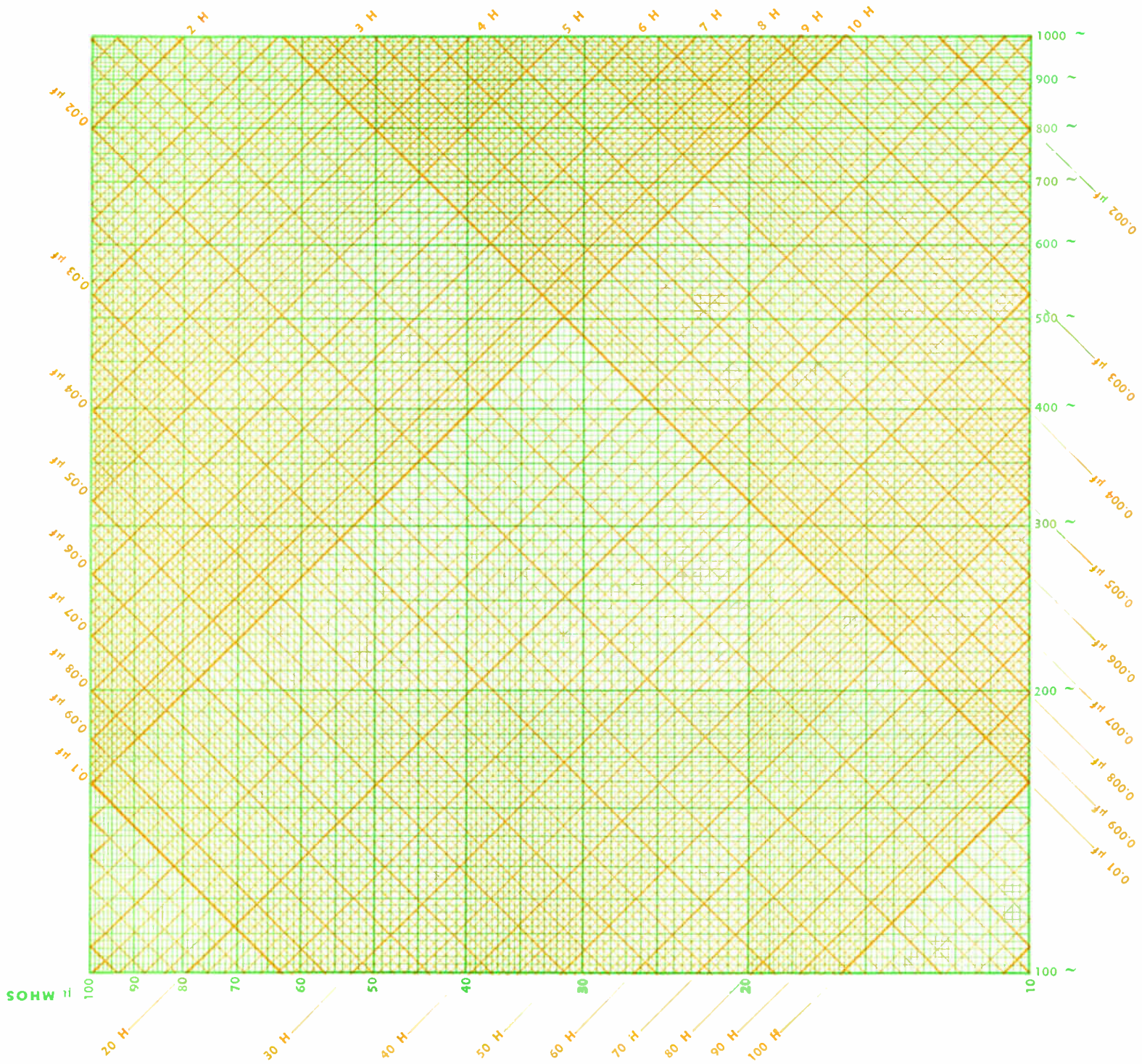
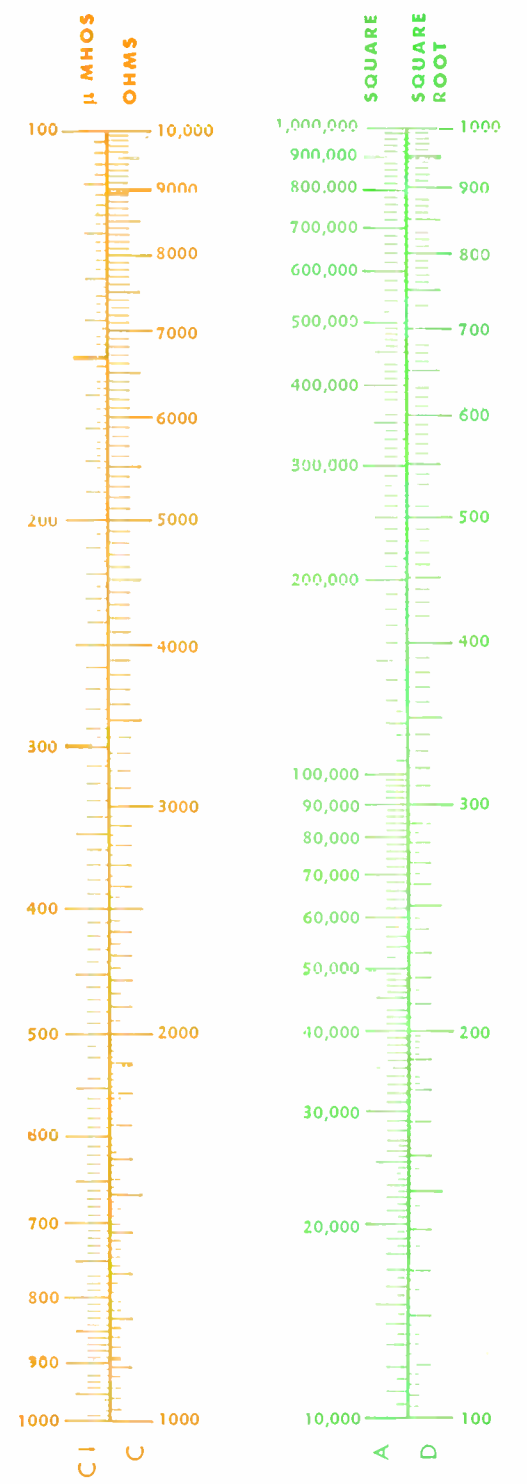
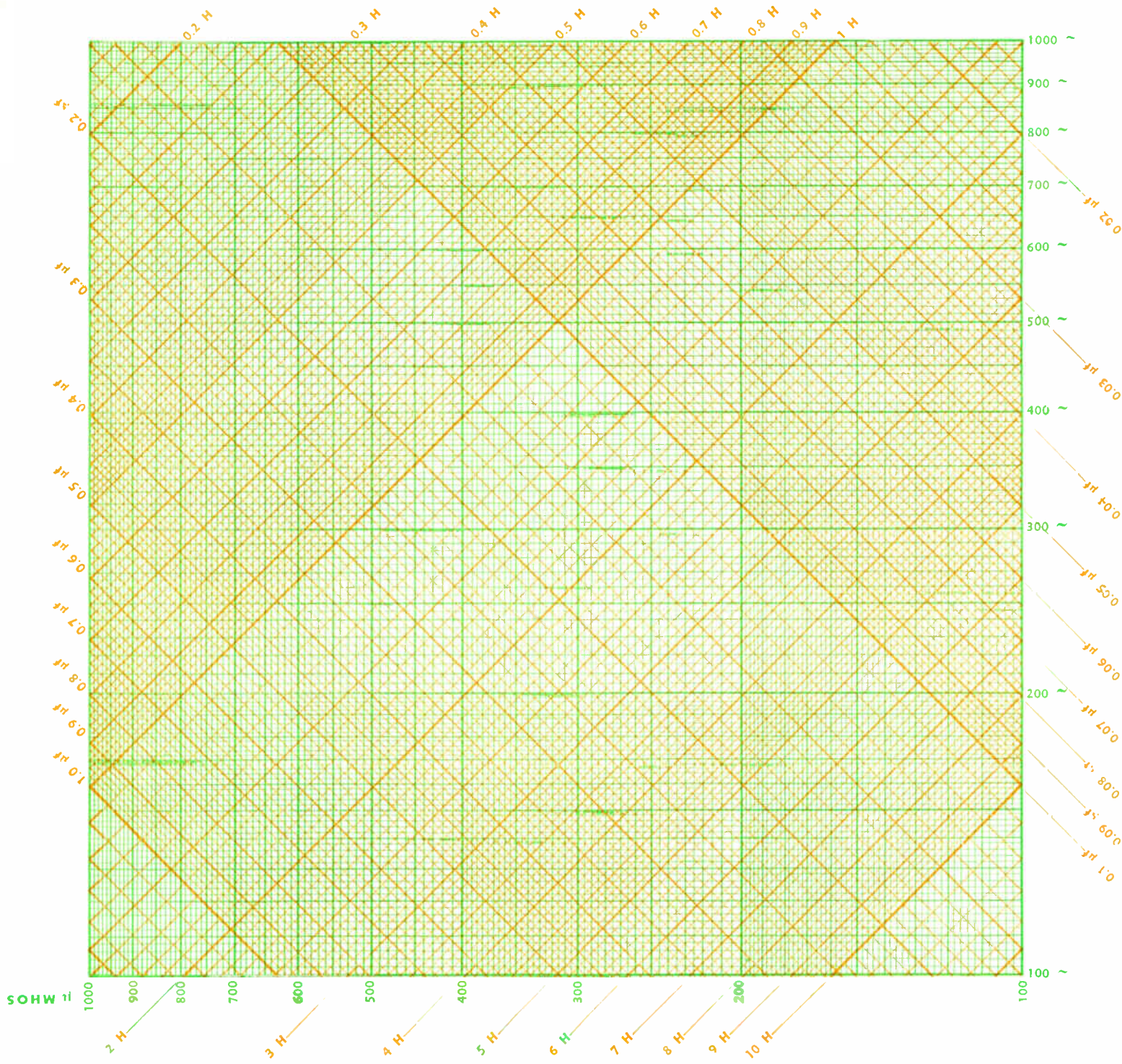
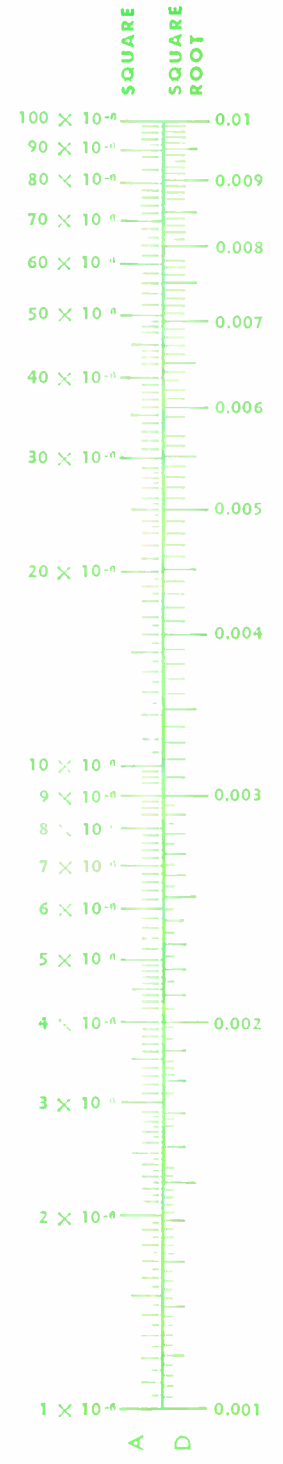
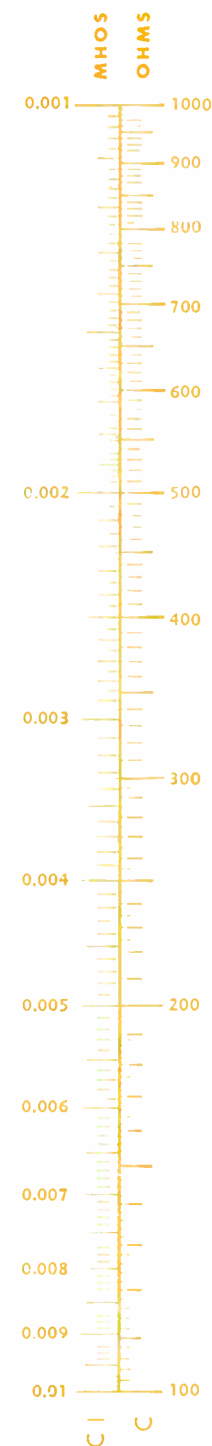
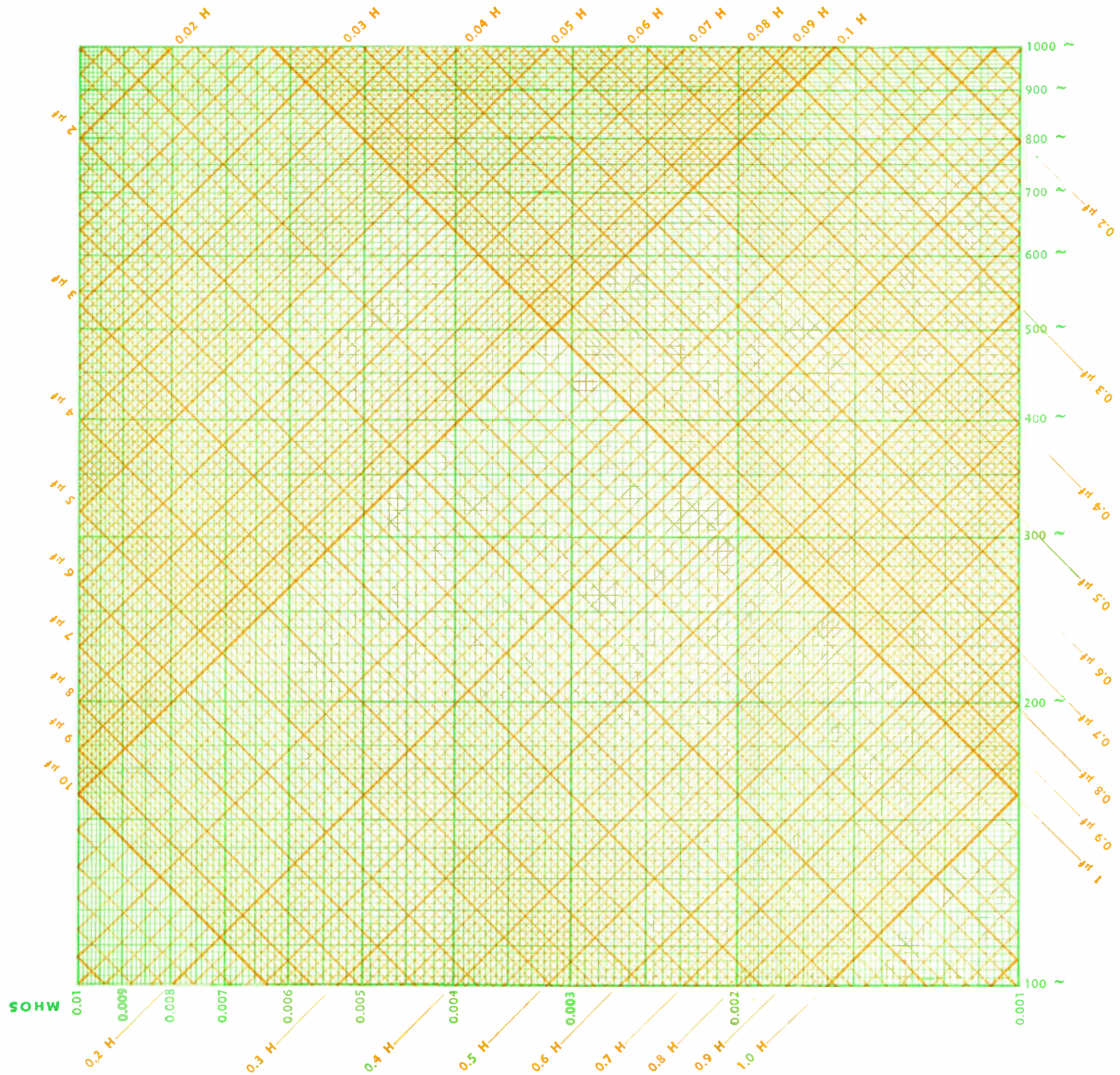


PLATE 84









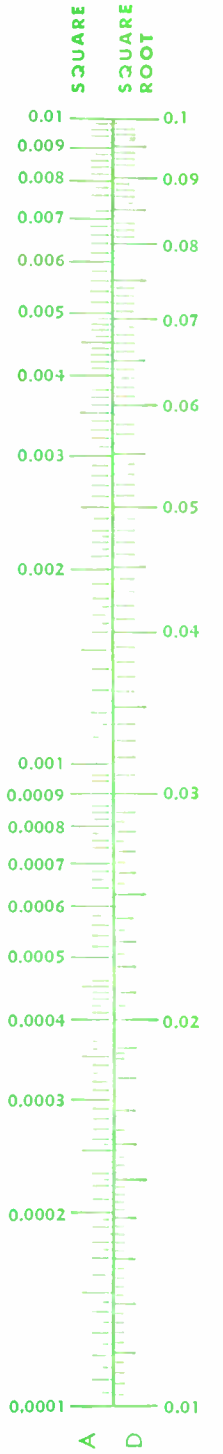
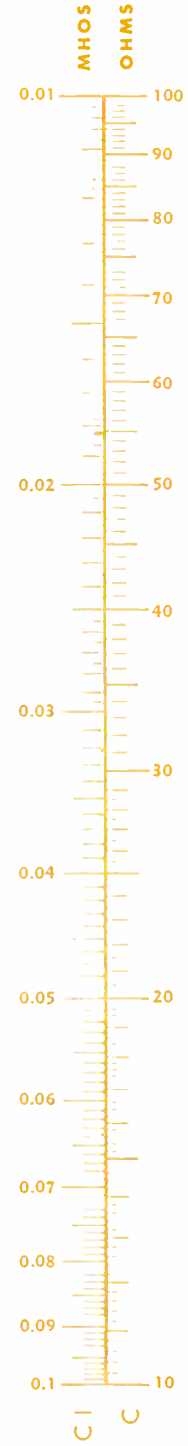
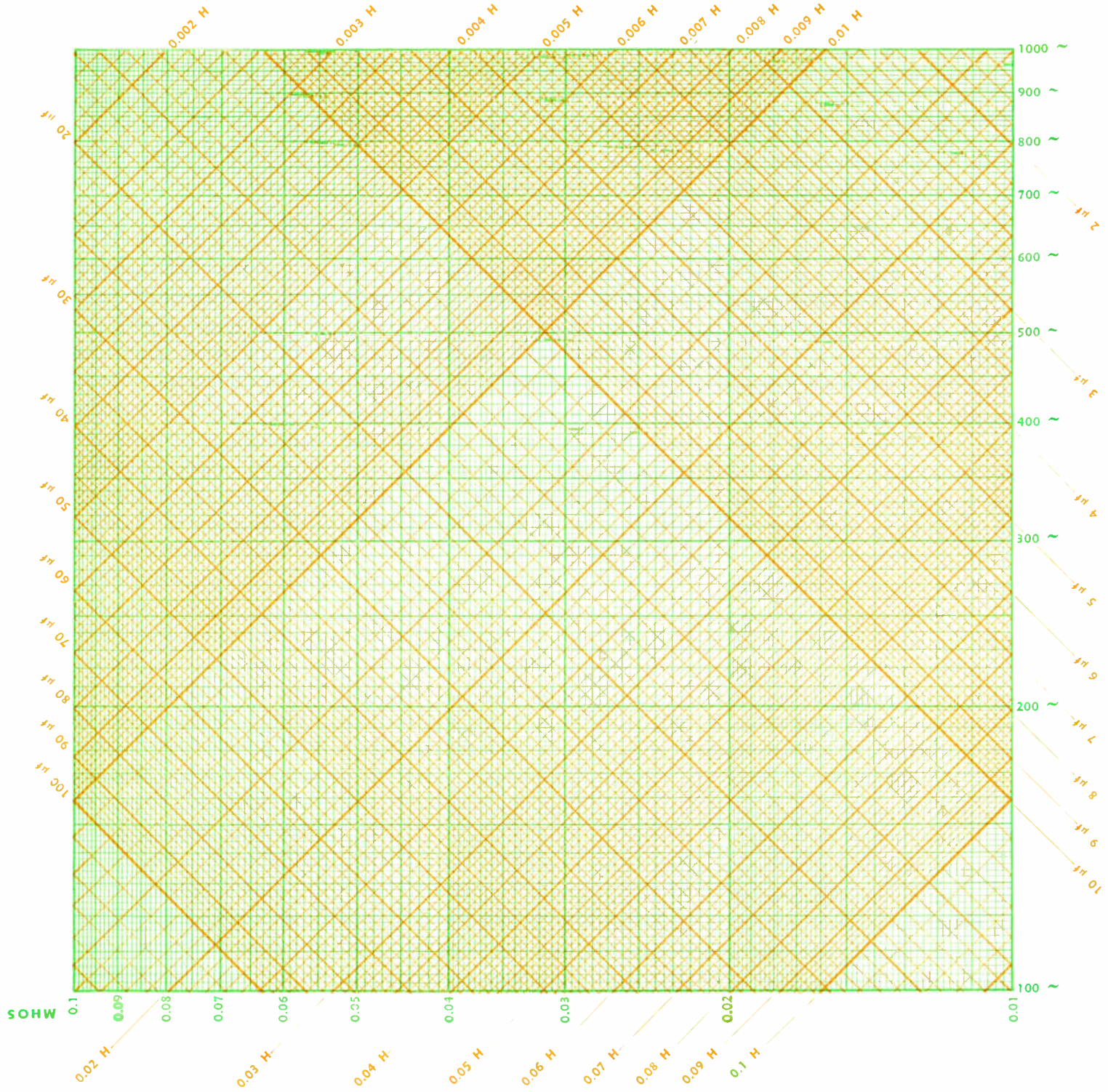
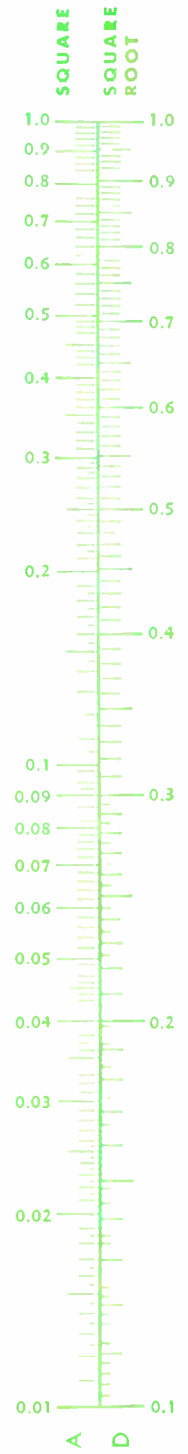
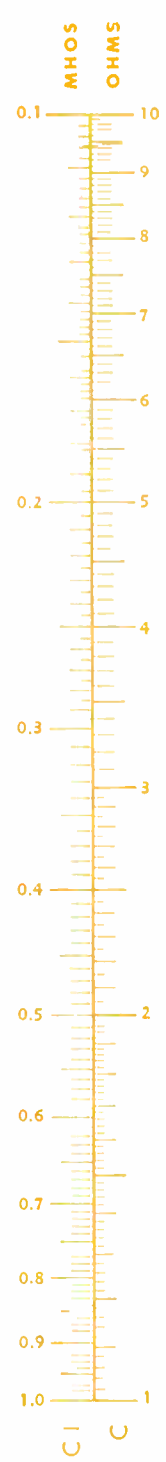
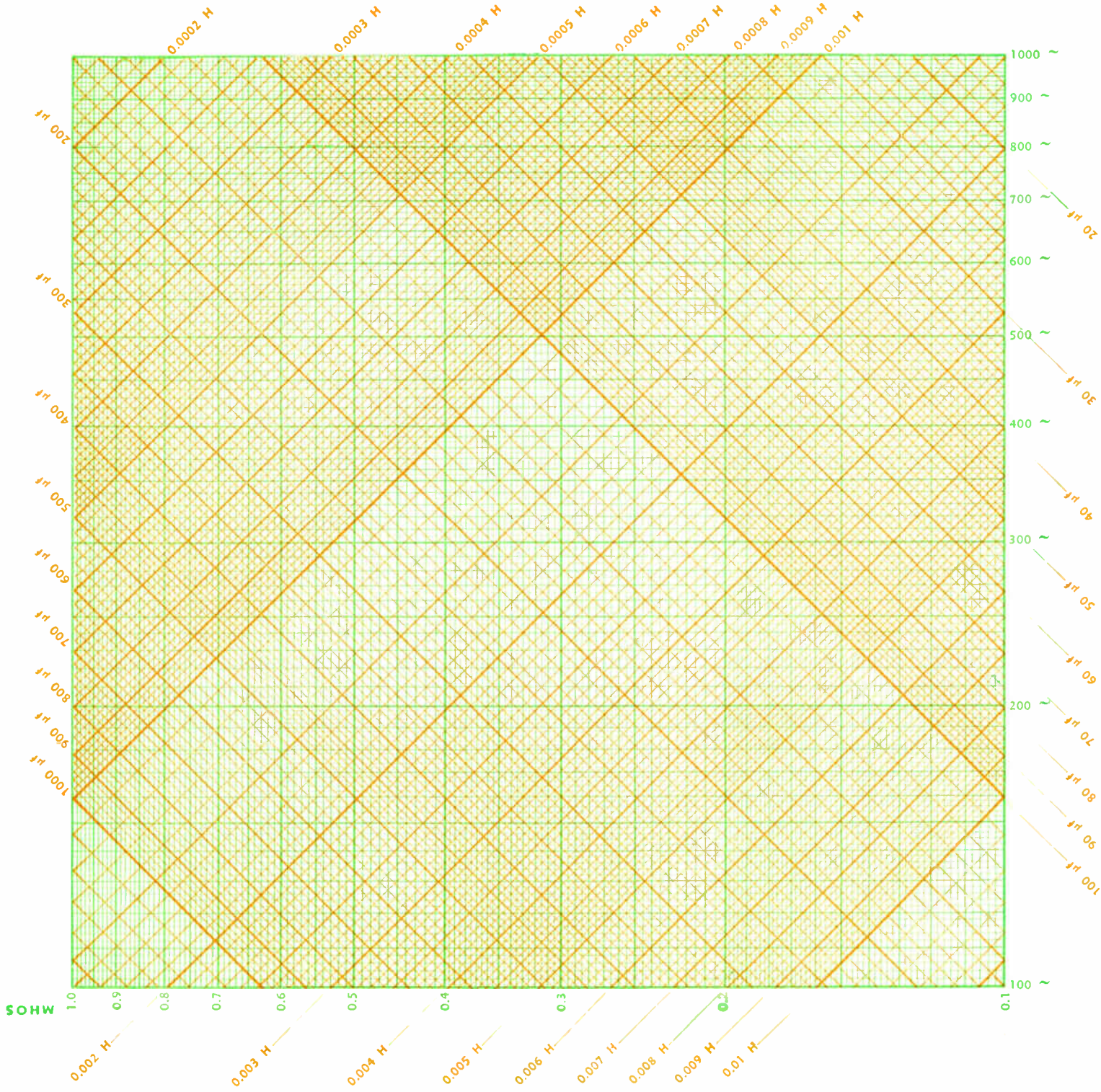
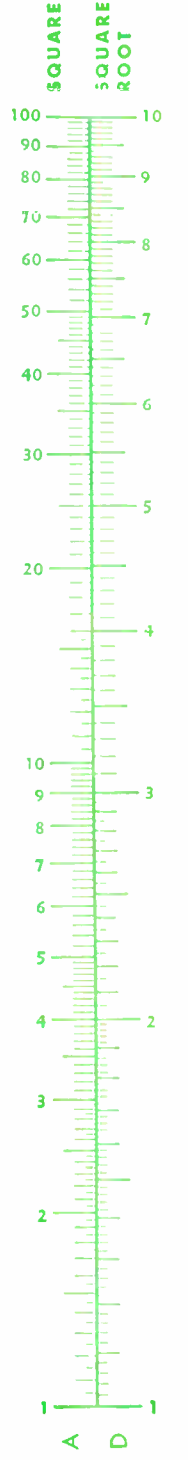
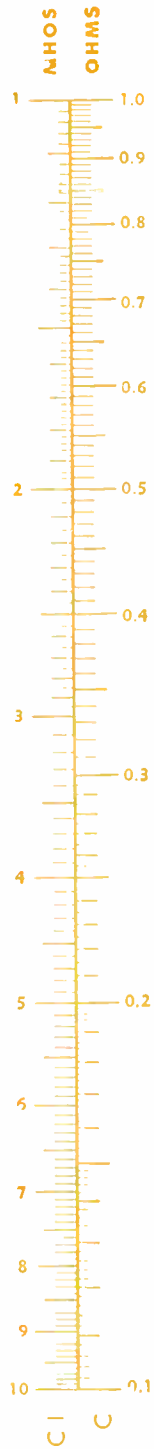
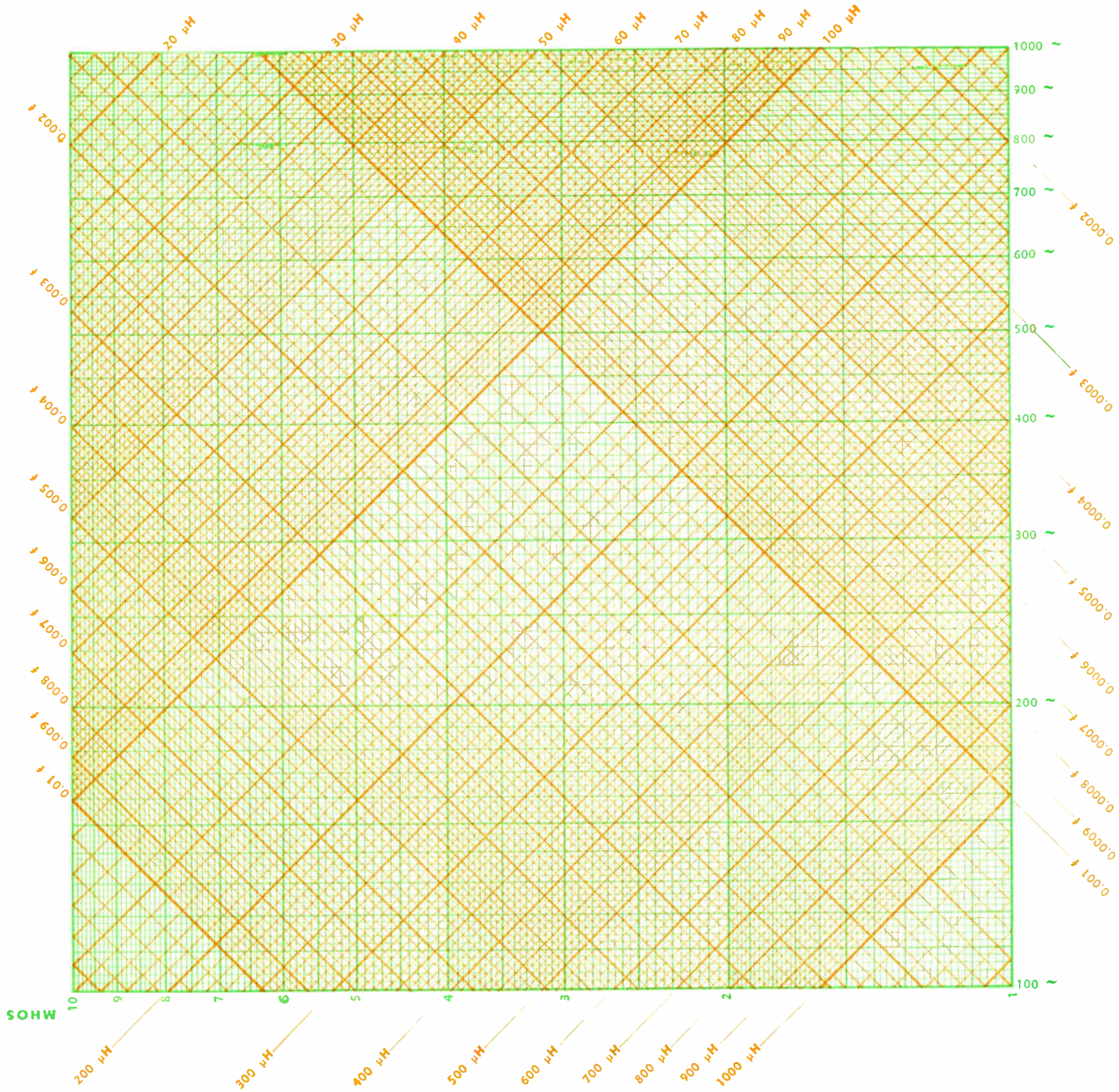
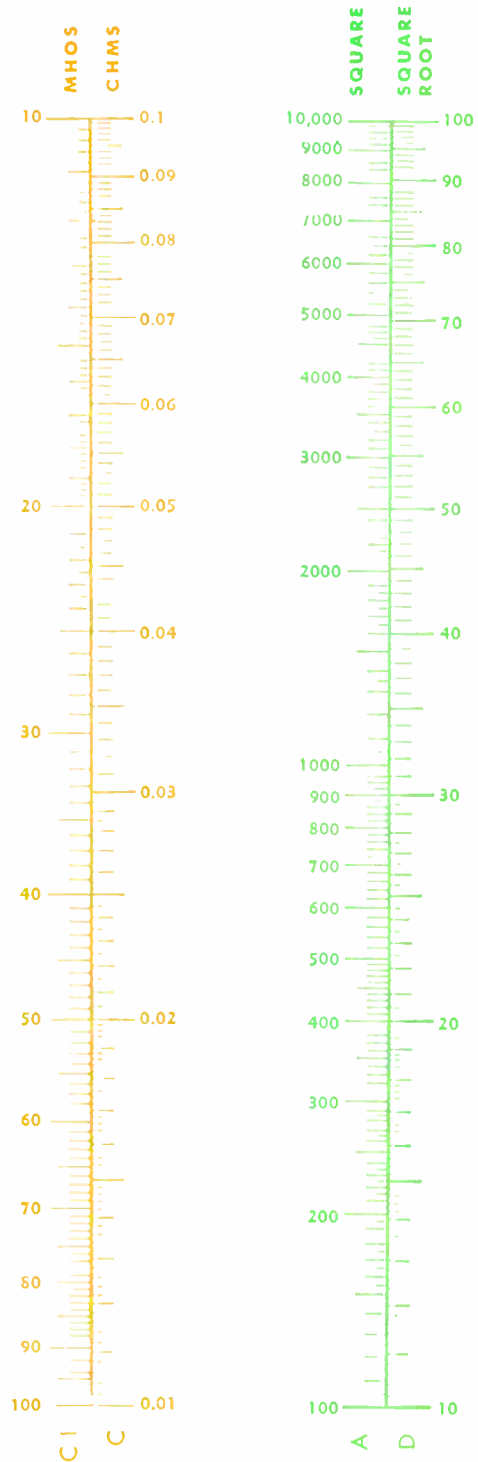
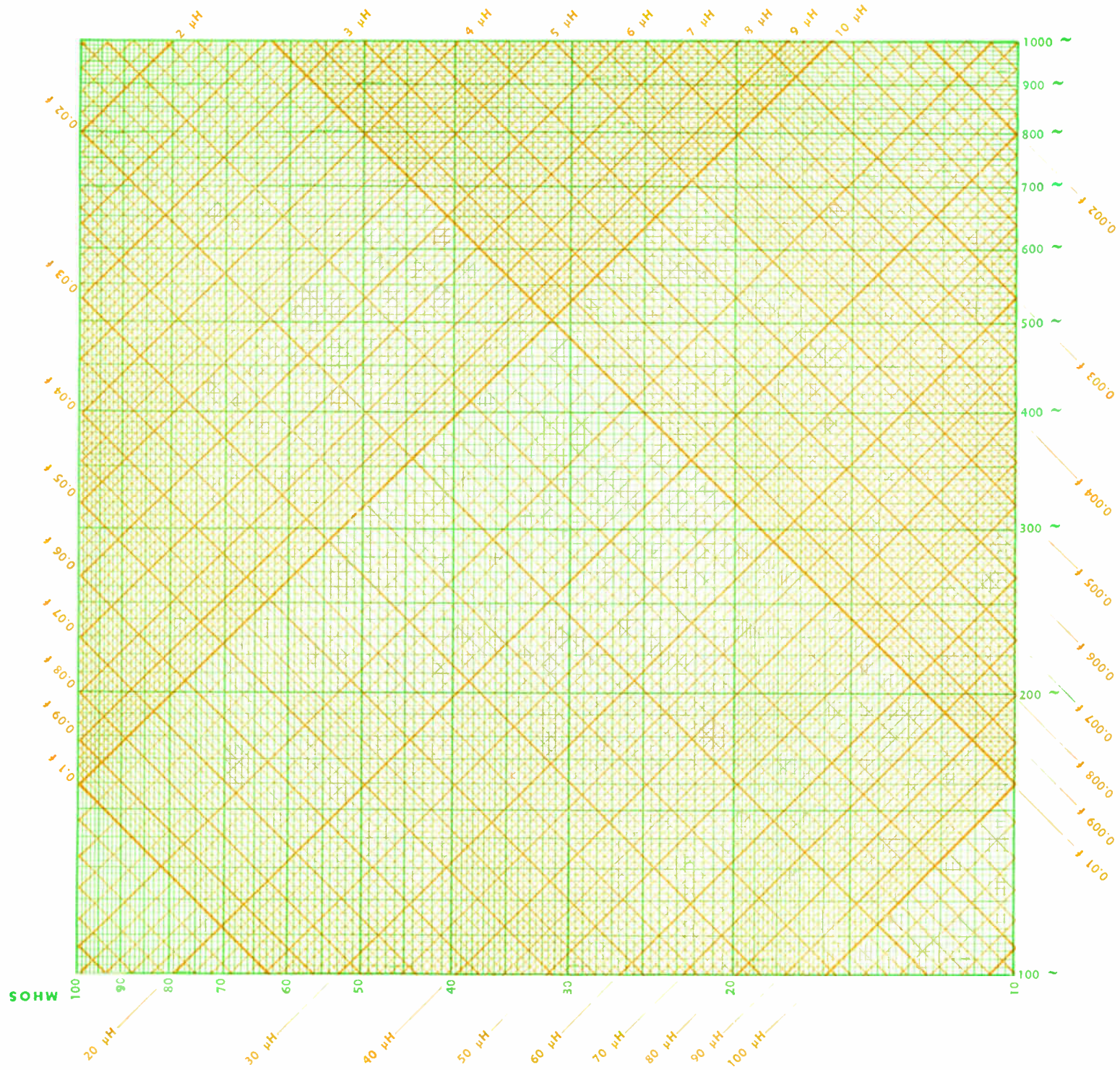


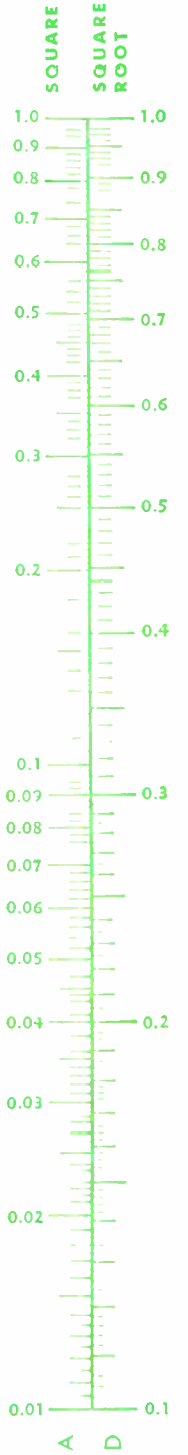
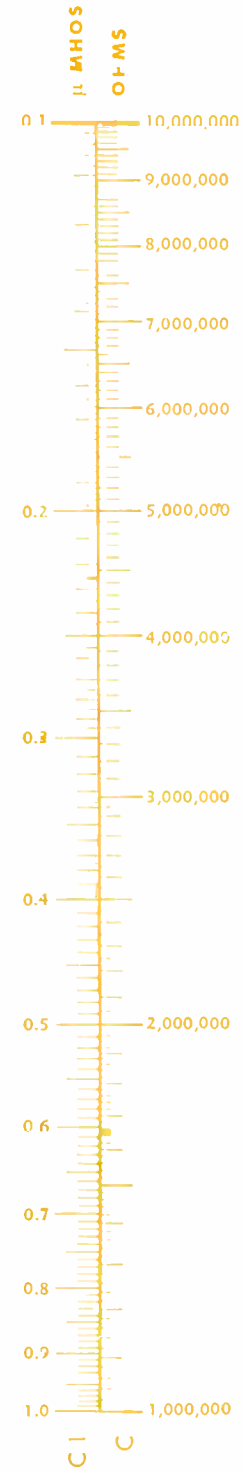
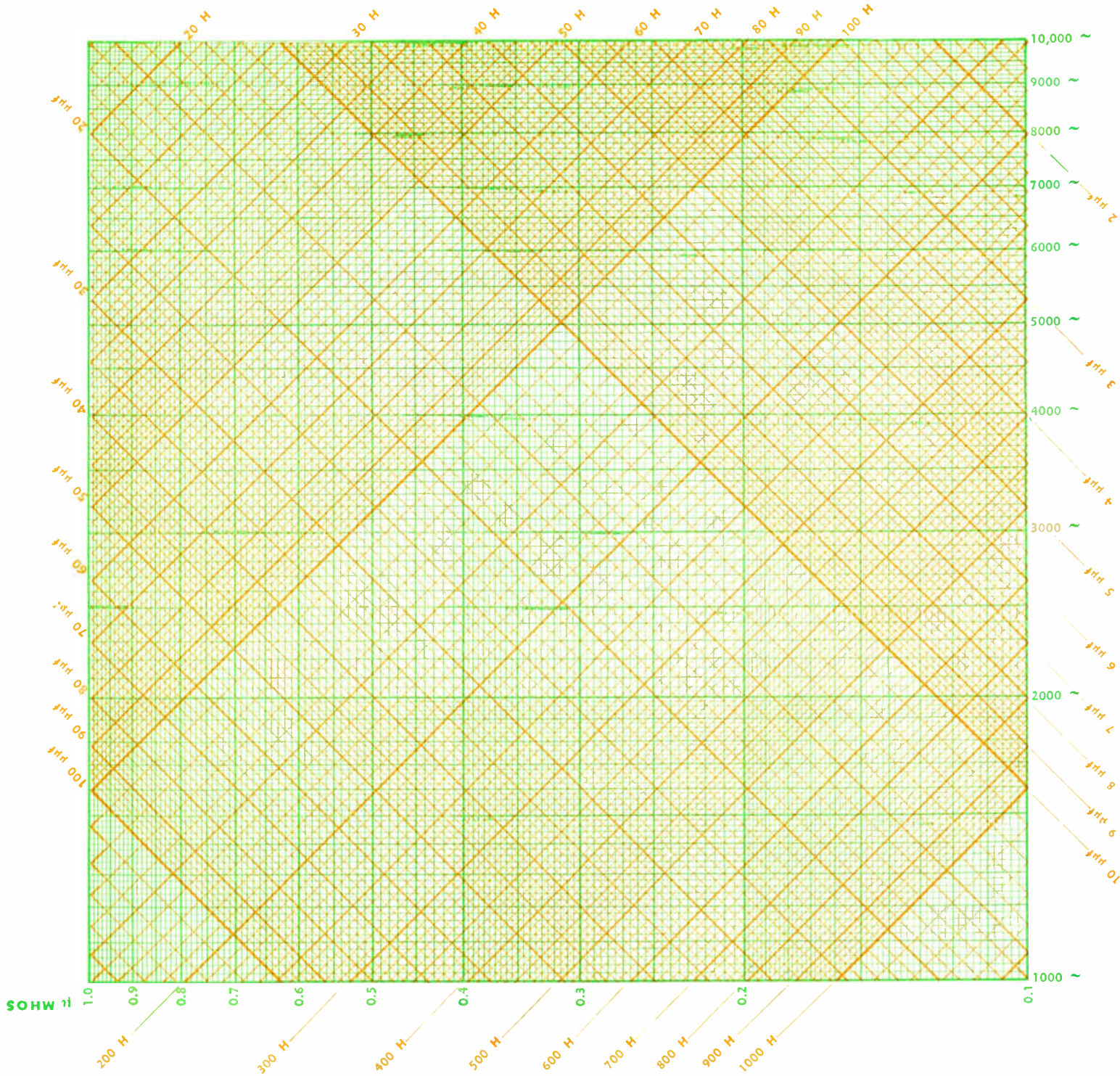
PLATE 88



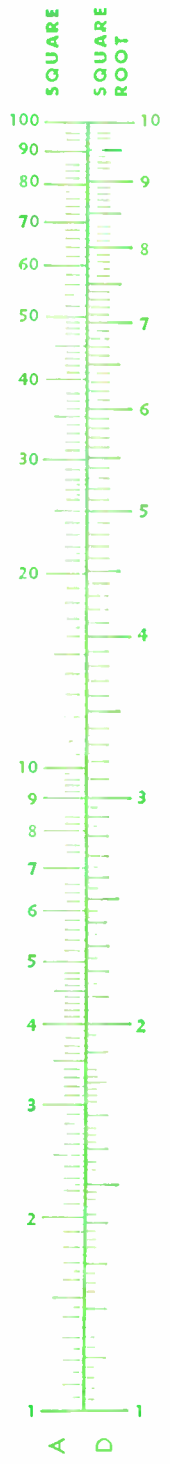
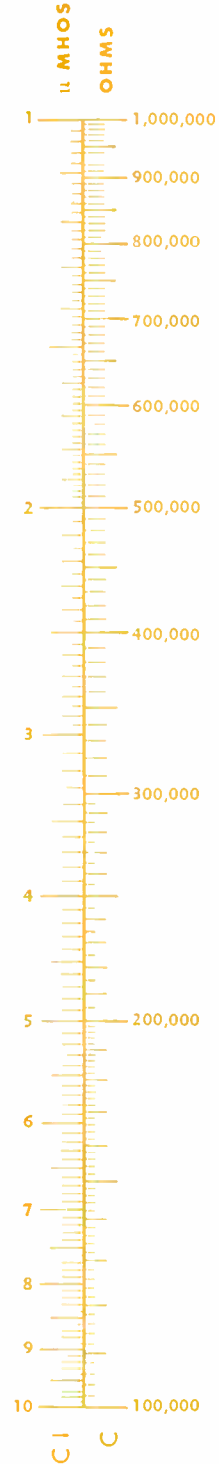
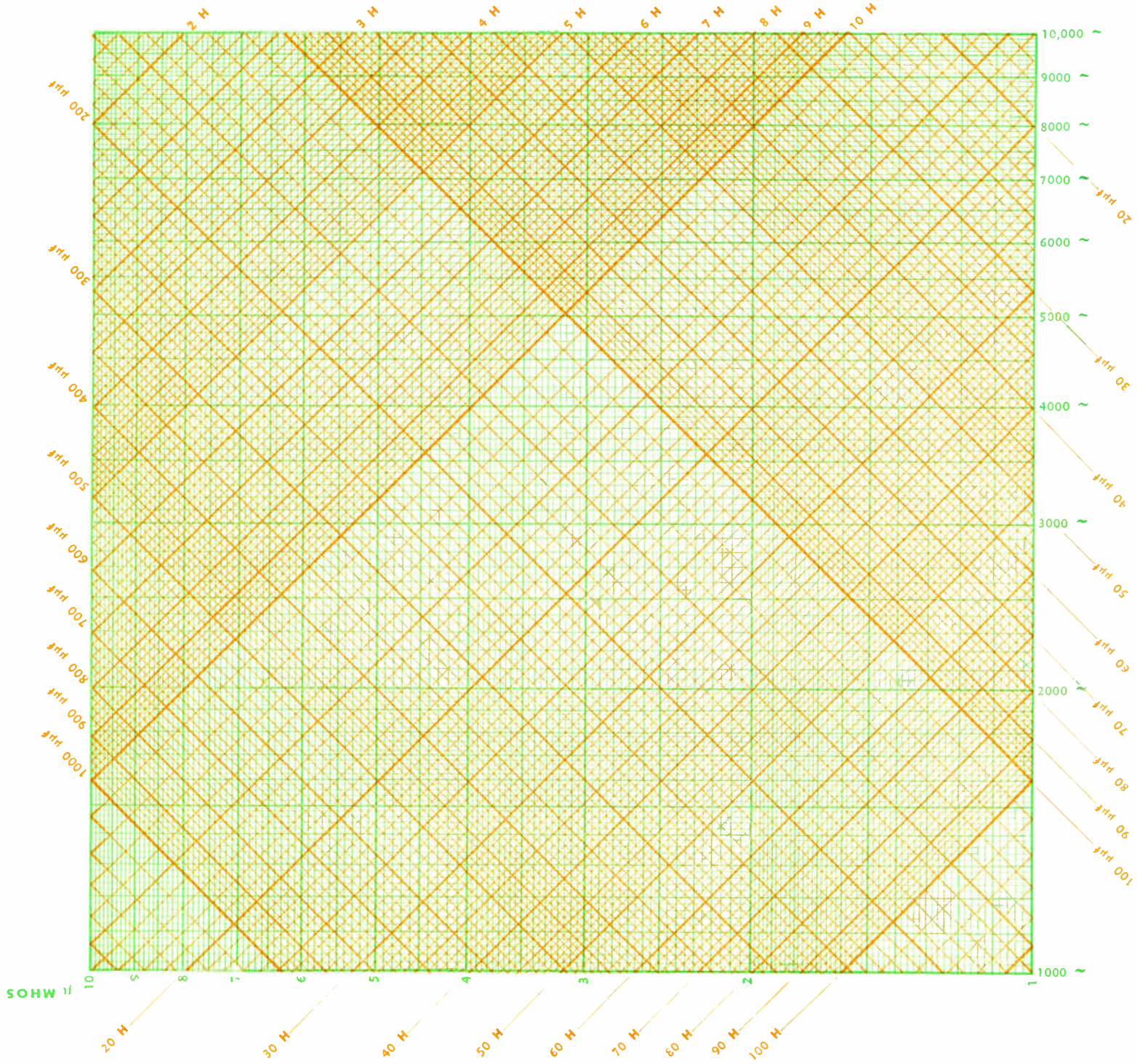


# PLATE 90

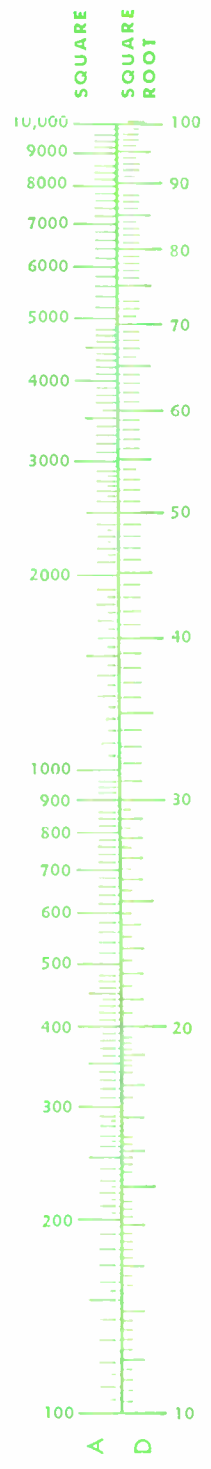
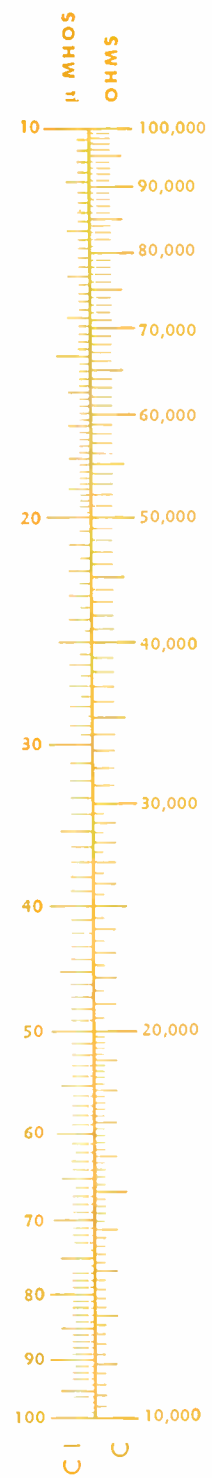
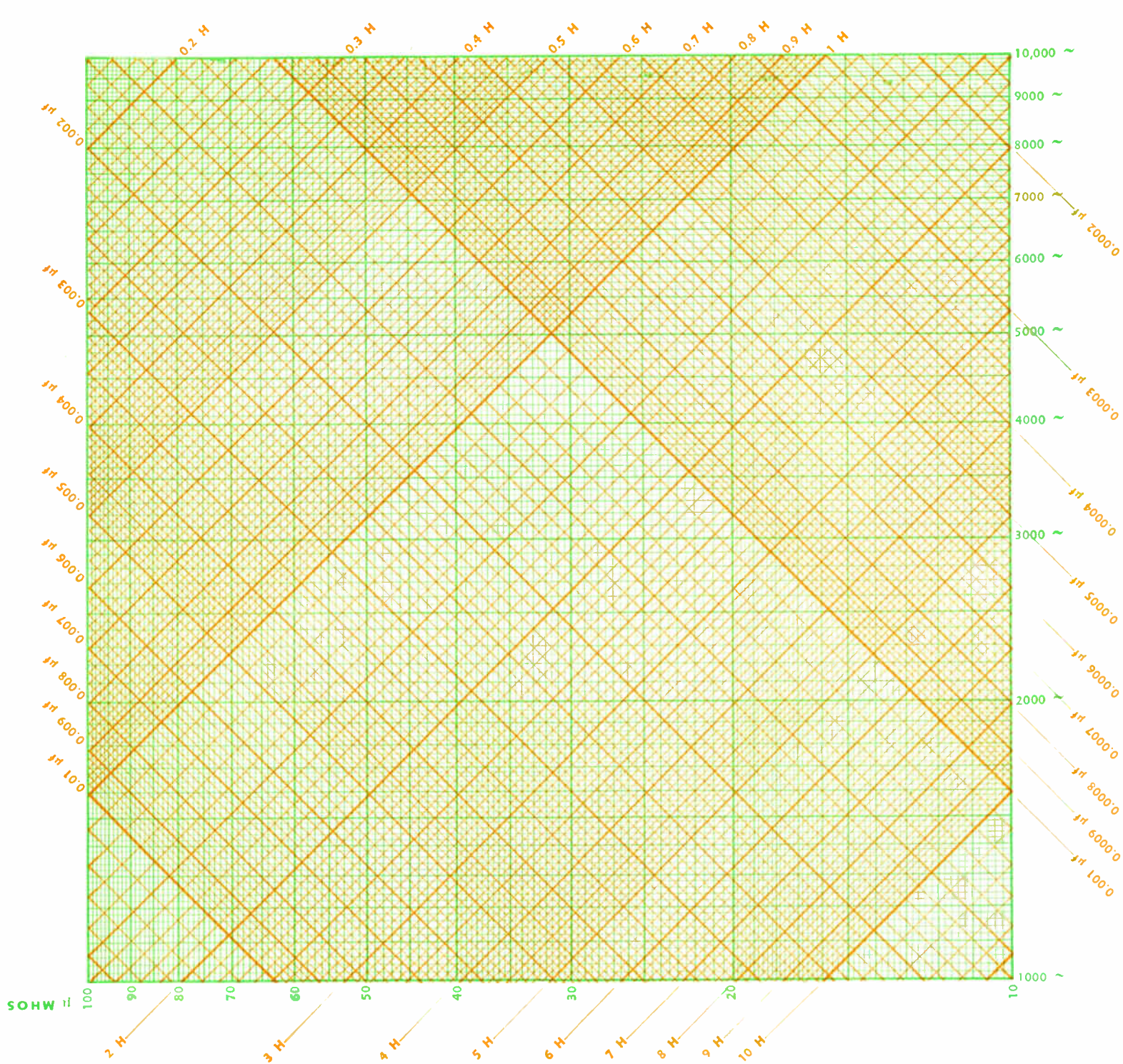




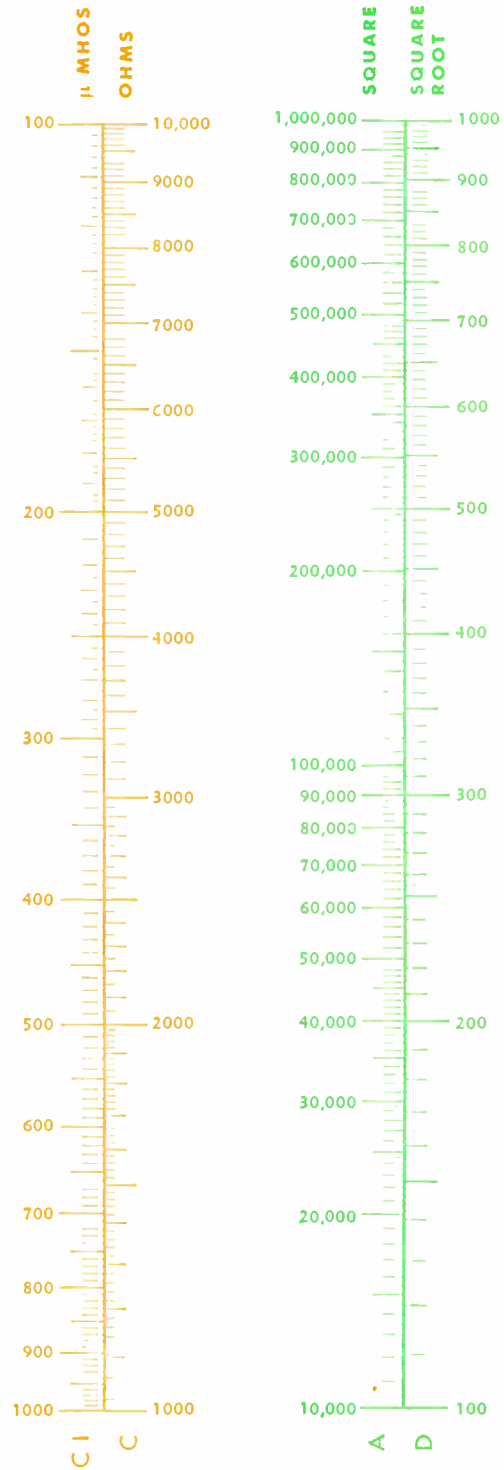
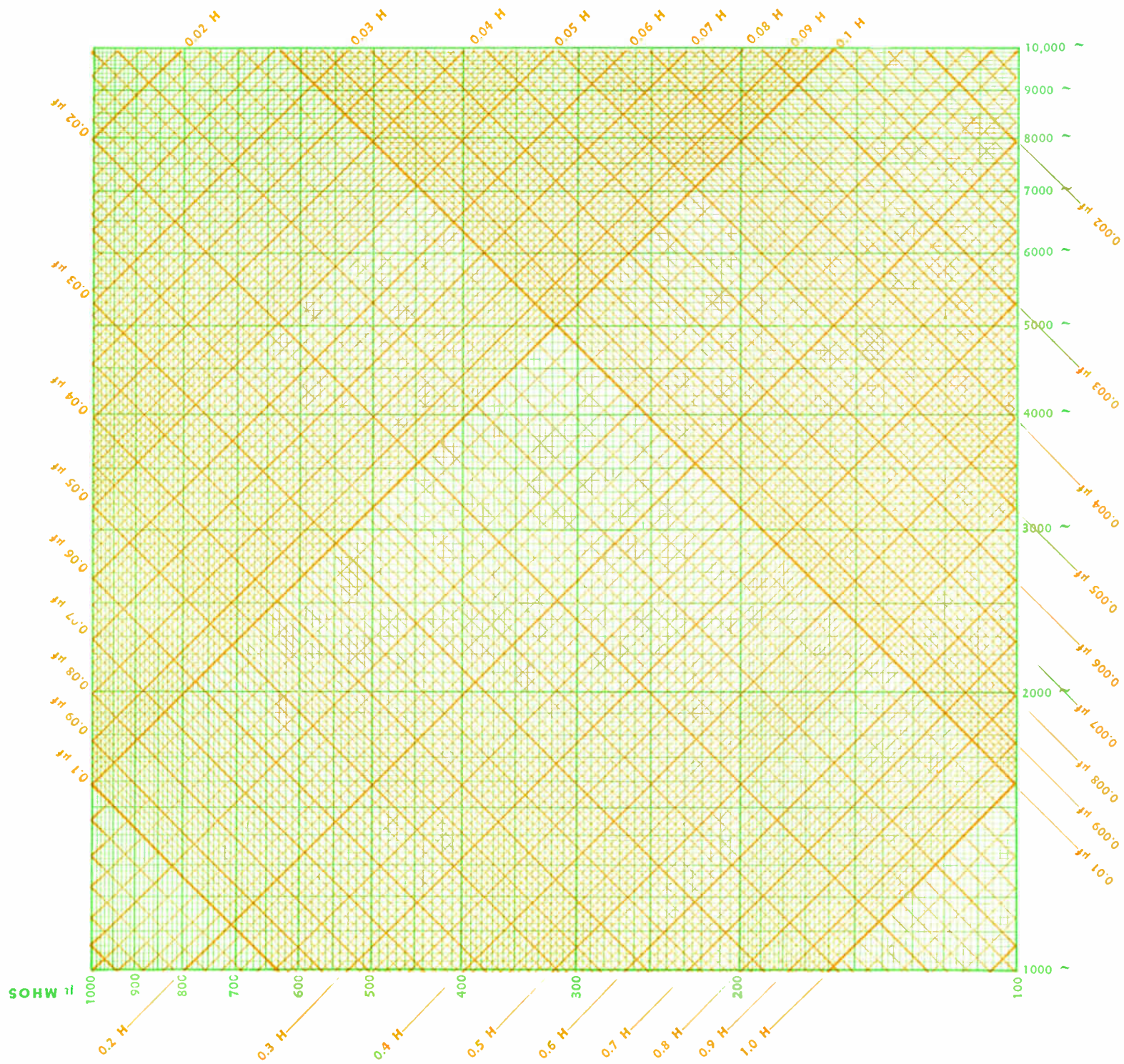
# PLATE 92







# PLATE 94



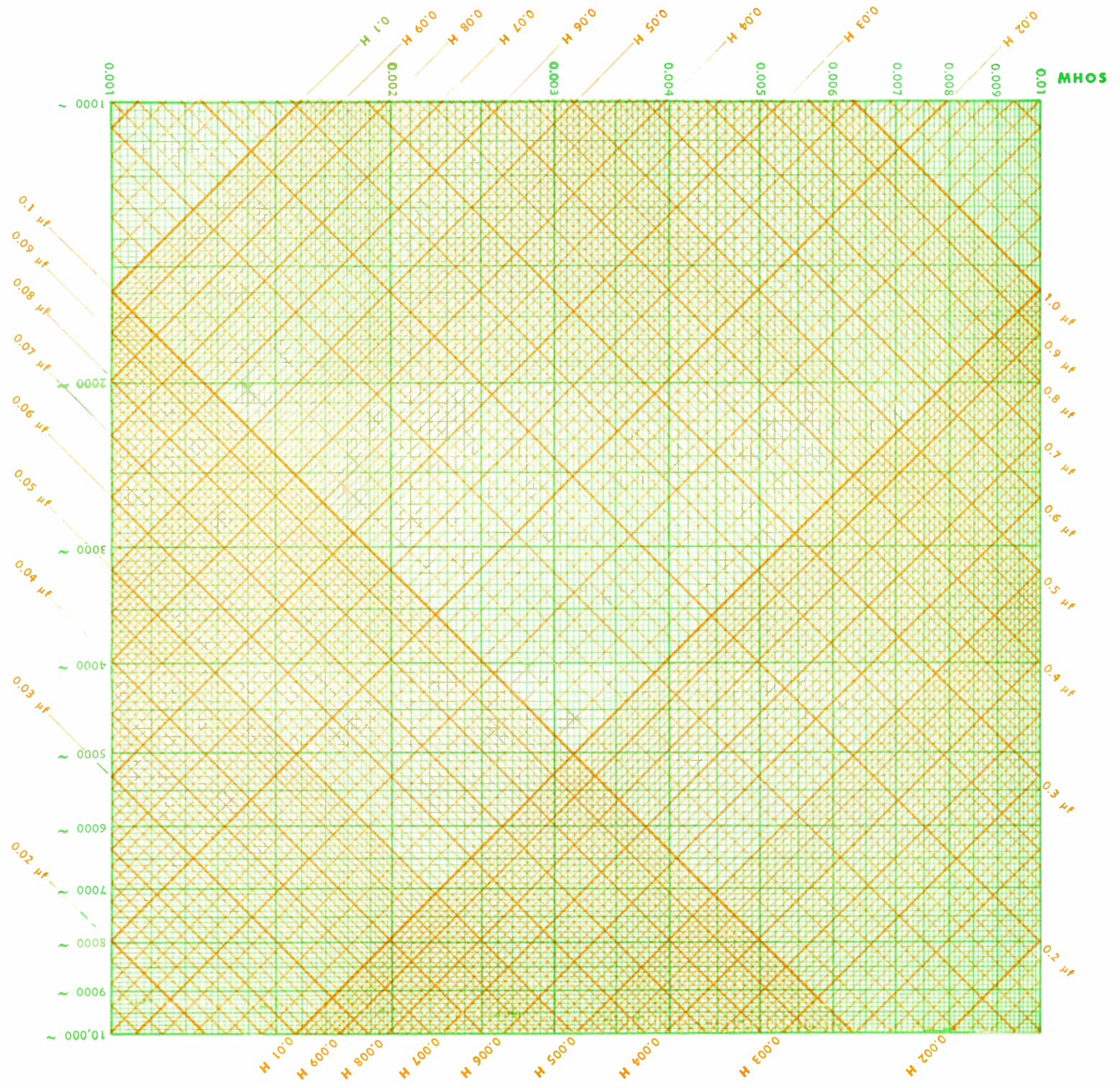
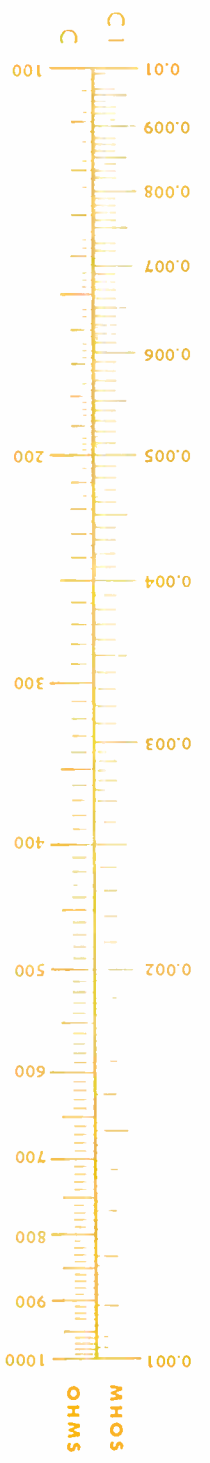
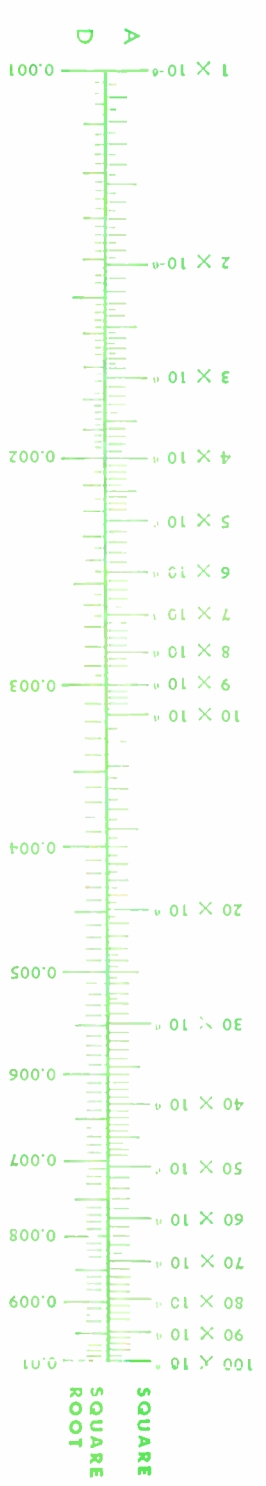
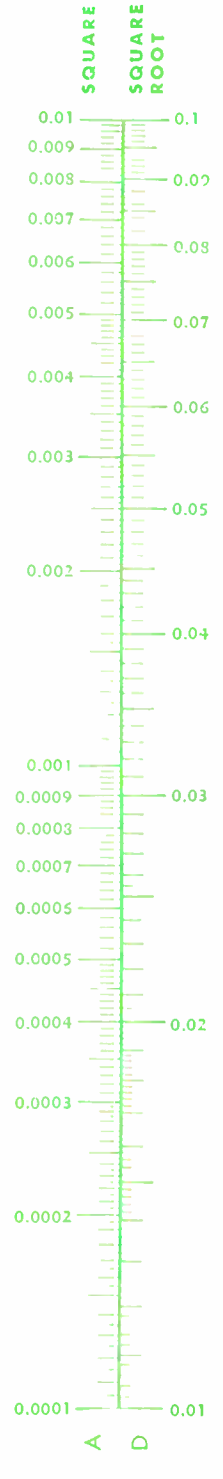
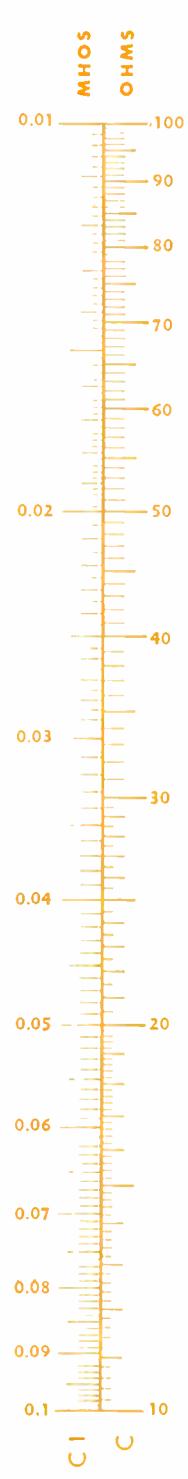
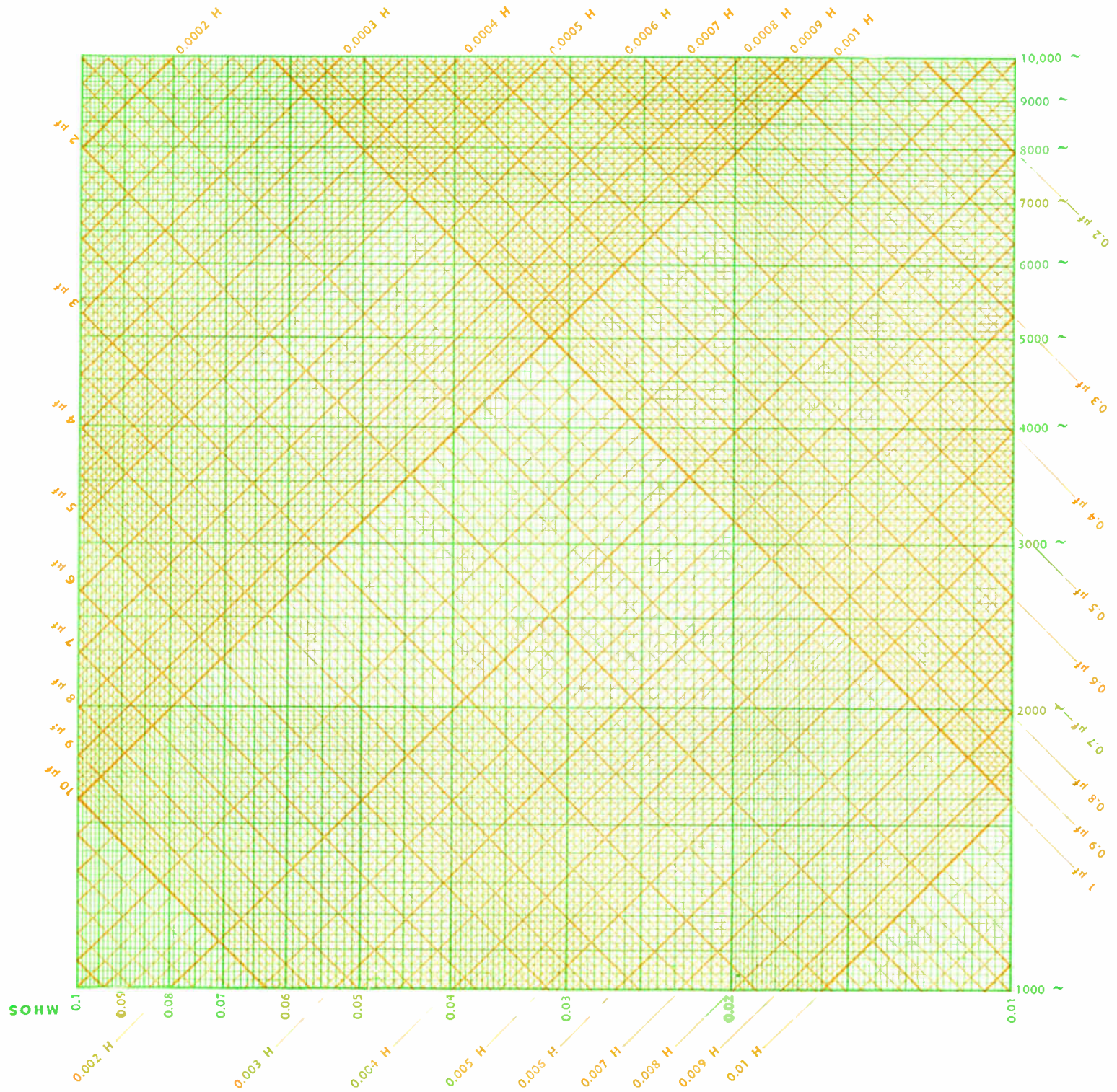
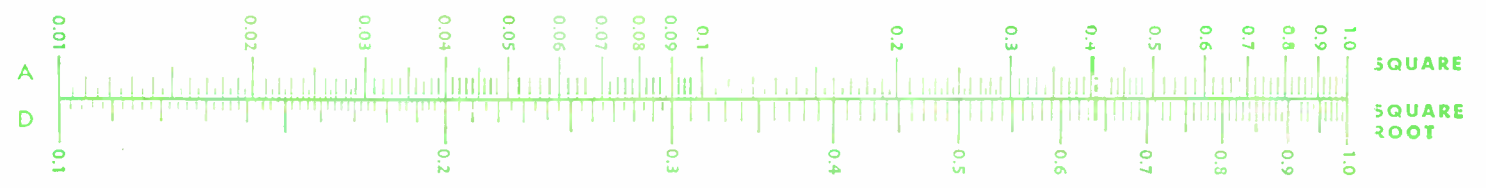
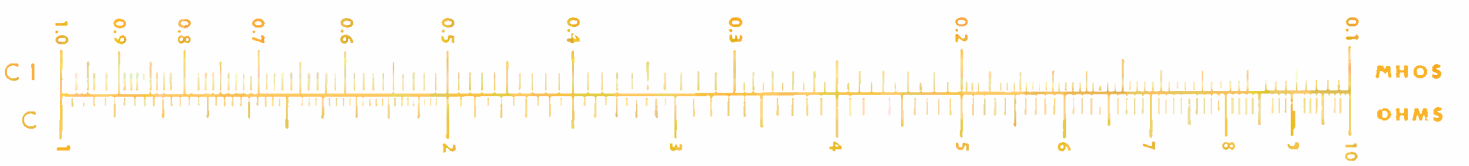
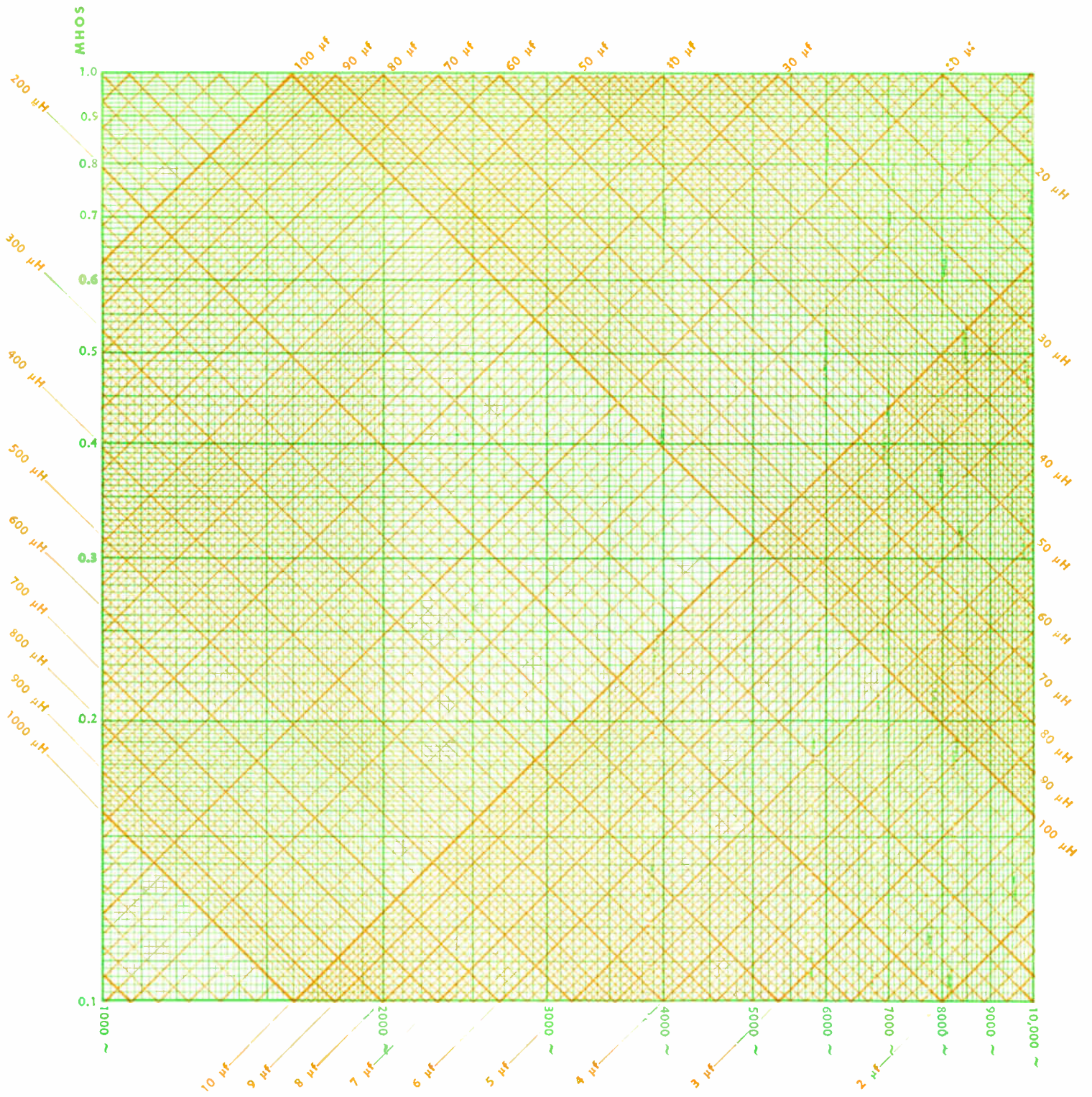


PLATE 96





# PLATE 98

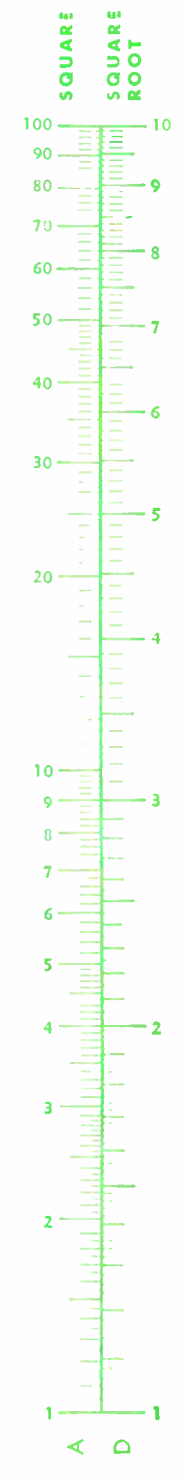
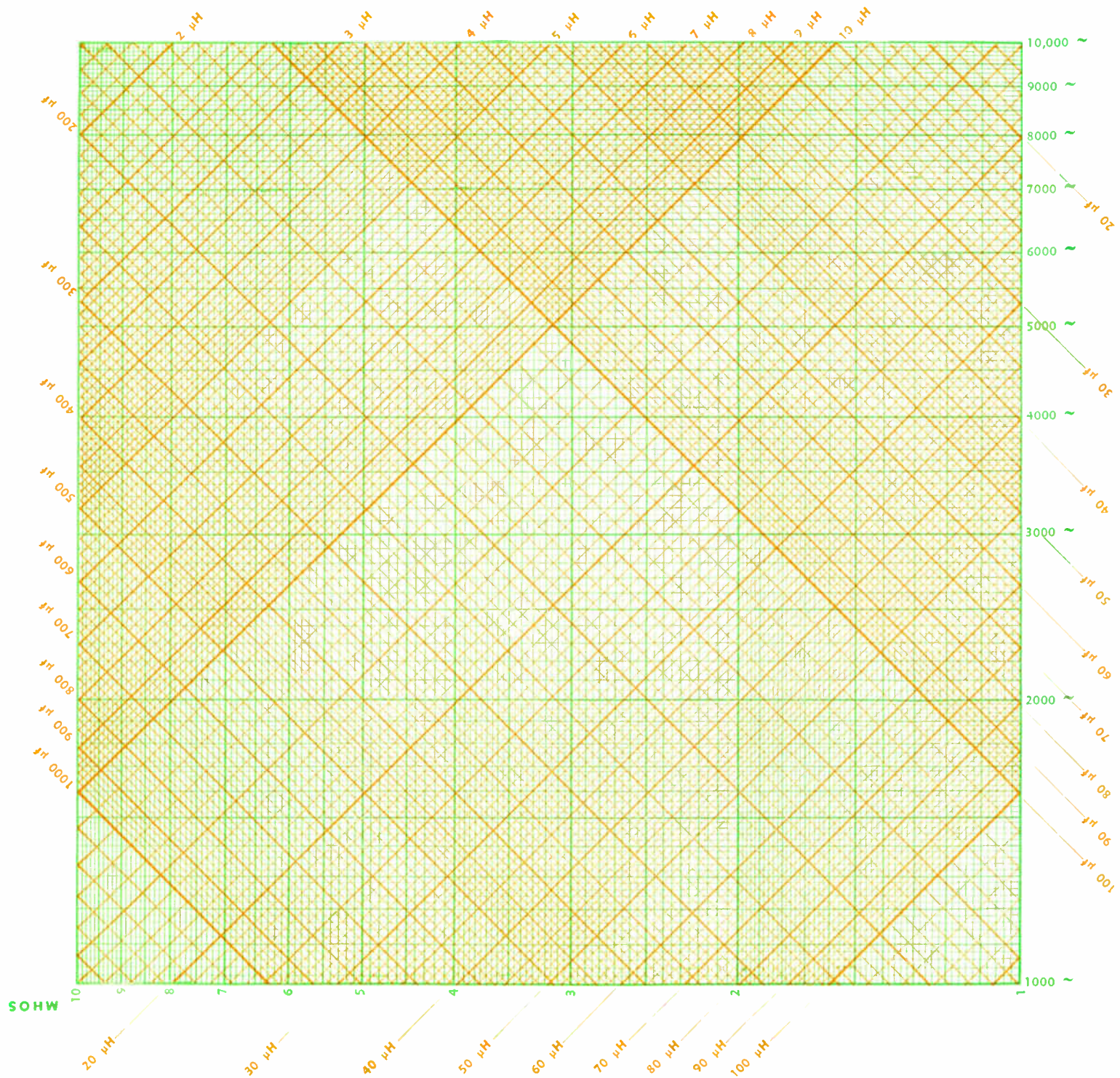
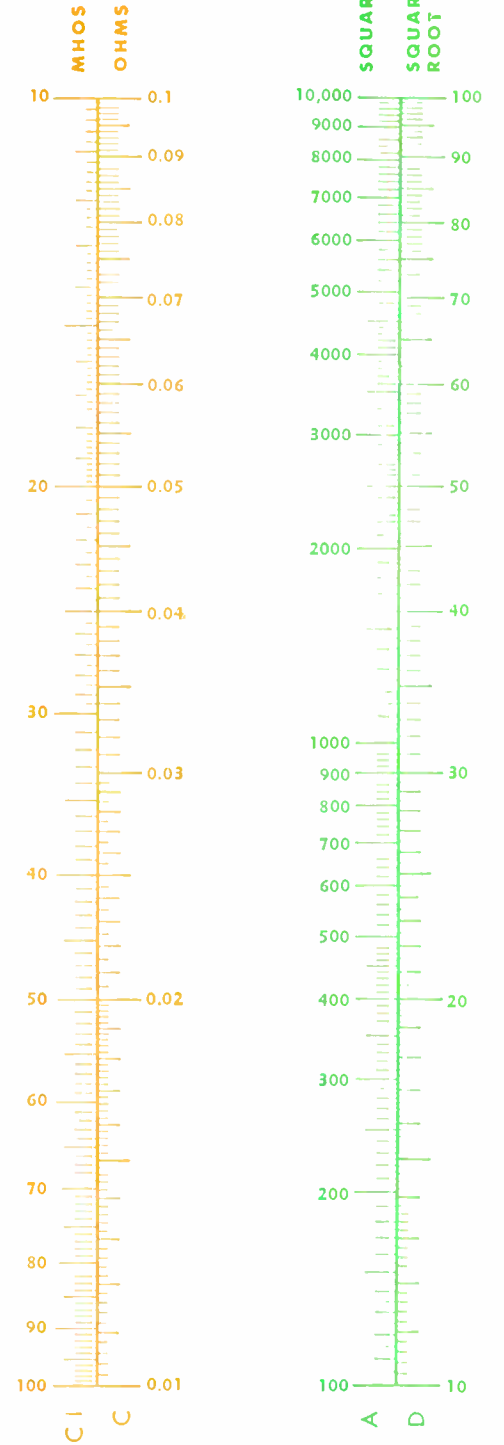
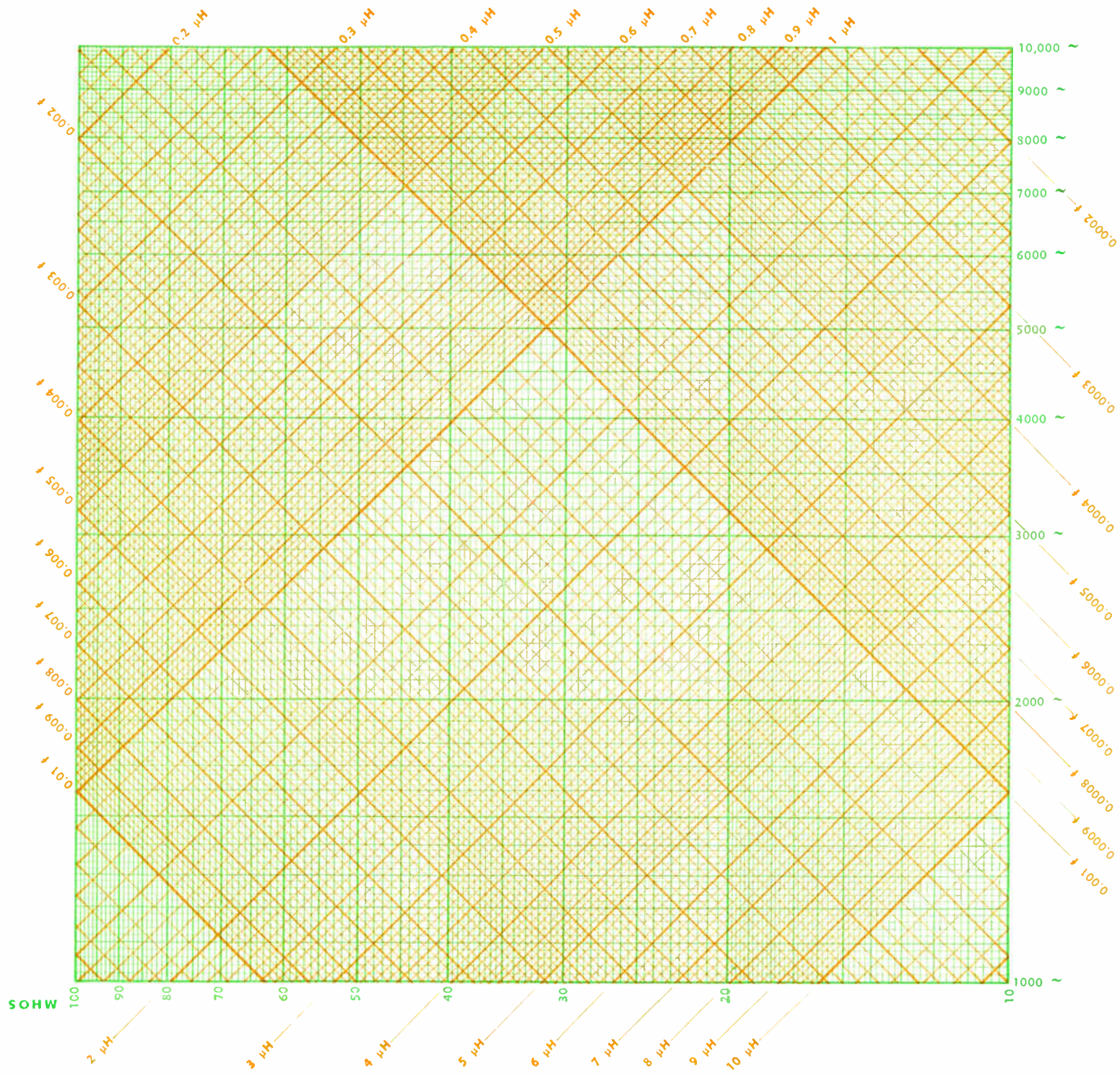
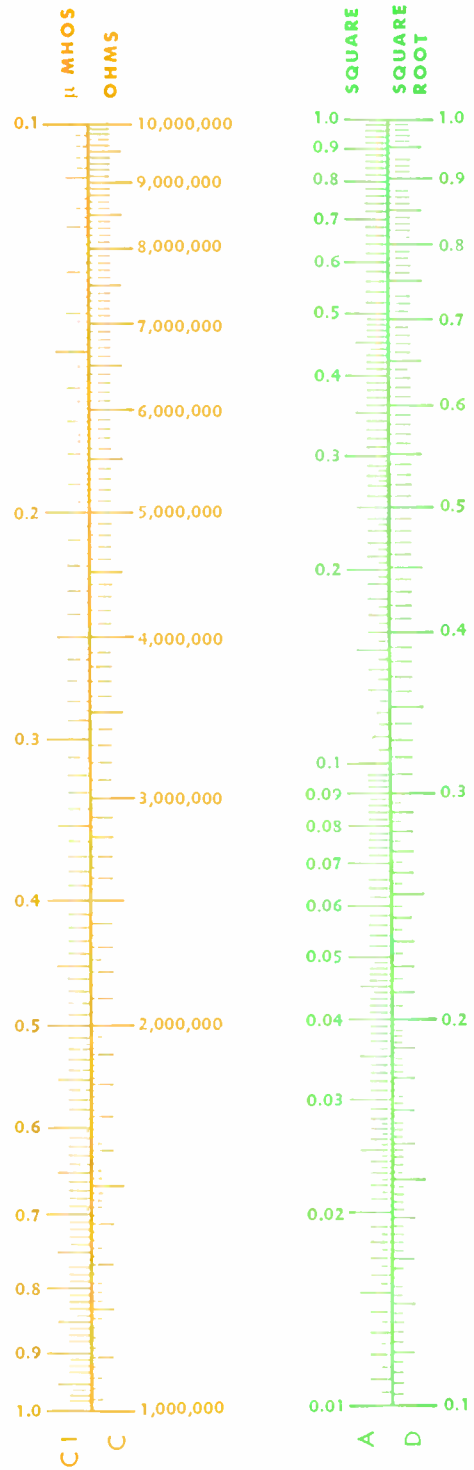
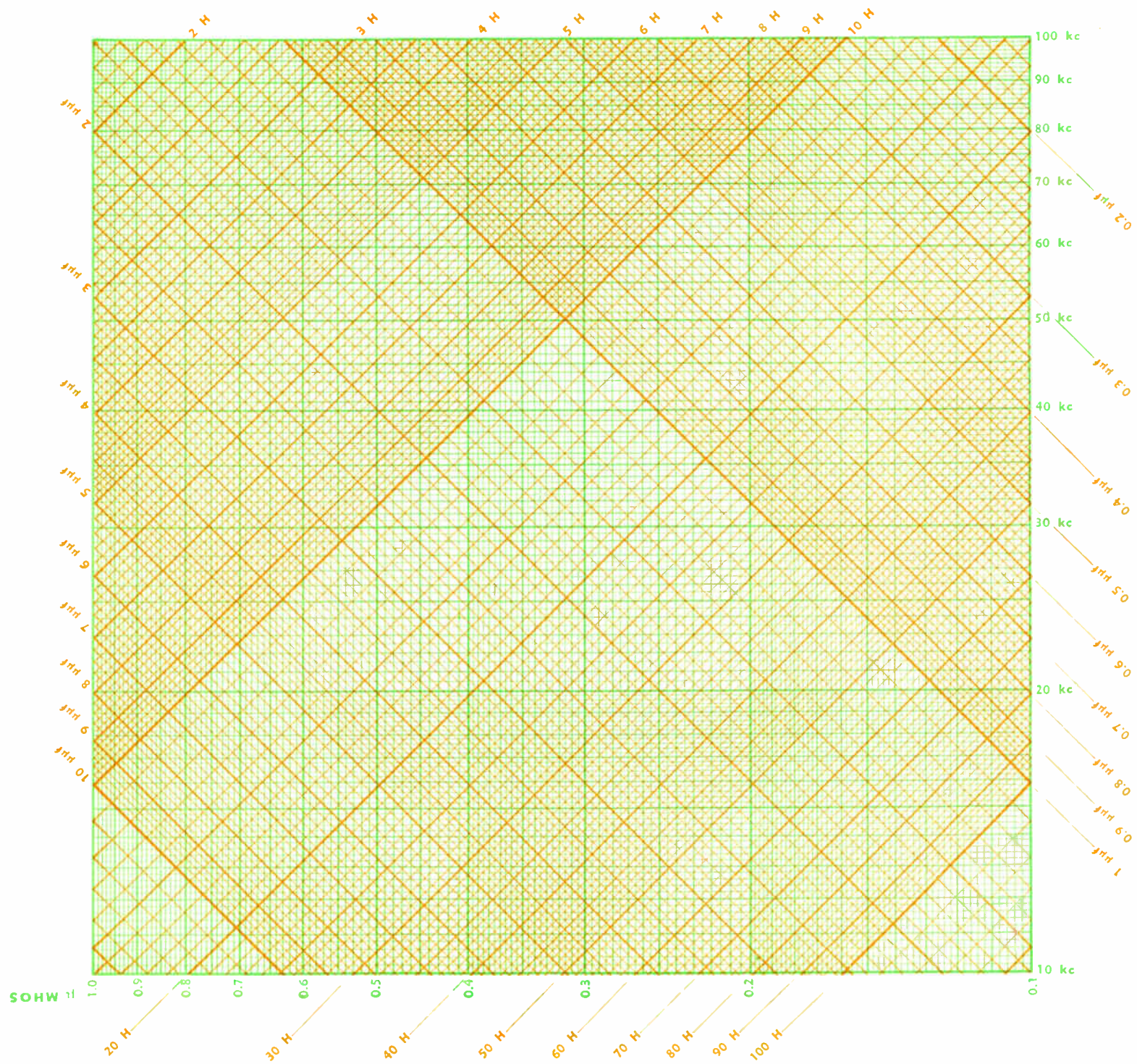


PLATE 99

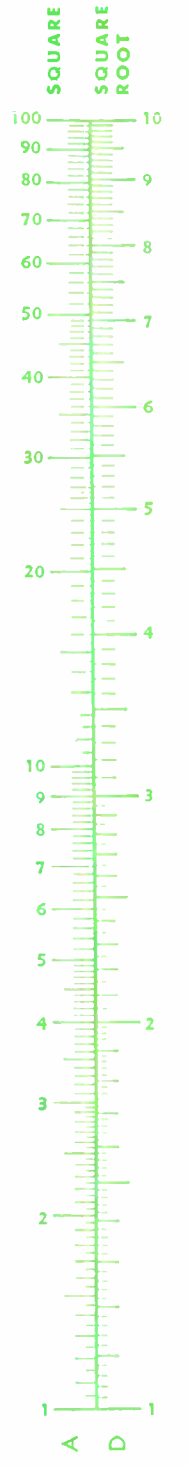
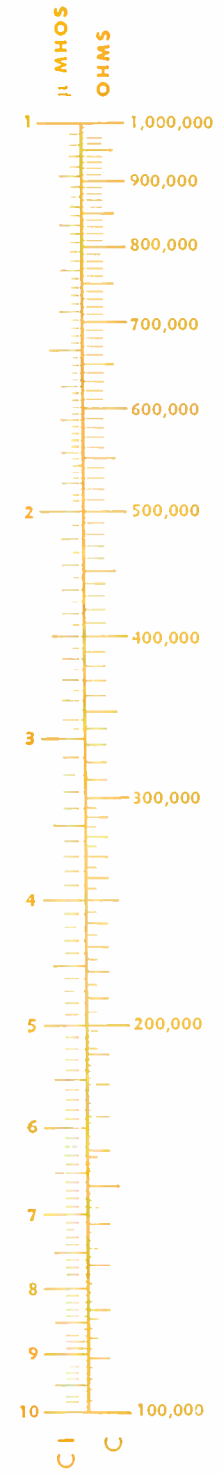
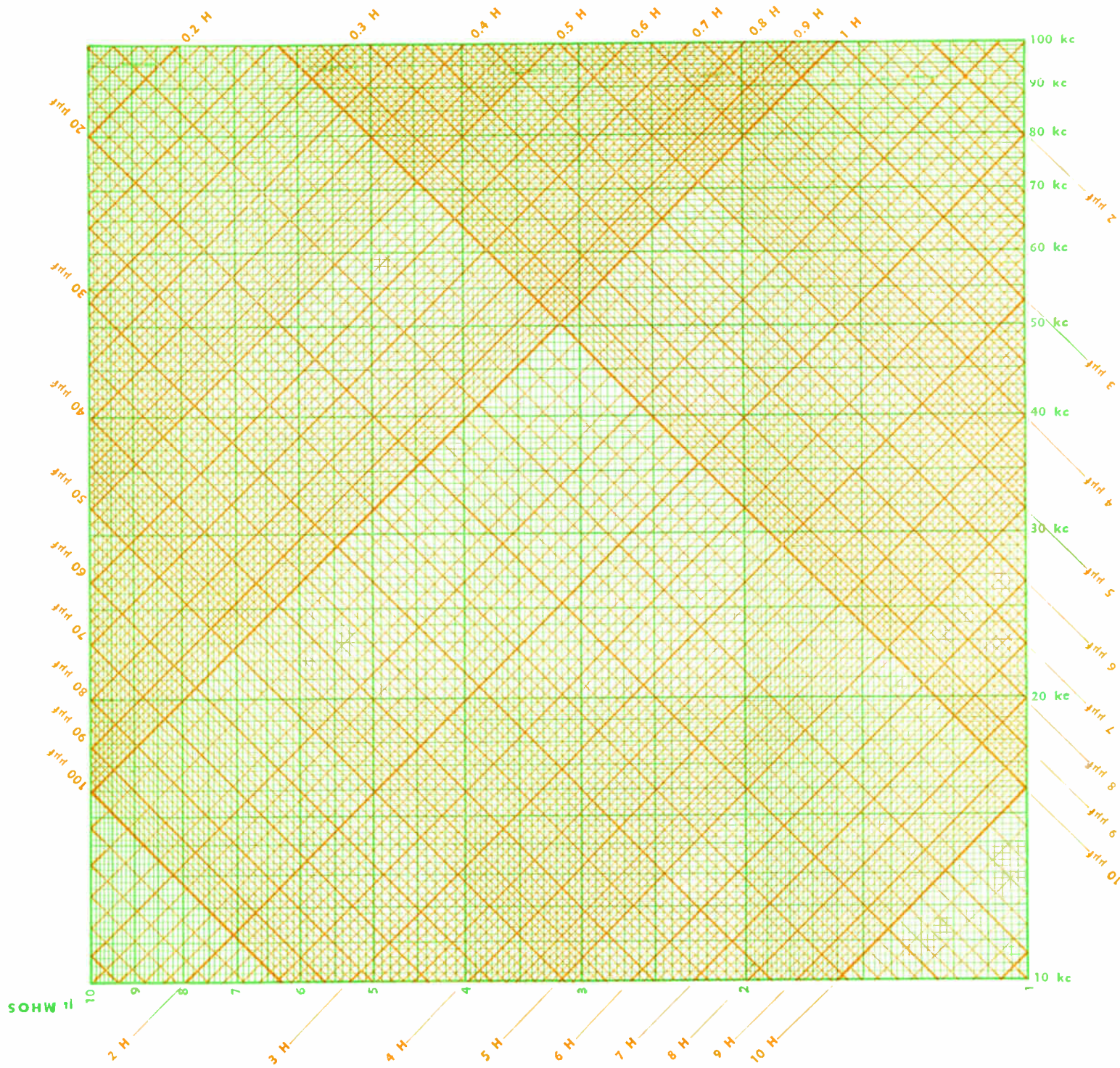


# PLATE 100

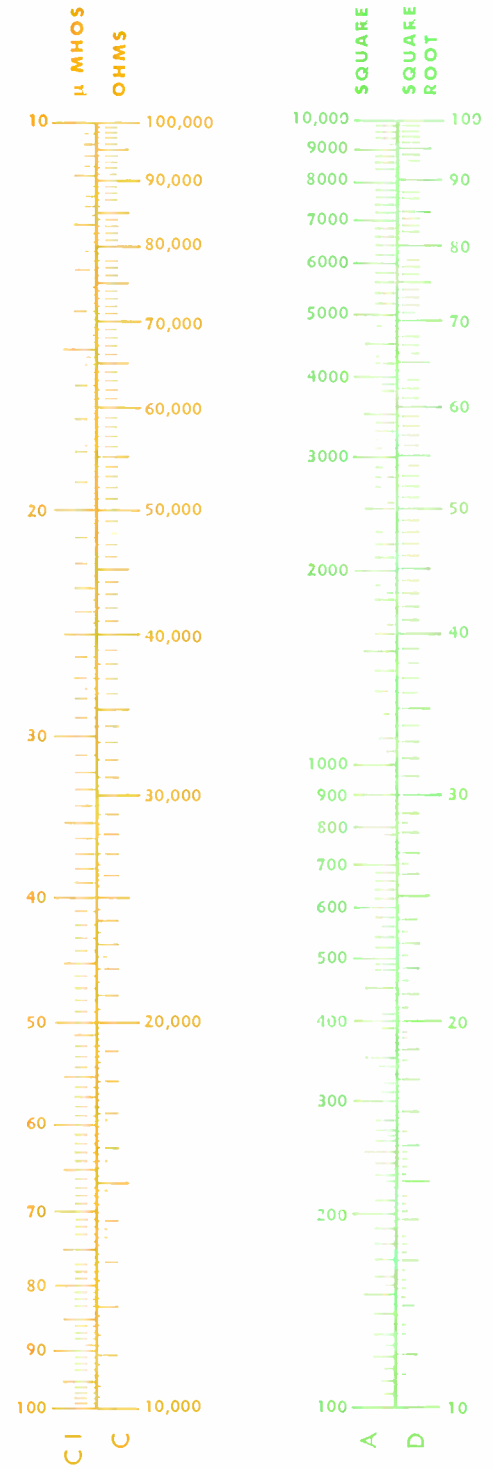
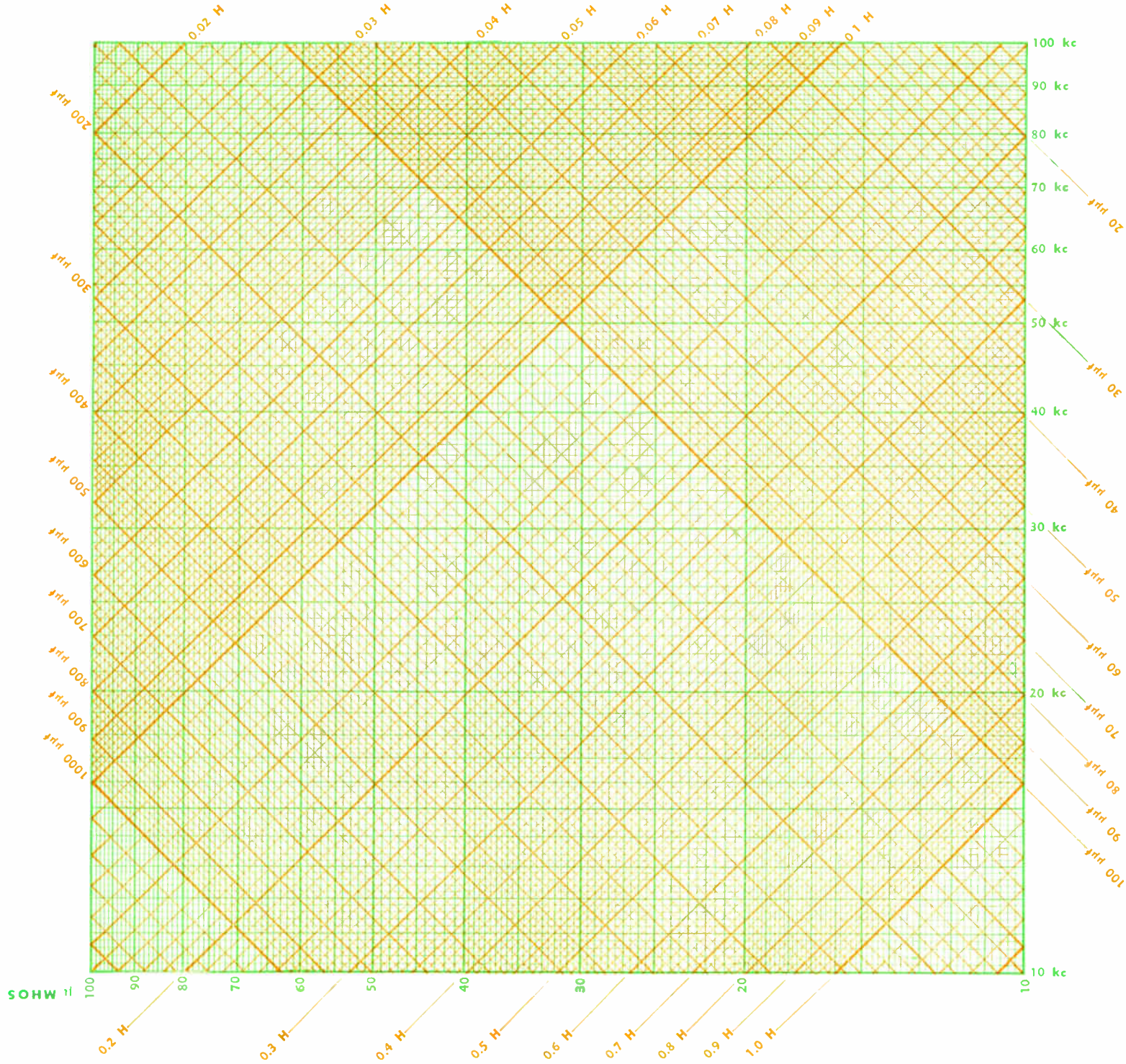




# PLATE 101



# PLATE 102



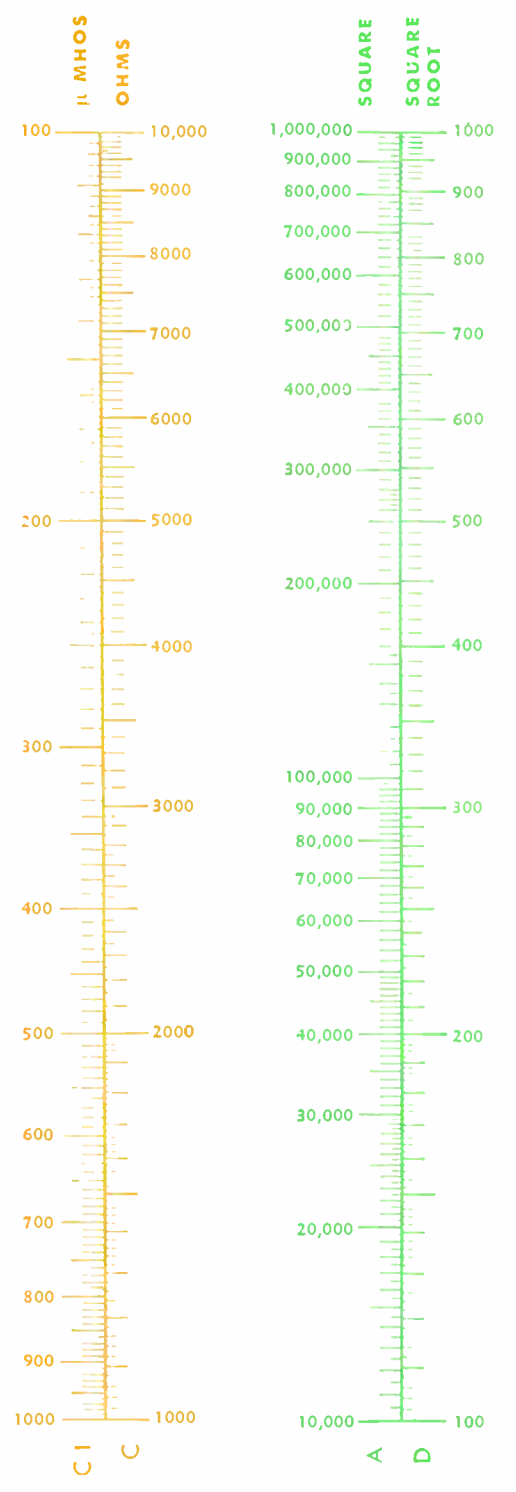
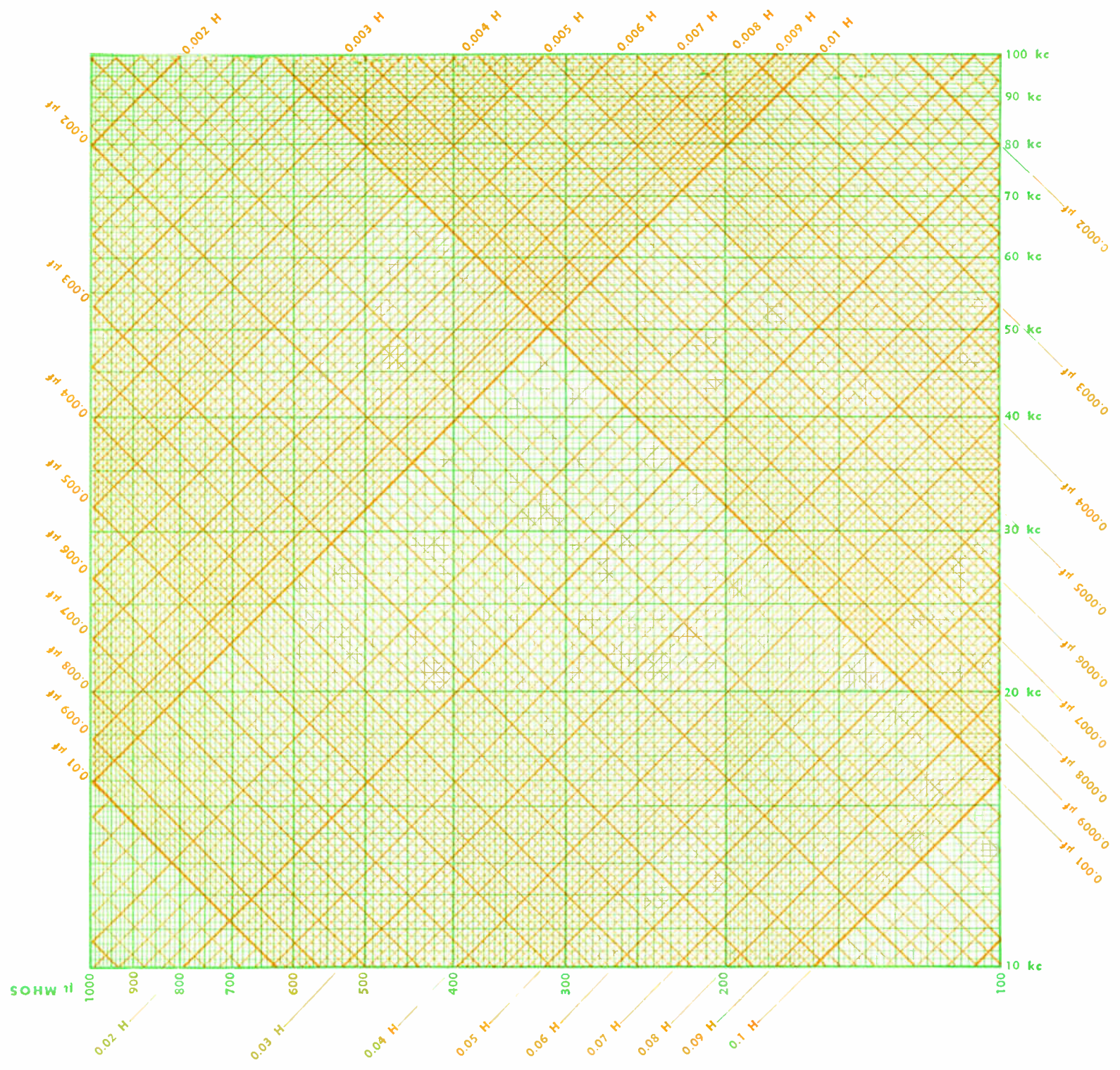


PLATE 104

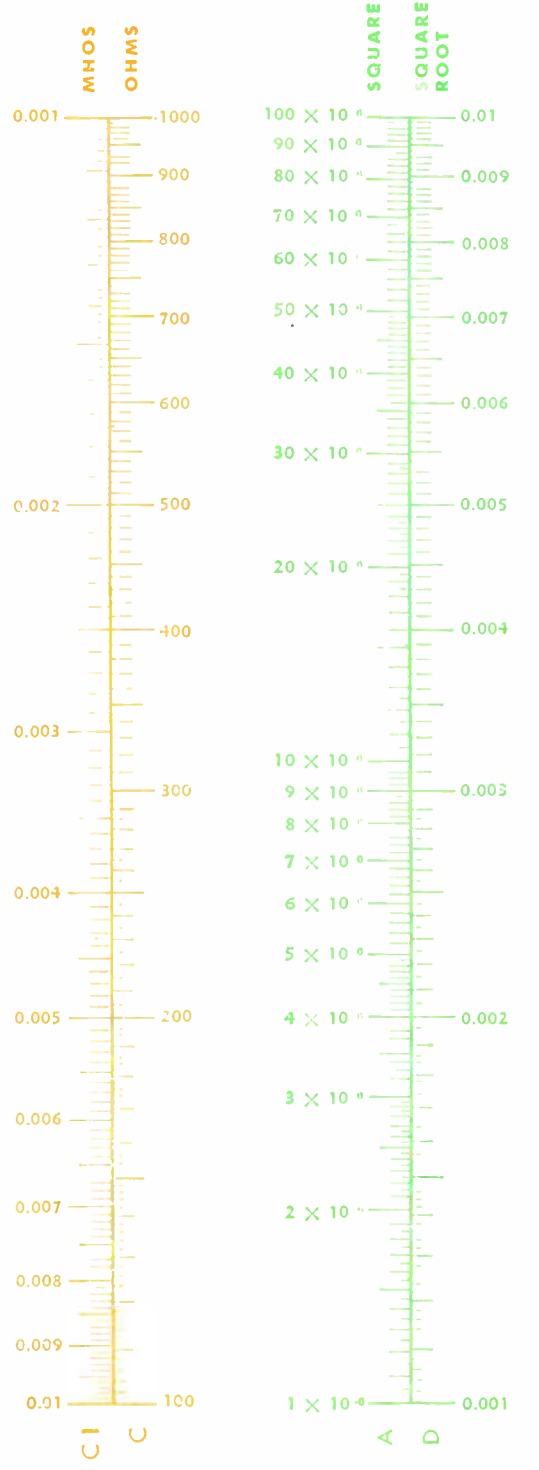
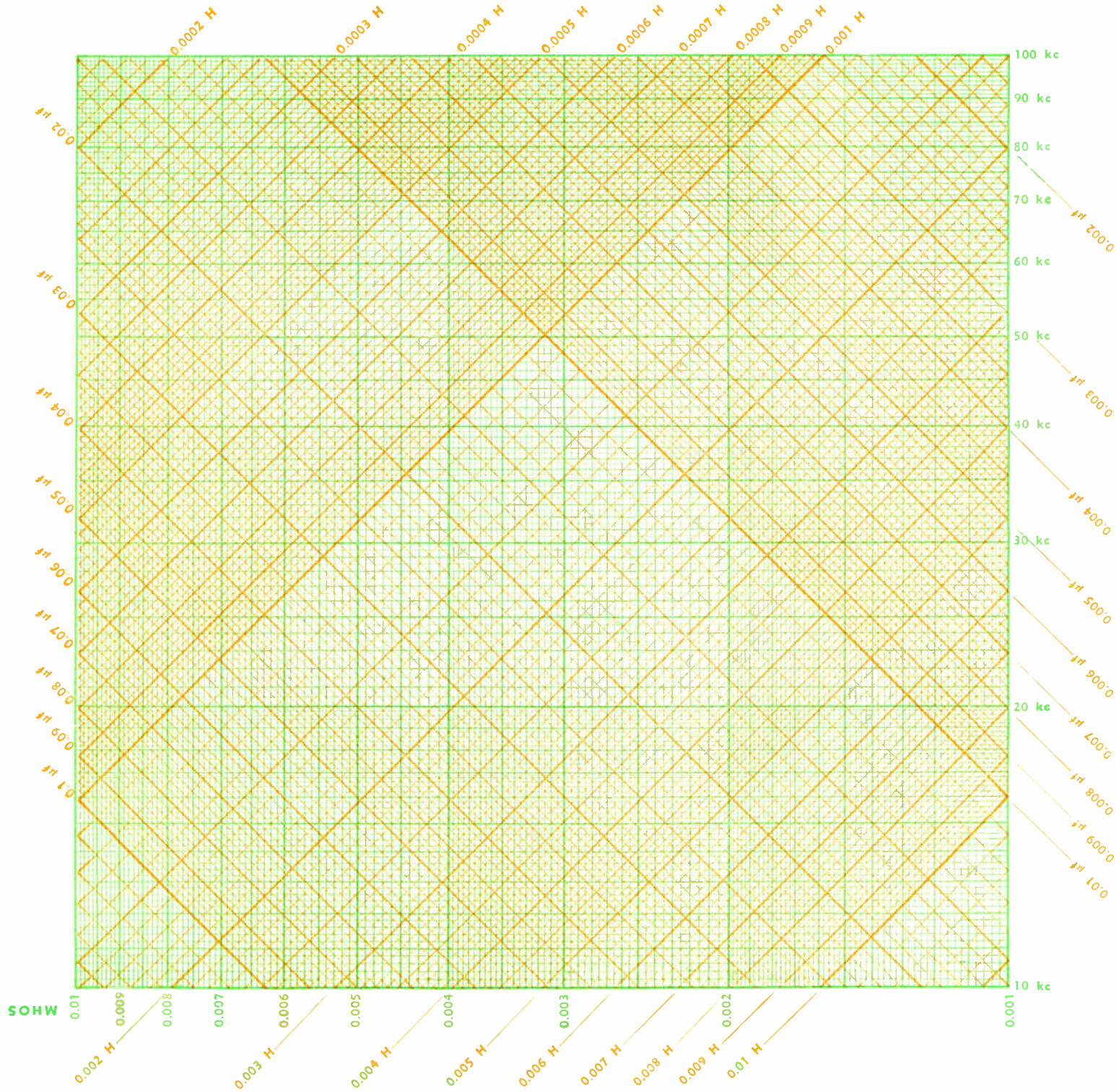
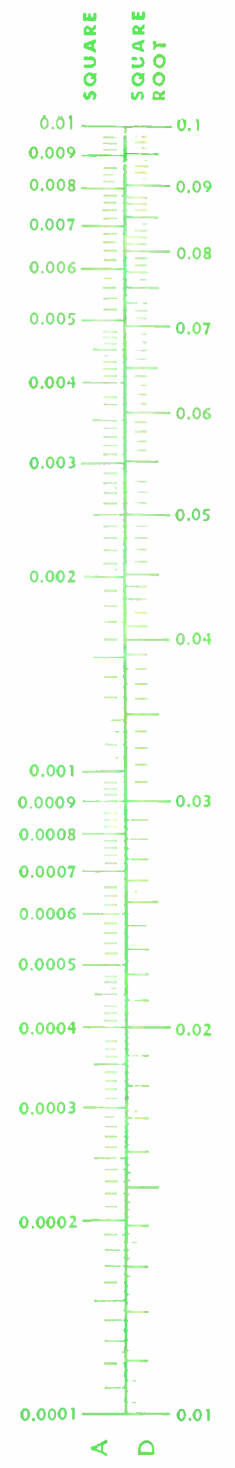
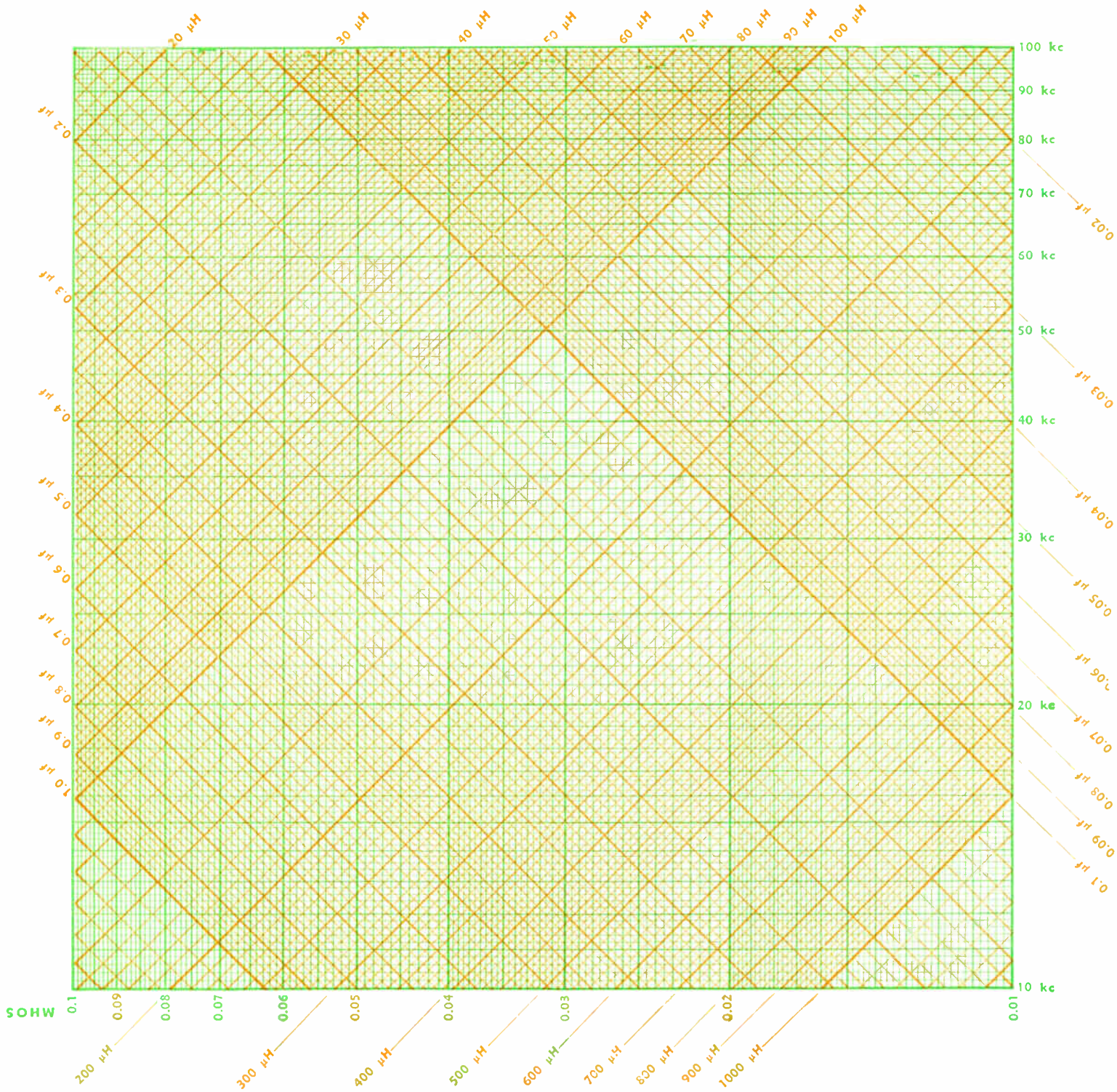
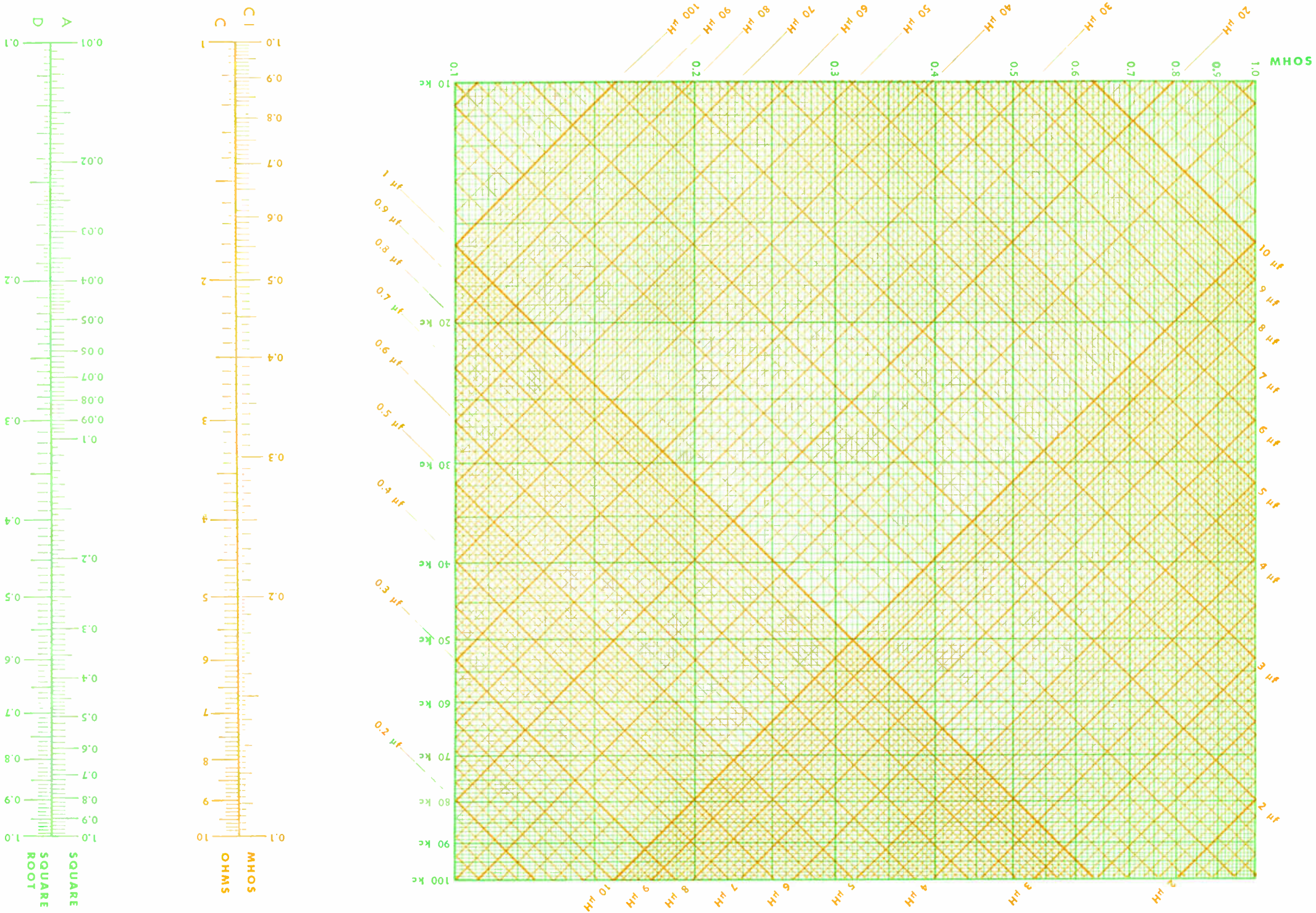


PLATE 105





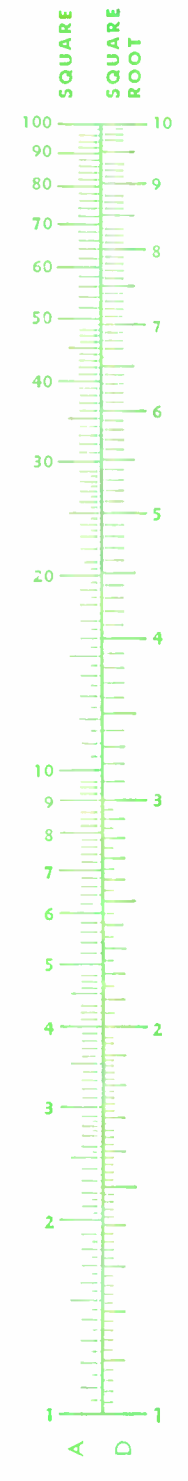
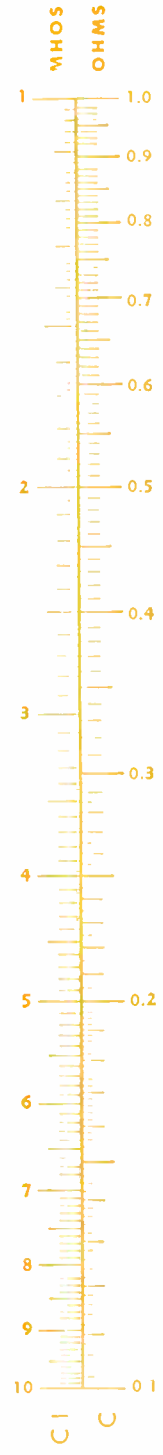
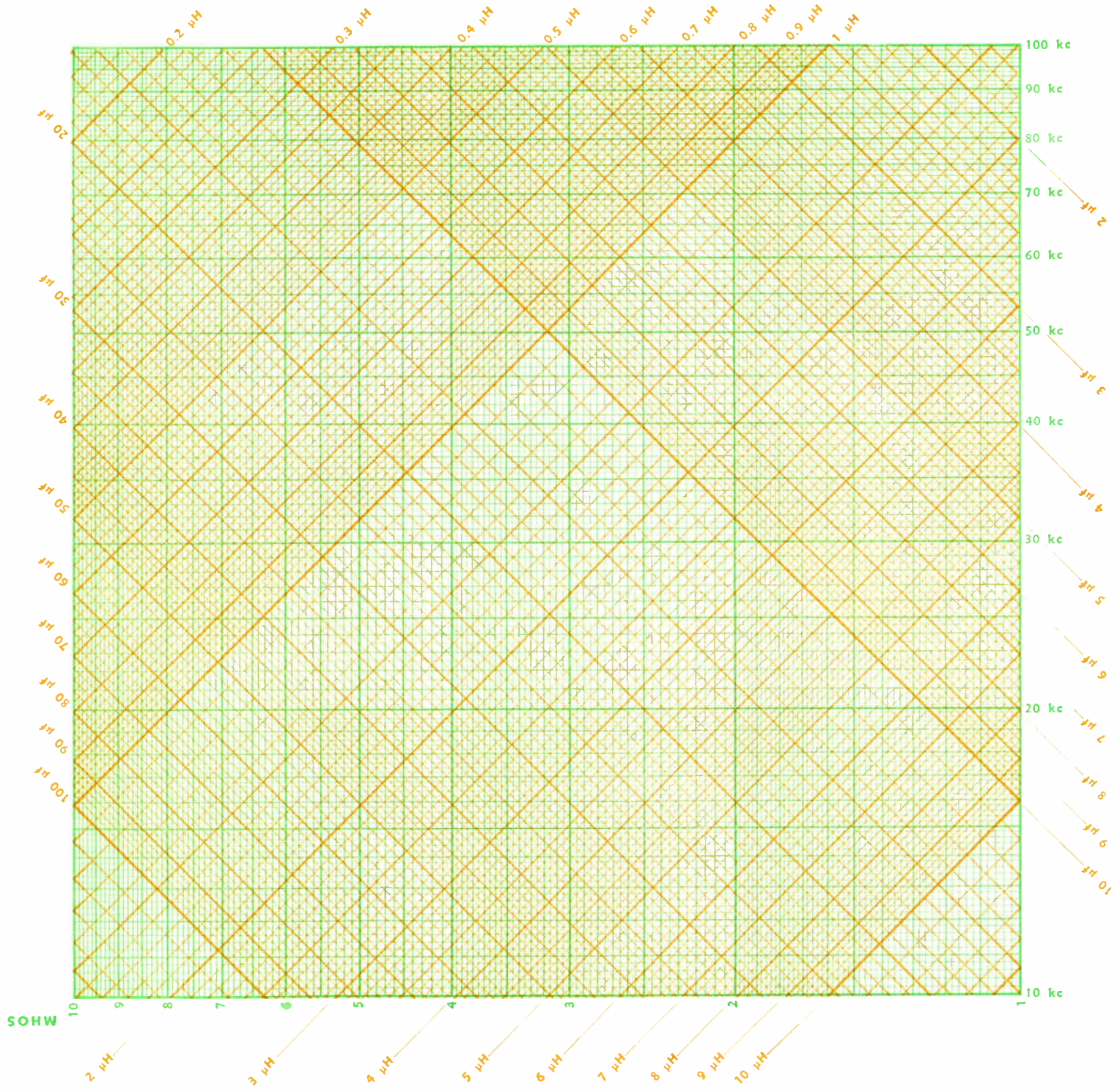
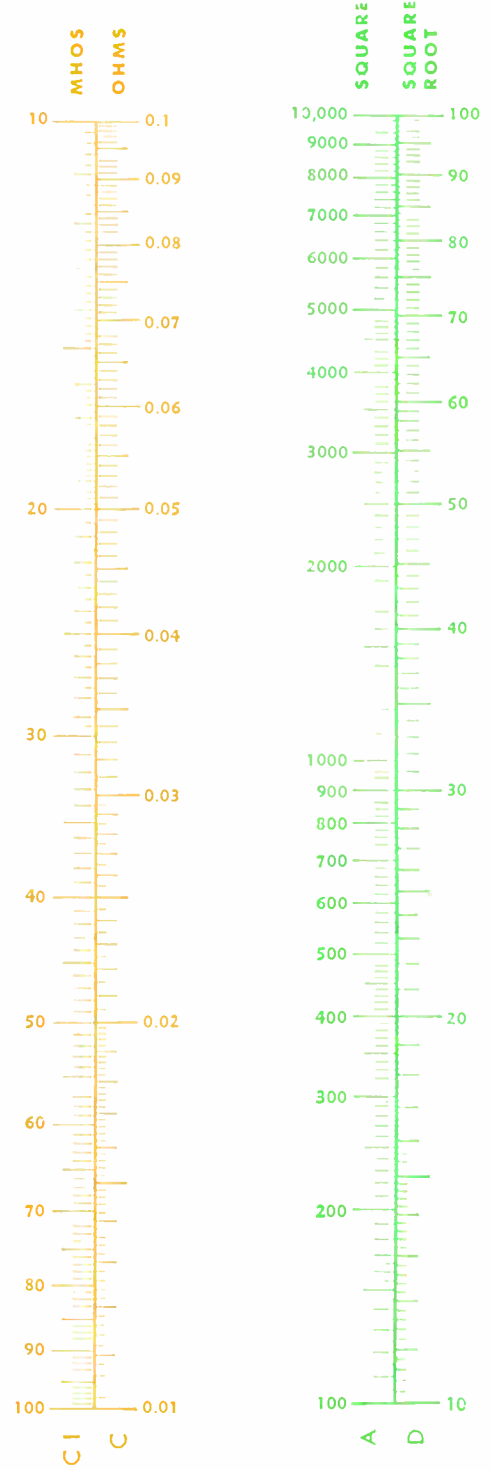
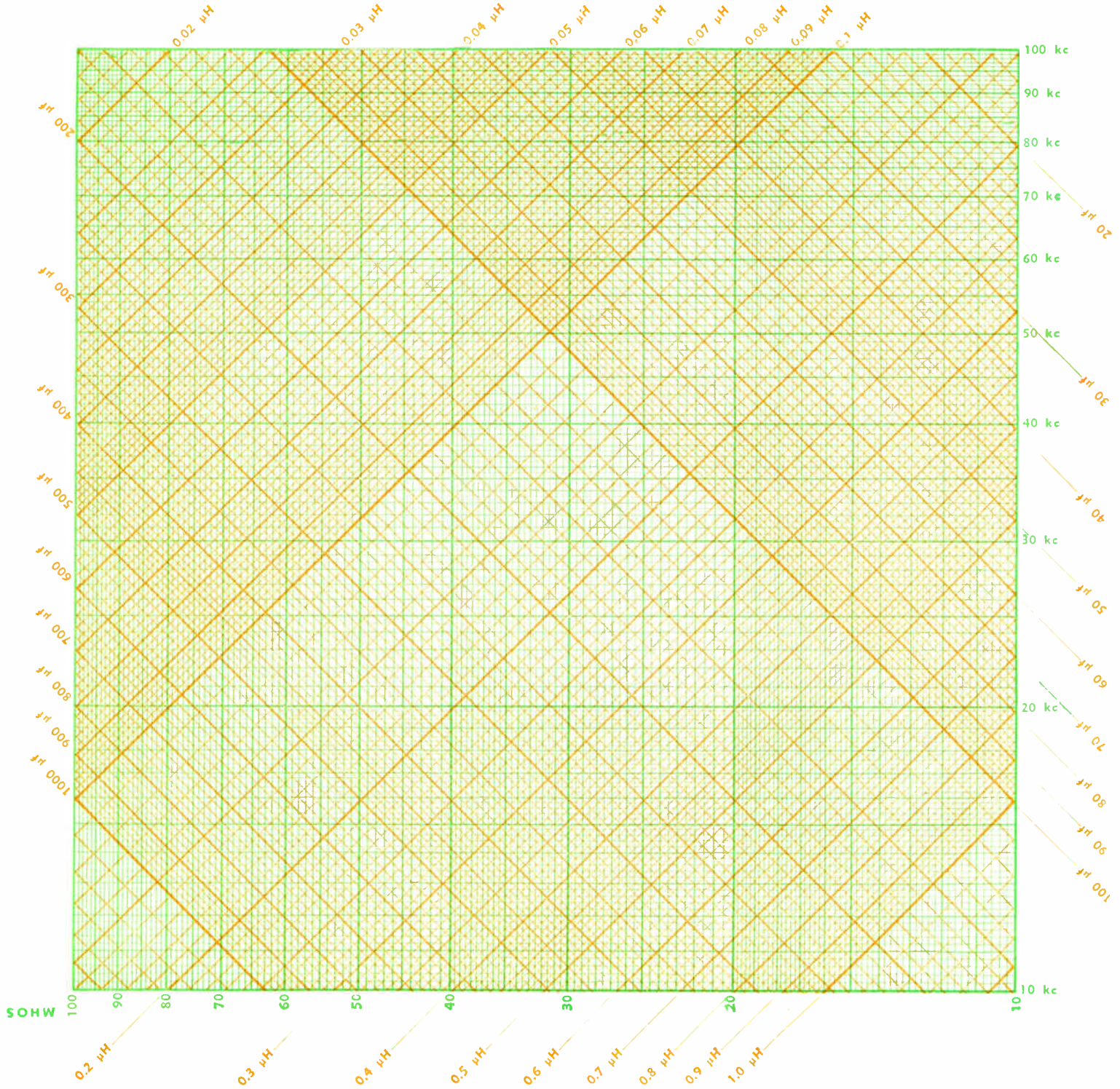
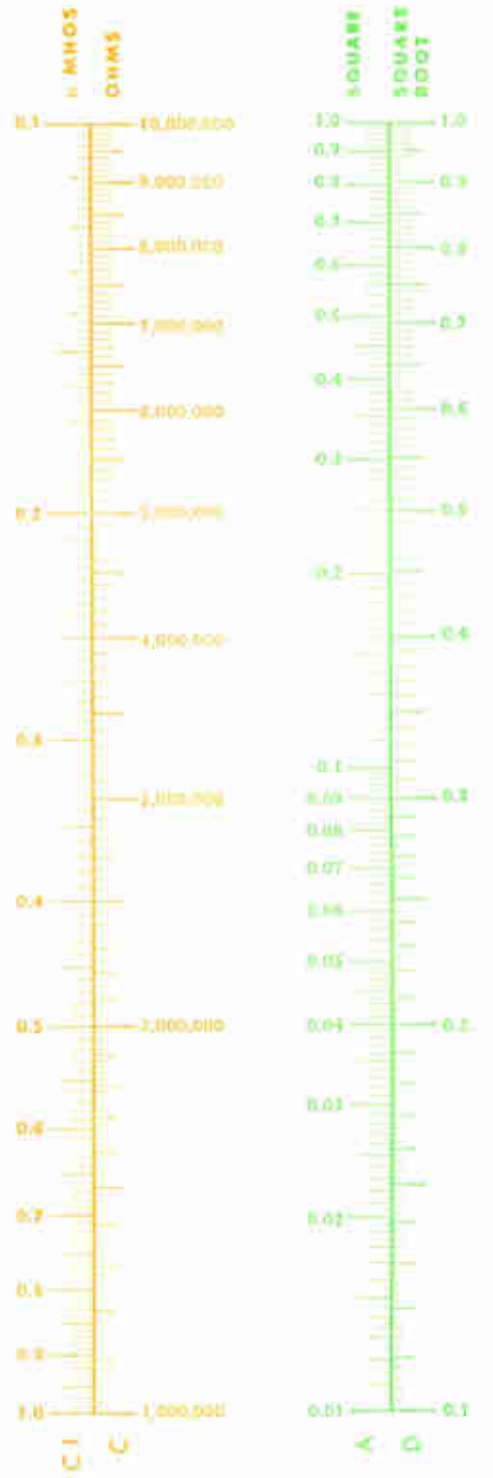
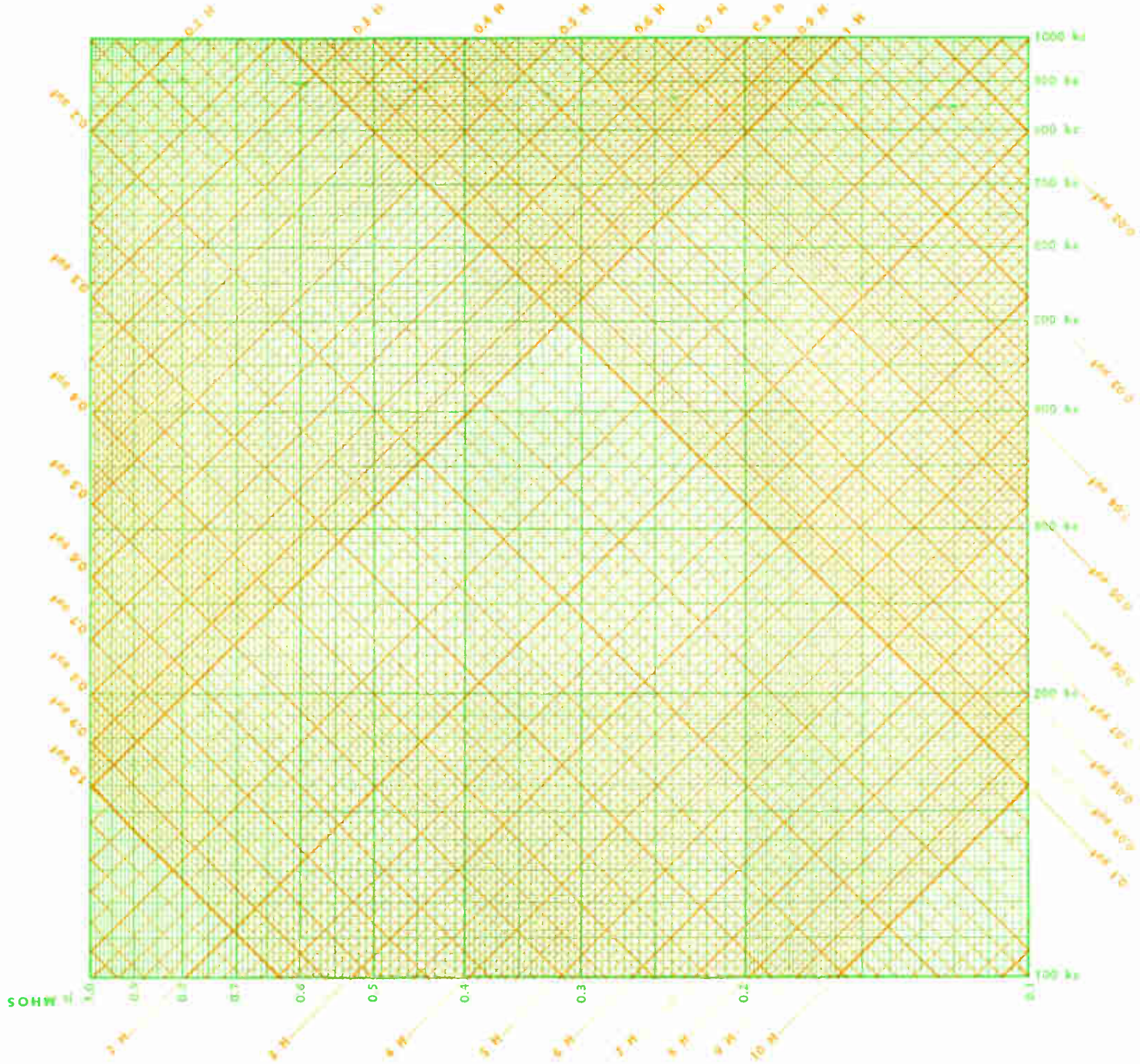


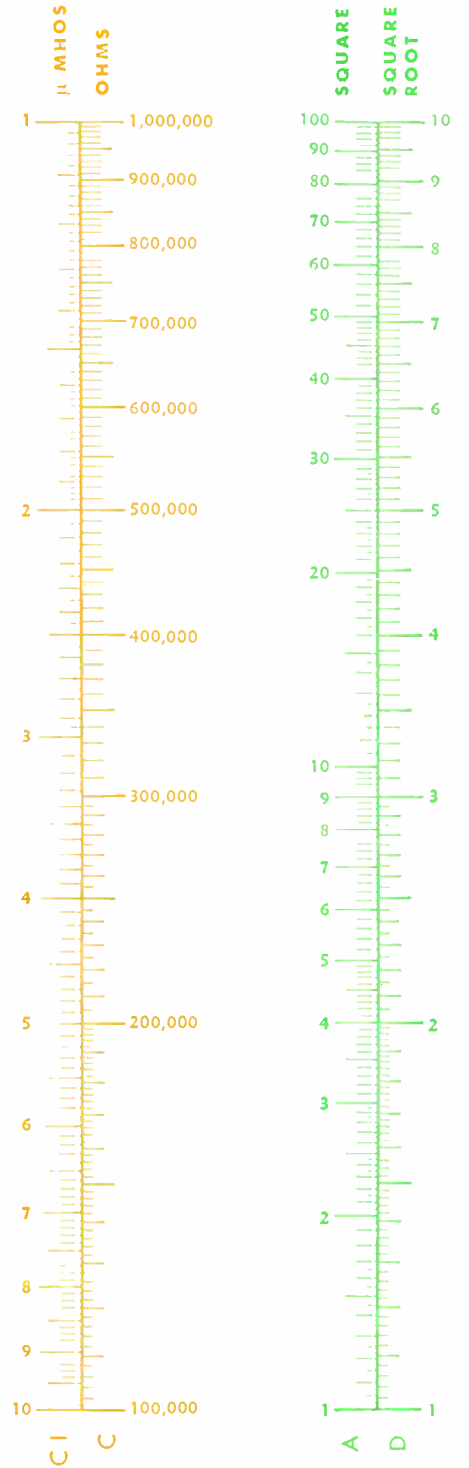
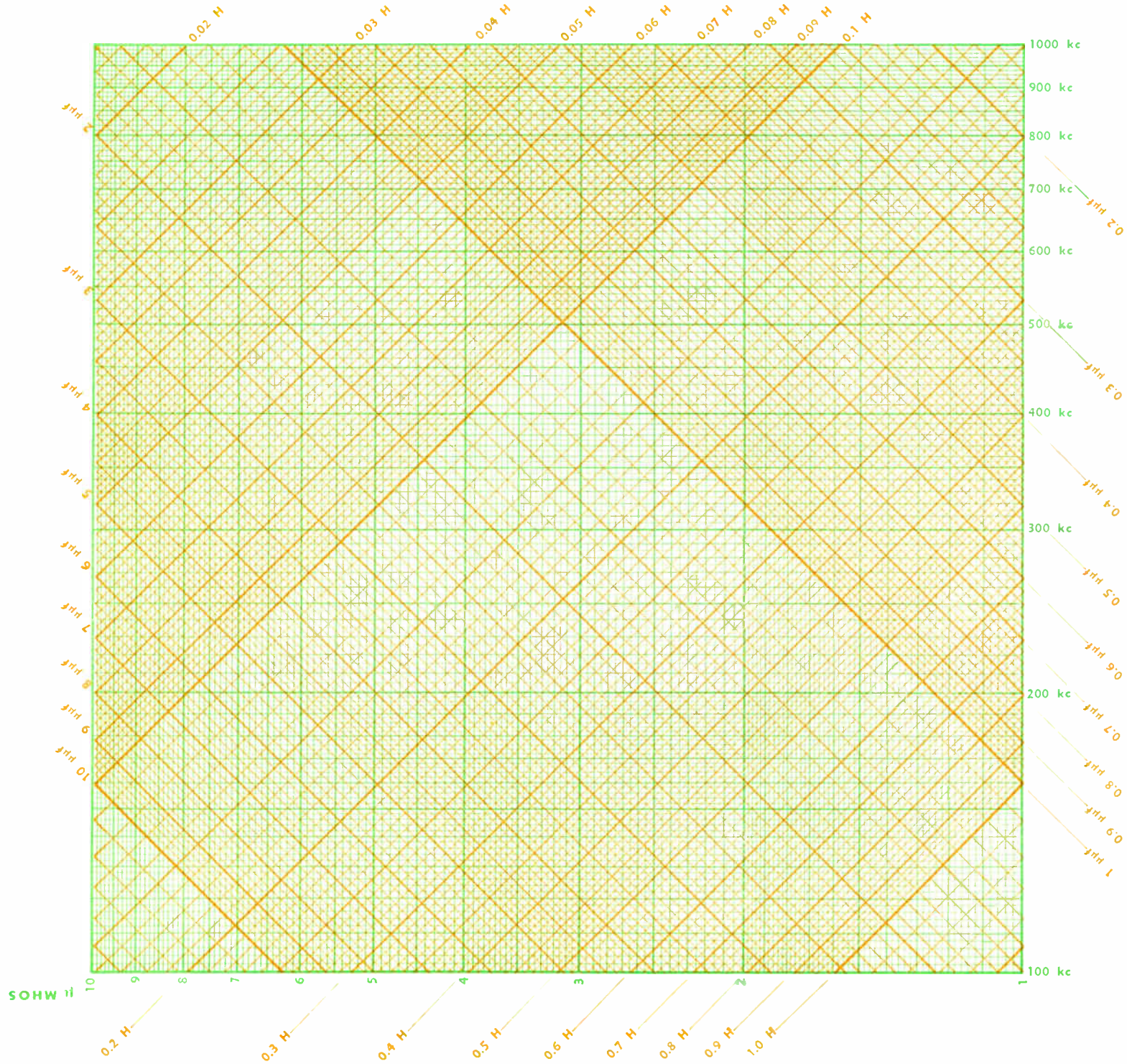
PLATE 108

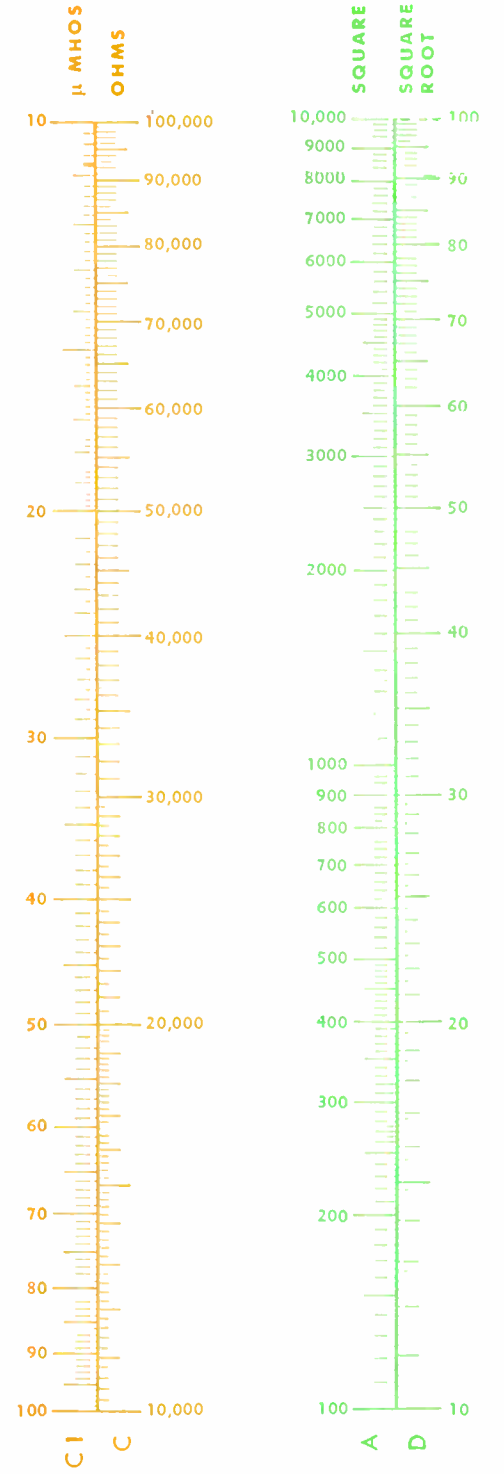
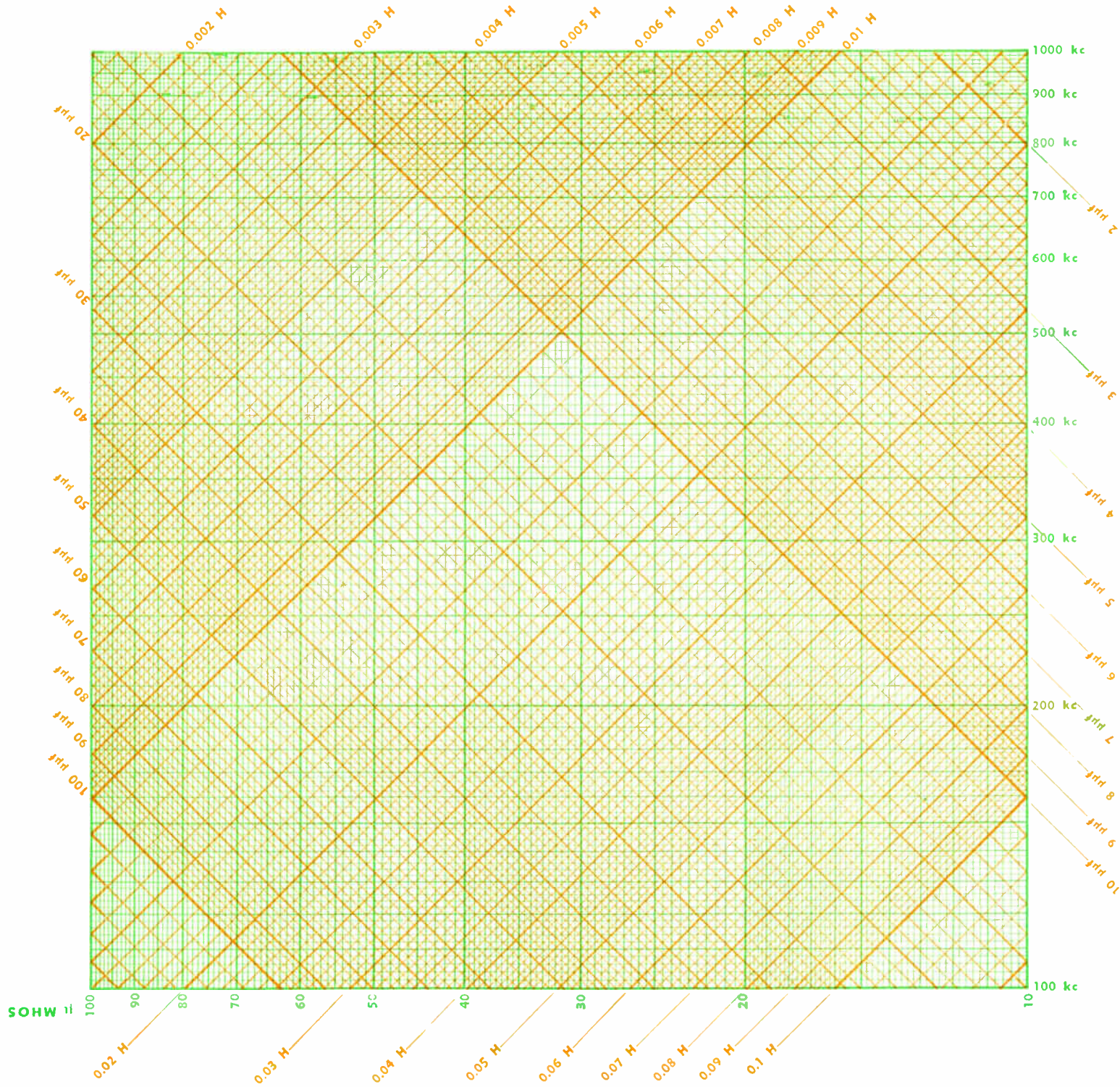




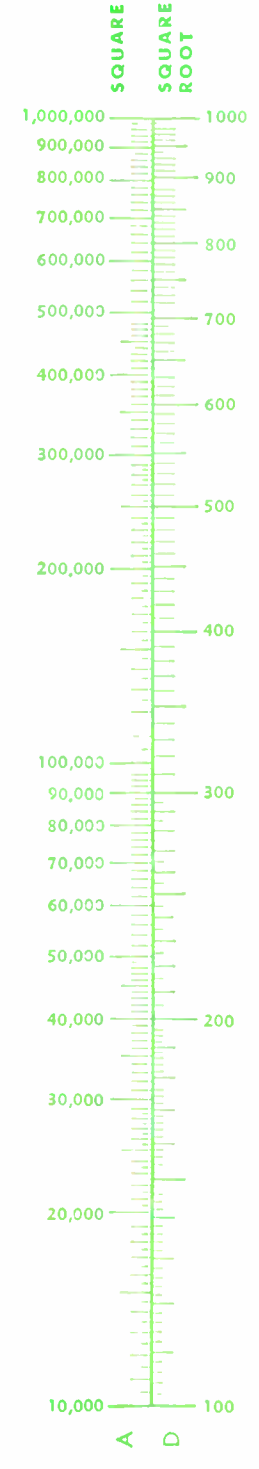
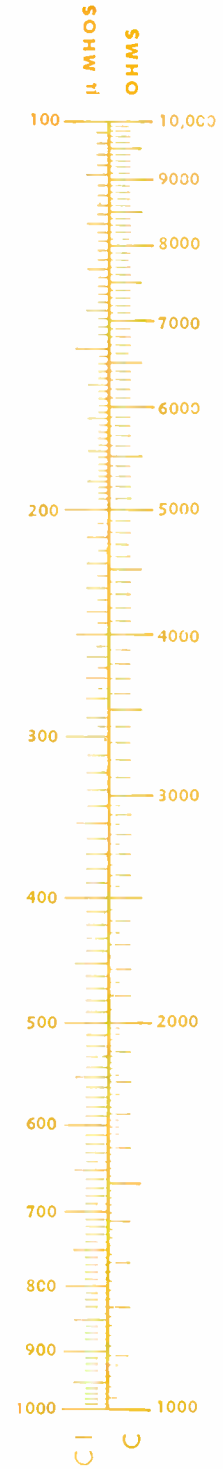
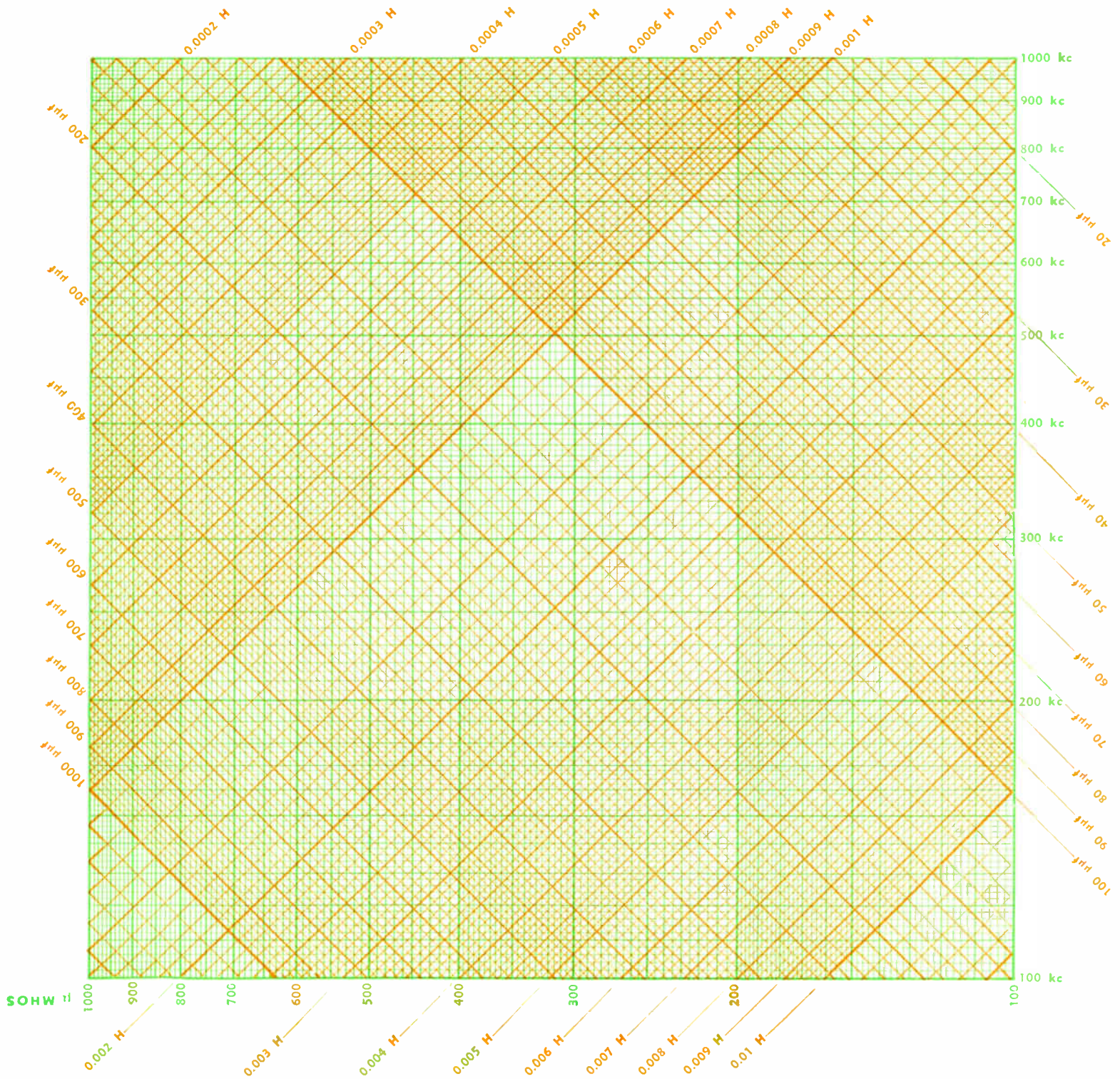


# PLATE 110





# PLATE 112



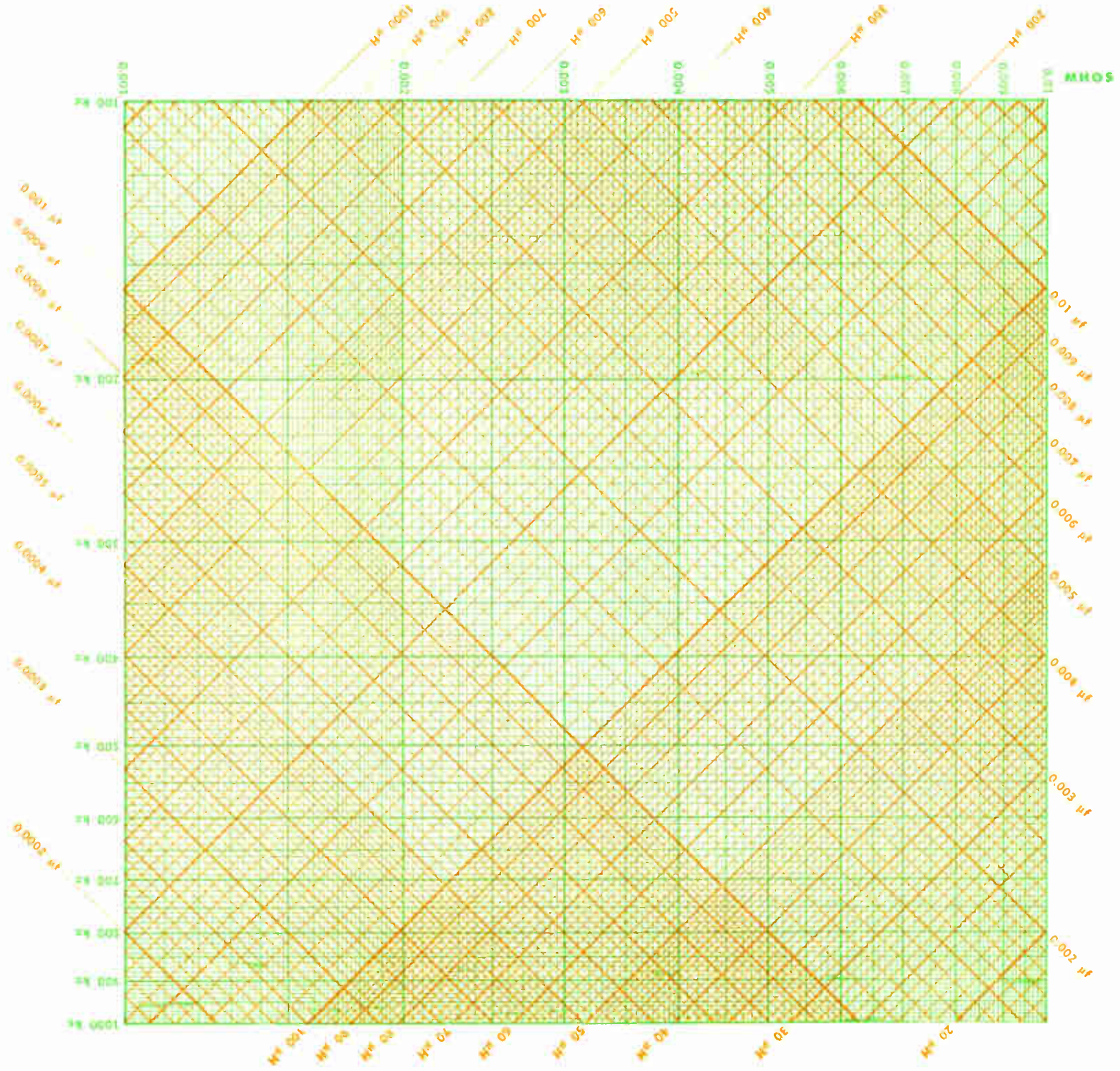
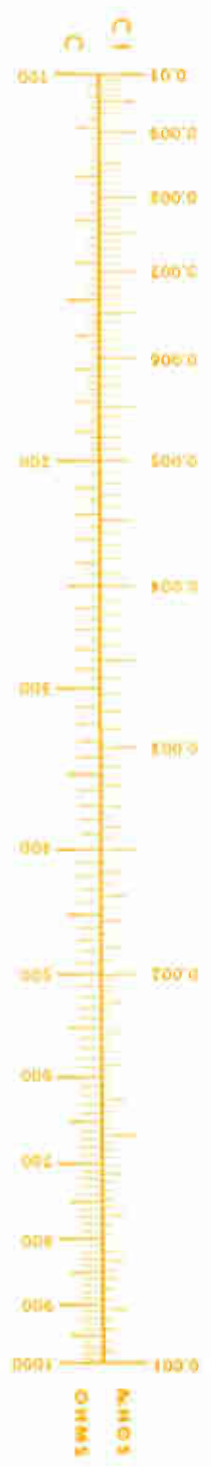
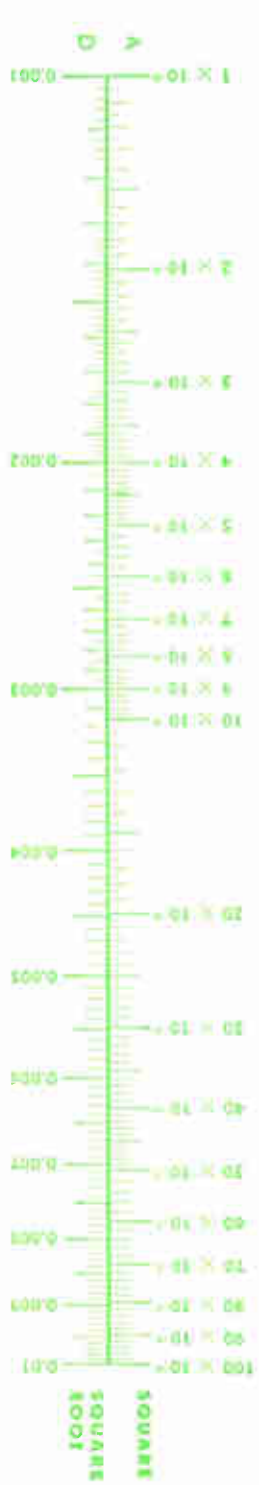
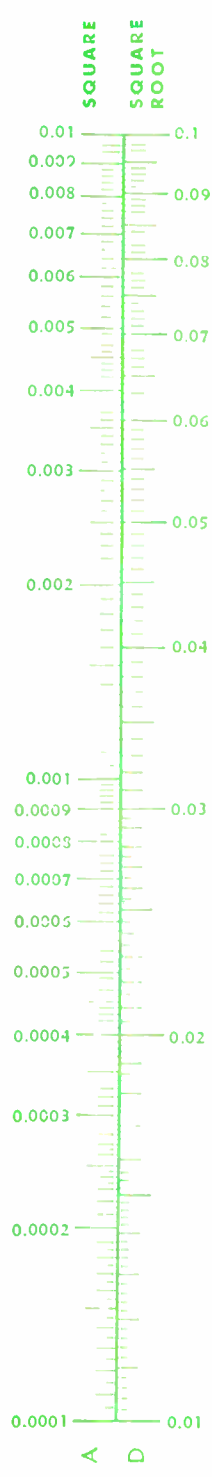
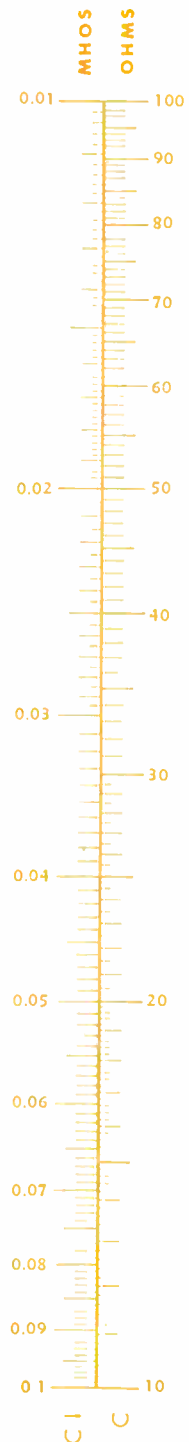
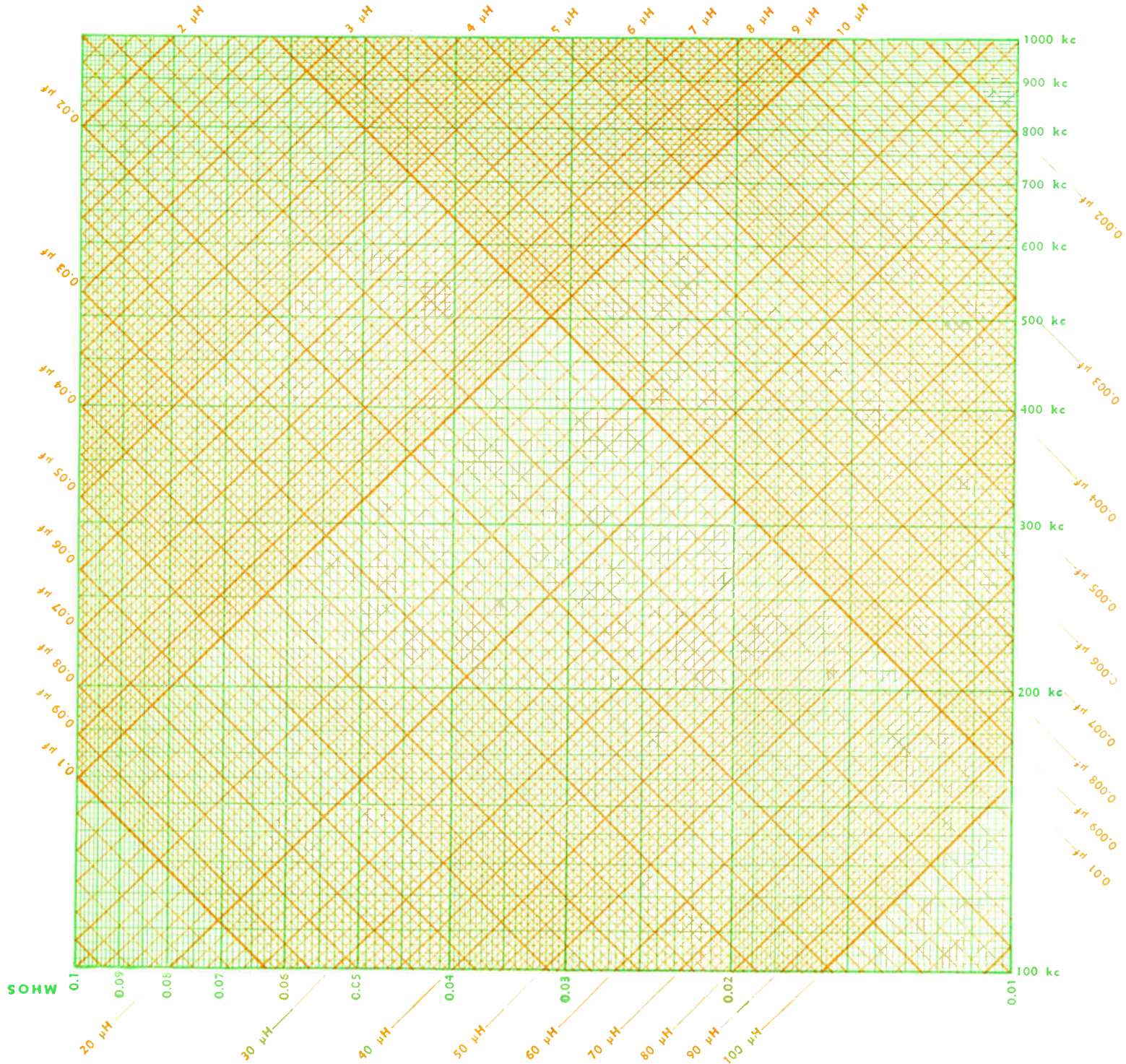


PLATE 114



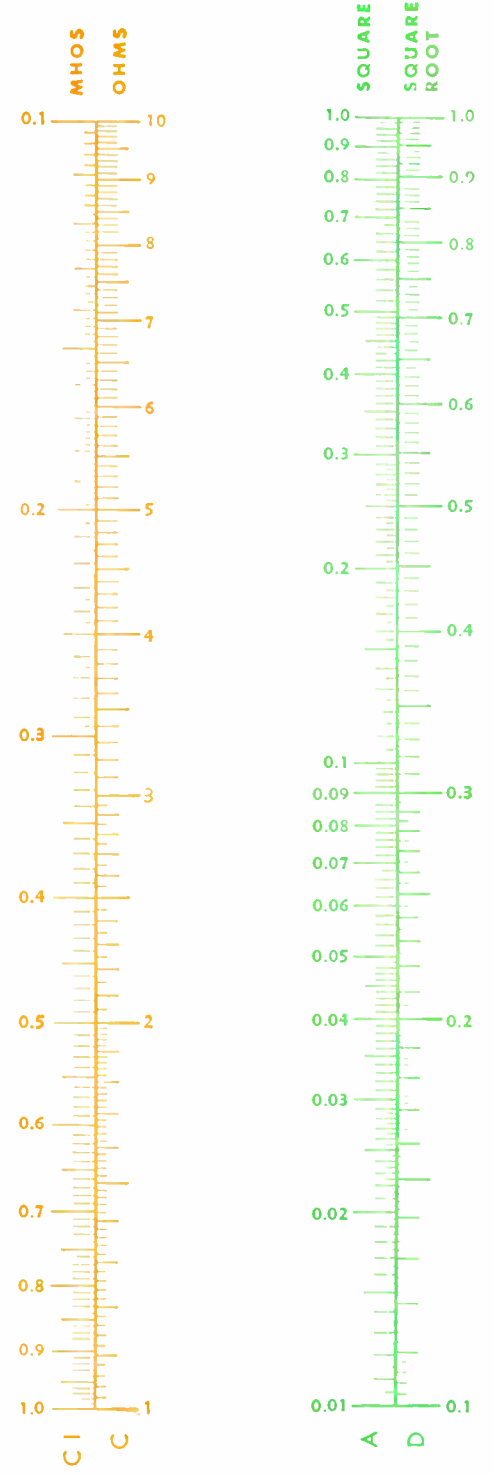
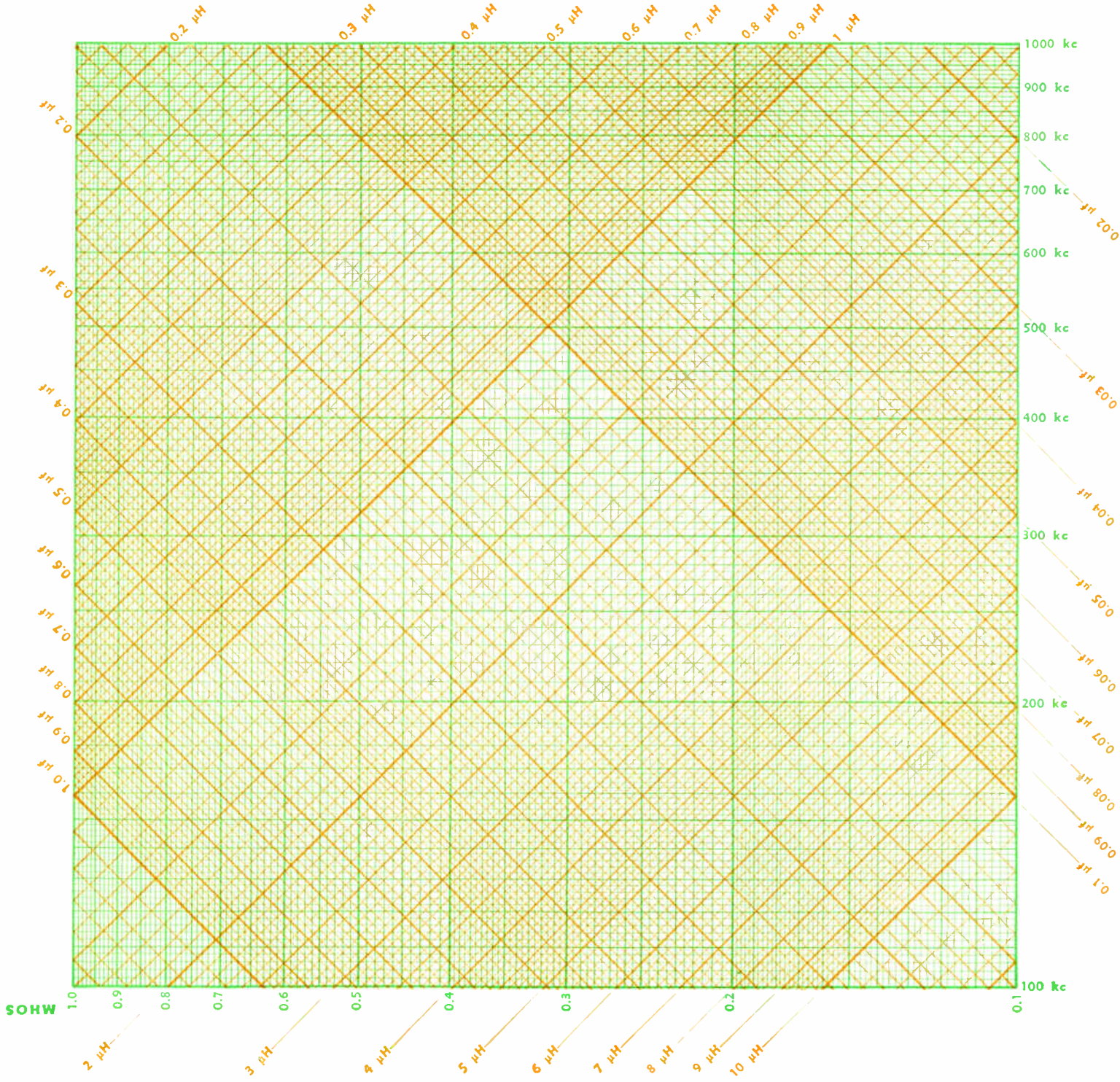
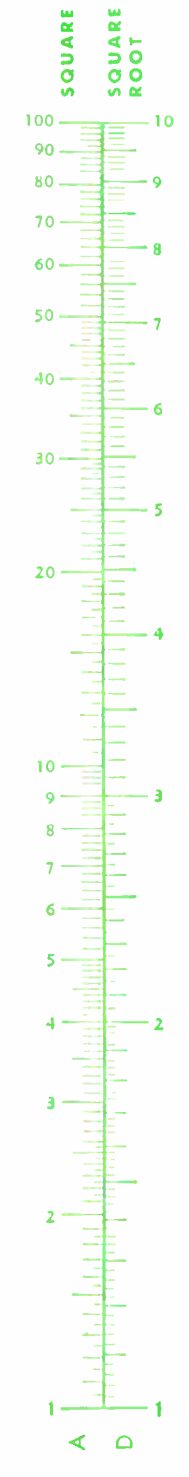
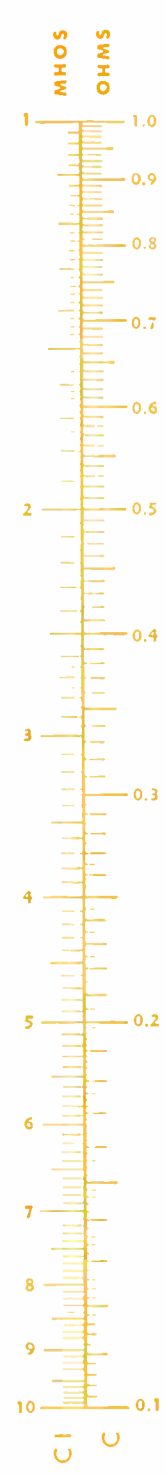
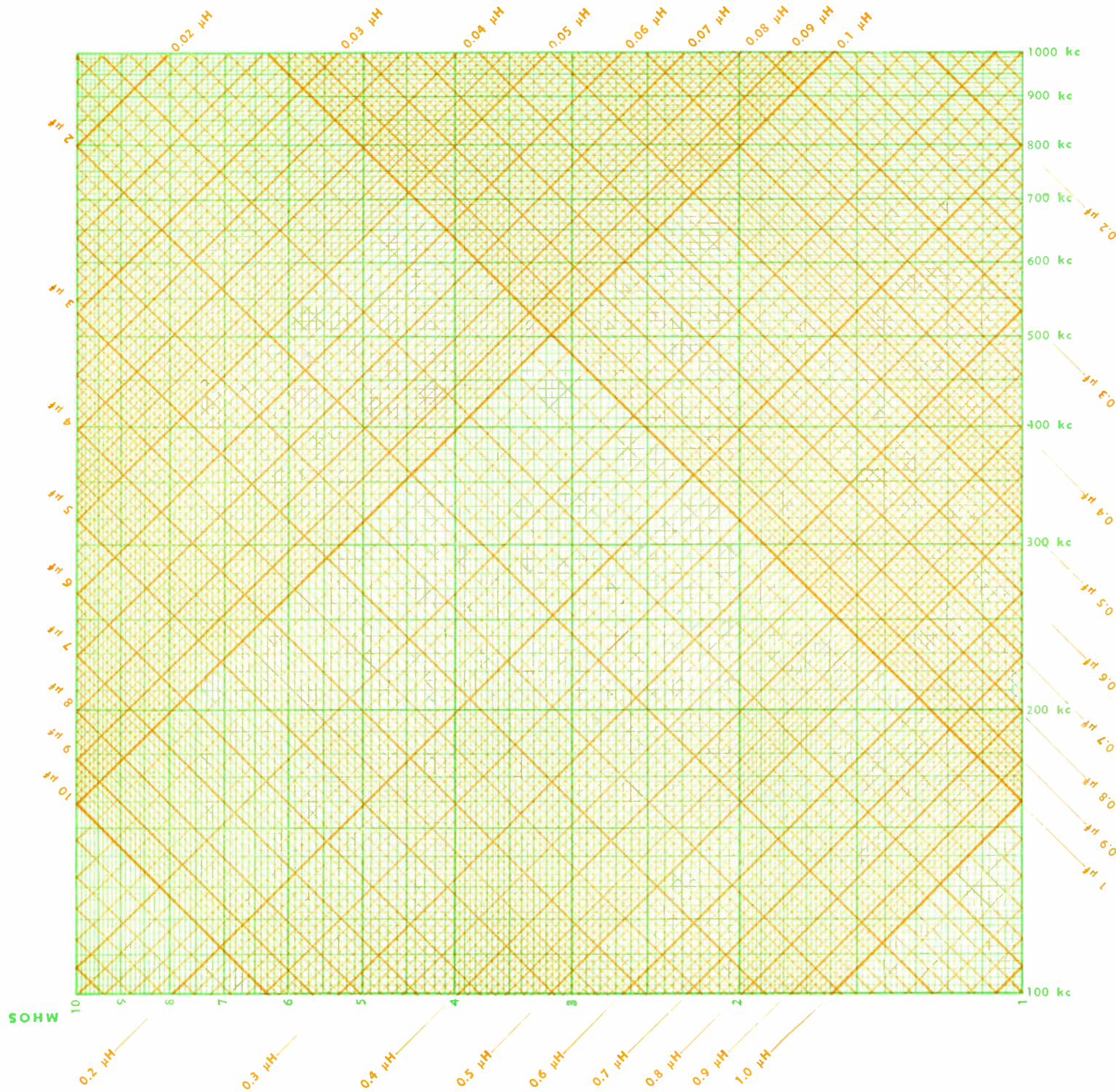
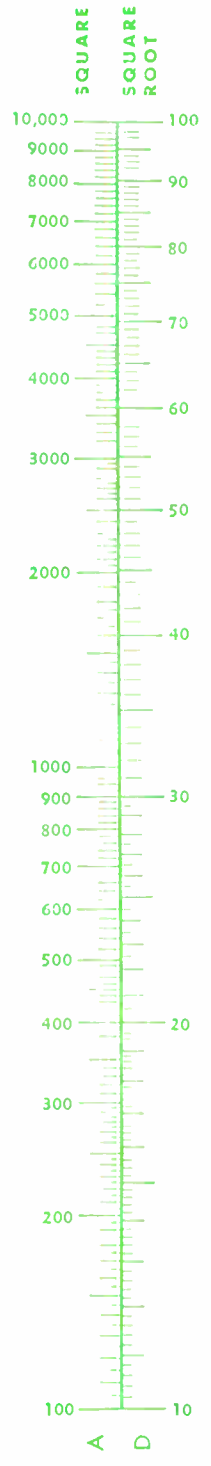
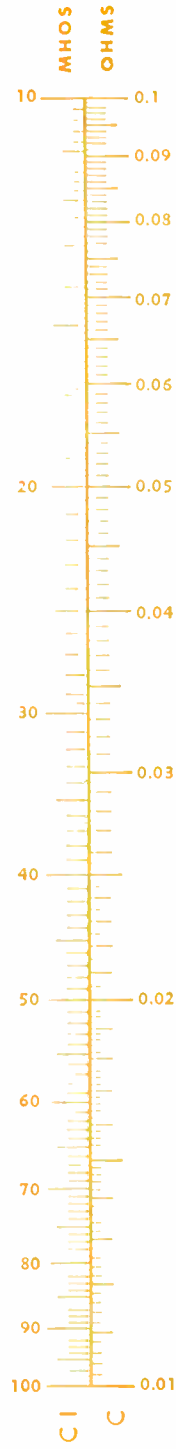
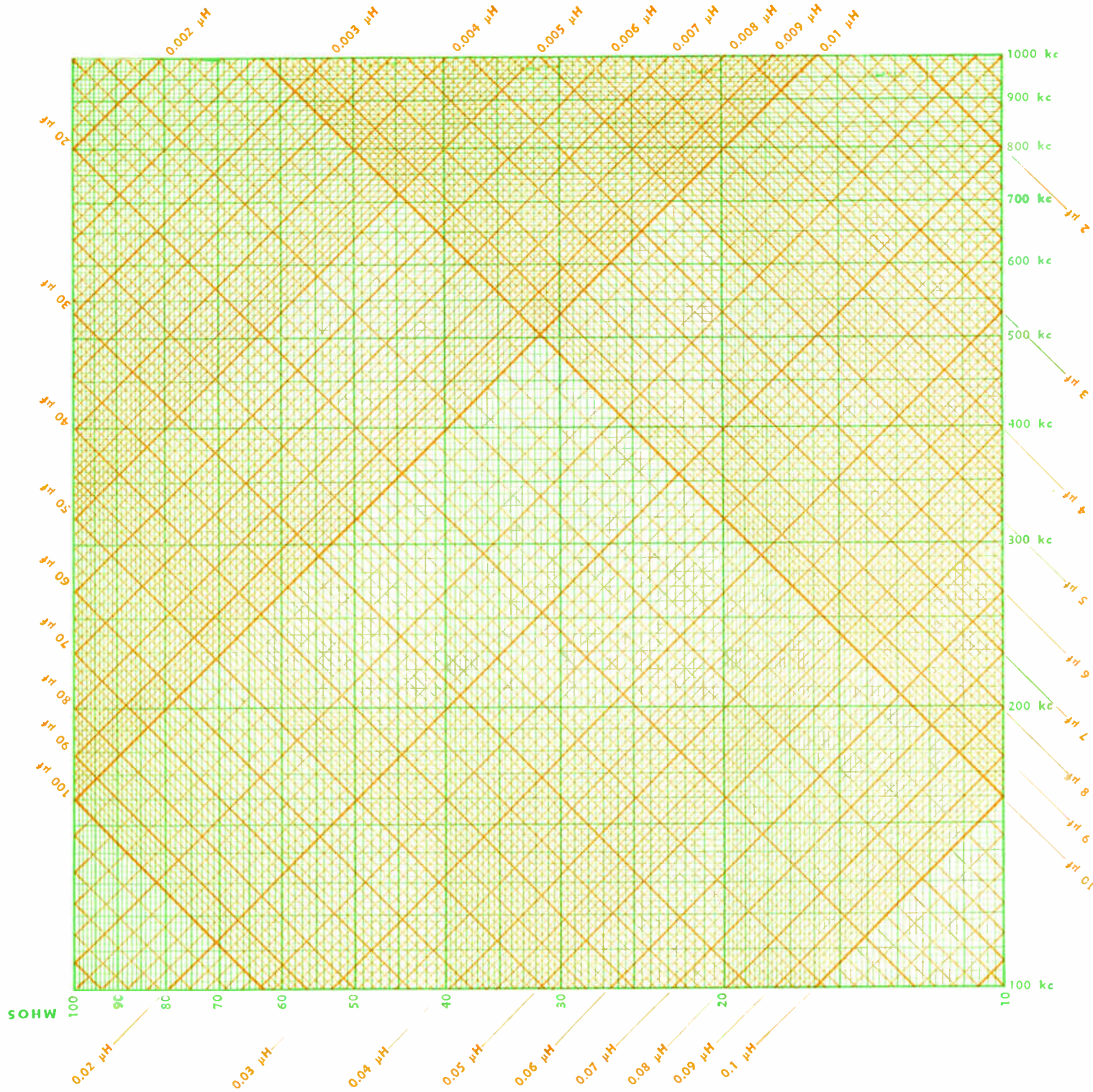


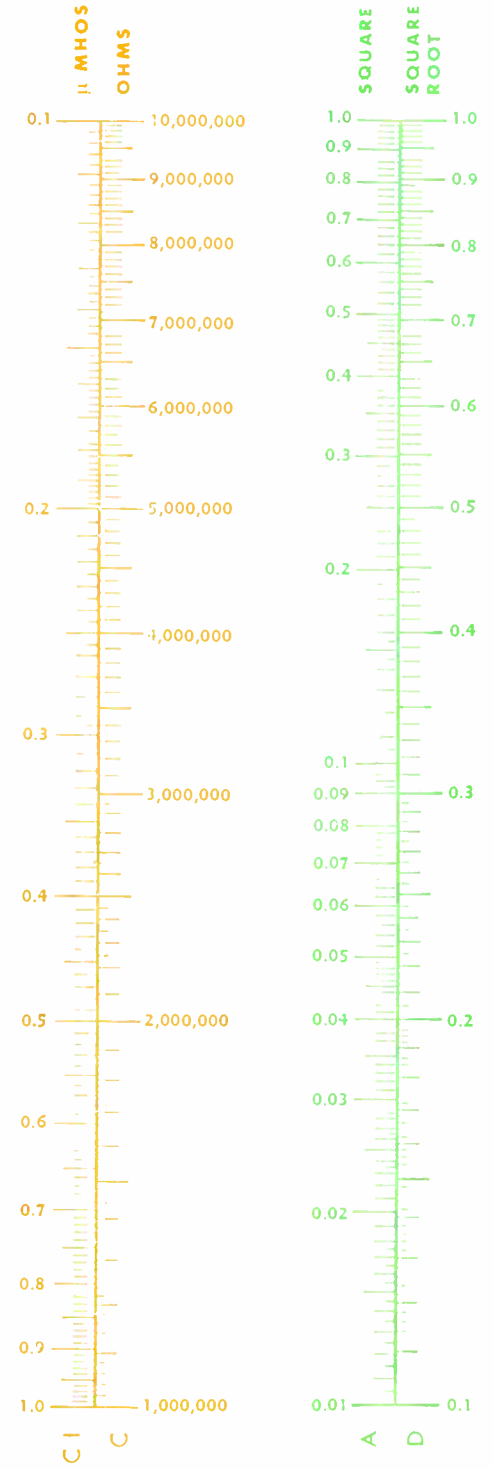
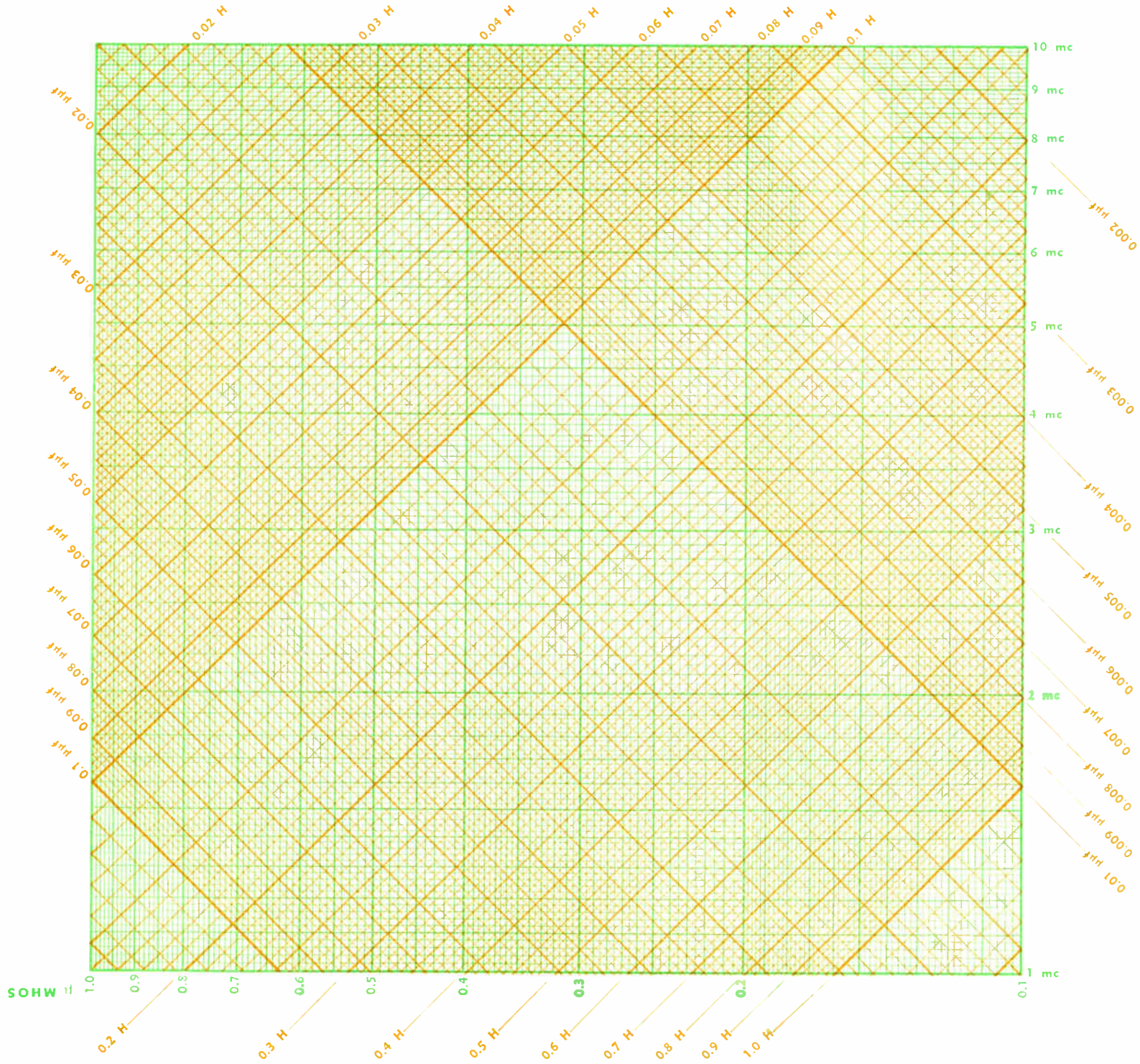
PLATE 116

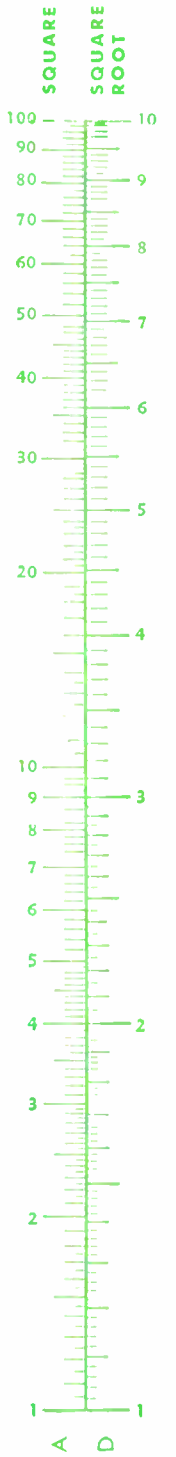
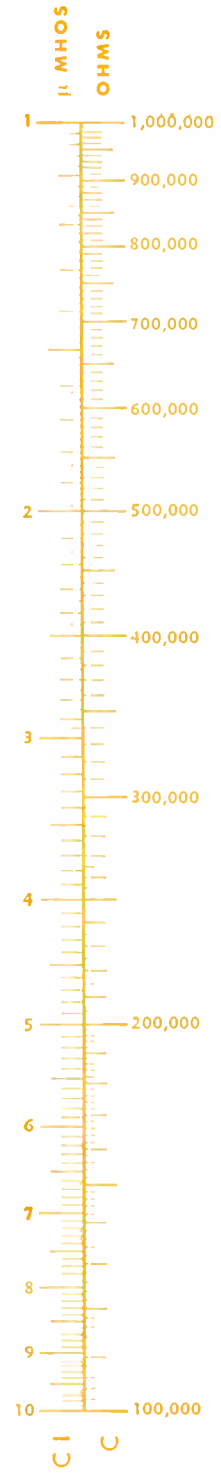
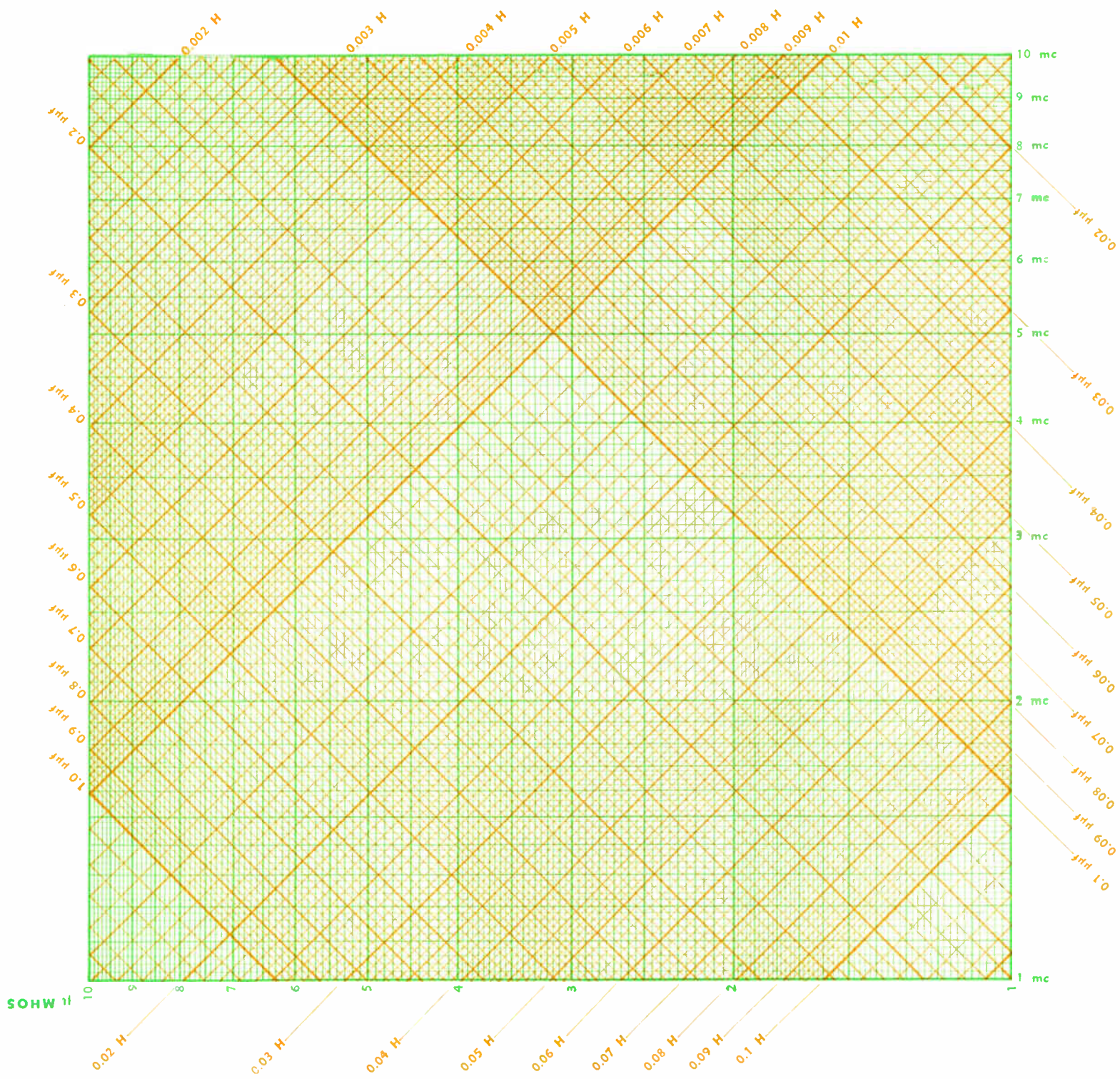






# PLATE 118





# PLATE 120

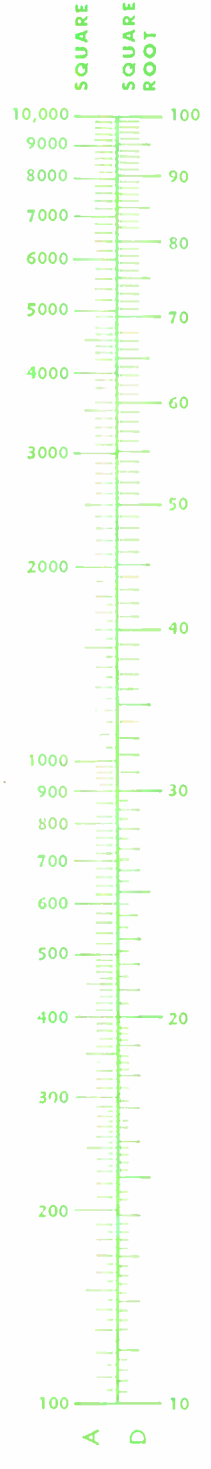
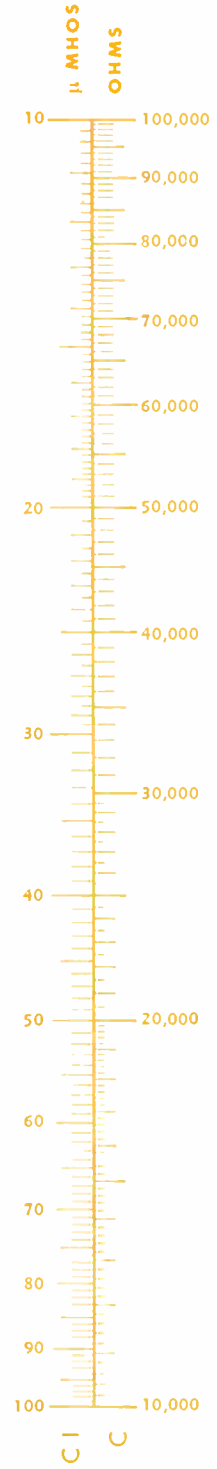
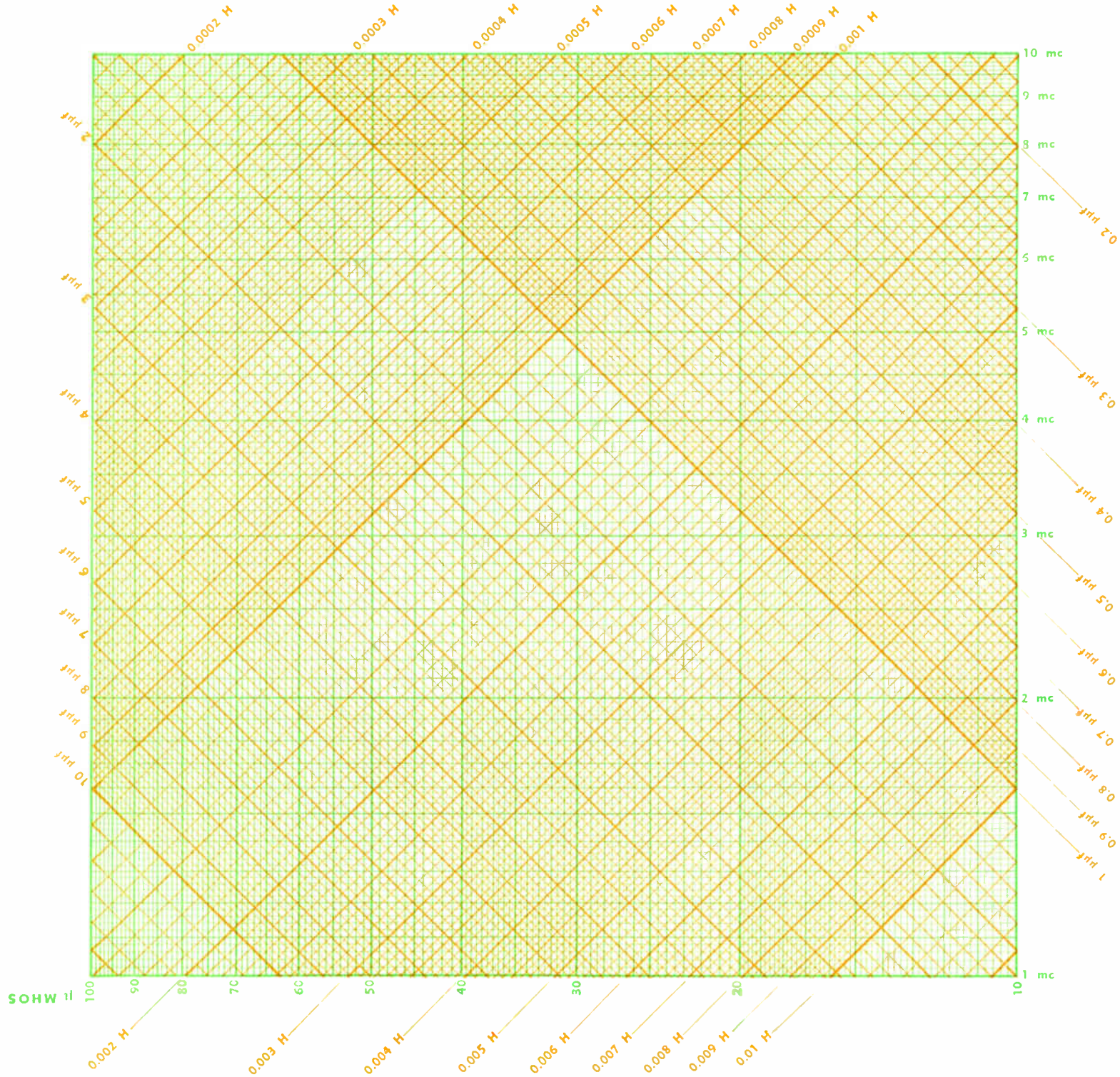


PLATE 121

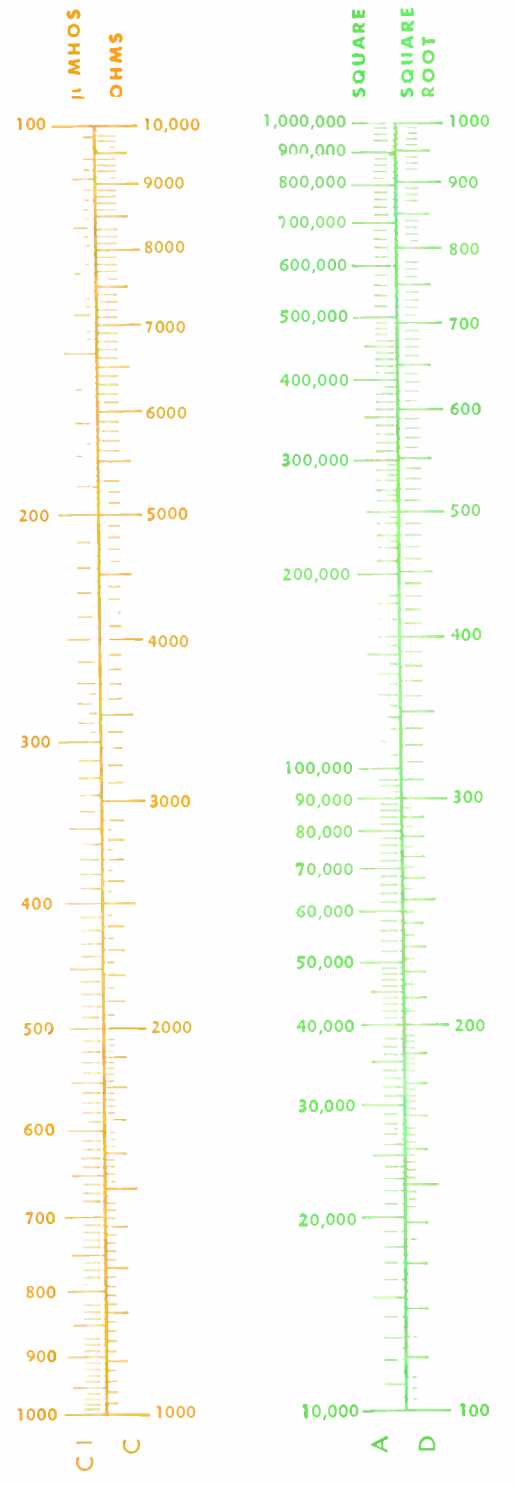
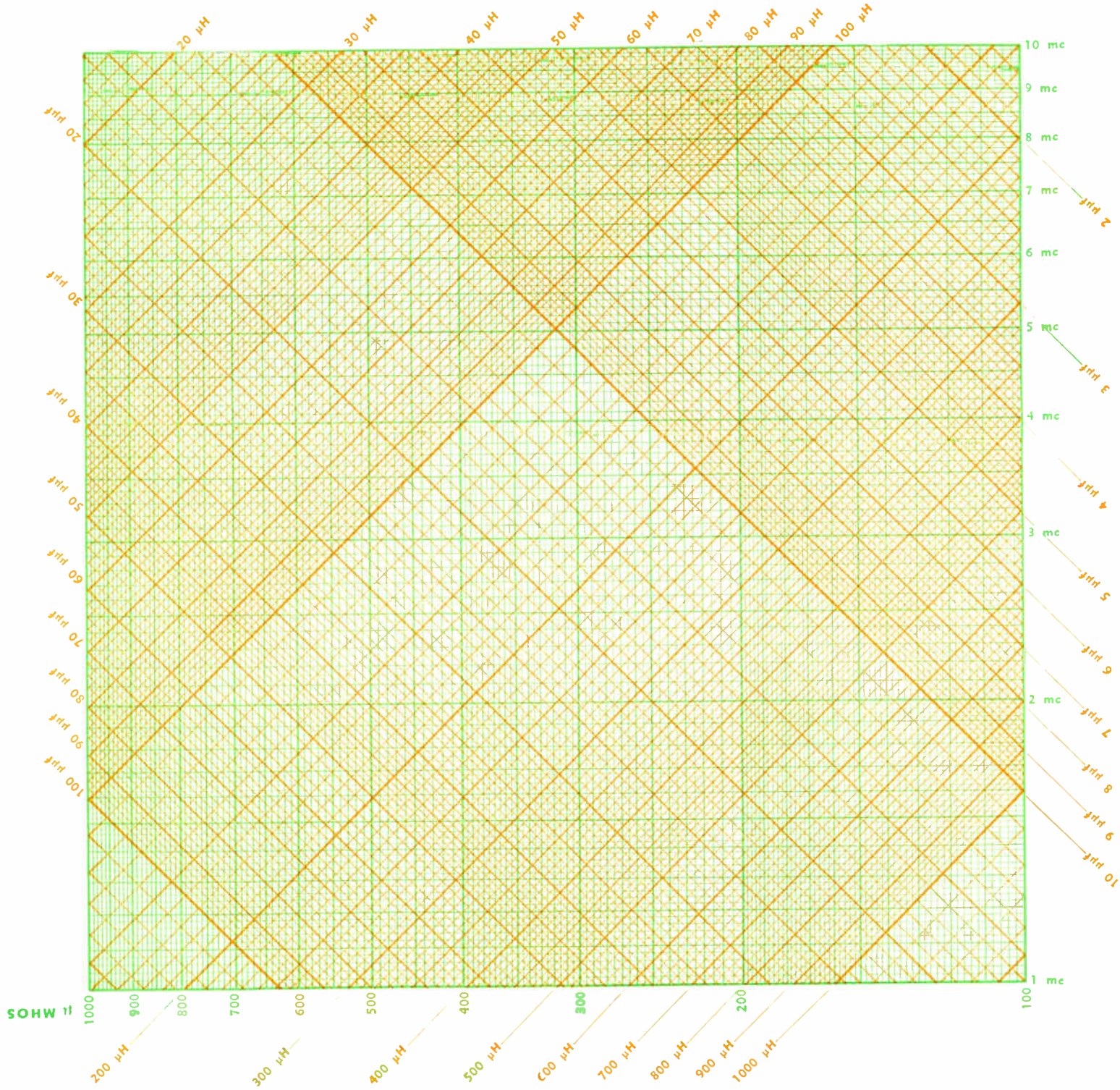
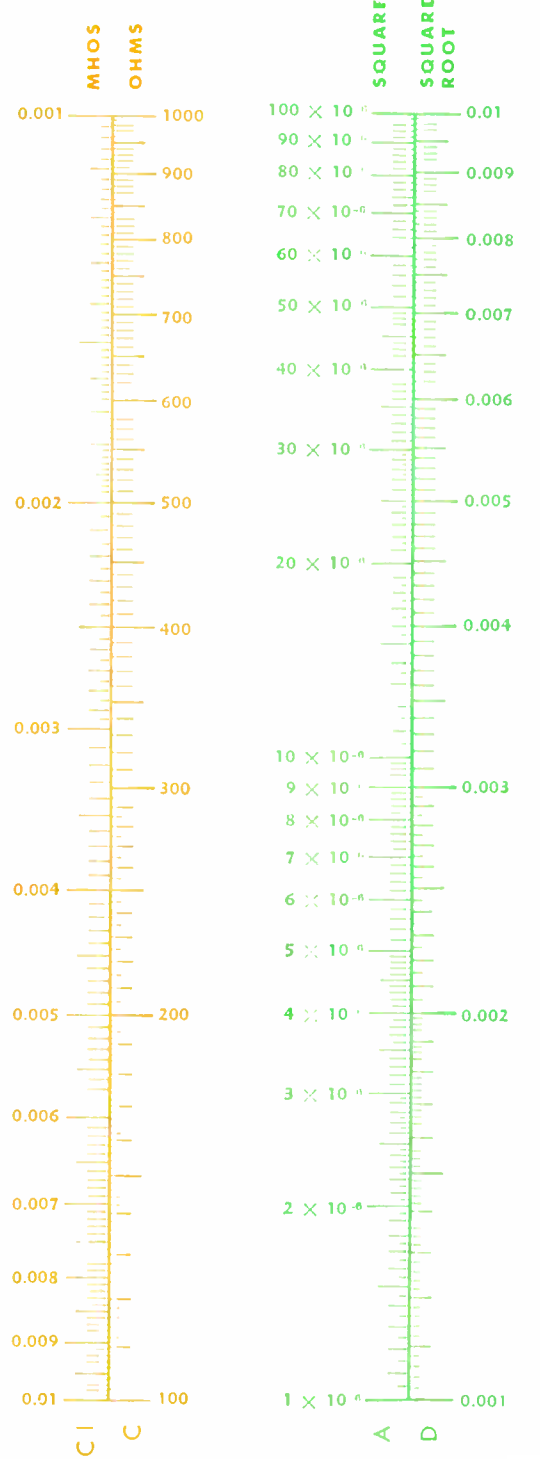
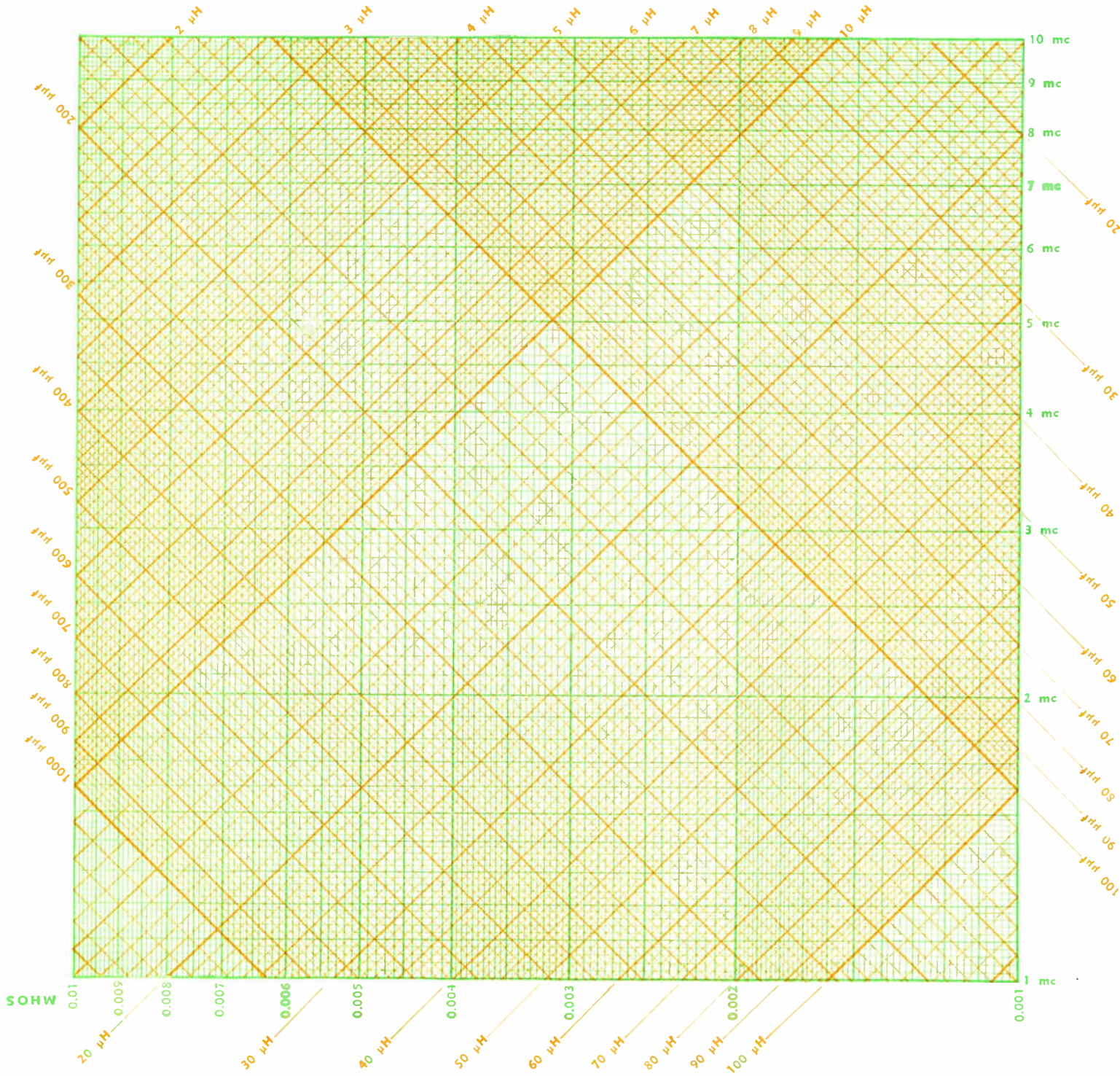


PLATE 122



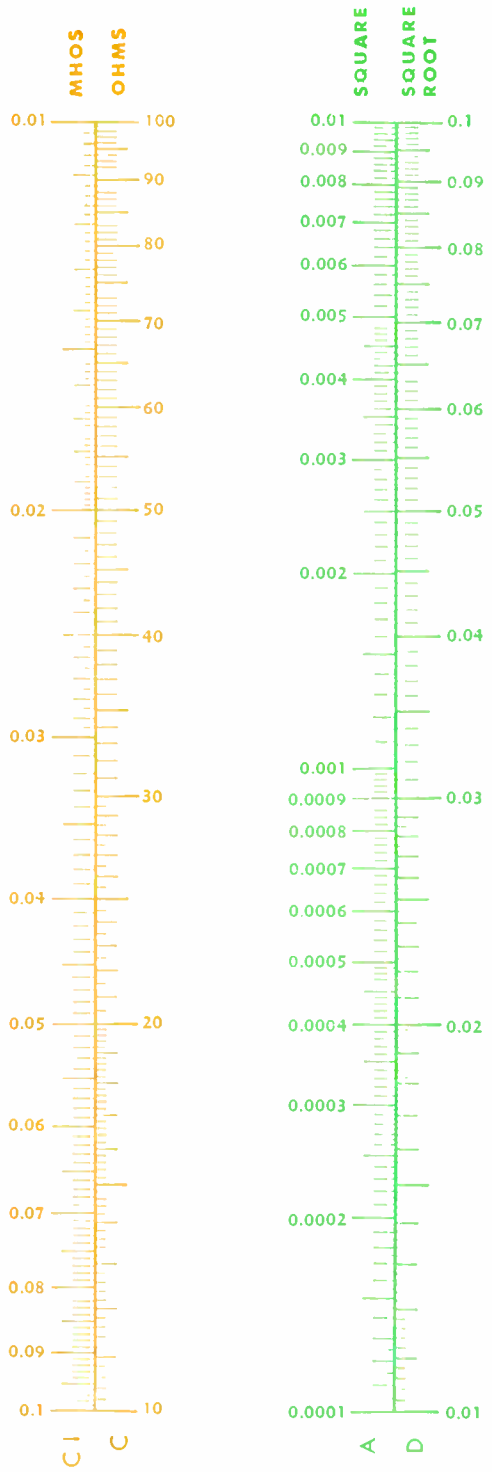
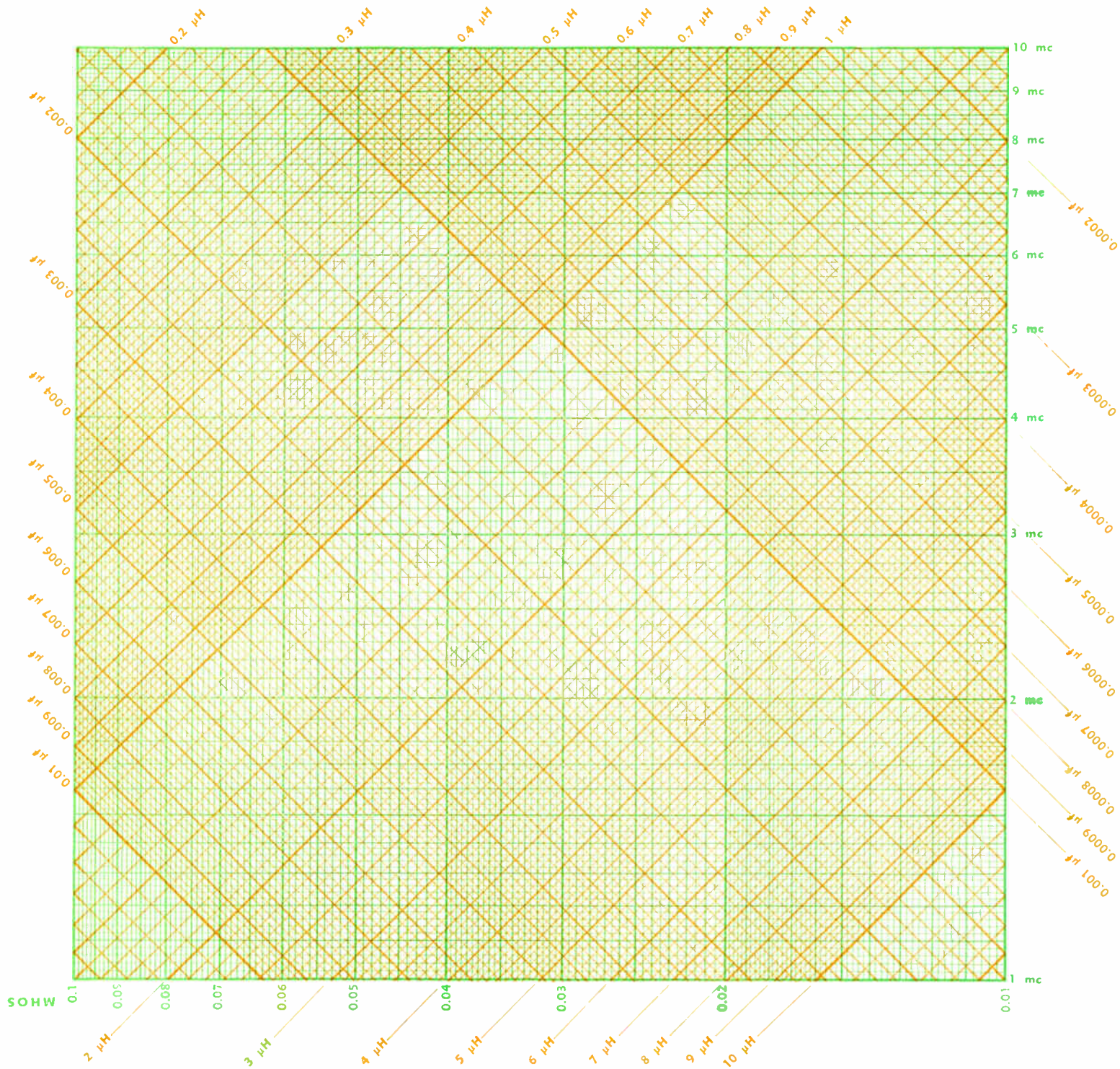
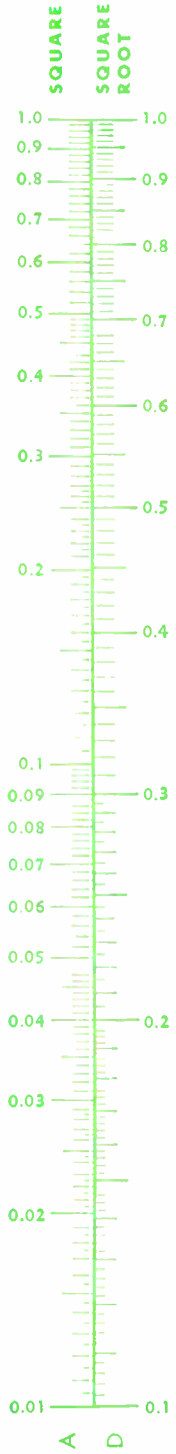
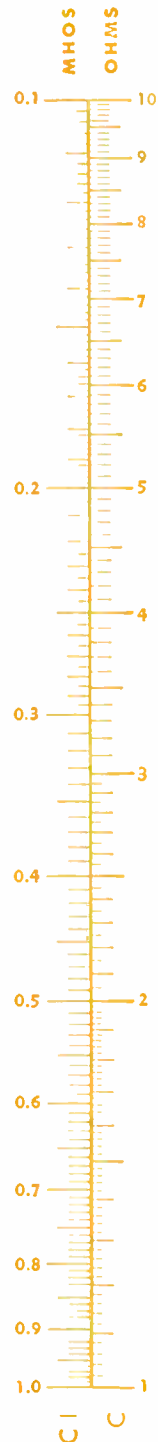
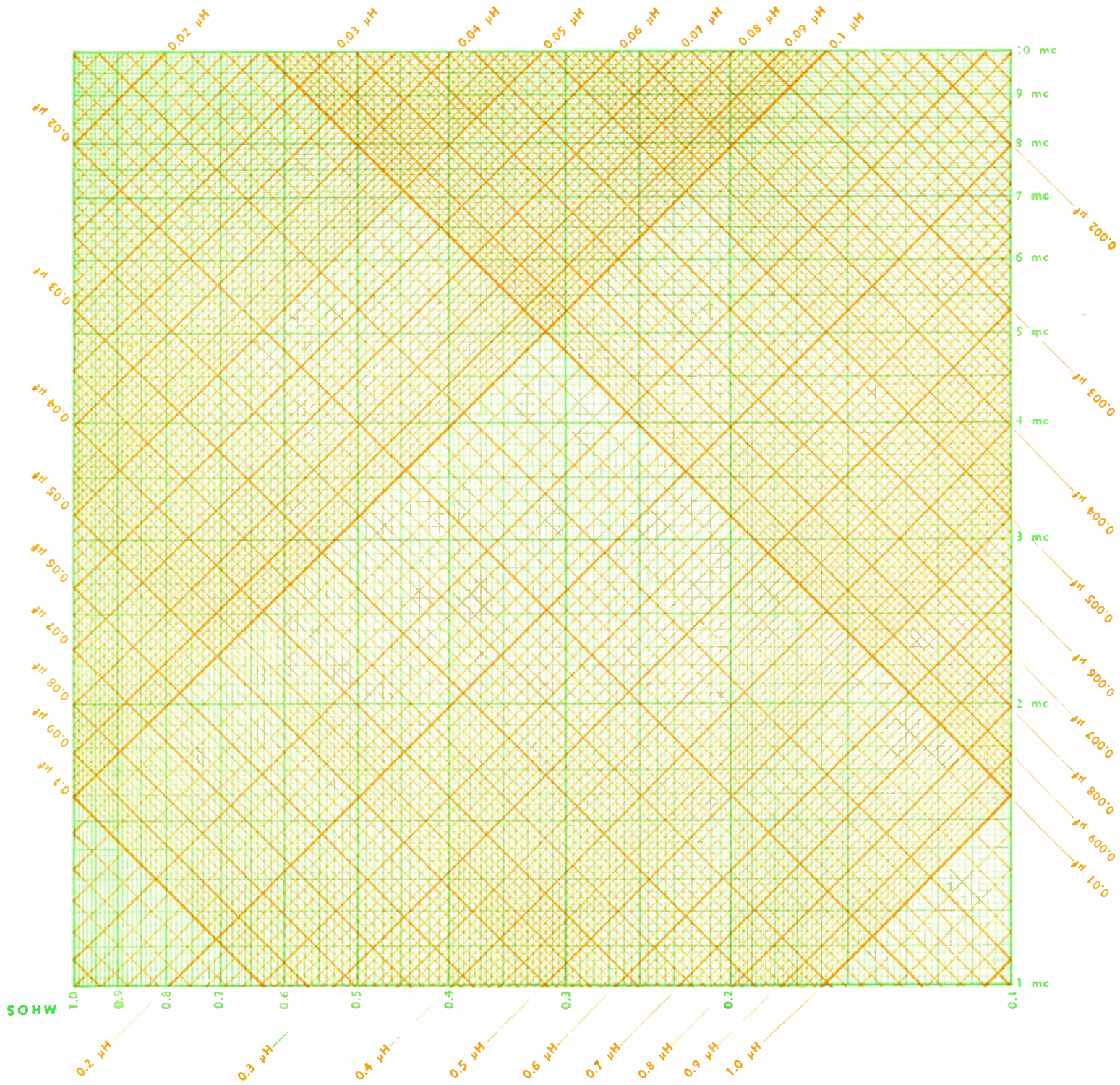


PLATE 124





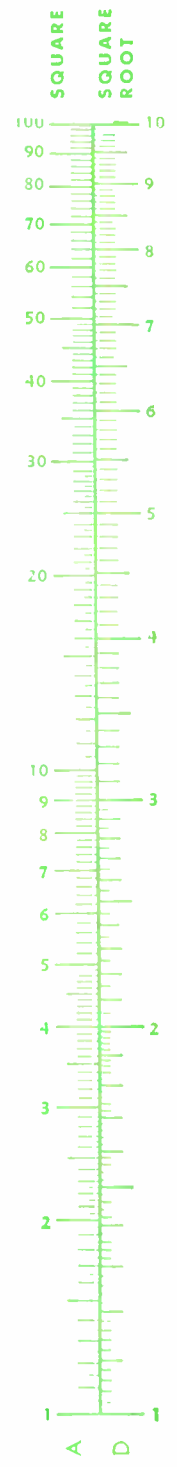
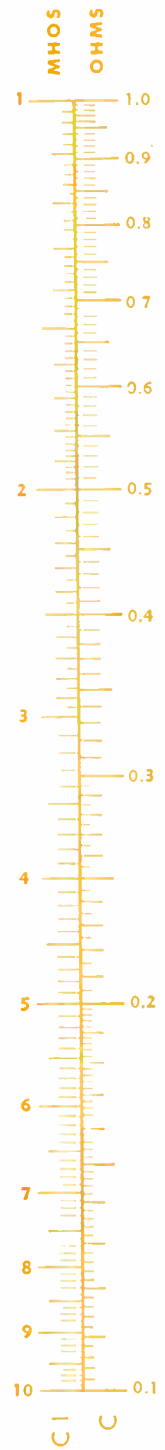
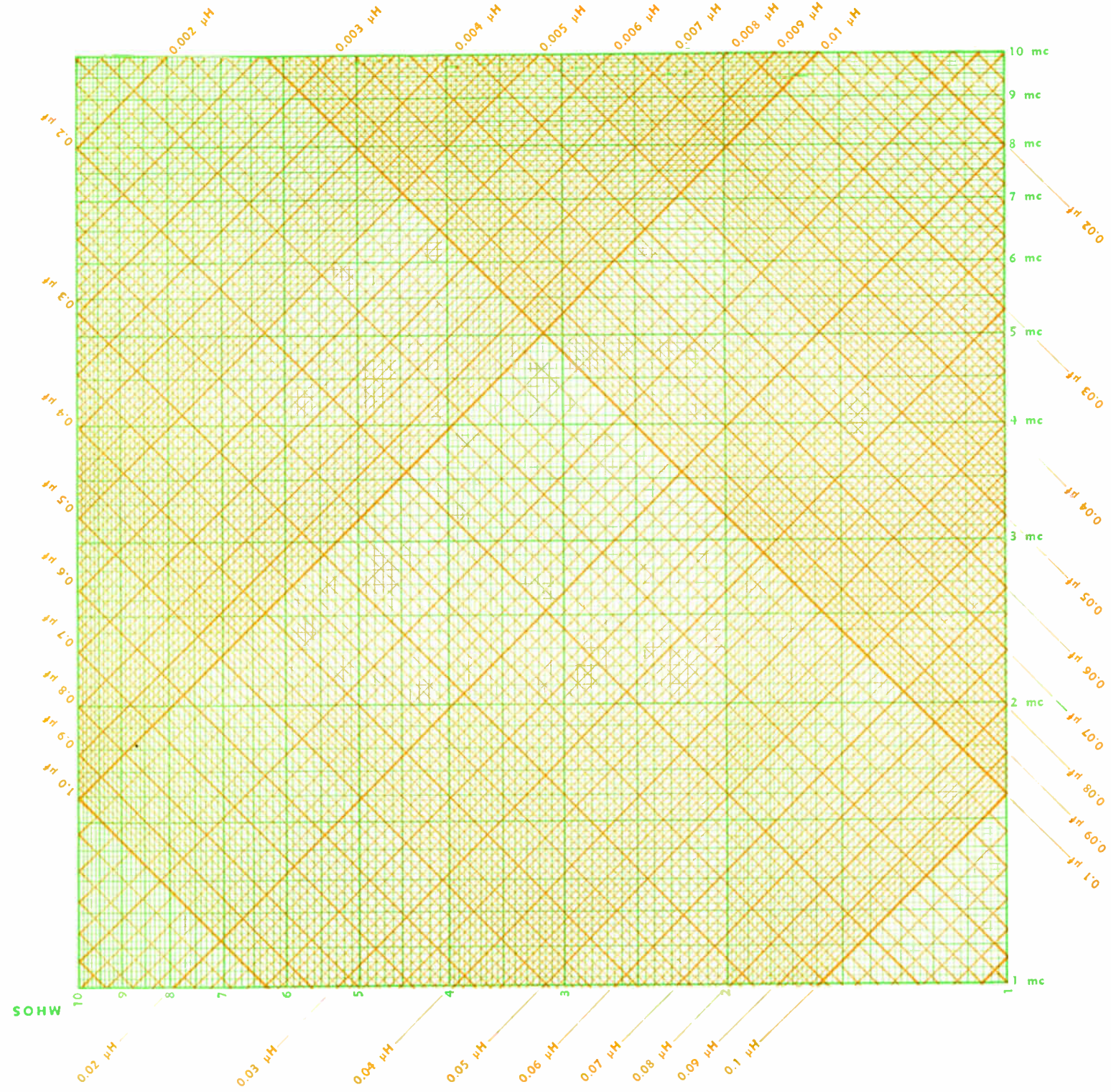
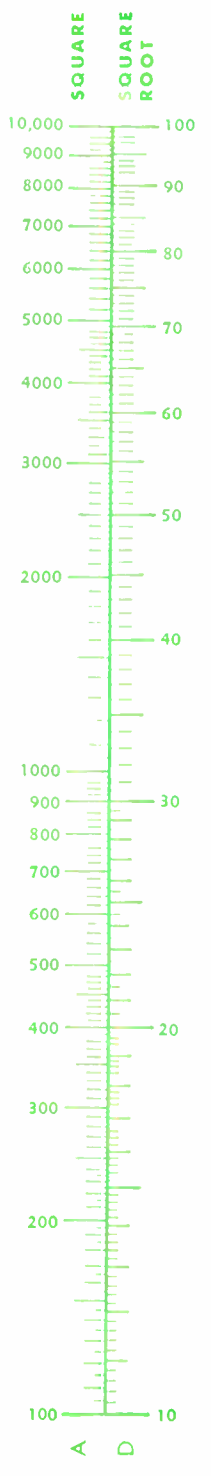
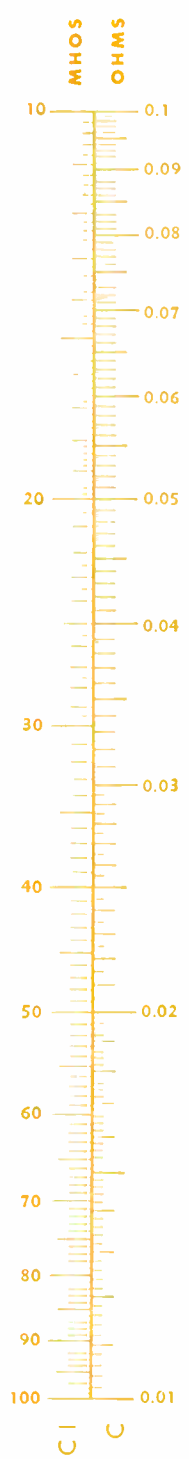
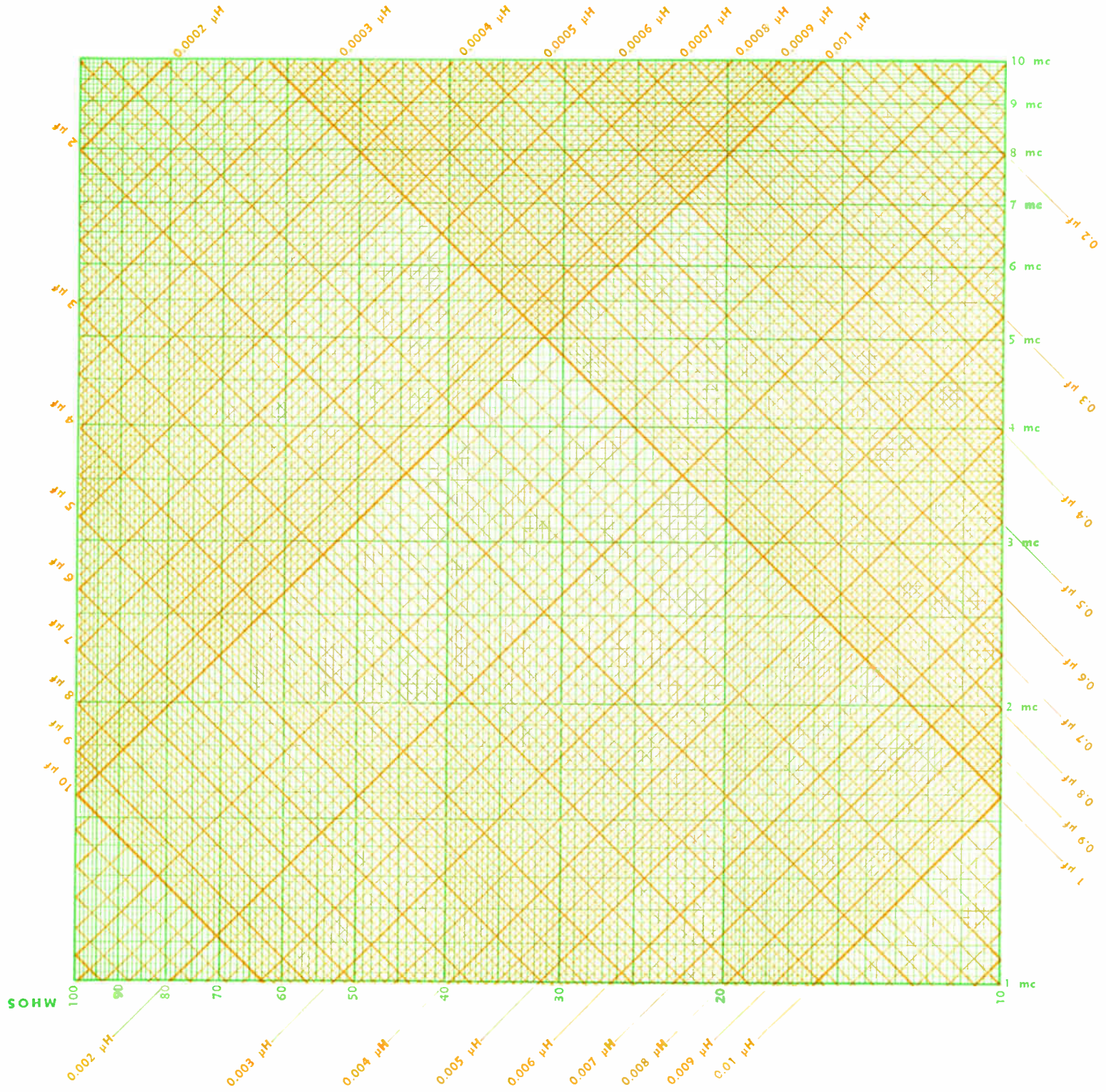


PLATE 126



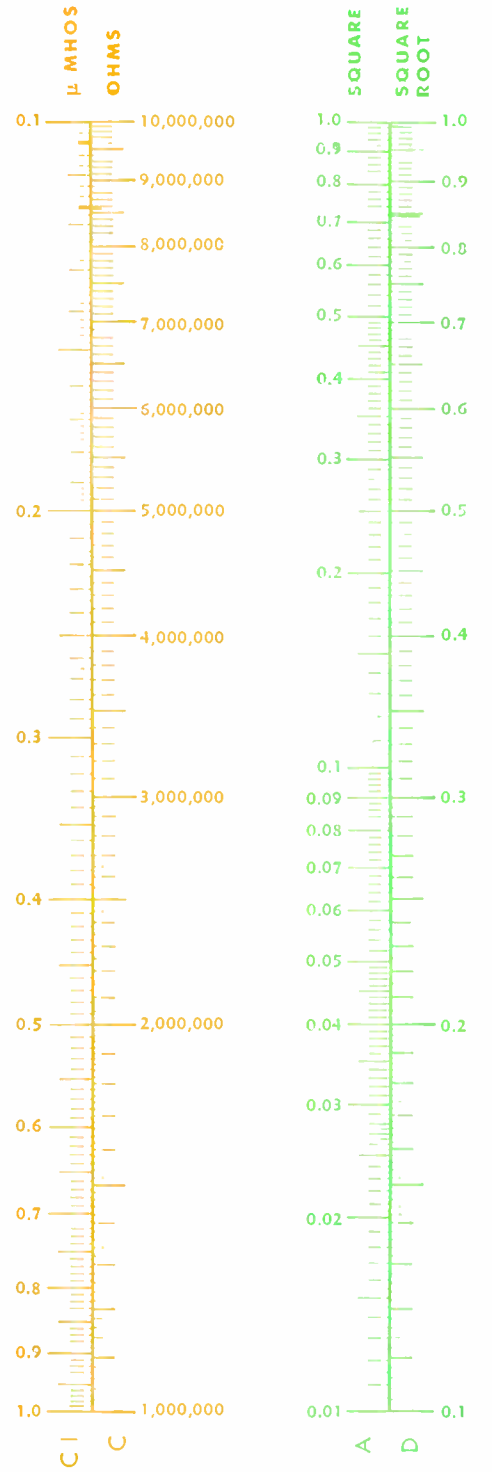
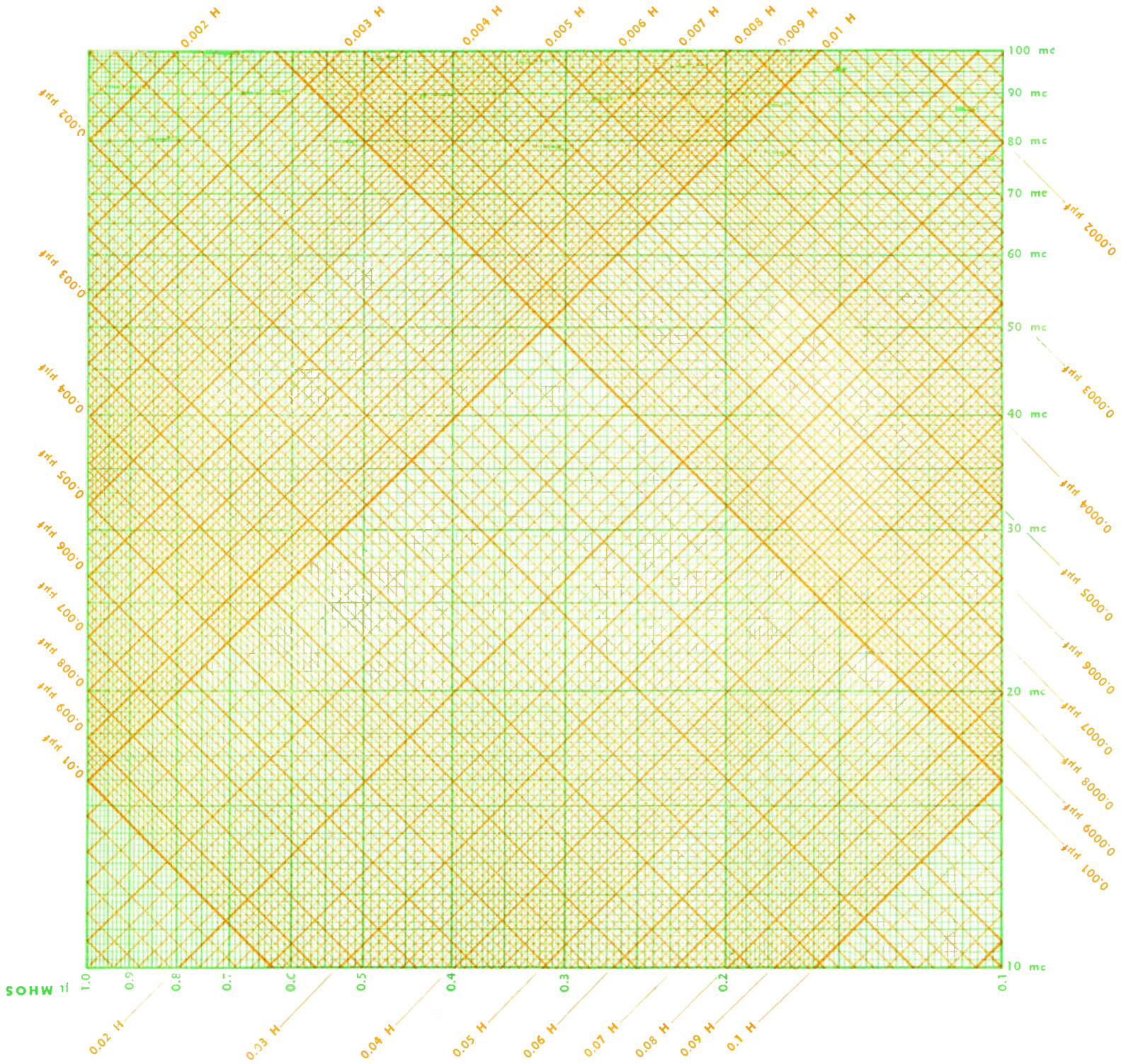
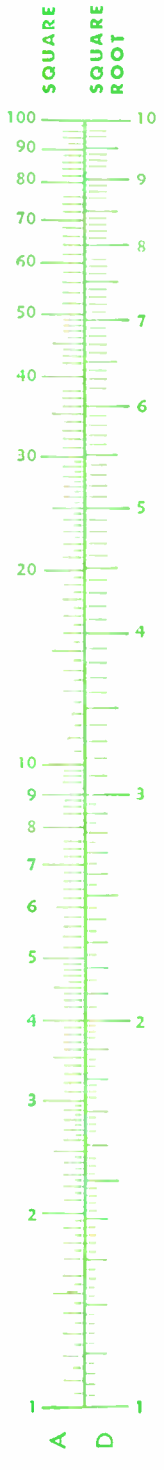
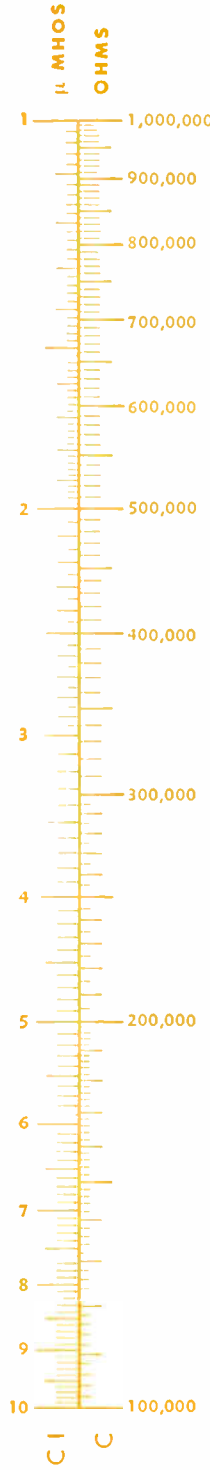
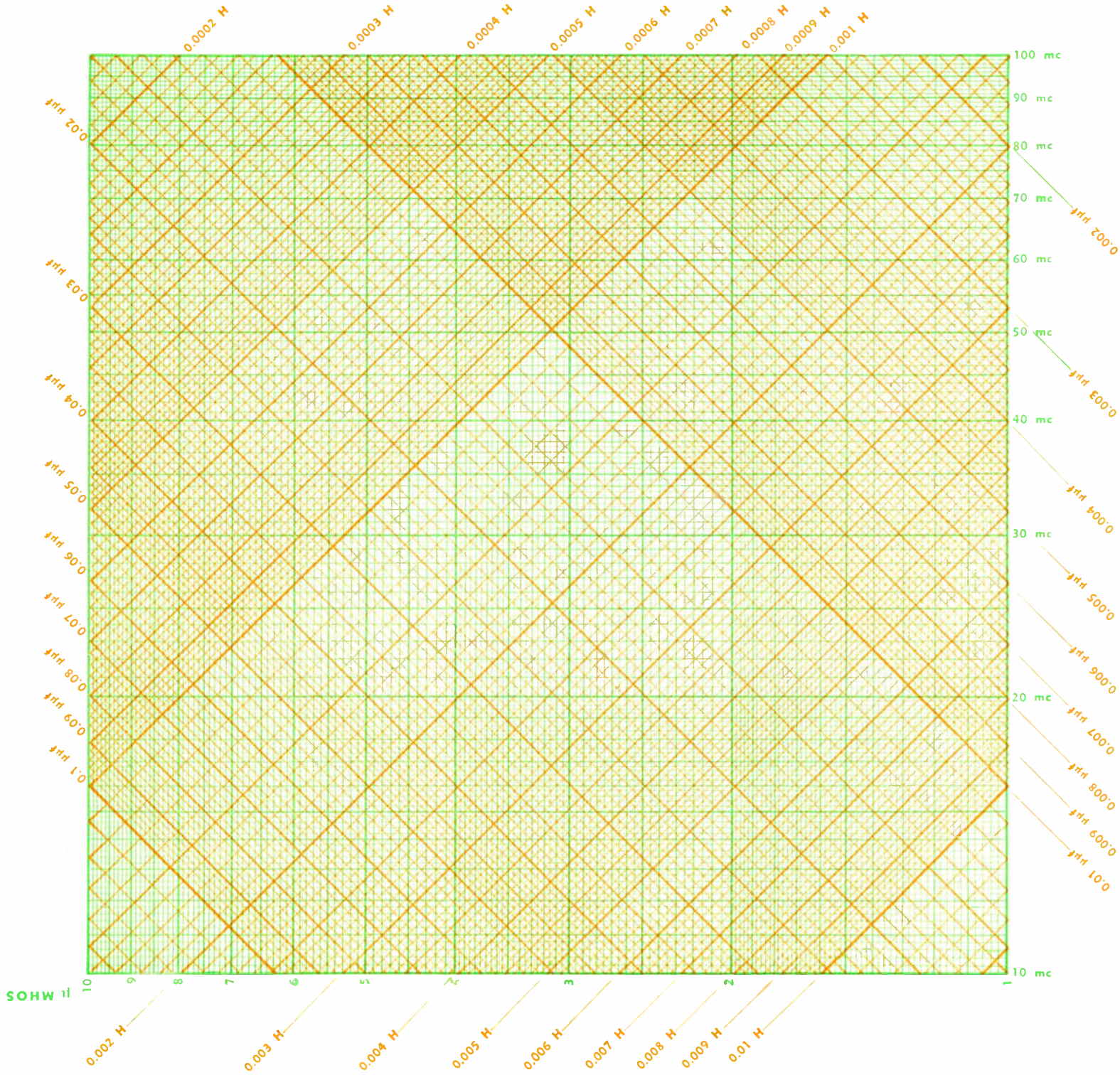
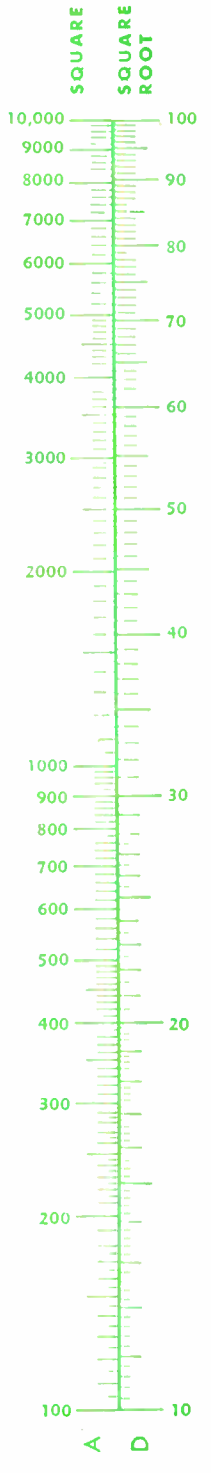
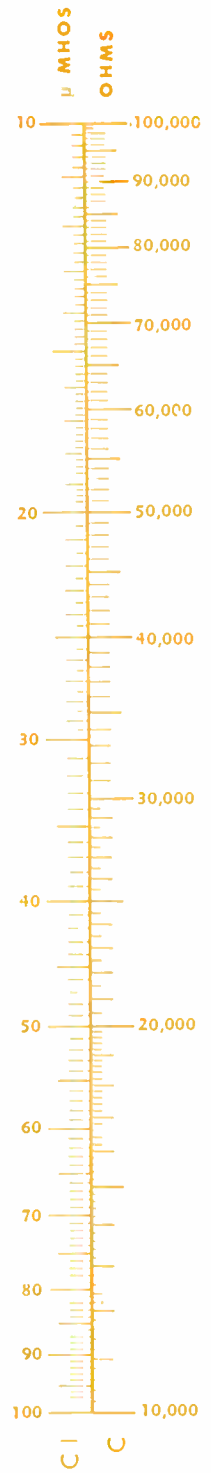
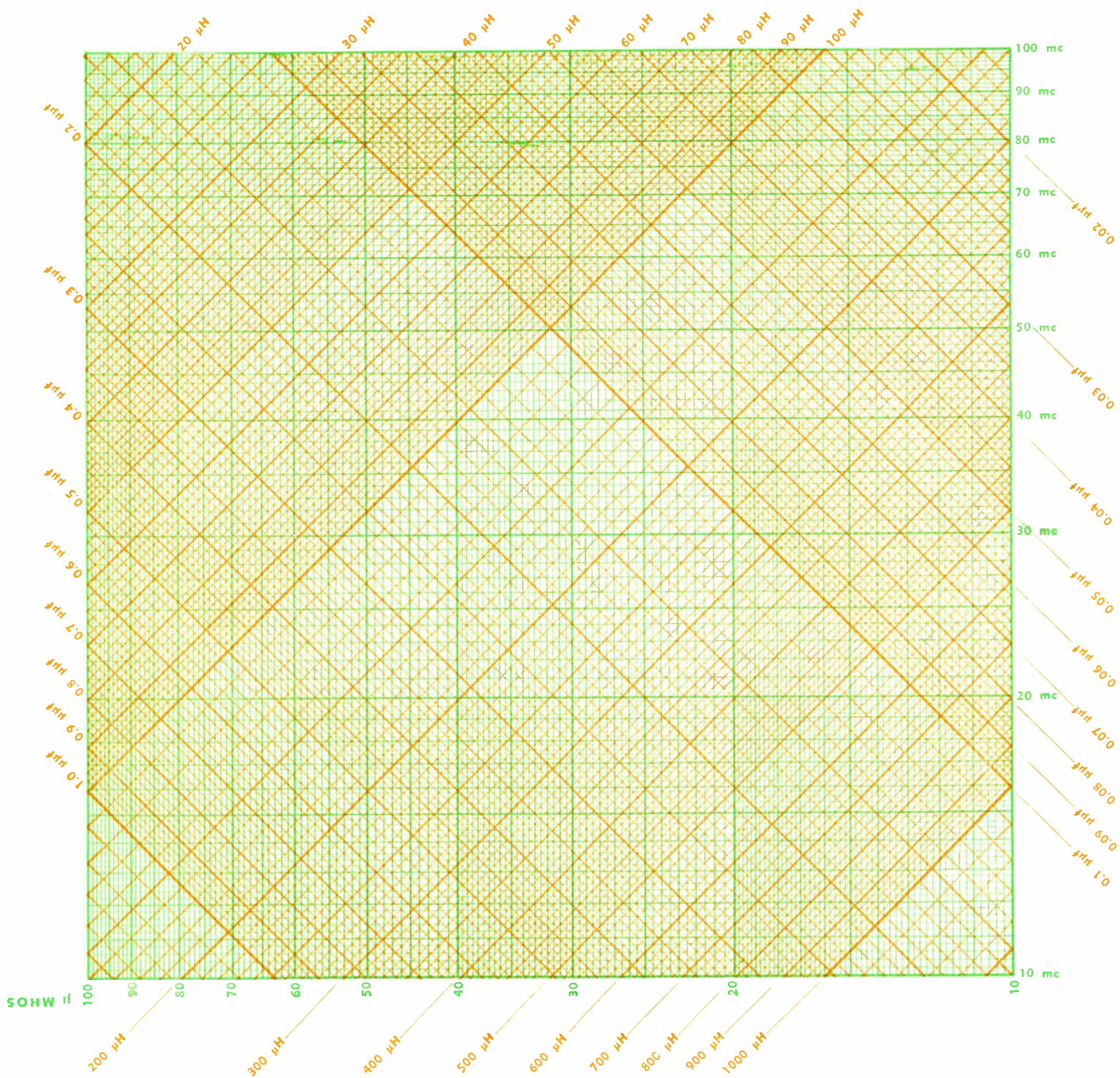
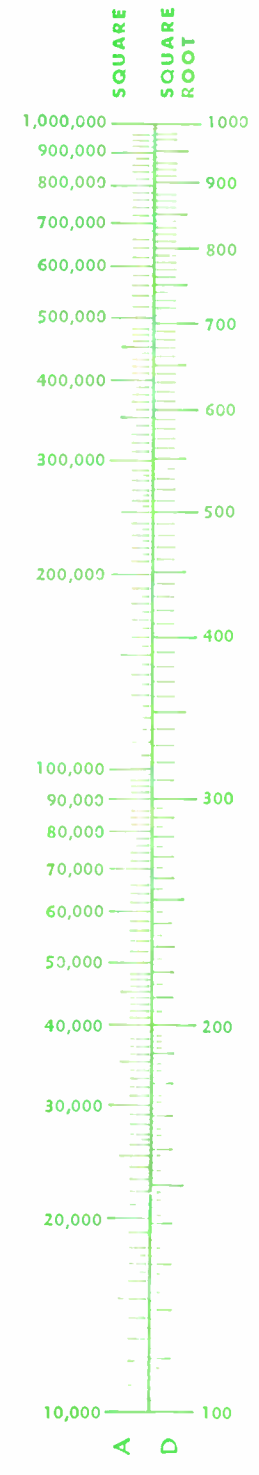
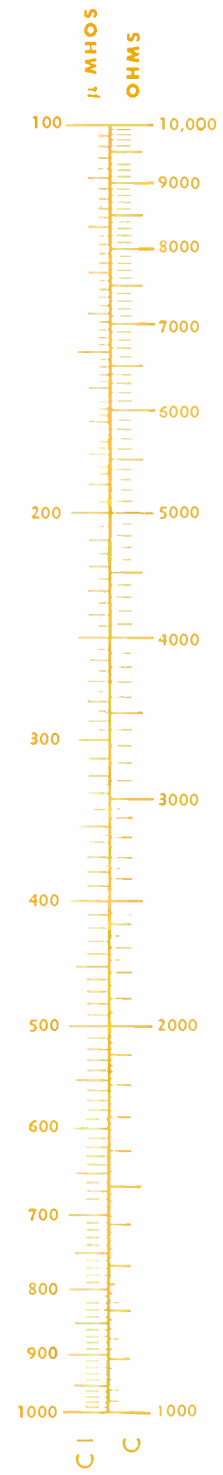
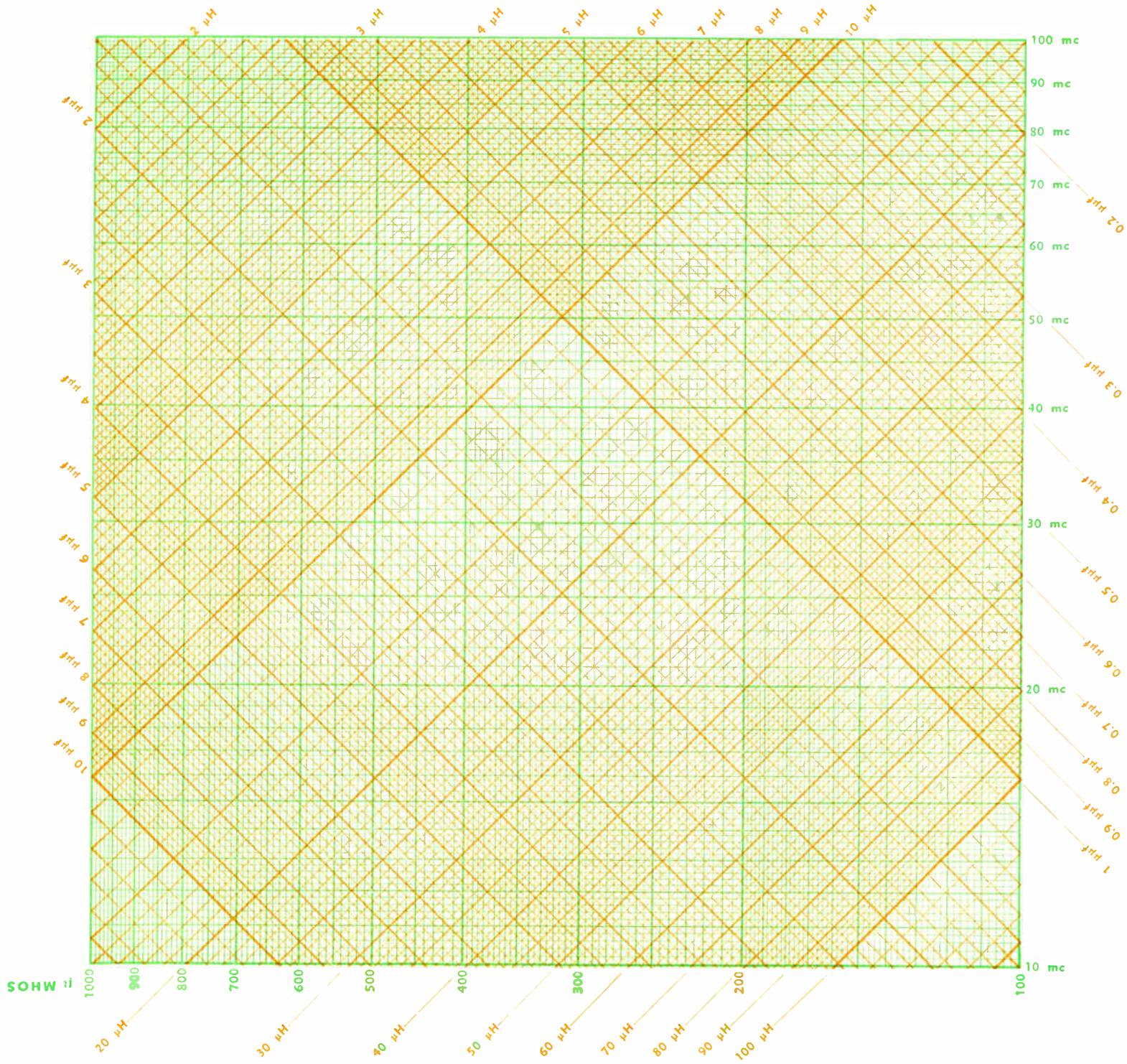


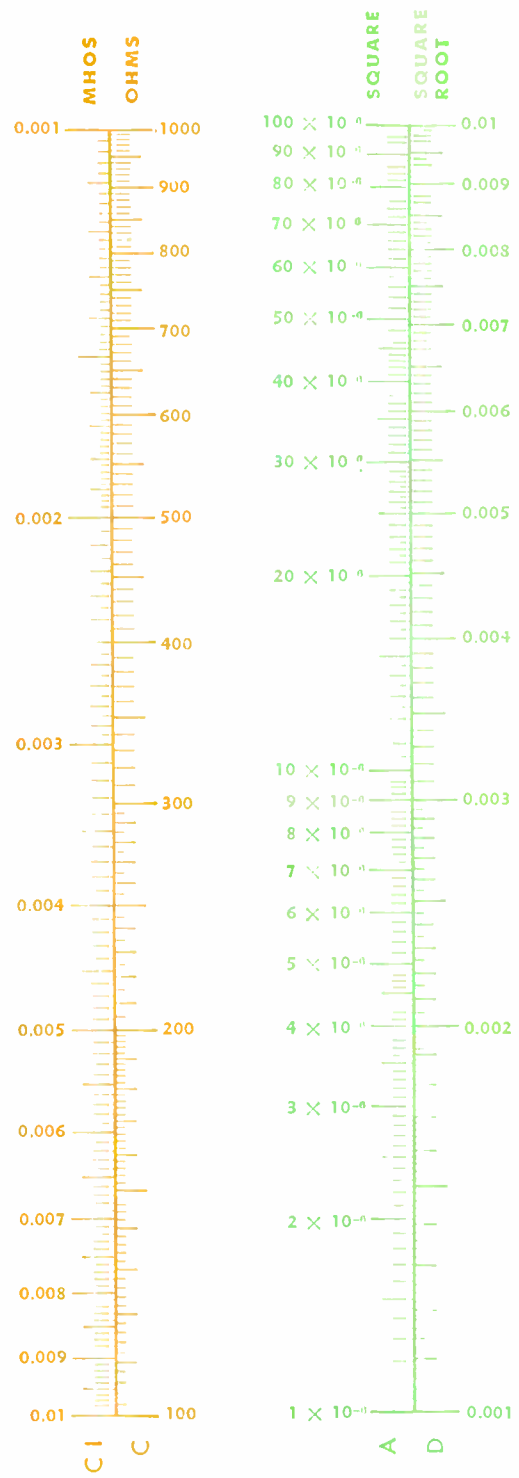
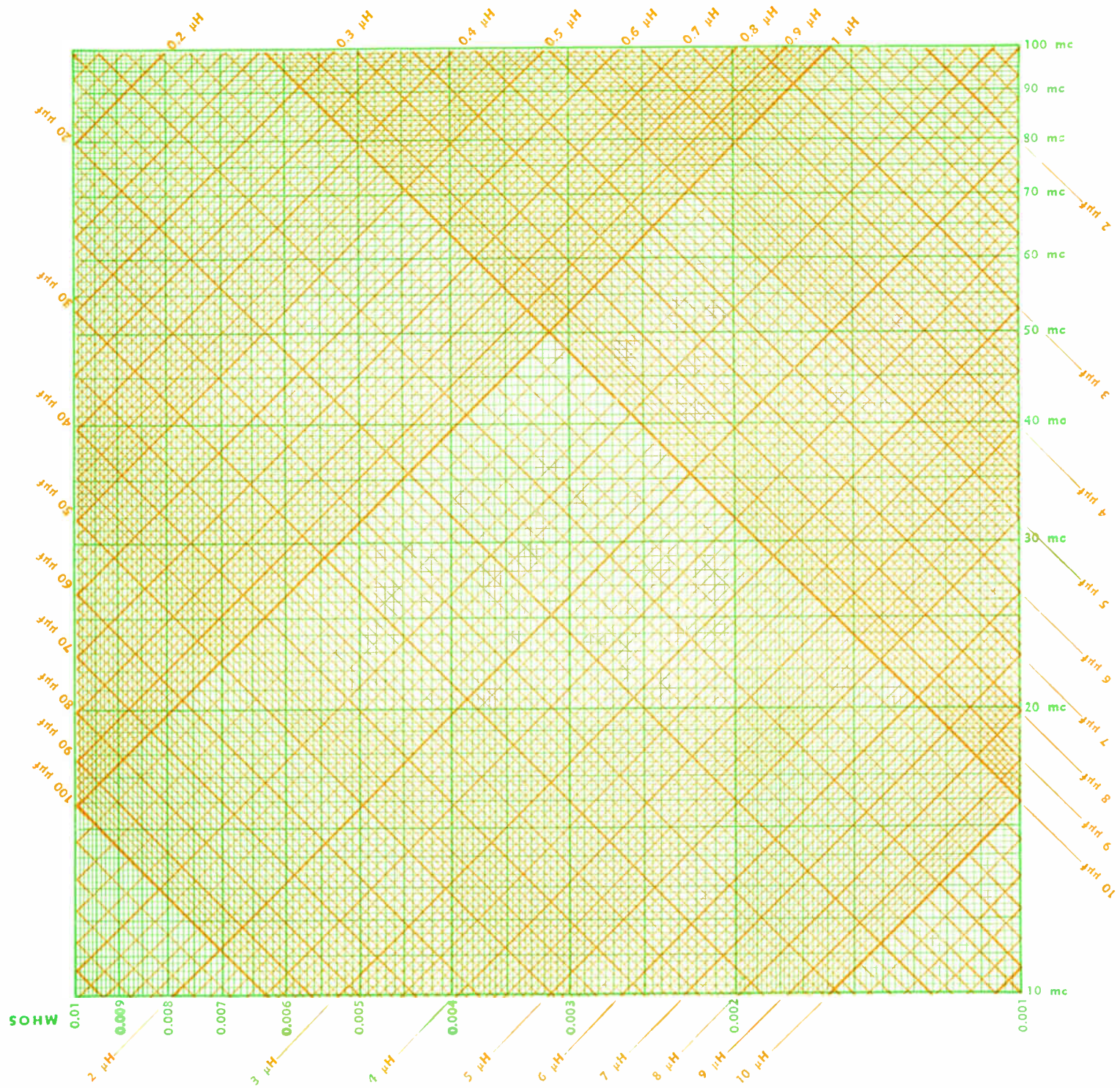
PLATE 128



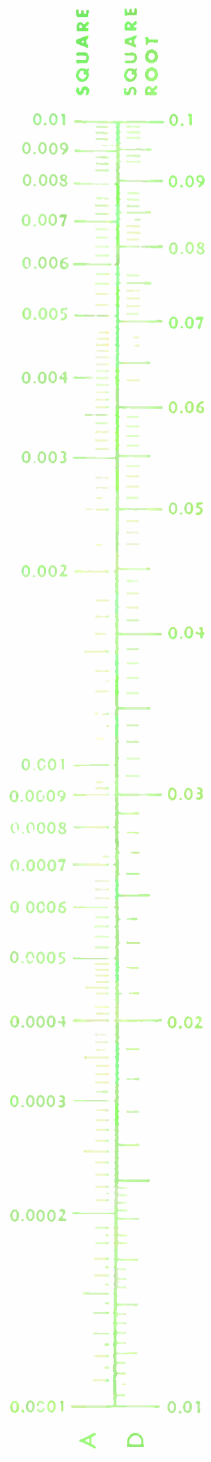
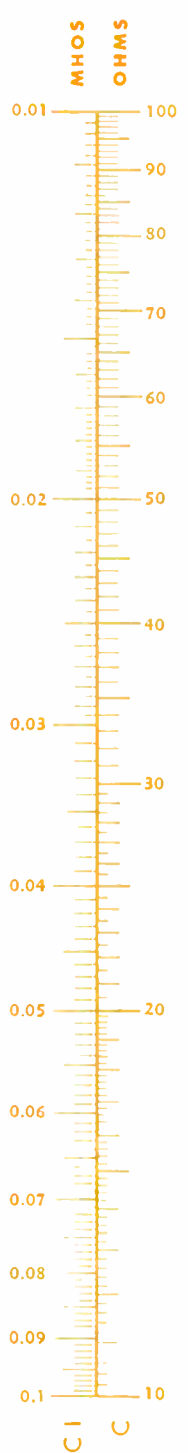
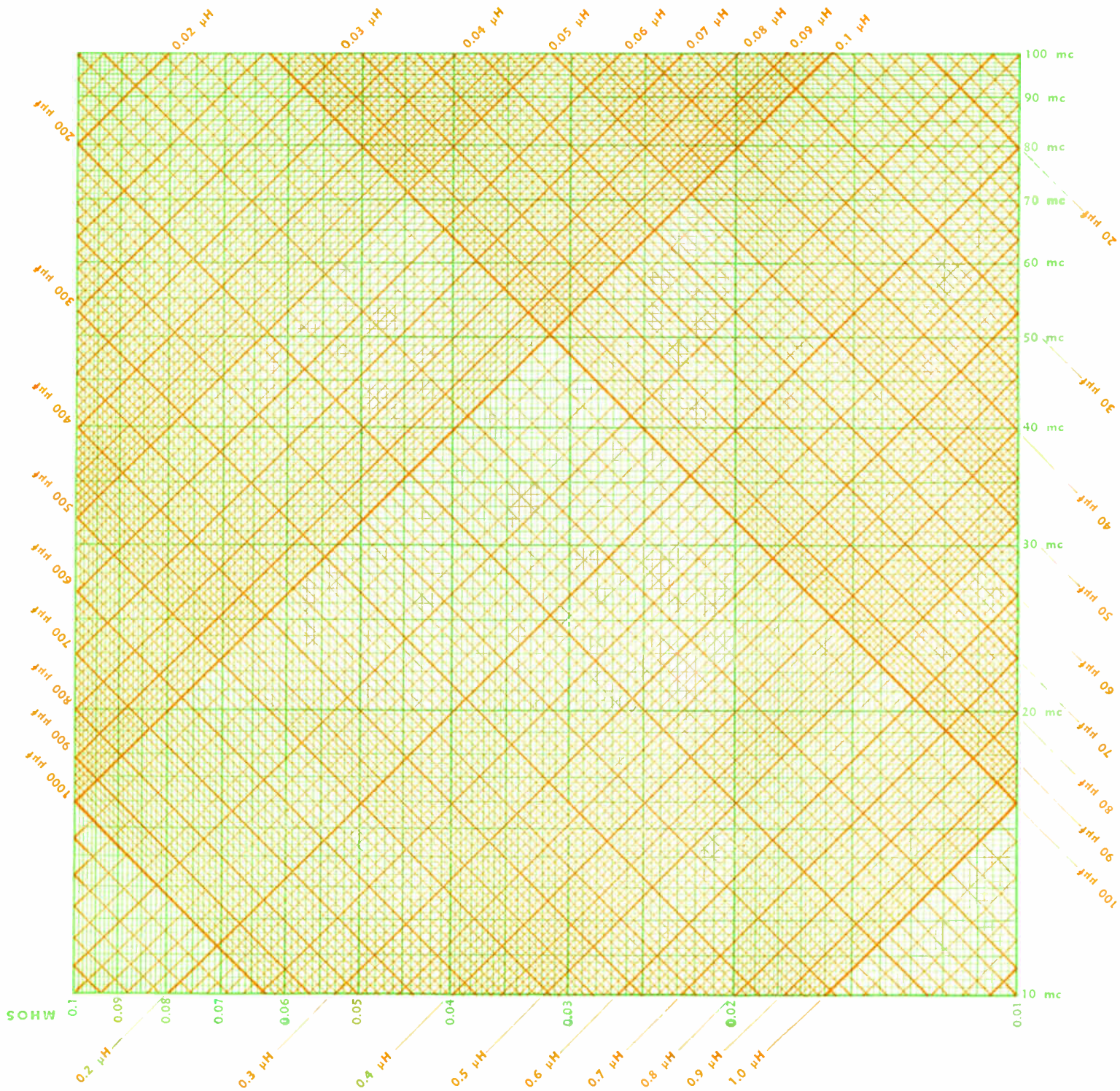


# PLATE 130

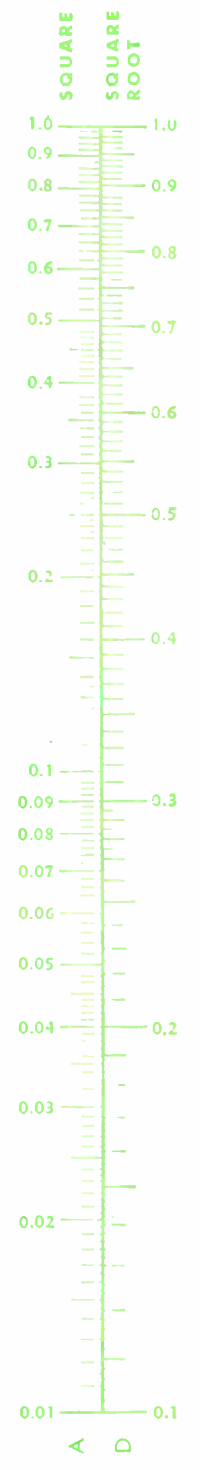
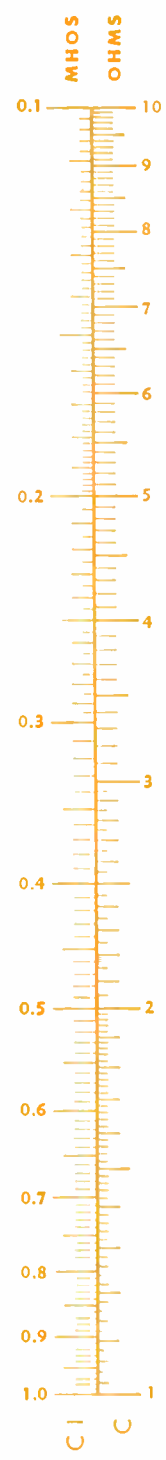
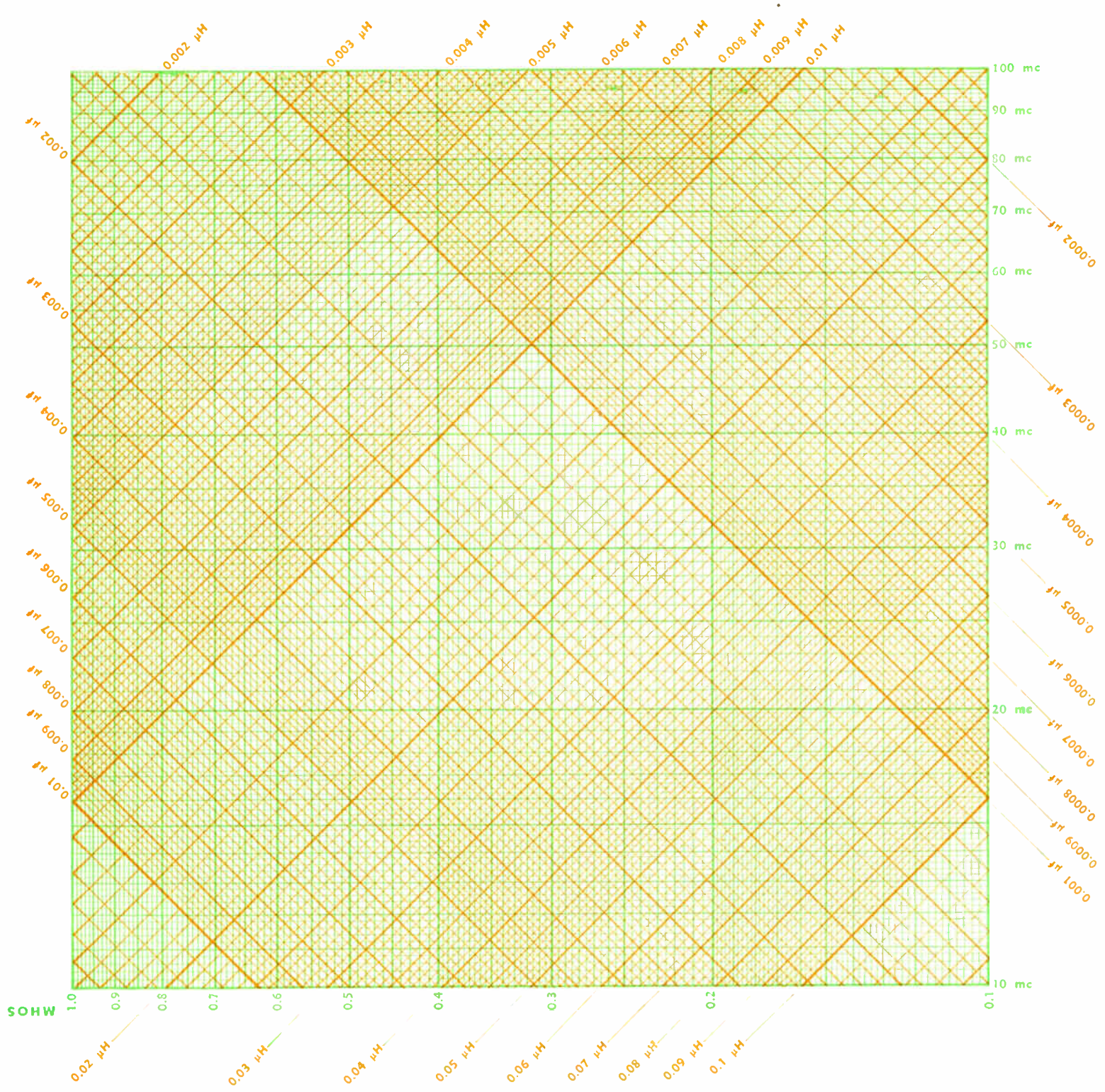




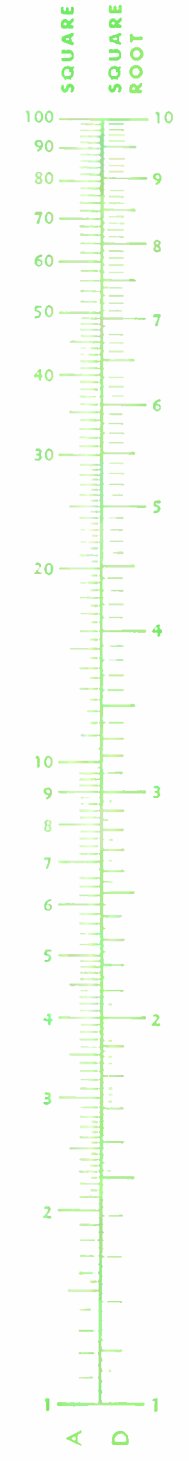
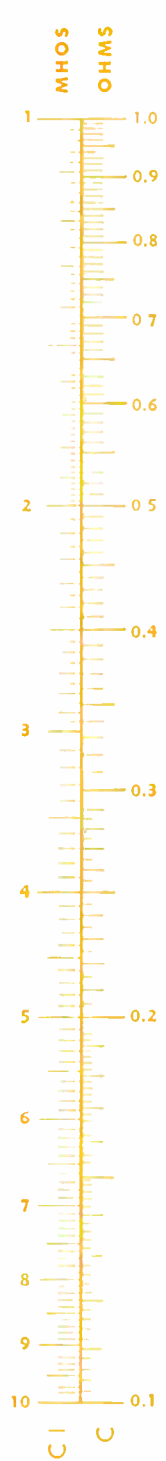
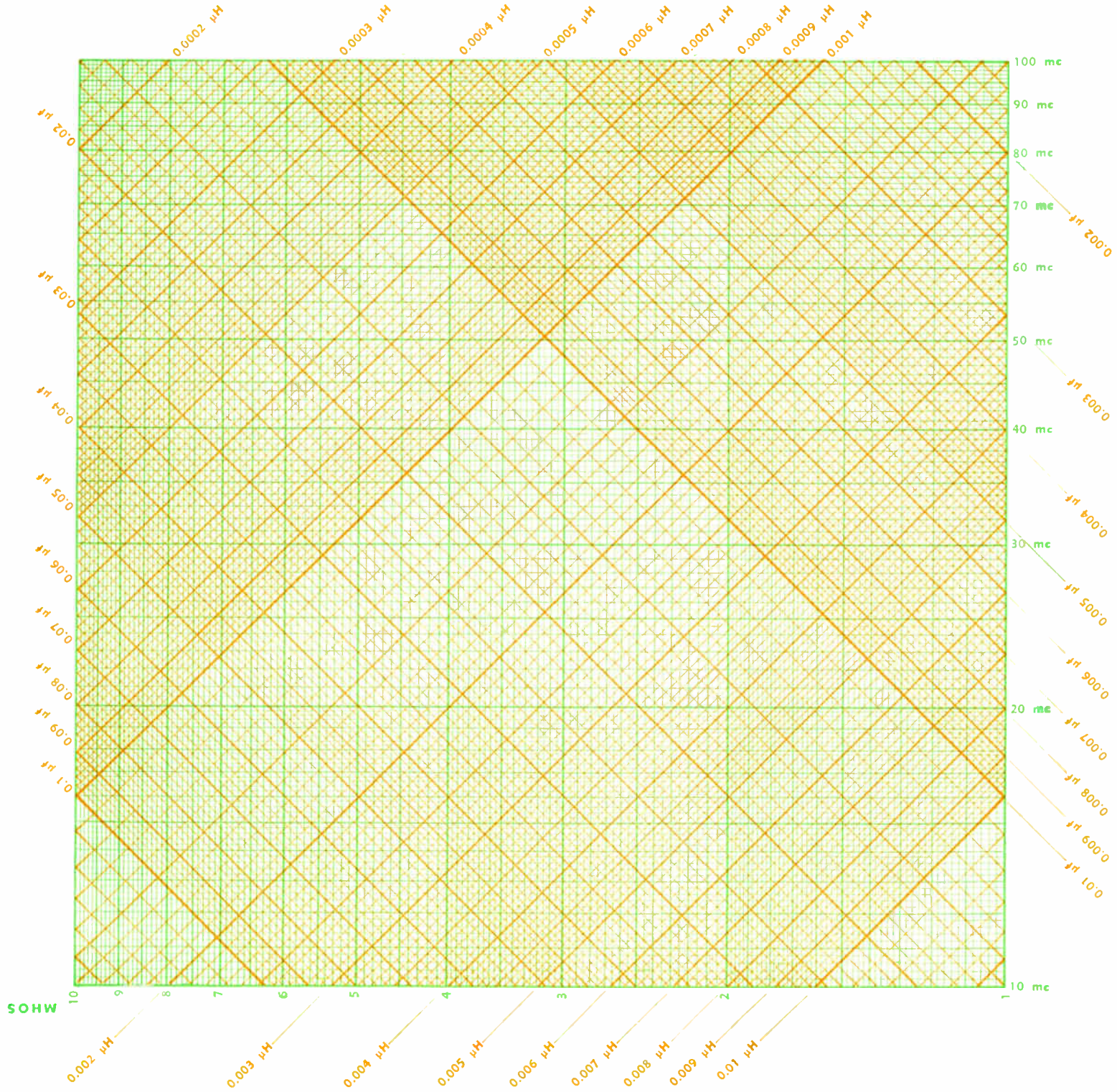
**PLATE 132**

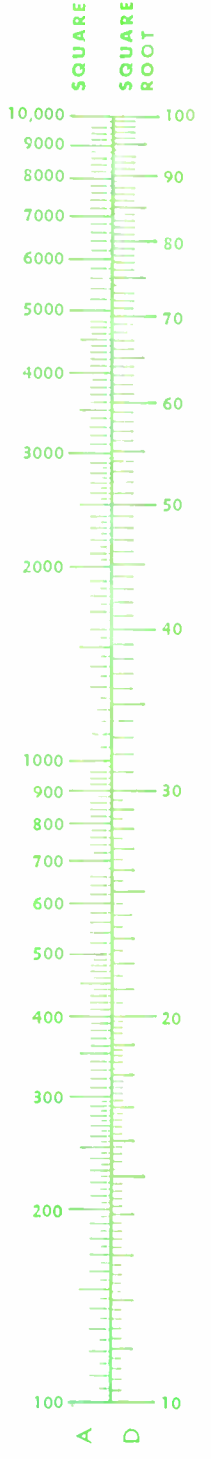
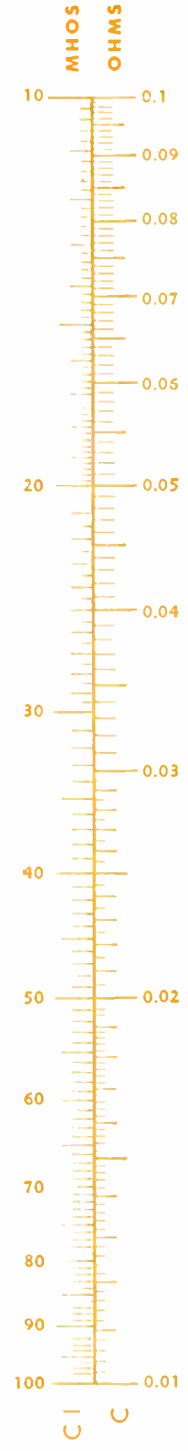
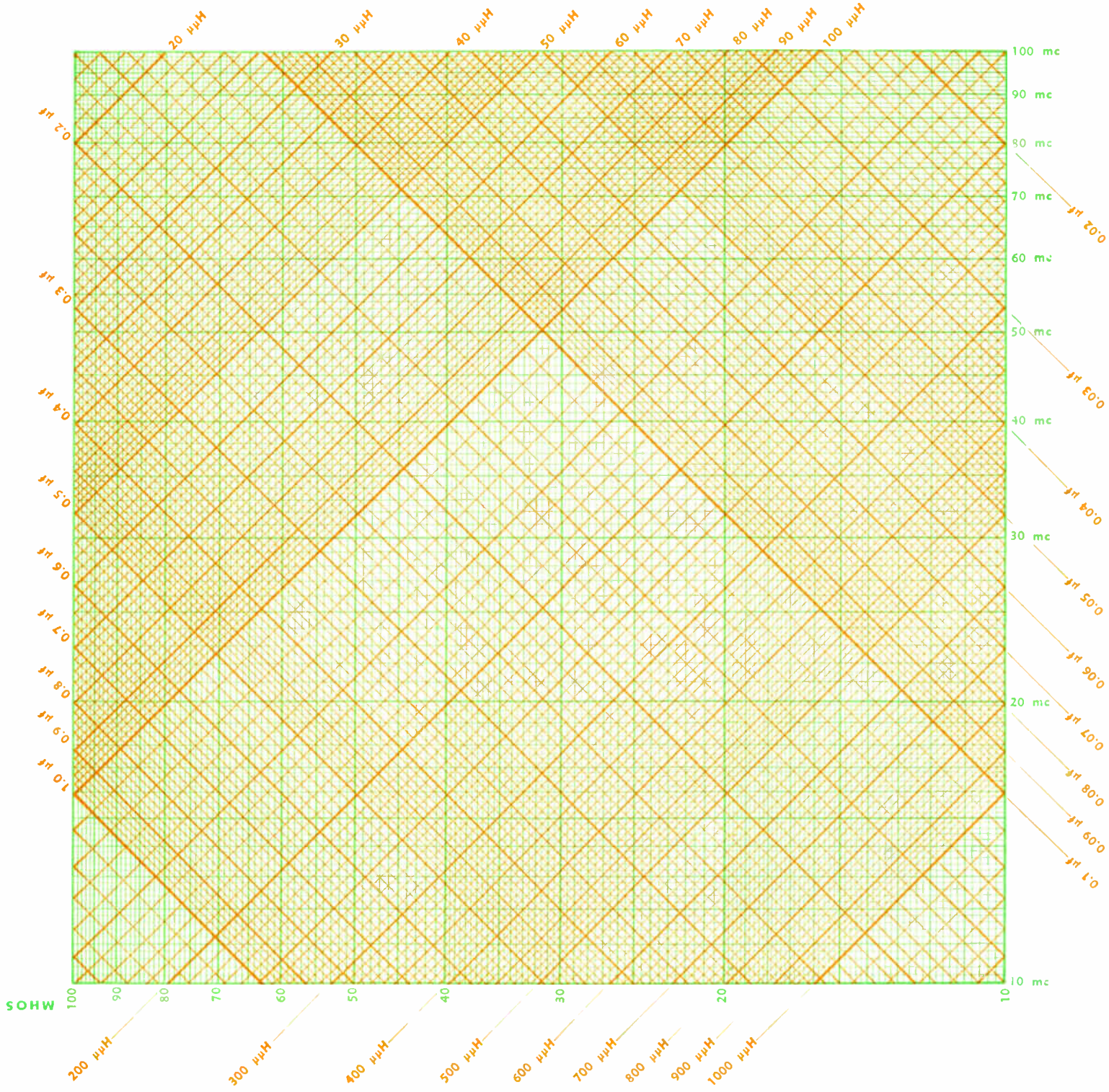




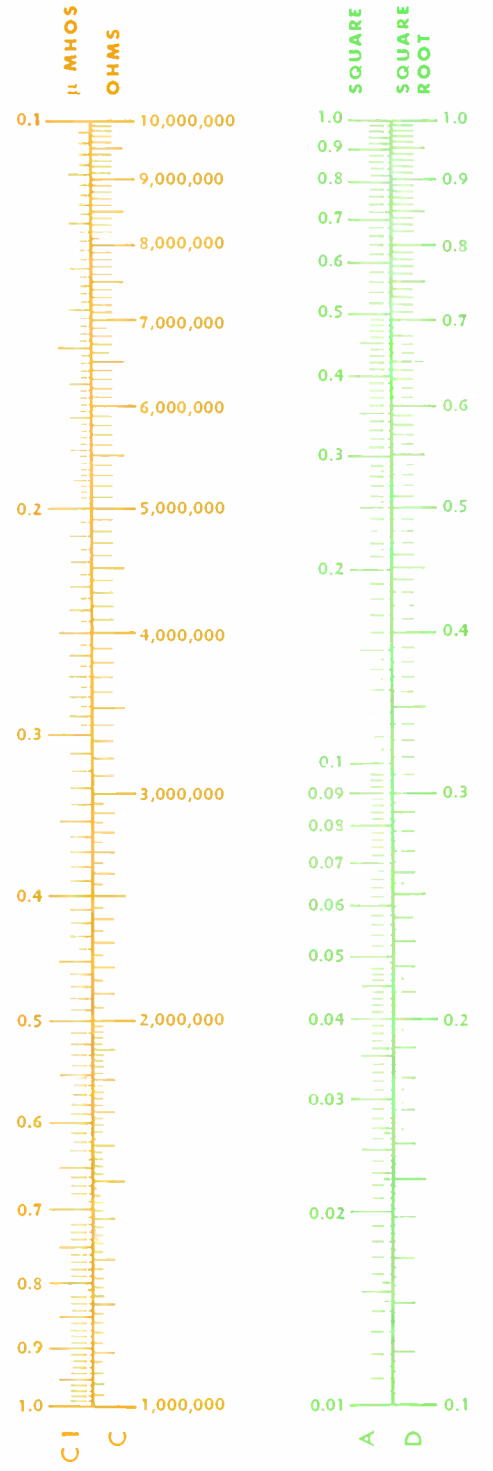
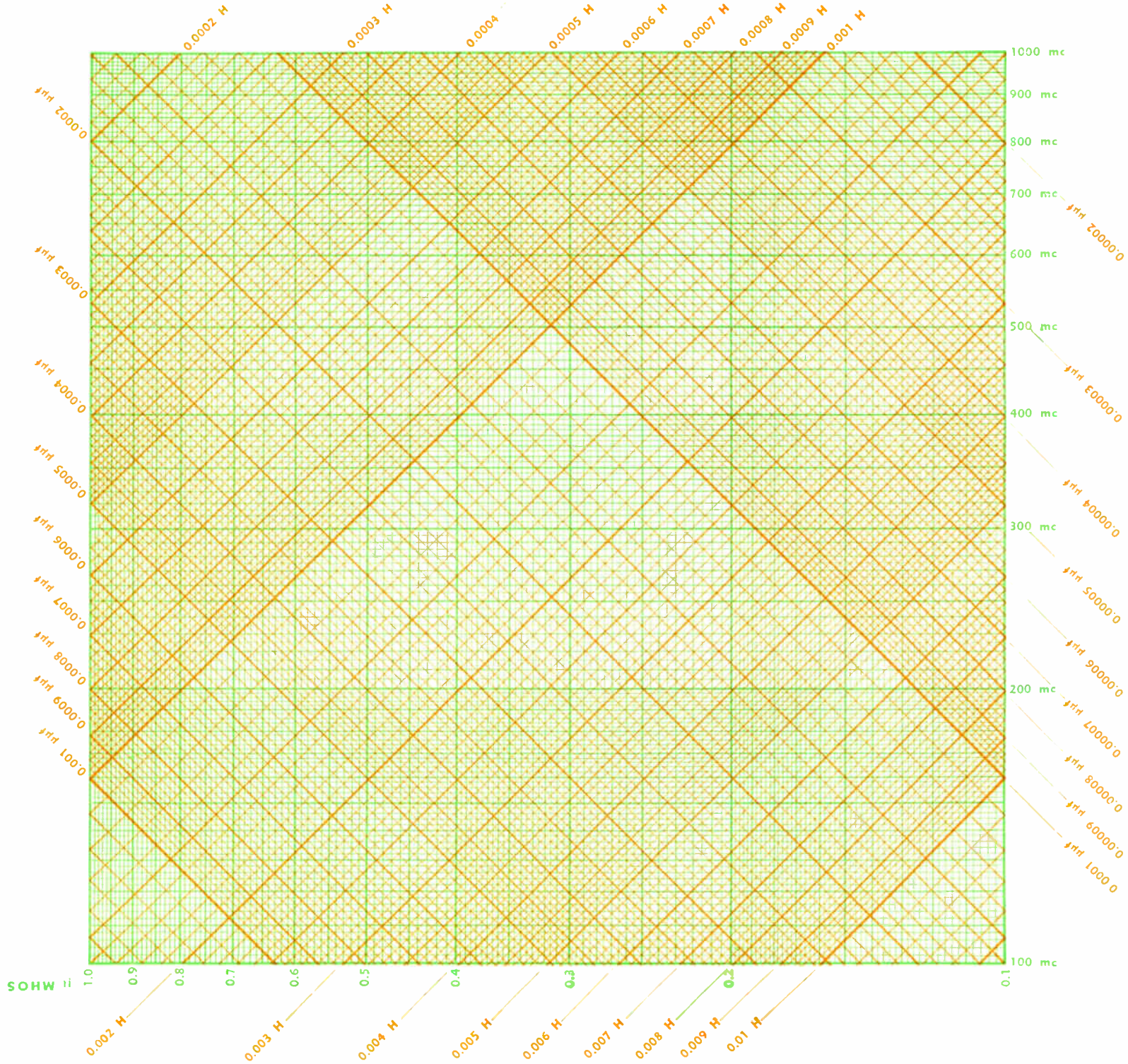


# PLATE 134





# PLATE 136



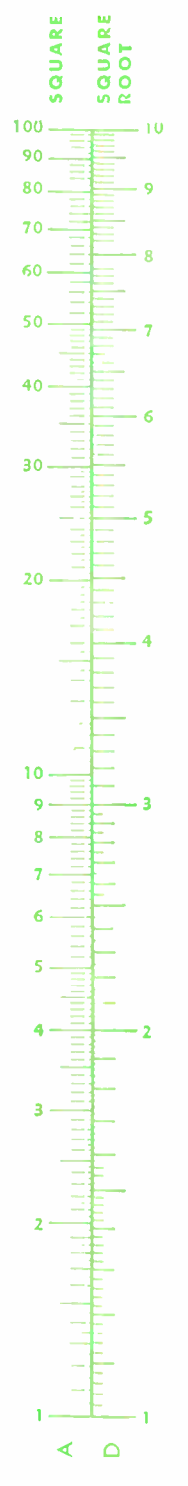
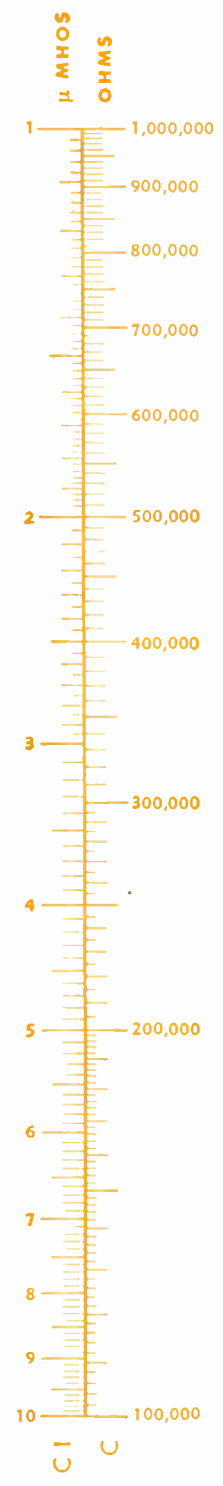
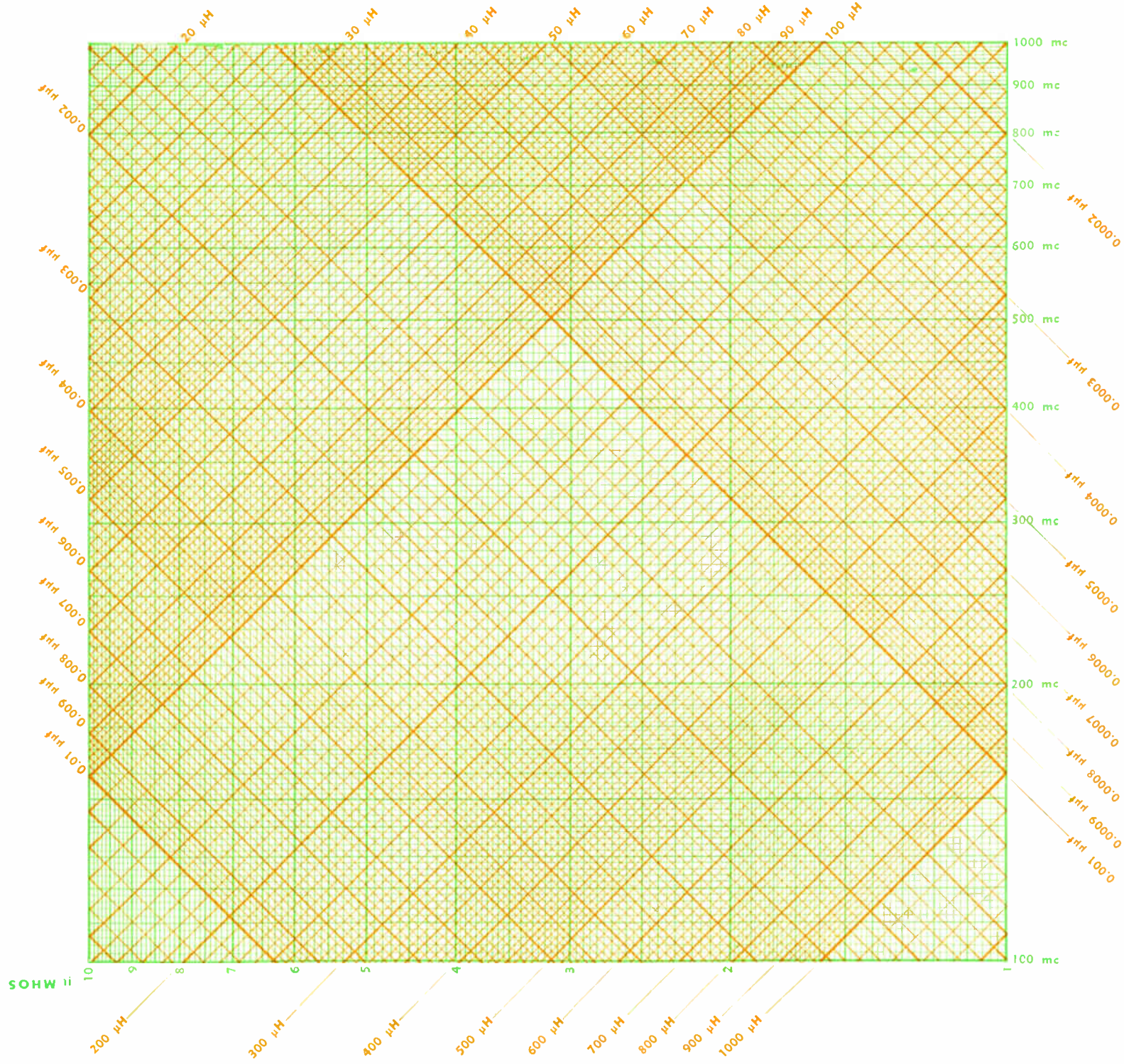
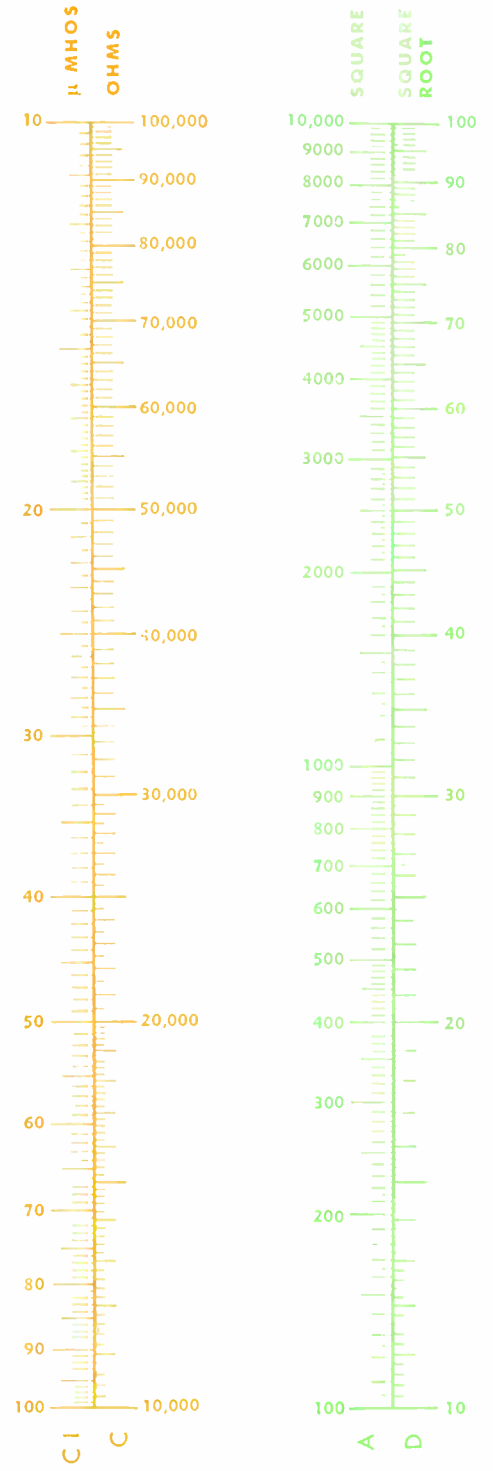
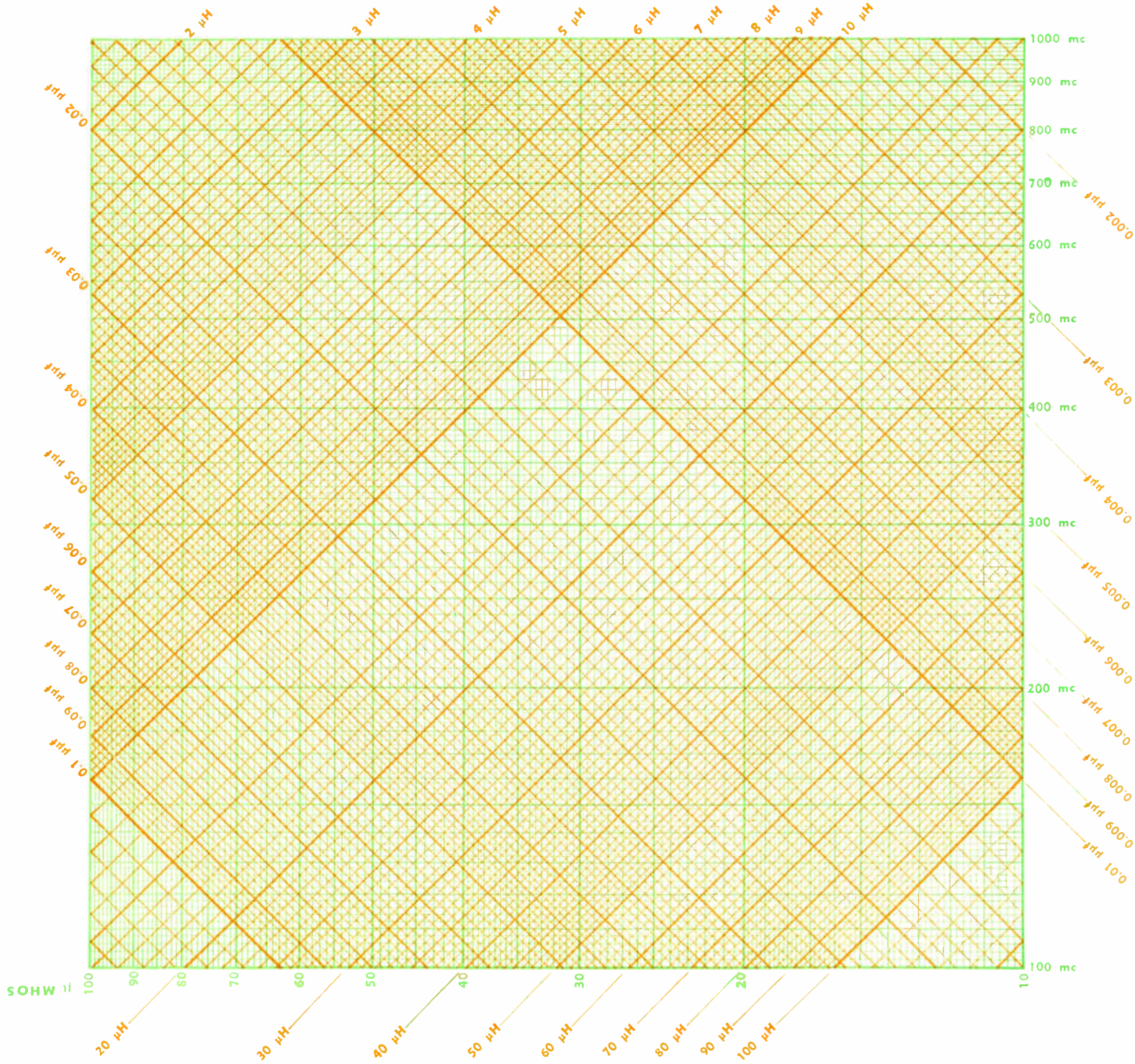


PLATE 138



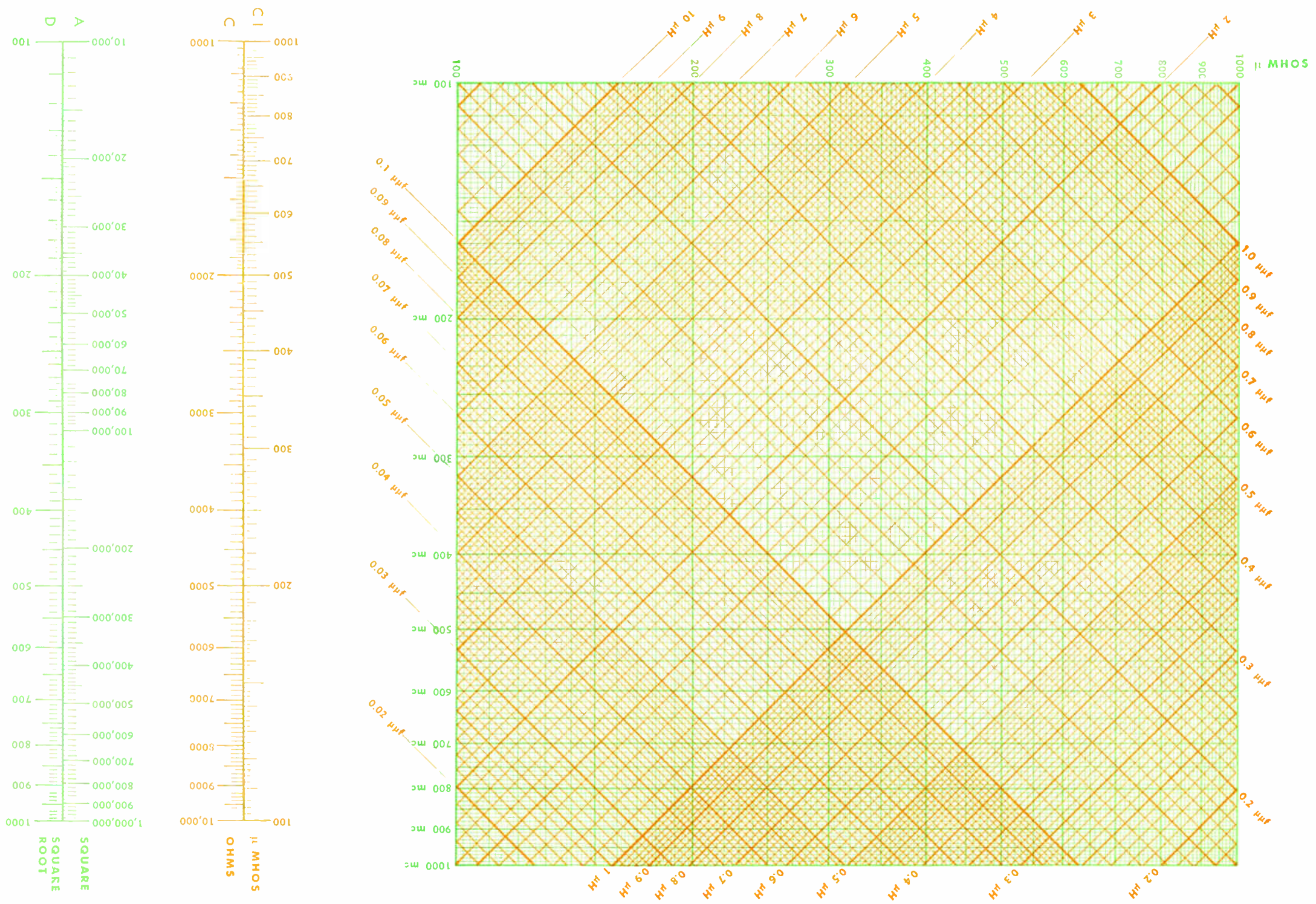


PLATE 140

