

ELECTRONIC TECHNOLOGY SERIES

R-C/R-L TIME CONSTANT

a **RIDER** **publication**

\$.90

R-C/R-L
time
constant

Edited by

Alexander Schure, Ph. D., Ed.D.



JOHN F. RIDER PUBLISHER, INC.
480 Canal Street • New York 13, N.Y.

Copyright 1954 by

JOHN F. RIDER PUBLISHER, INC.

All rights reserved. This book or parts thereof may not be reproduced in any form or in any language without permission of the publisher.

FIRST EDITION

Library of Congress Catalog Card No. 54-9285

Printed in the United States of America

PREFACE

Every experienced instructor in electronics is aware of the inherent difficulty presented to students by the concepts involved in *R-C* and *R-L* time constant applications. Yet, this subject is seldom given more than cursory treatment in text-books written for radio, television, and industrial electronics. The subject is a deceptive one; the simplicity of the time constant equation often leads the student to believe he has mastered the concepts when he has only just begun to scratch the surface.

The organization and phraseology used in this book have been planned to help the student crystallize the important ideas relating to capacitor charge and discharge in his mind prior to studying the applications. At the same time, the depth to which the analyses are carried should assist the advanced student or practicing engineer to review the fundamental concepts and basic applications to his advantage.

The close parallelism that exists between *R-C* and *R-L* timing circuits has made it possible to apply the emphasis to the *R-C* type in the body of each chapter with references to the *R-L* types at the end of the chapter.

Thousands of circuits in which time constants play important parts are published yearly, so that it is tremendously important to have a clear understanding of the basic concept of the time constant. No attempt has been made to list or catalog all possible applications since this would be impossible in a work of this size. The few illustrative circuits used herein were chosen for their simplicity and ease of construction.

Grateful acknowledgement is made to the staff of the New York Technical Institute for its preparation of the manuscript for this booklet.

New York, N. Y.
May, 1954

A.S.

CONTENTS

Chapter	Page
1 Capacitance, Resistance and Inductance	1
2 The Development of the Charge Curve	10
3 The Development of the Discharge Curve	19
4 The Meaning of the Time Constant	24
5 Long and Short Time Constant Waveforms	30
6 Application of the Time Constant	38
Index	47

Chapter 1

CAPACITANCE, RESISTANCE AND INDUCTANCE

1. Capacitance and Capacitors

Stored electricity in the form of electric charges held in a capacitor has been known for a long time. The Leyden Jar as originally developed was demonstrated as a device which could store electrical energy in potential form and which could restore this energy to an electrical circuit when properly connected. This fundamental property leads to another, broader concept which expresses and defines *capacitance*: *Capacitance is that property of a component or circuit which allows it to store energy in such a way as to oppose a change of voltage across its terminals.*

The structure of a capacitor (or condenser) is shown in Fig. 1. In its simplest form, a capacitor consists of a pair of similar metal plates separated by an insulating material known as a *dielectric*. The dielectric must be of the type and characteristics capable of withstanding, without puncturing or otherwise being damaged, whatever voltage appears between the plates. Capacitors used in electronic circuits vary widely in physical appearance and in the choice of materials for the plates and the dielectric, but these differences do not entail new concepts insofar as their operation is concerned. Capacitance is a quantitative, measurable property, and its value determines the extent to which a capacitor opposes voltage changes. Capacitance is also a function of the physical and chemical make-up of the capacitor, being dependent upon the area of the plates, the distance between them, and the dielectric constant of the dielectric. For the moment it is sufficient to recognize that the capacitance is *increased* by increasing the plate area, decreasing the distance between plates, and raising the value of the dielectric constant.

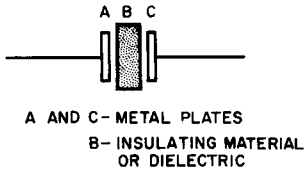

Fig. 1 Structure of a capacitor

The latter is a number which is determined by the atomic structure of the insulating material; a more detailed discussion of its character will be given in a subsequent paragraph.

Commercial capacitors may have parallel plate structure or may be tubular in shape; they may have thick or thin plates made of metals like aluminum, steel, copper, silver plated base metals, and so on; they may have any one of a host of dielectrics, the most popular being waxed paper, oiled paper, mica, air and ceramic materials. In a capacitor of the parallel-plate form, alternate plates are connected together. Because there is dielectric material between each plate and adjacent plates the total *effective* plate area and consequently the capacitance, are much greater than for capacitors of just two plates. In the tubular structure, the same effect is obtained in a different manner. The plates are long strips, or a series of strips, of a material like aluminum foil. These foil strips are sandwiched between thin layers of waxed paper, which is the dielectric. The combined foil and paper strips are then rolled into the form of a tube. Figure 2 illustrates each of these two types of capacitor construction.

2. The Meaning of Q (Charge)

Consider a capacitor connected in a circuit such as that of Fig. 3. Starting with the switch open, the only potential in the circuit exists at the terminals of the source. When the switch is closed, this potential is applied to plates *A* and *C* but no continuous current can flow due

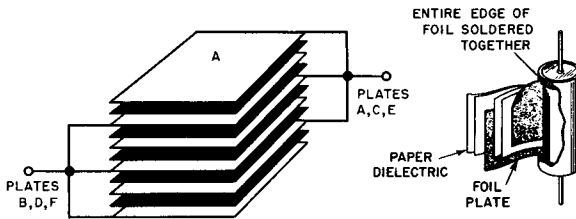

Fig. 2 Two types of capacitors

to the extremely high resistance offered by the dielectric. There will be a surge of electrons, however, out of plate *C* and into plate *A* as shown by the arrows as a result of the electrical "pumping" action of the source emf. Since these plates are metallic, they are, at the time the switch is first closed, free to give up or take on electrons easily under the potential provided by the source. After the switch has been closed, plate *C*, having fewer electrons as compared with its former, neutral state, becomes positively charged while plate *A* with its comparative excess of electrons becomes negative. Should the switch now be opened, the charge will remain on the plates because the electrons on the negative plate are "bound" there by the attraction of the positive charge on the other plate. Energy has been stored in the capacitor. At the same time, the dielectric material will be in a state of atomic "distor-

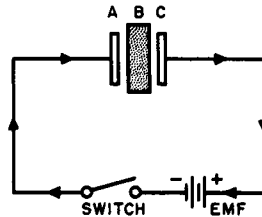

Fig. 3 Simple charging circuit

tion". That is, the orbital electrons which make up the shells of the atoms in the dielectric will suffer a shift in position due to the electrical "tension" that results from the electrostatic field produced by the charged plates. This accounts for the commonly accepted statement that the "charge (energy) in a capacitor really resides in the dielectric rather than on the plates". Given the opportunity to force electrons from the plates through an external closed circuit, the dielectric will restore itself to the undistorted state and restore to the circuit the energy originally absorbed from it. This process is called the *discharge* of the capacitor. The *stored* electrical energy is released to the external closed circuit. Figure 4 is drawn to illustrate in fundamental form the sequence of events just described. In the charged condition, the normally circular orbits of the electrons around the nucleus of the atom are distorted into ellipses; after discharge, the orbits have again become circular, dissipating the electrical energy of this change in the form of electron flow through the resistor, *R*.

The quantity of electrons stored in the charged capacitor is controllable by two means. First, the greater the applied emf, the larger will be the number of electrons which move from plate *C* toward plate

R-C AND R-L TIME CONSTANT

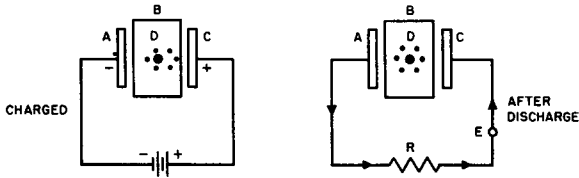

Fig. 4 Atomic distortion in dielectric

A, through the external circuit. Second, a larger capacitance obtained by using large, closely spaced plates and a dielectric having a sizeable dielectric constant will permit a greater number of electrons to move from one plate to the other before the limit of the “pumping” ability of the source is reached. The size of the charge, then, is a measurable quantity and must be assigned a unit of measure. The unit in common use is the *coulomb*, a quantity of charge equal to 6.28×10^{18} electrons. Thus, when 6.28×10^{18} electrons move from one plate toward the other and remain bound in this location, the capacitor is said to have taken on a charge of one coulomb. The extent of charge, or the number of coulombs in a capacitor, may be loosely compared with the number of pints of water in a two or three gallon jug; if the capacitor is capable of accepting more charge than has been given it, it is like a partially empty water jug.

If the applied voltage is unvarying, the surge of electrons flowing from plate C to plate A constitutes a real but *transient* electric current lasting for a relatively short period of time just after application, or just before removal, of the voltage. In accordance with the standard accepted definition of an electric current, when one coulomb passes a given point in a circuit in one second, one *ampere* of current is said to flow. In our example, suppose that an observer were to count electrons flowing past point E in Fig. 4 during discharge; suppose further that he found one coulomb to pass this point (6.28×10^{18} electrons) during the entire discharge period which occupied exactly one second. He could say that one ampere of current had flowed in the circuit during the period of his observation. But, a rather fine point must be drawn here. In a normal electrical circuit containing a source of emf and a load, when we say that one ampere is flowing we mean that during each second the circuit is in operation, one coulomb flows out of the source and through the load; on the other hand, if the observer had timed his period for two seconds he would have counted two coulombs, for three seconds three coulombs, or for $\frac{1}{4}$ second only $\frac{1}{4}$ coulomb. In the case

of the capacitor discharge, this is not strictly true. As will be shown later, the true current is much greater at the beginning of the discharge period than it is near the end. This variation of current is also true during charging. This is an important idea and must be borne in mind for later reference. It is here that the "time" part of time constants enters the picture. If electric current is constantly viewed as "passage of charge per unit time" as described above, the time constant concept will be much easier to understand.

3. The Relationship Between C, Q, and E

If two water jugs of different capacities are placed side by side as shown in Fig. 5, and if an equal quantity of water, say one quart, is added to each, the levels of the two liquids will be different. It will be noted that this small quantity of water has raised the level of the liquid more in the case of the lower capacity jug.

The quantity of charge (number of coulombs, symbolized by Q) is analogous to the quantity of liquid (number of pints or quarts); the capacitance or ability to store charge is like the capacity or size of the jug, and water level is comparable to voltage or potential level. Following this analogy through, it appears that a given charge will raise the voltage of a small capacitance capacitor *more* than it will lift the potential level of a larger capacitor. This provides a suitable basis for the definition of the unit of capacitance: a capacitor is said to have one unit of capacitance if one coulomb of charge raises the potential across its terminals one volt.

From the water analogy, it can be concluded that the voltage developed across a capacitor is directly proportional to the amount of charge introduced (more coulombs, more volts) and inversely proportional to the capacitance of the capacitor (larger capacitance, smaller voltage). If the units are chosen properly, this proportionality may be converted into an equation:

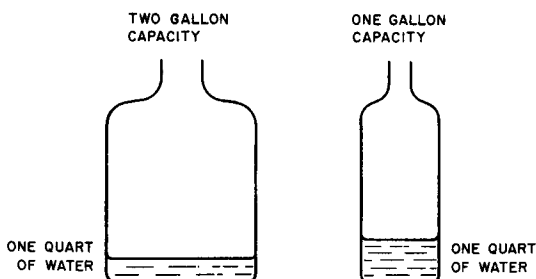

Fig. 5 Liquid levels depend upon capacity

$$E = Q/C \quad (a)$$

where E is voltage in volts, Q is charge in coulombs, and C is capacitance in farads.

The unit of capacitance is defined in this equation. It is given the name *farad*; a capacitor which has a capacitance of one farad, then, will develop a potential of one volt between its terminals when one coulomb of charge is fed into it.

The equation may be written in three forms,

$$1) \ E = Q/C \quad 2) \ Q = CE \quad 3) \ C = Q/E \quad (b)$$

The verbal implications of these three forms follow:

1) The voltage developed across a capacitor is directly proportional to the added charge and inversely proportional to the capacitance of the capacitor.

2) The charge which appears on a capacitor is directly proportional to both the capacitance of the capacitor and the charging voltage.

3) The capacitance of a capacitor in farads may be found by dividing the charge in coulombs placed upon it by the charging voltage measured in volts.

4. Enter the Time Element

In Paragraph 2, an electric current was defined as the number of coulombs passing a given point in a circuit per unit time. This may be stated in symbolic shorthand thus:

$$I = Q/t \quad (c)$$

where I is *average* current in amperes, Q is charge or quantity of electrons in coulombs, and t is time in seconds.

Converting the equation to the form in which Q is the "unknown", we have:

$$Q = It \quad (d)$$

From this equation it is evident that the charge that builds up on a capacitor depends upon *both charging current (I) and the time during which the charging current flows (t)*.

Substituting It for Q in equation (b) 2 we obtain:

$$It = CE \quad (e)$$

Solving for t :

$$t = \frac{CE}{I} \quad (f)$$

This states that the time required to build up a voltage E on a capacitor having a capacitance C , depends upon the size of the average charging current; furthermore, the inverse relationship of t and I informs us that the *larger the charging current is, the less time will be required to raise the voltage of the capacitor to the potential E* .

5. Resistive Control of Charge Time

The significant idea which emerges from the discussion above is that the time required to build up a given potential across the terminals of a capacitor may be controlled by increasing or decreasing the *magnitude* of the current flowing into the capacitor. Conversely, if the capacitor is charged to begin with, the time required for discharge may likewise be varied by changing the intensity of the discharging current.

A practical means of controlling current of any kind involves the use of a resistor in series with the load. Viewing the capacitor as a load, a resistor connected in series with the charging voltage and the capacitor can be made to govern the time which must elapse before the capacitor takes on a given potential E . A charging and discharging circuit is shown in Fig. 6.

With switch 2 open, current begins to flow into C as soon as switch 1 is closed. This charging current flows through R on its way into the capacitor and, as we have seen, is controlled in strength by the value of the resistor. If R is made very large, the voltage reading across C (E_1) will build up slowly so that the time required to reach voltage E_1 will be comparatively large. (Just what is meant by "comparatively" will be explained shortly).

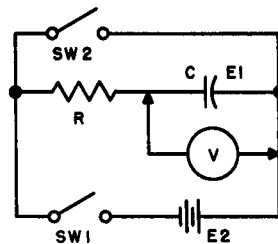

Fig. 6 A test circuit for charge and discharge

Conversely, after the capacitor is fully charged, switch 1 may be opened. Then, if switch 2 is closed, the capacitor will discharge through switch 2 and R . Again, the time required to discharge the capacitor fully will depend upon the resistance value of R ; if it is large, then a comparatively long time must elapse before full discharge is realized.

The reader will note that two voltages are shown in Fig. 6: E_1 and E_2 . Theoretically, E_1 can never rise enough to equal E_2 as will be proved in a forthcoming paragraph; in practical electronic circuits, however, E_1 may be considered to be equal to E_2 after the lapse of sufficient charging time.

Referring once again to equation (f), it is also evident that the capacitance C is a determining factor in time of charge or discharge. As the relationship between t and C is a direct one, the conclusion that larger capacitance means longer charge or discharge time is justifiable. The water analogy used in a prior discussion fits in well here. It takes longer to fill a large jug with water using a stream of given velocity than it does to fill a smaller jug with the same stream.

6. The Use of Inductance in Place of Capacitance

A considerable parallelism of ideas and concepts is found to exist when capacitors and inductances are compared side-by-side.

Capacitance

- a. Capacitance tends to hold *voltage* constant.
- b. A definite time is required to build up a potential E_c in a given capacitor with a charging current I_c .
- c. The amount of time required is directly proportional to C and inversely proportional to I_c . That is:

$$t = k \frac{C}{I_c}$$

where k is a simple proportionality constant.

- d. Charging current may be controlled by using a series resistor in accordance with Ohm's Law:

$$I = E/R$$

Inductance

- Inductance tends to hold *current* constant.
- A definite time is required to build up a current I_L through a given coil with an applied voltage E_L .
- The amount of time required is directly proportional to both L and E_L . That is:

$$t = KLE_L$$

where K is a proportionality constant.

- The voltage across the inductance may be controlled by means of a series resistor in accordance with Kirchoff's Second Law:

$$E_L = E_{source} - E_R$$

Thus, when a coil is connected in series with a resistor, the time element again enters in a fashion similar to that found in $R-C$ circuits. The larger the inductance, the longer the time required for the circuit *current* to reach a steady state and the larger the series resistance, the shorter the time required for the circuit current to reach a steady state.

The final comparative statement — one which will be of more value than any other — may be written thus:

For *capacitance*

$t = kRC$ in which t is the time in seconds for the capacitor voltage to reach some predetermined value, k is a proportionality constant which will enable us to use common units of measure; R is resistance in ohms or some multiple thereof, and C is capacitance in farads or some sub-multiple thereof.

For *inductance*

$t = K\frac{L}{R}$ in which t is the time in seconds for the coil current to reach a steady state, K is a proportionality constant inserted so that we may use common units, L is inductance in henries or some sub-multiple thereof, and R is resistance in ohms or some multiple thereof.

7. Review Questions

- (1). Define capacitance. What are the basic units for measuring this circuit characteristic?
- (2). Name the factors which determine the capacitance of a given capacitor.
- (3). Name three common commercial capacitor dielectrics.
- (4). What is meant by "bound charges"? What is meant by "electrical dielectric distortion"?
- (5). If a total charge of 15 coulombs builds up on the plates of a capacitor in $\frac{1}{2}$ second, what average current has flowed during the charge time?
- (6). In the capacitor discussed in the previous question, what voltage must appear across its terminals if its capacitance is $50 \mu\text{f}$?
- (7). How much time would be required to charge a capacitor to a potential of 100 volts if the capacitance is $2\mu\text{f}$ and the charging current (average value) is .05 ma?
- (8). A certain circuit contains capacitance and resistance in series with a voltage source, and requires a time t to charge to a voltage E . If the capacitance is doubled, what must be done to the resistance in order to keep the charge time the same?
- (9). A circuit containing resistance and inductance takes 5 seconds to reach a steady-current state. If the inductance is halved, what must be done to the resistance in order to keep the time the same?
- (10). What factors determine the voltage breakdown rating of capacitors?

Chapter 2

THE DEVELOPMENT OF THE CHARGE CURVE

8. The Growth of Capacitor Voltage

In the discussions of capacitor charging in previous paragraphs, a certain logical outcome of this process was intentionally omitted in order not to introduce issues which might create confusion.

To illustrate the nature of the outcome of this process, let us consider a simple circuit containing a source of emf and a means of connecting it to any kind of load we wish. Since any practical current or voltage source has a definite internal resistance, we shall indicate this on our diagram and label it r .

Now suppose our source of emf is applied across a resistive load R , as shown in Fig. 7. A steady current is established in accordance with Ohm's law:

$$I = \frac{E}{R + r}$$

The sequence of events is depicted in the same figure. Before the switch is closed, the current in the circuit is zero; immediately after the circuit is completed through the switch — instantaneously — the current rises to the value determined by Ohm's law and stays at the same level as long as the switch remains closed. The voltage drop or IR drop across the resistive load follows exactly the same timing, starting at zero and climbing to maximum instantaneously as soon as the circuit is completed by the closed switch. This follows the law that the voltage drop across a purely resistive load is always directly proportional to the current flow through the load and *is always in the same phase*. This rule applies to varying currents in d-c circuits and a-c circuits carrying current of any frequency, and should be remembered as a "rule of thumb."

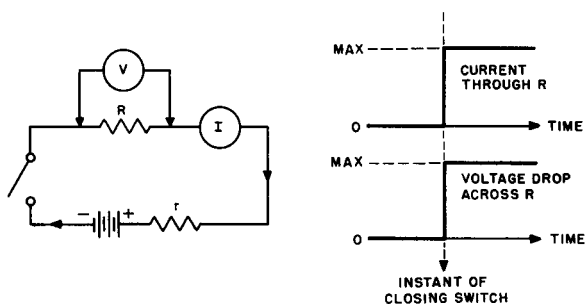

Fig. 7 Current and voltage in resistive load

When the resistor is replaced by a capacitor, an entirely different picture of current and voltage changes is obtained (Fig. 8). Consider the current rise first; when the circuit is first closed, a maximum current surge occurs as the electrons leave one plate of the capacitor and enter the other. The voltage across the capacitor is then zero. Very quickly, however, the capacitor begins to accumulate a charge and consequently, an emf of its own, the polarity of which is opposite to that of the source. Another way to say this is to state that the polarity of the voltage taken on by the charging capacitor *bucks* the voltage of the battery and, when the voltage value on the capacitor equals that of the battery, there will be effective neutralization or balance of voltage so that current will no longer flow. The outcome of this growth of back-voltage is to cause the current flowing into the capacitor to decrease slowly to zero between the instant of switch-closing and point *A* in Fig. 8. The current does not drop off in a straight line but follows a smooth curve whose slope gradually decreases, tapering off practically to a horizontal line at point *A*. This is an *exponential* or *logarithmic* type of curve with special characteristics to be discussed shortly.

At the same time, the current surge into the capacitor right after the switch is closed causes the voltage across it to *begin* to build up very rapidly (between start and point *B*) but as the charging current begins to taper off, the voltage increase takes place at a constantly slower pace, resulting in another exponential curve which is convex at the top rather than concave.

9. The Charging Curve

Additional resistance may be connected in series with the capacitor and source to increase the time needed to reach a given state of charge.

(Paragraph 5). If this is done, it becomes possible to take measurements of small time intervals during the charging process and to determine how much potential has built up on the capacitor at the end of each interval. Then if these time intervals are plotted along the *horizontal* or X-axis of a pair of rectangular coordinates, while the voltage at the end of each interval is shown along the *vertical*, or Y-axis, it should be possible to obtain the curve shown in the lower portion of Fig. 8.

Experimental measurements of this nature necessitate a judicious choice of capacitor and resistor values to provide a charge time that is long enough to permit careful readings of stop watch and voltmeter. The values given in the table below are representative of those obtained using a circuit having a rather large charge time.

Table 1

<i>Time During Which Charging Current Flows (seconds)</i>	<i>Voltage Developed Across Capacitor (volts)</i>
0	0
1	18
2	33
3	45
4	55
5	62
6	68
7	75
8	80
9	83
10	86
11	88
12	90
13	92
14	94
15	95

The graph of these coordinates is given in Fig. 9. It should be noted that the shape of the curve corresponds to the description of it previously given. Significant observations about the nature of this curve are:

(a) It climbs very rapidly at first as indicated by the steep slope. This is interpreted as large voltage changes over the first few time intervals or rapid charging.

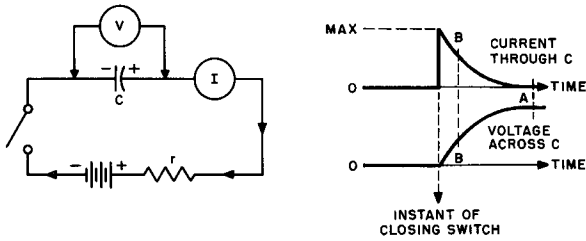

Fig. 8 Current and voltage in capacitive load

(b) Near the end of the charging period, the voltage added over each successive time interval becomes smaller and smaller.

(c) It has a logarithmic or exponential shape. For those who have had some mathematical training along these lines it may be useful to know that the equation of a curve like this takes the following general form:

$$y = I - k^{-x}$$

The chief reason for mentioning the name of this curve shape is to acquaint the reader with terminology commonly found in the literature dealing with time constants. Other than this, the name has little significance to those primarily interested in mentally crystallizing the meaning of time constants and their applications to electronics.

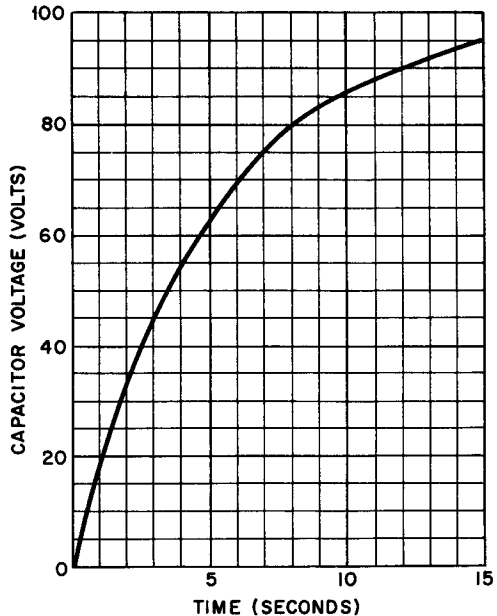

Fig. 9 Graph of values in Table 1

It is not feasible to attempt to measure charge time with a circuit like that illustrated in Fig. 8. The voltmeter connected across the capacitor tends to have a constant draining effect upon it and the capacitor does not show a voltage as high as it should be at any time. As a matter of fact, even a high input resistance meter, such as a good vacuum-tube voltmeter, produces spurious results in this way; the meter causes the capacitor to behave as though it had leakage. A simple circuit suitable for laboratory or test purposes is provided in the Appendix, but reference to it should be delayed until the reader fully comprehends the significance of percentage charge as compared with applied voltage. This circuit is designed to permit accurate measurement of time constants, using a minimum of equipment.

10. How Epsilon Enters the Picture

Epsilon, ϵ , is the base in the Naperian or natural system of logarithms; it has a constant value of 2.718. It is brought into this discussion because it appears in the equation for the charging curve just described. For the purposes of this discussion, a statement of this equation is desirable but extensive analysis or derivation of it is not.

$$e_c = E \left(1 - \epsilon^{-\frac{t}{RC}} \right) \quad (g)$$

in which e_c = the voltage which appears across the capacitor
 E = the voltage applied to the resistor-capacitor series circuit by the source
 ϵ = Epsilon, 2.718
 t = time in seconds during which charging current flows
 R = resistance, in ohms, in series with the capacitor
 C = capacitance, in farads, of the capacitor

This equation may be read as follows: the voltage which appears across a charging capacitor is equal to the applied voltage times the quantity one minus epsilon raised to the minus t over RC power.

Let us analyze, qualitatively at least, the meaning of the equation. A certain voltage, E , is applied by the battery in Fig. 10. After a given time interval, t , the capacitor has charged to the voltage e_c . The capacitor voltage is less than that of the source if the time interval for charging has been kept short and only after a comparatively long time will the capacitor voltage approach the source voltage in magnitude. The equation describes this in mathematical shorthand since the quantity in the parentheses can never be greater than one. That is, if the parenthetical quantity were exactly one, then e_c would be equal to E

Fig. 10 Circuit for showing growth of voltage in resistive-capacitive circuit

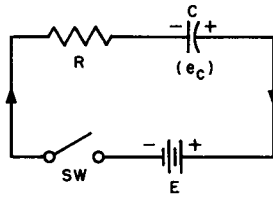

but this quantity is always 1 minus some real number so that e_c is equal to E reduced by a finite number. As the t factor is permitted to grow (longer charging time) the quantity inside the parentheses gets closer and closer to one thus making the value of the capacitor voltage (e_c) approach the value of the source voltage (E).

11. Implications of the Equation

The fundamental analysis of the charging equation given in Paragraph 10 is presented in general terms. Let us experiment with the equation using important numerical examples.

Assume for a moment that the circuit of Fig. 10 has been set up but that the switch has not yet been closed. This means, of course, that there can be no voltage on the capacitor as yet. (i.e., $e_c = 0$). We may use the equation to test this rather obvious conclusion since it is agreed that, before the switch is pressed, the charging time must be zero (i.e., $t = 0$). Substituting in the equation we have:

$$e_c = E \left(1 - \frac{-0}{\epsilon RC} \right)$$

The exponent of epsilon is $-0/RC$. When zero appears in the numerator of a fraction, the whole fraction is zero; thus the exponent of epsilon is zero. However, *any number raised to the zero power is equal to one*, hence the equation becomes:

$$\begin{aligned} e_c &= E(1 - 1) \\ e_c &= E(0) \\ e_c &= 0 \end{aligned}$$

which verifies the first conclusion and proves the equation to work out for this extreme case.

Now we shall examine the opposite extreme. Assume that the charge time is very long so $t =$ a very big number. In this case, the whole exponent of epsilon becomes a very large *negative* number which makes

$\frac{-t}{RC}$ get smaller and smaller, *approaching* zero. As this quantity *nears* zero, the entire equation approaches this condition:

$$e_c = E(1 - 0)$$

$$e_c = E(1)$$

$$e_c = E$$

It is evident from this example, a very long charging time permits the capacitor voltage to build up to a value which is *close to but never reaches* the source voltage.

One of the most useful tests for the equation is to assume that the time in seconds permitted for charging the capacitor is equal to the product RC . Let us see what happens when this substitution is made in the equation.

$$e_c = E \left(1 - e^{-\frac{RC}{RC}} \right)$$

$$e_c = E(1 - e^{-1})$$

$$e_c = E \left(1 - \frac{1}{e} \right)$$

$$e_c = E \left(1 - \frac{1}{2.7} \right)$$

$$e_c = E(1 - .37)$$

$$e_c = E(.63)$$

$$e_c = .63 E$$

This result is extremely informative. *It says that the capacitor will charge to 63% of the source voltage if the charging time is equal to the product of the resistance in ohms times the capacitance in farads.*

If $t = RC$, then

$$e_c = 63\% \text{ of } E \tag{h}$$

This result is a general one and is applicable to *any* group of values for R and C . As such, it is the most useful generalization we have obtained thus far; it will be applied to all future developments where charge time is a factor.

12. The Curve of Current Growth for Inductive-Resistive Circuits

The growth of current in a circuit such as that of Fig. 11 exactly parallels the rise of capacitor voltage in the examples just covered. When the switch is operated, the current flowing through the series circuit starts at zero, rises very rapidly at first, then increases at a decreasing rate because of the induced voltage that appears across the inductance, L . Since, in this particular case, Lenz's law demands that the polarity of this induced voltage *oppose* the applied voltage, the growing counter-emf causes the circuit *current* to taper off in exactly the same manner

Fig. 11 Circuit illustrating current growth in R-L circuit

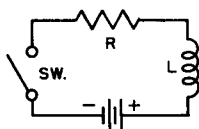

as the capacitor *voltage* did in the previous illustrations. It should be noted that the general statement of Lenz's law is that the induced voltage polarity is always such as to *oppose a change in current*. For example, if voltage applied is suddenly reduced, inductance tends to maintain high current, thus *aiding* the applied voltage.

As a matter of fact, the current growth in an inductor is identical with the voltage growth curve in a capacitor (Fig. 9) except for the label on the *Y*-axis. If the label "Capacitor Voltage — Volts" is changed to "Inductor Current — Amperes", the graph becomes perfectly correct as the curve of inductive current growth. In the case of inductance, the equation of the curve is:

$$i_L = I \left(1 - e^{-\frac{tR}{L}} \right) \quad (i)$$

where I_L = current in the inductor at any time t , I = final steady-state current of circuit, L = inductance in henries, and the other factors have the same meanings as in the capacitor explanations. The similarity of equation (i) to equation (g) should be evident at once. When L/R is substituted for t in equation (i), the outcome is:

$$\text{if } t = L/R \\ \text{then } i_L = 63\% \text{ of } I \quad (j)$$

Comparison of capacitive and inductive effects in this fashion indicates that previous conclusions concerning the parallelism of the two hold true all the way. In this case, if the flow time is permitted to be equal to the quotient of L/R , then the current flowing through the coil after time t will be 63% of the final value it will attain after a much longer time interval.

13. Review Questions

- (1) Why may the growth of voltage across the capacitor in a resistive-capacitive charging circuit be called "non-linear"?
- (2) What factor is responsible for the ever-decreasing rate of voltage growth across the capacitor in this type of circuit?
- (3) Theoretically, can a capacitor in a resistive-capacitive type of charge circuit ever develop a voltage equal to that of the source? Why?
- (4) What is the value of x in this statement: $x = 93\%$?

- (5) Prove that, if $t = L/R$ then $\epsilon^{\frac{-iR}{L}}$ becomes $1/\epsilon$
- (6) In the circuit of Fig. 10, the applied voltage E is 100 volts, the voltage which appears across C is 63 volts after time t , $C = 2$ farads and $R = 10$ ohms. Prove that t (charging time) must be 20 seconds.
- (7) If the applied voltage (Fig. 10) is 100 volts and $e_c = 25$ volts at a given time, what is the voltage drop across R at the end of the same time interval?
- (8) If you were to draw a graph representing the changing voltage drop across R (Fig. 10) during a long charging time interval, would this curve resemble that of Fig. 9? Describe differences, if any.
- (9) If the product RC were first computed for a case in which R was in ohms and C in farads, and then for the same case in which R was in megohms and C in microfarads, would the second answer be the same or different from the first? Prove.
- (10) If the resistance is given in ohms and the capacitance in microfarads, would the product come out in seconds, milliseconds, microseconds, or megaseconds? Prove.

Chapter 3

THE DEVELOPMENT OF THE DISCHARGE CURVE

14. The Discharge Curve of a Resistive-Capacitive Circuit

Both the charge and discharge characteristics of a capacitor in series with a resistor are important in electronic applications. Since the circuit starts with a different set of conditions on discharge than it has on charge, the behavior will be somewhat different.

We may start the analysis by considering a circuit like that illustrated in Fig. 12. The capacitor, C has been charged to 100 volts but the circuit is open so that discharge is not permitted. At this instant, $t = 0$ and $e_c = 100$ volts.

The switch is now closed. The potential across C causes a large current to flow through R . But as soon as current starts to flow, the voltage e_c begins to fall off; thus the current begins to decrease as well. Each time interval that passes sees a dropping emf and a resultant decay of current magnitude. The whole action may be compared to a defective battery which starts with a high terminal emf but begins to lose it as current is drained through the closed circuit in which it is the "prime mover".

An experimental table of values is given below. To arrive at these values, the capacitor was charged to 100 volts and permitted to discharge through a high value resistor. After each second of elapsed discharge time, a voltage reading was taken of the capacitor voltage, e_c . Here again, the values chosen for both C and R were quite large to permit accurate reading of timing device and voltmeter.

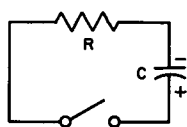

$e_c = 100$ VOLTS

Fig. 12 Simple discharge circuit

Table 2

(sec.) Discharge Time	Capacitor Voltage (volts)
0	100
1	84
2	67
3	55
4	45
5	37
6	31
7	25
8	21
9	17
10	14
11	11
12	9
13	7
14	6
15	5

The graph of Table 2 is given in Fig. 13. Its characteristics are very much like those of the charge curve (Fig. 9) in mirror-like reverse. The curve starts at a high voltage value, drops very quickly during the first few seconds, then its rate of decline begins to slow down more and more as additional time passes. Again, the curve is logarithmic or exponential in form; this time, however, it follows the equation given in the next paragraph rather than the original one (eq. g).

15. The Equation of the Discharge Curve

The equation of Table 2 is:

$$e_c = E_c \left(\epsilon^{\frac{-t}{RC}} \right) \quad (\mathbf{k})$$

Equation (k) may be read: the voltage across a discharging capacitor (e_c) at the end of any discharging time interval (t) is equal to

the original charged voltage on the capacitor times epsilon (ϵ) raised to the minus t over RC power. The quantity inside the parentheses differs from that in equation (g) only in that the epsilon factor is not subtracted from one. This difference explains the "mirror-image" characteristics of the discharge curve as compared with the charge curve.

16. Implications of the Equation

It is worth seeing how this equation reacts to the same important numerical substitutions used in Paragraph 11.

If zero discharge time is assumed, that is, if the capacitor is fully charged and has not been allowed to discharge at all, then $t = 0$ and the equation becomes:

$$e_c = E_o \left(\epsilon^{-\frac{t}{RC}} \right)$$

$$e_c = E_o (\epsilon^0)$$

$$e_c = E_o (1)$$

$$e_c = E_o$$

Thus, with zero discharge time, the voltage across the capacitor is still equal to its original full-charge voltage, a result to be expected.

The second condition assumed previously is that in which t is an extremely long time interval. As before, the negative exponent of epsilon grows larger as t gets bigger, making the entire epsilon factor shrink

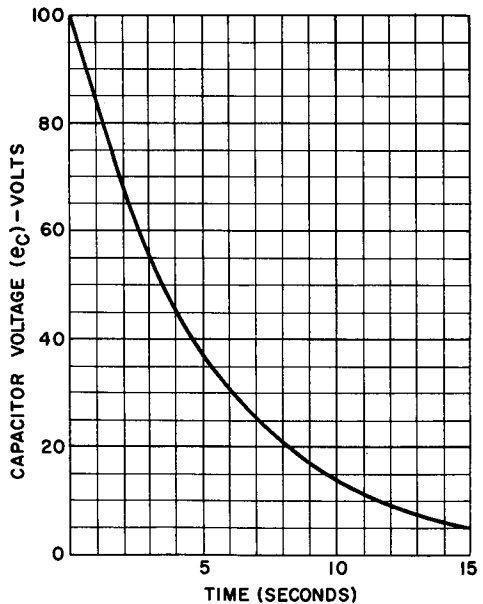

Fig. 13 Graph of values in Table 2

toward zero. Note the emphasis on the word "toward". The only way in which the epsilon factor could actually arrive at zero would be if the time interval were *infinitely large* — an obviously impossible condition. The conclusion, then, is that a capacitor, once charged, can *never be fully discharged*. This is reminiscent of the ancient paradox proposed by Zeno in which the tortoise led Achilles a merry chase. The situation set up was that the tortoise was to start moving from point A, while Achilles — certainly a worthy opponent — was to start from point B, some distance behind the tortoise, and attempt to catch the slow-moving animal by covering 75% of the distance remaining between them every second. That Achilles could never catch the tortoise came as quite a surprise to the thinkers of the ancient days, yet it is a fact. Under these circumstances, there is always some remaining distance between the two only a fraction of which is covered during the following time interval. Likewise, there is always some charge left in a capacitor which is fractionally dissipated during the next interval of time.

From a practical point of view, of course, a capacitor is considered discharged after a suitably long period of time has been permitted to elapse. Just what constitutes a "suitably long time" will be discussed in Chapter 5.

Finally, we shall want to observe the outcome of assuming that the time interval of discharge, t , is equal to the product of R times C ; that is, $t = RC$.

$$\begin{aligned} e_o &= E_o \left(\epsilon^{-\frac{RC}{RC}} \right) \\ e_o &= E_o \left(\epsilon^{-1} \right) \\ e_o &= E_o \left(\frac{1}{\epsilon} \right) \\ e_o &= E_o \times 1/2.7 \\ e_o &= .37E_o \end{aligned}$$

The interpretation of this statement is similar to the solution of the charging equation when t is assumed equal to RC . At a time $t = RC$ after a capacitor having a capacitance of C farads has been permitted to discharge through a resistor of R ohms, the *voltage across the capacitor will have declined to 37% of its initial, fully charged voltage*.

The percentages 63% and 37% are odd values to work with and the reader may inquire whether or not there is not some way to eliminate the need for them in practical work. Unfortunately, there is not because these numbers arise from the introduction of epsilon into the equation of the curve; epsilon is a necessary "evil", a constant essential to the

process of standard unit utilization. To help clarify this point, consider the following:

The distance between two points is 20 yards. To express this in feet, we may write:

$$\text{Distance in feet} = 3 \text{ times distance in yards}$$

The number "3" in this statement is a constant of proportionality which permits feet to be set equal to yards. Similarly, in the statement:

$$t = RC \quad \dots$$

we are setting "seconds" equal to the product of ohms and farads and so are using units that do not "match", like feet and yards. The introduction of .63 and .37, respectively, in the equations given below makes the conversion from one system of units to the other possible.

$$\text{Charge } e_c = .63 E \quad \text{when } t = RC$$

$$\text{Discharge } e_c = .37 E_c \quad \text{when } t = RC$$

17. Review Questions

(1) In a discharging resistive-capacitive circuit, at what point is the voltage drop across the resistor greatest: at the beginning or the end of the discharge period?

(2) If resistance is expressed in ohms and capacitance in microfarads, in what unit will t come out when the equation $t = RC$ is solved?

(3) How much time, from a purely theoretical standpoint, must go by before a charged capacitor can discharge to zero voltage through a resistor.

(4) To avoid accidental shock, the technician often "shorts out" charged filter capacitors (after removing the power source) with the blade of a screwdriver. Are his chances for getting a shock better or worse this way than if he had "shorted out" the capacitors through a one megohm resistor? Explain.

(5) A 40- μf filter capacitor charged to 400 volts can cause a much more severe shock than a .25- μf capacitor charged to the same voltage. Why?

(6) When a large capacitor charged to 1000 volts is permitted to discharge through a 100-ohm resistor, a current of 10 amperes flows instantly as the circuit is completed. Yet this resistor would normally burn out with a current of only one ampere flowing through it in a straightforward d-c or a-c. circuit. Why doesn't it burn out when discharging the capacitor?

(7) An 8- μf capacitor is caused to discharge through a 10-megohm resistor. How much time must elapse before the capacitor's voltage is down to 37% of its fully charged value?

(8) A 2- μf capacitor is charged to 1000 volts. We wish to have it discharge through a resistor so that its charge is approximately 370 volts at the end of 10 seconds. What value must the resistor have?

(9) A capacitor originally charged to a potential of 350 volts discharges through a 4000-ohm resistor. At the end of .024 seconds its voltage is down to 129.5 volts. What must be the capacitance of the capacitor in microfarads.

(10) A .025- μf capacitor discharging through a 5-megohm resistor starts with a voltage of 850 volts. What will its voltage be at the end of .625 seconds of discharge time?

Chapter 4

MEANING OF THE TIME CONSTANT

18. The Time Constant

The product RC has shown itself to be a convenient and definitive characteristic of capacitor-resistor charge and discharge circuits. We have found that the time for charge or discharge is wholly dependent upon both R and C , hence the product may be made to tell the whole "time" story. Once the values of R and C are fixed in any given circuit, the timing for the circuit becomes invariable in the sense that the capacitor voltage is a definite percentage of the original or applied voltage, when time t is allowed to pass.

Thus, the product RC is called the *time constant* of a capacitor-resistor circuit, and may be defined:

$$T = RC$$

where T is the time constant of the circuit in seconds, R is the resistance in ohms, and C is the capacitance in farads.

In our equation tests (Chapters 2 and 3) we repeatedly wrote the expression

$$t = RC$$

These two statements are *not the same*. The equation in which T appears as a capital letter defines the term "time constant" while the second equation simply states that the timing period for charge or discharge was made equal to the product RC . From this point on, whenever the equation appears, it will stand for the definition of time constant.

Many authors of contemporary articles on this subject use expressions such as " $3T$ ", " $\frac{1}{2}T$ ", etc. They indicate by this symbology the number of time constant periods about which they are writing or the

fraction of one time constant period, whatever the case may be. “ $3T$ ” stands for three time constant periods, “ $\frac{1}{2}T$ ” for one-half of one time constant period, etc. This is a convenient and explicit way to discuss various timing circuits as will be seen in Chapter 5.

19. Time Constant Measurements

A few of the review questions at the ends of preceding chapters dealt with R - C products in which R was not in ohms or C in farads. This is rather the rule than the exception because capacitors are never rated in farads. The chart given here should be retained or memorized to assist the reader in choosing the proper combinations of units.

T	R	C
seconds	ohms	farads
seconds	megohms	microfarads
microseconds	ohms	microfarads
microseconds	megohms	micro-microfarads

20. Capacitor Voltage After R-C Time

The graphs of Figs. 9 and 13 were based upon the assumption of certain representative figures which would permit actual measurement of time and voltage as the capacitor charged and discharged.

It should now be possible for the reader to determine the time constant of this theoretical circuit from the graphs themselves. It is easier to start with the discharge curve of Fig. 13 since the initial capacitor voltage is clearly shown as 100 volts.

To determine the time constant for discharge, first take 37% of 100 volts. This is 37 volts, of course. Then find 37 volts on the vertical voltage axis, move horizontally to the right until the 37 volt line intersects the curve, and finally move down vertically from the intersection point to the time (horizontal) axis. This is 5 seconds, the time constant T for this particular circuit.

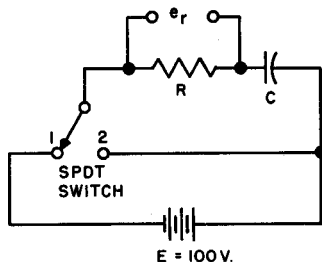

Fig. 14 Charge and discharge circuit for resistive current and voltage measurement

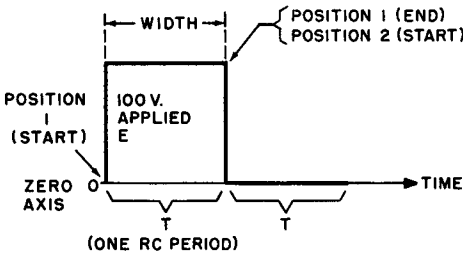

Fig. 15 Applied waveform

In Fig. 9, the source voltage used to produce the capacitor voltages shown was 100 volts. The time constant is found this time by taking 63% of 100 volts (63 volts) and tracing the intersection again to the time axis. Once more the time constant appears to be 5 seconds, as it should be since both Table 1 and Table 2 were obtained from the same circuit.

21. Current and Voltage for R-C Resistor

Occasional mention has been made of the current and voltage in the discharge resistor. Applications of time constant circuits so frequently involve the electrical effects taking place in the resistor that it becomes necessary now to leave the capacitor and turn our attention to the resistor.

To investigate the resistive effects, a circuit like that of Fig. 14 is first set up. A 100 volt source, a double-throw single pole switch, a capacitor, and a resistor are connected in such a way as to permit the capacitor to charge through the resistor in one position of the switch and to discharge when the switch is moved to its opposite position.

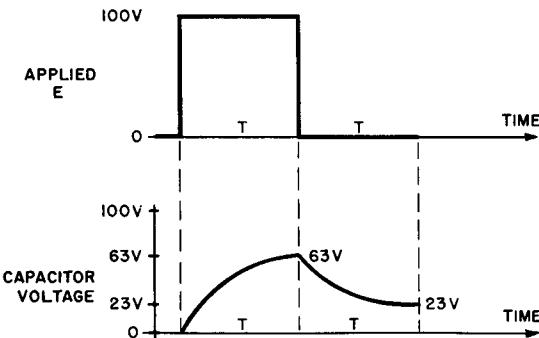

Fig. 16 Capacitor voltage changes with applied square wave

What is proposed is that the switch should be set at position No. 1, kept there for one $R-C$ time period, and then altered to position No. 2. This is the sequence of events for the application of source voltage and may be pictured as a *waveform* illustrated by Fig. 15. At the instant the switch is thrown to position 1, the applied voltage rises sharply from zero to 100 volts — this is the voltage which is impressed across the series circuit formed by the capacitor and the resistor, *not* the voltage across either the resistor or capacitor alone — and remains at this level throughout one T period; then, as the position of the switch lever is reversed, the battery is disconnected from the circuit and the *applied* emf drops instantly to zero.

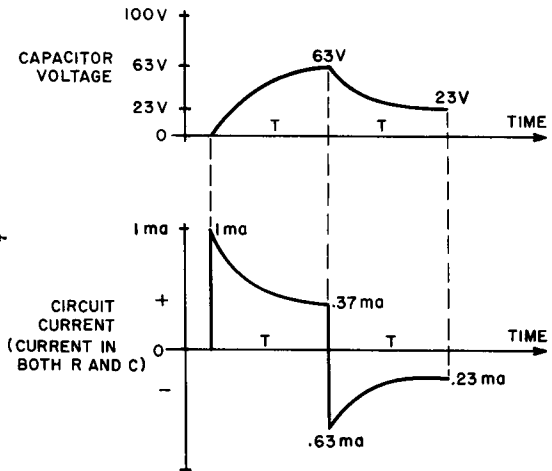

Fig. 17 Capacitor current waveform

Notwithstanding the fact that these potential changes are being created by a mechanically-actuated switching device, we may refer to them as composing a waveform and, furthermore, we may substitute the right kind of signal generator for the switch provided that the generator has a waveform output that corresponds to that of the switch. This will be done later in this discussion when the output of a *square-wave* generator is utilized as the applied voltage.

During the same T interval, the capacitor charges along the now familiar exponential curve, reaching 63 volts (63% of 100 volts) at the end of the interval. But what happens during the discharge T interval? The capacitor voltage decays along the exponential curve as anticipated, but it falls to 23 volts rather than some lower figure (see Fig. 16). The discharge equation has pointed out that the voltage across the

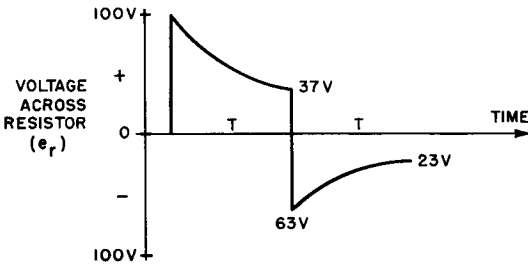

Fig. 18 Voltage across the resistance

capacitor falls to 37% of its original charged potential during one T period. This capacitor started out at 63 volts; 37% of 63 = 23.3 volts which we round off to 23 volts for purposes of illustration.

The current flowing "in and out" of the capacitor and hence the current in the resistor has the waveform shown in Fig. 17. When the switch is first closed, the capacitor has not yet built up a back-emf so that the current in the circuit is maximum, being limited only by the resistance R . Let us assume a maximum current of 1 ma as given on the curve; as the capacitor voltage grows, the current gradually drops until, at the end of the T period, it has fallen to .37 ma. This particular current flows at this time because the effective applied voltage has dropped to only 37 volts as a result of the bucking action of the 63 volts placed on the capacitor; thus, if 1 ma flows when the applied voltage is 100

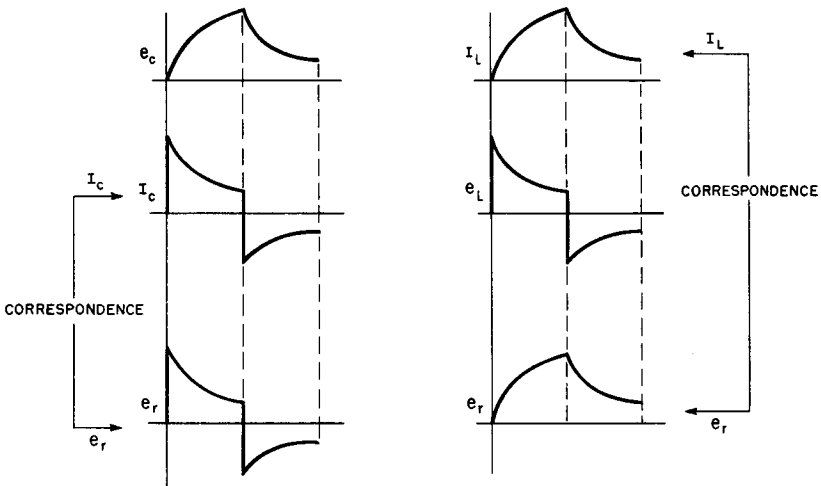

Fig. 19 Waveforms for R-C and R-L circuits compared

volts (at the start of the cycle), then when the applied voltage is reduced to 37 volts, the current will be .37 ma.

When the switch moves into position 2, the capacitor applies the full 63 volts it has gathered in the *reverse direction* as compared with the battery polarity. This produces a current of 63 ma in the opposite direction through the resistor, hence we encounter a dip below the zero axis for the first time. Then, with further discharge of the capacitor during the next T period, the current decays to .23 ma because the capacitor voltage has fallen to 23 volts as previously explained.

Adhering to the assumed values of components, the voltage waveform appearing across the resistor (e_r) is identical with the current through it (remember the rule of thumb given in Paragraph 8). Thus, the end result of this entire development is a voltage across R having the waveform shown in Fig. 18. The choice of one T period has produced a waveform of no particular significance, but as the reader will see, very important waveforms can be produced by varying the charge and discharge period to 5 or more T 's or to $1/5 T$ or less.

22. R-L Waveforms for Square-Wave Applied Voltage

The waveforms obtained from an $R-L$ circuit are practically identical with those in an $R-C$ circuit with *current and voltage variations interchanged*. This, of course, follows the pattern set up in Paragraph 12. The voltage across the resistor in the $R-L$ circuit does not resemble the resistor voltage in the $R-C$ arrangement because resistor voltage always depends for amplitude and phase on the current through it. The interchange mentioned above is responsible for the difference between e_{rc} and e_{rL} pictured in Fig. 19. For $R-L$ circuits, $T = L/R$.

23. Review Questions

- (1) What is the time constant in seconds of a circuit containing 10,000 ohms of resistance and $0.5 \mu f$ of capacitance?
- (2) What is the time constant in microseconds of an RC circuit containing 350 ohms and $2 \mu f$?
- (3) If the capacitor of (b) is replaced by one having a capacitance of 200 micro-microfarads, what size would the resistor have to be to maintain the same time constant for the circuit?
- (4) State the characteristics of a square-wave voltage input from the standpoint of waveform.
- (5) In what timing circuit (RC or RL) does an a-c voltage drop appear across R with d-c square-wave input?
- (6) If the applied square-wave voltage in an RC circuit is 250 volts, what negative voltage drop will appear across the resistor at the end of the first cycle?
- (7) Draw, one below the other, a series of sketches of waveforms, all over one $R-C$ interval, showing E_{app} (square-wave), e_c , I_c , and e_r .
- (8) In a circuit used in a television receiver, a time constant of 100 microseconds is required for integrating serrated vertical sync pulses. The resistor is 100,000 ohms. What is the value of the capacitor?

Chapter 5

LONG AND SHORT TIME CONSTANT WAVEFORMS

24. The Universal Time Constant Chart

For the designer, for the student, and the experimenter in timing circuits, the universal time constant chart in Fig. 20 is especially handy. Its use enables the engineer or technician to determine the percentage charge or discharge of the capacitor in an $R-C$ circuit and the percentage of the steady-state current flowing in an $R-L$ circuit. It will be recognized as an expansion of the graphs in Figs. 9 and 13 to cover five T 's or $R-C$ periods. Suppose, for example, that it is desired to find the residual voltage on a capacitor which had an initial charge of 150 volts, after discharging over $2\frac{1}{2}$ $R-C$ periods. Reference to the chart discloses that the residual percentage after $2.5 T = 8\%$. Hence the residual voltage is $.08 \times 150 = 12$ volts.

There are numberless ways to use the graphs. Here is a rather elegant illustration: a thyatron (a gas filled tube used in time delay relay circuits) triggers when its grid voltage rises to -4 volts. An emf is applied to the grid capacitor causing it to charge to -15 volts and when the "set button" is operated, the capacitor begins to discharge toward ground through the grid resistor. If the desired delay time is exactly 10 seconds between setting and triggering, what is the exact time constant needed?

First set 4 over 15 ($4/15$) to determine the percentage decay from full voltage. This is equal to 26.7%.

Second, find 26.7% on the discharge curve and determine the number of $R-C$ periods required. You will find this is 1.35 $R-C$ periods.

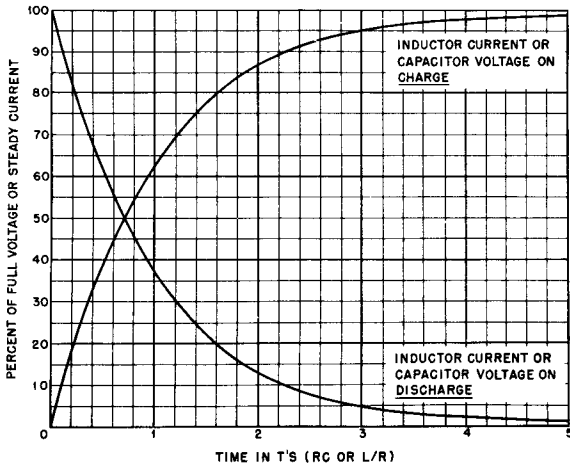

Fig. 20 The universal time constant chart

Third, consider that 1.35 R - C periods must take 10 seconds and ask yourself how long 1 R - C period will require. This is, of course, determinable by setting up a simple ratio:

$$\frac{10}{1.35} = \frac{x \text{ sec.}}{1}$$

$$x = 10/1.35 = 7.4 \text{ seconds.}$$

Hence, 1 R - C period is equal to 7.4 seconds in this problem and the resistor-capacitor combination must have a time constant of 7.4 seconds. Imagine that a good, oil-filled, low leakage capacitor of 2 μ f is available. The resistor to go with this capacitor is therefore:

$$7.4 = 2 \times R$$

$$R = 7.4/2 = 3.7 \text{ megohms}$$

25. Long and Short Time Constants

The waveforms depicted in Figs. 16, 17, and 18 are those seen in circuits where the square-wave of applied voltage is permitted a width of 1 R - C period. (See Fig. 15). Attention was drawn to the fact that these output waveforms are of no particular significance but that very important types of waveforms are obtained by using circuits in which the time constant is either very long or very short in comparison to the width of the wave.

A circuit is said to have a *long time constant* if its R - C period is 5 times (or more) greater than the width of the applied square wave. This

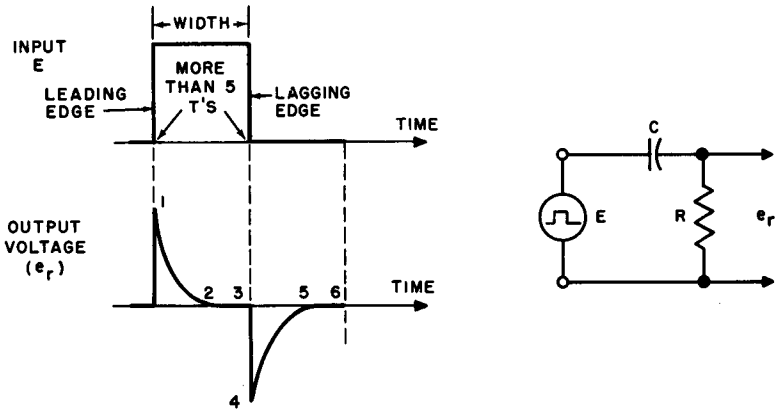

Fig. 21 Output of short time constant circuit with square wave input

is a rather arbitrary figure – but it is borne out by the universal time constant chart; note that, at the end of 5 $R-C$ periods, both charge and discharge are over 99% complete.

A circuit is said to have a *short time constant* if its $R-C$ period is $1/5$ (or less) of the width of the applied square wave.

Thus, a time constant is long if it does not permit the capacitor to take on an appreciable charge during the charge half-cycle of the applied voltage; a time constant is short if the capacitor can charge practically 100% during the time that the applied voltage is active.

26. Short T Waveforms, Differentiation Network

The output waveforms taken across the resistor in an $R-C$ circuit having a short time constant are given in Fig. 21.

Sudden application of the steeply rising leading edge of the square-wave causes maximum current to flow through R as the capacitor is not

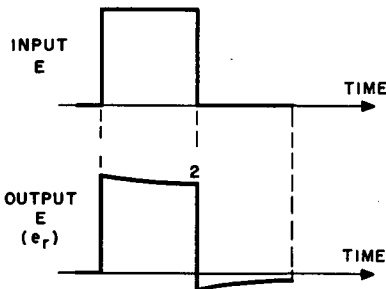

Fig. 22 Output of long time constant circuit with square wave input

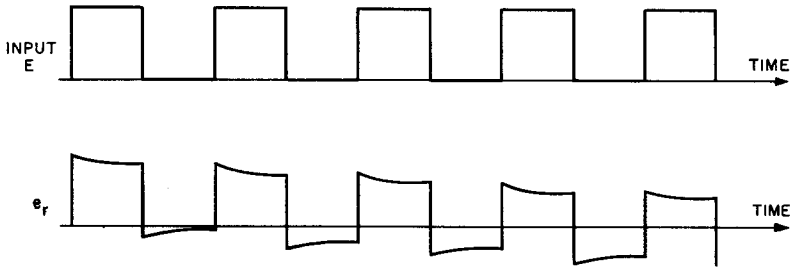

Fig. 23 Removal of d-c component of signal by capacitor

yet offering back-voltage opposition, thus the voltage drop across R rises steeply to point 1. Since the time constant is short compared to the width of the wave, the capacitor charges fully long before the trailing edge is reached, so that the current through R (and the voltage drop across it) drops to zero long before the end of the half-cycle. (point 2). Nor does current flow during the remainder of this half-cycle since the capacitor is fully charged and remains so until point 3 is reached. Here the applied voltage is removed (trailing edge) and the capacitor sends a surge of current through the resistor in the reverse direction, (the source of voltage is the return path) producing the sudden rise in negative voltage from point 3 to 4. Again, the short time constant assures that the capacitor will discharge fully in a very brief interval (point 4 to 5) with a consequent quick decay of resistor voltage to zero. Here it remains until point 6 is reached, at which time the cycle repeats.

27. Long T Waveforms, Coupling Networks

A resistive-capacitive coupling system must be designed with a long time constant. The prerequisite of a coupler is that it produces an output waveform as nearly identical with the input waveform as possible. Fulfillment of this requirement insures faithful reproduction in audio amplifiers and wide bandpass in r-f and i-f amplifiers. Waveforms for long T circuits are given in Fig. 22. The same analysis as used for short T circuits may be applied here, taking into account that the time constant is so long that the capacitor takes on very little charge during the wave-width period. Thus it does not develop a large back-emf and the circuit current is not materially reduced from the leading to the trailing edge; likewise, the output voltage remains pretty well up — near maximum — accounting for the fact that the top of the output waveform is almost horizontal (Points 1 to 2.) It will be observed that the output shape is very close to that of the input.

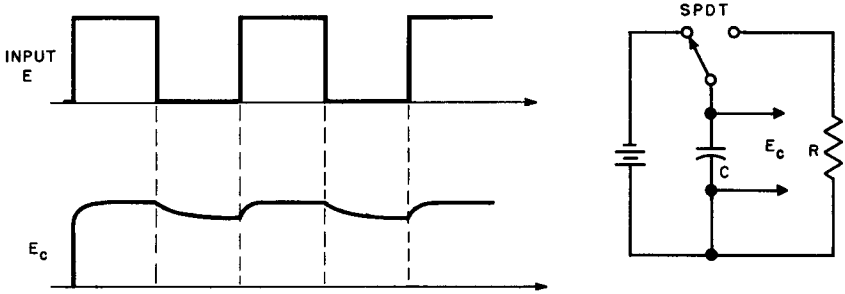

Fig. 24 Short time constant on charge — long time constant on discharge

Another rather obscure point is called to the attention of the reader. Within the space of about 5 or 6 cycles, the output waveform, which starts as practically perfect pulsating direct current, becomes pure alternating current, as shown in Fig. 23. This conversion occurs as a result of the "percentage charge-discharge" process with each successive cycle starting a little below the one before. This is clearly explained in Paragraph 20 with the aid of Figs. 15, 16, 17, and 18. *Time constant action is the phenomenon which accounts for the blocking action of a capacitor on the d-c component of a pulsating d-c voltage.*

28. Short T Charge and Long T Discharge Waveforms

Filter Systems. A time constant circuit may be arranged in such a way as to permit the charging circuit to contain very little resistance while the discharging circuit contains much resistance. The effect is to have a short charging time constant and a long discharging constant.

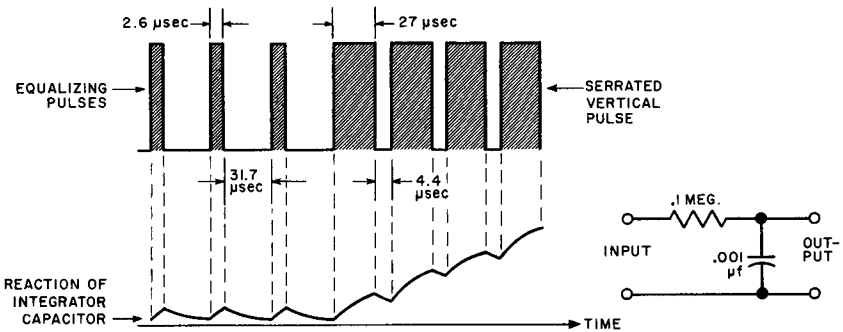

Fig. 25 Television sync pulses fed to integrator

The circuit included in Fig. 24 illustrates a mechanical arrangement of this nature; in power supplies, where the filter network following the rectifier needs this combination short-long characteristic, switching is done automatically by the uni-directional conduction of the rectifier.

In the case of a power supply filter, or an integrating network designed in a similar fashion, the output voltage is taken across the capacitor rather than the resistor. The short charge time permits the capacitor to charge fully long before the end of the first half input cycle; when the "off" period begins, the capacitor discharges very slowly, retaining the greater percentage of its charge throughout the "off" half-cycle. The filter action is easily seen as one in which the "valleys" between positive peaks are filled in by the long time constant, stored charge in the capacitor.

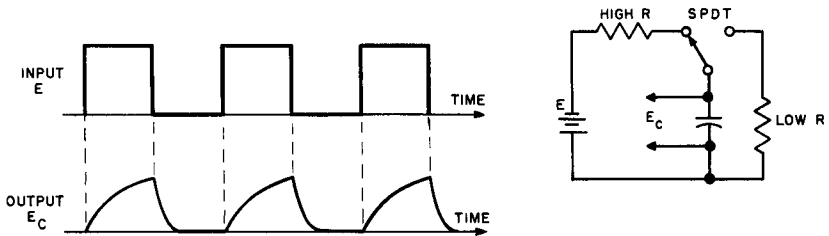

Fig. 26 Long time constant on charge — short time constant on discharge

The same principle, somewhat modified in component value, is used in the sync sections of TV receivers. The underlying objective of this circuit is the conversion of a series of short *pulses* of voltage into a single long pulse. Broadly speaking, that is just what a power supply filter does, using, of course, vastly different pulse width and time constant.

A standard, single-section television integrator might have a time constant of about 100 microseconds, obtained by using a 100,000 ohm resistor and a .001 μf capacitor. The pulses fed to the input of the integrator are of two different widths (equalizing and vertical sync pulses) with differently-timed intervals between them. (Fig. 25). The job of the R - C circuit is to "ignore" the equalizing pulses and take cognizance of the serrated vertical pulses by building up a voltage across the capacitor when the latter arrive. The capacitor charges up to only a very low voltage by the time the trailing edge of each equalizing pulse appears; then the long interval between equalizing pulses (31.7 micro-

seconds) is more than great enough to allow a discharge of the capacitor back to its original voltage. Thus, no voltage is built up during equalizing pulse time. But the serrated vertical pulse is made up of wider pulses having individual durations of approximately 27 microseconds with very short intervals (4.4 microseconds) between them. These pulse widths permit the capacitor to charge to significant voltages during passage of the pulse with very little discharge between pulses, ultimately giving rise to a relatively high voltage which is used for triggering the vertical oscillator in the television receiver.

29. Long T Charge and Short T Discharge Waveforms, Sawtooth Generator

When the arrangement explained in Paragraph 26 is reversed, an entirely different set of conditions prevails. Now the charge time is relatively long while the discharge time is short. Refer to Fig. 26. The capacitor, charging through a high resistance, develops considerable voltage along the exponential charge curve over the relatively long time period. This voltage is built up gradually, forming a gently sloping curve. On discharge the action occurs much more quickly because discharge occurs through a low resistance; hence, the capacitor discharges to zero in much less time than was needed to attain the initial charge voltage. The result is a sawtooth waveform. This waveform is extremely important in a great number of modern electronic circuits. Relaxation oscillators, multivibrators, blocking oscillators, and gas-discharge oscillators are all dependent upon this arrangement of time constants for discharge and charge.

30. R-L Time Constant Applications

Inductors sometimes find application in time-constant circuits in place of $R-C$ components, although their use is avoided where their magnetic fields may be troublesome. As a rule, furthermore, their inclusion is generally less economical and more space-consuming than capacitors.

The reader will encounter inductor applications in circuits such as these:

Short T – $R-L$ differentiators used in television.

Long T – Impedance coupling in audio amplifiers.

Short T Charge, Long T Discharge – $L-C$ filter networks in which the receiver itself, or a bleeder, serves as discharge “resistor”.

31. Review Questions

(1) At what percentage charge (or discharge) are the charge and discharge time constants identical?

(2) The time constant of a typical integrator network is 100 microseconds. What percentage of charge will be attained during one serrated vertical pulse interval (Fig. 25) (Make use of Universal Time Constant Chart)?

(3) Why is an interval of $5T$ periods chosen to represent the *minimum* interval that may be called "long time constant"?

(4) What percentage of charge has been lost by a capacitor discharging over $1/5T$?

(5) Explain why a coupling circuit used in an audio amplifier must have a long time constant.

(6) Use is often made of the fact that the first 10% of charge or discharge occurs along an essentially linear portion of the curve. Hold a straight edge along the curve for the first 10% to verify this statement.

(7) A circuit is to produce one sharp positive "pip" and one sharp negative "pip" for each cycle of applied square wave voltage. What must be true of its time constant? (long, short, medium)

(8) The frequency of a certain applied square-wave voltage is 15,750 cycles per second. (1) Find the period of this voltage, (2) determine the maximum time constant a differentiator may have to work properly at this frequency.

(9) A complex integrator network has a time constant of 200 microseconds. The input square wave has a peak voltage of 12 volts. To what voltage will the integrator capacitor charge over the interval of one equalizing pulse?

(10) How would you use the equations of charge and discharge to prove that the two universal curves intersect at the 50% mark?

Chapter 6

APPLICATION OF THE TIME CONSTANT

32. Circuit Applications of the Time Constant in Industrial Electronics

The functions performed by time constant circuits already described (differentiation, integration, coupling, filtering, etc.) are widely employed in industry for jobs that have requirements similar to those presented in previous chapters.

A somewhat different category of tasks in which time constant effects play significant roles are those which entail *timing circuits* like those encountered in X-ray timers, photo-exposure timers, welding controls, counters, and time-delay relays in general. Although there are as many different approaches to the solution of a given problem as there are design engineers, a few basic circuit conditions may be chosen as typical for the purpose of illustration.

Timing circuits are closely associated with relays. A representative set of sequential steps might be outlined as follows:

(a) A circuit is "set" to begin its timing by making a circuit alteration such as operating a switch, allowing light to fall on a photo-cell, interrupting a beam of light to a photo-cell, adding body capacity to the circuit, etc.

(b) Immediately when the circuit is "set", a capacitor connected with the control element, usually the grid, of a vacuum or gas tube begins to change its state of charge through a resistor.

(c) When the change has proceeded sufficiently far, the conductive condition of the tube has altered enough to operate a plate-circuit relay. When this occurs, the circuit is said to have been "triggered" and the timing period is at an end.

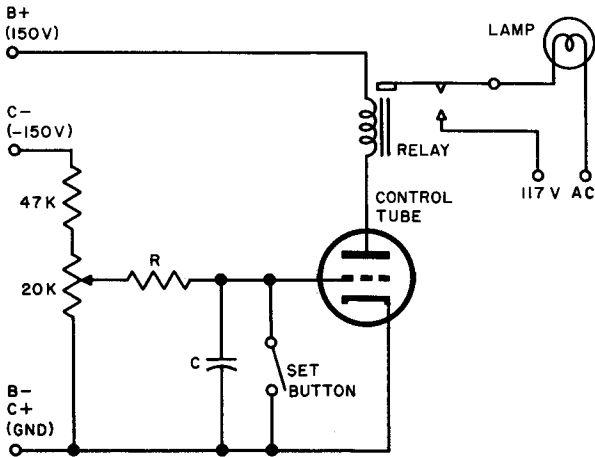

Fig. 27 Basic timing circuit

(d) The circuit then must either be reset by the operator or may reset itself automatically so that it is ready to accept the next cycle of operation.

To illustrate: a photo-timer is used to control the exposure time of an enlarger in making photographic prints. The time of exposure is first chosen by rotating a knob to the desired time, say, 12 seconds; the set button is then pushed and the enlarger light goes on; the timing circuit begins to change its state of charge and at the end of 12 seconds it operates a relay which turns the enlarger off; finally, the relay itself is arranged in the circuit so that when it extinguishes the enlarger lamp, it resets the circuit for the next exposure.

The basic timing circuit for such a device is given in Fig. 27. The initial conditions, governed by the setting of the 20k potentiometer, are such that the high negative bias on the grid of the control tube prevents the plate current from reaching a value necessary to pull in the relay. When the set button is pressed (spring-operated, normally open), the negative voltage present previously across C is discharged through the set button and the grid is placed at ground potential. The plate current of the tube rises enough to pull in the relay and the enlarger lamp ignites. In the meantime, the button is released, removing the short-circuit discharge path; C now begins to charge through R from the bias source, negatively on the grid side. At the end of the timing period, the grid becomes negative enough so that the plate current drops

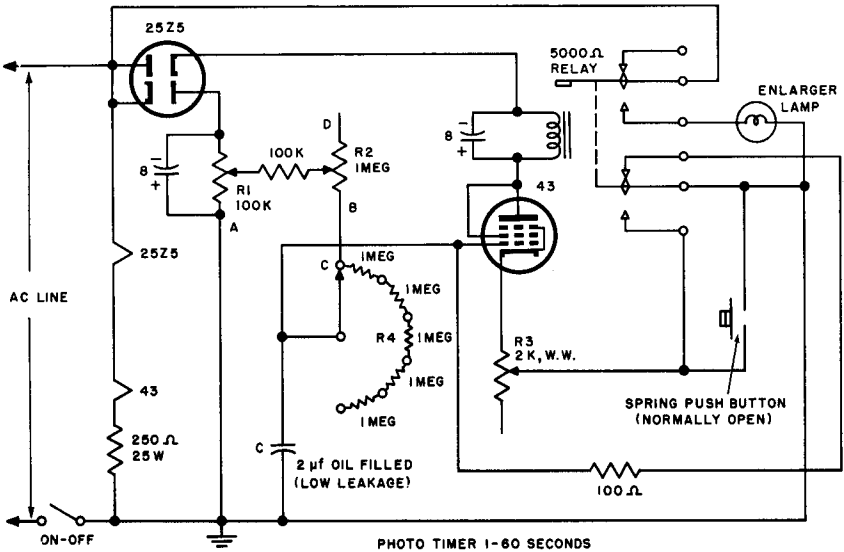

Fig. 28 Practical photo-timer circuit

sufficiently to release the relay armature, turning off the lamp. Since the circuit conditions have now returned to those initially present, re-setting is not necessary; it is ready to accept the next cycle. R and C both are usually made variable to provide for a wide range of time constants, and thus a wide range of timing periods.

It should be remarked that the time delay to be expected from this hook-up is a function, not only of the magnitudes of R and C but also of the charging voltage established by the setting of the 20K potentiometer. As the circuit stands, this potentiometer governs both the initial bias voltage on the triode and also the voltage applied to C through R for charging purposes.

Figure 28 illustrates a practical photo-timer circuit for enlarging exposures from 1 to 60 seconds and its basic operating principle is identical with that of Fig. 27. Refinements have been added to permit accurate calibration in seconds and wide timing range. The procedural steps for adjustment of this unit are:

(a) Run the wiper of $R1$ down to point A, of $R2$ down to point B, and set the selector switch at point C. This short circuits the capacitor (C) and places the grid at ground potential.

(b) Adjust the bias of the 43 using $R3$ so that the relay pulls in readily and positively when the spring button is pressed.

(c) Move the wiper of $R2$ to point D; now adjust the charging current with $R1$ so that the relay pulls in for exactly ten seconds and then releases when the spring button is operated. The dial or scale of $R2$ may later be subdivided into intervals of one second each by hand calibrations.

(d) Each time the moving contact of the wafer switch is advanced another notch, an additional resistance of one megohm is added to the charging circuit which should add 10 seconds more to the time delay. This may now be checked and the entire unit calibrated. Precision resistors are desirable if high accuracy is necessary, but for all practical photographic purposes ordinary carbon composition resistors are satisfactory. The 100-ohm resistor serves to discharge the capacitor once the timing cycle is finished; the release of the relay, then, automatically resets the circuit for the next operation, in addition to turning off the enlarging lamp. For really consistent operation, the capacitor C must be high quality having low leakage characteristics.

33. Other Applications of R-C Constant

High- and low-pass filters consisting of R - C circuits find universal application in audio and high fidelity amplifiers in the form of pre-emphasis and de-emphasis circuits, and tone controls of all descriptions.

The difference between high- and low-pass filters is indicated in Fig. 29. When the general arrangement is re-drawn as in (c) of this figure, it is apparent that the input voltage for either type of filter is applied across a series-connected R - C combination. The high pass effect

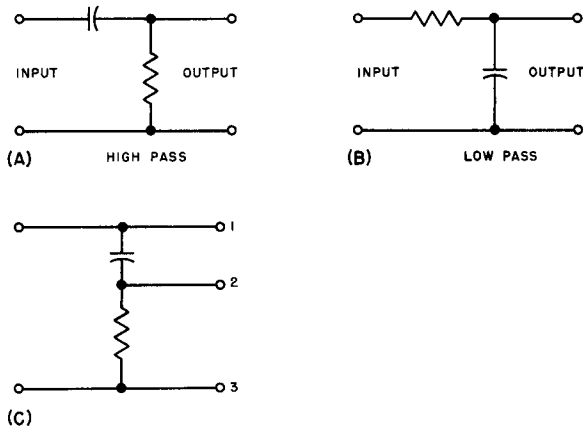

Fig. 29. Difference between high- and low-pass filters

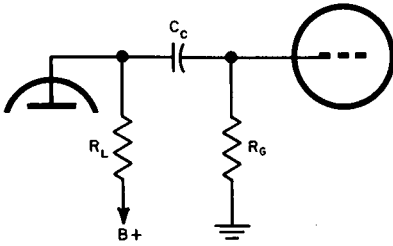

Fig. 30 R-C coupling circuit

is obtained when the output voltage is taken from across the resistor; the low pass response requires that the output comes from the terminals of the capacitor.

To facilitate the analysis of these filters, assume that signals of three frequencies, 500 cycles per second, 3,000 cycles per second, and 15,000 cycles per second, are all present at the input of the high-pass filter. The periods of these frequencies (Period = $1/\text{frequency}$ = time for 1 cycle) are respectively .002 sec., .0003 sec., and 66.5 microseconds (approximately). If the time constant is chosen so that it is *short* for the first two periods but *long* for the last period, then for 500 cps and 3,000 cps, the capacitor will be able to change its voltage *fully* during each half-cycle of the input variation. This means that practically the entire signal voltage appears across the capacitor, leaving very little signal voltage across the output resistor. It must be remembered that the capacitor and resistor form an a-c voltage divider with the output voltage being taken across the resistor in a high-pass filter, and that signal voltage appearing across the capacitor is *lost* to the output.

Consider the same frequencies applied to the *low-pass* filter. The time constant of the filter must now be long for the lower frequencies but *very, very* long for the high frequency. Now the high frequency signal cannot produce any significant voltage change in the capacitor since the time constant is too long to permit rapid charge and discharge; the low frequency signals, however, having much longer periods can force the capacitor voltage to rise and fall. Thus, the capacitor variations are taken as the signal voltages and are used as the output.

From the foregoing discussion, it is apparent that the two types of filters are the same with respect to the input signal but differ from each other only in their time constants and the place from which the output voltage is tapped.

Typical low-pass filters used in radio and television are integrating networks and de-emphasis networks. Integrators have already been discussed; a de-emphasis network has a time constant of 75 microseconds and is used to restore the low audio frequencies to the fm receiver output system. This is necessary since the signal at the transmitter is pre-

emphasized, i.e. more weight is given to the higher audio frequencies for the sake of improving the signal-to-noise ratio. De-emphasis brings about the restoration of the original tonal balance.

Most tone controls of the simple $R-C$ variety are shunt types of high-pass filters and operate to attenuate the higher audio frequencies thus yielding an apparently deeper tone.

A coupling circuit by the nature of its connection (Fig. 30) is a high-pass filter consisting of C_o and R_p . A difficulty here arises from the fact that a coupling network is required to pass all frequencies within a given range with equally little attenuation, otherwise distortion is introduced. Unless the coupler is properly designed with respect to its $R-C$ time constant, it will attenuate the low frequencies severely. Its time constant is, therefore, made as large as possible without increasing it to the point where other troubles begin to appear. The greater the T , the less the attenuation of the low frequencies.

As a final illustration of the use of $R-C$ time constant in radio, let us investigate the operation of a simple AVC system. Normally, the radio signal after detection consists of a pulsating audio voltage across the detector load resistor. This voltage comprises an a-c component (audio) and a d-c component whose size is dependent upon the original signal strength reaching the detector. It is desired to feed the d-c component back to the grids of variable mu tubes (r-f amplifier, converter, i-f amplifier) as a negative voltage to control their gain. In this way, a strong signal limits the gain to a low value and a weak signal allows the gain to be high. At the same time, the audio component must not be permitted to reach the controlled grids if undesired feedback is to be

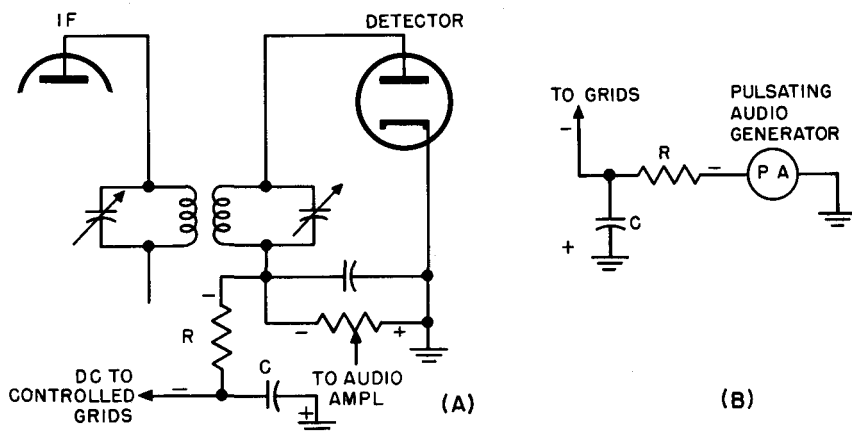

Fig. 31 AVC circuit and equivalent

avoided. Figure 31 (A) shows the actual AVC circuit; Fig. 31 (B) is a simplified version showing that the pulsating audio is applied across R and C in series, with the AVC output being taken from across the capacitor. The task of the network is to permit unimpeded passage to the negative d-c voltage, but to attenuate the audio component enough so that it does not affect the gains of the controlled tubes. Thus, the time constant of R and C must be long enough so that the voltage on C cannot follow the audio variations, yet not so long as to prevent the system from following normal carrier intensity changes such as occur when tuning from station to station or when the signal is fading.

Using the lowest practical audio frequency, say 30 cycles per second, as the basis for computation, we want to know what time constant would be necessary to completely attenuate the audio without making the system unresponsive to slower changes. The period of a 30 cycle wave is .03 seconds; if we make the time constant of this network equal to .15 seconds, then one cycle of the audio will be completed in $1/5$ of an RC period — hardly time enough to change the voltage on the AVC capacitor as explained in Paragraph 24. The capacitor will then charge up to the average value of the carrier wave, i.e. the d-c component of the detector output, while the audio variations will not appear across it at all. But it requires much more than .15 seconds to tune from one station to another; and even repetitive fading has a much smaller frequency than 7 “fades” per second. Hence, the system will be able to follow station changes and fading with little difficulty.

Examination of receiver circuits reveals that the R - C combination that has become standard today is 3 megohms and .05 μ f. The time constant of this combination is, of course, .15 seconds — exactly the same figure we arrived at from purely theoretical considerations.

34. Review Questions

(1) The fundamental timing circuit of Fig. 27 is a “positive” type; that is, push-button *on*, light *on* for timing period. Show the simple changes necessary to make this a negative type in which pushing the button on, causes the light to go off for the timing period. (Use the same relay.)

(2) Aside from the action of $R1$ in Fig. 28 as a bias control, in what other way does this resistor control timing?

(3) What action occurs in the photo-timer of Fig. 28 when the timing period is over, the relay releases, and resetting occurs? What part does the 100-ohm resistor play in this action?

(4) What is the time constant of the timing circuit in the same figure when it is adjusted to trigger after 30 seconds?

(5) State clearly the differences between a high-pass and a low-pass filter.

(6) Is a differentiation network a high-pass or low-pass filter?

(7) Is an AVC network a high or low pass system?

(8) Is a coupling network high or low pass in structure?

(9) Based upon the explanations given in this chapter, what general form must a pre-emphasis network take?

APPENDIX

Test Unit for Verification of Time Constant Laws

1. *Calibration.* Connect the circuit as shown, using for R a resistor to be used in your first measurement. Do not connect a capacitor across terminals 1 and 2 as yet.

Leave the switch open. Connect a vtvm between grid and cathode and run the slider of the 20K potentiometer down to the ground end.

Apply power, then adjust the 20K potentiometer so that the vtvm reads exactly 6.3 volts. Now read the milliammeter and carefully record the plate current. Whenever the milliammeter reads this value of current in subsequent steps you will know that the grid voltage is 6.3 volts.

2. Make sure the switch is open. Remove power. Connect the test capacitor across 1 and 2. Connect the vtvm between point A and ground. Apply power and adjust the 20K potentiometer so that the vtvm reads exactly 10 volts. Close the switch. The charging voltage has now been adjusted to 10 volts.

Prepare a watch with a sweep second hand for use in timing capacitor charge. With the switch closed, the capacitor is short-circuited and cannot charge but when the switch is opened, charging current flows into the capacitor producing a negative potential at terminal 1 with respect to ground. Thus as the capacitor charges, the grid becomes more and more negative with respect to cathode and the plate current drops.

Open the switch and time the interval required for the milliammeter reading to drop to the reference value recorded above. When this occurs, you know that the capacitor has charged to 63% of the applied voltage. That is:

$$\text{Applied voltage} = 10 \text{ volts}$$

$$\text{Reference ma reading} = 6.3 \text{ volts of charge}$$

$$6.3 \text{ is } 63\% \text{ of } 10$$

Thus the interval timed above is the time constant of this R - C combination. Comparison of this measurement with the results obtained from substituting in $T = RC$ will verify the equation of charge.

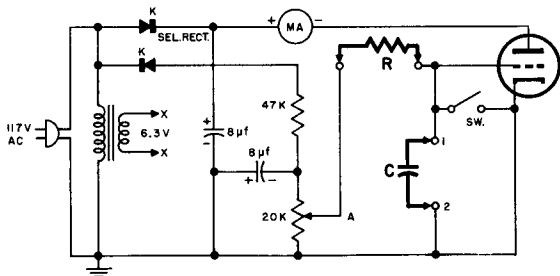

Test circuit for verification of time constant laws

INDEX

- Ampere, 4
- Applications of time constant, 38
- Atomic distortion, 3
- AVC system, 43, 44
- Average current, 6

- Blocking action of capacitor, 34
- Bound charges, 3
- Bucking voltage of capacitor, 11

- Calibration of test unit, 45
- Capacitance, definition of, 1
- Capacitor, 1
- Capacitor structure, 2
- Charging current, 6
- Charging curve, 11, 12
- Charging curve, development of, 10
- C, Q, and E relationships, 5, 6
- Coulomb, 4
- Coupling circuit, 43
- Coupling network, 33, 34

- De-emphasis network, 42
- Dielectric, 1, 2
- Differentiation network 32, 33
- Discharge curve, 19
- Discharging current, 7

- E and I in R-C resistor, 26
- Energy in capacitor, 3
- Epsilon, 14
- Equation of exponential curve, 13
- Equation of discharge curve, 20
- Exponential curve, 11, 13

- Factors affecting capacitance, 1, 2
- Farad, 6
- Filter systems, 34, 35

- Growth of capacitor voltage, 10

- High-pass filters, 41, 42

- Implications of charge equation, 15
- Implications of discharge equation, 21, 22
- Inductance, action of, 8
- Inductance, time for steady state current, 8
- Integrating network, 34, 35
- Kirchoff's Second Law, 8

- Lenz's Law, 16, 17
- Logarithmic curve, 11, 13
- Long time constant, 31, 32
- Long time constant wave-forms, 33, 34
- Low-pass filters, 41, 42

- Measurement of time constant, 25
(and Appendix)

- Naperian Logarithms, 14

- Ohm's Law, 8, 10

- Percentage of charge, 16
- Percentage of discharge, 22
- Phase, resistive E and I, 10
- Photo-cell, 38
- Photo-timer, 39, 40
- Pre-emphasis, 42
- Proportionality constant, 23
- Pulse integration, 35

- Q (charge), 2, 5

- Relays, 38
- Resistive control of charge time, 7
- R-L current growth, 16
- R-L time constant applications, 36
- R-L wave-forms, 29

- Sawtooth generator, 36
- Serrated vertical pulse (television), 35
- Short time constant, 32, 33
- Square wave forms, 27, 28, 29
- Stored charge, 1, 3

- Television integrator, 35
- Time constant, meaning of, 24
- Time delay circuits, 38, 39, 40
- Time of charge, 6
- Time of discharge, 7
- Tone controls, 43
- Transient current, 4

- Unit of capacitance, 5
- Universal time constant chart, 30

- Voltage after R-C time, 35
- Voltage on capacitor, 6