

ALIGNING PHILCO RECEIVERS

VOLUME TWO

by

JOHN

F.

RIDER

ALIGNING PHILCO RECEIVERS

VOLUME II

by
JOHN F. RIDER



JOHN F. RIDER PUBLISHER, INC.

404 Fourth Avenue

New York City

Copyright, 1941, by
JOHN F. RIDER

Copyright, 1937, 1938, 1939, 1940, 1941 by
PHILCO RADIO AND TELEVISION CORPORATION
Philadelphia, Pa.

All rights reserved, including translation into the
Scandinavian and other foreign languages.

Certain of the material herein contained has been
copyrighted by the Philco Radio and Television
Corporation. Permission to reproduce this material
in this book has been granted to John F. Rider.

Printed in the United States of America

AUTHOR'S FOREWORD

THIS volume picks up where Volume I left off. Those men who used the preceding book will recognize the tabular form of alignment instructions, the chassis layouts, and notes as following very closely the other's style. It has been retained because of the enthusiastic response with which it was received by thousands of servicemen all over the world.

The general alignment instructions have been brought up to date and will be found in the Appendix, which, it is suggested, the user of this book read before doing any actual alignment work. It will also be noted that the chassis layouts showing the locations of the trimmers, have been re-drawn in most instances to make for greater clarity and the adjustment frequencies for the trimmers added to make for greater ease in using the instructions as a whole.

We wish to thank Robert Herr, J. R. Jackson and others of the Philco Service and Engineering Divisions who cooperated with the author in the preparation of the material in this book.

JOHN F. RIDER.

June 19, 1941.

INDEX

Note: Code numbers in parentheses

<i>Model</i>	<i>Page</i>
PHXD	3
AR-1	1
TH-1	1
PT-2	2
AR-3	4
TH-3	5
AR-4	6
TH-4, TH-4T, TP-4, TP-4I	7
AR-5	8
TH-5, TH-5T, TP-5, TP-5I, TP-5T—See Model TH4	7
AR-6	9
PT-6—See Model PT-2	2
AR-7	10
AR-8—See Model AR-7	10
AR-9	11
TH-9	12
AR-10	13
TP-10	14
TP-11—See Model TP-10	14
PT-12	15
TP-12—See Model TH-4	7
12TP (Early)	16
12TP(Late)—See Model 39-6	52
TH-14	17
TH-15—See Model TH-14	17
TH-16—See Model TH-14	17
TH-17—See Model TH-14	17
TH-18, TH-18E—See Model TH-9	12
TP-20	18
TP-21—See Model TP-20	18
TH-22—See Model TH-9	12
PT-25 (121, 122)	19
PT-26—See Model TH-14	17
PT-27 (121, 122)—See Model PT25	19
PT-28—See Model TH-14	17
PT-29—See Model PT-25	19
PT-30	20
PT-31—See Model PT-25	19
PT-33—See Model TH-14	17
PT-35	21
PT-36—See Model TP-20	18
PT-37—See Model TH-9	12
37-62	22
37-620 (125)	23
37-630 (125, 126)—See Model 37-620	23
PT-38—See Model TH-9	12
38-1	24
38-2 (Runs 1, 2)	26
38-3	28
38-4	30
38-5—See Model 38-4	30
38-7	32

<i>Model</i>	<i>Page</i>
38-8—See Model 38-7	32
38-9—See Model 38-7	32
38-10—See Model 38-7	32
38-12	33
38-14 (121, 124)	34
38-15 (121, 124)	35
38-22 (121, 124)	36
38-23—See Model 38-22	36
38-33	37
38-34—See Model 38-33	37
38-35	38
38-38	39
38-39—See Model 38-38	39
38-40	40
38-60 (125)	41
38-62—See Model 37-62	22
38-89 (125)	42
38-116 (121)	43
38-116 (125)	46
38-620 (121, 125)	48
38-690 (125)	50
PT-39—See Model PT25	19
39-6	52
39-7—See Model 39-6	52
39-8, 39-8T—See Model 39-6	52
39-12, 39-12TP (Early)—See Model 12TP	16
39-12, 39-12TP (Late)—See Model 39-6	52
39-17 (121, 122)	53
39-18 (121, 122)—See Model 39-17	53
39-19 (121, 122), 39-19PA, 39-19PCS, 39-19PF, 39-19PT	54
39-25	55
39-30, 39-30PCX—See Model 39-25	55
39-31, 39-31XF, 39-31XK, 39-3-31PA—See Model 39-25	55
39-35—See Model 39-25	55
39-36	56
39-40, 39-40PCX, 39-2-40PC	57
39-45	58
39-55	59
39-70	60
39-71 (121, 122)	61
39-72T—See Model 39-71	61
39-75	62
39-80—See Model 39-75	62
39-85	63
39-116, 39-116PCX	64
39-117	65
39-118 (121, 122)—See Model 39-117	65
39-119 (121, 122)	66
39-175—See Model 39-75	62
39-711	67
39-744	68
39-751	69
39-770	70
39-2770—See Model 39-770	70
AR40	72
40-74 (121, 122)	73

<i>Model</i>	<i>Page</i>
40-81, 40-81T, 40-81CSL (121, 122)	74
40-82—See Model 40-81	74
40-83—See Model 40-81	74
40-84—See Model 40-81	74
40-88T, 40-88TL	75
40-90	76
40-95 (121, 122)	77
40-100 (121, 122)—See Model 40-95	77
40-105—See Model 40-95	77
40-110	78
40-115	79
40-120	80
40-124 (121, 122)—See Model 40-115	79
40-125—See Model 40-120	80
40-130	81
40-135—See Model 40-130	81
40-140	82
40-145—See Model 40-140	82
40-150	83
40-155—See Model 40-150	83
40-158	84
40-160	85
40-165	86
40-170CS—See Model 40-130	81
40-180—See Model 40-150	83
40-185—See Model 40-150	83
40-190—See Model 40-150	83
40-195	87
40-200, 40-200XX, 40-200XXS—See Model 40-195	87
40-201 (121, 122)—See Model 40-195	87
40-205	88
40-215, 40-215RX	89
40-216	90
40-217, 40-217RX—See Model 40-215	89
40-501	91
40-502 (121, 122)—See Model 40-501	91
40-503—See Model 40-130	81
40-504—See Model 39-71	61
40-506—See Model 40-130	81
40-507—See Model 40-140	82
40-508—See Model 40-150	83
40-509—See Model 40-150	83
40-510—See Model 40-205	88
40-515—See Model 40-150	83
40-516—See Model 40-216	90
40-525—See Model 40-130	81
40-526—See Model 40-130	81
40-527—See Model 40-130	81
40-710	92
40-715	93
40-725	94
40-748	95
40-755—See Model 40-725	94
40-756—See Model 40-748	95
40-780 (121, 125)	96
40-2710	97

<i>Model</i>	<i>Page</i>
40-2725	98
40-2780	99
PT-41 (121, 122)—See Model TH-14	17
41-81	100
41-83—See Model 41-81	100
41-84—See Model 41-81	100
41-85	101
41-90	102
41-95	103
41-100—See Model 41-95	103
41-105	104
41-110	105
41-220	106
41-221	107
41-225—See Model 41-220	106
41-226—See Model 41-221	107
41-230	108
41-231—See Model 41-221	107
41-235—See Model 41-230	108
41-240	109
41-245	110
41-246	111
41-250	112
41-255—See Model 41-250	112
41-256	113
41-258 (122)	114
41-260	115
41-265—See Model 41-260	115
41-280—See Model 41-250	112
41-285—See Model 41-250	112
41-287—See Model 41-250	112
41-290—See Model 41-250	112
41-295	116
41-300—See Model 41-295	116
41-316	117
41-601	118
41-602	119
41-603	120
41-604	121
41-605—See Model 41-604	121
41-607—See Model 41-604	121
41-608	122
41-609 (121, 122)—See Model 41-608	122
41-610	123
41-611—See Model 41-610	123
41-616P, 41-616PN—See Model 41-316	117
41-623	124
41-624—See Model 41-623	124
41-625—See Model 41-623	124
41-629	125
41-695	126
41-705	127
41-708	128
41-712	129
41-713—See Model 41-712	129
41-714—See Model 41-712	129

<i>Model</i>	<i>Page</i>
41-788 (121, 122)	130
41-841—See Model 41-695	126
41-842	132
41-843—See Model 41-842	132
41-844—See Model 41-842	132
41-851—See Model 41-85	101
PT-42	133
PT-43 (121, 122)—See Model TP-20	18
PT-44—See Model PT-42	133
AR-45—See Model AR-40	72
PT-45—See Model PT-25	19
PT-46—See Model TH-14	17
PT-47—See Model PT-25	19
PT-48—See Model TH-14	17
PT-49 (Early)—See Model PT-25	19
PT-49 (Late)—See Model PT-30	20
AR-50	134
PT-50—See Model TH-14	17
PT-51—See Model PT-25	19
PT53—See Model TH9	12
AR-55—See Model AR-50	134
PT-55—See Model TP-20	18
PT-57—See Model TH-14	17
PT-59—See Model PT-35	21
PT-61 (121, 122)—See Model TH-14	17
PT-63—See Model 40-81	74
AR-65	135
PT-65—See Model TH-14	17
PT-66—See Model TH-14	17
PT67—See Model TP20	18
PT-69—See Model TH-14	17
AR-75—See Model AR-50	134
PT-87	136
PT-89—See Model 41-81	100
101	137
105	138
107—See Model 39-6	52
108	139
821P	140
821PV	142
826	143
827, 827K—See Model 826	143
828, 828K—See Model 826	143
920	144
921	145
922—See Model 921	145
926	146
927—See Model 926	146
928K—See Model 926	146
931	147
932—See Model 931	147
933—See Model AR3	4
936	148
937, 937X—See Model 936	148
938K, 938KX—See Model 936	148
R-1415	149

<i>Model</i>	<i>Page</i>
W-1419—See Model R-1415	149
L-1420	150
P-1422—See Model L-1420	150
C-1423	151
L-1424—See Model L-1420	150
L-1425—See Model L-1420	150
P-1426—See Model L-1420	150
L-1427—See Model L-1420	150
L-1429—See Model L-1420	150
P-1432H—See Model C-1423	151
N-1434H—See Model C-1423	151
S-1437—See Model C-1423	151
L-1439—See Model L-1420	150
F-1440—See Model C-1423	151
F-1442—See Model C-1423	151
C-1450	152
C-1452—See Model C-1450	152
L-1460—See Model L-1420	150
N-1514	154
S-1516—See Model N-1514	154
P-1517—See Model N-1514	154
N-1524—See Model N-1514	154
S-1526—See Model N-1514	154
G-1528—See Model N-1514	154
P-1530—See Model N-1514	154
P-1535	153
F-1540	156
C-1550—See Model N-1514	154
L-1560—See Model P-1535	153
C-1606	158
C-1608	157
S-1616	160
P-1617—See Model S-1616	160
S-1622	162
S-1626	163
G-1628—See Model S-1626	163
P-1630—See Model S-1616	160
P-1635—See Model S-1616	160
F-1640	164
F-1641	165
L-1660	166
C-1708	167
S-1722	168
S-1726	169
F-1740	170
L-1760	171
L-1761—See Model L-1760	171
C-1808	172
S-1824	173
S-1825	174
S-1826—See Model S-1825	174
P-1835—See Model S-1825	174
P-1841	176
Adjusting Mystery-Control Frequency Amplifier	177
Adjusting Mystery Control for Reception of Stations	181
Appendix	185

INTRODUCTION

SINCE this book is a continuation of the previous volume "*Aligning Philco Receivers*," we shall not repeat all the general alignment instructions and introductory notes given in that first volume; they have been condensed and brought up to date. It is recommended that these notes, appearing in the Appendix, be read and studied. Since the tabular arrangement in this new volume has been improved and further simplified, we shall devote a few words to it.

General Notes

Before any alignment adjustments are made, the receiver should be turned on and allowed to heat for about 15 minutes in order to avoid the possibility of misalignment due to oscillator drift, this being of particular importance in multi-band receivers.

In all cases the Volume-Control should be turned on full, unless a note in the alignment procedure specifically indicates some other position. Appropriate notes also specify the various positions of other receiver controls, whenever they are involved in alignment procedure or other adjustments.

Signal-Generator Connection (Column 1)

The high side of the signal generator should be connected to the specific point of the receiver circuit that is indicated. When no mention is made regarding the connection of the low side of the signal generator to the receiver, it is understood that it is connected to the receiver chassis. In a num-

ber of a-c/d-c sets, in order to secure electrical isolation of the signal generator from the receiver, it is recommended that the high side of the signal generator should be connected to terminal No. 1 on a special Philco Set Transformer, part No. 32-2763, and the output-cable ground (connected to low side of signal-generator output) to terminal No. 2. Terminals Nos. 3 and 4 are connected to the receiver—as indicated in the notes.

Dummy Antenna (Column 2)

This column specifies the proper value of condenser or resistor that is to be connected in series between the high side of the signal-generator and the receiver. When an unusual value of capacitance is specified for the dummy antenna, such as 830 mmf, for instance, the nearest available value, as 800 mmf or 1000 mmf, may be employed instead.

A combined form of tabulation, in these two columns, is employed for loop receivers, to show that a special loop made up of several turns of wire is connected to the output terminals of the signal-generator; this loop being placed near the receiver loop. No dummy antenna is needed.

Signal-Generator Frequency (Column 3)

The third column specifies the frequency at which the signal generator should be set for making the necessary alignment adjustments.

Receiver Wave-Band Switch (Column 4)

In receivers incorporating two or more bands, it is important that the wave-band switch be turned to the correct position. In aligning i-f transformers, it is customary to throw the range switch to the "Broadcast" position. However, as will be seen in some of the tabulations, this is not an invariable rule; for, due to a change in "biasing," or to obtain lessened AVC action, the instructions occasionally call for the band switch to be thrown to the "Short-Wave" position.

Receiver-Dial Setting (Column 5)

This column indicates the setting of the receiver dial or tuning condenser. This setting is made after the dial calibration has been checked, or adjusted when necessary, according to the appropriate footnotes.

Trimmer Number (Column 6)

The final column lists the number or name of the trimmer or padder to be adjusted. Such adjustment is always made to secure a *maximum* output indication, unless instructions to the contrary are given in an accompanying footnote.

Special Symbols

Several special symbols have been employed to indicate certain operations:—

The asterisk (*) indicates a rocking adjustment, as is explained in the Appendix.

The double dagger (‡) signifies that the “Police” band is automatically aligned at the same time that the “Broadcast” band adjustments are made; that no aligning adjustments are provided on this band.

In making certain adjustments on loop receivers, it may happen that the receiver loop picks up a broadcast signal in addition to that of the signal-generator. When this occurs, the receiver (either cabinet and loop, or chassis) should be turned until the interfering broadcast signal disappears or reaches a minimum. If the broadcast signal is still present, the receiver tuning-condenser setting should be slightly changed from the position specified in Column 5; so that the broadcast signal is no longer heard. A star (*) is used on many tabulations to indicate this interference possibility.

MODEL AR-1

Signal Generator Connection	Dummy Antenna	Signal Generator Frequency	Receiver Wave-band Switch	Receiver Dial Setting	Trimmer Number
...	5 ¹
Ant. Recept.	0.1 mf	455 kc	...	Note 2	30
"	"	"	...	"	23
"	"	"	...	"	20
"	"	"	...	"	30
"	"	"	...	"	23
"	"	"	...	"	20
Ant. ³	30 mmf	1580 kc	...	"	18
"	"	1400 kc	...	1400 kc	8 ⁴
..... Note 5	1200-1400 kc	5 ⁵

- Note 1.—Adjust antenna condenser (5) two turns from tight position.
 Note 2.—Turn condenser rotor plates completely out of mesh as far as they will go.
 Note 3.—Connect antenna lead, Part No. 41-3191, to the antenna receptacle in the radio. Connect 30 mmf condenser in series between signal-generator and antenna lead.
 Note 4.—When the antenna-stage adjustment is made with the radio installed in the car, the radio antenna lead must be connected to the car antenna in the usual manner. Connect the signal-generator output lead to a wire placed near the car antenna, but not connected to it.
 Note 5.—When installing the radio in the car, follow the instructions carefully. Tune in a weak broadcast signal between 1200 and 1400 kc on the control scale. Remove the plug button on the side of the radio, and adjust aerial compensator (5) for maximum signal.

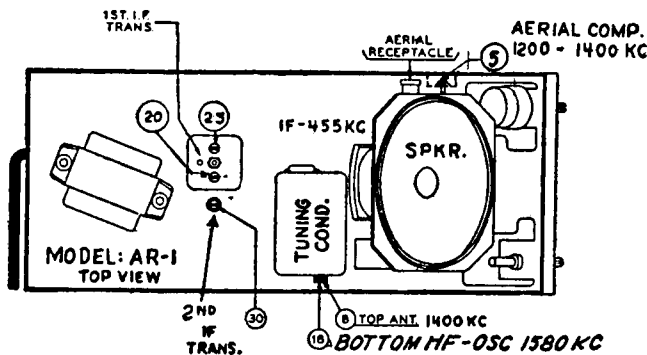

MODEL TH-1

Signal Generator Connection	Dummy Antenna	Signal Generator Frequency	Receiver Wave-band Switch	Receiver Dial Setting	Trimmer Number
...	Note 1	...
Ant.	100 mmf	1500 kc	...	1500 kc	3A ²
"	"	"	...	"	3B

- Note 1.—To adjust the dial pointer, turn the tuning condenser to maximum capacity position. With the condenser in this position, the dial pointer should be ½ inch below the 550 kc mark of the dial and horizontal with the chassis.
 Note 2.—(3A) Ant. and (3B) R.F. are on top of tuning-condenser.

MODELS PT-2, PT-6

Signal Generator Connection	Dummy Antenna	Signal Generator Frequency	Receiver Wave-band Switch	Receiver Dial Setting	Trimmer Number
Ant. sect. tuning-cond.	0.1 mf	455 kc	B.C.	540 kc ¹	12A ²
"	"	"	"	"	12B
"	"	"	"	"	10A
"	"	"	"	"	10B
..... Note 3		1600 kc	"	1600 kc ⁴	4B
"		1500 kc	"	1500 kc ⁵	4A

Note 1.—Tuning condenser fully closed.

DIAL CALIBRATION: With tuning condenser in this position, set tuning pointer on first small line stamped in scale plate on left side.

Note 2.—Before adjusting trimmers, turn down (10B) to the tight position.

Note 3.—When aligning r-f trimmers, a loop is made from a few turns of wire and connected to signal generator output terminals, this loop being placed close to loop of the radio.

Note 4.—1600 kc on dial is at first small line stamped in scale plate from right side of chassis.

Note 5.—1500 kc on dial is at second small line stamped in scale plate from right side of chassis.

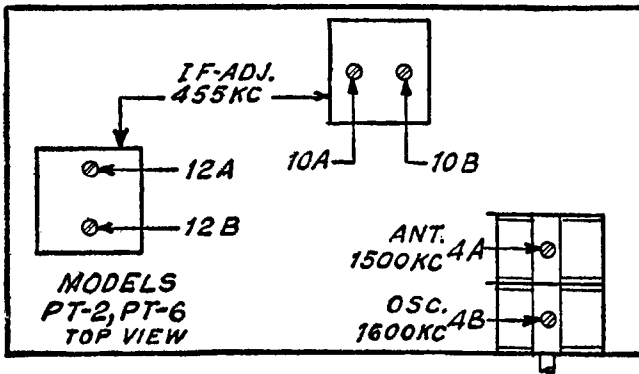

MODEL PHXD

Signal Generator Connection	Dummy Antenna	Signal Generator Frequency	Receiver Wave-band Switch	Receiver Dial Setting	Trimmer Number
Control grid of $39\frac{3}{44}$ IF	0.1 mf	260 kc	Note 1	...	27 ²
"	"	"	"	...	25 ³
Control grid of 6A7	"	"	"	...	19 ²
"	"	"	"	...	16 ³
Control grid of $39\frac{3}{44}$ RF	"	1500 kc	"	Note 4	10
"	"	"	"	"	9
"	"	580 kc	"	580 kc	14*
"	"	1500 kc	"	1500 kc	10
Ant. 5, 6	Note 5, 6	1400 kc	"	1400 kc	9
"	"	"	"	"	3

Note 1.—Remove the cover from the Receiver. The antenna lead must be disconnected. The sensitivity switch must be in the "distance" position. The tone control should be turned to the brilliant position.

Note 2.—This is the nut adjustment.

Note 3.—This is the screw adjustment. Note the maximum reading obtained and then turn the screw in again and readjust, just bringing the adjustment up to the maximum reading. Do not pass it and then back off. This adjustment is critical.

Note 4.—Using a piece of paper approximately .006" thick as a gauge between the heel of the rotor plates and the stator plates, turn the rotor plates until they strike against the paper. This is the true setting for 1500 kc; 150 on the dial scale.

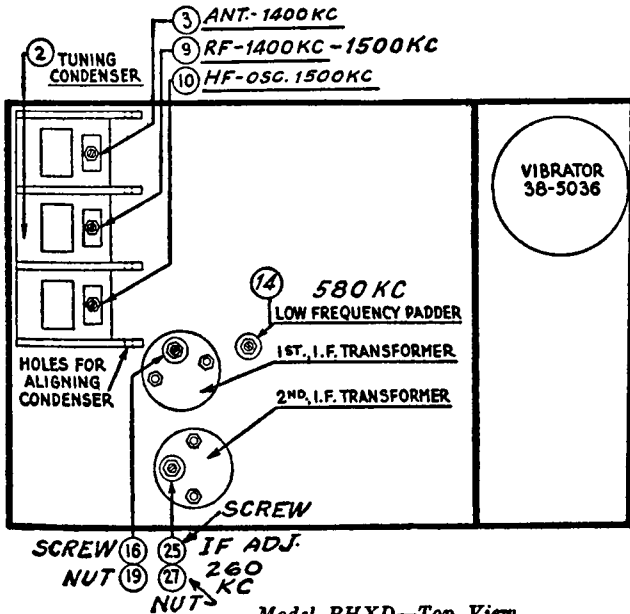

Note 5.—ANTENNA—Connect the generator lead to the antenna lead using a 200 mmf condenser in series between the two leads and the .1 mf condenser.

Note 6.—When the antenna stage adjustment is made with the Receiver installed in the car, the Receiver antenna lead must be connected to the car antenna in the usual manner. The signal generator output lead should be connected to a wire placed near the car antenna but not connected to it.

* While rocking.

MODELS AR3, 933

Signal Generator Connection	Dummy Antenna	Signal Generator Frequency	Receiver Wave-band Switch	Receiver Dial Setting	Trimmer Number
Ant. ³	30 mmf	470 kc	Note 1	Note 2	37
"	"	"	...	"	29
"	"	"	...	"	28
"	"	"	...	"	21
"	"	1580 kc	...	1580 kc	17
"	"	1500 kc	...	1500 kc	7 ⁴
Note 4	...	1400 kc	...	1400 kc	3 ⁴

Note 1.—Press the Automatic Station-Selector button until "DIAL" appears in the window and stations can be tuned in by manual tuning.

Note 2.—Turn tuning condenser plates out of mesh as far as they will go.

Note 3.—Connect antenna lead, Part No. 41-3191, to the antenna receptacle in the radio. Connect 30 mmf condenser in series between the signal generator and the antenna lead.

Note 4.—When the antenna stage adjustment is made with the radio installed in the car, the radio antenna lead must be connected to the car antenna in the usual manner. Connect the signal generator output lead to a wire placed near the car antenna but not connected to it. Also adjust the antenna compensator (3) for maximum on a weak signal at approximately 1400 kc.

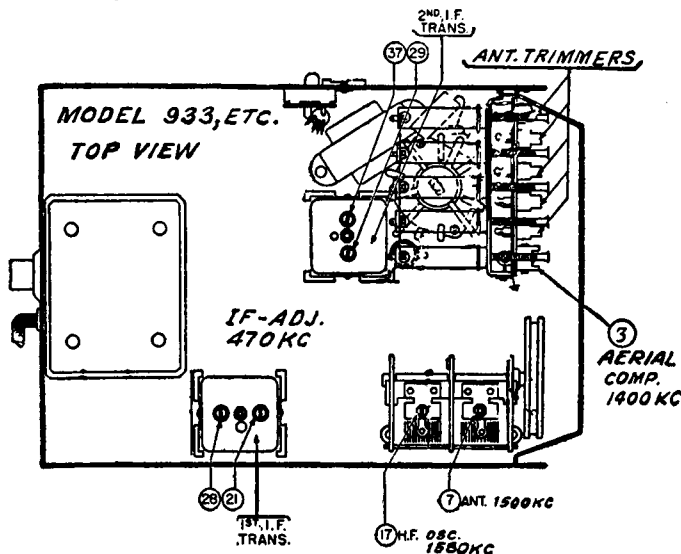

MODEL TH-3

Signal Generator Connection	Dummy Antenna	Signal Generator Frequency	Receiver Wave-band Switch	Receiver Dial Setting	Trimmer Number
Ant. Section Tuning Cond.	0.004 m μ f	470 kc	Note 1 ‡	Note 2	1
"	"	"	"	"	2 ^s
"	"	"	"	"	3
"	"	"	"	"	4
Ant.	100 m μ f	1700 kc	"	1700 kc	5
"	"	1500 kc	"	1500 kc	6

Note 1.—Push in "MANUAL" button on push-button models.

Note 2.—Leave tuning-condenser fully closed.

DIAL CALIBRATION: Dial pointers are adjusted by closing the tuning condenser (plates fully meshed) and setting the pointers on the dot below 55 on the dial.

Note 3.—No second-IF primary trimmer on TH-3.

‡ No adjustments needed on "police" band of models with two wave-band ranges.

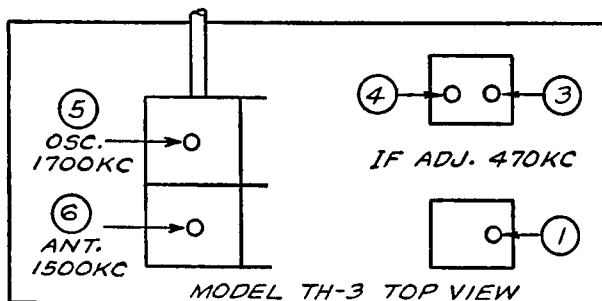

MODEL AR-4

Signal Generator Connection	Dummy Antenna	Signal Generator Frequency	Receiver Wave-band Switch	Receiver Dial Setting	Trimmer Number
...	6 ¹
Ant. Recept.	0.1 mf	455 kc	...	Note 2	30
"	"	"	...	"	27
"	"	"	...	"	23
"	"	"	...	"	21
"	"	"	...	"	30
"	"	"	...	"	27
"	"	"	...	"	23
"	"	"	...	"	21
Ant. ³	10 mmf	1580 kc	...	"	17
"	"	1400 kc	...	1400 kc	4
"	"	580 kc	...	580 kc	15*
"	"	1580 kc	...	Note 2	17
"	"	1400 kc	...	1400 kc	4 ⁴
"	"	580 kc	...	580 kc	15*
..... Note 5	1200-1400 kc	6 ⁵

Note 1.—Adjust aerial compensator (6) two turns from tight position.

Note 2.—Turn condenser rotor plates completely out of mesh as far as they will go.

Note 3.—Connect antenna lead, Part No. 41-3191, to the antenna receptacle in the radio. Connect 10 mmf condenser in series between signal-generator and antenna lead.

Note 4.—When the antenna stage adjustment is made with the radio installed in the car, the radio antenna lead must be connected to the car antenna in the usual manner. Connect the signal-generator output lead to a wire placed near the car antenna, but not connected to it.

Note 5.—After installing the radio in the car, tune in a weak broadcast signal between 1200 and 1400 kc on the control scale. Adjust aerial compensator (6) for maximum signal.

* While rocking.

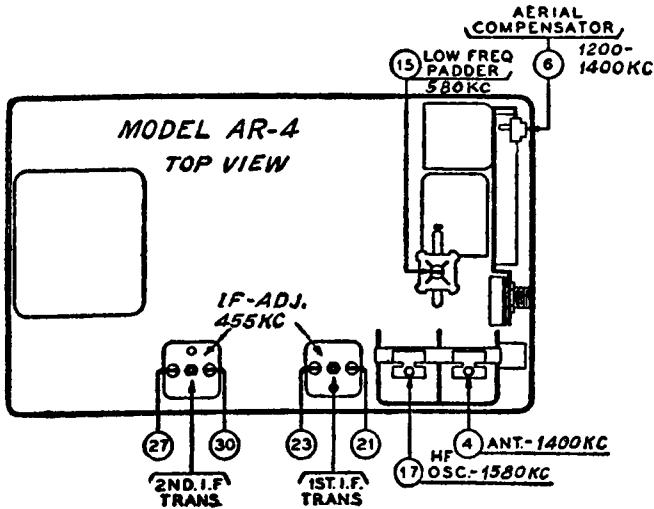

MODELS TH-4, TH-4T, TP-4, TP-4I, TH-5, TH-5T, TP-5, TP-5I, TP-5T, TP-12

Signal Generator Connection	Dummy Antenna	Signal Generator Frequency	Receiver Wave-band Switch	Receiver Dial Setting	Trimmer Number
Ant. Section Tuning Cond.	0.004 mfm	470 kc	Note 1 ‡	Note 2	1
"	"	"	"	"	2 ^s
"	"	"	"	"	3
"	"	"	"	"	4
Ant.	100 mmfm	1700 kc	"	1700 kc	5
"	"	1500 kc	"	1500 kc	6

Note 1.—Push in "MANUAL" button on push-button models.

Note 2.—Leave tuning-condenser fully closed.

DIAL CALIBRATION: Dial pointers are adjusted by closing the tuning condenser (plates fully meshed) and setting the pointers on the dot below 55 on the dial.

Note 3.—No second-IF primary trimmer on TH-3.

‡ No adjustments needed on "police" band of models with two wave-band ranges.

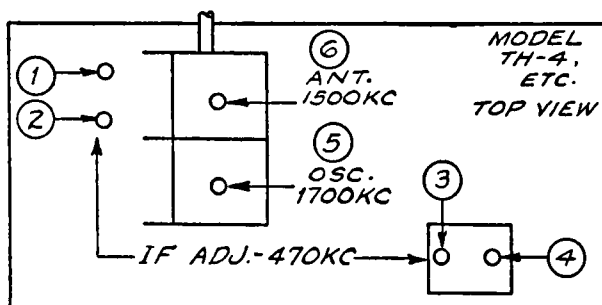

MODEL AR-5

Signal Generator Connection	Dummy Antenna	Signal Generator Frequency	Receiver Wave-band Switch	Receiver Dial Setting	Trimmer Number
Ant. Recept.	0.1 mf	455 kc	...	Note 1	3 ²
"	"	"	...	Note 3	47
"	"	"	...	"	45
"	"	"	...	"	30
"	"	"	...	"	23
"	"	"	...	"	47
"	"	"	...	"	45
"	"	"	...	"	30
"	"	"	...	"	23
"	"	"	...	"	13 ⁴
Ant. ⁵	10 mmf	1580 kc	...	"	19
"	"	1400 kc	...	1400 kc	9
"	"	580 kc	...	580 kc	37*
"	"	1580 kc	...	Note 3	19
"	"	1400 kc	...	1400 kc	9 ⁶
"	"	580 kc	...	580 kc	37*
..... Note 7				1200-1400 kc	3 ⁵

Note 1.—Push in right knob on control until "D" appears in the station-indicator window and the stations can be tuned in by manual tuning.

Note 2.—Adjust aerial compensator (3) two turns from tight position.

Note 3.—Turn condenser rotor plates completely out of mesh as far as they will go.

Note 4.—Adjust for *MINIMUM* output reading.

Note 5.—Connect antenna lead, Part No. 41-3191, to the antenna receptacle in the radio. Connect 10 mmf condenser in series between signal-generator and antenna lead.

Note 6.—When the antenna stage adjustment is made with the radio installed in the car, the radio antenna lead must be connected to the car antenna in the usual manner. Connect the signal-generator output lead to a wire placed near the car antenna, but not connected to it.

Note 7.—After installing the radio in the car, tune in a weak broadcast signal between 1200 and 1400 kc on the control scale. Remove the plug button on the end of the radio and adjust aerial compensator (3) for maximum signal.

* While rocking.

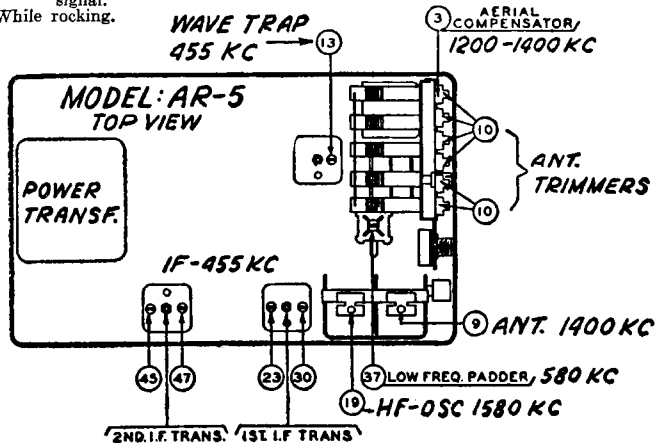

MODEL AR-6

Signal Generator Connection	Dummy Antenna	Signal Generator Frequency	Receiver Wave-band Switch	Receiver Dial Setting	Trimmer Number
...	2 ¹
Control grid of 6A7	0.1 mf	455 kc	...	Note 2	27
"	"	"	...	"	56
"	"	"	...	"	22
"	"	"	...	"	20
"	"	"	...	"	27
"	"	"	...	"	56
"	"	"	...	"	22
"	"	"	...	"	20
Ant. ³	10 mmf	1580 kc	...	"	17
"	"	1400 kc	...	1400 kc	5
"	"	580 kc	...	580 kc	13*
"	"	1580 kc	...	Note 2	17
"	"	1400 kc	...	1400 kc	5 ⁴
"	"	580 kc	...	580 kc	13*
..... Note 5	1200-1400 kc	2 ⁵

Note 1.—Adjust aerial compensator (2) two turns from tight position.

Note 2.—Turn condenser rotor plates completely out of mesh as far as they will go.

Note 3.—Connect antenna lead, Part No. 41-3191, to the antenna receptacle in the radio. Connect 10 mmf condenser in series between signal-generator and antenna lead.

Note 4.—When the antenna-stage adjustment is made with the radio installed in the car, the radio antenna lead must be connected to the car antenna in the usual manner. Connect the signal-generator output lead to a wire placed near the car antenna, but not connected to it.

Note 5.—After installing the radio in the car, tune in a weak broadcast signal between 1200 and 1400 kc on the control scale. Adjust aerial compensator (2) for maximum signal.

* While rocking.

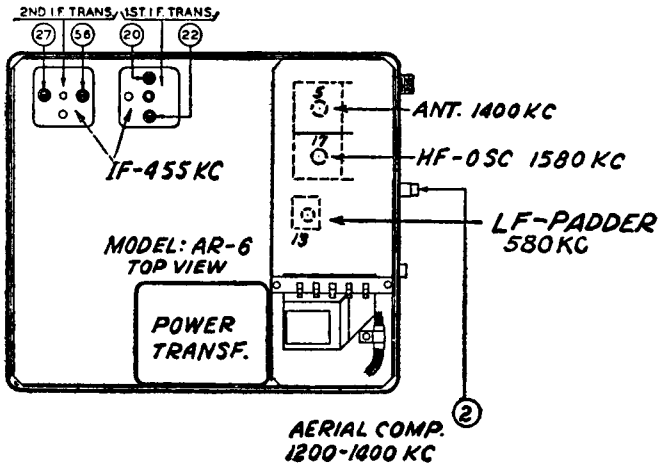

MODELS AR-7, AR-8

Signal Generator Connection	Dummy Antenna	Signal Generator Frequency	Receiver Wave-band Switch	Receiver Dial Setting	Trimmer Number
Control grid of 6A7	0.1 mf	455 kc	...	Note 1 Note 3	1 ² 2
"	"	"	...	"	3
"	"	"	...	"	4
"	"	"	...	"	5
"	"	"	...	"	2
"	"	"	...	"	3
"	"	"	...	"	4
"	"	"	...	"	5
Ant. ⁴	50 mmf	1580 kc	...	"	6
"	"	1400 kc	...	1400 kc	7 ⁵
"	"	580 kc	...	580 kc	8*
"	"	1580 kc	...	Note 3	6
"	"	1400 kc	...	1400 kc	7 ⁵
"	"	580 kc	...	580 kc	8*
..... Note 6.....	1200-1400 kc	1 ⁶

Note 1.—Press "RETURN TO DIAL" button until stations can be tuned in by manual tuning.

Note 2.—Adjust aerial compensator (1) two turns from tight position.

Note 3.—Turn condenser rotor plates completely out of mesh as far as they will go.

Note 4.—Connect antenna lead, Part No. 41-3191, to the antenna receptacle in the radio. Connect 50 mmf condenser in series between signal-generator and antenna lead.

Note 5.—When the antenna-stage adjustment is made with the radio installed in the car, the radio antenna lead must be connected to the car antenna in the usual manner. Connect the signal-generator output lead to a wire placed near the car antenna, but not connected to it.

Note 6.—After installing the radio in the car, tune in a weak broadcast signal between 1200 and 1400 kc on the control scale. Remove the plug button on the end of the radio and adjust the aerial compensator (1) for maximum signal.

* While rocking.

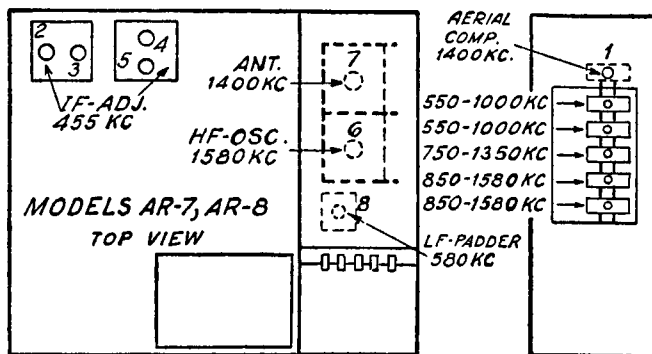

MODEL AR-9

Signal Generator Connection	Dummy Antenna	Signal Generator Frequency	Receiver Wave-band Switch	Receiver Dial Setting	Trimmer Number
Ant. Recept.	0.1 mf	455 kc	Note 1	Note 2	41
"	"	"	"	"	39
"	"	"	"	"	25
"	"	"	"	"	23
"	"	"	"	"	41
"	"	"	"	"	39
"	"	"	"	"	25
"	"	"	"	"	23
Ant. ³	10 mmf	1580 kc	"	"	69
"	"	1400 kc	"	1400 kc	65
"	"	580 kc	"	580 kc	21 *
"	"	1580 kc	"	Note 2	69
"	"	1400 kc	"	1400 kc	65 ⁴
"	"	580 kc	"	580 kc	21 *
"	"	10 mc	Note 5	Note 2	1
"	"	9.5 mc	"	9.5 mc	5
"	"	6.0 mc	"	6.0 mc	3
"	"	12.1 mc	Note 6	Note 2	2
"	"	11.9 mc	"	11.9 mc	6
"	"	11.7 mc	"	11.7 mc	4 ⁷

Note 1.—Push in right hand knob on the control until *BLACK* dot appears in band-indicator window and stations can be tuned in by manual tuning.

Note 2.—Turn condenser rotor plates completely out of mesh as far as they will go.

Note 3.—Connect antenna lead, Part No. 41-3191, to the antenna receptacle in the radio. Connect 10 mmf condenser in series between signal-generator and antenna lead.

Note 4.—When the antenna-stage adjustment is made with the radio installed in the car, the radio antenna lead must be connected to the car antenna in the usual manner. Connect the signal-generator output lead to a wire placed near the car antenna, but not connected to it.

Note 5.—Push in right hand knob on the control until *RED* dot appears in band-indicator window.

Note 6.—Push in right hand knob on the control until *WHITE* dot appears in band-indicator window.

Note 7.—Repeat adjustment of (6) and (4) successively until maximum signal is obtained.

* While rocking.

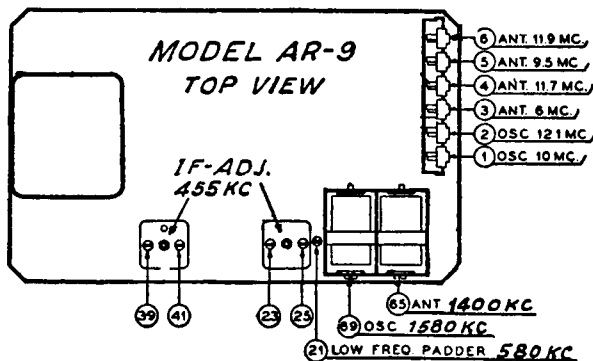

MODELS TH-9, TH-18, TH-18E, TH-22, PT-37, PT-38, PT-53

Signal Generator Connection	Dummy Antenna	Signal Generator Frequency	Receiver Wave-band Switch	Receiver Dial Setting	Trimmer Number
Ant. sect. tuning-cond.	0.004 mf	Note 1	B.C.	Note 2	18A
"	"	"	"	"	18B
"	"	"	"	"	17A
"	"	"	"	"	17B
Ant.	400 ohms	18 mc	S.W.	18 mc	3B
"	"	"	"	"	3A
"	100 mmf	1500 kc	B.C.	1500 kc	13A
"	"	580 kc	"	580 kc	13B*
"	"	1500 kc	"	1500 kc	13A

Note 1.—IF is 455 kc for models TH-9, -18, -22.

IF is 455, 460, or 470 kc (depending on run) for models PT-37, -38, -53.

Note 2.—Leave tuning-condenser in fully-closed position during IF adjustments

DIAL CALIBRATION: Dial pointers are adjusted by closing tuning-condenser (plates fully meshed), and setting the pointers slightly below top edge of brown center line at extreme left end of pointer.

* While rocking.

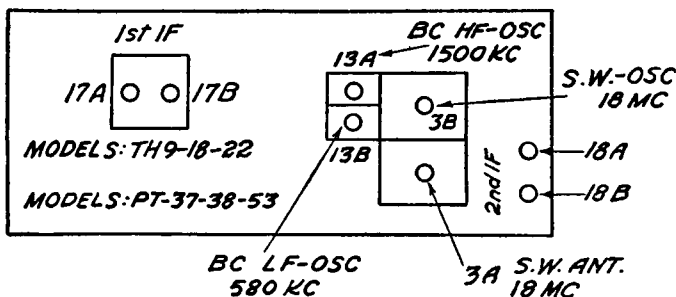

MODEL AR-10

Signal Generator Connection	Dummy Antenna	Signal Generator Frequency	Receiver Wave-band Switch	Receiver Dial Setting	Trimmer Number
...	Note 1
Ant. recept.	0.1 mf	455 kc	...	Note 2	30
"	"	"	...	"	23
"	"	"	...	"	20
"	"	"	...	"	30
"	"	"	...	"	23
"	"	"	...	"	20
Note 3	30 mmf	1580 kc	...	"	18
"	"	1400 kc	...	1400 kc	8 ⁴
...	1200-1400 kc	5 ⁵

Note 1.—Adjust antenna compensator (5) two turns from tight position.

Note 2.—Turn condenser rotor plates completely out of mesh as far as they will go.

Note 3.—Connect antenna lead, Part No. 95-0185, to antenna receptacle in the radio. Connect a 30 mmf condenser in series between signal generator and antenna lead.

Note 4.—When antenna stage adjustment is made with radio installed in car, the radio antenna lead must be connected to car antenna in usual manner. Connect signal generator output lead to a wire placed near car antenna but not connected to it.

Note 5.—After installing radio in car, tune in a weak broadcast signal between 1200 and 1400 kc. Remove plug button on side of radio and adjust antenna compensator (5) for maximum signal.

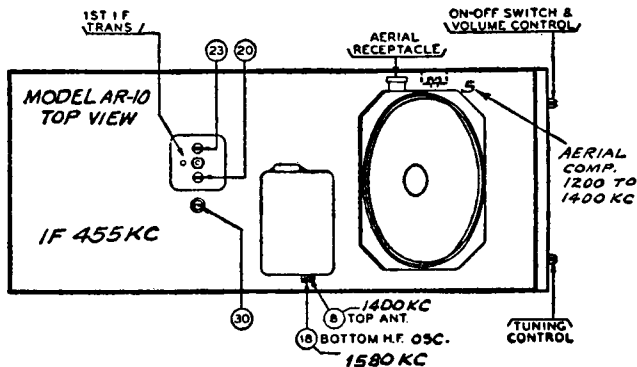

MODELS TP-10, TP-11

Signal Generator Connection	Dummy Antenna	Signal Generator Frequency	Receiver Wave-band Switch	Receiver Dial Setting	Trimmer Number
Ant. Sect. Tuning Cond.	0.004 mf	470 kc	Note 1‡	Note 2	1
"	"	"	"	"	2
"	"	"	"	"	3
"	"	"	"	"	4
Ant.	100 mmf	1720 kc	"	Note 3	5
"	"	1500 kc	"	Note 4	6

Note 1.—Push in "MANUAL" button on push-button models.

Note 2.—Leave tuning-condenser fully closed.

Note 3.—Insert a .004" gauge between the stationary and rotor plates of the oscillator condenser. If the gauge is not handy, a piece of bond writing paper can be used. After inserting gauge, turn rotor toward the low frequency end so that the gauge will be held in position.

Note 4.—Remove gauge and tune tuning-condenser for maximum reading on this signal; then adjust the antenna trimmer (6) for maximum output.

DIAL CALIBRATION: After alignment is completed, place set in cabinet so that the tuning arm on the tuning condenser engages the dial on the cabinet. After placing receiver in the cabinet and it is found that the dial does not track properly with station signals, the dial can be calibrated as follows: Set the signal generator to a low frequency signal (600 kc) and tune receiver until signal shows maximum reading on the output meter. The dial is then set to this signal by inserting a 6-32 Phillips screw driver to the adjustment screw on the tuning condenser pulley. Loosen screw and slightly turn dial so that it reads 600 kc then retighten screw. When doing this, however, precaution should be taken so that the tuning condenser is not disturbed while dial is being adjusted and screw is being tightened or loosened.

‡ No adjustments needed on "police" wave band.

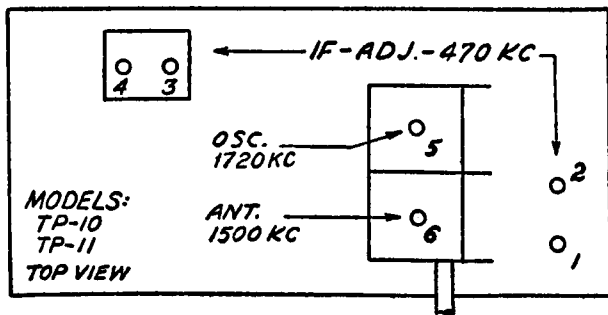

MODEL PT-12

Signal Generator Connection	Dummy Antenna	Signal Generator Frequency	Receiver Wave-band Switch	Receiver Dial Setting	Trimmer Number
Ant. sect. tuning-cond.	0.1 mf	455 kc	B.C.	540 kc ¹	12A ²
"	"	"	"	"	12B
"	"	"	"	"	10A
"	"	"	"	"	10B
..... Note 3		1600 kc	"	1600 kc ⁴	4B
"		1500 kc	"	1500 kc ⁵	4A

Note 1.—Tuning condenser fully closed.

DIAL CALIBRATION: With tuning condenser in this position, set tuning pointer on first small line stamped in scale plate on left side.

Note 2.—Before adjusting trimmers, turn down (10B) to the tight position.

Note 3.—When aligning r-f trimmers, a loop is made from a few turns of wire and connected to signal generator output terminals, this loop being placed close to loop of the radio.

Note 4.—1600 kc on dial is at first small line stamped in scale plate from right side of chassis.

Note 5.—1500 kc on dial is at second small line stamped in scale plate from right side of chassis.

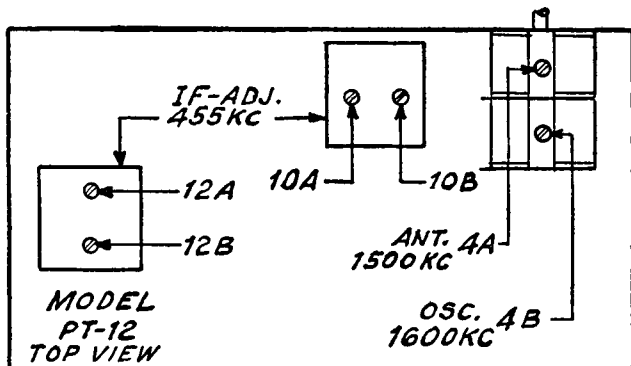

MODELS 12TP, 39-12, 39-12TP (Early)

Signal Generator Connection	Dummy Antenna	Signal Generator Frequency	Receiver Wave-band Switch	Receiver Dial Setting	Trimmer Number
Control grid of 6A7	0.1 mf	470 kc	...	580 kc ¹	12A
"	"	"	...	"	8B
"	"	"	...	"	8A
Ant. (white wire)	100 mmf	1500 kc	...	1500 kc	3B
"	"	"	...	"	3A

Note 1.—DIAL CALIBRATION: 1 Turn the tuning condenser to maximum capacity position (plates fully meshed). 2 Holding the tuning condenser in this position, turn the pointer until it is 1/16 of an inch below the three lines of the scale at the 550 kc end. This is the correct position of pointer at maximum capacity of tuning condenser.

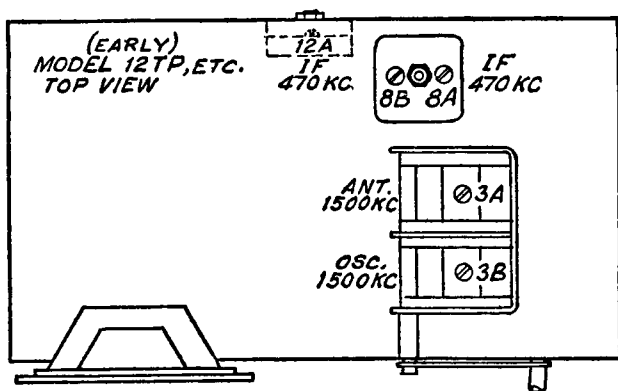

**MODELS TH-14, TH-15, TH-16, TH-17, PT-26, PT-28,
PT-33, PT-41 (121, 122), PT-46, PT-48, PT-50, PT-57,
PT-61 (121, 122), PT-65, PT-66, PT-69 (121, 122)**

Signal Generator Connection	Dummy Antenna	Signal Generator Frequency	Receiver Wave-band Switch	Receiver Dial Setting	Trimmer Number
Ant. sect. tuning-cond.	0.004 mf	455 kc	Note 1	540 kc ²	1
"	"	"	"	"	2
"	"	"	"	"	3
Ant. ³	100 mmf	1500 kc	"	1500 kc	4
Ant. ⁴	"	"	"	"	5 ⁴

Note 1.—Push in "DIAL" button on push-button models.

Note 2.—DIAL CALIBRATION: Dial pointers are adjusted by closing tuning-condenser (plates fully meshed), and setting the pointers slightly below top edge of brown center line at extreme left end of pointer.

Note 3.—Antenna terminal on loop.

Note 4.—On models PT-26, -28, -46, -48, antenna trimmer must be adjusted with loop connected and set assembled in cabinet. Antenna connection on these models is the wire attached to chassis at rear of tuning condenser. Remove wire lug from chassis to connect 100 mmf condenser.

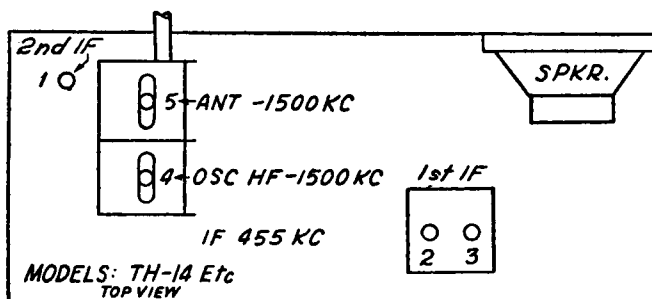

MODELS TP-20, TP-21, PT-36, PT-43 (121, 122), PT-55, PT-67

Signal Generator Connection	Dummy Antenna	Signal Generator Frequency	Receiver Wave-band Switch	Receiver Dial Setting	Trimmer Number
Ant. sect. tuning-cond.	0.004 mf	455 kc	Note 1	540 kc ²	1
"	"	"	"	"	2
"	"	"	"	"	3
Ant. ³	100 mmf	1600 kc	"	Note 4	4
"	"	1500 kc	"	Note 5	5 ^{6, 7}

Note 1.—Press in "DIAL" button on push-button models.

Note 2.—Tuning-condenser fully closed.

Note 3.—Antenna terminal on back of loop.

Note 4.—Turn the tuning condenser to the extreme high frequency position (all plates out of mesh). Insert a 0.004 gauge between the stationary and rotor plates of the oscillator condenser (end where both sections enter). If the gauge is not handy, a piece of bond writing paper can be used. After inserting gauge, turn the rotor toward the low frequency end so that both rotor and stator touch gauge. Then remove gauge, being careful not to disturb condenser setting.

Note 5.—After setting signal generator to 1500 kc, tune receiver tuning condenser for maximum reading on this signal, and then adjust the antenna trimmer for maximum output.

Note 6.—Model 36 antenna trimmer must be adjusted with the loop connected and assembled in the cabinet.

Note 7.—DIAL CALIBRATION: After alignment is completed, place set in cabinet so that the tuning arm on the tuning condenser engages the dial pointer on the cabinet. After placing receiver in the cabinet and it is found that the dial pointer does not track properly with station signals, the dial can be calibrated as follows: Set the signal generator to 600 kc and tune receiver until signal shows maximum reading on the output meter. The dial pointer is then set to this signal by inserting a screw driver to the adjustment screw on the tuning condenser pulley. Loosen screw and slightly turn dial so that it reads 600 kc, and then retighten screw. When doing this, however, precaution should be taken so that the tuning condenser is not disturbed while dial is being adjusted and screw is being tightened or loosened.

In Models PT-36 and PT-43, Code 122, the dial pointer is simply pushed onto the tuning-condenser shaft; and does NOT require the adjustment as given in the paragraph above.

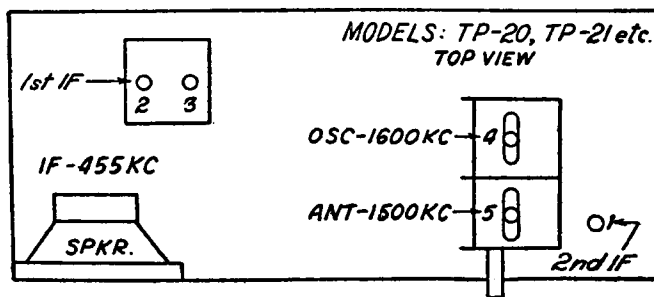

**MODELS PT-25 (121,122), PT-27 (121,122), PT-29,
PT-31, PT-39, PT-45, PT-47, PT-49, PT-51**

Signal Generator Connection	Dummy Antenna	Signal Generator Frequency	Receiver Wave-band Switch	Receiver Dial Setting	Trimmer Number
Ant. sect. tuning-cond.	0.004 mf	470 kc	Note 1	540 ²	2A
"	"	"	"	"	2B
"	"	"	"	"	1A
"	"	"	"	"	1B
Ant.	100 mmf	1700 kc	"	1700 kc	3B †
"	"	1500 kc	"	1500 kc	3A

Note 1.—Push in "DIAL" button on push-button models.

Note 2.—DIAL CALIBRATION: Dial pointers are adjusted by closing tuning-condenser (plates fully meshed), and setting the pointers slightly below top edge of brown center line at extreme left end of pointer.

† The Police Band on models PT-29, -31, -49, -51 is automatically aligned when osc. trimmer (3B) is adjusted.

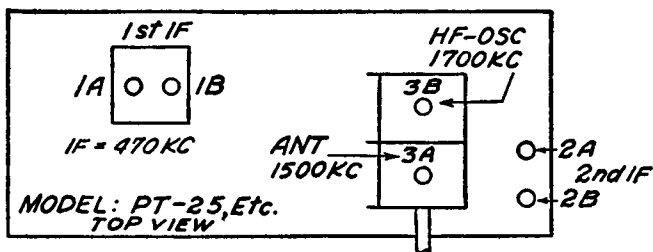

MODELS PT-30, PT-49 (Late)

Signal Generator Connection	Dummy Antenna	Signal Generator Frequency	Receiver Wave-band Switch	Receiver Dial Setting	Trimmer Number
Ant. sect. tuning cond.	0.1 mf	455 kc	B.C.	540 kc ¹	11A ²
"	"	"	"	"	13A
"	"	"	"	"	13B
"	"	"	"	"	11B
..... Note 3		1600 kc	"	1600 kc	4B
"		1500 kc	"	1500 kc	4A

Note 1.—Tuning condenser fully closed.

DIAL CALIBRATION: With condenser in this position, set tuning pointer on small dot below 550 kc.

Note 2.—Before adjusting i-f trimmers, turn trimmer (11B) clockwise to tight position.

Note 3.—When aligning r-f trimmers a loop is made from a few turns of wire and connected to signal generator output terminals, this loop being placed close to receiver loop.

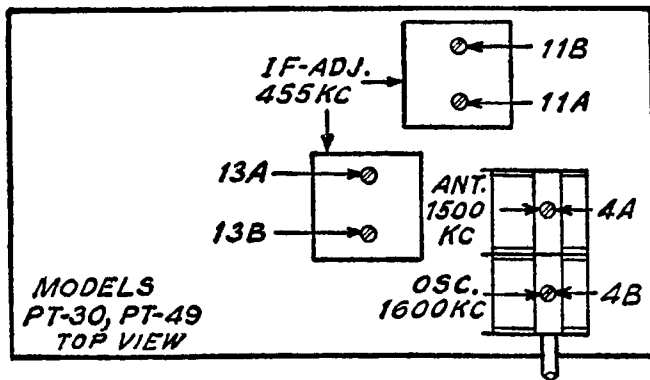

MODELS PT-35, PT-59

Signal Generator Connection	Dummy Antenna	Signal Generator Frequency	Receiver Wave-band Switch	Receiver Dial Setting	Trimmer Number
Ant. sect. tuning-cond.	0.004 mf	470 kc	Note 1	Note 2	1
"	"	"	"	"	2
"	"	"	"	"	3
"	"	"	"	"	4
Ant.	100 mmf	1720 kc	"	Note 3	5
"	"	1500 kc	"	Note 4	6

Note 1.—Press in "DIAL" button on push-button models.

Note 2.—Tuning-condenser fully closed.

Note 3.—Turn the tuning condenser to the extreme high frequency position (all plates out of mesh). Insert a .004 (four thousandths) gauge between the stationary and rotor plates of the oscillator condenser (end where both sections enter). If the gauge is not handy, a piece of bond writing paper can be used. After inserting gauge, turn the rotor toward the low frequency end so that both rotor and stator touch gauge. Then remove gauge, being careful not to disturb condenser setting.

Note 4.—After setting signal generator to 1500 kc, tune receiver tuning-condenser for maximum reading on this signal; then adjust the antenna trimmer for maximum output.

DIAL CALIBRATION: After alignment is completed, place set in cabinet so that the tuning arm on the tuning condenser engages the dial pointer on the cabinet. After placing receiver in the cabinet and it is found that the dial pointer does not track properly with station signals, the dial can be calibrated as follows: Set the signal generator to 600 kc and tune receiver until signal shows maximum reading on the output meter. The dial pointer is then set to this signal by inserting a screw driver to the adjustment screw on the tuning condenser pulley. Loosen screw and slightly turn dial so that it reads 600 kc, then retighten screw. When doing this, however, precaution should be taken so that the tuning condenser is not disturbed while dial is being adjusted and screw is being tightened or loosened.

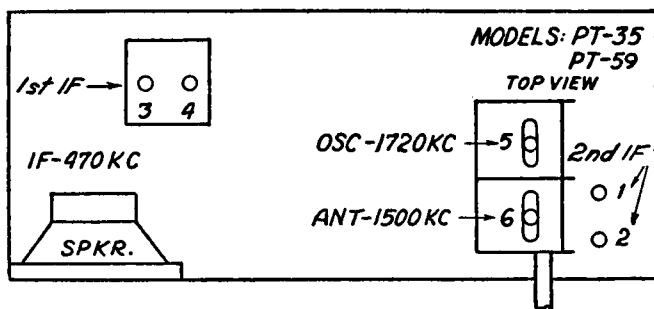

MODELS 37-62, 38-62

Signal Generator Connection	Dummy Antenna	Signal Generator Frequency	Receiver Wave-band Switch	Receiver Dial Setting	Trimmer Number
Control grid of 6A8G	0.1 mf	470 kc	B.C.	580 kc ¹	17S
"	"	"	"	"	17P
"	"	"	"	"	12S
"	"	"	"	"	12P
Ant.	200 mmf	1600 kc	"	1600 kc	3B
"	"	"	"	"	3A
"	"	580 kc	"	580 kc	10*
"	"	1600 kc	"	1600 kc	3B
"	"	"	"	"	3A

Note 1.—DIAL CALIBRATION: Set tuning condenser at maximum capacity position. Loosen set screw of dial hub and set dial, with the glowing indicator centered between first and second index lines, at low frequency end of the broadcast scale. Tighten set screw in this position.

NOTE—No adjustments are required for the short wave band, as this is automatically compensated for in aligning the broadcast band.

* While rocking.

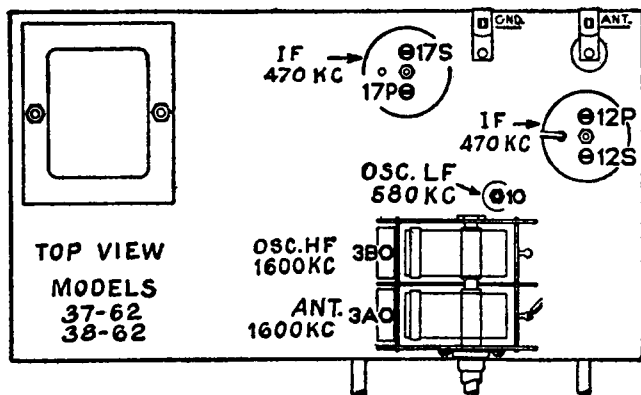

MODELS 37-620 (125), 37-630 (125, 126)

Signal Generator Connection	Dummy Antenna	Signal Generator Frequency	Receiver Wave-band Switch	Receiver Dial Setting	Trimmer Number
Control grid of 6A8G	0.1 mf	470 kc	Range 1	580 kc	36S
"	"	"	"	"	36P
"	"	"	"	"	28S
"	"	"	"	"	28P
Note 2	"	1600 kc	"	1600 kc	18
"	"	"	"	"	27B
"	"	"	"	"	27A
"	"	580 kc	"	580 kc	20*
"	"	1600 kc	"	1600 kc	18
"	"	1500 kc	"	1500 kc	27B
"	"	"	"	"	27A
"	"	6.0 mc	Range 2	6.0 mc	18A
"	"	18.0 mc	Range 3	18.0 mc	18B ³
"	"	"	"	17.060 mc	Image check
"	"	"	"	18.0 mc	9 ⁴
"	"	"	"	"	4 ⁴
"	"	"	"	"	18B ³
"	"	"	"	17.060 mc	Image check

Note 1.—DIAL CALIBRATION: With tuning-condenser in maximum capacity position, loosen dial-hub set-screw and turn dial until glowing-beam indicator is centered on first index line of dial scale.

Note 2.—Connect signal-generator output, through the 100 ohm resistor, to the "Red" terminal (No. 1) on the aerial input panel; and the signal-generator ground lead to the "Black" (No. 2). Leave terminals (3) and (4) linked together.

Note 3.—Turn (18B) clockwise to tight (maximum-capacity) position, and then adjust to maximum on second peak from this tight position.

Note 4.—Connect a variable-condenser (about 350 mmf) across oscillator-trimmer (18B), from switch-contact to chassis, and tune until second harmonic of receiver-oscillator beats against signal from signal-generator—resulting in maximum indication on output meter. Adjust (9) and (4) to maximum, and then remove the external variable-condenser.

* While rocking.

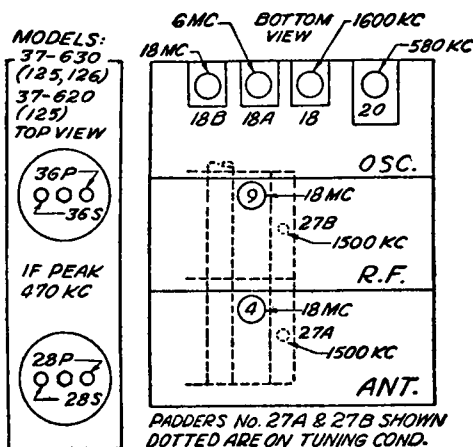

MODEL 38-1

Signal Generator Connection	Dummy Antenna	Signal Generator Frequency	Receiver Wave-band Switch	Receiver Dial Setting	Trimmer Number
Control grid of 6A8G	0.1 mf	470 kc	Range 1 ¹	580 kc ²	37C ³
"	"	"	"	"	37B
"	"	"	"	"	37A
"	"	"	"	"	37C
"	"	"	"	"	38C ⁴
"	"	"	"	"	38B
"	"	"	"	"	38A
Note 5	"	1550 kc	"	1550 kc	18
"	"	"	"	"	8B
"	"	"	"	"	8A
"	"	580 kc	"	580 kc	22*
"	"	1550 kc	"	1550 kc	18
"	"	"	"	"	8B
"	"	"	"	"	8A
"	"	6.0 mc	Range 2	6.0 mc	32
"	"	18 mc	Range 3	18 mc	32A ⁶
"	"	"	"	17.060 mc	Image check
"	"	"	"	18 mc	15*
"	"	"	"	"	4*
"	"	"	"	"	32A
"	"	1000 kc ⁷	Range 1 ⁸	1000 kc ⁹	38C ¹⁰

See Notes 11, 12

Note 1.—Turn Magnetic Tuning Switch to "OFF" position, and set Tone Control to the "First Position."

Note 2.—DIAL CALIBRATION: Loosen set screws on the shaft coupling of tuning condenser. Then turn tuning condenser until the plates are in the maximum capacity position. Now turn the dial until the glowing beam indicator is on the INDEX LINE at the low frequency end of Range-2. With the dial and tuning condenser in this position tighten the set screws. Next, turn the tuning condenser control until the indicator is on the 2.2 mc mark. With the dial in this position, loosen the shaft coupling set screws. Then turn the dial until the indicator is again on the INDEX LINE. Tighten the set screws in this position. NOTE: —Be careful when turning the dial that the position of the tuning condenser is not disturbed.

Note 3.—Turn trimmer (37C) "in" until the output meter reading decreases almost to zero.

Note 4.—Turn trimmer (38C) "in" about three turns. Leave this setting until final adjustment at end of alignment operations.

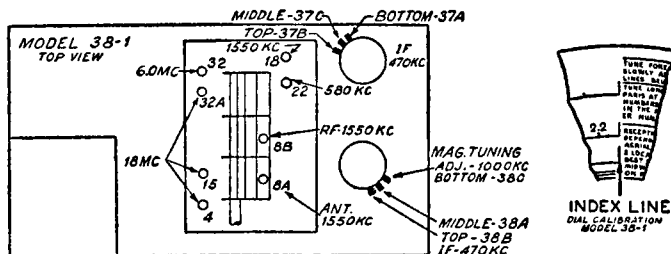

- Note 5.—Connect the high side of the signal-generator through the 0.1 mf condenser to the "Red" terminal of the receiver antenna panel (rear of chassis). The low side of the signal generator is connected to the "Black" terminal.
- Note 6.—Turn the oscillator trimmer (32A) clockwise to the maximum capacity position. From this position slowly turn counter-clockwise until a second peak is obtained on the output meter. Adjust for maximum output using this second peak.
- Note 7.—Turn the signal-generator indicator to 1000 kc and turn down the attenuator so as to produce a weak signal. Adjust the receiver volume control to produce a readable indication on the output meter.
- Note 8.—Magnetic Tuning switch in "OUT" position.
- Note 9.—Tune the receiver dial for maximum output at 1000 kc. The dial must be tuned very accurately to the 1000 kc signal in order to make the following adjustment correctly.
- Note 10.—Turn the Magnetic Tuning Switch to the "IN" position and adjust (38C) for maximum output.
- Note 11.—FREQUENCY TESTS: With the 1000 kc signal tuned for maximum output, turn the Magnetic Tuning control back and forth; that is, from the "out" to "in" position. The reading of the output meter should not change in either position. If the output meter reading changes, this adjustment procedure should be repeated. A further check on the magnetic tuning adjustment is to very carefully tune in a broadcasting station and turn the switch from the "out" to the "in" position. With the switch in either position, the tone of the station being received should not change. If a change of tone or hiss develops, repeat this adjustment procedure.
- Note 12.—SENSITIVITY TEST: Turn the magnetic tuning switch to the "off" position, and tune in the 1000 kc signal. Then adjust the attenuator control of the signal-generator for a strong audible signal, approximately 20 volts on the output meter. Now detune the signal; first above, and then below, the 1000 kc mark—to a point at which the signal is weakly heard. At each point turn the magnetic tuning control "on." When the control is turned on, the signal should return to normal output strength. If the magnetic tuning circuit does not pull the signal into resonance, (38C) should be carefully readjusted.

* While rocking.

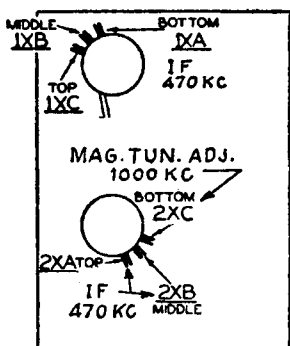

PARTIAL TOP VIEW
MODEL 38-2, CODE 121
RUN #2

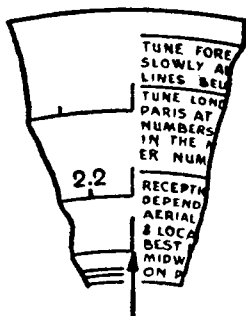

INDEX LINE
DIAL CALIBRATION
MODEL 38-2

MODELS 38-2 (RUN 1), 38-2 (RUN 2)

Signal Generator Connection	Dummy Antenna	Signal Generator Frequency	Receiver Wave-band Switch	Receiver Dial Setting	Trimmer Number
<i>RUN 1</i>					
Control grid of 6A8G	0.1 mf	470 kc	Range 1 ¹	Note 2	38A
"	"	"	"	"	39
"	"	"	"	"	37B
"	"	"	"	"	37A
<i>RUN 2</i>					
Control grid of 6A8G	0.1 mf	470 kc	Range 1 ¹	Note 2	1XB ^{x1}
"	"	"	"	"	1XA
"	"	"	"	"	1XC
"	"	"	"	"	1XB
"	"	"	"	"	2XC ^{x2}
"	"	"	"	"	2XA
"	"	"	"	"	2XB
<i>RUNS 1 and 2</i>					
Note 3	0.1 mf	1550 kc	Range 1	1550 kc	18
"	"	"	"	"	8B
"	"	"	"	"	8A
"	"	580 kc	"	580 kc	22*
"	"	1550 kc	"	1550 kc	18
"	"	"	"	"	8B
"	"	"	"	"	8A
"	"	6.0 mc	Range 2	6.0 mc	32
"	"	18.0 mc	Range 3	18 mc	32A ⁴
"	"	"	"	17.060 mc	Image check
"	"	"	"	18 mc	15*
"	"	"	"	"	4*
"	"	"	"	"	32A
"	"	1000 kc ⁵	Range 1 ⁶	1000 kc ⁷	Note 8
See Notes 9 and 10					

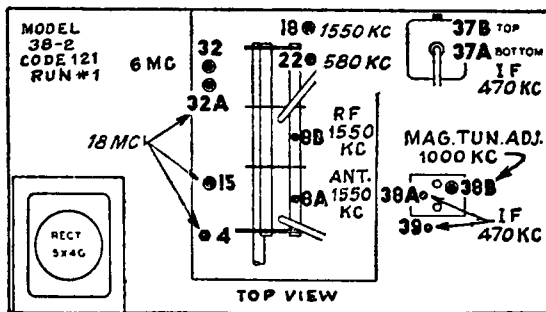

- Note 1.—Turn Magnetic-Tuning switch to “out” position. Turn Volume Control on full. Turn Tone Control and AC switch to first position.
- Note X1.—Turn (1XB) “in” until the output meter reading decreases almost to zero.
- Note 2.—DIAL CALIBRATION: Loosen set screws on the shaft coupling of tuning condenser. Then turn tuning condenser until the plates are in the maximum capacity position. Now turn dial until the glowing beam indicator is on the INDEX LINE at the low frequency end of “Range 2 scale.” With dial and tuning condenser in this position, tighten set screws. Turn tuning-condenser control until the indicator is on the 2.2 mark. With dial in this position, loosen the shaft coupling set screws. Then turn dial until the indicator is again on the INDEX LINE. Tighten the set screws in this position. Be careful when turning the dial that the position of the tuning condenser is not disturbed.
- Note X2.—Turn “in” about three turns. Leave this setting until final adjustment at end of alignment operations.
- Note 3.—Connect high side of signal-generator through the 0.1 mf condenser to “Red” terminal of receiver antenna panel (rear of chassis). Connect low side of signal-generator to “Black” terminal.
- Note 4.—Turn (32A) to the maximum capacity position (clockwise). Adjust to maximum output reading on the second peak from this tight position.
- Note 5.—Turn signal generator-indicator to 1000 kc, and adjust the attenuator so as to produce a weak output signal. Adjust receiver volume control so as to obtain a readable indication on the output meter.
- Note 6.—Magnetic-Tuning switch in “out” position.
- Note 7.—Tune receiver dial accurately for maximum output at 1000 kc.
- Note 8.—Turn Magnetic-Tuning switch “in” and adjust (38B) on Run 1 or (2XC) on Run 2 for maximum output.
- Note 9.—FREQUENCY TEST: With the 1000 kc signal tuned for maximum output, turn the Magnetic Tuning control back and forth; that is, from the “out” to the “in” position. The reading of the output meter should not change in either position. If the output meter reading changes, the preceding Magnetic-Tuning circuit adjustments should be repeated. A further check on the Magnetic-Tuning adjustment is to very carefully tune in a broadcasting station, and turn the switch from the “out” to the “in” position. With the switch in either position, the tone of the station being received should not change. If a change of tone or hiss develops, repeat the preceding Magnetic-Tuning adjustments.
- Note 10.—SENSITIVITY TEST: Turn the Magnetic-Tuning switch to the “out” position, and tune in the 1000 kc signal. Then adjust the signal-generator attenuator control to produce a good audible signal of about 20 volts on the output meter. Now detune the signal; first above, and then below, the 1000 kc mark—to a point at which the signal is weakly heard. At each point turn the magnetic tuning control “on.” When the control is turned on, the signal should return to normal output strength. If the magnetic tuning circuit does not pull the signal into resonance, (38B) or (2XC) should be carefully readjusted.

* While rocking.

MODEL 38-3

Signal Generator Connection	Dummy Antenna	Signal Generator Frequency	Receiver Wave-band Switch	Receiver Dial Setting	Trimmer Number
Control grid of 6ASG	0.1 mf	470 kc	Range 1 ¹	580 kc ²	53
"	"	"	"	"	51A
"	"	"	"	"	45A
"	"	"	"	"	45B
Red Term. on Ant. Panel	"	1600 kc	"	1600 kc	27
"	"	"	"	"	7B
"	"	"	"	"	7A
"	"	580 kc	"	580 kc	28*
"	"	1600 kc	"	1600 kc	27
"	"	1500 kc	"	1500 kc	7B
"	"	"	"	"	7A
"	"	6 mc	Range 2	6 mc	27A
"	"	18 mc	Range 3	18 mc	27B ³
"	"	"	"	17.060 mc	Image check
"	"	"	"	18 mc	11 ⁴
"	"	"	"	"	4
"	"	"	"	"	27B
"	"	Note 6	Range 1 ⁵	Note 6	51B ⁷

See Note 8

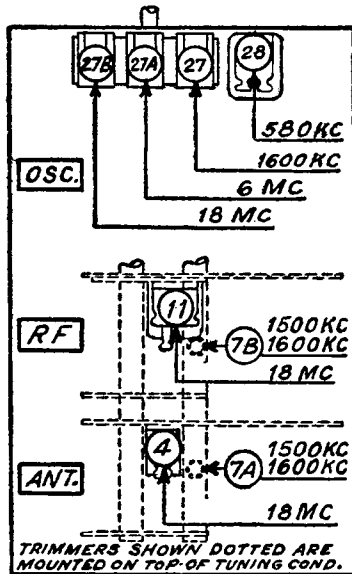
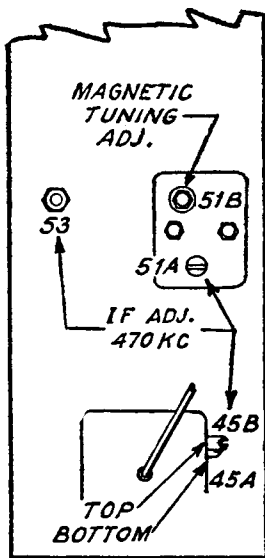

MODEL 38-3 - CODE 121

IF TRIMMERS
TOP OF CHASSIS

TRIMMER VIEW
UNDERSIDE OF CHASSIS

- Note 1.—Magnetic-Tuning control in "off" position. Tone-control "normal." Volume control at maximum position.
- Note 2.—DIAL CALIBRATION: Loosen the shaft-coupling set screws. Then turn the tuning-condenser fully closed, and the dial to the first index line. Now tighten the shaft-coupling set screws, and rotate the dial until the 520 kc mark is midway between the index line and the glowing-beam indicator. With condenser in this position, loosen the set screws of the shaft-coupling on the tuning-condenser. Then turn the tuning-dial until the glowing-beam indicator is centered on the index line. Be careful when turning the dial that the position of the tuning condenser is not disturbed.
- Note 3.—First turn (27B) to the maximum capacity position (clockwise); then carefully adjust to maximum output on second peak from this tight position.
- Note 4.—Either rock gang condenser while adjusting (11), or else the following procedure may be employed. Connect a variable condenser of approximately 350 mmf, across (27B); and tune this added condenser until the second harmonic of the receiver oscillator beats against the signal from the signal-generator, resulting in a maximum indication on the output meter. Then adjust trimmers for maximum output.
- Note 5.—Magnetic-Tuning switch in "out" position.
- Note 6.—Turn the signal-generator and receiver dials to any frequency in the Broadcast band. The receiver dial must be adjusted very accurately for maximum output.
- Note 7.—Set the Magnetic-Tuning control to the "on" position (clockwise), and adjust (51B) for maximum output.
- Note 8.—After adjusting (51B) for maximum output, the following test is made. Turn the Magnetic-Tuning control "off" and "on." In either position, there should be no change in the tone of the signal. If a change of tone or hiss develops, it indicates a shift in frequency; and the adjustment of (51B) must be repeated.

* While rocking.

MODELS 38-4, 38-5

Signal Generator Connection	Dummy Antenna	Signal Generator Frequency	Receiver Wave-band Switch	Receiver Dial Setting	Trimmer Number
Control grid of 6A8G	0.1 mf	470 kc	Range 1	580 kc ¹	28B
"	"	"	"	"	28A
"	"	"	"	"	23B
"	"	"	"	"	23A
Red Term. on Ant. Panel	"	18 mc	Range 2	18 mc	5C ²
"	"	"	"	17.060 mc	Image check
"	"	1500 kc	Range 1	1500 kc	16
"	"	"	"	"	5B
"	"	"	"	"	5A
"	"	580 kc	"	580 kc	17*
"	"	1500 kc	"	1500 kc	16
"	"	"	"	"	5B
"	"	"	"	"	5A

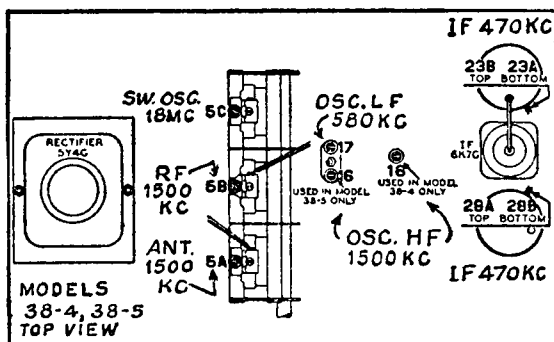

Note 1.—DIAL CALIBRATION (*Model 38-4*): Loosen tuning-condenser shaft-coupling set screws, and turn tuning condenser to the maximum capacity position (plates fully meshed). Turn selector knob until the dial-pointer is on the small black dot at the low frequency end of the "Range 1" scale. With condenser and pointer set in this position, tighten set screws. Now turn selector knob clockwise until the dial pointer moves 1/16 of an inch to the left of the small dot and the first straight line on the scale. Hold pointer and condenser in this position, and carefully loosen shaft-coupling set screws. Then turn selector knob until dial pointer is again on the small black dot at the low frequency end of "Range 1" scale. Tighten shaft-coupling set screws with condenser and dial-pointer in this position. Be careful when turning the selector knob that the position of the tuning condenser is not disturbed.

DIAL CALIBRATION (*Model 38-5*): Turn tuning-condenser to maximum-capacity position (plates fully meshed). Holding the tuning-condenser in this position, loosen the dial clamp. Then turn the dial until the indicator is centered on the middle index line. Tighten clamp in this position.

Note 2.—First turn (5C) to the maximum capacity position (clockwise). Adjust (5C) for maximum output on the second peak from this tight position.

* While rocking.

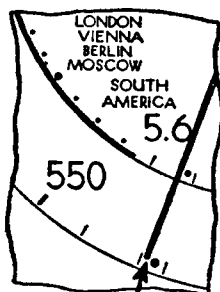

MOVE POINTER $\frac{1}{16}$ "
TO LEFT OF DOT.

MODEL 38-4, DIAL CALIBRATION

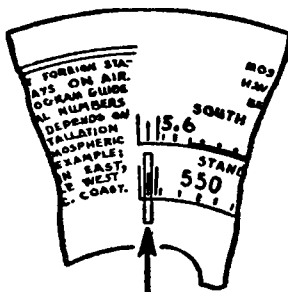

GLOWING BEAM
INDICATOR

MODEL 38-5, DIAL CALIBRATION

MODELS 38-7, 38-8, 38-9, 38-10

Signal Generator Connection	Dummy Antenna	Signal Generator Frequency	Receiver Wave-band Switch	Receiver Dial Setting	Trimmer Number
Control grid of 6A8G	0.1 mf	470 kc	Range 1	580 kc ¹	1
"	"	"	"	"	2
"	"	"	"	"	3
"	"	"	"	"	4
Note 2	"	18 mc	Range 2	18 mc	5 ³
"	"	"	"	17.060 mc	Image check
"	"	1500 kc	Range 1	1500 kc	Note 4
"	"	"	"	"	7
"	"	580 kc	"	580 kc	Note 5*
"	"	1500 kc	"	1500 kc	Note 4
"	"	"	"	"	7

Note 1.—DIAL CALIBRATION (*Model 38-7*): Loosen shaft-coupling set screws and turn tuning condenser to maximum capacity position (plates fully meshed). Now turn selector knob until dial pointer is on the small black circle at low frequency end of the "Range One" scale. With condenser and pointer set in this position, tighten the set screws. Now turn selector knob (clockwise) until dial pointer moves 1/16 of an inch from the small circle (clockwise). Leave pointer in this position and loosen the coupling set screws. After loosening the set screws, turn selector knob until pointer is again on the small black dot at the low frequency end of "Range One" scale. Be careful when turning the selector knob that the position of the tuning condenser is not disturbed. Tighten the coupling set screws with the condenser and dial pointer in this position. DIAL CALIBRATION (*Models 38-8, 38-9, 38-10*): Turn tuning condenser to maximum capacity position (plates fully meshed). Loosen the clamp of dial; then turn dial, being careful that the position of the tuning condenser is not disturbed, until the glowing indicator is centered on the middle index line at the low frequency end of Range One scale. Tighten dial clamp in this position.

Note 2.—Connect high side of the signal generator through the 0.1 mf condenser to the "Red" terminal of the antenna panel of the receiver, and the output-lead ground to the "Black" terminal.

Note 3.—Turn (5) to maximum capacity position (clockwise). Now, slowly turn counter-clockwise until a second peak is obtained on the output meter. The second peak is the fundamental signal, and must be used in adjusting for maximum output.

Note 4.—Trimmer (8) on *Model 38-10* only; (6) on all other models.

Note 5.—Trimmer (6) on *Model 38-10* only; (8) on all other models.

* While rocking.

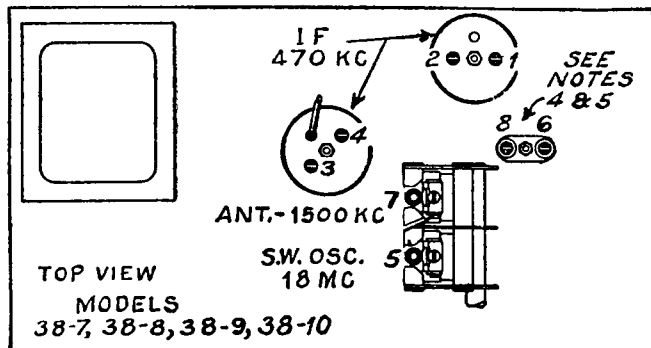

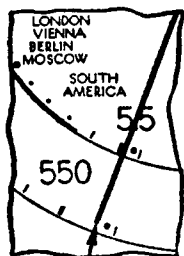

MOVE POINTER $\frac{1}{16}$ "
TO LEFT OF DOT.
DIAL CALIBRATION.
MODEL 38-7

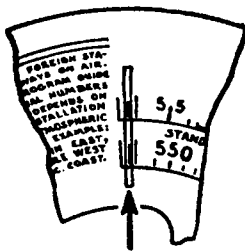

GLOWING BEAM
INDICATOR
DIAL CALIBRATION
MODELS 38-8, 38-9
38-10

MODEL 38-12

Signal Generator Connection	Dummy Antenna	Signal Generator Frequency	Receiver Wave-band Switch	Receiver Dial Setting	Trimmer Number
Control grid of 6A7	0.1 mf	470 kc	...	580 kc ¹	12A
"	"	"	...	"	8B
"	"	"	...	"	8A
Ant. (white wire)	100 mmf	1500 kc	...	1500 kc	3B
"	"	"	...	"	3A

Note 1.—DIAL CALIBRATION: Turn tuning condenser to maximum capacity position (plates fully meshed). Holding the tuning condenser in this position, turn pointer until it is $\frac{1}{16}$ of an inch below the ends of the three lines of the scale at the 550 kc end. This is the correct position of the pointer at the maximum capacity of the tuning condenser.

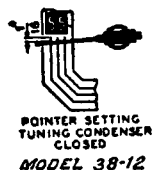
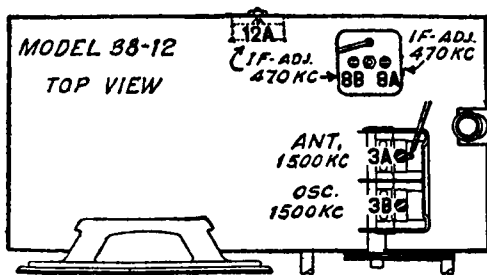

MODEL 38-14 (121, 124)

Signal Generator Connection	Dummy Antenna	Signal Generator Frequency	Receiver Wave-band Switch	Receiver Dial Setting	Trimmer Number
Note 1	0.1 mfd	470 kc	B.C.	580 kc ²	17A
"	"	"	"	"	14B
"	"	"	"	"	14A
Note 3	400 ohms	6 mc	S.W.	6 mc	4B
Note 4	100 mmf	1500 kc	B.C.	1500 kc	12A
"	"	"	"	"	4A
"	"	580 kc	"	580 kc	12*
"	"	1500 kc	"	1500 kc	12A
"	"	"	"	"	4A

Note 1.—Use Philco Set transformer, Part No. 32-2763: Connect high side of the signal-generator to terminal No. 1. Connect low side of the signal-generator to terminal No. 2. Connect terminal No. 3 to chassis. Connect terminal No. 4 through the 0.1 mfd condenser to the grid cap of the 6A7.

Note 2.—DIAL CALIBRATION: Turn tuning condenser to maximum capacity position (plates fully meshed). Holding tuning condenser in this position, turn pointer until it is parallel with the index lines. This is the correct position of the pointer at maximum capacity of tuning condenser.

Note 3.—On the Set Transformer, leave the connections to terminals 1, 2, and 3 as specified in Note 1. Remove the 0.1 mfd condenser connecting to terminal No. 4 and disconnect from grid cap of the 6A7. Connect terminal No. 4 to the antenna wire of the receiver through the 400 ohm resistor.

Note 4.—Use the connections indicated in Note 3, except that the 400 ohm resistor is removed, and replaced by the 100 mmf condenser.

* While rocking.

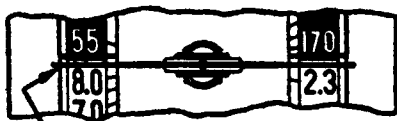
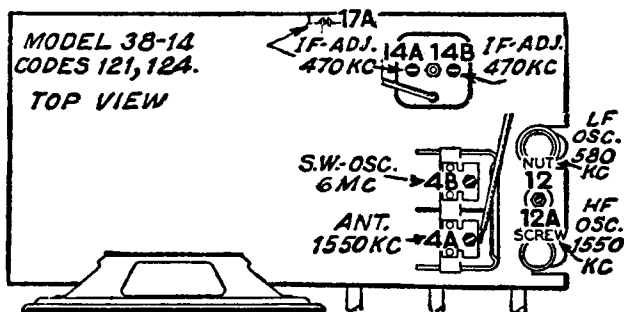

SET POINTER PARALLEL WITH INDEX LINES

MODEL 38-14

MODEL 38-15 (121, 124)

Signal Generator Connection	Dummy Antenna	Signal Generator Frequency	Receiver Wave-band Switch	Receiver Dial Setting	Trimmer Number
Control grid of 6A7	0.1 mf	470 kc	B.C.	580 kc ¹	15A
"	"	"	"	"	14B
"	"	"	"	"	14A
Ant. (white wire)	400 ohms	18 mc	S.W.	18 mc	4B
"	100 mmf	1550 kc	B.C.	1550 kc	9
"	"	"	"	"	4A
"	"	580 kc	"	580 kc	9A *
"	"	1550 kc	"	1550 kc	9
"	"	"	"	"	4A

Note 1.—DIAL CALIBRATION: Turn tuning condenser to maximum capacity position (plates fully meshed). Holding tuning condenser in this position, turn pointer until it is in the position shown in the figure. This is the correct position of the pointer at the maximum capacity of the tuning condenser.

* While rocking.

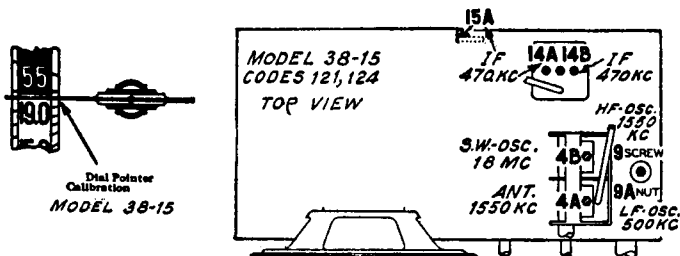

MODELS 38-22 (121, 124), 38-23 (121)

Signal Generator Connection	Dummy Antenna	Signal Generator Frequency	Receiver Wave-band Switch	Receiver Dial Setting	Trimmer Number
..... Note 1	1	470 kc	Range 1	580 kc ²	18B
" "	" "	" "	" "	" "	18A
" "	" "	" "	" "	" "	13B
" "	" "	" "	" "	" "	13A
..... Note 3	3	18 mc	Range 2	18 mc	4B ⁴
" "	" "	" "	" "	17.060 mc	Image check
" "	" "	1550 kc	Range 1	1550 kc	10B
" "	" "	" "	" "	" "	4A
" "	" "	580 kc	" "	580 kc	10*
" "	" "	1550 kc	" "	1550 kc	10B

Note 1.—When adjusting the trimmers, a Philco Set Transformer Part No. 32-2763 must be connected in the signal-generator output circuit as follows: Connect high side of the signal-generator to terminal No. 1 on the Set Transformer. Connect low side of the signal-generator to terminal No. 2. Connect terminal No. 3 to the chassis ground terminal. Connect terminal No. 4 through the 0.1 mf condenser to the grid cap of the 6A8G.

Note 2.—**DIAL CALIBRATION (Model 38-22):** Loosen the shaft coupling set screws and then turn tuning condenser to maximum capacity position (plates fully meshed). Now turn selector knob until dial pointer is on the small black dot at the low frequency end of the "Range One" scale. With condenser and pointer set in this position, tighten the set screws. Now turn selector knob (clockwise) until dial pointer moves 1/16 of an inch from the small black dot (clockwise). Leave the pointer in this position and loosen the coupling set screws. Now turn selector knob until pointer is again on the small black dot at the low frequency end of "Range One" scale. Be careful when turning the selector knob that the position of the tuning-condenser is not disturbed. Tighten the coupling set screws with the condenser and dial pointer in this position. **DIAL CALIBRATION (Model 38-23):** Turn tuning condenser to the maximum capacity position (plates fully meshed). Loosen the clamp of the dial; then turn dial, being careful that the position of the tuning condenser is not disturbed, until the glowing indicator is centered on the middle index line at the low frequency end of "Range One" scale. Tighten the dial clamp in this position.

Note 3.—Remove terminal No. 4 lead of the Set Transformer from the 6A8G grid, and connect to the red terminal of the antenna panel of the receiver through the 0.1 mf condenser.

Note 4.—Turn oscillator trimmer (4B) to the maximum capacity position (clockwise). Now, slowly turn this trimmer counter-clockwise to obtain maximum output on the second peak from the tight position.

* While rocking.

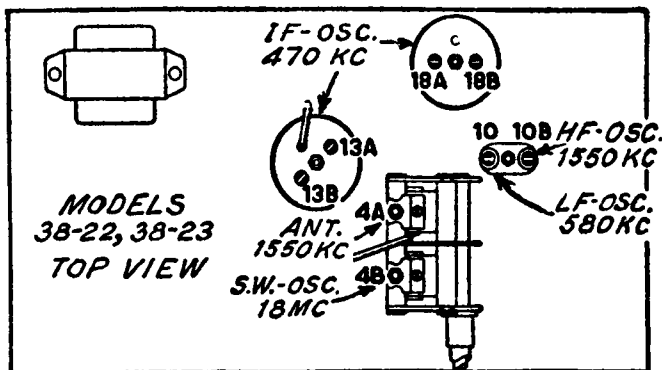

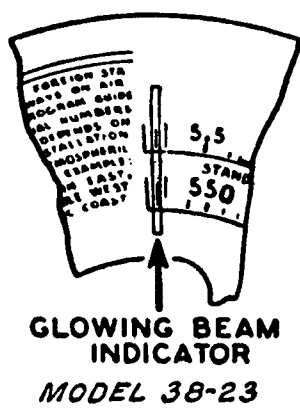
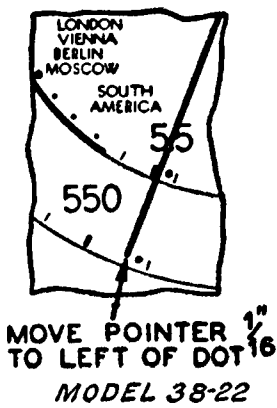

MODELS 38-33, 38-34

Signal Generator Connection	Dummy Antenna	Signal Generator Frequency	Receiver Wave-band Switch	Receiver Dial Setting	Trimmer Number
Control grid of 1D7G	0.1 mf	470 kc	...	580 kc ¹	1
"	"	"	...	"	2
"	"	"	...	"	3
"	"	"	...	"	4
Ant.	200 mmf	1500 kc	...	1500 kc	5
"	"	"	...	"	6
"	"	580 kc	...	580 kc	7*
"	"	1500 kc	...	1500 kc	5
"	"	"	...	"	6

Note 1.—**DIAL CALIBRATION:** Turn tuning condenser to maximum capacity position (plates fully meshed). Holding tuning condenser in this position, turn dial pointer until it is parallel with the INDEX LINE. This is the correct position of the pointer at the maximum capacity position.

* While rocking.

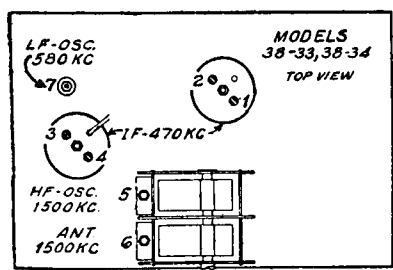

Locations of Compensators—Top of Chassis

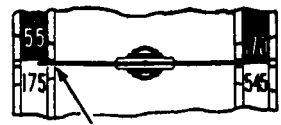

Dial Calibration. Set pointer as shown
MODELS 38-33, 38-34

MODEL 38-35

Signal Generator Connection	Dummy Antenna	Signal Generator Frequency	Receiver Wave-band Switch	Receiver Dial Setting	Trimmer Number
Control grid of 6A8G	0.1 mf	470 kc	B.C.	580 kc ¹	11B
"	"	"	"	"	11A
"	"	"	"	"	10B
"	"	"	"	"	10A
Ant.	200 mmf	1550 kc	"	1550 kc	9B
"	"	"	"	"	9A
"	"	580 kc	"	580 kc	9X*
"	"	1550 kc	"	1550 kc	9B
"	"	"	"	"	9A

Note 1.—DIAL CALIBRATION: Turn the tuning condenser to the maximum capacity position (plates fully meshed). Set pointer so as to be parallel with index line on dial.

* While rocking.

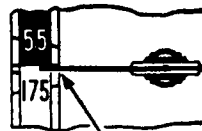
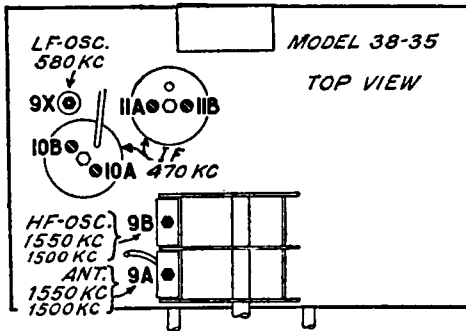

Fig. 3. Dial Calibration.
Set pointer as shown
MODEL 38-35

MODELS 38-38, 38-39

Signal Generator Connection	Dummy Antenna	Signal Generator Frequency	Receiver Wave-band Switch	Receiver Dial Setting	Trimmer Number
Control grid of 1C7	0.1 mf	470 kc	Range 1	580 kc ¹	1
"	"	"	"	"	2
"	"	"	"	"	3
"	"	"	"	"	4
Ant.	400 ohms	18 mc	Range 2	18 mc	5 ²
"	"	"	"	17.060 mc	Image check
"	200 mmf	1500 kc	Range 1	1500 kc	6
"	"	"	"	"	7
"	"	580 kc	"	580 kc	8*
"	"	1500 kc	"	1500 kc	6
"	"	"	"	"	7

Note 1.—DIAL CALIBRATION: Turn tuning condenser to maximum capacity position (plates fully meshed). Holding tuning condenser in this position, loosen the dial clamp and then dial until the indicator is centered on the middle index line. Tighten the clamp in this position.

Note 2.—First turn oscillator trimmer (4B) to the maximum capacity position (clockwise). Adjust this trimmer for a maximum output on the second peak from the tight position.

* While rocking.

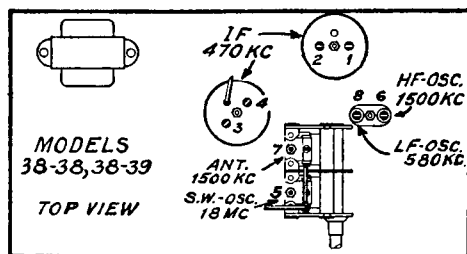

MODEL 38-40

Signal Generator Connection	Dummy Antenna	Signal Generator Frequency	Receiver Wave-band Switch	Receiver Dial Setting	Trimmer Number
Control grid of 6A8G	0.1 mf	470 kc	Range 1	580 kc ¹	12B
"	"	"	"	"	12A
"	"	"	"	"	11B
"	"	"	"	"	11A
Ant.	400 ohms	18 mc	Range 2	18 mc	4B
"	"	18 mc	"	17.060 mc	Image check
"	200 mmf	1550 kc	Range 1	1550 kc	7
"	"	"	"	"	4A
"	"	580 kc	"	580 kc	7A *
"	"	1550 kc	"	1550 kc	7
"	"	"	"	"	4A

Note 1.—DIAL CALIBRATION: Turn tuning condenser to maximum capacity position (plates fully meshed). Holding tuning condenser in this position, loosen the dial clamp; then turn dial until the indicator is centered on the middle index line. Tighten the clamp in this position.

* While rocking.

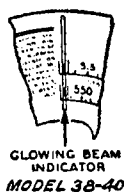
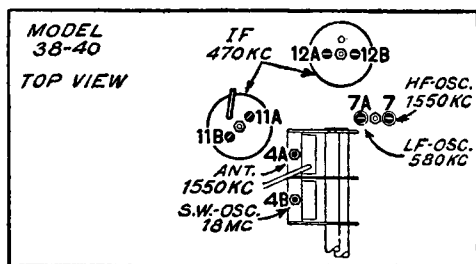

MODEL 38-60 (125)

Signal Generator Connection	Dummy Antenna	Signal Generator Frequency	Receiver Wave-band Switch	Receiver Dial Setting	Trimmer Number
Control grid of 6A8G	0.1 mf	470 kc	Range 1	580 kc ¹	18B
"	"	"	"	"	18A
"	"	"	"	"	14B
"	"	"	"	"	14A
Ant.	200 mmf	1500 kc	"	1500 kc	9
"	"	"	"	"	3
"	"	580 kc	"	580 kc	9A*
"	"	1500 kc	"	1500 kc	9
"	"	"	"	"	3
"	400 ohms	7.0 mc	Range 2	7.0 mc	11
"	"	6.0 mc	"	6.0 mc	3A

Note 1.—DIAL CALIBRATION: Turn tuning condenser to maximum capacity position. With condenser in this position, loosen the dial-hub set screws, and rotate dial until the glowing beam indicator is centered between the first and second index lines at the low frequency end of the broadcast scale. With the dial in this position, tighten the dial-hub set screws.

* While rocking.

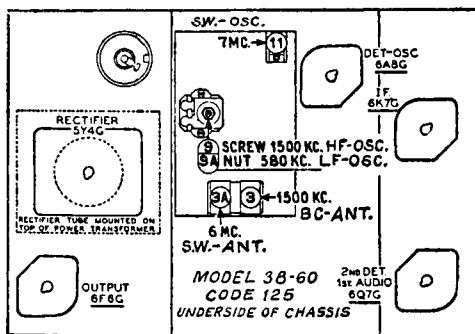

MODEL 38-60
CODE 125
TOP VIEW

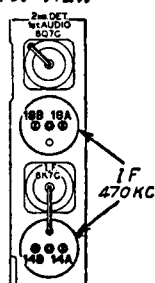

MODEL 38-89 (125)

Signal Generator Connection	Dummy Antenna	Signal Generator Frequency	Receiver Wave-band Switch	Receiver Dial Setting	Trimmer Number
Control grid of 6A8G	0.1 mf	470 kc	Range 1 ‡	580 kc ¹	24B
"	"	"	"	"	24A
"	"	"	"	"	16B
"	"	"	"	"	16A
Ant. term.	"	1500 kc	"	1500 kc	5C
"	"	"	"	"	5B
"	"	"	"	"	5A
"	"	580 kc	"	580 kc	10*
"	"	1500 kc	"	1500 kc	5C
"	"	"	"	"	5B
"	"	"	"	"	5A

Note 1.—DIAL CALIBRATION: Turn tuning condenser to the maximum capacity position (plates fully meshed). Then loosen dial-hub set screws, and rotate the dial (holding condenser at maximum capacity) until the glowing-beam indicator is centered on second index line at the low frequency end of the broadcast scale. With dial in this position, tighten dial-hub set screws.

* While rocking.

‡ Police band is automatically aligned when broadcast band is adjusted.

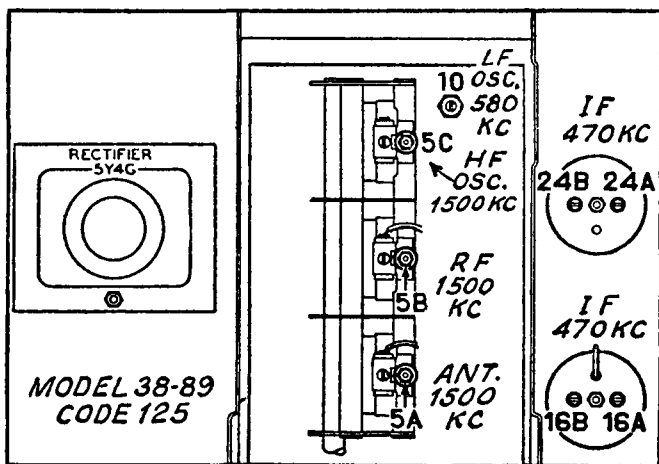

LOCATION OF TRIMMERS. TOP OF CHASSIS

MODEL 38-116 (121)

Signal Generator Connection	Dummy Antenna	Signal Generator Frequency	Receiver Wave-band Switch	Receiver Dial Setting	Trimmer Number
...	Range 1 ¹	Note 2	82B ³
Note 4	0.1 mf	470 kc	"	580 kc	82A
"	"	"	"	"	82B
Note 5	"	"	"	"	81D
"	"	"	"	"	81C
"	"	"	"	"	81A
"	"	"	"	"	81B
"	"	"	"	"	82A ⁶
Note 7	None	1500 kc	"	1500 kc	43 ¹
"	"	"	"	"	8
"	"	"	"	"	23
"	"	580 kc	"	580 kc	43A*
"	"	1500 kc	"	1500 kc	43
"	"	1400 kc	"	1400 kc	8
"	"	"	"	"	23
"	"	7 mc	Range 3	7 mc	44
"	"	5 mc	"	5 mc	44A
"	"	7 mc	"	7 mc	44
"	"	"	"	"	9
"	"	"	"	"	24
"	"	5 mc	"	5 mc	44A
"	"	"	"	"	9A
"	"	"	"	"	24A
"	"	7 mc	"	7 mc	44
"	"	"	"	"	9
"	"	"	"	"	24

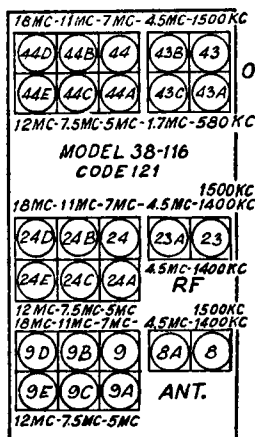
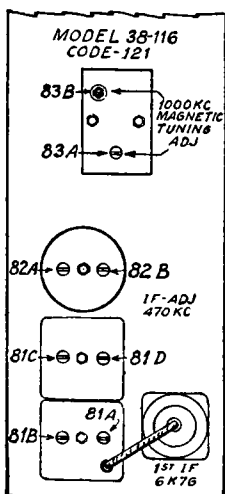

MODEL 38-116 (121) Cont.

Signal Generator Connection	Dummy Antenna	Signal Generator Frequency	Receiver Wave-band Switch	Receiver Dial Setting	Trimmer Number
Note 7	None	11 mc	Range 4	11 mc	44B
"	"	7.5 mc	"	7.5 mc	44C
"	"	11 mc	"	11 mc	44B
"	"	"	"	"	9B *
"	"	"	"	"	24B *
"	"	7.5 mc	"	7.5 mc	44C
"	"	"	"	"	9C
"	"	11 mc	"	11 mc	44B
"	"	"	"	"	9B *
"	"	"	"	"	24B *
"	"	4.5 mc	Range 2	4.5 mc	43B
"	"	"	"	"	8A
"	"	"	"	"	23A
"	"	1.7 mc	"	1.7 mc	43C
"	"	4.5 mc	"	4.5 mc	43B
"	"	"	"	"	8A
"	"	"	"	"	23A
"	"	18 mc	Range 5	18 mc	44D
"	"	12 mc	"	12 mc	44E
"	"	18 mc	"	18 mc	44D ⁸
"	"	"	"	17.060 mc	Image check
"	"	"	"	18 mc	9D *
"	"	"	"	"	24D *
"	"	12 mc	"	12 mc	44E
"	"	"	"	"	9E *
"	"	"	"	"	24E *
"	"	18 mc	"	18 mc	44D ⁸
"	"	"	"	17.060 mc	Image check
"	"	"	"	18 mc	9D *
"	"	"	"	"	24D *
"	"	1000 kc ⁹	Range 1 ¹⁰	1000 kc ¹¹	83B ¹²
"	"	"	"	"	83A ¹³
"	"	"	"	"	83B ¹³

See Notes 14 and 15

Note 1.—Turn Selectivity-Fidelity control clockwise. Turn Volume-control to maximum (clockwise). Turn Magnetic-Tuning switch to the "OFF" position. Turn Bass-Compensation switch to the first position from "off."

Note 2.—DIAL CALIBRATION: Loosen the set screws on the shaft coupling of the tuning-condenser. Then turn the tuning-condenser until the plates are in the maximum capacity position. Now turn the dial until the glowing-beam indicator is on the Index Line at the low frequency end of the broadcast band. With the dial and tuning-condenser in this position, tighten the set screws. Turn tuning-condenser control until the indicator is on the 520 kc mark. With the dial in this position, loosen the shaft-coupling set screws. Then turn the dial until the indicator is again on the Index Line. Tighten the set screws in this position. Be careful . . . when turning the dial . . . that the position of the tuning-condenser is not changed.

Note 3.—Close (82B) by turning it to the extreme clockwise position.

- Note 4.—Connect high side of signal-generator through the 0.1 mf condenser to grid cap of the second 6K7G 1-f tube.
- Note 5.—Connect high side of signal-generator through the 0.1 mf condenser to grid cap of the 6L7G tube.
- Note 6.—With the “fidelity” control in the “expanded” (counter-clockwise) position, slowly shift the signal-generator indicator between 460 and 480 kc. As the indicator is turned, two peaks will be noted on the output meter; one about 465 kc, and the other about 475 kc. These peaks should give the same deflection or reading on the output meter. If the peaks are unequal, (82A) must be slightly readjusted to the right or left (not more than $\frac{1}{8}$ of a turn) until the peaks are equalized. This adjustment is used to compensate for slight differences between peaks. If (82A) must be turned more than $\frac{1}{8}$ of a turn in either direction to equalize the peaks, all trimmers should be carefully readjusted as given under the intermediate-frequency adjustment procedure. Each time it is set in another position, rotate the signal generator through the 460 to 480 kc range and note the reading of each peak. After completing adjustments, turn Treble-Selectivity control back to clockwise position.
- Note 7.—Connect high side of signal-generator to the “Red” terminal on the antenna panel at the rear of the chassis. The low side of the signal-generator is connected to the “Blk” terminal. Set all controls as indicated in Note 1.
- Note 8.—Turn (44D) clockwise to maximum-capacity position. Then turn counter-clockwise, and adjust to maximum on second peak.
- Note 9.—Adjust the attenuator control of the signal-generator to produce a weak output signal, and turn the signal-generator indicator to 1000 kc.
- Note 10.—Magnetic-Tuning switch in the “out” position (counter-clockwise), Volume-Control at maximum (extreme clockwise), Treble-Selectivity control at “expanded” position (extreme clockwise).
- Note 11.—Adjust the receiver dial to obtain a MAXIMUM output of the 1000 kc signal.
- Note 12.—Turn the Magnetic-Tuning switch “on.” Turn (83B) slightly to the right or left (about $\frac{1}{4}$ turn).
- Note 13.—Leave Magnetic-Tuning switch in “on” position. Adjust (83A) for *minimum* output, and then readjust (83B) for *maximum* output.
- Note 14.—FREQUENCY TEST: With the 1000 kc signal tuned for maximum output, turn Magnetic-Tuning control back and forth; that is, from the “out” to “in” position. The reading of the output-meter should not change in either position. If the output-meter reading changes, the preceding magnetic-tuning circuit adjustments should be repeated.
- Note 15.—SENSITIVITY TEST: To check the magnetic-tuning circuit for sensitivity, turn magnetic-tuning switch to the “off” position and tune in the 1000 kc signal. Then adjust the attenuator-control of the signal-generator for a good audible signal (approximately 20 volts on output meter). Now detune the signal (first above and then below the 1000 kc mark) to a point at which the signal is weakly heard. At each point turn the magnetic-tuning control “on.” When the control is turned on, the signal should return to normal output strength. If the magnetic-tuning circuit does not pull the signal into resonance, the primary trimmer (83A) should be carefully readjusted.

* While rocking.

MODEL 38-116 (125)

Signal Generator Connection	Dummy Antenna	Signal Generator Frequency	Receiver Wave-band Switch	Receiver Dial Setting	Trimmer Number
...	Range 1 ¹	Note 2	52B ³
Note 4	0.1 mf	470 kc	"	580 kc	52A
"	"	"	"	"	52B
Note 5	"	"	"	"	51D
"	"	"	"	"	51C
"	"	"	"	"	51B
"	"	"	"	"	51A
"	"	"	"	"	52A ⁶
Note 7	None	1550 kc	"	1550 kc	36
"	"	"	"	"	18B
"	"	"	"	"	18A
"	"	580 kc	"	580 kc	34*
"	"	1550 kc	"	1550 kc	36
"	"	"	"	"	18B
"	"	"	"	"	18A
"	"	18 mc	Range 5	18 mc	36C ⁸
"	"	"	"	17.060 mc	Image check
"	"	"	"	18 mc	25*
"	"	"	"	"	6*
"	"	11 mc	Range 4	11 mc	36B
"	"	7 mc	Range 3	7 mc	34A
"	"	4.5 mc	Range 2	4.5 mc	36A
"	"	18 mc	Range 5	18 mc	36C ⁸
"	"	"	"	17.060 mc	Image check
"	"	"	"	18 mc	25*
"	"	"	"	"	6*
"	"	1000 kc ⁹	Range 1 ¹⁰	1000 kc ¹¹	53B ¹²
"	"	"	"	"	53A ¹³
"	"	"	"	"	53B ¹³

See Notes 14 and 15

Note 1.—Turn Selectivity-Fidelity control clockwise. Turn Volume-Control to maximum (clockwise). Turn Magnetic-Tuning Switch "off." Set Bass-Compensation switch to first position from "off."

Note 2.—DIAL CALIBRATION: Loosen the set screws on the shaft coupling of the tuning-condenser. Then turn the tuning condenser until the plates are in the maximum capacity position. Now turn the dial until the glowing-beam indicator is on the Index Line at the low frequency end of Range 3. With the dial and tuning-condenser in this position, tighten set screws. Now turn the tuning-condenser control until the indicator is on the 4.71 mc mark of Range 3. With the dial in this position, loosen the shaft-coupling set screws. Then turn the dial until the indicator is again on the Index Line. Tighten the set screws in this position. Be careful when turning the dial that the position of the tuning-condenser is not disturbed.

Note 3.—Close (52B) by turning to the extreme clockwise position.

Note 4.—Connect high side of signal-generator through the 0.1 mf condenser to the control grid of the second 6K7G i-f tube.

Note 5.—Connect the high side of the signal-generator through the 0.1 mf condenser to the control grid of the 6A8G mixer tube.

Note 6.—With the Treble-Selectivity control in "expanded" position (counter-clockwise), slowly shift signal generator between 460 and 480 kc. As the

indicator is turned, two peaks will be noted on the output meter—one about 465 kc and the other about 475 kc. These peaks should give the same deflection or reading on the output meter. If the peaks are unequal, (52A) must be slightly readjusted to the right or left (not more than $\frac{1}{4}$ of a turn) until the peaks are equalized. Each time (52A) is set in another position, rotate the signal generator through the 460 to 480 kc range and note the reading of each peak. This adjustment is used to compensate for slight differences between peaks. If (52A) must be turned more than $\frac{1}{4}$ of a turn in either direction to equalize the peaks, all trimmers should be carefully readjusted as given under the intermediate-frequency circuit-adjustment procedure. After completing adjustments, turn Treble-Selectivity control back to clockwise position.

- Note 7.—Connect high side of signal-generator to the "Red" terminal on the antenna panel at the rear of chassis. The low side of the signal generator should be connected to the "Blk" terminal. Set all controls as indicated in Note 1.
- Note 8.—Adjust (36C) to obtain maximum output on the second peak from the tight position.
- Note 9.—Adjust the attenuator of the signal-generator so as to produce a weak output signal.
- Note 10.—Magnetic-Tuning switch in the "out" position (counter-clockwise), Volume-Control at maximum (extreme clockwise), Treble-Selectivity control in "Selective" position (extreme clockwise).
- Note 11.—Very carefully adjust the receiver dial to obtain maximum output of the 1000 kc signal.
- Note 12.—Turn the Magnetic Tuning switch "on." Turn (53B) slightly to the right or left (about $\frac{1}{4}$ turn).

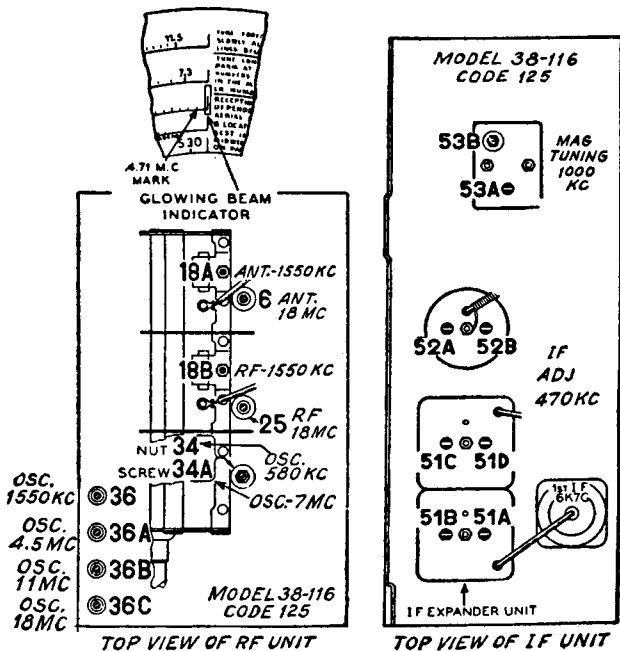

Note 13.—Leave Magnetic-Tuning switch in “on” position. Adjust (53A) for *minimum* output, and then readjust (53B) for *maximum* output.

Note 14.—FREQUENCY TEST: With the 1000 kc signal tuned for maximum output, turn the Magnetic-Tuning control back and forth; that is, from the “out” to “in” position. The reading of the output meter should not change in either position. If the output meter reading changes, the preceding Magnetic-Tuning adjustments should be repeated. A further check on the Magnetic-Tuning adjustment is to very carefully tune in a broadcasting station and then turn the Magnetic-Tuning switch from the “out” to the “in” position. With the switch in either position, the tone of the station should not change. If a change of tone or hiss develops, repeat the preceding Magnetic-Tuning adjustments.

Note 15.—SENSITIVITY TEST: Turn the Magnetic-Tuning switch to the “off” position, and tune in the 1000 kc signal. Then adjust the attenuator control of the signal-generator for a good audible signal (approximately 20 volts on the output meter. Now detune the signal (first above and then below the 1000 kc mark) to a point at which the signal is weakly heard. At each point turn the Magnetic-Tuning control “on.” When the control is turned “on” the signal should return to normal output strength. If the Magnetic-Tuning circuit does not pull the signal into resonance, (53A) should be carefully readjusted.

* While rocking.

MODEL 38-620 (121, 125)

Signal Generator Connection	Dummy Antenna	Signal Generator Frequency	Receiver Wave-band Switch	Receiver Dial Setting	Trimmer Number
Control grid of 6A8G	0.1 mf	470 kc	Range 1	580 kc ¹	33B
“	“	“	“	“	33A
“	“	“	“	“	32B
“	“	“	“	“	32A
Note 2	100 ohms	1600 kc	“	1600 kc	26B
“	“	“	“	“	7B
“	“	“	“	“	7A
“	“	580 kc	“	580 kc	27*
“	“	1600 kc	“	1600 kc	26B
“	“	1500 kc	“	1500 kc	7B
“	“	“	“	“	7A
“	“	6.0 mc	Range 2	6.0 mc	26A

MODEL 38-620, (121, 125) Cont.

Signal Generator Connection	Dummy Antenna	Signal Generator Frequency	Receiver Wave-band Switch	Receiver Dial Setting	Trimmer Number
Note 2	100 ohms	18.0 mc	Range 3	18.0 mc	26 ³
"	"	"	"	17.060 mc	Image check
"	"	"	"	18.0 mc	12 ⁴
"	"	"	"	"	4 ⁴
"	"	"	"	"	26 ³
"	"	"	"	17.060 mc	Image check

Note 1.—DIAL CALIBRATION: With tuning-condenser in maximum-capacity position, loosen dial-hub set-screw and turn dial until glowing-beam indicator is centered on first index line of dial scale.

Note 2.—Connect signal-generator output, through the 100 ohm resistor, to the "Red" terminal (No. 1) on the aerial input panel and the signal-generator ground lead to the "Black" (No. 2). Leave terminals (3) and (4) on Code 121 . . . (2) and (3) on Code 125 . . . linked together.

Note 3.—Turn (26) clockwise to tight (maximum-capacity) position, and then adjust to maximum on second peak from this tight position.

Note 4.—Connect a variable-condenser (about 350 mmf) across oscillator trimmer (26) . . . from switch-contact to chassis . . . and tune until second harmonic of receiver-oscillator beats against signal from signal-generator—resulting in maximum indication on output meter. Adjust (12) and (4) to maximum, and then remove the external variable-condenser.

* While rocking.

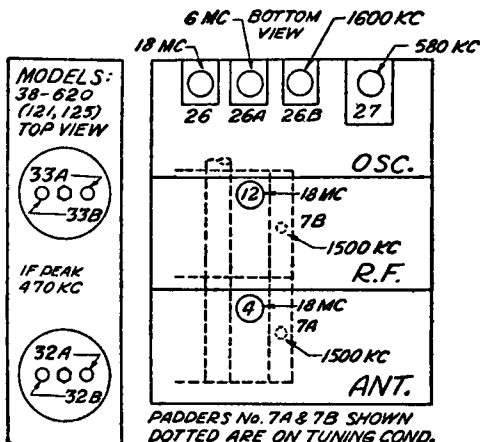

MODEL 38-690 (125)

Signal Generator Connection	Dummy Antenna	Signal Generator Frequency	Receiver Wave-band Switch	Receiver Dial Setting	Trimmer Number
Note 1	0.1 mf	470 kc	Range 1 ²	600 kc	70B
"	"	"	"	"	70A
"	"	"	"	"	49B
"	"	"	"	"	49A
"	"	"	"	"	48B
"	"	"	"	"	48A
Note 3	"	"	"	"	47B
"	"	"	"	"	47A
"	"	"	"	"	70A ⁴
..... Note 5		1550 kc	"	1550 kc	40
"		"	"	"	22B
"		"	"	"	22A
"		580 kc	"	580 kc	39 *
"		1550 kc	"	1550 kc	40
"		"	"	"	22B
"		"	"	"	22A
"		18 mc	Range 5	18 mc	40C
"		"	"	17.060 mc	Image check
"		"	"	18 mc	20 *
"		"	"	"	6 *
"		11 mc	Range 4	11 mc	40B
"		7 mc	Range 3	7 mc	39A
"		4.5 mc	Range 2	4.5 mc	40A
"		18 mc	Range 5	18 mc	40C
"		"	"	17.060 mc	Image check
"		"	"	18 mc	20 *
"		"	"	"	6 *
"		1000 kc ⁶	Range 1 ⁷	1000 kc ⁸	Note 9

See Notes 10 and 11

Note 1.—Connect high side of signal-generator through the 0.1 mf condenser to grid cap of the first i-f 6K7G tube.

Note 2.—Turn receiver Volume-Control to maximum. Turn Bass-Control counter-clockwise. Turn Magnetic-Tuning switch to "off" position. Turn Selectivity-Fidelity control clockwise.

Note 3.—Connect high side of signal-generator through the 0.1 mf condenser to grid cap of the 6A8G mixer tube.

Note 4.—Turn the Selectivity-Fidelity control counter-clockwise. Slowly shift the signal-generator indicator between 460 and 480 kc. As the indicator is turned, two peaks will be noted on the output meter, one at about 465 kc and the other at about 475 kc. These peaks should give the same deflection or reading on the output meter. If the peaks are unequal, (70A) must be slightly readjusted to the right or left (not more than 1/4 of a turn) until the peaks are equalized. Each time that (70A) is set in another position, rotate the signal-generator through the 460 to 480 kc range and note the reading of each peak. This adjustment is used to compensate for slight differences between peaks. If (70A) must be turned more than 1/4 of a turn in either direction to equalize the peaks, all the trimmers should be carefully readjusted as given under the intermediate frequency adjustment procedure. After completing adjustments, turn Selectivity-Fidelity control back to clockwise position.

Note 5.—Remove the 0.1 mf condenser which is used as a dummy antenna and

connect the high side of the signal-generator directly to the "Red" antenna terminal; other to "Black."

- Note 6.—Turn the signal-generator indicator to the 1000 kc mark and adjust the signal-generator attenuator to produce a weak output signal.
- Note 7.—Magnetic-Tuning switch in the "out" position (counter-clockwise). Volume-Control at maximum (extreme clockwise). Treble-Selectivity control at the "Selective" position (extreme clockwise).
- Note 8.—Adjust the receiver dial very accurately for maximum output of the 1000 kc signal.
- Note 9.—Turn the Magnetic-Tuning switch to the "on" position. Advance the attenuator of the signal-generator so as to produce a strong output signal. Turn (85B) slightly to the right or left about $\frac{1}{4}$ turn). Adjust (77A) and (85A) for *minimum* output. Now set the attenuator of the signal-generator so as to produce a weak output signal, and then readjust (85B) for *maximum* output.
- Note 10.—FREQUENCY TEST: With the 1000 kc signal tuned for maximum output, turn the Magnetic-Tuning control back and forth, that is, from the "out" to the "in" position. The reading of the output meter should not change in either position. If the output meter reading changes, the preceding Magnetic-Tuning circuit adjustments should be repeated. A further check on the Magnetic-Tuning adjustment is to very carefully tune in a broadcasting station, and then turn the Magnetic-Tuning switch from the "out" to the "in" position. With the switch in either position, the tone of the station should not change. If a change of tone or hiss develops repeat the preceding Magnetic-Tuning adjustments.
- Note 11.—To check the Magnetic-Tuning circuit for sensitivity, turn the Magnetic-Tuning switch to the "off" position, and tune in the 1000 kc signal. Then adjust the attenuator control of the signal-generator for a good audible signal (approximately 20 volts on the output meter). Now detune the signal (first above and then below the 1000 kc mark) to a point at which the signal is weakly heard. At each point turn the Magnetic-Tuning control "on." When the control is turned "on," the signal should return to normal output strength. If the Magnetic-Tuning circuit does not pull the signal into resonance, (77A) and (85A) should be carefully readjusted.

* While rocking.

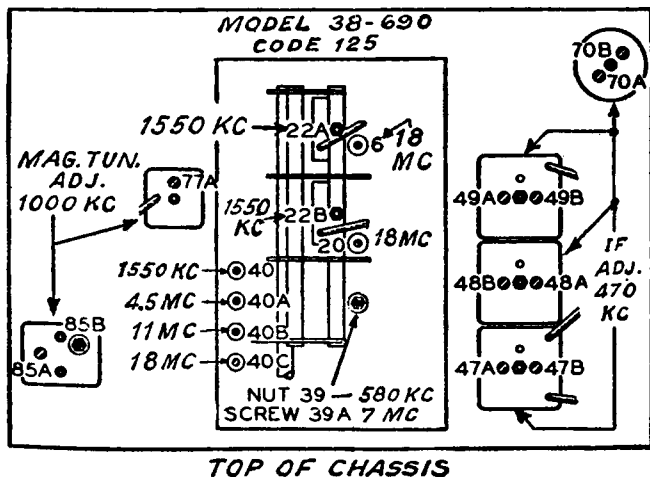

**MODELS 39-6, 39-7, 39-8, 39-8T, 39-12 (late),
39-12TP (late), 12TP (late), 107**

Signal Generator Connection	Dummy Antenna	Signal Generator Frequency	Receiver Wave-band Switch	Receiver Dial Setting	Trimmer Number
Control grid of 6A7	0.1 mf	470 kc	Note 1	580 kc ²	1
"	"	"	"	"	2
"	"	"	"	"	3
Ant.	100 mmf	1550 kc	"	1550 kc	4
"	"	"	"	"	5

Note 1.—Set push-button for "MANUAL" tuning on push-button models.

Note 2.—DIAL CALIBRATION: With the tuning condenser in "maximum capacity" position (plates fully meshed), set the dial pointer between the two horizontal lines at the low frequency end of the scale (550 kc).

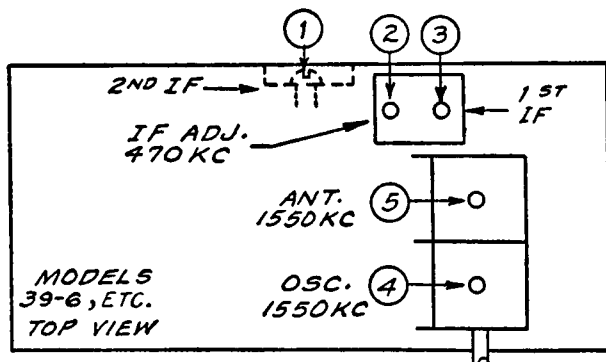

MODELS 39-17 (121, 122), 39-18 (121, 122)

Signal Generator Connection	Dummy Antenna	Signal Generator Frequency	Receiver Wave-band Switch	Receiver Dial Setting	Trimmer Number
Control grid ¹ of 6A7	0.1 mf ¹	470 kc	...	580 kc ²	12A
"	"	"	...	"	11A
"	"	"	...	"	11B
Ant. ³	100 mmf ³	1550 kc	...	1550 kc	3B
"	"	"	...	"	3A

Note 1.—39-18 only. Connect the high side of signal generator to terminal No. 1 on the Set Transformer, part No. 32-2763, and the cable ground to terminal No. 2. Nos. 3 and 4 terminals of Set Transformer are then connected to the chassis and 6A7 grid respectively of the receiver with short pieces of wire. Insert the 0.1 mf in series with the No. 4 lead which connects to the grid.

Note 2.—DIAL CALIBRATION: In order to adjust the receiver correctly, the dial must be aligned to track properly with the tuning condenser. To adjust the dial proceed as follows: With the push button unit disconnected from the gang; the pointer is to be set on the extreme left edge of the index line (low frequency end of the scale) with the gang closed. The gang is then opened until the pointer is at the right edge of the index line and, with the push-button shaft at its closed stop, the push-button coupling is tightened on the gang shaft.

Note 3.—39-18 only. Nos. 3 and 4 terminals of Set Transformer (see Note 1) are to be connected to the chassis and antenna lead respectively of the receiver with short pieces of wire. Insert the 100 mmf in series with the No. 4 lead which connects to the antenna lead.

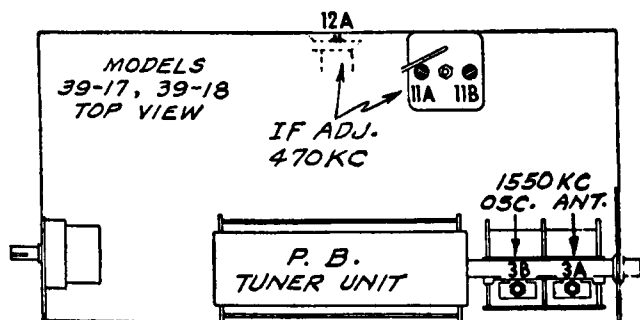

MODELS 39-19 (121, 122), 39-19PA, 39-19PCS, 39-19PF, 39-19PT

Signal Generator Connection	Dummy Antenna	Signal Generator Frequency	Receiver Wave-band Switch	Receiver Dial Setting	Trimmer Number
Control grid of 6A7	0.1 mfm	470 kc	B.C.	580 kc ¹	14A
"	"	"	"	"	13B
"	"	"	"	"	13A
Ant.	100 mmfm	18 mc	S.W.	18 mc	4B
"	"	1550 kc	B.C.	1550 kc	8
"	"	"	"	"	4A
"	"	580 kc	"	580 kc	8A *
"	"	1550 kc	"	1550 kc	8

Note 1.—DIAL CALIBRATION: With the push button unit disconnected from the gang, the pointer is to be set on the extreme left edge of the index line (low frequency end of the scale) with the gang closed. The gang is then opened until the pointer is at the right edge of the index line and, with the push button shaft at its closed stop, the push button coupling is tightened on the gang shaft.

* While rocking.

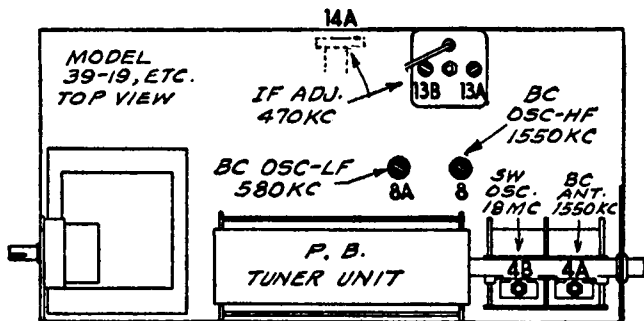

**MODELS 39-25, 39-30, 39-30PCX, 39-31, 39-31XF,
39-31XK, 39-3-31PA, 39-35**

Signal Generator Connection	Dummy Antenna	Signal Generator Frequency	Receiver Wave-band Switch	Receiver Dial Setting	Trimmer Number
Control grid of det. osc.	0.1 mf	470 kc	B.C.	580 kc ¹	20A
"	"	"	"	"	12B
"	"	"	"	"	12A
Ant.	100 mmf	18.0 mc	S.W.	18.0 mc	4B
"	"	1550 kc	B.C.	1550 kc	5
"	"	"	"	"	4A
"	"	580 kc	"	580 kc	5A*
"	"	1550 kc	"	1550 kc	5

Note 1.—DIAL CALIBRATION: In order to adjust the receiver correctly the dial pointer must be aligned to track properly with the tuning condenser. To adjust the dial proceed as follows: With the tuning condenser closed, set the dial pointer on the extreme left index line at the low frequency end of the scale.

* While rocking.

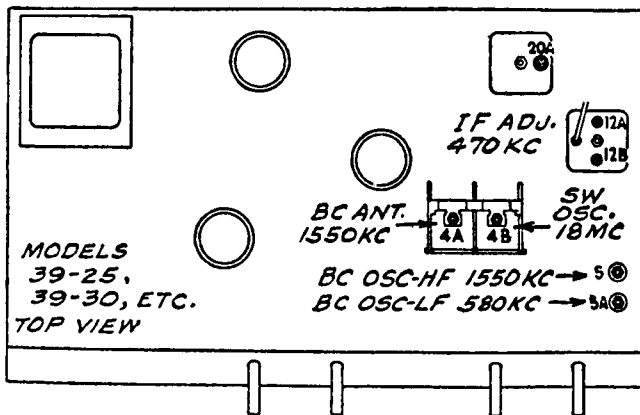

MODEL 39-36

Signal Generator Connection	Dummy Antenna	Signal Generator Frequency	Receiver Wave-band Switch	Receiver Dial Setting	Trimmer Number
Control grid of 6A7	0.1 mf	470 kc	B.C.	580 kc ¹	21A
"	"	"	"	"	12B
"	"	"	"	"	12A
Ant.	100 mf	18.0 mc	S.W.	18.0 mc	4B
"	"	1550 kc	B.C.	1550 kc	5
"	"	"	"	"	4A
"	"	580 kc	"	580 kc	5A*
"	"	1550 kc	"	1550 kc	5

Note 1.—DIAL CALIBRATION: In order to adjust the receiver correctly, the dial must be aligned to track properly with the tuning condenser. To adjust the dial, proceed as follows: With the tuning condenser closed (maximum capacity), set the dial pointer on the extreme left index line at the low frequency end of the broadcast scale.

* While rocking.

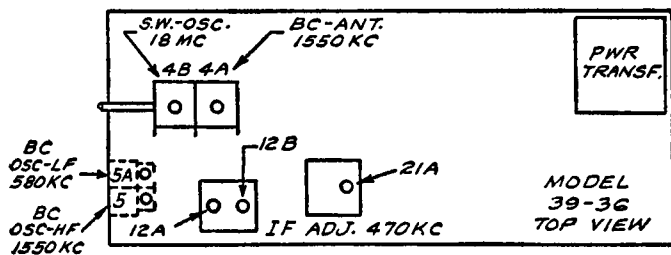

MODELS 39-40, 39-40PCX, 39-2-40PC

Signal Generator Connection	Dummy Antenna	Signal Generator Frequency	Receiver Wave-band Switch	Receiver Dial Setting	Trimmer Number
Control grid of 6A7	0.1 mf	470 kc	B.C.	580 kc ¹	26B
"	"	"	"	"	26A
"	"	"	"	"	23B
"	"	"	"	"	23A
Ant.	150 mmf	1550 kc	"	1550 kc	15
"	"	"	"	"	7B
"	"	"	"	"	7A
"	"	580 kc	"	580 kc	17*
"	"	1550 kc	"	1550 kc	15
"	400 ohms	18.0 mc	S.W.	18.0 mc	15A
"	"	"	"	"	12
"	"	"	"	"	5

Note 1.—DIAL CALIBRATION: In order to adjust the receiver correctly, the dial must be aligned to track properly with the tuning condenser. To adjust the dial, proceed as follows: With the tuning condenser closed (maximum capacity), set the dial pointer on the extreme left index line at the low frequency end of the broadcast scale.

* While rocking.

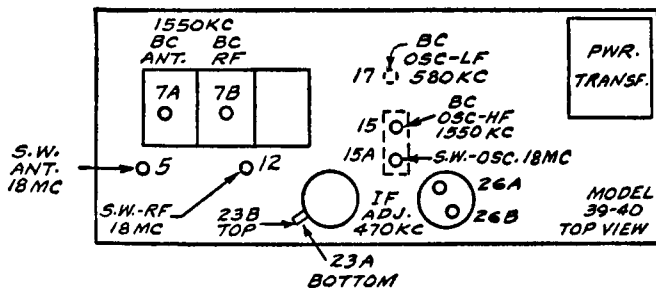

MODEL 39-45

Signal Generator Connection	Dummy Antenna	Signal Generator Frequency	Receiver Wave-band Switch	Receiver Dial Setting	Trimmer Number
Control grid of 6A7	0.1 mf	470 kc	B.C.	580 kc ¹	30B
"	"	"	"	"	30A
"	"	"	"	"	27B
"	"	"	"	"	27A
Ant.	150 mmf	1550 kc	"	1550 kc	21
"	"	"	"	"	8B
"	"	"	"	"	8A
"	"	580 kc	"	580 kc	22*
"	"	1550 kc	"	1550 kc	21
"	400 ohms	5.0 mc	Police	5.0 mc	21A
"	"	18.0 mc	S.W.	18.0 mc	21B
"	"	"	"	"	14
"	"	"	"	"	4

Note 1.—DIAL CALIBRATION: In order to adjust the receiver correctly, the dial must be aligned to track properly with the tuning condenser. To adjust the dial, proceed as follows: With the tuning condenser closed (maximum capacity), set the dial pointer on the extreme left index line at the low frequency end of the broadcast scale.

* While rocking.

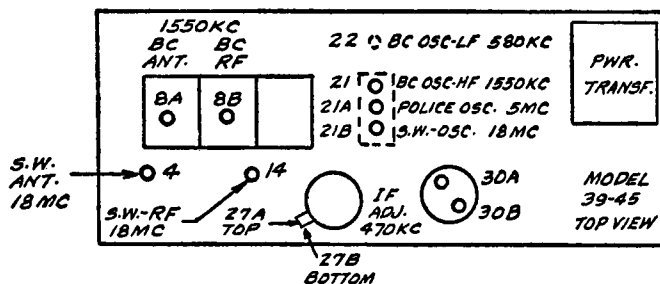

MODEL 39-55

Signal Generator Connection	Dummy Antenna	Signal Generator Frequency	Receiver Wave-band Switch	Receiver Dial Setting	Trimmer Number
Control grid of 78 IF	0.1 mf	470 kc	Manual Tuning	580 kc ¹	13B ²
"	"	"	"	"	14A
"	"	"	"	"	14B
Control grid of 6J8G	"	"	"	"	13C
"	"	"	"	"	13A
"	"	"	"	"	13B
"	"	"	"	"	14B
Ant.	150 mmf	1550 kc	"	1550 kc	3B
"	"	"	"	"	3A
"	"	580 kc	"	580 kc	7*
"	"	1550 kc	"	1550 kc	3B
"	"	"	"	"	3A

Note 1.—DIAL CALIBRATION: In order to adjust the receiver correctly, the dial must be aligned to track properly with the tuning condenser. To adjust the dial, proceed as follows: With the tuning condenser closed (maximum capacity), set the dial pointer on the extreme left index line at the low frequency end of the broadcast scale.

Note 2.—Turn 13B full out.

* While rocking.

For Mystery Control adjustments, see pages 177 and 181.

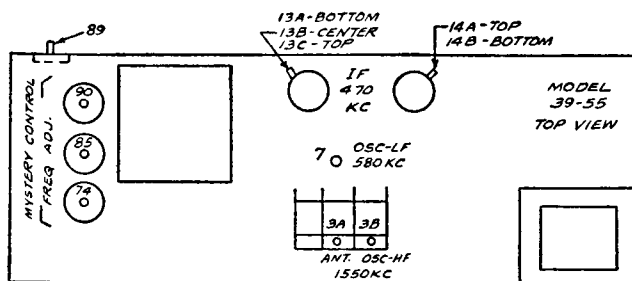

MODEL 39-70

Signal Generator Connection	Dummy Antenna	Signal Generator Frequency	Receiver Wave-band Switch	Receiver Dial Setting	Trimmer Number
Control grid of 1A7G	0.1 mf	470 kc	...	580 kc ¹	1
"	"	"	...	"	2
"	"	"	...	"	3
Ant. (white wire)	225 mmf	1550 kc	...	1550 kc	4
"	"	"	...	"	5

Note 1.—DIAL CALIBRATION: In order to adjust the receiver correctly, the dial must be aligned to track properly with the tuning condenser.

Model 39-70—Turn the tuning condenser to maximum capacity (plates fully meshed). With the tuning condenser in this position, set the pointer horizontally across the dial.

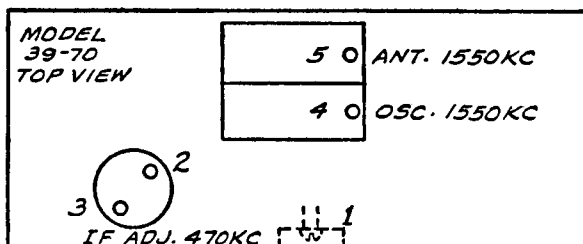

MODELS 39-71 (121, 122), 39-72T, 40-504

Signal Generator Connection	Dummy Antenna	Signal Generator Frequency	Receiver Wave-band Switch	Receiver Dial Setting	Trimmer Number
Control grid of 1A7G	0.1 mf	470 kc	...	580 kc ¹	12A
"	"	"	...	"	11B
"	"	"	...	"	11A
Ant. ²	400 ohms	1550 kc	...	1550 kc	2B ²
"	"	"	...	"	2A ²

Note 1.—DIAL CALIBRATION: In order to adjust the receiver correctly, the dial must be aligned to track properly with the tuning condenser. To adjust the dial proceed as follows: Turn the tuning condenser to maximum capacity (plates fully meshed). With tuning condenser in this position set the pointer to the small "black dot" at the low frequency end of the dial scale.

Note 2.—When adjusting the Antenna (2A) and Oscillator (2B) the chassis must be assembled in the cabinet with the batteries and loop in place. The Signal Generator output lead with the "Dummy Antenna" is then connected to the terminals marked "Ant" and "Grd" underneath the cabinet. The antenna and oscillator trimmers are then adjusted through the holes in the bottom of the cabinet.

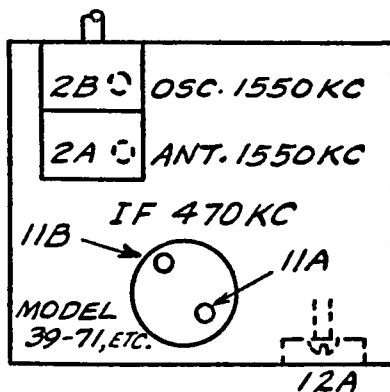

MODELS 39-75, 39-80, 39-175 (121, 122)

Signal Generator Connection	Dummy Antenna	Signal Generator Frequency	Receiver Wave-band Switch	Receiver Dial Setting	Trimmer Number
Control grid of 1A7G	0.1 mf	470 kc	...	580 kc ¹	1
"	"	"	...	"	2
"	"	"	...	"	3
Ant. (white wire)	225 mmf	1550 kc	...	1550 kc	4
"	"	"	...	"	5

Note 1.—DIAL CALIBRATION: In order to adjust the receiver correctly, the dial must be aligned to track properly with the tuning condenser.

Model 39-80—Turn the tuning condenser to maximum capacity (plates fully meshed). With the tuning condenser in this position, set the pointer horizontally across the dial.

Model 39-75—With the tuning condenser in the maximum capacity position (plates fully meshed), loosen the coupling screws connecting the push-button unit to the condenser. The pointer is then set on the extreme left edge of the index line (low frequency end of the scale) with the tuning condenser fully closed. The gang is then opened until the pointer is at the right edge of the index line. The push-button shaft is then turned counter-clockwise to its "stop." With the tuning condenser and push-button shaft in these positions tighten the coupling set screws.

Model 39-175—With tuning-condenser fully closed, set pointer on extreme left edge of index line at low-frequency end of scale.

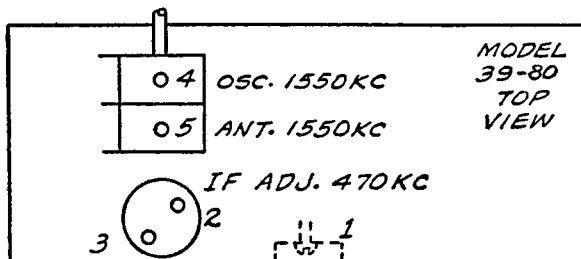
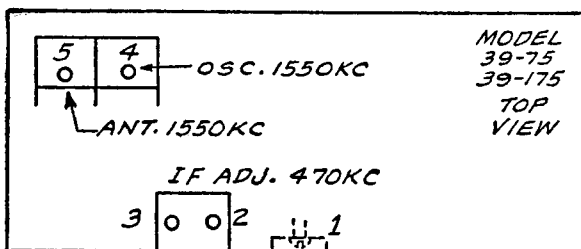

MODEL 39-85

Signal Generator Connection	Dummy Antenna	Signal Generator Frequency	Receiver Wave-band Switch	Receiver Dial Setting	Trimmer Number
Control grid of 1A7G	0.1 mf	470 kc	B.C.	580 kc ¹	20A
"	"	"	"	"	19B
"	"	"	"	"	19A
Ant. (white wire)	400 ohms	18.0 mc	S.W.	18.0 mc	6B
"	225 mmf	1550 kc	B.C.	1550 kc	9
"	"	"	"	"	6A
"	"	580 kc	"	580 kc	9A *
"	"	1550 kc	"	1550 kc	9

Note 1.—DIAL CALIBRATION: In order to adjust the receiver correctly, the dial must be aligned to track properly with the tuning condenser. To adjust the dial proceed as follows: Turn the tuning condenser to maximum capacity (plates fully meshed). With tuning condenser in this position set the pointer horizontally across the dial.

* While rocking.

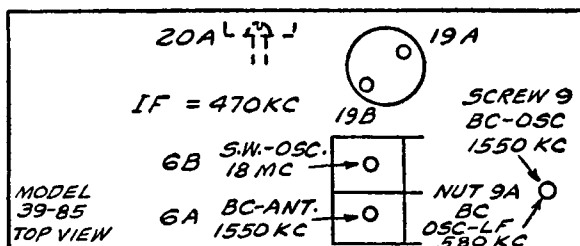

MODELS 39-116, 39-116PCX

Signal Generator Connection	Dummy Antenna	Signal Generator Frequency	Receiver Wave-band Switch	Receiver Dial Setting	Trimmer Number
Control grid of 78 IF	0.1 mf	470 kc	B.C.	580 kc ¹	33B ²
"	"	"	"	"	38A
"	"	"	"	"	38B
Control grid of 6A8	"	"	"	"	33C
"	"	"	"	"	33A
"	"	"	"	"	33B
"	"	"	"	"	38B
Ant	150 mmf	1550 kc	"	1550 kc	22
"	"	"	"	"	10B
"	"	"	"	"	10A
"	"	580 kc	"	580 kc	23*
"	"	1550 kc	"	1550 kc	22
"	400 ohms	5.0 mc	Police	5.0 mc	22A
"	"	18.0 mc	S.W.	18.0 mc	22B
"	"	"	"	"	16
"	"	"	"	"	4

Note 1.—DIAL CALIBRATION: In order to adjust the receiver correctly, the dial pointer must be aligned to track properly with the tuning condenser. To adjust the dial proceed as follows: With the tuning condenser closed, set the dial pointer on the extreme left index line at the low frequency end of the scale.

Note 2.—Turn 33B full out.

* While rocking.

For Mystery Control adjustments, see pages 177 and 181.

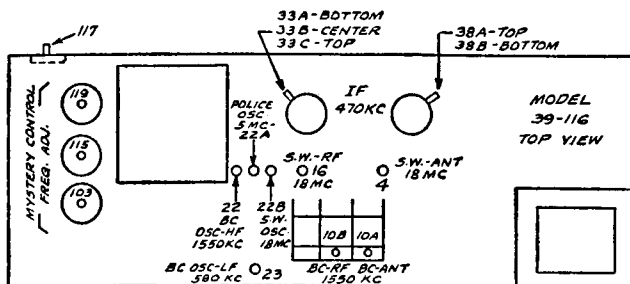

MODELS 39-117, 39-118 (121, 122)

Signal Generator Connection	Dummy Antennr	Signal Generator Frequency	Receiver Wave-band Switch	Receiver Dial Setting	Trimmer Number
Control grid ¹ of 6A7	0.1 mf ¹	470 kc	Manual Tuning	580 kc ²	12A
"	"	"	"	"	11A
"	"	"	"	"	11B
Ant. ³	200 mmf ³	1550 kc	"	1550 kc	3B
"	"	"	"	"	3A

Note 1.—Connect the high side of signal generator to terminal No. 1 on Set Transformer Part No. 32-2763, and the cable ground to terminal No. 2. Nos. 3 and 4 terminals of Set Transformer are then connected to the chassis and 6A7 grid respectively of the receiver with short pieces of wire. Insert the 0.1 mf in series with the No. 4 lead which connects to the grid.

Note 2.—DIAL CALIBRATION: In order to adjust the receiver correctly, the dial must be aligned to track properly with the tuning condenser. To do this, proceed as follows: Turn the tuning condenser to the maximum capacity position (plates fully meshed). With the condenser in this position, the tuning pointer is set on the first index line at the low frequency end of the scale (540 kc).

Note 3.—Nos. 3 and 4 terminals of Set Transformer (see Note 1) are then connected to the chassis and antenna lead respectively of the receiver with short pieces of wire. Insert the 100 mmf in series with the No. 4 lead which connects to the antenna lead.

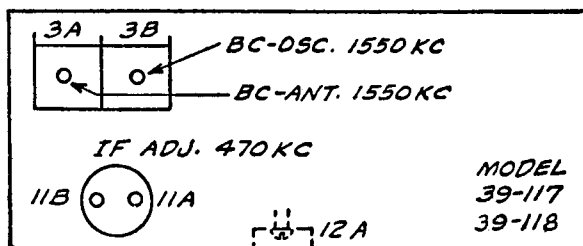

MODEL 39-119 (121, 122)

Signal Generator Connection	Dummy Antenna	Signal Generator Frequency	Receiver Wave-band Switch	Receiver Dial Setting	Trimmer Number
Control grid of 6A7	0.1 mfm	470 kc	B.C.	580 kc ¹	14A
"	"	"	"	"	13B
"	"	"	"	"	13A
Ant.	200 mmf	18.0 mc	S.W.	18.0 mc	4B
"	"	1550 kc	B.C.	1550 kc	8
"	"	"	"	"	4A
"	"	580 kc	"	580 kc	8A *
"	"	1550 kc	"	1550 kc	8
"	"	"	"	"	4A

Note 1.—DIAL CALIBRATION: With tuning-condenser fully closed, set pointer on first index line at low-frequency end of scale (540 kc).

* While rocking.

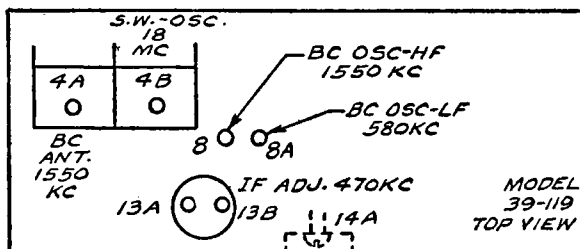

MODEL 39-711

Signal Generator Connection	Dummy Antenna	Signal Generator Frequency	Receiver Wave-band Switch	Receiver Dial Setting	Trimmer Number
Control grid of 6J8G	0.1 mf	470 kc	B.C. ¹	580 kc ²	22A
"	"	"	"	"	21B
"	"	"	"	"	21A
Ant.	200 mmf	1500 kc	"	1500 kc	14
"	"	"	"	"	11A
"	"	580 kc	"	580 kc	15 *
"	"	1500 kc	"	1500 kc	14
"	"	"	"	"	11A
"	400 ohms	7.0 mc	Police	7.0 mc	14A *
"	"	20 mc	S.W.	20 mc	6A ³
"	"	"	"	"	6
"	"	"	"	19.060 mc	Image check

Note 1.—Leave Tone-Control in "Treble" position.

Note 2.—DIAL CALIBRATION: With tuning-condenser closed (maximum capacity), set the dial pointer at the first mark on the left edge (low frequency end) of the broadcast scale.

Note 3.—When adjusting (6A), tune in the fundamental signal (20 mc) and not the image signal. If adjustment is correct, the image signal will be noted when dial is tuned 940 kc *below* the fundamental signal—which will be 19.060 mc.

* While rocking.

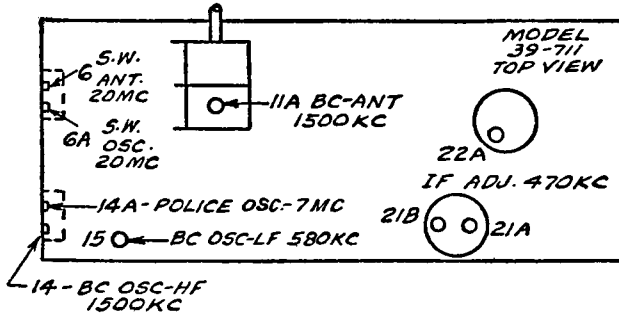

MODEL 39-744

Signal Generator Connection	Dummy Antenna	Signal Generator Frequency	Receiver Wave-band Switch	Receiver Dial Setting	Trimmer Number
Control grid of 6D8G	0.1 mf	470 kc	B.C. ¹	580 kc ²	29B
"	"	"	"	"	29A
"	"	"	"	"	28B
"	"	"	"	"	28A
Ant.	200 mmf	1500 kc	"	1500 kc	19
"	"	"	"	"	7B
"	"	"	"	"	7A
"	"	580 kc	"	580 kc	20*
"	"	1500 kc	"	1500 kc	19
"	"	"	"	"	7B
"	"	"	"	"	7A
"	400 ohms	6.0 mc	Police	6.0 mc	19A*
"	"	20.0 mc	S.W.	20.0 mc	23 ³
"	"	"	"	"	12
"	"	"	"	"	4
"	"	"	"	19.060 mc	Image check

Note 1.—Leave Tone-Control in "Treble" position.

Note 2.—DIAL CALIBRATION: In order to adjust the receiver correctly the dial must be aligned to track properly with the tuning condenser. To adjust the dial, proceed as follows: With the tuning condenser closed (maximum capacity), set the dial pointer on the first mark on the left edge (low frequency end) of the broadcast scale.

Note 3.—When adjusting (23) be sure to tune in the fundamental signal (20 mc—second signal from tight position of padder) instead of the image signal. If the compensator is correctly adjusted, the image signal will be found by turning the receiver dial 940 kc below the fundamental signal.

* While rocking.

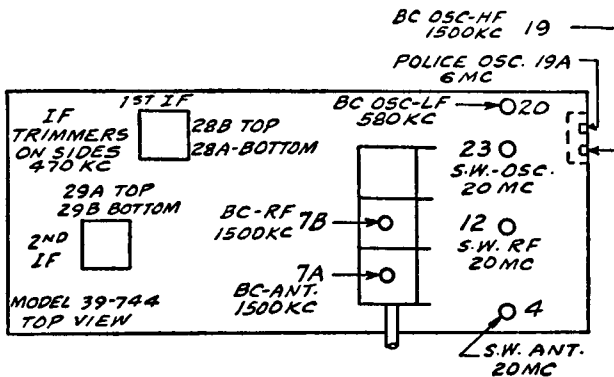

MODEL 39-751

Signal Generator Connection	Dummy Antenna	Signal Generator Frequency	Receiver Wave-band Switch	Receiver Dial Setting	Trimmer Number
Control grid of 6J8G	0.1 mfd	470 kc	B.C. ¹	580 kc ²	44B
"	"	"	"	"	44A
"	"	"	"	"	43B
"	"	"	"	"	43A
Ant.	200 mmf	1500 kc	"	1500 kc	30
"	"	"	"	"	26B
"	"	"	"	"	26A
"	"	580 kc	"	580 kc	31*
"	"	1500 kc	"	1500 kc	30
"	"	"	"	"	26B
"	"	"	"	"	26A
"	400 ohms	6.0 mc	Police	6.0 mc	30A*
"	"	20.0 mc	S.W.	20.0 mc	33 ³
"	"	"	"	"	19
"	"	"	"	"	6
"	"	"	"	19.060 mc	Image check

Note 1.—Leave Tone-Control in "Treble" position.

Note 2.—DIAL CALIBRATION: With tuning-condenser closed (maximum capacity), set the dial pointer at the first mark on the left edge (low frequency end) of the broadcast scale.

Note 3.—When adjusting (33), tune in the fundamental signal (20 mc) and not the image signal. If adjustment is correct, the image signal will be noted when dial is tuned 940 kc below the fundamental signal—which will be 19.060 mc.

* While rocking.

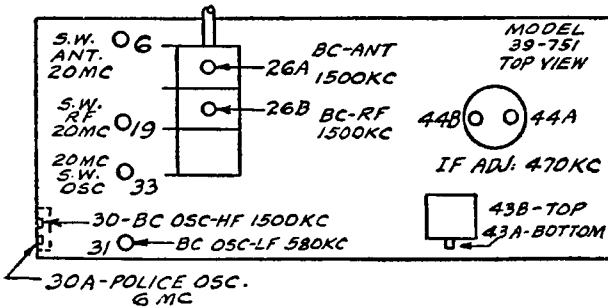

MODELS 39-770, 39-2770

Signal Generator Connection	Dummy Antenna	Signal Generator Frequency	Receiver Wave-band Switch	Receiver Dial Setting	Trimmer Number
Control grid of 6J8G	0.1 mf	470 kc	B.C. ¹	580 kc ²	34B ³
"	"	"	"	"	35B
"	"	"	"	"	35A
"	"	"	"	"	34C
"	"	"	"	"	34A
"	"	"	"	"	34B
Ant.	200 mmf	1500 kc	"	1500 kc	27
"	"	"	"	"	20B
"	"	"	"	"	20A
"	"	580 kc	"	580 kc	28*
"	"	5.0 mc ⁴	S.W."C"	5.0 mc	27A* ⁵
"	"	"	"	4.060 mc	Image check
"	"	350 kc ⁴	L.W.	350 kc	27A
"	"	160 kc ⁴	L.W.	160 kc	A1*
"	400 ohms	11.0 mc	S.W."B"	11.0 mc	30
"	"	"	"	"	14*
"	"	"	"	"	6* ⁶
"	"	"	"	11.940 mc	Image check
"	"	6.0 mc	"	6.0 mc	30A
"	"	"	"	"	14A*
"	"	"	"	"	6A* ⁶
"	"	"	"	6.940 mc	Image check
"	"	11.0 mc	"	11.0 mc	30
"	"	"	"	"	14*
"	"	"	"	"	6* ⁶
"	"	"	"	11.940 mc	Image check
"	"	20.0 mc	S.W."A"	20.0 mc	30B
"	"	"	"	"	14C*
"	"	"	"	"	6C* ⁶
"	"	"	"	20.940 mc	Image check
"	"	12.0 mc	"	12.0 mc	30C
"	"	"	"	"	14B*
"	"	"	"	"	6B* ⁶
"	"	"	"	12.940 mc	Image check
"	"	6.0 mc	S.W."B"	6.0 mc	30A
"	"	"	"	"	14A*
"	"	"	"	"	6A* ⁶
"	"	"	"	6.940 mc	Image check
"	"	11.0 mc	"	11.0 mc	30
"	"	"	"	"	14*
"	"	"	"	"	6* ⁶
"	"	"	"	11.940 mc	Image check

- Note 1.—Leave Tone-Control in "Treble" position.
- Note 2.—DIAL CALIBRATION: With tuning-condenser in fully closed (maximum capacity) position, set dial pointer on extreme left index line at low-frequency end of broadcast scale.
- Note 3.—Turn (34B) full "in."
- Note 4.—S.W. "C" band on Model 39-770 only. L.W. band on Model 39-2770 only.
- Note 5.—On Model 39-770; (27A) should be peaked to the Fundamental signal, which is the second signal from the tight (maximum capacity) position. If correctly adjusted, the "Image" signal will be found by turning the receiver dial 940 kc below 5.0 mc.
- Note 6.—Series-6 trimmers of Shortwave Ranges "A" and "B" should be peaked to the first signal from the tight (maximum capacity) position. If they are correctly adjusted, the "Image" signal will be found by turning the receiver dial 940 kc above the frequencies being used. Example: 11.0 mc (Image 11.940); 20.0 mc (Image 20.940).

* While rocking.

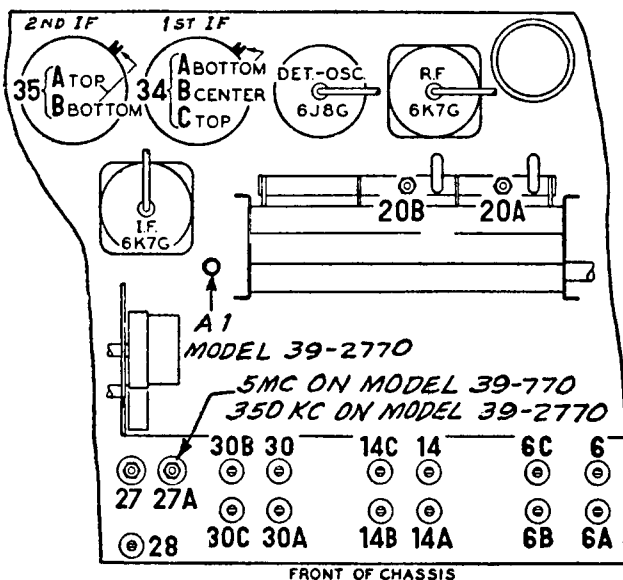

Compensator Locations: Top, Front View of Chassis.
MODELS 39-770 & 39-2770

MODELS 40-74; (121, 122)

Signal Generator Connection	Dummy Antenna	Signal Generator Frequency	Receiver Wave-band Switch	Receiver Dial Setting	Trimmer Number
Loop sect. tuning-cond.	0.1 mf	Note 1	...	580 kc ²	1
"	"	"	...	"	2
"	"	"	...	"	3
..... Note 3		Note 4	Note 5	Note 4	4
"		"	"	"	5

Note 1.—IF is 470 kc.

Note 2.—DIAL CALIBRATION: With tuning-condenser in closed (maximum capacity) position, set dial pointer on small dot below 550 kc.

Note 3.—Construct a loop antenna of several turns of wire, and connect to signal-generator output terminals. Place several feet away from receiver being adjusted.

Note 4.—1500 kc.

Note 5.—Receiver loop must be assembled in cabinet together with batteries and receiver.

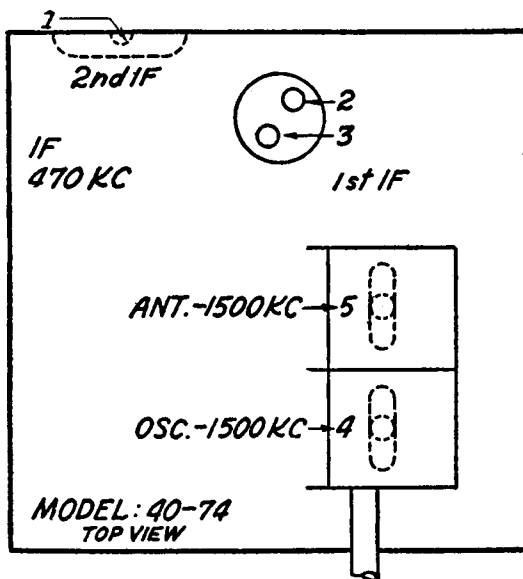

MODELS 40-81, 40-81T, 40-81CSL (121, 122); 40-82 (121), 40-83, 40-84, PT-63

Signal Generator Connection	Dummy Antenna	Signal Generator Frequency	Receiver Wave-band Switch	Receiver Dial Setting	Trimmer Number
Loop sect. tuning-cond.	0.1 mf	Note 1	...	580 kc ²	1
"	"	"	...	"	2
"	"	"	...	"	3
..... Note 3	Note 4	Note 5	Note 4	4
"	"	"	"	"	5

Note 1.—IF is 455 kc.

Note 2.—DIAL CALIBRATION: With tuning-condenser in closed (maximum capacity) position, set dial pointer on small dot below 550 kc.

Note 3.—Construct a loop antenna of several turns of wire, and connect to signal-generator output terminals. Place several feet away from receiver being adjusted.

Note 4.—1400 kc for Model 40-84; 1500 kc for all others.

Note 5.—Receiver loop must be assembled in cabinet together with batteries and receiver.

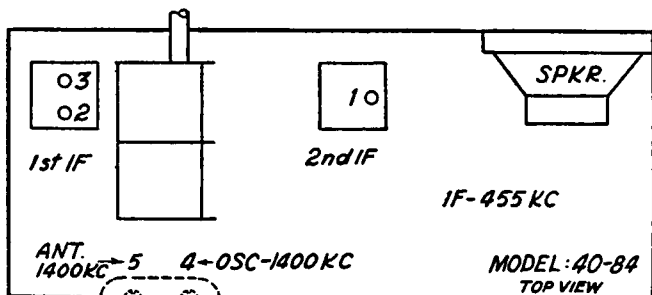
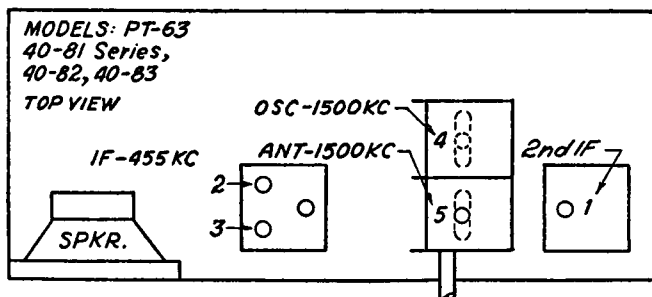

MODELS 40-88T, -TL

Signal Generator Connection	Dummy Antenna	Signal Generator Frequency	Receiver Wave-band Switch	Receiver Dial Setting	Trimmer Number
Loop sect. tuning-cond.	0.1 mf	455 kc	B.C.	580 kc ¹	21A
"	"	"	"	"	20B
"	"	"	"	"	20A
..... Note 2		18.0 mc	S.W.	18.0 mc	8B
"		1400 kc	B.C.	1400 kc	12
"		"	"	"	8A
"		580 kc	"	580 kc	12A *
"		1400 kc	"	1400 kc	12
"		"	"	"	8A
"		18.0 mc	S.W. ³	18.0 mc	3

Note 1.—DIAL CALIBRATION: With tuning-condenser in closed (maximum capacity) position, set dial pointer on small dot below 550 kc.

Note 2.—Construct a loop antenna of several turns of wire, and connect to signal-generator output terminals. Place several feet away from receiver being adjusted.

Note 3.—Receiver loop must be assembled in cabinet together with batteries and receiver.

* While rocking.

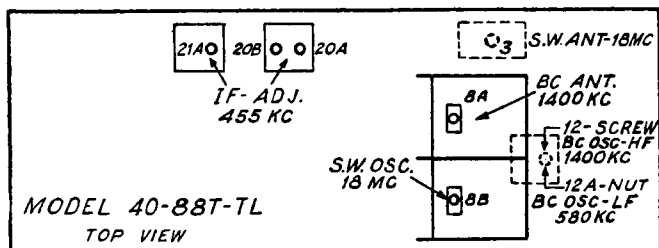

MODEL 40-90

Signal Generator Connection	Dummy Antenna	Signal Generator Frequency	Receiver Wave-band Switch	Receiver Dial Setting	Trimmer Number
Control grid of 1A7	0.004 mf	455 kc	Note 1	580 kc ²	1
"	"	"	"	"	2
"	"	"	"	"	3
Ant.	225 mmf	1500 kc	"	1500 kc	4
"	"	"	"	"	5

Note 1.—Turn switch to "MANUAL TUNING" position on push-button models.

Note 2.—DIAL CALIBRATION: With tuning-condenser in closed (maximum capacity) position; re-set pointer (if necessary) in the following manner, according to type of dial on receiver:—

- (a) set dial pointer on small dot below 550 kc; or
- (b) set dial pointer horizontal at low-frequency end of scale (530 kc).

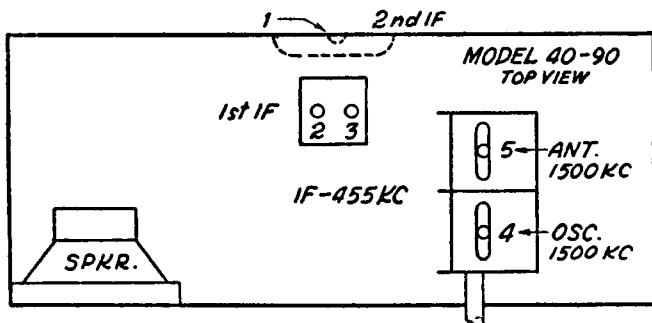

MODELS 40-95, (121, 122), 40-100 (121, 122), 40-105

Signal Generator Connection	Dummy Antenna	Signal Generator Frequency	Receiver Wave-band Switch	Receiver Dial Setting	Trimmer Number
Control grid of 1A7	0.004 mf	455 kc	Note 1	580 kc ²	1
"	"	"	"	"	2
"	"	"	"	"	3
Ant.	225 mmf	1500 kc	"	1500 kc	4
"	"	"	"	"	5

Note 1.—Turn switch to "MANUAL TUNING" position on push-button models.

Note 2.—DIAL CALIBRATION: With tuning-condenser in closed (maximum capacity) position; re-set pointer (if necessary) in the following manner, according to type of dial on receiver:—

- (a) set dial pointer on small dot below 550 kc; or
- (b) set dial pointer horizontal at low-frequency end of scale (530 kc).

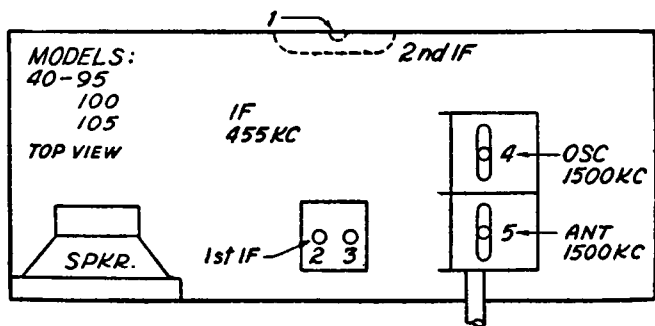

MODEL 40-110

Signal Generator Connection	Dummy Antenna	Signal Generator Frequency	Receiver Wave-band Switch	Receiver Dial Setting	Trimmer Number
Control grid of 1A7G	0.1 mf	455 kc	B.C. ¹	580 kc ²	18A
"	"	"	"	"	17A
"	"	"	"	"	17B
Ant.	400 ohms	18.0 mc	S.W.	18.0 mc	4B
"	225 mmf	1500 kc	B.C.	1500 kc	7 ³
"	"	"	"	"	4A
"	"	580 kc	"	580 kc	7A ^{4, *}
"	"	1500 kc	"	1500 kc	7

Note 1.—Leave "MANUAL" push-button pushed "in."

Note 2.—DIAL CALIBRATION: With tuning-condenser in closed (maximum capacity) position, set dial pointer horizontal at low-frequency end of scale (530 kc).

Note 3.—This is the screw adjustment.

Note 4.—This is the nut adjustment.

* While rocking.

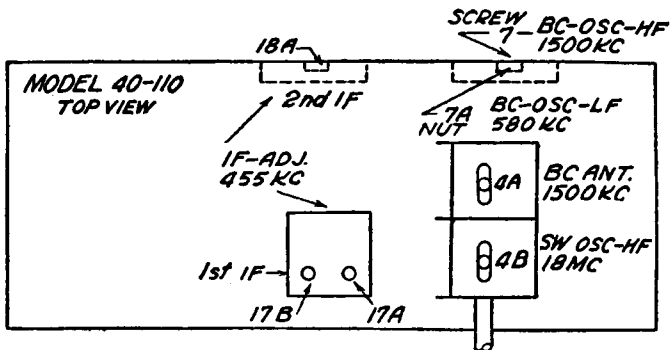

MODELS 40-115, 40-124 (121, 122)

Signal Generator Connection	Dummy Antenna	Signal Generator Frequency	Receiver Wave-band Switch	Receiver Dial Setting	Trimmer Number
Control grid of 7A8	0.004 mf	455 kc	B.C. ¹	580 kc ²	15A
"	"	"	"	"	14A
"	"	"	"	"	14B
Ant.	100 mmf	1580 kc	"	1580 kc	2B ‡
"	"	1500 kc	"	1500 kc	2A

Note 1.—Leave "MANUAL" push-button pushed "in" on model 40-124.

Note 2.—DIAL CALIBRATION: With tuning-condenser in closed (maximum capacity) position, set dial pointer horizontal at low-frequency end of scale (530 kc).

‡ The Police Band is automatically aligned when osc. trimmer (2B) is adjusted.

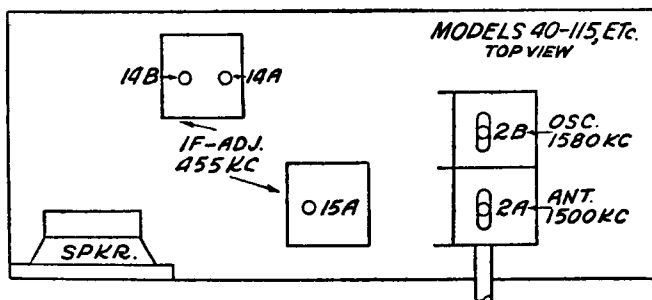

MODELS 40-120, 40-125

Signal Generator Connection	Dummy Antenna	Signal Generator Frequency	Receiver Wave-band Switch	Receiver Dial Setting	Trimmer Number
Ant. sect. tuning-cond.	0.1 mf	455 kc	B.C. ¹	580 kc ²	14A
"	"	"	"	"	14B
"	"	"	"	"	15A
Ant.	10 mmf	1600 kc	"	1600 kc	2B ‡
"	"	1400 kc	"	1400 kc	2A

Note 1.—Leave "MANUAL" push-button pushed "in" on model 40-125.

Note 2.—DIAL CALIBRATION: With tuning-condenser in closed (maximum capacity) position, set dial pointer horizontal at low-frequency end of scale (540 kc).

‡ The Police Band is automatically aligned when osc. trimmer (2B) is adjusted.

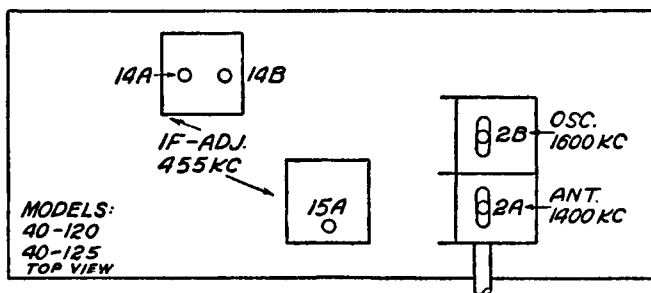

MODELS 40-130, 40-135, 40-170CS, 40-503, 40-506, 40-525, 40-526, 40-527

Signal Generator Connection	Dummy Antenna	Signal Generator Frequency	Receiver Wave-band Switch	Receiver Dial Setting	Trimmer Number
Note 1	0.1 mf	455 kc	B.C. ²	580 kc ³	21B
"	"	"	"	"	21A
"	"	"	"	"	18B
"	"	"	"	"	18A
..... Note 4		1500 kc	"	1500 kc	9A ‡
"	"	"	"	"	1A ⁵

Note 1.—When adjusting the IF trimmers the high side of the signal generator output is connected through the .1 mf condenser to terminal No. 1 of the loop terminal panel at the rear of the chassis.

Note 2.—Leave "MANUAL" push-button pushed "in" on push-button models.

Note 3.—DIAL CALIBRATION: Turn the tuning condenser to the maximum capacity position (plates fully meshed). With the condenser in this position, set the tuning pointer on the extreme left index line at the low frequency end of the broadcast scale.

Note 4.—When aligning the RF, a loop is made from a few turns of wire and connected to the signal generator output terminals. The signal generator is then placed two or three feet from the loop in the cabinet.

Note 5.—Antenna trimmer (1A) is located on the loop. When adjusting, the receiver loop should be held in place against the back of the cabinet.

‡ The Police Band is automatically aligned when osc. trimmer (9A) is adjusted.

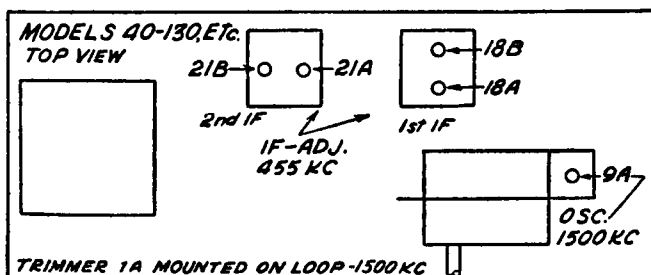

MODELS 40-140, 40-145, 40-507

Signal Generator Connection	Dummy Antenna	Signal Generator Frequency	Receiver Wave-band Switch	Receiver Dial Setting	Trimmer Number
Note 1	0.1 mf	455 kc	B.C. ²	580 kc ³	33A
"	"	"	"	"	33B
"	"	"	"	"	28A
"	"	"	"	"	28B
..... Note 4		18 mc	S.W.	18 mc	27A ⁵
"	"	"	"	"	2A ⁶
"	"	"	"	17.090 mc	Image check
"		1500 kc	B.C.	1500 kc ³	25A
"		"	"	"	1A ⁵
"		580 kc	"	580 kc	25*
"		1500 kc	"	1500 kc	25A
"		"	"	"	2A
"		18 mc	S.W.	18 mc	2A* ⁶

Note 1.—When adjusting the IF trimmers the high side of the signal generator output is connected through the .1 mf condenser to terminal No. 1 of the loop terminal panel at the rear of the chassis. The ground or low side of the generator is connected to the chassis of the receiver.

Note 2.—Leave "MANUAL" push-button pushed "in."

Note 3.—DIAL CALIBRATION: Turn the tuning condenser to the maximum capacity position (plates fully meshed). With the condenser in this position, set the tuning pointer on the extreme left index line at the low frequency end of the broadcast scale.

Note 4.—When aligning the RF Circuits a loop is made from a few turns of wire and connected to the generator output terminals; the signal generator is then placed two or three feet from the loop in the cabinet.

Note 5.—S. W. Oscillator trimmer (27A) is located on top of the tuning condenser. Antenna trimmers (1A) and (2A) are located on the loop. When adjusting the "Ant" trimmers, the receiver loop should be held in place against the back of the cabinet.

Note 6.—Adjust to first peak from tight position.

* While rocking.

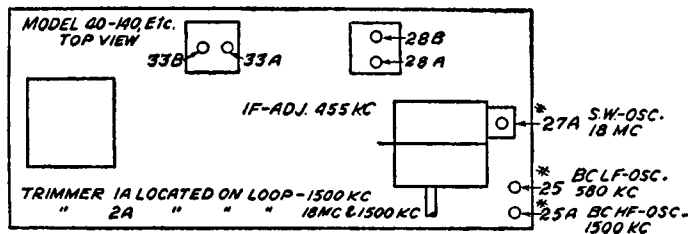

MODELS 40-150, 40-155; 40-180, 40-185, 40-190; 40-508, 40-509, 40-515

Signal Generator Connection	Dummy Antenna	Signal Generator Frequency	Receiver Wave-band Switch	Receiver Dial Setting	Trimmer Number
Note 1	0.1 mf	455 kc	B.C.	580 kc * 2	37A
"	"	"	"	"	30B
"	"	"	"	"	30A
..... Note 3		18 mc	S.W.	18 mc ²	21A ⁴
"		"	"	18 mc ⁵	"
"		1400 kc	B.C.	1400 kc	19A
"		"	"	"	21B ⁶
"		580 kc	"	580 kc	19*
"		1400 kc	"	1400 kc	19A*
"		"	"	"	21B*
"		18 mc	S.W.	18 mc	3*

Note 1.—When adjusting the IF trimmers, the high side of the signal generator is connected through a .1 mf condenser to terminal No. 1 of the loop terminal panel at the rear of the chassis. The ground or low side of the signal generator is connected to the chassis of the receiver.

Note 2.—Depress "DIAL" push-button.

Note 3.—When aligning the RF trimmers a loop is made from a few turns of wire and connected to the signal generator output terminals; the loop is then placed two or three feet from the loop in the cabinet. Do not remove the receiver loop from the cabinet. It is necessary when adjusting the trimmers that the receiver be left in the cabinet.

Note 4.—To accurately adjust the high frequency oscillator trimmer to the fundamental instead of the image signal, turn the oscillator trimmer to the maximum capacity position (clockwise). From this position slowly turn the trimmer counter-clockwise until a second peak is obtained on the output meter. Adjust the trimmer for maximum output at this second peak.

If the above procedure is correctly performed, the image signal will be found (much weaker) by turning the receiver dial 910 kc below the frequency being used on any high frequency range.

Note 5.—DIAL CALIBRATION: To adjust the dial, proceed as follows: With the tuning condenser closed (maximum capacity), set the dial pointer on the extreme left index line at the low frequency end of the broadcast scale.

Note 6.—No condenser 21B on Models 40-150 and 40-155.

* If receiver loop antenna picks up a broadcast signal, the receiver dial setting should be slightly changed from position indicated until broadcast signal is no longer heard.

* While rocking.

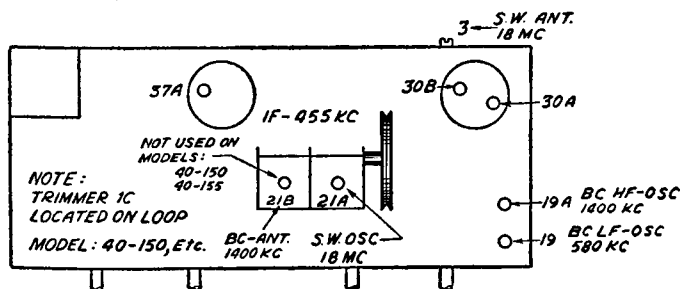

MODEL 40-158

Signal Generator Connection	Dummy Antenna	Signal Generator Frequency	Receiver Wave-band Switch	Receiver Dial Setting	Trimmer Number
Ant. Term.	None	455 kc	B.C.	580 kc ¹	18A
"	"	"	"	"	18B
"	"	"	"	"	14A
"	"	"	"	"	14B
"	"	1500 kc	"	1500 kc	13B ²
"	"	"	"	"	13A ²

Note 1.—DIAL CALIBRATION: Turn the tuning condenser to the maximum capacity position (plates fully meshed). Set the tuning pointer on the extreme left index line at the low frequency end of the broadcast scale.

Note 2.—The oscillator trimmer (13B) and the antenna trimmer (13A) are located on top of the tuning condenser, (13B) at the rear, and (13A) at the front of the tuning condenser.

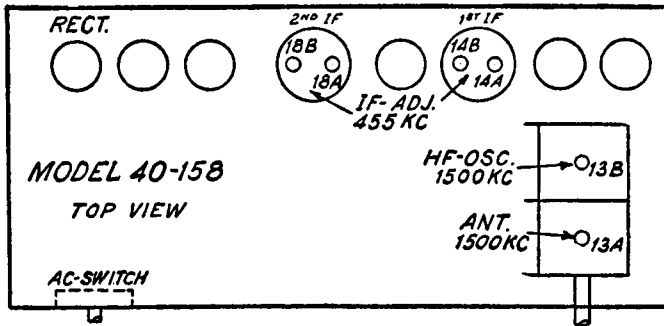

MODEL 40-160

Signal Generator Connection	Dummy Antenna	Signal Generator Frequency	Receiver Wave-band Switch	Receiver Dial Setting	Trimmer Number
Note 1	0.1 mf	455 kc	B.C. ²	580 kc	28A
"	"	"	"	"	28B
"	"	"	"	"	25A
"	"	"	"	"	25B
..... Note 3	1500 kc	"	1500 kc	16A ⁴
"	"	"	"	"	22 ⁴

Note 1.—Connect high side of signal generator to No. 1 terminal of loop panel through a 0.1 mf capacitor. Connect low side of signal generator to chassis.

Note 2.—Dial push button "in."

Note 3.—When aligning the RF trimmers a loop antenna is made from a few turns of wire and connected to the signal generator output terminals; the loop is then placed two or three feet from the loop in the cabinet. Do not remove the receiver loop from the cabinet. It is necessary when adjusting the trimmers that the receiver be left in the cabinet.

Note 4.—DIAL CALIBRATION: With the tuning condenser closed (maximum capacity), set the dial pointer on the extreme left index line at the lowest frequency end of the broadcast scale.

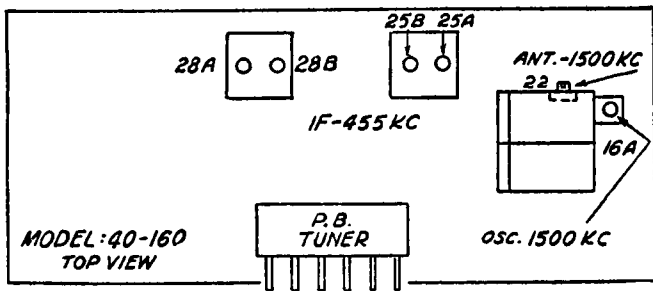

MODEL 40-165

Signal Generator Connection	Dummy Antenna	Signal Generator Frequency	Receiver Wave-band Switch	Receiver Dial Setting	Trimmer Number
Note 1	0.1 mf	455 kc	B.C. ²	580 kc *	37A
"	"	"	"	"	37B
"	"	"	"	"	34A
"	"	"	"	"	34B
..... Note 4		18 mc	S.W.	18 mc ³	61A
"		"	"	17.090 mc	Image check
"		1500 kc	B.C.	1500 kc	26
"		"	"	"	25
"		580 kc	"	580 kc	26A *
"		1500 kc	"	1500 kc	26
"		"	"	"	25
"		18 mc	S.W.	18 mc	2A ⁵ *

Note 1.—Connect high side of signal generator through a 0.1 mf condenser to terminal No. 1 of the loop terminal panel at the rear of the chassis. Connect the low side of the signal generator to chassis.

Note 2.—Depress "DIAL" push-button.

Note 3.—With the tuning condenser closed (maximum capacity) set the dial pointer on the extreme left index line at the low frequency end of the broadcast scale.

Note 4.—When aligning the RF trimmers a loop antenna is made from a few turns of wire and connected to the signal generator output terminals; the generator is then placed two or three feet from the loop in the cabinet. Do not remove the receiver loop from the cabinet. It is necessary when adjusting the trimmers that the receiver be left in the cabinet.

Note 5.—Turn loop trimmer to closed position (maximum capacity). Adjust to first signal peak from this position.

* If receiver loop antenna picks up a broadcast signal, the receiving dial setting should be slightly changed from position indicated until the broadcast signal is no longer heard.

* While rocking.

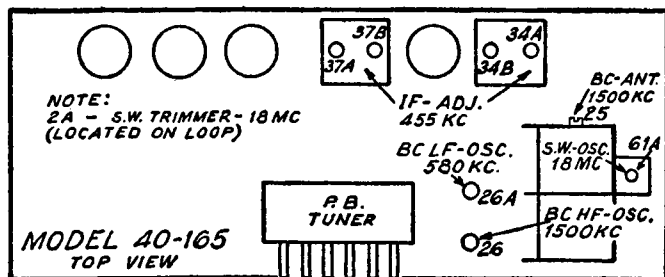

**MODELS 40-195, 40-200, 40-201 (121-122);
40-200XX, 40-200 XXS (121)**

Signal Generator Connection	Dummy Antenna	Signal Generator Frequency	Receiver Wave-band Switch	Receiver Dial Setting	Trimmer Number
Note 1	0.1 mf	455 kc	B.C.	580 kc *	39B
"	"	"	"	"	39A
"	"	"	"	"	38B
"	"	"	"	"	38A
..... Note 2		1500 kc	"	1500 kc ³	25B
"		"	"	"	4B
"		580 kc	"	580 kc	29 *
"		1500 kc	"	1500 kc	25B
"		"	"	"	4B
"		3.5 mc	Police	3.5 mc	25A
"		"	"	"	4A
"		18.0 mc	S.W.	18.0 mc	25
"		"	"	"	4
"		"	"	17.09 mc	Image check

Note 1.—Connect the high side of signal generator through a 0.1 mf condenser to terminal No. 1 of the loop terminal panel at the rear of the chassis. Connect low side of signal generator to receiver chassis.

Note 2.—When aligning the r-f trimmers, a loop is made from a few turns of wire and connected to the signal generator output terminals, and this loop is placed two or three feet from the loop in the cabinet. Do not remove the receiver loop from the cabinet. It is necessary when adjusting the trimmers, that the receiver be left in the cabinet.

Note 3.—DIAL CALIBRATION: With the tuning condenser closed (maximum capacity), set the dial pointer on the extreme left index line at the low frequency end of the broadcast scale.

* If receiver loop antenna picks up a broadcast signal, the receiver dial setting should be slightly changed from position indicated until the broadcast signal is no longer heard.

* While rocking.

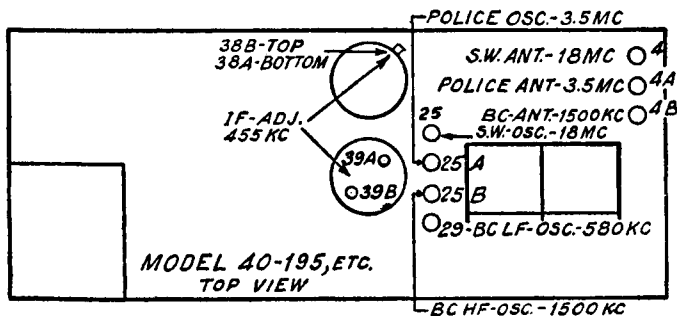

MODELS 40-205, 40-510

Signal Generator Connection	Dummy Antenna	Signal Generator Frequency	Receiver Wave-band Switch	Receiver Dial Setting	Trimmer Number
Control grid 78 tube	0.1	470 kc	B.C.	580 kc *	14A ¹
"	"	"	"	"	14B
Control grid 6J8 tube	"	"	"	"	13A
"	"	"	"	"	13C
"	"	"	"	"	13B
"	"	"	"	"	14A
..... Note 2		1500 kc	"	1500 kc	95B ³
"		"	"	"	95A
"		580 kc	"	580 kc	7*
"		1500 kc	"	1500 kc	95B
"		"	"	"	95A

Note 1.—Turn out 13B full.

Note 2.—When aligning the r-f trimmers, a loop is made from a few turns of wire and connected to the signal generator output terminals. This loop is placed two or three feet from the loop in the cabinet. Do not remove the receiver loop from the cabinet, as it is necessary, when adjusting the trimmers, that the receiver be left in the cabinet.

Note 3.—DIAL CALIBRATION: With the tuning condenser closed (maximum capacity), set the dial pointer on the extreme left index line at the low frequency end of the broadcast scale.

* If the receiver loop antenna picks up a broadcast signal, the receiver dial setting should be slightly changed from the position indicated until the broadcast signal is no longer heard.

* While rocking.

For Mystery Control adjustments, see pages 177 and 181.

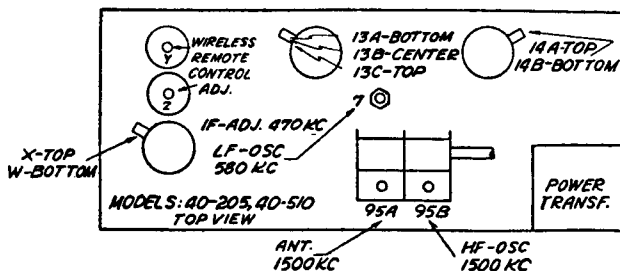

MODELS 40-216, 40-516

Signal Generator Connection	Dummy Antenna	Signal Generator Frequency	Receiver Wave-band Switch	Receiver Dial Setting	Trimmer Number
Control grid 78 IF tube	0.1 mf	470 kc	B.C.	580 kc ² , * 38A ¹	
"	"	"	"	"	38B
Control grid 6A8G	"	"	"	"	33C
"	"	"	"	"	33A
"	"	"	"	"	33B
..... Note 3		18.0 mc	S.W.	18.0 mc	22B ⁴
"		"	"	"	124A ⁵ , *
"		"	"	"	2A ⁵ , *
"		1500 kc	B.C.	1500 kc	22
"		"	"	"	13X
"		"	"	"	3X
"		580 kc	"	580 kc	23 *
"		1550 kc	"	1550 kc	22
"		3.5 mc	Police	3.5 mc	22A

Note 1.—Turn out 33B full.

Note 2.—With the tuning condenser closed (maximum capacity), set the dial pointer on the extreme left index line at the low frequency end of the broadcast scale.

Note 3.—When aligning the r-f trimmers, a loop is made from a few turns of wire and is connected to the signal generator output terminals. This loop is placed two or three feet from the loop in the cabinet. Do not remove the receiver loop from the cabinet as it is necessary that the receiver remain in the cabinet while adjusting the trimmers.

Note 4.—If two peaks (signals) are observed on the aligning meter when adjusting the oscillator trimmer (22B) tune the trimmer to the second peak from the maximum capacity position (screw all the way in).

Note 5.—If two peaks (signals) are observed on the aligning meter when adjusting the r-f and loop trimmers (124A) and (2A), tune the trimmers to the first peak signal from the maximum capacity position (screw all the way in). When adjusting the trimmers to this first peak roll the tuning condenser (rock) slightly back and forth to obtain the maximum readings on the aligning meter.

* If the receiver loop antenna picks up a broadcast signal, the receiver dial setting should be slightly changed from the position indicated until the broadcast signal is no longer heard.

* While rocking.

For Mystery Control adjustments, see pages 177 and 181.

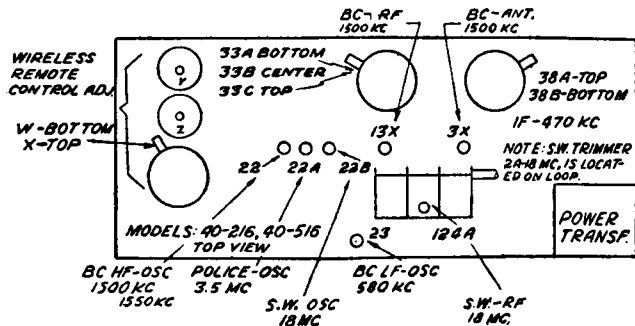

MODELS 40-501, 40-502 (121, 122)

Signal Generator Connection	Dummy Antenna	Signal Generator Frequency	Receiver Wave-band Switch	Receiver Dial Setting	Trimmer Number
Note 1	0.004 mf	470 kc	...	Note 2	11A
"	"	"	...	"	11B
"	"	"	...	"	10A
"	"	"	...	"	10B
Note 3	100 mf	1700 kc	...	1700 kc	5B
"	"	1500 kc	...	1500 kc	5A

Note 1.—Connect high side of signal generator through a 0.004 mf condenser to the antenna section of the tuning condenser. Connect low side of generator to receiver chassis. If set emits hum, reverse receiver power plug.

Note 2.—DIAL CALIBRATION: With the tuning condenser plates fully meshed, set the pointer on the dot below 55 on the dial.

Note 3.—Connect high side of signal generator through a 100 mmf condenser to the antenna of the receiver.

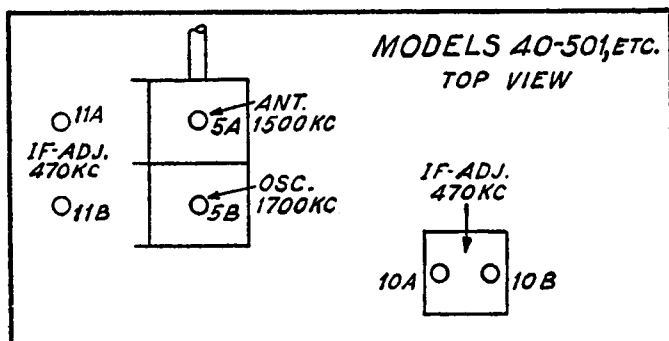

MODEL 40-710

Signal Generator Connection	Dummy Antenna	Signal Generator Frequency	Receiver Wave-band Switch	Receiver Dial Setting	Trimmer Number
Control grid 7A8	0.1 mfd	455 kc	B.C.	580 kc ¹	23A
"	"	"	"	"	19B
"	"	"	"	"	19A
Ant. term.	400 ohms	20 mc	S.W.2	20 mc	18B
"	"	"	"	19.090 mc	Image check
"	"	"	"	20 mc	18A
"	"	7.0 mc	S.W.1	7.0 mc	16A *
"	200 mmf	1400 kc	B.C.	1400 kc	16
"	"	580 kc	"	580 kc	15 *
"	"	1400 kc	"	1400 kc	16

Note 1.—DIAL CALIBRATION: With the tuning condenser closed (maximum capacity), set the dial pointer on the first mark on the left edge (low frequency end) of the broadcast scale.

* While rocking.

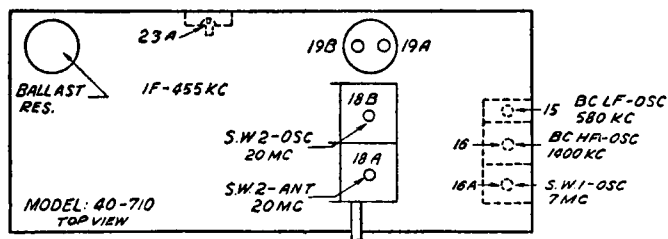

MODEL 40-715

Signal Generator Connection	Dummy Antenna	Signal Generator Frequency	Receiver Wave-band Switch	Receiver Dial Setting	Trimmer Number
Control grid 6J8G	0.1 mf	455 kc	B.C.	580 kc ¹	24A
"	"	"	"	"	16B
"	"	"	"	"	16A
Ant. term.	200 mmf	1500 kc	"	1500 kc	9A
"	"	"	"	"	15A
"	"	580 kc	"	580 kc	11*
"	"	1500 kc	"	1500 kc	9A
"	"	"	"	"	15A
"	400 ohms	7.0 mc	Police	7.0 mc	9*
"	"	20 mc	S.W.	20 mc	5A
"	"	"	"	19.090 mc	Image check
"	"	"	"	20 mc	5

Note 1.—DIAL CALIBRATION: With the tuning condenser closed (maximum capacity), set the dial pointer on the first mark on the left edge (low frequency end) of the broadcast scale.

* While rocking.

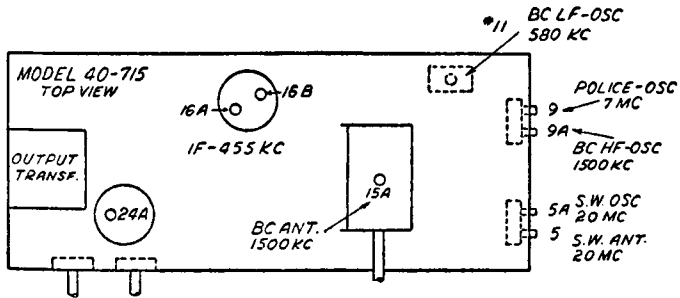

MODELS 40-725, 40-755

Signal Generator Connection	Dummy Antenna	Signal Generator Frequency	Receiver Wave-band Switch	Receiver Dial Setting	Trimmer Number
Control grid 6J8G	0.1 mf	455 kc	B.C.	580 kc ¹	1
"	"	"	"	"	2
"	"	"	"	"	3
"	"	"	"	"	4
Ant. Term.	200 mmf	1500 kc	"	1500 kc	5
"	"	"	"	"	6
"	"	"	"	"	7
"	"	580 kc	"	580 kc	8*
"	"	1500 kc	"	1500 kc	5
"	"	"	"	"	6
"	"	"	"	"	7
"	400 ohms	6.0 mc	S.W.1	6.0 mc	9*
"	"	20 mc	S.W.2	20 mc	10
"	"	"	"	19.090 mc	Image check
"	"	"	"	20 mc	11
"	"	"	"	"	12

Note 1.—DIAL CALIBRATION: With the tuning condenser closed (maximum capacity), set the dial pointer on the first mark on the left edge (low frequency end) of the broadcast scale.

* While rocking.

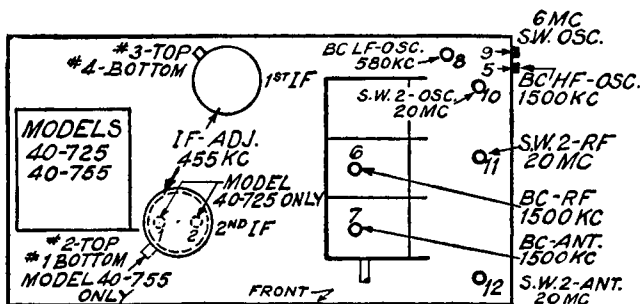

MODELS 40-748, 40-756

Signal Generator Connection	Dummy Antenna	Signal Generator Frequency	Receiver Wave-band Switch	Receiver Dial Setting	Trimmer Number
Control grid 6D8G	0.1 mf	455 kc	B.C.	580 kc ¹	1
"	"	"	"	"	2
"	"	"	"	"	3
"	"	"	"	"	4
Ant.	200 mmf	1500 kc	"	1500 kc	5
"	"	"	"	"	6
"	"	"	"	"	7
"	"	580 kc	"	580 kc	8*
"	"	1500 kc	"	1500 kc	5
"	"	"	"	"	6
"	"	"	"	"	7
"	400 ohms	6.0 mc	S.W.1	6.0 mc	9*
"	"	21 mc	S.W.2	21 mc	10 ²
"	"	"	"	20.090 mc	Image check
"	"	"	"	21 mc	11
"	"	"	"	"	12

Note 1.—DIAL CALIBRATION: With the tuning condenser closed (maximum capacity), set the dial pointer on the first mark on the left edge (low frequency end) of the broadcast scale.

Note 2.—Second signal from tight position.

* While rocking.

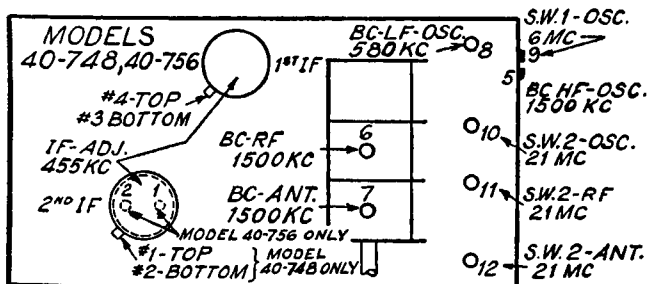

MODEL 40-780 (121, 125)

Signal Generator Connection	Dummy Antenna	Signal Generator Frequency	Receiver Wave-band Switch	Receiver Dial Setting	Trimmer Number
Control grid of 6J8G	0.1 mf	455 kc	B.C.	580 kc ¹	Note 2
"	"	"	"	"	38A
"	"	"	"	"	37A
"	"	"	"	"	37B
"	"	"	"	"	36A
"	"	"	"	"	36C
"	"	"	"	"	36B
Ant.	200 mmf	1500 kc	"	1500 kc	27
"	"	"	"	"	26B
"	"	"	"	"	26A
"	"	580 kc	"	580 kc	31 *
"	"	1500 kc	"	1500 kc	27
"	"	"	"	"	26B
"	"	"	"	"	26A
"	400 ohms	6.0 mc	S.W.1	6.0 mc	27A *
"	"	20 mc	S.W.2	20 mc	33
"	"	"	"	19.090 mc	Image check
"	"	"	"	20 mc	18
"	"	"	"	"	5

Note 1.—DIAL CALIBRATION: With the tuning condenser closed (maximum capacity), set the dial pointer on the first mark on the left edge (low frequency end) of the broadcast scale.

Note 2.—Turn trimmer 36B all the way out.

* While rocking.

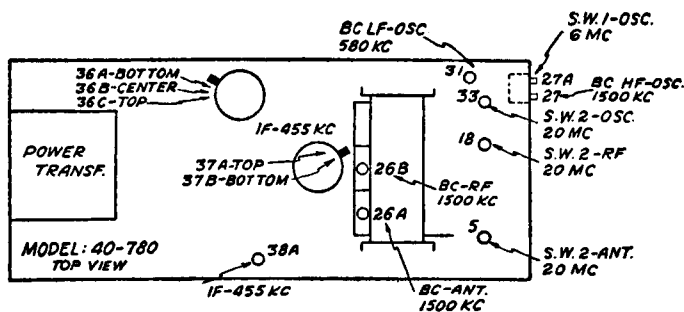

MODEL 40-2710

Signal Generator Connection	Dummy Antenna	Signal Generator Frequency	Receiver Wave-band Switch	Receiver Dial Setting	Trimmer Number
Ant.	0.1 mf	455 kc	B.C.	580 kc ¹	23A
"	"	"	"	"	19A
"	"	"	"	"	19B
"	400 ohms	21 mc	S.W.	21 mc	41B ²
"	"	"	"	20.090 mc	Image check
"	"	"	"	21 mc	41A
"	200 mmf	1500 kc	B.C.	1500 kc	14A
"	"	580 kc	"	580 kc	15A ^{3,*}
"	"	1500 kc	"	1500 kc	14A
"	"	300 kc	L.W.	300 kc	14
"	"	175 kc	"	175 kc	15 ^{4,*}
"	"	300 kc	"	300 kc	14

Note 1.—DIAL CALIBRATION: With tuning-condenser in closed (maximum capacity) position, set dial pointer on the first mark on the left edge (low frequency end) of the broadcast scale.

Note 2.—When adjusting (41B) be sure to tune in the fundamental signal (21 mc) instead of the image signal. If correctly adjusted, the image signal will be found by turning dial 910 kc below the fundamental signal, which will be 20.090 mc.

Note 3.—Nut adjustment.

Note 4.—Screw adjustment.

* While rocking.

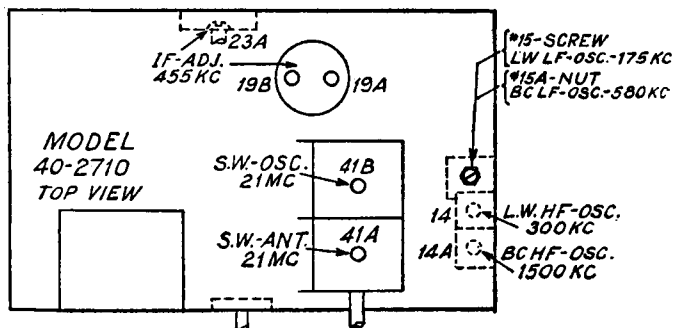

MODEL 40-2725

Signal Generator Connection	Dummy Antenna	Signal Generator Frequency	Receiver Wave-band Switch	Receiver Dial Setting	Trimmer Number
Grid cap of 6J8G	0.1 mf	455 kc	B.C.	580 kc ¹	38B
"	"	"	"	"	38A
"	"	"	"	"	32B
"	"	"	"	"	32A
Ant.	200 mmf	1500 kc	"	1500 kc	27
"	"	"	"	"	22B
"	"	"	"	"	22A
"	"	580 kc	"	580 kc	23 *
"	"	1500 kc	"	1500 kc	27
"	"	"	"	"	22B
"	"	"	"	"	22A
"	"	300 kc	L.W.	300 kc	27A
"	"	175 kc	"	175 kc	28 *
"	"	300 kc	"	300 kc	27A
"	400 ohms	21 mc	S.W.	21 mc	29 ²
"	"	"	"	20.090 mc	Image check
"	"	"	"	"	15
"	"	"	"	"	5

Note 1.—DIAL CALIBRATION: With tuning-condenser closed (maximum capacity), set the dial pointer on the first mark on the left edge (low frequency end) of the broadcast scale.

Note 2.—When adjusting (29) be sure to tune in the fundamental signal (21 mc) instead of the image signal. If correctly adjusted, the image signal will be 910 kc below the fundamental signal, which will be 20.090 mc.

* While rocking.

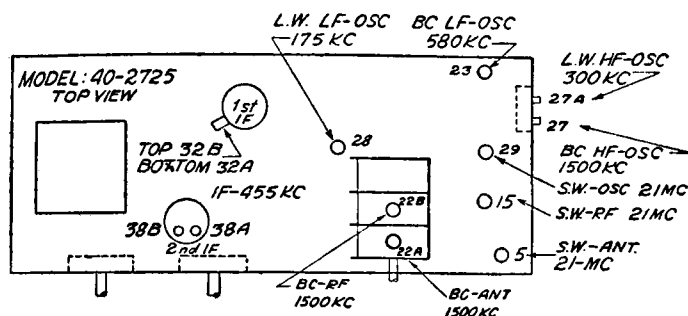

MODEL 40-2780

Signal Generator Connection	Dummy Antenna	Signal Generator Frequency	Receiver Wave-band Switch	Receiver Dial Setting	Trimmer Number
Grid cap of 6J8G	36B ¹
"	0.1 mf	455 kc	B.C.	580 kc ²	38A
"	"	"	"	"	37A
"	"	"	"	"	37B
"	"	"	"	"	36A
"	"	"	"	"	36C
"	"	"	"	"	36B
Ant.	200 mmf	1500 kc	"	1500 kc	27
"	"	"	"	"	26B
"	"	"	"	"	26A
"	"	580 kc	"	580 kc	31*
"	"	1500 kc	"	1500 kc	27
"	"	"	"	"	26B
"	"	"	"	"	26A
"	"	300 kc	L.W.	300 kc	27A
"	"	175 kc	"	175 kc	32*
"	"	300 kc	"	300 kc	27A
"	400 ohms	20 mc	S.W.	20 mc	33 ³
"	"	"	"	19.090 mc	Image check
"	"	"	"	20 mc	18
"	"	"	"	"	5

Note 1.—Turn trimmer (36B) all the way out.

Note 2.—DIAL CALIBRATION: With tuning condenser closed (maximum capacity), set the dial pointer on the first mark on the left edge (low frequency end) of the broadcast scale.

Note 3.—When adjusting (33), be sure to tune in the fundamental signal (20 mc) instead of the image signal. If correctly adjusted, the image signal will be 910 kc below the fundamental signal, which will be 19.090 mc.

* While rocking.

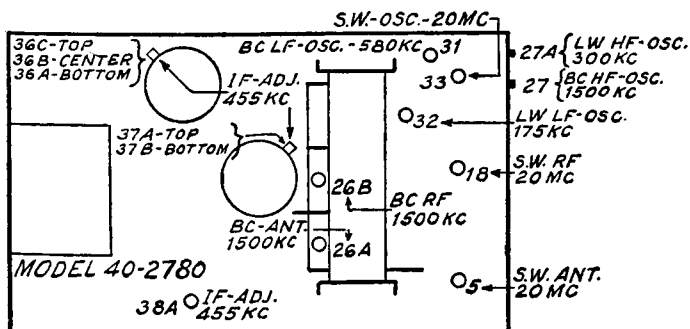

MODELS 41-81, 41-83, 41-84, PT-89

Signal Generator Connection	Dummy Antenna	Signal Generator Frequency	Receiver Wave-band Switch	Receiver Dial Setting	Trimmer Number
Control grid of 1A7G	0.1 mf	455 kc	...	Tuning-cond. ¹ fully closed	1
"	"	"	...	"	2
"	"	"	...	"	3
..... Note 2		1500 kc	...	1500 kc	4
"		"	...	"	5

Note 1.—DIAL CALIBRATION: With tuning-condenser at maximum-capacity position (fully closed), set tuning pointer on small dot at low-frequency end of scale.

Note 2.—Construct loop aerial of several turns of wire, and connect to signal-generator output terminals—place near receiver loop.

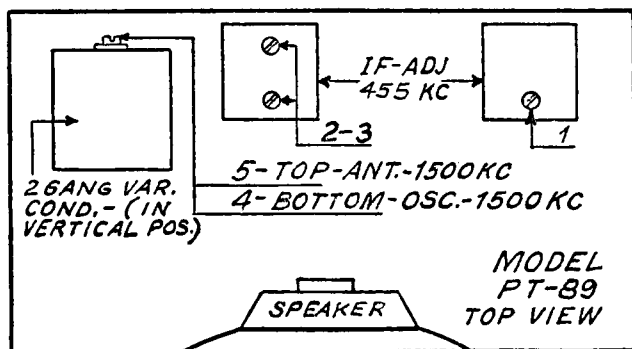
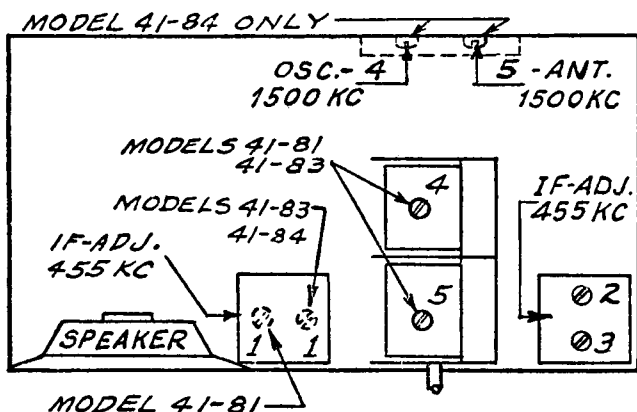

MODELS 41-85, 41-851

Signal Generator Connection	Dummy Antenna	Signal Generator Frequency	Receiver Wave-band Switch	Receiver Dial Setting	Trimmer Number
Note 1	0.1 mf	455 kc	B.C.	540 ²	1
"	"	"	"	"	2
"	"	"	"	"	3
..... Note 3		1500 kc	"	1500 kc	Note 4
"		"	"	"	Note 5
"		580 kc	"	580 kc	6 ⁶ , *
"		1500 kc	"	1500 kc	Note 4
"		"	"	"	Note 5
"		6 mc	S.W.	6 mc	7 ⁷ , *
"		15 mc	"	15 mc	8 ⁸
"		"	"	14.090 mc	Image check
"		"	"	15 mc	9

Note 1.—When adjusting i-f trimmers, the high side of signal-generator is connected through 0.1 mf condenser to loop-section stator lug of tuning-condenser.

Note 2.—DIAL CALIBRATION: With tuning-condenser fully closed (maximum capacity), set dial pointer on small dot below 550 kc.

Note 3.—When aligning r-f trimmers, a loop antenna is made from a few turns of wire and connected to signal-generator output terminals; this loop being placed a few feet from receiver loop.

Note 4.—Trimmer (4) on Model 41-85 or (5) on Model 41-851.

Note 4.—Trimmer (5) on Model 41-85 or (4) on Model 41-851.

Note 6.—Trimmer (6) is nut adjustment.

Note 7.—Trimmer (7) is screw adjustment.

Note 8.—Adjust to maximum on fundamental-signal peak.

* While rocking.

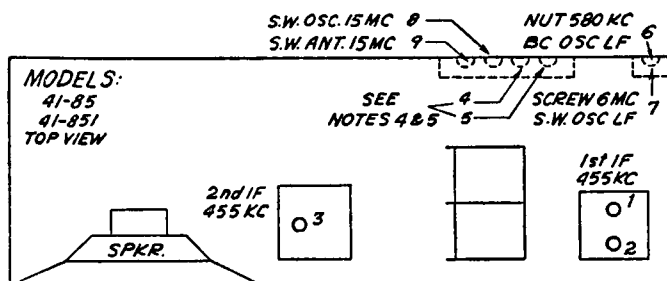

MODEL 41-90

Signal Generator Connection	Dummy Antenna	Signal Generator Frequency	Receiver Wave-band Switch	Receiver Dial Setting	Trimmer Number
Control grid of 1A7G	0.1 mf	455 kc	...	540 kc ¹	1
"	"	"	...	"	2
"	"	"	...	"	3
Ant. term.	225 mmf	1500 kc	...	1500 kc	4
"	"	"	...	"	5

Note 1.—DIAL CALIBRATION: With tuning-condenser in closed position (maximum capacity) set dial pointer on small dash below 540 kc.

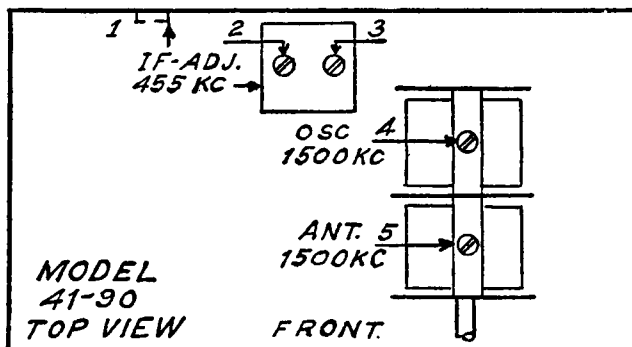

MODELS 41-95, 41-100

Signal Generator Connection	Dummy Antenna	Signal Generator Frequency	Receiver Wave-band Switch	Receiver Dial Setting	Trimmer Number
Control grid of 1A7G	0.1 mf	455 kc	...	540 kc ¹	1
"	"	"	...	"	2
"	"	"	...	"	3
Ant. term.	225 mmf	1500 kc	...	1500 kc	4
"	"	"	...	"	5

Note 1.—DIAL CALIBRATION: With tuning-condenser in closed position (maximum capacity) set dial pointer on small dash below 540 kc.

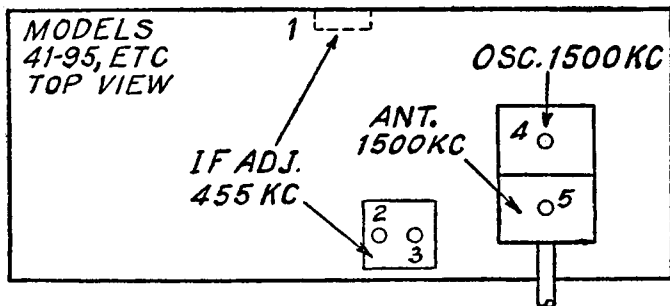

MODEL 41-105

Signal Generator Connection	Dummy Antenna	Signal Generator Frequency	Receiver Wave-band Switch	Receiver Dial Setting	Trimmer Number
Control grid of 1A7G	0.1 mf	455 kc	B.C.	540 kc ¹	1
"	"	"	"	"	2
"	"	"	"	"	3
Ant. term.	225 mmf	1500 kc	"	1500 kc	4
"	"	"	"	"	5
"	"	580 kc	"	580 kc	6*
"	"	1500 kc	"	1500 kc	4
"	"	"	"	"	5
"	400 ohms	12 mc	S.W.	12 mc	7 ²
"	"	12.910 mc	"	"	Image check

Note 1.—DIAL CALIBRATION: With tuning-condenser in closed position (maximum capacity) set dial pointer on small dash below 540 kc.

Note 2.—When adjusting trimmer (7) be sure to tune in fundamental signal (12 mc) instead of image signal. If trimmer is correctly adjusted, the image will be found by turning generator 910 kc above fundamental signal which will be 12.910 mc.

* While rocking.

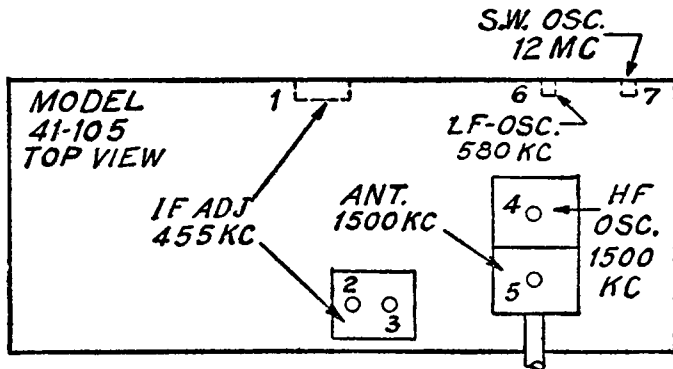

MODEL 41-110

Signal Generator Connection	Dummy Antenna	Signal Generator Frequency	Receiver Wave-band Switch	Receiver Dial Setting	Trimmer Number
Control grid of 1A7G	0.1 mf	455 kc	B.C.	540 kc ¹	15A
"	"	"	"	"	15B
"	"	"	"	"	22A
Ant. term.	225 mmf	1500 kc	"	1500 kc	6B
"	"	"	"	"	6A
"	"	"	"	"	2B
"	"	580 kc	"	580 kc	19B*
"	"	1500 kc	"	1500 kc	6B
"	"	"	"	"	6A
"	"	"	"	"	2B
"	400 ohms	12 mc	S.W.	12 mc	19A
"	"	"	"	"	13A
"	"	"	"	"	2A

Note 1.—DIAL CALIBRATION: With tuning condenser in closed position (maximum capacity) set dial pointer on small dash below 540 kc.

* While rocking.

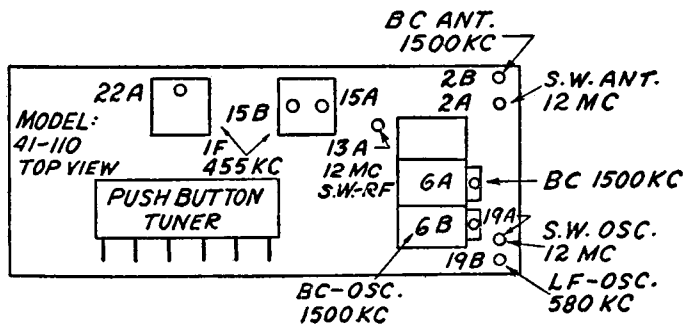

MODELS 41-220, 41-225

Signal Generator Connection	Dummy Antenna	Signal Generator Frequency	Receiver Wave-band Switch	Receiver Dial Setting	Trimmer Number
Ant. Sect.	0.1 mf	455 kc	B.C.	540 kc ¹	26A
Tuning Con.	"	"	"	"	23B
"	"	"	"	"	23A
..... Note 2		1600 kc	"	1600 kc	5B ³
"		1500 kc	"	1550 kc	5A ³

Note 1.—DIAL CALIBRATION: Turn tuning condenser to maximum capacity position (plates fully meshed). With condenser in this position, set tuning pointer on extreme left index line at low frequency end of broadcast scale.

Note 2.—When adjusting r-f trimmers a loop is made from a few turns of wire and connected to signal generator output terminals, this loop being placed close to receiver loop.

Note 3.—Located on tuning condenser.

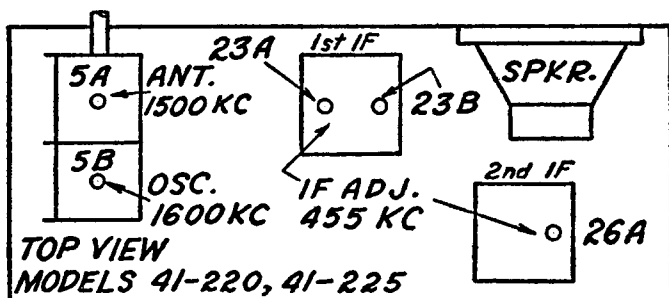

MODELS 41-221, 41-226, 41-231

Signal Generator Connection	Dummy Antenna	Signal Generator Frequency	Receiver Wave-band Switch	Receiver Dial Setting	Trimmer Number
Ant. Sect. Tuning Cond.	0.1 mf	455 kc	B.C.	540 kc ¹	37A
"	"	"	"	"	31A
"	"	"	"	"	31B
"	"	"	"	"	25A
"	"	"	"	"	25B
..... Note 2		1600 kc	"	1600 kc	15
"		1500 kc	"	1500 kc	6
"		12 mc	S.W.	12 mc	15A ³
"		"	"	"	8*

Note 1.—DIAL CALIBRATION: With tuning condenser plates fully meshed (maximum capacity) set tuning pointer on small dot below 550 kc.

Note 2.—When aligning r-f trimmers a loop is made from a few turns of wire and connected to signal generator output terminals, this loop being placed close to receiver loop.

Note 3.—When adjusting oscillator trimmer (15A), tune for maximum on the first signal peak from tight position (trimmer closed).

* While rocking.

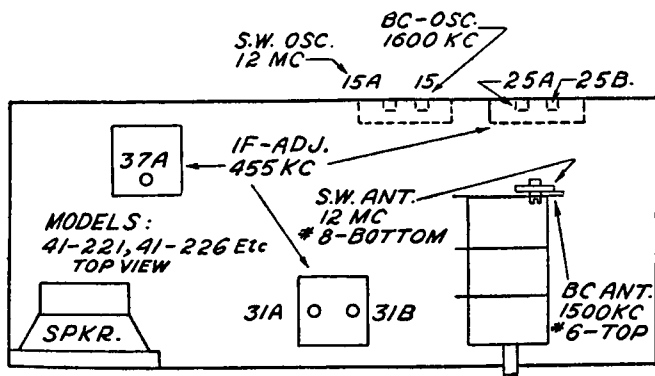

MODELS 41-230, 41-235

Signal Generator Connection	Dummy Antenna	Signal Generator Frequency	Receiver Wave-band Switch	Receiver Dial Setting	Trimmer Number
Ant. Sect. Tuning Cond.	0.1 mf	455 kc	B.C.	540 kc ¹	32A
"	"	"	"	"	20A
"	"	"	"	"	17B
"	"	"	"	"	17A
..... Note 2		1600 kc	"	1600 kc	7B
"		1500 kc	"	1500 kc	7A

Note 1.—DIAL CALIBRATION: With tuning condenser plates fully meshed (maximum capacity) set tuning pointer on extreme left index line at low frequency end of broadcast scale.

Note 2.—When aligning r-f trimmers a loop is made from a few turns of wire and connected to signal generator output terminals, this loop being placed close to receiver loop.

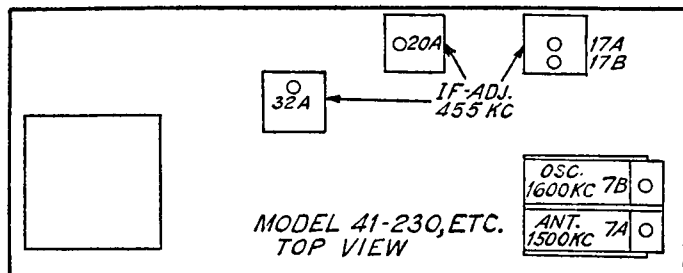

MODEL 41-240

Signal Generator Connection	Dummy Antenna	Signal Generator Frequency	Receiver Wave-band Switch	Receiver Dial Setting	Trimmer Number
Ant. Sect. Tuning Cond.	0.1 mf	455 kc	B.C.	Note 1	28A
"	"	"	"	"	15A
"	"	"	"	"	14A ²
"	"	"	"	"	14B
..... Note 3		1500 kc	"	1500 kc	20A
"		"	"	"	6
"		580 kc	"	580 kc	20*
"		1500 kc	"	1500 kc	20A
"		"	"	"	6
"		9.5 mc	S.W.	9.5 mc	19 ⁴
"		"	"	"	6A ⁵
"		12 mc	"	12 mc	19 ⁶
"		"	"	"	6A ^{7,*}

Note 1.—Tuning condenser fully closed.

DIAL CALIBRATION: With condenser in this position, set tuning pointer on extreme left index line at low frequency end of broadcast scale.

Note 2.—Turn trimmer (14A) all the way up, then slowly turn down and select first i-f peak.

Note 3.—When aligning r-f trimmers, a loop is made from a few turns of wire and connected to signal generator output terminals, this loop being placed close to receiver loop.

Note 4.—Set pointer at 9.5 mc and adjust trimmer (19) to second peak from tight position.

Note 5.—Adjust trimmer (6A) to first peak from tight position.

Note 6.—Tune in 2nd signal peak from tight position.

Note 7.—Rock padder (6A) slowly to maximum on first peak from tight position.

* While rocking.

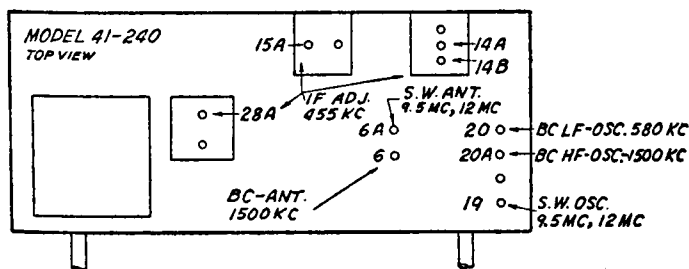

MODEL 41-245

Signal Generator Connection	Dummy Antenna	Signal Generator Frequency	Receiver Wave-band Switch	Receiver Dial Setting	Trimmer Number
Ant. Sect.	0.1 mf	455 kc	B.C.	Note 1	33A
Tuning Cond.	"	"	"	"	30A
"	"	"	"	"	29A ²
"	"	"	"	"	29B
..... Note 3	1500 kc	"	1500 kc	17A
"	"	"	"	"	9
"	"	580 kc	"	580 kc	17*
"	"	"	"	"	17A
"	"	"	"	"	9
"	"	6 mc	Police	6 mc	19*
"	"	9.5 mc	S.W.	9.5 mc	19A ⁴
"	"	"	"	"	5 ⁵
"	"	12 mc	"	12 mc	19A ⁶
"	"	"	"	"	5 ⁷ , *

Note 1.—Tuning condenser fully closed.

DIAL CALIBRATION: With condenser in this position, set tuning pointer on extreme left index line at low frequency end of broadcast scale.

Note 2.—Turn trimmer (29A) all the way up, then slowly turn down and select first i-f peak.

Note 3.—When aligning r-f trimmers, a loop is made from a few turns of wire and connected to signal generator output terminals, this loop being placed close to receiver loop.

Note 4.—Set pointer at 9.5 mc and adjust trimmer (19A) to second peak from tight position.

Note 5.—Adjust padder (5) to first peak from tight position.

Note 6.—Tune in 2nd signal peak from tight position.

Note 7.—Rock padder (5) slowly to maximum on first peak from tight position.

* While rocking.

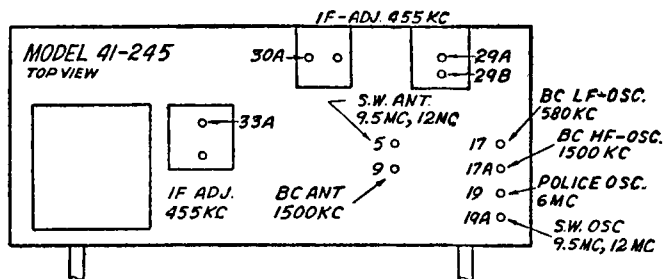

MODEL 41-246

Signal Generator Connection	Dummy Antenna	Signal Generator Frequency	Receiver Wave-band Switch	Receiver Dial Setting	Trimmer Number
Ant. Sect. Tuning Cond.	0.1 mf	455 kc	B.C.	Note 1	34A
"	"	"	"	"	30A
"	"	"	"	"	28A ²
"	"	"	"	"	28B
..... Note 3		1500 kc	"	1500 kc	11A
"		"	"	"	9B
"		580 kc	"	580 kc	11B *
"		1500 kc	"	1500 kc	11A
"		"	"	"	9B
"		12 mc	S.W.	12 mc	12A ⁴
"		"	"	"	9A
"		18 mc	"	18 mc	12B ⁵

Note 1.—Tuning condenser plates fully closed.

DIAL CALIBRATION: With condenser in this position, set tuning pointer on extreme left index line at low frequency end of broadcast scale.

Note 2.—Turn trimmer (28A) all the way up, then slowly turn down and select first i-f peak.

Note 3.—When aligning r-f trimmers a loop is made from a few turns of wire and connected to signal generator output terminals, this loop being placed close to receiver loop.

Note 4.—Adjust trimmer (12A) to first signal peak from tight position.

Note 5.—Adjust trimmer (12B) to second signal peak from tight position.

* While rocking.

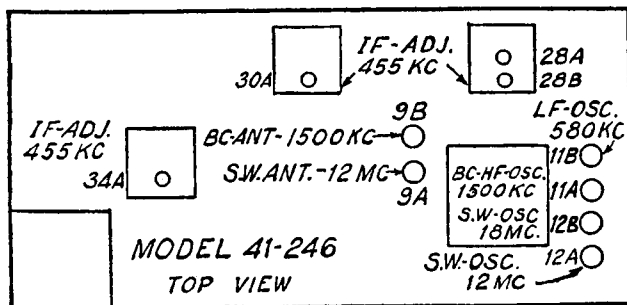

MODELS 41-250, 41-255; 41-280, 41-285, 41-287, 41-290

Signal Generator Connection	Dummy Antenna	Signal Generator Frequency	Receiver Wave-band Switch	Receiver Dial Setting	Trimmer Number
Note 1	0.1 mf	455 kc	S.W.	580 kc ²	1
"	"	"	"	"	2
"	"	"	"	"	3
"	"	"	"	"	4
..... Note 3.....		1500 kc	B.C.	1500 kc	5
"		"	"	"	6
"		580 kc	"	580 kc	7*
"		1500 kc	"	1500 kc	5
"		"	"	"	6
"		6 mc	Police	6 mc	8
"		12 mc	S.W.	12 mc	9 ⁴
"		"	"	12.910 mc	Image check
"		"	"	12 mc	10 ^{5, *}

Note 1.—Connect high side of signal generator through a 0.1 mf condenser to terminal 4 of loop antenna terminal panel at rear of the chassis.

Note 2.—DIAL CALIBRATION: With tuning condenser closed (maximum capacity), set dial pointer on extreme left index line at low frequency end of broadcast scale.

Note 3.—When aligning r-f trimmers a loop is made from a few turns of wire and connected to signal generator output terminals, this loop then being placed two or three feet from loop in cabinet. It is necessary that receiver be left in cabinet when adjusting trimmers.

Note 4.—Turn oscillator trimmer (9) to maximum capacity position (clockwise). From this position slowly turn trimmer counter-clockwise until a first peak is obtained on output meter. Adjust trimmer for maximum output at this first peak.

Note 5.—The aerial compensator (10) must be adjusted to maximum by rocking tuning condenser. If two signal peaks occur when turning the compensator, adjust to maximum output on second signal peak from tight position.

* While rocking.

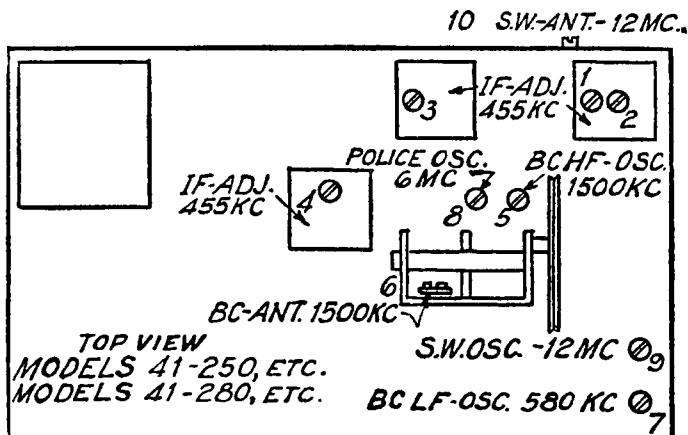

MODEL 41-256

Signal Generator Connection	Dummy Antenna	Signal Generator Frequency	Receiver Wave-band Switch	Receiver Dial Setting	Trimmer Number
Note 1	0.1 mf	455 kc	S.W.	580 kc ²	15A
"	"	"	"	"	15B
"	"	"	"	"	38A
"	"	"	"	"	43A
..... Note 3		1500 kc	B.C.	1500 kc	27
"		"	"	"	7A
"		580 kc	"	580 kc	25*
"		1500 kc	"	1500 kc	27
"		"	"	"	7A
"		12 mc	S.W.1	12 mc	27B ⁴
"		"	"	"	8A ^{5,*}
"		18 mc	S.W.2	18 mc	27A ⁶
"		"	"	"	87,*

Note 1.—When adjusting i-f trimmers, the high side of the signal generator is connected through a 0.1 mf condenser to terminal (3) of loop-antenna terminal panel at rear of chassis.

Note 2.—DIAL CALIBRATION: With tuning condenser closed (maximum capacity), set dial pointer on extreme left index line at low frequency end of broadcast scale.

Note 3.—When aligning r-f trimmers, a loop is made from a few turns of wire and connected to signal generator output terminals; this loop then being placed two or three feet from the loop in cabinet. When adjusting trimmers it is necessary that receiver be left in cabinet.

Note 4.—Adjust trimmer (27B) to *first* peak from closed position.

Note 5.—The antenna trimmer (8A) must be adjusted to maximum on *second* signal peak by rocking tuning condenser.

Note 6.—Adjust trimmer (27A) to *second* signal peak from closed position.

Note 7.—The antenna trimmer (8) must be adjusted to maximum on *first* signal peak while rocking tuning condenser.

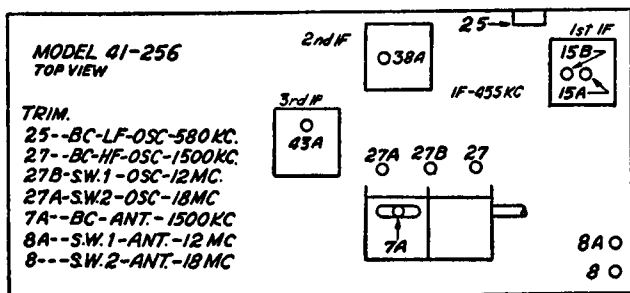

MODEL 41-258 (122)

Signal Generator Connection	Dummy Antenna	Signal Generator Frequency	Receiver Wave-band Switch	Receiver Dial Setting	Trimmer Number
Ant. sect.	0.1 mf	455 kc	B.C.‡	Note 1	16A
Tuning cond.	"	"	"	"	16B
"	"	"	"	"	22A
"	"	"	"	"	22B
"	"	"	"	"	25A
..... Note 2		1600 kc	"	1600 kc	6B ^s
"		1500 kc	"	1500 kc	6A ^s

Note 1.—DIAL CALIBRATION: With condenser plates fully closed (maximum capacity), set tuning pointer on small dot below 55 on dial.

Note 2.—When aligning r-f trimmers a loop is made from a few turns of wire and connected to signal generator output terminals, this loop being placed close to receiver loop.

Note 3.—Located on tuning condenser.

‡ The police band is automatically aligned at time of broadcast alignment.

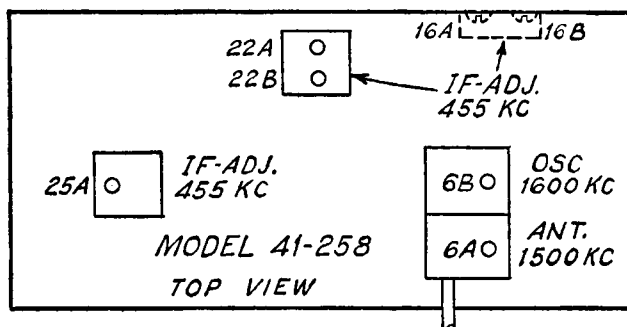

MODELS 41-260, 41-265

Signal Generator Connection	Dummy Antenna	Signal Generator Frequency	Receiver Wave-band Switch	Receiver Dial Setting	Trimmer Number
Ant. sect. tuning-cond.	0.1 mf	455 kc	B.C.	Tuning-cond. ¹ fully closed	35A
"	"	"	"	"	29A
"	"	"	"	"	22A ²
"	"	"	"	"	22B
..... Note 3		1720 kc	"	1720 kc	6A
"		1500 kc	"	1500 kc	14
"		580 kc	"	580 kc	14A *
"		1720 kc	"	1720 kc	6A
"		1500 kc	"	1500 kc	14
"		6.0 mc ⁴	Police ⁴	6.0 mc ⁴	6 ⁴ , *
"		12.0 mc ⁶	S.W. ⁵	12.0 mc ⁵	6 ⁵ , 6
"		12.0 mc ⁴	S.W. ⁴	12.0 mc ⁴	6B ⁴ , 6
"		12.0 mc	S.W.	12.0 mc	15 ⁶ , *

Note 1.—The receiver can be adjusted in the cabinet, or removed from the cabinet. If adjustments are made outside the cabinet, a Service Tuning Scale . . . Part No. 45-2825, Model 41-260 or Part No. 45-2826, Model 41-265 . . . will be required. This scale is placed underneath the pointer on the metal dial plate.

DIAL CALIBRATION: With tuning-condenser in maximum-capacity position, set tuning pointer on the extreme left index line at low-frequency end of broadcast scale.

Note 2.—Turn (22A) all the way "up," then turn "down"—adjusting to maximum on first peak.

Note 3.—When aligning the RF trimmers, a loop is made from a few turns of wire and connected to the signal generator output terminals—the signal generator is then placed close to the loop of the radio. When adjusting the radio outside the cabinet, the loop aerial should be placed in approximately the same position around or near the chassis, as when assembled.

Note 4.—On Model 41-265 only.

Note 5.—On Model 41-260 only.

Note 6.—Adjust to maximum on first peak from "tight" position.

* While rocking.

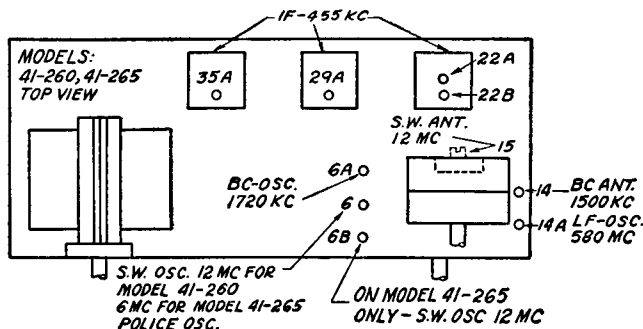

MODELS 41-295, 41-300

Signal Generator Connection	Dummy Antenna	Signal Generator Frequency	Receiver Wave-band Switch	Receiver Dial Setting	Trimmer Number
Note 1	0.1 mf	455 kc	S.W. 1	580 kc ²	36A
"	"	"	"	"	36B
"	"	"	"	"	37A
"	"	"	"	"	37B
"	"	"	"	"	42A
..... Note 3		1500 kc	B.C.	1500 kc	20A
"		"	"	"	10A
"		580 kc	"	580 kc	20*
"		1500 kc	"	1500 kc	20A
"		"	"	"	10A
"		6 mc	Police	6 mc	21 ⁴ , *
"		12 mc	S.W. 1	12 mc	21A ⁵
"		11.090 mc	"	12 mc	Image check
"		12 mc	"	12 mc	9A
"		18 mc	S.W. 2	18 mc	21B ⁶
"		18.910 mc	"	18 mc	Image check
"		18 mc	"	18 mc	9*

Note 1.—When adjusting the i-f trimmers, the high side of the signal generator is connected through a 0.1 mf condenser to terminal 4 of the loop antenna terminal panel at the rear of the chassis.

Note 2.—With the tuning condenser closed (maximum capacity), set the dial pointer on the extreme left index line at the low frequency end of the broadcast scale.

Note 3.—When aligning the r-f trimmers a loop is made from a few turns of wire and connected to the signal generator output terminals, this loop being placed two or three feet from the loop in the cabinet.

Note 4.—Adjust trimmer (21) to the second signal peak from the tight (closed) position.

Note 5.—Adjust trimmer (21A) to the first signal peak from the tight (closed) position.

Note 6.—Adjust trimmer (21B) to the second signal peak from the tight (closed) position.

* While rocking.

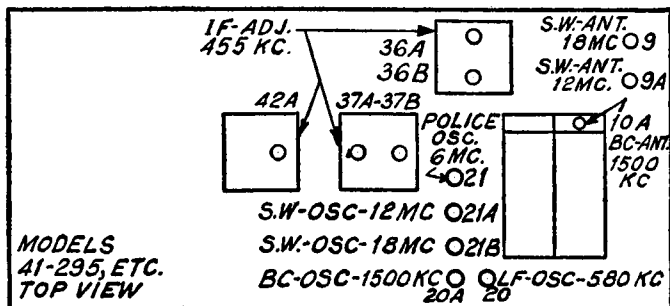

MODELS 41-316, 41-616P, 41-616PN

Signal Generator Connection	Dummy Antenna	Signal Generator Frequency	Receiver Wave-band Switch	Receiver Dial Setting	Trimmer Number
Note 1	0.1 mf	455 kc	S.W. 1	580 kc ²	1
"	"	"	"	"	2
"	"	"	"	"	3
"	"	"	"	"	4
"	"	"	"	"	5
..... Note 3		1500 kc	B.C.	1500 kc	6
"		"	"	"	7
"		580 kc	"	580 kc	8*
"		1500 kc	"	1500 kc	6
"		"	"	"	7
"		6 mc	Police	6 mc	9 ⁴
"		12 mc	S.W. 1	12 mc	10 ⁵
"		11.090 mc	"	"	Image check
"		12 mc	"	"	11
"		18 mc	S.W. 2	18 mc	12 ⁶
"		18.910 mc	"	18 mc	Image check
"		18 mc	"	18 mc	13

Note 1.—When adjusting i-f trimmers, the high side of signal generator is connected through a 0.1 mf condenser to terminal 3 of loop antenna terminal panel at rear of chassis.

Note 2.—DIAL CALIBRATION: With tuning condenser closed (maximum capacity), set dial pointer on the extreme left index line at low frequency end of broadcast scale.

Note 3.—When aligning r-f trimmers a loop is made from a few turns of wire and connected to signal generator output terminals, this loop being placed two or three feet from loop in the cabinet.

Note 4.—Adjust trimmer (18B) to *second* signal peak from tight (closed) position.

Note 5.—Adjust trimmer (18A) to *first* signal peak from tight (closed) position.

Note 6.—Adjust trimmer (18) to *second* signal peak from tight (closed) position.

* While rocking.

For Mystery Control adjustments, see pages 177 and 181.

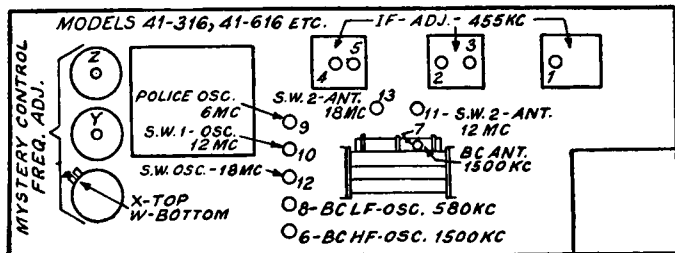

MODEL 41-601

Signal Generator Connection	Dummy Antenna	Signal Generator Frequency	Receiver Wave-band Switch	Receiver Dial Setting	Trimmer Number
Ant. sect. tuning-cond.	0.1 mf	455 kc	B.C.	540 kc ¹	12A
"	"	"	"	"	12B
"	"	"	"	"	10A
"	"	"	"	"	10B
..... Note 2		1600 kc	"	1600 kc	7B ³
"		1500 kc	"	1500 kc	7A ⁴

Note 1.—DIAL CALIBRATION: With tuning condenser fully closed (maximum capacity), set tuning pointer on first small line stamped in scale plate on left side.

Note 2.—When aligning r-f trimmers, a loop is made from a few turns of wire and connected to signal generator output terminals, this loop being placed close to receiver loop.

Note 3.—If receiver is removed from cabinet, turn tuning condenser until dial pointer is on first small line stamped in scale plate from right side of chassis.

Note 4.—If receiver is removed from cabinet, turn tuning condenser until dial pointer is on second small line stamped in scale plate from right side of chassis.

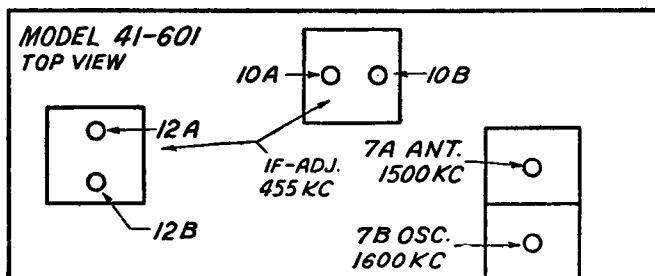

MODEL 41-602

Signal Generator Connection	Dummy Antenna	Signal Generator Frequency	Receiver Wave-band Switch	Receiver Dial Setting	Trimmer Number
Ant. sect. tuning-cond.	0.1 mf	455 kc	B.C.	Note 1	1
“	“	“	“	“	2
“	“	“	“	“	3
..... Note 2		1600 kc	“	1600 kc	4
“		1500 kc	“	1500 kc	5

Note 1.—Tuning condenser fully closed.

DIAL CALIBRATION: With condenser in this position, set tuning pointer on the small dot below 550 kc.

Note 2.—When aligning r-f trimmers a loop is made from a few turns of wire and connected to signal generator output terminals, this loop being placed close to receiver loop.

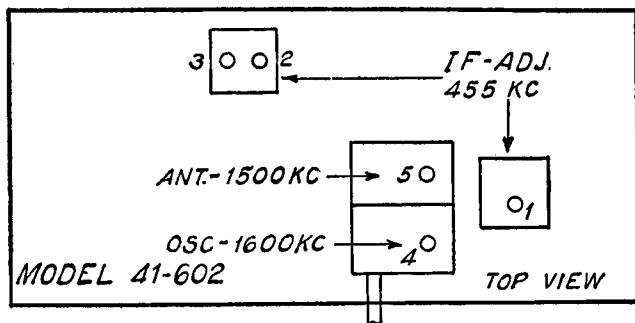

MODEL 41-603

Signal Generator Connection	Dummy Antenna	Signal Generator Frequency	Receiver Wave-band Switch	Receiver Dial Setting	Trimmer Number
Ant. sect. tuning-cond.	0.1 mf	455 kc	B.C.	Note 1	39A
"	"	"	"	"	23A
"	"	"	"	"	23B
"	"	"	"	"	22A
"	"	"	"	"	22B
..... Note 2		1600 kc	"	1600 kc	17A *
"		1500 kc	"	1500 kc	8
"		12 mc	S.W.	12 mc	17
"		"	"	"	4 *

Note 1.—DIAL CALIBRATION: With tuning condenser plates fully meshed (maximum capacity), set tuning pointer on small dot below 550 kc.

Note 2.—When aligning r-f trimmers a loop is made from a few turns of wire and connected to signal generator output terminals, this loop then being placed close to receiver loop.

Note 3.—When adjusting oscillator trimmer (17A), tune for maximum output signal on first signal peak from tight position.

* While rocking.

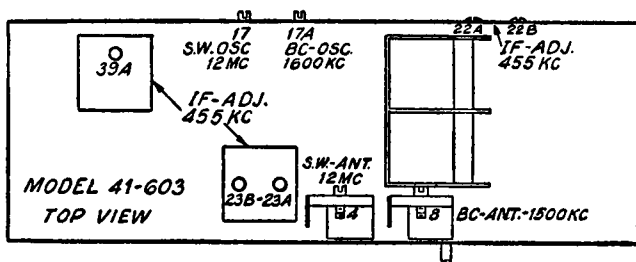

MODELS 41-604, 41-605, 41-607

Signal Generator Connection	Dummy Antenna	Signal Generator Frequency	Receiver Wave-band Switch	Receiver Dial Setting	Trimmer Number
Ant. sect. tuning-cond.	0.1 mf	455 kc	B.C.	Note 1	39A
"	"	"	"	"	23A
"	"	"	"	"	23B
"	"	"	"	"	22A
"	"	"	"	"	22B
..... Note 2		1600 kc	"	1600 kc	17A ^a
"		1500 kc	"	1500 kc	8
"		12 mc	S.W.	12 mc	17
"		"	"	"	4*

Note 1.—DIAL CALIBRATION: With tuning condenser plates fully meshed (maximum capacity), set tuning pointer on small dot below 550 kc.

Note 2.—When aligning r-f trimmers a loop is made from a few turns of wire and connected to signal generator output terminals, this loop then being placed close to receiver loop.

Note 3.—When adjusting oscillator trimmer (17A), tune for maximum output signal on first signal peak from tight position.

* While rocking.

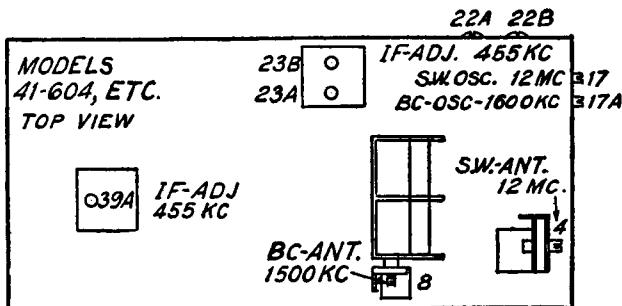

MODELS 41-608, 41-609 (121, 122)

Signal Generator Connection	Dummy Antenna	Signal Generator Frequency	Receiver Wave-band Switch	Receiver Dial Setting	Trimmer Number
Ant. sect. tuning-cond.	0.1 mf	455 kc	S.W.	Note 1	27A ²
"	"	"	"	"	27B
"	"	"	"	"	30A
"	"	"	"	"	40A
..... Note 3		1500 kc	B.C.	1500 kc	11A
"		"	"	"	7
"		580 kc	"	580 kc	7A *
"		1500 kc	"	1500 kc	11A
"		"	"	"	7
"		12 mc	S.W.	12 mc	11 ⁴
"		"	"	"	6 ⁵ , *

Note 1.—DIAL CALIBRATION: With tuning condenser plates fully meshed, set tuning pointer on extreme left index line at low frequency end of broadcast scale.

Note 2.—Turn trimmer (27A) all the way up, then turn down selecting first i-f peak.

Note 3.—When aligning r-f trimmers a loop is made from a few turns of wire and connected to signal generator output terminals, this loop then being placed close to receiver loop.

Note 4.—Adjust trimmer (11) to first signal peak from tight position.

Note 5.—Rock trimmer (6) slowly to maximum on second peak from loose position.

* While rocking.

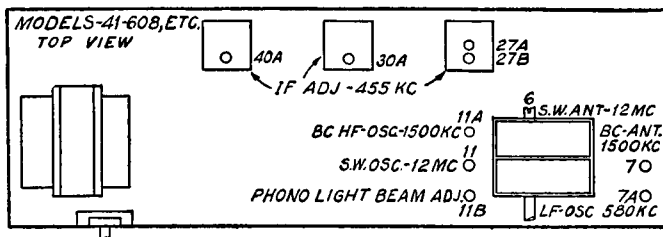

MODELS 41-610, 41-611

Signal Generator Connection	Dummy Antenna	Signal Generator Frequency	Receiver Wave-band Switch	Receiver Dial Setting	Trimmer Number
Note 1	0.1 mf	455 kc	S.W.	580 kc ²	1
"	"	"	"	"	2
"	"	"	"	"	3
"	"	"	"	"	4
..... Note 3		1500 kc	B.C.	1500 kc	5
"		"	"	"	6
"		580 kc	"	580 kc	7*
"		1500 kc	"	1500 kc	5
"		"	"	"	6
"		6 mc	Police	6 mc	8
"		12 mc	S.W.	12 mc	9 ⁴
"		"	"	12.910 mc	Image check
"		"	"	12 mc	10 ^{5,*}

Note 1.—Connect high side of signal generator through a 0.1 mf condenser to terminal 4 of loop antenna terminal panel at rear of the chassis.

Note 2.—DIAL CALIBRATION: With tuning condenser closed (maximum capacity), set dial pointer on extreme left index line at low frequency end of broadcast scale.

Note 3.—When aligning r-f trimmers a loop is made from a few turns of wire and connected to signal generator output terminals, this loop then being placed two or three feet from loop in cabinet. It is necessary that receiver be left in cabinet when adjusting trimmers.

Note 4.—Turn oscillator trimmer (9) to maximum capacity position (clockwise). From this position slowly turn trimmer counter-clockwise until a first peak is obtained on output meter. Adjust trimmer for maximum output at this first peak.

Note 5.—The aerial compensator (10) must be adjusted to maximum by rocking tuning condenser. If two signal peaks occur when turning the compensator, adjust to maximum output on second signal peak from tight position.

* While rocking.

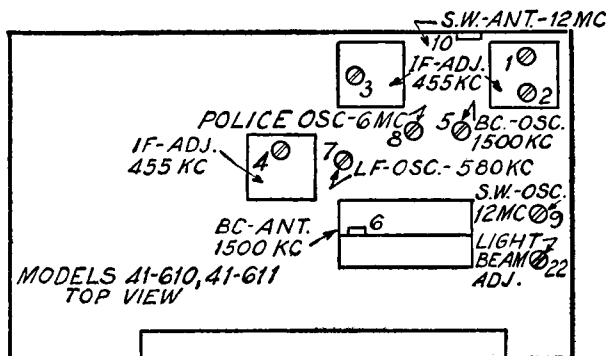

MODELS 41-623, 41-624, 41-625

Signal Generator Connection	Dummy Antenna	Signal Generator Frequency	Receiver Wave-band Switch	Receiver Dial Setting	Trimmer Number
Ant. sect. tuning-cond.	0.1 mf	455 kc	B.C.	Note 1	39A ²
"	"	"	"	"	36A
"	"	"	"	"	35A
"	"	"	"	"	35B
..... Note 3		1600 kc	"	1600 kc	3B
"		1500 kc	"	1500 kc	3A
"		12 mc	S.W.	12 mc	3C ⁴
"		"	"	"	3*

Note 1.—Tuning condenser fully closed.

DIAL CALIBRATION: With condenser in this position, set tuning pointer on small dot below 550 kc.

Note 2.—Before aligning i-f trimmers, first fully open trimmers (39A), (36A), (35A), (35B), and then align in sequence given above.

Note 3.—When aligning r-f trimmers a loop antenna is made from a few turns of wire and connected to signal generator output terminals, this loop then being placed close to receiver loop.

Note 4.—When adjusting oscillator trimmer (3C), adjust for maximum on first signal peak from tight position.

* While rocking.

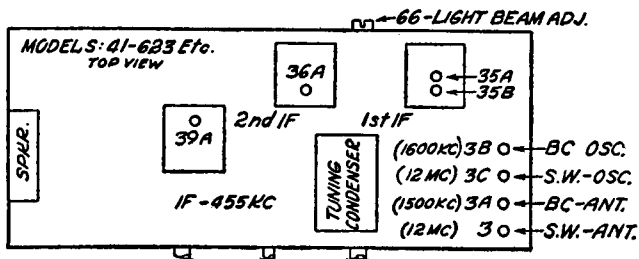

MODEL 41-629

Signal Generator Connection	Dummy Antenna	Signal Generator Frequency	Receiver Wave-band Switch	Receiver Dial Setting	Trimmer Number
Ant. sect. tuning-cond.	0.1 mf	455 kc	S.W.	Tuning-cond. ¹ fully closed	27A ²
"	"	"	"	"	27B
"	"	"	"	"	30A
"	"	"	"	"	40A
..... Note 3		1720 kc	B.C.	1720 kc	11A
"		1500 kc	"	1500 kc	7
"		580 kc	"	580 kc	37*
"		1720 kc	"	1720 kc	11A
"		12.0 mc	S.W.	12.0 mc	11 ⁴
"		"	"	"	6 ⁵ , *

Note 1.—DIAL CALIBRATION: With tuning-condenser in maximum-capacity position, set tuning pointer on the extreme left index line at low-frequency end of broadcast scale.

Note 2.—Turn (27A) all the way "up," then turn "down"—adjusting to maximum on first peak.

Note 3.—Construct a loop aerial, of several turns of wire—connect to signal-generator, and place close to receiver-loop. When adjusting receiver outside of cabinet, its loop aerial should be placed in approximately same position . . . around or near chassis . . . as when assembled in cabinet.

Note 4.—Adjust to maximum on *first* peak from "tight" position.

Note 5.—"Rock" slowly to maximum on *second* peak from "loose" position.

* While rocking.

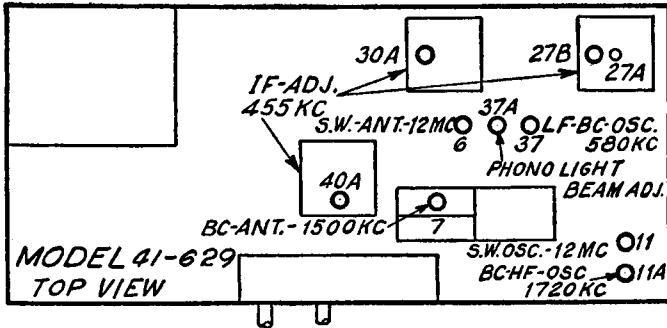

MODELS 41-695; 41-841

Signal Generator Connection	Dummy Antenna	Signal Generator Frequency	Receiver Wave-band Switch	Receiver Dial Setting	Trimmer Number
Note 1	0.1 mf	455 kc	...	540 kc ²	1
"	"	"	...	"	2
"	"	"	...	"	3
..... Note 3	1500 kc	...	1500 kc	4
"	"	"	...	"	5

Note 1.—On *Model 41-841*, when adjusting i-f trimmers, the high side of signal-generator is connected through 0.1 mf condenser to loop section (tuning-condenser) stator-lug; which connects to grid of first-detector oscillator tube. On *Model 41-695* (without loop), connection is also to ant. section of tuning-condenser through the 0.1 mf condenser.

Note 2.—DIAL CALIBRATION: With tuning condenser fully closed (maximum capacity), set dial pointer on small dot below 550 kc.

Note 3.—On *Model 41-841*, when aligning r-f trimmers, a loop antenna is made from a few turns of wire and connected to signal-generator output terminals; this loop being placed a few feet from receiver loop. On *Model 41-695* (without loop), connect signal-generator output through a 225 mmf condenser to antenna terminal.

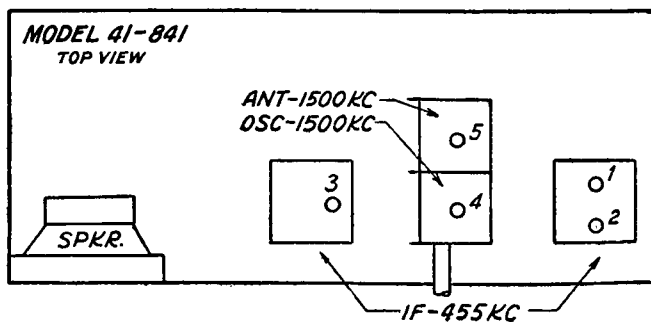
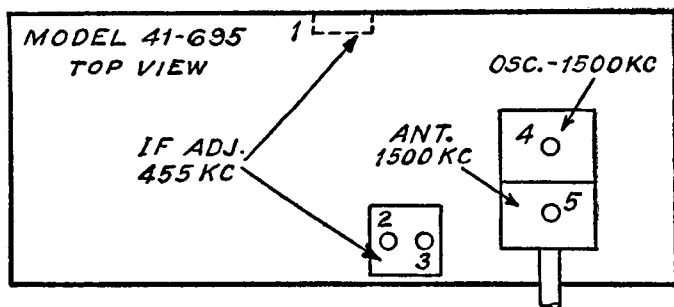

MODEL 41-705

Signal Generator Connection	Dummy Antenna	Signal Generator Frequency	Receiver Wave-band Switch	Receiver Dial Setting	Trimmer Number
Note 1	0.1 mf	455 kc	B.C. (1)	580 kc ²	19A
"	"	"	"	"	19B
"	"	"	"	"	22A
"	"	"	"	"	22B
Ant. lead	400 ohms	21 mc	S.W. (3)	21 mc	2B
"	"	"	"	20.090 mc	Image check
"	"	"	"	21 mc	2A
"	"	6 mc	S.W. (2)	6 mc	11*
"	200 mmf	1500 kc	B.C. (1)	1500 kc	11A
"	"	580 kc	"	580 kc	13*

Note 1.—When adjusting i-f trimmers, the high side of the signal generator is connected through a 0.1 mf condenser to lug of antenna tuning condenser, front section.

Note 2.—DIAL CALIBRATION: With tuning condenser fully closed, set dial pointer on first mark on left edge (low frequency end) of broadcast scale.

* While rocking.

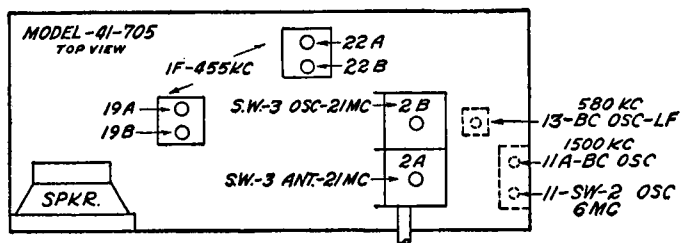

MODEL 41-708

Signal Generator Connection	Dummy Antenna	Signal Generator Frequency	Receiver Wave-band Switch	Receiver Dial Setting	Trimmer Number
Note 1	0.1 mf	455 kc	B.C. (1)	580 kc ²	2
"	"	"	"	"	3
"	"	"	"	"	1
Ant. lead	400 ohms	21 mc	S.W. (3)	21 mc	4
"	"	"	"	20.090 mc	Image check
"	"	"	"	"	5
"	"	6 mc	S.W. (2)	6 mc	6*
"	200 mmf	1500 kc	B.C. (1)	1500 kc	7
"	"	580 kc	"	580 kc	8*

Note 1.—When adjusting i-f trimmers, the high side of signal generator is connected through a 0.1 mf condenser to lug of antenna tuning condenser, front section.

Note 2.—DIAL CALIBRATION: With tuning condenser fully closed maximum capacity), set dial pointer on first mark on left edge (low frequency end) of broadcast scale.

* While rocking.

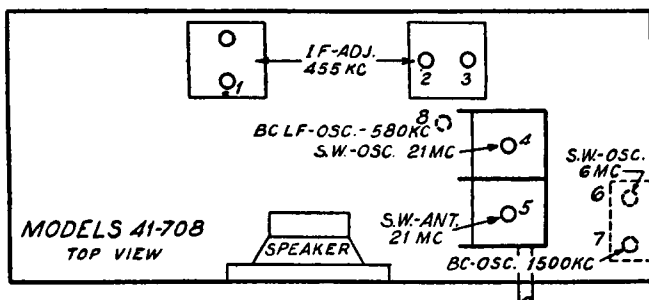

MODELS 41-712, 41-713, 41-714

Signal Generator Connection	Dummy Antenna	Signal Generator Frequency	Receiver Wave-band Switch	Receiver Dial Setting	Trimmer Number
Note 1	0.1 mf	455 kc	B.C. (1)	580 kc ²	2
"	"	"	"	"	3
"	"	"	"	"	1
Ant. lead	400 ohms	21 mc	S.W. (3)	21 mc	4
"	"	"	"	20.090 mc	Image check
"	"	"	"	"	5
"	"	6 mc	S.W. (2)	6 mc	6*
"	200 mmf	1500 kc	B.C. (1)	1500 kc	7
"	"	580 kc	"	580 kc	8*

Note 1.—When adjusting i-f trimmers, the high side of signal generator is connected through a 0.1 mf condenser to lug of antenna tuning condenser, front section.

Note 2.—DIAL CALIBRATION: With tuning condenser fully closed maximum capacity, set dial pointer on first mark on left edge (low frequency end) of broadcast scale.

* While rocking.

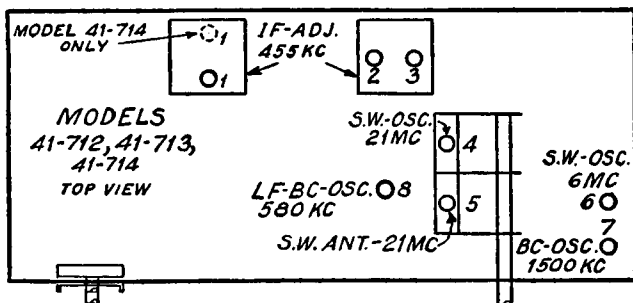

MODEL 41-788 (121, 122)

Signal Generator Connection	Dummy Antenna	Signal Generator Frequency	Receiver Wave-band Switch	Receiver Dial Setting	Trimmer Number
Note 1	0.1 mhf	455 kc	B.C.	580 kc ²	45A ³
"	"	"	"	"	45C
"	"	"	"	"	50A
"	"	"	"	"	50B
"	"	"	"	"	51A
"	"	"	"	"	45B
Ant. term.	200 mmf	1500 kc	"	1500 kc	34A
"	"	"	"	"	25X
"	"	"	"	"	4
"	"	580 kc	"	580 kc	34B [*]
"	"	1500 kc	"	1500 kc	34A
"	"	"	"	"	25X
"	"	"	"	"	4
"	400 ohms	6.0 mc	S.W. 1	6.0 mc	34C [*]
"	"	20 mc	S.W. 2	20 mc	38A
"	"	"	"	19.090 mc	Image check
"	"	"	"	20 mc	22A
"	"	"	"	"	8A ⁴
"	"	9.7 mc	Note 5	9.7 mc	38B
"	"	"	"	"	22B
"	"	"	"	"	8B ⁶
"	"	11.7 mc	Note 7	11.7 mc	38C
"	"	"	"	"	22C
"	"	"	"	"	8C ⁶
"	"	15.2 mc	Note 8	15.2 mc	44A
"	"	"	"	"	27A
"	"	"	"	"	11A ⁶
"	"	17.8 mc	Note 9	17.8 mc	44B
"	"	"	"	"	27B
"	"	"	"	"	11B ⁶
"	"	21.5 mc	Note 10	21.5 mc	44C
"	"	"	"	"	27C
"	"	"	"	"	11C ⁶

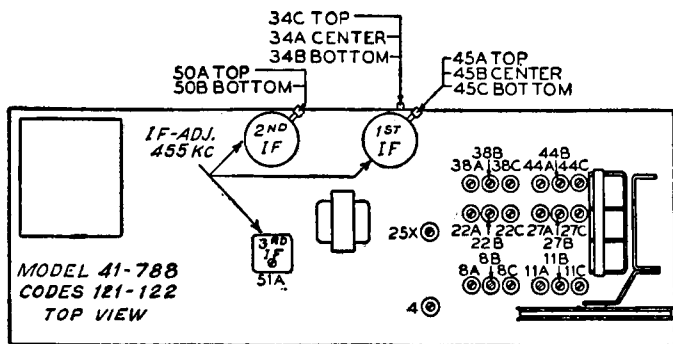

- Note 1.—Connect high side of signal generator through a 0.1 mf condenser to stator lug, middle section, of tuning condenser.
- Note 2.—With tuning condenser fully closed (maximum capacity) set dial pointer on the first mark on left edge (low frequency end) of broadcast scale.
- Note 3.—Before adjusting trimmer (45A), turn trimmer 45B to its full clockwise position (all the way out).
- Note 4.—Immediately after adjustment of trimmer (8A) has been completed, the following steps should be taken: (1) Turn band spread tuning control to extreme clockwise position (highest frequency). (2) Adjust location of the antenna and r-f iron cores so that the end of the iron core is 1/32 inch inside end of the transformer. This is done by loosening the screw which holds iron core bracket and then sliding bracket until the correct dimension is obtained. (3) The oscillator transformers and iron cores are adjusted in the same manner as antenna and r-f transformer, except that end of the iron core is 0.24 inch beyond end of transformer. (The diameter of a size "C" steel drill corresponds to this dimension.) (4) Now turn band spread tuning knob to its extreme counter-clockwise position. Set band spread dial pointer on first MARK on left edge (low frequency end) of 31 meter scale.
- Note 5.—Band Selector position "31" on Dial.
- Note 6.—After adjusting these last three trimmers with signal generator, to make sure that dial reads properly, a known station on each band near adjusting frequency should be tuned in with spread band tuning control. If dial reading is incorrect, adjust oscillator trimmers on each band until stations are heard at correct points on the dial. After adjusting the oscillator trimmers to correct frequency of known station, the antenna and r-f trimmers should be adjusted to maximum signal.
ALTERNATIVE METHOD: Locate a known station near center of each spread band and "zero beat" signal generator with it at the time of aligning the band. This makes available a signal of adjustable strength and known frequency.
- Note 7.—Band Selector position "25M" on Dial.
- Note 8.—Band Selector position "19M" on Dial.
- Note 9.—Band Selector position "16M" on Dial.
- Note 10.—Band Selector position "13M" on Dial.
- * While rocking.

MODELS 41-842, 41-843, 41-844

Signal Generator Connection	Dummy Antenna	Signal Generator Frequency	Receiver Wave-band Switch	Receiver Dial Setting	Trimmer Number
Note 1	0.1 mf	455 kc	...	540 kc	26A
"	"	"	...	"	25A
"	"	"	...	"	25B
"	"	"	...	"	15A
"	"	"	...	"	15B
..... Note 3	1500 kc	...	1500 kc	4B
"	"	"	...	"	4A

Note 1.—When adjusting i-f trimmers the high side of signal generator is connected through a 0.1 mf condenser to loop tuning condenser stator lug which connects to grid of first detector tube.

Note 2.—DIAL CALIBRATION: With tuning condenser fully closed (maximum capacity), set dial pointer on small dot below 540 kc.

Note 3.—When aligning r-f trimmers a loop antenna is made from a few turns of wire and connected to signal generator output terminals, this loop being placed a few feet from receiver loop.

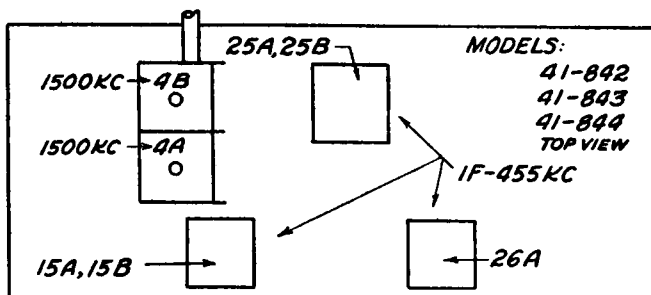

MODELS PT-42, PT-44

Signal Generator Connection	Dummy Antenna	Signal Generator Frequency	Receiver Wave-band Switch	Receiver Dial Setting	Trimmer Number
Ant. sect. tuning-cond.	0.1 mf	455 kc	B.C.	Note 1	1
"	"	"	"	"	2
"	"	"	"	"	3
..... Note 2		1600 kc	"	1600 kc	4
"		1500 kc	"	1500 kc	5

Note 1.—Tuning condenser fully closed.

DIAL CALIBRATION: With condenser in this position, set tuning pointer on the small dot below 550 kc.

Note 2.—When aligning r-f trimmers a loop is made from a few turns of wire and connected to signal generator output terminals, this loop being placed close to receiver loop.

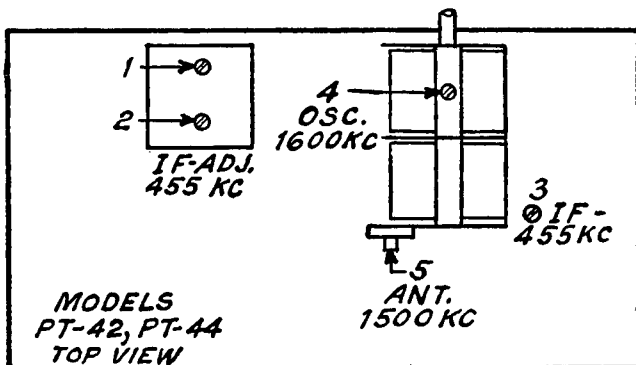

MODELS AR-50, AR-55, AR-75

Signal Generator Connection	Dummy Antenna	Signal Generator Frequency	Receiver Wave-band Switch	Receiver Dial Setting	Trimmer Number
...	Note 1	Note 2
Ant. recept.	0.1 mf	455 kc	...	Note 3	1
"	"	"	...	"	2
"	"	"	...	"	3
"	"	"	...	"	4
"	"	"	...	"	1
"	"	"	...	"	2
"	"	"	...	"	3
"	"	"	...	"	4
"	"	"	...	"	5 ⁴
Note 5	10 mmf	1580 kc	...	"	6
"	"	1400 kc	...	1400 kc	7 ⁶
"	"	580 kc	...	580 kc	8*
"	"	1580 kc	...	Note 3	6
"	"	1400 kc	...	1400 kc	7 ⁶
"	"	580 kc	...	580 kc	8*
...	1200-1400 kc	9 ⁷

Note 1.—Push in right knob on the control until "D" appears in station indicator window so stations can be tuned in by manual tuning.

Note 2.—Adjust antenna compensator (9) two turns from tight position.

Note 3.—Turn condenser rotor plates completely out of mesh as far as they will go.

Note 4.—Adjust (5) for *minimum* output signal.

Note 5.—Connect antenna lead, Part No. 95-0185, to antenna receptacle in radio. Connect a 10 mmf condenser in series between signal generator and antenna lead.

Note 6.—When antenna stage adjustment is made with radio installed in car, the radio antenna lead must be connected to car antenna in usual manner.

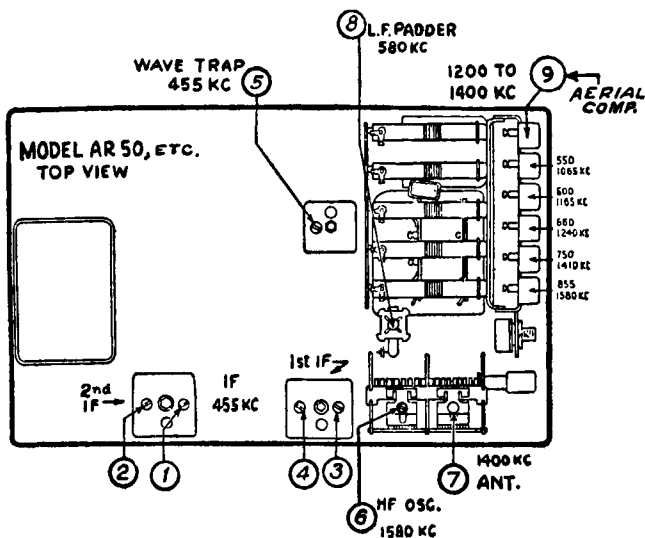

Connect signal generator output lead to a wire placed near car antenna but not connected to it.

Note 7.—After installing radio in car, tune in a weak broadcast signal between 1200 and 1400 kc on control scale. Remove plug button on end of radio and adjust antenna compensator (9) for maximum output signal.

* While rocking.

MODEL AR-65

Signal Generator Connection	Dummy Antenna	Signal Generator Frequency	Receiver Wave-band Switch	Receiver Dial Setting	Trimmer Number
Ant. recept.	0.1 mf	455 kc	Note 1	Note 2	41
"	"	"	"	"	39
"	"	"	"	"	25
"	"	"	"	"	23
"	"	"	"	"	41
"	"	"	"	"	39
"	"	"	"	"	25
"	"	"	"	"	23
Note 3	10 mmf	1580 kc	"	"	69
"	"	1400 kc	"	1400 kc	65 ⁴
"	"	580 kc	"	580 kc	21*
"	"	1580 kc	"	Note 2	69
"	"	1400 kc	"	1400 kc	65 ⁴
"	"	580 kc	"	580 kc	21*
"	"	10 mc	Note 5	Note 2	1 ⁶
"	"	9.5 mc	"	9.5 mc	2
"	"	6 mc	"	6 mc	3
"	"	12.1 mc	Note 7	Note 2	4
"	"	11.9 mc	"	11.9 mc	5
"	"	11.7 mc	"	11.7 mc	6

Note 1.—Push in right hand knob on the control until "black" dot appears in band indicator window and stations can be tuned in by manual tuning.

Note 2.—Turn condenser rotor plates completely out of mesh as far as they will go.

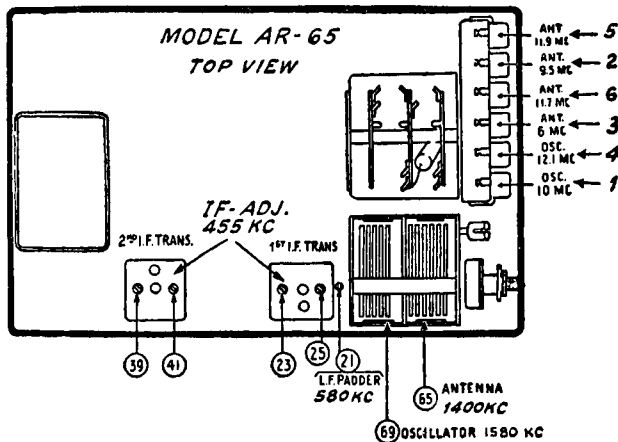

Note 3.—Connect antenna lead, Part No. 95-0185, to antenna receptacle in radio. Connect a 10 mmf condenser in series between signal generator and antenna lead.

Note 4.—When antenna stage adjustment is made with radio installed in car, the radio antenna lead must be connected to car antenna in usual manner. Connect signal generator output lead to a wire placed near car antenna but not connected to it.

Note 5.—Push in right hand knob on the control until “red” dot appears in band indicator window.

Note 6.—Trim to outer peak.

Note 7.—Push in right hand knob on the control until “white” dot appears in band indicator window.

* While rocking.

MODEL PT-87

Signal Generator Connection	Dummy Antenna	Signal Generator Frequency	Receiver Wave-band Switch	Receiver Dial Setting	Trimmer Number
Ant. sect. tuning-cond.	0.1 mf	455 kc	B.C.	Note 1	1
“	“	“	“	“	2
“	“	“	“	“	3
..... Note 2		1600 kc	“	1600 kc	4
“		1500 kc	“	1500 kc	5

Note 1.—Tuning condenser fully closed.

DIAL CALIBRATION: With condenser in this position, set tuning pointer on the small dot below 550 kc.

Note 2.—When aligning r-f trimmers a loop is made from a few turns of wire and connected to signal generator output terminals, this loop being placed close to receiver loop.

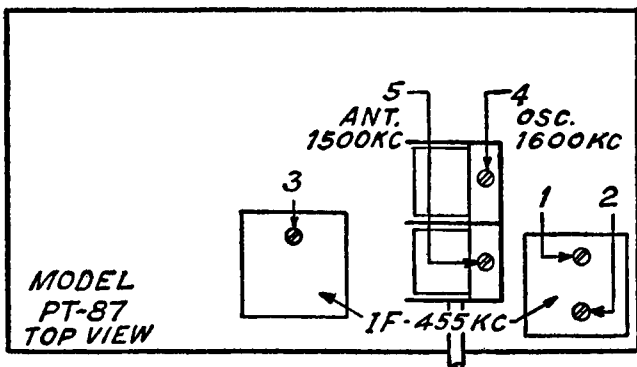

MODEL 101

Signal Generator Connection	Dummy Antenna	Signal Generator Frequency	Receiver Wave-band Switch	Receiver Dial Setting	Trimmer Number
Ant. Section Tuning Cond.	0.004 mf	470 kc	Note 1	540 kc	11A
"	"	"	"	"	11B
"	"	"	"	"	10A
"	"	"	"	"	10B
"	"	"	"	"	11B
Ant.	100 mmf	1500 kc	"	1500 kc	3B
"	"	"	"	"	3A

Note 1.—Leave Tone-Control in "Treble" position.

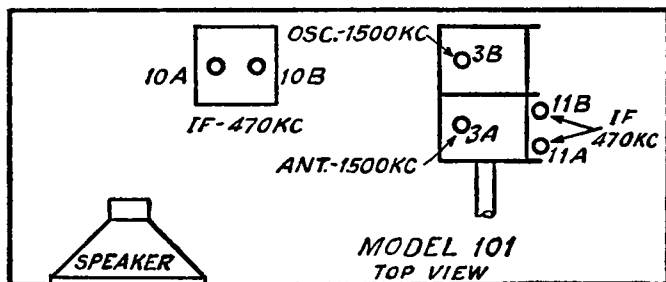

MODEL 105

Signal Generator Connection	Dummy Antenna	Signal Generator Frequency	Receiver Wave-band Switch	Receiver Dial Setting	Trimmer Number
Control grid of 6A7	0.1 mf	470 kc	Note 1	580 kc ²	11A
"	"	"	"	"	7B
"	"	"	"	"	7A
Ant.	100 mmf	1550 kc	"	1550 kc	3B
"	"	"	"	"	3A

Note 1.—Set push-button for "MANUAL" position.

Note 2.—DIAL CALIBRATION: With the tuning condenser in "maximum capacity" position (plates fully meshed), set the dial pointer between the two horizontal lines at the low frequency end of the scale (550 kc).

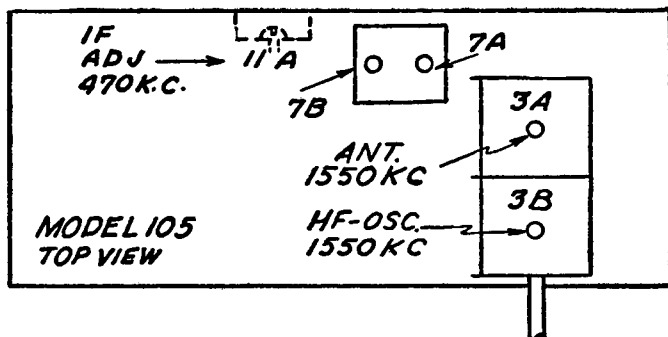

MODEL 108

Signal Generator Connection	Dummy Antenna	Signal Generator Frequency	Receiver Wave-band Switch	Receiver Dial Setting	Trimmer Number
Control grid of 6A7	0.1 mf	470 kc	B.C.	580 kc ¹	21A
"	"	"	"	"	12B
"	"	"	"	"	12A
Ant.	100 mmf	18.0 mc	S.W.	18.0 mc	4B
"	"	1550 kc	B.C.	1550 kc	5
"	"	"	"	"	4A
"	"	580 kc	"	580 kc	5A*
"	"	1550 kc	"	1550 kc	5

Note 1.—DIAL CALIBRATION: In order to adjust the receiver correctly, the dial must be aligned to track properly with the tuning condenser. To adjust the dial, proceed as follows: With the tuning condenser closed (maximum capacity), set the dial pointer on the extreme left index line at the low frequency end of the broadcast scale.

* While rocking.

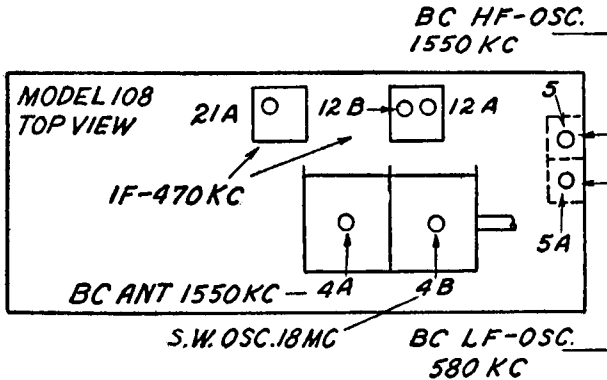

MODEL 821P

Signal Generator Connection	Dummy Antenna	Signal Generator Frequency	Receiver Wave-band Switch	Receiver Dial Setting	Trimmer Number
Control grid of 6A7	0.1 mf	Note 1	Note 2	21
"	"	"		"	23
"	"	"		"	24
"	"	"		"	26
Control grid of 78 RF	"	Note 3	...	Note 4	18 ⁵
"	"	"	...	"	11 ⁵
"	"	"	...	"	19 ⁵
Ant. ⁵	55 mmf	"	...	"	7
"	"	"	...	"	21
"	"	"	...	"	23
"	"	"	...	"	24
"	"	"	...	"	26

Caution: **DO NOT OPEN THE CRYSTAL HOLDER.** If for any reason whatever it has been opened, the crystal plates should be very carefully cleaned with carbon tetrachloride. After cleaning, the crystal must not be touched by the fingers. Use a clean cloth for handling.

Note 1.—The IF stages can be tuned to any frequency between 242 kc and 278 kc.

The IF frequency used in each Receiver is the difference between the frequency of the crystal in the Receiver and the frequency of the transmitter; i.e., the transmitter frequency is 2422 kc, the crystal used is 2696 kc, the difference is 274 kc, which is the frequency to which the IF amplifier must be tuned.

FREQ. OF CRYSTAL	RECEIVER FREQ.	PART No. CRYSTAL
1875 kc	1596-1610-1626 kc	45-2101
1908 kc	1630-1634-1642	
	1650-1658-1666 kc	45-2194
1953 kc	1674-1683-1690	
	1698-1706-1712 kc	45-2195
2578 kc	2310-2318-2326-2334 kc	45-2251
2618 kc	2342-2350-2358-2366-2374 kc	45-2231
2658 kc	2382-2390-2398	
	2406-2414 kc	45-2196
2696 kc	2422-2430-2442	
	2450 kc	45-2197
2734 kc	2458-2466-2474	
	2482-2490 kc	45-2198
3000 kc	2726 kc	45-2230
3360 kc	3105 kc	45-2496

Note 2.—Allow receiver to warm up before adjustment, and re-adjust after it has operated for several hours.

The Receiver "Q" switch must be in the off position; cutting out the carrier relay circuit during all alignment operations.

Note 3.—Signal-generator frequency same as transmitter frequency.

Note 4.—Tune variable condenser to transmitter frequency.

The Receivers, when used with the proper crystals, can be adjusted for any specified transmitter frequency between 1550 kc and 3600 kc. The different crystals are used to obtain these frequencies. The crystal frequency, however, is no indication of the Receiver frequency adjustment.

Note 5.—Notice the position of the trimmers. They should be out as far as possible, yet with sufficient tension to keep them firmly in place. If they are too tight, turn the tuning condenser plates in mesh slightly and

re-adjust (18) and (11). If they are too loose, turn the tuning condenser plates out of mesh slightly and re-adjust (18) and (11). Repeat these adjustments until the correct settings are obtained.

The low frequency padder (19) must be adjusted to a position where trimmers (11) and (18) are not too tight or too loose, i.e., if (18) is too tight and (11) too loose, turn the tuning condenser plates out of mesh slightly and screw in a little on (19). If (18) is too loose and (11) too tight, turn the tuning condenser plates in mesh slightly and loosen the padder (19) somewhat.

For any given frequency; padder (19) should be screwed in almost tight (approximately $\frac{1}{2}$ to $\frac{3}{4}$ of a turn from tight) for best results, and at the same time obtain the correct tuning condenser setting and adjustments of trimmers (11) and (18).

Special attention must be given to the adjustment of the oscillator trimmer (18), which should be backed off the peak slightly to obtain stable crystal operation.

Note 6.—ANTENNA STAGE—Connect antenna lead, Part No. 41-3191 to the antenna receptacle on the Receiver.

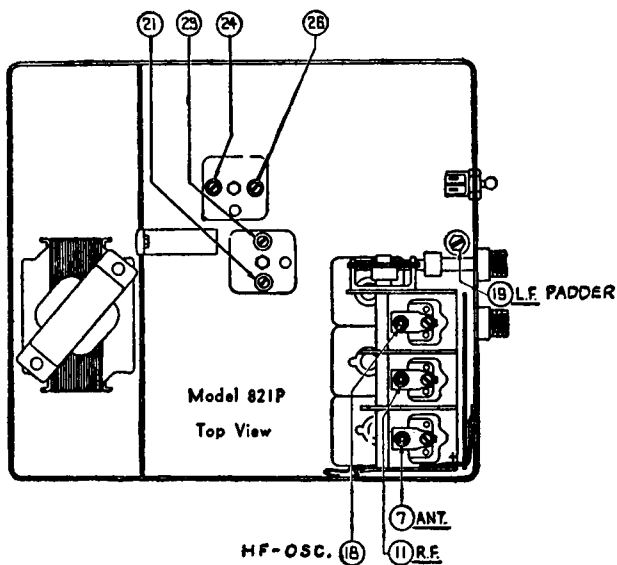

MODEL 821PV

Signal Generator Connection	Dummy Antenna	Signal Generator Frequency	Receiver Wave-band Switch	Receiver Dial Setting	Trimmer Number
Control grid of 78 IF	0.1 mfd	260 kc	Note 1	Note 2	24
"	"	"	"	"	26
Control grid of 6A7	"	"	"	"	21
"	"	"	"	"	23
"	"	"	"	"	24
"	"	"	"	"	26
Control grid of 78 RF	"	2550 kc ³ or 3600 kc	"	"	14
"	"	"	"	"	11
"	"	1650 kc or 2400 kc	"	1650 kc ³ or 2400 kc	18*
"	"	2550 kc or 3600 kc	"	Note 2	14
"	"	2400 kc or 3400 kc	"	2400 kc or 3400 kc	7
Note 4	55 mmf	3400 kc	"	"	11

Note 1.—The receiver "Q" switch must be in "off" position; cutting out the carrier relay circuit during all alignment operations.

Note 2.—Turn tuning-condenser plates out of mesh as far as they will go.

Note 3.—Lower frequencies are for receivers of 1550 kc to 2550 kc range. Higher frequencies are for receivers of 2300 kc to 3600 kc range.

Note 4.—Connect the antenna lead, Part No. 41-3191, to the antenna receptacle on the receiver.

* While rocking.

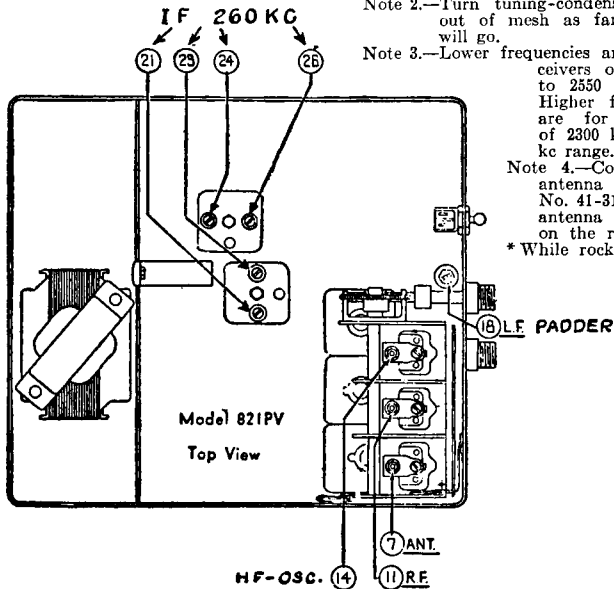

MODELS 826, 827, 827K, 828, 828K, S-1416

Signal Generator Connection	Dummy Antenna	Signal Generator Frequency	Receiver Wave-band Switch	Receiver Dial Setting	Trimmer Number
Control grid of 78 RF	0.1 mf	260 kc	1
"	"	"	2
Control grid of 6A7	"	"	3
"	"	"	4
"	"	"	2
"	"	"	1
Control grid of 78 RF	"	1550 kc	...	Note 1	7
"	"	"	...	"	6
"	"	580 kc	...	580 kc	8*
"	"	1550 kc	...	1550 kc	7
Ant. ^{2, 3}	Notes 2, 3	1400 kc	...	1400 kc	6
"	"	"	...	"	5

Note 1.—Turn the tuning condenser plates out of mesh as far as they will go. This is the true setting for 1550 kc, 155 on the dial scale.

Note 2.—**ANTENNA—WHEN ADJUSTING THE ANTENNA STAGE IT IS EXTREMELY IMPORTANT THAT THE PROPER DUMMY ANTENNA BE CONSTRUCTED AND USED.**

Connect the signal generator lead to the antenna cable assembly (made up of Part No. 41-3191 cable and a 200 mmf condenser Part No. 30-1013) in series between the Receiver antenna receptacle and the signal generator. Plug the cable into the antenna receptacle on the end of the Receiver.

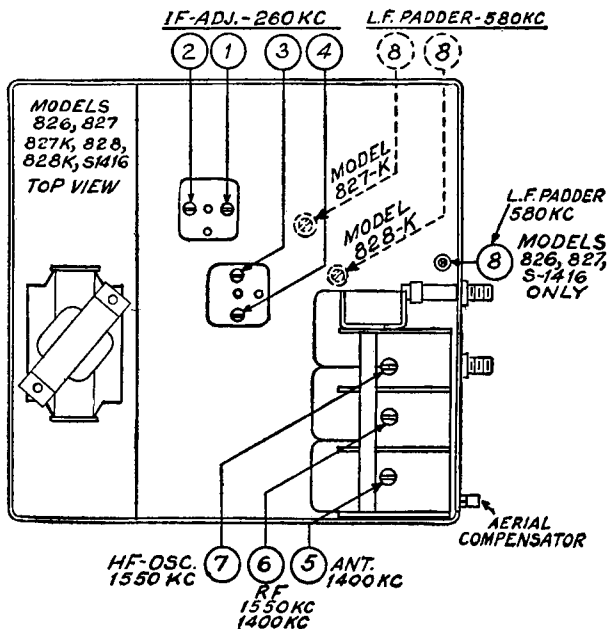

Note 3.—When the antenna stage adjustment is made with the Receiver installed in the car, the Receiver antenna lead must be connected to the car antenna in the usual manner. Connect the signal generator output lead to a wire placed near the car antenna but not connected to it.

* While rocking.

MODEL 920

Signal Generator Connection	Dummy Antenna	Signal Generator Frequency	Receiver Wave-band Switch	Receiver Dial Setting	Trimmer Number
Control grid of 6A7	0.1 mf	260 kc	17
"	"	"	19
"	"	"	13
"	"	"	15
"	"	"	17
Ant. ¹	50 mmf	1550 kc	...	Note 2	9
"	"	"	...	"	6
"	"	"	...	"	4
"	"	580 kc	...	580 kc	12*
"	"	1550 kc	...	Note 2	9
"	"	1400 kc	...	1400 kc	6
"	"	"	...	"	4 3

Note 1.—Connect antenna lead, Part No. 41-3191, to the antenna receptacle in the radio. Connect 50 mmf condenser in series between the signal generator and the antenna lead.

Note 2.—Turn tuning condenser plates out of mesh as far as they will go.

Note 3.—When the antenna stage adjustment is made with the radio installed in the car, the radio antenna lead must be connected to the car antenna in the usual manner. Connect the signal-generator output lead to a wire placed near the car antenna but not connected to it.

* While rocking.

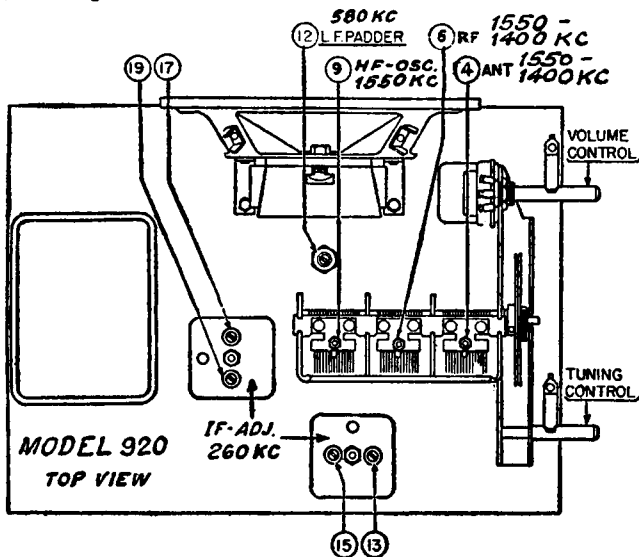

MODELS 921, 922

Signal Generator Connection	Dummy Antenna	Signal Generator Frequency	Receiver Wave-band Switch	Receiver Dial Setting	Trimmer Number
Ant. ¹	50 mmf	470 kc	...	Note 2	23
"	"	"	...	"	18
"	"	"	...	"	20
"	"	"	...	"	23
"	"	1550 kc	...	Note 3	12
"	"	1360 kc	...	1360 kc	5 ⁴
"	"	590 kc	...	590 kc	6

Note 1.—Connect antenna lead, Part No. 41-3191, to the antenna receptacle in the radio. Connect 50 mmf condenser in series between the signal generator and the antenna lead.

Note 2.—Turn tuning condenser plates out of mesh as far as they will go.

Note 3.—Turn the condenser rotor plates completely out of mesh. Use a piece of bond letterhead paper as a gauge between the heel of the rotor plates and the stator plates of the oscillator section of the tuning condenser, and turn the condenser plates in mesh until they strike the paper.

Note 4.—When the antenna stage adjustment is made with the radio installed in the car, the radio antenna lead must be connected to the car antenna in the usual manner. Connect the signal generator output lead to a wire placed near the car antenna but not connected to it.

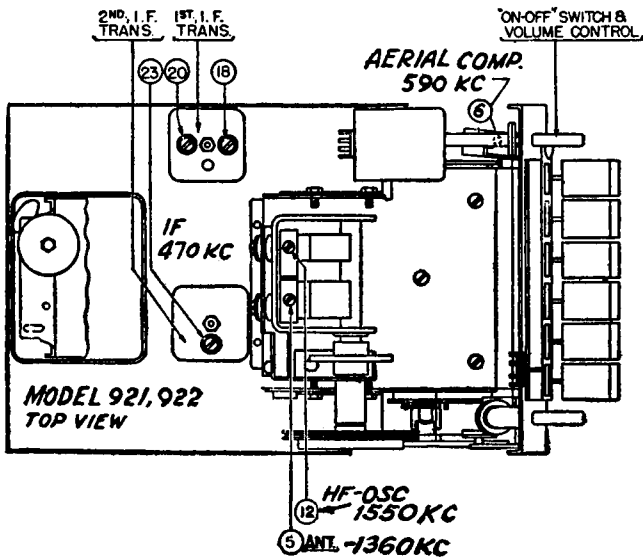

MODELS 926, 927, 928K

Signal Generator Connection	Dummy Antenna	Signal Generator Frequency	Receiver Wave-band Switch	Receiver Dial Setting	Trimmer Number
Control grid of 6A7	0.1 mf	260 kc	1
"	"	"	2
"	"	"	3
"	"	"	4
Ant. ¹	50 mmf	1550 kc	...	Note 2	5
"	"	"	...	"	6
"	"	580 kc	...	580 kc	8*
"	"	1550 kc	...	Note 2	5
"	"	1400 kc	...	1400 kc	6
"	"	"	...	"	7 ³
Note 4	...	600 kc	...	600 kc	9 ⁴

Note 1.—Connect antenna lead, Part No. 41-3191, to the antenna receptacle in the radio. Connect 50 mmf condenser in series between the signal generator and the antenna lead.

Note 2.—Turn tuning condenser plates out of mesh as far as they will go.

Note 3.—When the antenna stage adjustment is made with the radio installed in the car, the radio antenna lead must be connected to the car antenna in the usual manner. Connect the signal generator output lead to a wire placed near the car antenna but not connected to it.

Note 4.—When installing the radio in a car, follow the installation instructions carefully. Tune in a weak broadcast signal at approximately 60 on the control scale. With a small screw driver adjust the antenna compensating condenser (9) for maximum signal.

* While rocking.

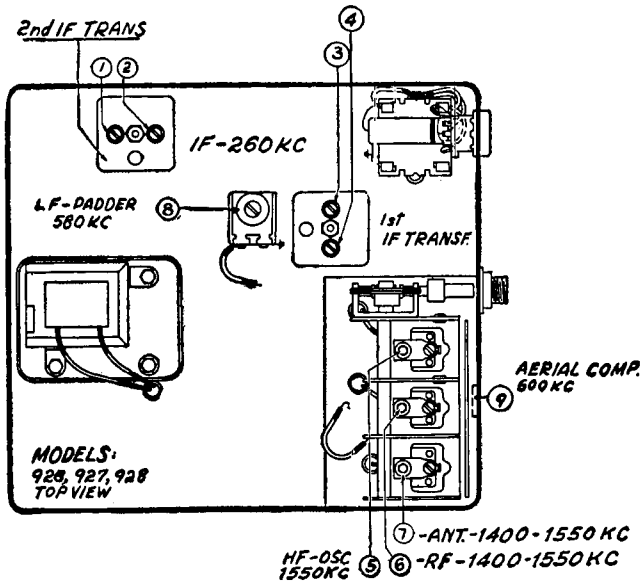

MODELS 931, 932

Signal Generator Connection	Dummy Antenna	Signal Generator Frequency	Receiver Wave-band Switch	Receiver Dial Setting	Trimmer Number
Ant. ¹	30 mmf	455 kc	...	Note 2	27
"	"	"	...	"	22
"	"	"	...	"	20
"	"	"	...	"	27
"	"	1580 kc	...	1580 kc	18
"	"	1400 kc	...	1400 kc	7 ³
Note 3	...	580 kc	...	580 kc	4 ⁸

Note 1.—Connect antenna lead, Part No. 41-3191, to the antenna receptacle in the radio. Connect 30 mmf condenser in series between the signal generator and the antenna lead.

Note 2.—Turn tuning-condenser plates out of mesh as far as they will go.

Note 3.—When the antenna stage adjustment is made with the radio installed in the car, the radio antenna lead must be connected to the car antenna in the usual manner. Connect the signal-generator output lead to a wire placed near the car antenna but not connected to it. Also adjust the aerial compensator (4) for maximum on a weak signal at approximately 580 kc.

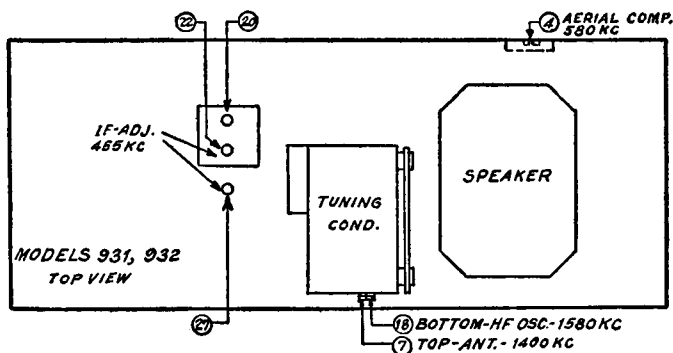

MODELS 936, 937, 937X, 938K, 938KX

Signal Generator Connection	Dummy Antenna	Signal Generator Frequency	Receiver Wave-band Switch	Receiver Dial Setting	Trimmer Number
Control grid of 6A7	0.1 mf	470 kc	...	Note 1 Note 3	7 ² 1
"	"	"	...	"	2
"	"	"	...	"	3
Ant. ⁴	50 mmf	1580 kc	...	"	4
"	"	1400 kc	...	1400 kc	5
"	"	580 kc	...	580 kc	6*
"	"	1580 kc	...	Note 3	4
"	"	1400 kc	...	1400 kc	5 ⁵
Note 6	7 ⁶

Note 1.—On 937 and 938 models, press the "return-to-dial" button until stations can be tuned in by manual tuning.

Note 2.—Adjust the antenna compensator (7) two turns from tight.

Note 3.—Turn tuning condenser plates out of mesh as far as they will go.

Note 4.—Connect antenna lead, Part No. 41-3191, to the antenna receptacle in the radio. Connect 50 mmf condenser in series between the signal generator and the antenna lead.

Note 5.—When the antenna stage adjustment is made with the radio installed in the car, the radio antenna lead must be connected to the car antenna in the usual manner. Connect the signal generator output lead to a wire placed near the car antenna but not connected to it.

Note 6.—When installing the radio in the car, follow the installation instructions carefully. Tune in a weak broadcast signal between 1200 and 1400 Kilocycles on the control scale. Remove the plug button on the end of the radio and adjust the antenna compensator (7) for maximum signal.

* While rocking.

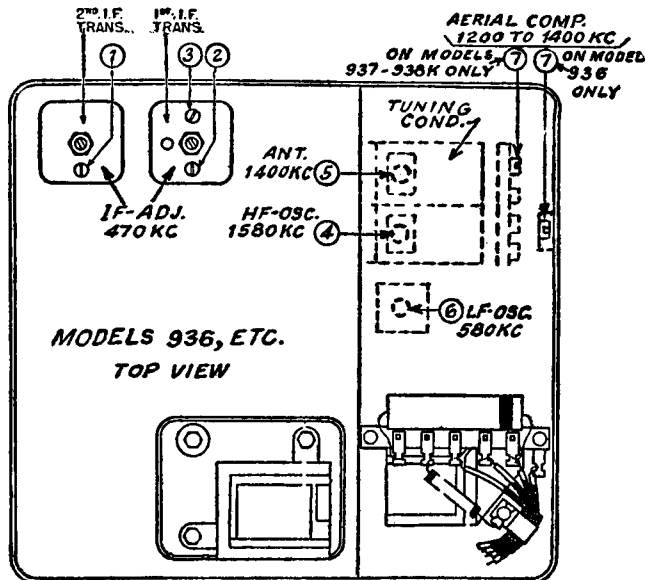

MODELS R-1415, W-1419

Signal Generator Connection	Dummy Antenna	Signal Generator Frequency	Receiver Wave-band Switch	Receiver Dial Setting	Trimmer Number
Control grid of 78 IF	0.1 mf	260 kc	27
"	"	"	25
Control grid of 6A7	"	"	24
"	"	"	22
"	"	"	25
"	"	"	27
Control grid of 78 RF	"	1550 kc	...	Note 1	16
"	"	"	...	"	11
"	"	600 kc	...	600 kc	20*
"	"	1550 kc	...	Note 1	16
Ant. ² 3	Note 2, 3	1400 kc	...	1400 kc	11
"	"	"	...	"	6

Note 1.—Turn the tuning condenser plates out of mesh as far as they will go. This is the true setting for 1550 kc; 155 on the dial scale.

Note 2.—Connect the signal generator lead to the antenna lead, Part No. 41-3191.

Note 3.—When the antenna stage adjustment is made with the receiver installed in the car, the receiver antenna lead must be connected to the car antenna in the usual manner. Connect the signal generator output lead to a wire placed near the car antenna but not connected to it.

* While rocking.

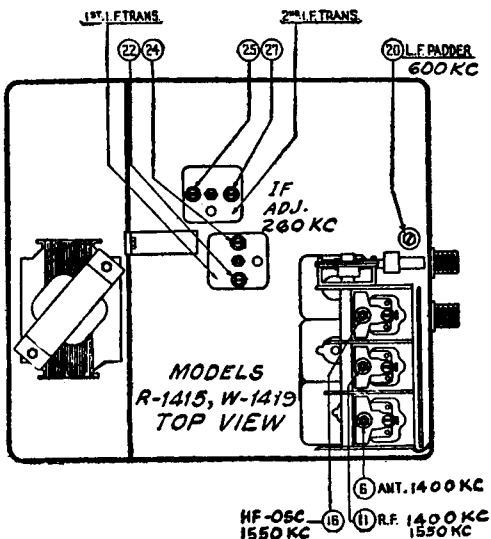

MODELS L-1420, P-1422, L-1424, L-1425, P-1426, L-1427, L-1429, P-1439, L-1460

Signal Generator Connection	Dummy Antenna	Signal Generator Frequency	Receiver Wave-band Switch	Receiver Dial Setting	Trimmer Number
Control grid of 78 IF	0.1 mf	260 kc	1
"	"	"	2
Control grid of 6A7	"	"	3
"	"	"	4
"	"	"	1
"	"	"	2
Control grid of 78 RF	"	1550 kc	...	Note 1	7
"	"	"	...	"	6
"	"	580 kc	...	580 kc	8*
"	"	1550 kc	...	1550 kc	7
Ant. ²	Note 2	1400 kc	...	1400 kc	6
"	"	"	...	"	5

Note 1.—Turn the condenser rotor plates completely out of mesh. Use a piece of bond letterhead paper as a gauge between the heel of the rotor plates and the stator plates and turn the condenser plates in mesh until they strike against the paper. This is the true setting for 1550 kc; 155 on the dial scale.

Note 2.—Connect the Antenna lead Part No. 41-3191 to the Antenna receptacle on the receiver in series with the correct dummy capacity. For the L1420, L1424 and L1425 use a 585 mmfd condenser; for the P1422, P1426 and P1439 use a 230 mmfd condenser; for the L-1427, L-1429 and L-1460 use a 30 mmfd condenser.

* While rocking.

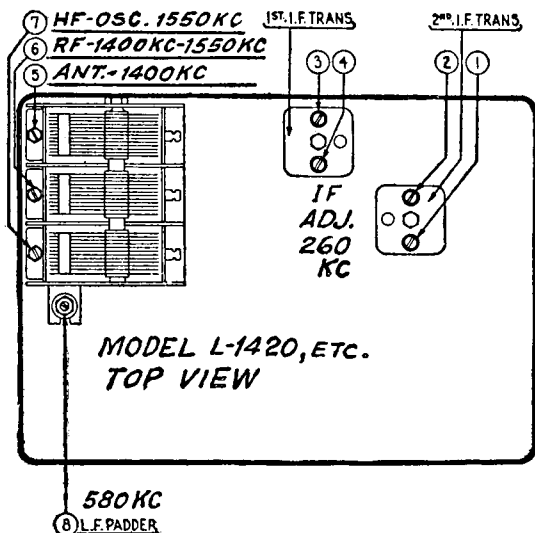

MODELS C-1423, P-1432H, N-1434H, S-1437, F-1440, F-1442

Signal Generator Connection	Dummy Antenna	Signal Generator Frequency	Receiver Wave-band Switch	Receiver Dial Setting	Trimmer Number
Control grid of 78 IF	0.1 mf	260 kc	1
"	"	"	2
Control grid of 6A7	"	"	3
"	"	"	4
"	"	"	1
"	"	"	2
Control grid of 78 RF	"	1550 kc	...	Note 1	7
"	"	"	...	"	6
"	"	580 kc	...	580 kc	8*
"	"	1550 kc	...	1550 kc	7
Ant. ²	Note 2	1400 kc	...	1400 kc	6
"	"	"	...	"	5

Note 1.—Turn the condenser rotor plates completely out of mesh. Use a piece of bond letterhead paper as a gauge between the heel of the rotor plates and the stator plates and turn the condenser plates in mesh until they strike against the paper. This is the true setting for 1550 kc; 155 on the dial scale.

Note 2.—Connect the antenna lead Part No. 41-3191 to the antenna receptacle on the receiver in series with the correct dummy capacity. For the C-1423 use a 1700 mmfd condenser. For the P1432 use a 230 mmf condenser; for the N1434 and S1437 use the standard antenna lead connected directly to the output terminal on the signal generator.

For the F1440 use the Ford Antenna transformer and lead assembly, connected in series to the signal generator with a 15 mmfd condenser. For the F1442 use the standard antenna lead Part No. 41-3191 connected directly to the antenna terminal of the signal generator.

* While rocking.

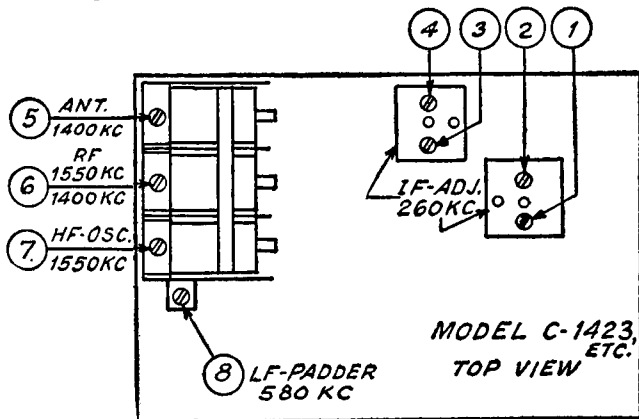

MODELS C-1450, C-1452

Signal Generator Connection	Dummy Antenna	Signal Generator Frequency	Receiver Wave-band Switch	Receiver Dial Setting	Trimmer Number
Control grid of 78 IF	0.1 mf	260 kc	2
"	"	"	1
Control grid of 6A7	"	"	4
"	"	"	3
"	"	"	1
"	"	"	2
Control grid of 78 RF	"	1550 kc	...	Note 1	7
"	"	"	...	"	6
"	"	600 kc	...	600 kc	8*
"	"	1550 kc	...	1550 kc	7
Ant. 2, 3	Note 2, 3	1400 kc	...	1400 kc	6
"	"	"	...	"	5

Note 1.—Turn the tuning condenser plates out of mesh as far as they will go using a piece of paper approximately .006" thick as a gauge between the heel of the rotor plates and the stator plates; turn the rotor plates in mesh until they strike against the paper. This is the true setting for 1550 kc, 155 on the dial scale.

Note 2.—**ANTENNA—WHEN ADJUSTING THE ANTENNA STAGE IT IS EXTREMELY IMPORTANT THAT THE PROPER DUMMY ANTENNA BE CONSTRUCTED AND USED.**

Connect signal generator to the antenna cable assembly (made up of "Skyway Antenna" lead, Part No. L-2665, with a 22 mmf condenser in series). Plug cable assembly into the antenna connection on receiver. Remove snap-button cover over antenna selector and advance the selector switch to the "Skyway Antenna" position. Follow this procedure regardless of whether receiver is used with "Roadway" or with "Skyway" antenna.

Note 3.—When the antenna stage adjustment is made with the receiver installed

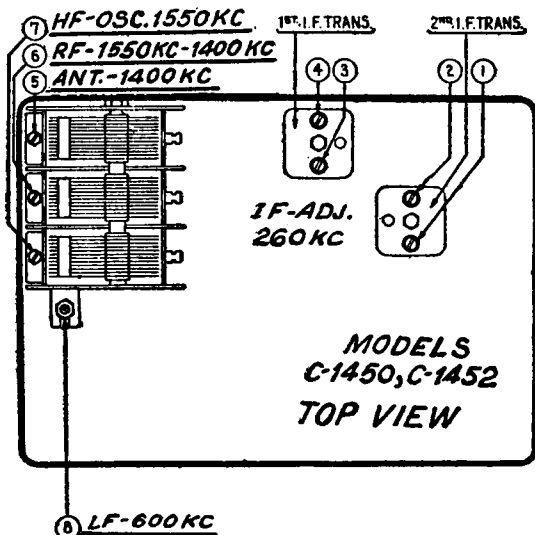

in the car, the receiver antenna lead must be connected to the car antenna in the usual manner. Connect the signal generator output lead to a wire placed near the car antenna but not connected to it.

* While rocking.

MODELS P-1535, L-1560

Signal Generator Connection	Dummy Antenna	Signal Generator Frequency	Receiver Wave-band Switch	Receiver Dial Setting	Trimmer Number
Control grid ¹ of 78 IF	0.1 mf	260 kc	1
"	"	"	2
Control grid of 6A7	"	"	3
"	"	"	4
"	"	"	1
"	"	"	2
Control grid of 78 RF	"	1500 kc	...	Note 2	7
"	"	"	...	"	6
"	"	580 kc	...	580 kc	8*
"	"	1550 kc	...	1550 kc	7
Ant. ³	Note 3	1400 kc	...	1400 kc	6
"	"	"	...	"	5

Note 1.—Do not connect antenna to receiver unless instructions to the contrary are given.

Note 2.—Turn condenser rotor plates completely out of mesh. Use a piece of bond letterhead paper as a gauge between the heel of the rotor plates and the stator plates, and turn the condenser plates in mesh until they strike against the paper.

Note 3.—Connect antenna lead, Part No. 41-3191, to the antenna receptacle on the receiver—in series with the correct dummy capacity.

For P-1535 use a 250 mmf condenser.

For L-1560 (COWL antenna) use a 20 mmf condenser.

For L-1560 (ROOF or DOOR antenna) use a 700 mmf condenser.

* While rocking.

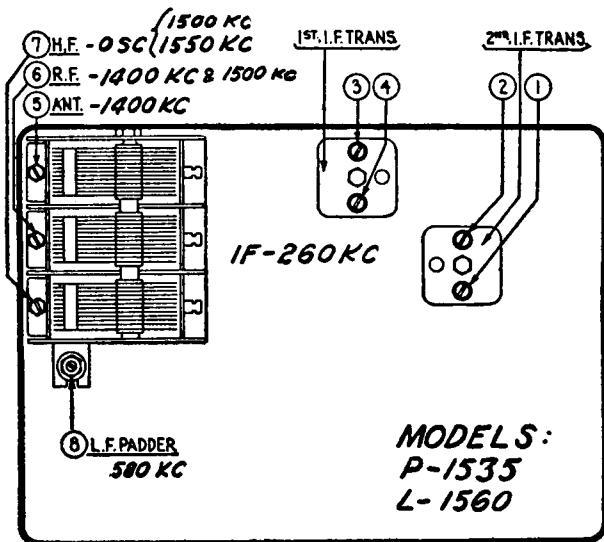

**MODELS N-1514, S-1516, P-1517; N-1524, S-1526,
G-1528, P-1530, C-1550**

Signal Generator Connection	Dummy Antenna	Signal Generator Frequency	Receiver Wave-band Switch	Receiver Dial Setting	Trimmer Number
Control grid ¹ of 78 IF	0.1 mf	260 kc	1
"	"	"	2
Control grid of 6A7	"	"	3
"	"	"	4
"	"	"	1
"	"	"	2
Control grid of 78 RF	"	1550 kc	...	Note 2	7
"	"	"	...	"	6
"	"	580 kc	...	580 kc	8*
"	"	1550 kc	...	Note 2	7
Ant. ³	Note 3	1400 kc	...	1400 kc	6
"	"	"	...	"	5

Note 1.—Do not connect the antenna to receiver unless specific instructions to the contrary are given.

Note 2.—Models N-1514, S-1516, P-1517: Turn tuning condenser plates out of mesh as far as they will go.

Models N-1524, S-1526, G-1528, P-1530, C-1550: Turn condenser rotor plates completely out of mesh. Use a piece of bond letterhead

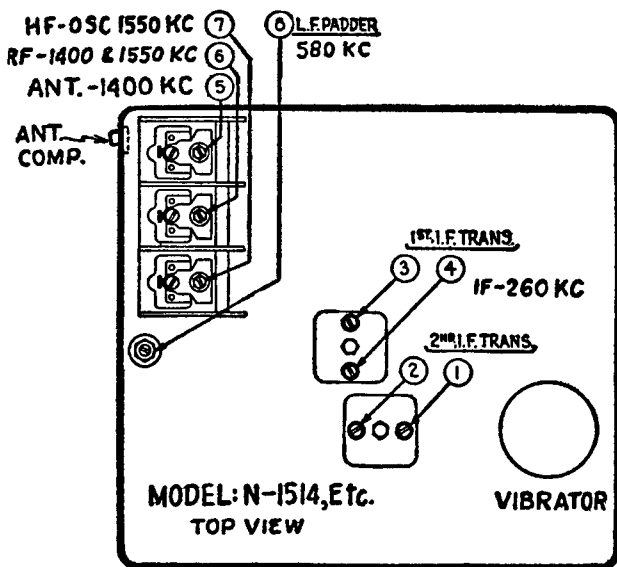

paper as a gauge between the heel of the rotor plates and the stator plates, and turn the condenser plates in mesh until they strike against the paper.

Note 3.—For Models N-1514, S-1516, P-1517, use standard antenna, Part No. 41-3191, connected directly to the "ANT" terminal of the signal generator. No dummy condenser is required.

For Models N-1524, S-1526, G-1528, P-1530, connect antenna lead, Part No. 41-3191, to the cowl antenna receptacle on the receiver. When using the undercar antenna use 180 mmf condenser.

For Model C-1550, use standard antenna lead connected directly to the output terminal of the signal-generator. Turn the antenna-selector switch to the "SKYWAY ANTENNA" position.

* While rocking.

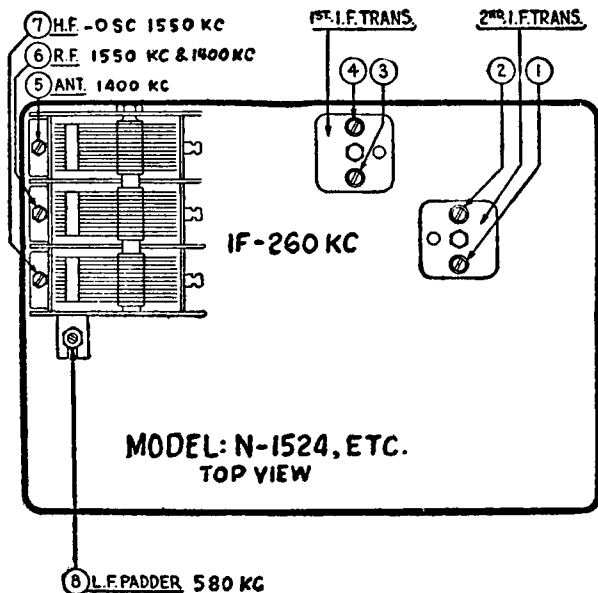

MODEL F-1540

Signal Generator Connection	Dummy Antenna	Signal Generator Frequency	Receiver Wave-band Switch	Receiver Dial Setting	Trimmer Number
Control grid ¹ of 6A7	0.1 mf	260 kc	24
"	"	"	22
"	"	"	21
"	"	"	19
Control grid of 78 RF	"	1500 kc	...	Note 2	14
"	"	"	...	"	11
"	"	580 kc	...	580 kc	17*
"	"	1550 kc	...	1550 kc	14
Ant. ³	Note 3	1400 kc	...	1400 kc	11
"	"	"	...	"	6 ⁴

Note 1.—Do not connect antenna to receiver unless instructions to the contrary are given.

Note 2.—Turn condenser rotor plates completely out of mesh. Use a piece of bond letterhead paper as a gauge between the heel of the rotor plates and the stator plates, and turn the condenser plates in mesh until they strike against the paper.

Note 3.—See Figure (A) for connections and dummy antenna.

Note 4.—When the antenna-stage adjustment is made with the radio installed in the car, the radio antenna lead must be connected to the car antenna in the usual manner. Connect the signal-generator output lead to a wire placed near the car antenna, but not connected to it.

* While rocking.

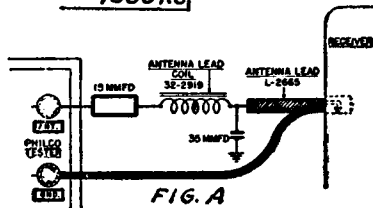
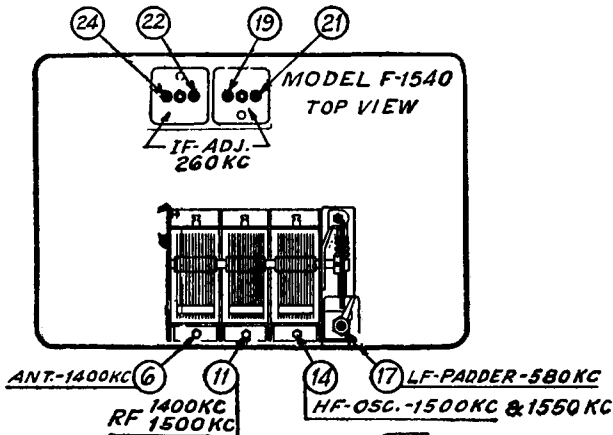

MODEL C-1608

Signal Generator Connection	Dummy Antenna	Signal Generator Frequency	Receiver Wave-band Switch	Receiver Dial Setting	Trimmer Number
Control grid of 6A7	0.5 mf	470 kc	Note 1	Note 2	23
"	"	"	"	"	16
"	"	"	"	"	18
Ant. ³	Note 3	1580 kc	"	"	67
"	"	1400 kc	"	1400 kc	68
"	"	580 kc	"	580 kc	43 *
"	"	1580 kc	"	Note 2	67
"	"	1400 kc	"	1400 kc	68 ⁴

Note 1.—Press "DIAL" button so that stations can be tuned in by dial tuning.

Note 2.—Turn condenser rotor plates completely out of mesh as far as they will go.

Note 3.—When a *COWL* antenna is used; connect antenna lead, Part No. L-2765, to the antenna receptacle in the radio. Connect a 25 mmf condenser in series between signal-generator and antenna lead. Be sure the lead to the antenna transformer is plugged into the "SKY" socket of the antenna transformer.

When *UNDERCAR* antenna is used; connect antenna lead, Part No. 41-3191, to the antenna receptacle in the radio. Connect a 250 mmf condenser in series between signal-generator and antenna lead. Be sure the lead to the antenna transformer is plugged into the "ROAD" socket of the antenna transformer.

Note 4.—When the antenna-stage adjustment is made with the radio installed in the car, the radio antenna lead must be connected to the car antenna in the usual manner. Connect the signal-generator output lead to a wire place near the car antenna, but not connected to it.

* While rocking.

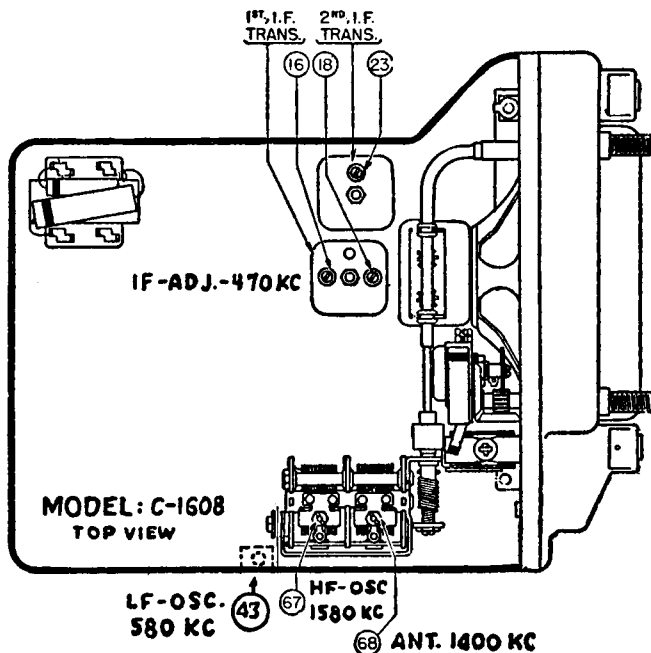

MODEL C-1606

Signal Generator Connection	Dummy Antenna	Signal Generator Frequency	Depress Push Button	Variator Position	Trimmer Number
Control grid of 6A7	0.5 mf	400 kc	...	Note 1	24
"	"	"	...	"	17
"	"	"	...	"	15

MODEL C-1606 PUSH BUTTONS

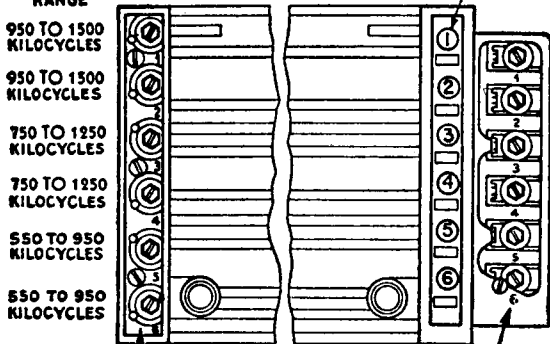

LEFT ADJUSTING SCREWS (OSC.) (ANT.) RIGHT ADJUSTING SCREWS

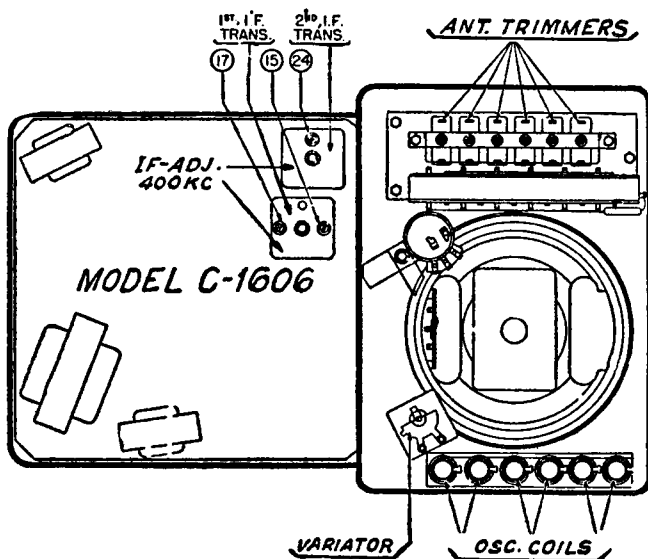

MODEL C-1606 Cont.

Signal Generator Connection	Dummy Antenna	Signal Generator Frequency	Receiver Wave-band Switch	Receiver Dial Setting	Trimmer Number
Ant. 2	Note 2	950-1500 kc ³	No. 1	Note 4	Ant. 1 ⁵
"	"	"	"	"	Osc. 1
"	"	"	No. 2	"	Ant. 2
"	"	"	"	"	Osc. 2
"	"	750-1250 kc ³	No. 3	"	Ant. 3
"	"	"	"	"	Osc. 3
"	"	"	No. 4	"	Ant. 4
"	"	"	"	"	Osc. 4
"	"	550-950 kc ³	No. 5	"	Ant. 5
"	"	"	"	"	Osc. 5
"	"	"	No. 6	"	Ant. 6
"	"	"	"	"	Osc. 6 ⁶

Note 1.—Turn VARIATOR (small variable condenser, left-hand knob on panel) to "indexed" position.

Note 2.—When a *COWL* antenna is used in the car; connect antenna lead, Part No. L-2765, to the antenna receptacle in the radio. Connect a 25 mmf condenser in series between signal-generator and antenna lead. Be sure the lead to the antenna transformer is plugged into the "SKY" socket of the Antenna Transformer.

When an *UNDERCAR* antenna is used; connect antenna lead, Part No. 41-3191 to the antenna receptacle in the radio. Connect a 250 mmf condenser in series between signal-generator and antenna lead. Be sure the lead to the antenna transformer is plugged into the "ROAD" socket of the antenna transformer.

Note 3.—Set to frequency of chosen broadcast station.

Note 4.—Leave VARIATOR at midway position—approximately half out of mesh.

Note 5.—Ant. trimmer screws are on the right.

Osc. coil adjustment screws are on the left.

Note 6.—Repeat all adjustments in order, as tabulated.

MODELS S-1616, P-1617; P-1630, P-1635

Signal Generator Connection	Dummy Antenna	Signal Generator Frequency	Receiver Wave-band Switch	Receiver Dial Setting	Trimmer Number
Control grid of 6A7	0.1 mf	470 kc	Note 1	Note 2	1
"	"	"	"	"	2
"	"	"	"	"	3
Ant. ^s	Note 3	1580 kc	"	"	4
"	"	1400 kc	"	1400 kc	5
"	"	580 kc	"	580 kc	6*
"	"	1580 kc	"	Note 2	4
"	"	1400 kc	"	1400 kc	5 ⁴

Note 1.—*Models S-1616, P-1617:* Press Automatic Station-Selector button until "DIAL" appears in the window and stations can be tuned in by manual tuning.

Models P-1630, P-1635: Press "RETURN-TO-DIAL" button until stations can be tuned in by manual tuning.

Note 2.—Turn condenser rotor plates completely out of mesh as far as they will go.

Note 3.—*Models S-1616, P-1617, P-1630:* When a COWL antenna is used, connect the antenna lead, Part No. L-2765, to the antenna receptacle in the radio. Connect a 20 mmf condenser in series between signal-generator and antenna lead. Be sure the lead to the antenna transformer is connected to the BLACK terminal of the Antenna Transformer.

When an *undercar or roof* antenna is used, connect the antenna lead, Part No. 41-3191, to the antenna receptacle in the radio. Connect a 250 mmf condenser in series between signal-generator and antenna lead. Be sure the lead to the antenna transformer is connected to the RED terminal of the antenna transformer.

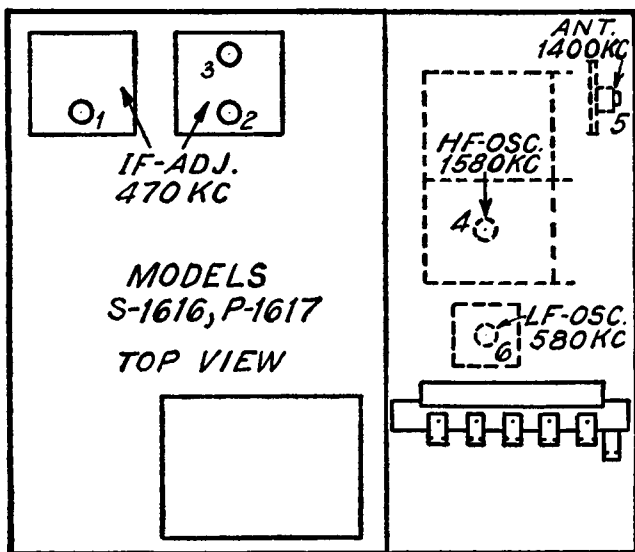

Model P-1635: When a *cowl* antenna is used, connect the antenna lead, Part No. 41-3191, to the antenna receptacle in the radio. Connect a 250 mmf condenser in series between signal-generator and antenna lead. Be sure the lead to the antenna transformer is connected to the **BLACK** terminal of the Antenna Transformer.

When an *undercar* or *roof* antenna is used, connect the antenna lead, Part No. L-2765, to the antenna receptacle in the radio. Connect a 20 mmf condenser in series between signal-generator and antenna lead. Be sure the lead to the antenna transformer is connected to the **RED** terminal of the antenna transformer.

Note 4.—When the antenna stage adjustment is made with the radio installed in the car, the radio antenna lead must be connected to the car antenna in the usual manner. Connect the signal generator output lead to a wire placed near the car antenna, but not connected to it.

* While rocking.

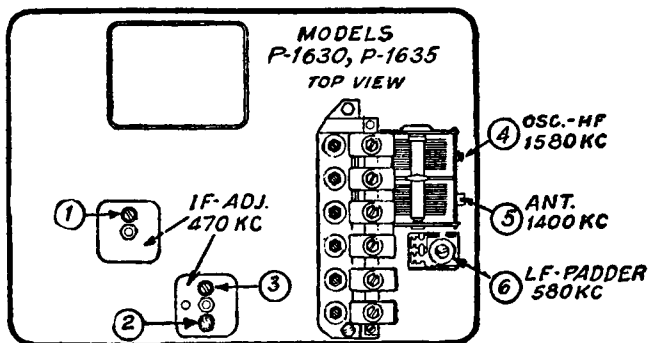

MODEL S-1622

Signal Generator Connection	Dummy Antenna	Signal Generator Frequency	Receiver Wave-band Switch	Receiver Dial Setting	Trimmer Number
Control grid of 78 IF	0.5 mf	470 kc	Note 1	Note 2	29
"	"	"	"	"	27
Ant. ³	35 mmf	"	"	"	21
"	"	"	"	"	17
"	"	1580 kc	"	"	67
"	"	1500 kc	"	1500 kc	66 ⁴

Note 1.—Press Automatic Station-Selector button until "DIAL" appears in the window and stations can be tuned in by manual tuning.

Note 2.—Turn condenser rotor plates completely out of mesh as far as they will go.

Note 3.—Connect antenna lead, Part No. L-2765, to the antenna receptacle in the radio. Connect 35 mmf condenser in series between signal-generator and antenna lead.

Note 4.—When the antenna-stage adjustment is made with the radio installed in the car, the radio antenna lead must be connected to the car antenna in the usual manner. Connect the signal-generator output lead to a wire placed near the car antenna but not connected to it.

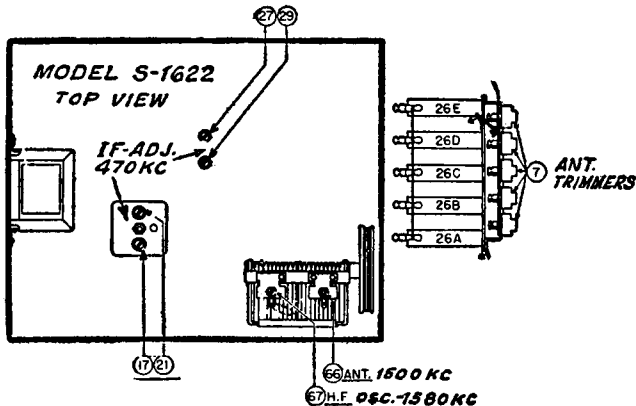

MODELS S-1626, G-1628

Signal Generator Connection	Dummy Antenna	Signal Generator Frequency	Receiver Wave-band Switch	Receiver Dial Setting	Trimmer Number
Control grid of 6A7	0.1 mf	470 kc	Note 1	Note 2	6
"	"	"	"	"	19
"	"	"	"	"	17
Ant. ³	20 mmf	1580 kc	"	"	81
"	"	1400 kc	"	1400 kc	78
"	"	580 kc	"	580 kc	77 *
"	"	1580 kc	"	Note 2	81
"	"	1400 kc	"	1400 kc	78 ⁴

Note 1.—Press Automatic Station-Selector button until "DIAL" appears in the window and stations can be tuned in by manual tuning.

Note 2.—Turn condenser rotor plates completely out of mesh as far as they will go.

Note 3.—Connect antenna lead, Part No. L-2785, to the antenna receptacle in the radio. Connect 20 mmf condenser in series between signal-generator and antenna lead.

Note 4.—When the antenna-stage adjustment is made with the radio installed in the car, the radio antenna lead must be connected to the car antenna in the usual manner. Connect the signal-generator output lead to a wire placed near the car antenna, but not connected to it.

* While rocking.

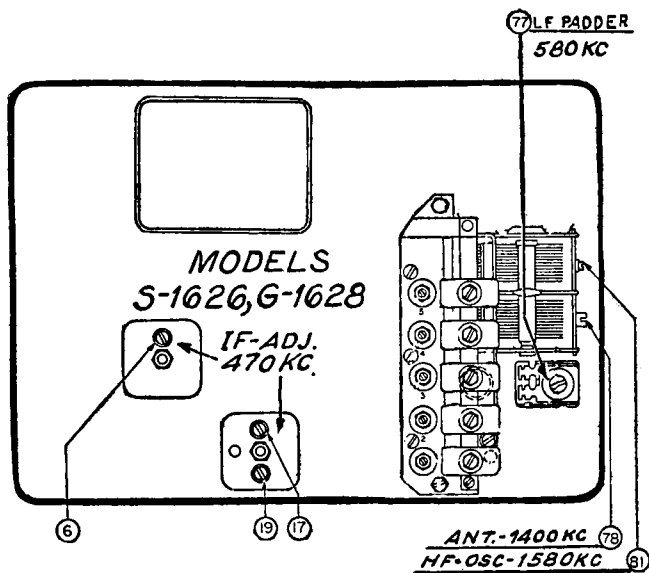

MODEL F-1640

Signal Generator Connection	Dummy Antenna	Signal Generator Frequency	Receiver Wave-band Switch	Receiver Dial Setting	Trimmer Number
Control grid of 6A7	0.5 mfd	470 kc	Note 1	Note 2	25
"	"	"	"	"	15
"	"	"	"	"	17
Note 3	30 mmf	1580 kc	"	"	78
"	"	1400 kc	"	1400 kc	77
"	"	580 kc	"	580 kc	56*
"	"	1580 kc	"	Note 2	78
"	"	1400 kc	"	1400 kc	77 ⁴

Note 1.—Press Automatic Station-Selector button until "DIAL" appears in the window and stations can be tuned in by manual tuning.

Note 2.—Turn condenser rotor plates completely out of mesh as far as they will go.

Note 3.—Connect antenna lead, Part No. 95-0063, to the antenna receptacle in the radio. Connect 30 mmf condenser in series between signal-generator and antenna lead.

Note 4.—When the antenna-stage adjustment is made with the radio installed in the car, the radio antenna lead must be connected to the car antenna in the usual manner. Connect the signal-generator output lead to a wire placed near the car antenna, but not connected to it.

* While rocking.

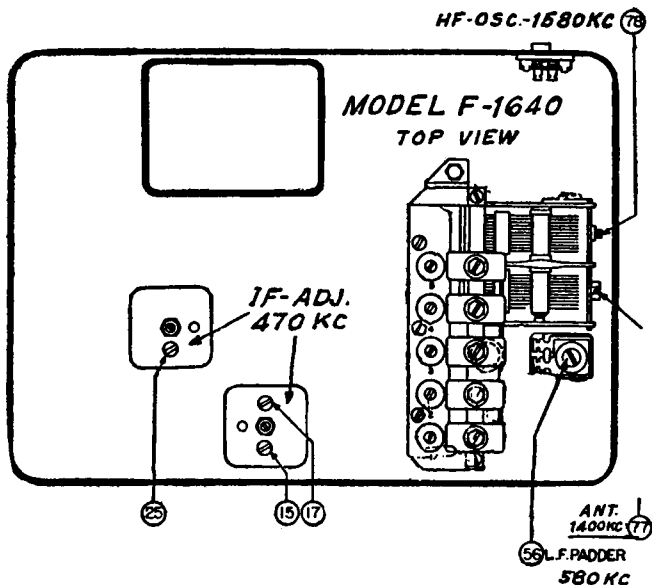

MODEL F-1641

Signal Generator Connection	Dummy Antenna	Signal Generator Frequency	Receiver Wave-band Switch	Receiver Dial Setting	Trimmer Number
Ant. Recept.	0.5 mf	470 kc	Note 1	Note 2	28
"	"	"	"	"	26
"	"	"	"	"	17
"	"	"	"	"	15
"	"	"	"	"	28
"	"	"	"	"	26
Ant. ^s	30 mmf	1580 kc	"	"	46
"	"	"	"	"	43 ⁴
"	"	580 kc	"	580 kc	45 [*]
"	"	1580 kc	"	Note 2	46

Note 1.—Press Automatic Station-Selector button until "DIAL" appears in the window and stations can be tuned in by manual tuning.

Note 2.—Turn condenser rotor plates completely out of mesh as far as they will go.

Note 3.—Connect antenna lead, Part No. 95-0063, to the antenna receptacle in the radio. Connect 30 mmf condenser in series between signal-generator and antenna lead.

Note 4.—When the antenna-stage adjustment is made with the radio installed in the car, the radio antenna lead must be connected to the car antenna in the usual manner. Connect the signal-generator output lead to a wire placed near the car antenna, but not connected to it.

* While rocking.

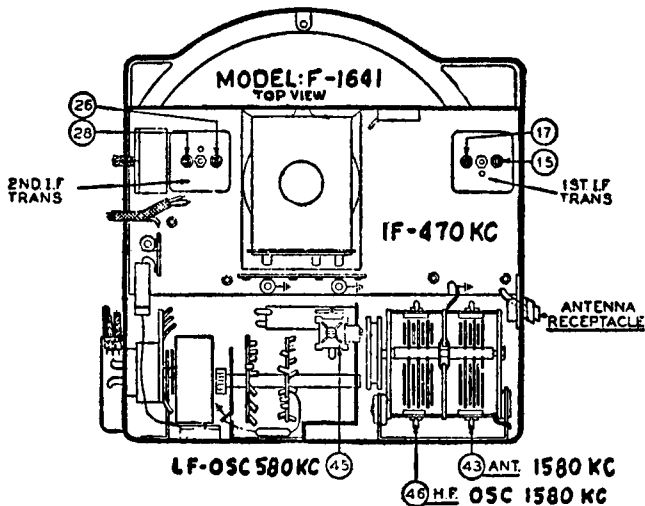

MODEL L-1660

Signal Generator Connection	Dummy Antenna	Signal Generator Frequency	Receiver Wave-band Switch	Receiver Dial Setting	Trimmer Number
Control grid of 6A7	0.1 mf	470 kc	Note 1	Note 2	27
"	"	"	"	"	20
"	"	"	"	"	17
Ant. ³	Note 3	1580 kc	"	"	55
"	"	1400 kc	"	1400 kc	50
"	"	580 kc	"	580 kc	52 *
"	"	1580 kc	"	Note 2	55
"	"	1400 kc	"	1400 kc	50 ⁴

Note 1.—Press Automatic Station-Selector button until "DIAL" appears in the window and stations can be tuned in by manual tuning.

Note 2.—Turn condenser rotor plates completely out of mesh as far as they will go.

Note 3.—When *TIRE-COMPARTMENT DOOR* antenna is used; connect antenna lead, Part No. 41-3191, to the antenna receptacle in the radio. Connect an 800 mmf condenser in series between signal-generator and antenna lead. Be sure the lead to the antenna transformer is connected to the red terminal of the antenna transformer.

When *COWL* antenna is used; connect antenna lead, Part No. 41-3191, to the antenna receptacle in the radio. No dummy capacity is necessary. Be sure the lead to the antenna transformer is connected to the black terminal of the antenna transformer.

Note 4.—When the antenna-stage adjustment is made with the radio installed in the car, the radio antenna lead must be connected to the car antenna in the usual manner. Connect the signal-generator output lead to a wire placed near the car antenna, but not connected to it.

* While rocking.

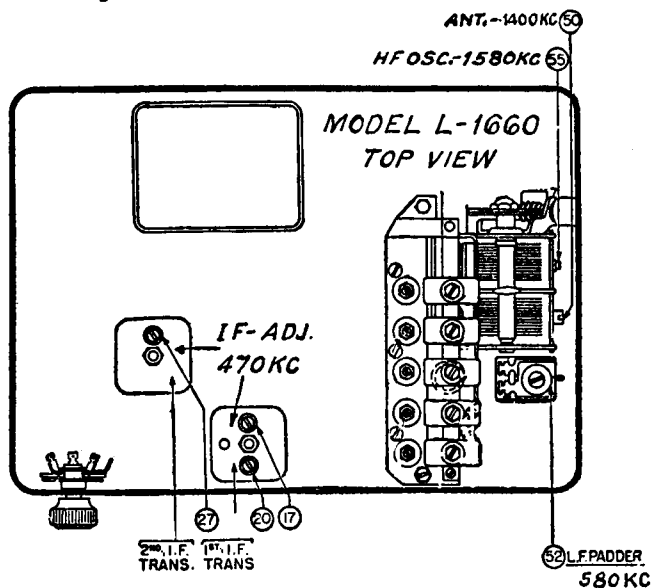

MODEL C-1708

Signal Generator Connection	Dummy Antenna	Signal Generator Frequency	Receiver Wave-band Switch	Receiver Dial Setting	Trimmer Number
Ant. Recept.	0.1 mf	455 kc	Note 1	Note 2	27
"	"	"	"	"	25
"	"	"	"	"	18
"	"	"	"	"	16
"	"	"	"	"	27
"	"	"	"	"	25
"	"	"	"	"	18
"	"	"	"	"	16
"	"	"	"	"	12 ³
Ant. ⁴	20 mmf	1400 kc	"	1400 kc	4
"	"	580 kc	"	580 kc	55*
"	"	1400 kc	"	1400 kc	4 ⁵

Note 1.—Press "DIAL" button so that stations can be tuned in by dial tuning.

Note 2.—Turn tuning-control knob clockwise as far as it will go.

Note 3.—Adjust (12) for minimum output.

Note 4.—Connect Chrysler antenna lead, Part No. 95-0106, to the antenna receptacle on the radio. Connect 20 mmf condenser in series between signal-generator and antenna lead.

Note 5.—When the antenna-stage adjustment is made with the radio installed in the car, the radio antenna lead must be connected to the cowl antenna in the usual manner. Connect the signal-generator output lead to a wire placed near the car antenna lead, but not connected to it; and adjust trimmer (4) for maximum signal at 1400 kc.

* While rocking.

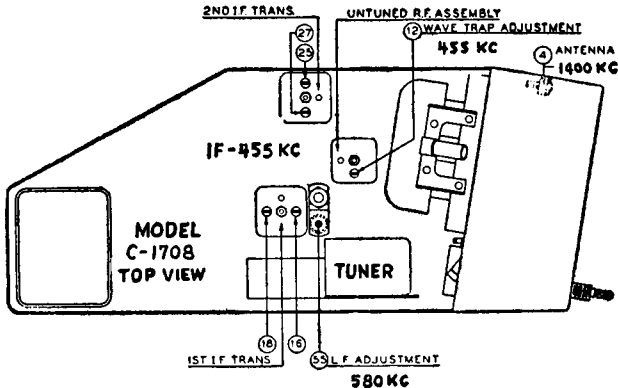

MODEL S-1722

Signal Generator Connection	Dummy Antenna	Signal Generator Frequency	Receiver Wave-band Switch	Receiver Dial Setting	Trimmer Number
Control grid of 78 IF	0.5 mf	470 kc	Note 1	Note 2	25
"	"	"	"	"	23
Ant. Recept.	"	"	"	"	15
"	"	"	"	"	13
Ant. ³	35 mmf	1580 kc	"	"	54
"	"	1360 kc	"	1360 kc	47 ⁴

Note 1.—Press Automatic Station-Selector button until "DIAL" appears in the window and stations can be tuned in by manual tuning.

Note 2.—Turn condenser rotor plates completely out of mesh as far as they will go.

Note 3.—Connect antenna lead, Part No. L-2765, to the antenna receptacle in the radio. Connect 35 mmf condenser in series between signal-generator and antenna lead.

Note 4.—When the antenna-stage adjustment is made with the radio installed in the car, the radio antenna lead must be connected to the car antenna in the usual manner. Connect the signal-generator output lead to a wire placed near the car antenna, but not connected to it.

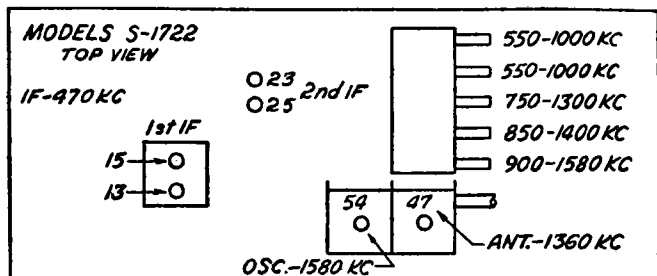

MODEL S-1726

Signal Generator Connection	Dummy Antenna	Signal Generator Frequency	Receiver Wave-band Switch	Receiver Dial Setting	Trimmer Number
Ant. Recept.	0.1 mf	455 kc	Note 1	Note 2	35
"	"	"	"	"	33
"	"	"	"	"	17
"	"	"	"	"	15
"	"	"	"	"	35
"	"	"	"	"	33
"	"	"	"	"	17
"	"	"	"	"	15
"	"	"	"	"	11 ^a
Ant. ⁴	30 mmf	1400 kc	"	1400 kc	2
"	"	580 kc	"	580 kc	57*
"	"	1400 kc	"	1400 kc	2 ^b

Note 1.—Press automatic push button until "DIAL" appears in the window and stations can be tuned in by manual tuning.

Note 2.—Turn tuning-control knob clockwise as far as it will go.

Note 3.—Adjust (11) to obtain minimum output.

Note 4.—Connect antenna lead, Part No. 95-0120, to the antenna receptacle on the radio. Connect 30 mmf condenser in series between signal-generator and antenna lead. Ground the shield pigtail to the signal-generator.

Note 5.—When the antenna-stage adjustment is made with the radio installed in the car, the radio antenna lead must be connected to the cowl antenna in the usual manner. Connect the signal-generator output lead to a wire placed near the car antenna lead, but not connected to it; and adjust trimmer (2) for maximum signal at 1400 kc.

* While rocking.

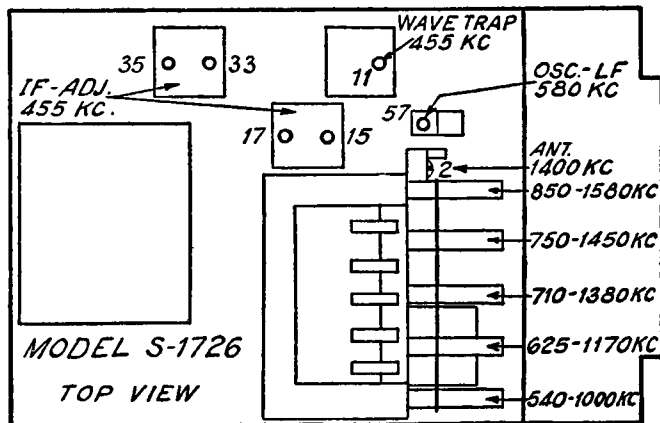

MODEL F-1740

Signal Generator Connection	Dummy Antenna	Signal Generator Frequency	Receiver Wave-band Switch	Receiver Dial Setting	Trimmer Number
Ant. Recept.	0.1 mf	455 kc	Note 1	Note 2	26
"	"	"	"	"	24
"	"	"	"	"	19
"	"	"	"	"	17
"	"	"	"	"	26
"	"	"	"	"	24
"	"	"	"	"	19
"	"	"	"	"	17
"	"	"	"	"	10 ³
Ant. ⁴	Note 4	1580 kc	"	"	59
"	"	1400 kc	"	1400 kc	2
"	"	580 kc	"	580 kc	56*
"	"	1580 kc	"	Note 2	59
"	"	1400 kc	"	1400 kc	2 ⁵

Note 1.—Press Automatic Station-Selector button until "DIAL" appears in the window and stations can be tuned in by manual tuning.

Note 2.—Turn condenser rotor plates completely out of mesh as far as they will go.

Note 3.—Adjust (10) for minimum output.

Note 4.—When *TIRE-COMPARTMENT DOOR* antenna is used; connect antenna lead, part number 95-0120, to the antenna receptacle on the radio. Connect an 830 mmf condenser in series between antenna lead and signal-generator. Ground the shield pigtail on the antenna lead to the signal-generator. Be sure antenna switch (3) is turned clockwise.

When *COWL* antenna is used; connect the antenna lead, part number 95-0120, to the antenna receptacle in the radio. Connect a 45 mmf condenser in series between antenna lead and signal-generator. Ground the shield pigtail on the antenna lead to the signal-generator. Be sure antenna switch (3) is turned counter-clockwise.

Note 5.—When the antenna-stage adjustment is made with the radio installed in the car, the radio antenna lead must be connected to the car antenna in the usual manner. Connect the signal-generator output lead to a wire placed near the car antenna, but not connected to it.

* While rocking.

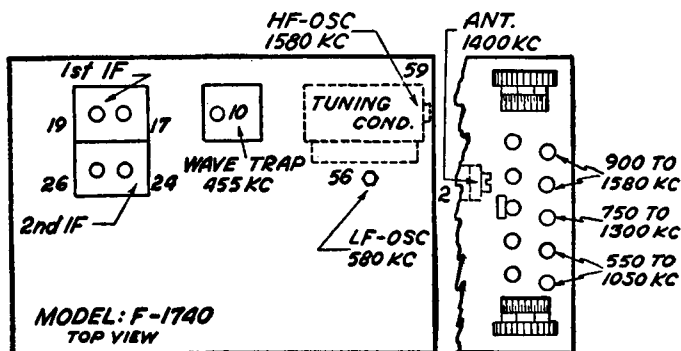

MODELS L-1760, L-1761

Signal Generator Connection	Dummy Antenna	Signal Generator Frequency	Receiver Wave-band Switch	Receiver Dial Setting	Trimmer Number
Ant. Recept.	0.1 mf	455 kc	Note 1	Note 2	27
"	"	"	"	"	25
"	"	"	"	"	19
"	"	"	"	"	17
"	"	"	"	"	27
"	"	"	"	"	25
"	"	"	"	"	19
"	"	"	"	"	17
"	"	"	"	"	9 ³
Ant. ⁴	Note 4	1580 kc	"	"	60
"	"	1360 kc	"	1360 kc	56
"	"	590 kc	"	590 kc	57*
"	"	1580 kc	"	Note 2	60
"	"	1360 kc	"	1360 kc	56 ⁵

Note 1.—Press "Rotomatic" Station-Selector button until "DIAL" appears in the window and stations can be tuned in by manual tuning.

Note 2.—Turn condenser rotor plates completely out of mesh as far as they will go.

Note 3.—Adjust (9) for minimum output.

Note 4.—When *TIRE-COMPARTMENT DOOR* antenna is used; connect antenna lead, part number 95-0120, to the antenna receptacle on the radio. Connect an 830 mmf condenser in series between antenna lead and signal-generator. Ground the shield pigtail on the antenna lead to the signal-generator. Be sure antenna switch (3) is turned clockwise.

When *COWL* antenna is used; connect the antenna lead, part number 95-0120, to the antenna receptacle in the radio. Connect a 45 mmf condenser in series between antenna lead and signal-generator. Ground the shield pigtail on the antenna lead to the signal-generator. Be sure antenna switch (3) is turned counter-clockwise.

Note 5.—When the antenna-stage adjustment is made with the radio installed in the car, the radio antenna lead must be connected to the car antenna in the usual manner. Connect the signal-generator output lead to a wire placed near the car antenna, but not connected to it.

* While rocking.

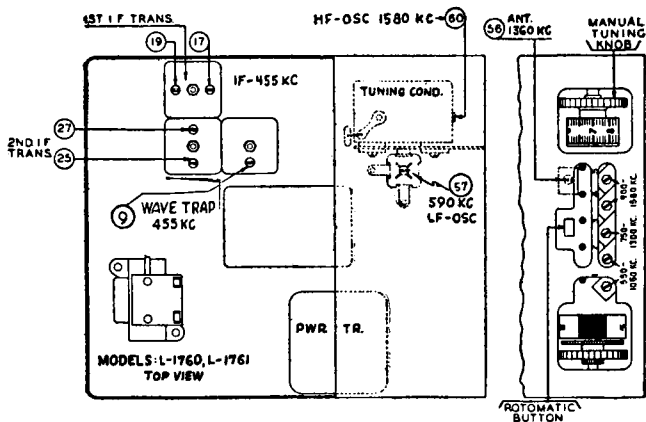

MODEL C-1808

Signal Generator Connection	Dummy Antenna	Signal Generator Frequency	Receiver Wave-band Switch	Receiver Dial Setting	Trimmer Number
Ant. recept.	0.1 mf	455 kc	Note 1	Note 2	38
"	"	"	"	"	40
"	"	"	"	"	30
"	"	"	"	"	32
"	"	"	"	"	38
"	"	"	"	"	40
"	"	"	"	"	30
"	"	"	"	"	32
"	"	"	"	"	27 ³
Note 4	25 mmf	1400 kc	"	1400 kc	17 ⁵
"	"	580 kc	"	580 kc	35 [*]
"	"	1400 kc	"	1400 kc	17 ⁵
"	"	580 kc	"	580 kc	35 [*]

Note 1.—Press "Dial" button so that stations can be tuned in by manual tuning.

Note 2.—Turn tuning control clockwise as far as it will go.

Note 3.—Adjust (27) for a minimum output signal.

Note 4.—Connect antenna lead, Part No. 95-0111, to antenna receptacle in radio. Connect a 25 mmf condenser in series between signal generator and antenna lead.

Note 5.—When antenna stage adjustment is made with radio installed in car, the radio antenna lead must be connected to car antenna in usual manner. Connect signal generator output lead to a wire placed near car antenna but not connected to it.

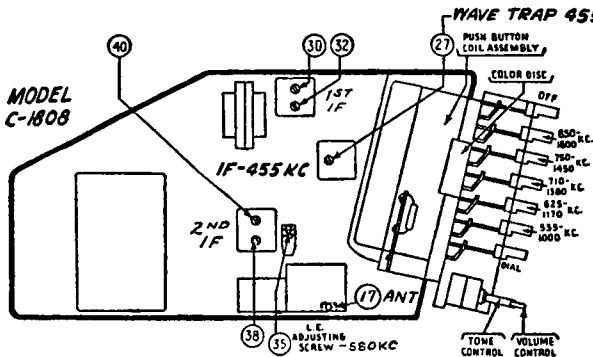

MODEL S-1824

Signal Generator Connection	Dummy Antenna	Signal Generator Frequency	Receiver Wave-band Switch	Receiver Dial Setting	Trimmer Number
Note 1	35 mmf	455 kc	...	Note 2	27
"	"	"	...	"	19
"	"	"	...	"	17
"	"	"	...	"	27
"	"	"	...	"	19
"	"	"	...	"	17
"	"	1360 kc	...	1360 kc	56
"	"	590 kc	...	590 kc	20*
"	"	1360 kc	...	1360 kc	56 ^s
...	1200-1400 kc	56 ^d

Note 1.—Connect antenna lead, Part No. 95-0111, to antenna receptacle in radio. Connect a 35 mmf condenser in series between signal generator and antenna lead.

Note 2.—Turn tuning control clockwise as far as it will go.

Note 3.—When antenna stage adjustment is made with radio installed in car, the radio antenna lead must be connected to car antenna in usual manner. Connect signal generator output lead to a wire placed near car antenna but not connected to it.

Note 4.—After installing the radio in car, tune in a weak broadcast signal between 1200 and 1400 kc on control scale. Remove plug button on end of radio and adjust antenna compensator (58) for maximum signal.

* While rocking.

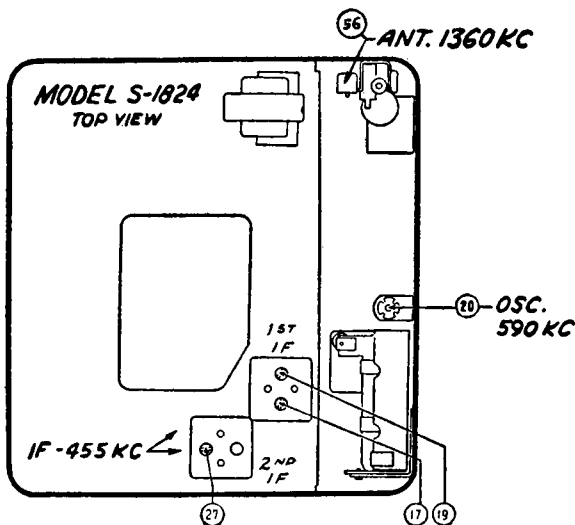

MODELS S-1825, S-1826; P-1835

Signal Generator Connection	Dummy Antenna	Signal Generator Frequency	Receiver Wave-band Switch	Receiver Dial Setting	Trimmer Number
Note 1	35 mmf	270 kc	Note 2	Note 3	1
"	"	"	"	"	2
"	"	"	"	"	3
"	"	"	"	"	4
"	"	"	"	"	1
"	"	"	"	"	2
"	"	"	"	"	3
"	"	"	"	"	4
"	"	1600 kc	"	1600 kc	5
"	"	1360 kc	"	1360 kc	6 ⁴
"	"	"	"	"	7
"	"	590 kc	"	590 kc	8*
"	"	1600 kc	"	1600 kc	5
"	"	1360 kc	"	1360 kc	6 ⁴
"	"	"	"	"	7
...	"	1200-1400 kc	6 ⁵

Note 1.—Connect antenna lead, Part No. 95-0111, to antenna receptacle in radio. Connect a 35 mmf condenser in series between signal generator and antenna lead.

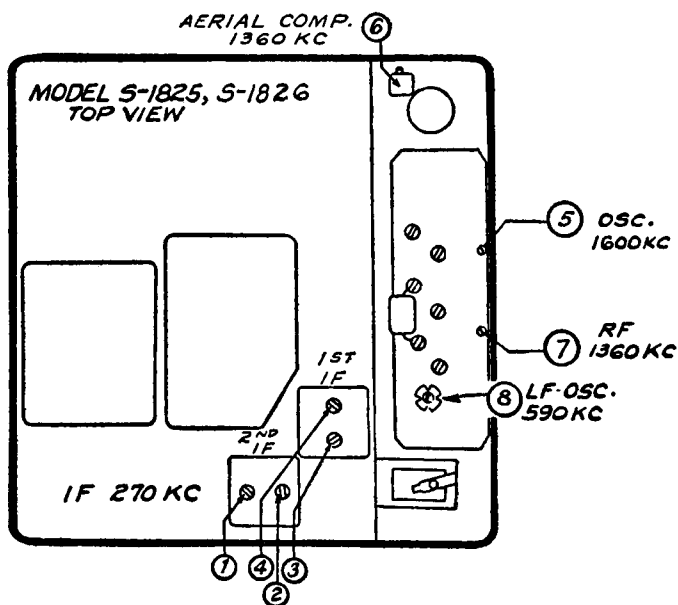

Note 2.—Push in tuning control knob so that stations can be tuned in by manual tuning.

Note 3.—Turn tuning control clockwise as far as it will go.

Note 4.—When antenna stage adjustment is made with radio installed in car, the radio antenna lead must be connected to car antenna in the usual manner. Connect signal generator output lead to a wire placed near the car antenna but not connected to it.

Note 5.—After installing radio in car, tune in a weak broadcast signal between 1200 and 1400 kc on the control scale. Remove the plug button on end of radio and adjust aerial compensator (6) for maximum signal.

* While rocking.

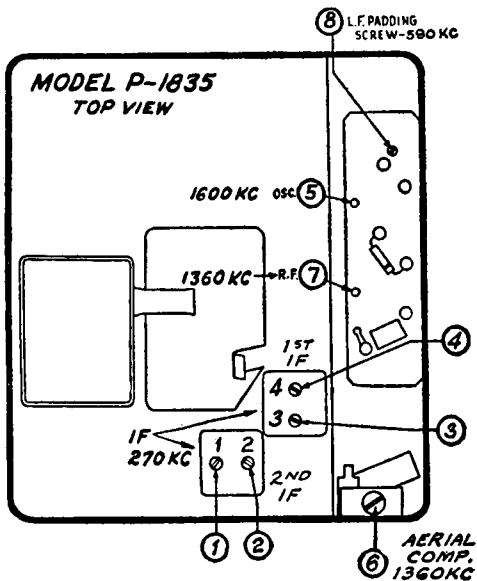

MODEL P-1841

Signal Generator Connection	Dummy Antenna	Signal Generator Frequency	Receiver Wave-band Switch	Receiver Dial Setting	Trimmer Number
Ant. recept.	0.1 mf	455 kc	Note 1	Note 2	37
"	"	"	"	"	39
"	"	"	"	"	51
"	"	"	"	"	53
"	"	"	"	"	37
"	"	"	"	"	39
"	"	"	"	"	51
"	"	"	"	"	53
"	"	"	"	"	33 ^s
Note 4	20 mmf	1360 kc	"	1360 kc	4 ⁵
"	"	590 kc	"	590 kc	26*
"	"	1400 kc	"	1400 kc	4 ⁵
"	"	590 kc	"	590 kc	26*

Note 1.—Turn selector switch knob to "D" so that stations can be tuned in by manual tuning.

Note 2.—Turn tuning control clockwise as far as it will go.

Note 3.—Adjust (33) for minimum output response.

Note 4.—Connect antenna lead, Part No. 95-0111, to antenna receptacle in radio. Connect a 20 mmf condenser in series between signal generator and antenna lead.

Note 5.—When antenna stage adjustment is made with radio installed in car, the radio antenna lead must be connected to car antenna in usual manner. Connect signal generator output lead to a wire placed near car antenna but not connected to it.

* While rocking.

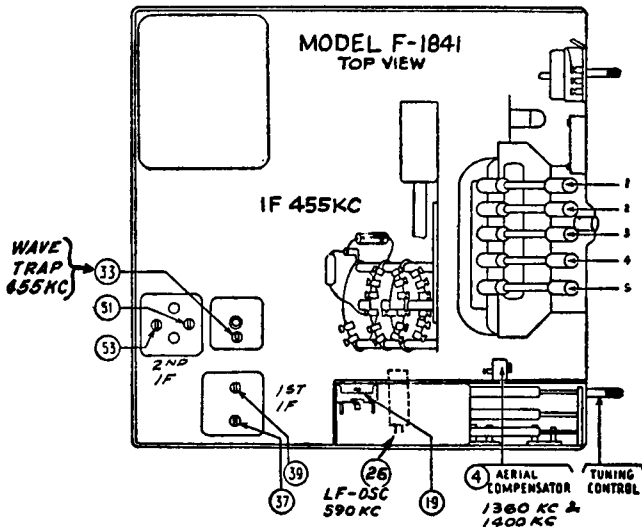

Image trap trimmer (19) adjusted at the factory. Do not disturb adjustment.

ADJUSTING MYSTERY-CONTROL FREQUENCY AMPLIFIER

The Mystery-Control receivers are shipped with five different control frequencies which range from 350 to 400 kc. These are identified by code numbers, appearing on the serial number ticket and on the rear of the chassis. These code numbers and frequencies are as follows:

Code 5—355 kc Code 6—367 kc Code 7—375 kc
Code 8—383 kc Code 9—395 kc

The purpose of the different control frequencies is to prevent interaction between two or more Mystery-Control receivers which are on the same floor, or are exceptionally close together. When several Mystery-Control receivers are to be located close together, it will be necessary to use different control frequencies. In order to prevent interaction between receivers, there should be a difference of 20 kc between their control frequencies.

If three receivers are to be operated at the same time . . . and are closely situated . . . it will be advisable to adjust the control frequency of the first set to 355 kc, the second set to 375 kc, and the third to 395 kc.

When realigning or changing the control frequency of the Mystery-Control circuit, a Philco Model 077 Signal Generator with a coil of wire (about 4 or 5 turns—12" in diameter) attached to the output terminals is required. The leads between the coil of wire and Signal-Generator should be long enough, so that the coil of wire can be placed near the large secondary inductor in the bottom of the receiver cabinet.

A Philco Aligning Screw Driver, Part No. 45-2610, and a Padding Wrench, Part No. 3164, are necessary for adjusting trimmers; and a Wireless Remote-Control Alignment Adaptor, Part No. 45-2769, is needed for the "40" series and "41" series receivers.

On the "39" Series receivers, the Control Frequency is adjusted as follows:

1. Turn range switch to position 1 (remote tuning). With the temporary coil of wire in the center of (or near) the secondary inductor, the control frequency to which the Mystery-Control Amplifier is tuned can be determined by tuning the Signal Gen-

erator between 350 and 400 kc. When the Signal Generator is tuned to the control frequency, the Thyatron (2A4G) tube will glow (blue haze). If this frequency is to be used, leave the Signal Generator indicator at this point; or turn the indicator to any other frequency desired between 350 and 400 kc.

2. When the control frequency is selected, turn the sensitivity control . . . (117) in Model 116 or (89) in Model 55, located on the left rear of the chassis . . . towards the position marked "extreme." Using the 2A4G Thyatron tube as a resonance indicator; adjust trimmers (103), (115), (119) in Model 116 . . . or (74), (85), (90) in Model 55 . . . for maximum signal. This will be indicated by the brilliance of the glow in the 2A4G Thyatron tube. As they are adjusted, gradually turn the sensitivity control to the "near" position—or reduce the output from the signal-generator. When they are correctly adjusted to maximum, the Thyatron will glow with the sensitivity control . . . (117) on Model 116, or (89) on Model 55 . . . at the "near" position and with a very weak signal from the signal-generator.
3. Next, adjust the trimmer condenser on the secondary inductor in the bottom of the receiver. It is located in one corner of the secondary inductor and is encased in a cardboard container. This condenser should be carefully adjusted for maximum glow in the 2A4G tube. Use the weakest signal possible from the Signal Generator that will cause the 2A4G to glow. Also, have the sensitivity control as close as possible to the "near" position. Extreme care should be used in adjusting to the exact point of resonance, as the secondary inductor is a very sharply tuned circuit. After adjusting the circuit, remove the Signal-Generator and loop from the receiver.
4. The WIRELESS REMOTE-CONTROL UNIT is now adjusted as follows:
 - A. Dial any one of the stations indicated on the remote unit by pulling the selector to the "Stop" position. Then, as the dial is released at the "Stop," press the "Stop" down and hold it in this position.
 - B. Holding the "Stop" in this position, bring the Mystery-Control unit close to the receiver. Using the padding wrench, adjust the trimmer screw . . . located on the bottom of the unit . . . until the 2A4G Thyatron in the receiver glows at full brilliance.

Now, turn the sensitivity control on the receiver towards the "near" position until a point is reached where the 2A4G tube almost stops glowing. Then, readjust the trimmer on the unit again for maximum brilliance in the 2A4G tube. The Mystery-Control unit should now be at the same frequency as the control frequency in the receiver.

On the "40" Series and "41" Series receivers, the control frequency is adjusted as follows:

1. Remove the 2A4G control tube from its socket and replace with the aligning adaptor. Connect the red lead of the aligning adaptor to the positive terminal of the vacuum-tube voltmeter. The black lead of the adaptor is connected to the negative terminal of the vacuum-tube voltmeter.
2. Remove the 78 control amplifier tube, its shield, and the shield of the 6J7G tube. Apply power to the set and turn the range selector disc to "remote."
3. Attach the "high" side of the signal-generator output through a 0.5 mf condenser to the grid of the 6J7G tube. Set the generator modulation control to "mod. on" and turn the attenuator control about one-fourth "on."
4. The control frequency to which the control amplifier is tuned can now be determined by tuning the signal-generator between 350 and 400 kc. When the signal generator is tuned to the control frequency, the vacuum tube voltmeter will show maximum deflection. If this frequency is to be used, leave the signal generator at this point; or turn the indicator to any other frequency desired between 350 and 400 kc.
5. After the control frequency has been found or changed, trimmers (W) and (X) are adjusted for maximum indication on the vacuum-tube voltmeter.
6. After adjusting this circuit, replace the 78 tube and shields in their sockets; and remove the signal-generator lead from the grid of the 6J7G tube.
7. Place the small loop previously mentioned into the "high" and "ground" of the signal-generator output terminals, and place the signal-generator near the secondary inductor loop in the bottom of the cabinet. When doing this, do not disturb the setting of the signal-generator indicator. On the "40" series receivers, turn the sensitivity control . . . located on the right rear of the chassis . . . toward the position marked "extreme"; then adjust trimmers (Y) and (Z) for maximum reading on the vacuum tube voltmeter. On the "41" series receivers, there is no adjustable sensitivity-control to be shifted; trimmers (Y) and (Z) are adjusted directly.
8. Next adjust the secondary inductor loop trimmer located in the bottom of the cabinet. This compensator is encased in a cardboard container that is attached to one corner of the loop. Extreme care should be used in adjusting to the exact point of resonance, as the secondary inductor is a very sharply tuned circuit.
9. If the vacuum-tube voltmeter pointer goes off scale when adjusting the trimmers, turn the attenuator control of the signal-generator toward the "off" position. After these trimmers are

adjusted to maximum, the control amplifier is correctly tuned to the frequency selected.

10. The WIRELESS REMOTE-CONTROL UNIT is now adjusted to the control frequency of the amplifier as follows:
 - A. Turn off the signal-generator, then dial any one of the stations indicated on the remote-control unit by pulling the selector to the stop position; release the selector and at the same time press the stop down and hold it in this position.
 - B. Now bring the wireless remote-control unit close to the receiver. Using padding wrench, Philco Part No. 3164, tune the trimmer . . . located on the bottom of the remote control unit . . . until a maximum voltage reading is indicated on the vacuum tube voltmeter. When tuning this trimmer, it should be done very slowly; so as not to pass over the frequency to which the control amplifier is tuned.
 - C. After adjusting with the sensitivity control on the "40" series receiver in the "extreme" position, the remote-control unit is adjusted for maximum sensitivity; by setting the sensitivity control in the "near" position, and placing the remote-control unit a few feet away from the receiver. The trimmer is then adjusted again for maximum voltage reading of the vacuum-tube voltmeter. On "41" series . . . without adjustable sensitivity control . . . the trimmer is directly adjusted after moving the control unit closer to the receiver.
 - D. After making these adjustments, remove the aligning adaptor from the socket and replace the 2A4G tube. The wireless remote-control unit is now adjusted to the same frequency as the control frequency in the receiver.

Note—Adjusting Remote-Control Unit Operating Distance on "41" Series Receivers.

When shipped from the factory, the wireless remote-control circuit is adjusted to control the radio from an average distance that has been found to be satisfactory in most installations. In some special cases, however, where the radio and control are situated near large metal objects, or installed in metal shielded areas, it may be necessary to change the control circuit to get adequate remote control (increase sensitivity) from certain distances. In these cases, the value of resistor (139) 15,000 ohms, located underneath the radio chassis, should be changed to a lower value that will give the desired range of control. The resistor, however, should not be lowered in value more than is found necessary for the special installation. If the control range is too sensitive, the resistor should be changed to a higher value (more resistance).

ADJUSTING MYSTERY CONTROL FOR RECEPTION OF STATIONS

On the "39" Series and "40" Series receivers; the procedure for setting up stations on the wireless remote-control is similar to the procedure in setting up Philco electric automatic-tuning models. The eight positions, however, are automatically dialed by the remote-control unit, instead of by pushing buttons.

On Phonograph Combination models; only seven stations can be automatically dialed—the eighth position being used to dial the "phono," which is permanently connected into the circuit. When using the wireless remote-control to operate the phonograph, the Inter-Mix Record-Changer can be started and stopped, records "rejected," and volume adjusted, from the remote control unit. The automatic record changer is selected . . . or records "rejected" . . . by dialing "PHONO" position.

To set up stations on these models for best reception, a signal-generator, Philco Model 077 and a vacuum-tube voltmeter Philco Model 027 or 028 should be used. With this equipment proceed as follows:

1. The lowest frequency station is at the first window on the left; and the remaining stations in the order of increasing frequency. Turn "on" power switch.
2. Connect the negative terminal of the vacuum tube voltmeter through a 2-megohm resistor to the grid of the 78 i-f tube. The resistor must be connected directly to the grid of the tube and the voltmeter attached to the resistor at this point. Connect the positive terminal to the chassis ground terminal.
3. Attach a loop consisting of a few turns of wire to the output terminals of the Model 077 signal-generator. Turn the signal-generator modulation control to "mod. on." Turn the receiver range-selector switch to "Broadcast" and manually tune in the lowest frequency station desired. This station should be between 540 and 1030 kc. The signal-generator is then tuned to the frequency of the station being received. A beat note should then be heard when the volume control is turned on.
4. Turn the range-selector disc of the receiver to "remote." Dial first low-frequency station on the right side of the bezel of the remote control unit.
5. Using a padding screw driver; adjust the first 540 to 1030 kc "Osc" padder (bottom row of holes) at the left rear of the chassis,

until the station . . . identified by the modulated signal of the generator . . . is tuned in to maximum on the vacuum-tube voltmeter. Next, adjust the first 540 to 1030 kc "Ant" padder (top row of holes) for maximum indication on the voltmeter.

6. Turn the signal-generator off the station frequency and readjust the "Ant" and "Osc" padders with the station signal for maximum reading on the voltmeter. This should be done with the volume control of the receiver adjusted for low volume. This procedure is repeated for each of the remaining stations to be set up. The next station to be set up should be within the frequency range of 540 to 1030 kc of the second set of padders. The third station is tuned in by the third set of padders and should be within a frequency range of 670 to 1160 kc. The remaining stations are then set up in the order of increasing frequency.

On the "41" Series receivers; broadcast stations can be tuned in automatically from the wireless-remote control unit, and in addition, can also be tuned in automatically by push-button operation. Eight push-buttons are provided on the radio chassis. One of these (extreme left) is used to select Remote-Control Tuning. The remaining push-buttons are used to select stations automatically by push-button operation.

By using the remote-tuning unit, seven broadcast stations can be tuned in; the volume can be raised and lowered; a "silent" position can be selected; and the radio can be turned "OFF."

On Phonograph Combination models; only six stations can be automatically dialed, or push-buttoned—the eighth position being used to dial, or to push-button, the "phono," which is permanently connected into the circuit as in the "39" series and "40" series receivers.

The selected broadcast stations are set up for push-button and remote-tuning control operation by adjusting the padders and coils located in back of the push-button assembly. Three adjustments must be made for each broadcast station selected.

The bottom row marked "ANT" is for the antenna padder for remote-control operation; the middle row of adjusting screws is for the oscillator coils used in remote-control; the top row of adjusting screws is for the oscillator adjustment for push-button tuning. Each set of three padders is numbered from "1 to 7"—set No. 1 for Position No. 2, set No. 2 for Position No. 3, etc.—only six sets being used on "phono" combination models.

To set up stations on these models for best reception, a signal-generator PHILCO Model 077; Vacuum-Tube Voltmeter PHILCO Model 027 or 028; and Aligning-Adaptor, Part No. 45-2767 should be used. With this equipment proceed as follows:

1. The lowest frequency station is at the second window on the left of the bezel, and the remaining stations in the order of increasing broadcast frequency.

2. Remove the 7C6 second-detector tube from its socket and insert the aligning-adaptor, Part No. 45-2767. Replace the tube in the adaptor. Connect the negative (—) terminal of the vacuum-tube voltmeter to the light colored wire which protrudes from the side of the adaptor. Attach the positive (+) terminal of the voltmeter to the black wire of the adaptor.
3. Turn volume-control and power-switch to the "ON" position, and allow the receiver to heat up. Attach a loop consisting of a few turns of wire to the output terminals of the Model 077 signal-generator. Turn the signal-generator power-switch to "MOD. ON." Turn the receiver "Band" selector to "Broadcast" and manually tune in the lowest-frequency station desired. This station should be between 540 to 1030 kc. Then tune the signal-generator to the frequency of the same station and a beat note will be heard. Leave the signal-generator pointer set at this frequency.
4. Press in the "Remote" push-button. Dial the first low-frequency station on the remote-control unit.
5. Using a padding screw driver; adjust No. 1 "OSC Remote" (middle row) until the station identified by the modulated signal of the signal-generator is tuned to maximum reading on the voltmeter. Next adjust the "No. 1 ANT" padder (bottom row) for maximum indication on the voltmeter.

Press in the No. 1 push-button on the radio and adjust No. 1 "P.BUTTON OSC" padder (top row) for maximum output on the same station.

6. Turn the signal-generator off the station frequency and readjust the No. 1 "OSC P.BUTTON" padder for maximum; then press REMOTE push-button and readjust No. 1 "Remote OSC" and No. 1 "ANT" padders for maximum reading with the station signal. This should be done with the volume control of the receiver at low volume.

Repeat this procedure for each of the remaining stations to be set up. They should be set up in the order of their increasing frequency.

7. After all stations have been set up for push-button and remote-control operation, press in the fifth (5) push-button; and adjust the padder "ANT COMPENSATOR," located to the right of the padder-strip unit below the dial, for maximum signal strength.

APPENDIX

Alignment Tool Reaction

In the course of aligning a receiver, you will observe that although a compensator is adjusted for maximum reading on the output meter, this reading falls as the alignment tool is removed. This occurs because the tool introduces a certain amount of capacity into the tuned circuit and consequently the circuit is detuned when the tool is removed. This is especially noticeable in the case of the oscillator adjustments on the short-wave bands.

Experience is of great assistance in overcoming this effect. You will find that if you adjust the trimmer for maximum output and then increase the adjustment slightly (clockwise) that the output will rise to its previous maximum value as the tool is withdrawn. If you do not obtain the correct adjustment the first time, you should repeat the adjustment until the output rises to approximately the same value when the tool is removed, that it had when you adjusted for maximum output with the tool on the trimmer.

Signal Strength

There are certain general practices which you should follow with regard to the strength of the signal which is used for alignment. As a general rule, unless otherwise stated in the instructions, you should make the input signal as weak as possible; yet at the same time strong enough to obtain a readable indication. This means that you will have to adjust the attenuator constantly during the course of the alignment so as to keep the output meter reading at about middle scale. Thus, as the set is brought into alignment, its sensitivity naturally increases and a smaller value of input signal is required. You should never attempt to prevent the output meter from going off scale by shifting to a higher output meter range, or by turning down the volume. Failure to observe this procedure will result in a poor alignment job.

The reason for keeping the signal input at a low level is to prevent the avc system from interfering with the proper peaking of the tuned circuits. When the signal input is high enough so that the avc system tends to keep the output at a constant level, it becomes very difficult to peak the trimmers properly.

Output Meter

With but a few exceptions, all Philco receivers are aligned with the conventional type of output meter which is connected so as to

measure the audio output of the receiver. For receivers which have but a single output stage it is convenient to connect the output meter from the plate terminal of the output tube to the cathode. It is, of course, assumed that the output meter contains a blocking condenser so as to prevent the d-c plate voltage from burning out the meter. In the case of push-pull output stages, the meter can be connected in the same way if it is so desired. It is also possible to connect the output meter across the plates of the push-pull tubes. This latter type of connection does not subject the blocking condenser in the output meter to a high plate voltage. However it should not be used where one terminal on the output meter is grounded to the case because of possibility of shock.

It is important that the proper scale range be used on the output meter. For general purposes the 0-30 or 0-50 volt scale range is quite satisfactory. If the signal input is constantly adjusted so as to keep the meter at half scale setting, there will be no danger of the AVC action introducing error as was previously explained.

I-F Alignment

With these general ideas in mind, we can proceed to a consideration of the points which you should observe as the alignment procedure gets under way. As you know the first step in the alignment of a superheterodyne receiver is the alignment of the i-f amplifier. The instructions given in the preceding pages are specific as to the manner in which the signal generator is to be connected. In most cases you will find it possible to drive a signal through the i-f amplifier with the signal generator connected to the grid of the first detector. Where this is not possible, it is advisable to connect the signal generator lead to the grid of the first i-f stage. After the trimmers for the last stage are aligned, you should shift the signal generator to the grid of the first detector and align the remaining i-f trimmers. As a general rule, you should start the i-f adjustments with the trimmer nearest the second detector and work towards the first detector. However, in some cases this order is not followed and in these cases you should carefully follow the procedure outlined for the specific model.

While the position of the tuning condenser and the waveband switch are not directly involved while the i-f amplifier is being aligned, it is good practice to set the waveband switch to the broadcast band position and the dial to the low frequency end of the band in the neighborhood of 550 kc. If instructions are given in the alignment tables, follow these instructions. Inability to drive a signal through the i-f amplifier can often be traced to the short-circuiting effect of the first-detector tuned circuit. This effect is minimized by tuning the receiver to the low-frequency end of the broadcast band. When the grid clip of the first detector is removed, the positions of the waveband switch and the tuning dial are of no importance.

Change of I-F Peak

In certain localities it has been found advisable to align two and three-gang Philco receivers at some i-f peak other than the one for which they were designed, i.e. 470 kc. This change has been found necessary because of certain types of interference peculiar to these localities, among which are Portland, Maine; Miami, Florida; New

Haven, Connecticut; San Diego, California; the northern one third of Long Island; Newark; and Southern New Jersey.

When interference is experienced in any one of these places, it is advisable to realign the i-f amplifier at 456 kc, 465 kc, or 480 kc. The i-f peak which is furthest away from the interference should be used. The wave trap should not be aligned at the i-f peak, but preferably to give maximum attenuation of the interference.

Dial Alignment

Special DIAL-CALIBRATION instructions, in the form of footnotes, are frequently given—to check the relative position of the dial with respect to the condenser shaft. They vary considerably in the many types of Philco receivers. In some models, you will find that the proper dial alignment is secured by completely meshing the plates; and then setting the dial so that the indicator falls on or between two index marks at the low-frequency end of the broadcast scale.

In other models, you will find that proper dial alignment is secured by inserting a thin gauge, generally .006 inch thick, between the stator and rotor plates; and with the condenser shaft in this position, adjusting the dial so that it reads say 1500 kc (the exact value is different for different receivers and is specified in the notes accompanying the alignment instructions). You should make it a practice to recheck the dial alignment, after the set screws are finally tightened, to insure against error due to possible movement of the shaft or dial while tightening the set screws.

In still other cases, the final adjustment of the dial is made in the middle of the band at 1000 kc; after the entire alignment of the receiver has been made. Also, in some receivers, the final dial alignment is performed after replacing the chassis in its cabinet.

This operation is very important and failure to carry it out (where it is necessary) will result in poor alignment and calibration.

Wave Trap Alignment

Following the alignment of the i-f amplifier and the check on the dial alignment, the next operation is the adjustment of the wave trap. Of course not all receivers have a wave trap; but when they have, the wave trap should be adjusted so as to prevent interaction between the wave trap and the r-f adjustments. This is avoided by carrying out the wave-trap adjustment before the r-f adjustments. The initial adjustment of the wave trap is made with the signal generator connected to the antenna post of the receiver.

Unlike practically all other adjustments, the wave trap trimmer is adjusted for *minimum* output with the signal generator frequency set to the i-f peak. In general, it will not be necessary to change this adjustment again. However, if after the receiver is installed, interference in the neighborhood of the intermediate frequency is present, then you should readjust the wave trap trimmer slightly. This readjustment should be made while the receiver is connected to the antenna and tuned to the point on the dial where the interference is most pronounced. With the receiver in this condition and the volume control fully advanced, you should adjust the wave trap trimmer so as to minimize this noise. This is the proper

adjustment, even though the wave trap is resonated to a frequency slightly different from the intermediate frequency.

Oscillator Adjustments

By far the most important of the adjustments which follow are those located in the oscillator circuit. They are of extreme importance because the frequency of the oscillator determines whether the beat frequency produced in the first detector is above, below, or exactly at the i-f peak. Improper adjustment of the oscillator impairs the sensitivity, selectivity and the dial calibration to a marked extent. On the other hand, the other adjustments which are made at radio frequencies affect the performance to a much smaller degree. The dial calibration in particular is controlled almost entirely by the oscillator adjustment.

High Frequency End of Band

As a general rule, the adjustment of the high-frequency oscillator trimmer is the first radio-frequency adjustment. This is carried out with the signal generator tuned to the high-frequency end of the band—generally 1400 kc or 1500 kc for the broadcast band. In general, the receiver should be tuned to the same frequency at which the signal generator is set; and an attempt should be made to pick up the signal. If the receiver is out of alignment appreciably, it will be impossible to pick up the signal at the correct point on the dial; but you will find that the signal comes in somewhere near the required point, perhaps as much as 100 kc on either side. If for example, the signal generator is set at 1400 kc and the signal appears at 1300 kc on the receiver dial, then the high-frequency oscillator trimmer should be turned clockwise slowly (increasing the capacity) until it is possible to hear the signal with the dial set at the proper frequency, which is 1400 kc in this example. You should now adjust the trimmer accurately for maximum output—both the signal generator and the dial reading exactly the same frequency. Following this adjustment, the r-f and antenna trimmers (generally located on the top of the tuning condenser gang) are adjusted for maximum output.

Low Frequency Oscillator-Rocking

Just as the high-frequency oscillator adjustment determines the performance of the receiver over the high-frequency portion of the band, so the low-frequency oscillator padder determines the performance over the low-frequency end of the band.

The procedure for making this adjustment is different from the usual manner in which the other compensating condensers in the receivers are adjusted, and is generally known as "rocking."

This rocking adjustment is carried out as follows: The receiver and signal generator are tuned to that point near the low-frequency end of the band which is specified in the table of instructions. To make this discussion more definite and easier to follow, we shall assume that the operation is being carried out for the broadcast band, in which case the signal generator would be set at about 600 kc. The next step is to tune the receiver so that the maximum output is obtained. In general, the dial reading will not be 600 kc but may be off by as much as 10 or more kilocycles on either side. That is, the

dial reading may be 590 kc or perhaps 610 kc. Whatever the dial reading, however, the next step is to try to increase the output by adjusting the low-frequency padder. After adjusting this for maximum output, rotate the dial of the receiver slightly in both directions and leave it in that position which gives the greatest output. Then readjust for maximum output again, and following this, reset the dial for maximum output. You should continue this alternate readjustment of the low-frequency padder and the dial position, until readjustment no longer raises the output.

To put it very briefly; the purpose of this so called rocking adjustment, the need for which is indicated in this book by an asterisk (*), is to secure the best possible alignment by tuning the r-f and detector circuits exactly to the signal and at the same time making the oscillator frequency higher than the signal by the amount of the intermediate frequency.

In the case of some receivers, you will observe that a slightly different method is indicated for the adjustment of low-frequency padders. This different method is needed because the selectivity of the r-f tuned circuits is purposely lowered so as to prevent sideband cutting and permit high-fidelity reception. In those cases where this procedure is called for, the instructions explain the method.

On some receivers this rocking procedure is also specified for some of the trimmers on the short-wave bands besides the low-frequency broadcast-oscillator series padder.

Image Check

The basic procedure for making the adjustments of the r-f and oscillator trimmers is the same for the short-wave bands as for the broadcast band. However, somewhat greater care must be exercised because of the possibility of error due to the image response of the receiver. This possibility of error arises since there are two settings of the oscillator frequency which will give the same output at the specific frequency at which the set is being aligned. In spite of the fact that two adjustments of the oscillator trimmer are possible, only one of these is correct and will produce good performance over the entire dial.

As you know a superheterodyne receiver can operate with the oscillator frequency above or below the intermediate frequency. For this reason, as you decrease the capacity of the oscillator trimmer, *starting from the maximum-capacity position, you will in general encounter two peaks.* The first of these occurs when the oscillator frequency is *less* than the signal frequency by the amount of the i-f peak. As the capacity is further decreased, the second peak occurs; and this is the correct setting at which the oscillator frequency is *higher* than the signal frequency. You will find in the preceding pages that the footnotes associated with the tabulations generally indicate which peak to use for the proper adjustment where necessary on a particular receiver.

In some cases, you will find that only one peak can be obtained. This means that the range of the trimmer capacity is not large enough to cause two peaks.

On all the short-wave bands, where called for in the footnotes, you should make the following check to guard against the possibility of oscillator misalignment. We shall illustrate the method for a spe-

cific case and the general procedure for checking the *image response* will then be clear. Suppose that a receiver (i.f. 460 kc) is being aligned at 18 mc. With the dial and signal generator set at 18 mc, the oscillator trimmer is adjusted for maximum output on the proper second peak as specified. After this is done, the receiver is slowly detuned below 18 mc; and at a dial reading of about 17.08 mc, it should be possible to pick up the image response. For this condition the oscillator frequency is now *below the signal frequency by the amount of the i-f peak*; but the r-f and detector circuits are detuned. *For this reason you will find it necessary to raise the output of the signal generator in order to find the image.* (It should be noted that on some receivers the image check is at a frequency higher than that of the signal generator output.)

If the oscillator trimmer has been incorrectly aligned, it will be impossible to find the image response at the specified point, i.e. to pick up the 18-mc signal at a point lower in frequency than the signal. However, you will find the image *above* the signal frequency instead of below. To continue with this same example, the image would then be found by tuning the receiver to about 18.92 mc. If the image is found above the signal frequency rather than below, it means that the oscillator has been aligned to the "greater capacity peak" instead of the "smaller capacity peak." Repeat the adjustment, this time setting the oscillator trimmer to the correct peak so that the image response occurs below the signal frequency, as explained above.

Likewise, if the first peak is the one to be used, as specified on some receivers, the image check will be at a higher frequency, as previously explained. Then for the above example, the corresponding dial positions would be 18.920 mc for the correct adjustment, and 17.080 for that one which is incorrect.

The above figures have been given for an i-f peak of 460 kc. For any i-f peak, the image should be found at a point below or above the signal frequency by an amount equal to *twice the i-f peak*. Thus for an i-f peak of 260 kc and a frequency of 18 mc, the two image points would be 17.480 and 18.520 mc.

Detector and R-F Alignment

As far as the broadcast band and the lower frequency short-wave bands are concerned, the alignment of the detector and antenna tuned circuits does not present any particular problem; and is made in the ordinary manner, as indicated in the instructions. However, on the high-frequency short-wave bands for certain receivers, a modified procedure is indicated; which we shall now explain.

When an attempt is made to adjust the antenna and r-f trimmers in the usual way, poor alignment occurs because of the interaction between the r-f tuned circuits and the oscillator; that is, a change in the oscillator trimmer affects the r-f adjustments and makes it difficult to secure accurate alignment.

To get around this difficulty, you will observe that the instructions call for placing a variable condenser, having a capacity of about 350 mmf and having a good vernier drive, across the oscillator tuned circuit. The procedure is as follows: The receiver and signal generator are first tuned to the value indicated in the tables, which we shall assume to be 18 mc. The oscillator trimmer is next adjusted to

maximum output and the image check made, as we explained in the previous section. The next step is to connect the external variable condenser across the oscillator tuned circuit and to adjust this condenser so that a signal is again received. (You should be careful not to disturb the dial setting while the condenser is being connected and adjusted.) When this is done, the oscillator is working at half of its normal operating frequency. In other words, the second harmonic, rather than the fundamental, of the oscillator mixes with the incoming signal. In this way, the interaction between the several circuits is reduced; so as to make possible an accurate adjustment of the r-f and detector compensating condensers.

Wherever this method is necessary, the instructions are specific as to the procedure. We have brought up this point here because it is frequently used, and it is desirable that you understand why this apparently complicated procedure is used. In this same connection, the external variable condenser must be connected across the *entire oscillator tuned circuit* for those models which employ a series condenser to accomplish electrical band spread. If the external variable condenser is connected across the oscillator section of the variable condenser for these models, it will be impossible to reduce the oscillator frequency to a sufficiently low value.

Magnetic Tuning Alignment

The Magnetic Tuning System employed in some Philco receivers is a system of automatic frequency control, designed to make possible quick and accurate tuning, and to compensate for the effects of oscillator drift. It is composed of two principal units; (1) the discriminator, which determines whether the set is mistuned and which provides control voltages whose magnitude and polarity indicate the extent and direction of the mistuning, and (2) the control circuit, which, in response to the control voltages, changes or shifts the oscillator frequency accordingly.

The control circuit does not present any problem from the point of view of alignment since there are no adjustments required. However, it is extremely important that the discriminator transformer be accurately aligned at the intermediate frequency. As you will observe by glancing through the alignment instructions for any one of the receivers equipped with a Magnetic Tuning system, the receiver is first aligned in the usual manner *with the Magnetic Tuning switch in the off position*. This includes the complete i-f., oscillator, and r-f. adjustments and also the primary winding of the discriminator transformer, since this winding feeds the second detector. We repeat: *these adjustments must be made with the Magnetic Tuning switch in the "off" position.*

With these adjustments completed, it remains to adjust the secondary trimmer of the discriminator transformer. This is accomplished in the following manner: Couple the signal generator to the antenna of the receiver and set the frequency at 1000 kc. *Tune in the signal very carefully for maximum output.* A strong value of input signal must be used. Without disturbing any of the settings, the Magnetic Tuning switch should be turned to the "on" position and the secondary trimmer of the discriminator transformer adjusted for maximum output.

When the Magnetic Tuning system is functioning properly, there

will be no hiss or change in tone as the automatic tuning switch is shifted on and off. If there is a change in tone or a hiss, it indicates that a frequency shift has taken place, and the adjustment of the secondary discriminator trimmer should be repeated.

10-KC Filter Adjustment

A number of Philco receivers incorporate an audio filter which should be adjusted to cut off at 10 kc. This filter will seldom require adjustment unless it has been tampered with.

In the event that adjustment proves to be necessary, it is best carried out with an audio oscillator, which should be set to generate a frequency of 10 kc. The output of the audio signal generator should be connected across the audio volume control. With the output meter connected as usual, the 10 kc filter adjustment should be made for minimum output.

Where an audio oscillator is not available, the following procedure can be used to effect an adjustment. Connect the signal generator to the grid of the first detector through a .0001 mf condenser and set the frequency at the i-f peak of the receiver. (The fidelity or selectivity switch for this adjustment should be in the "broad" position.) The next step is to tune in a local station and to adjust the output of the signal generator so that a beat (whistle) is obtained between the local station and the signal generator. Then adjust the receiver dial carefully so that zero beat is obtained.

The object of the next step is to obtain a 10 kc beat. This is done by advancing the setting of the signal generator by 10 kc. That is, for example, if the i-f peak is 260 kc, then the signal generator should be advanced to 270 kc. Having advanced the frequency of the signal generator by this amount, a 10-kc whistle will be heard and the adjustment of the filter is completed when the compensating condenser across the 10-kc tuned circuit is adjusted so that the output is a minimum.

Repetition of Adjustments

As a general rule it will be quite unnecessary to go over the trimmers to a greater extent than that indicated in the instructions. The exception to this rule occurs when the receiver is initially very badly out of line. When this is the case, you will find that an appreciable change in the capacity of the trimmer condensers is necessary on the first adjustment. The final adjustment in these cases will be considerably improved if the entire alignment procedure is repeated.

In this same connection, the final adjustment of the i-f amplifier can be made before the r-f alignment is attempted. The only exception to this rule is in the case where a composite oscillator-detector circuit is used. In this case there is some interaction between the r-f adjustments and the adjustment of the first i-f transformer. For this type of receiver, the *final* adjustment of the i-f amplifier should be made after a preliminary adjustment of the r-f and oscillator circuits.