

FIFTY CENTS

an *ALLIED* publication



Best Ways to Use Your **VOM** and **VTVM**

*a complete guide to the
understanding and proper use
of these basic test instruments*

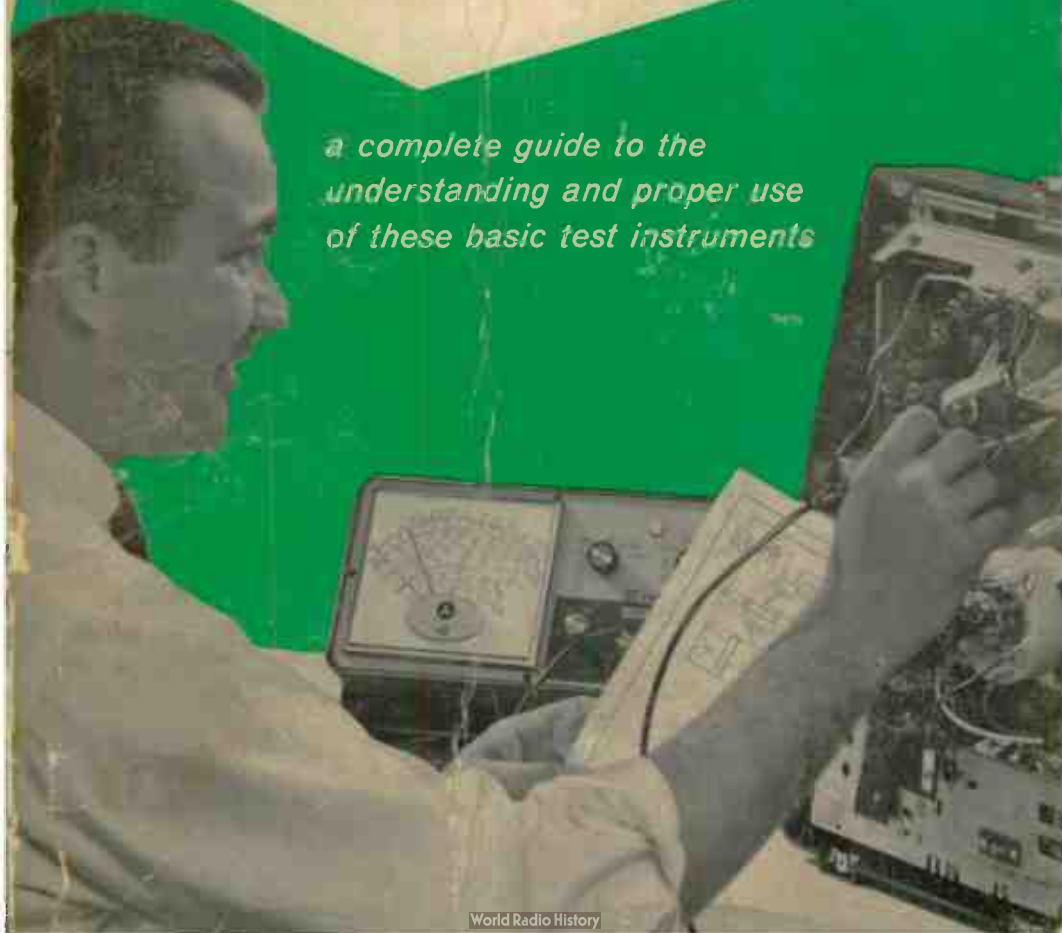



published by

ALLIED RADIO CORPORATION

CHICAGO, ILL. 60680

BEST WAYS TO USE YOUR VOM AND VTVM

**Written Under the Direction of
the Publications Division
Allied Radio Corporation**

**Edited by
Fred Shunaman
Managing Editor, Radio-Electronics**



ALLIED RADIO
CHICAGO, ILL. 60680

FIRST EDITION
FIRST PRINTING—JULY, 1965

**BEST WAYS TO USE YOUR
VOM and VTVM**

Copyright © 1965 by Allied Radio Corporation, Chicago 80, Illinois.
Printed in the United States of America.
Reproduction or use, without express permission, of editorial or pictorial content, in any manner, is prohibited. No patent liability is assumed with respect to the use of the information contained herein.

Library of Congress Catalog Card Number: 65-26009

PREFACE

Your own senses—sight, touch, smell—are the most basic test instruments. Your nose can react to the odor of a burning part, your eye can see a charred, blackened component. If all circuit problems presented such clear evidence, there would be little need for other test equipment. But the number and variety of instruments in the average service shop or lab indicate that our senses alone are not enough. Most troubles are completely hidden from view—or fall entirely beyond the range of human perception. We cannot, for example, *see* a radio wave or a flow of current.

These limits explain the need for test instruments. By sensing a whole range of electrical values, then converting them to meaningful readings, test equipment makes an electronic circuit surrender its secrets. Two of the most useful pieces of test equipment are the vacuum-tube voltmeter and the volt-ohm-milliammeter, and this book is devoted entirely to these two instruments.

There are many makes or brands of VOM's and VTVM's. Too, they are available in kit or wired form. There are models to fit every budget or money allowance. For the serious electronic hobbyist and experimenter, multiple-purpose meters are "must" items for the workbench. VOM's and VTVM's are basic equipment for radio-TV service technicians, 2-way radio maintenance men, lab technicians, electrical maintenance technicians in industry, circuit design engineers, computer maintenance technicians, and many others. No other electronic "tool" can do so many things. This book contains valuable information on how to use the instruments to do various jobs, showing where the prods should be placed in many different types of circuits and equipment, how to read the scales quickly and accurately, how to use the VOM and VTVM in preventive maintenance, troubleshooting, alignment, and repair. Information is given, too, on how to care for and maintain the instruments so they will hold their accuracy and have a useful, long life.

Ownership of VOM or VTVM is the important first step toward gaining practical knowledge of electronic circuits and components. However, there is a big difference between owning an instrument and using it to best advantage. The purpose of this book, therefore, is to help the reader recognize the extraordinary usefulness of his VOM and VTVM, and how to use them to best advantage.

ALLIED RADIO CORPORATION

TABLE OF CONTENTS

CHAPTER 1

Introduction	7
Definitions of VOM and VTVM—Advantages of VOMs—Advantages of VTVMs—Combination in- strument	

CHAPTER 2

Basic Setup	17
Measuring Voltage—Measuring Current—Measur- ing Resistance—Meter Protection—Accuracy— Panel Layout—Peak-to-Peak Measurements— High-Voltage Probe—RF Probe	

CHAPTER 3

Testing Components	29
Batteries—Resistors—Fixed Capacitors—Coils, Chokes, and Transformers—Determining Turns Ratio—Diodes—Transistors	

CHAPTER 4

Checking High-Fidelity Equipment	37
Output Power—Frequency Response—Balancing Push-Pull Stages—Balancing Loudspeakers— Phasing Loudspeakers	

CHAPTER 5

Servicing Receivers	47
Variable Capacitors—IF Transformers—Oscillator Coils — Volume Control — Output Transformer — Power Supply Circuit—Filament Circuits—Selenium Rectifiers — Transformer-Type Supply — Power Supply Ripple—Printed Circuits—Receiver Alignment — Stage Gain — Service Data — Wave Traps — Checking Hot Chassis — FM Receivers	

CHAPTER 6

CB and Ham Gear	63
Checking Antenna Systems—Transmission Line Leakage Test—Measuring Plate Input Power—RF Output Power — Field-Strength Indicator — Receiver S-Meters — RF Voltmeter — Transmitter Testing Precautions	

CHAPTER 7

Miscellaneous Applications	73
Liquid Level Indicator—Tachometer—Photometer —Temperature Indicator—Measuring Solutions—Soil Moisture Measurement—Tape Recorder Bias Relay Pull-In and Drop-Out	

CHAPTER 8

Taking Care of Your Meter	85
Observing Function and Range Settings—Battery Replacement—Care of Band-Switches—Test Prods —Meter Face and Faceplate—Aging Effects—Circuit Analysis	

CHAPTER ONE

INTRODUCTION

The abbreviation "VOM" stands for *Volt-Ohm-Milliammeter*. As its name implies, the VOM is actually three instruments in one. It contains a voltmeter for checking circuit voltage, an ohmmeter for making resistance measurements and a milliammeter for checking current. (Although the unit of current is the ampere, the milliampere—one thousandth of an ampere—is so much more common in electronic circuits that milliampere is used in naming the instrument.) The VOM is also occasionally called a "multimeter" or "multitester," names which also suggest its versatility. A typical model is shown in Fig. 1-1.

The letters "VTVM" signify *Vacuum-Tube Voltmeter*. In general appearance it is similar to the VOM (see Fig. 1-2). And like the



Fig. 1-1. Knight-Kit 20,000-ohms-per-volt VOM.



Fig. 1-2. Knight-Kit Model KG-620 VTVM.

Best Ways to Use Your VOM and VTVM

VOM it contains a section for measuring voltage and an ohmmeter for resistance measurements. Most VTVMs, however, have no milliammeter section for measuring current. One reason is that the VTVM is widely used in servicing radio and TV receivers, where voltage and resistance values alone provide just about all the information needed. Current measurements are more frequently required in transmitters (and, increasingly, in transistor circuits).

Another important difference between the VOM and VTVM is sensitivity. The VTVM, with its vacuum tubes and ability to amplify, is often far more sensitive than the VOM in measuring voltage. This is important in testing electronic circuits that could be disturbed by the loading effect of the meter. The least sensitive of the popular VOM models is the 1000 ohms-per-volt type. It is limited mostly to voltage checks in *electrical* circuits; home appliances and AC wiring, for example. For voltage testing in more delicate electronic devices, the 20,000 ohms-per-volt VOM is commonly used. This instrument is popular for much basic radio and TV servicing. Sensitivity, as used here, means the amount of current drawn by the instrument for a given measurement. In a voltmeter it is usually described by the amount of resistance opposed to the measured voltage, which, of course, simply states the same thing in another way ($I = E/R$). Thus, a VOM that draws 1 ma for every volt measured is called a 1000 ohms-per-volt instrument.

The VTVM can be considerably more sensitive. It has less short-circuiting effect on circuits with extremely low current flow—the grid of a vacuum tube or an automatic volume control circuit, for example. The sensitivity of most VTVMs is stated as “11 megohms input resistance.” Let us consider these and other differences—as well as the similarities—between the VOM and VTVM.

VOM Compactness and Portability

A significant advantage of the VOM is its compactness and lightness. The smaller models are easier to pick up, hold in one hand and carry about than the VTVM (Fig. 1-3). The VOM usually takes up less room on the workbench and can be included conveniently in a troubleshooting kit. Unlike the VTVM, the VOM does not have to be plugged into an AC power source.

Portability and freedom from an AC outlet are important in many locations: on a rooftop checking for shorts, opens or grounds in an antenna system; in the cellar trying to find the cause when a main fuse blows; or working outside on the electrical system of an automobile (Fig. 1-4). The VOM is not only immediately portable but requires no warmup time. Even where AC is available, the VTVM re-

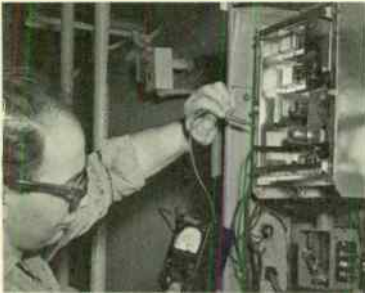

Fig. 1-3. VOM being used to check amplifier.



Fig. 1-4. VOM can be used where no power is available.

quires several minutes to warm up and reach a stable operating condition.

VOM Economy

The lower-priced VOMs cost less than the lower-priced VTVMs. This advantage of the VOM is important where high accuracy and the ability to measure a wide range of values is not needed, as in checking for shorts in AC wiring, measuring medium-value resistors, middle-range voltages on power supplies and transformer windings. (A typical low-cost model is shown in Fig. 1-5.)

The VOM is less costly to use and repair than the VTVM. The only item that normally deteriorates in the VOM is the battery (or

Fig. 1-5. An inexpensive VOM model.

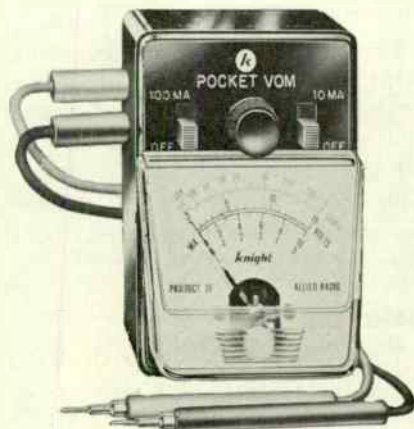

Best Ways to Use Your VOM and VTVM

batteries) in the ohmmeter section. In the VTVM not only batteries, but also vacuum tubes, need occasional replacement. When vacuum tubes are replaced in a VTVM the instrument must usually be recalibrated and readjusted. When a VOM battery is replaced no recalibration is needed other than the routine readjustment of the ohms-zero setting each time the instrument is used for resistance measurement.

Dependability

For constant, everyday use the VOM is somewhat more dependable than the VTVM. Its greater simplicity lessens the possibility of trouble. In the VTVM, circuits operate continuously as long as the instrument is on. Weakness in components due to age, defect, foreign matter inside the instrument or excessive humidity are more likely to make readings incorrect. The VOM, on the other hand, just "rests" except when actual measurements are being made.

Freedom From RF and Hum Pickup

The VTVM reading may be undependable when a measurement is made on a low-voltage circuit. Suppose that test leads are connected between a circuit component and the chassis and we expect some value of voltage between those points. Now assume that some other circuit component is defective and interrupts voltage across the points being checked. Under some circumstances, due to its high input resistance, the VTVM might give us a voltage indication anyway. This can happen because electromagnetic or strong RF (radio frequency) fields near the test probe might induce a small AC hum or RF voltage. It could occur in the test probe itself or in the open circuit, especially if the circuit has a high impedance.

This misleading voltage indication is less likely to occur with a VOM because of its lower input resistance, especially on low-voltage ranges. This loads down the circuit being tested, practically eliminating the possibility of any induced voltage deflecting the meter.

It must be emphasized that these cases, which lessen the dependability of the VTVM, are rare. But since they do happen, we must consider the VOM more dependable than the VTVM where such pick-up might prove troublesome.

Isolation

The VOM is better isolated, electrically, from the circuit under test than is the VTVM. One reason is that it need not be plugged into an AC power source, as must the VTVM. Typically, the VTVM gets its power from the same source as the equipment being tested, and often from the same outlet. It is not unusual for some very small percentage

of the RF, audio, pulse or other signal in the equipment being tested to feed back into the power line. And some percentage of this power-line signal might also get into the circuits of the VTVM—even though both the equipment and VTVM are well filtered to prevent it. (If these filters go bad the percentage will increase.) This false signal could possibly affect the measurement by adding to, or subtracting from, the voltage being measured.

In some cases, the equipment and VTVM may be better isolated from each other by grounding the metal case of the equipment, the VTVM, or both. But in rare cases adding grounds results in a false reading due to small currents between the equipment and VTVM chassis. Since the VOM case is never grounded (it is usually made of insulating material) and because it is less sensitive than the VTVM, the VOM is less susceptible to grounding problems.

Electrical Stability

The VOM is always “ready to go.” It does not need time to warm up or to stabilize. The VTVM will not work for at least a minute after it is plugged in and turned on, and should warm up a half-hour or so for greatest accuracy. Also, the VOM offers greater *repeatability* of measurement. Even though the VTVM is calibrated and adjusted properly, a shift in line voltage could upset its performance. The VOM also may indicate a change when the line voltage changes, but we know the change is taking place in the circuit being checked, not in the test instrument.

The VOM can be left connected to test points, and the hour-after-hour readings reflect what is actually going on in the circuit. With the VTVM, we’d have to check every now and then on the meter calibration or run the possibility that readings at any instant might be slightly incorrect.

Most advantages and drawbacks of the VOM and VTVM are minor considerations in everyday practical use and for the degree of accuracy normally required. However, in some circumstances one or more of these characteristics could be extremely important, and it is worth being aware of them.

Advantages of the VTVM

If the VTVM could talk, it would probably be in a rage at this point, having had so many of its supposed shortcomings so freely exposed. So now we shall speak on its behalf, explaining why and how it is superior (in many cases) to the VOM, and note its desirable features.

A very important advantage of the VTVM over the VOM is high input resistance. In the typical VTVM, as mentioned earlier, it is 11

Best Ways to Use Your VOM and VTVM

megohms. Some VTVMs have higher or lower input resistances, but 11 megohms is the rating for perhaps 90% of the instruments. This resistance is what you place across the two points in any circuit where voltage measurements are made. Furthermore, 11 megohms is the input resistance for the VTVM no matter which of the voltage ranges you use.

Less Circuit Loading

Because of high input resistance the VTVM has very little loading effect on most circuits. *Loading* refers to the changes in operating conditions in the circuit being tested that are caused by the instrument itself. It results in incorrect readings. For example, consider that a VTVM is being used to measure a voltage across a 50K (50,000-ohm) resistor. The 11-megohm internal resistance of the VTVM in parallel with the resistor has little effect; 11 megohms is 220 times greater than 50K.

Now consider a 1000-ohms-per-volt VOM in this measurement. Let us say that the voltage we expect to measure is somewhat under 50 volts. We would use the VOM on its 50-volt range. A 1000 ohms-per-volt VOM set to the 50-volt range would have an internal resistance of 50,000 ohms. This is determined simply by multiplying the voltage range in use by the sensitivity of the VOM; 50 by 1000 in this case. Refer now to Fig. 1-6, in which 100 volts is applied to a circuit consisting of three resistors in series; 50K, 50K, and 25K. The 100 volts, we can calculate, sends 0.8 ma through the three resistors, resulting in drops of 40 volts across each of the 50K resistors and 20 volts across the 25K resistor.

Let us take the 1000 ohms-per-volt VOM and, using it on the 50-volt range, see the results of measuring the voltage across R2, a 50K resistor. As soon as we connect the VOM across the 50K resistor, the 50K internal resistance of the VOM is in parallel with the 50K of R2. We now have an effective resistance at R2 of 25K instead of 50K. The total resistance in the circuit is now 100K instead of 125K, so current increases from 0.8 ma to 1.0 ma. The new current of 1.0 ma results in a voltage drop of 25 volts rather than 40. Thus the meter will give us an incorrect reading of 25 volts—instead of 40 volts.

The VOM gave a wrong reading because it *loaded* the circuit to such an extent that it changed conditions. In general, the error due to such circuit loading is greater when the measurement is made across comparatively high values of circuit resistance.

With a 20,000 ohms-per-volt VOM the error would be considerably less than for the 1000 ohms-per-volt instrument. The 50-volt range

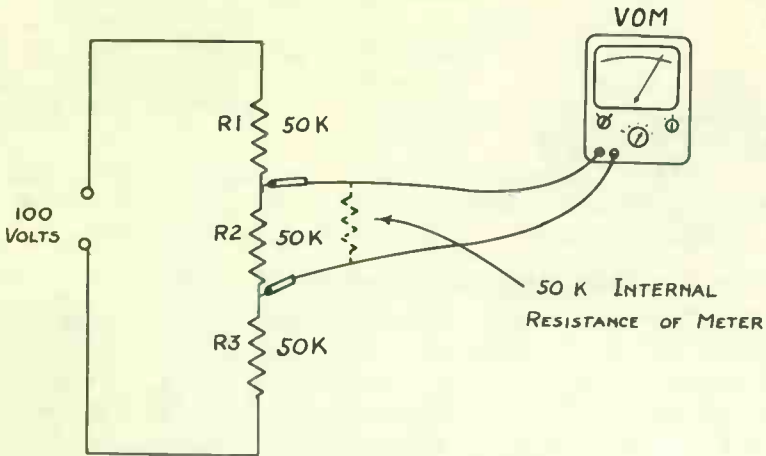

Fig. 1-6. Low-sensitivity VOM loads a high resistance circuit.

in this higher-sensitivity VOM has 1 megohm ($50 \times 20,000$) of resistance in its voltage-measuring circuit. This 1 megohm would parallel the 50K of R2 when the test leads were connected across it. The combined resistance would be a little less than 48K, or a change of less than 5% from 50K. There is less than 2% change in the total circuit resistance across which the 100 volts is applied. Thus we would expect a meter reading only slightly different from normal.

For general testing and troubleshooting in electronic circuits the 20,000 ohms-per-volt VOM is amply sensitive for about 80% to 90% of measurements. It is, therefore, the type of VOM most widely used. VOMs of higher sensitivity are available: a 100,000 ohms-per-volt instrument is shown in Fig. 1-7. It would have 5 megohms of resistance

Fig. 1-7. High sensitivity VOM—measures 16 μ a full scale.



Best Ways to Use Your VOM and VTVM

for its 50-volt range. Even more sensitive meters are available, and at least one 200,000-ohm instrument is on the market. Recently a VOM with a sensitivity of 1 megohm per volt has been announced. It would have a higher input resistance than a VTVM on all scales above the 10-volt range.

It should be evident that the VTVM, with an 11-megohm input resistance, offers the important advantage over conventional VOM's of negligible loading effect for nearly all circuit measurements.

Wider Frequency Response of VTVM

The VTVM can measure accurately a wider range of frequencies than can the VOM. Measurements made with some VOMs are not reliable above a few hundred cycles per second. With a VTVM we can measure AC voltages of frequencies well beyond the audio range. And with the addition of a special probe, voltage measurements in the megacycle range, or beyond, are usually practicable.

Higher Sensitivity of VTVM

The VTVM's amplifier stages give it greater sensitivity than a VOM. This advantage exists for both resistance and voltage measurements. Because very low voltages are amplified many times by the tubes (or transistors) for deflection of the pointer, very low currents are drawn from the circuit being checked.

Many VTVMs have low voltage ranges of 1.5 or 0.5-volts, full scale. General-purpose VOMs seldom provide a voltage range lower than 2.5 volts, full scale.

Protection From Overload

The VTVM is well protected against overloading its meter movement and burning out its component parts from excessive test voltages. The meter is protected because it is isolated from the circuit being checked. Even though input voltage is excessive, the amplifier tubes are unable to supply enough current to the meter to damage it. The higher input resistance of the VTVM, too, limits the amount of current due to excessive voltage.

The VOM, however, need not be entirely unprotected from overload. All Allied and Knight-Kit instruments may include *meter-guard* circuits in the form of diodes across the meter movement. The diodes (see Fig. 1-8) limit current to a safe value in the event of accidental overload. This type of circuit for meter-movement protection can be easily added to any VOM. It is a worthwhile investment, no matter how inexpensive your VOM might be. Normally the diodes act as open circuits for normal voltage across the meter terminals.

But if an abnormally high voltage is applied, one of the diodes (depending on polarity) suddenly conducts and shunts potentially damaging current around the meter movement.

Fig. 1-8. *Mefergard* protects against accidental overload.

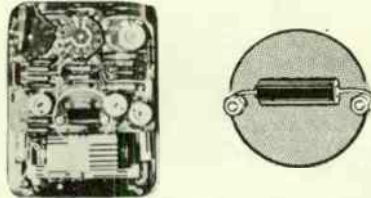

Wider-Range Resistance Measurement

The VTVM is able to measure a wider range of resistances than can the VOM. This is due to the VTVM's ability to amplify very low voltages in its measurement circuits when very high or very low values of resistance are being measured. Nearly any VOM can be used for measuring values of resistance much higher than it was designed for by adding batteries and series resistance in the measuring circuit. The VTVM, however, provides high-resistance measurement with only the 1.5-volt (usual) battery inside the case. Thus the possibility of damage to sensitive components such as diodes is negligible with the VTVM. VOMs of very high sensitivity can, of course, measure very high values of resistance; the one shown in Fig. 1-7 is rated as being usable to 200 megohms.

VOM or VTVM?

As we have seen, there are strong similarities and significant differences between the VOM and VTVM. In many instances—probably most cases—either may be selected for a particular testing job. Many hobbyists, technicians and others have found that both instruments, side by side, provide a full range of voltage, current and resistance functions. Whether it be high sensitivity on voltage ranges, the ability to check a very low resistance or taking checks out in the field, one or the other instrument can be selected for the task.

VOM and VTVM Combined Instrument

Some manufacturers offer the VOM and VTVM combined into one instrument, providing in one unit practically all the advantages of both instruments. In one model (Fig. 1-9) the VTVM section has an input impedance of 11 megohms; the VOM section is 20,000 ohms per volt. Whether it is operated as a VOM or a VTVM is determined by the position of the switch at the bottom center. The VTVM sec-

Best Ways to Use Your VOM and VTVM



Fig. 1-9. Triplet Model 631 VOM-VTVM combination.

tion is battery-operated. An interesting feature of this instrument is that there is no function switch (for the *functions* of voltage, resistance or current measurement). Both function and range are selected by operating a 24-position switch which covers all ranges of DC current, AC volts, DC volts and resistance.

CHAPTER TWO

BASIC SETUP

In this chapter we take a close look at the VOM and VTVM as they are used for taking measurements. Beginning by examining the front panels and considering the probes, we also discuss how connections are made into the circuit being tested. Some specialized accessories required by these instruments to take certain readings beyond their normal function and range will be described, as well.

Measuring Voltage

The basic rule in using any voltmeter is: the meter leads are connected in *parallel* with (across) the circuit under test. Fig. 2-1 shows how probes are touched to the ends of a resistor. The component is not disconnected from the circuit, and power is always applied.

Fig. 2-1. Measuring voltage drop across a resistor.

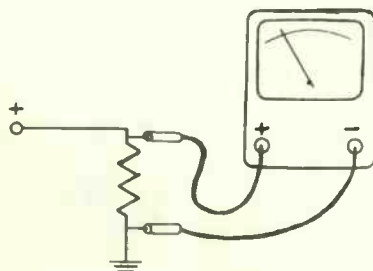

In many voltage checks the negative, or common lead of the voltmeter connects to the metal chassis of the equipment under test. The chassis, especially in tube-type devices, is generally the negative side of the circuit. The positive probe is touched to the terminal of the component which is away from the ground, or negative side. This causes the meter to read in the correct direction.

Measuring Current

The rule for measuring current is: the meter test leads are always connected in *series* with the leg of the circuit under test. Fig. 2-2 shows how the probes are inserted in series with a resistor whose current is being measured. As in voltage checking, power must be on. Determine test lead polarity before the leads are connected into the cir-

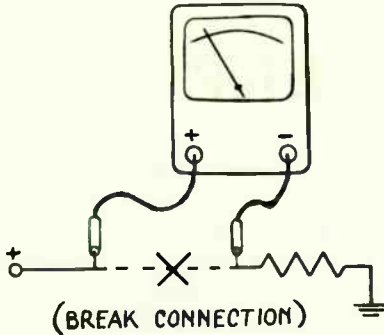

Fig. 2-2. Measuring current flow through a resistor.

cuit. This can be done by observing the power supply of the equipment. If, for example, it is a tube circuit with the negative side of the power supply at chassis ground, the negative test lead connects toward ground. The positive probe connects in the direction of the positive source. An example in a battery-powered circuit is shown in Fig. 2-3.

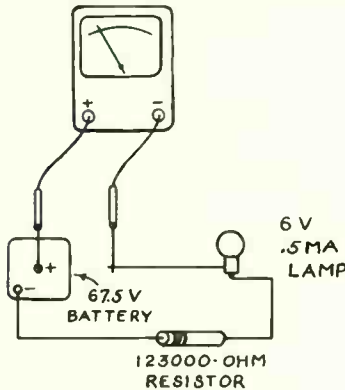

Fig. 2-3. Correct probe connection to measure battery current.

Measuring Resistance

Checking resistance is similar to making voltage checks, with several important exceptions. For one, resistance is *never* measured with power on. Note how probes are placed *across* a component (Fig.

2-4). In some cases, simply connecting probes across a component will not give a true resistance reading. Some other resistor in parallel may affect the total resistance "seen" by the meter. We can eliminate this possibility by disconnecting at least one lead from the part being tested (Fig. 2-5) to isolate it from the rest of the circuit.

Fig. 2-6 is an example in which leads do not have to be disconnected. Here we wish to obtain the value of R2. Since the circuit is

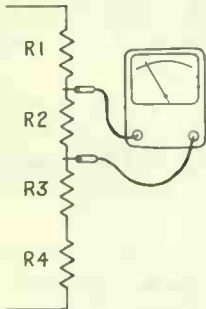

Fig. 2-4. Checking resistor value.

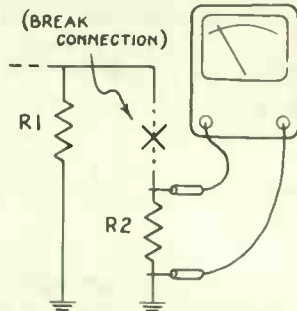
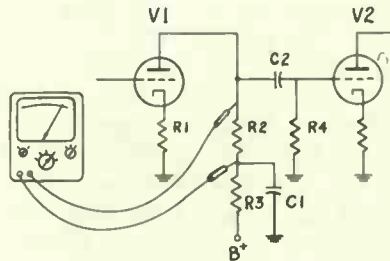

Fig. 2-5. Isolating resistor from parallel circuits.

turned off, there is no current path from the top of R2 through vacuum tube V1. If we assume that C2 is a good capacitor—very little leakage—it is practically an open circuit. We do not have to disconnect one of R2's leads while measuring its resistance. This is a fairly safe, quick approach to measuring resistance value. But there are several

Fig. 2-6. Isolation unnecessary in this case.



exceptions. What if the measured value of R2 is not what we expect? Unless you definitely know that R2 is defective, you will have to investigate the causes for your off-value reading. There could be a partial short at the socket of V1, providing a DC path through R2; C2 could be leaky, creating a path through R2 by way of R4 and

Best Ways to Use Your VOM and VTVM

the power supply; or one of the resistor leads or some other circuit connection could be partially shorted to the chassis. When to measure the value of a resistor without lifting one end is a matter of judgment based on experience in troubleshooting and on the ability to analyze a circuit carefully.

A variable resistor is measured the same way. But you check not only its total rated resistance across the two outside terminals but also between the center terminal (which connects to the movable contact) and one of the end contacts. Observe the meter while the control is adjusted first to one end and then to the other. At one, you should measure the full value of the resistor; at the other you should measure zero ohms. (Reset the range switch to Rx1 or LOW OHMS, if necessary). Next measure between the center terminal and the other end terminal, checking again for rated value and zero while the control is varied.

When measuring a resistor, set the range switch so the value is indicated somewhere near midscale. Say that 15 is the midscale mark on the ohmmeter and we wish to measure a resistor color-coded as 820 ohms. The range switch should be set to Rx100 (or the highest resistance range if it does not go that high). Before measuring the resistor touch the probe tips together and adjust the ZERO-OHMS control for a zero reading on the ohmmeter scale. Then separate the tips. If you are using a VTVM set the OHMS control for a reading of infinity with the probe tips apart, making sure you are not touching the metal tips with your fingers. Then recheck the zero-ohms setting to see if you have changed it while adjusting the OHMS-ADJUST control. To measure the resistance value, place one probe tip against one of the resistor leads and the other against the other resistor lead. Read the value of the resistor and multiply by 100. An 8200-ohm resistor should give an indication of slightly more than 80 on the scale.

If the measured value of a resistor is different from its color-coded value, notice its tolerance rating. For example, a resistor color-coded as 8200 ohms with silver as the fourth band can have any value from 10% less to 10% greater than 8200. It could lie between 7380 and 9020 ohms. However, on some ohmmeters you may not be able to notice a great difference between 8200 and 7380 or 9020, so any measured value very close to 80 on the Rx100 range is probably satisfactory for an 8200-ohm 10% resistor.

For the higher ohmmeter ranges, take special care not to touch the probe tips with fingers or you will parallel the resistance of your body across the resistor and get an incorrect reading. It is a good practice to avoid ever touching the probe tips—both for accuracy, and for safety—when measuring voltages and currents.

The resistance of your body from one dry hand to the other may range to approximately one megohm, depending on how tightly you hold the probe tips with your fingers, body chemistry, and the temperature. If your hands are damp, as with perspiration, for instance, your body resistance will be much lower. To prove that body resistance can interfere with measuring a high-value resistor, place the test leads across a resistor of 1.5 megohms or more, not touching the probe tips. Determine if its measured value is correct. Then, while still contacting the resistor leads with the probe tips, touch the tips with your fingers and notice that the measured resistance value drops. It will probably go down to 750,000 ohms ($\frac{3}{4}$ megohm) or less.

Meter Protection

Since it is sometimes difficult to predict a reading in advance, it is best to start with the range switch of the meter on its highest value. This prevents the pointer from slamming the pin at the end of the scale (and possibly bending) if the probes are accidentally placed on, say, 50 instead of 5 volts. It is a good idea to start with high ranges even when using a VTVM which has built-in protection against meter damage. Repeated banging of the pointer against the pin can bend it permanently.

Accuracy

When a VOM or VTVM is guaranteed to be accurate to within a certain percentage, the rating applies only at full-scale. For this reason it is important to take any final readings with the meter pin at the highest possible point. This is done by choosing the lowest range that provides an on-scale reading.

It is possible, for example, to read 1 volt on any voltage scale of a VTVM. In Fig. 2-7A, 1 volt is being indicated on a 15-volt range. If the meter is accurate to 5% (of 15 volts) the error may be 0.75 volt. Since the pointer is so far down the scale, the reading may be nearly one hundred per cent. But if a 1.5-volt scale is selected, as

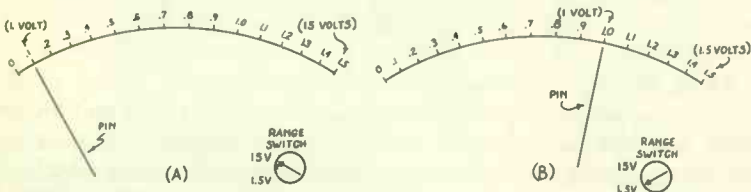

Fig. 2-7. Accuracy improves at high end of scale.

Best Ways to Use Your VOM and VTVM

shown in Fig. 2-7B, the higher position of the pointer reduces error to nearly the guaranteed, or full-scale, value.

Panel Layout

Fig. 2-8 shows a representative panel of a 1000 ohms-per-volt VOM with the major controls and scales identified. The two test leads plug into jacks near the bottom of the instrument. Usually one test lead is red and is plugged into the POS (positive) jack. The other lead is black and is inserted into the COM (common) jack. The test leads are flexible wires, well insulated for protection to the circuit and user. The probes which are held in the hand are made of an outer insulating plastic material for electrical protection. A conductor runs through them to a metal tip at the end for contacting the circuit being tested. The probes are colored to match the leads: red is +, black is -.

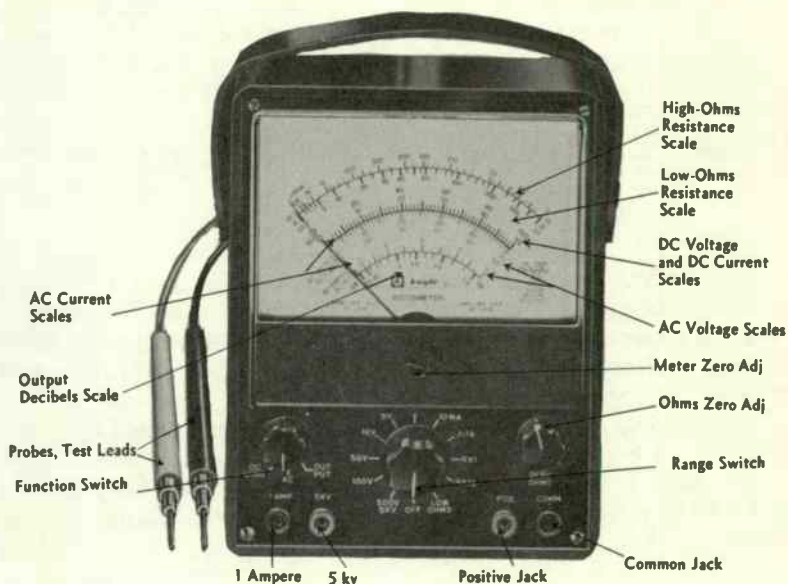

Fig. 2-8. Typical 1,000 ohms-per-volt VOM.

An important safety precaution must be observed! Never connect one test lead to a voltage point in a live circuit and then touch the end of the other probe with the fingers—you may receive a severe shock. The reason is that the test lead connecting to the circuit provides a path from the voltage source through the meter to the other test lead.

The three-position switch at the lower left in Fig. 2-8 is the FUNC-

TION switch. It permits a choice of using the instrument on DC or OHMS, AC CURRENT or VOLTAGE, or OUTPUT. The output function operates with the bottom figures on the scale. This scale is marked DB (decibels). The output of an audio amplifier is sometimes measured in terms of decibels, as will be explained in a later chapter.

The switch at the lower center is the range switch. It has an OFF position (bottom). In this meter a short circuit is placed across the meter terminals at this setting. This keeps the pointer of the meter movement from swinging excessively during shipment or when the instrument is carried in the field. The switch also selects AC or DC voltage ranges. Their full-scale markings are: 5, 10, 50, 100, 500 and 5000 volts. Ranges for DC current measurements to 10 ma, 0.1 ampere or 1 ampere may also be selected on the range switch.

Resistance ranges on the same switch are Rx1, Rx10 and LOW OHMS. The scale at the very top of the faceplate is for Rx1 and Rx10. In the Rx1 range values are read directly: that is, if you are measuring a resistance on that range and the pointer rests at 100, the value is 100 ohms. If the range switch is set to Rx10 and the pointer indicates 100, the resistance is 1000 ohms. If the pointer is at 350 (the first scale division to the left of 300) and the range switch on Rx10, the resistance value is 3500 ohms, etc.

When using low ohms (second scale from top) in this instrument, the lowest values of resistance start at the left side of the scale and the highest are at the right. The reason is that full-scale current flows when the resistance-measuring circuit is set to LOW OHMS and the test leads are not touching. Do not leave the range switch in the low ohms position when the VOM is not in service. That would shorten battery life.

For most measurements the test-lead plugs are inserted in the positive and common jacks. For measuring ohms or DC current and voltage, the function switch is set to the DC-OHMS position and the range switch set as required. For AC measuring, the function switch is set to AC with the test-lead plugs still in the positive and common jacks. But for current measurement in the 1-ampere range, the common test-lead plug is moved to the 1 ampere jack at the extreme left, the range switch set to .1-1A. For voltages above 500 volts and up to 5000 volts, the black test lead is inserted in the common jack, the red test lead in the 5KV jack and the range switch to 5KV, and the function switch to DC or AC, as required.

Moving the test leads about may sound confusing. For most measurements, however, test leads are left in the common and positive jacks. It is only when you want to measure currents between 0.1 ampere and 1 ampere, or voltages between 500 volts and 5000 volts,

Best Ways to Use Your VOM and VTVM

that one of the leads must be moved. This method protects both the user and the instrument.

VTVM Panel

The VTVM (Fig. 2-9) is similar to the VOM in meter scale markings, range and function switch. One additional control is used in the VTVM—a full-scale as well as a ZERO-OHMS ADJUST. The ZERO ADJUST knob at the bottom left resets the pointer to zero, if necessary, when the function or range switch is changed. The OHMS knob to the right sets the pointer to the top of the scale before resistance measurements are taken.

Note that there is a slightly different arrangement in the probes. The large probe handle on this meter contains a switch for selecting AC/OHMS or DC. This convenient feature eliminates the need for plugging probes into different jacks, as is necessary in some VTVMs. The probe connects into the panel of the VTVM through a fitting which grounds a shield inside the lead to the case. This reduces the possibility of stray pickup and erroneous reading.

A valuable feature in the VTVM is the *zero-center* scale which appears at the lowest point on the faceplate. By adjusting the zero knob so the pointer rests at the zero-center point the meter indicates positive or negative voltage. This scale has no voltage calibration, since readings are only relative. One application where the zero-center

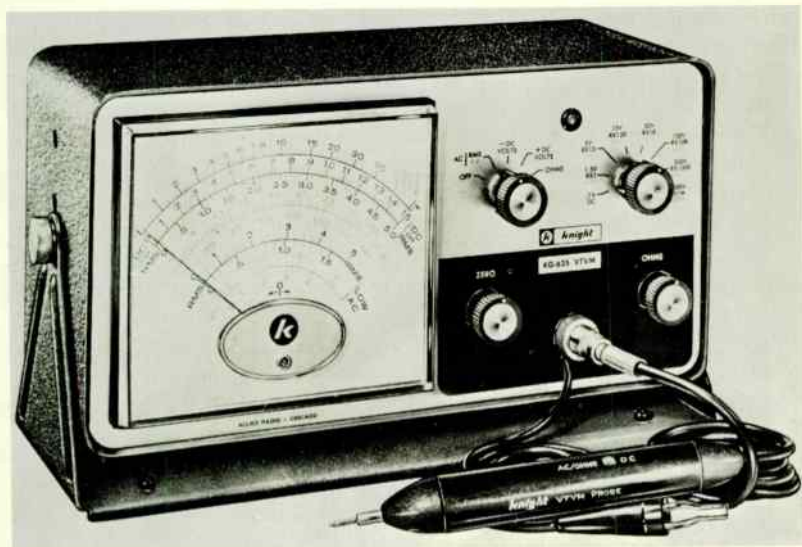

Fig. 2-9. Close-up view of the KG-625 VTVM.

feature is required is alignment of an FM detector. This circuit is adjusted for a zero reading, but may shift rapidly between positive and negative as alignment proceeds.

There is no provision for measuring current. This is typical in most VTVMs. Omitting the current-measuring circuits in a VTVM keeps the instrument simpler, less costly, less liable to damage and permits the use of a less sensitive meter. The absence of current-measuring facilities in a VTVM is seldom a serious disadvantage. Experienced workers often calculate the amount of current by Ohms Law. They measure voltage across the resistor or other part and calculate current by the formula:

$$I = \frac{E}{R}$$

Peak-to-Peak Measurements

VOMs and VTVMs are reasonably accurate on sine wave AC voltages, but not for a complex wave like the typical television signal shown in Fig. 2-10. If a VTVM has a peak-to-peak indicating scale we can read the correct value from it. But if the VTVM has only a peak scale the indicated value will not necessarily be correct, since the peak-positive and peak-negative values will not usually be the same in a complex signal. We can see this in the TV waveform of Fig. 2-10. The peak-to-peak voltage is the voltage from the bottom, or negative

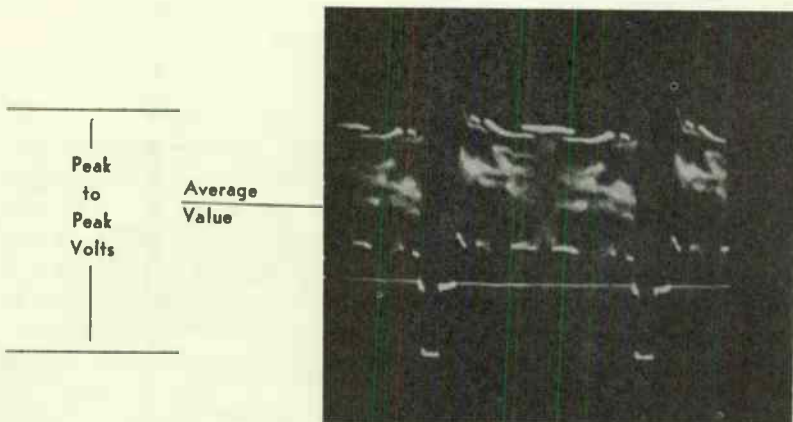

Fig. 2-10. Measuring TV signal voltage.

Best Ways to Use Your VOM and VTVM

peak, to the top, or positive peak. The average of this voltage wave is somewhere *above* the halfway point between the positive and negative peaks, because the most negative peaks occur only briefly. Both a VOM and a peak-reading VTVM will indicate a different voltage for one polarity of the test leads than when the leads are reversed.

A peak-to-peak VTVM, in which both polarities of an AC signal are rectified and amplified, measures complex waveforms more accurately. An instrument designed especially for TV service work is shown in Fig. 2-11. It has a full-wave high-frequency rectifier circuit and the meter provides peak-to-peak readings even if DC voltages are present. Other scales measure rms, DC voltages and resistance.

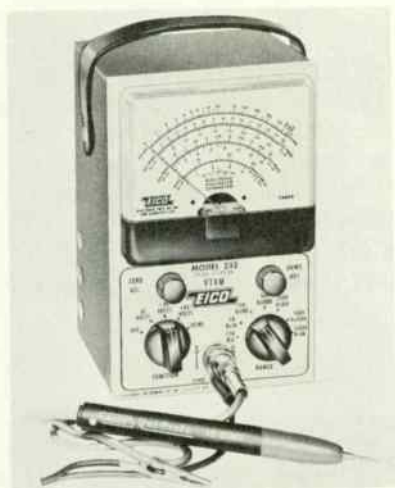

Fig. 2-11. Peak-to-peak measuring VTVM.

High-Voltage Probe

Both the VOM and VTVM can be used to measure relatively high DC and AC voltages. (Some VOMs have a top voltage range higher than that in many VTVMs.) For measurements beyond 1500 volts, the VTVM can easily be equipped with a high-voltage probe. It contains a multiplier resistor of special design. A probe of this type is shown in Fig. 2-12. It is made of high-grade insulating material; the wide flange near the end prevents the user from getting his hand too close to the circuit being tested. The end of the probe cable is connected to the DC-volts input of the VTVM.

The meter reading is increased by a multiplying factor that depends on the resistance in the probe. For an 11-megohm VTVM, the usual value for the multiplier inside the high-voltage probe is 1089 meg-

ohms. It is in series with the VTVM's 11 megohms and the two total 1100 megohms. Since 11 megohms is 1/100th of 1100 megohms, only 1/100th of the voltage at the probe tip is applied to the input of the VTVM. To use this probe, we would: First, determine the approximate value of the voltage to be measured. Next, set the VTVM

Fig. 2-12. High voltage probe containing multiplier.



to the + or - DC function, as required, and the voltage-range selector to a range higher than 1/100th of the value you expect to measure. Connect the probe cable to the VTVM DC-VOLTS input terminal. Make sure the equipment on which the measurement is to be made is turned off and observe all safety precautions carefully; for example, discharge any high-voltage capacitors.

Connect the common test lead to the equipment chassis or low-voltage side of the circuit to be checked. If the low-voltage side is not the chassis, the VTVM case *must be well insulated* from any metal surface or other object and *must not be touched* until the equipment is *turned off* and the high-voltage capacitors in the circuit safely discharged. Next, connect the probe to the high-voltage side of the circuit being measured. Then, standing clear of the equipment and VTVM, turn on the equipment and observe the meter. After the required warmup time note the voltage reading and multiply by 100. This is the DC voltage being measured.

Let us say we want to measure the output of a rectifier that provides 12,000 volts DC for the picture tube of a TV receiver. Since 1/100th of 12,000 is 120, we would set the VTVM to its 150-volt range. And since the high voltage on a picture tube is positive, set the function switch to + DC. Normally we connect the common lead to the chassis of the TV receiver and the high-voltage probe to the picture-tube anode connector. For glass picture tubes this connection is at the side of the tube. In metal tubes the anode connection is the metal rim near the face of the tube. Stand back from the set, turn it on and after a few minutes observe the meter reading. If the pointer indicates 120, the high voltage is 100X120, or 12,000 volts. If the pointer indicates 90, actual voltage is 90X100, or 9,000 volts.

Best Ways to Use Your VOM and VTVM

For measuring more than 15,000 volts, use a higher range, perhaps 300 or 500 volts. No matter what the range, the reading obtained is multiplied by 100. Some high-voltage probes are available for use with VOMs, but are not quite as practical because of the lower input resistance of these instruments.

RF Probe

Most VTVMs can measure AC voltages of frequencies far beyond the audio range. For measurement in the RF range the VTVM can be provided with an RF probe. The example shown in Fig. 2-13 is a crystal-diode probe designed for measuring sine wave voltages at frequencies up to 250 mc. The output voltage of the probe (input to the VTVM) is a DC voltage proportional to the peak value of the RF signal being measured. For sinewave RF signals the value is read directly on the DC scales.



Fig. 2-13. RF probe for RCA VoltOhmyst.

RF probes are usually designed for relatively low voltages. The one shown is limited to signals up to 20 volts. RF probes are used to measure RF and IF voltages in TV receivers, video tape recorders, signals generated in low-level transmitter stages, and in general circuit design and experiment.

CHAPTER THREE

TESTING COMPONENTS

Whether you are a beginner, experimenter, technician or engineer, you must know how to use a meter to test individual components. "Testing" here means determining whether a component is good or bad, but not necessarily whether it meets its design specifications exactly. For example, we could use a VOM to check most types of capacitors for leakage and, very approximate capacitance. We cannot, however, measure capacitance to within a specific low percentage, nor small changes due to temperature or humidity. Let us consider some practical everyday tests.

Batteries

A seriously run-down battery indicates on a VTVM or VOM a voltage considerably lower than its rated value. For example, a bad 1.5-volt dry cell, which measures 1.55 volts or more when new, might measure only 1 volt. Batteries in most modern automobiles are commonly referred to as 12-volt batteries. But each of the six cells in a car battery is rated at 2.2 volts. When fully charged the battery should measure near 13.2 volts with the ignition and all other electrical equipment turned off.

Testing batteries correctly is important. In many cases bad batteries actually test "good" when out of the radio or car. This happens for an important reason: a battery must provide current for the circuit it operates in. It may not be able to supply $\frac{1}{4}$ ampere to its circuit, but may test good on a meter which draws microamperes. So the best way to check a battery is by measuring its output voltage *while it provides normal current* in a given circuit. The voltage of transistor batteries is measured when the radio is on and playing at a relatively loud level. Measure the voltage of a car battery when normally used electrical equipment is turned on (but with the engine off).

A common cause of low voltage in an automobile electrical system

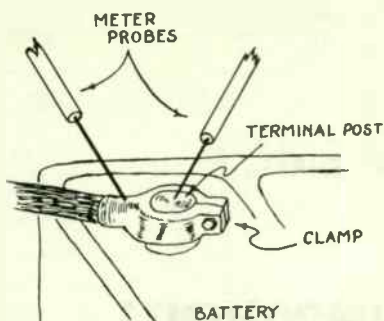

Fig. 3-1. Checking for high resistance battery connection.

is a poor or loose connection between the battery cable clamp and the battery terminal post. Even if a cable clamp is fastened tightly the connection may be poor because of corrosion or other poor-conducting material between the surfaces of the clamp and battery post. Fortunately, a poor connection here can be determined easily. Assume that you have measured the battery voltage under load and it checks good. Next, place one test-lead probe of the DC voltmeter on one of the clamps and the other probe on the terminal post, as shown in Fig. 3-1. Now, as the car is started there should be no indication on the voltmeter. Do the same at the other clamp and battery post. If the voltmeter shows voltage between post and clamp, the connection is poor. Remove the clamp and clean all surfaces with a fine file or sandpaper, apply a special protective lubricant (available at auto-parts stores) to the clamp and post, then refasten it. Now there should be no voltage drop and the trouble should be eliminated. It is not unusual in cases of this sort to lose 4, 8 or more volts in the battery connection, giving the starter little chance to operate.

Batteries in transistor radios often consist of several dry cells in series. A quick check, with the radio on, is made by measuring the voltage across the whole series, as in Fig. 3-2. If, for example, four 1.5-volt cells in series measure 6 volts or more, probably all batteries

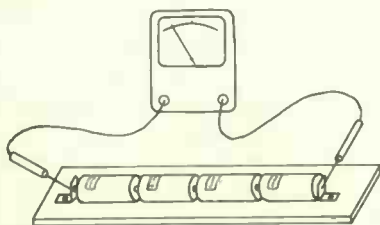
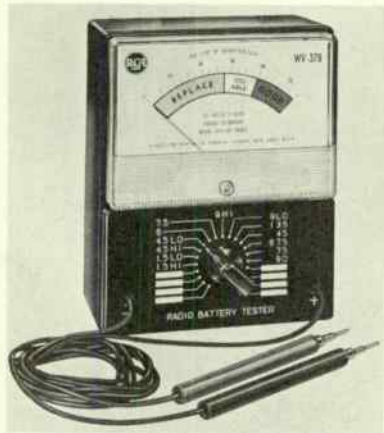

Fig. 3-2. Measuring batteries in series.

are good. But to be sure, or to locate a weak one, you can measure the voltage across each battery individually. Those measuring noticeably lower than rated voltage should be replaced. If they are relatively low-cost batteries it is best to replace them all to prevent an early failure. Generally, if a battery is down by 25% or more from its rated voltage when under normal load, it should be replaced (or recharged, if it is a rechargeable type).

Many types of batteries are now in wide use. In electronic equipment both dry and wet rechargeable batteries are popular. Examples of rated voltage values for single cells are: nickel-cadmium, 1.25 volts; alkaline, 1.5 volt; mercury, 1.35 volts. Helpful data on battery types, applications, expected life, care, and testing are available from battery manufacturers or distributors. Also, data is provided with instruments designed especially for battery testing, such as the RCA-WV-37B

Fig. 3-3. A specially designed battery tester.



Radio Battery Tester shown in Fig. 3-3. This instrument is actually a voltmeter which contains resistors to load batteries down properly during tests.

Resistors

Although resistor testing was considered in Chapter 2, let us examine some special cases. One frequent cause of resistor defects or failures is overheating by excessive current. Overheating discolors the part, usually to dark brown or black. Sometimes a resistor cracks and tests open or shows a higher resistance than its rated value. In some cases the crack is nearly impossible to see. To check whether a resistor is cracked apply a bending force to it with your fingers. If its

Best Ways to Use Your VOM and VTVM

two leads are soldered in circuit push firmly at a right angle against it with a pencil eraser. Often the resistor will separate into two pieces.

A resistor that is discolored from overheating usually has a resistance different from its original rating. Sometimes a discolored resistor measures the correct resistance when cold, but changes under operating conditions. Therefore, replace discolored resistors whether they measure correctly or not.

Fixed Capacitors

Relatively small-value capacitors indicate high resistance on an ohmmeter. A theoretically perfect capacitor would measure open or infinite resistance. Actually, capacitors usually show some leakage. A good paper or mica capacitor under $1 \mu\text{f}$ should measure at least 150 megohms.

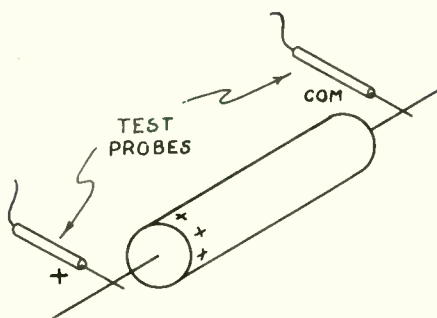

Fig. 3-4. Measuring electrolytic capacitor leakage.

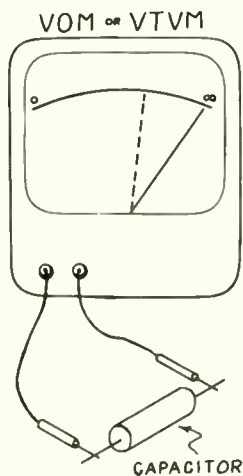

Fig. 3-5. "Kick" test for open capacitor.

When checking an electrolytic capacitor's leakage resistance, the reading is lower if the negative meter lead is toward the positive lead of the electrolytic. Use the test-lead polarity that shows the higher resistance measurement. In a case such as shown in Fig. 3-4 a good electrolytic capacitor's leakage resistance might measure about 75K to 100K.

Lower values of leakage resistance than those indicated here for typical capacitors suggest a defect. Some leakage resistance might not

seriously affect many circuits. (A cathode bypass already has a low resistance across it.)

It is best to test for leakage resistance while a capacitor is operating at the voltage it is designed for. Capacitor testers designed especially for checking capacitance values and leakage resistance are available at fairly low cost. They give better results than the ohmmeter section of a multitester. An ohmmeter can, however, indicate leaky capacitors which must be replaced.

Another capacitor check you can make with an ohmmeter is the "kick" test. Set the ohmmeter to a high range and place the test leads across a capacitor. The pointer will "kick" or deflect briefly toward zero resistance at the instant the test leads are connected (see Fig. 3-5). The pointer then drifts slowly or quickly back toward the high end of the resistance scale. How far the pointer deflects and how quickly it returns depends on capacitance. The greater it is, the farther the kick in the direction of zero ohms, and the slower the return. The pointer finally stops moving at the point that indicates the capacitor's leakage resistance. Watching for the kick when checking a capacitor is a good way of telling if it is open. (Since a capacitor retains a charge if it is good, it should be discharged by shorting its leads together before repeating a measurement.)

Remove one lead of a capacitor from a circuit during tests unless you know other circuits common to the capacitor and understand their effect on your measurement. In-circuit capacitor testers are available for testing while a capacitor is still connected in the circuit. They give good results in most instances, but sometimes a capacitor still must be disconnected for a positive check of its condition.

Coils, Chokes and Transformers

Two types of defects often cause trouble in an inductor. One defect common to all types is a short circuit between turns. Coils with many turns are wound in layers, and a turn in one layer might short against a turn in another. Sometimes this can be located by measuring the resistance of the coil. If the expected coil resistance is known and the measured resistance is considerably less, a short between turns is probable and the coil or transformer should be replaced.

Another defect is a short to the inductor core. This is found by a resistance test between any end of the winding and the core. The resistance should be very high; at least 25 megohms depending on the type of coil or transformer and the grade of insulation between the winding and core.

In transformers another possible trouble is a short between different windings. To locate this trouble, connect one ohmmeter test lead to

an end of a primary winding and the other lead to one end of the secondary winding. Note the resistance. This should be high—20 to 100 megohms or more. In multiwinding transformers, check between all windings.

Determining Turns Ratio

The turns ratio of a transformer can be determined by applying a known AC voltage to one winding and measuring the AC voltage across the other winding. The turns ratio formula is

$$\text{Turns Ratio} = \frac{\text{Primary voltage}}{\text{Secondary voltage}}$$

Specifications for a transformer may give primary and secondary voltages for which it is designed. This tells the turn ratio.

Knowing either the rated voltages or the turns ratio is helpful if trouble is suspected in the transformer. If only a few turns are shorted on a transformer, the decrease in resistance might not be noticeable in a resistance check. But the defect would show up in a voltage-ratio check.

For instance; in a transformer designed for 115 volts on the primary and 350 on the secondary, which is almost a 1 to 3 voltage (or turns) ratio, apply 6.3 volts AC to the primary and then measure the secondary (Fig. 3-6). If the secondary voltage is not fairly close to 3×6.3 , or 19 volts, we would suspect trouble. What if it were 25 volts? Since this represents a higher turns ratio, it means that some primary turns might be shorted.

Remember to operate a transformer at its rated load before judging whether or not the secondary voltage indicates trouble. To be relatively sure, look at the transformer specifications and load it as it would be loaded under typical operating conditions. If the 115-volt primary on a transformer, in our example, was supposed to supply 350 volts on the secondary when the secondary was drawing 70 ma of current, we could connect a resistor that would draw the required current across the secondary. The value of the resistor would be:

$$R = F/I = 350/0.070$$
$$R = 5000 \text{ ohms.}$$

With 115 volts applied to the primary and a 5000-ohm resistor connected across the secondary, a reading more than 10% away from the rated transformer secondary voltage would indicate trouble—probably a short in one of the windings. Defects may become apparent only at operating voltages. Ohmmeter tests might not turn up a clue to such troubles.

Transformers usually operate quite warm, some almost too hot to

touch. But they should never smoke, or sizzle when a drop of water is dripped onto the case.

Diodes

Utmost care is required in testing certain types of diodes. The safe current or voltage of a diode can easily be exceeded by an ohmmeter. Most VTVMs and VOMs that use a battery not greater than 1.5 volts are acceptable for diode tests. But to be safe, check your instrument's specifications to determine its maximum possible voltage on various ohmmeter ranges. Before checking a particular diode, be sure that its maximum forward and reverse voltage will not be exceeded. (Note that the *higher* resistance ranges of an ohmmeter will often put less voltage across a diode, because of the greater drop across resistors in the instrument, and will always limit currents more.)

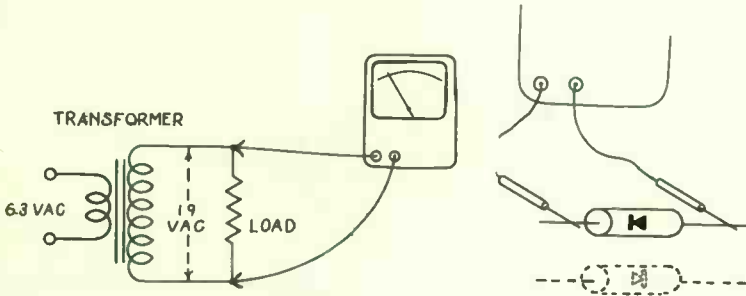

Fig. 3-6. Determining transformer turns ratio.

Fig. 3-7. Diode testing method.

To test diodes, connect the ohmmeter test leads across the diode leads, as in Fig. 3-7, and note the resistance reading (turn the RANGE switch for a readable indication). Then reverse the test leads and note the resistance. The higher resistance reading divided by the smaller one is the approximate front-to-back ratio for the diode. This varies, depending on whether it is a low-current signal diode or a rectifier diode, and whether voltage from the ohmmeter is close to the value for which the diode is designed. Some diodes have about a 1 to 10 forward-to-reverse ratio. The forward resistance might be 10 ohms and the reverse might be 100 to 200 ohms or more. In others, the forward resistance might be a few tenths of an ohm; the reverse resistance would be megohms. One method of testing a diode is to compare its measurements with those of a diode of the same type known to be good.

Transistors

Transistors usually have three or four leads. In the more common three-lead type, one lead connects to the base of the transistor, another to the emitter and the third to the collector. Ohmmeter tests on transistors are similar to those on diodes. (Check first to make sure that the maximum ratings of the transistor will not be exceeded.) Generally, a 20,000 ohms-per-volt VOM or a VTVM should be used to test transistors. The meter battery should not exceed 1.5 volts.

Transistors are either of the NPN or the PNP type, as shown in Fig. 3-8. On an NPN transistor, the resistance reading is low if the negative lead of the ohmmeter is placed on the emitter terminal and the positive terminal on the base. The resistance is high with the leads reversed. The third measurement is between base and collector. With the negative lead on the collector terminal and the positive lead on the base the resistance is low, and vice-versa with the leads reversed.

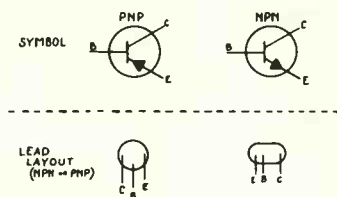

Fig. 3-8. Transistor element identification.

For a PNP-type transistor, the results obtained will be just the opposite. For example, with the positive ohmmeter lead on the emitter and negative on the base, the resistance reading is low.

The difference in resistance readings when leads are reversed for any of the transistor tests should be fairly high. One direction might read only about 10 ohms; the other might read 150,000 ohms or more.

An ohmmeter will not give an accurate indication of overall transistor performance—it will only show up transistors that are grossly defective. For more accurate measurements a transistor checker, such as shown in Fig. 3-9, is necessary.



Fig. 3-9. Hickok transistor tester.

CHAPTER FOUR

CHECKING HIGH-FIDELITY EQUIPMENT

The VOM and VTVM are useful in making a number of checks and tests in high-fidelity and other audio equipment. They can measure an amplifier's frequency response and output power. The decibel scales can indicate relative levels. And they are used in two important types of balancing: the push-pull output stages of an amplifier and in phasing loudspeakers for stereophonic reception.

Output Power

To find out if an amplifier is able to deliver its rated output power, begin with a known input signal. The most convenient source is an audio signal generator. Unlike music or voice signals, which vary in level, the audio generator provides a steady tone. This simplifies the measuring process. It also produces tones of any audio frequency, an important feature for checking frequency response.

The audio generator should be a standard type; one with a low output impedance (about 600 ohms or less). It should have an attenuator control that can adjust generator output voltage to all signal levels required by the audio amplifier. Many high-fidelity amplifiers, for example, require a 1-volt input into an auxiliary jack to provide full power output.

The generator signal is connected to the amplifier as shown in Fig. 4-1, and the test meter is used to measure input voltage. Since these measurements are with AC signal the meter is set to its AC scale. (Note that most VTVMs are least sensitive on AC scales, the usual rating being 5000 ohms. But since this is much higher than the low-impedance output of the audio generator there should be little shorting effect on the generator signal.)

Best Ways to Use Your VOM and VTVM

A wirewound power resistor is connected on the output side of the amplifier, in place of the loudspeaker. Its resistance should match that of the amplifier's output tap; 8 ohms, for example. The resistor's power rating should be at least equal to the power output of the amplifier. Set the audio generator to a frequency of 1000 cps and the amplifier tone controls to their middle (flat) positions.

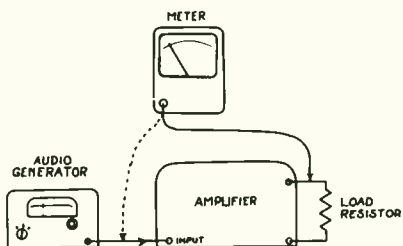

Fig. 4-1. Audio amplifier power measurement.

Let us say this is a 10-watt amplifier and we have the volume control set to $\frac{2}{3}$ of maximum. With the required input signal, assume that we measure 5 volts AC across the 8-ohm power resistor. We can calculate power with the formula $P = \frac{E^2}{R}$. We know that R is 8 ohms and have measured audio output at 5 volts. Calculating power: $P = \frac{E^2}{R} = \frac{5^2}{8} = \frac{25}{8} = 3 \frac{1}{8}$ or 3.125 watts.

We have thus determined that the amplifier is putting out only 3.125 watts. Perhaps turning up the volume control will produce the full 10 watts. If it does not it could be an indication of trouble in the amplifier; a weak tube is often the cause. Tubes can be tested, weak ones replaced and measurements repeated. If the problem is not tubes, probably there is a defective component or connection in the amplifier. (There is also the possibility that the amplifier was over-rated by the manufacturer, and never did put out 10 watts.)

Frequency Response

Frequency response is measured to determine amplification at different frequencies. An audio amplifier is said to be "flat" if it has equal gain throughout the audio range. An amplifier may also be specified as flat within a limited range; from 100 cps to 18 kc, for example. Just how flat an amplifier is—whether gain is exactly the same for all frequencies or whether it varies—is usually stated in the manufacturer's specifications. The amount its response departs from a standard at a certain frequency is usually stated in decibels (db).

Checking High-Fidelity Equipment

For example, say an amplifier output is given as 10 watts, ± 1 db, 50 cps to 18,000 cps, with the reference as 1000 cps. This means that if amplifier output at 1000 cps is 10 watts, all frequencies between 50 cps and 18,000 cps will not be less than 1 db below, nor greater than 1 db above, 10 watts. The *output* scale of a VOM or VTVM is used for making such measurements in decibels. Let us consider this in greater detail.

Voltages and currents of all frequencies can be measured in decibels. On the DB scale of a VOM or VTVM, the designation 0 DB usually appears somewhere below or at the middle of the scale (see Fig. 4-2). Values to the left of 0 are minus; to the right are plus. The figure 2 to the left of 0 db means -2 db; the figure 3 to the right of 0 is $+3$ db, etc. The gain of an amplifier might be given as 10 db, meaning its output level is 10 db greater than its input level. Where the term db is used in specifying gain and frequency response, a relationship between two quantities is meant. It may be how output compares with input, or how output at one frequency compares with output at a reference frequency.

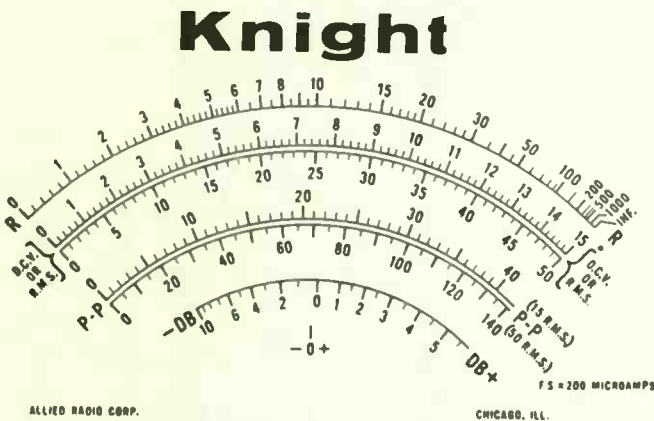

Fig. 4-2. Typical db scale location.

Power level is often specified in decibels with no reference power stated. An amplifier might be said to have an output of 3 db. We can generally assume that 0 db is equal to 0.006 watt (6 milliwatts). This is a standard reference used in audio work. (It is equal to 1.73 volts across a 500-ohm resistor.) As explained later, 3 db is equivalent to a power gain of 2. For this amplifier, then, the output is 2×6 mw, or 12 mw.

Best Ways to Use Your VOM and VTVM

Decibel—Voltage, Current and Power Ratio Table

-		DB	+		-		DB	+	
Voltage or Current Ratio	Power Ratio		Voltage or Current Ratio	Power Ratio	Voltage or Current Ratio	Power Ratio		Voltage or Current Ratio	Power Ratio
1.0000	1.0000	0	1.000	1.000	4898	2.399	6.2	2.042	4.169
.9886	.9772	.1	1.012	1.023	4842	2.344	6.3	2.065	4.266
.9772	.9550	.2	1.023	1.047	4786	2.291	6.4	2.089	4.365
.9661	.9333	.3	1.035	1.072	4732	2.239	6.5	2.113	4.467
.9550	.9120	.4	1.047	1.096	4677	2.188	6.6	2.138	4.571
.9441	.8913	.5	1.059	1.122	4624	2.138	6.7	2.163	4.677
.9333	.8710	.6	1.072	1.148	4571	2.089	6.8	2.188	4.786
.9226	.8511	.7	1.084	1.175	4519	2.042	6.9	2.213	4.898
.9120	.8318	.8	1.096	1.202	4467	1.995	7.0	2.239	5.012
.9016	.8128	.9	1.109	1.230	4416	1.950	7.1	2.265	5.129
.8913	.7943	1.0	1.122	1.259	4365	1.905	7.2	2.291	5.248
.8810	.7762	1.1	1.135	1.288	4315	1.862	7.3	2.317	5.370
.8710	.7586	1.2	1.148	1.318	4266	1.820	7.4	2.344	5.495
.8610	.7413	1.3	1.161	1.349	4217	1.778	7.5	2.371	5.623
.8511	.7244	1.4	1.175	1.380	4169	1.738	7.6	2.399	5.754
.8414	.7079	1.5	1.189	1.413	4121	1.698	7.7	2.427	5.888
.8318	.6918	1.6	1.202	1.445	4074	1.660	7.8	2.455	6.026
.8222	.6761	1.7	1.216	1.479	4027	1.622	7.9	2.483	6.166
.8128	.6607	1.8	1.230	1.514	3981	1.585	8.0	2.512	6.310
.8035	.6457	1.9	1.245	1.549	3936	1.549	8.1	2.541	6.457
.7943	.6310	2.0	1.259	1.585	3890	1.514	8.2	2.570	6.607
.7852	.6166	2.1	1.274	1.622	3846	1.479	8.3	2.600	6.761
.7762	.6026	2.2	1.288	1.660	3802	1.445	8.4	2.630	6.918
.7674	.5888	2.3	1.303	1.698	3758	1.413	8.5	2.661	7.079
.7586	.5754	2.4	1.318	1.738	3715	1.380	8.6	2.692	7.244
.7499	.5623	2.5	1.334	1.778	3673	1.349	8.7	2.723	7.413
.7413	.5495	2.6	1.349	1.820	3631	1.318	8.8	2.754	7.586
.7328	.5370	2.7	1.365	1.862	3589	1.288	8.9	2.786	7.762
.7244	.5248	2.8	1.380	1.905	3548	1.259	9.0	2.818	7.943
.7161	.5129	2.9	1.396	1.950	3508	1.230	9.1	2.851	8.128
.7079	.5012	3.0	1.413	1.995	3467	1.202	9.2	2.884	8.318
.6998	.4898	3.1	1.429	2.042	3428	1.175	9.3	2.917	8.511
.6918	.4786	3.2	1.445	2.089	3388	1.148	9.4	2.951	8.710
.6839	.4677	3.3	1.462	2.138	3350	1.122	9.5	2.985	8.913
.6761	.4571	3.4	1.479	2.188	3311	1.096	9.6	3.020	9.120
.6683	.4467	3.5	1.496	2.239	3273	1.072	9.7	3.055	9.333
.6607	.4365	3.6	1.514	2.291	3236	1.047	9.8	3.090	9.550
.6531	.4266	3.7	1.531	2.344	3199	1.023	9.9	3.126	9.772
.6457	.4169	3.8	1.549	2.399	3162	1.000	10.0	3.162	10.000
.6383	.4074	3.9	1.567	2.455	2985	.08913	10.5	3.350	11.22
.6310	.3981	4.0	1.585	2.512	2818	.07943	11.0	3.548	12.59
.6237	.3890	4.1	1.603	2.570	2661	.07079	11.5	3.758	14.13
.6166	.3802	4.2	1.622	2.630	2512	.06310	12.0	3.981	15.85
.6095	.3715	4.3	1.641	2.692	2371	.05623	12.5	4.217	17.78
.6026	.3631	4.4	1.660	2.754	2239	.05012	13.0	4.467	19.95
.5957	.3548	4.5	1.679	2.818	2113	.04467	13.5	4.732	22.39
.5888	.3467	4.6	1.698	2.884	1995	.03981	14.0	5.012	25.12
.5821	.3388	4.7	1.718	2.951	1884	.03548	14.5	5.309	28.18
.5754	.3311	4.8	1.738	3.020	1778	.03162	15.0	5.623	31.62
.5689	.3236	4.9	1.758	3.090	1585	.02512	16.0	6.310	39.81
.5623	.3162	5.0	1.778	3.162	1413	.01995	17.0	7.079	50.12
.5559	.3090	5.1	1.799	3.236	1259	.01585	18.0	7.943	63.10
.5495	.3020	5.2	1.820	3.311	1122	.01259	19.0	8.913	79.43
.5433	.2951	5.3	1.841	3.388	1000	.01000	20.0	10.000	100.00
.5370	.2884	5.4	1.862	3.467	03162	.00100	30.0	31.620	1,000.00
.5309	.2818	5.5	1.884	3.548	.01	.00010	40.0	100.00	10,000.00
.5248	.2754	5.6	1.905	3.631	.003162	.00001	50.0	316.20	10 ⁵
.5188	.2692	5.7	1.928	3.715	.001	10 ⁻⁴	60.0	1,000.00	10 ⁶
.5129	.2630	5.8	1.950	3.802	.0003162	10 ⁻⁷	70.0	3,162.00	10 ⁷
.5070	.2570	5.9	1.972	3.890	.0001	10 ⁻⁹	80.0	10,000.00	10 ⁸
.5012	.2512	6.0	1.995	3.931	.00003162	10 ⁻⁹	90.0	31,620.00	10 ⁹
.4955	.2455	6.1	2.018	4.074	10 ⁻⁸	10 ⁻¹⁰	100.0	10 ⁵	10 ¹⁰

Fig. 4-3. Voltage and power ratios vs. decibels.

The output scale on the meter is a voltage scale calibrated in db according to the standard given above. So, for a db reading to be accurate, the measurement *must be made across a 500-ohm circuit*. If the circuit is not 500 ohms another technique is used. Obtain an AC voltage reading and, knowing circuit resistance, convert to power by the formula $P = E^2/R$. From the decibel table shown in Fig. 4-3, determine the number of decibels this is equivalent to.

If the circuit is not a 500-ohm circuit, *relative* db measurements can be obtained. In many cases this will be all that is needed. This is true in measuring frequency response. If on one frequency the meter indicates -4 db and at another, -6 db, we can say that the output is down 2 db at the second frequency.

As mentioned before, the db scale can be read *directly* only when measurements are made across a 500-ohm circuit and on just one AC scale of the meter. For instance, on the Knight-Kit 1000 ohms-per-volt VOM, the db scale applies only to the 5-volt range. On higher AC ranges we must add a number of decibels to the reading. For this VOM, the number added for each AC range is printed in the lower right corner on the faceplate of the meter. For the 10-volt range we must add 6 db to the indicated reading; for the 50-volt range, 20 db, etc. Thus on the 50-volt range a reading of 0 db is really equal to 20 db, -2 is equal to 18 db, $+3$ is equal to 23 db and so on.

Measuring Frequency Response

The equipment setup for measuring frequency response is practically the same as the one for measuring power output shown earlier. First adjust the volume control and input level from the signal generator to give the required output level or power at the reference frequency. Then, with tone controls adjusted to the middle or flat position, measure output power for various frequencies. Adjust the output level of the signal generator, if necessary, each time the frequency is changed so the signal to the amplifier is the same for each frequency. Also, check the output power at the reference frequency from time to time to make sure it has not changed due to line-voltage fluctuation. Now let's consider how to draw a curve which shows the overall frequency response of the amplifier clearly.

Plotting Frequency Response

Let us say we have an amplifier rated at 2 watts output and the reference frequency is given as 1000 cps. (If no reference frequency is stated, we can assume it is 400 or 1000 cps.) We will check the response at about a dozen frequencies. A typical group, stated in cps, is: 20, 50, 100, 400, 1000, 1500, 7500, 10,000, 15,000 and

Best Ways to Use Your VOM and VTVM

20,000. We can add more values at any desired point, especially where frequencies seem to be somewhat off in value from what is expected. (For instance, if 1500 and 5000 are a little higher than the level before and after them, there may be a high peak at, say, 3000 cps.)

We start by connecting the VOM or VTVM across the amplifier's output load resistor, then apply 1000 cps from the audio generator to the input. The volume is set almost all the way up, tone controls are set to midrange. Increase the output of the signal generator until the power output from the amplifier is 2 watts. We will assume that amplifier output impedance is 8 ohms and that it is terminated by an 8-ohm load resistor. To obtain 2 watts of power we can convert the

power formula $P = \frac{E^2}{R}$ to one that has voltage (E) on the left side:

$E^2 = PR$, or $E = \sqrt{PR}$. Substituting 2 watts for P, which is the power we want from the amplifier, and 8 ohms for R, we get:

$$E = \sqrt{2 \times 8} = \sqrt{16} = 4 \text{ volts}$$

So we adjust the audio generator till we read 4 volts across the 8-ohm resistor. Power output is then 2 watts.

Next we take a series of voltage readings with the meter across the output resistor. Shown in Fig. 4-4 are readings which might result during a typical frequency run. Various test frequencies are listed in the left column. These are followed by the output voltage measured at each frequency. Notice that voltage is low at the lower frequencies, rises for the middle tones, then drops off again at the higher audio frequencies. This is one clue to the fact that the amplifier is not am-

Test Frequency (cps)	Output Voltage (volts)	Output Power (watts)
20	2.0	1/2
50	2.84	1
100	4.0	2
400	4.0	2
1000	4.0	2
1500	4.0	2
5000	5.65	4
7500	4.0	2
10,000	2.84	1
15,000	2.0	1/2

Fig. 4-4. Output voltage/watts conversion.

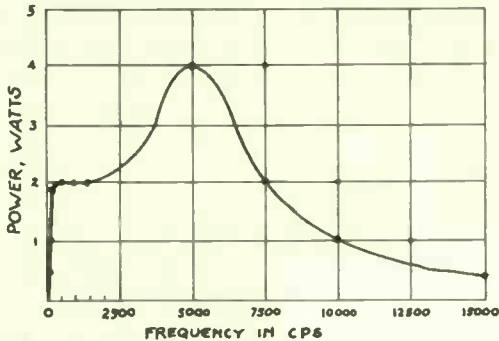

Fig. 4-5. Plotting output power and frequency.

plifying all tones equally. But amplifier performance is generally measured in terms of output *power*, so we convert voltage readings to watts, as shown in the last column of Fig. 4-4. Since resistance and voltage are known, power can be calculated as described earlier.

We can put this data on a graph, plotting frequency along the horizontal line and power vertically, as shown in Fig. 4-5. The various points on the graph have been connected together to form a curve. Notice that most points on the curve are crowded near the extreme left side. This *linear* type of graph is not used in practice. Rather, a *logarithmic* graph is employed. This is especially useful, since the ear responds to logarithmic changes in frequency. This means that at low frequencies the ear detects small changes in frequency, but at high frequencies a much greater change is required. On a logarithmic graph, shown in Fig. 4-6, each major division along the horizontal line increases by a factor of 10. If the first point along the horizontal is

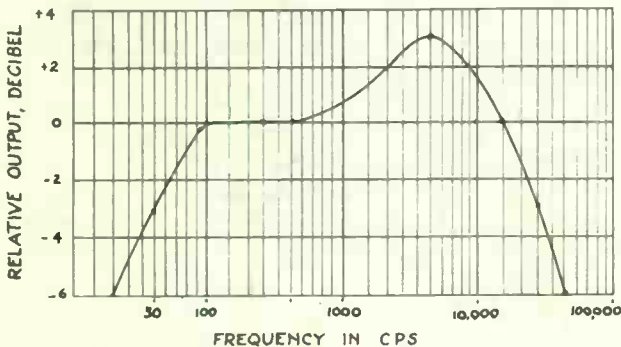

Fig. 4-6. Logarithmic frequency response graph.

Best Ways to Use Your VOM and VTVM

marked 10, the next will be 100, followed by 1000, 10,000 etc. Also, the output is plotted in decibel values, rather than in power or voltage. The output in decibels for our amplifier on each test frequency can be determined from the table in Fig. 4-3. Let us consider how this information is transferred from table to graph.

The output power of 2 watts at 1000 cps is our *reference frequency* or 0 db. The power at 20 cps, as determined earlier, is $\frac{1}{2}$ watt. This is a 1-to-4 power ratio: 2 watts \div $\frac{1}{2}$ watt. Go down the first power-ratio column in the table and find a value closest to the ratio 1 to 4, or $\frac{1}{4}$, or 0.250. The closest is 0.2512. Just to the right of this value is 6.0 which is the equivalent decibel value. (Stated another way, a decrease in power of 75% is equal to a 6-db loss.) Next, for 50 cps where output is 1.0 watt, the ratio is $\frac{1}{2}$, or 0.5. We see from the table that the closest value is 0.5012. This is equal to -3.0 db. At 7500 cps the output is up to 4.0 watts. This is a 1 to 2 ratio, equal to 3 db, but this time it is $+3$ db because power at 7500 cps is greater than at the reference frequency. At 10,000 cps, output is 1 watt again, or -3 db; and at 15,000 cps the output is $\frac{1}{2}$ watt, or -6 db.

With these db values for the amplifier response we can return to the curve again, this time in terms of db and a logarithmic scale along the frequency axis (Fig. 4-6). The difference between it and the earlier linear graph of power versus frequency is obvious immediately. This is the type of graph used by manufacturers and design engineers, since it more truly represents the way the ear responds to power output levels and frequencies.

Frequency response checks are seldom made on inexpensive amplifiers, such as those in low-cost radio receivers. But for modern high-fidelity equipment it is sometimes necessary to measure response to determine whether a certain trouble actually has been cured or if the amplifier is performing according to specifications. Tests on elaborate amplifier systems should be attempted only after carefully following the manufacturer's directions on input signal, level, setting of tone and other controls, output power etc.

Anyone who devotes a substantial part of his work to audio systems will find an investment in test instruments designed for audio work is worthwhile. Such instruments as audio VTVMs, audio generators, distortion meters and analyzers became almost necessities. Also, an oscilloscope is a recommended instrument for examining actual waveforms for distortion, checking for hum and other disturbances.

Balancing Push-Pull Stages

The push-pull output stage (Fig. 4-7) is widely used in audio amplifiers because it cancels even harmonics and thus reduces distortion

generated within the amplifier. The tubes, however, must amplify equally. A VOM or VTVM can be used to balance a push-pull stage and to check whether one of the tubes is operating improperly. If the cathodes of the two tubes are connected together, as in Fig. 4-7, the common lead of the meter is connected to this point. Then, using the positive lead, the DC voltage on one plate is compared with the DC voltage on the other. Assuming the tubes are reasonably balanced, amplification of each should be the same.

Fig. 4-7. Basic push-pull audio output stage.

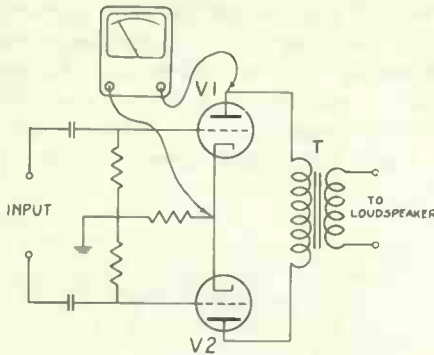

Sometimes two tubes may show the same DC voltage, but amplify unequally. To check, set the meter on a high AC range (500 volts or better) and connect it from the center tap of the output transformer (B+) to each of the plates in turn. Use a 1,000-cycle note from the audio generator, and operate the amplifier at or near full output wattage. The AC output signal from each tube should be the same. If not, swap the output tubes in their sockets. If the low amplification follows the tube, replace the tube that shows low and check again. If the lower amplification is across the same half of the output transformer with the tubes reversed, then there is other trouble in the circuit—either the output circuitry, the driver, or the inverter.

Balancing Loudspeakers

In a stereo installation it is often desirable to know which position of the volume or balance controls produces equal sound output in the loudspeakers. This can be checked by feeding a steady tone signal of about 1000 cps into both channels of the stereo amplifier and measuring the output audio fed to each speaker. Use the meter on a low AC scale and connect the test leads directly across each pair of output terminals on the amplifiers. If voltages do not agree, adjust the amplifier controls. Once the correct positions are found the controls may be marked so they can always be set for correct balance.

Phasing Loudspeakers

When two or more loudspeakers are located within the same room they must be *phased*. This means that the speakers are wired so their paper cones move in the same direction in any given instant. If they do not, there is some cancellation of sound waves at certain frequencies.

The ohmmeter section of a test meter can be used to phase speakers, as shown in Fig. 4-8. Set the meter on a low-ohms range, then touch the two test leads to the speaker terminals. (You must be able to observe the speaker cones closely during this step.) As the leads touch the terminals the cone will move in or out. Touch the test leads so the cone moves out—away from the metal body of the speaker. Now note which speaker terminal is being touched by the meter's positive lead. Mark that speaker terminal with a pencil or a dab of red nail polish.

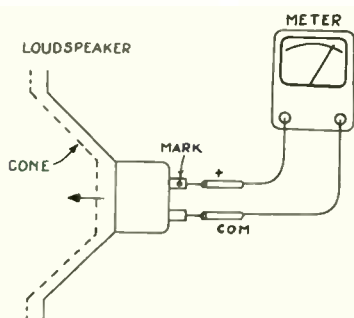

Fig. 4-8. Loudspeaker phasing method.

Repeat the identical steps for the other speaker and mark its terminal. When the amplifier is connected to the speakers, be certain the wiring is the same for each speaker; that is, connect the same amplifier lead to the marked terminal on each speaker. This applies in a monophonic system where several speakers are connected in parallel to the same amplifier. If two speakers are connected to a stereo amplifier you would also observe the marks. The ground, or common, lead from each amplifier would connect to the equivalent terminal on each loudspeaker.

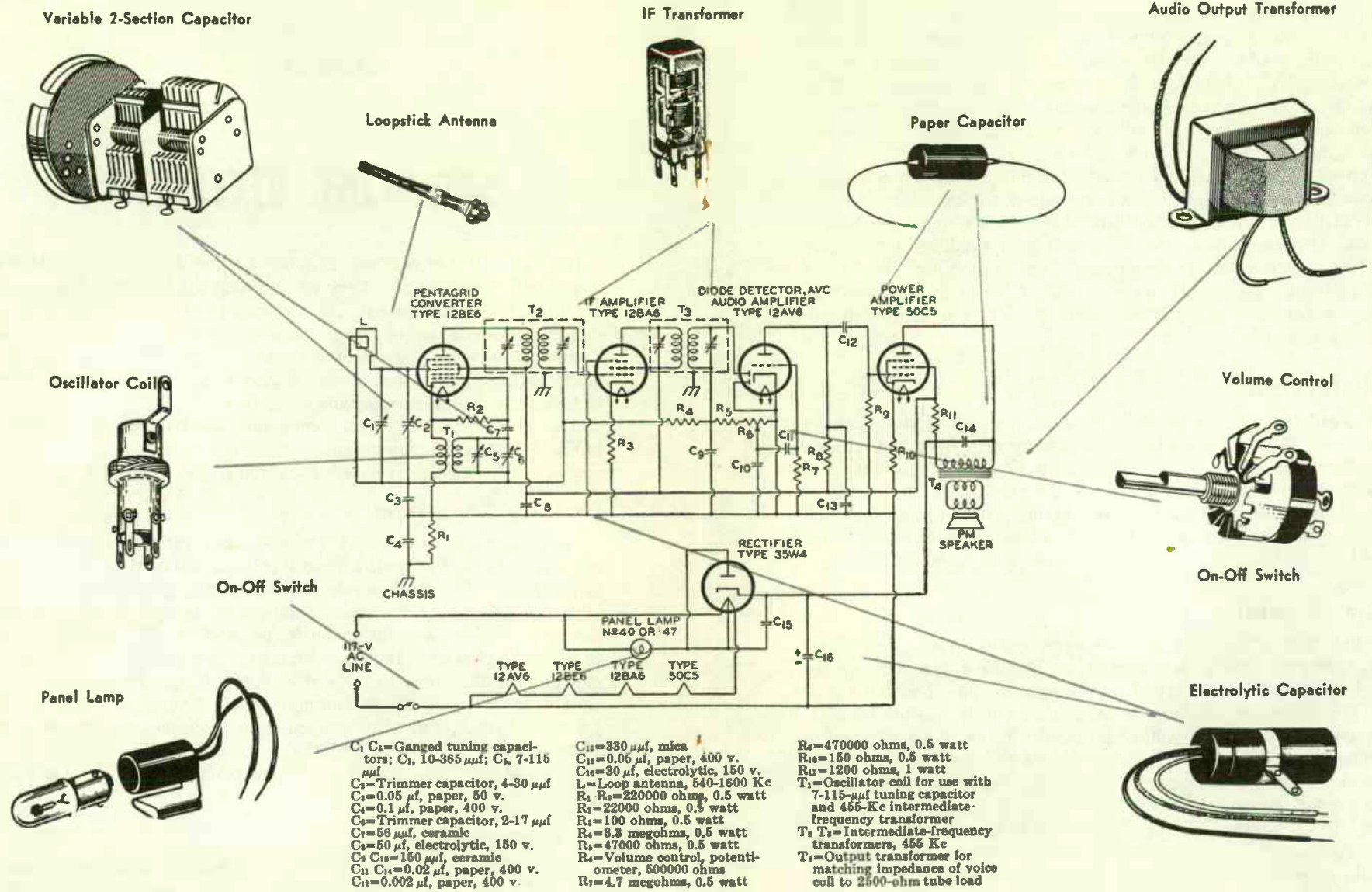

Fig. 5-1. Major components and schematic of a 5-tube superheterodyne receiver.

tuned IF transformer (the type shown for this receiver), the variable capacitors are mounted internally. They can be seen within the dashed lines around T2 and T3 in the schematic.

To test IF transformers, connect one ohmmeter lead to a terminal of one of the windings and the other test lead to a terminal of the other winding. You should get an open circuit, since the two windings are not directly connected. If there is less than a few thousand ohms between windings there is a complete or partial short. The transformer is defective and should be replaced.

To check a single transformer winding or a capacitor across a winding, remove the can and disconnect one side of the capacitor or winding. Transformer windings should measure a few ohms—less than a hundred. (Compare with other IF transformer windings in the same set.) The capacitor, when disconnected from the winding, should test open. In troubleshooting IF transformers, it is usually less costly to replace the complete unit than to repair it. Exact replacements are commonly available.

Oscillator Coils

The oscillator coil, T1 in the schematic, is a two-winding type in this receiver. Between windings you should measure open and through each winding between 2 to 30 ohms or so. One winding usually has a higher resistance than the other. Some oscillator coils are three-terminal types with one continuous winding; one terminal for each end, and a tap that connects somewhere along the continuous winding and one end.

Volume Control

At the right of Fig. 5-1 is the volume control (R6) and on-off switch combined in a single component. The three terminals are for the volume-control and the two on the rear are on-off switch terminals. The full-rated value of the resistance (500K in this case) is measured across the outer volume terminals. From center terminal to one outer terminal measures from zero ohms to full value as the shaft is turned. Sometimes the element and contact inside a control become dirty or pitted, producing erratic readings as the shaft is turned. This causes sudden volume changes or scratching noises when the radio plays. A cleaning-lubricating fluid sprayed or injected into one of the control openings often restores the contact surfaces.

The switch section of the volume control can be a source of trouble. It may not make proper contact or may freeze in the *on* position. For poor contact, spray in the lubricating fluid, then turn the switch on

CHAPTER FIVE

SERVICING RECEIVERS

It is in the field of receiver servicing that the VOM and VTVM find their greatest application. They are probably the two most indispensable pieces of test equipment. After vacuum tubes have been checked, the second major step in troubleshooting is almost always to measure circuit voltages, resistances or currents. In this chapter we consider many checks and measurements required in servicing several types of home-entertainment receiving equipment.

The schematic of a typical 5-tube superheterodyne radio is shown in Fig. 5-1. Several major components which often require testing also are pictured, and their symbols indicated in the schematic.

Variable Capacitors

At the upper left of Fig. 5-1 is a two-section variable capacitor. The two rotors (movable plates) are driven by a dial cord or directly by a tuning knob. The rotors mesh with the stators (fixed plates). A variable capacitor of this type should show zero ohms, or a short, between the rotor sections and the metal frame, and usually from the frame to the radio chassis. (In some circuits the capacitor is insulated from chassis.) If the wires to the stator terminals are disconnected there should be an open circuit (infinite ohms) from each stator to the frame and rotor, and also between stator sections. Sometimes rotor plates get bent and short against the stator plates, resulting in noise and loss of received signal. Check for a possible short with the plates fully meshed.

IF Transformers

An IF transformer case, or can, is shown at the upper center of Fig. 5-1. The can contains the transformer windings, and usually other components. For instance, in a slug-tuned IF transformer fixed capacitors are also located in the can. In the variable-capacitance

and off several times. If the switch is permanently closed it is usually beyond repair.

Output Transformer

The output transformer shown is a two-winding, four-terminal type. Five-terminal types, for push-pull output stages, have the fifth wire connected to the middle point of the primary winding (upper side of T4 in schematic). The secondary winding connects to the loudspeaker. The primary of an output transformer typically measures between 50 and a few hundred ohms. The secondary should measure between 1 and approximately 8 ohms. Sometimes a short will occur between the two windings, between turns of the same winding or between a winding and ground. These can be checked by the meter.

Power Supply Circuit

The DC power supply in the circuit of Fig. 5-1 consists mainly of rectifier tube 35W4, a No. 47 panel lamp, capacitor C15 which filters out noise from the AC line, and capacitor C16. Resistor R11 (the screen grid resistor for the 50C5 tube) and capacitor C8 are also part of the power-supply filter circuit since the current of all tubes except the plate current of the 50C5 passes through it.

The resistance between the cathode of the 35W4 rectifier and the negative side of the supply (negative side of electrolytic capacitor C16), should be high. Be certain to observe proper test-lead polarity (+ to 35W4 cathode). If C16 is excessively leaky you might measure 10,000 ohms or less. The DC voltage between the cathode and the negative side of C16 in this circuit measures about 135. If it is not over 100 volts the rectifier is probably weak, or C16, C15 or C8 is leaky or shorted. If C8 is defective R11 will overheat. The top of R11 at the screen grid of the 50C5 should measure a little over 100 volts with respect to B—.

When checking power-supply voltage the negative side of the supply can sometimes be the radio chassis, but do not use the chassis unless you are sure. Instead, find the negative lead of the large electrolytic filter capacitor and consider that the negative side. The common voltmeter lead can be left connected at that point while making voltage measurements to positive points in the circuit.

Filament Circuits

In the receiver of Fig. 5-1 the filaments are connected in series. The tubes have filament-voltage ratings totaling nearly 117 (three tubes are rated at 12 volts each, one at 50 and the other at 35). In this hookup, known as a series-string, if one filament opens, all tubes go out.

To troubleshoot this circuit, check for AC voltage on the receiver side of the on-off switch. If the set is receiving voltage, unplug the AC cord and measure with the ohmmeter across each tube filament to find the one that is open. A bad filament can also be located by a voltmeter test, using the 150-volt AC range. Plug in the AC cord during this test. As the voltmeter leads are connected across the filament terminals at each tube socket, *no* voltage reading is obtained across *good* filaments (since no current flows through them, there is no voltage drop). Across the open filament nearly the full AC line voltage is indicated on the meter. In its position across the open filament the voltmeter resistance completes the circuit, permitting current to flow. The reason the meter indicates line voltage is that the voltmeter resistance is much higher than normal tube-filament resistance, so practically all the voltage drop in the circuit is across the voltmeter.

Selenium Rectifiers

Many radio receivers use a selenium or silicon rectifier instead of a tube. For polarity identification, one side of such a rectifier will have “+” or “CATH” marked on it, indicating the side of the rectifier toward the positive voltage output. The power-supply portion of the circuit in Fig. 5-1 using an equivalent selenium rectifier is shown in Fig. 5-2. The resistor R_f in series with the four filaments drops the line voltage the same amount as would a 35W4 tube filament. The filaments, therefore, receive proper voltages. R_s , the *surge* resistor prevents sudden current surges into the rectifier when the receiver is first turned on. It also acts like a fuse and prevents a virtual short

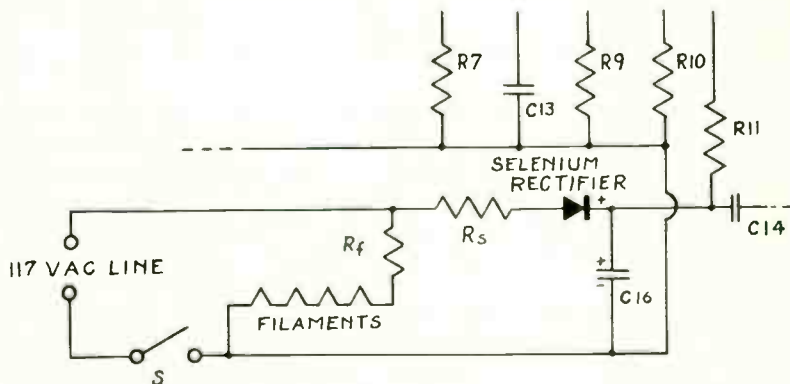

Fig. 5-2. Selenium rectifier power supply.

circuit across the AC line should there be a short across the power supply.

A shorted or overheated selenium rectifier generally emits a very noticeable odor. Find out why it overheated before replacing it, or the replacement may burn out at once. It is not unusual for selenium to increase in forward resistance, reducing the output voltage. Since this is usually due to aging, replace the rectifier. A selenium should measure about 10 times more resistance in one direction than the other

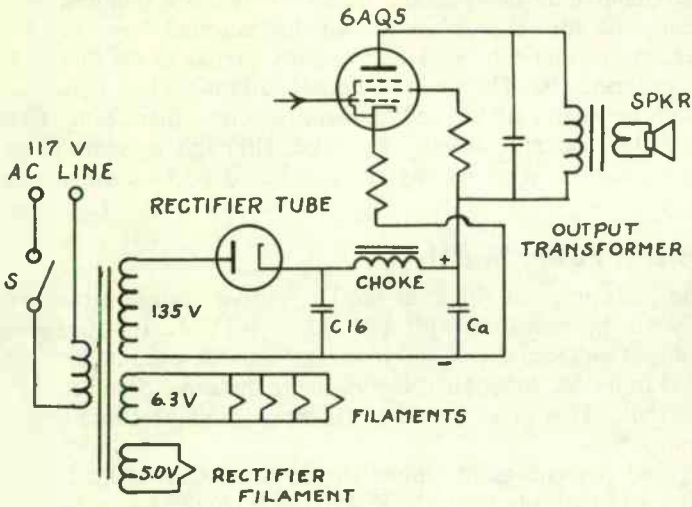

Fig. 5-3. Transformer-vacuum tube power supply.

when tested with the ohmmeter. In a circuit such as shown in Fig. 5-2, you can measure the rectifier while it is in the circuit by removing one of the tubes, thus opening the filament circuit.

Transformer-Type Supply

In a transformer power supply (Fig. 5-3) only the primary winding is connected directly to the power line. This makes the circuit much safer to both the user and serviceman. The transformer in this circuit has three secondary windings; one for the rectifier filament, one for all other filaments and one (the high-voltage winding) for the rectifier plates. The choke and additional filter capacitor (Ca) improve filtering. (Sometimes a resistor from 1000 ohms up is used instead of a choke.)

In a transformer power supply only the tube filament that opens goes dark, since the tube filaments are wired in parallel. If the bad

tube is a glass-envelope type it can be located easily by eye. If it has a metal envelope it can be located by its cold feel.

To check resistance of a power supply choke simply remove the rectifier tube and measure between the choke terminals. A good choke should measure between 20 and 200 ohms, or even more depending on its specifications. To measure for a short or leakage to the core of the choke it is best to disconnect its leads from the circuit because filter capacitor leakage may interfere with the meter readings. Where measurement indicates possible leakage between a winding and core or frame, be sure the choke is also disconnected from the rectifier socket. A rectifier tube socket frequently breaks down due to arcing between terminals. The socket material carbonizes and makes a leakage path between cathode and filament or some other point. Replacement of the socket is usually required, although in some cases you might be able to scrape away the blackened part of the socket and reuse it.

Ripple in Power Supply

The percentage of ripple in the DC output voltage from a power supply can be measured with a VOM or VTVM. First measure the DC output voltage. Next, set your VOM to the output function or a VTVM to its AC function. Now measure the same point on the rectifier output. This gives you the AC ripple voltage contained in the DC output.

To find percentage of ripple, divide the AC reading by the DC reading and multiply by 100. For example, if the measured AC is 2 volts and the measured DC is 280 volts, the percentage of ripple is:

$$\% \text{ Ripple} = \frac{2}{280} \times 100 = 0.7\% \text{ (approximately).}$$

Some receiver and amplifier manufacturers specify the per cent of ripple at the power supply output. If you are not certain, consider the ripple excessive if hum can be heard easily from the speaker when the volume control is turned all the way down.

Printed Circuits

In a printed circuit the conductors are not wires but metallic foil bonded to an insulating board which supports the circuitry and most or all of the components. The conducting side of a printed circuit board is shown in Fig. 5-4. On this side are all interconnections for components fastened to the other side of the board.

A break or crack can develop in the conducting foil, or a short between adjacent conducting paths can occur. Cracks in a foil may need a magnifying glass to locate, but an ohmmeter check between different

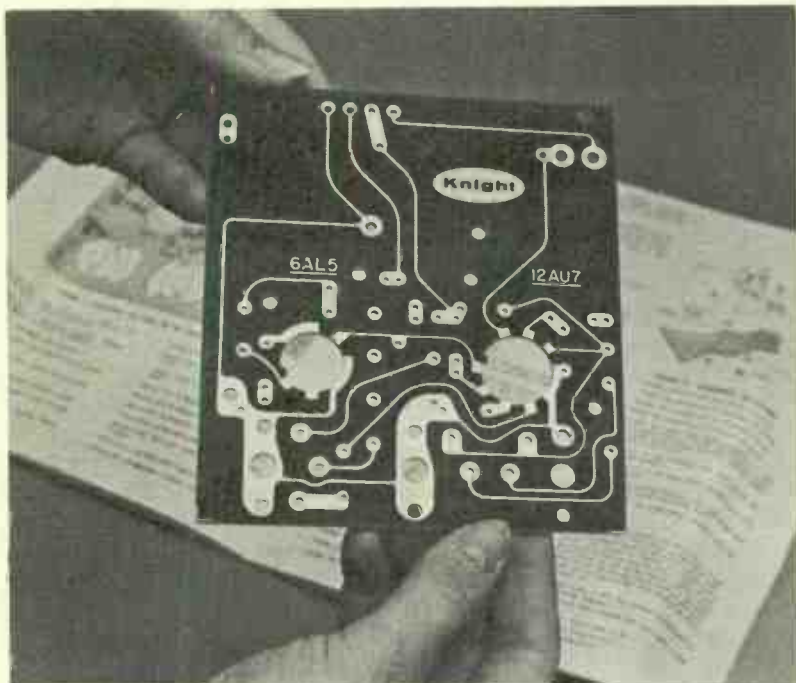

Fig. 5-4. Example of printed circuit board.

points on the same conducting path will reveal whether a crack has occurred. Sometimes the crack opens only when the board is mounted in the receiver chassis. Placement inside the chassis can cause slight twisting or bending, which opens the circuit. For this reason make continuity checks of printed-circuit conductors while gently twisting and bending the board in various directions—but be careful not to introduce new cracks or breaks!

You can also check between metal eyelets and foil with an ohmmeter to locate a poor connection. Any reading of more than zero ohms is a sign of a bad joint. Use a wire brush—normally part of a printed-circuit repair kit—to clean the joint, then resolder it. Leakage paths between adjacent conductors can also be cleaned by a wire brush. A coating of epoxy, also part of a repair kit, should then be applied over the cleaned area for protective insulation.

Receiver Alignment

To align tuned circuits, a signal generator designed to provide the



Fig. 5-5. RF signal generator.

required frequencies is needed. As the generator output is connected to various points in the circuit and tuning adjustments are made, a meter is used to measure and observe changes in output level. In AM radio receivers, RF and IF trimmers or slugs are varied for maximum output as indicated on the VOM or VTVM connected across the speaker voice coil or other point in the circuit. Follow carefully the exact alignment instructions provided by the receiver manufacturer.

Stage Gain

If trouble is suspected in a vacuum tube amplifier, it is possible to measure the stage gain with a signal generator (Fig. 5-5) or a received station as the signal source. In an RF or IF stage the VTVM needs good IF or RF response. If the instrument does not have good response at the required frequency a crystal or RF probe is used to equip the meter for these measurements (Fig. 5-6). With a signal passing through the amplifier, connect the common probe to the receiver ground and the other probe tip first to the grid (point 1 in Fig. 5-7) and note the reading. After moving the range switch to a higher voltage setting move the probe tip to the plate (point 2) and note the new reading. The reading at point 2 divided by the reading at

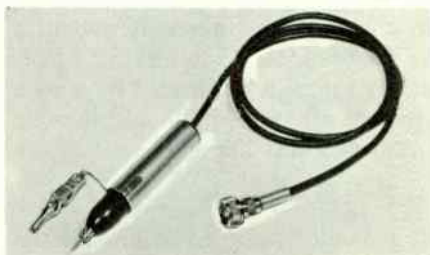

Fig. 5-6. Knight-Kit RF probe for use with VTVM.

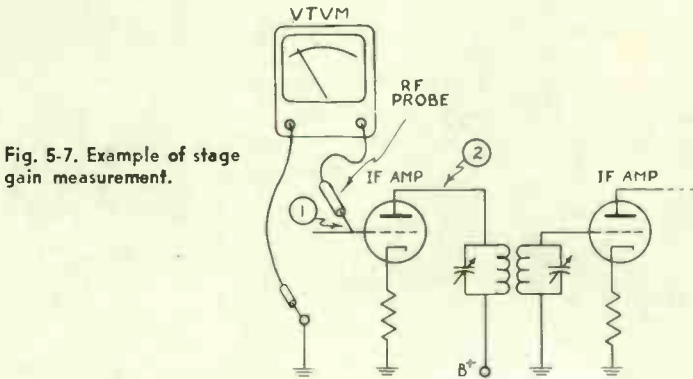

Fig. 5-7. Example of stage gain measurement.

point 1 is the voltage gain for the stage. Values of approximately 5 to 20 are typical in an IF or RF stage.

Service Data

In troubleshooting, repairing or aligning a radio, always consult the available service data. This can save much time and trouble and perhaps prevent further damage to the circuit. Servicing data generally includes test-point locations, circuit voltages, component values, coil and transformer resistances and location of each component.

Servicing information provided by a manufacturer for a typical battery-operated transistor radio is shown in Fig. 5-8. Information in the schematic includes colors of wires, part values, voltages, transistor types and so on. The "Notes" at lower left state that coil resistances are measured while the coils are connected in the circuit, voltages are measured with the + lead of the voltmeter connected to the positive side of the battery, that voltages are measured with no signal (receiver tuned to dead spot), volume control is at minimum, and that for these conditions battery current drain will be 8 milliamperes. This information is important, and ignoring it while testing may lead to misleading results.

Service data also includes alignment instructions for the radio. A typical chart appears in Fig. 5-9. The instructions tell us, among other things, to connect the VTVM or oscilloscope across the speaker voice coil, how to fashion a simple radiating loop, the dial setting for each step, signal-generator frequency, instructions for adjustment and the components to be adjusted in each step.

Wave Traps

A wave trap is a tuned circuit which passes or rejects signals over a

MODEL NT601 ALIGNMENT CHART

Allow Test equipment at least 15 minutes to warm up and stabilize. Connect VTVM or OSCILLOSCOPE across speaker Voice Coil. Use an AM R-F Signal Generator connected as indicated in chart. Keep Generator output as low as possible to avoid AGC overload. Set volume to maximum.

SIGNAL GENERATOR			RADIO		
STEP	CONNECTION TO RADIO	DIAL SETTING	DIAL SETTING	SPECIAL INSTRUCTIONS	ADJUST
1	USE RADIATING LOOP SEE NOTE	455KC	TUNING GANG FULLY OPEN	ADJUST FOR MAX. OUTPUT	T4, T3, T2
2	REPEAT STEP 1 UNTIL NO FURTHER IMPROVEMENT IS OBTAINED				
3	SAME AS STEP 1	525KC	TUNING GANG FULLY CLOSED	ADJUST FOR MAX. OUTPUT	T1 OSC. COIL
4	SAME AS STEP 1	1630KC	TUNING GANG FULLY OPEN	ADJUST FOR MAX. OUTPUT	VC1B OSC. TRIM.
5	REPEAT STEPS 3 AND 4				
6	SAME AS STEP 1	1400KC	1400KC	ADJUST FOR MAX. OUTPUT	VC1A ANT. TRIM.
7	SAME AS STEP 1	600KC	600KC	ADJUST COIL ONLY IF NECESSARY	E1 ANT. COIL

NOTE: FOR RADIATING LOOP, USE A 6 TO 8 TURN, 6 INCH DIAMETER LOOP MADE OF INSULATED WIRE. CONNECT LOOP TO GENERATOR TERMINALS AND PLACE ABOUT 12 INCHES FROM RADIO.

Fig. 5-9. AM receiver alignment instructions.

narrow frequency range. Sometimes it is helpful to determine if a wave trap or other resonant circuit is adjusted close to its desired value. A signal generator and VTVM can be used to set a trap to its approximate correct adjustment. Connect the signal generator, set to the required frequency, across the input side of the wave trap, as shown in Fig. 5-10. The VTVM is across the output, measuring AC. Tune the variable element(s) of the wave trap for the desired response (high or low) as indicated by the VTVM. The wave trap can be adjusted more accurately after it is connected in its circuit. Use the manufacturer's directions.

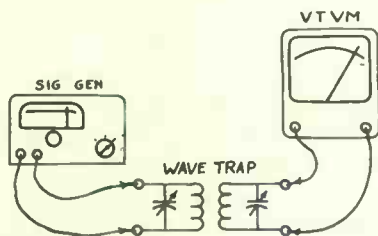

Fig. 5-10. Wave-trap adjustment setup.

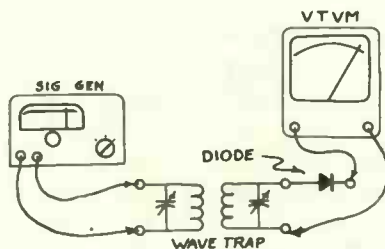

Fig. 5-11. Wave-trap adjustment setup for a DC output.

Another method of wave-trap adjustment, using the DC function of a VOM or a VTVM, is shown in Fig. 5-11. Here a crystal diode is connected in series with one side of the trap output. The rectified DC voltage can be read on the meter.

Either of these methods can be used to determine the frequency to which a tuned circuit is set. For this check, connect the test instruments as shown, but do not adjust the tuned circuit. Instead, vary the frequency of the signal generator. The frequency of the circuit is the point where response on the meter is maximum or minimum as required.

Checking for Hot Chassis

Normally, one side of the 117-volt AC line in residential and commercial buildings is grounded. AC-DC radio receivers, phono amplifiers, TV receivers and other electronic devices are wired so that one side of the AC line cord is connected to the chassis. Unless the line cord plug is polarized (a rare situation) there is a 50-50 chance that the chassis may be connected to the hot side rather than the grounded side of the line. This is a hazard when the chassis is out of its cabinet for servicing. If you touch the chassis or other metal part with one hand while touching a ground (such as a water pipe) you may receive a 117-volt shock.

Also, if two pieces of equipment are plugged into the line so that one chassis is hot and the other is grounded, a direct short circuit across the line results if the two chassis touch. This could also happen if they are connected together through test leads, for example.

A VOM or VTVM can show whether the chassis is connected to the hot side of the AC line. Set the range and function switches to 150 volts and AC. Then connect one test lead to the chassis and the other to a good earth ground, like a cold water pipe. If the meter reads full line voltage the chassis is hot. Reverse the AC plug to correct it and check again before working on the circuit.

FM Receivers

Servicing FM receivers is much like servicing AM receivers, especially for RF, IF, power supply and audio stages. Only in the limiter and detector (discriminator or ratio detector) do the circuits differ significantly. For tracing down many troubles the signal-injection technique can be used. In cases of low sensitivity (weak reception), connect a VTVM equipped with an RF probe to the grid of the limiter, as in Fig. 5-12. Apply the injected signal to the grid of the last IF stage, then proceed to the next-to-last stage, and so on. Watch the VTVM for an increase in gain as each stage is added. Where there

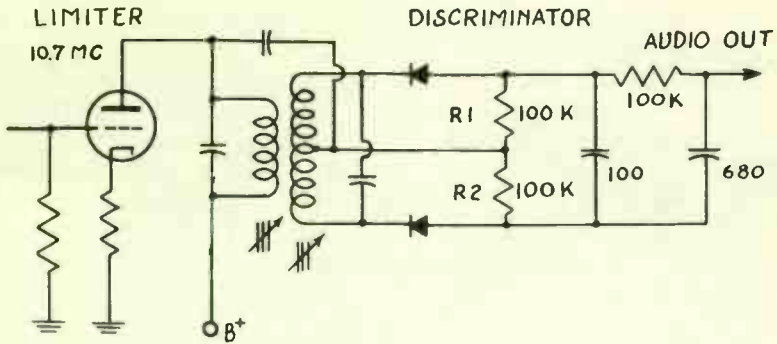
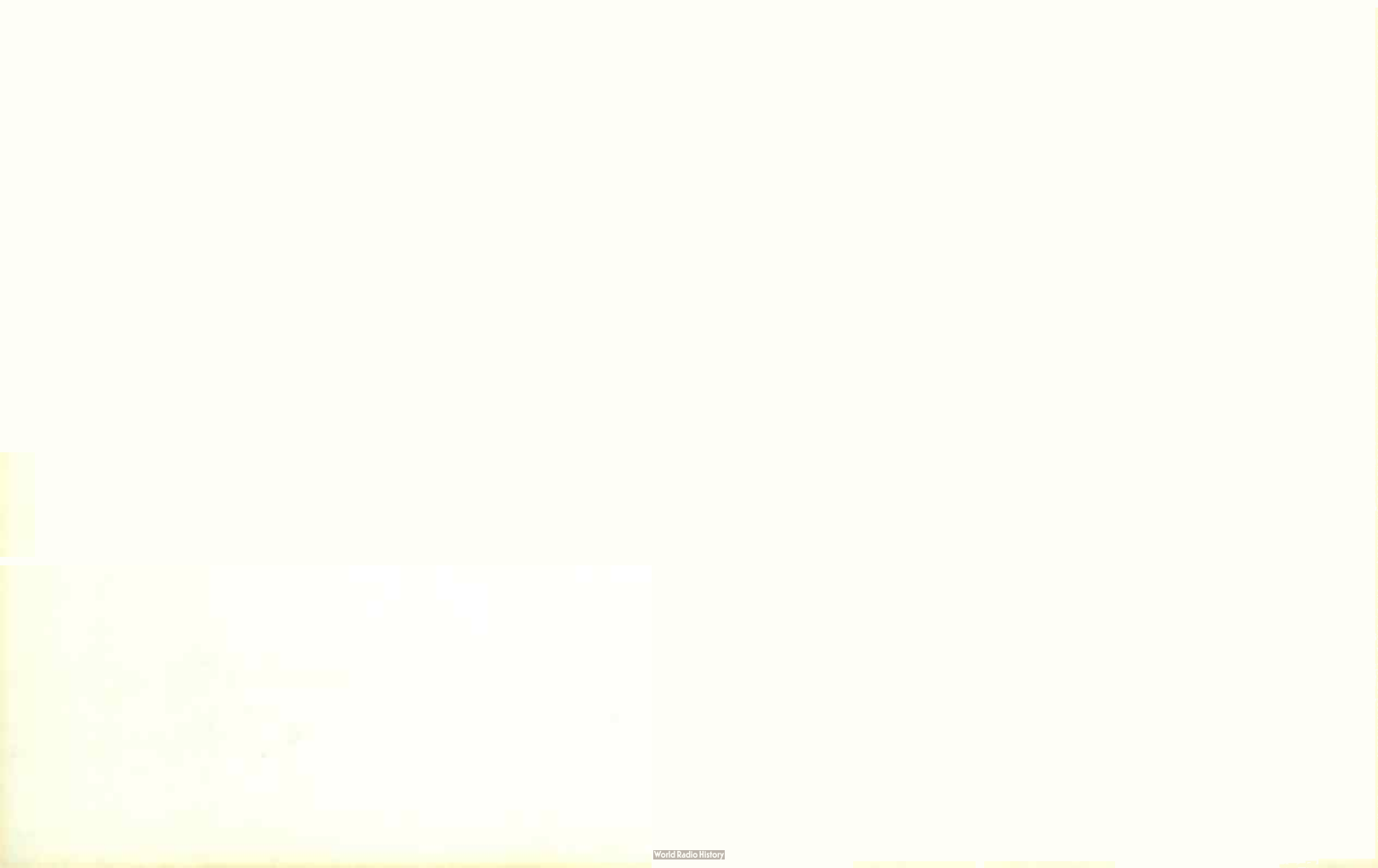

Fig. 5-12. FM limiter and detector.

is no increase in amplification, that stage is the likely source of trouble. Measure voltages and components for that circuit to pinpoint the trouble.

In some FM limiters an increase in signal causes grid current to flow, increasing bias on the limiter grid. The output of these limiters, can be measured with a DC VTVM across the limiter grid resistor, or a 0-200 or 0-500 microammeter in series with it.



CHAPTER SIX

CB AND HAM GEAR

The VOM and VTVM are essential for locating troubles and making adjustments in Citizens Band and Amateur (ham) radio. One important use is for testing transmission lines. The line connects receiver and transmitter to the antenna, as shown in Fig. 6-1. If the signal is weak or missing or reception is intermittent, possibly the trouble is in the line.

The transmission line may be either the coaxial-cable (Fig. 6-2A) or the open-wire type (Fig. 6-2B). Coaxial cable consists of a center wire or conductor and inner insulation which separates the center conductor from the shield or outer conductor. The center conductor is fastened to one antenna terminal and the shield to the other. Open-wire line consists of parallel conductors held an exact distance apart by insulating spacers. Troubles in transmission lines include opens, shorts and leakage (usually due to moisture).

With many types of ham and CB antennas, a hurried ohmmeter check across the two disconnected ends of the transmission line at

Fig. 6-1. Antenna system for CB or amateur radio.

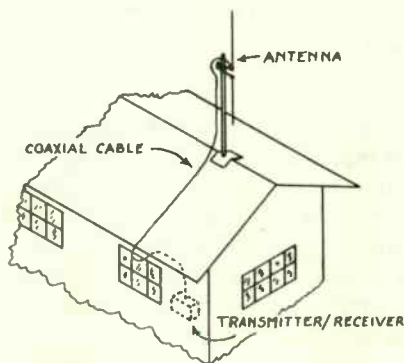

the receiver end may not tell conclusively whether the line is open or not (by "open" here we mean a break somewhere in the line between its two ends). You will not be able to measure the resistance of the line if the antenna itself is an open circuit (see Fig. 6-3A). But you can check its resistance or continuity by going to the antenna end of the line, shorting the conductor temporarily then taking a measurement at the transmitter end of the line. The resistance might be practically zero, or a few ohms, depending on the line length. Remember to remove the short later.

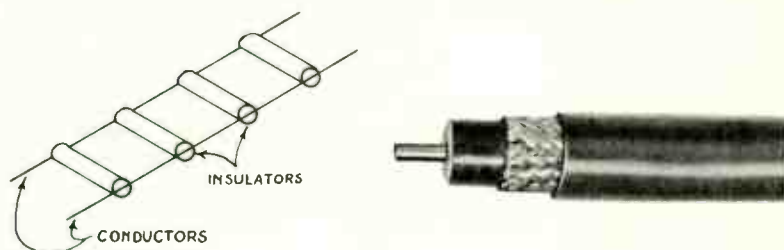

Fig. 6-2. Types of transmission line for CB and amateur radio.

If your antenna is a closed-circuit type (the folded dipole in Fig. 6-3B), rhombic (Fig. 6-3C) or loop (Fig. 6-3D), you will be able to measure the resistance without shorting the far end of the line. The resistance of the folded dipole antenna usually is low and will not add much to the line resistance. Some rhombic antennas are designed with a resistor (about 400 ohms) at the far end. With the rhombic antenna connected the resistance reading should be the normal resistance of the line plus the value of the resistor.

Experienced technicians can tell in some cases if a transmission line is open, even with an open-type antenna, if the line is fairly long. Capacitance between the two conductors can be appreciable. When the ohmmeter is connected across the line, a capacitive kick is noted on the meter and then the pointer returns to zero (unless the line is shorted). Knowing the amount of kick to expect from a particular line can be time-saving when trying to isolate troubles.

A shorted transmission line is a little harder to establish with closed-circuit antenna types unless the line is purposely opened at the antenna for measurement. When you know your line is all right, make careful resistance checks ahead of time under several conditions of outside temperature. You might know, for example, that the line has an average resistance of 4 ohms for dry outside conditions at 76 degrees F.

If trouble develops and it measures only 1 ohm for the same outside conditions, your line might be shorted about one-fourth its total distance from the near end.

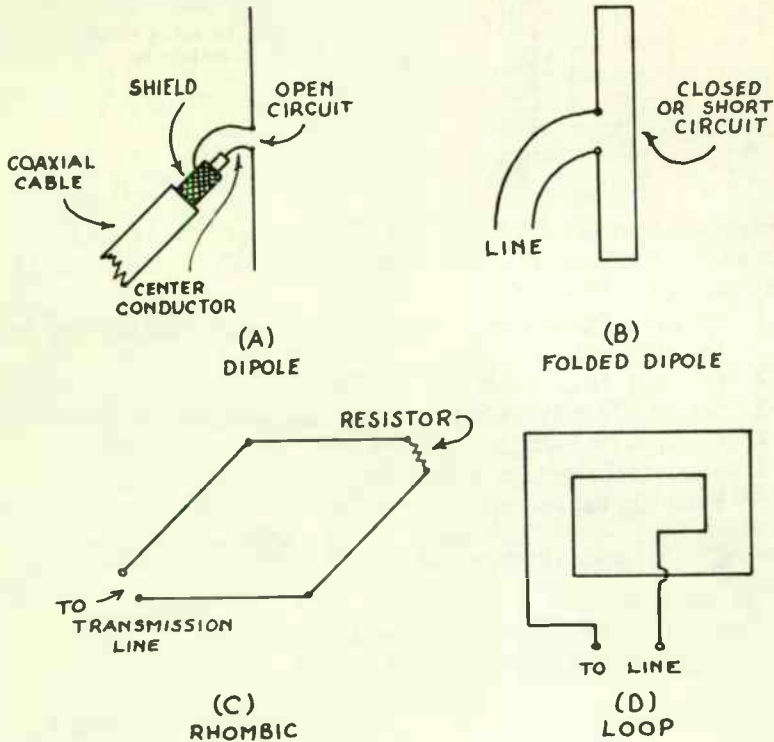

Fig. 6-3. Popular communications antenna types.

When checking for leakage disconnect a closed-circuit type antenna, then measure the resistance of the line on your highest ohmmeter range. On a good line during dry weather resistance should be in the megohms. Anything less indicates possible moisture in a line, soot, paint, or a conducting film on the spacers if it is an open-wire line. If the line measures high resistance and you still suspect leakage, measure the resistance between the antenna terminals. The resistance of an open-type antenna should be very high.

Extending Range for Leakage Test

It is a good idea to measure leakage resistance of a line as soon as it is installed; later you will be able to tell if it is deteriorating. Leak-

Best Ways to Use Your VOM and VTVM

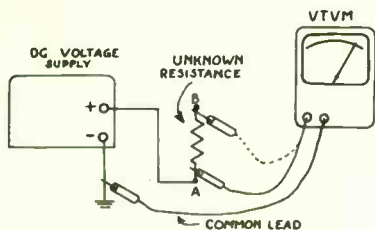

Fig. 6-4. Extending resistance range for leakage tests.

age-resistance measurements of over 1000 megohms can be made with the arrangement shown in Fig. 6-4. With a VTVM having an 11-megohm input resistance:

1. Obtain a DC power supply capable of producing between 50 and 500 volts.
2. Set up a circuit as shown.
3. Set VTVM controls to measure + DC voltage.
4. Measure the voltage at point A.
5. Measure the voltage at point B.
6. Calculate the leakage resistance with this formula:

$$\text{Leakage Resistance (in megohms)} = \frac{11 (\text{A voltage} - \text{B voltage})}{\text{B volts}}$$

For example:

A voltage source of 200 volts is used. Thus the voltage at A is 200 volts. The voltage measured at B is 1 volt.

$$\text{Leakage resistance} = \frac{11 (200-1)}{1} = \text{approximately } 2200 \text{ megohms.}$$

For VTVMs having other than an 11-megohm input resistance, replace the 11 in the numerator of the formula with the input resistance (in megohms) of the VTVM.

Measuring Plate Input Power

Ham and CB transmitters are licensed for a specified maximum amount of input power. Depending on the type and class of transmitter and operating conditions, the output power can be measured by the indirect method. In this system the DC power applied to the final stage, less losses, is considered rated output power.

The general way of determining power is by multiplying voltage by current. For measuring power input to the final stage of a transmitter, the basic arrangement of Fig. 6-5 is used. A voltmeter is connected to measure the plate voltage—the DC voltage between plate and cathode. An ammeter is connected in series with the cathode for a

triode tube or the plate supply for a tetrode or pentode. The cathode or plate circuit must be opened to insert the VOM as an ammeter (unless the transmitter has a jack for the purpose). The voltmeter reading multiplied by the ammeter reading is the final stage input power. If the output stage is a transistor, the product of collector voltage and current is the input power.

Most CB transmitters (Class D) are licensed for 5 watts maximum plate input power. If in the previous measurement you obtained readings of 250 volts and 20 ma (0.02 amp), output power is 250×0.02 , or 5 watts. Since the efficiency of a CB transmitter is seldom greater

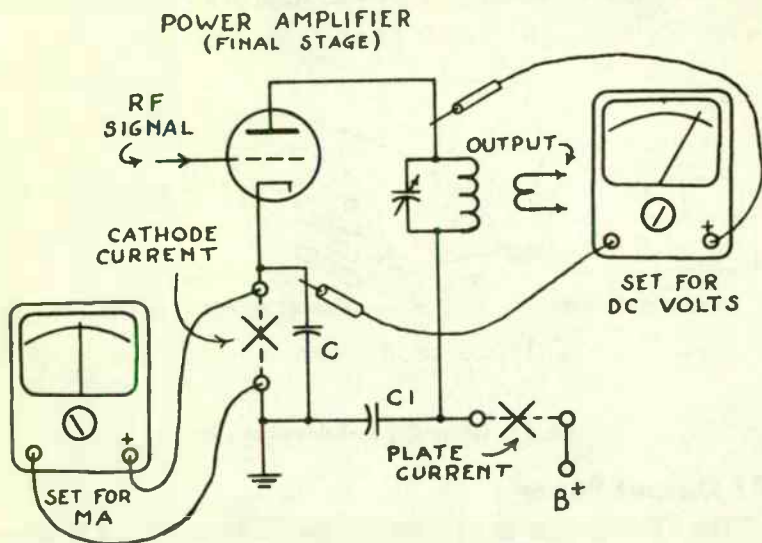

Fig. 6-5. Measuring plate input power.

than 70%, this 5 watts of input power may be about 3.5 watts of RF output power at the antenna.

Measure the input power to the final stage with the transmitter disconnected from the antenna and connected instead to a dummy load. This is a load whose resistance is equal to the output impedance of the transmitter. It may be a lamp of high enough wattage rating. If a home-made load is used the power rating of the resistors should be at least as great as the power to be measured. For an amateur transmitter rated at 90 watts and 50 ohms output you might use an ordinary 100-watt incandescent lamp (Fig. 6-6A). For a 5-watt CB transmitter whose output impedance is 50 ohms, use ten 500-ohm $\frac{1}{2}$ -watt resistors in parallel, or five 250-ohm 1-watt resistors in parallel (Fig. 6-6B).

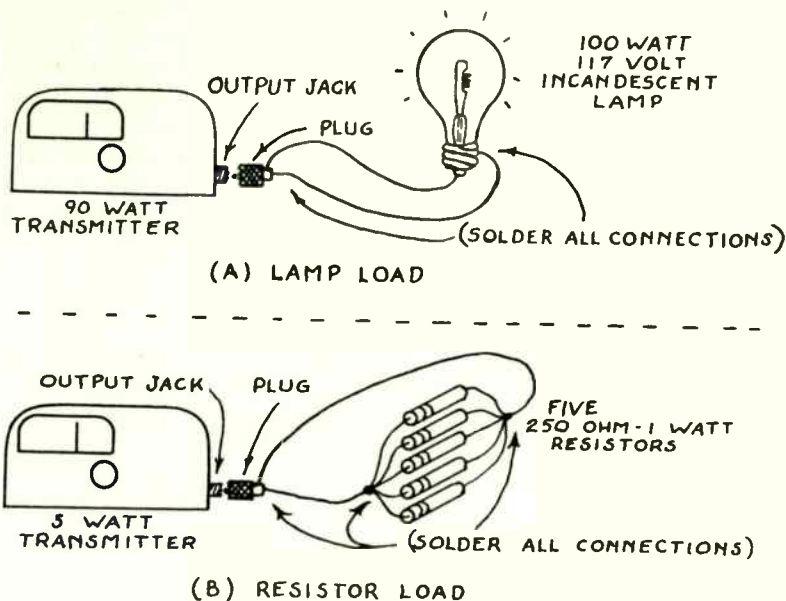

Fig. 6-6. Two readily available dummy loads.

RF Output Power

The RF output power of a transmitter can be measured by using a dummy load and a VTVM with an RF probe. The meter is used to measure RF voltage across the load. If the transmitter is terminated in its proper load resistance, output power is the square of the RF voltage divided by the resistance, or $P = \frac{E^2}{R}$. If the RF voltage reading, for instance, is 16 volts and output resistance is 52 ohms, the output power is:

$$P = \frac{16^2}{52} = \frac{256}{52} = 5 \text{ watts, approximately}$$

Direct-reading RF wattmeters which connect directly to the transmitter output are also available for accurate measurements. The transmitter connects to the wattmeter through a short coaxial cable. The coaxial line to the antenna is then connected to the wattmeter output. RF output power may then be observed or monitored continuously while the transmitter is operating.

Field-Strength Indicator

A convenient monitor for RF output power, which can also be used as a field-strength meter, is constructed easily from inexpensive parts. The VOM or VTVM is the indicating device. Field-strength indicator readings taken at several points equally distant from a transmitter can tell you, for example, if a beam antenna is radiating maximum power in the desired direction or if a nondirectional antenna is radiating equally in all directions.

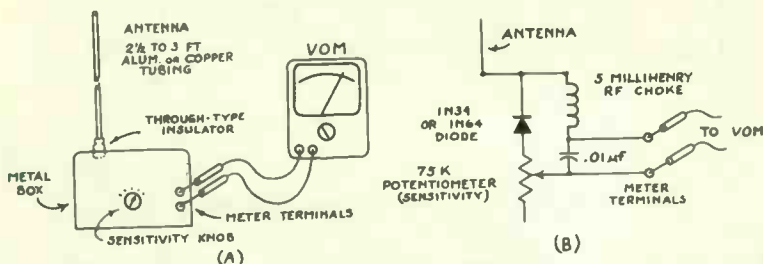

Fig. 6-7. A simple field-strength meter.

The circuit for the field-strength meter is in Fig. 6-7. In Fig. 6-7A the physical construction is shown; the antenna is mounted on a metal box with an insulator. The sensitivity control and terminals for the meter test leads mount on the front of the box. The circuit is shown in Fig. 6-7B. The 75K potentiometer is adjusted for a convenient indication on the VOM or VTVM each time the device is used. As you move the field-strength indicator closer to or farther from the transmitting antenna, the readings will vary. The indicated reading should increase, too, as the transmitter is modulated.

Receiver S-Meters

Communications and amateur receivers often include a signal-strength, or S-meter, to indicate relative strength of signals received. The VOM or VTVM can be used as an S-meter by connecting it to the receiver's automatic volume control (avc) voltage. The connecting points for a typical receiver are shown in Fig. 6-8. The voltmeter is set for negative DC volts on the 10-volt range or lower. If the instrument does not have a polarity reversal switch, be sure to connect the positive lead to the chassis ground or common negative of the receiver and the negative lead to the AVC, as shown.

The stronger the received signal the more negative the voltage indicated by the meter. Tune the receiver to the strongest station and select

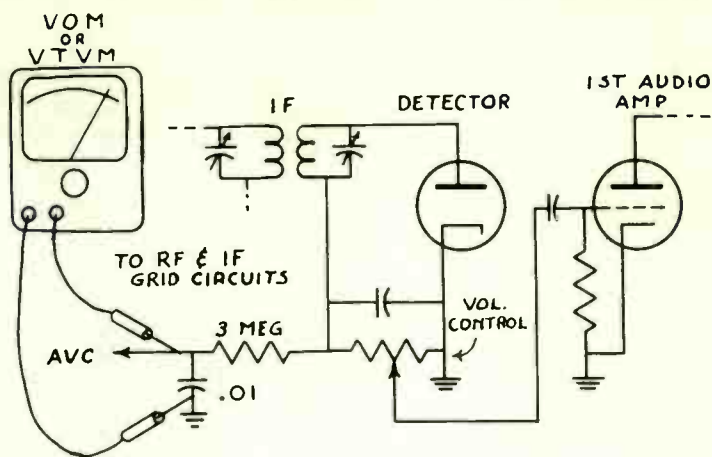

Fig. 6-8. General S-meter connection points.

the range that gives a meter reading near full scale. The readings on all other received signals should then be lower. This provides continuous monitoring of reception conditions or relative power of various signals.

RF Voltmeter

The VTVM equipped with an RF probe is used to measure voltages directly at frequencies into the 200-mc range. The VOM can also be adapted with an auxiliary circuit for use as an RF voltmeter (see circuit in Fig. 6-9). The VOM is set to measure DC current on the 0-1 ma range. All interconnections between components must be kept short. High accuracy is not possible in this system, but it can prove helpful for relative readings.

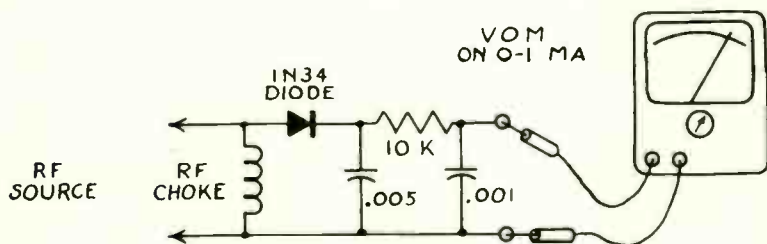
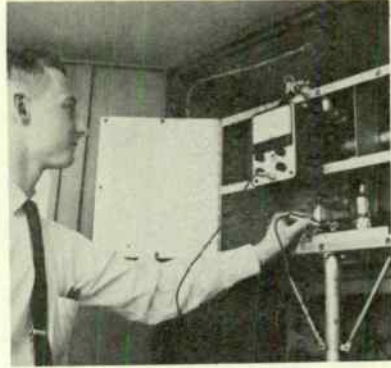

Fig. 6-9. RF adaptor circuit for VOM.

Fig. 6-10. Method of safely measuring high voltage.



Transmitter Precaution

On a high-powered ham transmitter, turn off the high-voltage final and driver stages whenever possible when testing low-level stages! Also, fasten the VTVM or place it in a safe location during measurements so it cannot fall into live circuits. Do *not* hold it in your hand! In fact, when checking out high voltage circuits as shown in Fig. 6-10, make sure that the VTVM is firmly supported, and use only one hand in making connections or handling leads. Keep the other hand safely behind you or in your pocket.



CHAPTER SEVEN

MISCELLANEOUS APPLICATIONS

Liquid Level Indicator

We have by no means covered all the uses for multimeters; a list of possible applications would be practically endless. Some of those in this chapter are not unusual ones but using them will perhaps suggest other ideas to the reader. A novel use for a multimeter, for example, is as a liquid-level indicator. Various schemes could be designed, but the basic details of a simple arrangement are shown in Fig. 7-1. A VOM is connected to read current provided by a battery in series with a potentiometer. The shaft of the potentiometer is turned through a gear-reduction arrangement by a vertical rod having horizontal teeth which mesh with the gear teeth.

Fig. 7-1. Measuring liquid level in a container.

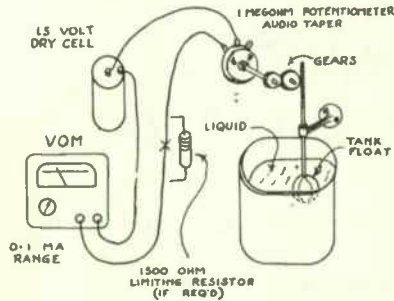

With the arrangement shown, an increase in liquid level reduces the potentiometer resistance. In series with the battery and milliammeter, the potentiometer thus increases the current indication on the meter. The VOM need not be left connected permanently. Wires can be connected to tip jacks fastened to a mounting plate or board at some convenient location. When a check on the level of the liquid is desired, the meter can be plugged into the jacks temporarily.

Best Ways to Use Your VOM and VTVM

When the tank is full the current reading on the meter is read and noted. It may be necessary to include a limiting resistor in the series circuit to prevent excessive drain on the battery if the VOM is left connected for any length of time.

A VTVM could also be used as a level indicator by replacing the VOM with a resistor. It would measure the voltage drop across the resistor as an indication of the level.

Typical circuit values for Fig. 7-1 are a 1.5-volt battery, a 1500-ohm series-limiting resistor and a potentiometer of 1.5 megohms having a logarithmic resistance element, or audio taper. This taper is desirable so meter current will drop to a sufficiently low value when the liquid is near the bottom. The VOM is set on the 0-1 MA DC RANGE.

Tachometer

A tachometer indicates revolutions-per-minute (rpm) of a motor or generator shaft, flywheel, gear or pulley. Often in practical tachometers a miniature electrical generator is fastened to the shaft. As it rotates voltage is generated. The output voltage or frequency (if the generator is AC) increases with shaft rpm. Other types of tachometers also are in use; there are models in kit form that can be used on the instrument panel of your car to observe engine rpm continuously.

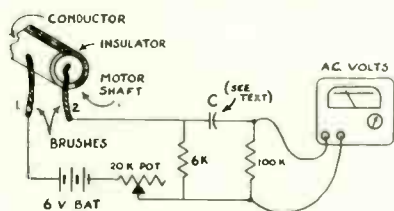

Fig. 7-2. Construction of a simple tachometer.

A simple tachometer using a VOM or VTVM can be constructed from the arrangement of Fig. 7-2. In the end view, the motor shaft is shown as two half-circles. One half-circle is made of an insulating material such as mica; the other is cut and filed smooth from a piece of conducting material such as copper, of about the same thickness as the insulating segment. The two half-circles are fastened to the end of the shaft with conducting cement or solder.

Two brass or beryllium brushes form the contacts on the shaft. One brush is positioned so it is forced by spring tension against the end of the shaft, as shown, and the other brush positioned at right angles to the first so it rests continuously against the steel shaft. As the shaft rotates, a circuit through the brushes and shaft is established during

each half-turn that the end brush is in contact with the conducting segment.

The 6-volt battery, 20K potentiometer and 6K resistor are in series with the brush circuit. The average voltage developed across the 6K resistor will be approximately 3 volts (if the 20K pot is adjusted to zero ohms). It will be a DC voltage pulsating at a rate depending on the shaft rpm. The faster the shaft rotates the higher the frequency and the lower the capacitive reactance of capacitor C.

For high rpm, nearly the full 3 volts will appear across the 100K resistor, across which the VOM or VTVM is connected. The meter is set to measure AC VOLTS. Therefore, the greater the rpm the higher the meter reading. The meter can be calibrated in rpm-versus-volts AC if an accurate tachometer is available to check calibration. An approximate voltage-versus-rpm chart can be made for future use.

The value of C depends upon the average rpm to be measured. Its minimum value can be found from the formula:

$$C = \frac{1.6}{f}$$

where C is capacity in microfarads, and f is the revolutions-per-minute of the shaft.

For example, if f is 1700 rpm,

$$C = \frac{1.6}{1750} = 0.001 \mu\text{f, approximately}$$

With this value for the capacitor, the voltage reading on the meter will be approximately 3 volts, or slightly less, at 1750 rpm.

Photometer

Resistive and semiconductor devices that are highly sensitive to changes in light are available at reasonable cost. It is possible to build a photometer or light meter for measuring illumination with one of these photosensitive devices. The basic circuit illustrated here could be used for photography or to turn a light on or off as darkness or day-light approaches.

First let us look briefly at a typical circuit which can monitor one level of illumination and switch a light off or on, depending on the illumination extremes for which the circuit is set. The circuit, which is more fully explained in Allied's "Getting Started in Electronics" book, is shown in Fig. 7-3. A parts list also is included for obtaining components. The photocell is designated as LDR C-1 in the schematic. It changes resistance for different levels of light. For example, with 92 foot-candles its resistance is 200 ohms, and in total darkness its resistance increases to 10 megohms.

Best Ways to Use Your VOM and VTVM

If you construct this circuit you will have a photoelectric light-relay. Whatever device is plugged into the AC outlet (top right) will be turned on or off depending on the setting of the sensitivity control and the amount of light striking the photocell. If the load is a lamp, illumination from the controlled light must not fall on the photocell. If it does, the light being turned on will turn itself off again and will repeat this process rapidly.

Fig. 7-3. Photoelectric light relay circuit.

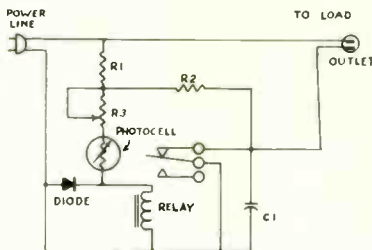

A portion of the photocell light-relay circuit can be used with a VOM as an instrument to reveal the relative amount of illumination striking the photocell. The photometer circuit (Fig. 7-4) is the same as the light-relay circuit but with some parts removed. The VOM is used as the indicator. It is set to the required DC voltage range for a convenient-to-read indication. With total darkness the photocell resistance is 10 megohms. If the VOM is connected across the 1500-ohm resistor, the indicated voltage drop should be practically zero. With an increase in light level the resistance of the photocell decreases, resulting in a greater portion of the rectified voltage appearing across the 1500-ohm resistor. Thus, if the VOM is set for a useful DC range, the deflection of the pointer is in proportion to the illumination on the photocell.

Fig. 7-4. Photometer circuit for use with a VOM.

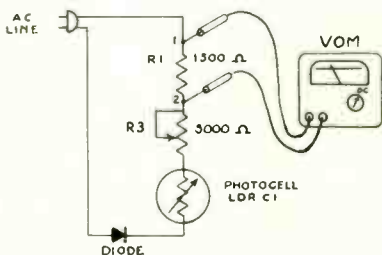

For high levels of illumination, and using a 20,000 ohms-per-volt VOM, the 50-volt range will probably be most suitable. (A VTVM

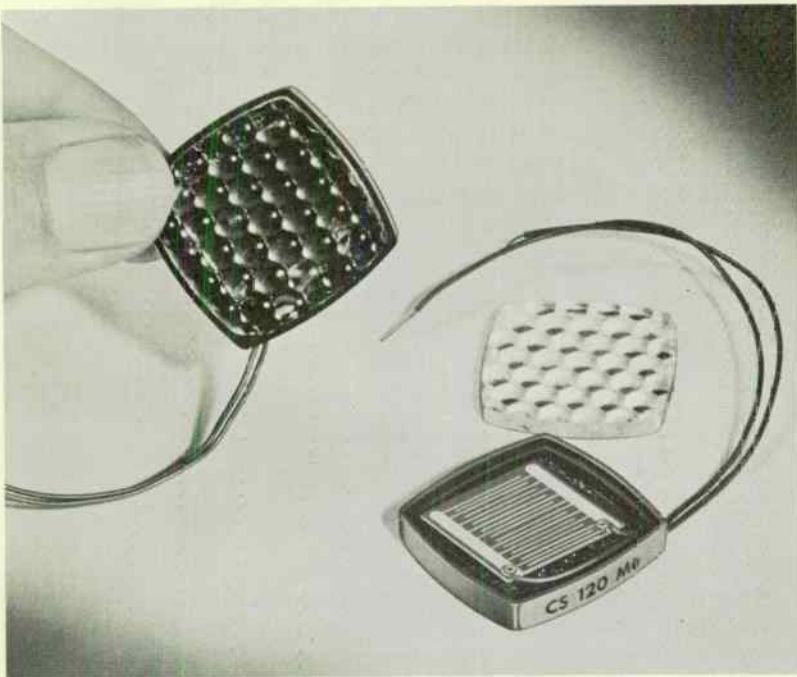

Fig. 7-5. Typical photovoltaic cell.

is not recommended in this circuit since a metal-cased instrument connected to the line could become a shock hazard.)

There are many types of photosensitive devices for experimenting, and many photocell kits, such as the Sylvania PCK-10 Photoconductor Kit and instrument manual. They describe experiments and devices which can be constructed. Such kits are available from Allied Radio Corp.

A closer view of one type of photocell, an IRC cadmium-sulphide type, is shown in Fig. 7-5. This is a *photovoltaic cell*, which means it generates a voltage when light strikes it. The voltage is in proportion to the amount of light. The front of the photocell is at the left, a back view at the lower right and the rear cover above.

Temperature Indicator

A thermistor is a resistive component whose resistance varies with a change in temperature. Thermistors are available in many values and are used widely as temperature-indicating and controlling devices, fire alarms and for equipment protection. Some of the shapes in which

Best Ways to Use Your VOM and VTVM

thermistors are available include disk, bead, probe, washer and rod. Their sizes range from $\frac{1}{8}$ inch to about 1 or 2 inches in length or diameter.

You can use a VOM or VTVM connected to a simple thermistor circuit as an indicator of relative temperature between the limits of 150°F below zero to 500°F above zero. It will also indicate exact temperature within these extremes if you calibrate the meter over a range of different temperature conditions.

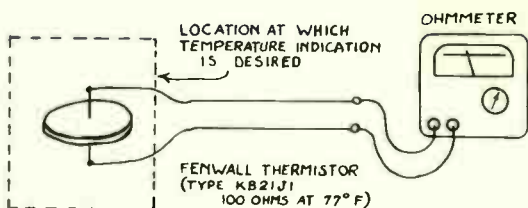

Fig. 7-6. Thermistor circuit for temperature control.

An example of such a circuit is shown in Fig. 7-6. The thermistor has a negative temperature coefficient, meaning that its resistance decreases as its temperature increases. In listing the specifications for thermistors, catalogs give their ratio of change in resistance between typical extremes of temperature. For example, the Fenwall Type KB21J1 is a disk-shaped thermistor with a resistance of 100 ohms at 25°C (77°F), and a resistance ratio of approximately 7 to 1 between 0°C and 50°C (32°F to 122°F). The change in resistance for a particular thermistor may be linear over a certain range of temperature—that is, for each 1-degree change, it changes the same number of ohms in resistance. Many thermistors are not linear, especially over a wider range of operating temperatures.

The circuit shown uses the Fenwall-type KB21J1 mentioned above. Its resistance, as described, is 100 ohms for a temperature of 77°F. If you select an ohmmeter having an indication of 100 ohms at mid-scale, this 100-ohm point will be equivalent to 77°F if the resistance of the interconnecting wires is low. An increase in temperature at the thermistor causes the pointer to move toward the low-resistance end of the scale, and a decrease to the other end of the scale.

Current flowing through a thermistor can also cause it to change temperature and therefore resistance. This should be taken into account when calibrating a resistance-versus-temperature chart or interpreting your ohmmeter readings in terms of temperature. Make sure your ohmmeter is functioning properly and reads zero when the

test leads are shorted. You can then use a thermometer for calibrating the ohmmeter for various temperatures over the range desired. Give the thermistor a half minute or so to adjust resistance for each temperature change, and be sure that its maximum current rating is not exceeded.

Measuring Solutions

The VOM and VTVM can be used to indicate the conductivity of a liquid, for measuring the salinity of a solution or indicating the percent saturation of a solution. Here is a simple experiment to show how the resistance or conductivity of a liquid changes as the soluble material is added.

Fill a glass of water to about 1/2-inch from the top. Use the ohmmeter function of your multimeter on the Rx10 or Rx100 range. Using test leads with alligator clips on the ends, hook onto each side of the top rim of the glass so there is good contact with the water (see Fig. 7-7). Note carefully the resistance of the water. A typical reading for a glass about 2 inches wide at the top filled with ordinary tap water might be somewhere near 10,000 ohms. With distilled water the resistance reading will be much higher.

Fig. 7-7. Measuring liquid conductivity.

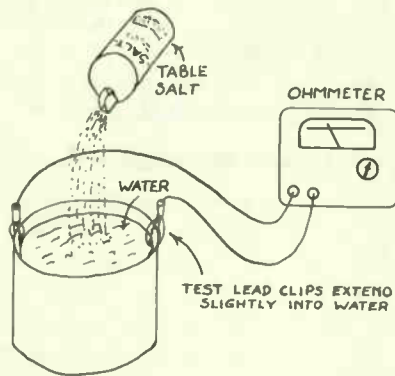

Next, shake some ordinary table salt into the water, a little at a time. Notice that the resistance reading decreases. Continue adding salt, occasionally mixing the solution with a spoon. You will eventually reach a point (perhaps 300 ohms) at which the resistance decreases no farther, no matter how much more salt is added. It is at this point that the salt-water solution is 100% saturated with salt molecules. It can dissolve only that much; if more is added, the salt sinks to the bottom of the glass.

Best Ways to Use Your VOM and VTVM

If you repeat the experiment, starting with a clean glass and fresh water, weigh the salt and the shaker before you begin, then weigh it again when your ohmmeter indicates that saturation has been reached. You can tell how many grams of salt are required to saturate the glassful of tap water. Further, if you measure the amount of tap water accurately, you can make up a general formula that will tell you how much salt is needed to make a 100%-saturated solution.

If we measure the salt in grams and the water in ounces, the general formula is:

$$\text{Grams salt needed per ounce of water} = \frac{\text{grams of salt used}}{\text{ounces of water}}$$

Some factors to keep in mind in using an ohmmeter as a salinity tester are:

1. 100% saturation conditions are different at different liquid temperatures.
2. More salt is needed for a chemically pure liquid (distilled water) than for nonpure liquid (tap water).
3. Be cautious about the liquids you are working with—they may be inflammable or explosive.
4. In some cases, current flowing through the liquid from the ohmmeter circuit might change the chemical characteristics of the liquid. If so, other means must be used.
5. Do not use this test with acids which could damage your test leads. Wash and dry test leads and clips thoroughly when finished to prevent corrosion.

Soil-Moisture Measurement

An interesting use of a multitester is measuring the relative moisture content of soil. This is done by measuring the soil resistance. The actual measured resistance and the usefulness of the measurement depend on how efficient the connection is to the soil, the amount of water or moisture it contains, the characteristics of the soil (how much acid, lime, gravel, sand or clay it contains) and how much moisture is ideal. Soil resistance varies widely over different parts of the country and at different locations in each general area. The gardener is generally interested in the moisture of his soil between the surface and a depth of about 4 to 6 inches. The resistance and relative moisture content between any two points in the soil can be measured with an ohmmeter.

One method for most practical cases is shown in Fig. 7-8. With this arrangement soil resistance is measured between a point at the far end of the garden and a good ground, which can be located inside the house, such as in the kitchen or cellar. Having the garden soil-contact point at the far end makes it possible to measure average moisture

of the whole garden. To establish a good electrical connecting point to the soil, a sheet of copper of about 24 square inches is positioned vertically and buried so the bottom edge is not deeper than about 6 inches, and the top about 2 inches below the surface. The copper sheet is solder-connected to a ground rod driven to a depth of not more than 6 inches, and to the conductor (number 14 wire or larger) which is insulated from the ground and extends back to the measuring point where the ohmmeter is located. One test lead is connected to the wire coming from the garden ground and the other lead fastened to a cold-water pipe or other good earth ground. The resistance reading might vary in different locations from 2 or 3 ohms up to several thousand or more, depending upon the conditions mentioned previously.

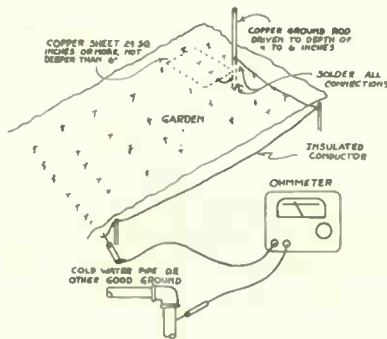

Fig. 7-8. Measuring moisture content of soil.

It is important to have a good electrical contact between the copper sheet and the soil. Dig a circular trench about 4 inches deep, with a radius of about 18 inches, around the sheet. Fill it with rock salt or magnesium sulphate (which is less likely to corrode the copper). Then dampen the chemical and cover it with earth. This provides a good contact for 2 or 3 years, after which it should be renewed. If this chemical method of establishing a good earth connection is used, the grounding system (sheet, rod and chemicals) should be located at least 4 feet away from plants.

Resistance readings are observed over a period of several days. Note when the soil is thoroughly wet to a saturated degree, as after heavy rainstorms. For the next few days observe ohmmeter readings, noting the weather, temperature and soil conditions each time. Take readings, too, when the soil is extremely dry. By compiling the data, and with experience, the resistance method of measuring soil moisture can provide a fairly accurate and immediate check on garden conditions without even going outside the house.

Tape-Recorder Bias

In tape recording, an AC bias signal (independent of the audio signal to be recorded) is applied to the recording head. It is usually at a frequency between 50 kc and 180 kc. It is not heard during tape playback because it is higher in frequency than the upper limits of hearing. The purpose of bias is to overcome the inertia or lag in movement of magnetic molecules in the tape during the recording process. Without bias, the recording would be noticeably distorted.

A VOM or VTVM can be employed to measure the bias signal, if

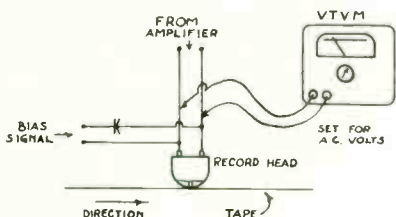

Fig. 7-9. Tape recorder bias measurement.

it has good response at the bias frequency. Bias is usually measured across the two terminals of the recording head while the recorder is in the record function. No audio signal is applied to the input of the recording amplifier.

The test meter, set for an AC voltage reading, is connected to the head and the amplitude of the bias signal noted. The actual value depends upon the specific recorder, and here the manufacturer's instructions should be followed closely. Values for bias signals might range from 2 or 3 volts AC up to 20 or more.

The method of making this measurement is shown in Fig. 7-9. Usually the tape recorder manufacturer provides specific instructions on how to make the measurement, what it should read, and adjustments to make for incorrect amplitude of bias signal. One sign of insufficient bias level is poor high-frequency performance during playback.

Relay Pull-In and Drop-Out

If a voltmeter is connected across the coil of a relay, as shown in Fig. 7-10, and a variable voltage supply connected to the relay, two important operating voltages can be measured. The *pull-in voltage* is the voltage at which the relay armature is actuated. The *drop-out voltage* is the voltage across the coil below which the relay spring pulls the armature away from the contacts.

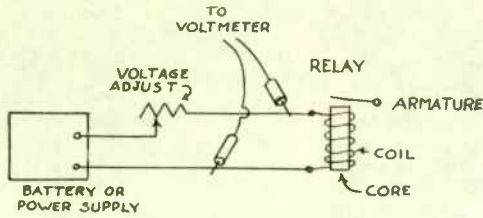
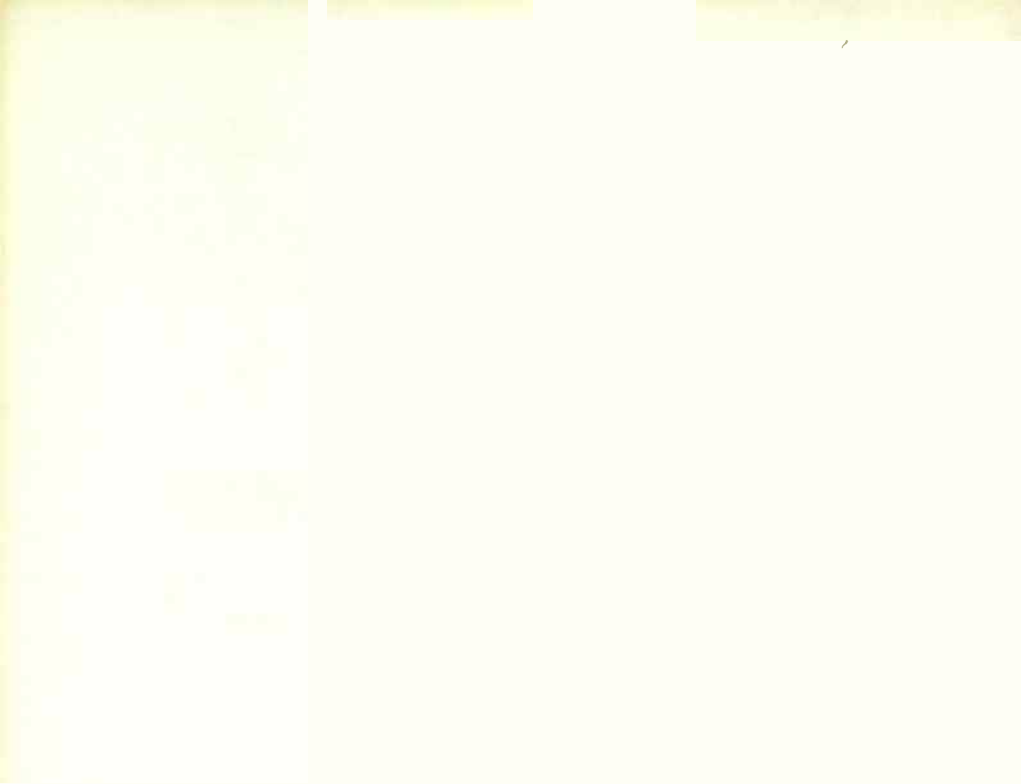

Fig. 7-10. Checking relay pull-in and drop-out voltages.

To measure pull-in voltage, start with zero voltage and slowly adjust the power source until the armature pulls in. The reading on the meter is the pull-in voltage. Next, slowly decrease the voltage until the relay armature drops out; this meter reading is the drop-out voltage. If a relay is to be held reliably in a closed position, coil voltage should never fall too close to the drop-out value.



CHAPTER EIGHT

TAKING CARE OF YOUR METER

If a test meter (especially a VOM) is set to the wrong function (ohms instead of volts, for example) or on the correct function but too low a range, the instrument can be damaged or destroyed, depending on how badly it is overloaded. Multiplier resistors or shunts can burn out, and the meter itself can be damaged or burned out (unless protected by a *Metergard* or similar diode arrangement). Because the input resistance of the usual VTVM is 11 megohms for all ranges, and because the meter is isolated from the input circuit, damage due to using the wrong scale is unlikely.

If a VOM or VTVM is set for the ohmmeter function and an attempt is made to measure a voltage, one or more resistors in the resistance-measuring circuit may burn out. The person making the measurement often does not realize that damage has occurred. If he obtains no reading, looks over the meter settings and discovers the error, he may correct the switch setting and continue with voltage measurements. Not until later, when the instrument is used for resistance measurement, does he discover that it is no longer working. Often it is only after much searching and circuit analyzing that a burned-out resistor is discovered in an ohmmeter circuit. To minimize this possibility the meter should be used with care, especially when operating the function switch.

Battery Replacement

Replace batteries periodically whether they appear to be weak or not. Batteries discharge, even without being used, over a period of time. Also, if a VOM or VTVM has been left in a warm place the batteries may deteriorate, leak or burst open and the chemicals cause damage. A VOM or VTVM is worth good care, especially with regard to batteries. Install new ones at least every six months.

When batteries are replaced, examine and clean the contacts on

Best Ways to Use Your VOM and VTVM

the battery holder. Corrosive materials can be removed and spring contacts coated with a thin film of switch or contact lubricant to help prevent future corrosion. Use leakproof or industrial batteries, if available, for greater protection.

The most obvious indication of a weak battery is failure of the ohmmeter to "zero" when the test prods are shorted together. If you find you are replacing batteries often, recheck your technique of using the VOM or VTVM. Perhaps you are leaving the instrument on the LOW-OHMS range when you are not using it. This practice can run down a battery in a short period of time.

Function, Range and Other Switches

The switches in a multimeter ordinarily are not lubricated or cleaned, since they are designed to be troublefree for the normal life of the instrument. The contacts are self-wiping; that is, they clean themselves as the knob is rotated from one position to another. If dirt, dust or other foreign particles accumulate on internal parts, these are gently and carefully removed with a "popsicle"-type stick or other blunt insulated tool. Sometimes dirt and foreign particles can be dislodged by gently blowing with a syringe or bellows.

Only after you are sure your switch contacts are not operating reliably should you consider doing anything to restore them. First, rotate the switch several times through all positions. Doing this may be all that is needed to clean the contacts. If it does not, you can try depositing one drop of contact cleaning-lubricating fluid on the movable contact. Then turn the switch through all positions several times, permitting the moving contact to distribute the fluid over the surfaces of all contacts.

Test Prods and Probes

Inspect test leads, prods, jacks and probes regularly to be sure that insulation is not cracked, wires not frayed or loose and that contact between the test-lead wire and the prods and plugs is good. If the insulating surfaces of a wire or the probe handles become dirty or greasy, wipe them clean with a cloth dampened in alcohol. Follow the manufacturer's directions for maintenance if available.

Probes for VTVMs are checked for sufficient tightness of the probe tip in the end of the handle, proper grounding of the cable shield and ground clip, good soldered connections of diode and resistor leads and for possible damage to the slide switch. A high-voltage probe and test-lead cable should get special attention. Check very carefully the end of the cable nearest the instrument panel.

Meter Face and Plastic Cover

A test meter should not be left standing where the sun shines directly on the meter faceplate. Numbers and calibration marks may fade, especially red ones. On nearly all modern multitesters, the protective covering over the faceplate is plastic. If it gets dirty or accumulates a static electricity charge (making the pointer movement erratic) prepare a mild solution of liquid detergent. Dip a clean cloth in the solution, squeeze out most of the liquid, then wipe off the plastic cover. This will neutralize the charge.

Unnecessary Use

Occasionally we need to make a continuous measurement especially in tracking down an intermittent. Rather than to tie up a versatile, relatively expensive VOM or VTVM for extended measurements, you might consider whether a less-expensive instrument is available which might do the job even better under the special circumstances. One example is continuous monitoring of power-line voltage. A relatively inexpensive instrument for that purpose is shown in Fig. 8-1. This is

Fig. 8-1. Rugged AC line voltage monitor.



a rugged instrument of good accuracy and designed to respond to voltage changes faster than the average multimeter. The meter faceplate is calibrated only in AC line voltage. The large, easily read numerals and scale are in black, except for the 120-volt indication which is red, permitting immediate identification. Another advantage of this monitor is that it includes a moving vane-type meter movement which actually responds to the rms value of the AC voltage. Where the voltage is not a pure sine wave it is even more accurate for power-line measurements than either the VOM or VTVM. An instrument to monitor the power line is useful when plugged in near the workbench or into the outlet with a troublesome radio, TV or amplifier when the difficulty seems to be associated with line-voltage changes.

Aging Effects

The VTVM occasionally needs recalibration, especially if it is left unused for periods of several weeks or more at a time, is left in a damp cellar, warm attic or used continually in an atmosphere of corrosive fumes or high humidity. Time also takes its toll on the VTVM.

Due to any one of these causes, capacitor and resistor values may change, soldered connections may break, connections might loosen or corrode, etc. The VTVM should be completely checked over periodically and recalibrated on the AC, Resistance, and Plus and Minus DC Ranges. Follow the instructions of the manufacturer exactly. Some of the major components and calibration adjustments for a typical VTVM are shown in Fig. 8-2. With many VTVMs the instrument must be removed from the cabinet for these adjustments. The controls in the model shown, however, are accessible through holes in the side of the cabinet.

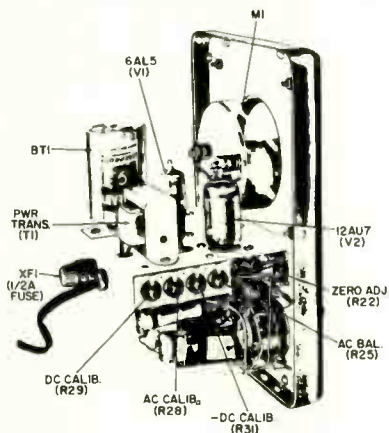

Fig. 8-2. Calibration adjustments in a typical VTVM.

Fig. 8-3 shows a schematic diagram of a typical quality VTVM. In this case it's a Knight KG-625, which uses a conventional dual-triode bridge circuit. When the two plate voltages are equal the meter reads zero since there is no current flow through it. The front panel zero control R-20 is in the plate circuit of V-2. This control balances the B + voltage applied to the plates of the tube. When a positive voltage is applied to pin 7 grid, current through V-2A increases, resulting in a lowered voltage at the plate of V-2A. This current flows through a common cathode resistor R-22, causing a voltage drop in proportion to the increased current through V-2A. As a result the grid of V-2B is biased more negatively, causing a current de-

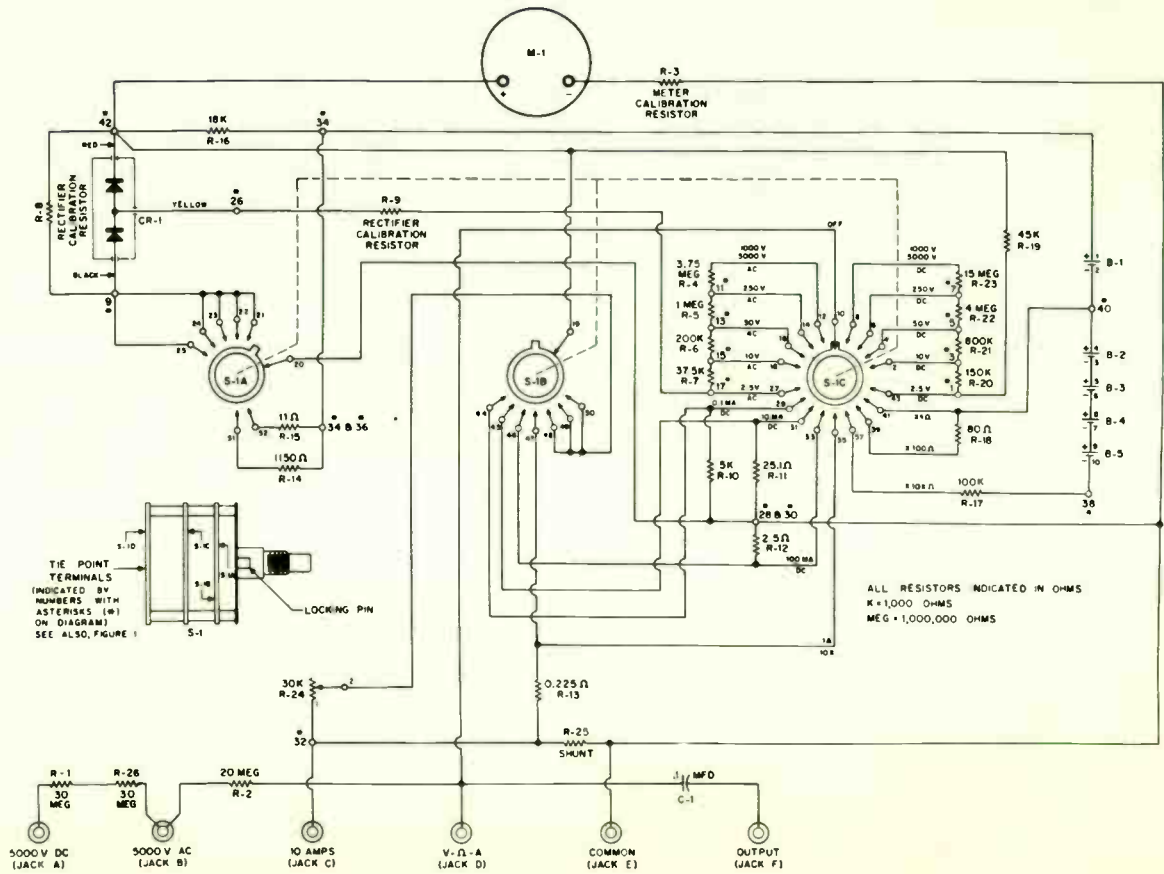

Fig. 8-4. Knight-Kit 20,000 ohms/volt VOM circuit.

crease through V-2B and an increase in voltage at the plate pin 1. This difference in voltage between the two plates will cause current to flow through the meter, which is directly calibrated to indicate the magnitude of the voltage applied to the grid of V-2A. The various ranges are created by switching in a number of precision resistors in series with the grid of V-2A. V-1 is a full wave peak-to-peak rectifier which makes AC voltage measurements possible. For resistance measurements, a 1.5v battery is connected through a series of precision resistors and the unknown resistance, forming a voltage dividing network across the battery. The resulting voltage is applied to the bridge circuit and the meter is calibrated in OHMS.

A typical VOM of acceptable quality is shown schematically in Fig. 8-4, the Knight 20,000 Ohms/Volt kit. This instrument will perform a great variety of measurements, selected by different panel jacks and by the function switch. The meter has a highly sensitive $50\mu\text{a}$ moving coil permanent magnet movement. A calibrating resistor R-3 provides a high degree of accuracy for all dial indications. The meter has separate scales for AC and DC voltages, decibels, resistance and current.

INDEX

A

- AC peak-to-peak voltage, 25
- AC voltage, 28
- Accuracy, meter, 21
- Adjustments, meter, 88-89
- Alignment, FM detector, 25
 - receiver, 55
 - wavetrap, 59
 - FM receiver, 60
- Amateur gear, 63
- Ampere, milliampere, 7
- Antennas, 63-64
 - dipole, 64
 - rhombic, 64
 - loop, 64
 - resistance, 64-65-66
 - dummy, 67
- Application, VOM, VTVM, 8-9, 11
- Audio output measurement, 23
- Audio power output, 37

B

- Balancing, push-pull output, 44
 - loudspeakers, 45
- Batteries
 - life, 23, 29
 - replacement, ohmmeter, 85
 - testing, 29
 - tester, 31
 - types, 31
 - VOM, 10
- Bias, tape recorder, 82

C

- Cable, auto battery, 30
- Cadmium-sulphide photocell, 77
- Calibration, meter, 11, 88-89
- Capacitors, electrolytic, 32
 - fixed, 32
 - mica, 32
 - paper, 32
 - variable, 47
- Care, meter, 86-91
- CB gear, 63, 66-68
- Checker, transistor, 36
- Checks, current, 18, 23
 - hot chassis, 60
 - voltage, 17

- Chokes, 33
 - defects, 33, 54
- Coax transmission lines, 63
- Coils, 33
 - defects, 33
 - oscillator, 50
- Combination VOM-VTVM, 15
- Controls, meter, 22
- Control, volume, 50
- Current measurement, 7-8, 18

D

- DC power supply
- Decibels, 39
- Dependability, meter, 10
- Diodes, 35
- Dipole antenna, 64
- Drop-out, relay, 82
- Dummy antennas, 67-68

E

- Error, meter, 21-22

F

- Field-strength meter, 69
- Filament circuits, 51
- Fire alarms, 77
- FM detector alignment, 25, 60
- FM receivers, 60
- Folded dipole antennas, 64
- Frequency response, audio amplifier, 38, 41
 - plotting, 41
 - VTVM-VOM, 14
- Function, high voltage probe, 26
 - meter, 23-24, 86
 - RF probe, 28

G

- Gain, FM stage, 60
 - measuring stage, 56

H

- Ham gear, 63, 71
- High voltage measurement, 23, 41
 - probe, 26
- Hot chassis, 60
- Hum pick-up, meter, 10

I
IF transformers, 47
Inductors, 33
Input power, plate, 66
Input resistance, VTVM, VOM, 12
Isolation, meter, 10

K
"Kick" test, capacitors, 33

L
Layout, meter panel, 22
Leakage, capacitors, 32
 transmission lines, 65
Leakage paths, 8, 12
Level indicators, 73
Life, batteries, 23, 29
Light relay, 76
Light sensitive devices, 75
Limiters, FM, 61
Liquid level indicator, 73
Loading, battery testing, 29
Loading effect, meter, 8, 12
Loop antennas, 64
Loudspeakers, balancing, 45
 phasing, 46

M
Measurement, audio output power,
 37
 audio frequency response, 38, 41
 batteries, 29
 capacitor leakage, 32-33
 current, 18, 23
 decibels, 39
 diodes, 35
 high voltage, 23, 27
 "kick" test, 33
 peak-to-peak, 25
 plate input power, 66
 RF, 28
 repeatability, 11
 resistance, 19, 23
 soil moisture, 80
 solutions, 79
 stage gain, 56
 transistors, 36
 voltage, 17
Metergard, 84
Meter calibration, 88-89
 care, 86-91
 protection, 14, 21, 84
Milliampere, ampere, 7
Multimeter, multitester, 7

N
NPN transistors, 36

O
Ohmmeter operation, 18-19
Open-wire transmission lines, 63
Oscillator coils, 50
Output, audio measurement, 23, 37
 CB power, 68
 transformers, 57
Overheated resistors, 31
Overload, protection, meter, 14, 21

P
Panel, VOM, 22
 VTVM, 24
Peak-to-peak voltage, 25
Performance, amplifier, 43
Phasing, loudspeakers, 46
Photocell, 76
Photometer, 75
Photosensitive devices, 75
Photovoltaic cell, 77
Plate input power measurement, 66
Plotting frequency response, 41
PNP transistors, 36
 AC line, 60
Polarity, current measurements, 18,
 23
 loudspeakers, 46
 selenium rectifiers, 52
 test leads, 22
 voltage measurement, 17
Power, audio output, 37
 CB output, 67
 formula, 41-42
 level, DB, 39
Power supply circuit, 51
 transformer, 53
Printed circuits, 54
Probe, high voltage, 26
 meter, 28, 86
 RF, 28
Prods, 86
Protection-high voltage measure-
 ments, 27
 meter, 14, 21, 84
Pull-in, relay, 82
Push-pull audio output, 44

R
Range, meter, 21, 24, 86
 high voltage measurements, 27
 RF measurement, 28
Range resistance, 15, 23

Ratio, turns, 34
Receiver servicing, 47, 57
 alignment, 55
 FM alignment, 60
Rectifiers, selenium, 52
Reference frequency, 44
Relay, pull-in, drop-out, 82
Resistance, measurement, 18
 range, 15, 23
 water, 79
Resistors, 31
 defects, 31
 measurement, 20
 overheating, 31
 tolerance, 20
 variable, 20
RF output, CB gear, 68
 voltmeter, 70
RF pickup, meter, 10
RF probe, 28, 86
Rhombic antennas, 64
Ripple, 54

S

Scale, meter, 21
 output, 41
Selenium rectifiers, 52
Sensitivity, meter, 11-14
Service data, 57
 FM receivers, 60
Servicing receivers, 47
Soil moisture, 80
Solution measurement, 79
Speakers, balancing, 45
 phasing, 46
 polarity, 46
S-meters, 69
Stability, meter, 11-14
Stage gain, 56, 60
Supply, DC power, 57
 filament, 57
 transformer, 53
Switches, range and function, 86

T

Tachometer, 74
Tape recorder bias, 82
Temperature indicator, 77
Temperature sensitive devices, 77-78
 antennas, 64-66

Testing, auto battery cable connection, 30
 batteries, 29
 capacitor leakage, 32, 33
 chokes, 54
 diodes, 35
 IF transformers, 50
 "kick" test, 33
 oscillator coils, 50
 output transformers, 51
 printed circuits, 54-55
 selenium rectifiers, 52
 transistors, 36
 transistor batteries, 30
 transmission lines, 63-66
 volume controls, 50
Thermistors, 77-78
Tolerance, resistors, 20
Transformers, 33
 defects, 33
 IF, 47
 output, 51
 power supply, 53
 turns ratio, 34
Transistors, 36
 batteries, 30
Transmission lines, 63-66
Transmitter output, CB, 67-68
 safety, 71
Tuning capacitors, 47
 wavetraps, 59
Turns ratio, 34

V

Variable resistors, 20
Voltage, measurement, 17, 23
Voltage, peak-to-peak, 25
Voltmeter, RF, 70
Volume controls, 50

W

Water resistance, 79
Wattmeters, RF, 68
Wavetraps, 57

Z

Zero center scale, 24
Zero ohms adjust, 24

THE ALLIED ELECTRONICS LIBRARY

ELECTRONICS DATA HANDBOOK



Edited by Nelson M. Cooke, Lt. Cmdr., U.S. Navy (Ret.). A comprehensive listing of formulas, data, standards, tables and charts used in solution of everyday problems in electronics. Includes Log and Trig tables, EIA color codes for chassis wiring, math constants, decibel ratios, speaker matching formulas, coil winding formulas, pilot lamp data, interchangeable tube data,

fundamental algebraic formulas, symbols, abbreviations, etc. Packed with practical information for students, servicemen, engineers, instructors, etc. 88 pages. Size, 6x9".

37 U 398. Postpaid in U.S.A. 75¢

DICTIONARY OF ELECTRONIC TERMS



Up-to-date definitions of more than 3800 terms used in TV, Radio, Electronics and Nucleonics. Edited by Robert E. Beam, Ph.D., Professor of E.E., Northwestern University. Includes over 125 helpful illustrations and diagrams. Appendix covers EIA color code, standard schematic symbols, Greek alphabet, letter symbols for vacuum tubes, other letter symbols, basic series-

parallel formulas and abbreviations used in electronics. Special section on Citizens Band Radio terms. 88 pages. Size, 6x9".

37 U 756. Postpaid in U.S.A. 75¢

UNDERSTANDING AND USING CITIZENS BAND RADIO



For both Citizens Band newcomers and oldtimers. Edited by Tom Kneitel, Editor of 59 Magazine. Chapter headings: Getting acquainted With CB Radio. Obtaining the License. About the Equipment. Setting Up A Station (Mobile and Base Station Installations), CB Antennas, Operating CB Equipment. The Uses and Abuses of CB Radio. Discusses test equipment for

CB servicing with servicing hints. Covers operating procedure and using the "10" signals. Helps anyone to understand, select and make best use of Citizens Band equipment. 112 pages. Size, 5 1/2 x 8 1/2".

37 U 701. Postpaid in U.S.A. 50¢

HOW TO BUILD ELECTRONIC KITS



A complete beginner's guide to electronic kit building. Edited by R. G. Beason, Editor, *Electronics Illustrated*. Answers all the questions a novice kit builder might have. Discusses types of kits available, how to select kits, how to follow instruction manuals, tools required. Chapters include: The Values of Kit Building; How to Identify Parts and Components; Installing and Connecting Components; Electrical Wiring, Soldering—The Secret of Good Kit Building. Includes details on building 3 popular kits. 96 pages, 5 1/2 x 8 1/2".

37 U 066. Postpaid in U.S.A. 50¢

GETTING STARTED IN ELECTRONICS



Easy to read and understand. Edited by Oliver P. Ferrell, Editor *Popular Electronics*. Covers radio signals and types of transmission AM, FM, TV, CW and short wave. Explains uses of basic component electron theory, resistance, inductance, capacitance, inductance, stages of radio and their function. Discusses antennas and test equipment. Tells how to read schematics

Includes building projects on a crystal set, walk talkie, 1-tube set, transistor set, intercom, burg alarm, light detector, code practice oscillator, a 5-tube superhet receiver. 112 pages, 5 1/2 x 8 1/2".

37 U 705. Postpaid in U.S.A. 50¢

BASIC ELECTRONICS HANDBOOK



Written for beginners without a previous electronics experience. A step-by-step guide to the principle of electronic communications a control circuits. Discusses the vacuum tube, rectifiers and power supplies, amplifiers, detectors and radio receiver, oscillators, superhet a electronic control circuits. Includes six fascinating experiments based on the Knight-Kit 12-in-1 Electro-

Lab Kit. Numerous diagrams. Ideal for elementary courses in science, physics, radio, electricity and industrial arts. 24 pages, 8 1/2 x 11".

37 U 060. Postpaid in U.S.A. 25¢

ALL ABOUT HIGH FIDELITY AND STEREO



Non-technical explanation that will help you understand, select and enjoy your music system. Edited by C. G. McProud, Publisher *Audio*. Explains high fidelity a monophonic and stereo sound; covers amplifiers, pre-amplifiers, tuners, speaker systems and enclosure record players, tone arms, cartridge and needles; tells about program sources—records, tape, broadcast

discusses tape recorders, kits, transistorized circuit. Discusses merits of components versus package. Gives definitions of hi-fi terms. 96 pages. Size, 5 1/2 x 8 1/2".

37 U 699. Postpaid in U.S.A. 50¢

UNDERSTANDING TRANSISTORS AND HOW TO USE THEM



Covers basic transistor application characteristics, and construction. Discusses NPN, PNP, alloy-junction, drift, tetrode, surface barrier power types, etc. Circuit theory related to transistor operation presented in simple terms. Interesting construction projects. Transistors include building instructions with parts lists for a General Purpose Audio Amplifier, a Transistor Radio, Capacity-Operated Relay, a Practice Oscillator, Wireless Broadcaster, a Tin Electronic Flasher, and Photoelectric Controller. pages. Size, 5 1/2 x 8 1/2".

37 U 602. Postpaid in U.S.A. 50¢