

TELEVISION

Volume VI

(1949-1950)

TELEVISION

Volume VI

(1949-1950)

TELEVISION

Volume VI

(1949-1950)

Edited by

ALFRED N. GOLDSMITH
ARTHUR F. VAN DYCK
ROBERT S. BURNAP
EDWARD T. DICKEY
GEORGE M. K. BAKER

AUGUST, 1950

Published by

RCA REVIEW
RADIO CORPORATION OF AMERICA
RCA LABORATORIES DIVISION
Princeton, New Jersey

Copyright, 1950, by
Radio Corporation of America,
RCA Laboratories Division

Printed in U.S.A.

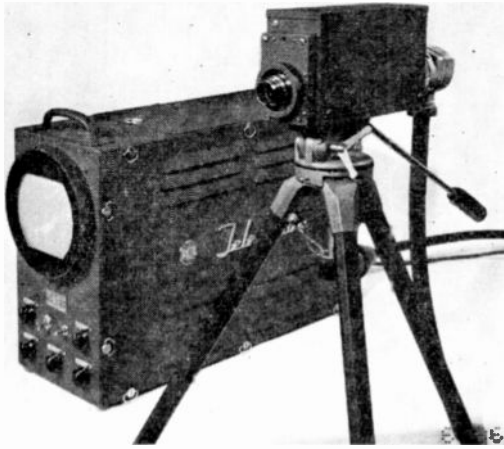

INDUSTRIAL TELEVISION



TRI-COLOR KINESCOPE

TELEVISION, Volume VI

PREFACE

TELEVISION, Volume VI, covering the years 1949 to June, 1950, is the twelfth volume in the **RCA Technical Book Series**, and the sixth volume devoted exclusively to television. The first television volume was published in 1936 followed by Volume II in 1937. Volumes III and IV appeared in 1947.

Original plans called for the publication in 1950 of a volume covering the years 1947-1949. Because of the extraordinarily large amount of work done in television during this period, too many valuable papers would have had to be excluded for lack of space in a single volume. For this reason, two volumes are being published simultaneously, covering the periods 1947-1948 (TELEVISION, Vol. V) and 1949-June, 1950 (TELEVISION, Vol. VI).

Even with the two-volume presentation, the large number of excellent papers on the subject of television has made necessary a very stringent selection process. All the available material can not be included in full form. A number of papers are, therefore, presented herein in summary form only; it has been necessary to omit others entirely. Suitably balanced presentation of the various phases of television was the major criterion in deciding which papers to include in full and which in summary. The presentation of a paper in summary form (or the non-inclusion of any particular paper) is not intended to indicate any deficiency in technical accuracy, literary merit, or importance.

The papers in this volume are presented in six sections: pickup, transmission, reception, color, UHF, and general.

RCA Review gratefully acknowledges the courtesy of the Institute of Radio Engineers (*Proc. I.R.E.*), the McGraw-Hill Book Company, Inc. (*Electronics*), Caldwell-Clements, Inc. (*Tele-Tech*) and the Graduate School of Business Administration, Harvard University (*Harvard Business Review*) in granting to RCA Review permission to republish material by RCA authors which has appeared in their publications. The appreciation of RCA Review is also extended to all authors whose papers appear herein.

RCA Laboratories
Princeton, N. J.

The Manager, RCA REVIEW

July 18, 1950

TELEVISION

Volume VI

(1949-1950)

CONTENTS

	PAGE
FRONTISPIECE	—v—
PREFACE <i>The Manager, RCA Review</i>	—vii—

PICKUP

Development and Performance of Television Camera Tubes	1
R. B. JANES, R. E. JOHNSON AND R. R. MOORE	
A New Image Orthicon	34
R. B. JANES, R. E. JOHNSON AND R. R. HANDEL	
The Vidicon — Photoconductive Camera Tube	41
P. K. WEIMER, S. V. FORGUE AND R. R. GOODRICH	

Summaries:

The Image Isocon — An Experimental Television Pickup Tube Based on the Scattering of Low Velocity Electrons	49
P. K. WEIMER	
New TV Studio Relay Switching System	49
W. E. TUCKER AND C. R. MONRO	
Mixing Local and Remote Television Signals	50
W. E. WELLS AND J. M. WEAVER	
Television Photometry and Optical Background	50
R. L. KUEHN	

TRANSMISSION

Standardization of the Transient Response of Television Transmitters	51
R. D. KELL AND G. L. FREDENDALL	
Phase and Amplitude Equalizer for Television Use	69
E. D. GOODALE AND R. C. KENNEDY	
Artificial Lines for Video Distribution and Delay	77
A. H. TURNER	

RECEPTION

Development of a Large Metal Kinescope for Television	90
H. P. STEIER, J. KELAR, C. T. LATTIMER AND R. D. FAULKNER	
Reversible-Beam Antenna for Twelve-Channel Television Reception	106
O. M. WOODWARD, JR.	
Characteristics of High-Efficiency Deflection and High-Voltage Supply Systems for Kinescopes	123
O. H. SCHADE	
Automatic Frequency Phase Control of Television Sweep Circuits	156
E. L. CLARK	
A Study of Cochannel and Adjacent-Channel Interference of Television Signals, Part I — Cochannel Studies	164
A Study of Cochannel and Adjacent-Channel Interference of Television Signals, Part II — Adjacent-Channel Studies	186

ULTRA-HIGH FREQUENCIES

Method of Multiple Operation of Transmitter Tubes Particularly Adapted for Television Transmission in the Ultra-High-Frequency Band	195
G. H. BROWN, W. C. MORRISON, W. L. BEHREND AND J. G. REDDECK	

	PAGE
Experimental Ultra-High-Frequency Television Station in the Bridgeport, Connecticut Area	
R. F. GUY, J. L. SEIBERT AND F. W. SMITH	207
An Experimental Ultra-High-Frequency Television Tuner	
T. MURAKAMI	220
Ultra-High-Frequency Antenna and System for Television Transmission	
O. O. FIET	232
A New Ultra-High-Frequency Television Transmitter	
J. R. BENNETT AND L. S. LAPPIN	248

COLOR

A Six-Megacycle Compatible High-Definition Color Television System	270
An Analysis of the Sampling Principles of the Dot-Sequential Color Television System	291
A General Description of Receivers for the Dot-Sequential Color Television System Which Employ Direct-View Tri-Color Kinescopes	338

Summaries:

Mixed Highs in Simultaneous Color Television	343
Colorimetric Analysis of RCA Color Television System	344
A Simplified Receiver for the RCA Color Television System	344
Recent Developments in Color Synchronization in the RCA Color Television System	345

GENERAL

Television: Techniques and Applications	A. N. GOLDSMITH	346
Simplified Television for Industry	R. C. WEBB AND J. M. MORGAN	387
Theater Television	A. N. GOLDSMITH	396
APPENDIX — TELEVISION BIBLIOGRAPHY		403

DEVELOPMENT AND PERFORMANCE OF TELEVISION CAMERA TUBES*†

BY

R. B. JANES, R. E. JOHNSON AND R. S. MOORE

Summary—Three new television camera tubes have resulted from an intensive development program extending over several years. These are (1) the well-known 2P23 image orthicon which is especially suited for remote pickups where a wide range of illumination is encountered and versatility is of the greatest importance; (2) the 5655 image orthicon which is capable of producing pictures of studio quality when the illumination can be controlled; (3) the 5769 image orthicon which may be used for either remote or studio pickups. The construction and operation of these tubes are described in detail. The development of image orthicons is traced by an examination of their limitations and the improvements which have resulted from changes in their construction.

INTRODUCTION

DURING the past fifteen years a number of television camera tubes have been developed. The first to be considered here is the iconoscope¹. This tube is still used for the transmission of motion picture films and has been extensively used in studio work. When carefully used with the needed complicated correcting circuits, bias and frame lighting, it is capable of producing a high-quality picture. Its resolution is satisfactory and its half-tone response is good. It is also completely stable at all light levels. However, in order to obtain satisfactory pictures, incident light levels of 800 to 1,200 foot-candles are needed on the subject. Even under these conditions "dark spot" and "flare" can be troublesome, particularly for rapid changes of illumination and for scenes that contain dark areas near the bottom of the picture. Although the signal-to-noise ratio may be satisfactory at lower light levels, shading becomes nearly impossible to correct unless the scene is evenly lighted. Lowering the beam current to decrease dark spot is of little help because the signal output drops nearly as rapidly as the dark spot and the tube becomes unusable because of low signal-to-noise ratio.

The type of iconoscope presently available is the 1850-A, which has a diameter of 6¾ inches and a mosaic area of 17 square inches.

* Decimal Classification: R583.6.

† Reprinted from *RCA Review*, June, 1949.

¹ V. K. Zworykin and G. A. Morton, *TELEVISION*, John Wiley and Sons, Inc., New York, N. Y., 1940.

The signal output in microamperes for a typical tube is shown in Figure 1 plotted against illumination on the mosaic in foot-candles for two values of beam current. These two values of 0.15 and 0.2 microampere are, in general, the values used in operation. As the operating personnel become more conscious of dark spot and flare, they tend to use the lower value of beam current. However, some may prefer the greater signal and signal-to-noise ratio obtained from the higher value. With a beam current of 0.2 microampere and a mosaic illumination of 6 foot-candles, a signal-to-noise ratio (assuming 3×10^{-3} microamperes of amplifier noise) of 60 can be obtained. Because this is

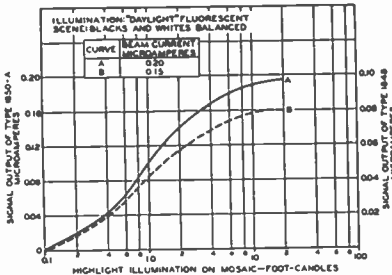

Fig. 1 — Typical signal output characteristics for iconoscopes type 1850-A and type 1848.

“peaked-channel noise”, i.e., noise of high frequency which consequently appears to the eye as fine grain, it is not objectionable; it is equivalent to a flat-channel noise ratio² of 180 to 1. The use of “high peaking” to improve resolution may reduce this ratio to about 100 to 1. It should be noted that these signal-to-noise ratios are expressed as the ratio of highlight signal to root-mean-square noise.

Another type of iconoscope which has been manufactured is the 1848. It has a $4\frac{1}{2}$ inch diameter and a mosaic area of a little over 6 square inches. The signal output in microamperes is shown in Figure 1 plotted against illumination on the mosaic in foot-candles for 0.15 and 0.2 microampere beam current. At 6 foot-candles and with the same amplifier noise as for the 1850-A, the value of signal to peaked-channel noise is about 30 to 1. To many users this performance has not been acceptable when compared with that of the 1850-A. The 1848, however, has certain advantages over the 1850-A. When the amount of mosaic illumination is the same, the depth of focus of the 1848 is better because only about $\frac{1}{3}$ as much total light is needed to obtain the same mosaic illumination. Not only is the shading of the 1848 usually somewhat easier to handle, but its smaller size makes the final equipment less bulky. Because of its size the 1848 has been used to a certain extent in portable outdoor equipment but here its low sensitivity has not made it popular. In motion picture applications where design factors of size and depth of focus are not important, the

² For a comparison of peaked- and flat-channel noise, see O. H. Shade, “Electro-Optical Characteristics of Television Systems”, Part I, *RCA Review*, Vol. IX, No. 1, pp. 32-34, March, 1948.

1850-A, because of its greater signal-to-noise ratio, appears to be the logical choice. For studio work, the choice between the 1848 and 1850-A is more difficult.

There have been many proposals for increasing the sensitivity of iconoscopes to make them more useful for studio and perhaps outdoor pickup. One involves the use of an image stage of multiplication.³ This proposal permits the use of a continuous photocathode instead of a photosensitive mosaic with a possible increase in photosensitivity of 2 or 3. However, in order to keep the tube to a practical size, the photocathode area has to be small, usually about three square inches in size. This size requires the use of a small diameter lens. Although the depth of focus improves, there is little, if any, reduction in the light level needed, because the signal from a pickup tube depends on the total amount of light striking the photosensitive surface rather than upon the illumination per unit area. There is, however, a gain of four or five because of the secondary-emission gain at the mosaic or target. Focusing the electron image from the photocathode to the mosaic is tricky even with magnetic focusing with the result that a loss of resolution and distortion of the picture is likely. Also, care must be taken to prevent interaction between the image-focusing coil and the beam-deflecting coil. Because the gain in sensitivity of such a tube is small unless very high photosensitivities can be obtained, it has not been considered as desirable as the tubes described later in this article.

Another possibility for increasing sensitivity of the iconoscope is the use of signal multiplication. This method involves collecting the secondary emission from the iconoscope mosaic and putting it through a multiplier. This procedure is very difficult with the iconoscope because the large area from which electrons must be collected adds spurious signals. Furthermore, neither image multiplication nor signal multiplication offers any hope of eliminating an inherent fault of the iconoscope—the dark spot.

The next pickup tube to be developed was of the orthicon type⁴, the now obsolete 1840. In design and operation this tube was a tremendous departure from iconoscope tradition. Instead of the use of a high-velocity electrostatically focused beam to discharge the mosaic, a low-velocity beam focused by a long magnetic field was used. The vertical deflection is magnetic but in order to avoid the need for high

³ H. A. Iams, G. A. Morton, and V. K. Zworykin, "The Image Iconoscope", *Proc. I.R.E.*, Vol. 27, No. 9, pp. 541-547, September, 1939.

⁴ A. Rose and H. A. Iams, "The Orthicon", *RCA Review*, Vol. 4, No. 2, pp. 189-199, October, 1939.

power the horizontal deflection is electrostatic. Because the beam strikes the mosaic at a velocity of only one or two volts in the lighted areas and not at all in the dark areas, there is no secondary-electron redistribution and, consequently, no dark spot. Also, the sensitivity of the tube is greater because of more efficient collection of the photoelectrons emitted during storage. A curve of signal output is given in Figure 2. As the curve shows, the signal-to-noise ratio is the same

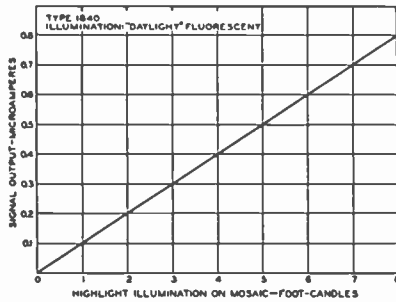

Fig. 2—Typical signal output characteristics for orthicon type 1840.

as at 1 to 2 foot-candles on the mosaic as at 6 for the iconoscope. In addition, even lower light levels can be used because of the absence of dark spot. Part of this sensitivity is usually used to provide greater depth of focus because of the smaller mosaic size (4 square inches). The tube was very useful in picking up scenes where the incident illumination was only 100 to 200 foot-candles.

Although the 1840 has two advantages over the iconoscope: freedom from dark spot and greater sensitivity, it has many disadvantages. The iconoscope is stable at all light levels, but the orthicon will tend to charge up in areas of bright illumination because the mosaic potential is not limited to small values. The "sharpness" of the picture in still scenes approaches that transmitted by the iconoscope, but in moving scenes the tube loses resolution much more readily because, in part, of its much longer storage period. Scenes reproduced by the orthicon, moreover, show a smaller range of intermediate grays than the same scenes reproduced by the iconoscope. The lack of any detail in the low lights is particularly noticeable and is the result of the linear signal output characteristic of the orthicon as compared to the non-linear output characteristic of the iconoscope which saturates at high light levels.

In order for the orthicon to handle the very large signals from local highlights, the grays are pushed down into the noise. It is nearly impossible to transmit any information in dark areas of the picture when other parts are bright. This limitation is a severe disadvantage at baseball or football games when shadows begin to fall across the field. Although the orthicon is useful because it can transmit scenes which the iconoscope cannot, its versatility is severely limited.

Further development work has been done to overcome some of

these limitations. Best results were obtained from a tube of the orthicon type which uses all-magnetic scanning and a 5-stage signal multiplier. With all-magnetic scanning any difficulty with "sharpness" of the picture on stationary scenes disappeared, although on moving scenes the same loss of resolution was still apparent. The tube had greater sensitivity than the 1840 because of the use of the signal multiplier, but such factors as instability and the inability to transmit the darker areas in scenes were not improved. The greatest advantage of the tube is that its resolving power for still scenes exceeds that of any other tube. The signal-to-noise ratio was also adequate for light levels of 100 foot-candles but not all of the most severe limitations of orthicons were overcome in this developmental tube.

GENERAL DESCRIPTION OF THE IMAGE ORTHICON

The most important development in camera tubes for the past several years has been the now-well-known image orthicon. This tube,

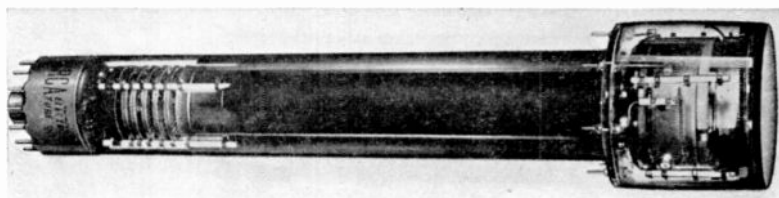

Fig. 3—Typical image orthicon.

on which fundamental work was done by Rose, Law, and Weimer⁵, appears to offer the most promise, both for outdoor and studio pickup. The development has led to three commercial types, the 2P23 for poorly lighted, remote pickups, the 5655 for studio work, and the 5769 for general use.

The image orthicon, pictured in Figure 3, combines the features of several of its predecessors. It includes in one envelope an image section, a target or mosaic assembly, low-velocity scanning of the orthicon type, and a 5-stage signal multiplier. Before its performance is described, a brief summary of its construction and operation will be given.

The tube itself consists of a three-inch-diameter image section and a two-inch-diameter scanning and multiplier section. The over-all length is 15½ inches. This size has proven to be a good compromise between camera performance and portability. Although a smaller size

⁵ A. Rose, P. K. Weimer and H. B. Law, "The Image Orthicon — A Sensitive Television Pickup Tube", *Proc. I.R.E.*, Vol. 34, No. 7, pp. 424-432, July, 1946.

would make a lighter-weight camera possible, the loss in performance would be objectionable. For convenience, the image orthicon may be described in three parts — one covering the image section, one the scanning section, and one the multiplier section. Figure 4 is a schematic drawing of the tube.

The image section contains a semi-transparent photocathode on the inside of the face plate, a grid (grid No. 6) to provide an electrostatic accelerating field, and a target which consists of a thin glass disc with a fine mesh screen very closely spaced to it on the photocathode side. Focusing is accomplished by means of a magnetic field produced by an external coil, and by varying the photocathode voltage. Light from a scene being televised is picked up by an optical lens system and focused on the photocathode which emits electrons from each illuminated area in proportion to the intensity of the light striking the area. The

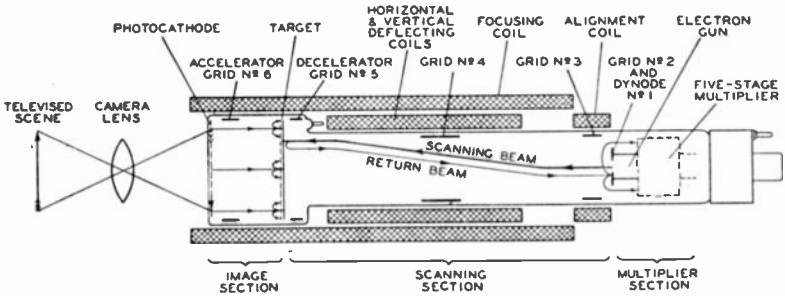

Fig. 4—Schematic arrangement of image orthicon.

streams of electrons are focused on the target by the magnetic and electrostatic fields.

On striking the target, the photoelectrons cause secondary electrons to be emitted from the glass. The secondaries thus emitted are collected by the adjacent mesh screen which is held at a definite potential of 1.5 to 2.5 volts above that of the scanned side of the glass target. The potential of the glass disc, therefore, is limited for all values of light and stable operation is achieved. Emission of the secondary electrons leaves on the photocathode side of the glass a pattern of positive charges which corresponds with the pattern of light from the scene being televised. Because the target is a very thin sheet of partially conducting glass, the charge image is also seen on the scanned side of the target by the scanning beam.

The electrons are emitted from the gun through a small defining aperture and are focused into a fine beam by means of the magnetic field of an external focusing coil and the electrostatic field of grid No. 4. Magnetic deflection is used to scan the target. Grid No. 5 serves to

adjust the shape of the decelerating field between grid No. 4 and the target in order to obtain uniform landing of the scanning beam over the entire target area. The electrons stop their forward motion at the surface of the glass and are turned back, except when they approach the positively charged portions of the pattern and are deposited on the glass. This deposition leaves the glass with a negative charge on the scanned side and a positive charge on the photocathode side. These charges will neutralize each other by conductivity through the glass in less than the time of one frame.

The electrons turned back at the target form the return beam which has been amplitude modulated by absorption of electrons at the target in accordance with the charge pattern. The returning modulated beam strikes the first dynode which as a result, emits secondary electrons. These secondaries in turn are drawn down through a series of multipliers of high secondary emission which increase the signal a 1000 fold. The increased signal is finally collected at the anode of the multiplier and fed to a pre-amplifier through a resistance of the order of 10,000 to 30,000 ohms.

As this brief summary shows, the image orthicon has all the advantages of the orthicon together with the added advantages of greater sensitivity due to the image section, and of greater stability due to the mesh screen near the target. Its sensitivity is about 100 times greater than that of the iconoscope and it is stable over a light range of several hundred to one. These features make it very versatile and especially useful for outdoor scenes. Without any change in adjustment, the tube can handle a high light scene and then be used for a scene in deep shadow. It is also far superior to the orthicon in reproducing scenes containing both high lights and shadows.

This gain in sensitivity, particularly for the earlier image orthicons, was achieved only with a loss of signal-to-noise ratio and useful resolution. Also, the half-tone response differs from that of the orthicon. Why the tube possesses these properties can probably be best explained by a detailed examination of its construction and a description of how each section of the tube contributes to these properties. Image orthicons now available include the 2P23, 5655 and 5769. Because the 2P23 is the oldest and most widely used, it will be described first.

CONSTRUCTION AND OPERATION OF THE 2P23

Photocathode

The photocathode of the 2P23 consists of a semi-transparent layer of the cesium-silver-oxide type. As in the 1840 orthicon, the layer must

be semi-transparent because the light strikes it from one side and photoelectrons are emitted from the other. However, the 2P23 has the advantage over the 1840 in that this layer can be continuous. Higher sensitivities are possible with such a layer, the sensitivity to incandescent light being of the order of 10 to 20 microamperes per lumen compared to about 3 for the 1840. (This figure for the 1840 includes the loss in the semi-transparent signal plate needed in that tube.) It has proven difficult, however, to obtain a reproducible color response from tube to tube in the 2P23. Figure 5 shows the spectral response characteristics for typical low and high sensitivity tubes. Individual tubes may have spectral response characteristics anywhere between these two extremes. The high infrared sensitivity of some 2P23 tubes leads to very good sensitivity when low-temperature incandescent lighting is used but also leads to peculiar renditions of certain colors

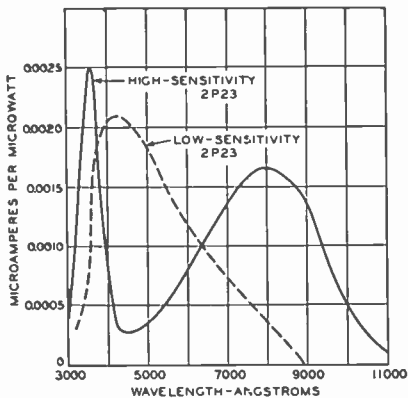

Fig. 5—Approximate spectral sensitivity characteristics of image orthicon type 2P23.

or objects. In outdoor use, for example, green grass appears to be white or very light gray. A fairly good color response with a two-fold or more loss of sensitivity can be obtained by the use of fluorescent lighting or by proper filters with incandescent light. Care must also be taken in the processing of the tube to keep the conductivity of the photosurface fairly high. Otherwise, for high light scenes, the picture will be distorted geometrically because of the voltage drop in the photosurface.

The size of the target limits the size of the picture on the photocathode to a rectangle with a diagonal of about 1.6 inches. This size is much smaller than that of any of the other pickup tubes so far discussed and means that available short-focal-length lenses having a rather small diameter may be used. Part of the increased photosensitivity, therefore, will have to be used to obtain greater depth of focus. Because of the high sensitivity of the tube the exchange of depth of focus for sensitivity is not a disadvantage. On the other hand, the use of small lenses makes it much easier to use a revolving turret containing three or four lenses of different focal length. The use of such a turret has become universal in the latest camera design.

Focusing of electron image

The use of a magnetic field to focus the emitted photoelectrons onto the target gives uniform resolution with little distortion. In general, this resolution is much higher than that of other sections of the tube. When a magnetic field of about 75 gauss and a photocathode voltage of about -400 volts are used, the electrons will make one "loop" in going from the photocathode to the target. Only a small improvement in resolution is possible at higher fields and voltages, but a serious deterioration of the resolution and signal occurs with a photocathode voltage below -200 volts. The voltage on grid No. 6, a cylindrical-type grid nearest to the photocathode, is adjusted to minimize picture distortion (in particular, the so-called "S" distortion) and to improve corner resolution. Best results are obtained when the voltage of this grid is about 80 per cent of the photocathode voltage. A lower grid No. 6 voltage produces "S" distortion in one direction and a higher voltage, "S" distortion in the opposite direction. With the focusing coil usually used with the 2P23 there is a small reduction in the image size at the target. Because the image section is near the end of the focus coil where the magnetic field is flaring, the image size at the target has a diagonal of about 1.4 inches for a 1.6 inch diagonal on the photocathode.

Image section crosstalk

Although the image section is not a serious limit to the resolution of the 2P23 directly, the resolution in this section can be seriously impaired by leakage of the strong magnetic deflection fields from the scanning yoke into the image section. The leakage fields cause a vibration of the image electrons from the photocathode around their normal path during the 1/30-second storage time on the target and, as a result, blur the charge image. Because the storage time decreases with increased illumination, this "crosstalk" effect on resolution is more serious at low light levels on the photocathode. Since the tube is generally used so that the high lights are just out of the storage range, "crosstalk" control is a serious problem. Although the effect may be reduced within limits by going to high magnetic fields and photocathode voltages, more than 75 gauss is not practical in portable equipment because of the added scanning power needed. Other approaches to the problem offer better practical solutions.

Magnetic shielding to reduce crosstalk

A number of methods will reduce "crosstalk" difficulty, all of which, in one way or another, involve the shielding of the image section from

the stray magnetic fields of the deflecting coils. One method which has worked out quite well is to wrap the outside of the external focusing coil with some magnetic shielding material such as silicon steel or Mu metal. In order to avoid high absorption of scanning power, the shielding material should be thin strips and wound in several layers separated by insulating material. For the same reason, the strips making up each layer should not be too wide. The use of such a winding tends to pull the stray flux lines away from the photocathode into the shielding material. Resolution gains of as much as 200 lines have been achieved by this method.

Loss of resolution due to initial velocities of emission

There is another cause that can impair the resolution in the image section: the initial emission velocity of the photoelectrons from the photocathode. This problem has been analyzed in a paper by H. B. DeVore⁶. The loss of resolution is most noticeable when blue light is used to illuminate the scene being televised and the photocathode of the camera tube has red and infrared response. Under such conditions the initial emission velocities of the photoelectrons are appreciable and can visibly limit the resolution. Because many 2P23's have high red and infrared response this limitation applies chiefly to this tube. The photocathodes used in the 5655 and the 5769 on the other hand, have little red and no infrared response, so the loss of resolution is not appreciable. In scenes where there is considerable "blue" light such as in skylight, the resolution of the 2P23 will be inferior.

Target mesh structures

When light causes photoelectrons to be emitted from the photocathode, the image section focuses these photoelectrons onto the target mesh assembly. This assembly is truly the heart of the tube and is the main reason for its amazing performance. This type of target differs from any which have been used before in commercial pickup tubes in that the signal is impressed on one side and taken off the other. Such a structure is called a two-sided target or mosaic.

There have been many attempts in the past to fabricate a successful two-sided target. The patent literature is evidence of many types, most of which have proven to be too difficult to manufacture. The use of two-sided mosaics was first attempted in connection with iconoscopes. An image section was also used and the mosaic or target consisted of an insulated (generally enameled) wire mesh in which

⁶ Henry B. DeVore, "Limiting Resolution in an Image Orthicon Type Tube", *Proc. I.R.E.*, Vol. 36, No. 3, pp. 335-346, March, 1948.

the openings were closed with metal plugs. Such tubes actually operated, but the difficulty of making a target free of blemishes such as pinholes and surface irregularities proved almost insurmountable. If low-velocity scanning is used, such a target would also have too high a capacitance and lead to bad lag effects under low lighting conditions. The two-sided problem was solved through an entirely different approach*. This consisted of a very thin glass membrane of controlled resistance together with a fine mesh screen mounted close to it on the image or photocathode side. Such a glass membrane can readily be made free of pinholes and bad surface imperfections. Many problems, however, had to be solved in order to obtain a practical assembly that was free enough from other imperfections to be used in commercial television.

Target resistivity

The operation of the tube makes several demands on the glass target. The photoelectrons striking the image side of the glass through the mesh openings give rise to secondary electrons that are collected by the mesh. At low light levels the potential of the glass target does not ordinarily reach that of the mesh screen during the 1/30-second storage time. In order to obtain good resolution for such a storage time, the lateral leakage or leakage between elements is kept as low as possible, by the use of a high-resistance glass and by the use of a target as thin as possible. When the scanning beam approaches the scanned side of an element that has been charged, the beam "sees" the same potential as that of the charged side because of the thinness of the target. Electrons are deposited from the beam on the target until the potential returns to nearly the equilibrium potential under the beam when no light is present. After the beam leaves the element, the positive charge on the image side and the negative charge on the scanned side must combine in less than a frame time or 1/30th second. Otherwise, a "sticking picture" which will be of opposite polarity from the original picture will be seen if the picture is moved. If the picture is stationary the signal output from lighted areas will decrease. If the glass resistivity is very high the signal output for a stationary picture will, after a few scans, fall nearly to zero. If the resistivity is only slightly too high, the sticking picture will disappear as the tube warms up in the camera because the resistivity of glass falls about 2 or 3 to 1 for each 10-degree-centigrade rise in temperature. A satisfactory upper limit for the glass resistivity has been found to be about 9×10^{11} ohms per centimeter measured at 20 degrees

* See reference (5).

centigrade temperature. For the 2P23 a temperature of about 35 degrees centigrade at the target is needed to eliminate picture sticking entirely, when the glass has this value of resistivity.

The "sticking picture" puts a top limit to the resistivity of the glass. Mechanical handling puts a lower limit of about 0.0001 inch on the thinness of the target. A lower limit for the glass resistivity, necessary to keep lateral leakage low, is approximately 3×10^{11} ohms per centimeter measured at 20 degrees centigrade. With such a resistivity the tube can be operated at a temperature of about 65 degrees centigrade before serious loss of resolution sets in. At higher temperatures the resistivity will fall below 10^{10} ohms per centimeter, and a serious loss of resolution will occur particularly at low lights.

Target surface effects

Besides the mechanical difficulties of making a glass target of sufficient thinness and of the necessary strength, many other problems arise during the processing of the tube. In order to obtain sensitivity, the image side should have as high a ratio of secondary-electron emission as possible. Enough cesium reaches the image side of the target during processing of the photocathodes to give a ratio of 4 or 5 to 1. At times, however, too much cesium gets on the image side, the lateral leakage falls, and the target becomes "leaky", i.e., the resolution of the picture is poor. Such leakage, of course, shows up first at low light levels, where storage is complete over a frame time. During operation or shelf life, it sometimes happens that enough cesium will migrate to the target to cause "target leakage". This trouble can be minimized by operating the tube at the lowest possible temperature. (A minimum lower limit would, of course, be 35 degrees centigrade because of the target resistivity problem.)

Target contact-potential effects

There are other changes which occur in the glass that are largely the same in all tubes. During operation the scanned area on the beam side changes slowly in contact potential with respect to the unscanned area. With uniform light on the photocathode, overscanning will show the previously scanned area to be, in general, darker than its surroundings because the contact potential of the scanned area changes with respect to the thermionic cathode. When the tube is placed in operation the maximum area of the target which makes the picture magnification smallest should be used, because later it will be impossible to increase the area used because of the white edges that will show in the picture.

In addition to the "sticking picture" that can occur when the tube

target is too cold, another type of sticking can develop. If the camera is stationary and the tube "looks at" a strongly lighted area for a period of time (5 minutes or more), a sticking picture of the same or most often of opposite polarity can develop. This trouble is more likely to occur when the tube is cold, but it will develop in all tubes if the picture is left stationary too long, regardless of temperature. Unlike resistivity sticking, the sticking or "burning-in" disappears slowly. This type of sticking can be avoided only by care in handling the camera. In order to remove a sticking picture once it has been developed, point the camera at a flat lighted scene and operate it for several hours.

Target secondary emission

One last point should be mentioned before leaving the rather complicated glass target. Whereas the image side should have high secondary emission to produce as much signal as possible, the scanned side should have low secondary emission. Although the scanning beam approaches the target at nearly zero velocity and is turned back in the dark areas, it strikes in the lighted areas with a velocity corresponding to one or two electron volts. Even at such potentials, some secondary emission will occur. Any such emission increases the number of electrons returning to the multiplier from the lighted areas and thus increases the noise, because more beam current is needed to discharge lighted areas. The secondary emission of the scanned side is reduced by evaporating on it a very light layer of some metal such as silver which has low secondary emission. The reduction in the amount of noise is readily noted after such an evaporation. During operation there is generally a slow increase in the secondary emission so that after several hundred hours of operation the picture becomes more noisy. A re-evaporation of silver at this time by the manufacturer will once more reduce the secondary emission.

Loss of scanning

It is important to note what damage can be done to the target by a stationary beam. With light on the photocathode and a sharply defined beam, a hole can actually be started in the target. If the beam is defocused the bombarded area may become either darker or lighter than the rest of the target. Removing the multiplier voltage will not, of course, be of any help because the beam still will strike the target. Removal of the photocathode voltage is only a partial solution because light can pass through the photocathode and strike the target, which being nearly always somewhat photosensitive, will charge up and allow the beam electrons to land. The only positive method of preventing

damage in case of scanning failure is to bias off the beam or target. This precaution should always be taken when the equipment is not being monitored.

Target-to-mesh spacing — close spacing

For proper functioning of the glass target, a fine mesh screen the potential of which can be varied is needed on the image side. This mesh serves a two-fold purpose—as an element to increase the capacitance of the target, and as a limiter to prevent the target from charging to high potentials such as occurs in the 1840 orthicon. The maximum amount of charge that can be deposited on an element of the target depends on the capacitance of the element and the potential of the mesh above the potential of the scanned side of the target. This

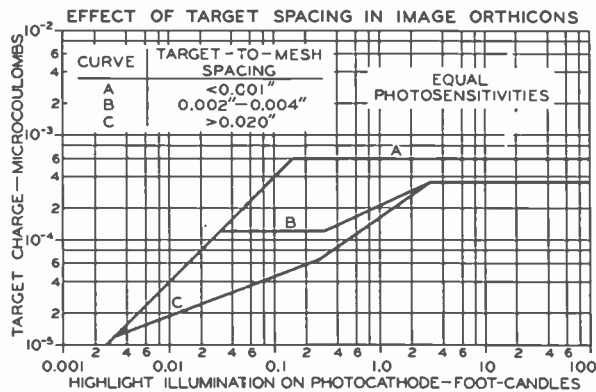

Fig. 6 — Effect of target-mesh spacing in image orthicons.

maximum charge also determines the maximum signal-to-noise ratio of the tube. At low light levels the target element never reaches mesh potential so that the charge rises linearly with light. In this region the tube has the same characteristic as a regular orthicon, namely, a loss of resolution for scenes in motion. For a spacing of the mesh to the target much less than the diameter of a picture element (for a 500-line picture this diameter is somewhat less than 0.002 inch), the charge rises linearly with light until it becomes limited by the capacitance and mesh voltage. When this limit is reached the charge caused by the high lights cannot increase, although that due to the low lights continues to rise. Curve A, Figure 6 shows an extremely simplified curve of the charge developed on the target during the time for a complete picture frame plotted against the illumination on the photocathode for a target-to-mesh spacing of less than 0.001 inch. Ordinarily, it would be assumed that the picture contrast would decrease

rapidly after the high light signal becomes constant. Redistribution of secondary electrons from the bright areas onto the lowlight areas, however, tends to preserve the contrast even when the high lights are well above the knee. If an intense small area of light, such as a direct reflection of the sun from the windshield of a car, is present in the picture, this redistribution gives rise to a disturbing black border around the light area. The image orthicon cannot faithfully transmit such a scene. Also, in pictures with large black and white areas the contrast is preserved only at the area boundaries when the high lights are well above the knee. In such pictures the blacks appear gray although the resolution and "snap" may appear to improve because of the outlining of the edges.

The redistribution of secondary electrons makes a valuable contribution to the resolution of moving objects. As the picture moves, the border around the high lights discharges the high light signal at its former position in less than a frame time so that only the latest image is seen when the picture is scanned. To obtain the best picture contrast and the most natural-appearing picture (that is, with blacks "black" instead of gray) the high lights should be run just at the knee of the curve. To take advantage of the better resolution in motion some loss of contrast is usually taken by operation somewhat above the knee.

Target-to-mesh spacing — wide spacing

If the spacing between the mesh and the target is much greater than the diameter of an element, the charge curve becomes more complicated. In the case of the close-spaced target, the capacitance of an element to the mesh greatly exceeds the "free space" capacitance of the element itself. For a wide-spaced target the "free space" capacitance is larger than its capacitance to the mesh. For low lights the charge will rise linearly with light until the point is reached where it is limited by the product of the capacitance of the element to the mesh and the mesh voltage. This point, as curve C of Figure 6 shows, is lower than the equivalent point for a close-space target because of the much smaller mesh-to-target capacitance of each element. However, as the light is increased above this point, the charge of the wide space target can increase because of the free-space capacitance of each element. This increase is at a slower rate because the discharge of the first part of each lighted section also partially discharges sections beyond it. Because the "free-space" capacitance is largely between neighboring elements, the edges of a lighted section both horizontally and vertically will produce a greater signal because of the partial dis-

charge of nearby elements. As the light is increased, these partially discharged elements are more and more recharged before the beam reaches them. Finally, a point is reached where the free-space capacitance of an element and its mesh voltage limits further increase. As curve C of Figure 6 shows, this point occurs at a light level a hundred times above that needed to reach the first knee of the curve. The effect in the transmitted picture of the free space or interelement capacitance is that the blacks are outlined with a white edge at the transition to white, occurring at the right end and the bottom of the blacks when the beam is scanning from black to white or gray.

Experience has shown that the proper target-to-mesh spacing depends on what the tube is expected to do. Very wide spacings, where the interelement capacitance is the only one that needs to be considered, has the advantage of taking the mesh completely out of focus. However, because the signal-to-noise ratio is too small to be useful except at very high light levels and because the resulting white edges are very annoying, the useful range is limited to intermediate and close spacings. The best spacing is determined by actual tests.

Tests of target-to-mesh spacing

Tubes with a wide variety of target-to-mesh spacings have been tested. For very wide spacings in the order of 0.020 inch to 0.080 inch the signal is far too low and the white edges are annoying. Spacings of the order of 0.004 inch to 0.008 inch produce useful tubes, but even in this range the signal-to-noise ratio is borderline and the white edges are still troublesome. A range of 0.002 inch to 0.004 inch was finally selected as the best for the 2P23 and the 5769. The white edges have largely disappeared and the signal-to-noise ratio is improved. Such tubes are of "intermediate" spacing, since the spacing is only slightly larger than an element diameter. Nearly all the properties are those of close-spaced targets as curve B, Figure 6 shows; only at high lights is there an increase in charge due to "wide-spaced" characteristics. In general applications this increase is not evident and can largely be overlooked. The properties of tubes with "close spacings" will be discussed in connection with the 5655.

Target potential

With regard to the mesh, two further points are important. As we have seen, one of the items limiting the target charge is the capacitance of an element, which is determined by the spacing of the target to the mesh. For the 2P23 and 5769 the spacing is in the range of 0.002 inch to 0.004 inch. The target charge is also determined by the ex-

ternally applied mesh potential. Experience has shown that the optimum potential depends to a great extent on the picture content. For scenes with flat, even lighting, especially when the scene illumination remains constant, the mesh potential can be set in the range of 2 to 2.5 volts above the point where the picture is cut off. (In actual experience, this cutoff point is at -1.0 to -2.0 volts with respect to the thermionic cathode.) Above 2.5 volts the picture will be stable but may have a peculiar "differentiated" appearance. When the potential difference between the target and the mesh is more than 2.5 or 3 volts, the beam will be bent by the more positive areas of the high lights and a premature discharge of these areas will occur. This action is known as beam bending and gives a picture reproduction inconsistent with the charge distribution on the target. When the tube has to pick up a scene with high lights and then one that is largely in the shadows, a mesh potential range of 1.5 to 2.0 volts is preferable. In general, the mesh potential should be kept as high as possible, without endangering picture fidelity in order to obtain the best signal-to-noise ratio.

Development of a suitable mesh

The problem of a satisfactory mesh has been the subject of a long development program. The first experimental image orthicon tubes were made with woven screens. Attempts to obtain woven screens that had uniformly spaced wires proved unsuccessful. In addition, the finest weave that could be obtained with a usable opening was only 325 to the inch which severely limited the resolution because the size of the picture on the target has a diagonal of only 1.4 inches. Various methods of electroplating mesh have been tried in the past, but, although they are capable of producing mesh of up to 400 lines per inch, the open area is small, generally not over 25 per cent for the finer meshes. A new method of producing an electroplated mesh, was originated at RCA Laboratories⁷, and has been developed to a degree that meshes of 500 openings to the inch with 50 to 65 per cent open area can be produced. Special methods of mounting and tightening the mesh, which is only a few tenths of a mil thick, were worked out. Because the mesh is so close to the target, it is nearly at the point of focus of the image electrons. If a wide-band amplifier is used, this mesh can be seen by looking carefully at the kinescope picture. With the standard television bandwidth it is just noticeable. However, a problem of a "beat" pattern does arise. Because the picture height on

⁷ H. B. Law, "A Technique for the Making and Mounting of Fine Mesh Screens", *Rev. Sci. Instr.*, Vol. 19, No. 12, December, 1948.

the target is approximately an inch, there will be about 500 wires of mesh to a picture height. These wires can beat with the 525-line scanning frequency to produce a low-frequency beat pattern. In the construction of the tube this possibility is reduced to a minimum by mounting the mesh at a 45-degree angle to the scanning beam. Even in this case some regions of the picture may show beat patterns, particularly in highly lighted areas. These patterns, also can be eliminated at a sacrifice in resolution, by slightly defocusing the beam. In operation the beat pattern can be minimized by scanning as large a part of the target as possible so as to keep the picture height at a maximum.

Electron gun

The gun which produces the beam consists of a thermionic cathode which is held at ground potential, a control grid (grid No. 1) and an accelerating grid (grid No. 2). Grid No. 2 contains a small aperture about 0.002 inch in diameter which serves to define the beam. After emerging from this aperture, the beam with a velocity corresponding to about 300 volts, passes through the grid No. 3 region which is also at 300 volts. It then emerges into the focusing section which consists of a uniform electric field of about 200 volts and a magnetic field in the direction of the beam of 75 gauss. Any component of the electron beam which has only forward velocity will go straight down the magnetic field. Other components which have radial velocities will form loops around the magnetic field and return to a disc of focus at the end of each loop. By means of the fields previously mentioned the beam is focused on the target at the end of the 5th loop. When the beam passes through the focusing section, it is also deflected in vertical and horizontal directions by means of magnetic fields at right angles to the focusing field.

Landing of beam at target⁸

As the beam approaches the target it is slowed down. If no light is on the target the electrons in the beam will continue to land until the target potential drops to a value determined by the initial velocities of the thermionic electrons and the contact-potential difference between the thermionic cathode and the target. When this potential is reached, all of the beam will be turned back unless the tube is illuminated. In the lighted areas all the electrons of an ideal beam would land on the

⁸ P. K. Weimer and A. Rose, "The Motion of Electrons Subject to Forces Transverse to a Uniform Magnetic Field", *Proc. I.R.E.*, Vol. 35, No. 11, p. 1273, November, 1947.

target until the target is driven back to equilibrium potential. This ideal condition, however, is not reached for several reasons. After the beam emerges from the aperture, its direction, as a whole, may not be along the magnetic field. In this case the radial velocity of the beam may be so high that none of it can land at the target under normal conditions. Nothing will be visible in the kinescope picture except noise, unless the mesh voltage is raised to a very high value. This condition is corrected by the use of an alignment coil which produces a magnetic field at right angles to the beam direction near the aperture. This field can be rotated and varied in intensity until the direction of the beam is along the magnetic field. Even after best alignment, however, all of the electrons will not land because of variations in the initial emission velocities which range from 0 to about 0.5 volt. For low light levels only those electrons with the highest initial velocity will land and the percentage landing or the "beam modulation" will be poor. However, even for higher light levels only a portion of the available electrons will land because of the radial velocities introduced by the gun and because of the secondary emission which occurs at the target. Some preliminary data indicate that even for a target on which silver is evaporated the secondary-emission ratio may be as high as 0.5 in the high lights. All of these effects combine to lower the possible signal-to-noise ratio since a larger beam current is needed to discharge the target. The failure to land at low lights can give rise to another condition which is described by the term "picture lag". So few electrons land that a picture is not discharged by the beam in 1/30 second. If the picture is moved there will be a trail behind it of the same polarity. This condition is not serious in the 2P23 except at very low light levels because of the very small target capacitance. The condition is more serious, however, in the 5655.

Edge landing

Besides the lack of 100 per cent landing in the center of the target, a problem of poor landing at the edges arises because of the radial velocities introduced by the deflecting field. In a transmitted picture with poor edge landing the signal will be the highest in the center and drop off progressively towards the edges. The radial velocities introduced by the deflection are largely counterbalanced by the use of a decelerator grid (grid No. 5) which is in the form of a short cylinder. This grid, when operated at a positive voltage between that of the target and the focusing grid (grid No. 4) produces a radial electrostatic field which is zero at the center of the picture and increases

toward the edges. This field gives the electron beam a radial velocity opposite to that produced by the deflecting field.

Landing can also be influenced by many other factors. In the design of the tube it has been found necessary to control accurately the shape of the glass near the decelerating region. Otherwise, the deflected beam tends to strike the glass in this region and not reach the target. Also, the deflecting coil, image socket, and focusing coil must be carefully designed. Best results have been obtained with a deflecting coil 5 inches long. With a longer or shorter coil, the flare fields are different and cannot be counterbalanced as readily with a simple grid. For the same reason the three-inch image section of the tube should be as close to the end of the deflecting coil as possible. This space is limited to 0.5 inch by the length of the image leads and the socket thickness. Slightly better results can be obtained with a spacing of 0.3 inch. The effect on landing of any shielding windings on either the deflecting or focusing coil must also be considered. It is general practice to wrap the deflecting coil with a layer of iron wire, to help prevent leakage of the deflecting field into the target lead which generally returns over the deflecting coil from the image section to the rear of the focusing coil. However, this winding has a slight deteriorating effect on the landing because of its modifications of the flare field. When image focus was studied, it was found necessary to reduce the "crosstalk" from the deflecting field into the image section. As mentioned previously, "crosstalk" can be reduced by the use of an external shield over the focusing coil. Such shields, because they modify the flaring of the deflecting field, can also affect the landing. The shields, therefore, should be designed with this item in mind. In fact, proper arrangement of shields will actually lead to better landing than can be obtained with no shields.

In general, the beam imposes no severe limitation on the center resolution of the 2P23 in its present state of development if a field of approximately 75 gauss and a focusing voltage of about 200 volts are used. However, the corner resolution is somewhat deteriorated when the center is in best focus. This deterioration occurs chiefly in the beam section rather than the image section. Some improvement can be obtained by proper adjustment of grid No. 5 provided the landing is not seriously affected. The resolution limits of the beam will be considered more thoroughly in the discussion of the 5655.

Return beam

The portion of the beam that does not land on lighted sections of the target returns and strikes the accelerating grid (grid No. 2) which

also serves as the first dynode of the signal multiplier. The amount of deflection received in going to the target is not quite balanced by that received in returning so that the beam scans a small area of the first dynode. The size of this scan is roughly $\frac{1}{4}$ inch. This $\frac{1}{4}$ -inch scan poses quite a serious problem in keeping the dynode free from spots because it is magnified by 25 or more in the kinescope picture. Fortunately, the dynode is not quite in focus for best focus at the target. In operation, however, it is usually necessary to defocus the picture slightly in order to minimize the spots, especially for dark scenes. These spots are nearly always white, indicating a lower secondary emission. In general, for dark scenes these spots are the most severe limitation on resolution, while for well-lighted scenes the target mesh is the limiting factor. Several methods have been tried for reducing the dynode spots including the use of highly polished surfaces and uniformly roughened ones for the dynode both being coated finally with an evaporated film of a metal with a high secondary emission. No completely successful solution, however, has as yet been found. In any event, the spot due to the aperture opening is always present.

Signal multiplier

The first orthicons and image orthicons were generally made with only one stage of signal multiplication. The signal in the form of secondary emission from this stage was collected by a nearby electrode. In general, the gain from this single stage was found to be insufficient. The purpose of signal multiplication by secondary emission is to obtain a nearly noiseless multiplication of the small signal which modulates the return beam to a level well above the noise of the first stage of the video amplifier so that amplifier noise is no longer a limitation. As mentioned previously, the maximum charge that a target element can have is limited by the product of its capacitance and the mesh voltage swing. For the 2P23 with a mesh voltage of 2 volts, the total charge for the whole target, if it is entirely highlighted, is about 1.6×10^{-10} coulombs. Because this capacitance is discharged in $1/30$ second, the calculated signal current at the target is only about 5.0×10^{-9} amperes from the highlights. If the first video amplifier is connected directly to the target, a root-mean-square noise current of 3×10^{-9} amperes may be assumed. It can be seen that the high-light signal-to-noise ratio is less than 2 to 1 with the amplifier the limiting item. The gain of the multiplier should at least be such that the beam noise is the limiting item. This noise which is, of course, due to shot effect of the temperature-limited thermionic emission, is given by the expression $(2ei\Delta f)^{1/2}$. In this expression, e is the charge

of an electron (1.59×10^{-19} coulombs), i is the beam current in amperes, and Δf is the frequency bandwidth of the picture in cycles per second. For a bandwidth of 4.25 megacycles and if it is assumed that all of the beam is useful in discharging the picture, the beam noise is 0.08×10^{-9} amperes. A gain of at least 40 is needed to bring this value up to the level of the amplifier noise. If the tube is to be used to pick up lower light scenes with no highlights so that the beam current can be reduced, a higher gain is useful. This condition is unusual in the field. Another reason for higher gains, however, is to reduce the number of electron tube amplifier stages required. For this purpose, a gain of several hundred is useful.

In order to obtain a gain of several hundred several multiplier stages are needed because the average gain per stage is usually only about 4. Many multiplier designs have been suggested and tried. Because the second stage must collect all of the electrons from an appreciable area of the first stage (because of the scanning of this stage), it has been found advisable to use a symmetrical multiplier. Such a multiplier can be a series of screens set one below the other around the gun and first dynode. The principal problem has been to get all the secondaries from the first stage over to the second stage. The best solution has proven to be the use of an extra cylindrical grid (grid No. 3) above the first dynode. The voltage of this grid is generally set at or slightly below the first-dynode potential. The beam, which emerges from the aperture in the first dynode with a 300-volt velocity, passes through an aperture in the top of grid No. 3 into the grid No. 4 section without being affected. However, the slow-velocity secondaries emitted by the return beam find themselves in a region of uniform potential except for the second dynode and will be attracted to it. This second dynode is parallel to the first but generally slightly below it. The magnetic field should also be weak near the first dynode to prevent the secondaries from spiraling about it and eventually returning to the first dynode. Any failure to collect all the secondaries at the second dynode will lead to a picture that is darker in one section than another. As in the iconoscope, this condition shows up most clearly when there is no signal due to light so it also is referred to as "shading". This shading signal differs from iconoscope shading in that it is smaller than the picture signal and can usually be cancelled by the insertion of a simple horizontal-sawtooth component in the amplifier. It does not vary greatly with illumination as does the iconoscope shading but depends almost entirely on the beam current. Consequently, the shading control requires little readjustment once it has been set.

The second dynode is an efficient multiplier consisting of a 32-blade pinwheel with the blades set at an angle of about 30 degrees to the plane of the multiplier. Primary electrons which strike the blades emit secondaries which are drawn through the slots to the next stage. A high-transmission screen is mounted on top of the pinwheel to prevent the secondaries from being pushed back into the surface by the lower voltage of the preceding stage. Such multipliers will give gains of about 4 per stage at a primary electron velocity of 300 volts. A 5-stage multiplier as used in the 2P23 will give gains of about 1000. The signal output which will be discussed later is about 10 microamperes. This value is considerably higher than the 0.018 microampere output of the 1850-A iconoscope. The gain of the external amplifier can thus be reduced by a value of about 500 permitting the elimination of at least two amplifier stages.

Generally, the recommended voltage per stage of the multiplier is between 200 and 300 volts except for the first dynode which is held at 300 volts. The over-all voltage required by the multiplier stages will then be in the range of 1100 to 1500 volts.

Operation of 2P23

Although the 2P23 has proved very successful for field use because of its high sensitivity, wide light range, and the relative freedom from shading, it has several limitations. Because of the low capacitance of the mosaic, the maximum charge any element can attain is small. This limitation, and the fact that all the beam that approaches a lighted area of the target does not land, limits the signal-to-noise ratio to a relatively low value so that the picture appears somewhat "noisy". The type of photocathode used, although it has a high over-all response does not faithfully reproduce colors in black and white. This poor color response is particularly troublesome in studio work. Also, the "white edge" effect gives a somewhat unnatural looking picture which, although it is not too serious for outside pickup, is very noticeable on high-quality studio scenes.

The effect of beam modulation on the signal-to-noise ratio and its improvement by a change in gun design will be considered first because the results are applicable to both the 2P23 and 5655. In low lighted sections of the target it has been pointed out that the percentage of the beam that lands is low because of the spread in initial velocities at the thermionic cathode. When light is not present, the target is driven to a voltage corresponding to the highest initial velocities. For small illuminations there is only a small percentage of the total beam which can discharge the target. At high lights this limitation is no longer

present and it would be expected that the initial velocities would not be a problem. However, with the original gun design of the 2P23 the percentage of the beam that landed in the highlights was only about 15 per cent. For a maximum signal at the target of 0.005 microampere the beam current needed is 0.033 microampere. The beam noise given by the expression $(2e i \Delta f)^{1/2}$ is 0.0002 microampere. The maximum signal-to-noise ratio is, therefore, about 25 to 1. The type of noise, because it is due to the beam, is not "peaked channel noise" but is spread over the entire bandwidth so that long noise pulses in the form of streaks come through. This ratio is less favorable than the 60-to-1 ratio of the 1850-A iconoscope with a "peaked channel noise" in which the noise pulses are all short and appear only as small dots.

Development of an improved gun

The original gun of the 2P23 consisted of a thermionic cathode and a control grid with a large aperture spaced at a rather large distance from the cathode. The spacing between the control grid and the accelerating grid (grid No. 2) was also high. This gun could readily be manufactured but the beam current was drawn from a rather large area of the thermionic cathode. Because only the center portion of this beam passes through the small aperture in grid No. 2, it was expected that only the part of the beam that is emitted by the center of the cathode would be used. Extensive study, however, has shown that the center of the beam is not all that is used. The electrons drawn from parts away from the center of the cathode and which would be expected to have a radial component of velocity enter the beam and raise its radial component.

A new gun design has been developed to draw electrons, as far as possible, only from the center of the cathode area. The grid No. 1 aperture was made smaller, the grid No. 1-to-cathode spacing was made as close as possible and an extra accelerating aperture which is also at grid No. 2 potential was added close to the grid No. 1 aperture. The result of these changes is that the cathode is much more heavily loaded; i.e., for a given beam current a much higher percentage of the electrons are drawn from the center of the cathode. Because these electrons have a smaller radial velocity, most of their energy is in the forward direction and they will be more likely to land at the target. When the new gun is used, the percentage of modulation rises to about 30; the signal-to-noise ratio is increased to about 35 to 1. Although this value is still on the low side, it is acceptable for outside pickups. It is interesting to note that the signal-to-noise ratio of good 35-millimeter film is also 35 to 1.

In addition to the improvement in signal-to-noise ratio, this new gun provides an improvement in resolution due probably to the smaller radial velocities which make the final spot smaller. (The presence of radial velocities cause a point source to be imaged as a spot of measurable magnitude at the target.) With the new gun, the beam itself is at present not a limitation on the usable resolution of the tube unless the magnetic field and grid No. 4 focusing voltages are too low. In general, a field of 75 gauss and a grid No. 4 voltage of 200 volts is a good compromise between good resolution and the need for excessive scanning power. With such operating conditions the beam is able to resolve better than 1000 lines in the roughly one-inch vertical height of the picture, or more than 1000 lines per inch.

Whether the 30 per cent modulation efficiency represents a limit to what can be done with gun design is not known. Initial velocities of electron emission at the thermionic cathode, of course, even at highlights present some limitation. Measurements at a variety of cathode temperatures have shown no definite improvement. The main limitation may be the secondary emission and electron reflection that comes at the target.

The new gun was originally developed in connection with the new 5655 studio image orthicon. However, it is equally useful in the 2P23 and has been adopted there. The 5655 now differs from the 2P23 only in the target to mesh spacing and in the photocathode surface. Why these changes give a tube (the 5655) which is superior for studio use but which is not so versatile for remote pickup will be discussed next.

Use of closer target-to-mesh spacings

In discussing target-to-mesh spacing for the 2P23 tube, the spacings were arbitrarily divided into two groups: wide-spaced where the spacing is much greater than the size of a target element; and close-spaced where it is much less. Wide spacing is not used because the low capacitance results in an unusable signal-to-noise ratio and annoying white edges around lighted areas. The 2P23 has a spacing of 0.003 inch which is in the intermediate range where the signal-to-noise ratio is usable and the white edges are not particularly annoying. The question of what occurs as the spacing becomes closer is an important one.

If the spacing is reduced to 0.001 inch, the capacitance rises by a factor of about 3. The signal output will also be three times as high and the signal-to-noise ratio is improved by a factor of $\sqrt{3}$ or about 1.7, provided the modulation for the higher beam currents required

does not change. Numerous experimental tubes have been made with this reduced target-to-mesh spacing in which the signal-to-noise ratio is definitely improved but is still borderline for high-quality studio work. The white edges have disappeared and the half-tone response is improved. This improvement is due to the much longer straight-line portion of the curve of target charge vs. illumination which is shown in curve A of Figure 6. If these tubes are operated so that the highlights are at a point somewhat over the knee of the curve, the half tones will have a better signal-to-noise ratio than the 2P23. The improved signal-to-noise ratio and the lack of white edges make the picture look more "natural".

The close-spaced assembly, however, is not without its drawbacks. Because an inferior picture is obtained below the knee of the signal-output curve, it is nearly always preferable to operate these tubes at the knee or slightly above it. Although a better picture is obtained at this point with a close-spaced target, for the 0.001-inch spacing three times as much light is required. This requirement makes the sensitivity of the experimental tubes appear to be lower than that of the 2P23. The close spacing is also not satisfactory for low-light scenes because the higher capacitance causes picture "lag". The higher capacitance causes a smaller potential rise at the target for a given amount of light. At these small potentials, the beam modulation is very poor and the target is not completely discharged in one frame time. For outdoor scenes the greatest drawback is probably a lack of versatility in handling a wide range of lighting. This drawback shows up in two ways. The beam current needed in the 2P23 is very small and the multiplier shading is a minor item. If the beam is set for a high-light condition and the camera swung over to a low-lighted scene, the shading is not noticeable and the scene can readily be handled. In the close spaced tubes, the higher beam current causes disproportionately more shading. Thus, when the camera is used on a high-light scene a picture of better quality can be obtained; but when the camera is swung to a low-light scene the shading and beam noise are often troublesome. If the beam current is reduced this trouble disappears. In field use, however, this reduction is not always possible, especially when a scene contains both sunlight and shadow which often happens during sport events. Also, because of the long straight section of the target-charge curve, the highlights have more tendency to cause "blooming" at the kinescope. In a scene with a few high lights the picture is set so that the normally lighted parts appear bright at the kinescope. The signal in the highlights therefore, can be high enough to cause loss of resolution in the kinescope and consequent "blooming".

From a manufacturing standpoint the close spacing also puts a greater demand on the thermionic cathode because of the need for a higher beam current. If the center of the cathode is slightly low in emission, the beam will be insufficient to discharge the highlights completely and loss of resolution will occur. Because of this demand for higher beam currents, grid No. 2 of the close-spaced tubes is operated as near to 300 volts as possible and not near 200 volts which has been satisfactory in some cases for the 2P23.

OPERATION AND CONSTRUCTION OF THE 5655

Target-to-mesh spacing

Because it has not been possible to make a completely universal tube, it was decided to design the close-spaced tube for studio use where the lighting can be controlled. Under such conditions the apparent decrease of sensitivity and inability to handle scenes of widely varying illumination is not important. Because a 0.001-inch spacing does not give too good a signal-to-noise ratio, the question arises as to what happens at closer spacings. For a 500-mesh screen the center-to-center spacing is 0.002 inch. For 60 per cent transmission the hole size is about 0.0016 inch, that is, the center of the target element under each hole is 0.0008 inch from the mesh. One would expect that the capacitance would increase slowly for values of spacing less than 0.001 inch. However, the increase is definitely apparent in tubes with still smaller spacings. The capacitance increases until the target and mesh touch. The gain in capacitance over a 2P23 target is about 4 to 6 to 1 and the gain in signal-to-noise ratio is about 2 to 2.5 to 1. The signal is, of course, about 4 to 6 times higher and the apparent sensitivity $\frac{1}{4}$ to $\frac{1}{6}$ as high. This gain in signal-to-noise ratio is very worthwhile and makes the tubes acceptable for studio application. For such tubes, the signal-to-noise ratio has an average value of about 80 to 1.

Target-mesh structure

The actual manufacture of a target-mesh structure with such a close spacing (the spacings are held between contact and 0.0004 inch) presents many problems. A description of the manufacturing process follows. The thin glass target is sealed at its edges to a metal ring. Before sealing, the surface of this ring is coated with a binder. After the seal is made, there is a measurable thickness of this binder above the glass. Also, at the inner edge of the ring the glass target tends to seal around the edge so that it is slightly depressed below the metal. If

the mesh is then placed against this structure, it will have about the correct spacing for the 2P23. To obtain closer spacing it is necessary to design the structure so higher points on the mesh are actually pushed into contact with the glass target. The tolerances are so small that careful fabrication is needed. Any minor deviation from flatness of either the mesh or the target will also show up much more clearly in the close-spaced target.

Picture sticking

Before leaving the close-spaced structure, it is interesting to note that its "picture sticking" characteristics due to glass resistivity are different from those of the 2P23. It has been mentioned previously that in a cycle of operation the charges, remaining on the target after the beam has scanned it, must be neutralized in a frame time by conduction through the glass. If charge neutralization does not take place, the signal will fade for a fixed scene and return to its full value only when the picture is moved. A picture of opposite polarity will then be left on the target and can be seen if this area is lighted. The point of interest here is that for a given glass thickness and conductivity, fading depends on the target-to-mesh spacing in the region of very close spacings because, with the close-spaced assembly the capacitance and, consequently, the amount of charge to be neutralized are greater. For a 2P23 with a target of average thickness and conductivity, the percentage of fading at 20 degrees centigrade is about 10 per cent. If the temperature is increased to 30 or 35 degrees centigrade, the lowered resistivity makes the fading nearly negligible. For a close-spaced tube, however, the value at 20 degrees is closer to 30 per cent. A higher temperature of operation is needed to reduce fading to a low value. Generally, a temperature in the range of 40 to 45 degrees is sufficient. This need for a higher operating temperature, of course, reduces the operating temperature range of the close-spaced tube over that of the 2P23 because the 5655 is limited on the high side by lateral leakage in the same way as the 2P23. During tube life the 5655 target also changes more noticeably than that of the 2P23 because of the greater amount of charge that has to be transported through the glass. The change in contact potential, which generally makes the scanned area appear darker, may amount to several volts and requires shifting the mesh potential to more positive values during the life of the tube. In addition during operation the resistivity of the target slowly increases and after several hundred hours a higher temperature of operation may be needed.

Beat pattern

Because the mesh of the 5655 is nearly in contact with the target, the mesh is in better focus and is more visible than in the 2P23. The beat patterns also show up more readily. Some improvement has been made by using higher-transmission mesh with a transmission of 60 per cent or better. This value is equivalent to a wire 0.0004 inch in diameter. At present, however, the mesh limits the resolution of the tube in the highlights. As the techniques for manufacturing meshes improve, it is expected that eventually a finer mesh will be available.

Photocathode

Because the close-spaced tube has been designed for studio work a high sensitivity, especially for incandescent light, is not of prime importance. The spectral response, however, is of importance. Because of the variation in the spectral response of the 2P23 from tube to tube and because of the high infrared sensitivity of many of the tubes, it is very difficult to light the scene properly and get reproducible results. For these reasons, a different photosurface has been developed for the close-spaced 5655 tube.

The well-known photosensitive surfaces are those of cesium, silver-oxide, and silver, and those of cesium-antimony. Both can be made in the form of semi-transparent surfaces. It has already been shown that the first is not satisfactory for the 5655. The cesium-antimony surface gives a high response to both incandescent and fluorescent sources which is quite reproducible from tube to tube. It has no infrared response but, unfortunately, also very little red response. Even with incandescent illumination its red response is too low to be satisfactory. A photosurface that overcomes this objection, however, has been developed. It consists of a silver-antimony surface sensitized with cesium. The silver and antimony are made into an alloy in the proportions that give best results. This alloy is evaporated onto the face plate at exhaust and then sensitized. The surface as shown in the spectral response curve of Figure 7 has the high blue response of the cesium-antimony (S4) surface plus an added red response. The over-all sensitivity to incandescent light is only about one-third of that of the 2P23 surface. For fluorescent light and sunlight, the surface compares very favorably with the 2P23. Under certain conditions such as near sunset when considerable blue light is scattered, the 5655 surface is more sensitive.

Operation

Because of the greater capacitance and different photocathode

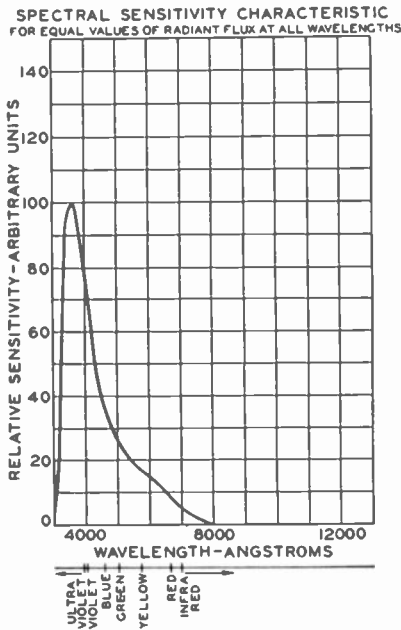

Fig. 7—Approximate spectral sensitivity characteristics of image orthicon types 5655 and 5769.

color temperature are most suitable for obtaining a good level of lighting. However, when only fluorescent lighting is used, the red response is somewhat lower than the yellow or blue. The use of incandescent flood lights will help this condition and at the same time permit high lighting of various scenes. Although the 5655 is able to handle a wide range of light it is more restricted than the 2P23. For this reason care should be taken to eliminate very brightly lighted

surface, the signal-output of the 5655 differs from the 2P23. The signal output curve is given in Figure 8. Because the maximum output is 4 to 6 times that of the 2P23, a two-fold or better increase in the signal-to-noise ratio results although more light is needed to obtain this higher value. As the curve indicates, the illumination is of the order of 0.2 foot-candle at the photocathode. In order to obtain good depth of focus, a minimum of 100 foot-candles should be used on a scene, with 200 to 300 a better choice.

The type of lighting needed to get a good spectral response is fairly well met with a mixture of fluorescent and incandescent sources. In general fluorescent lamps of 3500 or 4500 degrees Kelvin

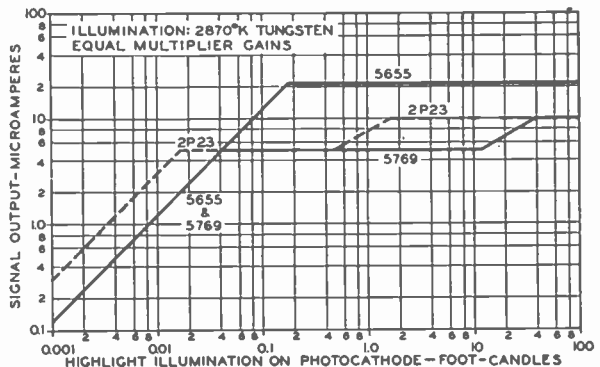

Fig. 8 — Simplified signal output characteristics for image orthicon types 2P23, 5655, and 5769.

areas such as can be caused by highly reflecting objects or by the use of intense spot lighting.

OPERATION AND CONSTRUCTION OF THE 5769

As has been discussed, the 2P23 has the advantages of fair signal-to-noise ratio, good ability to handle a wide range of scenes, and good sensitivity particularly for incandescent lighting. However, because of its high red and infrared response, it does not portray colors faithfully and resolution suffers particularly for the colors near the blue. The 5655, on the other hand, has a good color response. The 5769 is a new tube which is identical with the 2P23 except that it has the 5655 photocathode surface and color response. Its sensitivity for incandescent light is only about one third that of the 2P23 but for fluorescent and daylight it is nearly the same. For a large majority of outdoor pickups it is superior to the 2P23 because of its color response. In addition, operating experience has shown the 5769 to be more stable. Because the photocathode surface of the 2P23 demands an excess of cesium for best sensitivity, it is difficult to prevent migration of the cesium around the tube while it is on the shelf or in operation. If the excess cesium migrates to the target the resolution and signal output of the tube will be lowered, and the tube will fail because of "target leakage". The 5655 and 5769 have, in general, proved less susceptible to this condition and, consequently, are more stable. Because of its good color response, the 5769 can also be used for studio operation. In this use it is somewhat easier to handle because of its wide light range. The 5655, however, is superior in its signal-to-noise ratio and rendition of grays.

OVER-ALL OPERATING CHARACTERISTICS

The over-all operating characteristics of image orthicon tubes can best be considered in terms of the curves of signal output versus light. Figure 6 shows curves of the charge built up during a frame time for increasing illumination on the photocathode. If the charge is divided by the frame time of $1/30$ second and multiplied by the multiplier gain, the signal output will be obtained. For a gain of 1000, the maximum signal for a 2P23 of average mesh spacing is about 5 microamperes. For a photocathode sensitivity of 14 microamperes per lumen and a secondary emission ratio of 2.5 at the target (the ratio of the cesiated glass is probably about 4 at 400 volts but the mesh transmission is 60 per cent), the high light illumination on the photocathode needed to obtain this maximum signal is about 0.02 foot-candle. With this information the signal output curve (Figure 8) for the 2P23 can

be constructed. As in the charge curve, the signal-output curve rises linearly with light until a point is reached which corresponds to the maximum signal output. Above this point it does not rise except for very high values of light where interelement capacitance comes into effect. This curve is extremely simplified. It holds more closely for the case of a small area of light on a dark background, but even under this condition the break at the knee is rounded off because of the initial emission velocities of the secondaries from the target. These velocities range from 0 up to 5 volts with an average value of about 2 volts.

Should there be more than one bright spot, the curve becomes more complicated. Any lighted area tends to preserve its contrast by reducing the charge on the areas with a smaller amount of light by spraying them with secondary electrons. This spray, however, will also tend to discharge the poorly lighted areas which already have a rather low signal. Brightly lighted areas will, consequently, suppress the grays and make the gray parts of the scene appear flat and noisy. Gray suppression can be reduced by keeping the mesh potential high so that more of the electrons are collected and not redistributed. However, this expedient is of the most help when the highlights are just above the knee of the curve.⁹

In its present state the image orthicon can handle a scene containing very bright high lights and grays better than an orthicon. In outdoor work many such scenes will be encountered. Inferior results in the grays will always occur, however, so that where lighting is under control such as in the studio, every attempt should be made to avoid extreme highlights. Not only do the secondary electrons redistributed directly from the highlight parts of the target suppress the grays, but also secondary electrons from the mesh have the same effect. Internal reflection of the highlights inside the lens and tube add to this limitation. Very poor results are obtained if a direct light gets into the lens from the sun or other sources.

A simplified signal output curve is also shown in Figure 8 for the 5655. Because of its high capacitance, the maximum signal output of the 5655 is higher than that of either the 2P23 or 5769. This advantage leads to a higher possible signal-to-noise ratio and a better gray scale because of the longer straight part of the curve. For the same photosensitivity, however, more light is needed to reach these improved conditions. In addition, more beam current is necessary to discharge

⁹ O. H. Schade, "Electro-Optical Characteristics of Television Systems", *RCA Review*, Vol. IX, No. 4, pp. 663-665, December, 1948.

the highlights. For any given scene, the 5655 can produce, in general, a picture as good or better than that produced by a wide-spaced tube. It also has about the same ability to hold down highlights. However, because of the greater beam current needed for a strongly illuminated picture, when the camera is turned to a low light scene, the high beam current produces more noise and shading than is produced by the 2P23 or 5769. If the beam current is reduced for the low-light scene, the picture is again good. Because a continual shifting of the beam current is not practical, the 5655, in general, is not recommended when high-light and low-light scenes must be picked up in quick succession.

CONCLUSION

This paper has discussed in some detail the limitations and operating problems as well as the advantages of the image orthicon. As a result of a continuous program of development, many of the limitations of this tube have been minimized and the image orthicon has evolved from a laboratory device to its present status of being the work horse of television. With continued development, the possibilities of which have by no means been exhausted, the image orthicon can be expected to show further steady improvement.

The operating problems show a measure of the complexity of the image orthicon. This complexity, however, makes it possible for this tube to do what no other camera tube can do. An outstanding advantage of the image orthicon is its exceptional sensitivity which enables the tube to pick up scenes illuminated at very low light levels—only a few foot-candles—and greatly extends the range of outdoor subjects which can be televised. In addition, the image orthicon can reproduce scenes having great depth of field—a valuable advantage which provides flexibility of operation. Both in outdoor and studio pickups, the use of image orthicons has resulted in steady improvement in picture quality. The tube has earned its place today as the best choice for a universal camera tube.

ACKNOWLEDGMENT

This development program has involved the continual aid of many groups. In particular, the authors wish to acknowledge the help of the following persons: A. Rose, P. Weimer and H. B. Law of RCA Laboratories Division, Princeton; O. H. Schade of the Tube Department at Harrison; H. N. Kozanowski, N. Bean and J. H. Roe of the Engineering Products Department at Camden; E. D. Goodale and the operating groups of NBC; D. Ulrey, L. B. Headrick, P. A. Richards, R. E. Barrett, R. Handel and L. Young of the Tube Department at Lancaster.

A NEW IMAGE ORTHICON*†

BY

R. B. JANES, R. E. JOHNSON AND R. R. HANDEL

Tube Department, RCA Victor Division,
Lancaster, Pa.

Summary—The design of a new panchromatic high-sensitivity photosurface has resulted in the development of a new image orthicon, RCA-5820, which permits the televising of low-level illuminated scenes with a faithful gray-scale rendition of colors. Performance results of this new tube in comparison with other types for both remote and studio pickup are given.

INTRODUCTION

IN 1946 the 2P23 image orthicon was introduced for remote pickup use.¹ In spite of drawbacks such as a rather low signal-to-noise ratio and unfaithful gray-scale color rendition because of its infra-red sensitivity, the versatility of the 2P23 in picking up scenes having wide ranges of illumination quickly led to its nearly universal adoption for remote pickups. Further development² brought about a considerable improvement in its signal-to-noise ratio and resolution, but the color rendition still presented difficulties, especially for studio use. In 1947, the 5655 was brought out to fill the urgent need for a studio tube.² The use of a different photosurface with no infra-red response gave a considerably better color rendition. The signal-to-noise ratio was also improved by a change in the target structure which raised the target capacitance. The photosurface of the 5655, however, had a lower sensitivity, particularly to incandescent light, than that of the 2P23. Because of the lower sensitivity and the greater capacitance of the target, the 5655 requires the use of more light. Studio lighting levels of 200 to 300 foot-candles of incandescent light or 150 to 200 foot-candles of fluorescent light have been needed for use with this tube in order to obtain good depth of focus. The better color rendition, however, was so advantageous that in 1948 the 5769, which has the same target structure as the 2P23 but with the photosurface of the

* Decimal Classification: R583.6.

† Reprinted from *RCA Review*, December, 1949.

¹ A. Rose, P. K. Weimer and H. B. Law, "The Image Orthicon — A Sensitive Television Pickup Tube", *Proc. I.R.E.*, Vol. 34, No. 7, pp. 424-432, July 1946.

² R. B. Janes, R. E. Johnson and R. S. Moore, "Development and Performance of Television Camera Tubes", *RCA Review*, Vol. X, No. 2, pp. 191-223, June 1949.

5655, was introduced. The 5769 has found wide use in both remote pickups and studio use. In the studio, it has been preferred by many over the 5655 because it requires less light and because of its ability to handle a wide range of illumination.

Although the 5655 and 5769 have better color rendition than the 2P23, they have two shortcomings. First, their over-all sensitivity is only about one-third that of the 2P23 for incandescent lighting. For fluorescent lighting and daylight, the tubes are more comparable partly because the sensitivity of the 2P23 falls off for this type of lighting. Second, the spectral response of the 5655 and 5769 is largely in the blue end of the spectrum. Unless a considerable amount of incandescent "modeling" lighting is used, facial tones which are largely in the yellow and red come out too dark. For example, light beards when televised would appear almost black.

Experience with these three image orthicons has pointed to the need for a high-sensitivity photosurface which more closely matches the response of the eye. Such a surface has now been incorporated in a new image orthicon, the RCA-5820. The 5820, which uses the wider-spaced, lower-capacitance target structure of the 2P23 and 5769, is especially useful for remote pickups. In addition, it may be preferred by many for studio use because of its ability to handle wide ranges of illumination.

SPECTRAL SENSITIVITY CHARACTERISTICS OF IMAGE ORTHICONS

Curves comparing the spectral sensitivity characteristics of all the image orthicons are given in Figure 1. The curves are plotted on an absolute scale, i.e., for any given wavelength of light the response is given in microamperes of photo current for one microwatt of light energy falling on the photo cathode. The over-all response of the different surfaces to incandescent light of 2870 degrees Kelvin is also given. This figure must be used with care because incandescent light, which contains a good deal of red and infra-red, makes the response of a tube with infra-red sensitivity higher than it would be for sources with less red.

Two curves (C and D) are given for the 2P23 to show the wide range of response that may be encountered in different tubes of this type. The higher-sensitivity tubes (curve C) have a high infra-red sensitivity resulting in a high sensitivity to tungsten illumination (20 microamperes per lumen). These tubes have been useful in the past for picking up scenes illuminated with low-level incandescent light. The infra-red response, however, causes peculiar color renditions.

Reds appear almost white and objects which reflect infra-reds such as green grass appear a light gray. Tubes of lower sensitivity (curve D) have a smaller response to infra-red, but also lack high sensitivity to incandescent light. Because of the wide range in spectral response, it is difficult to obtain two matched 2P23's. In one tube grass might appear gray and in another nearly white. Usually, in operation, a higher-sensitivity tube tends to lose infra-red response and sensitivity so that its characteristics gradually shift towards those of the lower-sensitivity tube.

The 5769 and 5655 make use of a photosurface that has a fairly good blue response but is deficient in the yellow and red compared to the response of the human eye. Curve B of Figure 1 is a typical curve for these two tube types. The sensitivity to 2870 degrees Kelvin

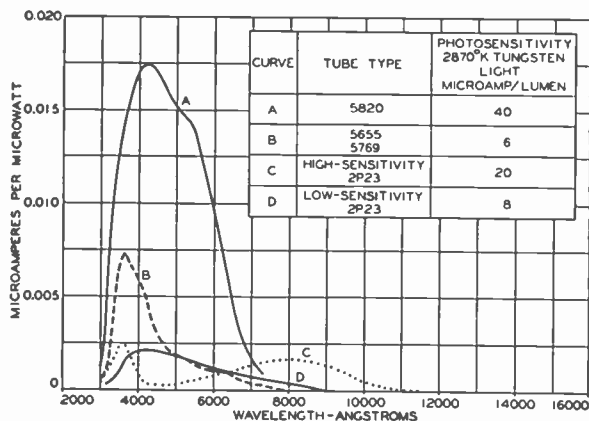

Fig. 1—Spectral sensitivity characteristics of image orthicons.

incandescent sources is much lower than that of the higher 2P23. For blue-rich sources such as fluorescent lights or blue skylight, however, the sensitivity of the 5769 or 5655 may be actually higher. In the studio, the use of a proper balance of fluorescent base lighting and incandescent "modeling" leads to a fairly good color rendition with the 5655 or 5769, but the lack of good yellow and red response tends to give flat facial appearances.

CHARACTERISTICS OF THE 5820

Curve A of Figure 1 shows the spectral sensitivity characteristic of the new photosurface incorporated in the 5820. The surface has a high sensitivity to 2870 degrees Kelvin incandescent sources—on the average 40 microamperes per lumen. Because its spectral response is fairly close to that of the eye, the total response does not depend greatly on the type of light source. For incandescent, fluorescent, and

daylight sources, the response of the surface will average about the same. The curves of Figure 2 show how the spectral response of the 5820 compares with that of the eye. Curve A of Figure 2 gives the uncorrected response of the tube, Curve B the response when a Wratten No. 6 filter is used, and Curve C gives the eye response. If a picture of various colored objects is observed critically on a 5820 without a filter, it can be noted that although the reds and yellows give about the same response as the eye, the blues and greens appear to be somewhat lighter to the tube than to the eye. This characteristic, however, will be objectionable only under special conditions. The use of a Wratten No. 6 filter drops the blue and green response to nearly the eye value with a loss of sensitivity of only about one lens stop. The closeness of the response to that of the eye makes the problem of proper scenery and makeup a much simpler one. In general, if lighting and makeup look satisfactory to the eye, the camera will also give a good color rendition. Any further changes that are made can be checked with the eye without the

need of televising the scene.

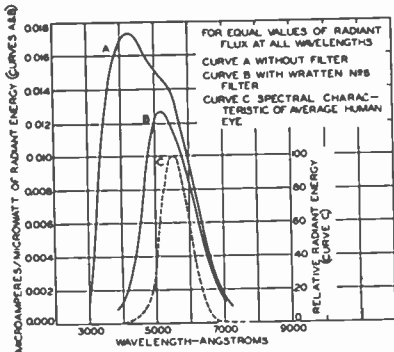

Fig. 2—Comparison of spectral sensitivity characteristic of type 5820, with and without a filter, with that of the average human eye.

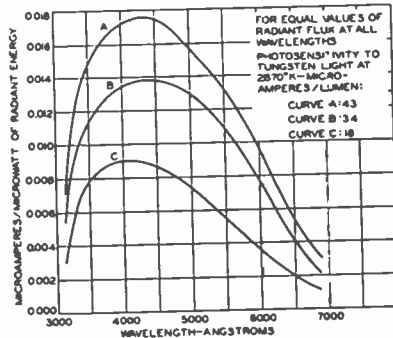

Fig. 3—Spectral sensitivity characteristic of three different 5820's.

Figure 3 gives the spectral response characteristic of three different 5820's all with the new photosurface. As these curves indicate, there is some variation in spectral response from tube to tube, especially in the region of 5000 to 6000 angstrom units. This variation is much less than that encountered among 2P23's and, under normal use, is not noticeable.

OPERATING CONSIDERATIONS

The much higher sensitivities of the 5820 poses some problems in its use. With a lens aperture of f:2.8 it is possible to obtain a usable

picture with only 1 or 2 foot-candles of illumination. Such low light levels, however, should be used only when there is no other way of obtaining a picture. To obtain good depth of focus and to pick up the grays near black, a light level of 20 to 30 foot-candles should be used. In the studio, it is very seldom worthwhile to drop below about 100 foot-candles. With too low a light level, modeling lights will give too sharp contrasts which are undesirable unless special effects are wanted. It is better to use a base lighting of perhaps 50 to 60 foot-candles of fluorescent light and to use modeling lights to build up the total illumination to approximately 100 foot-candles. In the studio, slim-line instant-start white fluorescent lights of 3500 to 4500 degrees Kelvin are satisfactory for base lighting.

When the 5820 is used for outdoor pickup, operators will encounter a problem of too much light on very bright days. In this case, the use of neutral filters is helpful. When the illumination is of the order of several thousand foot-candles, as is obtained with bright sunshine, a Wratten neutral filter with a transmission of 5 per cent can be used. For slightly cloudy days with an illumination of 500 to 1000 foot-candles, a filter with a transmission of 10 per cent should be satisfactory. Because of the higher sensitivity of the 5820, stray light also will be troublesome. Wherever the possibility of stray light entering the lens exists, a lens shield should be used.

FEATURES OF PHOTOSURFACE

In addition to the gain in sensitivity and the improvement in spectral response, the use of the new photosurface has led to other desirable characteristics. In the 5769 and 5655 the photosurface is quite transparent so that a good deal of light passes through it. This light may be reflected from different parts of the image section and return to the photocathode where it will cause unwanted photo emission. Also, because all of the targets are somewhat photosensitive, light passing through the photosurface can cause trouble in the darker parts of the picture. The lower degree of transparency of the new surface reduces both of these effects. In addition, the much higher photosensitivity of the new surface will in itself cause a reduction in the amount of light reaching the target and, therefore, reduce the emission of unwanted electrons from the target. Because of these features, the 5820 gives a picture with a better gray scale and more "snap". The new tube also has, on the average, better resolution than its predecessors although all the reasons for this improvement have not as yet been fully determined.

Fig. 4—Typical signal output of type 5820.

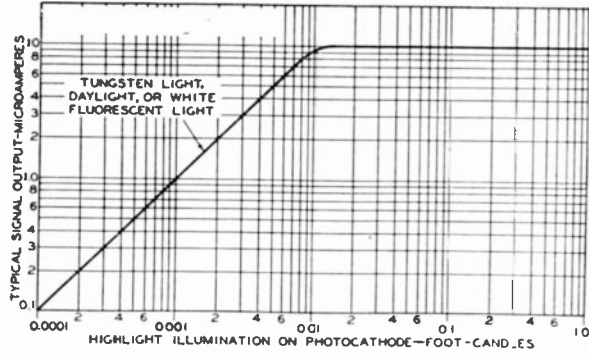

ILLUMINATION AND CAMERA REQUIREMENTS

Figure 4 is a simplified curve of the signal output of the 5820. This curve is for a small white object on a black background, but it holds reasonably well for a more complicated picture. Photocathode illumination at the knee of the curve averages about 0.01 foot-candle. The curves of Figures 5a and 5b show how much illumination is needed for a given angle of view and for a lens with a given *f*: number. Two sets of curves are given—one for black-and-white rendition and one for better half-tone rendition. These curves are calculated from the simple formula,

$$I_s = \frac{4f^2 I_{pc} (m + 1)^2}{TR}$$

where

I_s = scene illumination in foot-candles. This value is the illumina-

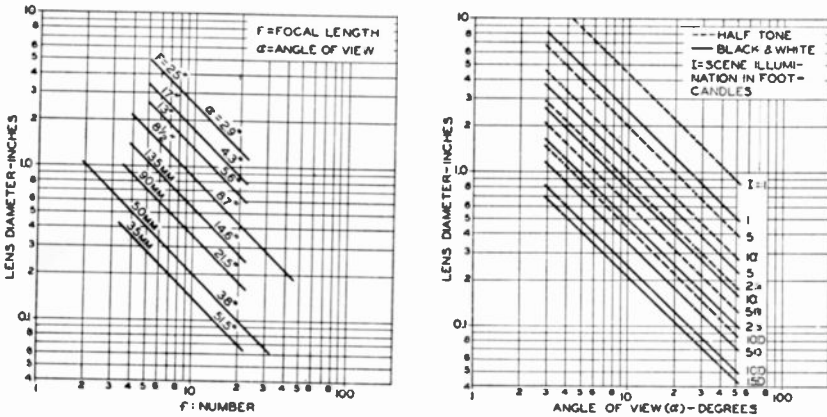

Fig. 5—Illumination requirements for various lens diameters, *f*: numbers, and angles of view.

tion on the scene measured with a light meter positioned towards the lens of the camera,

$f = f$: number of lens,

I_{pc} = photocathode illumination in foot-candles,

m = linear magnification of scene to target,

T = total transmission of lens,

R = reflectance of principal subject in scene.

For black-and-white rendition, the conditions are set up for a barely acceptable picture, i.e., one in which the high lights just reach the knee of the curve. The reflectance R for these high lights is taken as 0.5, the lens transmission as 75 per cent (there will be some error here as not all the lenses will have this transmission), I_{pc} is taken as 0.01 foot-candle, and m can be neglected. For half-tone rendition, the conditions are the same as for black and white except it is assumed that the reflectance of the object when the high lights just reach the knee of the curve is 0.16. Figure 5a shows the effective lens diameter or opening in inches plotted against the f : number of the lens. Curves are given for many of the lenses used with television cameras along with their respective angle of view. Figure 5b gives the lens diameter plotted against angle of view for different values of scene illumination for both black-and-white and half-tone rendition. The following examples illustrate how these curves can be used. In the studio, a scene has an illumination of 100 foot-candles. For half-tone rendition and an angle of view of 8.7 degrees, the required lens diameter of 0.5 inch is determined from Figure 5b. In Figure 5a, it can be seen that for an 8.7-degree lens with a diameter of 0.5 inch, an f : number of 17 is satisfactory. For an outdoor shot with a scene illumination of only 10 foot-candles where black and white may be useful, Figure 5b shows that a 2.9-degree angle of view calls for a lens diameter of 2.6 inches. In Figure 5a this value of lens diameter corresponds to an f : number of 10.

For complete information, curves of depth of focus for each lens should be included. These curves, however, would be very complicated because a separate curve is needed for each f : number and each object distance. This information, in most cases, is either given on the lens or can be obtained from the lens manufacturer.

ACKNOWLEDGMENT

Many groups have contributed to the success of these new tubes. In the Tube Department at Lancaster, the authors wish to acknowledge the help of L. Young, A. D. Cope and J. K. Johnson in the fabrication and processing of the tubes, and A. A. Rotow for his extensive testing.

THE VIDICON — PHOTOCONDUCTIVE CAMERA TUBE*†

BY

PAUL K. WEIMER, STANLEY V. FORGUE AND ROBERT R. GOODRICH

Research Department, RCA Laboratories Division,
Princeton, N. J.

Summary—Simplification of design, high sensitivity and good resolution are available in a new tube having a photoconductive target. Its application results in economy of equipment designed for unattended industrial applications as well as broadcast use.

THE phenomenon of photoemission of electrons has been widely used for the light-sensitive surface of television pickup tubes. This is true for the image orthicon¹ as well as for its predecessors, the orthicon and the iconoscope.

The related phenomenon of photoconductivity has not been employed in any commercially useful pickup tube. However, this application of photoconductivity has by no means been ignored either in the experimental laboratories or in the patent literature. In fact, one of the earliest proposals for a television system envisioned the use of a selenium photoconductive cell in combination with a mechanical scanning disc. Actually, the sluggish frequency response of the selenium cells made them inadequate for this application. Photoemissive cells which became available in the early part of this century were found to be much more suitable.

During the middle 1930's, work on photoconductive targets for television pickup tubes was carried on in this country,² as well as in England³ and Germany.⁴ In these experiments an electron beam similar to that used in the iconoscope scanned the photoconductive target. This mode of operation allowed the possibility of obtaining increased

* Decimal Classification: 621.388.

† Reprint from *Electronics*, May, 1950.

¹ Rose, Weimer and Law, "The Image Orthicon—A Sensitive Television Pickup Tube", *Proc. I.R.E.*, Vol. 34, No. 7, p. 424, July, 1946.

² Iams and Rose, "Television Pickup Tubes with Cathode Ray Beam Scanning", *Proc. I.R.E.*, Vol. 25, No. 8, p. 1048, August, 1937.

³ Miller and Strange, "The Electrical Reproduction of Images by the Photoconductive Effect", *Proc. Phys. Soc.*, Vol. 50, p. 374, 1938.

⁴ Knoll and Schroeter, "Transmission of Pictures and Signals by Insulating and Semi-conducting Surface", *Phys. Zeitschrift*, Vol. 38, p. 330, 1937.

sensitivity by means of storage. Furthermore, the photoconductor needed to respond to changes in light intensity no faster than thirty cycles per second as compared to the several million per second that is required for nonstorage operation.

None of these experiments resulted in a useful tube able to compete with the iconoscope available at that time. The principal defects were insensitivity, retention of images and spurious spots on the target. Once again photoconductivity for pickup tubes was set aside at least temporarily in favor of photoemission whose processing art was somewhat more advanced.

Work done during the war on photoconductive materials for infrared detectors has served to focus attention on the basic advantages which photoconductivity has to offer to television pickup tubes. It is well known that the light sensitivity obtainable with photoconductive cells greatly exceeds that reported for any photoemissive cells. Whereas a sensitivity of 50 microamperes per lumen (about 0.10 electron per quanta) is considered good for photoemission, tens of thousands of microamperes per lumen (many electrons per quanta) are not uncommon with some photoconductive materials. (An image orthicon employing a photocathode giving 50 microamperes per lumen has an operating sensitivity comparable to that of the human eye.)

If high-sensitivity materials suitable for pickup tube targets could be found, the benefits could be used in two ways. Perhaps least important at present would be the possibility of developing tubes capable of operating at much lower light levels. An improvement of about 10 times over that of the present day image orthicon⁵ is theoretically possible, assuming that on the average, the best photoemitting surfaces are only 10 per cent efficient. Second and more important, any sizeable increase in target sensitivity would permit such simplification in pickup tube design as to open up entirely new fields of application. The electron image section and the electron multiplier, which have been required in the image orthicon for good sensitivity, may be entirely eliminated. The tube is reduced to the basic elements of gun and target. This makes for economy, compactness and simplicity of operation.

In addition, all the tube dimensions may be scaled down, if desired, because the extra target sensitivity is available to compensate for the reduction in target area. It was easily conceivable that a simple, compact and dependable television pickup tube would find many applications in industry, business and in scientific investigations far wider than that of entertainment broadcasting.

⁵ Janes, Johnson and Moore, "Development and Performance of Television Camera Tubes", *RCA Review*, Vol. 10, No. 2, p. 191, June, 1949.

Work on photoconductive pickup tubes has been carried on intensively at RCA Laboratories during the past several years. High-sensitivity materials suitable for targets have been found and many experimental photoconductive tubes of various sizes have been tested. The name "vidicon" has been coined to distinguish these tubes from the photoemissive tubes.

The particular form of vidicon to be described is in an advanced stage of experimental development. It is one inch in diameter and six inches long, and is particularly suited to industrial applications. It appears likely that both larger and smaller forms of vidicons will eventually become available for other applications.

The comparative sizes of the vidicon and the image orthicon are shown in an accompanying photograph. A miniature television camera⁶ employing the vidicon is also illustrated.

Experimental one-inch-diameter vidicon, with the standard commercial image orthicon in the background.

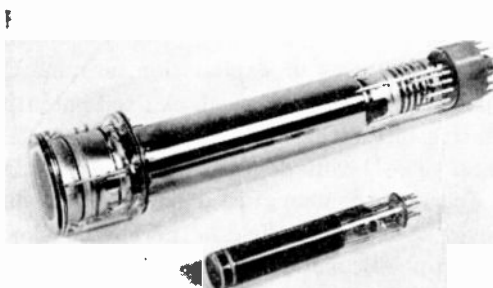

ONE-INCH VIDICON

The cross-sectional diagram of an experimental tube given in Figure 1 shows the relative positions of the gun and the target.

As shown in Figure 2, the photoconductive material is deposited on the transparent conducting signal plate and scanned directly by the electron beam. A uniform magnetic field is used to focus the beam. The velocity of impact of the beam may be either below first crossover as in the orthicon, or above first crossover as in the iconoscope. The video signal is taken from the target by connecting the amplifier to the transparent signal plate. The wall screen shown in Figure 1 provides a uniform field in front of the target, but does not appear in the transmitted picture.

⁶ Webb and Morgan, "Industrial Television System", paper presented at IRE National Convention, New York, March, 1950.

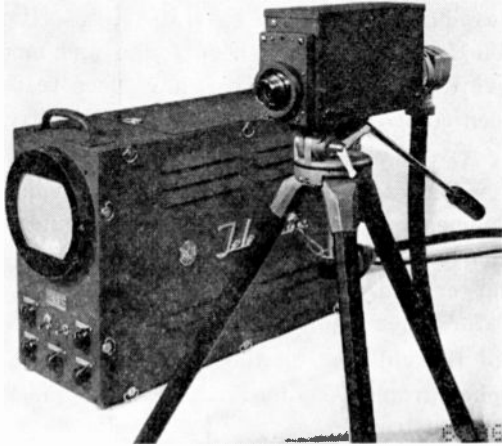

Miniature television camera employing the vidicon pickup tube⁶, monitor in background.

CHARGE-DISCHARGE CYCLE

For purposes of explanation, assume that a low-velocity orthicon-type scanning beam is used. A fixed potential of about 20 volts positive, relative to the thermionic cathode, is applied to the transparent signal plate. The beam deposits electrons on the scanned surface of the photoconductor charging it down to thermionic cathode potential. Although considerable field is thereby developed across the opposite faces of the photoconductor, its conductivity is sufficiently low that very little current flows in the dark.

If a light image is focused on the target, its conductivity is in-

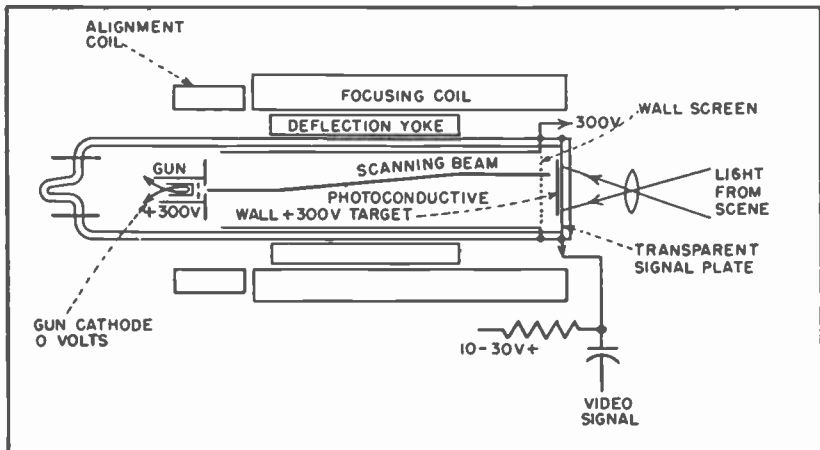

Fig. 1—Cross-sectional diagram of an experimental vidicon photoconductive television pickup tube.

creased in the illuminated portions, thus permitting charge to flow. In these areas the scanned surface gradually becomes charged a volt or two positive with respect to the cathode during the 1/30-second interval between successive scans.

The beam deposits sufficient electrons to neutralize the accumulated charge, and in doing so generates the video signal in the signal plate lead. It will be noted that the target is sensitive to light throughout the entire frame time permitting full storage of charge.

The charge-discharge cycle is identical to that of the orthicon with the exception that the positive charging effect is achieved by photoconduction through the target itself,

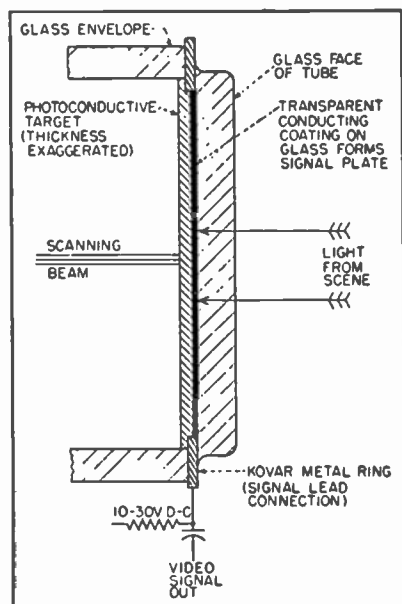

Fig. 2—Detail of the target construction in the experimental photoconductive camera tube.

rather than by photoemission from the scanned surface. This mode of operation requires that the resistivity of the photoconductive target be sufficiently high that its time constant exceeds the 1/30-second television frame time. A dark resistivity of 10^{12} ohm-centimeter or greater is satisfactory.

Many materials such as selenium, sulfur, as well as the sulfides, selenides and oxides are known to be photoconducting. Several of these materials when properly processed have been found suitable for pickup tube targets. The spectral response is a function of the material and the processing. Targets which are sensitive to the entire visible range of the spectrum have been made.

OPERATING CHARACTERISTICS

Photoconductive targets free from the spurious spots and lag which troubled the earlier workers, have been made. Sensitivities in excess of 1,000 microamperes per lumen are obtainable. Resolution is limited only by the electron optics of the beam while in the image orthicon a fine mesh screen at the target limits resolution.

The one-inch diameter vidicon is capable of resolving more than 600 lines. Under similar conditions the larger image orthicon will give about fifteen hundred lines. The capacity of the target may be made

sufficiently large in any size target that the high light signal-to-noise ratio of the output signal can be as high as needed.

The signal-versus-light curve is linear at low lights as in an orthicon, but with some flattening off at high light levels. In general, the photoconductive targets made to date will not accommodate as wide a range of light levels for a given lens aperture as an image orthicon. For extremely bright illumination on the target, the picture loses contrast without any tendency for unstable charge up as in the early orthicon. An image orthicon under similar conditions would maintain good contrast by virtue of the redistribution of secondary electrons on the picture side of the glass target.



Photograph of picture transmitted by a one-inch vidicon.

In general, pickup tubes with photoconductive targets are simpler in operating adjustments than an image orthicon. The electron image focusing control is completely eliminated, and the target voltage adjustment is somewhat less critical.

The high signal level obtainable at the target removes the need for an electron multiplier whose contribution to spurious spots and shading in the image orthicon has been a steady source of concern. The beam-current adjustment is accordingly less critical. In short, the simplicity of operation of the photoconductive targets combined with

their adaptability for small tubes has made them particularly suitable for equipment designed for unattended industrial applications.

Sufficient satisfactory tubes have been constructed in the laboratory to demonstrate the advantages listed above. However, questions of tube life, allowable temperature limits and reproducibility of results will require additional intensive development before equipment reliable enough for industrial use can be made available. For example, conditions necessary to ensure targets free of objectionable time lag are still in an experimental stage.

SENSITIVITY OF THE TUBE

A one-inch vidicon possessing a target sensitivity of 300 microamperes per lumen will transmit a noise-free picture with a scene brightness of several foot-lamberts using an $f/2$ lens. Since this light level is less than ordinarily present in most laboratories or factories, special lighting is not required.

It is impossible to compare the relative sensitivities of the vidicon and the image orthicon without specifying at what light level the comparison is being made. At intermediate light levels, with a few foot-lamberts scene brightness, the two tubes will transmit a picture having about the same signal-to-noise ratio. At higher light levels, the vidicon will deliver a higher signal-to-noise ratio than the image orthicon since its target capacity is higher. At lower light levels its signal-to-noise ratio will be inferior to that of an image orthicon with a multiplier.

This follows from the fact that the noise background for the vidicon is the amplifier noise that remains fixed at all light levels, while for the image orthicon it is shot noise in the scanning beam, which may be reduced somewhat for low signal levels. With the development of still more sensitive targets, the vidicon without a multiplier may be expected to exceed the present image orthicon at all light levels.

It will be noted that the elimination of the electron multiplier will require a stronger beam current at the target of the vidicon than in the image orthicon. Assuming the input noise of the video amplifier to be 2×10^{-3} microampere, a target current of 0.2 microampere is required for a signal-to-noise ratio of 100. This current is about ten times that required in the image orthicon.

Some explanation as to why a smaller pickup tube may require a more sensitive target for equal scene brightnesses is in order. If the entire tube and optical system are scaled down in size, keeping the same f number lens, the quantity of light in lumens intercepted by

the lens is reduced. The output signal of the tube in microamperes is also reduced unless the target sensitivity in microamperes per lumen is increased.

On the other hand, if the lens diameter for the small tube were kept the same as for the large tube, no increase in target sensitivity is necessary. However, for the same angle of view this means a faster or slower *f* number lens. Such lenses, if available at all, are likely to be less highly corrected and more expensive. Thus, in general, the smaller tube will be operated with smaller diameter lenses requiring higher scene brightnesses or more sensitive targets. The gain in depth of focus accompanying the use of the smaller diameter lens may, however, be very useful. Motion picture 16-millimeter lenses have been found to be satisfactory.

ACKNOWLEDGMENT

The writers wish to thank V. K. Zworykin and Albert Rose for their continued interest and advice during the course of this work. The construction and testing of tubes has been greatly aided by the cooperation and assistance of A. D. Cope and P. G. Herkart. We are indebted to S. M. Thomsen for preparation of photoconductive materials. The development of miniature camera equipment by R. C. Webb and J. M. Morgan has facilitated the evaluation of tube performance.

THE IMAGE ISOCON — AN EXPERIMENTAL TELEVISION PICKUP TUBE BASED ON THE SCATTERING OF LOW VELOCITY ELECTRONS*†

BY

PAUL K. WEIMER

Research Department, RCA Laboratories Division,
Princeton, New Jersey

Summary

The image isocon is a new experimental television pickup tube similar in performance and physical appearance to an image orthicon. However, a novel method of generating the video signal is used giving an output signal of opposite polarity with the maximum current in the light. This results in an improved signal-to-noise ratio in the darker parts of the picture and freedom from spurious signals caused by multiplier dynode spots. The low-light sensitivity is comparable to that of the image orthicon, but a wider range of light levels can be accommodated without readjustment of the beam current. Resolution of experimental image isocons has been slightly inferior to the conventional image orthicons but this is partially compensated by their inherent freedom from dynode spots whose presence in the image orthicon occasionally requires deliberate defocusing of the beam. The more exact electron optical requirements of an image isocon place a greater burden on the skill and patience of the operating crew. Most experimental tubes have shown more objectionable time lag than found in an image orthicon. Closer tolerances in tube and coil design are required in an image isocon for consistent and reproducible results. Applications of the electron optical techniques used in the image isocon are suggested for storage tubes and pickup tubes for color.

(21 pages, 14 figures)

* Decimal Classification: R583.11.

† RCA Review, September, 1949.

NEW TV STUDIO RELAY SWITCHING SYSTEM*†

BY

W. E. TUCKER AND C. R. MONRO

Engineering Department, RCA Victor Division
Camden, N. J.

Summary

A video switching system is described which provides an economical means of switching for small stations, is adaptable to modifications for

* Decimal Classification: R583.3.

† Tele Tech, August, 1949.

enlargement, and which finds important applications in large stations where it is impossible to use manual switching.

(3 pages, 7 figures)

MIXING LOCAL AND REMOTE TELEVISION SIGNALS*†

BY

J. M. WEAVER AND W. E. WELLS

Engineering Department, National Broadcasting Co., Inc.,
New York

Summary

Circuits are described which solve the problem of fading composite video signals from sources controlled by different sync-generators.

(3 pages, 5 figures)

* Decimal Classification: R583.3.

† *Tele Tech*, January, 1950.

TELEVISION PHOTOMETRY AND OPTICAL BACKGROUND*†

BY

R. L. KUEHN

Engineering Department, National Broadcasting Co., Inc.,
New York

Summary

A method is suggested for obtaining direct and precise light measurements for scenes being televised with an image orthicon. The use of projected backgrounds is discussed.

(3 pages, 6 figures)

* Decimal Classification: R583.2.

† *Tele Tech*, July, 1949.

STANDARDIZATION OF THE TRANSIENT RESPONSE OF TELEVISION TRANSMITTERS*†

BY

R. D. KELL AND G. L. FREDENDALL

Research Department, RCA Laboratories Division,
Princeton, N. J.

Summary—Standardization of the square-wave response of a television transmitter is suggested on the basis of a comparison of the response of a standard monitor to square-wave signals generated by the transmitter and the calibrated response of the monitor to a double-sideband television signal modulated by a square-wave.

Standardization of picture monitors also appears to be imperative because uniform quality of transmission is desirable from all broadcasters.

INTRODUCTION

WHEN the standards of the present television system were agreed upon by the engineers of the industry, it was realized that additional standards relating to the amplitude and phase or some equivalent characteristics of the transmitter would have to be adopted later in order to fully specify the picture quality or fidelity. At that time there was insufficient technical data and operating experience with the complete television system to specify the additional standards and tolerances. There was, however, sufficient experience with vestigial sideband transmission and reception for standardization of the radio-frequency amplitude characteristics of the transmitter and receiver, which are shown in idealized form in Figure 1. It is specified that the carrier position in the receiver shall be at the point of 50 per cent amplitude response and that the lower sideband spectrum and part of the upper sideband spectrum shall be attenuated as shown. It is standard that the amplitude response in the transmitter shall substantially cover the receiver characteristic since the basic premise of the entire arrangement is that receiver operation shall be essentially the same whether the receiver is supplied with signal from a double-sideband signal generator or from a transmitter in which the lower sideband is suppressed beyond the frequency at which the receiver has no response. It was assumed that eventually the phase characteristic of the vestigial sideband transmitter would be specified. Adherence to standards is required of broadcasters. The observance by manufacturers of receivers can only be advised.

* Decimal Classification: R140.

† Reprinted from *RCA Review*, March, 1949.

During the seven years since the adoption of the standards shown in Figure 1, considerable knowledge concerning the fidelity of transmitters and receivers has been accumulated. In this paper a basis is proposed for additional standards equivalent to a specification of amplitude and phase but logically superior. The suggested standards will include phase compensation networks for installation in the video section of the transmitter that will make possible the attainment of the fidelity of which the present system is capable.

Sole dependence on the amplitude and phase characteristics of various parts of the system as the criterion of fidelity of picture transmission has proven to be illusive because these quantities are not directly observable in a television picture, and therefore are difficult to specify with logical tolerances. In a television picture of high fidelity the transitions in half-tones corresponding to abrupt changes in the subject are sharp and there is a minimum of spurious halftone variations, such as leading whites or blacks, ringing, long black or white smears, and so forth. Possible tolerances or permissible deviations

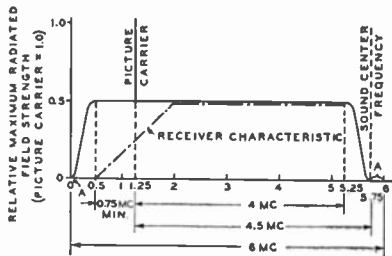

Fig. 1—RMA idealized amplitude characteristics of transmitter and receiver.

of phase and amplitude from the distortionless state within the channel would have to be tried in connection with the transmission of critical waveforms which permit observation of abrupt transitions and spurious signals. Such a critical waveform that has received general recognition by engineers is the unit function or its practical equivalent, the square wave. The abrupt transition in a square wave

represents an abrupt transition in picture halftone value that involves the transmission of video frequencies ranging from a few hundred kilocycles to 4 megacycles per second. The flat part of a square wave permits testing for long black or white smears and involves the lower frequencies of the video spectrum beginning with 60 cycles per second. It is reasonable, therefore, to use the square-wave response as the primary measure of the overall performance of the television system. In brief, the standard of Figure 1, which defines the type of transmission, may be supplemented by standards which prescribe certain significant characteristics of the wave shape of the output of a

standard monitoring receiver in response to a square wave applied

SQUARE-WAVE RESPONSE OF A TELEVISION RECEIVER

The concept of a standard receiver appears to be necessary in the discussion of transmission and reception in a vestigial sideband system. The sidebands of the radiated signal are not in proper balance until the signal is passed through a selective receiving circuit having an appropriate amplitude response such as the standard response of Figure 1. It is obvious that all broadcasters should monitor with a standardized receiver so the transmission characteristics of various transmitters will not vary. A chaotic condition is likely to occur if monitors are non-standard. At this point it is sufficient to observe that a monitor should be a good receiver, the performance of which could be duplicated in a high-grade commercial television receiver. The combined radio-frequency and intermediate-frequency amplitude response should approximate that shown in Figure 1. Before a basis for the specification of standard monitor is given, a preliminary study of the square-wave response of actual television receivers is helpful.

The response of a certain commercial receiver to a square-wave transition generated by a double-sideband laboratory signal generator is shown by curve 4, in Figure 2. This simulates the ideal functioning of the transmitting portion of the television system and permits analysis of the receiver alone¹. The ultimate criterion by which the real receiver may be judged is curve 3, the response of an idealized receiver having the RMA amplitude characteristic of Figure 1 and a linear phase characteristic. The real response (curve 4) departs from the idealized response in two respects. First, the time of rise of the real transition (0.13 microseconds) as measured between the points of 10 per cent and 90 per cent response is greater than that of the idealized transition (0.1 microseconds), and second, the transition itself is dissymmetrical. The time of rise T , is a measure of capability of the receiver for the reproduction of sharp edges or transitions in picture halftones. Symmetry or dissymmetry of the transition as relates principally to the damped oscillatory component, commonly termed a "cutoff transient", occurs before and after the main transition of curve 3, but only after the transition of curve 4. Cutoff transients appear visually as striated patterns near the transition and are seen more clearly when the amplitude is large and the frequency of repetition is low. The question which naturally arises concerning the desira-

¹In all observations cited, the depth of modulation of the radio-frequency carrier was moderate so that the peculiarities of vestigial sideband transmission near 100 per cent modulation were avoided. For a discussion of these effects see R. D. Kell and G. L. Fredendall, "Selective Sideband Transmission in Television", *RCA Review*, Vol. 4, pp. 425-440, April, 1940.

bility of a symmetrical cutoff transient is answered in the following section.

In practice, means must be provided at the transmitter for the attenuation of one sideband in accordance with Figure 1. This attenuation is provided in the output of the laboratory signal generator by the use of a commercial vestigial sideband filter identical in design to those currently used in the field². In some transmitters sideband attenuation is accomplished in several cascade stages of band-pass amplification at the radio-frequency level³. Ideally, the square-wave response measured at the output of the receiver should remain

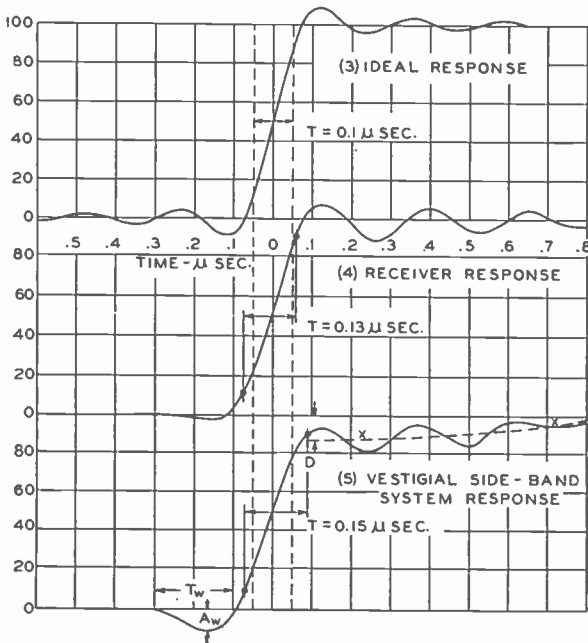

Fig. 2—Square-wave response of ideal receiver and an actual receiver.

unchanged when the vestigial sideband transmission is substituted for a double-sideband transmission. However, there is additional waveform distortion introduced into the response due principally to phase distortion associated with the attenuation of the sideband spectrum. This is shown in curve 5 of Figure 2. A leading spurious signal T_w which is barely evident in double sideband operation, curve 4, is prominently displayed in curve 5. If the transition is from white to black the spurious signal appears as a leading white; if the transition is from black to white the spurious signal is a leading black. The

² RCA vestigial sideband filter, type M19104-4 for channel 4.

³ "Design Trends in Television Transmitters", *Electronics*, Vol. 21, p. 76, January 1948.

time interval occupied by this signal, as well as its amplitude, is of considerable importance. Usually the interval T_w is about equal to a complete cycle of the cutoff transient, and therefore represents a visible halftone variation when the viewing distance is such that the eye tends to average the variation of a cycle of the cutoff transient without responding to the halftone variation over the cycle. The axis XX of the cutoff transient represents the general trend in halftone variation as the transition attains the final level of 100 per cent. If the axis does not coincide with the final level a smear component is thereby introduced following the abrupt transition. A measure of the smear component is the deviation D of the axis from the reference level of 100 per cent and the length of time required for the axis to attain this level. The slope may be either positive or negative, depending in part upon the position of the carrier on the receiver characteristic. Operation below the point of 50 per cent response tends to result in a negative slope.

Recourse to the steady-state characteristics of amplitude and phase is helpful in explaining the various aspects of the square-wave response. Fortunately, the square-wave response contains all of the information necessary for derivation of the effective or overall amplitude and phase distortion of the receiver⁴. The term "overall video distortion" is especially appropriate

since the picture signal enters the signal generator as a video signal and reappears at the terminals of the picture tube as a video signal. Distortion originating in the radio-frequency, intermediate-frequency, or the video sections of the receiver are conveniently lumped as an equivalent video distortion. Figure 3 shows the steady-state characteristics for double-sideband operation of the receiver. A more convenient term, the relative time delay, equal to $\phi/2\pi f$ is substituted for the phase angle, ϕ . The amplitude and delay characteristics of an ideal receiver would be independent of frequency out to a limit imposed by the width of the television channel. However, in practice both the amplitude and delay characteristics fall short. The delay distortion in Figure 3 exhibits a sharp up-turn at the end of the video band in

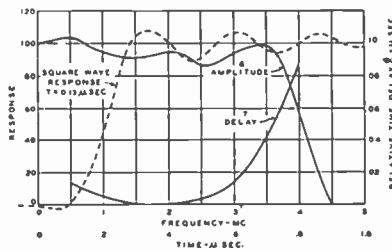

Fig. 3—Receiver (A) DSB transmission.

⁴ A. V. Bedford and G. L. Fredendall, "Analysis, Synthesis, and Evaluation of the Transient Response of Television Apparatus", *Proc. I.R.E.*, Vol. 30, pp. 440-457, October, 1942.

the range 3 to 4 megacycles as a consequence of the cutoff of the intermediate-frequency and video-frequency amplifiers of the receiver. A more gradual increase in delay occurs as the frequency becomes lower over the range below 1.5 megacycles. If the delay distortion in the lower frequency interval and the delay distortion above 3 megacycles are removed, the magnitude of the following cutoff transients of curve 4, Figure 2 is approximately halved and a similar transient is added before the advent of the transition. That is, when the delay distortion in curve 4, Figure 2, is arbitrarily removed, the resulting response closely resembles curve 3, Figure 2, which is the ideal response. The remaining discrepancy in the compensated response is a slower time of rise caused by deficiencies in amplitude response, as revealed in Figure 3.

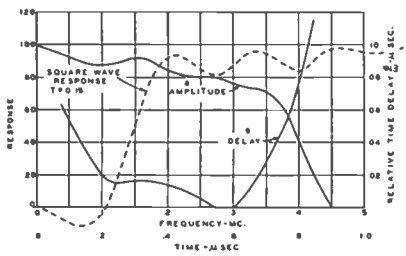

Fig. 4—Receiver (A) VSB transmission.

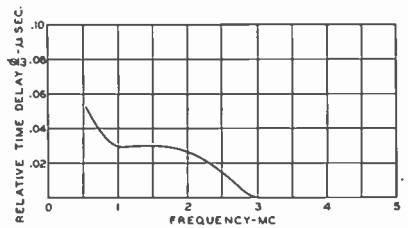

Fig. 5—Delay distortion introduced by VSB transmission.

A steady-state analysis corresponding to the square-wave response (curve 5) of the complete vestigial sideband system appears in Figure 4. It is seen here (curve 9) that the introduction of vestigial sideband transmission has acted chiefly to increase the delay distortion in the frequency range below 3 megacycles. The shape of the delay curve 9 above 3 megacycles is unaltered and is still controlled exclusively by the cutoff of the receiver. There is some modification of the amplitude characteristic. The effective delay distortion introduced by the filter as shown in Figure 5 is the difference between the overall delay characteristic measured with and without the filter.

The existence of this delay distortion due to the means for obtaining sideband attenuation prevents the reception of pictures with the full fidelity possible within the 4-megacycle video channel unless corrected. Fortunately, the delay distortion can be substantially removed by the use of phase compensating networks connected in the video input of the transmitter. For complete compensation, the delay of the correcting network is complementary to the overall time delay characteristic as calculated from the square-wave response of the receiver when supplied with signal from a vestigial sideband transmitter. A

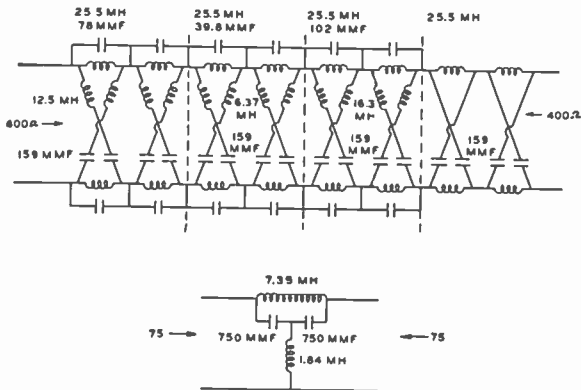

Fig. 6
Equalizer for phase distortion due to cut-off in receiver.

Equalizer for phase distortion due to VSB transmission.

very considerable improvement in the square-wave response of the receiver resulted when delay networks shown in Figure 6 were connected in the video input of the laboratory signal generator. The total correction consisted of two parts, (1) a bridged-T all-pass section for correction of the delay distortion introduced by the vestigial sideband transmission and (2) an eight-section lattice type network for the correction of delay distortion due to cutoff in the receiver. Figure 7 illustrates the successive stages of the improvement. Curve 4 is the response of the receiver to a double sideband signal taken from Figure 2; curve 5 is the uncompensated response of the receiver to the vestigial sideband signal taken from Figure 2; curve 11 is the response after compensation of the delay distortion due to the sideband filter; curve 12 is the response involving compensation of the delay distortion due to cutoff in the receiver, as well as compensation for the filter.

Compensation of the effective delay distortion due to vestigial sideband operation by means of video networks is not absolutely independent of the amplitude and delay characteristics of the particular receiver over the range for which the upper and lower sidebands are present⁵. This dependence does not exist if the correction is made in the radio-frequency section of the transmitter, but the utilization of all-pass networks at television radio-frequencies is not feasible in general. However, since the present television system has been established on the basis of the receiver characteristic illustrated in Figure 1, it is not anticipated that the

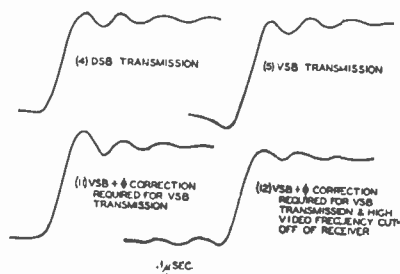

Fig. 7—Television receiver square-wave response.

⁵ See appendix 1, Eqs. (8) and (9); appendix 2, Eq. (14).

designs of various commercial receivers will differ to such an extent that a network can not be found that yields a high measure of correction for all receivers. Figure 8 confirms this assumption. Here the effective delay characteristic of the filter has been calculated from square-wave measurements made on unselected television receivers of five different manufacturers. In this figure no curve deviates seriously from the arithmetic average of all curves. Curve ϕ is the delay which is exactly compensated by the bridged-T network shown in Figure 6. It may be concluded, therefore, that this network connected in the video input of a transmitter will substantially compensate for the delay distortion due to vestigial sideband transmission. The means for attenuating one sideband of the transmitter in accordance with Figure 1 will differ depending upon the transmitter design of the various manufacturers. This means merely that the appropriate phase compensation networks for the transmitters of various types may differ slightly. Some amplitude compensation may also be required.

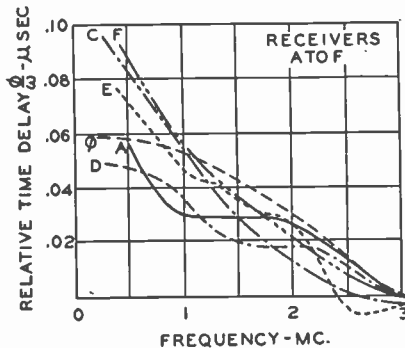

Fig. 8—Delay distortion introduced by VSB transmission.

The fidelity of receivers would be measurably improved if the delay distortion due to the high-frequency cutoff were compensated. Since involved networks such as the lattice structure in Figure 6 probably are required, their use would be justified only in receivers of the deluxe class. However, it is to be anticipated that the compensation required by the receivers of various manufacturers will be similar, since the amplitude response of all receivers must show high attenuation at the associated sound carrier. Similarity follows from application of the minimum phase shift law⁶. The possibility of including in the video section of the transmitter a delay correction for all receivers is convincingly demonstrated by the data taken on the receivers of various manufacturers as shown in Figure 9. The amplitude characteristics of this group of receivers ranged from substantially flat out to 4 megacycles to very low at 2 megacycles. The delay curves of this group of receivers are seen to be similar in the range 2.5 to 4 megacycles. Curve ϕ in Figure 9 is

⁶H. W. Bode, NETWORK ANALYSIS AND FEEDBACK AMPLIFIER DESIGN, p. 276, D. Van Nostrand Company, Inc., New York, N. Y., 1945.

the delay characteristic which is exactly compensated by the all-pass lattice structure shown in Figure 6.

COMPENSATION OF A TELEVISION TRANSMITTER

A working illustration of compensation is given in Figure 10, which shows the uncompensated and compensated response of a television receiver located in Princeton, New Jersey, to a signal radiated from television station WNBT in New York.

Figure 11 is a demonstration of the extent of phase compensation possible in television transmitter WNBT, Washington, D. C., when the networks shown in Figure 6 were inserted in the video frequency section of the transmitter without modification of this particular transmitter. In practice, adjustments would be made based on square-wave measurements of the transmitter.

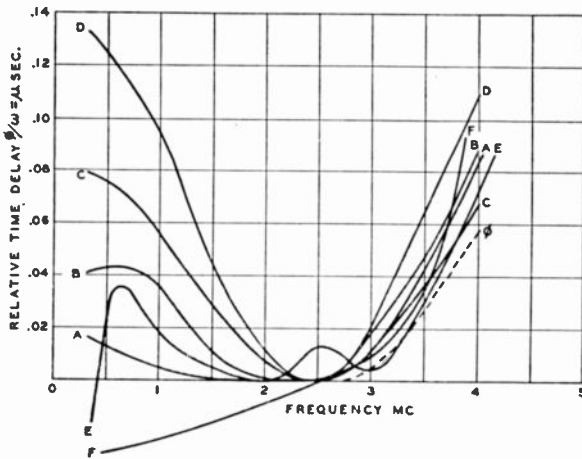

Fig. 9 — Overall delay characteristics of receivers of 6 manufacturers.

THE STATION PICTURE MONITORING RECEIVER

A standardized monitor is the first step in the direction of achieving uniform transmission characteristics among the television stations. Such a monitor should have the characteristics of a receiver of a high class that could be duplicated for domestic use if desired. The monitor would not include costly compensating circuits for the correction of delay distortion due to cutoff. There are various alternative approaches to the specification of a standard monitor. One alternative involves only steady-state amplitude and phase characteristics. It has been pointed out above, however, that this approach must depend finally upon transient response as a primary criterion. Hence, in devising the standards which are proposed here, reference is made only to

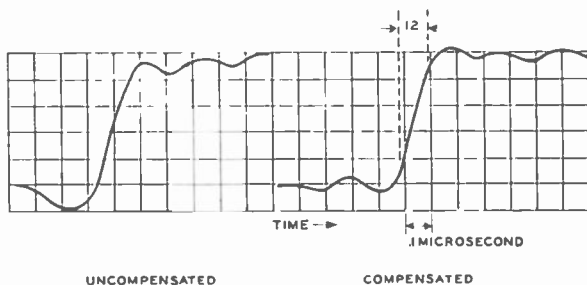

Fig. 10—Overall response of station WNBT + receiver at Princeton, N. J.

certain frequency intervals of the Radio Manufacturers Association (RMA) idealized receiver characteristics in Figure 1 that affect critically the performance of the monitor. One such interval is f_1 to f_4 (Figure 12) which contains the sloping portion of the amplitude characteristic. Tolerance in amplitude response of about ± 5 per cent are proposed from f_2 to f_3 as shown in Figure 12. This amounts to a definite restriction upon the position of the carrier between the points of 45 and 55 per cent response. Symmetry of the remainder of the sloping characteristic about the carrier position is desirable within limits as suggested in Figure 12. The amplitude of the wing response which occurs in the lower adjacent channel should not exceed a specified maximum of about 5 per cent. A restriction on this wing response is necessary in connection with the following specification of the transient response of the monitor. The portion of the RMA receiver characteristic between a frequency such as f_4 and the frequency associated sound, f_s , does not require specification since the overall video amplitude and phase response corresponding to this region may be divided in any physically possible way between the carrier-frequency and the video-frequency portions of the monitor. The net contribution is implicitly contained in the square-wave response of the monitor. The wing response beyond the associated sound should be restricted to a maximum amplitude of about 30 per cent. The response of the monitor to a double-sideband signal which is modulated with a square wave should be subjected to the tolerances illustrated in Figure 13. Such

Fig. 11—Overall response of station WNBW + station monitor.

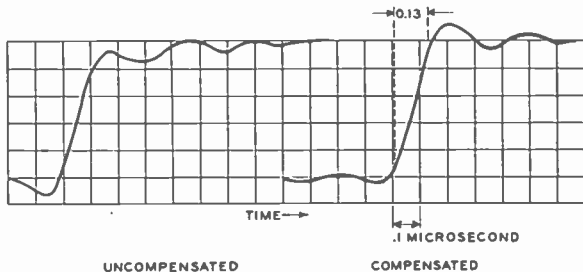
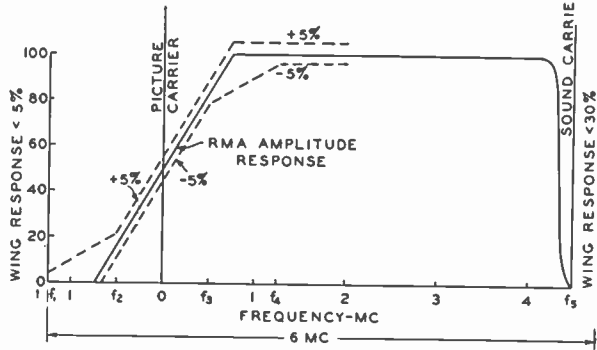

Fig. 12 — Standardization of amplitude characteristic of monitor.



tolerances pertain to the fidelity of a response to an abrupt transition, and therefore do not involve the low-frequency characteristics of the monitor. The time of rise as measured between the points of 10 and 90 per cent response shall not exceed a specified value, that is, the transition must lie within the region *ALG*. A time of rise at least as fast as 0.12 microseconds is attainable. The anticipatory signal shall be contained within the region *DEFLGHJ*. This limits the amplitude and length of the leading white and leading black signals. The cutoff transient shall be a damped sinusoid with a periodicity equal to or greater than 4 megacycles. Cutoff transients having a periodicity appreciably below the video cutoff frequency of $4\frac{1}{2}$ megacycles are visible at normal viewing distances. The axis of the damped cutoff transient shall lie within *A, B, C, C', B', A'*. This sets limits on the smear signal component. The maxima and minima of the cutoff transient measured from the axis of the transient shall not exceed a specified amplitude of about 20 per cent. Provision for a minimum rate of damping can be imposed by stating for example that the fourth

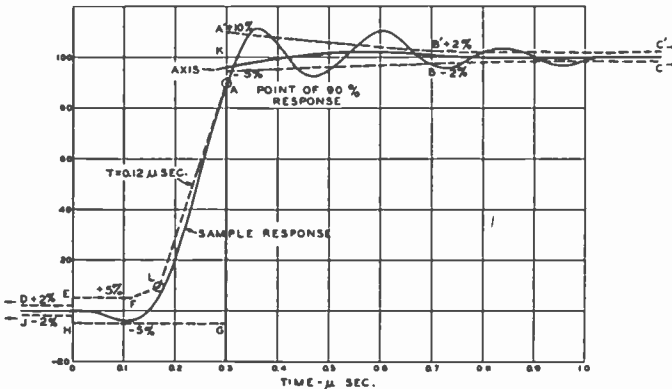

Fig. 13—Standardization of square-wave response of monitor.

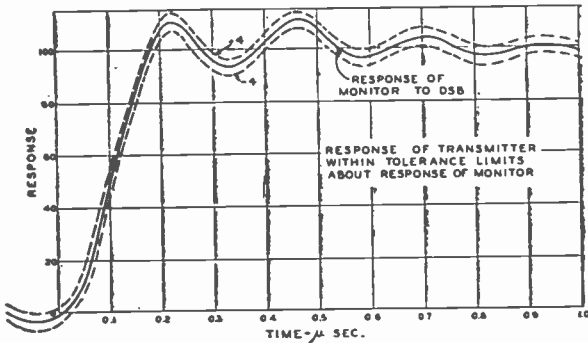

Fig. 14 — Standardization of square-wave response of transmitters.

and successive maxima and minima shall not exceed 2 per cent.

The response of the monitor corresponding to the rising and falling transitions of a square wave shall be subject to the same standard.

TRANSMISSION STANDARDS FOR TELEVISION TRANSMITTERS

A proposed standard for transmitters, including the means for sideband attenuation, involves essentially a substitution method wherein the monitoring receiver is the instrument for comparison of the transmitter with a double-sideband signal from a distortionless source such as a signal generator. Figure 14 illustrates one method for establishment of tolerances. The square-wave response of the monitor for a double sideband source is enclosed by two limiting curves, which represent the tolerable limits. The response of the monitor to an acceptable transmitter would lie within the area formed by these. Compensating networks such as those used for compensation of phase distortion introduced by the sideband attenuating means would be regarded as an integral part of the transmitter when the comparison with a double-sideband signal is made. The standardized phase compensation for distortion due to cutoff in the average receiver is conveniently specified on a basis of the steady-state delay and is not included when Figure 14 is considered. Figure 15 is the delay characteristic of the compensating network shown in Figure 6.

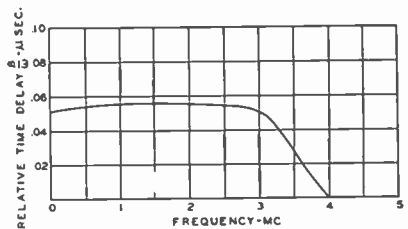

Fig. 15 — Delay characteristic of network for compensation of phase distortion associated with cut-off in receiver.

STANDARDS FOR LOW-FREQUENCY RESPONSE

The effects of amplitude and phase distortion in the low-frequency video spectrum ranging from 60 cycles per second to about 100 kilocycles per second has been extensively studied by means of square-waves having a repetition rate of 60 cycles per second. The fidelity of television apparatus is judged by the extent of the deviation of the output over the constant portion of the square wave, as illustrated in Figure 16. A standard governing the low-frequency response of the monitoring receiver may be set up by assigning limits within which the flat top of the response must fit as shown in Figure 16A, and Figure 16B illustrates limits centered about the response of the monitor within which the response of the transmitter may fall. In a manner analogous to Figure 14, the low-frequency square-wave response of the transmitter may be assigned limits centered about the response of the monitor to a double sideband signal bearing 60 cycles square-wave modulation. Such tolerances are indicated in Figure 16B.

CONCLUSIONS

A square-wave response is set forth as the logical criterion of fidelity for reproduction of television detail, involving frequencies above 100 kilocycles per second, and also subject matter involving the low frequencies between 60 cycles and about 100 kilocycles per second.

An experimental study of vestigial sideband transmission shows that the phase distortion introduced by the means of obtaining sideband attenuation in the transmitter and the phase distortion associated with high frequency cutoff in the receiver may be compensated by all-pass networks inserted in the video input of the transmitter. Definite indications resulting from an analysis of five receivers having different effective bandwidths are that a network designed for the compensation of the average delay distortion of these receivers in the range of $2\frac{1}{2}$ to 4 megacycles improves the square-wave response of all receivers. It is proposed that correction for such an average delay distortion be incorporated in the transmitter. Standardization

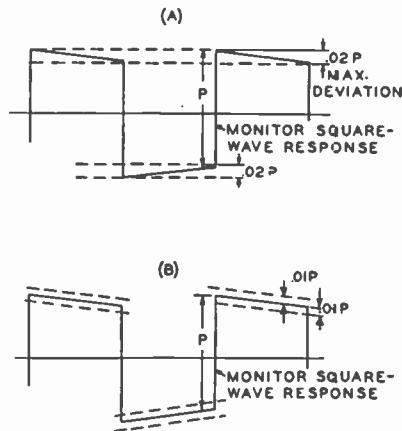

Fig. 16—Standardization of low-frequency square-wave response (A) Station monitor, (B) Transmitter.

of transmitters and station monitoring receivers is suggested through the medium of square-wave response. The tolerances to be applied in such standards involve engineering judgment as well as theoretical considerations, and therefore are matters for industry-wide agreement.

APPENDIX 1

OVERALL VIDEO AMPLITUDE AND PHASE CHARACTERISTICS OF A VESTIGIAL-SIDEBAND TRANSMISSION SYSTEM

As used here, a vestigial-sideband transmission system comprises the carrier-frequency portions of the transmitter and receiver. The input is a video signal applied as amplitude modulation of a carrier wave and the output is the envelope of the carrier signal after passage through the system. The overall video amplitude and phase characteristics of the system refer to the ratio of output to input amplitudes of a sine-wave of video modulation and the relative phase shift of the output and input wave as a function of frequency.

A carrier wave of frequency f_c modulated by a video sine-wave of frequency f_1 has the well-known form:

$$\begin{aligned}
 e &= E (1 + m \cos \omega_1 t) \cos \omega_c t \\
 &= E \cos \omega_c t + \frac{mE}{2} \cos (\omega_c + \omega_1) t + \frac{mE}{2} \cos (\omega_c - \omega_1) t.
 \end{aligned} \tag{1}$$

The vestigial sideband system alters the relative amplitudes and phases of the signal so that (1) becomes:

$$\begin{aligned}
 v = E \left[A_c \cos (\omega_c t + \phi_c) + \frac{mA_u}{2} \cos \{ (\omega_c + \omega_1) t + \phi_u \} \right. \\
 \left. + \frac{mA_L}{2} \cos \{ (\omega_c - \omega_1) t + \phi_L \} \right]
 \end{aligned} \tag{2}$$

in which the subscripts c , u , and L refer to the carrier frequency, the upper sideband, and the lower sideband, respectively⁷. The way in which the alteration is divided between transmitter and receiver has no significance provided the system is linear.

Since the envelope of the carrier signal is sought, (2) is expressed

⁷ D. W. Epstein and W. J. Poch, "Partial Suppression of One Sideband in Television Reception", *RCA Review*, Vol. 1, pp. 19-35, January, 1937.

in the form:

$$v = V_e \cos (\omega_c t + \alpha). \quad (3)$$

The envelope V_e is found to be a function of all of the amplitude and phase factors and the percentage of modulation, namely,

$$V_e = E \left[A_c^2 + \frac{m^2}{4} \{A_u^2 + A_L^2 + 2A_u A_L \cos (2\omega_1 t + \phi_u - \phi_L)\} + mA_c \{A_u \cos (\omega_1 t + \phi_u - \phi_c) + A_L \cos (\omega_1 t + \phi_c - \phi_L)\} \right]^{\frac{1}{2}} \quad (4)$$

Although no use is made of α in (3), it is interesting to note that $\tan \alpha$ as given by

$$\tan \alpha = \frac{A_c \sin \phi_c + \frac{mA_u}{2} \sin (\omega_1 t + \phi_u) - \frac{mA_L}{2} \sin (\omega_1 t - \phi_L)}{A_c \cos \phi_c + \frac{mA_u}{2} \cos (\omega_1 t + \phi_u) + \frac{mA_L}{2} \cos (\omega_1 t - \phi_L)} \quad (5)$$

is in general a function of time and that therefore there is some phase modulation of the carrier in a vestigial sideband system.

In all of the following derivations the assumption is made that the percentage of modulation is sufficiently small that terms in m^2 and higher orders can be neglected. That is,

$$v_e = E \left[A_c + \frac{m}{2} \{A_u \cos (\omega_1 t + \phi_u - \phi_c) + A_L \cos (\omega_1 t + \phi_c - \phi_L)\} \right]. \quad (6)$$

The amplitude of the envelope is therefore proportional to

$$A_u \cos (\omega_1 t + \phi_u - \phi_c) + A_L \cos (\omega_1 t + \phi_c - \phi_L) = V(f_1) \cos \{\omega_1 t + \phi(f_1)\}. \quad (7)$$

Therefore, the overall video amplitude characteristic is given by

$$V(f_1) = [A_u^2 + A_L^2 + 2A_u A_L \cos (\phi_u + \phi_L - 2\phi_c)]^{\frac{1}{2}} \quad (8)$$

and the overall video phase characteristic by

$$\phi(f_1) = \tan^{-1} \frac{A_u \sin(\phi_u - \phi_c) + A_L \sin(\phi_c - \phi_L)}{A_u \cos(\phi_u - \phi_c) + A_L \cos(\phi_c - \phi_L)}. \quad (9)$$

APPENDIX 2

EQUALIZATION OF OVERALL AMPLITUDE AND PHASE DISTORTION IN A VESTIGIAL SIDEBAND SYSTEM

Since, in general, $V(f_1)$ is not independent of frequency and $\phi(f_1)$ is not proportional to frequency within the video band, some amplitude and phase distortion will exist. It is possible to insert equalizers in the video input of the transmitter for the compensation of the output of the system at the receiver.

A. Phase equalization

If a phase angle $\beta(f_1)$ is introduced into the video input of the transmitter by a phase equalizer, (1) modified

$$e = E [1 + m \cos(\omega_1 t + \beta)] \cos \omega_c t \quad (10)$$

and

$$\phi_e(f_1) = \tan^{-1} \frac{A_u \sin(\phi_u - \phi_c + \beta) + A_L \sin(\phi_c - \phi_L + \beta)}{A_u \cos(\phi_u - \phi_c + \beta) + A_L \cos(\phi_c - \phi_L + \beta)}. \quad (11)$$

An equivalent form for (11) is

$$\tan \phi_e = \tan(\phi + \beta)$$

or

$$\phi_e = \phi + \beta \quad (12)$$

where ϕ is the uncompensated phase characteristic. Hence, if $\beta(f_1)$ is defined such that

$$\phi_e = \phi + \beta = af \quad (13)$$

where a is a constant, the overall phase is proportional to frequency and there is no phase distortion.

A different requirement may be that the overall phase characteristic of a given receiver and an imperfect vestigial-sideband transmitter with a suitable phase equalizer in the video input is the same as the response of the receiver and an ideal double sideband transmitted. That is, only the phase distortion due to the vestigial sideband transmitter is to be compensated. For this case

$$\beta = \omega_1 T - (\phi_{vs} - \phi_{ds}) \quad (14)$$

in which T is a constant time delay, ϕ_{vs} is the phase shift in the uncorrected vestigial sideband system, and ϕ_{ds} is the phase shift of the system when the transmitter is ideal double sideband. If the value of β in (14) is substituted in (11) or (12) there results

$$\phi_e = \phi_{vs} + \beta = \phi_{vs} + \omega_1 T - (\phi_{vs} - \phi_{ds}) = \omega_1 T + \phi_{ds}. \quad (13)$$

That is, the partially phase equalized vestigial sideband system has the same distortion ϕ_{ds} as the receiver operating in a double sideband system. A formula for β may be developed as follows:

From (14):

$$\tan(\beta - \omega_1 T) = \tan(\phi_{ds} - \phi_{vs}) = \frac{\tan \phi_{ds} - \tan \phi_{vs}}{1 + \tan \phi_{ds} \tan \phi_{vs}}. \quad (14)$$

According to (9)

$$\tan \phi_{ds} = \frac{A_{u1} \sin \nu_1 + A_{L1} \sin \epsilon_1}{A_{u1} \cos \nu_1 + A_{L1} \cos \epsilon_1} \quad (15)$$

$$\tan \phi_{vs} = \frac{A_{u1} A_{u2} \sin(\nu_1 + \nu_2) + A_{L1} A_{L2} \sin(\epsilon_1 + \epsilon_2)}{A_{u1} A_{u2} \cos(\nu_1 + \nu_2) + A_{L1} A_{L2} \cos(\epsilon_1 + \epsilon_2)} \quad (16)$$

where

$$\begin{aligned} \nu_1 &= \phi_{u1} - \phi_{c1} & \epsilon_1 &= \phi_{c1} - \phi_{L1} \\ \nu_2 &= \phi_{u2} - \phi_{c2} & \epsilon_2 &= \phi_{d2} - \phi_{L2} \end{aligned}$$

The subscript 1 refers to the amplitude and phase response of the receiver alone to the sidebands, and the subscript 2 refers to the amplitudes and phases of the sidebands as radiated by the vestigial sideband transmitter.

Case 1.

β in region of transmitted sideband for which $A_{L1} = A_{L2} = 0$. Setting $A_{L1} = A_{L2} = 0$ in (15) and (16) and substituting the values of $\tan \phi_{ds}$ and $\tan \phi_{vs}$ in (14), there results

$$\beta = -\nu_2 + \omega_1 T = -\phi_{u2} + \phi_{c2} + \omega_1 T. \quad (17)$$

Case 2.

β in region in which both sidebands are transmitted.

$$\begin{aligned} \beta &= \tan^{-1} A_{L1} A_{u1} A_{u2} \sin (\epsilon_1 - \nu_1 - \nu_2) \\ &\quad + A_{u1} A_{L1} A_{L2} \sin (\nu_1 - \epsilon_1 - \epsilon_2) \\ &\quad - \frac{A_{u1}^2 A_{u2} \sin \nu_2 - A_{L1}^2 A_{L2} \sin \epsilon_2}{A_{L1} A_{u1} A_{u2} \cos (\epsilon_1 - \nu_1 - \nu_2) + A_{u1} A_{L1} A_{L2} \cos (\nu_1 - \epsilon_1 - \epsilon_2)} \\ &\quad + A_{u1}^2 A_{u2} \cos \nu_2 + A_{L1}^2 A_{L2} \cos \epsilon_2 \quad (18) \\ &\quad + \omega_1 T. \end{aligned}$$

B. *Amplitude equalization.*

Phase and amplitude equalization may be applied independently and without interaction. The amplitude characteristic $V(f_1)$ given by (8) is the basis for design.

PHASE AND AMPLITUDE EQUALIZER FOR TELEVISION USE*†

BY

E. DUDLEY GOODALE AND RALPH C. KENNEDY

National Broadcasting Company, Inc.,
New York, N. Y.

Summary—A phase and amplitude equalizer is described which permits considerable improvement to be made in the performance of a transmission system whose overall response has been deteriorated by poor phase and amplitude characteristics. Specific examples are given in which it is shown that the picture quality is appreciably enhanced by the use of such a device. A brief discussion of the effects of phase and amplitude distortion on square waves is included.

INTRODUCTION

AMPLITUDE equalizers for use on audio frequency systems have long been known to the art. Their use in conjunction with everyday transmission practice is as accepted as the use of an amplifier. Phase equalizers have not become so well known, probably because the effects of phase distortion are generally considered to be of secondary importance in the reproduction of sound and they may be made to occur at frequencies above the audio range by merely increasing the frequency response of the system. They are, however, employed on many long distance circuits to compensate for different times of transmission and to minimize the objectionable effects of echoes. In video systems¹ such is not the case. For the transmission of good television pictures the phase and amplitude characteristics of the system assume equal importance. As a matter of fact, in some instances the phase characteristic may be of greater significance than the amplitude characteristic in contributing to picture deterioration. This is particularly noticeable at the higher video frequencies when reproducing a sharp transition from white to black or black to white.

Considerable information is available on methods of measuring and calculating the phase and amplitude characteristics of a transmission

* Decimal Classification: R246.2×R583.

† Reprinted from *RCA Review*, March, 1949.

¹ H. E. Kallmann, R. E. Spencer and C. P. Singer, "Transient Response," *Proc. I.R.E.*, Vol. 33, No. 3, p. 169, March, 1945.

system,^{2,3} but thus far the art does not include much useful information on how to apply corrections to result in an improved phase and amplitude characteristic. One method of approach is to design constant impedance lattice networks to produce the desired correction.⁴ Then by a series of transformations they can usually be unbalanced and built in the Bridged-T configuration. This method is time consuming and difficult, and the networks are fixed allowing no adjustable correction to take care of normal variations in the many elements of the transmission system. With the equalizer described in this paper it is possible by simply turning knobs to effect not only amplitude correction in the response of a transmission system but also to effect phase correction within limits.^{5,6}

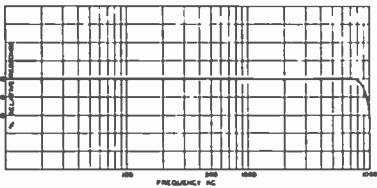

Fig. 1—Response curve of phase and amplitude equalizer when used as a video amplifier.

The amplitude corrections do cause some phase changes but the phase corrections do not cause amplitude variations. The equalizer may be used in camera chains, in transmitter feeds, at video relay points, or other locations where it is desired to effect some improvements in overall transmission.

EQUALIZER CHARACTERISTICS

The equalizer, when all phase and amplitude equalizing controls are at zero, consists of an eight stage video amplifier whose response is flat to 8 megacycles (see Figure 1) and down about 16 per cent at 10 megacycles. It is intended to be fed from a 75-ohm source and to work into a 75-ohm load. The normal output level is 1 volt peak to peak. The overall amplifier gain is 4. There is an 18 decibel variable wide band attenuator located in the input circuit together with an additional 6 decibels of fixed attenuation which may be inserted if required. Thus an input signal level of 0.25 volts peak to peak minimum and 4 volts peak to peak maximum may be used to feed the equalizer to produce

² R. D. Kell, A. V. Bedford and H. H. Kozanowski, "A Portable High Frequency Square Wave Oscillograph for Television," *Proc. I.R.E.*, Vol. 30, No. 10, p. 458, October, 1942.

³ A. V. Bedford and G. L. Fredendall, "Analysis, Synthesis, and Evaluation of the Transient Response of Television Apparatus," *Proc. I.R.E.*, Vol. 30, No. 10, p. 440, October, 1942.

⁴ O. J. Zobel, "Distortion Correction in Electrical Networks with Constant Resistance Recurrent Networks," *Bell Sys. Tech. Jour.*, July, 1928.

⁵ R. D. Kell and G. L. Fredendall, "Standardization of the Transient Response of Television Transmitters," pp. 17-34 of this issue.

⁶ E. L. C. White, U. S. Patent No. 2,178,012.

1 volt peak to peak output. The equalizer capacitively couples to input and output circuits. The load may be coupled to either the plate or cathode of the output stage thereby making available either polarity of signal for utilization. This greatly increases the flexibility of the unit. Facilities are also provided to terminate the unused output in 75 ohms. The equalizer requires 6.3 volts at 4.9 amperes for the heaters and +285 volts regulated at 140 milliamperes for the plates and screens. All the tubes are self biased.

The amplitude equalization is accomplished by having adjustable shunt peaked compensation circuits act as variable plate loads. There are two such circuits, one preceding and one following the phase correction sections of the equalizer. One consists of a single coil shunted with a variable resistance. This circuit provides high frequency peaking at about 7 megacycles depending upon the value of the coil inductance. The other amplitude correction circuit consists of three coils any one of which may be connected across a variable resistance. The

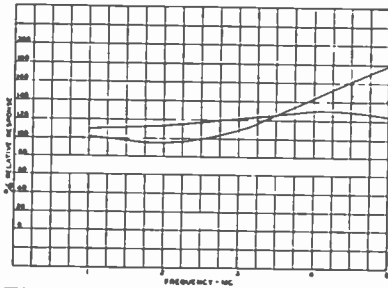

Fig. 2—Measured relative amplitude response of equalizer for two different settings of peaking controls.

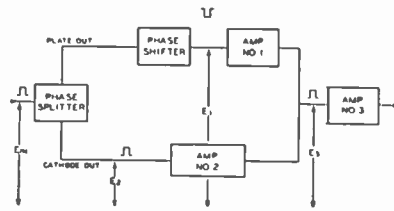

Fig. 3—Block diagram of phase compensating network.

three coils produce maximum peaking at approximately 4, 2.5, and 1.5 megacycles respectively. The maximum peaking ratio is in the order of 2 or 3 to 1. Figure 2 shows the measured amplitude peaking response curves for two different settings of the variable resistance across one of the coils.

The operation of the phase correcting portions of the equalizer may best be understood by referring to Figure 3. The signal E_{1Y} to be corrected is fed to the grid of the phase splitting tube. The plate output of the phase splitter E_1 is fed to Amplifier #1. A phase shifting network is included in the plate circuit of the phase splitting tube. The cathode output of the phase splitter E_2 is fed to Amplifier #2. The output of amplifiers #1 and #2 are added vectorially in the grid circuit of amplifier #3. The voltage E_3 applied to the grid of amplifier #3 is the vector sum of E_1 and E_2 .

It is possible to produce different degrees and types of phase shift by shunting the plate load resistor of the phase splitting tube with different variable reactances. In the schematic, Figure 4, there are shown two specific cases, one of which is a capacity across the load resistance, the other of which is a capacity in series with an inductance, the combination of which is across the load resistance. These two combinations permit the introduction of either leading or lagging phase throughout a limited range of frequencies.

Figure 5 shows the measured overall relative time delay characteristic of the unit for several typical settings of the phase knobs. Curve A is for resistance and capacitance only in the plate circuit of the phase splitter. Curves B, C, D, and E are for combinations of resistance, capacitance and inductance in the plate of the phase splitter.

Figure 6 shows the effect produced on a square wave by various values of inductance in the first "peaker" circuit. Likewise Figure 7 shows the effect on similar square waves of the second "peaker" circuit. It is obvious that the several coils operate throughout different frequency ranges. The purpose of these two compensating stages is, of course, to correct mainly for certain amplitude deficiencies in the incoming signal. As might be expected the rate of rise of the wave front is in general improved. Since the original signal used for test was not particularly deficient amplitudewise the effect produced on the signals exhibits itself as an overpeaking or an overshoot on the leading edge. This effect is characteristic of a high boost. By selecting the proper coil or combination of coils and an optimum amount of resistance across them it is possible to produce a large family of amplitude response curves. If the exact curve which is needed to compensate any given system is known, it is generally possible to design a two terminal network which could be inserted in place of the coil and resistor combination to serve as the plate load of one or both of the peaker stages in order to obtain the correct amplitude equalization.^{7, 8}

OPERATION

Figure 8 shows the effect of varying the capacity across the load resistor of one of the phase shifting sections. The general effect of an RC combination in the plate of the phase shifting tube is to produce an overall phase angle versus frequency curve which is concave toward the frequency axis. The slope of such a curve decreases with

⁷ T. E. Shea, TRANSMISSION NETWORKS AND WAVE FILTERS, D. Van Nostrand Company, Inc., New York, N. Y., 1929.

⁸ K. S. Johnson, TRANSMISSION CIRCUITS FOR TELEPHONIC COMMUNICATION, D. Van Nostrand Company, Inc., New York, N. Y., 1925.

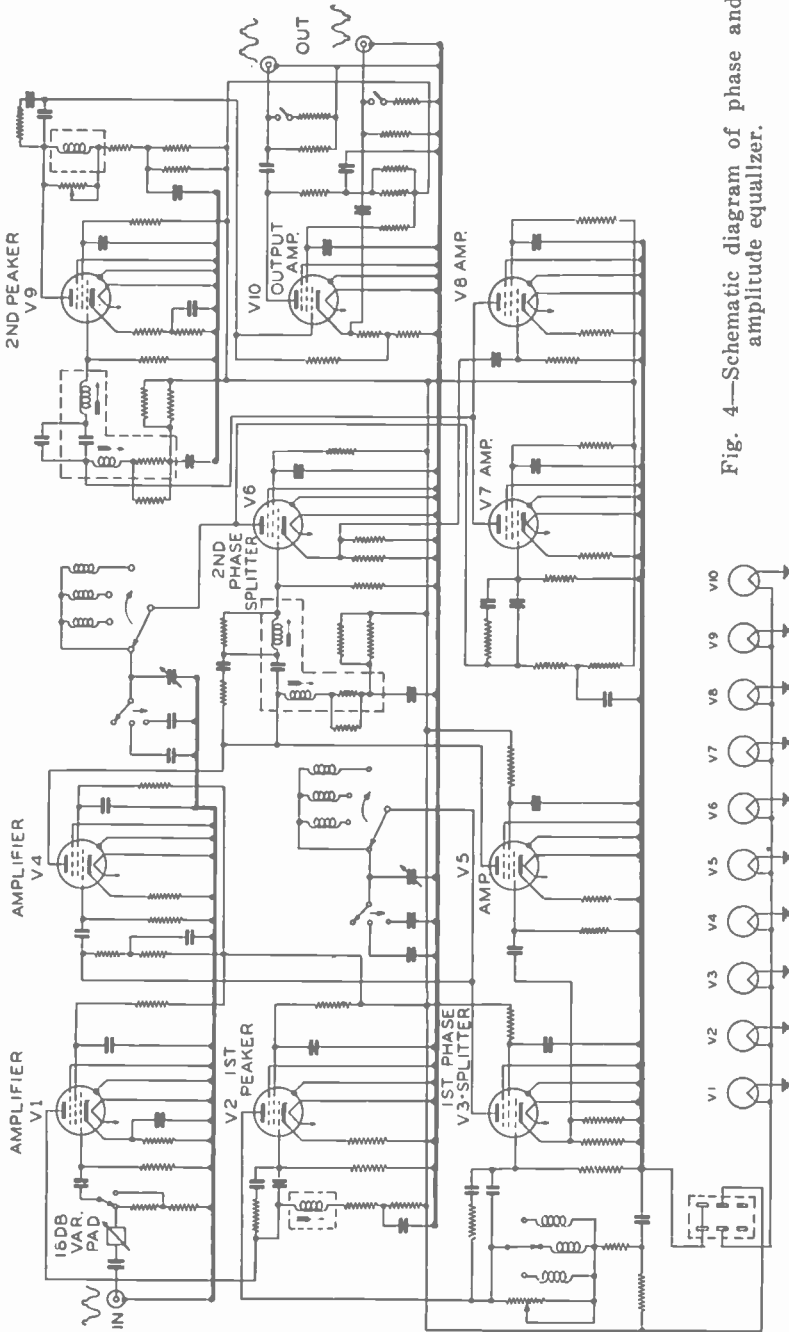

Fig. 4—Schematic diagram of phase and amplitude equalizer.

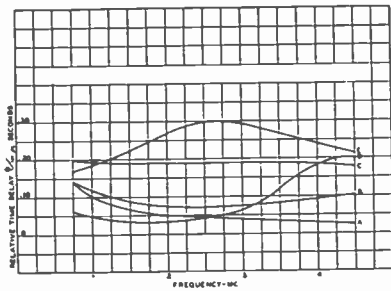

Fig. 5—Measured relative time delay characteristic obtained with various settings of phase controls.

increasing frequency. This has the effect of producing an anticipatory or leading transient as shown. By judicious juggling of the capacitance and resistance it is often possible to neutralize reasonably well a following transient or overshoot on the wave front. Practically speaking the use of such a phase section enables one to partially neutralize the following transient characteristic of an "overpeaked" chain of television equipment. In making the final overall adjustments on a chain of television gear it has generally been accepted practice to adjust the "high peaker" stage until either the following transient is objectionable or the noise level has been increased to the point where it becomes too noticeable. The peaking control is then reduced slightly to the point where the following transient and noise are acceptable. If, in the adjustment of such a chain, the noise level has not been the determining factor but rather the following transient has been the main limitation it is possible with the use of this device to partially neutralize the following transient, in some cases actually see it disappear from the right side of a transition from black to white and appear on the left side of the transition as an anticipatory transient. It is then possible to "repeak" the circuit and in many cases snap up the pictures and improve the overall performance of the chain of equipment.

In Figure 9 is shown the effect produced on the square wave of the various inductances in the phase section when they are added in



Fig. 8—Effects produced on a square wave by the introduction of various values of capacity in the phase shifting sections.



Fig. 6—Effect produced on a square wave with the peaker potentiometer open for various values of inductance (first peaker).



Fig. 7—Effect on a Square Wave with the peaker potentiometer open (second peaker).

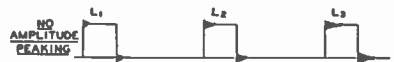

Fig. 9—Effects produced on a square wave by the introduction of various values of inductance in series with a small fixed capacity in the phase shifting sections.



Fig. 10—Effects produced on a square wave by the introduction of various values of inductance in series with additional capacity in the phase shifting sections.

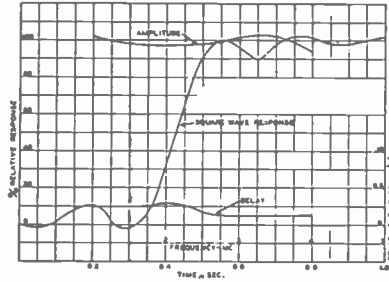

Fig. 11—Measured characteristics of equalized picture transmitter vestigial side band filter and WM-12A Monitor.

series with a small amount of capacitance. Figure 10 shows the effects produced on a square wave of the same coils in series with a larger capacitance. When the L and C are properly chosen it is possible to produce an overall phase versus frequency curve which is convex away from the frequency axis throughout a limited range of frequencies. For this range of frequencies the slope of the phase curve increases with frequency. This has the effect of producing an overshoot on the wave front or following transient similar in some respects to that produced as a result of overpeaking. Practically, such an adjustment of the phase equalizer has been used to advantage to partially compensate for or minimize the leading or anticipatory transient introduced by the side band filter at the transmitter.

In Figure 11 the overall amplitude, relative time delay and transient characteristics of a typical television transmitter after equalizations are shown.

When using the equalizer with the LC combination in the circuit as mentioned before the slope of the phase curve increases with increasing frequency only throughout a given range of frequencies.

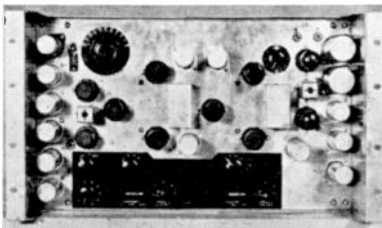

Fig. 12—Phase and amplitude equalizer (front view).

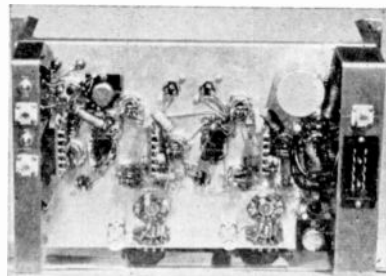

Fig. 13—Phase and amplitude equalizer (rear view).

Thereafter the slope reverses and starts to decrease with increasing frequency. The effect on a square wave then may be to produce, as in Figure 10, both leading and following overshoots. Generally speaking it has been found desirable to avoid this condition.

CONCLUSION

This type of equalizer has been successfully used at Station WNBT for over a year. Other similar units have been fabricated and used in conjunction with a new system of high speed communication called Ultrafax,⁹ the kinescope recording of television images on film,¹⁰ and outside plant shows originating in the field or out of town where noticeable deterioration of picture quality had taken place during transmission. In many cases a noticeable improvement in overall picture quality resulted from the use of the equalizer.

ACKNOWLEDGMENTS

Credit should be given the Television Operating Group of Station WNBT, and especially to T. J. Buzalski, for the excellent cooperation rendered during testing of the device, and to RCA Laboratories Division, in particular to G. L. Fredendall, for assistance in making the overall phase delay measurements.

⁹ D. S. Bond and V. J. Duke, "Ultrafax," pp. 99-115 of this issue.

¹⁰ R. M. Fraser, "Motion Picture Photography of Television Images," *RCA Review*, Vol. IX, No. 2, pp. 202-217, June, 1948.

ARTIFICIAL LINES FOR VIDEO DISTRIBUTION AND DELAY*#

BY

A. H. TURNER

Engineering Products Department, RCA Victor Division,
Camden, N. J.

Summary—The multisection artificial lines discussed in this paper have essentially lumped constants. Each section provides a low impedance feed point of full line voltage and a delay depending upon its position relative to the input end of the line. The branch lines from these feed points must behave as lumped capacitors and therefore must be unterminated and short compared to the signal wavelength.

Artificial lines composed of "T" sections, bridged-"T" sections, and especially combinations of these are capable of quite faithful distribution and delay of video signals. One combination of these is recommended because it has extremely small delay distortion to 0.85 of its cut-off frequency.

The quality of picture signals transmitted through several experimental lines of twenty sections each confirmed this theory.

The specifications of several other investigators of this subject are given but have not been tested by this writer.

The paper begins with a short history and ends with a bibliography of important closely related works.

HISTORY

WHILE working on telephone problems, G. W. Pierce^{4, †} discovered that inductive coupling of negative polarity provided useful correction of delay distortion in *T* networks. G. A. Campbell⁵ suggested the use of the lattice for delay correction and better impedance match. Very little use was made of these suggestions until about 1925 when improved lines were needed for picture and radio program transmission. The lattice⁶ became popular at this time for delay correction but not until a little later did the *B-T* (bridged-*T*) get much attention. It may have been used first on a radio program circuit between New York and Washington.

DISTORTION IN ARTIFICIAL LINES

The quality most needed in artificial lines is constant transmission time or delay of all significant components of the picture signal. This means that these components of different frequencies must arrive at

* Decimal Classification: R583.14.

Reprinted from *RCA Review*, December, 1949.

† Reference numbers refer to bibliography on pages 88-89.

the far end or at any tapping points at exactly the same instant to retain accurately the form of the transmitted signal. The other two causes of waveform change, (1) amplitude and (2) "phase-intercept" distortion, are not apt to degrade the picture quality as much as delay distortion.

Constant delay of all significant frequencies in the picture means that the phase rotation through the network is exactly proportional to frequency, inasmuch as the slope of this phase-angle versus frequency curve is the transmission time delay. It can be stated here that the "phase-intercept" distortion is zero when this phase-angle curve intercepts the zero-frequency ordinate at angles of zero or any whole number of π radians. Amplitude distortion is present in small amounts in all of the filter sections to be described. The transmission losses can be minimized by winding the coils with large sizes of wire, but this does not decrease the amplitude distortion.

The problem of delay distortion is capable of at least ten partial solutions as indicated in the concluding bibliography and summary. The single characteristic common to all ten of the artificial line prescriptions is that the delay correction in the low frequency region is obtained by various coefficients of mutual inductive coupling, k , between adjacent half-sections of T 's or whole sections of π 's. And, in general, it requires twice the percentage k between half sections as between whole sections for the same delay correction.

The use of inductive coupling between filter sections requires modification of the component values to maintain the same characteristic impedance and cut-off frequency as belong to their "constant- k " (constant impedance) prototypes without coupling. The modification is handled by a factor m from which the term " m -derived" is taken.

ANALYSES OF T AND $B-T$

The constants of the important m -derived low-pass T will be given first in Figure 1.

In this ladder the design cut-off or resonant frequency, in cycles, is

$$f_o = \frac{1}{\pi\sqrt{LC}}$$

the design series inductance, in henrys, of one whole line section is

$$L = \frac{R_o}{\pi f_o}$$

the design shunt capacitance, in farads, of one whole line section is

$$C = \frac{1}{\pi f_c R_o},$$

the design characteristic or surge impedance, in ohms, is

$$R_o = \sqrt{L/C},$$

and the mutual inductance, in henrys, of two half-sections is

$$M = \left(\frac{1 - m^2}{4m} \right) L.$$

m is the factor used in the design of m -derived filters.

M has a negative sign when the coils are wound continuously in the same direction ($m > 1$) and has a positive sign when the coils are wound oppositely or when a physical coupling inductance is inserted in the center leg ($m < 1$). In Figure 1

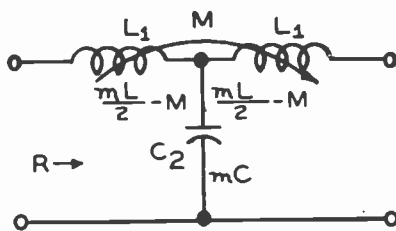

Fig. 1—Constants of the T .

$$L_1 = \frac{mL}{2} - M = \frac{2Lm^2 - Lm^2 + L}{4m} = \left(\frac{m^2 + 1}{4m} \right) L.$$

Coefficient of coupling is

$$k = \frac{M}{L_1} = \frac{m^2 - 1}{m^2 + 1} \text{ when } m > 1, \text{ from which } m^2 = \frac{1 + k}{1 - k}.$$

The angle of phase shift through one T section is

$$B = 2 \sin^{-1} \frac{m \frac{\omega}{\omega_c}}{1 - \sqrt{\left(\frac{\omega}{\omega_c} \right)^2 (1 - m^2)}} = T\omega \text{ radians,} \quad (1)$$

and the slope at each point of the curve of this angle versus the frequency ratio ω/ω_c is the time delay T_{ω_c} seconds per section between $f = 0$ and $f = f_c$ given by

$$\frac{dB}{d\frac{\omega}{\omega_c}} = \frac{2m}{\sqrt{1 - \left(\frac{\omega}{\omega_c}\right)^2 \left[1 - \left(\frac{\omega}{\omega_c}\right)^2 (1 - m^2)\right]}} = T_{\omega_c} \text{ seconds.} \quad (2)$$

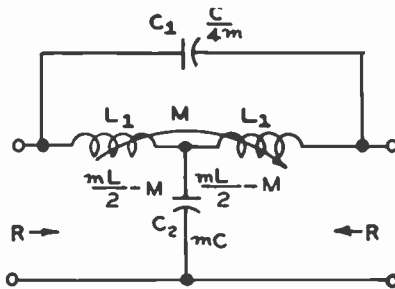

Fig. 2—Constants of the Bridged-T.

Before presenting plots of these delay curves, the constants of the other important delay network, the conventional *B-T* of Figure 2 will be given. All of the component values are exactly the same as given immediately above for the *T*, and an additional capacitor,

$$C_1 = \frac{C}{4m},$$

bridges $2L_1$. R is the same as for the *T* at zero frequency, but does not fall to zero at f_c as does the R of the *T*. In other words, the all-pass *B-T* is much more constant in impedance than the low-pass *T*. The phase shift of one section of *B-T* is given by

$$B = 2 \tan^{-1} \frac{m \frac{\omega}{\omega_c}}{1 - \left(\frac{\omega}{\omega_c}\right)^2} = T_{\omega} \text{ radians,} \quad (3)$$

and again the first derivative is the delay

$$\frac{dB}{d\frac{\omega}{\omega_c}} = \frac{2m \left[1 + \left(\frac{\omega}{\omega_c}\right)^2\right]}{\left[1 - \left(\frac{\omega}{\omega_c}\right)^2\right]^2 + m^2 \left(\frac{\omega}{\omega_c}\right)^2} = T_{\omega_c} \text{ seconds.} \quad (4)$$

Several plottings of Equations (2) and (4) for the more interesting values of m are given in Figure 3. If ω is zero, the T and $B-T$ both have the same delay of $2m$. It is quite apparent that the curves for the

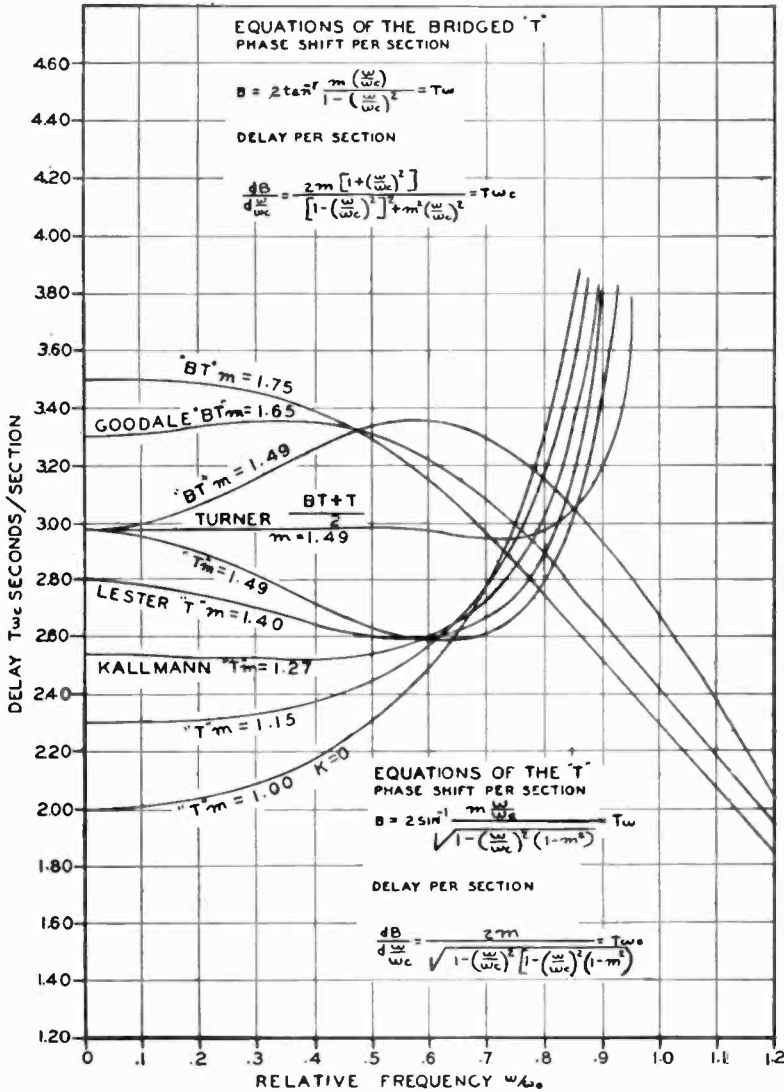

Fig. 3—Delay curves of interesting T 's and bridged- T 's, and one combination of these.

T sections pivot closely about a point $T\omega_c = 2.6$, $\omega/\omega_c = 0.6$, and the $B-T$ curves tend to pivot about $T\omega_c = 3.3$, $\omega/\omega_c = 0.47$. Furthermore, curves symmetrically located relative to these pivot points are quite compli-

mentary such that the delay distortion of a T can be compensated approximately by an equal and opposite distortion of a $B-T$ having the proper m . The most desirable combination of T and $B-T$ occurs with both having an m of 1.49 because this permits all coils to be alike. This combination also appears to maintain the compensation nearest to f_c , in this case to $0.9 f_c$.

An m of 1.75 for the $B-T$ and 1.15 for the T gives fair compensation to $0.75 f_c$ by combining curves that have no reverse curvature if this has any merit. Other single curves shown are the recommendations of Goodale (NBC) ($B-T$, $m = 1.65$), Kallmann¹³ (T , $m = 1.27$), Lester¹² (T , $m = 1.4$). Johnson⁶ recommended all T 's with an m of 1.225 or combinations of lattices and T 's which are probably quite effective but involve a mixture of balanced and unbalanced circuits. The combination of T and $B-T$ did not appear to have occurred to him, possibly because the equivalence to the lattice did not become generally realized until later.

To illustrate the use of the delay Equations (2) and (4), a delay line example will be given. Suppose a 10 microsecond delay for frequencies up to 5 megacycles is required. Using the preferred line of equal numbers of $B-T$ and T with an m of 1.49, the delay will remain very close to $2.98 T\omega_c$ seconds per section up to $.85f_c$. The resonant frequency f_c of this line of conservative design should be 5 megacycles divided by $.85$ or 5.9 megacycles.

The delay per section then becomes

$$T = \frac{2.98}{2\pi 5.9} = .0806 \text{ microseconds.}$$

The number of sections required is then

$$N = \frac{10}{.0806} = 124 \text{ sections}$$

and from this it obviously becomes necessary to keep the delay distortion per section at a minimum by choosing a preferred line assembly and by not operating the line too close to f_c .

EXPERIMENTS

Before describing some of the less conventional delay corrected artificial lines, experimental verification will be given of the foregoing analyses of the T , $B-T$, and combinations of these. Several artificial

lines of twenty sections each were assembled to test these theories. Picture quality on a 16-inch kinescope laboratory monitor was used to check the delay error. For those who wish to measure the delay error Kallmann¹² describes a convenient technique.

In general, there was a very marked difference in the character of the pictures transmitted through 20 sections of $B-T$ as through 20 sections of T . A white background test pattern came out of the $B-T$'s with white edges leading and following the black bars and ringing when the m was too low. From a similar line of T 's the pictures were "softer" and without the white edges and ringing. The effective resolutions were about the same even though the high frequency transmission was greater through the $B-T$'s. These fault differences were exaggerated by having the line resonant frequencies within the range of the transmitted picture components.

The superiority of the T over the $B-T$ was not easy to explain at first, especially since the $B-T$ was known to have much less amplitude distortion and impedance mismatch. The T and $B-T$ delay distortions were shown in Figure 3 to be roughly equal and opposite. The probable explanation of the poor behavior of the $B-T$ is that only slight attenuation occurs at f_c where the delay distortion is large. In contrast, the attenuation through the T is large at f_c , removing the faulty high frequency components.

To test the theory of combining the T 's and $B-T$'s, a 20 section line was assembled half and half. The actual m of 1.51 was close to the chosen value of 1.49. The quality of the test pattern transmitted through this combination line was the best of any of the tests with the low f_c of 5 megacycles. This result was checked several times by adding bridging capacitors one at a time while watching the output monitor. The picture slowly improved in resolution until leading and following transients appeared when more than twelve of the twenty sections were bridged.

The significance of the difference in faulty behavior of the lines near their cut-off frequencies may appear to be unimportant when a safer design is to be had by moving the filter resonances farther from the highest picture frequencies. This is safer from the delay and amplitude distortion standpoint, but still requires approximately the same total series inductance and shunt capacitance for a given time delay. However, for video distribution where vacuum tubes or short unterminated lines may replace the shunt capacitors of the line taps, lower values of f_c may be necessary to provide larger tap capacitances.

The subjects of input impedance and amplitude variation were studied in another series of tests with the T 's and $B-T$'s. A video

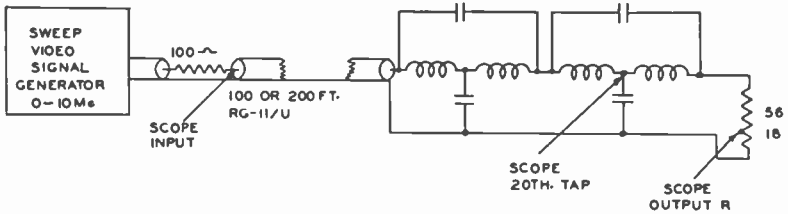

Fig. 4—Test setup to study the impedance match and attenuation of T 's and bridged- T 's.

sweep signal generator was connected to 100 or 200 feet of 75-ohm RG-11/U coaxial cable and the artificial lines under test provided the termination for this cable. The envelope outlines were observed and traced on an RCA Type 715 wideband oscilloscope. A rectifier and narrowband "scope" could have been used if certain of the linearity. Impedance mismatch was studied with the scope connected at the input of the 75-ohm reflection line. A 100-ohm resistor was used to accentuate the standing waves seen at this point. The test setup was essentially as shown in Figure 4. Typical half-envelope curves sketched from this equipment were as shown in Figure 5. This line was the only one assembled with separated coils. The curves of Figure 6 are of the same line with coils pushed together on each form.

The larger mutual coupling gives less disturbance through the f_c region and less high frequency voltage at the taps. Showing the result of still larger mutual coupling, a third coil group of twenty sections is presented as all B - T 's, all T 's, and half and half in Figures 7, 8, and 9.

It is evident from these three sets of curves that the amplitude and impedance variations of the combination of B - T 's and T 's are not as small as those of all B - T 's nor as large as those of all T 's. But more

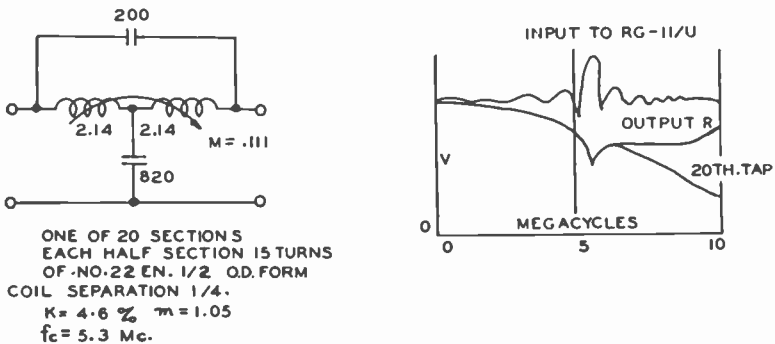

Fig. 5—Input standing wave and output voltage curves of 20 sections of bridged- T having the half-section coils separated to reduce the mutual coupling.

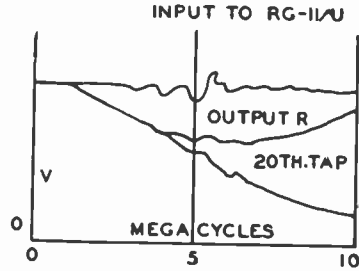
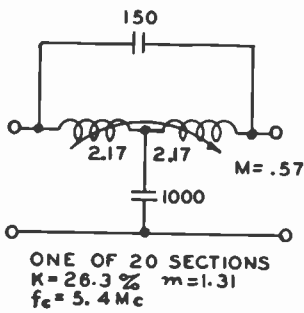

Fig. 6—Same as in Figure 5 except the half-section coils pushed together.

important is the earlier conclusion that the combination is much superior to either type alone in regard to delay variation.

The approximate relation between coil form factor, l/d , and k and m is as follows:

m	k	l/d
1.00	0	Spaced $> 2d$
1.15	0.138	2.0
1.27	0.236	1.45
1.40	0.324	0.95
1.49	0.379	0.72
1.65	0.462	0.45
1.75	0.507	0.35

$l/d =$ length of whole coil (close wound)/diameter.

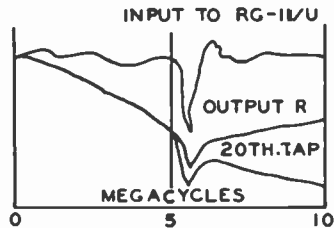
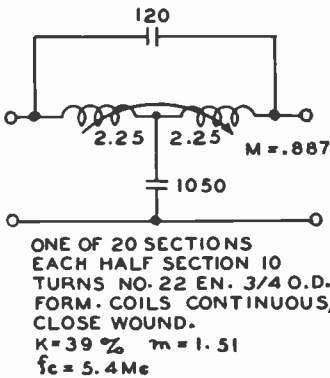

Fig. 7—Another group of coils of larger diameter to provide greater mutual coupling. Connected all bridged-T.

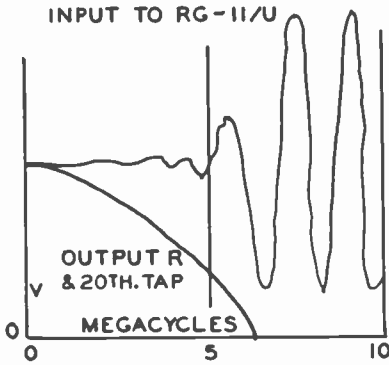

Fig. 8—Same coils as in Figure 7 except bridging capacitors removed making 20 sections of *T*.

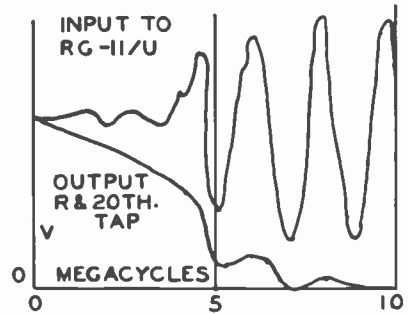

Fig. 9—Same coils as in Figures 7 and 8, but half of the 20 sections bridged, making 10 sections of *T*-bridged and 10 sections of *T*.

BRIEF DESCRIPTION OF OTHER DELAY CORRECTED ARTIFICIAL LINES

Less conventional approaches to the delay distortion problem have been made by several other investigators. Complete analyses of their works have not been made nor models of their lines tested by this writer. Some of their results appear reasonable and others do not.

Inasmuch as these lines differ largely in the treatment of the bridging reactance, a universal line is drawn in Figure 10 to show what determines the values of the bridging capacitors for a "single-frequency" network. In these continuous lines

$$f_c = \frac{1}{\pi\sqrt{LC}}$$

but in the usual isolated resonant circuit

$$f = \frac{1}{2\pi\sqrt{LC}}$$

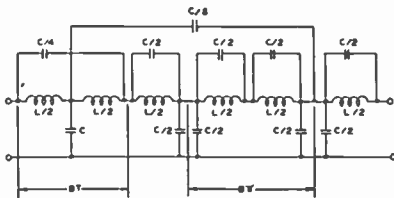
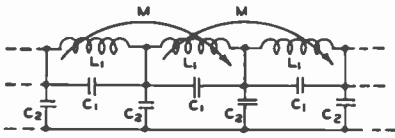

Fig. 10—Different ways of distributing *C* for "single-frequency" ladder lines.

Thus, the usual constant *LC* becomes *LC/4* for ladder lines. Accordingly, in the above sections, the product of each *C* and its shunting *L* is equal to *LC/4*. Previously it was shown that negative inductive coupling modifies these capacitor values, the bridging capacitor be-



$$k = \frac{M}{L_1} = 13.5\%$$

$$f_c = \frac{3}{2\pi T} \quad \text{WHERE } T = \text{DELAY PER SECTION}$$

$$Z_o = R = \sqrt{\frac{L_1 + 2M}{C_2}} \quad C_2 = \frac{T}{Z_o}$$

$$T = \frac{1}{\omega_c} = \sqrt{(L_1 + 2M)C_2} \quad L_1 + 2M = Z_o T$$

$$\frac{C_1}{C_2} = .022$$

$$L_1 = 787 Z_o T$$

$$M = .1063 Z_o T$$

Fig. 11 — Batchelder's line from Reference 10.

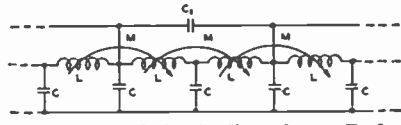

Fig. 12—Golay's line from Reference 11.

coming smaller, and shunt capacitor larger, by the factor m . With these relations in mind, we are ready to consider two more line prescriptions in Figures 11 and 12.

Whatever the basis of Batchelder's computation,¹⁰ in Figure 11, bridging capacitors having the value of $.022 C_2$ are too small to

resonate L_1 to f_c , but may be large enough to appreciably straighten the delay curve.

In Golay's work¹¹ of Figure 12, the coupling coefficient $k = 0.18$ and $C_1 = 0.08 C$. The bridging C_1 is across $2L$ as was the $C/8$ in one of the examples of Figure 10. Modifying C_1 for an m of 1.46 corresponding to this value of k would give a value of C_1 equal to $0.06 C$ instead of $0.08 C$. But the phase relations and the operation of this network with the wide bridge are not clear to this writer.

When two sections, having complex values of m , are combined into a single section, the result is as shown in Figure 13. Ghosh (RCA) found by deriving this bridged- T from its equivalent lattice, that delay is most constant when

$$m = 1.3 + j0.86,$$

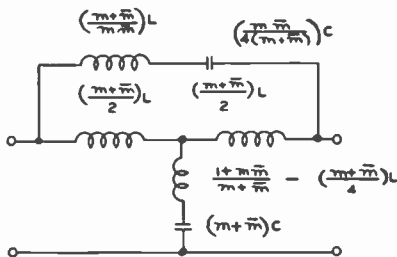

Fig. 13—The resultant network of a combination of two sections having complex values of m as calculated by S. P. Ghosh (RCA).

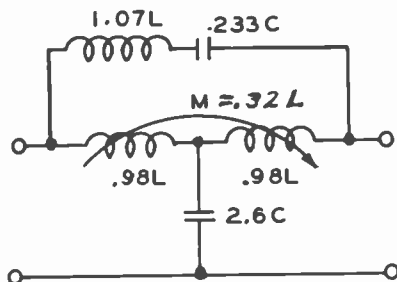

Fig. 14—In terms of the conventional L and C , Figure 13 reduces to these values.

and

$$\bar{m} = 1.3 - j0.86.$$

Thus

$$m + \bar{m} = 2.6,$$

and

$$m \bar{m} = 2.425.$$

The resulting values in terms of the conventional L and C of the ladder are as shown in Figure 14 and are: $M = .32 L$; $k = 32.7$ per cent. This uniform section solution has more elements than the BT - T combination recommended by this writer, but it may correct the delay just as accurately.

Summary of Delay Corrected Artificial Line Prescriptions

Writer	Type	m	Inductive Coupling Percent		Bridging C_1 in terms of C_2	Claimed Corrected To:
			$k = \frac{M}{L_1}$	$k = \frac{M}{2L_1}$		
Pierce ⁴	π			10	0	
Johnson ⁶	T	1.225	20		0	
Batchelder ¹⁰	π			12.5	0	.7 f.
Batchelder ¹⁰	$B\pi$			13.5	0.022 C_2	.955 f. (?)
Goodale (NBC)	BT	1.65	46.2		0.0917 C_2	.6 f.
Ghosh (RCA)	T	1.4	33		0	.85 f. (?)
Ghosh (RCA)	Sp. BT	$1.3 + j.86$ $1.3 - j.86$	32.7		0.09 C_2 in series with L	.95 f. (?)
Golay ¹³	$B\pi$			18	0.08 C_2 alt. taps	
Lester ¹⁴	T	1.4	33		0	.95 f. (?)
Kallmann ¹⁵	T	1.27	23.7		0	.6 f.
Turner	BT-T	1.49	37.9		0.1125 C_2 and 0	.9 f.

SELECTED REFERENCE BIBLIOGRAPHY IN CHRONOLOGICAL ORDER

1. G. A. Campbell, U. S. Patents 1,227,113 and 1,227,114. Filed May 22nd, 1917.
2. J. R. Carson, U. S. Patent 1,315,539. Filed July 3, 1918. Recognized the problem of phase shift (delay) correction.
3. K. S. Johnson, U. S. Patent 1,613,952. Filed December 31, 1920. Shows T's with mutual coupling, but in this case positive.

4. G. W. Pierce, U. S. Patent 1,576,459. Filed December 24, 1921. Use of negative mutual inductive coupling (10 per cent).
5. G. A. Campbell, "Physical Theory of Electric Wave Filter", *Bell Sys. Tech. Jour.*, Vol. II, p. 1, November, 1922. Suggests the use of the lattice for phase shift correction.
6. K. S. Johnson, U. S. Patent 1,781,396. Filed January 15, 1925.
7. O. J. Zobel, U. S. Patent 1,538,964. Filed May 26, 1925.
8. S. P. Mead, "Phase Distortion and Phase Distortion Correction", *Bell Sys. Tech. Jour.*, Vol. VII, p. 195, April, 1928.
9. O. J. Zobel, U. S. Patent 1,850,146. Filed March 22, 1932.
10. L. Batchelder, U. S. Patent 2,250,461. Filed May 28, 1938. A bridged- π artificial line.
11. M. J. E. Golay, "The Ideal Low-Pass Filter in the Form of Dispersionless Lag Line", *Proc. I.R.E.*, Vol. 34, p. 138, March, 1946. Bridged- π artificial line.
12. J. M. Lester, "Transient Delay Line", *Electronics*, Vol. 10, No. 4, p. 14, April, 1946. A conventional line of T 's with m of 1.4.
13. H. E. Kallmann, "Equalized Delay Lines". *Proc. I.R.E.*, Vol. 34, p. 646, September, 1946. Discusses lines with distributed and lumped constants.
14. A. T. Starr, *ELECTRIC CIRCUIT AND WAVE FILTERS*, Pitman Publishing Corp., New York, N. Y. This text, written in England, is one of the better reference books for the average engineer who is looking for design information.

DEVELOPMENT OF A LARGE METAL KINESCOPE FOR TELEVISION*†

BY

H. P. STEIER, J. KELAR, C. T. LATTIMER AND R. D. FAULKNER

Tube Department, RCA Victor Division,
Lancaster, Pa.

Summary—In recognition of the desirability of providing larger directly viewed television pictures at reasonable cost, a 16-inch metal kinescope has been developed. This tube provides a picture size intermediate between that obtained from the popular 10-inch kinescope and the large screen of projection television systems.

The envelope of this tube consists of a truncated metal cone. To the large end of the cone is fused a relatively flat glass face plate; to the smaller end, a tubular glass neck section containing the electron gun. The metal cone is made of a high-chromium iron alloy chosen for its excellent characteristics for sealing to high-quality inexpensive sheet glass. The shape of the cone was chosen after consideration of methods of tube fabrication adaptable to mass production and determination of strength requirements of the finished tube. Unique features of the tube are the large-area vacuum-tight seal between face plate and metal cone, and the stress system which permits the use of a relatively thin face plate of uniform curvature.

In order to fit into a wide range of applications, the tube was designed to operate either with a lower-cost power supply such as used in present 10-inch receivers, or at much higher voltages. Elimination of ion-spot blemishes is assured through the use of an ion trap in the electron gun. The ion-trap system employed separates a stream of mixed ions and electrons by means of a combined electrostatic tilted-lens and external magnetic fields.

INTRODUCTION

IN January, 1948, the development of a 16-inch directly-viewed metal kinescope was announced to television receiver manufacturers. This tube, the 16AP4, is the first metal kinescope ever developed and is the outgrowth of 13 years of research, development, and production in metal receiving tubes.

The 16-inch metal kinescope adds a very significant milestone in the quest for larger and brighter television pictures at reasonable cost in the home. Development of the metal-cone kinescope marks a distinct cleavage with past practice in the manufacture of large television picture tubes. In fact, the metal construction of the 16AP4 is the factor which makes volume production of large directly-viewed kinescopes practical. The $10 \times 13\frac{1}{2}$ -inch picture obtained with this tube

* Decimal Classification: R138.31×R331.

† Reprinted from *RCA Review*, March, 1949.

bridges the gap, both in entertainment value and cost, between the now popular 6×8 -inch picture of the 10-inch kinescope and the 15×20 -inch picture provided by home projection receivers. The picture size afforded by the 16AP4 answers the popular demand for larger pictures at a lower cost than is possible with all-glass construction for a directly-viewed tube with the same screen size.

A cathode-ray tube for television consists of three fundamental parts: an electron gun, a fluorescent viewing screen, an elongated envelope which contains the electron gun and fluorescent screen and through which the electrons are directed. As the picture size requirement increases so does the size of the tube envelope, and with that increase the advantages of the metal construction become increasingly evident.

This paper describes the design and construction problems encountered in the development of the new 16-inch low-cost kinescope for mass production. The discussion covers highlights of the metal kinescope design and structural requirements, the method used for sealing glass to metal, application of the screen materials and tube coatings, details of the ion-trap electron gun, and general electrical and physical characteristics of the tube.

REQUIREMENTS OF LARGE-SIZE KINESCOPE

In the development of the 16AP4, it was recognized first that to make a large-size picture available to a sizable portion of the television public, the kinescope to do the job must be designed for mass production and low cost. A design suitable for high-speed production by automatic machinery is inherently low in cost. A design with electrical requirements within the range of inexpensive high-voltage and deflection power supplies makes for lower-cost television receivers. A design having minimum volume and weight for a given picture size lowers cabinet cost which is important because of the critical relationship of cost to cabinet size. In addition, a kinescope must have a face of good optical quality and little curvature to provide high-quality pictures on an essentially flat viewing screen.

The 16AP4 metal kinescope meets these important criteria of low-cost design and quality quite effectively.

SELECTION OF ENVELOPE MATERIAL

The reasons for the selection of metal as a material for a cathode-ray tube envelope are lower cost, plentiful supply of raw materials,

ease of control of the dimensions of the fabricated part, durability, and adaptability of the tube assembly to mass production.

The cost of an all-glass envelope to obtain a picture size equivalent to that of the 16AP4 is, from all present indications, considerably greater than the cost of the metal and glass assembly used for this new tube. The formation of large masses of glass into the shape now common to kinescopes involves techniques which are inherently expensive. The art of heating and forming, and annealing and cooling heavy masses of glass is highly specialized. The extent of the art and science of metal working, on the other hand, is so vast that the supply and control of metal components gives the user the ability to make rapid changes at low cost. Glass as a raw material is not expensive compared to the high-quality chrome-iron alloy used for the metal cone of the 16AP4, but here the advantage ends. Large all-glass tube designs suffer in flexibility, because each minor change in shape or dimension often necessitates extensive developmental work and major tooling expense.

The manufacture of large glass products with accurate dimensions is very difficult. Tolerances of ± 0.030 inch or less are considered expensive in glass kinescope bulbs, while in metal forms of the shape used in this tube, tolerances of ± 0.010 inch are easy to maintain. Mass production of tube assemblies by high-speed automatic equipment requires close dimensional control if a high-quality product is to be assured.

The foregoing comparisons between glass and metal kinescopes are, of course, based on present conditions. They are not meant to imply that progress in glass has stopped. Indeed, when one considers the vast progress that has been made in the fabrication of large glass envelopes since the end of the war, the very considerable force of skilled technicians who are currently attacking the problems, and the competitive threat of the metal envelope, it is to be expected that additional improvements will be made. However, the art of using metal in kinescope envelopes is relatively new and, like all new techniques, is subject to rapid improvement. In certain respects, notably in weight, accuracy of dimensions, strength, and relative ease of manufacture it appears to have inherent advantages.

ESSENTIALS OF METAL-CONE KINESCOPE

The basic construction of a kinescope consists of a circular, nearly flat, glass plate on which is formed the picture image, and a conical body to the large end of which is attached the viewing screen and to

the small end a cylindrical neck containing the electron gun. The gun, cone, and screen have coaxial symmetry.

Associated with the tubes of this type are external magnetic, electron-beam-deflecting and focusing coils and ion-trap magnets. Because a minimum of magnetic shielding is desired between these external magnetic fields and the electron beam, glass serves best as the neck material. Also, there must be sufficient electrical insulation between the external magnetic coils and the high-voltage anode area of the metal cone.

As can be seen in the cross section of the tube given in Figure 1, the metal tube consists of a truncated metal cone to the large end of which is fused a relatively thin, nearly flat face plate, and to the smaller end of which is fused a glass flared neck section containing the

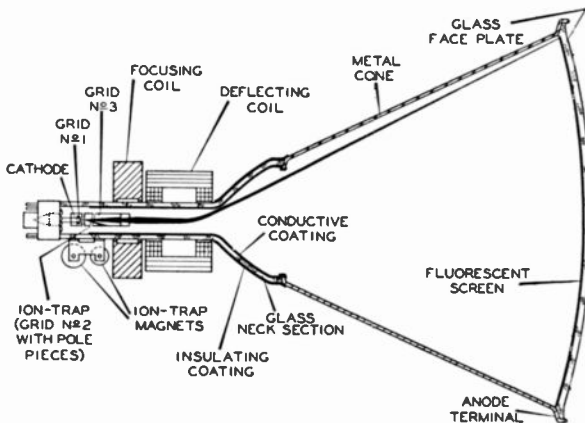

Fig. 1 — Cross section of metal kinescope 16AP4.

electron gun at its lower end. The flared section provides electrical insulation between the deflecting coils which operate at ground potential and the exposed metal cone surface which operates at high potential.

SELECTION OF METAL FOR CONE

In the selection of a metal for use in the cone portion of the tube the primary concern is with its glass-sealing properties. The major properties required of a good glass-sealing alloy are:

1. The coefficient of expansion of the metal must match that of the glass.
2. The metal oxide formed in heating the metal must be soluble in glass.
3. The metal oxide must have excellent adherence to the base metal.

4. The metal shall not be readily over-oxidized to form a thick porous oxide.

Of all the glass-sealing alloys available, those including chromium in their composition have the above properties to the largest degree. The investigation of metal suitable for the cones was, therefore, limited to the chromium-bearing alloys.

Additional requirements imposed on the metal by the use for which it is intended are that it have a high tensile strength, both at room temperature and at tube baking temperatures, that it have good corrosion resistance, and that it be vacuum tight.

The metal chosen after considerable experimentation was a modification of a commercially available high-chromium alloy — S.A.E. Type 446. Fortunately, it has most of the desired properties although it is difficult to form.

METAL-CONE DESIGN CONSIDERATIONS

In addition to the selection of a suitable metal, design of the metal cone involved a mathematical analysis of the mechanical stresses. As was anticipated, the critical point in the structure was found to be the junction between the glass face plate and the metal cone.

Atmospheric pressure on a face plate 16 inches in diameter exerts a total force of about $1\frac{1}{2}$ tons. For safety purposes, however, the 16-inch kinescope was designed to withstand a minimum of three atmospheres or 4.5 tons. In an all-glass bulb the loading created by the atmospheric pressure is supported by a relatively heavy wall near the maximum diameter of the bulb. In the case of the metal cone this support is achieved by building up the face-plate-sealing surface of the cone in the shape of a truncated rim-cone supported at one end by a cylindrical rim and at the other end by the main cone. Figure 2 gives a cross section of the face sealing area. The rim of the cone is shaped to afford maximum resistance to tangential tension forces applied to it by the face plate. This rim shape was designed during the early stages of development of the metal kinescope by Tube Department engineers in 1937 and has proved to be the most practical solution to the problem of providing sufficient strength at the tube face periphery where the forces of atmospheric pressure on the slightly curved face plate are concentrated. Figure 3 is a picture of the device used to measure mechanical deformation of the sealing rim during the experimental work on the tube. In making these measurements the tube was gradually evacuated and deformations of the rim and face were measured by the gauges shown in the picture.

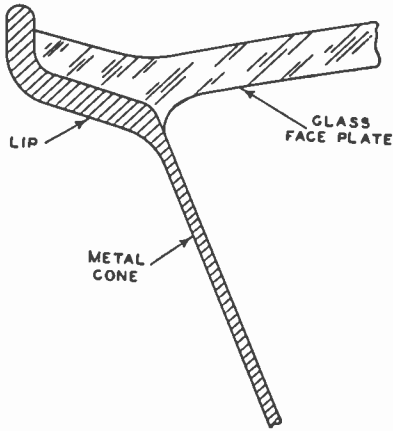

Fig. 2—Cross section of cone rim.

The conical shape was chosen for the metal cone to keep the volume as small as possible. The cone is fabricated by a spinning process, and, as is shown in Figure 2, the main cone wall thickness is thinner than the sealing surface. The extra strength is not needed in the side wall and so it is made proportionately thinner.

SELECTION OF FACE-PLATE MATERIAL

Most kinescopes, at the present time, have faces made by pressing molten glass in an iron mold. Face plates made by this method are characterized by roughness, light scattering, and visible foreign particles which cause noticeable reduction in picture quality. Improving the face plate quality without incurring additional cost was accomplished in the 16AP4 by selecting high-quality window glass for the face plate.

In a kinescope, some face curvature is made necessary by the fact that to support atmospheric pressures, an evacuated envelope must be curved or have an excessively thick wall. The glass face of even a 10-inch kinescope is subject to a total force of about 1200 pounds. As the glass kinescope becomes larger, the force on it becomes greater and the face, therefore, must be relatively thicker. With increasing

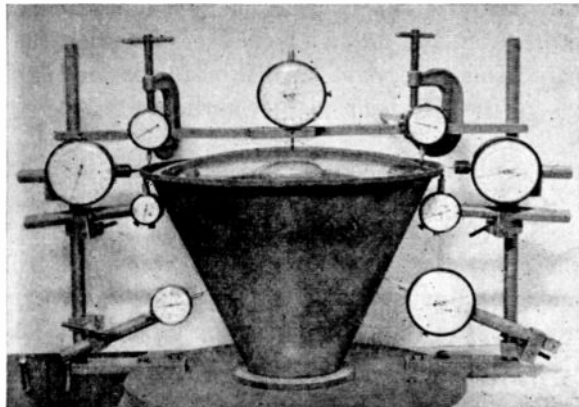

Fig. 3—Pressure deformation test equipment.

thickness, of course, the problem of achieving good optical quality becomes greater. The 16-inch metal kinescope was designed to have high strength in the metal rim so that the face plate can be relatively thin and nearly flat. The face plate is only $3/16$ inch thick and has a radius of curvature of about 27 inches. With glass of this thickness good optical quality is easily obtained.

An examination of the expansion curves of all the available brands of window and plate glass manufactured in the United States showed that they all had practically identical expansion curves. To check the expansion, however, samples of every brand of window glass that could be located were purchased and seals made. One of these glasses showed a substantial reduction in seal strain, being about one-half that of the other samples tested. This glass had a lower *setting* point which made the over-all expansion difference between the metal and glass lower. Because the glass was lower in expansion than the metal, the metal would contract more than the glass when cooling from the annealing point, and thereby would put the glass into compression. Since glass is very strong in compression it was decided to develop face plates of this glass. The initial seals proved disappointing because little was known of the sealing and annealing techniques necessary for the new glass-to-metal seal. As more experience was gained, however, a practical method was evolved which permitted control of the stress distribution in the face plate, so that finally both tangential and radial compression was obtained. The resulting assembly is considerably stronger than an all-glass envelope of comparable size.

The face plate used in this tube is made by either pressing or sagging window glass. It takes the form of a section of a sphere 27 inches in radius. This curvature was adopted as a compromise between cost, strength, and flatness after face plates of various radii of curvature were tested. The face-plate radius of curvature is uniform from center to edge. In an all-glass construction the face radius of curvature usually becomes smaller near the rim of the tube in the region where the television picture corners are located.

GLASS-NECK CONSIDERATIONS

The glass neck section for this tube requires a glass which matches the expansion characteristic of the chrome-iron cone, has softening and annealing temperature properties which permit its use and processing with the glass chosen for the face plate, and has expansion properties suitable for sealing to the stem glass containing the electrode connector leads. In addition, high electrical resistance between the

outside and inside of the neck is required. Lead glass, #0120 meets these qualifications fairly well and was adopted for use. As stated previously, insulation between the deflecting yoke coils and the metal cone is necessary. This requirement was met by the flared design of the lower portion of the glass cone as shown in Figure 1. The feasibility of manufacturing the lower cone by a pressing operation on high-production equipment reduced the cost of the part.

A butt seal between the lower glass cone and the metal lip at the small end of the metal cone was needed so that the operation of sealing the two parts could be performed on automatic machinery. The butt seals have been quite successful and a very clean sealing operation results between the two parts, although the expansion properties of #0120 glass are not matched to the chrome-iron of the cone as advantageously as are those of the face-plate glass. By a selective system of strain distribution through parts design and a proper annealing and cooling cycle, the correct structural strength is obtained.

GLASS-TO-METAL SEALING

Until now the discussion has been limited to the design and economy of components. The processing costs, however, as reflected in processing speeds are just as important to low-cost design.

The processing of bulbs in the manufacture of kinescopes involves heating, annealing, and cooling of the tube envelope. The time required for these three processes is approximately dependent upon the square of the glass thickness. Any reduction of glass thickness, therefore, permits reduction of processing time. Because the glass required for the 16AP4 is $\frac{1}{4}$ to $\frac{1}{3}$ the thickness used in an all-glass construction, a large reduction in processing time is possible.

As previously mentioned, the "sealing" of glass and metal parts depends, in general, upon the ability of glass in the molten state to partially dissolve strongly adherent metallic oxides, thus forming a mechanically strong bond between the glass and metal. The sealing process, therefore, consists of oxidizing the metal and then melting the glass in contact with the metal and holding it in the molten state until the bond is formed. The process used for sealing the glass face plate and the metal cone consists of placing the face plate and cone on the sealing machine, rotating the assembly, and heating it uniformly until it is close to the annealing point (temperature at which glass is fluid enough to allow stress relief without deforming) of the glass. At this time, the sealing heat is applied to the sealing area so that the glass in contact with metal is melted and the seal formed. Air

pressure is used inside the cone during this operation to hold the face plate in position and to work and form the seal. The shape of the seal is important, because a smooth contour eliminates points of high stress concentration in the seal area. Such stresses weaken the glass and may cause glass breakage. At the completion of the sealing operation, the bulb is transferred to an oven maintained near the annealing temperature of the glass and allowed to temperature-equalize. It is at this point that the most radical change in processing has been made. Normally, when glass is cooled from its annealing point, it is necessary to lower the temperature of the glass very slowly to avoid excessive strains. In the case of the metal kinescope, it was found that this slow cooling is not necessary and that the bulb can be removed from the oven at a temperature near the annealing temperature and then allowed to cool in air at room temperature. This operation is possible because cooling and shrinking of the metal places the glass in both tangential and radial compression to limit the formation of tensile stress.

Prior to the face-plate sealing operation, the neck assembly is sealed on by conventional glass-to-metal sealing methods and then flame annealed.

BULB STRENGTH TESTS

The mechanical strength of the bulb is extremely important. After the sealing operation, the cone-face plate-neck assembly should be able to withstand air pressure of 60 pounds per square inch, or pressure one atmosphere greater than specified for the finished tube. This extra strength is necessary to allow for any additional strain that might be caused during processing.

Figure 4 is a picture of a pressure-test failure which occurred at a higher-than-normal test pressure. Radial cracks indicate that the sealing lip was expanded under pressure, placing the glass in tangential tension.

In addition to the standard pressure test, other tests have been made to test the strength of the metal bulb. One of these was a thermal shock test in which the face end of the bulb was taken from boiling water and plunged into liquid air, allowed to temperature-equalize, and then transferred back to the boiling water. No breakage of the glass



Fig. 4—Pressure test failure.

occurred. Other tests have been made on the effects of deformation or impact *while the bulb is under vacuum*. It is interesting to note that the failure of a glass bulb under similar conditions is usually accompanied by an implosion which shatters the entire bulb. To date, all test failures of metal kinescopes have shown the typical radial crack pattern shown in Figure 4. The face plate is held together by compression until the vacuum is relieved. At worst, a portion of the face plate may then fall in and bounce out, but with insufficient force to cause appreciable damage. Failure of an all-glass bulb face is accompanied by a failure of the glass rim inward toward the bulb center where the glass meets and is again broken into smaller particles by the impact.

SCREEN APPLICATION

The phosphor employed in the screen of the 16AP4 is a mixture of blue-emitting zinc sulphide and yellow-emitting zinc cadmium sulphide. This combination, when properly manufactured, blended, and applied to the kinescope face plate, is a very efficient emitter of white light.

A most important preliminary step in the application of screens to the 16AP4 consists of a thorough cleaning of the interior of the bulb assembly. The slightest trace of dirt or grease would prevent the phosphor particles from adhering properly to the face plate. Handling marks such as fingerprints and etched areas on the face plate, would harm the appearance of the screen and the resulting picture. The presence of traces of certain metallic impurities, for example iron, cobalt, or nickel, can "poison" or decrease the efficiency of the phosphor. It is interesting to note that the limits of most chemical purification processes coincide with the order of magnitude of activator usually necessary to produce efficient phosphors, and with the magnitude of a poisoning element detrimental to phosphors. The magnitude of the activator is in the range of one thousand to one hundred million parts of phosphor to one part of activator or impurity.

The cleaning of the metal kinescope bulb is more difficult than that of a glass bulb because of the matte surface of the metal. In addition, the large areas of metallic oxide formed by the heat of the glass-sealing fires and the attendant possibility of scaling add to the problem. The cleaning process consists of flushing with solutions of sodium hydroxide and hydrofluoric acid, and rinsing thoroughly with tap and distilled water. Vigorous agitation is required to remove small flakes of metallic oxide hanging loosely from the metal. The washing is done by automatic machinery.

The screen is applied to the 16AP4 bulb by settling the phosphor from a suspension of double-distilled water and phosphor containing a suitable binder to promote adherence of the phosphor particles to the glass face plate. A "cushion" layer containing a dilute potassium silicate solution is poured into the bulb assembly and the suspension of screen material evenly distributed over the surface of the cushion layer.

In manufacture, the screens are applied to the bulb assemblies on a continuously moving belt, similar to that developed for the 10-inch television tubes. The bulbs are loaded into pockets on one end of the belt, face plate downward, and settling solutions introduced. All operations are conducted while the belt is advancing at the rate of a few inches per minute. By the time the bulb assembly has reached the opposite end of the belt, the screen has settled to the face plate, and the settling suspension is decanted as the belt moves around a large pulley at the end of the belt. When the neck end of the assembly is inverted and all the settling suspension drained off, the glass neck is cleaned with a dilute solution of hydrofluoric acid to remove the remaining silicate. As the bulb assembly moves along the underside of the belt, the screen is dried and the assembly is then removed by the same operator who loaded it.

Each screen is inspected by transmitted and reflected light, and with ultraviolet radiation before the tube is completed so that no defects such as spots, holes, or colored areas are present which can be detected by the eye at normal viewing distance.

COATING APPLICATION AND TUBE ASSEMBLY

A graphite conductive coating is applied to the inside of the glass neck section from the flared end down to just beyond the middle of the tubular section. This coating, shown in Figure 1, connects with the metal cone and is the conductor which maintains the inside of the glass neck section at the same potential as the metal cone. The screen and the conductive coating are baked to insure their adherence to the glass surfaces.

The electron gun is sealed into the bulb assembly and the tube is then exhausted by a straight-line exhaust machine initially developed for the 10-inch kinescope. The base is cemented to the tube neck. The cathode is aged to stabilize emission and the tube is then tested. Finally, the large sealing rim is wire-brushed to remove oxides in order to insure a good electrical connection for the anode high voltage.

Externally, the tube receives three different coats of paint. One is a conducting paint applied to the metal rim used as the anode con-

lector, the second is applied to the main cone as a decorative finish, and the third is an insulating paint applied to the flared part of the glass neck section. This coating prevents electrical leakage between the anode and the deflecting coils under conditions of high humidity.

ION-SPOT PROBLEM

The electron gun of the 16AP4, although it uses conventional assembly methods and parts, has some novel features worthy of discussion in detail. One of these features is the tilted-lens ion trap.¹ This particular type of ion trap is a post-war development and was first used in the television kinescope type 10BP4. The ion-spot problem, which was so common in earlier television tubes, will be reviewed briefly and the operation of the ion trap explained.

An ion spot is a dark discoloration which may appear on the screen of a cathode-ray tube using magnetic deflection after operating for, in some cases, only a few hours and in others, a few hundred hours. The discoloration often increases in intensity and becomes darker as the tube is operated. The spot is the result of deterioration or fatigue of the screen phosphor in the area bombarded by the relatively heavy negative ions in the beam. In 1935, Freisenwinkel² and Von Ardenne³ reported the presence of negative ions in the cathode-ray tube and discussed the effect of these ions on the screen. A number of methods have been proposed since then to prevent screen bombardment by negative ions. The problem can be approached in several ways. The most obvious method would be to prevent the formation of negative ions in the tube. If it were possible to evacuate the tube so that all residual gas were removed, positive ions, which are generally formed by direct electron collisions with gas molecules in the space, would not be formed along the path of the beam. The residual gas in the space, however, is not always the major source of ions. During the normal operation, the cathode as well as other parts in the tube are heated and some gases and ions are continuously emitted. H. Schaefer and W. Walcher⁴ indicate that the negative ions originate at the thermionic cathode largely as a result of positive ion bombardment and possibly as a result of direct emission. Exhaust methods alone, therefore, cannot be considered as a means of eliminating ion spot formation but serve merely

¹ J. Kellar—U. S. and Foreign Patents Applied For.

² Freisenwinkel—*Archiv für Elektrotechnik*, Vol. 29, 1935, p. 272.

³ Von Ardenne—*Archiv für Elektrotechnik*, Vol. 29, 1935, p. 731.

(Translation in *Television and Short Wave World*, Nov., 1936, p. 626.)

⁴ H. Schaefer and W. Walcher—*Zeitschrift für Physik*, Vol. 121, pp. 679-701, 1943.

to delay this formation. Another approach is to use a screen phosphor which can withstand ion bombardment without damage. However, such phosphors capable of fluorescing in the proper colors and with reasonable efficiency are, at present, not available.

Ever since the effect of ions on the screen was recognized, attempts have been made to prevent them from reaching the screen. Such attempts have usually been concerned with removal of negative ions from the beam. The fundamental principle of separating streams of particles of different mass by passing the mixed beam through a magnetic field is well known and has been used for a long time in the mass spectograph to obtain an ion spectrum. It was used by Strigel⁵ to separate positive ions from mixed beams of electrons and ions.

Because, in an electrostatic field, deflection of a beam of particles is independent of the mass of the particle and, in a magnetic field, is not, a method is available by which the electrons can be extracted from a mixed beam of electrons and relatively heavy ions. A number of designs have been proposed which use electrostatic and magnetic fields separately or in combination to separate electrons and ions.⁶ In television tube applications, it is desired to use the electron beam but to discard the ions. The device used to separate and discard the ions is called an ion trap.

TILTED-LENS ION TRAP

Most ion traps proposed in the past have used combinations of non-symmetrical gun structures, bent necks, and extra electrostatic deflecting electrodes which required additional connections for the application of voltages. Such designs were complicated and, therefore, added to the cost of the tube. Because of the need for a simple but dependable ion trap, a development program was undertaken which resulted in the tilted-lens ion trap used with the 16AP4. This design has been tested on many thousands of 10-inch tubes and has proved highly satisfactory. The principal feature of this method is the electron gun which has a tilted electron lens formed by cutting the adjacent ends of grid No. 2 and grid No. 3 at a slight angle to the plane normal to the gun axis. The arrangement is shown in Figure 5. The tilted lens deflects the mixed beam of electrons and ions away from the axis of the electron gun. In order to return the electron stream toward the axis of the gun a magnetic field of proper direction and strength is positioned in the

⁵ Strigel—U. S. Patent 1,911,976.

⁶ Branson—U. S. Patent 2,274,386. Bowie—U. S. Patent 2,211,613/4 and others.

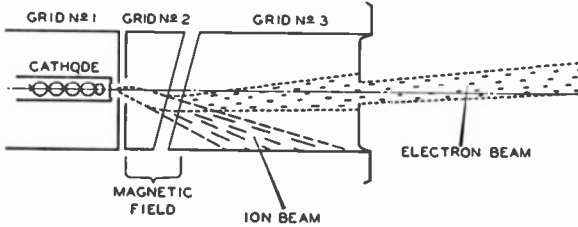

Fig. 5—Single-magnet ion-trap system.

vicinity of the bend. Because it is difficult to obtain a magnetic field which will, at all points along the axis, exactly neutralize the effect of the electrostatic field, the electron beam does not quite succeed in returning to the axis of the gun but can only approach or cross it. Operation of the tube with the beam off the neck axis is undesirable because it usually leads to spot distortion and requires additional centering current. A better solution was needed before the development could be considered complete.

The eventual solution was to use a second magnetic field on the ion-trap magnet. The first magnetic field was located as in Figure 5 but its strength was adjusted to cause the beam to cross the axis within the gun. The second field was of opposite polarity and of lower strength. It was located at the point where the beam crossed the axis and served to align the beam to coincide with the gun axis. Figure 6 shows the approximate path of the beam when the double magnetic field is used. It is obvious that, theoretically at least, both fields should be independently adjustable for each operating voltage on grid No. 2 and grid No. 3. In practice, however, the ratio of the two field strengths is fixed at the time of installation of the magnet assembly on the receiver, and by slight adjustment of position with respect to the gun a satisfactory adjustment is obtained. Various designs of ion trap magnets have been announced commercially ranging from double electromagnets to various permanent-magnet designs. The ion trap is a positive method of eliminating ion spots and is independent of gas pressures over a very wide range.

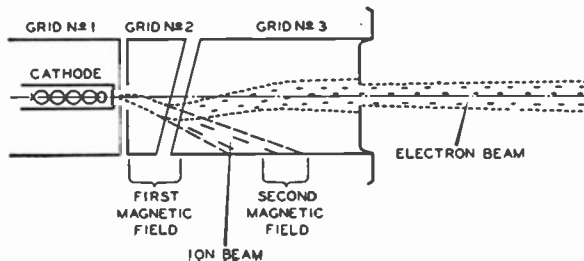

Fig. 6—Double-magnet ion-trap system.

The gun for the 16AP4 was designed for magnetic focus and deflection, and incorporates the tilted-lens ion-trap system. The gun is a tetrode type having a heater, thermionic cathode, and three grids. Magnetic pole pieces attached to grid No. 2 form part of the tilted-lens system of the ion trap.

Figure 6 shows the gun system and how the external ion-trap magnets and tilted-lens system affect the electron beam and ion stream. The limiting aperture in grid No. 3 serves to mask off the edges of the electron beam including most secondary electrons which may arise from collision with parts of the gun near the cathode. This action of the limiting aperture serves to produce a well-formed spot with clean edges and improves detail resolution. Although not shown in Figure 6, the edge of grid No. 2 in practice is rounded in the manner of a corona shield. This construction has been found necessary to reduce cold-emission of electrons from grid No. 2 to grid No. 3. Such emission is caused by the high potential difference, amounting to nearly the full anode voltage, between these two electrodes. Grid No. 3 is connected to the metal cone by the internal conductive coating on the flared glass section. As noted previously, this coating is carried up to the metal envelope. Contact to the coating is made by means of spring contacts on grid No. 3. Figure 1 shows that the limiting aperture in grid No. 3 is placed not at the end but inside the grid cylinder. This arrangement prevents extension of the magnetic focus field into the aperture. Such extension would result in interference with the normal path of the electron beam through the aperture depending upon the alignment of the focusing coil on the tube neck.

PHYSICAL AND ELECTRICAL CHARACTERISTICS

Many considerations determined the final physical dimensions and electrical characteristics of this tube, but the major aim was to develop a low-cost tube to provide a large picture of high quality and brightness which could be operated from low-cost power supplies. The 16AP4 kinescope as finally developed, and as shown in Figure 7, has a maximum outside diameter of 16 inches, and a length of 22¼ inches. Its shape permits efficient utilization of cabinet volume for component placement. The great strength of the metal lip to which the face plate is sealed provides a most efficient relationship between the outside tube diameter and picture size. In addition, it permits the use of a uniform face curvature right up to the corners of the picture area. Tests of the mechanical strength of this tube, have shown it to be unusually resistant to impact and air pressure.

Because a major portion of the external area of this tube is metal, a large anode contact is available. Provision for positive contact has been provided in the form of a low-resistance area on the outside of the cone lip at the face end of the tube. Over 30 square inches of contact area are available for the anode contact. Either a spring or the weight of the tube may be used to insure good contact between the contact area and a metal connector. For protection against corona, the upper rim lip of the tube is rounded. The 16AP4 weighs about 11 pounds and, thus, compares very favorably in weight with the 10BP4 kinescope which also weighs about 11 pounds.

Fig. 7—Metal Kinescope 16AP4.



The 16AP4 may be operated with an anode voltage ranging from 9 kilovolts to 14 kilovolts which is a wide range for a tube of this size. These voltages may be obtained from low-cost pulse-operated or radio-frequency-operated power supplies. With the chosen deflection angle of 53 degrees, full scanning of the useful screen area is possible without increasing deflection-power requirements over that needed for 10-inch picture tubes operating at the same voltages.

The 16AP4 provides a picture of approximately 130 square inches which is $2\frac{1}{2}$ times that of a 10-inch tube. Highlight brightness of 60 foot lamberts at an anode voltage of 12 kilovolts provides enough light so that the picture may be viewed under average conditions of ambient light in the home. Picture definition surpasses that required by present-day television practice.

REVERSIBLE-BEAM ANTENNA FOR TWELVE-CHANNEL TELEVISION RECEPTION*†

BY

O. M. WOODWARD, JR.

Research Department, RCA Laboratories Division,
Princeton, N. J.

Summary—This paper describes a unidirectional receiving antenna which is effective over all twelve of the presently assigned channels without adjustment.

The array is made up of dipole elements which themselves maintain desirable characteristics over the entire television range. These elements are united by a simple transmission line network to yield a directive pattern.

The antenna maintains a high front-to-back ratio over all channels, and is particularly useful in fringe areas where it is necessary to reduce co-channel interference.

The directional beam is reversed on any channel by a simple switch which transposes a single transmission line.

INTRODUCTION

THE rapid growth of television during the last few years has created new problems in securing satisfactory fringe-area reception. Several of these problems are directly related to the antenna system at the receiving location.

The television transmitters in a given region generally locate somewhat closely together in metropolitan areas to obtain the greatest population coverage. Therefore multi-channel reception of the stations at a distant point is restricted to a fairly narrow azimuth angle in direction, requiring a receiving antenna with a beam orientation that remains fixed in direction for all television channels. As the presently assigned twelve channels cover the widely separated bands of 54 to 88 and 174 to 216 megacycles, very broad-band response characteristics are necessary for efficient operation. Many of the simpler types of antennas in current use exhibit widely varying radiation properties in the higher television band. While a compromise may be effected by rotating the antenna for maximum signal or by the use of both low and high band antennas, a single antenna array having a fixed beam orientation is the more desirable solution.

Another difficulty confronts the viewer situated between co-channel stations. In many such instances the signal strength from one of the

* Decimal Classification: R125 × R326.61.

† Reprinted from *RCA Review*, June, 1949.

stations is sufficient to mar the otherwise good reception from the other. This interference is generally characterized by a "Venetian blind" effect of dark horizontal shadows moving up or down with the relative drift of the stations' carrier frequencies. Tests have shown that the interfering signal amplitude need only be a very small fraction of the desired signal to cause this interaction. Hence the receiving antenna should have a unidirectional beam throughout the television ranges to reduce the objectionable interference as well as to improve the power gain and signal-to-noise ratio.

Many of these viewers are located in regions where multi-channel reception is possible from opposite directions. For example, in the Princeton, New Jersey area, usable signals are received from six stations serving the New York City area and three Philadelphia stations at the present time. This requires an antenna with a unidirectional beam capable of being reversed in direction at will on any television channel.

Unidirectivity is quite easily obtained electrically by means of surface reflectors such as parabolic and plane screens. However, to secure an appreciable suppression of the backward lobe at the lower channels, their size becomes impractically large.

Arrays using sharply tuned parasitic elements have not been found to provide good front-to-back field ratios over a wide frequency band. Also such antennas are not suited for beam-reversing.

Long wire antennas, such as rhombics, are fairly broad-band and also electrically reversible in direction, but the large area needed for installation rejects their application for the average set owner.

On considering the limitations of these various types of antennas it was concluded that an array made of phased dipoles presented a better solution.

The simplest system of this type consists of the familiar two-dipole end-fire antenna producing a cardioid unidirectional pattern. However, a four-dipole phased array was chosen for its broad-band properties as the better system satisfying the outlined requirements.

This paper describes such an array constructed without the mechanical and electrical difficulties of reflectors, parasitic elements, or tuning adjustments.

GENERAL PRINCIPLES OF ARRAY

The reciprocal relationship between transmitting and receiving antennas makes it possible, for purposes of explanation, to consider the simplified array of four point source radiators (Figure 1). The

four sources are arranged in the form of a square and equally spaced one-quarter wavelength from the center (*O*) of the array. The currents are assumed to be equal in amplitude and phased with respect to the center as indicated in Figure 1.

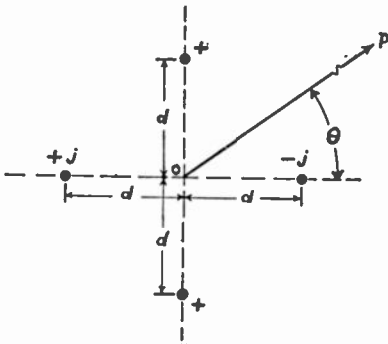

Fig. 1 — Simplified four-radiator array.

The currents are assumed to be equal in amplitude and phased with respect to the center as indicated in Figure 1.

The system is seen to be a combination of a broadside array superimposed upon and fed in quadrature with an end-fire array. Both arrays have bi-directional properties. Relative field patterns in the elevation plane of each array taken separately with respect to point *O* are, respectively:

$$F \text{ (broadside)} = K \cos (90^\circ \sin \theta) \tag{1}$$

and

$$F \text{ (end-fire)} = K \sin (90^\circ \cos \theta) \tag{2}$$

where

F = field strength at a distant point, *P*.

K = a proportionality constant.

θ = elevation angle, degrees.

Figures 2-A and 2-B show these field distributions graphically in polar form.

Simultaneous operation of both arrays permits direct addition of the lobes on one side and subtraction on the other side, resulting in the unidirectional pattern given by:

$$F \text{ (combination)} = K [\cos (90^\circ \sin \theta) + \sin (90^\circ \cos \theta)] \tag{3}$$

and plotted in Figure 2-C.

The elevation field pattern of Equation (3) will remain unchanged if the point source radiators are replaced by four horizontal dipoles parallel to one another. However, the dipole field distribution becomes a factor in the relative azimuth field patterns as follows:

$$F \text{ (broadside)} = K f(\phi), \tag{4}$$

$$F \text{ (end-fire)} = K f(\phi) \sin (90^\circ \cos \phi) \tag{5}$$

and F (combination) = $K f(\phi) [1 + \sin(90^\circ \cos \phi)]$ (6)

where $f(\phi)$ = the relative field pattern of individual dipole.

ϕ = azimuth angle, degrees.

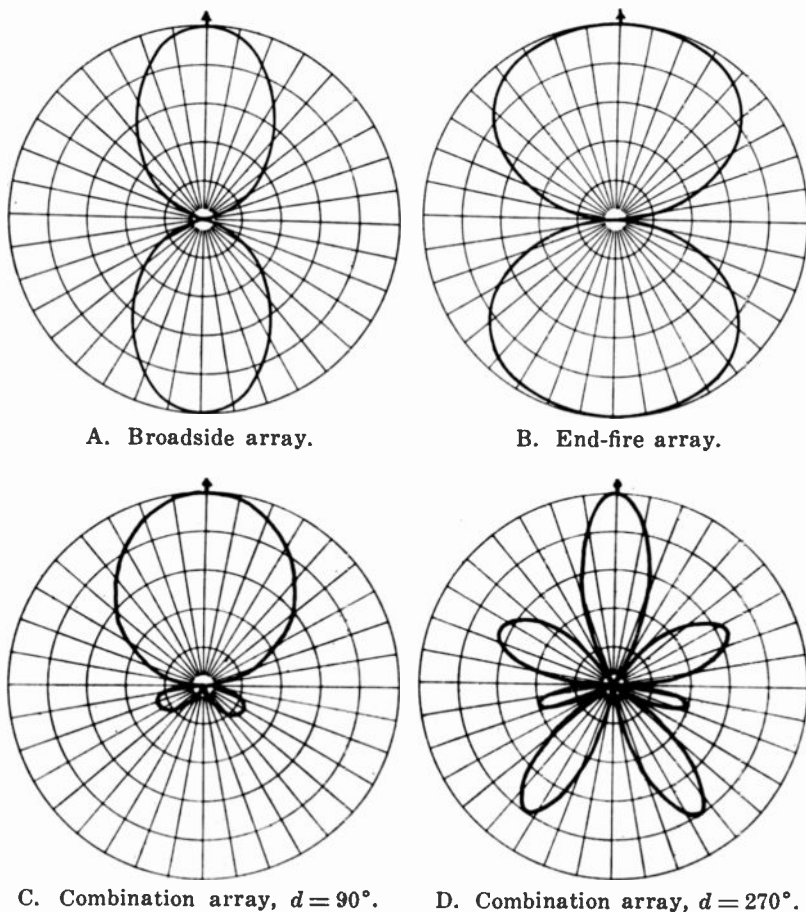

Fig. 2—Relative elevation field patterns.

Several important points become apparent from inspection of Equations (3) and (6). Under the previously assumed conditions of feed, the dipole spacing (d) from the center of the array may depart considerably from one-quarter wave length without seriously affecting the front-to-back field ratio, thus permitting a coverage equivalent in percentage frequency variation to the lower television band. Furthermore, unidirectivity may be obtained with the dipole spacing (d) made

odd multiples of one-quarter wave length. Since the higher television band bears a three-to-one frequency ratio with a portion of the lower band, satisfactory operation is assured at the higher band. In this case, however, the beam is reversed in direction, (Figure 2-D).

Azimuth field patterns for dipole spacings of 90 and 270 electrical degrees, respectively, are shown in Figures 3-A and 3-B. The function $f(\phi)$ was taken to be that of a simple half-wave dipole in both instances.

It is evident, also, that a 180-degree phase reversal of the currents in either the broadside or the end-fire arrays will reverse the direction of the unidirectional pattern. This property is independent of frequency variation and dipole spacing.

Finally, since the field distribution of the individual dipole is a multiplying factor in Equation (6), it is observed that $f(\phi)$ should maximize at $\phi = 0$ degrees. Stated in other words, this means that the

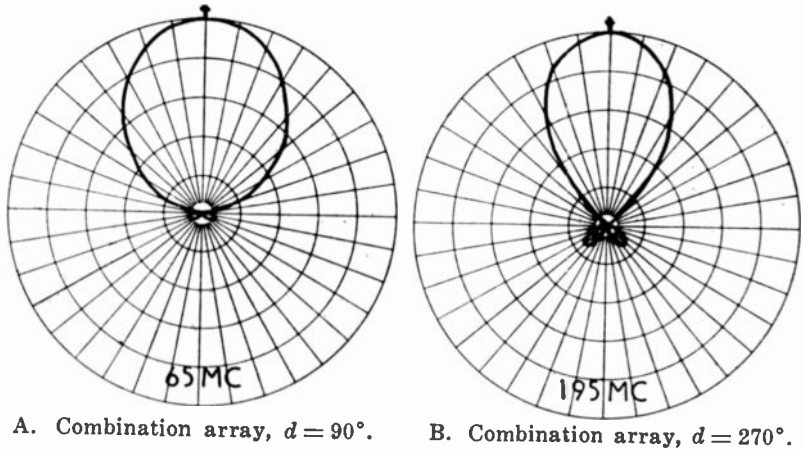

A. Combination array, $d = 90^\circ$. B. Combination array, $d = 270^\circ$.

Fig. 3—Relative azimuth field patterns.

individual dipole pattern must be oriented in the same direction as the array and have essentially the same radiation characteristics throughout the required frequency ranges.

It is desirable at this point to describe the dipole modifications required to fulfill this latter condition.

MODIFIED DIPOLE

In order to prevent the efficiency from falling off too rapidly at the lower frequencies, the dipoles are made one-half wave in length in that region. Azimuth field patterns taken at representative frequencies in the lower television band of such a dipole are shown in Figure 4-A. The arrows shown on all of the field patterns indicate the direction

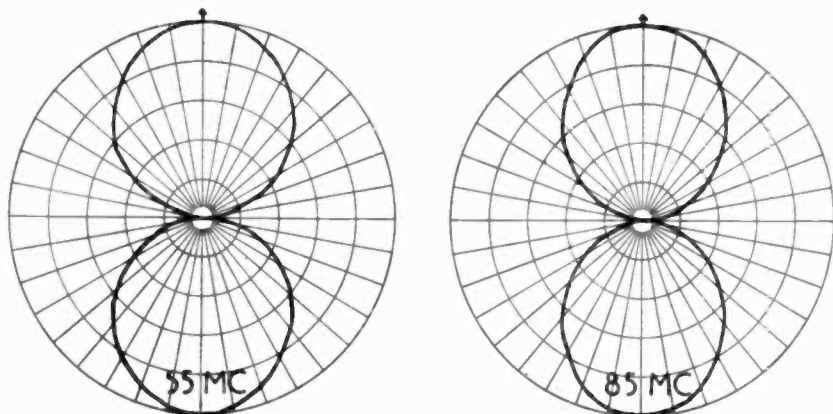

A. At lower band frequencies;

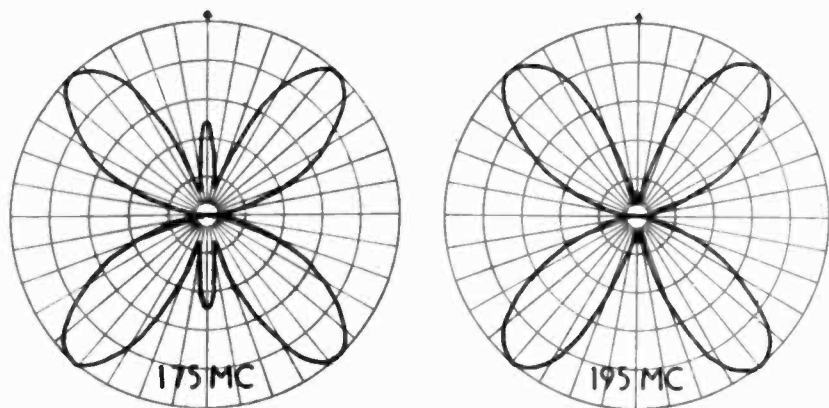

B. At higher band frequencies.

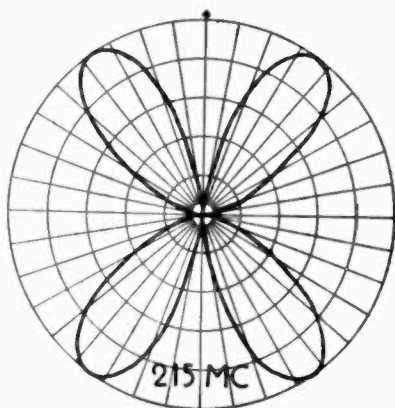

Fig. 4 — Measured azimuth field patterns of simple dipole.

normal to the dipole axis. In the higher band of 174 to 216 megacycles, however, the dipole becomes in the order of $1\frac{1}{2}$ wave lengths long, producing multi-lobe configurations with little radiation broadside to the dipole axis (Figure 4-B).

The desired bi-directional characteristics may be obtained at the higher frequencies by altering the current distribution along the dipole legs. One manner of accomplishing this result is by the use of the well-known "sectionalizing" method of inserting a series reactance at the proper position in each of the dipole legs as diagrammed in Figure 5-A. A coaxial sleeve element shorted at one end, (Figure 5-B), offers a practical means of securing this series reactance at the television frequencies. Tests, however, have shown this type of dipole to be rather

narrow in band width, due partially to the low characteristic impedance obtainable with the coaxial-sleeve element.

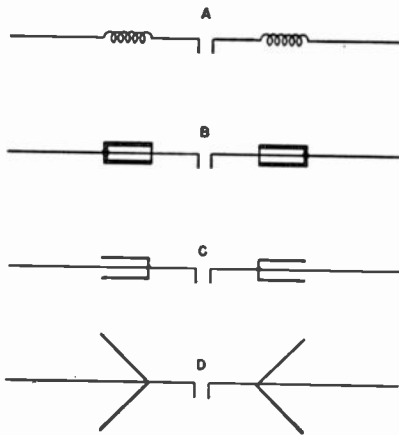

Fig. 5—Development of high frequency "vees".

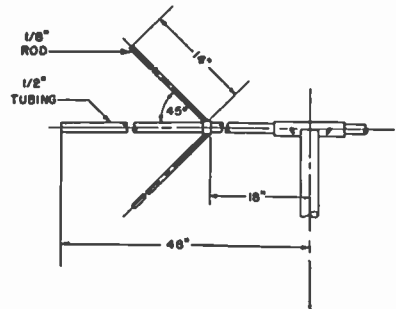

Fig. 6—Modified dipole details.

A higher characteristic impedance and correspondingly increased band width is obtained by replacing the coaxial sleeves with open-wire "hairpin" loops as shown in Figure 5-C. As a final step, the loops are straightened out into right-angle "vees," Figure 5-D. Numerous field measurements were made to arrive at the optimum dimensions and placement of the "vees" as indicated in Figure 6.

While the evolution of the "vee" design outlined above was developed from a nonradiating, sectionalizing reactance, the final "vee" form may be considered also as part of the radiating system.

Installation of the "vees" was found to have practically no effect upon the dipole patterns in the lower band of frequencies. Measured azimuth field patterns of the dipole with "vee" attachments at the higher band of frequencies are given in Figure 7. The multi-lobe patterns of the simple dipole are seen to be altered to "figure-eight"

patterns with fixed orientation by the addition of the "vees." The elevation field distribution was found to be very slightly elliptical, with the maximum intensity normal to the plane of the "vees."

It will be noted that such a modified dipole by itself is well suited as a receiving antenna for many receiver locations where a "figure-eight," bi-directional pattern suffices for interference-free reception on all twelve channels.

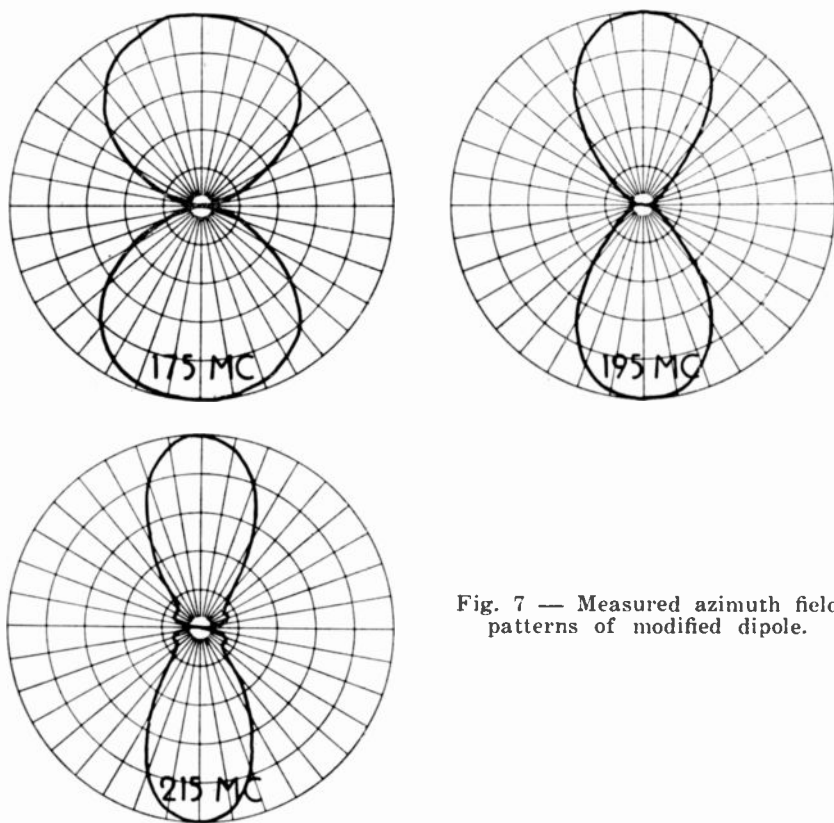

Fig. 7 — Measured azimuth field patterns of modified dipole.

Other field tests were made on the modified dipole constructed as in Figure 6 to determine its performance as a television receiving antenna. The standing-wave characteristics versus frequency, measured on a 300-ohm balanced transmission line, are plotted in Figure 8. The standing-wave ratio is given in terms of the ratio of minimum voltage to maximum voltage. The measured relative power gain, compared to a matched simple dipole one-half wave in length at each frequency of operation, is shown as the solid curves in Figure 9. The relative power gain as calculated from the measured field patterns and

standing-wave characteristics is plotted as the dashed curves. Part of the discrepancy between the curves in the higher band may be due to dielectric losses in the dipole mounting not considered in the calculated curves.

DIPLEXER NETWORK

Means must now be considered for securing the desired feed conditions of the array. Referring to the wiring diagram of Figure 10, the two dipoles of the broadside array are joined for in-phase feed by a length of balanced transmission line fed at its midpoint, *A*. The two dipoles of the end-fire array are similarly connected to midpoint, *B*, with the exception of a transmission line transposition as shown to provide for out-of-phase feed.

An important advantage is gained with this arrangement. As the broadside array is symmetrically located in the electrically neutral plane of the end-fire array, independent operation of the two arrays is assured at all frequencies.

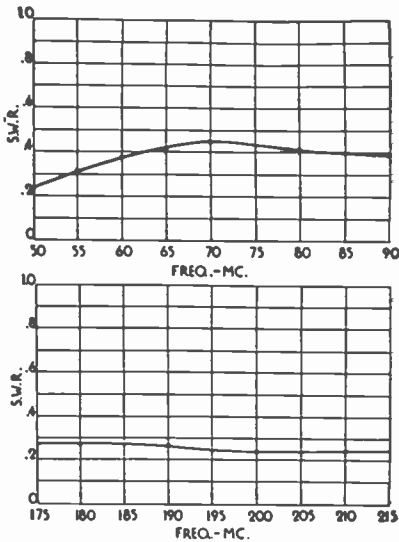

Fig. 8—Standing-wave characteristics of modified dipole.

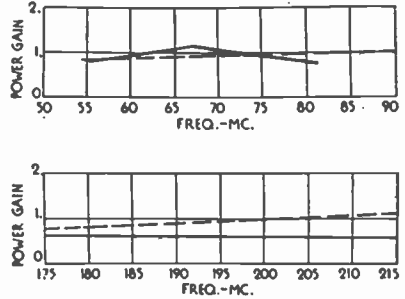

Fig. 9—Power-gain measurements of modified dipole.

The two feed points, *A* and *B*, are joined to terminals *C* and *D* of a four-terminal network called a diplexer. One of the two lines is made one-quarter wave length longer than the other to provide for the necessary quadrature phasing between the broadside and end-fire arrays as previously described.

The diplexer consists of a bridge made of four one-quarter wave-length lines, one of which is transposed. An absorbing resistor and the television receiver are connected, respectively, to the remaining two bridge terminals.

The explanation of the array in connection with the diplexer may

be described most simply by tracing the paths of the incident and reflected waves throughout the system, rather than on a more rigid mathematical basis.

Assume that an incoming signal approaches the array as indicated by the arrow in Figure 10. The two resulting main waves traveling down the lines from points *A* and *B* in quadrature phasing arrive at

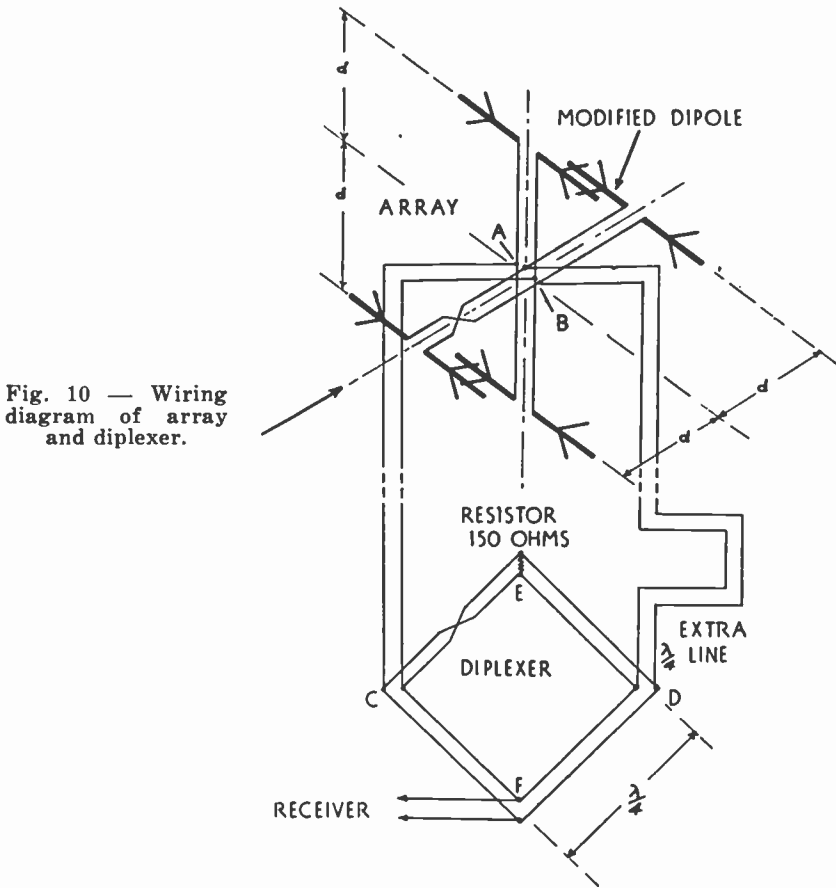

Fig. 10 — Wiring diagram of array and diplexer.

points *C* and *D* in-phase due to the quarter-wave difference in line lengths.

The in-phase voltages at *C* and *D* transfer to point *E* in opposite polarity because of the line transposition in one of the diplexer legs. Hence point *E* is at zero potential, and the resistor takes no power. It will be observed that this action is independent of frequency as the lengths of the legs are equal. At frequencies other than that at which

the legs are one-quarter wave length, the legs act as identical reactances attached at points *C* and *D*, respectively.

The two main waves arrive in-phase at point *F* and on to the receiver. In case the receiver input is mismatched, a reflected wave is propagated back to the antenna, where part of the energy is re-radiated and part is re-reflected back down the two lines.

These reflected waves, which left the receiver in-phase, now arrive at points *C* and *D* out-of-phase, since one of the waves has traveled over the extra quarter-wave phasing section twice. As the lower legs of the diplexer are not transposed, point *F* will now be at zero voltage

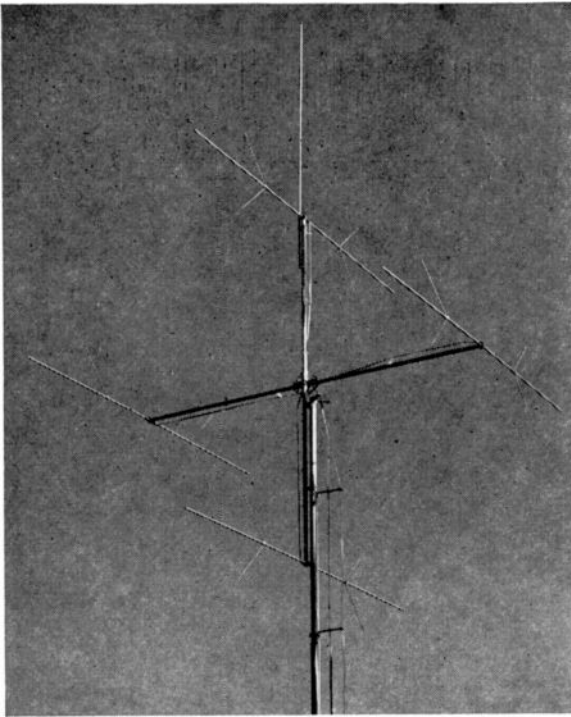

Fig. 11—Reversible-beam array.

and no energy delivered to the receiver. However, the out-of-phase voltages at *C* and *D* will now arrive at point *E* in-phase and be absorbed by the resistor. For complete absorption the value of the resistance should be one-half of the transmission line characteristic impedance, assuming that all lines in the system are identical.

Hence, it is seen that the reflected waves produced by the receiver and antenna mismatches are absorbed in the resistor only. As the diplexer may be installed quite close to the receiver, "ghost" images caused by transmission line reflections can thereby be eliminated.

Assuming now that the signal approaches the array from the opposite direction, a relative phase reversal occurs between the main waves leaving points *A* and *B*, and points *C* and *D* now become out-of-phase. Under this condition, all of the energy is absorbed by the resistor and none will pass to the receiver.

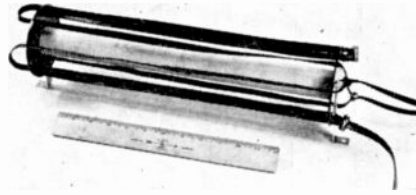

Fig. 12—Diplexer assembly.

Thus the resistor serves a dual purpose; absorbing the undesired signal from the backward direction as well as the reflections caused by mismatches in the system. The small reduction in power gain of the array due to this loss in the resistor is more than offset by the broadband, unidirectional properties gained.

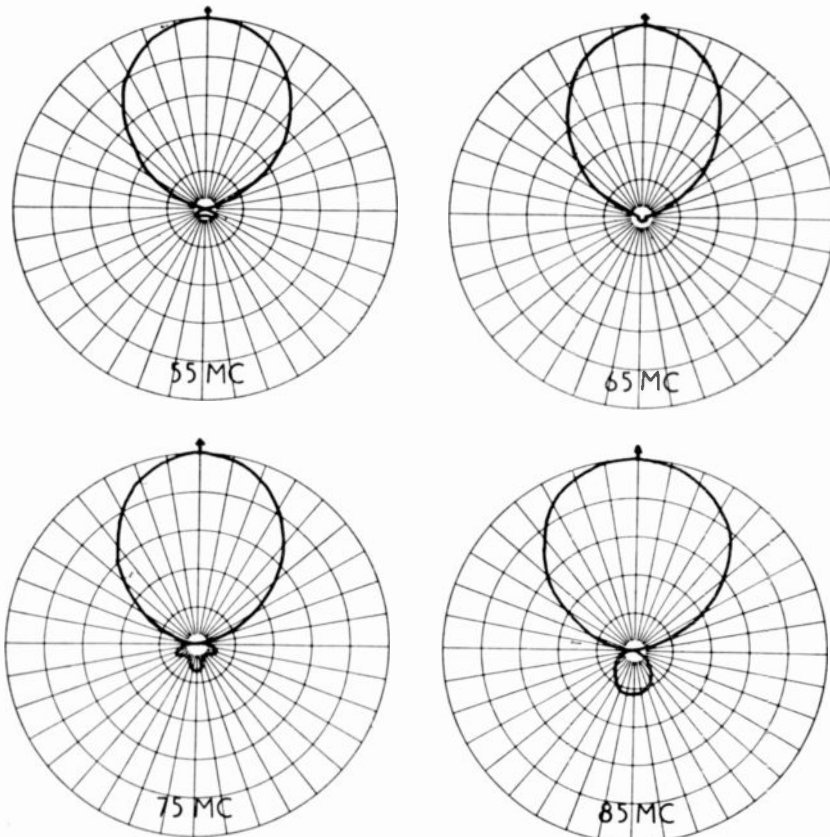

Fig. 13—Measured azimuth field patterns of array in lower band.

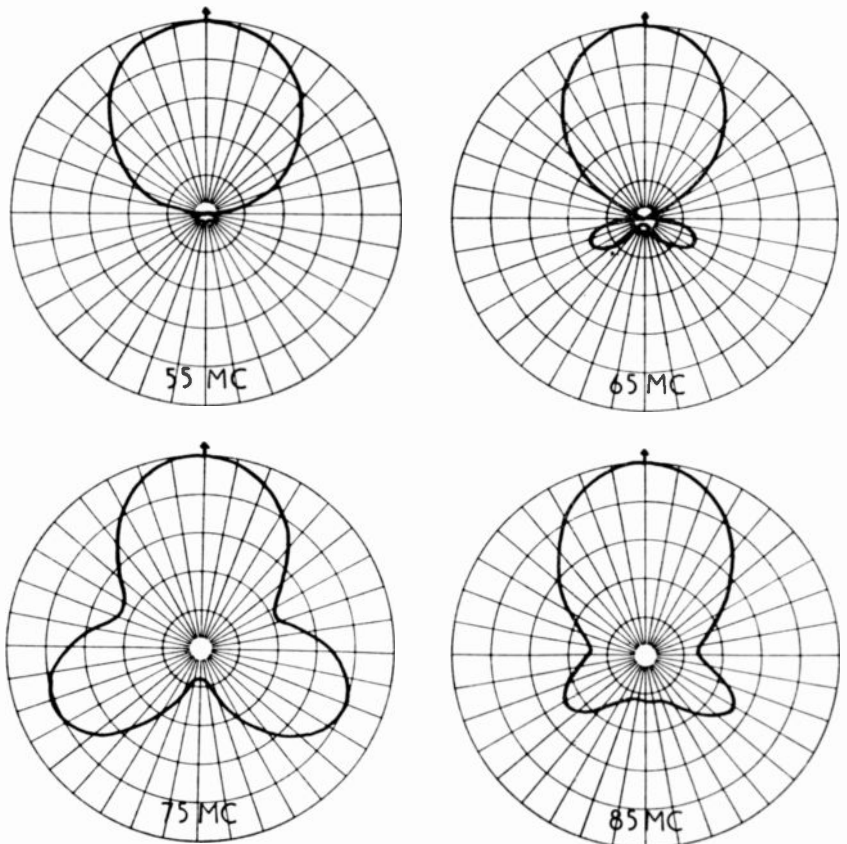

Fig. 14—Measured elevation field patterns of array in lower band.

The amplitudes of the main and reflected waves are a function of the impedances looking back into each of the two-dipole arrays. Hence, for the above action to take place as described, the impedances should be identical. By using arrays of two dipoles each, their impedances vary approximately together, being altered somewhat by the mutual coupling between individual dipoles of each array.

As the undesired signal is absorbed in the resistor, it is evident that the beam may be reversed in direction by interchanging the resistor and the receiver. This beam reversal may also be accomplished by merely transposing either of the two lines extending from the antenna to the diplexer. With either method, best results are secured by using a transposition switch which introduces little discontinuity on the transmission line.

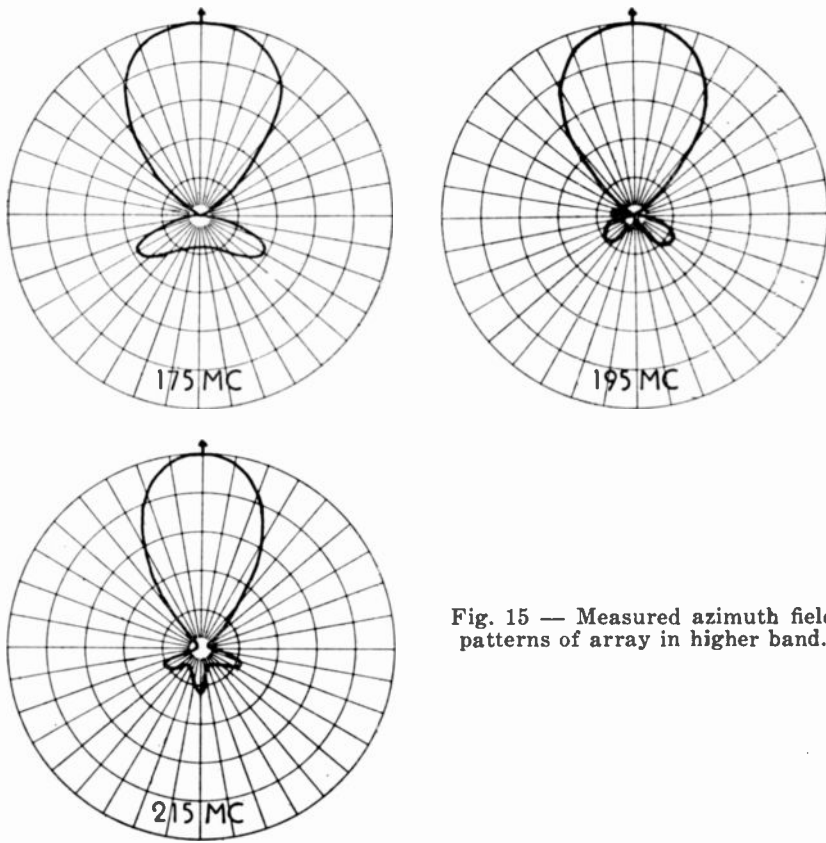

Fig. 15 — Measured azimuth field patterns of array in higher band.

The bridge legs, dipole spacing (d), and phasing line in the constructed array were chosen to be one-quarter wave length at a frequency of 65 megacycles. While some error occurs at other frequencies where the phasing line is not one-quarter wave length, overall measurements have shown it not to be serious. These dimensions become three-quarter wavelength at a frequency of 195 megacycles, the midband frequency of the higher band. Thus, proper operation of both the diplexer and dipole pairs is assured at the higher channels also. It will be noticed that the additional half-wavelength effectively added to the phasing line at the higher band compensates for the beam reversal in the higher band previously described, so that the beam remains in the same direction for all twelve channels with a given switch position.

CONSTRUCTION OF THE ARRAY

A photograph of the complete array is shown in Figure 11. The

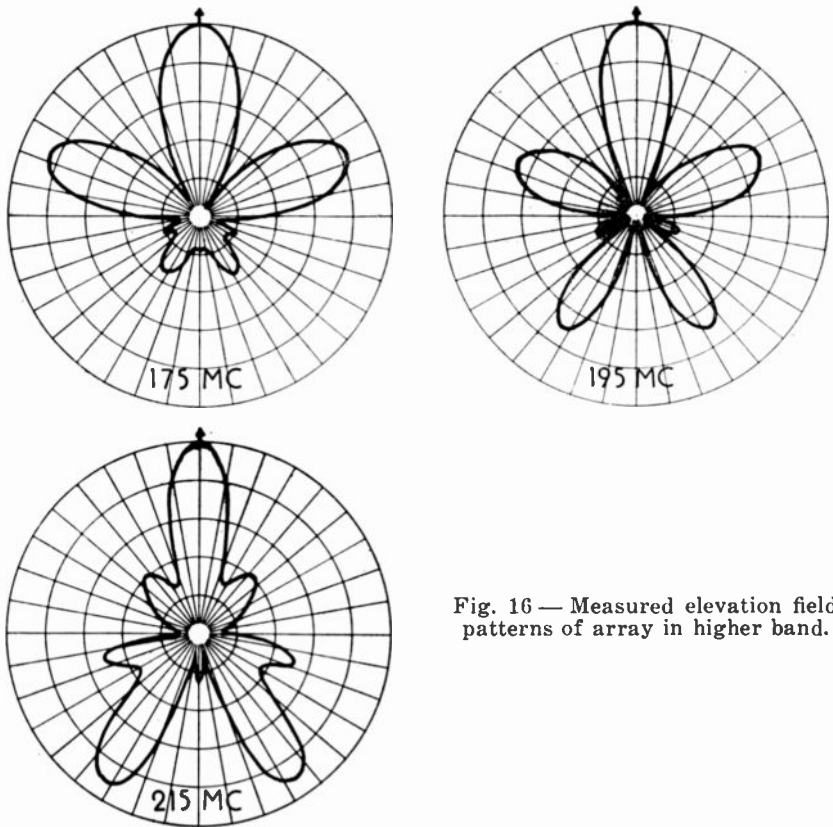

Fig. 16 — Measured elevation field patterns of array in higher band.

vertical rod extending above the antenna affords lightning protection and is not part of the array. The individual dipoles are mounted at the ends of tubular metal arms clamped at right angles at their mid-points. The array is attached on the mast by clamps to the lower portion of the vertical arm. Standard 300-ohm transmission line is used throughout. The lines are carefully supported with stand-off insulators to prevent undesired discontinuities.

The diplexer, (Figure 12), may be strung on spreaders to permit compact installation behind the television receiver. The resistor is an ordinary $\frac{1}{2}$ -watt carbon type with a resistance of 150 ohms. A double-pole, double-throw toggle switch (not shown), connected as a transposition switch in one of the feed lines, may be mounted conveniently near the front of the receiver.

Other variations are possible for certain requirements. For viewers desiring reception from opposite directions, the beam switching may be done automatically with the use of a relay and a tap switch ganged

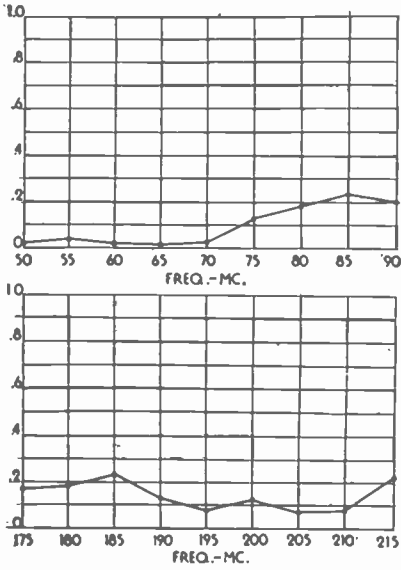

Fig. 17—Backward-to-forward field ratios of array.

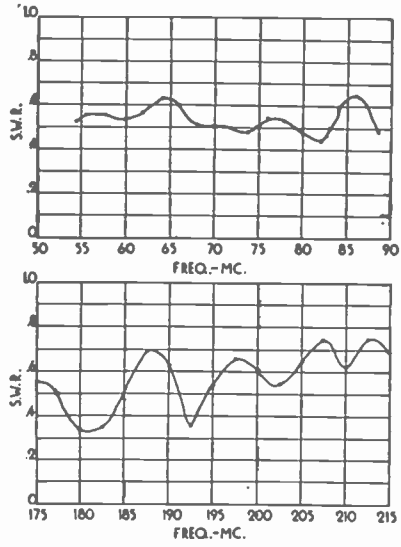

Fig. 18—Standing-wave characteristics of array.

to the station selector shaft of the receiver. For installations requiring reception from only one direction, the diplexer may be mounted near the array without the transposition switch and only one line extended down to the receiver.

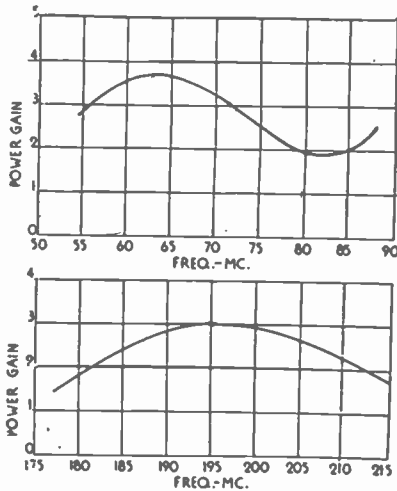

Fig. 19—Power-gain measurements of array.

FIELD TESTS

Measured azimuth and elevation field patterns of a typical array at representative frequencies throughout both bands are shown in Figures 13, 14, 15 and 16. The backward-to-forward field ratios taken from the measured field patterns are plotted in Figure 17. Slight changes in the length of the quarter-wave phasing line will alter the shape of this curve considerably. For example, a reduction in length of the phasing line to favor Channel six will cause an increase in the backward radiation on Channel two. In addition, the pattern will be changed in the higher band. In some installations minor corrections in this line length may be necessary to compensate for transmission line discontinuities.

The measured input standing-wave characteristics (Figure 18) show approximately a 2:1 standing-wave ratio throughout both bands.

Averaged results of several power gain tests are given in Figure 19. In making the power gain measurements, the array was compared to a matched 300-ohm dipole one-half wave in length at each test frequency.

CHARACTERISTICS OF HIGH-EFFICIENCY DEFLECTION AND HIGH-VOLTAGE SUPPLY SYSTEMS FOR KINESCOPES*†

BY O. H. SCHADE

Tube Department, RCA Victor Division,
Harrison, N. J.

Summary—The energy required for cathode-ray beam deflection is determined as a function of kinescope constants and operating voltages. The total power input to the deflection-coil system can be reduced if circuit and tube losses are minimized. Because power and regulation in an associated pulse-operated high-voltage supply system are functions of the stored energy in the circuit, the kinescope screen brightness depends on the kinescope parameters and the circuit efficiency. It is shown that practical deflection systems having high efficiency and employing inexpensive tubes and components can be designed to provide satisfactory kinescope performance.

INTRODUCTION

IT IS of great value in the development of new cathode-ray tubes and deflection circuits to be able to predict the energy and power required by ideal and practical circuits for deflection of the cathode-ray beam. One likes to think that deflection of an electron beam requires, in principle, only energy, and that large field energies can be maintained in a tuned circuit by a small oscillator tube. What then is the cause for the large power loss in deflection circuits? The answer to this question lies in the fact that the deflection system in television cameras and receivers does not function like a simple tuned circuit but more like a motor generator where the output of the generator is connected for a full load test back to the power line to circulate real power and not volt-amperes. In a deflection system, the electron tubes must control and supply not only the power loss but also the total reactive power circulating through the system. It is, therefore, of interest to determine the power required for beam deflection, express this deflection power in terms of the kinescope parameters, and derive general relations for determining the required direct-current input power from the circulating power, circuit element losses, and tube losses.

The first two sections of this paper deal with fundamental functions and relations in deflection systems, while the third section illustrates the application of these principles to the problem of determining the

* Decimal Classification: R583.15.

† Reprinted from *RCA Review*, March, 1950.

circuit constants and the power loss distribution in practical deflection systems.

ENERGY AND POWER REQUIREMENTS FOR KINESCOPE BEAM DEFLECTION AND LIGHT OUTPUT

Energy and Circulating Power

The deflection cycle in the basic circuit given in Figure 1 is started by closing the switch *S*. Energy is built up in the magnetic field of the deflection coil *L* by the current *i* which increases exponentially during the time *t*₁ to a value *i*₁. The value of *i*₁ is determined by the

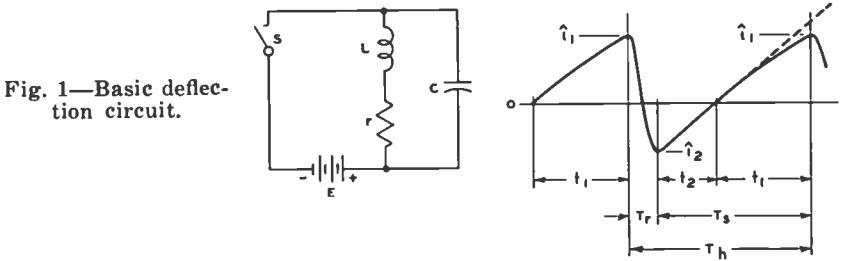

Fig. 1—Basic deflection circuit.

required beam deflection angle α . At *t*₁ the switch is opened. The stored field energy,

$$W = 0.5L i_1^2, \tag{1}$$

causes the tuned circuit *LC* to oscillate at its natural frequency *f*₀. Within one-half cycle of oscillation the current flow in *L* reverses and builds up to a negative peak value *i*₂ the magnitude of which depends on the circuit losses as expressed by the effective *Q*-value of the tuned circuit:

$$i_2 = -i_1 e^{-1.65/Q}. \tag{2}$$

Current and field reversal in *L* cause, therefore, a rapid beam deflection in the opposite direction beyond the kinescope screen center over a total angle $\alpha_1 + \alpha_2$ within the retrace period. The retrace period *T*_r is expressed by*

$$T_r = 0.525/f_0. \tag{3}$$

At the end of the retrace period the switch is closed again. The current

* The retrace time is approximately 5 per cent longer than one half cycle as shown in Figure 2 of Reference (1). This relation furnishes the constants given in the exponents of Equations (2), (3), (5), (8), (9) and Table I.

in L decreases now approximately at the rate $di/dt = E/L$ from the negative value i_2 to zero within the time t_2 thereby recharging the battery E and returning the beam to the center of the kinescope screen. After crossing the zero axis, the current increases again towards i_1 and the switching operation is repeated.

In loss-free circuits ($Q = \infty$) the energy W stored in the magnetic field of the coil provides deflection over a total angle $\alpha_1 + \alpha_2 = 2\alpha$ and the peak-to-peak current is $i_1 + i_2 = 2i_{1(\alpha)}$. The full deflection energy can then be recovered in the portion of the scanning period t_2 during which energy is returned to the power-supply system.

It is apparent that whatever the energy-control system (mechanical or electronic switches, transformers, etc.), it must handle the reactive energy W at the rate of the scanning frequency (f_h), i.e., 15,750 times in one second. The reactive power P_1 supplied to L during T_s is, hence,

$$P_1 = W f_h. \quad (4)$$

Because of circuit losses in practical systems, the current $i_{1(\alpha)}$ must be increased by the factor

$$q = i_1/i_{1(\alpha)} = 2/(1 + \epsilon^{-1.65/q}) \quad (5)$$

to maintain full deflection over the angle 2α . Furthermore, a synchronizing margin of approximately 3 per cent requires a current increase by the margin factor

$$m = 1.03. \quad (6)$$

The reactive power supplied to L (including the factors q and m given in Equations (5) and (6)) is, therefore, given by

$$P_1 = q^2 \times 0.5L f_h (m i_{1(\alpha)})^2 = q^2 P_o \quad (7)$$

where P_o is the reactive power required by a loss-free system and includes the synchronizing margin factor m . The fraction P_r of the power P_1 dissipated during the retrace time in the tuned circuit LC is given by

$$P_r = P_1 (1 - \epsilon^{-3.3/q}). \quad (8)$$

The power P_2 available for recirculation through the circuit is, therefore,

$$P_2 = P_1 \epsilon^{-3.3/q}. \quad (9)$$

The decay functions in (2), (5), and (9) are given in Table I of the Appendix.

Kinescope Constants and Circulating Power

The current $i_{1(\alpha)}$ is a function of the deflection angle α and the electron velocity in the beam, i.e., the anode potential E_a (in volts) of the kinescope, and the deflection-coil constants as expressed by the following equations:¹

$$i_{1(\alpha)} = 2.65l (\sin \alpha) \sqrt{E_a} / \lambda' N \text{ amperes}, \quad (10)$$

$$\text{and} \quad L = 4\pi N^2 D \lambda' / (110^9) \text{ henries}, \quad (11)$$

where N = number of turns in deflecting coil L ,

l = length, in centimeters, of the magnetic flux lines in air, which is taken as the inside diameter of the iron shell of the coil,

λ' = effective field width, in centimeters, acting on the beam, i.e., the effective yoke length,

D = average field height or coil diameter, in centimeters, which corresponds closely to the kinescope neck diameter (outside diameter).

When Equations (10) and (11) are combined with (7) an expression for the reactive input power P_1 in terms of kinescope and coil constants is obtained.

$$P_1 = 4.4q^2 m^2 (\sin^2 \alpha) E_a D l f_h / \lambda' 10^8. \quad (12)$$

To minimize the power P_1 , the kinescope neck diameter D and the iron shell diameter l should be small and the effective field length λ' should be large (See Figure 2). The effective field length λ' is given by

$$\lambda' = r'^2 \sin \alpha / (1 - \cos \alpha), \quad (13)$$

(r' , in centimeters, defined in Figure 2), and can be eliminated from Equation (12), yielding

$$P_1 / E_a = 8.8q^2 m^2 K D f_h \sin \alpha (1 - \cos \alpha) 10^{-6} \text{ watts per kilovolt} \quad (14)$$

with $K = l/2r'$ (dimensions in centimeters).

¹ O. H. Schade, "Magnetic-Deflection Circuits for Cathode-Ray Tubes", *RCA Review*, Vol. VIII, No. 3, p. 506, September, 1947.

The ratio $K = l/2r'$ can be regarded as a design constant for a given type of yoke design and has the value 1.66 for present kinescope yokes. It should be noted that r' and λ' are effective values (see Figure 2). For $2\alpha = 50-70$ degrees, r' is approximately 1.2 times the actual clearance radius r at the neckline, and λ' is approximately 1.2 times the physical "window" length λ of folded-yoke coils, because of the coil fringe fields. With the design values $K = 1.66$, $f_h = 15,750$ cycles

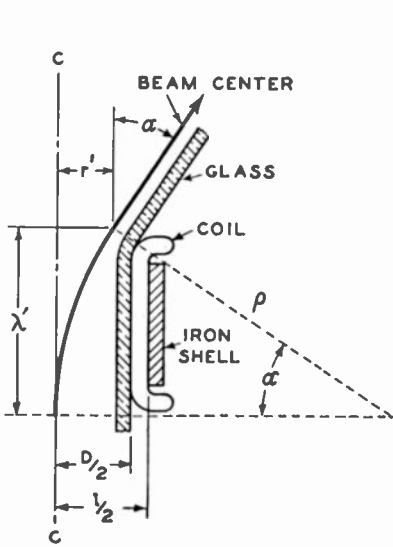

Fig. 2—Geometric relation of kinescope and deflection-coil dimensions to the beam-deflection angle α .

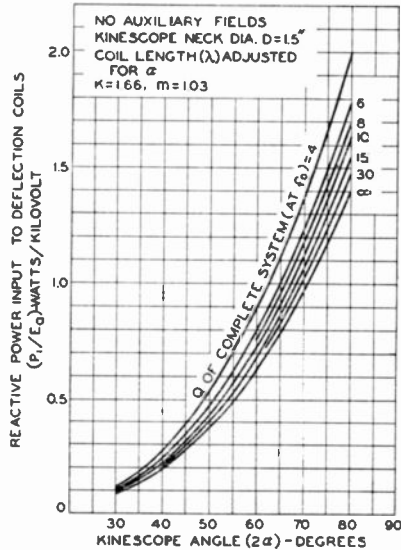

Fig. 3—Reactive power input to deflection coils as a function of kinescope angle 2α .

per second, $m = 1.03$, and $D = 3.8$ centimeters, the power input to the deflection coils per kilovolt of anode potential is expressed by

$$P_1/E_a = 9.33q^2 \sin \alpha (1 - \cos \alpha) \text{ watts per kilovolt.} \quad (15)$$

A plot of Equation (15) for full-diameter deflection (2α) is shown in Figure 3 for various values of Q .

Regulation and Reaction of an Associated High-Voltage Pulse Rectifier Circuit

A certain amount of power can be taken from the deflection power P_1 when a high-voltage pulse is generated in LC during the retrace period T_r . With the aid of a transformer and rectifier system, the pulse voltage can be adjusted to obtain the desired kinescope anode voltage E_a . Removal of power from P_1 during T_r reduces the initial

no-load value Q_o of the system at its natural frequency f_o to a lower full-load value Q_2 at the end of T_r , and thus decreases the value of the negative peak current i_2 . The beam current obtainable from the high-voltage supply circuit with a regulation of 10 per cent can be determined as follows. When 19 per cent of P_1 is taken out, the no-load peak anode voltage E_a is reduced to $\sqrt{0.81} E_a = 0.9E_a$ and the current i_2 available for scanning at the end of T_r is reduced to $0.9 i_2$. The effective deflection width on the kinescope screen remains, therefore, substantially constant. The 10 per cent change of the ratio i_2/i_1 does not seriously affect the deflection linearity. The pulse-voltage peak occurs at $0.5 T_r$, at which time, because of circuit losses, the available power has then decreased from P_1 to the lower value

$$P_{0.5T_r} = P_1 \epsilon^{-1.65/q}. \quad (16)$$

The anode current I_a at the 10 per cent regulation point $0.9E_a$ is, therefore,

$$I_a = 0.19P_{0.5T_r}/0.9E_a = 0.211 (P_1/E_a \epsilon^{-1.65/q}) \text{ microamperes.} \quad (17)$$

The value given by Equation (17) is obtainable at $0.9E_a$ from the deflection-coil energy alone assuming an ideal transformer and rectifier system. Practical transformers increase the stored energy in the deflection coils by their own field energy, which for good design, is on the order of 10 to 20 per cent of the deflection energy. Practical high-voltage rectifier tubes and series reactance cause a voltage drop which more than cancels the current increase due to the transformer energy. The value of the available beam current is *independent of the anode voltage* for a given neck diameter and tube angle α because Equation (17) is derived for the condition that the voltage E_a is adjusted to obtain full deflection over the selected angle 2α . The current at 10 per cent regulation is substantially constant for $Q_o \geq 4$ as shown by Figure 4.

High-Voltage Power and Light Output

The design of a satisfactory kinescope and deflection system has the primary objective of providing adequate picture brightness with good focus. The screen brightness, i.e., the light output per unit area of kinescope phosphors, is proportional to the average screen current per unit area but increases approximately as the square of the screen potential within the range of normal operation.

When the anode potential is limited, adequate screen brightness

may require operation with larger beam currents. Larger beam currents necessitate deflection systems in which the deflection field energy is supplemented by larger auxiliary fields in transformers or chokes to obtain the desired high-voltage power from a deflection pulse supply. In this case it may be advantageous to increase the deflection energy itself by selecting a shorter kinescope with a larger deflection angle.

It is, therefore, desirable to consider whether or not the high-voltage power available from an efficient deflection system with small auxiliary fields can provide adequate screen brightness.

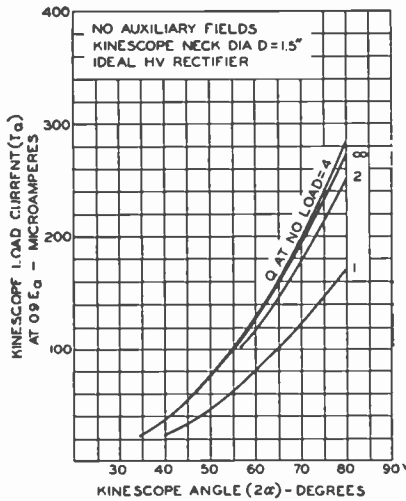

Fig. 4—Current obtained with 10 per cent regulation from ideal high-voltage-rectifier system supplied by the deflection-field energy.

The full deflection angle (2α) of a 10BP4 kinescope is 55 degrees. In a deflection system with a Q greater than 4, the beam current at $0.9E_a$ is, hence, 100 microamperes (Figure 4). This value represents the *average* beam current with picture modulation because the filter capacitance of the rectifier system can supply high peak currents without noticeable effect on the voltage stability. The ratio of peak to average current depends, obviously, on the picture content. For normal television images the peak beam currents which correspond to high-light brightness values are rarely less than 3 to 4 times the average beam current. For a peak current

of 300 to 400 microamperes, the published characteristics of the 10BP4, operated with an anode voltage of 9 kilovolts and with a 6×8 -inch focused raster, show a highlight brightness of 80 to 100 foot-lamberts. The highlight brightness is reduced to 58 to 73 foot-lamberts when a full screen raster of 7×9.35 inches is scanned. The brightness values obtainable with practical systems are from 10 to 20 per cent lower and can be considered adequate.

For the same brightness a 16-inch kinescope operated at 9 kilovolts would require that the current be increased by the ratio of the screen areas $16^2/10^2$, or 2.56. When the 16-inch kinescope is operated at an anode voltage of 12.6 kilovolts (0.9×14 kilovolts), the current ratio can be decreased to $(9/12.6)^2 \times 2.56 = 1.3$; i.e., the required average beam current is 100×1.3 or 130 microamperes. This current requires

a kinescope angle of 60 degrees. For better contrast in the presence of ambient light the use of a face plate made of a neutral filter glass with a transmission of 70 per cent requires that the beam current be increased to 186 microamperes for the same light output from a 16-inch tube. A short tube with a cone angle of 70 degrees provides theoretically 195 microamperes of beam current from an efficient deflection system and is, therefore, a more logical choice than a longer tube with a smaller angle operated with a deflection circuit of lower efficiency.

It is unfortunate that the performance of a television receiver is judged in some cases by the ability of the kinescope to light up the viewing room regardless of the fact that definition and picture quality are greatly reduced. It is of interest to describe what happens when a receiver with a 10-inch tube and limited high-voltage power is compared with one having unlimited high-voltage power. When the brightness test is made with a substantially "white" screen, as in certain test patterns, the pulse-operated, high-voltage supply will provide a maximum brightness in the order of 30 foot-lamberts; the brightness with a supply of unlimited power on the other hand, will remain at or even exceed 70 foot-lamberts. With normal television subjects on the screen, however, there will be very little difference between the two sets even when the kinescopes are over-driven because the average currents cannot exceed moderate values because the large peak signals cause rectification effects and overload in video and kinescope grid circuits.

CIRCUIT OPERATION AND CHARACTERISTICS

The Requirement for Linearity

The simple circuit shown in Figure 1 does not provide linear deflection current unless the circuit resistance is reduced to zero. Linearity is obtained during the scanning period T_s (switch closed) by inserting a negative resistance $-r$ in series with the switch, i.e., by inserting a power source generating the voltage $-ir$ to cancel the positive ir drop across the circuit resistance. This measure insures linearity of sawtooth current during T_s but does not compensate for the power loss in the retrace time.

A system compensated for series resistance in the inductive circuit L - S - E of Figure 1 by a "linearity control" generator but having a finite Q -value during T_r can, therefore, provide a linear deflection current within T_s . However, the power and the average current \bar{i}_1 furnished by the battery E to build up the field energy in L remain larger than the power and the average current \bar{i}_2 recovered after T_r to recharge the battery.

Circuit Q at No-load and Full-load

The no-load value of Q_o at the natural frequency, f_o , of a practical deflection circuit is determined largely by the power loss caused by eddy currents in copper and losses in the magnetic materials of the tuned-circuit inductances. The low loss of powdered (electrolytic) iron and particularly of ferrite cores has made it possible to obtain values of Q_o equal to or greater than 15 in circuits with inexpensive transformers. By use of these materials, the power dissipation during T_r in yoke and transformers has been reduced to less than 20 per cent of the reactive deflection power P_1 (Equation (7)). The Q_o of the circuit can be computed from the equivalent shunt resistance value R across the yoke and the associated transformer winding which, in parallel, have the inductance L ; $Q_o = R/\omega_o L$.

The total shunt resistance R is the parallel value of the shunt loss-resistances of yoke and transformer, and the reflected values of other resistance loads such as isolation or coupling resistors in high-voltage doubling circuits. Q_o and R are readily measured in a completed circuit by connecting a vacuum tube voltmeter across the yoke winding and exciting the circuit (scanning tubes not operating) at its natural frequency f_o (of the order of 70 kilocycles) by loose capacitive coupling with a signal generator. The frequency deviation Δf between the 0.707-voltage points on each side of f_o furnishes the value $Q_o = f_o/\Delta f$. The value of added shunt resistance which reduces the resonant voltage at f_o to one-half is equal to R thus giving also the inductance $L = R/\omega_o Q_o$.

The Q and the equivalent shunt resistance of the yoke can be found by tuning the yoke itself with a low-loss capacitor to f_o . These measurements furnish the distribution of the retrace-time power loss in the circuit elements which is proportional to the reciprocal value of their shunt resistances.

$$P_1 + P_2 + \dots + P_n = R (1/R_1 + 1/R_2 + \dots + 1/R_n) P_R. \quad (18)$$

Removal of power by the high-voltage supply system reduces the Q_o of the tuned circuit to an equivalent value Q_2 which would cause the same total power loss during the retrace period T_r . For example, a beam current with a 10 per cent regulation (see Equation (17)) causes a power loss of $0.19 P_1$ within T_r . This loss is equivalent to the loss in a circuit with $Q_1 \approx 15$ (Equation (8)). The equivalent Q of the circuit can then be computed from

$$1/Q_2 = 1/Q_o + 1/Q_1. \quad (19)$$

Q and Average Current Ratio

In circuits with electronic switch (Figure 5a), the bidirectional deflection current is carried by two electron tubes, V_1 and V_2 . The reactive current i is split into two components i_1 and i_2 joined at $i = 0$. This ideal "class B" operation is seldom realized in practical circuits. It is obvious, however, that this condition furnishes minimum average currents $I_{b_1} = \bar{i}_1$ and $I_{b_2} = \bar{i}_2$. These current values have a ratio equal to the triangular areas under the current waveforms i_1 and i_2 when the deflection current is linearized by proper control of V_1 and V_2 (see later). The ratio of the average currents is given by

$$\bar{i}_2/\bar{i}_1 = \hat{i}_2^2/\hat{i}_1^2 = \epsilon^{-3.3/Q_s} \tag{20}$$

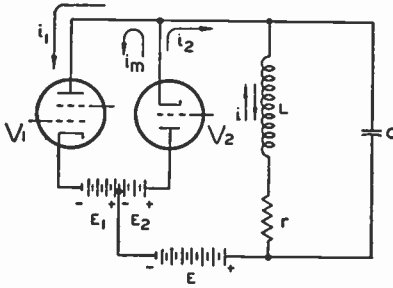

Fig. 5a—Basic deflection circuit with electronic switch.

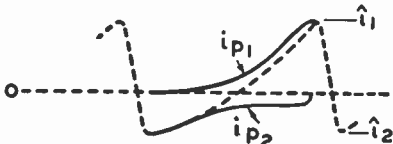

Fig. 5c—Waveform distortion in increasing the average value of i_2 .

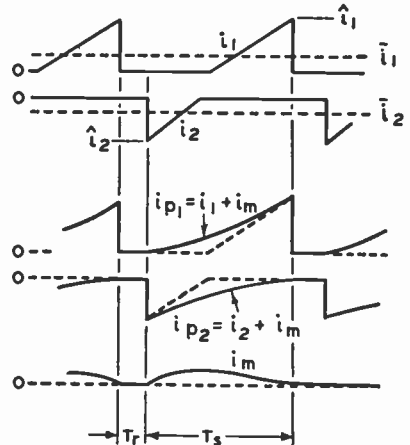

Fig. 5b—Current components in circuit of Figure 5a.

In practice the plate currents i_{p_1} and i_{p_2} may overlap in time as much as 100 per cent as indicated in Figure 5b. The "matching" current, $i_m = i_{p_1} - i_1 = i_{p_2} - i_2$, increases the average plate currents and the plate dissipation of V_1 and V_2 , but it cancels out in the common circuit branch E - r - L of Figure 5a.

It is, therefore, not possible without the use of a transformer to obtain equal charge and discharge currents of the battery E with the condition that the inductive current i have a linear or symmetric* waveform. It is possible to equalize charge and discharge currents

* By symmetric is meant an S-shaped current such as a section of a sine wave extending equal angles below and above the sine-wave axis.

by distorting the current waveforms i_1 and i_2 as shown, for example, in Figure 5c, but the resultant current i is then non-linear or asymmetric.

Requirements for Series Power Feedback (Transformer Ratios)

The operating principle of circuits with series power feedback is readily understood when it is considered that equal charge and discharge currents of the battery E result in a total average current equal to zero and the battery E of Figure 5a, therefore, may be replaced with a capacitor C_b without disturbing the circuit operation. In order to start functioning, the circuit must have current waveforms giving initially a current ratio \bar{i}_2/\bar{i}_1 slightly greater than unity so that C_b can be charged gradually and the voltage E_{C_b} built up to the normal value E .

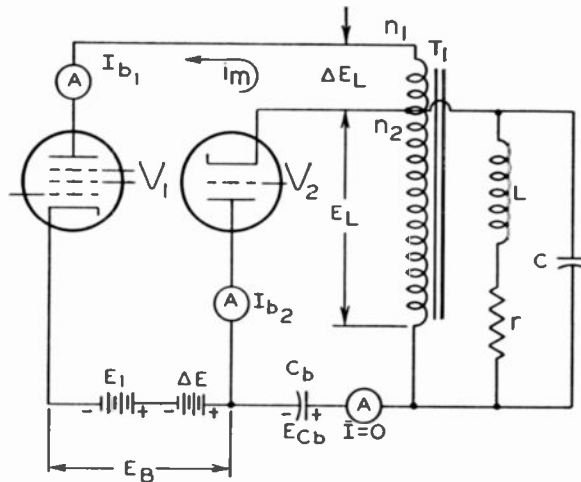

Fig. 6—Power feedback circuit with autotransformer.

Perfect linearity of deflection requires either an LC circuit with an infinite Q or the insertion of a transformer between the tubes V_1 and V_2 (Figure 6) to reduce the value of the larger current \bar{i}_1 so that $\bar{i}_1 = \bar{i}_2$.

Linearity of deflection current ($di/dt = \text{constant}$) results in constant reactive voltages on all of the transformer windings. The reactive power values are, therefore, equal to products of reactive voltages and average current values. The matching current, i_m , of V_1 and V_2 exists only in the section $n_1 - n_2$ of the transformer. (See Figure 6) The average current components in the common winding n_2 are, therefore, the values \bar{i}_1 and \bar{i}_2 of the ideal (triangular) class B currents, and the reactive powers with respect to this winding are $P_1 = \bar{i}_1 E_L$ and $P_2 = \bar{i}_2 E_L$, where $\bar{i}_1 > \bar{i}_2$. The power P_1 being supplied by V_1 is developed

actually in two windings; on n_1 by the current component \bar{i}'_1 , and on $(n_2 - n_1)$ by the full plate current I_{b_1} , so that $P_1 = E_L \bar{i}'_1 + \Delta E_L I_{b_1}$. When the turns ratio is adjusted so that $\bar{i}'_1 = \bar{i}_2$, it follows that $E_L \bar{i}'_1 = P_2$ and

$$\Delta E_L I_{b_1} = P_1 - P_2 = P_r \quad (21)$$

In practical circuits a fraction of P_2 is dissipated in the process of recharging C_b . Unless compensated, this power loss causes a reduction in the voltage E_{C_b} to a value less than that of E_L , but the voltage loss has no effect on E_L or \bar{i}_2 which determine Equation (21). It may, however, be desirable to use a fraction of the feedback power P_2 to supply external load circuits with current from the "boosted" B -supply voltage $E_{BB} = E_B + E_{C_b}$.

To supply this "bleeder" current from C_b , the charging current \bar{i}_2 must be increased by a current component equal to the bleeder current I_{BB} and a change is required in the transformer ratio to restore the power balance. The power loss P_x subtracted from the feedback power by the bleeder-current load is equal to $E_L I_{BB}$ and requires that Equation (21) be changed to

$$\Delta E_L I_{b_1} = P_r + P_x \quad (21a)$$

Substituting this expression into the voltage ratio $n_1/n_2 = (E_L + \Delta E_L)/E_L$, gives the equation

$$n_1/n_2 = 1 + (P_r + P_x)/I_{b_1} E_L \quad (22)$$

Equation (22) furnishes the required turns ratio n_1/n_2 between the V_1 and V_2 circuits. The ratio between V_1 and the deflection-coil connection can be left unchanged or may be given other values in practical circuits to adjust I_{b_1} and E_L . For the general case, the voltage E_L in Equation (22) is the inductive voltage $E_{(n_2)}$ across the transformer winding having n_2 turns and energizing the V_2 circuit. The substitution $E_{n_2} = E_{n_1} n_2/n_1$ results in the more useful form

$$n_2/n_1 = 1 - (P_r + P_x)/I_{b_1} E_{n_1} \quad (23)$$

where $P_x = I_{BB} E_{n_1}$.

With respect to the plate circuit of the power tube the net "reactive" power load $I_{b_1} (E_{n_1} - E_{C_b})$ has the characteristics of a "bucking battery" (square wave voltage drop). This load requires the increase, ΔE (Figure 6) in the supply voltage E_B but does not cause

any change in the plate dissipation of V_1 (See Part III). The reactive load $I_{n_1}(E_{n_1} - E_{Cb})$ does not contain the total copper loss or series resistance loss of the circuit. The V_1 plate circuit contains, therefore, also a series resistance load R_p (See next section).

Linearity Control Circuits and Functions

The action of the linearity control (tunable transformer T_2) in diode circuits (Figure 7) has been explained in detail in a previous article.¹ For the purpose of this discussion it is pointed out that the voltage generated across the diode winding of T_2 is equal and opposite to the resistive voltage drop in the diode circuit V_2-L-C_b and, in effect, cancels this circuit resistance, thereby providing linearity of deflection. The linearity transformer T_2 reflects, therefore, a series resistance into the plate circuit of V_1 in which the plate current i_{p_1} develops a power output equal to the diode-circuit resistance loss. This action permits these conclusions for *circuits with controlled diode* (V_2):

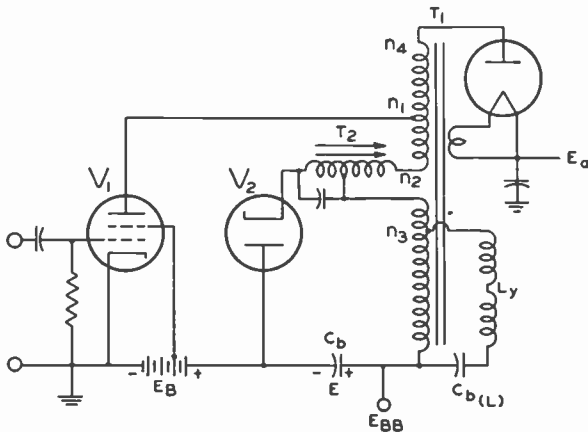

Fig. 7—Power feed-back circuit with controlled diode and autotransformer supplying high-voltage rectifier.

1. The potential E_{Cb} developed across C_b (termed the "boost voltage") is exactly equal to the inductive voltage $E_{n_2} = L di/dt$ energizing the diode circuit which may be treated as a loss-free rectifier circuit. The reactive power load of V_1 is, therefore, $(P_r + P_g)$.
2. The power tube V_1 supplies *all* copper losses as well as the diode plate loss occurring in the deflection circuit during the scanning period T_s . These losses are reflected into the plate circuit of V_1 as a resistive load R_p .

When a triode rectifier (V_2) is used in place of the diode, the negative resistance (and hence linearity) is generated in the tube by

applying a suitable control-grid signal. In this case the resistive power loss in the V_2 circuit is supplied from the reactive power P_2 . Consequently, it may be concluded for *circuits with triode rectifier (V_2)*:

1. The boost voltage E_{cb} is smaller than the inductive voltage and the reactive power tube load $I_{b1} (E_{n1} - E_{cb})$ containing resistive power losses is larger than in circuits with controlled diode.
2. The copper losses caused by the current components i_1 and i_{p1} only appear as a resistance load R_b in the plate circuit of the power tube V_1 . The reflected plate load R_p is, therefore, smaller than in circuits with controlled diode.

These characteristics must be considered when the total plate load of the power tube and the required B-power input are evaluated. The equivalent plate circuit of the power tube V_1 has, thus, the form shown

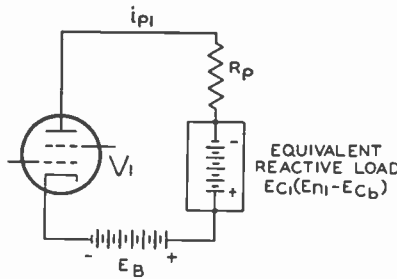

Fig. 8—Equivalent plate circuit of power tube V_1 .

in Figure 8 and will be discussed in Part III. It should be mentioned that constant velocity of the cathode-ray spot on a large-radius kinescope screen requires a reduction of the angular velocity (slightly S-shaped sawtooth current) for larger deflection angles. This velocity correction is controlled by adjusting the value of series capacitor $C_{b(L)}$ (Figure 7).

Pulse Voltage Step-up and Rectifier Circuits

The peak voltage \hat{e} built up across an LC circuit after $0.5 T_r$ can be expressed in terms of the circulating power $P_{0.5T_r}$ and the circuit capacitance; or in terms of current and the circuit impedance $\omega L = \sqrt{L/C}$. It follows from

$$P_{0.5T_r} = P_1 \epsilon^{-1.65/Q} = C \hat{e}^2 f_h / 2 \tag{25}$$

that
$$\hat{e} = \sqrt{2P_{0.5T_r} / C f_h} \tag{26}$$

Also:
$$\hat{e} = \hat{i}_1 \omega_0 L \epsilon^{-0.825/Q} \tag{27}$$

The voltage \hat{e} at the deflection-coil terminals of practical circuits ranges from 1.0 to 3.0 kilovolts. It is largest in direct-drive circuits (Figure 5a) where the capacitance C in Equation (25) is the sum of the capacitances of the deflection coils, the tubes V_1 and V_2 , and a filament isolation transformer for V_2 . This capacitance is equal to or greater than 150 micromicrofarads.

General requirements for generating voltages in the order of kinescope operating potentials are indicated by Equation (26).

a. For a given power, the capacitance C at the input terminals of the high-voltage rectifier must be reduced considerably below the value in the deflection circuit (by a factor between 5^2 and 10^2). This impedance transformation is effected by connecting a step-up transformer with low winding capacitance parallel to the deflection coils. (Figure 7). The voltage step-up obtainable by this method is limited by the specified retrace time. The progressive increase in the diameter of the high-voltage coil causes larger layer capacitance and leakage inductance within the step-up coil.

Parasitic tuned circuits are formed by leakage inductance and coil capacitance. These circuits (Figure 9) absorb power from the system

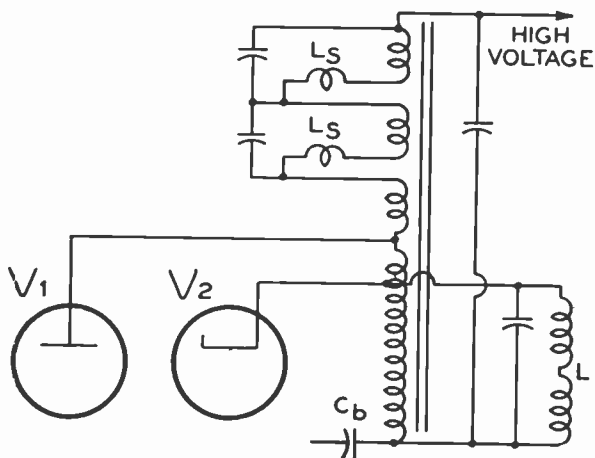

Fig. 9 — Tuned-circuit system formed by layer capacitance and leakage inductance of high-voltage winding.

particularly when their resonant frequencies approach the main resonant frequency f_o . Having no direct outlet into the V_2 circuit, the absorbed power is dissipated largely in the transformer winding. When limited by these difficulties the pulse voltage can be increased by raising the reactive power.

b. The circulating power in the circuit can be increased by connecting an auxiliary inductance in shunt or in series with the deflection-coil inductance. The shunt inductance of the transformer winding may, therefore, be reduced to serve this purpose, a lower limit being imposed by increasing core loss and saturation of the magnetic material.

A shunt inductance with a high Q does not disturb the general operation of the circuit because the additional circulating power is included in the power feedback. The increased plate currents, however, cause increased copper loss and plate loss in V_1 and V_2 . A sepa-

rate inductive shunt is used to advantage in deflection systems for projection tubes which require a large high-voltage power. Series inductance may be introduced into the plate circuit of V_1 in the form of a separate inductance or by leakage inductance (Figure 10) between the V_1 and V_2 windings of the transformer.

The series inductance L_s alter the system performance by introducing at least one new resonant system formed by L_s and associated capacitances C_s . This system has its own natural frequency f_s which is usually higher than f_o . The series circuit $L_s C_s$ is relatively undamped as it has no direct power outlet into the V_2 circuit and must, therefore, dissipate most of its power ($P_{1(s)}$) in the form of heat (partially in the plate resistance r_p of V_1). Coupling to the main circuit causes a trickle feed of oscillating current of frequency f_s into the main circuit and may produce "ripples" in the deflection current.

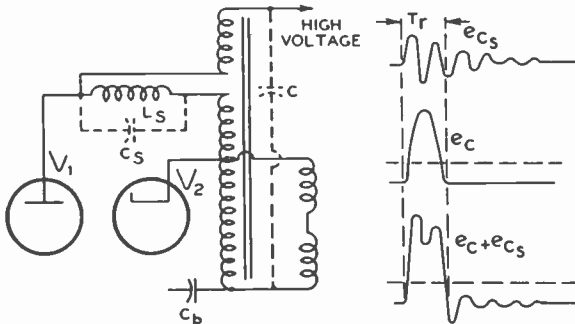
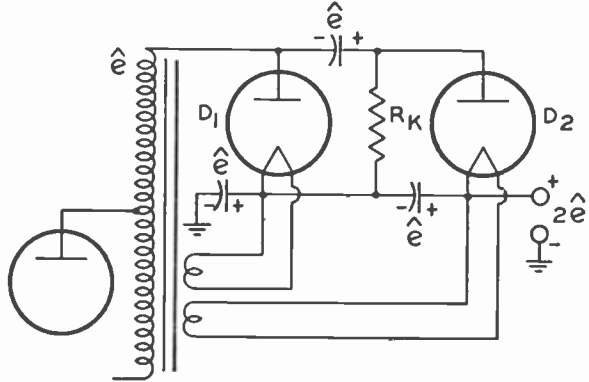

Fig. 10 — Deflection circuit with leakage inductance in plate lead of power tube causing negative plate-voltage swing.

Relatively small values of series inductance L_s cause an oscillating plate voltage (Figure 10) which becomes negative at the start of the scanning period T_s , giving rise to high-frequency Barkhausen oscillations which may be picked up by the receiver on one or more channels. These oscillations can be shifted in frequency by changes in the power tube structure, usually at the expense of increased plate dissipation. Barkhausen oscillations do not occur when a plate voltage swing below the "knee" of the power tube plate characteristic is prevented.

c. High direct-current potentials can be obtained from a low pulse voltage by connecting two or more pulse rectifiers in cascade. The voltage-doubling circuit Figure 11 removes many of the difficulties which have caused low efficiency in deflection systems. Insulation problems are eased considerably because transformer and circuit components operate at one-half the direct-current output potential. The low tube voltages and high current efficiency are reflected in the design of single-ended low-cost rectifiers and power tubes permitting convenient sub-chassis mounting of the circuit components. The efficiency

Fig. 11—Voltage-doubling circuit with coupling resistor.



of the rectifier circuit can be increased still further by replacing the coupling resistor R_k in Figure 11 by a diode as shown in Figure 12. The coupling diode D_k removes alternating-current loading of the transformer circuit during T_r and eliminates the direct-current voltage drop on R_k caused by the kinescope current. For a moderate high-voltage power, a resistor R_k is satisfactory. It can be given a high value such as 3 megohms which causes a 300-volt drop for a 100 micro-ampere current and at a pulse voltage $\hat{e} = 5$ kilovolts ($E_a = 10$ kilovolts) represents a shunt power loss of approximately 0.75 watts. Replacement of R_k by a diode D_k eliminates the direct-current voltage drop and reduces alternating-current loading to the 0.25 watts required for heating the diode filament.

PRACTICAL CIRCUIT DESIGN

The usefulness of the relations derived in the first two sections is best illustrated by a description of the sequence of steps encountered in the design of a practical deflection system with high efficiency. For a numerical example consider a deflection circuit with auto-transformer having the circuit arrangement indicated by Figure 7 to operate a 70-degree kinescope at an anode voltage E_a of 14 kilovolts. Given are the scanning frequency $f_k = 15,750$ cycles per second, the retrace

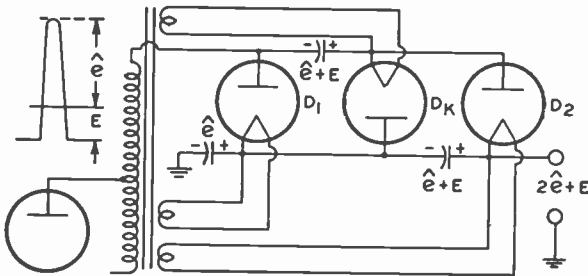

Fig. 12—Voltage-doubling circuit with coupling diode.

period $T_r = 7.5$ microseconds, and the scanning period $T_s = 56$ microseconds.

Yoke Inductance and Voltages

10 millihenries is chosen for the yoke inductance. This value can be readjusted later on if desirable. First, the voltages appearing on L_y are determined. It follows from Equation (7) that the peak current \hat{i}_1 is given by

$$\hat{i}_1 = 11.3 \sqrt{P_1/L} \text{ milliamperes} \quad (28)$$

for $f_h = 15,750$ cycles per second.

The inductive voltage during the 56-microsecond scanning period is constant and has a fixed value for a given peak-to-peak deflection current. It can, therefore, be computed from the reactive power P_o letting $Q = \infty$. With $E_L = L 2\hat{i}_1/T_s$ and Equation (28),

$$E_L = 404 \sqrt{P_o L}. \quad (29)$$

For $2\alpha = 70$ degrees, $E_a = 14$ kilovolts, and $Q = \infty$, from Figure 3 the value $P_1/E_a = 0.96$, hence, $P_o = 0.96 \times 14 \approx 13.5$ watts. With $L_y = 10$ millihenries, from Equation (29), $E_L = 148$ volts. The surge voltage \hat{e} can now be computed. For a normal waveshape and time ratios, Table II #4,

$$\hat{e} = 12.7 E_L \quad (30)$$

and the r-m-s value $|E| = 3.22 E_L. \quad (31)$

The numerical values are, hence, $\hat{e}_v = 1.88$ kilovolts and $|E|_v = 476$ volts.

Transformer Inductance, Shunt-Loss Diagram, and Q

The transformer inductance L_3 in shunt with the deflection coil inductance L_y increases the reactive currents of the deflection system by the factor

$$s = (1 + L_y/L_3). \quad (32)$$

The reactive power is increased by the same factor (s) because the total inductance L is decreased to the smaller parallel value

$$L = \frac{L_y L_3}{L_y + L_3}.$$

Large values of L_3 reduce the shunt power, but transformer windings with a large number of turns increase winding re-

distances and leakage reactance, which in turn can cause a more serious power loss. Practical ratios L_3/L_y vary between 5 and 10 depending on the permeability and the flux density $B_{max} = \epsilon 10^8 / \omega_0 n A$ in the selected core cross section (A in square centimeters) and magnetic core material. If, for the example, the value $L_3 = 70$ millihenries, $s = 1.143$ and $L = 8.75$ millihenries. To compute power, currents, and turns ratios it is necessary to determine the losses of the system from a shunt resistance diagram such as shown in Figure 13.

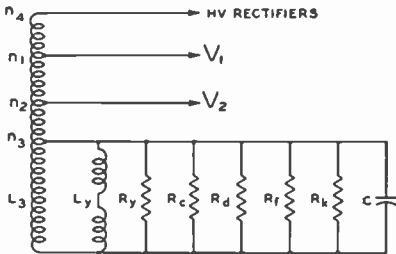

Fig. 13—Shunt-loss diagrams of deflection circuit.

Shunt Resistance (Megohms)	Representing Loss in
$R_y = 0.225$	Yoke with ferrite shell
$R_c = 2.$	Ferrite core of transformer
$R_d = 1.25$	Dielectric
$R_f = 0.302$	Rectifier filaments
$R_k = \infty$	Coupling resistors
<hr/>	
$R = 0.110$	Total Shunt
<hr/>	
	$L_y = 10$ millihenries
	$L_s = 70$ millihenries
	$L = 8.75$ millihenries

The yoke loss resistance, $R_y = 225,000$ ohms, is measured by tuning the inductance L_y with an air capacitor to $f_o = 70$ kilocycles as outlined previously. The transformer core loss R_c is determined as follows: A test coil wound on the transformer core with 10×38 Litz wire and having an inductance equal to that of L_3 is connected in shunt with the yoke. The value of the resistances R_y and R_c in parallel can then be measured and R_c calculated from this value. It will be observed that the shunt resistance values are substantially constant for flux densities below the saturation of the magnetic material and over a range of frequencies from 60 to 100 kilocycles. The value of f_o , therefore, does not have to be known accurately. The Q , however, changes inversely with f_o and requires an accurate frequency adjustment. It is pointed out that the saturation point of ferrites is also a function of temperature and that a relatively small core loss can cause a substantial temperature rise in materials having low thermal conductivity.

The shunt resistance R_d represents the dielectric loss in winding capacitances. It can be measured on the completed transformer and circuit or may be estimated by assuming a 0.3 per cent power factor for which $R_d = 330 / \omega_0 C = 330 \omega_0 L$.

The filament power P_f of high-voltage rectifier tubes is supplied by the transformer. The equivalent load resistance R_f reflected parallel to the yoke winding equals, therefore, E^2/P_f . The rectifier circuit selected for the example (Figure 12) contains 3 diodes and no coupling resistor ($R_k = \infty$).^{*} With the previously computed voltage $|E| = 476$ volts and the filament power $P_f = 0.75$ watts, we obtain the equivalent shunt resistance $R_f = 302,000$ ohms. The total shunt loss R of the circuit is, hence, 110,000 ohms and the value Q_o equals $R/\omega_o L$ for the circuit at f_o of 70 kilocycles and is, therefore, 26.

The retrace-power-loss distribution of the circuit, determined by Equation (18), is, hence, 110 $(1/225 + 1/2000 + 1/1250 + 1/302)P_R$. The power loss in the yoke represents 49 per cent, the transformer core loss 5.5 per cent, the dielectric loss 9 per cent, and the filament power 36.5 per cent of the power loss during retrace time. It should be mentioned that the low losses of yoke and transformer result from the use of ferrite cores operated with moderate flux densities. Should the transformer core loss prove too high, a higher inductance value L_3 is indicated because the shunt-loss resistance R_c is proportional to L_3 .

Retrace Power Loss, Reactive Power Input, and Recovered Power

The power loss occurring during T_r is readily computed from the shunt resistance $R = 110,000$ ohms and *the r-m-s voltage during T_r* , (not the actual r-m-s value $|E|$ given by Equation (31)).

$$P_r = (\hat{e}^2/2R)T_r f_h. \quad (33)$$

$$\text{For normal time ratios } P_r = \hat{e}^2/16.9R. \quad (34)$$

For the values of the example, $P_r = 2.1$ watts. The reactive power input to the circuit inductance L is increased to $P_{1(L)} = sP_1$. For $Q = 26$, Equations (15) and (5) or Figure 3 furnish $P_{1(L)} \approx 16.5$ watts. The recovered power $P_{2(L)}$, computed from the decay function (Equation (9)) is $P_{2(L)} = 0.875P_{1(L)} = 14.4$ watts and $P_r = 0.125P_{1(L)} = 2.1$ watts, which checks with the previously computed value.

The values just computed are the "no load" values at zero beam current. The beam current I_a with a regulation of 10 per cent from an ideal transformer and high-voltage rectifier system is given by Equation (17) or Figure 4. Because of the increase in reactive power required by the transformer shunt field ($s = 1.143$), we obtain for

^{*} The small high-voltage winding of the voltage-doubling circuit avoids resonance effects in the transformer design permitting, therefore, a close check of computed values by measurement.

$2\alpha = 70$ degrees the theoretical value $I_a = 204s$ microamperes = 235 microamperes. Series resistance and leakage reactance in the high-voltage winding, however, reduce the rectification efficiency. Experience indicates that the current of practical circuits at 10 per cent regulation has a value between 50 and 70 per cent of the theoretical value sI_a taken from the curve $Q = \infty$ in Figure 4. For our example, a 10 per cent regulation is expected to occur at a current I_a between 110 and 155 microamperes. A current of 186 microamperes will hence occur with a regulation between 12 and 17 per cent and give a screen brightness from 4 to 14 per cent less than the theoretical values stated in the discussion of high-voltage power and light output.

At this point it is necessary to select an average value of kinescope current I_a at which perfect linearity of deflection current is to be obtained. For this example, the value of 120 microamperes is selected. The high-voltage power load for the example is approximately $P_{HV} = 0.95 E_{\max} I_a = 1.6$ watts. This value increases the power loss during retrace from 2.1 watts at zero beam current to 3.7 watts at a 120-microampere beam current. The recovered power is reduced from 14.4 watts at no load to 12.8 watts at 120-microamperes beam current. The various design constants are assembled in Table III of the Appendix for further reference.

Currents and Voltages

The peak current values are readily computed from Equation (28). The peak currents $s\hat{i}$ in the total inductance for the no-load condition $I_a = 0$ are obtained with the values $P_1 = 16.5$ watts and $P_2 = 14.4$ watts and $L = 8.75$ millihenries. Under load ($I_a = 120$ microamperes) the value $s\hat{i}_1$ remains the same but $s\hat{i}_2$ is decreased because of the reduced power value $P_{2(L)}$. The numerical values are listed in Table III as well as the peak currents in the yoke inductance L_Y , which are obtained by multiplication with the factor $1/s$. The inductive voltage E_L for the no-load condition is identical with the value computed by Equation (29) for $Q = \infty$. The voltage E_L decreases with load in proportion to the peak-to-peak current ($\hat{i}_1 + \hat{i}_2$) which has the previously computed full-load-to-no-load ratio 0.926/0.949.

The numerical values of E_L so obtained are also listed in Table III.

Calculation of the average plate current values I_{b1} and I_{b2} requires the selection of a representative current waveform. Evaluation of the average-to-peak current ratio I/\hat{i} (See Table II) indicates values from 0.23 to 0.44 for a linear intermittent sawtooth wave when the operating time is varied from the ideal class B case to a full class A sawtooth lasting over T_s . An inverted sine wave class A operation (#3 Table II)

furnishes the factor $I/\hat{i} = 0.32$. A good practical waveform factor is

$$\hat{i}_p/I_b \approx 3. \quad (35)$$

The average plate current reflected into the transformer winding n_3 to which the yoke is connected is, therefore, $I_{b_1}' = 0.491/3 = 0.164$ amperes.

Transformer Turns Ratios

A general advantage of a transformer drive circuit is the flexibility available for adjusting the effective plate-circuit reactance by varying the transformation ratio n_3/n_1 between the deflection-coil terminals (n_3) and the power-tube plate circuit (n_1). With properly designed transformers the reflected plate-circuit inductance can be made considerably higher than the yoke inductance in direct-drive circuits for

Fig. 14—Autotransformer (right) has higher efficiency and smaller size than transformer with separate secondary winding (left). Both transformers have powdered-iron cores.

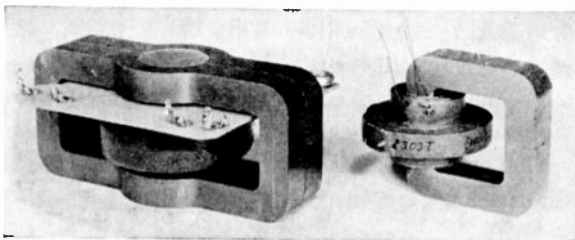

a specified retrace time. Auto-transformers are particularly suitable because the saving in winding space permits a considerable reduction in size (See Figure 14), reduces winding capacitances, and decreases leakage inductance values. The maximum plate inductance is limited by transformer and circuit capacitances and by the retrace time. Voltage-doubling circuits require only a small step-up coil to generate the required high voltage. Their small effective capacitance permits both a wider choice of transformation ratios and a higher operating efficiency than possible with single-stage high-voltage rectifier circuits.

Returning to the turns ratio n_3/n_1 between the deflection-coil circuit and V_1 suppose that V_1 is operated with a plate current value near 80 milliamperes and the ratio $n_1/n_3 = 2.1$. The peak and average plate currents and voltages $\hat{i}_p, I_{b_1}, E_{n_1}$ and \hat{e}_{p_1} are readily computed by reflecting the yoke circuit values into the plate winding as listed in Table III. It is obvious that selection of a ratio n_3/n_1 giving lower plate currents will cause higher plate voltages. It also must be considered that high ratios increase leakage inductance as well as the surge voltage and that it may, therefore, be desirable to increase the ratio n_3/n_1 later on by adjustment of L_Y to the subsequently computed value n_2/n_1 .

The transformer ratio n_2/n_1 between V_2 and V_1 is determined by the reactive power input and the power loss of the system

$$n_2/n_1 = 1 - (P_r + P_x)/E_{n_1}I_{b_1}. \quad (23)$$

The reactive plate power ($E_{n_1}I_{b_1}$) and the retrace power loss (P_r) for a beam current of 120 microamperes have been determined and require the values of the bleeder current I_{BB} and external power load $P_x = E_{n_2}I_{BB}$ taken from the "boosted" voltage E_{BB} . The voltage E_{n_2} in the expression for P_x must be estimated at first for a trial value P_x . The true values P_x , E_{n_2} and n_2/n_1 are found by successive approximation. A bleeder current of 17 milliamperes will be drawn to operate the vertical deflection circuit from E_{BB} , thus, for the 120-microampere beam-current load,

$$n_2/n_1 = 0.69; E_{n_2} = (n_2/n_1)E_{n_1} = 210 \text{ volts}, P_x = 3.6 \text{ watts}.$$

A diode booster tube V_2 with linearity transformer (Figure 7) supplies, therefore, a "boost voltage" $E_{Cb} = E_{n_2} = 210$ volts. Other voltages and currents in the V_2 circuit are readily computed from the yoke circuit values as listed in Table III.

The high-voltage stepup n_4/n_3 required for obtaining an E_a of 14 kilovolts with the circuit of Figure 12 is theoretically $n_4/n_3 = E_a/(2E_y + E_y)$. Table III furnishes the value $n_4/n_3 = 3.6$. A tap may be provided on the high-voltage winding at a ratio 10 per cent lower, because a correction for parasitic resonance effects may be necessary. A rectifier circuit with a single diode theoretically requires a step-up ratio $n_4/n_3 = 7.45$. Resonance effects in the high-voltage winding, however, can be effective in generating a higher voltage with a lower step-up ratio depending on the phase relation of the pulse voltage components. (Compare Figure 9). The power absorption increases the retrace power loss P_r , requiring, therefore, an increase of the ratio n_2/n_1 (Equation (23)).

r-m-s Currents, Transformer Windings, and Capacitances

The copper cross section of transformer and yoke windings should not be less than 500 circular mils per ampere of r-m-s current. The r-m-s value depends on waveshape (See Table II) and amplitude of the current. The current in the windings of the auto-transformer can be approximated closely by selecting waveforms representing normal efficient operating conditions.

The deflection coil current $|I|_y$ is a linear sawtooth current without direct-current component and is given accurately by:

$$|I|_y = 0.29 (i_1 + i_2). \quad (36)$$

The r-m-s plate current $|I|_{b_1}$ contains a matching current component. A practical plate current i_{p_1} has the shape of an inverted sine wave section (See Table II) which may have a slightly flattened peak (due to grid current). The r-m-s value is approximated with good accuracy by

$$|I|_{b_1} = 1.6 I_{b_1}. \quad (37)$$

This current value determines the wire size of the transformer winding $n_1 - n_2$ and part of the plate loss in V_1 (see later).

The r-m-s plate current $|I|_{b_2}$ can be computed from the diode peak current

$$i_{p_2} = \left(\frac{n_3}{n_2} \right) s i_2$$

and the relation $|I|_{b_2} = 0.41 i_{p_2}$ (38)

which assumes a normal waveshape matching the selected plate current waveform.

The currents in the auto-transformer windings ($n_2 - n_3$) and n_3 consist of a number of components which have substantially ideal triangular class B waveshapes.

The current in $n_2 - n_3$ is the sum of the reflected current $(n_3/n_2)si_2$, the component $(n_3/n_2)si_1$ reduced by the ratio n_2/n_1 , and the small direct-current I_{BB} which can be neglected. Because of the triangular class B waveshape the r-m-s current is closely

$$|I|_{n_2 - n_3} \approx 0.41 \left(\frac{n_3}{n_2} \right) \left[\left(s i_1 \frac{n_2}{n_1} \right)^2 + (s i_2)^2 \right]^{1/2}. \quad (39)$$

The current in n_3 consists of the deflection-coil currents $i_1 + i_2$ minus the components $si_1 (n_3/n_1)$ from V_1 and $si_2 (n_3/n_2)$ from V_2 , and may be approximated by

$$|I|_{n_3} \approx 0.41 \left[\left(i_1 - \frac{n_3}{n_1} s i_1 \right)^2 + \left(i_2 - \frac{n_3}{n_2} s i_2 \right)^2 \right]^{1/2}. \quad (40)$$

The current values computed for the example (listed in Table III) determine the wire sizes and permit calculation of coil dimensions, winding resistances, and the copper loss (See Table IV).

It is beyond the scope of this paper to describe the design of the windings in detail. The number of turns per layer and the insulation thickness between layers and wires are varied to obtain a most favorable balance between leakage inductance and the winding capacitances which can be computed with good accuracy as the series value of layer capacitances. The computed winding capacitances of the transformer furnish the capacitance network shown for the example in Figure 15. Reflected into the yoke winding, the capacitances add up to a total of 434 micromicrofarads making $f_o = 81.5$ kilocycles. The desired retrace frequency $f_o = 70$ kilocycles requires, therefore, a padding capacitance $C = 116$ micromicrofarads across the yoke terminals. (A faster retrace increases the surge voltages.)

Fig. 15 — Capacitance network of deflection system.

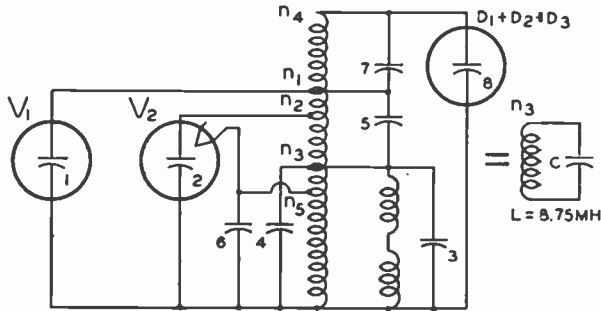

C	micro-microfarads)	Description	C_{ns} (micro-microfarads)
1	10	Plate V_1 and connection	44
2	15	Cathode V_2 and connection	32
3	80	Yoke and wiring	80
4	38	Winding n_3	38
5	40	Winding $n_2 - n_3$	48
6	260	Filament Winding (V_2)	60
7	8	Winding $n_4 - n_1$	54
8	6	High-voltage rectifier circuit	78
Total Capacitance $C = 434$			
$f_o = 81.5$ kilocycles			

Plate-Load Diagram, Power Loss Distribution, and Power Input

The effective load impedance in the plate circuit of the power tube (V_1) consists of a reactive load representing the power loss $I_{b1} (E_{n1} - E_{Cb}) = (P_r + P_x)$ and a resistive load R_p representing the diode plate loss and the copper losses of the circuit. (Compare Figure 8.) The equivalent plate-load diagram of V_1 is shown in Figure 16.

The power values for the reactive "square-wave voltage" section of the plate load have been computed except for P_r . Reactive loads of this

type do not contribute to the plate dissipation in V_1 and can, therefore, be assigned a direct-current to alternating-current conversion efficiency of 100 per cent. The net power which must be supplied by the B-supply for this load section is the sum of the retrace power loss P_r (containing the high-voltage power output), the direct-current power output P_s from the "boost" voltage, and the leakage- or series-inductance power loss P_s . The leakage inductance in the V_1 plate lead of the transformer is measured by shorting the yoke winding n_3 and measuring the inductance of the n_1 -winding. The transformer constructed according to our example has an inductance (L_s) of 2 millihenries. The inductive voltage drop developed by the plate current i_{p1} increases during T_s to the value

$$E_{L_s} = E_{n_1} L_s / L (n_1/n_3)^2. \tag{41}$$

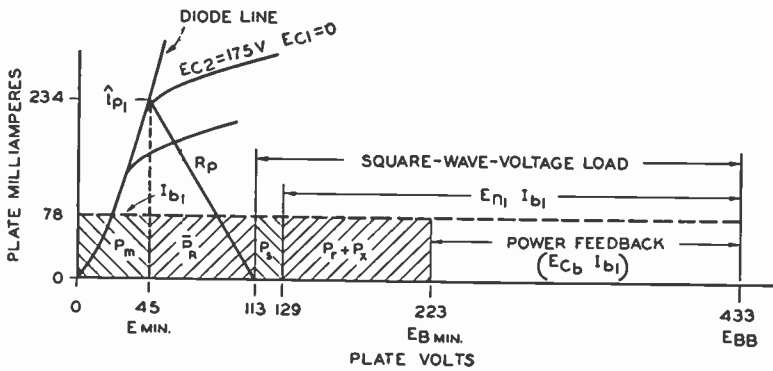

Fig. 16—Plate-load diagram of deflection power tube (V_1).

For the example, $E_{L_s} = 16$ volts and requires the B-power

$$P_s = E_{L_s} I_{b1}. \tag{42}$$

This power, $P_s = 1.25$ watts, is dissipated partly in the transformer and partly in the plate resistance of V_1 . The purely reactive power on L_s , dissipated in the transformer equals

$$P_{sr} = 0.5 L_s \hat{i}_{p1}^2 f_h = 0.87 \text{ watt}, \tag{42a}$$

the remaining power (0.38 watt) is dissipated in V_1 during T_s .

The direct-current power input to the resistive load section (R_p) is obviously

$$\bar{P}_R = I_{b1} E_{R_p}.$$

The alternating-current power dissipated in R_p is given by

$$P_{Rp} = |I|_{b_1}^2 R_p = |I|_{b_1}^2 E_{Rp} / \hat{i}_{p_1}.$$

The conversion efficiency is, hence,

$$P_{Rp} / \bar{P}_R = |I|_{b_1}^2 / \hat{i}_p I_{b_1}. \quad (43a)$$

The conversion efficiency is controlled by the plate-current waveform which relates peak, r-m-s, and average values. Letting $|I|_{b_1} / \hat{i}_{p_1} = K_1$ and $I_{b_1} / \hat{i}_{p_1} = K_2$, Equation (43a) can be rewritten in the form

$$P_{Rp} / \bar{P}_R = K_1^2 / K_2. \quad (43b)$$

It is readily shown (See Table II) that the conversion efficiency varies from 0.625 for an inverted sine-wave current to 0.667 for a linear sawtooth current both of which may be continuous or intermittent. The value $P_{Rp} / \bar{P}_R = 0.645$ is a close approximation to all practical waveforms, and furnishes the value of direct-current input power to the R_p section:

$$\bar{P}_R = 1.55 P_{Rp}. \quad (44)$$

The power difference $\Delta P = 0.55 P_{Rp}$ is lost in the form of plate dissipation in V_1 in addition to the minimum plate power loss $P_m = E_{\min} I_{b_1}$ which is determined by the "diode line" or "knee" of the plate characteristic. The power-tube plate dissipation is, hence, with Equation (42).

$$P_{p_1} = E_{\min} I_{b_1} + 0.55 P_{Rp} + (P_s - P_{sr}). \quad (45)$$

The power loss P_{Rp} is the sum of all copper losses in the circuit including the diode (V_2) plate dissipation. The copper loss $P_{cu} = (|I|^2 \times r)$ in the transformer windings and the deflection coil is readily computed and totals 1.41 watts (The power losses are itemized in Table IV). The diode plate loss can be computed from the r-m-s diode current (Equation (38)) and the equivalent diode resistance

$$|r|_d = 1.06 \hat{e}_p / \hat{i}_p. \quad (46)$$

With Equation (38) the diode plate loss is expressed by

$$P_{p_2} = 0.18 \hat{i}_{p_2} \hat{e}_{p_2}. \quad (47)$$

for the example $\hat{i}_{p_2} = 0.3$ ampere. A 6W4-GT diode has a peak plate-voltage drop \hat{e}_{p_2} of 24 volts at this current. The diode plate dissipation P_{p_2} is, hence, 1.3 watts. To these losses must be added the copper loss in the linearity transformer T_2 , which will be estimated as 25 per cent of the power ($P_{p_2} + P_{cu}$) handled by T_2 ; i.e., 0.70 watt. The total copper and diode loss is equal to P_{Rp} and equals 3.41 watts.

The total power input to the deflection system is the sum of all losses:

$$P_B = E_{\min} I_{b_1} + 1.55 P_{Rp} + P_s + (P_r + P_x). \quad (48)$$

The power tube 6AU5-GT has a plate voltage drop $E_{\min} = 45$ volts at $\hat{i}_{p_1} = 0.234$ ampere. The minimum plate-power input P_B is, hence, 17.35 watts, and requires a minimum B-supply voltage

$$E_{B\min} = P_B / I_{b_1} = 223 \text{ volts.}$$

The power-tube plate dissipation P_{p_1} (Equation (45)) is 5.4 watts. The power losses in the remaining circuit elements are listed in Table IV. The plate load diagram, Figure 16, indicates clearly the power distribution and voltages in the deflection circuit during the scanning period T_s .

Discussion of Results

The lower section of Table IV shows that the power losses of the circuit components are well balanced. The largest loss (5.78 watts) occurs in the power tube V_1 ; but V_1 controls a total plate-power input of $0.078 \times 433 = 33.8$ watts, operating, therefore, with an efficiency of 83 per cent. Equation (45) shows that the plate dissipation of V_1 is increased by the copper losses, the V_2 plate loss and the leakage inductance loss. These losses should, therefore, be made as small as possible. (The values in the example are probably lower than in present deflection systems.)

The second largest item in Table IV is the power output of the system ($P.O. = 5.2$ watts) which is used for kinescope light output and to operate the vertical deflection tube from the augmented voltage $E_{BB} = 433$ volts. In view of the fact that the conversion efficiency with respect to the resistive load section in the power-tube characteristic is 100 per cent for these loads, this method of obtaining a higher B-voltage for vertical deflection is very efficient and particularly so for a system operating with a low B-voltage on the order of 250 volts. A further advantage of supplying the vertical deflection power from E_{BB} is the fact that the aspect ratio of the raster changes little with

high-voltage power output because E_{BB} decreases when the kinescope voltage drops due to regulation of the pulse rectifier system. The transformer operates with a power input of 30.3 watts, its power loss is 1.45 watts, and its efficiency has, therefore, the excellent value of 96 per cent. Similarly, we find the yoke efficiency to be 86 per cent and the efficiency of the diode 93.5 per cent.

A deflection system with voltage-doubling circuit was built according to the specifications in the example. The currents and voltages measured were within the accuracy of meter errors. The variation from the computed r-m-s values did not exceed 10 per cent in portions of the circuit where insertion of a meter caused small changes in the capacitance and resistance values.

For the minimum B-voltage $E_B = 223$ volts (See Figure 16) the screen-grid voltage of the 6AU5-GT was 178 volts and the screen current 8 milliamperes. At a B-voltage of 250 volts, the screen current dropped to 6 milliamperes. The measured high-voltage regulation is 10 per cent at a beam current of 130 microamperes.

The power load diagram, Figure 16, gives graphically the effect of circuit changes. If, for example, the coupling diode in the high-voltage rectifier were replaced by a 2-megohm resistor, the resistor would be reflected as a 154,000-ohm shunt across the winding n_3 and cause a power loss $|E|_v^2/154,000 \approx 1.5$ watts. When the diode filament power (0.25 watts) is removed, the power loss, P_r , is increased by 1.25 watts which requires an increase of E_B to 240 volts. Similarly, if the load $P_x = 3.5$ watts of the vertical deflection circuit is removed, the required B-voltage E_B would decrease to 170 volts. Removing the high-voltage rectifier system also would drop E_B to 146 volts. It is, of course, necessary to readjust the transformer ratio n_1/n_2 in each of these cases to comply with Equation (23).

Replacement of the voltage-doubling rectifier circuit by a single-diode high-voltage rectifier requires a re-evaluation of the circuit constants. Because of the larger step-up and capacitance of the high-voltage winding, it is necessary to decrease the transformer inductance, and increase the flux density in the transformer.

A system for deflecting a 70-degree kinescope and generating the voltage $E_a = 14$ kilovolts with a single high-voltage rectifier was computed and built for comparison with the voltage-doubling system. The plate-power input increased from 17.35 watts to 19.0 watts because, for the same value I_{b1} , the B-voltage had to be increased to $E_B = 250$ volts. The plate dissipation in the power tube and the plate loss of V_2 remained approximately the same but the transformer loss

increased from 1.45 to 3.0 watts (increased core loss and leakage resonance loss in the high-voltage winding).

Both systems were free of "ripples" in the deflection raster as well as negative "overshoots" in the plate voltage of V_1 .

CONCLUSIONS

The analysis of energy and power in reactive deflection systems with associated high-voltage supply has led to a relatively simple method of designing and examining practical deflection systems. The distribution of the power loss in tubes and circuit elements can be accurately determined from data on available materials for any chosen type of circuit. The plate load diagram of the power tube is readily established by measurement of a few circuit constants and current values. Its use can contribute much to the design of efficient deflection systems having trouble-free operation of electron tubes. It is shown that modern magnetic materials permit the design of efficient deflection coils and transformers with negligible power loss which make it possible to control large deflection energies with inexpensive electron tubes.

APPENDIX

Table I—Decay Functions and Q-Factors.

Q	$e^{-1.65/Q}$	$e^{-3.3/Q}$	q	q^2
50	0.968	0.936	1.0162	1.0326
40	0.960	0.921	1.0204	1.0412
30	0.946	0.895	1.0277	1.0561
25	0.936	0.876	1.0330	1.0670
20	0.921	0.848	1.0411	1.0838
15	0.896	0.802	1.0548	1.1126
12.5	0.876	0.768	1.0660	1.1363
10	0.848	0.718	1.0822	1.1711
9	0.832	0.693	1.0917	1.1918
8	0.813	0.662	1.1031	1.2168
7	0.790	0.624	1.1173	1.2483
6	0.760	0.577	1.1363	1.2911
5	0.718	0.516	1.1641	1.3551

Table II—Average and r-m-s Values of Deflection-Circuit Waveforms.



#	Wave Form	Average Value	r-m-s Value	
1		$\bar{i} = 0$	$ I = 0.29 (\hat{i}_1 + \hat{i}_2)$	sawtooth (alternating current only)
2		$\bar{i}/\hat{i} = 0.5 t/T$	$ I /\hat{i} = 0.577 \sqrt{t/T}$	intermittent sawtooth (alternating current + direct current)
3		$\bar{i}/\hat{i} = 0.363 t/T$	$ I /\hat{i} = 0.476 \sqrt{t/T}$	intermittent 90-degree sine wave section (alternating current + direct current)
4		$\hat{e}/E = 12.7$	$\hat{e}/ E = 3.94$	inductive voltage normal time ratios

Table III—Circuit Constants and Operating Conditions of a Deflection System (example).

	Symbol	Value No Load	Value at $I_0 = 120$ microamperes
Circuit at 70 kilocycles	Q_0	26.	
Parallel value	L	0.00875 henries	
Shunt field factor	s	1.143	
Deflection power $Q = \infty$	P_0	13.5 watts	(Loss free circuit)
Reactive power Input	$P_{1(L)}$	16.5 watts	16.5 watts
Reactive power Output	$P_{2(L)}$	14.4 watts	12.8 watts
Retrace loss	P_r	2.1 watts	3.7 watts
High-voltage power output	P_{HV}	0	1.6 watts
Inductive voltage	$E_y = E_L$	148 volts	144 volts
Yoke peak voltage	$\hat{e}_L = \hat{e}_y$	1880 volts	Values for deflection coil circuit
Yoke r-m-s voltage	$ E _y = E _L$	476 volts	
Yoke peak current	\hat{i}_1	0.430 ampere	0.430 ampere
Yoke peak current	\hat{i}_2	0.400 ampere	0.380 ampere

Table III—(continued)

	Symbol	Value No Load	Value at $I_a = 120$ microamperes	
Peak current in L	$s\hat{i}_1$	0.491 ampere	0.491 ampere	
Peak current in L	$s\hat{i}_2$	0.458 ampere	0.435 ampere	
Equivalent average current	$I_{b'1}$	0.164 ampere	0.164 ampere	
Peak-to-peak yoke current	$\hat{i}_1 + \hat{i}_2$	0.830 ampere	0.810 ampere	
Peak-to-peak current in L	$s(\hat{i}_1 + \hat{i}_2)$	0.949 ampere	0.926 ampere	
Peak plate voltage	\hat{e}_{p1}	3950 volts + E_{BB}		Values for V_1
Peak plate current	\hat{i}_{p1}	0.234 ampere		
Average plate current	I_{b1}	0.078 ampere		
Yoke/ V_1	n_2/n_1	0.475		Transformer turns ratio
V_2/V_1	n_2/n_1	0.69		
Yoke/ V_2	n_3/n_2	0.687		
Inductive voltage	E_{n1}	311 volts	303 volts	Transformer inductive voltages
Boost voltage	$E_{n2} = E_{cb}$	214 volts	210 volts	
Reactive input power	$I_{b1}E_{n1}$	24.2 watts	23.6 watts	Power values (for $I_{BB} = .017$ ampere and $L_S = 0$)
Direct-current output power	P_s		3.6 watts	
Reactive power loss	$P_r + P_s$		7.3 watts	
Feedback power			16.3 watts	
Peak V_2 current	\hat{i}_{p2}		0.30 ampere	V_2
Peak V_2 voltage	\hat{e}_{p2}		—2720 volts	
V_1 current	$ I _{b1} = I _{n1-n2}$		0.125 ampere	r-m-s current values
Transformer current	$ I _{n2-n3}$		0.155 ampere	
Transformer current	$ I _{n3}$		0.052 ampere	
Yoke current	$ I _y$		0.235 ampere	
V_2 current	$ I _{b2}$		0.123 ampere	

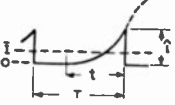
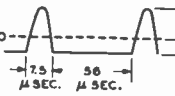
Table IV—Power-Loss Distribution in a Deflection System (example).

Description	Symbol		Power (Watts)	
Resistances and copper losses	r_y	19 ohms	1.050	Yoke
	$r_{n_1-n_2}$	10 ohms	0.155	Transformer
	$r_{n_2-n_3}$	6.5 ohms	0.156	Transformer
	r_{n_3}	17 ohms	0.046	Transformer
Total copper loss	P_{cu}		1.407	(During T_s)
V_1 plate loss	P_{p_2}		1.30	
Loss in linearity transformer	T_1		0.70	
Loss in R_p	P_{R_p}		3.41	Resistive losses during T_s
Loss in R_p load section	P_R		5.30	(P_{R_p} + conversion loss)
Minimum plate loss in V_1	P_m		3.50	($E_{min} I_{b_1}$)
Leakage reactance in V_1 plate circuit	P_L	($E_{L_s} = 16$ volts)	1.25	($E_{L_s} I_{b_1}$)
Reactive power loss	($P_r + P_s$)		7.30	(Loss during T_s and power output)
Total power input	P_B		17.35	
V_1 Plate loss	P_{p_1}		5.78	Equation (44)
V_2 Plate loss	P_{p_2}		1.3	During T_s
Total transformer loss	P_{T_1}		1.45	During T_s and T_r including P_{L_s}
Linearity transformer	P_{T_2}		0.70	
Total yoke loss	P_y	1.05 + 1.02	2.07	During T_s and T_r
Power output	$P.O.$	1.6 + 3.6	5.2	$P_{R_p} + P_s$
Rectifier filaments	P_f		0.75	
Total	P_B		17.35	

AUTOMATIC FREQUENCY PHASE CONTROL OF TELEVISION SWEEP CIRCUITS*†

BY

E. L. CLARK

RCA Victor Division,
Camden, N. J.

Summary—This paper describes three different types of automatic-frequency-control circuits: (1) sawtooth type, (2) sine-wave type, and (3) pulse-time type.

The sawtooth system forms a sawtooth from the pulse present across the deflection yoke. This sawtooth is compared in phase with the synchronizing pulse to produce a control voltage for frequency phase control of the sweep circuit.

The sine-wave type comprises a stable sine-wave oscillator which is controlled in phase and frequency by the synchronizing pulse, and in turn controls the sweep circuit.

The pulse-time system measures the area of the synchronizing pulse as it rests on the edge of a shelf. Phase variations change this area, and provide information to control the sweep circuit.

A TELEVISION PICTURE can be considered as being composed of horizontal lines of varying brightness. A line is traced by a flying spot starting at the left of the picture and uniformly traversing the raster to the right side of the picture, and then rapidly returning to the start of the next line. In this manner, the lines composing the picture are built downward from the top to the bottom of the picture.

In order that the picture be perfect, the elements of successive scanning lines must coincide exactly. To accomplish this, a trigger signal or synchronizing pulse accompanies every line to initiate retrace. When the circuit used is such that every line must be started by the synchronizing pulse, as in older television receivers, it is termed triggered-type synchronizing. This type of synchronizing is satisfactory if there is sufficient signal and no interference present. However, in practice these requirements are not always met, in which case some of the lines are triggered by noise or interference. This random triggering by the noise results in an imperfect picture.

To improve the picture register and reduce the effects of interference, the automatic-frequency-control system of synchronizing was

* Decimal Classification: R583.5 × R355.914.431.

† Reprinted from *Proc. IRE*, May, 1949.

developed. In essence, this system consists of integrating a number of synchronizing pulses to provide a control, rather than controlling each scanning line individually.

There are three commonly used systems for obtaining automatic frequency control. They are often referred to as (1) the sawtooth type, (2) the sine-wave type, and (3) the pulse-time type.

I. SAWTOOTH SYSTEM

A schematic diagram of the sawtooth-type automatic-frequency-control circuit as applied to horizontal deflection is shown in Figure 1. This diagram includes a synchronizing amplifier tube V1, a phase detector or keying-circuit tube V2, a direct-current-amplifier tube V3, and a blocking-oscillator tube V4. T1 is a pulse-type transformer that passes the horizontal synchronizing pulses, but not the vertical syn-

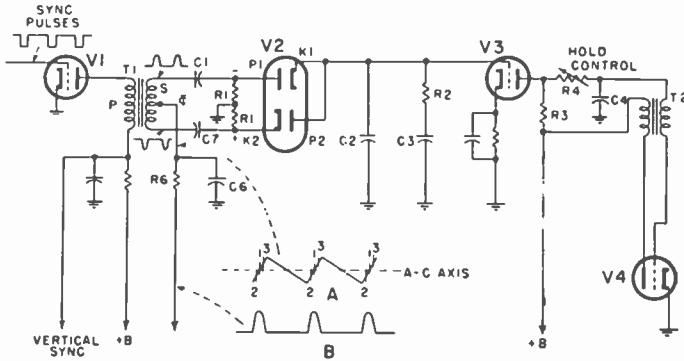

Fig. 1—The schematic diagram of the sawtooth-type automatic-frequency-control circuit, as applied to horizontal deflection.

chronizing pulse. The polarity of the pulse in the secondary of T1 is such as to cause current to flow in the diodes P1, K1 and P2, K2 of tube V2. The diode current charges capacitors C1 and C7 with polarity as shown, which is such as to bias the diodes of tube V2 open except when the pulse is present. This diode circuit is in the form of a bridge circuit with a voltage from P1 to K2, but no voltage from P2, K1 to ground. In operation, it can be used as a keying circuit to key the voltage existing on the transformer T1 centertap to capacitor C2. This keying action is present only when the diodes of tube V2 are caused to conduct by the action of the synchronizing pulses applied to them. A sawtooth of voltage as shown at A is applied to the centertap of transformer T1. This sawtooth of voltage is produced by partially integrating a positive pulse (curve B) obtained from the horizontal deflection transformer (not shown). The amplitude of

this sawtooth is adjusted so that it is less than the voltage developed across capacitors $C1$ and $C7$ by the synchronizing pulses, and hence will not cause diode conduction by itself. However, during the time the synchronizing pulse is present, the diodes conduct and can be considered as momentarily connecting the sawtooth to capacitor $C2$. With normal adjustment, the synchronizing pulse occurs at point 1 on curve A. Point 1 is on the alternating-current axis of the sawtooth voltage; hence no charge will be acquired by capacitor $C2$. Assume that the phase of the sawtooth voltage changes so that the synchronizing pulse occurs at point 2 on curve A. The voltage at this point is negative with respect to the alternating-current axis and will be keyed to capacitor $C2$, which will gradually acquire a negative charge equivalent to the voltage present at point 2. The grid of tube $V3$, being connected to capacitor $C2$, is also negative, which reduces its plate current, resulting in an increase of voltage on its plate. This increased voltage is connected by way of resistor $R4$ and transformer $T2$ to the grid of the blocking-oscillator tube $V4$. Its effect is to change the phase of the blocking oscillator in such a way that the synchronizing pulse is returned toward its original position 1 on curve A.

If the phase of the sawtooth had changed so the synchronizing pulse occurred at point 3 of curve A, the charge acquired by capacitor $C2$ would be positive and the voltage on the plate of tube $V3$ would be reduced, which would cause the phase of the blocking-oscillator tube $V4$ to change, again returning the position of the synchronizing pulse toward its original position, point 1. Thus, the frequency and phase of the blocking oscillator is held in step by integrating the synchronizing pulses. It does not matter whether the oscillator changes or the rate of the synchronizing pulse changes; the action is the same. The grid circuit of tube $V3$ has no direct-current return, and its potential can change only through the action of the keying-circuit tube $V2$. The time constant of the system is governed by the values of $C2$ and $R2, C3$.

This automatic-frequency-control system can also be applied to the vertical sweep circuits.

II. SINE-WAVE SYSTEM

The circuit of the sine-wave type of automatic frequency control is shown in Figure 2. This circuit embodies a stable sine-wave oscillator of the Hartley type ($V2$), a comparator ($V1$), and a reactance tube ($V3$).

Its features are automatic operation and good immunity from interference. Tube $V2$ is an extremely stable sine-wave oscillator operating

at the horizontal rate of 15,750 cycles per second. In operation, the phase of the sine wave and the synchronizing pulses are compared. A phase change will produce direct-current information which is applied to the grid of the reactance tube *V3*, which controls the frequency of the Hartley oscillator.

A double-diode tube *V1* is used as a comparator, and functions in much the same way as an FM detector. The plates of this tube are connected to the center-tapped coil *S* of *T1*, which is inductively coupled to *P* of *T1*, the tank coil of the Hartley oscillator.

Referred to the centertap of *S*, sine-wave voltages of equal amplitude and opposite polarity are applied to each of the diode plates of tube *V1*. The synchronizing pulses are applied to the centertap, and

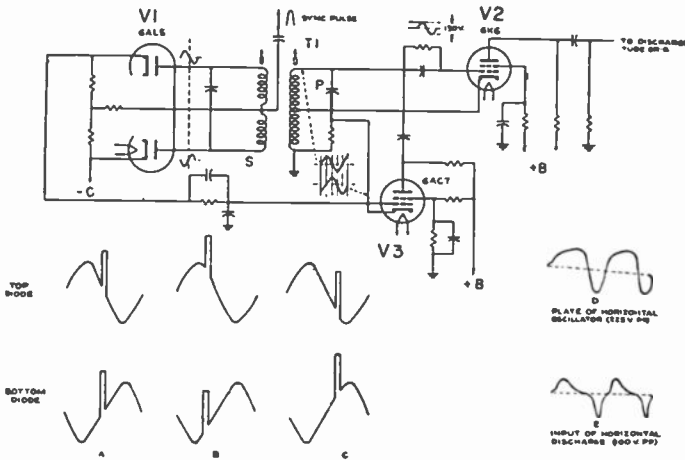

Fig. 2—The schematic diagram of the sine-wave type of automatic-frequency-control circuit, as applied to horizontal deflection.

consequently this voltage appears in the same phase and with equal amplitude on each diode plate.

When the synchronizing pulses and sine wave are properly phased (as shown in Figure 2, curve A), there will be zero voltage developed at the output of the comparator.

If the phase of the synchronizing pulse changes with respect to the sine wave (as shown in curve B), then the top diode will produce more voltage output than the bottom diode, resulting in a positive voltage at the comparator output. In curve C the reverse condition exists, and a negative voltage will appear. Obviously, then, the direct-current output of the comparator will run from negative through zero to positive, depending on the phase relation of the pulse and the sine wave. In this way, the necessary control information is produced and applied

to the grid of the control tube ($V3$) through a filter network which removes interference pulses and other misinformation, which would otherwise affect the frequency of the oscillator.

The oscillatory action takes place between the screen, grid, and cathode of tube $V2$. The peak-to-peak sine-wave voltage on the oscillator grid is approximately 130 volts. This grid swing produces the wave shape on the plate (as shown in curve D), which is differentiated by an RC network. The wave after differentiation is shown in curve E . The positive portion of this differentiated wave operates the discharge tube. In practice, it is necessary to phase the synchronizing pulse with the differentiated wave used to trigger the discharge tube. To do this, the winding S of transformer $T1$ is tuned off resonance from the oscillator tank circuit P of $T1$. This circuit is tuned on the low-frequency side of the oscillator tank circuit, which operates at 15,750 cycles per second. When properly adjusted, the picture raster will show a small percentage of blanking on the right side of the picture, and will also be blanked to the same extent on the left side. With this adjustment, the picture is properly phased with respect to the synchronizing pulses. If the blanking bar occurs in the middle of the picture, the winding S of $T1$ is badly out of adjustment, or the diode plates of tube $V2$ are interchanged with respect to the winding S of $T1$.

III. PULSE-TIME SYSTEM

The schematic diagram of the pulse-time or width-control type of automatic-frequency-control circuit is shown in Figure 3. Its operation is based on what may be described as "width modulation" of the synchronizing pulse. A locally generated sawtooth is phased to allow a varying portion of the synchronizing pulse to fall atop the positive corner of the sawtooth, while the remaining portion slides down the steep side. Control voltage is a function of the pulse width atop the positive corner of the sawtooth, the peak amplitude of the combined waves being essentially constant.

Width modulation constitutes the basic difference between the pulse-time and other forms of automatic-frequency-control systems. Satisfactory operation of this circuit depends upon the proper wave shape being formed to apply to the grid of the control tube.

An exploded view of the wave-shaping network and wave shapes as applied to the grid of the control tube is shown in Figure 4.

The synchronizing pulse E_1 is fed into the circuit at point 1, and appears as e_1 at point P , being attenuated by capacitors $C1$ and $C3$.

The wave shown as E_2 is obtained from the horizontal deflection

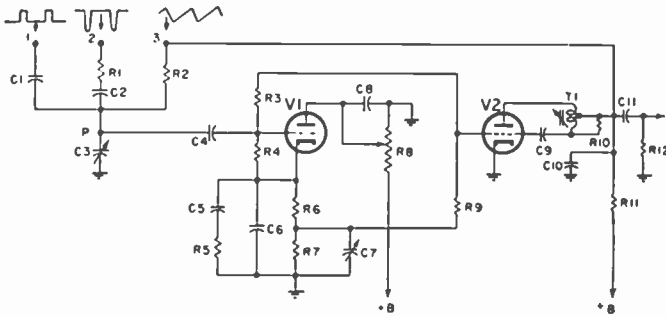

Fig. 3—The schematic diagram of the pulse-time type of automatic-frequency-control circuit, as applied to horizontal deflection.

system and is in the form of a high-voltage negative pulse, which is fed into the system at point 2. The network $R1, C2, C3$ partially integrates and attenuates this pulse, E_2 , to form the wave e_2 at point P . The third wave shape, E_3 , is obtained from the discharge capacitor connected to the tap on the blocking-oscillator transformer, and is fed into the network at point 3. Resistor $R2$ and capacitor $C3$ attenuate and integrate E_3 to form the parabola e_3 at point P .

A parabola has the advantage over a sawtooth of having a steeper slope near the peak, and therefore provides increased gating. The voltage e_2 is necessary to produce a sharp downward slope immediately following the peak of the parabola e_3 .

The combined wave e_0 at point P , which is coupled to the grid of the control tube, is shown for three different conditions of phase between the local oscillator and the synchronizing signal: (1) the curve at (a), when most of the synchronizing pulse is atop the parabola; (2) at (b), when one-half of the synchronizing pulse is atop the parabola;

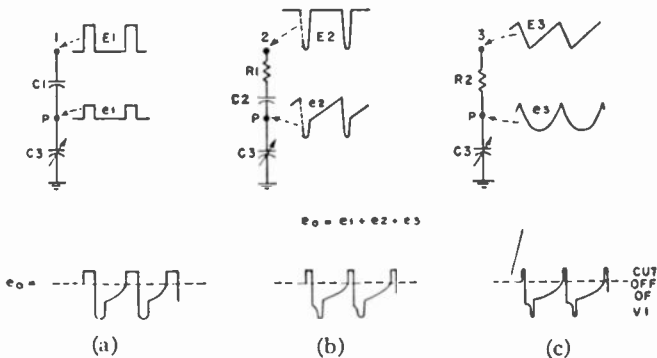

Fig. 4—An exploded view of the wave-shaping network and wave shapes, as applied to the grid of the control tube of the pulse-time type of automatic-frequency-control circuit.

and (3) at (c), when most of the synchronizing pulse is down the slope.

Tube *V1* (Figure 3) is the control tube and is biased near cutoff by the direct-current component of the oscillator grid voltage applied through resistors *R3* and *R4*. Its plate current consists essentially of pulses whose width is determined by the relative position of the synchronizing pulse atop the peak of the parabola. The voltage developed across resistor *R7* by this average plate current is injected from the cathode circuit of the control tube *V1* into the grid of the oscillator tube *V2* by way of resistor *R9*, and thus maintains the phase of the oscillator with respect to the synchronizing signal within very close limits. The cathode circuit is an integrating network with the following properties: a fast response as *C6* is relatively small, and a slow response as *C5* and resistors *R6* and *R7* are relatively large. The former integrates the pulses of current and also acts to prevent hunting, while the latter maintains control over a longer period of time, and filters out disturbances of greater duration. The plate circuit contains a potentiometer *R8*, which acts as a vernier speed control.

The capacitor *C3* is made adjustable, so that the control-tube's grid voltage can be varied to suit the characteristics of the individual tube, and thus maintain the control range at a uniform level.

The blocking-oscillator circuit used in this system is somewhat different from that of conventional blocking oscillators. The transformer *T1* is an autotransformer arranged in an i-f transformer can, and uses a powdered-iron core which permits a certain amount of frequency adjustment. This is limited by coupling requirements, and additional range is obtained by the use of a trimmer capacitor *C7*, which is connected across a portion of the blocking-oscillator's grid resistor *R7*. Tube *V2* functions not only as the blocking oscillator, but also as the discharge tube. A sawtooth of voltage is developed across capacitor *C10*, and is used for horizontal deflection.

The synchronizing separator used with the pulse-time automatic-frequency-control system must be of a type that provides synchronizing pulses of constant amplitude. This system has been called a width-modulation system; actually, it can be considered a variable-area system. If the synchronizing pulse amplitude is not maintained constant, the area of the effective portion of the synchronizing pulse will not contain the proper information, and poor results will be obtained.

CONCLUSIONS

In comparing these three systems of automatic frequency control, it can be said that they all provide better synchronizing than can be obtained by the use of a triggered synchronizing system.

The sawtooth type of afc (Figure 1) as shown does not snap into synchronism immediately, but takes an appreciable time. However, this undesirable feature of operation has subsequently been overcome.

The sine-wave type snaps into synchronism the instant the signal is applied. It is also the most noise-immune of the three systems. It requires more "B" current than the others and uses the most tubes.

The pulse-time system uses the fewest tubes of the three systems. The picture snaps into synchronism as soon as the signal is applied. The noise immunity is equally as good as the sawtooth type, and approaches the sine-wave type very closely.

A STUDY OF COCHANNEL AND ADJACENT-CHANNEL INTERFERENCE OF TELEVISION SIGNALS*†

A Report

BY

RCA LABORATORIES DIVISION, PRINCETON, N. J.

Part I — Cochannel Studies

Summary—The reduction of cochannel television interference with monochrome signals, color television signals, and combinations of monochrome and color signals by the use of the offset-carrier (10.5 kilocycles) method has been investigated in the laboratory through the medium of observer tests. Included in the study are the field-sequential, the line-sequential, and the dot-sequential color systems. The results of extensive field and laboratory experiments with synchronization of monochrome television carriers are reported in detail. On the basis of subjective viewing of interference by observers, ratios of desired to interfering carrier strengths are listed for tolerable interference and perceptible interference. Such data lead to a rational criterion for the allocation of monochrome and color television stations on an offset carrier (10.5 kilocycles) basis.

GENERAL DISCUSSION

IN THE Fall of 1948, when the Federal Communications Commission (FCC) held hearings on the problem of cochannel interference of very-high-frequency (VHF) television stations, established the Ad Hoc Committee to review the available data on tropospheric propagation in order to arrive at an acceptable method of predicting interference, and instituted the "freeze" on new television station construction, the Radio Corporation of America accelerated its program of development on a television carrier synchronizing system. At the engineering conference, December 2, a report on the laboratory tests concerning television carrier synchronization was made and the equipment used in the Princeton laboratory to synchronize WNBT, New York, with WNBW, Washington was described.

Early in 1949, the synchronizing equipment was moved to a field site midway between New York and Washington and field observations of the operation of the system were made for a period of several months. Concurrent with these tests, further laboratory development

* Decimal Classification: R171×R430.11×R583.16.

† Reprinted from *RCA Review*, March 1950.

was progressing which resulted in "offset carrier" operation. This latter method was simpler in operation, was more economical of equipment, and yielded results superior to television carrier synchronization. Field experience with a number of Channel 4 stations followed. In the Summer of 1949, quantitative data was obtained in the laboratory, in cooperation with the Joint Technical Advisory Committee (JTAC) of the Institute of Radio Engineers and the Radio Manufacturers Association with a large number of observers, to determine the probable desired-to-undesired signal ratio for unsynchronized signals, for synchronized signals, and for signals using offset carriers. These laboratory tests, as well as much field experience, firmly established the fact that offset carrier was a simple and effective method of reducing co-channel interference.

It is the purpose of this report to describe the early work on television carrier synchronizing, to discuss the offset carrier method and describe field observations of the method, to discuss briefly the JTAC observer tests, and to describe more recent work carried out by RCA in determining the desired-to-undesired signal ratios for offset carrier operation as applied to the RCA dot-sequential color television system and the Columbia Broadcasting System field-sequential color television system and in attempting to determine the appropriate ratios for the Color Television, Incorporated line-sequential color television system.

PRELIMINARY EXPERIMENTS WITH SYNCHRONIZED TELEVISION CARRIERS

When two cochannel television stations are operated normally, the carrier frequencies may differ by only a few cycles, by fifty to one hundred cycles, and at times by several hundred cycles. The resultant beat between the carrier of the desired signal and the carrier of the interfering signal appears as horizontal moving black bars in the television picture. With increased interfering signal, the undesired picture appears in the background of the desired picture. Experience has shown that the horizontal bars due to carrier beat become objectionable when the undesired picture in the background is barely visible. With the two carriers precisely synchronized in frequency, the moving bars are completely eliminated and the undesired picture becomes the next source of interference to be considered. Under this condition of precise synchronization, the improvement to be obtained depends upon the relative phases of the two carriers at the receiving point. If the two carriers could be held precisely in time quadrature, the largest improvement would be secured. The least improvement is achieved when the carriers are in phase or in phase opposition. Hence, in observer tests carried out in the laboratory to determine improvement ratios, it

seemed desirable to determine the improvement ratios which applied in the least favorable phase condition.

A laboratory test was conducted with twenty-five observers. The observers were shown a television picture with an unsynchronized signal as a source of interference. The interfering signal was adjusted to a value which the observer indicated to be objectionable. Then the carrier frequencies were synchronized, adjusted to the least favorable phase, and the undesired signal increased until the observer felt that the interference was of the same degree of objectionableness as for the unsynchronized condition. The improvement factor was taken as the number of decibels which the undesired signal was increased from the unsynchronized case to the synchronized case. The results of this laboratory test are shown in Figure 1, expressed as a probability distribution in terms of the percentage of observers noting an improvement greater than the corresponding ordinate value. It may be noted from Figure 1 that fifty per cent of the observers experienced an improvement of 17 decibels in favor of carrier synchronization.

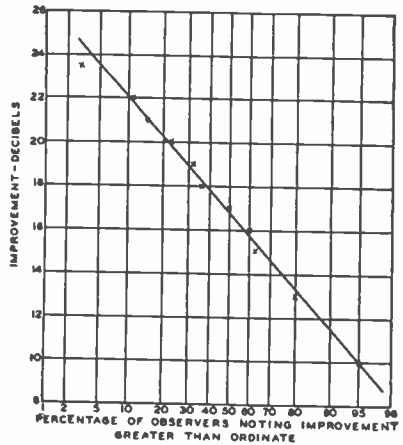

Fig. 1—Improvement in reception of a television signal in the presence of a cochannel interfering signal. (The improvement factor is that obtained with synchronized carriers in the least favorable relative phase, with nonsynchronous operation used as the reference standard.)

To obtain field experience under home receiving conditions, equipment was assembled which made possible the carrier synchronization of television station WNBT, New York, with WNBW in Washington. The equipment used in conducting the synchronizing test consisted of two units. The first unit was located in the RCA Laboratories in Princeton, New Jersey, and the second was located at Station WNBT in New York. The equipment at the Princeton Laboratories included two narrow-band superheterodyne receivers. The voltage from a single local oscillator was applied to the first detectors of both receivers, thus the frequency difference between the two incoming signals was retained. The output signals from the two intermediate-frequency amplifiers were mixed in a phase discriminator, the output voltage of which was a measure of the phase difference between the two incoming carriers. The output voltage of the phase discriminator was used to

frequency modulate an RC oscillator plus or minus 300 cycles about a mean frequency of 1000 cycles. This frequency-modulated 1000-cycle tone was the control signal which was transmitted from Princeton to New York over a normal telephone line. To receive the radio signal from WNBT, a dipole antenna with reflector was used. This arrangement did not receive enough signal from Washington to interfere with the control circuits. The second antenna, used to receive WNBW, was a bridge dipole and reflector combination. It had an excellent front-to-back ratio, but was not sufficiently good for the purpose. To further improve the discrimination against the New York signal, some signal from the New York antenna was introduced into the transmission line coming from the antenna directed at Washington. This injected signal from New York was adjusted in amplitude and phase so as to further reduce the undesired New York signal on the output terminals of the Washington receiver.

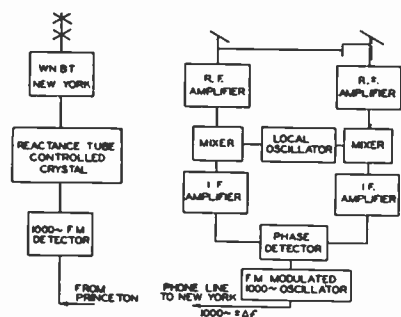

Fig. 2—Block diagram of the television carrier synchronizing system used to synchronize WNBT with WNBW.

In New York the frequency-modulated 1000-cycle tone was reconverted by a frequency discriminator to a control voltage corresponding to the output of the phase discriminator on the output of the two receivers in Princeton. This control voltage was applied to a reactance tube in the transmitter crystal circuit in such a way as to shift the crystal frequency as much as plus or minus 300 cycles. The general arrangement is shown in the block diagram of Figure 2.

The operation of the system was as follows. Signals from New York and Washington were compared in the phase discriminator at the output of the two receivers located in Princeton. The information regarding relationship of the two carriers was carried as frequency modulation of the 1000-cycle tone by telephone line to New York. The frequency shift of this tone was utilized to change the frequency and phase of the New York carrier to maintain a fixed phase relationship between the New York and Washington carriers as observed at Princeton.

During the months of November and December, 1948, and part of January, 1949, the apparatus of Figure 2 was used to synchronize WNBT with WNBW and observations were made at many home receiver locations in the vicinity of Princeton. A schedule was arranged

so that for a number of short periods through the evening hours the stations were operated unsynchronized with interference bars appearing in the received picture. It was demonstrated that carrier synchronization brought about a very real improvement in reception of WNBT in the Princeton area, a distance of 40 to 45 miles from New York. In some locations, the interference from WNBW in the unsynchronized condition was so severe that the picture from WNBT was not usable. At these same locations, synchronization generally improved the picture to such an extent that it was quite acceptable.

While these Princeton tests demonstrated the soundness of the principle of television carrier synchronization, real practical operating difficulties existed because of the strong WNBT signal and the weak WNBW signal at the receiving point where the synchronizing receivers were located. Even with the best balancing arrangement that could be devised, it was not always possible to balance out the WNBT signal in the receiving antenna used to receive WNBW. A decision was soon



Fig. 3—The receiving equipment site at Brandywine, near Wilmington, Delaware.

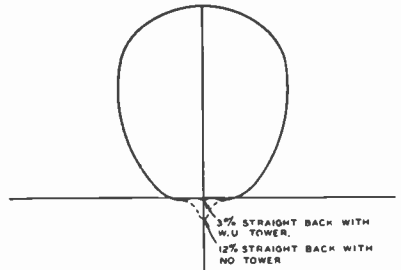

Fig. 4—The relative field patterns in the horizontal plane of the Brandywine receiving antennas.

reached to move the receiving apparatus to a point where the signals from the two stations would be of approximately the same value. Arrangements were made to use the building and land available at the Western Union microwave relay site at Brandywine, a few miles north of Wilmington, Delaware. This property was midway between the two transmitting stations, 103 miles from WNBT and 103 miles from WNBW. Two large receiving antennas were erected on poles 50 feet in height, as shown in Figure 3. The antenna at the right in this picture was used to receive WNBW, while the one on the left received WNBT. The relative horizontal field patterns of these antennas are shown in Figure 4. The proximity of the Western Union tower reduced the back signal of the WNBW antenna so that the WNBT signal in this antenna system was of no consequence. The antenna receiving

the WNBT signal was in an open field and had a back lobe of 12 per cent, so the antenna was turned slightly to further suppress the WNBW signal.

The transmitter control gear was installed at WNBW and a telephone line connected the receiving equipment at Brandywine with WNBW control equipment. Both the transmitter control equipment and the receiving equipment were those previously used at Princeton. Synchronization of WNBW and WNBT, using the Brandywine installation, began on January 22, 1949, and continued for several months. Shortly after the start of operations at Brandywine, the RCA Victor Division supplied new equipment of a more advanced design for use at Brandywine and at WNBW. This equipment included refinements not used in the original equipment, and in addition provided the means for synchronizing three stations. This was done in anticipation of the time when WGAL-TV, in Lancaster, Pennsylvania, would begin broadcasting on Channel 4. This latter receiving station synchronizing equipment and the transmitter control units are shown in Figure 5 and Figure 6, respectively.

Continued observations of signal reception in the fringe areas of WNBT and WNBW showed that the application of carrier synchronization had indeed proven beneficial to viewers who had been troubled by cochannel interference. As a result of the experience gained with the Brandywine installation, plans were made with the General Electric Company and the Westinghouse Radio Stations, Incorporated, to establish a receiving point at Wilbraham, Massachusetts, with the necessary equipment to synchronize WBZ-TV in Boston and WRGB in Schenectady with WNBT. Receiving antennas were erected and some equipment was installed at Wilbraham in preparation for this next step. This project was halted by the advent of "offset carrier" operation, which had resulted from continued research at RCA Laboratories on the problem of cochannel interference. Since it was soon apparent that offset operation was extremely simple, very economical, and yielded results superior to television carrier synchronization, the Wilbraham project was dropped, the Brandywine operation ceased, and offset carrier experiments were immediately started with WNBT and WNBW.

EXPERIMENTS WITH OFFSET CARRIERS

For the condition of nonsynchronous operation where there are four or five horizontal black bars in the picture, there are sections of positive and negative interfering pictures corresponding to the cycles of the beat between the two carriers. With this observation as a basis, it was concluded that if the beat difference between the two carriers were made to correspond exactly to one-half the line frequency, a

condition would be obtained where not only would the beat between carriers be a very fine pattern, but also the odd and even lines would contain interfering pictures of opposite polarities, with a tendency to integrate out when observed at normal viewing distance. To check this condition, an experimental arrangement was made in the laboratory where the carrier of the local signal was offset by precisely 7,875 cycles with respect to the interfering signal. A group of twenty-five observers was used to obtain the data shown in Figure 7, which

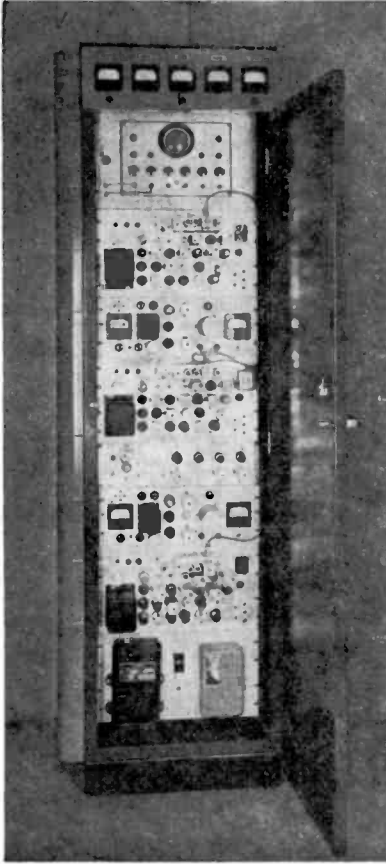

Fig. 5—Television carrier synchronization equipment, receiving station rack.

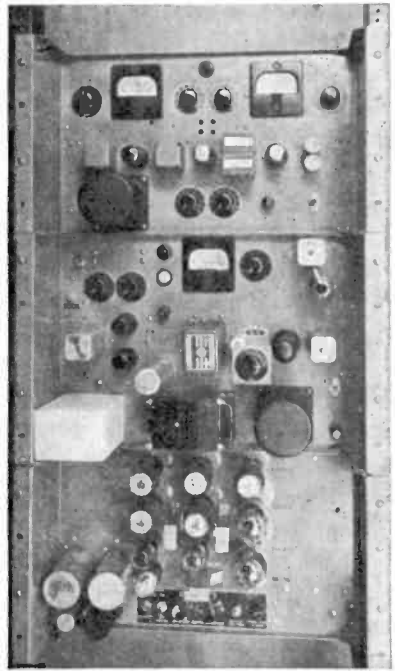

Fig. 6—Television carrier synchronization equipment, transmitter control units.

shows the improvement obtained by this precise offset method with respect to the normal unsynchronized condition. It may be seen from Figure 7 that fifty per cent of the observers experienced an improvement of at least 25 decibels. This was an improvement of approximately 8 decibels over the synchronized carrier condition.

To operate two stations under this condition requires the same equipment as used for carrier synchronization plus a few items of

auxiliary equipment required to produce the precise displacement of one-half line frequency, or 7,875 cycles obtained by dividing the actual received line frequency by 2. The precision of frequency control required to obtain the full advantage of this method of operation requires that the synchronizing generators at both transmitters be operated from crystals, rather than from 60-cycle power supplies which may not be tied into the same power network.

At the completion of this series of laboratory tests, it was thought that perhaps the frequency tolerance specified above for the half-line frequency condition could be reduced in exchange for some of the 8-

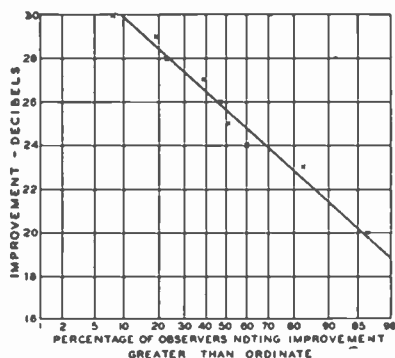

Fig. 7.—Improvement in reception of a television signal in the presence of a cochannel interfering signal. (The improvement factor is that obtained with carriers offset by one-half line frequency, 7875 cycles, with nonsynchronous operation used as a reference standard.)

decibel improvement obtained over the synchronized condition. In other words, if the frequency tolerance for the half-line frequency operating condition could be made the same as the normally-specified transmitter crystal stability, the 8-decibel improvement over the synchronous condition could be sacrificed to obtain this simple operating condition. If this arrangement were at least equal to the synchronized condition, it would be without the equipment difficulties, telephone line charges, personnel and plant facilities required for synchronized operation.

To determine the improvement as a function of the difference frequency between the two transmitter carriers, additional laboratory measurements were made. A group of observers made observations at a number of offset carrier frequencies. The curve of Figure 8 was the result. To obtain this data, the difference frequency between the two carriers was adjusted to give the fine horizontal black bars their most objectionable appearance, that is, they moved slowly either up or down in the picture. The data presented in Figure 8 is for the worst condition that could be realized for a given nominal offset or difference frequency between the two carriers. From the curve of Figure 8, it is seen that at a nominal half-line frequency difference between the two carriers, an improvement of approximately 20 decibels is obtained, as compared to the 25-decibel improvement obtained at the precise half-line frequency.

8-decibel improvement obtained over the synchronized condition. In other words, if the frequency tolerance for the half-line frequency operating condition could be made the same as the normally-specified transmitter crystal stability, the 8-decibel improvement over the synchronous condition could be sacrificed to obtain this simple operating condition. If this arrangement were at least equal to the synchronized condition, it would be without the equipment difficulties, telephone line charges, personnel and plant facilities required for synchronized operation.

To determine the improvement as a function of the difference frequency between the two transmitter carriers, additional laboratory measurements were made.

From Figure 8, it is seen that as the difference frequency between the two carriers is further increased, a minimum improvement is approached at line frequency, and again another favorable interference condition is reached at one and one-half times line frequency. With the data of Figure 8 in mind, it is seen that in a situation where three stations are involved, one station could be on frequency, the second station displaced half-line frequency above, and the third station displaced half-line frequency below. With this arrangement, the interference between stations 1 and 2 and between stations 1 and 3 would be at a minimum. However, the interference between stations 2 and 3, which would have a carrier difference corresponding to line frequency, could be very severe or at best little if any improvement would be noticed. To overcome this difficulty in a three-station situation, it was proposed that a displacement in carrier frequency of not half-line frequency but 10.5 kilocycles be used. Again referring to Figure 8, it is

Fig. 8—Improvement in reception in the presence of a co-channel interfering signal as a function of the frequency difference between carriers. (Fine adjustment of frequency for maximum visibility of interference.)

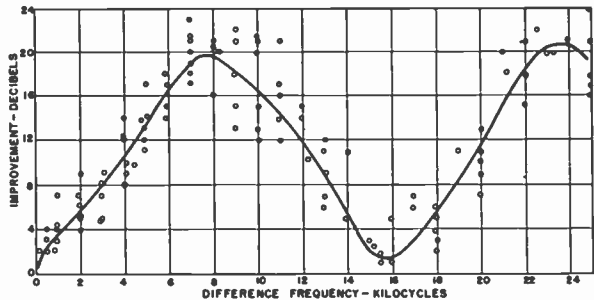

seen that with an offset of 10.5 kilocycles, an improvement of approximately 15 decibels is obtained. Also the frequency difference between stations 2 and 3 is now 21 kilocycles, with an improvement of approximately 15 decibels.

In order to put laboratory experience to a field test in the simplest form, it was only necessary to obtain a new crystal for the WNBT picture transmitter and another new crystal for the WNBT frequency monitor and to secure permission from the FCC to make this slight shift in frequency for experimental purposes. During the late Spring of 1949, observations in home receiving locations were made in the Princeton area. It was soon apparent that this simple offset carrier method was extremely effective in reducing cochannel interference on Channel 4 in the fringe area. Many demonstrations were made during this period where the WNBT frequency was periodically returned to its normally assigned value. The improvement due to offset carrier operation was indeed striking.

On June 17, 1949, WNBT in New York was returned to its normally

assigned frequency. At the same time, WBZ-TV, WRGB, and WNBW were offset 10.5 kilocycles from WNBT. Station WGAL-TV, Lancaster, began offset operation on June 24. Thus by late June, these five Channel 4 stations were operating in offset conditions planned to yield substantial mutual protection. The offset frequency conditions are listed in Table I.

Table I—Offset Carrier Conditions of Channel 4 Stations

Station	Effective Radiated Power (kilowatts)	Antenna Height Above Average Terrain (feet)	Frequency (kilocycles)
WRGB, Schenectady, N. Y.	18.25	832	67,250+10.5
WBZ-TV, Boston, Mass.	14.3	547	67,250-10.5
WNBT, New York, N. Y.	7.0	1280	67,250
WNBW, Washington, D. C.	20.5	330	67,250-10.5
WGAL-TV, Lancaster, Pa.	1.0	260	67,250+10.5

A panel truck was equipped with measuring gear for making observations and measurements in the field. An RCA-8TS30 television receiver, an RCA-WX1A Field Intensity Meter with Esterline-Angus recorder, a Hewlett Packard 200C audio oscillator, and an RCA-TMV122B oscillograph were included. The field intensity meter, together with the oscillograph and audio oscillator, afforded a simple and accurate means of determining the frequency difference between pairs of stations.

Picture observations were made in fringe area cities, localities where average field intensities ranged from 200 to 800 microvolts



Fig. 9—Fringe area cities where observations of cochannel interference were made.

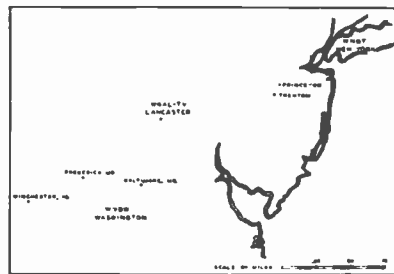

Fig. 10—Fringe area cities where observations of cochannel interference were made.

per meter. In each of the fringe area cities, the field intensity meter and recorder were used to make a survey through the particular city to determine the range of variation of field intensity and the median field intensity. Figures 9 and 10 show the fringe area cities visited during the Summer of 1949. Table II shows the results of field intensity measurements in these cities.

Table II—Field Strength in Fringe Area Cities

	Distance Miles	Surveyed Station	Field Intensity Corrected to 30 feet Microvolts per Meter		
			Median Field	Minimum	Maximum
Adams, Mass.*		WRGB			
Baltimore, Md.	13.0	WNBW	320	80	1200
Bridgeport, Conn.	3.2	WNBT	240	80	480
Fall River, Mass.	2.5	WBZ-TV	150	80	400
Frederick, Md.	2.2	WNBW	300	60	400
N. Adams, Mass.*		WRGB			
Newburgh, N. Y.	1.7	WBZ-TV	90	60	140
Norwalk, Conn.	3.3	WNBT	500	240	1200
Peekskill, N. Y.	1.4	WNBT	1100	240	8000
Pittsfield, Mass.	2.1	WRGB-TV	320	100	520
Providence, R. I.	5.4	WBZ-TV	120	40	400
Westport, Conn.	1.0	WNBT	590	240	1200
Worcester, Mass.	4.3	WBZ-TV	300	80	1400
Newport, R. I.	0.8	WNBT	120	40	280

* Field strength too low to be usable.

While observations were being made in each locality, the desired station and the nearest cochannel interfering station were operated, first with nominally the same frequencies but nonsynchronous, and secondly with carriers offset 10.5 kilocycles. Thus direct comparisons of the two modes of operation were made under like receiving conditions.

Characteristic moving bars or flickering pictures were generally seen in the first case and fine bars in the second. In every case where it was possible to see the fine bars of offset carrier operation, the picture deteriorated severely when the operation was shifted to the same nominal frequencies. The change was conspicuous and was seen repeatedly. The observers were thoroughly convinced by many field demonstrations of the value of offset carrier operation.

It should be pointed out that the most objectionable thing about nonsynchronous operation is either the movement of the bars or the

overall changes in average brightness of the picture which appears as flicker when the frequency difference is between frame frequency and zero beat.

During the field tour, WNBT picture was received well in Peekskill, Newburgh and Poughkeepsie, New York, except in depressions. WRGB is evidently quite well eliminated from this area by the Catskill Mountains which are also responsible for poor reception in Catskill, New York, of WRGB. Only a few miles east in Hudson, New York, WRGB was received well with little WNBT interference. In and to the north and south of Catskill, WNBT interference was very severe, with either nonsynchronous or offset operation. In many places in this locality, WNBT field strength exceeded WRGB. In western Massachusetts, WRGB was received well in Pittsfield and poorly in Great Barrington, Adams and North Adams. There was very little cochannel interference, day or night, probably because of the proximity of the Berkshires. All of these towns are surrounded by large hills.

Reception of WBZ-TV in Fitchburg, Worcester, Providence and Fall River, Massachusetts, was very good, with only slight traces of fine bars due to cochannel interference with offset operation. Severe interference from WNBT was observed in Newport, Rhode Island, at times, but again the improvement due to offset carrier operation was apparent.

WNBT was received well in Bridgeport and Norwalk, Connecticut. There was interference from WBZ-TV in Norwalk and interference from both WBZ-TV and WRGB in Bridgeport. However, with offset carrier operation, the pictures from WNBT were quite satisfactory. Good pictures from WNBT (over 110 miles across Long Island Sound) were seen in Mystic, Connecticut, in spite of strong WBZ-TV interference.

Very acceptable pictures were received from WNBT in Princeton and Trenton, New Jersey, throughout the Summer. Close scrutiny of the received picture revealed fine lines due to cochannel interference when offset carrier operation was used, while nonsynchronous operation usually resulted in a far from satisfactory picture.

The RCA Service Company reports that the Washington area cochannel interference problem has never been serious. Fringe area cities include only Baltimore, Annapolis and Frederick, Maryland. Baltimore television viewers are discouraged from use of Channel 4 because it is noisy relative to Baltimore stations and therefore cochannel interference complaints have been very few. In Frederick, the Channel 4 pictures are very noisy with no complaints of cochannel

interference. Annapolis cochannel interference complaints have been greatly reduced by offset carrier operation.

During the field tour, no cochannel interference was seen in Baltimore, but slight interference was observed a few miles north of Baltimore. No cochannel interference was observed in Frederick or reported by the local RCA dealer.

Severe cochannel interference was observed in Winchester, Virginia, where field strengths of WNBW are seldom over 300 microvolts per meter. Again offset carrier operation proved beneficial.

OBSERVER TESTS OF COCHANNEL INTERFERENCE,
IN COLLABORATION WITH JTAC

In the research phases of the program on television carrier synchronization and on offset carrier operation, observer data were obtained which showed the improvement of the two methods in terms of nonsynchronous operation. To be useful for allocation purposes, the data must consist of ratios of desired to undesired signal for a given method of operation, rather than of an improvement factor of one system over another. The assembly of such data requires a large amount of equipment and observations by many observers under controlled conditions.

In July, 1949, the facilities and assistance of RCA Laboratories were made available to JTAC in order to accumulate the desired data.

The television system tested was the standard black-and-white signal using 60 fields and 525 lines, interlaced in the usual manner. One hundred observers were used in the tests, and threshold and tolerable ratios of desired to undesired signal were obtained for three conditions of operation: 1, nonsynchronous; 2, synchronous; and 3, 10.5-kilocycle offset. A complete description of the tests and delineation of the data is contained in Proceedings of JTAC, Vol. 4, September 26, 1949, COMMENTS ON THE PROPOSED ALLOCATIONS OF TELEVISION BROADCAST SERVICES. A summary of the pertinent data is shown in Table III.

Table III—Minimum Ratios of Desired RF Signal to Undesired RF Signal as Obtained for Fifty Per Cent of the Observers in the JTAC Observer Tests, July, 1949.

	Type of Interference		
	Nonsynchronous	Synchronous	10.5-Kilocycle Offset
Threshold ratio	54.5 decibels	40.0 decibels	36.0 decibels
Tolerable ratio	44.6 decibels	32.4 decibels	27.2 decibels

These observer tests showed that synchronous operation was twelve decibels better than nonsynchronous operation with respect to tolerable ratios of desired to undesired signal, while 10.5-kilocycle offset was seventeen decibels better than nonsynchronous operation. The results of these extensive JTAC tests fully demonstrated the soundness of the philosophy behind the principle of offset carrier operation.

OBSERVER TESTS OF COCHANNEL INTERFERENCE WITH COLOR TELEVISION SYSTEMS

During the course of the hearings before the FCC in the Fall of 1949, three color television systems were advanced, namely, the field-sequential system, the line-sequential system, and the dot-sequential system. In order to establish a television allocation plan which included one of the above color systems as well as the present monochrome system, it will be necessary to have knowledge of the tolerable desired to undesired cochannel interference ratios for the color system in question as well as for the color system versus a standard monochrome system. Experiments were begun in October, 1949, in order to obtain data on this important question for the three color systems under consideration.

A. Field-sequential color television system

In the standard monochrome television system with 525 lines, 60 fields, and 30 frames, the line frequency is 15,750 cycles per second. Figure 8 showed that the maximum improvement in the operation of the offset carrier system occurred at one-half of line frequency or 7,875 cycles per second. A minimum improvement appeared at 15,750 cycles where beats occurred between the line frequency and the interfering carrier. It may be recalled that an offset of 10,500 cycles was chosen as a compromise which also gave protection in a three-station plan. The proposed field-sequential color television system has 405 lines, 144 fields, and 72 frames. Hence the line frequency is 29,160 cycles per second. From previous experience with offset operation, one quickly arrives at the conclusion that for maximum protection to this field-sequential system when the interfering signal is a similar field-sequential signal, the carriers should be offset by 14,580 cycles and that little improvement would be achieved with the carriers offset 29,160 cycles. It would seem reasonable to expect that 10,500 cycles and 21,000 cycles of offset carrier would be as effective for the field-sequential system as it was for standard monochrome.

The Columbia Broadcasting System has proposed that a dual set of standards be established which would permit some stations to operate

in color with the field-sequential system, while others continued to operate on the present monochrome standards. It seemed desirable to first investigate the interference conditions for this dual-standards condition.

An experiment was made with a small number of observers, using a field-sequential color signal as the desired signal and a standard black-and-white signal as the source of interference. Threshold (perceptible) interference ratios were determined as a function of difference between carrier frequencies. The results are shown in Figure 11, with the least interference occurring at a separation of 14,580 cycles, one-half the line frequency of the desired picture, and with practically no improvement over nonsynchronous operation at a separation of 29,160 cycles. It may be seen that 10,500 and 21,000 cycle offset is effective for a field-sequential signal. Since the interference is largely caused by beating of the undesired carrier with frequency components in the desired signal, it seems logical to conclude that the shape of a curve like that of Figure 11 is largely determined by the characteristics of the desired signal and that the interfering signal may be field-sequential, line-sequential, dot-sequential, or standard black-and-white without changing the major interfering effects.

It may be noted that a limited number of observers found a ratio of 38 decibels to be just perceptible for this combination with carriers offset by 10.5 kilocycles, while in the JTAC tests with 100 observers the corresponding ratio with standard monochrome for both the desired and undesired signals was found to be 36 decibels.

A group of fifteen observers was then assembled for a series of tests to determine cochannel ratios for a variety of conditions. Because of the great amount of time necessary for these types of tests and because Figure 11 showed the large improvement obtained by offset frequencies of 10.5 kilocycles, the remainder of the data was taken only for this condition of carriers.

The receiver used for observing the field-sequential pictures consisted of a modified chassis from an RCA-9T240 television receiver using a ten-inch tube with a picture equivalent to a seven-inch tube and a magnifying lens to give the equivalent of a ten-inch picture. A rotating color wheel was included.

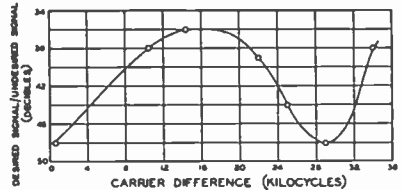

Fig. 11—Ratio of desired signal to interfering signal for threshold perceptibility as a function of the difference between carrier frequencies. The desired signal is field-sequential color. The interfering signal is standard monochrome.

For observations where the desired picture was standard monochrome, an unmodified RCA-9T240 television receiver was used.

A color slide was used for the desired picture in all cases. This slide is reproduced in black and white in Figure 12. The receivers were adjusted to achieve a high-light brightness of 15 foot-lamberts. The ambient room illumination was maintained at approximately four foot-candles.

Two field-sequential signals and a monochrome signal were used for the determination of threshold and tolerable ratios. At the same time, ratios were obtained using a standard monochrome signal interfering with a standard monochrome signal. The results for this latter condition are shown as Curves 5, Figure 14C and Figure 15C, where Figure 14 applies to threshold ratios and Figure 15 applies to tolerable ratios.

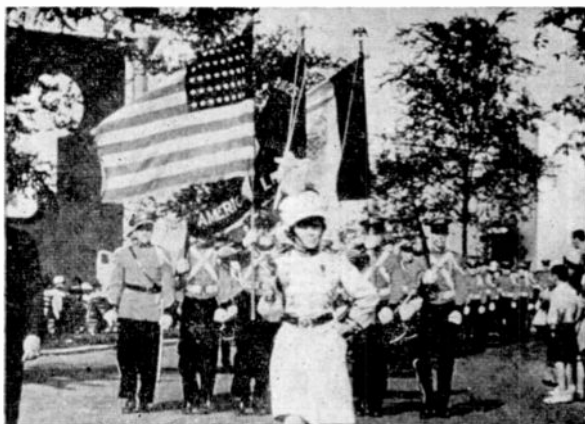

Fig. 12—Black-and-white reproduction of the color slide used as the desired picture in the co-channel tests.

Data were taken with a field-sequential picture as the desired signal and with another field-sequential signal as the interfering signal. The results are given by Curves 3, Figures 14B and 15B.

Next, the desired signal continues to be the field-sequential picture viewed on a color receiver, with standard monochrome signal as the interference. Curves 4, Figures 14B and 15B, depict the results of this test.

Then a standard monochrome signal was viewed on the black-and-white receiver, with a field-sequential signal as the source of interference, with the ratios displayed as Curves 6, Figures 14C and 15C.

Some difficulty was experienced when the field-sequential color picture was the desired signal, since many of the observers complained of flicker in the desired picture and felt that it was difficult to separate this effect from the interfering effects.

B. Line-sequential color television system

The line-sequential system uses the standards of normal monochrome, as far as the number of lines and scanning fields. A flying spot scanner, developed to produce color signals of the simultaneous type, was used as a picture source, together with suitable circuitry to

		LINE SEQUENCE B						
		FIELD→						
		I	II	III	IV	V	VI	VII
←LINE	1	RED		GREEN		BLUE		RED
	2		GREEN		RED		BLUE	
	3	GREEN		BLUE		RED		GREEN
	4		BLUE		GREEN		RED	
	5	BLUE		RED		GREEN		BLUE
	6		RED		BLUE		GREEN	
	7	RED		GREEN		BLUE		RED
	8		GREEN		RED		BLUE	

		LINE SEQUENCE C						
		FIELD→						
		I	II	III	IV	V	VI	VII
←LINE	1	RED		GREEN		RED		GREEN
	2		BLUE		RED		BLUE	
	3	GREEN		BLUE		GREEN		BLUE
	4		RED		GREEN		RED	
	5	BLUE		RED		BLUE		RED
	6		GREEN		BLUE		GREEN	
	7	RED		GREEN		RED		GREEN
	8		BLUE		RED		BLUE	

Fig. 13—Line-scanning sequences of the line-sequential color system. Sequence C was used to obtain Curves 8, Figures 14C and 15C.

provide sequential line selection from first the red signal, then the green signal, and then the blue signal. The necessary circuits were added to the receiver¹ to select the proper line sequence according to the transmitted synchronizing information. The sampler normally present in the dot-sequential color television receiver was not used, and the

¹ Radio Corporation of America, "A Six-Megacycle Compatible High-Definition Color Television System", pamphlet, September 26, 1949, Figure 10.

scanning and video signals were applied to the red, green and blue kinescopes in sequence. The two line-scanning sequences used in these tests are shown in Figure 13. When viewed on the color receiver, scanning sequence B was seen to have very coarse line structure and flickered badly on small objects or on nearly horizontal lines. Sequence C exhibited coarse line structure and had very poor vertical resolution. The pictures for either sequence were so poor in character that to determine interference ratios appeared to be without meaning, and no data was taken on this phase.

Interference ratios were determined where the desired signal was a standard monochrome picture viewed on a standard television receiver, with the line sequential signal using sequence C, Figure 13, as the interfering signal. The results are shown in Curves 3, Figures 14C and 15C.

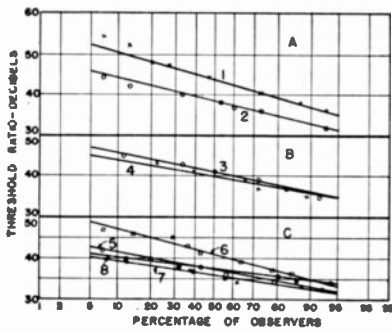

Fig. 14—Threshold values of co-channel interfering television signals, as a function of the percentage of observers requiring ratios greater than the ordinate values.

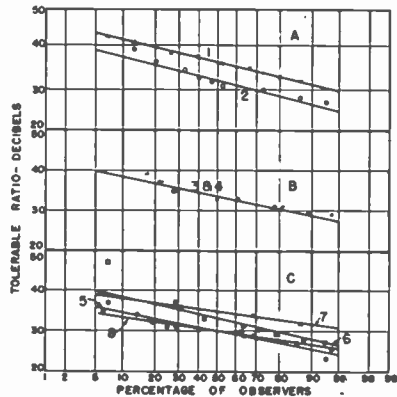

Fig. 15—Tolerable values of co-channel interfering television signals, as a function of the percentage of observers requiring ratios greater than the ordinate values.

C. Dot-sequential color television system

Interference ratios pertaining to the dot-sequential color television system were next determined. The direct-view receiver shown in Figure 16 of Reference (1) was used for observations. In the first run, the color picture was viewed on this receiver, with a standard monochrome signal as the interference (Curves 1, Figure 14A and 15A). Then the same color picture was viewed on an RCA-9T246 monochrome receiver, again with a standard monochrome signal as the interference, with the results shown in Curves 2, Figures 14A and 15A.

A third test was made, where a standard monochrome picture was received on a standard television receiver, with the dot-sequential signal as the interfering signal (Curves 7, Figures 14C and 15C).

The results of the observer tests on the three systems, field sequential, line sequential, and dot sequential, are summarized in Table IV. It may be seen that the tolerable ratios average five decibels higher than the corresponding ratio obtained in the previous JTAC tests, using standard monochrome for both the desired and undesired signal. This may be because only fifteen observers were used in these later tests on color television, while one hundred observers were used in the JTAC tests.

Table IV—Summary of Tolerable and Threshold Ratios of Desired to Undesired Cochannel Television Signals with Carriers Offset 10.5 Kilocycles.

Curve	Fig- ure	Sym- bol	Desired signal	Undesired signal	Average ratio re- quired by the observers (decibels)	
					Thresh- old	Toler- able
1	A	X	Dot-sequential color viewed on color receiver	Standard monochrome	42.0	36.0
2	A	O	Dot-sequential color viewed on standard monochrome receiver	Standard monochrome	37.0	32.0
			Dot-sequential color viewed on color receiver	Dot-sequential color	35.0	29.0
			Dot-sequential color viewed on standard monochrome receiver	Dot-sequential color	37.0	31.0
3	B	O	Field-sequential color viewed on color receiver	Field-sequential color	40.0	33.0
4	B	X	Field-sequential color viewed on color receiver	Standard monochrome	39.0	33.0
5	C	O	Standard monochrome viewed on standard monochrome receiver	Standard monochrome	36.0	29.0
6	C	□	Standard monochrome viewed on standard monochrome receiver	Field-sequential color	40.0	32.0
7	C	X	Standard monochrome viewed on standard monochrome receiver	Dot-sequential color	35.0	29.0
8	C	•	Standard monochrome viewed on standard monochrome receiver	Line-sequential color, Se- quence C	36.0	30.0
			Standard monochrome viewed on standard monochrome receiver (JTAC results)	Standard monochrome	36.0	27.2

The JTAC tests showed an average required ratio of approximately 45 decibels for monochrome pictures, using nonsynchronous operation of carriers. The observer tests conducted by RCA on the color television systems as well as the JTAC observer tests, both groups of tests with 10.5 kilocycles for the offset value, indicate that a ratio of 30 decibels is a very acceptable value, in round numbers. Figures 16, 17, 18, and 19 have been prepared to assist the reader in relating these interference ratios in terms of cochannel station separation. These curves were prepared by methods described in the report of the Ad Hoc Committee.*

In the above figures, only the effects on a line joining the desired station with the undesired station are considered. D is the distance between the two transmitters, d is the distance from the desired station to the receiving point along the line between the stations, and A is the ratio in decibels of the desired to the undesired signal. All four

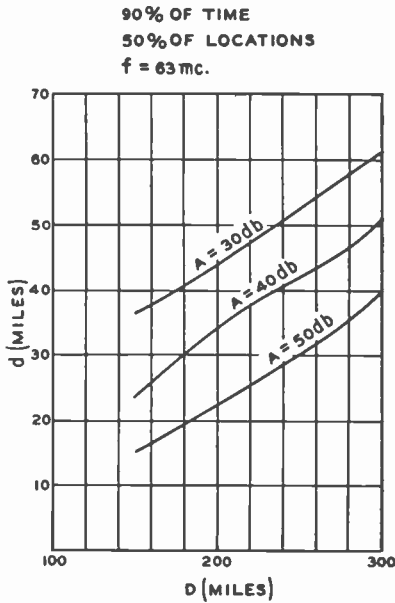

Fig. 16—Protection ratios A decibels existing at 50 per cent of the locations for 90 per cent of the time at a distance d miles from the desired station on a line toward the undesired station, with the stations separated D miles. The frequency is 63 megacycles.

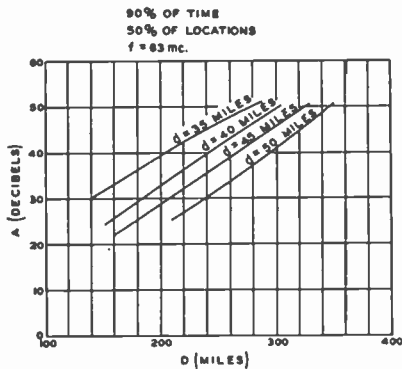

Fig. 17—Protection ratios A decibels existing at 50 per cent of the locations for 90 per cent of the time at a distance d miles from the desired station on a line toward the undesired station, with the stations separated D miles. The frequency is 63 megacycles.

* REPORT OF THE AD HOC COMMITTEE FOR THE EVALUATION OF THE RADIO PROPAGATION FACTORS CONCERNING THE TELEVISION AND FREQUENCY MODULATION BROADCASTING SERVICES IN THE FREQUENCY RANGE BETWEEN 50 AND 250 MEGACYCLES, Volume I, May, 1949.

figures relate to the probability of the particular ratio A occurring at 50 per cent of the locations for 90 per cent of the time. Figures 16 and 17 are estimates for a frequency of 63 megacycles, and may be considered to apply for Channels 2 to 6, inclusive, while Figures 18 and 19 are for the frequency of 195 megacycles and may be considered to apply for Channels 7 to 13, inclusive.

The reader may wish to draw conclusions of his own from these figures, together with a number of interference ratios. As an example of the type of information which may be readily extracted from these figures, one may assume a separation of two cochannel stations of 200 miles. If the stations are operating with offset carriers of 10.5 kilocycles, and a ratio A of 30 decibels is assumed, Figure 16 shows that this protection value holds for 50 per cent of the locations and 90 per cent of the time out to a service radius of 43.5 miles on the line toward the interfering station. If the two stations are operating nonsynchronously, the protected distance is shrunk to 28 miles if an interference ratio of 45 decibels is assumed for the nonsynchronous operation. On the other hand, it may be noticed that if the stations

are nonsynchronous and it is desired to give the same order of protection for the nonsynchronous operation as for offset operation, the stations should be separated by

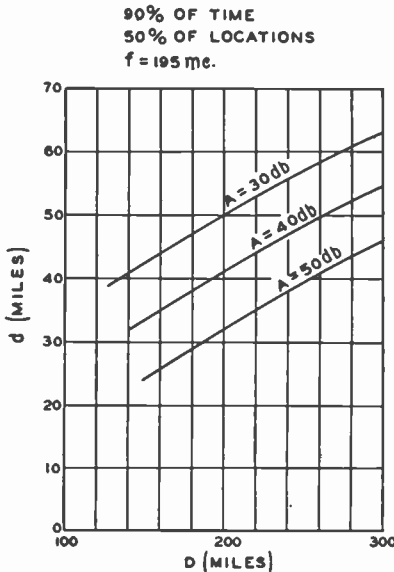

Fig. 18—Protection ratios A decibels existing at 50 per cent of the locations for 90 per cent of the time at a distance d miles from the desired station on a line toward the undesired station, with the stations separated D miles. The frequency is 195 megacycles.

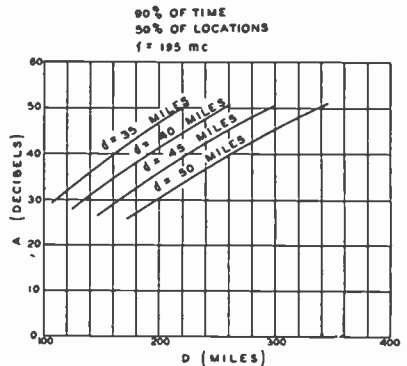

Fig. 19—Protection ratios A decibels existing at 50 per cent of the locations for 90 per cent of the time at a distance d miles from the desired station on a line toward the undesired station, with the stations separated D miles. The frequency is 195 megacycles.

a distance of 300 miles. The above observations apply to a frequency of 63 megacycles, or to the five lower television channels.

A similar inspection of Figure 18 reveals that at a frequency of 195 megacycles, or the upper seven television channels, offset carrier operation gives protection to a distance of 50 miles, with a protection ratio of 30 decibels and a station separation of 200 miles. With the same station separation, a protection ratio of 45 decibels (nonsynchronous operation) exists to a distance of 36 miles. Again, if the stations are nonsynchronous, the station separation must be 300 miles to secure a protection ratio of 45 decibels out to a distance of 50 miles.

A rough rule to apply seems to be as follows: (1) with a fixed separation of stations, offset carrier operation extends the service radius in the direction of the undesired station by about 50 per cent over nonsynchronous operation, or (2) for a fixed protected radius, nonsynchronous operation requires an increase in station separation of approximately 50 per cent over the separation required for offset carrier operation.

CONCLUSION

Television carrier synchronization has been demonstrated to be extremely advantageous in reducing cochannel television interference. Offset carrier operation has been shown to be superior in results and more economical to apply than television carrier synchronization.

Extensive application of offset carrier operation to existing television stations, many observations in a mobile laboratory and in homes, and the JTAC observer tests have fully demonstrated a remarkable improvement in television service when compared to conventional nonsynchronous operation.

Limited observer tests demonstrate that offset carrier operation is equally applicable to standard monochrome transmissions, the dot-sequential color television system and the field-sequential color television system. Limited data indicate that the line-sequential color television system interferes with a standard monochrome signal to the same extent as an interfering standard monochrome signal. No observer tests using a line-sequential signal as the desired picture were made for the reasons stated earlier.

It is recommended that for either standard monochrome or for color transmissions the amount of carrier offset shall be 10.5 kilocycles, or in a three-station combination one station shall remain on the assigned frequency, the second station shall be offset 10.5 kilocycles above the first, while the third shall be offset 10.5 kilocycles below the first.

NOTE: It is planned to print Part II of this paper—Adjacent-Channel Studies—in the June, 1950 issue.

A STUDY OF COCHANNEL AND ADJACENT-CHANNEL INTERFERENCE OF TELEVISION SIGNALS*†

A Report

By

RCA LABORATORIES DIVISION, PRINCETON, N. J.

Part II — Adjacent-Channel Studies

Summary—Included in the observer tests were color signals characteristic of the field-sequential, line-sequential, and dot-sequential systems. A standard monochrome signal was paired with a monochrome signal and the color signals in some of the tests. In all instances, the interfering sound signal was present. From the standpoint of allocation, no substantial difference in the tolerable ratios was found for the various combinations of color and monochrome signals used.

METHOD AND APPARATUS USED FOR THE DETERMINATION OF ADJACENT-CHANNEL INTERFERENCE RATIOS

Part II of this study summarizes the work with adjacent-channel interference. The approach to the problem was made through the use of subjective visual observations of a limited number of observers. The choice of personnel for the test group was made from laboratory employees with the intent of approximating a fair cross-section of the population by 15 observers. All observers were accustomed to the viewing of television pictures and had some previous acquaintance with the types of adjacent-channel interference ordinarily experienced in standard monochrome television.

Included in the tests were signals characteristic of the three proposed color television systems; the field-sequential system, the line-sequential system, and the dot-sequential system. A standard monochrome signal was paired with the color systems for certain tests to represent the coexistence of color and monochrome television on adjacent channels.

All signals were generated by low-power transmitters operating on Channels 3 and 4 within the laboratory. Attenuation of the lower sideband of an interfering signal on the upper adjacent channel was provided by a vestigial sideband filter with attenuation characteristics

* Decimal Classification: R171 × R430.11 × R583.16.

† Reprinted from *RCA Review*, June 1950.

as shown in Figure 20. Synchronizing waveforms for the interfering and desired signals were generated by independent synchronizing generators not locked to a common power supply.

Significant details of the observer tests of adjacent-channel interference correspond to the conditions for cochannel interference tests as set forth in Part I of this study; namely,

Receiver	—RCA Model 9T246 modified. Video output supplied signals for monochrome and color observations.
Picture Size	—As stated in Part I.
Desired Picture	—Stationary slide, band leader and band (see Figure 12, Part I.)
Interfering Picture	—Test pattern
High-Light Brightness	—15 fcot-lamberts
Ambient Room Illumination	—Up to 4 foot-candles

Observer tests of cochannel interference may ordinarily be conducted without regard for the selectivity characteristics of the receiver used, since the spectrums of both desired and interfering signals correspond and are treated equally by the receiver. On the contrary,

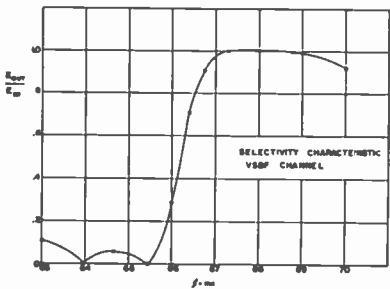

Fig. 20—Frequency-response characteristic of the vestigial sideband filter.

conclusions drawn from observations of adjacent-channel interference must take account of the selectivity characteristic of the television receiver since the spectrums of the desired and interfering signals are displaced by six megacycles. In order, therefore, to place these observations on a basis independent of a particular selectivity characteristic, all interference ratios are finally referred to the detector.

The over-all selectivity characteristics of the receiver used in tests at the RCA Laboratories are displayed in Figures 21 and 22.

SUBJECTIVE TESTS

In all tests, observers were instructed to inform the operator when the strength of the interfering signal corresponded (1) to interference on the threshold of visibility, and (2) to interference at the limit of tolerance. The observer was requested not to imagine that the test

slide was a favorite program, but to base judgment on the test subject as such. Hence, the ratios of desired signal to interfering signal which was obtained may be regarded as conservative values.

A fixed ratio of picture signal to sound signal equal to 3 decibels was maintained throughout.

a. Lower-Adjacent-Channel Interference

Subjective tests were conducted with the desired signal on channel 4 and the interfering signal on channel 3. There was unanimous agreement by 15 observers that the lower adjacent sound carrier was the determining factor in lower-adjacent-channel interference. That is, the

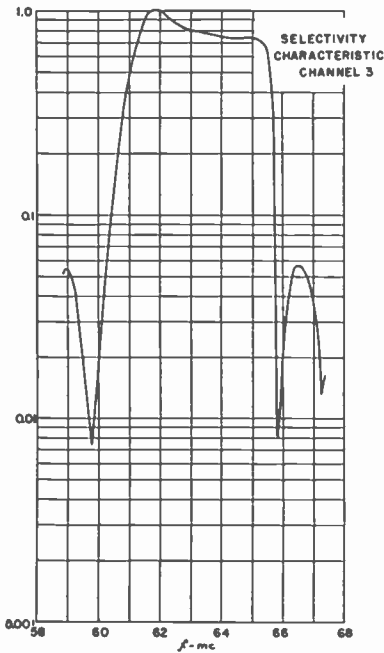

Fig. 21—Frequency characteristic of receiver on Channel 3.

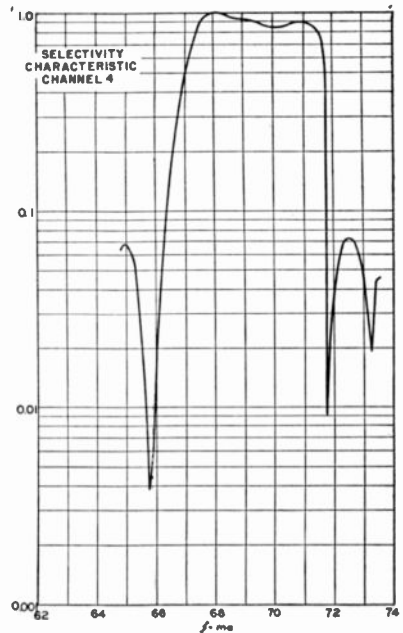

Fig. 22—Frequency characteristic of receiver on Channel 4.

presence of an interfering picture, monochrome or any of the types of color, was masked by the usual wavering fine bar pattern commonly associated in television with an interfering frequency-modulated sound carrier. Similar observations were made when a monochrome signal was on the lower adjacent channel and the desired signal was a dot-sequential picture viewed in color or monochrome or a field-sequential color picture.

In all of the foregoing observations, the average observer required a ratio of desired to interfering carriers of approximately -17 decibels

for tolerable interference and approximately -13 decibels for threshold interference. These values apply for the receiver selectivity characteristic shown in Figure 22. Since an attenuation of 48 decibels is afforded by the lower adjacent sound trap and the attenuation of the desired carrier is 5 decibels, the threshold and tolerable ratios referred to the input of the detector are 30 and 26 decibels respectively.

Table V—Summary of Tolerable and Threshold Ratios of Desired to Undesired Adjacent-Channel Television Signals

Channel 3—desired signal
 Channel 4—undesired picture and sound signals, ratio of sound to picture = 0.71

Desired Signal	Undesired Signal	Average ratio required by the observers (decibels) *	
		Threshold	Tolerable
Standard monochrome viewed on standard monochrome receiver	Standard monochrome	-9	-14
Standard monochrome viewed on standard monochrome receiver	Field-sequential color	-9	-12
Standard monochrome viewed on standard monochrome receiver	Line-sequential color, Sequence C	-10	-14
Standard monochrome viewed on standard monochrome receiver	Dot-sequential color	-9	-13

* Ratios measured at input to receiver. Add +33 decibels to readings for input to detector.

ö. Upper-Adjacent-Channel Interference

Measurements were made with the undesired signal on channel 4 properly restricted by the vestigial sideband filter characteristics as in Figure 20.

All observers agreed that the sound signal associated with the upper adjacent channel did not give rise to observable interference before interference due to the picture carrier exceeded the limit of tolerance. That is, the tolerable and threshold ratios were dictated by interference commonly known as "windshield wiper" effect caused by the subject matter of the nonsynchronous interfering picture.

The observer data are summarized in Tables V and VI. It is clear from Table V that the average observer did not distinguish between

sources of interference when viewing a monochrome picture. The tolerable and threshold ratios for the average observer were about -9 and -13 decibels respectively.

Table VI—Summary of Tolerable and Threshold Ratios of Desired to Undesired Upper-Adjacent-Channel Television Signals

Channel 3—desired signal
Channel 4—undesired picture and sound signals, ratio of sound to picture = 0.71

Desired Signal	Undesired Signal	Average ratio required by the observers (decibels)*	
		Threshold	Tolerable
Dot-sequential color viewed on color receiver	Standard monochrome	-5	-8
Dot-sequential color viewed on standard monochrome receiver	Standard monochrome	-6	-8
Field-sequential color viewed on color receiver	Field-sequential color	-10	-13
Field-sequential color viewed on color receiver	Standard monochrome	-15	-19
Dot-sequential color viewed on color receiver	Dot-sequential color	-11	-18
Dot-sequential color viewed on monochrome receiver	Dot-sequential color	-11	-18

* Ratios measured at input to receiver. Add $+33$ decibels to readings for input to detector.

In Table VI drawn up for the field-sequential and dot-sequential color signals as the desired signals and monochrome as the interfering signal, somewhat greater spread is recorded. It is believed, however, that more extensive observations would bring the data of Table VI into line with that of Table V.

It is reasonable to conclude that the average observer is tolerant to about the same extent of upper-adjacent-channel interference caused by a monochrome signal as color signals of any of the three types. Accepting this generalization, a ratio for threshold interference is about -9 decibels and for tolerable interference, about -13 decibels.

Since upper-adjacent-channel interference is controlled by the attenuation provided in the receiver at the frequency of the adjacent picture

carrier, the ratios may be referred to the input of the detector by reference to Figure 21. Taking values of 38 decibels and 5 decibels for adjacent picture carrier and desired picture carrier attenuations, the ratios of 24 and 20 decibels referred to the detector are deduced for threshold and tolerable interference ratios.*

Table VII—Summary of Average Threshold Ratios of Desired to Undesired Cochannel Television Signals (Decibels)

Desired Signal	Undesired Signal							
	BW Offset		FSC Offset		LSC Offset		DSC Offset	
	Normal	Normal	Normal	Normal	Normal	Normal	Normal	Normal
BW on BW Recv'r	36	55	40	57	36	57	35	56
FSC on Color Receiver	39	49	40	50	xxxx	xxxx	xxxx	xxxx
FSC on BW Recv'r	Note A	Note A	Note A	Note A	xxxx	xxxx	xxxx	xxxx
LSC on Color Receiver	Note B	46	xxxx	xxxx	Note C	Note C	xxxx	xxxx
LSC on BW Recv'r	Note B	52	xxxx	xxxx	Note C	Note C	xxxx	xxxx
DSC on Color Receiver	41	54	xxxx	xxxx	xxxx	xxxx	35	44
DSC on BW Recv'r	37	52	xxxx	xxxx	xxxx	xxxx	37	50

Note A.—No tests made.

Note B.—The coarse appearance of the scanning raster gave the same type effect as offset carrier interference so observers were unable to distinguish between interference and normal appearance of picture.

Note C.—This test would have required two sets of signal generating equipment for the line-sequential system. Only one set of equipment was available.

CONCLUSION

When the interfering signal is on the lower adjacent channel, the tolerable ratios of desired to undesired signal are very dependent upon the adjustment of the adjacent channel sound trap.

* The standard unmodified receiver type 9T246 has an adjacent picture carrier attenuation of approximately 50 decibels.

Upper-adjacent-channel interference comes mainly from the undesired picture carrier and sidebands closely associated with this carrier, and is determined by the attenuation achieved in the upper-adjacent-channel picture carrier trap.

Table VIII—Summary of Average Tolerable Ratios of Desired to Undesired Cochannel Television Signals (Decibels).

Symbols:
 BW—Standard Black and White Offset—Carriers offset 10.5 kilocycles.
 FSC—Field-Sequential Color
 LSC—Line-Sequential Color Normal—Cochannel with normal frequency tolerances.
 DSC—Dot-Sequential Color

Desired Signal	Undesired Signal							
	BW		FSC		LSC		DSC	
	Offset	Normal	Offset	Normal	Offset	Normal	Offset	Normal
BW on	29		32		30		29	
BW Recv'r		47		47		48		48
FSC on	33		33		xxxx		xxxx	
Color Receiver		42		42		xxxx		xxxx
FSC on	Note A		Note A		xxxx		xxxx	
BW Recv'r		Note A		Note A		xxxx		xxxx
LSC on	Note B		xxxx		Note C		xxxx	
Color Receiver		40		xxxx		Note C		xxxx
LSC on	Note B		xxxx		Note C		xxxx	
BW Recv'r		45		xxxx		Note C		xxxx
DSC on	33		xxxx		xxxx		29	
Color Receiver		45		xxxx		xxxx		38
DSC on	32		xxxx		xxxx		31	
BW Recv'r		45		xxxx		xxxx		43

Note A.—No tests made.

Note B.—The coarse appearance of the scanning raster gave the same type effect as offset carrier interference so observers were unable to distinguish between interference and normal appearance of picture.

Note C.—This test would have required two sets of signal generating equipment for the line-sequential system. Only one set of equipment was available.

Lower-adjacent-channel interference is more severe than upper-adjacent-channel interference by about 6 decibels when referred to the detector input.

From the standpoint of channel allocations, no substantial difference in the tolerable ratios was found for the various combinations of color and monochrome signals tested.

SUMMARY OF DATA OF PARTS I AND II*

For the convenience of the reader, the test data given in Part I of "A Study of Cochannel and Adjacent-Channel Interference of Tele-

Table IX—Summary of Average Ratios of Desired to Undesired Lower-Adjacent-Channel Television Signals (Decibels).

Interference of lower adjacent sound signal controlling for all combinations of monochrome and color signals used.

Tolerable ratio 26 decibels
 Threshold ratio 30 decibels

Ratios are referred to the input of the detector.

Table X—Summary of Average Ratios of Desired to Undesired Adjacent-Channel Television Signals (Decibels).

Ratios Referred to Input of Detector
 (Interfering signal on upper adjacent channel.)

Symbols:

BW —Standard Black and White Toler.—Tolerable
 FSC—Field-Sequential Color Thres.—Threshold
 LSC—Line-Sequential Color
 DSC—Dot-Sequential Color

Desired Signal	Undesired Signal							
	BW		FSC		LSC		DSC	
	Toler.	Thres.	Toler.	Thres.	Toler.	Thres.	Toler.	Thres.
BW on	19		21		19		20	
BW Recv'r		24		24		23		24
FSC on	14		20		xxxx		xxxx	
Color Receiver		18		23		xxxx		xxxx
FSC on	Note A		Note A		xxxx		xxxx	
BW Recv'r		Note A		Note A		xxxx		xxxx
LSC on	Note B		xxxx		Note C		xxxx	
Color Receiver		Note B		xxxx		Note C		xxxx
LSC on	Note B		xxxx		Note C		xxxx	
BW Recv'r		Note B		xxxx		Note C		xxxx
DSC on	25		xxxx		xxxx		15	
Color Receiver		28		xxxx		xxxx		22
DSC on	25		xxxx		xxxx		15	
BW Recv'r		27		xxxx		xxxx		22

Note A.—No tests made.

Note B.—The coarse appearance of the scanning raster made it difficult and meaningless to make observations.

Note C.—This test would have required two sets of signal generating equipment for the line-sequential system. Only one set of equipment was available.

* "A Study of Cochannel and Adjacent-Channel Interference of Television Signals—Part I," *RCA Review*, Vol. 9, No. 1, pp. 99-120, March, 1950.

vision Signals" together with additional data pertaining to cochannel interference is summarized in Table VII for threshold interference and in Table VIII for tolerable interference.

Tables IX and X repeat the data for adjacent-channel interference with ratios referred to the input of the detector.

METHOD OF MULTIPLE OPERATION OF TRANSMITTER TUBES PARTICULARLY ADAPTED FOR TELEVISION TRANSMISSION IN THE ULTRA-HIGH-FREQUENCY BAND*†

BY

GEORGE H. BROWN, WENDELL C. MORRISON, W. L. BEHREND AND
J. G. REDDECK

Research Department, RCA Laboratories Division,
Princeton, N. J.

Summary—A combining network has been developed which allows two transmitting tubes to be operated simultaneously into a common load without interaction between tubes and without reduction in band width. A number of variations of the combining network are discussed and a theoretical analysis is presented which shows that the necessary balancing adjustments are not critical.

A pair of tubes and a combining network may then be considered as a unit, with this unit combined with several other identical units to provide a transmitter with a large number of tubes in multiple operation. In this arrangement, each tube is free from interaction with other tubes.

Rather simple circuits which apply the principles set forth are described for operation at low radio frequencies. A complete television transmitter with a carrier frequency of 850 megacycles has been developed, using four tubes in multiple to demonstrate the principle of operation.

INTRODUCTION

THE ability to generate radio-frequency power has generally kept abreast of the demand for increases in power, particularly in the broadcast band of frequencies and in the medium-high frequencies. With large power tubes available and the techniques of multiple use of tubes in push-pull or parallel operation quite commonplace, transmitter design resolves itself into a problem of economics and good engineering practice. Estimates of power requirements for ultra-high-frequency television broadcasting, however, are far in excess of the power capabilities of any commercially available single tube or of any simple push-pull combination of these tubes.^{1,2}

* Decimal Classification: R355.16 × 583.4.

† Reprinted from *RCA Review*, June 1949.

¹ George H. Brown, J. Epstein, and D. W. Peterson, "Comparative Propagation Measurements; Television Transmitters at 67.25, 288, 510, and 910 Megacycles," *RCA Review*, Vol. IX, No. 2, pp. 177-201, June, 1948.

² George H. Brown, "Field Test of Ultra-High-Frequency Television in the Washington Area," *RCA Review*, Vol. IX, No. 4, pp. 565-584, December, 1948.

Several tubes may be used in essentially parallel operation by arranging the tubes in a circle on a common cavity.³ In this method, the number of tubes is limited by practical considerations of high circulating currents in the tank circuit and criticalness of tuning, both effects due to the paralleling of the tube capacities. The authors have undertaken a study of circuit arrangements which alleviate these difficulties and have developed a simple bridge circuit which permits the multiple operation of transmitter tubes into a common load without interaction between tubes and with no limitation on band width other than that imposed by a single tube and tank circuit. In this method of operation, each final amplifier tube has its own associated tank circuit, feeds into a pure resistance load, and is entirely oblivious to the existence of the other amplifier tubes.

THE PHILOSOPHY OF THE USE OF A BRIDGE CIRCUIT TO ACCOMPLISH MULTIPLE OPERATION OF AMPLIFIER STAGES

The bridge circuit which forms the heart of this multiple operation method may be depicted for illustrative purposes by Figure 1. However, the reader should remember that this circuit *per se* is not readily applicable to the problem at hand. Circuits appropriate to particular frequency ranges will be described later in the paper.

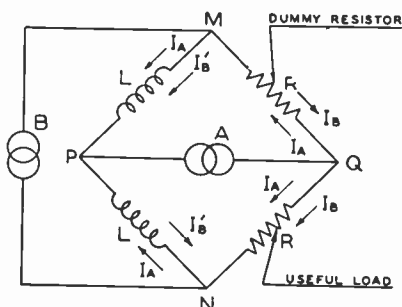

Fig. 1—A bridge circuit used to illustrate the principle of multiple operation.

The bridge of Figure 1 consists of two equal inductances and two equal resistances. This bridge is balanced, that is, the generator *A* produces no voltage across the terminals *M-N* and the generator *B* produces no voltage across the terminals *P-Q*. Thus, the two generators may operate simultaneously without interaction and the currents in the network produced by generator *B* simply superimpose upon the currents produced by

generator *A*. The voltages generated by *A* and *B* are assumed to be sine waves of identical frequency.

Suppose for the moment that generator *B* is inoperative. Then generator *A* produces the two currents denoted as I_A in each of the resistors. One resistor in Figure 1 is called the useful load while the

³ Donald H. Preist, "Annular Circuits for High-Power Multiple-Tube Generators at VHF and UHF," presented at the 1949 I.R.E. National Convention, New York City, March 9, 1949.

other is designated as a dummy resistor, for reasons which will soon become apparent. The power dissipated in the dummy resistor is $I_A^2 R$ and the power in the useful load is of exactly the same value. Hence the power delivered by generator A is

$$P_A = 2 I_A^2 R. \quad (1)$$

If generator A now becomes inoperative and generator B delivers power to the bridge, the currents in the two resistors will be I_B and the total power delivered by generator B is

$$P_B = 2 I_B^2 R \quad (2)$$

with this power divided equally between the two resistors.

Now let both generators become operative and assume that the voltage produced by generator B can be completely controlled with respect to both amplitude and phase. Control is exercised until the current I_B in the useful load is exactly equal to I_A in both amplitude and phase. Under this condition, the net current in the dummy resistor is zero and no power is dissipated in this dummy resistor. The power in the useful load is

$$P_U = (I_A + I_B)^2 R = (2 I_A)^2 R = 4 I_A^2 R \quad (3)$$

and the total power of the two generators is delivered to the useful load. The two generators remain uncoupled one from the other, with the total power concentrated in the single useful load. It is interesting to note that when one generator ceases to operate, the current in the useful load is halved and the power in this load goes to one quarter of the full load power.

When the bridge circuit was first considered, the ability to maintain sufficiently accurate balance of amplitude and phase was immediately questioned. A subsequent analysis, given below, soon showed the rather remarkable insensitiveness and practicality of the circuit arrangement. To illustrate this point, assume that the currents I_A and I_B are no longer equal and in phase but are related as follows:

$$I_A = K I_B \angle \beta \quad (4)$$

where K is a simple numerical coefficient. For this condition

$$P_B = 2 I_B^2 R \quad (5) \quad \text{and} \quad P_A = 2 I_A^2 R = 2 K^2 I_B^2 R \quad (6)$$

with the total power given by $P_A + P_B = 2(1 + K^2) I_B^2 R$. (7)

Then the total current in the useful load is

$$I_U = I_B(1 + K \cos \beta + jK \sin \beta) \quad (8)$$

and the power in the useful load is

$$P_U = (1 + K^2 + 2K \cos \beta) I_B^2 R. \quad (9)$$

Likewise, the current in the dummy load is

$$I_D = I_B(1 - K \cos \beta - jK \sin \beta) \quad (10)$$

and the power lost in the dummy resistor is

$$P_D = (1 + K^2 - 2K \cos \beta) I_B^2 R. \quad (11)$$

One may easily note that the sum of the Equations (9) and (11) is identical with Equation (7).

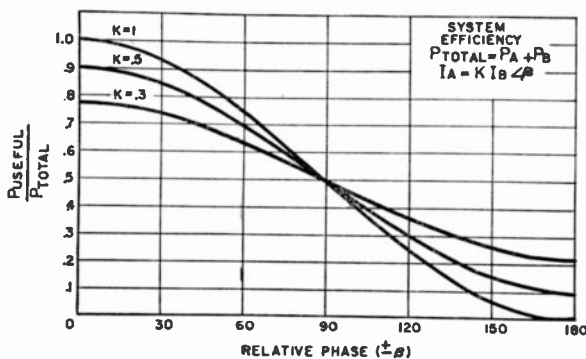

Fig. 2—Power in the useful load in terms of the total power as a function of the phase relationship between the currents produced by the two generators.

Dividing Equation (9) by Equation (7) gives

$$\frac{P_U}{P_A + P_B} = \frac{1 + K^2 + 2K \cos \beta}{2(1 + K^2)}. \quad (12)$$

Equation (12) is plotted in Figure 2 as a function of the phase angle, β , with the numerical value of K as a parameter on each curve. This diagram reveals the inherent insensitiveness of the circuit to correct phase adjustment. To be specific, suppose that generators A and B are each delivering 500 watts to the circuit. Then with truly

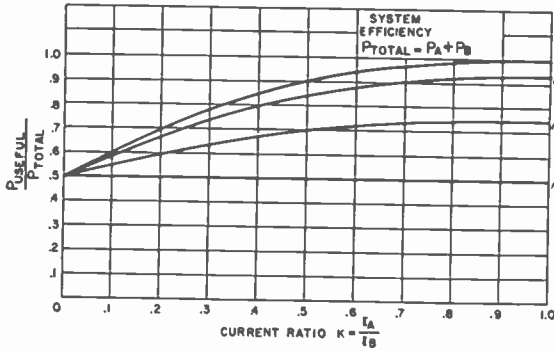

Fig. 3—Power in the useful load in terms of the total power as a function of the ratio of the currents produced by the two generators.

zero phase the power into the useful load will be 1000 watts. Reference to Figure 2 shows that with β equal to 30 degrees, the power into the useful load will be 933 watts. If the useful load is an antenna, the field strength will drop less than four per cent with this degree of phase misadjustment.

The calculations of Figure 2 have been replotted in Figure 3 to better illustrate the relative “flatness” of circuit conditions with variation in the parameter K.

So far in the analysis, it has been assumed that the two generators produced sine waves of identical frequency. It is reasonably apparent that if the signals are of complex wave form, but identical, cancellation in the dummy resistor will still be secured and the additive condition in the useful load realized. If the two generators represent modulated power amplifiers, the necessary conditions of operation are that the carriers are substantially in phase in the useful load and that the modulation of the two output stages is identical and simultaneous.

A pair of output tubes and a combining network may now be considered as a unit, with this unit combined with several other identical units to provide a transmitter with a large number of tubes in multiple operation. In this arrangement each tube is free from interaction with other tubes. Figure 4 illustrates the manner in which eight tubes are combined with seven bridges, or diplexers. It is now apparent that if n tubes are combined, the number n must be 2 raised to an integral power, that is, n must be 2, 4, 8, 16, and so on.

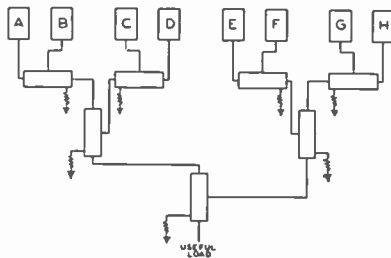

Fig. 4 — A combination of eight tubes and seven diplexers to accomplish simultaneous operation into a common load without interaction between tubes.

Also, the number of bridges required is $n - 1$.

Since the currents in the outputs of the bridges are additive, it is a simple matter to estimate the overall efficiency and other operating conditions of interest without tracing through the rather involved bridge network. To accomplish this estimate, the following nomenclature has been set up:

P = power output of each output stage.

n = total number of stages.

nP = total power in useful load when all n stages are turned on.

mP = total power available when m stages are turned on.

I_n = current in useful load with n stages turned on.

I_m = current in useful load when m stages are turned on.

$$I_m = (m/n) \cdot I_n.$$

P_m = power in useful load when m stages are turned on.

$$P_m = I_m^2 R = (m/n)^2 (I_n^2 R) = (m/n)^2 \cdot (nP).$$

Ratio of power into useful load with m stages turned on to total power available from n stages = $P_m/(nP) = (m/n)^2$.

Circuit efficiency when m tubes are on = $(P_m/mP) \cdot 100 = m/n \cdot 100$.

Table I—Conditions of Operation in Seven Combining Networks and Eight Output Stages

m (Number of stages operative)	$\frac{mP}{nP} = \frac{I_m}{I_n}$	$P_m/(nP)$
8	1.0	1.0
7	0.875	0.766
6	0.75	0.562
5	0.625	0.391
4	0.5	0.25
3	0.375	0.141
2	0.25	0.063
1	0.125	0.016
0	0	0

As an example, suppose that each of eight tubes is capable of delivering 100 watts. Then a total of 800 watts is available for the useful load. With any three of the tubes turned on, the power delivered to the networks is 300 watts. The current in the useful load is m/n or $\frac{3}{8}$ of the current found there when eight tubes are on. The power into the useful load, P_m , is 112.5 watts, and the combining circuit efficiency is 37.5 per cent.

Table I illustrates still further the conditions of operation for n tubes, with n equal to eight.

PRACTICAL BRIDGE CIRCUITS FOR LOW-FREQUENCY AND HIGH-FREQUENCY OPERATION

A simple method of applying the bridge circuit principles at low frequencies, of the order of a few megacycles or less, is illustrated in Figure 5. It is apparent that this elementary application is a one-step bridge circuit which does not lend itself to the repetitive use outlined

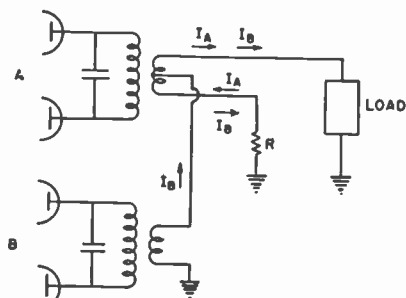

Fig. 5—A means of combining four tubes at a low frequency.

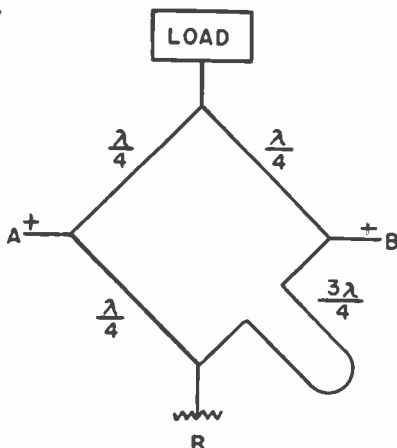

Fig. 6—A bridge arrangement constructed of lengths of transmission line.

above. A circuit much better suited to cascading at low frequencies may be best developed by referring to Figure 6. In this particular diagram, the arms of the bridge are coaxial transmission lines. Three of the arms are each one-quarter wave length at midband, while the fourth arm is three-quarters of one wave length. For the sake of simplicity, only the inner conductors are shown in Figure 6. Perfection of uncoupling between points A and B depends upon the exactness of these line lengths and the device is strictly limited to a narrow band of frequencies. When the useful load and the dummy resistor have a resistance of R ohms, and the characteristic impedance

of the transmission line arms is chosen as $\sqrt{2} \cdot R$, the resistance looking in at points A or B will be R ohms at midband. While the above choice of characteristic impedance plays no part in the balancing action at midband, affecting only the input impedance, this same choice does help in broadbanding the circuit.

The circuit of Figure 6 may now be used as a guide in forming a lumped-circuit network for use at low frequencies. This has been done in Figure 7. Each one-quarter-wave line has been replaced by a Pi network consisting of two capacitors and one inductance coil. The inductance and capacitance values have been so chosen that X_L equals X_C at midband. The fourth arm is formed from two inductances and one capacitance to be the equivalent of the three-quarter wave long branch. When $X_L = X_C = MR$, the input impedance at A and B is

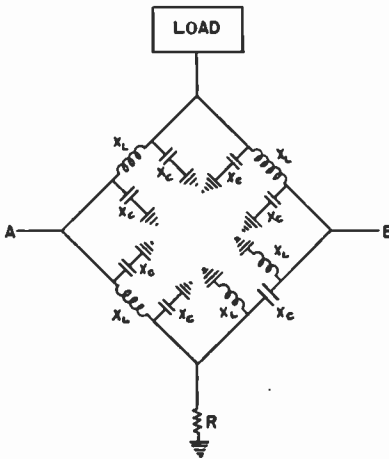

Fig. 7—A bridge circuit constructed of lumped elements, to be the equivalent of Figure 6.

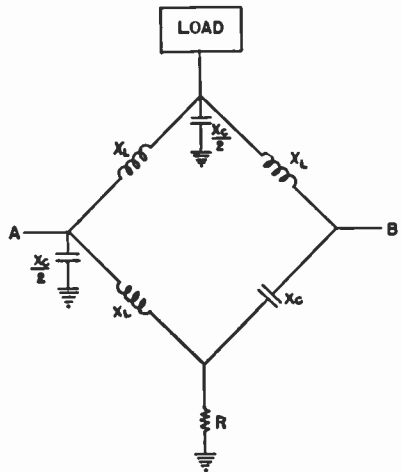

Fig. 8—A simplified circuit, equivalent to Figure 7.

$M^2R/2$ ohms. Again a choice of M equal to $\sqrt{2}$ gives maximum broadbanding for the input impedance. Figure 7 may be considerably simplified as shown in Figure 8 when it is noted that an inductive reactance in parallel with an equal capacitive reactance forms a parallel resonant circuit and both elements may then be omitted from the system.

The narrow-band limitations of Figure 6 may be avoided by the use of the circuit shown in Figure 9. Here the balance between feed points is independent of frequency and the variation of impedance at the feed points establish the limits on the frequency band.

If a circuit balanced to ground is desired, the circuit shown in Figure 10 is useful. Here the arms of the bridge may be either parallel

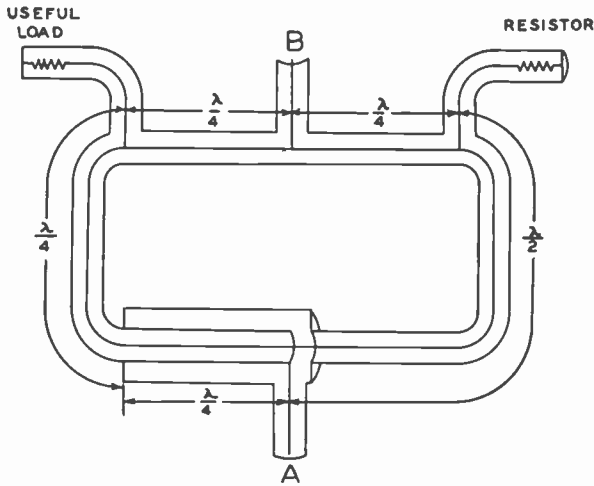

Fig. 9—A high-frequency bridge which is not sensitive to frequency change.

wire lines or two coaxial cables. This circuit does not depend on the line lengths being one-quarter wave for balance. The line lengths shown do establish the midband frequency as far as the input impedance is concerned. Here again a choice of characteristic impedance equal to MR ohms yields an input impedance of $M^2R/2$ ohms and a value of M equal to $\sqrt{2}$ gives the broadest input impedance characteristic. The circuit of Figure 10 with M equal to unity is described by Westcott.⁴ The authors have found that a choice of M equal to $\sqrt{2}$ yields a much more desirable input impedance versus frequency characteristic.

For higher frequencies, particularly the ultra-high frequencies, the authors have found the bridge or diplexer of the slotted type shown in Figure 11 to be the simplest and most easily balanced. This is the same diplexer which has been used so very successfully to diplex a Turnstile antenna, a method of operation which permits both picture and sound transmitters to be fed to a single Turnstile.

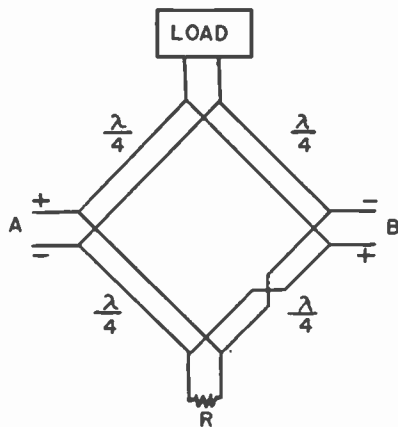

Fig. 10—A bridge arrangement which is balanced to ground.

⁴ C. H. Westcott. "Transmission-Line Bridge," *Wireless Engineer*, Vol. XXV, No. 298, p. 215, July, 1948.

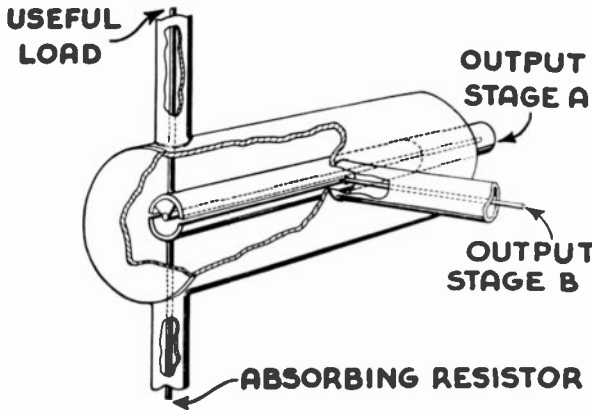

Fig. 11 — A slotted diplexer or bridge which is particularly useful at ultra-high frequencies.

AN ULTRA-HIGH-FREQUENCY TELEVISION TRANSMITTER APPLYING THE BRIDGE ARRANGEMENTS FOR MULTIPLE OPERATION OF OUTPUT STAGES

To demonstrate the principle of multiple operation, the authors developed a television transmitter using four RCA-5588 tubes in the output stages, to produce a total power of 400 watts. The circuit arrangement is shown in Figure 12. A crystal oscillator operated at a frequency of 7870.4 kilocycles. When the output of this oscillator was passed through suitable frequency multiplying stages, the exciter developed a signal with a frequency of 212.5 megacycles. At this point, the chain was broken into four parallel paths. Each path then led through two doubler stages to furnish driving voltage to a final amplifier stage at 850 megacycles. Three diplexers and three absorbing resistors were used as shown to combine the four output stages into a

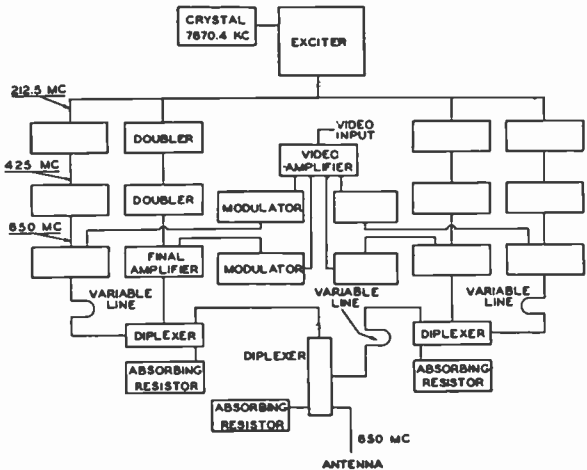

Fig. 12—A block diagram of an 850-megacycle television transmitter using the principle of multiple operation.

single antenna. Each final amplifier was cathode modulated from a single picture source to accomplish simultaneous modulation of each final amplifier. The diplexers were of the type shown in Figure 11.

Three variable length lines, shown in Figure 12, were used to provide phase adjustment of the radio-frequency carriers. These variable length lines were constructed of overlapping tubes, adjusted by a rack and pinion. Experience has indicated that these lines may be omitted and small phase adjustments accomplished by slight tuning of amplifier tank circuits in the doubler stages.

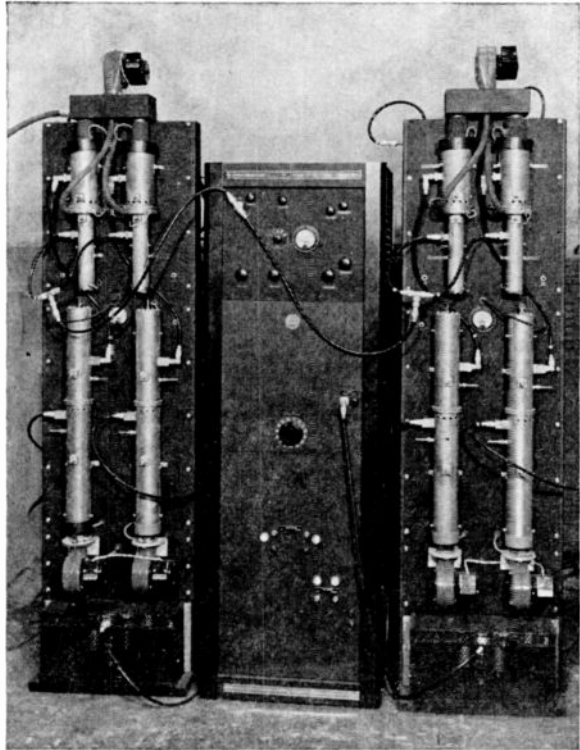

Fig. 13—The experimental 850-mega-cycle television transmitter.

One or more of the final amplifier stages could be turned on or off without reaction on the remaining stages. Signal strength in the antenna circuit changed according to theoretical predictions.

The transmitter is shown in Figures 13 and 14, with the diplexers visible in Figure 14. This transmitter was operated under an experimental license as Station W3XCY in Washington, D. C. in the fall of 1948 and has since been in operation in Princeton, N. J., as Station KE2XAY for the purpose of providing further test data in connection with the principle of multiple operation.

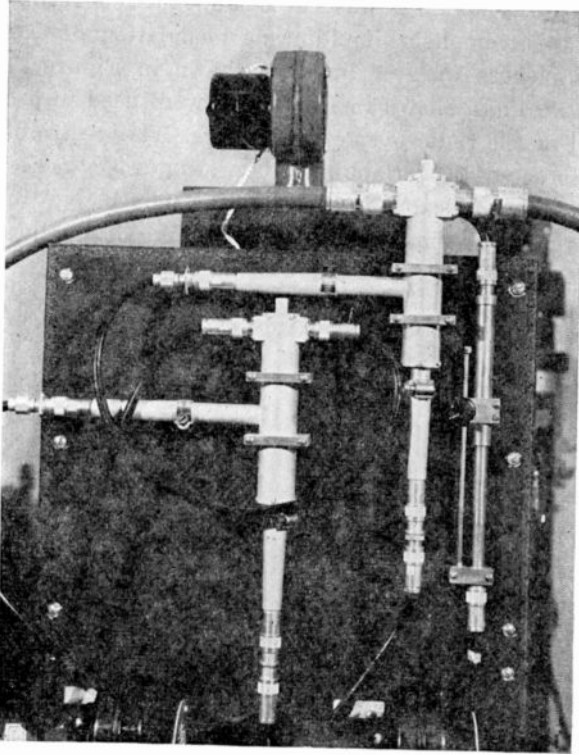

Fig. 14—Another view of the 850-megacycle television transmitter, showing the diplexers used in securing multiple operation.

CONCLUSION

A combining network has been developed which allows transmitting tubes to be operated simultaneously into a common load without interaction between tubes and without reduction in band width. A transmitter has been constructed which shows the method to be applicable to the design of ultra-high-frequency transmitters for television use. While relatively low power tubes were used in this demonstration transmitter, it was done for purposes of expediency and to demonstrate the principle of operation. The authors do not mean to imply that several small tubes are to be preferred to one large one. However, when the largest tube available does not approach the power desired for the particular service under consideration, multiple operation with diplexing circuits seems to be indicated as a practical solution.

EXPERIMENTAL ULTRA-HIGH-FREQUENCY TELEVISION STATION IN THE BRIDGEPORT, CONNECTICUT AREA*†

By

RAYMOND F. GUY, JOHN L. SEIBERT AND FREDERICK W. SMITH

Radio and Allocations Engineering, National Broadcasting Company, Inc.,
New York, N. Y.

Editor's Note: This paper constitutes the first in a series of reports on the NBC UHF field tests at Bridgeport, Connecticut. The second of the series—"An Experimental Ultra-High-Frequency Television Tuner"—appears on pages 68-79 of this issue.

It is currently planned to include the following two papers in the June 1950 issue of *RCA Review*:

"A New Ultra-High-Frequency Transmitter"

"Ultra-High-Frequency Antenna and System for Television Transmission"

Subsequent papers will include reports on propagation studies, service area surveys, service operating characteristics of equipment, and subsequent equipment and other technical developments.

Summary—The engineering considerations involved in the construction and operation of an experimental television broadcast station in the ultra-high-frequency band are presented. The transmitter, KC2XAK, is located in the Bridgeport, Connecticut area and operates in a standard bandwidth of six megacycles from 529 to 535 megacycles with a newly developed transmitter and high-gain antenna. Programs are picked up directly from Station WNBT in New York on Channel 4 and are demodulated, processed and retransmitted on the ultra-high-frequency band.

INTRODUCTION

AS World War II drew to its close, it became apparent that great expansion in radio service was imminent, particularly in the very-high-frequency (VHF) and ultra-high-frequency (UHF) spectrums. It was also evident that the whole field of frequency allocations in these spectrums should be reviewed in preparation for these new and extensive services of the future. One of the most important of the new services under consideration for the postwar period was television broadcasting. Accordingly, the Federal Communications Commission (FCC) held a public hearing which began on September 28, 1944, with the purpose of reviewing existing allocations in the light of future needs. As a result of this hearing and subsequent developments, commercial television is now assigned twelve channels in the VHF band on which there are currently in operation approximately one hundred stations. But it has been apparent that twelve

* Decimal Classification: R588×R310.

† Reprinted from *RCA Review*, March 1950.

channels do not permit adequate television service for a truly nationwide system.

For future use the FCC set aside a block of ultra-high frequencies in the 475-890 megacycle band for television. Insufficient information was available with which to adopt standards and allocate frequencies at that time. The need for this information has been most apparent and both government and the industry have undertaken to obtain such information. It is necessary to determine whether or not the television transmitter standards presently used for VHF could be adopted for UHF service. It is also necessary to determine the propagation characteristics of the ultra-high frequencies. These two generalized fields require a large amount of data which must be obtained and integrated. The areas which could be served by UHF television transmitters with practicable radiated powers and antenna heights must be determined. Moreover, the propagation characteristics which determine the minimum separation which can be tolerated between cochannel stations, and the characteristics of transmitting and receiving apparatus and the propagation characteristics which determine the minimum separation necessary between adjacent-channel stations must be known.

During the last several years, much has been learned from work done in the development of apparatus and the studies of propagation undertaken by various government and private laboratories and by manufacturing and operating companies.

Radio Corporation of America has conducted, concurrently, a number of projects^{1,2} to determine the propagation characteristics and the television service potential of the ultra-high frequencies, particularly in the band from 475 to 890 megacycles, and has made this information available to the FCC and the industry at large.

Upon completion of the tests described in Reference (2), it was decided that an experimental ultra-high-frequency television transmitting station should be erected in a representative city which was not adequately served by a local VHF transmitter. It was felt that such a station should be a full scale custom built prototype of future commercial installations in the UHF band so that the results obtained would be truly indicative of the practical possibilities of ultra-high-frequency broadcasting in the type of community in which many of these stations would be operated. Accordingly, such a project was initiated.

¹ G. H. Brown, J. Epstein and D. W. Peterson, "Comparative Propagation Measurements; Television Transmitters at 67.25, 288, 510 and 910 Megacycles", *RCA Review*, Vol. 9, No. 2, p. 177, June 1948.

² G. H. Brown, "Field Test of Ultra-High-Frequency Television in the Washington Area", *RCA Review*, Vol. 9, No. 4, p. 565, December 1948.

SELECTION OF THE SITE

After considerable investigation, an area having Bridgeport, Connecticut as its approximate center was selected for the station site. Application for a construction permit for an experimental television station, to transmit in the band from 529 to 535 megacycles and specifying Bridgeport as the general location, was made to the FCC on February 8, 1949. The permit was granted May 4, 1949, assigning the call KC2XAK.

The city of Bridgeport is located on Long Island Sound (see Figures 1 and 2) at the mouth of the Poquonock River and has a popula-



Fig. 1—Map of general area surrounding Bridgeport transmitter location.

Courtesy Esso Standard Oil Company (Copyrighted by General Drafting Company, Inc., New York.)

tion, for the metropolitan district, of approximately 216,600 according to the 1940 census. While fringe reception of television stations in New York and New Haven is obtained in this area, there is no locally originated television service.

As can be seen from Figure 2, the city is ringed with a series of hills all of which are about 200 feet high. Of these, Success Hill, in Stratford, Connecticut, which is north-northeast of the center of Bridgeport and just outside the city limits, was chosen after extensive surveys as the most suitable site for the installation of a television transmitter. From the standpoint of covering not only Bridgeport, but



Fig. 2—Topographic map of Bridgeport and immediate vicinity.
(Geological Survey, United States Department of the Interior.)

Fig. 3—Transmitter Building (front view).



also neighboring communities such as Stratford, Devon and Milford adequately, Success Hill appeared to be the most attractive location.

Application was thereupon made to the FCC, modifying the Construction Permit to show Success Hill as the exact location of the transmitter site. This modification was granted by the FCC on October 12, 1949, with a proviso that construction should start on or about December 12, 1949, and be complete on or before June 12, 1950.

TRANSMITTER BUILDING

The transmitter building resembles a conventional Cape Cod cottage from the exterior, as shown in Figure 3. The floor plans of this structure are shown in Figure 4. The useful floor area of the apparatus rooms is 1164 square feet.

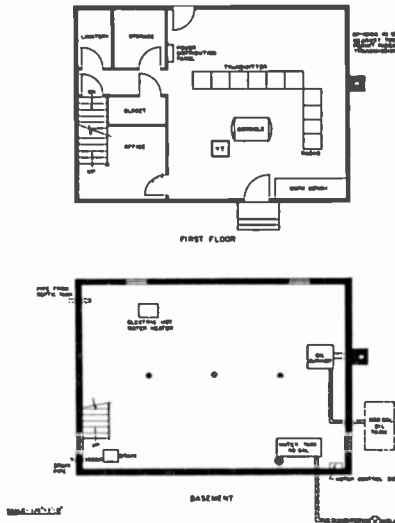

Fig. 4—Floor plans of transmitter building.

The peak power requirement of the installation was initially estimated as 50 to 60 kilovolt-amperes at 240-120 volts alternating current and it was therefore necessary to provide a 400-ampere service in order to achieve adequate regulation. Ventilation of the transmitting equipment is secured by means of vents located in the first floor ceiling which are arranged to accept the air exhausted from the transmitter racks. The attic in turn is ventilated by a pair of two speed 24-inch exhaust fans which are operated whenever it is undesirable to retain the equipment heat within the building. The construction of

the transmitter building started on September 22, 1949 and was completed on November 15, 1949.

As a supporting structure for the transmitting antenna, a steel tower 210 feet in height with a base 24 feet square was erected next to the transmitter building as shown in Figure 3. In order to adequately ground the tower as protection against lightning discharges, copper straps six inches wide were attached to three of the four tower legs and these were separately bonded to the well casing. A considerable reduction in cost of the tower lighting system was effected by employing a newly developed weatherproof cable, Simplex Anhydrex, for the lighting cable runs, rather than conventional cable in conduit. These cables were secured to the tower ladder risers by means of worm-type hose clamps and this arrangement permitted installation of the tower wiring in a fraction of the time normally required.

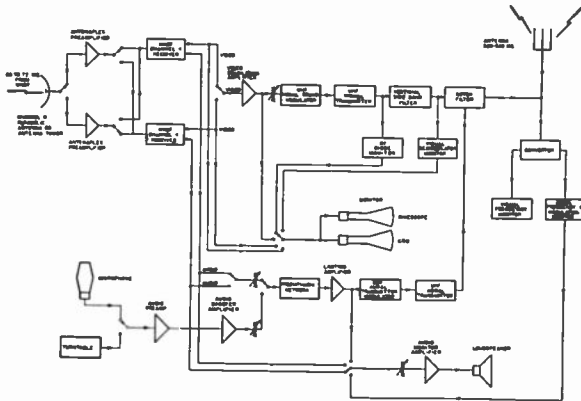

Fig. 5—Block diagram of transmitting system.

An efficient ground system for the radio transmitting equipment installed in the building was secured by situating all equipment racks on a continuous copper sheet placed over the flooring. This sheet was grounded to the well casing in the manner described above. Erection of the tower was started on November 17 and completed on November 24.

TRANSMITTING SYSTEM

The transmitting system employed at Station KC2XAK is outlined in the overall system block diagram shown in Figure 5. The transmitter is arranged to operate as a satellite of the VHF television station WNBT in that the visual and aural program signals are picked up directly from WNBT and retransmitted on the UHF band. While provisions are incorporated for local aural station identification, none are included for local origination of test pattern or other video signal.

The manner in which this system of satellite operation is accom-

plished may be seen from Figure 5. The signal from WNBT is picked up directly from the transmitter located atop the Empire State Building in New York City at a distance of approximately 54 miles by means of a parabolic antenna located on the antenna tower. The signal is then fed to a preamplifier located in the station building which in turn provides the radio-frequency signal for two specially constructed receivers tuned to Channel 4.

The video signal is taken from the receiver through a built-in isolation amplifier and is then processed by a stabilizing amplifier which improves the quality of the signal and corrects any degradation which may have occurred in the synchronizing information. The video signal is then applied to the UHF visual transmitter modulator and final power amplifier. The output of the visual transmitter is filtered by a vestigial sideband filter to attenuate the lower sideband in accordance with the television transmission standards established by the FCC.

The demodulated audio signal from the receiver is taken from the audio output stage of the receiver, pre-emphasized, and fed into a limiting amplifier which prevents over-modulation of the transmitter by audio surges. In the event that a local station identification is to be made, the output of either a microphone or a turntable may be introduced into the system at this point as indicated in Figure 5.

The output of the limiting amplifier is then applied directly to the frequency-modulation exciter which constitutes the UHF aural transmitter modulator. The outputs of the UHF aural and visual transmitters are combined in a notch type cross coupling filter and the resultant signal is used to excite a newly developed high gain UHF television transmitting antenna through a coaxial transmission line. Thus, programs originating from Station WNBT on the present VHF band are received, demodulated, processed and retransmitted on the UHF band.

In addition to the facilities just described, monitoring equipment has been provided which permits observation of either picture or sound quality anywhere within the system as indicated by Figure 5. Also, frequency monitoring equipment has been installed which makes it possible to hold the frequency of the visual and aural carriers well within the tolerances set for standard television broadcasting.

INPUT EQUIPMENT FEATURES

Although certain components in the overall transmitting system are standard units, most contain innovations which are of technical interest and will therefore be described.

The parabolic receiving antenna is located on a platform on the

160-foot level of the antenna tower as shown in Figure 6. It consists of a dipole which is mounted in the focus of a circular, parabolic screen 10 feet in diameter. The parabola has a focal length of $29\frac{1}{2}$ inches and provides an antenna gain of 3.5 decibels as compared to a simple dipole. The receiving antenna transmission line consists of an ATV-225 balanced shielded pair which has a nominal characteristic impedance of 225 ohms and a loss of 2.3 decibels per hundred feet at 50 megacycles. Although the line loss incurred with this cable is greater, the use of shielded transmission line affords a degree of noise immunity not possible with the standard unshielded 300-ohm line.

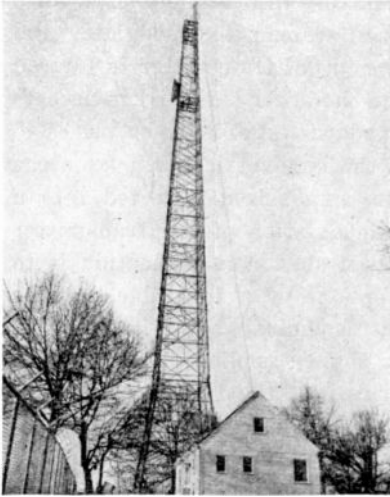

Fig. 6—Transmitter building (side view) and antenna tower. The Channel 4 parabolic receiving antenna can be seen at the 160 foot level of the tower.

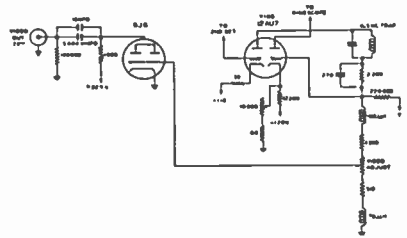

Fig. 7a—Revised video output circuit of Channel 4 receivers.

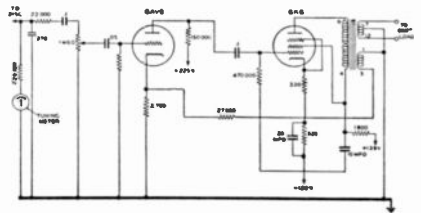

Fig. 7b—Revised audio amplifier circuit of Channel 4 receivers.

The preamplifiers which precede the Channel 4 receivers are fixed tuned amplifiers and are identical with the type SX9A amplifier normally furnished as part of the RCA Antenaplex television distributing system. The amplifier consists of two 6J6 push-pull cross-neutralized amplifier stages in cascade which provide a gain of approximately 20 decibels, as well as an improvement in the signal to noise ratio. The output stages of these amplifiers are equipped with isolation pads which permit a signal to be fed to one or both of the 300-ohm receiver inputs without undesirable interaction.

The Channel 4 receivers used for the actual detection of the Channel 4 signal are standard RCA 9T246 receivers with 10-inch screens which have been specially modified for this particular application. The

major changes made in this receiver are modifications of the audio and video output circuits and these are illustrated in Figures 7a and 7b.

The revised video output circuit is shown in Figure 7a. The normal plate load of the first half of the 12AU7 video amplifier has been divided in such a way that the input of the 6J6 isolation amplifier may be shunted across a portion of it without undesirably affecting normal operation of the receiver video circuits. This isolation amplifier will provide an output signal of 2 volts peak to peak at an output impedance of 75 ohms when the "video adjust" and receiver automatic gain controls are properly adjusted.

Figure 7b indicates the modifications made in the receiver audio amplifier. The power amplifier has been altered to provide a standard audio output impedance of 600 ohms and the overall distortion characteristics of the amplifier have been improved by the addition of an inverse feedback loop from a separate winding on the output transformer to the cathode of the penultimate audio amplifier stage. In addition, a tuning meter has been connected across the output of the discriminator which permits adjustment of the fine tuning control of the receiver for minimum audio distortion, which point is indicated by a zero indication on the meter. By this means an audio output of +5 dbm* with but .4 per cent second harmonic distortion can be obtained. The receivers have also been completely shielded, housed in a manner suitable for rack mounting, and have been aligned for optimum reception on Channel 4.

The video stabilizing amplifier employed in the system is a type ND-329 Clamp and Sync Amplifier. It incorporates clamp circuits which stabilize the video signal and contains provisions for the independent adjustment and restoration of sync pulse amplitude so that the video signal fed to the visual modulator will at all times meet FCC standards. The remaining input equipment consists mainly of standard commercial audio amplifiers.

UHF TRANSMITTER

The television transmitter, which constitutes the major link in the transmitting system, is an RCA type TTU-1A. The TTU-1A, which operates in the UHF band, meets the FCC standards for VHF television broadcast transmitters.

The transmitter is housed in six racks, as is shown in Figure 8, the left hand 3 racks containing the aural portion of the transmitter and the right hand 3 racks containing the visual portion. The transmitter includes, as an integral part, a slightly modified RCA type

* Decibels referred to a zero level of 1 milliwatt in 600 ohms.

TT-500B television transmitter which comprises the center two racks in Figure 8.

In the visual section of the transmitter, the radio-frequency output of the 4X150A's in the final stage of the TT-500B is used to drive a tripler employing eight type 4X150A tubes in parallel in a single cavity. The output of the tripler in turn drives a power amplifier containing eight additional 4X150A tubes and employing a cavity design similar to the tripler. These cavities can be seen in the second rack from the right in Figure 8. The video modulator circuits of the TT-500B have been modified to drive a direct-coupled cathode follower stage, consisting of eight 6L6 tubes, which serves as a modulator for the UHF power amplifier.

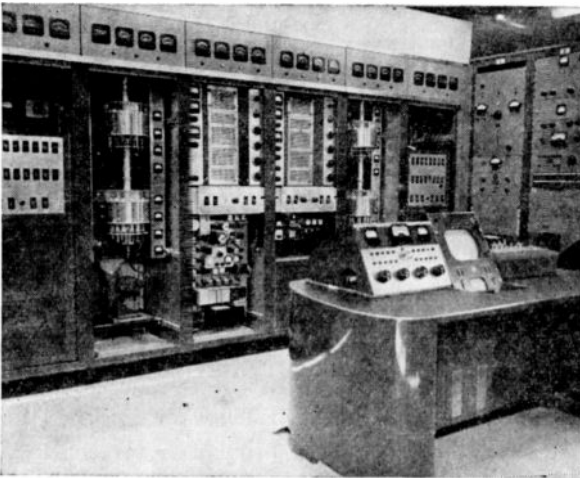

Fig. 8—The RCA TTU-1A transmitter, input and monitoring racks and control console.

In the aural section of the transmitter the arrangement of tripler and power amplifier cavities is identical to that just described, and these are located in the second rack from the left in Figure 8. Modulation, of course, takes place in the frequency modulation exciter which is located in the TT-500B.

The transmitter operates in a standard six-megacycle band, 529 to 535 megacycles, the visual and aural carrier frequencies being 530.25 and 534.75 megacycles respectively. This requires that the TT-500B output stages which drive the UHF triplers operate at 176.75 and 178.25 megacycles. An overall frequency multiplication of 108 occurs between the oscillator and the final frequency in both the visual and aural transmitters. The visual carrier is held within ± 0.02 per cent of the assigned operating frequency and the sound carrier is automatically maintained 4.5 megacycles above the visual by means of a

novel system of frequency control which eliminates relative drift between the visual and aural carriers. This arrangement makes it unnecessary to hold transmitter carrier frequency stability closer than the present FCC requirements for carrier frequency stability in the UHF band even though the intercarrier sound reception feature may be incorporated in future UHF television receivers.

Each of the transmitter sections is designed to work into a 51.5-ohm, 1 $\frac{5}{8}$ -inch transmission line, and will deliver normal power outputs of .5 kilowatt aural and 1.0 kilowatt peak visual.

FREQUENCY MONITORING EQUIPMENT

The arrangement of frequency and aural modulation monitoring equipment used in conjunction with the UHF transmitter is illustrated in Figure 9. As can be seen, the method used to monitor the transmitter is to convert the transmitter signal frequencies to 45.25 megacycles for the picture carrier and 49.75 megacycles for the sound carrier and then monitor at these frequencies with a standard RCA WF-49A and WF-50A visual frequency monitor and General Radio type 1170-AT FM aural monitor. The converter heterodyning signal is supplied by a standard frequency crystal oscillator at 30.3 megacycles and a multiplying chain. The crystal used in this oscillator is of a special design that has a long term stability of better than 2 parts per million per 30 days. In order to check the actual amount of frequency drift, means have been provided for the calibration of the oscillator against WWV. For this purpose, a 250-kilocycle oscillator is used as a secondary frequency standard and is calibrated against WWV at 5 or 10 megacycles by the use of an external communications receiver. The 250-kilocycle signal frequency is then multiplied and the resultant signal frequency compared to that of the heterodyning signal so that the heterodyne signal can be set to exact zero beat.

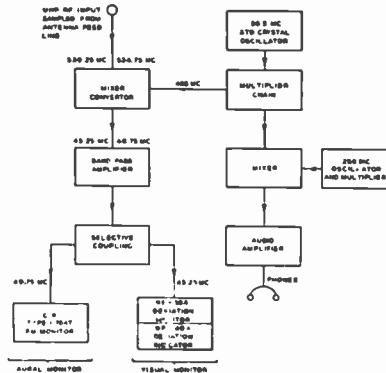

Fig. 9—Block diagram of transmitter monitoring equipment.

OUTPUT NETWORK, TRANSMISSION LINE AND ANTENNA

The coaxial vestigial sideband filter and notch filter indicated in the block diagram of the system (Figure 5) are located behind the

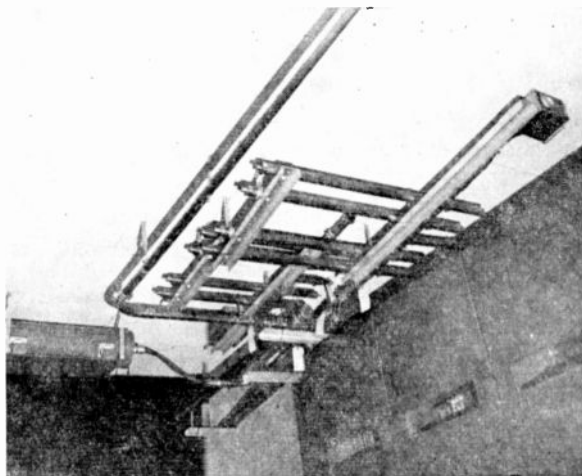

Fig. 10 — Coaxial vestigial sideband filter and diplexer suspended on ceiling behind the transmitter.

transmitting equipment in the station building as shown in Figure 10. The output of these networks is fed to the antenna by means of special $3\frac{1}{8}$ -inch UHF transmission line pressurized with nitrogen, similar to that employed in the UHF transmission tests in the Washington area.^{2,3}

The antenna itself is an RCA type TFU-20A. It is similar in structure to the standard pylon antenna (See Figure 11) but is operated as a slot antenna. The slot radiators are covered by polyethylene covers which are the protrusions which appear on the antenna pole in Figure 11.

The antenna has gain of 17, a diameter of $10\frac{3}{4}$ inches and an overall height of forty feet above the pole socket in which it mounts. Because of the nature of the antenna structure, efficient operation requires that ice formation over the slot radiators be prevented. A thermostatically controlled de-icing system consisting of a hot air

Fig. 11—The RCA TFU-20A UHF antenna in test position before erection on tower



³ D. W. Peterson, "Notes on a Coaxial Line Bead", *Proc. I.R.E.*, Vol. 37, No. 11, p. 1294, November, 1949.

blower has therefore been installed to prevent icing conditions and losses due to extreme humidity. The output of the blower is forced into the antenna at the base of the antenna pole and is exhausted at the top of the antenna just below the beacon. The electrical power input to the blower heaters can be increased to as much as 14 kilowatts if conditions demand. The overall height above ground of the antenna and antenna tower is 250 feet and the overall height above mean sea level is 440 feet. The height of the antenna radiation center above average terrain is 330 feet.

SYSTEM EFFICIENCY

The overall system efficiency from the transmitter to the antenna is approximately 80 per cent. With an antenna gain of 17 and a visual transmitter power output (peak) of one kilowatt, the effective radiated power of the system will be roughly 13.9 kilowatts peak visual. It is estimated that the power costs for the entire system for 16 hours per day, 7 days per week operation would be roughly \$4000 per year.

Additional developments are under way to increase the efficiency of the various UHF system components and raise the antenna gains. It would be possible, for example, to employ wave guide operating in the $TE_{0,1}$ mode for the antenna feed system. Such a wave guide would have dimensions of roughly $15 \times 9\frac{1}{2}$ inches and would have an efficiency of about 92 to 93 per cent for the length of guide necessary.

FIELD TESTS

Experimental television station KC2XAK went on the air with full power and full modulation on December 29, 1949. A number of television receivers and converters designed to receive KC2XAK are being installed in homes in the Bridgeport area. Field tests will include observations in homes throughout the service area, at distances and under conditions which will determine the extent of coverage of the station. Various types of receiving antenna will be tested, shadow areas and multipath problems investigated and extensive field intensity measurements will be made.

Such measurements will be taken at representative receiver locations and will include actual voltages obtained at receiver terminals. In addition, measurements will be conducted along various radials and an investigation made of field intensity versus receiving antenna height under various conditions. Upon completion of the surveys, the results obtained will be disclosed to the FCC and the industry in subsequent papers.

AN EXPERIMENTAL ULTRA-HIGH-FREQUENCY TELEVISION TUNER*#

By

T. MURAKAMI

Home Instrument Department, RCA Victor Division,
Camden, N. J.

Summary—This paper describes an ultra-high-frequency television tuner developed for use in field tests of the experimental television station, KC2XAK, located in Bridgeport, Connecticut. A compact tuning system utilizing modified transmission lines is used in this tuner which covers a frequency range of 500 to 700 megacycles. Each tuning element consists of two strips of copper foil mounted on a thin cylindrical coil form, tuned by means of a copper or brass core. A double heterodyne system is used to convert the ultra-high-frequency signals to the 21-27 megacycle intermediate frequency of the conventional television receiver, with a switching arrangement provided to change from the very-high-frequency to the ultra-high-frequency head end.

INTRODUCTION

THE experimental ultra-high-frequency (UHF) television station KC2XAK† in Bridgeport, Connecticut operates in the channel from 529 to 535 megacycles (Mc). This is near the low frequency end of the UHF band; therefore, it has been possible to obtain satisfactory performance using conventional tubes in this particular tuner, which covers the range from 500 to 700 Mc. A tuner which is to perform satisfactorily in the region above 700 Mc would probably require a different tube complement, and other design changes. For this reason, the tuner described here is not intended to represent a finished commercial design, but rather is an experimental model to be used on a limited basis to acquire further technical information pertinent to UHF television transmission and reception.

The particular type of UHF tuned circuit used in this tuner was originally developed for a converter built for reception of the experimental UHF television transmitter in Washington, D.C., which operated during the fall of 1948 in the channel from 504 to 510 Mc. The converter used in the Washington tests tuned from 500 to 600 Mc using the same tube complement as the present model for the radio-frequency

* Decimal Classification: R583.5.

Reprinted from *RCA Review*, March 1950.

† R. F. Guy, J. L. Seibert and F. W. Smith, "Experimental Ultra-High-Frequency Television Station in the Bridgeport, Connecticut Area", pp. 207-219 of this volume.

(r-f) amplifier and the mixer-oscillator. These tests indicated that the tuning system was satisfactory; therefore, a similar type was adapted for the tuner described here.

The amplified output signal of the tuner is fed to the intermediate-frequency (i-f) amplifier of any conventional television receiver; in this way either very-high frequencies (VHF) or UHF may be received by switching the output of the head ends. Both the tuner and its power supply may be mounted directly on the television receiver chassis or operated as a separate unit.

GENERAL CONSIDERATIONS

As shown in the block diagram of Figure 1, the tuner consists of an input high-pass filter cutting off at 500 Mc, an r-f amplifier, a first mixer-oscillator, a 132-138 Mc first i-f amplifier, a second mixer-oscillator, the output of which is at 21-27 Mc and low impedance. The UHF amplifier and oscillator tuning elements are designed to cover the signal range of 500 to 700 Mc.

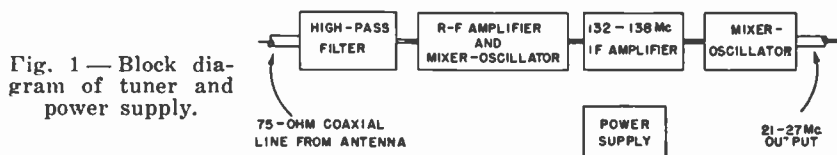

The first i-f has been chosen high enough to provide satisfactory image rejection with two UHF tuned circuits, but low enough so that reasonable i-f gain and noise factor can be realized with conventional tubes. If the sound and picture i-f in the VHF receiver were redesigned for higher frequencies, a single superheterodyne system might be more satisfactory.

DESCRIPTION OF CIRCUIT

A circuit diagram of the tuner and its power supply is shown in Figure 2. The high-pass input filter reduces (1) the image response, (2) the direct i-f response, (3) the oscillator radiation, because in this double superheterodyne receiver the first local oscillator is below the signal frequency. This filter, shown schematically in Figure 2, is a "printed" circuit, as shown in Figures 3 and 4. The "printing" is accomplished by photoengraving a 1.5 mil copper sheet bonded to a paper-base bakelite sheet. A high-pass filter was used since it was less critical to variations in photoengraving than the band-pass type. The filter and the r-f amplifier are designed to operate with 75-ohm coaxial antenna transmission line. The insertion loss of the high-pass filter is

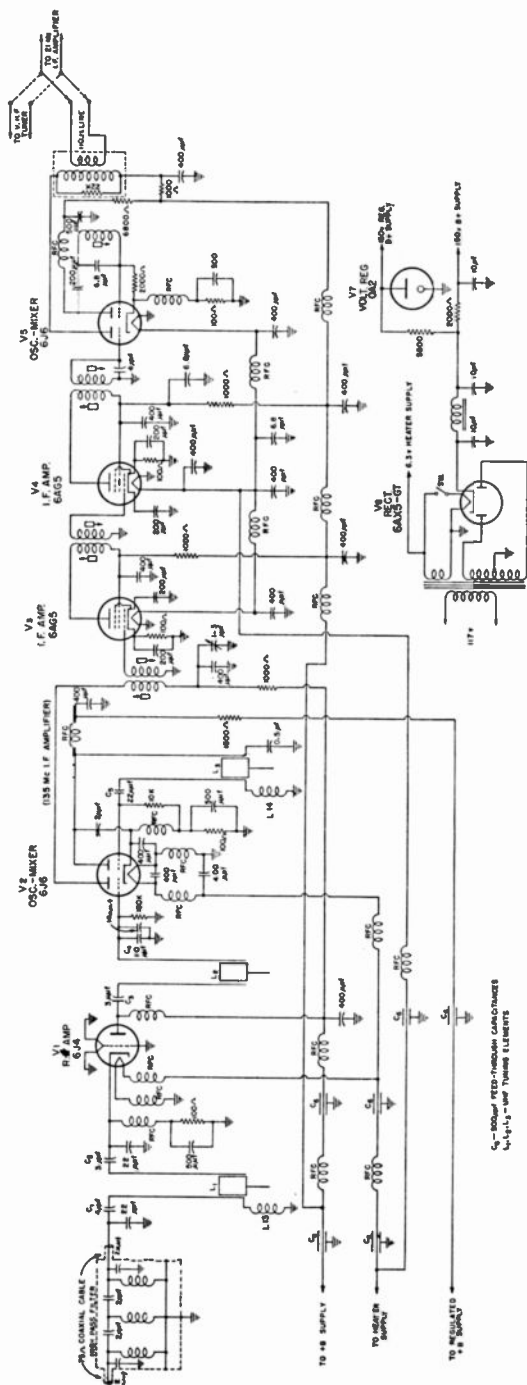

Fig. 2—Circuit diagram of UHF tuner and power supply.

C—5000 PFD. RESON. COIL ELEMENTS
 L₁, L₂, L₃—UHF TUNER ELEMENTS

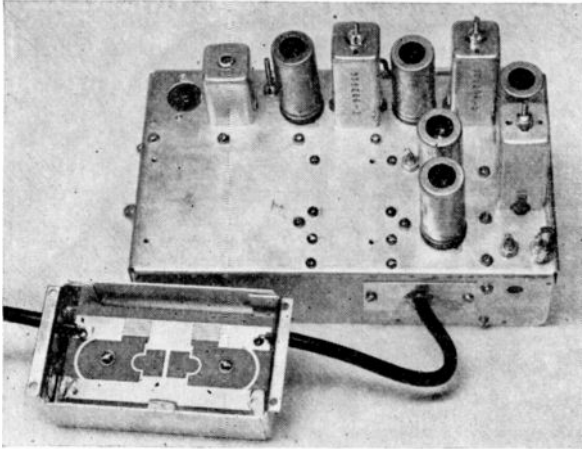

Fig. 4—Photograph of tuner, showing high-pass filter.

the first mixer. Automatic gain control is not applied to this amplifier because of the effect of varying transconductance on the selectivity curve shape.

A 6J6 tube is also used as the second oscillator-mixer to heterodyne the 132-138 Mc signal to 21-27 Mc. The output from the tuner is linked-coupled to the first picture i-f amplifier of a standard VHF television receiver through a low-impedance line. 110-ohm shielded twin line is used. If the tuner is to be used with a receiver which has an i-f of other than 21-27 Mc, it is only necessary to retune the fixed oscillator to the appropriate frequency and redesign the output i-f transformer. Switching between the UHF tuner and the conventional VHF tuner (which is normally an integral part of the television receiver) is made in the low-impedance link circuit. In some television receivers it may be necessary to modify either this switching arrangement or the 21-27 Mc i-f amplifier, since the link circuit may alter the band-pass characteristics of the amplifier.

UHF TUNING ELEMENTS

The tuning elements used in the r-f and oscillator circuits are shown in Figure 6. These elements consist of strips of 2.5-mil copper foil mounted with a low loss cement on natural paper base bakelite tubing with an inside diameter of 0.251 inch and a 10-mil wall thickness. The input and interstage elements

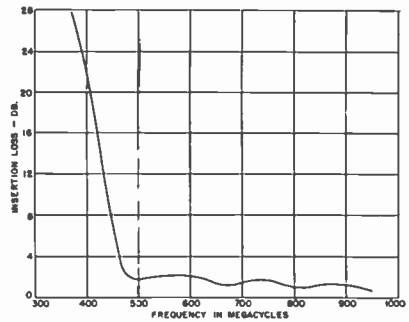

Fig. 5—Insertion loss of high-pass filter.

When the metal core is moved in the tube, both the effective length of the line and the capacitive reactance terminating the line are varied. The tuning range of a particular unit can be changed by varying the maximum and minimum amount of the capacitive and inductive reactance of the line. This can be most readily done by changing the diameter of the thin-walled tubing and the size of the foil strips. If the diameter of the tube is increased, the tuning range, in general, will increase. If the length of the line is increased, the open-ended line extending beyond the core may become a quarter wave length at some frequency in the tuning range. This may cause the impedance of the line to fall below a usable value depending upon the core position when this critical frequency is reached. However, the length of line will determine the highest frequency which can be obtained with the core in the extreme "in" position due to the capacity loading effect of the overhanging end of the line.

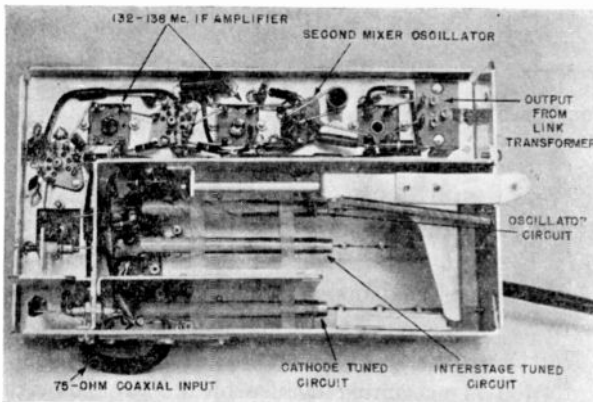

Fig. 8—Bottom view of tuner.

The unloaded Q of the tapered transmission line tuning elements measures between 100 and 200 in the 500 to 700 Mc frequency range. The effective operating Q of these tuning elements is approximately 25 at 500 Mc and the overall bandwidth of the input and interstage circuits is about 12 Mc at 500 Mc.

Figure 8 shows a bottom view of the tuner with the r-f and oscillator tuning elements in place. The 75-ohm coaxial cable and the high-pass filter can be seen to come in to the tuned circuit in the cathode of the grounded-grid stage. The tuning element between the plate of the grounded-grid amplifier and the mixer grid is shown in the center next to the oscillator tuning element. The 132-138 Mc i-f amplifier is placed near the edge of the chassis with the second mixer oscillator. The output terminals from the link transformer can be seen in the upper right hand corner.

PERFORMANCE

Sensitivity

The sensitivity of the tuner is defined as the input signal required to give a 10 to 1 ratio between peak to peak modulation and peak to peak noise. The modulation on the carrier is 400 cycles at 30 per cent. The measurements shown in Table I were made with the carrier at the top of the picture i-f selectivity curve.

Table I

Frequency in Mc	Sensitivity (Microvolts)
500	140
600	200
700	220

Noise Factor

The noise factor of the UHF tuner was measured using the signal generator method. The receiver and the signal generator used in this measurement were an RCA 9T246 and a Measurements Corporation Model 84. The fixed bias applied to the receiver i-f amplifier was such that 1.0 volts direct current of rectified noise was developed across the second detector load resistor with the tuner coupled to the receiver. The detector was checked to insure operation in the linear portion of the detector characteristic. With the Model 84 matched to the input of the tuner with an M-255 pad (50-72 ohms, 6-decibel voltage attenuation), enough carrier was fed into the tuner so that 1.41 volts direct current of carrier plus noise was read at the second detector. In Equation (1) below, e_o is the open circuit voltage of the signal generator. The signal generator is calibrated in terms of the voltage developed across a load resistor equal to the impedance of the generator; therefore, to find e_o the output reading of the generator was multiplied by the factor 2. With the M-255 matching pad, e_o was equal to the output reading of the signal generator.

$$F = \frac{e_o^2}{4KT\Delta fR_o}, \quad (1)$$

where $R_o = 72$ ohms, $\Delta f = 3.4$ Mc, $T = 290$ degrees Kelvin, $K = 1.38 \times 10^{-23}$ joules per degree (Boltzmann's constant).

Expressing the noise factor in decibels

$$F_{db} = 10 \log (0.254e_o^2), e_o \text{ in microvolts.}$$

The noise factor measurements for a representative tuning unit are shown in Table II.

Table II

Frequency (Mc)	500	530	550	600	650	700
e_o (Microvolts)	8	8	9	13	15	15
Noise factor (decibels) without high-pass filter	12	12	13	16	17.5	17.5
e_o (Microvolts)	10	10	11	16	17	16
Noise factor (decibels) with high-pass filter	14	14	15	18	18.5	18

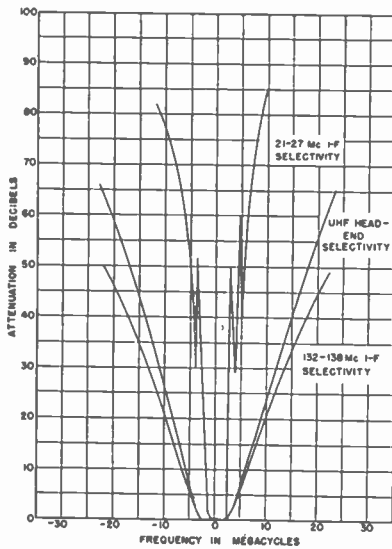

Fig. 9—Tuner selectivity curves.

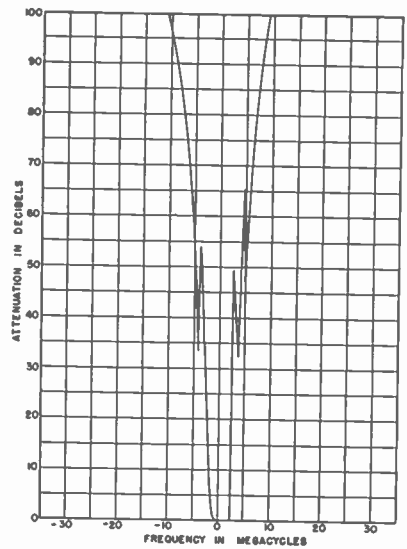

Fig. 10—Overall tuner selectivity curves.

Gain

The voltage gain of the tuner is 49 decibels at 500 Mc, 48 decibels at 600 Mc and 46 decibels at 700 Mc.

Selectivity

Curves in Figure 9 show the 132-138 Mc i-f selectivity, UHF head-end selectivity (including 135 Mc i-f) at 500 Mc, and the 21-27 Mc i-f selectivity of the 9T246 receiver. The overall selectivity curve for the UHF tuner and receiver, with the UHF head end tuned to 500 Mc is shown in Figure 10.

Oscillator Stability

The UHF tuner operates with the heaters of the tubes on at all times. Regulation of the plate voltage for the UHF oscillator is used to prevent frequency change due to variations in supply voltage. The oscillator drift at 500 Mc with preheated heaters is 150 kilocycles from the frequency measured $\frac{1}{2}$ minute after the time B plus is turned on. All of the drift occurs in less than $2\frac{1}{2}$ minutes, the oscillator stabilizing after that time. At 600 and 700 Mc the drift characteristics are very similar to those at 500 Mc.

Oscillator Radiation

The power measured across 75 ohms at the antenna terminals is less than 0.2 microwatt over the tuning range of 500 to 700 Mc.

Spurious Responses

A table of spurious responses with their attenuation relative to the desired signal is given in Table III. These values were obtained using the constant output method of measurement; in this case sufficient signal at the spurious response frequency was fed into the tuner to give the same output as would a given amount of desired signal. The undesired signal in each case was set at approximately 0.1 volt to the UHF unit. Since some spurious response ratios depend on signal level, 0.1 volt was chosen as representative of a reasonably strong interfering signal. It is also a value that can be obtained from available signal generators.

Table III

Signal frequency (megacycles)	Image (decibels)	Half i-f (decibels)	2nd harmonic of oscillator heterodyning with undesired signal to give 135 Mc (decibels)
500	78	78	42
550	73	73	42
600	66	66	58
650	67	67	59
700	70	70	—

The i-f response is more than 80 decibels down from the desired signal frequency response when the high-pass filter is used in the input circuit. To suppress spurious responses caused by harmonics of the fixed oscillator it is necessary to isolate this circuit from the UHF circuits. In addition to the mechanical shielding attained by careful

placement of components, it is necessary to decouple thoroughly the B-plus and heater-supply leads.

There is a spurious response caused by the fourth harmonic of the fixed oscillator (158 Mc) feeding back to the r-f circuits at 632 Mc. The 6.8-micromicrofarad capacitor in the B-plus supply line and the 1-3 micromicrofarad trimmer in the low side of the primary winding of the first 132-138 Mc transformer are used to suppress this 632-Mc harmonic. This response can be further reduced with a 632-Mc trap circuit inductively coupled to the fixed oscillator.

TUNING CHARACTERISTIC AND TRACKING

The tuning curve for the tuner is shown in Figure 11. The tuning curve consists very nearly of two linear sections, from 500 to 600 Mc and 600 to 700 Mc. The tuning elements for the r-f and oscillator circuits track within 1/16 inch of core movement; this tracking error, which corresponds to 7 to 10 Mc in frequency, does not appreciably degrade the sensitivity.

Tracking is accomplished first by adjusting the lead length of the UHF oscillator capacitance C_5 (Figure 2) with the oscillator core in its low-frequency position so that the frequency is about 365 Mc. Concurrently, the UHF tuned circuits are tuned to 498 Mc with their cores in the low-frequency position by adjustment of the lead lengths of capacitances C_1 to C_4 in Figure 2. If the tuning cores are made too loose in the coil forms, the values of the capacitors C_1 - C_5 may have to be increased. The tracking is further improved over the band by adjustment of the relative positions of the cores.

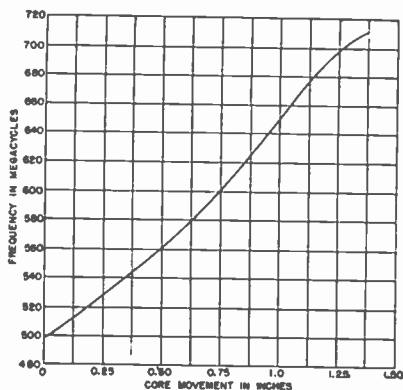

Fig. 11—Tuning curve.

UHF-VHF RECEIVER

The tuner chassis does not include its power supply, which is on a separate small chassis. One method of mounting the tuner and its power supply is shown in Figure 12, where the tuner is mounted directly above the regular VHF tuner, and the power supply is mounted in front of the horizontal deflection high voltage compartment. Figure 13 shows a view of the UHF-VHF receiver with the UHF tuning dial and directly below it the UHF-VHF switch.

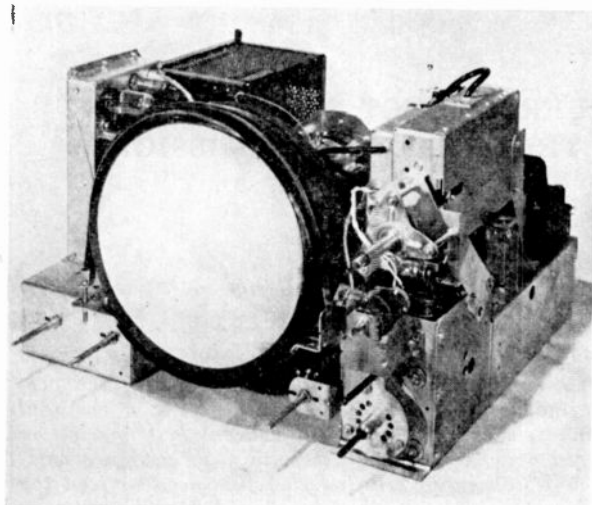
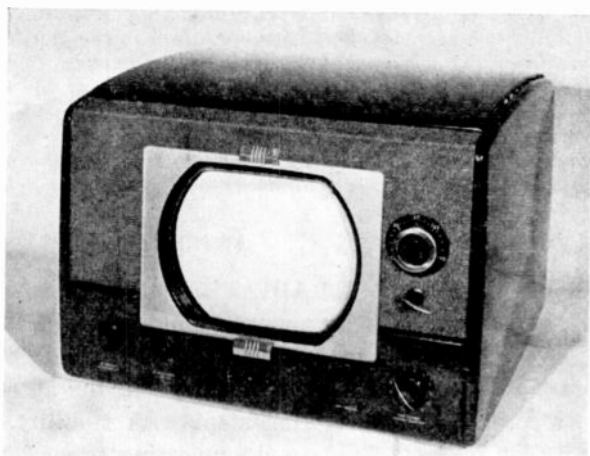

Fig. 12—Standard VHF chassis with UHF tuner added.

Fig. 13—Standard VHF receiver with UHF tuner added. UHF controls are to the right of the kinescope.



ACKNOWLEDGMENTS

The author wishes to acknowledge the valuable work contributed by S. Klein and the suggestions given by W. R. Koch and Wm. F. Sands of the Home Instrument Advanced Development Section in the development of this tuner. The design of the tuning mechanism is credited to E. D. Dawson.

ULTRA-HIGH-FREQUENCY ANTENNA AND SYSTEM FOR TELEVISION TRANSMISSION*#

BY

O. O. FIET†

Engineering Products Department, RCA Victor Division,
Camden, N. J.

Summary—An omni-directional, horizontally polarized ultra-high-frequency antenna with a power gain of 17.3 is described. Some of the performance characteristics and development problems are given. A vestigial sideband filter and notch diplexer constructed of concentric transmission line is described. Measured performance characteristics and design considerations are also given. The concentric transmission line used to feed the transmitter output to the antenna is described briefly. A broad frequency characteristic is obtained by use of compensated undercut insulators supporting the inner conductor. Waveguide, elbows, and transitions to concentric line have been developed for operation in the 500 to 750 megacycle band. Considerations which make waveguide attractive for ultra-high-frequency television service and measured characteristics of the components developed are presented. The antenna system was developed for the operation at ultra-high-frequency experimental television station KC2XAK at Bridgeport, Connecticut. The antenna system involves the antenna, transmission line or waveguide, a notch diplexer and vestigial sideband filter.

ANTENNA

AN EFFECTIVE RADIATED power of 10 to 20 kilowatts was desired for the experimental ultra-high-frequency (UHF) television broadcast station at Bridgeport, Connecticut.¹ A study of the problems involved indicated the antenna should have as much gain as practical, consistent with stability of radiated signal. Deflection of the antenna and supporting tower by high winds causes the vertical pattern of the antenna to tilt from the horizontal. This may cause the received signal to decrease to an unacceptable value in some receiver locations during high winds. Previous experience and study of the vertical pattern accompanying a given gain indicated a gain of 20 to 25 would give acceptable coverage. Experience obtained

* Decimal Classification: R326.81×R117.2.

Reprinted from *RCA Review*, June 1950.

† The material in this paper for which the author is directly responsible, together with certain other material, forms the basis of a Doctor's thesis in Electrical Engineering to be presented to the faculty of the Graduate School of the University of Pennsylvania.

¹ R. F. Guy, J. L. Seibert and F. W. Smith, "Experimental Ultra-High-Frequency Television Station in the Bridgeport, Connecticut Area," *RCA Review*, Vol. XI, No. 1, pp. 55-67, March, 1950.

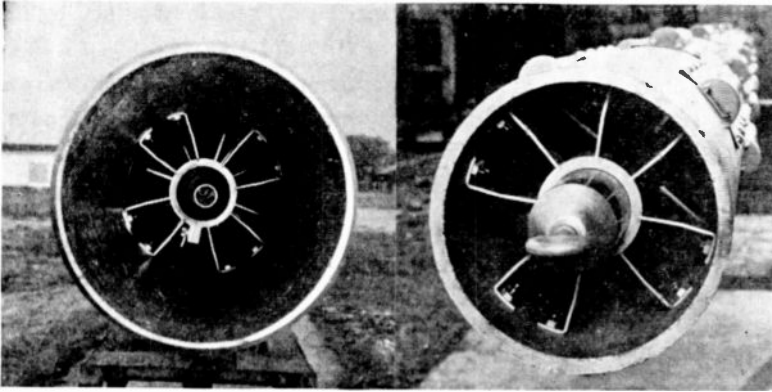

Fig. 1—End views of the antenna.

with the antenna herein described, which has a power gain of 17.3, will determine the practicability of higher power gains.

Very-high-frequency television transmitting antennas utilize a branching-type feeder system to each radiating element to obtain the desired bandwidth and pattern characteristics. An extension of this practice to UHF high-gain antennas would result in a very complicated feeder system due to the large number of radiating elements involved. In the case of the antenna constructed for Bridgeport, the radiating system would have required 88 branch lines; this clearly was not desirable and a feed system of greater simplicity was developed.

The antenna consists of a $3\frac{1}{8}$ -inch outside diameter copper tube mounted coaxially inside a $10\frac{3}{4}$ -inch outside diameter, $\frac{1}{2}$ -inch wall steel tube (Figure 1). The steel



Fig. 2—Antenna installed in the normal vertical position in a rotating socket for measuring horizontal patterns.

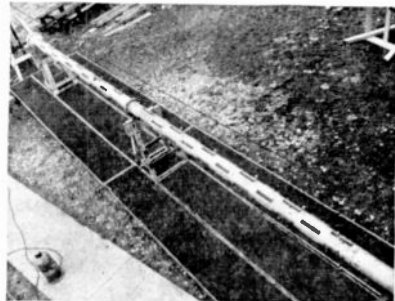

Fig. 3—Antenna mounted on horses horizontally over space cloth to absorb ground reflections.

tube is in two lengths, each approximately 20 feet long joined by means of flanges at the radiation center of the antenna (Figures 2 and 3).

Each layer of the radiating system consists of four half-wave slots equally spaced around the circumference of the steel tube. There are twenty-two such layers of half-wave slots, making eighty-eight individual slots in the steel tube.

The antenna is divided into two electrically identical groups of half-wave slots, the slots being spaced approximately a half wave length between ends or approximately a full wave length between centers. The upper and lower groups of slots consist of eleven layers each with a space of 1.66 wave lengths between the ends of the two groups. Each successive layer of slots is rotated 45 degrees to suppress transmission of the $TE_{1,1}$ and other noncylindrical modes within the steel cylinder. The modes which do not have cylindrical symmetry would cause unequal excitation of individual slots in a layer resulting in a non-circular horizontal pattern. Horizontal patterns deviating considerably from circular were observed during development work and the staggering of the layers was found to eliminate such variations from circular. It was interesting to observe, when only one layer was driven, that the pattern was closely circular, checking theoretical calculations.²

The $3\frac{1}{8}$ -inch copper tube installed within the antenna tube acts as a transmission line to distribute the transmitter output to the various layers of slots. The slots are driven by radial probes fastened within the antenna tube on one edge opposite the center of each slot. The current passing through the probe capacity also passes through the driving point impedance of each radiating slot. A set of radial probes is used between each layer to obtain an impedance bandwidth at the input of each succeeding layer of the antenna which is approximately equal to the bandwidth of the end layers.³ A similar antenna may be constructed without the tuning probes between layers. However, it is observed that the system input bandwidth becomes progressively narrower as the number of layers, and consequently the gain, is increased.

The $3\frac{1}{8}$ -inch diameter copper tube within the antenna has an inner conductor within the lower half which serves as a transmission line to carry the transmitter output to the center of the antenna feed system. The center feed avoids any tilt or other dissymmetry in the vertical pattern with changes in frequency which would be character-

² G. Sinclair, "Patterns of Slotted Cylinder Antennas," *Proc. I.R.E.*, Vol. 36, No. 12, p. 1487, December, 1948.

³ H. J. Riblet, "Microwave Omni-directional Antennas," *Proc. I.R.E.*, Vol. 35, No. 5, p. 477, May, 1947.

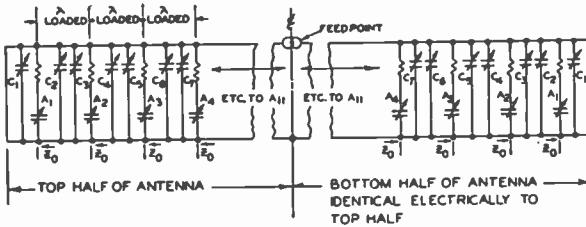

Fig. 4—Diagram of electrical distribution system.

istic of an end fed broadside array. The feed point may be shifted from the center of the array if desired to produce a phase difference of the currents in the upper and lower half of the antenna. Any such phase difference between currents in the two halves of the antenna is accompanied by a corresponding tilt in the vertical pattern. This adjustable tilt in vertical pattern may be used to advantage in any particular installation to adjust for particular terrain conditions or cover densely populated valleys, etc.

Figure 4 is a line diagram illustrating the electrical operation of the feed system used in the antenna. The tuning and feed probe settings for successive layers are different. The probe settings required for matched impedances in the corresponding layers of the top and bottom half of the antenna were usually different due to small mechanical variations in the antenna structure.

A study of the characteristics of the antenna was made using a microwave model at approximately 5000 megacycles (Figure 5). A matched load was inserted in the end of the microwave antenna tube. The relative magnitude and phase of the voltage across the load was measured by conventional methods. Phase and magnitude measurements made with one layer of the antenna matched by means of the tuning probes for various settings of the slot probes gave a curve of additional phase retardation versus relative power absorbed by the radiating layer. This curve was used to determine the proper spacing between layers to compensate for the additional phase shift introduced by the tuning probes. The proper amount of power absorbed by each layer of slots relative to the power transmitted to the subsequent layers is determined as follows for the eleven layers in the top and bottom halves of the antenna.

The end layers, top and bottom extremity of the complete 22-layer antenna, have no succeeding layers to which power must be trans-

Fig. 5—One-tenth scale microwave model of one-half of the antenna (top or bottom half).



mitted. Consequently, they must absorb all of the power which is contained in the incident wave. This is accomplished by adjusting the four slot feed probes and the shorting plug at the end of the antenna until this layer matches the characteristic impedance of the concentric line within the antenna, which is approximately 68 ohms. The second layer from each end must absorb $\frac{1}{2}$ of the power and transmit $\frac{1}{2}$ of the power to the end layers. A combination of feed probe and tuning probe settings is then found which will give this power distribution; i.e., reduce the voltage on the matched load in the end of the antenna to .707 of the value obtained when no tuning or feed probes are inserted. The tuning probes must be adjusted for an impedance match each time the feed probe setting is changed. The setting of the feed probe for the third layer transmits $\frac{2}{3}$ of the incident power and absorbs $\frac{1}{3}$, the fourth layer absorbs $\frac{1}{4}$ and transmits $\frac{3}{4}$ of the power etc. to the 11th layer which absorbs $\frac{1}{11}$ of the power and transmits $\frac{10}{11}$. The settings of the feed and tuning probes and the spacing between each layer of slots determined by this experiment were made and the vertical pattern and gain of the model were measured. The measured vertical pattern closely resembled the expected pattern for 11 layers in phase with equal currents. The power gain measured by substitution of a standard horn reference for the microwave model was 11.4. This checked the gain obtained by integration of Poynting's vector obtained from the measured vertical pattern.

The spacing of successive layers of the full scale UHF antenna was obtained by scaling the dimensions of the microwave model.

The tuning probe locations and settings could not be successfully scaled from the model, and it was necessary to repeat the work of adjusting the tuning probes individually for each layer. The probes were adjusted to obtain an impedance match leaving the slot feed probes set at the dimension determined by scaling the model. Since the magnitude and phase of the currents in each layer of the full scale antenna were not checked, some degradation of vertical pattern and gain of the full size UHF antenna resulted. The gain of the full size antenna was 17.3 instead of 23 or 24 which would have been obtained if the individual layers were directly adjusted for equal phase and currents. The variation of results between the model and full size antenna is attributed to mechanical variations between the model and the full size antenna. It has been found quite difficult to duplicate, electrically and mechanically, all of the practical requirements of the full scale antenna in a one-tenth scale model.

Each layer of the full scale antenna was adjusted to obtain an impedance match at 531 megacycles. Difficulty in adjustment of the

entire antenna by adjusting each successive layer from each end simultaneously led to the discovery that the tuning probe settings for corresponding layers from each end were not the same if the input impedance was matched. The proper reference conditions on the slotted measuring line for each half of the antenna were obtained by shorting out one-half of the antenna a wave length from the feed point and substituting a matched load in the unshorted half of the antenna after all feed probes and tuning screws had been removed. The matched load was constructed of four radial fins of phenolic laminate about 10 feet long mounted on a sleeve which would permit the fins to slide freely on the $3\frac{1}{8}$ -inch diameter inner conductor of the antenna and just clear the inside of the outer steel tube. The fins were covered on both sides with 377 ohms per square space cloth and had a linear taper on the input end about three wave lengths long. When the load was adjusted for a match, the input impedance to the antenna feeder system did not change when the load was moved on the $3\frac{1}{8}$ -inch inner conductor. After the reference conditions were obtained with the matched load, it was possible to tune each half of the antenna either by using the matched load in one half and tuning the other half or shorting out the one half with the shorting disk installed at a point located an integral number of half waves from the feed point.

Experiments with the microwave model and a large sheet of metal to simulate a perfect conducting earth indicated an error in free space impedance measurements of about ± 6 per cent would occur if the UHF antenna were mounted horizontally 6 feet above the earth's surface. This was considered undesirable, and experiments using the microwave model with space cloth having the impedance of free space (377 ohms per square) and a metal ground sheet with space cloth equivalent to a full size sheet of space cloth (9×40 feet) placed under the antenna $\frac{1}{4}$ wavelength above the ground plane indicated that impedance measurements could be made with the horizontal antenna above the ground if the 9×40 foot space cloth absorber were placed $\frac{1}{4}$ wave above the ground. The full size space cloth absorber was constructed on a group of wooden frames with space cloth on the top and wire screen on the bottom to assure terminating the wave in a good conductor placed at the earth's surface. The setup of the antenna for impedance tests over the space cloth absorbers is shown in Figure 3. Later impedance measurements on the horizontal antenna 6 feet over plain earth without the ground reflection absorbing sheets indicated the ground may not affect the impedance as much as expected (see Figure 6).

Calculations of reflection coefficient of the earth's surface for

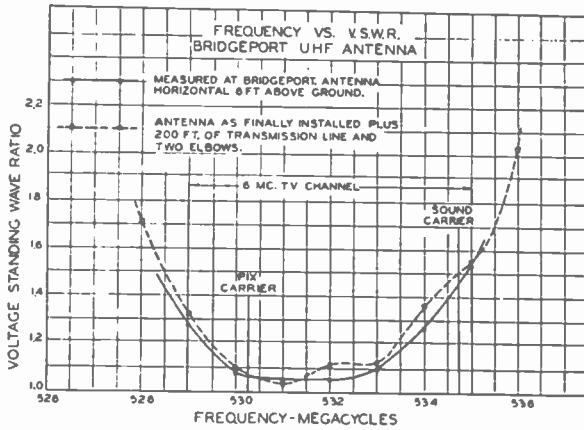

Fig. 6—Standing-wave-ratio characteristic of the antenna.

normal incidence using a dielectric constant of 16 for earth gives a reflection coefficient of -0.6 compared to the assumed perfectly conducting earth reflection coefficient of -1 . If this were the case, one might expect the error in impedance measurements, due to the ground 6 feet distant, to be in the order of ± 3.6 per cent. Observations have indicated that it is probably less than this.

Vertical patterns were measured by horizontally rotating the antenna while mounted on a vertical spindle under the center of radiation as shown in Figure 7. A receiver was set up at a distance sufficiently great from the transmitting antenna that the transmission path length difference to the receiving antenna from the ends and from the center of the transmitting antenna was less than one-tenth wave length. The observer at the receiver setup was in constant communication with the engineer at the transmitting antenna (see right inset, Figure 7). An accurate compass dial and vernier were installed on the transmit-

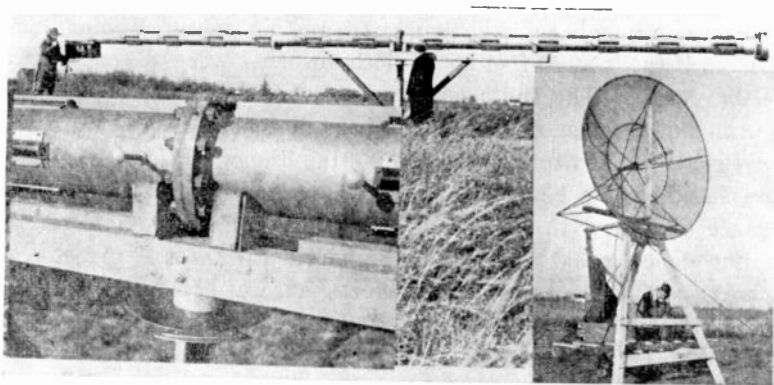
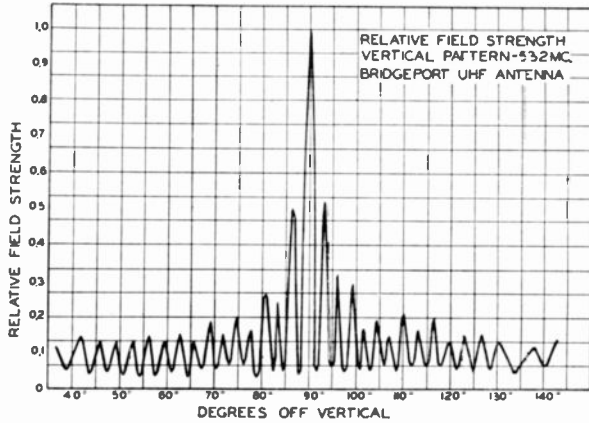

Fig. 7—Vertical pattern test setup for the antenna.

Fig. 8—Vertical pattern measured for the antenna.



ting antenna spinner to indicate the azimuth with better than .1 degree accuracy, as the transmitting antenna was rotated by hand and the signal recorded point by point. The vertical pattern was measured at 529, 532 and 535 megacycles and found to remain about as shown in Figure 8. Poynting's vector integrations using the measured vertical patterns, give the gain frequency characteristic shown in Figure 9. The vertical pattern calculated from the eleven section microwave model pattern measurements is shown in Figure 10. The greater side lobe levels of the full scale antenna and the deviation of the null angles compared to those obtained with the microwave model are largely due to variations of the amplitude and phase of the currents in the various layers of the full size UHF antenna. The side lobe level of the full size antenna may be reduced to compare with the microwave model if the current magnitude and phase of each layer are correctly adjusted.

Calculations were made to determine what transmitter power would give an adequate received signal for the vertical pattern measuring set-up used (Figure 7).

Based on the premise that the ground reflection coefficient near grazing incidence was -1 , these calculations indicated that a transmitter power in the order of 100 watts would be required. Experiments with the actual test setup and location indicated adequate received signal could be obtained with about 2 milliwatts transmitter power. This suggests the ground reflection coefficient including the effects of brush, grass

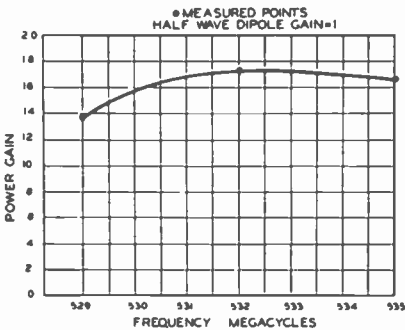

Fig. 9—Power gain versus frequency.

and irregular terrain is nearly zero or is actually positive (see terrain of Figure 7).

The horizontal pattern was measured in the setup shown in Figure 2. The antenna was mounted vertically in a socket and could be readily rotated. The receiver and antenna were mounted at a distance, opposite the radiation center of the transmitting antenna. The measured horizontal pattern varied less than ± 1 per cent from circular, which is in close agreement with the pattern calculated for staggered slots.²

TRANSMISSION LINE

The commercial very-high-frequency, air dielectric, concentric transmission line has a uniform tubular inner conductor with supporting ceramic disc insulators clamped to it at one-foot intervals. This type of line is satisfactory for very-high-frequency service where the characteristic impedance is practically constant. However, the uncom-

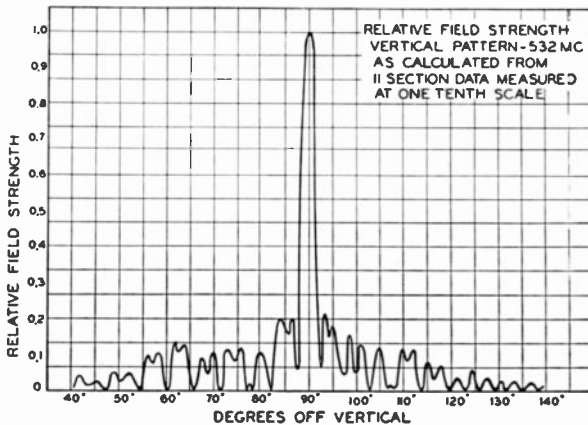

Fig. 10—Vertical pattern for full antenna calculated from measurements on the microwave model.

pensated beads at periodic intervals make the line have characteristics similar to a low pass filter with attenuating bands in the UHF region. The characteristic impedance fluctuates rapidly with frequency and is reactive over much of the UHF band. A line of this type is clearly not suitable for the stringent standing wave requirements of television transmitting antenna systems in the UHF band where a nearly constant resistance load must be used.

There appear to be many approaches to the UHF insulator support problems^{4, 5} for concentric line. The method developed by D. W. Peter-

⁴ R. W. Cornes, "A Coaxial Line Support for 0-4000 Mc," *Proc. I.R.E.*, Vol. 37, No. 1, p. 94, January, 1949.

⁵ D. W. Peterson, "Notes on A Coaxial Line Bead," *Proc. I.R.E.*, Vol. 37, No. 11, p. 1294, November, 1949.

son was used in the Bridgeport installation because satisfactory line of this type was available. The transmission line in the installation changed the standing wave characteristic of the antenna very little, as indicated by measurements, taken with the antenna mounted on the tower, through 200 feet of transmission line (Figure 6).

The insulator supports on the transmission line used at Bridgeport were mounted in undercut spaces on the inner conductor. Small series inductances were cut in the faces of the undercut to compensate for the step capacity^{6, 7} as shown in Figure 11. The standing wave characteristic of a sample of the transmission line used is shown in Figure 12. The line was terminated in a resistance of 52 ohms and measured on a 52-ohm measuring line.

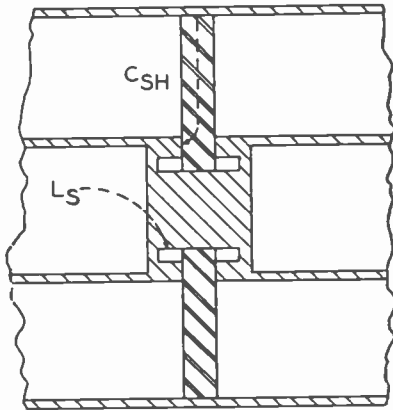

Fig. 11—Section of compensated undercut insulator for $3\frac{1}{2}$ -inch diameter coaxial line.

The standing wave characteristic of a sample of the transmission line used is shown in Figure 12. The line was terminated in a resistance of 52 ohms and measured on a 52-ohm measuring line.

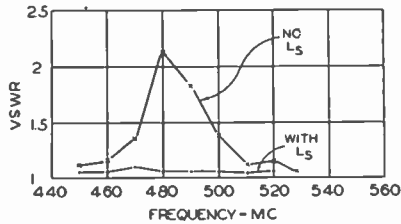

Fig. 12—Standing wave ratio of sample run of UHF transmission line.

WAVE GUIDE

The simplicity and relatively low loss of wave guide led to its consideration for experimental line to transmit power from the transmitter to the antenna. Various wave-guide components were developed for this purpose including transitions for terminating the wave guide in coaxial lines and E and H plane bends (Figures 13, 14, 15 and 16). The problems of using wave guide near the lower end of the UHF band are new, and considerable development work and experimentation is required before it can be utilized commercially.

The wave guide investigated is rectangular having inside dimensions $7\frac{1}{2} \times 15$ inches. It is fabricated from sheet metal. Hot dipped galvanized steel, aluminum or copper clad steel are suitable materials.

A comparison of the loss of wave guide and common size concentric

⁶ HANDBOOK OF DESIGN DATA, Brooklyn Polytechnic Institute, Report No. R-158-47.

⁷ J. R. Whinnery, H. W. Jamieson and T. E. Robbins, "Coaxial Line Discontinuities," *Proc. I.R.E.*, Vol. 32, No. 11, p. 695, November, 1944.

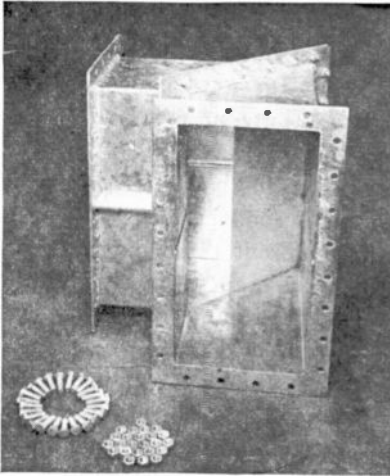

Fig. 13—E plane bend for $7\frac{1}{2} \times 15$ -inch wave guide.

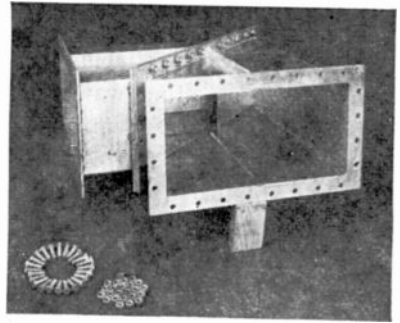

Fig. 14—H plane bend for $7\frac{1}{2} \times 15$ -inch wave guide.

transmission lines is given in Figure 17. The standing wave frequency characteristics of some of the wave-guide components developed for experimental work are

shown in Figures 18, 19, 20 and 21.

The wave guide and components developed correspond closely to those employed in current microwave practices. However, the large size created new electrical and mechanical problems. It was convenient to do much of the development work on the wave guide and components using $\frac{1}{2}$ and $\frac{1}{10}$ scale models at higher frequencies. No difficulties similar to those observed in scaling the antenna were experienced, since the wave guide was so simple that all important features could be accurately scaled.

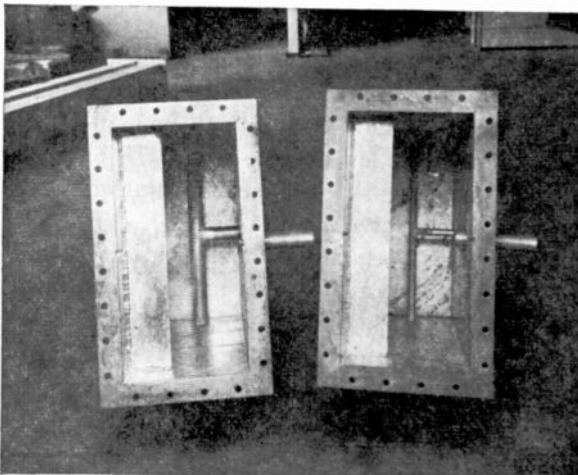

Fig. 15—Transitions from $7\frac{1}{2} \times 15$ -inch wave guide to coaxial line.

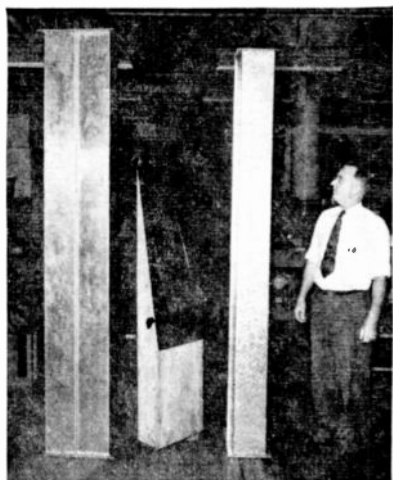

Fig. 16—Straight wave-guide section $7\frac{1}{2} \times 15$ inches.

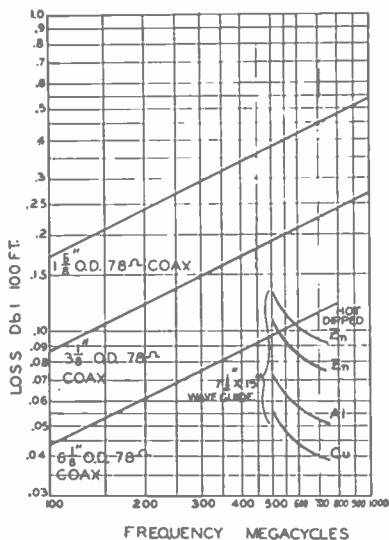

Fig. 17—Curve showing loss of various $7\frac{1}{2} \times 15$ -inch wave guides and standard size coaxial lines.

VESTIGIAL SIDEBAND FILTER

A high-level vestigial sideband filter for use on the output of the transmitter was developed. The filter used was designed to present a constant input resistance for picture carrier and both sidebands, although only the upper sideband and a portion of the lower sideband is transmitted. The transmission characteristic of the sideband filter installed at Bridgeport is shown in Figure 22.

The sideband filter was constructed of coaxial transmission line (Figure 23). A line diagram of the circuit arrangement used is shown in Figure 24. Some of the resonant

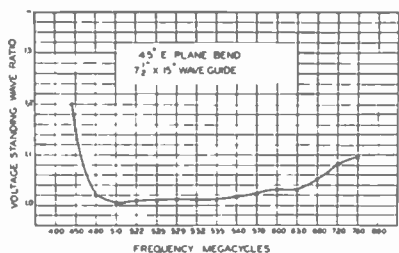

Fig. 18—45-degree E plane bend standing-wave ratio versus frequency.

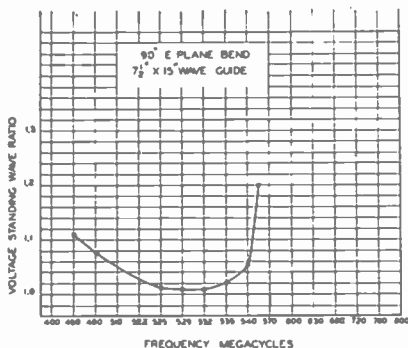

Fig. 19—90-degree E plane bend standing-wave ratio versus frequency.

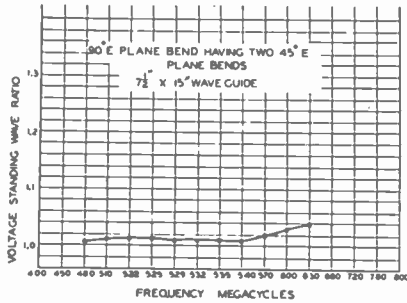

Fig. 20—90-degree E plane bend consisting of two 45-degree bends—standing-wave ratio versus frequency.

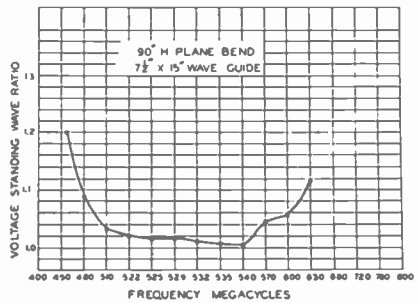

Fig. 21—90-degree H plane bend standing-wave ratio versus frequency.

circuit elements are constructed of stepped quarter-wave sections to obtain a high reactance slope without using long transmission lines. The reactance slope obtained with a stepped open-end transmission line is:

$$\begin{array}{c}
 \begin{array}{c}
 \xrightarrow{x} \left[\begin{array}{c} Z_1 \\ \hline \boxed{Z_2} \\ \hline Z_3 \end{array} \right] \left[\begin{array}{c} Z_3 \\ \hline \boxed{Z_4} \\ \hline Z_5 \end{array} \right] \left[\begin{array}{c} Z_5 \\ \hline \boxed{Z_6} \\ \hline Z_{2n-2} \end{array} \right] \left[\begin{array}{c} Z_{2n-1} \\ \hline \boxed{Z_{2n}} \\ \hline Z_{2n+1} \end{array} \right]
 \end{array} \\
 \\
 \frac{dx}{df} = \frac{\pi Z_1}{2f_0} \left\{ 1 + \frac{Z_1}{Z_2} \left[1 + \frac{Z_3}{Z_2} \left(1 + \frac{Z_3}{Z_4} \left\{ 1 + \frac{Z_5}{Z_4} \left[\dots \left(1 + \frac{Z_{2n+1}}{Z_{2n}} \right) \right] \right\} \right) \right] \right\} \cdot \quad (1)
 \end{array}$$

The equation for the reactance slope of a stepped shorted-end transmission line is obtained by letting Z_{2n+1} equal zero in Equation (1):

$$\begin{array}{c}
 \begin{array}{c}
 \xrightarrow{x} \left[\begin{array}{c} Z_1 \\ \hline \boxed{Z_2} \\ \hline Z_3 \end{array} \right] \left[\begin{array}{c} Z_3 \\ \hline \boxed{Z_4} \\ \hline Z_5 \end{array} \right] \left[\begin{array}{c} Z_5 \\ \hline \boxed{Z_6} \\ \hline Z_{2n-3} \end{array} \right] \left[\begin{array}{c} Z_{2n-2} \\ \hline \boxed{Z_{2n-1}} \\ \hline Z_{2n} \end{array} \right]
 \end{array} \\
 \\
 \frac{dx}{df} = \frac{\pi Z_1}{2f_0} \left\{ 1 + \frac{Z_1}{Z_2} \left[1 + \frac{Z_3}{Z_2} \left(1 + \frac{Z_3}{Z_4} \left\{ 1 + \frac{Z_5}{Z_4} \left[\dots \left(1 + \frac{Z_{2n-1}}{Z_{2n}} \right) \right] \right\} \right) \right] \right\} \cdot \quad (2)
 \end{array}$$

All steps in impedance are a quarter-wave long at the resonant frequency.

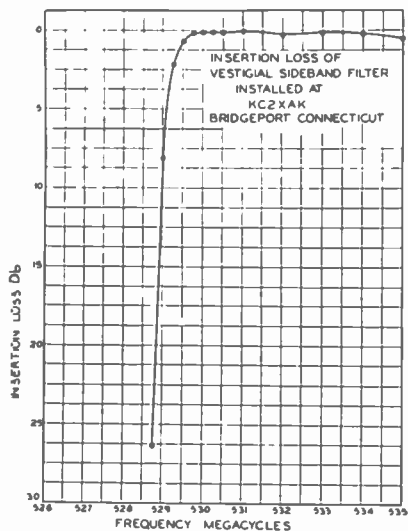

Fig. 22—Sideband filter insertion loss versus frequency.

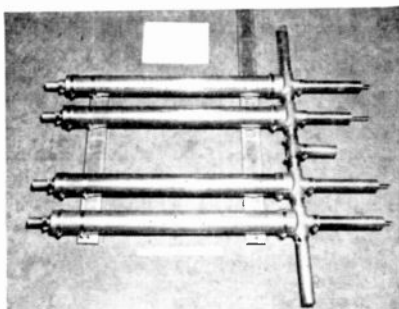
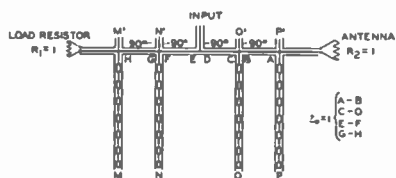

Fig. 23—Sideband filter photograph.

The sideband filter is designed to have five points of input impedance match. One is at the crossover frequency, where the output to the antenna is reduced 3 decibels. This is obtained by making the input impedance of the low pass and high pass portion of the sideband filter complementary.

The normalized conductance of the input to the low pass and high pass sections are equal to $+\frac{1}{2}$ at the crossover frequencies. The normalized susceptances are equal and opposite in sign, thus making the input admittance to the filter system a normalized conductance of one with zero susceptance at crossover. The rejector circuits in the high pass portion of the filter are parallel resonated at one frequency $f_0 + \Delta_2$ in the pass band. The impedance is matched at a frequency very close to this parallel resonant frequency. The rejector circuits in the low pass portion of the filter are similarly parallel resonated at a frequency $f_0 - \Delta_2$ in the reject band resulting in a similar matched impedance point in the reject band. The reject circuits in the high pass and low pass portions of the filter are tuned to different frequencies. Proper selection of the reactance slopes and reject frequencies causes one rejector circuit to compensate for the mismatch introduced by the other to obtain an additional matched impedance point in the pass and reject band. The



REACTANCE SLOPES USED - M & O 159 OHMS/MC
M & P 7 OHMS/MC

LINE	SHORT CIRCUIT FREQ.
M	$f_0 + \Delta_1$
N	$f_0 + \Delta_2$
O	$f_0 - \Delta_2$
P	$f_0 - \Delta_1$

AT $f_0 - \Delta_2$ PARALLEL RESONATE M' WITH M AND N' WITH N
AT $f_0 + \Delta_2$ PARALLEL RESONATE O' WITH O AND P' WITH P

Fig. 24—Sideband filter line diagram.

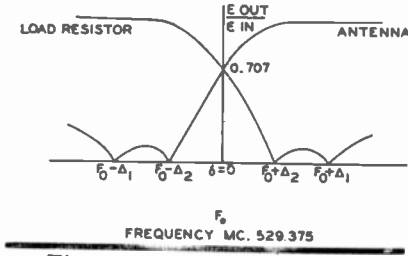

Fig. 25—Sideband filter ideal response.

the vestigial sideband filter is shown in Figure 25.

NOTCH DIPLEXER

A notch diplexer is a filter circuit which is required to feed the sound and picture transmitter output into the single antenna transmission line without interaction between the transmitter outputs. A coaxial line circuit was developed for the Bridgeport installation (Figure 26). A line diagram of the circuit arrangement used is shown in Figure 27. The circuit used does not differ greatly from the notch diplexers used for very-high-frequency television.

The operation of the notch diplexer is as follows, referring to Figure 27: The lines of length $11\lambda/4$ are tuned for a short circuit at picture frequency on junctions *D* and *E*. The short circuit at picture

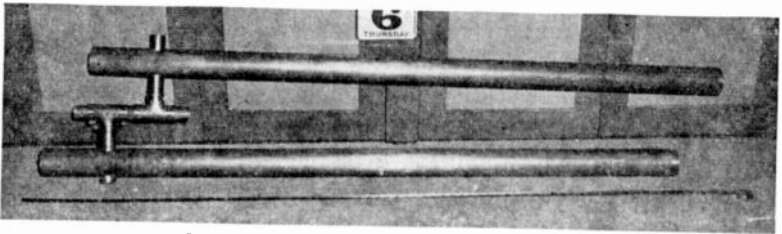

Fig. 26—Notch diplexer photograph.

frequency for junction *D* is transformed to an open circuit at junction *F* by a quarter-wave line *DF*. The open circuit at junction *F* permits the picture transmitter output to go to the antenna. The line *CA* is selected a quarter-wave at picture carrier and therefore does not shunt junction *C* at picture carrier. The length between junction *F* and *C* is selected to obtain a good impedance match for picture fre-

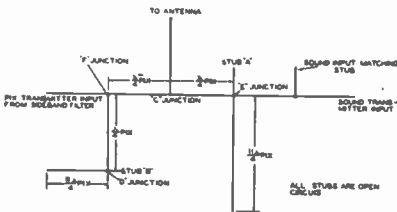

Fig. 27—Notch diplexer line diagram.

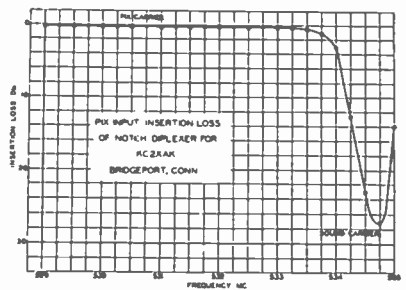

Fig. 28—Notch diplexer insertion loss.

quencies just below the sound notch thus obtaining a sound notch with steep skirts and a sharp shoulder. Stubs *A* and *B* are adjusted so that when each $11\lambda/4$ circuit is attached at junction *D*, maximum rejection of sound frequency on the picture input exists. This adjustment does not correspond to minimum standing wave ratio on the sound input and an additional stub is used on the sound input line to obtain a matched input at sound carrier frequency. The standing wave ratio and transmission characteristics obtained on the picture input for the coaxial line diplexer installed at Bridgeport, Connecticut are shown in Figures 28 and 29.

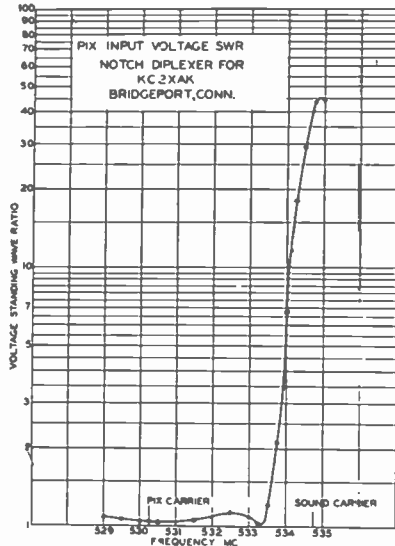

Fig. 29—Notch diplexer standing-wave ratio versus frequency.

CONCLUSION

The various components of the UHF television antenna system have been constructed and tested. The practicability of UHF television transmitting antenna equipment has been demonstrated by the experimental test results obtained and will be confirmed by operational experience with the experimental UHF Television Station KC2XAK in Bridgeport, Connecticut. Adequate power gain can be realized in a practical structure to permit adequate service with low power transmitters. The antenna development indicated no fundamental obstacles in the design of a practical commercial antenna for ultra-high-frequency television. The antenna described is a prototype of the improved type TFU-20A commercial ultra-high-frequency transmitting antenna.

ACKNOWLEDGMENT

The developments described were the contributions of many engineers of the RCA Victor Division, RCA Laboratories Division and the National Broadcasting Company, Inc.

A NEW ULTRA-HIGH-FREQUENCY TELEVISION TRANSMITTER*†

BY

L. S. LAPPIN AND J. R. BENNETT

Engineering Products Department, RCA Victor Division,
Camden, N. J.

Summary—A description is given of a new television transmitter which operates in the proposed ultra-high-frequency band at a frequency of 529-535 megacycles with a power output at the peak of the synchronizing pulses of 1000 watts. Several novel circuits have been developed, including multi-tube cavities operating as tripler and power amplifier stages. The transmitter conforms to all the standards pertaining to transmitters operating in the very-high-frequency band and is comparable in performance to present day very-high-frequency transmitters.

INTRODUCTION

THE increasing need for additional television channels placed greater emphasis on the utilization of the ultra-high-frequency channels which have been proposed by the Federal Communications Commission. Practical employment of these frequencies was hampered by the lack of operational experience which could only be obtained by scheduled operation at power levels capable of delivering a useful signal in an urban area. While propagation tests and demonstrations were conducted during the Summer of 1948, it became obvious that further tests under practical operating conditions would be required to demonstrate the suitability and possible limitation of television broadcasting in these channels. It was decided that an output power of the order of one kilowatt would be satisfactory for this purpose.

In November 1948, the development of such a television transmitter was undertaken. The frequency was to be 529-535 megacycles, the power output was to be of the order of one kilowatt using currently available tubes, and the design was to be such that the transmitter could be used in commercial operation and would conform with present very-high-frequency (VHF) television standards. Thirteen months later, on December 29, 1949, the completed transmitter, designated TTU-1A, went on the air at Bridgeport, Connecticut.

* Decimal Classification: R583.4 × R310.

† Reprinted from *RCA Review*, June 1950.

The first consideration in the development of this transmitter was to find a type of tube suitable for the job. In the interest of expediting the design it was decided to employ multiple operation of readily available tubes. Two tubes which offered possibilities were the 4X150A and the 5588. To make comparison tests, single tube cavities were built, and the characteristics of each tube were measured at 530 megacycles. The final decision was in favor of the 4X150A for two reasons. First, the 4X150A, a tetrode, would have a higher stage gain and be easier to modulate than the 5588 triode. Second, the 4X150A was much more stable than the 5588 which would definitely require neutralization. Even though it might become necessary to neutralize the 4X150A, neutralization of a tetrode would be much simpler and much less critical in practical operation.

The second consideration was to determine the type of radio-frequency circuits to be used. The most straightforward way would be to use several single tube cavities and combine their outputs by suitable passive networks. Another possibility would be to arrange the tubes around a circle in a single cavity and drive them in parallel. A test cavity was built to see if the proper mode could be set up in such a cavity. The encouraging results obtained led to the decision to use this type of circuit.

A tentative radio-frequency tube lineup was decided upon, and from these basic decisions, the TTU-1A transmitter was developed.

DESCRIPTION

The TTU-1A transmitter is housed in six cabinets fastened together to form a single assembly as shown in Figures 1 and 2. On the left is the aural section and on the right is the visual section.

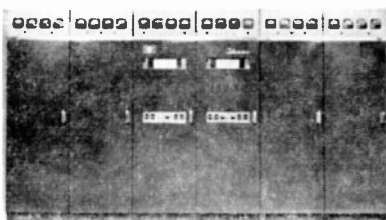

Fig. 1—Front view—doors closed.

The TTU-1A is built around the RCA TT-500B Television Transmitter, a commercial transmitter operating on channels 7 to 13 with a peak visual power output rating of 500 watts and an aural power output rating of 250 watts. The TT-500B serves as a driver for the ultra-high-frequency stages and the video modulator as shown in block diagrams Figures 3 and 4. The visual radio-frequency chain comprises a crystal oscillator and four multiplier stages followed by an amplifier all of which are part of the TT-500B transmitter. These in turn drive an eight-tube tripler consisting of eight type 4X150A tubes in parallel in a single cavity. The power amplifier consists of eight type 4X150A

tubes in a similar cavity. The output of the power amplifier is fed to the antenna through a reflectometer which measures the incident and reflected waves on the transmission line and thus indicates the standing wave ratio. The reflectometer is calibrated in peak output power so that the output of the transmitter may be continuously metered.

The video modulator chain consists of three low-power video amplifiers, including a clamp circuit, all located in the TT-500B transmitter and direct coupled to the modulator through a regulated "bucking bias" power supply to provide the necessary bias to the modulator. The modulator consists of eight type 6L6 tubes fed in parallel and connected as cathode followers with the output of each tube directly coupled to the grid of a single power amplifier tube. A video monitor amplifier is supplied to provide the necessary phase reversal for viewing on a monitor tube.

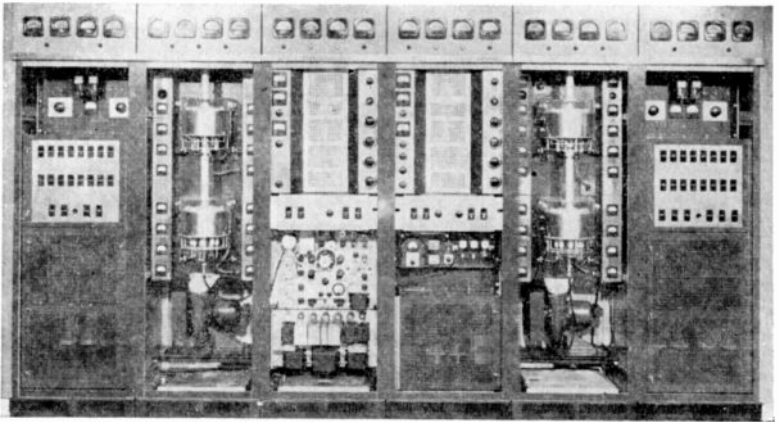

Fig. 2—Front view—doors removed.

The aural radio-frequency chain comprises the frequency-modulation exciter, to be described later, followed by two multiplier stages and an amplifier, all located in the TT-500B transmitter. The output of the TT-500B, which is at one third carrier frequency is followed by an eight-tube tripler cavity and an eight-tube power amplifier cavity identical to those used in the visual transmitter.

The tripler and power amplifier cavities are designed as plug-in units so that in the event of the failure of any component other than a tube, the faulty cavity may be removed and replaced by a spare cavity.

The control circuits are conventional except that indicators are provided to assist in the rapid location of a faulty tube in the cluster. Individual circuit breakers are connected in the cathode circuit of each tripler and power amplifier tube so that, in the event of an over-current

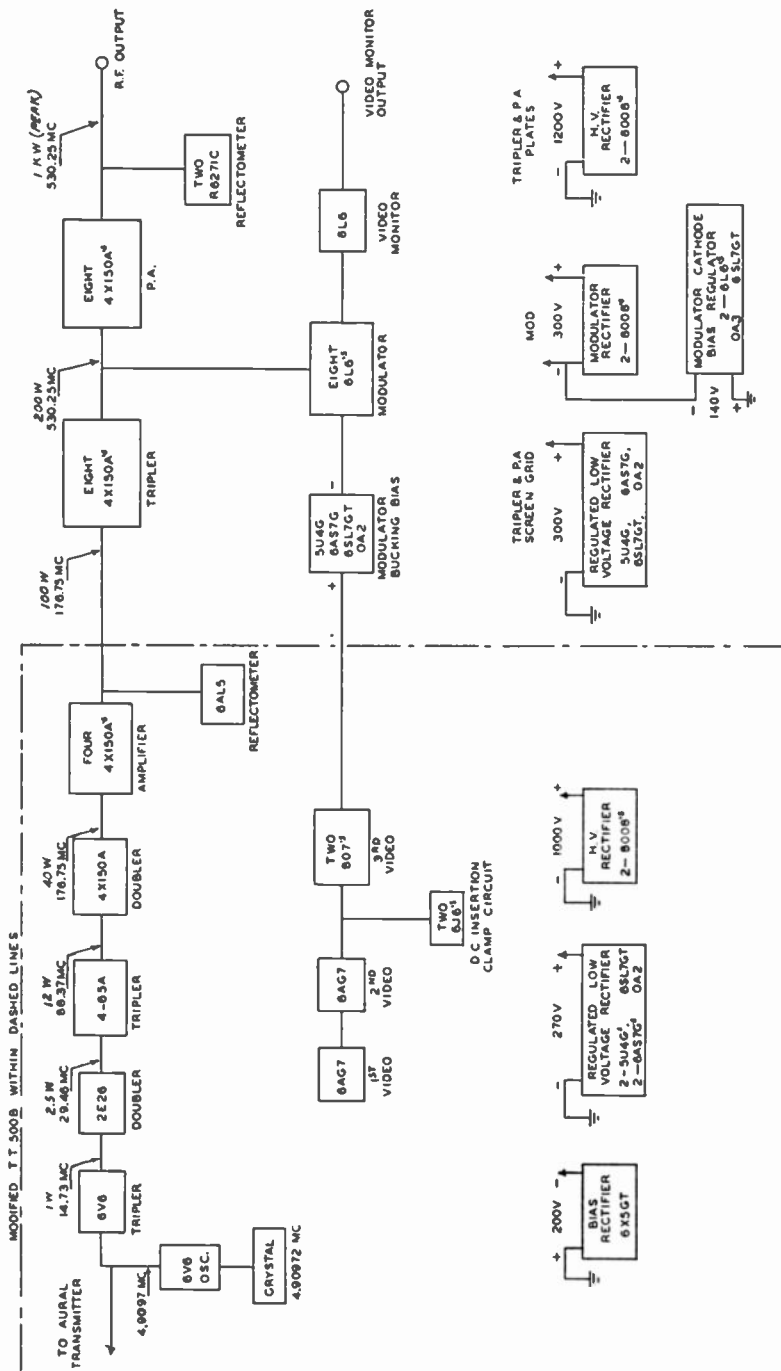

Fig. 3—Block diagram of visual transmitter.

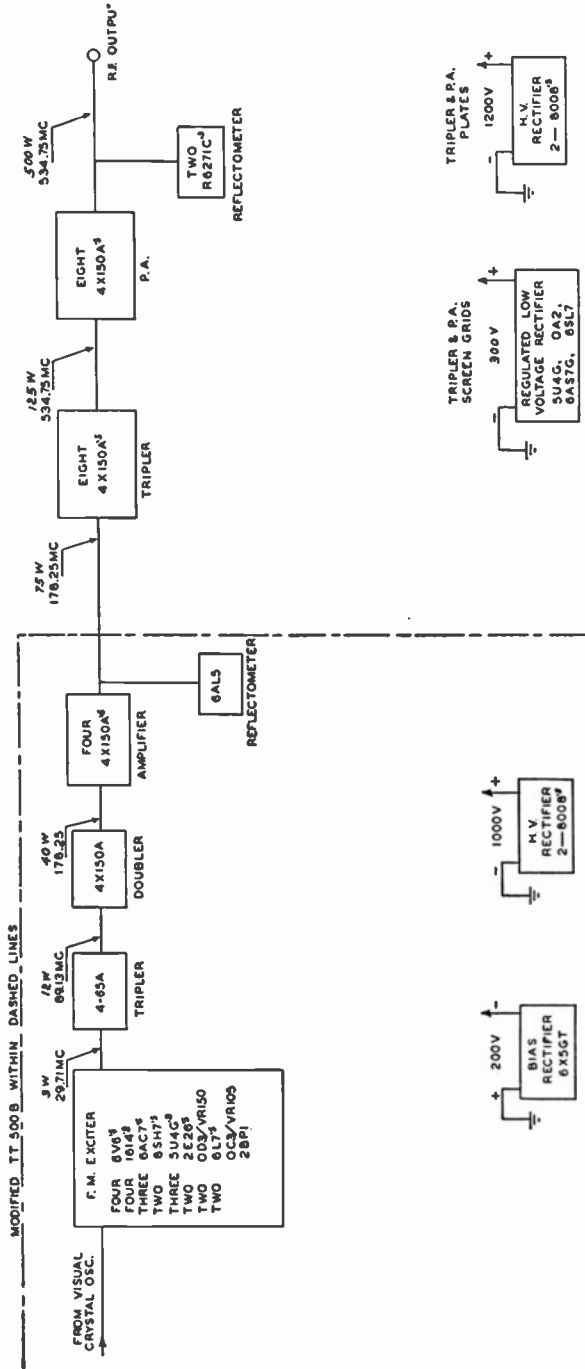

Fig. 4—Block diagram of aural transmitter.

in any tube, the associated circuit breaker trips instantly, providing the desired indication and at the same time removing the plate voltage from all tubes. Indicator lamps are also provided so that there is an overload indication even when the doors are closed.

A separate meter is provided to measure the cathode current of each tripler and power amplifier tube to facilitate the tuning of the cavities.

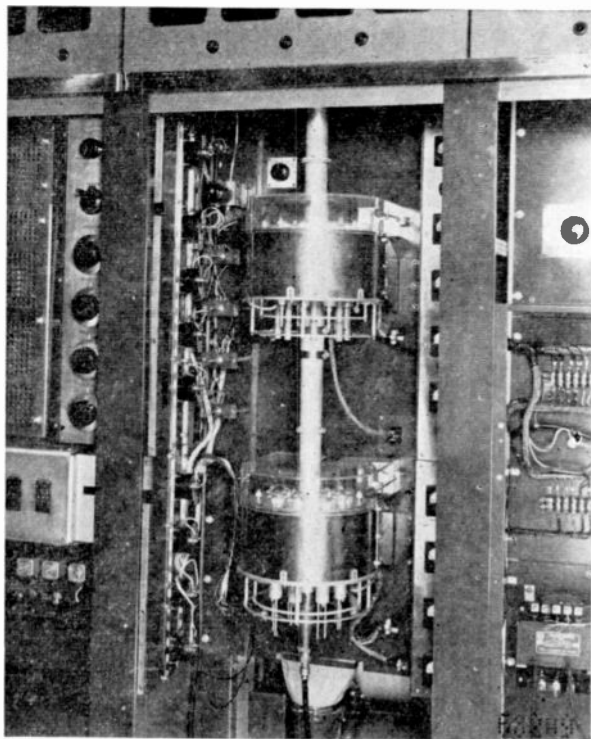

Fig. 5—Tripler and power amplifier stages.

The power supply circuits are conventional except that all circuits in the visual transmitter which are critical to voltage variations are supplied by regulated power supplies. These circuits include all video amplifier stages as well as the screen grids of the intermediate power amplifier, tripler, and power amplifier tubes.

RADIO-FREQUENCY CAVITY DESCRIPTION

The high-frequency tripler and power amplifier are operated as grounded cathode-grounded screen amplifiers. Each uses eight 4X150A tubes mounted in a single cavity. Figure 8, a cross-sectional view of the cavities and the coupling between them, shows that the power

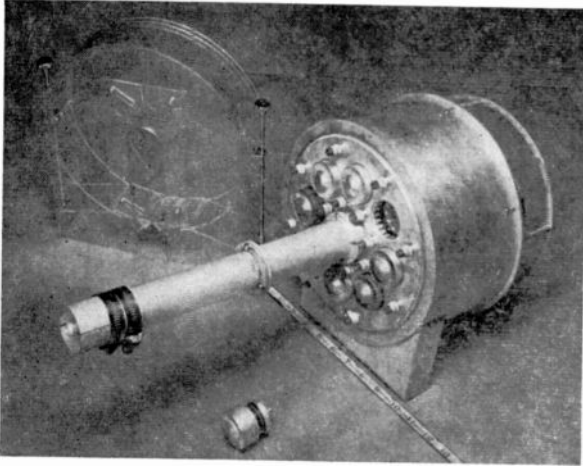

Fig. 6—Power amplifier cavity.

amplifier and tripler cavities are identical except for the grid circuits. Each cavity consists of three concentric cylinders shorted at one end and capped by three flat circular plates, referred to as the anode, screen, and grid plates. These plates provide a base on which the tubes and sockets are mounted.

A sheet of silvered mica placed over the "anode-plate" of the cavity forms the plate blocking capacitor. A thin phosphor-bronze sheet which is cut and formed to provide spring contact fingers for the anodes of all the tubes is laid over the mica and a metal plate provides rigidity to the assembly. The entire assembly is fastened together by means of insulated studs.

The screen grid of each tube is terminated in a ring at the base of the tube. These rings are connected through the screen contact fingers to a flat circular plate. A sheet of mica between this plate and the "screen plate" of the cavity forms the screen by-pass capacitor.

The center conductor of the output transformer is connected to the screen grid. That part of the conductor inside the cavity is an induct-



Fig. 7—Disassembled cavity.

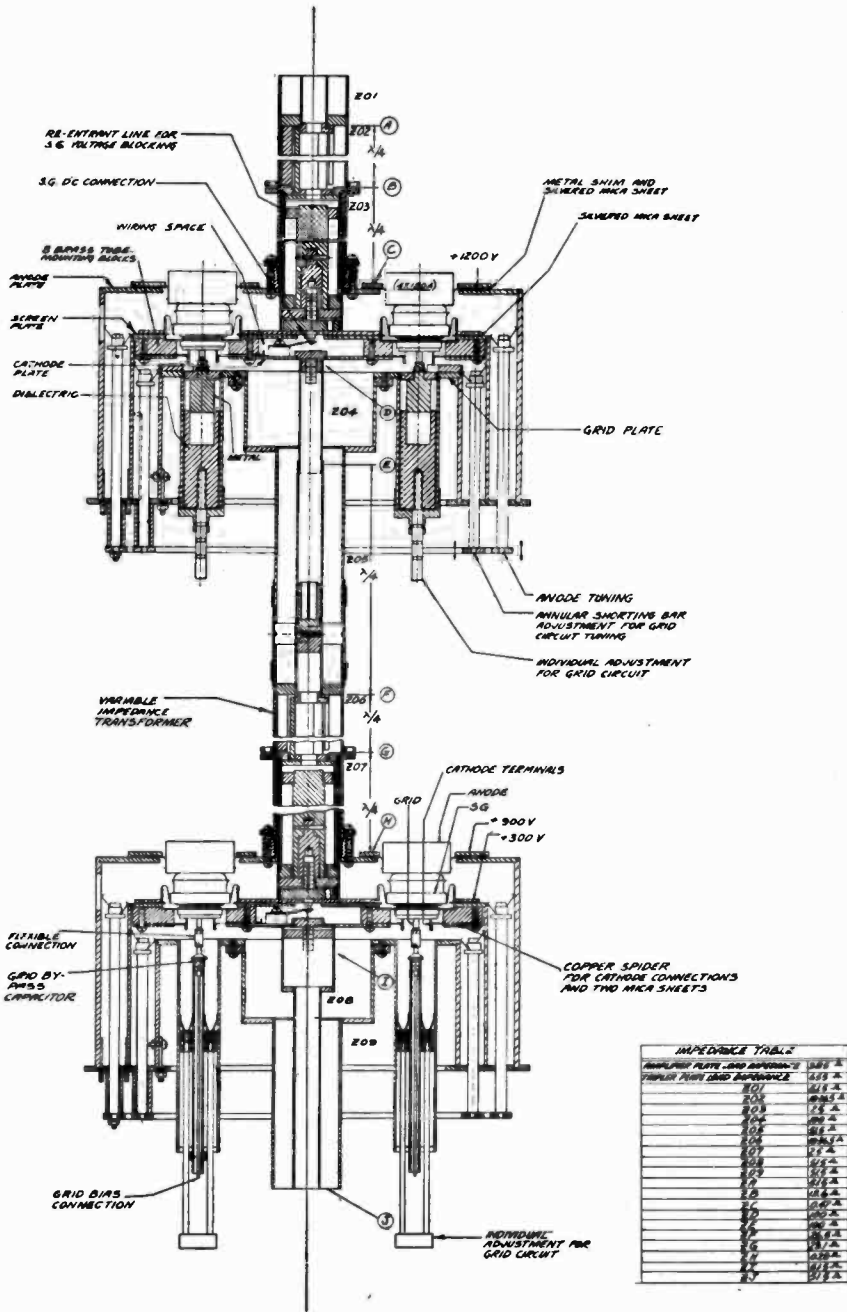

Fig. 8—Cavity cross section diagram.

ance which is a part of the resonant circuit of the cavity. If the cavity were to be cut into eight pie sections, each tube would be in the center of a half-wave resonant line foreshortened by the tube capacity. The equivalent electric circuit is shown in Figure 9. The circuit has been designed so that when it is resonated at 530 megacycles, approximately half the tube displacement current will flow out toward the shorting bar, and half will flow in toward the transformer. This tends to keep the current distribution uniform in the tube seals. The output impedance of the power amplifier is about $\frac{1}{2}$ ohm at full power output, while the impedance in the tripler is about $\frac{1}{4}$ ohm.

The cathode of each tube is individually by-passed to a "cathode plate" which is connected electrically to the "screen plate." Thus the direct-current component of the cathode current of each tube may be metered separately. There is no radio-frequency field in the space between the "screen plate" and the "cathode plate"; therefore this space is used for the direct-current and 60-cycle leads to the filament, screen, and cathode. These leads are brought out from the cavity through four copper tubes which are mounted along the inside of the "screen cylinder."

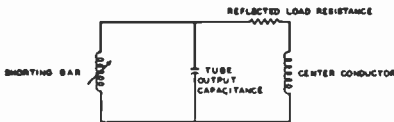

Fig. 9—Equivalent plate circuit of a single tube.

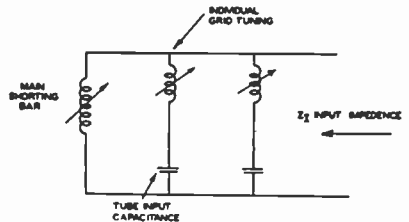

Fig. 10—Equivalent circuit of tripler grid cavity.

In the tripler, the grid of each tube is connected to a feed-through type by-pass capacitor which is screwed into the center conductor of each tuning stub. The outer conductor of each tuning stub is soldered to the "grid plate" of the cavity. The equivalent electrical circuit is as shown in Figure 10 where only two of the eight grids are shown. By adjusting the main shorting bar and the individual tuning adjustments, the grid cavity can be resonated and the drive on each tube can be balanced. By differentially tuning the main shorting bar and all eight of the individual tuning adjustments, the input impedance, Z_1 may be varied for proper matching. The tripler has been designed to match a 51.5-ohm coaxial line.

The design of the power amplifier grid tank is different from that in the tripler because at 530 megacycles, the reactance of the cathode and grid leads is approximately equal to the input capacitive reactance.

In order to resonate the power amplifier grids with the main shorting bar, an equivalent capacitance is inserted in series with the grid. This is done by the individual open circuited tuning stubs the capacitance of which is made adjustable by means of a movable dielectric sleeve. The equivalent circuit for the grid tank is shown in Figure 11.

The input impedance to the grids can be adjusted by differentially adjusting the main shorting bar and individual tuning adjustments as described for the tripler, but the power amplifier grid circuit is designed to have an input impedance of 100 ohms.

The power amplifier grid bias connection is not shown in Figure 8. The requirements of such a circuit are that it prevent all radiation outside the cavity, and present a high impedance to ground for the video frequencies. Eight quarter-wave chokes do this quite effectively. Since the radio-frequency impedance is low at the grid terminal of the socket, the center conductor of each choke is connected at this point. The choke is mounted in an insulating block adjacent to the individual grid tuning stub and the outer conductor of the choke is connected to the modulator output.

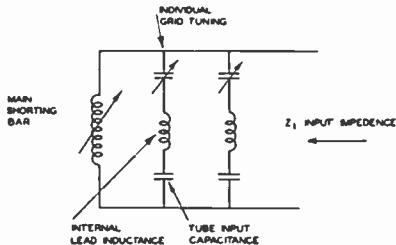

Fig. 11—Equivalent circuit of power amplifier grid cavity.

Both the anodes and grids of the 4X150A tubes require forced air cooling to prevent overheating of the seals. To accomplish this, air is forced through a screened slot in the side of the cavity in the anode tank. Inside the cavity, the air splits into two paths. Part of the air is forced out of the cavity through the anode radiators, and the rest is forced down across the grid seals of the tubes and out the grid cavity. To increase the air flow across the grid seals, three short bakelite pins are cemented into the tube socket. These raise the tube slightly above the socket and allow the air to pass across the base of the tube and through the center hole in the socket into the grid cavity. A plastic shield fastened over the top of the cavity creates a back pressure which further increases the flow of air across the grid seals and in addition provides a safety cover for the anodes of the tubes which would otherwise be exposed.

OUTPUT COUPLING TRANSFORMERS

The output coupling of the power amplifier cavity consists of a two-section impedance matching transformer. Each section is a quarter wavelength long, and together they transform the 51.5-ohm

line impedance down to $\frac{1}{2}$ ohm at the output of the power amplifier cavity. Since the inner conductor of the first section is at the same direct-current potential as the screen of the tubes, a re-entrant quarter wave section blocks the direct-current screen voltage but provides a low impedance radio-frequency path between the inner conductors of the first and second sections of the output coupling transformer.

Transforming from 51.5 to 0.5 ohms would ideally require two sections of surge impedance, 1.59 and 16.2 ohms respectively for maximum broadbanding, but if a $1\frac{5}{8}$ -inch line is used as the outer conductor a section of 1.59-ohm surge impedance is mechanically impractical especially since a potential of about 300 volts exists between the outer and inner conductor. As a compromise, a surge impedance of 2.5 ohms was chosen for the first section. This fixes the surge impedance of the next section at 25 ohms, but in order to vary the loading on the power amplifier, this section was made variable. A two-to-one change in surge impedance of this section results in a four-to-one change in power amplifier output impedance, which was considered adequate. The surge impedance of the second transformer section should therefore be adjustable between 18 ohms and 36 ohms.

A cross section of a tentative design was laid out to scale and a flux plot was made to determine the capacitance per unit length. A flux plot gives a fairly accurate determination of the capacity if it is done carefully. To make one, the electric and magnetic lines are sketched free-hand following a knowledge that:

1. The electric lines terminate perpendicular to the conductor.
2. Electric and magnetic lines are mutually perpendicular.

If the electric and magnetic lines are drawn to approximate squares, then:

$$C = \frac{\text{Number of "squares" along magnetic lines}}{\text{Number of "squares" along electric lines}} \times 8.854 \text{ micromicrofarads per meter.}$$

A cross-sectional view of the final design is shown in Figure 12. The outer conductor consists of three square rods soldered to the inside of the $1\frac{5}{8}$ -inch tube and the inner conductor consists of three half-round rods supported by a plate at each end as shown. To change the surge impedance, the outer conductor is rotated with respect to the inner conductor. A slotted flange at one end limits the travel from maximum to minimum surge impedance. From the flux plot, $Z_{0 \text{ max.}}$ and $Z_{0 \text{ min.}}$ were found to be 38.7 ohms and 18.1 ohms respectively. After the transformer was built, the surge impedance was measured

on a slotted line. The realized values of $Z_{0 \max}$ and $Z_{0 \min}$ were 37.3 and 20.2 ohms respectively.

Although the output impedance of the tripler cavity is $\frac{1}{4}$ ohm, it is desirable to use the same type of output coupling. If this is done, the variable section of the output coupling must be terminated in 25 ohms. Since the input impedance to the power amplifier grid cavity is 100 ohms, a quarter-wave section of 51.5-ohm line will provide the proper match. The cavities are mounted far enough apart to do this, and a short section of 100 ohm line completes the connection.

MODULATOR

The modulator design is based on the TT-500B modulator which is designed to operate from a standard RMA composite video signal. The TT-500B modulator (two type 807 tubes in parallel) is capable of fully grid modulating four 4X150A tubes with a bandwidth of about 5 megacycles. Since the TTU-1A transmitter requires that the eight 4X150A tubes be similarly modulated, it is clear that sufficient voltage can be obtained for modulation, but at a reduced bandwidth due to the additional grid capacity of the extra tubes. In order to reduce the capacity that the 807 tubes must work into, they are followed by a cathode follower which in turn delivers its output to the grids of the power amplifier tubes. Several advantages are gained by the use of the cathode follower. The input capacitance of the cathode follower is considerably reduced because of degeneration provided by the cathode resistor and the linearity is very much improved. In addition, with a given capacitance load and bandwidth, it is possible to use a larger load resistor, which results in less modulator plate current.

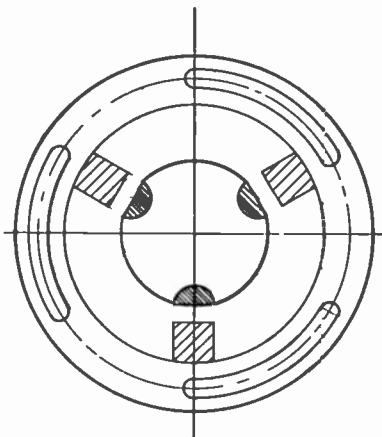

Fig. 12—Cross section of variable impedance transformer.

The choice of a modulator tube was the next problem. It was decided to use eight modulator tubes with the grids connected in parallel for video signals, rather than one larger tube for several reasons. First, by providing a separate bias control for each modulator tube and direct coupling each modulator tube to a single power amplifier tube it becomes quite simple to compensate for any unbalance in static plate currents. Secondly, an unreasonably large tube operating

at a fairly high plate voltage would be needed to deliver the required 71 volts peak to peak to the 300-micromicrofarad load presented by the grids of the eight power amplifier tubes. The one objection to the use of a multiplicity of modulator tubes was the high input capacitance which made the design of the input circuit more difficult. The number of components in the input circuit becomes quite large when the direct-current grid potentials must be separately adjustable as noted above. Thus, it becomes essential that the components be as small as possible and the location of all grid circuit components becomes very critical.

A simplified schematic diagram of the modulator is shown in Figure 13. The video output tubes of the TT-500B transmitter are direct coupled to eight 6L6 tubes with grids connected in parallel for video frequencies and each tube is direct coupled to a single power amplifier tube.

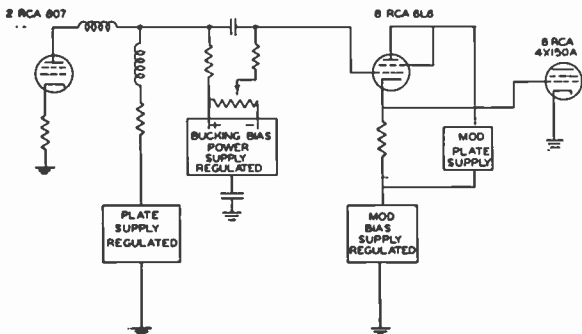

Fig. 13 — Simplified schematic diagram of modulator.

A "bucking bias" power supply was connected between the plates of the 807 tubes and the grids of the 6L6 tubes in order to overcome the positive voltage at the plates of the 807 tubes. Since the power supply has a considerable capacity to ground and is at video potential above ground it was necessary to isolate the supply by means of high resistance in both positive and negative leads. This was possible since the modulator tubes do not draw grid current. In order that the shunt impedance presented by these resistors and the power supply capacitance be held constant over the video frequency range, the power supply capacity was increased to make the RC constant of the shunt network equal to 0.025 second. Thus, for all frequencies above approximately 40 cycles there is a loss of about 2 per cent compared to the direct-current response.

A video amplifier is provided for monitoring the modulator output. The input to the monitor amplifier is obtained from the grids of the power amplifier tubes by means of eight voltage dividers. These are

connected together at the low-potential end which is connected to the grid of the amplifier. Thus, the video input is the average of the signals applied to the eight power amplifier tubes. The resistors used for the voltage dividers are of the deposited carbon type which have good high frequency characteristics and a shunt capacitance of only 0.8 micromicrofarads. This value of capacitance is almost sufficient for high frequency compensation of the divider. However, a capacitance of 1.5 micromicrofarads across only one of the resistors results in nearly complete compensation up to about 5 megacycles. By proper choice of resistance values, the voltage divider also serves as a meter multiplier, so that the average grid voltage of the eight power amplifier tubes may be read on a single meter.

In modulating the power amplifier it was found that the response of the modulated wave had a deep valley at approximately 3.5 to 4 megacycles, although the video voltage applied to the grids of the power amplifier was flat to 5 megacycles. This was traced to resonance in the cathode circuits of the power amplifier between the cathode bypass capacitors and the cathode lead inductance. These leads are of necessity quite long because the cavities are plug-in. The inductance was reduced as much as possible by shortening the lead length and shielding the leads and in addition each cathode circuit was critically damped by means of a blocking capacitor and damping resistor connected to ground. This eliminated all traces of cathode resonance.

SOUND EXCITER

The frequency-modulation sound exciter is designed to accept the standard RMA audio input signal of 10 dbm* \pm 2 dbm at 600 ohms and deliver to the multiplier stages of the transmitter a frequency modulated signal at 1/18 the output frequency of the transmitter and at a power level of about three watts. The exciter is similar to the standard frequency-modulation exciter¹ developed for the RCA FM broadcast transmitters except that the center frequency is stabilized so that the output frequency of the aural transmitter is maintained 4.5 megacycles higher than that of the visual transmitter within \pm 450 cycles. This relative stability is considerably in excess of that which is required for the satisfactory operation of receivers of the inter-carrier-sound type. The tolerance proposed by several RMA technical committees is \pm 5 kilocycles.

Figure 14 shows a block diagram of the frequency control system.

* Decibels referred to a zero level of 1 milliwatt in 600 ohms.

¹ N. J. Oman, "A New Exciter Unit for Frequency Modulated Transmitters", *RCA Review*, Vol. 7, No. 1, pp. 118-130, March, 1946.

The visual and aural transmitters are driven by a crystal oscillator operating at 4.9097 megacycles and a master oscillator operating at 4.9514 megacycles respectively. The master oscillator is frequency modulated by a reactance tube modulator.

The frequency of the master oscillator is accurately maintained at 1/108 of the transmitter output frequency by means of a motor controlled capacitor connected in the oscillator tank circuit. The motor is controlled by a frequency detector which compares two frequencies derived respectively from a crystal oscillator and from the difference frequency between the visual and aural oscillators. Thus, any error in the master oscillator frequency causes a correcting force to be applied to the tuning capacitor.

One of the reference frequencies operating the frequency detector is obtained directly from an auxiliary crystal oscillator operating at a frequency of 104.165 kilocycles through a frequency divider with a division ratio of five to one to produce the reference frequency of approximately 20.8 kilocycles.

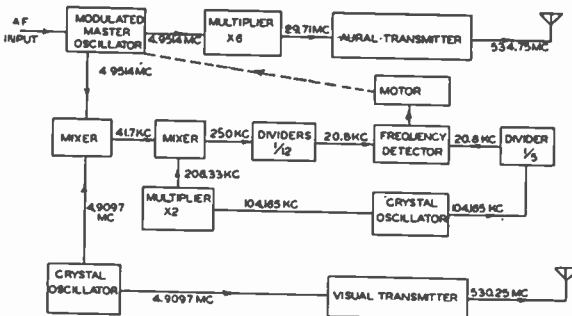

Fig. 14 — Block diagram of frequency control system.

The other reference frequency is obtained by combining the outputs of the visual and aural oscillators in a mixer to produce a frequency of approximately 41.7 megacycles which is the difference between the oscillator frequencies. This frequency is mixed again with the second harmonic of the auxiliary crystal oscillator to obtain a new frequency of 250 kilocycles, which after being divided by 12 becomes the second reference frequency of 20.8 kilocycles. Thus any deviation of the master oscillator frequency from 4.9514 megacycles causes a change in the second reference frequency which in turn causes the motor to rotate and correct the oscillator frequency. In this manner, the frequency stability of the visual transmitter is determined only by the visual crystal oscillator. The center frequency of the aural transmitter is stabilized with reference to the visual output frequency so that the frequency difference is maintained within the specified limits.

TANK CIRCUIT

During the initial operating tests of the cavity, a power output of 475 watts was obtained with a power input of 2000 watts. The difference between output and input power represents loss due to plate dissipation in the tubes and also radio-frequency losses in the tank circuit. The tank circuit losses were found in the following manner.

The unloaded Q of the cavity was measured to be 94 and an output capacity reactance of 8 ohms was calculated for the eight tubes in parallel. Substituting these values in the formula

$$P_d = \left[\frac{E_{\max}^2}{2 X_c} \right] \left[\frac{1}{Q_d} \right], \quad (1)$$

and assuming a radio-frequency output voltage of 900 volts peak, which is consistent with the plate voltage applied, the power dissipated in tank circuit losses is shown to be 540 watts.

It is interesting to note that the loaded Q of the cavity can also be calculated. Restating (1) and substituting $P = 475 + 540 = 1015$ watts gives

$$Q_0 = \frac{E_{\max}^2}{2X_c P} = 49.7, \quad (2)$$

where Q_0 is the loaded Q of the cavity.

The above calculations are not strictly accurate because they neglect the energy stored in the electric field of the cavity itself, but they do give a fair enough approximation to indicate an excessive amount of circuit loss and in addition point to a possible method of obtaining a quantitative breakdown of the various losses in the cavity.

Since the Q of any electrical circuit is the ratio of the stored energy to the energy dissipated in the circuit, the quantity $1/Q$ is proportional to the power loss in that circuit. Thus, to find the loss factor, $1/Q$, of any component, the Q of the cavity can be measured with the component in and out. As long as the stored energy in the circuit has not been changed, the loss factor for the particular component will be the difference between the two $1/Q$ factors. It was decided to break down the circuit losses by successive Q measurements to determine which parts of the cavity contributed the most loss.

Originally, it was supposed that the low current densities resulting from the size of the cavity would allow the top plates to be fitted to the cylinders by a press fit. These seams were soldered and a considerable improvement was measured.

Various other possible losses were measured in order to isolate each loss as much as possible. For example, the loss in the shorting bar was measured by opening half the finger contacts and measuring the increase in loss. This increase is equal to the loss in the shorting bar. In this manner, many of the losses in the cavity were measured.

A summary of these results is given in Table I. The values represent the average of several readings, and are probably accurate to within 10 or 15 per cent.

Table I

Loss	Loss Factor — (1/Q)	
Total		87.5×10^{-4}
Plate—cylinder seams	30.5×10^{-4}	
Plate mica by-pass	24.4×10^{-4}	
Screen mica by-pass	6.4×10^{-4}	
Tubes	11.7×10^{-4}	
Transformer section	3.3×10^{-4}	
Main plate shorting bar	6.5×10^{-4}	82.8×10^{-4}
Unaccounted for		4.7×10^{-4}

It should be noted that the unaccounted loss contains the accumulated error of all readings and is approximately 5 per cent of the total loss.

Both the plate and screen micas were silvered, and the direct-current screen terminal was changed from the tube sockets to the center point of the screen finger plate (see Figure 8). Table I shows that these improvements together with the improvement made by soldering the seams should have increased the Q to 380 if all losses in the plate and screen by-pass capacitors had been eliminated. When the unloaded Q was again measured, it was found to be 350. With these changes a power output of 1050 watts was measured.

There are two other items of importance in connection with the design of the radio-frequency cavities. The first is the spurious responses in the plate cavity. When the cavity is operated in the desired mode, the electric field is constant around the cavity. Since the cross section of the cavity represents an electrical half-wave circuit, it acts like a wave guide at cut-off, and there can be no mode propagated around the cavity at the fundamental frequency. A few megacycles above the resonant frequency however, such modes can be propagated and a great many spurious resonances can occur above the fundamental resonance because of the multiple reflections of the curved walls of the cavity.

The frequencies of these spurious resonances are far enough away from the fundamental frequency so that they are not excited by either the carrier or the radio-frequency modulation components.

One other item of interest is the method of neutralizing the tubes. Although the 4X150A proved very stable as far as oscillation was concerned, it was found necessary to neutralize the amplifier in order to reduce the "feed through" power and improve the modulation characteristic at the cut-off end. Since the screen by-pass capacitance was fixed, it was decided to neutralize by means of a Bridged-T circuit. The neutralizing voltage is provided by the inductance of the screen contact fingers. A single-tube cavity was set up and several different types of screen fingers were measured for minimum feed-through.

EIGHT-TUBE CAVITY PERFORMANCE

The following discussion of the performance of the eight-tube cavity is divided into two parts. First, a comparison of tube performance at 530 megacycles and at low frequencies, and second a comparison of the performance of an eight-tube cavity versus the performance of a single-tube cavity.

There are four principal differences between the tube performance at 530 megacycles and the calculated performance which is based on low frequency operation. These are:

1. Increased driving power,
2. Lower apparent plate efficiency,
3. Increased radio-frequency grid voltage required for a given value of plate current,
4. Back heating of the cathode.

The first two effects were determined to be almost entirely due to circuit losses. If all the known circuit losses are taken into account by the method previously described, the measured radio-frequency power is 90 per cent of the calculated value. The remaining 10 per cent is due to transit time effects and to variation in tube characteristics.

The increased radio-frequency grid voltage and cathode back heating are probably both due to transit time effects at ultra-high frequencies. Measurements showed that the grid drive was about 50 per cent more than the calculated value for any specified plate current. The back heating was easily compensated for by reducing the filament voltage from 6.0 to 5.2 volts.

An accurate comparison between the operation of an eight-tube

cavity and a single-tube cavity requires the operation of eight tubes, one at a time, in a single-tube cavity and comparing this operation with the operation of the same eight tubes in an eight-tube cavity. Although this was not done, the performance of a single-tube cavity had been observed on numerous occasions, and enough data was available to compare the two types of operation under equivalent conditions. For example, a 4X150A in a single-tube cavity developed 150 watts power output at 240 milliamperes plate current, and under the same conditions each 4X150A developed an average of 137 watts or 92 per cent of the single-tube output in the eight-tube cavity. The unloaded Q of the single-tube and eight-tube cavities were found to be 488 and 350 respectively. Loaded Q of a single-tube cavity was not measured, but assuming it to be the same as the value measured for the eight-tube cavity ($Q = 58$) it can be shown that the circuit efficiencies of the eight-tube and single-tube cavities are 83.5 and 88 per cent respectively. From this one would expect the output of the eight-tube cavity to be 95 per cent of the output of the single-tube cavity, a discrepancy of 3 per cent from the measured value.

The conclusion is that when cavity losses are taken into account the operation is essentially the same in either a single-tube or an eight-tube cavity.

PERFORMANCE

The TTU-1A transmitter is designed to meet the proposed standards for commercial ultra-high-frequency television transmission. The performance limits for VHF transmitters as stated in RMA standards and in the FCC "Standards of Good Engineering Practice Concerning Television Broadcast Stations," have been met wherever they apply. In addition the relative stability of the carrier separation has been greatly improved over that required by current or proposed standards.

The visual transmitter is conservatively rated at a peak output power of one kilowatt when transmitting a black picture. Under these conditions the output tubes are operating considerably below the maximum allowable plate dissipation. The regulation of the output is such that the peak output varies less than 5 per cent from an all black picture to an all white picture.

The output of the transmitter contains both sidebands; however, the lower sideband is removed by means of a vestigial sideband filter externally connected. The radiated signal has the standard RMA vestigial sideband characteristic.

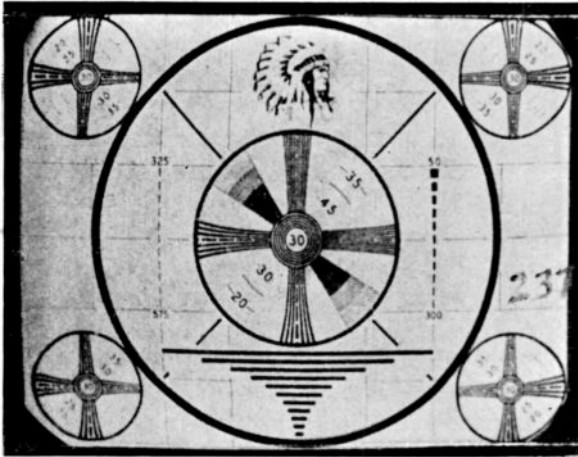

Fig. 15—Picture at input of transmitter.

The aural transmitter is rated at a power output of 500 watts. It is frequency modulated and is capable of more than ± 50 kilocycles swing with less than 5 per cent distortion from 30 cycles to 15 kilocycles; ± 25 kilocycles swing represents 100 per cent modulation. The distortion at 100 per cent modulation is less than the limits stated in RMA Standard TR104-A.

The carrier frequency of the visual transmitter is held constant to within 0.002 per cent of the assigned value. The frequency difference between the aural and visual carrier frequencies is constant to within ± 450 cycles which compares very favorably with the stated requirement of ± 5 kilocycles.

The bandwidth of the plate circuit of the power amplifier is sufficiently broad so that the picture quality is not affected by plate circuit

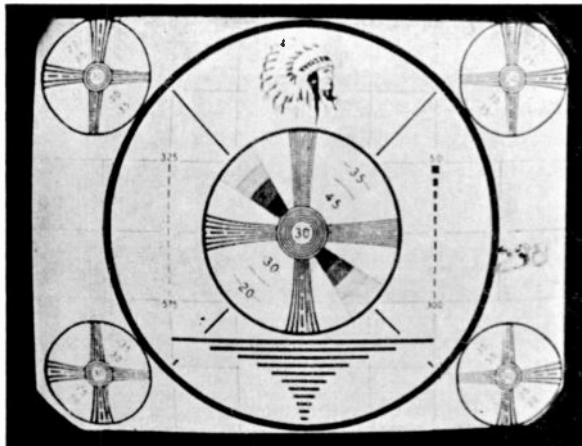

Fig. 16—Picture at output of transmitter.

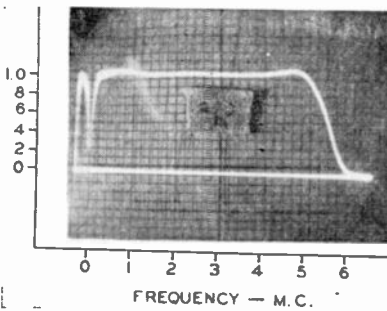

Fig. 17—Modulator video response.

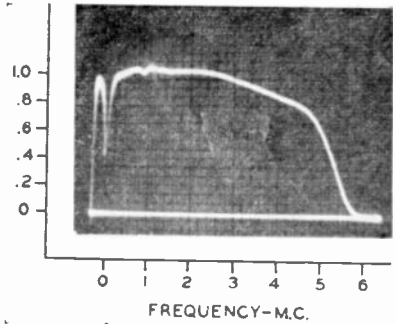

Fig. 18—Overall video response.

tuning. In tuning the transmitter, the plate circuit is tuned for maximum output. Optimum broadbanding of the grid circuit is readily obtained by slightly detuning on the high frequency side of resonance.

The performance of the visual transmitter is shown by Figures 15 to 20. Figures 15 and 16 show the input and output signal respectively when the standard test pattern is transmitted and viewed on a commercial master monitor.

Inspection of Figure 16 shows a vertical resolution of about 460 lines. Figure 17 shows the video response of the modulator measured at the grids of the power amplifier tubes. The response is flat to approximately 5 megacycles. Figure 18 shows the overall frequency response of the transmitter when operating into a dummy load and Figure 19 shows the response to a square wave pulse with a rise time of 0.07 microsecond. It indicates an increase in rise time to 0.11 microsecond. Figure 20 shows the overall modulation characteristic and indicates a feed-through power of only 0.3 watt. A maximum power of 1460 watts is indicated.

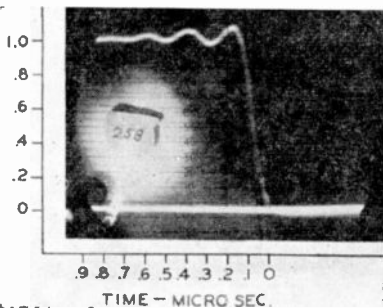

Fig. 19—Square wave response.

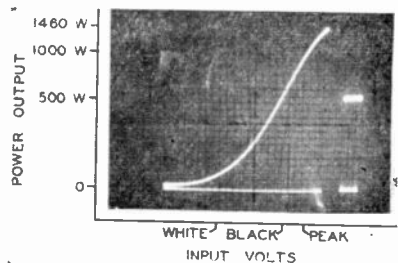

Fig. 20—Modulation characteristics.

CONCLUSION

The TTU-1A transmitter is capable of radiating a signal in accordance with the current FCC "Standards of Good Engineering Practice Concerning Television Broadcast Stations," and the RMA "Electrical Performance Standards for VHF Television Transmitters."

The quality of the transmitted picture is equal to that transmitted by commercial transmitters currently in operation on the VHF channels. In construction and design this transmitter is entirely suited for commercial operation from both the operational and performance standpoints.

A SIX-MEGACYCLE COMPATIBLE HIGH-DEFINITION COLOR TELEVISION SYSTEM*†

A Report

By

RCA LABORATORIES DIVISION, PRINCETON, N. J.

Editor's Note: This report comprises Exhibit No. 209 submitted by Radio Corporation of America at the Hearing before the Federal Communications Commission in Docket Nos. 8736, 8975, 9175 and 8976, September 26, 1949 et seq.

Previous reports on the new color system are contained in Exhibit Nos. 206 and 207 submitted to the Federal Communications Commission on August 25 and September 6, 1949.

Additional information on various aspects of the system is under preparation. It is planned to publish this information as it becomes available.

INTRODUCTION

THE color system described herein has its roots in the simultaneous method first disclosed on October 30, 1946 and subsequently described in detail at a Hearing before the Federal Communications Commission in Docket No. 7896 and in various published technical papers.^{1,2}

The new system, as in the case of the wide-band simultaneous system, is completely compatible with the current black-and-white television system.

In addition, the new system includes later developments which, in essence, compress the simultaneous system into a 4-megacycle band suitable for a total channel assignment of 6 megacycles. Not only is the system so compressed, but no detail is lost in the process. This in turn insures a high-definition color picture, while at the same time preserving the normal definition of the black-and-white picture.

The compression of the simultaneous system is accomplished by a combination of two processes:

- (a) use of the mixed-highs principle; and
- (b) color-picture sampling and time-multiplex transmission.

These band-saving techniques are described in the following pages.

* Decimal Classification: R583.

† Reprinted from *RCA Review*, December 1949.

¹ RCA Laboratories Division, "Simultaneous All-Electronic Color Television," *RCA Review*, Vol. VII, No. 4, p. 459, December, 1946.

² R. D. Kell, G. C. Sziklai, R. C. Ballard, A. C. Schroeder, K. R. Wendt and G. L. Fredendall, "An Experimental Simultaneous Color Television System," *Proc. I.R.E.*, Vol. 35, No. 9, p. 861, September, 1947.

STUDIO AND RELATED EQUIPMENT CHARACTERISTICS

A block diagram of the color television broadcasting station is shown in Figure 1.

Studio Apparatus

The color camera (live, film, or slide), its related equipment, and the synchronizing generator are the same components used in the wide-band simultaneous system. These were described in Dockets No. 7896 and No. 8976 and in References (1) and (2).

This studio apparatus provides three signals, one for each of the primary colors (green, red and blue). Each of these signals may contain frequency components out to a maximum of four megacycles, and in addition an average or dc component.

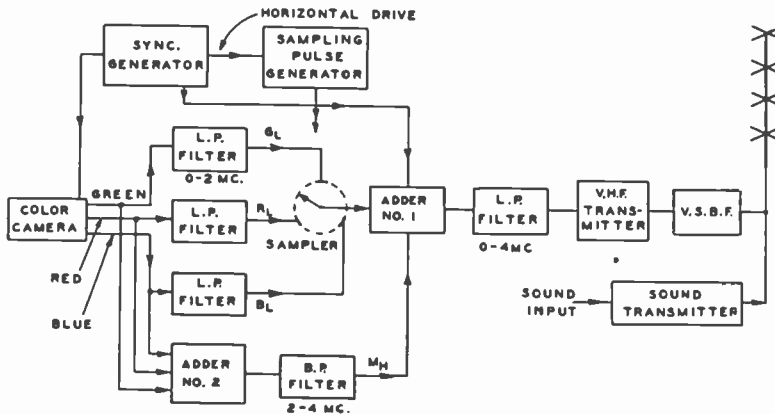

Fig. 1.—Block diagram of the color television transmitter.

Signal Routing

For one signal routing of Figure 1, each color signal passes through a low-pass filter which eliminates frequency components above two megacycles. The green-channel signal coming out of its particular low-pass filter is designated as G_L on Figure 1, indicating that at this point the signal contains the dc component and ac components with frequencies of two megacycles or less. The three low-frequency signals, G_L , R_L and B_L are then sent into an electronic commutator or sampler (discussed below).

For the second signal routing of Figure 1, the three-color signals from the camera are combined in electronic Adder No. 2 and then are passed through a band-pass filter. The output of this filter contains

frequencies from two to four megacycles, with contributions from each of the three color channels. The signal at the output of the band-pass filter is designated as M_H , the mixed-high signal. The mixed-high frequencies are fed to Adder No. 1 which, as will be seen, is also receiving the signal from the sampler and from the synchronizing generator.

Mixed-Highs

The principle of mixed-highs, referred to above, was described in Docket Nos. 7896 and 8976. It has been demonstrated that the mixed-highs procedure is successful and satisfactory in a wide-band simultaneous system.

In the new system, at the transmitting end, the sampling process (discussed below) is capable by itself, of providing high-frequency components of each color signal. Since the sampling frequency determines the highest frequency which will be passed, when the high-frequency components of each color signal are combined the resulting band-width does not exceed four megacycles.

However, photocells used with flying-spot devices in film and slide scanners inherently have poor high-frequency response, particularly in the red. It is often necessary, therefore, to peak the higher-frequency response of such devices. This peaking, of course, raises the level of the high-frequency noise components. When the entire frequency band of zero to four megacycles is sampled, the 3.8-megacycle sampling frequency beats the high-frequency noise to low frequency and vice versa. Because, in the case of pickup devices of the type referred to above, the high-frequency noise has been peaked, an even interchange of noise components does not occur, as it would if the noise spectrum were uniform. Consequently, after the sampling process has taken place, the low-frequency noise components will have been accentuated. This causes a coarse-grain structure in the picture which may be objectional to the eye.

Experience has shown, therefore, that there is a definite advantage gained in sampling only the lower half of the video band (up to two megacycles) and using the principle of mixed-highs for the upper half of the video band (from two to four megacycles), and this procedure is used at the transmitting end.

In pick-up equipment with uniform noise characteristics, no such effects as above described exist. This means that either the dual procedure given in the above paragraph or sampling only may be used. This also applies to receiving equipment.

Sampling and Combining Process

The sampling pulse generator, which embodies time-multiplexing techniques, is an integral part of the electronic commutator and makes use of the trailing edge of the horizontal synchronizing pulse to time the sampling of each of the color signals.

In the sampler, each color signal is sampled for a very short time, at a rate of 3.8 million times per second for each color. The samples for each scanning line are timed with respect to the horizontal synchronizing pulse for that line. However, for alternate line scans the timing of the sampling pulse is such that samples of any one color

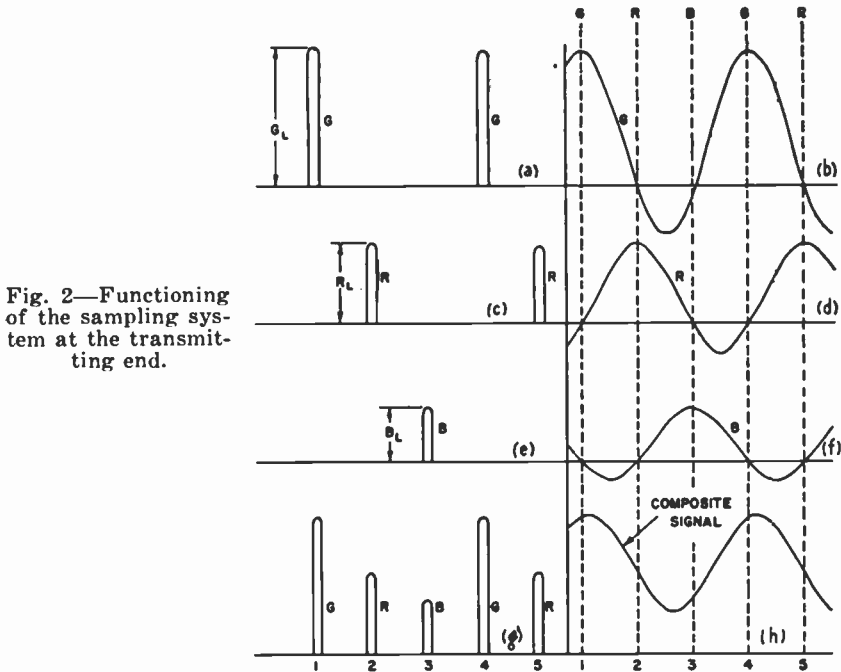

Fig. 2—Functioning of the sampling system at the transmitting end.

are taken at a point midway between samples of the same color in the line above. Alternate scans of the same line are displaced in this same way. Thus, the second samples are taken midway between the first samples, resulting in dot interlacing (to be discussed in more detail in Part IV).

Figure 2 illustrates the functioning, at the transmitting end, of the sampling system in the pickup of large uniform polychromatic areas, with the three primary colors represented by three different signal strengths. Figure 2(a) shows the output of the sampler due to the green signal only. The green channel signal is sampled every

0.263 microsecond ($0.263 = 1/3.8$). At a time 0.0877 microsecond after a green sample, a sample is taken of the red signal. This time delay is one-third of the time between successive green samples. The red samples continue to be taken 0.263 microsecond apart as shown in Figure 2(c). The blue samples are taken at the same rate and follow the red samples by a time of 0.0877 microsecond, as indicated in Figure 2(e). The composite output of the sampler consists of a superposition of the green, red, and blue trains of pulses or samples. Figure 2(g) shows the signal in the circuit at the output of the sampler.

From the sampler the signals pass to an electronic combining device called Adder No. 1 in Figure 1. Standard synchronizing signals from the synchronizing generator are also applied at this point.

This signal and the synchronizing pulses from Adder No. 1 feed into the low-pass filter. In the case of large area color only, the mixed-highs signal is not present.

The narrow green pulses of Figure 2(a), occurring at a rate of 3.8 million pulses per second, are smoothed by the low-pass filter to give the result shown in Figure 2(b). This wave consists of a dc component, which is the average of the pulse sample, plus a sine wave which has a frequency of 3.8 megacycles (the filter having removed the higher order harmonics). The 3.8-megacycle sine wave and the dc component change together, as the green signal changes in strength, in such a way that the signal of Figure 2(b) always passes through zero at the same interval of time after the peak regardless of the strength of the green signal. The smoothed sample of the green signal may be expressed as: $\frac{1}{3} G(t) [1 + 2\cos(2\pi ft)]$ where $G(t)$ is the green signal as a function of time, and f is the sampling frequency, namely 3.8 megacycles. A study of this expression reveals that the smoothed green sample goes through zero 120 and 240 electrical degrees after the signal has reached its maximum value.

The above equation is an excellent approximation of the conditions existing in the circuit when the duty cycle of the samples for a given color is 15 per cent or less. Accordingly, the duty cycle of the system is maintained within these limits.

The red samples of Figure 2(c) are smoothed by the filter to yield the result shown in Figure 2(d). This again is made up of a dc component and a sine wave with a frequency of 3.8 megacycles.

Smoothing of the blue sampling pulses results in the contribution shown in Figure 2(f). It should be noted in Figures 2(b), 2(d), and 2(f) that when any one color signal reaches its maximum value, the other two responses are crossing the zero axis.

While the curves of Figures 2(b), 2(d), and 2(f) have been shown separately for illustrative purposes, it should be remembered that the pulse train of Figure 2(g) goes into the low-pass filter. Thus the composite signal of Figure 2(h) comes out of this filter. In this figure, the dc component is the sum of the dc components of the green, red, and blue signals, while the 3.8 megacycle sine wave is the sum of three sine waves of the same frequency. This results in a composite 3.8-megacycle sine wave with a new amplitude and phase position superimposed on the composite dc component.

The action of the system in the pick-up of varying color areas is illustrated by means of Figure 3. In Figure 3(a), the three color signals are shown as they enter the sampler, with the appropriate sampling pulses as they come out of the sampler indicated by vertical lines. These same pulses are shown in Figure 3(b), with the envelope indicating the result of smoothing in the filter. It will be appreciated that Figure 3 is not quantitative and is used purely for illustrative purposes. Fine detail of the color picture, carried by the higher frequency components, is, of course, now supplied by the mixed-highs signal, but this cannot be easily shown in the diagram.

TRANSMITTER

The output (time-multiplexed color signal, mixed-high color signal, and synchronizing signals) of the low-pass filter (zero to four megacycles) in the right center of Figure 1 is applied to the modulator of a conventional VHF or UHF television transmitter.

From this point on, including the transmitter itself, together with the vestigial sideband filter, diplexer, sound channel and antenna, the system is that of a normal black-and-white television station, with no changes necessary.

The signal transmitted is consistent with the "Standards of Good Engineering Practice Concerning Television Broadcast Stations."

RECEIVING EQUIPMENT CHARACTERISTICS

Figure 4 is a block diagram of one type of color television receiver. The radio-frequency circuits, the picture intermediate-frequency amplifiers, the second detector, the sync separator, the sound intermediate-frequency amplifiers, the discriminator, and the audio circuits are identical with those of a conventional black-and-white receiver.

The composite video and synchronizing signals from the second detector enter the sync separator, which removes the video signal and

sends the synchronizing pulses to the deflection circuits and to the sampling pulse generator.

Sampling and Smoothing Process

The sampling pulse generator utilizes the trailing edge of the horizontal synchronizing pulse to actuate the receiver sampler in identical fashion and in synchronism with the transmitter sampler.

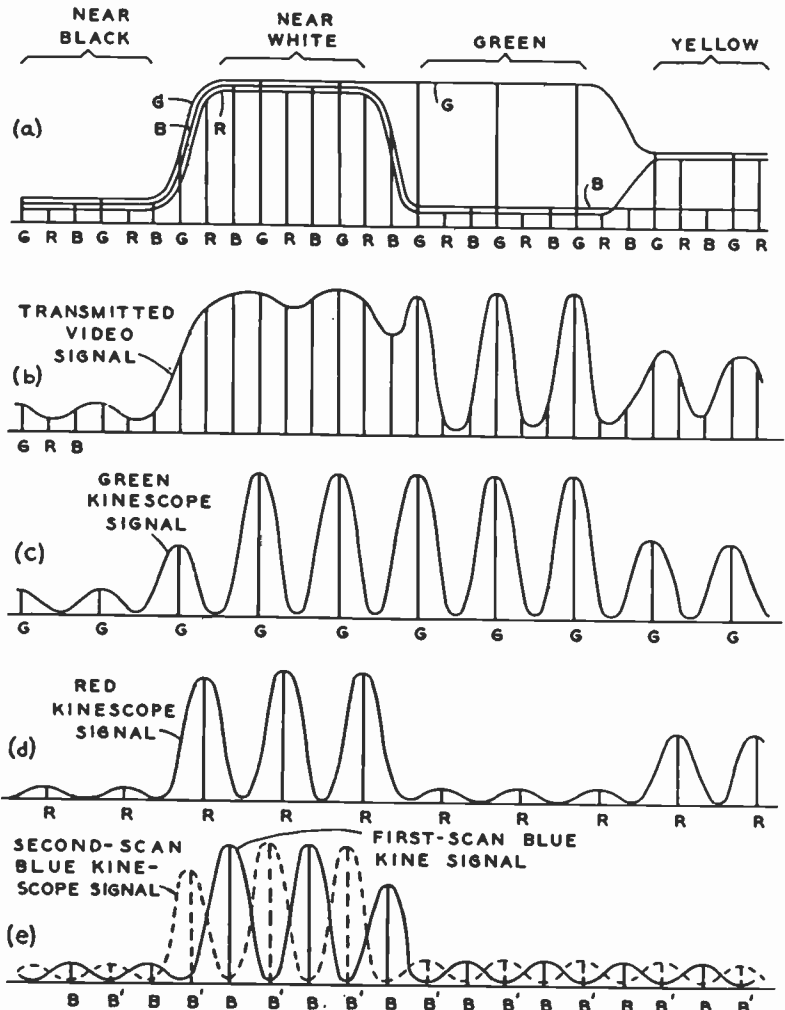

Fig. 3—Action of the system in the presence of varying color areas.

The signal from the second detector also enters the sampler. It has the same form as the composite signal of Figure 2(h), or as the solid

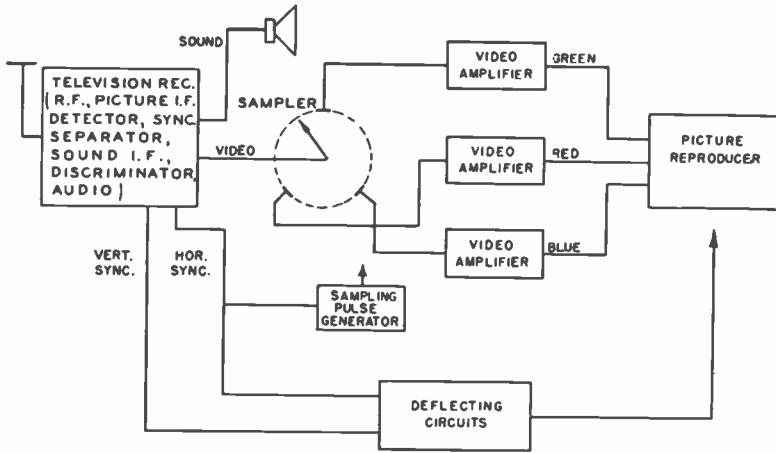

Fig. 4—Block diagram of one type of color television receiving equipment.

envelope of Figure 3(b). For ease of reference, Figure 2(h) has been reproduced as Figure 5(a). Again, the case of large uniform polychromatic areas is used for illustrative purposes.

The electronic commutator samples the composite signal every 0.0877 microsecond, producing the short pulses shown in Figure 5(a). The amplitude of each of these pulses is determined by the amplitude of the composite wave at that particular instant.

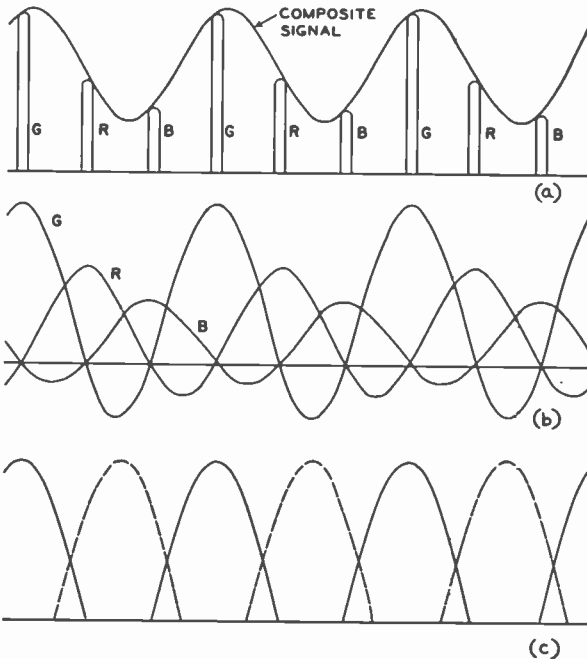

Fig. 5—Functioning of the sampling system at the receiving end.

The commutator feeds these pulses into three separate video amplifiers which in turn control the picture-reproducing apparatus which may consist of three cathode-ray tubes or kinescopes having appropriate color-producing phosphors. This method for portraying the single color picture with three kinescopes is similar to that demonstrated to the Commission during the Hearing on Docket No. 7896 and in References (1) and (2).

The video amplifiers have a flat frequency response to four megacycles, and must cut off completely at 7.6 megacycles. (Reference here is to the frequency response of the video amplifiers only and not to channel requirements.)

The sampler sends the pulses to each of the video amplifiers and its attendant kinescope in succession. For instance, in Figure 5(a), the first pulse shown in green goes to the green kinescope, the next pulse goes to the red, while the third pulse is sent to the blue. The green receives the fourth, seventh, tenth, and so on. Thus, while the individual pulses coming out of the sampler are 0.0877 microsecond apart, the green pulses going to the video amplifier for the green picture repeat every 0.263 microsecond. The green channel pulses of Figure 5(a), in passing through the video amplifier, lose all frequency components except the fundamental frequency of 3.8 megacycles and the dc component. The resultant smoothed signals are shown in Figure 5(b). The green, red, and blue signals are shown in superposition on this figure for illustration. It should be remembered that at this point the green signal shown is that fed to the green kinescope, while the red and blue signals are applied to their individual kinescopes.

Examination of Figures 2(b), 2(d), 2(f), and 2(h), has already revealed that, when the green signal is maximum, the red and blue signals are passing through zero. Hence, since the composite signal is sampled for green by a narrow pulse at the receiver at this exact instant, the receiver sampling pulse is a true measure of the green signal and includes no dilution from the red or blue signals. Likewise, the red and blue samples are each taken at points on the composite signal where no crosstalk is contributed from the other two color signals.

The above statement concerning absence of crosstalk holds good for all frequency components up to one-half the sampling frequency. For frequency components approaching the sampling frequency in order of magnitude, from a purely circuit aspect, crosstalk is present. However, the physiological characteristics of the eye which make possible the application of the mixed-highs principle apply equally well

to the crosstalk of the higher-frequency components. Consequently, crosstalk in the fine detail is of no consequence.

Assuming that the kinescope actually cuts off with negative applied signal, and neglecting the nonlinearity of the input control-voltage versus light-output characteristic of the kinescope, the solid lines of Figure 5(c) may be regarded as the effective light intensity along one line scan in green. Figures 3(c), 3(d), and 3(e) show the effective signals for the green, red, and blue kinescopes, again for a single line scan.

Picture Dot Interlacing and Scanning Sequence

Returning now to Figure 5(c), it may be seen that a single line scan on the green channel lays down a series of green dots on the screen as shown by the solid lines. As was indicated above, these dots occur at a rate of 3.8 million times per second. If fine detail were involved to such an extent that two adjacent pulses in the green channel in a single line scan were of different amplitude, it is basic that the highest frequency component of use in establishing picture detail would be a sine wave which went from a crest to a trough in the time between the two adjacent green pulses. This sine wave would then have a frequency of 1.9 megacycles.

The fact that each pulse has a rise equivalent to twice this frequency allows the use of picture-dot interlacing to secure full detail up to a frequency band 3.8 megacycles wide. This is accomplished by shifting the sampling pulses the next time that the same line is scanned so that the dots are then laid down between the dots that were laid down in the first scan. This second series of green dots is shown by the broken curves in Figure 5(c). In this figure, the dots shown by broken curves are the same amplitude as the dots shown by the solid curves. For resolution of very fine detail, the dots laid down in the first scan would differ in amplitude from the dots laid down in the second scan of this same line.

Inspection of Figure 5(d) reveals that while a single line scan lays down a series of green dots on the screen with space between dots, this space is filled at the same time by red and blue dots, with great overlapping of the dots. The effect of the successive scans of a single line, Figure 5(e), shows even more clearly the complete covering of the line area with picture dots of three colors.

The scanning and interlace pattern used in the new color television system is illustrated in Figure 6. Each letter represents the center of a color dot area on the screen. The actual areas, of course, overlap to a great extent as discussed above.

During the first scanning field, illustrated in the upper diagram in Figure 6, the odd numbered lines are scanned in order. Colored dots are laid down in order along line 1 as shown. Next, line 3 is scanned with a displacement for each color dot shown, in the same fashion as described for the sampling at the transmitting end. The remaining odd lines are scanned in order. This scanning of the first field takes place in one-sixtieth of a second.

During the second field, the even lines are scanned, first line 2 with the colors laid down as shown, then line 4, and so on. The dot pattern laid down during the third field is shown by the lower diagram, where the odd lines are scanned in succession. During the fourth field, the even lines are again scanned in succession with the color dot pattern shown.

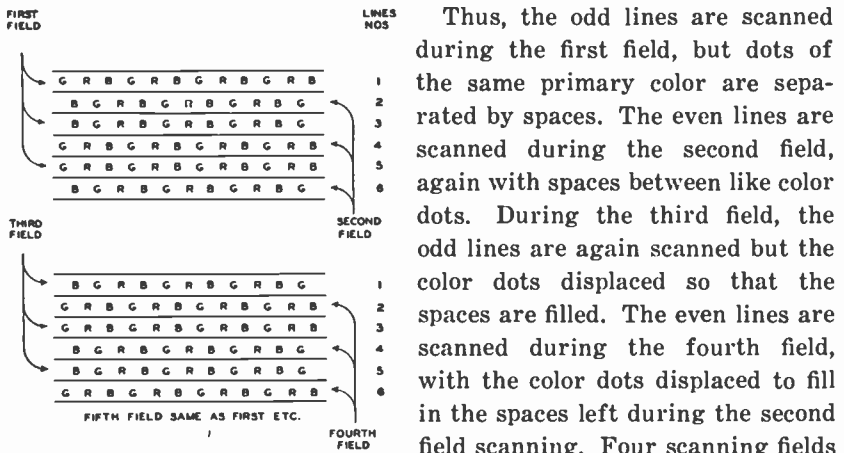

Fig. 6—Scanning and interlace pattern.

with say, green dots. Simultaneously, the area is being covered with red dots and with blue dots. Since there are 60 fields per second, it may be said that there are 15 complete color pictures per second.

It should be remembered that the effective rate for large-area flicker is 60 fields per second, the same as for current black-and-white receivers. At viewing distances such that the picture line structure is not resolved, the effect of small-area flicker due to line interlace and picture-dot interlace is not visible.

Receiving Systems

In the receiver shown in Figure 4, the total signal consisting of the sampled signal plus the mixed highs has been inserted in the

receiver sampler and picture-dot interlacing has been used to achieve high definition as discussed in detail above.

Another receiver arrangement is possible. In such a receiver, shown in Figure 7, the entire signal is fed into the sampler as before, but, in this case, low-pass filters with cut-off frequencies of approximately two megacycles are inserted between the sampler and the kinescopes. The low-frequency filters smooth out the pulses of Figure 5(c), so that the adjacent dots of a single color in one line scan now almost completely overlap. Because the pulses have been broadened by the two-megacycle filters in this receiver, horizontal resolution will not be increased by picture-dot interlacing at the receiver. Full resolution, however, is restored by obtaining mixed highs from the signal ahead of the receiver sampler and by-passing the mixed highs through a band-pass filter to the green, red, and blue kinescopes.

The color television receiver of Figure 4 and the alternate receiver of Figure 7 are examples of the flexibility afforded by this color system.

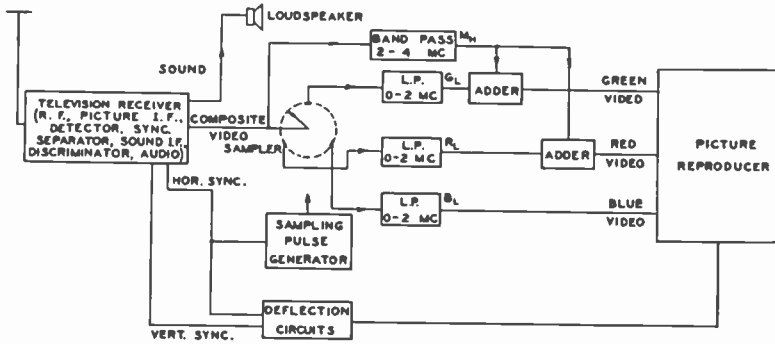

Fig. 7—Block diagram of color television receiver using by-passed highs

Reception in Black-and-White

When the color television signal is received on a current black-and-white receiver, the output of the second detector is represented by Figure 2(h), or, when the picture is of varying color, by the envelope of Figure 3(b). With mixed highs also transmitted as shown in Figure 1, the black-and-white receiver then develops on its kinescope a black-and-white picture with full resolution. The 3.8-megacycle sine wave superimposed on the picture signal produces a dot pattern on the kinescope in high chroma areas, but the dots are not visible at normal viewing distance. Examination of Figure 2 shows that in white areas, where the dot pattern would be objectionable if present, the three color signals are of the same amplitude and the composite signal consists of the dc components only. Hence, there is no dot pattern.

For color transmissions received in monochrome on a current black-and-white receiver, no band saving is involved, but because the transmitted signal contains all the resolution which a black-and-white signal of the same scene would have, the resulting monochrome picture will have the full resolution of the current standards.

Using the standard wedge pattern to test horizontal resolution, the same resolution figure has been obtained when reproducing the color transmission on an unchanged current model black-and-white receiver as may be obtained with the same receiver on a well-designed, well-adjusted black-and-white system using present broadcast standards. The vertical resolution is also consistent with current black-and-white standards.

When a color receiver is tuned to a television broadcasting station transmitting a black-and-white signal, the picture will appear in black-and white with full resolution on the color receiver picture reproducer. The successive pulses delivered to the three kinescopes will all be of equal magnitude, and, hence, will produce varying intensities of white—or a normal black-and-white picture.

RECEIVERS AND COLOR CONVERTERS*

Picture Reproducing Systems

One method for portraying a single color picture makes use of three kinescopes, reflective optics, and dichroic mirrors in a projection system. This has been previously demonstrated and described during the Hearing in Docket No. 7896 and in References (1) and (2).

Another method also makes use of three kinescopes in a projection system but uses refractive optics and dichroics instead of reflective optics. This system appears to lend itself more readily to compact design.

A third method uses three kinescopes with a pair of dichroic mirrors so arranged to permit essentially direct viewing. This system appears to lend itself more readily to a lower cost design.

A fourth method uses two kinescopes with a single dichroic mirror. This system appears particularly attractive for use in inexpensive receivers and color converters.

Because color receivers will probably be simplified by a color picture

* The various receivers and color converters illustrated and described in this section are research models designed to test and demonstrate the basic principles of the system. While indicative of possible approaches to the design of suitable receiving equipment, they are not intended to represent receivers and color converters of commercial design.

reproducer of the single-tube type, intensive research efforts on the problem are being continued.

Direct-View Receiver

Figure 8 represents a direct-view picture-reproducing system utilizing three kinescopes which are standard in every respect except that the phosphors are green, red and blue, respectively. The green, red and blue signals are impressed on the grids of their respective tubes. The deflecting yokes of the three tubes are connected in parallel, so that the rasters produced on the three screens are identical.

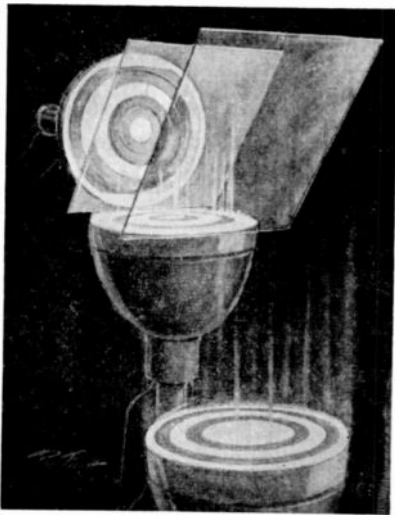

Fig. 8—Direct-view picture-reproducing system using three kinescopes and a pair of dichroic mirrors.

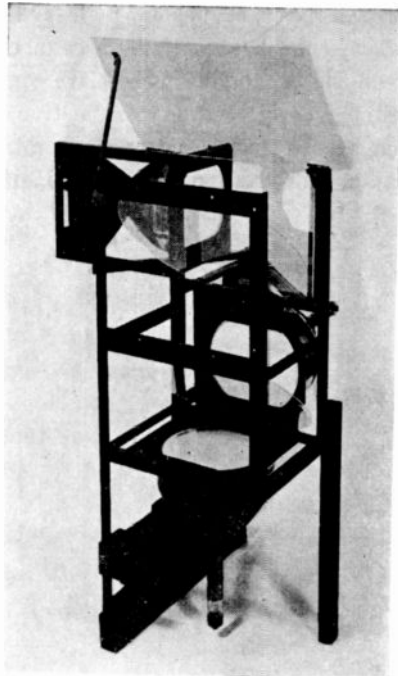

Fig. 9—Positioning of ten-inch kinescopes for direct-view picture-reproducing system.

The tubes are viewed through dichroic mirrors. The red dichroic mirror reflects the red image from the red tube, the blue dichroic mirror reflects the blue image from the blue tube, and both mirrors are transparent to green light, so that the green tube is viewed directly through both dichroic mirrors. The red dichroic mirror is also transparent to blue light, so it does not interfere with the blue image. The mirrors and tubes are properly arranged so that to the eye the three pictures appear superimposed and are viewed as one picture.

Figure 9 shows three standard-size ten-inch kinescopes and the two dichroic mirrors mounted in a framework for proper viewing from

the top, through a fully silvered mirror. A receiver using the above arrangement could be housed in a cabinet of the type shown in Figure 10. It is possible in this arrangement that, if the kinescopes are short-ended, the cabinet size can be materially reduced.

Projection Receiver

Another type of picture reproducing system is shown in Figure 11. This gives a projection picture, 15×20 inches. Three projection kinescopes are used which are standard except for the phosphors. Each tube control-grid is connected to the appropriate video channel, and the deflection yokes are supplied from a common source. Each tube is arranged in a reflective optical system. The light rays from each tube first strike a plane mirror, from which they are reflected to a spherical mirror of the proper focal length to produce an image on the screen. Beyond the spherical mirror the rays pass through a correcting lens and thence via a plane reflecting mirror to the projection screen.

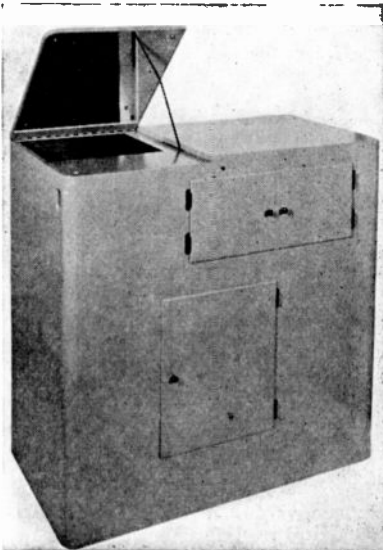

Fig. 10—One type of cabinet for direct-view receiver utilizing three kinescopes and a pair of dichroic mirrors.

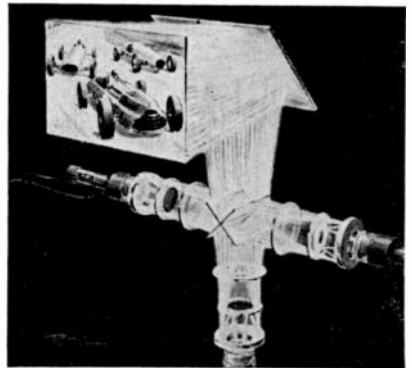

Fig. 11—Projection picture-reproducing system using three projection kinescopes, reflective optics and a pair of dichroic mirrors.

The green image passes through the red-and-blue-reflecting dichroic mirrors. The red image is reflected to the screen by the red-reflecting dichroic mirror. Similarly, the blue image is reflected to the screen by the blue-reflecting dichroic mirror. The complete optical system is so arranged that the three images are superimposed, in register and focus, on the projection screen, where they are viewed as a single color picture.

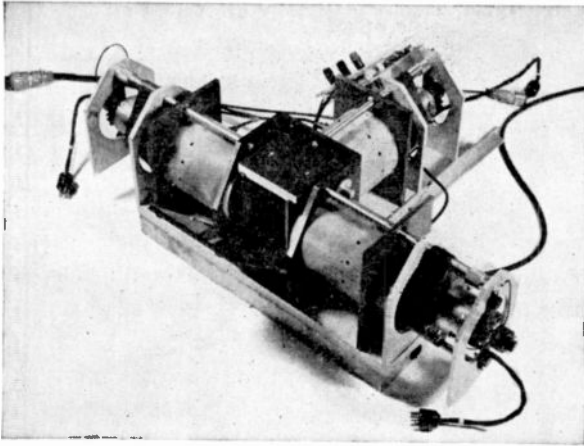

Fig. 12—Arrangement of the projection tubes and optical system used in the projection receiver.

Figure 12 is a photograph of the reflective optical system showing the mechanical arrangement of the projection tubes and the optical system. The receiver employing this system is shown in Figures 13 and 14.

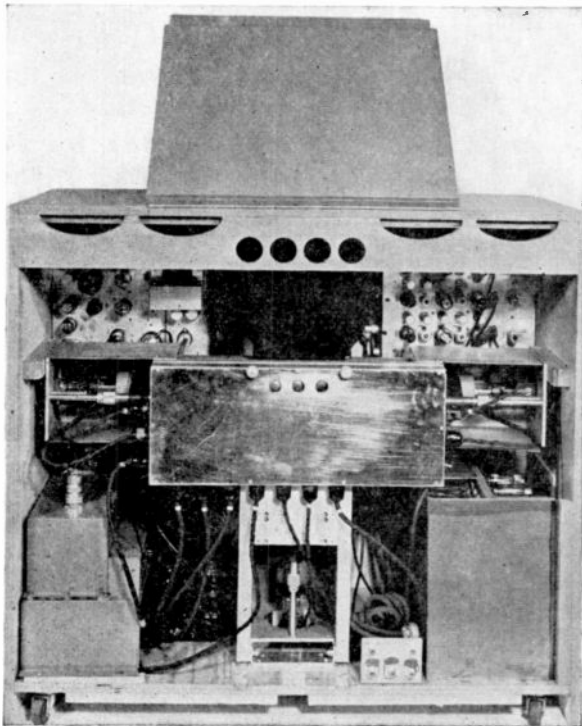

Fig. 13—Rear view of the projection receiver with 15 by 20 inch picture.

Projection Receiver with Magnifying Lens

The same type of projection picture reproducing system, referred to above, is used in the television receiver shown in Figure 15. Here the projected picture is smaller, and is viewed through a magnifying lens.

Color Converters

To convert a current black-and-white receiver to receive color transmissions in color requires the addition of color sampling circuits and a picture reproducer.

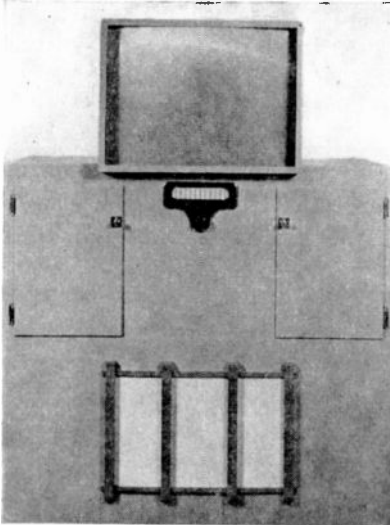

Fig. 14—Projection receiver with 15 by 20 inch picture.

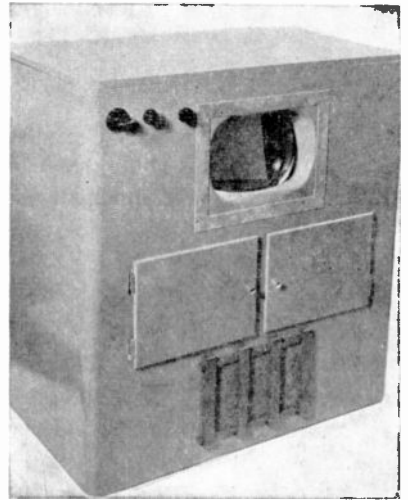

Fig. 15—Projection receiver using reflective optics and magnifying lens.

The size of the color converter for a direct-view picture or for a large projected picture is determined by the size of the kinescopes and the optical system. When the cabinet size and shape have been determined by these elements, the circuit components which need to be added to those already available in the black-and-white receiver can be fitted around the kinescopes and optical system in the cabinet without increasing its size.

A direct-view converter using three 10-inch kinescopes is shown in Figure 16. Interconnections between the standard receiver and the converter are made by a simple harness cable plugged into the tube sockets of the standard receiver. (Reduction in cabinet size through the use of shorter kinescopes, previously mentioned in connection with the direct-view color receiver, applies as well to this color converter.)

A smaller color converter can also be made which gives a projected picture. Three $1\frac{1}{2}$ -inch projection tubes are mounted as shown in Figure 17. The complete kinescope and optical system assembly is mounted on the back of a standard television receiver, which can be either a table model or a console. The kinescope (any size) is removed from the black-and-white receiver and the color picture is projected, through the space it occupied, to a screen mounted in the normal picture-mask opening. An additional chassis containing the sampling circuits, reflecting circuits and power supplies is mounted under or back of the television receiver.

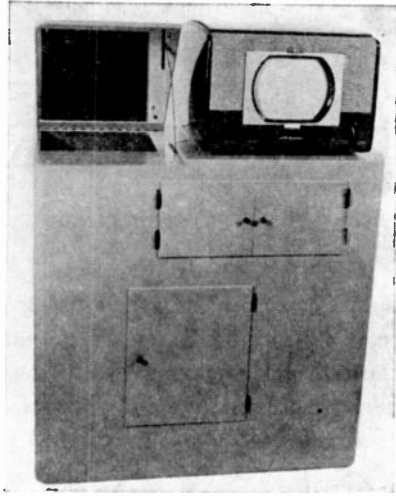

Fig. 16—Direct-view color converter.

Figure 17 shows this system as applied to a color converter, but the principles apply equally well for a color receiver.

Two-Color Systems

Color transmissions can be received on a simplified receiver which reproduces the picture in two colors only, instead of three. The two colors used are green-red and blue-green.

A block diagram of such a receiver is shown in Figure 18. This system is similar to that shown in Figure 4 except that only two video channels are required, and the method of sampling the composite signal is altered.

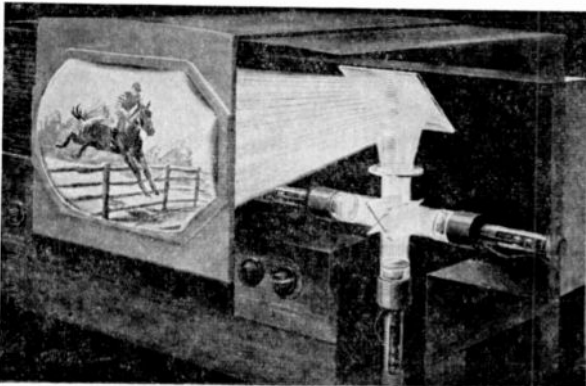
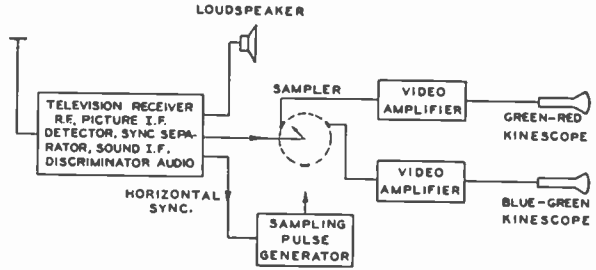

Fig. 17—Color converter using small projection kinescopes and refractive optics.

Fig. 18—Block diagram of two-color television receiver.



With reference to Figure 3, it was explained that, for the three-color system, the composite signal was sampled for green at the instant the red and blue components were passing through zero. In like manner, it was sampled for red and for blue when the other two colors in each case were zero. Figure 19 represents the same signals as Figure 2 and shows the different positions of the sampling pulses for a two-color picture-reproducing system.

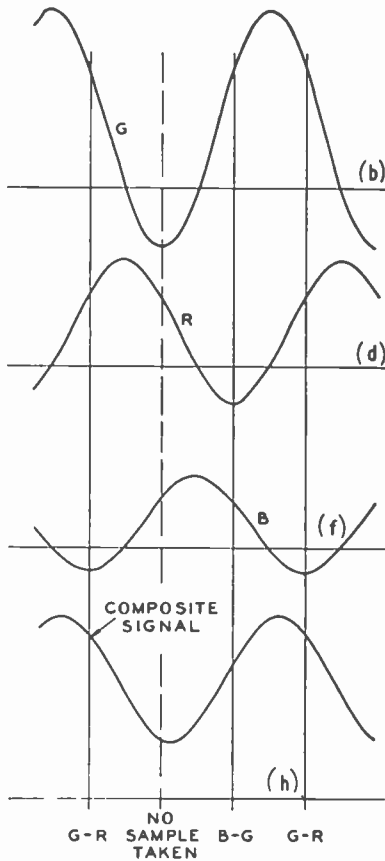

Fig. 19—Receiver sampling positions for the two-color system.

The composite signal is sampled for blue-green at a time when both blue and green components are present in a positive direction. This is indicated by the line labeled *B-G*. The composite signal is sampled for green-red at a time represented by the lines marked *G-R*. As indicated in Figure 19, no sample is taken at the third point. The sampling is repeated for each of the two color combinations once each 0.263 micro-second.

After the composite signal is sampled, the two color signals are amplified in separate video amplifiers having frequency cutoff characteristics as described in connection with the three-color receiver. They are then impressed on the grids of their respective kinescopes.

In the case of a color converter for an existing black-and-white receiver, the black-and-white kinescope in the receiver is used with a

suitable color filter placed in front of it. Another kinescope is added and viewed through a dichroic mirror and suitable color filter.

The color converter employing this two-color system is shown in Figure 20. All of the components of the standard black-and-white receiver are used, including the deflecting circuits and second anode power supply. The only equipment that is added is the second kinescope and the sampling circuit. Connections between the television receiver and the color converter are few and are easily made. The foregoing points to the possibilities for a very low-cost color converter.

The principle of the two-color system is illustrated in Figure 21.

The two-color picture-reproducing system is also applicable to a simple and inexpensive color re-

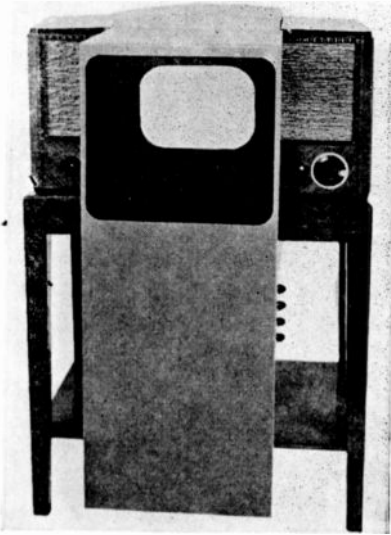

Fig. 20 — Color converter using two-color picture-reproducing system.



Fig. 21 — Two-color picture-reproducing system.

ceiver. In this case, however, the two kinescopes will be made with the proper color phosphors and no filters are required.

SUMMARY OF SYSTEM CHARACTERISTICS

The all-electronic color television system described herein is a fully compatible system, employing the current standards of 525 lines, sixty fields per second, and line interlacing. It provides a high-definition color (and black-and-white) picture in the standard six-megacycle channel through the use of the mixed-highs principle and time-multiplexing with picture dot interlacing.

The transmitted signal is consistent with the "Standards of Good Engineering Practice Concerning Television Broadcast Stations." This is the fundamental basis for compatibility and means that a current monochrome receiver will respond in the same way as it would if a standard black-and white camera originated the picture signal.

AN ANALYSIS OF THE SAMPLING PRINCIPLES OF THE DOT-SEQUENTIAL COLOR TELEVISION SYSTEM*†

A Report

By

RCA LABORATORIES DIVISION, PRINCETON, N. J.

Summary—This paper deals quantitatively with a number of aspects of the dot-sequential color television system, namely, the influence of sampling pulse width on color cross talk, the response of standard monochrome television receivers and color television receivers to sinusoidal variations and to step functions, the manner in which the method of mixed highs combines with the sampling procedure to produce high-frequency detail, and circuit methods of eliminating cross talk.

INTRODUCTION

A QUALITATIVE description of the sampling procedure and the use of mixed highs, as well as the dot-interlacing method of increasing detail used in the RCA dot-sequential color television system, has already been published.¹ The reader is referred to that paper for background material. A quantitative discussion of a number of aspects of the system is given in the following pages.

CROSS TALK AS A FUNCTION OF THE WIDTH OF THE SAMPLING PULSE

A block diagram of the color television broadcasting station is shown in Figure 1. The studio apparatus provides three electrical signals, one for each of the primary colors (green, red and blue). Each of these signals may contain frequency components out to at least four megacycles, and in addition an average or dc component.

For one signal routing of Figure 1, each color signal passes through a low-pass filter which eliminates frequency components above a frequency f_A megacycles. Where this paper deals with numerical values, f_A will be taken as 2.0 megacycles. The green-channel signal coming out of its particular low-pass filter is designated as G_L in Figure 1, indicating that at this point the signal contains the dc component and ac components with frequencies of f_A or less. The three low-frequency

* Decimal Classification: R583.1.

† Reprinted from *RCA Review*, June, September, 1950.

¹ "A Six-Megacycle Compatible High-Definition Color Television System", *RCA Review*, Vol. X, No. 4, pp. 504-524, December, 1949.

signals, G_L , R_L , and B_L are then sent into an electronic commutator or sampler.

For the second signal routing of Figure 1, the three color signals from the camera are combined in electronic Adder No. 2 and then are passed through a band-pass filter. The output of this filter contains frequencies from f_A to f_B megacycles, with contributions from each of the three color channels. For calculation purposes, f_B has been taken as 4.1 megacycles. The signal at the output of the band-pass filter is designated as M_H , the mixed-high signal. The mixed high frequencies are fed to Adder No. 1 which is also receiving the signal from the electronic sampler.

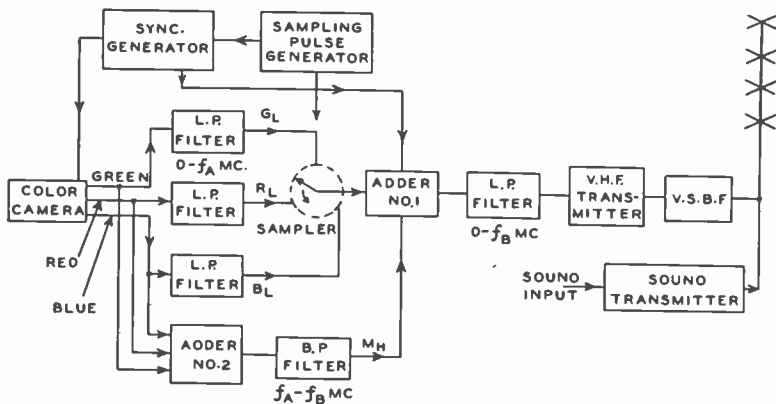

Fig. 1—Block diagram of the color television transmitter.

The frequency relationships in the system are depicted in Figure 2, with the following numerical values chosen for purposes of illustrative calculation:

f_0 = frequency of sampling pulse generator (3.8 megacycles),

f_A = upper limit of frequencies into the transmitter sampler and lower limit of mixed high frequencies (2.0 megacycles),

f_B = maximum frequency component transmitted by the system (4.1 megacycles). This upper limit may be determined by the receiver or transmitter cut-off characteristic, whichever is most restrictive.

$f_B - f_0$ = upper limit of frequencies free from inherent color cross talk without circuit devices (0.3 megacycle).

Figure 3 is a block diagram of one type of color television receiver. The output of the receiver sampler may go through separate video amplifiers to the picture reproducer, which may consist of three sepa-

rate kinescopes, as indicated in FCC Exhibit 309,² or the composite signal may go from the second detector through a single video amplifier to a point where the three kinescope grids are tied in parallel. The keying or sampling is accomplished by applying short negative pulses in sequence to the cathodes of the kinescopes, as described in FCC Exhibit 316.³

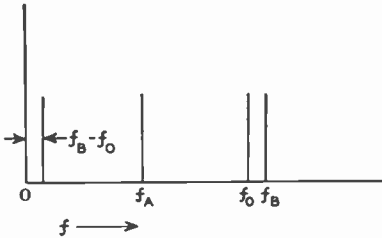

Fig. 2—Frequency relationships in the dot-sequential color television system.

f_B = upper frequency limit of system.

f_0 = frequency of sampling of individual colors.

f_A = maximum frequency of signals into the transmitter sampler (also lower frequency limit of mixed highs).

$f_B - f_0$ = upper limit of frequencies free from inherent color cross talk without circuit devices.

The sampling procedure, at either the transmitter or the receiver, may be described in mathematical terms. Suppose that a signal G is applied to one grid of an electronic tube and that the tube has such characteristics that the output signal is always proportional to the signal G . In addition, a second grid is heavily biased except for regular periodic short intervals when this grid is driven to some prescribed positive value. The signal on this second grid thus acts as a gate on the signal G , and the output signal is proportional to signal G when the second grid is positive and the output signal is zero when the second grid is heavily biased.

The output signal may then be regarded as the product of the signal G and the gating signal. A representative gating signal is shown in Figure 4. The period or time between successive gates is T , while the duration of a gate pulse is ΔT . The sampling frequency, $f_0 = 1/T$. The duty factor of the gate may be defined as $F = \Delta T/T$. Then, if the output is proportional to a signal G , the Fourier series for the gated product is

$$G(t) = G \cdot F \left[1 + 2 \sum_{n=1}^{n=\infty} a_n \cos(n\omega_0 t) \right], \quad (1)$$

where

$$a_n = \frac{\sin(n\pi F)}{n\pi F},$$

² "A Three-Color Direct-View Receiver for the RCA Color Television System", Bulletin, RCA Laboratories Division, January 9, 1950.

³ "A Simplified Receiver for the RCA Color Television System", Bulletin, RCA Laboratories Division, February 28, 1950.

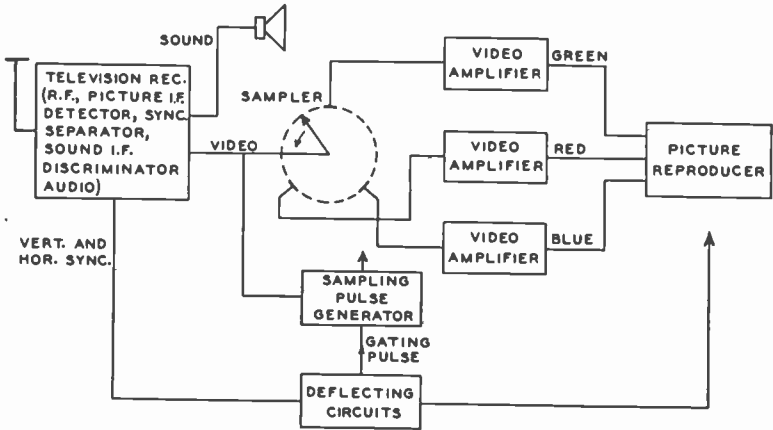

Fig. 3—Block diagram of one type of color television receiver.

and $\omega_0 = 2\pi f_0$.

The input signal G may be varying as a function of time, but for this first consideration of cross talk, G will be constant; that is, a flat green area is scanned.

The Fourier coefficients of the gating pulse shown in Figure 4 are displayed in Figure 5 for $n = 1$ and $n = 2$, as a function of the duty factor F .

Assume that the only signal from the color camera of Figure 1 is for the moment a dc signal from the green camera tube. After sampling at the transmitter, the signal at Adder No. 1 is

$$\frac{G}{3} \left[1 + 2 \sum_{n=1}^{\infty} a_n \cos(n\omega_0 t) \right]. \tag{2}$$

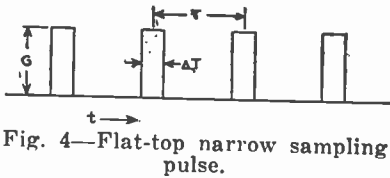

Fig. 4—Flat-top narrow sampling pulse.

$$G(t) = G \cdot F \left[1 + 2 \sum_{n=1}^{\infty} a_n \cos(n\omega_0 t) \right],$$

where $F = \text{duty factor} = \frac{\Delta T}{T}$,

$$a_n = \frac{\sin(n\pi F)}{n\pi F}, \quad \omega_0 = 2\pi f_0, \quad f_0 = \frac{1}{T}.$$

Since the sampling frequency is 3.8 megacycles and the upper pass limit of the transmitter is considered to be 4.1 megacycles, only the fundamental term of the summation is retained. Then the signal out of the receiver second detector is

$$\frac{G}{3} \left[1 + 2a_1 \cos(\omega_0 t) \right]. \tag{3}$$

The sampling of this signal at the receiver for a single color channel may be obtained by multiplying (3) by the Fourier series of (1), but assuming a phase displacement of θ degrees. (Green channel, $\theta = 0^\circ$; blue channel, $\theta = 120^\circ$; red channel, $\theta = 240^\circ$.) Hence the signal at a particular color kinescope is

$$\begin{aligned} \frac{G}{9} [1 + 2a_1\cos(\omega_0 t)] [1 + 2b_1\cos(\omega_0 t + \theta) + 2b_2\cos(2\omega_0 t + 2\theta) + \dots] \\ = \frac{G}{9} [1 + 2a_1b_1\cos\theta \\ + 2a_1\cos(\omega_0 t) + 2b_1\cos(\omega_0 t + \theta) + 2a_1b_2\cos(\omega_0 t + 2\theta) \\ + 2a_1b_1\cos(2\omega_0 t + \theta) + 2b_2\cos(2\omega_0 t + 2\theta) + 2a_1b_3\cos(2\omega_0 t + 3\theta) \\ + \dots]. \end{aligned} \quad (4)$$

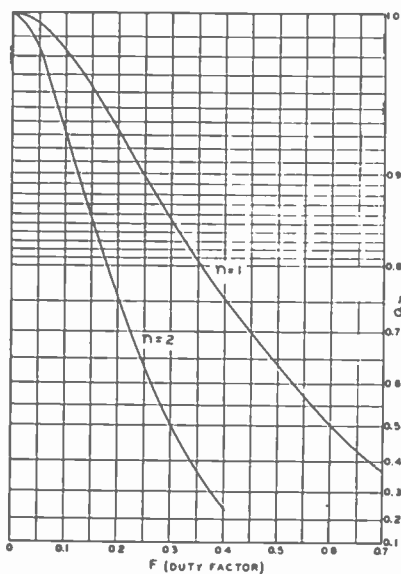

Fig. 5—Fourier coefficients of the sampling pulse of Figure 4 as a function of duty factor.

In (4), b_n has been used for the Fourier coefficients at the receiver sampling to avoid confusion with the a_n values used at the transmitter. Figure 5 applies equally well to b_1 and b_2 as it did to a_1 and a_2 .

The terms containing $2\omega_0 t$ or greater may be dropped from (4), with the result

$$\begin{aligned} \frac{G}{9} [1 + 2a_1b_1\cos\theta \\ + 2a_1\cos(\omega_0 t) + 2b_1\cos(\omega_0 t + \theta) \\ + 2a_1b_2\cos(\omega_0 t + 2\theta)]. \end{aligned} \quad (5)$$

The signal on the green kinescope is obtained by setting θ equal to zero in the above expression which then becomes

$$\frac{G}{9} [1 + 2a_1b_1 + 2(a_1 + b_1 + a_1b_2) \cos(\omega_0 t)], \quad (6)$$

and the peak signal on the green kinescope (PS_g) is

$$PS_p = \frac{G}{9} [1 + 2(a_1 b_1 + a_1 + b_1 + a_1 b_2)]. \quad (7)$$

By setting θ equal to 120 degrees or 240 degrees, and following through the proper manipulation, one may find the peak signal on the red or the blue kinescope. Since the peak signals on the blue and the red kinescopes due to cross talk are equal in magnitude and shifted in time, it is necessary to examine only one of these signals. Cross talk (CT) may be defined as the ratio of the peak signal on the red kinescope to the peak signal on the green kinescope. Then

$$CT = \frac{1 - a_1 b_1 + 2 \sqrt{a_1^2 + b_1^2 + a_1^2 b_2^2 - a_1 b_1 - a_1^2 b_2 - a_1 b_1 b_2}}{1 + 2(a_1 b_1 + a_1 + b_1 + a_1 b_2)}. \quad (8)$$

Three combinations of duty factor choices are interesting to examine.

Case I. Duty factor of sampling at transmitter equal to duty factor of sampling at the receiver ($a_1 = b_1$).

Equation (8) then becomes

$$CT = \frac{1 - b_1^2 + 2b_1(1 - b_2)}{1 + 2b_1(2 + b_1 + b_2)}. \quad (9)$$

The attendant cross talk is shown by the top curve of Figure 6.

Case II. Duty factor of sampling at transmitter very small ($a_1 = 1$).

Equation (8) then reduces to

$$CT = \frac{1 - b_1 + 2 \sqrt{1 + b_1^2 + b_2^2 - b_1 - b_2 - b_1 b_2}}{1 + 2(1 + 2b_1 + b_2)}, \quad (10)$$

and the cross talk is shown by the middle curve of Figure 6. It may be seen that for a large duty factor at the receiver, the reduction in cross talk achieved by a short duty factor at the transmitter is small.

Case III. Duty factor of sampling at receiver very small ($b_1 = b_2 = 1$).

In this case, Equation (8) reduces to the very simple form

$$CT = \frac{1 - a_1}{1 + 2a_1}. \quad (11)$$

This cross-talk condition is shown by the lower curve in Figure 6.

The analysis displayed in Figure 6 shows the importance of maintaining a short duty factor at the receiver sampler. Since it is possible

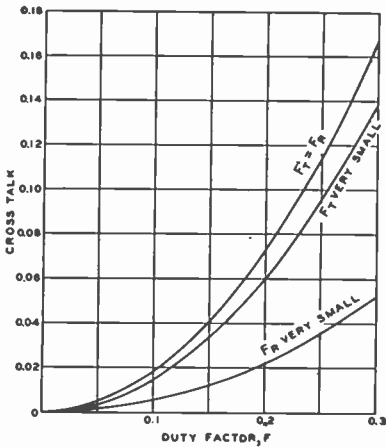

Fig. 6—Cross talk as a function of the duty factor of sampling.

Upper curve—duty factor of sampling at transmitter equal to duty factor of sampling at receiver.

Middle curve—duty factor of sampling at transmitter very small.

Lower curve—duty factor of sampling at receiver very small.

to maintain the effect of a short duty cycle at the transmitter sampler both by gating control and circuit adjustment, it would appear that the middle curve of Figure 6 would be applicable for the actual receiver conditions. It may be seen that when the duty factor at the receiver is maintained at less than 0.15, the cross-talk signal remains at least 30 to 1 down from the desired signal.

For the remainder of the analysis in this report, it will be assumed that the lessons pointed out by Figure 6 will be well learned. Hence $a_1=b_1=b_2=1$ will be used in the following analysis. To do otherwise would cloud the results in unnecessary rigor and would add little to the knowledge gained.

THE SAMPLING PROCEDURE APPLIED TO LARGE COLOR AREAS WITH A SINUSOIDAL VARIATION OF THE COLOR

a. A large green area with no variation

The green signal from the camera is assumed to be constant in magnitude, of value G . Figure 7(a) shows this fixed value, where G has been set equal to unity. Under the new assumptions ($a_1=b_1=b_2=1$), the signal to the transmitter modulator is given by Equation (3) as

$$\frac{G}{3} [1 \pm 2 \cos(\omega_0 t)], \quad (12)$$

where the plus sign applies for the first scan of the particular line and the minus sign applies to the second scan of the same line. This shift of the sampling by one half of the sampling cycle is accomplished by

the methods described in FCC Exhibit 314.⁴ The plot of Equation (12) for the two scans of the same line is shown in Figure 7(b).

The signal from the second detector or on the kinescope grid of a conventional black-and-white television receiver will also be given by Equation (12). Hence the solid line of Figure 7(b) may be regarded as the voltage applied to the kinescope grid of a black-and-white receiver during the first scan of a particular line, while the broken line is the corresponding voltage during the second scan of the same line.

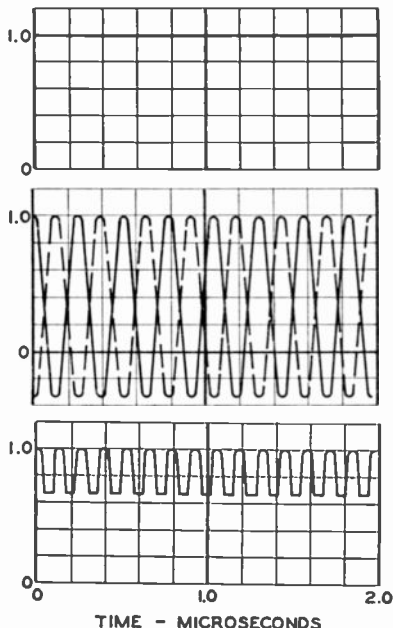

Fig. 7(a) (top)—Constant signal out of green camera tube.

(b) (middle) — Signal to transmitter modulator. Also the signal on the kinescope grid of a conventional black-and-white receiver, as well as the signal on the green kinescope grid of a color receiver.

(c) (bottom)—Combined light intensity of two successive scans of the same line on a conventional black-and-white receiver, and the combined light intensity of two successive scans of the same line on a color television receiver.

Assuming that the kinescope actually cuts off with negative applied signal, and neglecting the non-linearity of the input control-voltage versus light-output characteristic of the kinescope, the solid line above the axis may be regarded as the effective light intensity along one line scan, while the portion of the dotted line above the axis may be regarded as the effective light intensity along the same line in the next scan. Since the second scan of the same line occurs only one-thirtieth of one second after the first scan, Talbot's law indicates that the light intensities may be added as far as the effect upon the eye is concerned. Figure 7(c) was constructed from the positive values of Figure 7(b) and may be regarded as the response on a conventional black-and-white receiver.

Turning now to the color receiver of Figure 3, the signal on the green kinescope may be obtained directly from Equation (6) by letting $a_1 = b_1 = b_2 = 1$. Then Equation (6) becomes Equation (12), and Figure 7(b) may now be regarded as the voltage on the green kinescope

⁴ "Recent Developments in Color Synchronization in the RCA Color Television System", Bulletin, RCA Laboratories Division, February 9, 1950.

grid during the first and second scans of the same line, while Figure 7(c) depicts the light intensity distribution on one line of the green kinescope due to two successive scans of the line.

The signal on the grid of the red kinescope is determined by setting θ equal to 240 degrees in Equation (5), and for the assumed condition of narrow sampling which sets $a_1 = b_1 = b_2 = 1$, the result is identically zero. Similarly, by setting θ equal to 120 degrees, the signal on the grid of the blue kinescope is found to be zero. Hence, with narrow sampling of a dc signal which represents a flat field of a single color, there is no cross talk into the other two color channels.

b. $G + g \cdot \sin(\omega t)$ where $0 < f < f_B - f_o$

In this particular case, the green area is slowly varying so that the electrical signal is made up of a dc component and an ac component of frequency f where $0 < f < f_B - f_o$. This frequency region may be noted on Figure 2. For purposes of illustration, f_B has been chosen equal to 4.1 megacycles and f_o equal to 3.8 megacycles, hence the frequency of variation dealt with in this section must be less than 0.3 megacycle.

The signal out of the green camera tube is $G + g \cdot \sin(\omega t)$ where ω is $2\pi f$. This signal is sampled at the transmitter sampler in the fashion of Equation (3) so the signal at Adder No. 1 in Figure 1 is

$$[G + g \cdot \sin(\omega t)] \cdot \frac{1}{3} \cdot [1 + 2\cos(\omega_o t)]. \quad (13)$$

Equation (13) could be expanded to develop the sidebands generated by the product $\sin(\omega t) \cdot \cos(\omega_o t)$. It would be found that the sidebands have frequencies $f_o + f$ and $f_o - f$, both of which would pass through the filter and the transmitting system. Accordingly, there is no need to make the expansion for this case.

Equation (13) also represents the signal on the kinescope grid of a conventional black-and-white television receiver. Reversing the sign in the second bracket expression yields the equation for the second scanning of the same line.

When $G = 1$ and $g = 1/2$, the signal out of the green camera tube is $G + g \cdot \sin(\omega t) = 1 + 1/2 \sin(\omega t)$. The frequency has been taken as 0.2 megacycle. Figure 8(a) shows the signal out of the green camera tube for this condition.

Figure 8(b) shows a plot of Equation (13) for this same condition

and may be regarded as the voltage on the kinescope of a conventional black-and-white receiver for two successive scans of the same line. Figure 8(c) shows a summation which depicts the effective light intensity on the same line of the black-and-white receiver tube.

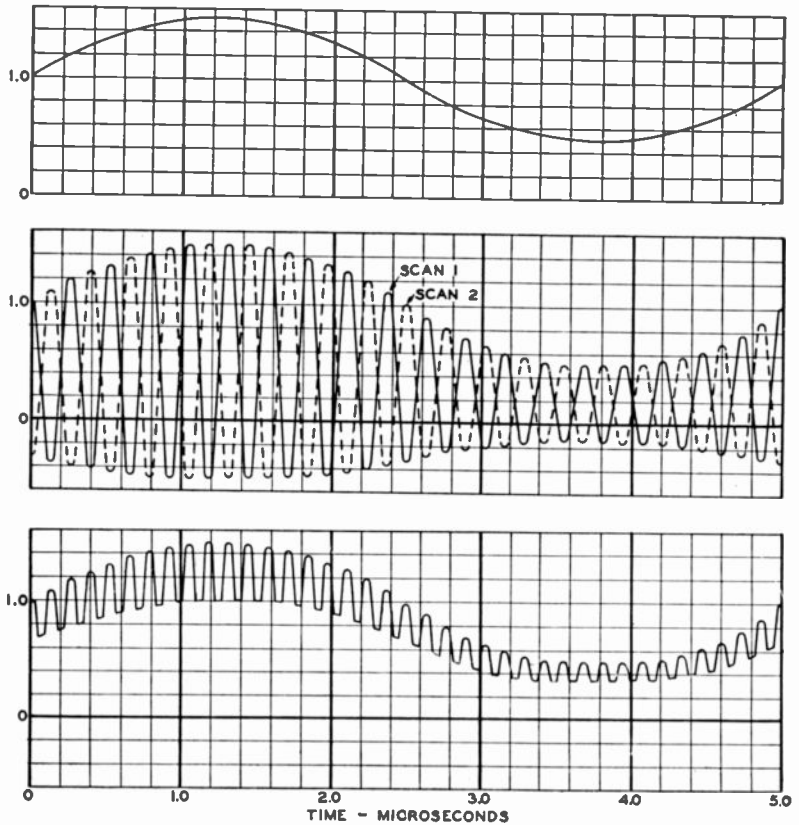

Fig. 8(a) (top)—Signal out of green camera tube; $f = 0.2$ megacycle, $G + g \cdot \sin(\omega t) = 1 + 1/2 \sin(\omega t)$.

(b) (middle)—Signal to transmitter modulator. Also the signal on the kinescope grid of a conventional black-and-white receiver, as well as the signal on the green kinescope grid of a color television receiver.

(c) (bottom)—Combined light intensity of two successive scans of the same line on a conventional black-and-white receiver, and the combined light intensity of two successive scans of the same line on a color television receiver.

Equation (13) is also the signal out of the second detector of the color receiver into the sampler. The sampling of this signal at the receiver for a single color channel may be obtained by multiplying (13) by the Fourier series of (1), but assuming a phase displacement of θ

degrees. Of course, a short sampling is assumed so that the Fourier coefficients are unity. Hence the signal at a particular color kinescope is

$$\begin{aligned} & \frac{1}{9} [G + g \cdot \sin(\omega t)] [1 + 2\cos(\omega_0 t)] [1 + 2\cos(\omega_0 t + \theta) \\ & \quad + 2\cos(2\omega_0 t + 2\theta) + \dots], \\ = & \frac{1}{9} [G + g \cdot \sin(\omega t)] [1 + 2\cos\theta \\ & \quad + 2\cos(\omega_0 t) + 2\cos(\omega_0 t + \theta) + 2\cos(\omega_0 t + 2\theta) \\ & \quad + 2\cos(2\omega_0 t + \theta) + 2\cos(2\omega_0 t + 2\theta) + 2\cos(2\omega_0 t + 3\theta) \\ & \quad + 2\cos(3\omega_0 t + 2\theta) + 2\cos(3\omega_0 t + 3\theta) + 2\cos(3\omega_0 t + 4\theta) \\ & \quad + \dots]. \end{aligned} \quad (14)$$

Now to find the signal on the green kinescope grid, simply let θ equal zero in (14), which reduces to

$$[G + g \cdot \sin(\omega t)] \cdot \frac{1}{3} \cdot [1 + 2\cos(\omega_0 t)]. \quad (15)$$

Since (15) is identical with (13), it is seen that Figure 8(b) may be regarded as the voltage applied to the kinescope of the green tube in the color receiver for two successive scans of the same line, and Figure 8(c) may be regarded as the equivalent light intensity variation for two scans of the same line.

To find the signal on the grid of the blue kinescope, set θ equal to 120 degrees in Equation (14) and it will be seen that the second bracketed expression goes to zero. If θ is then set equal to 240 degrees, an identical result is found, indicating no signal on the red tube.

Hence, when the frequency of variation is less than $f_B - f_0$, there is no cross talk and the single-color field is reproduced correctly in magnitude and position by the sampling procedure.

c. $G + g \cdot \sin(\omega t)$ where $f_B - f_0 < f < f_A$

In this case, the green area is varying so that the electrical signal is made up of a dc component and an ac component of frequency f , where $f_B - f_0 < f < f_A$. This frequency region may be noted on Figure 2, and for illustrative purposes lies between 0.3 megacycle and 2.0 megacycles.

The signal out of the green camera tube is $G + g \cdot \sin(\omega t)$. For purposes of illustration, f has been chosen to be 1.6 megacycles, $G = 1$ and $g = 1/2$. Figure 9(a) shows this signal, $1 + 1/2 \sin(\omega t)$.

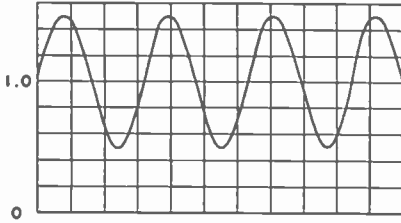

Fig. 9(a) — Signal out of green camera tube; $f = 1.6$ megacycles, $G + g \cdot \sin(\omega t) = 1 + 1/2 \sin(\omega t)$.

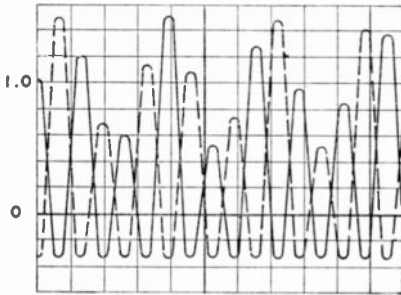

Fig. 9(b) — Signal to transmitter modulator. Also the signal on the kinescope grid of a conventional black-and-white receiver.

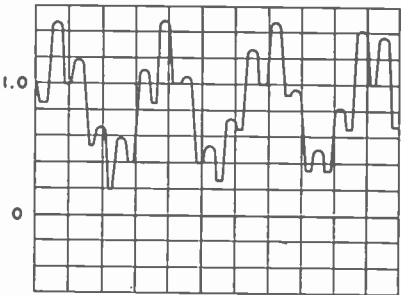

Fig. 9(c) — Combined light intensity of two successive scans of the same line on a black-and-white receiver.

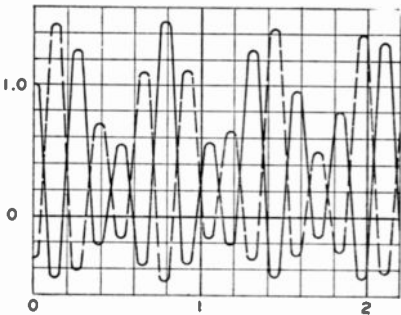

Fig. 9(d) — Signal on the green kinescope grid of a color television receiver.

TIME - MICROSECONDS

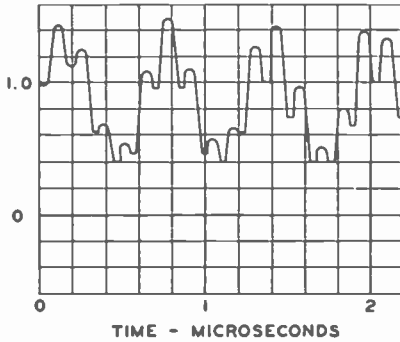

Fig. 9(e)—Combined light intensity of two successive scans of the same line on the green kinescope of a color television receiver.

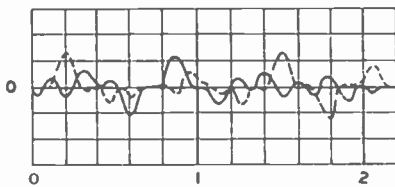

Fig. 9(f) — Cross talk voltage on red kinescope grid.

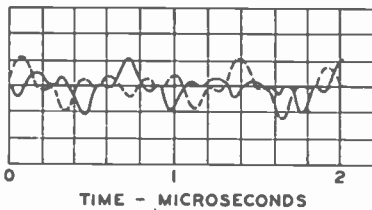

Fig. 9(g) — Cross talk voltage on blue kinescope grid

The signal from the green camera tube is sampled so that the signal at Adder No. 1 in Figure 1 is

$$\begin{aligned}
 & [G + g \cdot \sin(\omega t)] \cdot \frac{1}{3} [1 + 2\cos(\omega_0 t)] \\
 &= \frac{g}{3} [1 + 2\cos(\omega_0 t)] + \frac{g}{3} \sin(\omega t) - \frac{g}{3} \sin(\omega_0 - \omega)t + \frac{g}{3} \sin(\omega_0 + \omega)t. \quad (16)
 \end{aligned}$$

Since $f > f_B - f_0$, $f_0 + f > f_B$ and the last term in (16) is lost in going through the final filter before the transmitter in Figure 1. (This filter is not necessarily a physical reality, but serves the purpose of specifying the upper limit of frequencies that may be transmitted. It is likely that the upper frequency restriction will be imposed by the receiver rather than the transmitter.) Hence the signal at the modulator is

$$\frac{G}{3} [1 + 2\cos(\omega_0 t)] + \frac{g}{3} \sin(\omega t) - \frac{g}{3} \sin(\omega_0 - \omega)t. \quad (17)$$

Inspection of (17) shows that the loss of one of the terms with a coefficient $g/3$ has made it impossible for (17) to reproduce the desired variation in correct amplitude. This condition may be corrected by altering the response characteristics of the low-pass filters preceding the sampler in the transmitter of Figure 1. The filters should have a response in the region $f_B - f_o < f < f_A$ which is 1.5 times the gain in the region $0 < f < f_B - f_o$. Under this new condition, (17) becomes

$$\frac{G}{3} [1+2\cos(\omega_o t)] + \frac{g}{2} \sin(\omega t) - \frac{g}{2} \sin(\omega_o - \omega)t. \quad (18)$$

The condition where $G = 1$ and $g = 1/2$, computed from (18), is shown in Figure 9(b) for two successive line scans. These curves apply to the modulator signal in the transmitter and to the signal on the kinescope grid of a black-and-white receiver. Figure 9(c) shows the effective light intensity due to two scans of the same line on a black-and-white receiver.

Equation (18) may also be regarded as the signal into the sampler of the color receiver of Figure 3. The previously used expedient of multiplying by the generalized sampling function may now be resorted to just as was done in obtaining Equation (14). The result of sampling (18) is

$$\begin{aligned} & \frac{G}{9} [1+2\cos(\omega_o t)] [1+2\cos(\omega_o t + \theta) + 2\cos(2\omega_o t + 2\theta) + \dots] \\ & + \frac{1}{3} \left[\frac{g}{2} \sin(\omega t) - \frac{g}{2} \sin(\omega_o - \omega)t \right] [1+2\cos(\omega_o t + \theta) \\ & + 2\cos(2\omega_o t + 2\theta) + \dots] \\ & = \frac{G}{9} [1+2\cos(\omega_o t)] [1+2\cos(\omega_o t + \theta) + 2\cos(2\omega_o t + 2\theta) + \dots] \\ & \quad + \frac{g}{6} [\sin(\omega t) + \sin(\omega t + \theta) \\ & \quad + \sin([\omega_o + \omega]t + \theta) + \sin([\omega_o + \omega]t + 2\theta) \\ & \quad - \sin([\omega_o - \omega]t + \theta) - \sin([\omega_o - \omega]t + 2\theta) + \dots]. \end{aligned} \quad (19)$$

Now to find the signal on the green kinescope, let $\theta = 0$ in (19) and find

$$\frac{1}{3} [G + g \cdot \sin(\omega t)] [1+2\cos(\omega_o t)]. \quad (20)$$

The condition where $G = 1$ and $g = 1/2$, computed from (20), is shown in Figure 9(d) which depicts the voltage on the grid of the green kinescope for two successive line scans. Figure 9(e) shows the effective light intensity due to two scans of the same line on the green kinescope.

The signal on the grid of the red kinescope (due to color cross talk) is found by setting $\theta = 240$ degrees in Equation (19), with the result

$$\frac{g}{6} \sin(\omega t - 60^\circ) [1 + 2\cos(\omega_0 t - 120^\circ)] \quad (\text{on red kinescope}), \quad (21)$$

and setting $\theta = 120$ degrees gives

$$\frac{g}{6} \sin(\omega t + 60^\circ) [1 + 2\cos(\omega_0 t + 120^\circ)] \quad (\text{on blue kinescope}). \quad (22)$$

The voltage on the grid of the red kinescope due to the erroneous sampling of the green signal is shown in Figure 9(f) as computed from (21), while Figure 9(g) shows the signal on the grid of the blue kinescope.

These equations show that cross talk up to fifty per cent is possible in the region where the frequency is greater than $f_B - f_0$ and less than f_A , or in the example, when the frequency lies between 0.3 megacycle and 2.0 megacycles.

At first glance, this degree of cross talk might seem intolerable. In the case shown in Figure 9, it is likely that non-linearity of the light-output versus grid-voltage characteristic of the kinescopes would make the cross talk of negligible importance. In the converse case, if the average intensity of the red tube were high, the erroneous voltage of Figure 9(f) might be enhanced to a point where cross talk produced undesirable effects. While this cross talk has not appeared to be a serious problem in the dot-sequential color television system, means for eliminating the effect will be described later in this report.

d. $G + g \cdot \sin(\omega t)$ where $f_A < f < f_B$

In this case, the green area is varying so that the electrical signal is made up of a dc component and an ac component of frequency f where $f_A < f < f_B$. This frequency region may be noted on Figure 2, and for illustrative purposes lies between 2.0 and 4.1 megacycles.

The signal from the green camera tube is $G + g \cdot \sin(\omega t)$. For purposes of illustration, f has been chosen as 3.4 megacycles, $G = 1$ and $g = 1/2$. Figure 10(a) shows this signal $1 + 1/2 \sin(\omega t)$.

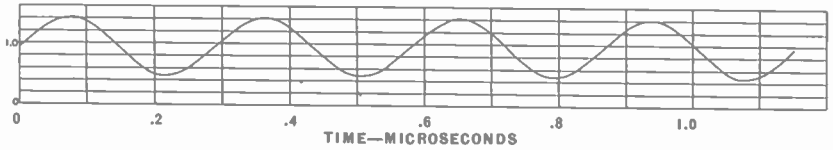

Fig. 10(a)—Signal out of green camera tube; $f = 3.4$ megacycles,
 $G + g \cdot \sin(\omega t) = 1 + 1/2 \sin(\omega t)$.

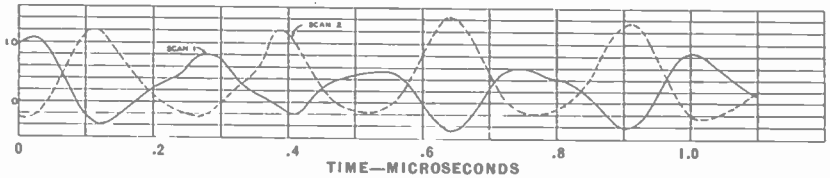

Fig. 10(b)—Signal on the green kinescope grid of a color television receiver.

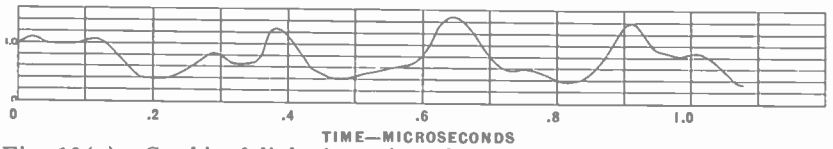

Fig. 10(c)—Combined light intensity of two successive scans of the same line on the green kinescope of a color television receiver.

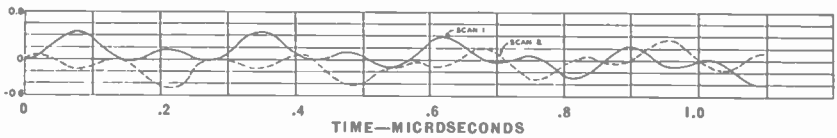

Fig. 10(d)—Voltage on the red kinescope grid.

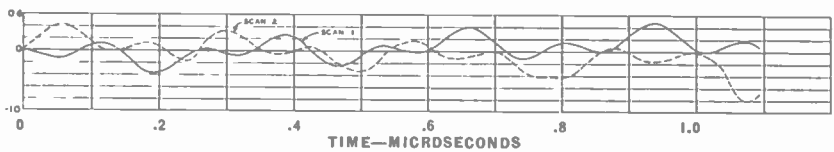

Fig 10(e)—Voltage on the blue kinescope grid.

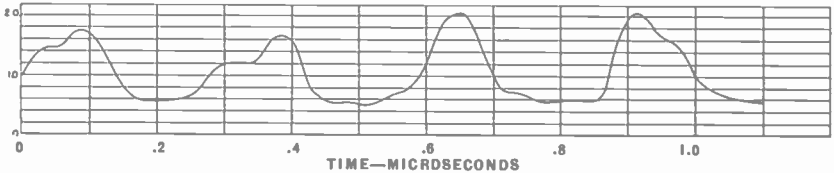

Fig 10(f)—Combined light intensity of two successive scans of the same line, obtained by adding light intensities of the green, red and blue tubes.

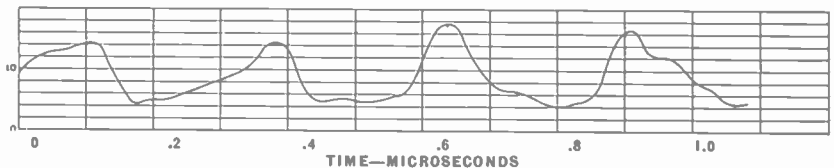

Fig. 10(g)—Combined light intensity of two successive scans of the same line, obtained by adding light intensities of the green and red tubes.

The dc signal G goes through the transmitter sampler, but since the ac term is of a frequency lying in the region committed to "mixed-highs," this latter signal goes through Adder No. 2 and the appropriate band-pass filter into Adder No. 1 of Figure 1. Hence the signal into the transmitter modulator is

$$\frac{G}{3} [1+2\cos(\omega_0 t)] + g \cdot \sin(\omega t). \quad (23)$$

Equation (23) also applies to the voltage on the kinescope grid of a black-and-white receiver. The background term is sampled while the mixed-high signal, unsampled, is superimposed to supply fine detail.

The signal out of the second detector of a color receiver also has the form of Equation (23). Sampling in the receiver results in a signal on the grid of the green kinescope of the form

$$\frac{1}{3} [G+g \cdot \sin(\omega t)] [1+2\cos(\omega_0 t)]. \quad (24)$$

A plot of this equation is shown by Figure 10(b), while Figure 10(c) shows the combined light intensity on a single line of the green tube for two successive scans of the same line. This latter plot shows the effect of the beat between the high-frequency component and the sampling frequency, so that Figure 10(c) is not a very faithful reproduction of Figure 10(a).

The output of the red sampler (the voltage on the grid of the red kinescope) is

$$\frac{g}{3} \sin(\omega t) [1+2\cos(\omega_0 t-120^\circ)], \quad (25)$$

while the voltage on the grid of the blue kinescope is

$$\frac{g}{3} \sin(\omega t) [1+2\cos(\omega_0 t+120^\circ)]. \quad (26)$$

The voltage on the red kinescope is shown in Figure 10(d), while the voltage on the blue kinescope is given by Figure 10(e).

It is obvious that the high-frequency signal mixing in this region is one hundred per cent, since the philosophy of the principle of "mixed-highs" has already been accepted, and the high frequency components of the three camera tubes have been deliberately combined at the trans-

mitter so that these signals have completely lost color identity. Because of the inability of the eye to see color in the fine detail, it is possible to combine the positive values of Figures 10(d) and 10(e) with Figure 10(c) with the result shown in Figure 10(f), which is a more satisfactory representation of Figure 10(a). However, it is well known that the resolution of the eye is very poor in blue, so it seems more fair to combine only Figure 10(d) with Figure 10(c), with Figure 10(g) resulting. The improvement in reproduction of Figure 10(a) by Figure 10(g) is striking, particularly when it is recalled that the rate of the variations in Figure 10(a) is at a high frequency, and that the differences between Figure 10(a) and Figure 10(g) represent still higher frequency components, which are beyond the limits of ordinary resolution.

THE SAMPLING PROCEDURE APPLIED TO STEP FUNCTIONS OF LIGHT INTENSITY

a. *Response of conventional black-and-white television receivers*

In the preceding pages, attention has been given to a color intensity change which produces an electrical signal consisting of a dc term and a single ac component. Such an analysis serves to demonstrate the detailed mechanism of the system. However, it is not a condition often encountered in producing an actual television image. Generally, it is more interesting to examine the action of the system near edges of objects in order to determine rise time, overshoot, and color cross talk.

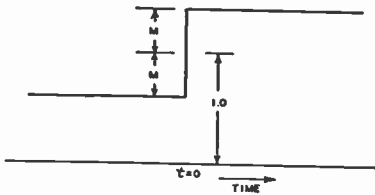

Fig. 11—Idealized step function of voltage which has a value of $1 - M$ for time less than zero and a value of $1 + M$ for time greater than zero.

For purpose of analysis, assume that the voltage coming from the green camera tube has the form shown in Figure 11, where the voltage has the value $1 - M$ for all values of time less than zero, and has the value of $1 + M$ for all times greater than zero. The function of Figure 11 may be produced exactly only when the associated circuits have unlimited frequency response. For this idealized condition, the signal from the green camera tube is given by the following Fourier Integral:

Green camera signal (G.C.S.)

$$= 1 + \frac{2M}{\pi} \int_{\beta=0}^{\beta=\infty} d\beta \int_{\omega=0}^{\omega=\infty} \sin(\omega\beta) \sin(\omega t) \cdot d\omega, \quad (27)$$

where β = an integration variable,

$$\omega = 2\pi f,$$

f = a frequency component lying between zero and infinity.

t = the instant of time at which the signal is to be evaluated.

Now assume that a circuit is imposed which has unity gain for all frequencies below f_B and zero response for all frequencies above f_B , and with no appreciable phase shift. Then Equation (27) becomes

$$\begin{aligned} \text{G.C.S.} &= 1 + \frac{2M}{\pi} \int_{\beta=0}^{\beta=\infty} d\beta \int_{\omega=0}^{\omega=2\pi f_B} \sin(\omega\beta) \sin(\omega t) \cdot d\omega \\ &= 1 + \frac{2M}{\pi} \cdot \text{Si}(2\pi f_B t), \end{aligned} \quad (28)$$

where $\text{Si}(x) = \text{Integral sine of } x = \int_0^x \frac{\sin u}{u} \cdot du$, a well-known and tabulated function.

Fig. 12—Response to the step function of Figure 11 ($M = 1/2$) for a circuit which has unity gain for all frequencies below 4.1 megacycles, zero response above 4.1 megacycles, and linear phase shift.

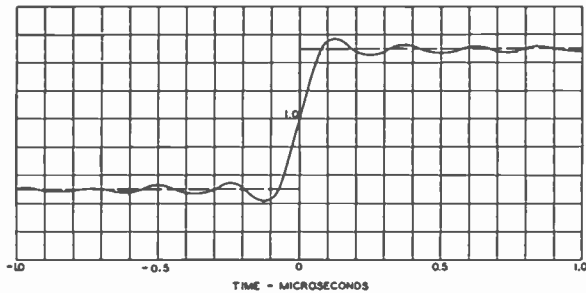

Figure 12 shows a plot of Equation (28) with $M = 1/2$ and with the upper frequency limit f_B equal to 4.1 megacycles. It should be noted that Figure 12 and not Figure 11 should be used in judging the response when other circuit factors have been added.

To find the signal at the transmitter modulator, use may be made of previously developed material to operate upon the term $\sin(\omega t)$ in Equation (28). Three frequency regions must be considered.

First, when $0 < f < f_B - f_o$, Equation (13) teaches that $\sin(\omega t)$ becomes $\frac{\sin(\omega t)}{3} [1 + 2\cos(\omega_o t)]$ at the transmitter modulator.

Secondly, when $f_B - f_o < f < f_A$, Equation (18) shows that $\sin(\omega t)$ becomes $1/2 \sin(\omega t) - 1/2 \sin(\omega_o - \omega)t$ at the transmitter modulator.

Then also in the region where $f_A < f < f_B$, Equation (23) shows that $\sin(\omega t)$ is unchanged.

Equation (12) tells that the unit value in Equations (27) and (28) becomes simply $1/3 [1+2\cos(\omega_0 t)]$.

When these operations are performed on Equation (27), the signal into the transmitter modulator (T.M.S.) is

$$\begin{aligned} \text{T.M.S.} &= \frac{1}{3} [1+2\cos(\omega_0 t)] \\ &+ \frac{2M}{3\pi} [1+2\cos(\omega_0 t)] \int_{\beta=0}^{\beta=\infty} d\beta \int_{\omega=0}^{\omega=2\pi(f_B-f_0)} \sin(\omega\beta) \sin(\omega t) d\omega \\ &+ \frac{M}{\pi} \int_{\beta=0}^{\beta=\infty} d\beta \int_{\omega=2\pi(f_B-f_0)}^{\omega=2\pi f_A} \sin(\omega\beta) \sin(\omega t) d\omega \\ &- \frac{M}{\pi} \int_{\beta=0}^{\beta=\infty} d\beta \int_{\omega=2\pi(f_B-f_0)}^{\omega=2\pi f_A} \sin(\omega\beta) \sin(\omega_0 - \omega) t \cdot d\omega \\ &+ \frac{2M}{\pi} \int_{\beta=0}^{\beta=\infty} d\beta \int_{\omega=2\pi f_A}^{\omega=2\pi f_B} \sin(\omega\beta) \sin(\omega t) d\omega. \end{aligned} \quad (29)$$

Integration and combination of terms yields

$$\begin{aligned} \text{T.M.S.} &= \frac{1}{3} \{1 \pm \cos(\omega_0 t)\} \left\{ 1 + \frac{2M}{\pi} \text{Si}[2\pi(f_B-f_0)t] \right\} \\ &+ \frac{M}{\pi} \{2\text{Si}(2\pi f_B t) - \text{Si}(2\pi f_A t) - \text{Si} 2\pi(f_B-f_0)t\} \\ &\pm \frac{M}{\pi} \cos(\omega_0 t) \{ \text{Si}(2\pi f_A t) - \text{Si}[2\pi(f_B-f_0)t] \} \\ &\pm \frac{M}{\pi} \sin(\omega_0 t) \{ \text{Ci}[2\pi(f_B-f_0)t] - \text{Ci}(2\pi f_A t) \}. \end{aligned} \quad (30)$$

where $\text{Ci}(x) = \text{Integral cosine of } x = - \int_x^\infty \frac{\cos u}{u} du$. Where the \pm signs appear in Equation (30), the plus sign applies to the first scan of the line and the minus sign applies to the second scan of the same line.

Fig. 13 — Transmitter modulator signal for two successive scans of the same line. Also the signal on the kinescope grid of a conventional black-and-white receiver.

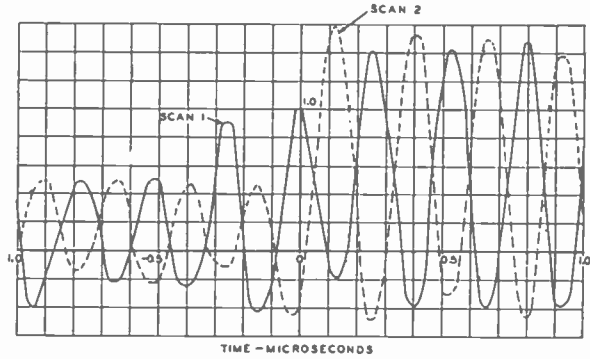

It should be noted that Equation (30) is also the voltage appearing on the kinescope grid in a black-and-white receiver. Figure 13 is a plot of Equation (30) for the following conditions:

$$M = \frac{1}{2},$$

$$f_B = 4.1 \text{ megacycles,}$$

$$f_0 = 3.8 \text{ megacycles,}$$

$$f_A = 2.0 \text{ megacycles,}$$

$$f_B - f_0 = 0.3 \text{ megacycle,}$$

and may be considered as the transmitter modulator signal for two successive scans of the same line, as well as the signal on the kinescope grid of a conventional black-and-white receiver. Figure 14 shows the combined light intensity of two successive scans of the same line on a black-and-white receiver. This latter figure, constructed graphically from Figure 13, shows close agreement with Figure 12.

b. Response of a color television receiver

To find the signal on the kinescopes of a color television receiver,

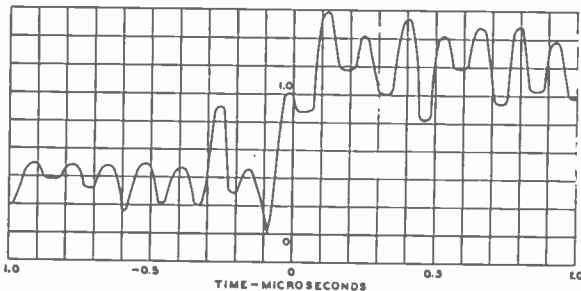
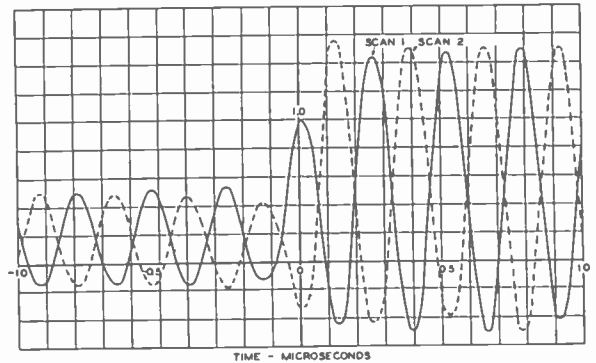

Fig. 14 — Combined light intensity of two successive scans of the same line on a black-and-white receiver.

Fig. 15—Signal on the green kinescope grid of a color television receiver.



the operating procedure on the $\sin(\omega t)$ term of Equation (27) is determined by referring to Equations (15), (20), and (24). These equations show that $\sin(\omega t)$ is converted to $\frac{\sin(\omega t)}{3} [1 + 2\cos(\omega_0 t)]$ in all frequency regions up to f_B so the signal on the green kinescope (G.K.S.) is simply

$$\text{G.K.S.} = \frac{1}{3} [1 \pm 2\cos(\omega_0 t)] \left[1 + \frac{2M}{\pi} \text{Si}(2\pi f_B t) \right], \quad (31)$$

where the \pm signs apply to the first and second scans of the same line.

Comparison of Equations (28) and (31) shows that the signal on the green kinescope is a perfect reproduction of the green camera signal multiplied by the sampling function. Figure 15 shows a plot of Equation (31), the signal on the green kinescope grid of a color television receiver, for the same frequency restrictions used in the previous calculations, while Figure 16 shows the combined light intensity of two successive scans of the same line on the green kinescope of a color television receiver.

The cross talk may be deduced by using Equations (21) and (25)

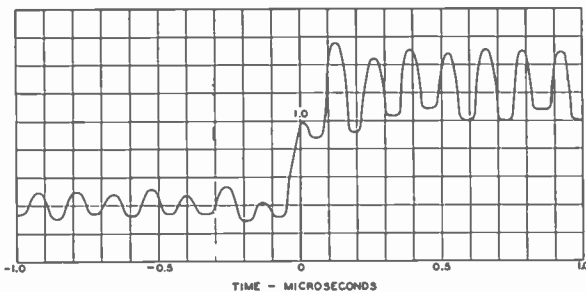

Fig. 16—Combined light intensity of two successive scans of the same line on the green kinescope of a color television receiver.

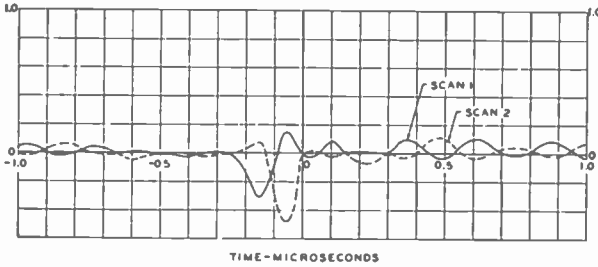

Fig. 17 — Cross-talk voltage on the red kinescope grid for two successive scans of the same line.

for the red tube cross talk and Equations (22) and (26) for the blue tube cross talk in conjunction with Equation (27). Then the red kinescope signal (R.K.S.) is

$$\begin{aligned}
 \text{R.K.S.} &= \frac{2M}{\pi} \{1 \pm 2\cos(\omega_0 t - 120^\circ)\} \left\{ \frac{1}{3} \text{Si}(2\pi f_B t) - \frac{1}{4} \text{Si}(2\pi f_A t) \right\} \\
 &- \frac{1}{12} \text{Si}[2\pi(f_B - f_0)t] + \frac{\sqrt{3}}{12} \text{Ci}[2\pi(f_B - f_0)t] - \frac{\sqrt{3}}{12} \text{Ci}(2\pi f_A t), \quad (32)
 \end{aligned}$$

and the blue kinescope signal (B.K.S.) is

$$\begin{aligned}
 \text{B.K.S.} &= \frac{2M}{\pi} \{1 \pm 2\cos(\omega_0 t + 120^\circ)\} \left\{ \frac{1}{3} \text{Si}(2\pi f_B t) - \frac{1}{4} \text{Si}(2\pi f_A t) \right\} \\
 &- \frac{1}{12} \text{Si}[2\pi(f_B - f_0)t] - \frac{\sqrt{3}}{12} \text{Ci}[2\pi(f_B - f_0)t] + \frac{\sqrt{3}}{12} \text{Ci}(2\pi f_A t). \quad (33)
 \end{aligned}$$

Figure 17 shows the cross-talk voltage on the red kinescope grid for two successive scans of the same line, while Figure 18 displays the combined light intensity of two successive line scans of the same line on the red kinescope.

Figures 19 and 20 show corresponding effects for the blue kinescope.

Fig. 18 — Combined light intensity of two successive line scans of the same line on the red kinescope.

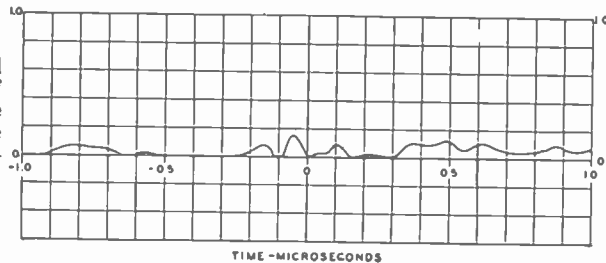
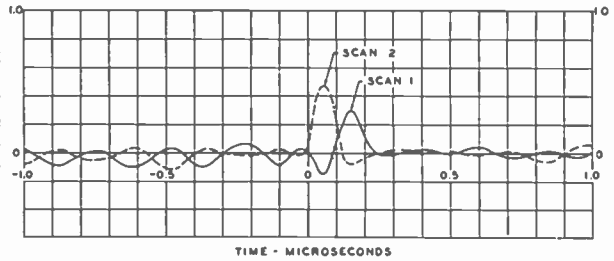

Fig. 19 — Cross-talk voltage on the blue kinescope grid for two successive line scans of the same line on the blue kinescope.



CROSS-TALK ELIMINATION BETWEEN THE GREEN AND RED CHANNELS WHEN $f_B - f_0 < f < f_A$

It was observed in Section III, where the frequency of the signal component lies between $f_B - f_0$ and f_A , that the color cross-talk terms may be up to fifty per cent of the desired terms. While it has not yet been clearly established that it is necessary to reduce or eliminate this cross talk, rather simple circuit expedients are possible to completely eliminate the cross talk. It should be remembered that the response in the mixed-high region has not been considered to be cross talk, since the crossing of signals in this region has been regarded as entirely legitimate.

a. Simple modification of the transmitter sampler

As a first step in describing a number of possibilities, a simple modification of the transmitter sampler may first be considered. Figure 21 shows the part of Figure 1 which has been changed somewhat. The mixed-high circuits have not been changed and are not shown. The low-pass filters in the red and the green channels, as before, pass frequencies up to f_A , but now have unity gain up to $f_B - f_0$ and have a gain of 2.0 from this frequency up to f_A . The low-pass filter in the blue channel may cut-off at $f_B - f_0$, since the eye is very poor in resolving power in the blue.

A band-pass filter and phase shifter connect the output of the low-pass filter in the green channel to the input of the red sampler. This

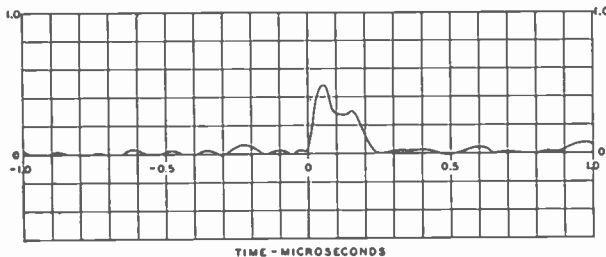

Fig. 20 — Combined light intensity of two successive line scans of the same line on the blue kinescope.

channel passes frequencies between $f_B - f_0$ and f_A , the region where it is desired to eliminate cross talk. The signal from the green channel to the red sampler position is made one half of the signal going to the green sampler position. In addition, all the frequency components

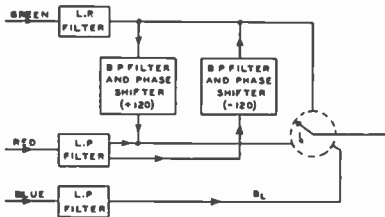

Fig. 21 — Circuit modifications at the transmitter to eliminate cross talk between the red and green channels.

are advanced 120 degrees in phase in passing through the circuit. This latter condition is quite easily brought about by a double modulating and filtering process. The corresponding element going from the red channel to the green sampling position has the same characteristics except that the phase of the components is retarded by 120 degrees.

With the signal $g \cdot \sin(\omega t)$ coming from the green camera, the signal going into the green sampler position at the transmitter is

$2g \cdot \sin(\omega t)$. This signal is sampled by the function $\frac{1}{3} [1 + 2\cos(\omega_0 t)]$

and becomes $\frac{2g}{3} \cdot \sin(\omega t) - \frac{2g}{3} \sin(\omega_0 - \omega)t$. The signal into the red sampler (from the green channel through the phase shifter) is

$g \cdot \sin(\omega t + 120^\circ)$. This signal is sampled by the function $\frac{1}{3} [1 + 2\cos$

$(\omega_0 t - 120^\circ)]$ yielding a signal out of the red sampler of $\frac{g}{3} \sin(\omega t + 120^\circ)$

$-\frac{g}{3} \sin[(\omega_0 - \omega)t - 240^\circ]$. The total signal into the modulator is

$$\frac{g}{\sqrt{3}} \{ \sin(\omega t + 30^\circ) - \sin[(\omega_0 - \omega)t + 30^\circ] \}. \quad (34)$$

When Equation (34) is sampled at the color receiver by the green sampler, using the sampling function

$$\frac{1}{3} [1 + 2\cos(\omega_0 t) + 2\cos(2\omega_0 t) + \dots],$$

the signal on the green kinescope grid becomes

$$\frac{g \sin(\omega t)}{3} [1 + 2\cos(\omega_0 t)].$$

However, when Equation (34) is sampled by the red sampler at the receiver, using the sampling function

$$\frac{1}{3} [1 + 2\cos(\omega_0 t - 120^\circ) + 2\cos(\omega_0 t - 240^\circ) + \dots],$$

the signal on the red kinescope grid becomes identically zero.

Thus a method of completely eliminating the cross talk between the red and the green channels in the frequency region above $f_B - f_o$ and below f_A has been displayed.

b. Addition of a low-pass filter to the color receiver

The additions of Figure 21 may be added to the transmitter without a single change in the receiver of Figure 3. If color receivers of this type were in operation in the field, the changes in the transmitter shown in Figure 21 could be made without altering a single receiver. The immediate effect would be an elimination of cross talk in the region in question between the green and red channels. The cross talk of red and green into the blue channel would be unchanged, but because of the high-frequency nature would probably be of no consequence. Cross talk of the blue into red or green would be eliminated by restricting the components of the blue signal to frequencies less than $f_B - f_o$ by means of the low-pass filter in the blue channel preceding the transmitter sampler.

As another experiment to investigate the matter of reduction of cross talk, a low-pass filter could be inserted in the video amplifier circuit leading to the blue kinescope in Figure 3. This filter would also remove the f_o sampling component in the blue channel.

Before proceeding with an examination of other circuit details, it may prove interesting to see what has happened to the step function response for the receiver and transmitter condition described in this section.

The desired response of the signal at the green kinescope has remained unchanged and is given by Equation (31) and by Figures 15 and 16. The cross-talk conditions have changed, however. For instance, in the red channel, the only signal mixing components are those that have been placed there deliberately by the use of mixed highs. The signal on the red kinescope grid due to the step function in the green channel is

$$\text{R.K.S.} = \frac{2M}{3\pi} [1 \pm 2\cos(\omega_0 t - 120^\circ)] [\text{Si}(2\pi f_B t) - \text{Si}(2\pi f_A t)]. \quad (35)$$

Fig. 22 — Signal on grid of red kinescope due to step function in the green channel and the use of mixed highs.

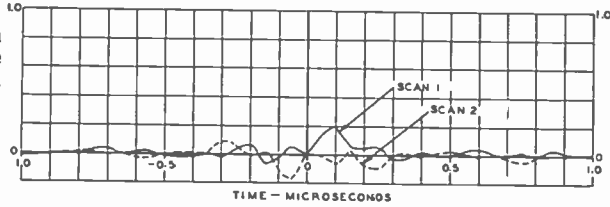

Figure 22 shows the signal corresponding to (35) for two scans of the same line, with $M = 1/2$, $f_B = 4.1$ megacycles, $f_A = 2.0$ megacycles, and $f_o = 3.8$ megacycles. Figure 23 shows the combined light intensities on the red tube for two scans of the same line, and Figure 24 has been constructed by adding Figure 23 to Figure 16, since the contribution from the red tube came entirely from the use of the mixed-highs.

c. Increased resolution in the blue channel

In the previous example, a method of eliminating cross talk between the red and green channels has been displayed, but the resolution in the blue channel to $f_B - f_o$ (0.3 megacycle in the numerical example) has been restricted. If it should prove desirable to follow the above path of exploration and it became evident that greater resolution were desired in the blue channel, the resolution could be doubled by a simple sampling or interrupting method with dot interlacing. By this method, the resolution could be increased to $2(f_B - f_o)$, or 0.6 megacycle in the example.

Suppose that a sampler with a very broad pulse but sampling at a rate of twice the frequency $f_B - f_o$ is incorporated in the blue channel and this sampler is followed by a low-pass filter which cuts off at one half the sampling frequency. Also a simple dot interlace is introduced. Let f_s be the sampling frequency. Then suppose the signal from the blue camera tube is $B + b \cdot \sin(\omega t)$. The function $1 + \cos(\omega_s t)$ will be used for sampling. When the frequency f is less than $f_s/2$, the signal out of the sampler and the low-pass filter is simply $B + b \cdot \sin(\omega t)$. This signal at the receiver is again sampled, this time by the function $\frac{1 \pm \cos(\omega_s t)}{2}$, giving

Fig. 23 — Combined light intensities on the red tube.

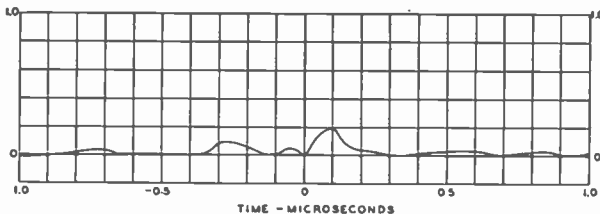

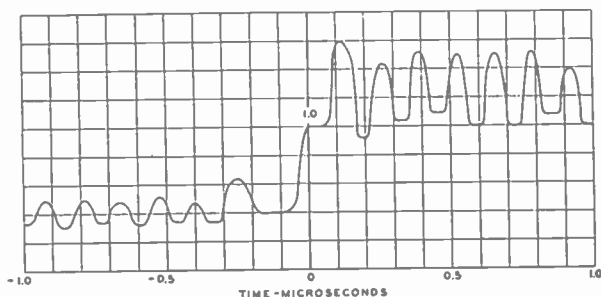

Fig. 24—Combined light intensities from red and green kinescopes.

$$[B + b \sin(\omega t)] \left[\frac{1 \pm \cos(\omega_s t)}{2} \right]$$

Figure 25 has been prepared, using

$$B = 1,$$

$$b = 1/2,$$

$$f = 0.1 \text{ megacycle},$$

$$f_s = 0.6 \text{ megacycle}.$$

Figure 25(a) shows the original function, while Figure 25(b) shows the effective light intensities for two scans. Figure 25(c) shows the sums of the light intensities for the two scans of Figure 25(b).

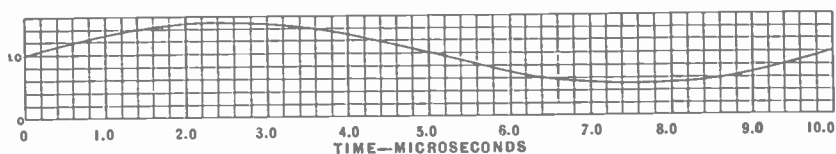

Fig. 25(a)—Signal out of the blue camera tube, $1 + 1/2 \sin(\omega t)$, with a frequency of 0.1 megacycle.

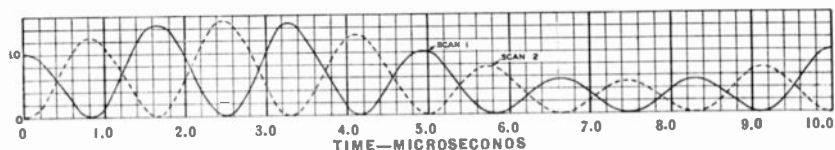

Fig 25(b)—Effective light intensities for two scans on the same line of the blue tube. Sampling frequency is 0.6 megacycle.

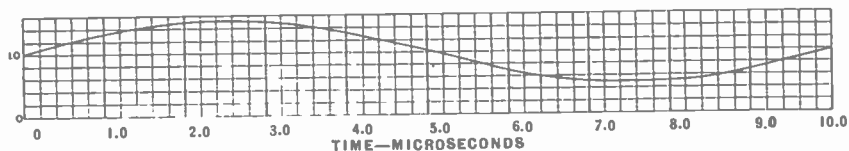

Fig. 25(c)—Sums of the light intensities for the two scans of Figure 25(b).

When the frequency f is greater than $f_s/2$, the response of the preceding circuits must be doubled. Hence the signal arriving at the sampler will be $B + 2b \sin(\omega t)$. After sampling at the transmitter by the function $1 \pm \cos(\omega_s t)$, the signal at the receiver second detector is $B \mp b \sin(\omega_s - \omega)t$. The second sampling at the receiver by the function $\frac{1 \pm \cos(\omega_s t)}{2}$ yields

$$\frac{B [1 \pm \cos(\omega_s t)]}{2} + \frac{b}{2} \sin(\omega t) \mp \frac{b}{2} \sin(\omega_s - \omega)t.$$

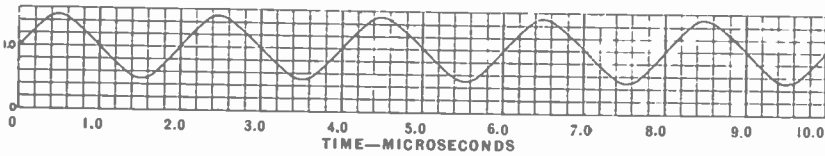

Fig. 26(a)—Signal out of the blue camera tube, $1 + 1/2 \sin(\omega t)$, with a frequency of 0.5 megacycle.

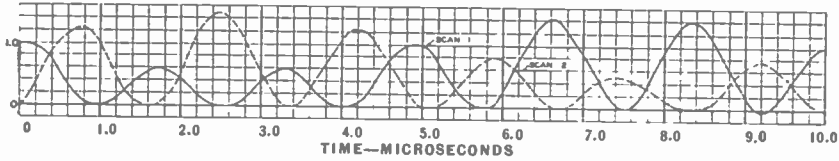

Fig. 26(b)—Effective light intensities for two scans on the same line of the blue tube. Sampling frequency is 0.6 megacycle.

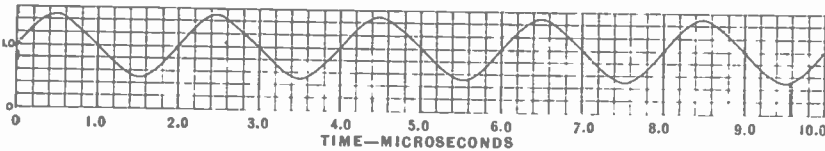

Fig. 26(c)—Sums of the light intensities for the two scans of Figure 26(b).

Figure 26 has been prepared, using

$$B = 1,$$

$$b = 1/2,$$

$$f = 0.5 \text{ megacycle},$$

$$f_s = 0.6 \text{ megacycle}.$$

Figure 26(a) shows the original function, while Figure 26(b) shows the effective light intensities for two scans. Figure 26(c) shows the sums of the light intensities for the two scans of Figure 26(b).

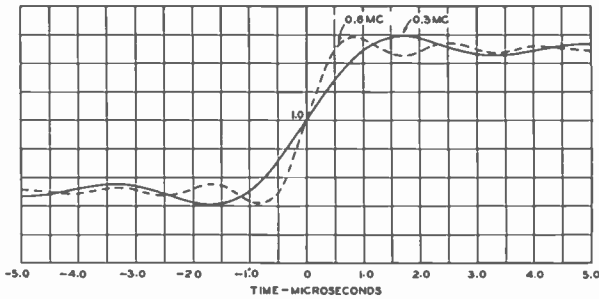

Fig. 27 — Change in step function for two frequency bands, one limited to 0.3 megacycle and the other limited to 0.6 megacycle.

This procedure illustrates the use of dot interlacing to obtain 0.6-megacycle resolution with a channel width of 0.3 megacycle.

The high-frequency sampling has been omitted from consideration in the above analysis. The signals from the blue channel are, of course, sampled at frequency f_s just as the red and green signals, but the filter at the receiver removes all traces of this sampling on the blue tube.

Figure 27 shows the change in a step function for two cases: first, where the frequency band is limited to 0.3 megacycle, and second, where the band is restricted to 0.6 megacycle. The increased steepness due to the wider band is apparent.

The step function response on the grid of the blue kinescope is given by

$$\text{B.K.S.} = \frac{[1 \pm \cos(\omega_s t)]}{2} \left[1 + \frac{2M}{\pi} \cdot \text{Si}(\omega_s t) \right] \pm \frac{M}{\pi} \sin(\omega_s t) \left[\text{Ci}\left(\frac{\omega_s t}{2}\right) - \text{Ci}(\omega_s t) \right]. \quad (36)$$

Figure 28 shows Equation (36) plotted for two line scans, where $M = 1/2$ and f_s is 0.6 megacycle. Figure 29 shows the addition of light intensities from Figure 28. It may be seen that Figure 29 is an exact reproduction of the dotted curve of Figure 27.

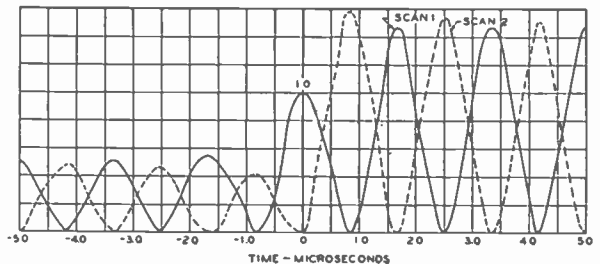

Fig. 28—Step function response on grid of blue kinescope tube with dot-interlacing and sampling.

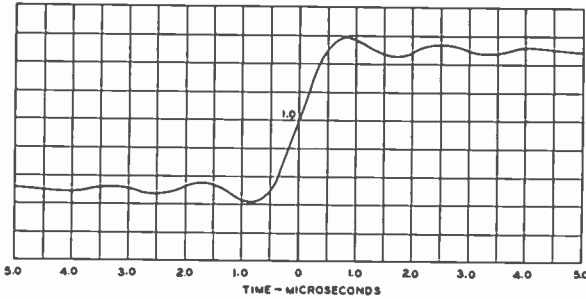

Fig. 29—Addition of light intensities on the blue tube, obtained by adding the curves of Figure 28.

CONCLUSION

Cross talk as a function of the width of the sampling pulse at both the transmitter and the receiver has been examined and limits established for reasonable cross talk. It is shown that narrow sampling at the receiver is more important than narrow sampling at the transmitter.

The sampling procedure was examined for large areas of color with a sinusoidal variation of the color. It was shown that the frequency passband was divided into three regions, the lower in which no cross talk existed, a middle region where fifty per cent cross talk was possible, and an upper region where signal mixing was expected because of the adoption of mixed highs. For the various cases, the role of dot interlacing was explained. In addition, the action on conventional black-and-white receivers as well as on color receivers was examined.

The sampling procedure was examined as it applied to step functions of light intensity. The response of a black-and-white receiver was examined and the desired and undesired responses of a color receiver were displayed.

A method of cross-talk elimination in the middle region is described. This method might be applied as an experiment in three parts. First, a simple cross-coupling and phase-shifting network is applied to the transmitter sampler. This circuit eliminates the cross talk between the red and the green channels in the middle region. No change is necessary at the receiver to take this first step. As a second improvement, a low-pass filter might be added in the blue channel at the receiver to knock out cross talk from the red and green into the blue channel. This step restricts the definition of the blue channel. A third step is suggested which doubles the resolution of the blue channel by a sampling and interlacing procedure.

The analysis and display of curves show that the sampling process in the dot-sequential color television system, together with the use of mixed highs provides a good uncoupling of the color channels together

with full resolution equivalent to black-and-white transmission in the same channel.

The construction leading to Figure 10(g) emphasizes that the output of the sampler is the *product* of input signal and the gating function. This fact, together with the principle of mixed highs, produces full detail limited only by total bandwidth available. A study of Equation (31) shows that the rise time of the envelope is determined by the highest frequency passed in the mixed-highs circuit at the transmitter.

Throughout this report, the signal under consideration originated from a single primary color. If an area is a mixture of colors, the analysis may be carried out on the basis of the superposition of the individual responses to the three primary colors. Where, in the mixture of colors, the two stronger primaries are nearly equal in intensity, the variation due to the sampling frequency shown in Figures 7(c) and 8(c) virtually disappears, particularly on a standard black-and-white receiver.

During November, 1949, the sampling frequency of the dot-sequential color television system used experimentally in Washington was reduced from 3.8 to approximately 3.6 megacycles. Many of the calculations contained in this report were already completed at that time and were made on the basis of a sampling frequency of 3.8 megacycles. Rather than repeat the many laborious computations for the slight change in sampling frequency, the remainder of the calculations were continued at a sampling frequency of 3.8 megacycles. No very major change would have been apparent in the plotted results. The region free of cross talk in the simplest form of the system ($0 < f < f_B - f_0$) would have been extended from 0.3 megacycle to 0.5 megacycle.

APPENDIX I

REPRODUCTION OF HIGH-FREQUENCY DETAIL WITH A
LOW SAMPLING RATE

THE previous analysis illustrated by Figure 10 showed the manner in which high-frequency detail was reproduced when the high-frequency component of the signal had a frequency in the mixed-high region. Specifically, in Figure 10, the frequency of the picture component was chosen to be 3.4 megacycles, while the sampling frequency was 3.8 megacycles. Figure 10(g) was noted to be a rather good reproduction of the original function shown in Figure 10(a). However, it was realized that since the sampling frequency was only ten per cent greater than the signal frequency, the construction of Figure 10 did not fully establish the fact that the high frequency detail was produced by a multiplication of the input signal and the gating function. Accordingly, the calculations have been repeated in this appendix, but this time using a sampling frequency of 2.4 megacycles and a picture signal component of 4.0 megacycles. Here, the picture signal component is sixty-seven per cent *higher* than the sampling frequency, so the phenomenon is well illustrated.

The signal from the green camera tube is $G + g \cdot \sin(\omega t)$. For purposes of this illustration, f has been chosen as 4.0 megacycles,

$G = 1$ and $g = 1/2$. Figure 30(a) shows this signal $1 + 1/2 \sin(\omega t)$.

The dc signal G goes through the transmitter sampler, but since the ac term is of a frequency lying in the region committed to "mixed-highs," this latter signal goes through Adder No. 2 and the appropriate band-pass filter into Adder No. 1 of Figure 1. Hence the signal into the transmitter modulator is

$$\frac{G}{3} [1 \pm 2 \cos(\omega_0 t)] + g \cdot \sin \omega t. \quad (37)$$

Expression (37) also applies to the voltage on the kinescope grid of a black-and-white receiver. The background term is sampled while the mixed-high signal, unsampled, is superimposed to supply fine detail. The positive polarity sign applies to the first scan of a line, while the negative sign applies to the second scan of the same line.

The signal out of the second detector of a color receiver also has the same form as Expression (37). Sampling in the receiver results in a signal on the grid of the green kinescope of the form

$$\frac{1}{3} [G + g \cdot \sin(\omega t)] [1 \pm 2 \cos(\omega_0 t)]. \quad (38)$$

A plot of this expression is shown in Figure 30(b) with a sampling frequency of 2.4 megacycles.

The output of the blue sampler (the voltage on the grid of the blue kinescope) is

$$\frac{g}{3} \sin(\omega t) [1 \pm 2 \cos(\omega_0 t + 120^\circ)], \quad (39)$$

while the voltage on the grid of the red kinescope is

$$\frac{g}{3} \sin(\omega t) [1 \pm 2 \cos(\omega_0 t - 120^\circ)]. \quad (40)$$

The voltage on the blue kinescope is shown in Figure 30(c), while the voltage on the red kinescope is given by Figure 30(d).

Following the procedure of Figure 10, the positive values of Figures 30(c) and 30(d) have been combined with the positive values of Figure 30(b) to show the effect of the combined light intensities for

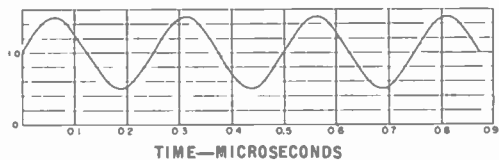

4-MEGACYCLE SINE WAVE

Fig. 30—(a) Signal out of green camera tube; $f = 4.0$ megacycles, $G + g \cdot \sin(\omega t) = 1 + \frac{1}{2} \sin(\omega t)$.

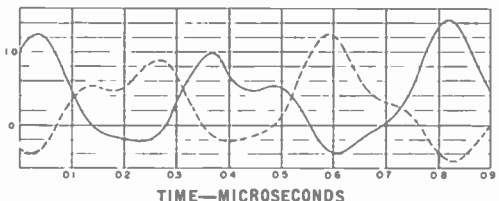

GREEN
 $f = 4.0$ Mc.
 $f_0 = 2.4$ Mc.

(b) Signal on the green kinescope grid of a color television receiver.

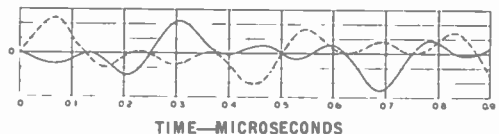

BLUE
 $f = 4.0$ Mc.
 $f_0 = 2.4$ Mc.

(c) Voltage on the blue kinescope grid.

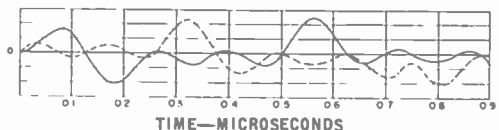

RED
 $f = 4.0$ Mc.
 $f_0 = 2.4$ Mc.

(d) Voltage on the red kinescope grid.

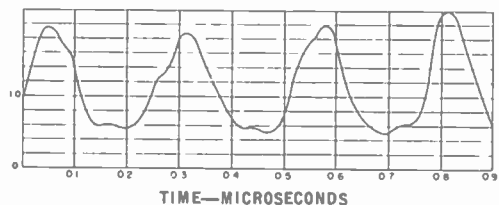

GREEN
RED
BLUE
 $f = 4.0$ Mc.
 $f_0 = 2.4$ Mc.

(e) Combined light intensity of two successive scans of the same line, obtained by adding light intensities of the green, red and blue tubes.

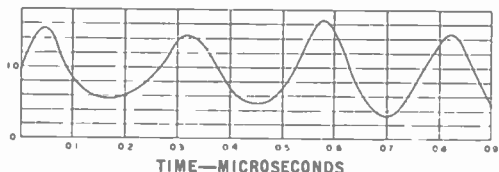

GREEN
RED
 $f = 4.0$ Mc.
 $f_0 = 2.4$ Mc.

(f) Combined light intensity of two successive scans of the same line, obtained by adding light intensities of the green and red tubes. The sampling frequency is 2.4 megacycles.

two successive scans of the same line. The result of this combination is shown in Figure 30(e).

Inspection shows that Figure 30(e) is a satisfactory reproduction of Figure 30(a). However, it is well known that the resolution of the eye is very poor in blue, so it seems better to combine only Figure 30(d) with Figure 30(b), with Figure 30(f) resulting. This latter curve is an excellent reproduction of Figure 30(a). It should be noted that the periodicity of the curve of Figure 30(f) corresponds to a frequency of 4.0 megacycles, and bears no relation to the periodicity of the sampling function.

The construction leading to Figure 30(f), and particularly Figure 30(b), emphasizes that the output of the sampler is the *product* of the input signal and the gating function. This fact, together with the

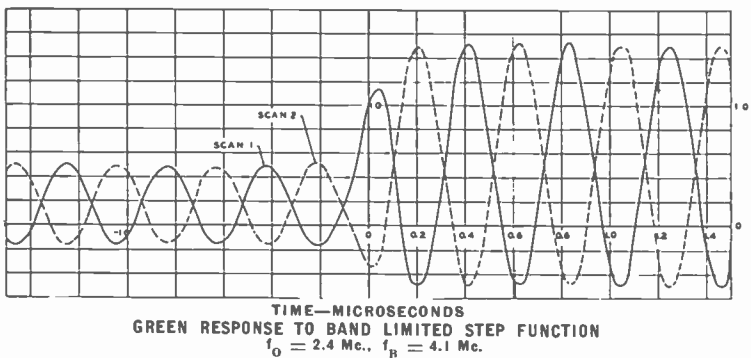
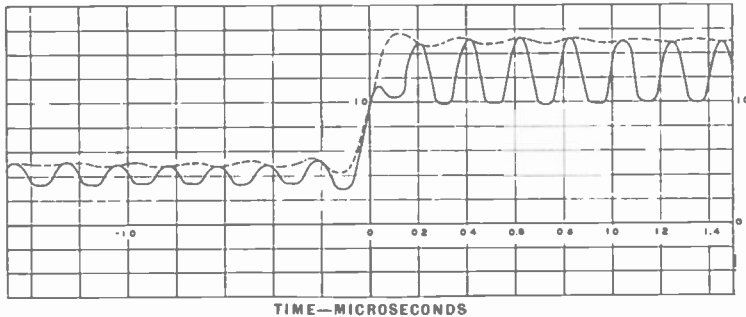

Fig. 31—Response to step function. Signal on the green kinescope grid of a color television receiver. Sampling frequency is 2.4 megacycles. principle of mixed highs, produces full detail limited only by total bandwidth available. This conclusion is further strengthened by examining the response of the system to a step function.

Figure 31 has been constructed from Equation (31) to show the signal on the green kinescope when the initial signal is a step function as shown in Figure 11, with $M = 1/2$, and with a sampling frequency of 2.4 megacycles. The transmission band has been limited to 4.1 megacycles. Figure 31 corresponds to Figure 15, except for the choice of sampling frequency.

Figure 32 shows the combined light intensity of two successive scans of the same line on the green kinescope of a color television receiver, obtained by adding the positive values of the two curves of Figure 31. The dashed line in Figure 32 is taken from Figure 12 to show the best response possible in a frequency band limited to video frequencies less than 4.1 megacycles.

The mixed-high signal on the red kinescope grid due to the step



GREEN RESPONSE TO BAND LIMITED STEP FUNCTION SUMS OF SCANS
 $f_o = 2.4$ Mc., $f_B = 4.1$ Mc., $f_A = 2.0$ Mc.

Fig. 32—Response to step function. Combined light intensity of two successive scans of the same line on the green kinescope of a color television receiver. Sampling frequency is 2.4 megacycles.

function in the green channel is given by Equation (35). The positive values of this function, when added to the curve of Figure 32, result in Figure 33. It should be noted that Figure 32 corresponds to Figure 16 and Figure 33 corresponds to Figure 24, except that in Figures 16 and 24 the sampling frequency is 3.8 megacycles, and in Figures 32 and 33 the sampling frequency is 2.4 megacycles.

APPENDIX II

TRANSMISSION OF THE DOT-SEQUENTIAL COLOR TELEVISION SIGNAL ON COAXIAL CABLES OF RESTRICTED BANDWIDTH

Presently available coaxial cables used in networking of monochrome television signals will pass no signals of frequencies greater than approximately 2.7 megacycles. Since the sampling frequency in the dot-sequential color television system as used experimentally in

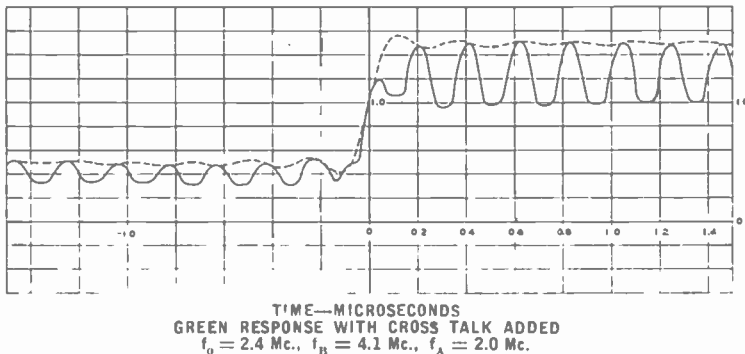

GREEN RESPONSE WITH CROSS TALK ADDED
 $f_o = 2.4$ Mc., $f_n = 4.1$ Mc., $f_A = 2.0$ Mc.

Fig. 33—Response to step function. Combined light intensities from the red and the green kinescopes. Sampling frequency is 2.4 megacycles.

Washington is approximately 3.6 megacycles,* color information is lost when the composite signal usually used to modulate the transmitter is transmitted over the coaxial cable.

While it is anticipated that coaxial cables of at least four-megacycle bandwidth will be made available by the time that such cables are needed for commercial color television transmission, it is desirable to make use of the present cables for experimental purposes in the interim period.

When a standard monochrome television signal containing information out to four megacycles is passed over the 2.7-megacycle cable, the picture definition is reduced accordingly. It is the purpose of this appendix to describe two versions of a method of transmitting dot-sequential color television signals over the present coaxial cables, retaining color information and accepting loss of resolution corresponding to that suffered by a monochrome signal over the same transmission medium.

Figure 34 shows a diagram of the first method of transmission. The normal color system components are shown with dashed lines at the left. The components added for the low frequency cable transmission are shown with solid lines at the right.

The crystal oscillator which provides the normal sampling signal feeds into a regenerative multiplier which produces a sampling signal which is exactly two-thirds the frequency of the normal sampling signal, namely, 2,388,750 cycles. This latter signal, together with the synchronizing signals and the simultaneous green, red and blue signals from the camera, are fed to a transmitter type sampler especially provided at the originating station. The output of this sampler then feeds into the coaxial cable. A color synchronizing burst with a frequency of 2,388,750 cycles is placed on the back porch of the horizontal synchronizing pedestal for transmission over the cable. At the receiving end of the cable, a receiver type sampler is provided, with sampling of each color taking place at a rate of 2,388,750 times per second. Low-pass filters, with cut-off below this sampling frequency, are placed in the green, red and blue outputs of this sampler. These

* In the above report, the sampling frequency was assumed to be 3.8 megacycles. Since November, 1949, the sampling frequency used at the WNBW transmitter in Washington has been 3,583,125 cycles per second. The ratio of this latter number to the scanning line frequency of 15,750 lines per second is $227\frac{1}{2}$. This fractional relationship affords a direct means of obtaining the dot interlace. At the present time, the color synchronization is obtained by transmitting a burst, several cycles duration, of the sampling signal on the back porch of the horizontal synchronizing pedestal. This burst, as well as the sampling component in the picture signal, is removed by the bandwidth limitations of the coaxial cable.

three signals are then used to feed a normal transmitter sampler at the station which is being programmed by the coaxial cable transmission. The 2,388,750-cycle burst coming over the cable is multiplied up to 3,583,125 cycles to provide the sampling control for the latter station.

The method shown in Figure 34 is a direct approach to the problem of transmitting the color information over the limited bandwidth coaxial cable. A second method is shown by the block diagram of Figure 35. This version applies mixed-highs to more effectively utilize the bandwidth available for transmission. Color information is transmitted with detail up to 0.3 megacycle, with signal mixing to apply mixed highs extending upward from 0.3 megacycle.

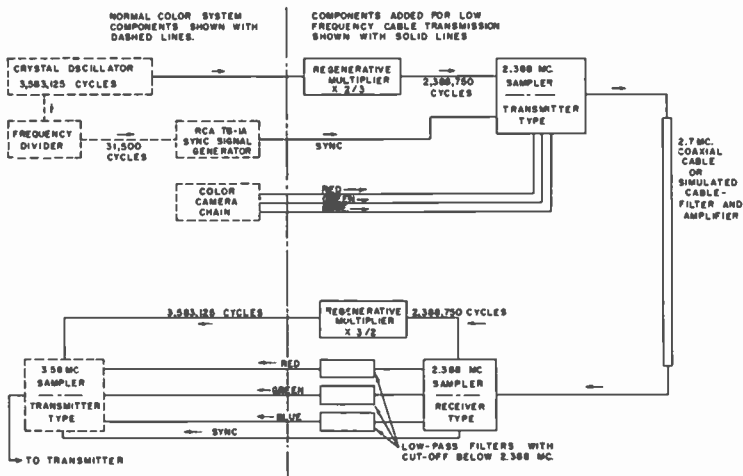

Fig. 34—Block diagram of the equipment used to transmit color television signals over coaxial cables of restricted bandwidth.

To illustrate the principles of operation, assume that the signal from the green camera tube is

$$\text{G.C.S.} = G + g \cdot \sin \omega_1 t + g_2 \sin \omega_2 t, \quad (41)$$

where $f_1 < 0.3$ megacycle,

and $0.3 < f_2 < 2.1$.

The signal into the 2.4-megacycle sampler at the sending end of the cable is simply

$$G + g_1 \sin \omega_1 t \quad (42)$$

since the low-pass (0-0.3 megacycle) filters remove the last term of (41).

When the signal of (42) is sampled in the usual fashion,

$$K_1 [G + g_1 \sin \omega_1 t] \left[\frac{1 + 2 \cos(\omega_s t)}{3} \right]$$

$$= \frac{K_1 G}{3} + \frac{K_1 g_1}{3} \sin \omega_1 t + \frac{2K_1}{3} [G + g_1 \sin \omega_1 t] \cdot \cos(\omega_s t), \quad (43)$$

where f_s is the sampling frequency of 2.4 megacycles. The band-pass

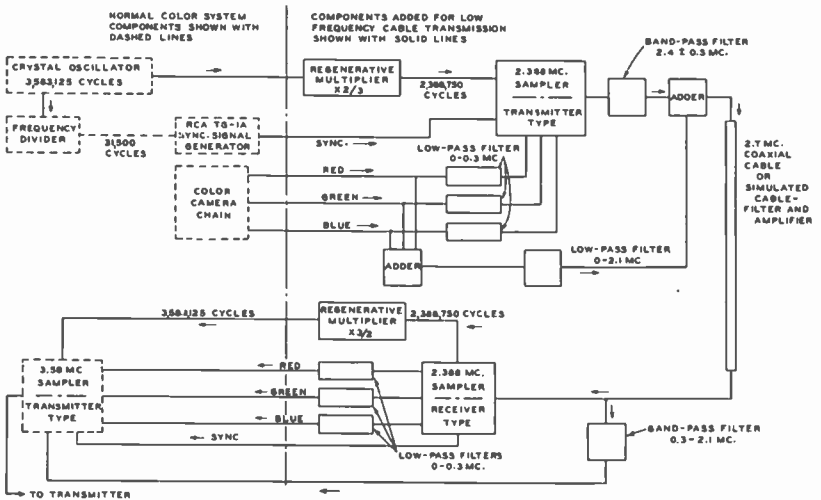

Fig. 35—A modification of the cable equipment which makes more effective use of the available band.

filter following the sampler wipes out the first two terms of (43) so the remaining signal going to the adder is simply

$$K_2 [G + g_1 \sin \omega_1 t] \cdot \cos(\omega_s t). \quad (44)$$

It should be noted that this filtering action has removed any requirement of short duty factor in sampling. In fact, the sampler can be an ordinary balanced modulator.

The entire signal given by (41) is bypassed around the sampler. The output of the adder feeding the cable is then the sum of (41) and (44),

$$\begin{aligned} \text{cable signal} = & K_3 [G + g_1 \sin \omega_1 t + g_2 \sin \omega_2 t] \\ & + K_2 [G + g_1 \sin(\omega_1 t)] \cos(\omega_s t). \end{aligned} \quad (45)$$

At the receiving end of the cable, the signal $K_3 g_2 \sin \omega_2 t$ goes through the band-pass filter and is used on retransmission as a regular mixed-highs signal.

Before studying the action of the sampler at the receiving end of the cable, assume that the gain controls at the transmitting end have been set so that $K_2 = 2K_3$. Then the cable signal of (45) becomes

$$K_3 [G + g_1 \sin \omega_1 t] [1 + 2 \cos \omega_s t] + K_3 g_2 \sin \omega_2 t. \quad (46)$$

Reference to Equations (14) and (15) and the adjacent text shows that when the signal of expression (46) goes through the sampler and low-pass filter at the receiving end of the coaxial cable, the signal on the green output is

$$K_4 [G + g_1 \sin \omega_1 t]. \quad (47)$$

This signal goes directly to the 3.6-megacycle sampler of the station which is programmed by the coaxial transmission.

This latter method provides color detail up to 0.3 megacycle, and intensity detail up to 2.1 megacycles.

APPENDIX III

THE ACTION OF THE DOT-SEQUENTIAL COLOR TELEVISION SYSTEM IN THE PRESENCE OF AN ABRUPT RED-GREEN TRANSITION

The analysis presented in the main body of the report, as it related to step functions, was confined to changes in a single color, that is, to intensity changes. Another effect which is encountered is that of abrupt changes in color where the colors are almost identical in intensity values.

To illustrate this effect, refer to Figure 36. Here a small patch of a scene is depicted where the scene is red on the left and green on the right. Assume that the red and green areas are of such color values that equal average electrical signals are produced by the red camera tube and the green camera tube.

The signal out of the green camera tube (with no frequency limitations) would be similar to that shown in Figure 11, with M set equal to unity. The signal out of the red camera tube would be an opposite

step, that is, the signal would have a prescribed value for t less than zero and would have zero value for t greater than zero. This would be achieved analytically by setting M equal to -1 .

If the signal from each camera is limited to less than the top pass frequency, f_B , the green camera signal (G.C.S.) is obtained from Equation (28). Then (with $M = 1$)

$$\begin{aligned} \text{G.C.S.} &= 1 + \frac{2}{\pi} \int_{\beta=0}^{\beta=\infty} d\beta \int_{\omega=0}^{\omega=2\pi f_B} \sin(\omega\beta) \sin(\omega t) d\omega \\ &= 1 + \frac{2}{\pi} \int_{\beta=0}^{\beta=\infty} d\beta \int_{\omega=0}^{\omega=2\pi f_A} \sin(\omega\beta) \sin(\omega t) d\omega \\ &\quad + \frac{2}{\pi} \int_{\beta=0}^{\beta=\infty} d\beta \int_{\omega=2\pi f_A}^{\omega=2\pi f_B} \sin(\omega\beta) \sin(\omega t) d\omega, \end{aligned} \quad (48)$$

and the red camera signal (R.C.S.) is (with $M = -1$)

$$\begin{aligned} \text{R.C.S.} &= 1 - \frac{2}{\pi} \int_{\beta=0}^{\beta=\infty} d\beta \int_{\omega=0}^{\omega=2\pi f_B} \sin(\omega\beta) \sin(\omega t) d\omega \\ &= 1 - \frac{2}{\pi} \int_{\beta=0}^{\beta=\infty} d\beta \int_{\omega=0}^{\omega=2\pi f_A} \sin(\omega\beta) \sin(\omega t) d\omega \\ &\quad - \frac{2}{\pi} \int_{\beta=0}^{\beta=\infty} d\beta \int_{\omega=2\pi f_A}^{\omega=2\pi f_B} \sin(\omega\beta) \sin(\omega t) d\omega. \end{aligned} \quad (49)$$

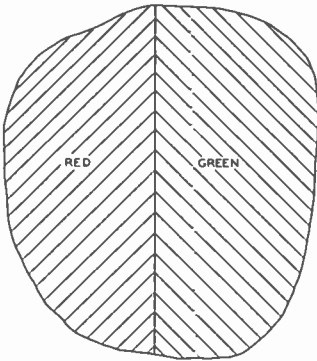

Fig. 36—An area where the transition from red to green produces constant light intensity.

The mixed-highs signal is found to be the sum of the last term in (48) and the last term in (49). This sum is seen to be zero. Physically, this result comes about from the fact that the alternating terms which make up the green step are identical, except for a reversal of polarity, to the alternating terms which make up the red step. For a standard monochrome camera viewing the patch of Figure 36, no transition would be visible.

Although it has been shown above that no mixed-high signal exists, the action of a color television receiver for this situation may still be analyzed by utilizing the principle of superposition. That is, the green step may be analyzed just as if the red step did not exist, and vice versa. Then the two solutions may be superimposed.

The signal on the green kinescope of a color television receiver, due to the green step alone, is found from Equation (31) to be

$$(\text{G.K.S.})_g = \frac{1}{3} [1 \pm 2 \cos(\omega_0 t)] \left[1 + \frac{2}{\pi} \text{Si}(2\pi f_H t) \right]. \quad (50)$$

According to Equation (35), this green step alone produces a signal on the red kinescope grid which is

$$(\text{R.K.S.})_g = \frac{2}{3\pi} [1 \pm 2 \cos(\omega_0 t - 120^\circ)] [\text{Si}(2\pi f_H t) - \text{Si}(2\pi f_A t)]. \quad (51)$$

Conversely, the signal on the red tube from the red step alone is found from (31) by setting M equal to -1 , and taking account of the fact that the red sampler lags the green sampler by 120 degrees. This latter signal is

$$(\text{R.K.S.})_r = \frac{1}{3} [1 \pm 2 \cos(\omega_0 t - 120^\circ)] \left[1 - \frac{2}{\pi} \text{Si}(2\pi f_H t) \right]. \quad (52)$$

The cross-talk term on the green kinescope due to the red step is likewise found from (35) to be

$$(\text{G.K.S.})_r = \frac{-2}{3\pi} [1 \pm 2 \cos(\omega_0 t)] [\text{Si}(2\pi f_H t) - \text{Si}(2\pi f_A t)]. \quad (53)$$

The total signal on the green kinescope grid due to the color transition shown in Figure 36 is found by adding (50) and (53), yielding

$$\text{G.K.S.} = \frac{1}{3} [1 \pm 2 \cos(\omega_0 t)] \left[1 + \frac{2}{\pi} \text{Si}(2\pi f_A t) \right]. \quad (54)$$

The total signal on the red kinescope grid due to the color transition shown in Figure 36 is found by adding (51) and (52).

$$\text{R.K.S.} = \frac{1}{3} [1 \pm 2 \cos(\omega_0 t - 120^\circ)] \left[1 - \frac{2}{\pi} \text{Si}(2\pi f_A t) \right]. \quad (55)$$

These last two equations show that the response to the transition in color shown in Figure 36 produces no detail greater than the frequency f_A . In other words, the mixed high-signals have cancelled to zero.

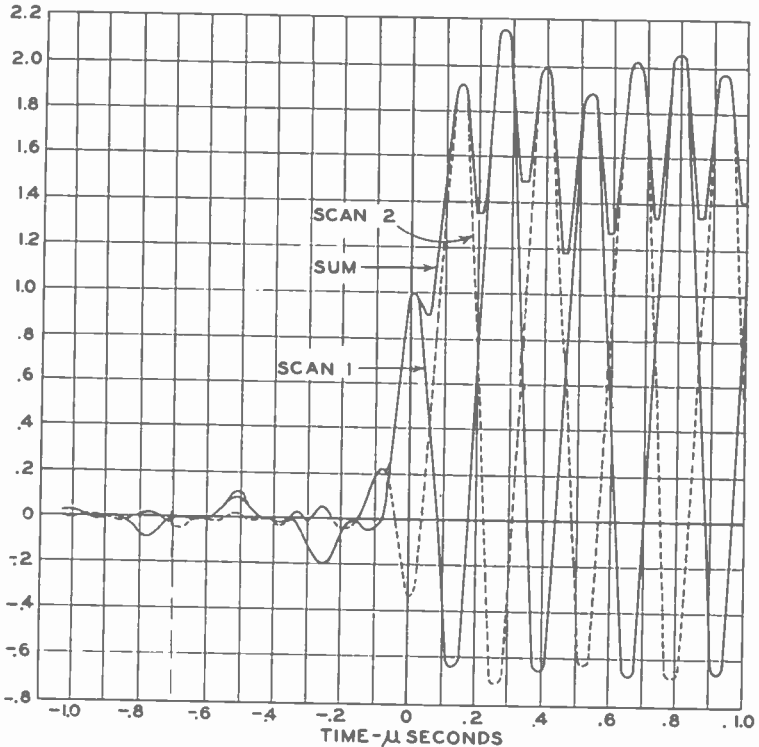

Fig. 37—Signal on the green kinescope grid of a color television receiver in the transition region of Figure 36. The sum curve may be regarded as the combined light intensity of two successive scans.

The green kinescope signal as found from Equation (54) for two successive scans of the same line is shown in Figure 37. The sum of the positive values of these two responses is also shown. This latter curve may be regarded as the light intensity, under the usual assumptions of kinescope and system linearity. The sampling frequency, f_o , has been taken as 3.8 megacycles.

Similar calculations, using Equation (55), are displayed in Figure 38. The sampling frequency, f_o , was taken to be 3.8 megacycles.

The red and green light intensity sums are shown in Figure 39, where it may be seen that the steepness of rise of the green and the steepness of fall of the red is limited to 2 megacycles, since f_A has been set at 2 megacycles in these calculations.

It is apparent that for a color transition such as shown in Figure 36, the detail at the transition is limited to frequencies no greater than f_A , the lower frequency limit of the mixed highs, and that detail between f_A and f_B is lost.

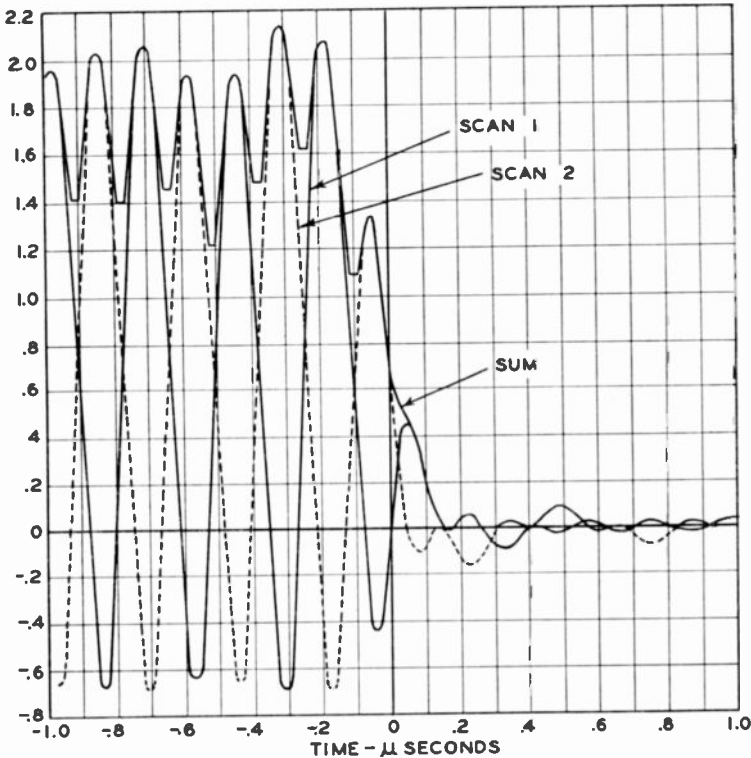

Fig. 38—Signal on the red kinescope grid of a color television receiver in the transition region of Figure 36. The sum curve may be regarded as the combined light intensity of two successive scans.

This effect might at first thought be considered to be a serious defect in the dot-sequential color television system. On the contrary, it is on this point that the dot-sequential color television system again makes use of the ability of the eye to distinguish detail in brightness and the inability of the eye to see detail in color differences. Observer tests made and reported by A. V. Bedford* shows that the acuity of

* A. V. Bedford, "Mixed Highs in Color Television", *Proc. I.R.E.*, Vol. 38, No. 9, p. 1003, September, 1950.

the eye for detail residing in color differences is less than half as great as the acuity for detail residing in brightness. To satisfy the eye observing a color television picture at a particular distance, it is not necessary to transmit information regarding the *color* of certain tiny areas even though these areas are large enough to be distinguished by differences in brightness. Accordingly, it is not necessary in scanning from area to area of the picture to be able to change from one color to another as quickly as it is necessary to change from one bright-

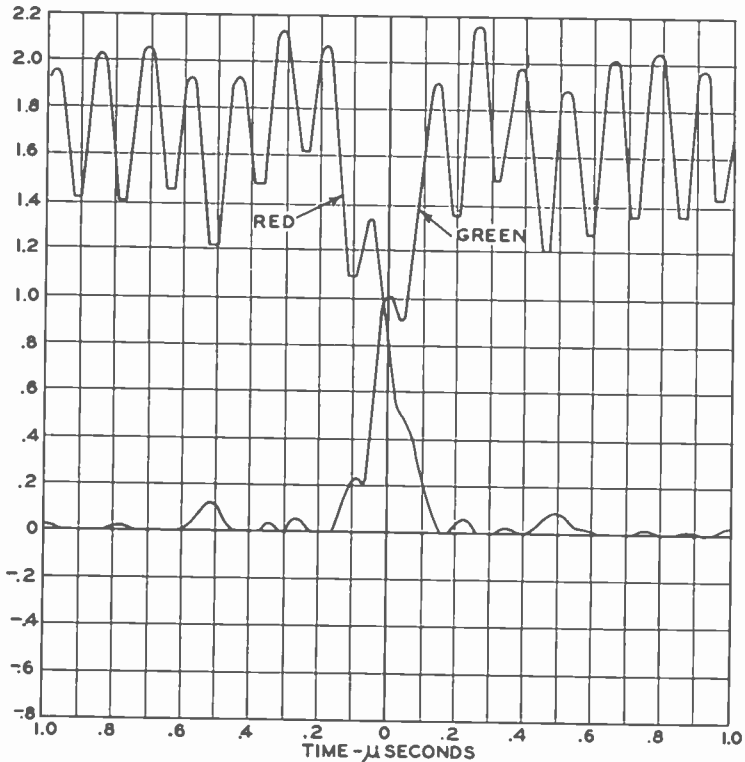

Fig. 39—Combined light intensity for two successive scans of the same line, for the transition region of Figure 36. The light intensity on the red and green tubes is shown separately.

ness to another. This report has demonstrated the ability of the dot-sequential color television system to produce brightness detail to an extent limited only by the total bandwidth allowed. Since the frequency f_A , the lower limit of the mixed-high region, has been chosen to be 2 megacycles with a 4 megacycle bandwidth, the system operates well within the limits set by physiological effects. As a matter of fact, Bedford's detailed results show that the choice of the lower limit of the mixed-highs has been a very sound one.

It is of interest to note from Figure 39 that a standard black and white receiver subjected to this color signal would show no distinction between the two areas. Likewise, a standard monochrome camera viewing the area showed in Figure 36 would not produce significant information on a black and white receiver.

GENERAL DESCRIPTION OF RECEIVERS FOR THE
DOT-SEQUENTIAL COLOR TELEVISION SYSTEM
WHICH EMPLOY
DIRECT-VIEW TRI-COLOR KINESCOPES*†

A Progress Report

By

RCA LABORATORIES DIVISION AND RCA VICTOR DIVISION,
Princeton, N. J., Harrison, N. J. and Lancaster, Pa.

Summary—Color television receivers are described which incorporate two forms of the first tri-color kinescopes to be successfully demonstrated. Each of the two forms employs the same type of direct-view color screen. In one of these forms three electron guns are used, the electron beams of which pass through the same tube neck and the same deflection yoke to strike the color screen. In the other form a single electron gun is used, again with a single deflection yoke. Both are fabricated in 16-inch metal cones and produce pictures approximately 9 inches by 12 inches.

The direct-view color screen is composed of an orderly array of small, closely spaced, aluminized phosphor dots arranged in triangular groups, each group comprising a green-emitting dot, a red-emitting dot and a blue-emitting dot. In the first laboratory sample tubes used in receivers, there are 351,000 such dots, 117,000 of each color; the objective is to double these numbers in later models. The screen is viewed in the same manner as a conventional black-and-white kinescope.

THREE-GUN TRI-COLOR KINESCOPE

THE manner in which the color screen produces a color picture is best understood by considering first the operation of the three-gun tri-color kinescope. An apertured mask is interposed between the three guns and the dot-phosphor screen in such a manner that the electrons from any one gun can strike only a single color phosphor no matter which part of the raster is being scanned. The mask is comprised of a sheet of metal spaced from the phosphor screen and containing 117,000 holes, or one hole for each of the tri-color-dot groups. This hole is so registered with its associated dot group that the difference in the angle of approach of the three oncoming beams determines which color is excited. Thus, three color signals applied to the three guns produce independent pictures in the three primary colors, the pictures appearing to the eye to be superimposed because of the close spacing of the very small phosphor dots.

Insofar as the color aspects are concerned, this three-gun tri-color kinescope may be utilized in a receiver in much the same manner as

* Decimal Classification: R583.5.

† Reprinted from *RCA Review*, June 1950.

three single-color kinescopes, except, of course, that no optical superposing or registration means need be provided and deflection power need be provided for only one deflection yoke.

The research-type receiver which employs the three-gun tri-color kinescope and high-level sampling,¹ utilizes 46 tubes and consists essentially of a 27-tube black-and-white television receiver to which have been added 19 tubes for color synchronization, sampling, additional power supplies, etc.

SINGLE-GUN TRI-COLOR KINESCOPE

The operation of the single-gun tri-color kinescope is analogous to the operation of the three-gun tri-color kinescope in that the beam from the single gun is magnetically rotated so that, in effect, it occupies, in time sequence, the three positions of the three guns in the three-gun kinescope. Thus, when the beam is in a position corresponding to the green gun of the three-gun kinescope it excites only the green phosphor dots and is at this particular time modulated only by the green component of the video signal. A short time later the beam has been rotated to a position corresponding to the red gun of the three-gun kinescope and is modulated by the red component of the video signal to excite red phosphor dots. A third position similarly produces the blue picture. Sampling is automatically provided by rotating the beam synchronously at sampling frequency.

The research-type receiver employing the single-gun tri-color kinescope utilizes 37 tubes and consists essentially of a 27-tube black-and-white television receiver to which have been added 10 tubes for color synchronization, beam rotation, additional power supplies, etc.

RECEIVER FOR THE THREE-GUN TRI-COLOR KINESCOPE

A block diagram of the principles of the circuit arrangement employed in the receiver utilizing the three-gun tri-color kinescope is shown in Figure 1. Video signal from a conventional black-and-white television receiver is applied simultaneously to the three, internally-connected, control grids of the three-gun kinescope. Another signal, derived from the video amplifier, is used to actuate an automatic color phasing and sampling synchronization circuit² which produces a local 3.58-megacycle sampling wave. The latter is applied through an ampli-

¹ "A Simplified Receiver for the RCA Color Television System," Bulletin, RCA Laboratories Division, February, 1950.

² "Recent Developments in Color Synchronization in the RCA Color Television System", Bulletin, RCA Laboratories Division, February, 1950.

fier tube and appropriate delay lines to three gating tubes which supply three sampling pulses, differing in phase by 120 degrees at 3.58 megacycles, to the three cathodes of the kinescope. Thus, each gun is turned on in time sequence corresponding to the original sampling process at the transmitter and the beam current from each gun excites only one of the three phosphor colors.

The tuning adjustment in the plate circuit of the 3.58-megacycle sampling-signal amplifier permits fine adjustment of the overall color phasing. However, proper color phasing is essentially determined by the permanently installed delay lines which are initially cut to proper length.

The front-panel operating controls are the same for color as for black-and-white operation. Individual service adjustment controls are provided in the cathode circuits of the three guns in order to permit initial equalization of the control characteristics of the three guns.

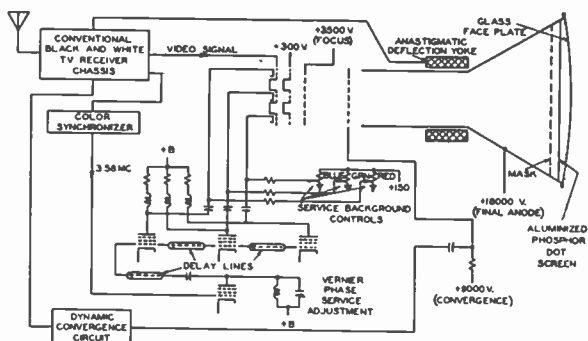

Fig. 1—Block diagram of receiver circuit principles for the three-gun tri-color kinescope.

The deflection circuitry is of the conventional type. Minor changes in deflection-tube types have been made to supply additional deflection power occasioned by the increased kinescope second-anode potential (18 kilovolts). The deflection yoke is of the anastigmatic type and has an internal diameter of two inches to accommodate the converged beams from the three guns.

The registration in this three-gun tube is built in by the proper registration of the masking apertures with their corresponding groups of phosphor dots. Means are also provided to converge the three beams to the same point on the phosphor screen during scanning. This is done for the undeflected beams by a convergence electrode, operated at 9000 volts, and, when necessary, by small correcting magnets set up initially as a permanent service adjustment when the tube is installed. Because of the essentially flat face of the phosphor screen, simple geometrical considerations show that slightly less convergence is desirable as the

beam is deflected from center. This dynamic convergence is accomplished by deriving a voltage from vertical and horizontal deflection circuits of the receiver and applying it to the convergence electrode through a capacitor.

A radio-frequency type anode voltage supply provides a potential of 18 kilovolts for the kinescope final anode, 9 kilovolts for the electrostatic converging electrode and approximately 3.5 kilovolts for the parallel-connected first anodes which produce initial electron-beam focus. A small auxiliary power unit provides heater and +B power for the other added circuits.

RECEIVER FOR THE SINGLE-GUN TRI-COLOR KINESCOPE

A block diagram of the principles of the circuit arrangement employed in the receiver utilizing the single-gun tri-color kinescope is shown in Figure 2. Video signal from the output of the video amplifier

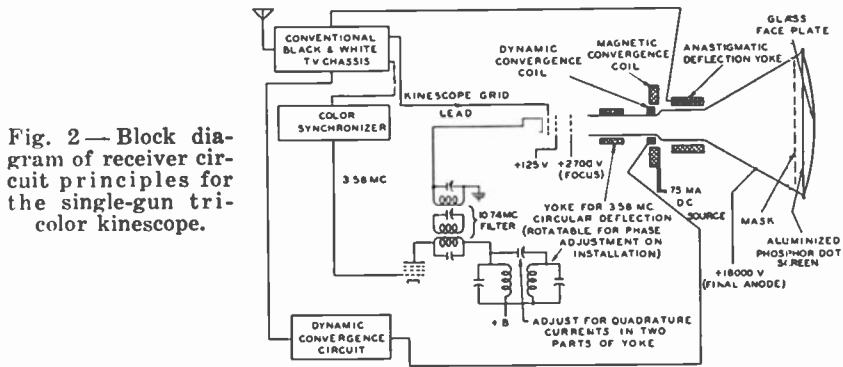

of a conventional black-and-white television receiver is applied to the control grid of the single-gun kinescope in the conventional manner. Here again, as in the previous receiver, another signal from the video amplifier actuates an automatic color phasing and sampling synchronization circuit² which produces a local 3.58-megacycle signal which is locked in step with the transmitter sampler. Circular deflection of the beam, which produces sampling automatically, is provided by a small deflection yoke having two sets of coils which are fed with quadrature currents at sampling frequency to produce a rotating field. Service adjustment of color phasing is provided by mechanical positioning of this yoke. The amplitude of the circular deflection is adjusted to produce the proper convergence angle as required by the mask and phosphor-dot screen. The duration of the sampling period is controlled by

a signal having a frequency three times the sampling frequency which is injected into the kinescope cathode circuit. The amplitude and phase of this 10.74-megacycle signal are determined by the alignment of a filter circuit which utilizes the third harmonic of the circular-deflection driver tube.

As in the receiver for the three-gun tube, the front panel controls of the single-gun set are the same as those used in a conventional black-and-white receiver. Because a single gun is used in this kinescope, color balance may be achieved by proper deposition of the phosphor dots. The deflection circuitry and deflection yoke are the same as those employed in the three-gun receiver described in the preceding section.

The kinescope gun which is employed is the same as that used in the commercial type 5TP4 kinescope. Potentials of 18 kilovolts for the final anode and 2.7 kilovolts for the electrostatic focus electrode are derived from the kick-back voltage on the horizontal-deflection output transformer just as in conventional black-and-white receivers. A small auxiliary power unit provides heater and +B power for the other added circuits.

Convergence of the circularly deflected beam is produced by a magnetic lens in this single-gun kinescope instead of the electrostatic method employed in the three-gun version. A coil similar to the focus coil normally employed in conventional black-and-white receivers is used for this purpose. The dynamic convergence variation is likewise applied magnetically in this tube and is introduced by means of a smaller auxiliary coil located near the main convergence coil. As in the previous receiver, the dynamic convergence waveforms are derived from the deflection circuits.

MIXED HIGHS IN SIMULTANEOUS
COLOR TELEVISION*†

A Report

By

RCA LABORATORIES DIVISION, PRINCETON, N. J.

Summary

A high-quality color television system could be made by transmitting independent red, green and blue images of equally-high quality. The bandwidth required by this method would be three times as great as that required for a black-and-white picture of equal resolution and repetition rate, regardless of whether the images are transmitted in sequence or simultaneously.

Tests made on the human eye and reported herein, indicate that the acuity for detail residing in color differences is less than half as great as the acuity for detail residing in brightness. Therefore, if the brightness values in a color television system are transmitted with fidelity up to $\frac{1}{2}$ megacycles, it is adequate to transmit the individual color values up to only 2 megacycles, with a corresponding saving in bandwidth. In the "mixed-highs" system described, each of the three color images uses frequencies from zero up to 2 megacycles and the "mixed-highs" which carries only the brightness values of the fine detail uses a video-frequency band from 2 to 4 megacycles. The total width of the video bands then is only 3 megacycles instead of 12 which would be required for three identical bands from zero up to 4 megacycles.

The bandwidth saved by the mixed-highs technique is obtained not at the expense of picture quality, but is a legitimate saving that arises by avoiding the transmission of information which the eye is unable to use. In this sense the saving could be compared to that which occurs by transmitting only the visible spectrum of colors, omitting the ultra violet which the eye cannot see.

The brightness-acuity eye tests were made with projected charts without the use of television apparatus. A new type test pattern was used having a calibrated blurred junction which corresponds to the light values resulting from the transient response of a video amplifier with restricted bandwidth in passing from a dark area to a light area. The measurement of acuity for detail in color was made with similar blurred junctions between areas of different colors.

Though the work reported was done a number of years ago and was applied to the simultaneous system demonstrated by RCA Laboratories in 1946, the principles and techniques are equally applicable to the new RCA color system demonstrated in 1949. In the latter system the mixed-highs and the dot-interlace jointly provide a three-to-one bandwidth reduction that allows a high-definition compatible color television service to be operated within the 6-megacycle radio-frequency channels now allocated for black-and-white television.

(10 pages, 5 figures, 2 tables)

* Decimal Classification: R583.1.

† Bulletin, RCA Laboratories Division, July 1950.

COLORIMETRIC ANALYSIS OF RCA COLOR TELEVISION SYSTEM*†

A Report

By

RCA LABORATORIES DIVISION, PRINCETON, N. J.

Summary

The objective of color television is the reproduction on the viewing screen of the receiver not only the relative luminances (brightness) but also the chromaticities (hues and saturations) of the details in the original scene. Colorimetry, the science of color measurement and specification, is of great importance to the color television engineer, since it is with the aid of the principles of colorimetry that he is able to determine quantitatively the quality of reproduction and to accumulate engineering data for the constant improvement of the reproduction.

The purpose of this bulletin is to present an analysis of the colorimetric capabilities of the RCA color television system. Since this report is addressed to people who may not be well versed in colorimetry, the first section will be devoted to an introduction to the subject. This is followed by a section describing the ideal requirements for perfect reproduction and an analysis of the fidelity of reproduction when ideal requirements are not fulfilled.

(19 pages, 19 figures, 13 tables)

* Decimal Classification: R583.1.

† Bulletin, RCA Laboratories Division, February 1950.

A SIMPLIFIED RECEIVER FOR THE RCA COLOR TELEVISION SYSTEM*†

A Report

By

RCA LABORATORIES DIVISION, PRINCETON, N. J.

Summary

This bulletin describes a simplified receiver for the RCA color television system. This model, which was demonstrated to the FCC on February 23, 1950, affords considerable reduction in size and circuit complexity as compared to earlier research models previously described and demonstrated.

The receiver is of the direct-view type employing three short ten-inch, 70-degree, metal-cone kinescopes and incorporating high-level sampling and automatic color synchronizing circuits.

Although these innovations mark a considerable advance in color television receiver art, it must be noted that they constitute only the first few steps in an overall process of simplification.

(9 pages, 11 figures)

* Decimal Classification: R583.5.

† Bulletin, RCA Laboratories Division, February 1950.

RECENT DEVELOPMENTS IN COLOR SYNCHRONIZATION IN THE RCA COLOR TELEVISION SYSTEM*†

A Report

By

RCA LABORATORIES DIVISION, PRINCETON, N. J.

Summary

This bulletin discusses two aspects of the RCA color television system; the application of a "flywheel" to the picture dot interlace synchronizing information and the provision of automatic color phase control.

The foundation upon which any successful television system is built is the complete cooperation between transmitter and receiver involving accuracies of timing of the order of one-eighth of a millionth of a second in the horizontal sweep circuits of conventional black-and-white receivers. This accuracy is obtained even in the presence of noise and interference by the use of "flywheel" circuits usually called automatic frequency control or, more simply, AFC circuits. The same basic concepts are applied in the RCA color television system to the color dot interlace synchronizing signal to obtain the necessary immunity to thermal agitation and impulse noise.

Any sequential color television system (field, line or dot) must solve the problem of reproducing the original color in the picture and not, for example, reproducing the original red color information as blue or green. Most color television systems demonstrated to date have depended upon the operator of the receiver to make the necessary adjustments to synchronize his receiver with the transmitter. The RCA color television system receivers previously demonstrated have had a manual color phase control to be manipulated by the operator. Means are now available to make this function automatic.

This bulletin describes systems for accomplishing both of the above described functions. Some of them have been reduced to practice and found to operate satisfactorily. Others are in the process of construction to permit testing while still others are under consideration. One or more of them will be demonstrated at ensuing demonstrations of the RCA color television system. The various systems are not identical in potential performance or probable cost so work is continuing to obtain an accurate evaluation of the potentialities of each.

(11 pages, 13 figures)

* Decimal Classification: R583.1.

† Bulletin, RCA Laboratories Division, February 1950.

TELEVISION: TECHNIQUES AND APPLICATIONS*†

BY

ALFRED N. GOLDSMITH

Consulting Engineer, Radio Corporation of America,
New York, N. Y.

Summary—It is the purpose of this analysis to present, in a summary form useful for businessmen, information about the technical, program, and advertising methods of television; the extent and nature of home ownership of television receivers; the more basic statistical and cost factors involved in television broadcasting and reception; the regulatory and allocation aspects of television; the status and prospects of some proposed extensions of, and improvements in, television broadcasting; and the possibilities of certain nonbroadcasting uses of television, including theater television and industrial applications. In the course of this presentation, occasional comparisons will be made between the developmental conditions of television in the United States and those in other countries.

It should be noted, with appreciation, that the major television broadcasting networks have cooperatively made available data concerning their stations, time rates, audience, and operations for the purposes of this analysis.

Unfortunately, the complexity of the television field—its many variables and ramifications, the rapid changes in its techniques and equipment, the incalculable effect of prolonged and frequent governmental hearings and the resulting complex regulations and allocations, and the partly formative nature of the television manufacturing and broadcasting industries—all combine to limit the dependability and utility of what might be normal and controlling data in other, further developed, and commercially stabilized industries.

Nevertheless, it is even now possible to “get the feel” of television and thus to chart, at least partly, the logical and practical procedures indicated for television. With this thought in mind, the present analysis has been planned to be of particular assistance to those now making commercial use of television or contemplating such use, as well as to those who are more generally interested in this, the most diversified and versatile medium of mass communication so far devised.

Part I — TECHNIQUES

THERE will first be considered the general techniques used in a modern television system, at both the transmitting and the receiving ends and including program syndication over appropriate networks.

* Decimal Classification: R583.

† This paper was originally prepared in October, 1949, and was published in the March, 1950, issue of the *Harvard Business Review*. The paper is reprinted herewith as it originally appeared with the exception that the data in certain sections and tables have been brought up to date in the light of developments and changes which have taken place since its preparation. The courtesy of the *Harvard Business Review*, in permitting the inclusion of these changes, is gratefully acknowledged.

Essentially, television offers an extension of the human senses beyond the normal limitation of horizon, opaque obstacles, and materials which absorb or deflect sound. In doing so, it provides four important factors of information: (1) sound; (2) sight, at present in monochrome, later in color; (3) motion; and (4) immediacy. Thus any sound may be heard at a distance; the source of that sound and the surroundings may be viewed; the motion of persons or objects in the viewed scene may be observed; and all of the preceding may be perceived by the recipient at the very instant of occurrence.

It is unnecessary to stress the importance of sight and sound since it is well known that the major portion of available information reaches men through these senses; but it is worth observing that the combination of the two adds more than proportionately to total effectiveness. In addition, motion is an interesting and commanding factor in any viewed scene. And the sense of simultaneity experienced in viewing television presentations serves psychologically to bind the members of the audience to the program source and to each other. In certain events—e.g., horse racing—the element of instantaneous presentation is obviously of outstanding importance.

The technical development of television has reached the point where it is certain that it can be effective over continental distances. There is no reason to doubt that ultimately television can operate over any desired terrestrial distances, although such world-wide extensions of television will necessarily await detailed technical development and economic conditions not now existent.

ORIGINATION OF PROGRAMS

Most prearranged programs presented by television originate in so-called studios which resemble motion picture studios in many respects. In the studio, provision is made for adequate illumination on all parts of the scenery or "set," as well as carefully adjusted lighting on the actors participating in the performance. A group of television cameras is arranged so that views of the entire set may be obtained, or views of particular parts of the set and even "close-up" views of individual actors or groups of actors.

Each camera is provided with a finder which shows the corresponding picture that is picked up. These finders actually show a miniature television picture, thus enabling the camera man to select his distance, location, and viewing direction for most effective or dramatic results. The cameras are usually mounted on dollies enabling them to be moved rapidly from one desired position to another. They are connected

by heavy but flexible cables to the control room where the pictures are viewed and coordinated.

Sound is picked up by microphones somewhat resembling those used in conventional radio programs but mounted on long rods or "microphone booms." By the use of the booms the microphone may be held suspended over or in front of individual actors to permit picking up speech at a moderate distance. Careful manipulation of the boom by a microphone operator keeps the microphone out of the field of view of any of the cameras (except in occasional embarrassing moments of error or carelessness).

Use of Film

Because television programs, in whole or in part, may also originate on sound motion picture film, projection rooms are a part of all normal television stations. In the projection room, film is run through a special projector, and the corresponding motion pictures are thrown on to the sensitive surface of a television camera tube. This tube then produces the electric signals (the so-called video signals) corresponding to the film pictures. These video signals are sent from the projection room to a control room where they are coordinated with the remainder of the program.

Given suitably photographed and processed film, appropriate film-projection equipment for television transmission, and skillful monitoring, the technical quality of film programs should be substantially indistinguishable from the corresponding live-talent presentation. However, the film technique is still in process of development toward this ultimate perfection. Present-day programs originating on film vary from highly acceptable to mediocre, depending on the extent to which the preceding specifications have been met.

Question of Studio Audiences

Following customs established in the radio field, many television studios are provided with seating facilities for a studio audience. Sharp differences of opinion exist as to the desirability of such an audience. Sponsors of television programs often desire such an audience as an added advertising factor. Certain actors, particularly in the variety field, insist that a visible audience and its reactions stimulate them to their best performance. However, motion picture comedies and musical feature films are made successfully enough by these actors in the absence of an audience, and it is accordingly doubtful whether the psychological need for an audience is as compelling as has been claimed.

From the standpoint of the broadcaster and his engineers, studio audiences are a complex and costly intrusion. Expensive space and seating facilities must be provided. Means for getting the audience into and out of the studios are necessary, together with groups of ushers and guides. The actors tend to play to the visible audience rather than the home audience, and those on the operating staff find their lighting, camera positions, insertion of film "clips" or program sections, and various other elements of operation either hampered or blocked by the presence of an audience.

It is not clear whether, in the future, studio audiences will be present at important television programs. The likelihood is that the studio audience will not be wholly eliminated in most stations.

Remote Pickups

Programs need not originate in the studios of the broadcasting stations. They may, instead, originate at any remote point as, for example, a sports stadium, a theater, a municipal gathering place, or even on the streets of a city. Such programs are known as "remote pickups" and add considerable variety to television programming. As a general rule they are costly since they involve carrying the equipment and staff to some remote point, setting up and operating the equipment for a relatively brief period, and then removing it.

Further, remote pickups involve an additional complication and expense, namely, a special link or connection between the remote pickup point and the control room of the central studios or transmitter. Generally it is necessary to bring the remote program to the same control rooms that are used for the station studios. This is usually done by means of a radio-relay link or by means of a special telephone line modified to permit television signals to pass over it without excessive distortion.

Control Room

Programs which have originated in a studio, on film, or at a remote point are all finally gathered together for utilization in the master control room.

Persons familiar with motion picture techniques are aware that most motion pictures originate largely in a so-called "cutting room." In this room the film editors cut and splice sections of film to form the final program. They are guided by their pictorial sense, their judgment of dramatic values, and their long experience in this art. They may work for hours on a comparatively brief film sequence.

In the television control room, the program producer assembles

the television programs in much the same way, but with two notable differences. In the first place, the pictures from the various studio cameras, or from the film projector or remote pickup point, are all visible to him instantaneously on different monitoring picture tubes. As he assembles the program, he selects the desired picture in each instance and splices it electronically, so to speak, into the program. More prosaically expressed, the producer can select any available picture and use it to control the television transmitter at any instant. An engineer or technician, following the producer's instructions, makes the corresponding instantaneous electrical switching connections.

Thus the knife and cement of a film splicing machine, as used in motion picture production, are replaced by the far faster electrical switching of video signals from various sources. It need hardly be added that a good television director is one capable of exercising excellent judgment with extraordinary rapidity and endowed as well with an unusual combination of dramatic sense, poise, and dependable reactions. It must also be remembered that a television program once transmitted is gone beyond recall. Errors are not open to correction, as in the case of motion picture production.

As might be expected, television control rooms contain intricate assemblies of switching equipment, monitoring picture tubes showing the available program sequences, phonographs for the introduction of music into the program, connections to film projectors, connections to remote pickup points, and all necessary associated apparatus. Indeed, the modern television control room is extraordinary for its complexity of electrical equipment, as well as its simplicity and rapidity of operations. Television may be regarded as the quintessence of arts based on modern scientific methods.

TRANSMISSION

Once the program has actually been assembled in the control room, the transmission of it to the public is a more or less routine matter. It is carried from the control room to the transmitter and there disseminated widely.

Present-day television transmitters have effective powers not exceeding a few tens of kilowatts. Picture signals are sent on one frequency. The sound portion of the program is simultaneously sent on another nearby frequency at the same transmitting location. Television transmitters differ from ordinary radio transmitters in several respects. For one thing, the picture transmitter is far more complex. It actually sends a group of different signals which enable

the picture to be reconstituted in all receivers. These include both the picture signal (with an appropriate background value inherent in it) and the line and field synchronizing signals.

Engineering Principles

It is beyond the scope of this analysis to discuss in any detail the methods of television engineering. Broadly, however, television pictures are sent by resolving each individual picture (or field) into a myriad of minute elements or dots. In the standard procedure, the picture is initiated at its upper lefthand corner. It is then drawn or "scanned" in a first horizontal line ending at the righthand edge of the picture. Almost immediately thereafter a second line of the picture is scanned for its values of light and shade, this second line lying closely below the first line. The process continues until the bottom edge of the picture is reached.

At this point, one field of the picture has been scanned and transmitted. The process is then immediately repeated to transmit a second field, and so on. In practice, 60 fields are transmitted each second. Each of these fields consists of 262.5 lines. The lines of each field are separated by their own width, and successive fields are "interlaced." Accordingly, two such interlaced fields produce one complete 525-line picture or "frame." And 30 such frames are sent each second.

Although, strictly speaking, the television picture is produced with only one luminous dot moving rapidly over the field of view, the entire process is so quick and precise that the eye and brain of the viewer are completely deceived. Persons viewing television pictures have the impression that a moving picture is continuously before them on the screen.

In all modern television systems the processes are purely electronic. That is, there are no moving mechanical parts in television transmission and reception; the only moving elements are practically mass-free beams of electrons which are rapidly deflected to scan the picture in the studio cameras and again to scan the reconstituted picture in the cathode-ray tubes or kinescopes in the home.

It is obvious that the scanning point at the transmitter and the corresponding scanning point at the receiver must be maintained closely in the same relative positions in order that picture distortion or destruction may be avoided. These processes of line synchronizing and field synchronizing lie outside the scope of this discussion. It may be of interest, however, that an error of one millionth of a second would be a serious matter in many cases!

The complex processes of television are not completed, of course,

by transmission from a single station. Economic considerations require the dissemination of each program to the largest possible audience. Since the audience of any one station is limited, it is necessary that syndication methods be found for the regional or national distribution of television programs.

Direct Networks

The syndication of programs may be carried out by individual stations or organizations over limited distances—as, for example, by means of the New York-Schenectady NBC-General Electric Company link previously in use, the New York-Philadelphia link established by Philco in collaboration with NBC, and the Washington-Philadelphia NBC radio-relay link.

Substantially all television network facilities, however, are already provided by a common carrier, namely, the American Telephone & Telegraph Company. The basic television facilities of this company now extend along the East Coast from Boston to Norfolk, and westward as far as Chicago, Milwaukee, Memphis, and St. Louis. There also exists a link on the West Coast between Los Angeles and San Francisco. A transcontinental extension from Chicago to San Francisco, via Omaha, is under construction, and is scheduled for completion in early 1952. On many of the intercity links, a number of simultaneously available connections are provided so that more than one network can furnish service at a given time.

Physically, the syndication facilities for television fall into a number of types. For moderate distances up to 10 or 20 miles, specially adjusted telephone lines can be used to carry television signals of acceptable quality. For longer distances, so-called coaxial cables are used. A coaxial cable is, in essence, an outside conducting sheath through the center of which runs a wire insulated from the sheath by means of disc insulators (or their equivalent) placed at regular intervals.

Another physical method of syndication, and a most important one for the future, is the radio-relay system. By the use of minute electromagnetic waves (the so-called microwaves), the program is transmitted in a narrow directional beam from a first transmitting station to a first receiving station perhaps 25 miles away. At this first receiving station, the incoming signal is used automatically to control a second beam transmitter which sends the signals perhaps another 25 miles to a second receiving station, whence it is again retransmitted. The process is repeated automatically over as many relay stations as may be required. For example, a radio-relay system from New York

to Chicago, shortly to be established, may use from 30 to 40 relay stations. Despite the numerous repetitions of the signal, the process is so accurate that a good radio-relay system may operate well in excess of 1,000 miles, or even over transcontinental distances, without introducing any objectionable distortion on the average television receiver.

It is not necessary, however, to use physical facilities for program syndication. One method which has been proposed, but not used up to the present, is the road-show form of syndication. This would involve sending actors and their scenery from city to city and arranging to have them appear at the local television station (and perhaps in the local theaters) in each city. A far more common method of syndication involves the use of film.

Film Syndication

For this method, the program is recorded as a sound motion picture film, either on 35-millimeter or 16-millimeter film. At present, 16-millimeter film is far more widely used because it is less expensive, easier to process and handle, is noninflammable, and can be projected in rooms and under conditions not meeting the elaborate safety regulations of many municipal codes covering 35-millimeter inflammable film.

The use of noninflammable 35-millimeter film, however, is planned for all theaters. It may be that ultimately only safety film will be available, and at that time the stringent regulations governing the use of 35-millimeter film may be relaxed. Inasmuch as superior picture quality is obtainable on the larger film, television syndication experts may seriously consider the wider use of 35-millimeter film at a later date in place of the 16-millimeter film which at present is largely standardized for television.

There are a number of ways in which film may be used for television syndication. Of course existing films can be used, but the quality and subject matter of regular motion pictures available for television use leaves much to be desired—a topic which will be discussed in some detail under programming, where it more properly belongs.

Alternatively, new productions may be photographed on film especially for television, using either existing motion picture techniques or improvements on such techniques. Another popular method of film syndication is to photograph an actual television performance. A live-talent show in the studio is sent through the control room to a monitoring picture tube or kinescope on which the program appears. A special 16-millimeter camera is focused on the screen of this tube, and

the program is thus "kinescope recorded." The quality of such recordings is regarded as marginal, but in view of the simplicity and relatively low cost of the process it has found considerable favor.

Programs presented either on the East Coast or the West Coast have often been kinescope recorded. Prints of the program are then sent to the television stations on the opposite coast, or to other stations not connected to the physical networks, and are thus used for television transmissions. The major networks (NBC, CBS, ABC, DuMont) have made television records of this type and have used them with some measure of success.

An attempt has also been made to establish a film network as such. The Paramount organization has announced its intention to provide about six hours per week of film recordings. These programs are stated to have been assigned to almost twenty stations, which will sell them to local advertisers, inserting commercial announcements as desired.

Relative Advantages

Direct or physical networks have the great advantage of immediacy and continuous availability. On the other hand, the connection charges at present are substantial. Stations connected to physical networks necessarily accept a program at the time of its arrival. Differences of time in the various zones in the United States (amounting to as much as three hours) somewhat limit the adjustment of program time to maximum audience availability. The fact remains that physical networks available on an all-day basis are often essential for broadcasting events of outstanding or transcendental importance.

Film networks are obviously more flexible than physical networks in that the time of presentation of a program is not fixed or necessarily simultaneous for all stations. Film programs can readily be repeated, and even under different sponsorship. Yet there are also offsetting disadvantages. Film prints must be made and shipped, inspected, and maintained in good condition. Further, the element of immediacy is of course lost in film presentations.

It would seem that physical networks will be established, at least on a regional basis, wherever economic considerations do not prevent their use. On the other hand, it is also clear that film syndication has its own place in television broadcasting and that, with skillful planning, it can be successfully used. One oddity of film syndication has involved the use of a film program over a physical network. It appears likely, in fact, that film syndication and physical networks will be complementarily used and that, under such circumstances, each method has a distinct contribution.

Need for National Network

Transcontinental television networking must await the completion of the previously mentioned Chicago-San Francisco link. Furthermore, it is likely that the lifting of the present "freeze" and the re-establishment of more nearly normal television conditions are essential to the successful operation of such a network.

Existing radio networks may run into tens of thousands of miles of interconnection, covering the United States fairly completely. A corresponding national television network would present serious economic problems. At the current rates for television connections, a 16-hour-per-day network of such dimensions, allowing for terminal charges, connection charges, and the like, might require an annual expenditure of the order of \$10 million to \$20 million.

The magnitude of this amount has led some television analysts to suggest that the Federal Government would be well advised to establish and subsidize one or more national physical television networks (although not the stations connected thereto). Such a network would offer many obvious advantages in relation to the national defense—both in time of peace and in time of war.

PROGRAMMING

The most usual television programs are of the live-talent variety. They range from news discussions by individual commentators to extremely elaborate dramatic presentations modeled on the format of the less pretentious motion pictures.

For the sake of economic operation, repeated attempts have been made to present the same program both as a standard radio broadcast and as a television broadcast (a so-called "simulcast"). This makes it necessary to arrange that the sound portion of the program shall be entertaining in itself, and also that the visual portion of the program shall add substantially to its entertainment value. These are difficult specifications which have not been wholly met in most instances.

It would be beyond the scope of this analysis to list the hundreds of types of programs which have been developed by the television broadcasters. Despite their diversity, they fall into a limited number of well-defined groups, mainly involving drama, comedy, variety, political discussions, news comments, sports events, children's programs, so-called "give-away" programs, musical presentations, and quizzes. Most of these programs have a prearranged action and dialogue.

The immediacy factor of television finds an excellent expression in the "remote" programs. These are picked up at the point of origin

at an event which is usually spontaneous or only partly prearranged. Sports events are a notable example of such remote programs. The type of remote program and the number of such programs used per month naturally vary with the seasons. For this reason, sports programs—and indeed most remote programs—are difficult to schedule over the major portion of a year. Certain sports programs, however, fit well into the 13-week or 26-week program groups which are now usual.

Film Presentations

Programs originating on film (that is, on sound motion picture records) are widely used. The actual proportion of film programs to total programs, however, varies greatly depending on the type of station. Certain stations not associated with or connected to any network may fill more than 50 per cent of their operating time with film presentations, whereas network stations tend to use a considerably smaller proportion of film programs.

The motion picture industry, as a not unnatural measure toward the preservation of its economic position, has refused to make available for television its recent and preferred product. It must be remembered that the average theater exhibitor of motion pictures would greatly resent the availability for television broadcasting of any film which he was attempting to present to a paying audience—or indeed of any film which he had recently presented.

Of course, distinctly antique feature films or shorts have been made available for television. Many of these are of the well-known "Western" type well-beloved by the juvenile audience. But these rather worn films do not satisfy the major portion of the adult television audience. Accordingly, except for a sprinkling of foreign films, the use of existing films by television broadcasters does not give any fair indication of the value of films in television.

The refusal of the major film producers to supply their current films for television purposes has led several of the smaller independent producers to enter into that field. These organizations have shown considerable enterprise and have improved the quality of their product at an acceptably rapid rate.

To a certain extent, the newer producers still utilize the conventional motion picture techniques in their work, photographing each scene separately and usually repeatedly in order to secure an acceptable sequence or "take." The process is lengthy and costly, frequently yielding only a few minutes of finished film as the result of a day's work, although of course the quality and "smoothness" of the final

product are outstanding. A finished feature film of high quality for theater use may have a cost of \$15,000 to \$30,000 per minute of running time. Such production costs are totally beyond the economic possibilities of present-day television.

Reducing Costs

There have been vigorous and fairly successful attempts by some of the independent producers to make film by speedier and less costly processes. Essentially the technique of television production has been adopted. For example, a number of cameras may be trained on the actors and set. The entire production may be run through without pause and recorded by each of the cameras. The resulting pictures may be cut, edited, and assembled quite readily, thus producing the final picture at a minor fraction of the cost which would result from the older methods.

It is rather startling that the new art of television should so soon have influenced the old and established art of the motion picture. It appears increasingly likely that motion picture techniques will be profoundly modified as the result of television methods and competition. While present-day film productions of this kind do not equal in quality the more elaborate motion picture productions, they are effective and entertaining, and serve the television audience satisfactorily.

The kinescope recording of an actual television performance, previously described, is another example of the attempt to cut costs. There is an obvious saving if a kinescope recording is made of a live-talent production on the East Coast for film syndication on the West Coast, or vice versa. As a matter of fact, the repetition of a program may sometimes be acceptable in the original area in which it was given, particularly since the television audience is increasing so rapidly that a repeat performance may play to a large group which has not previously seen it. The process is unusually simple and economic, and it has found wide favor. However, because the picture quality resulting is marginal, or even quite poor at times, it is not as yet certain whether kinescope recordings will be more than an interim method of providing film for television purposes.

That the high costs of television production, as compared to radio, have focused attention on methods which would markedly reduce costs is only natural when it is considered that live-talent performances range in production cost from \$20 or \$30 to over \$100 per minute.

There is as yet no definite indication of the relative acceptability of live and film performances on television. An original film program

(not a kinescope recording) generally costs more than a straight live show. On the other hand, since the film is made previous to transmission, there is no question as to its quality, no danger of the actors' forgetting their lines or action, and no possibility that the program will run either too short or too long. The stable and certain quality of a film program, as well as the ease of repeating it, are the major advantages which must be weighed against the actual cost of filming.

Legal Aspects

As might be anticipated, an attractive field like television, which is much in the public gaze, has not failed to draw the attention of legislators and the legal fraternity. It is beyond the scope of this analysis to consider all the various legal aspects of television programming at this time. However, it may be mentioned that it is often a difficult matter to secure copyright clearance for a television production—e.g., a drama. The difficulty is usually even greater when a musical comedy is involved and domestic or foreign musical rights must be secured.

Also of note is the fact that the Maryland Court of Appeals held that the owner of the broadcasting rights for a given event does not thereby secure the television rights, on the ground that television is a separate and distinct medium.

Again, in an extremely important case, decided by the United States District Court for Eastern Pennsylvania, it was held that the Pennsylvania State Board of Review, which censors motion picture films, does not have a similar right in relation to films displayed over television. That is, television films are not subject to censorship prior to their transmission. The Court held that television was interstate commerce and that it was regulated by Congress.

Further, television falls within the provisions of freedom of the press as guaranteed by the First and Fourteenth Amendments to the Constitution. The television program, as now developed, resembles radio and the newspapers in that it is an "organ of public opinion."

Worthy of mention, not only for its bearing on legal matters but also for what it adds to the indications that the motion picture and television industries may ultimately reach a better understanding, is the fact that the Motion Picture Association and the National Association of Broadcasters have arranged to cooperate in fields of mutual interest to the motion picture, radio, and television industries. They plan to appoint representatives who will draw up protective and cooperative proposals where joint action appears desirable.

Commercial Announcements

Television in the United States, like radio, receives its financial support from the advertising sponsor. Accordingly those programs which are not given as sustaining material by the network or individual station are sponsored by some industrial or service organization. Commercial announcements or advertising material of course appear at strategic points in the entertainment program.

Television advertising in general consists of sight, motion, and related sound. With the exception of motion picture advertising in the theater—which is rarely used and does not reach individuals in the home—no other medium has so powerful an impact on the senses of man. Television lacks only a permanent record in the home, such as may be presented by printed media. However, by frequent repetition, television commercials can produce a substantially continuous effect upon the audience. No authoritative data are generally available concerning the relative impact and persuasiveness of television as compared, for example, with radio, but it is certain that television is far more effective (estimates range from twice to ten times as effective).

Television advertising may be produced in a number of ways. With live talent, merchandise may be both attractively shown and demonstrated. Wearing apparel can be modeled. Anything from automobiles to cooking utensils can be shown in actual use under selected and favorable conditions. Film commercials are extremely popular and have shown great versatility. In addition to showing and demonstrating merchandise, film affords the opportunity to present animations, cartoons tied in with the product or its uses, and attractive repetitions of the brand name in either static or dynamic form. Numerous film commercials blend live sequences with animations, thus gaining the advantages of both methods of presentation.

On the whole, the use of film for commercials has been preferred by the more demanding advertisers. The timing is precise. There is no chance that a demonstration may fail or be less effective than desired. Reality and the whimsical or fantastic may be blended in any desired proportion for certain psychological effects. And, through trick photography, it is of course possible to present sequences which could not actually occur but which are entertaining, amusing, and sales-promotional.

Television broadcasters tend to restrict the amount of commercial time in a program to a certain percentage of the total running time. The permissible percentage varies inversely with the length of the program, being greater for short programs and vice versa. In the

so-called "spot commercials," running from 15 to 30 seconds, the entire material is commercial.

Certain problems have already arisen in connection with the limitation of the percentage of commercial time on a program. Sponsors tend to try to introduce their name or product in the running dialogue. Or the name of the product or its maker may appear on backdrops, stage curtains, signboards, or the like. In extreme cases, an entertainment program may show commercial mentions of this type during practically its entire length even though the specifically commercial dialogue may be rigidly limited.

There are as yet no generally accepted procedural standards on these matters, although it is likely that, in due course, the percentage of advertising in a given program will be controlled at the point of maximum psychological response—which is probably achieved when commercial mention is restricted to a modest fraction of the program time.

RECEIVERS AND RECEPTION

At the present time, television utilizes 12 channels, each 6 megacycles wide, in the general region of 50-200 megacycles. These are in the so-called very-high-frequency (vhf.) band. Practically all television receivers are arranged to select any one of these channels by a switch or push-button control.

Types of Receivers

The most common fixed receivers are the table models. In these the picture is produced on a tube screen having in general a diameter of between 10 inches and 19 inches. The actual picture size depends on the shape of the picture, which may vary from rectangular with curved corners (as on the motion picture screen) to completely circular. The general preference is for pictures of the rectangular type, although competitive considerations have led many manufacturers to produce pictures having hybrid shapes with curiously curved sides. The standard picture has an aspect ratio (ratio of width to height) of 4-to-3. Table receivers may have plastic, metal, or wooden cabinets. They fall in the general price range of \$150 to \$350.

Console receivers are complete furniture units provided with legs permitting the receiver to be placed in any part of the room without additional support. Most of them use picture tubes having diameters between 10 inches and 19 inches with some even larger sizes now in use, the picture being directly viewed on the tube screen. Many console receivers also include radio reception (AM and FM) and one or

more phonographs (permitting the use of existing 78, 45, and 33 revolutions-per-minute records). Such consoles cost from \$50 to \$150 more than the corresponding table receivers, as a general rule.

Another type of console model, producing the largest home pictures, is the projection receiver. In this kind of receiver the viewing screen is not within a tube. Rather, high-voltage electron beams are used to "paint the picture," very brilliantly, on the screen of a small tube (between 2 inches and 5 inches in diameter), and an efficient optical system then projects an enlarged image of that picture onto the viewing screen. Popular sizes of projected pictures are 12 x 16 inches, and 15 x 20 inches. Projection receivers in general fall in the \$600 to \$900 range.

A less usual but interesting type of television receiver is the portable model. Such receivers are not portable in the sense that they are independent of any power source or operate on self-contained batteries. They require a connection to the usual home power supply but can be carried from point to point quite readily. The pictures are produced, in general, on tubes having a diameter of between 7 inches and 10 inches.

A preferred viewing distance for most pictures is from 4 to 8 times picture height. It has been agreed by skilled oculists that television viewing under any normal conditions does not involve eyestrain. Usually the best receiving conditions imply a soft amber light in the room, with the lamp not in the field of view of the observers and its light not reflected directly by the screen to the eyes of the audience. Like other home appliances, television receivers usually have the approval of the Underwriters' Laboratory and accordingly present no appreciable hazard to the users or to home furnishings.

A simple though only approximate rule is to the effect that television receivers at present cost between \$10 and \$20 per inch of width of the picture if the direct-vision tube is contained in the set. Naturally the larger size pictures require circuits, cabinets, and adjustments costing more than those for the smaller sets.

Television prices have dropped during the last few years, but not at a rate equalling that which applied to ordinary radio receivers during the first years of mass production. Circuit and manufacturing economies have already been introduced into television receivers, and the most economical manufacturing methods are in large measure used in their construction. It is therefore most unlikely that television receivers will drop in price by any major fraction within the next five or ten years—assuming that no radical circuit novelties or unforeseen

advances in manufacturing methods become available during that period.

Installation and Servicing

The installation of a television receiver is a more complex matter than that of a radio receiver. In a modest percentage of the homes lying within the strong-signal area around a television station, it is possible to use a small indoor antenna with fair success. This antenna may even be self-contained (that is, within the receiver). Wherever signal strength of the desired stations is sufficiently high to permit the satisfactory use of such indoor antennas, they are naturally preferred.

In all other regions, where weaker signals or local interference exist, it becomes necessary to install a fairly specialized type of outdoor antenna on a carefully selected roof location (always assuming that the assent of the sometimes reluctant landlord of an apartment building can be obtained—and apparently he has the legal right to refuse). The outside antenna is connected to the receiving set by a special “transmission line” which carries the television signals without serious loss. Such antenna installations may cost \$20 to \$50 or more.

Centralized systems have been developed for apartment houses whereby the landlord installs one system of high-grade television aerials on the roof, feeds their output to amplifiers, and then sends the resulting strong signals over transmission lines to outlets in each apartment, where the tenant is required to pay a corresponding rental or other charge. Differences of opinion between landlords and tenants on the defraying of the initial installation costs of centralized systems have limited their acceptance up to the present, but there is a marked trend toward their wider use. They have the advantages of enabling the tenant to get clean signals anywhere in an apartment building without troubling to install and maintain his own aerial. Accordingly, architects are designing such installations into a number of new apartment buildings.

Television receivers require some servicing from time to time, including the replacement of tubes or, occasionally, of certain circuit elements. As a general rule, servicing agreements, limited in scope, are acceptable to the set owners.

Some manufacturers and dealers offer service for stated periods of time and for a given fee to the purchasers of their sets. Independent servicing organizations will either charge on a per-call basis or, in some instances, guarantee service over a given period for a fixed fee.

Television servicing has called for the training of many thousands

of competent technicians in this field. While some of these men have handled radio servicing in the past, many of them are members of a profession newly created by the recent field of television engineering.

Number of Receivers

Television receiver production has risen rapidly during the last few years. In 1949, companies which were members of the Radio Manufacturers Association produced 2,750,000 receivers, most of them table models. The average tube diameter was approximately 12.5 inches and the trend toward larger tube sizes is accelerating. It is estimated that as of January 1, 1950, there were over 3,900,000 television receiver installations in the United States, only a small percentage of which were in public places.

There has been a marked correspondence between the population of individual cities and the number of television receivers installed in each city. Television stations have naturally been established in major centers of population. The establishment of the stations has stimulated the growth of the television audience. Thus, New York City has over one quarter of the total number of receivers in the United States.

In estimating the ownership of television receivers for the future, it is assumed that present trends will continue and that regulatory restrictions will not unduly reduce television receiver manufacture and acceptance. The following list indicates the cumulative number of television receivers in use on January 1 of the years indicated (obviously the figures for future years represent roughly approximate estimates)*:

1948	186,000
1949	1,000,000
1950	3,900,000
1951	9,500,000
1952	16,000,000
1953	22,500,000
1954	30,000,000

Part II — BROADCASTING

In this section, the history and development of television will be briefly outlined; certain pertinent industry statistics will be presented, including number and location of stations, network financial data, and advertising expenditures and costs; and regulatory trends having a bearing on the commercial use of television in the future will be discussed.

* This can only assume no curtailment of production due to defense orders.

HISTORICAL OUTLINE

Television was originally based on mechanical methods. There was a wide variety of these, most of which are today obsolete or obsolescent. To take a few highlights, a German inventor, Nipkow, in the latter portion of the nineteenth century invented the basic idea of point-and-line scanning of television images at the transmitter and receiver, and produced a systematically perforated scanning disc enabling these methods to be carried out. Later the British Scophony Corporation engineers developed an optico-mechanical system of considerable ingenuity; and still later a group of Swiss engineers and scientists produced the Eidophore system which is partly mechanical but largely electronic in nature, and which uses certain advanced optical effects to produce large and bright images.

Up to the present time, no system containing mechanical elements has been able to compete successfully on a commercial basis with the purely electronic systems using a cathode-ray tube in one form or another for camera pickup and for picture reproduction.

The electronic methods were developed around the cathode-ray tube of a German scientist, Ferdinand Braun. Later, Professor Boris von Rosing, a Russian scientist, developed means for controlling the electron beam in Braun's cathode-ray tube. A British scientist, Campbell-Swinton, proposed an electronic camera tube, based on electrical storage of a luminous image. However, his contribution remained in the idea stage until V. K. Zworykin, a former student of von Rosing, developed the first successful electronic camera tube—the iconoscope—in a brilliant series of researches carried out in America.

Another American scientist, Philo Farnsworth, invented an ingenious form of nonstorage camera tube known as the "dissector tube." The present-day kinescope or picture tube is the product of the work of many capable inventors, some of whom were mentioned in the preceding list.

Recent Developments

More recently, a large number of new camera tubes have been produced. Most of these have higher sensitivity than the iconoscope and are free from certain other operational limitations of that tube. Among the newer and more useful camera tubes are the so-called orthicon, image orthicon (RCA), emitron (Electrical & Musical Instruments, Ltd.), image iconoscope, vidicon (RCA), and so on. Actually, modern camera tubes enable satisfactory pictures to be picked up when the lighting is so dim that the event—for example, a tennis match—can no longer be satisfactorily watched by the audience or for that

matter, carried on by the contestants! Yet the production of an extremely sensitive camera tube, capable of giving the highest definition in the image, is still under engineering development.

The picture tubes, used in the receivers, are also under intensive development. Recently glass in some of these tubes has been largely replaced by metal. Tubes with rectangular ends have been built and are being commercially introduced. The glass end or screen-carrying portion of the tube is sometimes made of a gray color, to reduce glare and to produce a more acceptable image. There is a steady trend toward increasing the size of picture tubes and reducing their unit costs, largely as a result of advanced mechanical, chemical, metallurgical, and production methods.

A multitude of television engineers and organizations have been active in all this work. The development of a practical television system, capable of commercialization, and the initiation of the operation of such a system may be properly ascribed in this country to the Radio Corporation of America and its affiliate NBC.

NUMBER AND LOCATION OF STATIONS

As of January 1, 1950, the Federal Communications Commission reported that there were in operation 2,047 standard radio stations, 734 FM radio stations, and 98 television stations. The television stations were in operation in 57 market areas. There were also 14 television station construction permits outstanding, and there were 351 television station applications pending.*

Of course, the pending applications are receiving no present attention in view of the "freeze" on television-station licensing, to be discussed in further detail below. But the very number of them indicates that if any plan for licensing of stations in the ultra-high-frequency bands is carried out according to proposals recently made by the FCC, there may be literally thousands of television stations in the United States within the next decade (assuming that economic considerations do not prevent the establishment and operation of so great a number of stations).

The ownership of television stations is not unlike that of radio stations except that the newspapers are playing a more important part in television broadcasting than they did in radio broadcasting. It may be that the newspaper managements have decided that it was a mistake for the newspapers to oppose broadcasting initially and that in the

* As of August 1, 1950, there were 106 television stations on-the-air, 3 construction permits outstanding and 351 applications pending.

case of television it is preferable for them to establish a strong position in that field from the very beginning.

Audience

In Exhibit I is shown the distribution of television receivers as of August 1, 1950. This table accordingly gives a general indication of the present distribution of the television audience and of its advertising possibilities. A more definitive estimate of television receivers in the United States will probably be available after the tabulation of the 1950 Census, in the course of which a substantial portion of the population were questioned as to their ownership of television receivers.

The United States has four operating television networks (the American Broadcasting Company, Columbia Broadcasting System, the DuMont Television Network, and the National Broadcasting Company) and one planned television network (the Mutual Broadcasting System). Data on these networks are shown in Exhibit II. (All material in Exhibits II, IV, and V is presented exactly as received through the courtesy of the corresponding networks.)

In Foreign Countries

In comparison with the United States, television station establishment and receiver ownership have lagged in other countries. Thus, England has only two television stations in operation, and the situations in France and Russia are similar. So far as is known, no foreign television network exists except the connection between the two British television stations.

Canada plans television broadcasting stations but has none at this time. In Canada there is a system of partly private and partly governmental radio broadcasting. The Canadian Broadcasting Commission carries out the governmental broadcasting and also acts as a regulatory authority over the private broadcasters. There are marked differences of opinion in that country as to whether or not television broadcasting should be handled by the government (as it is in the other foreign countries here mentioned).

OPERATING AND RELATED COSTS

The establishment of a television station is a substantial project. Space is required for studios, control rooms, storage of sets and properties, dressing rooms, cameras, microphone rooms, film projector rooms, and the actual transmitter. In addition, there must be space for executive and sales staff, program workers, and the like. This incomplete list indicates why the first cost (equipment, building or

building modification, and installation) may run from \$100,000 to \$600,000, averaging not far from \$300,000. In the case of a major network requiring elaborate studio facilities and special switching apparatus, expenditures running into the millions of dollars may be involved.

Exhibit I—The Television Audience (As of August 1, 1950)

INTERCONNECTED CITIES

<i>Area</i>	<i>Number of Stations</i>	<i>Number of Families</i>	<i>Number of Sets</i>
Baltimore	3	732,000*	192,000
Boston	2	1,175,000*	447,000
Buffalo	1	323,000*	109,000
Chicago	4	1,438,000	555,000
Cincinnati	3	384,000*	143,000
Cleveland	3	695,000	260,000
Columbus	3	225,000*	78,000
Dayton	2	291,000*	76,000
Detroit	3	839,000*	282,000
Erie	1	112,000*	26,500
Grand Rapids	1	182,000*	30,000
Johnstown	1	250,000*	26,500
Kalamazoo	1	143,000*	13,100
Lancaster	1	85,000*	54,400
Lansing	1	168,000*	13,500
Memphis	1	177,000	44,300
Milwaukee	1	327,000	129,000
New Haven	1	557,000	90,300
New York	7	3,597,000*	1,475,000
Norfolk	1	196,000	23,000
Philadelphia	3	1,184,000*	540,000
Pittsburgh	1	742,000*	122,000
Providence	1	1,011,000*	71,800
Richmond	1	130,000*	38,900
Rochester	1	208,000*	45,900
Schenectady	1	258,000*	90,500
St. Louis	1	474,000	153,000
Syracuse	2	199,000*	56,200
Toledo	1	241,000*	50,000
Utica	1	127,000*	19,800
Washington	4	691,000*	150,000
Wilmington	1	183,000*	38,100
Total Interconnected	59		5,443,800

Exhibit I (Continued)

NON-INTERCONNECTED CITIES

Area	Number of Stations	Number of Families	Number of Sets
Albuquerque	1	22,000	4,000
Ames (Des Moines)	1	126,000	12,300
Atlanta	2	233,000	52,300
Binghamton	1	131,000*	18,700
Birmingham	2	196,000	15,100
Bloomington	1	104,000*	7,500
Charlotte	1	171,000	19,200
{Dallas	2	277,000*	36,400
}Fort Worth	1	269,000*	29,200
Davenport-Rock Island	2	133,000	16,200
Greensboro	1	165,000	15,500
Houston	1	217,000	32,200
Huntington	1	132,000	16,000
Indianapolis	1	281,000*	60,000
Jacksonville	1	94,000	11,700
Kansas City	1	275,000	42,100
Los Angeles	7	1,372,000	595,000
Louisville	2	188,000	39,200
Miami	1	117,000	31,400
Minneapolis-St. Paul	2	333,000	105,000
New Orleans	1	225,000	30,800
Oklahoma City	1	138,000	36,900
Omaha	2	132,000	25,800
Phoenix	1	49,000	14,800
Salt Lake City	2	93,000	21,100
San Antonio	2	130,000	22,200
San Diego	1	113,000	47,600
San Francisco	3	825,000	74,800
Seattle	1	307,000	33,100
Tulsa	1	125,000	32,100
Total Non- Interconnected	47		1,498,200
Total Interconnected and Non-Interconnected	106		6,492,000

* Family figures are based on estimates of 1948 population. Note that following coverages (hence total families) overlap: Bloomington-Indianapolis; Grand Rapids-Lansing-Kalamazoo; Detroit-Lansing; Detroit-Toledo; Syracuse-Rochester-Utica-Binghamton; Binghamton-Utica; Philadelphia-Wilmington; Rochester-Syracuse-Schenectady-Utica; Pittsburgh-Johnstown; New York-Philadelphia; Boston-Providence; Buffalo-Rochester; Cincinnati-Columbus-Dayton; Washington-Baltimore; Lancaster-Baltimore; Dallas-Fort Worth.

Exhibit II—Television Network Stations
(As of December 1, 1949)

	ABC	CBS	DTN	MBS	NBC
Number of Owned and Operated Stations	5	1	3	5 ^a	5
Number of <i>Primary</i> Affiliated Stations	} 43 ^b	25 ^c	} 52 ^d	•	31
Number of <i>Secondary</i> Affiliated Stations		30 ^c		•	17
Average Number of Stations on <i>Network Programs</i>	} 16 (night)	20	15	•	29 ^f
		10 (day)			

^a Stations owned by stockholders of MBS.

^b No distinction made between primary and secondary affiliated stations; data as of December 12, 1949.

^c As of December 15, 1949.

^d No primary and secondary affiliation classification. All affiliated stations operate under multiple affiliation with 4 major networks; 26 stations (including 3 owned stations) interconnected; 26 noninterconnected.

^e Because of the FCC "freeze" which is currently limiting the number of network affiliates available in most of the markets of the country, MBS has not as yet contracted for regular connection among its stockholder stations in the East and other stations available for affiliation. It does not now plan to do so at any specific time in the future. However, it is expected that as and when new stations are getting on the air and affiliations become available, MBS will undertake television networking.

^f Per sponsored program.

Source: Figures supplied by the networks.

The actual operation of a major station is also a serious project. Excluding program costs, staff and maintenance may run from \$10,000 to \$50,000 per month, averaging in the neighborhood of \$200,000 per year. Operating costs depend on the number of hours of operation per day and days per week. Beyond a five-day (or six-day) week, and beyond a seven-hour (or eight-hour) per day operation, a second shift is usually required with a corresponding increase in operating costs.

Program Costs

Program costs are also considerable in television. The operating staff is larger and, in some respects, even more specialized and skilled than in the case of standard radio broadcasting. Elaborate facilities are needed and utilized. It must be remembered that television live-talent production is an art intermediate between standard radio and feature-film production as practiced in the major studios. It is naturally desirable to approximate good film quality as closely as possible in a dramatic production. On the other hand, the economic limitations of television prevent expenditures on the Hollywood scale.

With all reasonable care, and with the establishment of modest standards of quality, it is still evident that television production is a costly art. The planning, assembly, and installation of sets are involved. Lighting must be properly worked out, and the lights must be skillfully and rapidly handled. Capable camera men and experienced microphone-boom men are of course needed. The actors must be rehearsed for their parts until they are as nearly letter perfect as possible. All camera positions must be planned in advance.

Also, the script is more elaborate than in radio, involving as it does visible action as well as speech (or music). The producers, directors, and writers must have excellent judgment and considerable talent; further, the producers and directors must be especially agile mentally, capable of making correct decisions on a moment's notice and even under emergency conditions. All this means high salaries.

The television transmitter is a more costly and complex affair than standard radio transmitters, and it requires careful and continuous monitoring. (The estimated total sales of television transmitting equipment during 1949 were about \$7 million. Upon resumption of normal conditions in television broadcasting, subsequent to the lifting of the "freeze" by the Federal Communications Commission, the estimated annual transmitter sales would be \$25 million.)

These and numerous other factors place a floor beneath the cost of television productions. As for a ceiling, this is limited only by the ambitions and financial capabilities of the sponsor.

In addition to their normal operating costs, stations must assume the burden of the sustaining program costs—that is, the cost of those programs which are transmitted by the station to ensure continuity of service but which do not have commercial sponsorship.

The less expensive types of programs are given by commentators, by amateurs, or by sections of the public participating, for example, in a quiz. In such performances the cost of both actors and sets is at a minimum and may be less than \$10 per minute. By contrast, more elaborate live-talent performances (for example, dramatic programs or variety shows) may range from \$200 to \$700 per minute. Thus one-hour live-talent programs of a quality suitable for a major network will have a production cost, not including the network time, of from \$10,000 to \$30,000. Special one-hour films may run as high as \$300 per minute, and original-film productions of some pretensions frequently fall within the \$150 to \$250 per minute range.

Program costs tend to rise with the increasing discrimination on the part of the television audience and under the stress of competitive conditions. On the other hand, the appeal of the better television

programs seems to be steadily increasing. Such programs require careful and repeated rehearsal. Many stations and some networks limit or eliminate charges for normal amounts of rehearsal time.

Impact of Unions

As television expands, it is natural that the labor groups involved in its operations are becoming more interested in conditions of work and payments to their members, and that they also are tending to expand their claimed jurisdiction. As a result, there have been numerous disputes between unions and broadcasters, and also between one union and another. The types of workers in television are numerous, and the scope of their individual activities is not clearly defined. To give some idea of the situation, there follows a list of some of the unions (AFL, CIO, and Independent) which are interested in television operations:

- International Alliance of Theatrical Stage Employees, covering particularly projectionists and stage hands
- National Association of Broadcast Engineers and Technicians
- International Brotherhood of Electrical Workers
- American Federation of Radio Artists
- American Guild of Variety Artists
- Association Actors and Artists of America
- Actors Equity
- Screen Actors Guild
- Screen Extras Guild
- United Scenic Artists
- United Electrical, Radio, and Machine Workers (recently disaffiliated from the CIO)
- International Union of Electrical, Radio, and Machine Workers (recently formed by CIO)
- Radio Directors Guild
- Radio Writers Guild
- American Society of Composers, Authors, and Publishers (not strictly a union but an association of the corresponding groups)
- Radio and Television Directors Guild
- Communications Workers of America

The complete definition of jurisdiction among all the preceding, so far as television is concerned, is likely to require considerable debate and time.

ADVERTISING COSTS AND EXPENDITURES

The costs involved in a television presentation, from the point of view of the sponsor, include payments for the program and also payments for the station or network time. Program costs have already been broadly considered.

Time Costs

Station time costs per minute depend upon the length of the program. Exhibit III indicates the increasing cost per minute of the shorter programs. Exhibit IV presents certain network time-rate data.

Exhibit III—Cost of Shorter Programs

<i>Length of Program (In Minutes)</i>	<i>Applicable Rate As Percentage of One-Hour Rate</i>	<i>Cost per Minute as Ratio of Cost at One-Hour Rate</i>
60	100%	1.00
40	80	1.20
30	60	1.20
20	50	1.50
15	40	1.60
10	35	2.10
5	25	3.00

Source: Based in part on material in *Television*, Vol. VI, No. 11 (November 1949), p. 26.

Discounts are offered by stations according to the amount of program time purchased as a unit, the combination of television and standard radio or FM broadcasting, the extent to which successive weeks are used, or some combination of these factors. The following are typical schedules of discounts based on number of programs:

Schedule A — 26 programs, discount 5 per cent; 52 programs, discount 10 per cent; and 104 programs, discount 15 per cent.

Schedule B — 13 programs, discount 5 percent; 26 programs, discount 10 per cent; 52 programs, discount 15 per cent; and 104 programs, discount 20 per cent.

Appraisal of Results

The purchasing power of the individuals residing within the areas covered by television represents a growing percentage of the total national income. As pointed out by the writer in a discussion before the Association of National Advertisers, assuming a national income of \$171 billion, the net effective buying income of persons within the television coverage areas on January 1, 1949, was 50.1 per cent of the total national income. It was estimated that for January 1, 1950,

Exhibit IV—Television Network Time-Rate Data
(As of December 1, 1949)

	ABC	CBS	DTN	MBS	NBC
Average Evening Network Gross Time Rates per Station	\$375 ^a	\$319 ^b	\$325.50	c	\$344
Average Evening Gross Time Rates for Entire Network, per Hour	\$16,875 ^a	\$17,250 ^b	\$14,386 ^d	c	\$18,250
Average Gross Time Rates for <i>Film</i> Programs, per Hour					
Maximum	\$250 ^e	f	g	c	\$6,510 ^h
Average	135 ^e				5,230 ^h
Minimum	100 ^e				4,590 ^h
Average Gross Time Rates for <i>Studio</i> Programs, per Hour					
Maximum	\$1,307 ⁱ	f	g	e	\$8,685 ^h
Average	753 ⁱ				5,433 ^h
Minimum	277 ⁱ				1,515 ^h

^a Class A time.

^b 54 stations, total.

^c Not currently available.

^d Based on 52 stations averaging \$276.67.

^e Film rental cost only; no rehearsal charge unless silent film with live voice (seen or unseen) is used. Film air time not included but same as live air time.

^f Same as evening gross time rates, except for extra rehearsal costs for studio shows.

^g Film air time same as studio air time.

^h Includes time charges, *half-hour* program.

ⁱ Does not include time charges. Air time charges of \$2,000 per hour to be added (for station WJZ-TV). Figures given in table are for rehearsal and scenery.

Source: Figures supplied by the networks.

the percentage would rise to 63.2 per cent; and for January 1, 1951, to 67.2 per cent.

In view of the rapid increase of the television audience and the resulting changes in the service rendered to it and in its viewing habits, it is difficult at this time to estimate the cost of television programs per viewer or per family group. Such data as have been assembled indicate, however, a favorably low value of cost per individual reached in comparison with other media, particularly in the light of the admittedly powerful sales impact of television commercials.

As a result, the number of advertisers using television increased from about 400 in October 1948 to almost 1,900 in October 1949, a gain considerably over 300 per cent. This trend is further indicated in a survey carried out by the trade journal *Broadcasting* in late November 1949 among a sample group of executives of advertising agencies. They were asked to indicate whether they were going to use specific media more, less, or to the same extent. Results were as follows:

Those planning to spend more on television came to 70.8 per cent of the total; those planning to spend more on newspapers, 52.9 per cent; on magazines, 35.7 per cent; on radio broadcasting, 30.6 per cent; and on direct mail and billboards, about 27 per cent.

Those planning to make no change in magazine advertising were 57.2 per cent of the total; in direct mail and billboards, about 46 per cent; in newspapers, 38.3 per cent; in radio, 30.6 per cent; and in television, 25 per cent.

Those planning to spend less on radio advertising were 38.8 per cent of the total on direct mail and billboards, about 27 per cent; on magazines, 7.1 per cent; and on television, only 4.2 per cent.

There was obviously a marked preponderance of intention to concentrate on television advertising. It was accordingly estimated that total television time sales in 1949 would be approximately \$30 million as compared to about \$10 million for the corresponding expenditures in 1948. Network advertising data are presented in Exhibit V.

Reduction of Costs

So far as the selection of an appropriate program for the advertisers is concerned, it should be noted that for the advertiser's purposes the costs of various types of programs roughly parallel their popularity — a factor which must be taken into account. So far as public preferences are concerned, these are roughly in the following order: variety shows, comedies, give-away programs (offering prizes of merchandise or cash), dramas, sports events, and Westerns. There seems little difference in the audience preferences as among the

various cities served by television with the exception that sports events seem relatively more popular in newly opened television districts and in the western cities.

A number of methods have been suggested or adopted for reducing the cost of television advertising to the sponsor. One obvious method is multiple sponsorship of a given program, whereby the commercial announcements are divided between two or more organizations. The order of presentation of the commercials may be systematically changed so that each participating sponsor secures the presumably favorable position in turn. Similarly, a given program may be sponsored by one organization in a certain portion of the network but by another organization elsewhere.

Further, it has been found that weekly programs are costly and, if they involve the element of originality, lead to considerable strain on the writers and directors. Accordingly presentations every second, third, or fourth week have been suggested as an economy. Again, programs presented on a physical network may be recorded (e.g., by kinescope recording). The films can then be used on stations not connected to the network; and, further, the same program may be used for radio and television broadcasting. In such ways the original program can be more fully utilized.

Certain economies through the use of advanced electronic or optical techniques also seem possible. Thus, background views or scenes may be introduced into the television picture by either optical methods (background projection) or electronic methods (electronic insertion of backgrounds). Prerecorded sound may be used to cue the actors, thus reducing the rehearsal needs. It seems likely that, as television develops, numerous economies along such lines will be increasingly used and will be found to be effective.

REGULATORY ASPECTS

In the United States, the initial allocation of channels for radio communication, as between governmental and civilian uses, falls within the scope of the Interdepartmental Radio Advisory Committee (IRAC), a group containing representatives of all government departments utilizing radio and also a representative of the Federal Communications Commission (FCC). IRAC receives all requests for channels allegedly needed by government divisions. Only after these have been assigned are the remaining channels available for civilian allocation by the FCC. This bipartite allocation system is not generally understood by the public.

Exhibit V—Television Network Advertising Data
(As of December 1, 1949)

	ABC	CBS	DTN	MBS	NBC
Gross Time Cost, per Thousand Sets, for Network Television Areas	\$5.86	\$5.76	\$5.81	a	\$4.30 ^b
Total Number of Television Network Advertisers...	16	28	26	a	32
Total Television Gross Network Time Expenditures (first eleven months 1949)	\$1,166,595	about \$4,000,000	a	a	\$5,355,000 ^c
Percentages of Total Television Network Time devoted in November 1949 to					
Studio Programs	44% ^d	75%	77.5%	a	63.3% ^e
Remote Programs	42% ^{f,d}	8%	20.0%		23.7% ^e
Film Programs	14% ^d	17%	2.5%		13.0% ^e
Total Number of Network Hours during November 1949	108.17	169	150	a	177 ^g

^a Not currently available.

^b For evening hour; \$2.58 per evening half-hour (in each case for interconnected network).

^c Estimated.

^d Unusually high for this month.

^e For October 1949.

^f Percentages based on commercial business.

Source: Figures supplied by the networks.

The FCC determines which of the available channels may be used for specific civilian purposes, rules of good engineering practice for the use of such channels, and such other regulatory provisions as are deemed advisable in the "public interest, convenience, and necessity." In the broadcasting realm, it seems to be the established policy of the FCC to encourage a "truly nationwide and competitive service" in each instance.

One school of thought maintains that the FCC should extend its control of all radio operations into program structure, operating practices, business affiliations and procedures, and the like. Another school believes that the FCC should concentrate primarily on the technical rather than the political and social aspects of radio operations. Generally speaking, the trend of the FCC has been in the former direction during the last decade or more.

Certain television standards have been adopted in the United States, notably one requiring pictures to have 525 lines and to present 30 frames per second, with the sound portion of the program sent by FM. In England a 405-line picture with 25 frames per second is standard, with amplitude modulation of the sound. France, Canada, and Mexico cannot be said to have adopted final television standards. However, the French proposals are interesting. They call for 441-line pictures at present, with the later introduction and wider usage of a high-definition 819-line picture. The audience need and the economic justification for such high-fidelity pictures at present are not widely accepted.

Allocation of Channels

As indicated, only 12 very-high-frequency (vhf.) channels — lying approximately between 50 and 250 megacycles — are available for American television today. It is proposed to add 20 or more ultra-high-frequency (uhf.) channels in the broader and as yet commercially unused range of 500 to 900 megacycles. However, expansion of television stations to an ultimate number of perhaps several thousand, which conceivably might thus be made possible, would have to await the solution of some very real technical and economic problems.

At present, allocation procedures involve the following steps: assignment of a broad band of frequencies to a given service; assignment of channels within that band to individual cities (or towns and even villages!); and assignment of each city's channels among individual applicants.

Since each of these steps is plentifully sprinkled with lengthy hearings, the total time elapsing between initial consideration of a

new service by the FCC and the actual establishment and operation of individual stations giving that service may be several years. The purpose of the procedures is of course a democratic one. It is desired that all shall have an opportunity to express their views prior to the rendering of an official decision. In this instance, as in others involving democratic procedures and the ascertaining of public opinion, efficiency and speed of operation are rarely attainable.

The FCC has received advice, sometimes in response to its own questions, from a large number of committees and boards. Such advisory groups in the past have included the old National Television System Committee (an effective industrial committee), and the old Radio Technical Planning Board (a widely representative group). The recently organized Joint Technical Advisory Committee (established by the Institute of Radio Engineers and the Radio Manufacturers Association at the request of the FCC and hitherto not a major factor in FCC decisions), the Radio Manufacturers Association Television Committee and an ad hoc committee have reported to the Commission on recent problems. A committee of the National Bureau of Standards has also recently rendered a report to Congress. A revival of the National Television System Committee is now studying the overall television situation.

POSSIBLE EXTENSIONS OF SERVICE

In describing several extensions or modifications of television service and equipment, it is difficult to present a judicial and instructive picture; for in certain of these trends there is a confusing intermingling of economic, political, and technical factors.

Ultra-High Frequency

One obvious trend at present is toward ultra-high-frequency television. It is already known that the propagation of the uhf. waves is more difficult and erratic than on the present very high frequencies. Further, the equipment for uhf. operation is not as yet available, and it is not certain when acceptable prototype equipment of commercial acceptability will be available.

There are some who have gone so far as to question the practicability of an individual uhf. television station serving any reasonably large area. For this reason, one qualified engineer has proposed "polycasting"—a system wherein a number of low-power uhf. stations are established around the periphery of a market area at strategic points, all these stations broadcasting the same program.

There is little doubt that an extension of television service into

vhf. channels between 200 and 400 megacycles would be technically and economically superior to an extension into the uhf. channels. Better service could be rendered by simpler and less costly equipment. These additional vhf. channels, however, are now assigned to government departments and are therefore believed by some to be probably unavailable for television broadcasting.

If uhf. television is established, there probably will be required new receivers capable of reproducing the uhf. programs; new receivers capable of handling both vhf. and uhf. programs; and "adapters" which will permit the owner of a present vhf. receiver also to receive any desired uhf. transmission. The economic and technical feasibility of these various types of equipment are under intensive study in a new, experimental uhf. station established in Bridgeport, Connecticut, by the National Broadcasting Company. It is too early to form definite opinions upon the practicability of any or all of such equipment. Broadly, it is believed that a uhf. service of reasonable scope could be established over a period of years, although the fact remains that extension of the vhf. band (if the government were to relinquish the corresponding channels for that purpose) might provide superior and more economical service.

It is believed by some that vigorously expressed Congressional opinion has influenced the FCC in its hearings and studies of possible uhf. operations. Such opinion is well represented by a statement addressed to Chairman Wayne Coy of the FCC by Senator Edwin C. Johnson (Democrat, Colorado) in November 1949, as follows:

On the use of the uhf: "I hope, too, that the Commission will approve at the same time standards for the immediate commercial utilization of a large number of channels in the ultra-high-frequency band so that a realistic nationwide competitive system of television may be developed . . . [and] that the Commission's final allocation in both bands will take into consideration the problems both of set owners and television licensees and not provide a hodge-podge for each city which may have to be revamped again in a few years."

On the existing freeze: ". . . When the proposed forty-two uhf. channels are allocated on a city by city basis throughout the nation and standards for their use promulgated there will remain no reason for continuing the present freeze on vhf. licensing and, of course, it should then be lifted. The sooner that is done the better. But until a decision is made by the Commission on utilization and allocation of the ultra-high-frequencies, it would be shortsighted to lift the freeze on vhf. licensing. Easily identified selfish interests are laboring day and night to lift the freeze now and nothing more. To lift the freeze

without a definite plan for the allocation and use of uhf. channels would be both a scientific and economic absurdity."

Actually vhf. television is here; vhf. extension is logical; uhf. extensions may prove costly, inefficient, and perhaps even makeshift in some locations; and there is little or no scientific or economic relationship between vhf. licensing or "freezing," on the one hand, and any other problems or proceedings, on the other hand.

Coded Transmission

An entirely different proposal has been made by the president of a large radio manufacturing organization, advocating a form of subscriber television known as "Phonevision." According to this system the television programs would be broadcast in such fashion that, when received on an ordinary television set, the picture would shift or "jiggle" erratically and unpleasantly, thus being unavailable for entertainment purposes. The owner of the receiver, however, if provided with a phonevision adjunct, could secure over telephone lines a special decoding or unscrambling signal which, when applied to his receiver, would steady the picture and thus restore its entertainment value. Otherwise stated, a "denatured" picture would be transmitted, but means would be available, for a fee, to restore the picture to its original quality.

The advocates of this system believe that high-quality feature films and other important entertainment material could thus be sent into the home on a subscription basis. They thus envision a "television box office." Others have felt that the proposed system is not in accord with the American ideals of open broadcasting (since it would require the use of valuable and scarce television channels for a semiprivate and paid service), that it would be economically undesirable, and that the public response to the system would be insufficient for its maintenance.

Other systems of coded television transmission, correctly receivable in the home only by payment of a fee for some form of decoding mechanism or device, have been proposed but are apparently only in the idea stage at present.

COLOR TELEVISION

Recently, color television has moved toward the center of the stage. Color television is based on a curious characteristic of the human eye. It seems that practically all colors which the eye can see can be reproduced with reasonable fidelity by means of only three component or primary colors. These primary colors are red, green and blue. When

all three are produced together on a screen, the eye has the impression of white. When they are all absent, the impression, of course, is black. If red and green appear together, the eye receives the impression of yellow; with green and blue present together, the impression is that of green-blue; and with red and blue both present, the impression is that of purple. Without going into details, it may be mentioned that an astonishingly wide gamut of colors can thus be produced by the simple addition, in the correct proportions, of three primary-colored lights.

Color television is, therefore, best accomplished by the use of special fluorescent materials or "phosphors" each of which phosphors produces light in only one of the primary colors. If, by some suitable means, the red, green and blue phosphors are each excited by electron-beam scanning to the right extent, primary-color images may be produced. These images, appearing in effect in superposition or registry, will then give the impression of a bright picture in full color. Thus a new accomplishment of science can be created.

At the present time, three different systems of color television have been demonstrated and proposed to the Federal Communications Commission for standardization for commercial service. A field-sequential system, with primary colors changing after each scanning field, has been offered by the Columbia Broadcasting System. This color system is basically the same as that demonstrated by both CBS and RCA in 1940-41. A dot-sequential system, with primary colors changing with the scanning of each picture element or dot, has been advanced by the Radio Corporation of America. This color system is the outgrowth of RCA's work in 1945-48 with a wide-band simultaneous color system. A line-sequential system, with primary colors changing after each scanning line, has been proposed by Color Television, Inc. of San Francisco, California.

Several other proposals for color systems or variations of systems have been made in addition to the three systems referred to above. One of these — a variation of the dot-sequential system — has been demonstrated by the Hazeltine Laboratories. Other systems include one by Dr. DeForest and a frequency-interlaced system recently announced by the General Electric Company. In addition, a number of other companies are engaged in color television research and development.

Several fundamental forward steps have been made in the technology of color television. One of these is the pulse-multiplex transmission of the primary-color pictures in the dot-sequential system. The received picture is thus made up of vast numbers of suitably-

placed primary-color dots with each color present in all fields. Another ingenious expedient is the "mixed highs" principle. This method enables color pictures of full, sharp detail to be sent in normal black-and-white television channels. Simply described, it involves sending all but the finest detail of the picture in full color, and sending the finest detail in black-and-white. The method is effective because the human eye sees little color in the finest detail. Accordingly, pictures sent using the mixed-highs principle are not distinguishable from those sent entirely in full color.

It became evident some time ago to students of color television that this type of broadcasting could be successful only after direct-vision color kinescopes became available. There were required methods for somehow producing a color picture on the screen of the picture tube, or kinescope. Such pictures were required in a form that could be viewed directly, in full detail and correct color. The successful production, demonstration and use in color receivers of such a color kinescope by RCA is the most recent achievement in the field of color television and is unquestionably a truly historical accomplishment. A number of other organizations are actively engaged in tri-color tube research and development and several have indicated that demonstrations will be made in the not-too-distant future.

Among the tasks still remaining before the color engineer is the production of a single-screen color camera tube. Such a tube, in the studio camera, would enable the direct production of the video signal corresponding to the color-television picture. The underlying principles of such a tube, or its equivalent, are understood, and its production is a distinct probability.

An impartial engineering analysis indicates that an all-electronic dot-sequential system — such as the one demonstrated by RCA and Hazeltine, and of the general type proposed by the General Electric Company — is built on the firmest technical foundation and has the greatest potential for further development and for the provision of a lasting commercial service. However, certain embodiments of this broad system are markedly superior to others. Concerning the three color systems proposed, the FCC has not, as of August 15, 1950, rendered its decision.

Part III — OTHER USES

It is not only in the realm of television broadcasting that the new art of television will render valuable services. Certain other fields of application may be briefly mentioned.

THEATER TELEVISION*

It is possible to produce television receivers capable of throwing a picture on a theater screen as large as 18 feet by 24 feet (and therefore equivalent in size to the normal motion picture). The quality of the pictures is acceptable and can be improved further. The main systems involve either direct projection of the television picture as received (which means the event is received while it is actually happening) or delayed projection through the motion picture projector (which need not be more than a matter of minutes after the event has occurred).

In the latter system the incoming picture is produced on a monitoring kinescope and photographed on standard 35-millimeter film. The film is processed at high speed (in about one minute) and is then ready to be run through the regular theater film projector. Thus, not only can the pictures of the incoming program appear shortly after actual reception, if desired, but it is also possible to use the film record at any other time such as may more conveniently fit into the theater's regular motion picture program and to repeat the television program as often as wanted.

Transmitting theater-television programs to a group of theaters in a given city involves no unsolved radio or coaxial-cable problems—at least on the technical side. The syndication of television programs to theaters in a number of cities is a more elaborate procedure but also within the range of engineering accomplishment.

On the other hand, the economics of theater television remain unproved, and the television programs themselves are a subject for further experimentation and test. The suggested television programs, at present, include important sports events (perhaps on an exclusive basis), news (sometimes of educational value, such as the meetings of the United Nations groups); film trailers; short plays specially produced for television; and numerous other suggested experimental programs. Much remains to be done in the realm of theater-television programming, both as to its sources and content.

It must be noted that the necessary radio facilities for theater television are within the grant of the FCC. Various groups have petitioned the Commission for hearings on the grant of the necessary facilities for theater television, and the Commission has acceded to these requests. Accordingly the future of theater television will, in part at least, depend upon FCC hearings and decisions, perhaps in 1950.

* A more detailed discussion of theater television may be found on pages 396 to 402 of this volume.

It may be added that theater television also presents some problems in the labor field, since the handling of television equipment in the theater will require persons skilled in that field.

In general, it may be said that theater television, on a broad basis, will ultimately be realized in all likelihood and may prove a popular and prosperous portion of the entertainment field.

INDUSTRIAL APPLICATIONS

Inasmuch as television can show events occurring at a distance, it is clear that it may have a number of useful industrial applications. One of these is the actual supervision of processes and personnel—for example, the looms and operators in a textile mill or the operations on the stage of a motion picture studio.

Telemetering is also a possibility. This involves observing conditions or reading indications at a distance and thus avoiding dangers of breakdowns. A typical example is a study of conditions in the boilers of a power plant or water levels in a reservoir system.

In certain industrial processes there are dangers from noxious fumes, explosions, or excessive temperatures. Television cameras located at places which would otherwise have to be occupied by regular personnel eliminate the hazard of personal injury. Certain chemical plants and explosives factories may to advantage utilize television inspection combined with remote control of operations.

Observations can also be made by television cameras in places far too small to be occupied by a human being. In wartime it was possible to observe approaching fighter planes even if they took a path which kept them in the "blind spot" of the plane which they planned to attack. Such observations were carried out by a television camera located, for example, in a small section of the tail of the thus guarded airplane.

It has been suggested also that improved worker relations can be secured if talks are given by the management to a large number of workers via large-screen television—perhaps with two-way operation. Thus, it is quite possible that the modern scientific accomplishment of television will provide more of a man-to-man relationship between the workers and management than has hitherto been feasible.

SCIENTIFIC APPLICATIONS

The television pickup of a surgical operation can be carried to large groups of doctors or students in extremely convenient fashion. The method also has the advantage that asepsis can be readily main-

tained, that a large audience need not be accommodated in the operating room, that every observer has a preferred position, and that an enlarged view of the operating site is readily obtainable. Thus the techniques of master surgeons can be made readily available both to their colleagues and to students. Both monochrome and color television demonstrations of this sort have been repeatedly and successfully given.

It has also been proposed that television be used to improve X-ray diagnosis. It is a fact that television techniques enable the contrast and quality of an X-ray image to be altered at will within limits. After this field is successfully developed, X-ray diagnosis will become speedier, more flexible, and even more dependable.

MILITARY APPLICATIONS

It is obvious that an airplane carrying a television pickup and transmitter could be flown over a battlefield or scene of operations and used to transmit pictures of conditions back to headquarters for study, coordination, and decision.

As previously mentioned, television can also be used as a sentinel in otherwise restricted space in an airplane.

Missiles may similarly carry television pickup equipment, either to enable them to report back pictorially to headquarters or even to observe a given target and to guide their own path toward that target.

The entire field of military applications of television is a complex one and its operational limits have not been made public.

PUBLIC-SERVICE APPLICATIONS

The telephone has largely superseded the telegraph as a medium for person-to-person communication. Whether in the home, on a ship, or even in an automobile or airplane, telephonic communication between individuals is now popular. It is logical to expect that, in time, personal television communication will be added. Presumably such service would be started at television-telephone booths strategically located in the main cities, with the calls scheduled by prearrangement. In time, however, television-telephone pickup equipment might be made sufficiently compact and inexpensive so that it would replace, or at least complement, present-day telephone installations. Telephone round-table conferences, as now held by certain business groups, would have even more of the element of personal contact if television were added.

An experimental demonstration was given not long ago wherein

two audiences of engineers, in New York and Chicago, conducted joint sessions by television and telephone, using large-screen images at each end to bring the other audience visually to those attending each meeting. So far as is known, this is the first time in history that two large groups of men have seen and heard each other over the better part of a thousand miles.

CONCLUDING NOTE

Despite "growing pains," the complexity of the subject, and the many technical and economic factors involved, it is already clear that television places in the hands of humanity the most powerful means of contact and communication so far devised. Capably developed and wisely guided, it is certain to become an inherent, widely accepted, and favorably regarded element of all human life in the future.

SIMPLIFIED TELEVISION FOR INDUSTRY*†

By

R. C. WEBB AND J. M. MORGAN

Research Department, RCA Laboratories Division,
Princeton, N. J.

Summary—System uses recently introduced vidicon camera tube. Synchronizing signals follow RMA standards to allow use of commercial-broadcast tv receivers as monitors. Two units contain total of 48 tubes, including vidicon and monitoring scope.

INDUSTRIAL television installations usually employ a multiplicity of camera units and a common centrally-located viewer, in contrast to broadcast television where a handful of cameras is used to serve many thousands of receivers. The most logical approach to cutting the cost of industrial television equipment is to reduce the cost of the camera units and to make them usable with commercial broadcast viewing equipment, which has already undergone substantial price reduction.

There are other basic requirements for industrial television equipment besides low cost. It should be compact and light in weight for portability. It should require a minimum of servicing and be capable of dependable operation over long periods of time.

Such a system is described here. A significant reduction in camera cost has been made possible by the recent introduction of the vidicon tube, which was described in *Electronics* last month.¹ The advantages of this photoconductive camera tube include operational simplicity, low cost, good resolution, freedom from spurious signals and high light sensitivity.

VIDICON SYSTEM

The system consists of a small pickup camera and a master unit. These units are connected by a standard 24-conductor television camera cable, which may be up to 500 feet in length.

The camera shown in Figure 1 with its cover removed is 10 inches long, 3¼ inches wide, 5 inches high, and weighs approximately 8

* Decimal Classification: 621.388.

† Reprinted from *Electronics*, June, 1950.

¹ Paul K. Weimer, Stanley V. Forgue and Robert R. Goodrich, "The Vidicon—Photoconductive Camera Tube," *Electronics*, Vol. 23, No. 5, p. 70, May, 1950.

Fig. 1—Vidicon camera unit contains two miniature tubes and the picture tube.

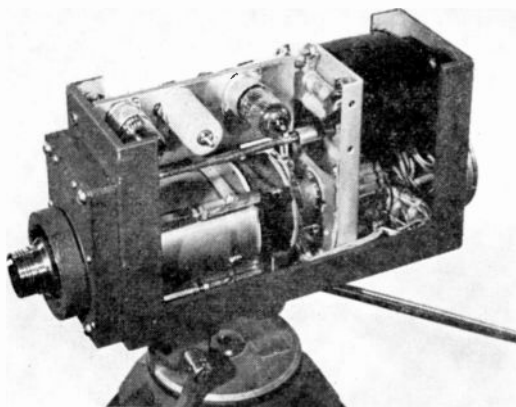

pounds. A typical 16-millimeter lens in a remote focusing mount permits optical focus adjustment by remote control from the front panel of the control unit along with the other camera adjustments.

The vidicon pickup tube can be seen extending inside of the focusing-coil—deflection-yoke assembly and the electron-gun alignment coil. The motor and gear assembly for operation of the remote focusing mechanism is located in the rear of the case and the video amplifier stages extend from the front of the camera toward the rear.

As shown in Figure 2 the camera has been kept as simple as possible, containing only the pickup tube and those elements intimately connected with it. Scanning currents for both vertical and horizontal deflection coils are sent in over the cable along with the direct currents for the focusing field and alignment coil as well as the operating potentials for various electrodes in the vidicon. A one-stage video

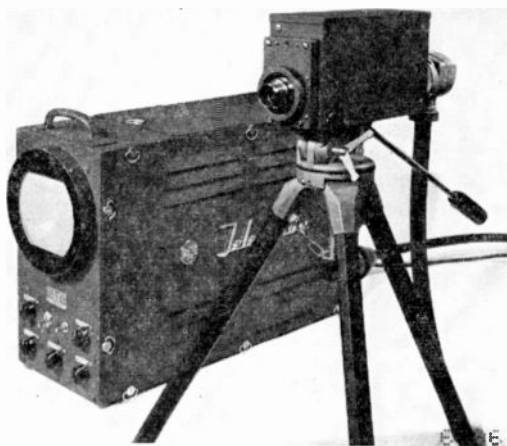

Complete industrial television system draws a total of 350 watts.

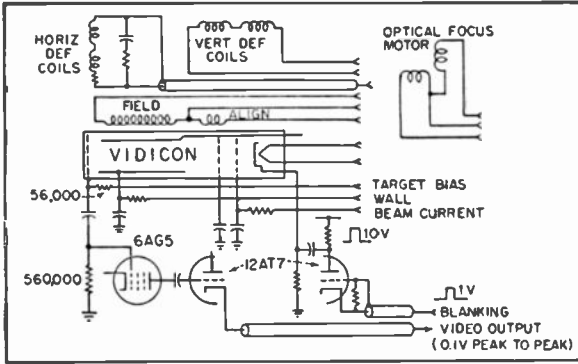

Fig. 2—A standard 24-conductor cable connects the camera and control units.

preamplifier followed by a cathode-follower prepare the signals from the target electrode for transmission over the coaxial cable back to the master unit. In order to establish black level it is necessary to blank the target of the vidicon during the scanning return time and this is most conveniently done by applying a positive ten-volt blanking pulse to the cathode. Since a ten-volt pulse on a 52-ohm line represents a very sizeable current it was found more economical to transmit a one-volt pulse and amplify it in the camera just before application to the vidicon cathode.

Views of each side of the master control unit are shown in Figures 3 and 4.

In order to operate standard broadcast television receivers from a system of this kind it is necessary to establish substantially the same scanning rates as those used in commercial broadcasting. Certainly it is necessary to transmit an interlaced signal because otherwise the resolution in the vertical direction will drop to approximately 250 lines. It was therefore decided to establish the same scanning rates for the industrial system as those standardized by the RMA for commercial broadcasting, namely 525 lines, 30 frames interlaced.

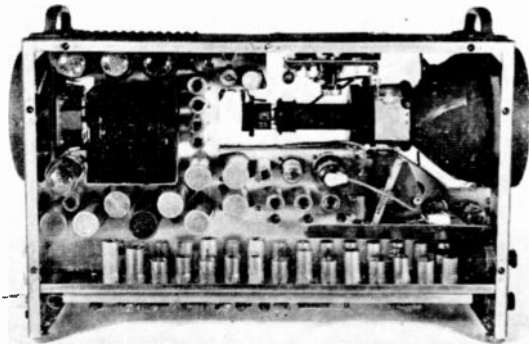
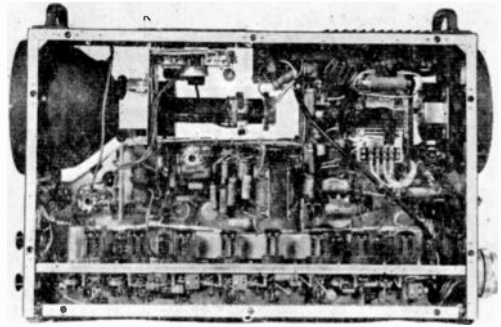

Fig. 3—Left-side view of control unit shows video strip and cooling fan.

Fig. 4—Right-side view shows frequency-division chain and high-voltage circuits.



SIMPLIFIED SYNC

One of the basic elements of the simplified synchronizing signal generator used in this equipment is an oscillator, which resembles the familiar multivibrator.²

This basic oscillator is illustrated in Figure 5A. Before the plate voltage is applied to the circuit, C is uncharged and the grid of V_2 is at ground potential. As soon as plate voltage is applied, the grid of V_1 is raised to some positive potential determined by the series of resistors. The plate resistor of V_1 is low and consequently a relatively large current can be drawn by that tube down through the common cathode resistance, which raises the cathode of both of the tubes to some positive voltage E_K . With the cathode of V_2 highly positive with

respect to its grid, the plate current in that tube is cut off and C is free to charge through R toward $B+$ according to the logarithmic curve shown in Figure 5B.

If nothing were to prevent it, C would charge up to a value $(1 - 1/\epsilon)$ of $B+$ in RC seconds. However, as the potential on the grid of V_2 increases as C charges, it will reach the shaded region below E_K that represents the negative bias range for which V_2 will be conductive. As soon as V_2 begins to conduct, the plate current flowing

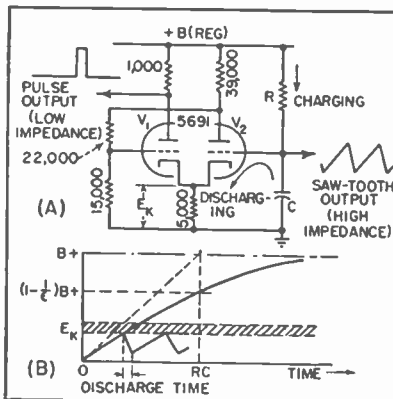

Fig. 5—Basic oscillator-counter operates at twice horizontal scanning frequency.

² Kurt Schlesinger, Patent No. 2,383,822 (RCA).

through its plate resistor lowers the potential of the grid of V_1 and that tube is quickly biased off. However, since it was largely the heavy current drawn in the left-hand tube that supported the cathode potential at the value E_K , this potential will now drop to a very low value and the grid of V_2 will find itself highly positive with respect to its cathode. Capacitor C then discharges through the diode formed by the grid and cathode of V_2 and the length of time required for the discharge to occur is determined by the value of C and the effective resistance of the diode and the cathode resistor.

Having discharged C to a low value the circuit is ready to restart the cycle. Thus a saw-tooth voltage waveform is available across C and a narrow pulse can be obtained from the plate resistor of V_1 . The exact frequency of oscillation of this circuit depends upon several factors including the value of the plate supply voltage, which is carefully regulated. It depends primarily upon the values of R and C , and the voltage E_K , and it has been found to be stable enough over long periods of time for this application.

The oscillator is susceptible to being synchronized to external signals. A positive pulse added to the capacitor voltage can precipitate entry into the conduction region periodically, or a negative pulse added to E_K or to the left-hand grid will do as well. A circuit of this kind is especially useful in a television synchronizing generator since use can be made of the square-topped pulse output as well as the nearly ideal saw-tooth wave.

FREQUENCY DIVISION

The positive pulse out of the master oscillator is added to the capacitor voltage of the next stage below, which is an identical oscillator but set to run free at $1/7$ or $1/5$ the master frequency, as shown in Figure 6. In this way the two oscillators are locked rigidly together and a third can be locked to the second and so on down to any submultiple frequency.

Seven of these oscillators are used in the synchronizing-signal generator. In order to obtain the half-integral relationship required between the horizontal and vertical scanning rates to produce odd-line interlacing, it is necessary to start with a master oscillator at 31.5 kilocycles, which is double the horizontal rate of 15,750 cycles. Subdivision of the master frequency by the numbers 7, 5, 5 and 3 yields the vertical scanning rate of 60 cycles. The vertical blanking pulse is taken from the 60-cycle oscillator that is made to have a discharge time approximately 5 per cent of the vertical period (V) by choice of the time constants governing that oscillator. A sample of the vertical

blanking signal is taken through a phase inverter to a phase detector where it is compared to the power-line frequency. The automatic-frequency-control signal thus developed is applied to the master oscillator to synchronize it with the power frequency.

The horizontal frequency generator is synchronized at $\frac{1}{2}$ the master frequency and is adjusted to produce a horizontal blanking pulse width that is approximately 15 per cent of the horizontal period. The saw-tooth output of this stage is also used as a scanning waveform.

Horizontal sync is made from blanking by differentiating the blanking pulse, clipping the leading pulse and sending it through a delay line to produce a front porch of about 2 per cent of the horizontal scanning period H .

The pulse is later amplified and clipped to produce a sync pulse with a steep front edge and a duration of approximately 5 per cent H . The horizontal sync and blanking pulses are thus similar to the RMA standard waveforms.

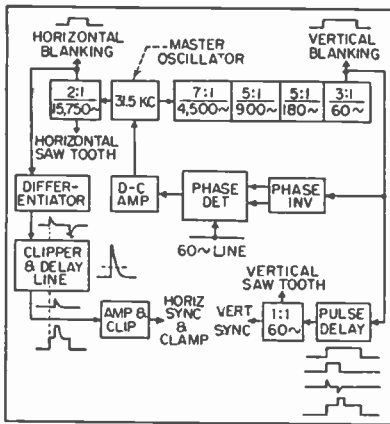

Fig. 6—Vertical and horizontal sync, scanning and blanking voltages are produced by this frequency-division and pulse-shaping network.

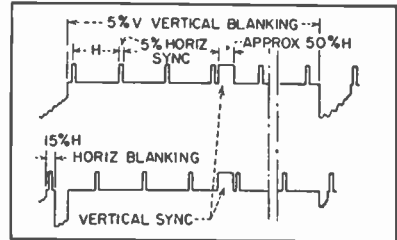

Fig. 7—Composite waveform for the industrial television system.

The vertical sync pulse, which is quite unorthodox, is produced by allowing the front edge of vertical blanking to key a pulse delay tube into operation. After a time interval, determined by time constants in the delay circuit, the delay tube falls out of its conductive condition having produced a pulse that is a fraction of the length of the vertical blanking period.

This pulse is then differentiated, and the pip corresponding to the trailing edge of the delay pulse used to synchronize a second 60-cycle saw-tooth oscillator. The discharge time or equivalent pulse width from this oscillator is made to be no greater than approximately $\frac{1}{2}$ of the time for one horizontal line in order that a short vertical sync pulse can be slipped in just ahead of one horizontal sync pulse and just after

another one in the odd and even fields. Thus 10 tubes have been used to produce all of the waveforms required for the entire system.

The composite waveform is shown in Figure 7. Although the vertical sync pulse is only about 10 times as long as the horizontal pulse no difficulty has been experienced in tests with commercial receivers in obtaining sufficient vertical sync signal. Furthermore, the signal in an industrial system is always noise free since it will be fed over closed circuits.

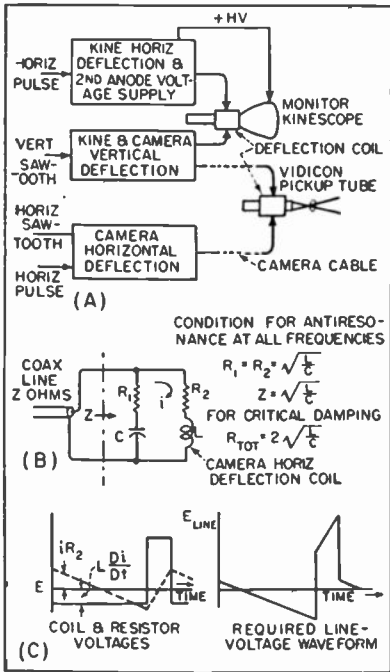

Fig. 8—Block diagram of scanning circuits. (B) and (C) explain operation.

connected serially in each arm is known to be antiresonant at all frequencies for the singular condition where $R_1 = R_2 = \sqrt{L/C}$. The terminal impedance Z , looking into the network is a pure resistance equal to $\sqrt{L/C}$ ohms at all frequencies. Such a constant resistance network as this makes an ideal termination for the transmission line and since it includes the horizontal deflection coil as one element it should be possible to produce any desired current waveform in the coil by impressing the proper voltage waveform upon the line. Ringing of the resonant circuit formed by the deflection coil and any capacitance that may be associated with it is very undesirable in the presence of

The scanning system used is shown in the block diagram of Figure 8A. A single verticle deflection amplifier is common to both the monitor kinescope and the camera since the power requirements are small and ordinary cable pairs are satisfactory for transmission out to the camera. The horizontal scanning and second anode voltage supply for the monitoring kinescope are combined in one conventional unit of the type normally used in home receivers.

The horizontal scanning for the camera is quite unconventional, however, since it is necessary to send the current to the camera through several hundred feet of 52-ohm coaxial cable. The method of accomplishing this can best be understood from Figure 8B.

The parallel-resonant circuit comprising C and L with R_1 and R_2

the impulse waveforms used in television scanning. The condition for critical damping of a resonant circuit requires that the total resistance around the series loop must be at least equal to $2\sqrt{L/C}$, a condition that coincides exactly with the foregoing.

Synthesis of the required voltage waveform is accomplished as shown in Figure 8C. The voltage across the inductance during the scanning period must be $L di/dt$ which for a constant rate of change of current is a small constant negative voltage. During retrace time the current change is in the opposite direction and many times faster, hence, the voltage required across the coil is of the form of a positive pulse. The voltage drop iR_2 across R_2 due to the saw-tooth current is of saw-tooth waveform as shown. The sum of these two voltages gives the required waveform that must be impressed upon the line to produce the ideal current saw-tooth in the coil.

Perfection of the scanning linearity depends entirely upon the accuracy with which this complex waveform is produced. It was fortunate that both the saw-tooth waveform and its companion pulse were available from the horizontal frequency stage in the synchronizing-signal generator since it was then only necessary to mix the two waveforms with appropriate amplitude adjustment to obtain the required shape.

VIDEO AMPLIFIER

The video amplifier is almost identical to those used in broadcast equipment. As shown in Figure 9, the signal goes through two stages of amplification before reaching the conventional high peaker.

Video gain is controlled by varying the screen voltage of the 6AG5's. Black level is established by means of a conventional driven clamp circuit; the clamping pulses are made from horizontal sync. Blanking is inserted in the cathode of the d-c setter and sync signals are mixed with video in the following stage. The composite signal is then sent to the external 75-ohm signal lines by means of a cathode-follower output stage. The output signal is polarized with blacks negative and is 2 volts peak to peak.

Signal for the internal kinescope is taken from a sampling resistor in the output stage and fed through a one-stage amplifier to the kinescope grid.

The gain in the kinescope loop is not adjustable and thus the kinescope serves as a rough monitor of the signal level on the outgoing line in addition to its other uses for black level setting, camera focus and beam adjustments, as well as a check on sync generator operation.

The television instrument described could easily be mass produced and sold within the price range of other business machines of comparable size and complexity. It will produce a sharp, steady picture of useful quality, and the pickup tube is sensitive enough to permit use of the equipment under the illumination levels normally encountered in industrial operations.

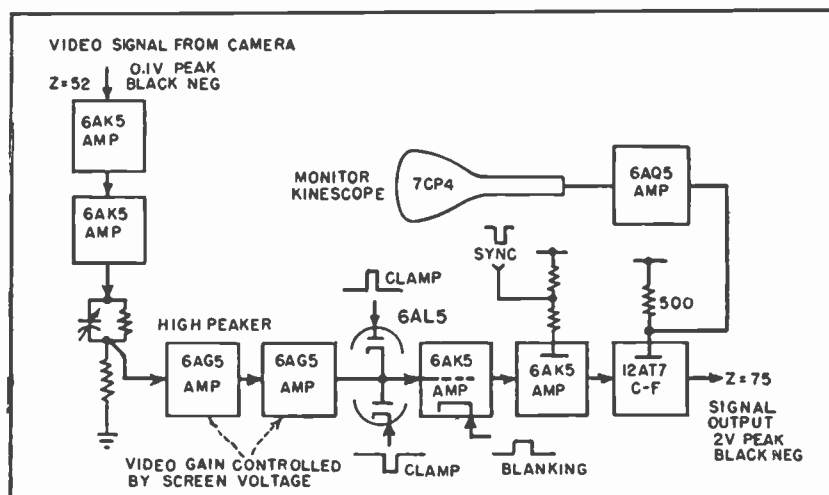

Fig. 9—Video path is similar to that used in broadcast transmitters.

The authors are indebted to Dr. V. K. Zworykin of the RCA Laboratories for much helpful encouragement and guidance during the development of this project.

THEATER TELEVISION*

By

ALFRED N. GOLDSMITH

Consulting Engineer, Radio Corporation of America,
New York, N. Y.

Summary—The present state (as of June 1950) and future possibilities of the art of theater television are described in non-technical terms. Consideration is given to both equipment and programming.

INTRODUCTION

THE rapid development of television broadcasting into the home is well known to all. Less known is the parallel development of theater television. This new art is well advanced technically but has not as yet crystallized into accepted program and commercial forms.

PSYCHOLOGICAL ASPECTS

The feasibility of theater television is based first, on its technical feasibility and second, on the demonstrated acceptability of television programs already sent to millions of viewers in their homes. It has thus become clear that large audiences in theaters could view programs carried by television just as smaller groups of individuals, by the millions, now enjoy television in the home.

There are reasons for believing that theater entertainment will long have a position of importance in the lives of the public. Man is a gregarious individual, well pleased when he is in the company of his fellows. Further, it is recognized by psychologists that emotions of large groups of people are more readily aroused and may be more intense than those of smaller groups or individuals. For these reasons people go to theaters and, once there, experience the thrill of a mass emotion.

There are other incidental attractions to theater entertainment. Comfortable seats, air conditioning, and impressive surroundings designed in accordance with good showmanship, present something of a contrast to home surroundings. Further, the ever-present usher serves as a reminder that good manners and consideration are required so that all may enjoy the program without accidental or deliberate interference. Admittedly, discipline of guests in the home presents difficult

* Decimal Classification: R583.17.

problems and often excellent television programs are spoiled by careless conversation or thoughtless interruptions.

Since theater television thus has attractions which encourage a belief in its long-time continuance, it is natural to seek methods for utilizing television in the theater. However, theater television brings a number of problems in its train. These are partly technical, and partly aesthetic.

TECHNICAL ASPECTS

Considering the technical questions, which are under increasingly good control, the first requisite is a large, bright picture on the theater screen. In the home, a directly viewed picture, 9 x 12 inches in size and with a brightness of 20 foot-lamberts, is easily produced. In the theater a projected picture, 9 x 12 feet in size and with a brightness of 10 foot-lamberts requires about 200 times as great a light output from the original picture tube, or kinescope. Improved tube constructions are of assistance. High anode voltages (even beyond 50,000 volts) contribute to the necessary picture brightness. And highly evolved optical systems, of the so-called Schmidt type, efficiently utilize the luminous output of the projection kinescope. Theater pictures of good size and adequate brightness are thus within reach.

There are also a number of other questions which might be asked at present, and which can be at least partially answered. Some of these questions will be briefly considered.

The necessary size of the theater television picture comes into consideration. Theater motion pictures range, in general, from 9 x 12 feet to 18 x 24 feet, or even larger. It is desirable that the television picture in the theater shall compare favorably in size with the motion picture. This standard is generally accepted.

Theater motion pictures have an average specified brightness of 10 foot-lamberts and with a range of from 7 to 14 foot-lamberts. Theater television pictures at present have somewhat lower brightness but are steadily approaching the motion picture values.

An important question in connection with theater television is the necessary sharpness of detail of the television picture. Admittedly, black-and-white motion pictures are generally sufficiently sharp and clear to satisfy even discriminating members of the audience. Color motion pictures in the theater, while slightly less sharp, are still adequately clear. Present television pictures, designed for the home, if projected to theater size and viewed at normal distances in the theater, seem slightly soft. These are nominal 525-line pictures, and are transmitted according to FCC regulations, within a 4.25-megacycle

channel width. Careful students of the requirements of theater television have reached the conclusion that somewhat higher detail is desirable for that purpose and have accordingly proposed 625-line pictures transmitted in an 8-megacycle channel width. It is thought that pictures of this type will be sufficiently sharp to stand normal comparisons with theater motion pictures.

If the television picture is to be received directly in the theater and to be projected instantaneously at the moment of its reception, it is produced on a high-brightness kinescope, operating at high voltage and associated with an efficient optical system. Such optical systems reach the high efficiency of about 35 per cent, that is, 35 per cent of the light output of the kinescope finally appears on the screen. Operators of motion picture theaters have sought, for decades, for brighter motion pictures. It seems that the public prefers bright pictures. They are easier to look at if properly projected and viewed. They show a wider range of brightness and give a more realistic imitation of nature. And they avoid the necessity for extremely dim house lights and consequent inconvenience to patrons endeavoring to find seats in a shadowy environment.

The screens used in theaters for motion pictures are somewhat directional but not sufficiently so for television purposes. It is necessary that all of the precious light output of the screen shall be directed to the audience in the orchestra and galleries but not wasted on the walls and ceiling of the theater. Accordingly, the screens used for theater television are made as highly directional as is practicable. Thus their light is thrown where it is needed and with little waste.

Modern motion picture projectors are generally placed in a projection room (or "booth") located in the second balcony or higher. The throw, or distance from the projector to the screen is thus about the same as the depth of the theater from the back of the orchestra to the back of the stage. The optics of motion picture projectors are flexible and, consequently, the projector can be placed wherever desirable. In fact, occasionally, motion picture projectors are placed behind a translucent screen and, therefore, project the light toward the audience onto a screen located between the projector and the audience.

The placement of a theater television projector is a less simple matter. The optics of such a projector are relatively restricted, and the available throw at present is usually not in excess of about 70 feet. Accordingly, the projector can be placed on the orchestra floor. This location, however, requires the removal of a number of orchestra seats and may obstruct viewing of the screen from some of the seats behind

the projector. Further, this location is usually artistically undesirable. Another possible location is at the front edge of the first balcony. Where structural strength is adequate, this location has certain advantages. Remote-control means are provided for operating the projector from the motion picture projection room.

Still another and novel location for the television projector is in the air over the orchestra. In this case the projector is suspended by suitable supports from the theater ceiling and at an appropriate distance from the screen. The accessibility of this location leaves something to be desired. Here, again, the projector is controlled from the booth.

It is to be expected that with further advances in this field, greater freedom in the selection of the projector location will become possible.

There is another method of projecting television pictures in the theater, namely, the so-called delayed projection based on film recording. In this system, the incoming television pictures, appearing on the screen of a monitoring kinescope of high quality, are photographed on motion picture film in the theater (usually in or near the motion picture projection room). The exposed film is run through a high speed processing machine where it is developed, fixed, washed, and dried in one or two minutes. The sound is, of course, separately recorded either on the film or otherwise. The resulting film is then run through the regular motion picture projectors of the theater and thus appears on the screen.

This process has the advantage that the picture size and brightness will be identical with that of the regular motion pictures. It further has the advantage that the film can be shown at any time. For example, it does not become necessary to interrupt a feature film which is being shown, since the television film can be shown at any time after its recording. Again, television film produced in this fashion can be repeatedly shown, providing motion picture rights have been secured, thus enabling performances in the afternoon and evening if desired. Greater program flexibility is achieved by this method of presentation.

On the other hand, complex, costly equipment is needed and additional operating personnel are required. Considerable film will be required for recording lengthy television programs. One of the basic advantages of television news, i.e., its immediacy, is lost. It is no longer possible by this process to view the event at exactly the instant it occurs. In some cases this is an unimportant limitation; in others it may be more serious.

Little has been said of the method of reproducing the sound portion of a theater-television program since it is obvious that the public

address or sound motion picture equipment of the theater can be conveniently used for this purpose.

Many exhibitors, or theater owners, are greatly interested in the possibility of color television in the theater. This is a distinct possibility, although it presents greater technical obstacles than does monochrome television. For one thing, it is considerably more difficult to obtain adequate picture brightness in a color picture than it is in a monochrome picture. By using advanced techniques, it may prove feasible to produce sufficiently bright color television pictures in the theater, and of adequate size. It is safe to assume that this quality will in time be achieved.

The delayed method of theater television, using film recording, may be possible for color presentations. In this case, the incoming program would be recorded on color film, which would then be rapidly processed and projected on the theater screen. Various methods of accomplishing this have been proposed and are under development. But color television in the theater remains a promising prospect rather than an available accomplishment.

The exhibitor is naturally greatly interested in the likely first-cost of a television outfit as well as the cost of its operation. At the present time a theater-television outfit of the direct projection types costs about \$25,000.00. The cost of the delayed type with film recording is of the same general magnitude. Quantity production of either type of equipment might somewhat reduce these costs. But exact figures on such reductions in cost are not available at this early stage in the development of theater television. The cost of operation of such an installation is an even more uncertain matter since the type and number of operating personnel, and their wage scales, are as yet unknown.

NETWORKS

The commercial success of a theater presentation depends in large measure on its cost *per member of the audience*. If a given performance is shown on the stage of a theater seating 500 persons, 1/500 of its cost of production must, of course, be charged to each member of the audience (assuming a full house).

The high production cost of feature films running into the millions of dollars for a 90-minute show, becomes commercially feasible because tens of millions of people may see the film. This is accomplished through syndication of a film, involving its showing in a large number of individual theaters.

Television broadcasting can similarly support programs of considerable cost (tens of thousands of dollars per hour) because of the large audience reached by the networks with their dozens of outlet stations scattered widely over the land and each catering to a substantial and separate audience.

It is, therefore, natural, in the case of theater television, to seek means of syndicating the programs so as to reduce their cost per member of the audience.

As in the case of television broadcasting, theater television has available two major methods of syndicating network facilities. The programs can be sent by coaxial cable, although a superior type of cable is required for the purpose, or they may be sent by radio relay systems which operate with at least equal effectiveness.

A hypothetical theater-television network might use programs originating in a central studio in some particular city. Intracity communications would carry this program directly to each of the theaters served in that city. Intercity communications would carry the program to all other cities where it is to be utilized. In such cities additional intracity communication facilities would bring the program to the individual theaters. It can thus be seen that a theater-television network may in time evolve into an elaborate and specialized system paralleling in large measure the facilities now used for television broadcasting.

Certain governmental aspects of theater television may be briefly mentioned. The exhibitors naturally desire that their programs shall reach them by an economic means (e.g., radio) but shall not be available to the general public (except in the theater). Accordingly, the exhibitors seek something different from the present broadcasting channels which are open for reception by all. They desire what is known as a "multiple-addressee service", wherein a message on special channels is privately addressed to a limited number of recipients and to no others. Under existing treaty arrangements and under the Federal Communications Act of 1934 it would then be illegal for anyone to pick up or to show such private communications without the assent of the sender.

There is also some questions as to whether theater television belongs in the ultra-high frequencies or in the microwaves. Further experimentation and economic study are required.

PROGRAMMING

From the preceding, it is clear that theater television is well within the bounds of technical accomplishment. In fact, technical limitations

are not a factor which need be seriously considered in the establishment of theater-television service. Far more puzzling is the matter of correct programming. Once a theater is provided with its television equipment, it can justify the installation only if it has available a reasonably continuous source of good programs at economic figures. Unless television can bring material of interest to the audience, its installation in the theater would meet only occasional and special needs.

Many persons have given serious thought to television programs for the theater. News events of major importance and leading sports events have been repeatedly proposed. Doubtless, these would offer some attractiveness. A wider diversity of program type is, however, needed and will doubtless be evolved in time.

CONCLUSIONS

It thus is obvious that the future of theater television will primarily be determined by the originality, experience, energy, showmanship, and the courage of the exhibitors and of those who devise television programs for them. Technically, no cause for concern is seen. Acceptably large, clear, and bright television pictures, to be shown in the theater, are attainable. But their subject matter must have an audience appeal as great as their technical excellence. Granted these conditions, theater television can fill an important part of the leisure-hour life of Americans.

APPENDIX

TELEVISION

A Bibliography of Technical Papers

by RCA Authors

1929 - 1950

This listing includes some 506 technical papers on TELEVISION and closely related subjects, selected from those written by RCA Authors and published during the period 1929—June 1950.

Papers are listed chronologically except in cases of multiple publication. Papers which have appeared in more than one journal are listed once, with additional publication data appended.

Any requests for copies of papers listed herein should be addressed to the publication to which credited. However, RCA Licensee Bulletins are not published and are issued only as a service to licensees of the Radio Corporation of America.

Abbreviations used in listing the various journals are given on the following page.

ABBREVIATIONS

<i>An. Amer. Acad. Polit. Soc. Sci.</i>	ANNALS OF THE AMERICAN ACADEMY OF POLITICAL AND SOCIAL SCIENCES
<i>Broad. Eng. Jour.</i>	BROADCAST ENGINEERS JOURNAL
<i>Elec. Eng.</i>	ELECTRICAL ENGINEERING (TRANSACTION A.I.E.E.)
<i>Electronic Ind.</i>	ELECTRONIC INDUSTRIES
<i>FM and Tele.</i>	FM AND TELEVISION
<i>Inter. Project</i>	INTERNATIONAL PROJECTIONIST
<i>Jour. Appl. Phys.</i>	JOURNAL OF APPLIED PHYSICS
<i>Jour. Frank. Inst.</i>	JOURNAL OF THE FRANKLIN INSTITUTE
<i>Jour. Opt. Soc. Amcr.</i>	JOURNAL OF THE OPTICAL SOCIETY OF AMERICA
<i>Jour. Soc. Mot. Pic. Eng.</i>	JOURNAL OF THE SOCIETY OF MOTION PICTURE ENGINEERS
<i>Jour. Tele. Soc.</i>	JOURNAL OF THE TELEVISION SOCIETY
<i>Phys. Rev.</i>	PHYSICAL REVIEW
<i>Proc. I.R.E.</i>	PROCEEDINGS OF THE INSTITUTE OF RADIO ENGINEERS
<i>Radio and Tele.</i>	RADIO AND TELEVISION
<i>Radio Eng.</i>	RADIO ENGINEERING
<i>Radio Tech. Digest</i>	RADIO TECHNICAL DIGEST
<i>RCA Rad. Serv. News</i>	RCA RADIO SERVICE NEWS
<i>RMA Eng.</i>	RMA ENGINEER
<i>Short Wave and Tele.</i>	SHORT WAVE AND TELEVISION
<i>TBA Annual</i>	ANNUAL OF THE TELEVISION BROADCASTERS ASSOCIATION
<i>Tele. News</i>	TELEVISION NEWS

TELEVISION BIBLIOGRAPHY

	Year
"The Selection of Standards for Commercial Radio Television", J. Weinberger, T. A. Smith and G. Rodwin, <i>Proc. I.R.E.</i> (September)	1929
"Television with Cathode-Ray Tube for Receiver", V. K. Zworykin, <i>Radio Eng.</i> (December)	1929
"Fidelity Tests for Television Systems", A. F. Murray, <i>Tele. News</i> (December)	1931
"Description of Experimental Television Receivers", G. L. Beers, <i>Proc. I.R.E.</i> (December)	1933
"An Experimental Television System", E. W. Engstrom, <i>Proc. I.R.E.</i> (December)	1933
"Description of Experimental Television Transmitting Apparatus", R. D. Kell, <i>Proc. I.R.E.</i> (December)	1933
"A Study of Television Image Characteristics", E. W. Engstrom, <i>Proc. I.R.E.</i> (December)	1933
"Description of an Experimental Television System and the Kinescope", V. K. Zworykin, <i>Proc. I.R.E.</i> (December)	1933
"Problems of Cathode-Ray Television", I. G. Maloff, <i>Electronics</i> (January)	1934
"The Iconoscope—A Modern Version of the Electric Eye", V. K. Zworykin, <i>Proc. I.R.E.</i> (January)	1934
"Transmission and Reception of Centimeter Waves", I. Wolff, E. G. Linder and R. A. Braden, <i>Proc. I.R.E.</i> (January)	1934
"Television", V. K. Zworykin, <i>Jour. Frank. Inst.</i> (January)	1934
"Improved Magnetron Oscillator for the Generation of Microwaves", E. G. Linder, <i>Phys. Rev.</i> (May 1)	1934
"An Experimental Television System—The Transmitter", R. D. Kell, A. V. Bedford and M. A. Trainer, <i>Proc. I.R.E.</i> (November)	1934
"An Experimental Television System—The Receivers", R. S. Holmes, W. L. Carlson and W. A. Tolson, <i>Proc. I.R.E.</i> (November)	1934
"The Radio-Relay Link for Television Signals", C. J. Young, <i>Proc. I.R.E.</i> (November)	1934
"Theory of Electron Gun", I. G. Maloff and D. W. Epstein, <i>Proc. I.R.E.</i> (December)	1934
"Cathode-Ray Tubes and Their Applications", J. M. Stinchfield, <i>Elec. Eng.</i> (December)	1934
"Transmission and Reception of Centimeter Waves", I. Wolff, E. G. Linder and R. A. Braden, <i>Proc. I.R.E.</i> (January)	1935
"The Secondary Emission Phototube", H. Iams and B. Salzberg, <i>Proc. I.R.E.</i> (January)	1935
"A Study of Television Image Characteristics, (Part II)", E. W. Engstrom, <i>Proc. I.R.E.</i> (April)	1935
"Television and the Motion-Picture Theater", A. N. Goldsmith, <i>Inter. Project.</i> (May)	1935
"Applications Illustrating the Use of Cathode-Ray Tubes", J. M. Stinchfield, <i>Electronics</i> (May)	1935
"Development of Transmitters for Frequencies Above 300 Megacycles", N. E. Lindenblad, <i>Proc. I.R.E.</i> (September)	1935
"Luminescent Materials for Cathode-Ray Tubes", T. B. Perkins and H. W. Kaufman, <i>Proc. I.R.E.</i> (November)	1935
"Cathode-Ray Tube Terminology", T. B. Perkins, <i>Proc. I.R.E.</i> (November)	1935
"Influence of Tube and Circuit Properties in Electron Noise", S. W. Seeley and W. S. Barden, <i>Electronics</i> (December)	1935
"Television", A. V. Bedford and E. W. Engstrom, <i>Section of BOOK OF KNOWLEDGE</i>	1935
"A Survey of Television Progress in America", W. R. G. Baker and L. Malter, Booklet, Geo. Newnes Ltd., England	1935

	Year
"Possibilities of the Iconoscope in Television", V. K. Zworykin and G. A. Morton, Booklet, Geo. Newnes, Ltd., England	1935
"Input Resistance of Vacuum Tubes as Ultra-High-Frequency Amplifiers", W. R. Ferris, <i>Proc. I.R.E.</i> (January)	1936
"A Turnstile Antenna for Use at Ultra-High Frequencies", G. H. Brown, <i>Electronics</i> (March)	1936
"The Secondary Emission Multiplier—A New Electronic Device", V. K. Zworykin, G. A. Morton and L. Malter, <i>Proc. I.R.E.</i> (March) ..	1936
"Scanning Sequence and Repetition Rate of Television Images", R. D. Kell, A. V. Bedford and M. A. Trainer, <i>Proc. I.R.E.</i> (April)	1936
"Applied Electron Optics", V. K. Zworykin and G. A. Morton, <i>Jour. Opt. Soc. Amer.</i> (April)	1936
"An Urban Field Strength Survey at 30 and 100 Mc.", R. S. Holmes and A. H. Turner, <i>Proc. I.R.E.</i> (May)	1936
"The Future of Radio and Public Interest, Convenience and Necessity", D. Sarnoff, <i>RCA Review</i> (July)	1936
"Television", C. B. Jolliffe, Statements Made by RCA Before FCC (June 15)	1936
TELEVISION, Vol. I, RCA Institutes Technical Press, New York, N. Y. (July)	1936
"The Cathode-Ray Tube in Television Reception", I. G. Maloff, TELEVISION, Vol. I, RCA Institutes Technical Press, New York, N. Y. (July)	1936
"Television in Advertising", David Sarnoff, TELEVISION, Vol. I, RCA Institutes Technical Press, New York, N. Y. (July)	1936
"Television", D. Sarnoff, TELEVISION, Vol. I, RCA Institutes Technical Press, New York, N. Y. (July)	1936
"RCA Television Field Tests", L. M. Clement and E. W. Engstrom, <i>RCA Review</i> (July)	1936
"Iconoscopes and Kinescopes in Television", V. K. Zworykin, <i>RCA Review</i> (July)	1936
<i>Jour. Soc. Mot. Pic. Eng.</i> (May)	1937
"Electron Optical System of Two Cylinders as Applied to Cathode-Ray Tubes", D. W. Epstein, <i>Proc. I.R.E.</i> (August)	1936
"Magnetron Oscillators for the Generation of Frequencies Between 300 and 600 Megacycles", G. R. Kilgore, <i>Proc. I.R.E.</i> (August) ..	1936
"Ultra-High-Frequency Transmission Between RCA Building and Empire State Building in New York City", P. S. Carter and G. S. Wickizer, <i>Proc. I.R.E.</i> (August)	1936
"Electrical Measurements at Wavelengths Less than Two Meters", L. S. Nergaard, <i>Proc. I.R.E.</i> (September)	1936
"Television Radio Relay", B. Trevor and O. E. Dow, <i>RCA Review</i> (October)	1936
"Electron Beams and Their Applications in Low-Voltage Devices", H. C. Thompson, <i>Proc. I.R.E.</i> (October)	1936
"Electron Optics of an Image Tube", G. A. Morton and E. G. Ramberg, <i>Physics</i> (December)	1936
"Fourth Estate Views Television", David Sarnoff, <i>Broadcast News</i> (December)	1936
"Partial Suppression of One Side Band in Television Reception", W. J. Poch and D. W. Epstein, <i>Proc. I.R.E.</i> (January)	1937
"Equipment Used in the Current RCA Television Field Tests", R. R. Beal, <i>RCA Review</i> (January)	1937
"Some Notes on Ultra-High-Frequency Propagation", H. H. Beverage, <i>RCA Review</i> (January)	1937
"Frequency Assignments for Television", E. W. Engstrom and C. M. Burrill, <i>RCA Review</i> (January)	1937
"Television and the Electron", V. K. Zworykin, <i>Short Wave and Tele.</i> (March)	1937
"Experimental Studio Facilities for Television", O. B. Hanson, <i>RCA Review</i> (April)	1937

	Year
"Television Studio Design", R. E. Shelby and R. M. Morris, <i>RCA Review</i> (July)	1937
"Television Transmitters Operating at High Powers and Ultra-High Frequencies", J. W. Conklin and H. E. Gihring, <i>RCA Review</i> (July)	1937
"A Circuit for Studying Kinescope Resolution", C. E. Burnett, <i>Proc. I.R.E.</i> (August)	1937
"Theoretical Limitation of Cathode-Ray Tubes", D. B. Langmuir, <i>Proc. I.R.E.</i> (August)	1937
"An Oscillograph for Television Development", A. C. Stocker, <i>Proc. I.R.E.</i> (August)	1937
"The Brightness of Outdoor Scenes and Its Relation to Television Transmission", W. H. Hickok, R. B. Janes and H. Iams, <i>Proc. I.R.E.</i> (August)	1937
"Development of the Projection Kinescope", V. K. Zworykin and W. H. Painter, <i>Proc. I.R.E.</i> (August)	1937
"Theory and Performance of the Iconoscope", V. K. Zworykin, G. A. Morton and L. E. Flory, <i>Proc. I.R.E.</i> (August)	1937
"High-Current Electron Gun for Projection Kinescope", R. R. Iaw, <i>Proc. I.R.E.</i> (August)	1937
"RCA Developments in Television", R. R. Beal, <i>Jour. Soc. Mot. Pic. Eng.</i> (August)	1937
"Television Pickup Tubes with Cathode-Ray Beam Scanning", H. Iams and A. Rose, <i>Proc. I.R.E.</i> (August)	1937
"Television Engineering Study Outline", S. W. Seeley, <i>RCA Licensee Bulletin LB-405</i> (August 13)	1937
TELEVISION, Vol. II, RCA Institutes Technical Press, New York, N. Y. (October)	1937
"Analysis and Design of Video Amplifiers", Part I, C. N. Kimball and S. W. Seeley, <i>RCA Review</i> (October)	1937
"The Magnatron as a High-Frequency Generator", G. R. Kilgore, <i>Jour. Appl. Phys.</i> (October)	1937
"Field Strength Observations of Transatlantic Signals, 40 to 45 Megacycles", H. O. Peterson and D. R. Goddard, <i>RCA Review</i> (October)	1937
<i>Proc. I.R.E.</i> (October)	1937
"Commercial Television—And Its Needs", A. N. Goldsmith, TELEVISION, Vol. II, RCA Institutes Technical Press, New York, N. Y. (October)	1937
"Television", David Sarnoff, <i>RCA Review</i> (October)	1937
"Televsual Use of Ultra-High Frequencies", A. N. Goldsmith, TELEVISION, Vol. II, RCA Institutes Technical Press, New York, N. Y. (October)	1937
"What of Television?", David Sarnoff, TELEVISION, Vol. II, RCA Institutes Technical Press, New York, N. Y. (October)	1937
"Problems Concerning the Production of Cathode Ray Tube Screens", H. W. Leverenz, TELEVISION, Vol. II, RCA Institutes Technical Press, New York, N. Y. (October)	1937
"Television—Description for Laymen", A. F. Van Dyck, TELEVISION, Vol. II, RCA Institutes Technical Press, New York, N. Y. (October)	1937
"A Transformation for Calculating the Constants of Vacuum Tubes with Cylindrical Elements", W. van B. Roberts, <i>Proc. I.R.E.</i> (October)	1937
"Television Economics", A. N. Goldsmith, <i>Communications</i> (October)	1937
"Television Among the Visual Arts", A. N. Goldsmith, TELEVISION, Vol. II, RCA Institutes Technical Press, New York, N. Y. (October)	1937
"Screens for Television Tubes", I. G. Maloff and D. W. Epstein, <i>Electronics</i> (November)	1937
"Figure of Merit for Television Performance", A. V. Bedford, <i>RMA Eng.</i> (November)	1937
<i>RCA Review</i> (July)	1938

	Year
"Direct Viewing Type Cathode-Ray Tube for Large Television Images", I. G. Maloff, <i>Proc. I.R.E.</i> (November)	1937
<i>RCA Review</i> (January)	1938
"Television Cathode-Ray Tubes for the Amateur", R. S. Burnap, <i>RCA Review</i> (January)	1938
"Video I. F. System Considerations", S. W. Seeley and W. S. Barden, <i>RCA Licensee Bulletin LB-417</i> (January 5)	1938
"A Discussion on Television Receiving Antennas", W. S. Barden and S. W. Seeley, <i>RCA Licensee Bulletin LB-423</i> (January 27)	1938
"Problems of American Television", A. N. Goldsmith, <i>Radio Craft</i> (February)	1938
"Television Receivers", E. W. Engstrom and R. S. Holmes, <i>Elec- tronics</i> (April)	1938
"Some Notes on Video-Amplifier Design", A. Preisman, <i>RCA Review</i> (April)	1938
"Effect of the Receiving Antenna on Television Reception Fidelity", S. W. Seeley, <i>RCA Review</i> (April)	1938
"Probable Test Equipment Requirements for Design and Test of Domestic Television Receivers", J. M. Brumbaugh, <i>RMA Eng.</i> (May)	1938
"Preliminary Discussion of Television Requirements With the Under- writers' Laboratories", E. T. Dickey, <i>RMA Eng.</i> (May)	1938
"Television I-F Amplifiers", E. W. Engstrom and R. S. Holmes, <i>Electronics</i> (June)	1938
"A Discussion on Video Modulation Detection", W. S. Barden, <i>RCA Licensee Bulletin LB-435</i> (June 27)	1938
"A Discussion of Television Deflecting Systems", S. W. Seeley and C. N. Kimball, <i>RCA Licensee Bulletin LB-433</i> (June 30)	1938
"Television Antenna for Good Reception", S. W. Seeley, <i>Radio Craft</i> (August)	1938
"Television V-F Circuits", R. S. Holmes and E. W. Engstrom, <i>Elec- tronics</i> (August)	1938
"High Frequency Correction in Resistance-Coupled Amplifiers", E. W. Herold, <i>Communications</i> (August)	1938
"Television Development and Test Equipment", H. B. Deal, <i>RCA Licensee Bulletin LB-447</i> (August 30)	1938
"Improvements in High Frequency Amplifiers", D. E. Foster and A. E. Newlon, <i>RCA Licensee Bulletin LB-450</i> (September 22)	1938
"Building Television Receivers with Standard Cathode-Ray Tubes", J. B. Sherman, <i>QST</i> (October)	1938
"Review of Ultra-High-Frequency Vacuum-Tube Problems", B. J. Thompson, <i>RCA Review</i> (October)	1938
"A Survey of Ultra-High-Frequency Measurements", L. S. Nergaard, <i>RCA Review</i> (October)	1938
"A Video Mixing Amplifier", A. A. Barco, <i>RCA Licensee Bulletin LB-453</i> (October 11)	1938
"An Experimental Television Receiver", D. E. Foster and G. Mount- joy, <i>RCA Licensee Bulletin LB-458</i> (October 13)	1938
"Iconoscope Pre-Amplifier", A. A. Barco, <i>RCA Licensee Bulletin LB-448</i> (October 17)	1938
"Transmission Lines as Coupling Elements in Television", S. W. Seeley and C. N. Kimball, <i>RCA Licensee Bulletin LB-456</i> (October 17) ..	1938
"Analysis and Design of Video Amplifiers", Part II, C. N. Kimball and S. W. Seeley, <i>RCA Licensee Bulletin LB-461</i> (October 20) ...	1938
<i>Jour. Tele. Soc.</i> (October)	1938
<i>RCA Review</i> (January)	1939
"Television Synchronizing and Blanking Signal Generator", H. B. Deal, <i>RCA Licensee Bulletin LB-452</i> (October 27)	1938
"A Practical Television Receiver for the Amateur", C. C. Shumard, <i>QST</i> (December)	1938
"Television", A. F. Van Dyck, <i>World Almanac</i>	1938

	Year
CATHODE-RAY TUBE IN TELEVISION, I. G. Maloff and D. W. Epstein, McGraw-Hill Book Co., New York, N. Y.	1938
"Practical Application of an Ultra-High-Frequency Radio-Relay Circuit", J. E. Smith, F. H. Kroger and R. W. George, <i>Proc. I.R.E.</i> (November)	1938
"Television Synchronization", E. W. Engstrom and R. S. Holmes, <i>Electronics</i> (November)	1938
"Deflection Circuits in Television Receivers", E. W. Engstrom and R. S. Holmes, <i>Electronics</i> (January)	1939
"New Television Amplifier Receiving Tubes", A. P. Kauzmann, <i>RCA Review</i> (January)	1939
"Observations on Sky-Wave Transmission on Frequencies Above 40 Megacycles", D. R. Goddard, <i>Proc. I.R.E.</i> (January)	1939
"A Fixed-Focus Electron Gun for Cathode-Ray Tubes", H. Iams, <i>Proc. I.R.E.</i> (February)	1939
"An Ultra-High-Frequency Power Amplifier of Novel Design", A. V. Haeff, <i>Electronics</i> (February)	1939
"Some Television Problems from the Motion Picture Standpoint", G. L. Beers, E. W. Engstrom and I. G. Maloff, <i>Jour. Soc. Mot. Pic. Eng.</i> (February)	1939
<i>Inter. Project</i> (February)	1939
"Television Economics", Part I, A. N. Goldsmith, <i>Communications</i> (February)	1939
"Using Electromagnetic-Deflection Cathode-Ray Tubes in the Television Receiver", J. B. Sherman, <i>QST</i> (February)	1939
"Electrostatic Deflection Kinescope Unit for the Television Receiver", J. B. Sherman, <i>QST</i> (March)	1939
"Television Economics", Part II, A. N. Goldsmith, <i>Communications</i> (March)	1939
"Application of Motion Picture Film to Television", E. W. Engstrom and G. L. Beers, <i>Jour. Soc. Mot. Pic. Eng.</i> (April)	1939
"Field Strength Measuring Equipment for Wide-Band U-H-F Transmission", R. W. George, <i>RCA Review</i> (April)	1939
"Gamma and Range in Television", I. G. Maloff, <i>RCA Review</i> (April)	1939
"Kinescopes for Television Receivers", L. C. Waller, <i>Communications</i> (April)	1939
"Measurement of Phase Shift in Television Amplifiers", A. A. Barco, <i>RCA Review</i> (April)	1939
"Power for Television Receivers", E. W. Engstrom and R. S. Holmes, <i>Electronics</i> (April)	1939
"Television Economics", Part III, A. N. Goldsmith, <i>Communications</i> (April)	1939
"Television Transmitting Antenna for Empire State Building", N. E. Lindenblad, <i>RCA Review</i> (April)	1939
"Transient Response of Multistage Video-Frequency Amplifiers", A. V. Bedford and G. L. Fredendall, <i>Proc. I.R.E.</i> (April)	1939
"Radio Frequency Generator for Television Receiver Testing", A. H. Turner, <i>RMA Eng.</i> (May)	1939
"Television Economics", Part IV, A. N. Goldsmith, <i>Communications</i> (May)	1939
"Television Lighting", W. C. Eddy, <i>Communications</i> (May)	1939
"How NBC Television Evolved", O. B. Hanson, <i>Radio and Tele.</i> (June)	1939
"Opportunities in Television", A. N. Goldsmith, <i>Radio and Tele.</i> (June)	1939
"Television Economics", Part V, A. N. Goldsmith, <i>Communications</i> (June)	1939
"Simplified Television I-F Systems", G. Mountjoy, <i>RCA Licensee Bulletin LB-478</i> (June)	1939
"Circuit Diagrams of Television Signal Generating Equipment", E. I. Anderson, <i>RCA Licensee Bulletin LB-479</i> (June)	1939
"An Iconoscope Pre-Amplifier", A. A. Barco, <i>RCA Review</i> (July) ..	1939

	Year
"Antennas", H. H. Beverage, <i>Radio and Tele.</i> , (July)	1939
<i>RCA Review</i> (July)	1939
"Application of Motion Picture Film to Television", E. W. Engstrom, G. L. Beers and A. V. Bedford, <i>Jour. Soc. Mot. Pic. Eng.</i> (July) ..	1939
<i>RCA Review</i> (July)	1939
"A Television Demonstration System for the New York World's Fair", D. H. Castle, <i>RCA Review</i> (July)	1939
"Effect of Electron Transit Time on Efficiency of a Power Amplifier", A. V. Haeff, <i>RCA Review</i> (July)	1939
"Luminescent Materials", H. W. Leverenz and F. Seitz, <i>Jour. Appl.</i> <i>Phys.</i> (July)	1939
"Planning Programs for Television", T. H. Hutchinson, <i>Radio and</i> <i>Tele.</i> (July)	1939
"Probable Influences of Television on Society", David Sarnoff, <i>Jour.</i> <i>Appl. Phys.</i> (July)	1939
"Television Economics", Part VI, A. N. Goldsmith, <i>Communications</i> (July)	1939
"Television Lighting—Part I", W. C. Eddy, <i>Jour. Soc. Mot. Pic. Eng.</i> (July)	1939
"Television Receiving and Reproducing Systems", E. W. Engstrom, <i>Jour. Appl. Phys.</i> (July)	1939
"Television Studio Technic", A. W. Protzman, <i>Jour. Soc. Mot. Pic.</i> <i>Eng.</i> (July)	1939
"Contrast in Kinescopes", R. R. Law, <i>Proc. I.R.E.</i> (August)	1939
"Television Antennas and Their Installation", W. Hollander Bohlke, <i>Radio and Tele.</i> (August)	1939
"Television Economics", Part VII, A. N. Goldsmith, <i>Communications</i> (August)	1939
"Recent Improvements in the Design and Characteristics of Icono- scopes", R. B. Janes and W. H. Hickok, <i>Proc. I.R.E.</i> (September) ..	1939
"Space Charge Effects in Electron Beams", A. V. Haeff, <i>Proc. I.R.E.</i> (September)	1939
"Television Pickup Tubes Using Low-Velocity Beam Scanning", A. Rose and H. Iams, <i>Proc. I.R.E.</i> (September)	1939
"Television Economics", Part VIII, A. N. Goldsmith, <i>Communications</i> (September)	1939
"The Image Iconoscope", H. Iams, G. A. Morton and V. K. Zworykin, <i>Proc. I.R.E.</i> (September)	1939
"A Theoretical Analysis of Single Side-Band Operation of Television Transmitters", L. S. Nergaard, <i>Proc. I.R.E.</i> (October)	1939
"Programming the Television Mobile Unit", T. H. Hutchinson, <i>RCA</i> <i>Review</i> (October)	1939
"Simple Television Antennas", P. S. Carter, <i>RCA Review</i> (October) ..	1939
"Television Economics", A. N. Goldsmith, <i>Radio Tech. Digest</i> (October)	1939
"Television Economics", Part IX, A. N. Goldsmith, <i>Communications</i> (October)	1939
"Television Signal-Frequency Circuit Considerations", G. Mountjoy, <i>RCA Review</i> (October)	1939
"The Orthicon, a Television Pickup Tube", A. Rose and H. Iams, <i>RCA</i> <i>Review</i> (October)	1939
"Ultra-High-Frequency Propagation Formulas", H. O. Peterson, <i>RCA</i> <i>Review</i> (October)	1939
"Video Output Systems", D. E. Foster and J. A. Rankin, <i>RCA Licensee</i> <i>Bulletin LB-494</i> (October)	1939
"Monitor Kinescope", C. N. Kimball, <i>RCA Licensee Bulletin LB-500</i> (November)	1939
"Television Economics", Part X, A. N. Goldsmith, <i>Communications</i> (November)	1939
"Transatlantic Reception of London Television Signals", D. R. God- dard, <i>Proc. I.R.E.</i> (November)	1939

	Year
"Television Economics", Part XI, A. N. Goldsmith, <i>Communications</i> (December)	1939
"Superheterodyne Converter System Considerations in Television Receivers", E. W. Herold, <i>RCA Review</i> (January)	1940
"A New Method for Determining Sweep Linearity", S. W. Seeley and C. N. Kimball, <i>RCA Review</i> (January)	1940
"Simplified Television I-F Systems", G. Mountjoy, <i>RCA Review</i> (January)	1940
"Television Reception in an Airplane", R. S. Holmes, <i>RCA Review</i> (January)	1940
"RCA Television Field Pickup Equipment", T. A. Smith, <i>RCA Review</i> (January)	1940
"The Formation and Maintenance of Electron and Ion Beams", L. P. Smith and P. L. Hartman, <i>Jour. Appl. Phys.</i> (March)	1940
"A Wide-Band Inductive-Output Amplifier", A. V. Haeff and L. S. Nergaard, <i>Proc. I.R.E.</i> (March)	1940
"Selective Sideband Transmission in Television", R. D. Kell and G. L. Fredendall, <i>RCA Review</i> (April)	1940
"Mobile Field Strength Recordings of 49.5, 83.5 and 142 Mc. from Empire State Building, New York—Horizontal and Vertical Polarization", G. S. Wickizer, <i>RCA Review</i> (April)	1940
"Television Studio Technique", A. W. Protzman, <i>RCA Review</i> (April) ..	1940
"Television Lighting", W. C. Eddy, <i>RCA Review</i> (April)	1940
"Low Cost Television Receiver", G. Mountjoy and D. E. Foster, <i>RCA Licensee Bulletin LB-520</i> (May)	1940
"Antennas and Transmission Lines at the Empire State Building". N. E. Lindenblad, <i>Communications</i> (May)	1940
(April and May)	1941
"A Receiver for the New Amateur Television System", J. B. Sherman, <i>QST</i> (June)	1940
"Picture Signal Analyzer", H. B. Deal, <i>RCA Licensee Bulletin LB-525</i> (July)	1940
"Field Strength Measuring Equipment at 500 Megacycles", R. W. George, <i>RCA Review</i> (July)	1940
"Determination of Optimum Number of Lines in a Television System", R. D. Kell, A. V. Bedford and G. L. Fredendall, <i>RCA Review</i> (July)	1940
"A 500-Megacycle Radio Relay Distribution System for Television", F. H. Kroger, B. Trevor and J. E. Smith, <i>RCA Review</i> (July)	1940
"Optimum Efficiency Conditions for White Luminescent Screens in Kinescopes", H. W. Leverenz, <i>Jour. Opt. Soc. Amer.</i> (July)	1940
"An Efficient U.H.F. Unit for the Amateur Television Transmitter". L. C. Waller, <i>QST</i> (July)	1940
"Field-Strength Survey, 52.75 Megacycles from Empire State Building", G. S. Wickizer, <i>Proc. I.R.E.</i> (July)	1940
"A Precision Television Synchronizing Signal Generator", A. V. Bedford and J. P. Smith, <i>RCA Review</i> (July)	1940
"Some Factors Affecting the Choice of Lenses for Television Cameras". H. B. DeVore and H. Iams, <i>Proc. I.R.E.</i> (August)	1940
"The RCA Portable Television Pickup Equipment", G. L. Beers, O. H. Schade and R. E. Shelby, <i>Proc. I.R.E.</i> (October)	1940
"Cathodoluminescence as Applied in Television", H. W. Leverenz, <i>RCA Review</i> (October)	1940
"Vertical versus Horizontal Polarization", G. H. Brown, <i>Electronics</i> (October)	1940
"An Electrically-Focused Multiplier Phototube", J. A. Rajchman and R. L. Snyder, <i>Electronics</i> (December)	1940
TELEVISION, V. K. Zworykin and G. A. Morton, <i>John Wiley & Sons</i> , New York, N. Y.	1940
TELEVISION BROADCASTING, L. Lohr, McGraw-Hill Book Co., New York, N. Y.	1940

	Year
"Recent Developments in Television", E. W. Engstrom, <i>An. Amer. Acad. Polit. Soc. Sci.</i> (January)	1941
"RCA-NBC Television Presents a Political Convention as First Long-Distance Pick-Up", O. B. Hanson, <i>RCA Review</i> (January)	1941
"A Vestigial Side-Band Filter for Use with a Television Transmitter", G. H. Brown, <i>RCA Review</i> (January)	1941
"A New Ultra-High Frequency Tetrode and its Use in a One Kilowatt Television Sound Transmitter", A. K. Wing and F. E. Young, <i>Proc. I.R.E.</i> (January)	1941
"Cascade Amplifiers with Maximal Flatness", V. D. Landon, <i>RCA Review</i> (January and April)	1941
"Video Output Systems", D. E. Foster and J. Rankin, <i>RCA Review</i> (April)	1941
"A New Era in Television", David Sarnoff, <i>RCA Review</i> (July)	1941
"A Résumé of the Technical Aspects of RCA Theatre Television", I. G. Maloff and W. A. Tolson, <i>RCA Review</i> (July)	1941
"A Simplified Television System for the Radio Amateur and Experimenter", L. C. Waller and P. A. Richards, <i>RCA Review</i> (October)	1941
"A Method and Equipment for Checking Television Scanning Linearity", V. J. Duke, <i>RCA Review</i> (October)	1941
"Recent Television Developments", R. E. Shelby and V. K. Zworykin, <i>Reports on Progress in Physics (British)</i> , (Vol. 8) (December) ..	1941
"Orthonicon Portable Television Equipment", M. A. Trainer, <i>Proc. I.R.E.</i> (January)	1942
"Measurements of the Slope and Duration of Television Synchronizing Impulses", R. A. Monfort and F. J. Somers, <i>RCA Review</i> (January)	1942
"Factors Governing Performance of Electron Guns in Television Cathode-Ray Tubes", R. R. Law, <i>Proc. I.R.E.</i> (February)	1942
"Low-Frequency Characteristics of the Coupling Circuits of Single and Multi-Stage Video Amplifiers", H. L. Donley and D. W. Epstein, <i>RCA Review</i> (April)	1942
"Television Reception with Built-in Antennas for Horizontally and Vertically Polarized Waves", W. L. Carlson, <i>RCA Review</i> (April) ..	1942
"The Relative Sensitivities of Television Pick-Up Tubes, Photographic Film and The Human Eye", A. Rose, <i>Proc. I.R.E.</i> (June)	1942
"Analysis, Synthesis and Evaluation of the Transient Response of Television Apparatus", A. V. Bedford and G. L. Fredendall, <i>Proc. I.R.E.</i> (October)	1942
"A Portable High-Frequency Square-Wave Oscillograph for Television", R. D. Kell, A. V. Bedford and H. N. Kozanowski, <i>Proc. I.R.E.</i> (October)	1942
"Automatic Frequency and Phase Control of Synchronization in Television Receivers", K. R. Wendt and G. L. Fredendall, <i>Proc. I.R.E.</i> (January)	1943
"Contemporary Problems in Television Sound", C. L. Townsend, <i>Proc. I.R.E.</i> (January)	1943
"The Focusing View-Finder Problem in Television Cameras", G. L. Beers, <i>Proc. I.R.E.</i> (March)	1943
<i>Jour. Soc. Mot. Pic. Eng.</i> (March)	1943
"Television—Far-Seeing Eye of the Future", R. E. Shelby, <i>Electronics</i> (March)	1943
"R-F Operated High-Voltage Supplies for Cathode-Ray Tubes", O. H. Schade, <i>Proc. I.R.E.</i> (April)	1943
"Cathode-Ray Control of Television Light Valves", J. S. Donal, Jr., <i>Proc. I.R.E.</i> (May)	1943
"A Type of Light Valve for Television Reproduction", J. S. Donal, Jr., and D. B. Langmuir, <i>Proc. I.R.E.</i> (May)	1943
"Electron Bombardment in Television Tubes", I. G. Maloff, <i>Electronics</i> (January)	1944
"Automatic Frequency Control of Synchronization in Television." <i>RCA Licensee Bulletin LB-624</i> (August)	1944

	Year
"Reflective Optical System for Television", E. W. Wilby, <i>RCA Licensee Bulletin LB-630</i> (November)	1944
"Reflective Optics in Projection Television", I. G. Maloff and D. W. Epstein, <i>Electronics</i> (December)	1944
"Postwar Television Standards", A. N. Goldsmith, <i>Televiiser</i> (Fall) ..	1944
"Possible Social Effects of Television", David Sarnoff, <i>Am. Amer. Acad. Polit. Soc. Sci.</i> (January)	1945
"Television", David Sarnoff, <i>TBA Annual</i> (January)	1945
"Cathode Coupled Wide-Band Amplifiers", <i>RCA Licensee Bulletin LB-631</i> (January)	1945
"Future of Theater Television", A. N. Goldsmith, <i>Television</i> (February)	1945
"The Clamp Circuit", C. L. Townsend, <i>Broad. Eng. Jour.</i> (February and March)	1945
"Improved Electron Gun for Cathode-Ray Tubes", L. E. Swedlund, <i>Electronics</i> (March)	1945
"Projection Television", D. W. Epstein and I. G. Maloff, <i>Jour. Soc. Mot. Pic. Eng.</i> (June)	1945
"Multiple-Dwelling Television", A. N. Goldsmith, <i>Television</i> (June) ..	1945
"Researcher Views Television", E. W. Engstrom, <i>Televiiser</i> (July-August)	1945
"Converting from Radio to Video Broadcasting", A. N. Goldsmith, <i>Televiiser</i> (September)	1945
"Planning the Television Station, Part I", A. N. Goldsmith, <i>Televiiser</i> , (September-October)	1945
"Band-Pass Bridged-T Network for Television Intermediate-Frequency Amplifiers", G. C. Sziklai and A. C. Schroeder, <i>Proc. I.R.E.</i> (October)	1945
"Cathode-Coupled Wide-Band Amplifiers", G. C. Sziklai and A. C. Schroeder, <i>Proc. I.R.E.</i> (October)	1945
"Planning the Television Station, Part II", A. N. Goldsmith, <i>Televiiser</i> , (November-December)	1945
"Gimbels and RCA Test Intra-Store Television", J. J. Alesi, <i>Broadcast News</i> (January)	1946
"The Teleran Proposal", P. J. Herbst, I. Wolff, D. Ewing, and L. F. Jones, <i>Electronics</i> , (February)	1946
"Transmission of Television Sound on the Picture Carrier", G. L. Fredendall, K. Schlesinger and A. C. Schroeder, <i>Proc. I.R.E.</i> (February)	1946
"Practical Aspects of Television", W. H. Bolke and N. M. Brisbin, <i>RCA Rad. Serv. News</i> (February)	1946
"Input Impedance of Several Receiving-Type Pentodes at F-M and Television Frequencies", F. Mural, <i>RCA Licensee Bulletin LB-661</i> (March)	1946
"Improved Cathode-Ray Tubes with Metal-Backed Luminescent Screens", D. W. Epstein and L. Pensak, <i>RCA Review</i> (March)	1946
"Local Oscillator Radiation and Its Effect on Television Picture Contrast", E. W. Herold, <i>RCA Review</i> (March)	1946
"Image Orthicon Camera", R. D. Kell and G. C. Sziklai, <i>RCA Review</i> (March)	1946
"Field Television", R. E. Shelby and H. P. See, <i>RCA Review</i> (March) ..	1946
"Compensating Amplifier", C. N. Gillespie, <i>Electronics</i> (March)	1946
"Super Turnstile Antenna", R. F. Holtz, <i>Communications</i> (April) ..	1946
"Photographic Film, Television Pick-Up Tubes and the Eye", A. Rose, <i>Inter. Project.</i> , (May)	1946
"Pioneering in Television", David Sarnoff, Booklet, RCA Department of Information, New York, N. Y., (May)	1946
"Practical Television", R. A. Monfort, <i>Radio News</i> (May)	1946
"Radar Aids to Navigation—Loran, Teleran, Television", I. Wolff, <i>Princeton Eng.</i> , (May)	1946
"An Experimental Color Television System", R. D. Kell, G. L. Fredendall, A. C. Schroeder and R. C. Webb, <i>RCA Review</i> (June)	1946

	Year
"A Method of Measuring the Degree of Modulation of a Television Signal", T. J. Buzalski, <i>RCA Review</i> (June)	1946
"Development of an Ultra Low Loss Transmission Line for Television", E. O. Johnson, <i>RCA Review</i> (June)	1946
"Electron Guns for Television Application", G. A. Morton, <i>Rev. Mod. Phys.</i> (July)	1946
"The Image Orthicon—A Sensitive Television Pickup Tube", A. Rose and P. K. Weimer and H. B. Law, <i>Proc. I.R.E.</i> (July)	1946
"Super-sensitive Tele-Pickup Tube", W. L. Lawrence, <i>Radio Service Dealer</i> (July)	1946
"Micro-Wave Television Relays, Operating on 6,800 to 7,050 Mc", W. J. Poch and J. P. Taylor, <i>FM and Tele.</i> (August)	1946
"A New Synchronizing and Blanking Signal Generator", E. Schoenfeld, W. Milwitt and W. Brown, <i>RCA Licensee Bulletin LB-678</i> , (August 1)	1946
"Television High Voltage R-F Supplies", R. S. Mautner and O. H. Schade, <i>RCA Licensee Bulletin LB-675</i> (August 15)	1946
"The Relationship of FM to Television", A. N. Goldsmith, <i>FM Business</i> (August)	1946
"Current Oscillator for Television Sweep", G. C. Sziklai, <i>Electronics</i> (September)	1946
"Flying Torpedo with an Electric Eye", V. K. Zworykin, <i>RCA Review</i> (September)	1946
"Naval Airborne Television Reconnaissance System", R. E. Shelby, F. J. Somers and L. R. Moffett, <i>RCA Review</i> (September)	1946
"Miniature Airborne Television Equipment", R. D. Kell and G. C. Sziklai, <i>RCA Review</i> (September)	1946
"Mimo—Miniature Image Orthicon", P. K. Weimer, H. B. Law and S. V. Fergie, <i>RCA Review</i> (September)	1946
"The TK-30A Camera with the Image Orthicon", N. S. Bean, <i>Broadcast News</i> (October)	1946
"Microwave Equipment for Television Relay Service", W. J. Poch and J. P. Taylor, <i>Broadcast News</i> (October)	1946
"A Unified Approach to the Performance of Photographic Film, Television Pickup Tubes, and the Human Eye", <i>Jour. Soc. Mot. Pic. Eng.</i> (October)	1946
"The Use of Powdered Iron in Television Deflecting Circuits", A. L. Friend, <i>RCA Licensee Bulletin LB-688</i> , (October 3)	1946
"An M-Type Band Pass Television Amplifier", F. Mural, <i>RCA Licensee Bulletin LB-687</i> , (November 7)	1946
"A Bar-Signal Generator For Testing Television Apparatus", E. Schoenfeld and W. Milwitt, <i>RCA Licensee Bulletin LB-689</i> , (November 13)	1946
"Recent Developments in Television Deflection Systems", A. A. Barco and C. E. Torsch, <i>RCA Licensee Bulletin LB-694</i> , (November 29)	1946
"Simultaneous All Electronic Color Television", <i>RCA Review</i> (December)	1946
<i>RCA Licensee Bulletin LB-702</i> (December 23)	1946
"Teleran", D. H. Ewing and R. W. K. Smith, <i>RCA Review</i> (December)	1946
"Television Equipment for Aircraft", M. A. Trainer and W. J. Poch, <i>RCA Review</i> (December)	1946
"Television: United States", G. L. Beers and B. E. Shackelford, Section of 1946 BRITANNICA BOOK OF THE YEAR	1946
"The Clamp Circuit", C. L. Townsend, <i>Broad. Eng. Jour.</i> , Part I (January)	1947
Part II (April)	1947
"Military Television", George M. K. Baker, TELEVISION, Volume IV (January)	1947
"The Outlook for Television—1941", A. F. Van Dyck, TELEVISION, Volume III (January)	1947
"The Progress of Television, 1938-1941", A. N. Goldsmith, TELEVISION, Volume III (January)	1947

	Year
TELEVISION, Volume III (1938-1941), RCA REVIEW, RCA Laboratories Division, Princeton, N. J. (January)	1947
TELEVISION, Volume IV (1942-1946), RCA REVIEW, RCA Laboratories Division, Princeton, N. J. (January)	1947
"Television Broadcasting—1946", O. B. Hanson, TELEVISION, Volume IV (January)	1947
"Television—A Review, 1946", E. W. Engstrom, TELEVISION, Volume IV (January)	1947
"Television Today and Its Problems—1946", A. N. Goldsmith, TELEVISION, Volume IV (January)	1947
<i>Inter. Project.</i> (May)	1947
"Automatic Frequency-Phase Control in TV Receivers", A. Wright, <i>Tele-Tech</i> (February)	1947
"Film Projectors for Television", R. V. Little, Jr., <i>Jour. Soc. Mot. Pic. Eng.</i> (February)	1947
"Table Model Television Receiver", A. Wright, <i>RCA Licensee Bulletin LB-704</i> (February 15)	1947
"Input Circuit Noise Calculations for F-M and Television Receivers", W. J. Stolze, <i>Communications</i> (February)	1947
"Television Deflection Circuits", A. W. Friend, <i>RCA Review</i> (March)	1947
"Television High Voltage R-F Supplies", R. S. Mautner and O. H. Schade, <i>RCA Review</i> (March)	1947
"Television Receivers", A. Wright, <i>RCA Review</i> (March)	1947
"Television R-F Tuners", R. F. Romero, <i>RCA Licensee Bulletin LB-697</i> (March 17)	1947
"Transmission Lines and Antennas for F.M. and Television", M. Kaufman, <i>Radio Maintenance</i> (March and April)	1947
"Dipole Antennas for Television Reception", O. M. Woodward, Jr. and W. J. Stolze, <i>RCA Licensee Bulletin LB-712</i> (May 12)	1947
"Film Projectors for Television", R. V. Little, Jr., <i>Inter. Project.</i> (May)	1947
"An Analysis of Modern Antennas for FM and Television Reception", M. Kaufman, <i>RCA Rad. Serv. News</i> (June-July)	1947
"Image Orthicon Field Equipment", J. H. Roe, <i>Broadcast News</i> (June)	1947
"New Techniques in Synchronizing Signal Generators", E. Schoenfeld, W. Brown and W. Milwitt, <i>RCA Review</i> (June)	1947
A Precision Device for Television Pulse Width and Slope Measurement", H. L. Morrison, <i>RCA Licensee Bulletin LB-717</i> (June 20) ..	1947
"Projection Screens for Home Television Receivers", R. R. Law and I. G. Maloff, <i>RCA Licensee Bulletin LB-718</i> (June 25)	1947
"Simplified Television for Industry", R. E. Barrett and M. M. Goodman, <i>Electronics</i> (June)	1947
"Television Antenna Installations Giving Multiple Receiver Outlets", R. J. Ehret, <i>Tele-Tech</i> (June)	1947
"Sync Generator Frequency Stability and TV Remote Pickups", W. J. Poch, <i>Communications</i> (July)	1947
"Television Power Supplies", M. Kaufman, <i>Service</i> (July)	1947
"Television: Threshold of New Opportunities", David Sarnoff, <i>Rad. Appl. Jour.</i> (July)	1947
"Triplex Antenna for Television and F-M", L. J. Wolf, <i>Electronics</i> (July)	1947
"Curing Interference to Television Reception", M. Seybold, <i>QST</i> (August)	1947
"Pulsed Rectifiers for Television Receivers", I. G. Maloff, <i>Electronics</i> (August)	1947
"Television", V. K. Zworykin, <i>Jour. Frank. Inst.</i> (August)	1947
"The Use of Wave Traps as a Remedy for Interference in Your Reception", <i>RCA Rad. Serv. News</i> (August-September)	1947
"Application of I.C.I. Color System to Development of All-Sulphide White Television Screen", A. E. Hardy, <i>RCA REVIEW</i> (September)	1947

	Year
"Camera Placement and Switching for Baseball Broadcasting", J. P. Taylor, <i>Broadcast News</i> (September)	1947
"Colorimetry in Television", W. H. Cherry, <i>RCA Review</i> (September)	1947
"Electrostatic Deflection for 7GP4 Kinescope", W. Milwitt and E. Schoenfeld, <i>RCA Licensee Bulletin LB-701</i> (September 22)	1947
"An Experimental Simultaneous Color Television System", <i>RCA Licensee Bulletin LB-729</i> (September 3)	1947
"An Experimental Simultaneous Color-Television System, Part I—Introduction", R. D. Kell, <i>Proc. I.R.E.</i> (September)	1947
"An Experimental Simultaneous Color-Television System, Part II—Pickup Equipment", G. C. Sziklai, R. C. Ballard and A. C. Schroeder, <i>Proc. I.R.E.</i> (September)	1947
"An Experimental Simultaneous Color-Television System, Part III—Radio-Frequency and Reproducing Equipment", K. R. Wendt, G. L. Fredendall and A. C. Schroeder, <i>Proc. I.R.E.</i> (September)	1947
"How NBC Uses the RCA Image Orthicon Camera", F. A. Wankel and E. C. Wilbur, <i>Broadcast News</i> (September)	1947
"Intercarrier Sound System for Television", H. M. Bach and E. I. Anderson, <i>RCA Licensee Bulletin LB-727</i> (September 10)	1947
"Learn as You Build—Television", A. Liebscher, <i>Radio News</i> (September)	1947
"Magnetic-Deflection Circuits for Cathode-Ray Tubes", O. H. Schade, <i>RCA Review</i> (September)	1947
"Projection Type Television Receiver", E. L. Clark, <i>Radio News</i> (September)	1947
"The RCA Type TJ-50A Television Mobile Unit", W. J. Poch and H. C. Shepard, <i>Broadcast News</i> (September)	1947
"Reflective Optical System for Projection Television", V. K. Zworykin, <i>Radio News</i> (September)	1947
"Television Receiver Production Test Equipment", J. A. Bauer, <i>Communications</i> (September, October)	1947
"Suppression of Arc-Over, Corona, and High-Voltage Leakage in the 5TP4 Kinescope", <i>RCA Application Note AN-124</i> , RCA Tube Department, Harrison, N. J. (November 15)	1947
"Television Field Equipment", J. H. Roe and N. S. Bean, <i>FM & Tele.</i> (November)	1947
"Television Progress", David Sarnoff, <i>Broad. Eng. Jour.</i> (November)	1947
"Transformerless Seven-Inch Television Receiver", W. J. Stolze and E. I. Anderson, <i>RCA Licensee Bulletin LB-731</i> (November 3)	1947
"Interlocked Scanning for Network Television", J. R. DeBaun, <i>RCA Review</i> (December)	1947
"New Television Field-Pickup Equipment Employing the Image Orthicon", J. H. Roe, <i>Proc. I.R.E.</i> (December)	1947
"Storage Orthicon and Its Application to Teleran", S. V. Forgue, <i>RCA Review</i> (December)	1947
"Technical Aspects of Television Studio Operation", R. W. Clark and H. C. Gronberg, <i>RCA Review</i> (December)	1947
"TELERAN—Part II, First Experimental Installation", D. H. Ewing, H. J. Schrader and R. W. K. Smith, <i>RCA Review</i> (December) ..	1947
"Television Field Equipment", J. R. Smith, <i>FM & Tele.</i> (December) ..	1947
"Television Progress", David Sarnoff, <i>Broadcast News</i> (December) ..	1947
THE FUTURE OF TELEVISION. (Rev. Ed.), O. E. Dunlap, Jr., Harper and Bros., New York, N. Y.	1947
"Radio-Scientific Developments and Television in the U. S.", G. L. Beers, SECTION OF TEN EVENTFUL YEARS, (1937-1946), Encyclopedia Britannica	1947
"Circuit Design Precautions to Prevent Internal Arcs from Damaging Kinescopes", <i>RCA Application Note AN-128</i> , RCA Tube Department, Harrison, N. J. (January 15)	1948
"Progress in Television", V. K. Zworykin, <i>Radio Craft</i> (January) ...	1948
"Teleran", W. W. Watts, <i>Signals</i> (January-February)	1948

	Year
"Theater Television Prospects", A. N. Goldsmith, <i>Inter. Project.</i> (January)	1948
"Optical Problems in Theatre Television", I. G. Maloff, <i>RCA Serv. Company News</i> (February)	1948
"Pulse-Operated High-Voltage Power Supply for Television Receivers", <i>RCA Application Note AN-130</i> , RCA Tube Department, Harrison, N. J. (February 16)	1948
"The Sensitivity Performance of the Human Eye on an Absolute Scale", A. Rose, <i>Jour. Opt. Soc. Amer.</i> (February)	1948
"The Television DC Component", K. R. Wendt, <i>RCA Licensee Bulletin LB-745</i> (February 20)	1948
"Theater Television—a General Analysis", A. N. Goldsmith, <i>Jour. Soc. Mot. Pic. Eng.</i> (February)	1948
<i>Inter. Project.</i> (April, May, June, July)	1948
"Electro-Optical Characteristics of Television Systems: Introduction; Part I—Characteristics of Vision and Visual Systems", O. H. Schade, <i>RCA Review</i> (March)	1948
"How to Convert a Standard Television Receiver into a Direct-Viewing Video Extension Monitor", E. K. Price, <i>Broadcast News</i> (March)	1948
"Radio-Frequency Performance of Some Receiving Tubes in Television Circuits", R. M. Cohen, <i>RCA Review</i> (March)	1948
"Review and Preview of Television", David Sarnoff, <i>Inter. Photo.</i> (March)	1948
"Television DC Component", K. R. Wendt, <i>RCA Review</i> (March)	1948
"Triplexed Antenna System at WNBW/WRC-FM", L. J. Wolfe, <i>Broadcast News</i> (March)	1948
"TT-5A Television Transmitter", C. D. Kentner, <i>Broadcast News</i> (March)	1948
"WNBW and WRC-FM, NBC, Washington", R. F. Guy, <i>Broadcast News</i> (March)	1948
"Television Today", F. W. Wentker, <i>Transmitter</i> (Spring)	1948
"Dynamic Operating Conditions in Video Amplifiers", Frank Mural, <i>RCA Licensee Bulletin LB-750</i> (April 20)	1948
"How to Use the Television Stabilizing Amplifier", J. H. Roe, <i>Broadcast News</i> (May)	1948
"The Magic of Making Television Picture Tubes", Pamphlet, RCA Department of Information, New York, N. Y. (April)	1948
"Incidental Phase Modulation of Television Picture Transmitters", W. R. Alexander and S. W. Seeley, <i>RCA Licensee Bulletin LB-755</i> (May 20)	1948
"Note on Means of Measurement of Output Plate A. C. Voltage of a Television Deflection Circuit During Scanning Interval", J. M. Brumbaugh, <i>Broadcast News</i> (May)	1948
"Preamplifiers for Television Receivers", R. F. Romero, <i>RCA Licensee Bulletin LB-748</i> (May 10)	1948
"TV Field Equipment", J. M. Brumbaugh, <i>FM and Tele.</i> (April)	1948
"Television Progress", David Sarnoff, <i>Television</i> (May)	1948
"Television Service. Part I. Using the Test Pattern", J. R. Meagher, <i>RCA Rad. Serv. News</i> (May-June)	1948
"The TP-16A 16mm. Television Projector", R. V. Little, Jr. <i>Broadcast News</i> (May)	1948
"Comparative Propagation Measurements; Television Transmitters at 67.25, 288. 510 and 910 Megacycles", G. H. Brown, J. Epstein and D. W. Peterson, <i>RCA Review</i> (June)	1948
"Electro-Optical Characteristics of Television Systems. Part II—Electro-Optical Specifications for Television Systems", O. H. Schade, <i>RCA Review</i> (June)	1948
"Motion Picture Photography of Television Images", R. M. Fraser, <i>RCA Review</i> (June)	1948
"A Permeability-Tuned Television Tuner", R. F. Romero, <i>RCA Licensee Bulletin LB-756</i> (June 20)	1948

	Year
"Projection Screens for Home Television Receivers", R. R. Law and I. G. Maloff, <i>Jour. Opt. Soc. Amer.</i> (June)	1948
"Design Factors for Intercarrier Television Sound", S. W. Seeley, <i>Electronics</i> (July)	1948
"Developments in Large-Screen Television", R. V. Little, Jr., <i>Jour. Soc. Mot. Pic. Eng.</i> (July)	1948
"New Test Equipment Speeds Video Servicing", Arthur Liebscher, <i>Radio News</i> (July)	1948
<i>Radio Service Dealer</i> (July)	1948
"Optical Problems in Large-Screen Television", I. G. Maloff, <i>Jour. Soc. Mot. Pic. Eng.</i> (July)	1948
"Overload Protection for the Horizontal Deflection Circuit in Television Receivers", <i>RCA Application Note AN-136</i> , RCA Tube Department, Harrison, N. J. (July 15)	1948
"Photometry in Television Engineering", D. W. Epstein, <i>Electronics</i> (July)	1948
"Television Service—Part II", J. R. Meagher, <i>RCA Rad. Serv. News</i> (July-August)	1948
"Automatic Gain Controls for Television Receivers", K. R. Wendt and A. C. Schroeder, <i>RCA Review</i> (September)	1948
<i>RCA Licensee Bulletin LB-757</i> (September 1)	1948
"Electro-Optical Characteristics of Television Systems. Part III—Electro-Optical Characteristics of Camera Systems", O. H. Schade, <i>RCA Review</i> (September)	1948
"Ultra-High-Frequency Television Converters", <i>RCA Licensee Bulletin LB-760</i> (September 20)	1948
"A Novel Ten-Inch Television Receiver", W. J. Stolze and E. I. Anderson, <i>RCA Licensee Bulletin LB-761</i> (October 1)	1948
"RCA-NBC Views on TV Expansion", E. W. Engstrom, <i>FM & Tele.</i> (October)	1948
"Television Service—Part III", J. R. Meagher, <i>RCA Rad. Serv. News</i> (September-October)	1948
"Television Antennas and Transmission Lines", J. R. Meagher, <i>RCA Rad. Serv. News</i> (November-December)	1948
"Using TV Test Patterns", John R. Meagher, <i>Radio-Electronics</i> (November)	1948
"500 Watt TV Transmitter", M. L. Gaskill, <i>Tele-Tech.</i> (November) ..	1948
"Colorimetry in Television", W. H. Cherry, <i>Jour. Soc. Mot. Pic. Eng.</i> (December)	1948
"Developmental Television Transmitter for 500-900 Megacycles", R. R. Law, W. B. Whalley and R. P. Stone, <i>RCA Review</i> (December) ...	1948
"Electro-Optical Characteristics of Television Systems; Part IV—Correlation and Evaluation of Electro-Optical Characteristics of Imaging Systems", O. H. Schade, <i>RCA Review</i> (December)	1948
"Field Test of Ultra-High-Frequency Television in the Washington Area", G. H. Brown, <i>RCA Review</i> (December)	1948
"Flying Spot Scanner for Television", Donald Pike, <i>Broad. Eng. Jour.</i> (December)	1948
"Planning Radio and Television Studios", G. M. Nixon, <i>Broadcast News</i> (December)	1948
"Practical Equipment Layouts for Television Stations", <i>Broadcast News</i> (December)	1948
"Scale Models Made from Paper Cutouts Aid TV Station Planning", M. L. Gaskill, <i>Broadcast News</i> (December)	1948
"Sensitometric Aspect of Television Monitor-Tube Photography", F. G. Albin, <i>Jour. Soc. Mot. Pic. Eng.</i> (December)	1948
"A Technique for the Making and Mounting of Fine Mesh Screens", H. B. Law, <i>Rev. Sci. Instr.</i> (December)	1948
"Radio—Scientific Developments Television—U.S.A.", G. L. Beers, SECTION OF ENCYCLOPAEDIA BRITANNICA YEAR BOOK (Spring)	1948

	Year
UNDERSTANDING TELEVISION, Orrin E. Dunlap, Jr., Greenberg: Publisher, New York, N. Y.	1948
"Television Antennas and Transmission Lines, Part II — Ghosts", J. R. Meagher, <i>RCA Rad. Serv. News</i> (January-February)	1949
"Television Service. Part IV", J. R. Meagher, <i>RCA Rad. Serv. News</i> (January-February)	1949
"Television Tuner Analysis and Design Considerations", R. F. Romero, <i>RCA Licensee Bulletin LB-764</i> (January 15)	1949
"Video Receiver Circuits Simplified", D. D. Cole, <i>Tele-Tech.</i> (January)	1949
"Philosophy of Our Television System", J. H. Roe, <i>Broadcast News</i> (February)	1949
"Stability vs. Chaos in TV", A. N. Goldsmith, <i>Inter. Project</i> (February)	1949
"Development of a Large Metal Kinescope for Television", H. P. Steier, J. Kelar, C. T. Lattimer and R. D. Faulkner, <i>RCA Review</i> (March)	1949
"Phase and Amplitude Equalizer for Television Use", E. D. Goodale and R. C. Kennedy, <i>RCA Review</i> (March)	1949
"A Reversible Beam Antenna for Twelve Channel Television Reception", O. M. Woodward, Jr., <i>RCA Licensee Bulletin LB-768</i> (March 7)	1949
"A Simple Keyed AGC System for Television Receivers", G. F. Rogers and E. I. Anderson, <i>RCA Licensee Bulletin LB-769</i> (March 15) ..	1949
"Standardization of the Transient Response of Television Transmitters", R. D. Kell and G. L. Fredendall, <i>RCA Review</i> (March) ..	1949
"Television Antennas and Transmission Lines", J. R. Meagher, <i>RCA Rad. Serv. News</i> (March-April)	1949
"TV, Electronics and Radio in '49", David Sarnoff, <i>Radio-Electronics</i> (March)	1949
"Ultrafax", D. S. Bond and V. J. Duke, <i>RCA Review</i> (March)	1949
<i>Journal of The British Institution of Radio Engineers</i> (April) ..	1949
"Television Service. Part V, How RF-IF Alignment Affects Picture Quality", J. R. Meagher, <i>RCA Rad. Serv. News</i> (March-April) ..	1949
"How to Get the Best Picture Out of Your Image Orthicon Camera", H. Kozanowski, <i>Broadcast News</i> (April)	1949
"Large Screen Projection Television", R. V. Little, <i>Elec. Eng.</i> (April) ..	1949
"The Philosophy of Our TV System (Part II)", J. H. Roe, <i>Broadcast News</i> (April)	1949
PHOTOELECTRICITY AND ITS APPLICATIONS, V. K. Zworykin and E. G. Ramberg, John Wiley & Sons, Inc., New York, N. Y. (April)	1949
"The Pictorial Situation Display in Air Navigation and the Control of Aerial Traffic", H. H. Spencer, <i>Avro Digest</i> (April)	1949
"Tips on Use of Image Orthicons", Booklet, Tube Department, RCA Victor Division, Harrison, N. J. (April)	1949
"Television Film Recording", R. V. Little, Jr., <i>Broadcast News</i> (April) ..	1949
"Automatic Frequency Phase Control of Television Sweep Circuits", E. L. Clark, <i>Proc. I.R.E.</i> (May)	1949
"Demonstration of Large-Screen Television at Philadelphia", Roy Wilcox (coauthor), <i>Jour. Soc. Mot. Pic. Eng.</i> (May)	1949
"Elimination of Reflections on Video Lines", C. A. Meyer and R. G. Middleton, <i>Radio News</i> (May)	1949
"High-Speed Production of Metal Kinescopes", H. P. Steier and R. D. Faulkner, <i>Electronics</i> (May)	1949
"Image Orthicon—Making Fine Mesh Screens", H. B. Law, <i>Broad. Eng. Jour.</i> (May)	1949
"An Inexpensive Waveform Monitor for TV Broadcasters", J. R. DeBaun, <i>Broad. Eng. Jour.</i> (May)	1949
"Recommendations for Support and Insulation of Kinescope RCA-16AP4", <i>RCA Application Note AN-140</i> , RCA Tube Department, Harrison, N. J. (May 2)	1949

	Year
"Sound Co-Channel Interference Measurements on Conventional and Intercarrier Television Receivers", George Hesse and Jack Avins, <i>RCA Licensee Bulletin LB-774</i> (May 20)	1949
"TV Film Projectors", G. W. Tunnell, <i>Inter. Project.</i> (May)	1949
BASIC TELEVISION — PRINCIPLES AND SERVICING, Bernard Grob, McGraw-Hill Book Co., New York, N. Y. (June)	1949
"Development and Performance of Television Camera Tubes", R. B. Janes, R. E. Johnson and R. S. Moore, <i>RCA Review</i> (June)	1949
"Method of Multiple Operation of Transmitter Tubes Particularly Adapted for Television Transmission in the Ultra-High-Frequency Band", G. H. Brown, W. C. Morrison, W. L. Behrend and J. G. Reddeck, <i>RCA Review</i> (June)	1949
"The Philosophy of Our TV System (Part III)", J. H. Roe, <i>Broadcast News</i> (June)	1949
"Reversible-Beam Antenna for Twelve-Channel Television Reception", O. M. Woodward, Jr., <i>RCA Review</i> (June)	1949
"A Television and FM Noise Generator", I. J. Melman, <i>RCA Licensee Bulletin LB-776</i> (June 20)	1949
"TV and FM Site Testing", E. S. Clammer and E. M. Brown, <i>Broadcast News</i> (June)	1949
"Television Receiving Systems", C. M. Sinnett, <i>Elec. Eng.</i> (June) ..	1949
"TV Site Testing and Measurement Techniques", E. S. Clammer, <i>Communications</i> (June)	1949
"Video Announcer", E. P. Bertero, <i>RCA Review</i> (June)	1949
"Modern Television Producing Plant", M. M. Ellwell, <i>Televiser</i> (July) ..	1949
"Television Photometry and Optical Background", R. L. Kuehn, <i>Tele-Tech.</i> (July)	1949
"Television Service, Part VI—Troubles in Horizontal-Deflection and High-Voltage Circuits", John R. Meagher, <i>RCA Rad. Serv. News</i> (July)	1949
"Comments of Radio Corporation of America", C. B. Jolliffe, (Letter concerning color television) (August 25)	1949
"Engineering Techniques in Motion Pictures and Television", A. N. Goldsmith, <i>Jour. Soc. Mot. Pic. Eng.</i> (August)	1949
"New TV Studio Relay Switching System", W. E. Tucker and C. R. Monro, <i>Tele-Tech.</i> (August)	1949
"Problems of Television Deflection and High-Voltage Supply", A. A. Barco, <i>RCA Licensee Bulletin LB-781</i> (August 10)	1949
"Progress Report—Theater Television", B. Kreuzer, <i>Jour. Soc. Mot. Pic. Eng.</i> (August)	1949
"American Television Film Equipment", R. E. B. Hickman, <i>Journal of the Television Society (British)</i> (September)	1949
"Baseball Television", J. P. Taylor, <i>Broadcast News</i> (September) ..	1949
"Engineering Statement Supplemental to Comments of Radio Corporation of America", E. W. Engstrom, (Letter concerning color television) (September 6)	1949
"Illumination for Television Studios—Part I", H. M. Gurin, <i>Tele-Tech.</i> (September)	1949
"The Image Isocon—An Experimental Television Pickup Tube Based on the Scattering of Low Velocity Electrons", P. K. Weimer, <i>RCA Review</i> (September)	1949
"A Six-Megacycle Compatible High-Definition Color Television System", Bulletin (September 26)	1949
<i>RCA Review</i> (December)	1949
"Television Service, Part VII—Vertical Deflection Troubles", J. R. Meagher, <i>RCA Rad. Serv. News</i> (September-October)	1949
"Illumination for Television Studios—Part II", H. M. Gurin, <i>Tele-Tech</i> (October)	1949
"Synchronization for Color Dot Interlace in the RCA Color Television System", Bulletin, RCA Laboratories Division (October)	1949

Year

"A 15 by 20-inch Projection Receiver for the RCA Color Television System", Bulletin, RCA Laboratories Division (October)	1949
"A Two-Color Direct-View Receiver for the RCA Color Television System", Bulletin, RCA Laboratories Division (November)	1949
"Television Service, Part VIII—Vertical Oscillator Troubles", John R. Meagher, <i>RCA Rad. Serv. News</i> (November and December) ..	1949
"Artificial Lines for Video Distribution and Delay", A. H. Turner, <i>RCA Review</i> (December)	1949
"A Direct-Drive Deflection and High Voltage System for Television Receivers", W. E. Scull, Jr., R. G. Wolcott and S. I. Tourshou, <i>RCA Licensee Bulletin LB-789</i> (December 23)	1949
"The Evaluation of Chromium-Iron Alloys for Metal Kinescope Cones", A. S. Rose and J. C. Turnbull, <i>RCA Review</i> (December)	1949
"An Experimental UHF Television Tuner", Bulletin, RCA Laboratories Division (December)	1949
"Hints on Using Sweep Generators for TV Receiver Alignment", John A. Cornell, <i>Radio News</i> (December)	1949
"A New Image Orthicon", R. B. Janes, R. E. Johnson and R. K. Handel, <i>RCA Review</i> (December)	1949
"Design of 41.25-MC Video I-F Amplifiers", J. Avins, <i>RCA Licensee Bulletin LB-790</i> (January 10)	1950
"An Experimental Determination of the Sideband Distribution in the RCA Color Television System", Bulletin, RCA Laboratories Division (January 17)	1950
"An Experimental UHF Television Converter", Bulletin, RCA Laboratories Division (January 30)	1950
"Mixing Local and Remote Television Signals", W. E. Wells and J. M. Weaver, <i>Tele-Tech</i> (January)	1950
"Radio and Television in 1949-1950", David Sarnoff, <i>Broad. Eng. Jour.</i> (January)	1950
"A Single Tube A.F.C. Circuit for TV Deflection Systems", J. A. Cornell, <i>Radio & Tele. News</i> (January)	1950
"A Study of Cochannel and Adjacent-Channel Interference of Television Signals, Part I", Bulletin, RCA Laboratories Division (January 17)	1950
<i>RCA Review</i> (March)	1950
"A Study of Cochannel and Adjacent Channel Interference of Television Signals, Part II", Bulletin, RCA Laboratories Division (January 30)	1950
<i>RCA Review</i> (June)	1950
"Supplemental Data on UHF Tuner Described in Bulletin 'An Experimental UHF Television Tuner'", Bulletin, RCA Laboratories Division (January)	1950
"A Three-Color Direct-View Receiver for the RCA Color Television System", Bulletin, RCA Laboratories Division (January 9)	1950
"Characteristics of High-Efficiency Deflection and High-Voltage Supply Systems for Kinescopes", O. H. Schade, <i>RCA Licensee Bulletin LB-791</i> (February 10)	1950
"Colorimetric Analysis of RCA Color Television System", Bulletin, RCA Laboratories Division (February 15)	1950
"Directional Antenna Systems for Microwave TV — Part I", C. A. Rosencrans, <i>Tele-Tech</i> (February)	1950
"First UHF TV Transmitter Shipped", <i>Broadcast News</i> (January-February)	1950
"Giving TV a New Meaning", V. K. Zworykin, <i>Televiiser</i> (February)	1950
"How to Use the TM-5A Monitor to Check Sync Signals by the 'Pulse Cross' Method", H. J. Markley, <i>Broadcast News</i> (January-February)	1950
"Recent Developments in Color Synchronization in the RCA Color Television System", Bulletin, RCA Laboratories Division (February 8)	1950

	Year
"A Simplified Receiver for the RCA Color Television System", Bulletin, RCA Laboratories Division (February 28)	1950
"Answers to Questions about Color Television", Pamphlet, RCA Department of Information (March 30)	1950
"Behind the Scenes at a Television Show", Milton Brown, <i>Rad. & Tele. News</i> (March)	1950
"Characteristics of High-Efficiency Deflection and High-Voltage Supply Systems for Kinescopes", O. H. Schade, <i>RCA Review</i> (March)	1950
"Directional Antenna Systems for Microwave TV, Part II", C. A. Rosencrans, <i>Tele-Tech</i> (March)	1950
"Experimental Ultra-High-Frequency Television Station in the Bridgeport, Connecticut Area", R. F. Guy, J. L. Seibert and F. W. Smith, <i>RCA Review</i> (March)	1950
"An Experimental Ultra-High-Frequency Television Tuner", T. Murakami, <i>RCA Review</i> (March)	1950
"The Genlock for Improved TV Programming", J. H. Roe, <i>Broadcast News</i> (March-April)	1950
"High Efficiency Deflection and High Voltage Circuits for Short Metal Kinescope RCA-16GP4", <i>RCA Application Note AN-142</i> , RCA Tube Department, Harrison, N. J. (March 31)	1950
"High Gain and Directional Antennas for Television Broadcasting", L. J. Wolf, <i>Broadcast News</i> (March-April)	1950
"How to Adjust Frequency Response in Video Amplifiers for TV", J. H. Roe, <i>Broadcast News</i> (March-April)	1950
"Television Service. Part IX—Blanking and Synchronizing Signals", J. R. Meagher, <i>RCA Rad. Serv. News</i> (Spring)	1950
"TV Remote Control Switching", W. E. Tucker and C. R. Monro, <i>Broadcast News</i> (March-April)	1950
"Use of Sharp-Cutoff Miniature Pentode RCA 6CB6 in Television Receivers", <i>RCA Application Note AN-143</i> , RCA Tube Department, Harrison, N. J. (March 31)	1950
"A Five-Inch Television Oscilloscope", E. I. Anderson, <i>RCA Licensee Bulletin LB-793</i> (April 20)	1950
"General Description of Receivers for the RCA Color Television System Which Employ the RCA Direct-View Tri-Color Kinescopes", Bulletin, RCA Laboratories Division (April)	1950
<i>RCA Review</i> (June)	1950
"Shielded Low Capacitance Video Frequency Oscilloscope Probes", J. Avins, <i>RCA Licensee Bulletin LB-794</i> (April 20)	1950
"UHF Television Field Test", R. F. Guy, <i>Electronics</i> (April)	1950
"The Vidicon—Photoconductive Camera Tube", P. K. Weimer, S. V. Forgue and R. R. Goodrich, <i>Electronics</i> (May)	1950
"An Analysis of the Sampling Principles of the Dot-Sequential Color Television System", <i>RCA Review</i> (June)	1950
"A New Ultra-High Frequency Television Transmitter", J. R. Bennett and L. S. Lappin, <i>RCA Review</i> (June)	1950
"Simplified Television for Industry", R. C. Webb and J. M. Morgan, <i>Electronics</i> (June)	1950
"Stainless Steel for Television", A. Rose, <i>Metal Progress</i> (June)	1950
"Ultra-High Frequency Antenna and System for Television Transmission", O. O. Fiet, <i>RCA Review</i> (June)	1950