

Receiving Tube MANUAL

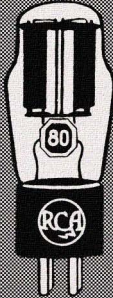

TECHNICAL SERIES RC-14 PRICE 25 CENTS

CONTENTS

er

	PAGE
ELECTRONS AND ELECTRODES	3
Electrons, Cathodes, Generic Tube Types, Diodes, Triodes, Pentodes, Beam Power Tubes, Multi-Electrode and Multi-Unit Types	
RADIO TUBE CHARACTERISTICS	10
RADIO TUBE APPLICATIONS	
Amplification, Rectification, Detection, Automatic Volume Control, Tuning Indication with Electron-Ray Tubes, Oscillation, Frequency Conversion	
RADIO TUBE INSTALLATION	34
Filament and Heater Supply, Heater-to-Cathode Connection, Plate Voltage Supply, Grid Voltage Supply, Screen Voltage Supply, Shield- ing, Filters, Output-Coupling Devices	
RECEIVING TUBE CLASSIFICATIONS	42
INTERPRETATION OF RECEIVING-TUBE RATINGS	44
KEY TO TERMINAL DESIGNATIONS OF SOCKETS	45
TECHNICAL DATA FOR EACH TUBE TYPE	45
RADIO TUBE MATERIALS CHART	194
RECEIVING-TUBE TESTING	195
RESISTANCE-COUPLED AMPLIFIER CHART	198
CIRCUITS	204
OUTLINES	215
INDEX	217
RECENTLY ADDED TUBE TYPES	219
READING LIST	Inside back cover

er

The license extended to the purchaser of tubes appears in the License Notice accompanying them. Information contained herein is furnished without assuming any obligations.

Printed in U.S.A.



DATA ON RECENTLY
ADDED TUBE TYPES
ARE GIVEN STARTING
ON PAGE 219.

RECEIVING TUBE MANUAL

This Manual like its preceding editions, has been prepared to assist those who work or experiment with radio tubes and circuits. It will be found valuable by radio servicemen, radio technicians, experimenters, radio amateurs, and all others technically interested in radio tubes.



In addition to the tube types
described in this book
RCA MANUFACTURING COMPANY, INC.
offers a complete line of

TUBES

for

Amateur Transmitters
Broadcast Transmitters
Radio Communicating Systems
Cathode-Ray Oscillographs
Television Equipment
Phototube Equipment
Laboratory Equipment
etc. etc.



For sales information regarding any RCA product, write to
Sales Department, RCA MANUFACTURING COMPANY, INC.,
Camden, N. J.

For technical information on RCA Tubes, write to Commer-
cial Engineering Section, RCA MANUFACTURING COMPANY, INC.,
Harrison, N. J.

Structure of a Metal Radio Tube

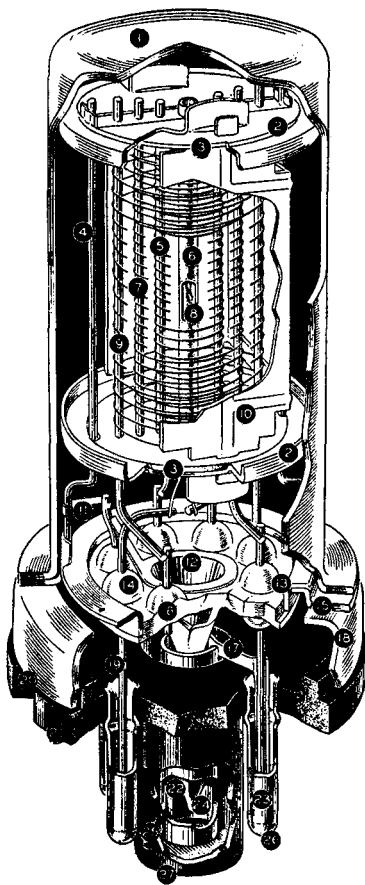

- 1 — METAL ENVELOPE
- 2 — SPACER SHIELD
- 3 — INSULATING SPACER
- 4 — MOUNT SUPPORT
- 5 — CONTROL GRID
- 6 — COATED CATHODE
- 7 — SCREEN
- 8 — HEATER
- 9 — SUPPRESSOR

- 10 — PLATE
- 11 — BATALUM GETTER
- 12 — CONICAL STEM SHIELD
- 13 — HEADER
- 14 — GLASS SEAL
- 15 — HEADER INSERT
- 16 — GLASS-BUTTON STEM SEAL
- 17 — CYLINDRICAL BASE SHIELD
- 18 — HEADER SKIRT

- 19 — LEAD WIRE
- 20 — CRIMPED LOCK
- 21 — OCTAL BASE
- 22 — EXHAUST TUBE
- 23 — BASE PIN
- 24 — EXHAUST TIP
- 25 — ALIGNING KEY
- 26 — SOLDER
- 27 — ALIGNING PLUG



RECEIVING TUBE MANUAL

Electrons and Electrodes

The radio tube is a marvelous device. It makes possible the performing of operations, amazing in conception, with a precision and a certainty that are astounding. It is an exceedingly sensitive and accurate instrument—the product of coordinated efforts of engineers and craftsmen. Its construction requires materials from every corner of the earth. Its use is world-wide. Its future possibilities, even in the light of present-day accomplishments, are but dimly foreseen; for each development opens new fields of design and application.

The importance of the radio tube lies in its ability to control almost instantly the flight of the millions of electrons supplied by the cathode. It accomplishes this with a minimum of control energy. Because it is almost instantaneous in its action, the radio tube can operate efficiently and accurately at electrical frequencies much higher than those attainable with rotating machines.

ELECTRONS

All matter exists in the solid, liquid, or gaseous state. These three forms consist entirely of minute divisions known as molecules. Molecules are assumed to be composed of atoms. According to a present accepted theory, atoms have a nucleus which is a positive charge of electricity. Around this nucleus revolve tiny charges of negative electricity known as **electrons**. Scientists have estimated that these invisible bits of electricity weigh only 1/46 billion, billion, billion, billionths of an ounce, and that they may travel at speeds of thousands of miles per second.

Electron movement may be accelerated by the addition of energy. Heat is one form of energy which can be conveniently used to speed up the electron. For example, if the temperature of a metal is gradually raised, the electrons in the metal gain velocity. When the metal becomes hot enough to glow, some electrons may acquire sufficient speed to break away from the surface of the metal. This action, which is accelerated when the metal is heated in a vacuum, is utilized in most radio tubes to produce the necessary electron supply.

A radio tube consists of a cathode, which supplies electrons, and one or more additional electrodes, which control and collect these electrons, mounted in an evacuated envelope. The envelope may be a glass bulb, or it may be the more compact and efficient metal shell.

CATHODES

A cathode is an essential part of a radio tube because it supplies the electrons necessary for tube operation. Electrons are released from the cathode by means of some form of energy applied to it. Generally, heat is used. The method of heating the cathode may be used to distinguish between the different forms of cathodes. For example, a directly heated cathode, or filament-cathode, is a wire heated by the passage of an electric current. An indirectly heated cathode, or heater-cathode, consists of a filament, or heater, enclosed in a metal sleeve. The sleeve carries the electron-emitting material on its outside surface and is heated by radiation and conduction from the heater.

A filament, or directly heated cathode, may be further classified by identifying the filament or electron-emitting material. The materials in regular use are tungsten, thoriated-tungsten, and metals which have been coated with alkaline-earth oxides. Tungsten filaments are made from the pure metal. Since they must operate at high temperatures (a dazzling white) to emit sufficient electrons, a relatively large amount of filament power is required. Thoriated-tungsten filaments are made from tungsten impregnated with thoria. Due to the presence of thorium, these filaments liberate electrons at a more moderate temperature of about 1700°C (a bright yellow) and are, therefore, much more economical of filament power than are pure tungsten filaments. Alkaline earths are usually applied as a coating on a nickel alloy wire or ribbon. This coating, which is dried in a relatively thick layer on the filament, requires only a very low temperature of about 700-750°C (a dull red) to produce a copious supply of electrons. Coated filaments operate very efficiently and require relatively little filament power. However, each of these cathode materials has special advantages which determine the choice for a particular application.

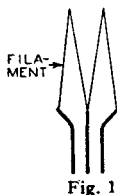

Fig. 1

Directly heated filament cathodes require comparatively little heating power. They are used in almost all of the tube types designed for battery operation because it is, of course, desirable to impose as small a drain as possible on the batteries. Examples of battery-operated filament types are the 1A7-GT, 1F5-G, 1H4-G, 1H5-G, and 31. A-c operated types having directly heated filament-cathodes are the 2A3 and 45.

An indirectly heated cathode, or heater-cathode, consists of a thin metal sleeve coated with electron-emitting material. Within the sleeve is a heater which is insulated from the sleeve. The heater is made of tungsten or tungsten-alloy wire and is used only for the purpose of heating the cathode sleeve and sleeve coating to an electron-emitting temperature. Useful emission does not take place from the heater wire.

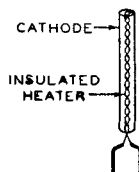

Fig. 2

The heater-cathode construction is well adapted for use in radio tubes intended for operation from a-c power lines and from automobile batteries. The use of separate parts for emitter and heater functions, the electrical insulation of the heater from the emitter, and the shielding effect of the sleeve may all be utilized in the design of the tube to prevent the introduction of hum from the a-c heater supply and to minimize electrical interference which might enter the tube circuit through the heater-supply line. From the viewpoint of circuit design, the heater-cathode construction offers advantages in connection flexibility, due to the electrical separation of the heater from the cathode. Another advantage of the heater-cathode construction is that it makes practical the design of a rectifier tube with close spacing between its cathode and plate, and of an amplifier tube with close spacing between its cathode and grid. In a close-spaced rectifier tube the voltage drop in the tube is low and the regulation is, therefore, improved. In an amplifier tube, the close spacing increases the gain obtainable from the tube. Because of the advantages of the heater-cathode construction, almost all present-day receiving tubes designed for a-c operation have heater cathodes.

GENERIC TUBE TYPES

Electrons are of no value in a radio tube unless they can be put to work. A tube is, therefore, designed with the necessary parts to utilize electrons as well as to produce them. These parts consist of a cathode and one or more supplementary electrodes. The electrodes are enclosed in an evacuated envelope with the necessary connections brought out through air-tight seals. The air is removed from the envelope to allow free movement of the electrons and to prevent injury to the emitting surface of the cathode. When the cathode is heated, electrons leave the cathode surface and form an invisible cloud in the space around it. Any positive electric potential within the evacuated envelope will offer a strong attraction to the electrons (unlike electric charges attract; like charges repel).

DIODES

The simplest form of radio tube contains two electrodes, a cathode and an anode (plate) and is often called a "diode", the family name for a two-electrode tube. In a diode, the positive potential is supplied by a suitable electrical source connected between the plate terminal and a cathode terminal. Under the influence of the positive plate potential, electrons flow from the cathode to the plate and return through the external plate-battery circuit to the cathode, thus completing the circuit. This flow of electrons is known as the plate current and may be measured by a sensitive current meter.

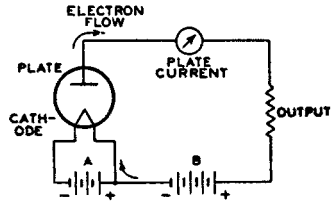

Fig. 3

If a negative potential is applied to the plate, the free electrons in the space surrounding the cathode will be forced back to the cathode and no plate current will flow. Thus, the tube permits electrons to flow from the cathode to the plate but not from the plate to the cathode. If an alternating voltage is applied to the plate, the plate is alternately made positive and negative. Plate current flows only during the time when the plate is positive. Hence the current through the tube flows in one direction and is said to be rectified. See Fig. 4. Diode rectifiers are used in a-c receivers to convert a.c. to d.c. for supplying "B," "C," and screen voltages to the other tubes in the receiver. Rectifier tubes may have one plate and one cathode. The 1-v and 1Z3 are of this form and are called **half-wave rectifiers**, since current can flow only during one-half of the alternating-current cycle. When two plates and one or more cathodes are used in the same tube, current may be obtained on both halves of the a-c cycle. The 5T4, 5Y3-G and 5Z3 are examples of this type and are called **full-wave rectifiers**.

Not all of the electrons emitted by the cathode reach the plate. Some return to the cathode while others remain in the space between the cathode and plate for a brief period to form an effect known as **space-charge**. This charge has a repelling action on other electrons which leave the cathode surface and impedes their passage to the plate. The extent of this action and the amount of space-charge depend on the cathode temperature and the plate potential. The higher the plate potential, the less is the tendency for electrons to remain in the space-charge region and repel others. This effect may be noted by applying increasingly higher plate voltages to a tube operating at a fixed heater or filament voltage. Under these conditions, the maximum number of available electrons is fixed, but increasingly higher plate voltages will succeed in attracting a greater proportion of the free electrons.

Beyond a certain plate voltage, however, additional plate voltage has little effect in increasing the plate current. The reason is that all of the electrons emitted by the cathode are already being drawn to the plate. This maximum current is called **saturation current** (see Fig 5) and because it is an indication of the total number of electrons emitted, it is also known as the **emission current**, or, simply, **emission**. Tubes are sometimes tested by measurement of their emission current. However, in this test it is generally not feasible to measure the full value of emission because this value would be sufficiently large to cause change in the tube's characteristics, or to damage the tube. For that reason, the test value of current in an emission test is less than the full emission current. However, this test value is larger than the maximum value which will be required from the cathode in the use of the tube. The emission test, therefore, indicates whether the tube's cathode can supply a sufficiently large number of electrons for satisfactory operation of the tube.

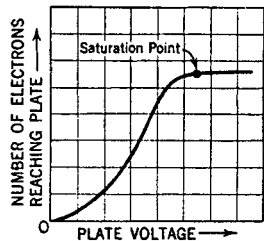

Fig. 5

If space charge were not present to repel electrons coming from the cathode, it follows that the same plate current could be produced at a lower plate voltage. One way to make the effect of space charge small is to make the distance between plate and cathode small. This means is used in rectifier types, such as the 83-v and the 25Z5, having heater-cathodes. In these types the radial distance between cathode and plate is only about two hundredths of an inch. Another means for reducing space-charge effect is utilized in the mercury-vapor rectifier tubes, such as the 83. This tube contains a small amount of mercury, which is partially vaporized when the tube is operated. The mercury vapor consists of mercury atoms permeating the space inside the bulb. These atoms are bombarded by the electrons on their way to the plate. If the electrons are moving at a sufficiently high speed, the collisions will tear off electrons from the mercury atoms. When this happens, the mercury atom is said to be "ionized," that is, it has lost one or more electrons and, therefore, is charged positive. Ionization, in the case of mercury vapor, is made evident by a bluish-green glow between the cathode and plate. When ionization due to bombardment of mercury atoms by electrons leaving the filament occurs, the space-charge is neutralized by the positive mercury ions so that increased numbers of electrons are made available. A mercury-vapor rectifier has a small voltage drop between cathode and plate (about 15 volts). This drop is practically independent of current requirements up to the limit of emission of electrons from the filament, but is dependent to some degree on bulb temperature.

An ionic-heated cathode rectifier tube is another type which depends for its operation on gas ionization. The 0Z4 and 0Z4-G are tubes in this classification. They are of the full-wave design and contain two anodes and a coated cathode sealed in a bulb under a reduced pressure of inert gas. The cathode in each of these types becomes hot during tube operation but the heating effect is caused by bombardment of the cathode by the ions from within the tube rather than by heater or filament current from an external source. The internal structure of the tube is designed so that when sufficient voltage is applied to the tube, ionization of the gas occurs between the anode which is instantaneously positive and the cathode. Under normal operating voltages, ionization does not take place between the anode that is negative and the cathode. This, of course, satisfies the principle of rectification. The initial small flow of current through the tube is sufficient to raise the cathode temperature quickly to incandescence whereupon the cathode emits electrons. The voltage drop in such tubes is slightly higher than that of the usual hot-cathode gas rectifiers because energy is taken from the ionization discharge to keep the cathode at operating temperature. Proper operation of these rectifiers requires that a minimum load current always flow in order to maintain the cathode at the temperature required to supply sufficient emission.

TRIODES

When a third electrode, called the grid, is placed between the cathode and plate, the tube is known as a triode, the family name for a three-electrode tube. The grid usually is a winding of wire extending the length of the cathode. The spaces between turns are comparatively large so that the passage of electrons from cathode to plate is practically unobstructed by the turns of the grid. The purpose of the grid is to control the flow of plate current. When a tube is used as an amplifier, a negative d-c voltage is usually applied to the grid. Under this condition the grid does not draw appreciable current.

The number of electrons attracted to the plate depends on the combined effect of the grid and plate polarities. When the plate is positive, as is normal, and the d-c grid voltage is made more and more negative, the plate is less able to attract electrons to it and plate current decreases. When the grid is made less and less negative, the plate more readily attracts electrons to it and plate current increases. Hence, when the voltage on the grid is varied in accordance with a signal, the plate

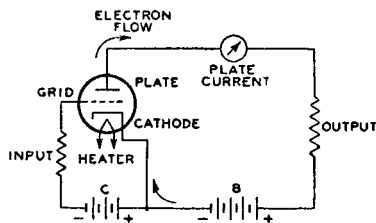

Fig. 6

current varies with the signal. Because a small voltage applied to the grid can control a comparatively large amount of plate current, the signal is amplified by the tube. Typical three-electrode tube types are the 6C5, 76, and 2A3.

The grid, plate, and cathode of a triode form an electrostatic system, each electrode acting as one plate of a small condenser. The capacitances are those existing between grid and plate, plate and cathode, and grid and cathode. These capacitances are known as **interelectrode capacitances**. Generally, the capacitance between grid and plate is of the most importance. In high-gain radio-frequency amplifier circuits, this capacitance may act to produce undesired coupling between the **input circuit**, the circuit between grid and cathode, and the **output circuit**, the circuit between plate and cathode. This coupling is undesirable in an amplifier because it may cause instability and unsatisfactory performance.

TETRODES

The capacitance between grid and plate can be made small by mounting an additional electrode, called the screen, in the tube. With the addition of the screen, the tube has four electrodes and is, accordingly, called a tetrode. The screen is mounted between the grid and the plate and acts as an electrostatic shield between them, thus reducing the grid-to-plate capacitance. The effectiveness of this shielding action is increased by connecting a by-pass condenser between screen and cathode. By means of the screen and this by-pass condenser, the grid-plate capacitance of a tetrode is made very small. In practice, the grid-plate capacitance is reduced from an average of 8.0 micromicrofarads ($\mu\mu\text{f}$) for a triode to 0.01 $\mu\mu\text{f}$ or less for a screen-grid tube.

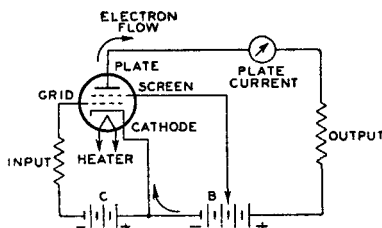

Fig. 7

The screen has another desirable effect in that it makes plate current practically independent of plate voltage over a certain range. The screen is operated at a positive voltage and, therefore, attracts electrons from the cathode. But because of the comparatively large space between wires of the screen, most of the electrons drawn to the screen pass through it to the plate. Hence the screen supplies an electrostatic force pulling electrons from the cathode to the plate. At the same time the screen shields the electrons between cathode and screen from the plate so that the plate exerts very little electrostatic force on electrons near the cathode. Hence, as long as the plate voltage is higher than the screen voltage, plate current in a screen-grid tube depends to a great degree on the screen voltage and very little on the plate voltage. The fact that plate current in a screen-grid tube is largely independent of plate voltage makes it possible to obtain much higher amplification with a tetrode than with a triode. The low grid-plate capacitance makes it possible to obtain this high amplification without plate-to-grid feedback and resultant instability. Representative screen-grid types are the 32 and 24-A.

PENTODES

In all radio tubes, electrons striking the plate may, if moving at sufficient speed, dislodge other electrons. In two- and three-electrode types, these dislodged electrons usually do not cause trouble because no positive electrode other than the plate itself is present to attract them. These electrons, therefore, are drawn back to the plate. Emission caused by bombardment of an electrode by electrons from the cathode is called **secondary emission** because the effect is secondary to the original cathode emission. In the case of screen-grid tubes, the proximity of the positive screen to the plate offers a strong attraction to these secondary electrons and particularly so if the plate voltage swings lower than the screen voltage. This effect lowers the plate current and limits the permissible plate-voltage swing for **tetrodes**.

The plate-current limitation is removed when a fifth electrode is placed within the tube between the screen and plate. This fifth electrode is known as the suppressor and is usually connected to the cathode. Because of its negative potential

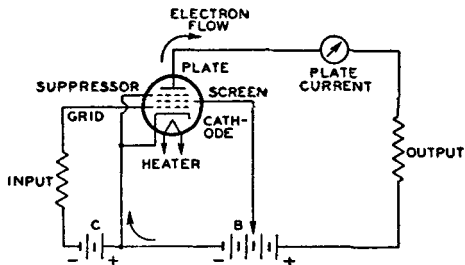

Fig. 8

with respect to the plate, the suppressor retards the flight of secondary electrons and diverts them back to the plate where they cannot cause trouble. The family name for a five-electrode tube is "pentode." In power-output pentodes the suppressor makes possible higher power output with lower grid-driving voltage; in radio-frequency amplifier pentodes the suppressor permits of obtaining high voltage amplification at moderate values of plate voltage. These desirable features are due to the fact that the plate-voltage swing can be made very large as compared with that of tetrodes. In fact, the plate voltage may be as low as, or lower than, the screen voltage without serious loss in signal gain capability. Representative power-amplifier pentodes are the 1A5-G, 6F6, and 25A6; representative r-f amplifier pentodes are the 1N5-G, 6J7, and 12SJ7.

BEAM POWER TUBES

A beam power tube is a tetrode or pentode in which use is made of directed electron beams to contribute substantially to its power-handling capability. Such a tube contains a cathode, a control-grid, a screen, a plate, and, optionally, a suppressor grid. When a beam power tube is designed without an actual suppressor, the electrodes are so spaced that secondary emission from the plate is suppressed by space-charge effects between screen and plate. The space charge is produced by the slowing up of electrons traveling from a high-potential screen to a lower potential plate. In this low-velocity region, the space charge produced is sufficient to repel secondary electrons emitted from the plate and to cause them to return to the plate. Beam power tubes of this design employ beam-forming plates at cathode potential to assist in producing the desired beam effects and to prevent stray electrons from the plate from returning to the screen outside of the beam. A feature of a beam power tube is its low screen current. The screen and the grid are spiral wires wound so that each turn of the screen is shaded from the cathode by a grid turn. This alignment of the screen and grid causes the electrons to travel in sheets between the turns of the screen so that very few of them flow to the screen. Because of the effective suppressor action provided by space charge and because of the low current drawn by the screen, the beam power tube has the advantages of high power output, high power sensitivity, and high efficiency.

Fig. 9 shows the structure of a beam power tube employing space-charge suppression and illustrates how the electrons are confined to beams. The beam condition illustrated is that for a plate potential less than the screen potential. The high-density space-charge region is indicated by the heavily dashed lines in the beam. Note that the edges of the beam-forming plates coincide with the dashed portion of the beam and thus extend the space-charge potential region beyond the beam boundaries to prevent stray secondary electrons from returning to the screen outside of the beam. The 6L6 and 6L6-G are examples of beam power tubes utilizing this construction.

In place of the space-charge effect just described, it is also feasible to use an actual suppressor to repel the secondary electrons. Examples of beam power tubes using an actual suppressor are the 6V6 and 6G6-G.

INTERNAL STRUCTURE OF TYPE 6L6 BEAM POWER TUBE

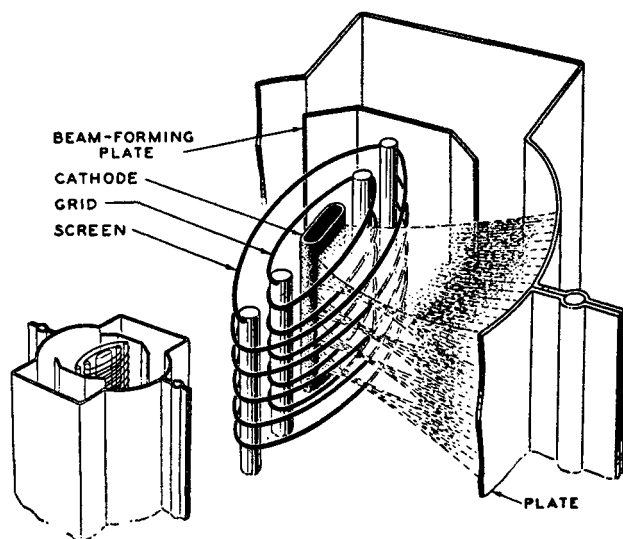

Fig. 9

MULTI-ELECTRODE and MULTI-UNIT TUBES

Early in the history of tube development and application, tubes were designed for general service; that is, a single tube type—a triode—was used as a radio-frequency amplifier, an intermediate-frequency amplifier, an audio-frequency amplifier, an oscillator or as a detector. Obviously, with this diversity of application, one tube did not meet all requirements to the best advantage.

Later and present trends of tube design are the development of "specialty" types. These types are intended either to give optimum performance in a particular application or to combine in one bulb functions which formerly required two or more tubes. The first class of tubes includes such examples of specialty types as the 6F6, 12SJ7, 6L7, and 6K8. Types of this class generally require more than three electrodes to obtain the desired special characteristics and may be broadly classed as multi-electrode types. The 6L7 is an especially interesting type in this class. This tube has an unusually large number of electrodes, namely seven exclusive of the heater. Plate current in the tube is varied at two different frequencies at the same time. The tube is designed primarily for use as a mixer in superheterodyne receivers. In this use, the tube mixes the signal frequency with the oscillator frequency to give an intermediate-frequency output.

Tubes of the multi-electrode class often present interesting possibilities of application besides the one for which they are primarily designed. The 6L7, for instance, can also be used as a variable-gain audio amplifier in volume-expander and compressor application. The 6F6, besides its use as a power output pentode, can also be connected as a triode and used as a driver for a pair of 6L6's.

The second class includes multi-unit tubes such as the duplex-diode triodes 1H6-G and 6SQ7, as well as the duplex-diode pentodes 1F7-GV and 12C8 and the twin class A and class B types, 6C8-G and 6B8, respectively. In this class also is included the multi-unit type 1D8-GT. This tube combines in one bulb three units—a diode for use as detector and avc, a triode for use as the first audio-frequency amplifier, and a power-output pentode. Related to multi-unit tubes are the electron-ray types 6E5 and 6N5. These combine a triode amplifier with a fluorescent target. Full-wave rectifiers are also multi-unit types.

A third class of tubes combines features of each of the other two classes. Typical of this third class are the pentagrid-converter types 1A7-G and 12SA7.

These tubes are similar to the multi-electrode types in that they have seven electrodes, all of which affect the electron stream; and they are similar to the multi-unit tubes in that they perform simultaneously the double function of oscillator and mixer in superheterodyne receivers.

Complete classification of tubes by services and cathode voltages is given on the chart at the beginning of the DATA SECTION.

Radio Tube Characteristics

The term "CHARACTERISTICS" is used to identify the distinguishing electrical features and values of a radio tube. These values may be shown in curve form or they may be tabulated. When given in curve form, they are called characteristic curves and may be used for the determination of tube performance and the calculation of additional tube factors.

Tube characteristics are obtained from electrical measurements of a tube in various circuits under certain definite conditions of voltages. Characteristics may be further described by denoting the conditions of measurements. For example, Static Characteristics are the values obtained with different d-c potentials applied to the tube electrodes, while Dynamic Characteristics are the values obtained with an a-c voltage on the control grid under various conditions of d-c potentials on the electrodes. The dynamic characteristics, therefore, are indicative of the performance capabilities of a tube under actual working conditions.

Static characteristics may be shown by plate characteristics curves and transfer (mutual) characteristics curves. These curves present the same information, but in two different forms to increase its usefulness. The plate characteristic curve is obtained by varying plate voltage and measuring plate current for different control-grid bias voltages, while the transfer-characteristic curve is obtained by varying control-grid bias voltage and measuring plate current for different plate voltages. A plate-characteristic family of curves is illustrated by Fig. 10. Fig. 11 gives the transfer characteristic family of curves for the same tube.

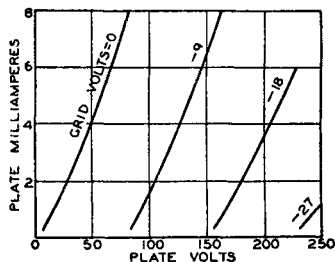

Fig 10

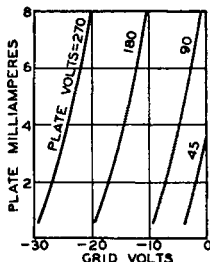

Fig. 11

Dynamic characteristics include amplification factor, plate resistance, control-grid—plate transconductance and certain detector characteristics, and may be shown in curve form for variations in tube operating conditions.

The **amplification factor**, or μ , is the ratio of the change in plate voltage to a change in control-electrode voltage in the opposite direction, under the condition that the plate current remains unchanged, and that all other electrode voltages are maintained constant. For example, if, when the plate voltage is made 1 volt more positive, the grid voltage must be made 0.1 volt more negative to hold plate current unchanged, the amplification factor is 1 divided by 0.1, or 10. In other words, a small voltage variation in the grid circuit of a tube has the same effect on the plate current as a large plate voltage change—the latter equal to the product of the grid voltage change and amplification factor. The μ of a tube is useful for calculating stage gain, as discussed on page 13.

function of the available emission and the duration of the pulsating current flow from the rectifier tube during each half cycle. In a given circuit, the actual value of peak plate current is largely determined by filter constants. If a large choke is used in the filter circuit next to the rectifier tubes, the peak plate current is not much greater than the load current, but if a large condenser is used in the filter next to the rectifier tubes, the peak current is often many times the load current. In order to determine accurately the peak current in any circuit, the best procedure usually is to measure it with a peak-indicating meter or to use an oscillograph.

Plate dissipation is the power dissipated in the form of heat by the plate as a result of electron bombardment. It is the difference between the power supplied to the plate of the tube and the power delivered by the tube to the load.

Screen dissipation is the power dissipated in the form of heat by the screen as a result of electron bombardment. With tetrodes and pentodes, the power dissipated in the screen circuit is added to the power in the plate circuit to obtain the total B-supply input power.

The **plate efficiency** of a power amplifier tube is the ratio of the a-c power output to the product of the average d-c plate voltage and d-c plate current at full signal, or

$$\text{Plate efficiency (\%)} = \frac{\text{power output watts}}{\text{average d-c plate volts} \times \text{average d-c plate amperes}} \times 100$$

The **power sensitivity** of a tube is the ratio of the power output to the square of the input signal voltage (RMS) and is expressed in mhos as follows:

$$\text{Power sensitivity (mhos)} = \frac{\text{power output watts}}{(\text{input signal volts, RMS})^2}$$

Radio Tube Applications

The diversified applications of a radio tube may, within the scope of this chapter, be grouped broadly into five kinds of operation. These are: Amplification, rectification, detection, oscillation, and frequency conversion. Although these operations may take place at either radio or audio frequencies and may involve the use of different circuits and different supplemental parts, the general considerations of each kind of operation are basic.

AMPLIFICATION

The amplifying action of a radio tube was mentioned under TRIODES, page 7. This action can be utilized in radio circuits in a number of ways, depending upon the results to be achieved. Four classes of amplifier service recognized by engineers are covered by definitions standardized by the Institute of Radio Engineers. This classification depends primarily on the fraction of input cycle during which plate current is expected to flow under rated full-load conditions. The classes are class A, class AB, class B, and class C. The term, cut-off bias, used in these definitions is the value of grid bias at which plate current is some very small value.

Class A Amplifier. A class A amplifier is an amplifier in which the grid bias and alternating grid voltages are such that plate current in a specific tube flows at all times.

Class AB Amplifier. A class AB amplifier is an amplifier in which the grid bias and alternating grid voltages are such that plate current in a specific tube flows for appreciably more than half but less than the entire electrical cycle.

Class B Amplifier. A class B amplifier is an amplifier in which the grid bias is approximately equal to the cut-off value so that the plate current is approximately zero when no exciting grid voltage is applied, and so that plate current in a specific tube flows for approximately one-half of each cycle when an alternating grid voltage is applied.

Class C Amplifier. A class C amplifier is an amplifier in which the grid bias is appreciably greater than the cut-off value so that the plate current in each tube is zero when no alternating grid voltage is applied, and so that plate current flows

function of the available emission and the duration of the pulsating current flow from the rectifier tube during each half cycle. In a given circuit, the actual value of peak plate current is largely determined by filter constants. If a large choke is used in the filter circuit next to the rectifier tubes, the peak plate current is not much greater than the load current, but if a large condenser is used in the filter next to the rectifier tubes, the peak current is often many times the load current. In order to determine accurately the peak current in any circuit, the best procedure usually is to measure it with a peak-indicating meter or to use an oscillograph.

Plate dissipation is the power dissipated in the form of heat by the plate as a result of electron bombardment. It is the difference between the power supplied to the plate of the tube and the power delivered by the tube to the load.

Screen dissipation is the power dissipated in the form of heat by the screen as a result of electron bombardment. With tetrodes and pentodes, the power dissipated in the screen circuit is added to the power in the plate circuit to obtain the total B-supply input power.

The **plate efficiency** of a power amplifier tube is the ratio of the a-c power output to the product of the average d-c plate voltage and d-c plate current at full signal, or

$$\text{Plate efficiency (\%)} = \frac{\text{power output watts}}{\text{average d-c plate volts} \times \text{average d-c plate amperes}} \times 100$$

The **power sensitivity** of a tube is the ratio of the power output to the square of the input signal voltage (RMS) and is expressed in mhos as follows:

$$\text{Power sensitivity (mhos)} = \frac{\text{power output watts}}{(\text{input signal volts, RMS})^2}$$

Radio Tube Applications

The diversified applications of a radio tube may, within the scope of this chapter, be grouped broadly into five kinds of operation. These are: Amplification, rectification, detection, oscillation, and frequency conversion. Although these operations may take place at either radio or audio frequencies and may involve the use of different circuits and different supplemental parts, the general considerations of each kind of operation are basic.

AMPLIFICATION

The amplifying action of a radio tube was mentioned under TRIODES, page 7. This action can be utilized in radio circuits in a number of ways, depending upon the results to be achieved. Four classes of amplifier service recognized by engineers are covered by definitions standardized by the Institute of Radio Engineers. This classification depends primarily on the fraction of input cycle during which plate current is expected to flow under rated full-load conditions. The classes are class A, class AB, class B, and class C. The term, cut-off bias, used in these definitions is the value of grid bias at which plate current is some very small value.

Class A Amplifier. A class A amplifier is an amplifier in which the grid bias and alternating grid voltages are such that plate current in a specific tube flows at all times.

Class AB Amplifier. A class AB amplifier is an amplifier in which the grid bias and alternating grid voltages are such that plate current in a specific tube flows for appreciably more than half but less than the entire electrical cycle.

Class B Amplifier. A class B amplifier is an amplifier in which the grid bias is approximately equal to the cut-off value so that the plate current is approximately zero when no exciting grid voltage is applied, and so that plate current in a specific tube flows for approximately one-half of each cycle when an alternating grid voltage is applied.

Class C Amplifier. A class C amplifier is an amplifier in which the grid bias is appreciably greater than the cut-off value so that the plate current in each tube is zero when no alternating grid voltage is applied, and so that plate current flows

in a specific tube for appreciably less than one-half of each cycle when an alternating grid voltage is applied.

NOTE:—To denote that grid current does not flow during any part of the input cycle, the suffix 1 may be added to the letter or letters of the class identification. The suffix 2 may be used to denote that grid current flows during some part of the cycle.

For radio-frequency amplifiers which operate into a selective tuned circuit, as in radio transmitter applications, or under requirements where distortion is not an important factor, any of the above classes of amplifiers may be used, either with a single tube or a push-pull stage. For audio-frequency amplifiers in which distortion is an important factor, only class A amplifiers permit single-tube operation. In this case, operating conditions are usually chosen so that distortion is kept below the conventional 5% for triodes and the conventional 7 to 10% for tetrodes or pentodes. Distortion can be reduced below these figures by means of special circuit arrangements such as that discussed under **inverse feedback**. With class A amplifiers, reduced distortion with improved power performance can be obtained by using a push-pull stage for audio service. With class AB and class B amplifiers, a balanced amplifier stage using two tubes is required for audio service.

As a **class A voltage amplifier**, a radio tube is used to reproduce grid voltage variations across an impedance or a resistance in the plate circuit. These variations are essentially of the same form as the input signal voltage impressed on the grid, but of increased amplitude. This is accomplished by operating the tube at a suitable grid bias so that the applied grid-input voltage produces plate-current variations proportional to the signal swings. Since the voltage variation obtained in the plate circuit is much larger than that required to swing the grid, amplification of the signal is obtained. Fig 13 gives a graphical illustration of this method of amplification and shows, by means of the grid-voltage vs. plate-current characteristics curve, the effect of an input signal (S) applied to the grid of a tube. O is the resulting amplified plate-current variation.

The plate current flowing through the load resistance (R) of Fig. 14 causes a voltage drop which varies directly with the plate current. The ratio of this voltage variation produced in the load resistance to the input signal voltage is the voltage

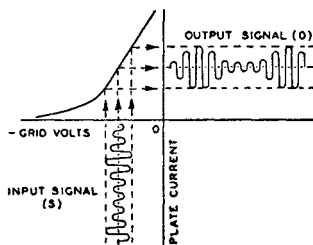

Fig. 13

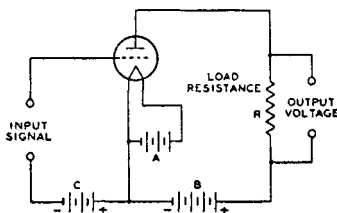

Fig. 14

amplification, or **gain**, provided by the tube. The voltage amplification due to the tube is expressed by the following convenient formulas:

$$\text{Voltage amplification} = \frac{\text{amplification factor} \times \text{load resistance}}{\text{load resistance} + \text{plate resistance}}, \text{ or}$$

$$\frac{\text{transconductance in micromhos} \times \text{plate resistance} \times \text{load resistance}}{1000000 \times (\text{plate resistance} + \text{load resistance})}$$

From the first formula, it can be seen that the gain actually obtainable from the tube is less than the tube's amplification factor but that the gain approaches the amplification factor when the load resistance is large compared to the tube's plate resistance. Fig. 15 shows graphically how the gain approaches the mu of the tube as load resistance is increased. From the curve it can be seen that to obtain high gain in a voltage amplifier, a high value of load resistance should be used.

In a resistance-coupled amplifier, the load resistance of the tube is approximately equal to the resistance of the plate resistor in parallel with the grid resistor of the following stage. Hence, to obtain a large value of load resistance, it is necessary

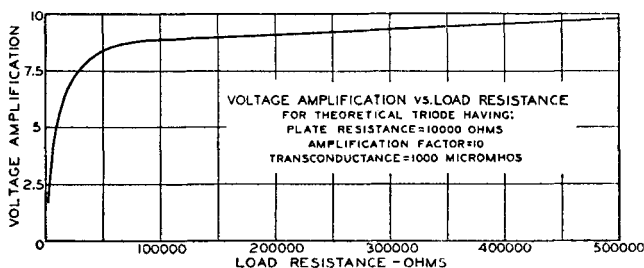

Fig. 15

to use a plate resistor and a grid resistor of large resistance. However, the plate resistor should not be too large because the flow of plate current through the plate resistor produces a voltage drop which reduces the plate voltage applied to the tube. If the plate resistor is too large, this drop will be too large, the plate voltage on the tube will be too small and the voltage output of the tube will be too small. Also, the grid resistor of the following stage should not be too large, the actual maximum value being dependent on the particular tube type. A higher value of grid resistance is permissible when cathode bias is used than when fixed bias is used. When cathode bias is used, a loss in bias due to grid-emission effects is nearly completely offset by an increase in bias due to the voltage drop across the cathode resistor. The recommended values of plate resistor and grid resistor for the tube types used in resistance-coupled circuits, and the values of gain obtainable, are shown in the RESISTANCE-COUPLED AMPLIFIER SECTION.

The input impedance of a radio tube, that is, the impedance between grid and cathode, consists of (1) the capacitance between grid and cathode, (2) a resistance component resulting from the time of transit of electrons between cathode and grid, and (3) a resistance component developed by the part of the cathode lead inductance which is common to both the input and output circuits. Components (2) and (3) are dependent on the frequency of the incoming signal. The input impedance is very high at audio frequencies when a tube is operated with its grid biased negative. Hence, in a class A_1 or class AB_1 transformer-coupled audio amplifier, the loading imposed by the grid on the input transformer is negligible. The secondary impedance of a class A_1 or class AB_1 input transformer can, therefore, be made very high since the choice is not limited by the input impedance of the tube; however, transformer design considerations may limit the choice. At the higher radio frequencies, the input impedance may become very low even when the grid is negative, due to the finite time of passage of electrons between cathode and plate and to the appreciable lead reactance. This impedance drops very rapidly as the frequency is raised and increases input-circuit loading. In fact, the input impedance may become low enough at very high radio frequencies to affect appreciably the gain and selectivity of a preceding stage. Tubes such as the Acorn* types have been developed to have low input capacitances, low electron transit time and low lead inductance so that their input impedance is high even at the ultra-high radio frequencies.

A super-control amplifier tube is a modified construction of a pentode or a tetrode type and is designed to reduce modulation-distortion and cross-modulation in radio-frequency stages. Cross-modulation is the effect produced in a radio receiver by an interfering station "riding through" on the carrier of the station to which the receiver is tuned. Modulation-distortion is a distortion of the modulated carrier and appears as audio-frequency distortion in the output. This effect is produced by a radio-frequency amplifier stage operating on an excessively curved

* Registered Trademark.

characteristic when the grid bias has been increased to reduce volume. The offending stage for cross-modulation is usually the first radio-frequency amplifier, while for modulation-distortion, the cause is usually the last intermediate-frequency stage.

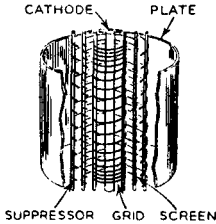

Fig. 16

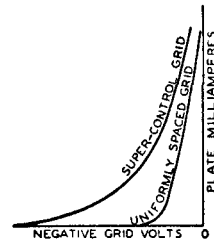

Fig. 17

The characteristics of super-control types are such as to enable the tube to handle both large and small input signals with minimum distortion over a wide range. A cross-section of the structure of a 6K7, a typical super-control pentode, is shown in Fig. 16. The super-control action is due to the structure of the grid which provides a variation in amplification factor with change in grid bias. The grid is wound with coarse spacing at the middle and with close spacing at the ends. When weak signals and low grid bias are applied to the tube, the effect of the non-uniform turn spacing of the grid on cathode emission and tube characteristics is essentially the same as for uniform spacing. As the grid bias is made more negative to handle larger input signals, the electron flow from the sections of the cathode enclosed by the ends of the grid is cut off. The plate current and other tube characteristics are then dependent on the electron flow through the coarse section of the grid. This action changes the gain of the tube so that large signals may be handled with minimum distortion due to cross-modulation and modulation distortion. Fig. 17 shows a typical plate-current vs. grid-voltage curve for a super-control type compared with the curve for a type having a uniformly spaced grid. It will be noted that while the curves are similar at small grid-bias voltages, the plate current of the super-control tube drops quite slowly with large values of bias voltage. This slow change makes it possible for the tube to handle large signals satisfactorily. Since super-control types can accommodate large and small signals, they are particularly suitable for use in sets having automatic volume control. Super-control tubes also are known as remote cut-off types.

As a class A power amplifier, a radio tube is used in the output stage of radio receivers to supply relatively large amounts of power to the loudspeaker. For this application, large power output is of much greater importance than high-voltage amplification, so that gain possibilities are sacrificed in the design of power tubes to obtain power-handling capability. Power tubes of the triode type in class A service are characterized by low power sensitivity, low plate-power efficiency, and low distortion. Power tubes of the pentode type are characterized by high power sensitivity, high plate-power efficiency, and relatively high distortion. Beam power tubes such as the 6L6 have a still higher power sensitivity and efficiency and have a higher power output capability than triode or conventional pentode types.

A class A power amplifier is also used as a driver to supply power to a class AB or a class B output stage. It is usually advisable to use a triode type, rather than a pentode, in a driver stage because of the lower distortion of the triode.

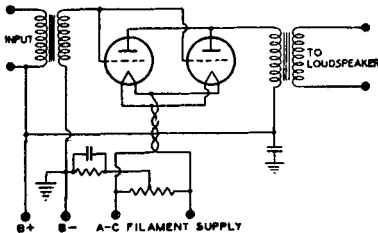

Fig. 18

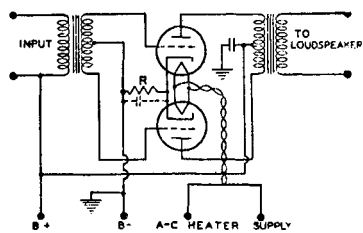

Fig. 19

Either push-pull or parallel operation of power tubes may be employed with class A amplifiers to obtain increased output. The parallel connection (Fig. 18) provides twice the output of a single tube with the same value of grid-signal voltage. The push-pull connection (Fig. 19) requires twice the input-signal voltage, but has, in addition to an increase in power, a number of important advantages over single-tube operation. Distortion due to even-order harmonics and hum due to plate-supply-voltage fluctuations are either eliminated or decidedly reduced through cancellation. Since distortion is less than for single-tube operation, appreciably more than twice single-tube output can be obtained by decreasing the load resistance. Should oscillations occur in the push-pull or parallel stages, they can often be eliminated by connecting a non-inductive resistor of approximately 500 ohms in series with each grid lead at the tube socket.

Operation of power tubes so that the grids run positive is inadvisable except under conditions such as are discussed later in this section for class AB and class B amplifiers.

Power output for triodes as single-tube class A amplifiers can be calculated without serious error from the plate family of curves by assuming a resistance load. The proper plate current, grid bias, and optimum load resistance, as well as the per cent second-harmonic distortion, can also be determined. The calculations are made graphically and are illustrated by Fig. 20 for given conditions. The procedure is as follows: Draw a straight line XY through the points P and X on the plate family of curves. P is known as the zero-signal bias point and may readily be located by determining the zero-signal bias, E_c , from the following formula:

$$\text{Zero-signal bias (P)} = \frac{0.68 \times E_b}{\mu}$$

where E_b is the chosen value of d-c plate voltage at which the tube is to be operated and μ is the amplification factor of the tube. X is a point on the d-c bias curve at zero volts and is determined by the value of the maximum-signal plate current, $I_{\text{max.}}$, which is equal to twice the zero-signal plate current, or $2I_0$. In the case of filament types of tubes, the calculations are given on the basis of a d-c operated filament. When, however the filament is a-c operated, the calculated value of d-c bias should be increased by approximately one half the filament-voltage rating of the tube.

Line XY is known as the load resistance line. Its slope corresponds to the value of the load resistance. The load resistance in ohms is equal to $(E_{\text{max.}} - E_{\text{min.}})$ divided by $(I_{\text{max.}} - I_{\text{min.}})$, where E is in volts and I in amperes.

For power output calculations, it is assumed that the peak alternating grid voltage is sufficient (1) to swing the grid from the zero-signal bias value to zero bias on the positive swing and (2) to a value twice the zero-signal bias value on the negative swing. During the positive swing, the plate voltage and plate current reach values of $E_{\text{min.}}$ and $I_{\text{max.}}$; during the negative swing, they reach values of $E_{\text{max.}}$ and $I_{\text{min.}}$. Since power is the product of voltage and current, the average power output, as indicated by a wattmeter, is given by

$$\text{Power output} = \frac{(I_{\text{max.}} - I_{\text{min.}})(E_{\text{max.}} - E_{\text{min.}})}{8}$$

where E is in volts, I in amperes, and power output in watts.

In the output of a power amplifier triode, some distortion is present. This distortion is predominately second-harmonic in single-tube amplifiers. The percentage of second-harmonic distortion may be calculated by the following formula:

$$\% \text{ 2nd harmonic distortion} = \frac{I_{\text{max.}} + I_{\text{min.}} - I_0}{2(I_{\text{max.}} - I_{\text{min.}})} \times 100$$

where I_0 is the zero-signal plate current in amperes.

Example: Determine the load resistance and undistorted power output of a triode operated at 250 volts on the plate, given its amplification factor of 3.5 and its plate characteristics curves as shown in Fig. 20.

Procedure: Draw the load line XY through the operating point (P) and the zero d-c grid bias point (X)

$$P = \frac{0.68 \times 250}{3.5}, \text{ or } -48.5 \text{ volts}$$

$$X = 2 \times 0.0335, \text{ or } 0.067 \text{ amperes}$$

By substituting the curve values in the power output formula, we find

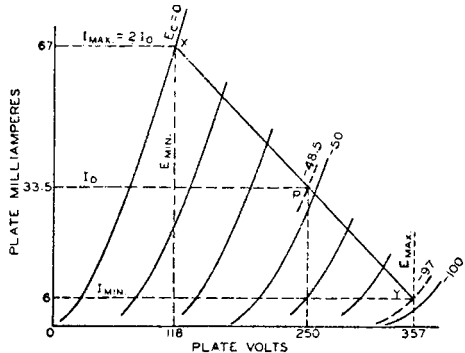

Fig. 20

$$\text{Power output} = \frac{(0.067 - 0.006) (357 - 118)}{8} = 1.8 \text{ watts}$$

The resistance of the load line XY is

$$\frac{357 - 118}{0.067 - 0.006}, \text{ or } 3920 \text{ ohms}$$

If now, the values from the curves are substituted in the distortion formula, we have

$$\text{2nd harmonic distortion} = \frac{\frac{0.067 + 0.006}{2} - 0.0335}{0.067 - 0.006} \times 100 = 4.9\%$$

It is customary to make the selection of load resistance such that the distortion as calculated from the above equation does not exceed 5 per cent. When the method shown above is used to determine the slope of the load resistance line, 2nd harmonic distortion in the output of a triode power amplifier is generally less than 5 per cent. Ordinarily, the plate load resistance for a single-tube amplifier is approximately equal to twice the plate resistance.

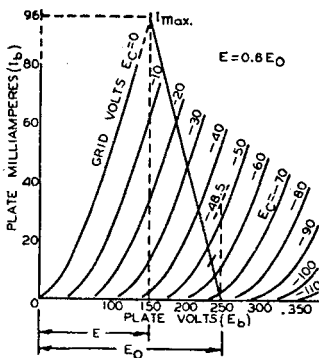

Fig. 21

Power output for triodes in push-pull power amplifiers may be determined by means of the plate family, given E_o as the desired operating plate voltage. The method is to erect a vertical line at $E = 0.6 E_o$ (see Fig. 21), intersecting the $E_c = 0$ curve at the point I_{max} . This establishes I_{max} . Then,

$$\text{Power output} = \frac{I_{max} \times E_o}{5}$$

If I_{max} is expressed in amperes and E_o in volts, power output is in watts.

Fig. 21 illustrates the application of this method to the case of two type 45's operated at $E_o = 250$ volts.

$$\text{Power output} = \frac{0.096 \times 250}{5} = 4.8 \text{ watts}$$

The method for determining the proper load resistance for triodes in push-pull is as follows: Draw a load line through I_{max} and through the E_o point on the zero-current axis. Four times the resistance represented by this load line is the

The conversion curves given in Fig. 23 apply to radio tubes in general but are particularly useful for power tubes. These curves can be used for calculating approximate operating conditions for a plate voltage which is not included in the published data on operating conditions. For instance, suppose it is desired to operate two 6L6's in class A₁ push-pull, fixed bias, with a plate voltage of 200 volts. The nearest published operating conditions for this class of service are for a plate voltage of 250 volts. The operating conditions for the new plate voltage can be determined as follows: First compute the ratio of the new plate voltage to the plate voltage of the published data. In the example, this ratio is $200/250 = 0.8$. This figure is the Voltage Conversion Factor, F_v . Multiply by this factor to obtain the new values of grid bias and screen voltage. This gives a grid bias of $-16 \times 0.8 = -12.8$ volts, and a screen voltage of $250 \times 0.8 = 200$ volts for the new conditions.

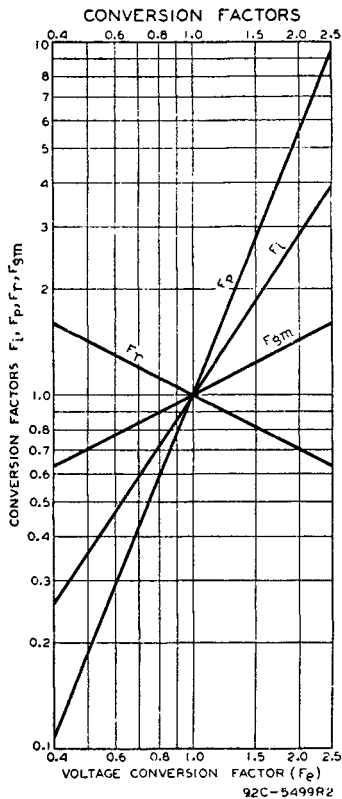

Fig. 23

To obtain the rest of the new conditions, multiply the published values by factors shown on the chart as corresponding to a voltage conversion factor of 0.8. In this chart,

F_i applies to plate current and to screen current,

F_p applies to power output,

F_r applies to load resistance and plate resistance,

F_{gm} applies to transconductance.

Thus, to find the power output for the new conditions, determine the value of F_p for a voltage conversion factor of 0.8. The chart shows that this value of F_p is 0.6. Multiplying the published value of power output by 0.6, the power output for the new conditions is $14.5 \times 0.6 = 8.7$ watts.

A class AB power amplifier employs two tubes connected in push-pull with a higher negative grid bias than is used in a class A stage. With this higher negative bias, the plate and screen voltages can usually be made higher than for class A because the increased negative bias holds plate current within the limit of the tube's plate dissipation rating. As a result of these higher voltages, more power output can be obtained from class AB operation.

Class AB amplifiers are subdivided into class AB₁ and class AB₂. In class AB₁ there is no flow of grid current. That is, the peak signal voltage applied to each grid is not greater than the negative grid-bias voltage. The grids therefore are not driven to a positive potential and do not draw grid current. In class AB₂, the peak signal voltage is greater than the bias so that the grids are driven positive and draw grid current.

Because of the flow of grid current in a class AB₂ stage there is a loss of power in the grid circuit. The sum of this loss and the loss in the input transformer is the total driving power required by the grid circuit. The driver stage should be capable of a power output considerably larger than this required power in order that distortion introduced in the grid circuit be kept low. The input transformer used in a class AB₂ amplifier usually has a step-down turns ratio.

Because of the large fluctuations of plate current in a class AB₂ stage, it is important that the power supply should have good regulation. Otherwise the fluctuations in plate current cause fluctuations in the voltage output of the power supply, with the result that power output is decreased and distortion is increased. To obtain satisfactory regulation it is usually advisable to use a choke-input filter.

It is sometimes advisable to use a mercury-vapor rectifier tube rather than a vacuum type because of the better regulation of the mercury-vapor type. In all cases, the resistance of the filter chokes and power transformer should be as low as possible.

A class B power amplifier employs two tubes connected in push-pull, so biased that plate current is almost zero when no signal voltage is applied to the grids. Because of this low value of no-signal plate current, class B amplification has the same advantage as class AB, that large power output can be obtained without excessive plate dissipation. The difference between class B and class AB is that, in class B, plate current is cut off for a larger portion of the negative grid swing.

There are several tube types designed especially for class B amplification. The characteristic common to all these types is high amplification factor. With this high amplification factor, plate current is small when grid voltage is zero. These tubes, therefore, can be operated in class B at a bias of zero volts so that a bias supply is not required. A number of the class B amplifier tube types consist of two triode units mounted in one tube. The two triode units can be connected in push-pull so that only one tube is required for a class B stage. Examples of class B twin triode types are the 6N7, 6A6, and 1G6-G.

Because a class B amplifier is usually operated at zero bias, each grid is at a positive potential during the positive half-cycle of its signal swing and consequently draws considerable grid current. There is, therefore, a loss of power in the grid circuit. This imposes the same requirement on the driver stage as in a class AB₂ stage; that is, the driver should be capable of considerably more power output than the power required for the class B grid circuit in order that distortion be low. The interstage transformer between the driver and class B stage usually has a step-down turns ratio.

The fluctuations in plate current in a class B stage are large so that it is important that the power supply have good regulation. The discussion of the power supply for a class AB₂ stage, therefore, also applies to the power supply for a class B amplifier.

An inverse-feedback circuit, sometimes called a degenerative circuit, is one in which a portion of the output voltage of a tube is applied to the input of the same or a preceding tube in opposite phase to the signal applied to the tube. Two important advantages of feedback are: (1) reduced distortion from each stage included in the feedback circuit and (2) reduction in the variations in gain due to changes in line voltage, possible differences between tubes of the same type, or variations in the values of circuit constants included in the feedback circuit.

Inverse feedback is used in audio amplifiers to reduce distortion in the output stage where the load impedance on the tube is a loudspeaker. Because the impedance of a loudspeaker is not constant for all audio frequencies, the load impedance on the output tube varies with frequency. When the output tube is a pentode or beam power tube having high plate resistance, this variation in plate load impedance can, if not corrected, produce considerable frequency distortion. Such frequency distortion can be reduced by means of inverse feedback. Inverse feedback circuits are of the constant voltage type and the constant-current type.

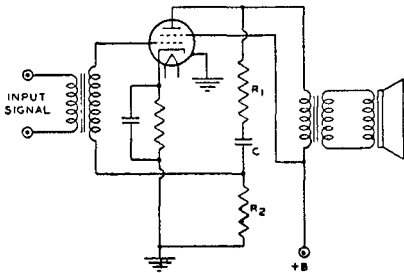

Fig. 24

The application of the constant voltage type of inverse feedback to a power output stage using a single beam power tube is illustrated by Fig. 24. In this circuit, R_1 , R_2 , and C are connected across the output of the 6L6 as a voltage divider. The secondary of the grid-input transformer is returned to a point on this voltage divider. Condenser C blocks the d-c plate voltage from the grid. However, a portion of the tube's a-f output voltage, approximately equal to the output voltage multiplied by the fraction $R_2/(R_1 + R_2)$, is applied

to the grid. There results a decrease in distortion which can be explained by the curves of Fig. 25.

Consider first the amplifier without the use of inverse feedback. Suppose that when a signal voltage e_s is applied to the grid the a-f plate current i'_p has an irregularity in its positive half-cycle. This irregularity represents a departure from the waveform of the input signal and is, therefore, distortion. For this plate-current waveform, the a-f plate voltage has a waveform shown by e'_p . The plate-voltage waveform is inverted compared to the plate-current waveform because a plate-current increase produces an increase in the drop across the plate load. The voltage at the plate is the difference between the drop across the load and the supply voltage; thus, when plate current goes up, plate voltage goes down; when plate current goes down, plate voltage goes up.

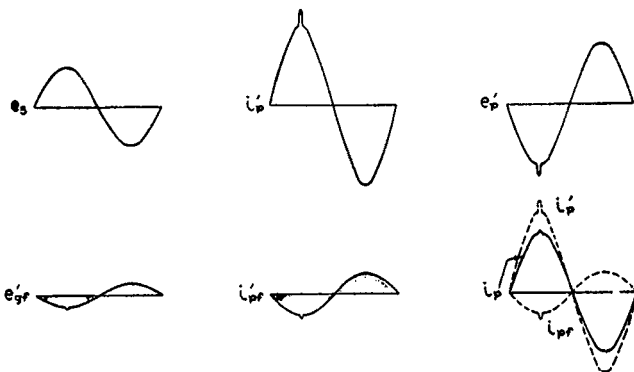

Fig. 25

Now suppose that inverse feedback is applied to the amplifier. The distortion irregularity in plate current is corrected in the following manner. With an inverse feedback arrangement, the voltage fed back to the grid has the same waveform and phase as the plate voltage, but is smaller in magnitude. Hence, with a plate voltage of waveform shown by e'_p , the feed-back voltage appearing on the grid is as shown by e'_{gf} . This voltage applied to the grid produces a component of plate current i'_{pf} . It is evident that the irregularity in the waveform of this component of plate current would act to cancel the original irregularity and thus reduce distortion.

After the correction of distortion has been applied by inverse feedback, the relations are as shown in the curve for i_p . The dotted curve shown by i'_{pf} is the component of plate current due to the feedback voltage on the grid. The dotted curve shown by $i'_{p'}$ is the component of plate current due to the signal voltage on the grid. The algebraic sum of these two components gives the resultant plate current shown by the solid curve of i_p . Since i'_p is the plate current that would flow without inverse feedback, it can be seen that the application of inverse feedback has reduced the irregularity in the output current. In this manner, inverse feedback acts to correct any component of plate current that does not correspond to the input signal voltage, and thus reduces distortion.

From the curve for i_p , it can be seen that, besides reducing distortion, inverse feedback also reduces the amplitude of the output current. Consequently, when inverse feedback is applied to an amplifier there is a decrease in power output as well as a decrease in distortion. However, by means of an increase in signal voltage, the power output can be brought back to its full value. Hence, the application of inverse feedback to an amplifier requires that more driving voltage be applied to obtain full power output but this output is obtained with less distortion.

Inverse feedback may also be applied to resistance-coupled stages as shown in Fig. 26. The circuit is conventional except that a feedback resistor, R_f , is connected between the plates of tubes T_1 and T_2 . The output signal voltage of T_1 and a portion of the output signal voltage of T_2 appears across R_f . Because the distortion generated in the plate circuit of T_2 is applied to its grid out of phase with the input signal, the distortion in the output of T_2 is comparatively low. With sufficient inverse feedback of the constant-voltage type in a power-output stage, it is not necessary to employ a network of resistance and capacitance in the

a very large volume range. For instance, in the music of a symphony orchestra, the sound intensity of the loud passages is very much higher than that of the soft passages. When this music is recorded, it is not feasible to make the ratio of maximum amplitude to minimum amplitude as large on the record as it is in the original music. The recording process is therefore monitored so that the volume range of the original is compressed on the record. To compensate for this compression, a volume-expander amplifier has a variable gain which is greater for a high-amplitude signal than for a low-amplitude signal. The volume expander therefore amplifies loud passages more than soft passages and thus can restore to the music reproduced from the record the volume range of the original.

A volume expander circuit is shown in Fig. 27. The action of this circuit depends on the fact that the gain of the 6L7 as an audio amplifier can be varied by variation of the bias on the No. 3 grid. When the bias on the No. 3 grid is made less negative, the gain of the 6L7 increases. In the circuit, the signal to be amplified is applied to the No. 1 grid of the 6L7 and is amplified by the 6L7. The signal is also applied to the grid of the 6C5, is amplified by the 6C5, and is rectified by the 6H6. The rectified voltage developed across R8, the load resistor of the 6H6, is applied as a positive bias voltage to the No. 3 grid of the 6L7. Then, when the amplitude of the signal input increases, the voltage across R8 increases, and the bias on the No. 3 grid of the 6L7 is made less negative. Because this increases the gain of the 6L7, the gain of the amplifier increases with increase in signal amplitude and thus produces volume expansion of the signal.

The No. 1 grid of the 6L7 is a variable-mu grid and therefore will produce distortion if the input signal voltage is too large. For that reason, the signal input to the 6L7 should not exceed a peak value of 1 volt. This value is of the same order as the voltage obtainable from the usual magnetic phonograph pick-up. The no-signal bias voltage on the No. 3 grid is controlled by adjustment of contact P. This contact should be adjusted initially to give a no-signal plate current of 0.15 milliamperes in the 6L7. No further adjustment of contact P is required if the same 6L7 is always used. If it is desired to delay volume expansion until the signal input reaches a certain amplitude, the delay voltage can be inserted as a negative bias on the 6H6 plates at the point marked X in the diagram.

Another circuit using volume expansion is shown in CIRCUIT SECTION. This circuit can also be used to provide volume compression for microphone operation. Volume compression prevents overloading and blasting and compensates for differences in voice level produced by movements of the speaker at the microphone. In this circuit the 6H6 is connected as a voltage doubler. The d-c output is applied across potentiometer R₂₁. The arm and one side of R₂₁ is connected to the d.p.d.t. switch S₂ to permit reversing of the polarity of the voltage taken from R₂₁. The amount of d-c voltage across R₂₂ is dependent on the average signal level. When the level tends to increase, the voltage across R₂₂ increases; when the level decreases, the voltage decreases. The voltage taken from R₂₂ is applied in series with the control-bias of the master mixer tube. When the switch is set to "expand," the voltage becomes opposite in polarity to the bias of the tube. This lowers the bias and increases the amplification factor of the tube. When the switch is set to "compress," the two voltages are additive. The negative bias is, therefore, increased and the amplification factor is decreased.

A phase inverter is a circuit used to provide resistance coupling between the output of a single-tube stage and the input of a push-pull stage. The necessity for a phase inverter arises because the signal-voltage inputs to the grids of a push-pull stage must be 180 degrees out of phase and approximately equal in amplitude with respect to each other. Thus, when the signal voltage input to a push-pull stage swings the control grid of one tube in a positive direction, it should swing the other grid in a negative direction by a similar amount. With transformer coupling between stages, the out-of-phase input voltage to the push-pull stage is supplied by means of the center-tapped secondary. With resistance coupling, the out-of-phase input voltage is obtained by means of the inverter action of a tube.

Fig. 28 shows a push-pull power amplifier, resistance-coupled by means of a phase-inverter circuit to a single-stage triode T₁. Phase inversion in this circuit

a very large volume range. For instance, in the music of a symphony orchestra, the sound intensity of the loud passages is very much higher than that of the soft passages. When this music is recorded, it is not feasible to make the ratio of maximum amplitude to minimum amplitude as large on the record as it is in the original music. The recording process is therefore monitored so that the volume range of the original is compressed on the record. To compensate for this compression, a volume-expander amplifier has a variable gain which is greater for a high-amplitude signal than for a low-amplitude signal. The volume expander therefore amplifies loud passages more than soft passages and thus can restore to the music reproduced from the record the volume range of the original.

A volume expander circuit is shown in Fig. 27. The action of this circuit depends on the fact that the gain of the 6L7 as an audio amplifier can be varied by variation of the bias on the No. 3 grid. When the bias on the No. 3 grid is made less negative, the gain of the 6L7 increases. In the circuit, the signal to be amplified is applied to the No. 1 grid of the 6L7 and is amplified by the 6L7. The signal is also applied to the grid of the 6C5, is amplified by the 6C5, and is rectified by the 6H6. The rectified voltage developed across R8, the load resistor of the 6H6, is applied as a positive bias voltage to the No. 3 grid of the 6L7. Then, when the amplitude of the signal input increases, the voltage across R8 increases, and the bias on the No. 3 grid of the 6L7 is made less negative. Because this increases the gain of the 6L7, the gain of the amplifier increases with increase in signal amplitude and thus produces volume expansion of the signal.

The No. 1 grid of the 6L7 is a variable-mu grid and therefore will produce distortion if the input signal voltage is too large. For that reason, the signal input to the 6L7 should not exceed a peak value of 1 volt. This value is of the same order as the voltage obtainable from the usual magnetic phonograph pick-up. The no-signal bias voltage on the No. 3 grid is controlled by adjustment of contact P. This contact should be adjusted initially to give a no-signal plate current of 0.15 milliamperes in the 6L7. No further adjustment of contact P is required if the same 6L7 is always used. If it is desired to delay volume expansion until the signal input reaches a certain amplitude, the delay voltage can be inserted as a negative bias on the 6H6 plates at the point marked X in the diagram.

Another circuit using volume expansion is shown in CIRCUIT SECTION. This circuit can also be used to provide volume compression for microphone operation. Volume compression prevents overloading and blasting and compensates for differences in voice level produced by movements of the speaker at the microphone. In this circuit the 6H6 is connected as a voltage doubler. The d-c output is applied across potentiometer R₂₄. The arm and one side of R₂₄ is connected to the d.p.d.t. switch S₂ to permit reversing of the polarity of the voltage taken from R₂₄. The amount of d-c voltage across R₂₄ is dependent on the average signal level. When the level tends to increase, the voltage across R₂₄ increases; when the level decreases, the voltage decreases. The voltage taken from R₂₄ is applied in series with the control-bias of the master mixer tube. When the switch is set to "expand," the voltage becomes opposite in polarity to the bias of the tube. This lowers the bias and increases the amplification factor of the tube. When the switch is set to "compress," the two voltages are additive. The negative bias is, therefore, increased and the amplification factor is decreased.

A phase inverter is a circuit used to provide resistance coupling between the output of a single-tube stage and the input of a push-pull stage. The necessity for a phase inverter arises because the signal-voltage inputs to the grids of a push-pull stage must be 180 degrees out of phase and approximately equal in amplitude with respect to each other. Thus, when the signal voltage input to a push-pull stage swings the control grid of one tube in a positive direction, it should swing the other grid in a negative direction by a similar amount. With transformer coupling between stages, the out-of-phase input voltage to the push-pull stage is supplied by means of the center-tapped secondary. With resistance coupling, the out-of-phase input voltage is obtained by means of the inverter action of a tube.

Fig. 28 shows a push-pull power amplifier, resistance-coupled by means of a phase-inverter circuit to a single-stage triode T₁. Phase inversion in this circuit

example, when two full-wave rectifier tubes are connected in parallel, the plates of each tube are connected together and each tube acts as a half-wave rectifier. The allowable voltage and load conditions per tube are the same as for full-wave

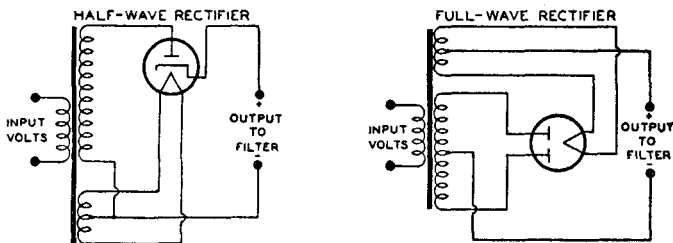

Fig. 30

service but the total load-handling capability of the complete rectifier is approximately doubled. When mercury-vapor rectifier tubes are connected in parallel, a stabilizing resistor of 50 to 100 ohms should be connected in series with each plate lead in order that each tube will carry an equal share of the load. The value of the resistor to be used will depend on the amount of plate current that passes through the rectifier. Low plate current requires a high value; high plate current, a low value. When the plates of mercury-vapor rectifier tubes are connected in parallel, the corresponding filament leads should be similarly connected. Otherwise the tube drops will be considerably unbalanced and larger stabilizing resistors will be required. Two or more high-vacuum rectifier tubes can also be connected in parallel to give correspondingly higher output current and, as a result of paralleling their internal resistances, give somewhat increased voltage output. With high-vacuum types stabilizing resistors may or may not be necessary depending on the tube type and the circuit.

A voltage-doubler circuit of simple form is shown in Fig. 31. The circuit derives its name from the fact that its d-c

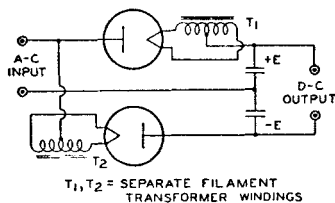
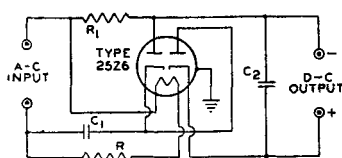
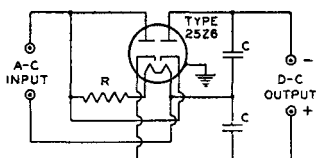

Fig. 31

the a-c input, when the upper side of the line is negative with respect to the lower side, the lower diode passes current so that a negative voltage builds up across the lower condenser. As long as no current is drawn at the output terminals from the condensers, each condenser can charge up to a voltage of magnitude E , the peak value of the a-c input. It can be seen from the diagram that with a voltage of $+E$ on one condenser and $-E$ on the other, the total voltage across the condensers is $2E$. Thus the voltage doubler supplies a no-load d-c output voltage twice as large as the peak a-c input voltage. When current is drawn at the output terminals by the load, the output voltage drops below $2E$ by an amount that depends on the magnitude of the load current and the capacitance of the condensers. The arrangement shown in Fig. 31 is called a full-wave voltage doubler because each rectifier passes current to the load on each half of the a-c input cycle.

Two rectifier types especially designed for use as voltage doublers are the metal 25Z6 and the glass 25Z5. These tubes combine two separate diodes in one tube. As voltage doublers, the tubes are used in "transformerless" receivers. In these receivers, the heaters of all tubes in the set are connected in series with a

voltage-dropping resistor across the line. The connections for the heater supply and the voltage-doubling circuit are shown in Figs. 32 and 33.



R = HEATERS OF OTHER TUBES IN SERIES WITH VOLTAGE-DROPPING RESISTOR
 R₁ = PROTECTIVE RESISTOR
 C, C₁, C₂ = CONDENSER

Fig. 32

Fig. 33

With the full-wave voltage doubler circuit in Fig. 32, it will be noted that the d-c load circuit can not be connected to ground or to one side of the a-c supply line. This presents certain disadvantages when the heaters of all the tubes in the set are connected in series with a resistance across the a-c line. Such a circuit arrangement may cause hum because of the high a-c potential between the heaters and cathodes of the tubes. The circuit in Fig. 33 overcomes this difficulty by making one side of the a-c line common with the negative side of the d-c load circuit. In this circuit, one half of the tube is used to charge a condenser which, on the following half cycle, discharges in series with the line voltage through the other half of the tube. This circuit is called a half-wave voltage doubler because rectified current flows to the load only on alternate halves of the a-c input cycle. The voltage regulation of this arrangement is somewhat poorer than that of the full-wave voltage doubler.

DETECTION

When speech or music is transmitted from a radio station, the station radiates a radio-frequency wave whose amplitude varies in accordance with the audio-frequency signal being transmitted. The r-f wave is said to be modulated by the a-f wave. The effect of modulation on the waveform of the r-f wave is shown in Fig. 34.

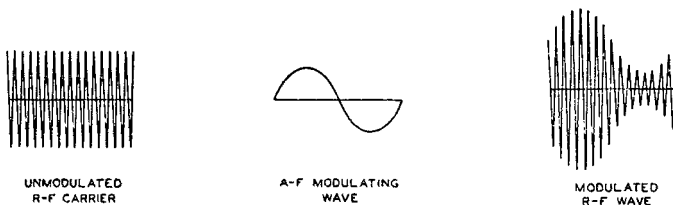

Fig. 34

In the receiver it is desired to reproduce the original a-f modulating wave from the modulating r-f wave. In other words, it is desired to demodulate the r-f wave. The receiver stage which performs this demodulation is called the demodulator or detector stage. There are three different detector circuits in general use, the diode detector, the grid-bias detector, and the grid-leak detector. These detector circuits are alike in that they eliminate, either partially or completely, alternate half-cycles of the r-f wave. With the alternate half-cycles eliminated, the audio variations of the other half of the r-f wave can be amplified to drive a loudspeaker or headphones.

A diode-detector circuit is shown in Fig. 35. The action of this circuit when a modulated r-f wave is applied is illustrated by Fig. 36. The r-f voltage applied to the circuit is shown in light line; the output voltage across condenser C is shown in heavy line. Between points (a) and (b) on the first positive half-cycle of the applied r-f voltage, condenser C charges up to the peak value of the r-f voltage.

Then as the applied r-f voltage falls away from its peak value, the condenser holds the cathode at a potential more positive than the voltage applied to the anode. The condenser thus temporarily cuts off current through the diode. While the diode current is cut off, the condenser discharges from (b) to (c) through the diode load resistor R. When the r-f voltage on the anode rises high enough to exceed the potential at which the condenser holds the cathode, current flows again and

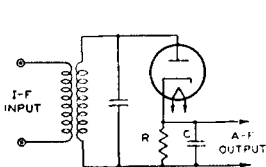

Fig. 35

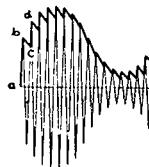

Fig. 36

the condenser charges up to the peak value of the second positive half-cycle at (d). In this way, the voltage across the condenser follows the peak value of the applied r-f voltage and reproduces the a-f modulation. The curve for voltage across the condenser, as drawn in Fig. 36, is somewhat jagged. However, this jaggedness, which represents an r-f component in the voltage across the condenser, is exaggerated in the drawing. In an actual circuit the r-f component of the voltage across the condenser is negligible. Hence, when the voltage across the condenser is amplified, the output of the amplifier reproduces the speech or music originating at the transmitting station.

Another way of understanding the action of a diode detector is to consider the circuit as a half-wave rectifier. When the r-f signal on the plate swings positive, the tube conducts and the rectified current flows through the load resistance R. Because the d-c output voltage of a rectifier depends on the voltage of the a-c input, the d-c voltage across C varies in accordance with the amplitude of the r-f carrier and thus reproduces the a-f signal. Condenser C should be large enough to smooth out r-f or i-f variations but should not be so large as to affect the audio variations. Two diodes can be connected in a circuit similar to a full-wave rectifier to give full-wave detection. However, in practice, the advantages of this connection generally do not justify the extra circuit complication.

The diode method of detection has the advantage over other methods in that it produces less distortion. The reason is that its dynamic characteristic can be made more linear than that of other detectors. It has the disadvantages that it does not amplify the signal, and that it draws current from the input circuit and therefore reduces the selectivity of the input circuit. However, because the diode method of detection produces less distortion and because it permits the use of simple AVC circuits without the necessity for an additional voltage supply, the diode method of detection is most widely used in broadcast receivers.

A typical diode-detector circuit using a duplex-diode triode tube is shown in Fig. 37. Both diodes are connected together. R₁ is the diode load resistor. A

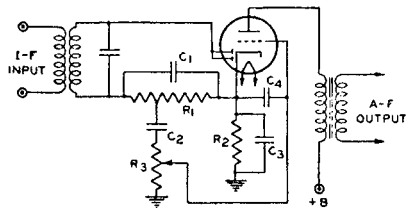

Fig. 37

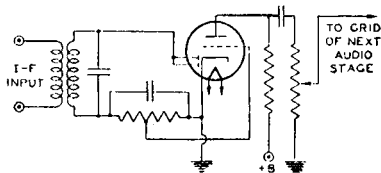

Fig. 38

portion of the a-f voltage developed across this resistor is applied to the triode grid through the volume control R₃. In a typical circuit, resistor R₁ may be tapped so that five-sixths of the total a-f voltage across R₁ is applied to the volume control.

This tapped connection reduces the a-f voltage output of the detector circuit slightly but it reduces audio distortion and improves the r-f filtering. D-c bias for the triode section is provided by the cathode-bias resistor R_1 and the audio by-pass condenser C_1 . The function of condenser C_2 is to block the d-c bias of the cathode from the grid. The function of condenser C_3 is to by-pass any r-f voltage on the grid to cathode. A duplex-diode pentode may also be used in this circuit. With a pentode, the a-f output should be resistance-coupled rather than transformer-coupled.

Another diode detector circuit, called a diode-biased circuit, is shown in Fig. 38. In this circuit, the triode grid is connected directly to a tap on the diode load resistor. When an r-f signal voltage is applied to the diode, the d-c voltage at the tap supplies bias to the triode grid. When the r-f signal is modulated, the a-f voltage at the tap is applied to the grid and is amplified by the triode. The advantage of this circuit over the self-biased arrangement shown in Fig. 37 is that the diode-biased circuit does not employ a condenser between the grid and the diode load resistor, and consequently does not produce as much distortion of a signal having a high percentage of modulation.

However, there are restrictions on the use of the diode-biased circuit. Because the bias voltage on the triode depends on the average amplitude of the r-f voltage applied to the diode, the average amplitude of the voltage applied to the diode should be constant for all values of signal strength at the antenna. Otherwise there will be different values of bias on the triode grid for different signal strengths and the triode will produce distortion. Since there is no bias applied to the diode-biased triode when no r-f voltage is applied to the diode, sufficient resistance should be included in the plate circuit of the triode to limit its zero-bias plate current to a safe value. These restrictions mean, in practice, that the receiver should have a separate-channel avc system. With such an avc system, the average amplitude of the signal voltage applied to the diode can be held within very close limits for all values of signal strength at the antenna. The tube used in a diode-biased circuit should be one which operates at a fairly large value of bias voltage. The variations in bias voltage are then a small percentage of the total bias and hence produce small distortion. Tubes taking a fairly large bias voltage are types such as the 6R7 or 1H6-G having a medium- μ triode. Tube types having a high- μ triode or a pentode should not be used in a diode-biased circuit.

A grid-bias detector circuit is shown in Fig. 39. In this circuit, the grid is biased almost to cut-off, i.e., operated so that the plate current with zero signal is practically zero. The bias voltage can be obtained from a cathode-bias resistor, a C battery, or a bleeder tap. Because of the high negative bias, only the positive half cycles of the r-f signal are amplified by the tube. The signal is, therefore, detected in the plate circuit. The advantages of this method of detection are that it amplifies the signal, besides detecting it, and that it does not draw current from the input circuit and therefore does not lower the selectivity of the input circuit.

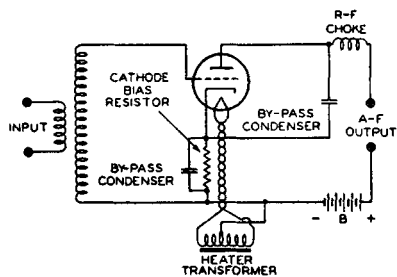

Fig. 39

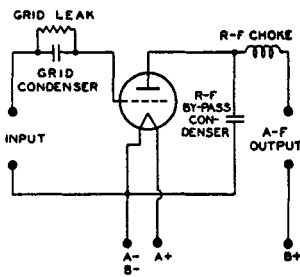

Fig. 40

The grid-leak and condenser method, illustrated by Fig. 40, is somewhat more sensitive than the grid-bias method and gives its best results on weak signals. In this circuit, there is no negative d-c bias voltage applied to the grid. Hence, on the positive half-cycles of the r-f signal, current flows from grid to cathode. The

grid and cathode thus act as a diode detector, with the grid-leak resistor as the diode load resistor and the grid condenser as the r-f by-pass condenser. The voltage across the condenser then reproduces the a-f modulation in the same manner as has been explained for the diode detector. This voltage appears between the grid and cathode and is therefore amplified in the plate circuit. The output voltage thus reproduces the original a-f signal.

In this detector circuit, the use of a high-resistance grid leak increases selectivity and sensitivity. However, improved a-f response and stability are obtained with lower values of grid-leak resistance. This detector circuit has the advantage that it amplifies the signal but has the disadvantage that it draws current from the input circuit and therefore lowers the selectivity of the input circuit.

AUTOMATIC VOLUME CONTROL

The chief purposes of automatic volume control in a receiver are to prevent fluctuations in loudspeaker volume when the signal at the antenna is fading in and out, and to prevent an unpleasant blast of loud volume when the set is tuned from a weak signal, for which the volume control has been turned up high, to a strong signal. To accomplish these purposes, an automatic volume control circuit regulates the receiver's r-f and i-f gain so that this gain is less for a strong signal than for a weak signal. In this way, when the signal strength at the antenna changes, the avc circuit reduces the resultant change in the voltage output of the last i-f stage and consequently reduces the change in the speaker's output volume.

The avc circuit reduces the r-f and i-f gain for a strong signal usually by increasing the negative bias of the r-f, i-f, and frequency-mixer stages when the signal increases. A simple avc circuit is shown in Fig. 41. On each positive half-cycle of the signal voltage, when the diode plate is positive with respect to the cathode, the diode passes current. Because of the flow of diode current through R_1 , there is a voltage drop across R_1 which makes the left end of R_1 negative with respect to ground. This voltage drop across R_1 is applied, through the filter R_2 and C , as negative bias on the grids of the preceding stages. Then, when the signal strength at the antenna increases, the signal applied to the avc diode increases, the voltage drop across R_1 increases, the negative bias voltage applied to the r-f and i-f stages increases, and the gain of the r-f and i-f stages is decreased. Thus the increase in signal strength at the antenna does not produce as much increase in the output of the last i-f stage as it would produce without avc. When the signal strength at the antenna decreases from a previous steady value, the avc circuit acts, of course, in the reverse direction, applying less negative bias, permitting the r-f and i-f gain to increase, and thus reducing the decrease in the signal output of the last i-f stage. In this way, when the signal strength at the antenna changes, the avc circuit acts to prevent change in the output of the last i-f stage, and thus acts to prevent change in loudspeaker volume.

The filter, C and R_2 , prevents the avc voltage from varying at audio frequency. The filter is necessary because the voltage drop across R_1 varies with the modulation of the carrier being received. If avc voltage were taken directly from R_1 without filtering, the audio variations in avc voltage would vary the receiver's gain so as to smooth out the modulation of the carrier. To avoid this effect, the avc voltage is taken from the condenser C . Because of the resistance R_1 in series with C , the condenser C can charge and discharge at only a comparatively slow rate. The avc voltage therefore cannot vary at frequencies

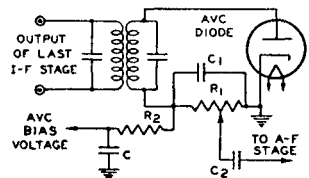

Fig. 41

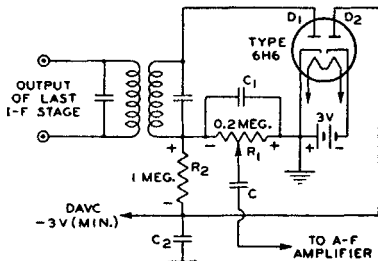

Fig. 42

as high as the audio range but can vary at frequencies high enough to compensate for most fading. Thus the filter permits the avc circuit to smooth out variations in signal due to fading, but prevents the circuit from smoothing out audio modulation.

It will be seen that an avc circuit and a diode detector circuit are much alike. It is therefore convenient in a receiver to combine the detector and the avc diode in a single stage. Examples of how these functions are combined in receivers are shown in CIRCUIT SECTION.

In the circuit shown in Fig. 41, a certain amount of avc negative bias is applied to the preceding stages on a weak signal. Since it may be desirable to maintain the receiver's r-f and i-f gain at the maximum possible value for a weak signal, avc circuits are designed in some cases to apply no avc bias until the signal strength exceeds a certain value. These avc circuits are known as delayed avc, or d-avc circuits. A d-avc circuit is shown in Fig. 42. In this circuit, the diode section D_1 of the 6H6 acts as detector and avc diode. R_1 is the diode load resistor and R_2 and C_2 are the avc filter. Because the cathode of diode D_2 is returned through a fixed supply of -3 volts to the cathode of D_1 , a d-c current flows through R_1 and R_2 in series with D_2 . The voltage drop caused by this current places the avc lead at approximately -3 volts (less the negligible drop through D_2). When the average amplitude of the rectified signal developed across R_1 does not exceed 3 volts, the avc lead remains at -3 volts. Hence, for signals not strong enough to develop 3 volts across R_1 , the bias applied to the controlled tubes stays constant at a value giving high sensitivity. However, when the average amplitude of rectified signal voltage across R_1 exceeds 3 volts, the plate of diode D_2 becomes more negative than the cathode of D_2 , and current flow in diode D_2 ceases. The potential of the avc lead is then controlled by the voltage developed across R_1 . Therefore, with further increase in signal strength, the avc circuit applies an increasing avc bias voltage to the controlled stages. In this way, the circuit regulates the receiver's gain for strong signals, but permits the gain to stay constant at a maximum value for weak signals.

It can be seen in Fig. 42 that a portion of the -3 volts delay voltage is applied to the plate of the detector diode D_1 , this portion being approximately equal to $R_1/(R_1 + R_2)$ times -3 volts. Hence, with the circuit constants as shown, the detector plate is made negative with respect to its cathode by approximately one-half volt. However, this voltage does not interfere with detection because it is not large enough to prevent current flow in the tube.

TUNING INDICATION WITH ELECTRON-RAY TUBES

Electron-ray tubes are designed to indicate visually by means of a fluorescent target the effects of a change in controlling voltage. They are widely used as tuning indicators in radio receivers. Types such as the 6U5/6G5 and the 6N5 contain

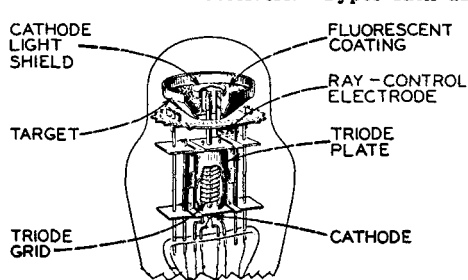

Fig. 43

two main parts: (1) a triode which operates as a d-c amplifier and (2) an electron-ray indicator which is located in the bulb as shown in Fig. 43. The target is operated at a positive voltage and therefore attracts electrons from the cathode. When the electrons strike the target they produce a glow on the fluorescent coating of the target. Under these conditions, the target appears as a ring of light.

A ray-control electrode is mounted between the cathode and target. When the potential of this electrode is less positive than the target, electrons flowing to the target are repelled by the electrostatic field of the electrode, and do not reach that portion of the target behind the electrode. Because the target does not glow where it is shielded from electrons, the control electrode casts a shadow on the glowing target. The extent of this shadow varies from approximately 100° of the target when the control

electrode is much more negative than the target to 0° when the control electrode is at approximately the same potential as the target.

In the application of the electron-ray tube, the potential of the control electrode is determined by the voltage on the grid of the triode section, as can be seen in Fig. 44. The flow of the triode plate current through resistor R produces a voltage drop which determines the potential of the control electrode. When the voltage of the triode grid changes in the positive direction, plate current increases, the potential of the control electrode goes down because of the increased drop across R, and the shadow angle widens. When the potential of the triode grid changes in the negative direction, the shadow angle narrows.

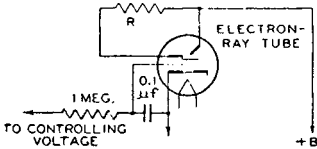

Fig. 44

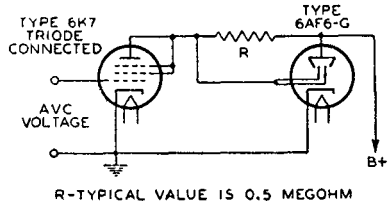

Fig. 45

Another type of indicator tube is the 6AF6-G. This tube contains only an indicator unit but employs two ray-control electrodes mounted on opposite sides of the cathode and connected to individual base pins. It employs an external d-c amplifier. See Fig. 45. Thus, two symmetrically opposite shadow angles may be obtained by connecting the two ray-control electrodes together, or, two unlike patterns may be obtained by individual connection of each ray-control electrode to its respective amplifier.

In radio-receivers, avc voltage is applied to the grid of the d-c amplifier. Since avc voltage is at maximum when the set is tuned to give maximum response to a station, the shadow angle is at minimum when the receiver is tuned to resonance with the desired station. The choice between electron-ray tubes depends on the avc characteristic of the receiver.

CIRCUIT FOR WIDE-ANGLE TUNING

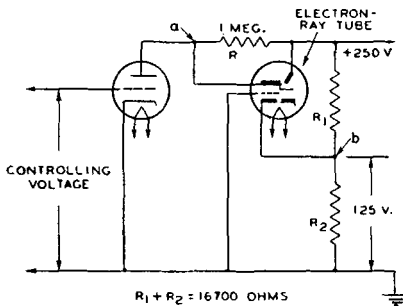

Fig. 46

The 6E5 contains a sharp cut-off triode which closes the shadow angle on a comparatively low value of avc voltage. The 6N5 and 6U5/6C5 each have a remote cut-off triode which closes the shadow on a larger value of avc voltage than the 6E5. The 6AF6-G may be used in conjunction with d-c amplifier tubes having either remote or sharp cut-off characteristics. Examples showing how electron-ray tubes are incorporated in receiver circuits are given in CIRCUIT SECTION.

The sensitivity indication of electron-ray tubes can be increased by using a separate d-c amplifier to control the action of the ray-control electrode in the tuning indicator tube. This arrangement increases the maximum shadow angle from the usual 100° to approximately 180°. A circuit for obtaining wide-angle tuning is shown in Fig. 46.

OSCILLATION

As an oscillator, a radio tube can be employed to generate a continuously alternating voltage. In present-day radio broadcast receivers, this application is limited practically to superheterodyne receivers for supplying the heterodyning

frequency. Several circuits (represented in Figs. 47 and 48) may be utilized, but they all depend on feeding more energy from the plate circuit to the grid circuit than is required to equal the power loss in the grid circuit. Feed-back may be

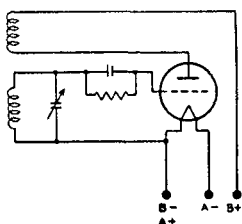

Fig. 47

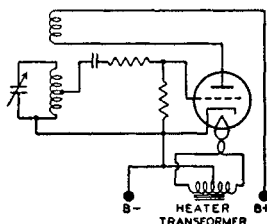

Fig. 48

produced by electrostatic or electromagnetic coupling between the grid and plate circuits. When sufficient energy is fed back to more than equal the loss in the grid circuit, the tube will oscillate. The action consists of regular surges of power between the plate and the grid circuit at a frequency dependent on the circuit constants of inductance and capacity. By proper choice of these values, the frequency may be adjusted over a very wide range.

FREQUENCY CONVERSION

Frequency conversion is used in superheterodyne receivers to change the frequency of the r-f signal to an intermediate frequency. To perform this change in frequency, a frequency-converting device consisting of an oscillator and a frequency mixer is employed. In such a device, shown diagrammatically in Fig. 49,

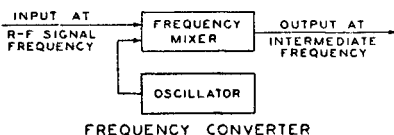

Fig. 49

two voltages of different frequency, the r-f signal voltage and the voltage generated by the oscillator, are applied to the input of the frequency mixer. These voltages beat, or heterodyne, within the mixer tube to produce a plate current having, in addition to the frequencies of the input voltages, numerous sum and difference frequencies. The output circuit of the mixer stage is provided with a tuned circuit which is adjusted to select only one beat frequency, i.e., the frequency equal to the difference between the signal frequency and the oscillator frequency. The selected output frequency is known as the intermediate frequency, or i.f. The output frequency of the mixer tube is kept constant for all values of signal frequency by tuning the oscillator to the proper frequency.

Important advantages gained in a receiver by the conversion of signal frequency to a fixed intermediate frequency are high selectivity with few tuning stages and a high, as well as stable, overall gain for the receiver.

Three methods of frequency conversion for superheterodyne receivers are of interest. These methods are alike in that they employ a frequency-mixer tube in which plate current is varied at a combination of the signal frequency and the oscillator frequency. These variations in plate current produce across the tuned plate load a voltage of the desired intermediate frequency. The three methods differ in the types of tubes employed and in the means of supplying input voltages to the mixer tube.

A method widely used before the availability of tubes especially designed for frequency-conversion service, employs as mixer tube either a triode, a tetrode, or a pentode, in which oscillator voltage and signal voltage are applied to the same grid. In this method, coupling between the oscillator and mixer circuits is obtained by means of inductance or capacitance.

The second method employs a tube having an oscillator and frequency mixer combined in the same envelope. In one form of such a tube, coupling between the two units is obtained by means of the electron stream within the tube. One arrangement of the electrodes for this type is shown in Fig. 50. Since five grids are used, the tube is called a pentagrid converter. Grids No. 1, No. 2 and the cathode are connected to an external circuit to act as a triode oscillator. Grid No. 1 is the grid of the oscillator and grid No. 2 is the anode. These and the cathode can be considered as a composite cathode which supplies to the rest of the tube an electron stream that varies at the oscillator frequency. This varying electron stream is further controlled by the r-f signal voltage on grid No. 4. Thus, the variations in plate current are due to the combination of the oscillator and the signal frequencies. The purpose of grids No. 3 and No. 5, which are connected together within the tube, is to accelerate the electron stream and to shield grid No. 4 electrostatically from the other electrodes. The 6A8 is an example of a pentagrid-converter type.

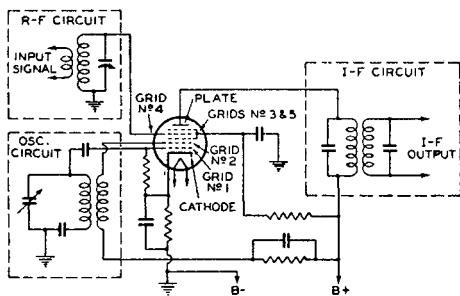

Fig. 50

Pentagrid-converter tubes of this design are good frequency-converting devices at medium frequencies but their performance is better at the lower frequencies than at the high ones. This is because the output of the oscillator drops off as the frequency is raised and because certain undesirable effects produced by interaction between oscillator and signal sections of the tube increase with frequency. To minimize these effects, several of the pentagrid converter tubes are designed so that no electrode functions alone as the oscillator anode. In these tubes, grid No. 1 functions as the oscillator grid, and grid No. 2 is connected within the tube to the screen (grid No. 4). The combined two grids No. 2 and 4 shield the signal grid (grid No. 3) and act as the composite anode of the oscillator triode. Grid No. 5 acts as the suppressor. Converter tubes of this type are designed so that the space charge around the cathode is unaffected by electrons from the signal grid. Furthermore, the electrostatic field of the signal grid also has little effect on the space charge. The result is that r-f voltage on the signal grid produces little effect on the cathode current. There is, therefore, little detuning of the oscillator by avc bias because changes in avc bias produce little change in oscillator transconductance or in the input capacitance of grid No. 1. Examples of the pentagrid converters discussed in this paragraph are the single-ended types 1R5 and 6SA7.

Another method of frequency conversion utilizes a separate oscillator having its grid connected to the No. 1 grid of a mixer hexode. A tube utilizing this construction is the 6K8 and a top view of its electrode arrangement is shown in Fig. 51. The cathode, triode grid No. 1, and triode plate form the oscillator unit of the tube.

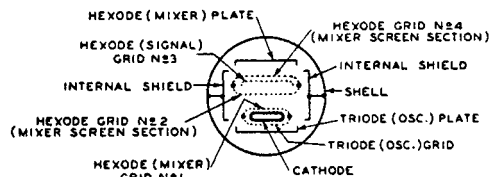

Fig. 51

The cathode, hexode mixer grid (grid No. 1), hexode double-screen (grids No. 2 and 4), hexode mixer grid (grid No. 3) and hexode plate constitute the mixer unit. The internal shields are connected to the shell of the tube and act as a suppressor for the hexode unit. The action of the 6K8 in converting a radio-frequency signal to an inter-

mediate frequency depends on (1) the generation of a local frequency by the triode unit, (2) the transferring of this frequency to the hexode grid No. 1, and (3) the mixing in the hexode unit of this frequency with that of the r-f signal applied to the hexode grid No. 3. The 6K8 is not critical to changes in oscillator-plate voltage

or signal-grid bias and, therefore, finds important use in all-wave receivers to minimize frequency-shift effects at the higher frequencies.

The third method of frequency conversion employs a tube particularly designed for short-wave reception. This tube, called a pentagrid mixer, has two independent control grids and is used with a separate oscillator tube.

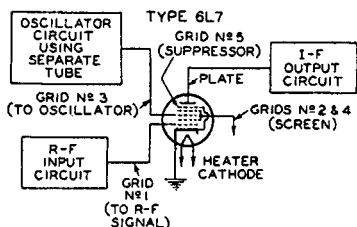

Fig. 52

R-F signal voltage is applied to one of the control grids and oscillator voltage is applied to the other. It follows, therefore, that the variations in plate current are due to the combination of the oscillator and signal frequencies. The arrangement of electrodes in a pentagrid-mixer tube is shown in Fig. 52. The tube contains a heater cathode, five grids, and a plate. Grids No. 1 and 3 are control grids. The r-f signal voltage is applied to grid No. 1. This grid has a remote cut-off characteristic and is suited for control by avc bias voltage. The oscillator voltage is applied to grid No. 3. This grid has a sharp cut-off characteristic and

produces a comparatively large effect on plate current for a small amount of oscillator voltage. Grids No. 2 and 4 are connected together within the tube. They accelerate the electron stream and shield grid No. 3 electrostatically from the other electrodes. Grid No. 5, connected within the tube to the cathode, functions similarly to the suppressor in a pentode. The 6L7 and 6L7-G are pentagrid-mixer tubes.

Radio Tube Installation

The installation of radio tubes requires care if high-quality performance is to be obtained from the associated radio circuits. Installation suggestions and precautions which are generally common to all types of tubes are covered in this section. Careful observance of these suggestions will do much in helping the experimenter and radio technician to obtain the full performance capabilities of radio tubes and circuits. Additional and pertinent information is given under each tube type and in the **CIRCUIT SECTION**.

FILAMENT AND HEATER POWER SUPPLY

The design of radio tubes allows for some variation in the voltage and current supplied to the filament or heater, but most satisfactory results are obtained from operation at the rated values. When the voltage is low, the temperature of the cathode is below normal, with the result that electron emission is limited. This may cause unsatisfactory operation and reduced tube life. On the other hand, high cathode voltage causes rapid evaporation of cathode material and shortens life. To insure proper tube operation, the filament or heater voltage should be checked at the socket terminals by means of an accurate voltmeter while the receiver is in operation. In the case of series operation of heaters or filaments, correct adjustment can be checked by means of an ammeter in the heater or filament circuit.

The filament or heater voltage supply may be a direct-current source (a battery or a d-c power line) or an alternating-current power line, depending on the type of service and type of tube. Frequently, a resistor (either variable or fixed) is used with a d-c supply to permit compensation for battery voltage variations or to adjust the tube voltage at the socket terminals to the correct value. Ordinarily, a step-down transformer is used with an a-c supply to provide the proper filament or heater voltage. Receivers intended for operation on both d-c and a-c power lines have the heaters connected in series with a suitable resistor and are supplied directly from the power line.

D-c filament or heater operation should be considered on the basis of the source of power. In the case of the battery supply for the new 1.4-volt filament tubes, it is unnecessary to use a voltage-dropping resistor in series with the filament and a single dry-cell; the filaments of these tubes are designed to operate satisfactorily over the range of voltage variations that normally occur during the life of a dry-cell. Likewise, no series resistor is required when the 2-volt filament type tubes are operated from a single storage cell or when the 6.3-volt series are operated from a 6-volt storage battery. In the case of dry-battery supply for 2-volt filament tubes, a variable resistor in series with the filament and the battery is required to compensate for battery variations. It is also recommended that an accurate voltmeter or milliammeter be permanently installed in the receiver to insure operation of the tubes at their rated filament voltage. Turning the set on and off by means of the rheostat is advised to prevent over-voltage conditions after an off-period, for the voltage of dry-cells rises during off-periods. In the case of storage-battery supply, air-cell-battery supply, or d-c power supply, a non-adjustable resistor of suitable value may be used. It is well to check initial operating conditions, and thus the resistor value, by means of a voltmeter or ammeter.

The filament or heater resistor required when filaments and/or heaters are operated in parallel can be determined easily by a simple formula derived from Ohm's law.

$$\text{Required resistance (ohms)} = \frac{\text{supply volts} - \text{rated volts of tube type}}{\text{total rated filament current (amperes)}}$$

Thus, if a receiver using three 32's, two 30's, and two 31's is to be operated from dry batteries, the series resistor is equal to 3 volts (the voltage from two dry cells in series) minus 2 volts (voltage rating for these tubes) divided by 0.56 ampere (the sum of 5×0.060 ampere + 2×0.130 ampere), i.e., approximately 1.8 ohms. Since this resistor should be variable to allow adjustment for battery depreciation, it is advisable to obtain the next larger commercial size, although any value between 2 and 3 ohms will be quite satisfactory. Where much power is dissipated in the resistor, the wattage rating should be sufficiently large to prevent overheating. The power dissipation in watts is equal to the voltage drop in the resistor multiplied by the total filament current in amperes. Thus, for the example above $1 \times 0.56 = 0.56$ watt. In this case, the value is so small that any commercial rheostat with suitable resistance will be adequate.

For the case where the heaters and/or filaments of several tubes are operated in series, the resistor value is calculated by the following formula, also derived from Ohm's law

$$\text{Required resistance (ohms)} = \frac{\text{supply volts} - \text{total rated volts of tubes}}{\text{rated amperes of tubes}}$$

Thus, if a receiver having one 6SA7, one 6SK7, one 6B8, one 25A6, and one 25Z6 is to be operated from a 117-volt power line, the series resistor is equal to 117 volts (the supply voltage) minus 68.9 volts (the sum of 3×6.3 volts + 2×25 volts) divided by 0.3 ampere (current rating of these tubes), i.e., approximately 160 ohms. The wattage dissipation in the resistor will be 117 volts minus 68.9 volts times 0.3 ampere, or approximately 14.4 watts. A resistor having a wattage rating in excess of this value should be chosen.

It will be noted in the example for series operation that all tubes have the same current rating. If it is desired to connect in series tubes having different heater- or filament-current ratings, each tube of the lower rating should have a shunt resistor placed across its heater or filament terminals to pass the excess current. The value of this shunt resistor can be calculated from the following formula, where tube A is the tube in the series connection having the highest heater current rating and tube B is any tube having a heater current rating lower than tube A.

$$\text{Heater shunt resistance (ohms), tube B} = \frac{\text{heater volts, tube B}}{\text{rated heater amperes, tube A} - \text{rated heater amperes, tube B}}$$

For example, if a 6A6 having a 6.3-volt, 0.8-ampere heater is to be operated in a series-heater circuit employing several 6.3-volt tubes having heater ratings of 0.3

ampere the required shunt resistance for each of the latter types would be

$$\text{Heater shunt resistance} = \frac{6.3}{0.8 - 0.3}, \text{ or } 12.6 \text{ ohms.}$$

The value of a series voltage-dropping resistor for a sequence of tubes having one or more shunt resistors should be calculated on the basis of the tube having the highest heater current rating.

When the series-heater connection is used in a-c/d-c receivers, it is usually advisable to arrange the heaters in the circuit so that the tubes most sensitive to hum disturbances are at or near the ground potential of the circuit. This arrangement reduces the amount of a-c voltage between the heaters and cathodes of these tubes and minimizes the hum output of the receiver. The order of heater connection, by tube function, from chassis to the rectifier-cathode side of the a-c line is shown in Fig. 53.

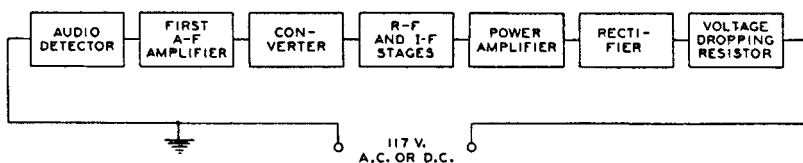

Fig. 53

A-c filament or heater operation should be considered on the basis of either a parallel or a series arrangement of filaments and/or heaters. In the case of the parallel arrangement, a step-down transformer is employed. Precautions should be taken to see that the line voltage is the same as that for which the primary of the transformer is designed. The line voltage may be determined by measurement with an a-c voltmeter (0-150 volts).

If the line voltage measures in excess of that for which the transformer is designed, a resistor should be placed in series with the primary to reduce the line voltage to the rated value of the transformer primary. Unless this is done, the excess input voltage will cause proportionally excessive voltage to be applied to the tubes. Any radio tube may be damaged or made inoperative by excessive operating voltages.

If the line voltage is consistently below that for which the primary of the transformer is designed, it may be necessary to install a booster transformer between the a-c outlet and the transformer primary. Before such a transformer is installed, the a-c line fluctuations should be very carefully noted. Some radio sets are equipped with a line-voltage switch which permits adjustment of the power transformer primary to the line voltage. When this switch is properly adjusted, the series-resistor or booster-transformer method of controlling line voltage is seldom required.

In the case of the series arrangements of filaments and/or heaters, a voltage-dropping resistance in series with the heaters and the supply line is usually required. This resistance should be of such value that, for normal line voltage, tubes will operate at their rated heater or filament current. The method for calculating the resistor value is given above.

HEATER-TO-CATHODE CONNECTION

The cathodes of heater-type tubes, when operated from a.c., should be connected either to the mid-tap on the heater-supply winding or to the mid-tap of a 50-ohm (approximate) resistor shunted across the winding. This practice follows the general recommendation that the potential difference between heater and cathode be kept low. In high-gain resistance-coupled circuits, it is suggested that the heater be made 10 volts positive with respect to the cathode in order to prevent emission from taking place from heater to cathode and producing hum. If a large resistor is used between heater and cathode, it should be by-passed by a suitable

filter network or objectionable hum may develop. The hum is due to the fact that even a minute pulsating leakage current flowing between the heater and cathode will develop a small voltage across any resistance in the circuit. This hum voltage is amplified by succeeding stages. When 6.3-volt heater-cathode types are operated from a storage battery, the cathodes are connected either directly or through biasing resistors to the negative battery terminal. When a series-heater arrangement is used, the cathode circuits should be connected either directly or through biasing resistors to the negative side of the d-c plate supply, which is furnished either by the d-c power line or by the a-c power line through a rectifier.

PLATE VOLTAGE SUPPLY

The plate voltage for radio tubes is obtained from batteries, devices for rectifying a.c., direct-current power lines, and small local generators. Auto radios have caused the commercial development of a number of devices for obtaining a high-voltage d-c supply either from the car storage-battery or from a generator driven by the car engine.

The maximum plate voltage value for any tube type should not be exceeded if most satisfactory performance is to be obtained. Plate voltage should not be applied to a tube unless the corresponding recommended grid voltage is also supplied to the grid.

It is recommended that the primary circuit of the power transformer be fused to protect the rectifier tube(s), the power transformer, filter condenser, and chokes in case a rectifier tube fails.

GRID VOLTAGE SUPPLY

The recommended grid voltages for different operating conditions have been carefully determined to give the most satisfactory performance. Grid voltage may be obtained from a separate C-battery, a tap on the voltage divider of the high-voltage d-c supply, or from the voltage drop across a resistor in the cathode circuit. This last is called the "cathode-bias," or "self-bias" method. In any case, the object is to make the grid negative with respect to the cathode by the specified voltage. When a C battery is used, the negative terminal is connected to the grid return and the positive terminal is connected to the negative filament socket terminal, or to the cathode terminal if the tube is of the heater-cathode type. If the filament is supplied with alternating current, this connection is usually made to the center-tap of a low resistance (20-50 ohms) shunted across the filament terminals. This method reduces hum disturbances caused by the a-c supply. If bias voltages are obtained from the voltage divider of a high-voltage d-c supply, the grid return is connected to a more negative tap than the cathode.

The cathode-biasing method utilizes the voltage drop produced by the cathode current flowing through a resistor connected between the cathode and the negative terminal of the B-supply. See Fig. 54. The cathode current is, of course, equal

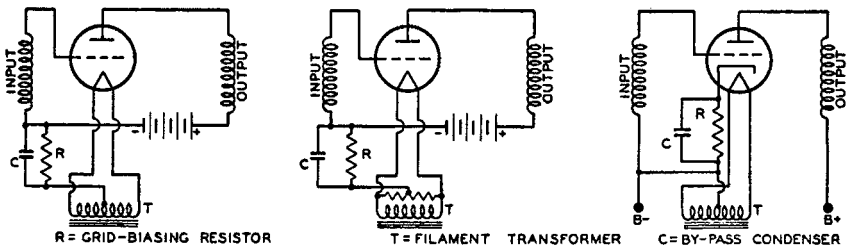

Fig. 54

to the plate current in the case of a triode, or to the sum of the plate and screen currents in the case of a tetrode, pentode, or beam power tube. Since the voltage drop along the resistance is increasingly negative with respect to the cathode, the required negative grid-bias voltage can be obtained by connecting the grid return to the negative end of the resistance.

The size of the resistance for cathode-biasing a single tube can be determined from the following formula:

$$\text{Resistance (ohms)} = \frac{\text{desired grid-bias voltage} \times 1000}{\text{rated cathode current in milliamperes}}$$

Thus, the resistance required to produce 9 volts bias for a triode which operates at 3 milliamperes plate current is $9 \times 1000/3 = 3000$ ohms. If the cathode current of more than one tube passes through the resistor, or if the tube or tubes employ more than three electrodes, the size of the resistor will be determined by the total current.

By-passing of the cathode-bias resistor depends on circuit design requirements. In r-f circuits the cathode resistor should always be by-passed. In a-f circuits the use of an unby-passed resistor will reduce distortion by introducing degeneration into the circuit. However, the use of an unby-passed resistor decreases power sensitivity. When by-passing is used, it is important that the by-pass condenser be sufficiently large to have negligible reactance at the lowest frequency to be amplified. In the case of power output tubes of high transconductance such as the beam power tubes, it may be necessary to shunt the bias resistor with a small mica condenser (approximately $0.001 \mu f$) in order to prevent oscillations. The usual a-f by-pass may or may not be used, depending on whether or not degeneration is desired. In tubes such as the 6AB7/1853 and 6AC7/1852 having a very high value of transconductance, there are appreciable changes of input capacitance and input conductance with plate current. In order to minimize such changes when a tube of this type is used as an r-f or i-f amplifier, a portion of the cathode-bias resistor may be left unby-passed. Additional information on this subject is given in the DATA SECTION under the 6AB7.

Grid-bias variation for the r-f and i-f amplifier stages is a convenient and frequently used method for controlling receiver volume. The variable voltage supplied to the grid may be obtained: (1) from a variable cathode resistor as shown in Figs. 55 and 56; (2) from a bleeder circuit by means of a potentiometer as shown in Fig. 57 or (3) from a bleeder circuit in which the bleeder current is varied by a tube used for automatic volume control. The latter circuit is shown in Fig. 41. In all cases it is important that the control be arranged so that at no time will the bias be less than the recommended grid-bias voltage for the particular tubes used. This requirement can be met by providing a fixed stop on the potentiometer, by connecting a fixed resistance in series with the variable resistance, or by connecting a fixed cathode resistance in series with the variable resistance used for regulation.

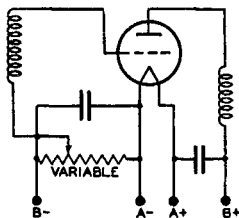

Fig. 55

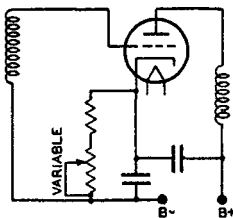

Fig. 56

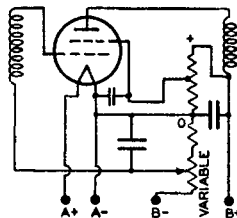

Fig. 57

Where receiver gain is controlled by grid-bias variation, it is advisable to have the control voltages extend over a wide range in order to minimize cross-modulation and modulation-distortion. A remote cut-off type of tube should, therefore, be used in the controlled stages.

SCREEN VOLTAGE SUPPLY

The positive screen voltage for pentodes and beam power tubes may conveniently be obtained from a high-voltage supply through a series resistor because tubes having suppressor action provide high uniformity of the screen-current

characteristic. Fig. 58 shows a pentode with its screen voltage supplied through a series resistor. The positive screen voltage for tetrodes (screen-grid tubes) should be obtained from a proper voltage tap or from a potentiometer connected across the B supply. It should not be obtained from a high-voltage supply through a series resistor because of the characteristic screen-current variations in tetrodes. Fig. 59 shows a tetrode with its screen voltage obtained from a potentiometer. It is important to note that the plate voltage for tetrodes or pentodes should be applied before or with the screen voltage. Otherwise, with voltage on the screen only, the screen current may rise high enough to cause excessive screen dissipation.

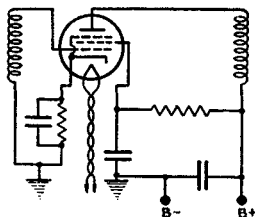

Fig. 58

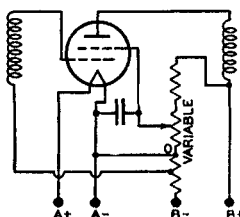

Fig. 59

Screen-voltage variation for the r-f amplifier stages has sometimes been used for volume control in older type receivers. Reduced screen voltage lowers the transconductance of the tube and results in decreased gain per stage. The voltage variation is obtained by means of a potentiometer shunted across the screen voltage supply. See Fig. 59. When the screen voltage is varied, it is essential that the screen voltage never exceed the rating of the tube. This requirement can be met by providing a fixed stop on the potentiometer.

SHIELDING

In high-frequency stages having high gain, the output circuit of each stage must be shielded from the input circuit of that stage. Each high-frequency stage also must be shielded from the other high-frequency stages. Unless shielding is employed, undesired feedback may occur and may produce many harmful effects on receiver performance. To prevent this feedback, it is a widely followed practice to shield separately each unit of the high-frequency stages. For instance, in a superheterodyne receiver, each i-f and r-f coil may be mounted in a separate shield can. Baffle plates may be mounted on the ganged tuning condenser to shield each section of the condenser from the other sections. The oscillator coil may be especially well-shielded by being mounted under the chassis. The shielding precautions required in a receiver depend on the design of the receiver and the layout of the parts. In all receivers having high-gain high-frequency stages, it is necessary to shield separately each tube in the high-frequency stages. When metal tubes, and in particular the single-ended types, are used, complete shielding of each tube is provided by the metal shell which is grounded through its grounding pin at the socket terminal. The grounding connection should be short and heavy.

FILTERS

Feed-back effects also are caused in radio receivers by coupling between stages through common voltage-supply circuits. Filters find an important use in minimizing such effects. They should be placed in voltage-supply leads to each tube in order to return the signal current through a low-impedance path direct to the tube cathode rather than by way of the voltage-supply circuit. Fig. 60 illustrates several forms of filter circuits. Condenser C forms the low-impedance path, while the choke or resistor assists in diverting the signal through the condenser by offering a high-impedance to the power-supply circuit.

The choice between a resistor and a choke depends chiefly upon the permissible d-c voltage drop through the filter. In circuits where the current is small (a few

milliamperes) resistors are practical; where the current is large, or regulation important, chokes are more suitable.

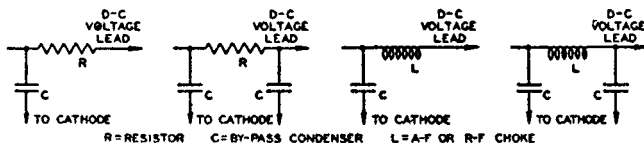

Fig. 60

The minimum practical size of the condensers may be estimated in most cases by the following rule: The impedance of the condenser at the lowest frequency amplified should not be more than one-fifth of the impedance of the filter choke or resistor at that frequency. Better results will be obtained in special cases if the ratio is not more than one-tenth. Radio-frequency circuits, particularly at high frequencies, require high-quality condensers. Mica condensers are preferable. Where stage shields are employed, filters should be placed within the shield.

Another important application of filters is to smooth the output of a rectifier tube. See RECTIFICATION. A smoothing filter usually consists of condensers and iron-core chokes. In any filter-design problem, the load impedance must be considered as an integral part of the filter because the load is an important factor in filter performance. Smoothing effect is obtained from the chokes because they are in series with the load and offer a high impedance to the ripple voltage. Smoothing effect is obtained from the condensers because they are in parallel with the load and store energy on the voltage peaks; this energy is released on the voltage dips and serves to maintain the voltage at the load substantially constant. Smoothing filters are classified as choke-input or condenser-input according to whether a choke or condenser is placed next to the rectifier tube. See Fig. 61.

The CIRCUIT SECTION gives a number of examples of rectifier circuits with recommended filter constants.

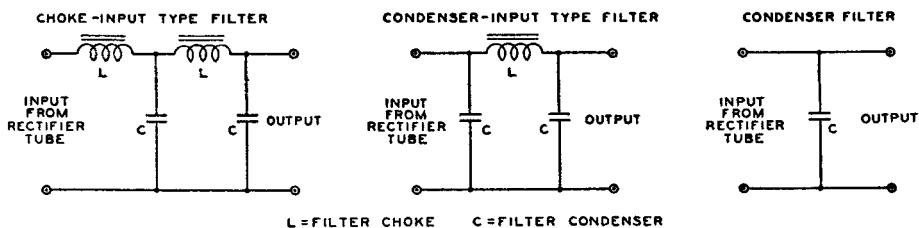

Fig. 61

If an input condenser is used, consideration must be given to the instantaneous peak value of the a-c input voltage. This peak value is about 1.4 times the RMS value as measured by an a-c voltmeter. Filter condensers, therefore, especially the input condenser, should have a rating high enough to withstand the instantaneous peak value if breakdown is to be avoided. When the input-choke method is used, the available d-c output voltage will be somewhat lower than with the input-condenser method for a given a-c plate voltage. However, improved regulation together with lower peak current will be obtained.

Mercury-vapor and gas-filled rectifier tubes occasionally produce a form of local interference in radio receivers, through direct radiation or through the power line. This interference is generally identified in the receiver as a broadly tunable 120-cycle buzz (100 cycles for 50-cycle supply line, etc.). It is usually caused by the formation of a steep wave front when plate current within the tube begins to

flow on the positive half of each cycle of the a-c supply voltage. There are several ways of eliminating this type of interference. One is to shield the tube. Another is to insert an r-f choke having an inductance of one millihenry or more between each plate and transformer winding and to connect high-voltage, r-f by-pass condensers between the outside ends of the transformer winding and the center tap. See Fig. 62. The r-f chokes should be placed within the shielding of the tube. The r-f by-pass condensers should have a voltage rating high enough to withstand the peak voltage of each half of the secondary, which is approximately 1.4 times the RMS value. Transformers having electrostatic shielding between primary and secondary are not likely to transmit r-f disturbances to the line. Often the interference may be eliminated simply by making the plate leads of the rectifier extremely short. In general, the particular method of interference elimination must be selected by experiment for each installation.

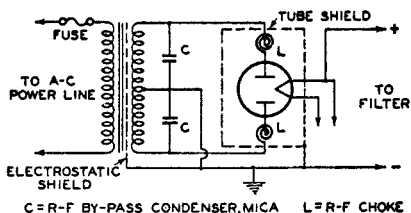

Fig. 62

OUTPUT-COUPLING DEVICES

An output-coupling device is used in the plate circuit of a power output tube to keep the comparatively high d-c plate current from the winding of an electro-magnetic speaker and also to transfer power efficiently from the output stage to a loudspeaker of either the electro-magnetic or dynamic type.

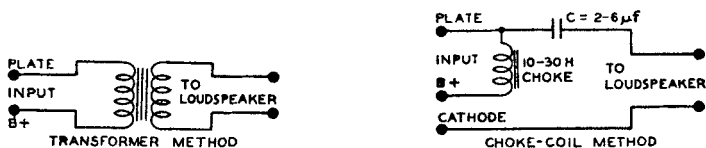

Fig. 63

Output-coupling devices are of two types, (1) choke-condenser and (2) transformer. The choke-condenser type consists of an iron-core choke with an inductance of not less than 10 henrys which is placed in series with the plate and B-supply. The choke offers a very low resistance to the d-c plate current component of the signal voltage but opposes the flow of the fluctuating component. A by-pass condenser of 2 to 6 μf supplies a path to the speaker winding for the signal voltage. The transformer type is constructed with two separate windings, a primary and a secondary wound on an iron core. This construction permits of designing each winding to meet the requirements of its position in the circuit. Typical arrangements of each type of coupling device are shown in Fig. 63. Examples of transformers for push-pull stages are shown in several of the circuits given in the CIRCUIT SECTION.

RCA Receiving Tube Classifications

The following chart classifies RCA tubes according to their cathode voltages and their functions. It will assist the tube user in identifying type numbers and in choosing a tube type for an application. Types having similar characteristics are grouped in parentheses.

Cathode Volts		1.4	2.0	2.5	5.0	6.3	12.6 to 117
DIODE DETECTORS & RECTIFIERS							
Detectors, twin						(6H6, 6H6-G) 7A6	
Rectifiers	half-wave					1-v	12Z3 35Z3-LT 35Z4-GT 35Z5-GT 45Z5-GT
	half-wave, with beam power amplifier						70L7-GT
	half-wave with power pentode						12A7 25A7-G
	full-wave	vacuum				(5T4, 5U4-G, 5X4-G, 5Z3), (5W4, 5Y3-G, 5Z4, 5Y4-G, 80), (5V4-G, 83-v)	(6X5, 6X5-G, 6X5-GT, 84), 6ZY5-G, 7Y4
mercury gas				82	83		
Rectifier-Doublers							(25Z6, 25Z6-G, 25Z6-GT, 25Z5) 117Z6-GT
Cold-Cathode Types: 0Z4, 0Z4-G.							
DIODE DETECTORS with AMPLIFIERS							
One Diode	with high-mu triode	1H5-G, 1H5-GT					
	with high-mu triode and r-f pentode	3A8-GT*					
	with medium-mu triode, and power pentode	1D8-GT					
	with pentode	1S5					
Two Diodes	with medium-mu triode		(1B5, 1H6-G)	55		(6SR7, 6R7, 6R7-G, 85)	12SR7
	with high-mu triode			2A6		(6SQ7, 6Q7, 6Q7-G, 6Q7-GT, 6T7-G, 6B6-G, 75) 7C6	(19SQ7, 12Q7-GT)
	with pentode		(1F7-GV, 1F6)	2B7		(6B8, 6B8-G, 6B7)	12C8
CONVERTERS & MIXERS							
Pentagrid Converters		(1A7-G, 1A7-GT), 1R5	(1C7-G, 1C6), (1D7-G, 1A6)	2A7		(6SA7, 6A8, 6A8-G, 6A8-GT, 6D8-G, 6A7), 7B8-LM	(12SA7, 12A8-GT)
Triode-Hexode Converters						6K8	12K8
Octode Converters						7A8	
Pentagrid Mixers						(6L7, 6L7-G)	

NOTE: This classification does not include the following old types: 00-A, 01-A, 10, 11, 12, 20, 22, 26, 40, 48, 50, 71-A, 81, 99, 112-A, 874, 876, and 886. Data on these types, however, are given in subsequent pages.

RCA RECEIVING TUBE MANUAL

Cathode Volts		1.4	2.0	2.5	5.0	6.3	12.6 to 117
VOLTAGE AMPLIFIERS, DETECTORS, OSCILLATORS							
Triodes	medium-mu	single unit	1G4-G	(1H4-G, 30)	27, 56	(6C5, 6C5-G), (6J5, 6J5-G, 6J5-GT), 6L5-G, 76, 37, 6P5-G, 6AE5-GT	12J5-GT
		twin unit				6C8-G, 6F8-G	
		twin plate				6AE6-G	
	high-mu	with power pentode				6AD7-G	
		with diode, power pentode	1D8-GT				
		single unit					(6SF5, 6F5, 6F5-G, 6F5-GT), 6K5-G
	twin unit				6SC7	12SC7	
	with diode, r-f pentode	3A8-GT*					
Tetrodes	remote cut-off			35			
	sharp cut-off			32, 24A		36	
Pentodes	remote cut-off	1T4	(1D5-GP, 1A4-P), 34	58		(6SK7, 6K7, 6K7-G, 6K7-GT, 78), (6S7, 6S7-G), (6U7-G, 6D6), 6W7-G, 39/44, 7A7-LM, 7B7, 6AB7●, 6AC7●	(12SK7, 12K7-GT)
	remote cut-off, with triode					6F7	
	sharp cut-off	(1N5-G, 1N5-GT)	(1E5-GP, 1B4-P), 15	57		(6SJ7, 6J7, 6J7-G, 6J7-GT), 6C6, 77, 7C7	(12SJ7, 12J7-GT)
	sharp cut-off, with diode, high-mu triode	3A8-GT*					
POWER AMPLIFIERS							
Triodes	low-mu, single unit		31	2A3, 45			
	high-mu	single unit	49	46		6AC5-G	25AC5-GT
Beam Power Tubes	without rectifier	twin unit	1G6-G	(1J6-G, 19)	53	(6N7, 6N7-G, 6A6), 6Z7-G, 79	
			1Q5-GT, 1T5-GT, 3Q5-GT [†]			(6L6, 6L6-G), (6V6, 6V6-G, 6V6-GT), 6Y6-G, 7C5-LT	(25L6, 25L6-G, 25L6-GT), 35A5-LT, 35L6-GT, 50L6-GT
	with rectifier						70L7-GT
Pentodes	single unit	1A5-G, 1C5-G, 1S4	(1F5-G, 1F4), 1G5-G, 33	2A5, 47, 59		(6F6, 6F6-G, 42), (6K6-G, 6K6-GT, 41), 6G6-G, 38, 6A4, 89, 7B5-LT	(25A6, 25A6-G, 43), 25B6-G
	twin unit		1E7-G★				
	with diode and triode	1D8-GT					
	with medium-mu triode					6AD7-G	
	with rectifier						12A7, 25A7-G
video						6AG7●	
Direct-Coupled Amplifiers						(6B5, 6N6-G)	
ELECTRON-RAY TUBES							
Indicators	single	with remote cut-off triode				6AB5/6N5, 6U5/6G5	
		with sharp cut-off triode				6E5	
	twin, without triode					6AF6-G	

GAS-TRIODES

Cold-Cathode, Starter-Anode Type: 0A4-G.

★ Two 1F5-G's in one bulb.

● Designed for television applications.

*Filament arranged for either 1.4 volt or 2.8-volt operation.

Interpretation of Receiving-Tube Ratings

A star before CHARACTERISTICS under any tube type indicates that the maximum ratings for this type are to be interpreted in accordance with RMA Standard M8-210. This standard establishes a new system of ratings in which the meaning of *maximum rating* is changed from "absolute maximum" to "design maximum." This change has been made to take into account the normal voltage variations of the various power-supply sources used for modern radio receivers. The Standard M8-210* follows:

It shall be standard to interpret the ratings on receiving types of tubes according to the following conditions:

CATHODE — The heater or filament voltage is given as a normal value unless otherwise stated. This means that transformers or resistances in the heater or filament circuit should be designed to operate the heater or filament at rated value for full-load operating conditions under average supply-voltage conditions. A reasonable amount of leeway is incorporated in the cathode design so that moderate fluctuations of heater or filament voltage downward will not cause marked falling off in response; also, moderate voltage fluctuations upward will not reduce the life of the cathode to an unsatisfactory degree.

PLATE and SCREEN — In the case of plate voltage and screen voltage, however, recommended maximum values are given. The interpretation of this maximum value depends on the power source, as follows:

A-C or D-C Power Line: The maximum ratings of plate and screen voltages and dissipations given on the tube type data sheets are Design Maximums. For equipment designed for use in the United States on nominal power-line services of 105-125 volts, satisfactory performance and serviceability may be anticipated provided the equipment is designed so as not to exceed these Design Maximums at a line voltage of 117 volts.

Automobile Storage Batteries: When a tube is used in automobile receivers and other equipment operated from automobile storage batteries, consideration should be given to the larger percentage range over which the battery voltage varies as compared with the power-line voltage. The average voltage value of automobile batteries has been established as 6.6 volts. Automobile-battery-operated equipment should be designed so that when the battery voltage is 6.6 volts, the plate voltage, the plate dissipation, the screen voltage, the screen dissipation, and the rectifier load current will not exceed 90% of the respective recommended design maximum values given in the data for each tube type.

"B" Batteries: Equipment operated from "B" batteries should be designed so that under no condition of battery voltage will the plate voltage, the plate dissipation, the screen voltage, and the screen dissipation ever exceed the recommended respective maximum values shown in the data for each type by more than 10%.

OTHER ELECTRODES — When a tube is of the multigrid type, the voltages applied to the additional positive electrodes will be governed by the considerations stated under Plate and Screen.

TYPICAL OPERATION — For many receiving tubes, the data show typical operating conditions in particular services. These typical operating values are given to show concisely some guiding information for the use of each type. They are not to be considered as ratings, because the tube can be used under any suitable conditions within its rating limitations.

* Used by permission of the Engineering Department of the Radio Manufacturers Association.

Key to Terminal Designations of Sockets

Alphabetical subscripts D, P, T, and HX indicate, respectively, diode unit, pentode unit triode unit, and hexode unit in multi-unit types.

Numerical subscripts are used (1) in multi-grid types to indicate relative position of grids to cathode or filament, and (2) in multi-unit types to differentiate between two identical electrodes which would otherwise have the same designation.

- | | | |
|-----------------------|----------------------------|-----------------------|
| BP = Bayonet Pin | HL = Tap for Panel Lamp | S = Shell |
| BS = Base Shell | K = Cathode | SI = Interlead Shield |
| F = Filament | NC = No Connection | SL = Base Sleeve |
| FM = Filament Mid-Tap | P = Plate (Anode) | TA = Target |
| G = Grid | PBF = Beam-Forming Plates | U = Unit |
| H = Heater | RC = Ray-Control Electrode | ● = Gas-Type Tube |

Bottom views of sockets are shown throughout this book.

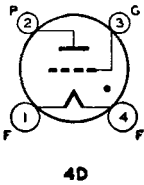

DETECTOR TRIODE

The 00-A is a storage-battery triode of the gas-filled type. Operating conditions as grid-leak detector: maximum plate volts of 45, grid leak of 2 to 3 megohms, grid condenser of 0.00025 μ f, and grid return to (-) filament. Filament volts, 5; amperes, 0.25. For dimensions, see Fig. 2-24., OUTLINES SECTION. The 00-A is a discontinued type; it is retained for reference only.

00-A

DETECTOR AMPLIFIER TRIODE

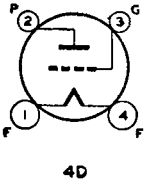

The 01-A is a storage-battery triode used chiefly for replacement in receivers designed for it. Operating conditions as grid-leak detector are the same as for 00-A except that grid return is to (+) filament; as biased detector, maximum plate volts of 135, bias of -13.5 volts (approx); as amplifier, maximum plate volts of 135, bias of -9 volts. Filament volts, 5; amperes, 0.25. For dimensions, see Fig. 2-25, OUTLINES SECTION. The 01-A is a discontinued type; it is retained for reference only.

01-A

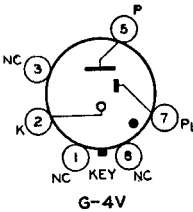

GAS TRIODE

The 0A4-G is an ionic-cathode, glow-discharge tube. It contains a plate (anode), a grid (starter anode), and a cold cathode. These electrodes are sealed in a bulb filled with an inert gas or vapor at reduced pressure. In normal operation of the 0A4-G, a

0A4-G

relatively small amount of electrical energy supplied to the starter-anode circuit initiates a glow discharge between cathode and starter-anode. This discharge produces positive ions which assist in initiating the main discharge between cathode and anode. The anode current which flows during the cathode-anode discharge actuates a relay or other device connected in the anode circuit. Because the discharge can be initiated with so little energy, it is practical to obtain remote control of line-operated electrical devices by means of an electrical impulse generated at radio frequencies and transmitted over the same power line. The 0A4-G may also be used as a voltage regulator or as a relaxation oscillator.

CHARACTERISTICS

PEAK ANODE BREAKDOWN VOLTAGE (Starter-anode tied to cathode)	225 min.	Volts
PEAK POSITIVE STARTER-ANODE-BREAKDOWN VOLTAGE	70 min.	Volts
STARTER-ANODE CURRENT (For transition of discharge to anode at 140 volts peak)	90 max.	Volts
STARTER-ANODE DROP	100 max.	Microamperes
ANODE DROP	60 approx.	Volts
	70 approx.	Volts

MAXIMUM RATINGS and TYPICAL OPERATING CONDITIONS

Relay Service

PEAK CATHODE CURRENT.....	100 max.	Milliamperes
D-C CATHODE CURRENT.....	25 max.	Milliamperes
TYPICAL OPERATION WITH A-C SUPPLY:		
Anode-Supply Voltage (RMS).....	105-130	Volts
A-C Starter-Anode Voltage (Peak).....	70 max.	Volts
R-F Starter-Anode Voltages (Peak).....	55 min.	Volts
Sum of A-C and R-F Starter-Anodes Voltages (Peak).....	110 min.	Volts

INSTALLATION and APPLICATION

The base of the OA4-G fits the standard octal socket which may be installed to hold the tube in any position. For physical characteristics of the OA4-G, see Fig. 2-17, OUTLINES SECTION.

As a relay tube, the OA4-G can be operated in the circuit shown below. In this circuit, the starter-anode is maintained at a potential just below that required for breakdown by means of the bleeder R_1R_2 . When a carrier having the frequency of the tuned circuit LC is impressed on the power line, a resonant voltage appears across L and C. The effect of the voltage across the condenser C is to increase the negative potential peaks on the cathode and thus to increase the potentials between cathode and starter-anode. These peaks start a discharge between cathode and starter-anode. This discharge produces free ions which enable the discharge to transfer to the anode if circuit values are such that sufficient starter-anode current flows. Because a.c. is supplied to the anode, the OA4-G ceases to discharge when the carrier is removed.

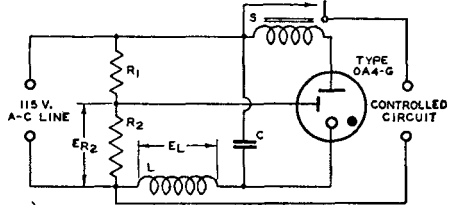

- C } = HIGH-Q TUNED CIRCUIT FOR R-F SIGNAL
- L }
- R₁ = 15000 OHMS (½ WATT)
- R₂ = 10000 OHMS (½ WATT)
- S = RELAY—CHOSEN FOR DESIGN REQUIREMENTS
- = GAS TUBE TYPE

If the OA4-G is to be operated from a d-c power line, it will be necessary to provide means for reducing the anode voltage to a value under 60 volts (extinction voltage). This can be done conveniently by opening the anode circuit.

Most of the voltage on the starter-anode required to cause breakdown is supplied by the bleeder circuit. As a result, the tuned circuit is required to supply only the difference between breakdown voltage and applied a-c voltage. Provision should be made, therefore, to supply an r-f starter-anode voltage having a minimum peak value of 55 volts.

Typical breakdown characteristics of the OA4-G are shown for conditions where the starter-anode and anode are either positive or negative, respectively. The tube is designed to be operated so that the discharge takes place when the starter-anode and anode are both positive (first quadrant). Breakdown between cathode and starter-anode occurs when the starter-anode voltage reaches 85 volts approximately. This discharge initiates a discharge between cathode and anode, provided the anode potential is adequate. The required anode potential is a function of the current flowing to the starter-anode circuit. In practice, it is desirable to have a current of at least 200 microamperes flowing to the starter-anode.

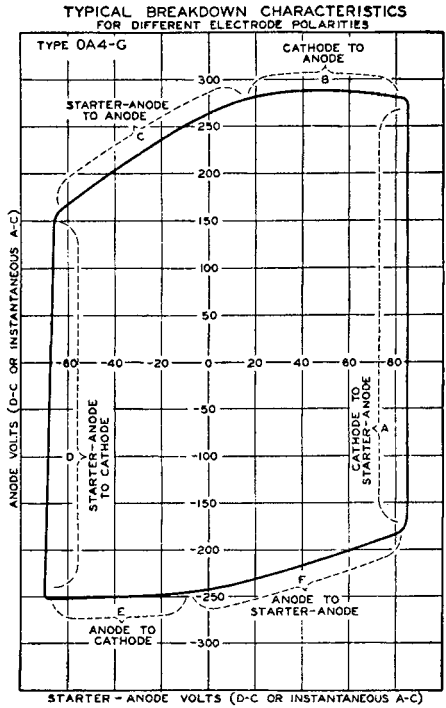

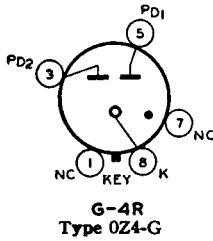
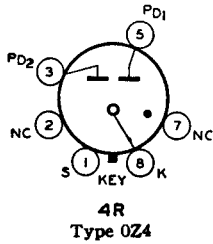

**FULL-WAVE
GAS RECTIFIERS**

The 0Z4 and 0Z4-G are full-wave, gas-filled rectifiers of the cold-cathode type. They are used principally for renewal in vibrator-type B-supply units. The bases of these types fit the standard octal socket which may be installed to hold the tubes in any position. For physical characteristics of the 0Z4 and 0Z4-G, see Figs. 1-2 and 2-3, respectively, in the OUTLINES SECTION. The shell of the 0Z4 and the external shield required for the 0Z4-G should be grounded. The use of filters may be necessary to eliminate objectionable noise.

0Z4

0Z4-G

MAXIMUM RATINGS

STARTING-SUPPLY VOLTAGE PER PLATE	300 <i>min.</i>	Peak Volts
PEAK PLATE-TO-PLATE VOLTAGE	1000 <i>max.</i>	Volts
PEAK PLATE CURRENT	200 <i>max.</i>	Milliamperes
D-C OUTPUT CURRENT	{ 75 <i>max.</i>	Milliamperes
	{ 30 <i>min.</i>	Milliamperes
D-C OUTPUT VOLTAGE	300 <i>max.</i>	Volts
AVERAGE DYNAMIC TUBE VOLTAGE DROP	24	Volts

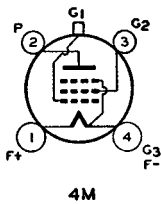

**SUPER-CONTROL R-F
AMPLIFIER PENTODE**

The 1A4-P is a super-control pentode of the 2-volt filament type for battery-operated receivers. Its rating, characteristics, and application are the same as for the Type 1D5-GP, except

1A4-P

that the interelectrode capacitances are as shown below. Filament operation is discussed under Type 1C7-G. The base of the 1A4-P fits the standard four-contact socket which should be installed to hold the tube preferably in a vertical position, but horizontal operation is permissible if pins 1 and 4 are in a vertical plane. For physical characteristics of the 1A4-P, refer to Fig. 2-16, OUTLINES SECTION.

GRID-PLATE CAPACITANCE (With shield-can)	0.007 <i>max.</i>	$\mu\mu\text{f}$
INPUT CAPACITANCE	5	$\mu\mu\text{f}$
OUTPUT CAPACITANCE	11	$\mu\mu\text{f}$

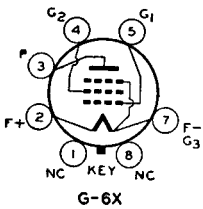

**POWER AMPLIFIER
PENTODE**

The 1A5-G is a power-amplifier pentode of the 1.4-volt filament type for use in the output stage of battery-operated receivers. The filament is designed for operation directly across

1A5-G

a 1.5-volt dry cell. Operation of the filament is discussed under Type 1A7-G.

★ CHARACTERISTICS

FILAMENT VOLTAGE (D.C.).....	1.4	Volts
FILAMENT CURRENT.....	0.05	Ampere
PLATE VOLTAGE.....	85	90 <i>max.</i>
SCREEN VOLTAGE (Grid No. 2).....	85	90 <i>max.</i>
GRID VOLTAGE (Grid No. 1).....	-4.5	-4.5
PLATE CURRENT.....	3.5	4.0
SCREEN CURRENT.....	0.7	0.8
PLATE RESISTANCE (Approx.).....	0.3	0.3
TRANSCONDUCTANCE.....	800	850
LOAD RESISTANCE.....	25000	25000
CATHODE RESISTOR.....	1000	940
POWER OUTPUT (10% total harmonic distortion).....	100	115
		Milliwatts

INSTALLATION and APPLICATION

The base fits the standard octal socket which may be installed to hold the tube in any position. For physical characteristics of the 1A5-G, refer to Fig. 2-13, OUTLINES SECTION.

For the power-amplifier stage of radio receivers, the 1A5-G may be used either singly or in push-pull combination. Transformer- or impedance-coupling devices are recommended. Cathode biasing of the 1A5-G is to be preferred so that the grid bias will be proportionately less as the B-battery voltage falls off during battery life.

PENTAGRID CONVERTER

1A6

The 1A6 is a multi-electrode type of vacuum tube designed to perform simultaneously the function of a mixer tube and of an oscillator tube in super-heterodyne circuits. Its electrical characteristics are identical with those of the 1D7-G, except that the interelectrode capacitances are as shown below.

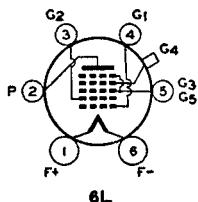

Filament operation is discussed under Type 1C7-G. For general discussion of pentagrid types, see Frequency Conversion in RADIO TUBE APPLICATION section. A typical pentagrid converter circuit for the 1A6 is shown under Type 1A7-G. The base of the 1A6 fits the standard six-contact socket which should be installed to hold the tube preferably in a vertical position, but horizontal operation is permissible if pins 1 and 6 are in a vertical plane. Physical characteristics of the 1A6 are shown in Fig. 2-16, OUTLINES SECTION.

DIRECT INTERELECTRODE CAPACITANCES (Approx.):

Grid No. 4 to Plate (With shield-can).....	0.25	$\mu\mu\text{f}$
Grid No. 4 to Grid No. 2 (With shield-can).....	0.2	$\mu\mu\text{f}$
Grid No. 4 to Grid No. 1 (With shield-can).....	0.1	$\mu\mu\text{f}$
Grid No. 1 to Grid No. 2.....	0.8	$\mu\mu\text{f}$
Grid No. 4 to All Other Electrodes (R-F Input) ...	10.5	$\mu\mu\text{f}$
Grid No. 2 to All Other Electrodes (Osc. Output) ..	6	$\mu\mu\text{f}$
Grid No. 1 to All Other Electrodes (Osc. Input) ...	5	$\mu\mu\text{f}$
Plate to All Other Electrodes (Mixer Output)	9	$\mu\mu\text{f}$

PENTAGRID CONVERTERS

1A7-G

1A7-GT

The 1A7-G and 1A7-GT are multi-electrode tubes of the 1.4-volt filament type. Each type is intended for use as a combined mixer and oscillator in battery-operated receivers. Through the use of either type, the independent control of each of these functions is made

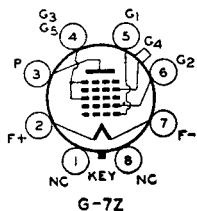

possible within a single tube. A general discussion of pentagrid converters is given under Frequency Conversion in the section on RADIO TUBE APPLICATIONS.

★ CHARACTERISTICS

FILAMENT VOLTAGE (D.C.)	1.4	Volts
FILAMENT CURRENT	0.05	Ampere
DIRECT INTERELECTRODE CAPACITANCES:		
	<i>Type 1A7-G</i>	<i>Type 1A7-GT</i>
Grid No. 4 to Plate	0.30*	0.4* μμf
Grid No. 4 to Grid No. 2	0.26*	0.25* μμf
Grid No. 4 to Grid No. 1	0.12*	0.12* μμf
Grid No. 1 to Grid No. 2	0.90*	1.5 μμf
Grid No. 4 to All Other Electrodes (R-F Input)	6.5*	7.5 μμf
Grid No. 2 to All Other Electrodes Except Grid No. 1 (Osc. Output)	4.6*	4.0 μμf
Grid No. 1 to All Other Electrodes Except Grid No. 2 (Osc. Input)	4.0*	3.2 μμf
Plate to All Other Electrodes (Mixer Output)	11*	10 μμf

* With close-fitting shield connected to negative filament terminal.

Converter Service

PLATE VOLTAGE	90 max.	Volts
SCREEN VOLTAGE (Grids No. 3 and No. 5)	55 max.	Volts
SCREEN SUPPLY VOLTAGE	90 max.	Volts
ANODE-GRID VOLTAGE (Grid No. 2)	90 max.	Volts
TOTAL CATHODE CURRENT	3 max.	Milliamperes
TYPICAL OPERATION:		
Plate Voltage	90	Volts
Screen Voltage	45**	Volts
Anode-Grid Voltage	90	Volts
Control-Grid Voltage (Grid No. 4)	0	Volts
Oscillator-Grid (Grid No. 1) Resistor	200000	Ohms
Plate Current	0.55	Milliampere
Screen Current	0.6	Milliampere
Anode-Grid Current	1.2	Milliamperes
Oscillator-Grid Current	0.035	Milliampere
Total Cathode Current	2.4	Milliamperes
Plate Resistance	0.6	Megohm
Conversion Transconductance	250	Micromhos
Conversion Transconductance (Approx.) with Control-Grid Volts = - 3	5	Micromhos

The transconductance of the oscillator portion of the 1A7-G and 1A7-GT is 600 micromhos under the following conditions: plate voltage, 90 volts; screen voltage, 45 volts; control-grid voltage, 0 volts; anode-grid voltage, 90 volts; and oscillator-grid voltage, 0 volts.

** Obtained preferably by using a properly by-passed 70000-ohm voltage-dropping resistor in series with a 90-volt supply.

INSTALLATION and APPLICATION

The base of either the 1A7-G or the 1A7-GT fits the standard octal socket which may be mounted to hold the tube in any position. Physical characteristics of the 1A7-G and the 1A7-GT are shown in Figs. 2-11 and 2-6, respectively, in the OUTLINES SECTION. Complete shielding of the 1A7-G and 1A7-GT is generally necessary to prevent intercoupling between its circuit and those of other stages.

The filament of either the 1A7-G or the 1A7-GT may be connected directly across a 1.5-volt dry cell. Series operation of the filament with the filaments of other 1.4-volt battery types is permissible provided shunt resistors are employed across certain filaments to carry the plate current returning from other tubes through these filaments. The shunt resistors should be adjusted to maintain the filament voltage of each tube at its rated value of 1.4 volts under operating conditions. It is obvious that the shunt resistor can also be used to adjust for a differ-

ence in filament-current ratings. Series-parallel operation of 1.4-volt types is not recommended because failure of one tube may cause excessive voltage across other tubes.

As a frequency-converter in superheterodyne circuits, either the 1A7-G or the 1A7-GT can supply the local oscillator frequency and at the same time mix it with the r-f input frequency to provide the desired intermediate frequency. It is important to note that the anode-grid voltage and the plate voltage must each be higher than the screen voltage. Conventional oscillator coils may be used because these tubes are not critical for frequencies up to 15 mega-cycles. The size of the oscillator-grid resistor is not critical but requires design adjustment, depending on the values of the anode-grid voltage and of the screen voltage. The circuit should be adjusted so that the cathode current is approximately 2.4 milliamperes. A resistance of at least one megohm should be in the control-grid return to the negative filament.

Since the capacitance between grid No. 4 and plate is in a parallel path with the capacitance and inductance of the plate load, it is important to use a load capacitance of sufficient size to limit the magnitude of the r-f voltage built up across the load. If this is not done, r-f voltage feed-back will occur between plate and grid No. 4 to produce degenerative effects. For this reason, the size of the load condenser in the plate circuit should be not less than 50 $\mu\mu\text{f}$. A typical converter circuit which provides exceptionally uniform oscillator output over the entire grid-bias range is shown below.

TYPICAL PENTAGRID CONVERTER CIRCUIT FOR FILAMENT-TYPE TUBES

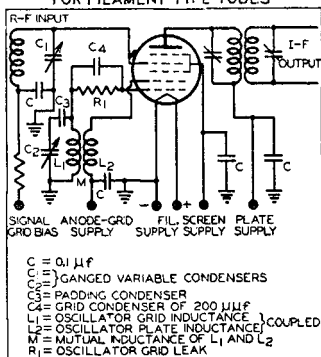

OPERATION CHARACTERISTICS

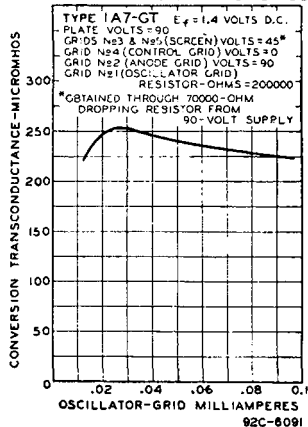

R-F AMPLIFIER PENTODE

1B4-P

The 1B4-P is a pentode of the filament type. It is used primarily as a radio-frequency amplifier or detector in battery-operated receivers. The standard four-pin socket for the 1B4-P should be mounted to hold the tube preferably in a vertical position. Horizontal

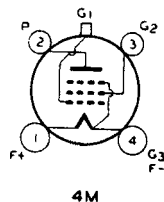

operation is permissible if pins 1 and 4 are in a vertical plane. Filament operation is discussed under Type 1C7-G. Physical characteristics of the 1B4-P are shown in Fig. 2-16, OUTLINES SECTION. For characteristics, refer to Type 1E5-GP.

DUPLEX-DIODE TRIODE

1B5/25S

The 1B5/25S is a filament type of tube containing two diodes and a triode in a single bulb. It is used as a combined detector, amplifier, and automatic-volume-control tube in bat-

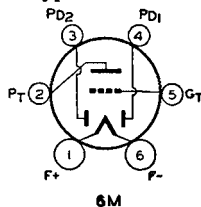

tery-operated receivers. The standard six-contact socket for the 1B5/25S should be mounted to hold the tube preferably in a vertical position. Horizontal operation is permissible if pins 1 and 4 are in a vertical plane. Filament operation is discussed under Type 1C7-G. Physical characteristics of the 1B5/25S are shown in Fig. 2-19, OUTLINES SECTION. For characteristics, see Type 1H6-G.

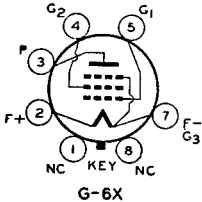

**POWER AMPLIFIER
PENTODE**

1C5-G

The 1C5-G is a power-amplifier pentode of the 1.4-volt filament type for use in battery-operated receivers in which economy of filament current is important.

★ CHARACTERISTICS

FILAMENT VOLTAGE (D.C.)	1.4	Volts
FILAMENT CURRENT	0.1	Ampere
PLATE VOLTAGE	83	90 max. Volts
SCREEN VOLTAGE (Grid No. 2)	83	90 max. Volts
GRID VOLTAGE (Grid No. 1)	-7	-7.5 Volts
PLATE CURRENT	7	7.5 Milliamperes
SCREEN CURRENT	1.6	1.6 Milliamperes
PLATE RESISTANCE (Approx.)	110000	115000 Ohms
TRANSCONDUCTANCE	1500	1550 Micromhos
LOAD RESISTANCE	9000	8000 Ohms
CATHODE RESISTOR	920	825 Ohms
POWER OUTPUT*	200	240 Milliwatts

* 10% total harmonic distortion.

INSTALLATION and APPLICATION

The base of the 1C5-G fits the standard octal socket which may be installed to hold the tube in any position. Physical characteristics of the 1C5-G are shown in Fig. 2-13, OUTLINES SECTION. The filament of the 1C5-G is designed so that it may be operated directly from a 1.5-volt dry battery. For further discussion of filament operation, see Type 1A7-G. Application of the 1C5-G is the same as for the Type 1F5-G.

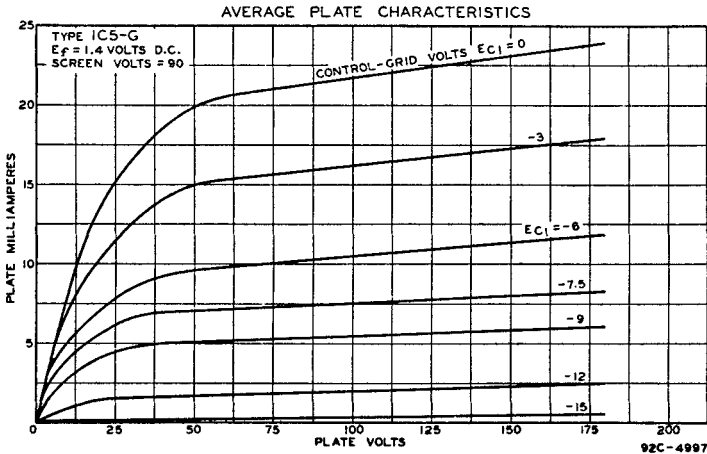

PENTAGRID CONVERTER

1C6

The 1C6 is a multi-electrode vacuum tube of the 2-volt filament type designed to perform simultaneously the functions of mixer and oscillator in superheterodyne circuits. For general discussion of pentagrid types, see Frequency Conversion in RADIO TUBE

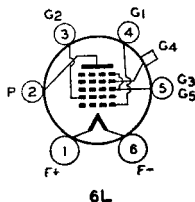

APPLICATIONS section. The electrical characteristics of the 1C6 and its applications are identical with those of Type 1C7-G, except for capacitances which are shown below. For installation, see Type 1A6. Physical characteristics of the 1C6 are shown in Fig. 2-16, OUTLINES SECTION.

DIRECT INTERELECTRODE CAPACITANCES (Approx.):

Grid No. 4 to Plate	0.3*	μμf
Grid No. 4 to Grid No. 2	0.3*	μμf
Grid No. 4 to Grid No. 1	0.15*	μμf
Grid No. 1 to Grid.No. 2	1.5	μμf
Grid No. 4 to All Other Electrodes (R F Input) ...	10	μμf
Grid No. 2 to All Other Electrodes (Osc. Output) ..	6	μμf
Grid No. 1 to All Other Electrodes (Osc. Input) ...	6	μμf
Plate to All Other Electrodes (Mixer Output)	10	μμf

* With shield-can connected to (-) filament.

PENTAGRID CONVERTER

1C7-G

The 1C7-G is a multi-electrode type of vacuum tube designed to perform the functions of both mixer and oscillator in superheterodyne circuits. This tube is designed for use in battery-operated receivers. It is especially useful in multi-range receivers which are

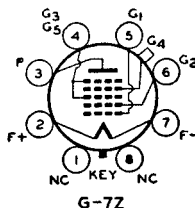

often designed to cover frequencies as high as 20 megacycles. For general discussion of pentagrid types, see Frequency Conversion in RADIO TUBE APPLICATIONS section.

★ CHARACTERISTICS

FILAMENT VOLTAGE (D.C.)	2.0	Volts
FILAMENT CURRENT	0.120	Ampere
DIRECT INTERELECTRODE CAPACITANCES (Approx.):*		
Grid No. 4 to Plate	0.26	μμf
Grid No. 4 to Grid No. 2	0.32	μμf
Grid No. 4 to Grid No. 1	0.11	μμf
Grid No 1 to Grid No. 2	1.2	μμf
Grid No. 4 to All Other Electrodes (R-F Input) ...	10	μμf
Grid No. 2 to All Other Electrodes Except Grid No. 1 (Osc. Output)	5.5	μμf
Grid No. 1 to All Other Electrodes Except Grid No. 2 (Osc. Input)	4.8	μμf
Plate to All Other Electrodes (Mixer Output)	14	μμf

* With shield-can connected to (-) filament.

Converter Service

PLATE VOLTAGE	180 max.	Volts
SCREEN VOLTAGE (Grids No. 3 and 5)	67.5 max.	Volts
SCREEN VOLTAGE SUPPLY	180 max.	Volts
ANODE-GRID VOLTAGE (Grid No. 2)	135 max.	Volts
ANODE-GRID VOLTAGE SUPPLY*	180 max.	Volts
CONTROL-GRID VOLTAGE (Grid No. 4)	0 min.	Volts

* Applied through 20000-ohm dropping resistor, by-passed by 0.1 μf condenser.

PLATE DISSIPATION	0.3	max.	Watt
SCREEN DISSIPATION	0.2	max.	Watt
ANODE-GRID DISSIPATION	0.4	max.	Watt
TOTAL CATHODE CURRENT	9	max.	Milliamperes
TYPICAL OPERATION:			
Plate Voltage	135	180	Volts
Screen Voltage	67.5	67.5	Volts
Anode-Grid Voltage Supply	135*	180*	Volts
Control-Grid Voltage	-3	-3	Volts
Oscillator-Grid Resistor (Grid No. 1) ..	50000	50000	Ohms
Plate Current	1.3	1.5	Milliamperes
Screen Current	2.5	2	Milliamperes
Anode-Grid Current	3.1	4	Milliamperes
Oscillator-Grid Current	0.2	0.2	Milliamperes
Total Cathode Current	7.1	7.7	Milliamperes
Plate Resistance (Approx.)	0.6	0.7	Megohm
Conversion Transconductance	300	325	Micromhos
Conversion Transconductance (At -14 volts on Grid No. 4) (Approx.)	4	4	Micromhos

The transconductance of the oscillator portion (not oscillating) of the 1C7-G is 1000 micro-mhos under the following conditions: Plate voltage, 135 to 180 volts; screen voltage, 67.5 volts; anode-grid voltage (no voltage-dropping resistor), 135 volts; and zero oscillator grid volts. Under these same conditions, the anode-grid current is 4.9 milliamperes.

* Applied through 20000-ohm dropping resistor, by-passed by 0.1 μ f condenser

INSTALLATION and APPLICATION

The base of the 1C7-G requires the use of the standard octal socket which may be installed to hold the tube preferably in a vertical position. Horizontal operation is permissible with pins 2 and 7 in a vertical plane. For physical characteristics of the 1C7-G, see Fig. 2-15, OUTLINES SECTION.

The coated filament of the 1C7-G may be operated conveniently from dry-cells, from a single lead storage-cell, or from an air-cell battery. For dry-cell operation, a filament rheostat may be used together with a permanently installed voltmeter to insure the proper filament voltage. For operation from a 2-volt lead storage-cell, the 1C7-G requires no filament resistor. Operation from an air-cell battery requires a fixed resistor in the filament circuit. This resistor should have a value such that with a new air-cell battery, the voltage applied across the filament terminals will not initially exceed 2.15 volts.

Series operation of the filament of the 1C7-G with those of other two-volt battery types is permissible provided certain precautions are observed. It is essential that shunt resistors be employed across certain filaments to carry the plate current returning from other tubes through these filaments. The shunt resistors should be adjusted to maintain the filament voltage of each tube at its rated value of 2.0 volts under operating conditions. It is obvious that the shunt resistor can also be used to adjust for a difference in filament current ratings. Series-parallel operation of two-volt types is not recommended because failure of one tube may cause excessive voltage across other tubes. Socket terminal No. 1 (see socket connections) should be connected to the positive battery terminal.

Complete shielding of the 1C7-G is generally necessary to prevent intercoupling between its circuit and those of other stages. A typical converter circuit is shown under 1A7-G.

As a frequency converter in superheterodyne circuits, the 1C7-G can be operated in the same way as the 1A7-G. Final adjustment of the 1C7-G circuit should be such that the cathode current is as shown under Typical Operation.

This tube, which is similar to the 1D7-G although not directly interchangeable with it, requires twice the filament current of the latter, but offers the feature of an extended operating range at the higher frequencies. This feature is of particular value in the design of multi-range receivers, since the oscillator section of the 1C7-G has sufficient transconductance to function at frequencies as high as 25 megacycles. In order to cover this same range of operation, the 1D7-G requires the use of a triode connected in parallel with the oscillator section for frequencies above 10 megacycles.

The maximum conversion transconductance is obtained with an oscillator-grid current of slightly less than 0.2 milliamperere. The size, inductance, and coupling of the oscillator-grid and plate coils will determine this value. The coupling of these coils should be adjusted to make the oscillator-grid current the proper value (approximately 0.2 milliamperere) when a grid condenser of 250 $\mu\mu\text{f}$ and a grid leak of 50000 ohms are used. For details of oscillator-coil assemblies, refer to Type 6A8.

**SUPER-CONTROL R-F
AMPLIFIER PENTODE**

1D5-GP

The 1D5-GP is a super-control pentode of the filament type designed for use as a radio-frequency or intermediate-frequency amplifier in battery-operated receivers.

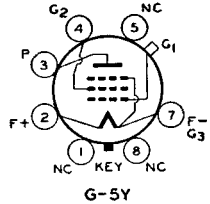

CHARACTERISTICS

FILAMENT VOLTAGE (D.C.)	2.0	Volts
FILAMENT CURRENT	0.060	Ampere
PLATE VOLTAGE	90	180 <i>max.</i> Volts
SCREEN VOLTAGE (Grid No. 2)	67.5	67.5 <i>max.</i> Volts
GRID VOLTAGE (Grid No. 1)	-3 <i>min.</i>	-3 <i>min.</i> Volts
PLATE CURRENT	2.2	2.3 Milliampere
SCREEN CURRENT	0.9	0.8 Milliampere
PLATE RESISTANCE (Approx.)	0.6	1.0 Megohm
TRANSCONDUCTANCE	720	750 Micromhos
TRANSCONDUCTANCE (At -15 volts bias)	15	15 Micromhos

INSTALLATION and APPLICATION

The base of the 1D5-GP fits the standard octal socket which should be installed to hold the tube preferably in a vertical position. Horizontal operation is permissible if pins 2 and 7 are in a vertical plane. Physical characteristics of the 1D5-GP are shown in Fig. 2-15, OUTLINES SECTION. Filament operation is discussed under Type 1C7-G. Screen voltage may be obtained in the same way as for Type 1E5-GP.

As an r-f or i-f amplifier, the 1D5-GP is applicable in receivers designed for it. Stage shielding enclosing the components of each stage is, in general, necessary for multi-stage amplifier circuits.

Volume control of the receiver is accomplished effectively by variation of the negative voltage applied to the grid. In order to obtain adequate volume control, an available grid-bias voltage of approximately -15 volts will be required. The exact value will depend upon the circuit design and operating conditions. This voltage may be obtained from a potentiometer, a bleeder circuit, or a separate source, depending on receiver requirements.

Owing to the fact that the super-control feature of the 1D5-GP requires a comparatively large grid-bias change, the screen and plate voltage may vary considerably for various volume settings, depending on receiver design. It is recommended, therefore, that design features be incorporated in the receiver so that the screen voltage will not exceed 67.5 volts under conditions of minimum grid bias and maximum plate current. With a design arrangement of this kind, the screen voltage at decreased values of plate current may reach a value higher than 67.5 volts but should not exceed 100 volts. It should be recognized that under the condition of screen voltage above 67.5 volts at low plate current, an increase in the grid-bias voltage supply must be provided for adequate volume control.

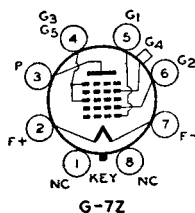

PENTAGRID CONVERTER

The 1D7-G is a multi-electrode vacuum tube designed to perform the functions of both mixer and oscillator in superheterodyne circuits which use battery power supply. For general discussion of pentagrid types, refer to Frequency Conversion in RADIO TUBE APPLICATIONS section.

1D7-G

CHARACTERISTICS

FILAMENT VOLTAGE (D.C.).....	2.0	Volts
FILAMENT CURRENT.....	0.060	Ampere
DIRECT INTERELECTRODE CAPACITANCES (Approx.):		
Grid No. 4 to Plate (With shield-can)	0.25	$\mu\mu\text{f}$
Grid No. 4 to All Other Electrodes (R-F Input) ...	13	$\mu\mu\text{f}$
Plate to All Other Electrodes (Mixer Output)	14	$\mu\mu\text{f}$

Converter Service

PLATE VOLTAGE	180 max.	Volts
SCREEN VOLTAGE (Grids No. 3 and 5)	67.5 max.	Volts
ANODE-GRID VOLTAGE (Grid No. 2)	135 max.	Volts
ANODE-GRID VOLTAGE SUPPLY*	180 max.	Volts
CONTROL-GRID VOLTAGE (Grid No. 4)	-3 min.	Volts
TOTAL CATHODE CURRENT	9 max.	Milliamperes

TYPICAL OPERATION:

Plate Voltage	135	180	Volts
Screen Voltage	67.5	67.5	Volts
Anode-Grid Voltage	135	135	Volts
Anode-Grid Voltage Supply	135	180*	Volts
Control-Grid Voltage	-3	-3	Volts
Oscillator-Grid Resistor (Grid No. 1)	50000	50000	Ohms
Plate Current	1.2	1.3	Milliamperes
Screen Current	2.5	2.4	Milliamperes
Anode-Grid Current	2.3	2.3	Milliamperes
Oscillator-Grid Current	0.2	0.2	Milliamperes
Total Cathode Current	6.2	6.2	Milliamperes
Plate Resistance	0.4	0.5	Megohm
Conversion Transconductance	275	300	Micromhos
Conversion Transconductance (At -22.5 volts on Grid No. 4)	4	4	Micromhos

The transconductance of the oscillator portion (not oscillating) of the 1D7-G is 425 micromhos under the following conditions: Plate voltage, 135 to 180 volts; screen voltage, 67.5 volts; anode-grid voltage (no voltage-dropping resistor), 135 volts; and zero oscillator grid volts. Under these same conditions the anode-grid current is 2.3 milliamperes.

* Applied through 20000-ohm dropping resistor, by-passed by 0.1 μf condenser.

INSTALLATION and APPLICATION

The base of the 1D7-G fits the standard octal socket which should be installed to hold the tube preferably in a vertical position. Horizontal operation is permissible if pins 2 and 7 are in a vertical plane. Physical characteristics of the 1D7-G are shown in Fig. 2-15, OUTLINES SECTION. Filament operation is discussed under Type 1C7-G. Complete shielding of the 1D7-G is generally necessary to prevent intercoupling between its circuits and those of other stages.

As a frequency converter in superheterodyne circuits, the 1D7-G can supply the local oscillator frequency and at the same time mix it with the radio-input frequency to provide the desired intermediate frequency. For this service, design information is given under CHARACTERISTICS. It is important to note that the anode-grid voltage and the plate voltage must each be higher than the screen voltage.

For the oscillator circuit, the coils may be constructed according to conventional design, since the tube is not particularly critical for frequencies up to 10

megacycles. For higher frequencies the 1C7-G should be used. However, it should be noted that the 1C7-G requires additional filament current. The voltage applied to the anode-grid (No. 2) of the 1D7-G should not exceed the maximum value of 135 volts, but should always be higher than the screen (grids No. 3 and No. 5) voltage. The anode-grid voltage may be obtained from a suitable tap on the B battery or from the plate-supply tap through a voltage-dropping resistor of 20000 ohms shunted by a by-pass condenser of 0.1 μ f. The size of the resistor in the grid circuit of the oscillator is not critical but requires design adjustment, depending upon the values of the anode-grid voltage and of the screen voltage. Adjustment of the circuit should be such that the cathode current is approximately 6 milliamperes. *Under no condition of adjustment should the cathode current exceed the recommended maximum value of 9 milliamperes.*

The bias voltage applied to grid No. 4 can be varied over relatively wide limits to control the translation gain of the tube. For example, with 67.5 volts on the screen (grids No. 3 and No. 5), the bias voltage may be varied from -3 to plate current cut-off (approximately -25 volts). With lower screen voltages, the cut-off point is proportionately less. The extended cut-off feature of the 1D7-G in combination with the similar characteristics of super-control tubes can be utilized advantageously to adjust receiver sensitivity.

Since the capacitance between grid No. 4 and plate is in a parallel path with the capacitance and inductance of the plate load, it is important to use a load capacitance of sufficient size to limit the magnitude of the r-f voltage built up across the load. If this is not done, r-f voltage feed-back will occur between plate and grid No. 4 to produce degenerative effects. For this reason, the size of the load condenser in the plate circuit should be not less than 50 μ f.

Converter circuits employing the 1D7-G may easily be designed to have a translation gain of approximately 40. A typical circuit which provides exceptionally uniform oscillator output over the entire grid-bias range is shown under Type 1A7-G.

1D8-GT

DIODE-TRIODE POWER AMPLIFIER PENTODE

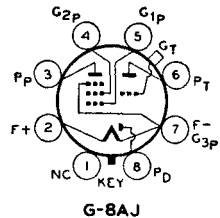

The 1D8-GT is a multi-unit tube having a 1.4-volt filament for use in compact battery-operated receivers designed for it. This tube combines in a single bulb three units—a diode

for use as detector and avc, a triode for use as the first audio amplifier, and a power output pentode.

★ CHARACTERISTICS

FILAMENT VOLTAGE (D.C.)	1.4	Volts
FILAMENT CURRENT	0.1	Ampere

Pentode Unit as Class A₁ Amplifier

PLATE VOLTAGE	45	67.5	90 max.	Volts
SCREEN VOLTAGE (Grid No. 2)	45	67.5	90 max.	Volts
GRID VOLTAGE (Grid No. 1)	-4.5	-6	-9	Volts
PLATE CURRENT	1.6	3.8	5	Milliamperes
SCREEN CURRENT	0.3	0.8	1.0	Milliamperes
PLATE RESISTANCE	0.3	0.2	0.2	Megohm
TRANSCONDUCTANCE	650	875	925	Micromhos
LOAD RESISTANCE	20000	16000	12000	Ohms
TOTAL DISTORTION	10	10	10	Per cent
POWER OUTPUT	35	100	200	Milliwatts

Triode Unit as Class A₁ Amplifier

PLATE VOLTAGE	45	67.5	90 max.	Volts
GRID VOLTAGE	0	0	0	Volts

PLATE CURRENT.....	0.3	0.6	1.1	Milliamperes
AMPLIFICATION FACTOR.....	25	25	25	
PLATE RESISTANCE.....	77000	55500	43500	Ohms
TRANSCONDUCTANCE.....	325	450	575	Micromhos

Diode Unit

The diode plate is located at the negative end of the filament, and is independent of the triode and pentode units except for the common filament.

INSTALLATION and APPLICATION

The base fits the standard octal socket which may be installed to hold the tube in any position. Physical characteristics of the 1D8-GT are shown in Fig. 2-5, OUTLINES SECTION. Filament operation is discussed under Type 1A7-G.

The diode may be used in conventional circuits as a detector and to supply avc voltage to r-f, i-f, and mixer stages. The diode should not be used for bias supply due to the probability of triode plate-current cut-off and to the fact that a varying bias would be applied to the pentode unit.

Resistance or transformer coupling may be employed between the triode and pentode.

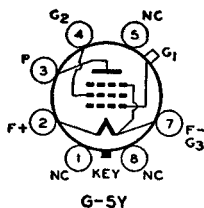

R-F AMPLIFIER PENTODE

The 1E5-GP is a pentode of the 2.0-volt filament type for use in battery-operated receivers as a radio-frequency amplifier or as a detector.

1E5-GP

CHARACTERISTICS

FILAMENT VOLTAGE (D.C.).....	2.0	Volts
FILAMENT CURRENT.....	0.060	Ampere
PLATE VOLTAGE.....	90	180 <i>max.</i> Volts
SCREEN VOLTAGE (Grid No. 2).....	67.5 <i>max.</i>	67.5 <i>max.</i> Volts
GRID VOLTAGE (Grid No. 1).....	-3	-3 Volts
PLATE CURRENT.....	1.6	1.7 Milliamperes
SCREEN CURRENT.....	0.7	0.6 Milliampere
PLATE RESISTANCE.....	1	1.5 Megohms
TRANSCONDUCTANCE.....	600	650 Micromhos
GRIL VOLTAGE* (Approx.).....	-8	-8 Volts
GRID-PLATE CAPACITANCE (With shield-can).....	0.007 <i>max.</i>	μ f
INPUT CAPACITANCE.....	5	μ f
OUTPUT CAPACITANCE.....	11	μ f

* For plate current cut-off.

INSTALLATION and APPLICATION

The base of the 1E5-GP fits the standard octal socket which should be installed to hold the tube preferably in a vertical position. Horizontal operation is permissible if pins 2 and 7 are in a vertical plane. Physical characteristics of the 1E5-GP are given in Fig. 2-15 OUTLINES SECTION. Filament operation is discussed under Type 1C7-G.

The screen voltage may be obtained from a tap on the B-supply battery or from a bleeder circuit across the battery, as a whole or in part. Due to the screen current characteristics of the 1E5-GP, a resistor in series with the B-supply may be employed, if desired, for obtaining the screen voltage, provided the maximum voltage between screen and filament does not exceed 100 volts under conditions of reduced plate current.

**TWIN-PENTODE
POWER AMPLIFIER**

1E7-G

The 1E7-G is a multi-electrode vacuum tube containing two power-amplifier pentodes in one envelope. This construction permits the use of one tube in the final, push-pull stage of battery-operated receivers.

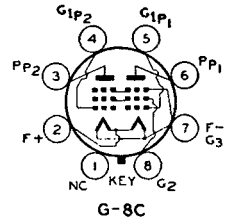

★ CHARACTERISTICS

FILAMENT VOLTAGE (D.C.).....	2.0	Volts
FILAMENT CURRENT	0.24	Ampere
AVERAGE CHARACTERISTICS OF SINGLE UNIT: -		
Plate Voltage	135	Volts
Screen Voltage (Grid No. 2).....	135	Volts
Grid Voltage (Grid No. 1).....	-4.5	Volts
Plate Current	7.5	Milliamperes
Screen Current	2.2	Milliamperes
Plate Resistance (Approx.).....	0.26	Megohm
Transconductance	1425	Micromhos

As Push-Pull Class A₁ Amplifier

Values are for two units

PLATE VOLTAGE	135 <i>max.</i>	Volts
SCREEN VOLTAGE	135 <i>max.</i>	Volts
GRID VOLTAGE*	-7.5	Volts
PEAK A-F GRID-TO-GRID VOLTAGE	1.5	Volts
ZERO-SIGNAL PLATE CURRENT (Approx.).....	7	Milliamperes
MAX.-SIGNAL PLATE CURRENT (Approx.).....	10.5	Milliamperes
ZERO-SIGNAL SCREEN CURRENT (Approx.)	2	Milliamperes
MAX.-SIGNAL SCREEN CURRENT (Approx.)	3.5	Milliamperes
LOAD RESISTANCE (Plate-to-Plate).....	24000	Ohms
TOTAL HARMONIC DISTORTION.....	5.5	Per cent
THIRD HARMONIC DISTORTION.....	4.5	Per cent
MAX.-SIGNAL POWER OUTPUT†.....	0.575	Watt

† A power output of 1.0 watt with 10% total distortion can be obtained in class A₁ operation with a peak a-f grid-to-grid voltage of 21 volts.

* The d-c resistance in the grid circuit should not exceed 1.0 megohm with cathode bias, or 0.5 megohm with fixed bias.

INSTALLATION and APPLICATION

The base of the 1E7-G fits the standard octal socket which should be installed to hold the tube preferably in a vertical position. Horizontal operation is permissible if pins 2 and 7 are in a vertical plane. Physical characteristics of the 1E7-G are shown in Fig. 2-17, OUTLINES SECTION. Filament operation is discussed under Type 1C7-G. The two units of the 1E7-G are used in the same manner as two separate tubes in conventional push-pull, audio-frequency amplifier circuits.

POWER AMPLIFIER PENTODE

1F4

The 1F4 is a power-amplifier pentode of the 2-volt filament type for use in the output stage of battery-operated receivers. Its electrical characteristics are the same as those of the Type 1F5-G. The base of the 1F4 fits the standard five-contact socket which should be installed to hold the tube

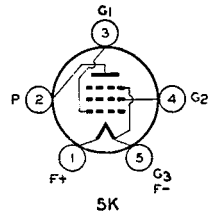

preferably in a vertical position with the base down. Horizontal operation is permissible if pins 1 and 5 are in a vertical plane. Physical characteristics of the 1F4 are shown in Fig. 2-25, OUTLINES SECTION. Filament operation is discussed under Type 1C7-G. Application is the same as for Type 1F5-G.

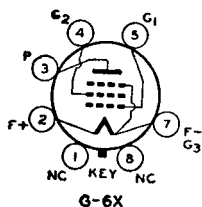

POWER AMPLIFIER PENTODE

The 1F5-G is a power-amplifier pentode of the 2-volt filament type for use in the output stage of battery-operated receivers. This tube has low filament- and plate-current requirements, high power sensitivity, and is capable of delivering a considerable amount of audio power with low distortion.

1F5-G

★ CHARACTERISTICS

FILAMENT VOLTAGE (D.C.).....	2.0	Volts
FILAMENT CURRENT.....	0.12	Ampere

As Single-Tube Class A₁ Amplifier

PLATE VOLTAGE.....	180 <i>max.</i>	Volts
SCREEN VOLTAGE.....	180 <i>max.</i>	Volts
PLATE DISSIPATION.....	1.75 <i>max.</i>	Watts
SCREEN DISSIPATION.....	0.75 <i>max.</i>	Watt

TYPICAL OPERATION:

Plate Voltage.....	90	135	Volts
Screen Voltage (Grid No. 2).....	90	135	Volts
Grid Voltage (Grid No. 1).....	-3	-4.5	Volts
Peak A-F Grid Voltage.....	3	4.5	Volts
Plate Current.....	4	8	Milliamperes
Screen Current.....	1.1	2.4	Milliamperes
Plate Resistance (Approx.).....	0.24	0.20	Megohm
Transconductance.....	1400	1700	Micromhos
Load Resistance.....	20000	16000	Ohms
Cathode Resistor.....	588	432	Ohms
Total Harmonic Distortion.....	6	5	Per cent
Power Output.....	110	310	Milliwatts

As Push-Pull Class AB₁ Amplifier

Values are for two tubes

PLATE VOLTAGE.....	180 <i>max.</i>	Volts	
SCREEN VOLTAGE.....	180 <i>max.</i>	Volts	
PLATE DISSIPATION.....	1.75 <i>max.</i>	Watts	
SCREEN DISSIPATION.....	0.75 <i>max.</i>	Watt	
TYPICAL OPERATION:			
Plate Voltage.....	180	Volts	
Screen Voltage.....	180	Volts	
Grid Voltage.....	-7.5	Volts	
Peak A-F Grid-to-Grid Voltage.....	15	Volts	
Zero-Signal Plate Current.....	19	Milliamperes	
Max.-Signal Plate Current.....	21	Milliamperes	
Zero-Signal Screen Current.....	5.5	Milliamperes	
Max.-Signal Screen Current.....	7	Milliamperes	
Load Resistance (Plate-to-plate).....	20000	Ohms	
Total Harmonic Distortion.....	4.5	Per cent	
Max.-Signal Power Output.....	1.25	Watts	

INSTALLATION and APPLICATION

The base of the 1F5-G fits the standard octal socket which should be installed to hold the tube preferably in a vertical position with the base down. Horizontal operation is permissible if pins 2 and 7 are in a vertical plane. Physical characteristics of the 1F5-G are shown in Fig. 2-21, OUTLINES SECTION. Filament operation is discussed under Type 1C7-G.

For the power amplifier stage of radio receivers, the 1F5-G is recommended either singly or in push-pull combination. More than one audio stage preceding the 1F5-G is undesirable because of the possibility of microphonic disturbances

resulting from the high level of amplification. Transformer- or impedance-coupling devices are preferable. If resistance coupling is employed, the d-c resistance in the grid circuit should not exceed 1.0 megohm under cathode-bias conditions; with fixed bias, the maximum value is 0.5 megohm.

DUPLEX-DIODE PENTODE

1F6

The 1F6 is a duplex-diode pentode of the 2-volt filament type. Its electrical characteristics are the same as those of the Type 1F7-GV, except for capacitances which are given below. The base of the 1F6 fits the standard six-contact socket which should be installed to hold the tube preferably in a vertical position with the base down. Horizontal operation is permissible if pins 1 and 6 are in a vertical plane. Physical characteristics of the 1F6 are shown in Fig. 2-16, OUTLINES SECTION. Filament operation of the 1F6 is discussed under Type 1C7-G.

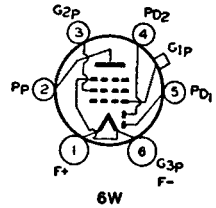

installed to hold the tube preferably in a vertical position with the base down. Horizontal operation is permissible if pins 1 and 6 are in a vertical plane. Physical characteristics of the 1F6 are shown in Fig. 2-16, OUTLINES SECTION. Filament operation of the 1F6 is discussed under Type 1C7-G.

<i>Pentode:</i> GRID-PLATE CAPACITANCE*	0.007 max.	$\mu\mu\text{f}$
INPUT CAPACITANCE	4	$\mu\mu\text{f}$
OUTPUT CAPACITANCE	9	$\mu\mu\text{f}$

* With shield-can.

DUPLEX-DIODE PENTODE

1F7-GV

The 1F7-GV is a duplex-diode pentode consisting of two diodes and a pentode in a single bulb. It is recommended for service as a combined detector, amplifier (radio-, intermediate-, or audio-frequency), and automatic-volume-control tube in battery-operated receivers. For diode detector and avc considerations, refer to the RADIO TUBE APPLICATIONS section.

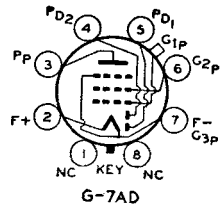

operated receivers. For diode detector and avc considerations, refer to the RADIO TUBE APPLICATIONS section.

★ CHARACTERISTICS

FILAMENT VOLTAGE (D.C.)	2.0	Volts
FILAMENT CURRENT	0.06	Ampere
<i>Pentode:</i> GRID-PLATE CAPACITANCE*	0.01 max.	$\mu\mu\text{f}$
INPUT CAPACITANCE*	3.8	$\mu\mu\text{f}$
OUTPUT CAPACITANCE*	9.5	$\mu\mu\text{f}$

* With shield-can connected to (-) filament.

Pentode Unit—As Class A₁ R-F or I-F Amplifier

PLATE VOLTAGE	180 max.	Volts
SCREEN VOLTAGE (Grid No. 2)	67.5 max.	Volts
GRID VOLTAGE (Grid No. 1)	-1.5	Volts
PLATE CURRENT	2.2	Milliamperes
SCREEN CURRENT	0.7	Milliampere
PLATE RESISTANCE (Approx.)	1	Megohm
TRANSCONDUCTANCE	650	Micromhos
TRANSCONDUCTANCE (At -12 volts bias)§	20	Micromhos

Pentode Unit—As Resistance-Coupled A-F Amplifier

PLATE-SUPPLY VOLTAGE	135	135	Volts
SCREEN-SUPPLY VOLTAGE	135	135	Volts
D-C GRID VOLTAGE†	-1.0	-2.0	Volts
PEAK A-F GRID VOLTAGE	0.64	0.62	Volt
ZERO-SIGNAL D-C PLATE CURRENT	0.42	0.42	Milliampere

‡ For cathode current cut-off.

† If a grid-coupling resistor is used, its maximum value should not exceed 1.0 megohm.

MAX.-SIGNAL D-C PLATE CURRENT	0.34		0.34		Milliampere
PLATE RESISTOR	0.25		0.25		Megohm
SCREEN RESISTOR	1		0.8		Megohm
LOAD RESISTANCE	**		**		
GRID RESISTOR†	1.0	0.5	1.0	0.5	Megohm
VOLTAGE AMPLIFICATION	48	43	46	41	
TOTAL HARMONIC DISTORTION	5	5	5	5	Per cent
PEAK VOLTAGE OUTPUT	30.8	28	28	25.2	Volts

** The load resistance across which the output voltage is developed, consists of the plate resistor, coupling condenser, and grid resistor of the following tube.

† For the following tube.

Diode Units

The two diodes and the pentode are independent of each other except for the common filament. The two diode units are placed at the negative end of the filament. Operation curves for diode units are given under Type 6B7.

INSTALLATION and APPLICATION

The base of the 1F7-GV fits the standard octal socket which should be installed to hold the tube preferably in a vertical position with the base down. Horizontal operation is permissible if pins 2 and 7 are in a vertical plane and the long leg of the filament is below the short leg. Information on filament operation is given under Type 1C7-G. Physical characteristics of the 1F7-GV are shown in Fig. 2-15, OUTLINES SECTION. The 1F7-GV is similar in application to Type 6B8.

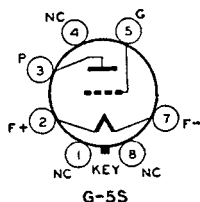

DETECTOR AMPLIFIER TRIODE

1G4-G

The 1G4-G is a medium-mu triode of the 1.4-volt filament type for use as a detector or voltage amplifier.

★ CHARACTERISTICS

FILAMENT VOLTAGE (D.C.)	1.4	Volts
FILAMENT CURRENT	0.05	Ampere
GRID-PLATE CAPACITANCE	2.8	μμf
GRID-FILAMENT CAPACITANCE	2.2	μμf
PLATE-FILAMENT CAPACITANCE	3.4	μμf

As Class A₁ Amplifier

PLATE VOLTAGE	90 max.	Volts
GRID VOLTAGE	-6	Volts
PLATE CURRENT	2.3	Milliamperes
PLATE RESISTANCE	10700	Ohms
AMPLIFICATION FACTOR	8.8	
TRANSCONDUCTANCE	825	Micromhos

INSTALLATION and APPLICATION

The base of the 1G4-G fits the standard octal socket which may be installed to hold the tube in any position. The filament is designed to be operated directly from a 1.5-volt dry battery; other information on filament operation is given under Type 1A7-G. For physical characteristics of the 1G4-G, refer to Fig. 2-13, OUTLINES SECTION.

The 1G4-G is similar in application to the 1H4-G except that it is not recommended for class B service. The 1G4-G is especially useful as a driver for Type 1G6-G.

POWER AMPLIFIER
PENTODE

1G5-G

The 1G5-G is a power-amplifier pentode with a 2-volt filament for use in battery-operated receivers where economy of filament-current drain is important.

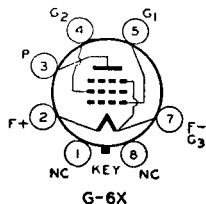

★ CHARACTERISTICS

FILAMENT VOLTAGE (D.C.)	2.0	Volts
FILAMENT CURRENT	0.12	Ampere

As Class A₁ Amplifier

PLATE VOLTAGE	135 max.	Volts
SCREEN VOLTAGE	135 max.	Volts
PLATE DISSIPATION	1.25 max.	Watts
SCREEN DISSIPATION	0.6 max.	Watt

TYPICAL OPERATION:

Plate Voltage	90	124	135	Volts
Screen Voltage	90	124	135	Volts
D-C Grid Voltage	-6	-11	-13.5	Volts
Peak A-F Grid Voltage	6	9.9	9.2	Volts
Zero-Signal Plate Current	8.5	10	8.7	Milliamperes
Max.-Signal Plate Current	8.7	10.7	9.7	Milliamperes
Zero-Signal Screen Current	2.5	3	2.5	Milliamperes
Max.-Signal Screen Current	3	4.3	3.6	Milliamperes
Plate Resistance (Approx.)	133000	145000	160000	Ohms
Transconductance	1500	1500	1550	Micromhos
Load Resistance	8500	8000	9000	Ohms
Total Harmonic Distortion	6	10.5	11	Per cent
Second Harmonic Distortion	3	7	8	Per cent
Third Harmonic Distortion	5	7.5	7	Per cent
Max.-Signal Power Output	250	600*	550**	Milliwatts

* A power output of 650 milliwatts with 13% total distortion (6% second, 11% third) can be obtained with a peak a-f grid voltage of 11 volts.

**A power output of 750 milliwatts with 18% total distortion (9% second, 15% third) can be obtained with a peak a-f grid voltage of 13.5 volts.

INSTALLATION and APPLICATION

The base of the 1G5-G fits the standard octal socket which should be installed to hold the tube preferably in a vertical position with the base down. Horizontal operation is permissible if pins 2 and 7 are in a vertical plane. Physical characteristics of the 1G5-G are shown in Fig. 2-21, OUTLINES SECTION. Filament operation is discussed under Type 1C7-G.

Application of the 1G5-G is similar to that of the 1F5-G. Transformer- or impedance-coupling devices are recommended. When the grid circuit has a resistance not higher than 0.5 megohm, fixed bias may be used; for higher values, cathode bias is required. With cathode bias, the grid circuit may have a resistance as high as, but not greater than one megohm.

CLASS B
TWIN AMPLIFIER

1G6-G

The 1G6-G combines in one bulb two high- μ triodes designed for class B operation. It is intended for use in the output stage of battery-operated receivers and is capable of

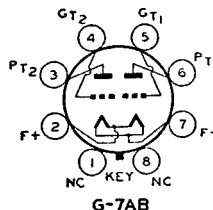

supplying considerable audio-frequency power. The two units have separate external terminals for all electrodes except the filaments, so that circuit design is similar to that of class B amplifiers using individual tubes.

CHARACTERISTICS

FILAMENT VOLTAGE (D.C.).....	1.4	Volts
FILAMENT CURRENT.....	0.1	Ampere

As Class B Amplifier

PLATE VOLTAGE.....	110 max.	Volts
PEAK PLATE CURRENT (Per plate).....	20 max.	Milliamperes

TYPICAL OPERATION:

Unless otherwise specified, values are for both units

Plate-Supply Impedance.....	0	0	Ohms
Effective Grid-Circuit Impedance (Per unit).....	0	2530	Ohms
Plate Voltage.....	90	90	Volts
D-C Grid Voltage.....	0	0	Volts
Peak A-F Grid-to-Grid Voltage.....	42	48	Volts
Zero-Signal D-C Plate Current.....	2	2	Milliamperes
Max.-Signal D-C Plate Current.....	14	11	Milliamperes
Peak Grid Current (Per unit).....	5	6	Milliamperes
Effective Load Resistance (Plate-to-plate).....	12000	12000	Ohms
Total Harmonic Distortion.....	3	4	Per cent
Power Output (Approx.).....	675	350	Milliwatts

INSTALLATION and APPLICATION

The base of the 1G6-G fits the standard octal socket which may be installed to hold the tube in any position. Physical characteristics of the 1G6-G are shown in Fig. 2-13, OUTLINES SECTION. The 1.4-volt filament is designed to operate directly from a 1.5-volt dry battery. Refer to Type 1A7-G for further information on filament operation.

The 1G6-G is designed to be operated with zero bias. A discussion of class B operation is given in the RADIO TUBE APPLICATIONS section.

In the conditions shown under TYPICAL OPERATION, the plate-supply impedance of zero ohms indicates that battery supply is required for the plate. The effective grid-circuit impedance of 2530 ohms is for a class B stage in which the effective resistance per grid circuit is 2500 ohms at 400 cycles and the leakage reactance of the coupling transformer is 155 millihenrys. The driver stage should be capable of supplying the grids of the class B stage with the specified values at low distortion. Type 1G4-G is satisfactory for this service.

The 1G6-G may also be used under class A conditions as follows: maximum plate volts, 90; grid volts, 0; amplification factor, 30; plate resistance, 45000 ohms; transconductance, 675 micromhos; plate current, 1 milliampere. These values are for each triode unit.

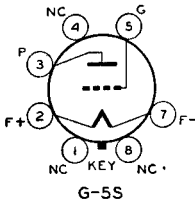

DETECTOR AMPLIFIER TRIODE

The 1H4-G is a three-electrode tube for use as detector or amplifier in battery-operated receivers where economy of filament-current drain is important.

1H4-G

CHARACTERISTICS

FILAMENT VOLTAGE (D.C.).....	2.0	Volts
FILAMENT CURRENT.....	0.060	Ampere

As Class A₁ Amplifier

PLATE VOLTAGE.....	90	135	180 max.	Volts
GRID VOLTAGE.....	-4.5	-9	-13.5	Volts
PLATE CURRENT.....	2.5	3.0	3.1	Milliamperes
PLATE RESISTANCE.....	11000	10300	10300	Ohms
AMPLIFICATION FACTOR.....	9.3	9.3	9.3	
TRANSCONDUCTANCE.....	850	900	900	Micromhos

As Class B Amplifier

PLATE VOLTAGE	180 max.	Volts
PEAK PLATE CURRENT	50 max.	Milliamperes
ZERO-SIGNAL CURRENT (Per tube)	1.5 max.	Milliamperes

TYPICAL OPERATION:

Unless otherwise specified, values are for two tubes

Plate Voltage	157.5	Volts
Grid Voltage	-15	Volts
Zero-Signal Plate Current (Per tube)	1.0	Milliampere
Effective Load Resistance (Plate-to-plate)	8000	Ohms
Max.-Signal Driving Power	260	Milliwatts
Max.-Signal Power Output (Approx.)*	2.1	Watts

* With one Type 1H4-G as driver operated under the following conditions: Plate voltage, 157.5 volts; negative grid-bias voltage, 11.3 volts; plate load of approximately 18000 ohms; input transformer ratio (primary to one-half secondary), 1.165; and total distortion of 6 to 7%

INSTALLATION and APPLICATION

The base of the 1H4-G fits the standard octal socket which should be installed to hold the tube preferably in a vertical position with the base down. Horizontal operation is permissible if pins 2 and 7 are in a vertical plane. Cushioning of the socket in the detector stage may be desirable if microphonic disturbances are encountered. Physical characteristics of the 1H4-G are shown in Fig. 2-17, OUTLINES SECTION. For filament operation, refer to INSTALLATION on Type 1C7-G.

As a detector, the 1H4-G may be operated either with grid leak and condenser or with grid bias. The plate voltage for grid-leak detection should not be more than 45 volts. A grid leak of from 1 to 5 megohms used with a grid condenser of 0.00025 μ f is satisfactory. The grid return should be connected to the positive filament socket terminal. For grid-bias detection, plate voltage up to the maximum value of 180 volts may be used. The corresponding grid bias should be adjusted so that the plate current is about 0.2 milliampere when no signal is being received.

In resistance-coupled service, the 1H4-G should not be used with a d-c resistance in the grid circuit greater than 2 megohms.

DIODE HIGH-MU TRIODES

1H5-G

1H5-GT

The 1H5-G and 1H5-GT are multi-electrode tubes of the 1.4-volt filament type. Each type contains a single diode and a high-mu triode, and is for use as a combined detector and amplifier in radio receivers designed for its characteristics.

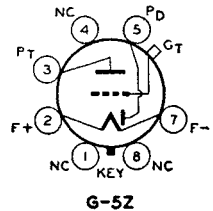

★ CHARACTERISTICS

FILAMENT VOLTAGE (D.C.)	1.4	Volts
FILAMENT CURRENT	0.05	Ampere

	Type 1H5-G	Type 1H5-GT	
Triode: GRID-PLATE CAPACITANCE*	1.0	1.0	μ f
GRID-FILAMENT CAPACITANCE* ..	1.1	1.2	μ f
PLATE-FILAMENT CAPACITANCE* ..	5.8	5.0	μ f

* Approximate.

Triode Unit—As Class A₁ Amplifier

PLATE VOLTAGE	90 max.	Volts
GRID VOLTAGE	0	Volts
PLATE CURRENT	0.14	Milliampere
PLATE RESISTANCE	240000	Ohms
AMPLIFICATION FACTOR	65	
TRANSCONDUCTANCE	275	Micromhos

Diode Unit

The diode and the triode are independent of each other except for the common filament. The diode is located at the negative end of the filament. Further consideration of diodes is given in the RADIO TUBE APPLICATIONS section.

INSTALLATION and APPLICATION

The base of either the 1H5-G or the 1H5-GT type fits the standard octal socket which may be installed to hold the tube in any position. Physical characteristics of the 1H5-G and 1H5-GT are shown in Figs. 2-11 and 2-6, respectively, in the OUTLINES SECTION. Filament operation is discussed under Type 1A7-G.

The triode unit is recommended for use with resistance-coupled circuits because of its high amplification factor. Diode biasing of the triode is not suitable because of the probability of plate-current cut-off, even with relatively small signal voltages applied to the diode circuit.

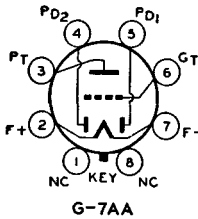
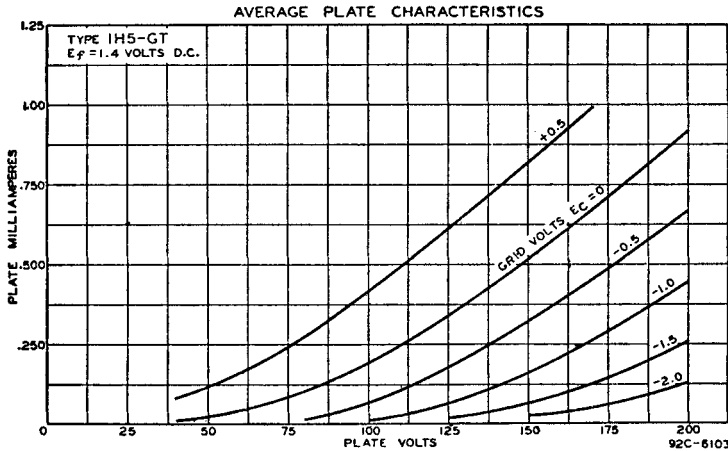

DUPLEX-DIODE TRIODE

The 1H6-G is a 2-volt filament type of tube containing two diodes and a triode in a single bulb. It may be used as a combined detector, amplifier, and automatic-volume-control tube in battery-operated receivers. For diode-detector considerations, refer to RADIO

1H6-G

TUBE APPLICATIONS. The base requires the use of the standard octal socket which should be installed to hold the tube preferably in a vertical position with the base down. Horizontal operation is permitted if pins 2 and 7 are in a vertical plane. Physical characteristics of the 1H6-G are shown in Fig. 2-17, OUTLINES SECTION. Filament operation is discussed under Type 1C7-G.

★ CHARACTERISTICS

FILAMENT VOLTAGE (D.C.)	2.0	Volts
FILAMENT CURRENT	0.06	Ampere
Triode: GRID-PLATE CAPACITANCE*	4.8	μf
GRID-FILAMENT CAPACITANCE*	4.0	μf
PLATE-FILAMENT CAPACITANCE*	2.6	μf

* Approximate.

Triode Unit—As Class A₁ Amplifier

PLATE VOLTAGE	135 max.	Volts
GRID VOLTAGE	-3	Volts

PLATE CURRENT	0.8	Milliampere
PLATE RESISTANCE	35000	Ohms
AMPLIFICATION FACTOR	20	
TRANSCONDUCTANCE	575	Micromhos

Diode Units

The two diodes and the triode are independent of each other except for the common filament. Diode plate No. 1 is located at the negative end of the filament; diode plate No. 2 is located at the positive end. Because of this arrangement, diode plate No. 1, when the diodes are used for different purposes, should be used for detection to avoid signal-delay effects. Operation curves for the diode units are given under Type 6B7.

CLASS B TWIN AMPLIFIER

1J6-G

The 1J6-G combines in one bulb two high- μ triodes designed for class B operation. It is intended for use in the output stage of battery-operated receivers and is capable of supplying approximately 2 watts of audio power. The triode units have separate external

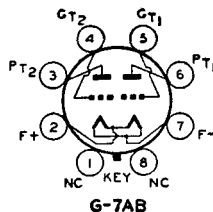

terminals for all electrodes except the filaments, so that circuit design is similar to that of class B amplifiers utilizing individual tubes in the output stage.

★ CHARACTERISTICS

FILAMENT VOLTAGE (D.C.)	2.0	Volts
FILAMENT CURRENT	0.24	Ampere

As Class B Power Amplifier

PLATE VOLTAGE	135 <i>max.</i>			Volts
PEAK PLATE CURRENT (Per plate)	50 <i>max.</i>			Milliamperes
TYPICAL OPERATION:				
Plate Voltage	135	135	135	Volts
Grid Voltage	-6	-3	0	Volts
Zero-Signal Plate Current (Per plate)	0.1	1.7	5	Milliamperes
Effective Load Resistance (Plate-to-plate)	10000	10000	10000	Ohms
Average Power Input (Approx.)*	95	130	170	Milliwatts
Power Output (Approx.)	1.6	1.9	2.1	Watts

* Applied between grids to give indicated values of power output.

INSTALLATION and APPLICATION

The base of the 1J6-G fits the standard octal socket which should be installed to hold the tube preferably in a vertical position with the base down. The tube may be mounted horizontally if pins 1 and 4 are in a vertical plane. Physical characteristics of the 1J6-G are shown in Fig. 2-17, OUTLINES SECTION. For filament operation, refer to Type 1C7-G.

As a class B power amplifier in the output stage of battery-operated receivers, the 1J6-G should be operated as shown under CHARACTERISTICS. In such service, it may be operated either with zero grid bias or with negative grid bias. The latter method may be of advantage in cases where plate-battery drain must be conserved, even at some sacrifice in power output.

The type of driver tube chosen to precede the 1J6-G should be capable of handling enough power to operate the class B amplifier stage. Allowance should be made for transformer efficiency. It is most important, if low distortion is desired, that the driver tube be worked well below its class A undistorted-output rating, since distortion produced by the driver stage and the power stage will be present in the output. A discussion of class B amplifier features is given in the RADIO TUBE APPLICATION section.

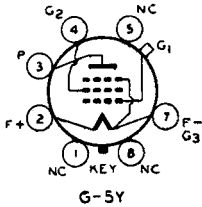

R-F AMPLIFIER PENTODES

The 1N5-G and 1N5-GT are r-f pentodes of the 1.4-volt filament type for use in battery-operated receivers. The two types are identical except for their capacitances and the smaller physical size of the 1N5-GT.

1N5-G
1N5-GT

★ CHARACTERISTICS

FILAMENT VOLTAGE (D.C.).....	1.4	Volts
FILAMENT CURRENT.....	0.05	Ampere
PLATE VOLTAGE.....	90 max.	Volts
SCREEN VOLTAGE.....	90 max.	Volts
GRID VOLTAGE.....	0	Volts
PLATE CURRENT.....	1.2	Milliamperes
SCREEN CURRENT.....	0.3	Milliampere
PLATE RESISTANCE (Approx.).....	1.5	Megohms
TRANSCONDUCTANCE.....	750	Micromhos
TRANSCONDUCTANCE (At -4 volts bias).....	5	Micromhos

	Type 1N5-G	Type 1N5-GT	
GRID-PLATE CAPACITANCE*.....	0.007 max.	0.007 max.	μμf
INPUT CAPACITANCE.....	3.2	3.2	μμf
OUTPUT CAPACITANCE.....	11.0	10.0	μμf

* With shield-can.

INSTALLATION and APPLICATION

The base of either the 1N5-G or the 1N5-GT fits the standard octal socket which may be mounted to hold the tube in any position. Physical characteristics of the 1N5-G and 1N5-GT are shown in Figs. 2-11 and 2-5, respectively, in the OUTLINES SECTION. Filament operation is discussed under Type 1A7-G.

These types are designed to be operated with equal screen and plate voltages. The operating conditions are given for maximum efficiency of these types as r-f or i-f amplifiers. In avc circuits, these types should be only partially controlled to avoid excessive reduction in receiver sensitivity with large signal input.

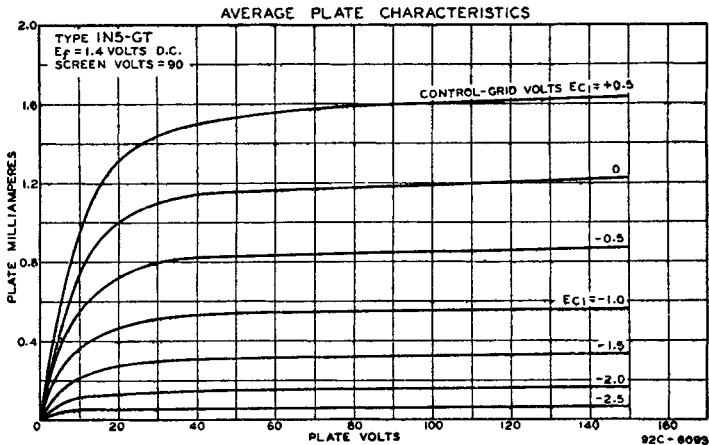

BEAM POWER AMPLIFIER

1Q5-GT

The 1Q5-GT is a power amplifier of the beam type having a 1.4-volt filament. It is designed for use in the output stage of battery-operated receivers.

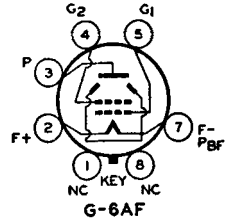

★ CHARACTERISTICS

FILAMENT VOLTAGE (D.C.).....	1.4	Volts
FILAMENT CURRENT.....	0.1	Ampere
PLATE VOLTAGE.....	90 <i>max.</i>	Volts
SCREEN VOLTAGE.....	90 <i>max.</i>	Volts
GRID VOLTAGE.....	-4.5	Volts
PEAK A-F GRID VOLTAGE.....	4.5	Volts
PLATE CURRENT.....	9.5	Milliamperes
SCREEN CURRENT.....	1.6	Milliamperes
TRANSCONDUCTANCE.....	2100	Micromhos
LOAD RESISTANCE.....	8000	Ohms
TOTAL HARMONIC DISTORTION.....	7.5	Per cent
POWER OUTPUT.....	0.27	Watt

INSTALLATION and APPLICATION

The base of the 1Q5-GT fits the standard octal socket which may be mounted to hold the tube in any position. Physical characteristics of the 1Q5-GT are shown in Fig. 2-8, OUTLINES SECTION. Filament operation is discussed under Type 1A7-G.

The 1Q5-GT may be operated as a single-tube class A₁ amplifier under conditions given above. The type of input coupling used should not introduce too much resistance in the grid circuit. Transformer- or impedance-coupling devices are recommended. When the grid circuit has a resistance not higher than 0.1 megohm, fixed bias may be used; for higher values, cathode bias is required. With cathode bias, the grid circuit may have a resistance as high as, but not greater than, 0.5 megohm.

PENTAGRID CONVERTER

1R5

The 1R5 is a miniature type of multi-electrode vacuum tube designed to perform simultaneously the functions of a mixer tube and of an oscillator tube in superheterodyne circuits. Through its use, the independent control of each function is made possible

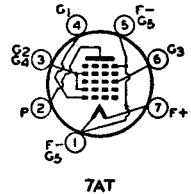

within a single tube. The 1R5 is designed with high operating efficiency especially for compact, light-weight, portable equipment. The high operating efficiency even with only a 45-volt B-supply has been attained by a new design which provides the miniature size without decreasing the size of essential electrode parts. The conventional base has been replaced with a glass button base. For general discussion of pentagrid types, see Frequency Conversion in RADIO TUBE APPLICATIONS section.

★ CHARACTERISTICS

FILAMENT VOLTAGE (D.C.).....	1.4	Volts
FILAMENT CURRENT.....	0.05	Ampere
DIRECT INTERELECTRODE CAPACITANCES: †		
Grid No. 3 to All Other Electrodes (R-F Input) ...	7.0	μf
Plate to All Other Electrodes (Mixer Output)	7.0	μf
Grid No. 1 to All Other Electrodes.....	3.8	μf
Grid No. 3 to Plate.....	0.4 <i>max.</i>	μf
Grid No. 1 to Grid No. 3.....	0.2 <i>max.</i>	μf
Grid No. 1 to Plate.....	0.1 <i>max.</i>	μf

† With no external shield.

Converter Service

PLATE VOLTAGE	90 max.	Volts
SCREEN VOLTAGE (Grids No. 2 and No. 4)	67.5 max.	Volts
SCREEN SUPPLY VOLTAGE	90 max.	Volts
CONTROL-GRID VOLTAGE (Grid No. 3)	0 min.	Volts
TOTAL CATHODE CURRENT	5.5 max.	Milliamperes

TYPICAL OPERATION:

Plate Voltage	45	90	90	Volts
Grids No. 2 and No. 4 Voltage	45	45	67.5	Volts
Grid No. 3 Voltage	0	0	0	Volts
Grid No. 1 Resistor	0.1	0.1	0.1	Megohm
Plate Current	0.7	0.8	1.7	Milliampere
Grids No. 2 and No. 4 Current	1.9	1.8	3	Milliamperes
Grid No. 1 Current	0.15	0.15	0.25	Milliampere
Total Cathode Current	2.75	2.75	5	Milliamperes
Plate Resistance (Approx.)	0.6	0.75	0.5	Megohm
Conversion Transconductance	235	250	300	Micromhos
Conversion Transconductance (Approx.)	5*	5*	5**	Micromhos

The transconductance between grid No. 1 and grids No. 2 and No. 4 tied to plate (not oscillating) is approximately 1200 micromhos when grids No. 1 and No. 3 are at zero volts, and grids No. 2 and No. 4 and plate are at 45 volts.

* With grid No. 3 bias of -9 volts. ** With grid No. 3 bias of -15 volts.

INSTALLATION and APPLICATION

The base of the 1R5 fits a button-base socket which may be installed to hold the tube in any position. Physical characteristics of the 1R5 are shown in Fig. 2-2, OUTLINES SECTION. For filament operation, see Type 1A7-G.

As a frequency converter in superheterodyne circuits, the 1R5 can supply the local oscillator frequency and at the same time mix it with the radio-input frequency to provide the desired intermediate frequency. For this service, design information is given under CHARACTERISTICS.

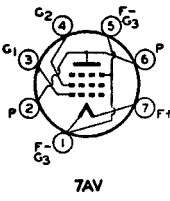
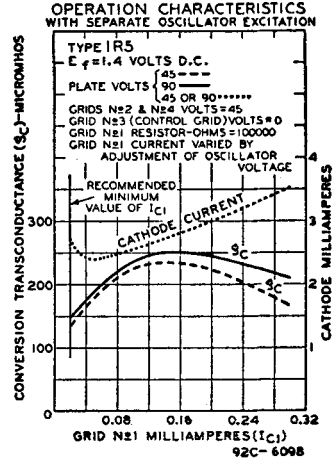
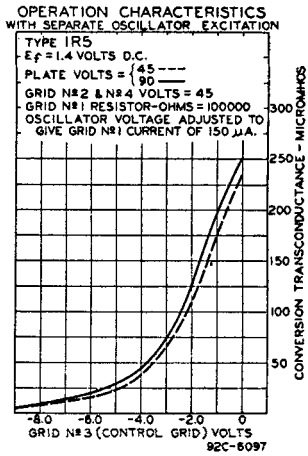

POWER AMPLIFIER PENTODE

The 1S4 is a miniature type of power-output pentode designed with high efficiency and good power sensitivity especially for compact, lightweight, portable equipment operating with a B-supply battery of 45 volts. It has the same structural features as the 1R5.

1S4

★ CHARACTERISTICS

FILAMENT VOLTAGE (D.C.).....	1.4	Volts
FILAMENT CURRENT.....	0.1	Ampere

As Class A₁ Amplifier

PLATE VOLTAGE.....	67.5 max.	Volts
SCREEN VOLTAGE.....	67.5 max.	Volts
TOTAL CATHODE CURRENT.....	11 max.	Milliamperes
TOTAL CATHODE CURRENT**.....	9 max.	Milliamperes

TYPICAL OPERATION:

Plate Voltage.....	45	67.5	Volts
Screen Voltage.....	45	67.5	Volts
Grid Voltage (Grid No. 1).....	-4.5	-7	Volts
Peak A-F Grid Voltage.....	4.5	7	Volts
Zero-Signal Plate Current.....	3.8	7.2	Milliamperes
Zero-Signal Screen Current.....	0.8	1.5	Milliamperes
Plate Resistance (Approx.).....	0.1	0.1	Megohm
Transconductance.....	1250	1550	Micromhos
Load Resistance.....	8000	5000	Ohms
Total Harmonic Distortion.....	12	10	Per cent
Max.-Signal Power Output.....	0.065	0.180	Watt

*Under maximum-signal conditions.

**Under no-signal conditions.

INSTALLATION and APPLICATION

The base of the 1S4 fits a button-base socket which may be installed to hold the tube in any position. Physical characteristics of the 1S4 are shown in Fig. 2-2, OUTLINES SECTION. For filament operation, see Type 1A7-G. Application is similar to that for Type 1A5-G.

DIODE-PENTODE

1S5

The 1S5 is a miniature type of multi-electrode tube containing a diode and an audio-frequency pentode in a single bulb. The 1S5 is designed especially for compact, light-weight, portable equipment. It will provide high gain even when operated with a B-battery

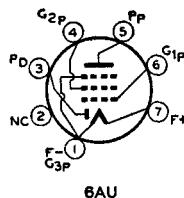

voltage of only 45 volts. The structural features of the 1S5 are the same as those of the 1R5.

★ CHARACTERISTICS

FILAMENT VOLTAGE (D.C.).....	1.4	Volts
FILAMENT CURRENT.....	0.05	Ampere

AVERAGE CHARACTERISTICS OF PENTODE UNIT:

Plate Voltage.....	67.5	Volts
Screen Voltage.....	67.5	Volts
Grid Voltage.....	0	Volts
Plate Resistance.....	0.4	Megohm
Transconductance.....	625	Micromhos
Plate Current.....	2.3	Milliamperes
Screen Current.....	0.6	Milliamperes

Pentode Unit — As Class A₁ Amplifier

PLATE VOLTAGE.....	90 max.	Volts
SCREEN VOLTAGE.....	90 max.	Volts
GRID VOLTAGE.....	0 min.	Volts
TOTAL CATHODE CURRENT.....	3.7 max.	Milliamperes

TYPICAL OPERATION AS RESISTANCE-COUPLED AMPLIFIER:

Plate-Supply Voltage.....	45	67.5	90	Volts
Screen-Supply Voltage.....	45	67.5	90	Volts
Grid Voltage.....	0	0	0	Volts

Plate Resistor	1	1	1	Megohm
Series Screen Resistor	3	3	3	Megohms
Screen By-Pass Condenser	0.1	0.1	0.1	μ f
Grid Resistor	10	10	10	Megohms
Voltage Gain (Approx.)*	30	40	50	

*Obtained when the grid of the pentode unit is fed from a source having an impedance of 1.0 megohm.

Diode Unit

The diode is located at the negative end of the filament, and is independent of the pentode unit except for the common filament.

INSTALLATION and APPLICATION

The base of the 1S5 fits a button-base socket which may be installed to hold the tube in any position. Physical characteristics of the 1S5 are shown in Fig. 2-2, OUTLINES SECTION. For filament operation, see Type 1A7-G.

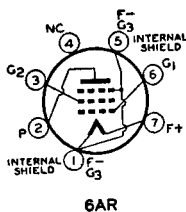
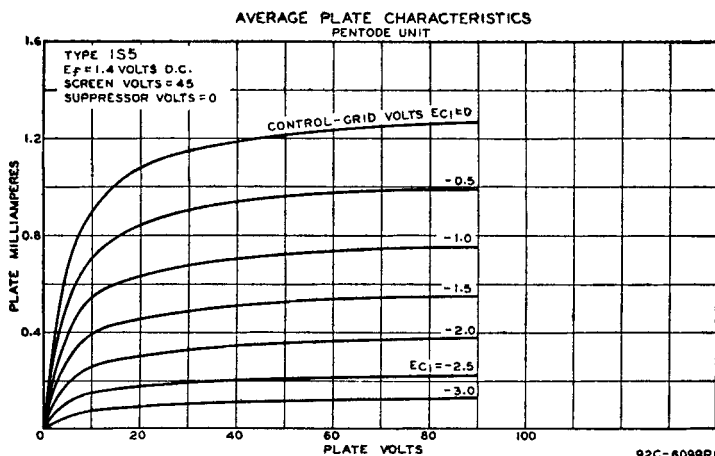

SUPER-CONTROL R-F AMPLIFIER PENTODE

1T4

The 1T4 is a miniature type of super-control pentode designed for use as a radio-frequency or intermediate-frequency amplifier in compact, light-weight, portable equipment. The

super-control feature is explained under Super-Control Amplifier in RADIO TUBE APPLICATIONS section. The 1T4 features internal shielding which eliminates the need for an external bulb shield, but a socket with shielding is essential if minimum grid-plate capacitance is to be obtained. The general appearance and size of the 1T4 is the same as that of the 1R5

★ CHARACTERISTICS

FILAMENT VOLTAGE (D.C.)	1.4	Volts
FILAMENT CURRENT	0.05	Ampere
GRID-PLATE CAPACITANCE*	0.01 max.	μ f
INPUT CAPACITANCE*	3.5	μ f
OUTPUT CAPACITANCE*	7.3	μ f

* With no external shield

As Class A₁ Amplifier

PLATE VOLTAGE	90 <i>max.</i>	Volts
SCREEN VOLTAGE (Grid No. 2)	67.5 <i>max.</i>	Volts
SCREEN SUPPLY VOLTAGE	90 <i>max.</i>	Volts
GRID VOLTAGE (Grid No. 1)	0 <i>min.</i>	Volts
TOTAL CATHODE CURRENT	5.5 <i>max.</i>	Milliamperes

TYPICAL OPERATION:

Plate Voltage	45	90	90	Volts
Screen Voltage	45	45	67.5	Volts
Grid Voltage	0	0	0	Volts
Plate Current	1.9	2	3.7	Milliamperes
Screen Current	0.7	0.65	1.25	Milliamperes
Plate Resistance	0.35	0.8	0.5	Megohm
Transconductance	700	750	900	Micromhos
Grid Voltage for transconductance of 10 micromhos	-10	-10	-18	Volts

INSTALLATION and APPLICATION

The base of the 1T4 fits a button-base socket with shielding. The socket may be installed to hold the tube in any position. Physical characteristics of the 1T4 are shown in Fig. 2-2, OUTLINES SECTION. For filament operation, see Type 1A7-G. Application of the 1T4 is similar to that of other remote cut-off, filament-type tubes.

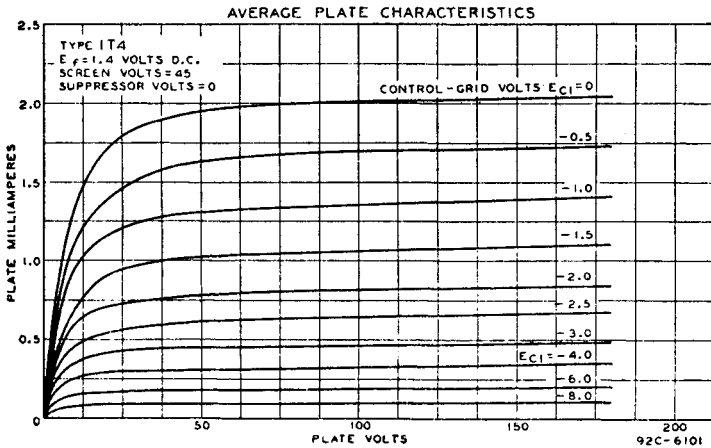

BEAM POWER AMPLIFIER

1T5-GT

The 1T5-GT is a power-output amplifier of the directed-beam type for use in battery-operated radio receivers. The 1T5-GT is used in applications where a moderate power output is desired and very low filament-current drain is necessary.

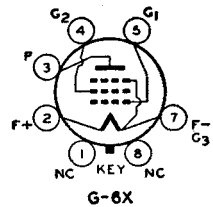

★ CHARACTERISTICS

FILAMENT VOLTAGE (D.C.)	1.4	Volts
FILAMENT CURRENT	0.05	Ampere
PLATE VOLTAGE	90 <i>max.</i>	Volts
SCREEN VOLTAGE	90 <i>max.</i>	Volts
GRID VOLTAGE	-6	Volts
PEAK A-F GRID VOLTAGE	6	Volts
PLATE CURRENT	6.5	Milliamperes

SCREEN CURRENT	1.4	Milliamperes
TRANSCONDUCTANCE	1150	Micromhos
LOAD RESISTANCE	14000	Ohms
TOTAL HARMONIC DISTORTION	7.5	Per cent
POWER OUTPUT	0.17	Watt

INSTALLATION and APPLICATION

The base of the 1T5-GT fits the standard octal socket which may be mounted to hold the tube in any position. Physical characteristics of the 1T5-GT are shown in Fig. 2-8, OUTLINES SECTION. Filament operation is discussed under Type 1A7-G. Information on the value of resistance in the grid circuit is the same as that given for Type 1Q5-GT.

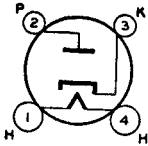

4G

HALF-WAVE RECTIFIER

The 1-v is a half-wave, high-vacuum rectifier tube employing a heater type of cathode. It is used principally for renewal purposes in radio equipment of either the a-c/d-c or the automobile type designed for its characteristics.

1-v

★ CHARACTERISTICS

HEATER VOLTAGE (A.C. or D.C.)	6.3	Volts
HEATER CURRENT	0.3	Ampere

As Half-Wave Rectifier

PEAK INVERSE VOLTAGE	1000 max.	Volts
PEAK PLATE CURRENT	270 max.	Milliamperes
D-C HEATER-CATHODE POTENTIAL	500 max.	Volts
TYPICAL OPERATION WITH CONDENSER-INPUT FILTER:		
A-C Plate Voltage (RMS)	117 150	325 max. Volts
Total Effective Plate-Supply Impedance†	0 min. 30 min. 75 min.	Ohms
D-C Output Current	45 max. 45 max. 45 max.	Milliamperes

†When a filter-input condenser larger than 40 μf is used, it may be necessary to use more plate-supply impedance than the minimum value shown to limit the peak plate current to the rated value.

INSTALLATION and APPLICATION

The base of the 1-v fits the standard four-contact socket which may be mounted to hold the tube in any position. Physical characteristics of the 1-v are shown in Fig 2-19, OUTLINES SECTION. For heater operation, see Type 6A8.

OPERATION CHARACTERISTICS

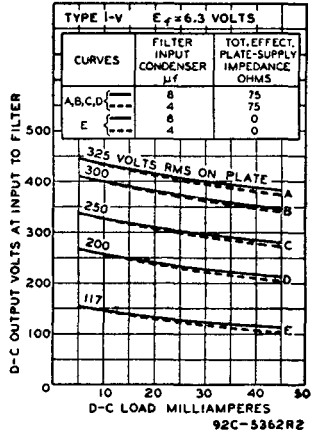

92C-5362R2

POWER-AMPLIFIER TRIODE

2A3

The 2A3 is a three-electrode, high-vacuum type of power amplifier tube for use in the power-output stage of a-c operated receivers. The exceptionally large power-handling ability of the 2A3 is the result of its design features. Among these are its extremely high transconductance and its large effective cathode area.

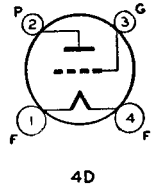

CHARACTERISTICS

FILAMENT VOLTAGE (A.C. or D.C.)	2.5	Volts
FILAMENT CURRENT	2.5	Amperes
GRID-PLATE CAPACITANCE (Approx.)	16.5	$\mu\mu\text{f}$
GRID-FILAMENT CAPACITANCE (Approx.)	7.5	$\mu\mu\text{f}$
PLATE-FILAMENT CAPACITANCE (Approx.)	5.5	$\mu\mu\text{f}$

As Single-Tube Class A₁ Amplifier

FILAMENT VOLTAGE (A.C.)	2.5	Volts
PLATE VOLTAGE	250 <i>max.</i>	Volts
GRID VOLTAGE*	-45	Volts
CATHODE RESISTOR	750	Ohms
PLATE CURRENT	60	Milliamperes
PLATE RESISTANCE	800	Ohms
AMPLIFICATION FACTOR	4.2	
TRANSCONDUCTANCE	5250	Micromhos
LOAD RESISTANCE	2500	Ohms
UNDISTORTED POWER OUTPUT	3.5	Watts

As Push-Pull Class AB₁ Amplifier (Two Tubes)

Fixed Bias Cathode Bias

FILAMENT VOLTAGE (A.C.)	2.5	2.5	Volts
PLATE VOLTAGE (Maximum)	300	300	Volts
GRID VOLTAGE*	-62	—	Volts
CATHODE RESISTOR	—	780	Ohms
ZERO-SIGNAL PLATE CURRENT	80	80	Milliamperes
EFFECTIVE LOAD RESISTANCE (Plate-to-plate)	3000	5000	Ohms
TOTAL HARMONIC DISTORTION	2.5	5	Per cent
POWER OUTPUT	15	10	Watts

* Grid volts measured from mid-point of a-c operated filament.

INSTALLATION and APPLICATION

The base of the 2A3 fits the standard four-contact socket which should be installed to hold the tube preferably in a vertical position. Horizontal operation is permissible if pins 1 and 4 are in horizontal position. Sufficient ventilation should be provided to prevent overheating. Physical characteristics of the 2A3 are shown in Fig. 2-27, OUTLINES SECTION.

As a power amplifier (Class A₁), the 2A3 is usable either singly or in push-pull combination in the power-output stage of a-c receivers. Recommended operating conditions are given under CHARACTERISTICS.

The values recommended for push-pull operation are different than the conventional ones usually given on the basis of characteristics for a single tube. The values shown for Push-Pull Class AB₁ operation cover operation with fixed bias and with cathode bias, and have been determined on the basis of no grid current flow during the most positive swing of the input signal and of cancellation of second-harmonic distortion by virtue of the push-pull circuit. The cathode resistor should preferably be shunted by a suitable filter network to minimize grid-bias variations produced by current surges in the cathode resistor.

When 2A3's are operated in push-pull, it is desirable to provide means for

adjusting independently the bias on each tube. This requirement is a result of the very high transconductance of these tubes—5250 micromhos. This very high value makes the 2A3 somewhat critical as to grid-bias voltage, since a very small bias-voltage change produces a very large change in plate current. It is obvious, therefore, that the difference in plate current between two tubes may be sufficient to unbalance the system seriously. To avoid this possibility, simple methods of independent cathode-bias adjustment may be used, such as (1) input transformer with two independent secondary windings, or (2) filament transformer with two independent filament windings. With either of these methods, each tube can be biased separately so as to obtain circuit balance.

Any conventional type of input coupling may be used provided the resistance added to the grid circuit by this device is not too high. *Transformers or impedances are recommended.* When cathode bias is used, the d-c resistance in the grid circuit should not exceed 0.5 megohm. With fixed bias, however, the d-c resistance should not exceed 50000 ohms.

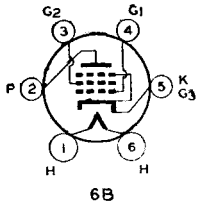
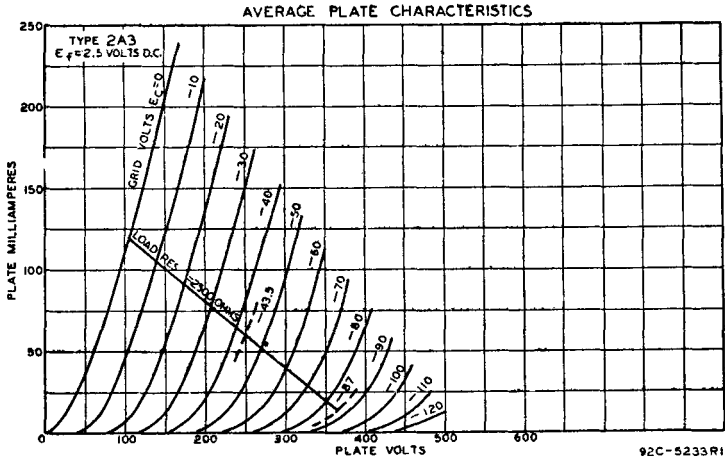

POWER AMPLIFIER PENTODE

The 2A5 is a heater-cathode type of power-amplifier pentode for use in the audio-output stage of a-c receivers. It is capable of giving large power output with a relatively small input-signal voltage. Except for its heater rating (2.5 volts, 1.75 ampere), the 2A5 has electrical characteristics identical with those of the 6F6. Applications, also, are the same as for the 6F6.

2A5

The base of the 2A5 fits the standard six-contact socket which may be installed to hold the tube in any position. Physical characteristics of the 2A5 are shown in Fig. 2-25, OUTLINES SECTION. The bulb of the 2A5 will become very hot under certain conditions of operation. Sufficient ventilation should be provided to prevent overheating. The heater of this type is designed to operate at 2.5 volts. The transformer-winding supplying the heater circuit should be designed to operate the heater at this recommended value for full-load operating conditions at average line voltage. The cathode should preferably be connected directly to a mid-tap on the heater winding or to a center-tapped resistor across the heater winding. If this practice is not followed, the potential difference between heater and cathode should be kept as low as possible. This type is used principally for renewal purposes.

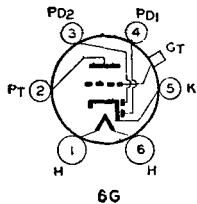

DUPLEX-DIODE HIGH-MU TRIODE

The 2A6 is a heater type of tube consisting of two diodes and a high-mu triode in a single bulb. It is for use as a combined detector, amplifier, and automatic-volume-control tube in radio receivers designed for its characteristics. Except for its heater rating (2.5 volts,

2A6

0.8 ampere), the 2A6 has electrical characteristics identical with those of the 75. The base of the 2A6 fits the standard six-contact socket which may be installed to hold the tube in any position. Physical characteristics of the 2A6 are shown in Fig. 2-16, OUTLINES SECTION. This type is used principally for renewal purposes.

PENTAGRID CONVERTER

2A7

The 2A7 is a multi-electrode type of vacuum tube designed to perform simultaneously the functions of a mixer (first detector) tube and of an oscillator tube in superheterodyne circuits. Except for its heater rating (2.5 volts, 0.8 ampere) and capacitances (same as for the 6A7), the 2A7 has electrical characteristics identical with those of the 6A8. The base of the 2A7 fits the seven-contact (0.75-inch pin-circle diameter) socket which may be installed to hold the tube in any position.

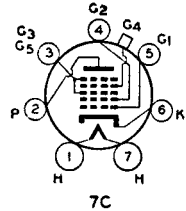

Physical characteristics of the 2A7 are shown in Fig. 2-16, OUTLINES SECTION. Complete shielding of the 2A7 is generally necessary to prevent intercoupling between its circuit and the circuits of other stages. Refer to APPLICATION on Type 6A8. This type is used principally for renewal purposes.

DUPLEX-DIODE PENTODE

2B7

The 2B7 is a heater type of tube consisting of two diodes and a pentode in a single bulb. It is designed for service as a combined detector, amplifier (radio-, intermediate-, or audio-frequency), and automatic-volume-control tube in radio receivers. Except for its heater rating (2.5 volts 0.8 ampere) and capacitances (same as for 6B7), the 2B7 has electrical characteristics identical with those of the 6B8-G. The base of the 2B7 fits the seven-contact (0.75-inch pin-circle diameter)

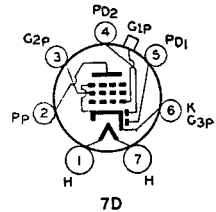

socket which may be installed to hold the tube in any position. Physical characteristics of the 2B7 are shown in Fig. 2-16, OUTLINES SECTION. Complete shielding of detector circuits employing the 2B7 is generally necessary to prevent r-f or i-f coupling between the diode circuits and the circuits of other stages. Refer to APPLICATION under Type 6B8. The 2B7 is used principally for renewal purposes.

BEAM POWER AMPLIFIER

3Q5-GT

The 3Q5-GT is a filament type of power-amplifier tube which employs directed electron-beam principles. It is intended for use in a-c/d-c battery receivers. The filament has a center tap so as to permit of either a series-filament or a parallel-filament arrangement. For discussion of beam power

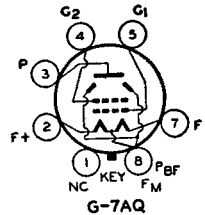

amplifier considerations, refer to section on ELECTRONS and ELECTRODES.

★ CHARACTERISTICS

	Series-Filament Arrangement	Parallel-Filament Arrangement	
FILAMENT VOLTAGE (D.C.).....	2.8	1.4	Volts
FILAMENT CURRENT.....	0.05	0.1	Ampere
PLATE VOLTAGE.....	90 <i>max.</i>	90 <i>max.</i>	Volts
SCREEN VOLTAGE (Grid No. 2)....	90 <i>max.</i>	90 <i>max.</i>	Volts
GRID VOLTAGE (Grid No. 1).....	-4.5	-4.5	Volts
PLATE CURRENT.....	7.5	9.5	Milliamperes
SCREEN CURRENT.....	1.0	1.6	Milliamperes
PLATE RESISTANCE (Approx.).....	0.11	0.1	Megohm
TRANSCONDUCTANCE.....	1800	2100	Micromhos
LOAD RESISTANCE.....	8000	8000	Ohms
TOTAL HARMONIC DISTORTION.....	7.5	7.5	Per cent
MAX.-SIGNAL POWER OUTPUT.....	250	270	Milliwatts

INSTALLATION and APPLICATION

The base of the 3Q5-GT fits the standard octal socket which may be mounted to hold the tube in any position. Physical characteristics of the 3Q5-GT are shown in Fig. 2-8, OUTLINES SECTION.

The coated filament is designed to be operated either with the two sections in series across two dry cells in series or with the two sections in parallel across one dry cell. With the series arrangement, the filament voltage is applied between pins No. 2 (+) and No. 7 (-). Pin No. 8 is not used. With the parallel arrangement, the filament voltage is applied between pin No. 8 (-) and Pins No. 2 and No. 7 (+) connected together. For further information on filament operation, see Type 1A7-G.

The 3Q5-GT may be operated as a single-tube class A₁ amplifier under conditions given above. The type of input coupling used should not introduce too much resistance in the grid circuit. Transformer- or impedance-coupling devices are recommended.

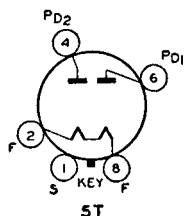

FULL-WAVE HIGH-VACUUM RECTIFIER

The 5T4 is a full-wave, high vacuum rectifier of the metal type for use in a-c receivers having high current requirements.

5T4
METAL

★ CHARACTERISTICS

FILAMENT VOLTAGE (A.C.)	5.0	Volts
FILAMENT CURRENT	2.0	Amperes

As Full-Wave Rectifier

PEAK INVERSE VOLTAGE	1550 max.	Volts
PEAK PLATE CURRENT PER PLATE	675 max.	Milliamperes
TYPICAL OPERATION WITH CONDENSER-INPUT FILTER:		
A-C Plate Voltage per Plate (RMS)	450 max.	Volts
Total Effective Plate-Supply Impedance per Plate†	150 min.	Ohms
D-C Output Current	225 max.	Milliamperes
TYPICAL OPERATION WITH CHOKE-INPUT FILTER:		
A-C Plate Voltage per Plate (RMS)	550 max.	Volts
Input-Choke Inductance	3 min.	Henries
D-C Output Current	225 max.	Milliamperes

†When a filter-input condenser larger than 40 μf is used, it may be necessary to use more plate-supply impedance than the minimum value shown to limit the peak plate current to the rated value.

INSTALLATION and APPLICATION

The base of the 5T4 fits the standard octal socket which should be installed to hold the tube preferably in a vertical position. Horizontal operation is permissible if pins 2 and 4 are in a vertical plane. Physical characteristics of the 5T4 are shown in Fig. 1-9, OUTLINES SECTION. Provision should be made for adequate ventilation to prevent overheating. The coated filament of the 5T4 is designed to operate from the a-c line through a step-down transformer. The voltage at the filament terminals should be 5.0 volts under operating conditions at an average line voltage of 117 volts. Filters are discussed in the RADIO TUBE APPLICATIONS section.

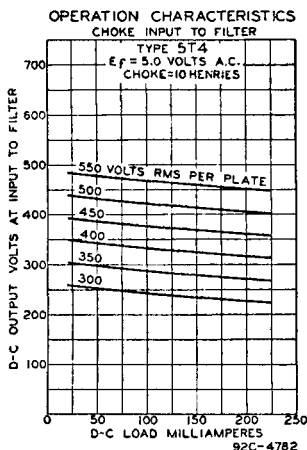
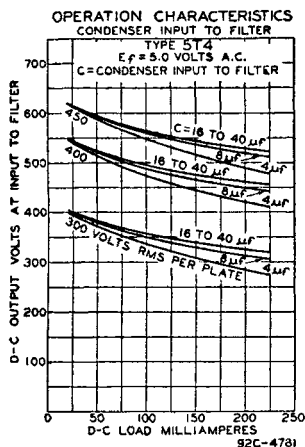

5U4-G

FULL-WAVE HIGH-VACUUM RECTIFIER

The 5U4-G is a full-wave, high vacuum rectifier of the filament type for use in a-c receivers having high current requirements.

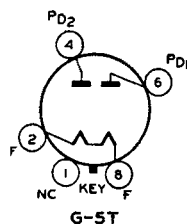

★ CHARACTERISTICS

FILAMENT VOLTAGE (A.C.)	5.0	Volts
FILAMENT CURRENT	3.0	Amperes

As Full-Wave Rectifier

PEAK INVERSE VOLTAGE	1550 max.	Volts
PEAK PLATE CURRENT PER PLATE	675 max.	Milliamperes
TYPICAL OPERATION WITH CONDENSER-INPUT FILTER:		
A-C Plate Voltage per Plate (RMS)	450 max.	Volts
Total Effective Plate-Supply Impedance per Plate†	75 min.	Ohms
D-C Output Current	225 max.	Milliamperes
TYPICAL OPERATION WITH CHOKO-INPUT FILTER:		
A-C Plate Voltage per Plate (RMS)	550 max.	Volts
Input-Choke Inductance	3 min.	Henries
D-C Output Current	225 max.	Milliamperes

† When a filter-input condenser larger than 40 μf is used, it may be necessary to use more plate-supply impedance than the minimum value shown to limit the peak plate current to the rated value.

INSTALLATION and APPLICATION

The base of the 5U4-G fits the standard octal socket which should be installed to hold the tube preferably in a vertical position. Horizontal operation is permissible if pins 1 and 4 are in a vertical plane. Physical characteristics of the 5U4-G are shown in Fig. 2-26, OUTLINES SECTION. Filament operation and ventilation are discussed under Type 5T4. Information on filter circuits is given in the RADIO TUBE APPLICATIONS section.

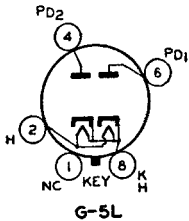
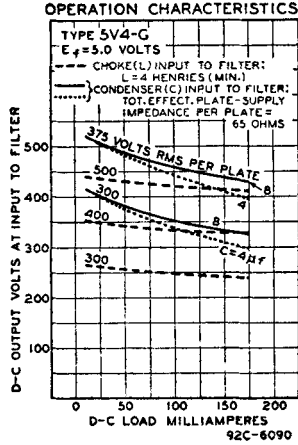
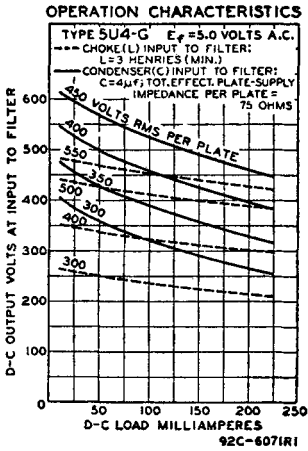

FULL-WAVE HIGH-VACUUM RECTIFIER

The 5V4-G is a full-wave, high-vacuum rectifier of the heater-cathode type capable of supplying large d-c currents. The close electrode spacing in this tube permits excellent voltage regulation.

5V4-G

★ CHARACTERISTICS

HEATER VOLTAGE (A.C.)	5.0	Volts
HEATER CURRENT	2.0	Amperes

As Full-Wave Rectifier

PEAK INVERSE VOLTAGE	1400 max.	Volts
PEAK PLATE CURRENT PER PLATE	525 max.	Milliamperes
TYPICAL OPERATION WITH CONDENSER-INPUT FILTER:		
A-C Plate Voltage per Plate (RMS)	375 max.	Volts
Total Effective Plate-Supply Impedance per Plate †	65 min.	Ohms
D-C Output Current	175 max.	Milliamperes
TYPICAL OPERATION WITH CHOKE-INPUT FILTER:		
A-C Plate Voltage per Plate (RMS)	500 max.	Volts
Input-Choke Inductance	4 min.	Henries
D-C Output Current	175 max.	Milliamperes

† When a filter-input condenser larger than 40 μf is used, it may be necessary to use more plate-supply impedance than the minimum value shown to limit the peak plate current to the rated value.

INSTALLATION and APPLICATION

The base of the 5V4-G fits the standard octal socket which may be mounted to hold the tube in any position. The bulb becomes hot during continuous operation and requires adequate ventilation to prevent overheating. Physical characteristics of the 5V4-L are shown in Fig. 2-21. OUTLINES SECTION. The heater is designed to operate from the a-c line through a step-down transformer. The voltage at the heater terminals should be 5.0 volts under operating conditions at a line voltage of 117 volts. For information on filter circuits, refer to the RADIO TUBE APPLICATIONS section. Operation curves for the 5V4-G are shown above

FULL-WAVE HIGH-VACUUM RECTIFIER

5W4
METAL

The 5W4 is a full-wave, high-vacuum rectifying tube of the metal type for use in a-c receivers having low current requirements.

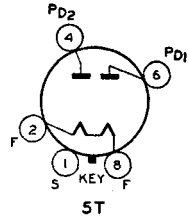

★ CHARACTERISTICS

FILAMENT VOLTAGE (A.C.).....	5.0	Volts
FILAMENT CURRENT.....	1.5	Amperes

As Full-Wave Rectifier

PEAK INVERSE VOLTAGE.....	1400 max.	Volts
PEAK PLATE CURRENT PER PLATE.....	300 max.	Milliamperes
TYPICAL OPERATION WITH CONDENSER-INPUT FILTER:		
A-C Plate Voltage per Plate (RMS).....	350 max.	Volts
Total Effective Plate-Supply Impedance per Plate†.....	25 min.	Ohms
D-C Output Current.....	100 max.	Milliamperes
TYPICAL OPERATION WITH CHOKE-INPUT FILTER:		
A-C Plate Voltage per Plate (RMS).....	500 max.	Volts
Input-Choke Inductance.....	6 min.	Henries
D-C Output Current.....	100 max.	Milliamperes

† When a filter-input condenser larger than 40 μ f is used, it may be necessary to use more plate-supply impedance than the minimum value shown to limit the peak plate current to the rated value.

INSTALLATION and APPLICATION

The base of the 5W4 fits the standard octal socket which should be installed to hold the tube preferably in a vertical position with the base down. Horizontal operation is permissible if pins 2 and 8 are in a vertical plane. Physical characteristics of the 5W4 are shown in Fig 1-7. OUTLINES SECTION. Refer to Type 5T4 for filament operation. Filter circuits are discussed in RADIO TUBE APPLICATIONS section.

OPERATION CHARACTERISTICS

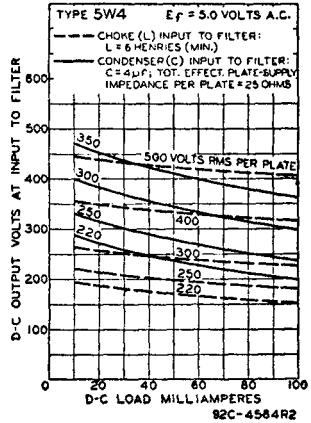

FULL-WAVE HIGH-VACUUM RECTIFIER

5X4-G

The 5X4-G is a full-wave, high vacuum rectifying tube of the filament type for use in a-c receivers having high current requirements. Its maximum ratings and typical operating conditions

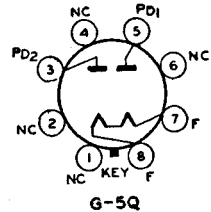

are the same as those for Type 5U4-G. The base of the 5X4-G fits the standard octal socket which should be mounted to hold the tube preferably in a vertical position. Horizontal operation is permissible if pins 2 and 7 are in a horizontal plane. Physical characteristics of the 5X4-G are shown in Fig. 2-26, OUTLINES SECTION.

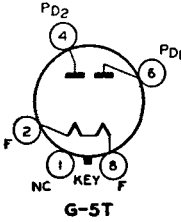

FULL-WAVE HIGH-VACUUM RECTIFIER

The 5Y3-G is a full-wave, high-vacuum rectifier of the filament type for use in a-c receivers of moderate current requirements.

5Y3-G

★ **CHARACTERISTICS**

FILAMENT VOLTAGE (A.C.).....	5.0	Volts
FILAMENT CURRENT.....	2.0	Ampere

As Full-Wave Rectifier

PEAK INVERSE VOLTAGE.....	1400 <i>max.</i>	Volts
PEAK PLATE CURRENT PER PLATE.....	375 <i>max.</i>	Milliamperes
TYPICAL OPERATION WITH CONDENSER-INPUT FILTER:		
A-C Plate Voltage per Plate (RMS).....	350 <i>max.</i>	Volts
Total Effective Plate-Supply Impedance per Plate.....	10 <i>min.</i>	Ohms
D-C Output Current.....	125 <i>max.</i>	Milliamperes
TYPICAL OPERATION WITH CHOKE-INPUT FILTER:		
A-C Plate Voltage per Plate (RMS).....	500 <i>max.</i>	Volts
Input-Choke Inductance.....	5 <i>min.</i>	Henries
D-C Output Current.....	125 <i>max.</i>	Milliamperes

‡ When a filter-input condenser larger than 40 μ f is used, it may be necessary to use more plate-supply impedance than the minimum value shown to limit the peak plate current to the rated value.

INSTALLATION and APPLICATION

The base of the 5Y3-G fits the standard octal socket which should be mounted to hold the tube preferably in a vertical position. Horizontal operation is permissible if pins 2 and 7 are in a horizontal plane. Physical characteristics of the 5Y3-G are shown in Fig. 2-21, OUTLINES SECTION. Filament operation and ventilation of the 5Y3-G are the same as for Type 5T4. Filters are discussed in the RADIO TUBE APPLICATIONS section.

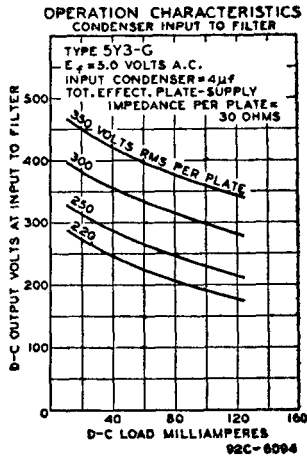
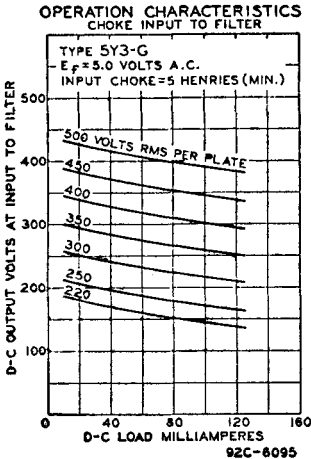

FULL-WAVE HIGH-VACUUM RECTIFIER

5Y4-G

The 5Y4-G is a full-wave, rectifying tube of the filament type for use in a-c receivers of moderate current requirements. Its maximum ratings and typical operating conditions are the same as those for Type 5Y3-G. The base of the 5Y4-G fits the standard octal

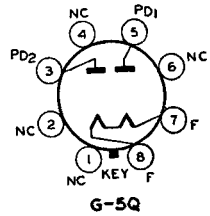

socket which should be mounted to hold the tube preferably in a vertical position. Horizontal operation is permissible if pins 2 and 7 are in a horizontal plane. Physical characteristics of the 5Y4-G are shown in Fig. 2-21, OUTLINES SECTION. Filament operation and ventilation are the same as for Type 5T4.

FULL-WAVE HIGH-VACUUM RECTIFIER

5Z3

The 5Z3 is a full-wave rectifier of the filament type intended for supplying rectified power to radio equipment having very large direct-current requirements. Its maximum ratings

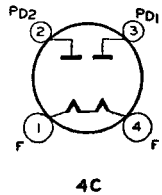

and typical operating conditions are the same as those for the Type 5U4-G. The base of the 5Z3 fits the standard four-contact socket which should be mounted to hold the tube preferably in a vertical position with the base down. Horizontal operation is permissible if pins 1 and 4 are in a horizontal plane. Physical characteristics of the 5Z3 are shown in Fig. 2-27, OUTLINES SECTION. Filament operation and ventilation are discussed under Type 5T4.

FULL-WAVE HIGH-VACUUM RECTIFIER

5Z4
METAL

The 5Z4 is a full-wave, high-vacuum rectifying tube of the metal type with an indirectly heated cathode. This tube is intended for supplying rectified power to radio equipment having moderate direct-current requirements.

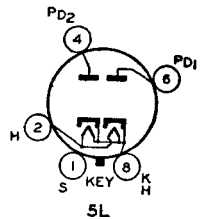

★ CHARACTERISTICS

HEATER VOLTAGE (A.C.)	5.0	Volts
HEATER CURRENT	2.0	Amperes

As Full-Wave Rectifier

PEAK INVERSE VOLTAGE	1400 max.	Volts
PEAK PLATE CURRENT PER PLATE	375 max.	Milliamperes
TYPICAL OPERATION WITH CONDENSER-INPUT FILTER:		
A-C Plate Voltage per Plate (RMS)	350 max.	Volts
Total Effective Plate-Supply Impedance per Plate†	30 min.	Ohms
D-C Output Current	125 max.	Milliamperes
TYPICAL OPERATION WITH CHOKE-INPUT FILTER:		
A-C Plate Voltage per Plate (RMS)	500 max.	Volts
Input-Choke Inductance	5 min.	Henries
D-C Output Current	125 max.	Milliamperes

† When a filter-input condenser larger than 40 μf is used, it may be necessary to use more plate-supply impedance than the minimum value shown to limit the peak plate current to the rated value.

INSTALLATION and APPLICATION

The base of the 5Z4 fits the standard octal socket which may be installed to hold the tube in any position. Physical characteristics of the 5Z4 are shown in Fig. 1-7, OUTLINES SECTION. Heater operation and ventilation are discussed under Type 5V4-G. For discussion of rectifiers and filter circuits, refer to RADIO TUBE APPLICATIONS section.

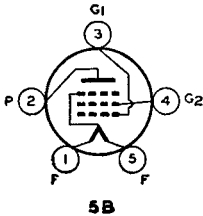
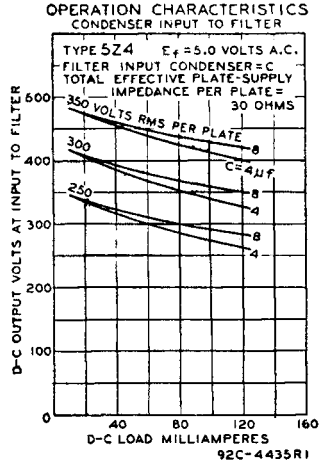
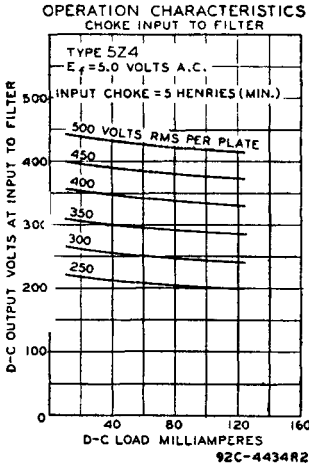

POWER AMPLIFIER PENTODE

The 6A4 is a power-amplifier pentode of the 6.3-volt filament type for use in receivers employing a six-volt storage-battery filament supply. The 6A4 is interchangeable with Type LA.

6A4

CHARACTERISTICS

FILAMENT VOLTAGE (A.C. or D.C.)	6.3				Volts
FILAMENT CURRENT	0.3				Ampere
PLATE VOLTAGE	100	135	165	180	max. Volts
SCREEN VOLTAGE (Grid No. 2)	100	135	165	180	max. Volts
GRID VOLTAGE* (Grid No. 1)	-6.5	-9	-11	-12	Volts
PLATE CURRENT	9	14	20	22	Milliamperes
SCREEN CURRENT	1.6	2.5	3.5	3.9	Milliamperes
PLATE RESISTANCE (Approx.)	83250	52600	48000	45500	Ohms
TRANSCONDUCTANCE	1200	1900	2100	2200	Micromhos
LOAD RESISTANCE	11000	9500	8000	8000	Ohms
CATHODE-BIAS RESISTOR	615	545	470	465	Ohms
POWER OUTPUT†	0.31	0.7	1.2	1.4	Watts

* Grid volts measured from negative end of d-c operated filament. If the filament is a-c operated, the tabulated values of grid bias should each be increased by 4.0 volts and be referred to the mid-point of filament. The d-c resistance in the grid circuit should not exceed 0.5 megohm † 9 per cent total harmonic distortion.

INSTALLATION and APPLICATION

The base of the 6A4 fits the standard five-contact socket which should be mounted to hold the tube preferably in a vertical position. Horizontal operation is permissible if pins 1 and 5 are in a vertical plane. Physical characteristics of the 6A4 are shown in Fig. 2-25, OUTLINES SECTION. The coated filament of the 6A4 is primarily intended for operation from a six-volt storage battery. Socket terminal No. 1 should be connected to the positive battery terminal.

CLASS B TWIN AMPLIFIER

6A6

The 6A6 is a heater-cathode type of tube combining in one bulb two high-mu triodes designed for class B operation. The triode units have separate terminals for all electrodes except heater and cathode, so that circuit design is similar to that of class B amplifiers using two tubes. The 6A6 (with

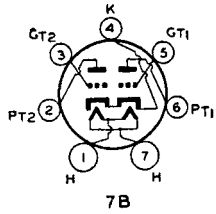

the two units in parallel) may also be used as a class A₁ amplifier to drive a 6A6 as class B amplifier. Electrical characteristics of the 6A6 are the same as those of Type 6N7. The base of the 6A6 fits the medium seven-contact (0.855-inch, pin-circle diameter) socket which may be mounted to hold the tube in any position. Physical characteristics of the 6A6 are shown in Fig 2-25, OUTLINES SECTION. For heater operation and application, refer to Type 6N7 and to RESISTANCE-COUPLED AMPLIFIER CHART.

PENTAGRID CONVERTER

6A7

The 6A7 is a multi-electrode type of vacuum tube designed to perform simultaneously the functions of a mixer tube and of an oscillator tube in superheterodyne circuits. For discussion of pentagrid types, see Frequency Conversion under RADIO TUBE APPLICATIONS. Except for capacitances, which are given below, the electrical

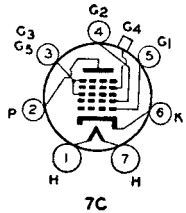

characteristics of the 6A7 are identical with those of the 6A8.

DIRECT INTERELECTRODE CAPACITANCES:

Grid No. 4 to Plate (With shield-can)	0.3	μf
Grid No. 4 to Grid No. 2 (With shield-can)	0.15	μf
Grid No. 4 to Grid No. 1 (With shield-can)	0.15	μf
Grid No. 1 to Grid No. 2	1.0	μf
Grid No. 4 to All Other Electrodes (R-F Input)	8.5	μf
Grid No. 2 to All Other Electrodes (Osc. Output) ..	5.5	μf
Grid No. 1 to All Other Electrodes (Osc. Input) ...	7.0	μf
Plate to All Other Electrodes (Mixer Output)	9.0	μf

INSTALLATION and APPLICATION

The base of the 6A7 fits the seven-contact (0.75-inch pin-circle diameter) socket which may be installed to hold the tube in any position. Physical characteristics of the 6A7 are shown in Fig. 2-16, OUTLINES SECTION. For heater and cathode operation, refer to Type 6A8. Complete shielding of the 6A7 is generally necessary to prevent intercoupling between its circuit and the circuits of other stages. Application of this type is similar to that of Type 6A8. A typical circuit is shown under Type 6A8.

6A8
METAL

6A8-G

PENTAGRID CONVERTER

The 6A8 and 6A8-G are multi-electrode vacuum tubes. Each type is designed to perform simultaneously the functions of a mixer (first detector) tube and of an oscillator tube in superheterodyne circuits. Through the use of either type, the independent control of each function is made possible within a single tube. For general discussion of

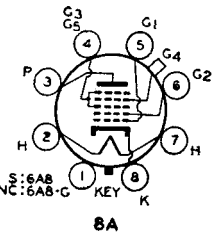

pentagrid types, refer to Frequency Conversion under RADIO TUBE APPLICATIONS.

★ CHARACTERISTICS

HEATER VOLTAGE (A.C. or D.C.)	6.3	Volts
HEATER CURRENT	0.3	Ampere

Type 6A8 Type 6A8-G

DIRECT INTERELECTRODE CAPACITANCES*:

Grid No. 4 to Plate	0.03	0.26	μf
Grid No. 4 to Grid No. 2	0.1	0.19	μf
Grid No. 4 to Grid No. 1	0.09	0.16	μf
Grid No. 1 to Grid No. 2	0.8	1.1	μf
Grid No. 4 to All Other Electrodes (R-F Input)	12.5	9.5	μf
Grid No. 2 to All Other Electrodes Except Grid No. 1 (Osc. Output)	5.0	4.6	μf
Grid No. 1 to All Other Electrodes Except Grid No. 2 (Osc. Input)	6.5	6	μf
Plate to All Other Electrodes (Mixer Output)	12.5	12	μf

* With shell of 6A8 connected to cathode, and with close-fitting shield on 6A8-G connected to cathode.

As Frequency Converter

PLATE VOLTAGE	300 max.	Volts
SCREEN VOLTAGE (Grids No. 3 and No. 5)	100 max.	Volts
SCREEN SUPPLY VOLTAGE	300 max.	Volts
ANODE-GRID VOLTAGE (Grid No. 2)	200 max.	Volts
ANODE-GRID SUPPLY VOLTAGE	300 max.	Volts
CONTROL-GRID VOLTAGE (Grid No. 4)	0 min.	Volts
PLATE DISSIPATION	1.0 max.	Watt
SCREEN DISSIPATION	0.3 max.	Watt
ANODE-GRID DISSIPATION	0.75 max.	Watt
TOTAL CATHODE CURRENT	14 max.	Milliamperes

TYPICAL OPERATION:

Plate Voltage	100	250	Volts
Screen Voltage	50	100	Volts
Anode-Grid Voltage	100	250**	Volts
Control-Grid Voltage	-1.5	-3	Volts
Oscillator-Grid Resistor (Grid No. 1)	50000	50000	Ohms
Plate Current	1.1	3.5	Milliamperes
Screen Current	1.3	2.7	Milliamperes
Anode-Grid Current	2	4	Milliamperes
Oscillator-Grid Current	0.25	0.4	Milliamperes
Total Cathode Current	4.6	10.6	Milliamperes
Plate Resistance (Approx.)	0.6	0.36	Megohm
Conversion Transconductance	360	550	Micromhos
Conversion Transconductance (Approx.) ..	3†	6††	Micromhos

† With control-grid bias of -20 volts

†† With control-grid bias of -35 volts.

** Anode-grid supply voltage applied through a properly by-passed 20000-ohm voltage-dropping resistor.

INSTALLATION and APPLICATION

The base of either the 6A8 or the 6A8-G fits the standard octal socket which may be installed to hold the tube in any position. Physical characteristics of the 6A8 and the 6A8-G are shown in Figs. 1-5, and 2-15, respectively, in the OUT-LINES SECTION.

The heater of the 6A8 or the 6A8-G is designed to operate on either a.c. or d.c. When either type is operated on a.c. with a transformer, the winding which supplies the heater circuit should operate the heater at its recommended value for full-load operating conditions at average line voltage. For service in automobile receivers, these types should have their heater terminals connected directly across a 6-volt battery. In receivers that employ a series-heater connection, the heater of either the 6A8 or 6A8-G may be operated in series with the heaters of other types having a 0.3-ampere rating. The current in the heater circuit should be adjusted to 0.3 ampere for an average line voltage of 117 volts.

The cathode of the 6A8 and of the 6A8-G when either type is operated from a transformer, should preferably be connected directly to the electrical mid-point of the heater circuit. When either type is operated in receivers employing a 6-volt storage battery for the heater supply, the cathode circuit is tied in either directly or through bias resistors to the negative side of the d-c plate supply which is furnished either by the d-c power line or the a-c line through a rectifier. In circuits where the cathode is not directly connected to the heater, the potential difference between them should be kept as low as possible. If the use of a large resistor is necessary between the heater and cathode in some circuit designs, it should be by-passed by a suitable filter network or objectionable hum may develop.

As a frequency converter in superheterodyne circuits, the 6A8 or the 6A8-G can supply the local oscillator frequency and at the same time mix it with radio-input frequency to provide the desired intermediate frequency. For this service, design information is given under CHARACTERISTICS.

For the oscillator circuit, the coils may be constructed according to conventional design, since neither tube type is particularly critical. The supply voltage applied to the anode-grid No. 2 should not exceed the maximum value of 300 volts. In fact, from a performance standpoint, a lower value is to be preferred, because it will be adequate to provide for optimum translation gain. Under no condition of adjustment should the cathode current exceed a recommended maximum value of 14 milliamperes.

The bias voltage applied to grid No. 4 can be varied from zero to cut-off to control the translation gain of either type. With lower screen voltages, the cut-off point is less remote. The extended cut-off feature of the 6A8 and the 6A8-G in combination with the similar characteristic of super-control tubes can be utilized advantageously to adjust receiver sensitivity.

Typical coil data and circuit are shown below. When the 6A8 is used in this circuit, its shell should be connected to ground. Complete shielding of the 6A8-G is generally necessary to prevent intercoupling between its circuits and the circuits of other stages.

Since the capacitance between grid No. 4 and plate is in a parallel path with the capacitance and the inductance of the plate load, it is important to use a load capacitance of sufficient size to limit the magnitude of the r-f voltage built up across the load. If this is not done, r-f voltage feed-back will occur between plate and grid No. 4 to produce degenerative effects. For this reason, the size of the load condenser in the plate circuit should not be less than 50 $\mu\mu\text{f}$.

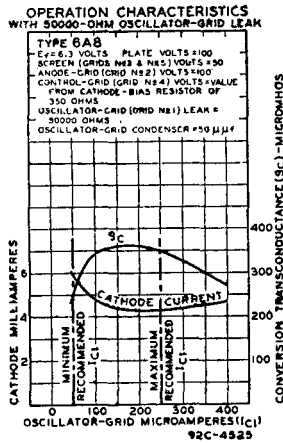
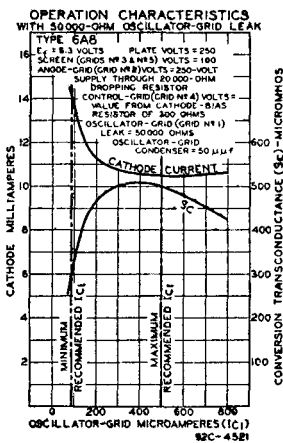

TYPICAL PENTAGRID CONVERTER CIRCUIT

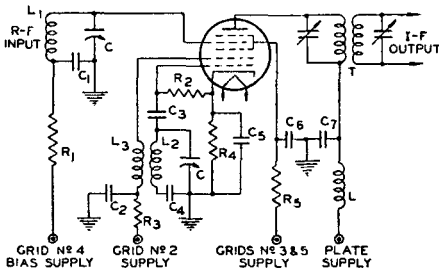

- C = GANGED TUNING CONDENSER (40 TO 350 $\mu\mu\text{f}$)
- $C_1, C_2, C_5, C_6, C_7 = 0.1 \mu\mu\text{f}$
- $C_3 = 0.00025 \mu\mu\text{f}$
- $C_4 = \text{SEE TABLE BELOW}$
- $R_1 = 250\,000 \text{ OHMS}, 0.1 \text{ WATT}$
- $R_2 = 10\,000 - 50\,000 \text{ OHMS}, 0.1 \text{ WATT}$
- $R_3 = \text{OSCILLATOR-ANODE (GRID \#2) VOLTAGE-DROPPING RESISTOR}$
- $R_4 = 150 - 300 \text{ OHMS}, 0.1 \text{ WATT}$
- $R_5 = \text{SCREEN (GRIDS \#3 \& 5) FILTER RESISTOR}$
- L = 60-MILLIHENRY R-F CHOKE
- T = 465-KC I-F TRANSFORMER

COIL-DESIGN DETAILS

FREQUENCY BAND MEGACYCLES	0.15 TO 0.40		0.55 TO 1.5		1.5 TO 4.0		4.0 TO 10		10 TO 25	
ASSEMBLY N ^o	1		2		2		3		3	
	TURN	WIRE #	TURN	WIRE #	TURN	WIRE #	TURN	WIRE #	TURN	WIRE #
R-F COIL (L ₁)	422	36 SSE	116	30 SSE	146	32 ENAM	36.2	30 ENAM	10.1	30 ENAM
OSC. GRID COIL (L ₂)	198	36 SSE	80	30 SSE	92	32 ENAM	30.9	30 ENAM	9.7	30 ENAM
OSC. PLATE COIL (L ₃)	60	36 SSE	30	30 SSE	20	32 ENAM	12	30 ENAM	12	36 ENAM
OSC. TRACKING COND. (C ₄)	117 $\mu\mu\text{f}$		400 $\mu\mu\text{f}$		1070 $\mu\mu\text{f}$		2900 $\mu\mu\text{f}$		7300 $\mu\mu\text{f}$	

N ^o 1		N ^o 2		N ^o 3	
MULTI-LAYER COILS		SINGLE-LAYER COILS		SINGLE-LAYER COILS	

PENTAGRID CONVERTER

The 6A8-GT is a multi-electrode tube designed to perform simultaneously the functions of mixer tube and of oscillator tube in superheterodyne circuits. For general discussion of pentagrid converters, see Frequency Conversion under RADIO TUBE APPLICATIONS. Physical characteristics of the 6A8-GT are shown in Fig. 2-6, OUTLINES SECTION. Maximum Ratings and Typical Operation for the 6A8-GT are the same as for the 6A8.

6A8-GT

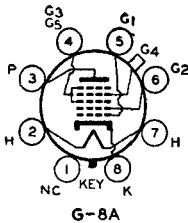

6A8-GT

ELECTRON-RAY TUBE

6AB5/6N5 is the new designation for the electron-ray tube 6N5. See type 6N5 for further data. Physical characteristics of the 6AB5/6N5 are shown in Fig. 2-18, OUTLINES SECTION.

6AB5/6N5

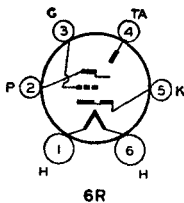

TELEVISION AMPLIFIER
PENTODE

6AB7/1853
METAL

The 6AB7 is a pentode of the single-ended metal type for use in television receivers. Because of its extended cut-off characteristic, it is recommended for use in the r-f and i-f stages of the picture amplifier of such receivers, particularly those employing automatic

gain control. The 6AB7 can also be used as a mixer and makes a good oscillator in low-voltage applications. The shielded-construction features of the 6AB7 are similar to those of the 6AC7/1852.

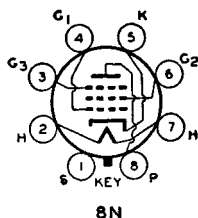

CHARACTERISTICS

HEATER VOLTAGE (A.C. or D.C.)	6.3	Volts
HEATER CURRENT	0.45	Ampere
GRID-PLATE CAPACITANCE°	0.015 max.	μμf
INPUT CAPACITANCE°	8	μμf
OUTPUT CAPACITANCE°	5	μμf

* With shell connected to cathode.

As Class A₁ Amplifier

PLATE VOLTAGE	300 max.	Volts
SCREEN VOLTAGE	200 max.	Volts
SCREEN SUPPLY VOLTAGE	300 max.	Volts
PLATE AND SCREEN DISSIPATION (Total)	4.4 max.	Watts
SCREEN DISSIPATION	0.65 max.	Watt

TYPICAL OPERATION:

	Condition I †	Condition II ††	
Plate Voltage	300	300	Volts
Suppressor Voltage	0	0	Volts
Screen Supply Voltage	200	300*	Volts
Screen Series Resistor	-	30000	Ohms
Grid Voltage	-3	-3	Volts
Plate Resistance (Approx.)	0.7	0.7	Megohm
Transconductance	5000	5000	Micromhos
Grid Bias for Transconductance = 50 micromhos	-15	-22.5	Volts
Plate Current	12.5	12.5	Milliamperes
Screen Current	3.2	3.2	Milliamperes

† With fixed screen supply.

†† With series screen resistor.

* Screen supply voltages in excess of 200 volts require the use of a series dropping resistor to limit the voltage at the screen to 200 volts when the plate current is at its normal value of 12.5 milliamperes.

INSTALLATION and APPLICATION

The base of the 6AB7 fits the standard octal socket which should be mounted to hold the tube preferably in a vertical position. Horizontal operation is permissible if the socket is positioned so that pins No. 2 and 7 are in a vertical plane. Physical characteristics of the 6AB7 are shown in Fig. 1-3, OUTLINES SECTION. For heater operation and cathode connection, refer to Type 6AG7.

Control-grid bias may be obtained by means of a cathode-bias resistor adjusted to give a plate current of 12.5 milliamperes, or from a fixed source, depending on the application.

In tubes such as the 6AB7 with a very high value of transconductance, appreciable changes in input capacitance and input conductance occur with changes in plate current. In order to minimize these changes when the 6AB7 is used as an r-f or i-f amplifier, a portion of the cathode-bias resistor may be left unby-passed. Reducing the changes of input capacitance and input conductance in this manner, however, is accomplished with some sacrifice in effective transconductance and some increase in effective grid-plate capacitance. To prevent excessive effective

grid-plate capacitance, precautions should be observed to keep external plate-cathode capacitances at a minimum. It should be observed that with this method of minimization, the cathode is not at a-c ground potential. Because of this fact, the most favorable connection of the tube electrodes will be obtained with suppressor and screen at a-c ground potential as shown in the circuit diagram below.

In some installations having automatic bias control which provides a fixed minimum bias adequate to limit plate current to 12.5 milliamperes, and also using a 30000-ohm series screen resistor, the cathode may be connected through an unby-passed resistor to ground. This resistor may conveniently form part of the fixed minimum bias. Such an arrangement serves to minimize changes of input capacitance and input conductance.

The d-c resistance in the grid circuit should not exceed 0.25 megohm with fixed bias. When full cathode bias and a series screen resistor are used, the d-c resistance may be as high as 0.5 megohm.

The screen voltage may be obtained from a potentiometer, a bleeder across the B-supply source, or through a series resistor. Use of the series screen resistor (Condition II) provides a somewhat more extended cut-off characteristic than is obtained with fixed screen voltage (Condition I).

The suppressor should be connected directly to ground in r-f and i-f circuits to minimize feedback.

As an amplifier, the 6AB7 is especially useful in the r-f and i-f stages of the picture amplifier of television circuits employing automatic gain control.

In circuits where changes of input capacitance and input conductance are not minimized by a partially unby-passed cathode-bias resistor, it will be advisable to operate the 6AB7 with circuits heavily loaded with resistance and capacitance. Although such circuits minimize the effect of the relatively small variations in tube capacitance and conductance, they also cause some sacrifice in gain.

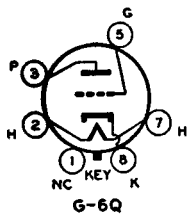
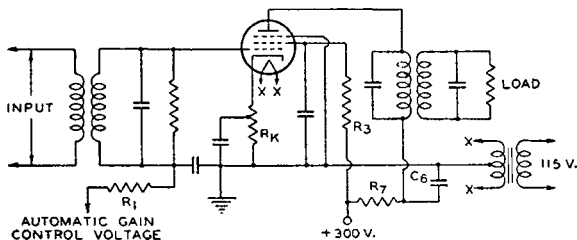

**HIGH-MU
POWER AMPLIFIER TRIODE**

6AC5-G

The 6AC5-G is a high-mu triode designed for use in either single-ended or push-pull audio-frequency power amplifiers. It is especially useful in direct-coupled circuits in which the driver tube develops positive grid bias for a single 6AC5-G. In push-pull class B service, conventional zero-bias operation is employed.

CHARACTERISTICS

HEATER VOLTAGE (A.C. or D.C.)	6.3	Volts
HEATER CURRENT	0.4	Ampere
AVERAGE CHARACTERISTICS:		
Plate Voltage.....	250	Volts
Grid Voltage.....	+13	Volts
Plate Resistance.....	36700	Ohms
Amplification Factor.....	125	
Transconductance.....	3400	Micromhos
Plate Current.....	32	Milliamperes
Grid Current.....	5	Milliamperes

As Class B Power Amplifier

PLATE VOLTAGE	250 max.	Volts
PEAK PLATE CURRENT (Per tube).....	110 max.	Milliamperes
AVERAGE PLATE DISSIPATION	10 max.	Watts

TYPICAL OPERATION:

Values are for two tubes

Plate Voltage	250	Volts
Grid Voltage	0	Volts
Peak A-F Grid-to-Grid Voltage.....	70	Volts
Zero-Signal D-C Plate Current	5	Milliamperes
Effective Load Resistance (Plate-to-plate)	10000	Ohms
Power Output (Approx.)*	8	Watts

* With peak input of 950 milliwatts applied between grids.

INSTALLATION and APPLICATION

The base of the 6AC5-G fits the standard octal socket which may be installed to hold the tube in any position. Physical characteristics of the 6AC5-G are shown in Fig. 2-17, OUTLINES SECTION. For heater operation, refer to Type 6K6-G. Cathode connection is the same as that for Type 6A8.

In push-pull class B service, the 6AC5-G should be operated as shown under CHARACTERISTICS.

In direct-coupled power amplifier service, a single 6AC5-G is preceded by a Type 76 in the dynamic-coupled circuit shown below. Bias voltage for both tubes is developed by the elements of the circuit which are common to both tubes. The total d-c resistance in the grid circuit of the driver should not exceed one megohm. The main purpose of the 25000-ohm resistor is to prevent a current surge occurring while the tube is warming up. In this service, the maximum plate voltage is 250 volts, the maximum average plate dissipation is 10 watts, the average plate current is 32 milliamperes, and the average plate current of driver is 5.5 milliamperes. With an input signal to the driver of 16.5 volts (rms) and a load resistance of 7000 ohms, the power output is 3.7 watts with 10% distortion. When the driver tube is operated up to the grid-current point, a power output of 4.3 watts with approximately 16% distortion may be obtained

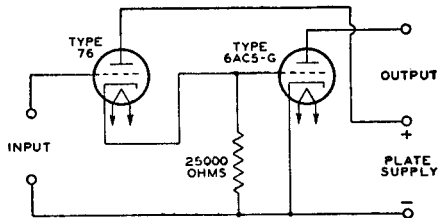

TELEVISION AMPLIFIER
PENTODE

6AC7/1852
METAL

The 6AC7 is a pentode of the single-ended metal type for use in television receivers. It is recommended for use in the r-f and i-f stages of the picture amplifier of such receivers as well as in the first stages of the video amplifier.

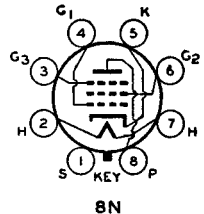

The 6AC7 can also be used as a mixer and is a good oscillator in low-voltage applications.

The 6AC7 has the same electrode assembly as the RCA-1851, but a special shielded-lead construction has been employed in the 6AC7, to permit bringing out the control-grid lead to a base pin rather than to a pin cap, without increase in the grid-plate capacitance. From a circuit standpoint, the proximity of grid pin to cathode pin simplifies wiring and decreases the size of the inductance loop connecting the input circuit to the tube. These are features important at high frequencies because they provide decreased feedback and improved circuit stability

CHARACTERISTICS

HEATER VOLTAGE (A.C. or D.C.)	6.3	Volts
HEATER CURRENT	0.45	Ampere
GRID-PLATE CAPACITANCE ^o	0.015 max.	μf
INPUT CAPACITANCE ^o	11	μf
OUTPUT CAPACITANCE ^o	5	μf

^o With shell connected to cathode.

As Class A Amplifier

PLATE VOLTAGE	300 max.	Volts
SCREEN VOLTAGE	150 max.	Volts
SCREEN SUPPLY VOLTAGE	300 max.	Volts
PLATE AND SCREEN DISSIPATION (Total)	3.4 max.	Watts
SCREEN DISSIPATION	0.38 max.	Watt

TYPICAL OPERATION:

	Condition I*	Condition II**	
Plate Voltage	300	300	Volts
Suppressor Voltage	0	0	Volts
Screen Supply Voltage	150	300 \ddagger	Volts
Screen Series Resistor	-	60000	Ohms
Cathode-Bias Resistor	160 min.	160 min.	Ohms
Plate Resistance (Approx.)	0.75	0.75	Megohm
Transconductance	9000	9000	Micromhos
Plate Current	10	10	Milliamperes
Screen Current	2.5	2.5	Milliamperes

* With fixed screen supply.

** With series screen resistor.

\ddagger Screen supply voltages in excess of 150 volts require use of a series dropping resistor to limit the voltage at the screen to 150 volts when the plate current is at its normal value of 10 milliamperes.

INSTALLATION and APPLICATION

The base of the 6AC7 fits the standard octal socket which should be installed to hold the tube preferably in a vertical position. Horizontal operation is permissible if the socket is positioned so that pins No. 2 and 7 are in a vertical plane. Physical characteristics of the 6AC7 are shown in Fig. 1-3, OUTLINES SECTION. For heater operation and cathode connection, refer to Type 6AG7.

Voltage supply considerations are similar to those for Type 6AB7. In video stages the cathode-bias resistor should not be by-passed if it is desired to have degeneration and freedom from distortion. When, however, no degeneration and maximum amplitude are desired, the cathode-bias resistor should be by-passed with a large condenser (350 μf).

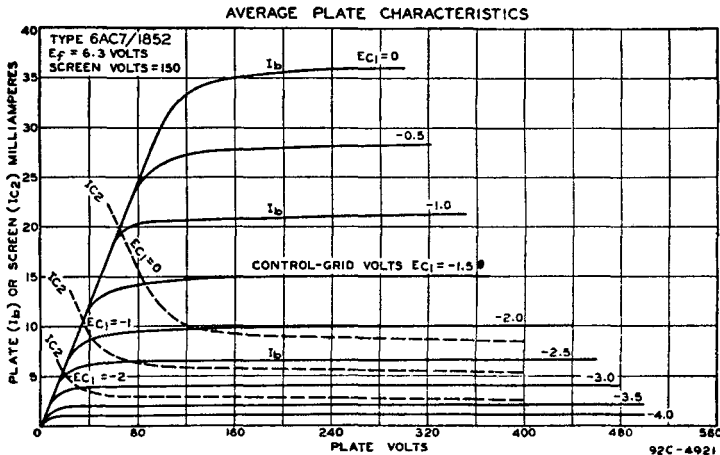

As an amplifier, the 6AC7 is especially suited for use in the r-f and i-f stages of the picture amplifier of television receivers and may also be used in the first video stages when several such stages are used. The use of the 6AC7 as a high-gain audio amplifier is not recommended unless the heater is operated from a battery source. Additional information on application of the 6AC7 is the same as shown for Type 6AB7.

AMPLIFIER TRIODE

6AE5-GT

The 6AE5-GT is a low- μ amplifier triode of the heater-cathode type intended for use in a-c/d-c receivers. The base of the 6AE5-GT fits the standard octal socket which may be mounted to hold the tube in any position. Physical characteristics of the 6AE5-GT are shown in Fig. 2-8, OUTLINES SECTION. For heater operation and cath-

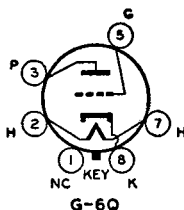

ode connection, refer to Type 6A8. The 6AE5-GT may be used as a driver for the Type 25AC5-GT.

CHARACTERISTICS

HEATER VOLTAGE (A.C. or D.C.)	6.3	Volts
HEATER CURRENT	0.3	Ampere
PLATE VOLTAGE	95	Volts
GRID VOLTAGE*	-15	Volts
PLATE CURRENT	7	Milliamperes
AMPLIFICATION FACTOR	4.2	
PLATE RESISTANCE	3500	Ohms
TRANSCONDUCTANCE	1200	Micromhos

* The d-c resistance in the grid circuit should not exceed 1.0 megohm.

ELECTRON-RAY TUBE

Twin Indicator Type

6AF6-G

The 6AF6-G is a high-vacuum, heater-cathode type of tube designed to respond visually, by means of two shadows on a fluorescent target, to changes in the voltages applied to the

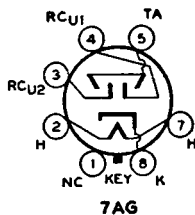

control electrodes. The tube, therefore, is a voltage indicator and as such is particularly useful as a convenient and non-mechanical means to indicate accurate tuning of a receiver to the desired station. Features of the 6AF6-G are its small size and its flexibility of application.

CHARACTERISTICS

HEATER VOLTAGE (A.C. or D.C.)	6.3	Volts
HEATER CURRENT	0.15	Ampere

As Tuning Indicator

TARGET VOLTAGE	{ 135 max.	Volts
	{ 90 min.	Volts
RAY-CONTROL ELECTRODE SUPPLY VOLTAGE	135 max.	Volts

TYPICAL OPERATION:

Target Voltage	100	135	Volts
Target Current*	0.9	1.5	Milliamperes
Ray-Control Electrode Voltage (Approx.)†	60	81	Volts
Ray-Control Electrode Voltage (Approx.)‡	0	0	Volts

* With 0 volts on ray-control electrode.

† For shadow angle of 0° produced by either ray-control electrode.

‡ For shadow angle of 100° produced by either ray-control electrode.

INSTALLATION and APPLICATION

The base of the 6AF6-G fits the standard octal socket which may be mounted to hold the tube in any position. The plane through the ray-control electrodes passes through pins 3 and 7. Physical characteristics of the 6AF6-G are shown in Fig. 2-1, OUTLINES SECTION. Heater operation is the same as for Type 6D8-G. For cathode connection, refer to Type 6A8.

The ray-control electrodes may be tied together to give twin shadows or they may be connected to separate control tubes to give two independently controlled shadows. In either case, the voltage or voltages required for control are supplied to the 6AF6-G through one or more voltage amplifier tubes. A typical circuit for the 6AF6-G is shown below. For further information on the performance of tuning indicators, refer to Type 6E5.

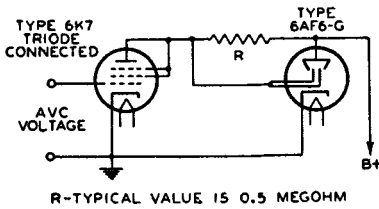

AVERAGE CHARACTERISTICS

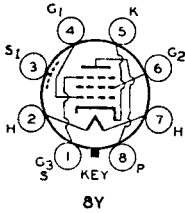
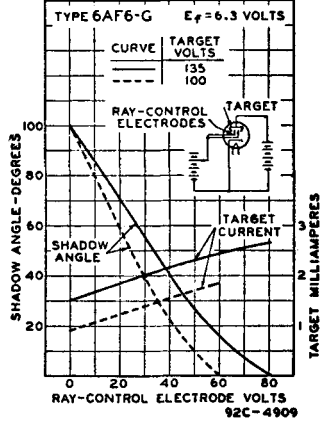

VIDEO POWER AMPLIFIER PENTODE

RCA-6AG7 is a heater-cathode type of metal tube intended for use primarily in the output stage of the video amplifier of television receivers. It may also be used advantageously in television transmitters as a coupling device between video-frequency stages and transmission lines.

6AG7

The design of the 6AG7 features not only an exceedingly high value of trans-conductance but also high plate-current capability. As a result, a large voltage for modulating a Kinescope can be built up across the relatively low load resistance required for coupling the 6AG7 to the Kinescope.

★ CHARACTERISTICS

HEATER VOLTAGE (A.C. or D.C.)	6.3	Volts
HEATER CURRENT	0.65	Ampere
DIRECT INTERELECTRODE CAPACITANCES:		
Grid to Plate	0.06 max.	μf
Input	12.5	μf
Output	7.5	μf
Grid to Screen (Approx.) ..	5.8	μf
Grid to Cathode (Approx.) ..	5.2	μf
Heater to Cathode (Approx.) ..	10.7	μf

AVERAGE CHARACTERISTICS:

Plate Voltage	300	Volts
Screen Voltage	300	Volts
Grid Voltage	-10.5	Volts
Interlead Shield	Connected to cathode at ground	
Plate Resistance	0.1	Megohm

Transconductance	7700	Micromhos
Plate Current	25	Milliamperes
Screen Current	6.5	Milliamperes

As Video Voltage Amplifier — Class A₁

PLATE VOLTAGE	300 <i>max.</i>	Volts
SCREEN VOLTAGE	300 <i>max.</i>	Volts
PLATE DISSIPATION	8.7 <i>max.</i>	Watts
SCREEN INPUT	2 <i>max.</i>	Watts

TYPICAL OPERATION IN 4-MC BANDWIDTH AMPLIFIER:

	<i>Grid-Leak Bias †</i>	<i>Cathode Bias</i>	
Plate-Supply Voltage.....	300	300	Volts
Screen Voltage	125°	125°	Volts
Grid Voltage.....	0*	-2	Volts
Grid Resistor.....	0.25-0.5	Megohm
Cathode Resistor ††	57	Ohms
Interlead Shield.....	Connected to ground		
Grid Signal Swing (Peak to peak)....	4	4	Volts
Plate Current	52*	28	Milliamperes
Screen Current	15*	7	Milliamperes
Load Resistance.....	3500	3500	Ohms
Voltage Output (Peak to peak).....	140	140	Volts

†Intended for use where d-c restoration is accomplished in the grid circuit of the 6AG7.

*Obtained from supply having good regulation.

**Obtained preferably from plate supply through series resistor.

*Zero-signal value.

††By-passed by 250 μ f, approx.

INSTALLATION

The base of the 6AG7 fits the standard octal socket which should be installed to hold the tube preferably in a vertical position with the base either up or down. Horizontal operation is permissible if the socket is positioned so that pins No. 2 and No. 7 are in a vertical plane. Physical characteristics of the 6AG7 are shown in Fig. 1-7, OUTLINES SECTION.

The heater of the 6AG7 is designed to operate on either a.c. or d.c. Under any condition of operation, the heater voltage should not deviate more than plus or minus 10% from the normal value of 6.3 volts.

The cathode when the 6AG7 is operated from a transformer, should be connected through a bias source either to one side or to the electrical mid-point of the heater circuit. In the case of d-c operation from a 6-volt storage battery, the cathode circuit should be tied through a bias source to the negative battery terminal. The potential difference between heater and cathode should be kept as low as possible.

Control-grid bias may be obtained from a fixed supply, from a cathode resistor, or from a variable voltage supplied for automatic control purposes. In video use, the latter method provides for control of the picture background. With the cathode-resistor bias method, the resistor should not be by-passed if it is desired to have degeneration and freedom from distortion. When, however, no degeneration and maximum signal amplitude are desired, compensation can be provided by utilizing filters with equal time constants in the cathode circuit and in the plate circuit.

The screen voltage for the 6AG7 operated with fixed bias or cathode-resistor bias, should preferably be obtained through the use of a resistor in series with the high-voltage B-supply. The use of a series screen resistor requires the use of a large by-pass condenser in the screen circuit. The size of the by-pass condenser can be reduced if a suitable compensating filter is used in the plate circuit. When the bias for the 6AG7 is obtained by the automatic background-control method, it is recommended that the screen voltage be obtained from a source of good regulation.

The interlead shield is connected within the tube to pin No. 3. This pin should be grounded at the socket to provide a shield between the grid and heater (pin No. 2).

APPLICATION

As a video amplifier, the 6AG7 is especially designed for use in the final video stage to modulate the Kinescope in a television receiver. In such service, the 6AG7 will provide adequate modulating voltage without frequency discrimination

over the wide bandwidth required for high-definition television reception. The extremely high transconductance and the large plate current of this tube make possible relatively high voltage gain with the low load resistance needed to give uniform output over the wide frequency range. A typical circuit showing suitable constants for a video amplifier is shown below.

TYPICAL VIDEO VOLTAGE AMPLIFIER
HAVING BANDWIDTH OF 4 MEGACYCLES

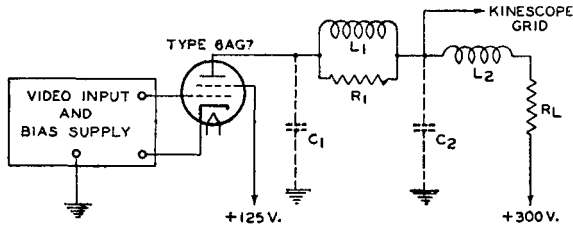

- $C_1 = 9.5 \mu\text{f} = \text{Tube Capacitance} + \text{Socket Capacitance} + \text{Wiring Capacitance} + \text{Coil Capacitance}$
- $C_2 = 19 \mu\text{f} = \text{Kinescope Capacitance} + \text{Socket Capacitance} + \text{Wiring Capacitance} + \text{Coil Capacitance}$
- $L_1 = 250 \mu\text{h}$ Filter Inductor
- $L_2 = 125 \mu\text{h}$ Filter Inductor
- $R_1 = 20000\text{-Ohm}$, Non-Reactve Resistor
- $R_L = 3500\text{-Ohm}$, 10-Watt, Non-Reactve Resistor

AVERAGE PLATE CHARACTERISTICS
WITH E_{C1} AS VARIABLE

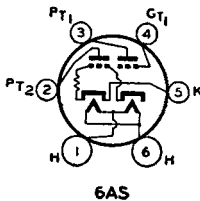
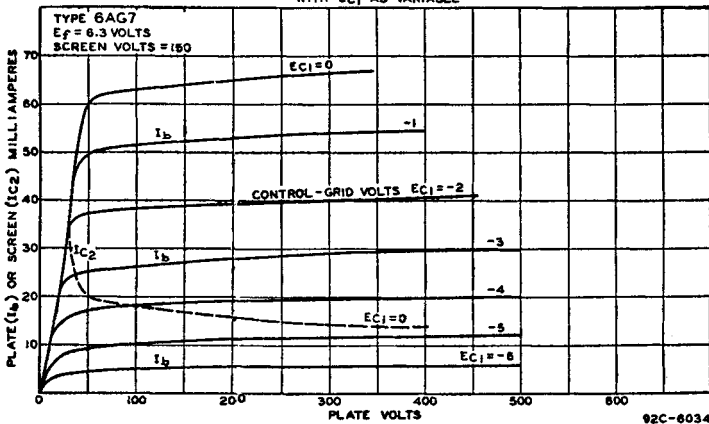

DIRECT-COUPLED
POWER AMPLIFIER

6B5

The 6B5 is a multi-electrode tube of the heater-cathode type consisting of two triodes in one bulb and used chiefly for replacement in receivers designed for its characteristics. One triode, the driver, is directly connected within the tube to the second, or output, triode. Electrical characteristics of the 6B5 are identical with those of the 6N6-G.

The base of the 6B5 fits the standard six-contact socket which may be mounted to hold the tube in any position. Physical characteristics of the 6B5 are shown in Fig. 2-25. OUTLINES SECTION. For heater operation, see Type 6N7

DUPLEX-DIODE HIGH-MU TRIODE

6B6-G

The 6B6-G is a heater-cathode type of tube consisting of two diodes and a high-mu triode in one bulb. It is for use as a combined detector, amplifier, and automatic-volume-control tube. For diode-detector considerations, refer to RADIO TUBE APPLICATIONS section.

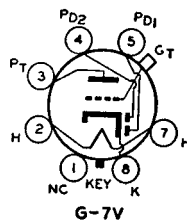

★ CHARACTERISTICS

HEATER VOLTAGE (A.C. or D.C.)	6.3	Volts
HEATER CURRENT	0.3	Ampere
<i>Triode:</i> GRID-PLATE CAPACITANCE*	1.3	μmf
GRID-CATHODE CAPACITANCE*	2.7	μmf
PLATE-CATHODE CAPACITANCE*	4.5	μmf

* With close-fitting shield connected to cathode. Values are approximate.

Triode Unit — As Class A₁ Amplifier

PLATE VOLTAGE	250 <i>max.</i>	Volts
GRID VOLTAGE	-2	Volts
PLATE CURRENT	0.9	Milliampere
PLATE RESISTANCE	91000	Ohms
AMPLIFICATION FACTOR	100	
TRANSCONDUCTANCE	1100	Micromhos

Diode Units

The two diode plates are placed around a cathode, the sleeve of which is common to the triode unit. Each diode plate has its own base pin. Diode biasing of the triode unit of the 6B6-G is not suitable. Operation curves for the diode units are given under Type 6B7.

INSTALLATION and APPLICATION

The base of the 6B6-G fits the standard octal socket which may be installed to hold the tube in any position. Physical characteristics of the 6B6-G are shown in Fig. 2-15, OUTLINES SECTION. Heater operation and cathode connection are the same as for Type 6A8. Application of the 6B6-G is similar to that of Type 6SQ7.

DUPLEX-DIODE PENTODE

6B7

The 6B7 is a heater-cathode type of tube consisting of two diodes and a pentode in a single envelope. It is used as a combined detector, amplifier (radio-, intermediate-, or audio-frequency), and automatic-volume-control tube in a-c receivers having a 6.3-volt

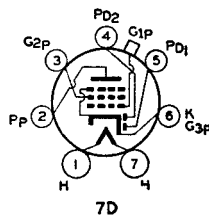

heater supply. Its electrical characteristics, except for capacitances, are identical with those of the 6B8-G. Capacitances of the 6B7 are given below. For diode-detector considerations, refer to RADIO TUBE APPLICATIONS section. Installation is discussed under Type 6A8 and application under Type 6B8. Physical characteristics of the 6B7 are shown in Fig. 2-16, OUTLINES SECTION.

Pentode Capacitances

GRID-PLATE*	0.007 max.	$\mu\mu\text{f}$
INPUT	3.5	$\mu\mu\text{f}$
OUTPUT	9.5	$\mu\mu\text{f}$

* With shield-can.

AVERAGE CHARACTERISTICS
HALF-WAVE RECTIFICATION-SINGLE DIODE UNIT

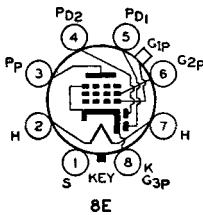
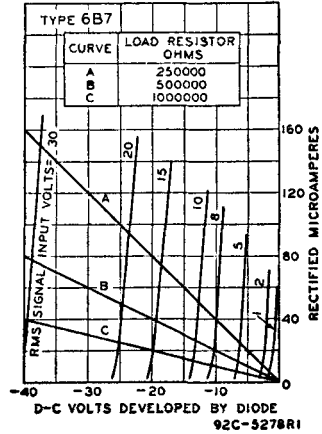

DUPLEX-DIODE PENTODE

The 6B8 is a heater-cathode type of metal tube consisting of two diodes and a pentode in the same envelope. It is recommended for use as a combined detector, amplifier (radio-, intermediate-, or audio-frequency), and automatic-volume-control tube in a-c receivers having a 6.3-volt heater supply.

6B8
METAL

For diode-detector considerations, refer to RADIO TUBE APPLICATIONS section.

★ CHARACTERISTICS

HEATER VOLTAGE (A.C. or D.C.)	6.3	Volts
HEATER CURRENT	0.3	Ampere
Pentode: GRID-PLATE CAPACITANCE*	0.005 max.	$\mu\mu\text{f}$
INPUT CAPACITANCE*	6	$\mu\mu\text{f}$
OUTPUT CAPACITANCE*	9	$\mu\mu\text{f}$

* With shell connected to cathode.

Pentode Unit — As Class A₁ Amplifier

PLATE VOLTAGE	300 max.	Volts
SCREEN VOLTAGE (Grid No. 2)	125 max.	Volts
SCREEN SUPPLY VOLTAGE	300 max.	Volts
GRID VOLTAGE (Grid No. 1)	0 min.	Volts
PLATE DISSIPATION	2.25 max.	Watts
SCREEN DISSIPATION	0.3 max.	Watt
TYPICAL OPERATION:		
Plate Voltage	250	Volts
Screen Voltage	125	Volts
Grid Voltage**	-3	Volts
Plate Current	10	Milliamperes
Screen Current	2.3	Milliamperes
Plate Resistance (Approx.)	0.6	Megohm
Transconductance	1325	Micromhos
Grid Bias Voltage (Approx.)†	-21	Volts

† For cathode current cut-off.

** The d-c resistance in the grid circuit should not exceed 1.0 megohm.

Diode Units

Two diode plates are placed around a cathode, the sleeve of which is common to the pentode unit. Each diode plate has its own base pin. Operation curves for the diode units are given under Type 6B7.

INSTALLATION and APPLICATION

The base of the 6B8 fits the standard octal socket which may be installed to hold the tube in any position. Physical characteristics of the 6B8 are shown in Fig. 1-5, OUTLINES SECTION. Heater operation and cathode connection are the same as for Type 6A8.

For detection, the diodes of this tube may be utilized in a full-wave circuit or in a half-wave circuit. In the latter case, one plate only or the two plates in parallel may be employed. The use of the half-wave arrangement will provide approximately twice the rectified voltage as compared with the full-wave arrangement.

For automatic volume control, a rectified voltage which is dependent on the r-f or i-f carrier is usually employed. This voltage may be utilized to regulate the gain of the r-f and/or i-f amplifier stages so as to maintain essentially constant-carrier input to the audio detector. Refer to discussion of automatic-volume-control methods in RADIO TUBE APPLICATIONS section.

For r-f or i-f amplification, the pentode unit of the 6B8 may be employed in conventional circuit arrangements. It is designed so that its cut-off is somewhat extended to permit of moderate gain control by grid-bias variation without introducing cross-modulation effects. The cut-off point and the ability to handle the larger signals may be altered by choice of screen voltage to suit the requirements of the circuit. For many types of circuits a convenient and practical method of obtaining the desired benefit of the extended cut-off is to supply the screen voltage from a high-voltage tap through a series resistor. This arrangement provides automatically an increase in the voltage applied to the screen as the grid-bias is made more negative, with the result that the maximum signal-handling ability is obtained.

For a-f amplification, the pentode unit of the 6B8 may be used in a resistance-coupled circuit arrangement to provide high gain under operating conditions given in the Resistance-Coupled Amplifier Chart.

Typical duplex-diode pentode circuits are shown in the CIRCUIT SECTION. When the 6B8 is used in these circuits, its shell should be connected to ground.

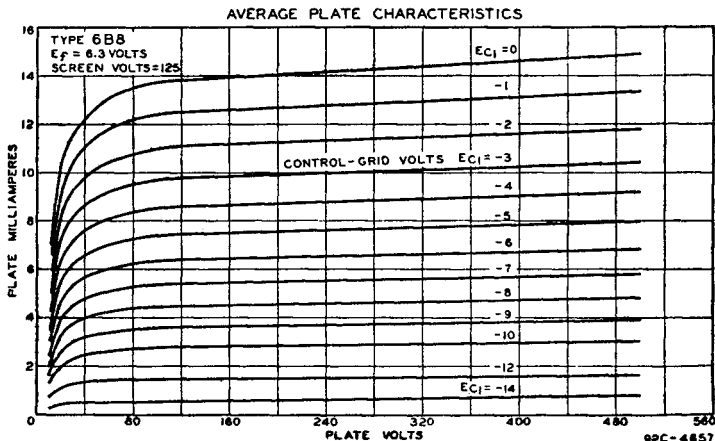

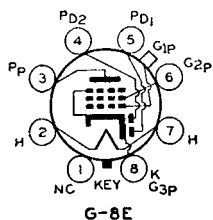

DUPLEX-DIODE PENTODE

The 6B8-G is a heater-cathode type of tube consisting of two diodes and a pentode in the same bulb. It is recommended for use as a combined detector, amplifier (radio-, intermediate-, or audio-frequency), and automatic-volume-control tube. For diode-detector considerations, refer to RADIO TUBE APPLICATIONS section.

6B8-G

★ CHARACTERISTICS

HEATER VOLTAGE (A.C. or D.C.)	6.3	Volts
HEATER CURRENT	0.3	Ampere
Pentode: GRID-PLATE CAPACITANCE†	0.01 max.	μf
INPUT CAPACITANCE†	3.6	μf
OUTPUT CAPACITANCE†	9.5	μf

† With close-fitting shield connected to cathode.

Pentode Unit — As Class A₁ Amplifier

PLATE VOLTAGE	300 max.	Volts
SCREEN VOLTAGE (Grid No. 2)	125 max.	Volts
SCREEN SUPPLY VOLTAGE	300 max.	Volts
GRID VOLTAGE (Grid No. 1)	0 min.	Volts
PLATE DISSIPATION	2.25 max.	Watts
SCREEN DISSIPATION	0.3 max.	Watt

TYPICAL OPERATION:

Plate Voltage	100	250	250	Volts
Screen Voltage	100	100	125	Volts
Grid Voltage**	-3	-3	-3	Volts
Plate Current	5.8	6	9	Milliamperes
Screen Current	1.7	1.5	2.3	Milliamperes
Plate Resistance (Approx.)	0.3	0.8	0.6	Megohm
Transconductance	950	1000	1125	Micromhos
Grid-Bias Volt. (Approx.)†	-17	-17	-21	Volts

† For cathode current cut-off.

** The value of the resistance in the grid circuit should not exceed 1.0 megohm.

Diode Units

Two diode plates are placed around a cathode, the sleeve of which is common to the pentode unit. Each diode plate has its own base pin. Operation curves for the diode units are given under Type 6B7.

INSTALLATION and APPLICATION

The base of the 6B8-G fits the standard octal socket which may be installed to hold the tube in any position. Physical characteristics of the 6B8-G are shown in Fig. 2-15, OUTLINES SECTION. For heater operation and cathode connection, refer to Type 6A8.

Complete shielding of detector circuits employing the 6B8-G is generally necessary to prevent r-f or i-f coupling between the diode circuits and the circuits of other stages. Refer to APPLICATION on the Type 6B8 and to the RESISTANCE-COUPLED AMPLIFIER CHART.

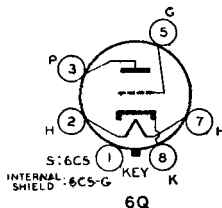

DETECTOR AMPLIFIER TRIODES

6C5

METAL

6C5-G

The 6C5 and 6C5-G are three-electrode tubes of the heater-cathode type recommended for use as detectors, amplifiers, or oscillators. They have a high transconductance together with

a comparatively high amplification factor. Except for capacitances, the electrical characteristics of the two types are identical.

★ CHARACTERISTICS

HEATER VOLTAGE (A.C. or D.C.)	6.3	Volts
HEATER CURRENT	0.3	Ampere
	6C5*	6C5-G**
GRID-PLATE CAPACITANCE	2.0	2.2 μf
GRID-CATHODE CAPACITANCE	3.0	4.4 μf
PLATE-CATHODE CAPACITANCE	11	12 μf

* With shell connected to cathode.

** With close-fitting shield connected to cathode.

As Class A₁ Amplifier

PLATE VOLTAGE	300 <i>max.</i>	Volts
GRID VOLTAGE	0 <i>min.</i>	Volts
PLATE DISSIPATION	2.5 <i>max.</i>	Watts
TYPICAL OPERATION:		
Plate Voltage	250	Volts
Grid Voltage ^{oo}	-8	Volts
Plate Current	8	Milliamperes
Plate Resistance	10000	Ohms
Amplification Factor	20	
Transconductance	2000	Micromhos

^{oo} The d-c resistance in the grid circuit should not exceed 1 megohm.

INSTALLATION and APPLICATION

The base of either the 6C5 or the 6C5-G fits the standard octal socket which may be installed to hold the tube in any position. For heater operation, and cathode connection, refer to Type 6A8. Physical characteristics of the 6C5 and 6C5-G are shown in Figs. 1-2 and 2-17, respectively, in the OUTLINES SECTION.

As amplifiers, the 6C5 and 6C5-G are applicable to radio-frequency or audio-frequency circuits. Recommended operating conditions for service using transformer coupling are given under CHARACTERISTICS. Operating conditions for the 6C5 and 6C5-G as resistance-coupled audio-frequency amplifiers are given in the RESISTANCE-COUPLED AMPLIFIER CHART.

As detectors, the 6C5 and 6C5-G may be of the grid-leak and condenser or grid-bias type. The plate voltage for the grid-leak-condenser method should be 45 to 100 volts. A grid leak from 0.1 to 1.0 megohm with a grid condenser of 0.00005 to 0.0005 μf is satisfactory. For the grid-bias method of detection, a plate-supply voltage of 250 volts may be used together with a negative grid-bias voltage of approximately 17 volts. The plate current should be adjusted to 0.2 milliamperes with no input signal voltage. The grid-bias voltage may be supplied from the voltage drop in a resistor between cathode and ground.

AVERAGE PLATE CHARACTERISTICS

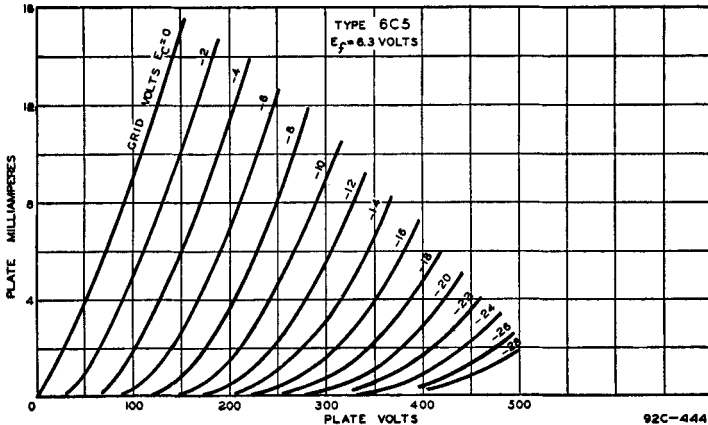

92C-4441

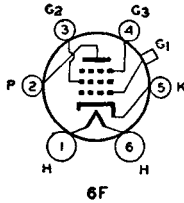

**TRIPLE-GRID DETECTOR
AMPLIFIER**

6C6

The 6C6 is a triple-grid tube of the heater-cathode type recommended for service as a biased detector in radio receivers designed for its characteristics. This tube is capable of delivering a large audio-frequency output voltage with relatively small input voltage. Significant among its electrical features are its sharp plate current "cut-off" with respect to grid voltage. The 6C6 is constructed with an internal shield connected to the cathode within the tube.

★ CHARACTERISTICS

HEATER VOLTAGE (A.C. or D.C.)	6.3	Volts
HEATER CURRENT	0.3	Ampere
PENTODE CONNECTION:		
Grid-Plate Capacitance*	0.007 max.	$\mu\mu\text{f}$
Input Capacitance	5	$\mu\mu\text{f}$
Output Capacitance	6.5	$\mu\mu\text{f}$
TRIODE CONNECTION †		
Grid-Plate Capacitance	2	$\mu\mu\text{f}$
Grid-Cathode Capacitance	3	$\mu\mu\text{f}$
Plate-Cathode Capacitance	10.5	$\mu\mu\text{f}$

* With close-fitting shield connected to cathode.
 † With screen and suppressor connected to plate.

Other characteristics of this type are the same as for Type 6J7.

INSTALLATION and APPLICATION

The base of the 6C6 fits the standard six-contact socket which may be installed to hold the tube in any position. Physical characteristics of the 6C6 are shown in Fig. 2-20 OUTLINES SECTION. For heater operation and cathode connection, refer to Type 6A8. Application of this type is similar to that of Type 6J7.

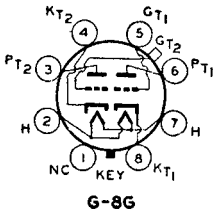

TWIN-TRIODE AMPLIFIER

6C8-G

The 6C8-G is a multi-electrode type of vacuum tube consisting of two high-mu voltage-amplifier triodes in one bulb. It will be found useful as a voltage amplifier or as a phase inverter. Except for the common heater, each triode is independent of the other.

★ CHARACTERISTICS

HEATER VOLTAGE (A.C. or D.C.)	6.3	Volts
HEATER CURRENT	0.3	Ampere
	<i>Triode Unit 1</i>	<i>Triode Unit 2</i>
GRID-PLATE CAPACITANCE*	2.5	2.4 $\mu\mu\text{f}$
GRID-CATHODE CAPACITANCE*	3.4	2.5 $\mu\mu\text{f}$
PLATE-CATHODE CAPACITANCE*	3.5	3.9 $\mu\mu\text{f}$
GRID-GRID CAPACITANCE*		0.1 $\mu\mu\text{f}$
PLATE-PLATE CAPACITANCE*		1.5 $\mu\mu\text{f}$

* Approximate.

Each Triode Unit — As Class A₁ Amplifier

PLATE VOLTAGE	250 max.	Volts
GRID VOLTAGE	0 min.	Volts
PLATE DISSIPATION	1.0 max.	Watt

TYPICAL OPERATION:

Plate Voltage	250	Volts
Grid Voltage	4.5	Volts
Plate Current	3.2	Milliamperes
Plate Resistance	22500	Ohms
Amplification Factor	36	
Transconductance	1600	Micromhos

INSTALLATION and APPLICATION

The base of the 6C8-G fits the standard octal socket which may be installed to hold the tube in any position. Physical characteristics of the 6C8-G are shown in Fig. 2-15, OUTLINES SECTION. For heater operation and cathode connection, refer to Type 6A8.

As a class A₁ amplifier, the 6C8-G may be operated under conditions shown under CHARACTERISTICS. Additional information is given in the RESISTANCE-COUPLED AMPLIFIER CHART. In high-gain amplifiers, hum may be reduced or eliminated by grounding pin No. 7 (heater) or by grounding the arm of a potentiometer of 100 or 500 ohms connected across the heater terminals.

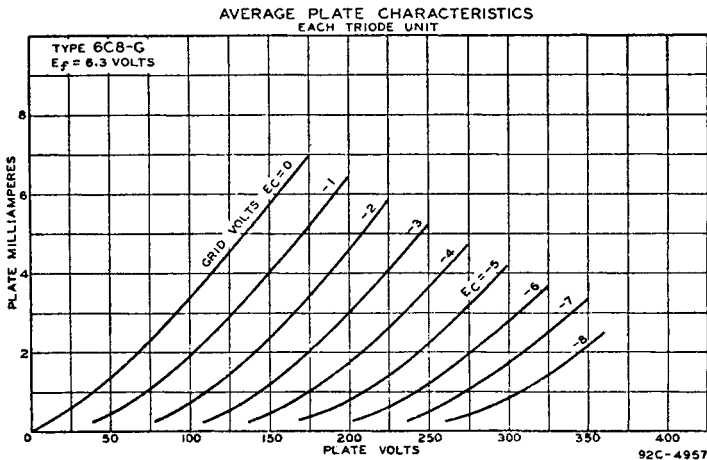

6D6

**TRIPLE-GRID
SUPER-CONTROL AMPLIFIER**

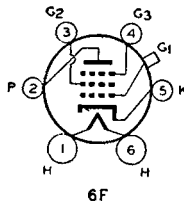

The 6D6 is a triple-grid super-control amplifier tube recommended for service in the radio-frequency and intermediate-frequency stages of radio receivers designed for its characteristics.

The ability of the tube to handle the usual signal voltages without cross-modulation and modulation distortion makes it adaptable to the r-f and i-f stages of receivers employing automatic volume control. The 6D6 is constructed with an internal shield connected to the cathode within the tube. Except for capacitances, given below, the electrical characteristics of the 6D6 are identical with those of the 6U7-G.

GRID-PLATE CAPACITANCE	0.007 max.*	μμf
INPUT CAPACITANCE	4.7	μμf
OUTPUT CAPACITANCE	6.5	μμf

* With close-fitting shield connected to cathode.

INSTALLATION and APPLICATION

The base of the 6D6 fits the standard six-contact socket which may be installed to hold the tube in any position. Physical characteristics of the 6D6 are shown in Fig. 2-20, OUTLINES SECTION. For heater operation and cathode connection, refer to Type 6A8. For control-grid bias, screen voltage, and suppressor connection, refer to Type 6SK7. Shielding of all stages is necessary if maximum gain per stage is to be obtained. Refer to APPLICATION on Type 6SK7.

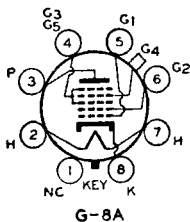

PENTAGRID CONVERTER

The 6D8-G is a multi-electrode tube designed to perform simultaneously the functions of a mixer (first detector) and of an oscillator tube in superheterodyne circuits. The 6D8-G permits economy in circuit design due to the low heater current of 0.15 ampere. For

6D8-G

general discussion of pentagrid converters, see FREQUENCY CONVERSION in the RADIO TUBE APPLICATIONS section.

★ CHARACTERISTICS

HEATER VOLTAGE (A.C. or D.C.)	6.3	Volts
HEATER CURRENT	0.15	Ampere
DIRECT INTERELECTRODE CAPACITANCES (Approx.):*		
Grid No. 4 to Plate	0.2	$\mu\mu\text{f}$
Grid No. 4 to Grid No. 2	0.2	$\mu\mu\text{f}$
Grid No. 4 to Grid No. 1	0.16	$\mu\mu\text{f}$
Grid No. 1 to Grid No. 2	1.1	$\mu\mu\text{f}$
Grid No. 4 to All Other Electrodes (R-F Input) ..	8.0	$\mu\mu\text{f}$
Grid No. 2 to All Other Electrodes except Grid No. 1 (Osc. Output)	4.6	$\mu\mu\text{f}$
Grid No. 1 to All Other Electrodes except Grid No. 2 (Osc. Input)	5.5	$\mu\mu\text{f}$
Plate to All Other Electrodes (Mixer Output)	11.0	$\mu\mu\text{f}$

* With close-fitting shield connected to cathode.

As Frequency Converter

PLATE VOLTAGE	300 max.	Volts
SCREEN VOLTAGE (Grids No. 3 and No. 5)	100 max.	Volts
SCREEN SUPPLY VOLTAGE	300 max.	Volts
ANODE-GRID VOLTAGE (Grid No. 2)	200 max.	Volts
ANODE-GRID SUPPLY VOLTAGE†	300 max.	Volts
CONTROL-GRID VOLTAGE (Grid No. 4)	0 min.	Volts
PLATE DISSIPATION	1.0 max.	Watt
SCREEN DISSIPATION	0.3 max.	Watt
ANODE-GRID DISSIPATION	0.75 max.	Watt
TOTAL CATHODE CURRENT	13 max.	Milliamperes

TYPICAL OPERATION:

Plate Voltage	135	250	Volts
Screen Voltage	67.5	100	Volts
Anode-Grid Supply Voltage	135	250†	Volts
Control-Grid Voltage	-3	-3	Volts
Oscillator-Grid Resistor (Grid No. 1)	50000	50000	Ohms
Plate Current	1.5	3.5	Milliamperes
Screen Current	1.7	2.6	Milliamperes
Anode-Grid Current	3	4.3	Milliamperes
Oscillator-Grid Current	0.2	0.4	Milliamperes
Total Cathode Current	6.4	10.8	Milliamperes

Anode grid supply voltages in excess of 200 volts require the use of 20000-ohm voltage-dropping resistor by-passed by 0.1 μf condenser.

Plate Resistance (Approx.).....	0.6	0.4	Megohm
Conversion Transconductance.....	325	550	Micromhos
Conversion Transconductance (Approx.)..	5‡	6‡‡	Micromhos

The transconductance of the oscillator portion (not oscillating) of the 6D8-G is 1200 micromhos under the following conditions: plate voltage, 250 volts; screen voltage, 100 volts; anode-grid voltage, 200 volts (no voltage-dropping resistor); and oscillator-grid voltage, 0 volts.

‡ With control-grid bias of -25 volts. ‡‡ With control-grid bias of -35 volts.

INSTALLATION and APPLICATION

The base of the 6D8-G fits the standard octal socket which may be installed to hold the tube in any position. Physical characteristics of the 6D8-G are shown in Fig 2-15, OUTLINES SECTION.

The heater of the 6D8-G is designed to operate on either a.c. or d.c. For operation on a.c. with a transformer, the winding which supplies the heater circuit should operate the heater at its recommended value for full-load operating conditions at average line voltage. For service in automobile receivers, the heater terminals of the 6D8-G should be connected directly across a 6-volt battery. In receivers that employ a series-heater connection, the heater of the 6D8-G may be operated in series with the heaters of other types having 0.15-ampere rating, or in series with the heaters of other types requiring more than 0.15 ampere if the 6D8-G heater is shunted by a suitable resistor to pass the current in excess of 0.15 ampere. The current in the heater circuit of the 6D8-G should be adjusted to 0.15 ampere for the normal supply-line voltage. The cathode connection is the same as for Type 6A8. Complete shielding of the 6D8-G is generally necessary to prevent intercoupling between its circuits and the circuits of the other stages.

Application of the 6D8-G is the same as for Type 6A8

ELECTRON-RAY TUBE (Indicator Type)

6E5

The 6E5 is a high-vacuum, heater-cathode type of tube designed to indicate visually, by means of a fluorescent target, the effects of a change in the controlling voltage.

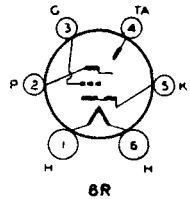

The tube, therefore, is essentially a voltage indicator and as such is particularly useful as a convenient and non-mechanical means to indicate accurate tuning of a receiver to the desired station. The 6E5 is similar to the 6U5/6G5 except that the 6U5/6G5 triode unit is designed with a remote plate-current cut-off characteristic. For discussion of Electron-Ray Tube considerations, refer to RADIO TUBE APPLICATIONS section.

★ CHARACTERISTICS

HEATER VOLTAGE (A.C. or D.C.)	6.3	Volts
HEATER CURRENT	0.3	Ampere

As Tuning Indicator

PLATE-SUPPLY VOLTAGE	250 max.	Volts
TARGET VOLTAGE	{ 250 max. Volts	
	{ 100 min. Volts	

TYPICAL OPERATION:

Plate- and Target-Supply Voltage	100	200	250	Volts
Series Triode-Plate Resistor	0.5	1	1	Megohm
Target Current (Approx.).....	1	3	4	Milliamperes
Triode-Plate Current*.....	0.19	0.19	0.24	Milliampere
Triode-Grid Voltage (Approx.):				
For Shadow Angle of 0°	-3.3	-6.5	-8.0	Volts
For Shadow Angle of 90°	0	0	0	Volts

* For zero triode-grid voltage.

INSTALLATION and APPLICATION

The base of the 6E5 fits the standard six-contact socket which may be installed to hold the tube in any position. For convenience, the tube is usually mounted horizontally so that the fluorescent screen is readily visible when the receiver circuit is tuned. A small hood, placed over the dome and fluorescent target, will help to eliminate external light reflections. Physical characteristics of the 6E5 are shown in Fig. 2-19, OUTLINES SECTION.

For heater operation and cathode connection, refer to Type 6A8. The bulb of this tube becomes hot under certain conditions of operation. Sufficient ventilation should be provided to prevent overheating.

The visible effect is observed on the fluorescent target located in the dome of the bulb. The pattern on the target varies from a shaded angle of 90° with zero bias (off tune) to a shaded angle of approximately 0° at resonance with a strong carrier. Exact tuning is indicated by the narrowest shaded angle that can be obtained. The stronger the carrier, the narrower is the shadow.

The diagrams below show typical tuning-indicator circuits employing the 6E5. If the strongest carrier received produces sufficient AVC voltage to exceed the cut-off bias value of -8 volts, the shadow area of the fluorescent target will overlap. To overcome this effect resistor R₁ should be connected, as shown, between the triode-unit grid and cathode in order to reduce the control voltage. The value of

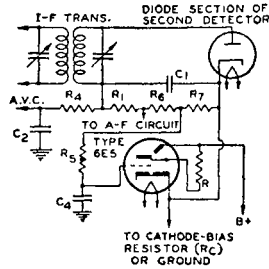
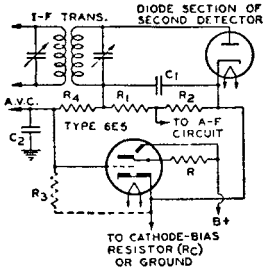

- R = { 1.0 Megohm for B+ = 250 Volts
- 0.5 Megohm for B+ = 100 Volts
- R₁ = 0.05 Megohm (R-F Filter)
- R₂ = 0.2 Megohm
- R₃ = Determined by test. See text.
- R₄ = AVC Filter Resistor

- R₅ = R₄
- R₆ + R₇ = 0.2 Megohm
- C₁ = 100 to 200 μf
- C₂ = AVC Filter Condenser
- C₃ = 0.05 to 1.0 μf
- C₄ = C₃

R₃ may easily be determined by applying a strong signal and adjusting R, until the shadow-angle is nearly zero. If the resultant value of R, is so low as to reduce the AVC voltage appreciably, the d-c controlling voltage for the 6E5 should be obtained from a tap on the diode load resistor as shown in the diagram at the right.

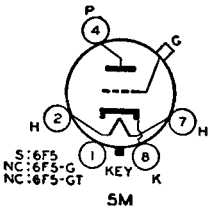

HIGH-MU TRIODES

The 6F5, 6F5-G, and 6F5-GT are high-mu triodes designed for use in resistance-coupled amplifier circuits. Except for capacitances given below, the electrical characteristics of these types are identical with those of Type 6SF5.

6F5
METAL
6F5-G
6F5-GT

	Type 6F5*	Type 6F5-G**	Type 6F5-GT**	
GRID-PLATE CAPACITANCE	2.3	2.6	2.8	μf
GRID-CATHODE CAPACITANCE . .	5.5	2.2	2.2	μf
PLATE-CATHODE CAPACITANCE . .	4.0	2.8	3.2	μf

* With shell connected to cathode. Values are approximate.
 ** With no shields. Values are approximate.

INSTALLATION and APPLICATION

The base of each of these tubes fits the standard octal socket which may be installed to hold the tube in any position. Physical characteristics of the 6F5, 6F5-G, and 6F5-GT are shown in Figs. 1-5, 2-15, and 2-5, respectively, in the OUTLINES SECTION. For heater operation and cathode connection, refer to Type 6A8.

Application of these tubes is similar to that of the 6SF5. The maximum d-c resistance in the grid circuit should not exceed one megohm. For additional data, see the RESISTANCE-COUPLED AMPLIFIER CHART.

6F6

METAL

6F6-G

POWER AMPLIFIER
PENTODES

The 6F6 and 6F6-G are power-amplifier pentodes of the heater-cathode type for use in the audio-output stage of a-c receivers. These types are capable of giving large power output with a relatively small input voltage. Because of the heater-cathode construction, uniformly low hum-level is attainable in power-amplifier design.

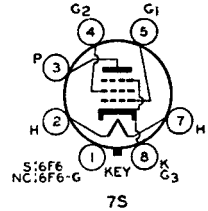

★ CHARACTERISTICS

HEATER VOLTAGE (A.C. or D.C.)	6.3	Volts
HEATER CURRENT	0.7	Ampere

As Single-Tube Class A₁ Amplifier — Pentode Connection

PLATE VOLTAGE	375 <i>max.</i>	Volts
SCREEN VOLTAGE (Grid No. 2)	285 <i>max.</i>	Volts
PLATE DISSIPATION	11 <i>max.</i>	Watts
SCREEN DISSIPATION	3.75 <i>max.</i>	Watts

TYPICAL OPERATION:

	<i>Fixed Bias</i>		<i>Cathode Bias</i>		
Plate Voltage	250	285	250	285	Volts
Screen Voltage	250	285	250	285	Volts
Grid Voltage (Grid No. 1) ..	-16.5	-20	-	-	Volts
Cathode Resistor	-	-	410	440	Ohms
Peak A-F Grid Voltage ..	16.5	20	16.5	20	Volts
Zero-Signal Plate Current...	34	38	34	38	Milliamperes
Max.-Signal Plate Current ..	36	40	35	38	Milliamperes
Zero-Signal Screen Current ..	6.5	7	6.5	7	Milliamperes
Max.-Signal Screen Current..	10.5	13	9.7	12	Milliamperes
Plate Resistance (Approx.) ..	80000	78000	-	-	Ohms
Transconductance	2500	2550	-	-	Micromhos
Load Resistance	7000	7000	7000	7000	Ohms
Total Harmonic Distortion..	8	9	8.5	9	Per cent
Max-Signal Power Output..	3.2	4.8	3.1	4.5	Watts

As Single-Tube Class A₁ Amplifier — Triode Connection †

PLATE VOLTAGE	350 <i>max.</i>	Volts
PLATE AND SCREEN DISSIPATION (Total)	10 <i>max.</i>	Watts

TYPICAL OPERATION:

	<i>Fixed Bias</i>		<i>Cathode Bias</i>		
Plate Voltage	250	250	250	250	Volts
Grid Voltage (Grid No. 1) ..	-20	-	-	-	Volts
Cathode Resistor	-	-	650	-	Ohms
Peak A-F Grid Voltage ..	20	20	20	20	Volts
Zero-Signal Plate Current ..	31	31	31	31	Milliamperes
Max.-Signal Plate Current ..	34	34	32	32	Milliamperes

Screen connected to plate.

R C A R E C E I V I N G T U B E M A N U A L

Plate Resistance	2600	-	Ohms
Amplification Factor	6.8	-	
Transconductance	2600	-	Micromhos
Load Resistance	4000	4000	Ohms
Total Harmonic Distortion	6.5	6.5	Per cent
Max.-Signal Power Output	0.85	0.8	Watt

As Push-Pull Class A₁ Amplifier — Pentode Connection

PLATE VOLTAGE	375 max.	Volts
SCREEN VOLTAGE	285 max.	Volts
PLATE DISSIPATION	11 max.	Watts
SCREEN DISSIPATION	3.75 max.	Watts

TYPICAL OPERATION: *Values are for two tubes*

Fixed Bias Cathode Bias

Plate Voltage	315	315	Volts
Screen Voltage	285	285	Volts
Grid Voltage	-24	-	Volts
Cathode Resistor	-	320	Ohms
Peak A-F Grid-to-Grid Voltage	48	58	Volts
Zero-Signal Plate Current	62	62	Milliamperes
Max.-Signal Plate Current	80	73	Milliamperes
Zero-Signal Screen Current	12	12	Milliamperes
Max.-Signal Screen Current	19.5	18	Milliamperes
Effective Load Resistance (Plate-to-plate)	10000	10000	Ohms
Total Harmonic Distortion	4	3	Per cent
Max.-Signal Power Output	11	10.5	Watts

As Push-Pull Class AB₁ Amplifier — Pentode Connection

PLATE VOLTAGE	375 max.	Volts
SCREEN VOLTAGE	285 max.	Volts
PLATE DISSIPATION	11 max.	Watts
SCREEN DISSIPATION	3.75 max.	Watts

TYPICAL OPERATION: *Values are for two tubes*

Fixed Bias Cathode Bias

Plate Voltage	375	375	Volts
Screen Voltage	250	250	Volts
Grid Voltage	-26	-	Volts
Cathode Resistor*	-	340	Ohms
Peak A-F Grid-to-Grid Voltage	82	94	Volts
Zero-Signal Plate Current	34	54	Milliamperes
Max.-Signal Plate Current	82	77	Milliamperes
Zero-Signal Screen Current	5	8	Milliamperes
Max.-Signal Screen Current	19.5	18	Milliamperes
Effective Load Resistance (Plate-to-plate)	10000	10000	Ohms
Total Harmonic Distortion	3.5	5	Per cent
Max.-Signal Power Output	18.5	19	Watts

* The value given for the cathode resistor is determined for a grid bias of -21 volts.

As Push-Pull Class AB₂ Amplifier — Triode Connection †

PLATE VOLTAGE	350 max.	Volts
PLATE AND SCREEN DISSIPATION (Total)	10 max.	Watts

TYPICAL OPERATION: *Values are for two tubes*

Fixed Bias Cathode Bias

Plate Voltage	350	350	Volts
Grid Voltage	-38	-	Volts
Cathode Resistor ‡	-	730	Ohms
Peak A-F Grid-to-Grid Voltage	123	132	Volts

† Screen connected to plate.

‡ The value given for the cathode resistor is determined for a grid bias of -36.5 volts.

Zero-Signal Plate Current	48	50	Milliamperes
Max.-Signal Plate Current	92	61	Milliamperes
Effective Load Resistance (Plate-to-plate)	6000	10000	Ohms
Total Harmonic Distortion	2	3	Per cent
Max.-Signal Power Output	13	9	Watts

INSTALLATION and APPLICATION

The base of either the 6F6 or the 6F6-G fits the standard octal socket which may be installed to hold the tube in any position. Physical characteristics of the 6F6 and 6F6-G are shown in Figs. 1-7 and 2-21, respectively, in the OUTLINES SECTION.

The heater in both types is designed to operate on either a.c. or d.c. When a-c operation with a transformer is used, the winding which supplies the heater should operate the heater at its recommended value for full load operating conditions at average line voltage. In automobile receivers, the heater terminals of both types should be connected directly across a 6-volt battery. In a series-heater circuit employing several 6.3-volt types and one or more 6F6's or 6F6-G's, the heaters of the 6F6's or 6F6-G's should be placed on the positive side. Furthermore, since most 6.3-volt types have 0.3-ampere or 0.15-ampere heaters, a bleeder circuit across these heaters is required to take care of the additional heater current of the 6F6's or 6F6-G's. Each 6.3-volt tube of the 0.3-ampere type in the series circuit should, therefore, be shunted by a bleeder resistance of 16 ohms. Similarly, each 6.3-volt tube of the 0.15-ampere type should be shunted by a bleeder resistance of 11.5 ohms.

For cathode connection, refer to Type 6A8.

As class A₁ power-amplifier pentodes, the 6F6 and 6F6-G may be used either singly or in push-pull. Recommended operating conditions are given under CHARACTERISTICS.

As class A₁ power-amplifier triodes, the 6F6 and 6F6-G may be used either singly or in push-pull. For this service the screen is connected to the plate. Recommended operating conditions are given under CHARACTERISTICS.

As class AB₂ power-amplifier triodes or pentodes the 6F6 and 6F6-G should be operated as shown under CHARACTERISTICS. The values shown cover operation with fixed bias and with cathode bias, and have been determined on the basis of some grid-current flow during the most positive swing of the input signal and of cancellation of second-harmonic distortion by virtue of the push-pull circuit.

In any service the type of input coupling used should not introduce too much resistance in the grid circuit. Transformer- or impedance-coupling devices are

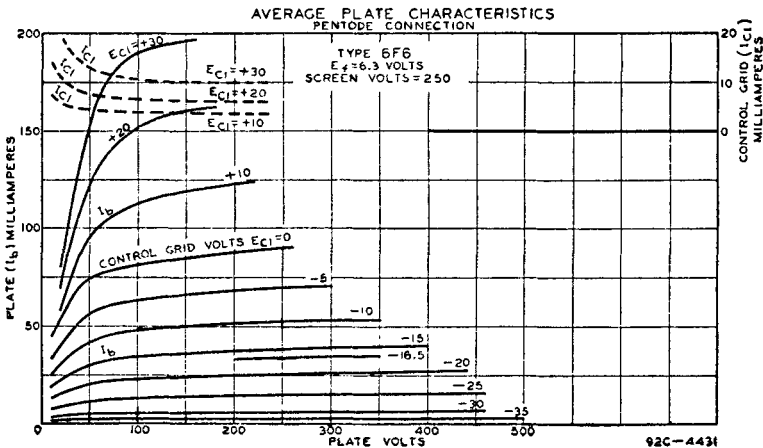

recommended. When the grid circuit has a resistance not higher than 0.1 megohm, fixed bias may be used; for higher values, cathode bias is required. With cathode bias, the grid circuit may have a resistance as high as, but not greater than, 0.5 megohm provided the heater voltage is not allowed to rise more than 10% above rated value under any condition of operation.

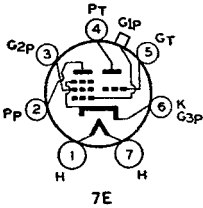
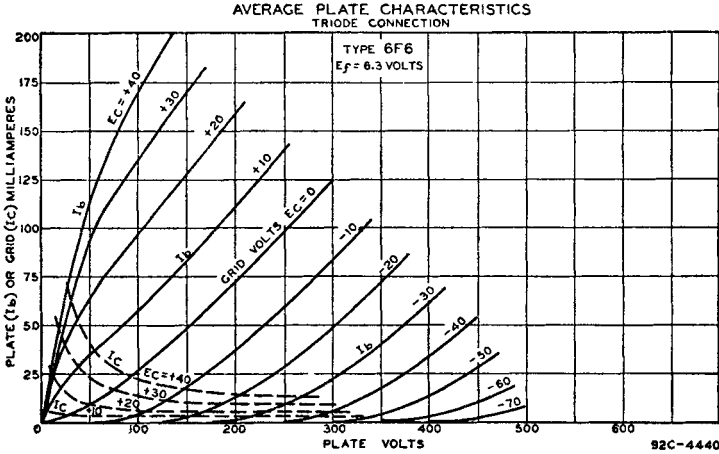

TRIODE-PENTODE

The 6F7 is a heater-cathode type of tube combining in one bulb a triode and an r-f pentode of the remote cut-off type. Since these two units are independent of each other except for the common cathode, the 6F7 may be adapted to circuit design in several ways.

6F7

CHARACTERISTICS

HEATER VOLTAGE (A.C. or D.C.)	6.3	Volts
HEATER CURRENT	0.3	Ampere
DIRECT INTERELECTRODE CAPACITANCES:		
<i>Triode Unit</i> —Grid to Plate		
	2.0	μf
	2.5	μf
	3.0	μf
<i>Pentode Unit</i> —Grid to Plate (With shield-can)		
	0.008 max.	μf
	3.2	μf
	12.5	μf

As Class A₁ Amplifier

	<i>Triode Unit</i>	<i>Pentode Unit</i>	
PLATE VOLTAGE	100 max.	100	250 max. Volts
SCREEN VOLTAGE (Grid No. 2)	—	100	100 max. Volts
GRID VOLTAGE (Grid No. 1)	-3 min.	-3 min.	-3 min. Volts
PLATE CURRENT	3.5	6.3	6.5 Milliamperes
SCREEN CURRENT	—	1.6	1.5 Milliamperes
AMPLIFICATION FACTOR	8	—	—
PLATE RESISTANCE	0.016	0.29	0.85 Megohm
TRANSCONDUCTANCE	500	1050	1100 Micromhos
TRANSCONDUCTANCE	—	9	10 Micromhos
(At -35 volts bias)	—	—	—

INSTALLATION and APPLICATION

The base fits the standard small 7-pin socket which may be installed to hold the tube in any position. Physical characteristics of the 6F7 are shown in Fig. 2-16, OUTLINES SECTION. For heater operation and cathode connection, refer to Type 6A8.

TWIN-TRIODE AMPLIFIER

6F8-G

The 6F8-G is a multi-electrode tube consisting of two medium-mu voltage amplifier triodes in one bulb. It may be used as a voltage amplifier or as a phase inverter. Except for the common heater, each triode is independent of the other. The heater rating and capacitances are given below; other characteristics for

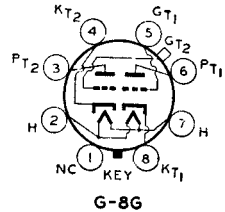

each triode unit are identical with those of the 6J5.

★ CHARACTERISTICS

HEATER VOLTAGE (A.C. or D.C.)	6.3	Volts
HEATER CURRENT	0.6	Ampere

DIRECT INTERELECTRODE CAPACITANCES:*

	Triode Unit 1	Triode Unit 2	
Grid to Plate	4.0	3.6	μf
Grid to Cathode	3.2	3.0	μf
Plate to Cathode	3.2	3.8	μf
Grid to Grid		0.2	μf
Plate to Plate		0.4	μf
Grid of Unit 2 to Plate of Unit 1		0.1	μf

* With close-fitting shield connected to cathode. Values are approximate.

INSTALLATION and APPLICATION

The base of the 6F8-G fits the standard octal socket which may be mounted to hold the tube in any position. Physical characteristics of the 6F8-G are shown in Fig. 2-15, OUTLINES SECTION. For heater operation and cathode connection, refer to Type 6A8, but give consideration to the greater heater current of the 6F8-G. As a phase inverter, the 6F8-G may be operated as shown in the RESISTANCE-COUPLED AMPLIFIER CHART.

POWER AMPLIFIER PENTODE

6G6-G

The 6G6-G is a power-amplifier pentode of the heater-cathode type for use in the output stage of radio receivers. In applications where a moderate power output is desired, the 6G6-G is economical because of its low plate-power requirements and low heater current.

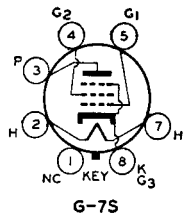

★ CHARACTERISTICS

HEATER VOLTAGE (A.C. or D.C.)†	6.3	Volts
HEATER CURRENT	0.15	Ampere

As Class A₁ Amplifier — Pentode Connection

PLATE VOLTAGE	180 max.	Volts
SCREEN VOLTAGE	180 max.	Volts
PLATE DISSIPATION	2.75 max.	Watts
SCREEN DISSIPATION	0.75 max.	Watt

† In no case should the heater voltage fluctuate so that it exceeds 7.0 volts.

TYPICAL OPERATION:

Plate Voltage	135	180	Volts
Screen Voltage (Grid No. 2)	135	180	Volts
Grid Voltage (Grid No. 1)*	-6	-9	Volts
Peak A-F Grid Voltage	6	9	Volts
Zero-Signal Plate Current	11.5	15	Milliamperes
Zero-Signal Screen Current	2	2.5	Milliamperes
Plate Resistance (Approx.)	0.17	0.175	Megohm
Transconductance	2100	2300	Micromhos
Load Resistance	12000	10000	Ohms
Total Harmonic Distortion	7.5	10	Per cent
Max.-Signal Power Output	0.6	1.1	Watts

* The d-c resistance in the grid circuit may be as high as 0.5 megohm with cathode bias or 0.1 megohm with fixed bias, provided the heater voltage is not allowed to rise more than 10% above the rated value under any condition of operation.

As Class A₁ Amplifier — Triode Connection
(Screen tied to plate)

PLATE VOLTAGE	180 max.	Volts
PLATE DISSIPATION	2.5 max.	Watts

TYPICAL OPERATION:

Plate Voltage	180	Volts
Grid Voltage	-12	Volts
Peak A-F Grid Voltage	12	Volts
Zero-Signal Plate Current	11	Milliamperes
Plate Resistance	4750	Ohms
Amplification Factor	9.5	
Transconductance	2000	Micromhos
Load Resistance	12000	Ohms
Total Harmonic Distortion	5	Per cent
Max.-Signal Power Output	0.25	Watt

INSTALLATION and APPLICATION

The base of the 6G6-G fits the standard octal socket which may be installed to hold the tube in any position. Physical characteristics of the 6G6-G are shown in Fig. 2-17, OUTLINES SECTION. Heater operation is similar to that of the 6D8-G; for cathode connection, refer to Type 6A8. Application of the 6G6-G is similar to that of the 6K6-G.

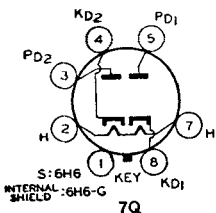

TWIN DIODE

The 6H6 and 6H6-G are tubes of the heater-cathode type containing two diodes in one envelope. Except for the common heater, the two units are independent of each other. This arrangement offers flexibility in design of circuits using these types for detection,

6H6
METAL

6H6-G

low-voltage rectification, or automatic volume control. For diode-detector considerations, refer to RADIO TUBE APPLICATIONS section.

★ CHARACTERISTICS

HEATER VOLTAGE (A.C. or D.C.)	6.3	Volts
HEATER CURRENT	0.3	Ampere

DIRECT INTERELECTRODE CAPACITANCES:

	Type 6H6*	Type 6H6-G**	
Plate No. 1 to Cathode No. 1	3.0	3.1	μf
Plate No. 2 to Cathode No. 2	3.4	4.0	μf
Plate No. 1 to Plate No. 2	0.1 max.	0.1 max.	μf

With shell connected to cathode.

** With close-fitting shield connected to cathode.

As Rectifier

A-C PLATE VOLTAGE PER PLATE (RMS)	117 max. Volts
D-C OUTPUT CURRENT PER PLATE	4 max. Milliamperes

INSTALLATION and APPLICATION

The base of either the 6H6 or 6H6-G fits the standard octal socket which may be mounted to hold the tube in any position. Physical characteristics of the 6H6 and 6H6-G are shown in Figs 1-1 and 2-17, respectively, in the OUTLINES SECTION. For heater operation and cathode connection, refer to Type 6A8.

For detection, the diodes may be utilized in a full-wave circuit or in a half-wave circuit. In the latter case, one plate only, or the two plates in parallel, may be employed. The use of the half-wave arrangement will provide approximately twice the rectified voltage as compared with the full-wave arrangement.

For automatic-volume control, the 6H6 and 6H6-G may be used in circuits similar to those employed for any of the duplex-diode types of tubes. The only difference is that the 6H6 and 6H6-G are more adaptable due to the fact that each diode has its own separate cathode.

Since the diodes by themselves do not provide any amplification, it is usually necessary to provide gain by means of a supplementary tube. Types such as the 6C5, 6SF5, 6SJ7, and 6SK7 are very suitable for this purpose. Their use in combination with the 6H6 or 6H6-G is similar to that of the amplifier sections of duplex-diode triode or pentode types.

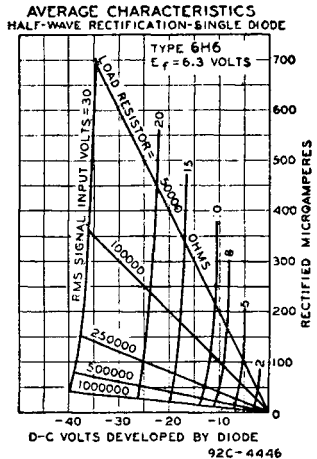

6J5

METAL

6J5-G

6J5-GT

DETECTOR AMPLIFIER TRIODES

The 6J5, 6J5-G, and 6J5-GT are triodes of the heater-cathode type designed for use as detectors, amplifiers, or oscillators. These tubes have a high transconductance together with a comparatively high amplification factor.

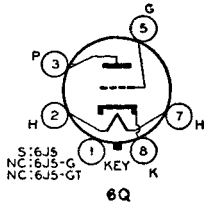

★ CHARACTERISTICS

HEATER VOLTAGE (A.C. or D.C.)	6.3	Volts
HEATER CURRENT	0.3	Ampere

	Type 6J5*	Type 6J5-G**	Type 6J5-GT	
GRID-PLATE CAPACITANCE(Approx.)...	3.4	4.0	—	μf
GRID-CATHODE CAPACITANCE(Approx.)	3.4	4.2	—	μf
PLATE-CATHODE CAPACITANCE(Approx.)	3.6	5.0	—	μf

* With shell connected to cathode.

** With close-fitting shield connected to cathode.

As Class A₁ Amplifier

Types 6J5, 6J5-G Type 6J5-GT

PLATE VOLTAGE	300 max.	250 max. Volts
GRID VOLTAGE	0 min.	0 min. Volts
PLATE DISSIPATION	2.5 max.	2.5 max. Watts
TYPICAL OPERATION (6J5, 6J5-G, 6J5-GT):		
Plate Voltage	90	250 Volts
Grid Voltage*	0	-8 Volts

Plate Current	10	9	Milliamperes
Plate Resistance	6700	7700	Ohms
Amplification Factor	20	20	
Transconductance	3000	2600	Micromhos

*The d-c resistance in the grid circuit should not exceed 1.0 megohm.

INSTALLATION and APPLICATION

The base of each type fits the standard octal socket which may be installed to hold the tube in any position. Physical characteristics of the 6J5, 6J5-G, and 6J5-GT are shown in Figs. 1-3, 2-17, and 2-8, respectively, in the OUTLINES SECTION. For heater operation and cathode connection, refer to Type 6A8. For application, see Type 6C5, and Type 6F8-G in RESISTANCE-COUPLED AMPLIFIER CHART.

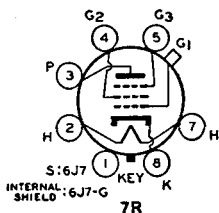
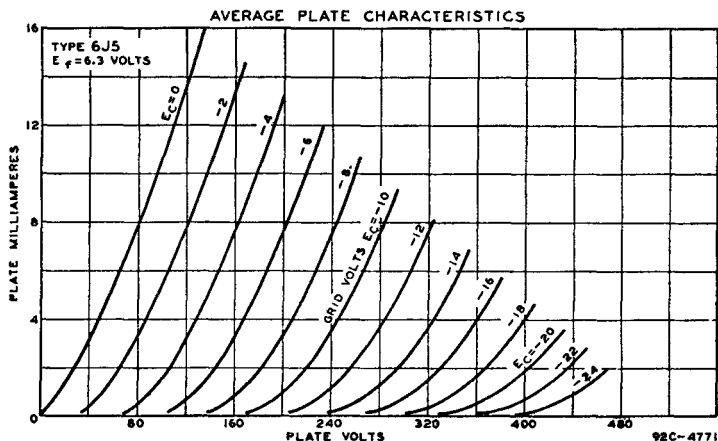

TRIPLE-GRID DETECTOR AMPLIFIERS

The 6J7 and 6J7-G are triple-grid tubes of the heater-cathode type recommended for service as biased detectors. In such service these tubes are capable of delivering a large audio-frequency output voltage with relatively small input. Other applications include their use as high-gain amplifiers.

6J7

METAL

6J7-G

★ CHARACTERISTICS

HEATER VOLTAGE (A.C. or D.C.)	6.3	Volts
HEATER CURRENT	0.3	Ampere
PENTODE CONNECTION:		
Grid-Plate Capacitance	Type 6J7* 0.005 max.	Type 6J7-G 0.007 max.**
Input Capacitance	7	4.6**
Output Capacitance	12	12**
TRIODE CONNECTION:		
Grid-Plate Capacitance	2	1.8°
Grid-Cathode Capacitance	5	2.6°
Plate-Cathode Capacitance	14	1.7°

* With shell connected to cathode.
° Without shield-can.

** With close-fitting shield connected to cathode

As Class A Amplifier — Pentode Connection

PLATE VOLTAGE	300	max.	Volts
SCREEN VOLTAGE (Grid No. 2).....	125	max.	Volts
SCREEN SUPPLY VOLTAGE	300	max.	Volts
GRID VOLTAGE (Grid No. 1).....	0	min.	Volts
PLATE DISSIPATION	0.75	max.	Watt
SCREEN DISSIPATION	0.1	max.	Watt
TYPICAL OPERATION:			
Plate Voltage	100	250	Volts
Screen Voltage	100	100	Volts
Grid Voltage†	-3	-3	Volts
Suppressor	Connected to cathode at socket		
Plate Current	2	2	Milliamperes
Screen Current	0.5	0.5	Milliamperes
Plate Resistance	1.0	†	Megohm
Transconductance	1185	1225	Micromhos
Grid Voltage (Approx.) ^{oo}	-7	-7	Volts

^{oo} For cathode-current cut-off. † Greater than 1.0 megohm.

As Class A₁ Amplifier — Triode Connection
(Screen and suppressor tied to plate)

PLATE VOLTAGE	250	max.	Volts
GRID VOLTAGE	0	min.	Volts
PLATE & SCREEN DISSIPATION (Total).....	1.75	max.	Watts
TYPICAL OPERATION:			
Plate Voltage	180	250	Volts
Grid Voltage†	-5.3	-8	Volts
Plate Current	5.3	6.5	Milliamperes
Plate Resistance	11000	10500	Ohms
Amplification Factor	20	20	
Transconductance	1800	1900	Micromhos

† The d-c resistance in the grid circuit should not exceed 1.0 megohm.

INSTALLATION and APPLICATION

The base of either the 6J7 or 6J7-G fits the standard octal socket which may be installed to hold the tube in any position. Physical characteristics of the 6J7 and the 6J7-G are shown in Figs 1-5 and 2-15, respectively, in the OUTLINES SECTION. For heater operation and cathode connection, refer to Type 6A8.

The screen voltage may be obtained from a potentiometer or bleeder circuit across the B-supply source. Due to the screen-current characteristics of these tubes, a resistor in series with the high-voltage supply may be employed for obtaining the screen voltage, provided the cathode-resistor method of bias control is used. This method, however, is not recommended if the high-voltage B-supply exceeds 300 volts.

As a biased detector, the 6J7 or 6J7-G can deliver a large audio-frequency output voltage of good quality with a fairly small radio-frequency signal input. Typical recommended conditions for either of these types as a biased detector are as follows:

Plate Supply*	100	100	250	250	Volts
Screen Voltage	12	30	50	100	Volts
Grid Voltage	-1.16	-1.83	-2	-4.3	Volts
Cathode Resistor	18000	10000	3000	10000	Ohms
Suppressor	Connected to cathode at socket				
Cathode Cur. (Zero Signal)	0.63	0.183	0.65	0.43	Milliamperes
Plate Resistor	1.0	0.25	0.25	0.50	Megohm
Blocking Condenser	0.01	0.01	0.03	0.03	μf
Grid Resistor†	1.0	0.5	0.25	0.25	Megohm
R-F Signal (RMS)**	1.05	1.6	1.18	1.37	Volts

* Voltage at plate will be PLATE-SUPPLY voltage less voltage drop in plate resistor caused by plate current.

† For the following amplifier tube.

** With these signal voltages modulated 20%, the voltage output under each set of operating conditions is 17 peak volts at the grid of the following amplifier, a value sufficient to insure full audio output from a Type 6F6 at 250 volts on plate.

Detector bias may be obtained from a bleeder circuit, from a resistor in the cathode circuit, or from a partial cathode-biasing circuit. The cathode-resistor method permits of higher output at low percentage modulation, since the input signal may be increased almost in inverse proportion to the modulation without resulting in objectionable distortion.

As audio-frequency amplifier pentodes in resistance-coupled circuits, these tubes may be operated as shown in the RESISTANCE-COUPLED AMPLIFIER CHART.

As a radio-frequency amplifier pentode, the 6J7 or 6J7-G may be used particularly in applications where the r-f signal applied to the grid is relatively low, that is, of the order of a few volts. In such cases either screen or control-grid voltage (or both) may be varied to control the receiver volume. When larger signals are involved, a super-control amplifier tube should be employed to prevent the occurrence of excessive cross-modulation and modulation-distortion. Recommended operating conditions for amplifier services are given under CHARACTERISTICS.

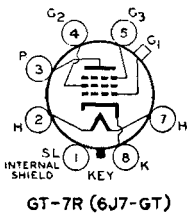
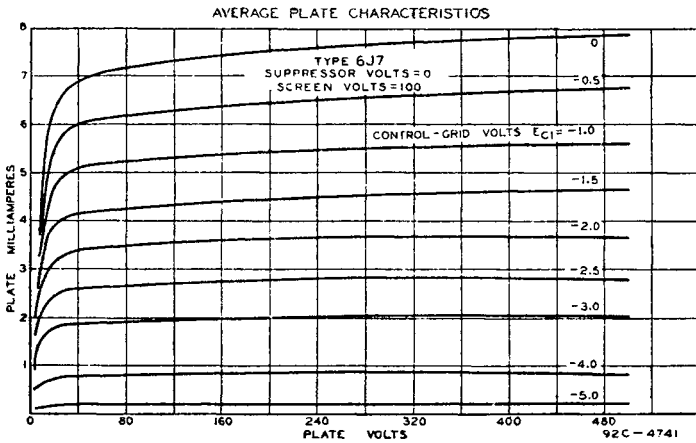

**TRIPLE-GRID
DETECTOR AMPLIFIER**

The 6J7-GT is a triple-grid detector amplifier of the heater type recommended for service as a biased detector. In such service it is capable of delivering a large audio-frequency output voltage with relatively small input.

6J7-GT

★ CHARACTERISTICS

HEATER VOLTAGE (A.C. or D.C.)	6.3	Volts
HEATER CURRENT	0.3	Ampere
GRID PLATE CAPACITANCE*	0.005 max.	μf
INPUT CAPACITANCE*	5.2	μf
OUTPUT CAPACITANCE*	12	μf

* With close-fitting shield connected to cathode. Values are approximate.

As Class A₁ Amplifier — Pentode Connection

PLATE VOLTAGE	250 max.	Volts
SCREEN VOLTAGE	125 max.	Volts
SCREEN SUPPLY VOLTAGE	250 max.	Volts
GRID VOLTAGE	0 min.	Volts

PLATE DISSIPATION 0.75 max. Watt
 SCREEN DISSIPATION 0.1 max. Watt

TYPICAL OPERATION:

Values are same as those shown for Type 6J7.

As Class A₁ Amplifier — Triode Connection
 (Screen and suppressor tied to plate)

Maximum ratings and typical operation are the same as for the Type 6J7.

INSTALLATION and APPLICATION

For installation, refer to Type 6D8-G; and for application, to Type 6J7. Physical characteristics of the 6J7-GT are shown in Fig. 2-6, OUTLINES SECTION. Complete shielding of the 6J7-GT is generally necessary to prevent intercoupling between its circuits and the circuits of other stages.

6K5-G

HI-MU TRIODE

The 6K5-G is a high-mu triode of the heater-cathode type designed for use as a voltage amplifier in receiver circuits designed for its characteristics.

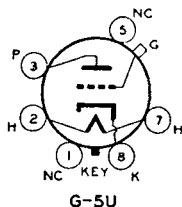

CHARACTERISTICS

HEATER VOLTAGE (A.C. or D.C.)	6.3	Volts
HEATER CURRENT	0.3	Ampere
PLATE VOLTAGE	100	250
GRID VOLTAGE	-1.5	-3
PLATE CURRENT	0.35	1.1
PLATE RESISTANCE	78000	50000
AMPLIFICATION FACTOR	70	70
TRANSCONDUCTANCE	900	1400
GRID-PLATE CAPACITANCE*		2.0
GRID-CATHODE CAPACITANCE*		2.4
PLATE-CATHODE CAPACITANCE*		3.6

* With no shield. Values are approximate.

INSTALLATION and APPLICATION

The base of the 6K5-G fits the standard octal socket which may be mounted to hold the tube in any position. Physical characteristics of the 6K5-G are shown in Fig. 2-15, OUTLINES SECTION. Heater operation and cathode connection are the same as for Type 6A8.

As a class A₁ amplifier, the 6K5-G may be operated in resistance-coupled amplifier circuits. When the 6K5-G is used to amplify the output of the 6H6 diode, it is recommended that fixed bias be employed. Diode-biasing of the 6K5-G is not suitable because of the probability of plate-current cut-off, even with small signal voltages applied to the diode circuit.

POWER AMPLIFIER PENTODE

6K6-G

The 6K6-G is a power-amplifier pentode of the heater-cathode type for use in circuits designed for its characteristics. It is capable of delivering a moderate power output with a relatively small input voltage.

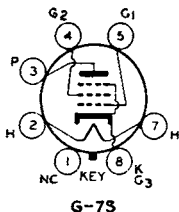

★ CHARACTERISTICS

HEATER VOLTAGE (A.C. or D.C.)	6.3	Volts
HEATER CURRENT	0.4	Ampere

As Class A₁ Amplifier

PLATE VOLTAGE	315 <i>max.</i>	Volts
SCREEN VOLTAGE	285 <i>max.</i>	Volts
PLATE DISSIPATION	8.5 <i>max.</i>	Watts
SCREEN DISSIPATION	2.8 <i>max.</i>	Watts

TYPICAL OPERATION:

Plate Voltage	100	250	315	Volts
Screen Voltage	100	250	250	Volts
Grid Voltage	-7	-18	-21	Volts
Peak A-F Grid Voltage	7	18	21	Volts
Zero-Signal Plate Current	9	32	25.5	Milliamperes
Max.-Signal Plate Current	9.5	33	28	Milliamperes
Zero-Signal Screen Current	1.6	5.5	4	Milliamperes
Max.-Signal Screen Current	3	10	9	Milliamperes
Plate Resistance	104000	68000	75000	Ohms
Transconductance	1500	2300	2100	Micromhos
Load Resistance	12000	7600	9000	Ohms
Total Harmonic Distortion	11	11	15	Per cent
Max.-Signal Power Output	0.35	3.4	4.5	Watts

INSTALLATION and APPLICATION

The base of the 6K6-G fits the standard octal socket which may be installed to hold the tube in any position. Heater operation is the same as that for Type 6A8, except for series operation. The heater of the 6K6-G may be operated in series with the heaters of other types having lower heater-current ratings if the heaters of these types are shunted with suitable resistors to pass the current in excess of that for which the types are rated. For cathode connection, refer to Type 6A8. Physical characteristics of the 6K6-G are shown in Fig. 2-17, OUTLINES SECTION.

For the power amplifier stage of receivers, the 6K6-G may be used either singly or in push-pull combination. More than one audio stage preceding the 6K6-G is undesirable because of the possibility of microphonic disturbances resulting from the high level of amplification.

Any conventional type of input coupling may be used provided the resistance added to the grid circuit by this device is not too high. Transformer- or impedance-coupling devices are recommended. When the grid circuit has a resistance not higher than 0.1 megohm fixed bias may be used; for higher values, cathode bias is required. With cathode bias, the grid circuit may have a resistance as high as, but not greater than, 1.0 megohms, provided the heater voltage does not rise more than 10% above the rated value under any condition of operation.

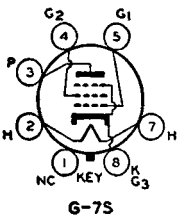

POWER AMPLIFIER PENTODE

The 6K6-GT is a power-amplifier pentode of the heater-cathode type. It is similar to the 6K6-G but is constructed in a smaller bulb. Physical characteristics of the 6K6-GT are shown in Fig. 2-8, OUTLINES SECTION. Installation and application of the 6K6-GT are the same as for the Type 6K6-G.

6K6-GT

CHARACTERISTICS

HEATER VOLTAGE (A.C.)	6.3	Volts
HEATER CURRENT	0.4	Ampere
PLATE VOLTAGE	180	250 <i>max.</i>
SCREEN VOLTAGE	180	250 <i>max.</i>

GRID VOLTAGE	-13.5	-18	-16.5	Volts
PLATE CURRENT	18.5	32	34	Milliamperes
SCREEN CURRENT	3.0	5.5	5.7	Milliamperes
PLATE RESISTANCE (Approx.) .	81000	68000	65000	Ohms
TRANSCONDUCTANCE	1850	2200	2300	Micromhos
LOAD RESISTANCE	9000	7600	7000	Ohms
TOTAL HARMONIC DISTORTION .	10	10	7	Per cent
POWER OUTPUT	1.5	3.4	3.2	Watts

6K7
METAL

6K7-G

**TRIPLE-GRID
SUPER-CONTROL AMPLIFIER**

The 6K7 and 6K7-G are triple-grid super-control amplifiers of the heater-cathode type recommended for service in the radio- or intermediate-frequency stages of radio receivers. The ability of these tubes to handle unusual signal voltages without cross-modulation and

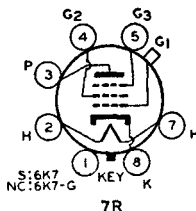

modulation-distortion makes them adaptable to the r-f and i-f stages of receivers employing automatic volume control.

★ CHARACTERISTICS

HEATER VOLTAGE (A.C. or D.C.)	6.3	Volts
HEATER CURRENT	0.3	Ampere

Type 6K7° Type 6K7-G°°

GRID-PLATE CAPACITANCE	0.005 max.	0.005 max.	μμf
INPUT CAPACITANCE	7	5	μμf
OUTPUT CAPACITANCE	12	12	μμf

° With shell connected to cathode.

°° With close-fitting shield connected to cathode. The shield in the dome is connected internally to the cathode.

As Class A₁ Amplifier

PLATE VOLTAGE	300 max.	Volts
SCREEN VOLTAGE	125 max.	Volts
SCREEN SUPPLY VOLTAGE	300 max.	Volts
CONTROL-GRID VOLTAGE	0 min.	Volts
PLATE DISSIPATION	2.75 max.	Watts
SCREEN DISSIPATION	0.35 max.	Watt

TYPICAL OPERATION:

Plate Voltage	90	180	250	250	Volts
Screen Voltage	90	75	100	125	Volts
Grid Voltage	-3	-3	-3	-3	Volts
Suppressor	Connected to cathode at socket				
Plate Current	5.4	4.0	7.0	10.5	Milliamperes
Screen Current	1.3	1.0	1.7	2.6	Milliamperes
Plate Resistance (Approx.) ..	0.3	1.0	0.8	0.6	Megohm
Transconductance	1275	1100	1450	1650	Micromhos
Grid Voltage (Approx.) for transcond. of 2 micromhos.	-38.5	-32.5	-42.5	-52.5	Volts

INSTALLATION and APPLICATION

The base of either the 6K7 or the 6K7-G fits the standard octal socket which may be installed to hold the tube in any position. Physical characteristics of the 6K7 and 6K7-G are shown in Figs. 1-5 and 2-15, respectively in the OUTLINES SECTION. For heater operation and cathode connection, refer to Type 6A8. Voltage supplies and applications are the same as for Type 6SK7.

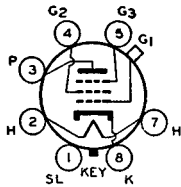
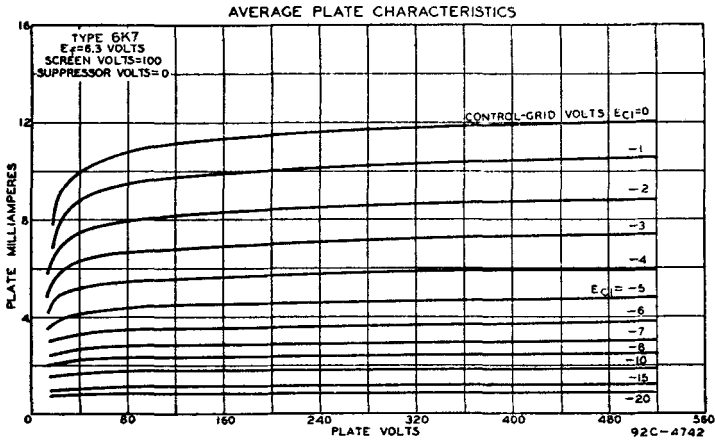

GT-7R (6K7-GT)

TRIPLE-GRID SUPER-CONTROL AMPLIFIER

6K7-GT

The 6K7-GT is a triple-grid super-control amplifier. It is similar in characteristics, installation, and application to the 6K7-G, but is somewhat smaller in size. Physical characteristics are shown in Fig. 2-6, OUTLINES SECTION.

★ CHARACTERISTICS

HEATER VOLTAGE (A.C. or D.C.)	6.3	Volts
HEATER CURRENT	0.3	Ampere
GRID-PLATE CAPACITANCE*	0.005 max.	μf
INPUT CAPACITANCE*	4.6	μf
OUTPUT CAPACITANCE*	12	μf

* With close-fitting shield connected to cathode. Values are Approximate.

As Class A₁ Amplifier

PLATE VOLTAGE	250 max.	Volts
SCREEN VOLTAGE	125 max.	Volts
SCREEN SUPPLY VOLTAGE	250 max.	Volts
CONTROL-GRID VOLTAGE	0 min.	Volts
PLATE DISSIPATION	2.75 max.	Watts
SCREEN DISSIPATION	0.35 max.	Watt

TYPICAL OPERATION:

Plate Voltage	100	250	Volts
Screen Voltage	100	100	Volts
Grid Voltage	-3	-3	Volts
Suppressor	Connected to cathode at socket		
Plate Current	6.5	7.0	Milliamperes
Screen Current	1.6	1.7	Milliamperes
Plate Resistance (Approx.)	0.25	0.8	Megohm
Transconductance	1325	1450	Micromhos
Grid Voltage (Approx.) for transcond. of 2 micromhos	-38.5	-42.5	Volts

6K8
METAL

**TRIODE-HEXODE
CONVERTER**

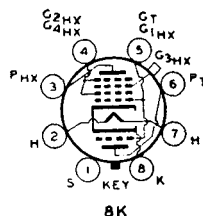

The 6K8 is a multi-electrode tube of metal construction consisting of a triode oscillator and a hexode mixer in a single envelope. The design of the 6K8 reduces interaction between

the oscillator and mixer sections of the tube, and thereby permits optimum performance at the high as well as the low radio frequencies.

★ CHARACTERISTICS

HEATER VOLTAGE (A.C. or D.C.)	6.3	Volts
HEATER CURRENT	0.3	Ampere
DIRECT INTERELECTRODE CAPACITANCES (Approx.):*		
Hexode Grid No. 3 to Hexode Plate	0.03 max.	$\mu\mu\text{f}$
Hexode Grid No. 3 to Triode Plate	0.02 max.	$\mu\mu\text{f}$
Hexode Grid No. 3 to Triode Grid and Hexode Grid No. 1	0.2 max.	$\mu\mu\text{f}$
Triode Grid and Hexode Grid No. 1 to Triode Plate	1.1	$\mu\mu\text{f}$
Triode Grid and Hexode Grid No. 1 to Hexode Plate	0.1 max.	$\mu\mu\text{f}$
Hexode Grid No. 3 to All Other Electrodes = R-F Input	6.6	$\mu\mu\text{f}$
Triode Plate to All Other Electrodes except Triode Grid and Hexode Grid No. 1 = Oscillator Output	3.2	$\mu\mu\text{f}$
Triode Grid and Hexode Grid No. 1 to All Other Electrodes except Triode Plate = Oscillator Input	6.0	$\mu\mu\text{f}$
Hexode Plate to All Other Electrodes = Mixer Output	3.5	$\mu\mu\text{f}$

* With shell connected to cathode.

As Frequency Converter

HEXODE PLATE VOLTAGE	300 max.	Volts
HEXODE SCREEN VOLTAGE (Grids No. 2 and 4)	150 max.	Volts
HEXODE SCREEN SUPPLY VOLTAGE	300 max.	Volts
HEXODE CONTROL-GRID VOLTAGE (Grid No. 3)	0 min.	Volts
TRIODE PLATE VOLTAGE	125 max.	Volts
HEXODE PLATE DISSIPATION	0.75 max.	Watt
HEXODE SCREEN DISSIPATION	0.7 max.	Watt
TRIODE PLATE DISSIPATION	0.75 max.	Watt
TOTAL CATHODE CURRENT	16 max.	Milliamperes

TYPICAL OPERATION:

Hexode Plate Voltage	100	250	Volts
Hexode Screen Voltage	100	100	Volts
Hexode Control-Grid Voltage	-3	-3	Volts
Triode Plate Voltage	100	100	Volts
Triode Grid Resistor	50000	50000	Ohms
Hexode Plate Resistance (Approx.)	0.4	0.6	Megohm
Conversion Transconductance	325	350	Micromhos
Hexode Control-Grid Voltage (Approx.) for conversion transconductance of 2 micromhos	-30	-30	Volts
Hexode Plate Current	2.3	2.5	Milliamperes
Hexode Screen Current	6.2	6.0	Milliamperes
Triode Plate Current	3.8	3.8	Milliamperes
Triode Grid and Hexode Grid No. 1 Current	0.15	0.15	Milliampere
Total Cathode Current	12.5	12.5	Milliamperes

The transconductance of the triode section, not oscillating, of the 6K8 is approximately 3000 micromhos when the triode plate voltage is 100 volts, and the triode grid voltage is 0 volts.

INSTALLATION and APPLICATION

The base of the 6K8 fits the standard octal socket which may be installed to hold the tube in any position. Physical characteristics of the 6K8 are shown in Fig. 1-6, OUTLINES SECTION. Heater operation and cathode connection are the same as for Type 6A8.

As a frequency converter in superheterodyne circuits, the 6K8 supplies the local oscillator frequency and mixes it with the radio-input frequency to provide the intermediate frequency. Design information for this service is given under CHARACTERISTICS.

The stability of operation of the 6K8 is due to the fact that the oscillator frequency is not critical to changes in oscillator-plate voltage or signal-grid bias. In some circuits, changes in these voltages are due to poor power-supply regulation and the normal action of the avc circuit. Operation of the 6K8 with a hexode-screen supply of 100 volts is recommended with a plate supply of either 100 or 250 volts. In series-fed oscillator circuits, the 100-volt hexode-screen supply may be taken from the same point in the power-supply system as are the screen supplies for the r-f and i-f tubes. In shunt-fed circuits, a resistor or choke must be used in the oscillator-plate circuit. The common point in the supply circuit must be adequately by-passed to ground.

The recommended oscillator-grid current of 150 microamperes is obtained easily; a value below 100 microamperes is not recommended. The oscillator coils used with pentagrid converter types may not be suitable for the 6K8 due to the possibility of over-exciting the oscillator unit. Such coils may be used if the oscillator-plate voltage is reduced, or if the number of turns on the tickler coil or the mutual inductance between tickler and secondary coils is reduced.

The bias voltage applied to the hexode control-grid may be varied from -3 volts to cut-off to control the translation gain of the tube. The extended cut-off may be used in combination with that of super-control amplifier tubes to adjust receiver sensitivity.

OPERATION CHARACTERISTICS

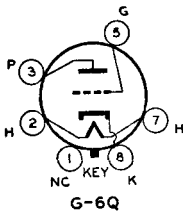
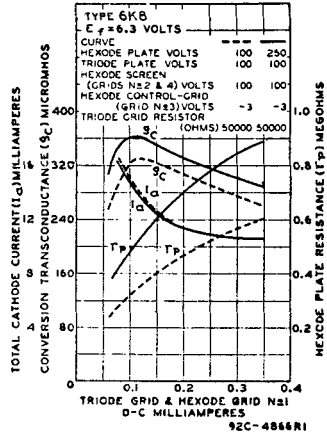

DETECTOR AMPLIFIER TRIODE

The 6L5-G is a three-electrode tube of the heater-cathode type for use as an amplifier, detector, or oscillator in circuits designed for its characteristics. The low heater current is a consideration in applications where economy of power is important.

6L5-G

CHARACTERISTICS

HEATER VOLTAGE (A.C. or D.C.)	6.3	Volts
HEATER CURRENT	0.15	Ampere
PLATE VOLTAGE	135	250 max. Volts
GRID VOLTAGE	-5	-9 Volts
PLATE CURRENT	3.5	8 Milliamperes
PLATE RESISTANCE	11300	9000 Ohms
AMPLIFICATION FACTOR	17	17
TRANSCONDUCTANCE	1500	1900 Micromhos
GRID BIAS VOLTAGE (Approx.)°	-11	-20 Volts
GRID-PLATE CAPACITANCE (Approx.)*	2.7	μμf
GRID-CATHODE CAPACITANCE (Approx.)*	3.0	μμf
PLATE-CATHODE CAPACITANCE (Approx.)*	5.0	μμf

* For cathode current cut-off.

° With close-fitting shield connected to cathode.

INSTALLATION and APPLICATION

The base of the 6L5-G fits the standard octal socket which may be mounted to hold the tube in any position. Physical characteristics of the 6L5-G are shown in Fig. 2-17, OUTLINES SECTION. Heater operation and cathode connection are discussed under Type 6A8.

As a class A₁ amplifier, the 6L5-G may be operated in resistance-coupled circuits as shown in the RESISTANCE-COUPLED AMPLIFIER CHART.

BEAM POWER AMPLIFIERS

6L6
METAL
6L6-G

The 6L6 and 6L6-G are power-amplifier tubes for use in the output stage of radio receivers, especially those designed to have ample reserve of power-delivering ability. The 6L6 and 6L6-G provide high power output sensitivity and high efficiency. The power output at all levels has low third

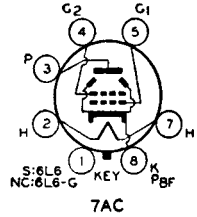

and negligible higher-order harmonic distortion. For discussion of beam power amplifier considerations, refer to section on ELECTRONS and ELECTRODES.

★ CHARACTERISTICS

HEATER VOLTAGE (A.C. or D.C.)	6.3	Volts
HEATER CURRENT	0.9	Ampere

As Single-Tube Class A₁ Amplifier

PLATE VOLTAGE	360 max.	Volts
SCREEN VOLTAGE	270 max.	Volts
PLATE DISSIPATION	19 max.	Watts
SCREEN DISSIPATION	2.5 max.	Watts

TYPICAL OPERATION:

	Fixed Bias		Cathode Bias		
Plate Voltage	250	350	250	300	Volts
Screen Voltage	250	250	250	200	Volts
Grid Voltage	-14	-18	-	-	Volts
Cathode Resistor	-	-	170	220	Ohms
Peak A-F Grid Voltage	14	18	14	12.5	Volts
Zero-Signal Plate Current	72	54	75	51	Milliamperes
Max.-Signal Plate Current	79	66	78	54.5	Milliamperes
Zero-Signal Screen Current	5	2.5	5.4	3	Milliamperes
Max.-Signal Screen Current	7.3	7	7.2	4.6	Milliamperes
Plate Resistance	22500	33000	-	-	Ohms
Transconductance	6000	5200	-	-	Micromhos
Load Resistance	2500	4200	2500	4500	Ohms
Total Harmonic Distortion	10	15	10	11	Per cent
Max.-Signal Power Output	6.5	10.8	6.5	6.5	Watts

As Single-Tube Class A₁ Amplifier — Triode Connection †

PLATE VOLTAGE	250 max.	Volts
PLATE AND SCREEN DISSIPATION (Total)	10 max.	Watts

TYPICAL OPERATION:

	Fixed Bias	Cathode Bias	
Plate Voltage	250	250	Volts
Grid Voltage	-20	-	Volts
Cathode Resistor	-	490	Ohms
Peak A-F Grid Voltage	20	20	Volts
Zero-Signal Plate Current	40	40	Milliamperes
Max.-Signal Plate Current	44	42	Milliamperes
Plate Resistance	1700	-	Ohms

† Screen connected to plate.

Amplification Factor	8	-	
Transconductance	4700	-	Micromhos
Load Resistance	5000	6000	Ohms
Total Harmonic Distortion..	5	6	Per cent
Max.-Signal Power Output..	1.4	1.3	Watts

As Push-Pull Class A₁ Amplifier

PLATE VOLTAGE	360 max.	Volts
SCREEN VOLTAGE	270 max.	Volts
PLATE DISSIPATION	19 max.	Watts
SCREEN DISSIPATION	2.5 max.	Watts

TYPICAL OPERATION: *Values are for two tubes*

	<i>Fixed Bias</i>	<i>Cathode Bias</i>	
Plate Voltage	250	270	Volts
Screen Voltage	250	270	Volts
Grid Voltage	-16	-17.5	Volts
Cathode Resistor	-	-	125 Ohms
Peak A-F Grid-to-Grid Voltage..	32	35	40 Volts
Zero-Signal Plate Current	120	134	134 Milliamperes
Max.-Signal Plate Current	140	155	145 Milliamperes
Zero-Signal Screen Current	10	11	11 Milliamperes
Max.-Signal Screen Current	16	17	17 Milliamperes
Plate Resistance	24500	23500	- Ohms
Transconductance	5500	5700	- Micromhos
Effective Load Resistance (Plate-to-plate)	5000	5000	5000 Ohms
Total Harmonic Distortion	2	2	2 Per cent
Max.-Signal Power Output	14.5	17.5	18.5 Watts

As Push-Pull Class AB₁ Amplifier

PLATE VOLTAGE	360 max.	Volts
SCREEN VOLTAGE	270 max.	Volts
PLATE DISSIPATION	19 max.	Watts
SCREEN DISSIPATION	2.5 max.	Watts

TYPICAL OPERATION: *Values are for two tubes*

	<i>Fixed Bias</i>	<i>Cathode Bias</i>	
Plate Voltage	360	360	360 Volts
Screen Voltage	270	270	270 Volts
Grid Voltage	-22.5	-22.5	- Volts
Cathode Resistor	-	-	250 Ohms
Peak A-F Grid-to-Grid Voltage..	45	45	57 Volts
Zero-Signal Plate Current	88	88	88 Milliamperes
Max.-Signal Plate Current	132	140	100 Milliamperes
Zero-Signal Screen Current	5	5	5 Milliamperes
Max.-Signal Screen Current	15	11	17 Milliamperes
Effective Load Resistance (Plate-to-plate)	6600	3800	9000 Ohms
Total Harmonic Distortion	2	2	4 Per cent
Max.-Signal Power Output	26.5	18	24.5 Watts

As Push-Pull Class AB₂ Amplifier

PLATE VOLTAGE	360 max.	Volts
SCREEN VOLTAGE	270 max.	Volts
PLATE DISSIPATION	19 max.	Watts
SCREEN DISSIPATION	2.5 max.	Watts

TYPICAL OPERATION: *Values are for two tubes*

	<i>Fixed Bias</i>		
Plate Voltage	360	360	Volts
Screen Voltage	225	270	Volts
Grid Voltage	-18	-22.5	Volts
Peak A-F Grid-to-Grid Voltage	52	72	Volts

Zero-Signal Plate Current.....	78	88	Milliamperes
Max.-Signal Plate Current.....	142	205	Milliamperes
Zero-Signal Screen Current.....	3.5	5	Milliamperes
Max.-Signal Screen Current.....	11	16	Milliamperes
Effective Load Resistance (Plate-to-plate).	6000	3800	Ohms
Peak Grid-Input Power*.....	140	270	Milliwatts
Total Distortion**.....	2	2	Per cent
Max.-Signal Power Output.....	31	47	Watts

* Driver stage should be capable of supplying the grids of the class AB₂ stage with the specified peak values at low distortion. The effective resistance per grid circuit of the class AB₂ stage should be kept below 500 ohms and the effective impedance at the highest desired response frequency should not exceed 700 ohms.

** With zero-impedance driver and perfect regulation, plate-circuit distortion does not exceed 2%. In practice, plate-voltage regulation, screen-voltage regulation, and grid-bias regulation should be not greater than 5%, 5% and 3%, respectively.

INSTALLATION and APPLICATION

The base of either the 6L6 or the 6L6-G fits the standard octal socket which may be installed to hold the tube in any position. Physical characteristics of the 6L6 and the 6L6-G are shown in Figs. 1-9 and 2-26, respectively, in the OUT-LINES SECTION.

The heater is designed to operate at 6.3 volts. The transformer supplying this voltage should be designed to operate the heater at this recommended value for full-load operating conditions at average line voltage. Under the maximum screen and plate dissipation conditions, the heater voltage should never fluctuate so that it exceeds 7.0 volts. For cathode connection, refer to Type 6A8.

In all services, precautions should be taken to insure that the dissipation rating is not exceeded with expected line-voltage variations, especially in the cases of fixed-bias operation. When the push-pull connection is used, fixed-bias values up to 10% of each typical screen voltage can be used without increasing distortion.

As class A₁ power amplifiers, the 6L6 and 6L6-G should be operated as shown under CHARACTERISTICS. The values cover cathode- and fixed-bias operation for both types where used as beam power tubes as well as where they are connected as triodes, and have been determined on the basis that no grid current flows during any part of the input signal swing. The second harmonics can easily be eliminated by the use of push-pull circuits. In single-tube resistance-coupled circuits, the second-harmonics can be minimized by generating out-of-phase second harmonics in the pre-amplifier.

As push-pull class AB₂ power amplifiers, the 6L6 and 6L6-G may be operated as shown under CHARACTERISTICS. The values shown cover cathode- and fixed-bias operation and have been determined on the basis that no grid current flows during any part of the input signal swing.

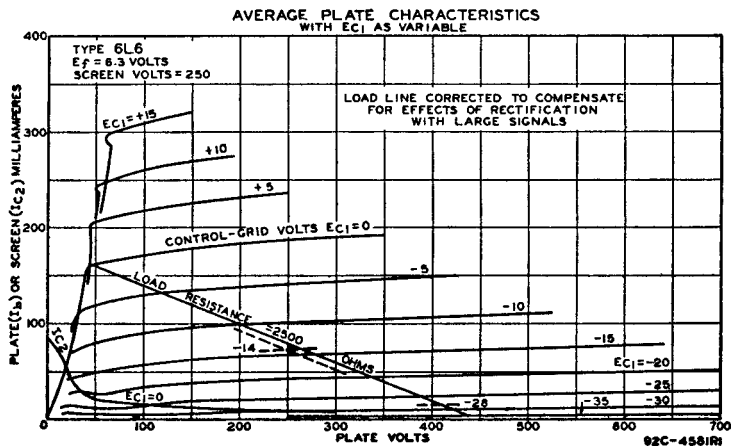

The type of input coupling used in class A₁ and class AB₁ service should not introduce too much resistance in the grid circuit. Transformer- or impedance-coupling devices are recommended. When the grid circuit has a resistance not higher than 0.1 megohm, fixed bias may be used; for higher values, cathode bias is required. With cathode bias the grid circuit may have a resistance as high as, but not greater than, 0.5 megohm provided the heater voltage is not allowed to rise more than 10% above the rated value under any condition of operation.

As push-pull class AB₂ power amplifiers, the 6L6 and the 6L6-G may be operated as shown under CHARACTERISTICS. The values cover operation with fixed bias and have been determined on the basis that some grid current flows during the most positive swing of the input signal.

Refer to CIRCUIT SECTION for circuits employing the 6L6 or 6L6-G, and to the RADIO TUBE APPLICATIONS section for discussion of inverse-feedback arrangements.

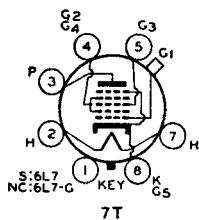
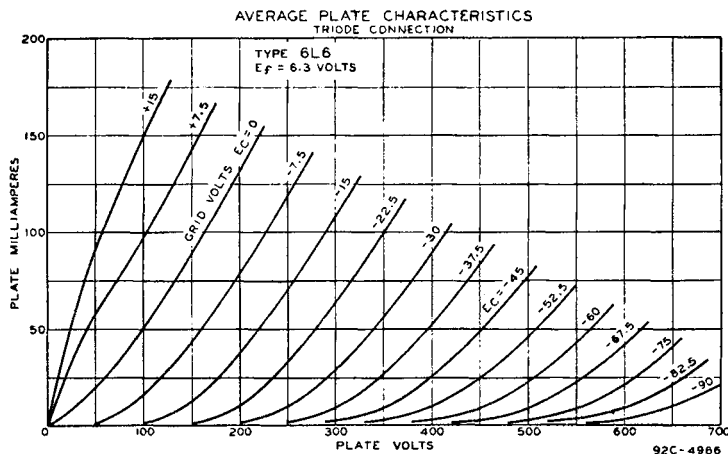

**PENTAGRID MIXER
AMPLIFIERS**

6L7
METAL

6L7-G

The 6L7 and 6L7-G are multi-electrode vacuum tubes. Each type is designed with two separate control grids shielded from each other. This design permits each control grid to act independently on the electron stream. These tubes, therefore, are especially useful as mixers in superheterodyne circuits having a separate oscillator stage, as well as in other applications where dual control is desirable in a single stage. The design of the tubes is such that coupling effects between oscillator and signal circuits are made very small. This feature enables the 6L7 and 6L7-G to give high gain in high-frequency circuits. For general discussion of pentagrid types, see Frequency Conversion in the RADIO TUBE APPLICATIONS section.

★ CHARACTERISTICS

HEATER VOLTAGE (A.C. or D.C.)	6.3	Volts
HEATER CURRENT	0.3	Ampere
DIRECT INTERELECTRODE CAPACITANCES:		

	<i>Type 6L7* Type 6L7-G*</i>	
Grid No. 1 to Grid No. 3	0.2 max.	0.2 max. μf
Grid No. 1 to Plate	0.001 max.	0.005 max. μf

* With shell connected to cathode. * With close-fitting shield connected to cathode.

Grid No. 3 to Plate	0.1	0.24	$\mu\mu\text{f}$
Grid No. 1 to All Other Electrodes...	7.5	6	$\mu\mu\text{f}$
Grid No. 3 to All Other Electrodes...	10	12	$\mu\mu\text{f}$
Plate to All Other Electrodes	11	10	$\mu\mu\text{f}$

As Mixer

PLATE VOLTAGE	300 <i>max.</i>	Volts
SCREEN VOLTAGE (Grids No. 2 and No. 4).....	150 <i>max.</i>	Volts
PLATE DISSIPATION	1.0 <i>max.</i>	Watt
SCREEN DISSIPATION	1.5 <i>max.</i>	Watts

TYPICAL OPERATION:

Plate Voltage	250	250†	Volts
Screen Voltage	100	150†	Volts
Signal-Grid Voltage (Grid No. 1)	-3 <i>min.</i>	-6 <i>min.</i> †	Volts
Oscillator-Grid Voltage (Grid No. 3)** ..	-10	-15	Volts
Peak Oscillator Voltage Applied to Grid No. 3	12 <i>min.</i>	18 <i>min.</i>	Volts
Plate Current	2.4	3.3	Milliamperes
Screen Current	7.1	9.2	Milliamperes
Plate Resistance	Greater than 1		Megohm
Conversion Transconductance	375	350	Micromhos
Signal-Grid Voltage for Conversion Transconductance of 5 Micromhos	-30	-45	Volts

** The d-c resistance in oscillator-grid circuit should be limited to 50000 ohms.

† Recommended values for all-wave receivers.

As Class A₁ Amplifier

PLATE VOLTAGE	300 <i>max.</i>	Volts
SCREEN VOLTAGE	100 <i>max.</i>	Volts
PLATE DISSIPATION	1.5 <i>max.</i>	Watts
SCREEN DISSIPATION	1.0 <i>max.</i>	Watt

TYPICAL OPERATION:

Plate Voltage	250	Volts
Screen Voltage (Grids No. 2 and No. 4)	100	Volts
Control-Grid Voltage (Grid No. 1)	-3	Volts
Control-Grid Voltage (Grid No. 3).....	-3	Volts
Plate Current	5.3	Milliamperes
Screen Current	6.5	Milliamperes
Plate Resistance (Approx.)	0.6	Megohm
Transconductance (Grid No. 1 to Plate)	1100	Micromhos
Transconductance with -15 volts bias on Grid No. 1	5	Micromhos
Transconductance with -15 volts bias on Grid No. 3	5	Micromhos

INSTALLATION and APPLICATION

The base of either the 6L7 or the 6L7-G fits the standard octal socket which may be installed to hold the tube in any position. Physical characteristics of the 6L7 and the 6L7-G are shown in Figs. 1-5 and 2-15, respectively, in the OUTLINES SECTION. For heater operation and cathode connection, refer to Type 6A8.

As mixers in superheterodyne circuits, the 6L7 and 6L7-G can mix the input from an external oscillator with the radio-input frequency to provide the desired intermediate frequency. For this service, design information is given under CHARACTERISTICS.

As radio-frequency or intermediate-frequency amplifiers, the 6L7 and 6L7-G should be operated as shown under CHARACTERISTICS. In general, properly designed radio-frequency transformers are preferable to interstage coupling impedances, especially in cases where a high-impedance B-supply may cause oscillation below radio frequencies. The fact that the grid No. 1-plate capacitance of these types is extremely small is advantageous in circuits where high attenuation is required.

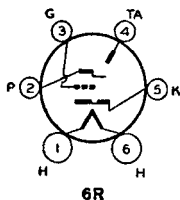
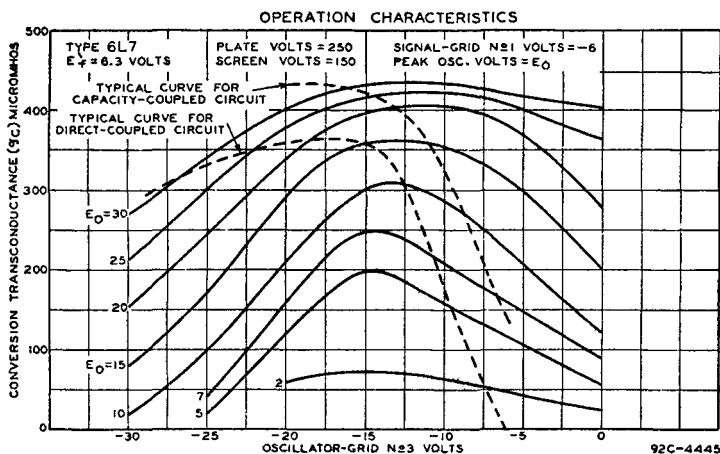

ELECTRON-RAY TUBE

Indicator Type

6N5

The 6N5 is a high-vacuum heater-cathode tube designed to indicate visually, by means of a fluorescent target, the effects of a controlling voltage. The tube is a voltage indicator and as such is a convenient means to indicate accurate tuning of a radio receiver. For a discussion of Electron-Ray Tube considerations, see the RADIO TUBE APPLICATIONS section. This type has been superseded by 6AB5/6N5.

★ CHARACTERISTICS

HEATER VOLTAGE (A.C. or D.C.)	6.3	Volts
HEATER CURRENT	0.15	Ampere
PLATE-SUPPLY VOLTAGE	180 max.	Volts
TARGET VOLTAGE	{ 180 max. Volts 100 min. Volts	

TYPICAL OPERATION:

Plate-and-Target Supply	135	135	Volts
Series Triode-Plate Resistor	0.25	1.0	Megohm
Target Current †	2	1.9	Milliamperes
Triode-Plate Current°	0.5	0.13	Milliampere
Triode-Grid Voltage (Approx.):			
For shadow angle of 0°	-10	15.5	Volts
For shadow angle of 90°	0	0	Volts

† Subject to wide variations.

° For zero triode-grid voltage.

INSTALLATION and APPLICATION

The base of the 6N5 fits the standard 6-contact socket which may be installed to hold the tube in any position. Physical characteristics of the 6N5 are shown in Fig. 2-19, OUTLINES SECTION. Heater operation is similar to that of the 6D8-G; for cathode connection, see Type 6A8.

Application and circuits are similar to those for Type 6E5. The low heater current makes this tube useful in applications where economy of heater power is important. The cut-off characteristic of the triode of the 6N5 is somewhat more extended than that of the 6E5.

AVERAGE CONTROL CHARACTERISTICS

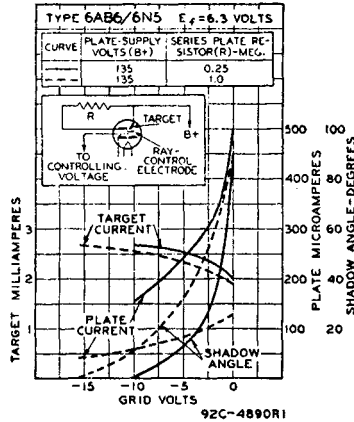

DIRECT-COUPLED POWER AMPLIFIER

6N6-G

The 6N6-G is a multi-electrode tube of the heater-cathode type consisting of two triodes in one bulb. One triode, the driver, is directly connected within the tube to the second, or output, triode. The 6N6-G is used chiefly for replacement in receivers designed for its characteristics.

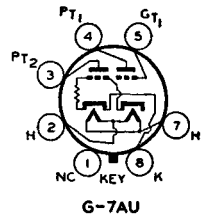

★ CHARACTERISTICS

HEATER VOLTAGE (A.C. or D.C.)	6.3	Volts
HEATER CURRENT	0.8	Ampere

As Class A₁ Power Amplifier

OUTPUT-TRIODE PLATE (PT ₂) VOLTAGE	300 max.	Volts
INPUT-TRIODE PLATE (PT ₁) VOLTAGE	300 max.	Volts
INPUT-TRIODE GRID (GT ₁) VOLTAGE	0	Volts
PEAK A-F GRID (GT ₁) VOLTAGE	21	Volts
OUTPUT-TRIODE PLATE CURRENT	42	Milliamperes
INPUT-TRIODE PLATE CURRENT	9	Milliamperes
PLATE RESISTANCE	24000	Ohms
TRANSCONDUCTANCE (GT ₁ to PT ₂)	2400	Micromhos
AMPLIFICATION FACTOR	58	
LOAD RESISTANCE	7000	Ohms
TOTAL HARMONIC DISTORTION	5	Per cent
POWER OUTPUT	4	Watts

INSTALLATION and APPLICATION

The base of the 6N6-G fits the standard octal socket which may be mounted to hold the tube in any position. Physical characteristics of the 6N6-G are shown in Fig. 2-21, OUTLINES SECTION. Heater operation is the same as for Type 6N7.

The 6N6-G may be operated as a class A₁ power amplifier under conditions shown under CHARACTERISTICS. The tube operates without external bias, but the input-triode grid does not draw current because a bias voltage for this grid is set up within the tube. If two 6N6-G's are operated in push-pull, the plate-to-plate load resistance should be 10000 ohms.

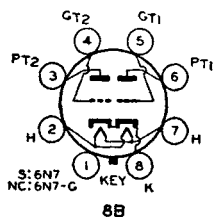

CLASS B TWIN TRIODES

The 6N7 and 6N7-G are multi-unit types of tubes. Each type contains in one envelope two high- μ triodes designed for class B operation. The triode units have separate terminals for all electrodes except the cathodes and heaters. The 6N7 and 6N7-G may also

6N7
METAL

6N7-G

be used as class A₁ amplifiers (triode units in parallel) to drive a single 6N7 or 6N7-G as a class B amplifier in the output stage.

★ CHARACTERISTICS

HEATER VOLTAGE (A.C. or D.C.)	6.3	Volts
HEATER CURRENT	0.8	Ampere

As Class B Power Amplifier

PLATE VOLTAGE	300 max.	Volts
PEAK PLATE CURRENT (Per Plate)	125 max.	Milliamperes
AVERAGE PLATE DISSIPATION (Per plate)	5.5 max.	Watts

TYPICAL OPERATION:

Unless otherwise specified, values are for the two units

Plate-Supply Impedance	0	1000	Ohms
Effective Grid-Circuit Impedance (Per unit)	0	516	Ohms
Plate Voltage	300	300	Volts
Grid Voltage	0	0	Volts
Peak A-F Grid-to-Grid Voltage	58	82	Volts
Zero-Signal D-C Plate Current	35	35	Milliamperes
Max.-Signal D-C Plate Current	70	70	Milliamperes
Peak Grid Current (Per unit)	20	22	Milliamperes
Effective Load Resistance (Plate-to-plate)	8000	8000	Ohms
Total Harmonic Distortion	4	8	Per cent
Third Harmonic Distortion	3.5	7.5	Per cent
Fifth Harmonic Distortion	1.5	3.5	Per cent
Max.-Signal Power Output	10	10	Watts

As Driver* — Class A₁ Amplifier

PLATE VOLTAGE†	250	294	Volts
GRID VOLTAGE	-5	-6	Volts
PLATE CURRENT	6	7	Milliamperes
PLATE RESISTANCE	11300	11000	Ohms
AMPLIFICATION FACTOR	35	35	
TRANSCONDUCTANCE	3100	3200	Micromhos

† Maximum plate voltage = 300 volts.

* Both grids connected together at socket: likewise both plates.

INSTALLATION and APPLICATION

The base of either the 6N7 or the 6N7-G fits the standard octal socket which may be installed to hold the tube in any position. Physical characteristics of the 6N7 and 6N7-G are shown in Figs. 1-7 and 2-21, respectively, in the OUTLINES SECTION.

The heater is designed to operate at 6.3 volts. In a series-heater circuit employing several 6.3-volt types and one or more 6N7's or 6N7-G's, the heaters of the 6N7's and 6N7-G's should be placed on the positive side. Furthermore, since most 6.3-volt types have 0.3-ampere heaters, a bleeder circuit across these heaters is required to take care of the additional 0.5-ampere heater current of the 6N7's and 6N7-G's. Each 6.3-volt tube of the 0.3-ampere type in the series circuit should, therefore, be shunted by a bleeder resistance of 13 ohms. Cathode connection is the same as for the 6A8.

As class B power amplifiers, the 6N7 and 6N7-G are used in circuits similar in design to those utilizing individual tubes in the output stage. They require no

grid-bias, since the high- μ feature of the triode units reduces the steady plate current at zero bias to a relatively low value. Refer to RADIO TUBE APPLICATIONS section for general class B amplifier design considerations.

Two 6N7's or 6N7-G's can be operated in a class B output stage with the two triode units of each tube connected in parallel to give a power output of 20 watts, approximate, under conditions of 300 volts on the plates and of a 5000-ohm plate-plate load.

In the second set of conditions shown under Typical Operation, the plate-supply impedance of 1000 ohms indicates a value that is obtainable in a practical design. The effective grid-circuit impedance of 516 ohms is for a class B stage in which the effective resistance per grid circuit is 500 ohms at 400 cycles and the leakage reactance of the coupling transformer is 50 millihenrys. The driver stage should be capable of supplying the grids of the class B stage with the specified values of driving voltage and current at low distortion.

As class A, amplifier triodes, the 6N7 and 6N7-G may be employed in the driver stage of class B amplifier circuits, and thus reduce the number of tube types necessary in a receiver. When operated in this way with a plate supply of 300 volts and corresponding grid-bias, these tubes are capable of supplying a power output upwards of 400-milliwatts. The load into which the driver works will depend largely on the design factors of the class B amplifier. In general, however, the load will be between 20000 and 40000 ohms. The d-c resistance in the grid circuit of the 6N7 and 6N7-G when operated as a class A amplifier, may be as high as 0.5 megohm with cathode bias. With fixed bias, however, the resistance should not exceed 0.1 megohm. Typical operating values as resistance-coupled amplifiers are given in the RESISTANCE-COUPLED AMPLIFIER CHART.

Among other and less conventional applications of the 6N7 and 6N7-G are the use of either type as (1) biased detector and one-stage a-f amplifier, (2) two-stage a-f amplifier, (3) amplifier and phase-inverter to supply resistance-coupled, push-pull output tubes, (4) two-tube oscillator, and (5) oscillator and amplifier.

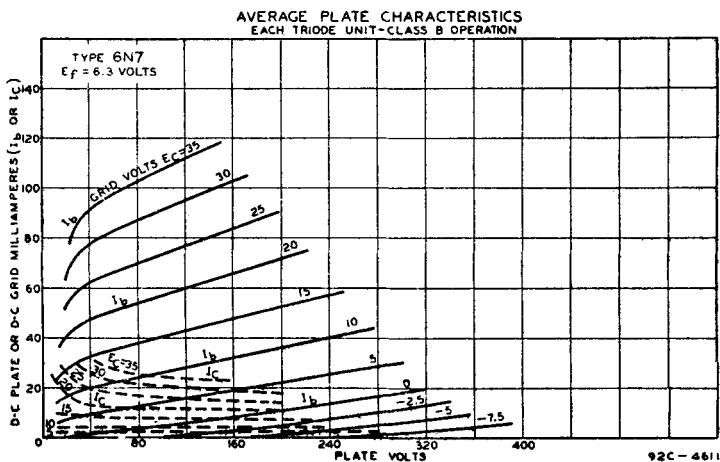

6P5-G

DETECTOR AMPLIFIER TRIODE

The 6P5-G is a triode of the heater-cathode type recommended for use as detector, amplifier, or oscillator. This tube, which is similar to the older type 76 in electrical characteristics, has high transconductance and comparatively high amplification factor

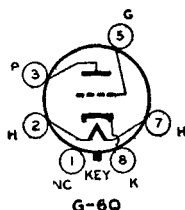

★ CHARACTERISTICS

HEATER VOLTAGE (A.C. or D.C.)		6.3	Volts
HEATER CURRENT		0.3	Ampere
PLATE VOLTAGE	100	250 <i>max.</i>	Volts
GRID VOLTAGE*	-5	-13.5	Volts
PLATE CURRENT	2.5	5	Milliamperes
PLATE RESISTANCE	12000	9500	Ohms
AMPLIFICATION FACTOR	13.8	13.8	
TRANSCONDUCTANCE	1150	1450	Micromhos
GRID-PLATE CAPACITANCE ^o		2.2	$\mu\mu\text{f}$
GRID-CATHODE CAPACITANCE ^o		3.4	$\mu\mu\text{f}$
PLATE-CATHODE CAPACITANCE ^o		5.5	$\mu\mu\text{f}$

^o With close-fitting shield connected to cathode. Values are approximate.
 * The d-c resistance in the grid circuit should not exceed 1.0 megohm.

INSTALLATION and APPLICATION

The base of the 6P5-G fits the standard octal socket which may be mounted to hold the tube in any position. Physical characteristics of the 6P5-G are shown in Fig. 2-17, OUTLINES SECTION. Heater operation and cathode connection are discussed under Type 6A8.

APPLICATION

As an amplifier, the 6P5-G is applicable either to radio-frequency or audio-frequency circuits. Recommended operating conditions for service using transformer coupling are given under CHARACTERISTICS. For operation as a resistance-coupled amplifier, refer to the RESISTANCE-COUPLED AMPLIFIER CHART.

As a detector, the 6P5-G may be of the grid-leak-and-condenser or grid-bias type. The plate voltage for the grid-leak-and-condenser method should be about 45 volts. A grid leak of from 1 to 5 megohms with a grid condenser of 0.00025 μf is satisfactory. For the grid-bias method of detection, a plate-supply voltage of 250 volts may be used together with a negative grid bias voltage of approximately 20 volts. The plate current should be adjusted to 0.2 milliampere, with no input signal voltage. The grid-bias voltage may be supplied from the voltage drop in a resistor between cathode and ground. The value of this cathode resistor is not critical, 30000 to 150000 ohms being suitable. The higher value will permit the application of a larger input signal.

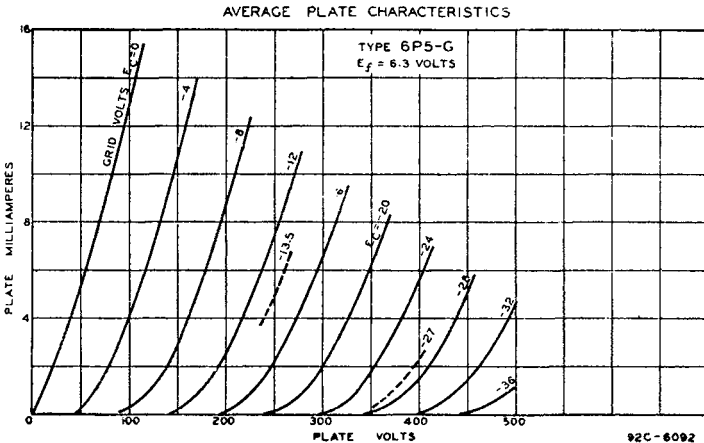

6Q7
METAL
6Q7-G
6Q7-GT

**DUPLEX-DIODE
HIGH-MU TRIODES**

The 6Q7, 6Q7-G, and 6Q7-GT are multi-unit types of tubes. Each type contains two diodes and a high-mu triode in one envelope and is for use as combined detector, amplifier, and automatic-volume-control tube in radio receivers designed for its characteristics. For diode-detector considerations, refer to RADIO TUBE APPLICATIONS section.

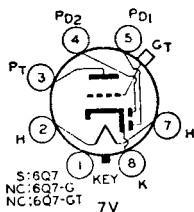

★ CHARACTERISTICS

HEATER VOLTAGE (A.C. or D.C.)	6.3	Volts
HEATER CURRENT	0.3	Ampere

	Type 6Q7*	Type 6Q7-G**	Type 6Q7-GT	
Triode: GRID-PLATE CAPACITANCE	1.5	1.7	—	μf
GRID-CATHODE CAPACITANCE	5.5	2.2	—	μf
PLATE-CATHODE CAPACITANCE	5	3.2	—	μf

* With shell connected to cathode. Values are approximate.

** With no shield. Values are approximate.

Triode Unit — As Class A₁ Amplifier

PLATE VOLTAGE	100	250 max.	Volts
GRID VOLTAGE	-1.5	-3	Volts
PLATE CURRENT	0.35	1.1	Milliamperes
PLATE RESISTANCE	87500	58000	Ohms
AMPLIFICATION FACTOR	70	70	
TRANSCONDUCTANCE	800	1200	Micromhos

Diode Units

The two diode plates are placed around a cathode, the sleeve of which is common to the triode unit. Each diode plate has its own base pin. Operation curves for the diode units are given under Type 6B7.

INSTALLATION and APPLICATION

The base of either the 6Q7, the 6Q7-G, or the 6Q7-GT fits the standard octal socket which may be installed to hold the tube in any position. Physical characteristics of the 6Q7, 6Q7-G, and 6Q7-GT are shown in Figs. 1-5, 2-15, and 2-6, respectively.

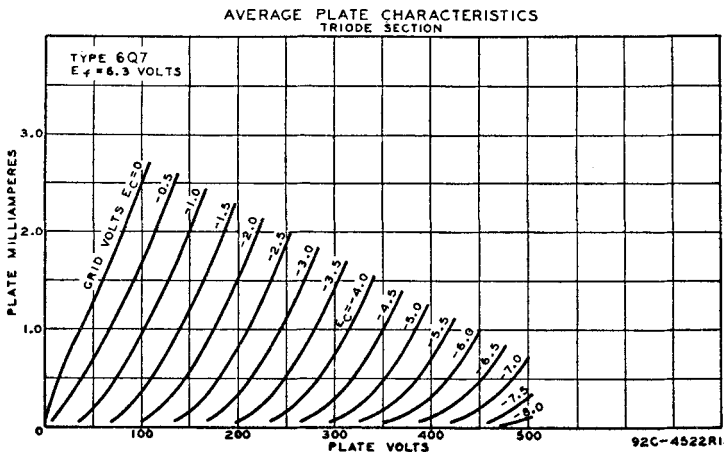

ively, in the OUTLINES SECTION. Heater and cathode considerations are the same as for Type 6A8.

These three types are in many respects similar to the 6SQ7 except that they have a lower amplification factor which permits of handling somewhat larger input driving voltage without overloading. The triode unit is recommended for use only in resistance-coupled circuits. Typical recommended operating conditions are given in the RESISTANCE-COUPLED AMPLIFIER CHART.

Grid bias for the triode unit of the 6Q7, 6Q7-G, and 6Q7-GT may be obtained from a fixed source, such as a fixed-voltage tap on the d-c power supply or from a cathode-bias resistor. It should not be obtained by the diode-biasing method because of the probability of plate-current cut-off, even with relatively small signal voltages applied to the diode circuit.

DUPLEX-DIODE TRIODES

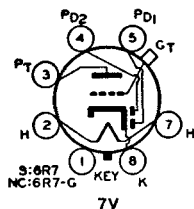

The 6R7 and 6R7-G are multi-unit tubes. Each type contains two diodes and a triode in a single envelope and is for use as combined detector, amplifier, and automatic-volume-control tube in radio receivers designed for its characteristics. For diode-detector considerations, refer to the RADIO TUBE APPLICATIONS section.

6R7
METAL

6R7-G

★ CHARACTERISTICS

HEATER VOLTAGE (A C. or D.C.)	6.3	Volts
HEATER CURRENT	0.3	Ampere

	Type 6R7*	Type 6R7-G**	
<i>Triodes:</i>			
GRID-PLATE CAPACITANCE (Approx.)	2.2	2.4	μf
GRID-CATHODE CAPACITANCE (Approx.)	5.0	2.6	μf
PLATE-CATHODE CAPACITANCE (Approx.)	3.2	5.2	μf

* With shell connected to cathode. ** With shield.

Triode Unit — As Class A₁ Amplifier

PLATE VOLTAGE	250 max.	Volts
GRID VOLTAGE	-9	Volts
PLATE CURRENT	9.5	Milliamperes
PLATE RESISTANCE	8500	Ohms
AMPLIFICATION FACTOR	16	
TRANSCONDUCTANCE	1900	Micromhos
LOAD RESISTANCE	10000	Ohms
POWER OUTPUT	300	Milliwatts

Diode Units

The two diode plates are placed around a cathode, the sleeve of which is common to the triode unit. Each diode plate has its own base pin. Operation curves for the diode units are given under Type 6B7.

INSTALLATION and APPLICATION

The base of either the 6R7 or the 6R7-G fits the standard octal socket which may be installed to hold the tube in any position. Physical characteristics of the 6R7 and 6R7-G are shown in Figs. 1-5 and 2-15, respectively, in the OUTLINES SECTION. Heater and cathode considerations are the same as those for Type 6A8.

As transformer-coupled amplifiers, the triode units of the 6R7 and 6R7-G may be employed in conventional circuit arrangements. Operating conditions are shown under CHARACTERISTICS. As resistance-coupled amplifiers, the triode units may be used under conditions given in the RESISTANCE-COUPLED AMPLIFIER CHART.

Grid bias for the triode units of the 6R7 and 6R7-G may be obtained from a fixed source, such as a fixed-voltage tap on the d-c power supply or from a cathode-bias resistor. It should not be obtained by the diode-biasing method because of the probability of plate-current cut-off, even with relatively small signal voltages applied to the diode circuit.

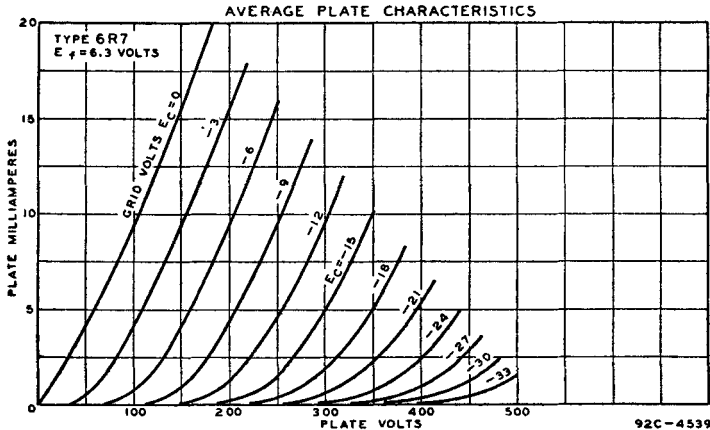

6S7
METAL
6S7-G

**TRIPLE-GRID
SUPER-CONTROL
AMPLIFIERS**

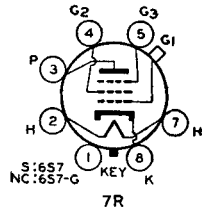

The 6S7 and 6S7-G are triple-grid super-control amplifier tubes of the heater-cathode type designed for use in radio- or intermediate-frequency amplifiers. The ability of these tubes

to handle unusual signal voltages without cross-modulation or modulation distortion makes them adaptable to receivers employing automatic volume control. These tubes may be used to advantage in applications where economy of heater power is important.

★ CHARACTERISTICS

HEATER VOLTAGE (A.C. or D.C.) 6.3 Volts
HEATER CURRENT 0.15 Ampere

	Type 6S7*	Type 6S7-G**	
GRID-PLATE CAPACITANCE	0.005 max.	0.008 max.	μf
INPUT CAPACITANCE	6.5	4.4	μf
OUTPUT CAPACITANCE	10.5	8	μf

* With shell connected to cathode. ** With close-fitting shield connected to cathode.

As Class A₁ Amplifier

PLATE VOLTAGE	300 max.	Volts
SCREEN VOLTAGE (Grid No. 2)	100 max.	Volts
SCREEN SUPPLY VOLTAGE	300 max.	Volts
GRID VOLTAGE (Grid No. 1)	0 min.	Volts
PLATE DISSIPATION	2.25 max.	Watts
SCREEN DISSIPATION	0.25 max.	Watt

TYPICAL OPERATION:

Plate Voltage	135	250	Volts
Screen Voltage	67.5	100	Volts
Grid Voltage	-3	-3	Volts

Suppressor	Connected to cathode at socket		
Plate Current	3.7	8.5	Milliamperes
Screen Current	0.9	2	Milliamperes
Plate Resistance (Approx.)	1.0	1.0	Megohm
Transconductance	1250	1750	Micromhos
Grid Voltage for transconductance of 10 micromhos	-25	-38.5	Volts

INSTALLATION and APPLICATION

The base of either the 6S7 or the 6S7-G fits the standard octal socket which may be installed to hold the tube in any position. Physical characteristics of the 6S7 and 6S7-G are shown in Figs. 1-6 and 2-15, respectively, in the OUTLINES SECTION. For heater operation and cathode connection, refer to Type 6D8-G. Voltage supplies and applications are similar to those discussed under Type 6SK7.

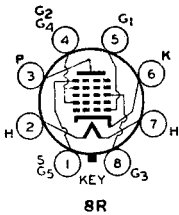
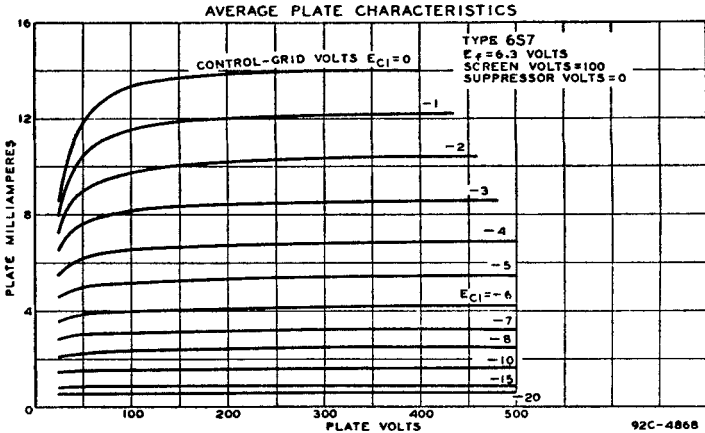

PENTAGRID CONVERTER

The 6SA7 is a multi-electrode vacuum tube of the single-ended metal type designed to perform simultaneously the functions of a mixer (first detector) tube and of an oscillator tube in super-heterodyne circuits, especially those of the all-wave type. Utilizing a special structure, the 6SA7 has excellent oscillator frequency stability, and offers mechanical advantage from a circuit standpoint as discussed under Application.

6SA7
METAL

oscillator frequency stability, and offers mechanical advantage from a circuit standpoint as discussed under Application.

★ **CHARACTERISTICS**

HEATER VOLTAGE (A.C. or D.C.)	6.3	Volts
HEATER CURRENT	0.3	Ampere
DIRECT INTERELECTRODE CAPACITANCES:		
Grid No. 3 to All Other Electrodes = R-F Input° ..	9.5	μf
Plate to All Other Electrodes = Mixer Output° ..	12	μf
Grid No. 1 to All Other Electrodes°	7	μf
Grid No. 3 to Plate°	0.13 max.	μf
Grid No. 1 to Grid No. 3°	0.15 max.	μf
Grid No. 1 to Plate°	0.06 max.	μf
Grid No. 1 to All Other Electrodes Except Cathode.	4.4	μf
Grid No. 1 to Cathode	2.6	μf
Cathode to All Other Electrodes Except Grid No. 1	5	μf

* With shell connected to cathode.

As Frequency Converter

PLATE VOLTAGE	300 max.	Volts
GRIDS No. 2 and No. 4 VOLTAGE	100 max.	Volts
GRIDS No. 2 and No. 4 SUPPLY VOLTAGE	300 max.	Volts
GRID No. 3 VOLTAGE	0 min.	Volts
PLATE AND GRIDS No. 2 and No. 4 DISSIPATION (Total)	2.0 max.	Watts
GRIDS No. 2 and No. 4 DISSIPATION	1.0 max.	Watt
TOTAL CATHODE CURRENT	14 max.	Milliamperes

TYPICAL OPERATION with Self-Excitation:

Plate Voltage	100	250	Volts
Grids No. 2 and No. 4 Voltage	100	100	Volts
Grid No. 3 (Control) Voltage	0	0	Volts
Grid No. 5 and Shell Voltage	0	0	Volts
Grid No. 1 Resistor	20000	20000	Ohms
Plate Current	3.3	3.5	Milliamperes
Grids No. 2 and No. 4 Current	8.5	8.5	Milliamperes
Grid No. 1 Current	0.5	0.5	Milliamperes
Total Cathode Current	12.3	12.5	Milliamperes
Plate Resistance (Approx.)	0.5	1.0	Megohm
Conversion Transconductance	425	450	Micromhos
Conversion Transconductance (Approx.) †	2	2	Micromhos

† With grid No. 3 bias of -35 volts.

The transconductance between grid No. 1 and grids No. 2 and No. 4 connected to plate (not oscillating) is approximately 4500 micromhos when grids No. 1, No. 2, No. 3, and shell are at 0 volts, and grids No. 2 and No. 4 and plate are at 100 volts.

INSTALLATION and APPLICATION

The base of the 6SA7 fits the standard octal socket which may be installed to hold the tube in any position. Physical characteristics of the 6SA7 are shown in Fig. 1-3, OUTLINES SECTION. Heater operation and cathode connection are the same as for Type 6A8.

The 6SA7 offers several advantages from a circuit standpoint over other converter types: (1) elimination of loose or broken grid wires encountered with types having a top cap; (2) wiring can be completed below the set panel, (3) neater appearance of the chassis, (4) use of simple oscillator-coil and switching arrangements, (5) higher conversion gain, (6) small frequency shift at high frequencies, and (7) simplification of tube renewal.

Because of the special structural arrangement of the 6SA7, a change in signal-grid voltage produces little change in cathode current. Consequently, an r-f voltage on the signal grid produces little modulation of the electron current flowing in the cathode circuit. This feature is important because it is desirable that the impedance in the cathode circuit should produce little degeneration or regeneration of the signal-frequency input and intermediate-frequency output. Another important feature is that, because signal-grid voltage has little effect on the space charge near the cathode, changes in avc bias produce little change in oscillator transconductance and in the input capacitance of the No. 1 grid. There is, therefore, little detuning of the oscillator by avc bias.

A typical self-excited oscillator circuit for use with the 6SA7 is similar to that shown for the 12SA7 in circuit 14-4 (CIRCUIT SECTION). For operation in frequency bands lower than approximately 6 megacycles, the circuit should generally be adjusted to provide, with recommended values of plate and screen voltage, a value of E_k of approximately 2 volts peak, and an oscillator-grid current of 0.5 milliamperes through a grid-leak resistance (R_g) of 20000 ohms. In the low- and medium-frequency bands, the recommended oscillator conditions can be readily met. However, in the band covering frequencies higher than approximately 6 megacycles, the tank-circuit impedance is generally so low that it is not easy to obtain these oscillator conditions. For optimum performance in this band, it is generally best to adjust the oscillator circuit for maximum conversion gain at the low-frequency end of the band. Maximum conversion gain at this end of the band is usually obtained by adjustment of the oscillator circuit to give a value

of E_k of approximately 2 volts peak and an oscillator-grid current of 0.20 to 0.25 milliampere, with a grid leak of 20000 ohms.

As a separately excited converter, the 6SA7 may be operated as shown under Characteristics except that Grid No. 3 should be supplied with a bias of -2 volts.

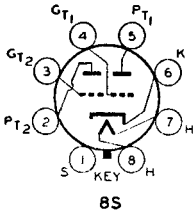
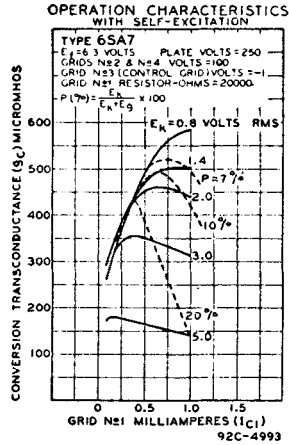
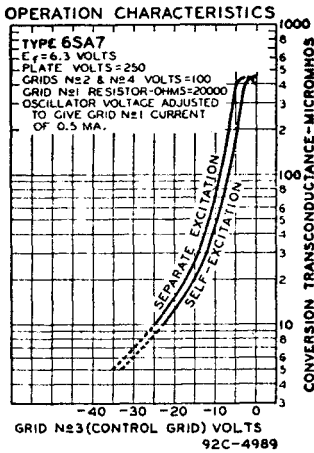

TWIN TRIODE AMPLIFIER

The 6SC7 is a twin-triode amplifier of the single-ended metal type intended primarily for phase-inverter service. Each triode unit is designed with a high mu-factor to give high gain.

6SC7
METAL

★ CHARACTERISTICS

HEATER VOLTAGE (A.C. or D.C.)	6.3	Volts
HEATER CURRENT	0.3	Ampere

As Class A₁ Amplifier — Each Triode Unit

PLATE VOLTAGE	250 max.	Volts
GRID VOLTAGE	-2	Volts
PLATE CURRENT	2	Milliamperes
PLATE RESISTANCE (Approx.)	53000	Ohms
AMPLIFICATION FACTOR	70	
TRANSDUCANCE (Approx.)	1325	Micromhos
GRID-PLATE CAPACITANCE*	2.4	$\mu\mu\text{f}$
GRID-CATHODE CAPACITANCE*	3.0	$\mu\mu\text{f}$
PLATE-CATHODE CAPACITANCE*	4.0	$\mu\mu\text{f}$

* With shell connected to cathode. Values are approximate.

INSTALLATION and APPLICATION

The base of the 6SC7 fits the standard octal socket which may be mounted to hold the tube in any position. Physical characteristics of the 6SC7 are shown in Fig. 1-3, OUTLINES SECTION. For heater operation and cathode connection, refer to Type 6A8. As a phase-inverter, the 6SC7 may be operated as shown in the RESISTANCE-COUPLED AMPLIFIER CHART.

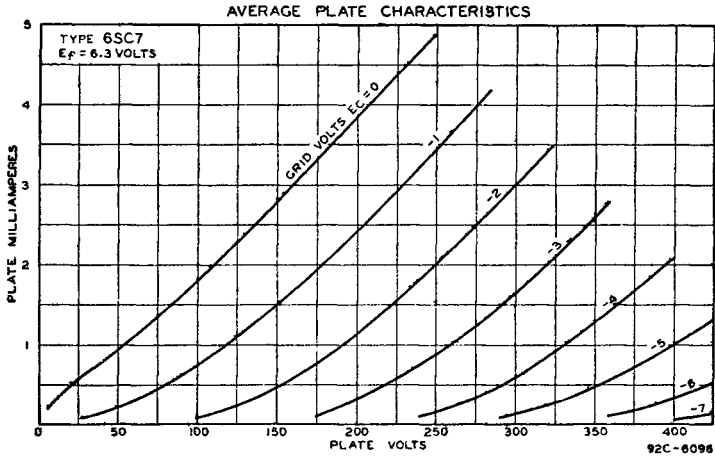

6SF5

METAL

HIGH-MU TRIODE

The 6SF5 is a high-mu triode of the single-ended metal type for use in resistance-coupled amplifier circuits.

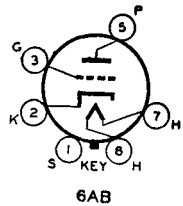

★ CHARACTERISTICS

HEATER VOLTAGE (A.C. or D.C.)	6.3	Volts
HEATER CURRENT	0.3	Ampere
PLATE VOLTAGE	250 <i>max.</i>	Volts
GRID VOLTAGE	-2	Volts
PLATE CURRENT	0.9	Milliampere
PLATE RESISTANCE	66000	Ohms
AMPLIFICATION FACTOR	100	
TRANSCONDUCTANCE	1500	Micromhos
GRID-PLATE CAPACITANCE*	2.4	$\mu\mu\text{f}$
GRID-CATHODE CAPACITANCE*	4.0	$\mu\mu\text{f}$
PLATE-CATHODE CAPACITANCE*	3.6	$\mu\mu\text{f}$

* With shell connected to cathode. Values are approximate.

INSTALLATION and APPLICATION

The base of the 6SF5 fits the standard octal socket which may be mounted to hold the tube in any position. Physical characteristics of the 6SF5 are shown in Fig. 1-3, OUTLINES SECTION. For heater operation and cathode connection, refer to Type 6A8.

As an amplifier in resistance-coupled a-f circuits, the 6SF5 may be operated under conditions given in the RESISTANCE-COUPLED A-F AMPLIFIER CHART. In resistance-coupled circuits, the d-c resistance in the grid circuit of the 6SF5 should not exceed 1.0 megohm.

When a 6SF5 is used to amplify the output of the 6H6 diode, it is recommended that fixed grid bias be employed. Diode-biasing of the 6SF5 is not suitable because of the probability of plate-current cut-off, even with relatively small signal voltages applied to the diode circuit.

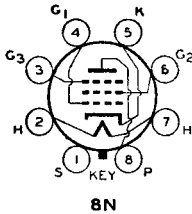
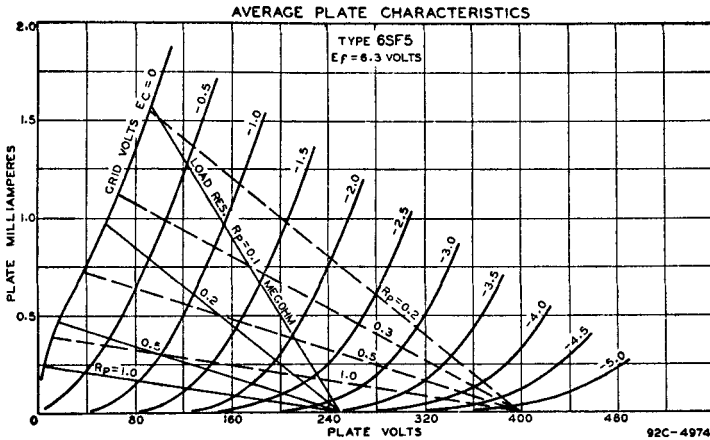

**TRIPLE-GRID
DETECTOR AMPLIFIER**

6SJ7
METAL

The 6SJ7 is an r-f amplifier pentode of the metal type featuring single-ended construction with interlead shielding, described under Type 6SK7. In comparison with capped types previously available, the 6SJ7 offers the circuit advantages of more stable amplifier operation, greater uniformity of gain in amplifiers, and higher gain. Because of its sharp cut-off characteristic, this type is also suitable for service as a biased detector. In such service the 6SJ7 is capable of delivering large audio-frequency output voltage with relatively small input voltage.

★ CHARACTERISTICS

HEATER VOLTAGE (A.C. or D.C.)	6.3	Volts
HEATER CURRENT	0.3	Ampere
PENTODE CONNECTION:		
Grid-Plate Capacitance*	0.005 max.	μf
Input Capacitance*	6	μf
Output Capacitance*	7	μf
TRIODE CONNECTION:†		
Grid-Plate Capacitance*	2.8	μf
Grid-Cathode Capacitance*	3.4	μf
Plate-Cathode Capacitance*	11	μf

* With shell connected to cathode. † With screen and suppressor connected to plate.

As Class A₁ Amplifier — Pentode Connection

PLATE VOLTAGE	300 max.	Volts
SCREEN VOLTAGE (Grid No. 2)	125 max.	Volts
SCREEN SUPPLY VOLTAGE	300 max.	Volts
GRID VOLTAGE (Grid No. 1)	0 min.	Volts
PLATE DISSIPATION	2.5 max.	Watts
SCREEN DISSIPATION	0.3 max.	Watt
TYPICAL OPERATION:		
Plate Voltage	100	250 Volts
Screen Voltage	100	100 Volts
Grid Voltage	-3	-3 Volts
Suppressor	Connected to cathode at socket	

Plate Current	2.9	3.0	Milliamperes
Screen Current	0.9	0.8	Milliamperes
Plate Resistance	0.7	†	Megohm
Transconductance	1575	1650	Micromhos
Grid Voltage ††	-9	-9	Volts

† Greater than 1.0 megohm. †† For cathode-current cut-off.

As Class A₁ Amplifier — Triode Connection
(Screen and suppressor tied to plate)

PLATE VOLTAGE	250	max.	Volts
GRID VOLTAGE	0	min.	Volts
PLATE DISSIPATION	2.5	max.	Watts

TYPICAL OPERATION:

Plate Voltage	180	250	Volts
Grid Voltage	-6	-8.5	Volts
Plate Current	6.0	9.2	Milliamperes
Plate Resistance	8250	7600	Ohms
Amplification Factor	19	19	
Transconductance	2300	2500	Micromhos

INSTALLATION and APPLICATION

The base of the 6SJ7 fits the standard octal socket which may be mounted to hold the tube in any position. Physical characteristics of the 6SJ7 are shown in Fig. 1-3, OUTLINES SECTION. For heater operation and cathode connection, refer to Type 6A8.

As a class A₁ amplifier, the 6SJ7 may be operated either as a pentode or as a triode, as shown under Characteristics. The screen voltage for the 6SJ7 operated as a pentode may be obtained from a potentiometer or bleeder circuit across the B-supply device. Due to the screen-current characteristics of the 6SJ7, a resistor in series with the high-voltage supply may be employed for obtaining the screen voltage, provided the cathode-resistor method of bias control is used. This method, however, is not recommended if the high-voltage B-supply exceeds 300 volts.

As a radio-frequency amplifier pentode, the 6SJ7 may be used particularly in applications where the r-f signal applied to the grid is relatively low, that is of the order of a few volts. In such cases either screen or control-grid voltage (or both) may be varied to control the receiver volume. When larger signals are involved, a super-control amplifier tube should be employed to prevent the occurrence of excessive cross-modulation and modulation distortion.

As an audio-frequency amplifier pentode in resistance-coupled circuits, the 6SJ7 may be operated under conditions shown in the RESISTANCE-COUPLED AMPLIFIER CHART.

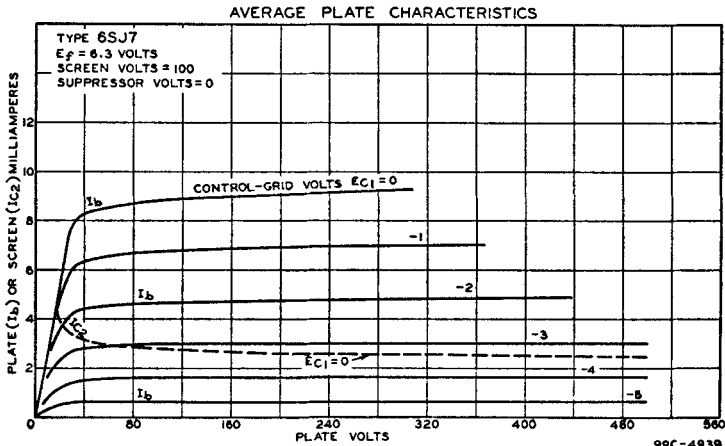

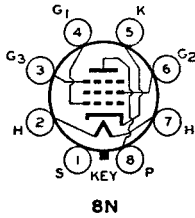

TRIPLE-GRID SUPER-CONTROL AMPLIFIER

6SK7
METAL

The 6SK7 is a triple-grid super-control amplifier of the metal type featuring single-ended construction with interlead shielding. In comparison with capped types previously available, the 6SK7 offers the circuit advantages of more stable amplifier operation,

greater uniformity of gain in amplifiers, and higher gain. Because of its remote cut-off characteristic, this type is able to handle unusual signal voltages without cross-modulation or modulation distortion. The 6SK7 is recommended for use in the r-f or i-f stages of receivers especially those employing automatic volume control.

★ CHARACTERISTICS

HEATER VOLTAGE (A.C. or D.C.)	6.3	Volts
HEATER CURRENT	0.3	Ampere
GRID-PLATE CAPACITANCE*	0.003 max.	μf
INPUT CAPACITANCE*	6	μf
OUTPUT CAPACITANCE*	7	μf

* With shell connected to cathode.

As Class A₁ Amplifier

PLATE VOLTAGE	300 max.	Volts
SCREEN VOLTAGE	125 max.	Volts
SCREEN SUPPLY VOLTAGE	300 max.	Volts
GRID VOLTAGE	0 min.	Volts
PLATE DISSIPATION	4 max.	Watts
SCREEN DISSIPATION	0.4 max.	Watt

TYPICAL OPERATION:

Plate Voltage	100	250	Volts
Screen Voltage	100	100	Volts
Grid Voltage	-3	-3	Volts
Suppressor	Connected to cathode at socket		
Plate Current	8.9	9.2	Milliamperes
Screen Current	2.6	2.4	Milliamperes
Plate Resistance (Approx.)	0.25	0.8	Megohm
Transconductance	1900	2000	Micromhos
Grid Bias for transconductance of 10 micromhos	-35	-35	Volts

INSTALLATION and APPLICATION

The base of the 6SK7 fits the standard octal socket which may be installed to hold the tube in any position. Physical characteristics of the 6SK7 are shown in Fig. 1-3, OUTLINES SECTION. For heater operation and cathode connection refer to Type 6A8.

The interlead shielding within the base of the 6SK7 is accomplished by means of a conical stem shield and a cylindrical base shield. The metal cone is inserted through the hole in the stem where the exhaust tube connects. The cone extends some distance into the exhaust tube and is connected to the common

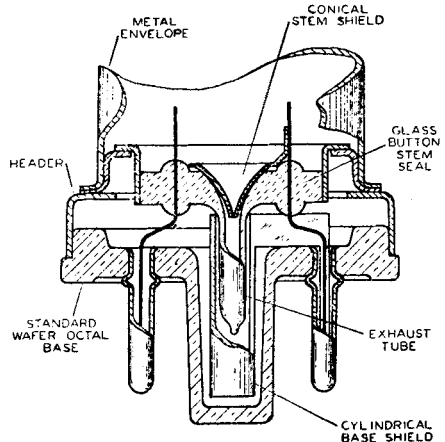

grounding pin (pin No. 1). The cylindrical base shield is positioned inside the locating base plug, and is also connected to pin No. 1. The conical shield reduces the capacitance between leads in the glass of the stem: the cylindrical shield reduces the capacitance between those pins that are diametrically opposite each other. Since the grid and the plate leads are diametrically opposite, the capacitance between them is kept to a value comparable with that obtainable with top-cap construction.

The single-ended construction offers distinct advantages from a circuit standpoint, as follows: (1) elimination of loose or broken grid leads, (2) wiring can be completed below the set panel, (3) neater appearance of the chassis, (4) more stable amplifier operation, (5) greater uniformity of gain in amplifiers, (6) higher gain per stage, (7) lowered cost, and (8) simplification of tube renewal.

Control-grid bias variation will be found effective in changing the volume of the receiver. In order to obtain adequate volume control, an available grid-bias voltage of approximately 50 volts will be required. The exact value will depend upon the circuit design and operating conditions. This voltage may be obtained, depending on the receiver requirements, from a potentiometer across a fixed supply voltage or by the use of a variable cathode-bias resistor.

The screen voltage may be obtained from a potentiometer or bleeder circuit across the B-supply source. Due to the screen current characteristics of the 6SK7, a resistor in series with the high-voltage supply may be employed for obtaining the screen voltage provided the cathode-resistor method of bias control is used. This method, however, is not recommended if the high-voltage B-supply exceeds 300 volts. Furthermore, it should be noted that the use of a resistor in the screen circuit will have an effect on the change in plate resistance with variation in suppressor voltage in case the suppressor is utilized for control purposes.

The suppressor may be connected directly to the cathode or it may be made negative with respect to the cathode. For the latter condition, the suppressor voltage may be obtained from a potentiometer or bleeder circuit for manual volume- and selectivity-control, or from the drop in a resistor in the plate circuit of the automatic volume-control tube.

As a radio-frequency amplifier, the 6SK7 is especially applicable to radio receiver design because of its ability to reduce cross-modulation effects, its remote "cut-off" feature, and its flexible adaptability to circuit combinations and to receiver design. Recommended conditions for the 6SK7 as an amplifier are given under CHARACTERISTICS.

To realize the maximum benefit of the long "cut-off" feature of this tube, it is necessary to apply a variable grid bias and to maintain the screen at a constant potential with respect to the cathode. Good results, however, may be obtained by using a variable cathode resistance. Such a resistance, of course, reduces the screen potential by the amount that the bias is increased and thus hastens the "cut-off."

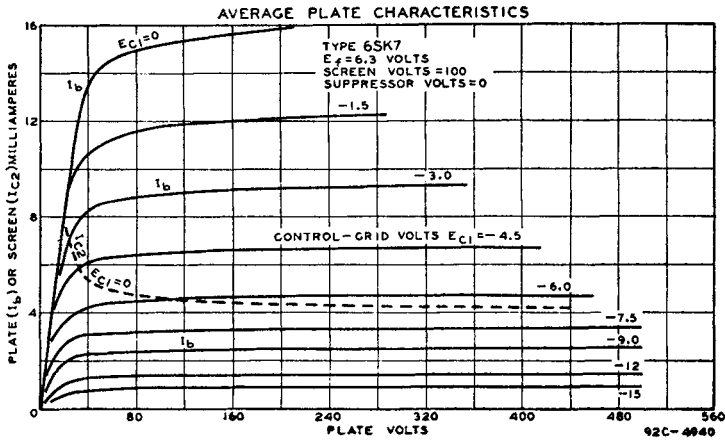

Therefore, the ability of the tube to handle large signals is somewhat impaired. This effect may be nullified by means of a series resistor in the screen circuit.

The use of series resistors for obtaining satisfactory control of screen voltage in the case of four-electrode tubes is usually impossible because of secondary emission phenomena. In the 6SK7, however, the suppressor practically removes these effects and it is therefore possible to obtain satisfactorily the screen voltage from the plate supply or from some high intermediate voltage providing these sources do not exceed 300 volts. With this method, the screen-to-cathode voltage will fall off very little from minimum to maximum value of cathode-control resistor. In some cases, it may actually rise. This rise of screen-to-cathode voltage above the normal maximum value is allowable because the screen and the plate current are reduced simultaneously by a sufficient amount to prevent damage to the tube. It should be recognized in general that the series-resistor method of obtaining screen voltage from a higher voltage supply necessitates the use of the variable cathode-resistor method of controlling volume in order to prevent too high a voltage on the screen. When screen and control-grid voltage are obtained in this manner, the remote "cut-off" advantage of the 6SK7 may be fully realized.

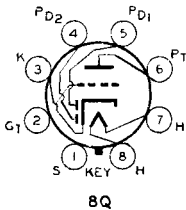

DUPLEX-DIODE
HIGH-MU TRIODE

6SQ7
METAL

The 6SQ7 is a multi-unit tube of the metal type containing two diodes and a high-mu triode in one envelope. The 6SQ7 is designed for use as a combined detector, amplifier, and automatic-

volume-control tube. For diode-detector considerations, see RADIO TUBE APPLICATIONS section.

★ CHARACTERISTICS

HEATER VOLTAGE (A.C. or D.C.)	6.3	Volts
HEATER CURRENT	0.3	Ampere
Triode: GRID-PLATE CAPACITANCE*	1.8	μμf
GRID-CATHODE CAPACITANCE*	3.6	μμf
PLATE-CATHODE CAPACITANCE*	3.2	μμf

* With shell connected to cathode. Values are approximate.

Triode Unit — As Class A₁ Amplifier

PLATE VOLTAGE	250 max.	Volts
GRID VOLTAGE	-2	Volts
PLATE CURRENT	0.9	Milliampere
PLATE RESISTANCE	91000	Ohms
AMPLIFICATION FACTOR	100	
TRANSCONDUCTANCE	1100	Micromhos

Diode Units

The two diode plates are placed around a cathode, the sleeve of which is common to the triode unit. Each diode plate has its own base pin. Operation curves for the diode units are given under Type 6B7.

INSTALLATION and APPLICATION

The base of the 6SQ7 fits the standard octal socket which may be mounted to hold the tube in any position. Physical characteristics of the 6SQ7 are shown in Fig. 1-3. OUTLINES SECTION. Heater operation and cathode connection are the same as for Type 6A8.

The 6SQ7 in many respects is similar in application to the 6Q7. The outstanding difference, however, is that the 6SQ7 has a higher-mu triode. The tube is recommended for use only in resistance-coupled circuits. Furthermore, diode-biasing of the triode unit is not suitable because of the probability of triode plate-

current cut-off, even with relatively small signal voltages applied to the diode circuit.

As an amplifier in resistance-coupled a-f circuits, the 6SQ7 may be operated under the conditions given in the RESISTANCE-COUPLED AMPLIFIER CHART.

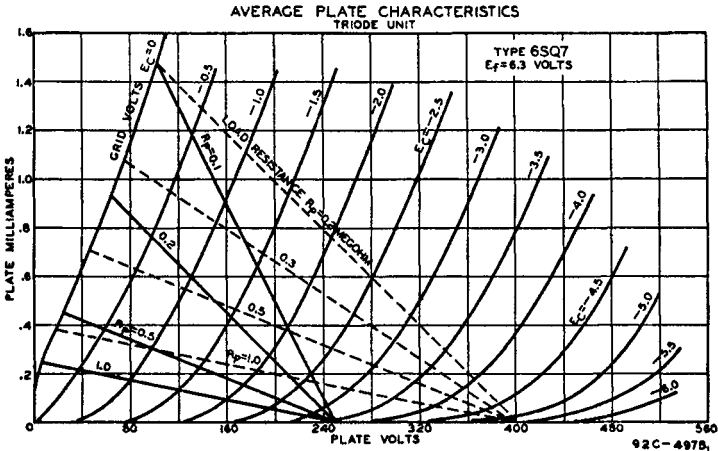

6T7-G

DUPLEX-DIODE HIGH-MU TRIODE

The 6T7-G is a heater-cathode type of tube containing two diodes and a high-mu triode in one bulb. The 6T7-G is used as a detector, amplifier, and automatic-volume-control tube.

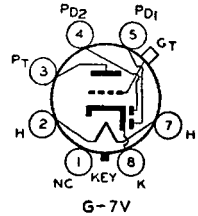

The low heater current is a feature in applications where economy of power is important. For diode-detector considerations, refer to RADIO TUBE APPLICATIONS section.

CHARACTERISTICS

HEATER VOLTAGE (A.C. or D.C.)	6.3	Volts
HEATER CURRENT	0.15	Ampere
<i>Triode:</i> GRID-PLATE CAPACITANCE°	1.7	$\mu\mu\text{f}$
GRID-CATHODE CAPACITANCE°	1.8	$\mu\mu\text{f}$
PLATE-CATHODE CAPACITANCE°	3.1	$\mu\mu\text{f}$

* With close-fitting shield connected to cathode. Values are approximate.

Triode Unit — As Class A Amplifier

PLATE VOLTAGE	100	250 max.	Volts
GRID VOLTAGE	-1.5	-3	Volts
PLATE CURRENT	0.3	1.2	Milliamperes
PLATE RESISTANCE	95000	62000	Ohms
AMPLIFICATION FACTOR	65	65	
TRANSCONDUCTANCE	680	1050	Micromhos

Diode Units

The two diode plates are placed around a cathode, the sleeve of which is common to the triode unit. Each diode plate has its own base pin. Operation curves for the diode units are given under Type 6B7.

INSTALLATION and APPLICATION

The base of the 6T7-G fits the standard octal socket which may be installed to hold the tube in any position. Physical characteristics of the 6T7-G are shown in Fig. 2-15, OUTLINES SECTION. Heater and cathode considerations are the same as for Type 6D8-G. For application refer to Type 6SQ7. Additional data are given in the RESISTANCE-COUPLED AMPLIFIER CHART.

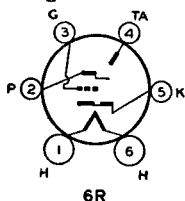

ELECTRON-RAY TUBE

Indicator Type with Triode

6U5/6G5

The 6U5/6G5 is a high-vacuum, heater-cathode type of tube designed to indicate visually, by means of a fluorescent target, the effects of change in controlling voltage. The tube,

therefore is essentially a voltage indicator and as such is particularly useful as a convenient and non-mechanical means to indicate accurate tuning of a radio receiver. The 6U5/6G5 supersedes both the 6U5 and the 6G5 and it may also be used to replace the 6H5 and the 6T5. For a discussion of Electron-Ray Tube considerations, refer to the RADIO TUBE APPLICATIONS section.

★ CHARACTERISTICS

HEATER VOLTAGE (A.C. or D.C.)	6.3	Volts
HEATER CURRENT	0.3	Ampere
PLATE-SUPPLY VOLTAGE	250 max.	Volts
TARGET VOLTAGE	{ 250 max. Volts 100 min. Volts	

TYPICAL OPERATION:

Plate- and Target-Supply Voltage	100	200	250	Volts
Series Triode-Plate Resistor	0.5	1	1	Megohm
Target Current†	1	3	4	Milliamperes
Triode-Plate Current *	0.19	0.19	0.24	Milliampere
Triode-Grid Voltage (Approx.):				
For shadow angle of 0°	-8	-18.5	-22	Volts
For shadow angle of 90°	0	0	0	Volts

* For zero triode-grid voltage.

† Subject to wide variations.

INSTALLATION and APPLICATION

Installation and application of the 6U5/6G5 are the same as for Type 6E5. Physical characteristics of the 6U5/6G5 are shown in Fig. 2-18, OUTLINES SECTION. The essential differences between the 6E5 and the 6U5/6G5 are that the 6U5/6G5 is constructed in a tubular bulb and has a remote plate-current cut-off characteristic.

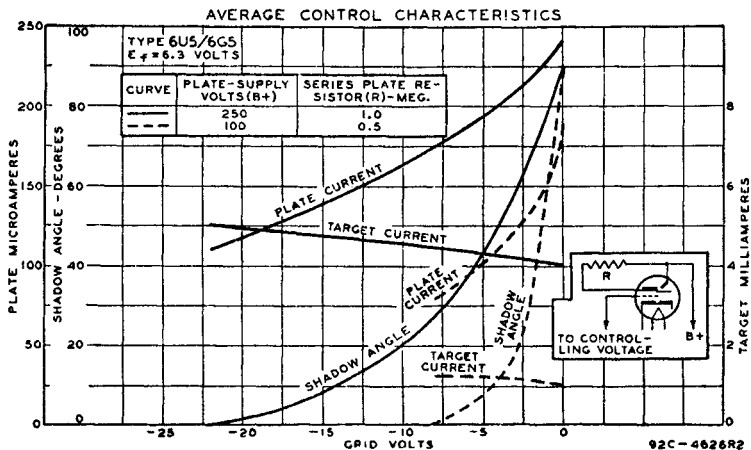

TRIPLE-GRID SUPER-CONTROL AMPLIFIER

6U7-G

The 6U7-G is a triple-grid super-control amplifier tube recommended for service in the radio-frequency and intermediate-frequency stages of radio receivers designed for its characteristics. The ability of this tube to handle the usual signal voltages without cross-

modulation and modulation distortion makes it adaptable to the r-f and i-f stages of receivers employing automatic volume control. The 6U7-G is constructed with an internal shield connected to the cathode within the tube.

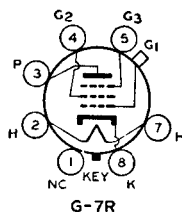

★ CHARACTERISTICS

HEATER VOLTAGE (A.C. or D.C.)	6.3	Volts
HEATER CURRENT	0.3	Ampere
GRID-PLATE CAPACITANCE*	0.007 <i>max.</i>	μ f
INPUT CAPACITANCE*	5	μ f
OUTPUT CAPACITANCE*	9	μ f

* With close-fitting shield connected to cathode.

As Class A₁ Amplifier

PLATE VOLTAGE	300 <i>max.</i>	Volts
SCREEN VOLTAGE	100 <i>max.</i>	Volts
SCREEN SUPPLY VOLTAGE	300 <i>max.</i>	Volts
GRID VOLTAGE	0 <i>min.</i>	Volts
PLATE DISSIPATION	2.25 <i>max.</i>	Watts
SCREEN DISSIPATION	0.25 <i>max.</i>	Watt

TYPICAL OPERATION:

Plate Voltage	100	250	Volts
Screen Voltage	100	100	Volts
Grid Voltage	-3	-3	Volts
Suppressor	Connected to cathode at socket		
Plate Current	8.0	8.2	Milliamperes
Screen Current	2.2	2.0	Milliamperes
Plate Resistance (Approx.)	0.25	0.8	Megohm
Transconductance	1500	1600	Micromhos
Transconductance (At -50 volts bias)	2	2	Micromhos

INSTALLATION and APPLICATION

The base of the 6U7-G fits the standard octal socket which may be installed to hold the tube in any position. The maximum overall length of the 6U7-G is 4 $\frac{1}{8}$ in. and the maximum diameter is 1 $\frac{3}{8}$ in.; the tube has a small shell octal base and a miniature cap. For heater operation and cathode connection, refer to Type 6A8. For control-grid bias, screen voltage, suppressor connection, and application, refer to Type 6SK7. Stage shielding enclosing the components of each stage is, in general, necessary for multi-stage amplifier circuits.

6V6
METAL

6V6-G

BEAM POWER AMPLIFIERS

The 6V6 and 6V6-G are power amplifiers of the beam type for use in the output stage of radio receivers. They are particularly useful in automobile and other battery-operated receivers in which reduced plate-current drain is desirable.

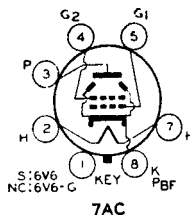

★ CHARACTERISTICS

HEATER VOLTAGE (A.C. or D.C.)	6.3	Volts
HEATER CURRENT	0.45	Ampere

As Single-Tube Class A₁ Amplifier

PLATE VOLTAGE	315 max.	Volts
SCREEN VOLTAGE	285 max.	Volts
PLATE DISSIPATION	12 max.	Watts
SCREEN DISSIPATION	2 max.	Watts

TYPICAL OPERATION:

Plate Voltage	180	250	315	Volts
Screen Voltage	180	250	225	Volts
Grid Voltage	-8.5	-12.5	-13	Volts
Peak A-F Grid Voltage	8.5	12.5	13	Volts
Zero-Signal Plate Current	29	45	34	Milliamperes
Max.-Signal Plate Current	30	47	35	Milliamperes
Zero-Signal Screen Current	3	4.5	2.2	Milliamperes
Max.-Signal Screen Current	4	7	6	Milliamperes
Plate Resistance	58000	52000	77000	Ohms
Transconductance	3700	4100	3750	Micromhos
Load Resistance	5500	5000	8500	Ohms
Total Harmonic Distortion	8	8	12	Per cent
Max.-Signal Power Output	2	4.5	5.5	Watts

As Push-Pull Class AB₁ Amplifier

PLATE VOLTAGE	315 max.	Volts
SCREEN VOLTAGE	285 max.	Volts
PLATE DISSIPATION	12 max.	Watts
SCREEN DISSIPATION	2 max.	Watts

TYPICAL OPERATION: *Values are for two tubes*

Plate Voltage	250	285	Volts
Screen Voltage	250	285	Volts
Grid Voltage	-15	-19	Volts
Peak A-F Grid-to-Grid Voltage	30	38	Volts
Zero-Signal Plate Current	70	70	Milliamperes
Max.-Signal Plate Current	79	92	Milliamperes
Zero-Signal Screen Current	5	4	Milliamperes
Max.-Signal Screen Current	13	13.5	Milliamperes
Effective Load Resistance (plate-to-plate)	10000	8000	Ohms
Total Harmonic Distortion	5	3.5	Per cent
Max.-Signal Power Output	10	14	Watts

INSTALLATION and APPLICATION

The base of either the 6V6 or 6V6-G fits the standard octal socket which may be installed to hold the tube in any position. Physical characteristics of the 6V6 and 6V6-G are shown in Figs. 1-7 and 2-21, respectively, in the OUTLINES SECTION.

The heater is designed to operate at 6.3 volts. Under the maximum screen and plate dissipation conditions, the heater voltage should never fluctuate so that it exceeds 7.0 volts. For cathode connection, refer to Type 6A8.

In all services precautions should be taken to insure that the dissipation rating is not exceeded with expected line-voltage variations, especially in the cases of fixed-bias operation. When the push-pull connection is used, fixed-bias values up to 10% of each typical screen voltage can be used without increasing distortion.

As class A₁ power amplifiers, the 6V6 and 6V6-G should be operated as shown under CHARACTERISTICS. The values have been determined on the basis that no grid current flows during any part of the input signal swing. The second harmonics can easily be eliminated by the use of push-pull circuits. In single-tube, resistance-coupled circuits, the second harmonics can be minimized by generating out-of-phase second harmonics in the pre-amplifier.

As push-pull class AB₁ power amplifiers, the 6V6 and 6V6-G may be operated as shown under CHARACTERISTICS. The values have been determined on the basis that no grid current flows during any part of the input signal swing.

The type of input coupling used in class A₁ and class AB₁ service should not introduce too much resistance in the grid circuit. Transformer- or impedance-

coupling devices are recommended. When the grid circuit has a resistance not higher than 0.05 megohm, fixed bias may be used; for higher values, cathode bias is required. With cathode bias, the grid circuit may have a resistance as high as, but not greater than, 0.5 megohm provided the heater voltage is not allowed to rise more than 10% above the rated value under any condition of operation.

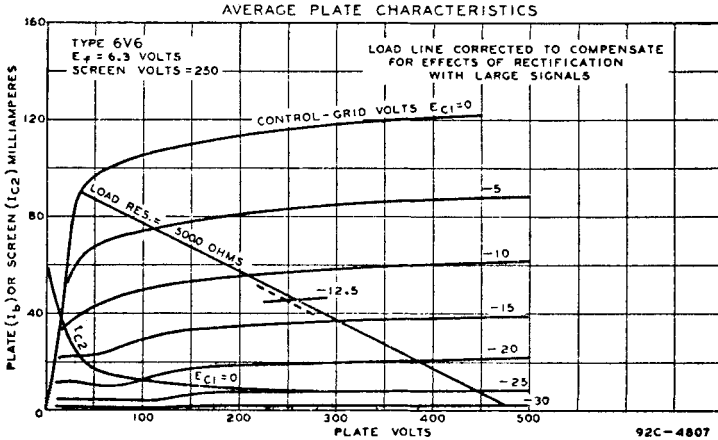

BEAM POWER AMPLIFIER

6V6-GT

The 6V6-GT is a beam power amplifier designed for use in the output stage of radio receivers, especially those having limited space. Its electrical characteristics are similar to those of the 6V6 and 6V6-G.

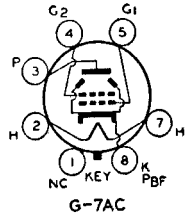

CHARACTERISTICS

HEATER VOLTAGE (A.C. or D.C.)	6.3	Volts
HEATER CURRENT	0.45	Ampere

As Single-Tube Class A₁ Amplifier

PLATE VOLTAGE	315 max.	Volts		
SCREEN VOLTAGE	285 max.	Volts		
PLATE DISSIPATION	12 max.	Watts		
SCREEN DISSIPATION	2 max.	Watts		
TYPICAL OPERATION:				
Plate Voltage	180	250	315	Volts
Screen Voltage	180	250	225	Volts
Grid Voltage	-8.5	-12.5	-13	Volts
Peak A-F Grid Voltage	8.5	12.5	13	Volts
Zero-Signal Plate Current	29	45	34	Milliamperes
Max.-Signal Plate Current	30	47	35	Milliamperes
Zero-Signal Screen Current	3	4.5	2.2	Milliamperes
Max.-Signal Screen Current	4	7	6	Milliamperes
Plate Resistance	58000	52000	77000	Ohms
Transconductance	3700	4100	3750	Micromhos
Load Resistance	5500	5000	8500	Ohms
Total Harmonic Distortion	8	8	12	Per cent
Max.-Signal Power Output	2	4.5	5.5	Watts

As Push-Pull Class AB₁ Amplifier

PLATE VOLTAGE	315	max.	Volts
SCREEN VOLTAGE	285	max.	Volts
PLATE DISSIPATION	12	max.	Watts
SCREEN DISSIPATION	2	max.	Watts
TYPICAL OPERATION: <i>Values are for two tubes</i>			
Plate Voltage	250	285	Volts
Screen Voltage	250	285	Volts
Grid Voltage	-15	-19	Volts
Peak A-F Grid-to-Grid Voltage	30	38	Volts
Zero-Signal Plate Current	70	70	Milliamperes
Max.-Signal Plate Current	79	92	Milliamperes
Zero-Signal Screen Current	5	4	Milliamperes
Max.-Signal Screen Current	13	13.5	Milliamperes
Effective Load Resistance (plate-to-plate)	10000	8000	Ohms
Total Harmonic Distortion	5	3.5	Per cent
Max.-Signal Power Output	10	14	Watts

INSTALLATION and APPLICATION

The base of the 6V6-GT fits the standard octal socket which may be installed to hold the tube in any position. Physical characteristics of the 6V6-GT are shown in Fig. 2-8, OUTLINES SECTION. See Type 6V6 for additional information on installation and applications.

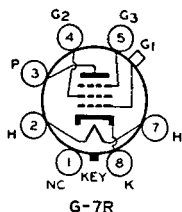

TRIPLE-GRID DETECTOR AMPLIFIER

6W7-G

The 6W7-G is a triple-grid tube of the heater-cathode type for use as an amplifier and biased detector. In such service, the 6W7-G is capable of delivering a large audio-frequency output voltage with relatively small input. The low heater current is a feature in applications where economy of power is important.

★ CHARACTERISTICS

HEATER VOLTAGE (A.C. or D.C.)	6.3	Volts
HEATER CURRENT	0.15	Ampere
GRID-PLATE CAPACITANCE*	0.007	max. μf
INPUT CAPACITANCE*	5	μf
OUTPUT CAPACITANCE*	8.5	μf

* With close-fitting shield connected to cathode.

As Class A₁ Amplifier

PLATE VOLTAGE	300	max.	Volts
SCREEN VOLTAGE	100	max.	Volts
SCREEN SUPPLY VOLTAGE	300	max.	Volts
GRID VOLTAGE	0	min.	Volts
PLATE DISSIPATION	0.5	max.	Watt
SCREEN DISSIPATION	0.1	max.	Watt
TYPICAL OPERATION:			
Plate Voltage	250	Volts	
Screen Voltage	100	Volts	
Grid Voltage	-3	Volts	
Suppressor	Connected to cathode at socket		
Plate Current	2.0	Milliamperes	
Screen Current	0.5	Milliamperes	
Plate Resistance (Approx.)	1.5	Megohms	
Transconductance	1225	Micromhos	
Grid Voltage (Approx.)**	-7	Volts	

** For cathode-current cut-off.

INSTALLATION and APPLICATION

The base of the 6W7-G fits the standard octal socket which may be installed to hold the tube in any position. Physical characteristics of the 6W7-G are shown in Fig. 2-15, OUTLINES SECTION. For heater operation and cathode connection, refer to Type 6D8-G and 6A8, respectively. Application is similar to that of the 6SJ7. Additional data are given in the RESISTANCE-COUPLED AMPLIFIER CHART.

6X5

METAL

6X5-G

6X5-GT

FULL-WAVE HIGH-VACUUM RECTIFIERS

The 6X5, 6X5-G and 6X5-GT are full-wave, high-vacuum rectifiers of the heater-cathode type. They are intended for use in automobile-radio receivers or in a-c operated receivers designed for their characteristics.

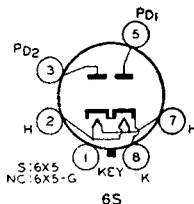

★ CHARACTERISTICS

HEATER VOLTAGE (A.C. or D.C.).....	6.3	Volts
HEATER CURRENT	0.6	Ampere

As Full-Wave Rectifier

PEAK INVERSE VOLTAGE	1250 max.	Volts
PEAK PLATE CURRENT PER PLATE	210 max.	Milliamperes
D-C HEATER-CATHODE POTENTIAL	450 max.	Volts
TYPICAL OPERATION WITH CONDENSER-INPUT FILTER:		
A-C Plate Voltage per Plate (RMS)	325 max.	Volts
Total Effective Plate-Supply Impedance per Plate†	150 min.	Ohms
D-C Output Current	70 max.	Milliamperes
TYPICAL OPERATION WITH CHOKE-INPUT FILTER:		
A-C Plate Voltage per Plate (RMS)	450 max.	Volts
Input-Choke Inductance	8 min.	Henries
D-C Output Current	70 max.	Milliamperes

† When a filter-input condenser larger than 40 μ f is used, it may be necessary to use more plate-supply impedance than the minimum value shown to limit the peak plate current to the rated value.

INSTALLATION and APPLICATION

The base of either the 6X5, 6X5-G, or 6X5-GT fits the standard octal socket. The socket for the 6X5 should be installed to hold the tube preferably in a vertical position. Horizontal operation is permissible if pins 3 and 5 are in a horizontal plane. The 6X5-G and 6X5-GT may be operated in any position. Physical characteristics of the 6X5, 6X5-G, and 6X5-GT are shown in Figs. 1-7, 2-17, and 2-8, respectively, in the OUTLINES SECTION. Pin 1 of the 6X5-GT has no connection.

The heater should be operated at 6.3 volts. Under no condition should the heater voltage ever fluctuate so that it exceeds 7.5 volts. For discussion of rectifiers and filter circuits, refer to RADIO TUBE APPLICATIONS SECTION.

OPERATION CHARACTERISTICS

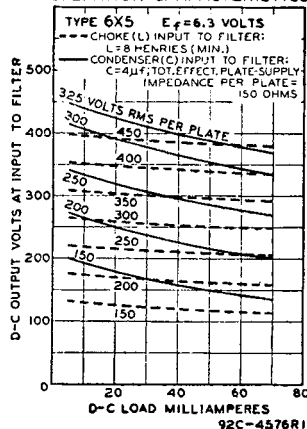

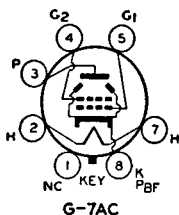

BEAM POWER AMPLIFIER

The 6Y6-G is a power amplifier of the beam type for use in the output stage of radio receivers designed for its characteristics.

6Y6-G

★ CHARACTERISTICS

HEATER VOLTAGE (A.C. or D.C.)	6.3	Volts
HEATER CURRENT	1.25	Amperes

As Class A₁ Amplifier

PLATE VOLTAGE	200 max.	Volts	
SCREEN VOLTAGE (Grid No. 2)	135 max.	Volts	
PLATE DISSIPATION	12.5 max.	Watts	
SCREEN DISSIPATION	1.75 max.	Watts	
TYPICAL OPERATION:			
Plate Voltage	135	200	Volts
Screen Voltage	135	135	Volts
Grid Voltage (Grid No. 1)	-13.5	-14	Volts
Peak A-F Grid Voltage	13.5	14	Volts
Zero-Signal Plate Current	58	61	Milliamperes
Max.-Signal Plate Current	60	66	Milliamperes
Zero-Signal Screen Current	3.5	2.2	Milliamperes
Max.-Signal Screen Current	11.5	9	Milliamperes
Plate Resistance (Approx.)	9300	18300	Ohms
Transconductance	7000	7100	Micromhos
Load Resistance	2000	2600	Ohms
Total Harmonic Distortion	10	10	Per cent
Max.-Signal Power Output	3.6	6	Watts

INSTALLATION and APPLICATION

The base of the 6Y6-G fits the standard octal socket which may be installed to hold the tube in any position. Physical characteristics of the 6Y6-G are shown in Fig. 2-21, OUTLINES SECTION.

The heater is designed to operate at 6.3 volts for full-load operating conditions at average line voltage. Under the maximum screen and plate dissipation conditions, the heater voltage should never fluctuate so that it exceeds 7.0 volts. For cathode connection, refer to Type 6A8.

As a class A₁ power amplifier, the 6Y6-G should be operated as shown under CHARACTERISTICS. The values have been determined on the basis that no grid current flows during any part of the input signal swing. The second harmonics can easily be eliminated by the use of push-pull circuits. In single-tube, resistance-coupled circuits, the second-harmonics can be minimized by generating out-of-phase second harmonics in the pre-amplifier.

The type of input coupling used should not introduce too much resistance in the grid circuit. Transformer- or impedance-coupling devices are recommended. When the grid circuit has a resistance not higher than 0.1 megohm, fixed bias may be used; for higher values, cathode bias is required. With cathode bias, the grid circuit may have a resistance as high as, but not greater than, 0.5 megohm provided the heater voltage is not allowed to rise more than 10% above the rated value under any condition of operation.

CLASS B TWIN TRIODE

6Z7-G

The 6Z7-G is a power amplifier containing two triodes in one envelope. The two triodes, designed for class B operation, have separate terminals for all electrodes except the cathodes and heaters.

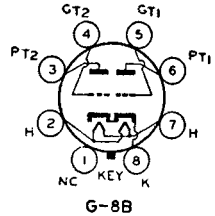

CHARACTERISTICS

HEATER VOLTAGE (A.C. or D.C.)	6.3	Volts
HEATER CURRENT	0.3	Ampere

As Class B Power Amplifier

PLATE VOLTAGE	180 <i>max.</i>	Volts
PEAK PLATE CURRENT (Per plate)	60 <i>max.</i>	Milliamperes
AVERAGE PLATE DISSIPATION	8 <i>max.</i>	Watts

TYPICAL OPERATION:

Plate Voltage	135	180	Volts		
Grid Voltage	0	0	Volts		
Zero-Signal Plate Current (Per plate)	3	4.2	Milliamperes		
Effective Load Resistance (Plate-to-plate)	15000	9000	20000	12000	Ohms
Max.-Signal Power Output (Approx.)	1.5*	2.5†	2.2*	4.2†	Watts

* With average input of 80 milliwatts applied between grids.
 † With average input of 320 milliwatts applied between grids.

INSTALLATION and APPLICATION

The base of the 6Z7-G fits the standard octal socket which may be installed to hold the tube in any position. Physical characteristics of the 6Z7-G are shown in Fig. 2-17, OUTLINES SECTION. For heater operation and cathode connection, see Type 6A8.

As a class B power amplifier, the 6Z7-G is used in circuits similar in design to those utilizing individual tubes in the output stage. It requires no grid bias, since the high-mu feature of the triode units reduces the steady plate current at zero bias to a relatively low value. For general class B amplifier design considerations, refer to RADIO TUBE APPLICATIONS section.

As a class A₁ amplifier, the 6Z7-G may be operated in resistance-coupled circuits as shown in the RESISTANCE-COUPLED AMPLIFIER CHART. Other applications of the 6Z7-G are similar to those discussed for Type 6N7.

FULL-WAVE HIGH-VACUUM RECTIFIER

6ZY5-G

The 6ZY5-G is a full-wave, high vacuum rectifier of the heater-cathode type. It is intended for use in applications where economy of power is important.

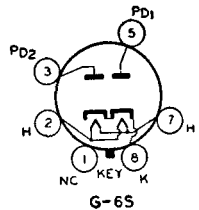

★ CHARACTERISTICS

HEATER VOLTAGE (A.C. or D.C.)	6.3	Volts
HEATER CURRENT	0.3	Ampere

As Full-Wave Rectifier

PEAK INVERSE VOLTAGE	1250 <i>max.</i>	Volts
PEAK PLATE CURRENT PER PLATE	120 <i>max.</i>	Milliamperes

D-C HEATER-CATHODE POTENTIAL.....	450 <i>max.</i> Volts
TYPICAL OPERATION WITH CONDENSER-INPUT FILTER:	
A-C Plate Voltage per Plate (RMS).....	325 <i>max.</i> Volts
Total Effective Plate-Supply Impedance per Plate†.	225 <i>min.</i> Ohms
D-C Output Current.....	40 <i>max.</i> Milliamperes
TYPICAL OPERATION WITH CHOKE-INPUT FILTER:	
A-C Plate Voltage per Plate (RMS).....	450 <i>max.</i> Volts
Input-Choke Inductance.....	13.5 <i>min.</i> Henries
D-C Output Current.....	40 <i>max.</i> Milliamperes

† When a filter-input condenser larger than 40 μ f is used, it may be necessary to use more plate-supply impedance than the minimum value shown to limit the peak plate current to the rated value.

INSTALLATION and APPLICATION

The base of the 6ZY5-G fits the standard octal socket which may be installed to hold the tube in any position. Physical characteristics of the 6ZY5-G are shown in Fig. 2-17, OUTLINES SECTION. The heater should be operated at 6.3 volts. Under no condition should the heater voltage ever fluctuate so that it exceeds 7.5 volts. For discussion of rectifiers and filter circuits, refer to RADIO TUBE APPLICATIONS section.

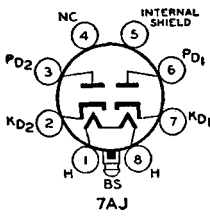

TWIN DIODE

The 7A6 is a heater-cathode type of tube containing two diodes in one bulb. Except for the common heater, the two units are independent of each other. The 7A6 is employed in receivers for detection, for low-voltage, low-current rectification, or for automatic volume control.

7A6

★ CHARACTERISTICS

HEATER VOLTAGE (A.C. or D.C.).....	6.3¶	Volts
HEATER CURRENT.....	0.15¶¶	Ampere

¶ Nominal value is 7 volts. ¶¶ Nominal value is 0.16 ampere.

As Rectifier

A-C PLATE VOLTAGE PER PLATE (RMS).....	150 <i>max.</i> Volts
D-C OUTPUT CURRENT PER PLATE.....	8 <i>max.</i> Milliamperes

INSTALLATION and APPLICATION

The base of the 7A6 fits the lock-type socket which may be mounted to hold the tube in any position. Physical characteristics of the 7A6 are shown in Fig. 2-4, OUTLINES SECTION. For heater operation, see Type 6D8-G; and for cathode connection, Type 6A8. Application is the same as that for Type 6H6-G.

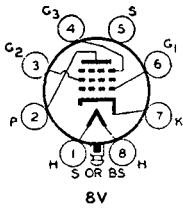

TRIPLE-GRID SUPER-CONTROL AMPLIFIER

The 7A7-LM is a triple-grid super-control amplifier of the single-ended metal type for use in the radio-frequency and intermediate-frequency stages of radio receivers. The 7A7-LM is interchangeable with the 7A7.

7A7-LM
METAL

★ CHARACTERISTICS

HEATER VOLTAGE (A.C. or D.C.).....	6.3¶	Volts
HEATER CURRENT.....	0.3¶¶¶	Ampere
GRID-PLATE CAPACITANCE°.....	0.005	μ f
INPUT CAPACITANCE°.....	6	μ f
OUTPUT CAPACITANCE°.....	7	μ f

° With shell connected to cathode.
¶ Nominal value is 7 volts. ¶¶¶ Nominal value is 0.32 ampere.

As Class A₁ Amplifier

PLATE VOLTAGE	250 max.	Volts
SCREEN VOLTAGE	100 max.	Volts
GRID VOLTAGE	-3 min.	Volts
TYPICAL OPERATION:		
Plate Voltage	250	Volts
Screen Voltage	100	Volts
Grid Voltage	-3	Volts
Suppressor	Connected to cathode at socket	
Plate Current	8.6	Milliamperes
Screen Current	2	Milliamperes
Plate Resistance	0.8	Megohm
Transconductance	2000	Micromhos
Transconductance (At -35 volts bias)	10	Micromhos

INSTALLATION and APPLICATION

The base of the 7A7-LM fits the lock-type socket which may be installed to hold the tube in any position. Physical characteristics of the 7A7-LM are shown in Fig. 1-4, OUTLINES SECTION. For heater operation and cathode connection, refer to Type 6A8. Application is similar to that for Type 6SK7.

7A8

OCTODE CONVERTER

The 7A8 is a multi-electrode tube of the heater-cathode type designed to perform simultaneously the functions of a mixer and of an oscillator tube in superheterodyne circuits.

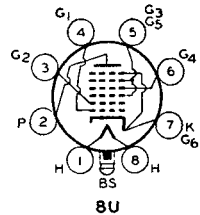

★ CHARACTERISTICS

HEATER VOLTAGE (A.C. or D.C.)	6.3‡	Volts
HEATER CURRENT	0.15‡‡	Ampere
DIRECT INTERELECTRODE CAPACITANCES:		
Grid No. 4 to Plate	0.15	μf
Grid No. 4 to Grid No. 2	0.12	μf
Grid No. 4 to Grid No. 1	0.12	μf
Grid No. 1 to Grid No. 2	0.60	μf
Grid No. 4 to All Other Electrodes (R-F Input) ...	7.5	μf
Grid No. 2 to All Other Electrodes		
Except Grid No. 1 (Osc. Output)	3.4	μf
Grid No. 1 to All Other Electrodes		
Except Grid No. 2 (Osc. Input)	3.8	μf
Plate to All Other Electrodes (Mixer Output)	9	μf
‡ Nominal value is 7 volts.		‡‡ Nominal value is 0.16 ampere.

As Frequency Converter

PLATE VOLTAGE	250 max.	Volts
SCREEN VOLTAGE (Grids No. 3 and No. 5)	100 max.	Volts
ANODE-GRID SUPPLY VOLTAGE (Grid No. 2)	250 max.	Volts
CONTROL-GRID VOLTAGE (Grid No. 4)	-3 min.	Volts
TYPICAL OPERATION:		
Plate Voltage	250	Volts
Screen Voltage	100	Volts
Anode-Grid Supply Voltage	250*	Volts
Control-Grid Voltage	-3	Volts
Oscillator-Grid Resistor (Grid No. 1)	50000	Ohms
Plate Current	3	Milliamperes
Screen Current	2.8	Milliamperes
Anode-Grid Current	4.5	Milliamperes

* Applied through 20000-ohm voltage-dropping resistor by-passed by 0.1 μf condenser

Oscillator-Grid Current.....	0.4	Milliamperes
Plate Resistance.....	0.7	Megohm
Conversion Transconductance.....	600	Micromhos
Conversion Transconductance with Control-Grid Bias of -30 Volts	2	Micromhos

INSTALLATION and APPLICATION

The base of the 7A8 fits the lock-type socket which may be installed to hold the tube in any position. Physical characteristics of the 7A8 are shown in Fig. 2-4, OUTLINES SECTION. For heater operation, refer to Type 6D8-G; for cathode connection and application, to Type 6A8.

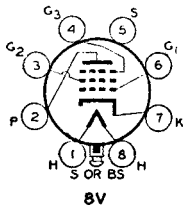

**TRIPLE-GRID
SUPER-CONTROL AMPLIFIER**

7B7

The 7B7 is a triple-grid super-control amplifier for use in the radio-frequency and intermediate-frequency stages of radio receivers.

★ CHARACTERISTICS

HEATER VOLTAGE (A.C. or D.C.)	6.3¶	Volts
HEATER CURRENT	0.15¶¶	Ampere
GRID-PLATE CAPACITANCE	0.005 max.	µf
INPUT CAPACITANCE.....	5	µf
OUTPUT CAPACITANCE.....	7	µf

¶ Nominal value is 7 volts.

¶¶ Nominal value is 0.16 ampere.

As Class A₁ Amplifier

PLATE VOLTAGE	250 max.	Volts
SCREEN VOLTAGE	100 max.	Volts
GRID VOLTAGE	-3 min.	Volts
TYPICAL OPERATION:		
Plate Voltage	250	Volts
Screen Voltage	100	Volts
Grid Voltage.....	-3	Volts
Suppressor.....	Connected to cathode at socket	
Plate Current	8.5	Milliamperes
Screen Current	2	Milliamperes
Plate Resistance.....	0.7	Megohm
Transconductance	1700	Micromhos
Transconductance (At -40 volts bias)	10	Micromhos

INSTALLATION and APPLICATION

The base of the 7B7 fits the lock-type socket which may be installed to hold the tube in any position. Physical characteristics of the 7B7 are shown in Fig. 2-4, OUTLINES SECTION. For heater operation, refer to Type 6D8-G; and for cathode connection, to Type 6A8. Application is similar to that for Type 6SK7.

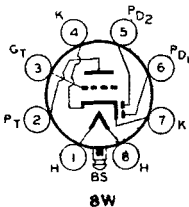

**DUPLEX-DIODE
HI-MU TRIODE**

7C6

The 7C6 is a multi-unit tube containing two diodes and a high-mu triode in one bulb. It is intended for use as a combined detector, amplifier, and automatic-volume-control tube.

★ CHARACTERISTICS

HEATER VOLTAGE (A.C. or D.C.)	6.3¶	Volts
HEATER CURRENT	0.15¶¶	Ampere
Triode: GRID-PLATE CAPACITANCE (Approx.)	1.4	μf
GRID-CATHODE CAPACITANCE (Approx.)	2.4	μf
PLATE-CATHODE CAPACITANCE (Approx.)	3	μf
AVERAGE CHARACTERISTICS — TRIODE UNIT:		
Plate Voltage	250	Volts
Grid Voltage	-1	Volt
Plate Current	1.3	Milliamperes
Plate Resistance	0.1	Megohm
Amplification Factor	100	
Transconductance	1000	Micromhos
¶ Nominal value is 7 volts.	¶¶ Nominal value is 0.16 ampere.	

Triode Unit — As Class A₁ Amplifier

PLATE VOLTAGE	250 max.	Volts
TYPICAL OPERATION:		
Plate Supply Voltage	250	Volts
Load Resistance	0.25	Megohm
Grid Resistor	10	Megohms

Diode Units

The two diode units are placed around a cathode, the sleeve of which is common to the triode unit. Each diode has its own base pin.

INSTALLATION and APPLICATION

The base of the 7C6 fits the lock-type socket which may be installed to hold the tube in any position. Physical characteristics of the 7C6 are shown in Fig. 2-4, OUTLINES SECTION. For heater operation, refer to Type 6D8-G; and for cathode connection, to Type 6A8. Application is similar to that for Type 6SQ7.

FULL-WAVE
HIGH-VACUUM RECTIFIER

7Y4

The 7Y4 is a full-wave, high-vacuum rectifier of the heater-cathode type. It is for use in automobile radio receivers and in compact a-c operated receivers.

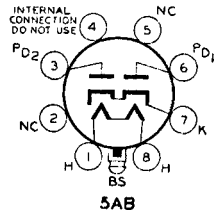

★ CHARACTERISTICS

HEATER VOLTAGE (A.C. or D.C.)	6.3¶	Volts
HEATER CURRENT	0.5¶¶	Ampere
¶ Nominal value is 7 volts.	¶¶ Nominal value is 0.53 ampere.	

As Full-Wave Rectifier

PEAK INVERSE VOLTAGE	1250 max.	Volts
PEAK PLATE CURRENT PER PLATE	180 max.	Milliamperes
D-C HEATER-CATHODE POTENTIAL	450 max.	Volts
WITH CONDENSER-INPUT FILTER:		
A-C Plate Voltage per Plate (RMS)	325 max.	Volts
Total Effective Plate-Supply Impedance per Plate*	150 min.	Ohms
D-C Output Current	60 max.	Milliamperes
WITH CHOKE-INPUT FILTER:		
A-C Plate Voltage per Plate (RMS)	450 max.	Volts
Input Choke Impedance	10 min.	Ohms
D-C Output Current	60 max.	Milliamperes

* When a filter input condenser larger than 40 μf is used, it may be necessary to use more plate-supply impedance than the value shown to limit the peak plate current to the rated value.

INSTALLATION and APPLICATION

The base of the 7Y4 fits the lock-type socket which may be installed to hold the tube in any position. Physical characteristics of the 7Y4 are shown in Fig. 2-4, OUTLINES SECTION. For heater operation, see Type 6X5.

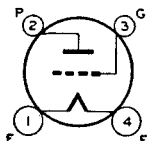

4D

POWER AMPLIFIER TRIODE

The 10 is a three-electrode, high-vacuum tube suitable for use as an audio-frequency amplifier in equipment designed for its characteristics.

10

CHARACTERISTICS

FILAMENT VOLTAGE (A.C. or D.C.)				7.5	Volts
FILAMENT CURRENT				1.25	Amperes
PLATE VOLTAGE	250	350		425 <i>max.</i>	Volts
GRID VOLTAGE*	-23.5	-32		-40	Volts
CATHODE RESISTOR	2350	2000		2220	Ohms
PLATE CURRENT	10	16		18	Milliamperes
PLATE RESISTANCE	6000	5150		5000	Ohms
AMPLIFICATION FACTOR	8	8		8	
TRANSCONDUCTANCE	1330	1550		1600	Micromhos
LOAD RESISTANCE	13000	11000		10200	Ohms
UNDISTORTED POWER OUTPUT	0.4	0.9		1.6	Watts

* Grid voltages are given with respect to the mid-point of filament operated on a.c. If d.c. is used, each stated value of grid voltage should be decreased by 5.0 volts and should be referred to the negative end of the filament.

INSTALLATION and APPLICATION

The base of the 10 fits the standard four-contact socket which should be installed to hold the tube in a vertical position with the base down. Physical characteristics of the 10 are shown in Fig. 2-28, OUTLINES SECTION.

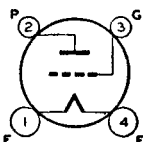

4D
Type 12

DETECTOR AMPLIFIER TRIODES

The 11 and 12 are three-electrode tubes used as detectors and amplifiers in dry-cell-operated receivers designed for their characteristics. The electrical characteristics of each type are identical, and are as follows: Filament volts, 1.1; amperes, 0.25; maximum plate volts, 135; grid volts, -10.5; amplification factor, 6.6; plate resistance (ohms), 15000; transconductance (micromhos), 440; and plate milliamperes, 3. Physical characteristics of the 11 and 12 are shown in Figs. 2-14 and 2-23, respectively, in the OUTLINES SECTION. The 11 and 12 are discontinued types; they are retained for reference only.

11

12

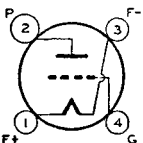

4F
Type 11

RECTIFIER-PENTODE

The 12A7 is a heater-cathode type of multi-unit tube which combines in one bulb a half-wave rectifier and a power-amplifier pentode. The heater rating is 12.6 volts, 0.3 ampere. RECTIFIER UNIT: Max. a-c plate volts, 125; max. d-c output ma., 30. PENTODE UNIT: Max. plate and screen volts, 135; grid-bias volts, -13.5:

12A7

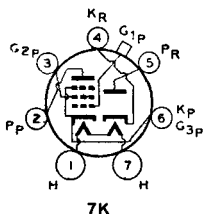

7K

load resistance, 13500 ohms; plate resistance, 102000 ohms; transconductance, 975 micromhos; plate ma., 9; screen ma., 2.5; and power output, 0.55 watt. The base fits the standard 7-contact socket (0.75-inch pin-circle diameter) which may be mounted to hold the tube in any position. Physical characteristics of the 12A7 are shown in Fig. 2-16. **OUTLINES SECTION.** For heater operation and cathode connection, refer to Types 12Z3 and 6A8, respectively.

PENTAGRID CONVERTER

12A8-GT

The 12A8-GT is a pentagrid converter of the heater-cathode type. Except for its heater which operates at 12.6 volts and 0.15 ampere, the electrical and physical characteristics of the 12A8-GT are the same as those of the Type 6A8-GT.

The heater of the 12A8-GT is designed to operate on either a.c. or d.c. When the heater is operated on a.c. with a transformer, the winding which supplies the heater circuit should operate the heater at its recommended value for full-load operating conditions at a line voltage of 117 volts. In receivers that employ a series-heater connection, the heater of the 12A8-GT may be operated in series with the heaters of the other types having 0.15-ampere rating, or in series with the heaters of other types requiring more than 0.15 ampere if the 12A8-GT heater is shunted by a suitable resistor to pass the current in excess of 0.15 ampere. The current in the heater circuit of the 12A8-GT should be adjusted to 0.15 ampere for the normal supply-line voltage. For cathode connection, refer to Type 6A8.

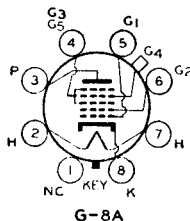

DUPLEX-DIODE PENTODE

12C8 METAL

The 12C8 is a metal type of tube having two diodes and a pentode in the same envelope. Except for its heater rating of 12.6 volts and 0.15 ampere, the electrical and physical characteristics of the 12C8 are the same as those of the Type 6B8. For heater operation and cathode connection, refer to Types 12A8-GT and 6A8, respectively.

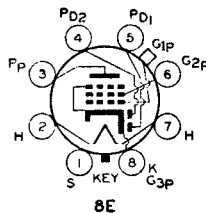

HIGH-MU TRIODE

12F5-GT

The 12F5-GT is a high-mu amplifier triode of the heater-cathode type. It is particularly useful in resistance-coupled amplifier circuits. Except for its heater rating of 12.6 volts and 0.15 ampere, and the capacitances, the electrical and physical characteristics are the same as those of the 6F5-GT.

The grid-plate capacitance is 2.8 $\mu\mu\text{f}$; grid-cathode, 2.2 $\mu\mu\text{f}$; plate-cathode, 3.2 $\mu\mu\text{f}$. For heater operation and cathode connection, refer to Types 12A8-GT and 6A8, respectively.

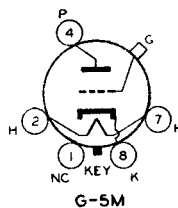

DETECTOR AMPLIFIER TRIODE

12J5-GT

The 12J5-GT is a triode of the heater-cathode type designed for use as detector, amplifier, or oscillator. It has a comparatively high amplification factor together with a high transconductance. Except for its heater rating of 12.6 volts and 0.15 ampere, the electrical and physical characteristics of the 12J5-GT are the same as those of the 6J5-GT.

For heater operation and cathode connection, refer to Type 12A8-GT and 6A8, respectively

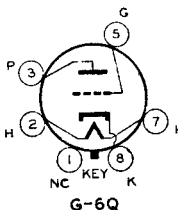

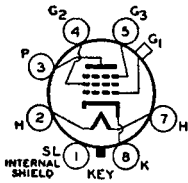

GT-7R(12J7-GT)

TRIPLE-GRID DETECTOR AMPLIFIER

12J7-GT

The 12J7-GT is a triple-grid detector amplifier of the heater-cathode type. Except for its heater rating of 12.6 volts and 0.15 ampere, the electrical and physical characteristics of the 12J7-GT are the same as those of the 6J7-GT. For heater operation and cathode connection, refer to Types 12A8-GT and 6A8, respectively.

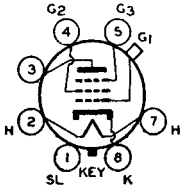

GT-7R(12K7-GT)

TRIPLE-GRID SUPER-CONTROL AMPLIFIER

12K7-GT

The 12K7-GT is a triple-grid super-control amplifier of the heater-cathode type. Except for its heater rating of 12.6 volts and 0.15 ampere, the electrical and physical characteristics of the 12K7-GT are the same as those of the 6K7-GT. For heater operation and cathode connection, refer to Types 12A8-GT and 6A8, respectively.

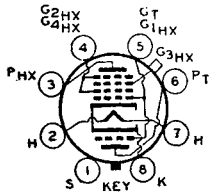

8K

TRIODE-HEXODE CONVERTER

12K8

METAL

The 12K8 is a multi-electrode tube of metal construction consisting of a triode oscillator and a hexode mixer in a single envelope. Except for its heater rating of 12.6 volts and 0.15 ampere, the electrical and physical characteristics of the 12K8 are the same as those of the 6K8. For heater operation and cathode connection, refer to Types 12A8-GT and 6A8, respectively.

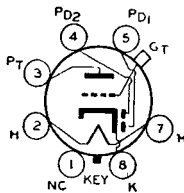

G-7V

DUPLEX-DIODE HIGH-MU TRIODE

12Q7-GT

The 12Q7-GT is a heater-cathode type of tube containing two diodes and a high-mu triode in one bulb. Except for its heater rating of 12.6 volts and 0.15 ampere, the electrical and physical characteristics of the 12Q7-GT are the same as those of the 6Q7-GT. For heater operation and cathode connection, refer to Types 12A8-GT and 6A8, respectively.

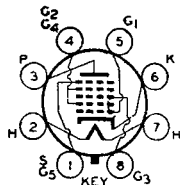

8R

PENTAGRID CONVERTER

12SA7

METAL

The 12SA7 is a multi-electrode vacuum tube of the single-ended metal type designed to perform simultaneously the functions of oscillator and mixer in superheterodyne receivers. Except for its heater rating of 12.6 volts and 0.15 ampere, the electrical and physical characteristics of the 12SA7 are the same as those of the 6SA7. For heater operation and cathode connection, refer to Types 12A8-GT and 6A8, respectively.

TWIN TRIODE AMPLIFIER

12SC7
METAL

The 12SC7 is a twin-triode amplifier of the single-ended metal type for use as a class A amplifier. Except for its heater rating of 12.6 volts and 0.15 ampere, the electrical and physical characteristics of the 12SC7 are the same as those of the 6SC7. For heater operation and cathode connection, refer to Types 12A8-GT and 6A8, respectively.

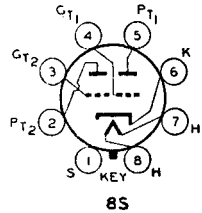

HIGH-MU TRIODE

12SF5
METAL

The 12SF5 is a high-mu triode of the single-ended metal type for use in resistance-coupled amplifier circuits. Except for its heater rating of 12.6 volts and 0.15 ampere the electrical and physical characteristics of the 12SF5 are the same as those of the 6SF5. For heater operation and cathode connection, refer to Types 12A8-GT and 6A8, respectively.

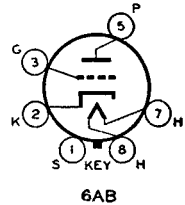

TRIPLE-GRID

12SJ7
METAL

DETECTOR AMPLIFIER

The 12SJ7 is a single-ended metal tube of the triple-grid type with a sharp cut-off characteristic. Except for its heater rating of 12.6 volts and 0.15 ampere, the electrical and physical characteristics of the 12SJ7 are the same as those of the 6SJ7. For heater operation and cathode connection, refer to Types 12A8-GT and 6A8, respectively.

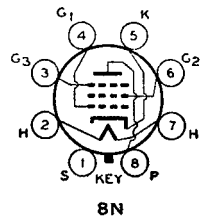

TRIPLE-GRID

12SK7
METAL

SUPER-CONTROL AMPLIFIER

The 12SK7 is a single-ended metal tube of the triple-grid type with a remote cut-off characteristic. Except for its heater rating of 12.6 volts and 0.15 ampere, the electrical and physical characteristics of the 12SK7 are the same as those of the 6SK7. For heater operation and cathode connection, refer to Types 12A8-GT and 6A8, respectively.

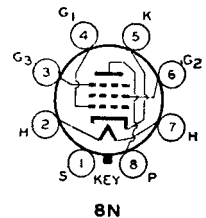

DUPLEX-DIODE HIGH-MU TRIODE

12SQ7
METAL

The 12SQ7 is a single-ended metal type of multi-unit tube containing two diodes and a high-mu triode. Except for its heater rating of 12.6 volts and 0.15 ampere, the electrical and physical characteristics of the 12SQ7 are the same as those of the 6SQ7. For heater operation and cathode connection, refer to Types 12A8-GT and 6A8, respectively.

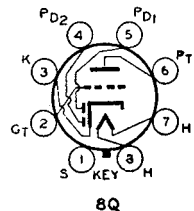

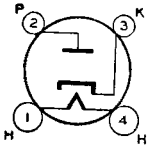

4G

HALF-WAVE HIGH-VACUUM RECTIFIER

12Z3

The 12Z3 is a half-wave, high-vacuum rectifier of the heater-cathode type for use in suitable circuits designed to supply d-c power from an a-c power line. It is intended for use in "transformerless" receivers of the "universal" (a.c.-d.c.) type. The adaptability of the 12Z3 to such receivers is facilitated by the heater design which permits of convenient series operation with other tube types.

★ CHARACTERISTICS

HEATER VOLTAGE (A.C. or D.C.)	12.6	Volts
HEATER CURRENT	0.3	Ampere

As Half-Wave Rectifier

PEAK INVERSE VOLTAGE	700 max.	Volts
PEAK PLATE CURRENT	330 max.	Milliamperes
D-C HEATER-CATHODE POTENTIAL	350 max.	Volts
TYPICAL OPERATION WITH CONDENSER-INPUT FILTER:		
A-C Plate Voltage (RMS).....	117 150	235 max. Volts
Total Effective Plate-Supply Impedance†.....		
	0 min.	30 min.
	75 min.	Ohms
D-C Output Current.....	55 max.	55 max.
		55 max. Milliamperes

† When a filter-input condenser larger than 40 μ f is used, it may be necessary to use more plate-supply impedance than the minimum value shown to limit the peak plate current to the rated value.

INSTALLATION and APPLICATION

The base of the 12Z3 fits the standard four-contact socket which may be installed to hold the tube in any position. Physical characteristics of the 12Z3 are shown in Fig. 2-19, OUTLINES SECTION. Sufficient ventilation should be provided to circulate air freely around the tube to prevent overheating.

The 12.6-volt heater of the 12Z3 is designed to operate under the normal conditions of line-voltage variation without materially affecting the performance or serviceability of this tube. For operation of the 12Z3 in series with the heaters of other types having 0.3 ampere rating, the current in the heater circuit should be adjusted to 0.3 ampere for the normal supply voltage.

A filter of the condenser-input type is recommended for use with this tube in order to obtain a d-c output voltage as high as possible. A large input capacitance in the order of 16 μ f is desirable. Typical output curves for several values of input condensers are shown in the accompanying diagram. As a supplement to the curves with an a-c input voltage, a curve is included to show the output when the receiver is operated from a d-c power line.

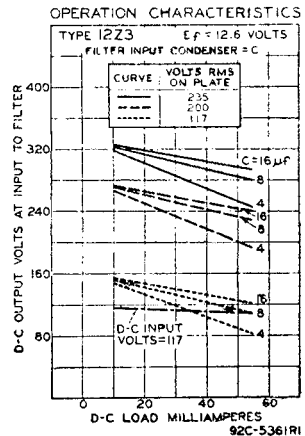

R-F AMPLIFIER PENTODE

15

The 15 is a heater-cathode type of pentode of the 2.0-volt type for use in battery-operated receivers that require a separate cathode connection. The heater is rated at 2.0 volts (d.c.) and 0.22 ampere. Characteristics at maximum plate volts of 135, maximum screen volts of 67.5, and grid-bias volts of -1.5 are: plate current, 1.85 milliamperes; screen current, 0.3 milliamperes; plate resistance, 0.63 megohm; transconductance, 750 micromhos.

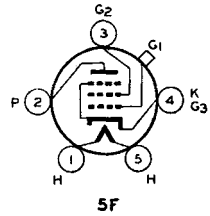

The base of the 15 fits the standard five-pin socket which may be mounted to hold the tube in any position. Physical characteristics of the 15 are shown in Fig. 2-16, OUTLINES SECTION. The heater-cathode potential should be kept as low as possible, but should never be greater than 22.5 volts. Application of the 15 is similar to that of Type 1E5-GP.

CLASS B TWIN AMPLIFIER

19

The 19 combines in one bulb two high- μ triodes designed for class B operation. It is intended for use in the output stage of battery-operated receivers and is capable of supplying approximately 2 watts of audio power. The triode units have separate external

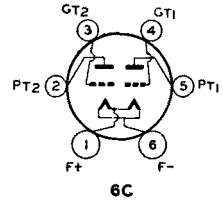

terminals for all electrodes except the filaments, so that circuit design is similar to that of class B amplifiers utilizing individual tubes in the output stage. Except for the filament current 0.26 ampere, the electrical characteristics of the 19 are the same as those of the 1J6-G. For filament operation, refer to Type 1C7-G. The base of the 19 fits the standard six-pin socket which should be mounted to hold the tube preferably in a vertical position with base down. Horizontal operation is permissible if pins 1 and 6 are in a horizontal plane. Physical characteristics of the 19 are shown in Fig. 2-19, OUTLINES SECTION.

POWER AMPLIFIER TRIODE

20

The 20 is a power-amplifier triode for dry-battery-operated receivers employing 3.3 volt filament tubes. The filament rating is 0.132 ampere at 3.3 volts (d.c.). Characteristics at maximum plate volts of 135, and grid-bias volts of -22.5 are: plate current, 6.5 milliamperes, plate resistance, 6300 ohms; amplification factor, 3.3; transconductance, 525 micromhos; load resistance, 6500 ohms; undistorted power output, 110 milliwatts. Physical characteristics of the 20 are shown in Fig. 2-14, OUTLINES SECTION. The 20 is a discontinued type; it is retained for reference only.

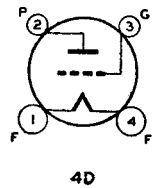

SCREEN-GRID RADIO-FREQUENCY AMPLIFIER

22

The 22 is a screen-grid, radio-frequency amplifier tube for use in dry-battery-operated receivers employing 3.3-volt filament tubes. The filament rating is 0.132 ampere at 3.3 volts (d.c.). Characteristics at maximum plate volts of 135, maximum screen volts of 67.5, and grid-bias volts of -1.5 are: plate current, 3.7 milliamperes; screen current, 1.3 milliamperes; plate resistance, 32500 ohms; transconductance, 500 micromhos. Physical characteristics of the 22 are shown in Fig. 2-22, OUTLINES SECTION. The 22 is a discontinued type; it is retained for reference only.

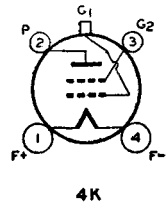

SCREEN-GRID RADIO-FREQUENCY AMPLIFIER

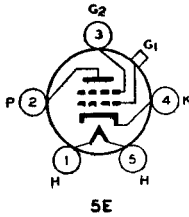

24-A

The 24-A is a screen-grid amplifier tube of the heater-cathode type for use primarily as a radio-frequency amplifier in a-c operated receivers.

The heater is rated at 2.5 volts (a.c. or d.c.) and 1.75 amperes. The maximum plate and screen volts are 275 and 90, respectively. Characteristics at plate volts of 250, screen volts of 90, and grid-bias volts of -3 are:

plate current, 4 milliamperes; screen current (max.), 1.7 milliamperes, plate resistance, 0.6 megohm; transconductance, 1050 micromhos. Capacitances (with shield-can) are: grid-plate 0.007 max. μ f; input 5.3 μ f; output, 10.5 μ f.

The base of the 24-A fits the standard five-contact socket which may be installed to hold the tube in any position. Physical characteristics of the 24-A are shown in Fig. 2-22, OUTLINES SECTION. For heater operation and cathode connection, refer to Type 2A5. The screen voltage for the 24-A may be obtained from a fixed or variable tap on a voltage divider across the high-voltage supply, or across a portion of the supply. Complete shielding in all stages of the circuit is necessary if maximum gain per stage is to be obtained.

POWER AMPLIFIER PENTODES

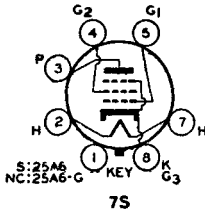

25A6

METAL

25A6-G

The 25A6 and 25A6-G are power-amplifier pentodes of the heater-cathode type having 25-volt heaters for operation on either a-c or d-c supply. They are especially useful in "d-c power line" or "universal" type

receivers. In such application, these tubes are capable of handling relatively large audio power.

★ CHARACTERISTICS

HEATER VOLTAGE (A.C. or D.C.)	25	Volts
HEATER CURRENT	0.3	Ampere

As Class A₁ Amplifier

PLATE VOLTAGE	160 max.	Volts
SCREEN VOLTAGE	135 max.	Volts
PLATE DISSIPATION	5.3 max.	Watts
SCREEN DISSIPATION	1.9 max.	Watts

TYPICAL OPERATION:

Plate Voltage	95	135	160	Volts
Screen Voltage	95	135	120	Volts
Grid Voltage	-15	-20	-18	Volts
Peak A-F Grid Voltage	15	20	18	Volts
Zero-Signal Plate Current	20	37	33	Milliamperes
Max.-Signal Plate Current	22	39	36	Milliamperes
Zero-Signal Screen Current	4	8	6.5	Milliamperes
Max.-Signal Screen Current	8	14	12	Milliamperes
Plate Resistance (Approx.)	45000	35000	42000	Ohms
Transconductance	2000	2450	2375	Micromhos
Load Resistance	4500	4000	5000	Ohms
Total Harmonic Distortion	11	9	10	Per cent
Max.-Signal Power Output	0.9	2	2.2	Watts

INSTALLATION and APPLICATION

The base of either the 25A6 or 25A6-G fits the standard octal socket which may be installed to hold the tube in any position. Physical characteristics of the 25A6 and 25A6-G are shown in Figs. 1-7 and 2-21, respectively, in the OUTLINES SECTION.

The 25-volt heater is designed to operate under the normal conditions of line-voltage variation without materially affecting the performance or serviceability

of these tubes. When the heater is operated in series with the heaters of other types having 0.3-ampere rating, the current in the heater circuit should be adjusted to 0.3 ampere for the normal supply voltage.

In a series-heater circuit of the "d-c power line" type employing several 0.3-ampere (6.3-volt) types and one or two 25A6's or 25A6-G's, the heater(s) of the 25-volt type(s) should be placed on the positive side of the line. Under these conditions, heater-cathode voltage of these tubes must not exceed the value given under cathode. In a series-heater circuit of the "universal" type employing a rectifier tube with 25-volt heater, one or two 25A6's or 25A6-G's and several 0.3-ampere (6.3-volt) types, it is recommended that the heater(s) of the 25A6('s) or 25A6-G('s) be placed in the circuit so that the higher values of heater-cathode bias will be impressed on the 25A6('s) or 25A6-G('s) rather than on the 6.3-volt types. This is accomplished by arranging the 25A6('s) or 25A6-G('s) on the side of the supply line which is connected to the cathode of the rectifier, i.e., the positive terminal of the rectified voltage supply. Between this side of the line and the 25A6('s) or 25A6-G('s), any necessary auxiliary resistance and the heater of the 25-volt heater type rectifier are connected in series.

The cathode circuit in "d-c power line" or "universal" receivers is tied in either directly or through biasing resistors to the negative side of the d-c plate supply which is furnished either by the d-c power line or by the a-c line by means of a rectifier. The potential difference thus introduced between heater and cathode of the 25A6 or 25A6-G should not exceed 90 volts d.c., as measured between the negative heater terminal and the cathode.

The cathode resistor should be shunted by a suitable filter network to avoid degenerative effects at low audio frequencies. The use of two 25A6's or 25A6-G's in push-pull eliminates the necessity for shunting the resistor. The cathode resistor for two tubes in the same stage is approximately one-half the value given for single-tube operation.

The total d-c resistance in the grid circuit should not exceed 0.5 megohm with cathode bias, or 0.5 megohm for the 95-volt condition and 50000 ohms for the 135-volt and 160-volt conditions with fixed bias.

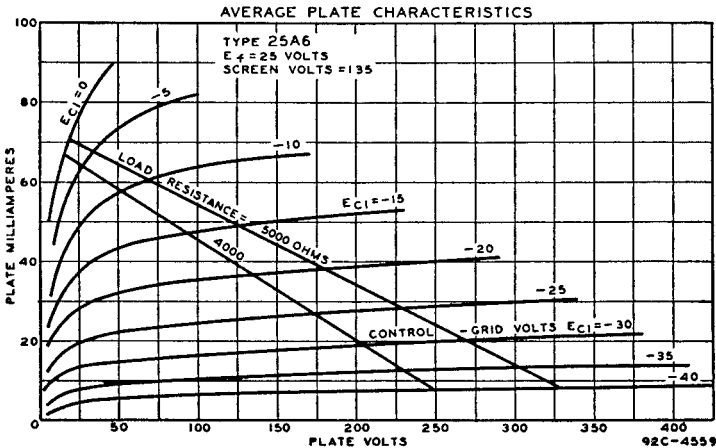

RECTIFIER-PENTODE

25A7-G

The 25A7-G is a heater-cathode type of tube containing a half-wave, high-vacuum rectifier and a power-amplifier pentode in one envelope. It is particularly useful in small receivers of the "universal" type.

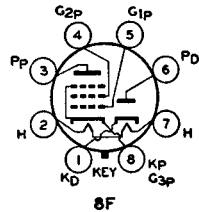

CHARACTERISTICS

HEATER VOLTAGE (A.C. or D.C.)	25	Volts
HEATER CURRENT	0.3	Ampere

Pentode Unit — As Class A₁ Amplifier

PLATE VOLTAGE	100 max.	Volts
SCREEN VOLTAGE (Grid No. 2)	100 max.	Volts
GRID VOLTAGE (Grid No. 1)	-15	Volts
PLATE CURRENT	20.5	Milliamperes
SCREEN CURRENT	4	Milliamperes
PLATE RESISTANCE	50000	Ohms
TRANSCONDUCTANCE	1800	Micromhos
LOAD RESISTANCE	4500	Ohms
OUTPUT*	0.77	Watt

* 9% total harmonic distortion.

Rectifier Unit

A-C PLATE VOLTAGE (RMS)	125 max.	Volts
D-C OUTPUT CURRENT	75 max.	Milliamperes

INSTALLATION and APPLICATION

The base of the 25A7-G fits the standard octal socket which may be installed to hold the tube in any position. Physical characteristics of the 25A7-G are shown in Fig. 2-21, OUTLINES SECTION. For heater operation and cathode connection of the pentode unit, refer to Type 25A6.

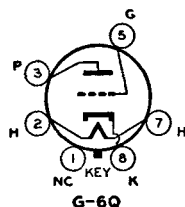

HIGH-MU POWER AMPLIFIER
TRIODE

The 25AC5-GT is a power amplifier triode of the heater-cathode type for use in the output stage of a-c/d-c radio receivers.

25AC5-GT

CHARACTERISTICS

HEATER VOLTAGE (A.C. or D.C.)	25	Volts
HEATER CURRENT	0.3	Ampere
AVERAGE CHARACTERISTICS:		
Plate Voltage	110	Volts
Grid Voltage	+15	Volts
Amplification Factor	58	
Plate Resistance	15200	Ohms
Transconductance	3800	Micromhos
Plate Current	45	Milliamperes
Grid Current	7	Milliamperes

As Class B Power Amplifier

PLATE VOLTAGE	180 max.	Volts
AVERAGE PLATE DISSIPATION	10 max.	Watts
TYPICAL OPERATION:		

Values are for two tubes

Plate Voltage	180	Volts
Grid Voltage	0	Volts
Peak A-F Grid-to-Grid Voltage	60	Volts
Zero-Signal D-C Plate Current	4	Milliamperes
Effective Load Resistance (Plate-to-plate)	4800	Ohms
Power Output*	6	Watts

* With peak input of 810 milliwatts applied between grids.

INSTALLATION and APPLICATION

The base of the 25AC5-GT fits the standard octal socket which may be installed to hold the tube in any position. For heater operation and cathode connection, refer to Type 25A6. Physical characteristics of the 25AC5-GT are shown in Fig. 2-8, OUTLINES SECTION.

In push-pull class B service, the 25AC5-GT should be operated as shown under CHARACTERISTICS.

In direct-coupled power-amplifier service, a single 25AC5-GT is preceded by a driver tube in a dynamic-coupled amplifier circuit similar to that shown under Type 6AC5-G. The only difference is that the 25000-ohm resistor is not required. Bias voltage for both the 25AC5-GT and the driver is developed by the dynamic-coupled connection shown in the circuit arrangement. The total d-c resistance in the grid circuit of the driver should not exceed 1.0 megohm. Maximum ratings for the 25AC5-GT in this service are: plate volts, 180; and average plate dissipation, 10 watts. Typical operating values with Type 6AE5-GT as driver are: plate-supply volts, 110; av. plate ma., 45; av. plate ma. of driver, 7; input signal volts (rms) to driver, 22; load resistance, 2000 ohms; and power output, 2 watts with 10% distortion. Typical operating values with Type 6P5-G as driver are: plate-supply volts, 180; av. plate ma., 27; av. plate ma. of driver, 4; input signal volts (rms) to driver, 12; load resistance, 8000 ohms; and power output, 2 watts with 10% distortion. In these typical operating conditions, current does not flow in the driver grid circuit during any part of the input cycle.

POWER AMPLIFIER
PENTODE

25B6-G

The 25B6-G is a power-amplifier pentode of the heater-cathode type for use in radio receivers of the "universal" type where large power output is desired.

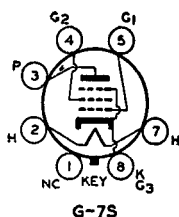

★ CHARACTERISTICS

HEATER VOLTAGE (A.C. or D.C.)	25	Volts
HEATER CURRENT	0.3	Ampere

As Class A₁ Amplifier

PLATE VOLTAGE	200 max.	Volts
SCREEN VOLTAGE (Grid No. 2)	135 max.	Volts
PLATE DISSIPATION	12.5 max.	Watts
SCREEN DISSIPATION	2 max.	Watts

TYPICAL OPERATION:

Plate Voltage	105	135	200	Volts
Screen Voltage	105	135	135	Volts
Grid Voltage (Grid No. 1)	-16	-22	-23	Volts
Peak A-F Grid Voltage	16	22	23	Volts
Zero-Signal Plate Current	48	61	62	Milliamperes
Max.-Signal Plate Current	55	69	71	Milliamperes
Zero-Signal Screen Current	2	2.5	1.8	Milliamperes
Max.-Signal Screen Current	10	14.5	13	Milliamperes
Plate Resistance	15500	15000	18000	Ohms
Transconductance	4800	5000	5000	Micromhos
Load Resistance	1700	1700	2500	Ohms
Total Harmonic Distortion	12.5	14	15	Per cent
Second Harmonic Distortion	7	8	8.5	Per cent
Third Harmonic Distortion	10	11	11	Per cent
Max.-Signal Power Output	2.4	4.3	7.1	Watts

INSTALLATION and APPLICATION

The base of the 25B6-G fits the standard octal socket which may be installed to hold the tube in any position. Physical characteristics of the 25B6-G are shown in Fig. 2-21, OUTLINES SECTION. For filament operation and cathode connection, refer to Type 25A6.

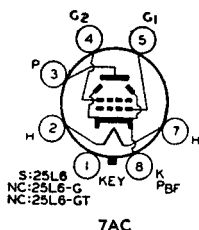

7AC

BEAM POWER AMPLIFIERS

25L6

METAL

25L6-G

25L6-GT

The 25L6, 25L6-G, and 25L6-GT are beam power amplifier tubes of the heater-cathode type designed for use in the output stage of "transformerless" (a.c.-d.c.) receivers. These tubes provide high power output at the relatively low plate and screen voltages available for transformerless receivers. The high power output is obtained with high power sensitivity and high efficiency. These distinctive features have been made possible by the application of directed-electron-beam principles in the design of these types. The design is similar to that of the RCA-6L6.

★ CHARACTERISTICS

HEATER VOLTAGE (A.C. or D.C.)	25.0	Volts
HEATER CURRENT	0.3	Ampere

As Class A₁ Amplifier

PLATE VOLTAGE	117 max.	Volts
SCREEN VOLTAGE (Grid No. 2)	117 max.	Volts
PLATE DISSIPATION	4 max.	Watts
SCREEN DISSIPATION	1.25 max.	Watts

TYPICAL OPERATION:

Plate Voltage	110	110	Volts
Screen Voltage	110	110	Volts
Grid Voltage (Grid No. 1)	-7.5	-7.5	Volts
Peak A-F Grid Voltage	7.5	7.5	Volts
Zero-Signal Plate Current	49	49	Milliamperes
Max.-Signal Plate Current	54	50	Milliamperes
Zero-Signal Screen Current	4	4	Milliamperes
Max.-Signal Screen Current	9	11	Milliamperes
Plate Resistance (Approx.)	10000	10000	Ohms
Transconductance	8200	8200	Micromhos
Load Resistance	1500	2000	Ohms
Total Harmonic Distortion	11	10	Per cent
Second Harmonic Distortion	10	3.5	Per cent
Third Harmonic Distortion	4	8.5	Per cent
Max.-Signal Power Output	2.1	2.2	Watts

INSTALLATION and APPLICATION

The base of either the 25L6, 25L6-G, or 25L6-GT fits the standard octal socket which may be installed to hold the tube in any position. Physical characteristics of the 25L6, 25L6-G, and 25L6-GT are shown in Figs. 1-7, 2-21, and 2-8, respectively in the OUTLINES SECTION. For heater operation and cathode connection, refer to Type 25A6.

The 25L6, 25L6-G, and 25L6-GT should be operated as shown under CHARACTERISTICS. The values have been determined on the basis that grid current does not flow during any part of the input cycle. The type of input coupling used should not introduce too much resistance in the grid circuit. Transformer- or impedance-coupling devices are recommended. When the grid circuit has a d-c resistance not higher than 0.1 megohm, fixed bias may be used; for higher values, cathode bias is required. With cathode bias, the grid circuit may have a d-c resistance as high as, but not greater than 0.5 megohm, provided the heater voltage is not allowed to rise more than 10% above the rated value under any condition of operation.

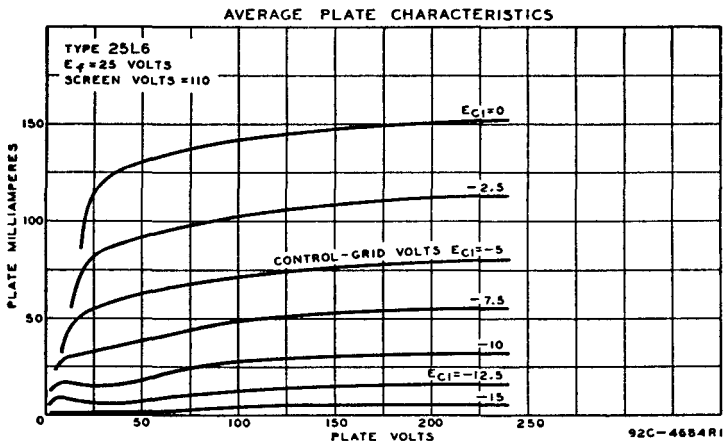

RECTIFIER-DOUBLERS

The 25Z5, 25Z6, 25Z6-G, and 25Z6-GT are full-wave, high-vacuum rectifiers of the heater-cathode type for use in suitable circuits designed to supply d-c power from an a-c power line. These tubes are well suited for "transformerless" receivers of either the "universal (a.c.-d.c.)" type or the "a-c operated" type. In "universal" receivers, these tubes may be used as half-wave rectifiers, while in the "a-c operated" type, they may be used as voltage doublers to provide about twice the d-c output voltage obtainable from the half-wave arrangement. This two-fold application is made possible by the use of a separate base pin for each of the two cathodes in the respective types. For voltage-doubler considerations, see RADIO TUBE APPLICATIONS section.

25Z5

25Z6
METAL

25Z6-G

25Z6-GT

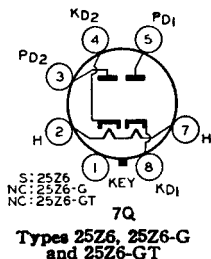
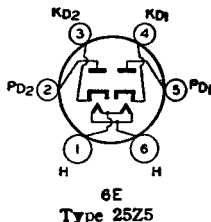

★ CHARACTERISTICS

HEATER VOLTAGE (A.C. or D.C.)	25	Volts
HEATER CURRENT	0.3	Ampere

As Rectifier or Doubler

PEAK INVERSE VOLTAGE	700 max.	Volts
PEAK PLATE CURRENT PER PLATE	450 max.	Milliamperes
D-C HEATER-CATHODE POTENTIAL	350 max.	Volts
TYPICAL OPERATION AS HALF-WAVE RECTIFIER:*		
A-C Plate Voltage per Plate (RMS) 117 150	235 max.	Volts
Total Effective Plate-Supply		
Impedance per Plate †	0 min. 40 min. 100 min.	Ohms
D-C Output Current per Plate ...	75 max. 75 max. 75 max.	Milliamperes

* The two units may be used separately or in parallel.

TYPICAL OPERATION AS VOLTAGE-DOUBLER:

	<i>Half-Wave</i>	<i>Full-Wave</i>	
A-C Plate Voltage per Plate (RMS)	117 max.	117 max.	Volts
Total Eff. Plate-Supply Imped. per Plate†	30 min.	0 min.	Ohms
D-C Output Current	75 max.	75 max.	Milliamperes

† When a filter-input condenser larger than 40 μf is used, it may be necessary to use more plate-supply impedance than the minimum value shown to limit the peak plate current to the rated value.

INSTALLATION and APPLICATION

The base of the 25Z5 fits the standard six-contact socket whereas the base of the 25Z6, 25Z6-G, and 25Z6-GT fits the standard octal socket. The sockets for any of these types may be installed to hold the tubes in any position. Physical characteristics of the 25Z5, 25Z6, 25Z6-G, and 25Z6-GT are shown in Figs. 2-19, 1-7, 2-17, and 2-8, respectively, in the OUTLINES SECTION. Sufficient ventilation should be provided to circulate air freely around these tubes to prevent overheating.

The heater in these types is designed to operate under the normal conditions of line voltage variation without materially affecting the performance or serviceability of the tubes. The current in the heater circuit should be adjusted to 0.3 ampere for the normal supply voltage.

A filter of the condenser-input type is recommended for use with any of these tubes in order to obtain a d-c output voltage as high as possible. A large input capacitance in the order of 16 μf is desirable for half-wave rectifier service, while a higher value is advantageous for voltage-doubler circuits.

Typical output curves for several values of input condensers are shown in the accompanying diagrams. Although these curves are set up for the 25Z6, they apply equally as well to the 25Z5, 25Z6-G, and 25Z6-GT. The voltage-doubler curves are for a full-wave doubler circuit and the rectifier curves are for the two diode units connected in parallel in a conventional half-wave circuit.

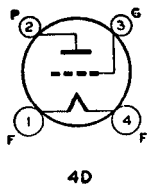
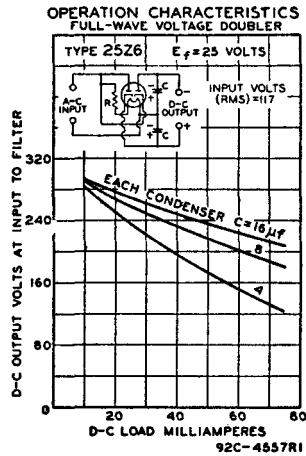
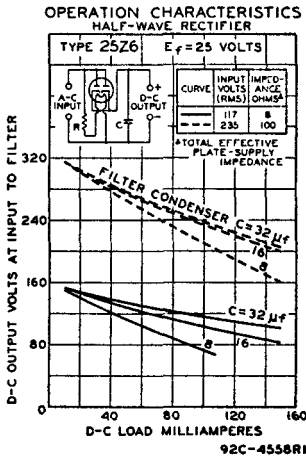

AMPLIFIER TRIODE

The 26 is an amplifier tube containing a filament designed for operation on alternating current. This tube is for use as an r-f or a-f amplifier in equipment designed for its characteristics. The 26 is not ordinarily suitable for use as a detector of power amplifier. The base of the 26 fits the standard four-contact socket which should be installed to hold the tube in a vertical position. Physical characteristics of the 26 are shown in Fig. 2-25, OUTLINES SECTION. The coated fila-

26

ment of the 26 should be operated at the rated voltage of 1.5 volts from the a-c line through a step-down transformer.

CHARACTERISTICS

FILAMENT VOLTAGE (A.C. or D.C.)			1.5	Volts
FILAMENT CURRENT			1.05	Amperes
PLATE VOLTAGE	90	135	180	Volts
GRID VOLTAGE*	-7	-10	-14.5	Volts
PLATE CURRENT	2.9	5.5	6.2	Milliamperes
PLATE RESISTANCE	8900	7600	7300	Ohms
AMPLIFICATION FACTOR	8.3	8.3	8.3	
TRANSCONDUCTANCE	935	1100	1150	Micromhos

* Grid voltage measured from mid-point of a-c operated filament.

27

DETECTOR, AMPLIFIER

The 27 is a three-electrode general purpose tube of the heater-cathode type for use as an amplifier and detector in a-c receivers.

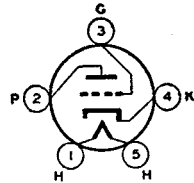

5A

CHARACTERISTICS

HEATER VOLTAGE (A.C. or D.C.)			2.5	Volts
HEATER CURRENT			1.75	Amperes
PLATE VOLTAGE*	90	135	180	Volts
GRID VOLTAGE†	-6	-9	-13.5	Volts
PLATE CURRENT	2.7	4.5	5.0	Milliamperes
PLATE RESISTANCE	11000	9000	9000	Ohms
AMPLIFICATION FACTOR	9	9	9	
TRANSCONDUCTANCE	820	1000	1000	Micromhos
GRID-PLATE CAPACITANCE (Approx.)			3.3	μmf
GRID-CATHODE CAPACITANCE (Approx.)			3.1	μmf
PLATE-CATHODE CAPACITANCE (Approx.)			2.3	μmf

* Maximum plate voltage = 275 volts.

† Maximum value of d-c resistance in grid circuit should not exceed 1.0 megohm.

INSTALLATION and APPLICATION

The base of the 27 fits the standard five-contact socket which may be installed to hold the tube in any position. Physical characteristics of the 27 are shown in Fig. 2-19, OUTLINES SECTION. For heater operation and cathode connection, refer to Type 2A5.

As an amplifier, the 27 is applicable to the audio- or the radio-frequency stages of a receiver. Recommended plate and grid voltages are shown under CHARACTERISTICS.

As a detector, the 27 may be operated either with grid leak and condenser or with grid bias. The plate voltage for grid-leak-and-condenser detection is 45 volts. A grid leak of from 1 to 5 megohms used with a grid condenser of 0.00025 μf is suitable. For grid-bias detection, a plate voltage of 275 volts or less may be used. The corresponding grid bias should be adjusted so that the plate current, when no signal is being received, is approximately 0.2 milliampere. For the condition of 250 volts on plate and transformer coupling, the grid bias will be approximately -30 volts.

DETECTOR AMPLIFIER TRIODE

30

The 30 is a detector and amplifier tube of the three-electrode type for battery-operated receivers where economy of filament-current drain is important. Except for capacitances, which are shown below, the electrical characteristics of the 30 are the same as those of the 1H4-G. The base of the 30 fits the standard four-contact socket which should be mounted to hold the tube preferably in a vertical position. Horizontal operation is permissible if pins 1 and 4 are in a vertical plane. Physical characteristics of the 30 are shown in Fig. 2-19, OUTLINES SECTION. For filament operation, refer to Type 1C7-G; for application, refer to Type 1H4-G.

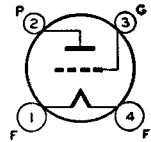

4D

GRID-PLATE CAPACITANCE (Approx.)	6.0	μmf
GRID-FILAMENT CAPACITANCE (Approx.)	3.0	μmf
PLATE-FILAMENT CAPACITANCE (Approx.)	2.1	μmf

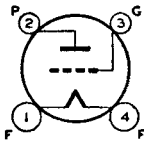

4D

POWER AMPLIFIER TRIODE

The 31 is a power-amplifier tube of the three-electrode type for battery-operated receivers where economy of filament-current drain is important.

31

The filament voltage and current are 2.0 volts (d.c.) and 0.13 ampere, respectively. Characteristics at maximum plate volts of 180 and grid-bias volts of -30 are: plate current, 12.3 milliamperes; plate resistance, 3600 ohms; amplification factor, 3.8; transconductance, 1050 micromhos; load resistance, 5700 ohms; undistorted power output, 0.375 watt. The base of the 31 fits the standard four-contact socket which should be mounted to hold the tube preferably in a vertical position. Horizontal operation is permissible if pins 1 and 4 are in a vertical plane. Physical characteristics of the 31 are shown in Fig. 2-19, OUTLINES SECTION. For filament operation refer to Type 1C7-G.

As a power amplifier, the 31 should be operated as shown under CHARACTERISTICS. Grid voltage may be obtained from a C-battery, or by means of a cathode-bias resistor connected in the negative plate-return lead. The latter method is required where a grid resistor (maximum value 1 megohm) is used. If more output is desired than can be obtained from a single 31, two 31's may be operated either in parallel or push-pull connection.

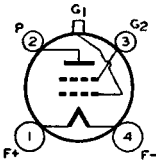

4K

SCREEN-GRID R-F AMPLIFIER

The 32 is a screen-grid tube primarily for use as a radio-frequency amplifier in battery-operated receivers where economy of filament-current drain is important. For base and socket mounting, see Type 30; for filament operation, see Type 1C7-G. Physical characteristics of the 32 are shown in Fig. 2-22, OUTLINES SECTION. For screen-voltage supply, shielding, and application, see Type 1E5-GP. The d-c resistance in the grid circuit of the 32 should not exceed 2 megohms.

32

CHARACTERISTICS

FILAMENT VOLTAGE (D.C.)	2.0	Volts
FILAMENT CURRENT	0.060	Ampere
PLATE VOLTAGE	135	180 max. Volts
SCREEN VOLTAGE (Grid No. 2)	67.5 max.	67.5 max. Volts
GRID VOLTAGE (Grid No. 1)	-3	-3 Volts
PLATE CURRENT	1.7	1.7 Milliamperes
SCREEN CURRENT (Maximum)	0.4	0.4 Milliampere
PLATE RESISTANCE	0.95	1.2 Megohms
TRANSCONDUCTANCE	640	650 Micromhos
GRID-PLATE CAPACITANCE (With shield-can)	0.015 max.	μuf
INPUT CAPACITANCE	5.3	μuf
OUTPUT CAPACITANCE	10.5	μuf

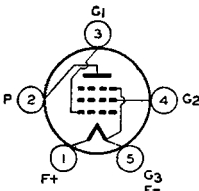

5K

POWER AMPLIFIER PENTODE

The 33 is a power-amplifier pentode for use in the output stage of battery-operated receivers where economy of battery consumption is important. The base of the 33 fits the standard five-contact socket which should be installed to hold the tube in a vertical position. In some cases, cushioning of the socket may be found desirable. Physical characteristics of the 33 are shown in Fig. 2-25, OUTLINES SECTION. For filament operation, refer to Type 1C7-G.

33

CHARACTERISTICS

FILAMENT VOLTAGE (D.C.)	2.0	Volts
FILAMENT CURRENT	0.260	Ampere
PLATE VOLTAGE	135	180 max. Volts
SCREEN VOLTAGE (Grid No. 2)	135	180 max. Volts
GRID VOLTAGE* (Grid No. 1)	-13.5	-18 Volts
PLATE CURRENT	14.5	22 Milliamperes
SCREEN CURRENT	3	5 Milliamperes
PLATE RESISTANCE (Approx.)	50000	55000 Ohms
TRANSCONDUCTANCE	1450	1700 Micromhos
LOAD RESISTANCE	7000	6000 Ohms
CATHODE-BIAS RESISTOR	770	670 Ohms
POWER OUTPUT (7% total harmonic distortion)	0.7	1.4 Watts

* D-c resistance in the grid circuit should not exceed 1.0 megohm under cathode-bias conditions; without cathode bias, the maximum value is 0.5 megohm.

**SUPER-CONTROL R-F
AMPLIFIER PENTODE**

34

The 34 is a super-control pentode for use primarily as a radio-frequency amplifier and intermediate-frequency amplifier in battery-operated receivers where economy of filament-current drain is important. The super-control feature is explained under Super-Control Amplifier in RADIO TUBE APPLICATIONS section. For base and socket mounting, see Type 30. Physical characteristics of

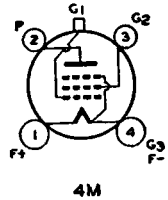

the 34 are shown in Fig. 2-22, OUTLINES SECTION. For filament operation, refer to Type 1C7-G; and for application, to Type 1D5-GP.

CHARACTERISTICS

FILAMENT VOLTAGE (D.C.)			2.0	Volts
FILAMENT CURRENT			0.060	Amperes
PLATE VOLTAGE	67.5	135	180 max.	Volts
SCREEN VOLTAGE (Grid No. 2)*	67.5 max.	67.5 max.	67.5 max.	Volts
GRID VOLTAGE, Variable (Grid No. 1)	-3 min.	-3 min.	-3 min.	Volts
PLATE CURRENT	2.7	2.8	2.8	Milliamperes
SCREEN CURRENT	1.1	1.0	1.0	Milliamperes
PLATE RESISTANCE	0.4	0.6	1.0	Megohm
TRANSCONDUCTANCE	560	800	620	Micromhos
TRANSCONDUCTANCE (At -22.5 volts bias)	15	15	15	Micromhos
GRID-PLATE CAPACITANCE (With shield-can)			0.015 max.	μ f
INPUT CAPACITANCE			6.0	μ f
OUTPUT CAPACITANCE			11.5	μ f

* Under conditions of maximum plate current.

SUPER-CONTROL R-F AMPLIFIER

35

The 35 is a super-control screen-grid amplifier tube of the heater-cathode type recommended as an r-f amplifier and an i-f amplifier in a-c receivers. The 35 is effective in reducing cross-modulation and modulation-distortion over the entire range of received signals. Its design is such as to permit easy control of a large range of signal voltages without the use of local-distance switches or antenna potentiometers. The 35 is interchangeable with Type 51.

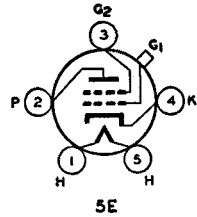

CHARACTERISTICS

HEATER VOLTAGE (A.C. or D.C.)			2.5	Volts
HEATER CURRENT			1.75	Amperes
PLATE VOLTAGE*	180		250	Volts
SCREEN VOLTAGE (Grid No. 2)	90 max.	90 max.	90 max.	Volts
GRID VOLTAGE, Variable (Grid No. 1)	-3 min.	-3 min.	-3 min.	Volts
PLATE CURRENT	6.3	6.5	6.5	Milliamperes
SCREEN CURRENT (Maximum)	2.5	2.5	2.5	Milliamperes
PLATE RESISTANCE	0.3	0.4	0.4	Megohm
TRANSCONDUCTANCE	1020	1050	1050	Micromhos
TRANSCONDUCTANCE (At -40 volts bias)	15	15	15	Micromhos
GRID-PLATE CAPACITANCE (With shield-can)			0.007 max.	μ f
INPUT CAPACITANCE			5.3	μ f
OUTPUT CAPACITANCE			10.5	μ f

* Maximum plate voltage = 275 volts.

INSTALLATION and APPLICATION

The base of the 35 fits the standard five-contact socket which may be installed to hold the tube in any position. Physical characteristics of the 35 are shown in Fig. 2-22, OUTLINES SECTION. For heater operation and cathode connection, refer to Type 2A5. The screen voltage for the 35 may be obtained from a fixed or variable tap on a voltage divider across the supply voltage or from a portion of the supply. Complete shielding for all stages of the circuit is necessary if maximum gain and the volume-control-range capabilities of this tube are to be realized.

As a radio-frequency and intermediate-frequency amplifier, the 35 should be operated as shown under CHARACTERISTICS. Volume control of receivers designed for the 35 may be accomplished by variation of the negative grid bias of this tube. In order to utilize the full volume-control range of the 35, an available grid-bias voltage of approximately 50 volts will be required, depending on the circuit design and operating conditions. This voltage may be obtained from a potentiometer, a bleeder circuit, or from an adjustable cathode resistor.

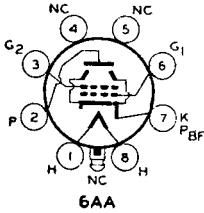

BEAM POWER AMPLIFIER

The 35A5-LT is a beam power amplifier of the heater-cathode type for use in the output stage of a-c/d-c receivers. The 35A5-LT is interchangeable with the 35A5.

35A5-LT

★ CHARACTERISTICS

HEATER VOLTAGE (A.C. or D.C.)	32	Volts
HEATER CURRENT	0.15	Ampere

As Class A₁ Amplifier

PLATE VOLTAGE	110 max.	Volts
SCREEN VOLTAGE	110 max.	Volts

TYPICAL OPERATION:

Plate Voltage	110	Volts
Screen Voltage	110	Volts
Grid Voltage	-7.5	Volts
Peak A-F Grid Voltage	7.5	Volts
Zero-Signal Plate Current	40	Milliamperes
Max.-Signal Plate Current	41	Milliamperes
Zero-Signal Screen Current	3	Milliamperes
Max.-Signal Screen Current	7	Milliamperes
Plate Resistance	14000	Ohms
Transconductance	5800	Micromhos
Load Resistance	2500	Ohms
Total Harmonic Distortion	6.5	Per cent
Max.-Signal Power Output	1.5	Watts

INSTALLATION and APPLICATION

The base of the 35A5-LT fits the lock-type socket which may be installed to hold the tube in any position. Physical characteristics of the 35A5-LT are shown in Fig. 2-9, OUTLINES SECTION. Heater operation and cathode connection are the same as for Type 35L6-GT. Application is also the same as for the 35L6-GT except as follows: with cathode bias, the grid current may have a d-c resistance not to exceed 0.5 megohm, provided the heater voltage is not allowed to rise more than 10% above the rated value under any condition of operation.

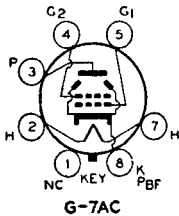

BEAM POWER AMPLIFIER

The 35L6-GT is a power amplifier of the directed-electron-beam type for use in the output stage of "transformerless" receivers where high power sensitivity is desired with low power consumption.

35L6-GT

★ CHARACTERISTICS

HEATER VOLTAGE (A.C. or D.C.)	35	Volts
HEATER CURRENT	0.15	Ampere

As Class A₁ Amplifier

PLATE VOLTAGE	200 max.	Volts
SCREEN VOLTAGE (Grid No. 2)	110 max.	Volts
PLATE DISSIPATION	8.5 max.	Watts
SCREEN DISSIPATION	1 max.	Watt

TYPICAL OPERATION:

Plate Voltage	110	200	Volts
Screen Voltage	110	110	Volts

Grid Voltage (Grid No. 1)	-7.5	-8	Volts
Peak A-F Grid Voltage	7.5	8	Volts
Zero-Signal Plate Current	40	41	Milliamperes
Max.-Signal Plate Current	41	44	Milliamperes
Zero-Signal Screen Current	3	2	Milliamperes
Max.-Signal Screen Current	7	7	Milliamperes
Plate Resistance (Approx.)	14000	40000	Ohms
Transconductance	5800	5900	Micromhos
Load Resistance	2500	4500	Ohms
Total Harmonic Distortion	10	10	Per cent
Max.-Signal Power Output	1.5	3.3	Watts

INSTALLATION and APPLICATION

The base of the 35L6-GT fits the standard octal socket which may be mounted to hold the tube in any position. Physical characteristics of the 35L6-GT are shown in Fig. 2-8, OUTLINES SECTION.

The 35-volt heater is designed to operate under the normal conditions of line-voltage variation without materially affecting the performance or serviceability of the 35L6-GT. For operation of the 35L6-GT in series with other types having 0.15-ampere rating, the current in the heater circuit should be adjusted to 0.15 ampere for the normal supply voltage.

In a series-heater circuit of the "d-c power line" type employing several 0.15-ampere types and one or two 35L6-GT's, the heater(s) of the 35L6-GT(s) should be placed on the positive side of the line. Under these conditions, heater-cathode voltage of the 35L6-GT must not exceed the value given under cathode. In a series-heater circuit of the "universal" type employing rectifier tube 35Z4-GT, one or two 35L6-GT's, and several 0.15-ampere types, it is recommended that the heater(s) of the 35L6-GT(s) be placed in the circuit so that the higher values of heater-cathode bias will be impressed on the 35L6-GT(s) rather than on the other 0.15-ampere types. This is accomplished by arranging the 35L6-GT(s) on the side of the supply line which is connected to the cathode of the rectifier, i.e., the positive terminal of the rectified voltage supply. Between this side of the line and the 35L6-GT(s), any necessary auxiliary resistance and the heater of the 35Z4-GT are connected in series.

The cathode circuit in "d-c power line" or "universal" receivers is tied in either directly or through biasing resistors to the negative side of the d-c plate supply which is furnished either by the d-c power line or by the a-c line by means of a rectifier. The potential difference thus introduced between heater and cathode of the 35L6-GT should not exceed 90 volts d.c., as measured between the negative heater terminal and the cathode.

As a power amplifier (class A₁), the 35L6-GT is recommended for use either singly or in push-pull combination in the power-output stage of "d-c power line" and "universal" receivers. The operating values shown under CHARACTERISTICS have been determined on the basis that grid current does not flow during any part of the input cycle. The type of input coupling used should not introduce too much resistance in the grid circuit. Transformer or impedance coupling devices are recommended. When the grid circuit has a d-c resistance not higher than 0.1 megohm, fixed bias may be used; for higher values, cathode bias is required. With cathode bias, the grid circuit may have a d-c resistance as high as, but not greater than 0.75 megohm.

HALF-WAVE HIGH-VACUUM RECTIFIER

35Z3-LT

The 35Z3-LT is a half-wave, high-vacuum rectifier of the heater-cathode type for use in a-c/d-c receivers. The 35Z3-LT is interchangeable with the 35Z3. The base of the 35Z3-LT fits the lock-type socket which may be installed to hold the tube in any position. Physical characteristics of the 35Z3-LT are shown in Fig. 2-7, OUTLINES SECTION. For heater operation, see Type 35L6-GT.

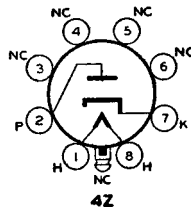

★ CHARACTERISTICS

HEATER VOLTAGE (A.C. or D.C.)	32	Volts
HEATER CURRENT	0.15	Ampere

As Half-Wave Rectifier

PEAK INVERSE VOLTAGE	700 max.	Volts		
PEAK PLATE CURRENT	600 max.	Milliamperes		
D-C HEATER-CATHODE POTENTIAL	350 max.	Volts		
TYPICAL OPERATION WITH CONDENSER-INPUT FILTER:				
A-C Plate Voltage (RMS)	117	150	235 max.	Volts
Total Effective Plate-Supply Impedance†				
	0 min.	40 min.	100 min.	Ohms
D-C Output Current	100 max.	100 max.	100 max.	Milliamperes

† When a filter-input condenser larger than 40 μ f is used, it may be necessary to use more plate-supply impedance than the minimum value shown to limit the peak plate current to the rated value.

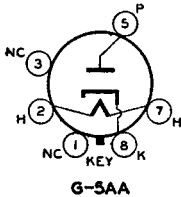

G-5AA

HALF-WAVE HIGH-VACUUM RECTIFIER

35Z4-GT

The 35Z4-GT is a half-wave, high-vacuum rectifier of the heater-cathode type for use in suitable circuits designed to supply d-c power from an a-c power line. The base of the 35Z4-GT fits the standard octal socket which may

be installed to hold the tube in any position. Physical characteristics of the 35Z4-GT are shown in Fig. 2-8, OUTLINES SECTION. For heater operation, refer to Type 35L6-GT.

CHARACTERISTICS

HEATER VOLTAGE (A.C. or D.C.)	35	Volts
HEATER CURRENT	0.15	Ampere

As Half-Wave Rectifier

PEAK INVERSE VOLTAGE	700 max.	Volts	
PEAK PLATE CURRENT	600 max.	Milliamperes	
D-C HEATER-CATHODE POTENTIAL	350 max.	Volts	
WITH CONDENSER-INPUT FILTER:			
A-C Plate Voltage (RMS)	117 max.	235 max.	Volts
Total Effective Plate-Supply Impedance*	15 min.	100 min.	Ohms
D-C Output Current	100 max.	100 max.	Milliamperes

* When a filter-input condenser larger than 40 μ f is used, it may be necessary to use more plate-supply impedance than the minimum value shown to limit the peak plate current to the rated value.

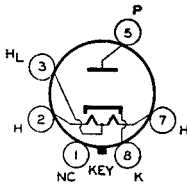

G-6AD

HALF-WAVE HIGH-VACUUM RECTIFIER

35Z5-GT

The 35Z5-GT is a half-wave, high-vacuum rectifier of the heater-cathode type for use in a-c/d-c radio receivers. The heater is provided with a tap for operation of a panel lamp.

★ CHARACTERISTICS

HEATER VOLTAGE (A.C. or D.C.)		
Entire Heater (Pins No. 2 and No. 7)	35	Volts
Panel-Lamp Section (Pins No. 2 and No. 3)	7.5	Volts
0.15 ampere flowing between pins No. 2 and No. 7	0.15	Ampere
HEATER CURRENT		

As Half-Wave Rectifier

A-C PLATE VOLTAGE (RMS)	235 max.	Volts
PEAK INVERSE VOLTAGE	700 max.	Volts
PEAK PLATE CURRENT	600 max.	Milliamperes

D-C OUTPUT CURRENT:

With Panel Lamp and { No Shunting Resistor	60 max.	Milliamperes
{ Shunting Resistor	90 max.	Milliamperes
Without Panel Lamp	100 max.	Milliamperes

SHUNTING RESISTOR:

For D-C Output Current of 70 ma.	800 max.	Ohms
80 ma.	400 max.	Ohms
90 ma.	250 max.	Ohms

D-C HEATER-CATHODE POTENTIAL	350 max.	Volts
PANEL-LAMP SECTION VOLT. (RMS) when panel lamp fails	15 max.	Volts

TYPICAL OPERATION:

With No. 40 or No. 47 Panel Lamp in Circuit Below with Condenser-Input Filter

Heater Cur. between Pins 3 & 7	0.15	0.15	0.15	0.15	0.15	Milliamperes
Heater Volt. between Pins 2 & 7	32	32	32	32	32	Volts
Section Volt. between Pins 2 & 3*	5.5	5.5	5.5	5.5	5.5	Volts
A-C Plate Voltage (RMS)	117	117	117	117	235	Volts
Effective Plate-Supply Impedance†	15	15	15	15	100	Ohms
D-C Output Current	60	70	80	90	60	Milliamperes
Shunting Resistor	—	300	150	100	—	Ohms

Without Panel Lamp—Conventional Half-Wave Circuit with Condenser-Input Filter

Heater Cur. between Pins 3 & 7	0.15	0.15	Milliamperes
Heater Volt. between Pins 2 & 7	35	35	Volts
Section Volt. between Pins 2 & 3*	7.5	7.5	Volts
A-C Plate Voltage (RMS)	117	235	Volts
Effective Plate-Supply Impedance†	15	100	Ohms
D-C Output Current	100	100	Milliamperes

* Maximum.

† Minimum values. When a filter-input condenser larger than 40 μ f is used, it may be necessary to use more plate-supply impedance than the minimum value shown to limit the peak plate current to the rated value.

INSTALLATION and APPLICATION

The base of the 35Z5-GT fits the standard octal socket which may be installed to hold the tube in any position. Physical characteristics of the 35Z5-GT are shown in Fig. 2-8, OUTLINES SECTION. For heater operation, refer to Type 35L6-GT.

With the panel lamp connected as shown in the circuit diagram, the panel-lamp voltage does not substantially exceed its operating value when the receiver is turned on and off. The plate current of the 35Z5-GT passes through the panel lamp and the panel-lamp section of the heater. As a result, a higher level of illumination is obtained when the receiver is in operation.

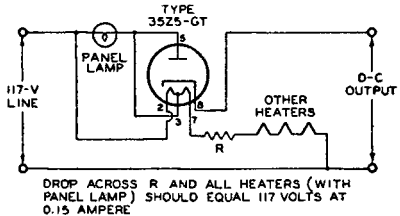

36

SCREEN-GRID R-F AMPLIFIER

The 36 is a heater-cathode type of screen-grid tube intended for use as a radio-frequency amplifier, intermediate-frequency amplifier, and detector.

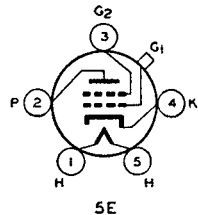

CHARACTERISTICS

HEATER VOLTAGE (A.C. or D.C.)	6.3	Volts
HEATER CURRENT	0.3	Ampere
PLATE VOLTAGE	250 max.	Volts
SCREEN VOLTAGE (Grid No. 2)	90 max.	Volts
GRID VOLTAGE (Grid No. 1)	-3	Volts
PLATE CURRENT	3.2	Milliamperes
SCREEN CURRENT	1.7 max.	Milliamperes
PLATE RESISTANCE	0.55	Megohm
	0.55	
	0.475	
	0.5	

TRANSCONDUCTANCE	850	1000	1050	1080	Micromhos
GRID-PLATE CAPACITANCE (With shield-can)				0.007 <i>max.</i>	μmf
INPUT CAPACITANCE				3.7	μmf
OUTPUT CAPACITANCE				9.2	μmf

INSTALLATION and APPLICATION

The base of the 36 fits the standard five-contact socket which may be installed to hold the tube in any position. Physical characteristics of the 36 are shown in Fig. 2-16, OUTLINES SECTION. For heater operation and cathode connection, refer to Type 6A8. For screen voltage and shielding, refer to Type 35.

As a radio-frequency amplifier, the 36 should be operated as shown under CHARACTERISTICS. As a detector, the 36 may be operated either with grid leak and condenser or with grid bias. For grid-bias detection, suitable operating conditions are: Plate-supply voltage, 180 volts applied through a plate-coupling resistor of 0.25 megohm or an equivalent impedance; screen voltage, 67.5 volts; and negative grid bias, 6 volts (approx.) so adjusted that a plate current of 0.1 milliampere is obtained with no input signal.

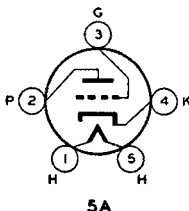

DETECTOR, AMPLIFIER

The 37 is a three-electrode general-purpose tube of the heater-cathode type for use as amplifier and detector.

37

CHARACTERISTICS

HEATER VOLTAGE (A.C. or D.C.)				6.3	Volts
HEATER CURRENT				0.3	Ampere
PLATE VOLTAGE	90	135	180	250 <i>max.</i>	Volts
GRID VOLTAGE*	-6	-9	-13.5	-18	Volts
PLATE CURRENT	2.5	4.1	4.3	7.5	Milliamperes
PLATE RESISTANCE	11500	10000	10200	8400	Ohms
AMPLIFICATION FACTOR	9.2	9.2	9.2	9.2	
TRANSCONDUCTANCE	800	925	900	1100	Micromhos
GRID-PLATE CAPACITANCE (Approx.)				2.0	μmf
GRID-CATHODE CAPACITANCE (Approx.)				3.5	μmf
PLATE-CATHODE CAPACITANCE (Approx.)				2.9	μmf

* The d-c resistance in the grid circuit should not exceed 1.0 megohm.

INSTALLATION and APPLICATION

The base of the 37 fits the standard five-contact socket which may be installed to hold the tube in any position. Physical characteristics of the 37 are shown in Fig. 2-19, OUTLINES SECTION. For heater operation and cathode connection, refer to Type 6A8.

As an amplifier, the 37 is applicable to the audio- or the radio-frequency stages of a receiver. Recommended plate and grid voltages are shown under CHARACTERISTICS. As a detector, the 37 may be operated with either grid leak and condenser or with grid bias. The plate voltage for the grid-leak-and-condenser method is 45 volts. A grid leak of from 1 to 5 megohms used with a grid condenser of 0.00025 μf is suitable. For grid-bias detection a plate voltage of 250 volts, together with a negative grid bias of approximately 28 volts, may be used. The plate current should be adjusted to 0.2 milliampere with no input signal.

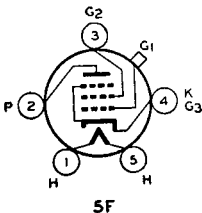

POWER AMPLIFIER PENTODE

The 38 is a power-amplifier pentode of the heater-cathode type. The relatively low heater current of this type makes it suitable for automobile receivers and for power-line-operated sets, particularly those with a series-heater arrangement.

38

CHARACTERISTICS

HEATER VOLTAGE (A.C. or D.C.)				6.3	Volts
HEATER CURRENT				0.3	Ampere
PLATE VOLTAGE	100	135	180	250 <i>max.</i>	Volts
SCREEN VOLTAGE (Grid No. 2)	100	135	180	250 <i>max.</i>	Volts
GRID VOLTAGE (Grid No. 1)	-9	-13.5	-18	-25	Volts
PLATE CURRENT	7	9	14	22	Milliamperes
SCREEN CURRENT	1.2	1.5	2.4	3.8	Milliamperes
PLATE RESISTANCE	0.14	0.13	0.115	0.10	Megohm
TRANSCONDUCTANCE	875	925	1050	1200	Micromhos

LOAD RESISTANCE	15000	13500	11600	10000	Ohms
CATHODE-BIAS RESISTOR	1100	1100	1100	970	Ohms
POWER OUTPUT	0.27*	0.55†	1.0*	2.5*	Watts

* 8% total harmonic distortion.
 † 10% total harmonic distortion.

INSTALLATION and APPLICATION

The base of the 38 fits the standard five-contact socket which may be installed to hold the tube in any position. Physical characteristics of the 38 are shown in Fig. 2-16, OUTLINES SECTION. For heater operation and cathode connection, refer to Type 6A8.

For the power amplifier stage of radio receivers, the 38 is recommended either singly or in push-pull combination. Transformer- or impedance-coupling devices are preferable. If, however, resistance coupling is used, the d-c resistance in the grid circuit should be limited to 1.0 megohm with plate voltages up to 250 volts, provided the heater voltage does not rise more than 10% above the rated value under any condition of operation.

SUPER-CONTROL R-F AMPLIFIER
 PENTODE

The 39/44 is a heater-cathode tube of the remote cut-off type suitable for use primarily as a radio-frequency amplifier and intermediate-frequency amplifier in receivers designed for its characteristics. The 39/44 is effective in reducing cross-modulation and modulation-distortion over the usual range of signal voltages without the use of antenna potentiometers or auxiliary volume-control switches.

39/44

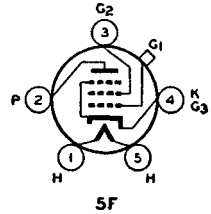

CHARACTERISTICS

HEATER VOLTAGE (A.C. or D.C.)		6.3	Volts
HEATER CURRENT		0.3	Ampere
PLATE VOLTAGE	90	180	250 max. Volts
SCREEN VOLTAGE (Grid No. 2)	90	90	90 max. Volts
GRID VOLTAGE (Grid No. 1)	-3 min.	-3 min.	-3 min. Volts
PLATE CURRENT	5.6	5.8	5.8 Milliampers
SCREEN CURRENT	1.6	1.4	1.4 Milliampers
PLATE RESISTANCE	0.375	0.75	1.0 Megohm
TRANSCONDUCTANCE	960	1000	1050 Micromhos
TRANSCONDUCTANCE (At -42.5 volts bias) ..	2	2	2 Micromhos
GRID-PLATE CAPACITANCE (With shield-can) ..			0.007 max. μ f
INPUT CAPACITANCE			3.5 μ f
OUTPUT CAPACITANCE			10 μ f

INSTALLATION and APPLICATION

The base of the 39/44 fits the standard five-contact socket which may be installed to hold the tube in any position. Physical characteristics of the 39/44 are shown in Fig. 2-16, OUTLINES SECTION. For heater operation and cathode connection, refer to Type 6A8. Complete shielding of all stages is necessary if maximum gain per stage is to be obtained.

The screen voltage for the 39/44 may be obtained from a section of the B-battery, from a fixed or variable tap on a voltage divider across the supply voltage, or from a portion of the supply. Care should be taken to keep the impedance between the screen and cathode as low as possible. When the 39/44 is cathode-biased, a resistor in series with the high-voltage supply may be used for obtaining the screen voltage. This is possible because of the stable screen-current characteristic of the 39/44 pentode. The resistor method of obtaining the screen voltage is limited to circuits where the screen-voltage supply does not exceed 180 volts as a maximum. The value of this resistance should be such that under the conditions of minimum grid bias and maximum plate current the screen voltage will not exceed 90 volts. A resistance of approximately 80000 ohms will be suitable.

As a radio-frequency and intermediate-frequency amplifier, the 39/44 should be operated as shown under CHARACTERISTICS. Volume control of receivers designed for the 39/44 may be accomplished by variation of the negative grid bias of this tube. In order to obtain adequate volume control, an available grid-bias voltage of approximately 45 volts will be required. The exact value will depend upon the circuit design and operating conditions. This voltage may be obtained from a potentiometer, a bleeder circuit, a variable resistor in the cathode circuit, or from a separate source.

VOLTAGE AMPLIFIER TRIODE

40

The 40 is a high-mu triode of the storage-battery type for use in resistance-coupled or impedance-coupled amplifier or detector circuits. Characteristics with maximum effective plate volts of 180 and grid-bias volts of -3 are: plate current, 0.2 milliamper; plate resistance, 150000 ohms; amplification factor, 30; transconductance, 200 micromhos. Filament volts, 5; amperes, 0.25. The effective

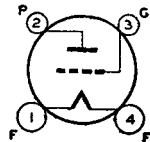

voltage at plate is plate-supply voltage minus voltage drop in load of 0.25 megohm caused by plate current. For physical characteristics of the 40, see Fig. 2-25, OUTLINES SECTION. The 40 is a discontinued type; it is retained for reference only.

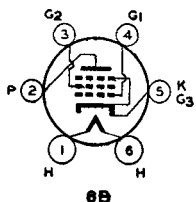

POWER AMPLIFIER PENTODE

The 41 is a power-amplifier pentode of the heater-cathode type for use in the output stage of radio receivers with 6.3-volt heater supply. Electrical characteristics, installation (except that the base requires the use of the standard six-contact socket), and application are the same as for the 6K6-G. Physical characteristics of the 41 are shown in Fig. 2-19, OUTLINES SECTION.

41

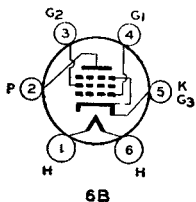

POWER AMPLIFIER PENTODE

The 42 is a power-amplifier pentode of the heater-cathode type for use in the output stage of a-c operated receivers. Electrical characteristics, installation (except that the base requires the use of the standard six-contact socket), and application are the same as for the 6F6. Physical characteristics of the 42 are shown in Fig. 2-25, OUTLINES SECTION.

42

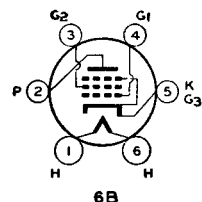

POWER AMPLIFIER PENTODE

The 43 is a power-amplifier pentode of the heater-cathode type for use in the output stage of radio receivers of the "d-c power line" type and the "universal" type. Electrical characteristics, installation (except that the base requires the use of the standard six-contact socket), and application are the same as for the 25A6. Physical characteristics of the 43 are shown in Fig. 2-25, OUTLINES SECTION.

43

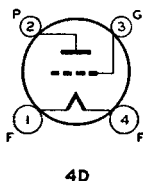

POWER AMPLIFIER TRIODE

The 45 is a power-amplifier triode of the filament type capable of supplying large undistorted power output from a-c operated receivers.

45

CHARACTERISTICS

FILAMENT VOLTAGE (A.C. or D.C.)	2.5	Volts
FILAMENT CURRENT	1.5	Amperes

As Single-Tube Class A₁ Amplifier

FILAMENT VOLTAGE (A.C.)	2.5	Volts
PLATE VOLTAGE	180 250 275 <i>max.</i>	Volts
GRID VOLTAGE*	-31.5 -50 -56	Volts
CATHODE-BIAS RESISTOR	1020 1470 1550	Ohms
PLATE CURRENT	31 34 36	Milliamperes
PLATE RESISTANCE	1650 1610 1700	Ohms
AMPLIFICATION FACTOR	3.5 3.5 3.5	
TRANSCONDUCTANCE	2125 2175 2050	Micromhos
LOAD RESISTANCE	2700 3900 4600	Ohms
UNDISTORTED POWER OUTPUT	0.825 1.6 2.0	Watts

* Grid volts measured from mid-point of a-c operated filament. Cathode bias is advisable in all cases; required if grid d-c resistance (max. value of 1.0 megohm) is used in grid circuit.

As Push-Pull Class AB₂ Amplifier

Values are for two tubes

	<i>Fixed Bias</i>	<i>Cathode Bias</i>	
FILAMENT VOLTAGE (A.C.)	2.5	2.5	Volts
PLATE VOLTAGE (Maximum)	275	275	Volts

GRID VOLTAGE	-68	—	Volts
CATHODE-BIAS RESISTOR	—	775	Ohms
AVERAGE DRIVING POWER (Grid-to-Grid)	656	460	Milliwatts
ZERO-SIGNAL PLATE CURRENT	28	36	Milliamperes
MAX.-SIGNAL PLATE CURRENT	138	90	Milliamperes
EFFECTIVE LOAD RESISTANCE (Plate-to-plate)	3200	5060	Ohms
TOTAL HARMONIC DISTORTION	5	5	Per cent
MAX.-SIGNAL POWER OUTPUT	18	12	Watts

INSTALLATION and APPLICATION

The base of the 45 fits the standard four-contact socket which should be installed to hold the tube preferably in a vertical position. Horizontal operation is permissible if pins 1 and 4 are in a vertical plane. Physical characteristics of the 45 are shown in Fig. 2-25, OUTLINES SECTION.

In a push-pull Class AB₁ stage, the 45 is operated under conditions such that a small amount of grid current flows during the most positive swing of the input signal and the second harmonic distortion is cancelled by virtue of the push-pull circuit. A driver stage, consisting of one 56 operated at 250 volts on the plate, will drive two 45's in push-pull (fixed bias or cathode bias) to the stated output values. A step-down interstage transformer of suitable design is required.

HALF-WAVE HIGH-VACUUM RECTIFIER

45Z5-GT

The 45Z5-GT is a half-wave rectifier of the heater-cathode type for use in a-c/d-c receivers. The heater is provided with a tap for operation of a panel lamp.

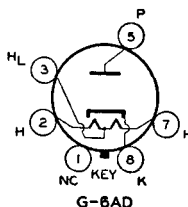

CHARACTERISTICS

HEATER VOLTAGE (A.C. or D.C.):			
Entire Heater (Pins No. 2 & No. 7)	45		Volts
Panel-Lamp Section (Pins No. 2 & No. 3) with 0.15 ampere flowing between pins No. 2 & No. 7		7.5	Volts
HEATER CURRENT	0.15		Ampere

As Half-Wave Rectifier

A-C PLATE VOLTAGE (RMS)			
Without Series Resistor	125	max.	Volts
With Series Resistor*	250	max.	Volts
PEAK PLATE CURRENT:			
Without Panel Lamp and No Plate-to-Heater Tap Connection	600	max.	Milliamperes
D-C OUTPUT CURRENT:			
Without Panel Lamp and No Plate-to-Heater Tap Connection	100	max.	Milliamperes
With Panel Lamp ^o and Plate-to-Heater Tap Connection†	60	max.	Milliamperes

* An a-c input voltage greater than 125 volts requires the use of a 100-ohm (min.) resistor in series with the plate lead.
^o Type 40, for example.

‡ See circuit under Type 35Z5-GT.

INSTALLATION and APPLICATION

The base of the 45Z5-GT fits the standard octal socket which may be installed to hold the tube in any position. Physical characteristics of the 45Z5-GT are shown in Fig. 2-8, OUTLINES SECTION. Except for the difference in heater voltage, the 45Z5-GT is similar in operation and application to the 35Z5-GT.

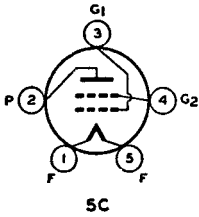

DUAL-GRID POWER AMPLIFIER

The 46 is a double-grid power-amplifier tube recommended especially for service in class B amplifier circuits of suitable design. The base of the 46 fits the standard five-contact socket which may be installed to hold the tube preferably in a vertical position. Horizontal operation is permissible if pins 1 and 5 are in a vertical plane. Physical characteristics of the 46 are shown in Fig. 2-27 OUTLINES SECTION.

46

CHARACTERISTICS

FILAMENT VOLTAGE (A.C. or D.C.)	2.5	Volts
FILAMENT CURRENT	1.75	Amperes

As Push-Pull Class B Amplifier

(Grids No. 1 and No. 2 connected together at socket)

PLATE VOLTAGE	400 max.	Volts
PEAK PLATE CURRENT	200 max.	Milliamperes
AVERAGE PLATE DISSIPATION	10 max.	Watts

TYPICAL OPERATION:

Values are for two tubes

Plate Voltage	300	400	Volts
Grid Voltage	0	0	Volts
Peak A-F Grid-to-Grid Voltage	113	116	Volts
Zero-Signal Plate Current	8	12	Milliamperes
Effective Load Resistance (Plate-to-plate)	5200	5800	Ohms
Max.-Signal Power Output (Approx.)	16*	20†	Watts

* With average power input of 950 milliwatts applied between grids.

† With average power input of 650 milliwatts applied between grids.

As Class A₁ Amplifier

(Grid No. 2 connected to plate at socket)

PLATE VOLTAGE	250 max.	Volts
GRID VOLTAGE	-33	Volts
PLATE CURRENT	22	Milliamperes
PLATE RESISTANCE	2380	Ohms
AMPLIFICATION FACTOR	5.6	
TRANSCONDUCTANCE	2350	Micromhos
LOAD RESISTANCE (For max. undistorted power)††	6400	Ohms
UNDISTORTED POWER OUTPUT	1.25	Watts

†† Approximately twice this value is recommended for load of this tube as driver for class B stage.

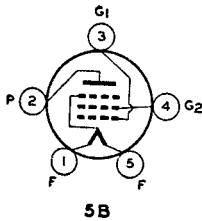

POWER AMPLIFIER PENTODE

The 47 is a power-amplifier pentode for use in the audio output stage of a-c receivers. In comparison with three-electrode class A power amplifiers of the same plate dissipation, the 47 is capable of greater output with the additional feature of higher amplification. The base of the 47 fits the standard five-contact socket which should be installed to hold the tube preferably in a vertical position. Horizontal operation is permissible if pins 1 and 5 are in a vertical plane. Filament operation is the same as for Type 46. Physical characteristics of the 47 are shown in Fig. 2-27 OUTLINES SECTION.

47

CHARACTERISTICS

FILAMENT VOLTAGE (A.C. or D.C.)	2.5	Volts
FILAMENT CURRENT	1.75	Amperes
PLATE VOLTAGE	250 max.	Volts
SCREEN VOLTAGE	250 max.	Volts
GRID VOLTAGE*	-16.5	Volts
CATHODE-BIAS RESISTOR	450	Ohms
PLATE CURRENT	31	Milliamperes
SCREEN CURRENT	6	Milliamperes
PLATE RESISTANCE	60000	Ohms
TRANSCONDUCTANCE	2500	Micromhos
LOAD RESISTANCE	7000	Ohms
POWER OUTPUT (6% total harmonic distortion)	2.7	Watts

* If filament is operated on d.c., the grid bias should be -15.3 volts. The d-c resistance in the grid circuit should not exceed 0.5 megohm with cathode bias, or 50000 ohms with fixed bias.

POWER AMPLIFIER TETRODE

48

The 48 is a power amplifier tetrode which has pentode characteristics when operated at the recommended screen and plate voltages. It is for use in the audio output stage of receivers designed to operate from d-c power lines. The base of the 48 fits the standard six-contact socket which should be mounted to hold the tube preferably in a vertical position with base down. Horizontal operation is permissible if pins 2 and 5 are in a vertical plane. Physical characteristics of the 48

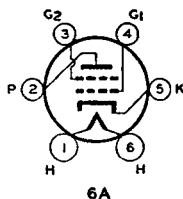

are shown in Fig. 2-27, OUTLINES SECTION. The heater is designed to operate on direct current. In a series-heater circuit employing one or more 48's, the heater(s) of the 48('s) should be placed on the positive side of the line. The cathode circuit in d-c receivers is tied in either directly or through biasing resistors to the negative side of the heater circuit. The potential difference thus introduced between heater and cathode of the 48 should not exceed 90 volts, as measured between the negative heater terminal and the cathode.

CHARACTERISTICS

HEATER VOLTAGE (D.C.)	30	Volts
HEATER CURRENT	0.4	Ampere
PLATE VOLTAGE	96	125 max. Volts
SCREEN VOLTAGE (Grid No. 2)	96	100 max. Volts
GRID VOLTAGE (Grid No. 1)†	-19	-20 Volts
CATHODE-BIAS RESISTOR	310	310 Ohms
PLATE CURRENT	52	56 Milliampere
SCREEN CURRENT	9	9.5 Milliampere
PLATE RESISTANCE	Subject to considerable variation	
TRANSCONDUCTANCE	3800	3900 Micromhos
LOAD RESISTANCE	1500	1500 Ohms
POWER OUTPUT*	2	2.5 Watts

† The d-c resistance in the grid circuit should not exceed 10000 ohms.
* 9% total harmonic distortion.

DUAL-GRID POWER AMPLIFIER

49

The 49 is a double-grid power amplifier designed for use in battery-operated receivers employing 2-volt tubes. In such service, it may be used either as a class B output tube or, by a change of socket conditions, as a class A driver tube. The base of the 49 fits the standard five-contact socket which should be installed to hold the tube in a vertical position. Physical characteristics of the 49 are shown in Fig. 2-25, OUTLINES SECTION. For filament operation, refer to Type 1C7-G.

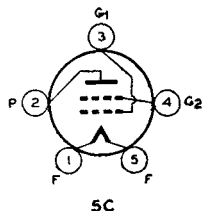

★ **CHARACTERISTICS**

FILAMENT VOLTAGE (D.C.)	2.0	Volts
FILAMENT CURRENT	0.12	Ampere

As Class B Power Amplifier

Grids No. 1 and No. 2 connected together at socket

PLATE VOLTAGE	180 max.	Volts
PEAK PLATE CURRENT PER TUBE	50 max.	Milliamperes

TYPICAL OPERATION:

Values are for two tubes

Plate Voltage	135	180	Volts
Grid Voltage	0	0	Volts
Peak A-F Grid-to-Grid Voltage	70	70	Volts
Zero-Signal Plate Current	2.5	4	Milliamperes
Effective Load Resistance (Plate-to-plate)	8000	12000	Ohms
Power Output (Approx.)	2.3	3.5	Watts

As Driver — Class A₁ Amplifier

Grid No. 2 connected to plate at socket

PLATE VOLTAGE	135 max.	Volts
TYPICAL OPERATION:		
Plate Voltage	135	Volts
Grid Voltage	-20	Volts
Plate Current	6.0	Milliamperes
Plate Resistance	4175	Ohms
Amplification Factor	4.7	
Transconductance	1125	Micromhos
Load Resistance	11000*	Ohms
Power Output (Approx.)	0.170	Watt

* Approximately twice this value is recommended for load of this tube as driver for class B stage.

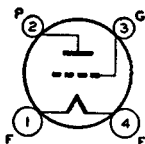

4D

POWER AMPLIFIER TRIODE

50

The 50 is a power-amplifier triode designed for use primarily in the output stage of an audio-frequency amplifier employing transformer coupling. It is capable of delivering large undistorted power. The base of the 50 fits the standard four-contact socket which should be installed to hold the tube in a vertical position with the base down. Physical characteristics of the 50 are shown in Fig.

2-29, OUTLINES SECTION. Any conventional type of input coupling may be used provided the resistance added to the grid circuit by this device does not exceed 10000 ohms.

CHARACTERISTICS

FILAMENT VOLTAGE (A.C. or D.C.)	7.5	Volts
FILAMENT CURRENT	1.25	Amperes
PLATE VOLTAGE	450	Volts
GRID VOLTAGE*	-63	Volts
CATHODE RESISTOR	-70	Volts
PLATE CURRENT	1400	1530
CATHODE RESISTOR	45	Ohms
PLATE RESISTANCE	1900	1800
AMPLIFICATION FACTOR	3.8	1800
TRANSCONDUCTANCE	2000	3.8
LOAD RESISTANCE	4100	2100
UNDISTORTED POWER OUTPUT	2.4	3670
		4.6

* Measured from mid-point of a-c operated filament.

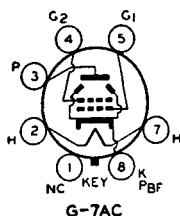

BEAM POWER AMPLIFIER

50L6-GT

The 50L6-GT is a power amplifier of the heater-cathode type designed for use in the output stage of a-c/d-c receivers. Except for its heater rating of 50 volts and 0.15 ampere, the 50L6-GT has electrical and physical characteristics identical with those of the 25L6-GT. For heater operation

and cathode connection, refer to Type 25A6, but take into consideration the difference in heater rating.

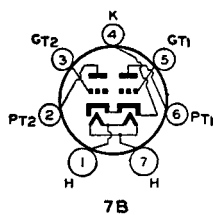

CLASS B TWIN AMPLIFIER

53

The 53 is a heater-cathode type of tube combining in one bulb two high- μ triodes designed for class B operation. It is intended primarily for use in the output stage of a-c operated receivers. Except for the heater rating of 2.5 volts and 2.0 amperes, the electrical characteristics of the 53 are identical with those of the 6N7. Additional data is given in the RESISTANCE-COUPLED

AMPLIFIER CHART. The base of the 53 fits the seven-contact (0.855 inch pin-circle diameter) socket which may be installed to hold the tube in any position. Physical characteristics of the 53 are shown in Fig. 2-25, OUTLINES SECTION. For heater operation and cathode connection, refer to Type 2A5.

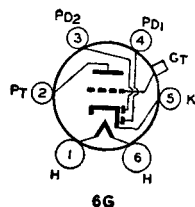

DUPLEX-DIODE TRIODE

55

The 55 is an a-c heater type of tube consisting of two diodes and a triode in a single bulb. It is recommended for service as a combined detector, amplifier, and automatic-volume-control tube. Except for its heater rating of 2.5 volts and 1.0 ampere, the 55 has electrical and physical characteristics identical with those of Type 85. For heater operation and cathode connection refer to Type 2A5.

DETECTOR AMPLIFIER TRIODE

56

The 56 is a three-electrode tube of the heater-cathode type for use as a detector, amplifier, or oscillator in co-operated receivers. Except for its heater rating and capacitances which are given below, the 56 has electrical and physical characteristics identical with those of the Type 76. Operating conditions for the 56 as a resistance-coupled amplifier are given in the RESISTANCE-COUPLED AMPLIFIER CHART.

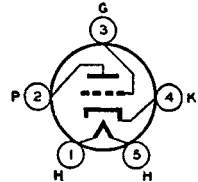

HEATER VOLTAGE (A.C. or D.C.)
HEATER CURRENT
GRID-PLATE CAPACITANCE (Approx.)
GRID-CATHODE CAPACITANCE (Approx.)
PLATE-CATHODE CAPACITANCE (Approx.)

2.5	Volts
1.0	Ampere
3.2	μmf
3.2	μmf
2.2	μmf

TRIPLE-GRID DETECTOR AMPLIFIER

57

The 57 is a triple-grid tube recommended especially for service as a biased detector in a-c receivers. The 57 is constructed with an internal shield connected to the cathode within the tube. Except for its heater rating and capacitances which are given below, the 57 has electrical characteristics identical with those of Type 6J7. Physical characteristics of the 57 are shown in Fig. 2-20, OUTLINES

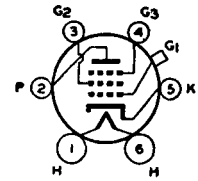

SECTION. The base of the 57 fits the standard six-contact socket which may be installed to hold the tube in any position. For heater operation and cathode connection, refer to Type 2A5. For screen voltage and shielding requirements, see Type 6C6.

HEATER VOLTAGE (A.C. or D.C.)
HEATER CURRENT
PENTODE CONNECTION:	
Grid-Plate Capacitance (With shield-can)
Input Capacitance
Output Capacitance
TRIODE CONNECTION:	
Grid-Plate Capacitance
Grid-Cathode Capacitance
Plate-Cathode Capacitance

2.5	Volts
1.0	Ampere
0.007 max.	μmf
5	μmf
6.5	μmf
2	μmf
3	μmf
10.5	μmf

TRIPLE-GRID SUPER-CONTROL AMPLIFIER

58

The 58 is a triple-grid super-control amplifier tube recommended especially for service in the radio-frequency and intermediate-frequency stages of a-c receivers. The 58 is constructed with an internal shield connected to the cathode within the tube. Except for its heater rating and capacitances which are given below, the 58 has electrical characteristics identical with those of Type 6U7-G.

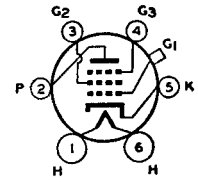

Physical characteristics of the 58 are shown in Fig. 2-20, OUTLINES SECTION. The base of the 58 fits the standard six-contact socket which may be installed to hold the tube in any position. For heater operation and cathode connection, refer to Type 2A5. For control grid bias variation, screen voltage, and suppressor connection, refer to Type 6SK7. Shielding requirements are similar to those for Type 6C6.

HEATER VOLTAGE (A.C. or D.C.)
HEATER CURRENT
GRID-PLATE CAPACITANCE (With shield-can)
INPUT CAPACITANCE
OUTPUT CAPACITANCE

2.5	Volts
1.0	Ampere
0.007 max.	μmf
4.7	μmf
6.3	μmf

TRIPLE-GRID POWER AMPLIFIER

59

The 59 is a triple-grid power-amplifier tube of the heater-cathode type for use in the output stage of a-c operated receivers. The triple-grid construction of this tube, with external connections for each grid, makes possible its application as (1) a class A power amplifier triode, (2) a class A power-output pentode, and (3) a class B power output triode.

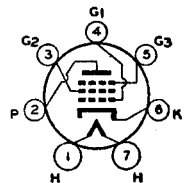

7A

CHARACTERISTICS

HEATER VOLTAGE (A.C. or D.C.)	2.5	Volts
HEATER CURRENT	2.0	Ampere

As Class A₁ Power Amplifier

	<i>Triode Connection*</i>	<i>Pentode Connection**</i>	
PLATE VOLTAGE	250 max.	250 max.	Volts
SCREEN VOLTAGE (Grid No. 2)	—	250 max.	Volts
GRID VOLTAGE (Grid No. 1)	-28	-18	Volts
CATHODE RESISTOR	1080	410	Ohms
PLATE CURRENT	26	35	Milliamperes
SCREEN CURRENT	—	9	Milliamperes
AMPLIFICATION FACTOR	6	—	
PLATE RESISTANCE	2300	40000	Ohms
TRANSCONDUCTANCE	2600	2500	Micromhos
LOAD RESISTANCE	5000*	6000	Ohms
POWER OUTPUT	1.25	3†	Watts

As Class B Power Amplifier — Triode Connection

Grids No. 1 and No. 2 tied together; grid No. 3 tied to plate

PLATE VOLTAGE	400 max.	Volts
PEAK PLATE CURRENT	200 max.	Milliamperes
AVERAGE PLATE DISSIPATION	10 max.	Watts
AVERAGE GRID DISSIPATION (Grids No. 1 and No. 2)	1.5 max.	Watts

TYPICAL OPERATION:

Values are for two tubes

Plate Voltage	300	400	Volts
Grid Voltage	0	0	Volts
Zero-Signal Plate Current	20	26	Milliamperes
Effective Load Resistance (Plate-to-plate)	4600	6000	Ohms
Power Output (Approx.)	15	20	Watts

* Grids No. 2 and No. 3 tied to plate; grid No. 1 is control grid.

** Grid No. 3 tied to cathode; grid No. 1 is control grid; grid No. 2 is screen.

* Optimum for maximum undistorted power output of 1.25 watts. Approximately twice this value is recommended for load of this type as driver for class B stage.

† 7% total harmonic distortion.

INSTALLATION and APPLICATION

The base of the 59 fits the seven-contact (0.855-inch pin-circle diameter) socket which may be installed to hold the tube in any position. Physical characteristics of the 59 are shown in Fig. 2-27, OUTLINES SECTION. For heater operation and cathode connection, refer to Type 2A5. The d-c resistance in the grid circuit of the 59 operating as a class A amplifier (either with triode or pentode connection) should not exceed 0.5 megohm if cathode bias is used. With fixed bias, the resistance should not exceed 10000 ohms.

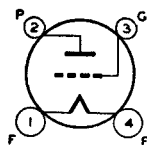

4D

POWER AMPLIFIER TRIODE

The 71-A is a power-amplifier tube of low-output impedance for use in the output stage of audio-frequency amplifiers. The base of the 71-A fits the standard four-contact socket which should be installed to hold the tube in a vertical position. Physical characteristics of the 71-A are shown in Fig. 2-25, OUTLINES SECTION. The coated filament of the 71-A may be operated from a storage battery or from the a-c line through a step-down transformer.

71-A

CHARACTERISTICS

FILAMENT VOLTAGE (A.C. or D.C.)	5.0	Volts
FILAMENT CURRENT	0.25	Ampere
PLATE VOLTAGE	90 135	180 max.
GRID VOLTAGE*	-16.5 -27	-40.5
CATHODE RESISTOR	1600	1700
PLATE CURRENT	10	17.3
PLATE RESISTANCE	2170	1820
AMPLIFICATION FACTOR	3	3
TRANSCONDUCTANCE	1400	1650
LOAD RESISTANCE	3000	3000
UNDISTORTED POWER OUTPUT	0.125 0.4	0.79

* For operation on a-c filament supply, increase grid-bias voltage 2.5 volts. The d-c resistance in the grid circuit should not exceed 0.5 megohm.

DUPLEX-DIODE HIGH-MU TRIODE

75

The 75 is a heater-cathode type of tube consisting of two diodes and a high-mu triode in a single bulb. It is for use as a combined detector, amplifier, and automatic-volume-control tube. For diode-detector considerations, refer to RADIO TUBE APPLICATIONS section. Except for capacitances which are given below, the electrical characteristics of the 75 are the same as those of

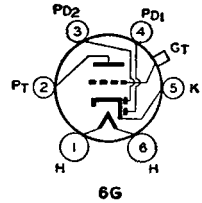

Type 6SQ7. Physical characteristics of the 75 are shown in Fig. 2-16, OUTLINES SECTION. The base of the 75 fits the standard six-contact socket which may be installed to hold the tube in any position. Operating conditions for the triode unit as a resistance-coupled amplifier are given in the RESISTANCE-COUPLED AMPLIFIER CHART.

<i>Triode:</i>	GRID-PLATE CAPACITANCE (Approx.)	1.7	μf
	GRID-CATHODE CAPACITANCE (Approx.)	1.7	μf
	PLATE-CATHODE CAPACITANCE (Approx.)	3.8	μf

DETECTOR AMPLIFIER TRIODE

76

The 76 is a three-electrode tube of the heater-cathode type for use as detector, amplifier, or oscillator. Except for capacitances which are shown below, the electrical characteristics of the 76 are the same as those of Type 6P5-G. The base of the 76 fits the standard five-contact socket which may be installed to hold the tube in any position. Physical characteristics of the 76 are shown in Fig. 2-19, OUTLINES SECTION.

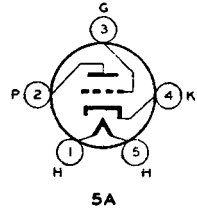

	GRID-PLATE CAPACITANCE (Approx.)	2.8	μf
	GRID-CATHODE CAPACITANCE (Approx.)	3.5	μf
	PLATE-CATHODE CAPACITANCE (Approx.)	2.5	μf

TRIPLE-GRID DETECTOR AMPLIFIER

77

The 77 is a triple-grid tube recommended for service as a biased detector in radio receivers designed for its characteristics. In such service, this tube is capable of delivering a large audio-frequency output voltage with relatively small input voltage. Other applications of the 77 include its use as a low-signal-input screen-grid amplifier tube and as an automatic-volume-control tube. The

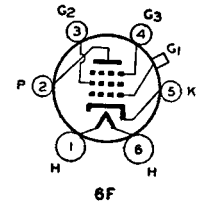

base of the 77 fits the standard six-contact socket which may be installed to hold the tube in any position. Physical characteristics of the 77 are shown in Fig. 2-16, OUTLINES SECTION. For heater operation and cathode connection, refer to Type 6A8. Shielding and screen voltage requirements are similar to those for Type 6C6. For detector operation, see Type 6J7.

★ CHARACTERISTICS

HEATER VOLTAGE (A.C. or D.C.)	6.3	Volts
HEATER CURRENT	0.3	Ampere
GRID-PLATE CAPACITANCE (With shield-can)	0.007 max.	μf
INPUT CAPACITANCE	4.7	μf
OUTPUT CAPACITANCE	11	μf

As Class A₁ Amplifier

PLATE VOLTAGE	300 max.	Volts
SCREEN VOLTAGE (Grid No. 2)	100 max.	Volts
SCREEN SUPPLY VOLTAGE	300 max.	Volts
GRID VOLTAGE (Grid No. 1)	0 min.	Volts
PLATE DISSIPATION	0.75 max.	Watt
SCREEN DISSIPATION	0.1 max.	Watt
TYPICAL OPERATION:		
Plate Voltage	100	250 Volts
Screen Voltage	60	100 Volts
Grid Voltage†	-1.5	-3 Volts
Suppressor	Connected to cathode at socket	
Plate Current	1.7	2.3 Milliamperes
Screen Current	0.4	0.5 Milliamperes
Plate Resistance (Approx.)	3.6	† Megohm
Transconductance	1100	1200 Micromho
Grid Voltage (Approx.) for cathode-current cut-off	-5.5	-7.5 Volts

‡ The d-c resistance in the grid circuit should not exceed 1.0 megohm.

† Greater than 1.0 megohm.

AVERAGE PLATE CHARACTERISTICS

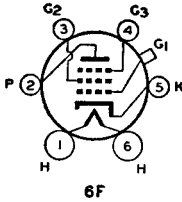
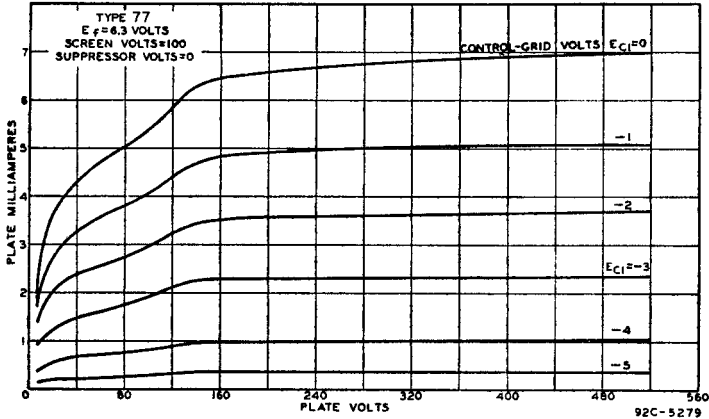

TRIPLE-GRID SUPER-CONTROL AMPLIFIER

The 78 is a triple-grid super-control amplifier tube recommended for service in the radio-frequency and intermediate-frequency amplifier stages of radio receivers. The internal shield around the plate of the 78 is connected to the cathode within the tube. Except for capacitances which are shown below, the electrical characteristics of the 78 are the same as those for the 6K7. The base

78

of the 78 fits the standard six-contact socket which may be installed to hold the tube in any position. Physical characteristics of the 78 are shown in Fig. 2-16, OUTLINES SECTION. Heater operation and cathode connection are the same as for the Type 6A8. Control-grid bias variation, screen-voltage supply, and suppressor connection follow the methods given under Type 6SK7. Shielding requirements are similar to those of Type 6C6.

GRID-PLATE CAPACITANCE*	0.007 max. μ f
INPUT CAPACITANCE*	4.5 μ f
OUTPUT CAPACITANCE*	11 μ f

* With close-fitting shield connected to cathode.

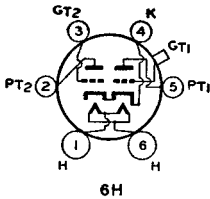

CLASS B TWIN AMPLIFIER

The 79 is a heater-cathode type of tube combining in one bulb two high- μ triodes designed for class B operation. It is intended for use in the audio-output stage of radio receivers with 6.3-volt heater supply. The triode units have separate external terminals for all electrodes except the cathode and heater so that circuits employing the 79 are similar to those of class B amplifiers utilizing

79

individual tubes in the output stage. The base of the 79 fits the standard six-contact socket which may be installed to operate the tube in any position. Physical characteristics of the 79 are shown in Fig. 2-16, OUTLINES SECTION. For heater operation and cathode connection, refer to Type 6A8, but give consideration to the greater heater current of the 79.

CHARACTERISTICS

HEATER VOLTAGE (A.C. or D.C.)	6.3	Volts
HEATER CURRENT	0.6	Ampere

As Class B Power Amplifier

PLATE VOLTAGE	250 max.	Volts
PEAK PLATE CURRENT PER PLATE	90 max.	Milliamperes
AVERAGE PLATE DISSIPATION	11.5 max.	Watts

TYPICAL OPERATION:

	<i>Values are for the two units</i>	
Plate Voltage	180	250
Grid Voltage	0	0
		Volts

Zero-Signal Plate Current	7.6	10.6	Milliamperes
Effective Load Resistance (Plate-to-plate).....	7000	14000	Ohms
Power Output (Approx.)*	5.5	8	Watts

* With average power input of 380 milliwatts applied between grids.

FULL-WAVE HIGH-VACUUM RECTIFIER

80

The 80 is a full-wave rectifying tube of the filament type for use in d-c power-supply devices which operate from the a-c supply line. Its maximum ratings and typical operating conditions are the same as those for Type 5Y3-G. The base of the 80 fits the standard four-pin socket which should be installed to hold the tube preferably in a vertical position. Horizontal operation is permissible if pins 1 and 4 are in a horizontal plane. Physical characteristics of the 80 are shown in Fig. 2-25, OUTLINES SECTION. Filament operation and ventilation are the same as for Type 5T4.

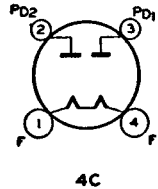

HALF-WAVE HIGH-VACUUM RECTIFIER

81

The 81 is a half-wave rectifier of the filament type for use in d-c power-supply devices operating from the a-c supply line. Full-wave rectification may be accomplished by the use of two 81's. The base of the 81 fits the standard four-contact socket which should be mounted to hold the tube preferably in a vertical position. Horizontal operation is permissible if pins 1 and 4 are in a vertical plane. Physical characteristics of the 81 are shown in Fig. 2-29, OUTLINES SECTION.

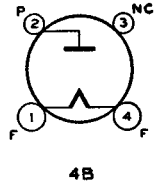

vertical plane. Physical characteristics of the 81 are shown in Fig. 2-29, OUTLINES SECTION

CHARACTERISTICS

FILAMENT VOLTAGE (A.C.)	7.5	Volts
FILAMENT CURRENT	1.25	Amperes

As Half-Wave Rectifier

PEAK INVERSE VOLTAGE	2000 max.	Volts
PEAK PLATE CURRENT	500 max.	Milliamperes
TYPICAL OPERATION WITH CONDENSER-INPUT FILTER:		
A-C Plate Voltage (RMS)	700 max.	Volts
D-C Output Current	85 max.	Milliamperes

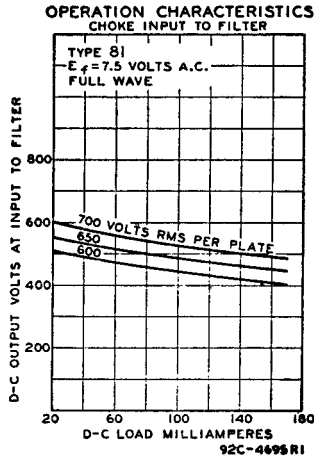
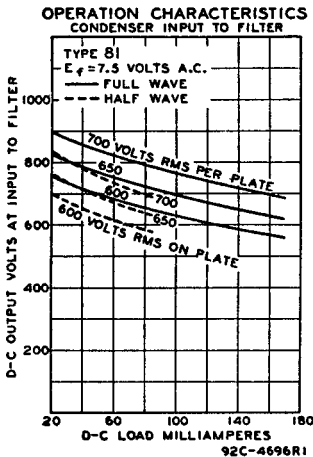

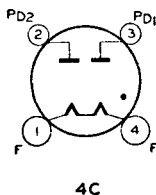

FULL-WAVE MERCURY-VAPOR RECTIFIERS

82

83

The 82 and 83 are full-wave mercury-vapor rectifiers of the hot-cathode type for use in suitable rectifying devices designed to supply d-c power of uniform voltage to receivers in which the direct-current requirements are subject to considerable variation. The excellent voltage-regulation characteristic of these tubes is due to the low and practically constant tube voltage drop for any current drain up to the full emission of the filament.

★ CHARACTERISTICS

	Type 82	Type 83	
FILAMENT VOLTAGE (A.C.)	2.5	5	Volts
FILAMENT CURRENT	3	3	Amperes

As Full-Wave Rectifiers

PEAK INVERSE VOLTAGE	1550 max.	1550 max.	Volts
PEAK PLATE CURRENT PER PLATE	345 max.	675 max.	Milliamperes
CONDENSED-MERCURY TEMPERATURE RANGE	24 -60	20 -60	°C
TYPICAL OPERATION WITH CONDENSER-INPUT FILTER:			
A-C Plate Voltage per Plate (RMS)	450 max.	450 max.	Volts
Total Effective Plate-Supply Impedance per Plate†	50 min.	50 min.	Ohms
D-C Output Current	115 max.	225 max.	Milliamperes
TYPICAL OPERATION WITH CHOKE-INPUT FILTER:			
A-C Plate Voltage per Plate (RMS)	550 max.	550 max.	Volts
Input-Choke Inductance	6 min.	3 min.	Henries
D-C Output Current	115 max.	225 max.	Milliamperes
TUBE VOLTAGE DROP (Approx.)	15	15	Volts

† When a filter-input condenser larger than 40 μ f is used, it may be necessary to use more plate-supply impedance than the minimum value shown to limit the peak plate current to the rated value.

INSTALLATION and APPLICATION

The base of either the 82 or 83 fits the standard four-contact socket which should be mounted to hold the tube in a vertical position with the base down. Only a socket making very good filament contact and capable of carrying 3 amperes continuously should be used. Poor contact at the socket will cause overheating at the pins, lowered filament voltage, and high internal drop with consequent injury to the tube. Adequate natural ventilation should be provided for the 82 and 83, especially if shielding is used. Physical characteristics of the 82 and 83 are shown in Figs. 2-25 and 2-27, respectively, in the OUTLINES SECTION.

The 82 and 83 have very low internal resistance. Therefore, current delivered by either type depends on the resistance of the load and the regulation of the power transformer. Sufficient protective resistance or reactance must always be used with these types to limit the current to the recommended maximum values. If these values are exceeded, the tube voltage drop will increase rapidly and the filaments may be damaged permanently.

The coated filament is designed to operate from the a-c line through a step-down transformer. The voltage at the filament terminals should be the rated value under operating conditions with a line voltage of 117 volts. The high current taken by the filament and the possibility of damage caused by applying plate voltage before the filament is sufficiently heated make it imperative that all connections in the filament circuit be of low resistance and of adequate current-carrying capacity.

The plate supply is obtained from a center-tapped high-voltage winding. The resistance of the transformer windings should, of course, be low if full advantage of the excellent regulation capabilities of these mercury-vapor rectifiers is to be obtained. Since the drop through the 82 and 83 is practically constant, any reduction in rectified voltage when the load is increased is due to the drop in the transformer and/or the filter windings. The return-lead from the plates, i.e., the positive bus of the filter and load circuit, should be connected to the center-tap of the filament winding.

Full plate load should not be applied to the 82 or 83 until their filaments have reached normal operating temperature. Under normal operating conditions, the filaments heat quickly when the set is "turned on" and are ready to supply full-load current before the tubes in the receiver require it.

Shielding of this tube, particularly in sensitive receivers, may be necessary to eliminate objectionable noise. Refer to Filters in the RADIO TUBE APPLICATIONS section. A fuse having a rating approximately 50% in excess of normal load requirements should be inserted in the primary of the power transformer to prevent damage in case of excessive current which may flow under abnormal conditions. *It is recommended that the entire equipment be disconnected from the a-c power supply whenever the 82 and 83 are removed from or installed in their sockets.*

As half-wave rectifiers, the 82 and 83 may be operated with plates connected in parallel. Two 82's or 83's so connected in a full-wave circuit can supply twice the output current of a single tube. Both plates within the same tube should be connected to the same terminal of the plate transformer. To equalize the current distribution between plates, a resistor of not less than 50 ohms should be connected in series with each plate.

FULL-WAVE HIGH-VACUUM RECTIFIER

83-v

The 83-v is a full-wave rectifier tube of the heater-cathode type intended for use in suitable rectifying devices designed to supply d-c power to receivers having large direct-current

requirements. The excellent voltage-regulation characteristic of the 83-v is due to the close spacing of the cathode and plate. Maximum ratings and typical operating conditions for the 83-v are the same as those for Type 5V4-G. The base of the 83-v fits the standard four-contact socket which may be mounted to hold the tube in any position. Physical characteristics of the 83-v are shown in Fig. 2-25, OUTLINES SECTION. Heater operation and ventilation are the same as for the 5V4-G.

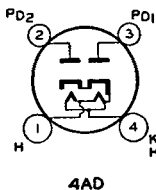

FULL-WAVE HIGH-VACUUM RECTIFIER

84/6Z4

The 84/6Z4 is a full-wave rectifier of the heater-cathode type intended for supplying rectified power to automobile-radio equipment designed for its characteristics.

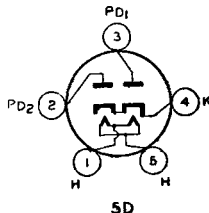

★ CHARACTERISTICS

HEATER VOLTAGE (A.C. or D.C.) 6.3
 HEATER CURRENT 0.5

Volts
 Ampere

As Full-Wave Rectifier

PEAK INVERSE VOLTAGE 1250 max. Volts
 PEAK PLATE CURRENT PER PLATE 180 max. Milliampere
 D-C HEATER-CATHODE POTENTIAL 450 max. Volts
 TYPICAL OPERATION WITH CONDENSER-INPUT FILTER:
 A-C Plate Voltage per Plate (RMS) 325 max. Volts
 Total Effective Plate-Supply Impedance per Plate† 125 min. Ohms
 D-C Output Current 60 max. Milliampere
 TYPICAL OPERATION WITH CHOKE-INPUT FILTER:
 A-C Plate Voltage per Plate (RMS) 450 max. Volts
 Input-Choke Inductance 10 min. Henries
 D-C Output Current 60 max. Milliampere

Volts
 Milliampere
 Volts
 Ohms
 Milliampere
 Volts
 Henries
 Milliampere

† When a filter-input condenser larger than 40 μf is used, it may be necessary to use more plate-supply impedance than the minimum value shown to limit the peak plate current to the rated value.

OPERATION CHARACTERISTICS

INSTALLATION and APPLICATION

The base of the 84/6Z4 fits the standard five-contact socket which may be mounted to hold the tube in any position. Physical characteristics of the 84/6Z4 are shown in Fig. 2-19, OUTLINES SECTION. The heater is designed so that the normal voltage variation of 6-volt automobile batteries during charge and discharge will not materially affect the performance or serviceability of this tube. Under no condition of operation should the normal operating heater voltage fluctuate to exceed a maximum of 7.5 volts. Adequate ventilation should be provided for cooling the tube by the use of chassis enclosures designed to radiate heat efficiently. Filters are discussed in the RADIO TUBE APPLICATIONS section.

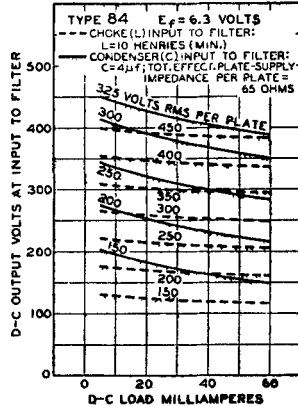

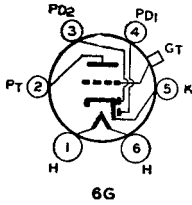

DUPLEX-DIODE TRIODE

85

The 85 is a heater-cathode type of tube consisting of two diodes and a triode in a single bulb for use as a combined detector, amplifier and automatic-volume-control tube. For diode-detector considerations and for a discussion of automatic volume control, refer to RADIO TUBE APPLICATIONS section.

CHARACTERISTICS

HEATER VOLTAGE (A.C. or D.C.)	6.3	Volts
HEATER CURRENT	0.3	Ampere
Triode: GRID-PLATE CAPACITANCE (Approx.)	1.5	μf
GRID-CATHODE CAPACITANCE (Approx.)	1.5	μf
PLATE-CATHODE CAPACITANCE (Approx.)	4.3	μf

Triode Unit — As Class A₁ Amplifier

PLATE VOLTAGE	135	180	250 max.	Volts
GRID VOLTAGE	-10.5	-13.5	-20	Volts
AMPLIFICATION FACTOR	8.3	8.3	8.3	
PLATE RESISTANCE	11000	8500	7500	Ohms
TRANSCONDUCTANCE	750	975	1100	Micromhos
PLATE CURRENT	3.7	6.0	8.0	Milliamperes
LOAD RESISTANCE	25000	20000	20000	Ohms
POWER OUTPUT	0.075	0.16	0.35	Watt

Diode Units

The two diode plates are placed around a cathode, the sleeve of which is common to the triode unit. Each diode plate has its own base pin. Operation curves for the diode units are given under Type 6B7.

INSTALLATION and APPLICATION

The base of the 85 fits the standard six-contact socket which may be installed to hold the tube in any position. Physical characteristics of the 85 are shown in Fig. 2-16, OUTLINES SECTION. For heater operation and cathode connection, refer to Type 6A8. Complete shielding of detector circuits employing the 85 is generally necessary to prevent r-f or i-f coupling between the diode circuits and the circuits of other stages. Diode biasing of the triode unit may be employed only when at least 20000 ohms resistance is used in the plate circuit. Conditions for the use of the triode unit as a resistance-coupled amplifier are given in the RESISTANCE-COUPLED AMPLIFIER CHART.

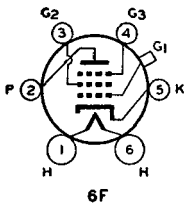

TRIPLE-GRID POWER AMPLIFIER

89

The 89 is a triple-grid power amplifier tube of the heater-cathode type recommended for use in receivers with 6.3-volt heater supply. The triple-grid construction of this tube, with external connections for each grid, makes possible its application as (1) a class A power-amplifier triode, (2) a class A power-output pentode, and (3) a class B power-output triode.

CHARACTERISTICS

HEATER VOLTAGE (A.C. or D.C.)	6.3	Volts
HEATER CURRENT	0.4	Ampere

Class A₁ Power Amplifier — Triode Connection

Grids No. 2 and No. 3 tied to plate

PLATE VOLTAGE	160	180	250 max.	Volts
GRID VOLTAGE (Grid No. 1)	-20	-22.5	-31	Volts
CATHODE RESISTOR	1180	1125	970	Ohms
PLATE CURRENT	17	20	32	Milliamperes
AMPLIFICATION FACTOR	4.7	4.7	4.7	
PLATE RESISTANCE	3300	3000	2600	Ohms
TRANSCONDUCTANCE	1425	1550	1800	Micromhos
LOAD RESISTANCE*	7000	6500	5500	Ohms
UNDISTORTED POWER OUTPUT	0.3	0.4	0.9	Watt

* Optimum for maximum undistorted power output. Approximately twice the value for any given set of conditions is recommended for load of this tube when used as driver for class B stage.

Class A₁ Power Amplifier — Pentode Connection

Grid No. 3 tied to cathode

PLATE VOLTAGE	100	135	180	250 max.	Volts
SCREEN VOLTAGE (Grid No. 2)	100	135	180	250 max.	Volts

GRID VOLTAGE (Grid No. 1)	-10	-13.5	-18	-25	Volts
CATHODE RESISTOR	900	830	785	670	Ohms
PLATE CURRENT	9.5	14	20	32	Milliamperes
SCREEN CURRENT	1.6	2.2	3.0	5.5	Milliamperes
PLATE RESISTANCE	104000	92500	80000	70000	Ohms
TRANSCONDUCTANCE	1200	1350	1550	1800	Micromhos
LOAD RESISTANCE	10700	9200	8000	6750	Ohms
POWER OUTPUT*	0.33	0.75	1.5	3.4	Watts

*9% total harmonic distortion.

Class B Power Amplifier — Triode Connection

Grids No. 1 and No. 2 tied together; grid No. 3 tied to plate

PLATE VOLTAGE	250 max.	Volts
PEAK PLATE CURRENT (Per tube)	90 max.	Milliampere
AVERAGE GRID DISSIPATION (Grids No. 1 and No. 2)	0.35 max.	Watt

<i>Values are for two tubes</i>		
Plate Voltage	180	Volts
Grid Voltage	0	Volts
Peak-A-F Grid-to-Grid Voltage	68	Volts
Zero-Signal Plate Current	6	Milliamperes
Effective Load Resistance (Plate-to-plate)	9400	Ohms
Total Harmonic Distortion	8	Per cent
Power Output (Approx.)	3.5	Watts

INSTALLATION AND APPLICATION

The base of the 89 fits the standard six-contact socket which may be installed to hold the tube in any position. Physical characteristics of the 89 are shown in Fig. 2-16, OUTLINES SECTION. Sufficient ventilation should be provided to circulate air freely around the tube to prevent overheating. For heater operation and cathode connection, refer to Type 6K6-G.

The d-c resistance in the grid circuit of the 89 operating as a class A amplifier (either with triode or pentode connection) may be as high as 1.0 megohm provided the heater voltage does not rise more than 10% above rated value under any condition of operation.

DETECTOR AMPLIFIER TRIODES

V99

X99

The V99 and X99 are general-purpose triodes designed for dry-cell operation, and used chiefly for renewal in receivers designed for them. The two types have different bases. Operating conditions as amplifiers: max. plate volts of 90, grid bias of -4.5 volts; as grid-leak detectors, plate volts of 45, grid leak of 1 to 5 megohms, grid condenser of 0.00025 μ f, and grid return to (+) filament; as biased detectors, max. plate volts of 90, bias of -10.5 volts. Filament volts, 3.0-3.3; amperes, 0.060-0.063. For dimensions of the V99 and X99 see Figs. 2-10 and 2-12, respectively in the OUTLINES SECTION. The V99 and X99 are discontinued types; they are retained for reference only.

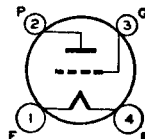

4D
Type X99

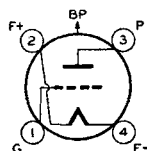

4E
Type V99

DETECTOR AMPLIFIER TRIODE

112-A

The 112-A is a general-purpose triode designed for storage battery operation and used principally for renewal purposes. Operating conditions as amplifier: max. plate volts of 180, grid bias of -13.5 volts, load resistance of 10650 ohms, power output of 0.285 watt; as biased detector, plate volts of 180, bias of -21 approx. volts. Filament volts, 5; amperes, 0.25. For dimensions, see Fig. 2-25, OUTLINES SECTION. The 112-A is a discontinued type; it is retained for reference only.

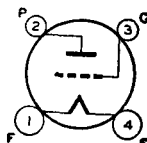

4D

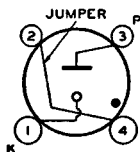

4S

VOLTAGE REGULATOR

874

The 874 is a voltage-regulator tube designed to maintain constant d-c output from rectifier devices for varying values of d-c load current. This type is used principally for renewal purposes. The base of the 874 fits the standard four-contact socket. Pins No. 2 and No. 4 are connected together within the base; the connection is used as a link in the primary circuit of the power transformer

to prevent the application of voltage when the 874 is removed from its socket. Physical characteristics of the 874 are shown in Fig. 2-28, OUTLINES SECTION. Sufficient resistance must always be used in series with the 874 to limit the current to 50 milliamperes when no load current is being drawn from the rectifier.

CHARACTERISTICS

STARTING SUPPLY VOLTAGE (D.C.)	125 min. Volts
OPERATING VOLTAGE (D.C.)	90 Volts
OPERATING CURRENT (D.C.)	10 to 50 Milliamperes
CONTINUOUS CURRENT (D.C.)	50 max. Milliamperes

CURRENT REGULATORS

876

The 876 and 886 are, within their ranges of operation, constant-current regulating devices. These two types are used principally for renewal purposes. The bases of these types fit the standard mogul screw socket which may be installed to hold the tubes in any position. These tubes operate at a high bulb temperature and must be surrounded by a metal ventilating stack. The 876 and 886 are discontinued types; they are retained for reference only.

886

CHARACTERISTICS

VOLTAGE RANGE	Type 876 40 to 60	Type 886 40 to 60	Volts
OPERATING CURRENT	1.7	2.05	Ampere
AMBIENT TEMPERATURE	150	150	°F
MAXIMUM OVERALL LENGTH	8	8	Inches
MAXIMUM DIAMETER	2- $\frac{1}{4}$	2- $\frac{1}{4}$	Inches
BASE	Mogul Screw	Mogul Screw	

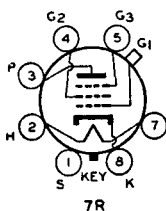

7R

TELEVISION AMPLIFIER PENTODE

1851

The 1851 is a pentode of the heater-cathode type for use in television receivers. Except for capacitances which are shown below, the electrical characteristics of the 1851 are identical

with those of the 6AC7/1852. Physical characteristics of the 1851 are shown in Fig. 1-8, OUTLINES SECTION.

GRID-PLATE CAPACITANCE*	0.02 max. μmf
INPUT CAPACITANCE*	11.5 μmf
OUTPUT CAPACITANCE*	5.2 μmf

* With shell connected to cathode.

LAVA · MICA · TIN · SODIUM CARBONATE · M O N E L · SILVER OXIDE
 SODIUM ALUMINUM FLUORIDE · RESIN (SYNTHETIC) · ETHYL ALCOHOL

MATERIALS USED IN RCA RADIO TUBES

LEAD ACETATE · MALACHITE GREEN · GLYCERINE · ZINC CHLORIDE · IRON
 MARBLE DUST · WOOD FIBER · STRONTIUM NITRATE · LEAD OXIDE · ZINC OXIDE
 MISCH METAL · NIGROSINE · PORCELAIN · PETROLEUM JELLY · ZINC

BARIUM CARBONATE
 ARSENIC TRIOXIDE
 STRONTIUM CARBONATE

CALCIUM CARBONATE
 AMMONIUM CHLORIDE
 POTASSIUM CARBONATE

ISOLANTITE
 MOLYBDENUM

BAKELITE
 PHOSPHORUS

ALUMINA
 BORAX
 BARIUM
 COPPER
 CARBON
 CHROMIUM
 CALCIUM
 CAESIUM
 COBALT
 SODIUM
 NITRATE
 MERCURY
 CALCIUM
 OXIDE
 BARIUM
 NITRATE

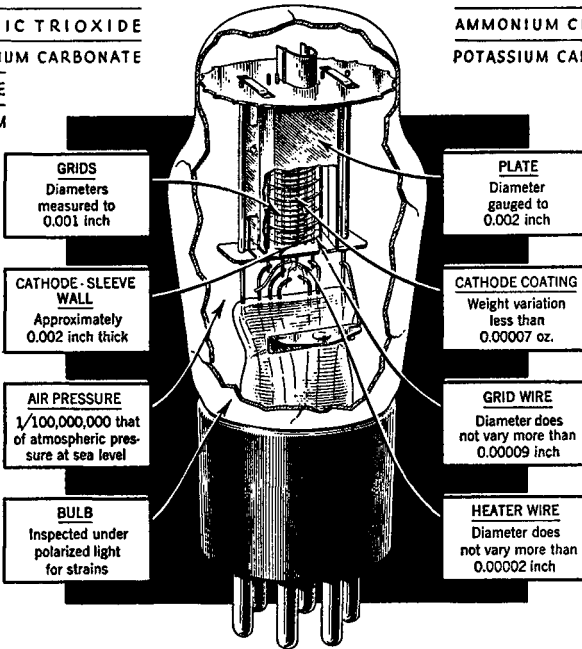

GRIDS
 Diameters measured to 0.001 inch

PLATE
 Diameter gauged to 0.002 inch

CATHODE-SLEEVE WALL
 Approximately 0.002 inch thick

CATHODE COATING
 Weight variation less than 0.00007 oz.

AIR PRESSURE
 1/100,000,000 that of atmospheric pressure at sea level

GRID WIRE
 Diameter does not vary more than 0.00009 inch

BULB
 Inspected under polarized light for strains

HEATER WIRE
 Diameter does not vary more than 0.00002 inch

SILICON
 SHELLAC
 TUNGSTEN
 TITANIUM
 SILICA
 GLASS
 MAGNESIA
 PLATINUM
 STRONTIUM
 MAGNESIUM
 ROSIN
 NICKEL
 COBALT
 OXIDE
 THORIUM
 NITRATE

Gases Used in Manufacture

NEON — HYDROGEN — CARBON DIOXIDE — ILLUMINATING GAS
 HELIUM — ARGON — NATURAL GAS — NITROGEN — OXYGEN

Elements Entering into the Manufacture

ARGON — ALUMINUM — BORON — BARIUM — CAESIUM — CALCIUM — COPPER — CARBON — CHROMIUM — CHLORINE
 COBALT — HYDROGEN — HELIUM — IRIIDIUM — IRON — LEAD — MAGNESIUM — MERCURY — MOLYBDENUM
 NICKEL — NEON — NITROGEN — OXYGEN — POTASSIUM — PHOSPHORUS — PLATINUM — SODIUM — SILVER
 SILICON — STRONTIUM — TUNGSTEN — THORIUM — TANTALUM — TITANIUM — TIN — ZINC — RARE EARTHS

Radio Tube Testing

The radio tube user — service man, experimenter, and non-technical radio listener — is interested in knowing the condition of his tubes, since they govern the performance of the device in which they are used. In order to determine the condition of a tube, some method of test is necessary. Because the operating capabilities and design features of a tube are indicated and described by its electrical characteristics, a tube is tested by measuring its characteristics and comparing them with representative values established as standard for that type. Tubes which read abnormally high with respect to the standard for the type are subject to criticism just the same as tubes which are too low.

Certain practical limitations are placed on the accuracy with which a tube test can be correlated with actual tube performance. These limitations make it unnecessary for the service man and dealer to employ complex and costly testing equipment having laboratory accuracy. Because the accuracy of the tube-testing device need be no greater than the accuracy of the correlation between test results and receiver performance, and since certain fundamental characteristics are virtually fixed by the manufacturing technique of leading tube manufacturers, it is possible to employ a relatively simple test in order to determine the serviceability of a tube.

In view of these factors, dealers and service men will find it economically expedient to obtain adequate accuracy and simplicity of operation by employing a device which indicates the status of a single characteristic. Whether the tube is satisfactory or unsatisfactory is judged from the test result of this single characteristic. Consequently, it is very desirable that the characteristic selected for the test be one which is truly representative of the tube's overall condition.

SHORT CIRCUIT TEST

The fundamental circuit of a short-circuit tester is shown in Fig. 64. While this circuit is suitable for tetrodes and types having less than four electrodes, tubes of more electrodes may be tested by adding more indicator lamps to the circuit. Voltages are applied between the various electrodes with lamps in series with the electrode leads. Any two shorted electrodes complete a circuit and light one or more lamps. Since two electrodes may be just touching to give a high-resistance short, it is desirable that the indicating lamps operate on very low current. It is also desirable to maintain the filament or heater of the tube at its operating temperature during the short-circuit test, because short-circuits in a tube may sometimes occur only when the electrodes are heated.

SELECTION OF A SUITABLE CHARACTERISTIC FOR TEST

Some characteristics of a tube are far more important in determining its operating worth than are others. The cost of building a device to measure any one of the more important characteristics may be considerably higher than that of a device which measures a less representative characteristic. Consequently, three methods of test will be discussed, ranging from relatively simple and inexpensive equipment to more elaborate, more accurate, and more costly devices.

An emission test is perhaps the simplest method of indicating a tube's condition. (Refer to DIODES, Page 5, for a discussion of electronic emission.) Since emission falls off as the tube wears out, low emission is indicative of the end of tube serviceability. However, the emission test is subject to limitations because it tests the tube under static conditions and does not take into account the actual operation of the tube. On the one hand, coated filaments, or cathodes, often develop active spots from which the emission is so great that the relatively small grid area adjacent to these spots cannot control the electron stream. Under these conditions, the total emission may indicate the tube to be normal although the tube is unsatisfactory. On the other hand, coated types of filaments are capable of such large emission that the tube will often operate satisfactorily after the emission has fallen far below the original value.

Fig. 65 shows the fundamental circuit diagram for an emission test. All of the electrodes of the tube, except the cathode, are connected to the plate. The filament, or heater, is operated at rated voltage; after the tube has reached constant temperature, a low positive voltage is applied to the plate and the electronic emission is read on the meter. Readings which are well below the average for a particular tube type indicate that the total number of available electrons has been so reduced that the tube is no longer able to function properly.

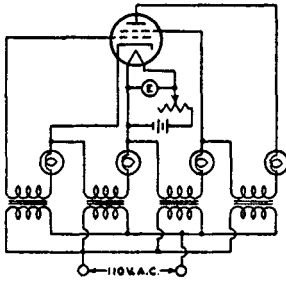

Fig. 64

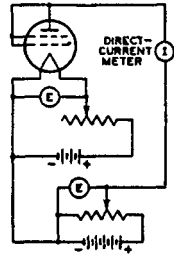

Fig. 65

A transconductance test takes into account a fundamental operating principle of the tube. (This will be seen from the definition of transconductance on page 11.) It follows that transconductance tests when properly made, permit better correlation between test results and actual performance than does a straight emission test.

There are two forms of transconductance test which can be utilized in a tube tester. In the first form (illustrated by Fig. 66 giving a fundamental circuit with a tetrode under test), appropriate operating voltages are applied to the electrodes of the tube. A plate current depending upon the electrode voltages, will then be indicated by the meter. If the bias on the grid is then shifted by the application of a different grid voltage, a new plate-current reading is obtained. The difference between the two plate-current readings is indicative of the transconductance of the tube. This method of transconductance testing is commonly called the "grid-shift" method, and depends on readings under static conditions. The fact that this form of test is made under static conditions imposes limitations not encountered in the second form of test made under dynamic conditions.

The dynamic transconductance test illustrated in Fig. 67 gives a fundamental circuit with a tetrode under test. This method is superior to the static transconductance test in that a-c voltage is applied to the grid. Thus, the tube is tested

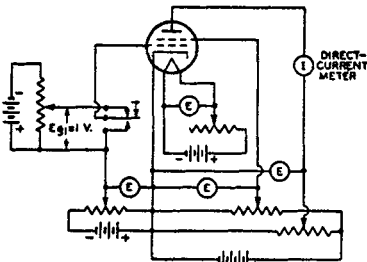

Fig. 66

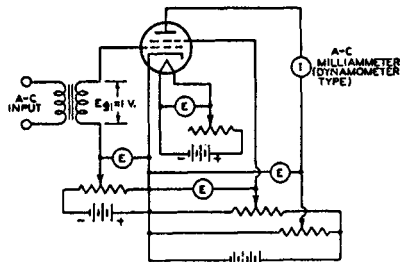

Fig. 67

under conditions which approximate actual operating conditions. The alternating component of the plate current is read by means of an a-c ammeter of the dynamometer type. The transconductance of the tube is equal to the a-c plate current divided by the input-signal voltage. If a one-volt RMS signal is applied to the

grid, the plate-current-meter reading in milliamperes multiplied by one thousand is the value of transconductance in micromhos.

The power output test probably gives the best correlation between test results and actual operating performance of a tube. In the case of voltage amplifiers, the power output is indicative of the amplification and output voltages obtainable from the tube. In the case of power output tubes, the performance of the tube is closely checked. Consequently, although more complicated to set up the power output test will give closer correlation with actual performance than any other single test.

Fig. 68 shows the fundamental circuit of a power output test for class A operation of tubes. The diagram illustrates the method for a pentode. The a-c output voltage developed across the plate-load impedance (L) is indicated by the current meter. The current meter is isolated as far as the d-c plate current is concerned by the condenser (C). The power output can be calculated from the current reading and known load resistance. In this way, it is possible to determine the operating condition of the tube quite accurately.

Fig. 69 shows the fundamental circuit of a power output test for class B operation of tubes. With a-c voltage applied to the grid of the tube, the current in the plate circuit is read on a d-c milliammeter. The power output of the tube is approximately equal to:

$$\text{Power output (watts)} = \frac{(\text{d-c current in amperes})^2 \times \text{load resistance in ohms}}{0.405}$$

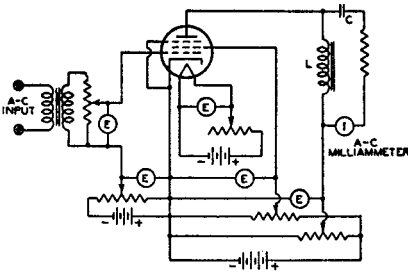

Fig. 68

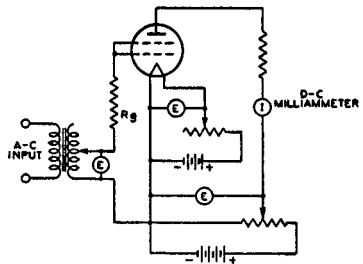

Fig. 69

ESSENTIAL TUBE TESTER REQUIREMENTS

1. It is desirable that the tester provide for a short-circuit test to be made prior to measurement of the tube's characteristics.
2. It is important that some means of controlling the voltages applied to the electrodes of the tube be provided. If the tester is a c operated, a line-voltage control will permit of supplying proper electrode voltages.
3. It is essential that the rated voltage applied to the filament or heater be maintained accurately.
4. It is suggested that the characteristics test follow one of the methods described. The method selected and the quality of the parts used in the test will depend upon the requirements of the user.

TUBE TESTER LIMITATIONS

A tube testing device can only indicate the difference between a given tube's characteristics and those which are standard for that particular type. Since the operating conditions imposed upon a tube of a given type may vary within wide limits, it is impossible for a tube testing device to evaluate tubes in terms of performance capabilities for all applications. The tube tester, therefore, cannot be looked upon as a final authority in determining whether or not a tube is always satisfactory. Actual operating test in the equipment in which the tube is to be used will give the best possible indication of a tube's worth. Nevertheless, the tube tester is a most helpful device for indicating the serviceability of a tube.

RESISTANCE-COUPLED AMPLIFIER CHART

- C = Blocking Condenser (μ f)
- Cc = Cathode By-Pass Condenser (μ f)
- Cd = Screen By-Pass Condenser (μ f)
- Ebb = Plate-Supply Voltage (Volts)
- Eo = Voltage Output (Peak Volts)
- Rc = Cathode Resistor (Ohms)
- Rd = Screen Resistor (Megohms)
- Rg = Grid Resistor (Megohms)
- RL = Plate Resistor (Megohms)
- V.G. = Voltage Gain

2A6, 2B7: See 6SQ7 and 6B8, respectively.
 6A6†, 6B6-G, 6B7: See 6N7, 6SQ7, and 6B8, respectively.
 6B8, 6B8-G, 12C8, 6B7, 2B7:

Ebb ¹	90			180					300		
	0.1	0.25	0.5	0.1	0.25			0.5	0.1	0.25	0.5
Rg ²	0.25	0.5	1	0.25	0.25	0.5	1	1	0.25	0.5	1
Rd	0.5	1.1	2.8	0.5	1.18	1.2	1.5	2.8	0.55	1.2	2.9
Rc	2200	3500	6000	1200	1900	2100	2200	3500	1100	1600	2500
Cd	0.07	0.04	0.04	0.08	0.05	0.06	0.05	0.04	0.09	0.06	0.05
Cc	3	2.1	1.55	4.4	2.7	3.2	3	2	5	3.5	2.3
C	0.01	0.007	0.003	0.015	0.01	0.007	0.003	0.003	0.015	0.008	0.003
Eo ³	28	33	29	52	39	55	53	55	89	100	120
V.G. ⁴	33	55	85	41	55	69	83	115	47	79	150

6C5, 6C5-G, (6C6, 6J7, 6J7-G, 6J7-GT, 6W7-G, 12J7-GT, 57 as triodes):

Ebb ¹	90			180					300		
	0.05	0.1	0.25	0.05	0.1			0.25	0.05	0.1	0.25
Rg ²	0.1	0.25	0.5	0.1	0.1	0.25	0.5	0.5	0.1	0.25	0.5
Rc	3400	6400	14500	2700	3900	5300	6200	12300	2600	5300	12300
Cc	1.62	0.84	0.4	2.1	1.7	1.25	1.2	0.55	2.3	1.3	0.59
C	0.025	0.01	0.006	0.03	0.035	0.015	0.008	0.008	0.04	0.015	0.008
Eo ³	17	22	23	45	41	54	55	52	70	84	85
V.G. ⁴	9	11	12	11	12	12	13	13	11	13	14

6C6: As pentode, see 6J7; as triode, see 6C5.
 6C8-G (one triode unit)††:

Ebb ¹	90			180					300		
	0.1	0.25	0.5	0.1	0.25			0.5	0.1	0.25	0.5
Rg ²	0.25	0.5	1	0.25	0.25	0.5	1	1	0.25	0.5	1
Rc	3700	7870	15000	3080	5170	6560	7550	12500	2840	6100	11500
Cc	1.48	0.81	0.43	1.84	1.25	0.95	0.85	0.5	2.01	0.96	0.48
C	0.0115	0.0065	0.0035	0.012	0.012	0.007	0.0035	0.004	0.013	0.0065	0.004
Eo ³	17	19	20	40	35	45	50	44	73	80	83
V.G. ⁴	20	23	24	22	24	25	26	26	23	26	27

†† The cathodes of the two units have separate terminals
 For other notes, see page 203

R C A R E C E I V I N G T U B E M A N U A L

6F5, 6F5-G, 6F5-GT: See 6SF5.

6F8-G (one triode unit)††, 6J5, 6J5-G, 6J5-GT, 12J5-GT:

Ebb ¹	90			180				300			
	0.05	0.1	0.25	0.05	0.1			0.25	0.05	0.1	0.25
Rg ²	0.1	0.25	0.5	0.1	0.1	0.25	0.5	0.5	0.1	0.25	0.5
Rc	2070	3940	9760	1490	2330	2830	3230	7000	1270	2440	5770
Cc	2.66	1.29	0.55	2.86	2.19	1.35	1.15	0.62	2.96	1.42	0.64
C	0.029	0.012	0.007	0.032	0.038	0.012	0.006	0.007	0.034	0.0125	0.0075
Eo ³	14	17	18	30	26	34	38	36	51	56	57
V.G. ⁴	12	13	13	13	14	14	14	14	14	14	14

6J5, 6J5-G, 6J5-GT: See 6F8-G.

6J7, 6J7-G, 6J7-GT, 6W7-G, 12J7-GT, 6C6, 57: As triodes, see 6C5:

Ebb ¹	90			180			300				
	0.1	0.25	0.5	0.1	0.25		0.5	0.1	0.25	0.5	
Rg ²	0.25	0.5	1	0.25	0.25	0.5	1	1	0.25	0.5	1
Rd	0.44	1.18	2.6	0.5	1.1	1.18	1.4	2.9	0.5	1.18	2.9
Rc	1100	2600	5500	750	1200	1600	2000	3100	450	1200	2200
Cd	0.05	0.03	0.05	0.05	0.04	0.04	0.04	0.025	0.07	0.04	0.04
Cc	5.3	3.2	2	6.7	5.2	4.3	3.8	2.5	8.3	5.4	4.1
C	0.01	0.005	0.0025	0.01	0.008	0.005	0.0035	0.0025	0.01	0.005	0.003
Eo ³	22	32	29	52	41	60	60	56	81	104	97
V.G. ⁴	55	85	120	69	93	118	140	165	82	140	350

6L5-G:

Ebb ¹	90			180			300				
	0.05	0.1	0.25	0.05	0.1		0.25	0.05	0.1	0.25	
Rg ²	0.1	0.25	0.5	0.1	0.1	0.25	0.5	0.5	0.1	0.25	0.5
Rc	2500	4620	10300	2240	3180	4200	4790	9290	2160	4140	9100
Cc	1.86	1.08	0.49	2.2	1.46	1.1	1	0.54	2.18	1.1	0.46
C	0.03	0.015	0.0085	0.03	0.03	0.0145	0.009	0.009	0.032	0.014	0.0075
Eo ³	18	22	22	41	36	46	50	46	68	79	80
V.G. ⁴	10 ^c	12 ^c	12 ^c	11 ^c	12 ^c	12 ^c	12 ^c	12 ^c	12 ^c	13 ^c	13 ^c

6N7†, 6N7-G†, 6A6, 53:

Ebb ¹	90			180			300				
	0.1	0.25	0.5	0.1	0.25		0.5	0.1	0.25	0.5	
Rg ²	0.25	0.5	1	0.25	0.25	0.5	1	1	0.25	0.5	1
Rc*	2250	4950	8500	1700	2950	3800	4300	6600	1500	3400	6100
C	0.01	0.006	0.003	0.015	0.015	0.007	0.0035	0.0035	0.015	0.0055	0.003
Eo ³	19	20	23	46	40	50	57	54	83	87	94
V.G. ⁴	19	22	23	21	23	24	24	25	22	24	24

†† The cathodes of the two units have separate terminals.

For other notes, see page 203.

R C A R E C E I V I N G T U B E M A N U A L

6P5-G, 76, 56:

Ebb ¹	90			180					300		
	0.25	0.1	0.25	0.05	0.1			0.25	0.05	0.1	0.25
Rg ²	0.1	0.25	0.5	0.1	0.1	0.25	0.5	0.5	0.1	0.25	0.5
Rc	3200	6500	15100	3000	4500	6500	7600	14700	3100	6400	15200
Cc	1.6	0.82	0.36	1.9	1.45	0.97	0.8	0.45	2.2	1.2	0.5
C	0.03	0.015	0.007	0.035	0.035	0.015	0.008	0.007	0.045	0.02	0.009
Eo ³	21	23	24	48	45	55	57	59	80	95	96
V.G. ⁴	7.7	8.9	9.7	8.2	9.3	9.5	9.8	10	8.9	10	10

6Q7, 6Q7-G, 6Q7-GT, 12Q7-GT:

Ebb ¹	90			180					300		
	0.1	0.25	0.5	0.1	0.25			0.5	0.1	0.25	0.5
Rg ²	0.25	0.5	1	0.25	0.25	0.5	1	1	0.25	0.5	1
Rc	4200	7600	12300	1900	3400	4000	4500	7100	1500	3000	5500
Cc	1.7	1.2	0.6	2.5	1.6	1.3	1.05	0.76	3.6	1.66	0.9
C	0.01	0.006	0.003	0.01	0.01	0.005	0.003	0.003	0.015	0.007	0.004
Eo ³	8	11	13	26	25	31	37	36	52	52	60
V.G. ⁴	28 ^b	32	33	33	36	38	40	40	39	45	46

6R7, 6R7-G:

Ebb ¹	90			180					300		
	0.05	0.1	0.25	0.05	0.1			0.25	0.05	0.1	0.25
Rg ²	0.1	0.25	0.5	0.1	0.1	0.25	0.5	0.5	0.1	0.25	0.5
Rc	2600	4400	9800	2100	3000	4100	4600	8800	2000	3800	8400
Cc	1.7	0.9	0.42	1.9	1.3	0.9	0.8	0.4	2	1.1	0.5
C	0.03	0.01	0.007	0.03	0.03	0.01	0.006	0.006	0.03	0.015	0.007
Eo ³	18	19	18	40	35	43	46	40	62	68	62
V.G. ⁴	9	10	11	9	10	10	10	10	9	10	11

6S7, 6S7-G:

Ebb ¹	90			180					300		
	0.1	0.25	0.5	0.1	0.25			0.5	0.1	0.25	0.5
Rg ²	0.25	0.5	1	0.25	0.25	0.5	1	1	0.25	0.5	1
Rd	0.65	1.6	3.5	0.68	1.6	1.8	1.9	3.6	0.67	1.95	3.9
Rc	900	1520	2800	540	850	890	950	1520	440	650	1080
Cd	0.061	0.044	0.03	0.07	0.05	0.044	0.046	0.037	0.071	0.057	0.041
Cc	5	3.23	1.95	6.9	4.6	4.7	4.4	3	8	5.8	3.9
C	0.01	0.0055	0.0026	0.01	0.0071	0.005	0.0037	0.003	0.01	0.005	0.0029
Eo ³	21	18	15	43	33	40	44	38	75	66	66
V.G. ⁴	47 ^c	66 ^c	84 ^c	66 ^c	79 ^c	104 ^c	118 ^c	134 ^c	78 ^c	122 ^c	162 ^c

For notes, see page 203.

RCA RECEIVING TUBE MANUAL

6SC7, 12SC7:

Ebb ¹	90			180				300			
	0.1	0.25	0.5	0.1	0.25			0.5	0.1	0.25	0.5
R _L											
R _g ²	0.25	0.5	1	0.25	0.25	0.5	1	1	0.25	0.5	1
R _c ³	1960	3750	6300	1070	1850	2150	2400	3420	930	1680	2980
C	0.012	0.006	0.003	0.012	0.011	0.006	0.003	0.003	0.014	0.006	0.003
E _o ⁴	5.9	8.6	10	24	21	28	32	32	50	55	62
V.G. ⁴	23 ^b	30	33	29	35	39	41	43	34	42	48

6SF5, 12SF5, 6F5, 6F5-G, 6F5-GT, 12F5-GT:

Ebb ¹	90			180				300			
	0.1	0.25	0.5	0.1	0.25			0.5	0.1	0.25	0.5
R _L											
R _g ²	0.25	0.5	1	0.25	0.25	0.5	1	1	0.25	0.5	1
R _c	4800	8800	13500	2000	3500	4100	4500	6900	1600	3200	5400
C _c	2.1	1.18	0.67	3.3	2.3	1.8	1.7	0.9	3.7	2.1	1.2
C	0.01	0.005	0.003	0.015	0.01	0.006	0.004	0.003	0.01	0.007	0.004
E _o ⁴	5	7	10	23	21	26	32	33	43	54	62
V.G. ⁴	34 ^b	43 ^c	46	44	48	53	57	63	49	63	70

6SJ7, 12SJ7:

Ebb ¹	90			180				300			
	0.1	0.25	0.5	0.1	0.25			0.5	0.1	0.25	0.5
R _L											
R _g ²	0.25	0.5	1	0.25	0.25	0.5	1	1	0.25	0.5	1
R _d	0.29	0.92	1.7	0.31	0.83	0.94	0.94	2.2	0.37	1.10	2.2
R _c	880	1700	3800	800	1050	1060	1100	2180	530	860	1410
C _d	0.085	0.045	0.03	0.09	0.06	0.06	0.07	0.04	0.09	0.06	0.05
C _c	7.4	4.5	2.4	8	6.8	6.6	6.1	3.8	10.9	7.4	5.8
C	0.016	0.005	0.002	0.015	0.001	0.004	0.003	0.002	0.016	0.004	0.002
E _o ⁴	23	18	22	60	38	47	54	44	96	88	79
V.G. ⁴	68	93	119	82	109	131	161	192	98	167	238

6SQ7, 12SQ7, 2A6, 6B6-G, 75:

Ebb ¹	90			180				300			
	0.1	0.25	0.5	0.1	0.25			0.5	0.1	0.25	0.5
R _L											
R _g ²	0.25	0.5	1	0.25	0.25	0.5	1	1	0.25	0.5	1
R _c	6600	11000	16600	2900	4300	4800	5300	8000	2200	3900	6100
C _c	1.7	1.07	0.7	2.9	2.1	1.8	1.5	1.1	3.5	2	1.3
C	0.01	0.006	0.003	0.015	0.015	0.007	0.004	0.004	0.015	0.007	0.004
E _o ⁴	5	7	10	22	21	28	33	33	41	51	62
V.G. ⁴	29 ^b	40 ^c	44	36	43	50	53	57	39	53	60

For notes, see page 203.

R C A R E C E I V I N G T U B E M A N U A L

6T7-G:

Ebb ¹	90			180					300		
	Rl	0.1	0.25	0.5	0.1	0.25			0.5	0.1	0.25
Rg ²	0.25	0.5	1	0.25	0.25	0.5	1	1	0.25	0.5	1
Rc	4750	8300	14200	2830	4410	5220	5920	9440	2400	4580	8200
Cc	1.5	1	0.6	2.25	1.5	1.25	1.11	0.74	2.55	1.35	0.82
C	0.012	0.0075	0.0045	0.0135	0.012	0.008	0.005	0.0045	0.0135	0.0075	0.0055
Eo ³	7.8	10	12	29	27	34	39	39	58	69	77
V.G. ⁴	24 ^b	30 ^c	33 ^c	28 ^c	34 ^c	36 ^c	38 ^c	41 ^c	32 ^c	40 ^c	43 ^c

6W7-G: See 6J7 and 6C5.

6Z7-G†:

Ebb ¹	90			180					300		
	Rl	0.1	0.25	0.5	0.1	0.25			0.5	0.1	0.25
Rg ²	0.25	0.5	1	0.25	0.25	0.5	1	1	0.25	0.5	1
Rc*	1760	3390	6050	1100	1820	2110	2400	3890	950	1680	3110
Cc	2.02	1.1	0.61	2.6	1.71	1.38	1.1	0.703	2.63	1.46	0.72
C	0.0115	0.006	0.003	0.0115	0.012	0.007	0.0035	0.0035	0.012	0.006	0.0035
Eo ³	11	15	18	28	28	34	41	38	52	59	70
V.G. ⁴	25	30	33	31	35	38	39	40	34	40	44

12C8, 12F5-GT, 12J5-GT: See 6B8, 6SF5, and 6F8-G, respectively.

12J7-GT, 12Q7-GT: See 6J7 and 6C5, and 6Q7, respectively.

12SC7, 12SF5, 12SJ7, 12SQ7: See 6SC7, 6SF5, 6SJ7, and 6SQ7, respectively.

53, 55, 56: See 6N7, 85, and 6P5-G, respectively.

57, 75, 76: See 6J7 and 6C5, 6SQ7, and 6P5-G, respectively.

79†:

Ebb ¹	90			180					300		
	Rl	0.1	0.25	0.5	0.1	0.25			0.5	0.1	0.25
Rg ²	0.25	0.5	1	0.25	0.25	0.5	1	1	0.25	0.5	1
Rc*	2200	4250	6850	1250	2050	2450	2750	4100	1000	2050	3600
C	0.015	0.006	0.004	0.02	0.02	0.01	0.005	0.0035	0.01	0.0055	0.003
Eo ³	8.4	9.7	12	27	26	34	40	39	57	66	75
V.G. ⁴	29 ^c	33	38	31	37	41	42	44	34	42	46

85, 55:

Ebb ¹	90			180					300		
	Rl	0.05	0.1	0.25	0.05	0.1			0.25	0.05	0.1
Rg ²	0.1	0.25	0.5	0.1	0.1	0.25	0.5	0.5	0.1	0.25	0.5
Rc	4600	9000	20500	4100	6200	8700	10000	20000	4100	8300	19400
Cc	1.1	0.55	0.25	1.6	0.9	0.7	0.57	0.29	1.5	0.54	0.22
C	0.03	0.015	0.007	0.045	0.04	0.015	0.008	0.008	0.045	0.015	0.006
Eo ³	19	22	23	44	37	47	50	48	74	82	84
V.G. ⁴	4.9	5.4	5.5	5.2	5.3	5.5	5.5	5.7	5.5	5.7	5.7

For notes, see page 203.

Voltage at plate equals Plate-Supply Voltage minus voltage drop in R_L and R_c . For other supply voltages differing by as much as 50% from those listed, the values of resistors, condensers, and gain are approximately correct. The value of voltage output, however, for any of these other supply voltages equals the listed voltage output multiplied by the new plate-supply voltage divided by the plate-supply voltage corresponding to the listed voltage output.

For following stage (see Circuit Diagrams).

³ Voltage across R_g at grid-current point.

Voltage Gain at 5 volts (RMS) output unless index letter indicates otherwise.

^b At 3 volts (RMS) output.

^c At 4 volts (RMS) output.

* Values are for phase-inverter service: See NOTES under RESISTANCE-COUPLED PHASE-INVERTER diagram.

† The cathodes of the two units have a common terminal.

In the discussions which follow, f_1 is the frequency at which the high-frequency response begins to fall off. f_2 is the frequency at which the low-frequency response drops below a satisfactory value, as discussed below. Decoupling filters are not necessary for two stages or less. The highest permissible value of R_g should always be used. A variation of 10% in values of resistors and condensers has only slight effect on performance.

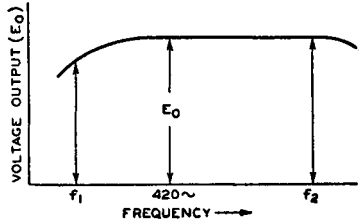

RESISTANCE-COUPLED TRIODE AMPLIFIER

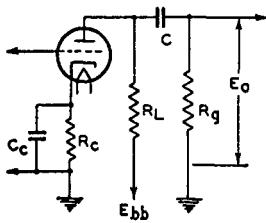

Condensers C and C_c have been chosen to give output voltages equal to 0.8 E_o for f_1 of 100 cycles. For any other value of f_1 , multiply values of C and C_c by $100/f_1$. In the case of condenser C_c , the values shown in the table are for an amplifier with d-c heater excitation; when a.c. is used, depending on the character of the associated circuit, the gain, and the value of f_1 , it may be necessary to increase the value of C_c to minimize hum disturbances. It may also be desirable to have a d-c potential difference of approximately 10 volts between heater and cathode.

The voltage output at f_1 of n like stages equals $(0.8 E_o)^n$. For an amplifier of typical construction, the value of f_1 is well above the audio-frequency range for any value of R_L .

RESISTANCE-COUPLED PENTODE AMPLIFIER

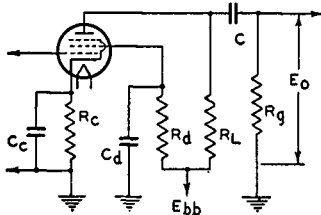

Condensers C , C_c , and C_d have been chosen to give output voltages equal to 0.7 E_o for f_1 of 100 cycles. For any other value of f_1 multiply values of C , C_c , and C_d by $100/f_1$. In the case of condenser C_c , the values shown in the table are for an amplifier with d-c heater excitation; when a.c. is used, depending on the character of the associated circuits, the gain, and the value of f_1 , it may be necessary to increase the value of C_c to minimize hum disturbances. It may also be desirable to have a d-c potential difference of approximately 10 volts between heater and cathode. The voltage output at f_1 for n like stages equals $(0.7 E_o)^n$. For an amplifier of typical construction, approximate values of f_1 for different values of R_L are: 0.1 meg., 20000 cps; 0.25 meg., 10000 cps; 0.5 meg., 5000 cps.

RESISTANCE-COUPLED PHASE INVERTER

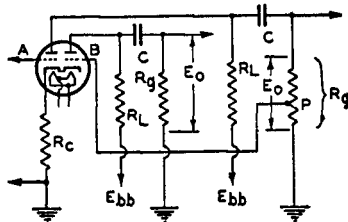

Information given for triode amplifiers, in general, applies also to this case. Condensers C have been chosen to give output voltages equal to 0.9 E_o for f_1 of 100 cycles. For other values, multiply values of C by $100/f_1$.

The signal input is supplied to grid of triode unit A. Grid of triode unit B obtains its signal from a tap (P) on the grid resistor (R_g) in the output circuit of unit A. The tap is chosen so as to make the voltage output of the unit B equal to that of unit A. Its location is determined by the voltage gain values given in the chart. For example, if V.G. is 20 (from the chart), P is chosen so as to supply 1/20 of the voltage across R_g to the grid of unit B.

For phase-inverter service, the cathode resistor may be left unby-passed unless a by-pass condenser is necessary to minimize hum; omission of the by-pass condenser assists in balancing the output voltages. The value of R_c is specified on the basis that both units are operating simultaneously at the same values of plate load and plate voltage.

Circuit Section

The circuit diagrams given on the following pages have been carefully chosen, not necessarily to illustrate commercial practice, but rather to show many different uses of radio tubes. All of the circuits are conservatively designed to give reliable and satisfactory performance. Although relatively few circuits are given, it is often practical to use a portion of one circuit in combination with portions of other circuits to obtain a design meeting the desired requirements. Tuned-circuit constants are omitted from the receiver diagrams because inductance and condenser values are usually subject to the individual requirements of the set builder. In addition, suitable, well-made tuned-circuit parts can generally be purchased at very reasonable cost. Information on the characteristics and the application features of each tube, given under each tube type, will prove of assistance in understanding and utilizing the circuits.

(14-1)

SUPERHETERODYNE AUTOMOBILE RECEIVER

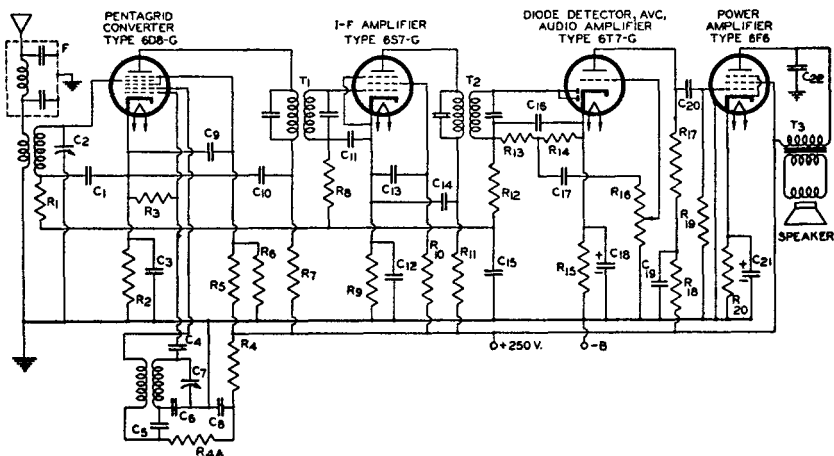

C₁ C₁₁ C₁₈ C₂₀ = 0.05 μ f paper
C₂ C₇ = Ganged tuning condenser, 365 μ f
C₃ C₄ C₉ C₁₀ C₁₂ C₁₃ C₁₄ = 0.1 μ f paper
C₅ = 50 μ f
C₆ C₁₇ = 0.01 μ f paper
C₈ = Oscillator padding condenser
C₁₆ = 100 μ f
C₁₉ = 10 μ f electrolytic, 25 v.
C₂₀ = 0.25 μ f paper, 400 v.

C₂₁ = 25 μ f electrolytic, 25 v.
C₂₂ = 0.005 μ f paper, 600 v.
F = Ignition-interference filter
R₁ R₄ = 100000 ohms, 0.5 watt
R₂ = 350 ohms, 0.5 watt
R₃ R₁₈ = 50000 ohms, 0.5 watt
R₄ R₇ = 5000 ohms, 0.5 watt
R_{4A} = 15000 ohms, 0.5 watt
R₅ = 30000 ohms, 1 watt
R₆ = 50000 ohms, 0.5 watt
R₉ = 400 ohms, 0.5 watt
R₁₀ = 75000 ohms, 0.5 watt

R₁₁ = 1000 ohms, 0.5 watt
R₁₃ = 1 megohm, 0.5 watt
R₁₄ R₁₇ R₁₉ = 250000 ohms, 0.5 watt
R₁₅ = 2500 ohms, 0.5 watt
R₁₆ = 1 megohm volume control
R₁₉ = 30000 ohms, 0.5 watt
R₂₀ = 400 ohms, 1 watt
T₁ T₂ = I-f transformer
T₃ = Output transformer; primary impedance, 7000 ohms

(14-2)

SUPERHETERODYNE RECEIVER FOR A-C OPERATION
 With Single-Tube Inverse-Feedback Power Amplifier

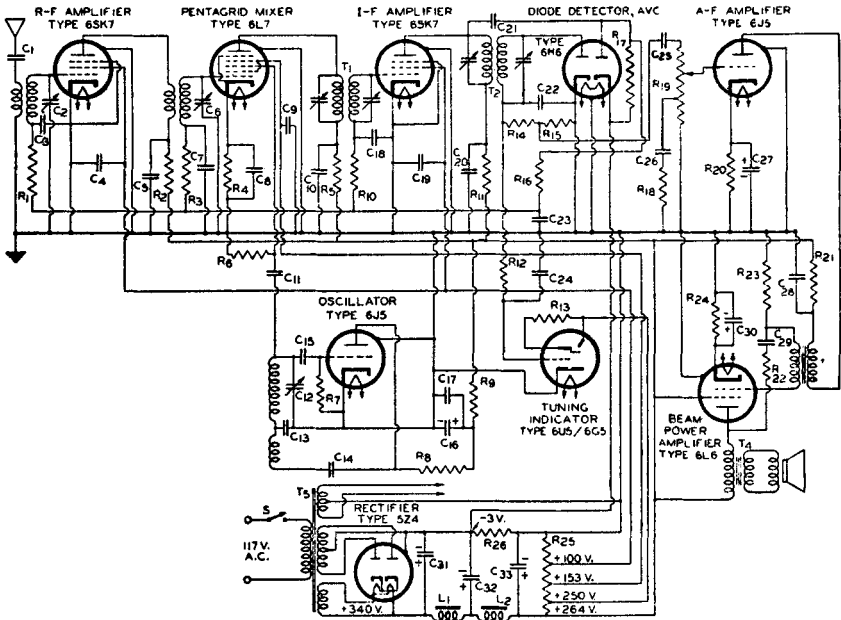

$C_1 = 50$ to $200 \mu\text{f}$
 $C_1 C_1 C_{11} =$ Ganged tuning condensers, $365 \mu\text{f}$
 $C_2 C_7 C_{13} C_{18} C_{21} C_{22} = 0.05 \mu\text{f}$ paper
 $C_4 C_9 C_{19} = 0.25 \mu\text{f}$ paper
 $C_3 C_5 C_{16} C_{17} C_{23} = 0.1 \mu\text{f}$ paper
 $C_{11} C_{21} = 100 \mu\text{f}$
 $C_{12} =$ Oscillator padding condenser
 $C_{14} C_{25} = 0.01 \mu\text{f}$
 $C_{15} C_{31} = 50 \mu\text{f}$
 $C_{16} C_{21} C_{22} C_{23} = 8 \mu\text{f}$ electrolytic, 500 v.
 $C_{27} = 10 \mu\text{f}$ electrolytic, 25 v.
 $C_{28} = 1 \mu\text{f}$ paper, 400 v.
 $C_{29} = 0.5 \mu\text{f}$ paper, 400 v.
 $C_{30} = 25 \mu$ electrolytic, 25 v.

$R_1 R_2 R_{16} = 100000$ ohms, 0.5 watt
 $R_2 R_{11} = 2000$ ohms, 0.5 watt
 $R_3 = 260$ ohms, 0.5 watt
 $R_4 = 3300$ ohms, 0.5 watt
 $R_4 R_7 R_{14} = 50000$ ohms, 0.5 watt
 $R_4 R_9 = 20000$ ohms, 0.5 watt
 $R_{12} = 2$ megohms, 0.5 watt
 $R_{13} R_{16} R_{17} = 1$ megohm, 0.5 watt
 $R_{15} = 200000$ ohms, 0.5 watt
 $R_{18} = 27000$ ohms, 0.5 watt
 $R_{19} = 1$ megohm volume control with tap at 250000 ohms for tone compensation
 $R_{20} = 900$ ohms, 0.5 watt

$R_{21} = 2000$ ohms, 0.5 watt
 $R_{22} = 90000$ ohms, 0.5 watt
 $R_{23} = 10000$ ohms, 0.5 watt
 $R_{24} = 170$ ohms, 2 watts
 $R_{25} = 20000$ ohms, 5 watts
 $R_{26} = 25$ ohms, 0.5 watt
 $L_1 = 20$ henries, 100 ohms, 120 ma.
 $L_2 = 500$ ohm speaker field, 8 watts
 $T_1 T_2 =$ I-f transformer
 $T_3 =$ Input transformer
 $T_4 =$ Output transformer; primary impedance, 2500 ohms
 $T_5 =$ Power transformer, $300-0-300$ volts RMS, 120 ma. d.c.

(14-3)

TUNED R-F RECEIVER WITH AVC AND INVERSE FEEDBACK
POWER AMPLIFIER

Class AB₁ 6L6's

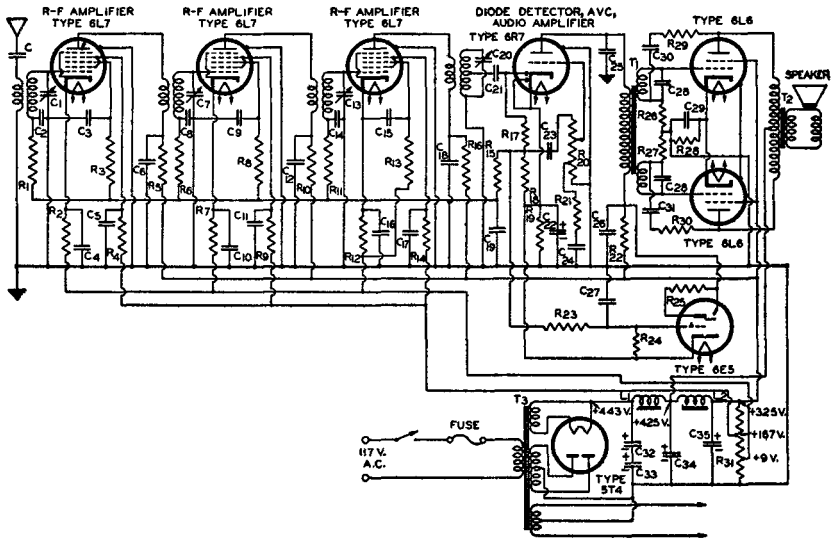

- C = 50 to 200 μ f
- C₁ C₇ C₁₃ C₂₉ = Ganged tuning condensers, 365 μ f
- C₂ C₃ C₄ C₅ C₆ C₈ C₉ C₁₀ C₁₁ C₁₂ C₁₄ C₁₅ C₁₆ C₁₇ C₁₈ C₂₀ C₂₁ C₂₂ C₂₃ C₂₄ C₂₅ C₂₆ C₂₇ C₂₈ C₃₀ C₃₁ C₃₂ C₃₃ C₃₄ C₃₅ = 0.05 μ f paper
- C₁ C₂ C₃ C₄ C₅ C₆ C₈ C₉ C₁₀ C₁₁ C₁₂ C₁₄ C₁₅ C₁₆ C₁₇ C₁₈ C₂₀ C₂₁ C₂₂ C₂₃ C₂₄ C₂₅ C₂₆ C₂₇ C₂₈ C₃₀ C₃₁ = 0.1 μ f paper
- C₂₁ C₂₂ = 100 μ f
- C₂₃ = 10 μ f electrolytic, 25 v.
- C₂₄ = Tone-compensation condenser, 0.01 μ f
- C₂₅ = 1 μ f, 400 v.
- C₂₆ = See note
- C₂₇ = 25 μ f electrolytic, 25 v.
- C₂₈ C₂₉ C₃₀ C₃₁ = 8 μ f electrolytic, 475 v.
- R₁ R₂ R₃ R₄ R₅ R₆ R₇ R₈ R₉ R₁₀ R₁₁ R₁₂ R₁₃ R₁₄ R₁₅ R₁₆ R₁₇ R₁₈ R₁₉ R₂₀ R₂₁ R₂₂ R₂₃ R₂₄ R₂₅ R₂₆ R₂₇ R₂₈ R₂₉ R₃₀ R₃₁ R₃₂ R₃₃ R₃₄ R₃₅ R₃₆ R₃₇ R₃₈ = 10000 ohms, 0.5 watt

- R₂ R₇ R₁₅ = 275 ohms, 0.5 watt
- R₁ R₆ R₁₄ = 10000 ohms, 1 watt
- R₃ R₁₀ R₁₆ = 12000 ohms, 0.5 watt
- R₁₅ R₂₁ = 1 megohm, 0.5 watt
- R₁₇ = 50000 ohms, 0.5 watt
- R₁₈ = 200000 ohms, 0.5 watt
- R₁₉ = 640 ohms, 0.5 watt
- R₂₀ = 1 megohm volume-control potentiometer with tap at 250000 ohms for tone compensation
- R₂₁ = Tone-compensation resistor; 27000 ohms, 0.5 watt
- R₂₂ = 5000 ohms, 1 watt
- R₂₃ R₂₄ = 2 megohms, 0.5 watt
- R₂₅ R₂₇ = 5000 ohms, 0.5 watt
- R₂₈ = 200 ohms, 5 watts

- R₂₉ R₃₀ = 50000 ohms, 1 watt
- R₃₁ = 12500 ohms, 10 watts
- L₁ = 20 henries, 100 ohms, 200 ma.
- L₂ = 1500 ohm speaker field, 7 watts
- T₁ = Input transformer for class AB₁ 6L6's with split secondary for inverse feedback. Ratio pri. to $\frac{1}{2}$ sec. = 1:1
- T₂ = Output transformer; plate-to-plate load, 6600 ohms
- T₃ = Power transformer, 425-0-425 v. RMS, 200 ma. d.c.

NOTE: Condensers C₂₆ may be required to suppress parasitics. Optimum value ranges from 0.0001 to 0.005 μ f and should be determined by test.

(14-4)

AC/DC SUPERHETERODYNE RECEIVER

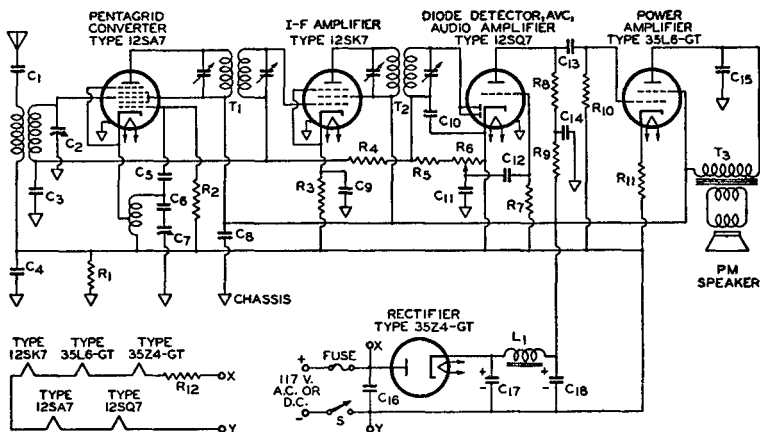

- C₁ = 500 μf
- C₂ C₇ = Ganged tuning condensers, 365 μf
- C₃ C₅ C₁₄ C₁₆ = 0.1 μf paper
- C₄ = 0.25 μf paper
- C₆ = 50 μf
- C₈ = Oscillator padding condenser
- C₉ = 0.05 μf paper
- C₁₀ C₁₁ = 250 μf
- C₁₂ = 0.005 μf
- C₁₃ = 0.01 μf paper

- C₁₅ = 0.025 μf
- C₁₇ C₁₈ = 40 μf electrolytic, 150 v.
- R₁ R₂ = 250000 ohms, 0.5 watt
- R₃ = 20000 ohms, 0.5 watt
- R₄ = 260 ohms, 0.5 watt
- R₅ = 2 megohms, 0.5 watt
- R₆ R₈ = 50000 ohms, 0.5 watt
- R₉ = 250000 ohm potentiometer
- R₇ = 10 megohms, 0.5 watt
- R₁₀ = 0.5 megohm, 0.5 watt

- R₁₁ = 150 ohms, 1 watt
- R₁₂ = Lamp-cord resistor; 73 ohms, 3 watts
- T₁ T₂ = 455 kc. i-f transformer
- T₃ = Output transformer; primary impedance, 2500 ohms
- L₁ = 200 ohm filter choke; inductance as large as practical
- S = S.P.S.T. line switch, mounted on shaft of R₆
- FUSE = 125 volta, 0.3 ampere

(14-5)

NON-MOTORBOATING RESISTANCE-COUPLED AMPLIFIER

Voltage Gain, 9000

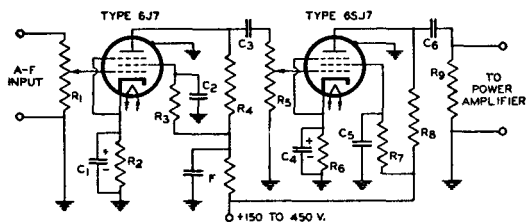

- C₁ C₄ = 8 μf electrolytic, 25 v
- C₂ C₃ = 0.06 μf, voltage rating as high as voltage supply
- C₅ C₆ = 0.006 μf, voltage rating as high as voltage supply
- R₁ = Volume-control potentiometer
- R₂ R₃ = 600 ohms, 0.5 watt
- R₄ R₇ R₈ = 500000 ohms, 0.5 watt
- R₅ R₆ = 100000 ohms, 0.5 watt
- R₉ = 500000 ohm volume-control potentiometer, ganged with R₁
- F = Decoupling filter

NOTE: Values of resistance and capacitance shown in this circuit are taken from the chart in the Resistance-Coupled Amplifier Section. The values in this chart are chosen to give a sharp low-frequency cut-off and, thus, to minimize tendency of multiple stages to motorboat. Three or more stages, including power stage, operated from a common B supply may require a decoupling filter in the plate-supply leads of one or more of the voltage amplifier stages. The constants of decoupling filters depend on the design requirements of the amplifier.

(14-6)

MINIATURE-TUBE PORTABLE SUPERHETERODYNE RECEIVER
Using 45-Volt "B" Supply

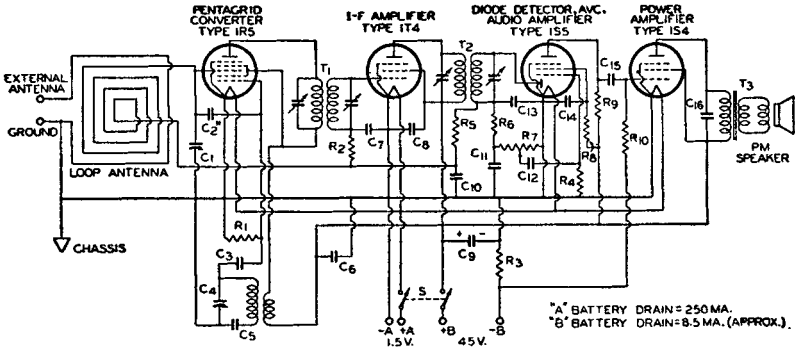

* "A" BATTERY DRAIN = 250 MA.
* "B" BATTERY DRAIN = 8.5 MA. (APPROX.)

- C₁ C₄ = 0.00041 μf ganged tuning condensers
- C₂ = 5 μμf†
- C₃ = 50 μμf
- C₅ = 420 μμf padder
- C₆ C₇ C₁₁ = 0.1 μf paper
- C₈ C₁₀ = 0.05 μf paper
- C₉ = 8 μf electrolytic, 50 v.
- C₁₁ C₁₂ = 100 μμf
- C₁₃ = 0.0025 μf
- C₁₄ = 0.0005 μf
- C₁₅ = 0.002 μf
- R₁ R₂ = 100000 ohms‡
- R₃ = 500 ohms‡
- R₄ = 10 megohms‡
- R₅ R₁₀ = 2 megohms‡
- R₆ = 50000 ohms‡
- R₇ = 1 megohm potentiometer
- R₈ = 3 megohms‡
- R₉ = 1 megohm‡
- S = Ganged D.P.S.T. switch
- T₃ = Output transformer; primary impedance, 8400 ohms

* C₂ is necessary only at frequencies higher than 5 Mc.
‡ All resistors can be of the 0.5 watt type.

(14-7)

CLASS B AMPLIFIER FOR PORTABLE USE
Power Output 10 Watts*

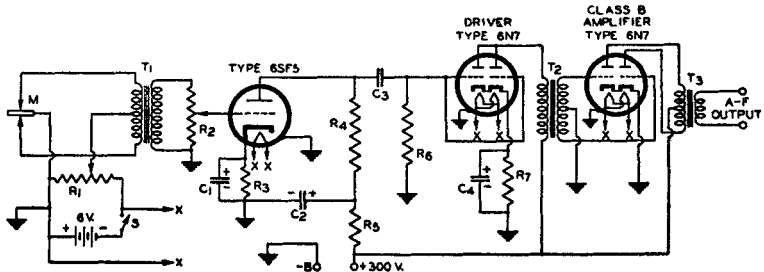

- C₁ = 5 μf electrolytic, 25 v.
- C₂ = 4 μf electrolytic, 25 v.
- C₃ = 0.025 μf
- C₄ = 25 μf electrolytic, 25 v.
- R₁ = 500 ohm wire-wound potentiometer
- R₂ = 500000 ohm potentiometer
- R₃ = 1300 ohms, 0.5 watt
- R₄ = 100000 ohms, 0.5 watt
- R₅ = 50000 ohms, 0.5 watt
- R₆ = 100000 ohms, 0.5 watt
- R₇ = 900 ohms, 0.5 watt
- M = Double-button microphone
- S = Microphone and heater switch
- T₁ = Microphone input transformer
- T₂ = Class B input transformer
- T₃ = Class B output transformer

* Peak signal input voltage to 6SF5 grid is 0.15 volt, for full power output.

(14-8)

BATTERY-OPERATED SUPERHETERODYNE RECEIVER
 With AVC and Class B Audio Amplifier

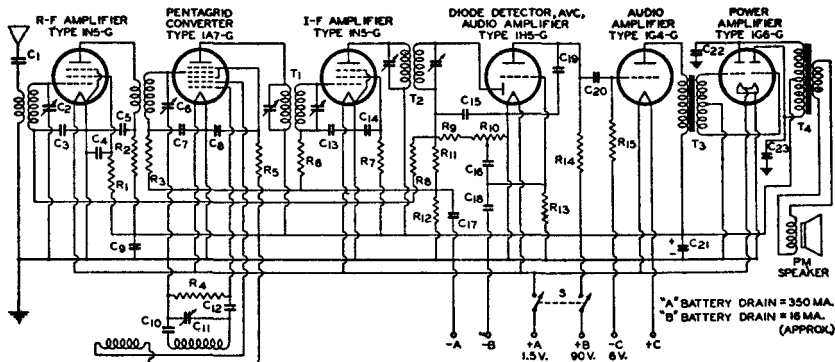

- C₁ = 0.0001 to 0.01 μf
- C₂ C₃ C₁₁ = Ganged tuning condensers, 365 μμf
- C₄ C₇ C₁₃ C₁₇ = 0.05 μf paper
- C₅ C₆ C₈ C₁₄ = 0.1 μf paper
- C₁₂ = Oscillator padding condenser
- C₁₅ = 50 μμf
- C₁₆ C₁₈ = 100 μμf
- C₁₉ C₂₁ C₂₂ = 0.005 μf
- C₂₀ = 250 μμf

- C₂₃ = 0.01 μf
- C₂₄ = 8 μf electrolytic, 100 v.
- R₁ R₇ = 5000 ohms‡
- R₂ = 10000 ohms‡
- R₃ R₅ = 100000 ohms‡
- R₄ = 200000 ohms‡
- R₆ = 70000 ohms‡
- R₈ R₁₁ R₁₃ = 2 megohms‡
- R₉ = 50000 ohms‡
- R₁₀ = 250000 ohm potentiometer

- R₁₂ = 10 megohms‡
- R₁₄ = 250000 ohms‡
- R₁₅ = 1 megohm‡
- T₁ T₂ = I-f transformer, 455 kc.
- T₃ = Class B input transformer
- T₄ = Class B output transformer; plate-to-plate impedance, 12000 ohms
- S = Ganged D.P.S.T. switch

‡ Resistors are 0.5 watt size.

(14-9)

TWO-CHANNEL AUDIO MIXER

Voltage Gain From Each Grid of 6SC7 to Output is Approximately 15

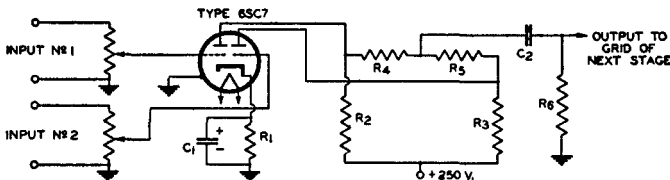

- C₁ = 8 μf electrolytic, 25 v.
- C₂ = 0.005 μf paper, 400 v.

- R₁ = 2000 ohms, 0.5 watt
- R₂ R₃ = 250000 ohms, 0.5 watt

- R₄ R₅ = 1 megohm, 0.5 watt

(14-10)

BATTERY-OPERATED SHORT-WAVE RECEIVER
1.4-Volt Types

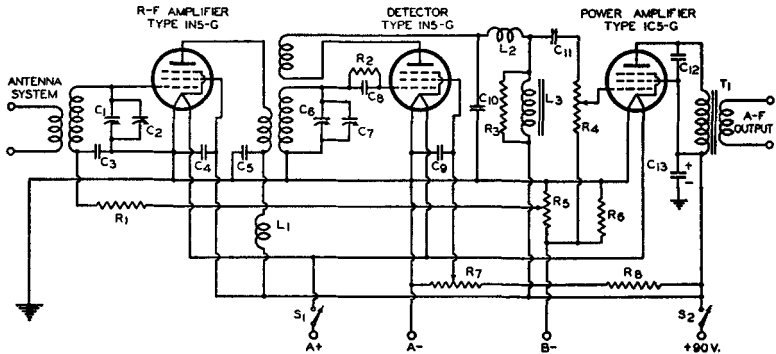

C₁ C₂ = 100 μ f midget
 C₃ C₇ = 35 μ f midget
 C₄ C₅ C₈ C₁₁ = 0.05 μ f
 C₆ C₉ = 0.00025 μ f
 C₁₀ = 1 μ f
 C₁₂ = 0.002 μ f
 C₁₃ = 8 μ f electrolytic, 100 v.

R₁ = 100000 ohms, 0.5 watt
 R₂ = 2 to 5 megohms, 0.5 watt
 R₃ = 0.25 megohm, 0.5 watt
 R₄ = 0.5 megohm potentiometer
 R₇ R₈ = 50000 ohm potentiometer

R₅ = 600 ohms, 0.5 watt
 R₆ = 30000 ohms, 0.5 watt
 L₁ L₂ = 8 mh. r-f choke
 L₃ = 300 to 500 henry a-f choke
 T₁ = Output transformer; primary impedance, 9000 ohms
 S₁ = Ganged D.P.S.T. switch

(14-11)

A-C OPERATED REGENERATIVE SHORT-WAVE RECEIVER

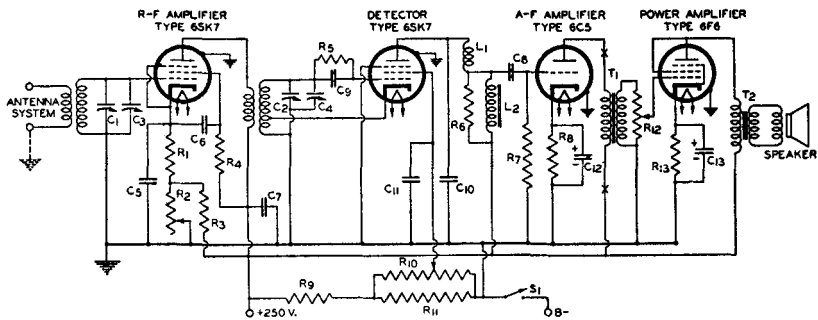

C₁ C₃ = 35 μ f midget
 C₄ C₅ = 100 μ f midget
 C₆ C₇ = 0.05 μ f
 C₈ = 0.01 μ f, 400 v.
 C₉ C₁₀ = 0.00025 μ f mica
 C₁₁ = 1 μ f, 200 v.
 C₁₂ = 8 μ f electrolytic, 25 v.
 C₁₃ = 16 μ f electrolytic, 25 v.
 R₁ = 250 ohms, 0.5 watt
 R₂ = 10000 ohm wire-wound potentiometer

R₃ = 100000 ohms, 1 watt
 R₄ = 60000 ohms, 1 watt
 R₅ = 2 to 5 megohms, 0.5 watt
 R₆ = 250000 ohms, 1 watt
 R₇ = 1 megohm, 0.5 watt
 R₈ = 1000 ohms, 1 watt
 R₉ = 15000 ohms, 5 watts
 R₁₀ = 50000 ohm potentiometer, regeneration control
 R₁₁ = 5000 ohms, 1 watt
 R₁₂ = 500000 ohm volume control

R₁₃ = 670 ohms, 1 watt
 S₁ = S.P.S.T. switch
 L₁ = 8 mh. r-f choke
 L₂ = 300 to 500 henry a-f choke
 T₁ = Interstage a-f transformer
 T₂ = Output transformer; primary impedance, 4000 ohms
 X-X = Insert double-circuit 'phone jack here

(14-12)

CLASS A₁ AUDIO AMPLIFIER FOR USE ON 115-VOLT D-C LINE
Power Output, 4 Watts*

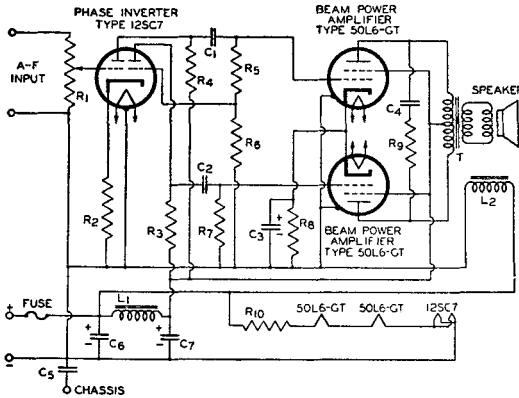

- C₁ C₂ = 0.006 μf
 - C₃ = 25 μf electrolytic, 25 v.
 - C₄ = 0.035 μf
 - C₅ = 2 μf paper, 150 v.
 - C₆ = 2 μf electrolytic, 150 v.
 - C₇ = 4 μf electrolytic, 150 v.
 - R₁ = 500000 ohm volume control
 - R₂ = 4000 ohms, 0.5 watt
 - R₃ R₄ = 250000 ohms, 0.5 watt
 - R₅ = 475000 ohms, 0.5 watt
 - R₆ = 16000 ohms, 0.5 watt
 - R₇ = 500000 ohms, 0.5 watt
 - R₈ = 70 ohms, 1 watt
 - R₉ = 4000 ohms, 2 watts
 - R₁₀ = 33 ohms, 1.0 watt
 - L₁ = Filter choke, 10 henries at 125 ma., 60 ohms
 - L₂ = Speaker field, 115 volts d.c.
 - T = Output transformer, plate-to-plate load 3000 ohms
- *Signal voltage input for full power output = 0.25 volt peak.

(14-13)

HIGH-POWER AUDIO-FREQUENCY AMPLIFIER
Class AB₂ 6L6's, Output 45 Watts

HIGH-POWER AUDIO-FREQUENCY AMPLIFIER
CLASS AB₂ 6L6's, OUTPUT 55 WATTS

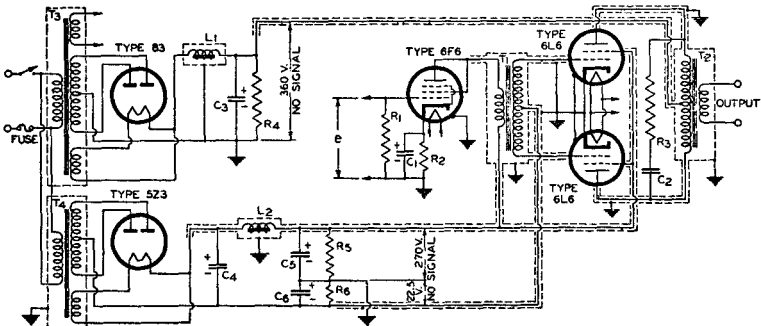

- C₁ C₂ = 25 μf electrolytic, 25 v.
- C₃ = 0.035 μf, 1000 v.
- C₄ = 14 μf electrolytic, 450 v.
- C₅ C₆ = 8 μf electrolytic, 450 v.
- R₁ = 0.5 megohm, 0.5 watt
- R₂ = 650 ohms, 0.5 watt
- R₃ = 5000 ohms, 20 watts

- R₄ = 50000 ohms, 5 watts
- R₅ = 3500 ohms, 30 watts
- R₆ = 200 ohms, 5 watts
- L₁ = 5 henries at 220 ma., 50 ohms or less
- L₂ = 20 henries at 150 ma., 100 ohms or less

- T₁ = Input transformer for class AB₂ 6L6's
- T₂ = Output transformer, plate-to-plate load 3800 ohms
- T₃ T₄ = Power transformer*

*T₃ = 440-0-440 volts RMS, 175 ma. d.c.

*T₄ = 315-0-315 volts RMS, 150 ma. d.c.

NOTE: Peak signal voltage (e) for maximum power output is 18 volts.

(14-14)

A-F VOLTAGE AMPLIFIER WITH SIGNAL MIXER, MASTER MIXER AND COMPRESSOR-EXPANDER

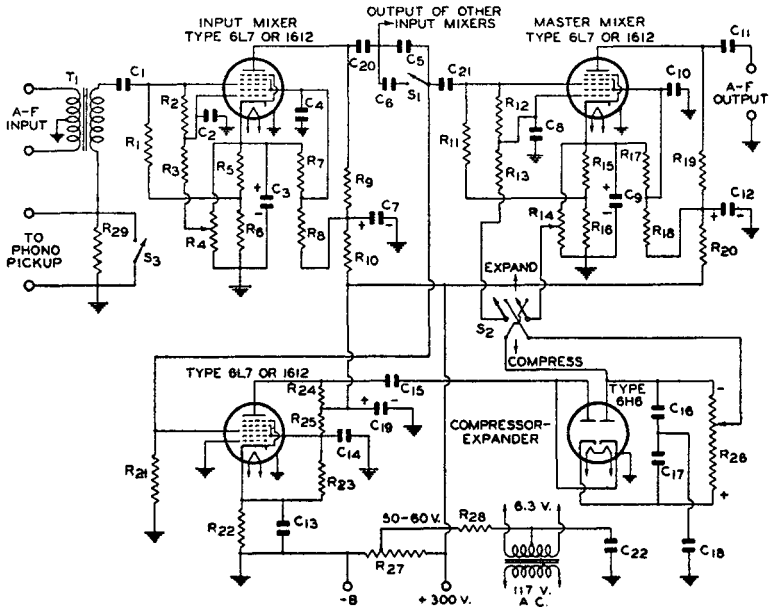

- C₁ C₄ C₅ C₁₀ C₁₁ C₁₄ C₁₅ C₁₆
- C₁₇ C₁₈ C₂₀ C₂₁ = 0.05 μ f
- C₂ C₃ = 0.25 μ f
- C₆ C₇ C₈ C₁₂ = 8 μ f
- C₉ = 0.0015 μ f
- C₁₃ = 0.5 μ f
- C₁₉ = 4 μ f
- C₂₂ = 0.1 μ f
- R₁ = 50000 ohms, 0.5 watt
- R₂ R₁₂ = 1.2 megohms, 0.5 watt
- R₃ R₁₃ = 820000 ohms, 0.5 watt

- R₄ R₁₄ = 250000 ohm potentiometer
- R₅ R₁₅ = 1000 ohms, 0.5 watt
- R₆ R₇ R₁₆ R₁₇ = 30000 ohms, 0.5 watt
- R₈ R₁₈ = 150000 ohms, 1 watt
- R₉ R₁₉ R₂₄ = 300000 ohms, 0.5 watt
- R₁₀ R₂₀ = 50000 ohms, 0.5 watt
- R₁₁ R₂₁ = 100000 ohms, 0.5 watt
- R₂₁ = 150000 ohms, 0.5 watt
- R₂₂ = 500 ohms, 0.5 watt
- R₂₃ = 40000 ohms, 0.5 watt

- R₂₅ = 1 megohm potentiometer
- R₂₇ = Bleeder resistor. Tapped at 50 to 60 volts to provide heater-circuit bias
- R₂₈ = 100000 ohms, 0.5 watt
- R₂₉ = 5000 ohms, 0.5 watt
- S₁ = Music-speech switch, S.P.S.T.
- S₂ = Expand-compress switch, D.P.D.T.
- S₃ = Phonograph switch; close when phono is not in use
- T₁ = Microphone input transformer

NOTE: Potentiometer R₄ controls the bias on grid No. 1 of the input mixer stage and thus controls the gain of this stage. When the contact is at the cathode end of R₄, gain is at maximum. Because the leads to R₄ do not carry a-f voltage, R₄ can be connected to the circuit through a long cable for remote control. Potentiometer R₁₄ controls the no-signal gain of the master mixer stage. When the circuit is to be used as a volume expander, the contact should be set at the ground end of R₁₄; when it is to be used as a compressor, the contact should be set at the cathode end of R₁₄. The degree of expansion or compression can be controlled by R₂₅. Maximum expansion or compression is obtained with the contact at the positive end. R₁₁ and R₂₁ can also be connected to the circuit through cables for remote control.

(14-15)

MICROPHONE AND PHONOGRAPH AMPLIFIER

With Phase Inverter and Vacuum-Tube Mixer*
Power Output, 10 Watts

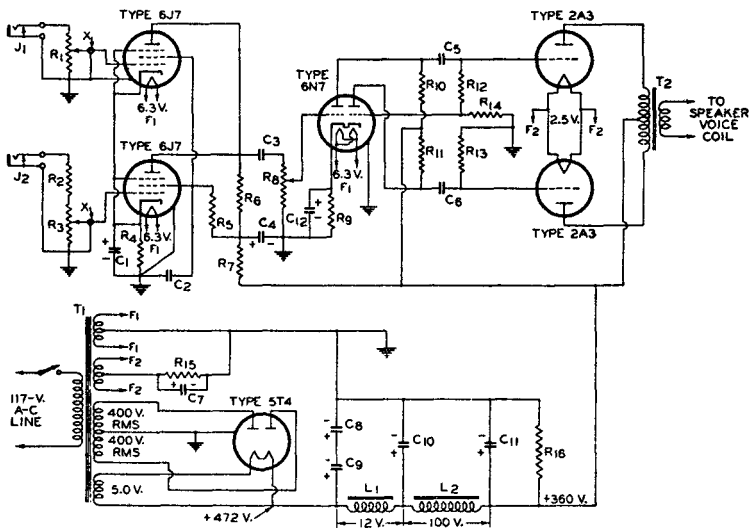

- C₁ = 10 μf electrolytic, 25 v.
- C₂ = 0.1 μf paper, 400 v.
- C₃ = 0.005 μf paper, 600 v.
- C₄ C₁₁ = 8 μf electrolytic, 450 v.
- C₅ C₆ = 0.01 μf paper, 600 v.
- C₇ = 50 μf electrolytic, 100 v.
- C₈ C₉ = 8 μf electrolytic, 250 v.
- C₁₀ = 8 μf electrolytic, 475 v.
- C₁₂ = 25 μf electrolytic, 25 v.
- R₁ = 1 megohm potentiometer
- R₂ = 0.5 megohm, 0.5 watt
- R₃ = 20000 ohm potentiometer

- R₄ = 800 ohms, 0.5 watt
- R₅ = 1.2 megohms, 0.5 watt
- R₆ = 0.25 megohm, 0.5 watt
- R₇ = 50000 ohms, 0.5 watt
- R₈ = 0.5 megohm potentiometer
- R₉ = 3000 ohms, 0.5 watt
- R₁₀ R₁₁ = 0.1 megohm
- R₁₂ R₁₃ = 0.27 megohm
- R₁₄ = 12000 ohms, 0.5 watt
- R₁₅ = 780 ohms, 10 watts
- R₁₆ = 20000 ohms, 15 watts
- T₁ = Power transformer; 400-0-400 v. RMS, 100 ma.

- T₂ = Output transformer; 5000 ohms plate-to-plate impedance
- L₁ = Filter choke; 12 henries, 120 ohms, 100 ma.
- L₂ = Speaker field; 1000 ohms, 10 watts
- J₁ = Jack for high-impedance crystal microphone input, 0.023 peak volt
- J₂ = Jack for high-impedance crystal phono pickup input, 0.6 peak volt
- X = Shielded lead

* Voltage gain of microphone channel up to 2A3 grids is better than 2700.

(14-16)

SLIDE-BACK VACUUM-TUBE VOLTMETER

Ranges 0-25 V. and 0-250 V.

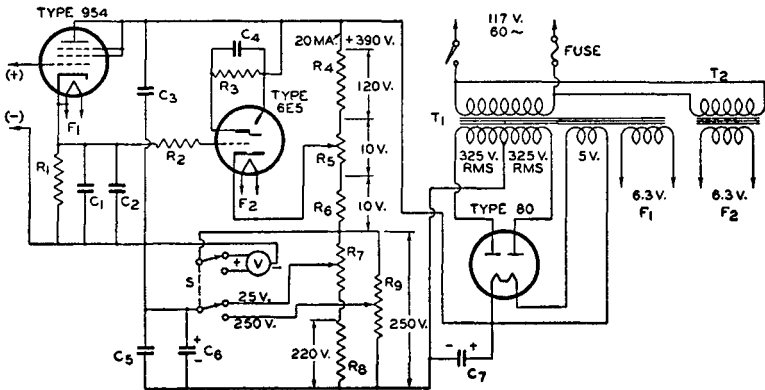

- C₁ = 4 μf paper, 400 v. (low-leakage)
- C₂ C₃ C₅ = 0.01 μf mica
- C₄ = 0.25 μf paper, 200 v.
- C₆ = 8 μf electrolytic, 350 v.
- C₇ = 30 μf electrolytic, 450 v.
- R₁ = 2 megohms, 0.5 watt
- R₂ = 200000 ohms, 0.5 watt
- R₃ = 500000 ohms, 0.5 watt

- R₄ = 6000 ohms, 5 watts
- R₅ = 500 ohm wire-wound linear potentiometer, 2 watts
- R₆ = 500 ohms, 1 watt
- R₇ = 3000 ohm wire-wound linear potentiometer, 2 watts
- R₈ = 22000 ohms, 5 watts
- R₉ = 25000 ohm wire-wound linear potentiometer, 4 watts

- S = Ganged D.P.D.T. switch
- V = 1000-ohms-per-volt voltmeter, 0-25 v. and 0-250 v. scales
- T₁ = Midget power transformer
- T₂ = Midget filament transformer

NOTE: If the 954 is mounted at the end of a shielded "goose-neck" probe, C₁ can be mounted on the main chassis. R₁, C₃, and C₅ should be mounted close to the 954 socket. For "zero" adjustment of the 6E5, short the 954 input terminals, set R₇ or R₈ so that "V" reads zero volts, and adjust R₅ until the 6E5 "eye" is just closed. The d-c or a-c voltage to be measured will cause the eye to reopen. Then adjust R₇ or R₈ until the eye is just closed again. "V" will then read the d-c or peak a-c value of the input voltage. The V-T voltmeter requires calibration only for very low values of a-c input voltage.

Outlines

METAL TUBES

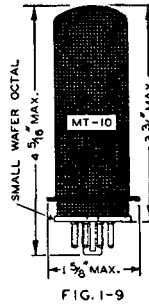
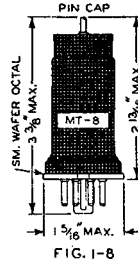
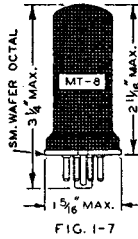
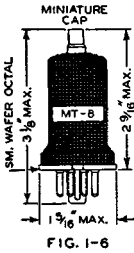
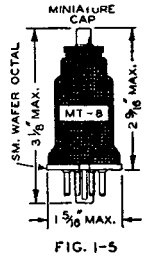
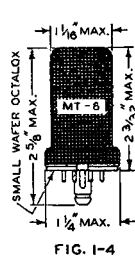
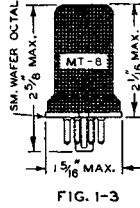
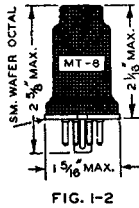
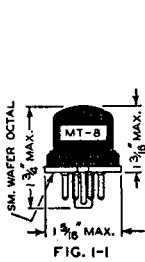

GLASS TUBES

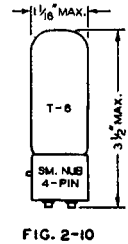
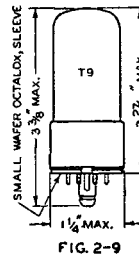
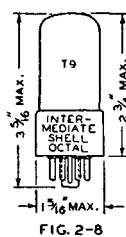
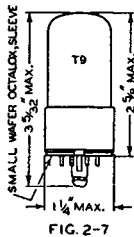
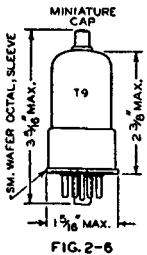
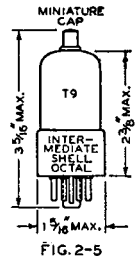
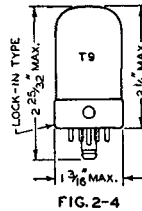
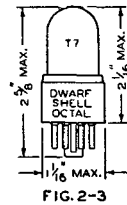
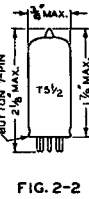
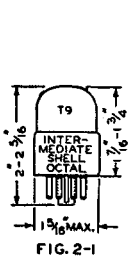

Outlines—Glass Tubes (Continued)

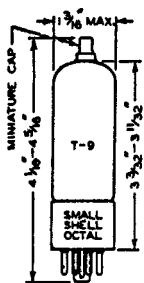

FIG. 2-11

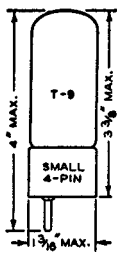

FIG. 2-12

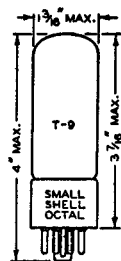

FIG. 2-13

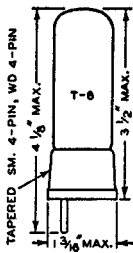

FIG. 2-14

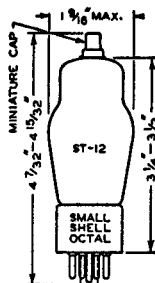

FIG. 2-15

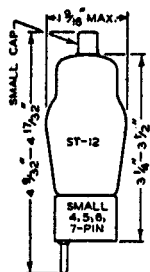

FIG. 2-16

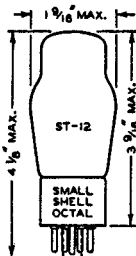

FIG. 2-17

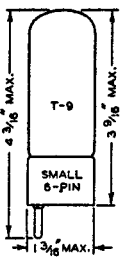

FIG. 2-18

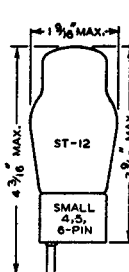

FIG. 2-19

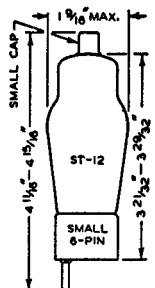

FIG. 2-20

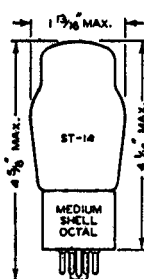

FIG. 2-21

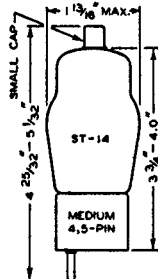

FIG. 2-22

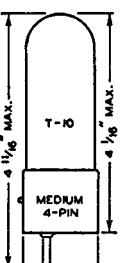

FIG. 2-23

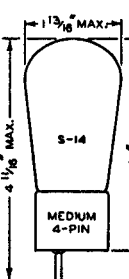

FIG. 2-24

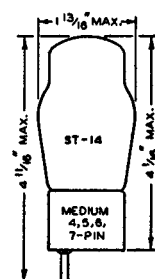

FIG. 2-25

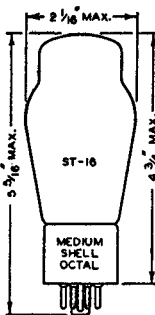

FIG. 2-26

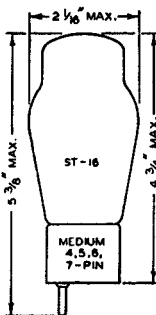

FIG. 2-27

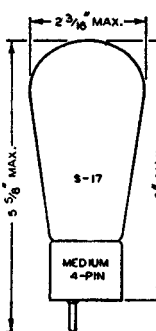

FIG. 2-28

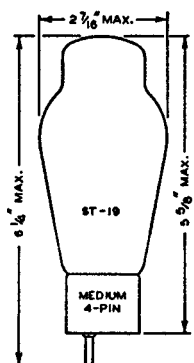

FIG. 2-29

INDEX

	<i>Page</i>		<i>Page</i>
Amplification Factor	10	diode detector	27
Amplifier:		duplex-diode triode	27
audio-frequency	12, 15	electron-ray tube	31
audio mixer		grid-bias detector	28
class A	12, 13, 15	grid-leak and condenser detector	28
class AB	12, 19	full-wave rectifier	25
class B	12, 20	half-wave rectifier	25
class C	12	high-gain a-f amplifier	207, 213
d-c	31	high-power a-f amplifier	211
parallel	16	inverse feedback	20, 22, 24
phase-inverter	23	microphone and phonograph	
push-pull	16	preamplifier	213
radio-frequency	12, 14	noise filter	41
super-control	14	oscillator	32
voltage	13	pentagrid converter	33
volume-compressor	23	phase inverter	24
volume-expander	22	r-f filter	40, 41
Anode	5	resistance-coupled amplifier	22, 24
Anode-Grid	33	short-wave regenerative receiver	210
Arc-Back Limit	11	superheterodyne receiver	
Automatic Volume Control (AVC)	29	204, 205, 207, 208, 209	
Beam Power Tube Considerations	8	tuned r-f receiver	206, 210
Bias:		voltage-doubler rectifier	25, 26
battery	37	vacuum-tube voltmeter	214
cathode	37	volume compressor-expander	212
diode	28	volume expander	22
grid-leak	29	Condenser-Input Filter	40
Calculation of:		Conversion Curve, Use of	19
amplification factor	10	Conversion Transconductance	11
cathode (self-bias) resistor	38	Corrective Filter	22
control-grid—plate transconductance	11	Cross-Modulation	14, 38
filament resistor power dissipation	35	Current:	
filament (or heater) resistor value	35, 36	cathode	37
harmonic distortion	16, 18	grid	13, 20
load resistance	16, 17	peak plate	11
operating conditions from conversion		plate	5
curves	19	Cut-Off	12
peak inverse voltage	12	D-C Amplifier	31
plate efficiency	12	Degeneration (see Inverse Feedback)	
plate resistance	11	Delayed Automatic Vol. Control (DAVC)	30
power output	16	Demodulation	26
power sensitivity	12	Detection:	
transconductance	11	diode	26
voltage amplification (gain)	13	full-wave diode	27
Cathode:		grid-bias	28
bias	37	grid-leak and condenser	28
by-passing	38	Diode:	
connection	36	biasing	28
current	37	considerations	5
directly heated	4	detection	26
indirectly heated	4	load resistor	27
resistor	37	Driver	15, 19, 20
types	3	Duplex Diode:	
Characteristics:		pentode	9
amplification factor	10	triode	9, 27
control-grid—plate transconductance	11	Dynamic Characteristics	10
conversion transconductance	11	Electron:	
dynamic	10	considerations	3
plate resistance	11	secondary	7, 8
static	10	Electron-Ray Tubes	30
Charts and Tables:		Emission:	
outline drawings chart	215	current	5
resistance-coupled amplifiers	198	secondary	7, 8
structure of metal tube	2	test	5
tube classification by use and by		Feedback:	
cathode voltage	42, 43	inverse	20, 24
materials chart	194	undesired	39
Choke-Input Filter	40	Filament (also see Heater and Cathode):	
Circuit Diagram of:		operation	3, 34
audio mixer	209, 212, 213	resistor	35
avc	29	series operation	35
class A ₁ amplifier	207, 211	shunt resistor	35
class AB ₁ amplifier	213	supply voltage	34
class AB ₂ amplifier	211		
class B amplifier	208		
davc amplifier	29		

INDEX (Continued)

	Page		Page
Filter:		efficiency	12
corrective.....	22	load.....	13, 17
radio-frequency.....	39, 41	resistance.....	11
smoothing.....	40	voltage supply.....	37
Formulas (see Calculation)		Plate-Cathode Capacitance	7
Frequency Conversion	32	Power-Output Calculations	16, 17, 18
Fuses, use of	37	Power Sensitivity	12
		Power Supply	37
Gain	13	Push-Pull Operation	16
Grid:		Radio-Frequency:	
anode.....	33	amplifier.....	12, 14
bias.....	37	filter.....	39
bias detection.....	28	Reading List	Inside back cover
considerations.....	6	Rectifiers:	
current.....	13	full-wave.....	5, 24
leak and condenser detection.....	28	half-wave.....	5, 24
resistor.....	14	ionic-heated cathode.....	6
voltage supply.....	37	parallel operation of.....	24
Grid-Plate Capacitance	7	voltage-doubler.....	25
Grid-Plate Transconductance	11	Remote Cut-Off Tubes (see Super-Control Tubes)	
Harmonic Distortion	16, 18	Resistance Coupling	14
Heater:		Resistance-Coupled Amplifier	21, 23
cathode.....	4	Resistor	
cathode bias.....	36	cathode (self-biasing).....	37
cathode connection.....	36	center-tap.....	37
resistor.....	35	filament.....	35
series operation.....	35, 36	filter.....	39
shunt resistor.....	35	grid.....	14
supply voltage.....	34	plate load.....	13
Hexode Mixer	33	screen.....	38
Impedance, input	14	Saturation Current	
Instantaneous Peak Voltage	40	Screen:	
Interelectrode Capacitances	7	considerations.....	7
Intermediate Frequency, production of	32	dissipation.....	12
Inverse-Feedback	20, 21	voltage supply.....	38
Ionization	6	Secondary Emission	7
		Secondary Electrons	7, 8
Load:		Self-Bias	37
resistance.....	13, 17	Shielding	39
resistance line.....	16, 17	Socket Terminal Designation Key	45
Mercury-Vapor Rectifier:		Space Charge	5, 8
considerations of.....	6	Static Characteristics	10
interference from.....	40	Super-Control Tube	14
Mho	11	Suppressor	8
Micromho	11	Tables and Charts (see Charts and Tables)	
Mixer:		Testing Radio Tubes	195
audio.....	209, 212, 213	Tetrode Considerations	7
hexode.....	33	Transconductance:	
pentagrid.....	34	conversion.....	11
Modulated Wave	26	grid-plate.....	11
Modulation	26	Triode Considerations	6
Modulation Distortion	14, 38	Tube:	
Multi-Electrode Tubes	9	materials chart.....	194
Multi-Unit Tubes	9	ratings interpretation (RMA).....	44
Mutual Conductance (see Transconductance)		types, data for.....	45
Oscillator	31	Tuning Indicators	30
Output-Coupling Devices	14	Voltage:	
Parallel Operation	16	amplification, class A.....	13
Parasitic Oscillations	16	doubler rectifier.....	25
Peak Inverse Voltage	11	peak inverse.....	11
Peak Plate Current	11	supply.....	34
Pentagrid Converter	9, 33	Voltage Conversion Factor	19
Pentagrid Mixer	23, 34	Volume Compressor	23
Pentode Considerations	7	Volume Control:	
Phase Inverter	23	automatic.....	29
Plate:		by grid-voltage variation.....	38
current.....	5	by screen-voltage variation.....	39
dissipation.....	12	Volume-Expander	22

Recently Added Types

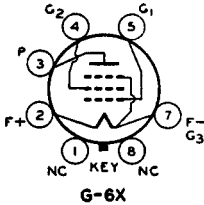

POWER AMPLIFIER PENTODE

The 1A5-GT/1A5-G is a power amplifier pentode of the 1.4-volt filament type for use in the output stage of battery-operated receivers. The 1A5-GT/1A5-G supersedes both the 1A5-G and the 1A5-GT. It has electrical characteristics identical to those of the 1A5-G. Physical characteristics are shown in Fig. 2-8, OUTLINES SECTION. The tube may be mounted in any position.

1A5-GT/
1A5-G

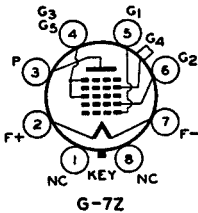

PENTAGRID CONVERTER

The 1B7-GT is a multi-electrode tube of the 1.4-volt filament type designed for use as a combined first detector and oscillator in superheterodyne receivers. Physical characteristics are shown in Fig. 2-5, OUTLINES SECTION. The tube may be mounted in any position.

1B7-GT

CHARACTERISTICS

FILAMENT VOLTAGE (D.C.)	1.4	Volts
FILAMENT CURRENT	0.1	Ampere
DIRECT INTERELECTRODE CAPACITANCES:*		
Grid No. 4 to Plate	0.34	$\mu\mu\text{f}$
Grid No. 4 to Grid No. 2	0.26	$\mu\mu\text{f}$
Grid No. 4 to Grid No. 1	0.12	$\mu\mu\text{f}$
Grid No. 1 to Grid No. 2	0.9	$\mu\mu\text{f}$
Grid No. 1 to All Other Electrodes = R-F Input	7	$\mu\mu\text{f}$
Grid No. 2 to All Other Electrodes Except Grid No. 1 (Oscillator Output)	4.2	$\mu\mu\text{f}$
Grid No. 1 to All Other Electrodes Except Grid No. 2 (Oscillator Input)	4	$\mu\mu\text{f}$
Plate To All Other Electrodes (Mixer Output)	7.5	$\mu\mu\text{f}$
TYPICAL OPERATION:		
Plate Voltage	90	Volts
Screen Voltage	45	Volts
Anode-Grid Voltage	90	Volts
Control-Grid Voltage (Grid No. 1)	0	Volts
Oscillator-Grid (Grid No. 1) Resistor	0.2	Megohm
Plate Current	1.5	Milliamperes
Screen Current	1.3	Milliamperes
Anode-Grid Current	1.6	Milliamperes
Oscillator-Grid Current	0.035	Milliampere
Plate Resistance	0.35	Megohm
Conversion Transconductance	350	Micromhos
Control-Grid Bias for conversion transconductance of 2 micromhos (approx.)	14.5	Volts

* With close-fitting shield connected to negative filament terminal.

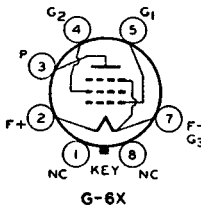

POWER AMPLIFIER PENTODE

The 1C5-GT/1C5-G is a power amplifier pentode of the 1.4-volt filament type for use in the output stage of battery-operated receivers. The 1C5-GT/1C5-G supersedes both the 1C5-GT and 1C5-G. Electrical characteristics are the same as for the 1C5-G. Dimensions are shown in Fig. 2-8, OUTLINES SECTION. The tube may be mounted in any position.

1C5-GT/
1C5-G

**SUPER-CONTROL R-F AMPLIFIER
TETRODE**

1D5-GT

The 1D5-GT is a super-control r-f amplifier tetrode of the 2.0-volt type for use in battery-operated receivers. Physical characteristics are shown in Fig. 2-15, OUTLINES SECTION. Vertical mounting is recommended; horizontal operation is permissible if pins 2 and 7 are in a vertical plane

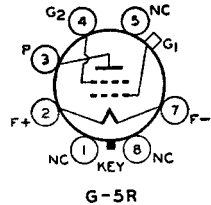

CHARACTERISTICS

FILAMENT VOLTAGE (D.C.)	2.0	Volts
FILAMENT CURRENT	0.06	Ampere
DIRECT INTERELECTRODE CAPACITANCES:		
Grid-Plate (with shield can)	0.01	$\mu\mu\text{f}$
Input	4.4	$\mu\mu\text{f}$
Output	10.8	$\mu\mu\text{f}$

As Class A₁ Amplifier

PLATE VOLTAGE	135	180	Volts
SCREEN VOLTAGE	67.5	67.5	Volts
GRID VOLTAGE	-3	-3	Volts
PLATE CURRENT	2.2	2.2	Milliamperes
SCREEN CURRENT	0.7	0.7	Milliamperes
PLATE RESISTANCE (Approx.)	0.35	0.6	Megohm
TRANSCONDUCTANCE	625	650	Micromhos
TRANSCONDUCTANCE (At -15 volts bias)	15	15	Micromhos

POWER AMPLIFIER PENTODE

1J5-G

The 1J5-G is a power amplifier pentode of the 2.0-volt filament type for use in battery-operated receivers. The filament current is 0.12 ampere. With 135 volts on both the plate and screen and -16.5 volts bias, the characteristics are: plate current, 7 ma.; screen current, 2 ma.; transconductance, 950 micromhos. With a load resistance of 13500 ohms, the power output is 0.45 watt. Dimensions are shown in Fig. 2-21, OUTLINES SECTION. The tube should be mounted vertically; horizontal operation is permissible if the plane of the filament is vertical.

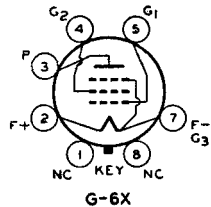

POWER AMPLIFIER PENTODE

1LA4

The 1LA4 is a power amplifier pentode of the 1.4-volt filament type for use in the output stage of battery-operated receivers. It is of the locking-base type and can be mounted in any position. It is identical to the 1A5-G except for physical characteristics. Dimensions are shown in Fig. 2-4, OUTLINES SECTION.

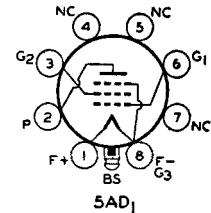

PENTAGRID CONVERTER

1LA6

The 1LA6 is a multi-electrode tube of the 1.4-volt filament type. It is intended for use as a combined mixer and oscillator in battery-operated receivers. It is of the locking-base type and can be mounted in any position. Dimensions are shown in Fig. 2-4, OUTLINES SECTION. Installation and application are the same as for the 1A7-GT.

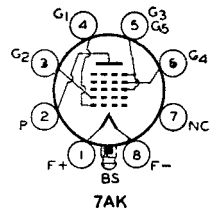

★CHARACTERISTICS

FILAMENT VOLTAGE (D.C.)	1.4	Volts
FILAMENT CURRENT	0.05	Ampere
DIRECT INTERELECTRODE CAPACITANCES:*		
Grid No. 4 to Plate	0.4	μmf
Grid No. 4 to grid No. 2	0.3	μmf
Grid No. 4 to Grid No. 1	0.15	μmf
Grid No. 1 to Grid No. 2	0.6	μmf
Grid No. 4 to All Other Electrodes (R-F Input)	7.7	μmf
Grid No. 2 to All Other Electrodes Except Grid No. 1 (Osc. Output)	3.3	μmf
Grid No. 1 to All Other Electrodes Except Grid No. 2 (Osc. Input)	2.9	μmf
Plate to All Other Electrodes (Mixer Output)	8	μmf

* With close-fitting shield connected to negative filament.

Converter Service

Maximum ratings and typical operation for the 1LA6 are the same as for the 1A7-GT except that the plate resistance is 0.75 megohm, conversion transconductance for control-grid bias of -3 volts is 10 micromhos, and the series screen-voltage resistor is 45000 to 75000 ohms.

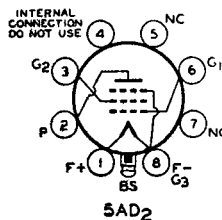

POWER AMPLIFIER PENTODE

The 1LB4 is a power amplifier pentode of the 1.4-volt filament type for use in the output stage of battery-operated receivers. It is of the locking-base type and it can be mounted in any position. Physical characteristics are shown in Fig. 2-4, OUTLINES SECTION. For electrical characteristics, refer to the data for the pentode section of the 1D8-GT.

1LB4

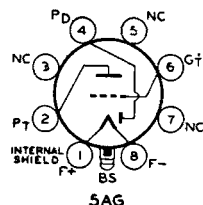

DIODE HIGH-MU TRIODE

The 1LH4 is a multielectrode tube of the 1.4-volt filament type for use in battery-operated receivers. It contains a single diode and a high-mu triode, and is for use as a combined detector and amplifier. It is of the locking-base type and can be mounted in any position. Dimensions are shown in Fig. 2-4, OUTLINES SECTION. Except for capacitances, the electrical characteristics are the same as for the 1H5-GT.

1LH4

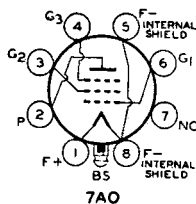

R-F AMPLIFIER PENTODE

The 1LN5 is an r-f amplifier pentode of the 1.4-volt filament type for use in battery-operated receivers. It is of the locking-base type and may be mounted in any position. Physical characteristics are shown in Fig. 2-4, OUTLINES SECTION. Installation and application are similar to that of the 1N5-GT.

1LN5

★CHARACTERISTICS

FILAMENT VOLTAGE (D.C.)	1.4	Volts
FILAMENT CURRENT	0.05	Ampere
GRID PLATE CAPACITANCES†	0.007 max.	μmf
INPUT CAPACITANCES‡	3.4	μmf
OUTPUT CAPACITANCES‡	8	μmf

† With close-fitting shield connected to negative filament terminal.

As Class A₁ Amplifier

PLATE VOLTAGE	110 max.	Volts
SCREEN VOLTAGE	110 max.	Volts
TYPICAL OPERATION:		
Plate Voltage	90	Volts
Screen Voltage	90	Volts
Grid Voltage**	0	Volts
Plate Current	1.6	Milliamperes
Screen Current	0.35	Milliamperes
Plate Resistance (Approx.)	1.1	Megohms
Transconductance	800	Micromhos
Transconductance with -4.5 volt bias (Approx.)	10	Micromhos

** Circuit returns to negative filament terminal.

DIODE-POWER AMPLIFIER
PENTODE

1N6-G

The 1N6-G is a multi-electrode tube of the 1.4-volt filament type containing a diode and a power amplifier pentode in one envelope. Dimensions are shown in Fig. 2-13, OUTLINES SECTION. The tube may be mounted in any position.

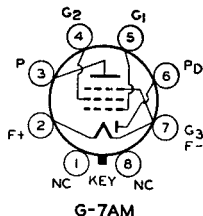

★CHARACTERISTICS

FILAMENT VOLTAGE (D.C.)	1.4	Volts
FILAMENT CURRENT	0.05	Ampere

Pentode Unit—As Class A₁ Amplifier

PLATE VOLTAGE	110 max.	Volts
SCREEN VOLTAGE	110 max.	Volts
TOTAL CATHODE CURRENT FOR ZERO SIGNAL	6	Milliamperes
TYPICAL OPERATION and CHARACTERISTICS:		
Plate Voltage	90	Volts
Screen Voltage	90	Volts
Grid Voltage	-4.5	Volts
Peak A-F Grid Voltage	4.9	Volts
Zero-Signal Plate Current	3.4	Milliamperes
Max.-Signal Plate Current	3.4	Milliamperes
Zero-Signal Screen Current	0.7	Milliamperes
Max.-Signal Screen Current	1.2	Milliamperes
Plate Resistance (Approx.)	0.3	Megohm
Transconductance	800	Micromhos
Load Resistance	25000	Ohms
Total Harmonic Distortion	7	Per cent
Max.-Signal Power Output	0.1	Watt

Diode Unit

The diode unit is independent of the pentode unit except for the common filament. The diode is located at the negative end of the filament.

R-F AMPLIFIER PENTODE

1P5-GT

The 1P5-GT is a pentode of the 1.4-volt filament type for use in battery-operated receivers as an r-f or i-f amplifier. Installation and application are the same as for the 1N5-GT. Physical characteristics of the 1P5-GT are shown in Fig. 2-6, OUTLINES SECTION. The 1P5-GT may be mounted in any position.

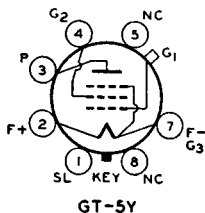

★CHARACTERISTICS

FILAMENT VOLTAGE (D.C.)	1.4	Volts
FILAMENT CURRENT	0.05	Ampere
GRID-PLATE CAPACITANCE*	0.007 max.	μsf
INPUT CAPACITANCE*	2.2	μsf
OUTPUT CAPACITANCE*	10	μsf

* With close-fitting shield connected to negative filament terminal.

As Class A₁ Amplifier

PLATE VOLTAGE	110 max.	Volts
SCREEN VOLTAGE	110 max.	Volts
TYPICAL OPERATION:		
Plate Voltage	90	Volts
Screen Voltage	90	Volts
Grid Voltage	0	Volts
Plate Current	2.3	Milliamperes
Screen Current	0.7	Milliamperes
Plate Resistance (Approx.)	0.8	Megohm
Transconductance	750	Micromhos
Transconductance with -12 volts bias	10	Micromhos

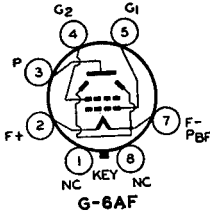

BEAM POWER AMPLIFIER

The 1Q5-GT/1Q5-G is a power amplifier of the beam type having a 1.4-volt filament. The 1Q5-GT/1Q5-G supersedes both the 1Q5-GT and the 1Q5-G. It has electrical and physical characteristics identical with those of the 1Q5-GT.

**1Q5-GT/
1Q5-G**

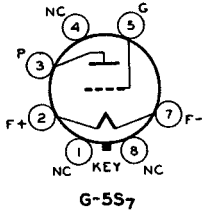

GAS-TRIODE

The 2A4-G is a grid-controlled, gaseous-discharge tube of the filament type. It is intended for use in relay-control equipment designed for its characteristics. Physical characteristics of the 2A4-G are shown in Fig. 2-17, OUTLINES SECTION. The 2A4-G may be mounted in any position.

2A4-G

CHARACTERISTICS*

FILAMENT VOLTAGE (A.C. or D.C.)	2.5	Volts
FILAMENT CURRENT	2.5	Amperes
PEAK INVERSE ANODE VOLTAGE	200 max.	Volts
PEAK FORWARD ANODE VOLTAGE	200 max.	Volts
PEAK VOLTAGE BETWEEN ANY TWO ELECTRODES	250 max.	Volts
PEAK ANODE CURRENT	1.25 max.	Amperes
AVERAGE ANODE CURRENT (Averaged over any period of 45 seconds)	0.10 max.	Ampere
ANODE DROP	15	Volts

* Filament voltage should be applied for 2 seconds before current is drawn from the anode.

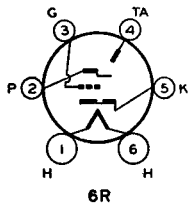

**ELECTRON-RAY TUBE
(Indicator Type)**

The 2E5 is a heater-cathode type of tube designed to indicate visually, by means of a fluorescent target, the effects of a controlling voltage. As such, it is useful as a convenient means of indicating accurate tuning of a radio receiver. Except for the heater rating of 2.5 volts and 0.8 ampere, the 2E5 has the same characteristics as the 6E5. Dimensions are shown in Fig. 2-19, OUTLINES SECTION.

2E5

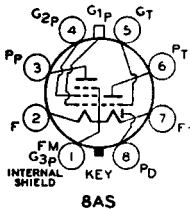

**DIODE-TRIODE-
R-F AMPLIFIER PENTODE**

The 3A8-GT is a filament type of tube containing a diode, a voltage amplifier triode, and an r-f amplifier pentode. Each unit is independent of the others except for the common filament. The filament is designed to be operated from either a single dry cell (parallel arrangement) or two dry cells in series (series arrangement).

3A8-GT

★CHARACTERISTICS

FILAMENT VOLTAGE (D.C.)	1.4 (parallel)	2.8 (series)	Volts
FILAMENT CURRENT	0.1 (parallel)	0.05 (series)	Ampere
DIRECT INTERELECTRODE CAPACITANCES:			
<i>Triode Unit</i> —Grid to Plate (approx.)			
		2.0	μf
		2.6	μf
		4.2	μf
<i>Pentode Unit</i> —Grid to Plate			
		0.012 max.	μf
		3.0	μf
		10	μf

* With close-fitting shield connected to negative filament terminal

MAXIMUM OVERALL LENGTH.....	3 1/4"
MAXIMUM SEATED HEIGHT.....	2 1/4"
MAXIMUM DIAMETER.....	1 1/4"
BULB.....	T-9
CAP.....	Skirted Miniature
BASE.....	Intermediate Shell Octal 8-Pin
MOUNTING POSITION.....	Any

Triode Unit as Class A₁ Amplifier

PLATE VOLTAGE.....	110 max.	Volts
TYPICAL OPERATION:		
Plate Voltage.....	90	Volts
Grid Voltage*.....	0	Volts
Amplification Factor.....	65	
Plate Resistance (Approx.).....	0.2	Megohm
Transconductance.....	325	Micromhos
Plate Current.....	0.2	Milliampere

Pentode Unit as Class A₁ Amplifier

PLATE VOLTAGE.....	110 max.	Volts
SCREEN VOLTAGE.....	110 max.	Volts
TYPICAL OPERATION:		
Plate Voltage.....	90	Volts
Screen Voltage.....	90	Volts
Grid Voltage*.....	0	Volts
Plate Resistance (Approx.).....	0.8	Megohm
Transconductance.....	750	Micromhos
Plate Current.....	1.5	Milliamperes
Screen Current.....	0.5	Milliampere

Diode Unit

The diode unit is located at the negative end of the filament and is independent of the triode and pentode except for the common filament.

* Grid voltage for the parallel-filament arrangement is referred for both triode and pentode to pins 2 and 7 connected together; for the series-filament arrangement, grid voltage for the triode is referred to pin 7 and for the pentode to pin 1.

POWER AMPLIFIER PENTODE

3Q4

The 3Q4 is a miniature type of power amplifier pentode which is suitable for use with 90 volts on both the plate and screen, and thus provides relatively high power output. The 3Q4 has a center-tapped filament so that the tube may be used with a 1.4-volt battery or in series with other miniature tubes having 0.05-ampere filaments. Physical characteristics are shown in Fig. 2-2, OUTLINES SECTION. The tube may be mounted in any position.

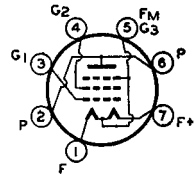

7BA

★CHARACTERISTICS

	Series Filament Arrangement	Parallel Filament Arrangement	
FILAMENT VOLTAGE (D.C.).....	2.8	1.4	Volts
FILAMENT CURRENT.....	0.05	0.1	Ampere

As Class A₁ Amplifier

PLATE VOLTAGE.....	90 max.	90 max.	Volts
SCREEN VOLTAGE.....	90 max.	90 max.	Volts
TOTAL CATHODE CURRENT.....	6 max.	12 max.	Milliamperes
TYPICAL OPERATION and CHARACTERISTICS:			
Plate Voltage.....	90	85	90
Screen Voltage.....	90	85	90
Grid Voltage.....	-4.5	-5	-4.5
Peak A-F Grid Voltage.....	4.5	5	4.5
Zero-Signal Plate Current.....	7.7	6.9	9.5
Zero-Signal Screen Current.....	1.7	1.5	2.1
Plate Resistance (Approx.).....	0.12	0.12	0.1
Transconductance.....	2000	1975	2150
Load Resistance.....	10000	10000	10000
Total Harmonic Distortion.....	7	10	7
Max.-Signal Power Output.....	0.24	0.25	0.27
			Watt

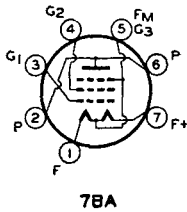

POWER AMPLIFIER PENTODE

3S4

The 3S4 is a miniature type of power amplifier pentode designed for use in the output stage of compact, light-weight, portable equipment. Construction is like that of the 1R5. The 3S4 has characteristics similar to those of the 1S4, but it has a filament which permits operation with either series connection on 2.8 volts or parallel connection on 1.4 volts. Dimensions are shown in Fig. 2-2, OUTLINES SECTION. The 3S4 may be mounted in any position.

CHARACTERISTICS

	Series Filament Arrangement	Parallel Arrangement	
FILAMENT VOLTAGE (D.C.)	2.8	1.4	Volts
FILAMENT CURRENT	0.05	0.1	Ampere
As Class A₁ Amplifier			
PLATE VOLTAGE	67.5 max.	67.5 max.	Volts
SCREEN VOLTAGE	67.5 max.	67.5 max.	Volts
TOTAL CATHODE CURRENT FOR MAXIMUM SIGNAL	9.5 max.	11 max.	Milliamperes
TOTAL CATHODE CURRENT FOR ZERO SIGNAL	7.5 max.	9 max.	Milliamperes
TYPICAL OPERATION and CHARACTERISTICS—Class A₁ Amplifier:			
Plate Voltage	67.5	67.5	Volts
Screen Voltage	67.5	67.5	Volts
Grid Voltage*	-7	-7	Volts
Peak A-F Grid Voltage	7	7.2	Volts
Zero-Signal Plate Current	6	7.2	Milliamperes
Zero-Signal Screen Current	1.2	1.5	Milliamperes
Plate Resistance (Approx.)	0.1	0.1	Megohm
Transconductance	1400	1550	Micromhos
Load Resistance	5000	5000	Ohms
Total Harmonic Distortion	12	10	Per cent
Max.-Signal Power Output	0.16	0.18	Watt

* For series filament arrangement, filament voltage is applied between pins 1 and 7; grid voltage is referred to pin 1. For parallel filament arrangement, filament voltage is applied between pins 5 and pins 1 and 7 connected together; grid voltage is referred to pin 5.

FULL-WAVE HIGH-VACUUM RECTIFIER

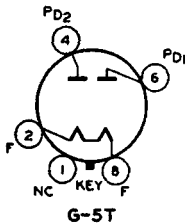

5W4-G

5W4-GT

The 5W4-G and 5W4-GT are full-wave high-vacuum rectifiers for use in a-c receivers having low current requirements. Electrical ratings are the same as those for the 5W4. Dimensions of the 5W4-G are shown in Fig. 2-21, OUTLINES SECTION; those of the 5W4-GT are: maximum overall length, 3 3/4 in., maximum seated height, 2 1/4 in., maximum diameter, 1 1/4 in., bulb, T-9, base, intermediate shell octal 5-pin. Horizontal operation of both types is permissible if pins 2 and 7 are in a horizontal plane

POWER AMPLIFIER TRIODE

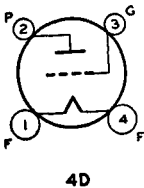

6A3

The 6A3 is a three-electrode type of power amplifier tube designed for use in the power-output stage of radio receivers designed for its characteristics. The filament is rated at 6.3 volts and 1.0 ampere. In single-tube class A₁ service, the characteristics and operating conditions are the same as for the 2A3 except that the power output is 3.2 watts. In push-pull class AB₁ service, the 6A3 may be operated with either fixed or cathode bias with a maximum plate voltage of 325 volts. With cathode resistor of 850 ohms; plate-to-plate load resistance, 5000 ohms; zero-signal plate current 80 milliamperes; power output, 10 watts. With fixed bias of -68 volts; plate-to-plate load resistance, 3000 ohms; zero-signal plate current, 80 milliamperes; power output, 15 watts.

Physical characteristics are the same as for the 2A3. If it is necessary to mount the 6A3 in a horizontal position, the plane of the filament should be vertical.

PENTAGRID CONVERTER

6A7-S

The 6A7-S is a pentagrid converter for use as a replacement in equipment designed for its characteristics. In general, the electrical characteristics of the 6A7-S are similar to those of the 6A7; however, the two types are not usually interchangeable.

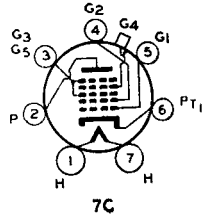

DIRECT-COUPLED POWER AMPLIFIER

6AB6-G

The 6AB6-G is a multi-electrode tube of the heater-cathode type consisting of two triodes in one bulb. It is used principally for replacement in receivers designed for its characteristics. One triode, the driver, is directly connected to the second, or output, triode. Physical characteristics are: maximum overall length, 4 1/4 in.; maximum seated height, 3 1/4 in.; maximum diameter, 1 1/4 in.; bulb, ST-12; base, small shell octal 7-pin. The tube may be mounted in any position.

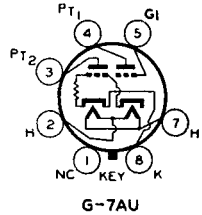

CHARACTERISTICS

HEATER VOLTAGE (A.C. or D.C.)	6.3
HEATER CURRENT	0.5

Volts	6.3
Ampere	0.5

As Class A₁ Amplifier

OUTPUT-TRIODE PLATE (PT ₁) VOLTAGE	250 max.
INPUT-TRIODE PLATE (PT ₁) VOLTAGE	250 max.
INPUT-TRIODE GRID VOLTAGE	0
PEAK A-F GRID VOLTAGE	25
OUTPUT-TRIODE PLATE CURRENT	34
INPUT-TRIODE PLATE CURRENT	5
PLATE RESISTANCE (Approx.)	40000
TRANSCONDUCTANCE (G _t to PT ₁)	1800
LOAD RESISTANCE	8000
HARMONIC DISTORTION	10
POWER OUTPUT	3.5

Volts	250 max.
Volts	250 max.
Volts	0
Volts	25
Milliamperes	34
Milliamperes	5
Ohms	40000
Micromhos	1800
Ohms	8000
Per cent	10
Watts	3.5

HIGH-MU POWER AMPLIFIER TRIODE

6AC5-GT/
6AC5-G

The 6AC5-GT/6AC5-G is a high-mu triode designed for use either in single-ended or push-pull audio-frequency amplifiers. The 6AC5-GT/6AC5-G supersedes both the 6AC5-G and the 6AC5-GT. It has electrical characteristics identical to those of the 6AC5-G. Dimensions are shown in Fig. 2-8, OUT-LINES SECTION. The 6AC5-GT/6AC5-G may be mounted in any position.

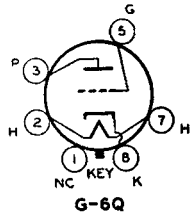

ELECTRON-RAY TUBE

6AD6-G

The 6AD6-G is a heater-cathode type of tube designed to respond visually, by means of two shadows on a fluorescent target, to changes in voltages applied to the control electrodes. This tube is intended for use as a voltage indicator to indicate accurate tuning of a receiver to the desired station. The application of the 6AD6-G is similar to that discussed under the 6AF6-G.

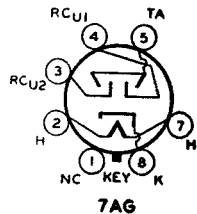

CHARACTERISTICS

HEATER VOLTAGE (A.C. or D.C.)	6.3	Volts
HEATER CURRENT	0.15	Ampere
MAXIMUM OVERALL LENGTH	2 3/4"	
MAXIMUM SEATED HEIGHT	2 1/8"	
MAXIMUM DIAMETER	1 1/8"	
BULB	T-9	
BASE	Small Wafer Octal 7-Pin, Sleeve	
MOUNTING POSITION	Any	

As Tuning Indicator

TARGET VOLTAGE		150 max.	Volts
TYPICAL OPERATION:			
Target Voltage	100	150	Volts
Target Current*	1.5	3	Milliamperes
Target Current**	1.0	2	Milliamperes
Target Current***	0.8	1.2	Milliamperes
Ray-Control Electrode Voltage (Approx.)*	45	75	Volts
Ray-Control Electrode Voltage (Approx.)**	0	8	Volts
Ray-Control Electrode Voltage (Approx.)***	-23	-50	Volts

* For shadow angle of 0° produced by either ray-control electrode.
 ** For shadow angle of 90° produced by either ray-control electrode.
 *** For shadow angle of 135° produced by either ray-control electrode.

TRIODE-POWER AMPLIFIER
PENTODE

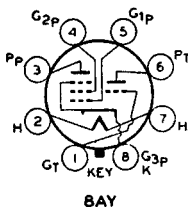

The 6AD7-G contains a voltage amplifier triode, and a power amplifier pentode similar to the 6F6-G. It is of the heater-cathode type. The 6AD7-G is especially useful in combination with a separate 6F6-G in a push-pull amplifier; in this service, the triode unit serves as the phase inverter. Curves shown under the 6F6-G apply to the pentode unit of the 6AD7-G. Physical characteristics are shown in Fig. 2-21, OUTLINES SECTION. The tube may be mounted in any position.

6AD7-G

★CHARACTERISTICS

HEATER VOLTAGE (A.C. or D.C.)	6.3	Volts
HEATER CURRENT	0.85	Ampere

Triode Unit

PLATE VOLTAGE	285 max.	Volts
PLATE DISSIPATION	1.0 max.	Watts
CHARACTERISTICS—Class A ₁ Amplifier		
Plate Voltage	250	Volts
Grid Voltage	-25	Volts
Amplification Factor	6	
Plate Resistance (Approx.)	19000	Ohms
Transconductance	325	Micromhos
Plate Current	4	Milliamperes

Pentode Unit

PLATE VOLTAGE	375 max.	Volts
SCREEN VOLTAGE	285 max.	Volts
PLATE DISSIPATION	8.5 max.	Watts
SCREEN DISSIPATION	2.7 max.	Watts
TYPICAL OPERATION and CHARACTERISTICS—Class A ₁ Amplifier:		
Plate Voltage	250	Volts
Screen Voltage	250	Volts
Grid Voltage	-16.5	Volts
Peak A-F Grid Voltage	16.5	Volts
Zero-Signal Plate Current	34	Milliamperes
Max.-Signal Plate Current	36	Milliamperes
Zero-Signal Screen Current	6.5	Milliamperes
Max.-Signal Screen Current	10.5	Milliamperes
Plate Resistance (Approx.)	80000	Ohms
Transconductance	2500	Micromhos
Load Resistance	7000	Ohms
Total Harmonic Distortion	8	Per cent
Max.-Signal Power Output	3.2	Watts

As Push-Pull Amplifier

Pentode Unit of 6AD7-G and Separat. 6F6-G

PLATE VOLTAGE.....	375 max.	Volts
SCREEN VOLTAGE.....	285 max.	Volts
PLATE DISSIPATION.....	8.5 max.	Watts
SCREEN DISSIPATION.....	2.7 max.	Watts

TYPICAL OPERATION WITH CATHODE BIAS—Class AB₁ Amplifier:
Values are for pentode unit of 6AD7-G and 6F6-G together

Plate Voltage.....	250	285	375	Volts
Screen Voltage.....	250	285	250	Volts
Cathode Resistor.....	560	470	470	Ohms
Peak A-F Grid-to-Grid Voltage.....	59	64	55	Volts
Zero-Signal Plate Current.....	36	47.5	41	Milliamperes
Max.-Signal Plate Current.....	41	54.5	50	Milliamperes
Zero-Signal Screen Current.....	6.7	8.2	6.7	Milliamperes
Max.-Signal Screen Current.....	11.7	13.5	9.2	Milliamperes
Effective Load Resistance (plate-to-plate).....	14000	12000	16000	Ohms
Total Harmonic Distortion.....	4	4	2	Per cent
Max.-Signal Power Output.....	6	8.5	9	Watts

TWIN-PLATE CONTROL TUBE

6AE6-G

The 6AE6-G is intended for use as a control tube for twin-type electron-ray tubes; it provides in effect two triodes with different cut-off characteristics. With airc voltage applied to the common control grid in suitable circuits, one triode section operates on weak signals while the other operates on strong signals. Physical characteristics are shown in Fig. 2-17, OUTLINES SECTION. The tube may be mounted in any position.

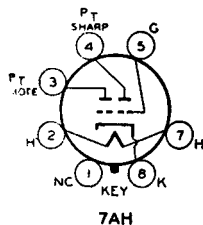

CHARACTERISTICS

HEATER VOLTAGE (A.C. or D.C.).....	6.3	Volts
HEATER CURRENT.....	0.15	Ampere

Remote Cut-Off Triode

PLATE VOLTAGE.....	250 max.			Volts
CHARACTERISTICS:				
Plate Voltage.....	250	250	250	Volts
Grid Voltage.....	-35	-15	-6	Volts
Amplification Factor.....	25			
Plate Resistance (Approx.).....	25000			Ohms
Transconductance.....	1000			Micromhos
Plate Current.....	0.01	0.8	2.8	Milliamperes

Sharp Cut-Off Triode

PLATE VOLTAGE.....	250 max.			Volts
CHARACTERISTICS:				
Plate Voltage.....	250	250	250	Volts
Grid Voltage.....	-9.5	-1.5	Volts	
Amplification Factor.....	33			
Plate Resistance (Approx.).....	35000			Ohms
Transconductance.....	950			Micromhos
Plate Current.....	0.01	4.5	Milliamperes	

TWIN-INPUT TRIODE AMPLIFIER

6AE7-GT

The 6AE7-GT is intended for use as a voltage amplifier triode or as a driver for two type 6AC5-GT tubes in dynamic-coupled push-pull amplifiers. In the latter service, the 6AE7-GT takes the place of the two tubes ordinarily required as drivers. Physical characteristics are shown in Fig. 2-8, OUTLINES SECTION. The 6AE7-GT may be mounted in any position.

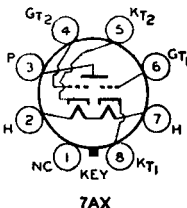

★CHARACTERISTICS

HEATER VOLTAGE (A.C. or D.C.).....	6.3	Volts
HEATER CURRENT.....	0.6	Ampere

As Class A₁ Amplifier

Both grids connected together at socket; likewise both cathodes

PLATE VOLTAGE	300	max. Volts
PLATE DISSIPATION	5	max. Watts
TYPICAL OPERATION and CHARACTERISTICS:		
Plate Voltage	250	Volts
Grid Voltage	-13.5	Volts
Plate Current	10	Milliamperes
Plate Resistance	4650	Ohms
Amplification Factor	14	
Transconductance	3000	Micromhos

As Driver for Two Type 6AC5-GT Tubes in Dynamic-Coupled Push-Pull Amplifier

PLATE VOLTAGE	300	max. Volts
PLATE DISSIPATION	5	max. Watts
TYPICAL OPERATION:		
Plate-Supply Voltage	250	Volts
Grid Voltage	‡	Volts
Grid-to-Grid Input Signal to Driver*	44	rms Volts
Zero-Signal Driver Plate Current	10	Milliamperes
Max.-Signal Driver Plate Current	19	Milliamperes
Zero-Signal Plate Current of 6AC5-GT's	64	Milliamperes
Max.-Signal Plate Current of 6AC5-GT's	76	Milliamperes
Load Resistance (plate-to-plate) (6AC5-GT's)	10000	Ohms
Harmonic Distortion (6AC5-GT's)	10	Per cent
Power Output (6AC5-GT's)	9.5	Watts

‡ Bias voltage for both the driver and the push-pull stage is developed by the dynamic-coupled connection.

* Current does not flow in the driver grid circuit during any part of the input cycle.

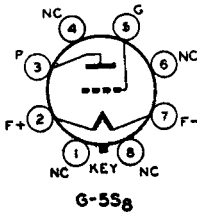

POWER AMPLIFIER TRIODE

The 6B4-G is a low- μ triode designed for the output stage of radio receivers. The electrical characteristics are the same as those of the 6A3, but the 6B4-G is provided with an octal base. Physical characteristics are shown in Fig. 2-26, OUTLINES SECTION. The tube should be mounted in a vertical position; horizontal operation is permissible if the plane of the filament is vertical.

6B4-G

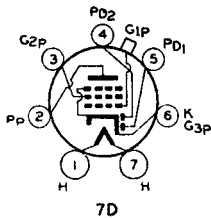

DUPLEX-DIODE PENTODE

The 6B7-S is a multi-electrode tube consisting of two diodes and an r-f pentode in one envelope. This tube is intended for use as a replacement in receivers designed for its characteristics. The characteristics of the 6B7-S are similar to those of the 6B7; however, the two types are not usually interchangeable.

6B7-S

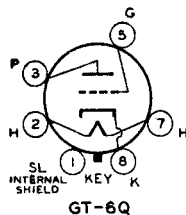

DETECTOR AMPLIFIER TRIODE

The 6C5-GT is a triode of the heater-cathode type designed for use as a detector, amplifier, or oscillator. Except for the capacitances, the electrical characteristics are the same as those of the 6C5. Capacitances are: grid-plate, 2.2 μ mf; grid-cathode, 4.4 μ mf; plate-cathode, 12 μ mf. Physical characteristics are: maximum over-all length, 3 $\frac{1}{4}$ in.; maximum seated height, 2 $\frac{3}{4}$ in.; maximum diameter, 1 $\frac{1}{4}$ in.; bulb, T-9; base, small wafer octal 6-pin with metal sleeve; mounting position, any

6C5-GT

DUPLEX-DIODE TRIODE

6C7

The 6C7 is a multielectrode tube consisting of two diodes and a medium- μ triode in one envelope. This type is intended for renewal in receivers designed for its characteristics. Characteristics are similar to those of the 85, but the 6C7 is not interchangeable with it.

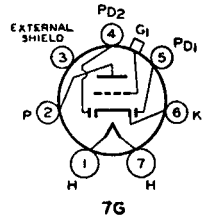

TRIPLE-GRID DETECTOR AMPLIFIER

6D7

The 6D7 is a triple-grid tube designed for use as a detector or amplifier. This type is intended for replacement in receivers designed for its characteristics. With plate volts of 250, screen volts of 100, and grid volts of -3, the plate current is 2 ma., screen current is 0.5 ma., transconductance is 1225 micromhos.

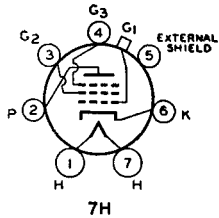

TWIN-TRIODE POWER AMPLIFIER

6E6

The 6E6 is a heater-cathode type of tube consisting of two low- μ triodes in one bulb. The 6E6 is designed for use as a class A amplifier in either parallel or push-pull circuits. Dimensions are shown in Fig. 2-25, OUTLINES SECTION. The tube may be mounted in any position. The heater voltage is 6.3 volts; current, 0.6 ampere. With plate volts of 250, and grid volts of -27.5, the characteristics for each unit are: plate cur-

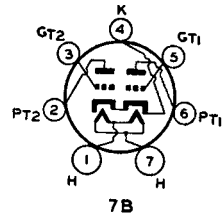

rent, 18 ma.; plate resistance, 3500 ohms; transconductance, 1700 micromhos; amplification factor, 6. With plate-to-plate load resistance of 14000 ohms, the power output for two tubes is 1.6 watts.

TRIPLE-GRID SUPER-CONTROL AMPLIFIER

6E7

The 6E7 is a triple-grid amplifier designed for use as an r-f or i-f amplifier. This type is intended for replacement in receivers designed for its characteristics. With plate volts of 250, screen volts of 100, and grid volts of -3, the plate current is 8.2 ma., the screen current is 2 ma., transconductance is 1600 micromhos.

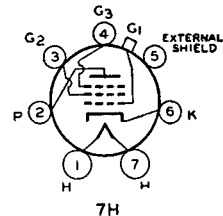

TWIN DIODE

6H6-GT

The 6H6-GT is a tube of the heater-cathode type containing two diodes in a single envelope. Except for physical characteristics, the 6H6-GT is identical to the 6H6. Physical characteristics are: maximum overall length, 2 1/4"; maximum seated height, 2 1/8"; maximum diameter, 1 1/4"; bulb, T-9; base, small wafer octal 7-pin, with sleeve; mounting position, any.

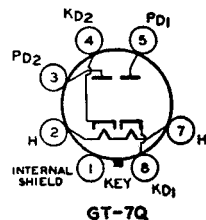

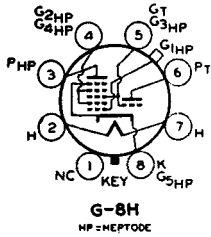

TRIODE-HEPTODE CONVERTER

The 6J8-G is a multi-unit tube consisting of a triode unit and a heptode unit in one envelope. The triode unit is designed to serve as the oscillator and the heptode unit as the detector in superheterodyne receivers. Application is similar to that for circuits employing separate oscillator and detector. The control grid of the triode is connected within the tube to grid No. 3 of the heptode unit for efficient electron coupling. Physical characteristics of the 6J8-G are shown in Fig. 2-15, OUTLINES SECTION. The 6J8-G may be mounted in any position.

6J8-G

CHARACTERISTICS

HEATER VOLTAGE (A.C. or D.C.)	6.3	Volts
HEATER CURRENT	0.3	Ampere
DIRECT INTERELECTRODE CAPACITANCES:		
Heptode Grid to Heptode Plate*	0.01	max. μ f
Heptode Grid to Triode Plate*	0.015	max. μ f
Heptode Grid to Triode Grid*	0.13	μ f
Triode Grid to Triode Plate	2.2	μ f
Heptode Grid to All Other Electrodes = R-F Input	4.4	μ f
Triode Plate to All Other Electrodes = Osc. Output	5.5	μ f
Triode Grid to All Other Electrodes = Osc. Input	11.7	μ f
Heptode Plate to All Other Electrodes = Mixer Output	8.8	μ f

* With shield-can

As Frequency Converter

HEPTODE PLATE VOLTAGE	250	max. Volts
HEPTODE SCREEN VOLTAGE (Grids No. 2 and 4)	100	max. Volts
TRIODE PLATE SUPPLY VOLTAGE†	250	max. Volts
TYPICAL OPERATION:		
Heptode Plate Voltage	100	250 Volts
Heptode Screen Voltage	100	100 Volts
Heptode Control-Grid Voltage (Grid No. 1)	-3	-3 Volts
Triode Plate Voltage	100	250† Volts
Triode Grid Resistor	50000	50000 Ohms
Heptode Plate Resistance (Approx.)	0.9	4 Megohms
Conversion Transconductance	250	290 Micromhos
Heptode Control-Grid Voltage for conversion transconductance of 2 micromhos	—	-20 Volts
Heptode Plate Current	1.4	1.3 Milliampere
Heptode Screen Current	3	2.9 Milliampere
Triode Plate Current	3	5 Milliampere
Triode Grid and Heptode Grid No. 3 Current	0.3	0.4 Milliampere

Characteristics of Triode Unit Only

The transconductance of the triode section, not oscillating, is approximately 1600 micromhos when the plate voltage is 150 volts, and the grid voltage is -3 volts.

† Applied through 20000-ohm voltage-dropping resistor.

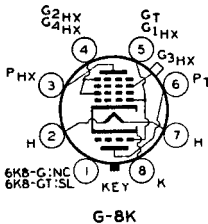

TRIODE-HEXODE CONVERTER

The 6K8-G and 6K8-GT are multi-electrode tubes consisting of a triode oscillator and a hexode mixer in a single envelope. Both of these types are identical electrically to the 6K8 except for the capacitances (given below). Refer to the 6K8 for Installation and Application. Physical characteristics of the 6K8-G are shown in Fig. 2-15 and of the 6K8-GT in Fig. 2-6, OUTLINES SECTION. Both types may be mounted in any position.

6K8-G

6K8-GT

★CHARACTERISTICS

HEATER VOLTAGE (A.C. or D.C.)	6.3	Volts
HEATER CURRENT	0.3	Ampere
DIRECT INTERELECTRODE CAPACITANCES:		
Hexode Grid No. 3 to Hexode Plate	0.08	max. μ f
Hexode Grid No. 3 to Triode Plate	0.05	μ f
Hexode Grid No. 3 to Triode Grid No. 1 and Hexode Grid No. 1	0.2	μ f
Triode Grid and Hexode Grid No. 1 to Triode Plate	1.8	μ f

Triode Grid and Hexode Grid No. 1 to Hexode Plate	0.15	$\mu\mu\text{f}$
Hexode Grid No. 3 to All Other Electrodes = R-F Input	4.6	$\mu\mu\text{f}$
Triode Plate to All Other Electrodes Except Triode Grid and Grid No. 1 = Osc. Output	3.4	$\mu\mu\text{f}$
Triode Grid and Hexode Grid No. 1 to All Other Electrodes Except Triode Plate = Osc. Input	6.5	$\mu\mu\text{f}$
Hexode Plate to All Other Electrodes = Mixer Output	4.8	$\mu\mu\text{f}$

DETECTOR AMPLIFIER TRIODE

**6P5-GT/
6P5-G**

The 6P5-GT/6P5-G is a triode of the heater-cathode type for use as detector, amplifier, or oscillator. It is also used as a driver for the 6AC5-GT/6AC5-G. Except for capacitances, the electrical characteristics of the 6P5-GT/6P5-G are the same as for the 6P5-G. The capacitances are: grid-plate, 2.8 $\mu\mu\text{f}$; grid-cathode, 3.5 $\mu\mu\text{f}$; plate-cathode, 2.5 $\mu\mu\text{f}$. Physical characteristics are shown in Fig. 2-8, OUTLINES SECTION. The 6P5-GT/6P5-G may be mounted in any position.

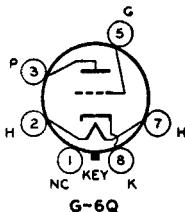

TRIODE PENTODE

6P7-G

The 6P7-G is a heater-cathode type of tube combining in one bulb a triode and an r-f pentode of the remote cut-off type. Electrical characteristics, (except for capacitances, installation and application for the 6P7-G are the same as for the 6P7 but the 6P7-G is equipped with a standard octal base. Capacitances of the tube are: grid-plate, 2 $\mu\mu\text{f}$; grid-cathode, 1.4 $\mu\mu\text{f}$; plate-cathode, 2 $\mu\mu\text{f}$; and for the pentode unit; grid-plate (with tube shield), 0.007 $\mu\mu\text{f}$; input, 2.8 $\mu\mu\text{f}$; output, 11.5 $\mu\mu\text{f}$. Dimensions are shown in Fig. 2-15, OUTLINES SECTION. The tube may be mounted in any position.

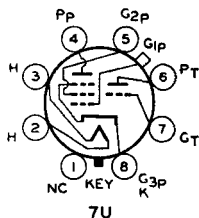

are shown in Fig. 2-15, OUTLINES SECTION. The tube may be mounted in any position.

DUPLEX-DIODE TRIODE

6R7-GT

The 6R7-GT is a multi-unit tube like Type 6R7 in electrical characteristics. Physical characteristics of the 6R7-GT are shown in Fig. 2-6, OUTLINES SECTION. The 6R7-GT may be mounted in any position.

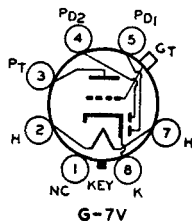

PENTAGRID CONVERTER

6SA7-GT

The 6SA7-GT is a multi-electrode tube of the single-ended type designed to perform simultaneously the functions of mixer (first detector) and of an oscillator tube in super-heterodyne circuits. Installation and application of the 6SA7-GT are similar to those for the 6SA7.

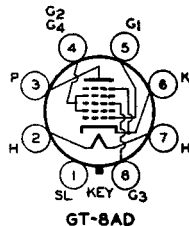

★CHARACTERISTICS

HEATER VOLTAGE (A.C. or D.C.)	6.3	Volts
HEATER CURRENT	0.3	Ampere
DIRECT INTERELECTRODE CAPACITANCES:		
Grid No. 3 to All Other Electrodes = R-F Input*	11	$\mu\mu\text{f}$
Plate to All Other Electrodes = Mixer Output*	12	$\mu\mu\text{f}$
Grid No. 1 to All Other Electrodes*	8	$\mu\mu\text{f}$

* With base shell connected to cathode.

Grid No. 3 to Plate*	0.2 max. μ f
Grid No. 1 to Grid No. 3*	0.2 max. μ f
Grid No. 1 to Plate*	0.2 max. μ f
Grid No. 1 to Shield and All Other Electrodes Except Cathode	5 μ f
Grid No. 1 to Cathode	3 μ f
MAXIMUM OVERALL LENGTH	3 1/4"
MAXIMUM SEATED HEIGHT	2 1/4"
MAXIMUM DIAMETER	1 1/4"
BULB	T-9
BASE	Small Wafer Octal 8-Pin, Sleeve
MOUNTING POSITION	Any

As Frequency Converter

TYPICAL OPERATION WITH SELF-EXCITATION:

Typical operation of the 6SA7-GT is the same as for the 6SA7.

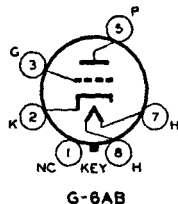

HIGH-MU TRIODE

The 6SF5-GT is a high-mu triode of the single-ended glass type for use in resistance-coupled amplifier circuits. Electrical characteristics, except capacitances are the same as for the 6SF5. Physical characteristics are shown in Fig. 2-5, OUTLINES SECTION.

6SF5-GT

DIODE SUPER-CONTROL AMPLIFIER PENTODE

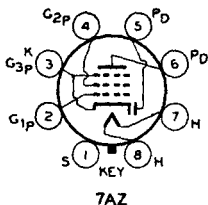

The 6SF7 is a single-ended metal tube consisting of a diode and a super-control amplifier pentode in the same envelope. The pentode unit is designed especially for use as an i-f amplifier although it may also be used as an a-f amplifier. Dimensions are shown in Fig. 1-3, OUTLINES SECTION. The 6SF7 may be mounted in any position.

6SF7

★CHARACTERISTICS

HEATER VOLTAGE (A.C. or D.C.)	6.3	Volts
HEATER CURRENT	0.3	Ampere
DIRECT INTERELECTRODE CAPACITANCES—Pentode Unit:*		
Grid to Plate	0.004 max.	μ f
Input	5.5	μ f
Output	6.5	μ f
Grid to Diode Plate	0.002 max.	μ f
Plate to Diode Plate	0.8	μ f

* With shell connected to cathode.

Pentode Unit—As Class A₁ Amplifier

PLATE VOLTAGE	300 max.	Volts
SCREEN VOLTAGE	100 max.	Volts
SCREEN SUPPLY VOLTAGE	300 max.	Volts
GRID VOLTAGE	0	min. Volts
PLATE DISSIPATION	3.5 max.	Watts
SCREEN DISSIPATION	0.5 max.	Watt

TYPICAL OPERATION and CHARACTERISTICS—Class A₁ Amplifier:

Plate Voltage	100	250	Volts
Screen Voltage	100	100	Volts
Grid Voltage	-1	-1	Volts
Plate Resistance (Approx.)	0.2	0.7	Megohm
Transconductance	1975	2050	Micromhos
Grid Voltage (Approx.) for transconductance of 10 micromhos	-35	-35	Volts
Plate Current	12	12.4	Milliamperes
Screen Current	3.4	3.3	Milliamperes

Diode Unit

The diode plate is placed around the cathode, the sleeve of which is common to the pentode unit.

TRIPLE-GRID SUPER-CONTROL AMPLIFIER

6SG7

The 6SG7 is an r-f amplifier of the single-ended metal type. The high transconductance, low grid-plate capacitance, and two separate cathode terminals are desirable characteristics for the design of receivers in high-frequency and wide-band applications. Physical characteristics are shown in Fig. 1-3, OUTLINES SECTION. The 6SG7 may be mounted in any position.

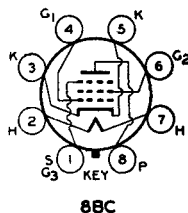

★CHARACTERISTICS

HEATER VOLTAGE (A.C. or D.C.)	6.3	Volts
HEATER CURRENT	0.3	Ampere
DIRECT INTERELECTRODE CAPACITANCES:		
Grid to Plate	0.003	max. μf
Input	8.5	μf
Output	7.0	μf

As Class A₁ Amplifier

PLATE VOLTAGE	300	max.	Volts	
SCREEN VOLTAGE (Grid No. 2)	150	max.	Volts	
SCREEN SUPPLY VOLTAGE	300	max.	Volts	
GRID VOLTAGE (Grid No. 1)	0	min.	Volts	
PLATE DISSIPATION	3	max.	Watts	
SCREEN DISSIPATION	0.6	max.	Watt	
TYPICAL OPERATION and CHARACTERISTICS—Class A ₁ Amplifier:				
Plate Voltage	100	250	250	Volts
Screen Voltage	100	125	150	Volts
Grid Voltage	-1	-1	-2.5	Volts
Suppressor	Connected to cathode at socket			
Plate Resistance (Approx.)	0.25	0.9	†	Megohm
Transconductance	4100	4700	4000	Micromhos
Grid Voltage (Approx.) for Transconductance = 40 micromhos	-11.5	-14	-17.5	Volts
Plate Current	8.2	11.8	9.2	Milliamperes
Screen Current	3.2	4.4	3.4	Milliamperes

† Greater than 1 megohm

TRIPLE-GRID DETECTOR AMPLIFIER

6SJ7-GT

The 6SJ7-GT is a single-ended glass tube of the triple-grid type with a sharp cut-off characteristic. Physical characteristics are: maximum overall length, 3 $\frac{1}{4}$ in.; maximum seated height, 2 $\frac{1}{4}$ in.; maximum diameter, 1 $\frac{1}{4}$ in.; bulb, T-9; base, small wafer octal 8-pin with metal sleeve. The tube may be mounted in any position.

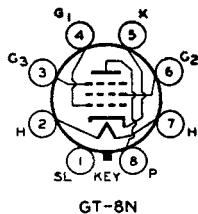

CHARACTERISTICS

HEATER VOLTAGE (A.C. or D.C.)	6.3	Volts
HEATER CURRENT	0.30	Ampere
DIRECT INTERELECTRODE CAPACITANCES:		
Grid-Plate	0.005	max. μf
Input	6.3	μf
Output	10	μf

As Class A₁ Amplifier

PLATE VOLTAGE	100	250	max.	Volts
SCREEN VOLTAGE	100	100	max.	Volts
GRID VOLTAGE	-3	-3		Volts
SUPPRESSOR	Connected to cathode at socket			
PLATE RESISTANCE (Approx.)	0.7	1.5		Megohms
TRANSCONDUCTANCE	1575	1650		Micromhos
PLATE CURRENT	2.9	3		Milliamperes
SCREEN CURRENT	0.9	0.8		Milliamperes

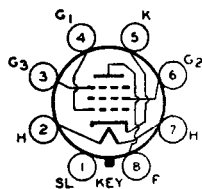

GT-8N

TRIPLE-GRID SUPER-CONTROL AMPLIFIER

The 6SK7-GT is a triple-grid super-control amplifier having single-ended construction. Installation and application of the 6SK7-GT are the same as for the 6SK7.

6SK7-GT

★CHARACTERISTICS

HEATER VOLTAGE (A.C. or D.C.)	6.3	Volts
HEATER CURRENT	0.3	Ampere
GRID-PLATE CAPACITANCE*	0.005 max.	μf
INPUT CAPACITANCE*	6.3	μf
OUTPUT CAPACITANCE*	10	μf
MAXIMUM OVERALL LENGTH	3 $\frac{1}{2}$ "	
MAXIMUM SEATED HEIGHT	2 $\frac{3}{4}$ "	
MAXIMUM DIAMETER	1 $\frac{1}{4}$ "	
BULB	T-9	
BASE	Small Wafer Octal 8-Pin, Sleeve	
MOUNTING POSITION	Any	

* With base sleeve connected to cathode.

As Class A₁ Amplifier

Maximum ratings and characteristics for the 6SK7-GT are the same as for the 6SK7.

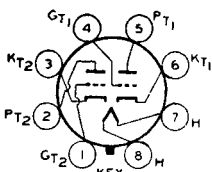

8BD

TWIN-TRIODE AMPLIFIER

The 6SN7-GT is a single-ended twin-triode amplifier having separate cathode terminals for each unit. It is designed for use as a resistance-coupled amplifier and phase inverter. Physical characteristics are shown in Fig. 2-8, OUTLINES SECTION. The tube may be mounted in any position.

6SN7-GT

★CHARACTERISTICS

HEATER VOLTAGE (A.C. or D.C.)	6.3	Volts
HEATER CURRENT	0.6	Ampere
DIRECT INTERELECTRODE CAPACITANCES (Approx.):‡		
	Triode Unit T ₁	Triode Unit T ₂
Grid to Plate	4	4 μf
Grid to Cathode	3.2	3.8 μf
Plate to Cathode	3.4	2.6 μf
Plate to Plate		0.5 μf
Grid to Grid		0.034 μf
Grid T ₁ to Plate T ₁		0.12 μf

‡ With close-fitting shield connected to cathode.

As Class A₁ Amplifier—Each Unit

Maximum ratings and characteristics for each unit are the same as those for the 6J5. Refer also to the 6F8-G in the RESISTANCE-COUPLED AMPLIFIER CHART.

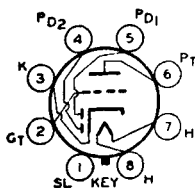

GT-8Q

DUPLEX-DIODE HIGH-MU TRIODE

The 6SQ7-GT is a single-ended glass tube containing two diodes and a high-mu triode. Installation and application are the same as for the 6SQ7.

6SQ7-GT

★CHARACTERISTICS

HEATER VOLTAGE (A.C. or D.C.)	6.3	Volts
HEATER CURRENT	0.3	Ampere
Triode: GRID-PLATE CAPACITANCE (Approx.)*	1.8	μf
GRID-CATHODE CAPACITANCE (Approx.)*	4.2	μf
PLATE-CATHODE CAPACITANCE (Approx.)*	3.4	μf
MAXIMUM OVERALL LENGTH	3 1/4"	
MAXIMUM SEATED HEIGHT	2 1/4"	
MAXIMUM DIAMETER	1 1/4"	
BULB	T-9	
BASE	Small Wafer Octal 8-Pin, Sleeve	
MOUNTING POSITION	Any	

* With base sleeve connected to cathode.

Triode Unit—As Class A₁ Amplifier

Maximum rating and typical operation for the 6SQ7-GT are the same as for Type 6SQ7.

DUPLEX-DIODE TRIODE

The 6SR7 is a metal tube of the single-ended type containing two diodes and a triode in a single envelope. It is designed for use as a combined detector, amplifier, and automatic-volume-control tube. The plate family for the 6SR7 is the same as that for the 6R7. Refer to Type 6R7 in RESISTANCE-COUPLED AMPLIFIER CHART for operating conditions as a resistance-coupled amplifier. Physical characteristics are shown in Fig. 1-3, OUTLINES SECTION. The 6SR7 may be mounted in any position.

6SR7
METAL

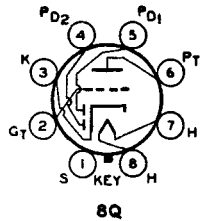

★CHARACTERISTICS

HEATER VOLTAGE (A.C. or D.C.)	6.3	Volts
HEATER CURRENT	0.3	Ampere
Triode—Grid-Plate Capacitance (Approx.)*	2.4	μf
Grid-Cathode Capacitance (Approx.)*	3.0	μf
Plate-Cathode Capacitance (Approx.)*	2.8	μf

* With shell connected to cathode.

Triode Unit as Class A₁ Amplifier

PLATE VOLTAGE	250 max.	Volts
PLATE DISSIPATION	2.5 max.	Watts
TYPICAL OPERATION WITH TRANSFORMER COUPLING:		
Plate Voltage	250	Volts
Grid Voltage	-9	Volts
Amplification Factor	16	
Plate Resistance	8500	Ohms
Transconductance	1900	Micromhos
Plate Current	9.5	Milliamperes
Load Resistance	10000	Ohms
Power Output	300	Milliwatts

Diode Unit

The diodes are independent of each other and of the triode unit except for the common cathode.

TRIPLE-GRID SUPER-CONTROL AMPLIFIER

The 6SS7 is a triple-grid super-control amplifier of the single-ended metal type. Its 6.3-volt, 0.15-ampere heater facilitates the design of equipment employing a series of 0.15-ampere tubes such that the total heater voltage will not exceed 117 volts. Physical characteristics are shown in Fig. 1-3, OUTLINES SECTION. The tube may be mounted in any position.

6SS7

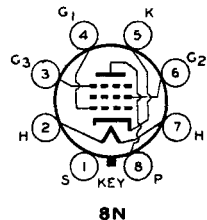

★CHARACTERISTICS

HEATER VOLTAGE (A.C. or D.C.)	6.3	Volts
HEATER CURRENT	0.15	Ampere
DIRECT INTERELECTRODE CAPACITANCES:*		
Grid to Plate	0.004 max	μuf
Input	5.5	μuf
Output	7	μuf

* With shell connected to cathode.

As Class A₁ Amplifier

PLATE VOLTAGE	300 max.	Volts
SCREEN VOLTAGE	100 max.	Volts
SCREEN SUPPLY VOLTAGE	300 max.	Volts
GRID VOLTAGE	0 min.	Volts
PLATE DISSIPATION	2.25 max.	Watts
SCREEN DISSIPATION	0.35 max.	Watt
TYPICAL OPERATION:		
Plate Voltage	100	250 Volts
Screen Voltage	100	100 Volts
Grid Voltage	-1	-3 Volts
Suppressor	Connected to cathode at socket	
Plate Current	12.2	9 Milliamperes
Screen Current	3.1	2 Milliamperes
Plate Resistance	0.12	1 Megohm
Transconductance	1930	1850 Micromhos
Grid Bias†	-35	-35 Volts

† For transconductance of 10 micromhos (approx.).

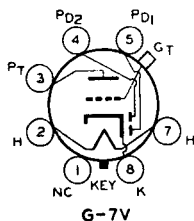

DUPLEX-DIODE TRIODE

The 6V7-G is a heater-cathode type of tube consisting of two diodes and a triode in a single bulb. Except for physical characteristics, the 6V7-G is identical to the 85. Dimensions are shown in Fig. 2-15, OUTLINES SECTION. The 6V7-G may be mounted in any position.

6V7-G

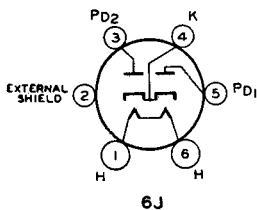

FULL-WAVE HIGH-VACUUM RECTIFIER

The 6Y5 is a full-wave, high-vacuum rectifier for replacement in receivers designed for its characteristics. The heater voltage is 6.3 volts; current, 0.8 ampere. The maximum a-c plate voltage per plate is 350 volts (RMS), and the d-c output current is 50 ma. Physical characteristics are shown in Fig. 2-19, OUTLINES SECTION.

6Y5

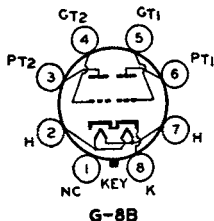

CLASS B TWIN AMPLIFIER

The 6Y7-G is a heater-cathode type of tube combining in one bulb two high-μu triodes designed for class B operation. Installation and application are the same as for the 79, except that the 6Y7-G requires an octal socket. Physical characteristics are shown in Fig. 2-17, OUTLINES SECTION. The 6Y7-G can be mounted in any position. Refer to Type 79 for electrical characteristics.

6Y7-G

FULL-WAVE HIGH-VACUUM RECTIFIER

6Z5

The 6Z5 is a full-wave, high vacuum rectifier for replacement in receivers designed for its characteristics. The heater is designed with a tap so that it may be operated with the two sections in series on 12.6 volts and 0.4 ampere, or in parallel on 6.3 volts and 0.8 ampere. The maximum a-c plate voltage is 230 volts (RMS), and the maximum d-c output current is 60 ma. Physical characteristics are shown in Fig. 2-19, OUTLINES SECTION.

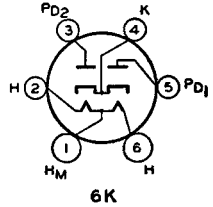

DETECTOR AMPLIFIER TRIODE

7A4

The 7A4 is a three-electrode general-purpose tube of the heater-cathode type for use as amplifier and detector. The base fits the lock-type socket which may be installed to hold the tube in any position. Physical characteristics of the 7A4 are shown in Fig. 2-4, OUTLINES SECTION. For heater operation and cathode connection, refer to the 6A8.

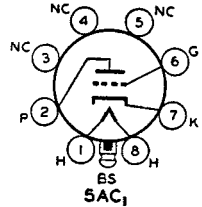

★CHARACTERISTICS

HEATER VOLTAGE (A.C. or D.C.).....	6.3†	Volts
HEATER CURRENT	0.3‡	Ampere
GRID-PLATE CAPACITANCE (Approx.)*.....	4	μf
GRID-CATHODE CAPACITANCE (Approx.)*.....	3.4	μf
PLATE-CATHODE CAPACITANCE (Approx.)*.....	3	μf

* With close-fitting shield connected to cathode. † Nominal value is 7 volts. ‡ Nominal value is 0.32 ampere.

As Class A₁ Amplifier

Maximum ratings and typical operation for the 7A4 are the same as for the 6J5.

BEAM POWER AMPLIFIER

7A5

The 7A5 is a beam power amplifier of the locking-base type. It is for use in the power-output stage of radio receivers designed for its characteristics.

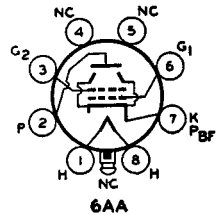

★CHARACTERISTICS

HEATER VOLTAGE (A.C. or D.C.).....	6.3†	Volts
HEATER CURRENT	0.7‡	Ampere
MAXIMUM OVERALL LENGTH.....	3 1/2"	
MAXIMUM SEATED HEIGHT.....	2 1/2"	
MAXIMUM DIAMETER	1 1/4"	
BASE.....	1 1/2"	
MOUNTING POSITION	Lock-type 8-Pin	
	Any	

† Nominal value is 7 volts. ‡ Nominal value is 0.75 ampere.

As Class A₁ Amplifier

PLATE VOLTAGE.....	125 max.	Volts
SCREEN VOLTAGE (Grid No. 2)	125 max.	Volts
PLATE DISSIPATION.....	5.5 max.	Watts
SCREEN DISSIPATION.....	1.2 max.	Watts
TYPICAL OPERATION:		
Plate Voltage	110	Volts
Screen Voltage	110	Volts

Grid Voltage (Grid No. 1)*	-7.5	-9	Volts
Peak A-F Grid Voltage	7.5	9	Volts
Zero-Signal Plate Current	40	44	Milliamperes
Max.-Signal Plate Current	41	45	Milliamperes
Zero-Signal Screen Current (Approx.)	3	3.3	Milliamperes
Max.-Signal Screen Current (Approx.)	7	9.5	Milliamperes
Plate Resistance (Approx.)	14000	17000	Ohms
Transconductance	5800	6000	Micromhos
Load Resistance	2500	2700	Ohms
Total Harmonic Distortion	10	10	Per cent
Max.-Signal Power Output	1.5	2.2	Watts

* The d-c resistance in the grid circuit should not exceed 0.1 megohm with fixed bias, or 0.5 megohm with cathode bias.

INTERNAL CONNECTION DO NOT USE

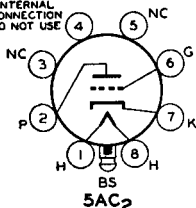

HIGH-MU TRIODE

The 7B4 is a high-mu triode of the locking-base type for use in resistance-coupled amplifier circuits. Physical characteristics are shown in Fig. 2-4, OUTLINES SECTION. The tube may be mounted in any position. Except as shown below, the electrical characteristics are the same as those for the 6SF5.

7B4

CHARACTERISTICS

HEATER VOLTAGE (A.C. or D.C.)	6.3*	Volts
HEATER CURRENT	0.3**	Ampere
DIRECT INTERELECTRODE CAPACITANCES—Triode Unit:		
Grid to Plate	1.6	μmf
Grid to Cathode	3.6	μmf
Plate to Cathode	3.4	μmf

* Nominal value is 7 volts.

** Nominal value is 0.32 ampere.

Triode Unit

PLATE VOLTAGE	250 max.	Volts
TYPICAL OPERATION and CHARACTERISTICS:		
Values are the same as for the 6SF5.		

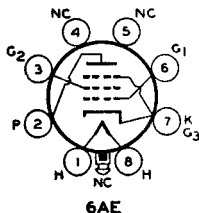

POWER AMPLIFIER PENTODE

The 7B5-LT is a power amplifier pentode of the locking-base type for use in the output stage of radio receivers designed for its characteristics. The 7B5-LT is interchangeable with the 7B5. Physical characteristics are shown in Fig. 2-7, OUTLINES SECTION. The tube may be mounted in any position.

7B5-LT

★CHARACTERISTICS

HEATER VOLTAGE (A.C. or D.C.)	6.3†	Volts
HEATER CURRENT	0.4††	Ampere

† Nominal value is 7 volts.

†† Nominal value is 0.43 ampere.

As Class A₁ Amplifier

Maximum ratings and typical operating conditions for the 7B5-LT are the same as for the 6K6-G.

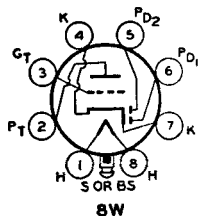

DUPLEX-DIODE HIGH-MU TRIODE

The 7B6-LM is a multi-unit tube of the locking-base type containing two diodes and a high-mu triode in one envelope. The 7B6-LM is designed for use as a combined detector, amplifier, and automatic-volume-control tube. The triode unit is recommended for use in resistance-coupled amplifier service and may be used under the same conditions as given for the 6SQ7 in the RESISTANCE-COUPLED AMPLIFIER CHART. The

7B6-LM

METAL

7B6-LM is interchangeable with the 7B6. Physical characteristics are shown in Fig. 1-4, OUTLINES SECTION. The tube may be mounted in any position.

★CHARACTERISTICS

HEATER VOLTAGE (A.C. or D.C.)	6.3†	Volts
HEATER CURRENT	0.3††	Ampere
† Nominal value is 7.0 volts. †† Nominal value is 0.32 ampere.		

Triode Unit

PLATE VOLTAGE	250 max. Volts
---------------------	----------------

TYPICAL OPERATION and CHARACTERISTICS:
 Values are the same as those for the 6SQ7.

Diode Unit

The diode units are independent of each other and of the triode unit except for the common cathode.

PENTAGRID CONVERTER

7B8-LM

METAL

The 7B8-LM is a multi-electrode tube of the locking-base type designed to perform simultaneously the functions of a mixer (first detector) and of an oscillator in superheterodyne circuits. The 7B8-LM is interchangeable with the 7B8. The physical characteristics of the 7B8-LM are shown in Fig. 1-4, OUTLINES SECTION. The 7B8-LM may be mounted in any position.

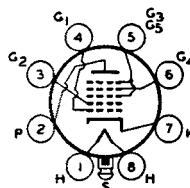

8X

★CHARACTERISTICS

HEATER VOLTAGE (A.C. or D.C.)	6.3†	Volts
HEATER CURRENT	0.3††	Ampere
DIRECT INTERELECTRODE CAPACITANCES:*		
Grid No. 4 to Plate	0.3 max.	μf
Grid No. 4 to Grid No. 2	0.2	μf
Grid No. 4 to Grid No. 1	0.15	μf
Grid No. 1 to Grid No. 2	0.8	μf
Grid No. 4 to All Other Electrodes = R-F Input	10	μf
Grid No. 2 to All Other Electrodes Except Grid No. 1 = Osc. Output	3	μf
Grid No. 1 to All Other Electrodes Except Grid No. 2 = Osc. Input	4.8	μf
Plate to All Other Electrodes = Mixer Output	12	μf

* With shell connected to cathode.

† Nominal value is 7 volts.

†† Nominal value is 0.32 ampere.

As Frequency Converter

PLATE VOLTAGE	250 max.	Volts
SCREEN VOLTAGE (Grids No. 3 and No. 5)	100 max.	Volts
ANODE-GRID VOLTAGE (Grid No. 2)	200 max.	Volts
ANODE-GRID SUPPLY VOLTAGE ‡	250 max.	Volts
TOTAL CATHODE CURRENT	14 max.	Milliamperes

TYPICAL OPERATION:

Plate Voltage	100	250	Volts
Screen Voltage	50	100	Volts
Anode-Grid Voltage	100	250 †	Volts
Control-Grid Voltage	-1.5	-3	Volts
Oscillator-Grid Resistance (Grid No. 1)	50000	50000	Ohms
Plate Resistance (Approx.)	0.6	0.36	Megohm
Conversion Transconductance	360	550	Micromhos
Conversion Transconductance	3†	6‡	Micromhos
Plate Current	1.1	3.5	Milliamperes
Screen Current	1.3	2.7	Milliamperes
Anode-Grid Current	2	4	Milliamperes
Oscillator-Grid Current	0.25	0.4	Milliamperes
Total Cathode Current	4.6	10.6	Milliamperes

† Anode-grid supply voltages in excess of 200 volts require the use of a 20000-ohm voltage-dropping resistor by-passed by a 0.1 μf condenser.

‡ With grid bias of -20 volts.

‡ With grid bias of -35 volts.

BEAM POWER AMPLIFIER

7C5-LT

The 7C5-LT is a beam power amplifier of the locking-base type for use in the output stage of radio receivers. The characteristics of the 7C5-LT are similar to those of the 6V6. The 7C5-LT is interchangeable with the Type 7C5. The physical characteristics of the 7C5-LT are shown in Fig. 2-9, OUTLINES SECTION. The tube may be mounted in any position.

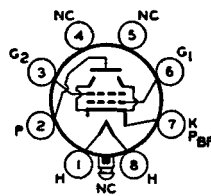

6AA

★CHARACTERISTICS

HEATER VOLTAGE (A.C. or D.C.).....	6.3‡	Volts
HEATER CURRENT	0.45‡‡	Ampere
‡ Nominal value is 7 volts.		‡‡ Nominal value is 0.45 ampere.

As Amplifier

The maximum ratings and typical operating conditions for 7C5-LT are the same as the 6V6.

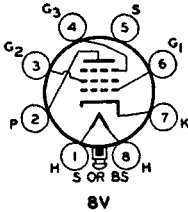

TRIPLE-GRID
DETECTOR AMPLIFIER

The 7C7 is a triple-grid detector amplifier of the locking-base type recommended for service as a biased detector. Physical characteristics of the 7C7 are shown in Fig. 2-4, OUTLINES SECTION. The 7C7 may be mounted in any position.

7C7

8V

★CHARACTERISTICS

HEATER VOLTAGE (A.C. or D.C.).....	6.3‡	Volts
HEATER CURRENT	0.15‡‡	Ampere
GRID-PLATE CAPACITANCE*.....	0.007 max.	μf
INPUT CAPACITANCE*.....	5.5	μf
OUTPUT CAPACITANCE*.....	6.5	μf
‡ Nominal value is 7 volts.		‡‡ Nominal value is 0.16 ampere
* With close-fitting shield connected to cathode.		

As Class A₁ Amplifier

PLATE VOLTAGE	300 max.	Volts
SCREEN VOLTAGE.....	100 max.	Volts
SCREEN SUPPLY VOLTAGE.....	300 max.	Volts
GRID VOLTAGE	0 min.	Volts
PLATE DISSIPATION.....	1.0 max.	Watt
SCREEN DISSIPATION.....	0.1 max.	Watt
TYPICAL OPERATION and CHARACTERISTICS:		
Plate Voltage	100	250 Volts
Screen Voltage	100	100 Volts
Grid Voltage.....	-3	-3 Volts
Suppressor	Connected to cathode at socket	
Internal Shield.....	Connected to cathode at socket	
Plate Resistance (Approx.).....	1.2	2 Megohms
Transconductance	1225	1300 Micromhos
Plate Current.....	1.8	2 Milliampere
Screen Current.....	0.4	0.5 Milliampere

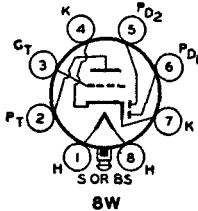

DUPLEX-DIODE TRIODE

The 7E6 is a multi-unit tube which contains two diodes and a medium- μ triode. It is of the locking-base type and may be mounted in any position. The 7E6 is designed for use as a combined detector, amplifier, and automatic-volume-control tube in radio receivers. Physical characteristics of the 7E6 are shown in Fig. 2-4, OUTLINES SECTION.

7E6

8W

★CHARACTERISTICS

HEATER VOLTAGE (A.C. or D.C.).....	6.3‡	Volts
HEATER CURRENT	0.3‡‡	Ampere
‡ Nominal value is 7 volts.		‡‡ Nominal value is 0.32 ampere.

Triode Unit—As Class A₁ Amplifier

Maximum ratings and typical operation for the 7E6 are the same as for the 6R7.

DUPLEX-DIODE PENTODE

7E7

The 7E7 is a multi-electrode tube containing two diodes and a pentode in one bulb. It is of the locking-base type, and can be mounted in any position. The 7E7 is intended for use as a combined detector, amplifier (audio-, radio-, or intermediate-frequency), and automatic-volume-control tube. Physical characteristics of the 7E7 are shown in Fig. 2-4, OUTLINES SECTION.

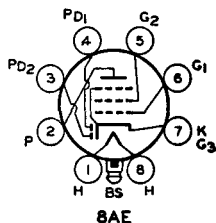

★CHARACTERISTICS

HEATER VOLTAGE (A.C. or D.C.)	6.3†	Volts
HEATER CURRENT	0.3‡	Ampere
GRID-PLATE CAPACITANCE*	0.005 max.	μf
INPUT CAPACITANCE*	4.6	μf
OUTPUT CAPACITANCE*	4.6	μf

* With close-fitting shield connected to cathode.

† Nominal value is 7 volts.

‡ Nominal value is 0.32 ampere.

Pentode Unit—As Class A₁ Amplifier

PLATE VOLTAGE	250 max.	Volts
SCREEN VOLTAGE (Grid No. 2)	100 max.	Volts
TYPICAL OPERATION:		
Plate Voltage	250	Volts
Screen Voltage	100	Volts
Grid Voltage (Grid No. 1)	-3	Volts
Plate Current	7.5	Milliamperes
Screen Current	1.6	Milliamperes
Plate Resistance (Approx.)	0.7	Megohm
Transconductance	1300	Micromhos
Grid Bias for transconductance of 2 micromhos	-42.5	Volts

TWIN-TRIODE AMPLIFIER

7F7

The 7F7 is a multi-electrode tube of the locking-base type employing two high-μ triodes in one bulb. It will be found useful as an amplifier or a phase inverter. The two units are independent except for the common heater. Physical characteristics of the 7F7 are shown in Fig. 2-4, OUTLINES SECTIONS. The 7F7 can be mounted in any position.

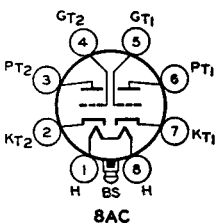

★CHARACTERISTICS

HEATER VOLTAGE (A.C. or D.C.)	6.3†	Volts
HEATER CURRENT	0.3‡	Ampere
† Nominal value is 7 volts.	‡ Nominal value is 0.32 ampere.	

Each Triode Unit—As Class A₁ Amplifier

PLATE VOLTAGE	250 max.	Volts
GRID VOLTAGE	0 min.	Volts
PLATE DISSIPATION	1.0 max.	Watt
TYPICAL OPERATION:		
Plate Voltage	250	Volts
Grid Voltage	-2	Volts
Plate Current	2.3	Milliamperes
Plate Resistance	44000	Ohms
Amplification Factor	70	
Transconductance	1600	Micromhos

TELEVISION AMPLIFIER PENTODE

7G7/
1232

The 7G7/1232 is a triple-grid tube of the locking-base type. It is intended for use in video amplifiers of television receivers and in other applications where a tube having high transconductance is required. Physical characteristics of the 7G7/1232 are shown in Fig. 2-4, OUTLINES SECTION. The 7G7/1232 can be mounted in any position.

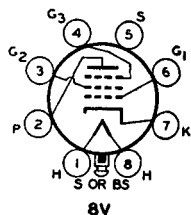

★CHARACTERISTICS

HEATER VOLTAGE (A.C. or D.C.)	6.3‡	Volts
HEATER CURRENT	0.45‡‡	Ampere
GRID-PLATE CAPACITANCE*	0.007 max.	μf
INPUT CAPACITANCE*	9	μf
OUTPUT CAPACITANCE*	7	μf

* With close-fitting shield connected to cathode.
 ‡ Nominal value is 7 volts. ‡‡ Nominal value is 0.48 ampere.

As Class A₁ Amplifier

PLATE VOLTAGE	250 max.	Volts
SCREEN VOLTAGE (Grid No. 2)	100 max.	Volts
SCREEN SUPPLY VOLTAGE	250 max.	Volts
PLATE DISSIPATION	1.5 max.	Watts
SCREEN DISSIPATION	0.2 max.	Watt
TYPICAL OPERATION:		
Plate Voltage	250	Volts
Screen Voltage	100	Volts
Grid Voltage (Grid No. 1)	-2	Volts
Suppressor	Connected to cathode at socket	
Plate Current	6	Milliamperes
Screen Current	2	Milliamperes
Plate Resistance (Approx.)	0.8	Megohm
Transconductance	4500	Micromhos
Grid Voltage*	-6	Volts

* For cathode current cut-off.

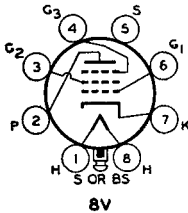

TRIPLE-GRID SUPER-CONTROL AMPLIFIER

The 7H7 is a triple-grid amplifier of the locking-base type. Physical characteristics are shown in Fig. 2-4, OUTLINES SECTION. The tube may be mounted in any position.

7H7

★CHARACTERISTICS

HEATER VOLTAGE (A.C. or D.C.)	6.3‡	Volts
HEATER CURRENT	0.3‡‡	Ampere
DIRECT INTERELECTRODE CAPACITANCES*:		
Grid to Plate	0.007 max.	μf
Input	8.0	μf
Output	7.0	μf

* With close-fitting shield connected to cathode.
 ‡ Nominal value is 7 volts. ‡‡Nominal value is 0.32 ampere.

As Class A₁ Amplifier

PLATE VOLTAGE	300 max.	Volts
SCREEN VOLTAGE (Grid No. 2)	150 max.	Volts
SCREEN SUPPLY VOLTAGE	300 max.	Volts
GRID VOLTAGE (Grid No. 1)	0 min.	Volts
PLATE DISSIPATION	2.5 max.	Watts
SCREEN DISSIPATION	0.5 max.	Watt
TYPICAL OPERATION as Class A ₁ Amplifier:		
Plate Voltage	100	250 Volts
Screen Voltage	100	150 Volts
Suppressor	Connected to cathode at socket	
Internal Shield	Connected to cathode at socket	
Grid Voltage	-1	-2.5 Volts
Plate Current	8.2	9.5 Milliamperes
Screen Current	3.3	3.5 Milliamperes
Plate Resistance (Approx.)	0.25	0.8 Megohm
Transconductance	3800	3800 Micromhos
Grid Voltage for Transconductance =35 micromhos	-12	-19 Volts

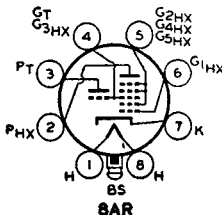

TRIODE-HEPTODE CONVERTER

The 7J7 is a multi-electrode tube consisting of a triode oscillator and a heptode mixer in a single bulb. It is of the locking-base type, and can be mounted in any position. Physical characteristics of the 7J7 are shown in Fig. 2-4, OUTLINES SECTION.

7J7

★CHARACTERISTICS

HEATER VOLTAGE (A.C. or D.C.)	6.3‡	Volts
HEATER CURRENT	0.3‡‡	Ampere
DIRECT INTERELECTRODE CAPACITANCES:**		
Heptode Grid No. 1 to Heptode Plate	0.01 max.	μf
Heptode Grid No. 1 to Triode Plate	0.1 max.	μf
Heptode Grid No. 1 to Triode Grid and Heptode Grid No. 3	0.2 max.	μf
Triode Grid to Triode Plate	1.0	μf
Heptode Grid No. 1 to All Other Electrodes = R-F Input	5.5	μf
Triode Plate to All Other Electrodes Except Triode Grid No. 1 and Heptode Grid No. 3 = Osc. Output	2	μf
Triode Grid and Heptode Grid No. 3 to All Other Electrodes Except Triode Plate = Osc. Input	8.5	μf
Heptode Plate to All Other Electrodes = Mixer Output	7.5	μf

** With close-fitting shield connected to cathode.

‡ Nominal value is 7 volts.

‡‡ Nominal value is 0.32 ampere.

As Frequency Converter

HEPTODE PLATE VOLTAGE	300 max.	Volts
HEPTODE SCREEN VOLTAGE (Grids No. 2, 4 and 5)	100 max.	Volts
HEPTODE SCREEN SUPPLY VOLTAGE	300 max.	Volts
HEPTODE CONTROL-GRID VOLTAGE (Grid No. 1)	0 min.	Volts
TRIODE PLATE VOLTAGE	150 max.	Volts
TRIODE PLATE SUPPLY VOLTAGE*	300 max.	Volts
HEPTODE PLATE DISSIPATION	0.5 max.	Watt
HEPTODE SCREEN DISSIPATION	0.3 max.	Watt
TRIODE PLATE DISSIPATION	1.25 max.	Watts
TOTAL CATHODE CURRENT	14 max.	Milliamperes

TYPICAL OPERATION:

Heptode Plate Voltage	100	250	Volts
Heptode Screen Voltage	100	100	Volts
Heptode Control-Grid Voltage	-3	-3	Volts
Triode Plate Voltage	100	250*	Volts
Triode Grid Resistor	50000	50000	Ohms
Heptode Plate Resistance	0.3	1.5	Megohms
Conversion Transconductance	260	300	Micromhos
Heptode Control-Grid Voltage for conversion transconductance of 2 micromhos	-20	-20	Volts
Heptode Plate Current	1.1	1.3	Milliamperes
Heptode Screen Current	3.1	2.9	Milliamperes
Triode Plate Current	3.7	5.4	Milliamperes
Triode Grid and Heptode Grid No. 3 Current	0.3	0.4	Milliamperes
Total Cathode Current	8.2	10	Milliamperes

* Applied through 20000-ohm voltage-dropping resistor.

Characteristics of Triode Unit Only

The transconductance of the triode unit, not oscillating, is approximately 1350 micromhos when the plate voltage is 150 volts and the grid voltage is -3 volts.

PENTAGRID CONVERTER

7Q7

The 7Q7 is a multi-electrode vacuum tube of the locking-base type designed to perform simultaneously the functions of a mixer (first detector) tube and of an oscillator tube in superheterodyne circuits. Dimensions of the 7Q7 are shown in Fig. 2-4, OUTLINES SECTION. The tube may be mounted in any position. Installation (except for the socket) and application are similar to that for the 6SA7.

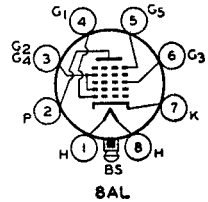

★CHARACTERISTICS

HEATER VOLTAGE (A.C. or D.C.)	6.3*	Volts
HEATER CURRENT	0.3**	Ampere
DIRECT INTERELECTRODE CAPACITANCES:‡		
Grid No. 3 to All Other Electrodes and Base Shell = R-F Input	9	μf
Plate to All Other Electrodes and Base Shell = Mixer Output	9	μf
Grid No. 1 to All Other Electrodes and Base Shell	7	μf
Grid No. 3 to Plate	0.2 max.	μf
Grid No. 1 to Grid No. 3	0.2 max.	μf
Grid No. 1 to Plate	0.15 max.	μf
Grid No. 1 to All Other Electrodes (Except Cathode) and Base Shell	5	μf
Grid No. 1 to Cathode	2.2	μf
Cathode to All Other Electrodes (Except Grid No. 1) and Base Shell	6	μf

‡ With close-fitting shield connected to cathode.

* Nominal value is 7 volts.

** Nominal value is 0.32 ampere.

As Frequency Converter

PLATE VOLTAGE.....		300 max.	Volts
GRID NO. 2 AND NO. 4 VOLTAGE.....		100 max.	Volts
GRIDS NO. 2 AND NO. 4 SUPPLY VOLTAGE.....		300 max.	Volts
GRID NO. 3 VOLTAGE.....		0 min.	Volts
PLATE AND GRIDS NO. 2 AND NO. 4 DISSIPATION (Total).....		2 max.	Watts
GRIDS NO. 2 AND NO. 4 DISSIPATION.....		1 max.	Watt
TOTAL CATHODE CURRENT.....		14 max.	Milliamperes
TYPICAL OPERATION with Self-Excitation:			
Plate Voltage.....	100	250	Volts
Grids No. 2 and No. 4 Voltage.....	100	100	Volts
Grid No. 3 (Control) Voltage.....	0	0	Volts
Grid No. 5 Voltage.....	0	0	Volts
Grid No. 1 Resistor.....	20000	20000	Ohms
Plate Current.....	3.3	3.5	Milliamperes
Grids No. 2 and No. 4 Current.....	8.5	8.5	Milliamperes
Grid No. 1 Current.....	0.5	0.5	Milliamperes
Total Cathode Current.....	12.3	12.5	Milliamperes
Plate Resistance (Approx.).....	0.5	1	Megohm
Conversion Transconductance.....	525	550	Micromhos
Conversion Transconductance (Approx.)††.....	2	2	Micromhos

†† With grid No. 3 bias of -35 volts.

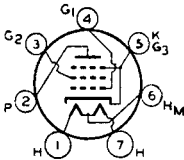

7F

POWER AMPLIFIER PENTODE

The 12A5 is a power amplifier pentode designed for use in a-c/d-c receivers or in automobile receivers. The heater is center-tapped to provide for either series or parallel operation. Physical characteristics are shown in Fig. 2-19, OUTLINES SECTION. The tube may be mounted in any position.

12A5

★CHARACTERISTICS

HEATER VOLTAGE (A.C. or D.C.).....	6.3 (parallel)	12.6 (series)	Volts
HEATER CURRENT.....	0.6	0.3	Ampere

As Class A₁ Amplifier

PLATE VOLTAGE.....		180 max.	Volts
SCREEN VOLTAGE.....		180 max.	Volts
PLATE DISSIPATION.....		8.25 max.	Watts
SCREEN DISSIPATION.....		2.5 max.	Watts
TYPICAL OPERATION and CHARACTERISTICS:			
Plate Voltage.....	100	180	Volts
Screen Voltage.....	100	180	Volts
Grid Voltage.....	-15	-25	Volts
Peak A-F Grid Voltage.....	15	25	Volts
Zero-Signal Plate Current.....	17	45	Milliamperes
Max.-Signal Plate Current.....	19	48	Milliamperes
Zero-Signal Screen Current.....	3	8	Milliamperes
Max.-Signal Screen Current.....	6.5	14	Milliamperes
Plate Resistance (Approx.).....	50000	35000	Ohms
Transconductance.....	1700	2400	Micromhos
Load Resistance.....	4500	3300	Ohms
Total Harmonic Distortion.....	12	11	Per cent
Max.-Signal Power Output.....	0.8	3.4	Watts

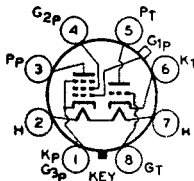

8T

TRIODE-PENTODE

The 12B8-GT is a heater-cathode type of tube combining a high- μ triode and an r-f pentode in one bulb. The triode may be used as a detector and the pentode as an r-f or i-f amplifier. Heater operation is similar to that of the 12A8-GT except for the difference in current rating. For cathode connection, refer to the 6A8.

12B8-GT

CHARACTERISTICS

HEATER VOLTAGE (A.C. or D.C.)	12.6	Volts
HEATER CURRENT	0.3	Ampere
DIRECT INTERELECTRODE CAPACITANCES:		
Triode Grid to Triode Plate	2.3	μf
Triode Grid to Triode Cathode	5	μf
Triode Plate to Triode Cathode	6.3	μf
Pentode Grid to Pentode Plate	0.015	μf
Pentode Input	5.2	μf
Pentode Output	9.6	μf
Pentode Grid to Triode Grid	0.002	μf
Pentode Plate to Triode Grid	0.078	μf
Pentode Grid to Triode Plate	0.003	μf
MAXIMUM OVERALL LENGTH	$3\frac{1}{8}''$	
MAXIMUM SEATED HEIGHT	$3\frac{1}{8}''$	
MAXIMUM DIAMETER	$1\frac{1}{4}''$	
BULB	T-9	
CAP.	Skirted Miniature	
BASE	Intermediate Shell Octal 8-Pin	
MOUNTING POSITION	Any	

As Class A₁ Amplifier

	Triode Unit	Pentode Unit	
PLATE VOLTAGE	90	90	Volts
SCREEN VOLTAGE (Grid No. 2)	-	90	Volts
GRID VOLTAGE (Grid No. 1)	0	-3	Volts
PLATE CURRENT	2.8	7	Milliamperes
SCREEN CURRENT	-	2	Milliamperes
AMPLIFICATION FACTOR	90	-	
PLATE RESISTANCE	37000	200000	Ohms
TRANSCONDUCTANCE	2400	1800	Micromhos
TRANSCONDUCTANCE with -42.5 volts bias	-	2	Micromhos

TWIN DIODE

12H6

The 12H6 is a metal tube of the heater-cathode type containing two diodes in one envelope. Except for the heater rating of 12.6 volts and 0.15 ampere, the electrical characteristics are the same as those of the 6H6. Physical characteristics are shown in Fig. 1-1, OUTLINES SECTION. The tube may be mounted in any position.

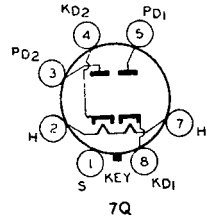

PENTAGRID CONVERTER

12SA7-GT

The 12SA7-GT is a pentagrid converter of the heater-cathode type. Except for its heater which operates at 12.6 volts and 0.15 ampere, and the interelectrode capacitances of the 12SA7-GT are the same as those of the 6SA7-GT. For heater operation, refer to the 12A8-GT.

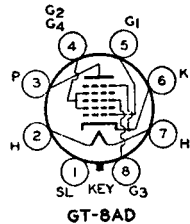

HIGH-MU TRIODE

12SF5-GT

The 12SF5-GT is a high-mu triode of the heater-cathode type. Refer to the 6SF5 for electrical characteristics except capacitances and heater rating. The heater is designed for operation at 12.6 volts and 0.15 ampere; refer to the 12A8-GT for discussion of heater operation. Dimensions are shown in Fig. 2-5, OUTLINES SECTION. The 12SF5-GT may be mounted in any position.

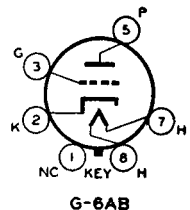

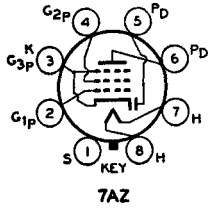

**DIODE SUPER-CONTROL
AMPLIFIER PENTODE**

The 12SF7 is a metal tube of the single-ended type containing a single diode and a super-control amplifier pentode. Except for the heater rating of 12.6 volts and 0.15 ampere, the electrical and physical characteristics of the 12SF7 are the same as those of the 6SF7. For heater operation, refer to the 12A8-GT. The 12SF7 may be mounted in any position.

12SF7

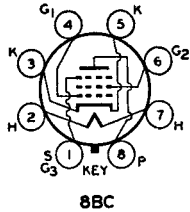

**TRIPLE-GRID SUPER-CONTROL
AMPLIFIER**

The 12SG7 is a metal tube of the single-ended type. Except for the heater rating of 12.6 volts and 0.15 ampere, the electrical and physical characteristics of the 12SG7 are the same as those of the 6SG7. For heater operation, refer to the 12A8-GT. The 12SG7 may be mounted in any position.

12SG7

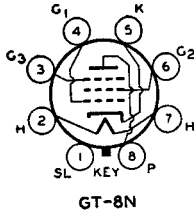

TRIPLE-GRID DETECTOR AMPLIFIER

The 12SJ7-GT is a single-ended glass tube of the triple-grid type with a sharp cut-off characteristic. Except for the heater rating of 12.6 volts and 0.15 ampere, the electrical and physical characteristics of the 12SJ7-GT are the same as those of the 6SJ7-GT. For heater operation, refer to the 12A8-GT.

12SJ7-GT

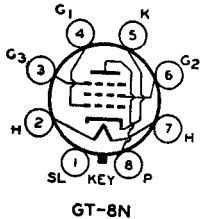

**TRIPLE-GRID SUPER-CONTROL
AMPLIFIER**

The 12SK7-GT is a triple-grid super-control amplifier having single-ended construction. Except for its heater rating of 12.6 volts and 0.15 ampere, the electrical and physical characteristics of the 12SK7-GT are the same as those of the 6SK7-GT. For heater operation, refer to the 12A8-GT.

12SK7-GT

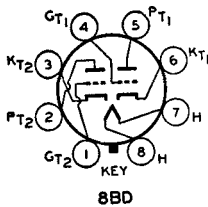

TWIN-TRIODE AMPLIFIER

The 12SN7-GT is a single ended twin-triode amplifier having separate terminals for each cathode. Except for the heater rating of 12.6 volts and 0.3 ampere, the electrical and physical characteristics of the 12SN7-GT are the same as those of the 6SN7-GT. For heater operation and cathode connection, refer to the 12A8-GT and 6A8, respectively, but give consideration to the greater heater current of the 12SN7-GT.

12SN7-GT

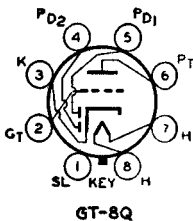

**DUPLEX-DIODE
HIGH-MU TRIODE**

The 12SQ7-GT is a single-ended glass tube containing two diodes and a high-mu triode in a single envelope. Except for its heater rating of 12.6 volts and 0.15 ampere, the electrical and physical characteristics of the 12SQ7-GT are the same as those of the 6SQ7-GT. For heater operation, refer to the 12A8-GT.

12SQ7-GT

DUPLEX-DIODE TRIODE

12SR7
METAL

The 12SR7 is a metal tube of the single-ended type containing two diodes and a triode in a single envelope. Physical characteristics are the same as those of the 6SR7. Except for the heater rating of 12.6 volts and 0.15 ampere, and the capacitances, the electrical characteristics of the 12SR7 are the same as those of the 6SR7. The capacitances of the 12SR7 are: grid-plate, 2.4 μmf ; grid-cathode, 3.6 μmf ; plate-cathode, 2.8 μmf .

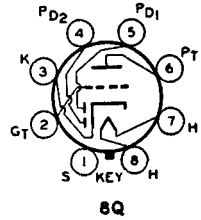

TRIPLE-GRID SUPER-CONTROL AMPLIFIER

14A7/
12B7

The 14A7/12B7 is a super-control amplifier pentode of the locking-base type. Except for heater rating and capacitances, the electrical characteristics are the same as those of the 6SK7. Grid-plate Capacitance is 0.005 μmf ; input, 6 μmf ; output, 7 μmf . The heater is designed to be operated at 12.6 volts and 0.15 ampere (nominal values are 14 volts, 0.16 ampere). Dimensions are shown in Fig. 2-4, OUTLINES SECTION. The 14A7/12B7 may be mounted in any position.

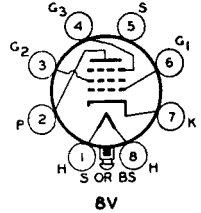

POWER AMPLIFIER PENTODE

25A6-GT

The 25A6-GT is a power amplifier pentode designed for use in "d-c power line" or "universal" type receivers. The electrical characteristics of the 25A6-GT are the same as those of the 25A6. Dimensions are shown in Fig. 2-8, OUTLINES SECTION. The tube may be mounted in any position.

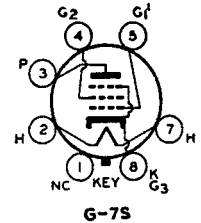

RECTIFIER-PENTODE

25A7-GT

The 25A7-GT is a heater-cathode type of tube containing a half-wave rectifier and a power amplifier pentode in one envelope. Electrical characteristics are the same as those of the 25A7-G. Dimensions are shown in Fig. 2-8, OUTLINES SECTION. The 25A7-GT may be mounted in any position.

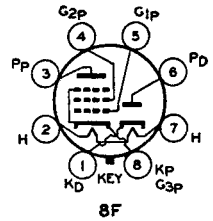

DIRECT-COUPLED POWER AMPLIFIER

25B5

The 25B5 is a multi-electrode tube of the heater-cathode type consisting of two triodes in one bulb. It is used chiefly for replacement in receivers designed for its characteristics. One triode, the driver, is directly connected to the second, or output, triode. The tube may be mounted in any position.

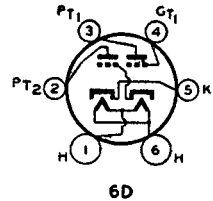

★CHARACTERISTICS

HEATER VOLTAGE (A.C. or D.C.)	25.0
HEATER CURRENT	0.3
MAXIMUM OVERALL LENGTH	4 1/2"
MAXIMUM SEATED HEIGHT	3 1/2"
MAXIMUM DIAMETER	1 1/2"
BULB	ST-12
BASE	Small 6-Pin

As Class A₁ Power Amplifier

OUTPUT-TRIODE PLATE (PT ₁) VOLTAGE		180 max.	Volts
INPUT-TRIODE PLATE (PT ₁) VOLTAGE		180 max.	Volts
OUTPUT TRIODE PLATE DISSIPATION		8.5 max.	Watts
INPUT TRIODE PLATE DISSIPATION		1.1 max.	Watts
TYPICAL OPERATION and CHARACTERISTICS:			
Output-Triode Plate Voltage	110	180	Volts
Input-Triode Plate Voltage	110	180	Volts
Input-Triode Grid Voltage	0	0	Volts
Peak A-F Grid (GT ₁) Voltage	29.5	29.5	Volts
Output-Triode Plate Current	45	46	Milliamperes
Input-Triode Plate Current	7	5.8	Milliamperes
Plate Resistance (Approx.)	11500	15000	Ohms
Transconductance (GT ₁ to PT ₁)	2200	2300	Micromhos
Load Resistance	2000	4000	Ohms
Total Harmonic Distortion	9	9	Per cent
Power Output	2	3.8	Watts

TRIODE-PENTODE

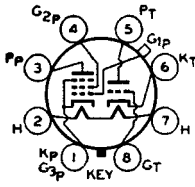

8T

The 25B8-GT is a heater-cathode type of tube containing a high- μ triode and an r-f pentode in one envelope. The triode unit may be used as a detector or amplifier and the pentode unit may be used as an r-f or i-f amplifier. Heater operation is similar to that of the 25A6 except for the difference in current rating. Refer to the 25A6 for information on cathode connection. Physical characteristics of the 25B8-GT are shown in Fig. 2-5, OUTLINES SECTION. The 25B8-GT can be mounted in any position.

25B8-GT

CHARACTERISTICS

HEATER VOLTAGE (A.C. or D.C.)	25	Volts
HEATER CURRENT	0.15	Ampere
DIRECT INTERELECTRODE CAPACITANCES:		
Triode Grid to Triode Plate (Approx.)	2.2	μ mf
Triode Grid to Triode Cathode (Approx.)	5	μ mf
Triode Plate to Triode Cathode (Approx.)	4.6	μ mf
Pentode Grid to Pentode Plate	0.02	μ mf
Pentode Input	5.5	μ mf
Pentode Output	10	μ mf
Pentode Grid to Triode Grid	0.02	μ mf
Pentode Plate to Triode Plate	0.075	μ mf
Pentode Grid to Triode Plate	0.009	μ mf

As Class A₁ Amplifier

	<i>Triode Unit</i>	<i>Pentode Unit</i>	
PLATE VOLTAGE	100	100	Volts
SCREEN VOLTAGE (Grid No. 2)	-	100	Volts
GRID VOLTAGE (Grid No. 1)	-1.0	-3	Volts
PLATE CURRENT	0.6	7.6	Milliamperes
SCREEN CURRENT	-	2	Milliamperes
AMPLIFICATION FACTOR	112	-	
PLATE RESISTANCE	75000	185000	Ohms
TRANSCONDUCTANCE	1500	2000	Micromhos
TRANSCONDUCTANCE with -41 volts bias	-	2	Micromhos

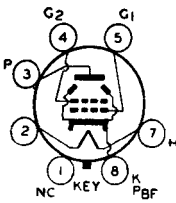

G-7AC

BEAM POWER AMPLIFIER

The 25C6-G is a beam power amplifier of the heater-cathode type, similar to the 6Y6-G except for its heater rating of 25 volts and 0.3 ampere. Physical characteristics are shown in Fig. 2-21, OUTLINES SECTION. The tube may be mounted in any position. For electrical characteristics, refer to the 6Y6-G.

25C6-G

DIRECT-COUPLED POWER AMPLIFIER

25N6-G

The 25N6-G is a multi-electrode type of tube like the 25B5 consisting of two triodes in one bulb. Refer to the 25B5 for electrical characteristics. Physical characteristics are: maximum overall length, 4 1/4 in.; maximum seated height, 3 1/4 in.; maximum diameter, 1 1/4 in.; bulb, ST-12; base, small shell octal 7-pin. The tube may be mounted in any position.

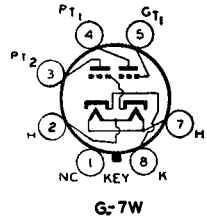

RECTIFIER-DOUBLER

25Y5

The 25Y5 is a high-vacuum rectifier which is designed for half-wave rectifier service on a 220-volt supply. The heater voltage is 25 volts, heater current, 0.3 ampere; maximum heater-cathode potential, 350 volts; maximum peak inverse voltage, 700 volts; the maximum d-c output current is 75 ma. and the maximum a-c plate voltage (RMS) is 235 volts. Physical characteristics are shown in Fig. 2-19, OUTLINES SECTION. The tube may be mounted in any position.

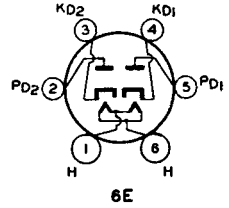

RECTIFIER-BEAM POWER AMPLIFIER

32L7-GT

The 32L7-GT is a heater-cathode type of tube containing a half-wave rectifier and a beam power amplifier in one envelope. The heater is designed for series operation in a-c/d-c receivers. Heater operation and cathode connection are the same as for the 35L6-GT except for the difference in heater voltage and current. The base of the 32L7-GT fits the standard octal socket which may be installed to hold the tube in any position. Physical characteristics of the 32L7-GT are shown in Fig. 2-8, OUTLINES SECTION.

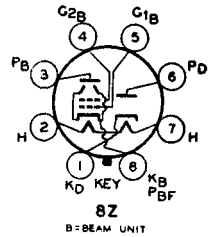

CHARACTERISTICS

HEATER VOLTAGE (A.C. or D.C.)	32.5	Volts
HEATER CURRENT	0.3	Ampere

Beam Power Unit—As Class A₁ Amplifier

PLATE VOLTAGE	90	90	Volts
SCREEN VOLTAGE (Grid No. 2)	90	90	Volts
GRID VOLTAGE (Grid No. 1)	-5	-7	Volts
PLATE CURRENT	38	27	Milliamperes
SCREEN CURRENT	3	2	Milliamperes
PLATE RESISTANCE (Approx.)	15000	17000	Ohms
TRANSCONDUCTANCE	6000	4800	Micromhos
LOAD RESISTANCE	2600	2600	Ohms
TOTAL HARMONIC DISTORTION	5.3	9	Per cent
SECOND HARMONIC DISTORTION	2.2	6.5	Per cent
THIRD HARMONIC DISTORTION	4.6	5.5	Per cent
POWER OUTPUT	0.8	1.0	Watt

Rectifier Unit

A-C PLATE VOLTAGE	125 max.	Volts
D-C OUTPUT	60 max.	Milliamperes

HALF-WAVE HIGH-VACUUM RECTIFIER

45Z3

The 45Z3 is a miniature half-wave rectifier of the heater-cathode type. It is designed for use in a-c/d-c/battery-operated portable receivers where small size and low heat dissipation are important. Physical characteristics are shown in Fig. 2-2, OUTLINES SECTION. The tube may be mounted in any position.

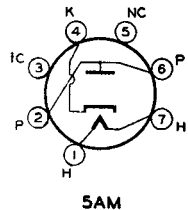

★CHARACTERISTICS

HEATER VOLTAGE (A.C. or D.C.)	45	Volts
HEATER CURRENT	0.075	Ampere

As Half-Wave Rectifier

PEAK INVERSE VOLTAGE	350 max.	Volts
PEAK PLATE CURRENT	390 max.	Volts
D-C HEATER-CATHODE POTENTIAL	175 max.	Volts
WITH CONDENSER-INPUT FILTER:		
A-C Plate Voltage (RMS)	117 max.	Volts
Total Effective Plate Supply Impedance	15 min.	Ohms
D-C Output Current	65 max.	Milliamperes

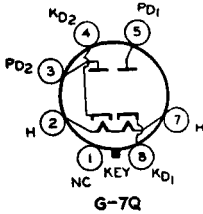

RECTIFIER-DOUBLER

The 50Y6-GT is a full-wave, high-vacuum rectifier of the heater-cathode type. This tube may be used in "transformerless" receivers of the "universal (a-c/d-c)" type. Refer to the 25A6 for heater operation and cathode connection, but note the difference in heater rating. Physical characteristics of the 50Y6-GT are shown in Fig. 2-8, OUT-LINES SECTION. The 50Y6-GT can be mounted in any position.

50Y6-GT

★CHARACTERISTICS

HEATER VOLTAGE (A.C. or D.C.)	50	Volts
HEATER CURRENT	0.15	Ampere

As Rectifier or Doubler

PEAK INVERSE VOLTAGE	700 max.	Volts
PEAK PLATE CURRENT PER PLATE	450 max.	Milliamperes
D-C HEATER-CATHODE POTENTIAL	350 max.	Volts
AS HALF-WAVE RECTIFIER:*		
A-C Plate Voltage per Plate (RMS)	117	150
Total Effective Plate-Supply Impedance		235 max.
per Plate	15 min.	40 min.
D-C Output Current per Plate	75 max.	75 max.
AS VOLTAGE DOUBLER:		
A-C Plate Voltage per Plate (RMS)	Half-Wave 117 max.	Full-Wave 117 max.
Total Effective Plate-Supply Impedance per Plate†	30 min.	15 min.
D-C Output Current	75 max.	75 max.

* The two units may be used separately or in parallel.

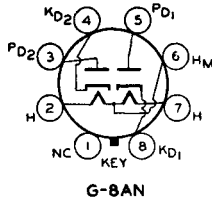

RECTIFIER-DOUBLER

The 50Z7-G is a full-wave, high-vacuum rectifier of the heater-cathode type for use in "transformerless" receivers of the "universal (a-c/d-c)" type. The heater is provided with a tap for the operation of a panel lamp. Dimensions are shown in Fig. 2-17, OUT-LINES SECTION. The tube may be mounted in any position.

50Z7-G

★CHARACTERISTICS

HEATER VOLTAGE (A.C. or D.C.)	50	Volts
Entire Heater (Pins No. 2 and No. 6)		
Panel Lamp Section (Pins No. 6 and No. 7) with 0.15 ampere flowing between pins No. 2 and No. 6	2.5	Volts
HEATER CURRENT	0.15	Ampere

As Rectifier or Doubler

PEAK INVERSE VOLTAGE	700 max.	Volts
PEAK PLATE CURRENT PER PLATE	400 max.	Milliamperes
D-C HEATER-CATHODE POTENTIAL	350 max.	Volts

As HALF-WAVE RECTIFIER:*

A-C Plate Voltage per Plate (RMS)	117	235 max.	Volts
Total Effective Plate-Supply Impedance per Plate†	15 min.	15 min.	Ohms
D-C Output Current per Plate	65 max.	65 max.	Milliamperes

As VOLTAGE DOUBLER:

A-C Plate Voltage per Plate (RMS)	117 max.	Volts
Total Effective Plate-Supply Impedance per Plate	15 min.	Ohms
D-C Output Current	65 max.	Milliamperes

* The two units may be used separately or in parallel.

RECTIFIER-BEAM POWER AMPLIFIER

70L7-GT

The 70L7-GT is a heater-cathode type of tube which combines in one bulb a half-wave rectifier and a beam power amplifier. It is designed for use in circuits employing heaters connected in series. Physical characteristics are shown in Fig. 2-3, OUTLINES SECTION. The 70L7-GT may be mounted in any position.

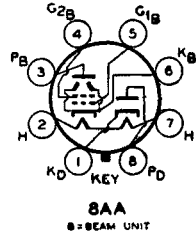

★CHARACTERISTICS

HEATER VOLTAGE (A.C. or D.C.)	70	Volts
HEATER CURRENT	0.15	Ampere

Beam Power Amplifier Unit

PLATE VOLTAGE	117 max.	Volts
SCREEN VOLTAGE	117 max.	Volts
PLATE DISSIPATION	5 max.	Watts
SCREEN DISSIPATION	1 max.	Watt
TYPICAL OPERATION and CHARACTERISTICS—Class A ₁ Amplifier:		
Plate Voltage	110	Volts
Screen Voltage	110	Volts
Grid Voltage*	-7.5	Volts
Peak A-F Grid Voltage	7.5	Volts
Zero-Signal Plate Current	40	Milliamperes
Max.-Signal Plate Current	43	Milliamperes
Zero-Signal Screen Current (Approx.)	3	Milliamperes
Max.-Signal Screen Current (Approx.)	6	Milliamperes
Plate Resistance	15000	Ohms
Transconductance	7500	Micromhos
Load Resistance	2000	Ohms
Total Harmonic Distortion	10	Per cent
Max.-Signal Power Output	1.8	Watts

Rectifier Unit

PEAK INVERSE VOLTAGE	350 max.	Volts
PEAK PLATE CURRENT	450 max.	Milliamperes
D-C HEATER-CATHODE POTENTIAL	175 max.	Volts
WITH CONDENSER-INPUT FILTER:		
A-C Plate Voltage (RMS)	117 max.	Volts
Total Effective Plate-Supply Impedance	15 min.	Ohms
D-C Output Current	70 max.	Milliamperes

* When the grid circuit has a resistance not higher than 0.1 megohm, fixed bias may be used; with cathode bias, the grid circuit may have a resistance not higher than 0.5 megohm.

RECTIFIER-BEAM POWER AMPLIFIER

117L7-GT/
117M7-GT

The 117L7-GT/117M7-GT is a heater-cathode type of tube which combines in one bulb a half-wave rectifier and a beam power amplifier. The heater is designed for operation directly across a 117-volt line. Except for the base connections, the electrical and physical characteristics of the 117L7-GT/117M7-GT are the same as for the 117P7-GT.

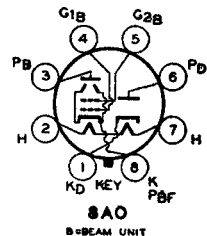

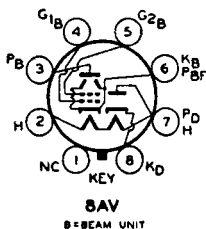

RECTIFIER-BEAM POWER AMPLIFIER

117N7-GT

The 117N7-GT is a heater-cathode type of tube which combines in one bulb a half-wave rectifier and a beam power amplifier. The heater is designed for use directly across the 117-volt supply line.

★CHARACTERISTICS

HEATER VOLTAGE (A.C. or D.C.)	117	Volts
HEATER CURRENT	0.09	Ampere
MAXIMUM OVERALL LENGTH	3 1/4"	
MAXIMUM SEATED HEIGHT	2 1/4"	
MAXIMUM DIAMETER	1 1/4"	
BULB	T-9	
BASE	Intermediate Shell Octal 8-Pin	
MOUNTING POSITION	Any	

Beam Power Amplifier Unit

PLATE VOLTAGE	117 max.	Volts
SCREEN VOLTAGE	117 max.	Volts
PLATE DISSIPATION	5.5 max.	Watts
SCREEN DISSIPATION	1.0 max.	Watt
TYPICAL OPERATION and CHARACTERISTICS—Class A ₁ Amplifier:		
Plate Voltage	100	Volts
Screen Voltage	100	Volts
Grid Voltage*	-6	Volts
Peak A-F Grid Voltage	6	Volts
Zero Signal Plate Current	51	Milliamperes
Zero-Signal Screen Current	5	Milliamperes
Plate Resistance (Approx.)	16000	Ohms
Transconductance	7000	Micromhos
Load Resistance	3000	Ohms
Total Harmonic Distortion	6	Per cent
Max.-Signal Power Output	1.2	Watts

* With fixed bias the d-c resistance of the grid circuit should not exceed 0.25 megohm; with cathode bias, 1.0 megohm.

Rectifier Unit

PEAK INVERSE VOLTAGE	350 max.	Volts
PEAK PLATE CURRENT	450 max.	Milliamperes
D-C HEATER CATHODE POTENTIAL	175 max.	Volts
WITH CONDENSER-INPUT FILTER:		
A-C Plate Voltage (RMS)	117 max.	Volts
Total Effective Plate-Supply Impedance	15 min.	Ohms
D-C Output Current	75 max.	Milliamperes

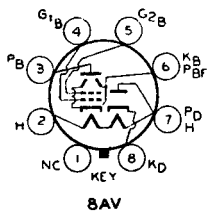

RECTIFIER-BEAM POWER AMPLIFIER

117P7-GT

The 117P7-GT is a heater-cathode type of tube which combines in one bulb a half-wave rectifier and a beam power amplifier. The heater is designed for use directly across a 117-volt supply line.

★CHARACTERISTICS

HEATER VOLTAGE (A.C. or D.C.)	117	Volts
HEATER CURRENT	0.09	Ampere
MAXIMUM OVERALL LENGTH	3 1/4"	
MAXIMUM SEATED HEIGHT	2 1/4"	
MAXIMUM DIAMETER	1 1/4"	
BULB	T-9	
BASE	Intermediate Shell Octal 8-Pin	
MOUNTING POSITION	Any	

Beam Power Amplifier Unit

PLATE VOLTAGE	117 max.	Volts
SCREEN VOLTAGE	117 max.	Volts
PLATE DISSIPATION	6 max.	Watts
SCREEN DISSIPATION	1 max.	Watt
TYPICAL OPERATION:		
Plate Voltage	105	Volts
Screen Voltage	105	Volts
Grid Voltage	-5.2	Volts
Peak A-F Grid Voltage	5.2	Volts
Zero-Signal Plate Current	43	Milliamperes
Max.-Signal Plate Current	43	Milliamperes
Zero-Signal Screen Current	4	Milliamperes
Max.-Signal Screen Current	5.5	Milliamperes
Plate Resistance (Approx.)	17000	Ohms
Transconductance	5300	Micromhos
Load Resistance	4000	Ohms
Total Harmonic Distortion	5	Per cent
Max.-Signal Power Output	0.85	Watt

Rectifier Unit

PEAK INVERSE VOLTAGE	350 max.	Volts
PEAK PLATE CURRENT	450 max.	Milliamperes
D-C HEATER-CATHODE POTENTIAL	175 max.	Volts
WITH CONDENSER-INPUT FILTER:		
A-C Plate Voltage (RMS)	117 max.	Volts
Total Effective Plate-Supply Impedance	15 min.	Ohms
D-C Output Current	75 max.	Milliamperes

† Type of input coupling should not introduce too much resistance in the grid circuit. With fixed bias, the resistance should not exceed 0.25 megohm; with cathode bias, 0.5 megohm.

RECTIFIER-DOUBLER

117Z6-GT

The 117Z6-GT is a full-wave high-vacuum rectifier of the heater-cathode type for use in suitable circuits to supply d-c power from an a-c power line. The heater of the 117Z6-GT is designed for operation directly across a 117-volt supply line. For voltage-doubler considerations, see RADIO TUBE APPLICATIONS SECTION. Physical characteristics are shown in Fig. 2-8, OUTLINES SECTION. The 117Z6-GT may be mounted in any position.

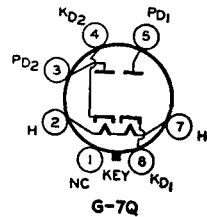

★CHARACTERISTICS

HEATER VOLTAGE (A.C. or D.C.)	117	Volts
HEATER CURRENT	0.075	Ampere

As Rectifier or Doubler

PEAK INVERSE VOLTAGE	700 max.	Volts		
PEAK PLATE CURRENT PER PLATE	360 max.	Milliamperes		
D-C HEATER-CATHODE POTENTIAL	350 max.	Volts		
AS HALF-WAVE RECTIFIER*				
A-C Plate Voltage per Plate (RMS)	117	150	235 max.	Volts
Total Effective Plate-Supply Impedance per Plate	15 min.	40 min.	100 min.	Ohms
D-C Output Current per Plate	60 max.	60 max.	60 max.	Milliamperes
AS VOLTAGE DOUBLER:			Half-Wave	Full-Wave
A-C Plate Voltage per Plate (RMS)		117 max.	117 max.	Volts
Total Effective Plate-Supply Impedance per Plate		30 min.	15 min.	Ohms
D-C Output Current		60 max.	60 max.	Milliamperes

* In half-wave service, the two units may be used separately or in parallel.

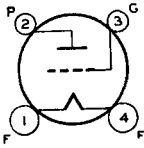

4D

POWER AMPLIFIER TRIODE

The 183/483 is a low- μ power amplifier triode for replacement in receivers designed for its characteristics. Dimensions are shown in Fig. 2-25, OUTLINES SECTION. Electrical characteristics are: filament voltage, 5.0 volts; current, 1.25 amperes; at plate volts of 250 and grid volts of -60, the plate current is 30 ma.; plate resistance, 1750 ohms; transconductance, 1700 micromhos; amplification factor, 3. With a load resistance of 5000 ohms, the power output is 1.8

183/
483

watts. The tube should be mounted in a vertical position, but horizontal operation is permissible if the plane of the filament is vertical.

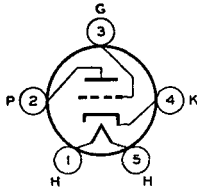

5A

DETECTOR AMPLIFIER TRIODE

The 485 is a heater-cathode type of tube intended for replacement in receivers designed for its characteristics. Dimensions are shown in Fig. 2-19, OUTLINES SECTION. The filament voltage is 3 volts, current, 1.25 ampere. At plate volts of 180 and grid volts of -9, the plate current is 5.8 ma.; plate resistance, 8900 ohms; transconductance, 1400 micromhos; amplification factor, 12.5. The tube may be mounted in any position.

485