

de Forest

AMATEUR TRANSMITTING TYPES

1934

RCA RADIOTRON CO., Inc.

de Forest AMATEUR RADIO DIVISION



203-A/503-A

R-F Power Amplifier, Oscillator, Class B Modulator

The RCA-203-A/503-A is a three-electrode transmitting tube designed for use as an oscillator, r-f power amplifier or Class B modulator. It is capable of giving high output with relatively low d-c plate voltage.

CHARACTERISTICS

| | | |
|---|-------------------|----------------|
| FILAMENT VOLTAGE (A.C.) | 10.0 | Volts |
| FILAMENT CURRENT | 3.25 | Amperes |
| AMPLIFICATION FACTOR | 25 | |
| GRID-PLATE CAPACITANCE | 14.5 | μpf |
| GRID-FILAMENT CAPACITANCE | 6.5 | μpf |
| PLATE-FILAMENT CAPACITANCE | 5.5 | μpf |
| BULB (For dimensions, see page 5) | T-18 | |
| BASE (For socket connections, see page 5) | Jumbo 4-Large Pin | |

MAXIMUM RATINGS and TYPICAL OPERATING CONDITIONS

As A-F Power Amplifier and Modulator - Class B

| | | |
|--------------------------------------|-----------------------|------------------|
| D-C PLATE VOLTAGE | 1250 max. Volts | |
| D-C PLATE CURRENT* | 175 max. Milliamperes | |
| PLATE DISSIPATION* | 100 max. Watts | |
| TYPICAL OPERATION: (2 tubes) | | |
| Filament Voltage (A.C.) | 10 | Volts |
| D-C Plate Voltage | 1000 | 1250 Volts |
| Grid Voltage (approximate) | -35 | -45 Volts |
| Static Plate Current (per tube) | 13 | 13 Milliamperes |
| Max.-Signal Plate Current (per tube) | 160 | 160 Milliamperes |
| Load Resistance (plate-to-plate) | 6900 | 9000 Ohms |
| Nominal Power Output (2 tubes) | 200 | 260 Watts |

As R-F Power Amplifier - Class B (Telephony)

(Carrier Conditions; for use with a Modulation Factor up to 1.0)

| | | |
|------------------------------|-----------------------|------------------|
| D-C PLATE VOLTAGE | 1250 max. Volts | |
| D-C PLATE CURRENT | 150 max. Milliamperes | |
| PLATE DISSIPATION | 100 max. Watts | |
| R-F GRID CURRENT | 6 max. Amperes | |
| TYPICAL OPERATION: | | |
| Filament Voltage (A.C.) | 10 | Volts |
| D-C Plate Voltage | 1000 | 1250 Volts |
| Grid Voltage (approximate) | -35 | -45 Volts |
| D-C Plate Current | 130 | 106 Milliamperes |
| Peak Power Output | 160 | 170 Watts |
| Nominal Carrier Power Output | 40 | 42.5 Watts |

* Averaged over any audio-frequency cycle.

As Plate-Modulated R-F Power Amplifier - Class C (Telephony)
(Carrier Conditions; for use with a Modulation Factor up to 1.0)

| | | |
|-------------------|--|-----------------------|
| D-C PLATE VOLTAGE | | 1000 max. Volts |
| D-C PLATE CURRENT | | 175 max. Milliamperes |
| PLATE DISSIPATION | | 67 max. Watts |
| R-F GRID CURRENT | | 6 max. Amperes |
| D-C GRID CURRENT | | 60 max. Milliamperes |

TYPICAL OPERATION:

| | | | |
|----------------------------|------|------|--------------|
| Filament Voltage (A.C.) | | 10 | Volts |
| D-C Plate Voltage | 750 | 1000 | Volts |
| Grid Voltage (approximate) | -100 | -135 | Volts |
| D-C Plate Current | 150 | 150 | Milliamperes |
| D-C Grid Current** | 50 | 50 | Milliamperes |
| Driving Power** | 12 | 14 | Watts |
| Nominal Power Output | 65 | 100 | Watts |

As R-F Power Amplifier and Oscillator - Class C (Telegraphy)
(Key Down Conditions)

| | | |
|-------------------|--|-----------------------|
| D-C PLATE VOLTAGE | | 1250 max. Volts |
| D-C PLATE CURRENT | | 175 max. Milliamperes |
| PLATE DISSIPATION | | 100 max. Watts |
| R-F GRID CURRENT | | 7.5 max. Amperes |
| D-C GRID CURRENT | | 60 max. Milliamperes |

TYPICAL OPERATION:

| | | | | |
|----------------------------|-----|------|-------|--------------|
| Filament Voltage (A.C.) | | 10 | Volts | |
| D-C Plate Voltage | 750 | 1000 | 1250 | Volts |
| Grid Voltage (approximate) | -75 | -100 | -125 | Volts |
| D-C Plate Current | 150 | 150 | 150 | Milliamperes |
| D-C Grid Current** | 25 | 25 | 25 | Milliamperes |
| Driving Power** | 5 | 6 | 7 | Watts |
| Nominal Power Output | 65 | 100 | 130 | Watts |

**Subject to wide variations depending on the impedance of the load circuit. High impedance load circuits require more grid current and driving power to obtain the desired output. Low impedance circuits need less grid current and driving power, but plate circuit efficiency is sacrificed. The driving stage should have a tank circuit of good regulation and should be capable of delivering considerably more than the required driving power.

INSTALLATION

The base of the RCA-203-A/503-A fits the standard transmitting, four-contact socket, such as the RCA type UT-541. The socket should be mounted so that the tube will operate in a vertical position, with the base end down. Because of the relatively heavy filament current taken by this tube, the socket should make firm, large-surface contact with the filament base pins. Heavy, well-soldered leads should be used for the filament circuit wiring.

The bulb of this tube becomes very hot during continuous operation. Free circulation of air should therefore be provided. The installation of all wires and connections should be made to allow at least several inches of free space around the tube in order to avoid trouble from peak voltage effects.

The filament of the 203-A/503-A should be operated preferably from an a-c source, although a d-c supply may be used. A voltmeter should be connected permanently across the filament circuit at the

socket terminals so that the filament voltage can be maintained at 10 volts. With an a-c source, rheostat control should be placed in the primary circuit of the filament transformer. Deviation from the rated voltage may result in a loss of filament emission. In radio transmitters during "standby" periods, the filament should be maintained at its rated voltage.

The grid and plate circuit returns should be connected to the center tap on the filament winding of the transformer, or to the midpoint of a center-tapped resistor across the filament terminals. In cases where d.c. is used on the filament, the grid and plate returns should be connected to the negative filament terminal.

The plate dissipation of the RCA-203-A/503-A (the difference between input and output) should never exceed the values given under MAXIMUM RATINGS and TYPICAL OPERATING CONDITIONS. The maximum value is indicated by a nearly imperceptible red color on the plate in the dark. To determine this, all power switches should be opened with the tube operating. This procedure avoids reflections from the lighted filament which would interfere with the observation.

Overheating of the 203-A/503-A by severe overload may decrease filament emission. Unless the overload has liberated a large amount of gas, the activity of the filament can sometimes be restored by operating it at rated voltage for ten minutes or more with no voltage on the plate or grid. This process may be accelerated by raising the filament voltage to 12 volts (not higher) for a few minutes.

A d-c milliammeter should be used in the plate circuit in order that the plate current can always be known. Under no condition should the d-c plate current exceed the maximum values given under MAXIMUM RATINGS and TYPICAL OPERATING CONDITIONS.

In order to prevent overheating due to improper circuit adjustments or to overloading, the plate circuit should be provided with a protective device such as a fuse or relay. This device should instantly remove the plate voltage when the d-c plate current reaches a value 50 per cent greater than normal.

Heavy leads and conductors together with suitable insulation should be used in all parts of the r-f plate tank circuit, in order that the losses due to the r-f voltages and currents be kept at a minimum. These losses are especially noticeable at the higher frequencies.

When a new circuit is being tried out or when adjustments are being made, the plate voltage should be reduced in order to prevent damage to the tube or associated apparatus in case the circuit adjustments are incorrect. It is advisable to use a protective resistance of about 3000 ohms in series with the plate lead during such adjustments.

The rated plate voltage of this tube is high enough to be exceedingly dangerous to the user. The greatest care should be taken when handling or adjusting circuits, especially those in which the plate tank coil and condenser are at the d-c plate potential.

APPLICATION

As a *Class B modulator or audio-frequency amplifier*, two 203-A/503-A's are used in a balanced circuit, each tube conducting only half the time. The d-c plate current should never exceed 175 milliamperes per tube. Two tubes, operating under the conditions shown for a 1000-volt plate supply, are capable of modulating 100 per cent an input of 400 watts.

The *input transformer* should be designed to give good frequency response when operated into an open circuit, such as that represented by the grid circuit of the Class B stage when the signal amplitude is small, and also to handle the required input power for a strong signal.

The *output transformer* should be designed so that the resistance load presented by the modulated Class C amplifier is reflected as a plate-to-plate load of 6900 ohms in the Class B stage, for the 1000-volt conditions. Since two 203-A/503-A's will modulate 400 watts, a convenient Class C stage amplifier would be one operating at 2000 volts and 200 milliamperes. These conditions represent a resistance of approximately 10000 ohms. The ratio of the output transformer is then $\sqrt{10000 \div 6900}$, or 1 to 1.20, step-up. The transformer should be designed with a core sufficiently large to avoid saturation effects, which would impair the quality of the output. If the secondary is to carry the d-c plate current of the modulated amplifier, the core should be made larger and include an air-gap, to compensate for the d-c magnetization current.

As a *Class B and Class C radio-frequency amplifier*, the RCA-203-A/503-A may be used as shown under MAXIMUM RATINGS and TYPICAL OPERATING CONDITIONS.

In *Class B* radio-frequency service, the plate voltage is unmodulated d.c. and the grid excitation is radio frequency modulated at audio frequency in one of the preceding stages. For this type of operation, the plate dissipation should never be allowed to exceed 100 watts.

Grid bias for the 203-A/503-A as a Class B amplifier should be obtained from a battery or other d-c source of good regulation. It should not be obtained from a high-resistance supply such as a grid-leak, nor from a rectifier, unless the latter has exceptionally good voltage regulation. For *Class C (telegraph) service*, grid bias may be obtained from a grid leak of about 5000 ohms, from a battery, from a rectifier of good regulation, or from a self-biasing resistor (preferably variable) by-passed with a suitable condenser. The self-biasing method is especially desirable, due to the fact that the grid bias is automatically regulated and that there is little chance of the plate current becoming dangerously high, regardless of whether the r-f grid excitation is applied or not. When the grid-leak method of obtaining grid bias is used, bias is on the tube only when r-f grid excitation is applied. Since grid bias values are not particularly critical, correct circuit adjustment may be obtained with widely different values. For *Class C (telephone) service*, fixed bias is recommended because it eliminates the problems of degeneration caused by a-c voltage variation developed across the biasing system.

The *d-c grid current* should never exceed 60 milliamperes. The exact value will vary with individual tubes.

The 203-A/503-A may be used at full ratings up to 6000 kilocycles (50 meters). Although this tube is not constructed for operation at the higher frequencies and although other tube types are recommended for regular operation at such frequencies, satisfactory operation with reduced input has been obtained in experimental circuits at frequencies as high as 30000 kilocycles. When the 203-A/503-A is operated at frequencies in excess of 6000 kc., the plate voltage and power input should be reduced as the frequency is raised, so that at 30000 kc. the plate current, plate dissipation, and d-c grid current will not exceed 50 per cent of the maximum ratings.

If more power output is required than can be obtained from a single 203-A/503-A, two of these tubes may be used either in parallel or in push-pull. The parallel connection provides approximately twice the power output of a single tube without an increase in exciting voltage, while the push-pull connection gives twice the output but requires twice the r-f excitation voltage; with either connection the grid bias is the same as for a single tube. The push-pull arrangement is advantageous in reducing the shunting effect of the interelectrode capacities, inasmuch as these capacities are in series. This reduction is especially desirable when the tubes are operated at the higher frequencies.

When two or more RCA-203-A/503-A's are operated in parallel, a non-inductive resistance of 10 to 100 ohms should be placed in series with the grid lead of each tube, close to the socket terminal, to prevent parasitic oscillations.

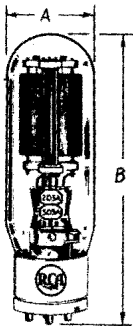

Overall Dimensions

A = 2-5/16" max.

B = 7-7/8" max.

Tube Symbol and Top View of Socket Connections.

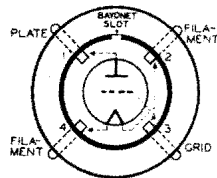

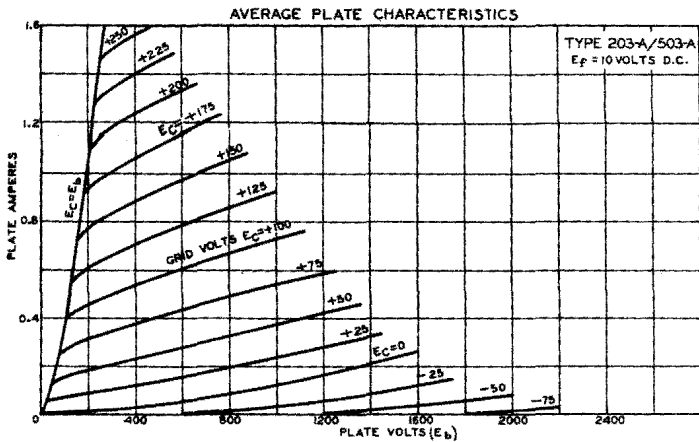

R-F POWER AMPLIFIER
NOMINAL OUTPUT, 100 WATTS

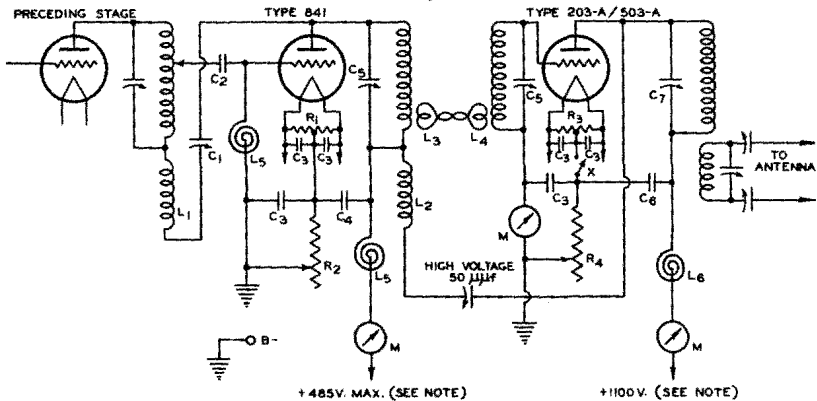

- C₁ = 35 μμF MIDGET VARIABLE
- C₂ = 0.0005 μF FIXED MICA
- C₃ = 0.002 μF FIXED MICA
- C₄ = 0.002 μF 800 VOLT FIXED MICA
- C₅ = 150 μμF (VARIABLE)
- C₆ = 0.002 μF 2500 VOLT FIXED MICA
- C₇ = 150 μμF TRANSMITTING VARIABLE
(MINIMUM AIR-GAP 0.080")

- L₁ & L₂ = NEUTRALIZING COILS
- L₃ & L₄ = LINK COUPLING COILS
- L₅ = 8 MILLIHENRIES, R-F CHOKE
- L₆ = 8 MILLIHENRIES, 200 MA., R-F CHOKE
- R₁ = 50 OHMS, CENTER-TAPPED
- R₂ = SELF-BIASING RESISTOR 1000 OHMS (5 WATT), ADJUSTABLE
- R₃ = 100 OHMS, CENTER-TAPPED
- R₄ = SELF-BIASING RESISTOR 1000 OHMS (25 WATT), ADJUSTABLE
- X = KEY

NOTE: THIS VALUE INCLUDES PROPER C-BIAS VOLTAGE. FOR TELEPHONY, FIXED BIAS IS RECOMMENDED.



204-A/504-A

R-F Power Amplifier, Oscillator, Class B Modulator

RCA-204-A/504-A is a three-electrode transmitting tube designed for use as an oscillator or radio-frequency power amplifier at frequencies of 3000 kilocycles or lower. As a Class B modulator, two of these tubes will modulate 100 per cent approximately 1200 watts of power to the modulated amplifier.

CHARACTERISTICS

| | | |
|----------------------------|---------------------|---------|
| FILAMENT VOLTAGE (A.C.) | 11 | Volts |
| FILAMENT CURRENT | 3.85 | Amperes |
| AMPLIFICATION FACTOR | 25 | |
| GRID-PLATE CAPACITANCE | 15 approx. | µf |
| GRID-FILAMENT CAPACITANCE | 12.5 approx. | µf |
| PLATE-FILAMENT CAPACITANCE | 2.3 approx. | µf |
| BULB | T-32 | |
| BASES | Types 1904 and 3502 | |

(For base connections and tube dimensions, see page 11)

MAXIMUM RATINGS and TYPICAL OPERATING CONDITIONS

As A-F Power Amplifier and Modulator - Class B

| | | |
|--------------------|-----------|--------------|
| D-C PLATE VOLTAGE | 3000 max. | Volts |
| D-C PLATE CURRENT* | 275 max. | Milliamperes |
| PLATE DISSIPATION* | 250 max. | Watts |
| D-C PLATE INPUT* | 650 max. | Watts |

TYPICAL OPERATION: (2 tubes)

| | | | |
|-------------------------------------|------|-------|--------------|
| Filament Voltage (A.C.) | 11 | Volts | |
| D-C Plate Voltage | 1500 | 2000 | Volts |
| Grid Voltage (approximate) | -40 | -60 | Volts |
| Static Plate Current (per tube) | 37 | 37 | Milliamperes |
| Max.-Signal Plate Current(per tube) | 250 | 250 | Milliamperes |
| Load Resistance(plate-to-plate)** | 7800 | 8800 | Ohms |
| Nominal Power Output (2 tubes) | 400 | 600 | Watts |

As R-F Power Amplifier - Class B (Telephony)

(Carrier Conditions; for use with a Modulation Factor up to 1.0)

| | | |
|-------------------|-----------|--------------|
| D-C PLATE VOLTAGE | 2500 max. | Volts |
| D-C PLATE CURRENT | 225 max. | Milliamperes |
| PLATE DISSIPATION | 250 max. | Watts |
| R-F GRID CURRENT | 8 max. | Amperes |

TYPICAL OPERATION:

| | | | |
|------------------------------|------|-------|--------------|
| Filament Voltage (A.C.) | 11.0 | Volts | |
| D-C Plate Voltage | 1500 | 2000 | Volts |
| Grid Voltage (approximate) | -50 | -70 | Volts |
| D-C Plate Current | 200 | 160 | Milliamperes |
| Peak Power Output | 320 | 400 | Watts |
| Nominal Carrier Power Output | 80 | 100 | Watts |

* Averaged over any audio-frequency cycle.

**This value is equal to four times the plate load per tube.

As Plate-Modulated R-F Power Amplifier - Class C (Telephony)
(Carrier Conditions; for use with a Modulation Factor up to 1.0)

| | | | |
|-------------------|--|-----------|--------------|
| D-C PLATE VOLTAGE | | 2000 max. | Volts |
| D-C PLATE CURRENT | | 275 max. | Milliamperes |
| PLATE DISSIPATION | | 167 max. | Watts |
| R-F GRID CURRENT | | 8 max. | Amperes |
| D-C GRID CURRENT | | 80 max. | Milliamperes |

TYPICAL OPERATION:

| | | | |
|----------------------------|------|------|--------------|
| Filament Voltage (A.C.) | | 11.0 | Volts |
| D-C Plate Voltage | 1500 | 1800 | Volts |
| Grid Voltage (approximate) | -200 | -250 | Volts |
| D-C Plate Current | 250 | 250 | Milliamperes |
| Nominal Power Output | 225 | 300 | Watts |

As R-F Power Amplifier and Oscillator - Class C (Telegraphy)

(Key Down Conditions)

| | | | |
|-------------------|--|-----------|--------------|
| D-C PLATE VOLTAGE | | 2500 max. | Volts |
| D-C PLATE CURRENT | | 275 max. | Milliamperes |
| PLATE DISSIPATION | | 250 max. | Watts |
| R-F GRID CURRENT | | 10 max. | Amperes |
| D-C GRID CURRENT | | 80 max. | Milliamperes |

TYPICAL OPERATION:

| | | | |
|----------------------------|------|------|--------------|
| Filament Voltage (A.C.) | | 11.0 | Volts |
| D-C Plate Voltage | 1500 | 2000 | Volts |
| Grid Voltage (approximate) | -150 | -175 | Volts |
| D-C Plate Current | 250 | 250 | Milliamperes |
| Nominal Power Output | 225 | 350 | Watts |

INSTALLATION

The bases of the RCA-204-A/504-A fit the standard RCA end mountings, type UT-1085 and UT-1086. The tube may be mounted either in a vertical position with the filament end up, or in a horizontal position with the plate in a vertical plane (on edge). Because of the relatively heavy filament current taken by this tube, the socket should make firm, large-surface contact with the filament base pins. Heavy, well-soldered leads should be used for the filament circuit wiring.

The bulb of this tube becomes very hot during continuous operation. Free circulation of air around the tube should therefore be provided. The installation of all wires and connections should be made to allow at least several inches of free space around the bulb to avoid trouble from peak voltage effects.

The filament of the 204-A/504-A should be operated preferably from an a-c source. In certain applications where freedom from hum is essential, the use of direct current is to be preferred. A suitable voltmeter should be connected permanently across the filament terminals so that the filament voltage can be maintained at 11.0 volts. With an a-c source, rheostat control should be placed in the primary circuit of the filament transformer. In radio transmitters during "standby" periods, the filament should be maintained at its rated voltage.

For grid and plate return connections, refer to INSTALLATION on RCA-203-A/503-A.

The plate dissipation of the 204-A/504-A (the difference between input and output) should never exceed the values given under MAXIMUM RATINGS and TYPICAL OPERATING CONDITIONS. These values are indicated by a dull red color on the plate. To determine this, all power switches should be opened with the tube operating in the dark. This procedure avoids reflections from the lighted filament which would interfere with the observation.

Overheating of the RCA-204-A/504-A by severe overload may decrease filament emission. Unless the overload has liberated a large amount of gas, the activity of the filament can sometimes be restored by operating it at rated voltage for ten minutes or more with no voltage on the plate or grid. This reactivation process may be accelerated by raising the filament voltage to 13 volts (not higher) for a few minutes.

A d-c milliammeter in the plate circuit is desirable in order that the plate current can always be known. Under no conditions should the d-c plate current exceed the maximum values given under MAXIMUM RATINGS and TYPICAL OPERATING CONDITIONS.

In order to prevent overheating due to improper circuit adjustments or to overloading, the plate circuit should be provided with a protective device such as a relay or fuse. This device should instantly remove the plate voltage when the d-c plate current reaches a value 50 per cent greater than normal. When the tube is used as an oscillator or as a radio-frequency power amplifier, a fuse designed to open the circuit at 10 amperes should be connected directly in series with the plate lead at the tube mounting. No protective device should be placed in the grid circuit, since its opening would leave the tube without bias.

Heavy leads and conductors together with suitable insulation should be used in all parts of the r-f plate tank circuit, in order that the losses due to the r-f voltages and currents be kept at a minimum. These losses are especially noticeable at the higher frequencies.

When a new circuit is tried out or when adjustments are being made, the plate voltage should be reduced in order to prevent damage to the tube or associated apparatus in case the circuit adjustments are incorrect.

The rated plate voltage used with this tube is high enough to be exceedingly dangerous to the user. The greatest care should be taken when handling or adjusting circuits, especially those in which the plate tank coil and condenser are at the d-c plate potential.

APPLICATION

As a Class B modulator or audio-frequency amplifier, two RCA-204-A/504-A's are used in a balanced circuit, each tube conducting only half the time. The d-c plate current should never exceed 275 milliamperes. Two tubes, operating under the conditions shown for a

2000-volt plate supply, are capable of modulating 100 per cent an input of 1200 watts to a Class C radio-frequency amplifier.

For Class B *input transformer* considerations, refer to APPLI-CATION on RCA-203-A/503-A.

The *output transformer* should be designed so that the resistance load presented by the modulated Class C amplifier is reflected as a plate-to-plate load of 8800 ohms in the Class B stage for the 2000-volt conditions. Since two RCA-204-A/504-A's will modulate as much as 1200 watts, a convenient Class C amplifier would be one operating at 2000 volts and 600 milliamperes. These conditions represent a resistance of approximately 3350 ohms. The ratio of the output transformer is then $\sqrt{8800 \div 3350}$, or 1.62 to 1, step-down. If a Class C amplifier operating at 2500 volts and 480 milliamperes is used, the equivalent resistance is approximately 5200 ohms. In this case, the transformer ratio is 1.3 to 1, step-down. The transformer should be designed with a core sufficiently large to avoid saturation effects, which would impair the quality of the output. If the secondary is to carry the d-c plate current of the modulated amplifier, the core should be made larger and include an air-gap to compensate for the d-c magnetization current.

As a *Class B or Class C radio-frequency amplifier*, the RCA-204-A/504-A may be used as shown under MAXIMUM RATINGS and TYPICAL OPERATING CONDITIONS.

In *Class B* service, the plate voltage is unmodulated d.c. and the grid excitation is radio-frequency modulated at audio frequency in one of the preceding stages. For this type of operation, the plate dissipation should never be allowed to exceed 400 watts.

Grid bias for the 204-A/504-A as a Class B amplifier should be obtained from a battery or other d-c source of good regulation. It should not be obtained from a high-resistance supply such as a grid-leak, nor from a rectifier, unless the latter has exceptionally good voltage regulation. For *Class C (telegraph) service*, grid bias may be obtained from a grid leak of about 5000 ohms, from a battery, from a rectifier of good regulation, or from a self-biasing resistor by-passed by a suitable condenser. The self-biasing method is especially desirable, due to the fact that the grid bias is automatically regulated and that there is little chance of the plate current becoming dangerously high regardless of whether the r-f grid excitation is applied or not. When the grid-leak method of obtaining grid bias is used, bias is on the tube *only when r-f grid excitation is applied*. Since grid bias values are not particularly critical, correct circuit adjustment may be obtained with widely different values. For *Class C (telephone) service*, fixed bias is recommended because it eliminates the problems of degeneration caused by a-c voltage variation developed across the biasing system.

The *d-c grid current* should never exceed 80 milliamperes. The exact value will vary with individual tubes and circuits.

At *frequencies* as high as 3000 kc., the RCA-204-A/504-A may be used at full ratings as shown under MAXIMUM RATINGS and TYPICAL OPER-

ATING CONDITIONS. Although it is not constructed for operation at higher frequencies, satisfactory operation with reduced plate voltage and input power has been obtained in experimental circuits at frequencies as high as 15000 kilocycles. When the 204-A/504-A is operated at frequencies in excess of 3000 kc., the plate voltage and power input should be reduced as the frequency is raised so that at 15000 kc. the plate current, plate dissipation and d-c grid current will not exceed 50 per cent of the maximum ratings.

If more r-f power output is required than can be obtained from a single 204-A/504-A, two of these tubes may be used either in parallel or in push-pull. See APPLICATION on the 203-A/503-A.

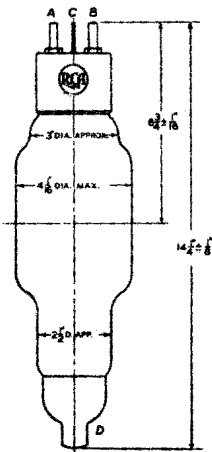
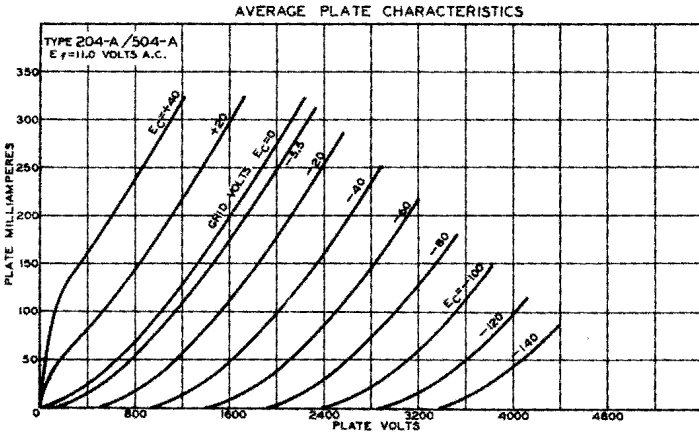

RCA-204-A/504-A CONNECTIONS

- | | |
|---------|----------|
| Post A | Filament |
| Post B | Filament |
| Blade C | Grid |
| Cap D | Plate |



211/511

Oscillator, R-F and A-F Power Amplifier, Modulator

RCA-211/511 is a three-electrode, general-purpose transmitting tube. It may be used as an oscillator, radio-frequency amplifier, audio-frequency power amplifier as well as a Class A or B Modulator. It is capable of giving high output with relatively low d-c plate voltage.

CHARACTERISTICS

| | | |
|---|-------------------|---------|
| FILAMENT VOLTAGE (A.C.) | 10.0 | Volts |
| FILAMENT CURRENT | 3.25 | Amperes |
| AMPLIFICATION FACTOR | 12 | |
| GRID-PLATE CAPACITANCE | 14.5 | μf |
| GRID-FILAMENT CAPACITANCE | 6 | μf |
| PLATE-FILAMENT CAPACITANCE | 5.5 | μf |
| BULB (For dimensions, see page 5) | T-18 | |
| BASE (For socket connections, see page 5) | Jumbo 4-Large Pin | |

MAXIMUM RATINGS and TYPICAL OPERATING CONDITIONS

As A-F Power Amplifier and Modulator - Class A

| | | | | |
|---------------------------|------|------|-----------|--------------|
| D-C PLATE VOLTAGE | | | 1250 max. | Volts |
| PLATE DISSIPATION | | | 75 max. | Watts |
| TYPICAL OPERATION: | | | | |
| Filament Voltage (A.C.) | | | 10 | Volts |
| D-C Plate Voltage | 750 | 1000 | 1250 | Volts |
| Grid Voltage (approx.) | -46 | -61 | -80 | Volts |
| Peak Grid Swing (approx.) | 41 | 56 | 75 | Volts |
| D-C Plate Current | 34 | 53 | 60 | Milliamperes |
| Load Resistance | 8800 | 7600 | 9200 | Ohms |
| Undistorted Power Output | 5.6 | 12.0 | 19.7 | Watts |

As A-F Power Amplifier and Modulator - Class B

| | | | | |
|-------------------------------------|--|------|-----------|--------------|
| D-C PLATE VOLTAGE | | | 1250 max. | Volts |
| D-C PLATE CURRENT* | | | 175 max. | Milliamperes |
| PLATE DISSIPATION* | | | 100 max. | Watts |
| TYPICAL OPERATION: (2 tubes) | | | | |
| Filament Voltage (A.C.) | | | 10 | Volts |
| D-C Plate Voltage | | 1000 | 1250 | Volts |
| Grid Voltage (approximate) | | -77 | -100 | Volts |
| Static Plate Current (per tube) | | 10 | 10 | Milliamperes |
| Maximum-Signal Plate Cur.(per tube) | | 160 | 160 | Milliamperes |
| Load Resistance (plate-to-plate) | | 6900 | 9000 | Ohms |
| Nominal Power Output (2 tubes) | | 200 | 260 | Watts |

* Averaged over any audio-frequency cycle.

As R-F Power Amplifier - Class B (Telephony)

(Carrier Conditions; for use with a Modulation Factor up to 1.0)

| | | | | |
|-------------------|--|--|-----------|--------------|
| D-C PLATE VOLTAGE | | | 1250 max. | Volts |
| D-C PLATE CURRENT | | | 150 max. | Milliamperes |
| PLATE DISSIPATION | | | 100 max. | Watts |
| R-F GRID CURRENT | | | 6 max. | Amperes |

TYPICAL OPERATION:

| | | | | |
|------------------------------|------|------|----|--------------|
| Filament Voltage (A.C.) | | | 10 | Volts |
| D-C Plate Voltage | 1000 | 1250 | | Volts |
| Grid Voltage (approximate) | -77 | -100 | | Volts |
| D-C Plate Current | 130 | 106 | | Milliamperes |
| Peak Power Output | 160 | 170 | | Watts |
| Nominal Carrier Power Output | 40 | 42.5 | | Watts |

As Plate-Modulated R-F Power Amplifier - Class C (Telephony)

(Carrier Conditions; for use with a Modulation Factor up to 1.0)

| | | | | |
|-------------------|--|--|-----------|--------------|
| D-C PLATE VOLTAGE | | | 1000 max. | Volts |
| D-C PLATE CURRENT | | | 175 max. | Milliamperes |
| PLATE DISSIPATION | | | 67 max. | Watts |
| R-F GRID CURRENT | | | 6 max. | Amperes |
| D-C GRID CURRENT | | | 50 max. | Milliamperes |

TYPICAL OPERATION:

| | | | | |
|----------------------------|------|------|----|--------------|
| Filament Voltage (A.C.) | | | 10 | Volts |
| D-C Plate Voltage | 750 | 1000 | | Volts |
| Grid Voltage (approximate) | -200 | -260 | | Volts |
| D-C Plate Current | 150 | 150 | | Milliamperes |
| D-C Grid Current** | 35 | 35 | | Milliamperes |
| Driving Power** | 12 | 14 | | Watts |
| Nominal Power Output | 65 | 100 | | Watts |

As R-F Power Amplifier and Oscillator - Class C (Telegraphy)

(Key Down Conditions)

| | | | | |
|-------------------|--|--|-----------|--------------|
| D-C PLATE VOLTAGE | | | 1250 max. | Volts |
| D-C PLATE CURRENT | | | 175 max. | Milliamperes |
| PLATE DISSIPATION | | | 100 max. | Watts |
| R-F GRID CURRENT | | | 7.5 max. | Amperes |
| D-C GRID CURRENT | | | 50 max. | Milliamperes |

TYPICAL OPERATION:

| | | | | |
|----------------------------|------|------|------|--------------|
| Filament Voltage (A.C.) | | | 10 | Volts |
| D-C Plate Voltage | 750 | 1000 | 1250 | Volts |
| Grid Voltage (approximate) | -135 | -175 | -225 | Volts |
| D-C Plate Current | 150 | 150 | 150 | Milliamperes |
| D-C Grid Current** | 18 | 18 | 18 | Milliamperes |
| Driving Power** | 5 | 6 | 7 | Watts |
| Nominal Power Output | 65 | 100 | 130 | Watts |

**Subject to wide variations depending on the impedance of the load circuit. High impedance load circuits require more grid current and driving power to obtain the desired output. Low impedance circuits need less grid current and driving power, but sacrifice plate circuit efficiency. The driving stage should have a tank circuit with good regulation and should be capable of delivering considerably more than the required driving power.

INSTALLATION

The base of the RCA-211/511 fits the standard transmitting, four-contact socket, such as the RCA type UT-541. The socket should be mounted so that the tube will operate in a vertical position with the base end down.

For additional information on installation of this type, refer to INSTALLATION on type 203-A/503-A.

APPLICATION

As a *Class A audio-frequency amplifier or modulator*, the RCA-211/511 is capable of delivering nearly 20 watts of audio-frequency power with very low distortion. Typical operating conditions are shown under MAXIMUM RATINGS and TYPICAL OPERATING CONDITIONS.

Grid bias for this type of service may be obtained from a separate voltage source or by means of a self-biasing resistor shunted by a filter network to avoid degenerative effects at the low audio frequencies. Separate filament supplies are of course necessary for each tube self-biased. When a group of 211/511's is operated in parallel, it is necessary to make provision for individual adjustment of grid bias to insure that the plate dissipation of any tube does not exceed the maximum value of 75 watts. This may be accomplished by means of a tapped "C" battery, or if self-bias is used, by means of a variable cathode resistor for each tube.

When a number of tubes are operated in parallel, a non-inductive resistance of 10 to 100 ohms should be placed in series with each grid lead, next to the tube mounting, to prevent parasitic oscillations.

An output device, such as a choke or transformer should be used to transfer power efficiently from the 211/511 to the reproducing unit or to the modulated r-f amplifier stage.

As a *Class B modulator or audio-frequency amplifier*, two 211/511's are used in a balanced circuit, each tube conducting only half the time. The d-c plate current should never exceed 175 milliamperes per tube. Two tubes, operating under the conditions shown for a 1000-volt plate supply, are capable of modulating 100 per cent an input of 400 watts.

For input transformer considerations refer to APPLICATION on type 203-A/503-A.

The output transformer should be designed so that the resistance load presented by the modulated Class C amplifier is reflected as a plate-to-plate load of 6900 ohms in the Class B stage, for the 1000-volt conditions. Since two 211/511's will modulate 400 watts, a convenient Class C stage amplifier would be one operating at 2000 volts and 200 milliamperes. These conditions represent a resistance of approximately 10000 ohms. The ratio of the output transformer is then $\sqrt{10000 \div 6900}$, or 1 to 1.20, step-up. The transformer should be designed with a core sufficiently large to avoid saturation effects which would impair the quality of the output. If the secondary is to carry the d-c plate current of the modulated amplifier, the

core should be made larger and include an air-gap, to compensate for the d-c magnetization current.

As a *Class B* and *Class C* radio-frequency amplifier, the RCA-211/511 may be used as shown under MAXIMUM RATINGS and TYPICAL OPERATING CONDITIONS.

In *Class B* radio-frequency service, the plate voltage is unmodulated d.c. and the grid excitation is radio frequency modulated at audio frequency in one of the preceding stages. For this type of operation, the plate dissipation should never be allowed to exceed 100 watts.

For grid bias of the 211/511 as *Class B* and *C* r-f amplifiers, refer to APPLICATION for type 203-A/503-A.

The d-c grid current should never exceed 50 milliamperes. The exact value will depend upon individual tubes and circuits.

The 211/511 may be used at full ratings as high as 6000 kilocycles (50 meters). Although this tube is not constructed for operation at the higher frequencies and although other tube types are recommended for regular operation at such frequencies, satisfactory operation with reduced input has been obtained in experimental circuits as high as 30000 kilocycles. When the 211/511 is operated at frequencies in excess of 6000 kc., the plate voltage and power input should be reduced as the frequency is raised, so that at 30000 kc. the plate current, plate dissipation, and d-c grid current will not exceed 50 per cent of the maximum ratings as shown under MAXIMUM RATINGS and TYPICAL OPERATING CONDITIONS.

If more r-f power output is required than can be obtained from a single 211/511, two of these tubes may be used either in parallel or in push-pull. See APPLICATION on the 203-A/503-A.

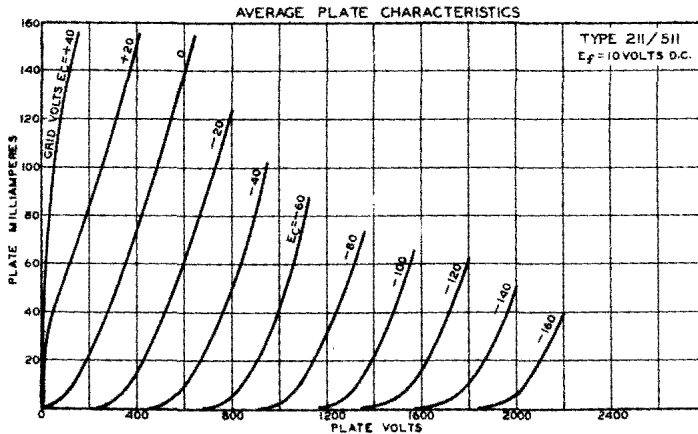



800

R-F Power Amplifier, Oscillator, Class B Modulator

The RCA-800 is a three-electrode transmitting tube for use as a radio-frequency power amplifier or oscillator, particularly at the higher radio frequencies; it may be used at full ratings at frequencies as high as 60 megacycles (5 meters). The grid and plate leads are brought out to metal caps at the top of the bulb, thus insuring high insulation and low capacity between leads.

CHARACTERISTICS

| | | |
|--|----------------------|---------|
| FILAMENT VOLTAGE (A.C.) | 7.5 | Volts |
| FILAMENT CURRENT | 3.25 | Amperes |
| AMPLIFICATION FACTOR | 15 | |
| GRID-PLATE CAPACITANCE | 2.5 | µpf |
| GRID-FILAMENT CAPACITANCE | 2.75 | µpf |
| PLATE-FILAMENT CAPACITANCE | 1.0 | µpf |
| BULB (For dimensions, see page 20) | S-21 | |
| CAPS (For connections, see page 20) | Small Metal | |
| BASE (For socket connections, see page 20) | Medium 4-Pin Bayonet | |

MAXIMUM RATINGS and TYPICAL OPERATING CONDITIONS

As A-F Power Amplifier and Modulator - Class B

| | | |
|--------------------|-----------|--------------|
| D-C PLATE VOLTAGE | 1250 max. | Volts |
| D-C PLATE CURRENT* | 115 max. | Milliamperes |
| PLATE DISSIPATION* | 35 max. | Watts |
| D-C PLATE INPUT* | 85 max. | Watts |

TYPICAL OPERATION: (2 tubes)

| | | | | |
|--------------------------------|------|-------|-------|--------------|
| Filament Voltage (A.C.) | | | 7.5 | Volts |
| D-C Plate Voltage | 750 | 1000 | 1250 | Volts |
| Grid Voltage (approximate) | -40 | -55 | -70 | Volts |
| Static Plate Cur. (per tube) | 13 | 14 | 15 | Milliamperes |
| Max-Sig. Plate Cur. (per tube) | 105 | 80 | 65 | Milliamperes |
| Load Res. (plate-to-plate) | 6400 | 12500 | 21000 | Ohms |
| Nominal Power Output (2 tubes) | 90 | 100 | 106 | Watts |

As R-F Power Amplifier - Class B (Telephony)

(Carrier Conditions; for use with a Modulation Factor up to 1.0)

| | | |
|---------------------------|-----------|--------------|
| D-C PLATE VOLTAGE | 1250 max. | Volts |
| D-C PLATE CURRENT | 45 max. | Milliamperes |
| PLATE DISSIPATION | 35 max. | Watts |
| R-F GRID CURRENT | 4 max. | Amperes |
| TYPICAL OPERATION: | | |
| Filament Voltage (A.C.) | 7.5 | Volts |

| | | | |
|------------------------------|-----|------|--------------|
| D-C Plate Voltage | 750 | 1000 | Volts |
| Grid Voltage (approximate) | -40 | -55 | Volts |
| D-C Plate Current | 45 | 42 | Milliamperes |
| Peak Power Output | 40 | 56 | Watts |
| Nominal Carrier Power Output | 10 | 14 | Watts |

As Plate-Modulated R-F Power Amplifier - Class C (Telephony)
(Carrier Conditions; for use with a Modulation Factor up to 1.0)

| | | | |
|-------------------|--|-----------|--------------|
| D-C PLATE VOLTAGE | | 1000 max. | Volts |
| D-C PLATE CURRENT | | 80 max. | Milliamperes |
| PLATE DISSIPATION | | 23 max. | Watts |
| R-F GRID CURRENT | | 4 max. | Amperes |
| D-C GRID CURRENT | | 25 max. | Milliamperes |

TYPICAL OPERATION:

| | | | |
|----------------------------|------|------|--------------|
| Filament Voltage (A.C.) | | 7.5 | Volts |
| D-C Plate Voltage | 750 | 1000 | Volts |
| Grid Voltage (approximate) | -150 | -200 | Volts |
| D-C Plate Current | 70 | 70 | Milliamperes |
| D-C Grid Current** | 15 | 15 | Milliamperes |
| Driving Power** | 3 | 4 | Watts |
| Nominal Power Output | 35 | 50 | Watts |

As R-F Power Amplifier and Oscillator - Class C (Telegraphy)
(Key Down Conditions)

| | | | |
|-------------------|--|-----------|--------------|
| D-C PLATE VOLTAGE | | 1250 max. | Volts |
| D-C PLATE CURRENT | | 80 max. | Milliamperes |
| PLATE DISSIPATION | | 35 max. | Watts |
| R-F GRID CURRENT | | 5 max. | Amperes |
| D-C GRID CURRENT | | 25 max. | Milliamperes |

TYPICAL OPERATION:

| | | | |
|----------------------------|------|------|-------|
| Filament Voltage (A.C.) | | 7.5 | Volts |
| D-C Plate Voltage | 750 | 1000 | Volts |
| Grid Voltage (approximate) | -100 | -135 | -175 |
| D-C Plate Current | 70 | 70 | 70 |
| D-C Grid Current** | 15 | 15 | 15 |
| Driving Power** | 2 | 3 | 4 |
| Nominal Power Output | 35 | 50 | 65 |

**Subject to wide variations depending on the impedance of the load circuit. High impedance load circuits require more grid current and driving power to obtain the desired output. Low impedance circuits need less grid current and driving power, but sacrifice plate circuit efficiency. The driving stage should have a tank circuit with good regulation and should be capable of delivering considerably more than the required driving power.

INSTALLATION

The base pins of the 800 fit the standard, four-contact socket, which should be installed so that the tube will operate in a vertical position. The filament terminals are connected to the two large base pins; the grid and plate leads are brought out to separate metal caps at the top of the bulb. Because of the relatively heavy filament current taken by the 800, the socket should make firm, large-surface contact with the filament pins of the tube; heavy, well-soldered leads should be used for the filament circuit wiring.

Flexible leads should be used to make connections to the grid and plate caps so that normal expansion will not place a strain on the glass at the base of the caps. Likewise, the caps should not be made to support coils, condensers, chokes, etc. Under no circumstances should anything be soldered to the caps, as the heat of soldering may crack the glass seals. The flexible leads should be heavy enough to handle adequately the large, circulating r-f current which flows at high frequencies.

The bulb of this tube becomes very hot during continuous operation. Free circulation of air should therefore be provided. The installation of all wires and connections should be made to allow at least several inches of free space around the tube in order to avoid trouble from peak voltage effects.

The filament of the 800 is preferably operated from an a-c source, although a d-c supply may be used. A voltmeter should be connected permanently across the filament circuit at the socket terminals so that the filament voltage may be kept at 7.5 volts. Deviation from the rated voltage may result in a loss of filament emission. With an a-c source, rheostat control should be placed in the primary circuit of the filament transformer. In radio transmitters during "standby" periods, the filament should be maintained at its rated voltage.

The grid and plate circuit returns should be connected to the center tap on the filament winding of the transformer or to the midpoint of a center-tapped resistor across the filament terminals. In cases where d.c. is used on the filament, the grid and plate returns may be connected to the negative terminal.

The plate dissipation of the 800 (the difference between input and output) should never exceed the values given under MAXIMUM RATINGS and TYPICAL OPERATING CONDITIONS. At the rated maximum of 35 watts the plate does not show any color in the dark. To determine this, all power switches should be opened with the tube operating. This procedure avoids reflections from the lighted filament which would interfere with the observation.

Overheating of the 800 by severe overload may decrease filament emission. Unless the overload has liberated a large amount of gas, the activity of the filament can sometimes be restored by operating it at rated voltage for ten minutes or more with no voltage on the plate or grid. The process may be accelerated by raising the filament voltage to 9.0 volts (not higher) for a few minutes.

A d-c milliammeter should be used in the plate circuit in order that the plate current can always be known. Under no condition should the d-c plate current exceed the maximum values given under MAXIMUM RATINGS and TYPICAL OPERATING CONDITIONS. In order to prevent overheating due to improper circuit adjustments or to overloading, the plate circuit should be provided with a protective device such as a relay or fuse. This device should instantly remove the plate voltage when the d-c plate current reaches a value 50 per cent greater than normal.

Heavy leads and conductors together with suitable insulation should be used in all parts of the plate tank circuit, in order that the losses due to the r-f currents and voltages be kept at a minimum. These losses are especially noticeable at the higher frequencies.

When a new circuit is being tried out or when adjustments are being made, the plate voltage should be reduced in order to prevent damage to the tube or associated apparatus in case the circuit adjustments are incorrect. It is advisable to use a protective resistance of about 5000 ohms in series with the plate lead during such adjustments.

The rated plate voltage of this tube is high enough to be exceedingly dangerous to the user. The greatest care should be taken when handling or adjusting circuits, especially those in which the plate tank coil and condenser are at the d-c plate potential.

APPLICATION

As a Class B modulator or audio-frequency amplifier, two RCA-800's are used in a balanced circuit, each tube conducting only half the time. The d-c plate input power should never exceed 85 watts per tube. Two tubes, operating under the conditions shown for a 1000-volt plate supply, are capable of modulating 100 per cent an input of 200 watts to a Class C radio-frequency amplifier.

For input transformer considerations, see APPLICATION on RCA-203-A/5C3-A.

The output transformer should be so designed that the resistance load presented by the modulated Class C amplifier is reflected as a plate-to-plate load of 12500 ohms in the Class B stage, for the 1000-volt conditions. Since two 800's will modulate 200 watts, a convenient Class C amplifier would be one operating at 1000 volts and 200 milliamperes. These conditions represent a resistance of approximately $1000 \div 0.200$, or 5000 ohms. The ratio of the output transformer is then $\sqrt{12500 \div 5000}$, or 1.59 to 1, step-down. If a Class C amplifier operating at 2000 volts and 100 milliamperes is used, the equivalent resistance is 20000 ohms; in this case the transformer ratio is 1 to 1.27, step-up. The transformer should be designed with a core sufficiently large to avoid saturation effects, which would impair the quality of the output. If the secondary is to carry the d-c plate current of the modulated amplifier, the core should be made larger and include an air-gap to compensate for the d-c magnetization current.

As a Class B and Class C radio-frequency amplifier, the RCA-800 may be used as shown under MAXIMUM RATINGS and TYPICAL OPERATING CONDITIONS.

In Class B service, the plate voltage is unmodulated d.c. and the grid excitation is radio frequency modulated at audio frequency in one of the preceding stages. For this type of operation, the plate dissipation should never be allowed to exceed 35 watts.

Grid bias for the 800 as a Class B amplifier should be obtained from a battery or other d-c source of good voltage regulation. It should not be obtained from a high-resistance supply such as a grid leak, nor from a rectifier, unless the latter has exceptionally good voltage regulation. For Class C (telegraph) service, grid bias may be obtained from a grid leak of about 10000 ohms, from a battery, from a rectifier of good regulation, or from a self-biasing resistor (preferably variable) by-passed by a suitable condenser. The self-biasing method is especially desirable, due to the fact that the grid bias is automatically regulated and that there is little chance of the plate current becoming dangerously high regardless of whether the r-f grid excitation is applied or not. When the grid-leak method of obtaining grid bias is used, bias is on the tube *only as long as the r-f grid excitation is applied*. For this reason, one of the other methods of obtaining grid bias is generally to be preferred. Since grid bias values are not particularly critical, correct circuit adjustment may be obtained with widely different values. For Class C (telephone) service, fixed bias is recommended because it eliminates the problems of degeneration caused by a-c voltage variation developed across the biasing system.

The d-c grid current should never exceed 25 milliamperes. The exact value will depend upon individual tubes and circuits.

At frequencies as high as 60 megacycles, the 800 may be used at full ratings. At still higher frequencies, the plate voltage should be reduced, the reduction being accompanied by a corresponding decrease in power output. The tabulation below gives the plate voltage rating of the 800 at frequencies between 90 and 200 megacycles (wavelengths between 3-1/3 and 1-1/2 meters).

| FREQUENCY | 90 | 120 | 150 | 200 | Megacycles |
|----------------------|------|------|-----|-----|------------|
| PLATE VOLTAGE (max.) | | | | | |
| Class B Telephony | 1125 | 1000 | 875 | 650 | Volts |
| Class C Telegraphy | 1125 | 1000 | 875 | 650 | Volts |
| Class C Telephony | 900 | 800 | 700 | 500 | Volts |

If more r-f power output is required than can be obtained from a single RCA-800, two of these tubes may be operated either in parallel or push-pull. See APPLICATION on the 203-A/503-A.

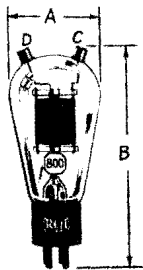

Overall Dimensions

- A 2-11/16" max.
- B 6-3/8" max.
- D Grid Connection
- C Plate Connection

Tube Symbol and Top View of Socket Connections,

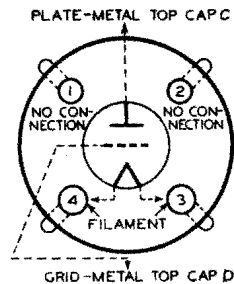

TYPICAL PUSH-PULL R-F AMPLIFIER CIRCUIT
CLASS C

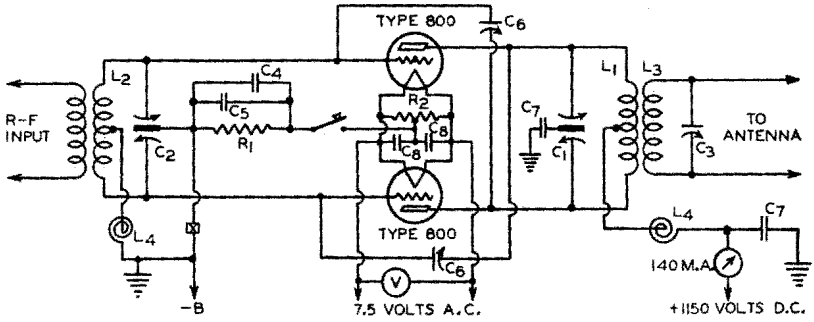

- $R_1 = 1000$ OHMS, 50 WATT
 $R_2 = 30$ OHMS, CENTER TAPPED
 $C_1 =$ SPLIT-STATOR HIGH-VOLTAGE TRANSMITTING CONDENSER (SEE TABLE 1)
 $C_2 =$ SPLIT-STATOR LOW-VOLTAGE CONDENSER, $0.0005 \mu\text{f}$ PER SECTION
 $C_4 = 25 \mu\text{f}$ (500 VOLT ELECTROLYTIC FOR MODULATED SERVICE ONLY)
 $C_5 = 0.01 \mu\text{f}$ (500 VOLT)
 $C_6 = 2.5 \mu\text{f}$ (APPROX.) HIGH-VOLTAGE CONDENSER
 $C_7 = 0.002 \mu\text{f}$ (3000 VOLT)
 $C_8 = 0.002 \mu\text{f}$ (RECEIVING TYPE)
 $L_3, C_3 =$ DEPENDENT ON ANTENNA & FEEDER DESIGN
 $L_1 =$ SEE TABLE 1
 $L_2 =$ SEE NOTE
 $L_4 =$ R-F CHOKE, EFFECTIVE AT FREQUENCY USED
 = POWER LINE CIRCUIT BREAKER (NON-RE-CLOSING TYPE, SET TO OPEN AT 210 MA.)

TABLE 1 (Design Data for L_1)

| FREQUENCY KILOCYCLES | TURN # | INSIDE DIA. INCHES | TURN # SPACING | C_1 MAX. μf PER SECTION |
|----------------------|--------|--------------------|----------------|--------------------------------------|
| 28000 | 4 | 1 1/2 | 5/8" | 0.0002 |
| 14000 | 8 | 2 1/2 | 1/2" | 0.0002 |
| 7000 | 14 | 3 | 1/4" | 0.0002 |
| 3500 | 24 | 4 | 1/8" | 0.0002 |
| 1750 | 20 | 6 | 1/8" | 0.0005 |

* ALL COILS OF 1/4" COPPER TUBING
 # SPACING IS BETWEEN TURNS (NOT CENTERS)

NOTE: L_2 SAME AS L_1 BUT WOUND WITH N#14 SOLID COPPER WIRE, SPACED THE DIAMETER OF THE WIRE. CONDENSER RATINGS ARE D-C WORKING VOLTAGE.

5-METER PUSH-PULL OSCILLATOR CIRCUIT

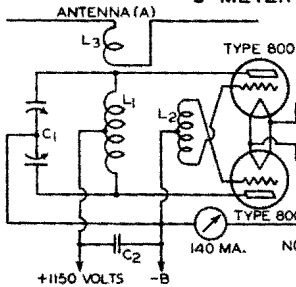

- $A = N\#14$ SOLID WIRE, 80" LONG EACH HALF
 $L_1 = 4$ TURNS 1/4" COPPER TUBING SPACED 1/2" INSIDE DIAMETER
 $L_2 =$ UNITY COUPLED GRID COIL, THREADED THROUGH L_1 , N#14 WIRE, EXTRA HEAVY RUBBER INSULATED.
 $L_3 = 1$ TURN N#14 SOLID WIRE, 2" DIA. SEE NOTE
 $C_1 =$ SPLIT STATOR TRANSMITTING CONDENSER, $80 \mu\text{f}$, PER SECTION
 $C_2 = 0.001 \mu\text{f}$, 3000 VOLTS (D-C WORKING VOLTAGE)
 $C_3 = 0.001 \mu\text{f}$, 250 VOLT
 $R_1 = 30$ OHMS, CENTER TAPPED
 $R_2 = 1000$ OHMS, 50 WATT
 NOTE: TOTAL LENGTH OF WIRE IN L_3 IS 16" (INCLUDING CONNECTIONS TO ANTENNA) L_3 IS PLACED IN EXACT CENTER OF L_1 ; IT SHOULD BE INSULATED SO THAT THE HIGH D-C PLATE VOLTAGE ON L_1 CAN NOT BE ACCIDENTLY APPLIED TO ANTENNA.

CLASS B MODULATOR
100% MODULATION OF 180 WATTS INPUT TO R-F AMPLIFIER

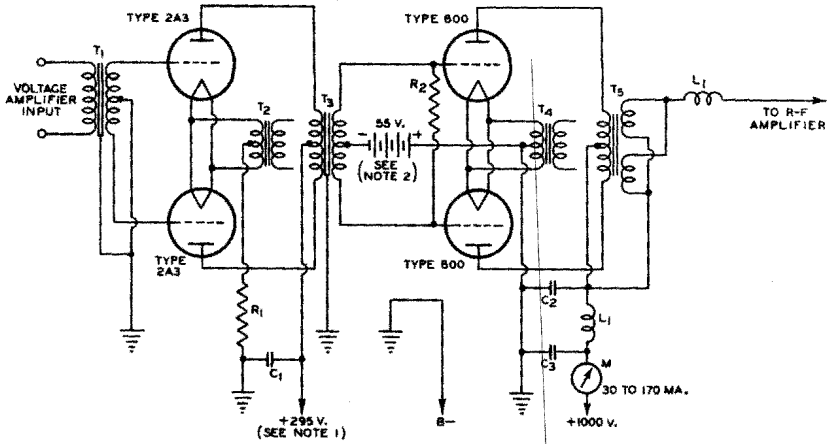

- C₁ = 8.0 μf (400 VOLTS)
- C₂ = 0.002 μf FIXED MICA (1500 VOLTS)
- C₃ = 4 TO 6 μf (1500 VOLTS)
- L₁ = 8 MILLIHENRIES, 200 MA., R-F CHOKE
- M = D-C MILLIAMMETER (0-200 MA. RANGE)
- R₁ = SELF-BIASING RESISTOR, 375 OHMS (10 WATT)

- R₂ = 40000 OHMS (2 WATT)
- T₁ = PUSH-PULL INPUT TRANSFORMER
- T₂ = 2.5 V., 5 AMP. FILAMENT TRANSFORMER
- T₃ = CLASS B INPUT TRANSFORMER
- T₄ = 7.5 V., 6.5 AMP. FILAMENT TRANSFORMER
- T₅ = CLASS B OUTPUT TRANSFORMER

NOTE 1: THIS VALUE INCLUDES PROPER C-BIAS VOLTAGE
NOTE 2: THE BIAS SUPPLY FOR THE 600'S MUST HAVE A LOW IMPEDANCE AT AUDIO FREQUENCIES.
BATTERY BIAS IS DESIRABLE.

AVERAGE PLATE CHARACTERISTICS

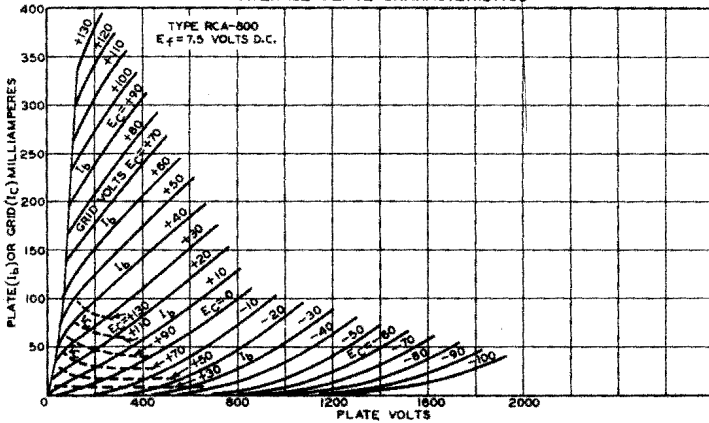



801

Oscillator, R-F and A-F Power Amplifier, Modulator

RCA-801 is a three-electrode transmitting tube well suited for use at high radio frequencies. It may also be used as an audio-frequency amplifier and modulator. The internal structure of this tube, together with the use of a ceramic base provides for full-rating operation at frequencies as high as 60 megacycles.

CHARACTERISTICS

Table with 3 columns: Characteristic, Value, and Unit. Includes FILAMENT VOLTAGE (7.5 Volts), FILAMENT CURRENT (1.25 Amperes), AMPLIFICATION FACTOR (8), GRID-PLATE CAPACITANCE (6.0 µf), GRID-FILAMENT CAPACITANCE (4.5 µf), PLATE-FILAMENT CAPACITANCE (1.5 µf), BULB (ST-16), and BASE (Medium 4-Pin Bayonet).

MAXIMUM RATINGS and TYPICAL OPERATING CONDITIONS

As A-F Power Amplifier and Modulator - Class A

Table with 5 columns: Parameter, and four columns of values. Includes D-C PLATE VOLTAGE (600 max. Volts), PLATE DISSIPATION (20 max. Watts), and TYPICAL OPERATION with values for Filament Voltage, D-C Plate Voltage, Grid Voltage, Peak Grid Swing, D-C Plate Current, Plate Resistance, Mutual Conductance, Load Resistance, and Undistorted Power Output.

As A-F Power Amplifier and Modulator - Class B

Table with 5 columns: Parameter, and four columns of values. Includes D-C PLATE VOLTAGE (600 max. Volts), D-C PLATE CURRENT* (70 max. Milliampères), PLATE DISSIPATION* (20 max. Watts), and TYPICAL OPERATION: (2 tubes) with values for Filament Voltage, D-C Plate Voltage, Grid Voltage, Zero-Sig. Plate Cur., Max.-Sig. Plate Cur., Load Resistance, Effective Load Resistance, and Power Output.

*Averaged over any audio-frequency cycle.

As R-F Power Amplifier - Class B (Telephony)

(Carrier Conditions; for use with a Modulation Factor up to 1.0)

| | | |
|-------------------|----------|--------------|
| D-C PLATE VOLTAGE | 600 max. | Volts |
| D-C PLATE CURRENT | 50 max. | Milliamperes |
| PLATE DISSIPATION | 20 max. | Watts |
| R-F GRID CURRENT | 4 max. | Amperes |

TYPICAL OPERATION:

| | | | |
|------------------------------------|-----|-----|--------------|
| Filament Voltage (A.C.) | 7.5 | 7.5 | Volts |
| D-C Plate Voltage | 500 | 600 | Volts |
| Grid Voltage (approximate) | -60 | -75 | Volts |
| D-C Plate Current | 45 | 45 | Milliamperes |
| Peak Power Output (approximate) | 24 | 30 | Watts |
| Carrier Power Output (approximate) | 6 | 7.5 | Watts |

As Plate-Modulated R-F Power Amplifier - Class C (Telephony)

(Carrier Conditions; for use with a Modulation Factor up to 1.0)

| | | |
|-------------------|-----------|--------------|
| D-C PLATE VOLTAGE | 500 max. | Volts |
| D-C PLATE CURRENT | 60 max. | Milliamperes |
| PLATE DISSIPATION | 13.5 max. | Watts |
| R-F GRID CURRENT | 4 max. | Amperes |
| D-C GRID CURRENT | 15 max. | Milliamperes |

TYPICAL OPERATION:

| | | | |
|----------------------------|------|------|--------------|
| Filament Voltage (A.C.) | 7.5 | 7.5 | Volts |
| D-C Plate Voltage | 400 | 500 | Volts |
| Grid Voltage (approximate) | -150 | -190 | Volts |
| D-C Plate Current | 55 | 55 | Milliamperes |
| D-C Grid Current** | 15 | 15 | Milliamperes |
| Driving Power** | 4.0 | 4.5 | Watts |
| Power Output (approximate) | 14 | 18 | Watts |

As R-F Power Amplifier and Oscillator - Class C (Telegraphy)

(Key Down Conditions)

| | | |
|-------------------|----------|--------------|
| D-C PLATE VOLTAGE | 600 max. | Volts |
| D-C PLATE CURRENT | 70 max. | Milliamperes |
| PLATE DISSIPATION | 20 max. | Watts |
| R-F GRID CURRENT | 5 max. | Amperes |
| D-C GRID CURRENT | 15 max. | Milliamperes |

TYPICAL OPERATION:

| | | | |
|----------------------------|------|------|--------------|
| Filament Voltage (A.C.) | 7.5 | 7.5 | Volts |
| D-C Plate Voltage | 500 | 600 | Volts |
| Grid Voltage (approximate) | -125 | -150 | Volts |
| D-C Plate Current | 65 | 65 | Milliamperes |
| D-C Grid Current** | 15 | 15 | Milliamperes |
| Driving Power** | 3.5 | 4 | Watts |
| Power Output (approximate) | 20 | 25 | Watts |

** Subject to wide variations depending on the impedance of the load circuit. High impedance load circuits require more grid current and driving power to obtain the desired output. Low impedance circuits need less grid current and driving power, but plate circuit efficiency is sacrificed. The driving stage should have a tank circuit of good regulation and should be capable of delivering considerably more than the required driving power.

INSTALLATION

The base pins of RCA-801 fit the standard, four-contact socket, which should be installed so that the tube will operate in a vertical position with the base down. If it is necessary to place the tube in a horizontal position, the socket should be mounted with the filament pin openings one vertically above the other.

The bulb of this tube becomes very hot during continuous operation. Free circulation of air, therefore, should be provided. Care should be taken that the bulb does not come in contact with any metallic object nor be subjected to the drops or spray of liquid. The installation of all wires and connections should be made to allow at least several inches of free space around the tube in order to avoid puncture of the glass due to peak-voltage effects.

The filament of the 801 is of the thoriated-tungsten type. For filament excitation, it is generally more convenient to use an a-c source, although a d-c supply may be used. The filament transformer should have a power rating sufficient to supply the current necessary for the filament of the 801, at the rated voltage. A voltmeter should be connected permanently across the filament circuit at the socket terminals so that the filament voltage can be maintained at 7.5 volts. This voltage should not vary more than plus or minus five per cent from the rated value. Deviation from the rated voltage may result in a loss of filament emission. In radio transmitters during "standby" periods, the filament should be maintained at its rated voltage.

The grid return and the plate return should be connected to the center tap on the filament winding of the transformer, or to the midpoint of a center-tapped resistor across the filament terminals. In cases where d.c. is used on the filament, these returns should be connected to the negative filament terminal.

The plate dissipation of the 801 (the difference between input and output) should never exceed the maximum value given under MAXIMUM RATINGS and TYPICAL OPERATING CONDITIONS. The plate should not show color under any condition of operation. To determine this, all power switches should be opened with the tube operating in the dark. This procedure avoids reflections from the lighted filament which would otherwise interfere with the observation.

Overheating of the 801 by severe overload may decrease filament emission. Unless the overload has liberated a large amount of gas, the activity of the filament can sometimes be restored by operating the filament at rated voltage for ten minutes or more with no voltage on the plate or grid. This process may be accelerated by raising the filament voltage to 9 volts (not higher) for a few minutes.

A d-c milliammeter should be used in the plate circuit in order that the plate current can always be known. Under no condition should the d-c plate current exceed the maximum values given under MAXIMUM RATINGS and TYPICAL OPERATING CONDITIONS.

Heavy leads and conductors together with suitable insulation should be used in all parts of the r-f plate tank circuit in order that the losses, due to the r-f voltages and currents, be kept at a minimum. These losses are especially noticeable at the higher frequencies.

When a new circuit is tried or when adjustments are made, the plate voltage should be reduced in order to prevent damage to the tube or associated apparatus in case the circuit adjustments are incorrect. It is advisable to use a protective resistance of about 3000 ohms in series with the plate lead during such adjustments.

The rated plate voltage of this tube is high enough to be dangerous to the user. Care should be taken when handling or adjusting circuits, especially those in which the plate tank coil and condenser are at the d-c plate potential.

APPLICATION

As a Class A audio-frequency amplifier or modulator, RCA-801 is capable of delivering 3.8 watts of audio-frequency power with very low distortion. Typical operating conditions are shown under MAXIMUM RATINGS and TYPICAL OPERATING CONDITIONS.

Grid bias for Class A service may be obtained from a separate voltage source or by means of the voltage drop in a resistor connected in the negative plate-return lead (self-bias). The proper value of this resistor for use with a single tube is 1335 ohms at a plate voltage of 500 volts and 1835 ohms at a plate voltage of 600 volts. When a group of 801's is operated in parallel, it is necessary to make provision for individual adjustment of grid bias to insure that the plate dissipation of each tube does not exceed the maximum value of 20 watts. This may be accomplished by means of a tapped "C" battery, or if self-bias is used, by means of a variable self-bias (cathode) resistor for each tube. Separate filament windings are necessary, of course, for each tube that is self-biased; each cathode resistor should be shunted by a filter network to avoid degenerative effects at low audio frequencies.

In cases where the input circuit to the 801 is resistance or impedance coupled, the resistance in the grid circuit should not be made too high. A resistance value of 0.5 megohm for one 801 is the recommended maximum when self-bias is used. Without self-bias, the grid resistance should not exceed 100000 ohms.

If more audio output is desired than can be obtained from a single RCA-801, two 801's may be operated either in parallel or push-pull. The parallel connection provides twice the output of a single tube without an increase in grid-signal voltage. The push-pull connection will give over twice the output at the same grid bias but requires twice the input signal. When two 801's are operated together (parallel or push-pull), the values of the self-biasing resistors will be approximately one-half the values given above for a single tube. When two 801's are operated in push-pull, the filter network across the self-biasing resistor may be omitted. When a number of

tubes are operated in parallel, a non-inductive resistance of 10 to 100 ohms should be placed in series with each grid lead, next to the tube socket, to prevent parasitic oscillations.

An output device should be used to transfer audio power efficiently from the RCA-801 to the voice coil of the reproducing unit, to the next audio stage, or to the modulated r-f amplifier stage.

As a Class B modulator or audio-frequency amplifier, two RCA-801's are used in a balanced circuit, each tube conducting only half the time. The d-c plate current should never exceed 70 milliamperes per tube. If an output transformer efficiency of 90 per cent is assumed, two tubes, operating under the conditions shown for a 600-volt plate supply, are capable of modulating 100 per cent an input of approximately 80 watts to a Class C radio-frequency amplifier.

The input transformer should be designed to give good frequency response when operated into an open circuit, such as that represented by the grid circuit of the Class B stage when the signal amplitude is small. It should also be designed to handle the required input power for a strong signal.

The output transformer should be so designed that the resistance load presented by the modulated Class C amplifier is reflected as a plate-to-plate load of 10000 ohms in the Class B stage, for the 600-volt conditions. Since two 801's will modulate 80 watts, a convenient Class A amplifier would be one operating at 600 volts and approximately 133 milliamperes. These conditions represent a resistance of approximately $600 \div 0.133$, or 4510 ohms. The ratio of the output transformer is then $\sqrt{10000 \div 4510}$, or 1.49 to 1, step-down. If a Class C amplifier operating at 1000 volts and 80 milliamperes is desired, the equivalent resistance is 12500 ohms; in this case the transformer ratio is 1 to 1.12, step-up. The transformer should be designed with a core sufficiently large to avoid saturation effects which would impair the quality of the output. If the secondary is to carry the d-c plate current of the modulated amplifier, the core should be made larger and include an air-gap to compensate for the d-c magnetization current.

As a Class B or Class C radio-frequency amplifier, the RCA-801 may be used as shown under MAXIMUM RATINGS and TYPICAL OPERATING CONDITIONS.

In Class B radio-frequency service, the plate is supplied with unmodulated d-c voltage and the grid is excited by r-f voltage modulated at audio frequency in one of the preceding stages. For this type of operation, the plate dissipation should never exceed 20 watts.

Grid bias for the 801 as a Class B r-f amplifier should be obtained from a battery or other d-c source of good regulation. It should not be obtained from a high-resistance supply such as a grid-leak, nor from a rectifier, unless the latter has exceptionally good voltage regulation. For Class C (telegraph) service, grid bias may be obtained from a grid leak of about 10000 ohms, from a battery, from a rectifier of good regulation, or from a self-biasing resistor

(preferably variable) by-passed with a suitable condenser. The self-biasing method is especially desirable due to the fact that the grid bias is automatically regulated and that there is little chance of the plate current becoming dangerously high either with or without r-f grid excitation. When the grid-leak method of obtaining grid bias is used bias is on the tube *only when r-f grid excitation is applied*. Since grid-bias values are not particularly critical, correct circuit adjustment may be obtained with widely different values. For *Class C (telephone) service*, fixed bias is recommended because it eliminates the problems of degeneration caused by a-c voltage variation developed across the biasing system.

The d-c grid current will vary with individual tubes. Under any condition of operation the maximum value should not exceed 15 milliamperes.

The 801 may be used at full ratings as high as 60000 kc. At higher frequencies, the d-c input power should be decreased. The tabulation below shows the maximum plate voltage values to be used at frequencies between 60 and 150 mc. (5 to 2 meters).

| FREQUENCY | 60 | 90 | 120 | 150 | Megacycles |
|----------------------|-----|-----|-----|-----|------------|
| PLATE VOLTAGE (max.) | | | | | |
| Class B Telephony | 480 | 360 | 310 | 260 | Volts |
| Class C Telegraphy | 600 | 455 | 390 | 330 | Volts |
| Class C Telephony | 480 | 360 | 310 | 260 | Volts |

If more power output is required than can be obtained from a single 801, two of these tubes may be used either in parallel or in push-pull. The parallel connection provides approximately twice the power output of a single tube without an increase in exciting voltage, while the push-pull connection gives twice the output but requires twice the r-f excitation voltage; with either connection the grid bias is the same as for a single tube. The push-pull arrangement is advantageous in reducing the shunting effect of the inter-electrode capacities, inasmuch as these capacities are in series. This reduction is especially desirable when the tubes are operated at the higher frequencies.

When two or more RCA-801's are operated in parallel, a non-inductive resistance of 10 to 100 ohms should be placed in series with the grid lead of each tube, close to the socket terminal, to prevent parasitic oscillations.

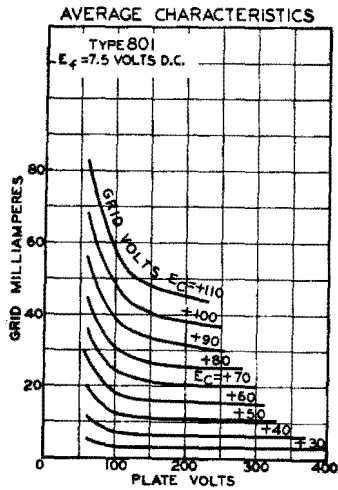
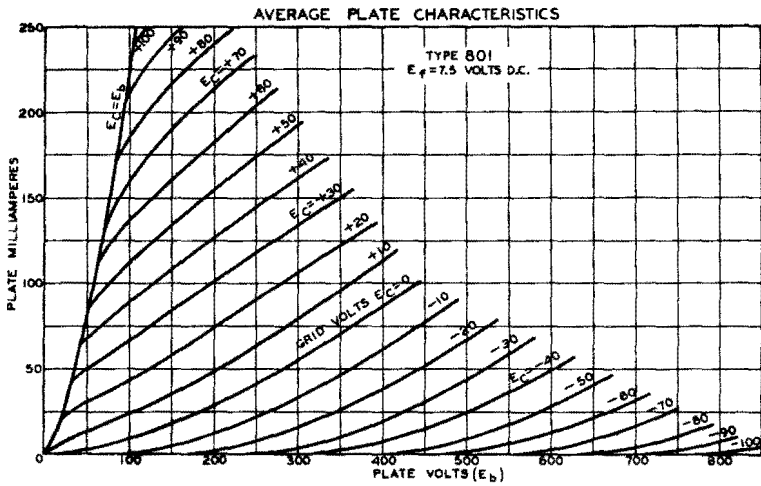

Tube Symbol and Top View of Socket Connections

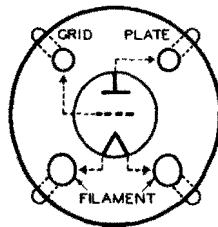



801

OUTLINE DRAWING

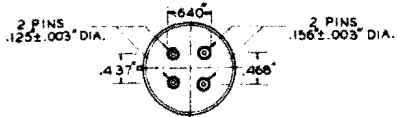
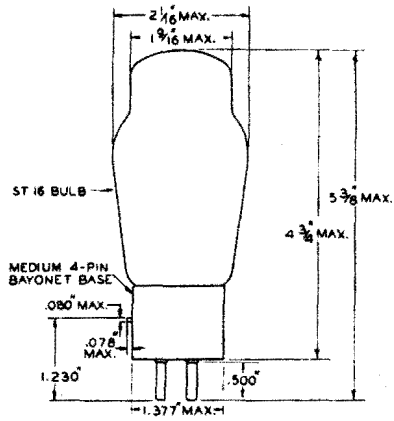

BOTTOM VIEW OF BASE



802

R-F Power Amplifier Pentode

RCA-802 is a pentode transmitting tube of the heater-cathode type for use as an r-f amplifier, frequency-multiplier, oscillator, and suppressor- or grid-modulated amplifier. The plate connection is brought out through a separate seal at the top of the bulb to maintain low grid-plate capacitance. Neutralization to prevent feedback and self-oscillation is generally unnecessary. The suppressor and the special internal shield of the 802 are connected to individual base pins.

TENTATIVE CHARACTERISTICS

| | | |
|---|----------------------|-------------------|
| HEATER VOLTAGE (A.C. or D.C.) | 6.3 | Volts |
| HEATER CURRENT | 0.95 | Ampere |
| MUTUAL CONDUCTANCE, For plate cur. of 20ma. | 2250 | approx. Micromhos |
| GRID-PLATE CAPACITANCE | 0.15 max. | µuf |
| SCREEN-PLATE CAPACITANCE | 0.5 | µuf |
| INPUT CAPACITANCE | 12 | µuf |
| OUTPUT CAPACITANCE | 8.5 | µuf |
| BULB (For dimensions, see page 8) | ST-16 | |
| CAP (For connection, see page 7) | Small Metal | |
| BASE (For socket connections, see page 7) | Medium 7-Pin Bayonet | |

MAXIMUM RATINGS and TYPICAL OPERATING CONDITIONS

As R-F Power Amplifier - Class B Telephony

Carrier Conditions; for use with a Modulation Factor up to 1.0

| | | |
|--------------------------------------|---------------------------------|------------------|
| D-C PLATE VOLTAGE | 500 max. | Volts |
| D-C SCREEN VOLTAGE (Grid No. 2) | 250 | Volts |
| D-C SUPPRESSOR VOLTAGE (Grid No. 3) | 40 max. | Volts |
| D-C PLATE CURRENT | 30 max. | Milliamperes |
| PLATE DISSIPATION | 10 max. | Watts |
| SCREEN DISSIPATION | 4 max. | Watts |
| TYPICAL OPERATION: | | |
| D-C Plate Voltage | 400 | 500 Volts |
| D-C Screen Voltage | 150 | 200 Volts |
| D-C Grid Volt., Approx. (Grid No. 1) | -72 | -28 Volts |
| Suppressor | Connected to cathode at socket* | |
| Internal Shield | Connected to cathode at socket | |
| Peak R-F Grid Voltage (approx.)** | 70 | 63 Volts |
| D-C Plate Current | 25 | 25 Milliamperes |
| D-C Screen Current | 6.5 | 7.0 Milliamperes |
| Screen Resistor | 38500 | 43000 Ohms |
| Driving Power (approximate)** | 0.5 | 0.18 Watt |
| Peak Power Output (approximate)** | 11 | 14 Watts |
| Carrier Power Output (approximate) | 2.75 | 3.5 Watts |

* Applying a positive voltage (40 volts max.) to the suppressor gives slightly increased output.

** At crest of a-f cycle.

As Suppressor-Modulated R-F Power Amplifier - Class C Telephony
Carrier Conditions; for use with a Modulation Factor up to 1.0

| | | | | |
|--------------------------------|--|--|--|-----------------------|
| D-C PLATE VOLTAGE | | | | 500 max. Volts |
| D-C SCREEN VOLTAGE (Grid No.2) | | | | 200 max. Volts |
| D-C PLATE CURRENT | | | | 30 max. Milliamperes |
| D-C GRID CURRENT | | | | 7.5 max. Milliamperes |
| PLATE DISSIPATION | | | | 10 max. Watts |
| SCREEN DISSIPATION | | | | 6 max. Watts |

TYPICAL OPERATION:

| | | | | |
|--|--------------------------------|-------|-------|--------------|
| D-C Plate Voltage | 400 | 500 | 500 | Volts |
| D-C Screen Voltage | 150 | 200 | 200 | Volts |
| D-C Grid Volt., Approx.(Grid No.1) | -85 | -90 | -90 | Volts |
| D-C Suppressor Voltage, Approx. (Grid No.3) | -40 | -53 | -45 | Volts |
| Internal Shield | Connected to cathode at socket | | | |
| Peak A-F Suppressor Volt. (approx.) | 40 | 53 | 65 | Volts |
| Peak R-F Grid Voltage (approx.) | 125 | 125 | 125 | Volts |
| D-C Plate Current | 18 | 20 | 22 | Milliamperes |
| D-C Screen Current | 28 | 28 | 28 | Milliamperes |
| Screen Resistor | 9000 | 10700 | 10700 | Ohms |
| D-C Grid Current | 7.5 | 5.0 | 4.5 | Milliamperes |
| Driving Power (approx.) | 0.9 | 0.6 | 0.5 | Watt |
| Peak Power Output (approx.)** | 8 | 12 | 14 | Watts |
| Carrier Power Output (approx.) | 2 | 3 | 3.5 | Watts |

As Grid-Modulated R-F Power Amplifier - Class C Telephony

Carrier Conditions; for use with a Modulation Factor up to 1.0

| | | | | |
|------------------------------------|--|--|--|----------------------|
| D-C PLATE VOLTAGE | | | | 500 max. Volts |
| D-C SCREEN VOLTAGE (Grid No.2) | | | | 250 max. Volts |
| D-C SUPPRESSOR VOLTAGE (Grid No.3) | | | | 40 max. Volts |
| D-C PLATE CURRENT | | | | 30 max. Milliamperes |
| PLATE DISSIPATION | | | | 10 max. Watts |
| SCREEN DISSIPATION | | | | 4 max. Watts |

TYPICAL OPERATION:

| | | | |
|-------------------------------------|---------------------------------|-------|--------------|
| D-C Plate Voltage | 400 | 500 | Volts |
| D-C Screen Voltage | 150 | 200 | Volts |
| D-C Grid Volt., Approx. (Grid No.1) | -105 | -130 | Volts |
| Suppressor | Connected to cathode at socket* | | |
| Internal Shield | Connected to cathode at socket | | |
| D-C Plate Current | 25 | 25 | Milliamperes |
| D-C Screen Current | 7.5 | 8 | Milliamperes |
| Screen Resistor | 33400 | 37500 | Ohms |
| D-C Grid Current | 2 | 1 | Milliamperes |
| Peak R-F Grid Voltage (approx.) | 125 | 145 | Volts |
| Peak A-F Grid Voltage (approx.) | 40 | 50 | Volts |
| Driving Power, R-F (approx.)** | 1 | 0.8 | Watt |
| Peak Power Output (approx.)** | 12 | 16 | Watts |
| Carrier Power Output (approx.) | 3 | 4 | Watts |

* Applying a positive voltage (40 volts max.) to the suppressor gives slightly increased output.

** At crest of a-f cycle.

As R-F Power Amplifier and Oscillator - Class C Telegraphy

Key-down Conditions

| | |
|------------------------------------|-----------------------|
| D-C PLATE VOLTAGE | 500 max. Volts |
| D-C SCREEN VOLTAGE (Grid No.2) | 250 max. Volts |
| D-C SUPPRESSOR VOLTAGE (Grid No.3) | 40 max. Volts |
| D-C PLATE CURRENT | 60 max. Milliamperes |
| D-C GRID CURRENT | 7.5 max. Milliamperes |
| PLATE INPUT | 25 max. Watts |
| PLATE DISSIPATION | 10 max. Watts |
| SCREEN DISSIPATION | 6 max. Watts |

TYPICAL OPERATION:

| | | | | |
|---------------------------------|--------------------------------|-------|-------|--------------|
| D-C Plate Voltage | 400 | 500 | 500 | Volts |
| D-C Screen Voltage | 200 | 200 | 250 | Volts |
| Grid Volt., Approx.(Grid No.1) | -100 | -100 | -100 | Volts |
| D-C Suppressor Voltage | 0 | 0 | 40 | Volts |
| Internal Shield | Connected to cathode at socket | | | |
| D-C Plate Current | 45 | 45 | 45 | Milliamperes |
| D-C Screen Current | 25 | 22 | 12 | Milliamperes |
| Screen Resistor | 8000 | 13700 | 20000 | Ohms |
| D-C Grid Current | 7 | 6 | 2 | Milliamperes |
| Peak R-F Grid Voltage (approx.) | 155 | 155 | 135 | Volts |
| Driving Power (approx.) | 1.1 | 0.9 | 0.25 | Watt |
| Power Output (approx.) | 10 | 14 | 16 | Watts |

INSTALLATION

The base pins of the RCA-802 fit the seven-contact (0.855-inch pin-circle diameter) socket which may be installed to hold the tube in any position. The plate lead of the tube is brought out at the top of the bulb to a metal cap. A flexible lead should be used to make connection to the plate cap so that a strain will not be placed on the glass at the base of the cap. Likewise, the cap should not be made to support coils, condensers, chokes, etc. Under no circumstances should anything be soldered to the cap, as the heat of soldering may crack the glass seal.

The *bulb* of this tube becomes very hot during continuous operation. For this reason it should not come in contact with any metallic body nor be subjected to drops or spray of any liquid. Free circulation of air should be provided.

The *heater* of the 802 is designed to operate at 6.3 volts. The heater supply may be either a.c. or d.c. A.c. is usually employed because of its convenience. The voltage across the heater terminals should be checked periodically. In radio transmitters during "stand-by" periods, the heater should be maintained at its rated voltage for convenience in promptly resuming transmission.

The *cathode* circuit of the RCA-802 should be connected to the electrical mid-point of the heater circuit when the heater is operated from an a-c supply. When the heater is operated from a d-c source, the cathode circuit is tied to the negative heater supply lead. In circuits where the cathode is not directly connected to

the heater, the potential difference between them should not exceed 100 volts. If the use of a large resistor is necessary between heater and cathode in some circuit designs, it should be by-passed by a suitable filter network to avoid the possibility of hum.

The plate dissipation of the 802 (the difference between plate input and power output) should never exceed the maximum value given under MAXIMUM RATINGS and TYPICAL OPERATING CONDITIONS. At these maximum values, the plate shows no color.

A d-c milliammeter should always be used in the plate circuit to provide a ready check of the plate current. Under no condition should the d-c plate current exceed the maximum values given under MAXIMUM RATINGS and TYPICAL OPERATING CONDITIONS.

The screen voltage may be obtained either from a separate source, from a potentiometer, or from the plate supply through a series resistor. In the latter case, the resistor should have a value sufficient to drop the high voltage to a value which is within the maximum screen voltage rating given under MAXIMUM RATINGS and TYPICAL OPERATING CONDITIONS. Suitable values of screen resistors are shown in these tabulations. The correct value of screen series resistor for any installation may be determined by dividing the difference between the plate-supply voltage and the rated screen voltage by the corresponding screen current. For example, under Class C Telegraphy, page 3, a series resistor value of 8000 ohms is shown for the 400-volt plate voltage condition. For this condition, the d-c screen current is 0.025 ampere (25 milliamperes). Since the plate-voltage supply must be dropped 200 volts to obtain 200 volts for the screen, the value of the screen resistor is $200 \div 0.025$, or 8000 ohms.

Suppressor voltage for the RCA-802 may be obtained from any suitable d-c supply. In cases where the suppressor draws current, the supply should be a battery or other d-c source of good regulation.

The internal shield is brought out of the tube to its own separate base pin. The internal shield should be tied to a terminal operating at zero r-f and/or a-f potential. In most cases, this connection will be made to the cathode or suppressor terminal.

Adequate shielding and isolation of the input circuit and the output circuit are necessary if optimum results are to be obtained. If an external shield is employed with the 802, it should be designed to enclose the base end of the tube and extend up to a point level with the bottom of the internal shield. Clearance between the glass bulb and external shield should be at least 1/16". The impedance between the screen and cathode must be kept as low as possible by the use of a by-pass condenser.

In order not to exceed the maximum ratings given under MAXIMUM RATINGS and TYPICAL OPERATING CONDITIONS, changes in electrode voltages due to line-voltage fluctuation, load variation, and manufacturing variation of the associated apparatus, must be determined.

An average value of voltage for each electrode should then be chosen so that under the usual voltage variations the maximum rated voltages will not be exceeded.

When a new circuit is tried or when adjustments are made, the plate voltage should be reduced in order to prevent damage to the tube or associated apparatus in case the circuit adjustments are incorrect. It is advisable to use a protective resistance of about 3000 ohms in series with the common negative high-voltage lead during such adjustments.

The rated plate voltage of this tube is high enough to be exceedingly dangerous to the user. Great care should be taken during the adjustment of circuits, especially those in which the plate tank coil and condenser are at the d-c plate potential.

APPLICATION

As a Class B radio-frequency amplifier, RCA-802 may be used as shown under MAXIMUM RATINGS and TYPICAL OPERATING CONDITIONS. Grid No.1 is the control-grid; grid No.2 is the screen; and grid No.3 is the suppressor which is usually tied to the cathode. The internal shield is connected to cathode. In Class B r-f service, the plate is supplied with unmodulated d-c voltage and the grid is excited by r-f voltage modulated at audio frequency in one of the preceding stages. The plate dissipation for this class of operation should not exceed 10 watts. Grid bias for the 802 as a Class B r-f amplifier should be obtained from a battery or other d-c source of good regulation. It should not be obtained from a high-resistance supply such as a grid-leak, nor from a rectifier, unless the latter has exceptionally good voltage regulation.

As a suppressor-modulated Class C r-f amplifier, RCA-802 may be used as shown under MAXIMUM RATINGS and TYPICAL OPERATING CONDITIONS. Grid No.1 is the control grid; grid No.2 is the screen; and grid No.3 is the suppressor. The internal shield is connected to cathode at the socket. Grid bias for this service may be obtained in the same manner as for Class C r-f telegraph service. Suppressor bias may be obtained from a battery, or a bleeder tap on the high-voltage supply.

As a grid-modulated Class C r-f amplifier, RCA-802 may be used as shown under MAXIMUM RATINGS and TYPICAL OPERATING CONDITIONS. Grid No.1 is the control grid; grid No.2 is the screen; and grid No.3 is the suppressor which is usually tied to the cathode. The internal shield is connected to cathode at the socket. In this class of service the plate is supplied with unmodulated d-c plate voltage and the grid bias is modulated at audio-frequency. Grid bias for this service should be obtained from a battery or other d-c source of good regulation. It should not be obtained from a high-resistance supply.

As a Class C r-f amplifier for telegraph service, RCA-802 may be operated as shown under MAXIMUM RATINGS and TYPICAL OPERATING CON-

DITIONS. Grid No.1 is the control grid; grid No.2 is the screen; and grid No.3 is the suppressor. The internal shield is connected to cathode at the socket. In this class of service a d-c plate voltage as high as 500 volts may be used provided the d-c plate current is reduced so that the maximum plate input rating of 25 watts is not exceeded. Grid bias for Class C telegraph service may be obtained from a grid leak of 20000 to 50000 ohms, depending upon amount of grid excitation; from a battery; from a rectifier; or from a cathode-bias resistor (preferably variable) by-passed with a suitable condenser. The cathode-bias method is especially desirable due to the fact that the grid bias is automatically regulated and that there is little chance of the plate current becoming dangerously high either with or without r-f grid excitation. When the grid-leak method of obtaining grid bias is used, bias is on the tube *only when r-f excitation is applied*. Since grid-bias values are not particularly critical, correct circuit adjustment may be obtained with widely different values.

The d-c grid current will vary with individual tubes. Under any condition of operation, the maximum recommended value should not be exceeded.

The 802 may be used in all recommended classes of service at full ratings as high as 30000 kc. At higher frequencies the d-c plate voltage, and consequently the d-c plate input, should be reduced as the frequency is raised. Special attention should be given to adequate ventilation and the maintenance of normal ambient temperatures. The tabulation below shows the maximum plate voltage values to be used at frequencies between 30 and 60 mc. (10 to 5 meters). The Maximum Plate Input values apply only for Class C Telegraph service.

| FREQUENCY | 30 | 45 | 60 | Megacycles |
|---|-----|-----|-----|------------|
| MAXIMUM PLATE VOLTAGE (All Classes of Service) | 500 | 350 | 275 | Volts |
| MAXIMUM PLATE INPUT (Class C Telegraph Service Only) | 25 | 18 | 14 | Watts |

If more power output is required than can be obtained from a single 802, two or more of these tubes may be used either in parallel or push-pull. Either connection provides approximately twice the power output of a single tube. The parallel connection requires no increase in exciting voltage; the push-pull connection requires twice the r-f excitation necessary to drive a single tube. With either connection the driving power required is approximately twice that for single tube operation while the grid bias is the same as for a single tube. The push-pull arrangement has the advantage of canceling the even-order harmonics from the output and of simplifying the balancing of high-frequency circuits.

When two or more RCA-802's are operated in parallel, a non-inductive resistance of 10 to 100 ohms should be placed in series

with the grid lead of each tube, close to the socket terminal, to prevent parasitic oscillations.

As a pentode oscillator (crystal or self-excited), the 802 should be connected the same as in amplifier service with its suppressor and internal shield tied to the cathode. Because the internal shielding, in general, is unusually effective, it is usually necessary in this service, where feedback depends on the control-grid-to-plate capacity, to introduce external feedback. This may be done by the use of a small condenser of 2 to 3 μf connected between control grid and plate.

RCA-802 is not recommended for use as a Class A triode amplifier, Class B a-f triode amplifier, or Class C plate-modulated tetrode amplifier, because it is inadvisable to operate grid No.2 or grid No.3 at the maximum rated plate voltage.

TRANSMITTING CIRCUIT DIAGRAM
SHOWING USES OF TYPE 802 R-F POWER PENTODE

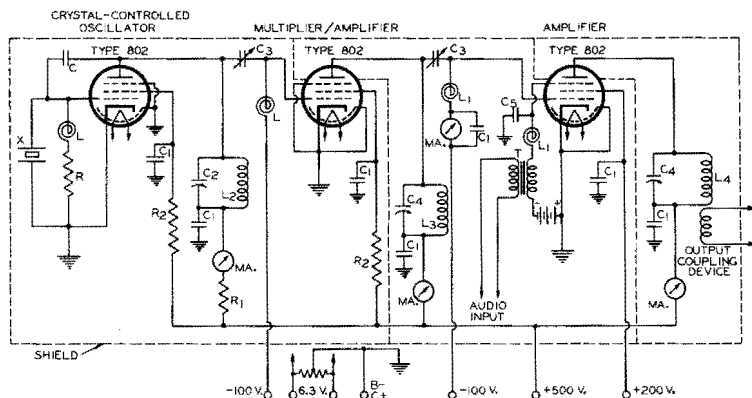

$C = 3 \mu\text{f}$ (APPROX.) FOR FEEDBACK
 $C_1 = .01 \mu\text{f}$
 $C_2 = 100 \mu\text{f}$ (MAX.)
 $C_3 = 30 \mu\text{f}$ (MAX.)
 $C_4 = 50 \mu\text{f}$ (MAX.)
 $C_5 = .0001 \mu\text{f}$
 $L_1, L_2 = \text{R-F CHOKES}$

$L_2, L_3, L_4 = \text{VALUE DEPENDENT ON FREQUENCY}$
 $R = 40,000 \text{ OHMS, 2 WATTS}$
 $R_1 = 4,000 \text{ OHMS, 10 WATTS}$
 $R_2 = 20,000 \text{ OHMS, 10 WATTS}$
 $T = \text{MODULATION TRANSFORMER}$
 $X = \text{CRYSTAL}$

NOTE: GROUND CONNECTIONS MADE TO SHIELD

The License extended to the purchaser of tubes appears in the License Notice accompanying them. Information contained herein is furnished without assuming any obligations.

Tube Symbol and Top
View of Socket Connections

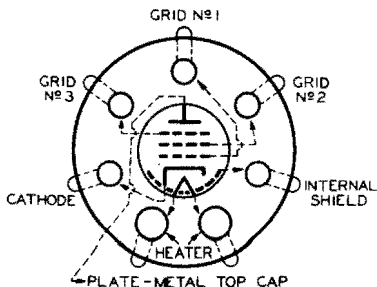



802

OUTLINE DRAWING

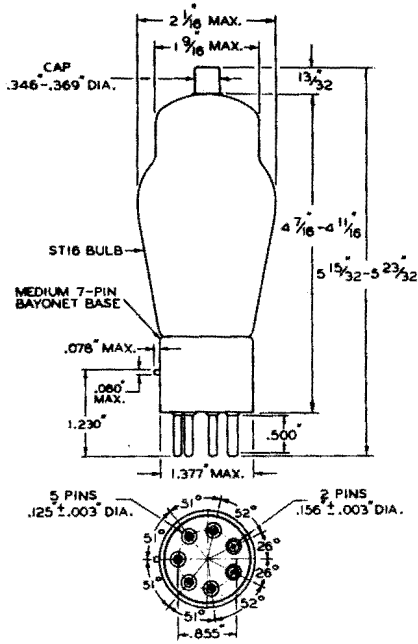

BOTTOM VIEW OF BASE

CONTROL-GRID MODULATION CHARACTERISTICS

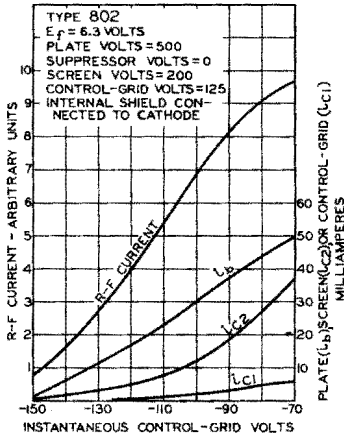

SUPPRESSOR MODULATION CHARACTERISTICS

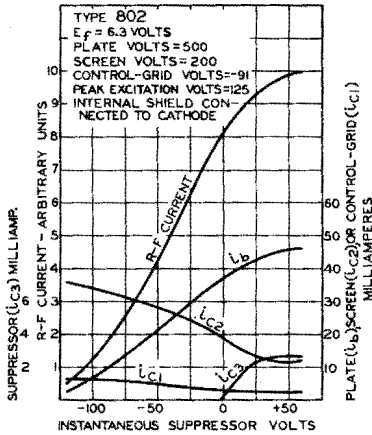



841

R-F Power Amplifier, Oscillator, A-F Voltage Amplifier

RCA-841 is a three-electrode tube of the high-mu type. It is particularly useful in radio amateur transmitters as a radio-frequency doubler, r-f power amplifier and oscillator (self-excited or crystal-controlled). It may also be used as an amplifier in resistance-coupled a-f circuits.

CHARACTERISTICS

| | | |
|--|----------------------|---------------|
| FILAMENT VOLTAGE (A.C. or D.C.) | 7.5 | Volts |
| FILAMENT CURRENT | 1.25 | Amperes |
| GRID-PLATE CAPACITANCE | 7 | μf |
| GRID-FILAMENT CAPACITANCE | 4 | μf |
| PLATE-FILAMENT CAPACITANCE | 3 | μf |
| BULB (For dimensions, see page 28) | 8-17 | |
| BASE (For socket connections, see page 28) | Medium 4-Pin Bayonet | |

MAXIMUM RATINGS and TYPICAL OPERATING CONDITIONS

As A-F Voltage Amplifier (Resistance-Coupled) - Class A

| | | |
|-----------------------|------|------------|
| PLATE VOLTAGE | 425 | max. Volts |
| PLATE SUPPLY VOLTAGE* | 1250 | max. Volts |
| PLATE DISSIPATION | 12 | max. Watts |

TYPICAL OPERATION;

| | | | |
|-------------------------------|--------|--------|--------------|
| Filament Voltage (D.C.) | 7.5 | Volts | |
| Plate Supply Voltage* | 425 | 1000 | Volts |
| Grid Voltage (approximate) | -6 | -9 | Volts |
| Load Resistance | 250000 | 250000 | Ohms |
| Plate Current | 0.7 | 2.2 | Milliamperes |
| Plate Resistance | 63000 | 40000 | Ohms |
| Amplification Factor | 30 | 30 | |
| Mutual Conductance | 450 | 750 | Micromhos |
| Peak Grid Swing (approximate) | 6 | 9 | Volts |
| Undistorted Voltage Output | 126 | 225 | Volts |

As A-F Power Amplifier and Modulator - Class B

| | | |
|---------------------|-----|-------------------|
| D-C PLATE VOLTAGE | 425 | max. Volts |
| D-C PLATE CURRENT** | 60 | max. Milliamperes |
| PLATE DISSIPATION** | 15 | max. Watts |
| PLATE INPUT** | 25 | max. Watts |

TYPICAL OPERATION: (2 tubes)

| | | | |
|--------------------------------------|------|-------|--------------|
| Filament Voltage (D.C.) | 7.5 | Volts | |
| D-C Plate Voltage | 350 | 425 | Volts |
| Grid Voltage (approximate) | -5 | -5 | Volts |
| Static Plate Cur. (per tube) | 3.5 | 6.5 | Milliamperes |
| Max.-Signal Plate Current (per tube) | 57 | 60 | Milliamperes |
| Load Resistance (plate-to-plate) | 5200 | 7000 | Ohms |
| Nominal Power Output (2 tubes) | 21 | 28 | Watts |

* Voltage effective at plate is less than supply voltage by an amount equal to voltage drop in load resistance.

**Averaged over any audio-frequency cycle.

As R-F Power Amplifier - Class B (Telephony)

(Carrier Conditions; for use with a Modulation Factor up to 1.0)

| | | | |
|-------------------|--|--|----------------------|
| D-C PLATE VOLTAGE | | | 450 max. Volts |
| D-C PLATE CURRENT | | | 50 max. Milliamperes |
| PLATE DISSIPATION | | | 15 max. Watts |
| R-F GRID CURRENT | | | 4 max. Amperes |

TYPICAL OPERATION:

| | | | |
|------------------------------|-----|-----|--------------|
| Filament Voltage (A.C.) | | 7.5 | Volts |
| D-C Plate Voltage | 350 | 450 | Volts |
| Grid Voltage (approximate)* | -9 | -12 | Volts |
| D-C Plate Current | 43 | 36 | Milliamperes |
| Peak Power Output | 12 | 16 | Watts |
| Nominal Carrier Power Output | 3 | 4 | Watts |

As Plate-Modulated R-F Power Amplifier - Class C (Telephony)

(Carrier Conditions; for use with a Modulation Factor up to 1.0)

| | | | |
|-------------------|--|--|----------------------|
| D-C PLATE VOLTAGE | | | 350 max. Volts |
| D-C PLATE CURRENT | | | 60 max. Milliamperes |
| PLATE DISSIPATION | | | 10 max. Watts |
| R-F GRID CURRENT | | | 4 max. Amperes |
| D-C GRID CURRENT | | | 20 max. Milliamperes |

TYPICAL OPERATION:

| | | | |
|-----------------------------|-----|------|--------------|
| Filament Voltage (A.C.) | | 7.5 | Volts |
| D-C Plate Voltage | 250 | 350 | Volts |
| Grid Voltage (approximate)* | -22 | -36 | Volts |
| D-C Plate Current | 50 | 50 | Milliamperes |
| D-C Grid Current** | 18 | 18 | Milliamperes |
| Driving Power** | 1.5 | 1.75 | Watts |
| Nominal Power Output | 7.5 | 11.5 | Watts |

As R-F Power Amplifier and Oscillator - Class C (Telegraphy)

(Key Down Conditions)

| | | | |
|-------------------|--|--|----------------------|
| D-C PLATE VOLTAGE | | | 450 max. Volts |
| D-C PLATE CURRENT | | | 60 max. Milliamperes |
| PLATE DISSIPATION | | | 15 max. Watts |
| R-F GRID CURRENT | | | 5 max. Amperes |
| D-C GRID CURRENT | | | 20 max. Milliamperes |

TYPICAL OPERATION:

| | | | |
|-----------------------------|------|------|--------------|
| Filament Voltage (A.C.) | | 7.5 | Volts |
| D-C Plate Voltage | 350 | 450 | Volts |
| Grid Voltage (approximate)* | -24 | -32 | Volts |
| D-C Plate Current | 50 | 50 | Milliamperes |
| D-C Grid Current** | 12.5 | 12.5 | Milliamperes |
| Driving Power** | 1.0 | 1.25 | Watts |
| Nominal Power Output | 10.0 | 14 | Watts |

* Grid voltages are given with respect to the mid-point of filament operated on a.c. If d.c. is used, each stated value of grid voltage should be decreased by 4.5 volts and should be referred to the negative end of the filament.

**Subject to wide variations depending on the impedance of the load circuit. High impedance load circuits require more grid current and driving power to obtain the desired output. Low impedance circuits need less grid current and driving power, but sacrifice plate circuit efficiency. The driving stage should have a tank circuit with good regulation and should be capable of delivering considerably more than the required driving power.

INSTALLATION

The base pins of the 841 fit the standard 4-contact socket. The socket should be installed so that the tube will operate in a vertical position with the base down. If it is necessary to place the tube in a horizontal position, the socket should be mounted with the filament-pin openings one vertically above the other.

The *bubb* of this tube becomes very hot during continuous operation. Free circulation of air should therefore be provided.

The *filament* of the RCA-841 should be operated preferably from an a-c source, although a d-c supply may be used. A suitable voltmeter should be connected permanently across the filament circuit at the socket terminals so that the filament voltage can be maintained at 7.5 volts. Deviation from the rated voltage may result in a loss of filament emission. In radio transmitters during "standby" periods, the filament should be maintained at its rated voltage.

The *grid and plate circuit returns* should be connected to the center tap on the filament winding of the transformer, or to the midpoint of a center-tapped resistor across the filament terminals. In cases where d.c. is used on the filament, the grid and plate returns should be connected to the negative filament terminal.

The plate dissipation of the 841 (the difference between input and output) should never exceed the values given under MAXIMUM RATINGS and TYPICAL OPERATING CONDITIONS. At these maximum values the plate shows no color in the dark. To determine this, all power switches should be opened with the tube operating. This procedure avoids reflections from the lighted filament which would interfere with the observation.

Overheating of the RCA-841 by severe overload may decrease filament emission. Unless the overload has liberated a large amount of gas, the activity of the filament can sometimes be restored by operating it at rated voltage for ten minutes or more with no voltage on the plate or grid. The process may be accelerated by raising the filament voltage to 9.0 volts (not higher) for a few minutes.

A d-c milliammeter should be used in the plate circuit in order that the plate current can always be known. Under no condition should the d-c plate current exceed the maximum values given under MAXIMUM RATINGS and TYPICAL OPERATING CONDITIONS. In order to prevent overheating due to improper circuit adjustments or to overloading, the plate circuit should be provided with a protective device such as a fuse. This device should instantly remove the plate voltage when the d-c plate current reaches a value 50 per cent greater than normal.

When a new circuit is being tried out or when adjustments are being made, the plate voltage should be reduced in order to prevent damage to the tube or associated apparatus in case the circuit adjustments are incorrect. It is advisable to use a protective resistance of about 3000 ohms in series with the plate lead during such adjustments.

APPLICATION

As an *audio-frequency voltage amplifier (Class A)* in resistance-coupled circuits, the 841 should be operated according to the conditions given under **MAXIMUM RATINGS** and **TYPICAL OPERATING CONDITIONS**.

Grid bias for this type of service may be obtained from a separate voltage source or by means of a self-biasing resistor shunted by a large condenser. Separate filament supplies are of course necessary for each tube self-biased. When a group of 841's is operated in parallel, it is necessary to make provision for individual adjustment of grid bias to insure that the plate dissipation of any tube does not exceed the maximum value of 12 watts. This may be accomplished by means of a tapped "C" battery, or if self-bias is used, by means of a variable cathode resistor for each tube shunted by a filter network to avoid degenerative effects at low audio-frequencies. The maximum value of grid-leak resistance for the 841 when used as a resistance-coupled audio-frequency amplifier should not exceed 0.5 megohm. The use of resistance higher than this may cause the tube to lose bias due to grid current with the result that the plate current will rise to a value high enough to damage the tube. The condition just described will not be encountered if a grid choke of relatively low d-c resistance is employed in place of the grid-leak resistor.

When a number of tubes are operated in parallel, a non-inductive resistance of 10 to 100 ohms should be placed in series with each grid lead, next to the tube mounting, to prevent parasitic oscillations.

As a *Class B modulator or audio-frequency amplifier*, two 841's are used in a balanced circuit, each tube conducting only half the time. The d-c plate current should never exceed 60 milliamperes per tube. Two tubes, operating under the conditions shown for a 425 volt plate supply, are capable of modulating 100 per cent an input of 56 watts.

The *input transformer* should be designed to give good frequency response when operated into an open circuit, such as that represented by the grid circuit of the Class B stage when the signal amplitude is small, and also to handle the required input power for a strong signal.

The *output transformer* should be designed so that the resistance load presented by the modulated Class C amplifier is reflected as a plate-to-plate load of 7000 ohms in the Class B stage for the 425 volt conditions. Since two 841's will modulate 56 watts, a convenient Class C stage amplifier would be one operating at 425 volts and 132 milliamperes. These conditions represent a resistance of approximately 3220 ohms. The ratio of the output transformer is then $\sqrt{7000 \div 3220}$, or 1.47 to 1, step-down. If a Class C amplifier operating at 1000 volts and 56 milliamperes is used, the equivalent resistance is approximately 17855; in this case the transformer ratio is 1 to 1.6, step-up. The transformer should be designed with a core sufficiently large to avoid saturation effects, which would impair the quality of the output. If the secondary is to carry the

d-c plate current of the modulated amplifier, the core should be made larger and include an air-gap, to compensate for the d-c magnetization current.

As a *Class B* or *Class C* radio-frequency amplifier, the RCA-841 may be used as shown under MAXIMUM RATINGS and TYPICAL OPERATING CONDITIONS.

In *Class B* service, the plate voltage is unmodulated d.c. and the grid excitation is radio-frequency modulated at audio frequency in one of the preceding stages. For this type of operation, the plate dissipation should never be allowed to exceed 10 watts.

Grid bias for the 841 as a *Class B* amplifier should be obtained from a battery or other d-c source of good regulation. It should not be obtained from a high-resistance supply such as a grid-leak, nor from a rectifier, unless the latter has exceptionally good voltage regulation. For *Class C (telegraph) service*, grid bias may be obtained from a grid leak of about 5000 ohms, from a battery, from a rectifier of good regulation, or from a self-biasing resistor (preferably variable) by-passed with a suitable condenser. The self-biasing method is especially desirable, due to the fact that the grid bias is automatically regulated and that there is little chance of the plate current becoming dangerously high regardless of whether the r-f grid excitation is applied or not. When the grid-leak method of obtaining grid bias is used, bias is on the tube *only when r-f grid excitation is applied*. Since grid bias values are not particularly critical, correct circuit adjustment may be obtained with widely different values. For *Class C (telephone) service*, fixed bias is recommended because it eliminates the problems of degeneration caused by a-c voltage variation developed across the biasing system.

The *d-c grid current* should never exceed 20 milliamperes. The exact value will vary with individual tubes and circuits.

If the 841 is used in transmitting circuits at frequencies above 6000 kilocycles, special precautions should be taken so that the tube is not harmed by abnormal conditions. Under no condition of operation should the grid or plate ever be allowed to reach such a temperature that it shows color.

If more r-f power is required than can be obtained from a single RCA-841, two of these types may be used either in parallel or in push-pull. For additional information, see APPLICATION on type 2C3-A/503-A.

As a *crystal-controlled oscillator*, the 841 should be operated at a reduced plate voltage of approximately 225 volts to insure frequency stability as well as to prevent damage to the crystal due to excessive r-f grid current.

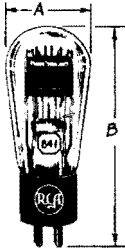
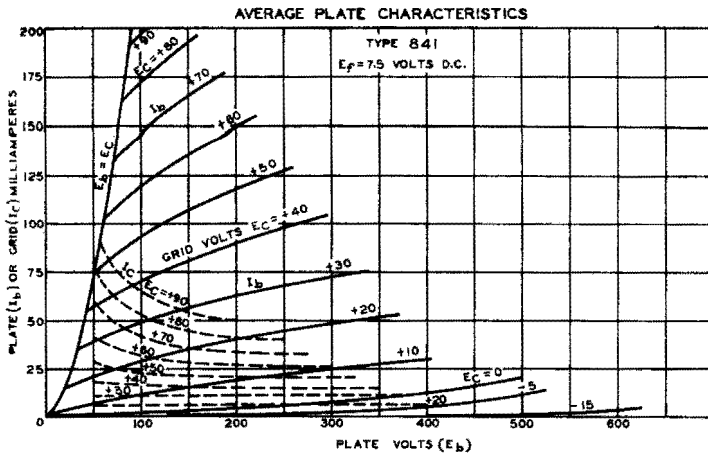

Overall Dimensions

$A = 2-3/16$ " max.
 $B = 5-5/8$ " max.

Tube Symbol and Top View of Socket Connections.

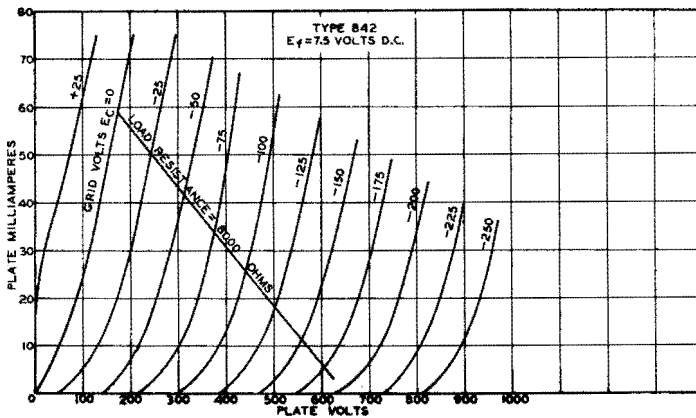
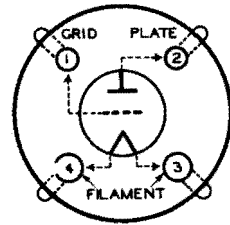



842

A-F Power Amplifier, Modulator

The RCA-842 is a three-electrode, low- μ tube for use primarily as a Class A power amplifier and as such is useful as a modulator in low-power amateur transmitting equipment.

CHARACTERISTICS

| | | |
|--|----------------------|---------|
| FILAMENT VOLTAGE (A.C. or D.C.) | 7.5 | Volts |
| FILAMENT CURRENT | 1.25 | Amperes |
| GRID-PLATE CAPACITANCE | 7 | μ f |
| GRID-FILAMENT CAPACITANCE | 4 | μ f |
| PLATE-FILAMENT CAPACITANCE | 3 | μ f |
| BULB (For dimensions, see page 30) | S-17 | |
| BASE (For socket connections, see page 30) | Medium 4-Pin Bayonet | |

MAXIMUM RATINGS and TYPICAL OPERATING CONDITIONS

As A-F Power Amplifier and Modulator - Class A

| | | | |
|--------------------------|-----------------|-------|--------------|
| PLATE VOLTAGE | 425 <i>max.</i> | | Volts |
| PLATE DISSIPATION | 12 <i>max.</i> | | Watts |
| TYPICAL OPERATION: | | | |
| Filament Voltage (A.C.) | 7.5 | Volts | |
| Plate Voltage | 350 | 425 | Volts |
| Grid Voltage* | -72 | -100 | Volts |
| Plate Current | 34 | 28 | Milliamperes |
| Plate Resistance | 2400 | 2500 | Ohms |
| Amplification Factor | 3 | 3 | |
| Mutual Conductance | 1750 | 1200 | Micromhos |
| Peak Grid Swing | 67 | 95 | Volts |
| Load Resistance | 5000 | 8000 | Ohms |
| Undistorted Power Output | 2.1 | 3.0 | Watts |

* Grid voltages are given with respect to the mid-point of filament operated on a.c. If d.c. is used, each stated value of grid voltage should be decreased by 5.0 volts and should be referred to the negative end of the filament.

INSTALLATION

For installation of this type, refer to INSTALLATION for RCA-841.

APPLICATION

As a modulator and audio-frequency power amplifier (Class A), the 842 should be operated as shown under MAXIMUM RATINGS and TYPICAL OPERATING CONDITIONS.

Grid bias for audio-frequency and modulator service may be obtained from a separate voltage source, or by means of the voltage drop in a resistor connected in the negative plate-return lead (self-bias). The latter method is preferable as it compensates automati-

cally for variation in the plate current of individual tubes. The proper value of this resistor for a single 842 is 2120 ohms for a plate voltage of 350 volts; and 3570 ohms for a plate voltage of 425 volts. The self-biasing resistor should be shunted by a suitable filter network to avoid degenerative effects at low audio-frequencies.

In cases where the 842 is employed in resistance-coupled circuits, the recommended safe maximum value of grid leak is 1.0 megohm when the self-biasing method of obtaining grid bias is used. With fixed bias, however, the d-c resistance should not exceed 0.25 megohm. The use of resistances higher than these may cause the tube to lose bias due to grid current with the result that the plate current will rise to a value sufficiently high to damage the tube.

If more audio output is desired than can be obtained from a single 842, two 842's may be operated either in parallel or push-pull. The parallel connection provides twice the output of a single tube without an increase in grid-signal voltage. The push-pull connection will give twice the output at the same grid bias, but requires twice the input signal. Output slightly greater than twice the single tube value can be obtained from the push-pull connection by increasing the bias. In the latter case, the output is limited almost entirely by 3rd harmonic distortion. When two 842's are operated together (parallel or push-pull), the values of the self-biasing resistors will be approximately one-half the values given above for a single tube. When two 842's are operated in push-pull, the filter network across the self-biasing resistor may be omitted. When a number of tubes are operated in parallel, a non-inductive resistance of 10 to 100 ohms should be placed in series with each grid lead, next to the tube socket, to prevent parasitic oscillations.

An output device should be used to transfer power efficiently to the windings of the reproducing unit when this tube is used as an audio-frequency power amplifier in transformer-coupled circuits.

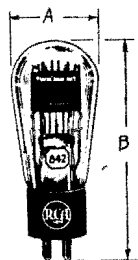

Overall Dimensions

A = 7-3/16" max.

B = 5-5/8" max.

Tube Symbol and Top View of Socket Connections.

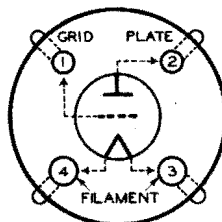



845/545

Modulator and A-F Power Amplifier

The RCA-845/545 is a three-electrode tube primarily designed for use as a modulator or as an audio-frequency amplifier. For radio-frequency applications, other tube types specially designed for the service are to be preferred.

CHARACTERISTICS

| | | |
|--|-------------------|---------------|
| FILAMENT VOLTAGE (A.C.) | 10.0 | Volts |
| FILAMENT CURRENT | 3.25 | Amperes |
| AMPLIFICATION FACTOR | 5.3 | |
| GRID-PLATE CAPACITANCE | 13.5 | μf |
| GRID-FILAMENT CAPACITANCE | 6 | μf |
| PLATE-FILAMENT CAPACITANCE | 6.5 | μf |
| BULB (For dimensions, see page 5) | | T-18 |
| BASE (For socket connections, see page 5) | Jumbo 4-Large Pin | |

MAXIMUM RATINGS and TYPICAL OPERATING CONDITIONS

As A-F Power Amplifier and Modulator - Class A

| | | | | |
|--------------------------|------|-----------|-------|--------------|
| D-C PLATE VOLTAGE | | 1250 max. | Volts | |
| PLATE DISSIPATION | | 75 max. | Watts | |
| TYPICAL OPERATION: | | | | |
| Filament Voltage (A.C.) | | 10.0 | Volts | |
| D-C Plate Voltage | 750 | 1000 | 1250 | Volts |
| Grid Voltage | -98 | -155 | -209 | Volts |
| Peak Grid Swing | 93 | 150 | 204 | Volts |
| D-C Plate Current | 95 | 65 | 52 | Milliamperes |
| Load Resistance | 3400 | 9000 | 16000 | Ohms |
| Undistorted Power Output | 15 | 21 | 24 | Watts |

INSTALLATION

The base of the RCA-845/545 fits the standard transmitting, four-contact socket such as the RCA type UT-541. The socket should be mounted so that the tube will operate in a vertical position with the base end down.

For additional information on installation of this type, refer to INSTALLATION on type 203-A/503-A.

APPLICATION

As a *Class A* audio-frequency amplifier or modulator, the 845/545 is capable of delivering 24 watts of audio-frequency power with very low distortion. Typical operating conditions are shown under MAXIMUM RATINGS and TYPICAL OPERATING CONDITIONS.

Grid bias for this type of service may be obtained from a separate voltage source or by means of a cathode-biasing resistor. When a group of 845/545's is operated in parallel, it is necessary to make provision for individual adjustment of grid bias to insure that the plate dissipation of each tube does not exceed the maximum value of 75 watts. This may be accomplished by means of a tapped "C"

battery, or if self-bias is used, by means of a variable cathode resistor for each tube. Separate filament windings are necessary, of course, for each tube that is self-biased; each cathode resistor should be shunted by a filter network to avoid degenerative effects at low audio frequencies.

In cases where the input circuit to the 845/545 is resistance or impedance coupled, the resistance in the grid circuit should not be made too high. A resistance of one-half megohm for one 845/545 may be taken as a safe maximum when self-bias is used. Without self-bias, the grid resistance should not exceed 100000 ohms.

For parallel and push-pull operation of the 845/545 in Class A audio and modulator service, refer to APPLICATION on RCA-842.

An output device should be used to transfer power efficiently to the windings of the reproducing unit when the RCA-845/545 is used as an audio-frequency amplifier.

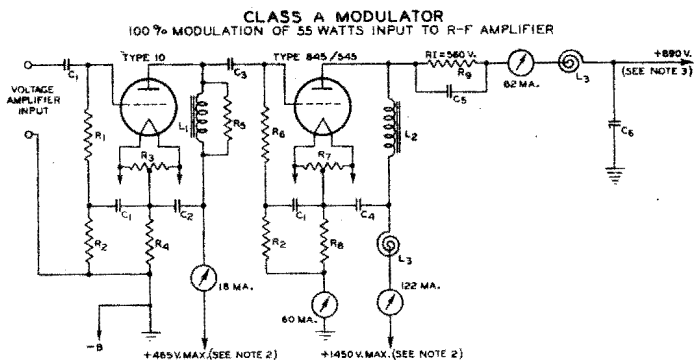

$C_1 = 0.1 \mu\text{f}$ (400 VOLTS)

$C_2 = 2$ TO $4 \mu\text{f}$ (600 VOLTS)

$C_3 = 0.05 \mu\text{f}$ (1000 VOLTS)

$C_4 = 2$ TO $8 \mu\text{f}$ (2000 VOLTS)

$C_5 = 2$ TO $6 \mu\text{f}$ (500 VOLTS)

$C_6 = 0.00025 \mu\text{f}$ (2000 VOLTS)

$L_1 = 30$ HENRIES AT 20 MA., 400 OHMS

$L_2 = 60$ HENRIES AT 125 MA., 400 OHMS

$L_3 = 8$ MILLIHENRIES

$R_1 = 400000$ OHMS (1 WATT)

$R_2 = 100000$ OHMS (1 WATT)

$R_3 = 50$ OHMS, CENTER TAPPED

$R_4 =$ SELF-BIASING RESISTOR, 2200 OHMS (2 WATT)

$R_5 = 50000$ OHMS (2 WATT)

$R_6 = 250000$ OHMS (2 WATT)

$R_7 = 100$ OHMS, CENTER TAPPED

$R_8 =$ SELF-BIASING RESISTOR, 3300 OHMS (25 WATT)

$R_9 = 9000$ OHMS (50 WATT)

NOTE 1: IT IS IMPORTANT THAT THE CLASS C AMPLIFIER BE ADJUSTED TO THE VALUES SHOWN AND THAT THE CORRECT VALUE OF R_9 BE USED IN ORDER TO OBTAIN THE CORRECT LOAD ON THE MODULATOR; TWO 845/545'S MAY BE USED TO MODULATE 110 WATTS INPUT TO R-F AMPLIFIER, PROVIDING SUITABLE CHANGES IN THE CIRCUIT CONSTANTS ARE MADE.

NOTE 2: THIS VALUE INCLUDES PROPER C-BIAS VOLTAGE.

NOTE 3: TO CLASS C AMPLIFIER, PRESENTING 14000 OHM LOAD.

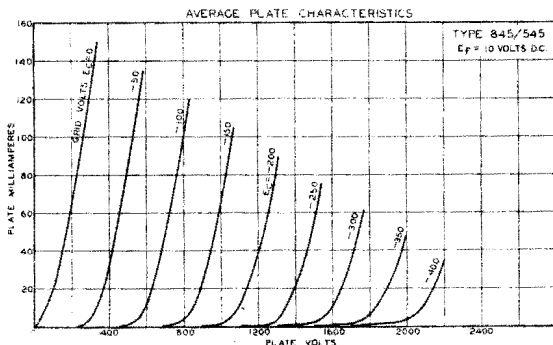



849/549

Modulator, A-F and R-F Power Amplifier, Oscillator

The RCA-849/549 is a three-electrode, general purpose transmitting tube. It is especially suited for use as an audio-frequency power amplifier or modulator.

CHARACTERISTICS

| | | |
|----------------------------|---------------------|---------|
| FILAMENT VOLTAGE (A.C.) | 11.0 | volts |
| FILAMENT CURRENT | 5.0 | Amperes |
| AMPLIFICATION FACTOR | 19 | |
| GRID-PLATE CAPACITANCE | 33.5 approx. | μf |
| GRID-FILAMENT CAPACITANCE | 17 approx. | μf |
| PLATE-FILAMENT CAPACITANCE | 3 approx. | μf |
| BULB | T-32 | |
| BASES | Types 1904 and 3503 | |

(For connections and dimensions, see page 38)

MAXIMUM RATINGS and TYPICAL OPERATING CONDITIONS

As A-F Power Amplifier and Modulator - Class A

| | | |
|-----------------------------------|------------|--------------|
| D-C PLATE VOLTAGE | 3000 max. | Volts |
| PLATE DISSIPATION | 300 max. | Watts |
| TYPICAL OPERATION: | | |
| Filament Voltage (A.C.) | 11.0 | Volts |
| D-C Plate Voltage | 2000 2500 | Volts |
| Grid Voltage (approximate) | -74 -104 | Volts |
| Peak Grid Swing (approximate) | 58 98 | Volts |
| D-C Plate Current | 135 110 | Milliamperes |
| Load Resistance | 6000 12000 | Ohms |
| Power Output (5% second harmonic) | 58 81 | Watts |

As A-F Power Amplifier and Modulator - Class B

| | | |
|-----------------------------------|--------------------------------------|--------------|
| D-C PLATE VOLTAGE | 3000 max. | Volts |
| D-C PLATE CURRENT* | 350 max. | Milliamperes |
| PLATE DISSIPATION* | 300 max. | Watts |
| PLATE INPUT* | 825 max. | Watts |
| TYPICAL OPERATION: (2 tubes) | | |
| Filament Voltage (A.C.) | 11.0 | Volts |
| D-C Plate Voltage | 2000 2500 | Volts |
| Grid Voltage (approximate) | -105 -130 | Volts |
| Zero-Signal Plate Cur. (per tube) | 7 10 | Milliamperes |
| Max.-Signal Plate Cur. (per tube) | 325 275 | Milliamperes |
| Load Resistance (plate-to-plate) | 7040 [#] 11480 [#] | Ohms |
| Nominal Power Output (2 tubes) | 870 920 | Watts |

As R-F Power Amplifier - Class B (Telephony)

(Carrier Conditions: for use with a Modulation Factor up to 1.0)

| | | |
|-------------------|-----------|--------------|
| D-C PLATE VOLTAGE | 2500 max. | Volts |
| D-C PLATE CURRENT | 350 max. | Milliamperes |
| PLATE DISSIPATION | 400 max. | Watts |
| R-F GRID CURRENT | 8 max. | Amperes |

*Averaged over any audio-frequency cycle.

[#]This value is equal to four times the plate load per tube.

TYPICAL OPERATION:

| | | | |
|------------------------------|------|------|--------------|
| Filament Voltage (A.C.) | | 11.0 | Volts |
| D-C Plate Voltage | 1500 | 2000 | Volts |
| Grid Voltage (approximate) | -70 | -95 | Volts |
| D-C Plate Current | 340 | 265 | Milliamperes |
| Peak Power Output | 620 | 700 | Watts |
| Nominal Carrier Power Output | 155 | 175 | Watts |

As Plate-Modulated R-F Power Amplifier - Class C (Telephony)*(Carrier Conditions; for use with a Modulation Factor up to 1.0)*

| | | | |
|-------------------|--|-----------|--------------|
| D-C PLATE VOLTAGE | | 2000 max. | Volts |
| D-C PLATE CURRENT | | 350 max. | Milliamperes |
| PLATE DISSIPATION | | 270 max. | Watts |
| R-F GRID CURRENT | | 8 max. | Amperes |
| D-C GRID CURRENT | | 125 max. | Milliamperes |

TYPICAL OPERATION:

| | | | |
|----------------------------|------|------|--------------|
| Filament Voltage (A.C.) | | 11.0 | Volts |
| D-C Plate Voltage | 1500 | 1800 | Volts |
| Grid Voltage (approximate) | -250 | -300 | Volts |
| D-C Plate Current | 300 | 300 | Milliamperes |
| Power Output | 300 | 390 | Watts |

As R-F Power Amplifier and Oscillator - Class C (Telegraphy)*(Key Down Conditions)*

| | | | |
|-------------------|--|-----------|--------------|
| D-C PLATE VOLTAGE | | 2500 max. | Volts |
| D-C PLATE CURRENT | | 350 max. | Milliamperes |
| PLATE DISSIPATION | | 400 max. | Watts |
| R-F GRID CURRENT | | 10 max. | Amperes |
| D-C GRID CURRENT | | 125 max. | Milliamperes |

TYPICAL OPERATION:

| | | | |
|----------------------------|------|------|--------------|
| Filament Voltage (A.C.) | | 11.0 | Volts |
| D-C Plate Voltage | 1500 | 2000 | Volts |
| Grid Voltage (approximate) | -175 | -200 | Volts |
| D-C Plate Current | 300 | 300 | Milliamperes |
| Power Output | 300 | 450 | Watts |

INSTALLATION

The bases of the RCA-849/549 fit the standard RCA end mountings, type UT-1085 and UT-1086. These mountings should be arranged to hold the tube either in a vertical position with the filament end up, or in a horizontal position with the plate in a vertical plane (on edge). A shock absorbing suspension should be used if the tube is to be subjected to vibration or shock. Outline dimensions and electrode connections are shown on page 38.

The plate dissipation of the RCA-849/549 (the difference between input and output) should never exceed the maximum values given for each class of service under MAXIMUM RATINGS and TYPICAL OPERATING CONDITIONS.

For additional information on installation of RCA-849/549, refer to INSTALLATION on type 204-A/504-A.

When new circuits are being tried out or when adjustments are being made, the plate voltage should be reduced in order to prevent damage to the tube or associated apparatus in case the circuit ad-

justments are incorrect.

The rated plate voltage is high enough to be exceedingly dangerous to the user. The greatest care should be taken when handling or adjusting circuits, especially those in which the plate tank coil and condenser are at the d-c plate potential.

APPLICATION

As a Class A audio-frequency amplifier or modulator, the RCA-849/549 is capable of delivering more than 80 watts of audio-frequency power with very low distortion. Typical operating conditions are shown under MAXIMUM RATINGS and TYPICAL OPERATING CONDITIONS.

Grid bias for this type of service may be obtained from a separate voltage source or by means of a self-biasing resistor shunted by a large condenser. Separate filament supplies are of course necessary for each tube self-biased. When a group of 849/549's is operated in parallel, it is necessary to make provision for individual adjustment of grid bias to insure that the plate dissipation of any tube does not exceed the maximum value of 300 watts. This may be accomplished by means of a tapped "C" battery, or if self-bias is used, by means of a variable cathode resistor for each tube.

In cases where the input circuit to the 849/549 is resistance- or impedance-coupled, the resistance in the grid circuit should not be made too high. A resistance of 0.25 megohm for one 849/549 may be taken as a safe maximum value of grid leak where self-bias is used. Without self-bias, the grid-leak resistance should not exceed 25000 ohms.

When a number of tubes are operated in parallel, a non-inductive resistance of 10 to 100 ohms should be placed in series with each grid lead, next to the tube mounting, to prevent parasitic oscillations.

An output device, such as a choke or transformer, should be used to transfer power efficiently from the 849/549 to its load circuit.

As a Class B modulator or audio-frequency amplifier, two RCA-849/549's are generally used in a balanced circuit, each tube conducting only half the time. The plate input power and plate dissipation should not exceed 825 watts and 300 watts per tube, respectively, when averaged over any audio-frequency cycle. Two tubes, operating under the conditions shown for a 2500-volt plate supply, are capable of modulating 100 per cent an input of 1840 watts to a Class C radio-frequency amplifier.

For Class B input transformer considerations, refer to APPLICATION on RCA-203-A/503-A.

The output transformer should be designed so that the resistance load presented by the modulated Class C amplifier is reflected as a plate-to-plate load of 11480 ohms for the 2500-volt conditions. Since two 849/549's will modulate 1840 watts, a convenient Class C amplifier would be one operating at 2000 volts and 920 milliamperes. These conditions represent a resistance of approximately 2175 ohms. The ratio of the output transformer is then $\sqrt{11480 \div 2175}$, or 2.3 to 1, step-down. If a Class C amplifier operating at 3000 volts and 615 milliamperes is used, the equivalent resistance is approximately

4875 ohms; in this case the transformer ratio is 1.53 to 1, step-down. The transformer should be designed with a core sufficiently large to avoid saturation effects, which would impair the quality of the output. If the secondary is to carry the d-c plate current of the modulated amplifier, the core should be made larger and include an air-gap, to compensate for the d-c magnetization current.

As a *Class B or Class C radio-frequency amplifier*, the 849/549 may be used as shown under MAXIMUM RATINGS and TYPICAL OPERATING CONDITIONS.

In Class B r-f service, the plate voltage is unmodulated d.c. and the grid excitation is radio frequency modulated at audio frequency in one of the preceding stages. For this type of operation, the plate dissipation should never be allowed to exceed 400 watts.

Grid bias for the RCA-849/549 as a Class B amplifier should be obtained from a battery or from a d-c generator. It should not be obtained from a high-resistance supply such as a grid-leak, nor from a rectifier, unless the latter has exceptionally good voltage regulation. For *Class C (telegraph) service*, grid bias may be obtained from a grid leak of about 5000 ohms, from a battery, from a rectifier of good regulation, or from a self-biasing resistor by-passed by a suitable condenser. The self-biasing method is especially desirable, due to the fact that the grid bias is automatically regulated and that there is little chance of the plate current becoming dangerously high regardless of whether the r-f grid excitation is applied or not. Since grid-bias values are not particularly critical, correct circuit adjustment may be obtained with considerably different values. For *Class C (telephone) service*, fixed bias is recommended because it eliminates the problems of degeneration caused by a-c voltage variation developed across the biasing system.

The *d-c grid current* should never exceed 125 milliamperes. The exact value will depend upon individual tubes and circuits.

The 849/549 may be used at full ratings up to 3000 kilocycles (100 meters). Although this tube is not constructed for operation at the higher frequencies and although other tube types are recommended for regular operation at such frequencies, satisfactory operation with reduced input has been obtained in experimental circuits at frequencies as high as 15000 kilocycles. When the 849/549 is operated at frequencies in excess of 3000 kc., the plate voltage and power input should be reduced so that at 15000 kc., the plate current, plate dissipation, and d-c grid current should not exceed 50 per cent of the maximum ratings. If more r-f power output is required than can be obtained from a single 849/549, two of these tubes may be used in parallel or in push-pull. See APPLICATION on type 203-A/503-A.

CHARACTERISTICS CURVES

The average plate characteristics (Fig. 1) are very useful for making calculations of the performance of the RCA-849/549. The curves of Fig. 2 and Fig. 3 were derived from the average plate characteristics in order to present the same information in more convenient form. This derivation was accomplished as follows: Different values of mean plate voltage and load resistance were chosen so that the plate input power with no signal was not allowed to exceed the maximum value of 300 watts. Pure resistance plate loads as well as

sinusoidal grid swings whose amplitude was never sufficient to cause the 849/549 to draw grid current, were assumed. The values of grid bias and grid swing for maximum output were then determined. The percentage of second harmonic in the output was in all cases held below 5 per cent.

For predicting the performance of the 849/549 as a Class A amplifier or modulator, the curves of Figs. 2 and 3 are valuable. They are particularly useful when the tube is to be used as a Class A modulator to modulate the plate circuit of a Class C radio-frequency amplifier. Such an amplifier can be adjusted so that, within limits, the amplitude of the output and the average plate current are substantially proportional to the plate voltage. Thus, over the range of modulation frequencies, the Class C amplifier is equivalent to a pure resistance whose value is equal to the plate voltage divided by the average d-c plate current. The Class A modulator can work directly (impedance coupled) into this load resistance, or transformer coupling can be employed to permit the modulator to work into its optimum load resistance, so that the maximum audio-frequency power can be obtained. Examples of both methods of coupling are given here to illustrate the use of the RCA-849/549 Class C data. The following symbols are used:

- E_b = Mean plate voltage for 849/549
- E_o = Mean plate voltage for Class C amplifier
- I_o = Mean plate current for Class C amplifier
- R_l = Load resistance for 849/549
- $R_o = E_o \div I_o$ = Equivalent resistance presented by Class C amplifier
- E_{pm} = Peak a-c output voltage of 849/549
- E_{gm} = Peak a-c input voltage of 849/549
- E_c = Negative grid voltage for 849/549
- M = Modulation factor
- T = Output transformer turns ratio, total sec./total prim.

1. Impedance Coupling:

- (a) Assume: $E_b = 2500$ volts; $E_o = 2000$ volts; and $I_o = 100$ milliamperes.

To Find: E_{gm} , E_c and M .

For optimum load on modulator, $R_l = R_o$ (approx.)

$$R_l = R_o = E_o / I_o = 2000 / 0.1 = 20000 \text{ ohms}$$

When $R_l = 20000$ ohms and $E_b = 2500$ volts, then

$$E_{pm} = 1620 \text{ volts (from Fig. 2)}$$

$$E_{gm} = 102 \text{ volts (from Fig. 3)}$$

$$E_c = -107.5 \text{ volts (from Fig. 3)}$$

$$M = E_{pm} / E_o = \frac{1620}{2000} = 0.81$$

- (b) Assume: $E_b = 2500$ volts; $E_o = 2000$ volts; and $M = 1.0$.

To Find: E_{gm} , E_c and I_o .

$$E_{pm} = M \times E_o = 1.0 \times 2000 = 2000 \text{ volts.}$$

When $E_{pm} = 2000$ volts and $E_b = 2500$ volts, then

$$R_1 = 88000 \text{ ohms (from Fig. 2)}$$

$$E_{gm} = 114 \text{ volts (from Fig. 3)}$$

$$E_c = -119.5 \text{ volts (from Fig. 3)}$$

$$I_o = E_o/R_1 = 2000/88000 = 0.023 \text{ ampere (23 ma.)}$$

2. Transformer Coupling:

(a) Assume: $E_b = 2500$ volts; $E_o = 3000$ volts; and $I_o = 100$ milliamperes.

To Find: E_{gm} , E_c , T and M.

$$R_o = E_o/I_o = 3000/0.1 = 30000 \text{ ohms.}$$

When $E_b = 2500$ volts, the maximum output occurs at $R_1 = 10500$ ohms (Fig. 2).

When $R_1 = 10500$ ohms and $E_b = 2500$ volts, then

$$E_{pm} = 1320 \text{ volts (from Fig. 2)}$$

$$E_{gm} = 98 \text{ volts (from Fig. 3)}$$

$$E_c = -103.5 \text{ volts (from Fig. 3)}$$

$$T = R_o/R_1 = 30000/10500 = 1.69$$

$$M = (T \times E_{pm})/E_o = (1.69 \times 1320)/3000 = 0.744$$

(b) Assume: $M = 1.0$.

To Find: T and I_o .

The operating conditions and load resistance for the modulator are the same as in 2 (a).

$$T = E_o/E_{pm} = 3000/1320 = 2.27.$$

$$R_o = R_1 \times T^2 = 10500 (2.27)^2 = 54100 \text{ ohms.}$$

$$I_o = E_o/R_o = 3000/54100 = 0.055 \text{ ampere (55 ma.)}$$

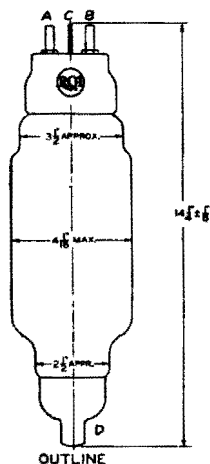

RCA-849/549 CONNECTIONS

| | |
|---------|----------|
| Post A | Filament |
| Post B | Filament |
| Blade C | Grid |
| Cap D | Plate |

AVERAGE PLATE CHARACTERISTICS

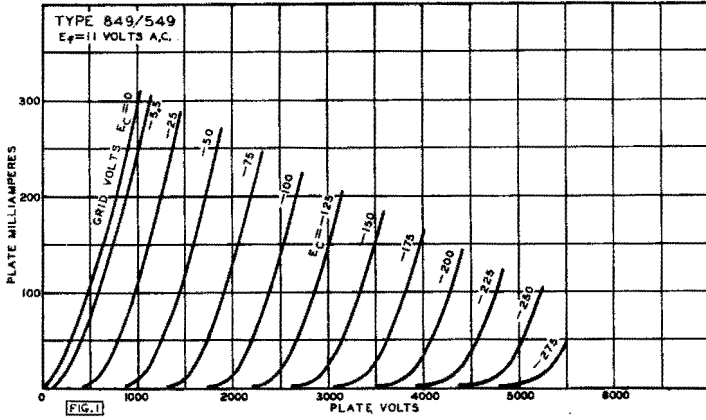

OPERATION CHARACTERISTICS
 CLASS A OPERATION

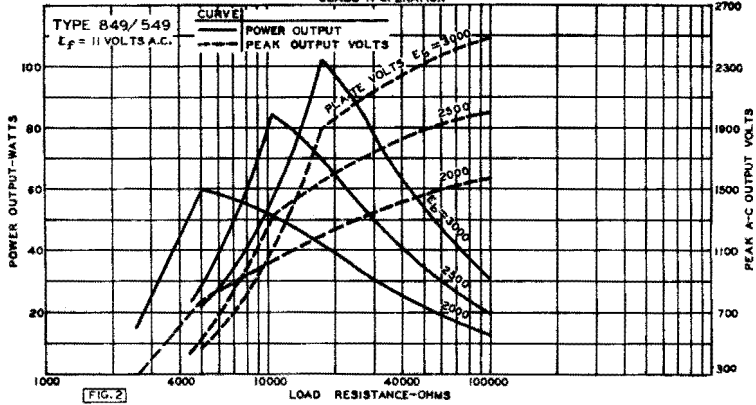

OPERATION CHARACTERISTICS
 CLASS A OPERATION

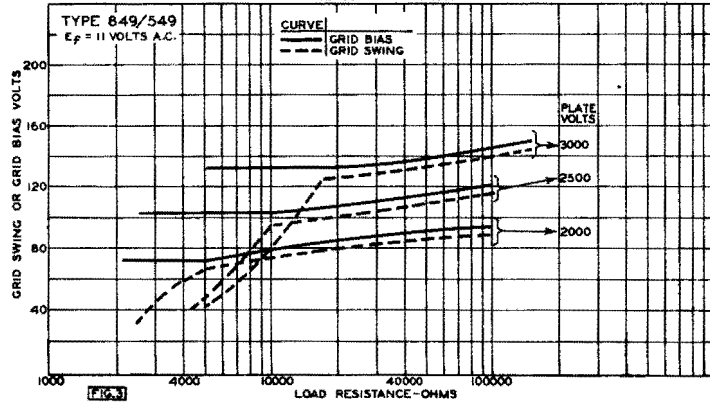



852/552

R-F Power Amplifier, Oscillator

RCA-852/552 is a three-electrode tube for use as an oscillator or a radio-frequency power amplifier in amateur transmitters, particularly at frequencies above 3000 kc. It may also be used as a Class B audio-frequency amplifier and modulator. Each electrode is supported on its own stem and has its leads brought out of the bulb through a separate seal, thus insuring high insulation and low inter-electrode capacities.

CHARACTERISTICS

| | | |
|--|----------------------------|---------|
| FILAMENT VOLTAGE (A.C.) | 10.0 | Volts |
| FILAMENT CURRENT | 3.25 | Amperes |
| AMPLIFICATION FACTOR | 12 | |
| GRID-PLATE CAPACITANCE | 2.6 | µuf |
| GRID-FILAMENT CAPACITANCE | 1.9 | µuf |
| PLATE-FILAMENT CAPACITANCE | 1.0 | µuf |
| BULB (For dimensions, see page 43) | GT-30 with arm | |
| BASE (For socket connections, see page 43) | Medium 4-Pin Metal Bayonet | |

MAXIMUM RATINGS and TYPICAL OPERATING CONDITIONS

As A-F Power Amplifier and Modulator - Class B

| | | |
|--------------------------------------|-----------------------|-----------------|
| D-C PLATE VOLTAGE | 3000 max. Volts | |
| D-C PLATE CURRENT* | 100 max. Milliamperes | |
| PLATE DISSIPATION* | 100 max. Watts | |
| TYPICAL OPERATION (2 tubes): | | |
| Filament Voltage (A.C.) | 10 | Volts |
| D-C Plate Voltage | 2000 | 3000 Volts |
| Grid Voltage (approximate) | -155 | -250 Volts |
| Static Plate Current (per tube) | 11 | 7 Milliamperes |
| Max.-Signal Plate Current (per tube) | 90 | 80 Milliamperes |
| Load Resistance (plate-to-plate) | 22000 | 36000 Ohms |
| Nominal Power Output (2 tubes) | 220 | 360 Watts |

As R-F Power Amplifier - Class B (Telephony)

(Carrier Conditions; for use with a Modulation Factor up to 1.0)

| | | |
|------------------------------|----------------------|-----------------|
| D-C PLATE VOLTAGE | 3000 max. Volts | |
| D-C PLATE CURRENT | 85 max. Milliamperes | |
| PLATE DISSIPATION | 100 max. Watts | |
| R-F GRID CURRENT | 8.0 max. Amperes | |
| TYPICAL OPERATION: | | |
| Filament Voltage (A.C.) | 10 | Volts |
| D-C Plate Voltage | 2000 | 3000 Volts |
| Grid Voltage (approximate) | -155 | -250 Volts |
| D-C Plate Current | 60 | 43 Milliamperes |
| Peak Power Output | 120 | 160 Watts |
| Nominal Carrier Power Output | 30 | 4C Watts |

* Averaged over any audio-frequency cycle.

As Plate-Modulated R-F Power Amplifier - Class C (Telephony)
(Carrier Conditions; for use with a Modulation Factor up to 1.0)

| | | | |
|-------------------|--|-----------|--------------|
| D-C PLATE VOLTAGE | | 2000 max. | Volts |
| D-C PLATE CURRENT | | 85 max. | Milliamperes |
| PLATE DISSIPATION | | 67 max. | Watts |
| R-F GRID CURRENT | | 8.0 max. | Amperes |
| D-C GRID CURRENT | | 40 max. | Milliamperes |

TYPICAL OPERATION:

| | | | |
|----------------------------|------|------|--------------|
| Filament Voltage (A.C.) | | 10 | Volts |
| D-C Plate Voltage | 1500 | 2000 | Volts |
| Grid Voltage (approximate) | -400 | -500 | Volts |
| D-C Plate Current | 70 | 67 | Milliamperes |
| D-C Grid Current** | 30 | 30 | Milliamperes |
| Driving Power** | 20 | 23 | Watts |
| Nominal Power Output | 45 | 75 | Watts |

As R-F Power Amplifier and Oscillator - Class C (Telegraphy)
(Key Down Conditions)

| | | | |
|-------------------|--|-----------|--------------|
| D-C PLATE VOLTAGE | | 3000 max. | Volts |
| D-C PLATE CURRENT | | 150 max. | Milliamperes |
| PLATE DISSIPATION | | 100 max. | Watts |
| PLATE INPUT | | 300 max. | Watts |
| R-F GRID CURRENT | | 10 max. | Amperes |
| D-C GRID CURRENT | | 40 max. | Milliamperes |

TYPICAL OPERATION;

| | | | |
|----------------------------|------|------|--------------|
| Filament Voltage (A.C.) | | 10 | Volts |
| D-C Plate Voltage | 2500 | 3000 | Volts |
| Grid Voltage (approximate) | -450 | -600 | Volts |
| D-C Plate Current | 90 | 85 | Milliamperes |
| D-C Grid Current** | 15 | 15 | Milliamperes |
| Driving Power** | 10 | 12 | Watts |
| Nominal Power Output | 135 | 165 | Watts |

**Subject to wide variations depending on the impedance of the load circuit. High impedance load circuits require more grid current and driving power to obtain the desired output. Low impedance circuits need less grid current and driving power, but plate circuit efficiency is sacrificed. The driving stage should have a tank circuit of good regulation and should be capable of delivering considerably more than the required driving power.

INSTALLATION

The base pins of the RCA-852/552 fit the standard four-contact socket. The socket should be installed so that the tube will operate in a vertical position. In order to adequately handle the large circulating current which flows at high frequencies, both stranded leads from each arm terminal should always be used.

The plate dissipation of the 852/552 (the difference between input and output) should never exceed the maximum value given under **MAXIMUM RATINGS** and **TYPICAL OPERATING CONDITIONS**. This value is indicated by a dull red color on the plate when the power switches are opened with the tube operating in the dark.

For additional information on installation of this type, refer to **INSTALLATION** on type 203-A/503-A.

When a new circuit is being tried out or when adjustments are being made, the plate voltage should be reduced in order to prevent damage to the tube or associated apparatus in case the circuit adjustments are incorrect. It is advisable to use a protective resistance of about 10000 ohms in series with the plate lead during such adjustments.

The rated plate voltage of this tube is high enough to be exceedingly dangerous to the user. The greatest care should be taken when handling or adjusting circuits, especially those in which the plate tank coil and condenser are at the d-c plate potential.

APPLICATION

As a Class B modulator or audio-frequency amplifier, two 852/552's are used in a balanced circuit, each tube conducting only half the time. The d-c plate current should never exceed 100 milliamperes per tube. Two tubes, operating under the conditions shown for a 2000-volt plate supply, are capable of modulating 100 per cent an input of 440 watts.

For Class B input transformer considerations, refer to APPLICATIO N on 203-A/503-A.

The output transformer should be so designed that the resistance load presented by the modulated Class C amplifier is reflected as a plate-to-plate load of 22000 ohms in the Class B stage for the 2000-volt conditions. Since two RCA-852/552's will modulate 440 watts, a convenient Class C amplifier would be one operating at 2000 volts and 220 milliamperes. These conditions represent a resistance of approximately $\frac{9100}{1}$ ohms. The ratio of the output transformer is then $\sqrt{22000 \div 9100}$, or 1.55 to 1, step-down. The transformer should be designed with a core sufficiently large to avoid saturation effects, which would impair the quality of the output. If the secondary is to carry the d-c plate current of the modulated amplifier, the core should be made larger and include an air-gap, to compensate for the d-c magnetization current.

As a Class B and Class C radio-frequency amplifier, the RCA-852/552 may be used as shown under MAXIMUM RATINGS and TYPICAL OPERATING CONDITIONS.

In Class B radio-frequency service, the plate voltage is unmodulated d.c. and the grid excitation is radio frequency modulated at audio frequency in one of the preceding stages. For this type of operation, the plate dissipation should never be allowed to exceed 100 watts.

Grid bias for the 852/552 as a Class B r-f amplifier should be obtained from a battery or other d-c source of good regulation. It should not be obtained from a high-resistance supply such as a grid-leak, nor from a rectifier, unless the latter has exceptionally good voltage regulation. For Class C (telegraph) service, grid bias may be obtained from a grid leak of about 10000 ohms, from a battery, from a rectifier of good regulation, or from a self-biasing resistor (preferably variable) by-passed with a suitable condenser. The self-biasing method is especially desirable, due to the fact that the grid bias is automatically regulated and that there is little chance of the plate current becoming dangerously high regardless of whether the r-f grid excitation is applied or not. When the grid-leak method of obtaining grid bias is used, bias is on the tube only when r-f grid excitation is applied. For this reason, one of the other methods of obtaining grid bias is generally to be preferred. Since

grid bias values are not particularly critical, correct circuit adjustment may be obtained with widely different values. For *Class C (telephone) service*, fixed bias is recommended because it eliminates the problems of degeneration caused by a-c voltage variation developed across the biasing system.

The *d-c grid current* should never exceed 40 milliamperes. The exact value will vary with individual tubes and circuits.

The 852/552 may be used at full ratings as high as 30000 kc. At higher frequencies, the d-c input power should be decreased. The tabulation below shows the maximum plate voltage values to be used at frequencies between 60 and 150 mc. (5 to 2 meters).

| FREQUENCY | 6C | 9C | 12C | 15C | Megacycles |
|----------------------|------|------|------|------|------------|
| PLATE VOLTAGE (Max.) | | | | | |
| Class B Telephony | 2400 | 1900 | 1500 | 1200 | Volts |
| Class C Telegraphy | 2400 | 1900 | 1500 | 1200 | Volts |
| Class C Telephony | 1600 | 1300 | 1000 | 800 | Volts |

If more r-f power output is required than can be obtained from a single 852/552, two of these tubes may be used either in parallel or in push-pull. See APPLICATION on type 203-A/503-A for additional information.

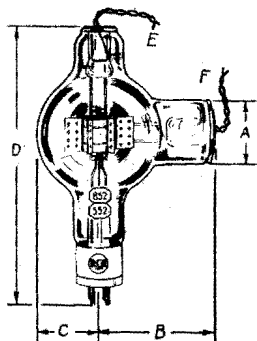
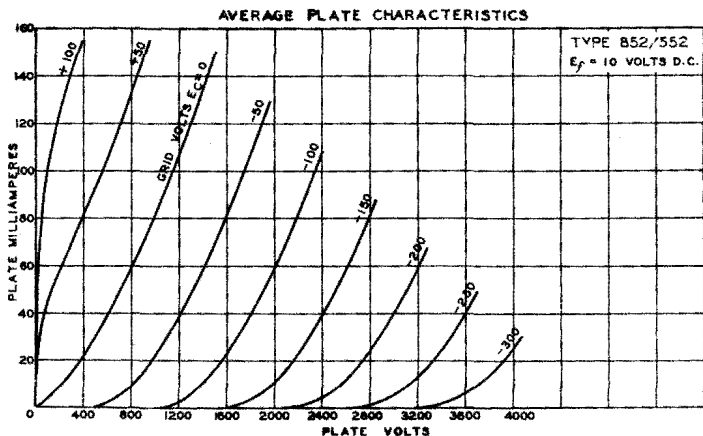

Overall Dimensions

- A = 2-1/16" max.
- B = 4-1/4" max.
- C = 1-7/8" max.
- D = 8-3/4" max.
- E = Grid Lead
- F = Plate Lead

Tube Symbol and Top View of Socket Connections.

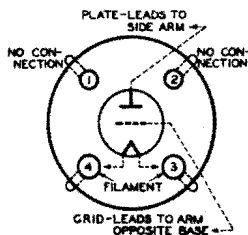



860/560

Screen Grid R-F Power Amplifier

The RCA-860/560 is a screen grid tube for use primarily as a radio-frequency power amplifier, particularly at frequencies greater than 3000 kc. The grid, plate and screen are supported on separate stems so that their leads are brought out of the bulb through separate seals, thus insuring high insulation and low interelectrode capacities. Neutralization to prevent feedback and self-oscillation is generally unnecessary when this tube is used in adequately shielded circuits.

CHARACTERISTICS

| | | |
|---|----------------------------|---------------|
| FILAMENT VOLTAGE (A.C.) | 10.0 | Volts |
| FILAMENT CURRENT | 3.25 | Amperes |
| AMPLIFICATION FACTOR (approximate) | 200 | |
| MUTUAL CONDUCTANCE (For plate cur. of 50 ma.) | 1100 | Micromhos |
| GRID-PLATE CAPACITANCE | 0.08 max. | μf |
| INPUT CAPACITANCE | 7.75 | μf |
| OUTPUT CAPACITANCE | 7.5 | μf |
| BULB (For dimensions, see page 48) | GT-30 with arm | |
| BASE (For socket connection, see page 48) | Medium 4-Pin Metal Bayonet | |

MAXIMUM RATINGS and TYPICAL OPERATING CONDITIONS

As R-F Power Amplifier - Class B (Telephony)

(Carrier Conditions; for use with a Modulation Factor up to 1.0)

| | | |
|--------------------|-----------|--------------|
| D-C PLATE VOLTAGE | 3000 max. | Volts |
| D-C PLATE CURRENT | 85 max. | Milliamperes |
| PLATE DISSIPATION | 100 max. | Watts |
| SCREEN DISSIPATION | 10 max. | Watts |
| R-F GRID CURRENT | 8 max. | Amperes |

TYPICAL OPERATION:

| | | | |
|----------------------------------|------|-------|--------------|
| Filament Voltage (A.C.) | 10 | Volts | |
| D-C Plate Voltage | 2000 | 3000 | Volts |
| D-C Screen Voltage (approximate) | 300 | 300 | Volts |
| Grid Voltage (approximate) | -50 | -50 | Volts |
| D-C Plate Current | 60 | 43 | Milliamperes |
| Peak Power Output | 120 | 160 | Watts |
| Nominal Carrier Power Output | 30 | 40 | Watts |

As Plate-Modulated R-F Power Amplifier - Class C (Telephony)

(Carrier Conditions; for use with a Modulation Factor up to 1.0)

| | | |
|--------------------|-----------|--------------|
| D-C PLATE VOLTAGE | 2000 max. | Volts |
| D-C PLATE CURRENT | 85 max. | Milliamperes |
| PLATE DISSIPATION | 67 max. | Watts |
| SCREEN DISSIPATION | 6.7 max. | Watts |
| R-F GRID CURRENT | 8 max. | Amperes |
| D-C GRID CURRENT | 40 max. | Milliamperes |

TYPICAL OPERATION:

| | | | | |
|------------------------------|------|------|------|--------------|
| Filament Voltage (A.C.) | | | 10 | Volts |
| D-C Plate Voltage | 1500 | 1800 | 2000 | Volts |
| Screen Voltage (approximate) | 300 | 300 | 300 | Volts |
| Grid Voltage (approximate) | -225 | -225 | -225 | Volts |
| D-C Plate Current | 70 | 67 | 67 | Milliamperes |
| D-C Grid Current* | 30 | 30 | 30 | Milliamperes |
| Driving Power* | 15 | 15 | 15 | Watts |
| Nominal Power Output | 45 | 60 | 75 | Watts |

As R-F Power Amplifier and Oscillator - Class C (Telegraphy)
(Key Down Conditions)

| | | | | |
|--------------------|--|--|--|-----------------------|
| D-C PLATE VOLTAGE | | | | 3000 max. Volts |
| D-C PLATE CURRENT | | | | 150 max. Milliamperes |
| PLATE DISSIPATION | | | | 100 max. Watts |
| SCREEN DISSIPATION | | | | 10 max. Watts |
| PLATE INPUT | | | | 300 max. Watts |
| R-F GRID CURRENT | | | | 10 max. Amperes |
| D-C GRID CURRENT | | | | 40 max. Milliamperes |

TYPICAL OPERATION:

| | | | | | |
|--------------------------|------|------|------|------|--------------|
| Filament Voltage (A.C.) | | | | 10 | Volts |
| D-C Plate Voltage | 1500 | 2000 | 2500 | 3000 | Volts |
| Screen Voltage (approx.) | 300 | 300 | 300 | 300 | Volts |
| Grid Voltage (approx.) | -150 | -150 | -150 | -150 | Volts |
| D-C Plate Current | 90 | 90 | 90 | 85 | Milliamperes |
| D-C Grid Current* | 15 | 15 | 15 | 15 | Milliamperes |
| Driving Power* | 7 | 7 | 7 | 7 | Watts |
| Nominal Power Output | 60 | 100 | 135 | 165 | Watts |

* Subject to wide variations depending on the impedance of the load circuit. High impedance load circuits require more grid current and driving power to obtain the desired output. Low impedance circuits need less grid current and driving power, but plate circuit efficiency is sacrificed. The driving stage should have a tank circuit of good regulation and should be capable of delivering considerably more than the required driving power.

INSTALLATION

The base pins of the RCA-860/560 fit the standard four-contact socket. The socket should be installed so that the tube will operate in a vertical position. In order to adequately handle the large circulating current which flows at high frequencies, both stranded leads from each arm terminal should always be used.

The bulb of this tube becomes very hot during continuous operation. Free circulation of air should therefore be provided. The installation of all wires and connections should be made to allow at least several inches of free space around the tube in order to avoid trouble from peak voltage effects.

For filament care and operation, refer to INSTALLATION on type 203-A/503-A.

For plate circuit considerations, refer to INSTALLATION on type 203-A/503-A.

For plate dissipation, refer to INSTALLATION on type 852/552.

The screen voltage for this tube may be obtained either from a separate source or from the plate supply through a series resistance. In the case of the latter method, the resistance should be chosen to reduce the high-voltage supply to approximately 300 volts at the screen. The screen should never be allowed to attain a temperature corresponding to more than a dull red color (approximately 10 watts dissipation). The following tabulation gives the minimum values of resistance (ohms) for various supply voltages.

| | | | | | |
|------------------------|-------|-------|--------|--------|--------|
| SUPPLY VOLTS | 1000 | 1500 | 2000 | 2500 | 3000 |
| SERIES RESISTOR (ohms) | 25000 | 60000 | 100000 | 160000 | 225000 |

The resistance method for obtaining screen voltage is generally to be preferred since it serves to maintain the proper screen current. With this method, however, it is important that the high-voltage-supply switch be opened before the filament circuit is opened; otherwise, full supply voltage will be placed on the screen. If the screen voltage is obtained from a separate source, or from a potentiometer, plate and screen voltage should be applied simultaneously in order not to exceed the screen dissipation rating of 10 watts.

The common negative plate and screen lead of the RCA-860/560 should be provided with a protective device to prevent the tube from drawing excessive plate and screen current. This device should preferably remove the high-voltage supply when the d-c plate current and d-c screen current reach a value 50 per cent greater than normal.

Adequate shielding and isolation of the input and output circuits is necessary if optimum results are to be obtained. The impedance between the screen and filament must be kept as low as possible by the use of a by-pass condenser. This condenser should have a voltage break-down rating high enough to withstand the full plate voltage of the tube. The capacity value will depend upon circuit design. See APPLICATION.

When a new circuit is being tried out or when adjustments are being made, the plate voltage should be reduced in order to prevent damage to the tube or associated apparatus in case the circuit adjustments are incorrect. It is advisable to use a protective resistance of about 10000 ohms in series with the plate lead during such adjustments.

The rated plate voltage of this tube is high enough to be exceedingly dangerous to the user. The greatest care should be taken when handling or adjusting circuits, especially those in which the plate tank coil and condenser are at the d-c plate potential.

APPLICATION

As a Class B and Class C radio-frequency amplifier, the RCA-860/560 may be used as shown under MAXIMUM RATINGS and OPERATING CONDITIONS.

In Class B radio-frequency service, the plate voltage is unmodulated d.c. and the grid excitation is radio frequency modulated

at audio frequency in one of the preceding stages. For this type of operation, the plate dissipation should never be allowed to exceed 100 watts.

Grid bias for the 860/560 as a Class B r-f amplifier should be obtained from a battery or other d-c source of good regulation. It should not be obtained from a high-resistance supply such as a grid-leak, nor from a rectifier, unless the latter has exceptionally good voltage regulation. For *Class C (telegraph) service*, grid bias may be obtained from a grid leak of about 10000 ohms, from a battery, from a rectifier of good regulation, or from a self-biasing resistor (preferably variable) by-passed with a suitable condenser. The self-biasing method is especially desirable, due to the fact that the grid bias is automatically regulated and that there is little chance of the plate current becoming dangerously high regardless of whether the r-f grid excitation is applied or not. When the grid-leak method of obtaining grid bias is used, bias is on the tube *only when r-f grid excitation is applied*. Since grid bias values are not particularly critical, correct circuit adjustment may be obtained with widely different values. For *Class C (telephone) service*, fixed bias is recommended because it eliminates the problems of degeneration caused by a-c voltage variation developed across the biasing system.

The *d-c grid current* should not exceed 40 milliamperes. The exact value will vary with individual tubes.

RCA-860/560 may be operated at full input at frequencies up to 30 megacycles (10 meters). The tube may be used at frequencies as high as 40 megacycles (7.5 meters) with reduced input. When the 860/560 is operated at frequencies in excess of 30 mc., the plate voltage, and input power should be reduced as the frequency is raised, so that at 40 mc. these values will be approximately 20 per cent less than the lower frequency rating. At 40 mc., the d-c grid current should not exceed 50 per cent of the maximum rating.

If more r-f power output is required than can be obtained from a single 860/560, two of these tubes may be used either in parallel or in push-pull. For additional information see APPLICATION on RCA-203-A/503-A.

As a *plate-modulated amplifier*, the 860/560 is capable of being modulated 100 per cent. Best results can usually be obtained by using a separate source of screen voltage of about one-sixth of the plate voltage. The screen voltage should be modulated with the plate voltage so that the percentage changes in both voltages are approximately equal. The series-resistance method for supplying the screen voltage to the modulated tube may also be used, provided the screen by-pass condenser is not larger than 0.1 pf, approximately. Values smaller than this may result in excessive feed-back from plate to grid. The best value of series-resistance, by-pass condenser and general operating adjustments will depend on the general transmitter design including the frequency or wavelength to be used and the fidelity required of the output signal.

As an *oscillator*, the screen of the 860/560 should be connected the same as in amplifier operation.

AVERAGE PLATE CHARACTERISTICS

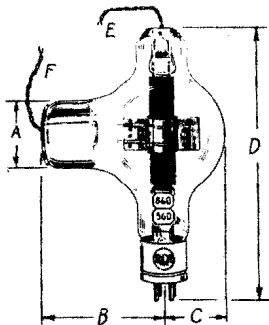
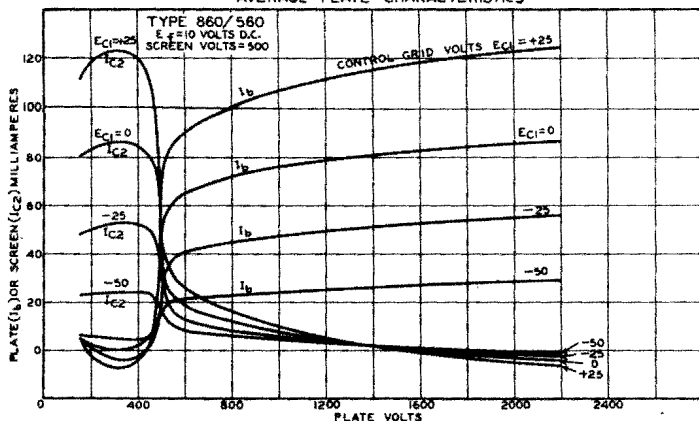

Overall Dimensions

- A = 2-1/16" max.
- B = 4-1/4" max.
- C = 1-7/8" max.
- D = 8-3/4" max.
- E = Grid Lead
- F = Plate Lead

Tube Symbol and Top View of Socket Connections

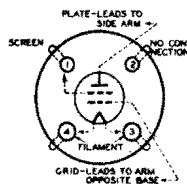

R-F AMPLIFIER OR R-F DOUBLER

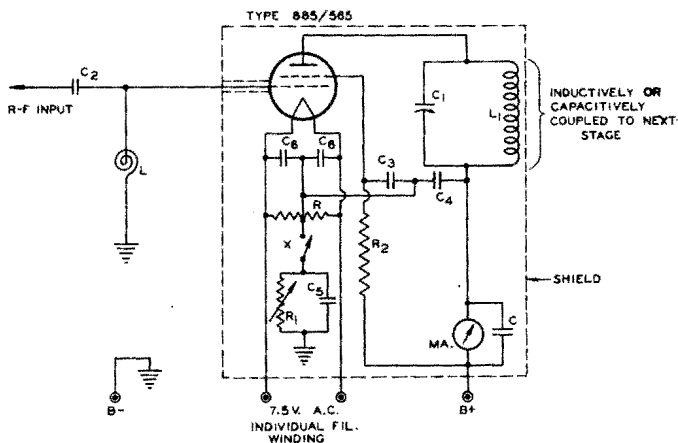

- C = .001 μf (LOW VOLTAGE)
- C₁ = 150 μμf (VARIABLE)
- C₂ = .0001 μf (LOW VOLTAGE)
- C₃ = .02 μf (1000 VOLT)
- C₄ = .002 μf (1000 VOLT)
- C₅ = .01 μf (LOW VOLTAGE)
- C₆ = .001 μf

- R = 50 OHMS, CENTER-TAPPED
- R₁ = 2000 OHMS, MAX. (25 WATT)
- R₂ = SEE APPLICATION ON 865/565
- L = R-F CHOKER, EFFECTIVE AT FREQUENCY USED
- L₁ = SEE TYPE 800, TABLE OF FIG. 1
- X = KEY

NOTE: GROUND CONNECTIONS MADE TO SHIELD



865/565

Screen Grid R-F Power Amplifier

RCA-865/565 is a screen grid transmitting tube designed primarily for use as a power amplifier at radio frequencies greater than 3000 kc. It is particularly useful as an r-f buffer amplifier and r-f doubler. Neutralization to prevent feed-back and self-oscillation is generally unnecessary when the tube is used in adequately shielded circuits.

CHARACTERISTICS

| | | |
|---|----------------------|-----------|
| FILAMENT VOLTAGE (A.C.) | 7.5 | Volts |
| FILAMENT CURRENT | 2.0 | Amperes |
| AMPLIFICATION FACTOR (approximate) | 150 | |
| MUTUAL CONDUCTANCE (For plate cur. of 18 ma.) | 750 | Micromhos |
| GRID-PLATE CAPACITANCE | 0.10 max. | μf |
| INPUT CAPACITANCE | 8.5 | μf |
| OUTPUT CAPACITANCE | 8.5 | μf |
| BULB (For dimensions, see page 52) | S-17 | |
| CAP | Small Metal | |
| BASE (For socket connections, see page 52) | Medium 4-Pin Bayonet | |

MAXIMUM RATINGS and TYPICAL OPERATING CONDITIONS

As R-F Power Amplifier - Class B (Telephony)

(Carrier Conditions; for use with a Modulation Factor up to 1.0)

| | | |
|--------------------|----------|--------------|
| D-C PLATE VOLTAGE | 750 max. | Volts |
| D-C PLATE CURRENT | 30 max. | Milliamperes |
| PLATE DISSIPATION | 15 max. | Watts |
| SCREEN DISSIPATION | 3 max. | Watts |
| R-F GRID CURRENT | 4 max. | Amperes |

TYPICAL OPERATION:

| | | | |
|----------------------------------|-----|-------|--------------|
| Filament Voltage (A.C.) | 7.5 | Volts | |
| D-C Plate Voltage | 500 | 750 | Volts |
| D-C Screen Voltage (approximate) | 125 | 125 | Volts |
| Grid Voltage (approximate) | -30 | -30 | Volts |
| D-C Plate Current | 30 | 22 | Milliamperes |
| Peak Power Output | 12 | 18 | Watts |
| Nominal Carrier Power Output | 3 | 4.5 | Watts |

As Plate-Modulated R-F Power Amplifier - Class C (Telephony)

(Carrier Conditions, for use with a Modulation Factor up to 1.0)

| | | |
|--------------------|----------|--------------|
| D-C PLATE VOLTAGE | 500 max. | Volts |
| D-C PLATE CURRENT | 60 max. | Milliamperes |
| PLATE DISSIPATION | 10 max. | Watts |
| SCREEN DISSIPATION | 2 max. | Watts |
| R-F GRID CURRENT | 4 max. | Amperes |
| D-C GRID CURRENT | 15 max. | Milliamperes |

TYPICAL OPERATION:

| | | | |
|----------------------------------|------|-------|--------------|
| Filament Voltage (A.C.) | 7.5 | Volts | |
| D-C Plate Voltage | 375 | 500 | Volts |
| D-C Screen Voltage (approximate) | 125 | 125 | Volts |
| Grid Voltage (approximate) | -120 | -120 | Volts |
| D-C Plate Current | 50 | 40 | Milliamperes |

| | | | |
|----------------------|-----|-----|--------------|
| D-C Grid Current* | 11 | 9 | Milliamperes |
| Driving Power* | 3 | 2.5 | Watts |
| Nominal Power Output | 8.5 | 10 | Watts |

As R-F Power Amplifier and Oscillator - Class C (Telegraphy)
(Key Down Conditions)

| | | |
|--------------------|----------|--------------|
| D-C PLATE VOLTAGE | 750 max. | Volts |
| D-C PLATE CURRENT | 60 max. | Milliamperes |
| PLATE DISSIPATION | 15 max. | Watts |
| SCREEN DISSIPATION | 3 max. | Watts |
| R-F GRID CURRENT | 5 max. | Amperes |
| D-C GRID CURRENT | 15 max. | Milliamperes |

TYPICAL OPERATION:

| | | | | | |
|-------------------------|-----|-------|-----|-----|--------------|
| Filament Voltage (A.C.) | 7.5 | Volts | | | |
| D-C Plate Voltage | 375 | 500 | 675 | 750 | Volts |
| D-C Screen Voltage | | | | | |
| (approximate) | 125 | 125 | 125 | 125 | Volts |
| Grid Voltage (approx.) | -80 | -80 | -80 | -80 | Volts |
| D-C Plate Current | 55 | 50 | 45 | 40 | Milliamperes |
| D-C Grid Current* | 11 | 9 | 6 | 5.5 | Milliamperes |
| Driving Power* | 2.5 | 2.0 | 1.2 | 1.0 | Watts |
| Nominal Power Output | 8.5 | 10 | 14 | 16 | Watts |

* Subject to wide variations depending on the impedance of the load circuit. High impedance load circuits require more grid current and driving power to obtain the desired output. Low impedance circuits need less grid current and driving power, but sacrifice plate circuit efficiency. The driving stage should have a tank circuit with good regulation and should be capable of delivering considerably more than the required driving power.

INSTALLATION

The base pins of the RCA-865/565 fit the standard four-contact socket. The socket should be installed to hold the tube in a vertical position. The plate lead of the tube is brought out at the top of the bulb to a metal cap.

A flexible lead should be used to make connection to the plate cap so that normal expansion will not place a strain on the glass at the base of the cap. Likewise, the cap should not be made to support coils, condensers, chokes, etc. Under no circumstances should anything be soldered to the cap, as the heat may crack the glass seal.

The bulb of this tube becomes very hot during continuous operation. Free circulation of air should therefore be provided.

For filament care and operation, refer to INSTALLATION on RCA-841.

For grid and plate return connections, refer to INSTALLATION on the RCA-841.

For plate dissipation and plate circuit considerations, refer to INSTALLATION on RCA-841.

The screen voltage for this tube may be obtained either from a separate source or from the plate supply through a series resistance. In the case of the latter method, the resistance should be chosen to reduce the high-voltage supply to 125 volts at the screen under

rated plate load. The following tabulation gives the *minimum* values of screen resistance (ohms) for various supply voltages.

| | | | | | |
|------------------------|------|-------|-------|-------|-------|
| SUPPLY VOLTS | 250 | 375 | 500 | 625 | 750 |
| SERIES RESISTOR (ohms) | 5000 | 12000 | 20000 | 32000 | 45000 |

The resistance method for obtaining screen voltage is generally to be preferred since it serves to maintain the proper screen current. With this method, however, it is important that the high voltage supply switch be opened before the filament circuit is opened; otherwise, full supply voltage will be placed on the screen. If the screen voltage is obtained from a separate source, or from a potentiometer, plate and screen voltage should be applied simultaneously in order not to exceed the screen dissipation rating of 3 watts.

Adequate *shielding* and isolation of the input and output circuits is necessary if maximum stability and gain per stage is to be obtained. The impedance between the screen and filament must be kept as low as possible by the use of a by-pass condenser. This condenser should have a voltage break-down rating high enough to withstand the full plate voltage of the tube. The capacity value of the condenser will depend upon circuit design. See APPLICATION.

When a new circuit is tried out or when adjustments are made the plate voltage should be reduced in order to prevent damage to the tube or associated apparatus in case the circuit adjustments are incorrect. It is advisable to use a protective resistance of about 5000 ohms in series with the plate lead during such adjustments.

APPLICATION

As a Class B and Class C radio-frequency amplifier, the 865/565 should be operated as shown under MAXIMUM RATINGS and TYPICAL OPERATING CONDITIONS.

In Class B radio-frequency service, the plate voltage is unmodulated and the grid excitation is radio frequency modulated at audio frequency in one of the preceding stages. For this type of operation, the plate dissipation should never be allowed to exceed 15 watts.

Grid bias for this tube as a Class B r-f amplifier should be obtained from a battery or other d-c source of good voltage regulation. It should not be obtained from a high-resistance supply such as a grid-leak, nor from a rectifier, unless the latter has exceptionally good voltage regulation. For Class C (telegraph) service, grid bias may be obtained from a grid leak of about 10000 ohms, from a battery, from a rectifier of good regulation, or from a self-biasing resistor (preferably variable) by-passed by a suitable condenser. The self-biasing method is especially desirable, due to the fact that the grid bias is automatically regulated and that there is little chance of the plate current becoming dangerously high regardless of whether the r-f grid excitation is applied or not. In this case when the grid-leak method of obtaining grid bias is used, bias is on the tube only when r-f grid excitation is applied. For this reason, one of the other methods of obtaining grid bias is generally to be preferred. Since grid bias values are not particularly critical, correct circuit adjustment may be obtained with widely different values. For Class C (telephone) service, fixed bias is recommended because it

eliminates the problems of degeneration caused by a-c voltage variation developed across the biasing system.

The d-c grid current of the RCA-865/565 must never be greater than 15 milliamperes. The exact value will vary with individual tubes.

RCA-865/565 may be operated at full input at frequencies as high as 15000 (20 meters) kilocycles. At higher frequencies the plate voltage, r-f grid current and input power should be reduced.

If more r-f power output is required than can be obtained from a single 865/565, two of these tubes may be used either in parallel or in push-pull. For additional information see APPLICATION on RCA-203-A/503-A.

As a plate-modulated amplifier, the 865/565 is capable of being modulated 100 per cent. Best results can usually be obtained by using a separate source of screen voltage of approximately 125 volts. The screen voltage should be simultaneously modulated with the plate voltage so that the percentage changes in both voltages are approximately equal. The series-resistance method for supplying the screen voltage to the modulated tube may also be used, provided the screen by-pass condenser is not larger than 0.02 μ f, approximately. Values smaller than this may result in excessive feed-back from plate to grid. The best value of series resistance, by-pass condenser, and general operating adjustments will depend on the general transmitter design including the frequency or wavelength to be used and the fidelity required of the output signal.

As an oscillator, the 865/565 should be connected the same as in an amplifier circuit.

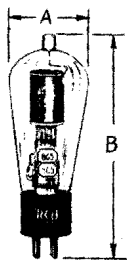
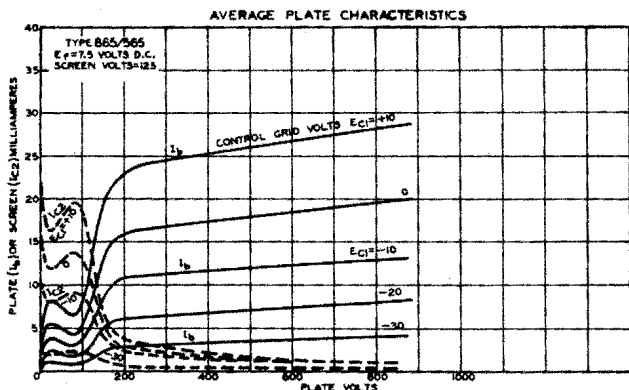

Overall Dimensions

A = 2-3/16" max.

B = 6-1/4" max.

Tube Symbol and Top View of Socket Connections.

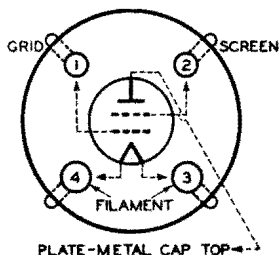



866-A

Half-Wave Mercury-Vapor Rectifier

RCA-866-A is a half-wave, mercury-vapor rectifier tube of the hot-cathode type. It is intended for use in high-voltage rectifying devices designed to supply d-c power of uniform voltage. In single-phase circuits, full-wave rectification is accomplished by using two or four 866-A's.

CHARACTERISTICS

| | | |
|--|----------------------|---------|
| FILAMENT VOLTAGE (A.C.) | 2.5 | Volts |
| FILAMENT CURRENT | 5.0 | Amperes |
| PEAK INVERSE VOLTAGE: | | |
| Ambient temp. range 15° - 50°C near base* | 10000 max. | Volts |
| Ambient temp. range 15° - 60°C near base** | 5000 max. | Volts |
| PEAK PLATE CURRENT | 0.6 max. | Ampere |
| TUBE VOLTAGE DROP | 10 approx. | Volts |
| BULB (For dimensions, see page 56) | S-19 | |
| CAP (0.5" diameter, 0.5" length) | Medium Metal | |
| BASE (For socket connections, see page 56) | Medium 4-Pin Bayonet | |
| * Supply frequency up to 150 cycles. | | |
| ** Supply frequency up to 1000 cycles. | | |

INSTALLATION

The base pins of the 866-A fit the standard four-contact socket which should be installed to hold the tube in a vertical position with the base down. Base pins #1 and #4, until recently, have been connected together inside the base; likewise, pins #2 and #3. The connecting of filament pins #3 and #4 to pins #1 and #2 is being discontinued. Only a socket making very good filament contact and capable of carrying 5 amperes continuously should be used with the 866-A.

The bulb becomes hot during continuous operation. Sufficient ventilation should be provided to prevent overheating. For operating temperatures, refer to CHARACTERISTICS. When operated under load, the tube has a characteristic blue glow. In service the bulb will eventually darken. This blackening is normal and is not an indication of the end of tube life.

The coated filament is intended for a-c operation from a secondary winding of a power transformer. This winding, provided with a center-tap or center-tap resistor, should supply at the socket terminals the rated voltage of 2.5 volts under operating conditions. All connections in the filament circuit should be of low resistance and of adequate current-carrying capacity. Less than the recommended filament voltage may cause a high voltage drop with consequent bombardment of the filament and eventual loss of emission. The filament of the 866-A is partially shielded from the plate to permit operation from a power supply having a frequency as high as 1000 cycles.

The filament of the 866-A should be allowed to come up to operating temperature before the plate voltage is applied. For average conditions, the delay should be approximately 30 seconds for the stated temperature under CHARACTERISTICS. If there is any evidence of arc-back in the tube, the time delay should be increased. In radio transmitters during "standby" periods, the filament should be kept at its rated voltage to avoid delay in "coming back."

Caution should be observed when measuring filament voltage because the filament winding is at high potential.

When an 866-A is first placed in service, its filament should be operated at normal voltage for approximately 30 minutes without plate voltage in order to distribute the mercury properly. This procedure need not be repeated unless, during subsequent handling, the mercury is spattered onto the filament and plate.

Shields and r-f filter circuits should be provided for the 866-A if it is subjected to extraneous high-voltage or high-frequency fields when in operation. These fields tend to produce break-down effects in mercury vapor and are detrimental to tube life and performance. External shielding is employed when the tube is in proximity to high-voltage fields. R-f filters are employed to prevent damage caused by radio-frequency currents which might otherwise be fed back into the rectifier tubes.

APPLICATION

As a single-phase or multiphase rectifier, the 866-A should be operated under conditions such that the maximum rated values under CHARACTERISTICS are not exceeded. Maximum Peak Inverse Voltage* and Maximum Peak Plate Current** are the fundamental limitations in the operation of this tube.

Filter circuits of either the condenser-input or the choke-input type may be employed. If the condenser-input type of filter

* *Maximum peak inverse voltage* is the highest peak voltage that a rectifier tube can safely stand in the direction opposite to that in which it is designed to pass current. It is the safe arc-back limit with the tube operating within the specified temperature range. The relations between the peak inverse voltage, the d-c voltage, and the RMS value of a-c voltage, depend largely upon the individual characteristics of the rectifier circuit and the power supply. The presence of line surges, keying surges, or any other transient or wave form distortion may raise the actual peak voltage to a value which is higher than that calculated from sine wave voltages. Maximum rating of the tube always refers to the actual inverse voltage and not to calculated values. A cathode-ray oscillograph or a spark gap connected across the tube is useful in determining the actual peak inverse voltage. In single-phase, full-wave circuits, where no condenser is used across the output, the peak inverse voltage on a rectifier tube for sine-wave conditions is approximately 1.4 times the RMS value of the plate voltage applied to the tube. In polyphase circuits, the peak inverse voltage must be determined vectorially. In single-phase, half-wave circuits using condenser input-to-filter connections, the peak inverse voltage may be as high as 2.8 times the RMS value of the applied voltage.

** *Maximum peak plate current* is the highest peak current that a rectifier tube can safely stand in the direction in which it is designed to pass current. If a large choke is used in the filter circuit next to the rectifier tubes, the peak plate current is not much greater than the load current, but if a large condenser is used in the filter next to the rectifier tube, the peak current is often as much as four times the load current. In order to determine accurately the peak current in any circuit, the best procedure usually is to measure it with a form of peak meter or to use an oscillograph.

is used, special consideration must be given to the instantaneous peak value of the a-c input voltage (see Maximum Peak Inverse Voltage) which is about 1.4 times the RMS value as measured with an a-c voltmeter. It is important, therefore, that the filter condensers (especially the input condenser) have a sufficiently high breakdown rating to withstand this instantaneous peak value. With the condenser-input type of filter, the peak plate current of the tube is considerably higher than the load current. When choke input to the filter is used, the peak plate current is considerably reduced. This type of circuit is preferable from the standpoint of obtaining the maximum continuous d-c output current from the 866-A under the most favorable conditions.

Table II gives empirical values of choke inductance (L) and condenser capacity (C) for choke-input-to-filter circuits which will keep the peak plate current below the recommended maximum, provided the average d-c load current for any installation does not exceed the maximum load current figures given in the table. Values of (L) and (C) are based on a 60 cycle a-c voltage supply. It is important that a good quality input choke be used so that its inductance will not drop below the required minimum value under full load-current conditions.

The capacitance (C) given in the table is small enough to prevent excessive surges when power is first applied to the circuit, and yet large enough to give adequate filtering. If the inductance (L) is increased, it is permissible to increase the capacitance in the same proportion. In a two-section filter with two inductances of unequal value, the larger inductance should be placed next to the rectifier tubes. With such an arrangement, the maximum value of each capacitance should be determined on the basis of the value of the inductance preceding it.

The first three circuits (Figs. 4, 5, 6) of Table II will give a ripple voltage of less than 5% when used with a two-section filter having a minimum of inductance and the corresponding maximum of capacitance. For most purposes, this is adequate filtering. Similarly, the next two circuits (Figs. 7, 8) will give a ripple voltage of less than 1%. The last set of conditions in the table applies to a single-phase, full-wave system using two tubes with condenser input to the filter. It will be noted that the maximum d-c output voltage available at the filter is 25% higher than for the choke-input system (Fig. 4); but the permissible d-c load current is 45% less. Similarly, these same percentages will hold for the single-phase, full-wave system using four tubes (Fig. 5).

For any of these circuits, better filtering may be obtained with inductances larger than the minimum given in the table. For these larger inductances, the corresponding capacitances may be increased by the same percent as the inductances to give still better results. For example, with a 100% increase in the inductance (L) next to the rectifier tubes, the d-c load current may be increased by 50%. A 200% increase permits an increase of 67% in load current. The use of additional sections in the filter, of course, is another way of obtaining greater smoothing.

TABLE II

| CIRCUIT (See Page 60) | A-C INPUT VOLTS (RMS) | MAX. D-C OUTPUT VOLTS TO FILTER | CHOKE INPUT ONE-SECTION FILTER | | MAX. D-C LOAD CURRENT AMPERES |
|--|--------------------------|---|-----------------------------------|----------------------------------|--|
| | | | MIN. CHOKE (L) HENRYS | MAX. CON- DENSER (C) µf | |
| SINGLE-PHASE FULL-WAVE (2 Tubes-Fig. 4) | 3535 max. per tube | 3180 | 13.3 | 0.75 | 0.3 |
| | 3000 per tube | 2700 | 11.3 | 0.88 | 0.3 |
| | 2000 per tube | 1800 | 7.5 | 1.3 | 0.3 |
| | 1500 per tube | 1350 | 5.6 | 1.7 | 0.3 |
| SINGLE-PHASE FULL-WAVE (4 Tubes-Fig. 5) | 7070 max. total | 6360 | 26.6 | 0.37 | 0.3 |
| | 6000 total | 5400 | 22.6 | 0.44 | 0.3 |
| | 5000 total | 4500 | 18.8 | 0.53 | 0.3 |
| | 4000 total | 3600 | 15.0 | 0.66 | 0.3 |
| THREE-PHASE HALF-WAVE (3 Tubes-Fig. 6) | 4080 max. per leg | 4780 | 5.0 | 0.8 | 0.3 |
| | 3000 per leg | 3510 | 3.6 | 1.2 | 0.3 |
| | 2000 per leg | 2340 | 2.4 | 1.8 | 0.3 |
| | 1500 per leg | 1755 | 1.8 | 2.4 | 0.3 |
| THREE-PHASE PARALLEL DOUBLE Y (6 Tubes-Fig. 7) | 4080 max. per leg | 4780 | 2.5 | 0.4 | 1.2 |
| | 3000 per leg | 3510 | 1.8 | 0.6 | 1.2 |
| | 2000 per leg | 2340 | 1.2 | 0.9 | 1.2 |
| | 1500 per leg | 1755 | 0.9 | 1.2 | 1.2 |
| THREE-PHASE FULL-WAVE (6 Tubes-Fig. 8) | 4080 max. per leg | 9570 | 3.1 | 0.3 | 0.6 |
| | 3000 per leg | 7020 | 2.3 | 0.4 | 0.6 |
| | 2000 per leg | 4680 | 1.5 | 0.7 | 0.6 |
| | 1500 per leg | 3510 | 1.1 | 0.9 | 0.6 |
| SINGLE-PHASE PULL-WAVE (2 Tubes-Fig. 4) Condenser Input | 3535 max. per tube | 3950 | - | - | 0.166 |
| | 3000 per tube | 3390 | - | - | 0.166 |
| | 2000 per tube | 2260 | - | - | 0.166 |
| | 1500 per tube | 1700 | - | - | 0.166 |

* Table II has been calculated for a range of operating conditions not to exceed a maximum peak inverse voltage of 10000 volts. For a maximum peak inverse voltage rating of 5000 volts, the table can be utilized to establish a new range of values by multiplying the values of the a-c input voltage and the d-c output voltage by a factor of 0.5. Obviously, values of L and C, which were calculated for 60 cycles, do not apply to other frequencies.

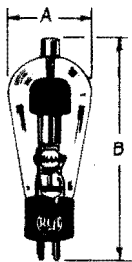

Overall Dimensions

A = 2-7/16" max.

B = 6-5/8" max.

Tube Symbol and Bottom View of Socket Connections

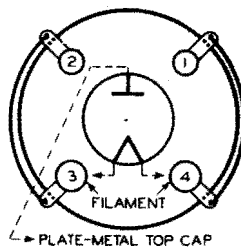



872/572 and 872-A

Half-Wave Mercury-Vapor Rectifiers

The RCA-872/572 and RCA-872-A are half-wave, mercury-vapor rectifier tubes of the hot-cathode type. They are intended for use in high-voltage devices designed to supply d-c power of uniform voltage. In single-phase circuits, full-wave rectification is accomplished by using two or four of these types. The major difference between the two tubes is the higher plate voltage rating of the 872-A. Other exceptions will be noted in the text.

CHARACTERISTICS

| | <u>872/572</u> | <u>872-A</u> | |
|--|-------------------|--------------|---------|
| FILAMENT VOLTAGE (A.C.) | 5.0 | 5.0 | Volts |
| FILAMENT CURRENT | 10 | 6.75* | Amperes |
| PEAK INVERSE VOLTAGE** | | | |
| Ambient temp. range 0°-50°C near base | 7500 max. | - | Volts |
| Ambient temp. range 15°-50°C near base | - | 10000 max. | Volts |
| Ambient temp. range 15°-60°C near base | - | 5000 max. | Volts |
| PEAK PLATE CURRENT (Maximum) | 2.5 | 2.5 | Amperes |
| TUBE VOLTAGE DROP (Approximate) | 15 | 10 | Volts |
| BULB | T-18 | T-18 | |
| CAP | Medium Metal | | |
| BASE# | Jumbo 4-Large Pin | | |

(For base connections and tube dimensions, see page 59)

* Filament transformer should be designed for 10 amperes per tube.

** Supply frequency up to 150 cycles.

Base shell is not connected to either filament lead within base.

INSTALLATION

The bases of the RCA-872/572 and RCA-872-A fit the standard, transmitting, four-contact socket, such as the RCA type UT-541. The sockets should be mounted so that the tubes will operate in a vertical position with the base end down.

The ambient temperature of the 872-A should be not less than 15°C (59°F) and not more than 50°C (122°F) to 60°C (140°F) depending upon the peak inverse voltage used. The ambient temperature of the 872/572 should not be less than 0°C and not more than 50°C. The ambient temperature is the temperature of the air which, coming into contact with the heated parts of the tube, carries off its heat. This temperature is to be measured by means of several thermometers placed at a distance of a few inches from the base. If the tube is used in a location where the circulation of air is restricted, the temperature should be taken adjacent to the filament base and with the thermometer shielded so that the effects of direct radiated heat are eliminated. If forced air cooling is used, the ambient temperature is to be measured by a thermometer in the cooling air stream before the air reaches the tube. The useful life of the tube may be seriously affected if these temperature ranges are not observed.

rigidly. Forced ventilation may be necessary to prevent exceeding the maximum allowable temperature under all conditions. In any case, adequate circulation of air is necessary and forced ventilation may be desirable from the standpoint of tube safety factor and life. When operated under load, the tubes have a characteristic blue glow. In service the bulbs will eventually darken. This darkening is normal and is not an indication of the end of tube life.

The coated *filaments* of these tubes are intended for a-c operation from a secondary winding of a power transformer. This winding, provided with a center-tap or center-tap resistor, should supply at the socket terminals the rated voltage of 5.0 volts under operating conditions. All connections in the filament circuit should be of low resistance and of adequate current-carrying capacity. Less than the recommended filament voltage may cause a high voltage drop with consequent bombardment of the filament and eventual loss of emission. The RCA-872-A differs from the RCA-872/572 in that its filament is partially shielded from the plate.

A filament voltmeter should be connected permanently across the filament circuit at the socket terminals so that the filament voltage can be maintained at 5.0 volts. *Caution should be observed when measuring filament voltage because the filament winding is at high potential.*

When an RCA-872/572 or RCA-872-A is first placed in service, its filament should be operated at normal voltage for approximately 15 minutes without plate voltage in order to distribute the mercury properly. This procedure need not be repeated unless, during subsequent handling, the mercury is again spattered on the filament, plate and top part of the bulb.

In radio transmitters during "standby" periods, the filaments should be kept at their rated voltage to avoid delay in "coming back." If this is not done, the filament should always be pre-heated for 30 seconds each time the plate voltage is applied.

Shields and r-f filter circuits should be provided for these tubes if they are subjected to extraneous high-voltage or high-frequency fields when in operation. These fields tend to produce breakdown effects in mercury vapor and are detrimental to tube life and performance. External shielding is employed when the tube is in proximity to high-voltage, high-frequency fields. R-f filters are employed to prevent damage caused by radio-frequency currents which might otherwise be fed back into the rectifier tubes.

APPLICATION

As single-phase or multi-phase rectifiers, the RCA-872/572 and RCA-872-A should be operated under conditions such that the maximum rated values under CHARACTERISTICS are not exceeded. Maximum Peak Inverse Voltage and Maximum Peak Plate Current are the fundamental limitations in the operation of the tubes. See definitions under RCA-866-A.

Rectifier circuits particularly suited for use with the 872/572 and 872-A are shown in Figs. 4 to 8, page 60. These circuits together with their safe maximum input and maximum output operating conditions, are classified in Table III, page 60.

Filter circuits of either the condenser-input or the choke-input type may be employed. If the condenser-input type of filter is used, special consideration must be given to the instantaneous peak value of the a-c input voltage (see Maximum Peak Inverse Voltage) which is about 1.4 times the RMS value as measured with an a-c voltmeter. It is important, therefore, that the filter condensers (especially the input condenser) have a sufficiently high breakdown-rating to withstand this instantaneous peak value. With the condenser-input type of filter, the peak plate current of the tube is considerably higher than the load current. When choke input to the filter is used, the peak plate current is considerably reduced. This type of circuit is preferable from the standpoint of obtaining the maximum continuous d-c output current from these tubes under the most favorable conditions.

The values given in Table III are based on the use of a suitable choke preceding any condenser in the filter circuit. If the choke is not used, the tabulated d-c output current values cannot be obtained without exceeding the peak current rating of the tubes. In the case of the double Y circuit (Fig. 7), the inter-phase reactor itself acts as a choke. Each tabulated value of d-c voltage is the effective d-c output voltage from the rectifier, and any drop in the filter, therefore, must be subtracted from the value given, in order to obtain the available output. Owing to the low tube voltage drop of approximately 10 to 15 volts, the only reduction in rectified voltage when the load is increased, is due to the drop in the transformer and filter windings. In the case of the three-phase full-wave (Fig. 8) and single-phase full-wave (Fig. 5) circuits, two 872/572's, or two 872-A's, are used in series. These two circuits are desirable where higher d-c voltages are required. In the three-phase full-wave circuit, six-phase wave form is obtained.

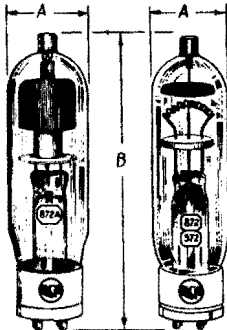

Overall Dimensions

A = 2-5/16" max.

B = 8-1/2" max.

Tube Symbol and Top View of Socket Connections

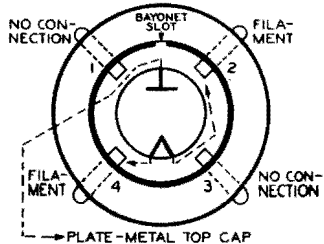

TABLE III

| CIRCUIT | A-C INPUT VOLTS (RMS) | | APPROX. D-C OUTPUT VOLTS TO FILTER | | MAX. D-C LOAD CURRENT AMPERES |
|---|-----------------------|--------------------|------------------------------------|--------|-------------------------------|
| | 872/572 | 872-A* | 872/572 | 872-A* | 872/572 and 872-A |
| SINGLE-PHASE FULL-WAVE RECTIFIER (2 Tubes-Fig. 4) | 2650 max. per tube | 3835 max. per tube | 2300 | 3180 | 1.6 |
| SINGLE-PHASE FULL-WAVE (4 Tubes-Fig. 5) | 5300 max. total | 7070 max. total | 4750 | 6360 | 1.6 |
| THREE-PHASE HALF-WAVE (3 Tubes-Fig. 6) | 3050 max. per leg | 4080 max. per leg | 3500 | 4780 | 2.1 |
| THREE-PHASE DOUBLE Y PARALLEL (6 Tubes-Fig. 7) | 3050 max. per leg | 4080 max. per leg | 3500 | 4780 | 5.0 |
| THREE-PHASE FULL-WAVE (6 Tubes-Fig. 8) | 3050 max. per leg | 4080 max. per leg | 7000 | 9570 | 2.5 |

* For 5000-volt rating, these values should be reduced to one-half.

SINGLE PHASE FULL-WAVE RECTIFIER CIRCUIT (TWO TUBES)

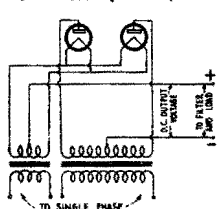

Fig. 4

SINGLE PHASE FULL-WAVE RECTIFIER CIRCUIT (FOUR TUBES)

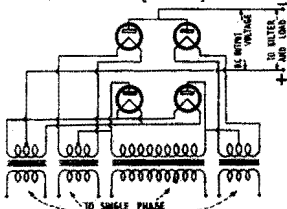

Fig. 5

THREE PHASE HALF-WAVE RECTIFIER CIRCUIT

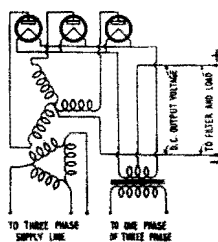

Fig. 6

THREE PHASE HALF WAVE DOUBLE Y (INTERCONNECTED) RECTIFIER CIRCUIT.

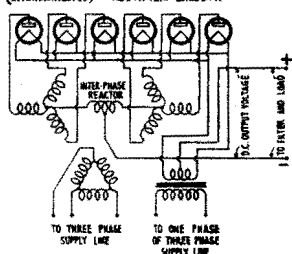

Fig. 7

THREE PHASE FULL-WAVE RECTIFIER CIRCUIT

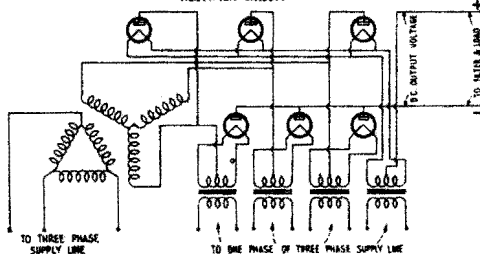

Fig. 8



954

Detector, Amplifier Pentode

The 954 is a heater-cathode type of pentode designed primarily for radio amateurs and experimenters working with wavelengths as short as 0.7 meter. As an r-f amplifier at a wavelength of one meter, the 954 is capable of gains of three or more in circuits of conventional design. Higher gains are, of course, attainable at longer wavelengths. Operation at short wavelengths is made possible by means of unconventional tube structure having small size, close electrode spacing, and short terminal connections.

TENTATIVE CHARACTERISTICS

| | | |
|---|-------------------|----------------|
| HEATER VOLTAGE (A.C. or D.C.) | 6.3 | Volts |
| HEATER CURRENT | 0.15 | Ampere |
| DIRECT INTERELECTRODE CAPACITANCES: | | |
| Grid-to-Plate (with shield baffle) | 0.007 <i>max.</i> | μpf |
| Input | 3 | μpf |
| Output | 3 | μpf |
| BULB (For dimensions, see page 7) | J-4 | |
| TERMINAL MOUNTING (For connections, see page 7) | Special | |

MAXIMUM RATINGS and TYPICAL OPERATING CONDITIONS

As an R-F or A-F Amplifier - Class A

| | | |
|--|--------------------------------|--------------------------|
| D-C PLATE VOLTAGE | 250 <i>max.</i> | Volts |
| D-C SCREEN (Grid No.2) VOLTAGE | 100 <i>max.</i> | Volts |
| D-C SUPPRESSOR (Grid No.3) VOLTAGE | 100 <i>max.</i> | Volts |
| TYPICAL OPERATION AND CHARACTERISTICS: | | |
| D-C Plate Voltage | 90 | 250 Volts |
| D-C Screen Voltage | 90 | 100 Volts |
| D-C Grid Voltage | -3 | -3 Volts |
| Suppressor | Connected to cathode at socket | |
| Plate Current | 1.2 | 2.0 Milliamperes |
| Screen Current | 0.5 | 0.7 Milliamperes |
| Amplification Factor | 1100 | Greater than 2000 |
| Plate Resistance | 1.0 | Greater than 1.5 Megohms |
| Mutual Conductance | 1100 | 1400 Micromhos |

As Detector

| | | |
|---------------------------------------|--------------------------------|-------|
| D-C PLATE VOLTAGE | 250 <i>max.</i> | Volts |
| D-C SCREEN (Grid No.2) VOLTAGE | 100 <i>max.</i> | Volts |
| D-C SUPPRESSOR (Grid No.3) VOLTAGE | 100 <i>max.</i> | Volts |
| TYPICAL OPERATION AS BIASED DETECTOR: | | |
| D-C Plate-Supply Voltage | 250 | Volts |
| D-C Screen Voltage | 100 | Volts |
| D-C Grid Voltage (approx.) | -6 | Volts |
| Suppressor | Connected to cathode at socket | |

shield in the control-grid end of the tube. It may be desirable, depending upon circuit requirements, to provide a small collar on the baffle hole in order to increase the shielding effect.

R-f grounding by means of condensers placed close to the tube terminals is required if the full capabilities of the 954 are to be realized at the ultra-high frequencies. Conventional by-passing methods and grounding are not adequate. One convenient method is to use ribbon lead-ins to the clips and to insulate the ribbon lead-ins and the terminal clips from the grounding plate by mica spacers to form by-pass condensers right at the tube terminals. It is important in the cases of the plate and control-grid circuits that separate r-f grounding returns be made to a common point in order to avoid r-f interaction through common return circuits. It may also be advisable in some applications to supplement the action of the by-pass condensers by r-f chokes placed close to the condensers in the return or supply lead for the control-grid, the screen, the suppressor, the plate, and the heater.

APPLICATION

As an *amplifier*, the 954 is applicable to the audio- or the radio-frequency stages of short-wave receivers, especially those operating at wavelengths as short as 0.7 meter. Typical operating conditions for this service are given under MAXIMUM RATINGS and TYPICAL OPERATING CONDITIONS.

For a-f amplifier circuits, typical operating conditions are as follows: Plate-supply voltage, 250 volts; screen voltage, 50 volts; grid voltage, -2.1 volts; suppressor, connected to cathode at socket; plate-load resistor, 250000 ohms; and plate current, 0.5 milliampere. The grid resistor may be made as high as 1.0 megohm. Under these conditions, an undistorted voltage output of 40 to 50 volts RMS may be obtained. The voltage amplification is approximately 100.

As a *grid-bias detector*, the 954 may be operated under the conditions given under MAXIMUM RATINGS and TYPICAL OPERATING CONDITIONS. The grid bias may be supplied from the voltage drop in a resistor between cathode and ground. The value of this resistor is not critical, 20000 to 50000 ohms being suitable.

For *miscellaneous applications* in the laboratory, the 954 offers important features. For instance, its small size permits the design of vacuum-tube voltmeters such that the tube itself can be placed at the point of measurement. Thus, long leads and high input capacitances are avoided with the desirable result that measurements can be made at radio frequencies with a minimum effect on the constants of the circuit under measurement.

AVERAGE PLATE CHARACTERISTICS
PENTODE CONNECTION

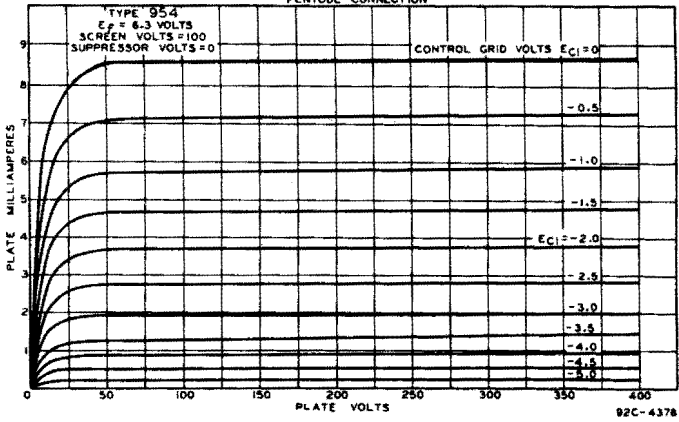

AVERAGE CHARACTERISTICS
PENTODE CONNECTION

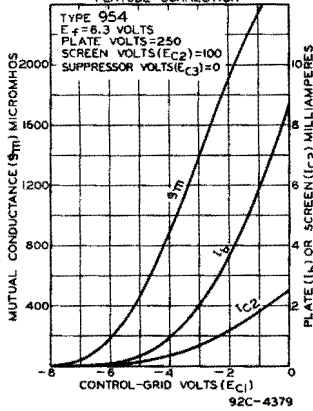

AVERAGE CHARACTERISTICS
PENTODE CONNECTION

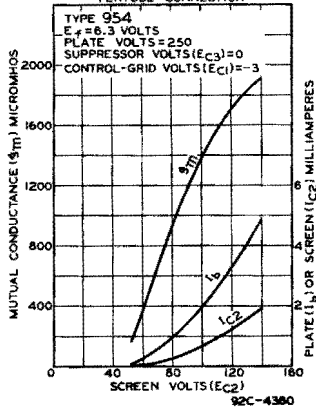

TYPICAL R-F AMPLIFIER CIRCUIT

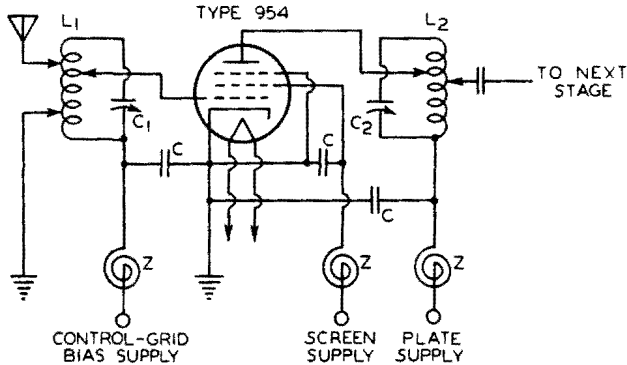

| WAVE-LENGTH RANGE | 2.75 TO 5.3 METERS APPROX. | 1 TO 3 METERS APPROX. | 0.8 METER APPROX. |
|---|-------------------------------|-------------------------------|-------------------------------|
| L_1, L_2 { TURNS WIRE OUTSIDE DIA. LENGTH | 10 No 16 B.C.* | 4 No 16 B.C.* | 5 No 30 B.C.* |
| C_1, C_2 (VARIABLE) | 3 TO 25 μmf | 3 TO 25 μmf | 3 TO 4 μmf |
| C | 100 TO 500 μmf | 100 TO 500 μmf | 100 TO 500 μmf |
| Z { TURNS WIRE OUTSIDE DIA. WINDING | 15 No 30 1/4" S.L. □ | 15 No 30 1/4" S.L. □ | 15 No 30 1/4" S.L. □ |

*B.C.= BARE COPPER

□ S.L.= SINGLE LAYER

NOTE: THE ABOVE DATA ARE NECESSARILY APPROXIMATE FOR ULTRA-HIGH FREQUENCIES, COILS L_1 AND L_2 MAY BE TAPPED AT SUITABLE POINTS DETERMINED BY TEST TO REDUCE EFFECT OF TUBE LOADING ON CIRCUIT IMPEDANCES. SINCE ELECTRONIC PLATE LOADING IS NOT SERIOUS IN A PENTODE, THE USE OF COIL L_2 WITH TAPPED PLATE CONNECTION MAY NOT BE NECESSARY TO GIVE SATISFACTORY RESULTS. THE CONDENSERS SHOULD ALL BE OF HIGH QUALITY AND BE DESIGNED FOR ULTRA-HIGH FREQUENCY OPERATION.

The license extended to the purchaser of tubes appears in the License Notice accompanying them. Information contained herein is furnished without assuming any obligations.

TYPICAL TUBE-VOLTMETER CIRCUIT
SPECIALLY ADAPTED FOR PROBE ARRANGEMENT

TYPE 954 (AS TRIODE)

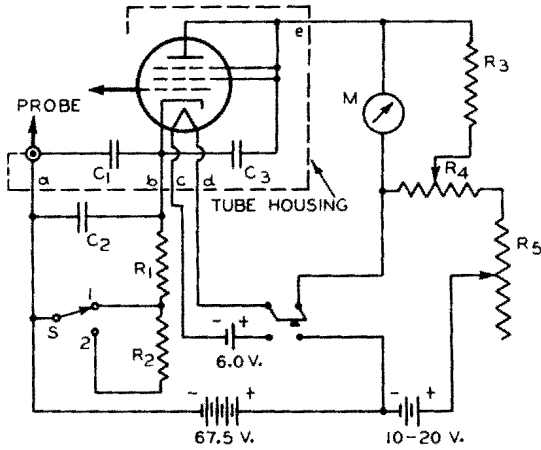

- $C_1 = 500 \mu\mu f$ CONDENSER (MICA) $R_4 = 40000$ -OHM POTENTIOMETER
 $C_2 = 16 \mu f$ COND. FOR CALIBRATION WITH AND MEASUREMENT OF LOW FREQUENCIES FOR COARSE ADJUSTMENT IN BALANCING OUT PLATE CURRENT
 $C_3 = 500 \mu\mu f$ CONDENSER (MICA) $R_5 = 2000$ -OHM RES. (VARIABLE)
 $M =$ MICROAMMETER (50 OHMS APPROX.) $\left. \begin{array}{l} \text{ON POSITION 1 GIVES RANGE} \\ \text{OF 2 VOLTS RMS} \\ \text{ON POSITION 2 GIVES RANGE} \\ \text{OF 14 VOLTS RMS} \end{array} \right\}$
 $R_1 = 2000$ -OHM RES. (WIRE WOUND)
 $R_2 = 50000$ -OHM RES. (WIRE WOUND)
 $R_3 = 10000$ -OHM RES. (WIRE WOUND)
- NOTE: LEADS b, c, d AND e RETURN INSIDE CABLE. LEAD a IS CONNECTED TO GROUNDED HOUSING.

CONSTRUCTION OF PROBE

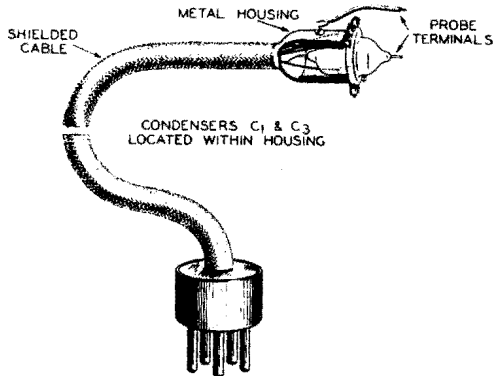

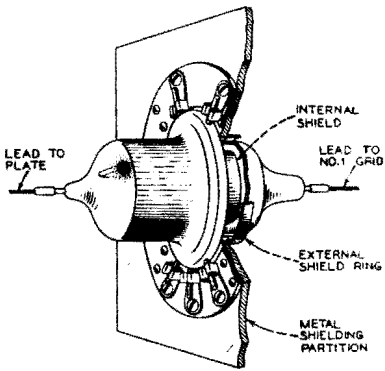
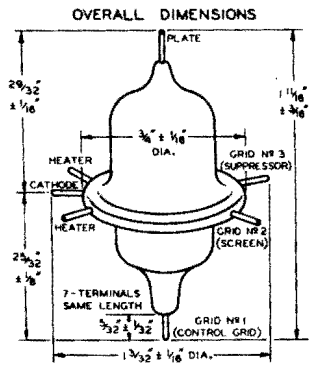

TERMINAL MOUNTING TEMPLATE
TOP VIEW

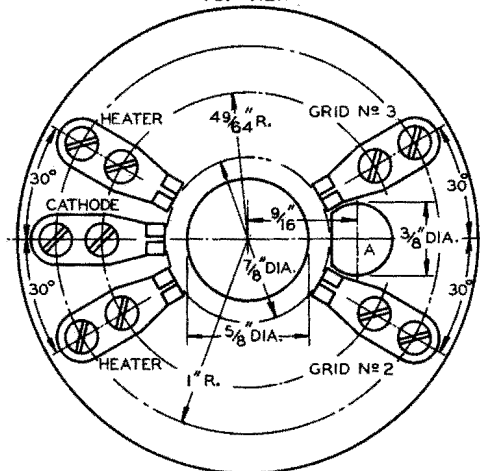

A = ALIGNMENT PLUG $\frac{1}{4}$ " HIGH

NOTE: INSERT TUBE IN CLIPS SO THAT SHORT END OF TUBE RESTS IN THE MOUNTING HOLE





955

Detector, Amplifier, Oscillator
(Acorn Type)

The 955 is a heater type of triode designed primarily for radio amateurs and experimenters working with wavelengths between 0.5 meter and 5 meters. Operation at these short wavelengths is made possible by means of an unconventional tube structure having small size, close electrode spacing, and short terminal connections.

TENTATIVE CHARACTERISTICS

| | | |
|-----------------------------------|---------|--------|
| HEATER VOLTAGE (A.C. or D.C.) | 6.3 | Volts |
| HEATER CURRENT | 0.16 | Ampere |
| AMPLIFICATION FACTOR | 25 | |
| GRID-PLATE CAPACITANCE | 1.4 | μf |
| GRID-CATHODE CAPACITANCE | 1.0 | μf |
| PLATE-CATHODE CAPACITANCE | 0.6 | μf |
| BULB (For dimensions, see page 4) | J-4 | |
| TERMINAL MOUNTING (See page 4) | Special | |

MAXIMUM RATINGS and TYPICAL OPERATING CONDITIONS

As R-F or A-F Amplifier - Class A

| | | | | |
|--------------------|-------|-------|----------|--------------|
| PLATE VOLTAGE | | | 180 max. | Volts |
| TYPICAL OPERATION: | | | | |
| Heater Voltage | | | 6.3 | Volts |
| Plate Voltage | 90 | 135 | 180 | Volts |
| Grid Voltage* | -2.5 | -3.75 | -5 | Volts |
| Plate Current | 2.5 | 3.5 | 4.5 | Milliamperes |
| Plate Resistance | 14700 | 13200 | 12500 | Ohms |
| Mutual Conductance | 1700 | 1900 | 2000 | Micromhos |
| Load Resistance | - | - | 20000 | Ohms |
| U. P. O. | - | - | 135 | Milliwatts |

* The d-c resistance in the grid circuit should not exceed 0.5 megohm.

As R-F Power Amplifier and Oscillator - Class C

(Plate Modulated or C.W.)

| | | | | |
|--------------------------------|--|--|----------|--------------|
| D-C PLATE VOLTAGE | | | 180 max. | Volts |
| D-C PLATE CURRENT | | | 8 max. | Milliamperes |
| D-C GRID CURRENT | | | 2 max. | Milliamperes |
| TYPICAL OPERATION: | | | | |
| Heater Voltage | | | 6.3 | Volts |
| D-C Plate Voltage | | | 180 | Volts |
| Grid Voltage (Approximate) | | | -35 | Volts |
| D-C Plate Current | | | 7 | Milliamperes |
| D-C Grid Current (Approximate) | | | 1.5 | Milliamperes |
| Power Output (Approximate)** | | | 0.5 | Watt |

**At 5 meters. Only moderate reduction in this value will be found for wavelengths as low as 1 meter. Below 1 meter, the power output decreases as the wavelength is decreased.

INSTALLATION

The *terminals* of the 955 require a special method of mounting by means of clips supplied with each tube. The clips may be fastened to a supporting insulator of glass, mica, or other suitable low-loss material, but for minimum losses, it is desirable to clip circuit parts directly to the grid terminal and to the plate terminal. Since the tube terminals are located asymmetrically, a stop of insulating material should be placed between the grid and plate terminals so that the cathode terminal will prevent insertion of the heater terminals in the grid and plate clips. This stop is identified on the Terminal Mounting Template (page 4) as Alignment Plug. *Do not attempt to solder connections to the terminals.* The heat of the soldering operation is almost certain to crack the bulb seal.

The *heater* is designed to operate on either a.c. or d.c. When a.c. is used, the winding which supplies the heater circuit should operate the heater at its recommended value for full-load operating conditions at average line voltage. When d.c. is used on the heater, the heater terminals should be connected directly across a 6-volt battery. Under any condition of operation, the heater voltage should not deviate more than plus or minus 10% from the normal value of 6.3 volts. Series operation of the 955 is not recommended.

The *cathode* of the 955 operated from a transformer, should preferably be connected directly to the electrical mid-point of the heater circuit. In the case of d-c operation from a 6-volt storage battery, the cathode circuit is tied in either directly or through bias resistors to the negative battery terminal. In circuits where the cathode is not directly connected to the heater, the potential difference between them should be kept as low as possible. If the use of a large resistor is necessary between heater and cathode in some circuit designs, it is essential that this resistor be by-passed by a suitable filter network or objectional hum may develop.

R-F grounding by means of condensers placed close to the tube terminals is required if the full capabilities of the 955 for ultra-high-frequency uses are to be obtained. Conventional by-passing methods and grounding, such as are employed in broadcast receivers, are not adequate. The grounding plate of the chassis should be of heavy copper. Figure 3 illustrates one form of by-passing where the ribbon leads to the terminal clips are insulated from the grounding plate by mica spacers to form r-f by-pass condensers right at the tube terminals.

APPLICATION

As an *amplifier*, the 955 is applicable to the audio- or the radio-frequency stages of short-wave receivers, especially those operating in the band between 0.5 meter and 5 meters. Typical operating conditions for this service are given under the corresponding heading on page 4.

For a-f amplifier circuits utilizing resistance coupling, typical operating conditions are as follows: Plate-supply voltage, 180

volts; grid-bias voltage, -3.5 volts; plate-load resistor, 250000 ohms; and plate current, 0.42 milliamperes. The grid resistor may be made as high as 0.5 megohm. With these values, an undistorted voltage output of 45 volts RMS may be obtained. The voltage amplification is approximately 20.

As a detector, the 955 may be of the grid-leak-and-condenser type or of the grid-bias type. The plate voltage for the grid-leak-and-condenser method should be about 45 volts. A grid leak of from 1 to 5 megohms with a condenser of 0.00025 μf is satisfactory. For the grid-bias method of detection, a plate-supply voltage of 180 volts may be used together with a negative grid-bias voltage of approximately -7 volts. The plate current should be adjusted to a little less than 0.2 milliampere with no input signal voltage. The grid-bias voltage may be supplied from the voltage drop in a resistor between cathode and ground. The value of this self-biasing resistor is not critical, 50000 ohms being suitable.

As an oscillator or r-f power amplifier (Class C), the 955 should be operated as shown under MAXIMUM RATINGS and TYPICAL OPERATING CONDITIONS. Typical oscillator circuits are shown in Figures 1 and 2. When bias is obtained by means of a grid resistor, a value of 20000 to 25000 ohms may be used. The use of a choke in series with this resistor is required in single-tube oscillator circuits to increase the r-f impedance of the input circuit. In push-pull oscillator circuits, the choke is not required.

In miscellaneous applications in the laboratory, such as vacuum-tube voltmeters, the 955 because of its small size, can be placed at the point of measurement. This feature, combined with that of low input capacitance, makes possible vacuum-tube voltmeter measurements with a minimum effect on the constants of the circuit under measurement.

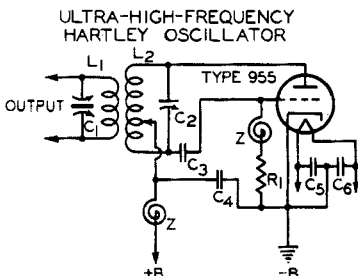

L_1, C_1, L_2, C_2 = DEPEND ON FREQUENCY RANGE DESIRED
 C_3 = 0.00005 μf
 C_4, C_5, C_6 = 0.0001 μf
 R_1 = 20 000 TO 25 000 OHMS, $\frac{1}{2}$ WATT

FIG. 1

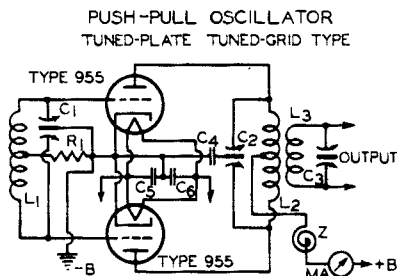

$L_1, C_1, L_2, C_2, L_3, C_3$ = DEPEND ON FREQUENCY RANGE DESIRED
 C_4, C_5, C_6 = 0.0001 μf
 R_1 = 10 000 TO 12 500 OHMS, $\frac{1}{2}$ WATT

FIG. 2

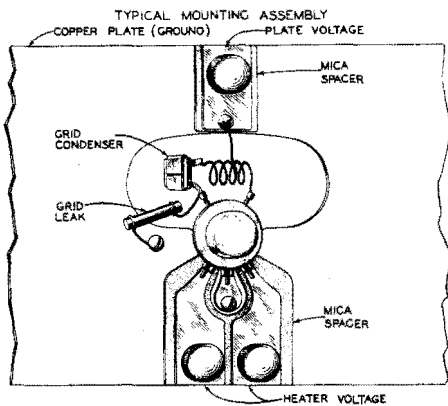
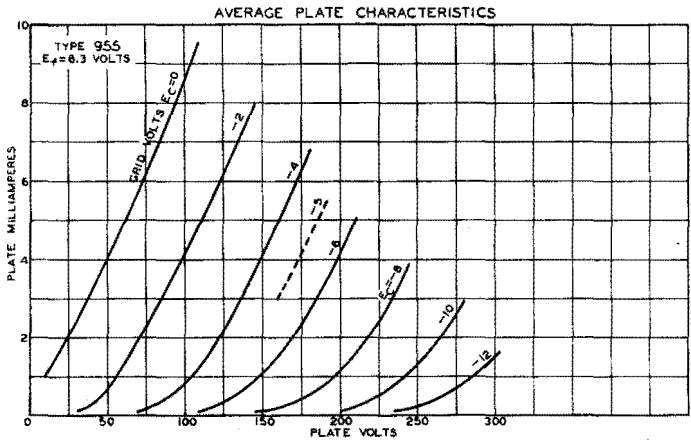
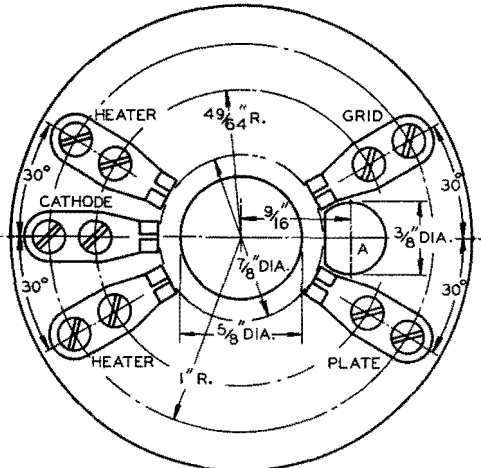
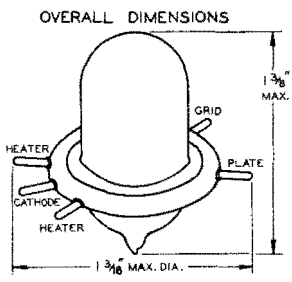

FIG. 3



TERMINAL MOUNTING TEMPLATE
TOP VIEW



A = ALIGNMENT PLUG $\frac{1}{4}$ " HIGH
 NOTE: INSERT TUBE IN CLIPS SO THAT SHORT TIPPED
 END OF THE BULB RESTS IN THE MOUNTING HOLE

ADDITIONAL RCA DeFOREST TUBES FOR AMATEUR RADIO USE

RCA-831 is a high-power 3-electrode tube designed for use as an oscillator and r-f amplifier, particularly at frequencies above 3000 kc. Filament volts, 11.0. Normal plate volts, 3000. Power Output (Class C), 500 watts.

RCA-843 is a 3-electrode, low-power tube of the heater-cathode type similar in characteristics to RCA-10. It is for use as an oscillator, a-f amplifier, and r-f amplifier. Heater volts, 2.5. Power Output (Class C), 5 watts.

RCA-844 is a screen-grid, low-power tube of the heater-cathode type, similar in characteristics to RCA-865/565. It is for use as a radio-frequency amplifier, particularly at frequencies above 3000 kc. Heater volts, 2.5. Power Output (Class C), 5 watts.

RCA-850 is a screen grid tube of the medium power type for use as a radio-frequency amplifier. Filament volts, 10. Plate volts, 1000. Power Output (Class C), 100 watts.

RCA-851/551 is a general purpose, high-power tube of the 3-electrode type especially suited as a modulator and audio-frequency amplifier or as a radio-frequency power amplifier. Filament volts, 11.0. Oscillator input per modulator tube, 400 watts. (Plate volts, 2000; modulation factor, 0.6).

RCA-861/561 is a high-power tube of the screen grid type designed for use as a radio-frequency amplifier. It is particularly useful at frequencies above 3000 kc. Filament volts, 11.0. Normal plate volts, 3000. Power Output (Class C), 500 watts.

RCA-878 is a high-vacuum, half-wave rectifier of the hot-cathode type for use in suitable devices to supply the d-c voltage requirements of cathode-ray tubes. Filament volts, 2.5. Maximum peak inverse volts, 20000. Maximum peak plate current, 20 milliamperes.

RCA-885 is a grid-controlled, gaseous-discharge tube of the heater-cathode type. It is designed for use as a sweep-circuit oscillator in cathode-ray tube circuits. Heater volts, 2.5. Maximum peak plate volts, 200. Maximum peak plate current, 300 milliamperes.

RCA-904, RCA-905, and RCA-906 are cathode-ray tubes with fluorescent viewing screens, having diameters of 5", 5", and 3", respectively. These tubes are recommended for use in oscillograph applications and, in such service, are especially useful for monitoring amateur radio transmitters.

Additional technical information on these types, or receiving types, may be obtained by writing to

COMMERCIAL ENGINEERING SECTION
RCA RADIOTRON DIVISION RCA MANUFACTURING CO., INC.
HARRISON, N.J.

