

6

(3) clear

# RCA

**an historical  
perspective**



## Introduction

RCA today is among the nation's largest industrial corporations, and one of the most broadly based enterprises in the field of electronics. In achieving this position, it has pioneered in the development of an art and industry which have compressed within a brief span of years a degree of business growth and technical progress that seldom is achieved in less than a century.

The history of RCA is an account of dynamic industrial growth. Among the forces responsible for this achievement have been the leadership and vision of David Sarnoff, and the outstanding array of research, engineering, production, and marketing talents which have thrived in the technical and business environment which he and his colleagues have done so much to foster and maintain through the years.

The first article was written almost 40 years ago. So rapid has been the evolution of both RCA and the electronics industry that many of the events described read like ancient history. Even the trade names familiar to a large public in the 1920s have vanished almost beyond recollection today. Very few will recall, for example, the Graphanola, a popular phonograph produced by the Columbia Talking Machine Company around 1922. In 1938, television was still a daring experiment, the ultra-high frequencies were in their infancy, and the vast area of solid-state electronics was yet to be opened.

The author, John Chester Warner, was an intimate part of the scene which he describes. Through the 1920s, Warner had been associated closely with receiving tube research at the General Electric Company in Schenectady. In 1932, following the separation of RCA from the General Electric and Westinghouse Companies, he was appointed Manager of Research and Development at the RCA Radiotron Company in Harrison, N.J. He was named Vice President of Radiotron in 1934, a year before the organization became the Radiotron Division of the new RCA Manufacturing Company. In the same year in which the article was written he met a tragic and untimely death in an automobile accident at the age of 42.

The author of the three subsequent articles was uniquely qualified to chronicle the further development of RCA. Before his retirement in 1969 after more than 45 years as an RCA employee, Dr. Elmer William Engstrom held several important executive assignments, and directed most of RCA's principal research and engineering programs through three decades to the early 1960s.

During the 1930s, Dr. Engstrom directed the research and development program which transformed television from a series of experiments into a practical service. In 1942, he became Director of General Research and subsequently Director of Research at the newly organized RCA Laboratories in Princeton, N.J. Elevated to a vice presidency in 1945, he entered upon a series of increasingly responsible executive assignments extending to all of the technical activities of the Corporation, becoming, successively, Executive Vice President, Research and Engineering, and Senior Executive Vice President of RCA. On December 1, 1961, Dr. Engstrom was named President of RCA, serving until January 1, 1966, when he was appointed Chairman of the Executive Committee of the Board until his retirement.

Dr. James Hillier, author of the latest two installments was likewise an intimate part of the scene he describes. As Executive Vice President, Research and Engineering, he was responsible for research and development throughout the Corporation. He first came into prominence for his contributions to the development of the electron microscope and for his subsequent role in encouraging the growth of electron microscopy as a research technique.

Dr. Hillier joined RCA as a research physicist in 1940. In 1957 he was appointed General Manager of RCA Laboratories and a year later was elected Vice President. He was named Vice President, RCA Research and Engineering in 1968 and in 1969 was appointed Executive Vice President, Research and Engineering. From 1976 till his retirement in September 1977 he was Vice President and Senior Scientist.

*The Editors*

# an historical perspective

## contents

### **Part I—The years to 1938** by J.C. Warner

*Branching out from telecommunications, RCA quickly diversified into broadcasting, radio receivers, and photographs—manufacturing and merchandising many of its own products.* 2

### **Part II—The years 1938—1958** by E.W. Engstrom

*RCA emerges from World War II with a new range of skills. But television is the major RCA development of this era.* 10

### **Part III—The years 1958—1962** by E. W. Engstrom

*The boom in color television, along with a constant progression of new and electronic products, ranging from microcircuits to space systems, characterized these years.* 17

### **Part IV—The years 1962—1966** by E.W. Engstrom

*Vigorous growth and an outward thrust took the company into such new areas of business as publishing, graphic arts, education, medical electronics, and car rentals.* 23

### **Part V—The years 1966—1971** by J. Hillier

*RCA met the challenge of changing market conditions by a program of diversification and emerged as a multinational company with worldwide industrial involvement.* 29

### **Part VI—The years 1971—1976** by J. Hillier

*No other period since the Great Depression affected RCA as severely as the recession of 1974-1975. Despite this, the company emerged at the end of 1976 leaner, stronger, and continuing to grow.* 36

# Part I —The years to 1938

J.C. Warner

*Branching out from telecommunications, RCA quickly diversified into broadcasting, radio receivers, and phonographs—manufacturing and merchandising many of its own products.*

It would be misleading for me to imply that anything approaching a complete history of the Radio Corporation of America could be covered in the brief time which we can spend together. While the company is only a little over 18 years old several volumes would be required to do a really thorough job. However, I shall try to review some of the high points in the history of the company, and to cite the progressive changes in organization and their relation to the progress of the company in radio and allied fields.

It has often been said that "the story of the Radio Corporation of America outlines the larger story of the radio era," i.e. the era of radio broadcasting. Peculiarly enough the company was not organized with radio broadcasting in mind, although it is significant that the man whose name is so closely associated with the history of RCA and who has for many years been its active head, had clearly visualized the possibilities of radio broadcasting service and even "electric tuning" long before broadcasting made its first appearance. I refer, of course, to Mr. David Sarnoff.

## Radio—a new communications service

At the close of the war the only company in a position to handle commercial transatlantic radio communications was the Marconi Wireless Telegraph Company of America, although the stations which it had operated before the war were in the hands of the Government who had taken over all such stations for wartime purposes. This company was an offshoot of the British Marconi Co. and was largely owned by English interests.

At this time the best known means of long-distance transmission was the Alexanderson high-frequency alternator, the patents on which were owned by the General Electric Company. Negotiations between General Electric and the American Marconi Company, which had started several years previous, but had been interrupted by the war were resumed in 1919 for the purpose of transferring patent rights as well as alternators to the Marconi Company which was anxious to expand its transatlantic services.



Send the following message "VIA MARCONI", subject to the terms on back hereof, which are hereby agreed to. } NEW YORK, MARCH 1st, 1920

GODFREY C. ISAACS,  
MANAGING DIRECTOR,  
MARCONI'S WIRELESS TELEGRAPH COMPANY LIMITED  
LONDON.

MAY THIS FIRST MESSAGE WHICH OPENS COMMERCIAL WIRELESS SERVICE BETWEEN AMERICA AND ENGLAND MARK AN EPOCH IN HISTORY FROM WHICH THE ACHIEVEMENTS OF THE FUTURE SHALL DATE. COMMUNICATION IS THE LEVERAGE WHICH SHALL LIFT THE WORLD TO BETTER UNDERSTANDING AND THUS LEAD TO CLOSER TIES OF FRIENDSHIP BETWEEN ALL NATIONS. IT IS THE MISSION OF OUR RESPECTIVE COMPANIES TO SO STRENGTHEN AND IMPROVE THE WIRELESS SERVICE THAT DISTANCE SHALL BE MADE NEGLIGIBLE AND COMMUNICATION PRACTICALLY INSTANTANEOUS.

BE 11/2.01 Am Edward S. Kelly  
M.A. President, R.C.A.

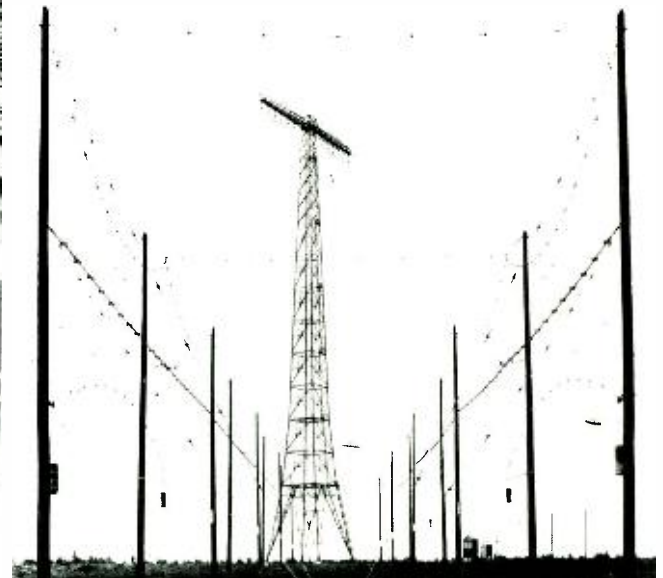
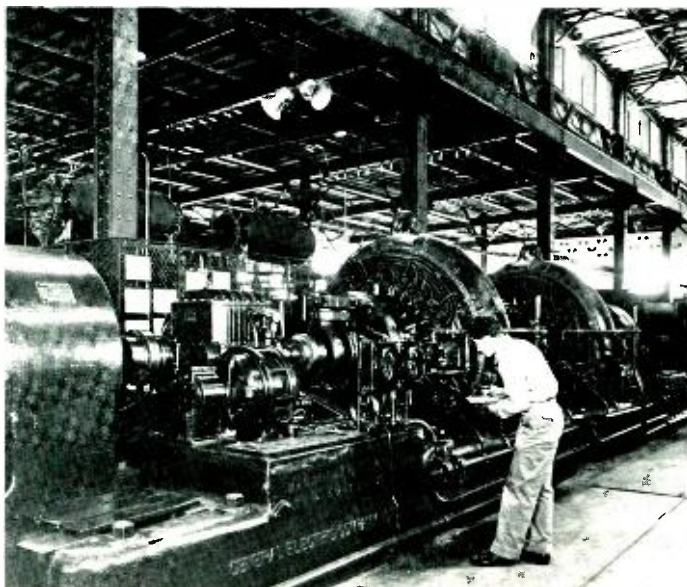



Certain high officials of the Government learned of these negotiations and were unwilling to see a growing communications service under foreign control, particularly since the transatlantic cables were in the hands of foreign, though friendly, nations. Consequently they suggested to the General Electric Company that negotiations be suspended until after discussion with the Navy Department. This was in April 1919 and it is interesting to note that the letter to the General Electric Company was written by Mr. Franklin D. Roosevelt, then Acting Secretary of the Navy.

## Formation of RCA

As a result of conferences with the Navy a plan was developed for forming a new American company to take over the assets of the American Marconi Company. So, on October 17, 1919, the Radio Corporation of America was incorporated, and on November 20, 1919 the entire business of the Marconi Company was taken over.

GE held a substantial interest in the new company, and immediate arrangements were made between RCA and GE to cross-license each other to use the radio patents of the GE Company and the patents RCA had just acquired from Marconi. Work was started at once on new high-power alternator stations in California, Massachusetts and Hawaii.



But another patent deadlock soon appeared particularly with respect to vacuum tubes. The possibilities of long-distance shortwave communications were unknown at this time. In fact, wavelengths under 200 meters were relegated to the supposedly unimportant use of amateurs. But, tube transmitters were needed for medium-power services and, of course, tube receivers were essential.

Strong patents on vacuum tubes were held by both GE and the Western Electric Company, but neither could make effective use of its own patents without infringement of the other's. Again the Navy lent a hand and persuaded the GE Company and AT&T Company to come to an understanding "for the good of the public." This was in January 1920.

## Transoceanic service begins

In February 1920, the stations which had been taken over from the Marconi Company by the Government during the war were turned back to the new RCA, and a foreign communications service was inaugurated. One of the principal stations was in New Brunswick, N.J., and the long-wave antenna there has no doubt been seen by a great many of you. During that year, foreign service was established with England, Germany, France, Norway, Japan, and Hawaii.

In July 1920 an agreement was reached between RCA, GE, and AT&T which permitted RCA to proceed with the use of all radio patents of these companies.

## Beginning of broadcasting

During the first year of the RCA attention was directed almost exclusively on communications, but in 1921 the first rumblings of what soon was to become a broadcasting boom began to be heard. A number of experimenters had been playing with the idea of transmitting phonograph music over somewhat crude telephone transmitters.

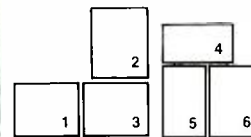

1 Alexanderson high-speed alternators like these at RCA's Rocky Point, Long Island, transmitting station once carried the entire load of overseas radio traffic. 2 Copy of first commercial wireless service message between the United States and England. 3 RCA Radio Central towers at Rocky Point, in the early 1920s. 4 In 1919, the first RCA laboratory was started in this tent, at Rocky Point. 5 Old RCA building at 66 Broad Street, New York City. 6 Chief Officer Elmer Pickerill of the U.S.S. *Leviathan* stands by the array of 1926 wireless equipment which permitted the vessel to keep in radio contact with both shores during transoceanic crossings.

## Westinghouse joins radio group

Westinghouse had done a certain amount of radio experimentation in its laboratories, and shortly after the formation of RCA began to consider going into the radio field. A subsidiary company was set up known as The International Radio Telegraph Company which had acquired a large group of Fessenden patents from the old National Electric Signaling Company. Consideration was given to going into the communications business, but difficulties were encountered in that the important European stations were all tied in with the stations of the Marconi Co. now held by RCA.

To strengthen their position Westinghouse acquired a group of Armstrong and Pupin patents, among which was the Armstrong "feedback" patent later to become quite famous. Finally, in 1921, a cross-license agreement was made between RCA, GE and Westinghouse, and Westinghouse now became a member of the radio group.

## Broadcasting begins

Meanwhile, strenuous efforts were being made to get broadcasting started. The pioneer licensed station of the United States, and of the world, was KDKA, of the Westinghouse Company, in Pittsburgh, licensed by the Department of Commerce on October 27, 1920. This station broadcast election returns in November of that year. RCA first entered this field on July 2, 1921, when a one-day broadcast was made from a temporary station at Hoboken,

N.J., on the occasion of the Dempsey-Carpentier fight. Soon after, RCA opened station WDY at Roselle Park, N.J., which continued for some months, when it was shut down on account of interference with station WJZ of the Westinghouse Company in nearby Newark. RCA then went in as half-partner with Westinghouse in the management of WJZ. Broadcasting was really on its way.

## Wireless Specialty Company

Another corporate element entered the picture in 1921, the Wireless Specialty Apparatus Company. This was a Massachusetts concern largely occupied in making apparatus for the Tropical Radio Company, which is turn was a subsidiary of the United Fruit Company, and which operated coast and ship service for the large United Fruit fleet. GE bought into Wireless Specialty, and again made license arrangements which cleared up a few more of the patent obstacles to RCA's progress.

## A formative period

These first two years cover what might be called the formative period of RCA. It was a period during which all of the important American companies which could play a part in the development of the radio field of that time were brought into a workable relationship.

It was a fortunate coincidence that the end of this two-year period came just at the threshold of the development of the new broadcasting industry. In fact it is a fair statement that

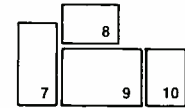
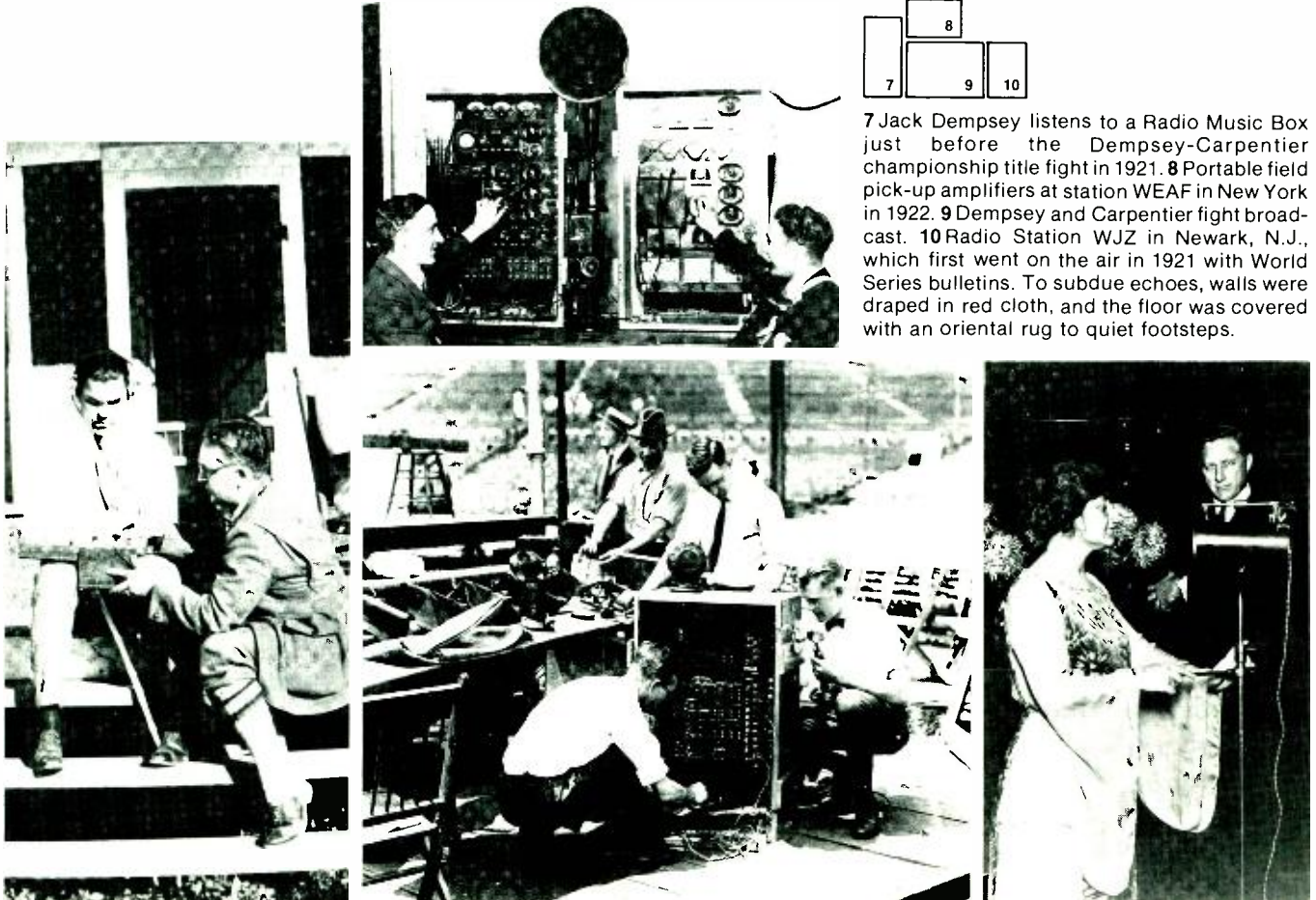

7 Jack Dempsey listens to a Radio Music Box just before the Dempsey-Carpentier championship title fight in 1921. 8 Portable field pick-up amplifiers at station WEA in New York in 1922. 9 Dempsey and Carpentier fight broadcast. 10 Radio Station WJZ in Newark, N.J., which first went on the air in 1921 with World Series bulletins. To subdue echoes, walls were draped in red cloth, and the floor was covered with an oriental rug to quiet footsteps.



without the removal of the many previous obstacles, broadcasting itself would never have developed on a national scale in such a short time.

### RCA enters merchandising field

Just prior to the start of broadcasting RCA had given thought to furnishing apparatus to radio amateurs both for reception and transmission. As broadcasting appeared, the line of amateur apparatus was expanded as quickly as possible to include home broadcast receiving equipment, and RCA now entered the merchandising field with GE and Westinghouse as manufacturers (Wireless Specialty also furnished a small amount of apparatus for a time). As later developed, this arrangement had many disadvantages but remember that at the time it was probably the only way in which the RCA could get started. It was, so to speak, a condition of RCA's birth.

In 1922, RCA got out a catalogue of radio equipment which well illustrates the conditions of that day in comparison with the present. For that reason I shall digress for a few moments to describe some of the things which were offered for sale. The catalogue was entitled "Radio Enters the Home," and since in this period every man had to be his own serviceman all the accessories imaginable were included as well as many parts for the experimenter to make his own set.

The cheapest receiver listed was a steel box containing a single-circuit tuner and crystal. This sold for \$25.50 with headphones, antenna equipment and "full instructions."

More elaborate crystal sets were available at \$32.50 and \$47.50. The cheapest tube set was the one-tube "Aeriola Senior" made by Westinghouse—it used a WD-11 tube in a regenerative circuit and sold for \$75.90 with batteries and antenna, and for \$65.00 without the accessories. This was a very popular set in its day and it is quite likely that a few of them are still in use.

GE supplied a set made in steel boxes. The two units comprised a tuning system in one box and a three-tube detector-amplifier in the other box, and sold complete for \$250.00. Westinghouse supplied a somewhat similar receiver in a wooden box at \$261.75. This also comprised two elements, one of which was a single circuit tuner, the other a detector-amplifier.

The most elaborate set was the "Aeriola Grand" made by Westinghouse. This had four tubes, a regenerative detector and, in addition, there were four ballast tubes to avoid use of a filament rheostat. No emphasis was placed on the number of tubes since the practice of stressing this had not yet appeared. This set sold for \$401 with all accessories.

The only loudspeaker shown was similar to a brass automobile horn with a telephone receiver on the end—which sold for \$30.00. It is interesting to note that a phonograph attachment was available at \$18.00 which consisted of a telephone receiver element to be attached to the tone arm of the phonograph so as to get the equivalent of a loudspeaker. There were two models—one for Victrolas and the other for Graphanolas.

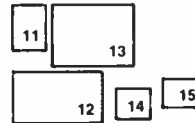

11 On July 6, 1924, RCA transmitted the first radio photo (of Charles Evans Hughes) across the Atlantic. 12 RCA's first broadcasting studio, station WDJ, in Roselle Park, N.J. 13 One of America's first remote broadcasts, October 1921. 14 The Aeriola Senior. 15 The 1923 Radiola III.

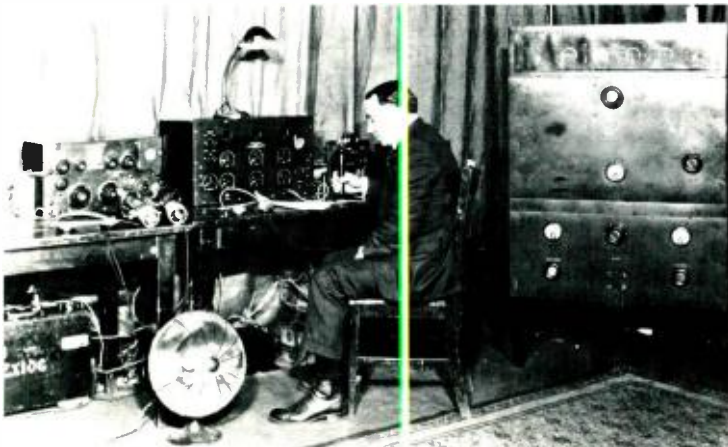

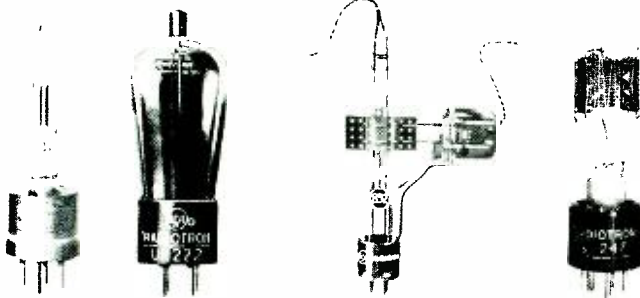

**Early radio tubes.** Left to right: WD-11 detector amplifier (1920); 852 transmitting triode (1927); UX-222 sharp-cutoff tetrode (1927); 247 power pentode (1931).

## First radio tubes

At this time RCA sold four types of receiving tubes. Two were made by Westinghouse and two by GE. The Westinghouse tubes were designed and manufactured in East Pittsburgh and the GE tubes were designed in their Research Laboratory at Schenectady and manufactured in two of the GE lamp factories, one at Nela Park, Cleveland, and the other in the Edison Lamp Works at Harrison, the same plant which is now the Radiotron Works of our own company.

Tubes were also sold by E.T. Cunningham, Inc., first on the West Coast, and later throughout the country. Mr. Cunningham for some years had been making tubes for amateurs on the West Coast, and seeing the possibilities of merchandising tubes on a large scale he entered into an arrangement with RCA in 1920 which gave him the right to sell tubes under his own name. They were the same as RCA tubes but had different type numbers.

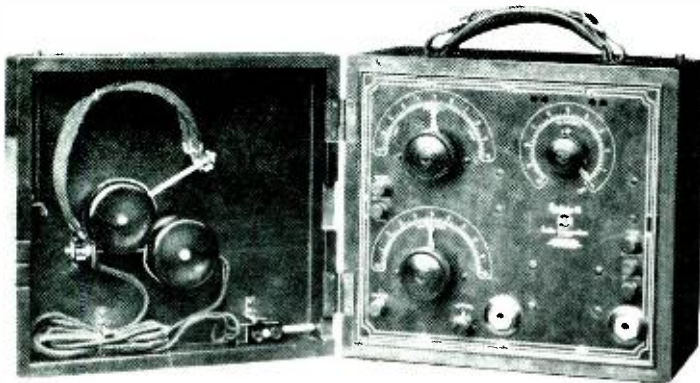

**Radiola II**, a radio marketed by RCA in the early 1920s.

## RCA progresses in all fields

The years 1923, 1924, and 1925 brought numerous advances in the RCA fields. To mention only a few—in 1923 two broadcasting stations were opened by RCA in New York and one in Washington. In 1925 the first WJZ transmitter was installed at Bound Brook, N.J. Short-waves came into use for long-distance communications, first to supplement the high-power long-wave transmitters, and later to take over practically all of the long-distance service. Transoceanic communications were extended to additional European and South American countries. The first superheterodyne receiver was brought out in 1924. In 1925 a receiver was sold with accessories permitting it to be operated from alternating current. In the same year the electrodynamic loudspeaker was brought out. Apparatus was developed for recording and reproducing records electrically. Improvements were made in tubes greatly reducing the power consumption.

In 1925, RCA furnished certain components to the Victor Talking Machine Company which were built into a radio-phonograph combination employing a single speaker. This is significant as the first step in very important later developments.



**Radiola 17**, the first ac radio. The receiver contained six tubes plus rectifiers and operated on a tuned radio frequency principle.

## RCA only a selling agency

Remember, that during this period and for several years after, in the merchandising field RCA itself was only a selling agency. The manufacturing was done entirely by the electronic companies. Receivers were made at Schenectady by GE and at East Pittsburgh by Westinghouse. Receiving tubes were engineered at East Pittsburgh and Schenectady, and were made in GE lamp factories at Cleveland, Harrison, and later at Newark—also in Westinghouse factories, at East Pittsburgh, Bloomfield, N.J., and later at Indianapolis (in what is now our Indianapolis Plant).

It must already be evident that the problems of coordination began to be tremendous. RCA first utilized the electrical



laboratory of the City College of New York, which was in charge of Dr. Alfred N. Goldsmith, to test new models of apparatus. This was quickly outgrown and the Technical and Test Department of RCA was established in its own building at the edge of Van Cortlandt Park in New York. Here samples of apparatus were submitted independently by GE and Westinghouse, tested and reported back to the manufacturing companies, with approval or suggested changes.

It soon became necessary for RCA to have the same apparatus regardless of which company made it. In the case of tubes it was particularly essential to have uniform designs from all factories so they could be interchangeable in any receiver. Of course, this was long before the time tubes were shipped in sets.

### Efforts on coordination

In an attempt to accomplish this necessary coordination, "design" or "standardization" committees were set up separately for receivers and tubes, comprising representatives of GE and Westinghouse. The tube committee which started in 1924 perhaps best serves to illustrate the unwieldiness of such an arrangement, which I will describe in some detail.

This committee was known as the Radiotron Standardization Committee. It was made up of representatives from East Pittsburgh, Cleveland, Schenectady, Bloomfield, and Harrison—two and sometimes three from each. It met once a month around the circle and attempted to arrive at agreements on tube designs, ratings, characteristics, and even some production problems. It had no direct representation from the receiver divisions so the coordination with them was supposedly handled by the East Pittsburgh and Schenectady tube representatives, and the ideas and needs of the receiver engineers carried to the tube meetings. The main committee carried with it a train of subcommittees and coordination groups intended to handle specific technical items. Needless to say this kind of an arrangement was in many ways unsatisfactory, yet it is difficult to visualize any better method under the then existing company relationships.

The design committee on receivers operated in much the same way as the tube committee, but with some advantage in having only two groups involved. It finally became necessary to set up an additional receiver coordination committee which included RCA representation. One of their first subjects of discussion in 1927 was the "Radiola 16," and another model which became the "Radiola 17," which was the first real ac receiver using ac tubes.

The loss of time inherent in the inter-company committee method of coordination was a major handicap to progress in engineering, manufacturing, and sales, but it remained until new major changes in organization came to pass, as we shall see later.

## Formation of National Broadcasting Company

Going back to 1924, the AT&T was actively developing the use of wire lines for furnishing programs to broadcast stations and they set up WEAJ as the source of these programs. In 1926 RCA and its associates took steps to integrate a complete broadcasting service and formed the National Broadcasting Company. This was a recognition by RCA officials that this new service had the possibilities of an important industry and that a specialized organization was necessary to develop programs, to install new stations and to maintain a satisfactory continuous service to their own as well as other stations.

The new company acquired station WEAJ from the AT&T, and also took over the stations owned by RCA and thereby created the real beginning of the network broadcasting industry.

### RCA licenses other radio companies

In 1927, a major step was taken in a new direction, the licensing of other manufacturers under RCA patents. It was inevitable that the demand for broadcast receivers would lead other companies into the business, and a large number had by this time become established. The granting of licenses of these companies strengthened their position, but at the same time gave RCA a rightful return for its huge investment in patents obtained through the research and engineering of the radio group and also by purchases from other inventors.

At first the superheterodyne patents were not included in the licenses. Also it was not until two years later that tube licenses were granted, although a number of lamp and other manufacturers were actively making tubes.

### Radiomarine company formed

Late in 1927, the ship-to-shore telegraph business of the RCA, which had been growing steadily, was segregated into a new subsidiary company—the Radiomarine Corporation of America.

### RCA Photophone organized

In 1928 a new offshoot of the radio business appeared. For several years work had been going on in the GE laboratories to perfect a system of recording sound on film. This was now ready for commercial exploitation in the motion picture industry and RCA Photophone Company was organized to handle this business.

### RCA purchases Victor Company

1929 was a year of far-reaching changes in the organization of the RCA group which constituted the first major step towards integration of the company into a self-contained, self-controlled radio business.

I have mentioned already some of the handicaps inherent in the arrangements whereby RCA did the selling while the

other companies manufactured. This method was wholly inadequate to meet the quick moves of the independent competitor. Furthermore, the electric companies naturally wanted to make a profit and so did RCA. This seriously handicapped the coordination of sales and production, which is so essential to the success of an entire operation. RCA needed its own manufacturing facilities.

The Victor Talking Machine Company at Camden had been seriously affected by the growth of radio and had not been particularly successful in its attempts to enter the radio field. In order to obtain manufacturing facilities RCA purchased the Victor Company including the manufacturing plant, what was left of the phonograph business, and the Victor dog trademark. Arrangements were also made whereby RCA took over tube manufacturing from GE and Westinghouse. RCA acquired the entire Edison Lamp Works property of the GE at Harrison, and also the Westinghouse factory at Indianapolis, and at the end of the year the RCA Victor Company and the RCA Radiotron Company were organized.

### RCA Communications formed

In this same year the RCA Communications Company was formed to take over all of the business in transoceanic communications.

### Consolidated research, engineering, manufacturing and sales

In 1930 RCA completed the consolidation in the RCA Victor and Radiotron companies of all facilities of research, engineering, manufacturing, and sales of RCA products which now for the first time included phonographs and records. Somewhat later, in 1932, the Photophone business also was taken over by the RCA Victor Company.

Licenses were now being granted to tube manufacturers and the superheterodyne patents were included in the set licenses. Agreements had also been made with a number of foreign radio manufacturers giving RCA rights under their patents and in some cases access to their laboratories.

### Cunningham Company bought

In 1931 the E.T. Cunningham Company was taken over by RCA and consolidated with the RCA Radiotron Company, giving RCA rights to the use of the Cunningham brand and bringing Mr. Cunningham into the RCA organization.

### Electric companies withdraw

The second and final step toward an independent RCA took place in 1932. In 1930 the Government had brought suit against RCA attacking certain exclusive features of the inter-company agreements, and as the result of a consent decree all the stock interest of GE and Westinghouse in RCA was disposed of by those companies. AT&T had disposed of its stock interest in RCA some years before. Modified cross-license patent agreements were entered into with the approval of the Attorney General and the sanction of the court. RCA now became a completely self-



Victrola plate used on phonographs; ca. 1925.

contained organization with wholly owned subsidiary companies operating a broadcasting business, a communications business, a marine radio business, a radio school, and a manufacturing and merchandising business.

### DeForest Company purchased

In 1934 the tube business was augmented by the purchase of certain patents from the defunct De Forest Radio Company. This brought about the beginning of transmitting tube manufacturing by RCA Radiotron.

### RCA Victor and RCA Radiotron merge

In 1935, the manufacturing and merchandising business was further consolidated by the merger of the RCA Radiotron and RCA Victor Companies which now became the RCA Manufacturing Co.

### Importance of diversification

Before concluding I want to emphasize one phase of the history of RCA which so far I have mentioned only indirectly, yet which stands out with clearness and significance in the whole course of the 18 years of RCA's life. I refer to product diversification. A study of the history of RCA is well worth while if it does no more than demonstrate the value of diversification, and its paramount importance to us in looking toward the future.

The corporate history is a sort of family tree in which certain elements contributed at the start, but which were later separated from the new growth. I shall use another horticultural analogy to illustrate product diversification.

Certain varieties of trees are responsive to wide differences of training. Two plants may sprout from the ground exactly





**Laboratory research work** in Camden in the mid-30s. Left to right: Clarence A. Gunther testing receivers; Dr. Elmer W. Engstrom working on a radio receiver; John B. Coleman inspecting a transmitter.

alike, side by side. One of them may be trained to grow perfectly straight with a central trunk and beautiful symmetry. The other may be trained into a large bush-like growth with many branches.

Two companies may also start in the same way from small beginnings. One may be concerned with a single product or a narrow field while the other grows many branches, large and small. We may have a great admiration for the tall straight tree, but if a storm comes along and breaks off the top it may be years before it recovers its original form. The same storm has little effect on the other tree. It may pass over without harm or even if a few branches are broken they may be trimmed off without showing.

The one-product company may do admirably in times of prosperity and we may envy its simple operation. But if it meets with changing conditions or times of depression the "one product" may no longer be in demand and the company has nowhere to turn.

Suppose that back in 1921 RCA had said "No, we aren't interested in radio entertainment, we are in the commercial communications business." Again suppose RCA had looked at talking pictures and said "No, we aren't interested, we are in the radio business." Again, after acquiring the Victor Company suppose RCA Victor had said "We will let the phonograph business die. It doesn't amount to much and we want to sell radio receivers." There are several obvious answers to these suppositions, but the uppermost in our minds probably is that if these things had happened most of us would not have our jobs.

## Public service is paramount

The strength of a company is in a large measure proportional to its service to the public. The RCA has grown

as it has extended its fields of public service. It will continue to grow just so long as it utilizes its variety of resources to give the public new or better services, or new or better products.

It should never be forgotten that a by-product often becomes a main product. Again, the limitations of a product or service today may turn into advantages of tomorrow. The often alleged lack of secrecy in radio communication was once talked of as a handicap, but broadcasting, as its name implies, made good use of this so called handicap.

## Research insures progress

Research has played a major part in the evolution of the RCA and must continue to do so. I use the term not alone in a technical sense but broadly—research in sales methods, in advertising, in relations with the public, in better understanding and organization of our personnel, as well as in engineering and manufacturing of our products.

Research provides the new food which the tree needs when the old is exhausted or no longer suitable. The tree must grow or it will die and a company must go ahead or back. It never stands still. RCA has made good use of its resources to expand its fields of activity. But it is a safe prediction that if we live up to our opportunities we will some day look back at 1938 and see that we have now only started to scratch the surface. Facsimile is barely started. Television is still ahead of us. Commercial sound applications are getting under way. A multitude of ultra-high frequency applications are certain. And outside the radio or entertainment fields the field of electronic devices is in its early infancy.

I hope that this brief story of the RCA has served to show something of how far we have come but more important, how much farther we can go in the future.

# Part II—The years 1938-1958

E.W. Engstrom

*RCA emerges from World War II as a major Government contractor with a new range of skills. But television is the major development of this era for RCA.*

As a historian writing in 1938, the late J.C. Warner, then Vice President, Radiotron Division, of the RCA Manufacturing Company, undertook to review the first 18 years of RCA's corporate life. His concluding words at the time were: "if we live up to our opportunities we will some day look back to 1938 and see that we have only started to scratch the surface."

None of us associated with Warner in 1938 would have disagreed with this estimate. At the same time, it is doubtful that anyone could have foreseen the phenomenal growth that has marked the second 18 years of RCA's existence. From a \$100 million corporation in 1938, RCA soared to the billion dollar corporate rank in 1955, a position it maintained in 1956 and 1957. In 18 years, its plant and equipment multiplied six times in value and the total number of employees quadrupled, to some 80,000 persons.

More significant than this impressive growth was the basic change in the nature of the Corporation itself. In 1938, RCA was in transition from a radio communications concern to a broadly diversified electronics organization with a growing interest in such new fields as radar, television, and airborne electronics. Today it has become an outstanding research, engineering and manufacturing enterprise, holding a position of leadership. The second 18 years of RCA not only have lived up to the opportunities which Warner referred to in 1938 but have created a host of new and exciting opportunities for the future.

Shortly after Warner had published his review, two events occurred which were to influence profoundly the future of the Corporation. In April, 1939, seven years of intensive research, engineering development and field testing by RCA culminated in the introduction, at the New York World's Fair, of the first public television service. Four

months later, Hitler's assault on Poland and the declarations of war by England and France opened the Second World War.

The official inauguration of television service was the harbinger of a new era in mass communications, but it required a keen eye to see in the actual event the shape of the nationwide television service we know today. It was an extremely limited service, covering only the New York metropolitan area, and operating on the "experimental" basis authorized by the Federal Communications Commission. Programs emanating from the NBC transmitter atop the Empire State Building were viewed on a relative handful of 9-inch direct view and 12-inch reflection-type receivers produced at Camden for sale in the New York area.

Standing before the Iconoscope cameras in front of the RCA Building at the World's Fair on April 20, David Sarnoff announced the beginning of regular television service by NBC. And he added:

"Now we add sight to sound. It is with a feeling of humbleness that I come to this moment of announcing the birth in this country of a new art so important in its implications that it is bound to affect all society. . . This miracle of engineering skill which one day will bring the world to the home, also brings a new American industry to serve man's material welfare. . ."

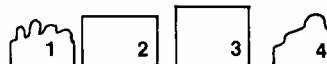

1 RCA developed tricolor picture tubes. Left to right: E.W. Herold; Dr. E.W. Engstrom; Dr. H.B. Law; Dr. V.K. Zworykin. 2 General Sarnoff addressing press at demonstration of all-electronic color tv in 1946. 3 RCA electronic equipment was used during World War II to test muzzle velocities of large-caliber guns. 4 Experimental RCA "Block" tv, forerunner of modern miniature tv systems, was developed and tested during World War II for airborne applications.





## RCA in war

The outbreak of World War II effectively halted the further progress of commercial television. The clear need for military preparedness led to increasingly heavy demands through 1940 and 1941 on industrial research, engineering and production facilities both for American forces at home and for Britain and France through the Lend Lease program. RCA, with long experience in communications and with a pre-war record of major contributions in the important military areas of radar, underwater sound and airborne electronics, was in the forefront of this program from the start. By the time of the Japanese attack on Pearl Harbor in December, 1941, virtually all of the Corporation's facilities were devoted to military requirements for radio equipment, radar, special tubes, acoustical devices and navigation systems.

The increasing demand for military electronic equipment led, early in the war, to several important changes in RCA's organization and facilities to expedite research, engineering and production. The first of these related to the RCA research organization.

During the 1930s RCA's research facilities had been concentrated largely at the manufacturing plants in Camden and Harrison in addition to the communications research groups on Long Island. By late 1940, the growth of defense activities had generated a need for increased staff and facilities, both for research and manufacturing. At the same time it was recognized that the research program could benefit from a separate environment in which the laboratories might physically be brought together to obtain better coordination and direction. Thus, in March, 1941, the research staffs were incorporated as a new department called RCA Laboratories. Concurrently, work was started on a new research center at Princeton, New Jersey, approximately midway between the Camden and Harrison operations.

Dedicated in September, 1942, the new building—the present David Sarnoff Research Center—provided the RCA

research staff for the first time with complete modern facilities in an environment fully conducive to creative research. Further, it provided a physical as well as an administrative unity impossible under previous conditions.

In addition to the new research center at Princeton, expansion early in the war included new facilities for production. Advances in military electronics, particularly in such high-frequency applications as radar and microwave communications, led to a greatly increased demand for special-purpose radio and electron tubes. To meet this need, the U.S. Navy undertook construction of a large new plant at Lancaster, Pennsylvania, to be operated by RCA. Completed in 1942, the plant operated at full capacity through the war to produce hundreds of thousands of tubes for military applications. At the war's end, it was purchased from the Navy by RCA.

A further organizational change of significance was made in December, 1942, to achieve closer coordination of all RCA manufacturing activities. The RCA Manufacturing Company, established in 1935 as a wholly owned subsidiary of RCA, was consolidated with the parent Corporation to become the RCA Victor Division, comprising all of the Corporation's tube and electronic equipment production facilities.

## Contributions to victory

The contributions to victory of the divisions and services of RCA, in research, engineering, production and service were extensive, varied and distinguished. Although the list is too long for more than brief mention, it includes the following:

*RCA Laboratories:* New devices, systems and techniques including the Shoran navigation and blind-bombing system, airborne radar equipment, electronic fire control, and airborne television equipment for aircraft, and guided missiles.

*RCA Victor Division:* Design and quantity production of tubes and electronic equipment including 200 types of electron tubes and 350 types of electronic apparatus.

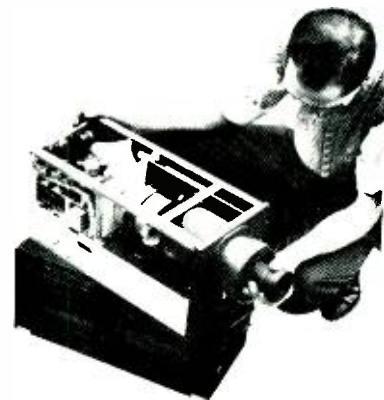
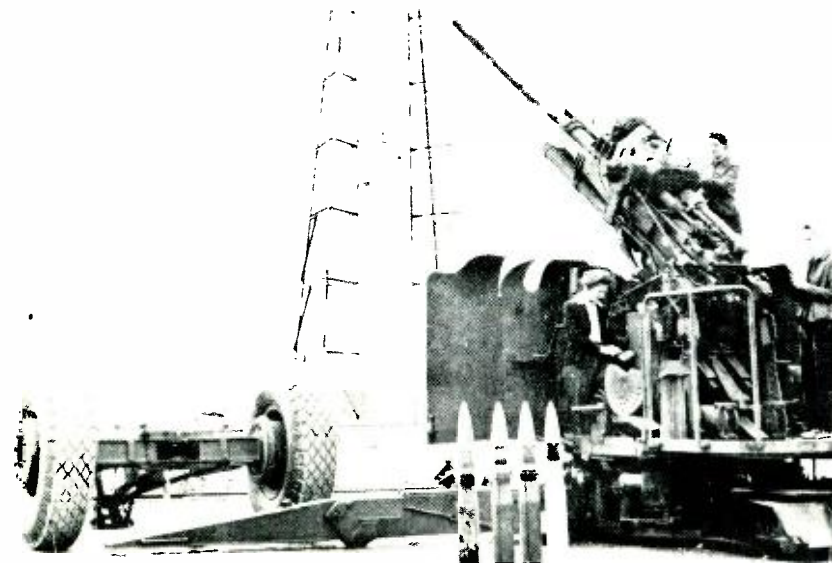

Among the large-quantity items were some 20 million miniature tubes and five million proximity fuses. Outstanding among types of equipment were radar altimeters, sound-powered telephones, battle announce equipment and rf power generators.

*RCA Communications:* Initially providing the only means of communication with the war zone, RCA Communications worked closely with the Government to keep vital networks in operation.

*Radiomarine Corporation:* Produced more than 40,000 major units of marine radio equipment, comprising 42 different types of radio and radar apparatus for installation on merchant and supply vessels.

*RCA Institutes:* Trained thousands of Army, Navy and Marine servicemen in radio and electronic techniques.

*National Broadcasting Company:* Provided world-wide coverage of military operations for broadcast to the public and developed many special morale programs. Television facilities, more limited than radio, were turned to morale and instruction purposes.

The outstanding performance of the various RCA divisions through the war was recognized by seven Army-Navy "E" pennants, two U.S. Navy Bureau of Ordnance Flags, the U.S. Maritime Pennant, the Victory Fleet Flag and 27 stars for continued excellence in operations.

## Return to peace

With the return of peace in 1945, RCA found itself, with all other electronics manufacturers, in a vastly changed environment. World War II had triggered a swift transformation in electronic technology. Research and engineering led to major advances in high-frequency techniques, in electronic systems development, in electron optics and in other fields of future peace-time importance.

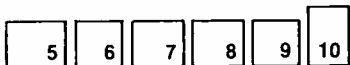

5 RCA tv production line in Camden; ca 1946. 6 Studio/field black-and-white camera with 3-inch orthicon pick-up tube, used during and immediately after World War II. 7 TK-10, first commercial black-and-white image orthicon tv camera, ca. 1945. 8 TK-40, first commercial color tv camera. 9 Experimental tricolor tv camera tube, smaller and with simpler circuitry than three-tube color cameras. 10 Miniature camera system developed by RCA for on-the-spot broadcasting was first used at 1956 political conventions.



The post-war environment for the industry was characterized by two totally novel features—a far more versatile and sophisticated technology than in the pre-war years, and a substantial increase in the number of participating and competing companies. Moreover, this greatly expanded art and industry faced a tremendous demand for its products and services from a public recently released from war-time austerity.

Plans for converting its research, engineering and production facilities to a peace-time basis were undertaken by RCA during the late stages of the war, when it had become apparent that victory was at hand. As a result, the process of conversion was rapidly carried out after V-J Day. Within eight weeks, RCA Victor plants at Bloomington, Indiana, and Camden were producing radios for the civilian market. Before the end of 1945, commercial tube production had been resumed at Harrison. By mid-1946, production of television picture tubes and tubes for broadcast transmitters and industrial uses was under way at the newly acquired Lancaster plant.

One organizational development of importance in the conversion pattern was the establishment, in February, 1945, of the RCA International Division. In anticipation of an expanded foreign market for electronic equipment, the new division was given responsibility for distribution of products manufactured by RCA, the operation of foreign subsidiaries, and coordination of all RCA international activities.

## Post-war television

Full attention could now be given to the expansion of a civilian television system which literally had been nipped in the bud by World War II. The pre-war sharing with other manufacturers of RCA's television research and engineering experience and the availability of important technical developments to RCA licensees had made possible a broad manufacturing base for home receivers. By 1941, standards for the present television system also had been worked out by the National Television System Committee, an industry group, and approved by the FCC.

Thus, by the end of the war, television not only was ready for commercial application; it also was a better system, because of research and engineering advances achieved



for military purposes. Among these were a more sensitive camera tube—the image orthicon; more powerful transmitting equipment operating over the full bandwidth allocated to commercial service; improved picture display techniques based on radar developments during the war, and effective network relay techniques.

Television activities resumed on a large scale during 1946, when the first network was opened, linking NBC facilities in New York and Washington by coaxial cable, and including Philadelphia and Schenectady.

It also was during 1946 that the RCA Victor Division placed the first post-war television sets on the market. The basic model was the famed 630TS, with a ten-inch picture tube. Marketed at a price of \$375, the 630TS' economy, reliability and high quality swept it into immediate popularity. The nation's first quantity produced and marketed receiver, it was television's equivalent of the "Model T." As much as any other single factor, the 630TS was responsible for the swift appearance of television in American homes during the early post-war years.

The pre-war practice of sharing with other manufacturers the results of RCA television research and engineering experience also was resumed vigorously. Engineering data relating to the 630TS was made available to other manufacturers in conjunction with industry symposia held at Camden. The result was a rapid growth of television production by many organizations in the industry.

Another factor in television growth was the initiation of large-scale picture tube production at the Lancaster plant during 1946. By 1948, nonetheless, receiver sales had expanded so rapidly that a shortage in picture tubes threatened to develop. This was minimized by RCA's ability to supply tubes from the surplus accumulated at Lancaster during the previous two years in anticipation of just such an emergency.

Further expansion of RCA manufacturing facilities, extension of the NBC network, and improvements in the television system itself characterized the years after 1946. A new plant for tube manufacture was acquired at Marion, Ind., and placed in operation during 1949. In February, 1950, the RCA Victor Division produced its one-millionth home television receiver. At the same time, the size of the picture

tube steadily grew larger, expanding in 1949 to the 16-inch metal cone, to 19 inches in 1950, to the popular 21-inch size by 1952. The NBC network, keeping pace with the growth of home television, reached rapidly across the nation to link principal cities in all of the 48 states. From the four-station network of 1946, it has grown today to more than 200 network affiliates.

## Color television

As the commercial television system expanded, RCA undertook an energetic post-war program of color television research and development. Although mechanical techniques offered promise in terms of early commercial advantage, RCA decided, soon after the war, to strive for an all-electronic color system fully compatible with black-and-white. Outstanding progress was achieved at RCA Laboratories during 1947 and 1948. Several demonstrations were held, showing a color system employing three kinescopes and combined with an optical system to present a composite color picture.

In 1949, the FCC scheduled a series of hearings to consider, among other matters, the establishment of standards for color television transmission. At issue were two competing systems—a noncompatible mechanical system of color, and the all-electronic compatible color system advocated by RCA.

As the hearings progress, the research staff of RCA Laboratories, supported by engineering groups at the tube plants at Harrison and Lancaster, moved with full speed to the development of the final basic element in the compatible system—a single tube capable of producing pictures in full color. The result of this extraordinary effort, demonstrated publicly in March, 1950, was the tricolor kinescope, one of the outstanding achievements in early post-war electronics. In the words of General Sarnoff: "Measured in comparison with every major development in radio and television over the past 50 years, this color tube will take its place in the annals of television as a revolutionary and epoch-making device. . .As the master key to practical color television, it is an outstanding development of our time."



Despite the basic technical superiority of all-electronic color transmission, the FCC gave its approval to the mechanical, noncompatible system. In effect, this banned the compatible system from the market place.

Through court actions, RCA vigorously sought reversal of the FCC decision. Meanwhile, it proceeded with further refinements in compatible color transmission. In December, 1953, the FCC finally approved new and compatible standards recommended by the NTSC.

While receiver and tube production forged ahead, color broadcasting equipment was speeded to television stations. By October, 1955, 111 stations of the NBC network alone were equipped to broadcast in the new medium. Today the compatible color system embraces roughly half the stations in America and is capable of reaching 96 percent of the nation's television homes.

In 1949, television, now firmly established as a national broadcast service, moved in a new and significant direction. Development by RCA scientists of the small and highly sensitive Vidicon pick-up tube opened vast opportunities for closed-circuit television for industry and education.

### Other developments

If television, in all its aspects, was perhaps the most spectacular of the early post-war electronic developments, by no means was it the only one. A dramatic transformation in which RCA played a dominant role, was under way in the phonograph and recording fields. In 1949, the Corporation introduced its 45-rpm system of recorded music, including the fastest automatic record changer ever devised.

By the end of the year, 45-rpm records of unbreakable vinyl plastic were being produced at the rate of more than

25,000,000 annually and the number doubled in 1950. That year also saw the introduction by RCA of a three-speed record instrument.

The growth of popular interest in high-fidelity music reproduction spurred a number of other RCA contributions to the new form of home entertainment. Among these was the LCIA duo-cone speaker, placed in production a year after its debut, in 1947, at the Berkshire Music Festival. In 1953, RCA introduced two high-fidelity Victrola phonographs designed for the mass market. At the same time it began to market a complete line of high-quality "intermatched" components for home assembly.

### National security

World War II, which saw the development of jet aircraft, radar, sonar, the V-2 rocket and other weapons of high complexity and growing effectiveness, presaged a new era of military technology in which electronics would play a determining role. Any doubts to the need to maintain a strong military posture, supported by the latest technology, moreover, were dispelled by the militant aggressiveness of the Soviet Union.

Thus RCA, which emerged from the war as one of the nation's foremost contributors to military progress, continued to devote a significant proportion of its research and development to problems of advanced military technology.

Its work for the Government included a variety of development and production projects in such fields as sonar, advanced radar apparatus and fire control. In 1950, for example, RCA Laboratories completed for the U.S. Navy the development and construction of the world's largest and most accurate electronic analog computer to evaluate the

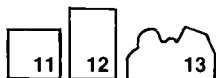

**11** TYPHOON, world's largest and most accurate electronic analog computer could evaluate performance of guided missiles, airplanes, ships, and submarines; ca. 1950-1951. **12** RCA Victrola Model 59V1; ca. 1946-1947. **13** RCA phonograph and radio; ca. late 40s.

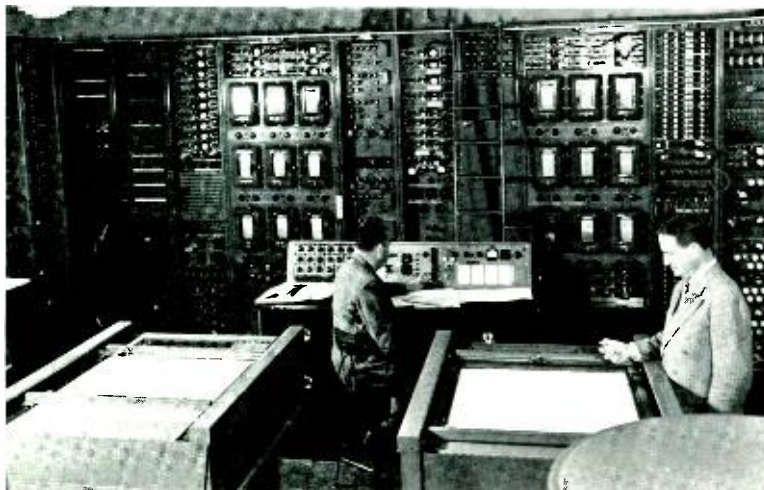



performance of guided missiles, airplanes, ships and submarines.

When war in Korea erupted in 1950, RCA's activities in the fields of military electronics increased sharply. The Government field service activity of the RCA Service Company stepped up to such an extent that by the end of the year, approximately twice as many trained field engineers were assigned to military activities as at the peak of World War II. In manufacturing, new projects for the military included equipment in the fields of electronic sound, sonar, missiles, navigation and communications.

This, in turn, necessitated additional plant expansion, devoted wholly or in large part to defense purposes. Cincinnati; Los Angeles; Woodbridge and Moorestown, New Jersey; and a new engineering laboratory at Waltham, Massachusetts, were some of the sites for these new RCA facilities. In 1954, announcement was made of what was to become one of the most significant RCA contributions to national defense—the beginning of RCA Service Company maintenance and analysis of electronic guidance apparatus for missiles at the Air Force Missile Test Center at Cape Canaveral, Florida.

The extent and scope of RCA's military electronic activities may be gauged from some of the projects in which it was engaged during 1957, such as, instrumentation radar, the Talos Defense Unit, and the "Telemite" television camera, fitting the palm of a man's hand.

## Organizational changes

The expansion by RCA into these many areas of electronics was paced by a comparable realignment and extension of RCA executive and administrative functions.



In July, 1947, following the retirement of Lieut. General James G. Harbord, David Sarnoff was elected Chairman of the Board of Directors of RCA. The following year, Frank M. Folsom was elected President of RCA. He was succeeded in January, 1957, by John L. Burns. At that time, Mr. Folsom was elected Chairman of the Executive Committee of the RCA Board of Directors.

Keeping in step with the needs of a steadily expanding business in a constantly changing industry, 1954 saw a series of sweeping revisions of the Corporate structure. The RCA Victor Division, formerly responsible for all RCA manufactured products, became two separate groupings, RCA Consumer Products and RCA Electronic Products, each under the direction of an executive vice president. RCA Sales and Service Subsidiaries formed a third grouping. The importance of RCA Laboratories to the progress of the Corporation was recognized by the elevation of its position in the Corporate structure. Behind these basic changes was the purpose of intensified research, expanded manufacturing capacity and greater diversity of output.

## The revolution in materials

Underlying the Corporation's growth and change after 1950 was a revolutionary transformation in the nature of electronics itself, resulting from fundamental advances in the field of new materials and their application. These opened the way to new devices, techniques, and systems that previously were impossible of achievement, either technically or economically.

Throughout the 30s and 40s, basic research interest grew in the field of physics of the solid state. This was fundamental to the forthcoming rapid advances in the use of electronically active solids—the semiconductors. RCA's effort blossomed first on photoconductors potentially useful in television camera tubes.

Bell Telephone Laboratories research in semiconductor materials led to development of the transistor. RCA research in this area moved at an early stage to an alloy junction type which soon became standard in receiving circuitry. Through the early and middle 1950s, the Corporation's research and development work ranged ever more widely over the materials field, covering the various semiconductor materials, including photoconductors, thermoelectric materials, and materials exhibiting photovoltaic effect; and a wide variety of luminescent and magnetic materials. Among the outstanding results of this work were new types of transistors with greater power output and higher frequency performance.

Other major accomplishments have resulted from increasing application of systems engineering techniques in both military and commercial electronics. Through the early 1950s, RCA engaged in an intensive program of research and engineering related to electronic systems to compute, sort, file, and recall large quantities of data and to perform a variety of computing, clerical and other paperwork functions. Out of this program came Bizmac, RCA's electronic data-processing system. In 1955, a four-unit Bizmac system, the world's largest electronic "brain,"

was purchased by the U.S. Army for its Ordnance Tank-Automotive Command at Detroit, to keep track of more than 100 million tank and automotive spare parts in the Army's world-wide inventory. During 1957, major Bizmac installations were purchased by the New York Life Insurance Company and the Travelers Insurance Company, Hartford, Connecticut.

## Progress and prospects

The quickened pace of electronic developments and the mounting importance of electronics to the national defense resulted in continued adaptation of the RCA organizational structure. In 1955, two new major operational units were created, Defense Electronic Products and Commercial Electronic Products. In 1957, CEP was reorganized into RCA Industrial Electronic Products, to provide still further impetus in this rapidly expanding area of electronic development. An indication of the rapid growth of RCA activities in the transistor field was the organization of the RCA Semiconductor Division.

Meeting the demands of the coming Age of Space, RCA established in early 1958 a new Astro-Electronic Products Division for the production of satellite and space vehicle systems.

What are these demands and what are the opportunities? As America enters the Space Age, electronics assumes a pivotal role in assuring continued national progress in the technologies of peace and security. As a leader in the industry, the Radio Corporation of America begins the third epoch of its existence with a flexibility in organization, a resourcefulness in research and a diversity of operations to meet the challenges of the years ahead.

In research, devices and systems now nearing final development point the way to new RCA opportunities for service to the consumer, to business and to industry. Participation by RCA in the cooperative nuclear reactor for industrial research in atomic energy at Plainsboro, New Jersey, will enable the Corporation to pursue fundamental electronics studies in the vital and closely related area of nucleonics. RCA research and engineering organizations are helping to explore methods for harnessing the power of the H-bomb for peaceful uses.

In products and devices, color television, pioneered and developed by RCA, will dominate the broadcast scene as black-and-white television has done for the ten years past. On the basis of industry-wide projections, automation and electronic data processing undoubtedly will provide another great market for RCA systems, as will closed-circuit tv for industry. Out of today's research and development will come other products for the consumer, such as new forms of lighting, personal communications equipment, home television tape recording, and a variety of other novel electronic adjuncts to living.

If J.C. Warner could foresee the time when historians would look back to 1938 as a period when the surface had barely been scratched, what is there to say about the potentialities for RCA today? For all of the RCA's tremendous past growth, not only is the surface of electronics still largely unscratched, but now there is the new challenge of the Space Age.

Writing in *Fortune* Magazine in 1955, General Sarnoff noted: "There is no element of material progress we know today...that will not seem, from the vantage point of 1980, a fumbling prelude." When that day finally comes, I am certain that some future historian will begin this review of RCA with exactly those words.



14 15

14 The RCA electron microscope was a major scientific development; shown are Dr. V.K. Zworykin (seated) and Dr. J. Hillier. 15 Development of a molded plastic aspherical correcting lens for the Schmidt-type optical system helped make projection tv practical. Ioury G. Maloff is shown removing a lens from a mold.



# Part III—The years 1958-1962

E.W. Engstrom

*The boom in color television, along with a constant progression of new and electronic products, ranging from microcircuits to space systems, characterized these years.*

In considering events and developments from 1958 through 1962, the past five years of RCA history have been fully as meaningful as the two preceding time spans in terms of change, accomplishment, diversification, and growth. All of the expectations for electronics and for RCA have been more than amply fulfilled.

RCA continued to achieve conspicuous successes in its established lines of business. During the half decade, it ventured into fields where growth and profit, halting at first, began to manifest themselves with increasing strength. At the same time, it advanced importantly in new technologies whose potentialities for growth and service are as great as any of the areas in which it now operates.

These developments are measurable in many forms, and among the most readily recognizable are the traditional yardsticks of corporate accomplishment. Thus, RCA sales of goods and services rose during the half decade to an all-time high of \$1.75 billion, *50 percent greater than at the end of 1957*. Profits increased to \$51.5 million, 34 percent over 1957.

In ten years, 1948 through 1957, total products and services sold amounted to \$7.78 billion. In the past *five* years, 1958 through 1962, the total was almost as large: \$7.36 billion.

At the close of 1962, space devoted to manufacturing was at a peak of 12 million square feet, comprising new, expanded, or renovated RCA plants in 12 of the nation's 50 states. RCA's activities reached into home instruments, electronic data processing, electron tubes and semiconductor devices, radar and microwave equipment, scientific instruments, weather and communications satellites, broadcasting, and technical services. In major part, its products and services were available throughout the Free World.

## Color tv

The most important development by far to RCA in the past five years was the emergence of color tv as a new industry and public service of massive and mounting proportions.

Technologically, the record requires little updating, for the major research and engineering advances had been made prior to 1958. What gives color such transcendent importance to RCA is that the past five years witnessed its transformation from a \$130 million investment to a major source of Corporate profits. *It vindicated the faith of one man—David Sarnoff—who staked his and the Corporation's prestige on the new medium while the rest of the industry stood aside or in opposition.*

In 1960, color tv earned a profit for RCA for the first time since its introduction in 1954, and color set profits alone were measurable in seven figures. By the following year, color tv—receivers, tubes, videotape, and other equipment—attained the status of a \$100 million business, an achievement of no mean proportions in seven brief years.

By 1961, there occurred—finally—the long-awaited color breakthrough. One by one, tv receiver manufacturers abandoned the sidelines and entered the ranks. By the following year, nearly every major tv manufacturer was actively marketing color, and industry volume reached \$200 million. RCA's set sales for 1962 doubled over the year before; its profits from color manufacturing and services increased fivefold; and color sets and tubes became the *largest* single profit contributor of any products sold by the company.

It is pointless to debate which came first in color tv—the sets or the programming. In all certainty, the development was concurrent, with receiver purchases soaring because of increased color programming, and programming benefiting in turn from the increase in color set ownership. Thus, while there were 291 stations equipped for network color and a bare total of 700 hours of network programming in 1958, five years later the number of stations equipped for network color came to 406 and network color broadcast hours had risen to some 2000 for the year.

Of the many brightly illuminated pages in RCA's history there are few that gleam more brilliantly than those dealing with color. Indeed, there are few companies which can validly claim to have created virtually single-handed a new industry, and few which more richly merit the rewards of pioneering than RCA.

RCA 601 computer system with four RCA 301 systems in use at Teaneck office of N.J. Bell.



## Electronic data processing

While RCA was mounting its major effort to make color television commercially viable, another decision had been made to enter in force a new, formidable, and costly area of business—electronic data processing.

The action entailed a bold and calculated risk: the entry fees were exceedingly heavy; returns were long delayed because of the large lease nature of the business; the competition was powerful and strongly entrenched.

As Board Chairman Sarnoff subsequently explained, the decision to go forward was made:

"First, because we have a technological background in electronics that gives us a capability in many computer areas which few, if any, other companies can rival. This is a young, fast-changing technology, and the research breakthroughs of today will shape the character of the industry tomorrow. We are well-positioned to make contributions of fundamental importance to this evolution.

"Second, because electronic data processing has become a vital element of most major defense and space contracts. The company with skills in this area has a decided competitive advantage.

"Third, because the commercial computer market is growing faster than the industry itself anticipated."

In 1958, RCA launched its major venture into the electronic data processing field with the introduction of the RCA 501, a medium-sized commercial business computer and the first fully transistorized system in the industry. By 1960, the Corporation had introduced the compact RCA 301 for medium-size and small businesses, and had announced a coming third entry, the RCA 601, for large enterprises and scientific computation.

One of the greatest of RCA's strengths lay in computer communications—backed by four decades of leadership, experience, and know-how in all types of communications systems and equipment.

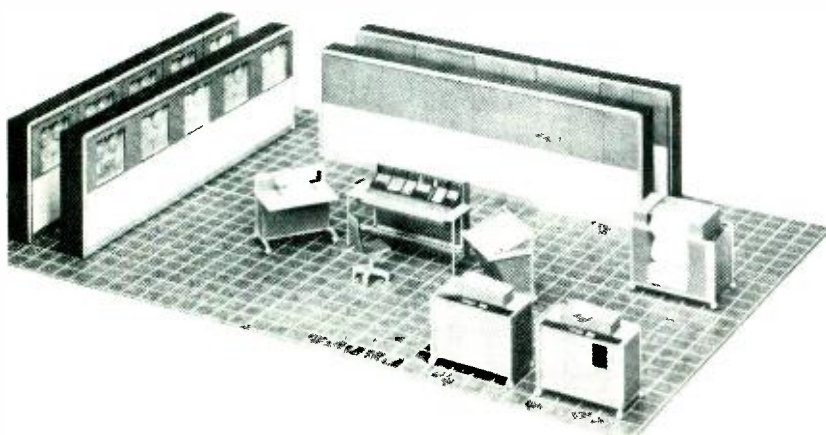

In 1959, RCA introduced DaSpan, a computer-to-computer communications system which could span a continent, and gather and coordinate vital data from the many plants of a large industrial enterprise.

The same computer-communications know-how made RCA the supplier to Western Union, the prime contractor of an automatic electronic data switching system for the Air Force Combat Logistics Network (ComLogNet) linking 350 bases and stations across the country in the world's most advanced communications systems.

Rapid economic expansion in other industrial nations also gave RCA an unexcelled opportunity to extend its computer activities overseas. In 1961, it concluded a series of multimillion dollar export sales agreements with three of the world's leading data processing equipment manufacturers—in Great Britain, Japan, and France. By the end of 1962, 158 computer systems had been ordered by the three companies, and further orders placed for components and peripheral equipment.

Domestically, in addition to the rental or sales of its computer systems, RCA established data-processing service centers in New York, Washington, D.C., Chicago, Cherry Hill, N.J., and San Francisco. These centers provide computer service to small businesses as well as offering programming and training services to buyers or lessees of RCA systems.

Whatever the risks and costs involved, the decision to enter data processing was extremely sound. RCA not only staked out its share in one of the major electronics growth markets but, equally important, it acquired the basis for continuing preeminence in other electronics fields where computers and computer systems were indispensable to progress. Among these were the vital areas of space and national security.

## Space and defense

On October 4, 1957, the first signals from a man-made object in the skies heralded the dawn of a new era—the Age of Space.

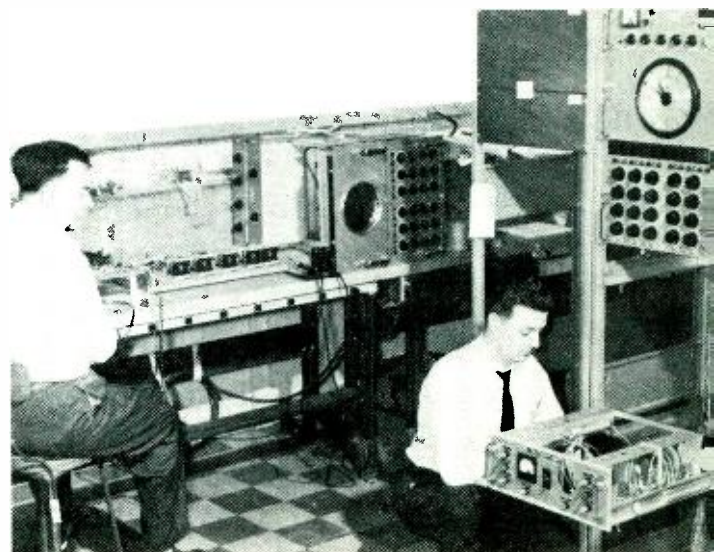



Swiftly, RCA realized that space was preeminently an electronics domain—for tracking, communications, computing and controls. Less than a year later, RCA set up a special division—Astro-Electronic Products—for the development and production of satellites, space-vehicle systems, and associated electronic ground equipment. (That organization is now called the Astro-Electronics Division.)

In December of the same year, the world's first successful satellite radio relay equipment, produced by RCA for the U.S. Army Signal Corps, lofted into orbit aboard an Atlas missile. It broadcast to the world a prerecorded Christmas message from President Eisenhower, and then performed a number of communications experiments never before attempted, looking to a new era in global communications.

Within the next four years, the Astro-Electronics Division had scored a series of achievements which quickly catapulted RCA into the front rank of space organizations.

Chief among these was a systems development of the first magnitude—an integrated ground and space complex for the televised observation of the world's weather via satellites. Between 1960 and 1962, as major elements of the system, RCA developed for the National Aeronautics and Space Administration six Tiros weather observation satellites, all of which were launched and operated with optimum effectiveness. Up to the end of 1962, the Tiros series—ranking as the nation's *most successful* space venture—provided a total of more than 200,000 televised images of cloud formations and other global weather data for use by weather scientists and forecasters. The average useful life span of the satellites was more than double the operating life called for by the initial design specifications.

Another significant feat was the Relay communications satellite, which after launching in December 1962, experienced initial operating difficulties. These subsequently were overcome, and by early 1963, Relay was transmitting television pictures of remarkable clarity between the United States and Europe, and conducting radio communications with Latin America.

The Astro-Electronics Division has also provided the advanced television equipment for the Ranger lunar probes, television systems and solar-cell power supplies for the second-generation Nimbus weather satellite, and was engaged in the design and construction of the SERT vehicle for the space testing of experimental electric propulsion systems.

Portending still greater growth in years to come, an environmental test facility, most advanced of its kind in the electronics industry, was put into full operation during 1962 at RCA's Space Center, near Princeton, N.J. Space concepts and systems now germinating in various RCA research areas may undertake their initial trials in this environmental center and so provide new episodes for future RCA historians to record.

The complexities manifested in computer and space electronics are fully matched in the area of defense. From the production of relatively simple hardware for communications, electronics for military purposes has burgeoned into vast and complicated systems—frequently global in scope, integrating multiple techniques and sub-systems, and employing the resources of many varied organizations.

RCA's depth of experience in systems engineering and its military electronics background dating to the mid-thirties earned for it one of the lead positions among designers and constructors of such advanced systems for the armed services.

In 1958, RCA received one of the largest contracts ever awarded by the Department of Defense, to assume the project management of the Ballistic Missile Early Warning System (BMEWS) to provide advance warning of an enemy

2 RCA 501 high-speed printer, an output device of the 501 electronic data processing system. 3 Ground control equipment for meteorological satellite applications at AEP. 4 Tiros II satellite mounted to third stage rocket (arrow). 5 Environmental test chamber at AEP. 6 BMEWS radome at Moorestown, N.J.

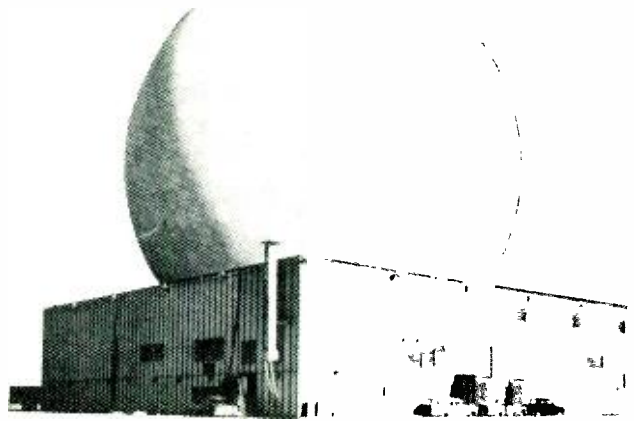
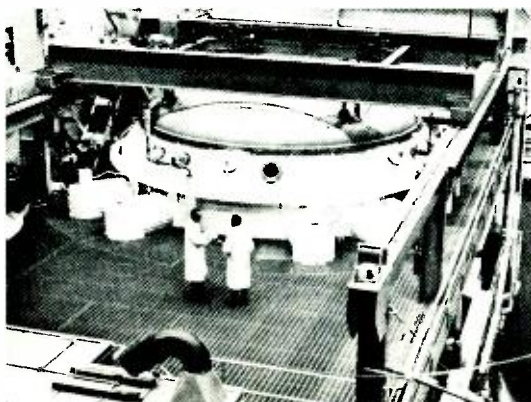
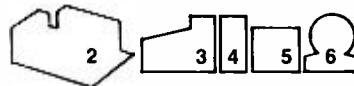
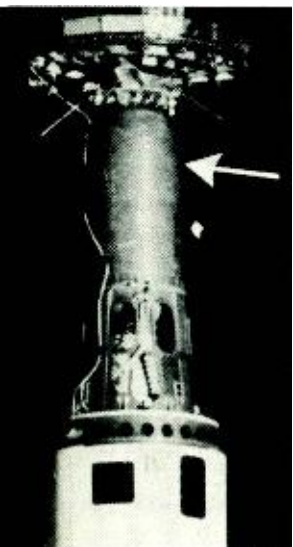

missile attack across the polar wastes. As manager of this vast undertaking, it employed 485 large companies and 2415 smaller firms spread over 29 states to get the job done swiftly and efficiently. By the end of 1962, two installations (Thule, Greenland, and Clear, Alaska) were operative and the third was nearing completion in Yorkshire, England.

The need for virtually instantaneous warning against impending missile attack assumes similar readiness for counterattack. In the past half-decade, RCA contributed significantly to a greatly strengthened defense posture with the development of automatic programmed checkout equipment (APCHE) and launch-control equipment for several series of the Atlas ICBM.

Subsequently, major RCA work on the Minuteman ICBM involved advanced concepts in command-and-control systems, including the sensitive-command and support-information networks, and checkout and test techniques. Especially challenging for both design and production were very high-reliability goals for sophisticated equipment—goals that pushed the state of the art.

By the end of 1962, RCA was deep into such diverse developments and constructions as a flight-control system and checkout for the super-powerful Saturn booster, telemetry equipment for the two-man Gemini space vehicle, miniaturized computers such as Micropac (built with micromodules) for military field use, and a variety of communications systems and test apparatus, including a lunar-landing simulator.

In 1962, RCA also could point to some 22,000 scientists, engineers, and production personnel—roughly a quarter of all RCA employees—working at eleven defense and space centers. In that year, the Corporation's total volume of government business exceeded \$600 million, or more than a third of the Corporate total.

## Circuitry and components

Basic to all RCA progress in both the old and new fields of electronics were the advances made in electronic circuitry and components.

RCA's Electron Tube Division, facing the growing competition of semiconductors, moved quickly and aggressively to sustain its position through intensified product and market development.

One decision was to concentrate production and sales in those areas where semiconductors could not yet compete. Conspicuous success was achieved in heavy-duty and special-purpose tubes. From 1958 through 1962, RCA developed some 800 new tubes of this variety.

Another decision was to compete directly with semiconductors through greatly improved low-cost vacuum tube products. In 1959, the Tube Division announced the revolutionary Nuvistor, a receiving tube as small as a thimble and incorporating high reliability and durability. This was followed the next year with a new line of metal-to-ceramic Cermolox power tubes for transmitter applications, one of which was aboard the famed Pioneer V Venus probe.

A third decision was to join the move toward semiconductors where this would blend with skills and technologies perfected in some three and a half decades of tube development. In 1960, for example, the Division began to manufacture solid-state photoconductors and silicon solar cells.

Finally, the Tube Division decided to diversify its product line and seek *wholly new products*. A new Business Development Department was set up for new items whose revenues could replace or even surpass those from older tube products. By the end of 1962, the first results were beginning to bear fruit—in thermoelectric power generation and cooling, thermionic energy conversion, superconductive magnets, electroluminescent materials, and high-speed reed switches for computer and telephone relay circuits.

Challenge and change also confronted RCA's Semiconductor and Materials Division. The challenge came in the form of intense competition where companies—old and new, large and small—thronged a market of supposedly unlimited profitability and growth. Change came in the rapid obsolescence of materials and devices under the stimulus of quickening research and development.

Organized in 1955 primarily to manufacture germanium transistor devices for consumer purposes, the Division swiftly expanded in size and scope. By 1962, for example, it had become the leading domestic producer of solid-state semiconductor devices for consumer products, and over 100 million of its germanium units were in use.

With the advent of high-power silicon devices, the semiconductor field grew to embrace industrial, computer, and military applications, and with this came corresponding growth in RCA activities. New manufacturing facilities were added, new devices developed, and new markets opened. Ultra-high-speed tunnel diodes, gallium arsenide rectifiers, and microferrites for computer memories were among the product developments of the period.

But the continuing solid-state revolution involved more than the geometric expansion of individual circuit devices and applications. Equally fundamental to the future of electronics was the emergence of materials and techniques leading from separate components to assemblies of components functioning as complete circuits and subsystems. In this, RCA played a leading role, with the U.S. Army Signal Corps, in the development of micromodules. With later developments—for example, thin-film active devices, and the insulated-gate MOS (metal-oxide-semiconductor) transistor—RCA reaffirmed its position as an industry leader in advanced integrated circuitry.

## Old areas—new opportunities

Change, diversification, and growth were readily evident in other divisions and services of the Corporation. New technologies, products and systems infused vigorous progress in both the older as well as the more recent RCA activities.

The RCA Victor Home Instruments Division, which in 1961 moved from Cherry Hill, N.J., to a consolidated operation in



Indianapolis, Indiana, continued to advance in the design and marketing of home entertainment products. Particular emphasis during the past half-decade was placed on stereophonic high-fidelity record and tape players for the growing high-fidelity music market, on transistorized pocket radios, and on black-and-white as well as color television.

One milestone was the production in 1958 of the ten millionth RCA Victor black-and-white television receiver. Another was the introduction, a year later, of the *first* miniature transistor radio to be produced entirely in the United States. By the end of 1962, Home Instruments could point to an overall sales increase of 30 percent over the previous year, exceeding the earlier all-time record established in 1956.

The RCA Victor Record Division made significant progress in new sound-reproduction techniques at the same time that it advanced briskly into new marketing methods and areas. In 1961, Victor Records introduced a new electronic process for reproducing stereo recording originally recorded in a monaural sound. The year following, it opened the world's largest and most modern recording studio, in Rome, Italy.

Early in 1963, after two years of intensive research and development, Victor Records also announced a striking new process of music reproduction—Dynagroove—bringing recorded music more closely than ever before to live music.

In the five-year period, Victor Records aggressively expanded its Record Clubs around the nation, while developing new retail sales outlets such as supermarkets and drug chains. Overseas, RCA became the leading U.S. company

in the international field, and by the end of 1962, Victor Records could report the largest sales volume in its history, with gains scored in all product lines.

For industry, for broadcasting and communications, RCA continued to develop new microwave systems, transistorized videotape recorders for both color and black-and-white broadcasting, and new color cameras. Among its pioneering advances were closed-circuit equipment for educational purposes.

In 1962, RCA also manufactured and delivered its 1000th electron microscope, assembled on the same production line that completed the first commercial instrument nearly a quarter century earlier.

Significant growth trends also manifested themselves at the National Broadcasting Company, which moved into commanding leadership in providing the public with a broad range of news and public affairs coverage. By 1962, 25 percent of NBS-TV's schedule was in this category.

Earlier, NBC pioneered an educational experiment by presenting a college level course, "Continental Classroom," demonstrating that commercial broadcasting could perform a significant role in education. And its massive programming on behalf of color was as responsible as any single factor in hastening the ultimate mass-market breakthrough. These and other developments culminated, in 1962, with the highest sales and earnings in NBC's 36-year history.

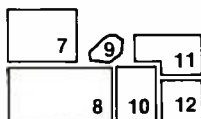

7 Thin-film transistor, first practical amplifying device made entirely by evaporation techniques, was produced by RCA Labs. 8 TRT-1 ac videotape recorders in U-shaped layout at NBC, New York in 1961. 9 Low-cost, quality tape recorders were developed for a growing hi-fi market. 10 Use of videotape helped in staging and integrating special scenes such as this from NBC's *Peter Pan*. 11 Thermionic converter; direct energy conversion was a major RCA effort during the 1957-62 period. 12 RCA Labs research produced the field-effect MOS transistor.

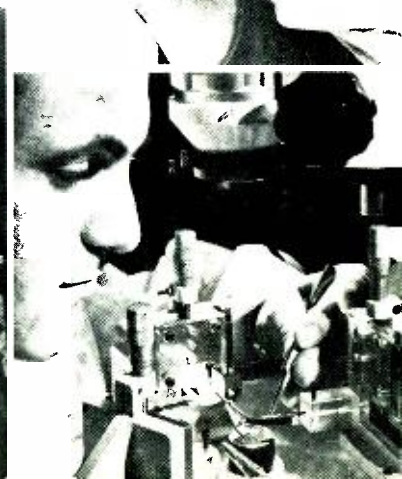
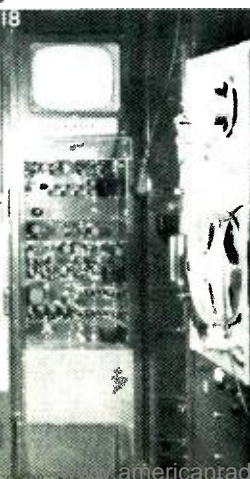
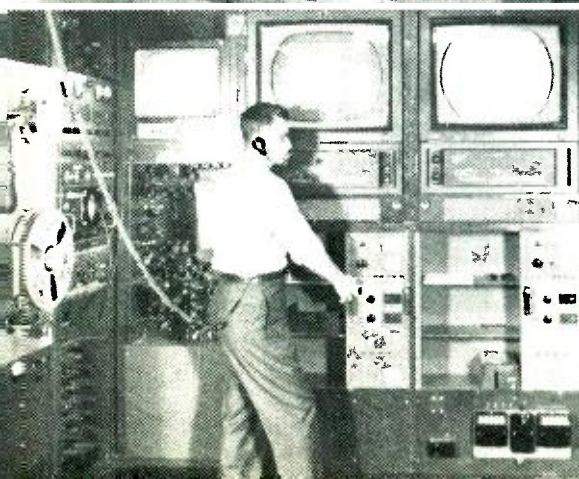

As meaningful as any aspect of electronics' growth during the past five years was its expansion on a global scale. It was reflected in the RCA Service Company where, by the end of 1962, there were some 16,000 employees in the United States and 36 foreign countries. Its activities ranged from maintenance of the BMEWS emplacements in Alaska and Greenland to responsibility for the control and data gathering activities at the Cape Canaveral, Florida, space center. Here, incidentally, where RCA undertook its first technical assignment 10 years earlier with 26 technicians and engineers, there were approximately 4000 RCA people in 1962.

By early 1963, the RCA Service Company was able to report that revenues for the year from installations and service on color-tv receivers could surpass for the first time revenues on black-and-white sets. And with equal portent for the future, the Service Company moved into still another space activity—the design and construction of space chambers and solar simulators.

World economic expansion and the emergence of new nations were reflected by the growing demand, during the five-year period, for basic and advanced types of communications and broadcast equipment. RCA sales and installations extended to every continent—from broadcasting equipment and stations to entire national and international television and communications systems.

The same economic expansion found further expression in the global communications services of RCA Communications, Inc. By the end of 1962, it was providing more channels between this country and 100 others than any other U.S. international communications carrier. In early 1963, RCA Communications applied for permission to purchase shares in the new Satellite Communications Corporation, thus assuring for RCA still another role in the rapidly unfolding progress of electronics.

## Research and progress

Behind the extraordinary five-year record of RCA change, diversification, and growth stood the basic and applied achievements of the RCA Laboratories—ranging from revolutionary high-speed computer techniques to submarine communications to space telescope guidance.

The variety of RCA research activities may be gleaned from a few samplings of the past five years. In 1958, RCA joined nine other companies in ownership and operation of a nuclear reactor, for the purpose of conducting radiation studies relating to RCA projects and areas of interest. That year too, RCA Laboratories joined in the design and construction of the C Stellarator, which may provide an answer to the control of thermonuclear fusion for peaceful purposes. The following year, it undertook two projects approaching the ultimate in geographic disparity. One was for the design and development of an advanced communications system for the Polaris program; the other was to build the television guidance system for the Stratoscope I and II balloon-borne telescopic observations of the sun and planets.

RCA scientists had the assignment of developing the key elements of a computer that would operate at speeds a thousand times faster than the swiftest computer yet built. On yet another tack, in 1960, they completed the "electronic highway" to demonstrate the feasibility of electronics for the control and movement of road traffic.

Most significant for the long run, perhaps, were the RCA Laboratories' contributions in the areas of basic circuitry, energy conversion, superconductivity, and laser technology. These have led in the past five years to such research advances as thin-film transistors, superconductive magnets capable of generating enormous magnetic fields, superconductive thin-film memories, crystals lasers activated by natural sunlight, and new thermoelectric and thermionic generators.

To the breadth and depth of its scientific probings, RCA also added the element of greater speed in converting research to applied development. Most of the Corporation's principal operating divisions now maintain development groups of their own engineering specialists at the RCA Laboratories at Princeton. These development groups work directly with the laboratory research teams, adding a vital new perspective to many RCA scientific projects, and furnishing the link for the swift transmission of new materials, devices, and techniques to the divisions to transform them into new products and market opportunities.

## Looking to the future

In reviewing the past, one's thoughts inevitably turn to the future of electronics and RCA, for it is there that the most interesting history will be written. For that future, it no longer seems sufficient to say, as in the first two segments of the RCA history, that the surface of electronics has barely been scratched. As electronics broadens its contributions to the nation and the individual, and as its influence extends around the globe and deep into space, new dimensions of service as well as new concepts of opportunity come into focus.

At the present point in time and historic development, electronics perhaps is *the single most important instrument at the disposal of mankind for the solution of present problems and the advance to new levels of well-being*. Electronics provides means of comprehension and action far beyond the capacity of the brain to grasp or the hand to move. In science, medicine, manufacturing and commerce, transportation, agriculture, education, energy, space exploration, and communications, *electronics* is the lever to still greater progress—directly or as the catalyst to other efforts. Its reach has extended far beyond the surface of technological growth to embrace virtually every activity, human or natural, affecting civilization.

In such a context of service and opportunity RCA is uniquely positioned to achieve the optimum. In these past five years, it has strengthened beyond measure its resources and capabilities for leadership in *any direction* which the science and industry of electronics may take.



# Part IV—The years 1962-1966

E.W. Engstrom

*Vigorous growth and an outward thrust took the company into such new areas of business as publishing, graphic arts, education, medical electronics, and car rentals.*

By any measure, the rate of growth during these years was impressive. Total annual sales increased from \$1.75 billion in 1962 to \$2.5 billion in 1966. During the same period, net profits more than doubled.

RCA's manufacturing capacity was vastly increased as more than \$500 million was spent to build new plant facilities and expand existing ones. In 1966 alone, the company undertook the largest domestic capital expenditure in its history, allocating \$198 million for the construction of new plants at 11 locations and substantial expansion at 15 other operating facilities. These additions involved such key activities as color television, home instruments, semiconductors, computers, and communications.

By early 1967, total employment had grown to exceed 120,000 people in the United States and abroad, up from approximately 93,000 five years earlier.

During the four-year period, RCA maintained a growth rate that consistently outpaced the average of all American manufacturing enterprises. In 1966, the percentage of sales increase over the previous year was double that of the average for all other manufacturers, and the company's profit increase of 28% contrasted with the average manufacturing rise of 11%.

This outstanding performance reflected many influences—a sustained period of strong consumer demand for RCA home entertainment products; a steady growth in other established areas of business, such as commercial and

industrial electronic products; and a vigorous involvement in new ventures, such as publishing, the graphic arts, education, and medical electronics.

Coupled with these trends was a gradual change in the character of the electronics industry. From its initial concern with communications and entertainment, electronics was steadily evolving into the role of a basic industry whose products and services are vital to virtually every other industrial activity. This provided a broader base than ever before for the company's growth.

## Color tv and the consumer market

While all these factors contributed materially, the force that gave the greatest impetus to RCA's performance between 1962 and 1966 was unquestionably color television. The pioneering days of the late fifties and early sixties were over, and in five short years, color television mushroomed from an annual retail sales level of \$200 million to more than \$3 billion. This latter figure was achieved in 1966, when consumers spent more money to purchase color television sets than they did for all other home instruments, including black-and-white televisions, radios, phonographs, and tape recorders.

Beyond the manufacture and sale of sets and tubes, the color television industry embraces the production of studio and transmitting equipment, such as color cameras and videotape machines. It includes broadcasting, programming, service, and the production of the many electronic components that go into the final assembly of a set.

Because of its decision to blaze a trail in color, RCA had long before developed its own capabilities in all these areas. It was recognized that if color television were to succeed, it had to be presented to the public as a total system. As a result, many divisions of RCA experienced major gains in sales as public opinion on color television changed from the cautious interest of 1962 to the unrestrained eagerness of 1966.



1 Portable tv sets are readied for shipment at Memphis plant. 2 RCA engineers in background discuss IC applications for portable, black-and-white tvs, while those in foreground examine complex deflection yoke for 90° color picture tube. Chassis in foreground shows trend toward slimmer cabinet styling.



RCA was in a position to take full advantage of the new opportunities presented by the rapid expansion of the market and to take the lead in many new developments. Slimmer cabinet styling replaced the earlier, bulkier models as the 90-degree rectangular color television picture tube gradually replaced the 21-inch round tube which had been the industry standard for nearly a decade. By the end of 1966, production of this older model was entirely phased out, and RCA was manufacturing four different color picture tube sizes—15, 19, 22, and 25 inches—for a diverse line of portable, tabletop and console model receivers. (When used in sets, these tube sizes are now designated as 14-, 18-, 20-, and 23-inch picture diagonal.)

The addition of rare earth phosphors from materials research added greater brightness and clarity to the color picture. In 1966, integrated circuits were introduced for the first time into home instruments when RCA employed them in the audio stage of its color and black-and-white tvs.

The years 1962 through 1966 also saw steady advances in the manufacture of color transmission equipment. A new, all-transistorized tape recorder for both color and black-and-white television, the TR-22, found a ready market among broadcasters and closed-circuit television operators both in the United States and abroad.

In 1964, as the result of a major engineering development effort, RCA's Broadcast and Communications Products Division presented an entirely new look in broadcasting

equipment. The new line featured sweeping changes in design, appearance, and function, and employed the use of solid-state components wherever possible.

By the end of 1966, 450 out of approximately 650 commercial television stations in the country were equipped to originate color programs from film. About 150 stations could originate live color programs.

Leading the way towards full conversion to color was the National Broadcasting Company. In the autumn of 1962, about 68% of NBC's total nighttime programming was in color. By the end of 1966, the entire network schedule was broadcast in color, with the occasional exception of feature films originally photographed in black-and-white.

The spectacular growth of color television was the principal feature of a generally thriving consumer market for electronics. In 1965, for example, RCA sold more black-and-white television sets than in any year since 1955. By the end of 1966, industry sales of both imported and domestic radios were approximately 44 million units, up from a little over 33 million units sold five years earlier.

Stereophonic sound was firmly rooted in the home instruments market, and industry sales of phonographs increased each year from 1962 to 1966, with RCA Victrola phonographs leading the way. Music on tape gained in popularity during the period, and the company responded by marketing a full line of reel-to-reel and cartridge tape recorders.

As phonograph and tape recorder sales increased, the RCA Victor Record Division also enjoyed a succession of peak years. In 1966 the Division completed three successive years in which all-time sales volume levels were reached. A significant development in 1965 added a new force to this aspect of the home entertainment market. This was the introduction of prerecorded Stereo 8 tape cartridges and players for use in automobiles and homes. RCA Victor Records pioneered in the production of musical selections on Stereo 8 cartridges, and a home player for the tapes was introduced in the 1966 home instruments line.

The Stereo 8 cartridge and player typified the growing trend to more casual electronic entertainment equipment, designed for use anywhere. The television set and the phonograph were no longer regarded only as items of furniture for the home, and demand grew for personalized, portable entertainment indoors, outdoors, and on the road.

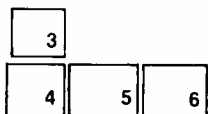

3 Sales of RCA Victrola phonographs and reel-to-reel stereo tape recorders increased. 4 Battery-powered tape recorders found new uses in home and school. 5 Spectra 70/45 data processing system used third generation monolithic IC. 6 Computers such as RCA's Electronic Telegraph System revolutionized international communications.





## Computers and industrial electronics

The expansion of the consumer electronics market in the five-year period had its counterpart in commercial and industrial markets. RCA served this market with a wide variety of products and services ranging from data processing installations to radar equipment for the aircraft industry.

Electronic data processing equipment was the most dynamic element on the commercial and industrial scene, both in technology and in business growth. In hardware alone, the sales volume of the computer industry rose from about \$1.8 billion in 1962 to more than \$3 billion in 1966.

The period brought significant advances for RCA in system design and programming concepts, and the company further solidified its position for the long run in the computer market.

At the end of 1962, the product line consisted largely of the 301 system for medium and small business enterprises and the larger RCA 601 for industrial and scientific use. In 1963, a versatile new unit, the 3301 Realcom, was added to the line as the first computer designed to span the full range of data handling capabilities in a single system—business data processing, high-speed communications, real-time management control, and scientific computation.

In the same year, a significant adjunct to these systems was introduced in the RCA 3488 mass memory, designed to hold several billion characters and to operate with either the 3301 or the 301.

Progress in circuit design and system concepts led in 1964 to a major step forward. RCA introduced the Spectra 70 series, the first in the industry of a new third generation of computers. The group initially included four compatible general-purpose computers—two of them employing the first monolithic integrated circuits to be used in commercial equipment. A fifth model was added in 1965.

Singly or in multiples, these systems were ordered by insurance companies, manufacturing industries, airlines, railroads, government agencies, and many other users in the United States and abroad.

As the 1960s progressed, computer systems were put to increasingly sophisticated use in a wide range of business and public functions. At its inception a decade and a half ago, electronic data processing equipment was regarded principally as an immensely powerful tool for use in the repetitive and clerical tasks of commerce and industry. Through the past few years, progress in programming techniques as well as hardware has led to increasing application of the systems in more complex tasks of information processing, from management simulation to the analysis of physical, social, and other problems with many variables.

Within RCA, for example, computers were employed on a growing scale for management information. In this function, systems at various operating divisions and at corporate headquarters were programmed to supply current

information on all aspects of the company's operations and to aid in planning and decision-making by indicating trends in the wide range of factors affecting production and marketing.

Another significant trend was the growing relationship between computers and communications—both in the development of computer-to-computer links and in the use of computers to increase the speed and flexibility of communications.

RCA introduced several advanced terminal devices during the 1962-1966 period for communication between computers and users. Among them were a voice response unit that provided spoken replies to inquiries telephoned directly to a computer, and a self-contained video display unit employing integrated circuitry.

The greater use of computers as tools in communication systems was evident in the operations and services of RCA Communications, Inc. In 1964, an Electronic Telegraph System (ETS), employing RCA computers of special design, was put into operation at the RCA Communications, Inc. facilities in New York to route, process, and transmit overseas message electronically, in great volume at high speed. The innovation came at a time when communications satellites were on the verge of multiplying international channel capacity. The combination of expanded channels and electronic message switching promised, by the end of 1966, to revolutionize international communications in terms of volume and scope of services.

There were indications of this in two new services introduced by RCA Communications. In 1965, the company announced Datel, a service for overseas data transmission from punched tape or cards, or magnetic tape, at speeds up to 1200 words a minute. In 1966, it introduced a new service concept incorporating computer techniques in an Automated Information and Reservations Computer Operated Network (AIRCON) for message processing and reservations.

In addition to its activities in computers and data processing, RCA played a significant part during the period in supplying new products and services for other business needs. Among the notable contributions were airborne weather radar systems for commercial and business aircraft, and at the end of 1966, RCA was one of the largest suppliers of such equipment. Two-way mobile radio communications systems were developed and installed in trucking fleets and public transportation bus systems, including those of the New York City Transit Authority. In the fall of 1964, the Western Union transcontinental microwave network, the longest single microwave project ever undertaken at one time, went into operation with RCA equipment in its 267 relay and terminal stations.

## Electronic components

In 1963, RCA's Semiconductor and Materials Division was consolidated with the Electron Tube Division to form a new operating unit known as Electronic Components and Devices. The blending of the newer technology with the

older in an organizational sense can be said to symbolize the coming of age of solid-state electronics as a business. The move enabled all of RCA's talents in the field of electronic components and circuitry to be employed on a more closely coordinated basis. The results of the union have since demonstrated both the potential of the young solid-state art, and the continuing vigor of electron tube technology.

Electron tubes remained unchallenged in many areas. In the fall of 1964, RCA produced its three-millionth color television picture tube, a short time after it had turned out its 25-millionth monochrome tube. Significant innovations were made in television pickup tubes, including improved vidicons for studio cameras and a number of special purpose types. Among the latter were several built for use in the Ranger lunar vehicle, and one employed for underwater television equipment used by the Navy to recover missiles and torpedoes.

Many other special tube types were provided by the new division, including a high-efficiency traveling-wave tube for microwave systems, high-efficiency thermionic converters, and special klystron power tubes employed in the 2-mile accelerator at Stanford University in 1966.

The application of new solid-state technology and materials research led to significant contributions during the period in new and improved components and devices for a variety of uses. In 1964 and 1965, for example, RCA introduced the new "overlay" transistors and a promising line of silicon power transistors for use in public address and home sound equipment. The company also continued as a leader in the production of transistors for use in automobile radios.

A major new activity was launched in 1963 to engineer, develop, and produce integrated circuits for general use. Two years later, RCA made its full-scale entry into this new market with an initial line of 17 types for application in communications, instrumentation, and industrial and military equipment, as well as computers. By mid-1966, the family of new circuits had been increased to 25, and integrated circuit sales had become a significant factor in RCA's total components business.

The new Electronic Components and Devices activity launched other vigorous programs to develop new

business. An outstanding example, based on pioneering work at RCA Laboratories, was the company's entrance into commercial production and sale of superconductive magnets, principally for use in nuclear research.

## Space and military electronics

The most dramatic achievement for RCA in space between 1962 and 1966 occurred in 1964 when NASA's Ranger 7, with a six-camera payload designed and built by RCA's Astro-Electronics Division, reached the moon and sent back the most detailed photographs ever taken of the lunar surface. This was followed in 1965 with the successful launch of the Ranger 8 and 9 spacecraft, which together obtained and transmitted to earth nearly 13,000 close-up views of the moon.

The Tiros television weather satellite program continued an unbroken series of successes. In 1962, three Tiros satellites, developed by RCA, were placed into orbit, providing television pictures for worldwide weather forecasting.

The following year, two more Tiros satellites were launched, and Relay I, a communications satellite built by RCA for NASA, completed its scheduled year-long mission. Among Relay's achievements were the first space transmission of a color telecast, simultaneous voice relays between the United States and Brazil, and the first trans-Pacific transmission from the United States to Japan.

RCA in 1963 was assigned major roles in the Apollo program, this country's attempt to land astronauts on the moon. The company was selected to develop communications and control systems for the Lunar Excursion Module, which was scheduled to perform the actual landing. In addition, RCA contracted to build the power and communications equipment for the Lunar Orbiter, designed to transmit pictures from an orbit around the moon in search of a suitable landing site. During 1965 and 1966, spacecraft in the Orbiter series returned remarkable pictures of selected areas from altitudes as low as 28 miles above the moon.

The major RCA contributions to the nation's space program in the 1962-1966 period included the picture-taking systems for NASA's experimental Nimbus satellite to map global

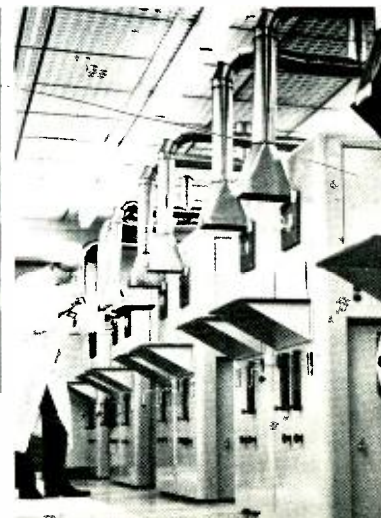
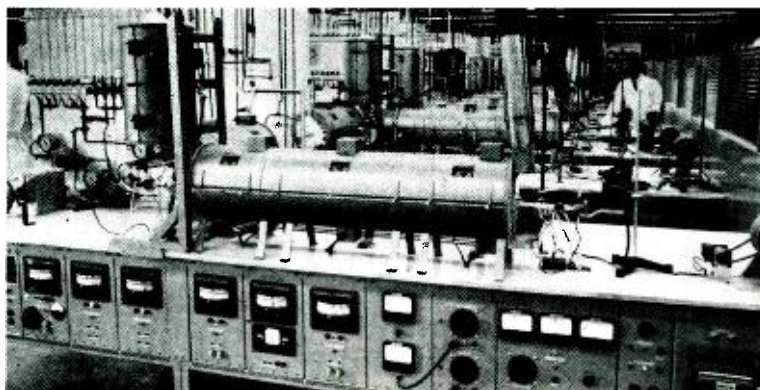



weather conditions; a second successful Relay communications satellite; three more Tiros weather satellites, and a continuation of the Tiros program under the name of ESSA (Environmental Science Services Administration) which established the first operational weather satellite system.

In other aspects of the space effort, RCA delivered tracking radars for the Apollo Radar Instrumentation Ships and the Apollo Recovery Ships. It provided communications links between NASA headquarters in the United States and various overseas tracking locations, including voice and teletypewriter circuits to tracking vessels at sea, alternate voice/data and teletypewriter circuits to Europe, Africa, the Caribbean, Australia, and several points in the Pacific. RCA computers were developed for test and checkout of the Saturn launch vehicle in the Apollo program.

In 1964, the RCA Service Company was awarded a contract for the planning, installation, operation, and maintenance of communications for NASA's Spaceport at Merritt Island, Florida.

The company's military support activities were highlighted by operation and maintenance of the Ballistic Missile Early Warning System, the electronic systems used on the Air Force Eastern Test Range at Cape Kennedy, and the White Alice communications system of the Air Force in Alaska. The company began delivery of communications equipment for the Department of Defense AUTODIN data communications network in 1964. Delivery continued throughout 1966, and when the project is completed, the continental portion of AUTODIN will be the most advanced data communications system in the world, with individual switching stations capable of handling six million messages a month.

As one of the leading industrial contractors to the Department of Defense, RCA continued to supply a wide range of military electronic devices and systems. Among them were microelectronic receiving equipment, various types of radar, secure communications systems, laser range finders and related equipment, and mobile radio relay units.

In 1966, RCA became extensively involved in the challenging new area of underwater technology through a three-year contract awarded by the U.S. Navy to manage, operate,

maintain, and support the Atlantic Undersea Test and Evaluation Center (AUTECE) in the Bahamas. AUTECE is a naval facility employing weapons, acoustic, and sonar ranges located in the deep-ocean areas south of Nassau.

## The international market

Technological progress and rising aspirations in most parts of the world between 1962 and 1966 created new international markets for electronic products and services. This was especially evident in the spread of color television abroad.

In 1964, RCA Victor Company, Ltd., of Montreal, began the assembly of color picture tubes. In the same year, RCA sent a specially built mobile unit on a six-month tour to demonstrate the United States color television system to European governmental authorities. By 1966, RCA's Canadian subsidiary had substantially expanded its color picture tube facility, and had started construction of a new cabinet plant in Ontario.

In anticipation of regular color broadcasting in Europe, a new company, RCA Colour Tubes, Ltd., was formed in England in association with the British firm of Radio Rentals, Ltd., to produce RCA color picture tubes for the British and European markets.

On the other side of the world, the Philippines became the second Far Eastern nation after Japan to begin color broadcasting, employing RCA color studio and transmitting equipment.

In addition to supplying color and black-and-white television equipment to nations in Asia, Africa, and the Middle East, many other RCA products were in use throughout the world.

In 1963, RCA's Canadian subsidiary received a contract from the Canadian government for the design and construction of an advanced satellite communications ground station in Newfoundland. The station began operations in 1966. RCA Communications, Inc., was selected by the government of Thailand in 1966 to install Southeast Asia's first communications satellite earth station.

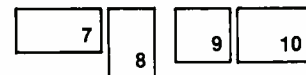
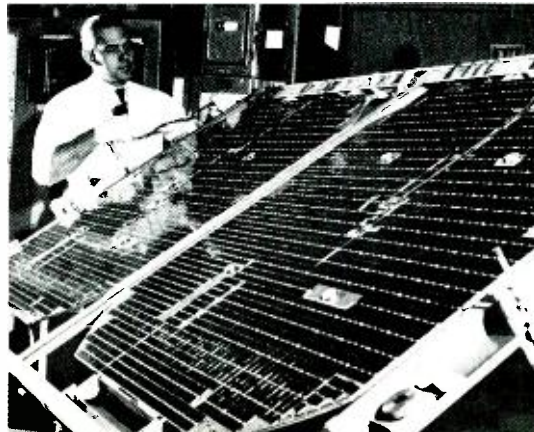

7 In 1966, vapor-deposition equipment produced superconductive ribbon used in commercial high-field-intensity magnets up to 100 kilogauss. 8 In 1965 high-temperature furnaces were added to RCA's integrated circuit facility in Somerville. 9 Weather pictures from the RCA APT camera system on the Nimbus 11 satellite were automatically transmitted to ground stations. 10 Solar panels for Lunar Orbiter II.

During the five-year period, RCA subsidiaries were active in the Latin American Free Trade Area, exporting electron tubes to this expanding market. The recording operations of RCA Italiana, conducted in Rome at Europe's most modern recording facilities, increased substantially. Two-way mobile radio units were supplied to the Hong Kong Ambulance and Fire Service, and to the Singapore Police Department, and NBC reached audiences in 93 countries through the sale of television films to government broadcasting authorities.

The continued growth of new opportunities abroad led at the end of 1966 to a realignment of RCA's organizational structure to capitalize upon its special skills for foreign markets. The change was designed to draw the domestic operating divisions more directly into RCA's overseas business in order to make the most effective use of the company's resources in an expanding world market.

### New business areas

Major diversification moves were made during the four-year period to develop positions of leadership in new technology and new markets, ranging over wide areas of information processing and education.

In 1965, RCA organized a Graphic Systems Division to apply computer and electronic technology to processes used in the printing industry. The following year the Division marketed its first two products—the Graphic 70 Videocomp electronic typesetter, and the Graphic 70 Color Scanner, which electronically produced the four basic color separations needed in full-color printing. At the same time, a vigorous applied research and development program was launched to supply a flow of new products.

The company expanded into publishing and took major steps into new areas of education. In 1966, Random House, Inc., became a wholly owned subsidiary of RCA.

The educational facilities of the RCA Institutes, Inc., were expanded substantially. In 1966, the RCA Service Company received multimillion-dollar contracts to operate two Job Corps Training Centers for the Office of Economic Opportunity.

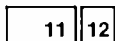

**11** In 1966 Service Company received contracts to operate two Job Corps Training Centers. **12** RCA's Graphic 70 Videocomp set type electronically.



In order to coordinate the sale of tv systems, cameras, learning laboratories, and other equipment to the educational market, RCA formed an Instructional Electronics Department in 1966. That same year, the nation's largest educational tv system, installed by RCA for the Catholic Archdiocese of New York, was put into operation, and a similar system serving the Miami Diocese was extended.

Other new opportunities explored in 1966 included an agreement with Hoffmann-LaRoche, a leading pharmaceutical firm, to collaborate in the development of new medical electronic equipment.

Also in 1966, the company established the Magnetic Products Division to speed the growth of RCA's business in computer and other tapes for use in industry and the home.

Finally, late in the year, the Boards of Directors of RCA and The Hertz Corporation approved an agreement for the acquisition of Hertz by RCA.

### Research

Many of the products that so radically changed the character of the electronics industry between 1962 and 1966 represented the successful application of research performed in earlier years in the laboratories of RCA.

The company's research and development activities during the period were scattered widely through the principal operating divisions, spearheaded by theoretical and applied research at the David Sarnoff Research Center of RCA Laboratories at Princeton, N.J.

In 1963, and again in 1965, major expansion programs were undertaken at the research center to increase laboratory facilities and to accommodate new research activities associated directly with specific product divisions of the company.

The research program itself penetrated increasingly into new areas of basic materials and phenomena, and it produced a number of significant advances leading to new devices and technology applicable to present and future business for RCA.





Extensive research efforts relating to lasers led to a number of new laser devices and techniques for employing lasers in possible future communications systems. A highlight of the program was the development in 1965 of an argon laser producing the highest power of any visible light laser yet known. The device was translated into a new commercial product and placed on the market by RCA in 1966. RCA's scientists also achieved in 1965 the first injection laser to emit visible light at room temperature.

Continued research in computer memories led to a number of new concepts and techniques of considerable promise for the future. The program followed several different lines, including new types of ferrite devices, thin-film techniques, and superconductive memories. The latter effort achieved in 1966 a new technology for making high-capacity superconductive arrays that promised to out-perform present mass storage electromechanical memory systems and to compete economically with them.

Experiments in thin-film techniques employing improved photosensitive materials resulted in an experimental tubeless television camera. This device employed networks of thin films of photoconductors and other semiconductor materials, and digital scanning techniques, to perform the functions of a pickup tube and picture processing elements in a conventional camera.

These are highlights of a wide-ranging effort that also produced new understanding of basic phenomena, explored new materials for a multitude of device applications, and developed new technologies for manufacturing microminiature devices in large arrays. The results promise to carry RCA forward in many existing and new areas of business in the years just ahead.

## Prospects for the future

In assessing the performance of RCA between 1962 and 1966, and looking ahead at the prospects for continued growth and development, David Sarnoff told shareholders at the 1965 Annual Meeting,

"In all my years with RCA, I have never seen our company more strongly positioned for progress than it is today—in personnel, in products and services, and in the promise of continuing profitability. Color, computers, components, and communications; broadcasting, service, records, and broadcast equipment are among the most active contributors to the country's growth—and they illustrate the breadth as well as the diversity of our strength."

These words were equally appropriate as 1966 drew to a close. Electronics in 1966 remained the nation's fastest growing industry, and its most challenging. No company was more determined than RCA to explore the many opportunities for service that electronics will offer in the years ahead.

## Part V— The years 1966-1971

*RCA met the challenge of changing market conditions by a program of diversification and emerged as a multinational company with worldwide industrial involvement.*

J. Hillier

A program designed to modernize the company's identity was completed in 1969 with the changing of the corporate name from Radio Corporation of America to RCA Corporation. RCA's famed circular trademark with its symbolic lightning flash was replaced by a contemporary design in which the three letters form a distinctive single unit.

In early 1970, RCA established an Office of Consumer Affairs at the top corporate level. It has responsibilities for the safety and reliability of all RCA products and services and ensures that consumer interests receive prompt attention at all levels of the company.

An era came to an end on January 7, 1970, when the Board of Directors accepted the resignation of General David Sarnoff as Chairman of the Board and a Director of RCA. At the same time, the Board elected General Sarnoff the first Honorary Chairman in the Corporation's history. The Board also adopted a resolution of appreciation, which stated, in part, that "more than any other man, David Sarnoff was the architect of RCA's rise to world leadership in electronics." General Sarnoff was succeeded by his son Robert W. Sarnoff.

## Computer activities

By the end of 1970, RCA had made a greater investment in its computer operations than in any previous venture. A major new peripheral-equipment plant was opened in Marlboro, Mass., in 1969. The following year, the Marlboro facility was doubled in size, and plans were announced for a \$16-million office building in that location to serve as the future headquarters for RCA's computer activities.

Throughout the late '60s and early '70s, RCA continued to develop new computers, peripheral equipment, and components to meet the accelerating need for more versatile data processing systems. The Spectra 70/46 was introduced in 1967 and the large-scale Spectra 70/61 two years later to serve the growing market for remote computing systems. These two remote computing systems were the first RCA processors equipped with virtual memory,

which means that the main computer memory could be expanded almost limitlessly through a series of auxiliary devices and specially developed software.

However, RCA did not concentrate entirely on remote computing. In 1969, the company marketed a large-scale Spectra 70/60 batch processor designed to handle credit and reservations systems, automate production control, and serve data banks. The following year, RCA introduced a new series of small- to medium-class computers—the RCA 2, 3, 6, and 7. Two of these new processors also have virtual memory.

Progress was also made in electronic composition systems. The speed of the RCA Videocomp was increased tenfold in 1968, making it possible to set the text of a novel the size of *War and Peace* in less than an hour. Two later developments further enhanced its capabilities: the ability to set complex line drawings and then position the drawings on a page together with text and the development of a program that enables the system to produce halftone photographs composed of small ideographic characters.

## Consumer electronics

The domestic color tv boom of the early and middle 1960s began to level off in 1967 as the industry matured. Nevertheless, RCA maintained its leadership in color sales and total domestic consumer electronics retail volume. In 1969, computers began to be used to help design, produce, test, and market many RCA home entertainment products. The company recognized the potential of the youth market by highlighting colorful portable models throughout its radio, phonograph, tape recorder, and television lines.

In 1970, RCA introduced one of the most comprehensive consumer-warranty programs in the industry and instituted a multimedia advertising campaign to promote AccuColor—more accurate, brighter color with expanded automatic control.

Solid-state components were incorporated in RCA color tv sets for the first time in 1968. By the end of 1971, these components will have replaced tubes, other than the kinescope, in a large number of RCA color sets.

The RCA line of tape recorders was expanded in these years and ranges from professional-type stereo recorders to popular, handheld cassette players.

The company also produced Stereo 8 tape decks for car owners in the United States. Four-channel sound in an eight-track cartridge configuration was introduced in 1970, providing a new dimension in musical realism.

RCA reentered the modular phonograph field in 1969 and added new models in various price ranges the following year. Late in 1970, RCA began test marketing personalized stereo consoles—an innovation that permitted the customer to choose from among 432 possible combinations of cabinet, speaker, and stereo components.

## Electronic components and solid-state devices

In recent years, RCA designed, produced, and marketed thousands of different types of electronic building blocks for uses that ranged from color tv to manned spacecraft. These were also years of technological change in the electronics industry. The receiving tube, one of the Corporation's oldest component lines, was slowly being replaced by products of the new solid-state technology. To coordinate activity in this field, RCA, in 1970, consolidated semiconductor activities into a Solid State Division. A new Solid State Technology Center was established at Somerville, N.J., as a focal point for semiconductor developments throughout RCA and in recognition of the need for a more intimate relationship between the RCA apparatus and systems producers and the producers of integrated circuits.

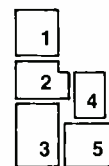

1 Spectra 70 served the growing market for remote computing systems. 2 RCA continued to maintain its leadership in color tv sales. 3 Solid-state modular chassis, introduced in 1971, replaced receiver tube design. 4 NBC control room during live coverage of Apollo mission in 1969. 5 Enlarged view of test-circuit probes contacting integrated circuit wafer.

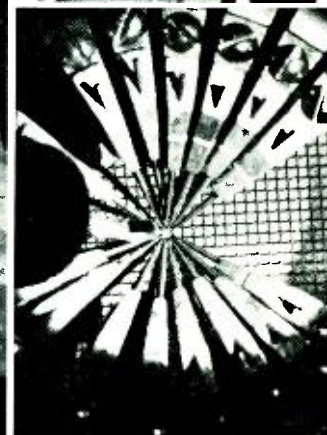
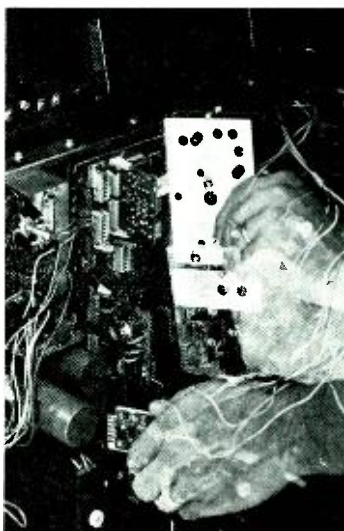



In 1967, the Corporation reinforced its position as the leading supplier of the triac, a new solid-state device that controls electrical operations with great precision and extremely low power consumption. These tiny components were used in many consumer products, including blenders, fans, and light dimmers. RCA triacs were also used in electronic scoreboards and in industrial lighting applications.

The following year, RCA made good progress in the application of microelectronics, using silicon monolithic integrated circuits. The company also pioneered the use of integrated circuits in consumer products and was the first in the industry to adopt integrated circuits for automatic fine tuning in color tv. RCA developed special COS/MOS integrated circuits for the aerospace market in 1968, which gave the company technological leadership in the field of low-power, low-speed digital integrated circuits.

In 1969, RCA developed a new, highly sensitive silicon-target vidicon through the combination of solid-state and electron-tube technology. The company also entered the digital display market with a Numitron readout device bright enough to be read in sunlight. It can be used for gas-pump indicators, desk calculators, cash registers, and automobile dashboards. In 1970, RCA expanded applications of silicon power transistors to include anti-pollution and vehicle safety systems.

Progress also was made in electron-tube technology. In 1967, new phosphors provided RCA color tv tubes with far brighter highlights than had been formerly possible. Two years later, the Corporation developed a new matrix color tv tube, twice as bright as any previous RCA tube.

In 1970, RCA developed transferred-electron amplifiers, a new family of multipurpose microwave solid-state devices. These devices, smaller and simpler than the traveling-wave tubes, have applications in electronic countermeasures; mobile, airborne, and spacecraft communications; and radar systems for weather and surveillance.

## Broadcasting and recording activities

Color tv ceased to be a novelty as CBS and ABC followed NBC's lead into full-color network programming. Television became truly international in scope by 1967, when NBC arranged the first live color tv transmissions by satellite to England.

Throughout this period, the NBC-TV Television Network attracted more advertisers than any other network. It was also first in attracting better educated and more affluent young adults, the category most prized by advertisers. In addition, in each of the years from 1967 through 1970, NBC-TV received more awards than any other broadcast organization: a total of more than 620, including Emmy and Peabody awards.

*NBC News* covered the headline-making stories of these years—the wars in Indochina and the Middle East, man's first landing on the moon, and the assassinations of Martin Luther King and Robert Kennedy. *NBC Sports* brought

many of the top athletic events, including the New York Mets' victory in the 1969 World Series and the New York Jets' upset win in the 1970 Super Bowl, into the nation's homes.

NBC expanded its overseas operations and, by the end of 1970, was providing programs to 114 nations. That year, *Bonanza*, the world's most popular tv series, had an estimated weekly audience of more than 400 million people in 83 countries.

RCA Records, which became part of NBC in 1969, made a number of artistic and marketing advances during this period. The Philadelphia Orchestra and its distinguished conductor, Eugene Ormandy, returned to the Red Seal label.

## Commercial services

Commercial and technical service volume of the RCA Service Company reached new peaks each year between 1967 and 1970. New branches were added to the nationwide network offering factory service to owners of RCA products, bringing the total to 180 by the end of 1970.

Commercial tv service activities also increased, largely because of the rising rate of conversions to color receivers by such institutions as hospitals, nursing homes, and hotels. In 1970, RCA reduced the cost of these conversions by designing a color installation compatible with existing black-and-white wiring.

The Service Company also handled maintenance and installation for RCA commercial communications products and provided service for other manufacturers and large users of such equipment. In 1969, it installed the hardware and provided remedial maintenance for more than 3000 reservations systems terminals at leading hotel and motel chains. The following year, technical maintenance services were extended for credit verification and airline reservations systems as well as data communications equipment. Also in 1970, RCA began to lease teletype equipment for both computing and communications uses.

## Global communications

The rapid expansion of world business and the need for greater interaction among nations spurred the growth of global communications during the later 1960s. To serve this need, RCA Global Communications was operating more than 2500 channels of various bandwidths by year-end 1970, nearly twice as many as were in use five years before.

The nature of the industry began to change during this period, with a pronounced trend toward increased use of telex and leased-channel services. Part of the reason for this was the development of new technological advances that permitted broad-based, tailor-made customer services at lower costs. For example, in 1967, RCA introduced AIR-CON, a unique remote computing application that permitted companies that have their own private teleprinting network to plug in to a master computer for automatic relay of messages. The following year, RCA customers were able to use international voice-grade channels for simultaneous transmission of telegraph and

voice, facsimile, and data communications over the same link.

In 1969, RCA inaugurated the Computer Telex Exchange, which provides international telex communications within seven seconds and reduces the possibility of error. Another new service, Interpolated Voice Data, allows two-way voice conversation on a circuit at the same time that data flows at high speeds in both directions. During pauses in conversation, the circuit instantly switches from the voice mode to data transmission. Also in 1969, the Executive Hot Line was opened between New York City and San Juan, allowing a businessman in his Manhattan office to establish immediate contact with an associate in Puerto Rico merely by lifting the handset of his special telephone.

## Commercial and industrial products

The market for broadcasting equipment expanded in the late 1960s under the impetus of increasing conversions of tv stations to color, a strong replacement market, and the opening of new uhf stations. However, after three consecutive peak years, domestic booking waned in 1970 largely because disappointing general business conditions resulted in a decline in tv advertising revenue, forcing broadcasters to defer purchases of major equipment.

Throughout this period, RCA continued to be the leading supplier to the broadcast industry. In 1968, for example, 55 uhf stations went on the air for the first time, and RCA provided transmitting equipment for more than half of them. The company strengthened its leadership that year with the introduction of the TK-44A camera, which can take acceptable color pictures at only 15 footcandles, a light level too low for reading. Within two years, it became the best-selling camera in the industry.

In 1969, the Corporation introduced a 30-kW uhf transmitter that improved the technical quality of tv transmissions by a margin of two to one. RCA also continued to be the prime supplier of multiple-antenna systems for tv broadcasting. In

1970, two tower antennas were installed on the 100-story John Hancock Center in Chicago, and an agreement was signed to construct an antenna stack atop Mt. Sutro for San Francisco tv stations.

RCA technology was also part of the new age of aviation. Most of the major airlines, including Pan Am and TWA, selected RCA weather radar for installation in their new fleet of Boeing 747 jets and other aircraft. The TWA order, placed in 1968, was the largest single purchase of weather radar equipment in airline history. In addition, RCA navigation/communications systems were standard equipment on many business and commercial jets.

In other areas, RCA expanded its mobile two-way radio line in 1970 with medium-priced systems designed to serve the growing communications needs of small businesses.

## Space and defense

When astronaut Neil Armstrong stepped from the Apollo 11 Lunar Module onto the magnificent desolation of the moon, his RCA-produced man-pack radio was his electronic link to home. It carried his historic first words across 225,000 miles of space to the world and on to posterity.

The radio was only one of the important RCA contributions to the Apollo program during the five-year period. In 1968, a tiny tv camera designed and built by the company for the Apollo 7 mission sent back the first live pictures of astronauts aboard a U.S. spacecraft. Another RCA camera flew on Apollo 8, man's first voyage to the vicinity of the moon. On the later Apollo missions, RCA was responsible for the rendezvous and landing radars that helped guide the astronauts in the LM to and from the lunar surface, as well as the attitude and engine control assemblies that aided them

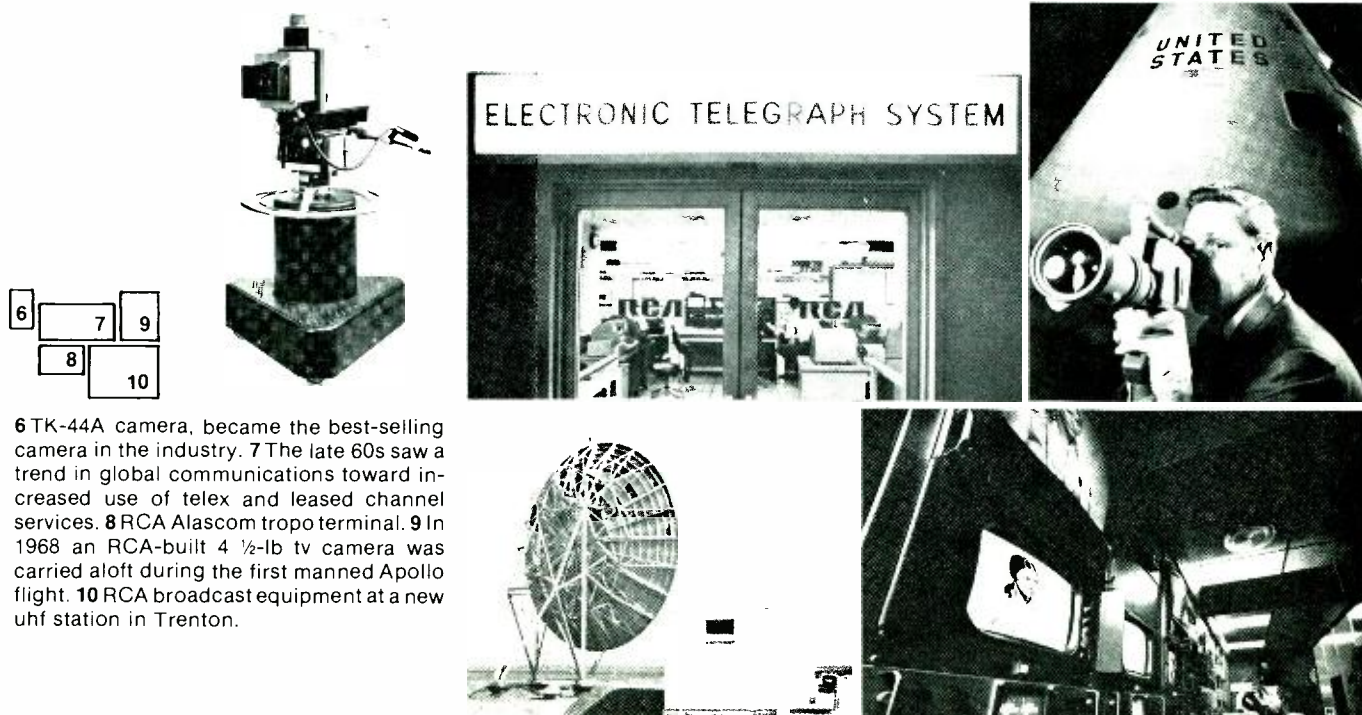

6 TK-44A camera, became the best-selling camera in the industry. 7 The late 60s saw a trend in global communications toward increased use of telex and leased channel services. 8 RCA Alascom tropo terminal. 9 In 1968 an RCA-built 4 1/2-lb tv camera was carried aloft during the first manned Apollo flight. 10 RCA broadcast equipment at a new uhf station in Trenton.



in making pinpoint landings on the moon. The RCA LM communications system enabled the astronauts to maintain continuous voice contact with earth, and the vhf communications/ranging system kept the LM in constant touch with the Command Module when the two spacecraft were separated in flight. Two RCA countdown computers at Cape Kennedy provided critical ground support for the moon mission, monitoring 3000 functions of the Saturn 5 rockets prior to launch.

RCA also has played a key role in developing spacecraft and systems for the nation's unmanned space program. RCA power supply and communications equipment was aboard all three Lunar Orbiter spacecraft that, in 1967, completely mapped the lunar surface.

The company was also the nation's leading developer of meteorological satellites. By year-end 1970, more than 1.5 million television pictures had been returned from space by RCA-built satellites, most of them from Tiros/ESSA weather satellites. In 1970, the first two in a series of RCA-built ITOS satellites were placed in earth orbit. These larger, more sophisticated, second-generation spacecraft provided improved coverage of the earth's weather systems.

In another program, operational transit satellites built for the Navy provided ships at sea with the most accurate navigational aid in history. RCA scientists and engineers also developed the power and data storage systems for NASA's experimental meteorological Nimbus satellite, and NASA selected RCA to build the high-resolution tv and recording systems for the first Earth Resources Technology Satellites, scheduled for launch in 1972 and 1973. The cameras will take highly detailed color pictures of the earth's surface to aid in the monitoring and controlling of natural resources.

RCA, in 1969, was assigned responsibility for the development of the Navy's new Aegis advanced surface missile system, and the preliminary design for the command and launch segments was completed in 1970. The \$253-million contract was the biggest for RCA in more than a decade and might develop into the largest defense contract ever received by the company—possibly more than \$1 billion. Other military projects during the five-year period included the study and development of an advanced airborne command center, over-the-horizon radars, and a robot sailboat that can be navigated by radio command to any point on the world's seas.

## Leasing and renting

In recent years, American motorists have logged several billion miles annually in automobiles they do not own. They were customers of one of the faster growing segments of the service industry—vehicle leasing and renting. In 1967, The Hertz Corporation, the largest company in this field, became a wholly owned subsidiary of RCA. By the end of December 1970, 150,000 cars and trucks were operated by Hertz and its licensees in the United States and 107 foreign countries. Hertz service was available at nearly 3000 locations in more than 1900 cities. Hertz and its subsidiaries also leased and rented construction, commercial, and industrial equipment and operated parking and exposition facilities.

Late in 1968, Hertz unveiled a new service approach for the air traveler—the Sky Center at the Huntsville, Ala., jetport, where transportation, lodging, business, banking, and recreational facilities, all operated by Hertz, are housed under one roof. In 1970, arrangements were completed for Hertz to build and operate a hotel/motel complex at the Jacksonville, Fla., airport.

Overseas, Hertz reached an agreement with Soviet officials in 1969 to make auto rental available in several major Russian cities. Earlier that year, Hertz service was established in Romania and Bulgaria.

Hertz Equipment Rental Corporation entered the foreign market in 1970 with its new subsidiaries, Air Mac International Corporation and Air Mac Philippines, Inc. These concerns operate construction-equipment locations in Singapore, the Philippines, and Seattle, Wash.

## Research and development

During the five-year period, thousands of scientists, engineers, technicians, and systems people at RCA laboratories in Princeton, N.J., Montreal, Tokyo, Zurich, and the product divisions provided the Corporation with viable technical alternatives on which to base future profit. These involved not only the discovery of new concepts and products but also the evaluation of technical achievements made elsewhere.

Some of this activity was devoted to the realization of the promise of the laser. In 1967, RCA combined television and laser technology, for the first time for transmission and recording of images. This system used a tv camera tube that

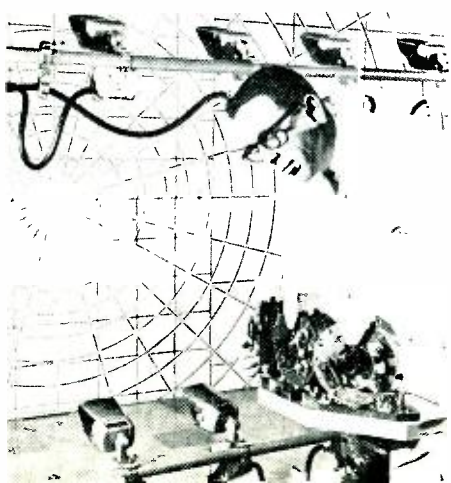

11 12

11 The advanced vidicon camera system developed for NASA by RCA for the Nimbus weather satellite. 12 In 1968 Hertz unveiled a new service approach for the air traveler—the Sky Center at the Huntsville, Ala., jetport.



sent its pictures to a gas laser, whose beam traced them on photographic film. The same year, a new laser technique was developed that made it possible to produce holograms of large stationary objects. In 1968, RCA's research in the control of light led to the development of the world's first holographic computer memory. Such memories are capable of storing large amounts of data in a very small space and are relatively immune to the effects of dust and scratches. The following year, RCA unveiled a laboratory model of a laser-based home video player. RCA plans to market a variety of home video player systems during the next decade under the SelectaVision trade name.

RCA scientists also developed gallium arsenide lasers—the most efficient solid-state lasers ever built.

One of the most important RCA research advances during this period was using liquid crystals for electronic control of the transmission and reflection of light. Liquid crystal products of the future may range from instrument displays for automobile dashboards to flat-screen tv receivers. Other achievements included the harnessing of an electronic "avalanche" within silicon diodes to produce the most powerful solid-state microwave generators ever built and the development of the silicon storage vidicon camera—a compact tv camera with stop-action capabilities.

In 1967, RCA Laboratories' Tokyo branch moved into new research laboratories just outside that city. Research there is concentrated on magnetic materials, semiconductors

and semimetals, plasma physics, and communications theory.

## Publishing

From *Rosemary's Baby* in 1967 to *The Greening of America* in 1970, Random House titles were consistently represented on the best-seller lists. However, the achievements of RCA's publishing subsidiary were not limited to the trade book division.

The commercial and critical success of *The Random House Dictionary of the English Language*, published in 1966, led to the publication of a college edition in 1968 and an elementary school version in 1970. Random House maintained its position of leadership in children's books with the introduction, in 1968, of *The Bright and Early Books* by Dr. Seuss.

To meet the changing requirements of modern education, Random House inaugurated a series of instructional materials for classroom use. Important multimedia programs were developed in all major languages and involved textbooks, audio tapes, and film strips. Supplementary materials were designed that offered individualized instruction for students at all grade levels who had difficulty in reading and mathematics. Efforts also were directed at the junior-college and community-college levels—the fastest growing segment of the college textbook market.

## New business activities

During the five-year period, RCA followed a flexible growth policy of diversification and expansion of present activities, selective new business ventures, and increased emphasis on marketing to assure a sound balance between manufacturing and service business. With all these changes, however, RCA remained basically an electronics and communications company—with approximately 75 percent of its products and services concentrated in these areas.

In addition to The Hertz Corporation, two other companies became wholly owned subsidiaries during this period. Banquet Foods, Inc., formerly the F. M. Stamper

13 New RCA research laboratory in Tokyo.  
14 A new laser technique made holograms of large stationary objects possible.

13 14



15 16 17 18

15 *The Random House Dictionary of the English Language* was the first major new dictionary in many years. 16 Banquet Foods became a wholly owned subsidiary in 1970. 17 RCA acquired Cushman & Wakefield, one of the nation's leading real estate firms. 18 A speech therapy session at a Keystone Job Corps Center.





Company—a leader in the frozen prepared foods industry—became an RCA subsidiary in March, 1970. The same year, RCA acquired Cushman & Wakefield, Inc., one of the nation's leading commercial real estate firms. Cushman & Wakefield's operations encompass project consultation, office leasing, building management, site improvement and development, sales, and appraisal. In late 1970, an agreement for merger was reached with Coronet Industries, Inc., of Dalton, Ga. Coronet's activities range from the manufacture of floor and wall coverings and commercial, residential, and institutional furniture to the fabrication of foams, plastics, and other materials.

RCA's managerial and technical capabilities were directed increasingly toward the improvement of public education and training in the United States. During this period, the Corporation received contracts to operate the Keystone Job Corps Center for Women in Pennsylvania and the Choanoke Area Development Center for seasonal farm workers and their families in North Carolina. And in 1970, RCA received a U.S. Department of Labor contract to operate a residential Job Corps Center for the training of underprivileged youth in New York City. The same year, the company contracted to direct a federally funded program aimed at upgrading the public school system of Camden, N.J.

In 1969, a new growth opportunity for RCA opened in the northernmost state, when the U.S. government accepted RCA Globcom's bid to purchase and operate the Alaska Communication System. Plans call for a telephone rate reduction that will save the people of Alaska some \$40 million during the first three years of operation. By the end of 1970, RCA Alaska Communications had already built a microwave system and a tropospheric and microwave link and initiated direct-distance-dialing installations in Anchorage, Fairbanks, Juneau, and Ketchikan.

RCA capitalized on the increasing need for prompt, quality service by launching ServiceAmerica, a new organization to service all makes of tv sets and other home entertainment products. Ten ServiceAmerica centers were opened during 1970—five each in the Philadelphia and San Francisco areas.

In manufacturing, RCA entered the glass business in 1970 with the completion of a \$19-million plant in Circleville, Ohio, for the manufacture of glass funnels and faceplates for large-screen color tv picture tubes.

## International operations

RCA also embarked on a program of global expansion during these five years. In 1967, a new approach to international marketing and manufacturing was formulated, with each major division given worldwide responsibility for its products and services. At the same time, a corporate staff function was set up to coordinate international activities. In 1968, a distribution center was established in Hong Kong to serve the Far East market. The same year, RCA House was opened in London as a headquarters for administrative and marketing functions in Europe, the Middle East, and Africa.

Other activities in the United Kingdom during the period have included the building of a new facility on the Isle of Jersey for commercial product activities in the European market and the construction of a solid-state applications engineering and test center at Sunbury-on-Thames. A record-pressing facility was built at Washington, in Yorkshire, and a magnetic products plant at Bryn Mawr, Wales.

In 1970, RCA constructed a \$10.7-million semiconductor manufacturing plant in Liege, Belgium. This marks RCA's first electronics manufacturing facility on the European continent.

A facility was opened in 1967 on Taiwan for the manufacture of integrated circuits and memory planes. Later, the plant was enlarged for the production of certain consumer electronic products. In 1970, a 49 percent interest was obtained in a new Taiwan company for the manufacture of black-and-white picture tubes for worldwide distribution.

In Canada, RCA opened a new color picture tube plant in Midland, Ont., in 1967 and announced plans for the construction of large new recording studios in Montreal. A year later, RCA entered the Canadian computer market with the opening of sales offices in Montreal and Toronto and the installation of a Spectra 70 data center, also in Montreal. Early in 1970, RCA Limited (Canada) moved into its new corporate headquarters at Ste. Anne-de-Bellevue, Que., on the outskirts of Montreal.

RCA was active in Mexico. The Corporation acquired Dispositive Electronicos S.A., a producer of receiving tubes for sale in Latin America. In 1969, a new Mexican corporate headquarters was established in Mexico City. A color picture tube assembly plant in Mexico City and a consumer electronics subassembly facility in Ciudad Juarez also began operations. The same year, a computer data center was opened in Mexico City for the marketing of electronic data processing equipment in that nation.

During this time, The Hertz Corporation greatly expanded its international operations. Its volume outside the United States and U.S. possessions increased an average of 30 percent a year during the five-year period ending in 1970.

## Prospects for the future

In his 1970 year-end statement to shareholders, Chairman Robert W. Sarnoff summed up the major goals of RCA. "Looking ahead through the 1970s, our program for progress aims for these major goals:

- Planned growth in areas of high profit potential, with particular emphasis upon services;
- Leadership in an expanding consumer market that is being profoundly altered by new technology and changing tastes.

As we move beyond the current period of economic adversity, the steps now being taken to achieve these objectives should position RCA for a new cycle of growth and profitability greater than any it has known in the past."

# Part VI—The years 1971-1976

J. Hillier

*No other period since the Great Depression affected RCA as severely as the recession of 1974-1975. Despite this, the company emerged at the end of 1976 leaner, stronger, and continuing to grow.*

The years 1971 through 1976 were difficult, and, in some instances, even traumatic for RCA Corporation. David Sarnoff, the man who personified RCA and led the company during most of its growth into a major international corporation, died in 1971 after 15 months of incapacitating illness. That same year, the Corporation withdrew from the general-purpose computer business. During the recession years of 1974 and 1975, the company's profits dipped to \$113.3 and \$110.0 million, respectively, compared with profits of \$178.3 million in 1973 and 172.0 million in 1976. Lastly, between the end of 1975 and September 1976, the company's top management was changed twice.

Yet, as this was being written, (year-end, 1977) the Corporation reported the best year in RCA's 58-year history. At the end of the six-year reporting period, RCA emerged leaner and stronger in the overall deployment of its financial, material, and managerial resources. It overcame its difficulties and is continuing to grow and prosper.

*Resolute management, RCA's scientific resources, and the non-electronic subsidiaries helped in renewing economic growth.*

There are many reasons for RCA's renewed growth in 1977 despite the adversity it faced a few years before 1976. A resolute, cost-conscious management that enforces profit objectives is an obvious and dominant factor. Management however needed the proper tools. Certainly, one of these tools was the scientific resources that have made RCA a pioneer and innovator in electronics for almost 60 years. The nonelectronic subsidiaries acquired during the past decade or so also gave RCA indispensable support through these trying years.

As a group, the diversified businesses withstood the recession years of 1974 and 1975 far better than RCA's electronic businesses, which suffered sharp declines in sales and profits, especially in tv receivers, picture tubes, and solid-state components. As 1975 came to a close, however, it became evident that major thrusts would continue to be based on products and services arising out of the company's strengths in electronics research, development, and production. This was typified by the increasingly close and coordinated relationships between RCA Laboratories and the product divisions. Among the benefits of these improved relationships were increased production efficiency, a heightened awareness of market needs and opportunities, and the emergence of cost-effective new and improved products and services to meet these needs and opportunities.

It is not possible here to go deeply into all that happened in the Corporation during the 1971-1976 period. Furthermore, this article is written for the engineers and scientists who made up the Corporation's research and development activities, and the emphasis will be placed in the R&D areas, though other areas will be mentioned to provide the proper perspective.

One example of RCA's renewed emphasis on R&D innovation came in the second half of 1975 with the introduction by RCA Consumer Electronics of its new all-solid-state Color-Trak television receivers. RCA, which had led the industry into color television 25 years earlier, reasserted its leadership with a receiver that incorporated several major technical advances. Three operations of RCA—Solid State, Picture Tubes, and RCA Laboratories—worked with Consumer Electronics in developing the ColorTrak system, which the Company expects will be the industry standard in performance and picture quality for some time to come.

At the end of 1975, RCA launched its Satcom I, the nation's most advanced and cost-effective communications satellite, to inaugurate the second phase of the RCA Satcom domestic satellite communications system. RCA Astro-Electronics built Satcoms I, II, and III. Satcom II was launched early in 1976 and Satcom III remains, as this is written, a backup spacecraft to be launched when the need arises. The RCA Satcom system actually went into service in 1973 as the nation's first domestic satellite communications carrier, with channels leased from Telesat Canada's Anik satellite.

As the 1971-1976 period was ending, RCA Laboratories and the Solid State Division were exploiting its microprocessor technology and expertise leading to the introduction in 1977 of the COSMAC VIP home computer kit.

Still in the development phase at RCA Laboratories and Consumer Electronics is the SelectaVision Videodisc system, which provides for the playback of recorded color tv entertainment, educational, and other materials from a disc, similar to an audio record. One major problem to be solved before a decision can be made whether to market the Videodisc system is development of a diversified supply of prerecorded program material. Meantime, RCA entered the rapidly growing home videotape market with the SelectaVision Video Cassette Recorder, supplied by the Matsushita Electric Industrial Company, Ltd.



*Consolidation, divestiture, and changes in leadership marked this time span.*

The growth and development that marked the end of the 1971-1976 period were preceded by consolidation and adjustment to new circumstances. In the second half of 1971, RCA withdrew from the general-purpose computer business. Adverse business conditions, a uniquely entrenched competition, and the need for continued massive infusions of capital led to this decision by RCA. A major result of this decision was an extraordinary one-time after-tax charge of \$250 million. The decision terminated the long-term critical drain on the company's resources and led to the freeing of management and technical skills as well as funds for the company's expanding operations.

During the 1971-1976 time frame, RCA discontinued or divested itself of several other businesses that had become technologically obsolete or marginally profitable, or were operating at a loss. The company went out of the audio products business in 1975. The major divestitures included the receiving tube operations at Harrison, N.J.; other divestitures involved the Graphic Systems Divisions, RCA Institutes, 16-mm projectors, West Palm Beach Division, Microwave Devices, and the government activities of RCA Ltd. in Canada.

RCA acquired Coronet Industries, a leader in the carpeting field in 1971, but in 1977, Shelby Williams Inc., a furniture subsidiary and J. Josephson, Inc., a wall-covering subsidiary of Coronet, were sold. Other acquisitions included Oriel Foods Limited, Morris & David Jones Limited, United Kingdom food companies, in 1974.

With divestment, acquisition, and other corporate changes in the six-year period came realignment and reorganization of the company's activities.

In 1975, Robert W. Sarnoff, who had succeeded his father as Chairman of the Board five years earlier, announced his resignation from that position at the end of the year. His successor, Anthony L. Conrad, resigned in 1976 after telling the Board that he had failed to file personal income tax returns for the years 1971 through 1975, though substantial taxes had been withheld from his compensation. Mr. Conrad's failure to file was not related to the corporation's business.

**Current tv model** sits atop first mass-produced set turned out by RCA in 1946. Original model weighed 85 lb. New 20-lb model has a built-in battery.

Edgar H. Griffiths, who joined RCA in 1948, and rose through a succession of executive positions to become responsible for all of RCA's electronics and diversified businesses, was elected President and Chief Executive Officer of RCA Corporation in September 1976.

## Consumer electronics

*XL-100 and ColorTrak were pacesetters for the industry.*

In 1971, RCA introduced the XL-100 television receiver series, the industry's broadest line of color receivers with a 100-percent solid-state chassis. In 1975, it introduced ColorTrak, the latest and most advanced of the XL-100 series. Among its advances, the ColorTrak system includes a picture tube with light-absorbing phosphors that provide blacker blacks and more vivid colors under strong ambient lighting conditions; special circuits for color-contrast tracking; circuits that automatically track brightness and hue to compensate for varying broadcast and room lighting conditions; as well as general improvements in sharpness, resolution, signal-to-noise ratio, colorimetry, and tuning. In 1976, ColorTrak's first full year as a complete line, it won strong acceptance by consumers and accounted for 42 percent of RCA's total dollar sales in color television.

Black-and-white television also shared in the product development program with the introduction of a completely redesigned line—the company's first total product line change in 28 years—featuring portable sets designed to appeal to a youthful, mobile market.

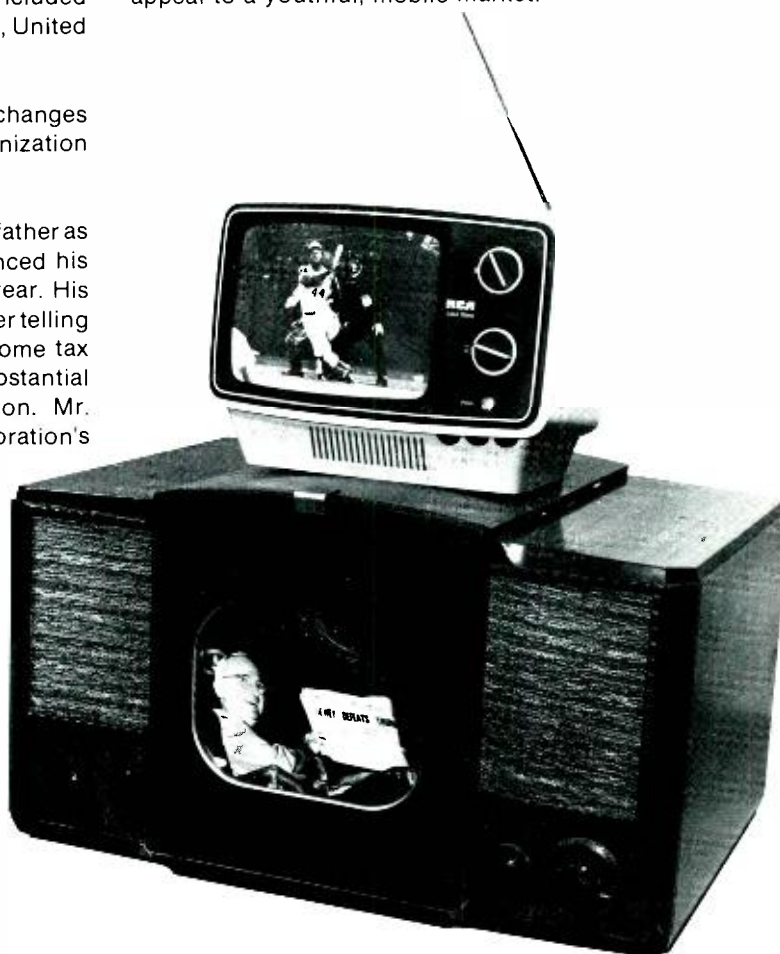

With the closing of the company's Memphis, Tenn. plant in 1971, RCA's domestic tv manufacturing was consolidated in two facilities at Bloomington and Indianapolis, Ind. At the same time, construction of an RCA Design Center was begun in Indianapolis to provide greater emphasis on innovative design in future consumer products.

RCA continued to increase sales of the XL-100 solid-state series, and in 1973 sold more color tv sets than in any previous year. The following year, RCA became the first full-line U.S. manufacturer to devote its tv production exclusively to 100-percent solid-state receivers. At the same time, it achieved significant production economies by streamlining its color line to 31 models employing fewer basic chassis designs. Comparable model and chassis reductions were made in 1975 in the new black-and-white "Sportable" tv line.

In mid-1974, RCA announced that the newly introduced line of radios, phonographs, and tape players would be its last. Audio products had declined to 5 percent of RCA's consumer electronics business, and, in a highly fragmented and crowded field, had lost their profitability.

## Records and tapes

*RCA Records increased its market share both here and abroad.*

RCA Records continued to strengthen its industry position with advances in marketing, overseas operations, and artists and repertoire. In 1976, for the second consecutive year, RCA Records achieved the largest sales and profits in its history.

In the early 1970s, RCA Records took over its own direct distribution enabling it to serve the bulk of the U.S. market through its own outlets. This resulted in greater market penetration. New licensee operations and subsidiary companies in such countries as France and West Germany increased foreign sales significantly. In 1975, RCA Records entered into a joint venture with the Victor Company of Japan, Ltd., giving it greater growth potential in the world's second-largest record market.

"The Sound of Music" continued to be the biggest selling album in recording history, and Van Cliburn's performance of Tchaikovsky's Piano Concerto No. 1 became the first classical record to sell more than a million copies. Popular artists such as John Denver, David Bowie, and the Jefferson Starship achieved peak records sales. In the classical field, Vladimir Horowitz, who rejoined RCA artists in 1975 after a 13-year absence, had his first new album release late in 1976.

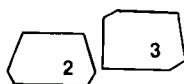

**2**RCA entered the home videotape market with Selecta-Vision video cassette recorder. **3**ColorTrak automatically tracks brightness and hue.



## Picture tubes

*RCA became a fully integrated producer and increased sales.*

The decline in demand for receiving tubes, resulting from the growth of solid-state technology—an 80-percent reduction in ten years—influenced the decision to realign the constituents of the RCA Electronic Components Division. One result was the establishment in 1975 of the RCA Picture Tube Division to take over the principal activities of the former Entertainment Tube Division.

In 1971, picture tube engineering emphasis centered on the development of the 25-inch 110-degree delta color picture tube primarily for the international market. RCA's Circleville, Ohio, glass plant began production of panels and funnels for color picture tubes. Thus, RCA became the first domestic tv producer to be fully integrated from sand to receiver.

The same year, color picture tube production was consolidated at Marion, Ind. and Scranton, Pa., and completely curtailed at the Lancaster, Pa. plant. Black-and-white tube production was discontinued. A new plant for the manufacture of shadow masks was dedicated at Barceloneta, in Puerto Rico.

RCA and the Thomson Group in France also joined in 1971 to form Videocolor S.A. with color tube manufacturing facilities in Anagni, Italy. A joint venture with Thorn Electrical Industries, Ltd. also saw the start-up of production in Skelmersdale, England. (Early in 1976, the decision was made to discontinue the joint venture with Thorn, Ltd., because of continuing losses and adverse economic conditions abroad, especially in the United Kingdom.)

In 1972, RCA announced its new Precision In-Line color tv tube system designed for lower cost solid-state portables. This tube provides economy during factory assembly of receivers, superior performance, and reliability for the consumer. The system incorporates an advanced-design electron gun, a factory-positioned yoke, and line-screen picture tube.

In 1974, the Precision In-Line concept was expanded to include large-screen sizes with 110-degree deflection, thus offering savings to European tv set manufacturers in circuitry and labor costs while maintaining excellent picture quality. While 110-degree PIE (Precision In-Line Euro) was the popular product for European customers, the highly competitive U.S. market reflected demands for still further economies. This, coupled with the power crunch, resulted





in a change of direction away from the higher cost 110-degree systems to the lower cost 90-degree systems.

Despite the adverse economy in 1975, RCA increased its share of the color tube market. The Picture Tube Division introduced, as part of RCA's new ColorTrak receiver, a new high-contrast phosphor picture tube that provided a contrast ratio improvement of approximately 25 percent over conventional phosphor tubes, and reduced reflections under high-ambient light conditions. For the international marketplace, 110-degree PIE engineering improvements included development of a quick heat gun and a new tube geometry system which resulted in improved color purity and white uniformity from turn-on through the warm-up cycle. This 25-inch 110-degree PIE system was to be carried into domestic production intended for export, and at Videocolor's Anagni, Italy, plant.

In 1976, the Picture Tube Division entered into a long-term technology transfer contract with the UNITRA agency of the People's Republic of Poland. This contract included the installation of complete color tube manufacturing facilities capable of producing up to 600,000 picture tubes per year. The 21-inch 110-degree PIE tube type was designated as the type to be produced in this new facility. The plant is expected to be operational in 1979.

1976 also saw the introduction into the European Market of the 21-inch (diagonal) 110-degree Precision In-line, self-converging tube. This tube, along with the 25-inch tube which was introduced in 1975, has received good acceptance in Europe and has helped to increase our share of the market.

## Solid state devices

*Microprocessors became the electronics brains of an increasing range of products and services.*

During the first half of the 1970s, RCA continued as a leader in semiconductor power devices, offering the industry's broadest line. Although power devices are the mature segment of the semiconductor business, the Solid State Division averaged 15 to 20 new types each year. RCA also led the way in establishing semiconductor electronics in the automotive market, enjoying the largest market share for applications other than car radios and tape players.

In the early 1970s, RCA paced the industry in introducing a new digital technology—COS/MOS. In 1974, the Solid State Division produced the industry's first combination of MOS and bipolar semiconductor technologies on a single chip,

as well as introducing the first linear COS/MOS circuits for higher performance in control functions. By late 1975, with the announcement of 40 new integrated circuits of its CD4000 series, the Solid State Division had more than 180 standard commercial circuits in the COS/MOS series, plus more than 100 custom circuits, the widest line in the industry of such low-power devices for computers, communications equipment, and industrial controls.

In 1975 Solid State introduced COSMAC, the industry's first COS/MOS microprocessor, the central processing unit of microcomputers. In 1976 a single-chip version and support circuits were announced. These units are capable of operating over extreme ranges of temperature, and in hostile industrial, consumer, and automotive environments. They are highly resistant to electrical interference, and highly tolerant to a wide power supply voltage range.

Another 1975 innovation was the introduction of the industry's first integrated circuits with hermetic performance in a low-cost plastic package compared with the more expensive hermetic ceramic or metal packages.

The first half of the decade also marked a significant expansion of the Solid State Division's production facilities. In 1971, it opened a semiconductor plant in Belgium to serve the Common Market. In 1974, it began assembling power devices and integrated circuits in its new plant in Malaysia. In 1975, it undertook the assembly of semiconductors in Brazil for the Latin American market. Early in 1976, the Division began production of LSI solid-state devices in a new wafer fabrication facility in RCA's Palm Beach Gardens plant.

Together with the rest of the semiconductor industry, the Solid State Division was severely affected by the 1974-1975 recession. This was compounded by excess industry capacity and heavy price competition which occurred simultaneously with rising costs. Conditions began to improve in late 1975, and by 1976 the division was again showing a profit.

*Electro-Optics and Devices was developing vidicons, all-solid-state tubeless black-and-white tv cameras, and lasers.*

As a consequence of the realignment of RCA Electronic Components in 1975, the Industrial Tube Division became

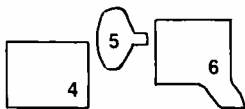

4 Pre-recorded tapes are monitored at RCA Records. 5 21-inch 110° Precision In-Line tube. 6 COSMAC contains up to 6000 transistors.

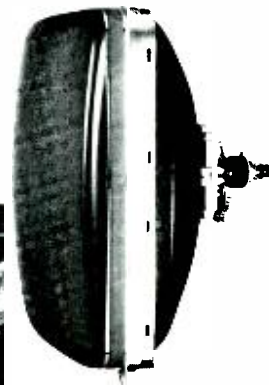

part of the Solid State Division under the new name of Electro-Optics and Devices.

In 1972 the Electro-Optics group within the former Industrial Tube Division entered the rapidly growing CCTV (closed-circuit television) market with television cameras and associated equipment designed not only around the conventional vidicon but also with the silicon vidicon, and with the SIT (silicon intensifier target) tube for very low light level tv surveillance. These devices also have been successfully marketed as components.

Three years later, in 1975, Electro-Optics and Devices demonstrated two all-solid-state, tubeless black-and-white tv cameras. The heart of the camera was the world's highest resolution and largest charged-coupled device (CCD) television image sensor. Subsequently, fully standard U.S. 525-line compatible video was demonstrated in both black-and-white and color CCD tv cameras.

In another area, Electro-Optics continued to lead in the development of photomultiplier tubes, particularly for such medical applications as the Gamma camera and CAT scanners. Solid-state lasers and detectors were developed and marketed for military and commercial fiber-optic communications.

## Receiving tubes

The steady shift to solid-state devices in nearly all electronic products, and the consequent steady decline in the receiving tube business resulted in RCA closing its receiving tube plant at Harrison, N.J., in April 1976.

## Distributor and special products

*This newly-created division provided greater economy of operation, more efficient distribution, and a birthplace for several new products.*

In 1975, RCA Corporation dissolved its Electronic Components Division at Harrison, N.J. and created two new divisions: Picture Tubes and Distributor and Special Products. At D&SPD, RCA merged the product lines and distributor network of the former Electronics Components organization with those of the Parts and Accessories Division in Deptford, N.J.

This unified division, having its own marketing, sales, financial, and warehousing functions, D&SPD became responsible for the worldwide distribution of replacement parts for RCA products: receiving tubes; indoor and outdoor tv antennas, rotators, antenna hardware, and related accessories; car radios, tape players and speakers; scanning receivers; as well as other miscellaneous and related accessory products. In addition, the new division became responsible in the distributor market for a complete line of tv picture tubes, certain replacement semiconductors, industrial tubes, and closed-circuit tv cameras.

CCD image sensor shown on the tv screen is the heart of the tubeless tv camera developed by Electro-Optics.

In mid-1976, RCA reentered the rapidly growing citizens band radio field with its Co-Pilot CB line. When the industry changed to 40 channels in January 1977, RCA unveiled a full-line of new citizens band products including mobile and base station units.

In February 1977, RCA began to test market a microprocessor video game named Studio II, which is based on the RCA-designed CMOS 1802 microprocessor, and utilizes optional plug-in cartridges for a variety of add-on games and programs.

## Broadcasting

*The 1971-1976 period was one of continued growth and innovation for the National Broadcasting Company.*

NBC News presented approximately 11,000 hours of television news programming, covering such major events as the final Apollo moon flights, the end of the Vietnam War, Presidential trips to Russia and China, the U.S. Senate Watergate hearings, impeachment proceedings by the House Judiciary Committee, the resignation of President Nixon, and the inaugurations of Presidents Ford and Carter. In 1976, NBC newsmen covered a record 30 Presidential primaries and used minicameras, and electronic tape and video cassettes extensively throughout the election campaign. NBC made the first projection of President Carter's victory and attracted the largest election night audience.

NBC continued its innovative programming with such new concepts as *NewsCenter 4* on WNBC-TV in New York and expanded local news programs at other owned stations; *Weekend*, a monthly television news magazine; *NBC Saturday Night*, a live, late-night comedy-variety series; *News Update*, a one-minute prime-time news summary, and *Best Sellers*, which presents popular novels in weekly episodes.

NBC Sports continued to attract large audiences for major events and has now carried four of the five most heavily viewed sports programs of all time in terms of total viewing homes. Early in 1977, NBC signed an agreement to cover the 1980 Olympic Games in Moscow.

Attesting to the quality of NBC's radio and television programs and personalities, the company won 790 major awards and citations during the six-year period, including 152 Emmy Awards and 26 George Foster Peabody citations.





In 1975 and 1976, NBC presented some 190 hours of special programming in celebration of the nation's Bicentennial, including a ten-hour live telecast on July 4, 1976, using 250 cameras coast-to-coast and in 13 foreign countries. In 1976, NBC observed its 50th year as the first national commercial broadcasting service, commemorating the milestone with a new, highly modern corporate identification program; a series of five network radio presentations, *The First Fabulous Fifty*; and a special network television program *The First Fifty Years*, which attracted one of the largest audiences of the year. National Book Award nominee Robert Campbell summarized NBC's first half-century in a lively, well-illustrated book, *The Golden Years of Broadcasting*.

A major project to automate Television Central in NBC's New York studios was started in 1969 and completed in 1974. This computer-controlled system, which serves the NBC Network and the local New York station, represents the most modern and complex switching and control television broadcast system in the Americas. The program was completed under the leadership of NBC Engineering with support from RCA Laboratories.

## Global and domestic communications

*In six years RCA went from one subsidiary in the telecommunications field to three.*

In 1971, RCA Global Communications Inc. was the only RCA subsidiary operating in the telecommunications field. Six years later there were two more—RCA Alascom to operate Alaska's long-lines telecommunications and RCA Americom to own and operate a domestic satellite communications system. The six-year span unquestionably was the most dynamic in the 58-year history of RCA as a communications company.

During this six-year period, RCA Globcom invested millions of dollars to increase its overseas cable capacity. RCA became part owner of TAT-6, a 4000-circuit cable going from Rhode Island to France and to more than 30 locations in Europe and beyond, and the TRANSPAC II cable between California and Hawaii and onward to several Pacific locations. The company also acquired circuits in CANTAT II between the United States, Canada, and the United Kingdom.

In 1971, a new computerized telex service feature called Telextra was introduced as RCA Globcom's answer to the "busy" signal. Telextra takes calls, and automatically forwards them to correspondents when the line is free. Camp-On, another new computerized telex improvement, was also made available. It repeatedly tries to make connections when overseas teleprinters or circuits are busy until it succeeds in getting through. And going into operation for the time was Datel service for exchange of computer data on a call-up basis between the U.S. and Tokyo, and the U.S. and Hong Kong.

In 1972, RCA Globcom was first in the industry to introduce UniCodes, permitting overseas telex call selection by dialing a single digit. That year, the company sold the first communications satellite earth stations to the People's Republic of China. A year later, RCA Globcom again assumed first position among U.S. carriers in overseas telex traffic.

In 1974, the RCA Globcom control center, housing a new computer-controlled telex exchange, was inaugurated, at Lodi, Calif., and another was completed at Piscataway, N.J. With the computer complex at Lodi, and those in San Francisco and New York, RCA was the only U.S. international carrier with four computer centers. The following year, work began on a new high-speed message telegram computer to more than double RCA Globcom's message-handling capacity over the coming years.

In 1971, RCA Globcom acquired the Alaska Communication System from the U.S. Air Force and established Alaska's first commercial long-lines communications system. RCA Alaska Communications, Inc., was formed initially as a subsidiary of RCA Globcom. In 1976, RCA Alascom became an independent subsidiary of RCA Corporation.

In 1974, RCA Alascom announced agreements for the development and installation of multimillion-dollar communications systems, both satellite and microwave, to serve the construction and operation of the Trans-Alaska oil pipeline. Those systems were completed and received preliminary acceptance for service by Alyeska Pipeline Service Company, builders of the 800-mile line, during 1976. In the summer of 1975, RCA Alascom, in cooperation

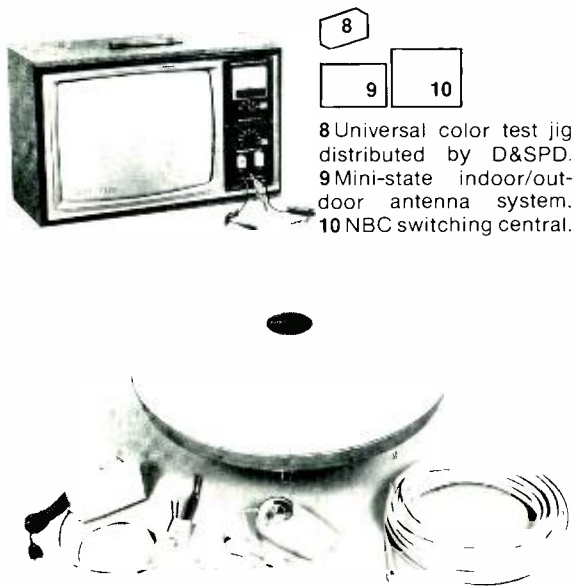

8  
9 10

8 Universal color test jig distributed by D&SPD.  
9 Mini-state indoor/outdoor antenna system.  
10 NBC switching central.



with the State of Alaska, undertook construction of the first 20 small earth stations to provide satellite communication services to villages in the rugged Alaskan bush. The first 20 stations went into operation during 1976, bringing telephone communications via satellite to small, isolated communities, which had never before had any reliable means of communication with the outside world. Most of the stations have a circuit for emergency medical use by the Alaska Area Native Health Service, in addition to the public village telephone. By the end of 1977, some 100 such stations are scheduled to be completed. Another joint RCA Alascom/State of Alaska project, which got under way early in 1977, is a one-year demonstration program to bring television via satellite to 23 rural communities. The project, authorized by the Alaska Legislature, also increases the amount of live or same-day satellite television to five urban areas.

The RCA Satcom System, initially employing leased capacity in a Canadian satellite, was the first to provide commercial domestic space communications services in the United States, beginning December 1973. These services were switched to RCA Satcoms I and II after their launches in 1975 and 1976, respectively. Subsequently, the Satcom System carried the first regularly scheduled pay-tv program service in 1976. RCA American Communications, Inc. was created as a separate subsidiary of RCA Corporation to operate the domestic satellite communications satellite system. The new Satcom satellites designed and built by RCA to be the most advanced and cost-effective of their kind, link the nation's largest business centers. With a growing network of earth stations, the RCA Satcom System was designed to make possible satellite voice, data, and television communications throughout the 50 states at rates substantially lower than conventional means.

By the end of 1976, major RCA Americom earth stations were situated near seven key U.S. cities: New York, Philadelphia, San Francisco, Los Angeles, Chicago, Houston, and Atlanta, with the last three stations joining the network in 1976. In all, including government and

specialized users, more than 115 earth stations were transmitting and/or receiving space communications via RCA satellite. During the year, RCA Americom also began providing dedicated earth stations carrying high-speed data and television transmission for NASA in support of its Viking Explorer mission on Mars and the Space Shuttle program.

## Commercial communications

*New and improved products helped Broadcast Systems withstand changing economic conditions*

RCA shared in the late 1960s boom in broadcast equipment sales, resulting from the conversion of tv stations to color and the launching of new stations. Although the market fell off in 1970 and 1971 as economic conditions declined, Broadcast Systems continued to develop equipment of improved quality and efficiency and was in a position to capitalize on the economic upswing in 1972 and 1973.

One product that contributed significantly to RCA's leadership was the TCR-100 Video Tape Cartridge Recorder/Player. First placed in service in 1971, the system ushered in a major change in television broadcast operations. It made possible the automatic on-air showings of pre-programmed commercials, program promotions, and other 30-second to 3-minute tape segments. The TCR-100 design achievement was recognized with the award in 1974 of an Emmy by the National Academy of Television Arts and Sciences.

In 1973, Broadcast Systems solved the technical problems of providing eight tv and four fm stations in San Francisco with a common antenna site—atop a 977-foot tower on Mt. Sutro—to overcome the topography and construction impediments that had previously marred reception.

In 1974, RCA introduced the TR-600 Video Tape Recorder which took advantage of the increasing emphasis on cost effectiveness by incorporating into its design capabilities

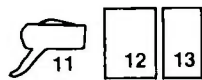
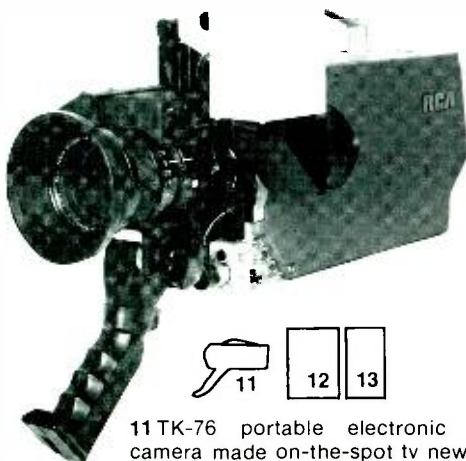

11 TK-76 portable electronic journalism camera made on-the-spot tv news possible.  
12 Microwave towers at RCA Alascom.  
13 Broadcast Systems solved reception problems in San Francisco with this tower on Mt. Sutro.





formerly offered as accessories. The TR-600 is on its way to becoming the largest selling VTR that RCA Broadcast Systems has every built.

Although the economy again declined in 1974, new products helped Broadcast Systems to maintain its position of leadership and increase sales and profits. An expanded international marketing effort also contributed to its ability to withstand downturns in the national economy. In 1976, for example, RCA became the leading tv-equipment supplier in Latin America and the Caribbean.

The most noteworthy accomplishment in 1975 was the TK-76, the first self-contained high-quality portable color television camera for electronic journalism. This lightweight camera, housing three imaging tubes and all required electronics, provides a new order of flexibility combined with high-quality performance. In 1976 orders for this camera tripled, putting RCA ahead of any competitor.

Other advances during the period included the development of a portable color camera, the TKP-45, that matched the TK-45 studio color camera in high-quality pictures; the introduction of the TK-28, a tv film system which greatly improved the reproduction of color film on television and quickly became the standard of the industry; and announcement of a circularly polarized tv antenna, designed to reduce reflections and ghosts caused by tall buildings and other obstructions in urban areas.

*Mobile Communications Systems designed improved two-way radios*

In 1973, RCA Mobile Communications engineers, employing advanced microelectronic types developed originally for space systems, produced the TACTEC line of portable two-way radios for the land mobile communications market. The use of integrated circuits and thick film hybrids, achieved with the cooperation of the Solid State Division and the military division of RCA Government and Commercial Systems, provided the radios with more functions, better performance, and greater reliability than conventional designs.

By 1976, in common with the industry, RCA's mobile-communications business suffered from a leveling-off in budgets of state and local governments. However, RCA's

international business continued to grow, and the introduction of a new moderately priced mobile-radio line called VEETAC, which incorporates advanced features, is expected to strengthen its worldwide competitive position.

*Avionics Systems developed weather radars.*

In 1975, RCA Avionics Systems introduced its new line of PRIMUS equipment to serve the aviation industry for weather radar and distance measuring equipment in the airline general business, and military aircraft categories. In addition to greatly improved reliability, the PRIMUS equipments integrate the use of digital display and microprocessor technology. For example, the PRIMUS 400, introduced in 1977, has a full-color display and an expanded memory for improved display resolution.

Three new weather radars were introduced in 1976 for the general aviation and airline market, laying the groundwork for further growth in 1977.

*The history of RCA Community Television Systems began when RCA acquired Electronic Industrial Engineering Company in 1972.*

The Electronic Industrial Engineering Company, which manufactured equipment for cable television systems, was originally a subsidiary and became an RCA division in 1973. During that year the division introduced a new series of amplifiers employing push-pull hybrids, which were an advancement to the state-of-the-art in cable tv technology. These amplifiers and continuing evolutionary improvements, established RCA Community Television Systems as a significant contender in cable tv distribution systems.

In 1975, RCA introduced a unitized family of compatible head-end equipment capable of delivering superior pictures for modern large-screen cable tv systems.

In the five years of RCA's operations, the business has tripled in volume and Community Television Systems has become a profitable business.

*Facilities management systems were installed in Florida and San Francisco.*

Early in the 1970s, RCA installed monitoring and information-handling systems that are extensively employed in the management of the Walt Disney World entertainment and recreation center at Lake Buena Vista,

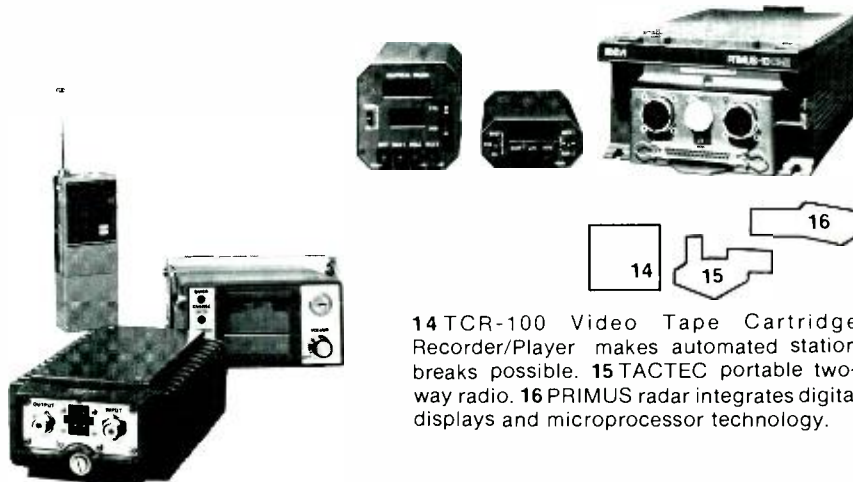

14 TCR-100 Video Tape Cartridge Recorder/Player makes automated station breaks possible. 15 TACTEC portable two-way radio. 16 PRIMUS radar integrates digital displays and microprocessor technology.

Florida. It also installed the electronic management system in the new 38-story Wells Fargo office in San Francisco.

## Space and defense

*RCA Government Systems continued its notable contributions to the nation's space and defense efforts during the 1971-1976 period.*

By the close of 1976, 24 RCA-built weather satellites had been successfully orbited and had returned some three-million photographs of the Earth's weather for use in weather forecasting. RCA was selected by NASA in 1975 to develop the Tiros-N, a third-generation weather satellite, and to build, integrate, and test eight of the polar-orbiting spacecraft for launch beginning in 1978. At 1400 pounds, Tiros-N will nearly double the weight of current weather satellites and will carry four times the payload. New sensors will enable the satellites to obtain high-quality atmospheric temperature and water vapor soundings, day and night worldwide cloud cover pictures, and radiometric information for sea-surface temperature mapping.

In 1972, an RCA Return Beam Vidicon Camera flew for the first time on the Earth Resources Technology Satellite and produced high-resolution multispectral pictures of excellent scientific value. The same year saw the successful orbiting of NOAA-2, first of a series of RCA-built environmental satellites to provide worldwide weather and ocean information never before available.

In 1973 an RCA-built Atmosphere Explorer satellite was orbited to make a continuing and systematic study of the Earth's upper atmosphere. The first Explorer was followed into orbit by two others, launched in 1975.

In addition to providing information about the Earth's weather, atmosphere, and oceans, RCA communications equipment was successfully used in two space probes, one to the Moon and the other to Mars. During the Apollo 15 manned lunar expedition in 1971, an RCA tv space camera produced the clearest color pictures made to date of the lunar surface. The camera was part of RCA's Ground Command Television Assembly (GCTA), a system which permitted controllers at Houston to operate the camera remotely from Earth. The GCTA was mounted on the astronauts' lunar roving vehicle along with a briefcase-size RCA communications set for direct two-way contact between the Moon and Earth. Apollo 16 and 17 astronauts used similar RCA systems as well as an RCA-built laser altimeter for accurate mapping of the lunar surface.

During 1976 RCA-built communications equipment was a vital part of the Viking missions that undertook scientific probes of Mars and a search there for life. The RCA equipment was dormant during the 11-month voyage, but shortly after the Viking Lander touched down it began to transmit color pictures and telemetry to Earth over a 250-million-mile link. The pictures were generally regarded as remarkable for their clarity and color rendition.

The RCA Satcom I and II communications satellites, delivered to RCA Globcom for launch in 1975 and 1976, respectively, made ingenious use of cross-polarized signals

to incorporate 24 channels in a frequency band that formerly accommodated only 12. The 24 channels each can carry one color-tv transmission, or 600 two-way voice circuits, or 64 million bits of data per second.

AEGIS, a key Government Systems development of the 1970s became the first Navy defensive system with the ability to automatically search, detect, and track multiple targets and to fire missiles. The system's heart is the AN/SPY-1 phased-array radar, which performs the simultaneous detection and tracking of multiple targets, and also provides designation data for target illuminators. RCA was chosen as the AEGIS prime contractor in 1969. Since then, AEGIS has become the nucleus of a total combat system, providing target-coordinate data to other weapons aboard ship and controlling their use through its integral computer subsystems. Installed aboard the *USS Norton Sound*, the system detected, tracked, and destroyed its first target drone in May 1974. Since that initial success, the AEGIS weapons system has had a near perfect intercept record of missile and aircraft targets.

AEGIS entered its second phase in 1976 with the award of a new \$159.2 million Navy contract calling for RCA to provide a combat system engineering development (CSED) prototype. Centered on AEGIS, it will include additional radars, electronic warfare, and surface and undersea weapons to form a complete combat system. Government shipbuilding plans during the 1978-1985 period feature the development of a number of guided missile destroyers and nuclear attack cruisers designed to use the AEGIS-based combat system.

In 1974 and 1975 RCA delivered to the U.S. Air Force four low-cost mobile instrumentation radars controlled by a minicomputer and capable of one-man operation and maintenance. Officially designated the AN/TPQ-39 (V), the system is intended for mini-ranges and temporary missions, and is lightweight, relatively small, quickly set up, and highly accurate. It is capable of a variety of tracking applications, including range safety, scoring, vehicle performance evaluation, and determination of discrete mission events.

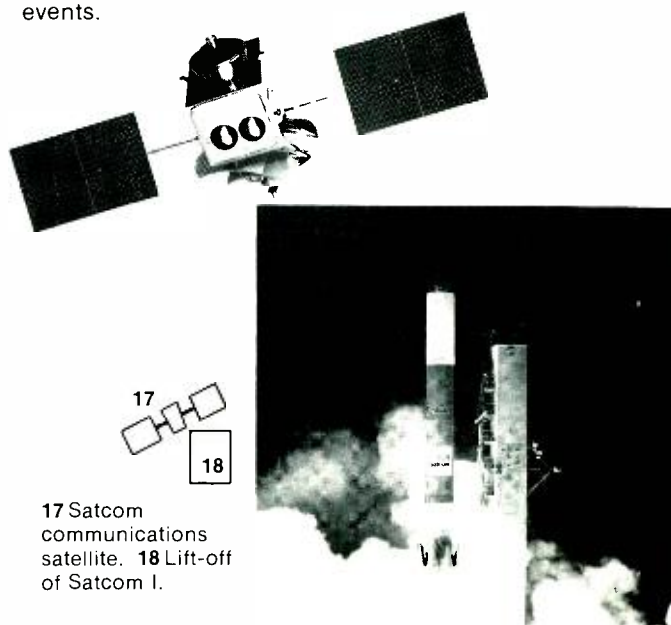

17 Satcom communications satellite. 18 Lift-off of Satcom I.



In military communications, Government Systems' development of a family of transportable satellite terminals led to a \$37 million U.S. Army contract to build 31 such stations. Readily transportable, the terminals can be put in use within 20 minutes and will permit tactical and strategic communications on a worldwide basis. Significant production of the terminals is expected in the next five years for tri-service use.

After a parallel study competition that began in 1972, RCA was named in 1975 to complete the prototype and subsequent production of a modern communications center, or Integrated Radio Room, for America's Trident-class submarines. The system will make it possible to control all ship-to-ship and ship-to-shore communications from a single console. Production and shipboard installation of the communications centers are expected to continue into the mid-1980s.

In 1975 the Armed Forces began testing the RCA-developed EQUATE (Electronic Quality Assurance Test Equipment), a system capable of testing virtually all types of military equipment. A computer-based third-generation system, EQUATE performs diagnostic, fault isolation, and performance testing.

During the early 1970s, RCA developed for the U.S. Army an automotive test system that performs more than 50 types of tests and maintenance checks on a wide range of engines and accessory systems. The system, known as Simplified Test Equipment for Internal Combustion Engines (STE/ICE), is capable of testing 15 different types of vehicles, including armored personnel carriers, trucks, jeeps, self-propelled howitzers, tanks, and recovery vehicles. The system produces a substantial reduction in maintenance time while significantly improving the accuracy of vehicle diagnosis.

A notable 1974 development was a hand-held laser system that accurately determines the range of a military target in one second. The GVS-5 system is about the size of field binoculars, which it resembles, and weighs only five pounds. The rangefinder's successful design resulted in contracts for several large production quantities.

In 1975 Government Systems began work on a major telecommunications project on Kish Island, in the Persian Gulf, which the Iranian government is developing as a resort. RCA designed, equipped, and installed a radio and tv production center, cable tv program distribution to serve 3500 color receivers, three fm stereo broadcasting stations, a two-way radio network, and a computerized cash register system.

Another successful venture was the introduction and marketing of PRICE (Programmed Review of Information for Costing and Evaluation), a unique parametric cost model service. The military services made PRICE a standard measurement tool for evaluating cost proposals, and a large number of companies in electronics and related fields have contracted to use it. The PRICE family now covers hardware, software and life-cycle cost models.

## Service

*The RCA Service Company continued to expand in both operations and volume.*

In 1976, the company marked the 22nd consecutive year of increased sales in consumer service, achieving an all-time high. By 1973, it had already topped the one-million mark in home service contracts for tv and appliances.

The Service Company maintained its position as the leading supplier of tv receivers to hotels, motels, hospitals, and schools. RCA Telephone Systems, the most recent addition to the commercial products line, experienced exceptional growth—reaching 200,000 telephone interconnect lines under contract to commercial and small business customers by late 1976, with an aggregate contract value in excess of \$100 million.

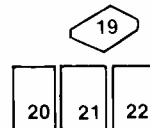

**19** AN/GVS-5 hand-held laser rangefinder can determine range of military targets 10 km away accurate to 10 m.

**20** This camera and control unit (GCTA) was a vital part of Viking missions. **21** Transportable satellite terminal. **22** AEGIS system firing a missile.



Technical services sales, which have improved year to year since 1958, grew even more rapidly in the early seventies. In 1970, RCA began to lease, as well as service, data communications equipment. By the end of 1976, the lease base of data communications terminals under contract exceeded 34,000 units. The Service Company also continued to be a major provider of installation and maintenance services for theatre, broadcast, marine, mobile radio, scientific, industrial, and reservations systems equipment.

The Service Company maintained its position as a leading supplier of technical services to the government, furnishing operational and management support for military test ranges, NASA space programs, and federal, state, and local educational programs.

In 1973, Service Company technicians and engineers celebrated the 20th year of service at the Air Force Eastern Test Range, operating electronic instrumentation systems at Cape Kennedy and the downrange stations in support of missile and space programs. The Service Company team provided the same support for the historic Apollo-Soyuz joint space flight in 1975. The same year it received a contract to provide support services for aerodynamic and space research at NASA's Langley Research Center in Virginia.

In the early 70s, the Service Company became firmly established as a leader in educational services to government agencies. Under a 1972 contract, the Service Company began providing comprehensive vocational and language training and placement services for unemployed men and women at training centers throughout New York City. The program provided year-round training to an ongoing student body of 1800.

In 1975, the Service Company was awarded contracts by the Department of Labor to operate major Job Corps Centers in Astoria, Ore., and Tulsa, Okla. These were added to continuing contracts for such centers in Hazleton, Pa., and Marion, Va. A fifth center, near Baltimore, Md., was added in 1976.

## Research and development

*The close teamwork between the product divisions and the Laboratories enabled scientists and engineers of RCA Laboratories to work with the divisional engineering staffs and assist them in development of new and improved products.*

The role of RCA Laboratories changed in several respects during 1971-1976 as a result of pressures to increase the speed with which research innovations are turned into commercial products, and the realization of carefully laid plans for greater integration of RCA's technical community.

The ColorTrak television receiver system, the RCA Satcom system, the NBC Television Central project, and the development of the RCA SelectaVision VideoDisc System are prime examples of the closer relationship between researchers and division engineers.

In 1973, RCA Laboratories developed a solid-state image sensor containing more than 120,000 electronic elements

on a silicon sensor chip the size of a nickel. This was the forerunner of the CCD cameras that RCA Electro-Optics and Devices demonstrated and made commercially available in 1975.

In 1975, the RCA Solid State Division announced the commercial availability of the industry's first COS/MOS microprocessor. The Solid State Technology Center of RCA Laboratories was responsible not only for the concept and development of the device, but also for the research and engineering that turned the experimental device into a commercial product. The same year, the Solid State Division also began offering silicon-on-sapphire (SOS) circuits to the electronics industry on a sampling basis. This was again the product of an extensive research and development program carried out by RCA Laboratories from 1971 through 1974. These low-power, high-speed devices are expected to take over an increasing share of the electronic watch business, as well as to play an important role in electronic data processing.

During 1975, the Laboratories also made significant progress with the research program on automotive electronics concerned with monitoring and controlling engine performance and pollution. In a related effort, the Laboratories started work as the electronics subcontractor for the development of a Research Safety Vehicle for the National Highway Traffic Safety Administration.

In 1976, Laboratories researchers developed high-speed logic circuits that process five billion bits of information per second under test conditions, functioning about ten times faster than logic circuits used in conventional information processing.

In cooperation with the Alaska Office of Telecommunications, RCA scientists developed frequency-modulation techniques to permit the transmission of satellite-borne tv signals requiring minimum power and bandwidth to small earth stations in the Alaskan bush. A related project resulted in the development of technologies that permit the simultaneous transmission of two tv channels by a single-satellite transponder, thus doubling the transmission capacity for tv programs from the lower 48 states to Alaska.





During 1971-1976, RCA Laboratories made good progress in new research areas. For example, in 1971, Laboratories scientists developed a new semiconductor laser with an optical capacity that doubled the output efficiency of previous devices, thus speeding the eventual use of such lasers in closed-circuit television and in commercial and military communications systems.

In 1974, a major development was an electro-optic modulator that could permit as many as 5,000 persons to talk simultaneously over a single-laser-beam, high-grade telephone circuit. The experimental device was the first electro-optic modulator compatible with integrated circuits and capable of aiming or switching the direction of a laser beam. In another phase of electro-optic research, the Laboratories demonstrated a document reader employing a semiconductor laser that can provide high-quality electronic reproductions of text, sketches, and photographs suitable for long-distance facsimile transmission.

In 1975, RCA Laboratories demonstrated a solid-state laser that produces visible light. This continuous-wave device, which operates at room temperature, is expected to enhance and speed the use of optical communications in many applications.

## Vehicle renting and leasing

*Despite fuel shortages and rising costs Hertz achieved record earnings for five consecutive years.*

The Hertz Corporation owed much of its success in the early and mid-1970s to a significant tightening of management procedures and controls, the implementation of innovative marketing concepts, and the move to leased "over-the-road" large tractor-trailers. In 1972, the Rent A Car division formed the Hertz No. 1 Club, a computerized service to save time for the repeat renter, and also to enable Hertz to schedule its fleet and manpower needs more efficiently. The service instantly retrieves from the computer file such driver information as license number, type of vehicle preferred, and charge card used. This concept was later extended to Canada, and, in 1975, throughout Europe.

Prior to the establishment of the No. 1 Club, a centralized reservation office and separate data center were established in Oklahoma City. The central reservation opera-

tion makes it possible for U.S. customers to reserve a car anywhere in the world with one toll-free telephone call.

The fuel crisis of 1973-1974 precipitated a radical change in the makeup of the domestic and international rental car fleets. In the domestic rental fleet alone, the fleet proportion changed from 60 percent standard cars to over 75 percent intermediate and smaller cars, providing greater fuel economy both for the renter and Hertz. To ensure efficient standards of vehicle maintenance, the Rent A Car division embarked on a capital spending program in 1975 to construct and equip new facilities at major airports. In 1972, Hertz Rent A Car began retailing used cars from its rental fleet. Most of the cars are sold with a 12-month 12,000-mile warranty on drive-train components.

In Europe, beginning in 1975, the company redirected its marketing thrust toward the business traveler as this market grew in importance. Fleets were concentrated at airports and commercial centers, and advertising was scheduled to reach potential renters where they lived, not where they rented cars. These moves, coupled with operating efficiencies, have resulted in the achievement of record performance levels in Hertz Europe.

Hertz passenger car leasing business, initially built around leasing to corporations, extended its operations to individuals in 1974. At the same time, it began to retail used cars to customers, and the following year began finance leasing to individuals.

During the 1971-1976 period, the Truck Division undertook a major shift from the city-suburban "van" type of rental delivery truck to the big tractor-trailer combinations. Until 1972, fewer than 10 percent of the Hertz truck units were in the heavy-duty over-the-road classification. By 1976, up to 25 percent of its units were in the long-distance category. As a result, Hertz expanded and revamped its service facilities. It increased the number of company-owned service facilities to more than 180 by 1976. In addition, at the end of the year, it had more than 300 franchised locations, plus 700 affiliated truck stops in its nationwide network. In 1975, Hertz completed a 24-hour emergency service system for its trucks on the road.

**23** Service Co. technician does final tv checkout.  
**24** Microprocessor-controlled automobile ignition.  
**25** Laser beams controlled by electro-optic modulators may someday carry 20 tv programs or 25,000 telephone conversations simultaneously. **26** Hertz remote area maintenance.



## Publishing

*In 1976, when revenues in the book publishing industry were relatively sluggish, Random House achieved the highest sales in its history.*

Together with two of its major imprints, Alfred A. Knopf and Pantheon, Random House placed 17 books on the national best seller lists during the year. Over the six-year period, offerings by Random House, Knopf, and Pantheon received major recognition, including Pulitzer Prizes for *The Americans: The Democratic Experience* by Daniel J. Boorstin, *Huey Long*, by T. Harry Williams, and *The Power Broker* by Robert A. Caro. In 1975, paperback rights to *Ragtime*, by E.L. Doctorow, were sold for \$1.85 million, the highest price ever obtained for such a sale. The juvenile department published books by such renowned authors as Richard Scarry, Dr. Seuss, and Roald Dahl, as well as Sesame Street and Charles Schulz's Charlie Brown.

In 1972, Random House acquired Ballantine Books, a mass-market paperback house that publishes originals, e.g., *Valency Girl* by Robin Moore and Susan Dietz, and *Star Trek Star Fleet Technical Manual*, and a variety of popular reprints such as *Something Happened* by Joseph Heller and the *Seven-per-cent Solution* by Nicholas Meyer. In 1975, the company acquired CRM textbooks, a major publisher in the college field.

Random House's High Intensity Learning Systems increased its operations significantly. This program focuses on reading centers where youngsters' reading difficulties are diagnosed and corrected with individually tailored reading prescriptions. By the end of 1976, there were over 2000 reading centers.

Random House Enterprises, a direct mail operation, was launched in 1973. By 1976, its most successful products, the *McCalls Great American Recipe Card Collection* and *Weight-Watcher's Recipe Card Collection*, had more than two million customers.

## Food processing and distribution

*The key to Banquet Foods' success was a continuing expansion program.*

During the six-year period, Banquet Foods Corporation enjoyed uninterrupted yearly increases in sales of its more than 100 products. It emerged the leading force in the frozen prepared food industry taking full advantage of its industry's recovery which had been building since late 1975. The easing of inflation and recessionary pressures on the company as well as the consumer, coupled with Banquet's increased marketing efforts in the eastern part of the United States, and better manufacturing efficiencies through newly implemented industrial engineering techniques, enabled the company to turn in a record year for sales and earnings in 1976.

In 1971, Banquet Foods successfully introduced a variety of new products, including frozen fried chicken, and opened a fully integrated frozen fried chicken operation in Batesville, Ark. The following year, it expanded its distribution to all 50 states and Canada. To improve its distribution in the Eastern market, Banquet Foods, in 1973, began operation of

a major frozen food processing plant in Wellston, Ohio. Production capacity was doubled at the Batesville plant. When recession hit the frozen prepared food industry in 1974, the company countered the problem with energetic promotional campaigns and the introduction of several product innovations.

By 1975, Banquet Foods' frozen fried chicken business had become the industry leader. In that year, a unique, fully automated massive freezer complex also was constructed at Wellston, further strengthening the company's market position in the Eastern United States.

Contributing to its 1976 success was Banquet's new package design system. Introduced during the fourth quarter of 1975, the new package design system has accomplished its overall objective of providing Banquet products with a uniform identity thereby allowing the consumer to easily identify, recall, and choose the Banquet brand over anything else in the retail freezer cabinet. Total conversion for all 100-plus Banquet products from the old packaging to the new uniform system is expected to be completed in 1977.

In 1974, RCA acquired Oriel Foods Limited, and Morris & David Jones Limited, both major food distributors in the United Kingdom. The two companies were integrated in 1975 to form the Oriel Foods Group.

## Home furnishings

*Despite depressed conditions in the carpet industry, Coronet continued to innovate and grow.*

The twin problems of inflation and recession that struck the nation during the later half of the 1971-1976 period created severe problems in the housing field. Fewer Americans bought new homes because of the economic situation, and fewer householders made major investments in furnishings. As a result, Coronet Industries, acquired by RCA in 1971, was adversely affected.

This did not prevent Coronet from continuing to innovate and grow. Do-it-yourself carpeting was introduced in 1971.

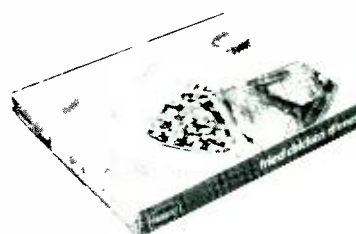

27

28

27 By 1975, Banquet Foods' fried chicken business had become the industry leader. 28 Random House High-Intensity Learning Systems diagnose reading difficulties and individually tailor reading prescriptions.





In 1973, new equipment and processes for tufting, dyeing, and finishing carpets highlighted expansion and modernization programs in five Coronet plants in the U.S. The following year, the new carpet-dyeing technology was extended to all plants in the U.S. and Canada. Construction of a new yarn-spinning facility was begun at Gainesville, Ga., within easy supply range of the main Coronet plant at Dalton. In the Far East, Coronet began marketing its floor coverings through a network of distributors in Japan, Hong Kong, Singapore, and Australia.

By 1976, profits for Coronet as a whole had more than doubled and sales reached a record high for the company's major product, floor coverings. To enable Coronet to concentrate on its more profitable and faster growing carpet business, the company acquired full ownership of Coronet Carpets, Ltd., of Canada and by 1977 had sold both its furniture and wall-covering operations.

## Corporate responsibility

*Over the 1971-1976 period, RCA broadened its interest and activities as a socially responsible corporation, both nationwide and in the communities where it operated.*

In addition to the long-standing Affirmative Action programs to assure improved opportunity for minority groups in recruitment and promotion, RCA, in 1971, developed a new program to assess the qualifications of women employees throughout the company, and to ensure them equal consideration with men for promotion to more responsible professional and supervisory positions. The same year, RCA also won national recognition for its company-wide environmental improvement program that included recycling centers at five major RCA locations.

In 1972, ground was broken for a major urban renewal program in Camden, N.J., supported by RCA and others and involving the rebuilding of most of Camden's downtown area. During this period, in one the nation's most successful inner-city housing programs, the company also aided in the rebuilding of more than 500 houses in Camden. Support was also given to certain community-based job training programs in cities where the company had facilities.

In 1974, purchasing officials throughout the company were instructed to seek bids from qualified suppliers who were members of minority groups. Concurrently, RCA sought to stimulate minority vendor interest through advertisements

in black and Hispanic media. As a result, 92 such vendors, an increase of 46 percent over 1973, sold some \$2.2 million worth of materials and services to RCA.

By the end of 1975, RCA could report that as a result of its vigorous Affirmative Action programs, approximately 12.5 percent of its employees in the United States were minority group members representing 15 percent of the hourly workforce, and 10.5 percent of salaried employees. Approximately 40 percent of all RCA employees were women, and they occupied 17 percent of the managerial, professional, and sales positions. In 1975, the company increased substantially its purchases from minority vendors, including black and American-Indian owned companies.

RCA also took part in the Minority Introduction To Engineering (MITE) program to encourage minorities and women to enter the engineering profession. In addition, it established the RCA-MEP (Minorities in Engineering Program), designed to interest minorities in engineering. In 1975, twelve RCA locations across the country had MEP programs, giving approximately 200 talented high school students an opportunity to learn firsthand about the profession.

## Prospects for the future

At the Annual Shareholders Meeting in May 1977, President Griffiths described 1976 as "a turn-around year, and the second best in the history of this Corporation." He then pointed out that in the first quarter of 1977 "our sales had advanced by 9 percent and our profit by 41 percent. Our profit dollars were \$48.5 million, and this represented the very best first quarter that RCA has ever experienced."

He then went on to say he expected that in 1977 RCA would do appreciably better than the predicted 12 to 14 percent increase of the corporate profit for American companies and that "we are on our way to another record year."

In summation, Mr. Griffiths said he has often been asked, "How much money can RCA make? And I've given them what is a totally honest answer: I don't know. And I've quickly added that we are embarked on a program to find out. I believe that we have the tools and the people, we have the buildings, the facilities, the test equipment, and we need now the energy and determination to do it. And that we have."

**29** Twelve RCA locations across the country had Minorities in Engineering Programs. **30** Coronet Industries continued to innovate and grow despite inflation and recession.



# RCA

Copyright © 1957 • 1958 • 1963 • 1964 • 1968 • RCA Corporation  
Printed in U.S.A.

