

1958

# PRACTICAL ELECTRONICS

A FAWCETT  
75¢  
HOW-TO BOOK

394

By Robert Hertzberg



Modulated Invisible Light Updates Heliograph



Hi-Fi Tips and Tests

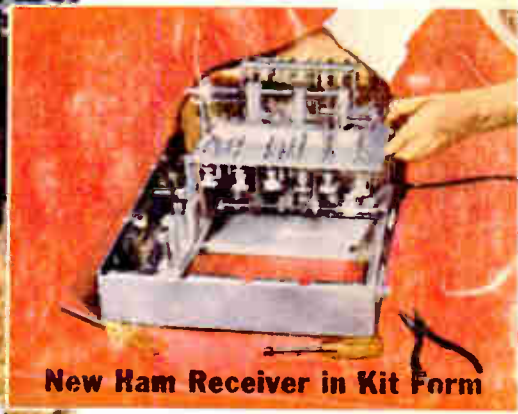

New Ham Receiver in Kit Form



The Latest in Test Equipment

**Transistor Care and Testing • Novice Ham Station  
Oscilloscope Use and Construction • Ham-Band Converters  
Microwave • Transistor Intercom • Troubleshooting**

IF YOU THINK THAT ALL BRANDS

OF RECORDING TAPE ARE ALIKE...

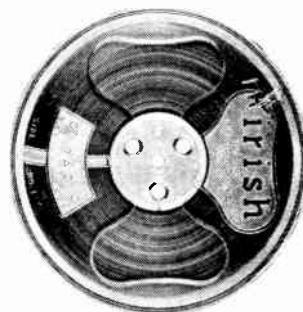

...WAIT TILL YOU TRY **Irish** FERRO-SHEEN!

F  
E  
R  
R  
O  
S  
H  
E  
E  
N

ON LAND IN THE AIR and ON THE SEA..

# BIG MONEY

*awaits*  
**TRAINED  
 TECHNICIANS**  
*in*  
**TELEVISION·RADIO·  
 ELECTRONICS·RADAR**

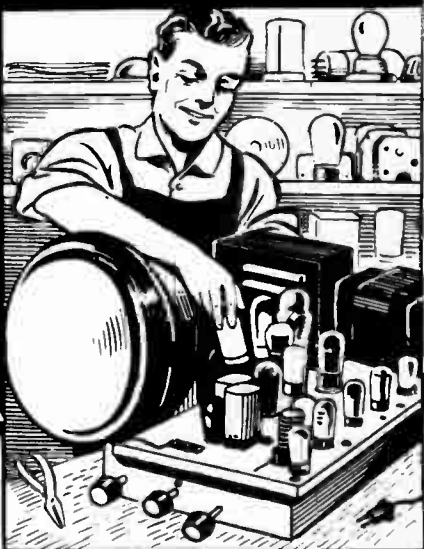

## EARN *As You Learn*

Christy Shop-Method Home Training makes you a more valuable and desirable technician, assures you of more money, faster progress and greater success. This practical step-by-step training makes everything interesting and easy, makes learning fun. You don't have to leave home or quit your job to learn this simple, easy way. A few hours of your spare time each week soon prepares you for earning while learning and later for a big-pay job or profitable business of your own in this fabulous, fast-growing new industry. 3 new books contain complete information. Describe the course and many opportunities in this fantastic new field. Send for your 3 free books today!

### The Only Complete Course!

C.T.S. training covers every phase of this fascinating new subject. You get this comprehensive training starting with your first lesson. You learn Radar, Sonar, Television, Radio and Electronics in C.T.S.'s Complete course. This broader knowledge and greater understanding means more jobs and higher pay for you. Why be satisfied with less? You learn faster and better with Christy Shop-Method Home Training. It gives you all the training you need in a clear, simple, easy-to-understand way. Big pay, interesting work, immediate success, await those thoroughly trained in all branches of electronics. And the C.T.S. Master Shop-Method Home Training Course is the only complete course in Radar, Sonar, Television, Radio and Electronics.

### 19 TRAINING INSTRUMENTS INCLUDED

In a few months you learn what used to take years of hard work to master, reach your goal sooner and are better prepared to make maximum progress. Send for complete information today!

**CHRISTY TRADES SCHOOL, INC.**  
 Dept. T-212  
 3214 W. Lawrence Ave., Chicago 25, Ill.

## MAIL COUPON TODAY!

**CHRISTY TRADES SCHOOL INC**  
 Dept. T-212, 3214 W. Lawrence Ave. Chicago 25, Ill.

Gentlemen:  
 Please send me, without cost or obligation, two FREE Lessons and the new 24-page illustrated book telling all about the C.T.S. Master Shop-Method Home Training Course in Radar, Sonar, Television, Radio and Electronics, and the many opportunities this new field offers.

Name ..... Age .....

Address .....

City ..... State .....



# PRACTICAL ELECTRONICS

By Robert Hertzberg

A FAWCETT BOOK • NUMBER 394  
LARRY EISINGER • EDITOR-IN-CHIEF  
GEORGE TILTON • MANAGING EDITOR  
HAROLD KELLY • ART EDITOR

W. H. Fawcett, Jr. . . . . President  
Roger Fawcett . . . . . General Manager  
Ralph Daigh . . . . . Editorial Director  
James B. Boynton . . . . . Advertising Director  
Al Allard . . . . . Art Director  
Ralph Mattison . . . . . Associate Art Director  
Annette Packer . . . . . Production Director

JOSEPH DAFFRON . . . . . EDITOR

SILVIO LEMBO . . . . . ASSOCIATE ART EDITOR  
Nick Carlucci . . . . . Assistant Art Editor  
Harold E. Price . . . . . Art Associate  
Michael Gaynor . . . . . Art Associate  
Larry Flanagan . . . . . Art Associate  
John S. Selvaggio . . . . . Art Associate  
Howard Katz . . . . . Art Associate  
Mike Eastman . . . . . Art Associate  
David Weiss . . . . . Art Associate  
Bob Van Osten . . . . . Art Associate  
Bob Vatter . . . . . Art Associate

Phyllis J. Bendremer . . . . . Production Editor  
Nancy Kay . . . . . Assistant Production Editor

PRACTICAL ELECTRONICS, Fawcett Book 394, is published by Fawcett Publications, Inc., Greenwich, Connecticut. Editorial and Advertising Offices: 67 West 44th Street, New York 36, New York. General Offices: Fawcett Building, Greenwich, Connecticut. Gordon Fawcett — Secretary-Treasurer. Roscoe Fawcett — Circulation Director. Printed in U.S.A. Copyright 1958 by Fawcett Publications, Inc.





# CHRISTY'S *Complete* ELECTRONIC COURSE

*Learn*

# TELEVISION, RADIO, RADAR, SONAR, ELECTRONICS



Why be satisfied with less? Get CHRISTY'S COMPLETE COURSE which trains you in your spare time at home all phases of Electronics. The new Christy Shop-Method Home Training makes learning interesting and easy. You learn Radar, Sonar, Electronics, Radio, Television. No previous experience needed. You learn by working with actual equipment. Makes learning fun. Speeds your progress. Helps you understand quicker and remember longer.

You get comprehensive training starting with your first CTS lesson! The complete knowledge CTS provides you with, gives you a broader knowledge, a greater understanding which will mean more jobs and a higher income for you for the rest of your life.

## HOME LABORATORY SENT! 19 TRAINING INSTRUMENTS INCLUDED

With CTS COMPLETE Home Training Course, you receive a Home Laboratory to assemble, use and keep for years of peak performance. You receive a Multi-Tester, Oscillator, Signal Tracer, Oscilloscope, Signal Generator, Electronic Timer, Regenerative Radio, Giant-size Television Receiver (optional) as well as many other valuable electronic devices. With these you will be able to make hundreds upon hundreds of exciting experiments.

## EARN WHILE YOU LEARN! EARN \$5.00-\$6.00 PER HOUR

Or MORE while still studying! Almost from the very first you receive training that enables you to repair radios and television sets for friends and neighbors. To install and service electronic computers, communication equipment, protective equipment for police and fire departments, etc., etc.

## FREE BOOK—SAMPLE LESSONS SENT

Get all there is to know about the Christy COMPLETE Electronic Course in Radio-Television-Radar-Sonar, etc. A complete, colorful, illustrated book on Electronics sent without obligation.

Also, we will send you Two sample lessons showing how the new CTS Shop-Method Home Training Course will train you for making big money in your spare time and for building a bright future for yourself.

CHRISTY TRADES SCHOOL, Dept. T-120, 3214 W. Lawrence Ave., Chicago 25, Ill.

## SIGN, MAIL FOR THREE BOOKS

CHRISTY TRADES SCHOOL, Dept. T-120, 3214 W. Lawrence Ave., Chicago 25, Ill.

Gentlemen:

Please send me, without cost or obligation, two FREE lessons and the new 24-Page illustrated book telling all about the CTS Master Shop-Method Home Training Course in Radar, Sonar, Television, Radio and Electronics, and the many opportunities this new field offers.

Name \_\_\_\_\_ Age \_\_\_\_\_

Address \_\_\_\_\_

City \_\_\_\_\_ Zone \_\_\_\_\_ State \_\_\_\_\_

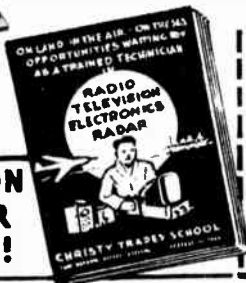
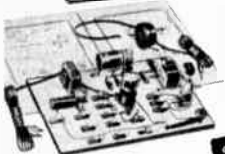

**MAIL COUPON  
TODAY FOR  
CATALOG !**

# Contents

|   |     |
|---|-----|
| Kc. Cops Ride the Airwaves.....         | 8   |
| Better Sound from Small TV Sets.....    | 12  |
| Complex Ham Receiver Simplified.....    | 14  |
| Army Tests New Electronic Gear.....     | 20  |
| All-Band Transistor Radio.....          | 28  |
| Hi-Fi Where You Want It.....            | 32  |
| How's Your Auditory Perception?.....    | 40  |
| Radio's Newest Workhorse--Microwave     | 46  |
| Introduction to Troubleshooting.....    | 50  |
| Know Your Components.....               | 60  |
| The Meaning of Tolerance Figures.....   | 72  |
| Magnification: 200,000 Times!.....      | 74  |
| Transistor Care and Testing.....        | 78  |
| Transistor Intercom.....                | 88  |
| Novice Ham Station.....                 | 92  |
| One Whip--Three Bands.....              | 95  |
| Ham-Band Converters.....                | 96  |
| Solo Code Practice.....                 | 99  |
| Ham Lingo.....                          | 100 |
| The Cathode-Ray Oscilloscope.....       | 102 |
| Crystals Are Here To Stay.....          | 114 |
| Operation Crystal.....                  | 116 |
| World's Most Powerful Radio Station.... | 117 |
| Flood Hero Gets Ham Award.....          | 118 |
| Which Way Does Current Flow?.....       | 120 |
| Small High-Voltage Supplies.....        | 122 |
| Self-Powered Flash Gun.....             | 127 |
| Sites of FCC Offices.....               | 128 |
| A. F. Precision Measurement.....        | 130 |
| An ABC of The FCC.....                  | 136 |
| Radio Station Calls.....                | 140 |

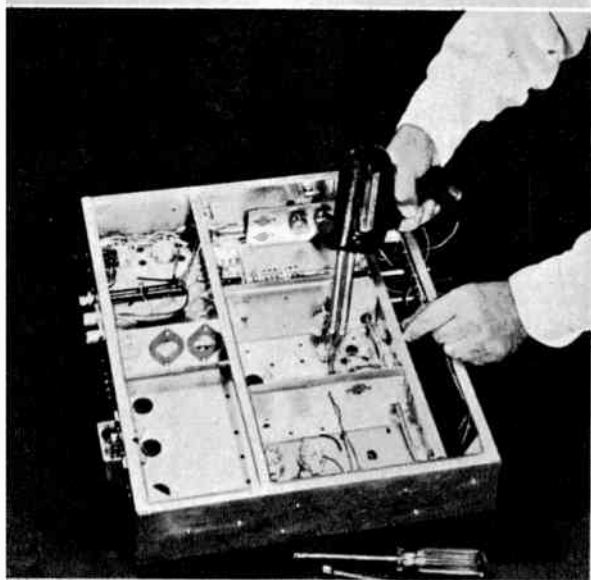

**LET DeVRY TECH PREPARE YOU IN  
SPARE TIME AT HOME AS AN**

# **ELECTRONICS TECHNICIAN**



**NO PREVIOUS TECHNICAL EXPERIENCE  
OR ADVANCED EDUCATION NEEDED!**

Laborers and bookkeepers, store clerks, shop men, farmers, salesmen — men of nearly every calling — have taken the DeVry Tech program and today have good jobs or service shops of their own in Electronics. You don't have to quit your present job. If you are 17 to 55, see how you may get yourself ready for a future in the fast-growing Electronics field.

Whether you prepare at home or in our well-equipped Chicago or Toronto Laboratories, you get sound, basic training in both principles and practice. At home, you use educational movies. You build actual circuits and test equipment. You read simple directions, follow clear illustrations. When you finish, you are prepared to step into a good job in an excitingly different field. You may even start a service shop of your own. Mail coupon for free facts today.

### **Live-Wire Employment Service**



Puts you in touch with job opportunities—or helps you toward a better position in the plant where you are now employed.

### **Draft Age?**

We have valuable information for every man of draft age; so if you are subject to military service, be sure to check the coupon.

## **SAMPLE BOOKLET FREE!**

We'll give you a free copy of an interesting booklet, "Electronics and YOU." See for yourself how you may take advantage of the opportunities in this fast-growing field.



**AN INDEX**  
to a  
**BETTER JOB,  
A BRIGHTER  
FUTURE**

Electronics

Radar

Guided  
Missiles

Television

Micro-Waves

Communications

Radio

Industrial  
Electronics

Computers

Automation  
Electronics

Remote Control  
Systems

Broadcasting

Your Own  
Service Shop

**MAIL TODAY FOR FREE FACTS**

"One of North America's Foremost Electronics Training Centers"



Accredited Member  
of National  
Home Study Council

## **DEVRY TECHNICAL INSTITUTE**

CHICAGO 41, ILLINOIS

FORMERLY

**DEFORREST'S TRAINING, INC.**



### **DeVry Technical Institute**

4141 Belmont Ave., Chicago 41, Ill., Dept. PPE-23-0

Please give me your FREE booklet, "Electronics and YOU," and tell me how I may prepare to enter one or more branches of Electronics as listed above.

NAME \_\_\_\_\_ AGE \_\_\_\_\_

STREET \_\_\_\_\_ Please Print \_\_\_\_\_ APT. \_\_\_\_\_

CITY \_\_\_\_\_ ZONE \_\_\_\_\_ STATE \_\_\_\_\_

Check here if subject to military training

DeVry Tech's Canadian Training Center is located at  
626 Roselawn Avenue, Toronto 12, Ontario



## Introduction

**W**HERE does your interest in electronics lie? Is it centered on high-fidelity sound, amateur radio, or test gear? Perhaps you are a builder by nature and, therefore, interested primarily in construction-kit projects. You may be more the observer type, one who enjoys merely reading of the most recent developments and experimental devices. Whatever the case may be, you will find much of value here.

For the audiophile, there are suggested installations for maximum convenience and listening pleasure, as well as instructions for assembling the popular pancake-shaped tuners and amplifiers. The acoustical perception of individuals varies greatly. This book shows you how to conduct frequency checks on people and set-ups.

Amateur radio operators—and aspiring “hams”—will find a wealth of information here. The structure of the Federal Communications Commission and the allocation of radio calls are explained. There is a detailed report on a new receiver kit that features a prealigned “front end” for ease of assembly. Code practice in solitude is described, and included is an inspiring report on an amateur radio operator’s heroism, which won him the Edison Award.

Test equipment that passed under the critical gaze of author Hertzberg includes the transistor checker, vacuum-tube voltmeter, and the cathode-ray oscilloscope. Kit assembly of the ‘scope is demonstrated by clear step-by-step photos; interpretation of screen patterns is explained in detail.

Regardless of the specific area of your interest, Practical Electronics has something for you. It can make a major contribution to your efficiency in the electronic art. We are convinced that it will.

*Joseph Saffron*

EDITOR



# Let me send you this amazing- ELECTRONIC KIT!

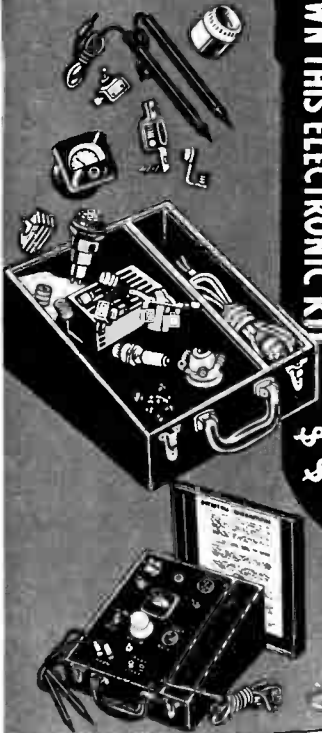

OWN THIS ELECTRONIC KIT



## ASSURE YOURSELF OF FINANCIAL SECURITY—INDEPENDENCE

Imagine being able to fix anything electrical from the tiniest home electric shaver to large industrial motors! Having a training that makes you command a better job with higher wages or a business of your own. You do not need previous special schooling. Just the ability to read and be mechanically inclined. We furnish you with everything! One of the kits sent to you is our famous ELECTRONIC KIT, an all-purpose trouble detector which shows you where the trouble lies. Training kits whose assembly will give you practical shop training or home during your spare time!

You learn practical electricity by using your hands. Best of all, these kits are yours to keep and use forever!

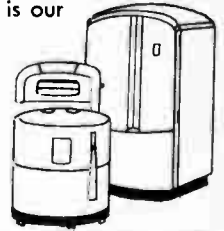

FRAZER

## REPAIR ELECTRICAL EQUIPMENT!

### ILLUSTRATED COURSE SHOWS EVERYTHING

The Christy maintenance and repair course is written in simple, easy-to-understand language. Each section is profusely illustrated by photographs and drawings and shows you what troubles to look for and then how to correct them. In addition, our course shows you how to build power tools at low cost. Also teaches you welding, nickel plating, general repairing (saw filing, bicycle and gas stove repairing, etc.). Should complicated technical problems arise or the need for a special repair part, simply call on us. We offer YOU our FREE Advisory Service for LIFE! We teach you how to solicit business, get repeat orders and what to charge. The Christy Course plus our home-shop training kits make a combination that will go a long way toward ASSURING YOUR SUCCESS.

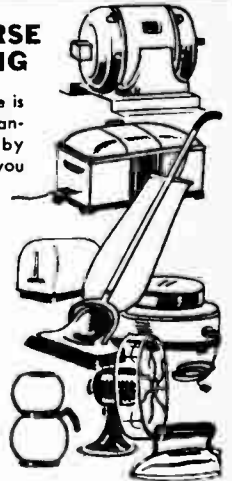

## 3 EASY STEPS TO SUCCESS

- ① WE SEND YOU AN ELECTRIC KIT
- ② WE TEACH YOU ELECTRICAL APPLIANCE REPAIRING
- ③ WE GIVE YOU LIFE-TIME ADVISORY SERVICE

## RUSH THIS COUPON TODAY!

CHRISTY TRADES SCHOOL Dept. D-174  
3214 W. Lawrence Ave., Chicago 25, Ill.

Please send me your FREE book on Electric Equipment Servicing and Instructions for paying later from EARNINGS WHILE LEARNING!

Name.....Age.....

Address.....

City.....Zone.....State.....



# Kc. Cops Ride the Airwaves

An informative and entertaining collection  
of experiences of the FCC field engineers

**W**ITH MORE than half a million radio transmitters of various kinds in operation in the United States, the policing of the air waves has become a gigantic and time-consuming job for the Federal Communications Commission. In tracking down interference and illegal stations, its engineers often function as detectives as well as technicians. Their other duties include the monitoring of the radio spectrum, furnishing bearings on ships and planes in distress, inspecting radio installations, and examining prospective operators.

Some of the experiences reported by FCC men in the field are amusing as well as interesting. Cases involving interference, particularly to television reception, often take the most unusual and unexpected turns. Here is a collection of actual incidents gleaned from official FCC reports.

\*\*\*

A Great Lakes coastal station asked the FCC to help locate the source of severe interference to marine radio communication. A mobile unit was dispatched to the area. After a two-hour search covering 28 miles, it discovered that sparks were jumping from an electric fence to an adjacent chicken-wire coop where dogs were kept. The owner promptly corrected the difficulty.

\*\*\*

Numerous complaints of "TVI" (television interference) were registered in a city in upper New York state. The spurious signals had a definite radio-frequency character, and were blamed variously on amateurs and owners of diathermy machines. The "ham" is the favorite whipping boy of complainants, but actually he is responsible for only a very small percentage of the interference blamed on him. A mobile FCC unit traced the onerous signals to a private residence, and to a TV booster amplifier that went into strong oscillation

when it was left on after the TV receiver itself was turned off. The owner amended his operating habits, and peace reigns again in the community.

\*\*\*

A complaint was received from a Maryland woman of interference to both radio and television reception from 9:15 p.m. through 6:00 a.m. It had been going on for three months. Although it sounded like a power leak, the local utility company reported all its lines and insulators in good condition. The woman was requested to check the electrical equipment in her own home. A few days later she reported that she had found the trouble—a defective electric blanket in her own bedroom!

\*\*\*

Surplus World War II "walkie-talkies" get many of their purchasers into trouble because they don't always understand the federal laws governing radio communication. The FCC has no control over the sale of merchandise, but it becomes very much concerned if transmitters are operated without licenses.

A magazine article about "souped-up jalopies with walkie-talkies" being used by hunters on coyote hunts on the prairie brought out engineers from the FCC's Kansas City office. They quickly hunted down the hapless hunters, who promised to behave in the future.

\*\*\*

Interference to an airline's radio communication was traced to an industrial heater in a Kentucky factory. Because of its hazard to life and property in the air, the plant agreed not to use the offending apparatus until corrective adjustments were made.

\*\*\*

The well-known skipping habits of the short waves are responsible for some queer

TRAIN FOR OPPORTUNITY FIELD OF

# ELECTRONICS

ON REAL EQUIPMENT  
IN THE GREAT SHOPS

OF **COYNE**



**LARGEST, OLDEST AND BEST EQUIPPED  
SCHOOL OF ITS KIND IN U.S.**

This five story Chicago building is occupied entirely by Coyne. Five big floors of Classrooms and over a quarter of a million dollars worth of Equipment. Thousands of successful men have trained at Coyne. There is no substitute for Coyne's wealth of experience.



## OPPORTUNITIES IN ELECTRICITY-ELECTRONICS

Train the Coyne way for a better job in *Electricity-Electronics*—a field that offers a world of opportunities now and in the years ahead. In industry—in the home—Electricity and Electronics are playing a vastly greater role than ever before. New developments and rapid growth are creating increasing job opportunities. Automation Electronics—one of the more recent applications of Industrial Electronics to manufacturing processes—promises to create additional demands for trained Electrical-Electronics men such as we have never seen. Electrical-Electronics Training can be taken separately or combined with Television-Radio training. Send coupon for more information.

*Training in Refrigeration and Electric Appliances can be included.*

**YOU TRAIN IN CHICAGO**—Learn the easier practical way in shops of Coyne in Chicago. Shop work plus technical training. No advanced education or previous experience needed. Lifetime Employment Service to Coyne Graduates.

### START NOW—PAY LATER

New liberalized credit terms and Finance Plans. Part-time employment service to students. Help in making housing arrangements.

### VETERANS OR NON-VETERANS

Coyne training is offered to Veterans and Non-Veterans alike. We'll send Bulletin giving full information. Send coupon for details.



## TELEVISION—RADIO ELECTRONICS

Great opportunity for a good job or your own business in one of America's fastest growing branches of Electronics! New stations by the hundreds . . . new sets by the millions . . . and now Color TV . . . all means greater opportunities in Sales and Service. Separate courses in Radio-Television or in combination with Electricity-Electronics available. Coupon brings details.

*Mail coupon for big free book!*

48 Page Illustrated Book, "Guide to Careers" gives you all the facts. Whether you prefer Electricity-Television-Radio or Combined Electronics Training this book describes all training offered.

Information comes by mail. No obligation and no salesman will call.



Coyne Electrical School, Dept. 88-9A  
500 S. Paulina St., Chicago 12, Ill

Send FREE BOOK, "Guide to Careers," and details of all training you offer.

Name

Address

City  State

(I understand no Salesman will call.)



1. You are told the how and why of each job.



2. You're shown how to do it by trained instructors.



3. You do the jobs yourself on finest equipment.

B. W. COOKE JR., President

**COYNE**  
ELECTRICAL SCHOOL

FOUNDED 1899

A Technical Trade Institute Operated Not For Profit  
500 S. Paulina Street, Chicago, Dept. 88-9A

ELECTRICITY • RADIO • TELEVISION • REFRIGERATION • ELECTRONICS

cases of interference. An aeronautical service in Honolulu, Hawaii, reported that strong signals were blotting out its air-to-ground traffic. The FCC direction-finding net was alerted. It soon fixed the source, not locally, but some 5,000 miles away, at a port on the east coast of the United States! It was a defective ground transmitter belonging to another airline.

\*\*\*

Remoteness of a suspected culprit doesn't deter FCC field engineers. Recently, they spotted an unlicensed television transmitter atop a 9,000-foot peak in Arizona, operated by remote control by a store owner in the valley to further the sale of receivers. The station was closed down.

\*\*\*

The Communications Act, under which the FCC operates, has sharp teeth in it. Fines and jail sentences await the perpetrators of serious and deliberate violations. For example:

Two youths were apprehended for breaking into the radio room of a moored vessel and transmitting hoax distress signals which brought on an extensive, expensive and futile air and sea search. One was sentenced to six years in a correctional institution, and the other was placed on two-year probation.

A false statement as to citizenship in an application for an operator's license brought an alien a suspended sentence of three years and an order to report to immigration authorities for possible deportation.

A man who posed as a licensed amateur, using call letters assigned to someone else, received a \$50 fine.

For using a radio illegally at a racetrack, a man was sentenced to jail for a year, placed on probation, and fined \$100.

A concern defied FCC orders to stop using heating equipment that caused interference to military radio communication. It was fined \$2,500 and its president was sentenced to 30 days in jail.

\*\*\*

With the help of an FCC field office and a local ham committee, a Massachusetts invalid was able to get an amateur license and assemble a station. However, before he actually went on the air, some neighbors imagined . . . get this, *imagined* . . . that he would ruin their TV reception, and they complained to him. This made him so nervous that he sought FCC help. Inspection showed that his equipment was in good order, and he began operation with-

out causing any trouble. He finds that "DX" conversation gives him relaxation, relief from boredom, and ability to endure an affliction of long standing.

\*\*\*

Fluorescent lights are notorious generators of interference, particularly on the short-wave bands. The entire radio system of a hospital in Hawaii, important as a means of therapy, was disrupted by a single defective fixture. The power company couldn't find it, but the FCC did.

\*\*\*

SOS distress signals on a marine frequency were heard over a wide area and set into motion vast search operations by the Coast Guard, Air Force, FCC and other agencies. The FCC monitored the signals to an Indiana factory making automatic distress transmitters for the government. They were being tested without proper shielding, and working only too well!

\*\*\*

Here's one for the birds!

Complaint of interference to a Texas police radio system resulted in a floor-by-floor search of a twelve-story hotel several blocks away. Finally, a defective TV receiver, radiating as strongly as some small transmitters, was found running in a room occupied by a parakeet and a canary. When the human occupant of the room returned, she explained that the birds enjoyed the set! A minor adjustment on the chassis relieved the police and the FCC and left the birds and their owner as happy as—well—birds and their owner.

\*\*\*

"Pictureless TV" on one channel aroused the residents of a city in New England, the loudest complainant being a prominent local manufacturer of radio tubes. FCC engineers had little trouble tracking the interference—to defective test equipment in the factory of guess what prominent local manufacturer!

\*\*\*

Old-style, pear-shaped electric light bulbs look innocent, but under many conditions are known to create very nasty interference in both TV and radio receivers. In one community they became such a problem that the local power company, cooperating with TV dealers, offered to replace free any outmoded bulb turned in by the public. •



Get into

# TELEVISION RADIO-ELECTRONICS



LEARN ALL 8 PHASES  
BY SHOP METHOD

OF THE INDUSTRY  
HOME TRAINING

1. Television . . . including Color TV
2. Radio . . . AM, FM
3. Industrial Electronics
4. Communications
5. Sound Recording & Hi-Fidelity
6. Automation
7. FCC License Preparation
8. Radar & Micro Waves

Let National Schools of Los Angeles, a Practical Resident Technical School for over 50 years, train you at home by Shop-Method for unlimited opportunities in All phases of TV, Electronics, Radio.

You get 19 big kits  
of equipment!

**GOOD JOBS . . . MORE MONEY  
SECURITY . . . ALL CAN BE YOURS**

YOU are needed in the great modern Television-Electronics industry. Trained technicians are in growing demand, at excellent pay, in sales and service, manufacturing, broadcasting, telecasting, communications, research, and many other important branches of the field. National Schools Master Shop-Method Training, with newly added lessons and equipment prepares you in your spare time right in your own home for these fascinating opportunities. **OUR OUTSTANDING METHOD IS PROVED BY THE SUCCESS OF GRADUATES ALL OVER THE WORLD!**

**YOUR TRAINING IS ALL INCLUSIVE**

We prepare you for a long list of job opportunities. Thousands of TV and Radio receivers are being sold every day—more than ever before. And, now, Color TV is here. Applications of Electronics in industry—**AUTOMATION**—are growing in tremendous strides. The whole field is alive—opening up new, important jobs rapidly. National Schools complete training program qualifies you in all phases of the industry.

**YOU EARN WHILE YOU LEARN**

Many students pay for their entire training—and more—with spare time earning. We'll show you how you can, too! Early in your course you receive material that shows you how to earn extra money servicing TV and Radio receivers, appliances, etc., for friends and acquaintances.

**YOU GET EVERYTHING YOU NEED**

Clear, profusely illustrated lessons, shop-tested manuals, modern circuit diagrams, practical job projects—all the valuable equipment shown above—many other materials and services—consultation privilege with our qualified staff, and Graduate Employment Service. **EVERYTHING YOU NEED** for outstanding success in Electronics.

**INDUSTRY NEEDS YOU. NATIONAL SCHOOLS WILL TRAIN YOU. SEND FOR FACTS TODAY NO OBLIGATION.**

**YOU LEARN BY SHOP METHOD . . .** you do servicing, circuit analysis, and do over 100 down-to-earth experiments. You build a Superhet Receiver and a modern TV Receiver, from the ground up, including a new, big screen picture tube. You also receive a professional, factory-made **MULTI-TESTER**. All of this standard equipment is yours to keep . . . at just one low tuition.

**RESIDENT TRAINING AT LOS ANGELES**

If you wish to take your training in our Resident School at Los Angeles, the world's TV capital, start NOW in our big, modern Shops, Labs and Radio-TV Studios. Here you work with latest Electronic equipment—professionally installed—finest, most complete facilities offered by any school. Expert friendly instructors. Personal attention. Graduate Employment Service. Help in finding home near school . . . and part time job while you learn. Check box in coupon for full information.

Approved for  
GI Training



**NATIONAL SCHOOLS**  
LOS ANGELES 37, CALIF.

**FREE!  
VALUABLE BOOK  
& SAMPLE LESSON**  
—Just Send  
Coupon!



**NATIONAL SCHOOLS**

TECHNICAL TRADE TRAINING SINCE 1905  
LOS ANGELES 37, CALIFORNIA

**GET FAST SERVICE—MAIL NOW TO**

NATIONAL SCHOOLS, DEPT. B6E-118  
4000 S. FIGUEROA ST. LOS ANGELES 37, CALIF.

Rush free TV-Radio "Opportunity" Book and sample lesson. No salesman will call.

NAME \_\_\_\_\_ AGE \_\_\_\_\_  
ADDRESS \_\_\_\_\_  
CITY \_\_\_\_\_ ZONE \_\_\_\_\_ STATE \_\_\_\_\_

Check if interested ONLY in Resident School training at Los Angeles.  
VETERANS Give date of discharge \_\_\_\_\_

# Better Sound from Small TV Sets



Tool points to leads that are removed for extension to added speaker. They're often merely clipped—not soldered. Added 8-inch speaker, plywood-enclosed, gives set a fine new voice.

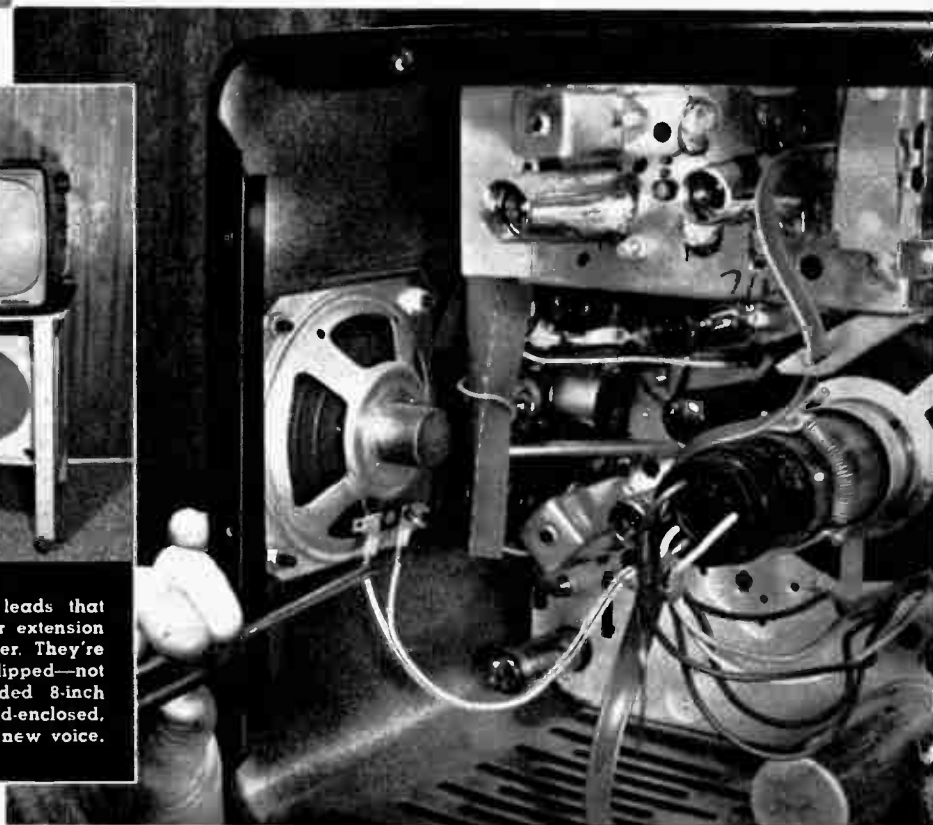

**T**HE PICTURE on my new 14-inch "portable" TV set was fine, but the sound was so miserable that something had to be done about it. The poor quality was due obviously to an inadequate little 3-inch loudspeaker. To make matters worse, this was mounted on the side of a thin metal cabinet, which rattled like a bunch of tin cans.

To permit its use in various parts of the house, the set was already mounted on a castered table. From  $\frac{1}{2}$ -inch plywood, I made a simple box to fit the entire space

between the legs, and in this I mounted an inexpensive 8-inch speaker. A couple of short jumper wires to the leads that formerly went to the small speaker were the only extra connections.

The improvement in sound reproduction was incredible. Gone are the tinny noises, and present are low notes that were inaudible before.

The idea can be applied to practically all so-called "portables," which are forced to use small speakers because of space limitations within their cabinets. •



RCA INSTITUTES offers you the finest of home study training. The equipment illustrated and text material you get with each course is yours to keep. Practical work with very first lesson. Courses for the beginner and the advanced student. Pay-as-you-learn. You need pay for only one study group at a time.

**Send for this  
FREE Book Now** ▶

RESIDENT SCHOOL courses in New York City offer comprehensive training in Television and Electronics. Day and evening classes start four times each year.

Detailed information on request

**RCA INSTITUTES, Inc.** Home Study Dept. XE-11

A Service of Radio Corporation of America

350 West Fourth Street, New York 14, N. Y.

Without obligation, send me FREE 52 page CATALOG on Home Study Courses in Radio, Television and Color TV. No salesman will call.

Name..... please print

Address.....

City..... Zone..... State.....

Korean Vets! Enter discharge date.....

**CANADIANS** — Take advantage of these same RCA courses at no additional cost. No postage, no customs, no delay. Send coupon to: RCA Victor Company, Ltd., 5001 Cote de Liesse Rd., Montreal 9, Quebec

To save time, paste coupon on postcard.



# Complex Ham Receiver

# Simplified

Front-end prealignment eliminates the most difficult part of kit construction and the need for elaborate, costly test equipment as well

A station of which any ham operator would be proud! Mohawk receiver is on the right, Apache transmitter on the left. At the microphone is Al Robertson, K8BLL, Heath engineer who designed the transmitter.

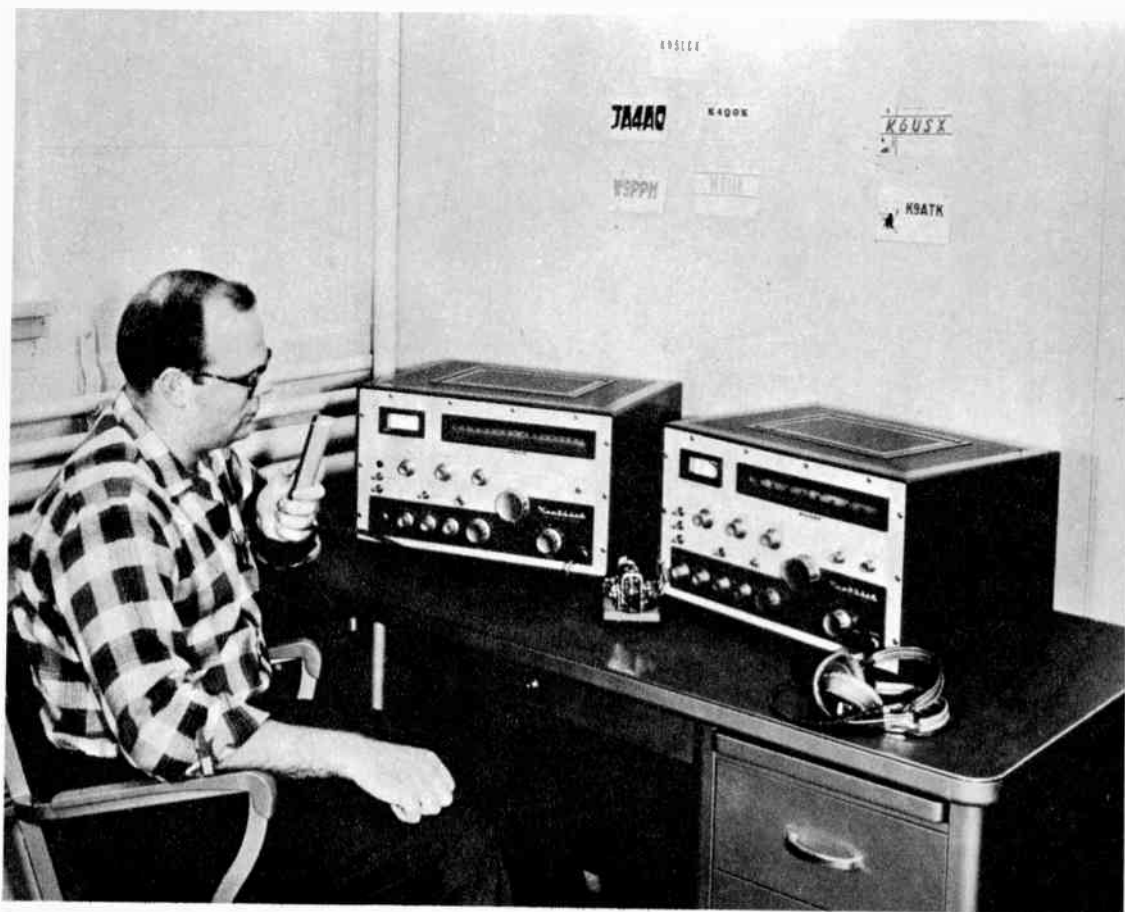



**F**OR MANY YEARS, kit manufacturers refused to produce multiband ham receivers because they believed that the alignment and calibration of the many critical circuits in them was simply beyond the abilities and facilities of most builders. It wasn't that the latter weren't willing, but they realized themselves that they needed rather elaborate test equipment of the kind receiver manufacturers used on production lines.

No such inhibitions bother the current crop of hams, who have grown up on a diet of atomic energy and missile propellants. They are miffed at any suggestions that an instrument or a project is too difficult or advanced for them; the more difficult or advanced, the better they like it! Having shown that they can put together large, heavy transmitters, they have been asking manufacturers for comparable receivers.

After two years of intensive development effort, Heath has come up with a receiver kit that will make the eager-beavers happy. This is the "Mohawk," a 12-knob, 15-tube, 7-channel, ham-band-only, double-conversion, selectable-sideband, crystal-controlled job. It weighs 52 pounds by itself without external loud-speaker. In this big set, critical front-end alignment and calibration is no problem for the very simple reason that the entire

front end, consisting of radio-frequency amplifier stage, high-frequency oscillator and first mixer, is furnished as a pre-assembled, prewired, and factory-adjusted package that drops into the chassis as a complete unit. There's still plenty of assembly, wiring and aligning to do, but the really tough part is eliminated. This premade front end is assurance to the builder that the completed receiver will work, and insurance for Heath that it won't bounce back for expensive and troublesome rehabilitation.

The clever circuit arrangement following the front end eliminates the need for any external alignment equipment. A crystal-controlled 100-kilocycle oscillator is the self-contained frequency yardstick. This is corrected right on the nose by checking its 100th harmonic against the 10-megacycle standard-frequency signals of WWV, the internationally-recognized station of the U. S. Bureau of Standards. The second intermediate-frequency amplifier stages work on 50 kilocycles, as does the beat-frequency oscillator. Using the second harmonic of the latter, it is only the work of a minute to zero-beat it against the 100-kc. standard. The BFO then becomes a miniature signal-generator for the alignment of the I. F. stages.

Fed into the input of the R. F. stage, the signals of the 100-kc. oscillator provide a

Heart of Mohawk receiver is this prealigned, preassembled front end. Six-prong plug on flexible cord is power take-off from chassis proper.

The front end drops neatly into cutout in the main chassis of the Mohawk receiver. Balance of the assembly is a simple nut-and-bolt job.

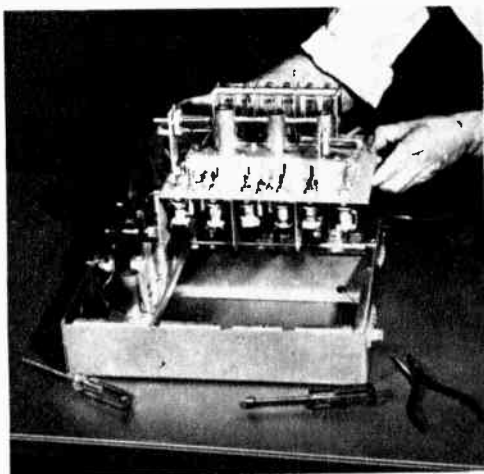
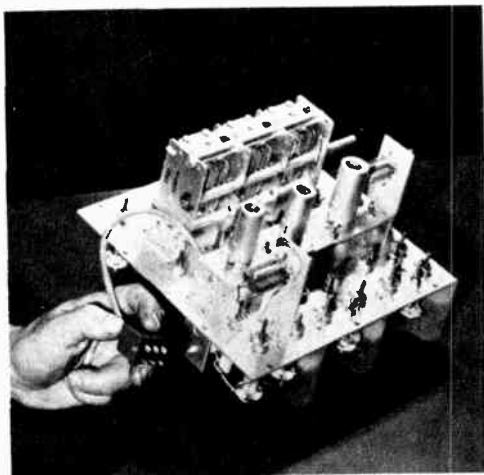

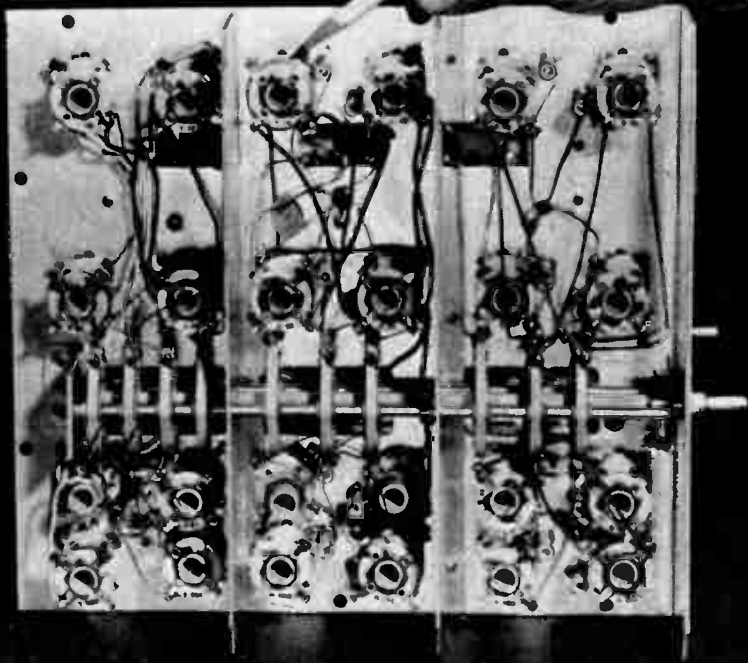

View from below front end of the Mohawk receiver. Pencil indicates one of 24 coils, all preset at the factory. Note ten-section bandswitch runs between the banks of coils.

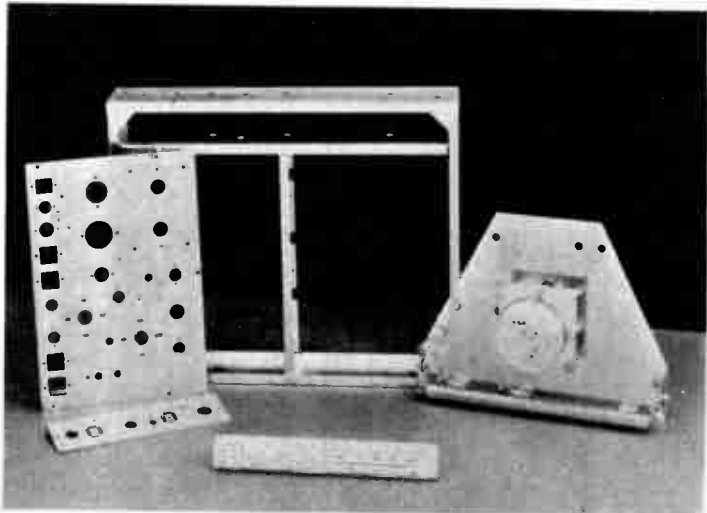

Chassis members include main tuning capacitor support and drive, completely punched main chassis and subchassis plates, expanded scale drum that turns with the bandswitch.

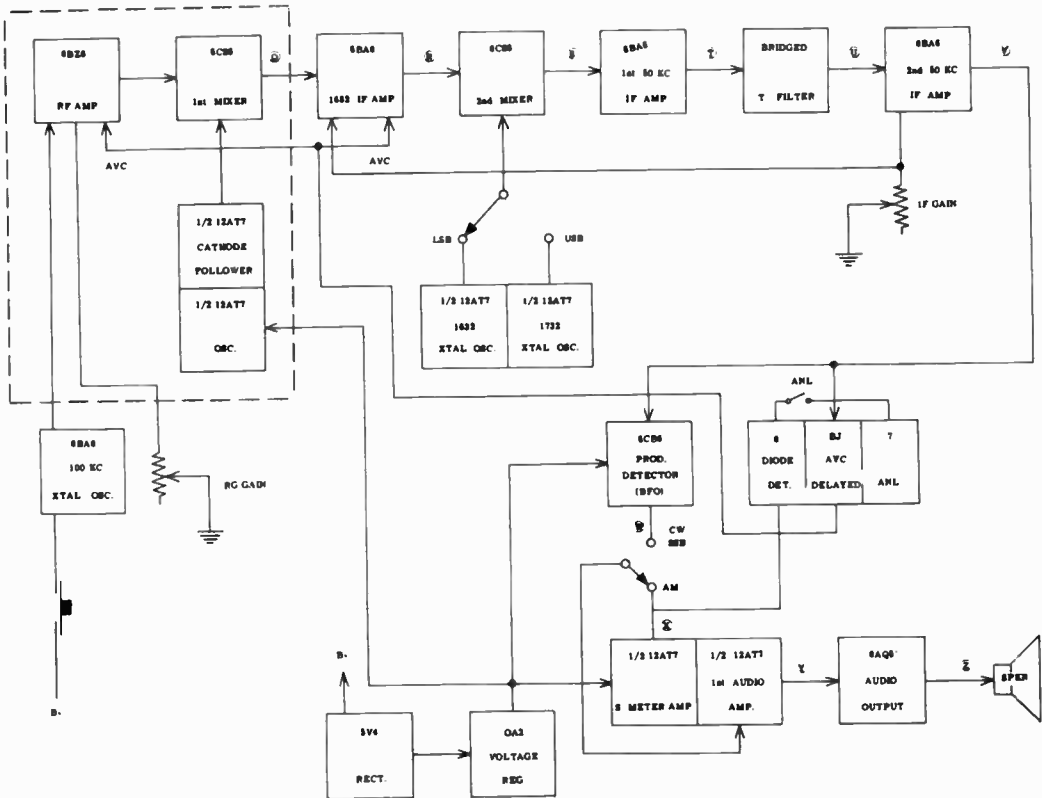

Dotted line enclosure at upper left of this block diagram indicates prealigned, preassembled front end. Signals leaving first mixer are at the I.F. of 1682 kcs.; those leaving second mixer are at 50 kc., whether lower sideband (LSB) or upper (USB) is switched. Arrows indicate signal path.

Rear view of completed Mohawk receiver. Front end is at left. I.F. and power components are at right. The braces support the dial mechanism.

There's only half as much wiring to do as this shot indicates, since entire left-hand section is the front end, factory-wired and assembled.

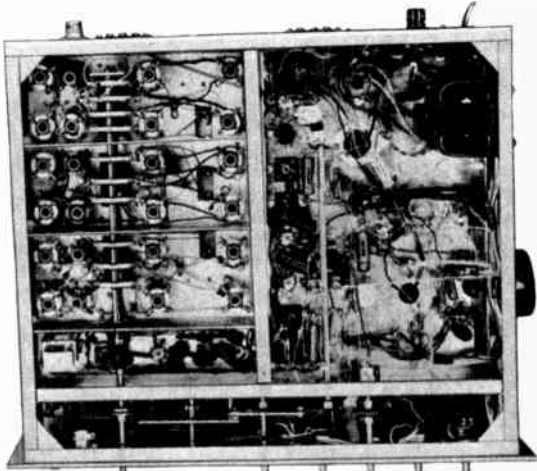
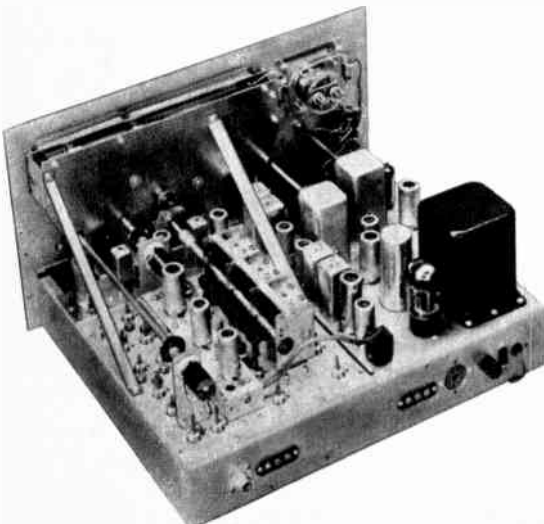

means of checking the entire receiver. Its rich and numerous harmonics, which occur at successive 100-kc. points, are convenient reference points for setting the tuning scale. For example, the 142nd harmonic should appear on the 14,200-kc. mark, the 285th at the 28,500-kc. mark. There is a calibrator control to make each of the seven bands register precisely.

The Mohawk is a big receiver, 19½ inches wide, 11⅞ inches high and 16 inches deep. The size is a help rather than a hindrance; the parts are more accessible and the wiring can be done more comfortably. A 15-tube set is hardly recommended for a novice, but it can be tackled with confidence by anyone who has worked on one or two simpler kits such as a VTVM, a hi-fi tuner or amplifier. A very detailed 70-page instruction book accompanies the receiver.

Since the announcement of the Mohawk, many hams have asked, "How does this receiver compare with Allied's Knight-Kit set?" The latter is the only other short-wave kit job on the market.

The question is thoroughly unfair to both receivers because they have entirely different technical characteristics and price

tags. The Mohawk is *ham-band only* and costs \$275; the Knight-Kit\* is of the general-coverage type and costs \$105. Each can do things the other can't. As a free and unbiased observer who has used both, the writer would like to suggest that a Mohawk with a Knight-Kit set atop it would make a terrific combination in any ham shack. The owner could spend twenty years of spare time at the dials without a dull moment and without exhausting the possibilities of the two units.

#### "Apache" Transmitter

Using the Mohawk's front panel and cabinet and a matching control arrangement, the Apache is a new Heathkit transmitter intended as a companion for the receiver. It is a straight AM phone and CW rig, rated at 150 and 180 watts in the respective modes of transmission. For single sideband operation, an external adapter can be used. Heath will have a suitable unit available as the Model DX-10SB. •

*\*A detailed report on this receiver appears in the September 1958 issue of ELECTRONICS ILLUSTRATED, also a Fawcett publication.*

Chassis of the Apache transmitter is seen here, partially assembled. This new Heathkit is designed as a companion for the Mohawk receiver.

Apache's chassis is compartmentalized for purposes of shielding. This photograph is a bottom view, with the wiring harness partially placed.

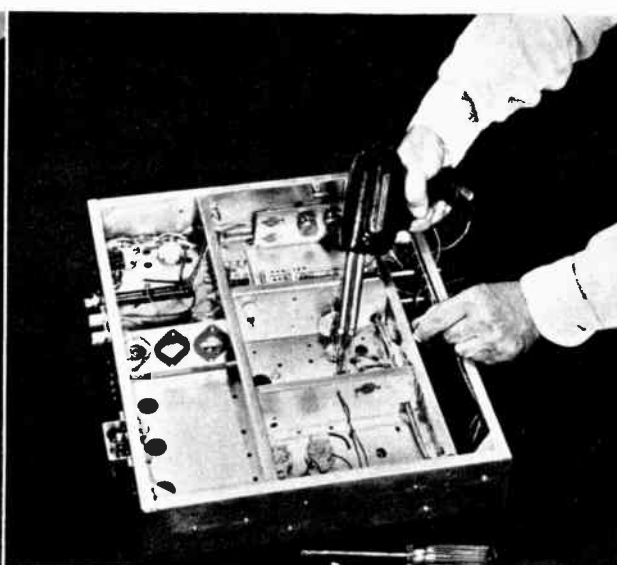
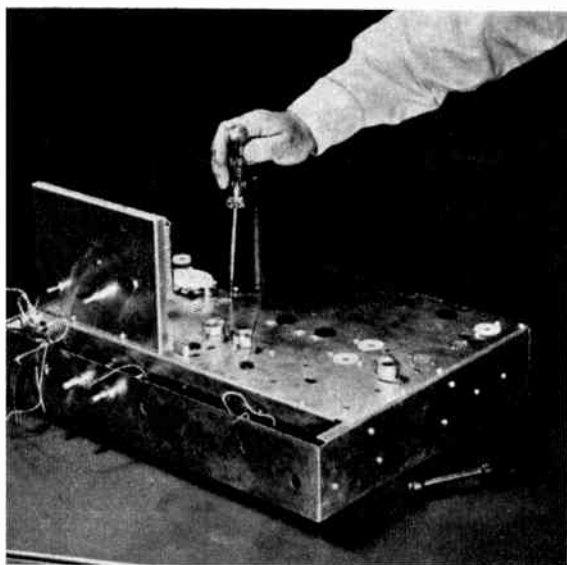



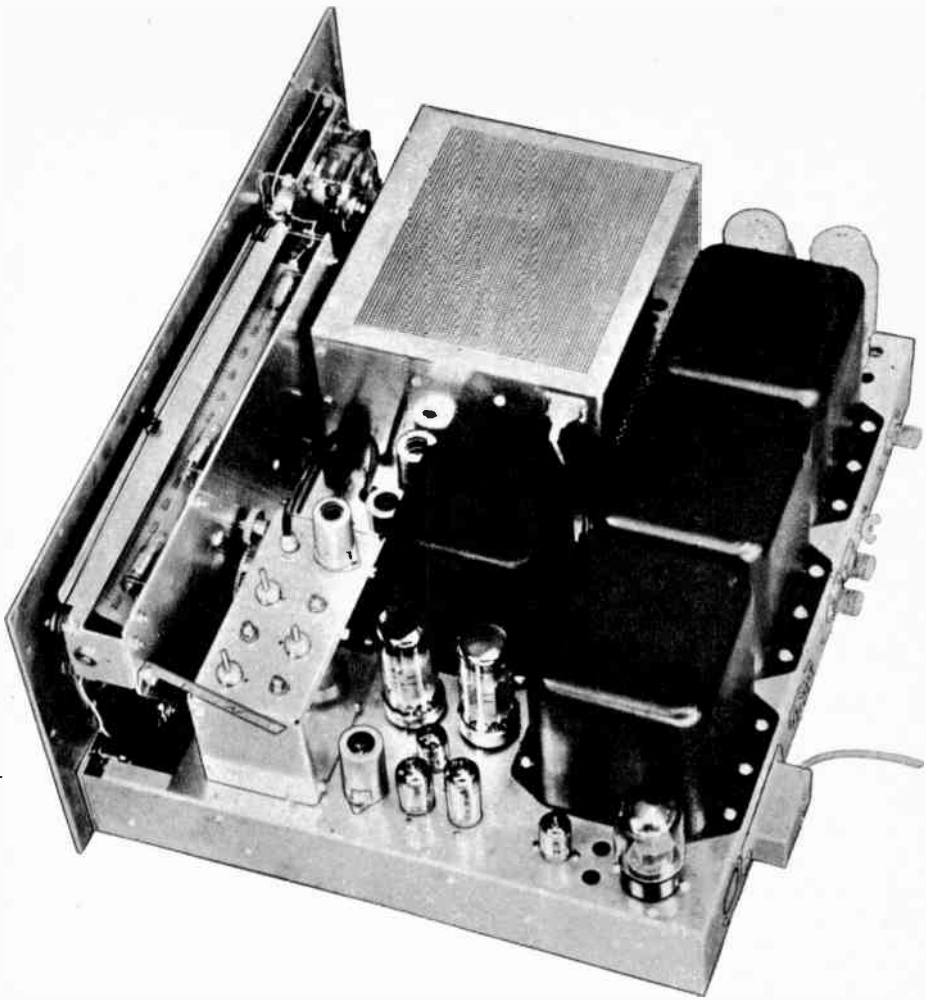

Rugged construction of the Apache is evident above. Note cage at the top of photograph. It serves to protect the final amplifier stage.

Where operating space is limited, the transmitter can be placed atop the Mohawk receiver to form a neat and extremely workable combination.



# Army Tests New Electronic Gear

Developments of an old Arizona Indian post make Buck Rogers "old hat"

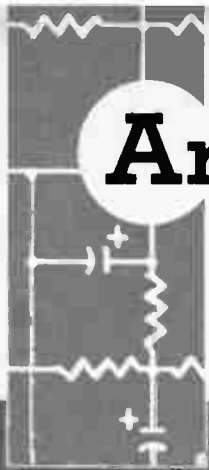

**G**ERONIMO, the fabled Apache war chief who terrorized Arizona Territory in the 1880's, would himself be terrified if he returned today to his old hunting ground in the Huachuca Mountains near the Mexican Border. Not by the hard-riding troopers of the Sixth U. S. Cavalry and their single-shot carbines, but by massive metal birds that fly straight up, down and backward as well as forward; by beardless young soldiers who carry no guns but ride snorting wagons fitted with strange apparatus; by iron towers stretching skyward like rain god's totems; by artillery that hits targets its handlers can't even see.

Geronimo would be viewing the United States Army Electronic Proving Ground at Fort Huachuca, the very same Fort Huachuca whose troops finally ran him down in 1886. Preserved by the arid, sunny climate, many of the post's original buildings are still in use, occupied by men who carry slide rules instead of sabers.

Prior to 1954, the focal point of military electronics was the Signal Corps Engineering Laboratories at Fort Monmouth, New Jersey. Located in a popular residential and resort area close to the Atlantic beaches, this growing establishment just

didn't have the space for field-testing the new signal equipment and techniques of the atomic age. It needed open ground, so that if it wanted to test a radar spotter for mortar fire, for instance, it could shoot mortars without plowing a real-estate development behind the next clump of trees. The Army found open ground—70,000 vast, wild acres of it—in a spot it already owned: Fort Huachuca. Like so many other training areas, it had been closed because of the shrinking of the military forces, and the Signal Corps was able to move in quickly in February of 1954.

At that time, the old Indian post had a population of scarcely 100 people. Today it is a bustling minor metropolis of 500 officers of special qualifications, 5,000 troops and 1,500 civilian engineers and technicians. Their activities make Buck Rogers almost as outdated as ugly old Geronimo. Many of the activities are highly classified, but the authorities permitted this writer to tour the place recently and to take away a collection of pictures showing some of the projects undergoing test. Here they are with explanatory captions.

Wondering how to pronounce that name? It's "wha-choo-ka." •



Geronimo, the Apache, is seen at right of center photo, after his capture by Fort Huachuca troops in 1886. Some original buildings yet border parade grounds of old post, above. Surrounding vastness makes it ideal for Army electronic tests. Tower, left, determines needed antenna height for microwave transmissions of given distances. "Dish pan" can be positioned anywhere along the structure.



Combat commanders will "see" many miles with radio-controlled drone planes, such as fighter-size, experimental, classified version of artist's rendition above. Drone at right is moved on carriage behind jeep. Pneumatic prop spinner starts its engine, and it climbs in jet-assisted take-off to circle vastness of Electronic Proving Ground in Arizona at relatively low speed, under the control of a radio director on the ground.





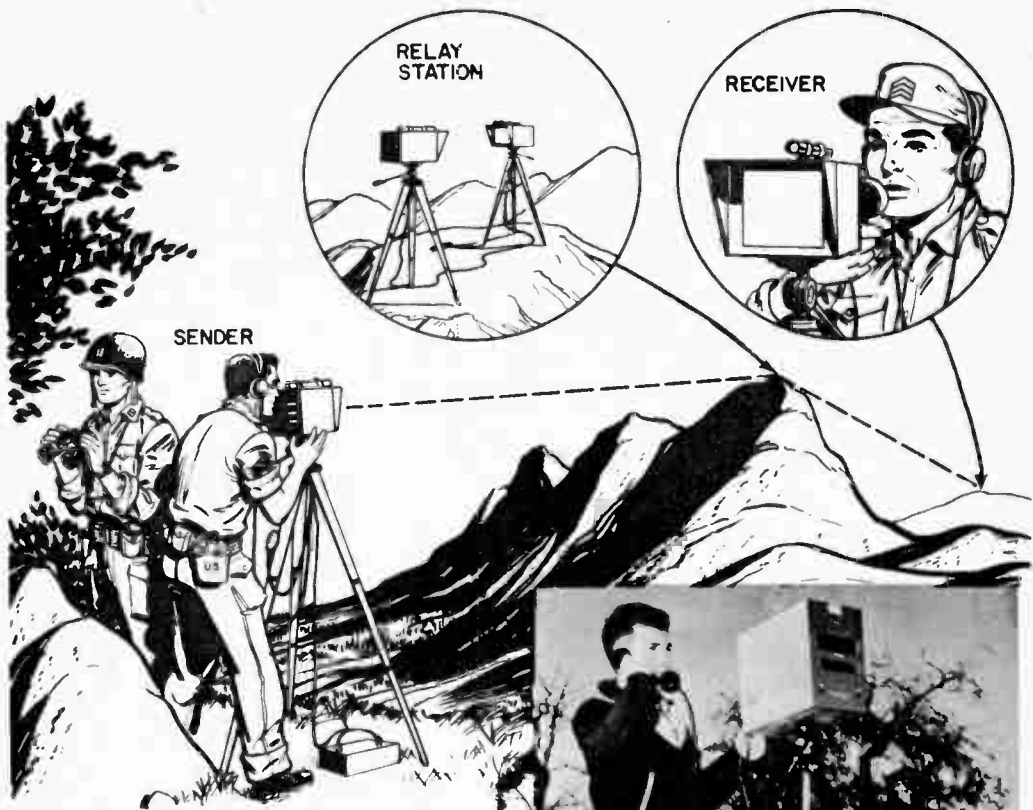

Among oldest forms of point-to-point signaling, the heliograph is being brought up to date by electronic principles. Infrared light is projected as a powerful, concentrated beam and is modulated by a telephone adapter for secure, reliable voice communication. Experimental model is tested here on mountain peak near Fort Huachuca. Equipment details are secret. Line-of-sight limitations are overcome by repeater stations between terminal points, which permits long-distance use.





For certain military purposes, wire communication is preferred over radio. But the problem has always been how to lay sufficient wire fast enough. Here's a method that is proving successful at the Electronic Proving Ground. A 'copter at tree-top height spews out two lines at a mile a minute. Five hundred miles have been laid at speeds to 70 mph. Men in the "whirlybird" are in constant contact with the ground via field telephone, connected to the wires being laid. Two types of dispensers are seen below: cylinders that are outboard-mounted, photo at the left, and split pods that hold spliced reels.

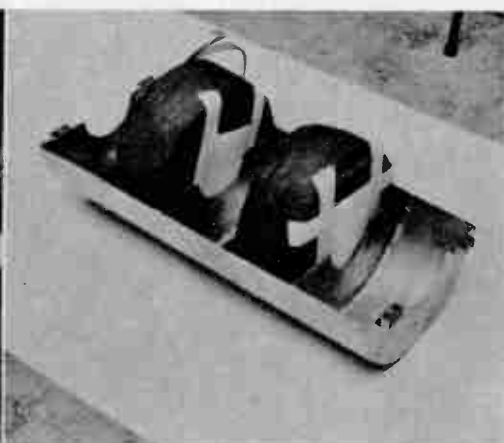

Practical to transport by air a massive radio station that normally moves by truck? The idea is explored in Arizona. A heavy radio-shelter is lowered inch by inch, and finally released without disturbing a tube. Sausage-shaped 'copter below brings up auxiliary equipment. Trailer below spills over. It will be rigged differently next trip. Wilderness backdrop is the Hauchuca Mountains.





Those aren't supermen jockeying that huge antenna. Lightweight rig inflates with air, part of complete air-dropped radio system. Entire station includes two shelters, power unit, and antenna.

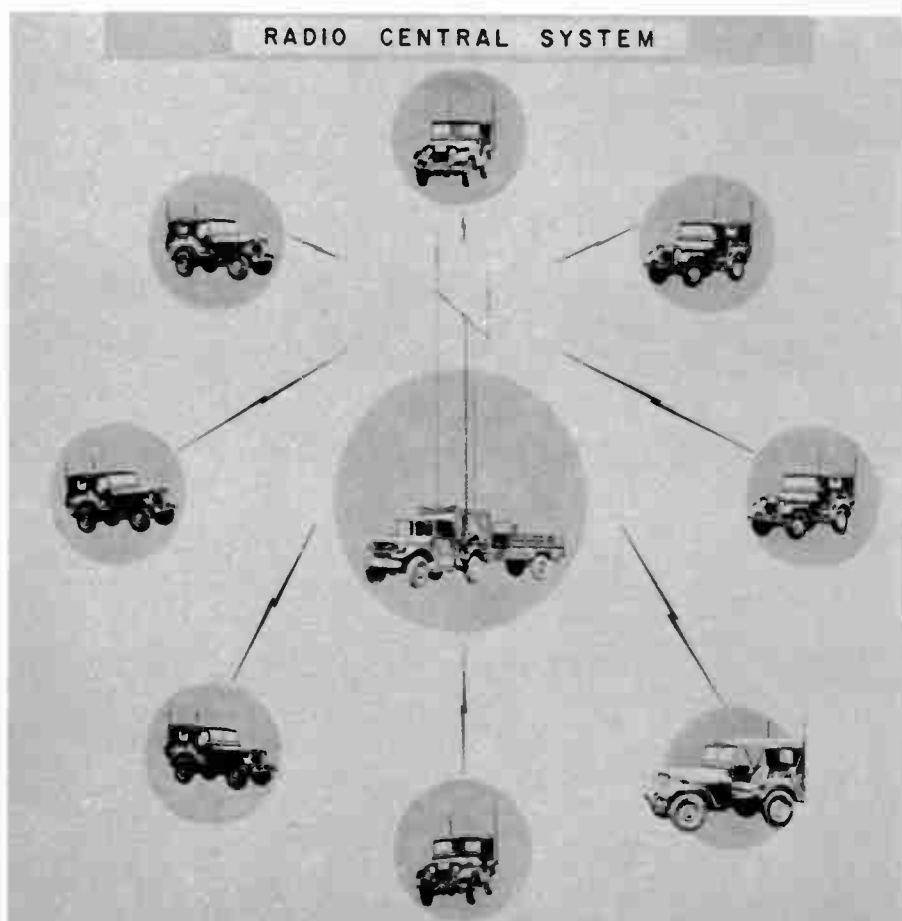





Mobile radio system, far more elaborate and dependable than any of World War II, is evaluated at the Electronic Proving Ground.

Providing eight channels for up to 32 vehicles, it requires only two frequencies. All equipment is single-sideband type. "Central," in a  $\frac{3}{4}$ -ton truck,

consists of a transmitter, receiver, and switchboard for interconnecting vehicles. Truck is on the air within minutes.

Permanently-mounted antenna telescopes, is quickly cranked to operating height.

Nominal range is 10 miles.

but system has performed up to 60 miles in tests at Fort Hauchuca, Arizona.



# All-Band Transistor Radio

Until now, fine portable receivers such as this one existed only in designers' dreams

**L**IGHT WEIGHT . . . compact . . . easily carried . . . wide frequency range . . . band-spread tuning . . . good tonal quality . . . built-in aerial . . . reliable operation on common flashlight batteries.

Until recently, a truly portable radio receiver having these specifications existed only in the dreams of designers. Today it is a reality, thanks to the development of transistors. The set is the new Zenith "Royal 1000," which creates a small sensation wherever it is shown and demonstrated. I can readily understand why.

having used one almost continuously for a period of about a month. I can't recall having so much fun with a radio set since I made a tuner out of an oatmeal box and bell wire and a crystal detector out of a piece of galena and a safety pin.

From its general appearance and the fine details of its construction, it is obvious that the manufacturers were determined to produce a high-quality instrument, something quite different from the sloppy radio and television sets afflicted on the public and service technicians during the past

Large knob facilitates tuning of critical short wave signals on the Zenith transistor portable. Time map and converter, on inside of cover, are handy in checking international stations' schedules.



decade. Closed up, the Royal 1000, also known as the "Trans-Oceanic," measures only 12½ inches wide, 10¼ inches high, and 4⅞ inches deep. Finished in simple black and chromium, with a comfortable carrying handle running the length of the case, it looks like an expensive handbag and not at all like a radio receiver. The only indication of its true status is a flat-folding knob on one end, marked "Band Selector."

Open the front of the case by pressing a catch under the handle, and your reaction most likely will be, "Wow!" Along the top is a direct-reading frequency scale, for the particular wave band brought into play by the outside band selector. At the lower right is a large diameter tuning control, silky smooth. At the lower left is a cluster consisting of a tone control, an on-off switch and volume control combined, an earphone jack and a dial-light switch.

The inside of the folding cover is a dull-etched aluminum plate. At the left end it carries a time zone conversion dial; the rest of the surface bears a world time-zone map. Protruding from the plate is a white tab marked "Pull Out." If you follow instructions, you find a specially-printed, spiral-bound, 28-page log book, listing hundreds of short-wave stations.

The back of the case is also hinged. When opened, it reveals the chassis, a very convenient holder for nine ordinary flashlight batteries, and a detachable aerial for broadcast reception, called the "Wavemagnet."

The Royal 1000 is quite accurately calibrated to work on the regular AM broadcast band, from 540 to 1600 kilocycles, and on seven short-wave bands, which take in international broadcasting stations, ship and weather stations, and some airplane and amateur stations. The spread of the bands is as follows:

- 2 to 4 megacycles
- 4 to 9 megacycles
- 9.4 to 10.1 megacycles
- 11.4 to 12.3 megacycles
- 14.6 to 15.8 megacycles
- 17.1 to 18.5 megacycles
- 20.7 to 22.5 megacycles

The dial scale is nicely illuminated when the dial-light switch on the front panel is pressed. However, this switch is of the momentary contact type, and the lights go off when it is released. These lights work on a single battery, which is not connected to the other eight batteries. The latter are reserved for the transistors, which alto-

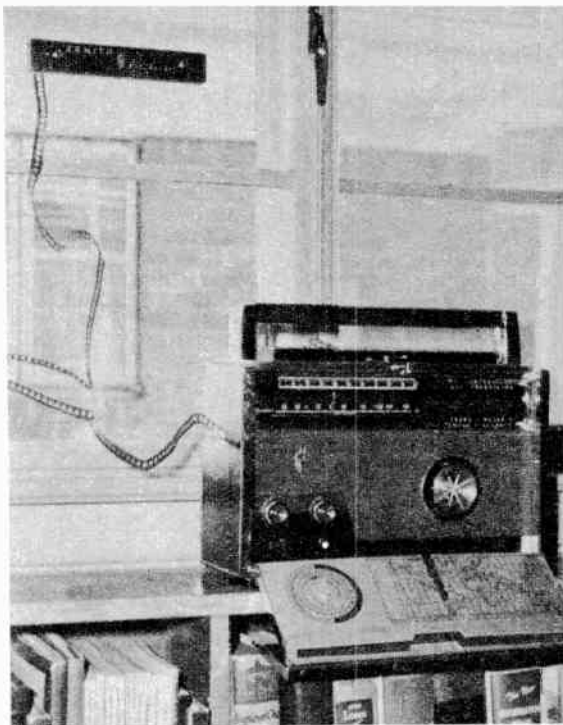

For broadcast reception, detachable Wavemagnet antenna is effective in shielded buildings, cars, etc. Suction cups hold it to the window.

Telescoping rod antenna, ingeniously concealed in handle of case, is for short-wave reception. Spring lock keeps it secure in the upright position.





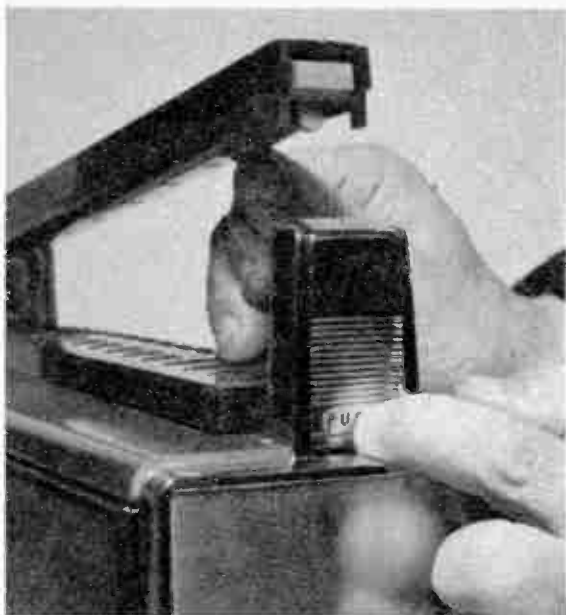

Handle of the Zenith Royal 1000, which contains the antenna, is released by means of a simple push plate. The handle then springs upright.

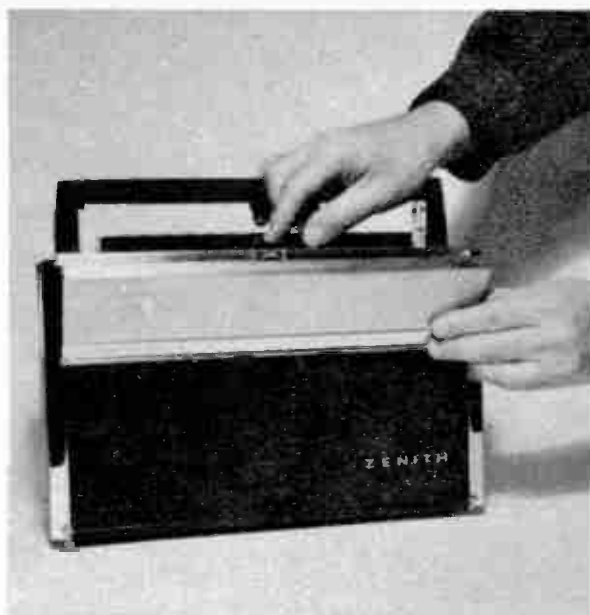

Handsome front cover protects operating controls of this transistor receiver. It is readily opened by merely pushing press catch at top.

Band selector switch is located in right end of the case. Key-type knob folds flat when not needed to prevent it from snagging clothing, etc.

Rear view, with cover lowered. Finger indicates one of nine tiny transistors. Note flashlight batteries in transparent case within the cover.





gether take much less current than the lights.

Battery life is estimated at about 300 hours, which I think is a bit conservative. A trick with all dry-battery-operated equipment is to turn it off frequently. This gives the batteries a chance to re-establish their chemical balance, and increases their useful life.

Of great importance to travelers, for whom the set is most valuable, is the world-wide availability of standard "D" size flashlight cells.

For normal broadcast reception, a built-in loop aerial is used. In difficult locations, such as trains, shielded buildings, etc., the "Wavemagnet" is fastened to a window by means of suction cups, and provides greater signal pick-up.

For short-wave reception, a telescoping

vertical rod antenna is brought into play. Opening to a height of five feet, this is actually the handle of the case. The arrangement is extremely ingenious.

And as for results! Within the first hour of listening on the short waves, late one afternoon, I heard three broadcasting stations in Europe and two in Asia, numerous airplane and ham stations, and a whole fleet of fishing boats. No matter where you go with a set of this kind, there's always diverting reception to be had at the flick of a dial.

Circuitwise, the Royal 1000 is a conventional superheterodyne, using nine transistors. The latter are operated at 12 volts, provided by eight flashlight cells in series. Audio output is given as  $\frac{1}{2}$  watt, which represents considerable sound from the loudspeaker. •

Wavemagnet antenna of the all-band transistor portable is normally fitted under top edge of the case, connects to receiver by length of flexible wire. Tonal quality of the set is exceptional.

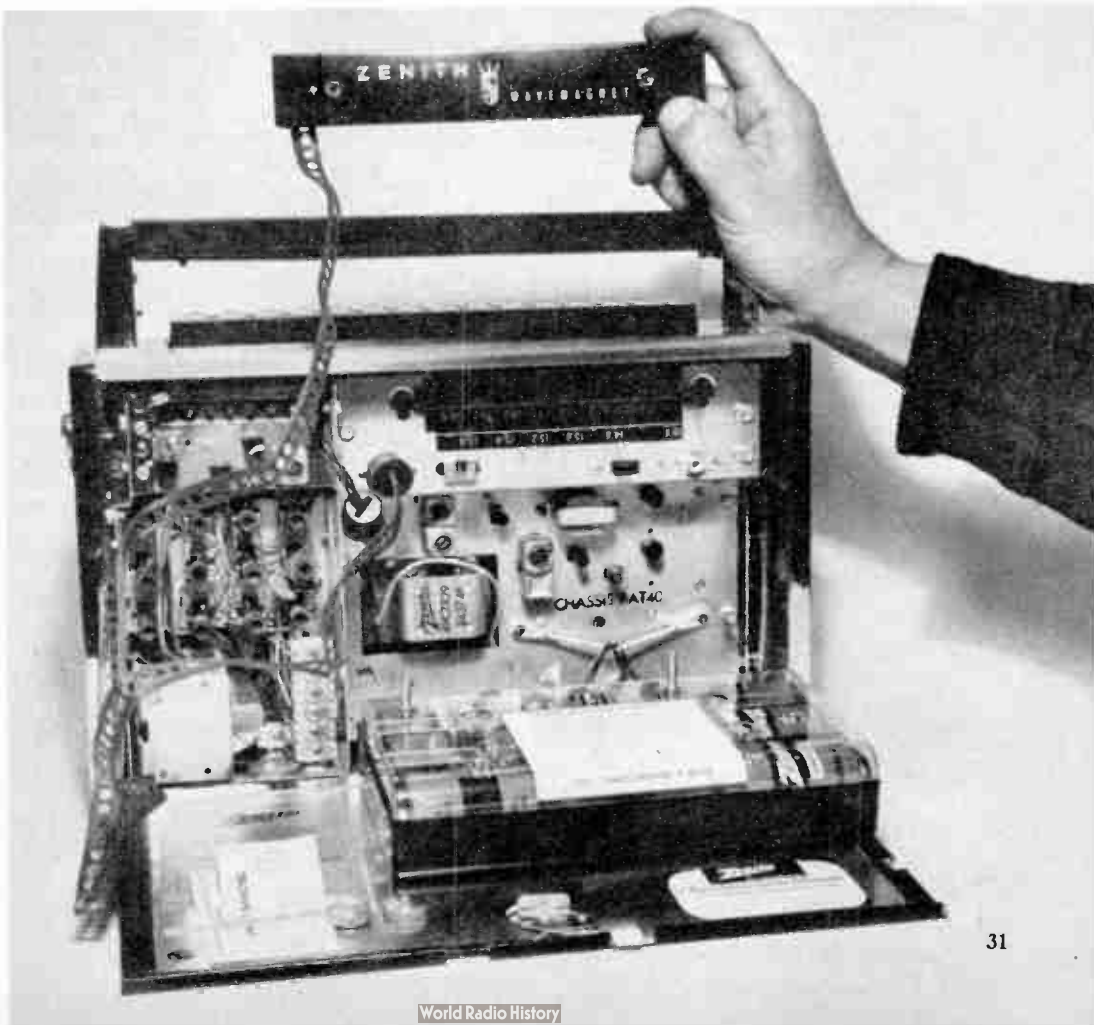

# Hi-Fi Where You Want It

Today's compact kit-built units can easily be mounted to satisfy your own listening habits

**E**ARLY high-fidelity tuners and amplifiers were generally large and heavy, and had to be mounted in bulky cabinets. The finished furniture invariably was placed in the living room of a house or apartment. Today, however, hi-fi equipment is much more compact, and therefore much more flexible as to both mounting requirements and the owner's particular listening habits.

Now proving very popular are tuners and amplifiers of flat "pancake" construction, only three or four inches high, about a foot wide, and eight or nine inches deep. They are provided with their own decorative metal cases, and lend themselves very nicely to quick, neat installation in bookshelves, on tops of desks or serving tables, at the bottom of end tables, and in many other locations. Tuners and amplifiers are usually of identical size, and can therefore be stacked vertically or spread horizontally to present a harmonious appearance.

The tuners are either straight FM or combination FM-AM jobs. The amplifiers run between 10 and 15 watts, which is

enough to shatter glassware around the house if opened up full.

Further flexibility in furniture arrangement and listening comfort is afforded by putting the loudspeaker in its own enclosure, independent of the tuner-amplifier unit. Invariably, a hi-fi system sounds best if the speaker and the listeners are separated a fair distance—often the full length of an apartment or house—with the volume turned up a bit high. Parking directly in front of the speaker is not recommended. You know why if you ever sat in the front row at a concert hall.

Pictures of some typical installations of flat-type hi-fi components are offered here to show what can be done with them. The tuner is the Eico Model HFT-90 and the amplifier the Eico Model HF-12. The units are available in both kit and factory-assembled form. I chose the kits, and found them interesting and rewarding as exercises with the screwdriver, the socket wrench and the soldering iron. A photograph of the bench job follows the installation pictures. •

Small end-table's lower shelf is ideal for tuner and amplifier stacked vertically. Controls are convenient. Wires to loudspeaker are under rug.



Side by side atop secretary, the components are a welcome addition to office in the home. Power, antenna, and speaker leads are behind the desk.





Serving table or buffet affords an attractive open spot for hi-fi units, leaving space for decorations, table accessories. Remember, in positioning amplifier, that it runs hot and requires adequate ventilation.

Loudspeaker, independent of other units, can be placed anywhere. Eico HFS-1, containing woofer and tweeter, is suspended from basement ceiling.



Here, speaker enclosure has been fitted with screw-on legs (hardware-store item) to bring it to window level. It doubles as a bench for tots.

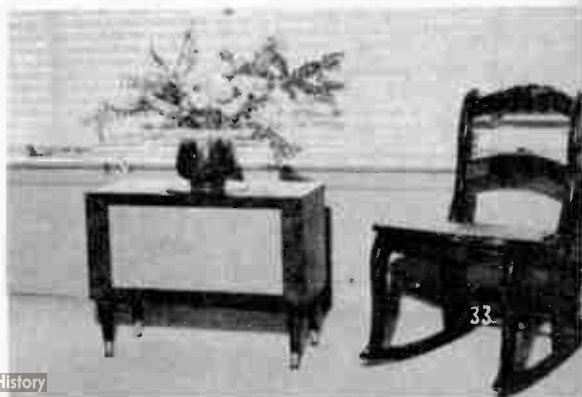



# Assembling the Units from Kits

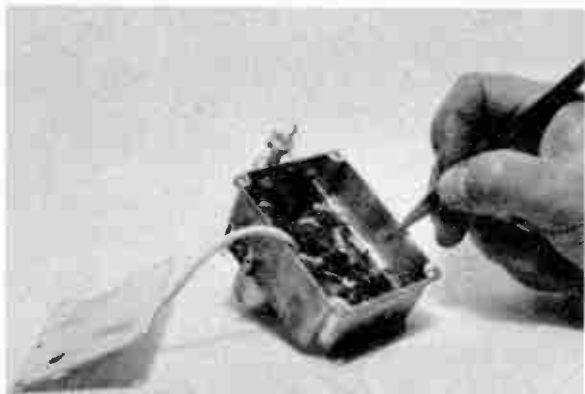

Eico HFT-90 tuner kit features a preassembled, "front end" in cast-aluminum box. Indicated are tuning coils of silver ribbon, wound on plastic. I.F. transformers have also been preadjusted.

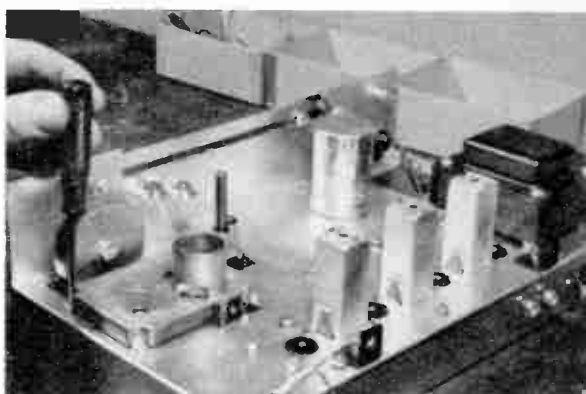

Rear view of the partially-assembled HFT-90 chassis. "Front end" is being fastened as complete unit behind front panel. Chassis is preformed and punched. Assembly is a simple task.

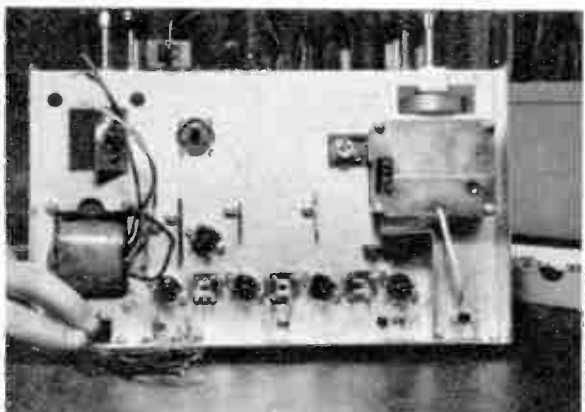

Bottom view of tuner chassis. Major parts have been mounted; no wiring done. Power transformer is at lower left; tube sockets and I.F. transformers along bottom; "front end," right center.

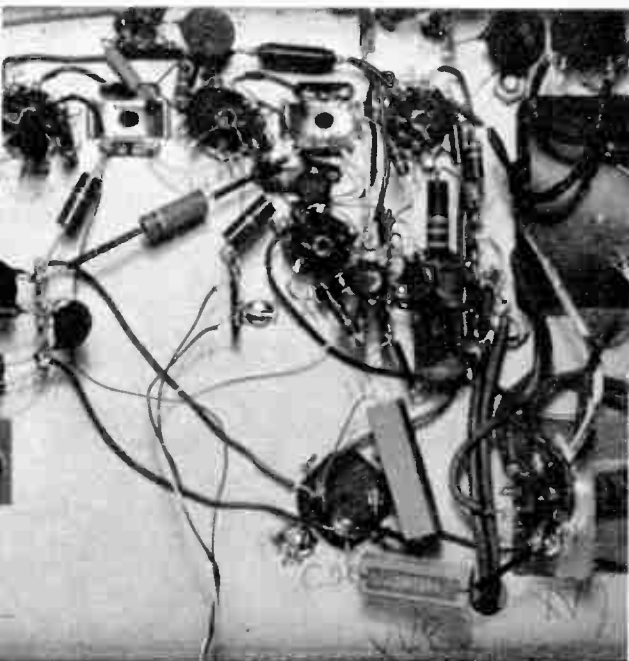
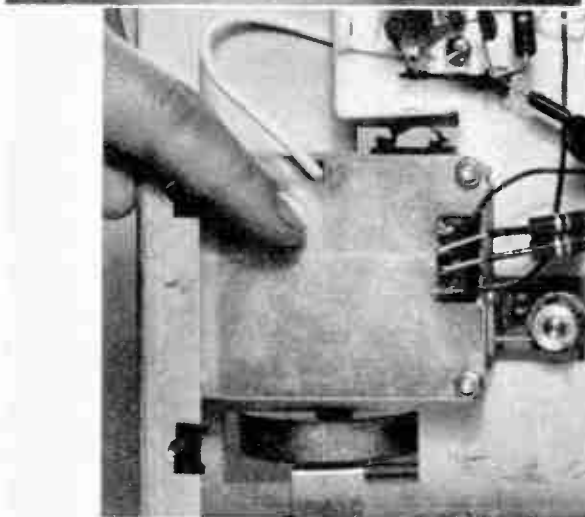

Bottom view of completed tuner shows all connections. Flat, open construction eases wiring. Resistors, capacitors are mounted by own "pig-tail" leads. Finger shows "front-end" housing.



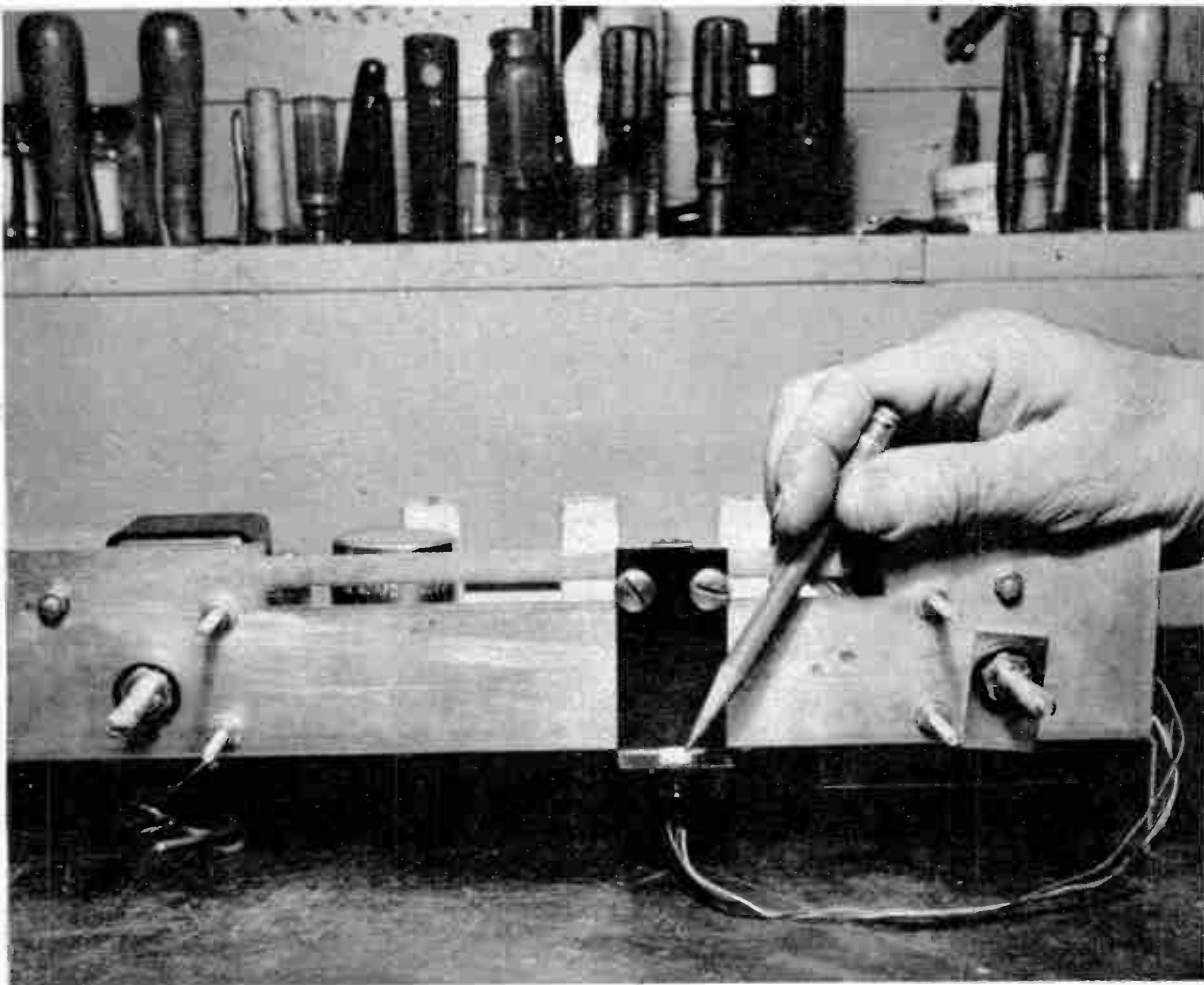

Front section of the Eico tuner kit is shown here, before the panel has been mounted. Indicated by the pencil is tiny socket for a special glow lamp, which acts as both pilot light and tuning indicator.

The light, a DM-70 tube, is a gas-filled triode. Via cord of tuning mechanism, it moves back and forth as tuner is adjusted.

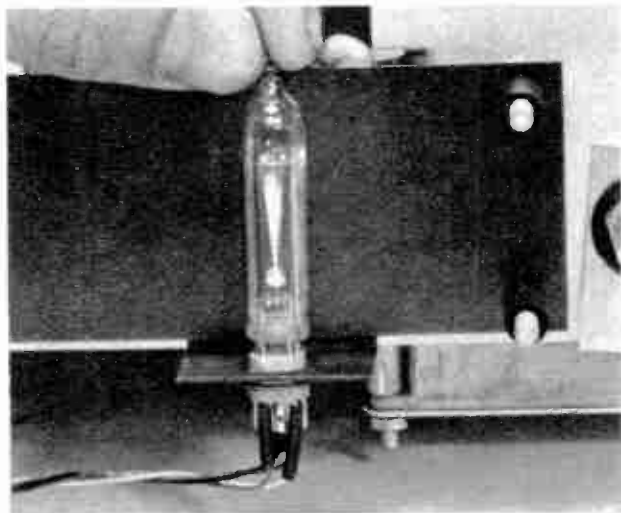

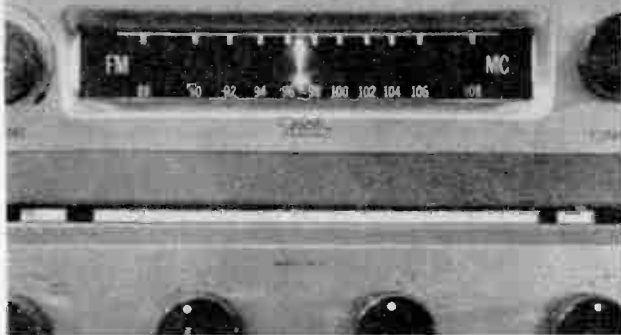

Completed tuner, used with an Eico HF-12 amplifier. It is not tuned to station accurately. The exclamation-point-shaped plate of DM-70 glows brightly overall, meaning no signal or weak one.

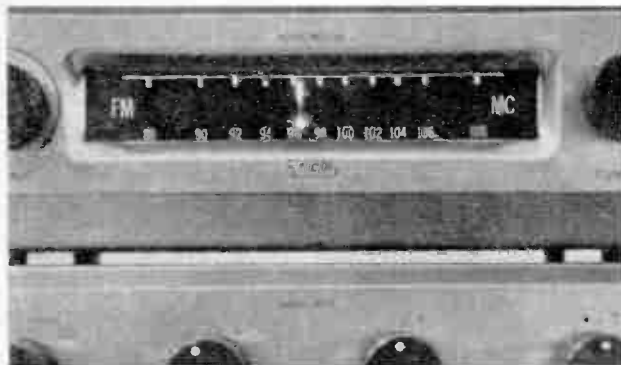

Tuner knob, turned slightly, brings in FM station on 96.3 mcs. Bottom part of exclamation point, almost dark, indicates maximum signal. This is clever and effective feature of this Eico model.

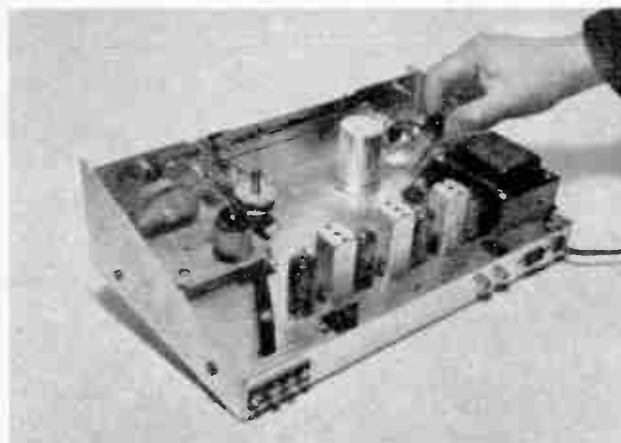

The completed tuner is shown in the photograph at lower left. The last tube is being inserted in its socket. It is installed at an angled position so that it will clear the tuner's metal enclosure.

Eico HF-12 amplifier is complete below, but for cover that slides into lips of sides and front. Note angled tubes between transformers. Jacks and binding posts are for radio tuner, phono, tape, etc.



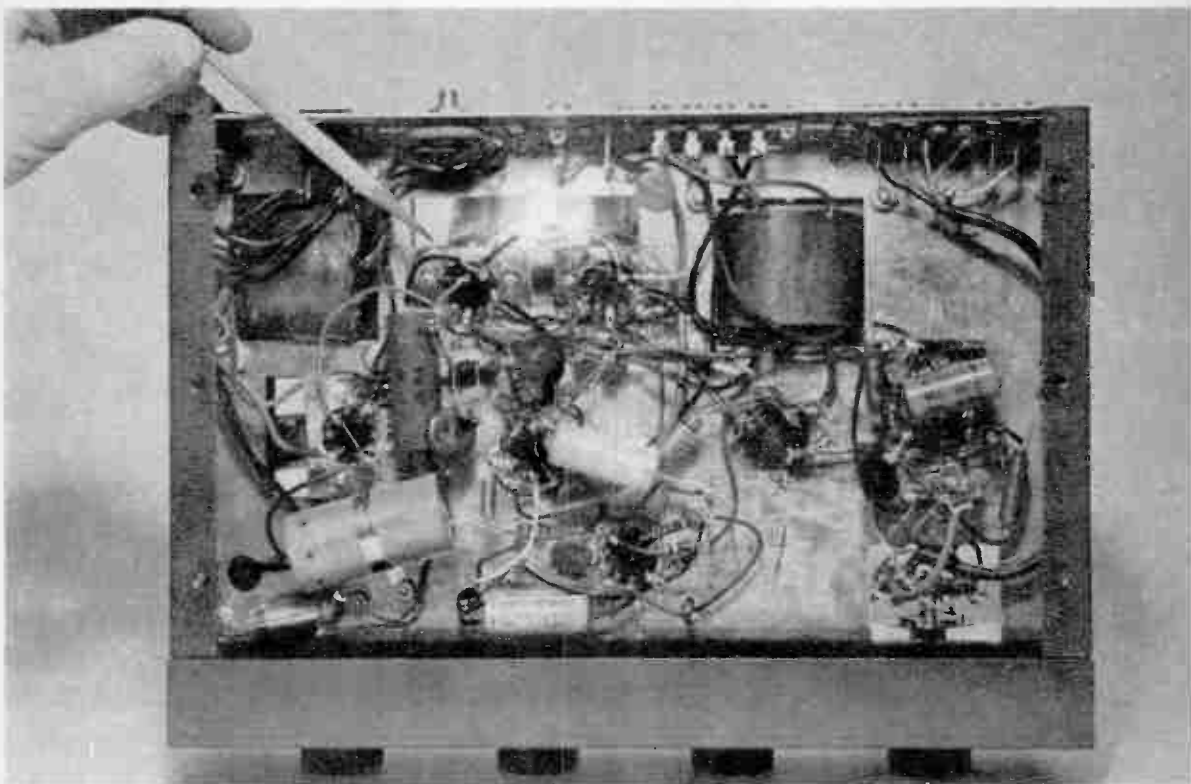

Bottom view of HF-12 amp. Wiring is much easier than it appears since there is plenty of space in which to use your soldering iron. Pencil at top left indicates angled sockets of type EL84 output tubes.

Elco HFS-1 loudspeaker kit in final assembly. Narrow vertical beside tweeter is vent for back waves from woofer. Of heavy plywood, box cannot vibrate and serves only as air chamber. (See next pages.)

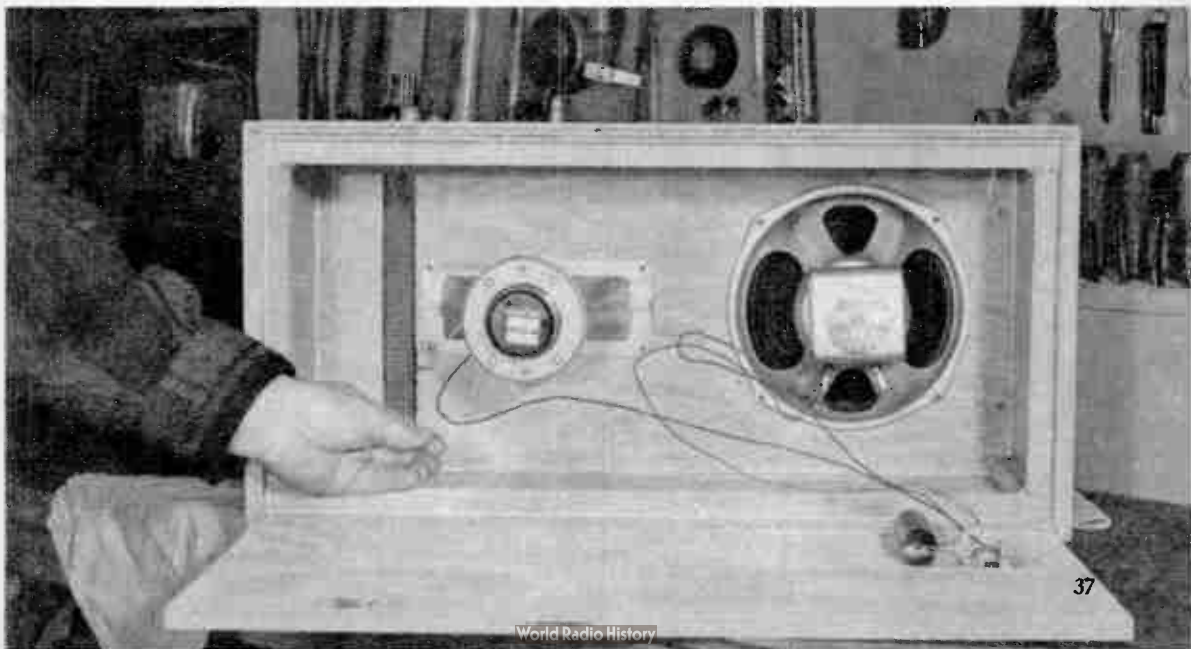

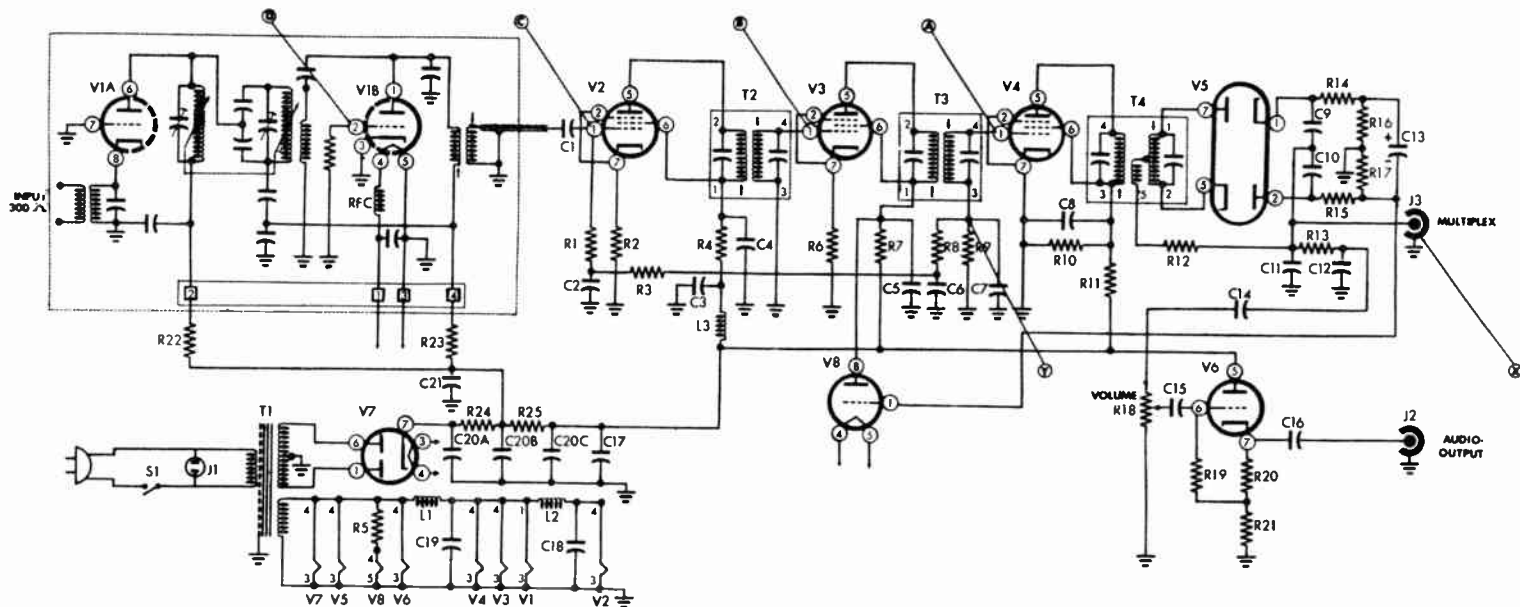

| Sym. | Description                  | Sym. | Description                    | Sym. | Description             | Sym. | Description             | Sym. | Description                 | Sym. | Description                 |
|------|------------------------------|------|--------------------------------|------|-------------------------|------|-------------------------|------|-----------------------------|------|-----------------------------|
| C1   | cap., disc., .10 mfd., ±10%  | C12  | cap., disc., .001 mfd., ±10%   | J1   | outlet, convenience     | R6   | res., 100 Ω, 1/2W, ±10% | R17  | res., 6.8KΩ, 1/2W, ±10%     | T2   | transformer, I. F., 1st     |
| C2   | cap., disc., .005 mfd., ±10% | C13  | cap., elec., 10 mfd - 25 V     | J2   | jack, single phone      | R7   | res., 1.2KΩ, 1W, ±10%   | R18  | pot., 250KΩ (volume) w/SPST | T3   | transformer, I. F., 2nd     |
| C3   | cap., disc., .005 mfd., ±10% | C14  | cap., disc., .01 mfd., ±10%    | J3   | jack, single phone      | R8   | res., 470KΩ, 1/2W, ±10% | R19  | res., 1MΩ, 1/2W, ±20%       | T4   | transformer, ratio detector |
| C4   | cap., disc., .01 mfd., ±10%  | C15  | cap., disc., .01 mfd., ±10%    | L1   | choke, 1.2 microhenry   | R9   | res., 100KΩ, 1/2W, ±5%  | R20  | res., 4.7KΩ, 1/2W, ±20%     | V1   | tube, 6CC8S                 |
| C5   | cap., disc., .01 mfd., ±10%  | C16  | cap., disc., .025 mfd          | L2   | choke, 1.2 microhenry   | R10  | res., 15KΩ, 1W, ±20%    | R21  | res., 47KΩ, 1/2W, ±10%      | V2   | tube, 6AU6                  |
| C6   | cap., disc., .005 mfd., ±10% | C17  | cap., disc., .01 mfd., ±10%    | L3   | choke, 2.2 microhenry   | R11  | res., 15KΩ, 1W, ±20%    | R22  | res., 10KΩ, 1W, ±10%        | V3   | tube, 6AL5                  |
| C7   | cap., disc., .47 mfd., ±10%  | C18  | cap., disc., .005 mfd., ±10%   | R1   | res., 470KΩ, 1/2W, ±10% | R12  | res., 68 Ω, 1/2W, ±10%  | R23  | res., 10KΩ, 1W, ±10%        | V4   | tube, 6AU6                  |
| C8   | cap., disc., .01 mfd., ±10%  | C19  | cap., disc., .005 mfd., ±10%   | R2   | res., 100 Ω, 1/2W, ±10% | R13  | res., 68KΩ, 1/2W, ±10%  | R24  | res., 500 Ω, 5W, ±10%       | V5   | tube, 6AL5                  |
| C9   | cap., disc., .330 mfd., ±10% | C20  | cap., elec., 40 × 20 mf - 350V | R3   | res., 470KΩ, 1/2W, ±10% | R4   | res., 1.2KΩ, 1W, ±10%   | R25  | res., 1.8KΩ, 5W, ±10%       | V6   | tube, 6X4                   |
| C10  | cap., disc., .330 mfd., ±10% | C21  | cap., disc., .01 mfd., ±10%    | R4   | res., 1.2KΩ, 1W, ±10%   | R5   | res., 220 Ω, 1W, ±5%    | S1   | switch, SPST, on R18        | V7   | tube, 6X4                   |
| C11  | cap., disc., .330 mfd., ±10% |      |                                |      |                         |      |                         | T1   | transformer, power          | V8   | tube, 6N70                  |

Schematic diagram of the Eico HFT-90 FM tuner is reproduced above. Section at upper left, enclosed by dotted lines, indicates preassembled "front-end" tuning elements. HF-12, rated at 12 watts, is diagramed below. Inputs, jacks at left, are selected by switch S1A-S1B. Parts symbols correspond to diagram.



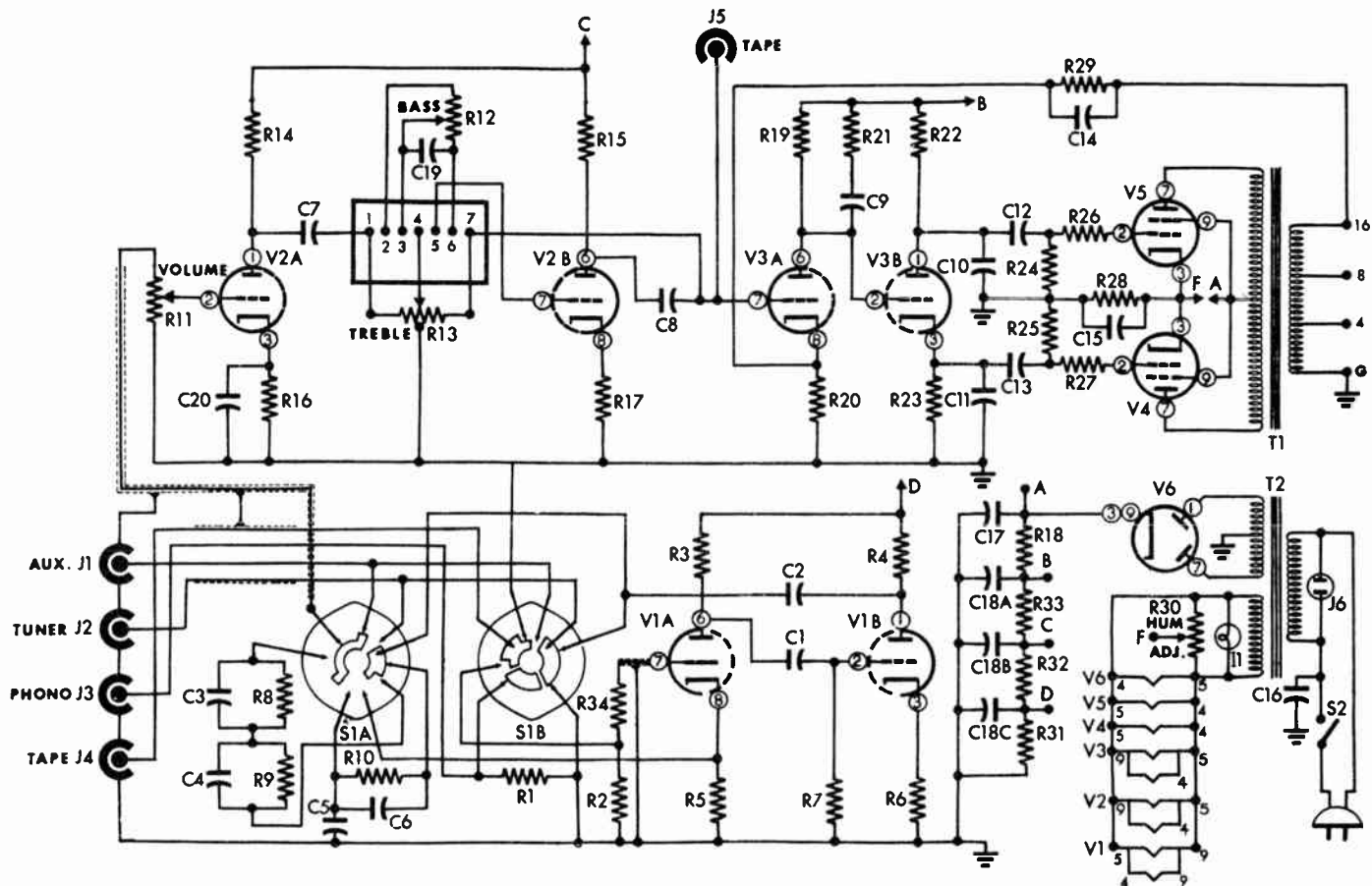

| Sym. | Description         | Sym. | Description                    | Sym. | Description              | Sym. | Description               | Sym. | Description                  |     |                             |
|------|---------------------|------|--------------------------------|------|--------------------------|------|---------------------------|------|------------------------------|-----|-----------------------------|
| C1   | cap., .01 mfd       | C13  | cap., .025 mfd                 | J5   | jack, tape output        | R9   | res., 90KΩ, 1/2W, ± 5%    | R20  | res., 1.8KΩ, 1/2W, ± 5%      | R31 | res., 68KΩ, 1/2W, ± 10%     |
| C2   | cap., .025 mfd      | C14  | cap., 47 mfd, 10%              | J6   | convenience outlet       | R10  | res., 4MΩ, 1/2W, ± 5%     | R21  | res., 10KΩ, 1/2W, ± 10%      | R32 | res., 68KΩ, 1/2W, ± 10%     |
| C3   | cap., 2700 mfd, 10% | C15  | cap., 50 mfd-25 V              | I1   | bulb, #47                | R11  | pot., 1MΩ, audio (volume) | R22  | res., 100KΩ, 1/2W, ± 5%      | R33 | res., 22KΩ, 1/2W, ± 10%     |
| C4   | cap., 850 mfd, 10%  | C16  | cap., 30 mfd-600 V             | R1   | res., 100KΩ, 1/2W, ± 10% | R12  | res., 200KΩ, 1/2W, ± 5%   | R23  | res., 100KΩ, 1/2W, ± 5%      | R34 | res., 10KΩ, 1/2W, ± 10%     |
| C5   | cap., .02 mfd, 10%  | C17  | cap., 30 mfd-400 V             | R2   | res., 100KΩ, 1/2W, ± 10% | R3   | res., 2.2KΩ, 1/2W, ± 10%  | R24  | pot., 500KΩ, linear (treble) | S1  | switch, selector            |
| C6   | cap., 850 mfd, 10%  | C18  | cap., 20-40-40 mfd-400-350-350 | R3   | res., 200KΩ, 1/2W, ± 5%  | R4   | res., 150KΩ, 1/2W, ± 10%  | R25  | res., 330KΩ, 1/2W, ± 10%     | S2  | switch, on-off, part of R13 |
| C7   | cap., .1 mfd-400 V  | C19  | cap., 2200 mfd, 10%            | R4   | res., 200KΩ, 1/2W, ± 10% | R5   | res., 100KΩ, 1/2W, ± 10%  | R26  | res., 10KΩ, 1/2W, ± 10%      | V1  | tube, 12AX7                 |
| C8   | cap., .1 mfd-400 V  | C20  | cap., 1500 mfd, 10%            | R5   | res., 2.2KΩ, 1/2W, ± 10% | R6   | res., 150KΩ, 1/2W, ± 10%  | R27  | res., 10KΩ, 1/2W, ± 10%      | V2  | tube, 12AX7                 |
| C9   | cap., 150 mfd, 10%  | J1   | jack, aux. input               | R6   | res., 2.2KΩ, 1/2W, ± 10% | R7   | res., 3.3KΩ, 1/2W, ± 10%  | R28  | res., 165 Ω, 5W, ± 5%        | V3  | tube, EL84                  |
| C10  | cap., 200 mfd, 10%  | J2   | jack, tuner input              | R7   | res., 1MΩ, 1/2W, ± 10%   | R8   | res., 10KΩ, 1W, ± 10%     | R29  | res., 22KΩ, 1/2W, ± 5%       | V4  | tube, EL84                  |
| C11  | cap., 200 mfd, 10%  | J3   | jack, phono input              | R8   | res., 2.2MΩ, 1/2W, ± 5%  | R19  | res., 470KΩ, 1/2W, ± 10%  | R30  | pot., 100 Ω, (hum adjust)    | V5  | tube, E281                  |
| C12  | cap., .025 mfd      | J4   | jack, tape input               |      |                          |      |                           |      |                              | V6  | tube, E281                  |

# How's Your Auditory Perception?

It's determined by many factors.



Hi-fi is no better than your ability to hear it. And hearing differs according to age, sex, and physical condition. Typical set-up for frequency testing of hi-fi set-ups and people includes Heath AG-10 audio generator working into Heath preamp and 25-watt power amp, all assembled from kits.



For checking overall frequency response, use an audio generator



“**F**LAT frequency response from 20 to 20,000 cycles.”

“Reproduces 15 to 25,000 cycles.”

“Faithful tone from 30 to 30,000 cycles.”

These are just a few of the claims made for the tone-handling ability of tuners, amplifiers and loudspeakers. Overlook for a moment the fact that the figures originate usually in the advertising rather than the engineering departments of the manufacturers, and consider the final link in the high-fidelity chain: YOU.

It's all very well to build fancy electronic equipment that can create the illusion of booming kettle drums and shrill violins. When the sounds come out of a loudspeaker, can you hear them? Is your auditory perception good, or do you have acoustical holes in your head? Many people do, and don't know it, and that explains why really high-grade hi-fi systems are wasted on them.

Age and sex, as well as physiological condition, contribute to an individual's hearing. Young people of both sexes normally have very deep perception, often into high-frequency regions usually considered supersonic; that is, beyond human audibility. This is sometimes demonstrated in an odd way when teen-agers listen to an ordinary television receiver. They complain of a very shrill, persistent tone that overrides the sound portion of programs. Parents sitting in the same room don't hear it at all, and tend to say, “Oh, it's just your imagination.”

It isn't. Television sets contain a circuit element called the “horizontal oscillator,” whose purpose is to sweep the flying spot of the picture tube across the glass face at a rapid rate. In all receivers made for the United States, this oscillator is accurately adjusted to a frequency of 15,750 cycles. It is not connected in any way with the sound

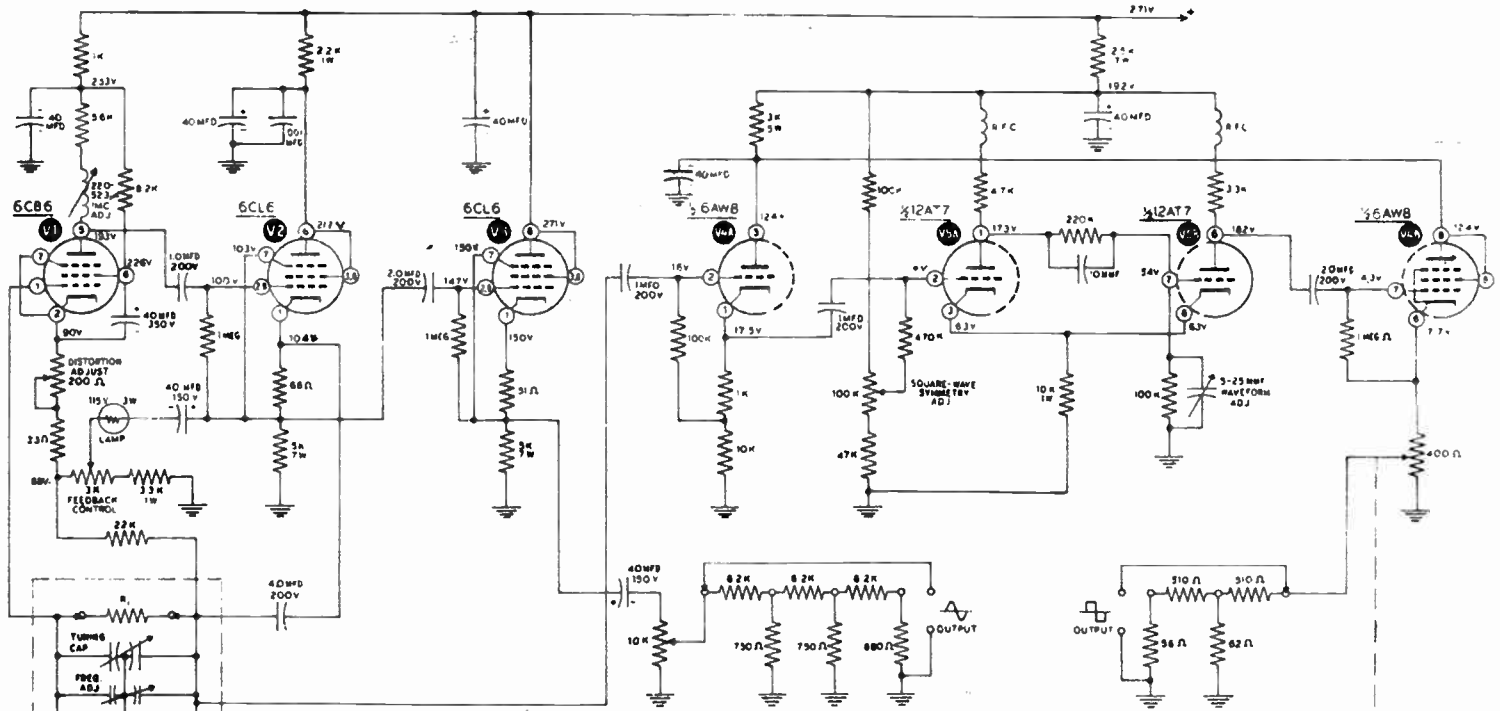

ALL RESISTORS 1/2 WATT UNLESS MARKED OTHERWISE

FREQ. MULT.

| POSITION | H <sub>1</sub> | H <sub>2</sub>  |
|----------|----------------|-----------------|
| 1        | 36 meg.        | 8 meg           |
| 10       | 36 meg         | 800K            |
| 100      | 360K           | 80K             |
| 1K       | 36K            | 8K and 10 p.p.f |
| 10 K     | 3.6K           | 710Ω            |

As you will note in this schematic diagram, AG-10 consists of many small capacitors and resistors.

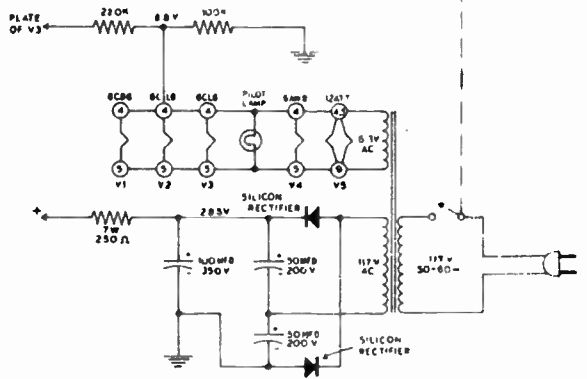



Heart of audio generator's frequency-determining network is this group of fixed resistors, mounted on 5-position switch. Front panel of switch is marked "Freq. Multiplier."

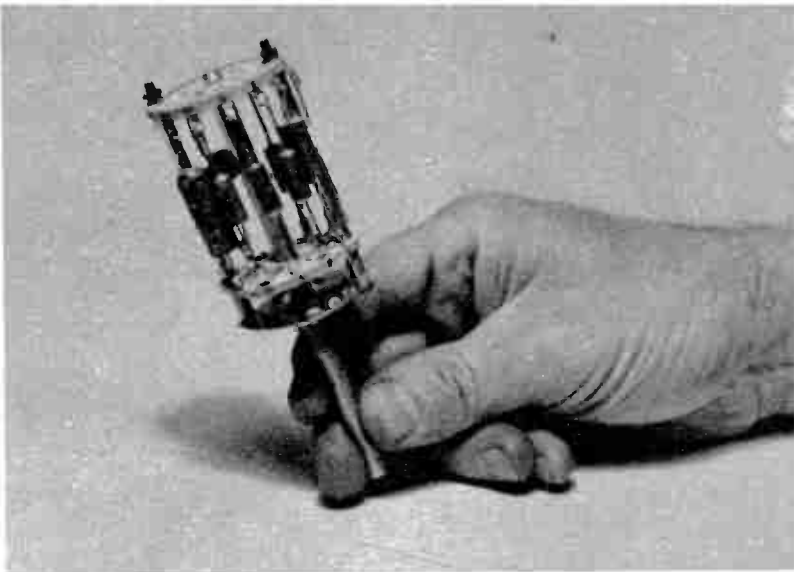

Construction of the AG-10 from a kit is interesting and instructive. All members of the chassis are preformed and punched so that assembly of the instrument is rather simple.

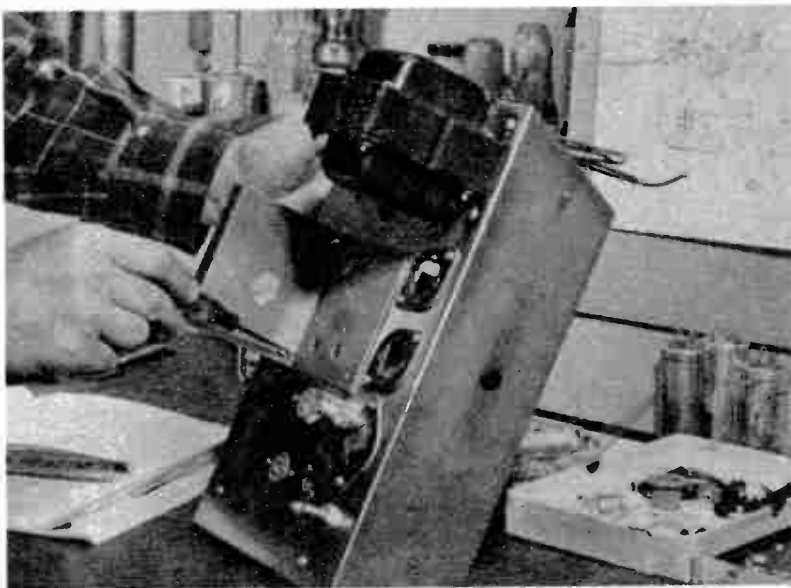

Underview of chassis is seen here, with most parts and a few wires in place. Finger indicates the shield compartment that contains frequency-multiplier switch assembly.

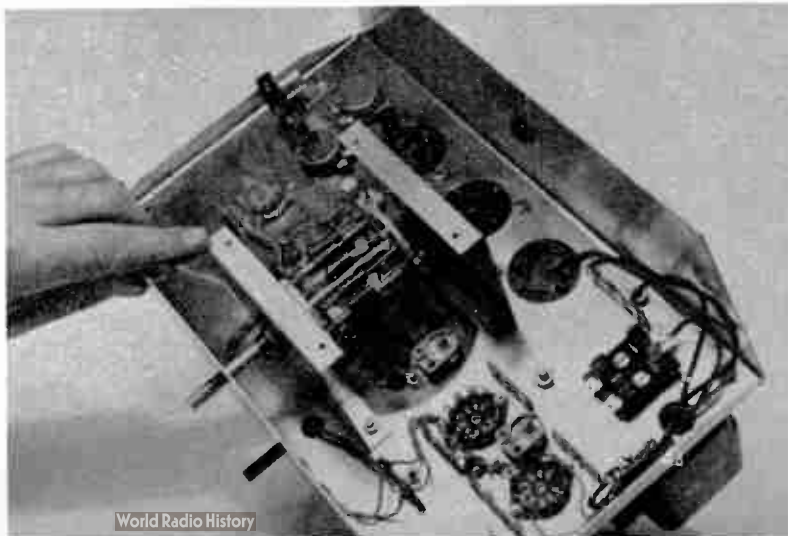

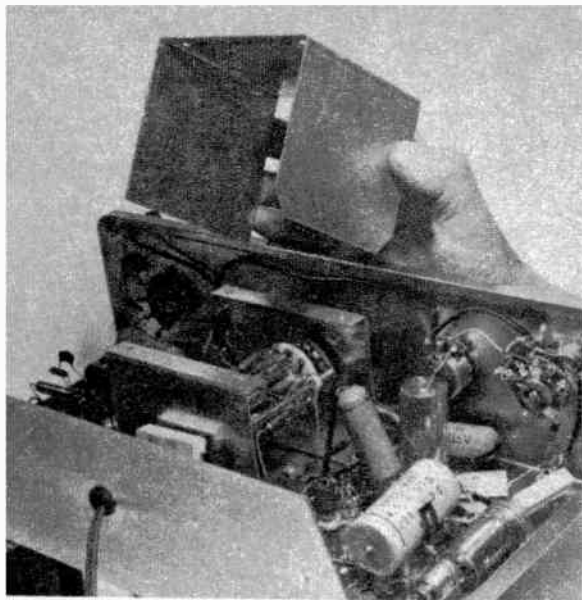

With all components mounted and wired, chassis of the audio generator is well filled. U-shaped metal cover is shield for the switch compartment.

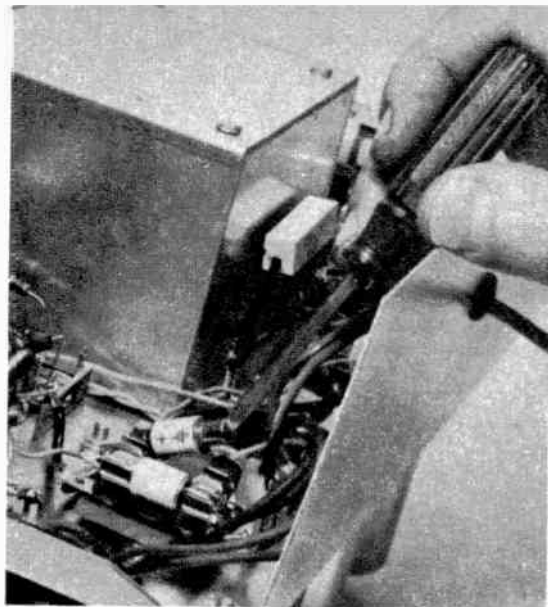

Left end of AG-10's under-chassis. Screwdriver points to one of the two silicon rectifiers that furnish high-voltage DC to generator circuits.

section of the set. Even if it were, it would not be reproduced by more than one set in ten thousand, the tone quality of most TV loudspeakers being notoriously bad. The sound audible to young ears emanates from a transformer carrying the 15,750-cycle energy; the molecules of the iron core or frame actually vibrate at this frequency and act as a sound transducer. In some cases the sound is strong enough to make an impression even on adults. It can be killed by the simple expedient of tightening the mounting screws of the transformer.

As people mature, their response to high-pitched tones falls off gradually. The effect is more marked in men than in women. This explains why in many households husbands and wives are continually battling over hi-fi tone controls.

"That music sounds awfully tinny," says Mrs., as she turns the treble knob counter-clockwise.

"Are you kidding?" rejoins Mr. "It sounds pretty flat to me."

Men like boomy music, because they hear it well. When a male customer appears in a hi-fi store, the sales people invariably steer him to the speakers with the strongest bass. His reaction usually is, "Great reproduction."

If a man and a woman come in together, they're good for an hour of arguing and indecision, for the simple reason that they don't hear alike.

At the early high-fidelity shows held in New York and other cities, several exhib-

itors set up listening rooms containing the best available amplifiers, speaker systems and variable audio-frequency generators, and invited visitors to test their hearings. The results were astonishing and sometimes disturbing to the participants. A representative family consisting of father, mother and teen-age children would check out in about this manner:

*Father:* Fine at the low starting frequencies of 35 or 40 cycles and through about 8000 cycles. Poor beginning about 9000, and virtually blank beyond 10,000.

*Mother:* Fair at the low tones, and good straight up to about 14,000.

*Children:* Good from the bottom all the way up to 16,000 or 17,000 cycles.

Some adults fared so poorly on these simple tests that they decided not to buy hi-fi equipment at all. Maybe that's why the hi-fi shows no longer offer the tests!

After all, business is business.

To paraphrase an old proverb, one man's music is another man's distortion. If a listener is happy with his tone controls twisted every which way, let him enjoy himself.

Some very interesting, edifying and entertaining experiments are possible with either a test record on a turntable or an audio generator. The latter is much more flexible and is recommended for the serious hi-fi enthusiast. Excellent generators in kit form for easy home assembly are available between about \$30 to \$50. The accompanying photos show a typical unit, the new Heath Model AG-10.

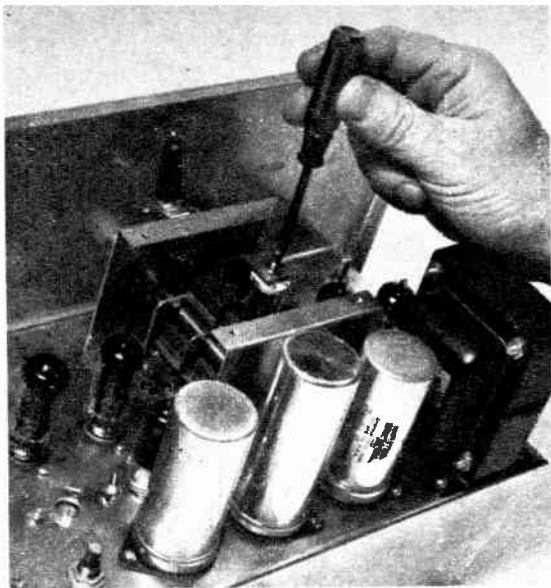

Completed generator chassis, with final shield cover being screwed down. The power transformer and filter capacitors are along the rear edge.



Front panel of the completed Heath AG-10. Upper central knob is tuning for different frequencies. Other knobs adjust strength of output signals.

The designation "generator" does not mean that the device is a rotating machine, like a car generator. It is strictly an electronic oscillator. The Heath unit starts at about 20 cycles and goes to 1,000,000 cycles. This actually is about half way into the regular AM broadcast band. For sound purposes, the more useful part of its range is up to 20,000 cycles.

Practically all hi-fi amplifiers have an input jack marked "Auxiliary," to which the audio generator can be connected conveniently. Treat the generator's signal like any other sound signal. The first couple of times you sweep from low to high tones you'll probably be surprised to observe that frequencies in the neighborhood of 5,000 or 6,000 cycles are much shriller than you anticipated. One thing is certain: you can trust the calibration of the generator more than you can your own judgment.

It is important to remember that an audio generator puts the *entire* electronic and human sound system to test, not just one part of it. It is relatively easy to make an amplifier of wide frequency range. The weakest link in the reproduction chain is the loudspeaker, because this has the job of converting electronic impulses into actual mass movements of air that the human ear can recognize as sound. However, a well-proportioned combination of large and small speakers, to handle the low and the high tones, respectively, can sound very satisfactory.

The audio generator is great for showing the effectiveness of tone controls, for ad-

justing the "crossover networks" of multi-speaker set-ups, and for positioning the speaker system in a room for best projection of high-tone signals, which are usually quite directional.

For checking hearing, the generator is best used when several people are present. The equipment and the operator should be behind the human guinea pigs, so they can't see him manipulate the controls. The procedure is to turn the signal on and off quietly by means of the output control, each time asking for the listeners' reactions. This way, imagination cannot enter into the latter. After a few sessions of this kind, you obtain a pretty fair idea of the frequency response of your particular system. Maybe you can't hear 13,500 cycles, but if someone else can, you know that the system reproduces to that figure.

Quite unexpectedly, the Heath generator I put together for serious technical investigation has also become a wonderful conversation piece and interest-maker at parties. It is good for half an evening of demonstration and testing, and if a musician of any kind happens to be in the gathering I can't tear him or her away from it. When visiting friends who have hi-fi installations of their own, I always carry the generator along (it weighs 12 pounds, about the same as a portable typewriter), and my hosts are grateful for the unusual entertainment it provides. Everybody has records, but who has an intriguing gadget like this? •





# Radio's Newest Workhorse — Microwave

Its uses are highly varied and ever increasing

**T**HE MICROWAVE portion of the radio-frequency spectrum is rapidly becoming one of radio's most useful communication mediums. In addition to furnishing links in the national telephone and telegraph systems, microwave is employed by broadcasters and others to relay television programs, by public agencies to protect life and property, and for a widening variety of industrial and other business purposes.

Normally, microwave signals are beamed from one point to another in line of sight. As the name ("micro," meaning "small") implies, microwaves are very short waves (12 inches or less in length) which are

found in the upper part of the radio spectrum. These radio waves have many of the characteristics of light waves which make them particularly useful for point-to-point communication.

Microwave signals can be directed to any selected spot within view of the transmitter and, by means of successive repeater stations, relayed over added distances. Microwave communication can be in the form of voice and telegraph correspondence, also teletype, facsimile and TV relay services. Further, microwave facilities permit "push-button" observation of industrial and other business operations, and remote control of devices throughout a sys-



Microwave antenna at left, 62 floors above NYC, picks up TV signals from remote transmitters. These are fed to the WNBC-TV transmitter on the Empire State Building. The "hot house" protects operator from wind and weather.

At right is an experimental "forward scatter" microwave antenna used by Western Union. It is essentially a parabolic reflector with reflecting surfaces of coarse screening instead of sheet metal for least susceptibility to the wind.



tem. By methods known as "multiplexing," many messages or functions can be handled simultaneously over a single microwave channel.

Because of their high position in the radio spectrum, microwaves are not affected in the same way by weather and man-made interference as are radio services operating on lower frequencies. In turn, their straight-line directivity permits the same channel to be used by parallel systems transmitting different kinds of information. Microwave systems are usually more economical to install and maintain than wire lines, where a substantial number of communication channels are required or a single broad communication channel, such as television, is involved. Also, since the transmitter energy may be concentrated and pointed, microwave requires comparatively little transmitter power.

Microwave communication requires successive relay stations in order to span great distances. A highly directional antenna focuses the waves in a beam—akin to a searchlight—on a distant repeater station within view of the initiating transmitter. The repeater station amplifies and retransmits these signals to the next repeater station, and so on until they reach the final terminal.

Since the range of a single microwave transmitter is generally limited to line of sight, spacing between microwave repeater

stations is usually of the order of 20 to 50 miles, depending upon the nature of the terrain and the height of the towers. Accordingly, most of these stations are located on high ground to permit furthest separation, thereby reducing the total number of relay stations necessary in a microwave system.

The major part of the nationwide TV program network operates over microwave systems provided by telephone companies. In other cases, where such facilities are not available from the telephone companies, individual TV stations have installed their own private microwave relay systems.

Also serving TV are the microwave links which carry programs from the local city studios of the broadcaster to the distant transmitter site of the TV broadcast station. Portable and mobile microwave transmitters make it possible to pick up news, sports and other events outside of the regular studios and deliver them to the transmitter for broadcast.

Microwave adjuncts for TV broadcasting, other than intercity circuits operated by common carriers, operate in bands at 2000, 7000 and 13,000 megacycles.

Common-carrier use of microwaves has become commonplace. Microwave links constitute about half of the Bell System's national coaxial-cable-microwave network. In addition to relaying TV programs, the Bell System can carry up to 600 two-

way telephone conversations at the same time on a pair of microwave channels.

The Federal Communications Commission has also authorized some nontelephone company microwave systems, usually in isolated places, to pick up and relay TV programs to particular TV broadcast stations or community TV antenna systems on a common carrier basis.

Since 1948, Western Union has had a microwave system connecting New York, Philadelphia, Washington and Pittsburgh, which it now plans to extend to Columbus, Cincinnati, Indianapolis and Chicago.

Common carrier microwave operation generally is provided in the region of 890-7200 megacycles.

It is in the noncommon carrier and non-broadcast services that the most varied utilization of microwave facilities is found. That is because practically all forms of communication which can be converted into electric impulses can be sent by microwave. Consequently, certain industries and business establishments harness microwave for many purposes. With it, they can direct

various activities at remote points. These field installations can, in turn, automatically report pertinent information back to the control office.

Thus, the central station in a microwave system can start, stop, slow, or speed unattended equipment; open and close valves; record pressure, temperature, engine speed, rate of processing and other data; telemeter voltage, current and power; locate line faults, and perform other functions.

Many public utilities—such as power systems and oil and gas pipelines—depend upon microwave to control installations along the way. Pipelines constitute about two thirds of the present route mileage of all private microwave systems, and power utilities about one fourth. One petroleum chain extends from Texas to New York, a distance of 1,700 miles. Some other systems are more than a thousand miles in length.

In addition to using other forms of electrical communication, railroads employ microwave for signaling and other traffic controls. Radar operation on land and water also involves some incidental micro-



At left is one of the many microwave towers that provide Western Union communications between New York, Philadelphia, Washington, and Pittsburgh. At second level (from top) is "dish-pan" antenna that beams waves, much as a searchlight does. Other antennas are in the enclosure.

Handsome, modernistic structure shown at the right is a microwave repeater station in Washington, employed on the communications route between New York and Pittsburgh. The "windows" about tower's top are electronic lenses that serve to concentrate the radio waves into sharp beams.

wave utilization. Some private microwave systems provide more than 100 channels for voice communication.

Present private microwave operation is mostly in the 2000-6000 megacycle range.

Federal, state, county and municipal governments find microwave systems a valuable adjunct in handling police, fire, highway maintenance, special emergency, conservation, civil defense and general administrative matters. The Bonneville Power Administration is one example of such Federal use. Microwave controls traffic and otherwise helps in the operation of state highways. The Pennsylvania, New Jersey and Ohio turnpikes are examples.

Possibilities of microwave for international communication, to the inclusion of TV program relay, are indicated by experiments with "over-the-horizon" or "tropospheric scatter" technique. This type of transmission does not follow the curvature of the earth, but goes in a straight line beyond the horizon into the atmosphere where some of it is "scattered" by the tropospheric layer back to earth far from

its origin. In 1956, the Commission made its first regular grant of such a service—for telephone—from Florida to Cuba.

The possibilities of microwave operation received some study after World War I. A test microwave telephone transmission was sent across the English Channel in 1930. Other experimentation followed, but it remained for developments born of World War II to intensify the interest in microwave potentialities. That conflict popularized general reference to the short waves around and above 1000 megacycles as "microwaves."

Two factors contributing to the practicability of microwave operation have been the postwar extension of the usable radio spectrum beyond 30 megacycles and development of equipment and techniques to operate there. The growing utilization of "upstairs" spectrum space is reflected in some exploratory radio operation in the vicinity of 30,000 megacycles, where the waves are less than one half an inch in length. However, equipment feasible for commercial use of those frequencies is not yet available.

As early as 1944, in connection with the general revision of frequency allocations, the Commission considered and subsequently provided spectrum space to further microwave experimentation and development. The first regular microwave system in this country—for telephone service between Boston and New York—was placed in operation in 1947.

In the present stage of development, all of the private microwave systems, except those of TV broadcasters, are licensed on an experimental or developmental basis. Now that apparatus and methods have improved, and practical operation has been demonstrated, the Commission is considering the possibility of placing many of the noncommon carrier microwave services on a regular basis.

However, various considerations are involved, such as present and future needs for microwave communication; the availability of channels to meet these needs and, if insufficient, who shall have prior rights in congested areas; and how to deal with interference which may be created by many microwave systems operating in, or converging upon, a single large metropolitan area. Also, the question as to whether, and under what conditions, private microwave systems shall be permitted to duplicate or parallel those of common carriers needs to be settled in an equitable manner, and in a way which will best serve the public interest. •

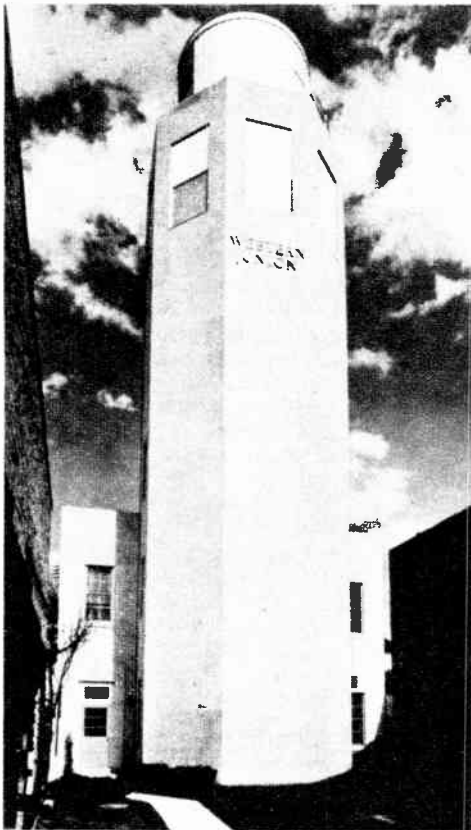



# Introduction to Troubleshooting

Start with a schematic of the unit involved, a vacuum tube voltmeter and this information

**YOU DO NOT** progress very far in any technical aspect of electronics before you're suddenly confronted with a piece of inoperative equipment. It might be a kitchen radio, a television set, a hi-fi amplifier, a hearing aid, a ham transmitter. Do you have the right tools for the repair job? Are you familiar with the general technique of troubleshooting?

The tools are easy. The major one is a vacuum tube voltmeter or a volt-ohmmeter, which perform the same functions of measuring AC and DC voltages and the resistance of circuits and components. There are a dozen other test instruments, but the VTVM or VOM is more useful than all of them combined. Because the VTVM is the more popular of the two types, it is used as the basic instrument in this article. However, all instructions apply to both.

The easiest way to learn how to fix ailing equipment is to run tests first on healthy units. This gives you excellent practice in handling of the meter and interpreting its readings. A good item on which to start is a small hi-fi amplifier or table radio receiver, both of which are generally available.

## The Schematic's a Must

You *must* have a schematic diagram of the unit, and you should also have a chart of normal voltage readings against which to check your own readings. Otherwise, you have no immediate way of knowing whether the latter are correct, too high or too low. Fortunately, this information is usually found in the instruction manual or booklet with the apparatus, or is obtainable from the manufacturer. Just poking around blindly with the meter probes will give readings, but they won't have any real significance.

The diagram on page 58 is of a typical small amplifier of conventional design. We'll assume that it is in normal operating order, and we'll take voltage readings all through it in accordance with the voltage comparison chart. We'll also put some not-so-imaginary troubles into the circuit and run them down.

Start at the very outlet into which the amplifier will be plugged. Set the meter for AC volts, 150-volt scale, and insert the AC probe tips carefully into the slots of the outlet. A standard so-called "110-volt" line is likely to register between 105 and 125 volts, depending on how old it is, where you live, the time of day, and the operation of heavy-current appliances in the house. The average reading is usually closer to 115 or 117 than to 110. Anyway, you know that the outlet is alive.

With the amplifier plugged in but turned off, and the meter still on AC volts, 150-volt scale, touch the probes to points 1 and 2. The meter reads exactly as before, showing that the line cord is OK. Turn on the amplifier by means of the line switch, and touch the probes to points 2 and 3; again the meter shows the line voltage. The tubes light up, showing that energy is reaching them by way of the power transformer.

The simple checkout just described often reveals a rarely-suspected source of trouble: a line switch that stays open electrically when it appears to snap closed mechanically. Sometimes the reverse effect is encountered. The switch contacts weld together, and the meter across points 2 and 3 reads the line voltage with the switch ostensibly "off."

Turn off the amplifier. Set the meter for AC volts, 15-volt scale. Clip the probes to socket terminals 2 and 8 of tube D, and 5Y3 rectifier. Remove your hands from the



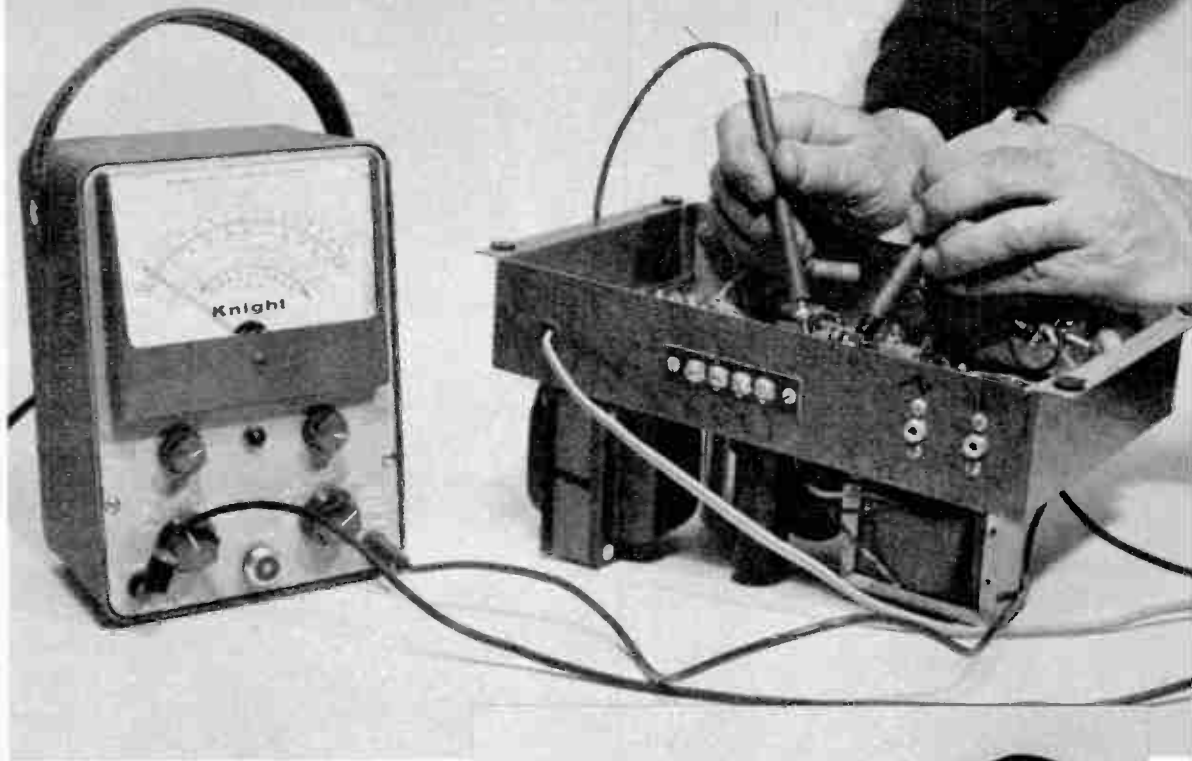

For checking AC voltages and making resistance measurements, it is usually convenient to use two long-handled probes with the VTVM (vacuum tube voltmeter) as demonstrated above.

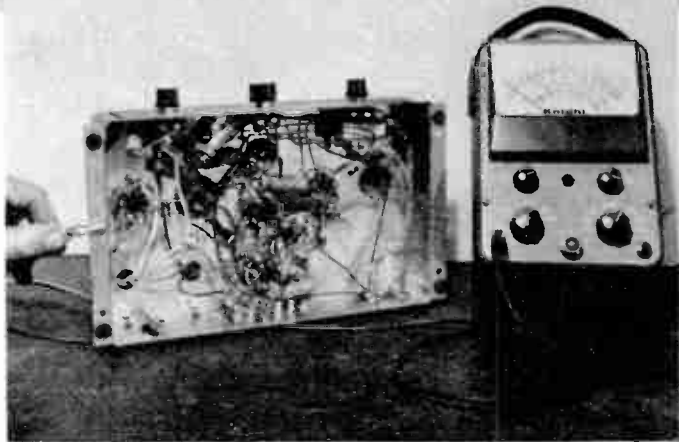

Metal chassis is usually common "ground" and "B" negative side of circuit. Measuring DC voltage, clip VTVM's "common" terminal to chassis, touch "hot" spots with the positive probe of your meter.



**Warning!** Never grasp the DC probe of the meter near its exposed end as shown here. It is a fine way to get a bad shock from high-voltage point of equipment you are troubleshooting.

probes and turn on the amplifier. The meter reads between 4 and 6 volts, 5 being the rated filament voltage. Why the caution above removing the hands? Because points 2 and 8 happen also to represent the highest DC voltage in the circuit, in relation to the metal chassis. We'll come to that in a minute.

Turn off the amplifier, remove the probes from pins 2 and 8, leave the meter on AC volts, switch to the 500-volt scale, and clip the common test lead anywhere to a bright, clean spot on the chassis. Turn on the amplifier. It can stay on now for all sub-

sequent voltage measurements you make.

Touch the other probe to terminal 4 of the 5Y3. According to the chart, this should give between 300 and 370 volts. Some leeway is always indicated because line voltages, transformer windings and meter accuracies vary considerably. Note carefully from the diagram that since the meter is connected between the red-yellow center tap (which is grounded to the chassis) and terminal 4 and the top end of the transformer secondary, it reads only HALF of that secondary's voltage. Shift the probe from terminal 4 to terminal 6 of the 5Y3

**This is the safe way of handling the meter's DC probe, grasping it well back on its insulation. Note that the "common" lead of the VTVM is clipped to the chassis, at extreme left of photograph.**

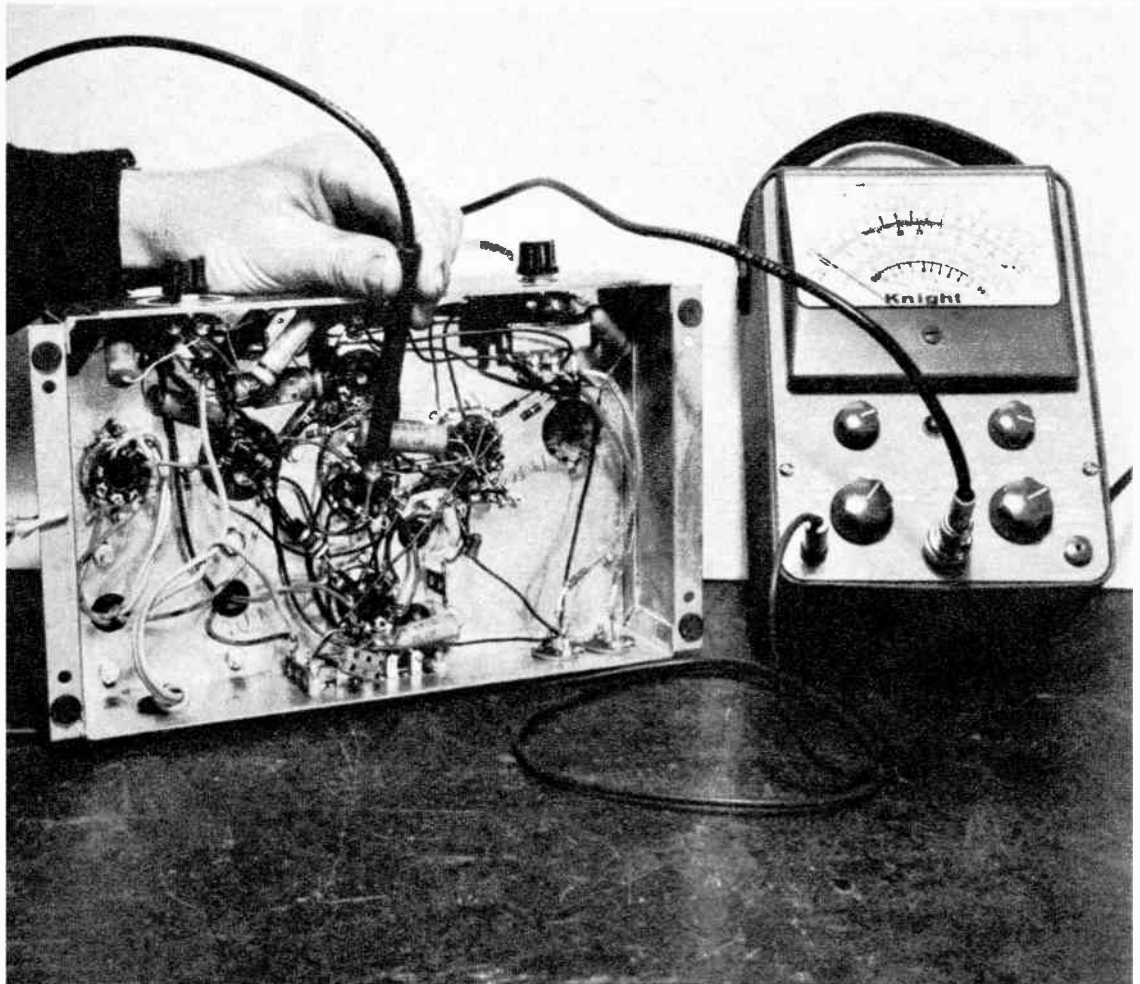

and the meter reads an almost identical voltage.

Suppose that terminal 4 reads 355 volts and terminal 6 shows nothing, a not unlikely situation. What's wrong? Obviously, the lower half of the high-voltage winding, between the center tap and terminal 6, is burned out, or there is an open connection between the end of the winding and 6. This can be double-checked by a resistance test, to be dealt with later.

The last AC measurement is on the heaters of the tubes. One heater terminal of each tube is grounded to the chassis, so

**Measuring transformers' resistances is instructive. The primary here measures about 3¼ ohms.**

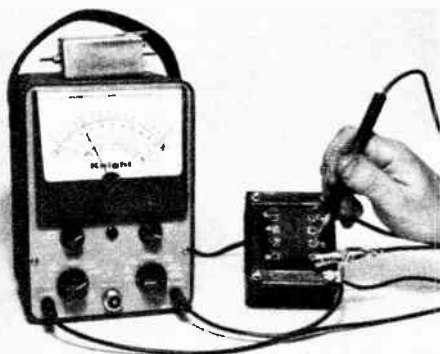

**Suspected "shorts" can be cleared or verified by tapping with equipment on. Rectifier tube is the suspected one here; meter checks output voltage.**

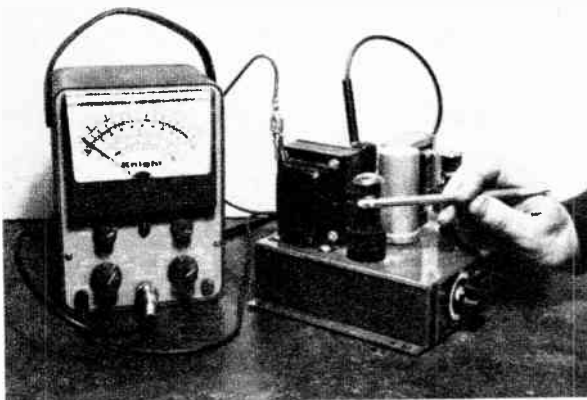

leave the meter's common lead clipped where it is, switch to the 15-volt scale, and touch the free probe to terminal 7 of tube C, 2 of B, 7 of A and 2 of E. Identical readings of 12 to 13 volts are obtained at all these points.

### DC Checks

Switch the meter to DC volts, 500-volt scale, attach the DC probe and remove the AC probe, leaving the common probe or test lead clipped to the chassis. The amplifier is still on.

The purpose of the 5Y3 is to change the AC from the transformer red-red secondary into DC. This rectification takes place between the plates (terminals 4 and 6) and the filament (terminals 2 and 8), so DC will appear for the first time between 2 or 8 and the grounded center tap, which is common to both the AC input and DC output circuits. Beginning with terminal 2 or 8 we have the DC section of the equipment; this side is "B" positive or plus in relation to the chassis ground, which is called "B" negative or minus. Touch the DC probe to terminal 2 of the 5Y3, or to point 4 near resistor R1, or to point 5 or the primary of the output transformer and the meter reads 350 to 400 volts. Continue to terminal 3 of tube B and also 3 of tube C and the same voltage, or perhaps a very slightly lower one, is shown on the meter. The reduction here is due to the resistance of the two equal halves of the primary winding of the amplifier's output transformer.

Suppose point 5 at the transformer and terminal 3 of tube B read 375 volts, but terminal 3 of tube C reads nothing. As in the case of the power transformer, this indicates a burned-out winding or an open connection between the winding and the tube.

Shift the probe to point 6, between the filter resistors R1 and R2, and then to terminals 4 of tubes B and C. Because there is unavoidably a voltage drop across the 10,000-ohm resistance of R1, the meter reads lower than it did at point 4; as the chart shows, normal here is 300 to 37 volts.

At point 7 the voltage drops even more because the 47,000-ohm resistance of R2 is in the way. It is about 175 to 200 volts. Point 7 feeds plate 5 of tube A, and the probe touched here shows only 40 to 70 volts because of the dropping effect of the 470,000-ohm (470K) resistor. Proceed to the left, and note that point 7 also feeds the screen 6 and the plate 8 of tube E, the



voltages at these points being 30 to 60 and 100 to 150 volts, respectively.

Point 6, the junction of resistors R1 and R2, also feeds DC to plate 2 of tube A, to the extent of 260 to 320 volts.

Pay special attention to the three-section filter capacitor connected around the filter resistors R1 and R2. The figures 40, 30 and 10 are the capacitances in microfarads. It is very common for only one section to go bad, by developing a partial internal short circuit. Voltage checks made at points 4, 6 and 7 show this up very neatly. Suppose point 4 reads 365 volts, which is fairly normal, but point 6 shows only 25 when it should show 350! This almost certainly means that the 30-mfd. filter section is bad. To be sure about it, unsolder the lead from the + post to point 6, and again check the voltage at the latter. If it springs back to several hundred volts, the 30-mfd. filter is definitely shot.

But suppose that point 6 still reads low with the center filter removed from the circuit. Check point 7 for normal or sub-

normal voltage, and disconnect the 10-mfd. section if necessary.

Low voltage at point 6 could conceivably be due to an internal short in tube B or C, from screen terminal 4 to cathode. Merely remove the tubes from their sockets one at a time and see what happens to the voltage readings.

Of course, it is also entirely possible that the 40-mfd. filter section can be the culprit. If it is short-circuited, the readings at 4, 6, and 7 will all be low or non-existent. An actual short of the 40-mfd. unit usually shows up, literally, by overloading the 5Y3 rectifier and causing it to glow dull red or bright blue, depending on whether the plates or the gases inside the bulb heat up. If the tube manages to survive, the overload is reflected back through the power transformer, and if this doesn't cook itself out the line fuse blows out.

Rectifier tubes run very hot under ordinary circumstances. Sometimes the filament sags a little and touches against a nearby plate, placing a nasty short circuit

**VTVM is most popular of all electronic-kit projects. Large range switch is on left, function switch on right, and meter-zeroing potentiometers across center of this partially assembled Knight meter.**

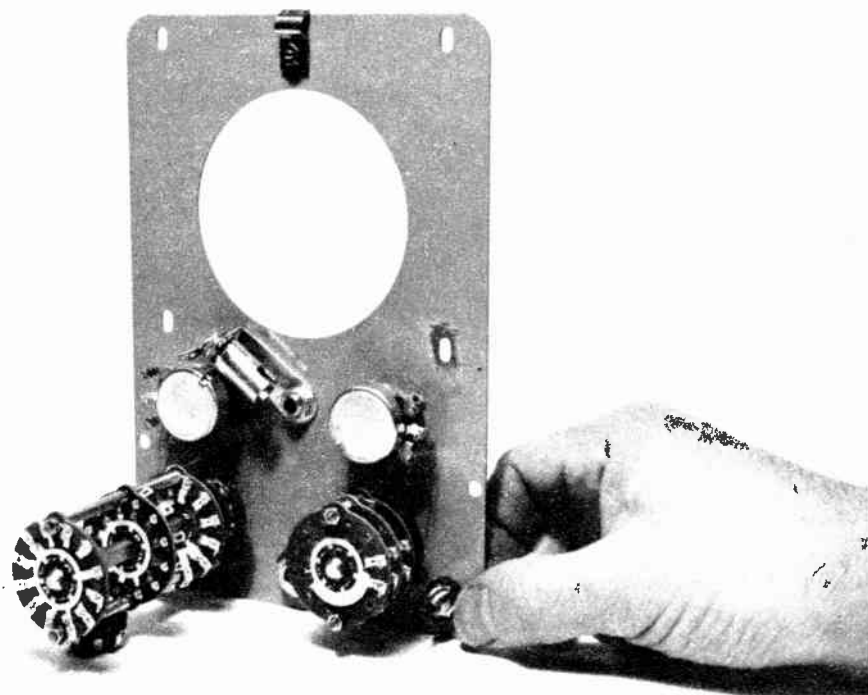



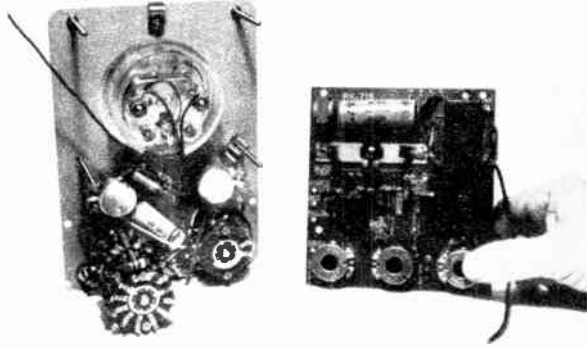
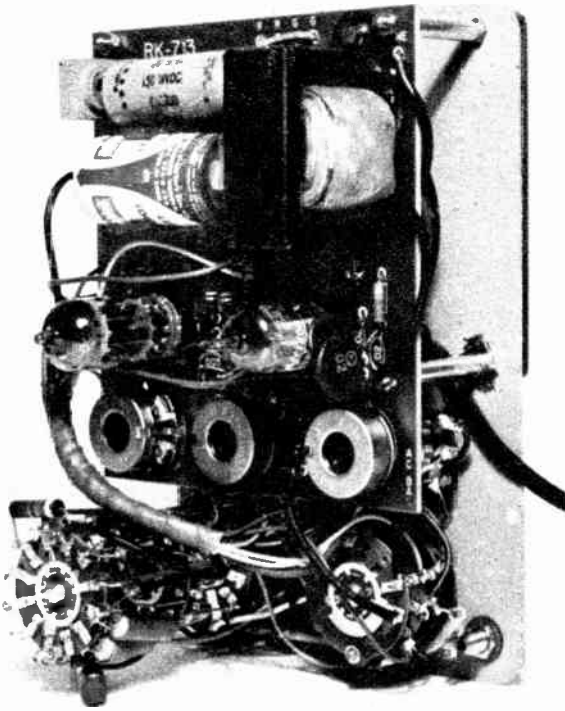

Tubes and other major circuit elements of the Knight VTVM mount on printed-circuit board, right of photo above. This in turn attaches by four long screws that surround meter. At the left is an interior view of the completed VTVM. Whole assembly job can be completed in two evenings.

across the high-voltage secondary of the power transformer. If the equipment does not have its own line fuse of the correct rating, but depends for protection on a much heavier fuse in the home's cutout box, the fine wire on the transformer secondary can readily burn up before the latter fuse even starts to simmer. If a transformer smells rather pungent, remove the rectifier tube and make an AC voltage check on the high-voltage winding to learn if it is still intact. Such burnouts are common in cheap television sets.

### Continuity Checking

When the meter is set for ohms, it is extremely valuable for making continuity checks. Actually, these are resistance measurements, but the resistance values themselves are often less important than the fact that the circuits or components under test are "open" or "closed."

A standard VTVM is readily able to measure resistance from as low as .2 (two tenths) ohm to as high as a thousand million ohms. The latter is to all practical pur-

poses an open circuit! If you have no idea at all as to what to expect of an unidentified part, start with the lowest scale and work up until the meter needle moves.

Remove the line plug of the guinea-pig amplifier, but turn the switch on. Set the meter to its lowest ohm scale and touch the common and ohms probes to the prongs of the line plug. A typical reading is 3 ohms. Open the line switch. The needle drops instantly to zero, as it should because there is no longer a complete circuit through the primary of the power transformer.

Open the switch, and clip the test probes directly to its terminals. The meter should not budge, because if the switch is OK it is completely open. Turn up the range selector and watch the needle closely. At the very top scale, which measures extremely high resistance, there may be a flicker because even the best insulating materials have some minute surface conduction. A low reading, of any value at all below a couple of million ohms, indicates leakage between the switch contacts, due

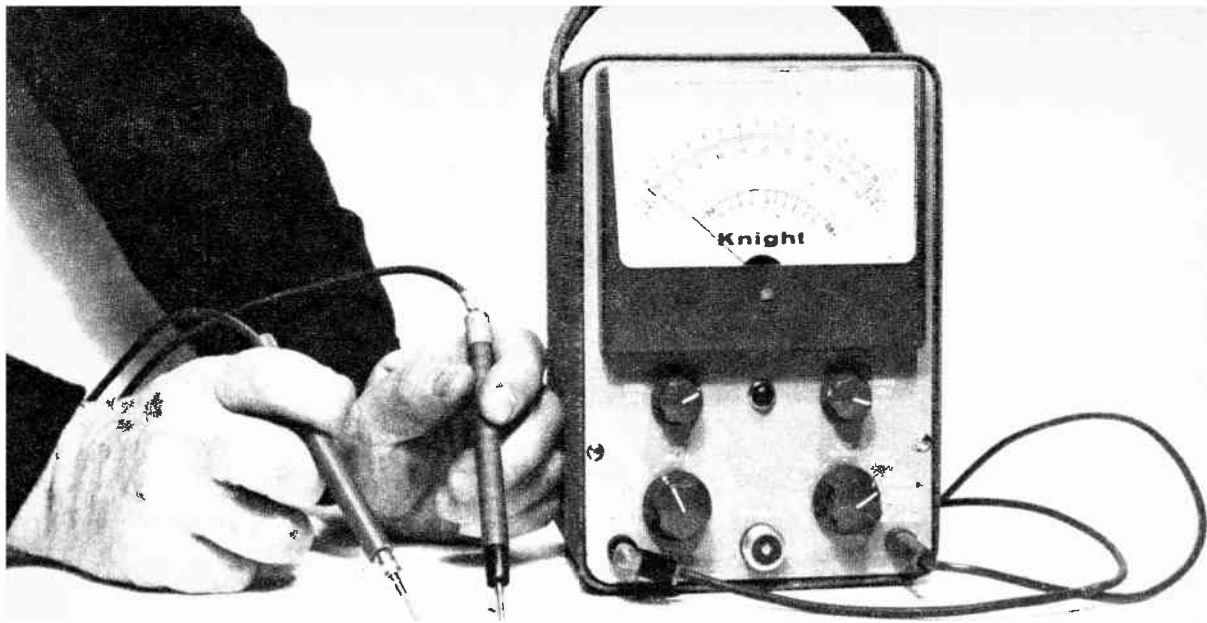

The Knight VTVM in its carrying case. The two probes at left are for AC voltage and resistance measurement. Note fitting at bottom center. It is for a third probe (adjacent photo) for DC voltage measurement.

possibly to metal particles rubbing off them to the insulation.

Close the switch. The meter still should not move, because now the switch represents a short circuit of virtually no resistance. At least it should. However, switches don't last forever. If their contacts become dirty, they might measure an appreciable fraction of an ohm or even several ohms in the closed position, and then they heat up badly. A simple ohmmeter test quickly tells you the condition that exists in any switch.

The high-voltage secondary of a power transformer consists of many turns of rather fine wire, and therefore it can be expected to have some resistance. Touch the ohm probes to terminals 4 and 6 of the 5Y3 rectifier, and the meter shows a little more than 200 ohms. The tube doesn't affect the reading because it is cold and therefore there is no electron path from the filament to the plates. From center tap to either 4 or 6 the value is half.

Entirely by coincidence, the primary of the output transformer also measures about 200 ohms, between terminals 3 and 3 of tubes B and C. The open secondary measures about .6 ohm. Don't be misled by the secondary output "impedances" of 4, 8 and 15 ohms. These values exist for alternating current, as it comes out of the transformer in the form of voice and music

modulation. All ohms measurements with a VTVM or VOM give DC or "ohmic" values.

These factors contribute to impedance values, but only slightly. For example, the 200-ohm output transformer primary has an actual impedance of several thousand ohms at voice frequencies. ("Ohmic" resistance is a fixed figure, depending only on the nature and the size of the metal forming the wire or other conductor. Impedance, however, depends largely on the frequency of the AC flowing through magnetic devices such as transformers and choke coils.)

To measure the resistances of the filament windings of the power transformer, it is necessary to remove all the tubes. These windings, made of a few turns of heavy wire, will be found to measure scarcely .1 or .12 ohm.

A small filter choke measures 150 to 230 ohms. The windings of I. F. transformers are in the neighborhood of 10 ohms. In running checks on these and similar transformers, it is usually necessary to disconnect one lead of each winding to isolate it from other components that might cause meter readings by themselves. This takes a bit of work with a soldering iron, but there's no alternative. The same requirement holds true for most connected resistors.

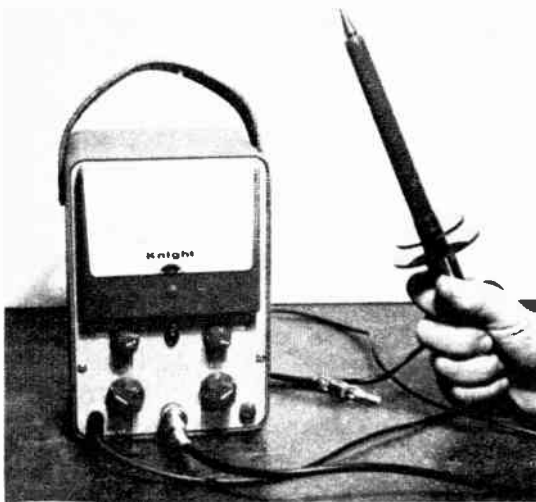

An especially-insulated accessory, this spear-like probe extends the DC range of the VTVM to 50,000 volts for checking of television picture tubes.

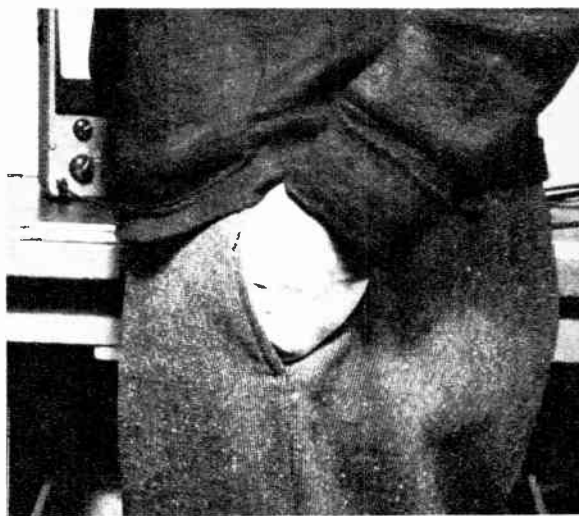

Avoid danger of high-voltage shock by clipping negative lead to chassis tested, using right hand for the probe and keeping the left hand pocketed.

### What of Capacitors?

By definition, a capacitor is a storage device for electron charges and consists of two or more metallic or other conducting surfaces or plates separated by a non-conducting material called a "dielectric." Variable capacitors use air as the separator. Fixed capacitors in small values use either mica or paper, and in large values an extremely thin chemical film formed on the plates by electrolytic methods. Theoretically, all capacitors should have infinite resistance, because the dielectric blocks the *direct* movement of electrons from one opposed plate to another. In practice this is far from the case. The only capacitors that show as open circuits on a VTVM are the air dielectric types.

You're in for a surprise the first time you put a meter on an electrolytic filter capacitor, like the three-section unit in the amplifier diagram. Set the meter for the highest range, which is usually the basic scale of 0-1000 ohms multiplied by one million. Disconnect the + lead of the middle unit and connect the common test probe to the can, which is almost always negative, and the ohms probe to the free lead. You won't believe your eyes, but the needle will bang over violently to zero, which would indicate a short circuit. But leave the probes connected and wait. In a second or

two the meter starts to move slowly, and after perhaps three or four full minutes it comes to rest at 9 or 10 megohms. This is hardly an open circuit when you consider that small fixed resistors ranging between 1 and 10 megohms are in widespread use in all kinds of electronic gear.

The meter action is no cause for alarm. Electrolytic capacitors are "formed" under the application of DC voltages during manufacture, and they stay formed only with continued use at their rated values. An idle electrolytic tends to de-form or un-form. The meter circuit includes a battery that applies perhaps 1½ or 3 volts to any component undergoing resistance measurement. Applied to the electrolytic, it starts the forming action over again. This takes a little time because the voltage is much lower than the rated figure of several hundred volts.

The larger the capacitor value, usually the lower the effective resistance. This is to be expected, since the plate area is larger and there is more contact surface for leakage of electrons between the plates. All electrolytic capacitors are of relatively large value: from about 5 or 10 microfarads to several hundred.

Because of their changing chemical nature, it is rather difficult to make any significant tests for the condition of electro-

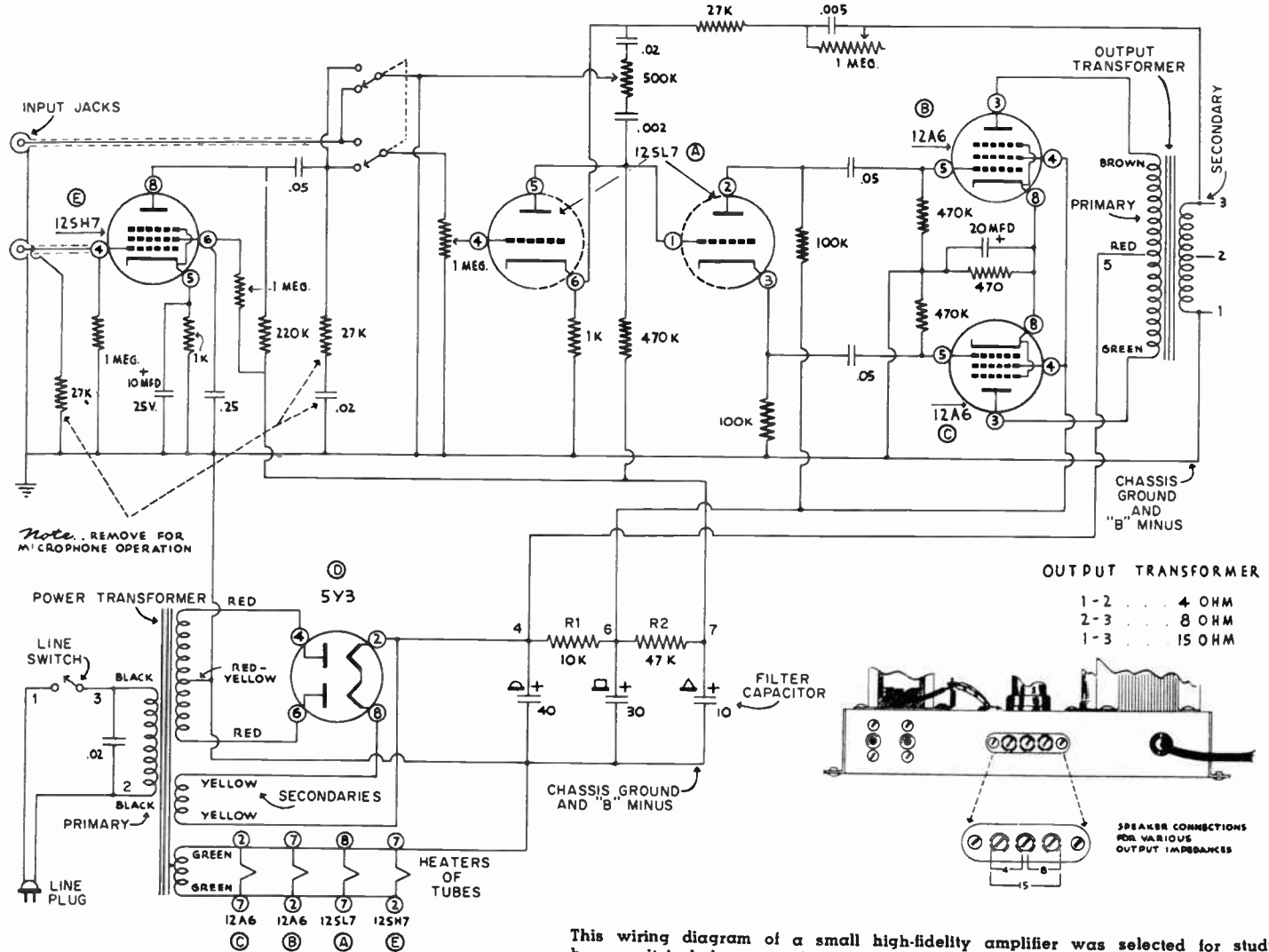

This wiring diagram of a small high-fidelity amplifier was selected for study because it includes many features and components basic to electronic equipment.



VOLTAGE COMPARISON CHART

| SOCKET | A                                   | B                  | C                  | D                    | E                                   |
|--------|-------------------------------------|--------------------|--------------------|----------------------|-------------------------------------|
| PIN    | 12SL7                               | 12A6               | 12A6               | 5Y3                  | 12SH7<br>(A7A only)                 |
| 1      | 40 to 70<br>V DC                    | 0                  | 0                  |                      | 0                                   |
| 2      | 260 to 320<br>V DC                  | 12 to 13<br>V AC   | 0                  | 350 to 400<br>* V DC | 0                                   |
| 3      | 50 to 80<br>V DC                    | 350 to 400<br>V DC | 350 to 400<br>V DC |                      |                                     |
| 4      | 0                                   | 300 to 370<br>V DC | 300 to 370<br>V DC | 300 to 370<br>V AC   | 0                                   |
| 5      | 40 to 70<br>V DC                    | 0                  | 0                  |                      | $\frac{1}{2}$ -1 $\frac{1}{2}$ V DC |
| 6      | $\frac{1}{2}$ -1 $\frac{1}{2}$ V DC |                    |                    | 300 to 370<br>V AC   | 30 to 60<br>V DC                    |
| 7      | 0                                   | 0                  | 12 to 13<br>V AC   |                      | 12 to 13<br>V AC                    |
| 8      | 12 to 13<br>V AC                    | 20 to 30<br>V DC   | 20 to 30<br>V DC   | 350 to 400<br>* V DC | 100 to 150<br>V DC                  |

\* Voltage between pin #2 and pin #8 on 5Y3, 4-6V AC

lytics. The simplest and cheapest way to test a suspected unit is to replace it temporarily with a new one or with one taken from equipment that is known to be in good order.

#### Paper and Mica Dielectrics

Smaller capacitors use paper or mica. These dielectrics are very stable and have very high resistance. Isolate the .05-mfd. capacitor connected to plate 8 of tube E. In this value it is sure to be of the paper type. With the meter still set for high ohms, touch the probes to its terminals. The initial reading is now well up near 2 megohms, and after three minutes it is closer to 200 megohms. These readings do not represent leakage as much as they do a charging action by the battery in the meter. Disconnect the meter, turn out the lights in the room and touch a screwdriver blade across the terminals of the capacitor.

You'll see a tiny spark at the point of contact. If the capacitor were merely leaky it wouldn't hold a charge, but would let electrons roll through it without being trapped.

Mica capacitors are even better. Take the .005-mfd. baby at the top right of the amplifier diagram. It shows 20 megohms at the start, and the meter needle climbs rapidly to 1000 megohms and infinity, meaning an open circuit.

There's never any question about a paper or mica capacitor. If it is good, the resistance reading is extremely high; if it's not good, the reading is zero ohms or close to it. A paper or mica capacitor rarely goes merely "open," which would show up as a misleading high resistance value. When it is abused by the application of too high voltages, it usually ruptures inside and develops a dead short between the active plates. •

# Know Your Components

It is vital to your technical education

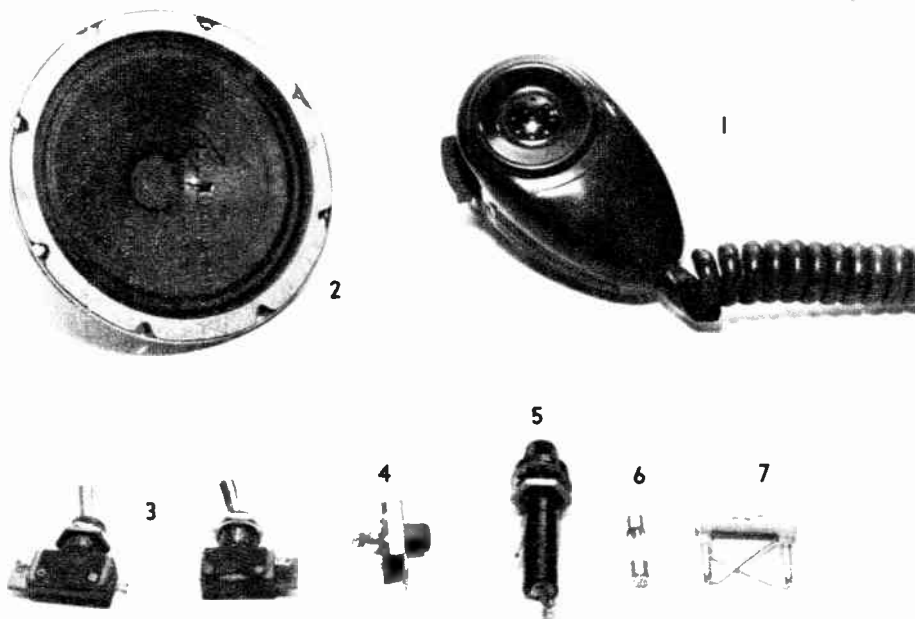

**O**NE of the things that makes electronics an interesting vocation or avocation is the number and variety of the components used in the construction of equipment of various kinds. Recognizing and becoming familiar with them is often an important part of one's technical education. The accompanying pictures and text may further the latter.

IT goes in here and comes out there! "In" means the microphone 1, and "out" the loudspeaker 2. This particular mike is hand-held and is designed for use in vehicles.

Loudspeakers consist generally of a stiff paper cone, edge mounted on a firm metal ring. The apex of the cone bears a light winding of fine wire, called the "voice coil," set closely inside a powerful permanent magnet. The cone's diameter is the size of the speaker. It runs from 2 to about 15 inches. A small unit mounted inside the

throat of a large one constitutes a "coaxial."

Switches are important control devices. No. 3 designates bat-wing toggles; No. 4 is of the slide type. There are many combinations of contact connections. A basic on-off switch is called "single pole single throw," more usually mentioned as S.P.S.T. When it has two poles which go on and off together, it is double pole single throw, or D.P.S.T. If a D.P.S.T. has two pairs of contacts for the poles, it becomes D.P.D.T. Switches of the rotary type can have many positions and contacts.

Small cartridge-type fuses, very much like those found in automobiles, are used to protect electronic equipment. The holder, 5, is usually an insulated sleeve, and the fuse, 6, is pushed into it at one end. No. 7 is found in some TV sets; it is a fuse that looks and normally acts like a small fixed resistor, but blows out on an overload.

VARIABLE capacitors usually consist of flat metal plates which interleave without touching. One set of plates is fixed, the other is rotary. The greater their area and the closer their spacing, the higher their "capacitance." This is expressed in "microfarads" or "micromicrofarads," abbreviated as "mf." and "mmf.," or "mfd." and "mmfd." Technically, the symbol for "micro" (meaning one millionth part) is the Greek letter *mu*, but because of type-setting difficulties *m* is widely used.

In the common capacitors found in radio and television equipment, values run from a few mmf, to several hundred. These stated figures are always understood to be the maximum capacitance, the minimum being a small fraction thereof.

Aluminum, brass and plated iron are used for the plates. In probably 95% of all variables made in the United States, the shaft diameter is 1/4 inch.

Multiple-section capacitors are used by the million in radio and TV receivers. In these, two, three or four rotor elements are mounted on a common shaft, the stators or fixed plates being attached to a heavy frame. The capacitance values of the various sections of such capacitors may or

may not be identical, depending on circuit requirements. In two-section variables found in small table-top radio sets, there is an appreciable difference in size between the sections.

In capacitors intended for receiving purposes, the plate spacing can be very close because the voltages in the tuning circuits are so low that they cannot even be measured. The units are therefore generally small and compact. For transmitting purposes, even in relatively low-power ham equipment, the spacing is made much greater to discourage spark-over at the high voltages existing in the circuits.

In the photo below, 1, 2 and 3 are typical two-section broadcast-band tuning capacitors. Nos. 4, 9 and 10 are wide-spaced transmitting variables in different capacitance sizes. Nos. 5, 6 and 11 are midgets of very close spacing. Nos. 7 and 8 are two-section midgets intended for use in small transistor radios. Nos. 12 and 13 are single-unit "trimmer" capacitors of low capacitance, with a thin piece of mica between the plates. No. 14 is a double-section trimmer, No. 15 a four-section unit. No. 5, and Nos. 11 through 15, are adjusted by means of a screwdriver or other flat blade tool.

## VARIABLE CAPACITORS

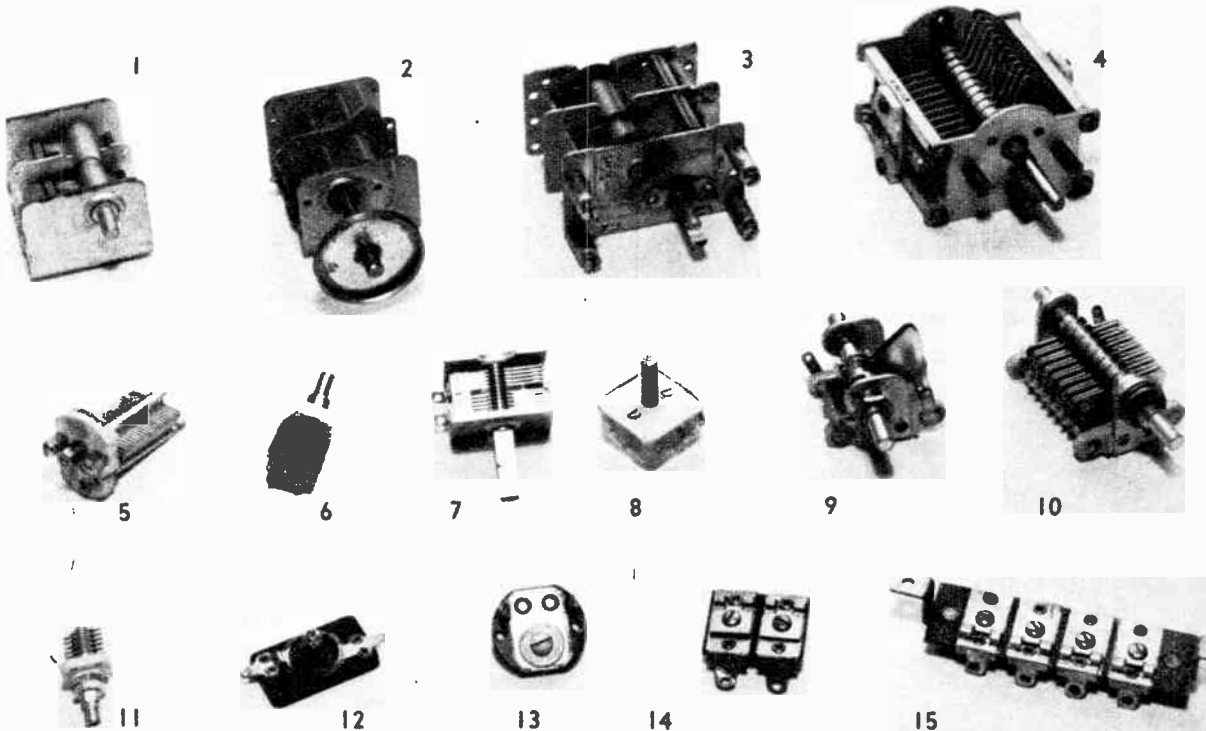

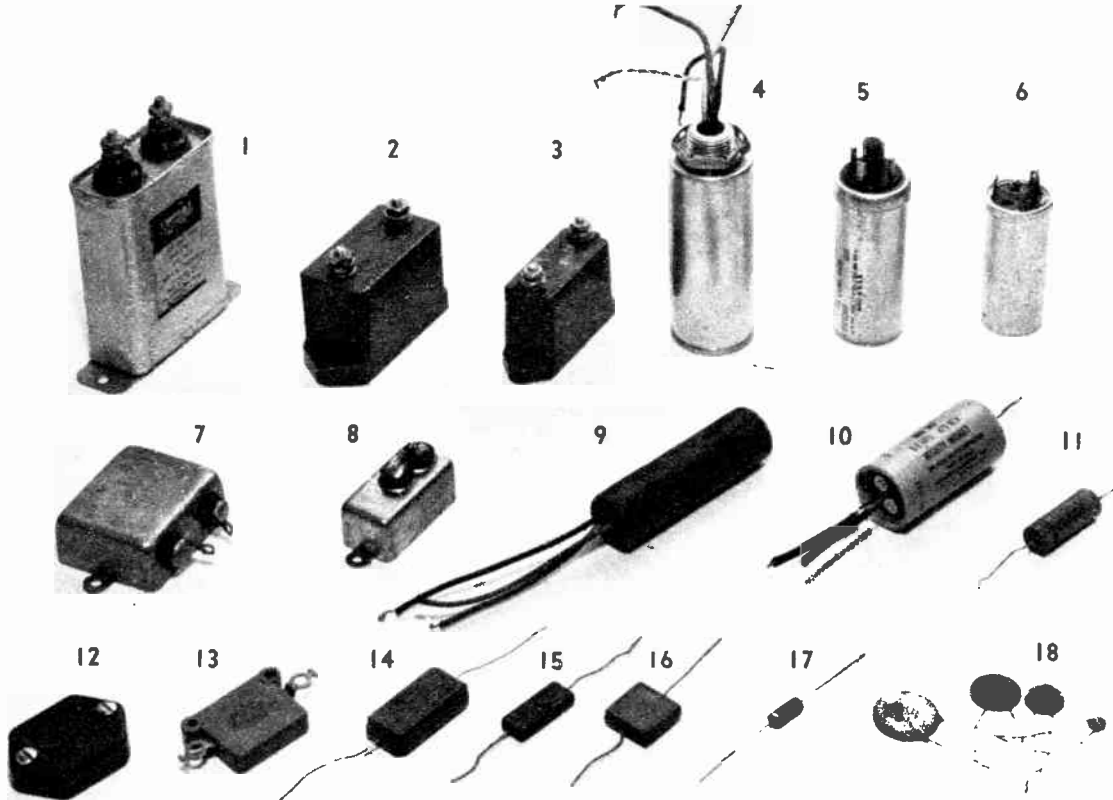

FIXED CAPACITORS

IN fixed capacitors, the plates are usually very thin metal foil. The insulating material that separates them, called the "dielectric," is paper, mica or a chemical formed electrolytically on the foil itself. Because this chemical film is extremely fine, electrolytic capacitors have very high capacitance for their physical size.

In a paper capacitor, the paper and the foil are simply rolled up tightly. The unit is put into a cardboard or metal case and the latter then filled with wax to exclude moisture. The capacitance depends on the thickness of the paper and the area of metal foil. The ability of the capacitor to withstand voltage depends on the thickness and the quality of the paper. Oil-impregnated paper is used in some capacitors.

In mica capacitors, small sheets of metal foil and slightly larger pieces of mica are alternated to form a multilayer sandwich. The capacitance again depends on the dielectric thickness and the foil area. Sealed in plastic, mica capacitors are noted for their long life, stability and ruggedness.

Paper and mica capacitors have no polarity; that is, they can be connected into circuits carrying either AC or DC, or both, without regard to the position of their terminals. However, electrolytics can be

used only on DC, pulsating DC rectified AC or any other form of unilateral current flow, and they must be connected strictly in accordance with their polarity markings. The formation and maintenance of the essential chemical film on the plates depends on the polarization. Connecting an electrolytic backward, and thus reversing the relative polarities of the plates, quickly ruins it.

Papers and micas are made generally as individual units, rarely as multiples. On the other hand, two- and three-section electrolytics are the rule rather than the exception. These are found usually in the rectifier-filter portion of AC-DC power supplies of electronic equipment.

Small electrolytics are paper-cased; larger ones are in aluminum cans. The can itself is almost always the common negative side of the multiple sections.

In the collection of fixed capacitors above, 1 is oil-impregnated high-voltage paper, 2 and 3 high-voltage micas. Nos. 4, 5 and 6 are can-type electrolytics; 9 and 10 paper-cased electrolytics. Nos. 7 and 8 are "bath-tub" (metal cased) papers; 11, paper-cased paper. Nos. 12 through 16 are medium-voltage micas. No. 17 is tubular ceramic capacitor; 18, disc ceramics.





1



2



3



4

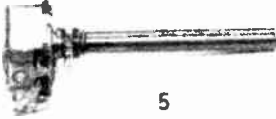

5



6



7



8



9



10

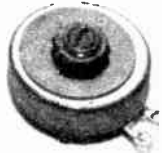

11

## VARIABLE RESISTORS

DEVICES that introduce deliberate resistance into circuits are called resistors. Variable resistors exist in many forms, for the purpose of controlling energy of both AC and DC nature at both low and high values.

In electronic entertainment equipment, variable resistors are represented by the knobs marked variously *volume*, *tone*, *bass*, *treble*, *loudness*, etc. These controls provide what is essentially voltage adjustment, and do not carry appreciable currents. They consist generally of strips of carbon-covered fiber or other insulating material, over which rides a rotating contact arm. The latter has a range of movement from the equivalent of about seven o'clock to five o'clock. Universally, these controls are wired so that they exert minimum effect at the starting or seven spot and increasing effect as the knob is turned clockwise. In some cases this means that the unit starts with no resistance in the circuit and finishes with maximum resistance; in other cases the values are reversed.

Most small controls of the volume type act as "potentiometer," which is another way of saying "voltage dividers." The word is an awkward one, so the controls

are almost always referred to simply as "pots." In this function, both ends of the resistance element, as well as the moving arm, are connected in the circuit.

In radio and TV sets, it has been standard line switch to the back of the volume control, so that the equipment comes on as the knob is turned. In a recent modification of this arrangement, the switch is actuated by a push-pull movement of the knob.

Two controls are often piggy-backed and reverse connected in the circuit, so that one furnishes increasing resistance while the other furnishes decreasing resistance in the same proportion.

In some communications receivers the two units function independently as volume controls in different parts of the circuit, only one at a time being cut in by a suitable switch.

In the photo, 1 and 2 are back and front views of a heavy wire-wound variable resistor, known as a "rheostat." No. 3 is of open construction, to dissipate heat. No. 4 is double-wound rheostat. Nos. 5, 6 and 7 are three forms of small "pots"; 8 and 9 are volume controls with switches attached. No. 10 is double pot. No. 11 is rheostat that has a screwdriver blade adjustment.

**FIXED** resistors are used in greater number in electronic equipment than any other component. By themselves, they deliver fixed voltages to various parts of a circuit. In conjunction with small fixed capacitors, they form filter networks that keep complicated signals flowing in the right directions. Most of the small resistors found in radio, TV, hi-fi and similar apparatus are of the carbon type, with wire leads at the ends of the bodies. They vary in size from about ½ inch to 2 inches long and ⅛ inch to ½ inch in diameter. Their range of values is enormous: from as low as 1 ohm to as high as 10,000,000 ohms. It is relatively simple to obtain these values by varying the composition and thickness of the carbon layer deposited on the resistor form.

In addition to their actual values in ohms, resistors are rated according to the power they can handle safely without burning up. The smallest are rated at ¼ and ⅓ watt; the next common sizes are ½, 1, 2 and 5 watts. It is entirely normal for resistors to become warm, hot or very hot.

Fixed resistors in the 10-watt and larger sizes are usually made of resistance wire. This is wound on ceramic tubes or forms to withstand the considerable heat that

the units often develop. Resistors of the 100-watt class can be a foot long and an inch in diameter.

Wire-wound resistors may be *adjustable* or *tapped*. In the adjustable type, a contact ring passes over a bared section of the wire, and is clamped into position by a locking screw. The exact desired value of resistance is obtained either by measurement with an ohmmeter, or, more usually, by checking the voltage at the contact ring with a voltmeter. Since this is a "hot" point, it is obviously essential that you exercise great caution in approaching it.

The tapped resistor has one or several fixed leads brought out from the winding, usually in the form of lugs. It is especially useful for delivering several values of voltage to different parts of a circuit from a single power supply.

Some resistors are made with metal end caps, but without pigtailed or other wires, and are designed to fit in clip holders, like plug fuses. They are especially convenient for experimental work.

No. 1 is a tapped resistor. No. 2 adjustable type. No. 3 is clip-in variety. Nos. 4, 5 and 6 are variations of wire-wounds. Nos. 7 through 11 are carbon types. No. 12 is small center-tapped wire-wound.

### FIXED RESISTORS

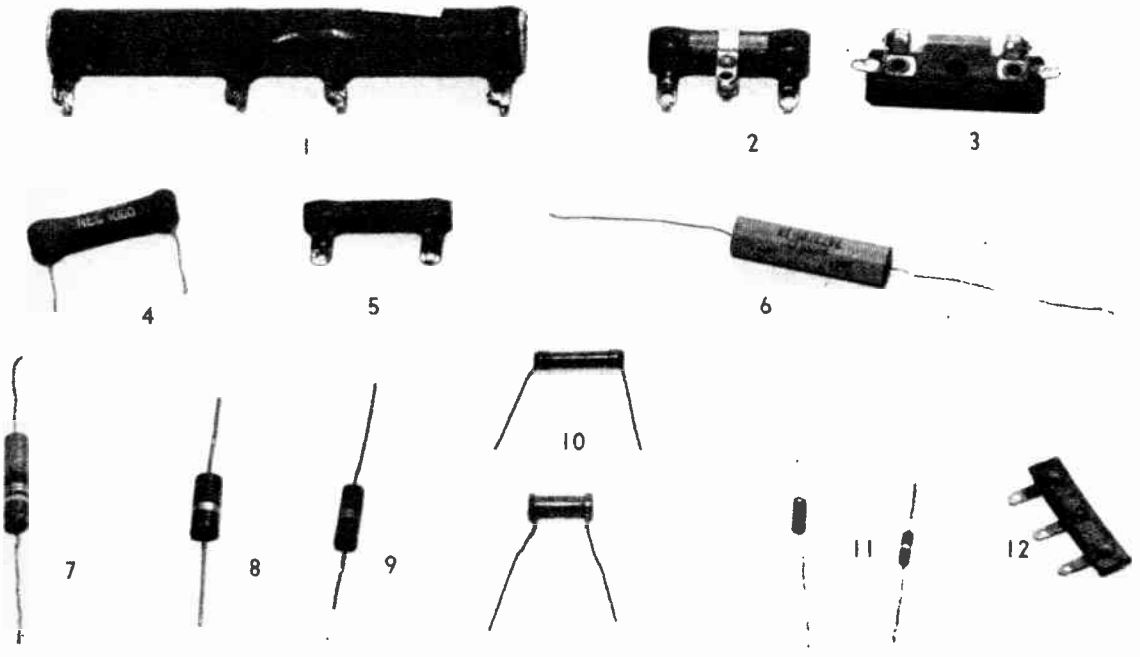

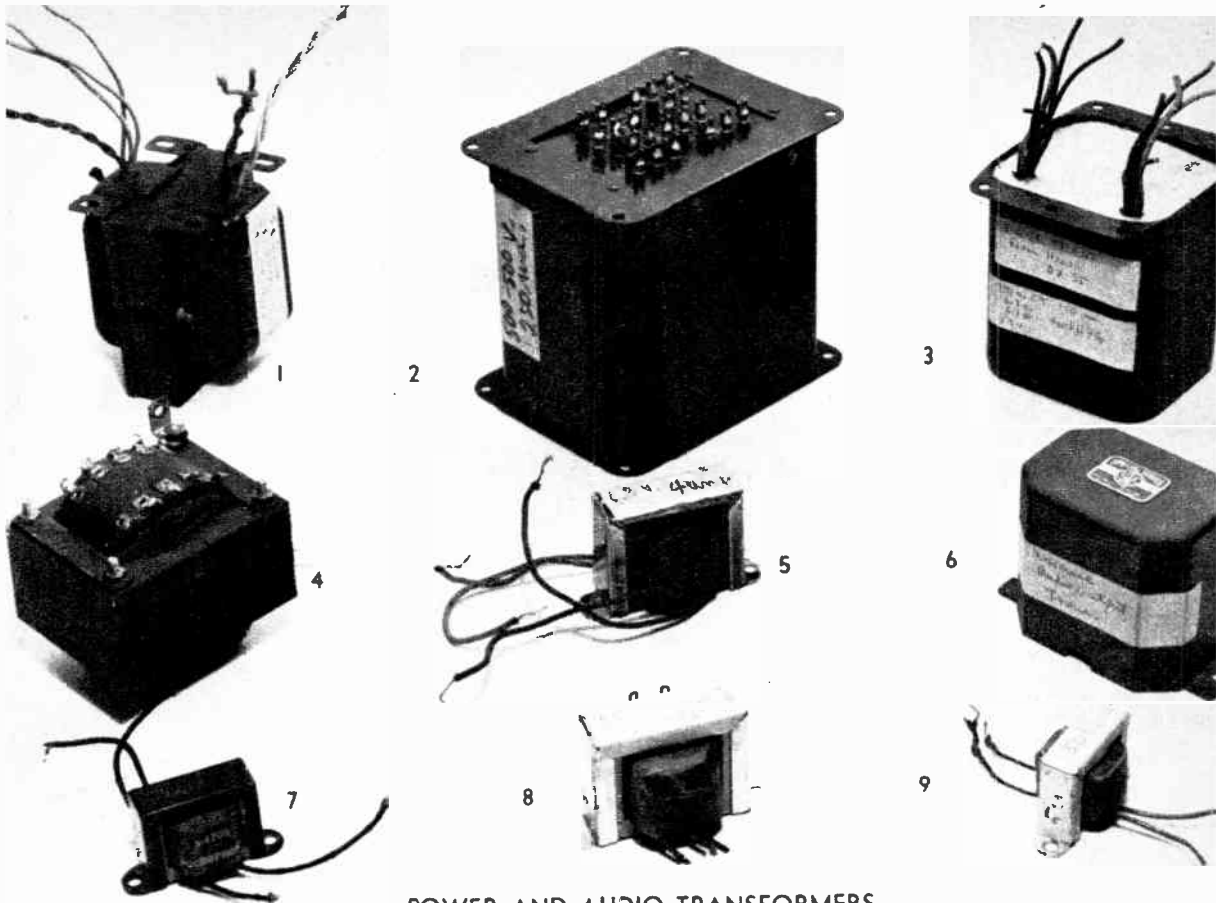

## POWER AND AUDIO TRANSFORMERS

POWER and audio transformers are the largest and heaviest individual electronic components. They consist basically of laminated soft iron frames or cores, of square or H shape, over which are wound two or more coils of wire. A power transformer usually has a single primary winding, connected to the house power line, and one or several secondary windings. Simultaneously, the latter can deliver low voltage at high current rates and high voltage at relatively low current rates, depending on the needs of the receiver, transmitter, amplifier, etc. Voltages can be stepped down or up, virtually without limit, directly in accordance with the turns ratio of the primary-to-secondary windings.

The more energy a transformer must deliver, the heavier must be its core and its windings. There is almost always some heat rise in a power transformer, not only because of the current flowing in its windings but also because of molecular friction in the iron core produced by the rapid reversals of the magnetic fields in it.

Audio transformers, intended for amplifying weak signal currents, likewise have primary and secondary windings, but generally they are smaller than power types.

The only really big ones are the output transformers used in high-fidelity and public-address amplifiers of the 30- to 70-watt class. Most output transformers have a center-tapped primary and a secondary with three or four taps.

Transformers for extremely low signal levels, such as those encountered in certain types of microphones, can be made the size of thimbles.

Most small transformers of all types have closed H-shaped cores, with the windings one over the other on the center arm of the H. Flexible leads, color coded for identification, are brought out from the ends of the windings. Lug terminals are found on some medium-size transformers and on many large ones.

Some units are "potted" in wax in drawn cases, for protection against moisture.

The picture above shows various forms of transformer cases and mountings. No. 1 is a fully enclosed small power transformer with three secondaries. No. 2 is a very large upright unit with lug terminals. Nos. 3 and 6 are potted transformers. No. 4 is an open-frame unit with lugs. Nos. 5, 7, 8 and 9 are small power, microphone and loudspeaker output transformers.

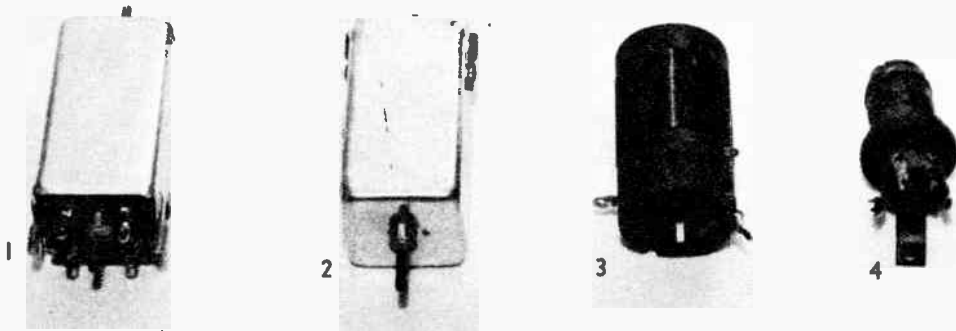

R.F. TRANSFORMERS

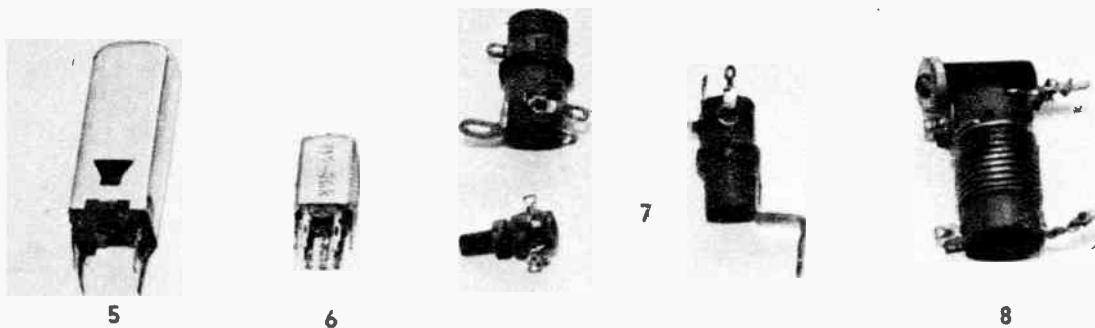

THERE is no physical similarity between power and R.F. (radio-frequency) transformers, but their basic operation is absolutely identical. They have two or more windings in close proximity, so that the varying magnetic field of one cuts through the others and induces voltages in them. However, the windings are much smaller, often consisting of only a few turns, and they are placed on insulated forms instead of on iron cores. In the case of large coils used in transmitters, the wire is heavy and self-supporting.

R.F. transformers are used with small variable capacitors, or some other tuning means, to make them respond best to certain frequencies. The "other means" are usually light powdered-iron slugs that move in and out of the windings and thereby change their effective inductance.

A single coil with a tap somewhere along its length also is a transformer, or more properly an "auto-transformer." The section from one end of the winding to the tap can act as primary and the entire winding as secondary, or vice versa. Such three-connection coils are very common.

While any two-winding or tapped single-winding coil is technically a "trans-

former," the small units employed for tuning purposes in electronic equipment are generally referred to as "coils" or "tuning coils." The word "transformer" in its R.F. sense is more usually used in connection with the small aluminum-can units found in the intermediate-frequency (I.F.) amplifier stages of superheterodyne receivers. These are universally called "I.F. transformers" or "I.F. cans."

The iron-slug method of tuning I.F.'s has almost completely replaced the older trimmer-capacitor method. The slugs are adjusted either by thin screws sticking out of the cans or by recessed hex or slot openings directly in the ends of the slugs themselves. A word of caution: Don't force these slugs when tuning up a set. They are a bit on the fragile side.

In the photo on this page, 1 and 2 are top and bottom views of identical I.F. transformers. Slotted screws adjust powdered-iron slugs inside coils. Nos. 3 and 4 are typical antenna tuning coils used in broadcast receivers. Nos. 5 and 6 are small I.F. cans used in midget sets. Group 7 shows three-connection oscillator coils. No. 8 is short-wave tuning coil with attached trimmer capacitor.



MANY choke coils look like transformers, but serve an entirely different purpose. A choke is technically a single-winding inductor. Large chokes, wound with heavy wire on iron cores, are used to smooth out the remaining variations in rectified alternating current; invariably they are accompanied by large fixed capacitors that assist them in this action. They are then called "filter" or "smoothing" chokes; in more highbrow circles, "filter reactors."

Filter chokes are rated according to their inductance value, expressed by the unit "henrys," and their safe current capacity in amperes or milliamperes. Common sizes run from 3 or 4 henrys at several hundred milliamperes to several hundred henrys at 3 or 4 amperes. A representative choke for a medium-size receiver is 20 henrys, 100 milliamps; for a transmitter, 10 henrys, 200 milliamps. High inductance and current capacity do not generally go together, as the combination requires lots of heavy wire and a heavy core. Where extra filtering is necessary, two chokes can be used in series.

R.F. (radio-frequency) chokes are much smaller than the filter type, are wound on ceramic or other insulating forms, and use small quantities of thin wire. They are used

in circuits that must pass DC or low-frequency AC but must not admit higher frequency AC signals. The impeding effect (impedance) is complicated by other factors, but broadly depends on the inductance. The frequency range of ordinary radio and television equipment is extremely wide, and R.F. chokes therefore vary in size from half a dozen turns the diameter of pencil lead to a few hundred turns the diameter of a quarter. Actual values run from a few microhenrys to a hundred or more millihenrys.

In sizes from about 1 millihenry up, the winding is usually distributed among several sections or "pies," connected in series but spaced apart physically.

Top row in the photo consists of representative iron-core audio or power chokes. No. 1 is a potted heavy-duty filter choke, suitable for upright or chassis-hole mounting. No. 2 is of leg-mounting type, with flexible leads. Nos. 3 and 4 are open frame chokes used in power-supply section of small radio receivers. Group 5 shows R.F. chokes consisting of several "pies" on ceramic forms. No. 6 is a dual R.F. choke intended for use in a power line to keep noise out of a receiver. Group 7 shows three sizes of small single-layer chokes.

### CHOKES

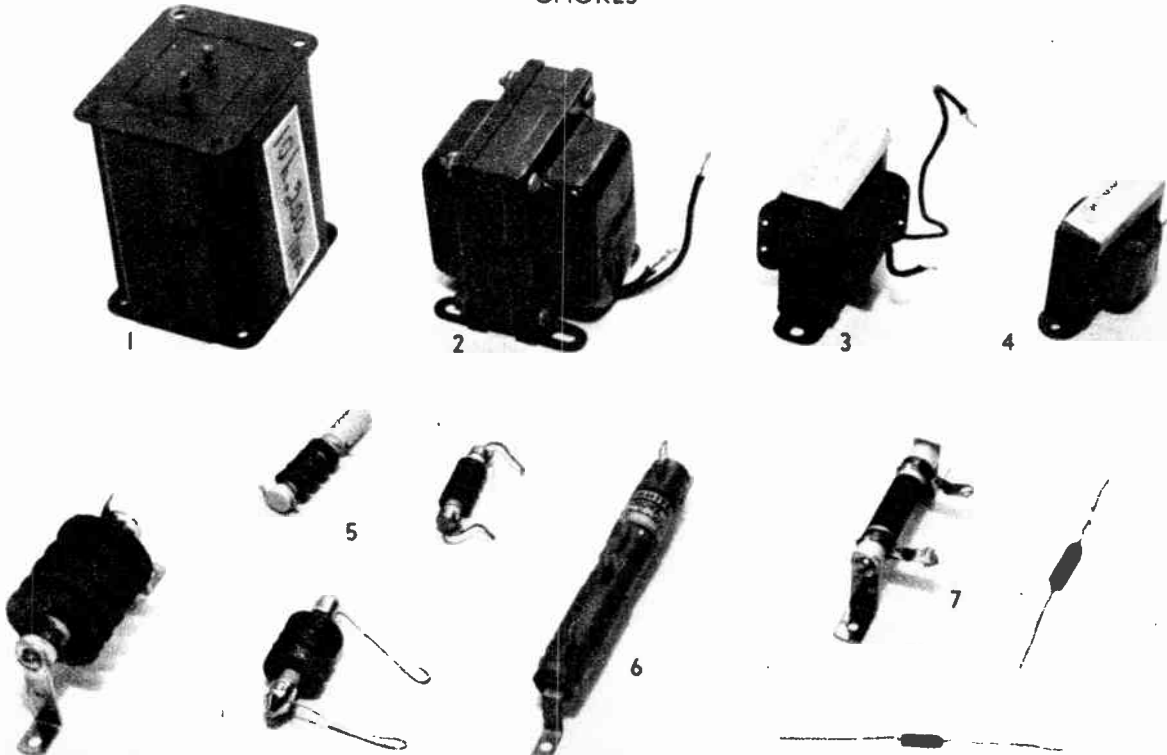

THERE was a time when radio engineers designed equipment to fit available tubes. In recent years the general policy has been the reverse. There must be several thousand different types of tubes now in common use, and new ones are announced weekly.

Fortunately, there has been a strong tendency to standardize on a few "envelopes", as the glass or metal shells are called, and on a few bases. Most small all-glass tubes use either the 7-pin or 9-pin "miniature" base, which is merely a glass button in the end of the envelope. The spacing between pins 1 and 7 and 1 and 9, respectively, is wider than that between the other pins, so a tube can be pushed into its socket only one way. Unfortunately, there is no indexing means, and sometimes it is a difficult and exasperating job to make the pins line up with the socket holes in a crowded radio or television chassis. The job may be impossible, not difficult, if any of the pins are bent.

The octal base (octal meaning 8) is one of the best things that ever happened in the electronics game. The pins are evenly spaced, but indexing is swift and positive because in the center of the base is a molded finger that engages a slotted hole

in the tube socket. You don't even have to see the latter; just drop the finger into the socket hole, turn in either direction until it engages the slot, and push down to lock the pins against the spring contacts in the socket. To remove the tube, pull straight up. This arrangement is so convenient and reliable that it has been adopted for plug-in devices of many kinds.

An octal base doesn't necessarily have all its eight pins, because many tubes don't have eight connections. The minimum number seems to be four. Regardless of how many pins are used, indexing remains virtually automatic.

Some octal tubes have terminals on the top of the glass, although only four or five base pins are present. This is done to provide maximum isolation of a high-voltage point.

Tubes 1, 3, 4 and 5 are glass-envelope octals. Note that center indexing finger is longer than pins, and therefore engages socket before latter do. No. 2 is older style 4-prong type; two of the pins are heavier than the others, and provide the necessary indexing action. No. 6 is metal envelope octal. Pair 7 shows short and long 9-pin miniatures; pair 8, long and short 7-pin tubes.

## TUBES

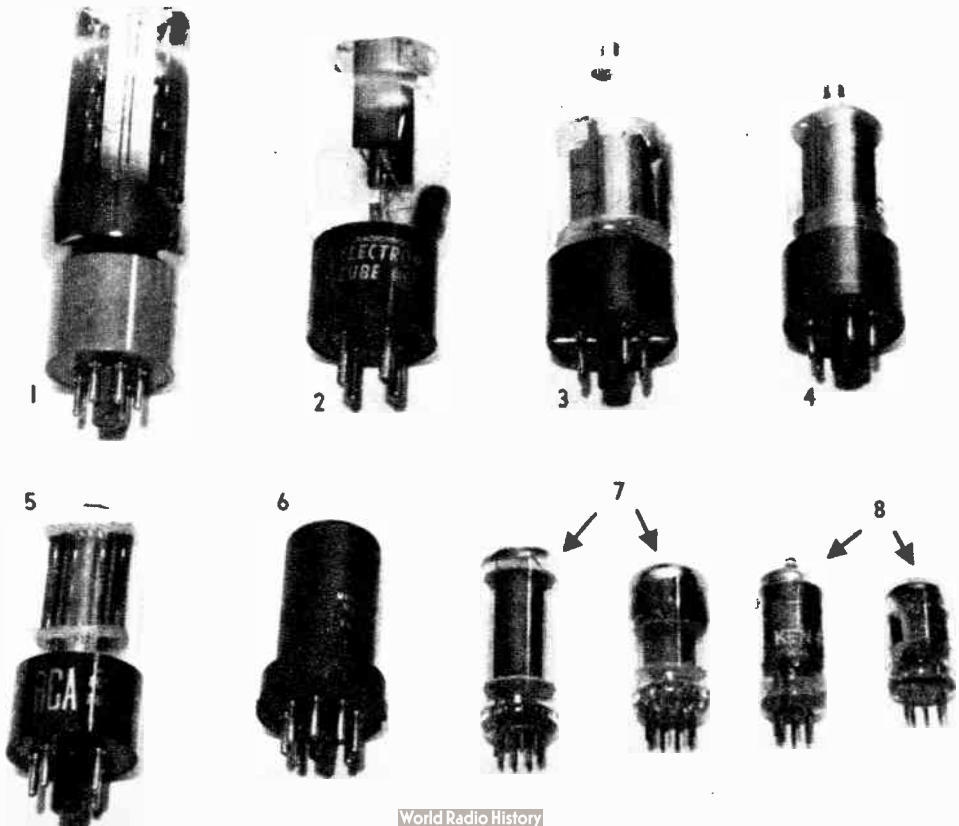

THE first radio receivers operated on messy storage batteries or short-lived dry cells and on banks of large, expensive "B" batteries. People were glad to discard them when the first power-line sets appeared, and batteries ceased to be important in radio. Today, with transistors improving in quality and versatility and rapidly replacing tubes in many applications, batteries are again important.

Ordinary dry batteries simply were not able to furnish the rather large currents required to heat the filaments of conventional tubes. Transistors have no filaments, and give fine results when drawing very small currents at the low voltages of 3, 6, 9 or 12. That's what makes even regular flashlight batteries practical for transistor sets, if their bulk and weight are not objectionable.

A whole new family of batteries, of dimensions commensurate with the small size of transistor equipment, has appeared only recently. Some are of the previous carbon-zinc type, many use mercury as the basic chemical in an entirely different type of construction. Mercury batteries have a number of outstanding features: high ratio of energy to volume and weight, long shelf life, uniform discharge characteristics, no

need for recuperation periods, resistance to humidity and corrosive conditions, and ability to operate over a wide temperature range.

These new batteries don't always go by the name "batteries." Eveready calls its products "battery energizers," and Mallory labels certain of its dime-size units "transistor energy capsules."

A popular style of mercury battery is identical in size and appearance with the familiar "pen light" cell, but rates special attention because its polarity is *reversed* from that of the latter; the case is *positive* and the top center button is *negative*. Watch this! Applying reverse polarity to transistors can kill them. Fortunately, the batteries are well marked, and will give no trouble if handled with reasonable care.

All sizes and shapes are shown in the photo below. No. 1 is made for electronic flash units. No. 2 delivers 9 volts, has snap connectors. Nos. 3 and 4 are standard "D" size flashlight batteries, popular because they're cheap and universally available. Nos. 4, 5 and 6 are mercury-type batteries; so are 7 and 8, but of compact button construction. No. 9 is a regular-type battery much used for flash guns, hearing aids, midget radios, etc.

## DRY BATTERIES

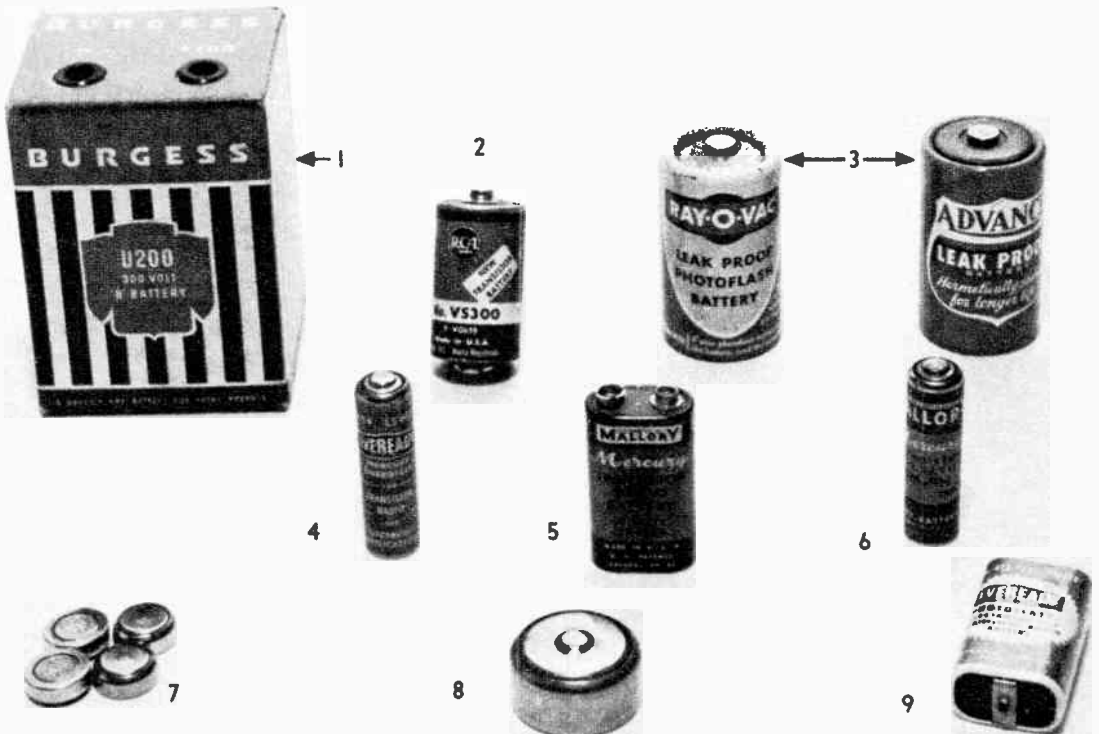

# Abbreviations Simplified

DO the words *micro*, *mega*, *milli*, *kilo*, *omega*, and *mu* sound like Greek to you? Some of them should; some are.

The units, terms and abbreviations used in electronic literature are not very consistent, and can be confusing until you get the swing of them.

The item that puzzles most people is the Greek letter pronounced *mew* or *mu*. In its usual lower-case form it looks like an italic *u* with a short tail hanging from the first stroke,  $\mu$ . Many composing rooms do not have Greek letters among their type supplies, so frequently the *mu* is set as an ordinary *u*. This is understood to be the abbreviation for the prefix *micro*, meaning the millionth part of whatever unit follows. So far so good.

The capital form of this same letter is still *mu*, but it looks exactly like our ordinary *M*, and this is the common abbreviation for both *mega* meaning million, and *milli*, meaning the thousandth part. How to tell them apart is often a problem.

The other Greek letter in general use is *omega*. It is never pronounced as such, but instead both its upper and lower case  $\Omega$  and  $\omega$ , represents the word *ohms*.

*Kilo* is the standard Metric System prefix for thousand, and is abbreviated as either *K* or *k*. *K* by itself *following* a number means that the latter must be multiplied by 1,000; it is a space saver on small resistors and capacitors.

The property of inductance is usually represented by the letter *L*; capacitance by *C*, and resistance by *R*. However, a lower-case *c* is the abbreviation for the actual word *cycles*.

Voltage is represented most often by *E*, sometimes by *V*, although in circuit diagrams *V1*, *V2*, etc., invariably designate vacuum tubes. Current in amperes is *I*, probably for "*intensity*." Resistance in ohms is again *R*. *I*, *R* and *E* are the elements of Ohm's Law, the oldest and still the most useful and widely used formula in electronics:

$$I = \frac{E}{R}$$

Incidentally and quite accidentally, I.R.E. also represents the Institute of Radio Engineers, the high society of the electronics world.

Power in watts is *W*. Impedance in ohms is *Z*.

The unit of inductance is the *henry*, or *h*; *hy* is sometimes encountered, too, although the *y* is entirely superfluous. The plural is either *henrys* or *henries*. Actual inductors vary in size from very small ones rated in microhenrys,  $\mu h$ , or *uh.*, through millihenrys, *mh.*, and well into full henrys. (Periods are usually placed after single-letter abbreviations to show that they are abbreviations.) Distinguish carefully between the fractional units. A microhenry is one-millionth part of one henry; a millihenry is one-thousandth part of one henry. One *mh.* is thus 1,000 times larger than one  $\mu h$ .

The unit of capacitance is the *farad*, or *f*. This is much too large for practical purposes, the common units being the microfarad,  $\mu f$  or  $\mu f.$ , one millionth of one farad, and the micromicrofarad,  $\mu\mu f$ , or  $\mu\mu f.$ , one-millionth of one-millionth.

## Know Your Circuit Symbols



OUTSIDE ANTENNA



LOOP ANTENNA



GROUND OR CHASSIS



FIXED RESISTOR



POTENTIOMETER



TAPPED RESISTOR



VARIABLE RESISTOR (RHEOSTAT)

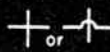

WIRES NOT CONNECTED



WIRES CONNECTED



AIR-CORE R.F. TRANSFORMER

POWDERED IRON CORE R.F. TRANS.

TAPPED INDUCTOR (COIL)



IRON CORE TRANSFORMER (POWER OR AUDIO)



IRON CORE FILTER CHOKE



AIR-CORE R.F. CHOKE



PILOT LIGHT



The abbreviation for microfarad is the most abused one in electronics. It is frequently given as *mfd.*, or *MFD.*, even in publications that meticulously use  $\mu$ h for microhenry and  $\mu$ a. for microampere. The initial letter *m* in all other applications specifically means *milli*. What saves *mfd.* from being a really serious trouble maker is the fact that the term millifarad is never used, for the simple reason that extremely large capacitors in millifarad values are very rare. There are some special low-voltage electrolytics of 1,000, 2,000, 3,000 and even 5,000  $\mu$ f., but they are designated as such instead of being listed as 1, 2, 3 and 5 *mf.*, the *mf.* in this case meaning millifarads, as it should.

The unit of resistance is the ohm, which is never abbreviated because it is a short word anyway. As previously mentioned, the Greek letter omega is sometimes used as a symbol rather than as an abbreviation for this unit.

Resistances are expressed only in fractions of an ohm, in whole numbers, and in megohms (mega-ohms), millions of ohms. The term *kilohms*, for thousands of ohms, sounds as if it should be useful, too, but it does not exist. Instead, the letter *K* is used in the same sense. Thus, a 10,000-ohm resistor might bear the actual marking "10K  $\Omega$ " or less often "10Kw". The capital omega is preferable because the lower-case letter is virtually identical with an ordinary *w*, the widely used abbreviation for watts. The marking *meg  $\Omega$* , for million ohms, is standard.

The unit of current is the ampere, *a*. The form *amps.* is popular in both spoken and

written material. Very small currents are common in electronic equipment, so the microampere,  $\mu$ a., and the *milliampere*, *ma.*, are both used, along with microamps, and milliamps. Large currents are less common, and the ampere unit alone, with a number preceding, is adequate for them.

Voltages cover an extremely wide range. The basic unit is, of course, the volt, or *v.*, and also in general use are microvolt,  $\mu$ v., millivolt, *mv.*, kilovolt, *kv.*, and megavolt, *Mv*. Notice here the fine distinction between the lower-case *m* for *milli* and the upper-case *M* for *mega*.

A similar situation prevails with the unit of alternating-current frequency, cycles, or *c.* (More correctly, this is cycles per second, or *cps.*, but the time unit is assumed). Low frequencies, such as those used for power lines, are expressed as 25 cycles, 60 cycles, 400 cycles, etc. Higher frequencies, found in radio transmission and reception, are more conveniently given as kilocycle, *kc.*, for instance 660 *kc.*, which is the same as 660,000 cycles. The abbreviations *kc.* and *KC.* cause no confusion. However, getting into still higher frequencies, we use megacycles, *Mc.*, for millions of cycles, invariably with an upper-case *M*. Now, *Mc.* or *mc.* could conceivably mean microcycles or millicycles, except that anything below a few cycles per second is considered pulsating direct current rather than actual alternating current; these latter terms don't exist.

Power is expressed in watts, *w.* or *W.* The range is like that of volts: microwatts,  $\mu$ w., miliwatts, *mw.*, kilowatts, *kw.*, and megawatts, *Mw.* •



EARPHONES

AMMETER

VOLTMETER

S. P. S. T.

S. P. D. T.

D. P. D. T.



FUSE

DIODE RECTIFIER

TRANSISTOR

VACUUM TUBE DIODE

TRIODE-CATHODE TYPE

TETRODE

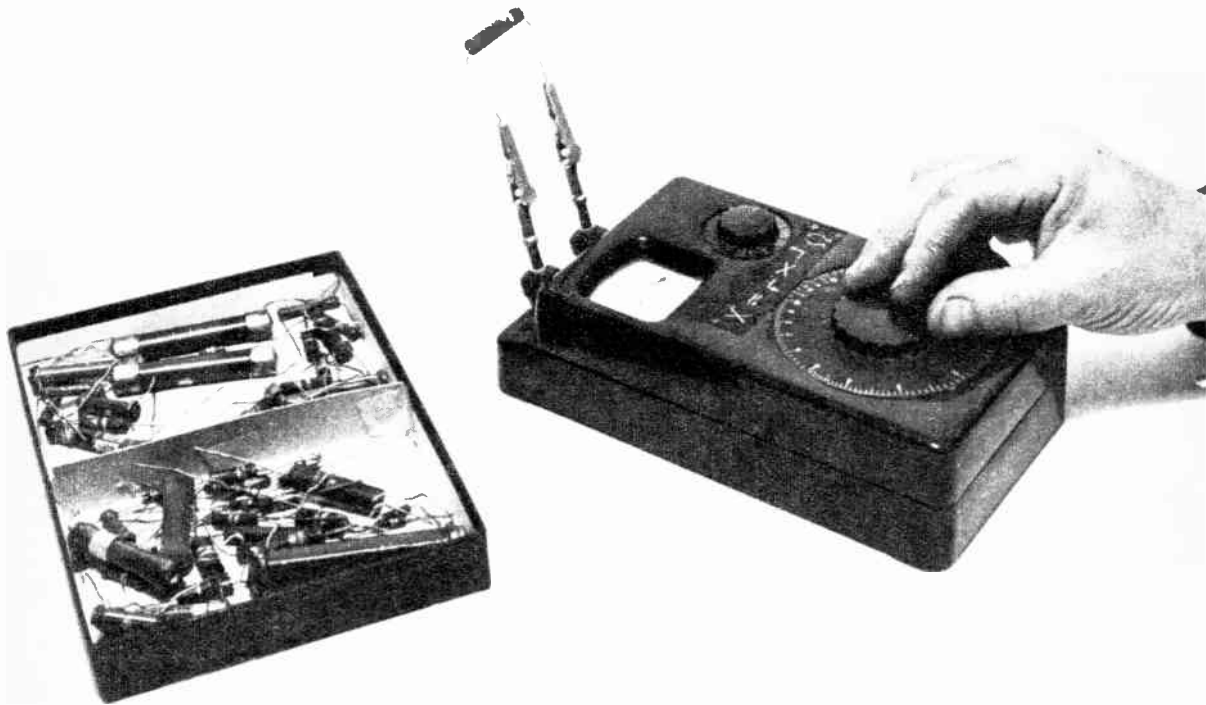

# The Meaning of Tolerance Figures

Expressed in percentage, they tell you what variation in component value you can expect

**T**HE SMALL RESISTORS sold by the million for a myriad of electronic circuit applications are usually rated according to their closeness to their marked values. This figure, expressed as a percentage, is known as their "tolerance." On small resistors whose resistance is indicated by three color bands, a fourth silver band represents a tolerance of 10% and a gold band of 5%. If there are only three bands, the tolerance is 20%. Precision resistors rated at 1% usually have all the pertinent data printed on their bodies.

The tolerance figures tell you how much variation you can expect up or down from the nominal value. For example, with a 1,000-ohm resistor marked silver for 10%, the actual value can run from 1,000 plus

100, or 1,100 ohms, to 1,000 minus 100, or 900 ohms. In most conventional electronic equipment such as radio and television receivers, high-fidelity units, communication receivers and transmitters, public-address amplifiers, intercoms, etc., circuit requirements are not particularly critical, and resistors rated at 20% or 10% tolerance are entirely satisfactory. In meters and other measuring equipment, the more accurate 1% resistors are generally used.

The lower the tolerance, the more care and time are required in manufacture, and naturally the higher the price. Typical 10% resistors sell for about 10 cents each, 5% resistors for about 20 cents, and 1% resistors for about 60 cents. In "bargain box" assortments, mixed lots of 20% and

Measurement of assorted resistors will show you that they are well within rated tolerance values. Instrument used for the purpose, photograph at left, is Wheatstone Bridge.

Variation in fixed capacitors' values is often considerable, but unimportant to circuit operation. In actual test, this ".05 mfd." unit is found to measure just a little above .04.

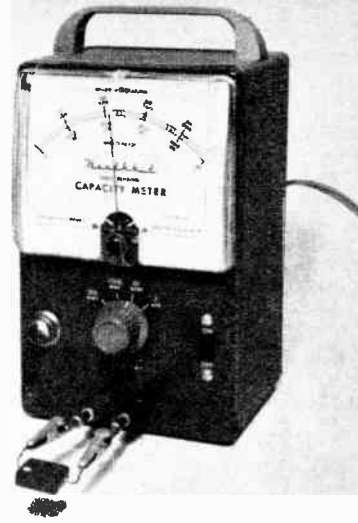

10% resistors can be had for a cent each. To give an idea of the validity of marked tolerance figures, I picked a handful of resistors at random from my resistor cabinet and measured them on a very accurate Wheatstone Bridge. Here's how they checked out:

| Marked Value, Ohms | Tolerance | Allowable Resistance | Measured Resistance |
|--------------------|-----------|----------------------|---------------------|
| 150                | 20%       | 120-180              | 150                 |
| 150                | 10%       | 135-165              | 150                 |
| 150                | 10%       | 135-165              | 145                 |
| 1,000              | 10%       | 900-1,100            | 990                 |
| 1,200              | 20%       | 960-1,440            | 1,400               |
| 1,200              | 20%       | 960-1,440            | 1,300               |
| 2,000              | 20%       | 1,600-1,400          | 1,900               |
| 2,000              | 10%       | 1,800-2,200          | 1,950               |
| 2,200              | 5%        | 2,090-2,310          | 2,400*              |
| 10,000             | 20%       | 8,000-12,000         | 9,600               |
| 10,000             | 10%       | 9,000-11,000         | 11,000              |
| 10,000             | 5%        | 9,500-10,500         | 10,300              |
| 50,000             | 10%       | 45,000-55,000        | 48,000              |
| 50,000             | 5%        | 48,450-53,550        | 50,000              |

\*This was the only resistor not within its tolerance. However, it was an old one, noticeably charred, and had undoubtedly changed in value because of over-heating.

Circuit requirements for capacitors are generally less critical than for resistors, and for this reason tolerance figures are not even given for some types. A few small mica capacitors are rated as close as 5%; other mica, disc ceramic and paper types are rated at 10% and 20%. Accurate capacitance is usually important only in frequency-determining or frequency-controlling circuits when it is not convenient or desirable to use variable capacitors.

Some small disc capacitors are rated at plus 80% to minus 20%, which gives the

manufacturers plenty of leeway. The widely-used .01 microfarad size, then, might run as high as .018 or as low as .008 mfd.

Measurements made with a Heathkit direct-reading capacity meter on a random bunch of capacitors show that micas hold closer to their marked values than papers. No actual tolerance figures were found on any of the units tested.

| Marked Value in Microfarads | Measured Value |
|-----------------------------|----------------|
| .01 mica                    | .009           |
| .01 mica                    | .0086          |
| .01 mica                    | .0094          |
| .01 mica                    | .01            |
| .002 mica                   | .0018          |
| .0025 mica                  | .002           |
| .005 mica                   | .004           |
| .005 paper                  | .006           |
| .05 paper                   | .044           |
| .05 paper                   | .064           |
| .1 paper                    | .16            |

Color-code markings on small capacitors are very confusing because at least four different systems have been used, and the color rings or dots themselves are often smeared. A six-dot method of identification is supposed to be industry standard, but some manufacturers are doing the sensible thing by marking capacitors with plain black figures, which are much easier to read. For example: typical micas furnished with a receiver kit are stamped "2000 ± 10%" and "680 ± 10%." The first figure is the capacitance in micromicrofarads; to get the equivalent in microfarads, move six places from right to left. Thus 2000 mmfd. is the same as .002 mfd.; 680 mmfd. the same as .00068 mfd. The % figure is, of course, the tolerance. •



# Magnification: 200,000 Times!

The story of the fabulous electron microscope

This is the RCA EMU-3 electron microscope, set up for actual use. Note that operating "console" bears resemblance to a ham radio station.

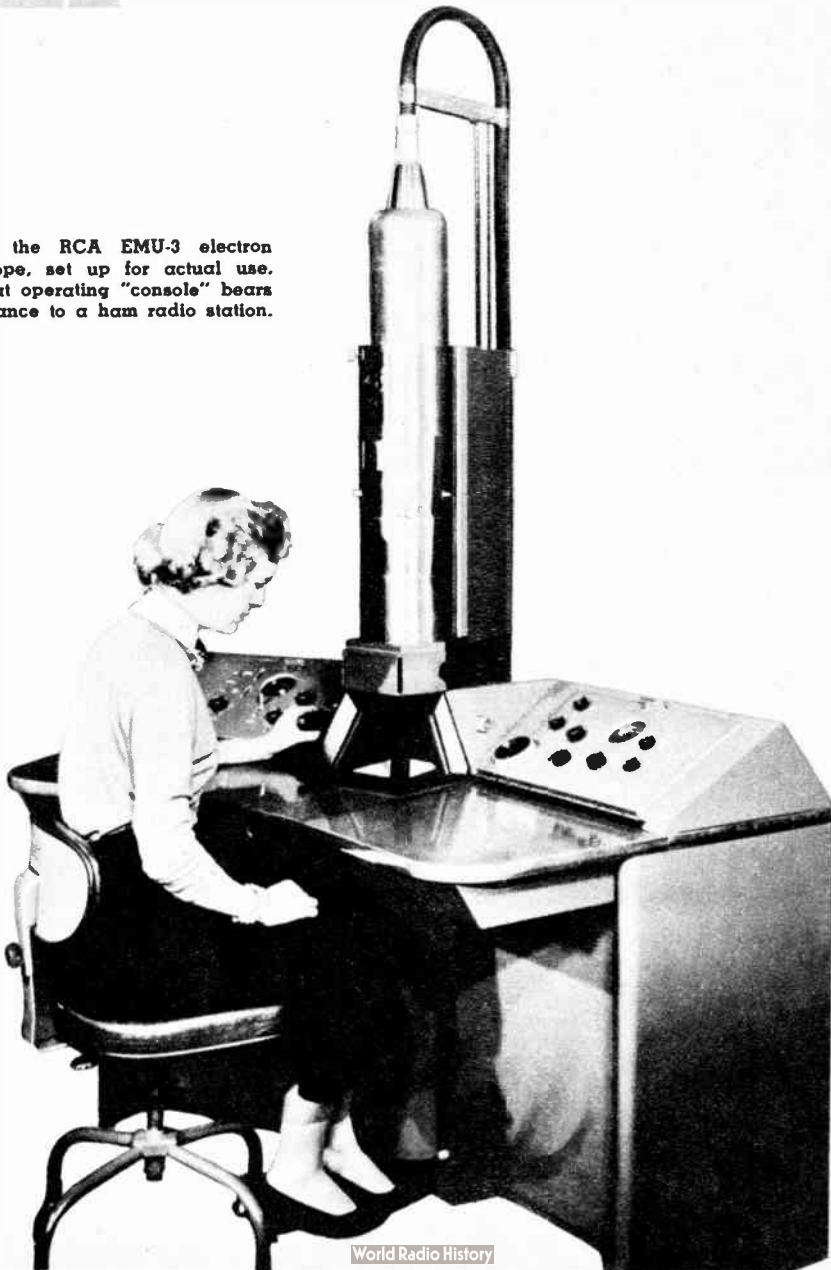



**E**VER SINCE man found that transparent stones magnified objects, he has tried in many ways to overcome the limitations of the human eye and to see into the world of the infinitesimal. Great progress was made in the seventeenth century when Anthony Van Leeuwenhoek of Holland developed one of the first compound microscopes. With the aid of this instrument, he was able to give the world the first accurate description of red blood corpuscles.

The optical microscope continued to improve, with improvements in glass manufacture and advances in lens design, until an impasse was reached in about 1885. At that time, scientists realized that microscopes were limited by the very nature of light itself, rather than by imperfections in the lenses. Just as the size of our fingers sets a limit to the smallness of objects we can pick up, so the wavelength of the light we use limits the size of the objects we can see. Some idea of the problem can be gained from the following:

Light waves are usually measured in terms of angstrom units\*. Lead from a pencil is about one millimeter in diameter, equal to 10,000,000 angstroms. On this scale, the darkest red we can see is rated at 7,600 angstroms, considered the longest wavelength of visible light. At the other end of the light scale is deep violet, with a wavelength of 3,900 angstroms.

Using visible light in an ordinary microscope, we can distinguish objects about 2,000 angstroms in diameter, about half

\* Named for a noted Swedish physicist, Anders Jonas Angstrom, 1814-1874

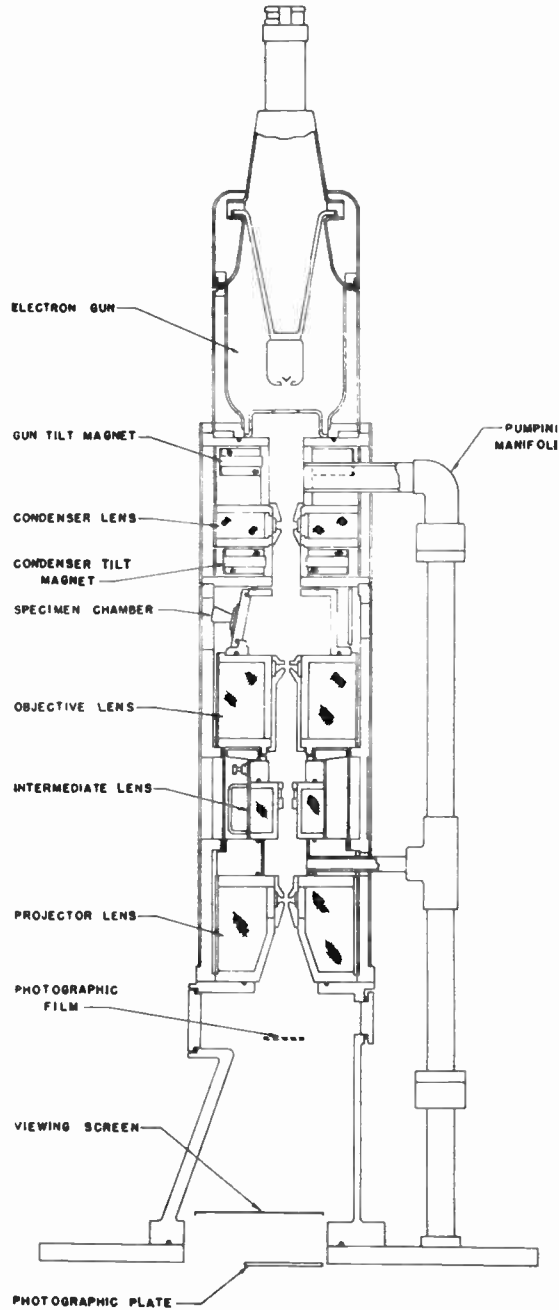

The "works" of the RCA electron microscope are shown in photograph at the left. Left section contains electronic components and controls; right, vacuum pump and associated machinery. "Pumping manifold," of the cross-section drawing reproduced above is part of vacuum system.

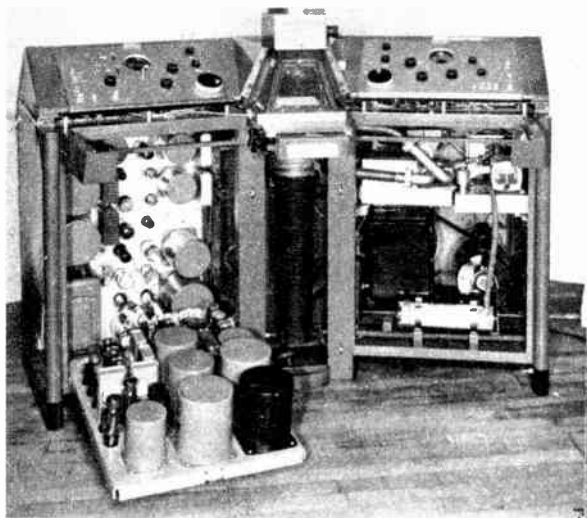

## ELECTRON MICROSCOPE

## LIGHT MICROSCOPE

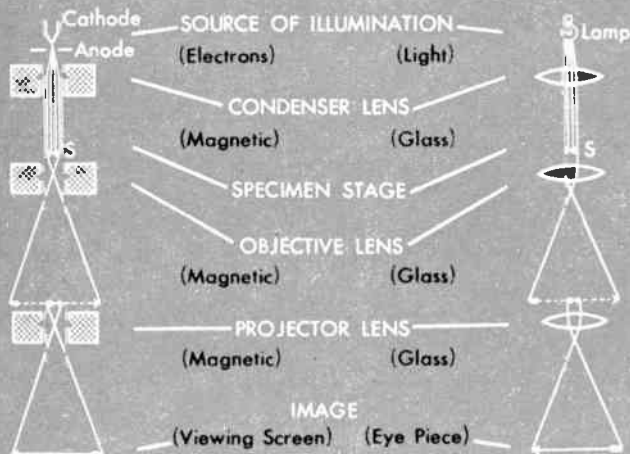

Similarities and differences of electron and light microscopes. Size differential is not indicated. RCA's EMU-3 more than seven feet high, almost five feet wide and deep, weighs 1400 pounds.

the wavelength of the shortest visible light ray. With ultraviolet light, using wavelengths about half as long as the shortest we can see, we can make out objects about 800 angstroms in diameter.

While the optical microscope was and still is a tool of great usefulness, it cannot be applied to the study of many small objects that are of extreme importance to science, medicine and industry. A radiation of still shorter wavelength than 200 Å was needed.

The key to the problem was the discovery of the electron by J. J. Thompson, an Englishman, in the late nineteenth century. In 1924, a French scientist named De Broglie developed a theory that every moving body has a characteristic wavelength associated with it, and the faster the body moves, the shorter the wavelength. Scientists already knew how to make electrons move at high speed, under the acceleration of high voltages. At the Bell Telephone Laboratories it was proved experimentally that under certain circumstances high-velocity electrons behave like light.

Another important discovery that did much to make possible the use of electrons for illuminating objects was that of Professor Hans Busch of Jena University, Germany, in 1926. He showed that a properly shaped magnetic field could be used as a lens to focus a beam of electrons, in much the same way as a glass lens bends and focuses a beam of light.

Using radiation with a wavelength of only .05 angstrom (100,000 times smaller than the wavelength of visible light), scientists were able to explore the secrets

of the microcosmic world. The electron microscope could magnify objects to such an extent that if we could see them in their entirety a blood corpuscle would be the size of a four-foot sofa pillow, a dime would be more than two miles in diameter.

The first commercial electron microscope produced in any quantity was developed by the Radio Corporation of America under the supervision of Dr. V. K. Zworykin and placed on the market in 1940. This is the same Zworykin whose electronic-optical inventions are basic elements of television broadcasting. Useful magnifications of 100,000 diameters were obtained regularly. The newest RCA instruments offer the fantastic magnification of 200,000 times! It would be more descriptive to call the electron microscope a "machine" rather than an "instrument." The RCA Model EMU-3, for example, stands 7 feet 8 inches high, almost 5 feet wide and deep, and weighs 1,383 pounds.

This size and bulk result from the need for highly regulated power supplies to produce and control the electron beam that illuminates the specimen and forms the image. In addition, because air would interfere with the movement of the electrons, the entire optical path of the microscope must be pumped to a high vacuum. The arrangement bears a strong resemblance to that embodied in a television picture tube.

The "lenses" of the electron microscope are the powerful magnetic fields of four coils. In the optical instrument, the image is brought into focus by changing the lens spacing. In the electron instrument the lenses remain fixed and focusing is accom-

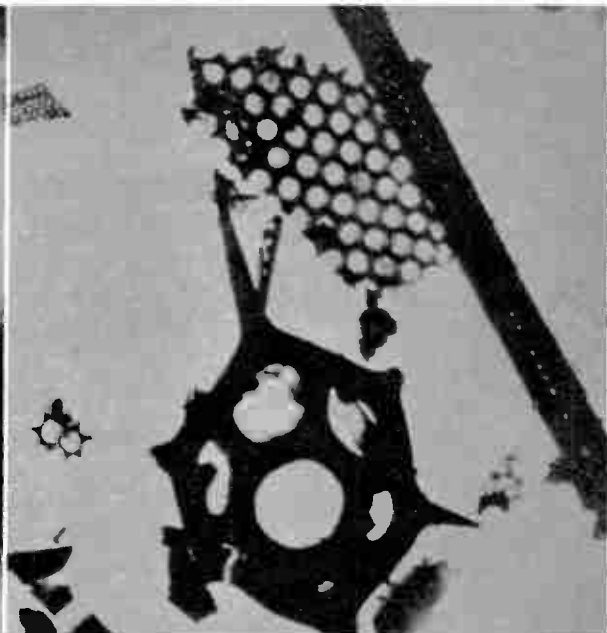
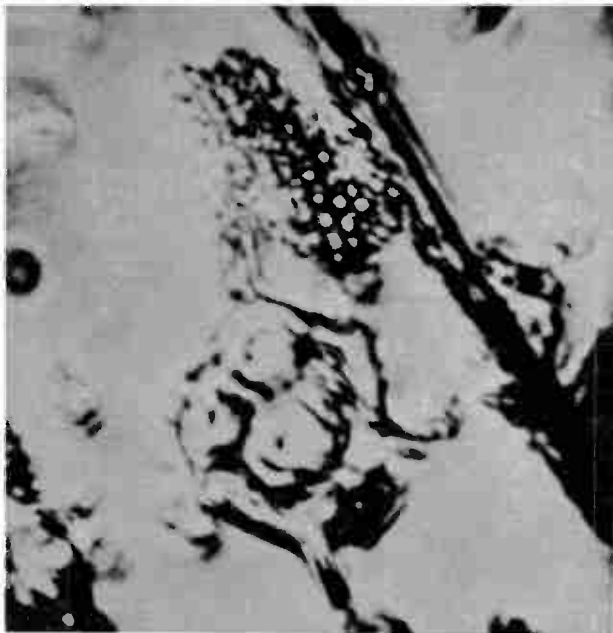

Optical instrument nears its limitations in the blurred micrograph, left above, while electron microscope's capabilities were barely tapped, right. Same diatom fragments; 3000 x normal size.

Research has benefitted dramatically through electron microscope's revelations. Significant to human health are such shots as those below. Magnification: between 10,000 and 78,570 times.

plished by changing the strength of the current in the coils.

The needed electrons are emitted by a hot tungsten filament, as in many common radio tubes, and are accelerated to form a high velocity beam. This is concentrated on the specimen by a condensing lens. Some of the electrons are absorbed by the specimen, others are scattered and lost. The number of electrons absorbed or scattered depends on the density or thickness of the specimen at each point. Thus, the distribution of the remaining electrons in the beam is determined by the details in the specimen.

As the beam passes through the magnetic field of the objective lens, it is focused and enlarged. Then a portion of the electrons in this image is brought into a second focus on a fluorescent viewing screen or a photographic plate by the projection lens.

Thus, in the electron microscope the image is not observed directly as in an optical microscope, but is seen as a pattern on a fluorescent screen, as in TV receivers. Electrons affect photographic emulsions in the same manner as light, so it is fairly easy to make direct, permanent pictures of the image for analysis and study.

Because conventional glass slides would stop the electron beam, they cannot be used in the electron microscope. Instead, the specimen is mounted on an extremely thin colloidal film only 100 angstroms thick. •

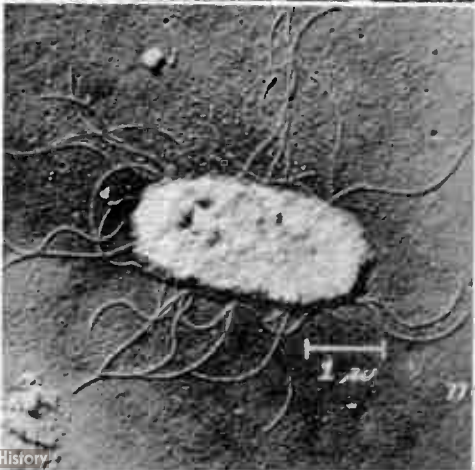
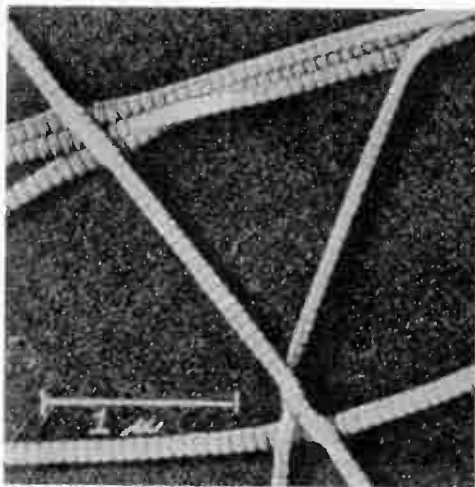



# Transistor Care and Testing

Durable in some ways, they're vulnerable in others

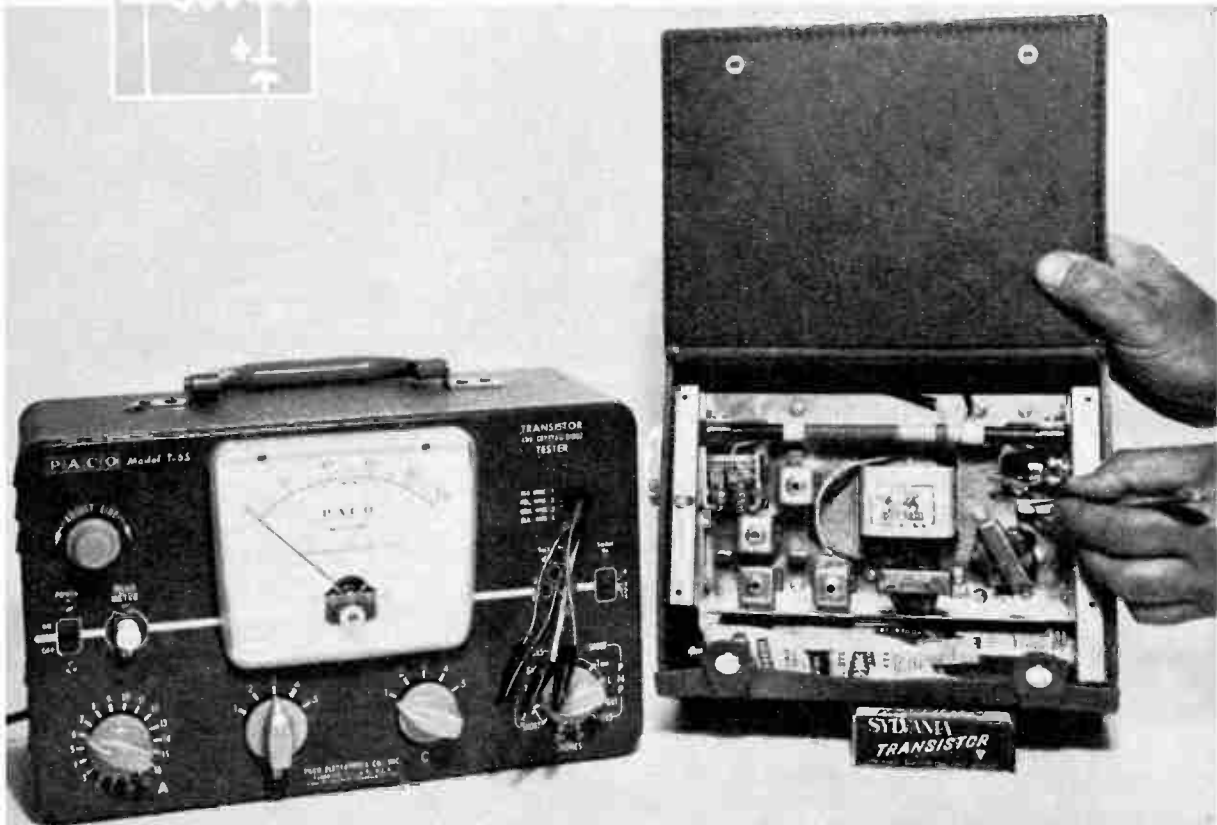

**T**HE TRANSISTOR was introduced in 1948. By the end of 1958 about 60% of all new electronic equipment will use transistors instead of vacuum tubes. It therefore behooves all radio technicians, experimenters, students and hams to become familiar with transistor characteristics and particularly with methods of testing them.

Somewhere along the line of transistor development there grew up the notion that transistors are indestructible. This was most unfortunate, as it left users unprepared for the stark reality that while they

are durable in some respects they are extremely vulnerable in others. Consisting only of tiny bits of silicon or germanium, they can withstand shock or vibration that would shatter vacuum tubes. However—and a big *however* because the fact isn't generally appreciated as it should be—transistors poop out very readily if they become too warm or if they receive operating voltages of the wrong polarity. Tubes, on the other hand, have to be hot to work at all, and aren't damaged in the slightest by reverse voltages.

Heat protection takes two forms. Direct



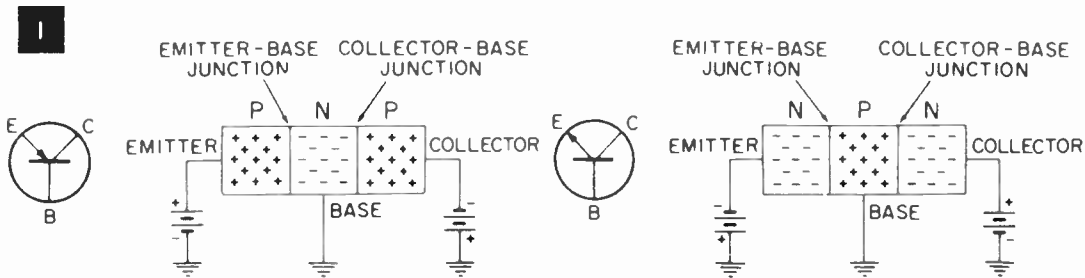

If new batteries don't solve transistor-radio trouble, remove transistors and check them on a tester, such as the new Paco T-65. Tweezers are handy for removing them from tight space and getting leads into the tester sockets. Figure 1, immediately above, shows construction of PNP and NPN transistors.

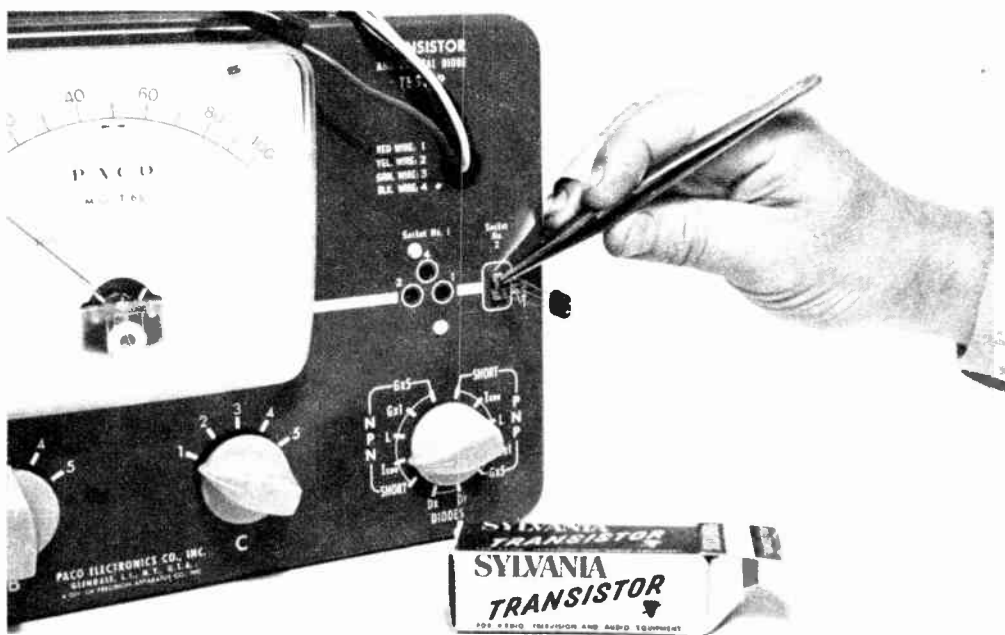

soldering of transistor leads should be avoided, or if this isn't possible, an iron with a small tip should be used and the leads should be held with long-nose pliers so that the mass of the latter will absorb heat that would otherwise pass to the transistor body. Also, the equipment itself should be kept out of hot areas. Undoubtedly you've felt the furnace-like blast from a car that has been left locked for a couple of hours on a summer day. You can understand then why some transistorized auto radios are such a service headache. The same applies to small portable

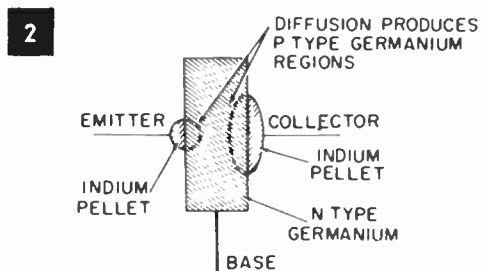
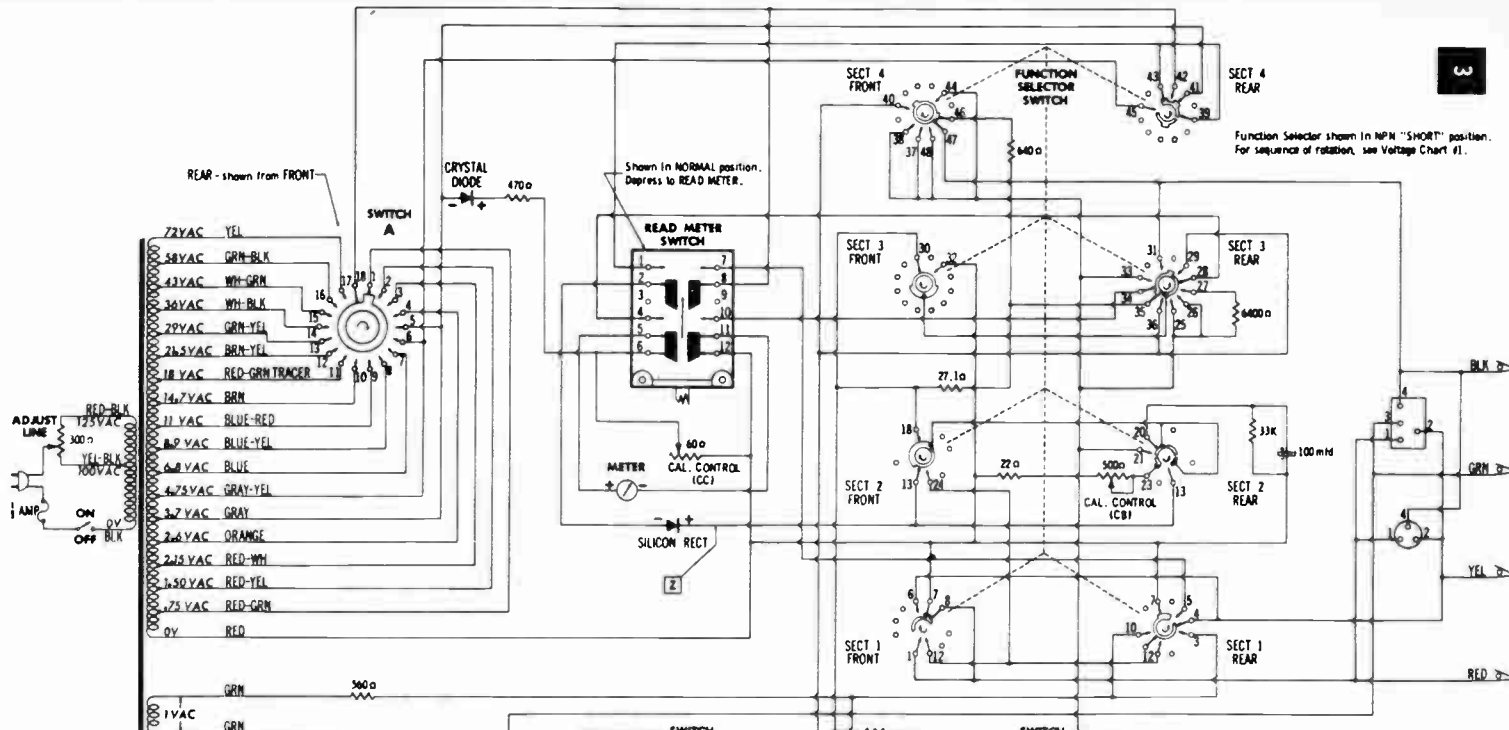

Figure 2. Cross-section construction of a typical transistor of the diffused germanium type.

Complete schematic diagram of the Paco T-65 transistor tester is reproduced here. Multi-tapped power transformer is at extreme left of the drawing; sockets, connections for transistors at right.



Function Selector shown in NPN "SHORT" position. For sequence of rotation, see Voltage Chart #1.

VOLTAGE CHART #1

| Function Selector Position | Voltage at point (Z) and across socket terminals specified under "CHECK-OUT PROCEDURE": (READ METER switch depressed.) |
|----------------------------|--|
| NPN                        | SHORT 4.5 VDC  |
|                            | ICBO Determined by switch "A" position. See CHART 2.   |
|                            | L 1.75 VDC   |
|                            | EX1 1.75 VDC   |
|                            | EX2 1.75 VDC   |
| PNP                        | SHORT 4.5 VDC  |
|                            | ICBO Determined by switch "A" position. See CHART 2.   |
|                            | L 1.75 VDC   |
|                            | EX1 1.75 VDC   |
|                            | EX2 1.75 VDC   |
| DICES                      | DR 1.25 VDC  |
|                            | DR Determined by switch "A" position. See CHART 2.   |

VOLTAGE CHART #2

| Switch "A" position | Voltages |
|---------------------|----------|
| 1                   | .5 VDC   |
| 2                   | 1.50 VDC |
| 3                   | 2.35 VDC |
| 4                   | 3 VDC    |
| 5                   | 4.5 VDC  |
| 6                   | 8 VDC    |
| 7                   | 9 VDC    |
| 8                   | 12 VDC   |
| 9                   | 15 VDC   |
| 10                  | 20 VDC   |
| 11                  | 25 VDC   |
| 12                  | 30 VDC   |
| 13                  | 40 VDC   |
| 14                  | 50 VDC   |
| 15                  | 60 VDC   |
| 16                  | 80 VDC   |
| 17                  | 100 VDC  |

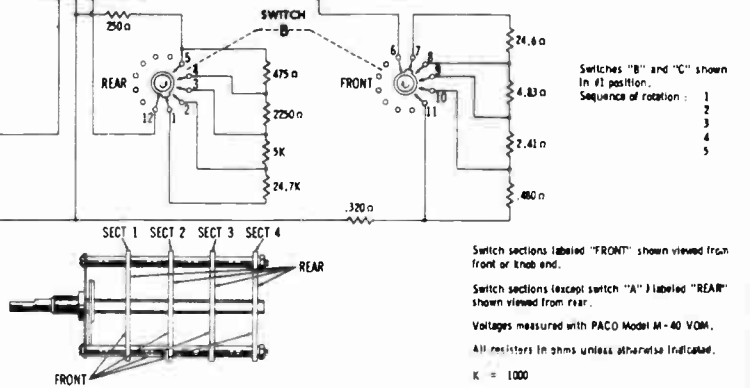

Switch sections labeled "FRONT" shown viewed from front or knob end.  
 Switch sections (except switch "A") labeled "REAR" shown viewed from rear.  
 Voltages measured with PACO Model M-40 VOM.  
 All resistors in ohms unless otherwise indicated.  
 K = 1000

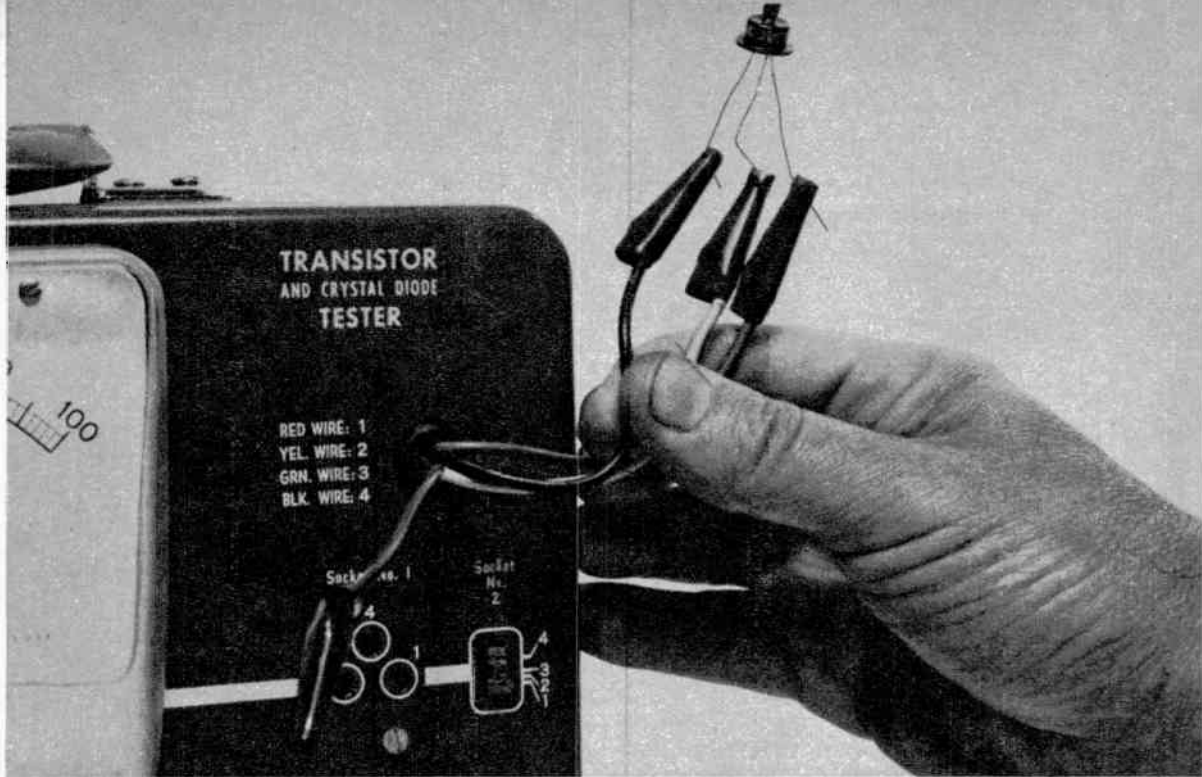

In most cases, you'll find that it's less trouble to connect a transistor for testing on the T-85 by means of these flexible wires with alligator clips. All of the wires parallel the socket connections.

sets that are left to cook on a sunny beach.

Transistor equipment works on small batteries, which last a long time because they are required to deliver only very small currents. However, these batteries do die out eventually, and do require replacement. In most sets a battery can be installed just as readily one way as another. If the user inadvertently flips it the wrong way and gets the positive connection where the negative should be, he and his pocketbook are pained to learn that some or all of the transistors expired quietly when he snapped the switch.

In the frenzied rush of transistor popularization, relatively little attention was given to testing techniques and instruments, both badly needed for the proper maintenance of transistor equipment of all kinds. Methods and meters for tube testing, perfected over a period of almost half a century, were not applicable at all, in spite of the fact that transistors perform the same general circuit functions as tubes. Initially, both engineers in the laboratory and service technicians in the field "tested"

suspected transistors by pulling them out and trying others in their place. This substitution system is perfectly good, but it is time-consuming and requires an extensive and expensive stock of transistors on which to draw. Happily, easily-used testers are now on the market, and are being added rapidly to the test racks of repairmen, experimenters, hams and other technical users of transistors.

#### Construction and Theory

Before discussing testing, it might be well to review transistor construction and what we know of transistor theory.

Transistors are made commonly of germanium or silicon, two members of a mineral family called "semiconductors." A vast amount of experimenting is being done with other minerals. A semiconductor is an odd material that acts either as a conductor of electricity or as a block or insulator against it, depending on circuit conditions. It occurs in two types, N and P, for negative and positive. The N type is so-called because it contains a surplus



Four switches along bottom of the tester are set according to transistor type. "Read Meter" button is then pressed. The transistor checked at the left is a good one. Terminal arrangements of four popular styles of transistors are in Fig. 4, below.

4

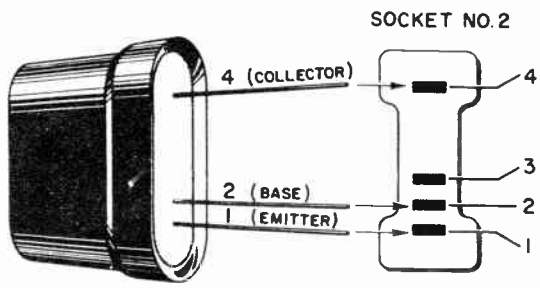

PLUG-IN TYPE LOW POWER TRANSISTOR (LP-1)

DON'T FORGET TO CLIP ON THE NO.4 LEAD

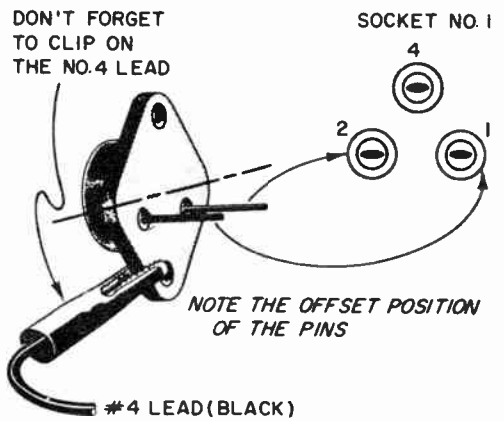

"TOP HAT" TYPE POWER TRANSISTOR (P-3)

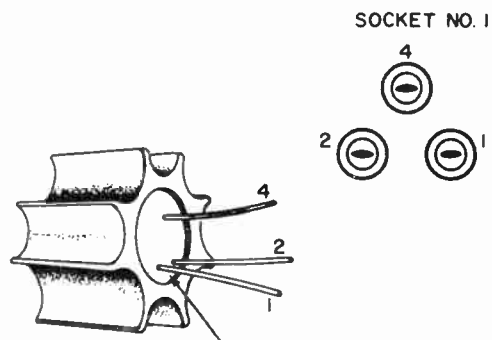

NOTE THE POLARIZATION OF THE LEADS.

(P-4)

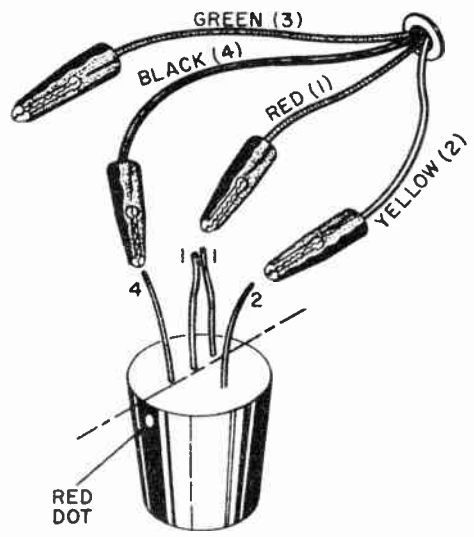

(LP-15)



of free electrons, which are essentially tiny negative charges. The P type suffers from a deficiency of electrons, and these deficiencies are called "holes." Current can flow in either direction in N and P materials if they are handled individually. However, if they are joined to form a single unit, the latter becomes a one-way street; that is, with a voltage applied in one direction, it exhibits a very low resistance and conducts electricity very well, but with the polarity reversed it offers a high resistance and permits very little if any current to flow. This is the familiar diode rectifier action, by which alternating current is changed to pulsating direct current.

Adding another bit of either N or P material to an N-P sandwich produces a transistor, which, like the vacuum tube, has the extraordinary ability to amplify voltages applied to it. Depending on the distribution of the materials, transistors are known as PNP or NPN, and are shown in simplified form in Figure 1. The three elements are identified as the emitter E, the base B and the collector C, and in the schematic symbol the emitter is represented by an arrow.

When voltage of the right polarity is applied to an N-P combination, electrons flow from N to P and holes\* from P to N. In the case of the PNP transistor with the battery polarities as indicated, electrons flow through the junction of the emitter and the base to the emitter and holes move into the base. Some of the holes are neutralized in the N base, but most of them continue on through the collector-base junction to the collector. Normally, there is no current through the essentially positive collector because of the negative bias imposed on it by the right-hand battery. However, because of the extra positive holes from the emitter, current now does flow, from the emitter through the collector. In effect, then, the emitter controls the collector current, much in the same way that the grid of a vacuum tube controls the plate current. Very little current flows through the base, which is connected to both batteries. It is common to both the emitter and the collector and is held in a sort of electronic

\* The word "holes" must not be taken too literally. Since a hole is by definition empty space, it cannot really move the way a finite object does. The "movement" is probably an exchange of electrons.

balance between them because of the opposition of the charges along the two junctions.

The action of the NPN transistor is the same as that of the PNP, except for the transposition of polarities.

For purposes of explanation, the diagrams show two batteries. Only one battery in actual equipment is used, in the collector circuit; the emitter voltage is provided by the input signal.

### Icbo Is a Yardstick

Transistor testing is not altogether easy, because the usual currents in them are of the order of only microamperes; that is, millionths of an ampere. A yardstick that is being used successfully is called *Icbo*, which is given orally by its individual letters, not as a pronounceable word. This represents the current flow between the collector and the base with the emitter disconnected. The letter I is the standard symbol for current; c and b are for collector and base; o indicates that the remaining element, the emitter, is open. A similar measurement that can be made between the emitter and the base, with the collector open, is designated *Icbo*. A test made with the emitter shortcircuited to the base is designated *Icbs*.

Beta, the second letter of the Greek alphabet, describes current gain in the transistor, and corresponds to the term amplification factor in vacuum tube practice.

Current figures obtained by applying voltages to a transistor in a tester mean nothing in themselves, but must be compared against typical and maximum and minimum figures averaged from a large number of readings made on production transistors of the same type number. There are already well over 500 different types in existence, and the number is growing rapidly as new ones are designed for old or new purposes. A transistor checker thus is only as useful as its charts of test data.

A simplified cross-section view of a typical diffused-junction PNP transistor is shown in Figure 2. The emitter and collector contacts are quite close, and internal short circuits are not unusual. A simple "short" test is therefore the first testing operation.

Transistor and diode testers in both kit and factory-made form are appearing on the market, and are being welcomed by

transistor users. The writer recently processed the Paco Model T-65 kit, and found its performance excellent. The heart of this tester is 5-inch-wide meter having a full-scale deflection at 100 microamperes and giving accurate readings in 2-microampere steps.

The mechanical assembly of the kit is the usual nut and bolt job. There's quite a

bit of wiring to do, but it isn't at all critical. As Figure 3 shows, the tester merely provides a large number of DC voltages for application to the transistors and diodes through current-limiting resistors. The meter readings are then checked against the listings of optimum values in a 10-page data folder furnished with the kit.

Just identifying the leads of match-head

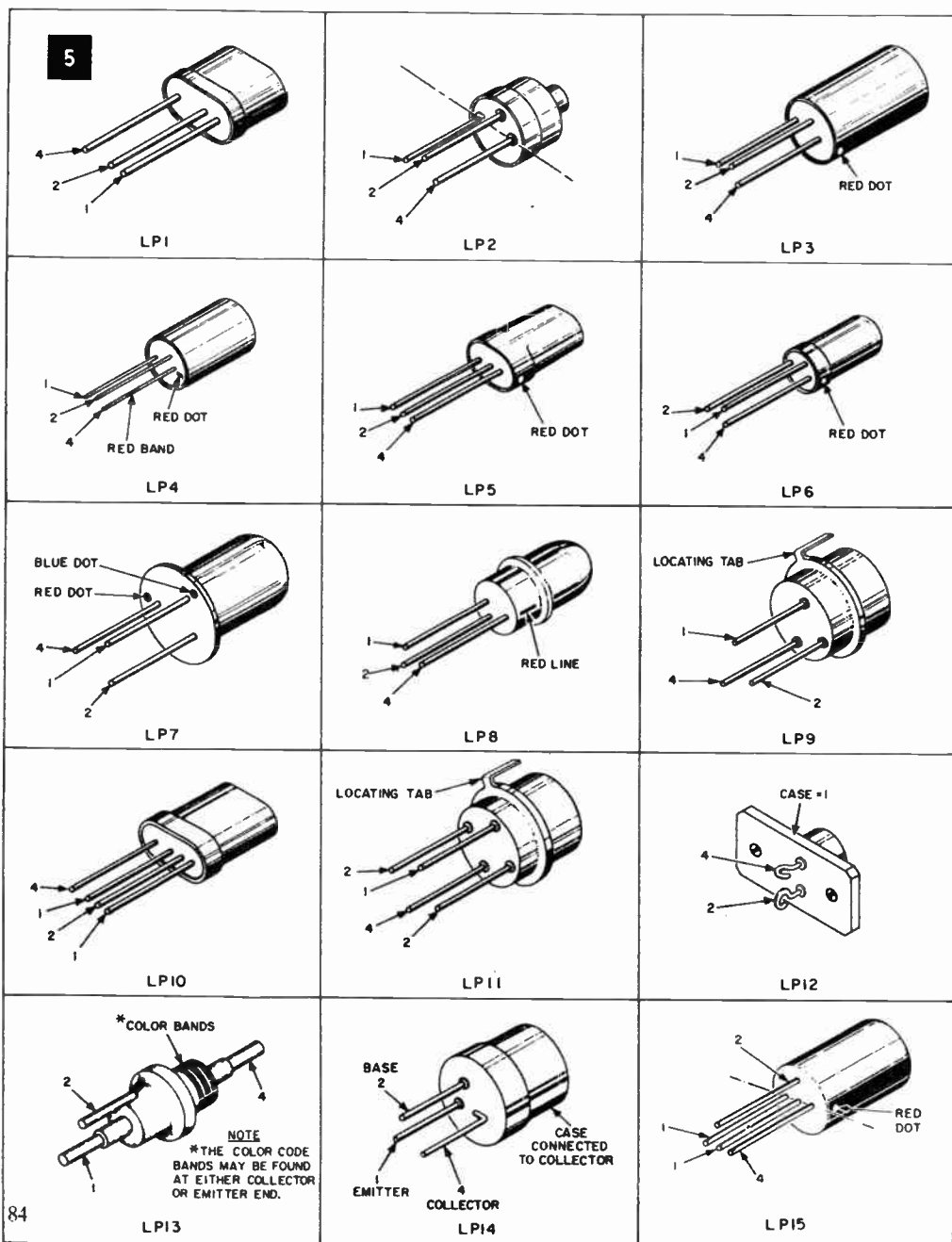

size transistors is half the work in testing them. The other half is getting the thin pig-tail wires into the correspondingly small openings of the sockets. Fortunately, the Paco people had the good sense to provide flexible leads with alligator clips on their ends, for connection directly to the transistors' wires, independent of the sockets.

### Check Leads Carefully

On most small transistors the collector terminal is offset slightly from the others or is marked by a red dot. With some of the larger power transistors the metal case might or might not be one of the several active terminals. Unlike vacuum tubes, which cannot be forced into their sockets in any way but the right way, transistors can

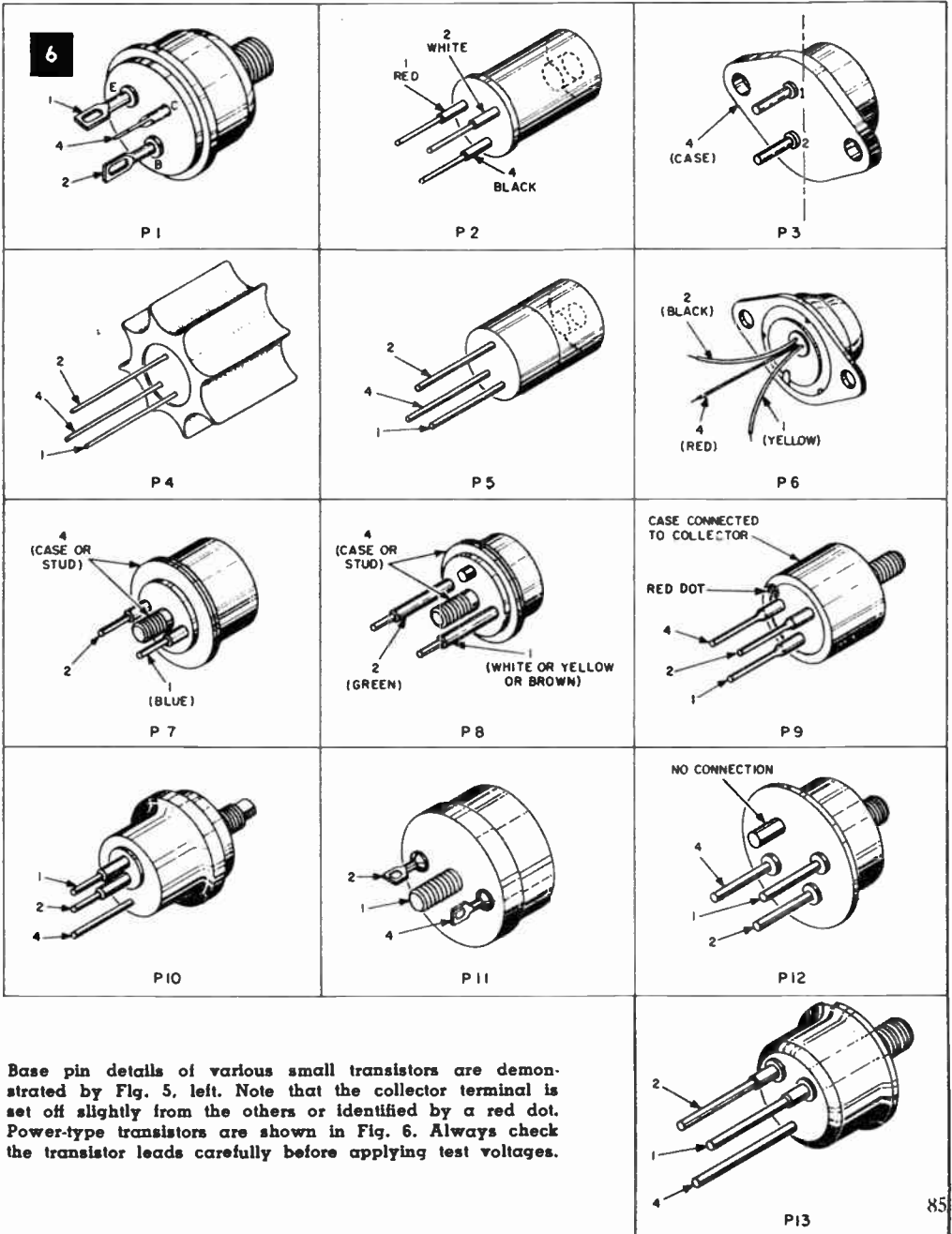

Base pin details of various small transistors are demonstrated by Fig. 5, left. Note that the collector terminal is set off slightly from the others or identified by a red dot. Power-type transistors are shown in Fig. 6. Always check the transistor leads carefully before applying test voltages.

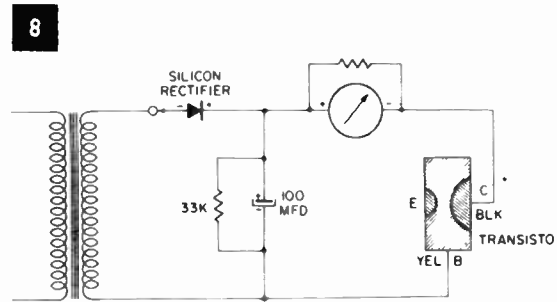
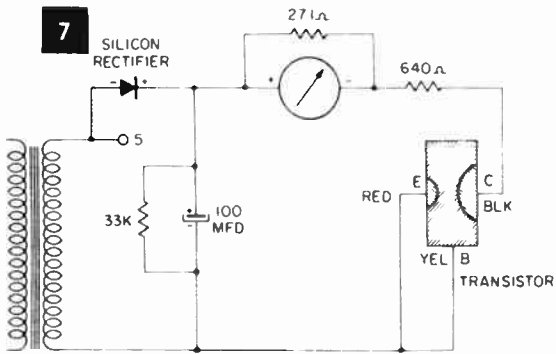

Shown here in simplified forms are circuit diagrams of Paco Engineering's T-65 tester, when set up for a short-circuit check, Fig. 7 above left; and when set up for base-to-collector current test, Fig. 8.

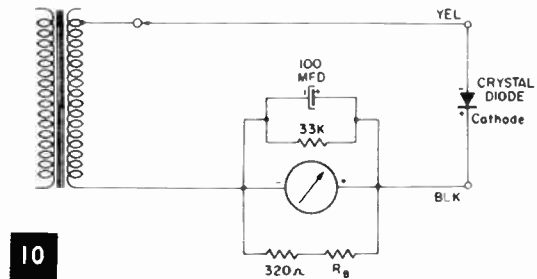
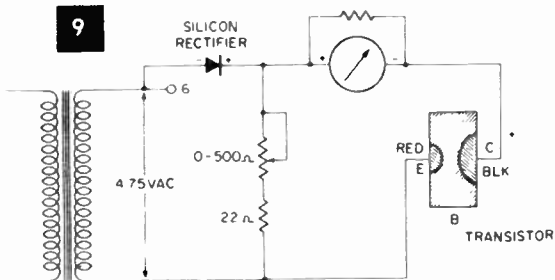
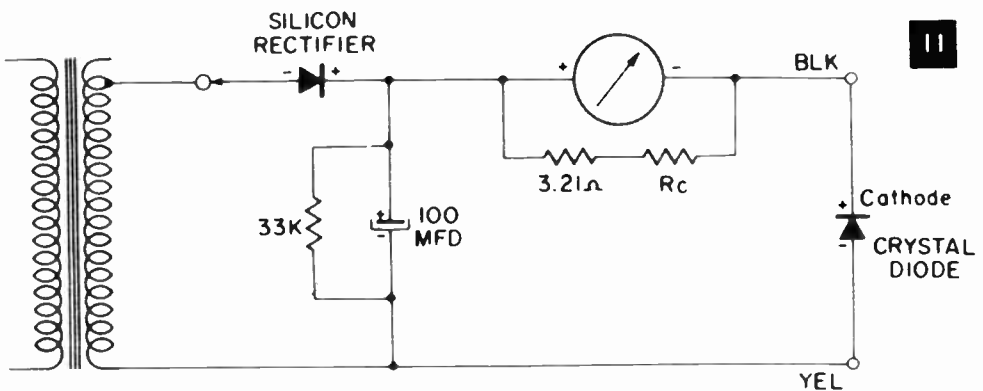
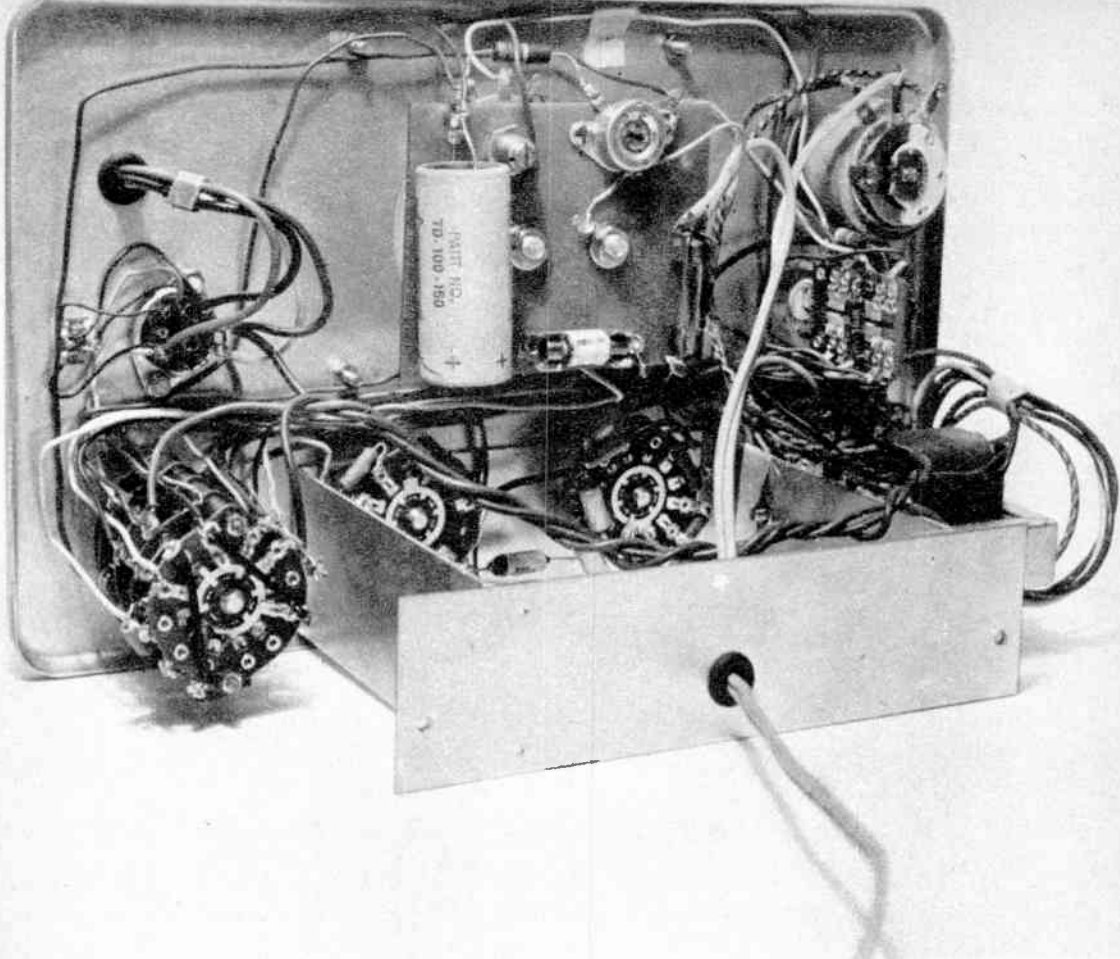

Fig. 9 shows T-65 circuitry for emitter-to-collector current test; Fig. 10, for forward-current test on crystal diode. Latter rectifies AC from the transformer, and the DC registers on the instrument's meter.



To check a diode's ability to withstand reverse current, DC is applied to it in this manner. In all cases, the meter readings must be compared to normal ones, as indicated by the test data chart.





Seen in this photograph is the interior of the Paco transistor checker, which was assembled from a kit. The wires carry only 60-cycle AC and low-voltage AC, so they can be pushed together safely.

be hooked up wrong very easily. The user must exercise great caution in checking the leads before applying test voltages. The lead arrangements of various common transistors are shown in Figures 4, 5 and 6, which are well worth saving for future reference.

The equivalent circuit of the Paco T-65 tester for a short-circuit test on transistors is shown as Figure 7. The silicon rectifier in combination with the 100 mfd. filter capacitor sends a small DC voltage through the transistor in series with the meter. The 27.1- and 640-ohm resistors are representative of the units that limit the current to a safe value for each type of transistor. Note that for this test the emitter and the base are connected together. The color notations *red*, *yel* and *blk* merely identify the

flexible test leads on the panel of the T-65 instrument.

The Icbo test circuit puts current through the base and the collector, as in Figure 8. For the beta or gain test, Figure 9 shows that the emitter and the collector are hooked in.

Crystal diodes are tested very simply. In Figure 10, the diode itself rectifies the AC from the tester's transformer, and the meter then reads the Df or diode forward current. The Dr or diode reverse current, which is very much smaller in a good rectifier, is obtained by putting DC through the diode, as in Figure 11. In all cases, as emphasized previously, the meter readings must be compared against the normal ones in the test data chart for the transistor being checked. •



# Transistor Intercom Is Always Ready

It draws no current in "stand-by" and can be turned on from either of two stations

**A** TWO-STATION INTERCOM that can be activated instantly at *either* end of the circuit, yet draws absolutely no current while it is in the stand-by condition, can now be constructed easily and inexpensively, thanks to the development of transistors of appreciable audio power capability. Furthermore, the system is

completely free of shock hazard, an important consideration for parents who find an intercom invaluable for baby-sitting purposes. The entire source of energy is a small nine-volt dry battery. There is no connection whatsoever to the 115-volt AC power line.

The feature of zero current in stand-by

makes the transistor intercom of particular interest to users who need direct communication only infrequently, but who want it quickly and without fuss. The common AC-DC tube-type intercom must be turned on at the "master" position and left on in anticipation of calls. Because it runs pretty hot, the owner tends to turn it off during what he thinks are quiet periods. Invariably, that's just when a call must be made in a hurry!

Many applications for such a convenient system suggest themselves: between front door and the kitchen, to help the woman of the house repel unwanted salesmen; between different levels of a house, particularly between the living quarters and a basement shop or darkroom; between a front office and a warehouse; between a sales floor and a stockroom; etc.

Two single-pole switches added to a more or less conventional audio amplifier circuit are unexpectedly the secret of the system. Look over the accompanying schematic diagram of an intercom available in kit form from Lafayette Radio. The resistors and capacitors are standard. The transformers are miniature units made especially for transistor equipment. T1 is

the Argonne AR125 input transformer; T2 the AR119 push-pull driver; and T3 the AR109 push-pull output. SW1, indicated by the dashed line, is a three-pole spring-loaded lever switch, Centralab No. 1457, the "press-to-talk" switch found in many commercial intercoms. SW2 is one of the extra switches mentioned before. In its open position it is marked "private," and closed, "baby sitter."

There is a third switch, SW3, mounted on the top of the remote loudspeaker. This remote connects to the master by a four-wire cable. Actually, a three-wire cable would do just as well, as one side of the remote speaker and one side of SW3 go to a common ground. SW3 is of the momentary contact type, and remains closed only as long as its button is pressed.

The diagram shows SW1 in its "receive" position; that is, the lever is up. SW2 is in its "private" or open position.

Now pick up the + side of the nine-volt battery, in the lower center of the diagram. Trace it to the left, where it goes to one side of SW2 and to pole A of SW1. Both of these switches being open, the + line is open here. Now trace the battery + to the right, and note that it goes only as far as

Intercom "master," seen in detailed view, left, is small and compact. It is mounted on filing cabinet in basement office, below, in easy reach, and connected to remote unit in kitchen upstairs.



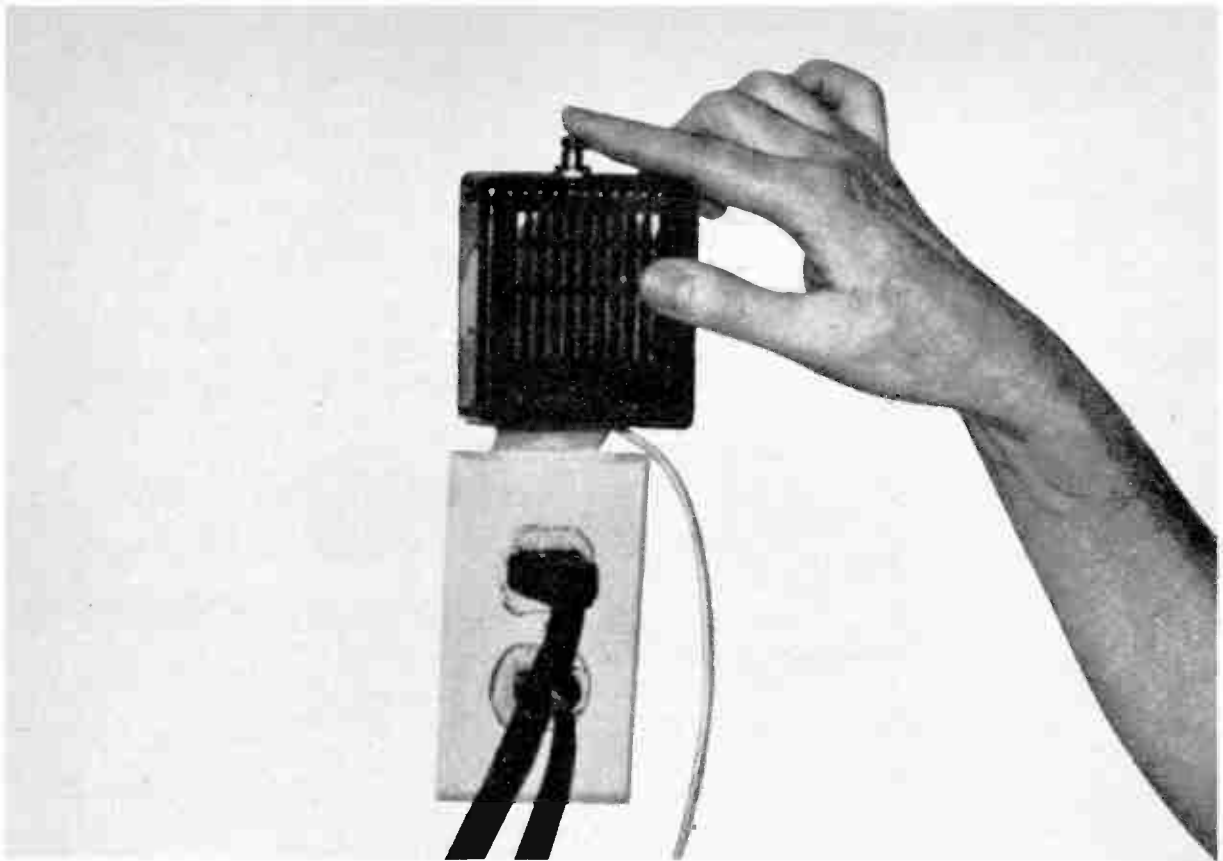

Tiny remote unit is attached to kitchen outlet plate, has convenient control switch on top edge. Indicated is one of three thumb-size transformers, in shot of partially-assembled master unit, left.

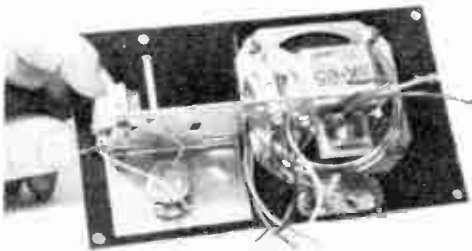

Completed master unit, with battery attached. The wiring is tight, but there isn't much of it.

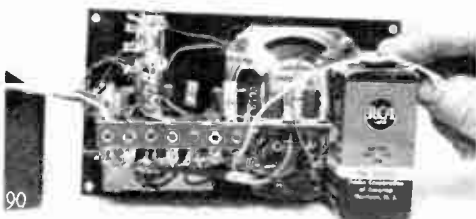

one side of SW3, which is also open. The battery + is isolated completely; in other words, the transistor amplifier circuit is dead because it receives no current from the battery.

Suppose the person at the remote position wishes to call in to the master. He presses SW3, and instantly the amplifier circuit is alive because the battery + connection to ground is completed. He talks into the remote speaker, which acts as a dynamic microphone. The weak current generated in the voice coil by the movement of the diaphragm goes over the connecting cable through contact C of SW1, into the primary of T1, and is amplified by the four transistors. The strengthened signal appears across the secondary of T3, goes through contact D of SW1, and comes out of the master's loudspeaker.

When remote is finished talking, he can keep SW3 down or release it. It doesn't make any difference because when master answers, he pushes SW1 down, closing contacts A and B and again putting battery + to ground. His own speaker, now connected to T1 through contact E of SW1, acts as a microphone, and his amplified voice goes out through contact F to the



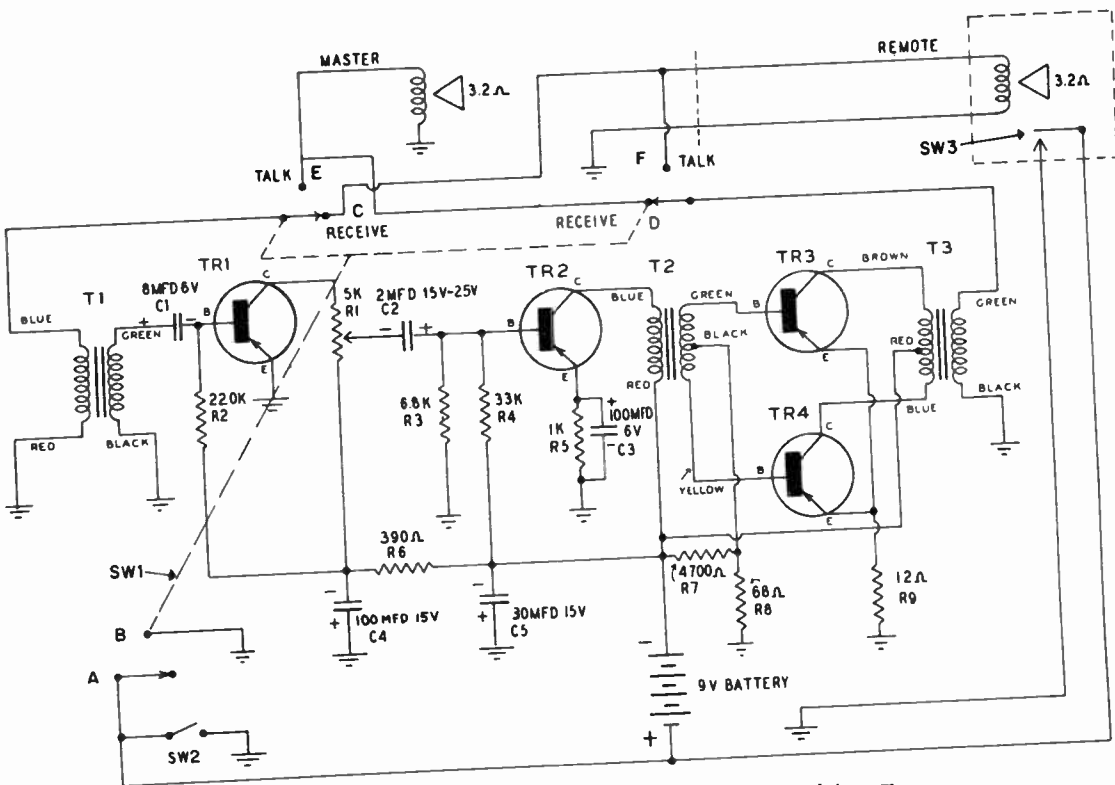

Wiring diagram of Lafayette Radio's KT-113 transistor intercom.

remote speaker. When both persons stop talking and take their hands off their respective switches, the system goes dead again, automatically.

If master wants to initiate a call, he merely presses SW1 down. Contacts A and B ground the battery and the system is alive, although SW3 at the remote is open.

Note that there is no actual "on-off" switch in this arrangement. SW2 serves the purpose.

If the conversation is to be a long one, master can move SW2 to the "baby sitter" position. This keeps the battery + grounded, and thus saves remote the bother of manipulating his switch SW3 when it's his turn to talk. Of course, master must still press his own switch SW1 to talk and release it to listen.

SW2 is kept closed for baby sitting and other applications requiring master to have complete control. With SW2 closed, any sound in the vicinity of the remote speaker is reproduced in the master. For front-door-to-kitchen communication, SW3 can be eliminated altogether and only a two-wire cable used between remote and master. SW2 then acts as a true on-off switch.

Following the diagram shown, you can build up this intercom in boxes or cabinets of any desired size. The Lafayette KT-113 kit includes a one-piece black molded meter case, measuring only 3¾ by 6 by 2 inches and containing the entire master, including the battery. The remote is about the size of a king pack of cigarettes. The speakers themselves are two inches in diameter. Of course, larger ones may be used with a considerable improvement in tonal quality.

The sensitivity of the system is nothing less than amazing. I have the master next to my desk in the basement of my house, with the remote fastened over the toaster outlet in the kitchen, on the floor above. When my wife talks anywhere in the kitchen, I have to turn the volume control R1 down almost to zero to keep the master speaker from blasting. At a measured distance of 30 feet down a hall and around a corner into a far bedroom, we are still in good contact without raising our voices. I particularly appreciate the advantages of this electronic communication when she presses the switch on the remote and whispers invitingly, "Supper's ready. Come and get it!" •



# Novice Ham Station

A 6-tube transmitter and 7-tube superhet all in one unit, Communicator III enables you to put that novice-class license to immediate use

Receiver controls are at left bottom, transmitter controls above them on Communicator III, powered by wall outlet here. Note 22-inch antenna.



**N**EW RADIO "HAMS" who obtain the novice-class Federal Communications Commission license usually want to go on the air immediately with a voice transmitter. They know that novices may use only one phone channel, 145 to 147 megacycles, part of the "2-meter" band. They are somewhat surprised to learn, from visiting radio dealers or studying manufacturers' catalogs, that none of the standard multi-band receivers or transmitters on the market take in 2 meters. Receivers can be adapted to this band by means of external converters, but transmitters are invariably more or less special.

Recognizing the eagerness of novices to put their newly-acquired licenses to work, veteran manufacturer Gonset developed an all-in-one 2-meter station of rather unique design. It can actually be put on the air, in complete operating order, in less than three minutes after being removed from its packing case.

Known as the "Communicator III," this equipment measures only 10¾ inches wide, 10½ inches high and 8 inches deep, weighs about 22 pounds, and can be carried comfortably for short distances by means of a handle at the top. Finished in cream white, a radical color for electronic gear,

Hamming in comfort! With extension cord from the house bringing AC, Communicator III goes outdoors. Square grille covers its loudspeaker.

it is a real eye-catcher and conversation piece.

No space inside the cabinet is wasted. The station comprises a full 7-tube super-heterodyne receiver with built-in loudspeaker, a 6-tube transmitter rated at six watts, and a versatile power supply that permits the station to be operated with equal effectiveness on either regular 115-volt AC house supply or the 12-volt DC system of an automobile. The latter section can be adapted for 6 volts if desired.

Two power cords are furnished, one for AC and the other for battery operation. The plug connections are arranged so that the right circuit elements are selected automatically for the respective supply voltage; no switching-over in the station is required.

A 6-inch-high telescoping antenna that opens up to 22 inches plugs into a connector behind the carrying handle. This is astonishingly effective for short-distance communication, say up to five or eight miles. However, because radio waves of this frequency tend to act like light waves, much greater range is obtained through the use of high, unobstructed antennas, which connect to the transmitter proper by ordinary coaxial cable. I know of one New York

Here the one-unit station takes battery power from a sports car. Its antenna, which telescopes to six inches, can be removed in a few seconds.





owner of a Communicator III who lives on the second floor of a 25-story apartment house and has a coax line almost 300 feet long running to an antenna on the roof. With this, he enjoys wonderful results.

The transmitter is crystal controlled, with six crystal positions. Operation with a standard hand microphone is convenient push-to-talk.

The ease and simplicity of tuning in both the transmitter and receiver sections make the Communicator III a joy to use. After examining a sample set in my den, I hooked up the AC line cord, pulled out the toy-like antenna, plugged in a beat-up Signal Corps T-17 microphone, and turned on the power, just to see how the controls worked. Within an hour I worked four stations, the nearest about a thousand yards away, the most distant about 15 miles. This was during the middle of a week-day afternoon, when the 2-meter band is normally very

quiet. Over a week-end, I contacted stations by the dozen.

With the AC extension cord run out from a nearby room, I set up the station on a small table in the back yard, and spent hours making and answering calls. To try the battery power supply, I packed the station into my car, drove to a nearby high spot, ran the power cord to the cigarette lighter, and in a few minutes my first CQ brought a deluge of answers. I can readily see that the Communicator III makes a wonderful portable rig. Use it at home, in favorable spots on the road, in motels or hotels when you travel.

It should be mentioned in passing that the 2-meter band is not the exclusive province of novice-class operators. Like all the other ham bands, it is fully open to general-class operators. Lots of experienced amateurs enjoy it as a change from the 10- through 80-meter bands. •

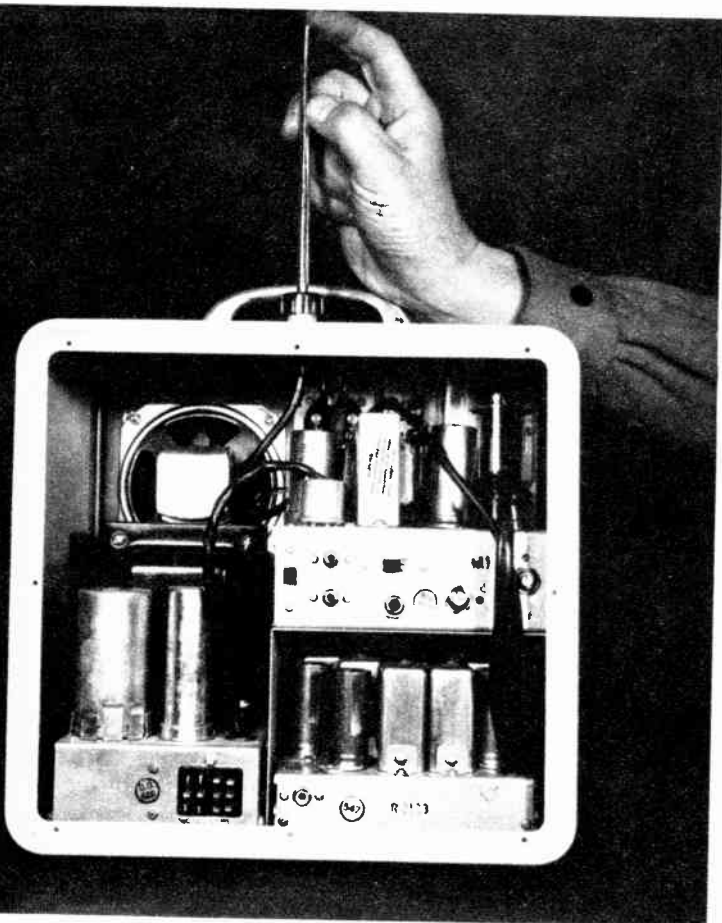

Rear view of Communicator III reveals its well-filled cabinet. Transmitter section is at upper right, receiver at lower right, convertible power supply and loud-speaker are at the left of photo.



# One Whip — Three Bands



**M**ULTI-BAND OPERATION of a mobile ham transmitter in an automobile has always been difficult because of physical restriction on the antenna. Ungainly loading coils, motor-driven tuning coils and other expedients have been used, and are generally cumbersome and unwieldy.

It will therefore be good news to mobileers that Carl Mosley, W4FQY, who is very well known for his excellent big beam antennas, has come out with an ingenious trap-type whip that works perfectly on 10, 15 and 20 meters without any adjustment or manipulation whatsoever. Just flip the band-change switch on the transmitter and you're in business on whichever of these bands happens to be open. Known as the MA-3, this antenna has one loading coil at its bottom and another about half way up, and is eight feet high overall.

Does it work? Here's an excerpt from the log of W2DJJ, operating mobile with a Gonset G-66B receiver and a Gonset G-77 transmitter and a new Mosley MA-3, from Long Island:

1.45 p.m. Heard K5ISD call CQ on 10 meters. Gave him short call. He came right back. Good contact. He's in Sweetwater, Texas.

2.05 p.m. Switched to 15 meters and called CQ myself. Immediate answer from W6IJU, in San Francisco.

2.15 p.m. Switched to 20 meters and called CQ again. Answered by W9MCE, in Springfield, Illinois.

Three hops clear across the country in half an hour on the first try! You can't do much better than that. •

The Mosley MA-3 whip mounts in regular antenna base. Loading coils at base, center, are completely sealed. This is W2DJJ/mobile installation.

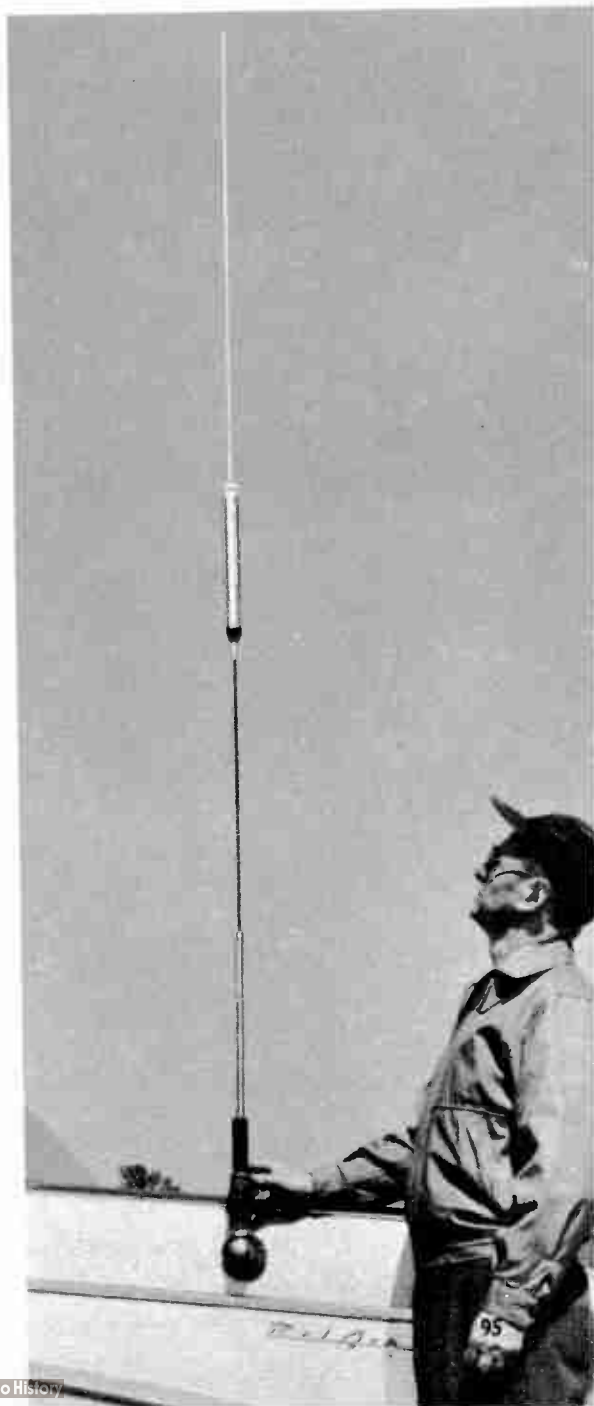

# Ham-Band

# Converters

Small two-tube units permit reception on 2- and 6-meter bands with regular receivers



**M**OST of the high-grade ham communications receivers now on the market cover the 10-meter through 80-meter or 10-meter through 160-meter bands. However, only a very few take in the 6-meter phone band assigned to holders of the "technician" grade license, and not one takes in the 2-meter phone band assigned to "novices." This means that technicians and novices must have special receivers for these bands or use converters in conjunction with standard receivers.

Since most hams own or expect to own some sort of a general-purpose communications receiver, the common practice is to hook converters to it. This is a cheap and simple solution, as such converters are very small, consisting usually of a stage of amplification at the signal frequency, an oscillator section and a mixer section. The oscillator and mixer functions are combined conveniently in a single triode-pentode converter tube. The schematic diagram of a typical converter is shown herewith.

The antenna is disconnected from the antenna post of the receiver and connected instead to the antenna post of the converter. The output post of the latter is now run to the antenna post of the set.

The antenna and the mixer grid circuits of the converter are made deliberately

broad so that they respond to an entire band without requiring manual tuning. In the case of a 6-meter unit, for instance, the circuits cover 50 to 54 megacycles; a 2-meter unit, 144 to 148 megacycles.

The oscillator is invariably crystal-controlled very accurately at a fixed frequency. A representative figure is 43 mc. for a 6-meter converter. All incoming signals from 50 to 54 mc. mix with the locally-generated 43 mc. signals. By conventional heterodyning action, "beat" or intermediate-frequency signals equal to the difference between them are produced. Thus, a 50 mc. signal appears in the output circuit of the mixer tube as 50 minus 43 or 7 mc.; 51 mc. as 51 minus 43 or 8 mc.; 52 mc. as 52 minus 43 or 9 mc., and so on to the end of the band at 54 mc., which comes out as 54 minus 43 or 11 mc. The output circuit of the converter is also broad-banded to handle this range of signals.

The idea now is merely to switch the receiver to the band that covers 7 through 11 mc. and to pick out the signals you want by turning the dial.

In the interest of accuracy, it must be mentioned that when two signals of slightly different frequency are mixed, not one but *two* "beats" are produced. One is the arithmetical *difference* and the other is



The FCV-2 converter is seen above receiver at left without its shield can, which is simply an aluminum box. The printed-circuit board directly above is part of the kit and makes construction simple. Numbers on board serve to identify parts.

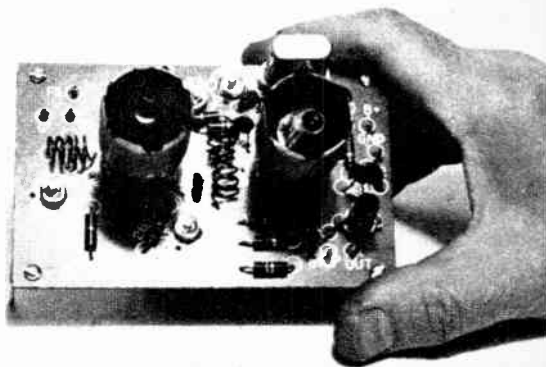

Completed converter is but a handful. Crystal is behind right-hand tube. Note how resistors, capacitors, and coils fit holes in the printed board.

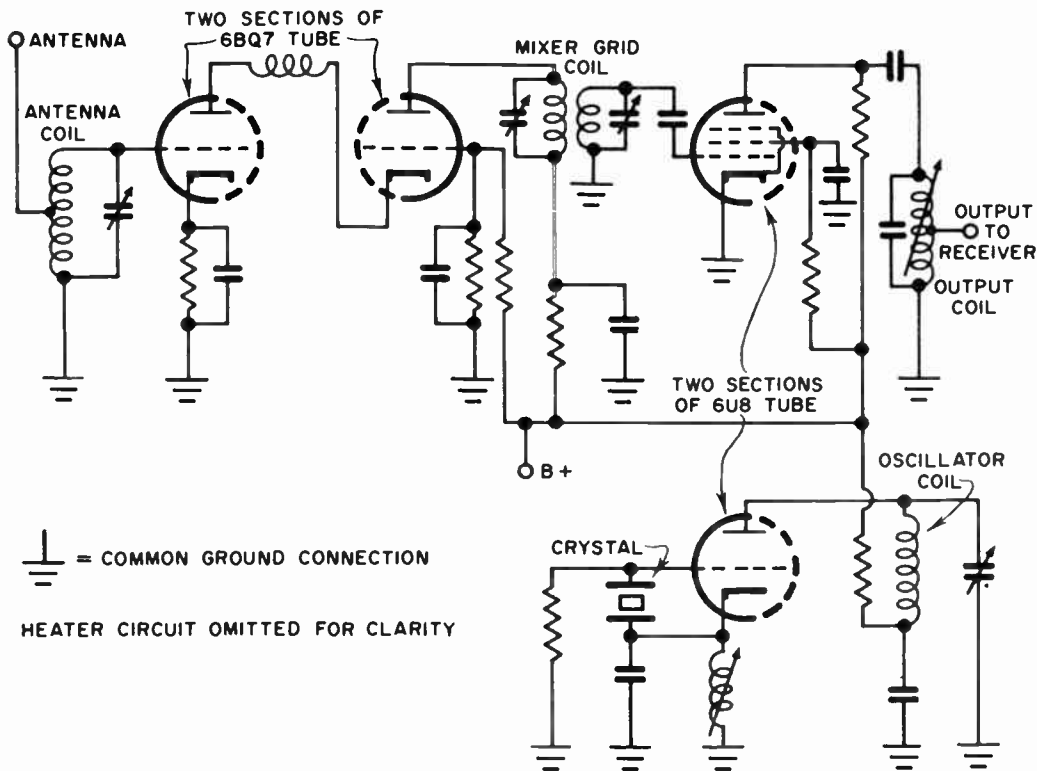

This is the basic diagram of the two-tube converter. Heater and plate power are obtained from "accessory" socket, found in most communications receivers.

the sum. Mixing 50 mc. with 43 mc., as described previously, gives signals of not only 7 mc. but also 93 mc.; mixing 54 mc. with 43 mc. gives not only 11 mc. but also 97 mc. Both sets of beats appear in the output circuit of the converter, but because this is tuned only to respond to the 7-11 mc. range, the 93-97 mc. beats are in effect lost.

For 2-meter operation, the crystal could be 45.666 mc., with the oscillator tuned to emphasize the third harmonic of this frequency, or 136.9998 mc.; let's call it 137 mc. The 2-meter band runs from 144 through 148 mc. Again only the difference or low-frequency beat is used, so signals at 144 mc. appear in the output stage as 144 minus 137 or 7 mc. and at 148 mc. as 148 minus 137 or 11 mc., exactly as before. The sum-frequency beats, between 281 and 285 mc., are again lost.

A point often overlooked by hands interested in using converters is that for full coverage of the technician and novice phone bands the receiver must be of the general-coverage type. Most of the special ham-band-only receivers are not suitable for the simple reason that they don't have the necessary frequency spread. In its

"40-meter" position, a typical set tunes only from 6.99 mc. to 7.31 mc.

An important operating detail is that both the converter itself and the lead between it and the receiver must be shielded quite thoroughly. Otherwise, the receiver picks up lots of signals on 7 through 11 mc., which happens to be a very busy section of the radio spectrum.

Since a converter for the high frequencies depends for its stability and accuracy on the quality of the crystal-controlled conversion oscillator, it is not surprising to find converter kits marketed by a crystal manufacturer. The little job shown in the illustrations is the FCV-2 for 2-meter operation; the FCV-6, for the 6-meter band, is of identical appearance. Both are put out by International Crystal Manufacturing Co.

The entire chassis measures only 2¾ by 4½ inches and uses two tubes and a palmyful of parts, so assembly and wiring are snaps. Because of the frequencies involved, alignment of the circuits is a little tricky, and is best accomplished with the aid of a signal generator and a vacuum tube voltmeter. •



# Solo Code Practice



Simple setup for taping code practice is above. Mike of the recorder picks up signals from the oscillator's speaker. Playback is demonstrated at the right. If you can copy your own sending, you have the makings of a good radio operator.

**T**HE USUAL ADVICE given to would-be radio hams, who must pass a code test to obtain their FCC licenses, can be summarized in one word: *Practice*. Practice is relatively easy if a partner is available, but many times you are alone when you have the time and the inclination to absorb a dose of dots and dashes. What then?

If you have a tape or wire recorder, in addition to a code-practice oscillator, you can readily engage in a unique and highly effective kind of solo instruction. This is the system.

Set up the oscillator and the recorder near each other on a table, with the microphone of the recorder close to the loudspeaker of the oscillator. Tape speed is not important. A standard three-inch reel at 3¾ inches per second provides 15 minutes, which represents a lot of code.

The big idea is for you to record your sending on the tape, and then to attempt to copy it back not sooner than a day later. This can be a very revealing experience indeed! Mercilessly, the tape will show up dots that are too long, dashes that are too short, combinations of dots and dashes that are run together too closely.

For "copy" to transmit for these practice sessions, pick something that you can't guess at during the playback. Stock market quotations from a newspaper are fine, because they consist of letters, full numbers and fractions. Also excellent are passages in a foreign language, which you can pick up from school books.

To check the accuracy of your sending and your receiving, merely compare your transcribed "copy" with the material you used originally.

You can also check your speed very easily. Start the recorder and begin sending some clear text at any convenient time when the sweep second hand of a clock starts around from 12. Send for three minutes. Rewind the tape, play it back, copy the text, count the number of words, divide by three, and you have the rate in words per minute, approximately. For a more accurate check, consider a "word" as a group of five letters.

For the novice class amateur license, the code speed requirement is five words per minute; for the general class license, thirteen. Consistent practice with the aid of the recorder will enable you to achieve either speed. •

# Ham Lingo

Learn the language of your hobby and use it correctly always, or you're strictly a "lid"

**L**IKE OTHER HOBBIES, ham radio has its own private lingo.\* Some of it is quite puzzling unless it is explained in detail.

The term "old man" is fairly familiar as a greeting between males of any age. Do you know how *female* hams are designated? Since women generally dislike the word "old," they are called "YL's," for "young ladies." A married she-ham no longer rates this, but becomes an "XYL," for "former young lady!"

Hams don't communicate with each other; they "work." And they never, never do any "broadcasting." Only a "lid" would use the word "broadcasting" in connection with amateur transmissions. A "lid," then,

\*See also "Electronics Guide," Fawcett Book No. 347, page 54.

is an ignorant person, and more specifically a beginner or prospective ham who hasn't progressed beyond the first lesson.

Voice operation by means of a microphone or "mike" is always "phone," short for "radio telephone." Dot-and-dash operation by means of a hand key is merely "CW," for "continuous waves." In the early days of radio telegraphy hand keys were massive affairs of machined brass, and operators became known as "brass pounders." "Pounding brass" is another way of describing CW operation. A semiautomatic key is a "bug" or "side-swiper."

Earphones are invariably "cans," because the first ones made for radio purposes were large and heavy and looked very much like cans. Loudspeakers, which came much later, don't seem to have ac-

QSL's typical of those received by W2DJJ. Countries represented: (upper row) Canada, Colombia, North Africa; (lower left) Spain, Canal Zone; (lower right) U. S., New Zealand; (center) Germany.



quired any nickname. However, ex-Navy personnel sometimes refer to them as "squawk boxes," which is descriptive.

The meanings of many of the international "Q" signals have been twisted slightly to make them useful as spoken rather than written symbols. For example, QSL? sent by CW means, "Can you acknowledge receipt?" and QSL without the question mark means "I am acknowledging receipt." In ham practice "a QSL" has become to mean a postcard that one amateur sends to another to confirm a contact. Most hams measure their success in the hobby by the area of QSL's decorating their shacks. A "shack," of course, is the

room containing the equipment. Because ham stations several decades ago used very noisy spark-type transmitters, they were often relegated to actual back-yard shacks, and that's how the word originated.

A "breaker" is a ham who tunes his transmitter to the frequency occupied by two others already working each other and then tries to get into the conversation by saying "Break, break." This is not necessarily considered rude; on the contrary, it is great fun for three, five or even more hams to get into a round-robin. Recently I participated in one that encompassed New York, Florida, Illinois, an airplane over Iowa, California, and London! •

"Bug," or semiautomatic key, which makes dots by action of vibrating reed, center, and dashes in usual manner. This is Lafayette Model MS-435.

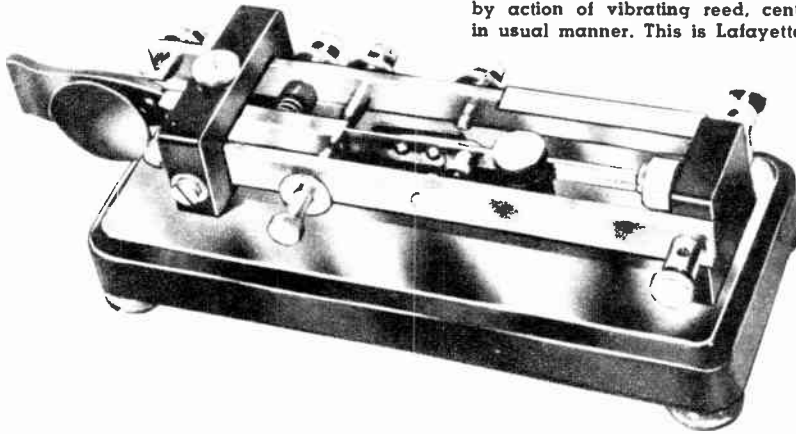

"Straight" key, the use of which is known as "pounding brass." In the early days of radio telegraphy, hand keys were of machined brass.

"Cans," favored by many hams for quiet listening. First made were large and heavy, and looked like cans. Speakers have acquired no nickname.

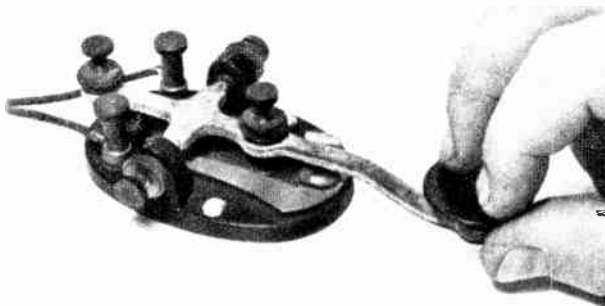

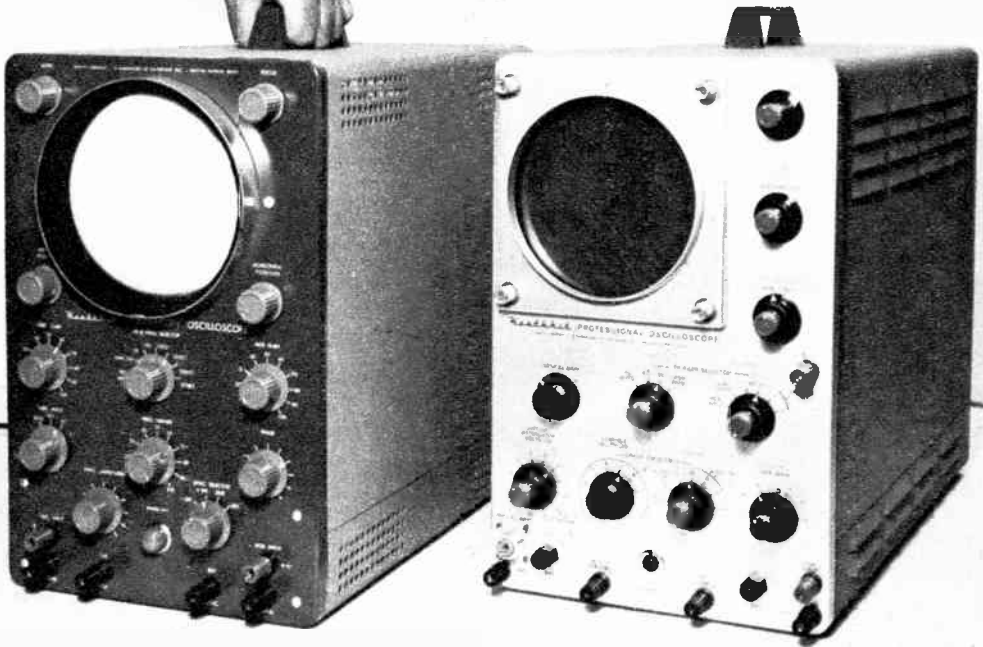

# The Cathode-Ray Oscilloscope

In its use, practice makes perfect. Here are the kit-construction details and basic screen patterns of the fascinating test instrument

**T**HE cathode-ray oscilloscope is undoubtedly the most interesting and versatile tool available to electronic investigators. However, it differs from most other testing instruments in that it requires careful interpretation; just glancing at it isn't enough.

Touch the probes of a voltmeter to a circuit and instantly you know the voltage there. Clip an unmarked capacitor to a capacitance meter and immediately the moving needle tells you its value. On the

other hand, the flickering green lines on a C.R. tube mean something only if you can compare them with published pictures obtained under controlled conditions, or with pictures fixed in your memory through previous experience with similar equipment. Thousands of patterns have been recorded as photographs or line tracings, and appear in numerous guides published for the benefit of electronic technicians in all categories.

The secret of scope success, then, is to



Heathkit O-11 and more advanced OP-1, seen at left, both use tubes of 5-inch diameter. Seemingly dark face of the OP-1 has a ruled green cover, used for comparative pattern measurements.

practice constantly on electronic gear known to be in good working order. A television receiver is an ideal guinea pig for two reasons: 1) It has half a dozen different kinds of signals running around in it; 2) The manufacturer's service notes invariably show the patterns that *should* be obtained at various points. It is highly instructive first to obtain correct patterns and then to observe what happens to them when you put deliberate faults into the circuit. These can be weak or dead tubes, burned-out or short-circuited resistors and capacitors, open connections, maladjusted coil slugs, etc.

If you wish to explore the almost endless capabilities of the scope but don't want to sacrifice the family's TV enjoyment, visit local television stores and see what you can pick up cheaply. Most dealers are eager to get rid of old but perfectly good 10- and 12-inch sets taken in on trade.

In any circuit experimenting, the chassis must be removed from the cabinet. This exposes many "hot" high-voltage points, so exercise all normal safety precautions.

The service notes for most TV sets are quite elaborate, and are indispensable for a complete understanding of the circuit operation. They are obtainable from most parts supply firms in the form of packets. It is absolutely essential to know the exact model number as well as the make of a set when ordering service data. About 50,000,000 television receivers have been produced since 1946, and the manufacturers themselves have difficulty in identifying some of the early units.

High-fidelity systems offer another rich field for scope practice and application. Advanced audiophiles find that while their

ears are often fooled by some apparently minor circuit adjustment, the sensitive eye of the scope isn't. This explains why they buy oscilloscopes in large numbers, along with auxiliary equipment such as signal generators. Many a system that just doesn't sound quite right can be aligned with the aid of a scope for perfect sound. In some FM tuners, a scope is absolutely necessary for the correct setting of the discriminator stage.

To make an impression on visitors, some hi-finatics leave a scope connected in the amplifier circuit, so that they can "see" the sound as well as hear it. This is eye-wash, but it does stimulate conversation.

The oscilloscope is often called the first cousin of the television set. More nearly, it is the grandfather! The cathode-ray tube was developed around the turn of the century by Karl Ferdinand Braun, a German professor who made many contributions to the early art of "wireless." He is hardly known today, but in 1909 he shared the Nobel prize for physics with the famous Marconi.

Prior to World War II the scope was an expensive laboratory instrument. Came radar and television and a flood of surplus military C.R. tubes, and almost overnight the oscilloscope became a fixture in the home labs of hams and experimenters and the shops of radio-TV repairmen.

The popularity of the scope was and still is due in large part to the availability of kits at bargain prices. Scopes using five-inch tubes (more or less the standard size) cost between \$40 and \$70 in knock-down form, and for the advanced technician there is a deluxe model that costs about \$180.

It should be pointed out that a scope is

Typical setup for testing amplifier with audio generator and oscilloscope. Value of load resistor depends on particular amplifier. It is not critical.

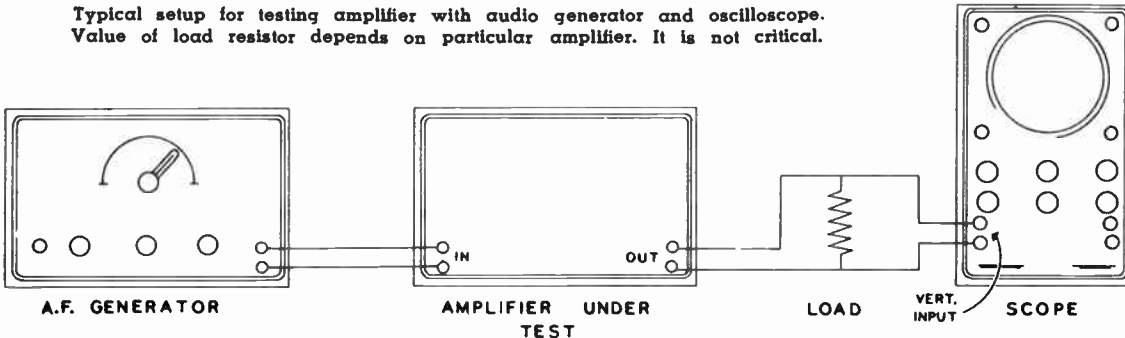

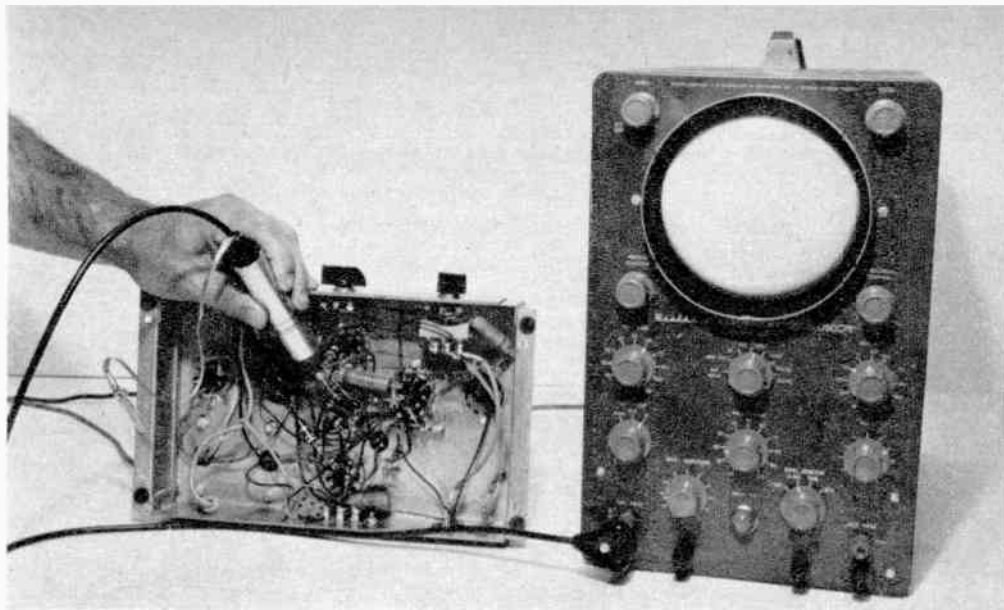

Signal or circuit position to be checked is connected to the vertical input posts of the oscilloscope through various probes that are similar in appearance to those employed with voltmeters.

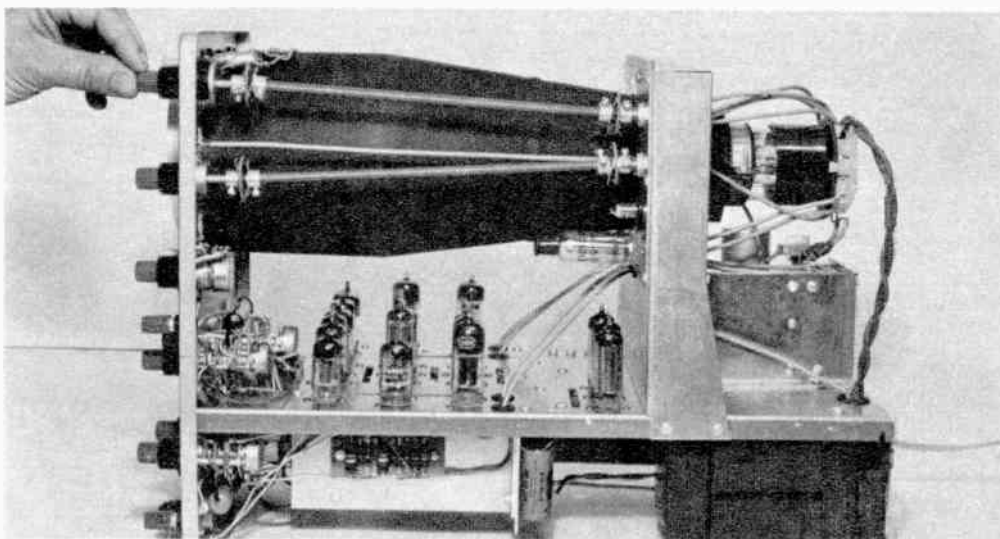

Interior view of completed Heath OP-1 professional type scope, made from a kit. This is a very high-grade instrument. It features 22 tubes, a shielded cathode-ray tube, many circuit refinements as well.

a large and complicated device, and uses from seven to as many as twenty-two tubes. The chassis must be quite deep to accommodate the long body of the C.R. tube, but its very size makes assembly and wiring relatively quick and easy. To show exactly what the job involves, the major steps in the construction of a typical five-inch scope were photographed in detail. Reproduced here, the pictures show the Heath 0-11.

Since they were made, this has been superseded by a new model, the 0-12, but the difference in appearance is slight.

Also included are some basic patterns photographed directly off the face of the C.R. tube. For practical purposes, stationary tracings were used, as the lines are green and require a rather long exposure. (Verichrome Pan film,  $\frac{1}{2}$  second at f. 5.6. normal development in D-76). •

# How to Assemble the O-11 Scope



Rear view of O-11 panel with first parts mounted. These include variable resistors, switches, pilot light, ring support for face of cathode-ray tube. Some wires have been soldered to center switch.

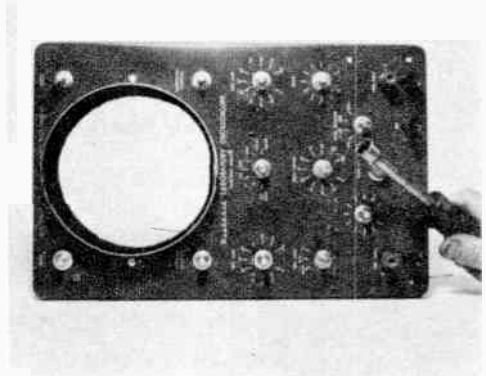

Avoid damaging front panel when mounting parts by using nut driver (or socket wrench), not an ordinary pair of pliers or adjustable jaw wrench.

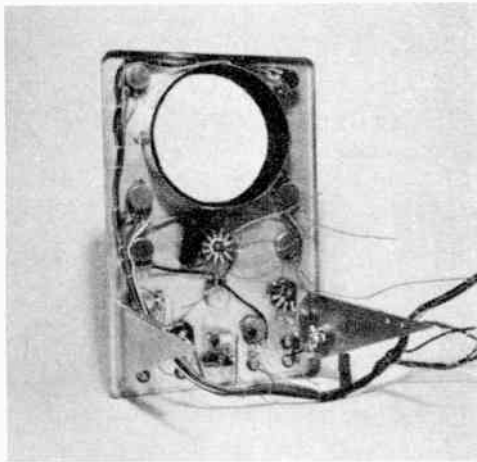

To front panel (left) have been added brackets to support main chassis, preformed wiring harness, and a few small resistors and capacitors.

Wiring of the scope is greatly simplified by use of these printed-circuit boards. Large round holes are for the tube sockets and filter capacitor.

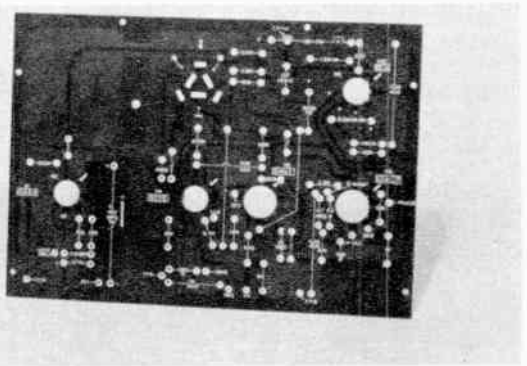
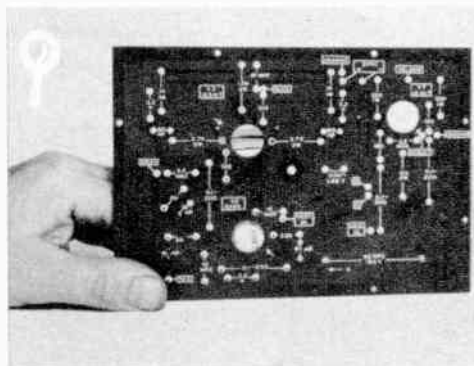

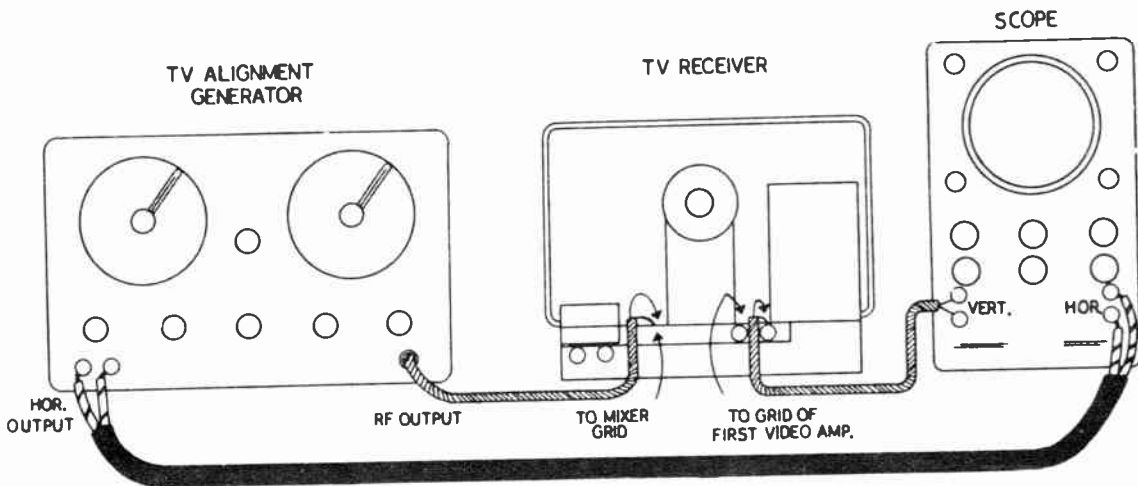

True "alignment" of a TV receiver, complicated and difficult by any other means, is accurately accomplished when the oscilloscope is used as a wave-form indicator. This is the typical bench setup.

Wires protruding through board are soldered to printed metal lines (right of photo). The board at left is complete, wire-ends having been cut.

A pair of side-cutters are employed to cut off the ends of soldered resistor and capacitor wires. They are to be snipped off very close to the board.

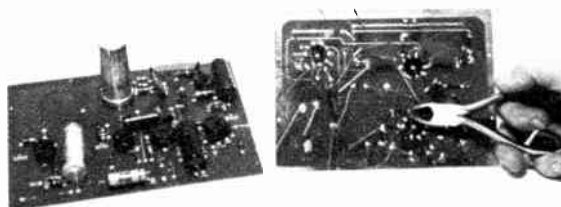
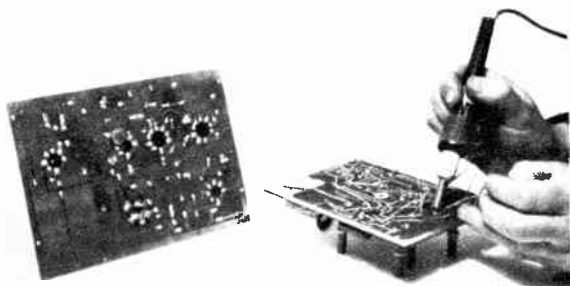

Appearance from top of printed circuit boards. Layouts are neat, uncluttered. Wires will be soldered later to color-identified edge holes.

Power supply chassis of the Heath O-11 oscilloscope. It forms the back end of the oscilloscope's chassis and is completed as a single unit.

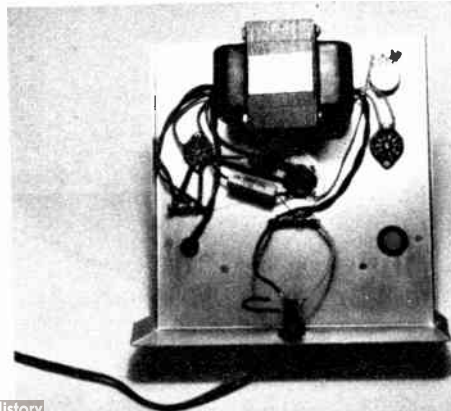
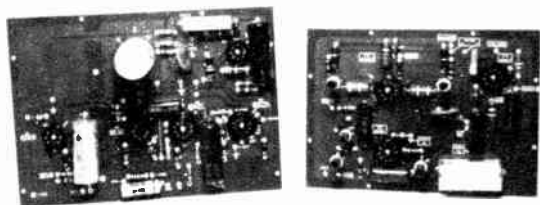



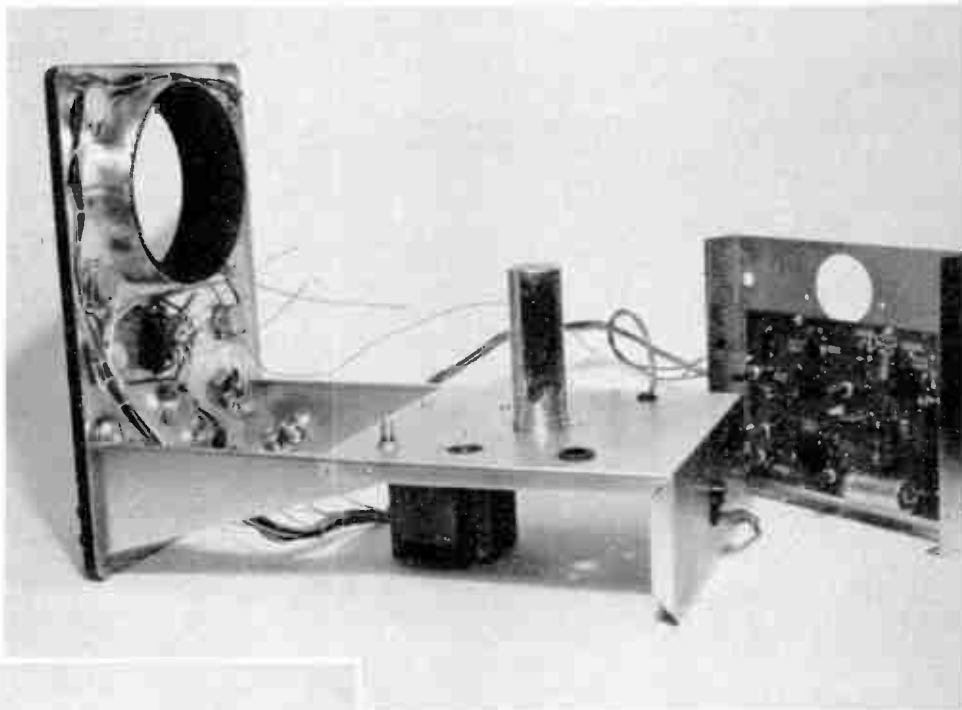

Above, power-supply chassis has been bracketed to front panel to form firm scope-foundation. Printed-circuit board mounts in shallow chassis.

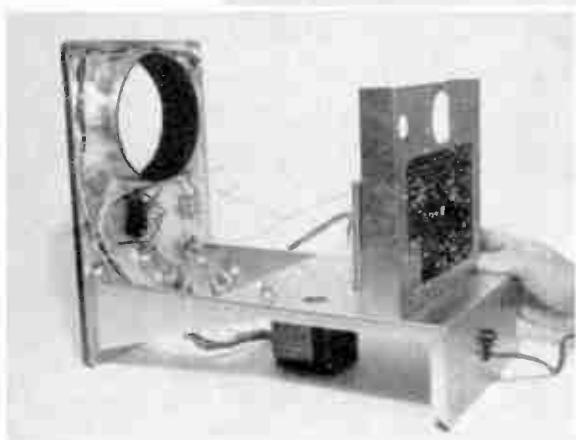

This shallow chassis bolts vertically to top of the power-supply section, as at left. This serves as support for the neck of the cathode-ray tube.

Next step in assembling the O-11 is addition of the second printed-circuit board. It screws into opening on the horizontal chassis, as shown below.

With installation of the second printed-circuit all chassis sections are in position. Interconnections that remain can now be made quickly and easily.

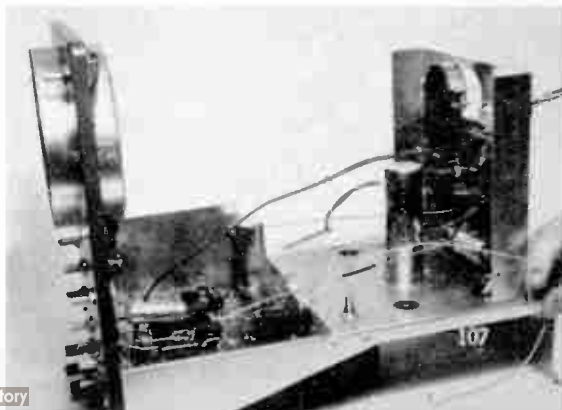
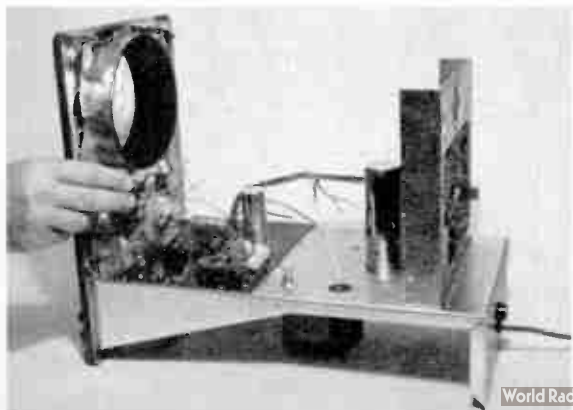

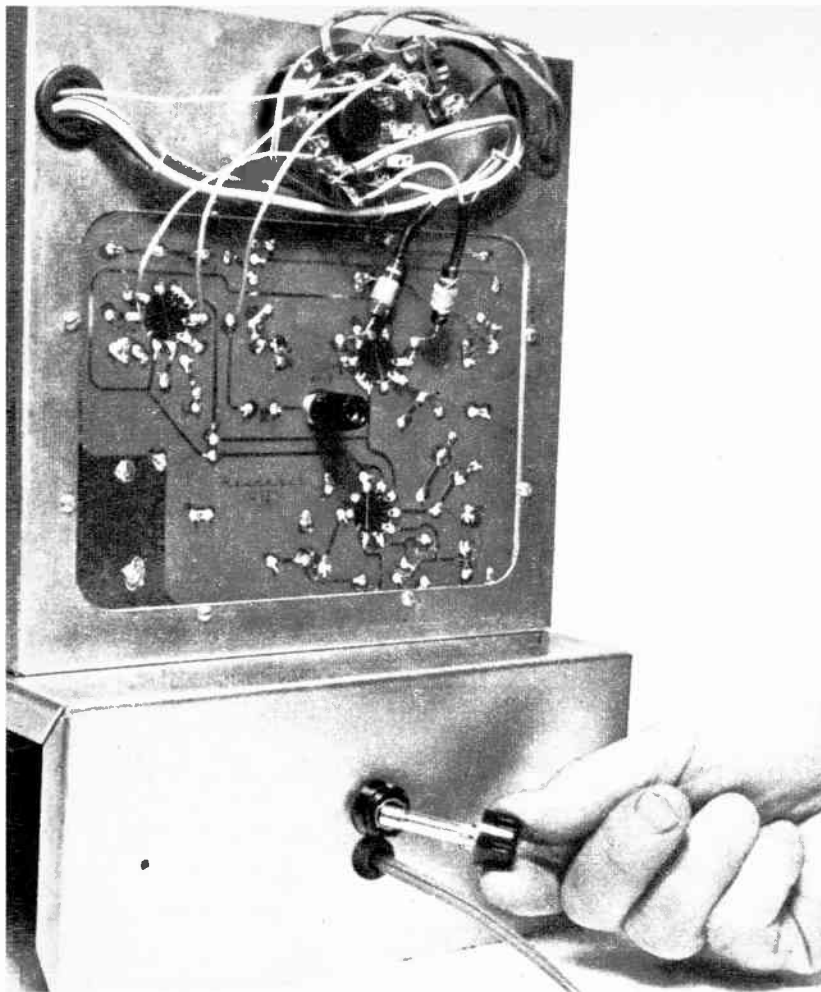

Wiring is complete and large socket is in place over base of C. R. tube. Important step is the insertion of line fuse. Electronic equipment often fails merely because this little detail has been overlooked.

Block diagram of TV receiver and points for oscilloscope application. At R, use direct probe; at D, demodulator probe; H, 7.875 or 15.-750 kc sweep; V, 20, 30, or 60 cycle sweep; A, audio test freq. sweep.

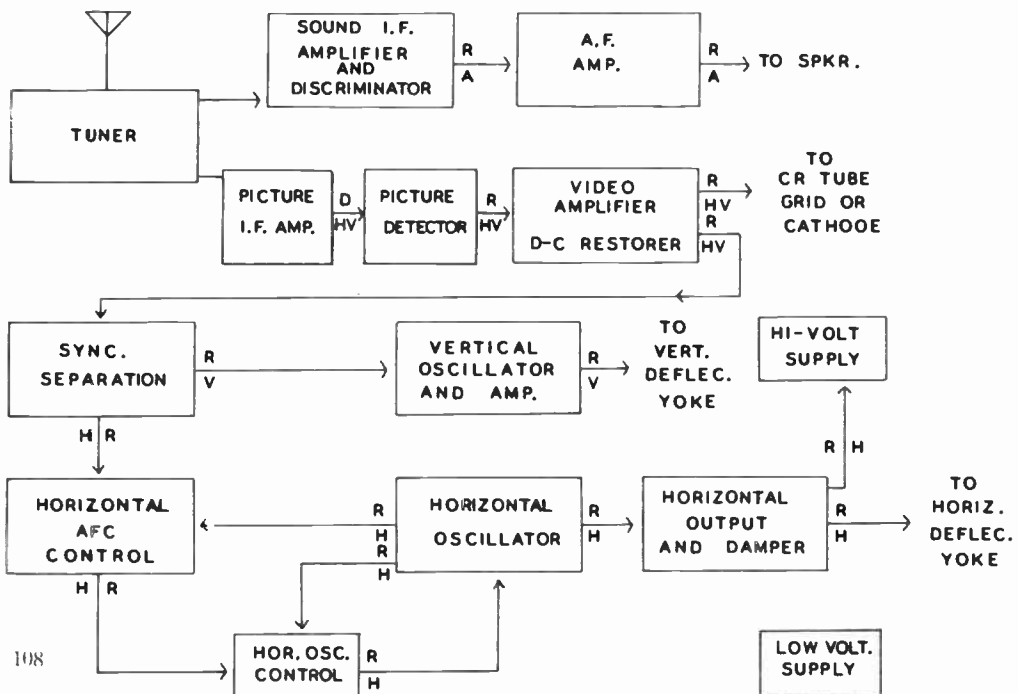

Circuitry of the Heath O-11 scope. As evident, ten tubes, many resistors and capacitors are employed.

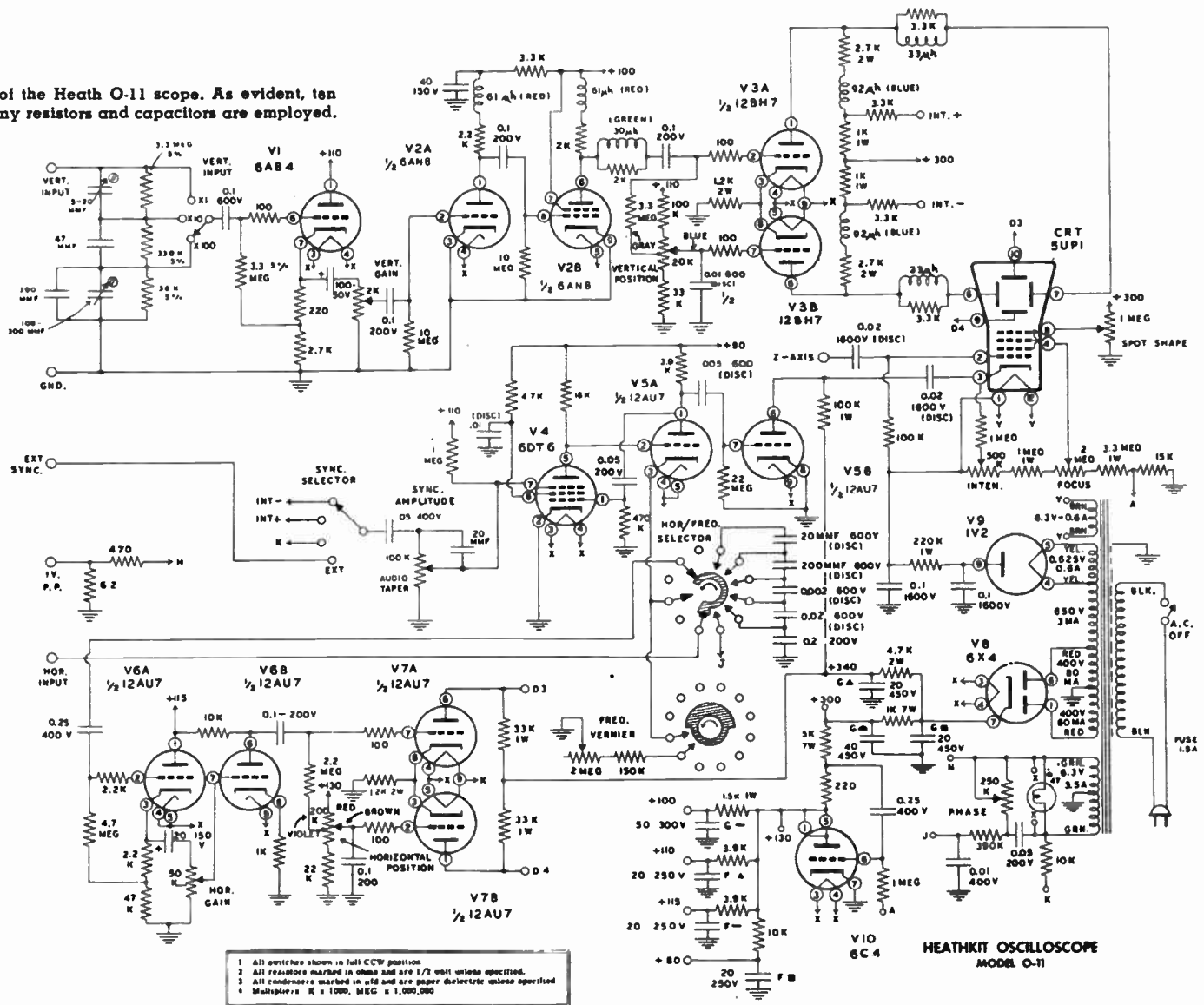

- 1 All switches shown in full CCW position
- 2 All resistors marked in ohms and are 1/2 watt unless specified.
- 3 All condensers marked in ufd and are paper dielectric unless specified
- 4 Multiplier: K = 1,000, MEG = 1,000,000

HEATHKIT OSCILLOSCOPE  
MODEL O-11

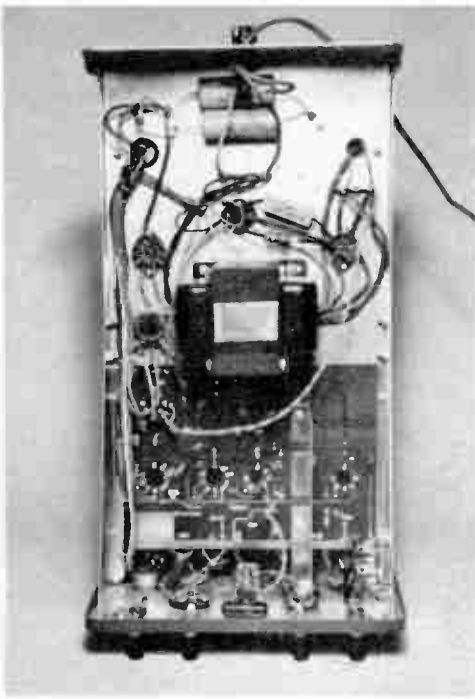

The O-11 oscilloscope stands upright on its front panel, photograph at the left, to show neat appearance of chassis' underside. Placing of the scope's ten tubes is all that remains to be done.

With the cathode-ray tube clamped securely, the scope is complete. Despite numerous interruptions for picture-taking, this fine piece of equipment worked perfectly when first turned on.

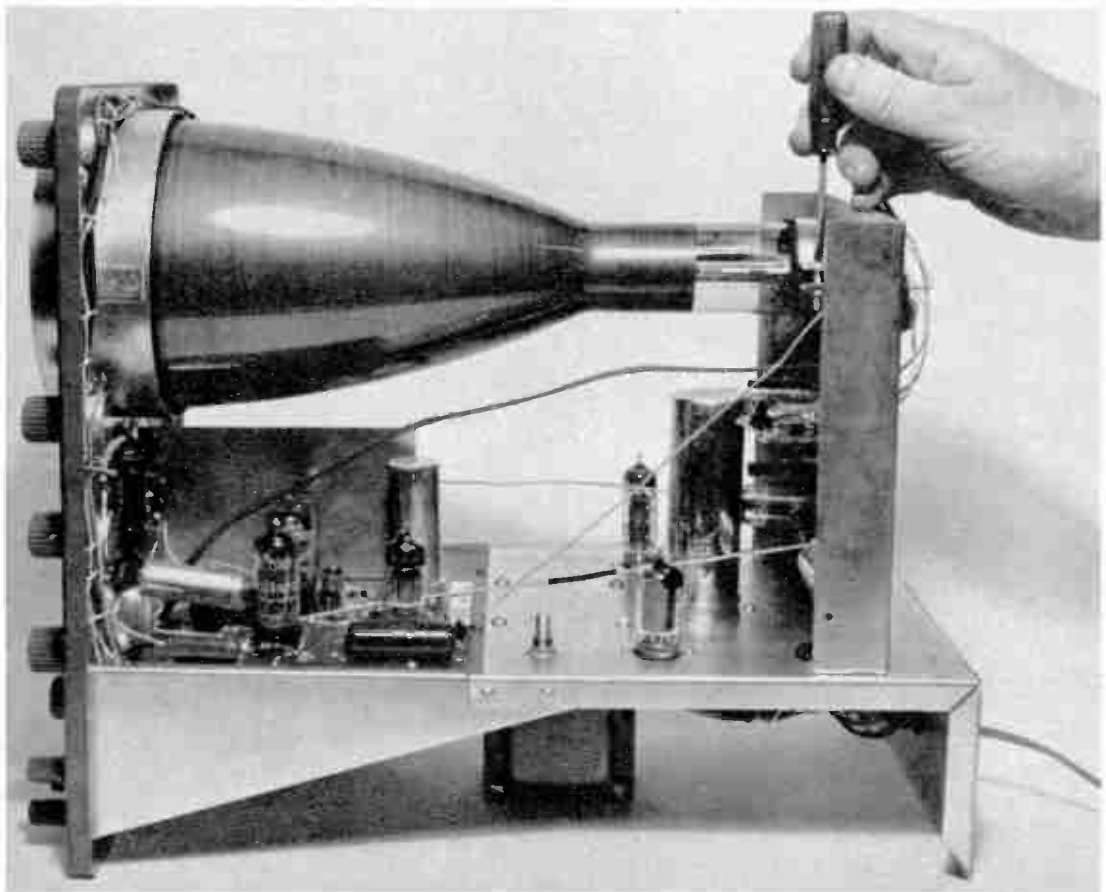



# How to Interpret Scope Patterns

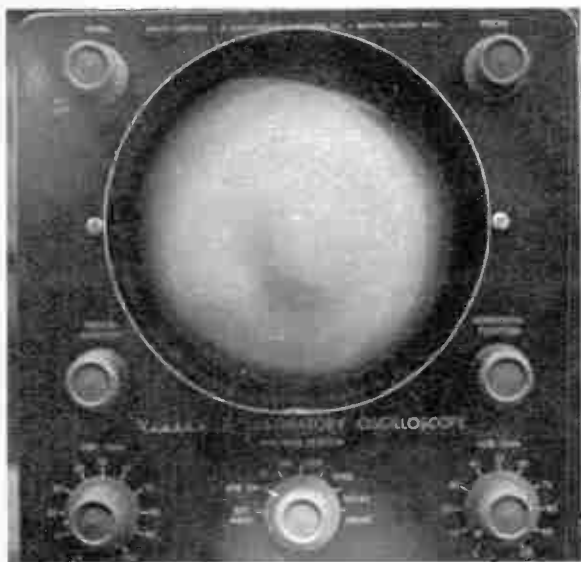

With no voltages applied to either the vertical or horizontal deflection plates, the beam of electrons emitted by the "gun" of the tube shows as a small spot in the oscilloscope screen's center.

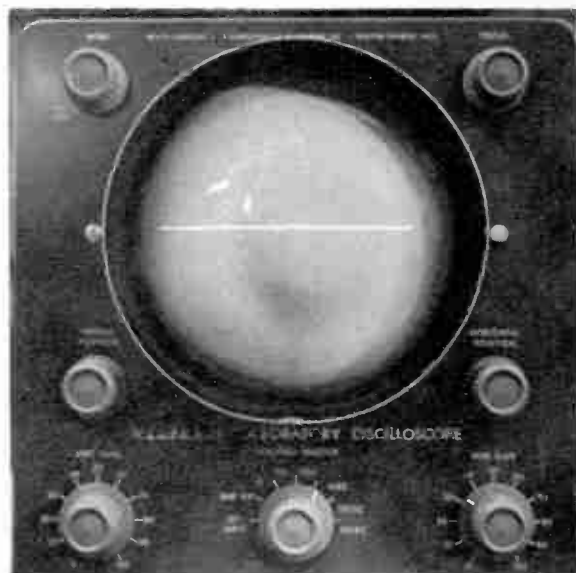

Alternating voltage on horizontal deflection plates (with no input on vertical) sweeps spot back and forth forming flat line. This voltage usually comes from "sweep" generator, an integral part of scope.

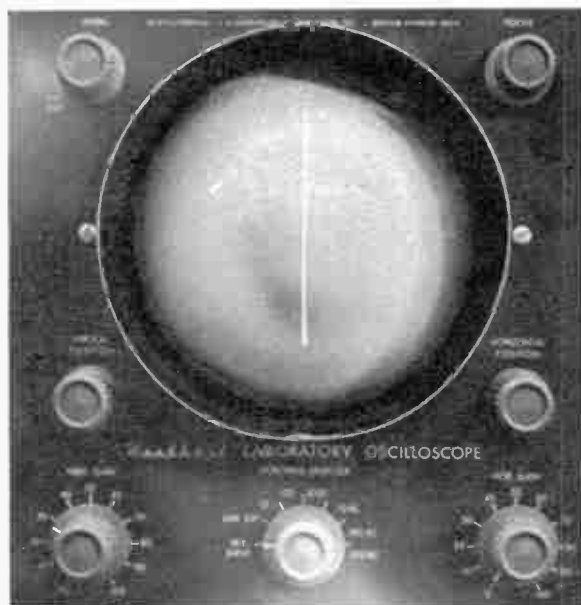

Alternating voltage on the vertical deflection plates (none on horizontal) moves spot up and down, producing a vertical line. Signal to be observed is always fed into vertical circuit.

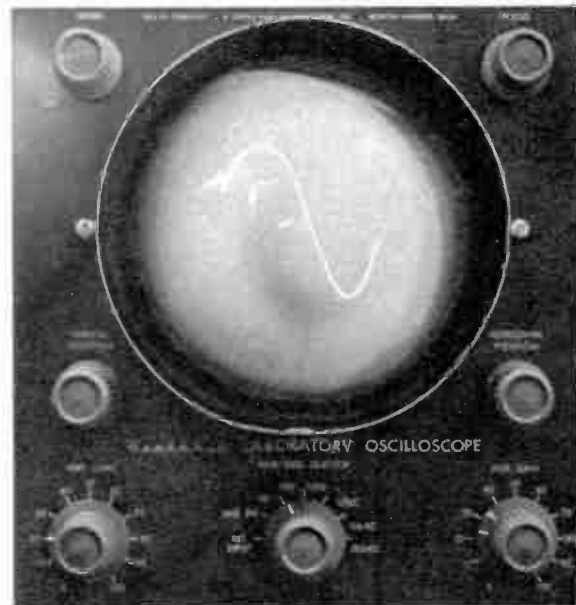

From zero, sweep voltage rises to a maximum, drops sharply, starts over. With sweep at 60 cps, and AC fed into vertical input, resulting interaction on electron beam creates AC "wave form."



Number of AC cycles produced on C. R. tube is ratio of input signal frequency to sweep frequency. Here the input is 60 cps but sweep has been reduced to 30, for two "sine wave" shapes.

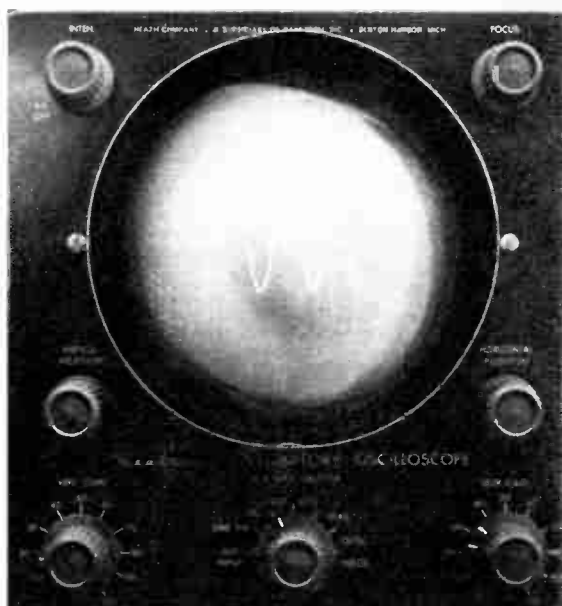

Sweep has now been reduced to 20 cycles, producing three wave forms. Here patterns become jumpy, because the sweep repetition rate nears limit of human eye's "retention of vision" effect.

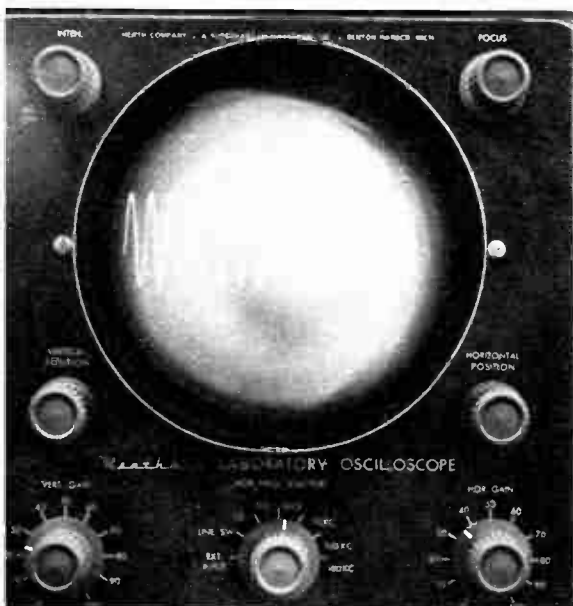

Flicker is no problem at high input signal frequencies; any number of stationary cycles can be obtained. Here, input is 1600 cps, sweep is at 100. The number of complete cycles is 16.



Compound and complex signals can be "seen" because electron spot moves extremely rapidly and the trace it makes on the fluorescent screen of C. R. tube lingers for a fraction of a second.

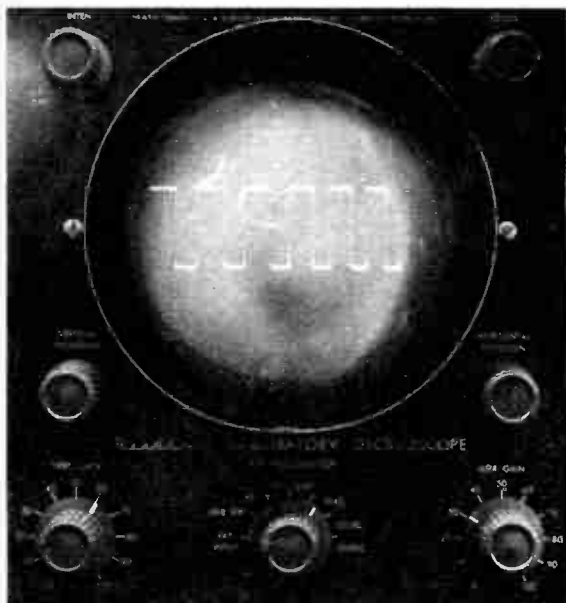

For testing a hi-fi system, a "square wave" is put through. Departure from right-angle pattern is easily spotted. Unlike ordinary AC, the square wave changes value and direction very abruptly.

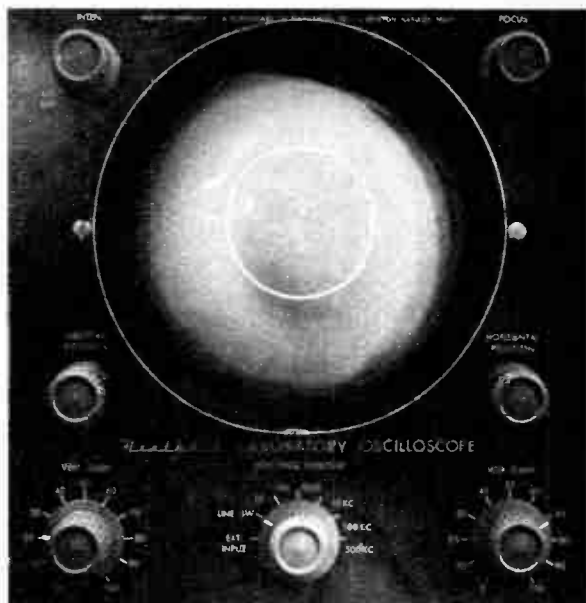

With ordinary AC signals of same frequency on horizontal and vertical deflection systems, pattern depends on "phase." A perfect circle results when they are 90 or 270° out of phase.

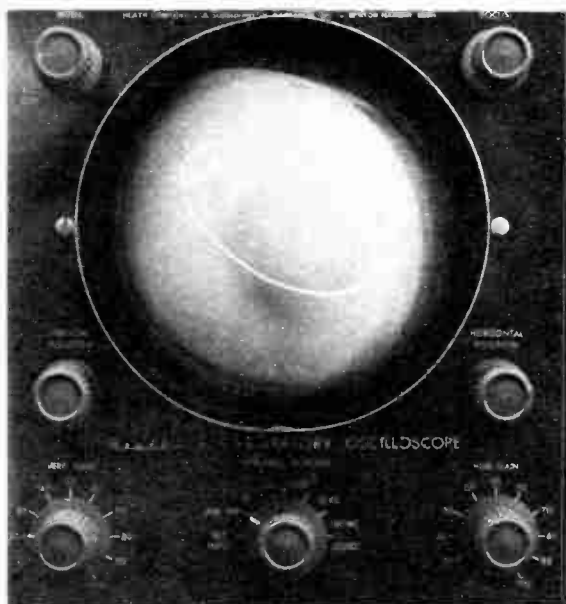

Such an ellipse indicates two AC signals of same freq. are 60 or 300° out of phase. (Signals that rise from zero to max., reverse direction, hit max. and second zero simultaneously are in phase.)

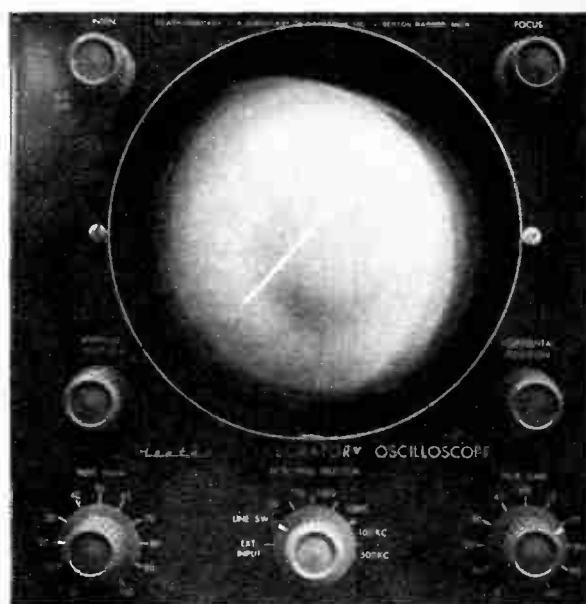

Such a flattened ellipse indicates 180° phase difference. Line leaning in other direction would mean in-phase condition. Intermediate phase relationships of signals can be readily determined.

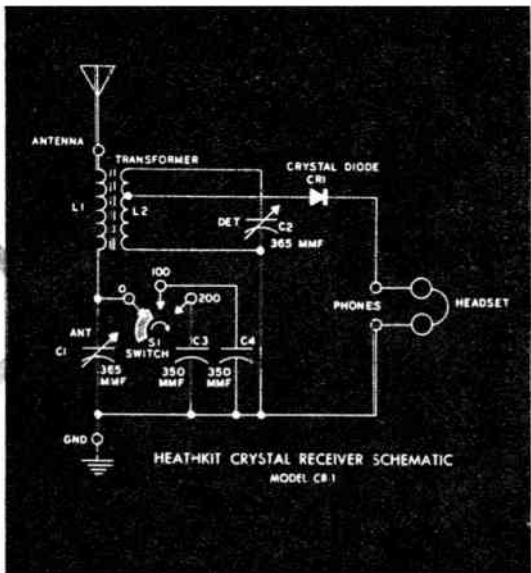

# Crystals Are Here to Stay

The crystal detector, introduced some 50 years ago, is still with us, and in its same identical form

**M**ORE than fifty years young and still going strong!

It is almost incredible that the crystal detector, in the identical form in which it was introduced around 1906, should still be listed in 1958 catalogs of radio supply firms and still be used for radio reception. There are several good reasons for this:

1) Crystals are very cheap. A piece of galena (chemically, lead sulphide), suitable for mounting in a simple holder, costs only six cents . . . *six cents!* A complete mounting kit sells for the large sum of fifteen cents. Somewhat better detectors of other types run between 35 cents and two dollars. And they last forever!

2) Crystals require no batteries or power of any kind. They work directly on the infinitesimal voltages picked up by the antenna.

3) Crystals provide clear signals.

There are some disadvantages, too. Signals generally are strong enough only for earphone reception, and selectivity is rather poor. But the signals are there.

The introduction of crystal detectors is credited to an American engineer, Greenleaf Whittier Pickard, who was a grand-

nephew of the famous poet. He found that many minerals acted more or less as rectifiers of alternating current; that is, they changed it into a rough form of pulsating direct current because they conducted electricity much better in one direction than the other. Galena proved to be the most sensitive to weak currents, but required rather delicate adjustment of a surface-contact wire known to this day as the "cat's whisker." Improved stability and ruggedness were provided by compounds containing silicon or carborundum, both products of the electric furnace.

Even a mineral as common as coal has rectifier properties. During World War II, a crude but workable receiver called the "fox hole radio" consisted of any exposed piece of wire as an aerial, a detector made of a bit of coal resting lightly on the edges of two razor blades, and an earphone.

Like his father or his grandfather before him, many a young radio experimenter undertakes a crystal set as his first effort in electronics. Most of the crystal kits now on the market use fixed, enclosed detectors of germanium. Three popular kits are illustrated herewith. •



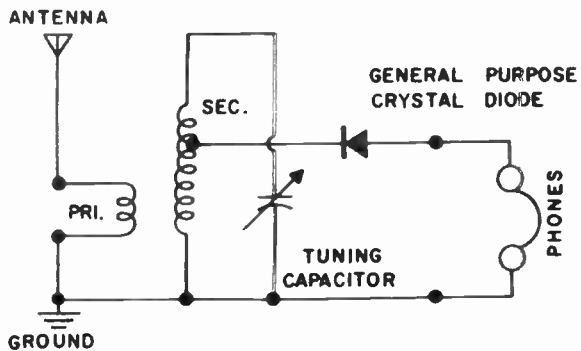
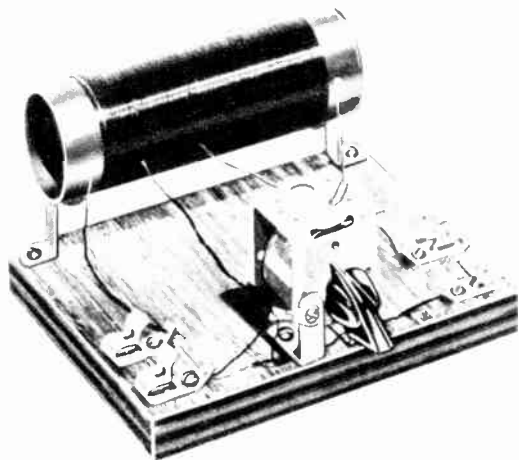

Heathkit crystal receiver, on opposite page, is mounted in molded meter case; earphones are needed. Knight-Kit set, above, is of open baseboard construction. Clips are for antenna, ground, phones.

Philmore's "Little Wonder," right, has classic cat's-whisker detector. It is tuned by center arm, which contacts wire on tuning coil. Germanium is used in Philmore "Selective" kit shown below.

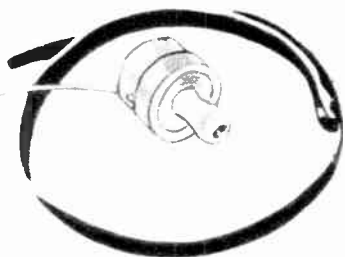
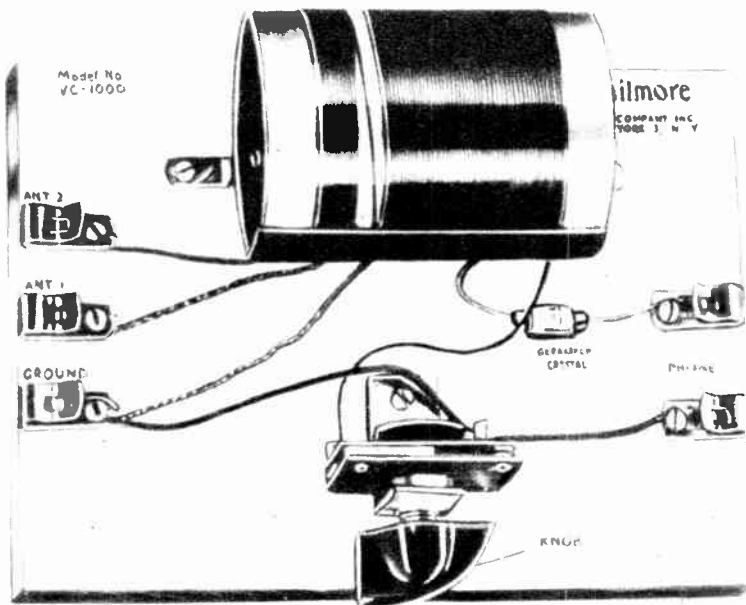

# Operation Crystal

**H**OW SIMPLE can a broadcast receiver be?

As an absolute minimum, you need an antenna of some kind to pick up signals, a crystal detector to change them into audio-frequency current, and an earphone to convert the audio into actual sound. Figure 1 shows the diagram of such a set. Selectivity is not very good, because there are no tuning circuits, but it does bring in local stations with any sort of an outside wire aerial. A ground connection is optional; sometimes it helps, sometimes it doesn't.

Better results can be realized from the circuit of Figure 2. The "tuning coil" shown at the left side of the diagram is one section of an old 2.5 millihenry radio-frequency choke coil. The detector is again a 1N48 diode. The coil, the diode and the .01 mfd. paper capacitor all fit fairly comfortably *inside* the earphone case, as the photo shows. The coiled flexible wire with the clip on it is the aerial lead, and is connected to any handy metal object. Loud, clear signals are obtained from such unlikely bodies as bed springs, fire hydrants, wire fences, automobiles, garden furniture, etc. A real antenna consisting of perhaps 25 or 35 feet of wire of any kind, hung from a window or thrown into a tree, usually brings in stations from miles around. A ground connection is again optional.

In more remote country areas, a fairly large antenna may be needed to extract energy from passing radio waves. Normally, an aerial is supposed to be well insulated at both ends, especially if it hangs from a metal tower or mast. However, an unusual twist is shown in Figure 3. The wire is insulated at the receiver end, but is well connected to the far tower. With a return path formed by the ground, the antenna acts as a huge loop, and under some circumstances gives better results than a conventional all-insulated aerial.

The foregoing ideas were submitted in a small contest called "Operation Crystal," conducted by the "G-E Ham News," the house organ of the receiving tube department of the General Electric Company. •

Earphone connects across 1N48 diode in simplest circuit, Fig. 1. Results are improved by the addition of coil, and capacitor across earphone, Fig. 2. A long wire aerial with grounded end boosts effectiveness a good deal in remote areas. Fig 3.

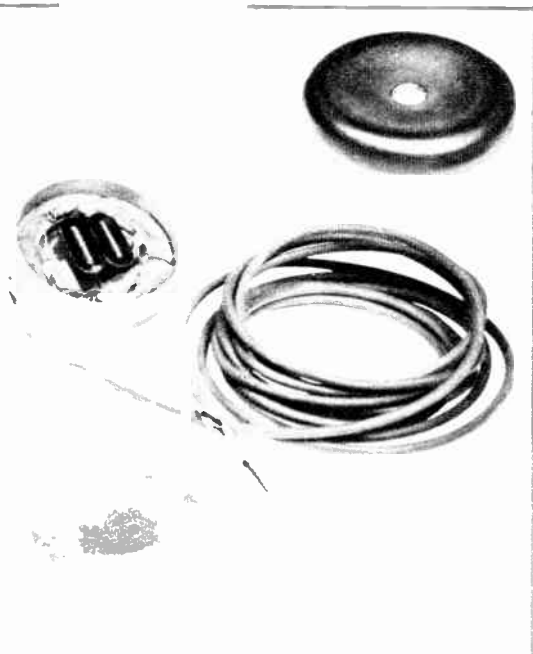

An entire receiver in an earphone! Coil, diode, capacitor of Fig. 2 fit in case. Wire with clip on end is for antenna connection.

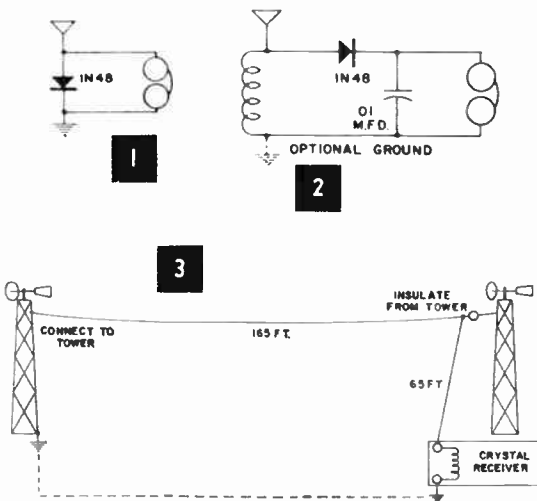



Navy's Jim Creek station, as seen from one of its 200-foot towers. At right is a six-wire "cage" antenna lead dropping to the building that houses transmitter. Antenna system uses 30 miles of wire.

# World's Most Powerful Radio Station

**T**HE world's most powerful radio station belongs to the United States Navy. It is located in Jim Creek, a 6000-acre site about 55 miles northeast of Seattle, Washington, and 20 miles inland from Puget Sound. It is rated at 1,200 kilowatts (one million, two hundred thousand watts), as compared with 50 kilowatts for sound broadcasting stations and about 10 to 25 for television stations. Its signals literally blanket the globe. They penetrate to submarines cruising below the surface of the sea, and to arctic outposts that are inaccessible to ordinary transmissions because of interference from magnetic storms and ionospheric disturbances.

Jim Creek, as the giant installation is popularly called, operates in the very low frequency range between 14.5 and 35 kilocycles. At these frequencies the radiated energy tends to spread fairly uniformly over the earth, instead of shooting off at odd angles as do high-frequency signals.

The transmitter building, which is windowless, air-conditioned and lined with copper throughout, lies at the bottom of a

valley between twin 3,000-foot mountain peaks. From the latter is hung a stupendous antenna array. This consists of ten spans, or catenaries, each over a mile in length, and forms a zig-zag pattern high over the valley. Twelve 200-foot steel towers erected along the crests of the mountains support the antenna spans. From the midpoint of each catenary, cables plunge straight down to a "busing" system which connects the antenna to the transmitter. Of the ten catenaries, the longest is 8,700 feet and the shortest 5,640 feet. To allow for the ice and wind conditions normal in the area, the spans are permitted to sag as much as 1000 feet.

The huge antenna acts as a fine lightning rod. Static charges often build up to a point where they jump an open gap a foot or more in length. For this reason, the array is grounded when not in actual use. More than 220 miles of copper wires, cables and screens are buried across the valley floor to provide effective grounding.

Jim Creek was designed and built by RCA, and took more than six years. •

# Flood Hero Gets Ham Award

Over 500 people died when a hurricane struck Louisiana's coast. More might have, but for Jim Harrington's courage and resourcefulness



Reward for a job well done. James Harrington, KSBQT (second from right) receives the 1957 Edison Radio Amateur Award from L. Berkley Davis, chairman of the award committee. At left, Harrington gets an assist from son Bill as he operates his station, KSBQT, Lake Charles, La.



**A** LOUISIANA radio amateur who for three days provided the only communications from a hurricane-devastated town received General Electric's annual Edison Radio Amateur Award for 1957. He is James E. Harrington, 45, 1625 Ninth St., Lake Charles, La., who operates amateur radio station K5BQT. He received the trophy and \$500 at a banquet where the principal speaker was Lieutenant General Francis H. Griswold, vice-commander of the Strategic Air Command. General Griswold, a radio amateur himself, talked on the public services provided by the nation's 150,000 licensed amateur radio operators.

The trophy was presented by L. Berkley Davis, G-E division general manager, who serves as committee chairman for the award which is granted to the radio amateur judged to have rendered the most outstanding public service during the calendar year. Guests at the banquet included high military and civilian communications officials.

Harrington, a food broker who received his amateur radio license less than three years ago, has lived in Louisiana for the past 27 years. He and his wife, Mae—a former nurse from Philadelphia—have two boys, Jim 11, and Bill 9.

After Hurricane Audrey hit the coastal town of Cameron on June 26, Harrington, then alternate civil defense radio officer in Lake Charles, gathered equipment and a crew of two amateur radio assistants and traveled by boat 40 miles southward through the swollen Calcasieu River. At

Cameron, Harrington and the two operators, Captain Neal H. Mabrey, W5VTU, and Sergeant Michael J. McDermott, K5CTQ, of the Lake Charles Air Force Base, waded waist-deep through mucky flood waters with radio transmitters and receivers, a heavy generator, a supply of gasoline and a three-day supply of food and water.

They set up a radio station in the Cameron court house and in three days and two nights handled 1,500 messages. These communiques told rescue agencies of the desperate need for drinking water, food, medical supplies. They reported the arrival of rescue boats and they scheduled the return trips so that hundreds of refugees would be met at points of debarkation with ambulances, clothing, medicine and food. Though thousands survived, more than 500 persons died in the disaster.

Harrington was nominated for the award by Major-General Raymond F. Hufft, Louisiana civil defense director, several other state civil defense officials, and the members of the New Orleans, Baton Rouge and Lake Charles radio clubs. He regards his nomination and ultimate selection as winner as symbolic and representative of the work of hundreds of other radio amateurs in the southwest during the hurricane emergency.

Judges for this sixth annual award were Commissioner Rosel Hyde, FCC; E. Roland Harriman, American National Red Cross; and G. L. Dosland, president, American Radio Relay League, the amateurs' national organization. •

**Mission of mercy re-enacted. This fishing boat took Harrington 40 miles to establish emergency radio communication when the hurricane struck.**



**The hero displays his call sign, which constitutes his automobile registration under Louisiana law. Cards are from stations he has worked.**



# Which Way Does Current Flow?

It is a movement of electrons, negative to positive, as Thomas Edison discovered

**I**N THE YEAR 1884, while he was developing the electric light, the famous American inventor Thomas A. Edison observed an odd effect in one of his lamps. He had already been able to make a thin carbon-coated filament glow a bright yellow by passing a heavy current through it from a battery. He also knew that it was necessary to remove the air from the glass bulb containing the filament, or the latter would combine with the oxygen in the air and simply burn up.

A keen experimenter who would try anything, Edison had added a small metal plate to the inside of a lamp, near the filament, and had connected an additional battery, in series with a simple ammeter, between this plate and one side of the filament. He noticed that the meter indicated a small flow of current when the second battery was connected one way, but absolutely no current when its connections were reversed.

Edison was interested at that time only in improving his electric light, which was

the scientific and popular sensation of the period and made his name a household word. Because the experiment produced no change whatsoever in the brightness of the filament, he merely recorded it and proceeded to other matters.

The real importance and significance of the "Edison Effect," as it became known later, lay in the polarity of the plate battery. Then as now, batteries and other sources of direct current had their terminals identified as "positive" and "negative" (or "plus" and "minus"), and it was the accepted theory that the mysterious "current" of electricity flowed from the positive pole, through the connected circuit, and back to the negative pole. In Edison's two-element vacuum tube, as shown just below, the meter indicated current flow when the *positive* side of the "B" battery was connected to the plate of the tube. This meant that the circuit was completed somehow through the seemingly impassable vacuum between the filament and the plate. Why, then, didn't current

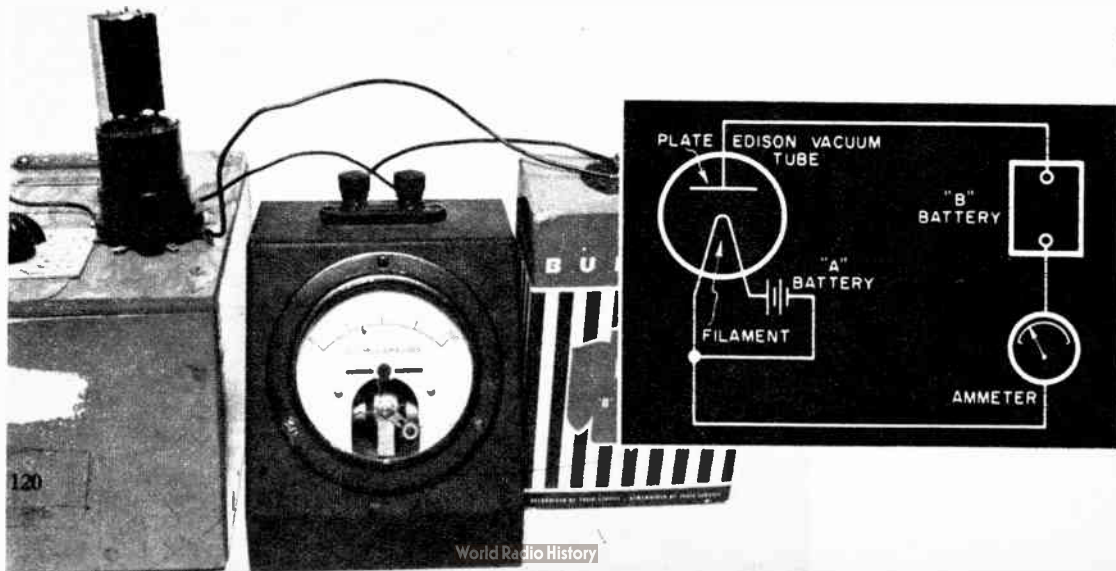

flow again when the battery was reversed?

You must understand that the polarity terms "positive" and "negative" were and are purely arbitrary, and to some extent slightly misleading. The battery terminals might just as well be designated A and B, or X and Y, or 1 and 2.

The idea that current flowed from positive to negative was so firmly entrenched that it persisted for almost fifty years.

The answer to the puzzle of the Edison Effect was given by an English physicist, Sir J. J. Thompson, the father of the electron theory of matter, as early as 1897. He demonstrated the electron as the basic building block of the atom, and showed that it had a fixed electrical charge of its own. In relation to "positive" and "negative" effects as they were then recognized, the electron was identified as "negative." It was also known that like charges tend to repel each other, and unlike to attract.

In Edison's experimental lamp, electrons apparently tore loose from the boiling hot filament. With no heavy air to impede their passage, they were attracted across the vacuum by the plate when the latter was made *positive* by the battery, and the ammeter needle moved to show that "current" was in the circuit. When the plate was made *negative*, it apparently repelled the negative electrons, keeping them around the filament and preventing them from jumping the vacuum to the plate. The ammeter remained stationary, and no current flow could be observed in the circuit.

The Edison Effect, easily demonstrable with any two-element radio tube and a "B" battery, pointed to an inescapable conclusion that bothered people who had been brought up on the positive-to-negative-flow theory: What was thought of previously as a "flow of electricity" is actually a circulation of electrons, the move-

ment being *negative to positive* around a circuit.

As late as the 1940's, teachers and writers continued to confuse students by differentiating between "electrical" circuits, in which they said the current flowed from positive to negative, and "electronic" circuits, in which it flowed the other way. They were really stumped when asked how the same battery used to power an "electrical" flashlight was able to reverse itself when used to power an "electronic" radio tube. Until even more recently, it was common in industry to use the term "electronic" for any equipment containing vacuum tubes, as distinguished from "electrical" for all other equipment. This practice was knocked out very effectively by the introduction of the transistor.

Progressive experimenters quickly envisioned some of the magic of Aladdin's Lamp in Edison's one-way electric light. Since plate current flowed only when the plate was positive in relation to the filament, the simple two-element tube was a perfect rectifier of alternating current. As early as 1890, Fleming in England used such a diode as a simple detector of radio signals, and it became widely known as the "Fleming valve." Edison's filament-and-plate construction in absolutely unchanged form is used to this very day in numerous rectifiers for changing AC to pulsating DC to operate communication and industrial devices of many kinds.

A German scientist named Braun put the hot, footloose electrons to work in the cathode-ray tube a full half century ago. This tube is the direct forerunner of the radar scope and of the television picture tube, yet Braun's name is hardly known today. In his time he ranked with Marconi, and in fact he shared with him the 1909 Nobel Prize in physics. •

Drawing is basically the circuit that revealed electrons in motion from hot filament of a bulb. Circuit can be duplicated with a modern rectifier. A 5Y3 gets filament current from boxed transformer, far left. Meter's in series with "B" battery, positive side of which goes to plate of tube. Meter shows current flow. With battery switched, negative side to plate of tube, right, no current flows. Plate's negative charge simply repels the negative electrons that boil out of hot filament.

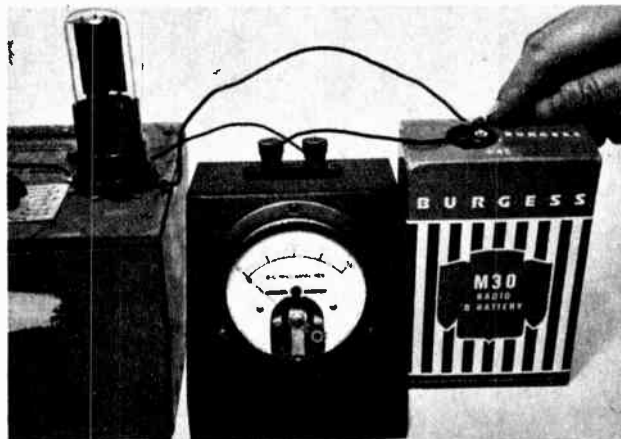

# Small



Radiation detectors and counters are among the many devices that require low-current high-voltage power sources. The uranium hunters above use a model made by Precision Radiation Instruments.



# High-Voltage Supplies

Demand for them has increased greatly. Here's help in choosing the best unit for your need

**By the Engineering Department, Aerovox Corp.**

**H**IGH-VOLTAGE, low-current power supplies are required in radiation detectors and counters, photoflash units, insulation testers, photomultiplier circuitry, cathode-ray equipment, photoluminescent sources, and X-ray devices. There are many other applications of these supplies.

Since most power supplies in the low-current category are small in size and light in weight, they are well suited to use in portable equipment, especially in battery-operated equipment. In recent years, there has been an increasing demand for small-sized, high-voltage, battery-operated supplies. The purpose of this article is to describe the types of circuits which are being employed, giving practical examples and comparing their characteristics. It is expected that this survey will be a guide in the selection of the proper supply unit for a given application.

Many arrangements are not included in this resumé, since they are highly experimental in nature or are of a makeshift character. Practical units which have proven themselves in the field generally fall under the headings: (a) batteries, (b) charged-capacitor type, (c) vibrator-transformer type, (d) vacuum-tube fly-back type, and (e) transistor oscillator type.

## Battery Supply

The simplest DC voltage supply is a battery. Miniature dry batteries are available from stock in 90- and 300-volt sizes. These batteries may be series-connected for higher voltages than their rated values and are used frequently to build up a high-potential supply.

In some applications, especially those in which circuitry must be kept simple and at a minimum, only batteries can be used. The complication and added space requirements attendant to the use of tubes, transformers, filter chokes and capacitors, and voltage regulators thus are avoided.

Despite its simplicity, high-voltage battery operation is the most expensive way

to obtain kilovolt potentials. A high-voltage supply using batteries only has the highest initial and replacement costs: about 26 cents per volt for the 300-volt units and approximately 31 cents per volt for the miniature 90-volt units. The milliampere-hours per dollar output rating likewise is poorer than that of other types of high-voltage supplies. There are several types of batteries available and the characteristics for these can be obtained from the manufacturer, but it is safe to state that these batteries are definitely low-current units, the useful lifetime of which is abbreviated sharply by all operation at high levels, as well as by long, continuous operation at low current drain.

Because of the expense of miniature high-voltage batteries, a current-limiting resistor should be connected in series with them, whenever circuit peculiarities permit, to prevent their rapid destruction in case of a short circuit. The operator should take care to switch the batteries off at all times when they are not actually in use. A cool, dry environment is the most satisfactory condition under which such batteries should be operated.

## Charged-Capacitor Circuits

In circuits in which current drain is quite low (i.e., under 1 milliampere), and operating time can be reduced to a series of short intervals, charged capacitors may be operated in series to supply high DC

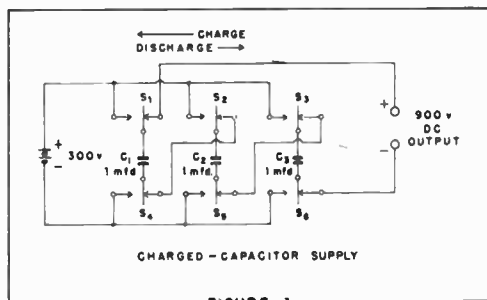
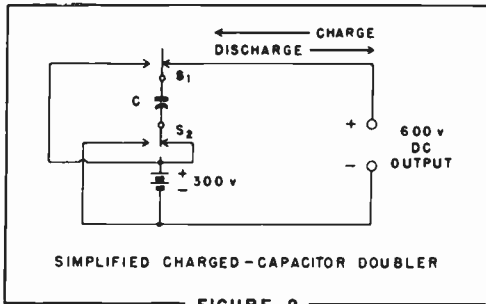

FIGURE 1



voltages. This permits a reduction of battery expense, since only one battery is needed to charge a number of capacitors in parallel which then may be switched in series to deliver many times the battery voltage.

The time interval during which the voltage obtained in this way may be held to a useful level depends upon the total capacitance of the series capacitor combination and upon the output current drain. At any current level, the higher the capacitance the longer the interval. In practical circuits in which this type of supply is used, a switch (usually a pushbutton) is provided for momentarily re-connecting the capacitors in parallel for charging.

Figure 1 shows a charged-capacitor type of supply operated from a miniature 300-volt battery (such as Burgess U200, Eveready 493, or RCA VS093) and delivering 900 volts DC. When the 6-pole, 2-position switch ( $S_1, S_2, S_3, S_4, S_5, S_6$ ) is temporarily at its left-hand CHARGE position, capacitors  $C_1, C_2,$  and  $C_3$  are connected in parallel with the battery and become charged. When the switch then is thrown to its right-hand DISCHARGE position, the capacitors are connected in series, and 900 volts is available at the output terminals of the circuit. The total capacitance in the discharge condition is 0.333 ufd. It is convenient to have the switch rest normally in the DISCHARGE position to provide a normal connection of the series combination to the output terminals. If the switch has a spring return, the capacitors are charged each time the switch is depressed or thrown, after which the switch returns automatically to the DISCHARGE position to deliver high-voltage output.

It might be expected that this scheme could be extended indefinitely, the voltage multiplication being proportional to the number of capacitors. It is limited, however, by the number of poles and contacts which may be included in a practical

switch without the latter reaching ungainly size. Also, in order to obtain a sufficiently high total capacitance with a large number of capacitors in series, the required individual capacitance values would become so large as to raise both the size and cost of the supply out of reasonable bounds.

Figure 2 shows a simplified charged-capacitor circuit which delivers twice the battery voltage. In this arrangement, when the dpdt switch ( $S_1, S_2$ ) temporarily is at its left-hand CHARGE position, capacitor C is charged from the 300-volt battery. When the switch is returned to its normal, right-hand DISCHARGE position, the charged capacitor is connected in series with the battery. The voltage at the output terminals then is the sum of the battery and capacitor voltages, or 600 volts.

Charged-capacitor supplies basically are low-current, short-interval units. At extremely low current drains, however, the time interval during which the voltage is maintained near its required level may be extended to a reasonable length by employing high capacitances. For example: Consider 1000 volts supplied by a total capacitance of 100 microfarads. At a current drain of 100 microamperes (load resistance of 10 megohms), the capacitor still will have 90% of its charge (output voltage will have fallen 10% from its original value) in 1½ minutes of operation. The circuit then may be pulsed with another charge to bring the voltage back up to the original level. After 16 minutes of operation, because of the exponential decay of the charge, the output voltage of this capacitor will be approximately 370 volts.

### Buzzer-Transformer Circuit

A miniature vibrator-transformer and rectifier combination, similar in principle to the conventional automobile radio power supply, provides the basis for a high-voltage DC operated from a small, inexpensive battery—often a single 1½-volt flashlight cell.

Figure 3(A) shows the circuit of a vibrator (buzzer) type high-voltage supply of this kind. The vibrator transformer here is a Precise Model 10. This is a small unit (having about the same dimensions as a 6L6 metal tube) which plugs into an octal socket. The step-up transformer, vibrator, and spark suppression capacitor ( $C_1$ ) are self-contained. A single 1½-volt, Size-D flashlight cell supplies the DC driving voltage. Current drain is approximately 35 milliamperes.

The high-voltage AC, generated by the vibrator-transformer, is rectified by a

single, high-voltage selenium cartridge-type rectifier and is filtered by the 0.1-ufd capacitor,  $C_2$ .

The open-circuit output potential is 6000 volts DC. Figure 3(B) shows the voltage regulation of the circuit. From this plot, it may be seen that the output voltage falls to approximately 500 volts at a current drain of 140 microamperes (load resistance of  $3\frac{1}{2}$  megohms). A potential of 1000 volts is obtained at 70  $\mu$ a drain. The output voltage may be regulated through the use of a filamentless, miniature regulator tube such as Type CK5517 for 2.3 kilovolts, 5841 for 900 volts, or CK1036 for 700 volts.

At light current drains (under 150  $\mu$ a), adequate filtering action will be provided by capacitor  $C_2$ . In applications requiring increased smoothing of the output, a 100,000-ohm filter resistor and an additional 0.01-ufd. capacitor may be employed.

The vibrator-type DC supply is compact and tubeless and is light in weight. The Size-D flashlight cell which drives it is small and inexpensive and will give 150 hours service when used continuously 2 hours per day, 90 hours on an 8 hours-per-day basis, and 60 hours on a 24 hours-per-day basis.

#### Flyback-Type Supply

Figure 4 shows the circuit of a high-voltage supply which utilizes the rapid decay of plate current (flyback) through a high inductance to generate high-voltage pulses. The resulting pulse train is rectified and filtered for DC output.

In this circuit, a relaxation oscillator (comprised by the NE-2 neon bulb, capacitor  $C_1$  and resistor  $R_1$ ) is operated from the 135-volt battery,  $B_2$ . The output of this oscillator is coupled, through capacitor  $C_2$ , to the 1T5 tube. (A miniature type 3S4 tube also may be used). Inductor  $L$  in the plate circuit of this tube is a miniature interstage transformer (U. T. C. Type 0-15) with its primary and secondary windings connected in series-aiding. Plate and screen potentials for the tube also are supplied by battery  $B_2$ . Filament current is supplied by  $B_1$ .

The quiescent plate current is quite small. However, the rising, positive-going portion of the saw-tooth pulse from the relaxation oscillator increases this current to a maximum. With the rapid fall, or flyback of the sawtooth, the plate current collapses and a high voltage pulse (e) is generated across inductor  $L$ . The high-voltage selenium cartridge rectifier (REC) serves to pass the positive swing of the

voltage pulse and to block the negative swing. The connections of this rectifier may be reversed for negative DC output, if desired.

Rheostat  $R_s$  serves as an output-voltage control by permitting adjustment of the plate current. Screen current is limited by the 200,000-ohm resistor,  $R_a$ . The circuit may be operated from a  $1\frac{1}{2}$ -volt, Size-D flashlight cell at  $B_1$ , and two midget  $67\frac{1}{2}$ -volt batteries in series for 135 volts at  $B_2$ .

Resistor  $R_s$  is included for output current limiting, to protect the rectifier in the event of an external short circuit and to safeguard the operator in case of contact. This resistor may be omitted if it causes too large a voltage drop for certain applications.

#### Transistorized Supply

In the compact power supply shown in Figure 5, the signal-output voltage of a transistorized oscillator operated from a small 6-volt battery is stepped up by transformer  $T$ . The secondary voltage of the transformer then is applied to a voltage quadrupler circuit (consisting of selenium cartridges rectifiers  $D_1, D_2, D_3, D_4$ ; and capacitors  $C_2, C_3, C_4$ , and  $C_5$ ) which delivers a DC output equal to 5.6 times the applied AC voltage.

The transistor oscillator is a Hartley-type circuit. The required, tapped coil is obtained by connecting to primary termi-

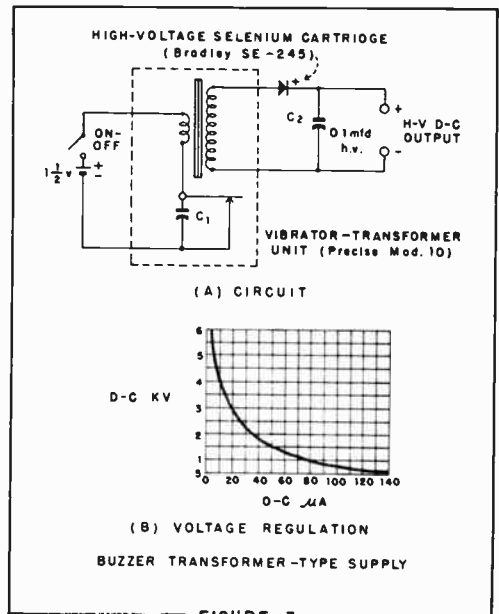

FIGURE 3

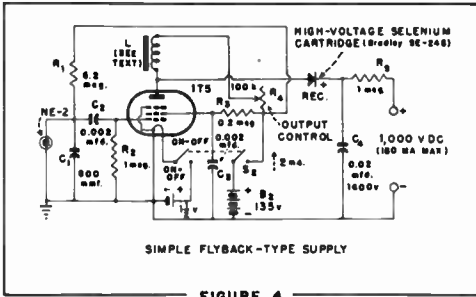

FIGURE 4

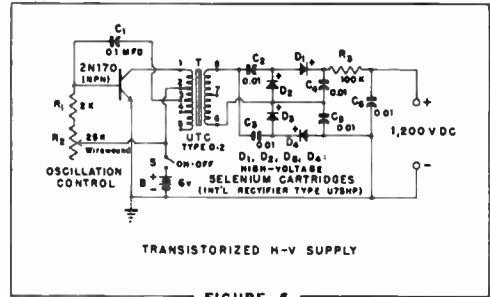

FIGURE 5

nals 1, 2, and 3 of the miniature line-to-grid transformer (U. T. C. Type 0-2). The entire secondary winding (taps 6 and 8) is used. Formerly, experimenters have been unsuccessful in boosting the voltage output of a low-voltage transistor oscillator because small transformers with sufficiently high turns ratios and primary inductance have not been commercially available.

The 25,000-ohm rheostat,  $R_2$ , allows the base bias current to be set for easy starting of the oscillator and for full 1200 volts DC output. This control should be set so that the oscillator starts up readily when the ON-OFF switch, S, is closed. A DC vacuum-tube voltmeter, set to its 0-1500-volt range and connected to the 1200-volt output terminals, should be used as an indicator during this adjustment.

The builder must be careful to follow the exact polarities indicated in Figure 5 for the transistor, battery B, and the rectifiers.

Capacitors  $C_2$ ,  $C_3$ ,  $C_4$ , and  $C_5$  are standard 500-volt mica components. Output capacitor  $C_6$ , however, must be rated at 1600 volts DC, or better.

Current drain from the 6-volt battery is approximately  $2\frac{1}{2}$  milliamperes. This low requirement may be met even with four series-connected  $1\frac{1}{2}$ -volt penlight cells.

### Recent Developments

Stock-model, transistorized high-voltage power supplies presently are available commercially in ratings up to 20,000 volts DC output. Custom units may be obtained up to 100,000 volts DC. All of these units operate from one or two  $1\frac{1}{2}$ -volt flashlight cells or from mercury cells. One such unit together with its cell is no larger than the Geiger tube it is designed to power.

One company has developed a miniature version of the Wimshurst static machine,

familiar to all science students. This reduced-scale model is spun by means of gearing operated by means of a pushbutton, and delivers several kilovolts from a charged capacitor. While this unit is not available at this writing, it is expected to reach production in the near future.

Attention again has turned to the electret as a repository of high-potential charges. Electrostatically, this device is somewhat analogous and dual to the permanent magnet. It has been known for several decades but has found no noteworthy practical application up to this time. Essentially, it is a cake of carnauba wax that has been cooled down from the molten state while in a high-voltage electrostatic field. Research and development work presently is being pursued to determine the potentialities of the electret as a high-voltage DC supply.

### Safety Precautions

Every high-voltage supply should be handled with caution. Miniature units are no exception. Although, in most instances, miniature supplies are incapable of delivering damaging currents, the voltages that they do put out can cause dangerous reflex actions which have been known to cripple the heart and cause death. High-voltage batteries are especially nasty.

Small, high-voltage supplies often are more deadly than full-size units, simply because of their deceptive size. Being small and quiet, they just do not look dangerous. However, the false sense of trust they inspire encourages only a stupid technician to grow the least bit careless with them.

Regard all high-voltage supplies as threats to personal safety and well-being. Know your circuit well and avoid all bodily contact with its high-voltage points. •



# Self-Powered Flash Gun



The bulb is in top, generator wheel in the lower half of Kodak Generator Flashholder's hinged case. Pencil points to generator's fixed winding; magnet turns below it. Hook-up is diagrammed, right.

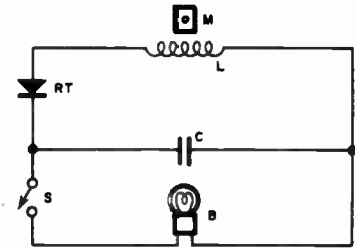
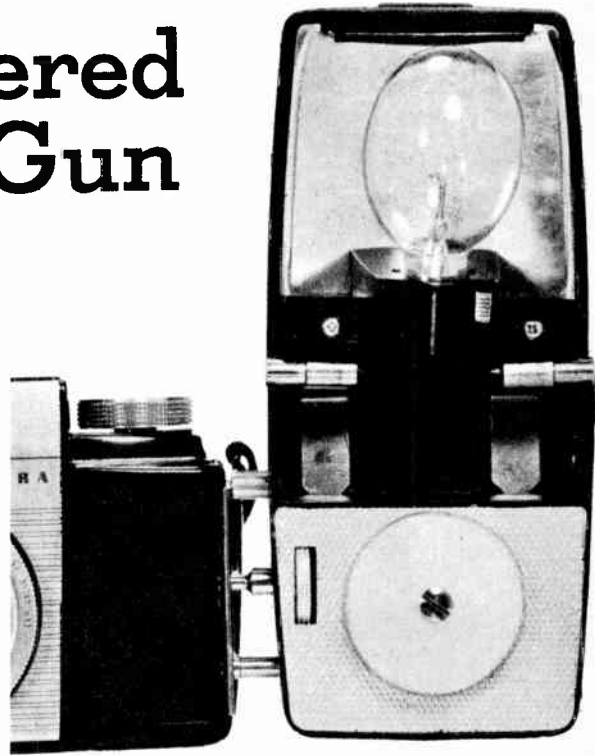

**T**HE CONVENTIONAL BATTERY has been eliminated entirely and replaced by a unique little generator system in a new flash gun introduced recently by Kodak. To charge the capacitor that actually fires the flashbulb, the user merely makes a half turn with a small nylon hand wheel that's approximately the size of an ordinary radio knob.

The generator itself consists of a coil (L) of many turns of fine wire, wound on an iron frame with a round jaw. Inside this jaw is a small Alnico magnet (M) attached to the hand wheel. When the magnet is twirled, the moving magnetic field in the iron frame induces a corresponding voltage in the coil. This alternating voltage is recti-

fied, or changed into pulsating direct voltage, by the rectifier (RT) which is a simple diode such as those used as detectors in radio and television receivers. The DC charges the capacitor (C) which is rated at 135 microfarads.

The charge remains in the capacitor until the synchronizer contacts S on the camera shutter, which is closed by the snapping of the shutter. The charge rushes through the filament of the flashbulb (B) causing it to flare up.

A sensitive voltmeter connected across the generator registers a good 30 or 35 volts with a rather slow half-turn of the wheel. The needle jumps to about 65 volts with a fast spin. •

# Sites of FCC Offices

**A**PPPLICATION FORMS for amateur radio licenses are obtainable free of charge from field offices of the Federal Communications Commission, and also from the main office, the address of which is Washington 25, D. C. You can usually save time by writing to the office nearest to your home. Here is a complete list. In all cases, address your letter to the Engineer-in-Charge, Federal Communications Commission.

Examinations for the novice, technician and conditional classes of ham licenses are conducted *only* by mail. Tests for the general class are held regularly at the offices listed above, and also, at various times during the year, at the following "examination points." Inquire at the numbered district offices for schedule dates.

If you live within 75 miles of an exam-



Aspiring amateur radio operators will want these locations sooner or later. Here would-be hams practice code under Signal Corps supervision.

## INDEX TO EXAMINATION POINTS

|                         |     |                       |      |
|-------------------------|-----|-----------------------|------|
| Albuquerque, N. M.      | 15  | Louisville, Ky.       | 18   |
| Anchorage, Alaska       | 23  | Marquette, Mich.      | 16   |
| Atlanta, Georgia        | 6   | Memphis, Tenn.        | 6    |
| Bakersfield, California | 11  | Miami, Florida        | 7    |
| Baltimore, Maryland     | 4   | Milwaukee, Wis.       | 18   |
| Bangor, Maine           | 1   | Mobile, Alabama       | 8M   |
| Beaumont, Texas         | 9B  | Nashville, Tenn.      | 6    |
| Billings, Montana       | 14  | New Orleans, La.      | 8    |
| Birmingham, Alabama     | 6   | New York, N. Y.       | 2    |
| Boise, Idaho            | 13  | Norfolk, Va.          | 5    |
| Boston, Mass.           | 1   | Oklahoma City, Okla.  | 10   |
| Buffalo, New York       | 20  | Omaha, Nebraska       | 17   |
| Charleston, W. Va.      | 19  | Philadelphia, Pa.     | 3    |
| Chicago, Ill.           | 18  | Phoenix, Arizona      | 11   |
| Cincinnati, Ohio        | 19  | Pittsburgh, Pa.       | 20   |
| Cleveland, Ohio         | 19  | Portland, Maine       | 1    |
| Columbus, Ohio          | 19  | Portland, Oregon      | 13   |
| Corpus Christi, Texas   | 9   | Rapid City, S. D.     | 15   |
| Dallas, Texas           | 10  | Roanoke, Va.          | 5    |
| Davenport, Iowa         | 18  | St. Louis, Missouri   | 17   |
| Denver, Colorado        | 15  | St. Paul, Minn.       | 16   |
| Detroit, Michigan       | 19  | Salt Lake City, Utah  | 15   |
| Des Moines, Iowa        | 17  | San Antonio, Texas    | 9    |
| El Paso, Texas          | 10  | San Diego, Calif.     | 11SD |
| Fort Wayne, Ind.        | 18  | San Francisco, Calif. | 12   |
| Fresno, California      | 12  | San Juan, Puerto Rico | 22   |
| Grand Rapids, Mich.     | 19  | Savannah, Georgia     | 6S   |
| Hartford, Conn.         | 1   | Schenectady, N. Y.    | 2    |
| Honolulu, Oahu          | 21  | Seattle, Washington   | 14   |
| Houston, Texas          | 9   | Sioux Falls, S. Dak.  | 16   |
| Indianapolis, Ind.      | 18  | Spokane, Washington   | 14   |
| Jackson, Miss.          | 8   | Syracuse, N. Y.       | 20   |
| Jacksonville, Fla.      | 7   | Tucson, Arizona       | 11   |
| Juneau, Alaska          | 23J | Tulsa, Oklahoma       | 10   |
| Kansas City, Mo.        | 17  | Washington, D. C.     | 27   |
| Klamath Falls, Oregon   | 13  | Wichita, Kansas       | 24   |
| Knoxville, Tenn.        | 6   | Williamsport, Pa.     | 20   |
| Little Rock, Ark.       | 8   | Wilmington, N. C.     | 5    |
| Los Angeles, Calif.     | 11  | Winston-Salem, N. C.  | 5    |

| District No. | OFFICE LOCATION   |               |
|--------------|---|---------------|
| 1            | Boston 9, Massachusetts<br>1600 Custom House  |               |
| 2            | New York 14, New York<br>748 Federal Building<br>641 Washington Street                            |               |
| 3            | Philadelphia 6, Pennsylvania<br>1005 New U. S. Custom House                                       |               |
| 4            | Baltimore 2, Maryland<br>400 McCawley Building<br>400 E. Lombard Street                           |               |
| 5            | Norfolk 10, Virginia<br>402 Federal Building  |               |
| 6            | Atlanta 3, Georgia<br>718 Atlanta National Bldg.<br>50 Whitehall St., S. W.                       |               |
| 7            | Miami 1, Florida<br>312 Federal Building  | P.O. Box 150  |
| 8            | New Orleans 12, Louisiana<br>608 Federal Office Building<br>600 South Street                      |               |
| 9            | Houston 11, Texas<br>324 U. S. Appraisers Building<br>7300 Wingate Street                         |               |
| 10           | Dallas 22, Texas<br>500 U. S. Terminal Annex Building<br>Corner Houston and Jackson Streets       | P.O. Box 5238 |
| 11           | Los Angeles 12, California<br>1425 U. S. Post Office and Court House<br>Temple and Spring Streets |               |
| 12           | San Francisco 26, California<br>323-A Custom House<br>555 Battery Street                          |               |
| 13           | Portland 5, Oregon<br>507 U. S. Court House<br>620 S. W. Main Street                              |               |
| 14           | Seattle 4, Washington<br>802 Federal Office Building<br>1st Avenue and Marion                     |               |

ination point and wish to obtain a general class license, you must take the test in person before FCC examiners. If you live more than 75 miles away, or are physically incapacitated, you can take the mail-order conditional ticket, which offers the same operating privileges.

Even if you live close to an FCC office or examination point, you must take the novice and technician tests by mail, under the supervision of a voluntary examiner. This can be any general-class ham over the age of 21. Originally, the novice and technician exams were given in person at FCC offices, in the same manner as the general-class, but the deluge of eager applicants swamped the FCC facilities and personnel. The program of permitting the tests to be run on the honor system has worked out very successfully for everyone. •

District  
No.

OFFICE LOCATION

|      |  |               |
|------|--|---------------|
| 15   | Denver 2, Colorado<br>521 New Custom House<br>19th between California and Stout Sts. |               |
| 16   | St. Paul 2, Minnesota<br>208 Federal Courts Bldg.<br>5th and Washington Streets      |               |
| 17   | Kansas City 6, Missouri<br>3100 Federal Office Building<br>911 Walnut Street         |               |
| 18   | Chicago 4, Illinois<br>826 U. S. Court House<br>219 South Clark Street               |               |
| 19   | Detroit 26, Michigan<br>1029 Federal Building  |               |
| 20   | Buffalo 3, New York<br>328 Post Office Building<br>Ellicott and Swan Streets         |               |
| 21   | Honolulu 1, Hawaii<br>502 Federal Building<br>Court House and Post Office            | P.O. Box 2987 |
| 22   | San Juan 13, Puerto Rico<br>322-323 Federal Building                                 |               |
| 23   | Anchorage, Alaska<br>Room 53<br>U. S. Post Office Bldg. and Court House              | P.O. Box 644  |
| 24   | Washington 25, D. C.<br>104 Briggs Building<br>415-22nd St., N. W.                   |               |
| 6S   | Savannah, Georgia<br>214 Post Office Building  | P.O. Box 77   |
| 8M   | Mobile 10, Alabama<br>419 U. S. Court House and Custom House                         |               |
| 9B   | Beaumont, Texas<br>301 Post Office Building<br>300 Willow Street                     | P.O. Box 1527 |
| 11SD | San Diego 1, California<br>15-C U. S. Custom House<br>Union and F Streets            |               |
| 23J  | Juneau, Alaska<br>6 Shattuck Building  | P.O. Box 1421 |

**COYNE** offers  
**LOW COST**  
**TELEVISION**  
Training in  
Spare Time **AT HOME**

The future is **YOURS** in  
**TELEVISION-RADIO-COLOR-TV!**

A fabulous field—good pay—fascinating work—a prosperous future! Good jobs, or independence in your own business!



Coyne brings you **MODERN—QUALITY** Television Home Training; training designed to meet Coyne standards. Includes **RADIO, UHF and COLOR-TV**. No previous experience needed. Practical Job Guides to show you how to do actual servicing jobs—make money early in course. You pay only for your training, no costly "put together kits."

**SEND COUPON FOR FREE BOOK**

and full details including easy Payment Plan. No obligation. no salesman will call.



Coyne—the Institution behind this training . . . the largest, oldest, best equipped residential school of its kind. Founded 1899.



B. W. Cooke, Jr. President

**500 S. Paulina, Chicago Dept. 88-H9**

**COYNE ELECTRICAL SCHOOL**

A Technical Trade Institute Chartered Not For Profit

**COYNE Television Home Training Division**  
**500 S. Paulina St., Chicago 12, Ill.**  
**Dept. 88-H9**

Send Free Book and details on how I can get Coyne Quality Television Home Training at low cost and easy terms.

Name \_\_\_\_\_

Address \_\_\_\_\_

City \_\_\_\_\_ State \_\_\_\_\_

(It is understood no salesman will call)

# A. F. Precision Measurement

Here are the instruments used as standards when audio frequencies are to be accurately measured

By the Engineering Department, Aerovox Corp.

**A** GREAT DEAL of space in technical publications has been devoted to precision measurements of radio frequencies. Even the neophyte soon becomes conversant with such topics as frequency standards, frequency meters, standard-frequency broadcasts, and zero-beat and interpolation methods.

The picture seems somewhat different with respect to audio frequencies. Some students have a vague impression that audio frequencies somehow are generated with such precision and remain so stable that they seldom need measurement, or that precision is not needed in the A. F. spectrum. While the latter may be true in some examples such as the generation of simple tone signals, there are countless instances in which audio frequencies must be known and maintained with high accuracy. The success of many electrical measurements performed with an A. F. tester signal depends upon close knowledge of the frequency.

Since radio-frequency standards seem to be much more generally familiar than those for audio frequencies, it is well at this point to examine the configuration and characteristics of several audio frequency standards.

Several types of instruments are available as audio-frequency standards. As is true of radio-frequency standards, these instruments provide different degrees of accuracy, and the selection depends upon individual demands. Unlike most radio-frequency standards, the demand for purity of waveform generally is greater in audio-frequency standards. The chief reason for this is that fundamental audio frequencies usually are employed in standardization, while a radio frequency standard is called upon to supply a great number of harmonics.

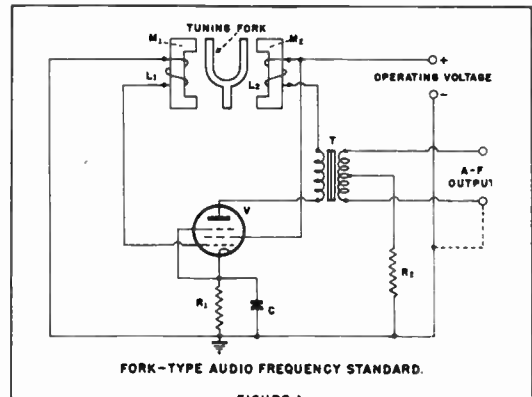

FIGURE 1  
Fork-Type

This is an electromechanical instrument having as its basis the tuning fork. The frequency is governed by the physical dimensions of the fork, and the frequency stability with respect to temperature depends upon the temperature coefficient of the metal from which the fork is made. Stability is improved by operating the fork inside a constant-temperature oven.

The tuning fork is employed as the frequency-determining element of an electronic oscillator. Figure 1 shows a typical circuit. The tuning fork, ground precisely to vibrate at a specified frequency, is mounted rigidly between two magnet pole pieces,  $M_1$  and  $M_2$ . Each pole piece is surrounded by a field winding ( $L_1$  and  $L_2$ , respectively). Coil  $L_1$  is connected in the grid circuit of vacuum tube  $V$ , and coil  $L_2$  in the plate circuit. Since these coils are phased for positive feedback, a simple tickler-type oscillator circuit is produced. This circuit maintains the fork in vibration at its natural frequency. Audio-frequency output is taken from the plate circuit through the coupling transformer,  $T$ .



# BUILD 16 RADIO

Reg. U.S.  
Pat. Off.

## CIRCUITS AT HOME

with the New Deluxe 1959  
PROGRESSIVE RADIO "EDU-KIT"®

only  
**\$22.95**



### A Practical Home Radio Course

#### Now Includes

- \* TRANSMITTER
- \* SIGNAL TRACER
- \* SIGNAL INJECTOR
- \* CODE OSCILLATOR
- \* No Knowledge of Radio Necessary
- \* No Additional Parts or Tools Needed
- \* EXCELLENT BACKGROUND FOR TV
- \* School Inquiries Invited
- \* SOLD IN 78 COUNTRIES

### YOU DON'T HAVE TO SPEND HUNDREDS OF DOLLARS FOR A RADIO COURSE

The "Edu-Kit" offers you an outstanding PRACTICAL HOME RADIO COURSE at a rock-bottom price. Our Kit is designed to train Radio & Electronics Technicians, making use of the most modern methods of home training. You will learn radio theory, construction practice and servicing. THIS IS A COMPLETE RADIO COURSE IN EVERY DETAIL. You will learn how to build radios, using regular schematics; how to wire and solder in a professional manner, how to service radios. You will work with the standard type of punched metal chassis as well as the latest development of Printed Circuit chassis. You will learn the basic principles of radio. You will construct, study and work with RF and AF amplifiers and oscillators, detectors, rectifiers, test equipment. You will learn and practice code, using the Progressive Code Oscillator. You will learn and practice trouble-shooting, using the Progressive Signal Tracer, Progressive Signal Injector, Progressive Dynamic Radio & Electronics Tester, and the accompanying instructional material. You will receive training for the Novice, Technician and General Classes of F.C.C. Radio Amateur Licenses. You will build 16 Receiver, Transmitter, Code Oscillator, Signal Tracer and Signal Injector, and learn how to operate them. You will receive an excellent background for Television, Hi-Fi and Electronics. Absolutely no previous knowledge of radio or science is required. The "Edu-Kit" is the product of many years of teaching and engineering experience. The "Edu-Kit" will provide you with a basic education in Electronics and Radio, worth many times the complete price of \$22.95. The Signal Tracer alone is worth more than the price of the entire Kit.

### THE KIT FOR EVERYONE

You do not need the slightest background in radio or science. Whether you are interested in Radio & Electronics because you want an interesting hobby, a well paying business or a job with a future, you will find the "Edu-Kit" a worthwhile investment. Many thousands of individuals of all

ages and backgrounds have successfully used the "Edu-Kit" in more than 78 countries of the world. The "Edu-Kit" has been carefully designed, step by step, so that you cannot make a mistake. The "Edu-Kit" allows you to teach yourself at your own rate. No instructor is necessary.

### PROGRESSIVE TEACHING METHOD

The Progressive Radio "Edu-Kit" is the foremost educational radio kit in the world, and is universally accepted as the standard in the field of electronics training. The "Edu-Kit" uses the modern educational principle of "Learn by Doing." Therefore you construct, learn schematic, study theory, practice trouble-shooting—all in a closely integrated program designed to provide an easily-learned, thorough and interesting background in radio. You begin by examining the various radio parts of the "Edu-Kit." You then learn the function, theory and wiring of these parts. Then you build a simple radio. With this first set you will enjoy listening to regular broadcast stations, learn theory, practice testing and trouble-shooting. Then you build a more advanced radio, learn more advanced theory and techniques in a progressive manner and at your own rate, you will find yourself constructing more advanced multi-tube radio circuits, and doing work like a professional Radio Technician.

Included in the "Edu-Kit" course are sixteen Receiver, Transmitter, Code Oscillator, Signal Tracer, and Signal Injector circuits. These are not unprofessional "breadboard" experiments, but genuine radio circuits, constructed by means of professional wiring and soldering on metal chassis, plus the new method of radio construction known as "Printed Circuitry." These circuits operate on your regular AC or DC house current.

### THE "EDU-KIT" IS COMPLETE

You will receive all parts and instructions necessary to build 16 different radio and electronics circuits, each guaranteed to operate. Our Kits contain tubes, tube sockets, variable, electrolytic, mica, ceramic and paper dielectric condensers, resistors, tie strips, coils, hardware, tubing, punched metal chassis, Instruction Manuals, hook-up wire, solder, etc. In addition you receive Printed Circuit materials, including Printed Circuit chassis, special tube sockets, hardware and instructions. You also receive a useful set of tools, a professional electric soldering iron, and a self-powered Dynamic Radio & Electronics Tester. The "Edu-Kit" also includes Code Instructions and an Audio Frequency Generator, in addition to F.C.C.-type Questions and Answers for Radio Amateur License training. You will also receive lessons for servicing with the Progressive Signal Tracer and the Progressive Signal Injector and Signal Injector. You receive Membership in Radio-TV Club, Free Consultation Service, Certificate of Merit and Discount Privileges. You receive all parts, tools, instructions, etc. Everything is yours to keep.

### UNCONDITIONAL MONEY-BACK GUARANTEE

The Progressive Radio "Edu-Kit" has been sold to many thousands of individuals, schools and organizations, public and private, throughout the world. It is recognized internationally as the ideal radio course. By popular demand, the Progressive Radio "Edu-Kit" is now available in Spanish as well as English.

It is understood and agreed that should the Progressive Radio "Edu-Kit" be returned to Progressive "Edu-Kits" Inc., for any reason whatever, the purchase price will be refunded in full, without quibble or deduction, and without delay. The high recognition which Progressive "Edu-Kits" Inc. has earned through its many years of service to the public is due to its unconditional insistence upon the maintenance of perfect engineering, the highest instructional standards and strict adherence to its Unconditional Money-Back Guarantee. As a result, we do not have a single dissatisfied customer throughout the entire world.

### FREE EXTRAS

- SET OF TOOLS
- SOLDERING IRON
- ELECTRONICS TESTER
- PLIERS CUTTERS • ALIGNMENT TOOL
- WRENCH SET
- VALUABLE DISCOUNT CARD
- CERTIFICATE OF MERIT
- TESTER INSTRUCTION MANUAL
- HIGH FIDELITY GUIDE • QUIZZES
- TELEVISION BOOK • RADIO
- TELEVISION BOOK • AMATEUR LICENSE TRAINING
- MEMBERSHIP IN RADIO-TV CLUB
- CONSULTATION SERVICE • FCC
- AMATEUR LICENSE TRAINING
- PRINTED CIRCUITRY

### SERVICING LESSONS

You will learn trouble-shooting and servicing in a progressive manner. You will practice repairs on the sets you construct. You will learn symptoms and causes of troubles in home, portable and car radios. You will learn how to use the professional Signal Tracer, the unique Signal Injector and the Dynamic Radio & Electronics Tester. While you are learning in this practical way, you will be able to do many a repair job for your friends and neighbors, and charge fees which will far exceed the price of the "Edu-Kit." Our Consultation Service will help you with any technical problems you may have.

J. Statkalis, of 25 Poplar Pl., Waterbury, Conn., writes: "I have repaired several sets for my friends, and made money. The "Edu-Kit" paid for itself. I was ready to spend \$240 for a Course, but I found your ad and sent for your Kit."

### FROM OUR MAIL BAG

Ben Valerio, Box 23, Magna, Utah: "The Edu-Kits are wonderful. Here I am sending you the questions and also the answers for them. I have been in Radio for the last seven years, but like to work with Radio Kits, and like to build Radio Testing Equipment. I enjoyed every minute I worked with the different kits; the Signal Tracer works fine. Also like to let you know that I feel proud of becoming a member of your Radio-TV Club."

Robert L. Shuff, 1834 Monroe Ave., Huntington, W. Va.: "Thought I would drop you a few lines to say that I received my Edu-Kit, and was really amazed that such a bargain can be had at such a low price. I have already started repairing radios and phonographs. My friends were really surprised to see me get into the swing of it so quickly. The trouble-shooting Tester that comes with the Kit is really swell, and finds the trouble, if there is any to be found."

### ORDER DIRECT FROM AD—RECEIVE FREE BONUS RESISTOR AND CONDENSER KITS WORTH \$7

- Send "Edu-Kit" Postpaid. I enclose full payment of \$22.95.
- Send "Edu-Kit" C.O.D. I will pay \$22.95 plus postage.
- Send me FREE additional information describing "Edu-Kit."

Name

Address

**PROGRESSIVE "EDU-KITS" INC.**  
1186 Broadway, Dept. 502-MM, Hewlett, N. Y.

## Crystal-Type

While not so generally known, quartz crystals are commercially available at low frequencies. One manufacturer, for example, offers mounted crystals for frequencies as low as 3000 cycles per second; 10- and 20-kc types are available in many models. When these crystals are temperature-controlled in constant-temperature ovens, high stability and accuracy are obtained.

The techniques of using a quartz crystal to control the frequency of an audio oscillator are similar to the common methods of crystal-controlling a radio-frequency oscillator. Some difficulty is to be expected, however, in obtaining highest operating efficiency with conventional grid- or plate-tuned circuits because of the reduced possibility of obtaining high-Q inductors at audio frequencies. The simplest application would be the "untuned" Pierce-type oscillator, such as shown in Figure 2. Here, the oscillator frequency is set by the very-low-frequency crystal, X, connected directly between the plate and grid of pentode tube V. The blocking capacitor,  $C_1$ , may be required to protect a particular crystal from DC polarization. The oscillator is followed by a buffer-amplifier, to isolate the Pierce circuit from output-load variations.

Low-frequency crystals are, in general, less active than the more conventional r-f types. Their vibration amplitude usually must be kept lower than that of the r-f types, in order to prevent breakage. For this reason, the DC plate and screen voltages of the oscillator tube usually are lower than conventional.

The temperature coefficient of frequency of the very low-frequency quartz crystal varies with type and model, but can be of the order of 30 parts per million per °C. Thus, at audio frequencies high stability is to be expected when the crystal temperature is oven-controlled.

## Magnetostriction-Type

Although the magnetostriction oscillator is not widely used in the United States nor readily available here commercially, its use as an audio frequency standard merits review.

The control element in this type of oscillator is a nickel-alloy rod. Certain nickel alloys have the property of magnetostriction; that is, longitudinal vibration when exposed to an alternating magnetic field. A magnetically-polarized rod of this kind will vibrate at the frequency of an applied field. The natural frequency of the magnetostrictive rod is  $v/2l$ , where  $v$  is the velocity of sound in the rod and  $l$  the length of the rod.

Figure 3 shows one type of circuit in which a magnetostrictive rod (supported

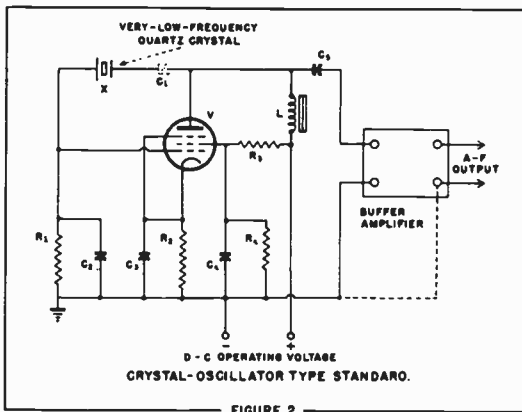

FIGURE 2

Supply voltages to the oscillator are regulated. Particular care is taken to minimize power-supply hum in the system. The feedback level is set by properly proportioning the inductance ratio of  $L_1$  and  $L_2$  and the coupling in the feedback loop. The entire oscillator, or at least the fork and magnet assembly, is placed within a constant-temperature oven. These measures maintain purity of waveform and minimize frequency drift.

Commercial, vacuum-tube driven forks similar to this arrangement usually are supplied for 400-, 500-, or 1000-cycle operation, but other frequencies are available. Depending upon type and model, accuracy of the order of 0.05% is obtainable at room temperature (25°C), and up to 0.001% or better with close temperature control. Thus, frequency is maintained as closely as 1 part in 10,000 without temperature control, and 1 part in 100,000 with temperature control. In a typical oven-controlled model, the temperature coefficient of frequency is 0.008% per °F, and the frequency is independent of output loading. Depending upon model, the output power into a matched load varies from approximately 1.5 to 50 milliwatts.

Fork-type frequency standards are provided for both battery and AC power line operation, transistorized or tube type.

## Reed-Type

In a similar system, the tuning fork is replaced with a ferrous-metal reed which vibrates between the pole pieces. The natural frequency of the reed is dependent upon the length, width, and thickness of the latter and to some extent upon the metal used. A number of single audio frequencies are provided by commercial oscillators of various types.

The reed-type oscillator is somewhat inferior in most specifications to the fork-type. However, when temperature controlled and operated from a voltage-regulated DC power supply, it is satisfactory as an A. F. frequency standard.



**HEATHKIT  
HIGH FIDELITY FM TUNER KIT**

This FM tuner is your least expensive source of high fidelity program material. Stabilized oscillator circuit assures negligible drift after initial warmup. Broadband IF circuits assure full fidelity, and 10 microvolt sensitivity pulls in stations with full volume. High-gain cascode RF amplifier, and automatic gain control. Ratio detector gives high-efficiency demodulation. All tunable components prealigned. Edge-illuminated dial for easy tuning. Here is FM for your home at a price you can afford.

MODEL FM-3A \$26.95 (with cabinet)

**HEATHKIT "BOOKSHELF"  
12 WATT HI-FI AMPLIFIER KIT**

Outstanding in both style and performance, this combination hi-fi power amplifier and preamplifier presents a truly remarkable value. Full range frequency response from 20 to 20,000 CPS within  $\pm 1$ db, with less than 1% harmonic distortion at full 12 watt output over this entire range, are just a few of the plus features. Provided are: three separate inputs, RIAA equalization on mag phono, separate bass and treble tone controls, volume control and special hum balance control. Matches performance of amplifiers costing many times more.

MODEL EA-2 \$28.95

**HEATHKIT "BASIC RANGE"  
HI-FI SPEAKER SYSTEM KIT**

This speaker system employs two Jensen speakers to cover the frequency range of 50 to 12,000 cps. Response is within  $\pm 5$  db through this range. Built-in cross-over functions at 1600 cps. System rated at 25 watts, with nominal impedance of 16 ohms. Enclosure is a ducted-port bass reflex type. The attractive "picture frame" molding blends with any decoration scheme. You merely assemble the cabinet, wire the speakers and crossover network, and treat the furniture-grade plywood in the finish of your choice.

MODEL SS-2 \$39.95



Many more kits to choose from! Send for this free catalog describing over 100 "Easy-to-build" electronic instruments in HI-FI, Test, Marine, and Amateur Radio Fields.

build your own



HI-FI and save!



Model FM-3A



Model EA-2

*No previous electronic experience is required to assemble a Heathkit. Easy-to-follow step-by-step instructions and pictorial diagrams supplied with each kit guarantee your success.*

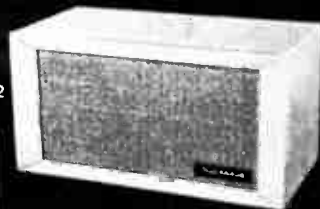

Model SS-2

pioneer in  
"do-it-yourself"  
electronics

**HEATH COMPANY**



Benton Harbor 7, Mich.

a subsidiary of Daystrom, Inc.

name \_\_\_\_\_

address \_\_\_\_\_

city—state \_\_\_\_\_



# LEARN BASIC TELEVISION

The whole world of black and white television is before you for only \$10.00.

NOW AVAILABLE



New 5-volume Rider "picture book" course by Dr. Alexander Schure teaches the complete basic principles and practices of black and white television easily, quickly and understandably. You can master the basics of television easily, rapidly and thoroughly with this "learn by pictures" training course.

No experience, education needed

**BASIC TELEVISION** uses the same methods that have proven so successful in the famous Rider "picture books" on electricity and electronics. This comprehensive course presents Basic Television in simple, down-to-earth language that everyone can understand—regardless of previous education. All that is assumed is that you have a knowledge of radio. Every phase of television is made instantly clear—explained in plain English supported by carefully prepared, large and exciting drawings that make every idea crystal-clear.

5 complete volumes

It starts with the transmitter and discusses in detail the following subjects: Volume 1 deals with the transmitter; the handling and the operation of the camera; formation of the picture signal and the general content of the transmitter. Volume 2 covers the organization of the entire TV receiver treating each section individually from antenna to picture tube. Volumes 3, 4 and 5 contain the TV receiver circuit explanations. Each volume covers a specific number of sections in the receiver. In effect, the presentation is like a spiral—first an overall view of the whole, and then the detailed explanation of each part. The most perfect modern teaching technique. The result—maximum understanding.

Learn at home—no correspondence

This course is so complete, so different—there's no need for the usual letter writing, question and correspondence. You learn in the comfort of your home, in your spare time... at your own pace.

An Opportunity to check your knowledge

Some people who have bought and read **BASIC TELEVISION** may feel that they would like to check their knowledge. For these people, an arrangement covering an examination service has been made with the New York Technical Institute, the extension division of the New York Institute of Technology, a non-profit two year term college chartered by the New York State Board of Regents. This service is completely independent of John F. Rider Publishers, Inc., and is offered as a non-profit public service of the Institute. Write for details to N. Y. Technical Institute, 500 Pacific St., Brooklyn 17, N. Y.

10-day examination—Money Back Guarantee

Send today for these exciting new training courses—you risk nothing! When you receive the volumes, examine them in your own home for 10 full days. If, at the end of that time, you're not completely satisfied, we will simply return your full purchase price! Total cost for this 5-volume course is only \$10.00! In Canada, prices approximately 5% higher.

ORDER TODAY

These books are sold by electronics parts jobbers and book stores. If YOUR dealer doesn't have these books, mail this coupon to us.

JOHN F. RIDER PUBLISHER, INC.  
118 West 14th St., N.Y.C.

EH-A

I have enclosed \$\_\_\_\_\_ Please send me

5-vol. **BASIC TELEVISION** set (soft cover) at \$10.00 per set

Deluxe cloth bound edition all 5 vols. in a single binding \$11.50

I understand I may return the books in 10 days, and receive a complete refund of the full purchase price if I am not satisfied.

NAME \_\_\_\_\_

ADDRESS \_\_\_\_\_

CITY & STATE \_\_\_\_\_

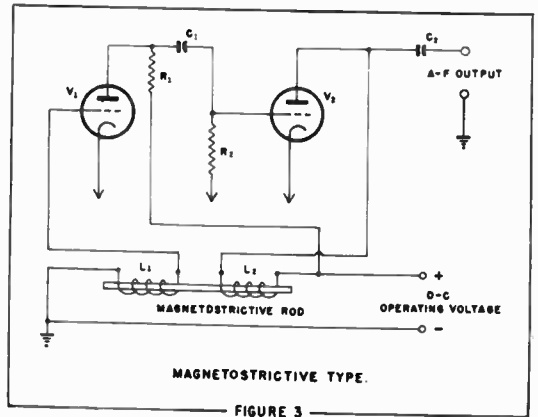

FIGURE 3

at its center) is used to control the frequency of oscillation. In principle, this circuit is seen to resemble Figure 1 with the rod replacing the fork. Positive feedback is supplied by inductive coupling through the frequency-control circuit comprised by grid coil  $L_1$ , plate coil  $L_2$ , and the rod. Audio-frequency output, transmitted through capacitor  $C_2$ , usually is presented to the high-impedance input of a buffer-amplifier stage inserted to isolate the oscillator from the effects of load variations.

## Crystal Oscillator-Multivibrator Type

The conventional frequency standard employed for R. F. standardization can supply highly-precise audio frequencies as well. Both primary and secondary radio frequency standards are adaptable to this service. The accuracy of laboratory-type primary and secondary frequency standards (such as General Radio Types 1100-AP and 1100-AQ, respectively) is 0.5 part in 100 million per year. Frequency stability during short intervals, such as during measurement periods, is such that frequency fluctuations are less than 1 part in one billion. The high precision of the instruments is due to a combination of factors such as low-drift quartz crystals, close control of temperature, and close regulation of operating voltages. The precision of service-type secondary frequency standards is much lower, 5 to 50 parts per million per °C being typical in the absence of temperature control and voltage regulation.

A frequency standard consists of a crystal-controlled oscillator (usually operated at 50, 100, or 1000 kc) which, in turn, controls several lower-frequency multivibrators. Standard audio frequencies (such as 10 kc, 1 kc, 100 cps, 50 cps) are derived from the multivibrators and have the same accuracy as the controlling oscillator. The oscillator is periodically standardized by setting it to zero beat with WWV transmissions. If the unit is a primary standard, it may be calibrated by comparing its frequency (as referred to operation of



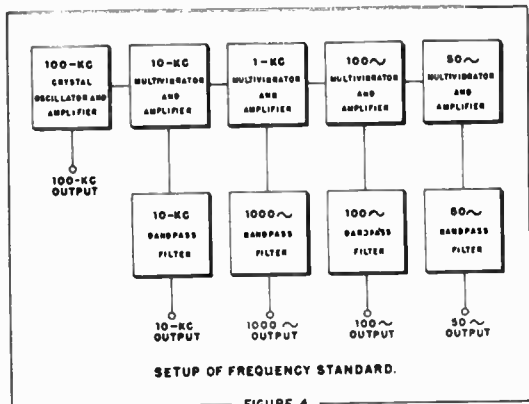

an electric clock from one of the low-frequency multivibrators) to standard time. The waveform of the A. F. signal voltages is purified by output filters.

The block diagram in Figure 4 shows the arrangement of a frequency standard. In this setup, a precise 100-kc crystal-controlled oscillator is the basis of the system. The oscillator is followed by multivibrators operated at 10, 1, 0.1, and 0.05 kc and synchronized with the oscillator. Each multivibrator and the oscillator are provided with output amplifiers for isolation. Audio-frequency outputs are derived from the multivibrators, at 10,000, 1000, 100, and 50 cps, respectively, through bandpass filters which purify the waveform of these signals. Other frequencies are obtainable by changing the multivibrator operating frequencies. However, the frequencies specified in Figure 4 will permit standardization and frequency measurement throughout the audio spectrum.

When the waveform of the audio signal is unimportant in a particular application, A. F. output may be taken directly from the multivibrator stage.

### BuStan Signals as A.F. Standard

The standard frequency signals broadcast from stations WWV and WWVH of the National Bureau of Standards are amplitude modulated during specific intervals at 440 and 600 cps, both sinusoidal.

These two audio frequencies are highly accurate and, when obtained from a distortion-free audio channel of a non-oscillating radio receiver tuned to WWV or WWVH, may be used as standards.

The carriers are modulated during the first four minutes of each five-minute interval, starting on the hour. During the first four-minute period, the audio frequency is 600 cps; during the second four-minute period, it is 440 cps. The two modulation frequencies are alternated in this manner each five minutes.

Transmissions from WWV are on 2.5, 5, 10, 15, 20, and 25 Mc. Those from WWVH are on 5, 10, and 15 Mc. •

## MASTER BASIC ELECTRICITY BASIC ELECTRONICS THE EASY "PICTURE BOOK" WAY!



fabulous ILLUSTRATED  
Training Course  
now used by U.S. Navy

### A Complete Idea on Every Page

Here's how this easy, illustrated course works: every page covers one complete idea! There's at least one big illustration on that same page to explain it! What's more, an imaginary instructor stands figuratively at your elbow, doing "demonstrations" that make it even easier for you to understand. Then, at the end of every section, you'll find review pages that highlight the important topics you've just covered. You build a thorough, step-by-step knowledge at your own pace—as fast as you yourself want to go! Sponsored by the Navy to turn out trained technicians in record time, this modern course presents Basic Electricity and Basic Electronics in a simple way that everyone can grasp—regardless of previous education!

### 10 Complete Volumes

Volumes 1 and 2 of "Basic Electricity" cover DC components and circuits; Volumes 3 and 4 cover AC components and circuits; Volume 5 covers AC and DC motors and machinery. Volume 1 of "Basic Electronics" covers Diodes and Power Supplies; Vols. 2 and 3 cover Amplifiers and Oscillators; Vols. 4 and 5 cover Transmitters and Receivers.

### Home Study Without Correspondence

This course is so different, so complete—there's no need for the usual letter writing, question and answer correspondence! Learn at home—at your own pace!

### An opportunity to check your knowledge

Some people who have bought and read BASIC ELECTRICITY or BASIC ELECTRONICS may feel that they would like to check their knowledge. For these people, an arrangement covering an examination service has been made with the New York Technical Institute, the extension division of the New York Institute of Technology, a non-profit two year term college chartered by the New York State Board of Regents. This service is completely independent of John F. Rider Publishers, Inc., and is offered as a non-profit public service of the Institute. Write for details to N. Y. Technical Institute, 500 Pacific St., Brooklyn 17, N. Y.

### 10 Day Examination — Money Back Guarantee

Send today for these exciting new training courses — you risk nothing! When you receive the volumes, examine them in your own home for 10 full days. If, at the end of that time, you're not completely satisfied, simply return the books to us and we'll gladly refund your full purchase price! Total cost for either 5-volume course is only \$10.00! In Canada, prices approximately 5% higher.

### ORDER TODAY!

These books are sold by electronics parts jobbers and book stores. If YOUR dealer doesn't have these books, mail this coupon to us!



JOHN F. RIDER PUBLISHER, INC.  
116 West 14th St., N.Y.C.

I have enclosed \$\_\_\_\_\_ Please send me

- 5-vol. Basic Electricity set @ \$10 set
- 5 vol. Basic Electronics set @ \$10 set
- Both sets. I understand I may return the books in 10 days, and receive a complete refund of the full purchase price if I am not satisfied. Add state or city sales tax where applicable.

Name \_\_\_\_\_

Address \_\_\_\_\_

City & State \_\_\_\_\_ EH-A



# An ABC

# of the FCC

Every electronics practitioner should be familiar with its structure and functions

**A**NYONE interested in electronics in any way should be familiar with the organization and functions of the Federal Communications Commission, more conveniently known as the FCC. Here's complete data in easily-read form.

*What is the Federal Communications Commission?*

It is the United States Government agency charged with regulating interstate and foreign communication by means of radio, wire, and cable.

*What is the object of FCC regulation?*

To provide for orderly development and operation of broadcasting services; to make available a rapid, efficient, nation-wide and world-wide telegraph and telephone service at reasonable charges; to promote the safety of life and property through improved communications systems; and by such means to strength the national defense.

*Is the FCC under any government department?*

No; it is an independent Federal establishment created by Congress and, as such, reports directly to Congress.

*How did the FCC come into being?*

Jurisdiction over electrical communications was formerly shared by the Department of Commerce, Post Office Department, and Interstate Commerce Commission and, later, by the Federal Radio Commission. Developments necessitated consolidation of supervisory and regulatory functions in a single agency. The Communications Act, signed June 19, 1934, created the Federal Communications Commission for this purpose.

*Is the Communications Act limited to the 48 states?*

No; it applies also to Alaska, Guam, Hawaii, Puerto Rico, and the Virgin Islands, but not to the Canal Zone.

*What are the major activities of the FCC?*

Allocating bands of frequencies to non-

government radio services and assigning frequencies to individual stations; licensing and regulating radio stations and radio operators; regulating common carriers engaged in interstate and foreign communication by telegraph and telephone; promoting safety through the use of radio on land, water, and in the air; encouraging more effective and widespread use of radio; and harnessing wire and radio communication facilities to the national defense.

*How is the FCC administered?*

By seven Commissioners appointed by the President with the approval of the Senate. One of the Commissioners is designated Chairman by the President. Not more than four Commissioners may be members of the same political party. Appointment is for seven years, except in filling an unexpired term. The salary of a Commissioner is \$20,000 a year, except the Chairman, who receives \$20,500.

*How does the FCC function?*

The Commissioners function as a unit, directly supervising all activities, with delegations of responsibilities to boards and committees of Commissioners, individual Commissioners, and staff units. The Chairman is responsible for the general administration of the internal affairs of the Commission. Policy determinations are made by the Commission as a whole. Commission practices conform to the Communications Act of 1934, as amended, the Administrative Procedure Act, and other applicable laws.

The Commission staff is organized on a functional basis. There are four operating bureaus—Field Engineering and Monitoring, Common Carrier, Safety and Special Radio Services, and Broadcast—and seven offices—Secretary, Administration, Chief Engineer, General Counsel, Hearing Examiner, Opinions and Review, and Reports and Information.

*What does the FCC field staff do?*

It is engaged largely in engineering

work. This includes monitoring the radio spectrum to see that radio station operation meets technical requirements, inspecting radio stations of all types, conducting radio operator examinations and issuing permits to those found qualified, locating and closing unauthorized transmitters, furnishing radio bearings on aircraft or ships in distress, doing special engineering work for other government agencies, and obtaining and analyzing technical data for Commission use.

*To what extent does the FCC cooperate with other agencies?*

In international and national matters, it cooperates with various governmental agencies concerned with radio and wire communication. It also cooperates with state regulatory commissions in matters of mutual interest, largely through the National Association of Railroad and Utilities Commissioners. There is further cooperation with radio users' groups.

*How many persons does the FCC employ?*

About 1,100, of which number one third are in the field. With few exceptions, its personnel is under Civil Service.

*What does FCC regulation of common carriers embrace?*

In addition to licensing radiotelephone and radiotelegraph circuits and assigning

frequencies for their operation, it supervises charges, practices, classifications and regulations in connection with interstate and foreign communication by radio, wire, and cable; considers applications for construction of new facilities and discontinuance or reduction of service; acts on applications for interlocking directorates and merger of domestic common carriers, and prescribes and reviews the accounting performed by communication carriers. The Commission does not regulate purely intrastate wire services. A broadcast station is not a common carrier.

*What does FCC regulation of radio embrace?*

Consideration of applications for construction permits and licenses for broadcast and other classes of radio stations; assignment of frequencies, power, and call letters; authorization of communication circuits; modification or revocation of licenses; inspection of equipment and regulation of its use; guarding against interference; reviewing technical operation; licensing radio operators; regulating radio common carriers, and otherwise carrying out provisions of the Communications Act. The latter enjoins the Commission from censoring broadcast programs.

*Is the privacy of messages protected?*

**ABRAHAM MARCUS MAKES AMAZING OFFER!**



**TRY MY**

# BASIC ELECTRONICS

**COURSE FOR 1 MONTH** *Free!*



**Shortcut to Thousands of \$100-\$150-per-Week Jobs  
Waiting in Radio, TV, Hi-Fi, Electronics Industry**

That's right! **ONE MONTH FREE . . .** with this guarantee: If in that time you haven't saved and made plenty of spare-time dollars with your new knowledge, just return the books and pay nothing.

Why do we make this amazing offer? First, because the entire course is written so you can't miss—the same clear, easy-to-understand language that has already made the author's "Elements of Radio" a 1,000,000-copy best-seller. Second, you use only elementary arithmetic. Third, do-it-yourself projects make you a qualified technician fast—able to command high pay, rapid promotion, enjoy a secure future in a zooming industry.

**BEGIN NOW!** You risk nothing by mailing the coupon. Even if you decide to keep the books, you pay on easy terms. Mail the coupon now.

**WHAT YOU GET IN THIS 3-BOOK COURSE**

**BASIC ELECTRICITY.** Basic theory through AC, DC generators, practical applications—circuits—measuring instruments—elements of resistance, inductance, capacitance—thermal, luminous, chemical, magnetic effects—the electron tube—semi-conductors—motors—etc.

**ELEMENTS OF RADIO.** Complete course in fundamentals of radio. Has outsold every other! Requires no previous knowledge of radio, physics, or higher math. Everything you need to know presented in 1-2-3 fashion—including all the latest developments.

**RADIO PROJECTS.** Build your own receivers! Gives you 10 easy-to-follow projects, including crystal detector receiver—diode detector receiver—regenerative receiver—audio-frequency amplifier—tuned-radio-frequency tuner—AC-DC superheterodyne receiver—power supplies—code practice oscillator—etc.

**MAIL COUPON TODAY**

PRENTICE-HALL, INC., Dept. 5708-P2  
Englewood Cliffs, New Jersey

Please send me Abraham Marcus' BASIC ELECTRONICS COURSE (3 volumes) for 10 days FREE examination. Within 10 days I will either return it and owe nothing, or send my first payment of \$5.65 plus few cents postage. Then, after I have used the course for a FULL MONTH, if I am not satisfied I may return it and you will refund my first payment. Or I will keep the course and send you two more payments of \$5.65 a month for two months.

Name .....

Address .....

City..... Zone.... State.....



The Communications Act expressly provides that wire and radio messages (except broadcast, amateur, and distress) may not be intercepted and used by unauthorized persons.

*Does the FCC charge for licensing?*

It exacts no fee or charge of any kind in connection with its licensing and regulatory functions.

*Must all radio operations be licensed?*

The Communications Act requires all non-government radio transmitters and their operators to be licensed. There are various grades of licenses for commercial and amateur radio operators. Waivers have been granted for certain "push-button" types of transmitters.

*Can aliens hold licenses?*

The license privilege is limited by the Communications Act to citizens of the United States. It is denied to corporations wherein any officer or director is an alien or of which more than one-fifth of the capital stock is owned or voted by aliens or their representatives.

*How are FCC orders enforced?*

By Commission action under its delegated powers, and by action through United States District Courts.

*What are some types of broadcast services?*

The list includes the older Standard or AM (amplitude modulation); FM (frequency modulation), commercial and non-commercial educational; TV (television), commercial and noncommercial educational; International; supplemental services such as FM functional music, TV translators, remote pickup, and studio-transmitter links; and experimental and developmental services.

*What are some other radio services?*

Aviation (planes and ground); Marine (ship and coastal); Public Safety (police, fire, forestry-conservation, highway maintenance, special emergency, and state guard); Industrial (power, petroleum, forest products, special industrial, low-power industrial, relay press, and motion picture); Land Transportation (railroad, motor carrier, taxicab and automobile emergency); Amateur, Citizens, Disaster, and Experimental; also common carrier communication to the inclusion of paging and TV relay services.

*How does the FCC figure in international matters?*

It is charged with domestic administration of communication provisions of treaties and international agreements to which the United States is a party. It participates in many related international conferences. It licenses related radio and cable circuits between the United States

and foreign points and regulates the operating companies. It also licenses radio stations on American planes and ships in international as well as domestic service, and, under international agreement, inspects the radio equipment of certain foreign vessels touching our ports.

*How is the FCC concerned with safety of life and property?*

The Communications Act stipulates: "For the purpose of obtaining maximum effectiveness from the use of radio and wire communications in connection with safety of life and property, the Commission shall investigate and study all phases of the problem and the best methods of obtaining the cooperation and coordination of these systems." Radio installations on vessels and aircraft, also police, fire, forestry, and other protective radio systems are in this category.

*How does radio aid business?*

Besides affording a speedy means of communication and being a factor in protecting life and property, radio contributes to economies and improvements in public and private business operations. Radio has become an important adjunct to rail, highway, water, and air transportation; and to public utility, industrial, and other business operations.

*Does the FCC engage in research?*

The Commission is required to keep informed on technical developments in wire and radio communication, and to "study new uses for radio, provide for experimental uses of frequencies, and generally encourage the larger and more effective use of radio in the public interest." Cooperation is maintained with Government and commercial research groups.

*What is the role of the FCC in national defense?*

Use of wire and radio communication to aid the national defense is one of the stated purposes of the Communications Act. It confers special powers on the President in time of national emergency. The Commission cooperates with government agencies engaged in national defense work, and with organizations and other elements of industries affected. The Commission has long maintained regional disaster emergency coordination with the Coast Guard, Navy, Army, Air Force, Red Cross, amateurs, and state and municipal police organizations. Its established radio services include special emergency, civil air patrol, state guard, disaster communications, and amateur civil emergency. It supervises a CONELRAD (CONtrol of ELEctromagnetic RADiation) program for the conduct of all radio services in event of an enemy air attack. •



# Handy Kinks



**Avoid shock danger; discharge filter capacitors.**

**F**ILTER capacitors of the mica, paper and oil-impregnated paper types, which are usually used in high-voltage circuits, can retain strong charges long after the equipment has been turned off. An unsuspecting person who touches the terminals or any part of the associated circuit can suffer a nasty shock. It is a smart idea to regard all such capacitors with suspicion and to discharge them by placing a screwdriver across their terminals, before putting a finger on them. The size of the resulting spark, and the sharp crack it makes, are often astonishing.

When you connect hi-fi components, intercom systems, call circuits, etc., it is often necessary to identify all wires at both ends. This is easy if the wires have insulation of different colors and the colors aren't faded or obscured by wax. If they are of the same or similar colors, a positive way to keep from mixing them up is to tie knots in their ends. If there is a common ground wire running through the system, let this be a plain one without a knot. The knots can remain permanently; they don't do any harm. •

**Identify wires by knotting them at both ends.**



## BUILD THE BEST! build ALLIED'S own amazing knight-kits

see them all in

**ALLIED'S 1959  
ELECTRONIC SUPPLY CATALOG**

**free**

**BUILD YOUR OWN!  
IT'S EASY—IT'S FUN—  
SAVE UP TO 50%**



HI-FI  
KITS

**452**  
value-packed  
pages



HAM  
KITS



HOBBY  
KITS

INSTRUMENT  
KITS



### SAVE on Everything in Electronics



**WORLD'S LARGEST STOCKS:** Everything for Experimenters, Builders, Amateurs, Servicemen, Engineers, Hi-Fi enthusiasts. Get more for your money in Hi-Fi systems and components, including latest Stereo; save on build-your-own KNIGHT-KITS; recorders and tape; Amateur station equipment; TV tubes, antennas, accessories; test instruments; industrial electronic equipment—plus the world's largest stocks of parts, tubes, transistors, tools and books. Send today for your **FREE 1959 ALLIED Catalog!**

EASY TERMS AVAILABLE

**ALLIED RADIO**

Everything in Electronics at Lowest Prices

ALLIED RADIO CORP., Dept. 135-9  
100 N. Western Ave., Chicago 80, Ill.

Rush FREE 1959 ALLIED 452-Page Catalog.

Name \_\_\_\_\_

Address \_\_\_\_\_

City \_\_\_\_\_ Zone \_\_\_\_\_ State \_\_\_\_\_

our 38th year

send for  
**FREE**  
Catalog

# Radio Station Calls

Here's how they are apportioned and assigned

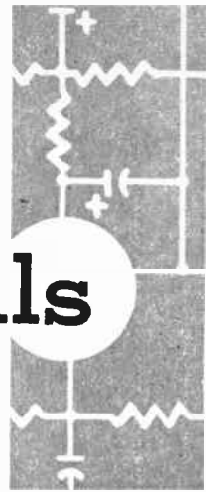

WITH MILLIONS of radio stations furnishing a variety of communication services throughout the world, it is necessary that their transmissions carry distinguishing calls. The latter are known as "call signs." In the case of broadcast stations, which use letters only, the term "call letters" is frequently used.

These calls have a three-fold purpose. First, they identify the *nationality* of the station. Then they identify the type of station. And, further, they identify the *particular* station. In some nonbroadcast services in our country, the combination of letters and numerals also indicates the area in which the station is *located*.

The need for station identification is emphasized by the fact that the United States leads all other countries in the use of radio. It now has some 65 different kinds of radio services which use one and a quarter million transmitters. Their transmissions not only provide communication services in domestic communities or areas, but also contact ships and aircraft en route, and span the oceans to reach foreign lands.

Since the early days of wireless telegraphy—which started with marine use—it has been essential that each radio station have a distinctive call. Under international agreement, the alphabet has since 1927 been apportioned among the nations for basic call use. The United States, for example, is assigned three letters—N, K, and W—to serve as initial call letters for the exclusive use of its radio stations. It also shares the initial letter A with some other countries. The letter N is assigned largely to the Navy and Coast Guard, while the letters K, W, and A are assigned to other domestic stations, both government and non-government.

The Communications Act makes the Federal Communications Commission responsible for assigning calls to all radio stations in this country, with some military

exceptions. This is done on an individual station basis except in the case of government stations, where blocks of appropriate calls are assigned for their use.

In general, call assignments are made from available call letter groups. In other words, each service has a reserve of calls available for new stations, and assignments are made in the order in which a station is authorized to operate in its respective service.

An exception is the case of program (AM, FM, and TV) broadcast stations. Since the start of broadcasting these stations have had the privilege of requesting particular call letters other than the initial letter. There has been a preference for letter combinations embodying initials of names, places, or slogans. Examples are: KNBC, San Francisco (National Broadcasting Co.); WCBS, New York (Columbia Broadcasting System); KABC, Los Angeles (American Broadcasting Co.); WABD, New York (Allen B. DuMont); WNYC, New York (New York City); WGN, Chicago ("World's Greatest Newspaper"); WCFL, Chicago (Chicago Federation of Labor); WACO (Waco, Texas); KAGH, Crossett, Ark. ("Keep Arkansas Green Home"); WTOP, Washington ("Top of the Dial"); KFDR, Grand Coulee, Wash. (Franklin D. Roosevelt); WMMN, Fairmont, W. Va. (Matthew M. Neely); WXGI, Richmond (Ex-G.I.); WXIX, Milwaukee (Roman numerals indicate TV Channel 19); and WQED, Pittsburgh (initials of Latin phrase applicable to education).

However, such requests can be accommodated only from letter combinations not yet assigned.

If a new broadcast station makes no specific request, it is assigned an appropriate call by the Commission. Since 1946 the Commission has reserved no broadcast call letters on request prior to the granting of a construction permit.

In the early days, stations could be assigned three-letter calls. As their number increased, it was necessary (about the time of World War I), to add a fourth letter. The four-letter combinations make about 50,000 assignments possible (if W, K, and N calls are included). The total number of AM, FM, and TV broadcast station authorizations is now nearing 5,000.

The advent of FM and TV in 1941 did not mean new call letters for all such stations. Since many FM and TV stations are operated by AM licensees in the same place, the general practice has been for the associated FM or TV station to simply add "-FM" or "-TV," as the case may be, to the call letters of the AM station.

Broadcast stations in this country are assigned call letters beginning with K or W. Generally speaking, those beginning with K are assigned to stations west of the Mississippi River and in the territories and possessions, while those beginning with W are assigned broadcast stations east of that river. During radio's infancy, most of the broadcast stations were in the East. As inland stations developed, the Mississippi was made the dividing line between K and W calls. A few existing calls at variance with this system are due to the fact that their holders received them before the allocation plan was adopted. Station KDKA, Pittsburgh, is one example.

Four-letter calls were not sufficient to take care of amateur radio stations, which now exceed 165,000. A special system of letter and numeral combinations had to be worked out for the self-styled "hams."

Treaty limits amateur calls to not more than six symbols. An amateur call comprises a prefix (beginning with W or K), a digit, and a suffix. A simple example is W1AA. The prefix (W) indicates the nationality (in this case one within the continental limits of the United States). The digit (1) indicates location in one of the 10 radio districts (in this case New England). The suffix (AA) identifies the individual station. For outlying areas, the prefix K followed by another letter is used. Thus, KL7AAF would indicate an amateur station in Alaska.

Assignment of amateur calls is on a regular basis from yet unused calls rather than on a request basis. The Commission's files bulge with supplications for special calls to match initials, etc. Many "hams" yearn for two-letter calls, the pride of old-timers. Though appreciating their interest, the Commission cannot grant most of these requests. Its assignment system was designed to be fair to all.

Free Trial Guarantees you can

# FIX ANY TV FAST!

.. or pay not one cent!

**NO EXPERIENCE OR HIGHER MATH NECESSARY**

Let 10 days' FREE use of this book prove—at our expense—you can install and repair any TV set like an expert. You'll be amazed how easy it is to spot most troubles by eye and ear alone—how the clear, step-by-step instructions and illustrations reduce even the most complicated problems to simple a-b-c's. Quickly and easily, with this manual to guide you, you can turn your up-to-the-minute knowledge into plenty of spare-time cash or be your own boss in a profitable business.

In this new edition you get: The latest circuits—Troubleshooting techniques—Transistorized TV sets—Remote control tuning—Troubleshooting printed wiring—Module type construction—Packaged circuits—Newest servicing hints—Latest information on color TV and test equipment . . . every new advancement plus the basic know-how you need to put any set back in perfect working order. Mr. C. W. Morris of Charleston, W. Va., says: "I have paid as much as \$200.00 for courses that haven't given me the clear understanding this book has."



**10-DAY TRIAL COUPON—MAIL TODAY**

PRENTICE-HALL, INC., Dept. 5708-P1  
Englewood Cliffs, New Jersey

Send me TELEVISION SERVICING for 10 days' FREE TRIAL. In that time I'll either return it and owe nothing, or keep it and pay \$2.75 down (plus postage) and \$2 monthly for 2 months.

Name .....

Address .....

City .....

Zone .....

State .....

**SAVE!** Send \$6.75 now and we'll pay postage. Refund and same return privilege guaranteed.

Now  
on  
Sale...



Fawcett Book # 389  
75¢

The latest, most comprehensive book on high fidelity by the noted authority Don Hoefler. In simple, every-day language, it covers all phases of the subject, from plain sound reproduction to the newest in stereophonic sound. Tells how to get the most out of Hi-Fi; how to pick your equipment; the best buys on the market; all about preamps, turntables, tuners, tape recorders, speakers, do-it-yourself kits, making your own tapes and records. Thoroughly illustrated.

**At Your Newsstand**

or order by mail from:  
FAWCETT BOOKS, Dept. 394, Greenwich, Conn.  
Add 10 cents per copy mailing charge

Though amateur calls are for the purpose of identifying the station rather than the operator, the holder likes to regard his call as something personal. Often it appears on his correspondence, as well as a marker for his automobile. There is nothing to prevent this practice, and gravestones even bear cherished calls of amateurs who have sent their final sign-off.

Experimental radio stations are generally assigned calls beginning with the letter K, followed by another designating the radio district, followed by the number 2, followed by the letter X to indicate experimental, followed by a group of not more than two letters to identify the particular station.

The call signal assignment pattern for other classes of radio stations can be summarized thus:

| Station   | Call  |
|---|---|
| Coastal telegraph (U. S. and Alaska)            | 3 letters                                     |
| Coastal telephone (U. S.)                       | 3 letters                                     |
| (Alaska)  | 3 letters, 2 digits                           |
| Aviation (land)                                 | 3 letters, 1 digit                            |
| Fixed   | 3 letters, 2 digits                           |
| Land (other than aviation and coast)            | 3 letters, 3 digits                           |
| Mobile telegraph (other than ship and aircraft) | 4 letters, 1 digit                            |
| Mobile telephone (other than ship and aircraft) | 2 letters, 4 digits                           |
| Ship telegraph                                  | 4 letters                                     |
| Ship telephone                                  | 2 letters, 4 digits                           |
| Aircraft telegraph                              | 5 letters                                     |
| Aircraft telephone                              | Plane registration number                     |
| Lifeboats and liferafts (telegraph)             | Call of parent ship or aircraft plus 2 digits |

The call signs of fixed, land and radio-navigation stations (except coast stations) indicate their geographic locations as follows:

| Calls                    | Location  |
|--------------------------|---|
| KAA to KBZ<br>WAA to WBZ | Colorado, Iowa, Kansas, Minnesota, Missouri, Nebraska, North Dakota and South Dakota        |
| KCA to KDZ<br>WCA to WDZ | Connecticut, Maine, Massachusetts, New Hampshire, Rhode Island, Vermont                     |
| KEA to KFZ<br>WEA to WFZ | New Jersey and New York   |
| KGA to KHZ<br>WGA to WHZ | Delaware, District of Columbia, Maryland and Pennsylvania                                   |
| KIA to KJZ<br>WIA to WJZ | Alabama, Georgia, Florida, Kentucky, North Carolina, South Carolina, Tennessee and Virginia |
| KKA to KLZ<br>WKA to WLZ | Arkansas, Louisiana, Mississippi, New Mexico, Oklahoma and Texas                            |
| KMA to KNZ<br>WMA to WNZ | California  |
| KOA to KPZ<br>WOA to WPZ | Arizona, Idaho, Montana, Nevada, Oregon, Utah, Washington and Wyoming                       |
| KQA to KRZ<br>WQA to WRZ | Michigan, Ohio and West Virginia  |
| KSA to KTZ<br>WSA to WTZ | Illinois, Indiana and Wisconsin   |
| KUA to KVZ<br>KWA to KZZ | Pacific areas   |
| WWA to WWZ               | Alaska<br>Atlantic-Caribbean areas  |

A story about radio calls would not be complete without distress calls.

It is recorded that a British vessel used radio as early as 1899 to summon aid. The first radio distress call from an American vessel has been traced to 1905. Jack Binns made the headlines in 1909 when he stuck to his post as radio operator of the stricken steamship *Republic* to send the then distress signal "CQD." In 1912 the ill-fated *Titanic* flashed the same call in vain.

Prior to the turn of the century there was no special radiotelegraph call for sea emergency. One pioneer operator simply sent the letters "HELP" in code. In 1903 Italy suggested "SSSDDD" as an international radio emergency call. By 1904 a number of ships engaged in the Atlantic trade were equipped with "wireless," as radio was then known, and they recruited land telegraph operators for sea duty. The latter resorted to the land-line general call "CQ," meaning "attention all stations." In 1904 the Marconi company added the letter "D" to signify distress.

Meanwhile, German ships had been using "SOE" and, in 1906, that country recommended those letters as an international distress call. However, this combination was deemed unsatisfactory to radiotelegraphy because the final dot was often obliterated by static or other interference. The American delegation to an international conference suggested "NC," which is the call for help in flag signaling. The ultimate result was that "SOS" became effective in 1906 by international agreement, though "CQD" continued to be used by British ships for some years thereafter.

"SOS" does not literally mean "Save Our Souls" or "Save Our Ship," as is sometimes claimed, any more than "CQD" meant "Come Quick, Danger." Such calls are based upon the speed and clarity with which they can be transmitted in radiotelegraphy.

The foregoing refers to radiotelegraph signals in the Morse code. For radiotelephone purposes, the international distress call is "Mayday," which corresponds to a French term meaning "help me." This was a British proposal approved by an international convention in 1927. It has since been used by military as well as by civilian sea and air craft equipped with radiotelephony. For obvious reasons, the Communications Act specifically bans transmission of false distress signals.

The digits "73" comprise a signal long used by telegraphers to signify best regards. And, to go further, "88" means love and kisses. Use with discretion! •



# Angled Meter



Meter to which  $\frac{1}{8}$  by  $\frac{3}{4}$ -inch Masonite legs have been added can be scanned quickly and easily.

**I**F YOU KEEP a volt-ohmmeter or vacuum tube voltmeter standing in its usual position, you undoubtedly have noticed that you must squat or stoop uncomfortably in order to read the scale. By propping the case with boxes, you can determine that the best viewing angle is about 45 degrees.

It is a very quick and simple job to fit the meter with permanent legs that can be set to any desired angle, yet do not interfere in any way with the instrument. These legs can be strips of aluminum, brass or pressed hardboard,  $\frac{1}{8}$  inch or less thick, with holes at one end to fit the same screws that hold the carrying handle of the meter. Cut the legs so that they don't quite reach the bottom edge of the case when they are folded in. •

Rounded at bottom, legs make good contact at any setting, fold neatly against the meter for carrying.

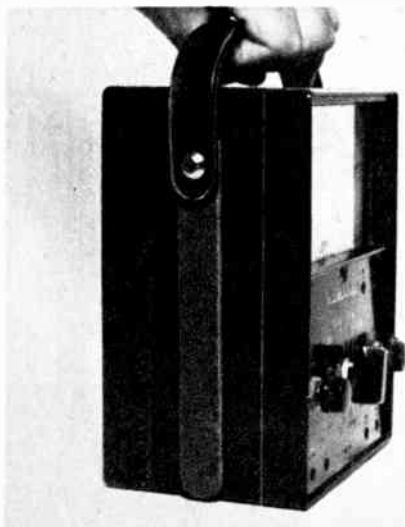

## Dr. Grabow PRE-SMOKED PIPES

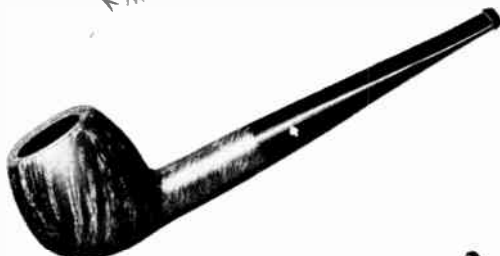

trademark of quality

Cool, sweet and mild from the first puff. No breaking-in because they're mechanically pre-smoked. All are hand-crafted of imported briar.

\$1.50 to \$10.00

DR. GRABOW PRE-SMOKED PIPES  
GREENSBORO, N. C.

Write to Department SP for  
free illustrated booklet

GET READY FOR THE SPACE ERA! SEE THE SATELLITES . . . THE MOON ROCKETS

# AMAZING TELESCOPE BUYS AND OTHER OPTICAL BARGAINS



See the Stars, Moon, Planets Close Up!

## 3" ASTRONOMICAL REFLECTING TELESCOPE

60 to 160 Power—Famous Mt. Palomar Type! An Unusual Buy! Assembled—Ready to use! You'll see the Rings of Saturn, the fascinating planet Mars, huge craters on the Moon, Star Clusters, Moons of Jupiter in detail! Galaxies! Equatorial mount with lock on both axes. Aluminized and over-coated 3" diameter high-speed f/10 mirror. Telescope comes equipped with a 60X eyepiece and a mounted Barlow Lens, giving you 60 to 160 power. Low-cost accessory eyepieces available for power up to 320. An Optical Finder Telescope, always so essential, is also included. Sturdy, hardwood, portable tripod. Valuable STAR CHART and 272-page "Handbook of Heavens." Stock No. 85,050-GE . . . \$29.95 prepaid



## STEREO MICROSCOPE



American-Made Instrument at Over 50% Saving. Up to 3" Working Distance—Erect Image—Wide 3-Dimensional Field. Used for inspections, examinations, counting, checking, assembling, dissecting. 2 sets of objectives on rotating turret. Standard pair of wide field 10X Kellner Eyepieces give you 23 power and 40 power. Helical rack and pinion focusing. 10-DAY TRIAL . . . Complete satisfaction or your money back. Order Stock No. 85,056-GE. Full price . . . \$99.50 f.o.b. Barrington, N. J. Low Power Supplementary Lens Attachment for above Stereo—provides 15X down to 6X with clear, extra large 1 1/4" field at 6X. Stock No. 30,276-GE . . . \$7.50

## 4 1/4" REFLECTING TELESCOPE! Up to 270X!

With this scope you can see everything as above but with greater power plus will split finer stars. Mirror has twice the light gathering power. Mirror guaranteed to give theoretical limit of resolution. Rack and pinion focusing, hardwood tripod, real equatorial mounting—only one adjustment follows stars! Aluminum tube. 6 power finder telescope. 2 standard size eyepieces and mounted Barlow lens give you powers of 40X, 90X, 120X, and 270X. Low-cost accessory eyepiece available for power up to 540. Free handbook and Chart. Shipping weight 25 lbs. Stock No. 85,006-GE . . . \$74.50 f.o.b.



## Check, Measure, inspect with this 6 POWER POCKET COMPARATOR

(Complete with Leather Case) MEASURES • Angles • Radii • Circles • Linear—in both decimal inches and millimeters. Used to check layouts, machining on tools, dies, gauges; to check threads, chamfers, wear on cutting tools, etc. Stock No. 30,061-GE . . . New Low Price . . . \$19.50 pstpd.

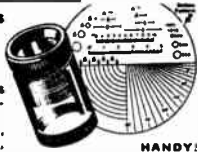

## SPECIAL! SPECIAL! INFRARED IP25A IMAGE TUBE

Stock No. 70,127-GE . . . \$9.95 pstpd. Send check or money order, money-back guarantee.

## COLOR TV TUBESCOPE

Saves time, effort in alignment of color dot pattern. Stock No. 50,129-GE . . . 22 power . . . \$24.50 pstpd. Send check or money order, money-back guarantee.

## MAKE YOUR OWN ASTRONOMICAL TELESCOPE

3 1/2" MIRROR KIT—Contains ready-to-use 3 1/2" diameter concave, aluminized objective mirror, lenses for 1" focal length eyepiece, and aluminized first surface diagonal mirror. Price \$19.25 postpaid 4 1/4" Mirror only . . . \$15.00 postpaid Stock No. 80,051-GE . . . \$15.00 postpaid We have additional eyepieces, tubes, tripods, in fact everything you need to build telescopes.



## New! 2 in 1 Combinational Pocket-Size 50 Power MICROSCOPE and 10 Power TELESCOPE

Useful Telescope and Microscope combined in one amazing, precision instrument. Imported! No larger than a fountain pen. Telescope is 10 Power. Microscope magnifies 50 Times Sharp focus at any range. Handy for sports, looking at small objects. Just plain snooting. Send Check or M.O. Satisfaction Guaranteed. Order Stock No. 30,059-GE . . . \$4.50 pstpd.

## WAR SURPLUS AMERICAN-MADE 7x40 BINOCULARS

Big savings! Brand new! Crystal clear viewing—7 power. Every optical element is coated. An excellent night glass—the size recommended for satellite viewing. Individual eye focus. Exit pupil 7mm. Approx. field at 1,000 yds. is 376 ft. Carrying case included. American 7 x 50's normally cost \$195. Our war surplus price saves you real money. Stock No. 1533-GE . . . only \$55.00 pstpd. (Tax Included)

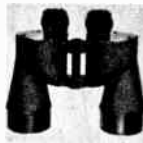

## DIRECT MEASURING POCKET MICROSCOPE —50 POWER

Fountain pen size, makes direct reading measurements; for checking small parts and dimensions under powerful magnification. Precision, glass etched reticle calibrated for measurements up to 1/16" by .001" divisions. Stock No. 30,225-GE . . . \$7.95 pstpd.



6X Finder Telescope, base fits any diameter tube. Stock No. 30,121-GE . . . \$8.00 postpaid Mounted Barlow Lens . . . double and triple your telescope's power. Stock No. 30,200-GE . . . \$8.00 postpaid KELLNER EYEPIECE—Large 50° field—mounted and ready to use. Stock No. 3223-GE . . . \$7.95 postpaid MOUNTED HERSCHTEL WEDGE—40mm x 55mm—10° angle—mounted with diagonal holder for reflectors for solar observation. Stock No. 30,266-GE . . . \$5.50 postpaid REFLECTING TELESCOPE EYEPIECE MOUNT—Rack and pinion focusing—takes standard 1 1/4" eyepieces. Stock No. 30,077-GE . . . \$9.95 postpaid

## SALE! TERRIFIC WAR SURPLUS BARGAIN! AERIAL CAMERA LENSES



Gov't Cost \$1218—Now Low as \$39.80 Used Made by B & L and E.K.—24" F.L. f/8, in 23" long Lens Cone. Use as long range, Big Bertha Telephoto lens or Richest field (wide field, low power) telescope, etc. Lenses are 4" dia.—precision 4-element type, Aero Tessar and Aero Ektr (no choice). Easily removed. Disphragm (f/8 to f/22) is included. Opens approx. 1" to 3 1/2" Lens and cone—wt. 25 lbs. Sturdy carrying trunk—wt. 26 lbs. Order Stock No. 85,080-GE 24" lens . . . Price \$39.80 f.o.b. Utah Order Stock No. 85,080-GE 24", new . . . Price \$59.80 f.o.b.

## BUILD A SOLAR ENERGY FURNACE



A fascinating new field. Build your own Solar Furnace for experimentation—many practical uses. Easy! Inexpensive! Use scrapwood! We furnish instructions. This sun powered furnace will generate terrific heat—2000° to 3000°. Fuses enamel to metal. Sets paper aflame in seconds. Use our Fresnel Lens—14 1/4" diameter . . . f.l. 14". Stock No. 70-130-GE . . . Fresnel Lens . . . \$6.00 pstpd.

# FREE CATALOG-GE

Yours for the asking

America's No. 1 source of supply for experimenters, hobbyists. Complete line of Astronomical Telescope parts and assembled Telescope. Also huge selection of lenses, prisms, war surplus optical instruments, parts and accessories. Telescopes, microscopes, satellite scopes, binoculars, infrared sniperscopes, etc.



REQUEST CATALOG-GE

ORDER BY STOCK NUMBER . . . SEND CHECK OR MONEY ORDER . . . SATISFACTION GUARANTEED!

EDMUND SCIENTIFIC CO. BARRINGTON, NEW JERSEY

# FOR REPAIRING ALL ELECTRICAL APPLIANCES MOTORS ★ AUTOMOBILES ★ TV TUBES



Superior's New Model 70 UTILITY TESTER®

## As an electrical trouble shooter the Model 70:

- Will test Toasters, Irons, Broilers, Heating Pads, Clocks, Fans, Vacuum Cleaners, Refrigerators, Lamps, Fluorescents, Fans, Switches, Thermostats, etc.
- Will test all TV tubes for open filaments, inter-element shorts, burned out tubes, etc. (Will not test TV tubes for quality. An emission type tester such as the model 82, described below, is required to test tubes for quality.)
- Measures A.C. and D.C. Voltages, A.C. and D.C. Current, Resistances, Leakage, etc.
- Will measure current consumption while the appliance under test is in operation.
- Incorporates a sensitive direct-reading resistance range which will measure all resistances commonly used in electrical appliances, motors, etc.
- Leakage detecting circuit will indicate continuity from zero ohms to 5 megohms (5,000,000 ohms).

## As an Automotive Tester the Model 70 will test:

- Both 6 Volt and 12 Volt Storage Batteries • Generators • Starters
- Distributors • Ignition Coils • Regulators • Relays • Circuit Breakers • Cigarette Lighters • Stop Lights • Condensers • Directional Signal Systems • All Lamps and Bulbs • Fuses • Heating Systems • Horns • Also will locate poor grounds, breaks in wiring, poor connections, etc.

Model 70 comes complete with 64 page book written in plain easy-to-understand language. Explains law of

electricity, how to proceed with repairs of appliances and automobile circuits, how to test TV Tubes, etc.

Only **\$15<sup>85</sup>**

## Superior's New Model 82

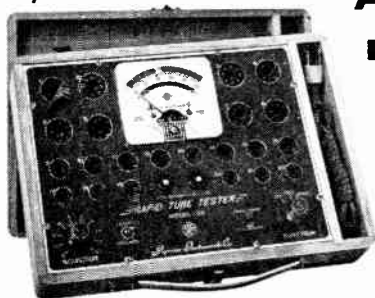

# A truly do-it-yourself type TUBE TESTER

**TEST ANY TUBE IN 10 SECONDS FLAT!**

- 1 Turn the filament selector switch to position specified.
- 2 Insert tube into a numbered socket as designated on our chart (over 600 types included).
- 3 Press down the quality button—

**THAT'S ALL! Read emission quality direct on bad-good meter scale.**

### FEATURES:

- Tests over 600 tube types.
- Tests OZ4 and other gas-filled tubes.
- Employs new 4" meter with sealed air-damping chamber resulting in accurate vibrationless readings.
- Use of 22 sockets permits testing all popular tube types and prevents possible obsolescence.
- Dual Scale meter permits testing of low current tubes.
- 7 and 9 pin straighteners mounted on panel.
- All sections of multi-element tubes tested simultaneously.
- Ultra-sensitive leakage test circuit will indicate leakage up to 5 meg-ohms.

Production of this Model was delayed a full year pending careful study by Superior's engineering staff of this new method of testing tubes. Don't let the low price mislead you! We claim Model 82 will outperform similar looking units which sell for much more — and as proof, we offer to ship it on our examine before you buy policy.

Model 82 comes complete, housed in portable, hand-rubbed oak cabinet with removable cover. Only

**\$36<sup>50</sup>**

# SHIPPED ON APPROVAL NO MONEY WITH ORDER — NO C. O. D.

Try any of the above instruments for 10 days before you buy. If completely satisfied then send down payment and pay balance as indicated on coupon. No Interest or Finance Charges Added! If not completely satisfied return unit to us, no explanation necessary.

MOSS ELECTRONIC DISTRIBUTING CO., INC.  
Dept. D-509, 3849 Tenth Ave., New York 34, N. Y.

Please send me the units checked on approval. If completely satisfied I will pay on the terms specified with no interest or finance charges added. Otherwise, I will return after a 10 day trial positively cancelling all further obligation.

Model 70 . . . Total price \$15.85  
\$3.85 within 10 days. Balance \$4.00  
monthly for 3 months.

Model 82 . . . Total Price \$36.50  
\$6.50 within 10 days. Balance \$6.00  
monthly for 5 months.

Name . . . . .  
Address . . . . .  
City . . . . . Zone . . . . . State . . . . .  
All prices net. F.O.B., N.Y.C.



# Learn Radio-Television

## Servicing or Communications

### by Practicing at Home in Spare Time

N.R.I. SENDS kits with which you practice building circuits common to Radio and TV sets. You LEARN-BY-DOING to locate Radio-TV troubles. As part of N.R.I. Servicing Course, you buy 1 Vacuum Tube Voltmeter and Ac-DC receiver. Use VTVM to conduct experiments, earn extra money fixing sets in spare time.

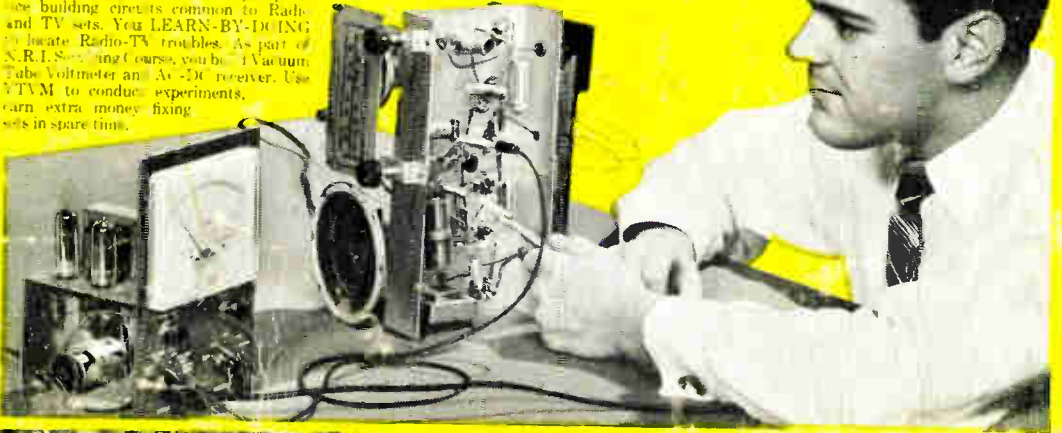

Color TV BROADCASTING now offers important positions to Operators and Technicians. RADIO-TV SERVICING Technicians (see below) needed in every community. Their services are respected, their skill appreciated.



## Fast Growing Field Offers You Good Pay, Success, Bright Future



J. E. SMITH  
Founder

Bigger than ever and still growing fast. That's why Radio-TV has special appeal to ambitious men not satisfied with their job and earnings. More than 4,000 Radio and TV stations. More than 150 million home and auto Radios, 40 million TV sets. Color TV promises added opportunities. For the

trained man, there are good jobs, bright futures in Radio-TV Servicing or Broadcasting. Training PLUS opportunity is the *ideal combination* for success. So plan now to get into Radio-TV. The technical man is locked up to. He does important work, gets good pay for it. Radio-Television offers that kind of work. NRI can supply training quickly, without expense of going away to school. Keep your job while training. You learn at home in your spare time. NRI is the **OLDEST** and **LARGEST** home study Radio-TV school. Its methods have proved successful for more than 40 years.

### Added Income Soon - \$10, \$15 a Week in Spare Time

Soon after enrolling in our NRI courses start to earn \$10, \$15 a week in spare time fixing sets. Some pay for their training and enjoy extra luxuries this way. Some make enough to start their own Radio-TV shops. NRI training is *practical*—gets quick results. Easy to understand, well illustrated lessons teach you basic principles. And you LEARN-BY-DOING by practicing with kits and equipment which "bring to life" things you study.

### Find Out What NRI Offers

NRI has trained thousands for successful careers in Radio-TV. Study fast or slow—as you like. Diploma when you graduate. Mail coupon now. Paste it on a postcard or mail in envelope. **ACTUAL LESSON FREE.** Also 64 page catalog that shows opportunities, shows equipment you get. Cost of NRI courses low. Easy terms. **NATIONAL RADIO INSTITUTE, Dept. BMB9, Washington 16, D. C.**

## N.R.I. TRAINED THESE MEN FOR SUCCESS



"I was repairing Radios by 10th lesson. Now have good TV job." **M. R. LINDEMUTH, Fort Wayne, Ind.**



"Doing spare time repairs on Radio and TV. Soon servicing full time." **CLYDE HIGGINS, Waltham, Mass.**

"I had a successful Radio repair shop. Now I'm Engineer for WHPK." **V. W. WORKMAN, High Point, N.C.**



"There are a number of NRI graduates here. I can thank NRI for this job." **JACK WAGNER, Lexington, N.C.**



## VETERANS Approved Under G. I. Bills

## SEND FOR BOTH FREE

**National Radio Institute**  
Dept. BMB9, Washington 16, D. C.

Mail me Simple Lesson and 64-Page Catalog FREE. (No salesman will call. Please write plainly.)

Name.....Age.....

Address.....

City.....Zone.....State.....

Accredited Member National Home Study Council

