

ANC

POPULAR MECHANICS

RADIO-TV and ELECTRONICS Handbook

60c 75c IN CANADA

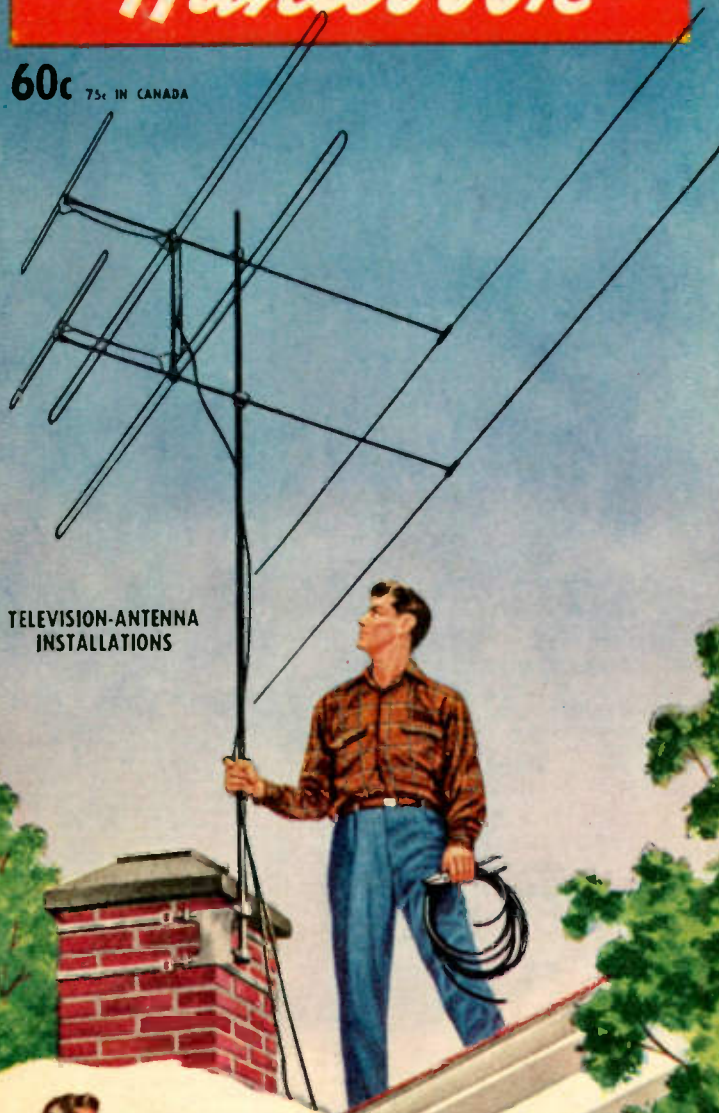

TELEVISION-ANTENNA INSTALLATIONS



TUNING and ADJUSTING TV RECEIVERS



AMPLIFIERS and RECORD PLAYERS



HOME SERVICE HINTS



BEGINNERS' SETS

POCKET SETS

How to...

- MAKE Money-Saving Home Set Repairs
- ADJUST and Operate Your Television Set
- INSTALL Antennas and Extension Speakers
- SOLDER, Mount Parts and Wire Circuits
- BUILD Amplifiers, Record Players, Test Sets
- MAKE Low-Cost Progressive Beginners' Sets
- BUILD Modern AM, FM and S-W Student Sets
- START in the Expanded Amateur Radio Field

By
F. L. BRITTIN

Senior Member of the Institute Radio Engineers,
Radio and Electronics Editor, Popular Mechanics Magazine

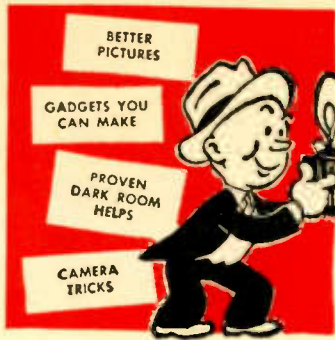

Photo Handbook

SPEND LESS AND GET MORE OUT OF YOUR CAMERA WITH THE POPULAR MECHANICS

1948 Publication — Entirely Different from Our Photo Guide

Packed with hundreds of helpful, practical articles by successful photographers far and near — reprinted from Popular Mechanics famous photography department. A guide to better pictures, more pleasure, more profit from your hobby. The one section on gadgets and equipment you can make yourself can easily save you hundreds of dollars.

158 Pages • 465 Illustrations
You Can Use Every Day and Save Money

Partial Contents

YOU CAN TAKE GOOD PICTURES
 8 Steps to Better Outdoor Photos
 Getting Good Composition in Your Photos
 Frame the Pictures Before You Shoot
 Put the Foreground to Work
 Taking Photos at Night
 Lighting for Better Photos
 Shoot 'Em Close Up
 Stop It With Flash
 Profits in Roadside Photos
 Shooting Single Column Pictures
 There Are Good Subjects All Around You

DEVELOP YOUR OWN PICTURES
 The Picture Means More When You Do
 Your Own Developing
 Make Your Darkroom Workable
 Restoring Old Prints
 Synchronized Flash for Your Box Camera
 Twin Tripod Head Aids Short-Distance Focusing

Photoprint Straightener From Wood
 Swivel-Head Tripod Is All-Wood

MAKE IT YOURSELF

Photo Kinks
 Camera Becomes Enlarger
 Film-Tank Agitator Is Motor-Driven
 Closeups With Focusing Attachment
 Tilting Tripod Holds Camera Firmly
 Focusing Spotlight for Indoor Photography
 Floodlamp Plus Tin Cans Equals Spotlight
 Apartment Darkroom
 Six-Feature Transparency Projector
 Adapting Your Camera for Color Transparencies
 Fluorescent Photo Lamp Gives Soft Light
 Color Processing Unit for Transparencies or Prints
 Make Your Own Movie Titrer
 Versatile Film Viewer
 Photo Subjects Cut From Paper
 Electronic Photoprint Timer for Enlarger



\$2.00 Postpaid

OUTDOOR SPORTS MANUAL

Popular Mechanics Fascinating New Book for all Outdoor Men

Over 200 Helpful Articles for the Hunter, Fisherman, Trapper, Camper, Archer and Boatman

Get Popular Mechanics Outdoor Sports Manual today — compiled by the editors of this famous magazine — to help you get more out of your sports and hobbies. It's a practical, helpful book with hundreds of ideas on fishing gear of all kinds, hunting, guns, traps and trapping, marketing furs, sailing, sail and other boats, outboard motors, camp equipment and camping hints, archery equipment and how to use it, etc. If you love the outdoors, get this new book now.

Partial Contents

FOR THE FISHERMAN, Tips on Tackle, Rods, Reels and Lures, Fly and Bait Casting, Bait Boxes, Fishing Through the Ice, Conditioning Bamboo Rods, Fishing Gear You Can Make. **FOR THE HUNTER**, Shotgun Chokes and Gauges, Rifle Conversion, Making a Duck-boat, Selecting the Shotgun, Clean Guns for Good Shooting, Training Dogs for Game Trails, Shotgun Footwork, Make Your Own Decoys. **FOR THE CAMPER**, Getting the Camp Ready, Portable Camp Stove, Camp Tents, "Sleeper" for Your Car, Camp Comforts. **FOR THE TRAPPER**, Tricks of Trapping, Turtle Traps, Trapping Fur Bearers, Preparing Furs for Market. **FOR THE ARCHER**, How to Make Good Bows, Archery Tackle Box, Shooting with Bow and Arrow, Modern Crossbows. **FOR THE BOATMAN**, How to Care for Outboard Motors, Servicing Boat Motors, How to Row a Boat, Sailing a Boat, Boat Kinks. And 187 other fascinating articles.

160 Pages
334 Illustrations
Cloth Binding
\$2.00



HELPFUL BOOKS for TRADES, HOME WORKSHOP, FARM, SPARE TIME WORK AND HOBBIES • WRITE for COMPLETE CATALOG
 Order from POPULAR MECHANICS PRESS, 200 E. ONTARIO STREET, CHICAGO 11, ILL.

30

Popular Mechanics

RADIO-TELEVISION and ELECTRONICS HANDBOOK

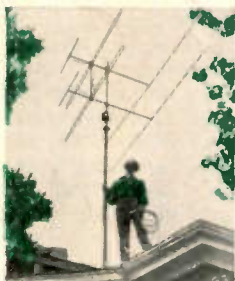

By F. L. BRITTIN

Radio-Television and Electronics Editor

Popular Mechanics Magazine

Senior Member,

Institute of Radio Engineers



Copyright 1950 by Popular Mechanics Co.

POPULAR MECHANICS PRESS

PRINTED
IN U.S.A.

200 EAST ONTARIO STREET



CHICAGO 11, ILLINOIS

INTRODUCTION

MANY OWNERS of radio sets, television receivers, auto sets, record players and amplifiers often feel the need of a little extra information that will enable them to obtain better results with their equipment. Electronic devices are not the mysterious magic boxes to as many today as they were before the last world war. As a matter of fact, they are so much a part of everyday life in many countries that they are commonly taken for granted. Now, television in the home combines sight with sound, and excellent TV programs are available from many stations in the United States. There is little doubt that you already have one or more radio receivers in your home, and if you live in or near any large city you either have a television receiver, or expect to own one soon. This book provides a non-technical guide for all owners, and prospective owners of radio and television sets. It will save you money in unnecessary service calls. It will help you with your installation problems and enable you to operate your equipment with maximum results. It supplements textbooks in providing non-technical and practical what-to-do and how-to-do-it information for millions of radio beginners, students and experimenters in easy-to-understand diagrams and illustrations.

A surprising number of the outstanding radio and electronic engineers of today will tell you that they began by building and repairing radio sets for fun. As a hobby they found it a fascinating type of educational entertainment that rapidly expands as the builder gains knowledge and confidence in his ability to make simple money-saving repairs, and to construct inexpensive workable radio and electronic units that he is proud to show his friends. This book can be your guide to that same knowledge and confidence. It is a project in which only a few simple tools are required, and it offers an ideal cooperative hobby for father and son.

You will learn how to identify and use radio parts, quickly becoming familiar with the schematic symbols used in circuit diagrams and with the standard abbreviations that are the "shorthand" of radio and electronics. In a very short time you will be ready for the more complicated set repairing and construction that you will also find in this book; no previous knowledge of radio is required. An ever-growing field awaits the radio and electronic experimenter.

In this book you will find many clearly illustrated home service hints and thoroughly tested construction plans. These plans give complete construction details for inexpensive radio receivers ranging from small crystal sets, to supers in table models, portables, and even pocket sets. There are also high quality audio amplifiers, hearing aid, record players, inter-room phone, simple set testers, code-practice set, amateur transmitters, photo-cell relay, photoprint timer and other electronic devices. All parts are standard and easily obtainable from radio supply stores and mail-order parts houses.

The needs of the set owner, beginner, student experimenter and amateur are well known to the writer, who answers thousands of their inquiries every year as Radio-Television and Electronics Editor of *Popular Mechanics Magazine*.

FRANK L. BRITIN

CONTENTS

How to Start - - - - -	4
How to Solder - - - - -	5
How to Make Simple Radio Repairs - - - - -	10
How to Remove a Radio Chassis from the Cabinet - - - - -	18
Service Hints for Student Experimenters - - - - -	21
How to Replace Volume Controls - - - - -	29
How to Mount Parts and Wire Circuits - - - - -	33
Signal Tracer for Radio Servicing - - - - -	38
Utility Volt-Ohm Checker - - - - -	41
"Popcorn Can" Signal Generator - - - - -	42
Three-Unit Test Bench for Beginners - - - - -	44
Auto-Radio Service Hints - - - - -	46
How to Care for Your Record Player - - - - -	50
Home Recording Hints - - - - -	53
Television in the Home - - - - -	54
Industrial Television - - - - -	63
Master TV Antenna - - - - -	64
How to Install TV and FM Antenna Systems - - - - -	65
Picture Defects and Corrections Using Test Pattern - - - - -	71
TV Picture-Tuning Procedure and Adjustment - - - - -	74
Hints for TV Set Owners - - - - -	77
Miniature Radio Tubes - - - - -	78
How Electronic Tubes Work - - - - -	79
Germanium Crystals - - - - -	80
Tapped-Coil Crystal Receiver and Amplifier - - - - -	82
One-Tube Progressive Receiver - - - - -	84
Four-Tube Progressive Receiver - - - - -	86
T.R.F. Dual-Purpose Receiver - - - - -	88
Three-Way Portable Super - - - - -	91
Two-Tube Pocket Set - - - - -	94
"Handi-Talkie" Emergency Receiver - - - - -	96
Four-Tube Super Broadcast Tuner - - - - -	98
High-Fidelity FM Tuner Unit - - - - -	100
Low-Cost Inter-Room Phone System - - - - -	104
Multi-Purpose Phototube Relay - - - - -	108
Electronic Photo-Print Timer - - - - -	110
Sensitive Capacity-Operated Switch - - - - -	112
Ten-Watt Phono-Radio Amplifier - - - - -	116
Utility Public Address Amplifier System - - - - -	118
Amplifier for 45 R.P.M. Record Changer - - - - -	120
Indoor A.C.-D.C. Amplifier for the Deaf - - - - -	123
How to Add Extension Speakers - - - - -	125
Bass-Reflex Speaker Enclosure - - - - -	127
How You Can Become a Ham - - - - -	128
Transceiver for 2-Meter Amateur Band - - - - -	136
Ten-Meter C.W. Transmitter for Beginners - - - - -	138
Appendix—	
Commonly Used Radio Parts (Pictorial) - - - - -	140
Schematic Symbols Used in Circuit Diagrams - - - - -	143
How to Read Standard Color Codes - - - - -	146
Common Radio and Electronic Terms - - - - -	150
Common Television Terms - - - - -	153
Abbreviations - - - - -	153
FCC Office Addresses . . . Ohm's Law . . . Electrical Prefixes . . .	
Electrical Unit Conversion Table . . . Wavelength-Frequency	
Conversion - - - - -	154
Detailed Material Lists - - - - -	155
Index - - - - -	159

HOW TO START

TO BEGIN, the only necessary requirements are that the person be able to carry out the basic mechanical details and know how to use a screwdriver, soldering iron and a few other simple tools. First, select the tools and become acquainted with the various basic radio parts illustrated in this book. The tools, hookup wire and rosin-core wire solder shown in the photo below are all that you need to make simple radio repairs or to construct any of the laboratory-tested radio or electronic units described and illustrated in the following pages. All parts specified are standard; if a metal chassis base is used in a construction article you can either make your own, or buy it from a radio parts house. However many student units are of the "breadboard" type, the parts being mounted on top of a wooden baseboard.

The essential tools shown include needle-nose side-cutting pliers, a 4-in. screwdriver with $\frac{1}{4}$ -in. tip, an inexpensive hand drill and a soldering iron. A tapered hand reamer, inexpensive chassis punches for tube-socket holes, and an ordinary ice pick which makes a handy scribe, are recommended as useful additions. Comparatively few beginners are lucky enough to own a workbench. Any table, even a sturdy card table, will do for ordinary assembly and circuit wiring. An old wooden kitchen chair and a short length of two-by-four, or other block of wood, will provide facilities for the chassis drilling operations. Plans for a simple and practical homemade test

bench for the radio beginner are to be found in this book.

It is a good idea to save all the small wide-mouth screw-top glass jars that you can find. They are very useful for holding screws, nuts, washers, soldering lugs and other small hardware. In glass jars, the contents are always in view and ready for use. Hunting for such small parts consumes time and patience, as every experienced radio worker knows. There are many reliable sources of supplies for the radio student and experimenter. Perhaps the best known are the large mail-order radio-parts houses. These issue illustrated catalogues, and advertise in magazines that publish practical, up-to-date construction articles of interest to beginners as well as advanced experimenters.

The beginner should become familiar with standard radio parts such as variable and fixed condensers, resistors, tubes, sockets, coils, jacks, plugs, transformers, chokes and various other parts used in radio and electronic circuits. A representative group of these simple basic parts appears in the appendix, also the standard symbols that represent these radio parts in schematic circuit diagrams. Many useful standard parts can be salvaged from discarded receivers if they meet specifications. Such parts include tube sockets, resistors, condensers, dials and small hardware. In the case of parts and tubes, it is always important that the values and types be as specified.

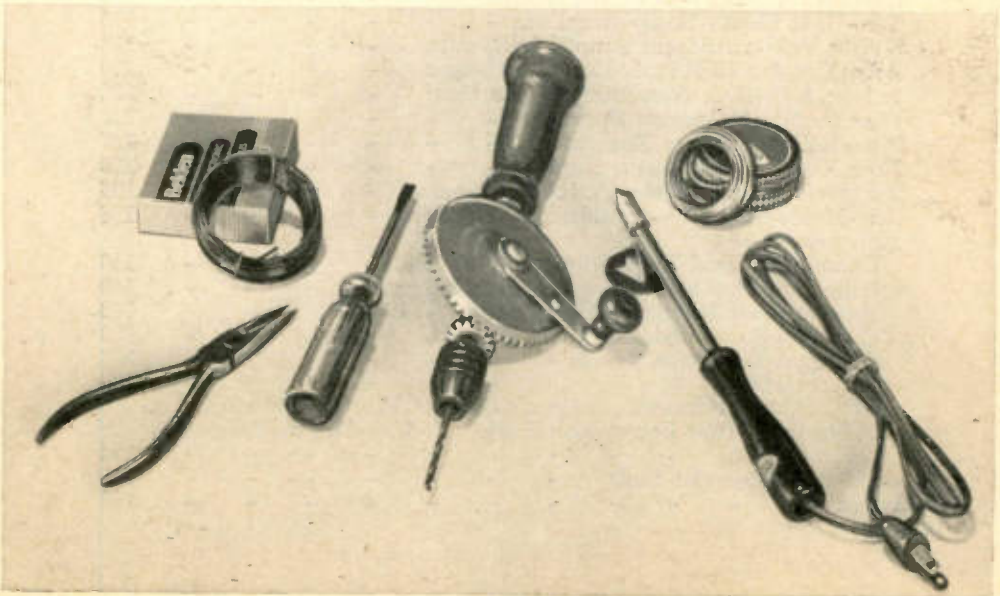

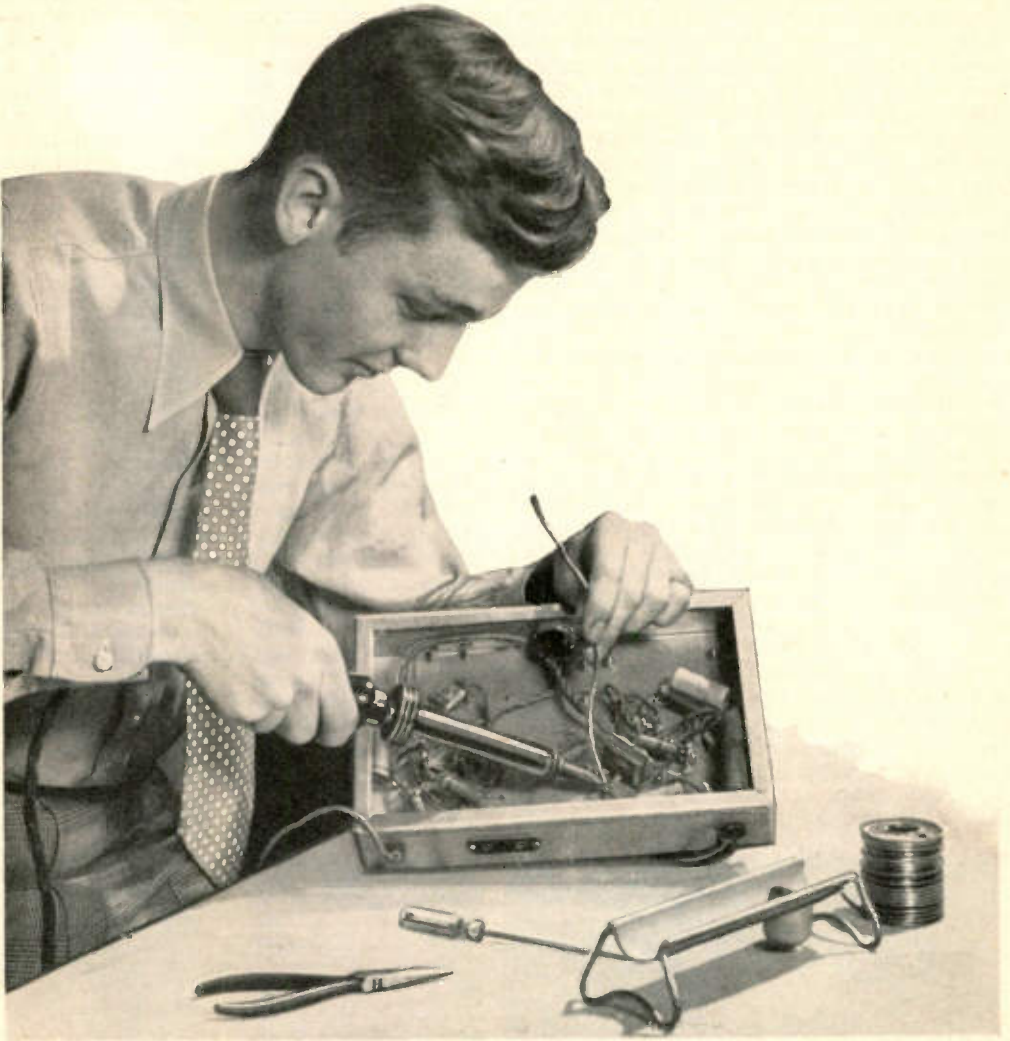

WELL-SOLDERED CONNECTIONS ARE IMPORTANT

HOW TO SOLDER

SOLDERING is a basic technique in many arts, but it is especially important in radio and electronics. Poorly soldered connections account for a large percentage of troubles in student units, and many radio service men could improve their soldering technique to good advantage. The beginner may wonder why it is necessary to solder a connection that can be neatly made by twisting two wires together, or by merely winding the wire around a machine screw under a hex nut; apparently this is all that is required. There are at least two very good reasons why such mechanical connections are not practical in radio circuits. First, when such connections are exposed to the air for some time the wire will oxidize and form a high-resistance joint. Second, mechanical bond, no matter how well it is made, will work loose under vibration, temperature changes and ordinary handling. Lock washers cannot be relied on for making good circuit connections. A high-resistance joint acts just the same as a high-value fixed resistor and changes the operating conditions of the circuit. When connections are well soldered the fused metals exclude air from the actual joint and any oxidation that may take place later occurs on the surface of the solder and not on the joint, thus no resistance will occur.

Keep Working Faces Clean

To do a good soldering job the iron's working faces must be kept clean and well-tinned at all times. By keeping these faces solder-coated, quickest heat delivery is made to the work and successful soldering demands rapid heat delivery to make the solder "flow" and cover the joint quickly

without overheating the material or part to which the leads are connected. To coat, or tin, the faces heat the iron well then quickly file the faces to remove all oxide. While the iron is still hot melt a piece of rosin-core wire solder on the lid of a tin can and rub the faces of the iron in this melted solder and flux, holding the faces of the iron flat against the tin in the correct position shown in Fig. 1. Continue rubbing until both faces are uniformly covered. When the iron is held in the "right" position indicated in Fig. 1, the greatest transfer of heat to the work is obtained; thus when soldering flat work such as in the construction of sheet metal chassis bases, this position would be employed with best results. For circuit soldering, the tip is used in most cases. Many radio workers have irons of two sizes on the bench.

Test All Connections

Ordinary steel wool may be used to keep the tip of the soldering iron clean at all times, as illustrated in photo A. An old porcelain lamp receptacle with mounting holes for wood screws makes a good bench holder for the steel wool. A bird-perch cleaner, available from dime stores, also makes a convenient tip cleaner as shown in photo B. A dirty soldering iron tip will not transfer sufficient heat to the work and the result will be a poor circuit connection that will probably cause trouble later. Always hold the work still after the solder flows, until the joint has thoroughly cooled. Then, to make sure that the joint is both mechanically and electrically good, test the connection by giving the connected wires a slight pull with your long-nose pliers.

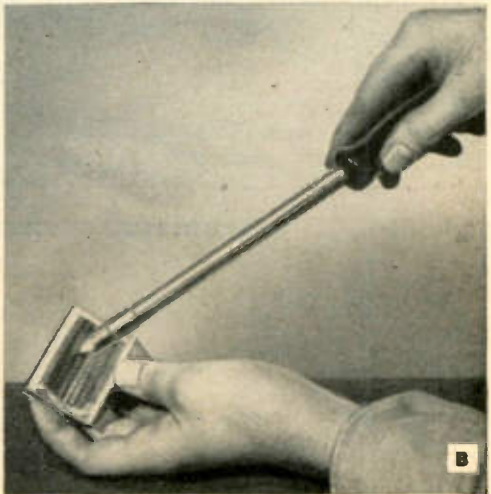
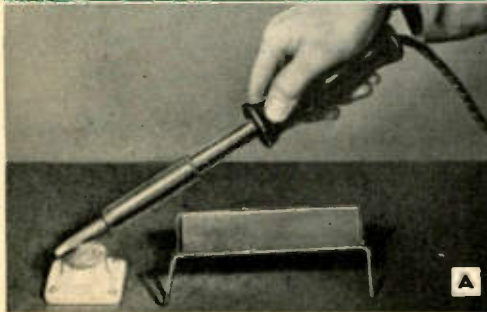
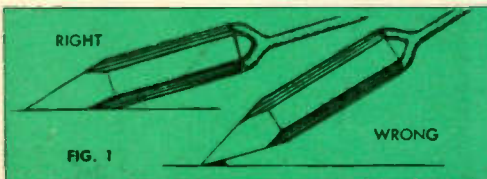

To prepare wires for soldering it is first necessary to remove the insulation from the ends. This insulation may consist of a cloth or rubber covering, or it may be enamel. Cloth or rubber covering may be removed with a wire stripper, a knife or a pair of pliers that has a side cutting section. If the wire is of the heavy type used for antenna lead-in or ground connection, the rubber-covered insulation may be removed by first crushing it between the handles of a pair of pliers at a point near the hinge of the pliers as illustrated in photo C. This is repeated until the insulation is crushed over the desired length. This crushed insulation is then pulled from the wire by using the nose of the pliers as in photo D. The insulation may then be cut off with the side cutting section of the pliers. Any ordinary solid-copper wire is easily "stripped" and cleaned by using the side cutters as illustrated in photo E. In this case however, care must be taken to avoid nicking the soft wire.

Thick and Thin Insulation

If the insulation is too tough to be broken by squeezing with the pliers, a pocket knife may be used as indicated in photo F. The knife must be held lightly when cutting through the outer braid covering to avoid cutting in too far and nicking or breaking the copper wire. Enamel insulation may be removed by heating the wire in a flame to burn off the thin coating of enamel, or it can be removed by carefully scraping with a knife. Fine enameled wire, or silk-covered wire must be handled carefully. In this case the insulation can be removed with a piece of emery cloth, or sandpaper, as illustrated in photo G. After the wire is cleaned the end should be tinned. Stranded wire should be stripped, fanned out, scraped free of insulation and tinned. When cool, the strands should be twisted together and fused into a single conductor.

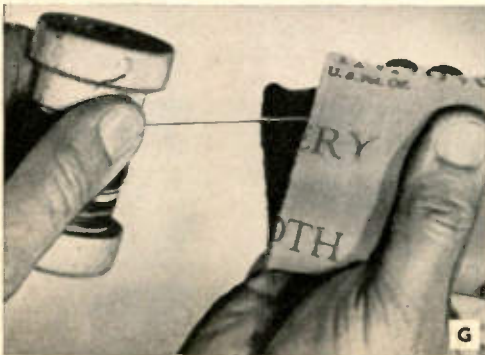
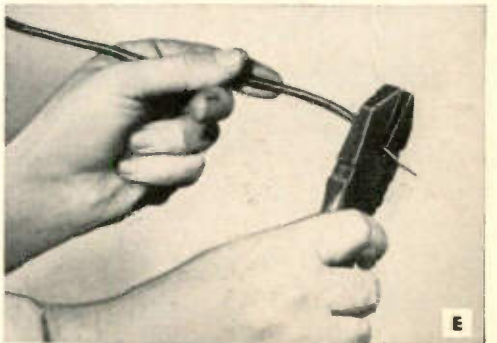
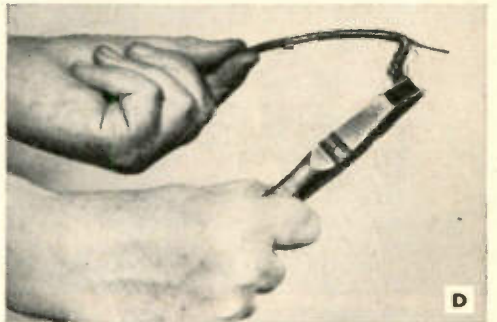
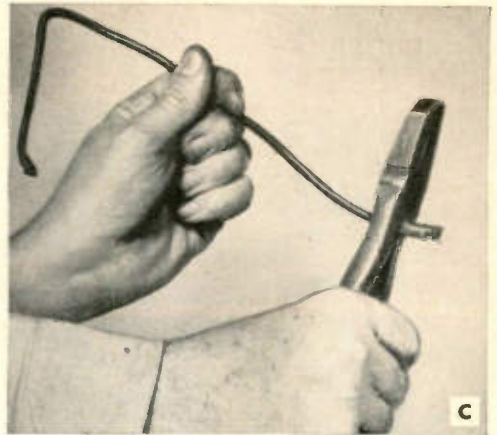

SOLDERING HINTS

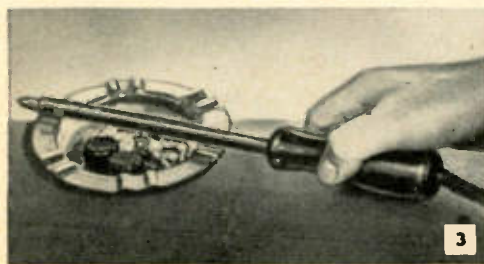
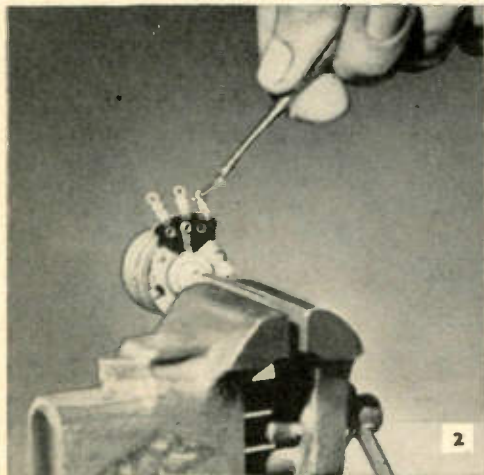
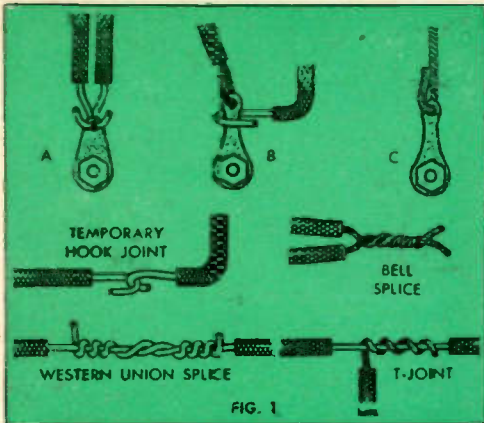
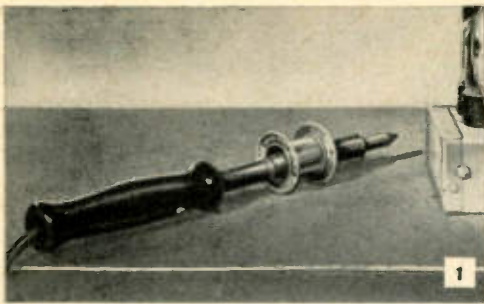

WHENEVER possible it is always best to make a good mechanical connection before applying the solder. This will strengthen the joint, as the wire will take mechanical stress and not the solder. Never merely place wire ends together and depend upon the solder alone to make the connection if it is possible to avoid doing so. It is best practice to cut a slightly longer piece of hookup wire that will enable you to make a better connection. Tinned, round-hole soldering lugs are commonly used by radio workers for soldered terminal connections as illustrated in Fig. 1. Temporary connections of the open hook type are recommended for experimental circuits, and for set servicing where the connection is not intended to be permanent. For example, when trying various values of fixed resistors and condensers, one or two wires are easily hooked to the soldering lug as indicated in A. If it is necessary to remove one or both wires you can do so easily. A temporary hook joint, made without the aid of a soldering lug, is shown in the sketch below A. Permanent, or closed, connections to soldering lugs are shown in B and C. To do this merely press the hooks together with a pair of pliers before applying the solder. There are several commonly used methods of connecting two wires together. These are known as the Bell splice, Western Union splice and the T-joint.

Soldering-Iron Rests

Hot soldering irons can cause painful burns and damage to table surfaces if they are handled carelessly. The best practice is to provide an inexpensive soldering iron rest. In an emergency, an empty metal spool that originally held rosin-core wire solder may be used as shown in photo No. 1. Workbench iron holders may be made by bending heavy galvanized iron wire into a suitable bracket-shaped holder with a mounting loop as indicated in photo No. 4. Even a small piece of sheet metal bent into a bracket, with a notch cut to provide a

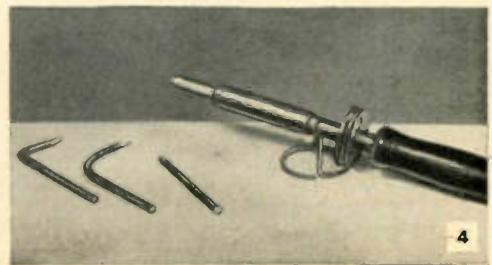

rest, will answer the purpose on the work-bench. A metal ash tray of the type shown in photo No. 3 serves both as an iron rest and as a convenient container to hold radio knobs and mounting screws when servicing a set. When using salvaged parts always remove old solder from the terminal lugs so that the connecting leads may be threaded through the small holes. An ice pick, or a nut pick, makes a good tool for this purpose as illustrated in photo No. 2.

When it is necessary to carry a hot soldering iron provide a suitable iron container consisting of a short length of pipe somewhat larger in diameter than the element of the iron as shown in photo No. 5. When the hot iron is inserted in the pipe the pipe may become warm, but not hot as the tip does not contact the pipe.

Soldering Cabled Leads

Where several wires are to be soldered together, bind the bared ends with fine copper wire as illustrated in photo No. 6. The same idea can also be applied to the tinsel conductors used in headphone cords. To extend cabled leads in battery-operated receivers, stagger the soldered connections as in photo No. 7. After soldering, the wires are taped individually and then bound into the cable without danger of shorts. Photo No. 8 shows how a wooden spring-type clothespin can be used to provide a third hand for soldering. When working on the underside of a radio chassis it is difficult to keep drops of solder from falling into the wiring. Photo No. 9 shows a drop-cloth placed directly under the soldering point.

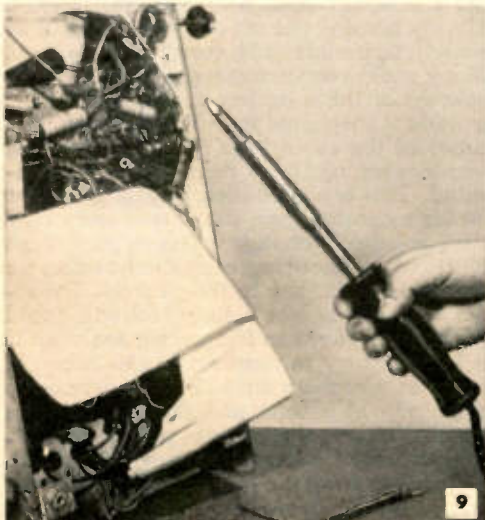
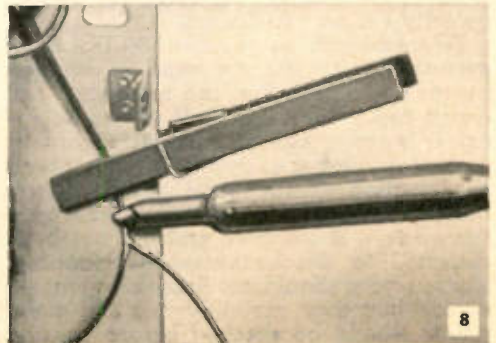
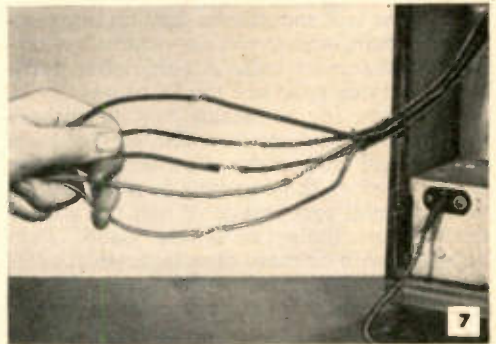
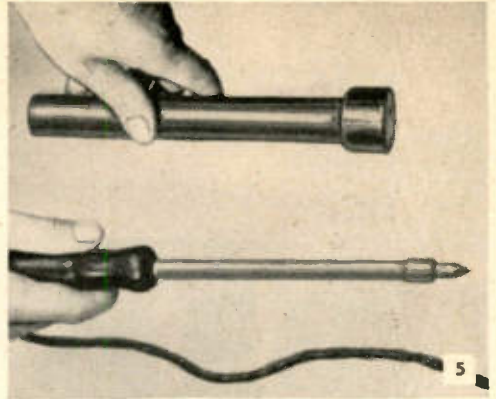

HOW TO MAKE SIMPLE RADIO REPAIRS

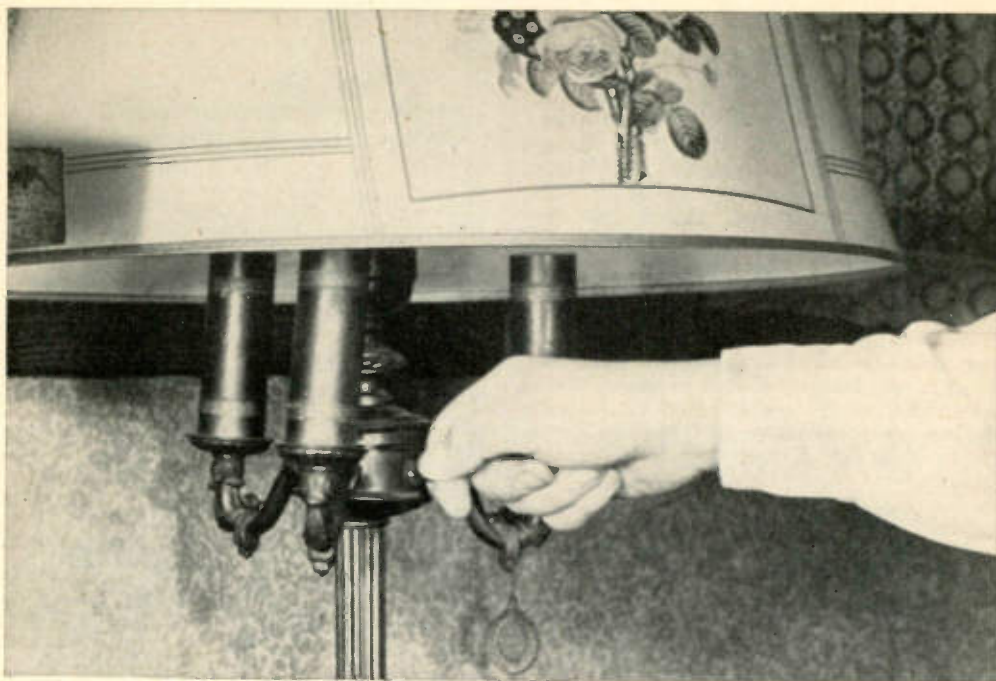

DEFECTIVE LIGHT BULBS MAY CAUSE INTERFERENCE; CHECK VARIOUS LAMPS IN THE HOME

THERE ARE a few things that any owner of a radio receiver can do in an emergency that will sometimes save an interesting program, and avoid an expensive, unnecessary service call. A surprising number of service calls are made, especially in large cities, for a reason that is embarrassing to the set owner. The service man arrives and makes the discovery that the power cord of the receiver is not plugged into the wall receptacle. When the owner tried to turn the set on it was "dead." Perhaps the wife or maid disconnected it accidentally when cleaning the room. In d.c. districts many unnecessary calls are made to merely reverse the power cord in the wall socket to obtain the necessary correct polarity for an a.c.-d.c. set.

Disconnected, or broken, antenna or ground connections are another common source of trouble that the set owner can check easily for himself. If the radio receiver is apparently working but no broadcasting stations are coming through, check the position of the band switch; many times service men find that it has been turned to a short-wave and has not been returned to the broadcast-band setting. These things should not happen to any set owner but they certainly do, and these points should be checked before wasting

time and money by calling the radio "doctor" unnecessarily.

While these hints are intended for the set owner who knows nothing, or very little, about his receiver, more experienced owners often call for help without first making these simple checks. Never attempt to check the tubes or make any repairs in a receiver without first disconnecting the power cord from the wall socket. Merely turning the set off is not enough as switch terminals still carry line voltage. Many radio receiver owners keep a duplicate set of tubes on hand, and, when tube trouble is suspected merely substitute new tubes of the same type for the old tubes, one-by-one, until the defective tube is located. This is a good idea, but the set must be disconnected from the power line every time a tube is changed. Great care must be taken in removing each tube so that no wiring is disturbed in the process. By removing one tube at a time you will avoid getting the tubes in the wrong sockets. If it is necessary to remove all the tubes in order to take them out to be tested, remove them one at a time and mark each tube number on the chassis base near its socket. In most cases it is not necessary to remove the chassis from the cabinet. Most all modern radio receivers have a tube position

HOW TO MAKE SIMPLE RADIO REPAIRS

chart either inside the cabinet or on the underside. However, it is always a good idea to mark the tube positions on the chassis base anyhow in order to avoid possible errors.

When checking tubes or testing a repair never turn the receiver on without all tubes being in their sockets. If you are not familiar with radio receiver circuits always replace the chassis in the cabinet before plugging in the power cord and do not touch the inside of the set or the chassis base when the power is on. If you observe these precautions you can make many simple repairs, have fun doing it and save money.

Do not attempt to change the tubes in any television receiver. The extremely high voltage used in all television receivers makes this a definitely dangerous job unless you are thoroughly experienced in TV servicing. The manufacturers of TV receivers do everything they can to provide safety factors such as automatic switches that cut off the power when the protecting back of the TV set is removed. However this is not always enough, since certain large condensers may have to be discharged to ground before the chassis is safe to handle. The service man knows where these are and you do not.

On the other hand, there are some things that the TV set owner can do for himself to keep his receiver in working order. Frequent checks should be made to see that the antenna and the lead-in cable, or twin-line, are in good condition, especially after a severe storm. Every outdoor antenna, either for a radio receiver or a TV receiver, should be equipped with a lightning arrester. In these days when most all radio-receiver antennas have "gone inside" in the form of built-in loops and other indoor antenna devices where no arrester is required, we find many outdoor TV antennas mounted on rooftops without a lightning arrester in the installation. Outdoor TV antennas and radio-receiver antennas act almost exactly like protective lightning rods when they are properly equipped with a lightning arrester connected to a good ground. They not only protect the receiver to which they are connected but also the building on which they are installed. Metal masts supporting TV and FM antennas should be directly grounded. Moisture, dust and quick temperature changes can cause trouble in receivers under certain conditions. If you live in a moist tropical climate, provide some means for keeping the set dry. Never place a receiver in a window, or near an open window.



Photo A—Dust collects inside every radio receiver as there is no way to keep it out and provide the necessary ventilation. A small power blower may be used to remove dust from the top of the chassis as illustrated. In this case a hair drier is used; it provides a blast of air to remove the dust and heat to dry out moisture.

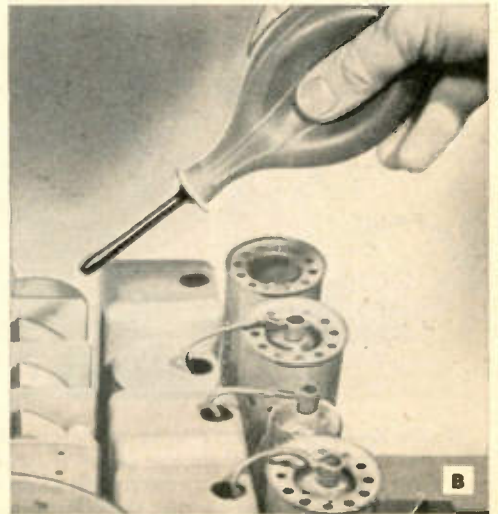

Photo B—Minute metallic particles in dust between variable condenser plates cause crackling noises when tuning; this may be blown out as shown or removed with a pipe-stem cleaner. Care must be taken not to disturb wiring.

HOW TO MAKE SIMPLE RADIO REPAIRS

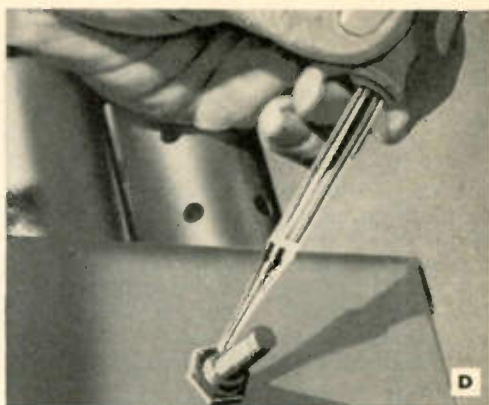
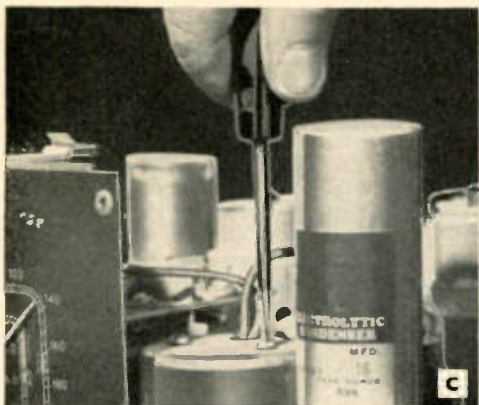

Photo C—Shields over radio coils often become loose in shipment or handling, and should be inspected if “singing” or vibration noises are heard. A lock washer may be placed under the head of the shield mounting screw and the screw tightened as illustrated. Vibration may also be traced to loose mounting screws used to fasten down transformers, coils and brackets.

Photo D—Noisy volume controls are a common source of trouble in older sets. Like any moving mechanical part they finally wear out and must be replaced. However, an emergency repair may be made by tipping the chassis back and applying carbon tetrachloride with an eye dropper as shown. To clean the wiping contact on the resistance element, the control shaft should be worked back and forth as the carbon tetrachloride is applied because it evaporates quickly. Instructions for replacing defective volume and tone controls will be found in this book.

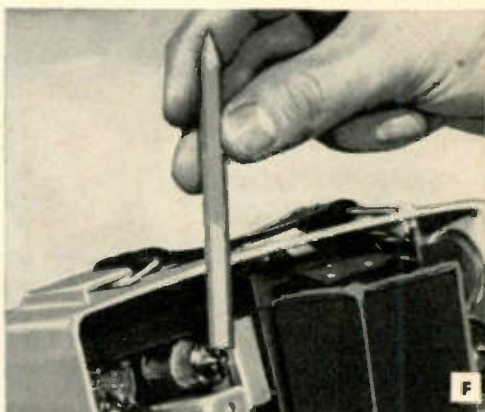
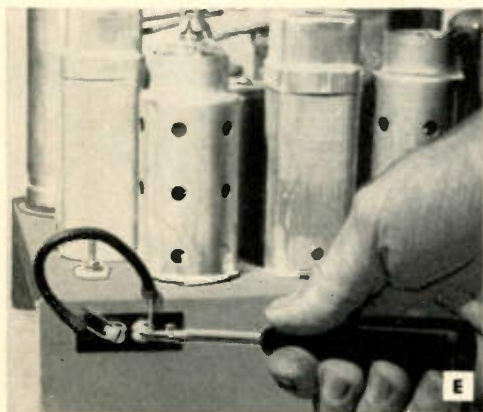

Photo E—You can save time when checking a radio receiver for noisy reception by first determining whether the noise is originating in the set or coming in on the antenna. On receivers which operate with external antenna and ground connections this may be quickly determined by merely disconnecting the antenna and ground wires and shorting out the terminals with a piece of wire as shown. With this shorting wire in position the noise will stop, or it will be greatly reduced if it is coming in through the antenna.

Photo F—The commonly used method of thumping or tapping a tube that is suspected of being noisy. The radio receiver should be turned on for about one half hour or longer before making this test and it is suggested for experienced set owners only. Tubes that are intermittently noisy can often be located by tapping them gently with a pencil or small rubber mallet.

HOW TO MAKE SIMPLE RADIO REPAIRS

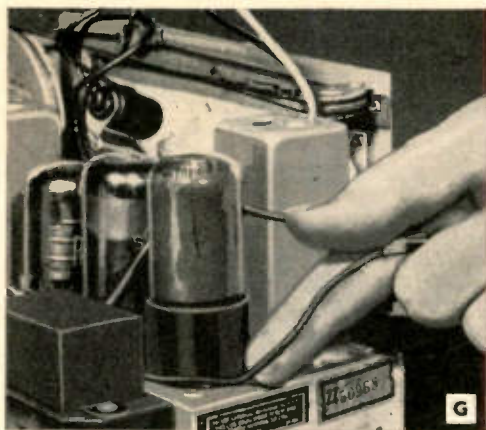

Photo G—When changing tubes in small-chassis radios of the type often mounted inverted as in some phono-radio combinations, it is difficult to see the socket when inserting new tubes and you must depend upon feel to put it in the proper position. In such cases any loose wire such as one leading from the radio to the phono pickup is easily caught under the tube base and the chassis as shown. Always check all loose wires before turning on the radio after tube replacements.

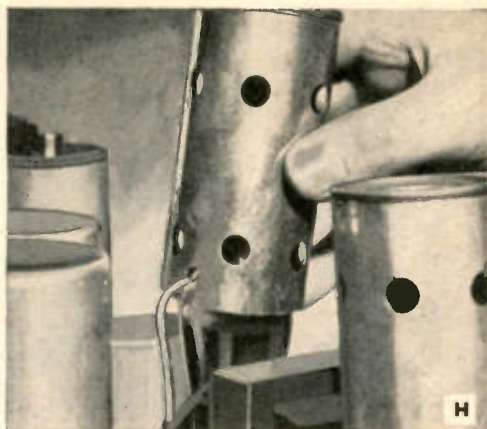

Photo H—Certain models of radios have one or more shielded tubes with the grid wires run down inside the shield; when replacing shield see that the slot in the shield is over the grid lead as illustrated. If this is not done the bottom of the shield will damage the lead.

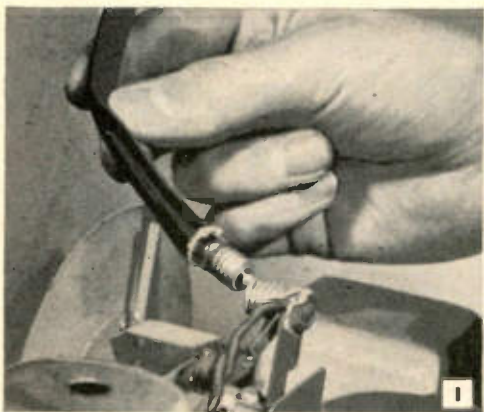

Photo I—A short length of fiber insulating sleeving may be used to remove or replace dial lamps in hard-to-reach places where the hand is too large for the job. Use sleeving slightly smaller than the glass bulb so that when it is forced over the bulb it grips it tightly, thus providing a tool that will enable you to unscrew any bulb of the screw-base type, or reinsert it in its socket. Rubber tubing may also be used, but the sleeving shown is stiffer and is sufficiently flexible.

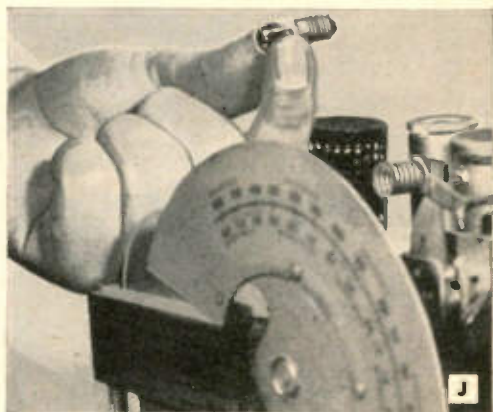

Photo J—Dial lamps are made in both screw and bayonet-base types, and must always be replaced with lamps having the same type number which is marked on the base. The voltage and ampere rating are also stamped on the base. If these markings are not legible, the type may be identified by the color of the glass bead inside the bulb. Types 40 and 47 have a brown bead; types 41, 43, 50 and 55, a white bead; type 45, green bead; types 44 and 46, blue bead; types 48, 49 and 51, pink bead.

HOW TO MAKE SIMPLE RADIO REPAIRS

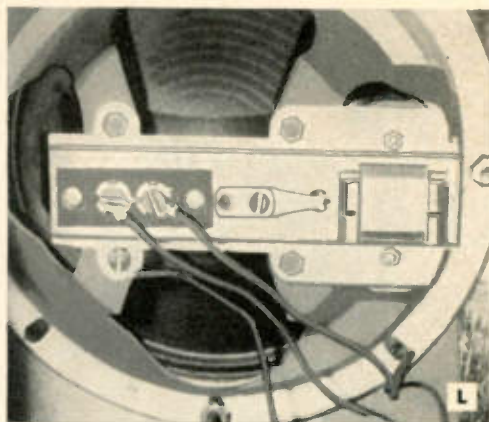
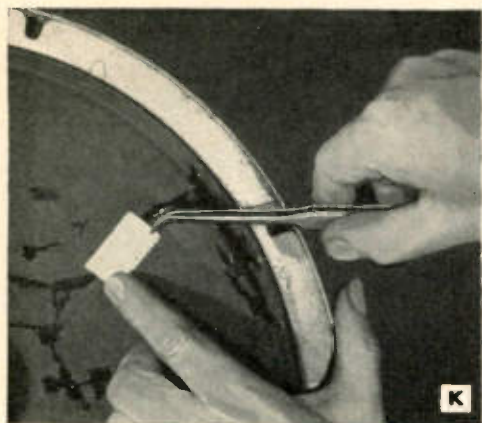

Photo K—A badly torn speaker cone may be temporarily repaired with quick-drying cement. Often all that is required is an application of the cement, bringing the torn edges together until it sets. If a portion of the paper cone is missing, or the tear cannot be held together with the cement alone, patches of any thin fabric material may be applied over the cement as shown. Use material of minimum weight and area, so that the speaker will not be affected.

Photo L—When a loudspeaker develops a rattle or distortion, check the connecting wires. They may be touching the speaker cone as in the photo. The speaker shown is a magnetic type. However, in permanent-magnet (PM) speakers where the output transformer may be on the speaker frame, the wires often touch in similar manner.

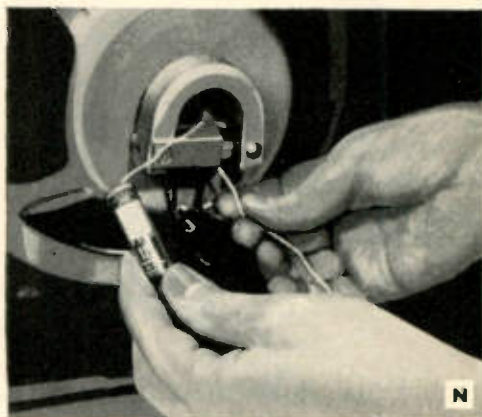
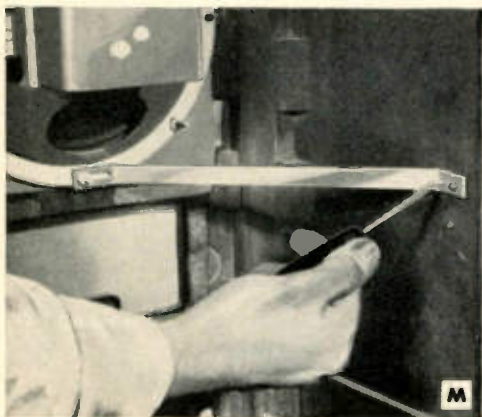

Photo M—Under certain speaker-mounting conditions the entire speaker assembly, including the mounting panel, vibrates and rattles to an annoying degree, especially when the volume is turned up. Space is often available, even in table models, to install a brace from the speaker frame to the side of the cabinet as illustrated. Light strap iron is easily drilled and bent to the desired form. This is a very simple job in large table-model receivers and in console cabinets; in many cases the improved vibration-free reproduction makes the job well worth while.

Photo N—Dental floss may be used to clean rust and dirt from between the pole pieces and the armature of some speakers to eliminate rattles and distortion. A tube of this floss can be obtained from any drug store and used as shown in the photo. It provides a strong thread which may be worked between the armature and the pole pieces.

HOW TO MAKE SIMPLE RADIO REPAIRS

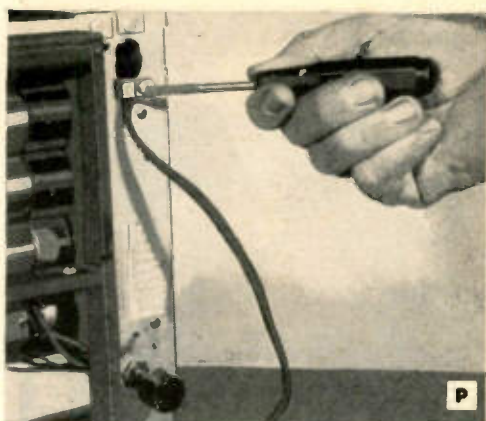
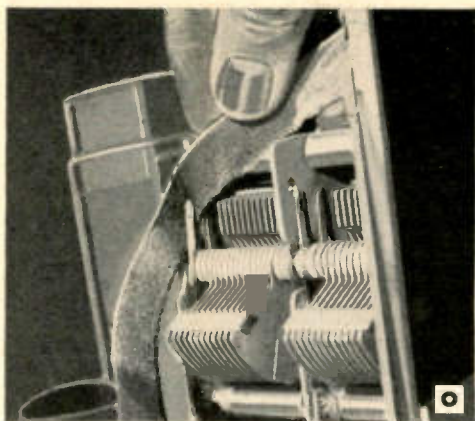

Photo O—Troublesome oscillations in radio receivers are often caused by poor contact at variable-condenser rotor clips. These clips are commonly used to make a wiping contact from the variable-condenser rotor plates to the frame of the condenser, which is chassis ground. If a poor contact occurs at this point, oscillations and squeals may result. A piece of emery cloth may be used to clean the clips as illustrated. Variable condensers differ widely in construction, but the rotor plates are usually common with the frame.

Photo P—If radio line cord is held in place on the chassis with a clamp as shown, handling may cause the insulation to wear through and cause a blown house fuse. Replace the line cord if necessary and eliminate the clamp by using a knot in the cord under the chassis to take the strain.

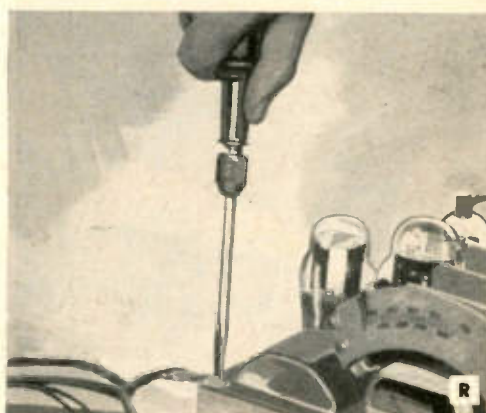
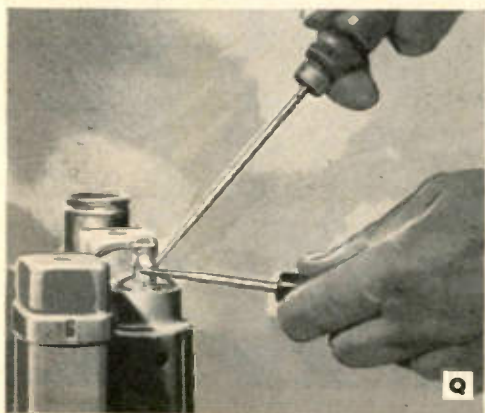

Photo Q—Some grid clips on the tops of tubes are very difficult to remove when changing tubes. Unless care is taken the grid cap on the top of the tube will be damaged when the clip is removed. Where the clip has an opening in its top, an ice pick may be pushed through this hole and held against the tube cap while the clip is worked up with a screwdriver. If there is no opening in the top of the clip, use the pick at one side of the cap as shown and push down while prying up with the screwdriver.

Photo R—Mechanical hum in a radio receiver or amplifier is often caused by loose laminations in the power transformer. This hum can usually be eliminated by tightening the long screws that hold the transformer core together; they often extend down through the chassis base in certain types of mountings.

HOW TO MAKE SIMPLE RADIO REPAIRS

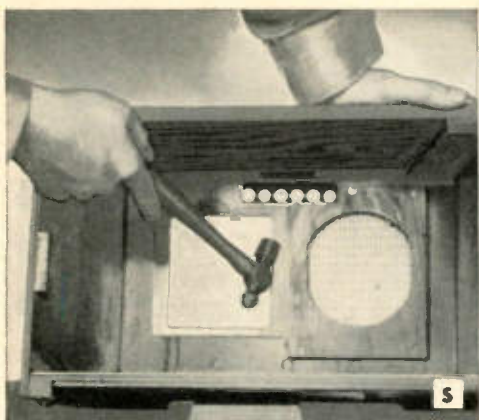

Photo S—Loose speaker baffles and dial covers may cause rattling noises that are sometimes difficult to locate. Dial covers made of clear plastic material are commonly tacked to the inside of wooden table-model cabinets and they frequently come loose and vibrate with the speaker. The only way to get at them is to remove the chassis from the cabinet, and then drive the tacks back into the wood case with a small hammer as shown in the photo.

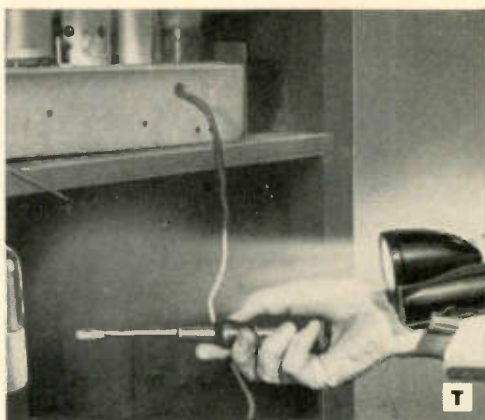

Photo T—Many operations, such as removing a radio speaker from a console cabinet, require the use of both hands and a good source of light. A flashlight of the type which has an elastic band to hold it on the wrist in the manner shown in the photo, will provide a good light where it is needed.



Photo U—A kneeling pad of sponge rubber, available from department stores, makes a convenient pad on which to place a small radio chassis to protect tables from scratches while making necessary cabinet repairs. In some locations where vibrations caused by the operation of heavy machinery interfere with reception, a pad of this type placed under the cabinet is helpful.



Photo V—The tuning eye, or indicator tube mounted above other chassis parts and facing an opening in the dial in many types of receivers, may cause chattering noises. If the clamp becomes loose the entire tube assembly moves and may strike the dial face or other parts when the set is operated with the volume control on full, or with strong local signals. The clamp screw should be tightened with a screwdriver as indicated, and in some cases it may be necessary to wedge the front of the tube against the dial.

HOW TO MAKE SIMPLE RADIO REPAIRS

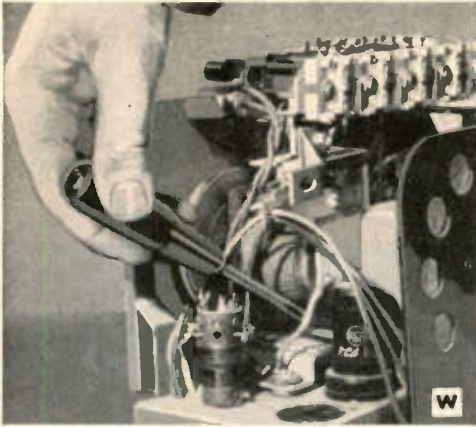

Photo W—Wires or cables sometimes interfere with the operation of variable tuning condensers. If the condenser turns with difficulty at certain places, or seems to strike some other part, disconnect the set, remove the chassis from the cabinet and examine the wiring near the variable condenser. In the illustration it will be noted that the rotor plates of the tuning condenser are striking the woven-wire cable used to bond the ganged variable condenser to the chassis. Touching plates in the variable condenser may result from such a contact. If this happens separate them with a paring knife.

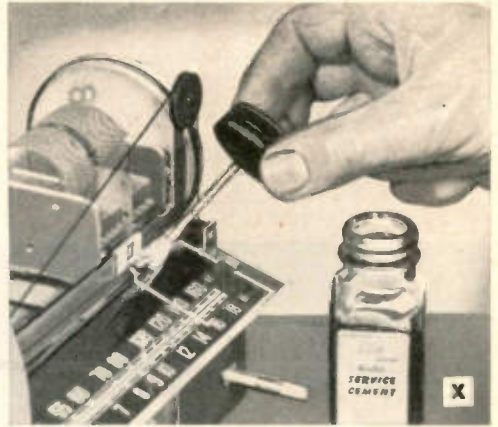

Photo X—Dial cords often become loosened where they are attached to the sliding pointer. A drop of radio service cement on the knot, or connecting loop, will eliminate further trouble at this point.

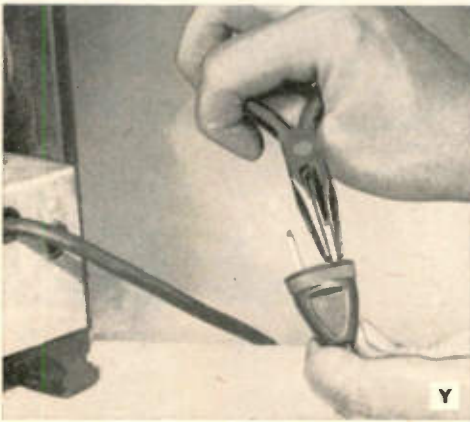
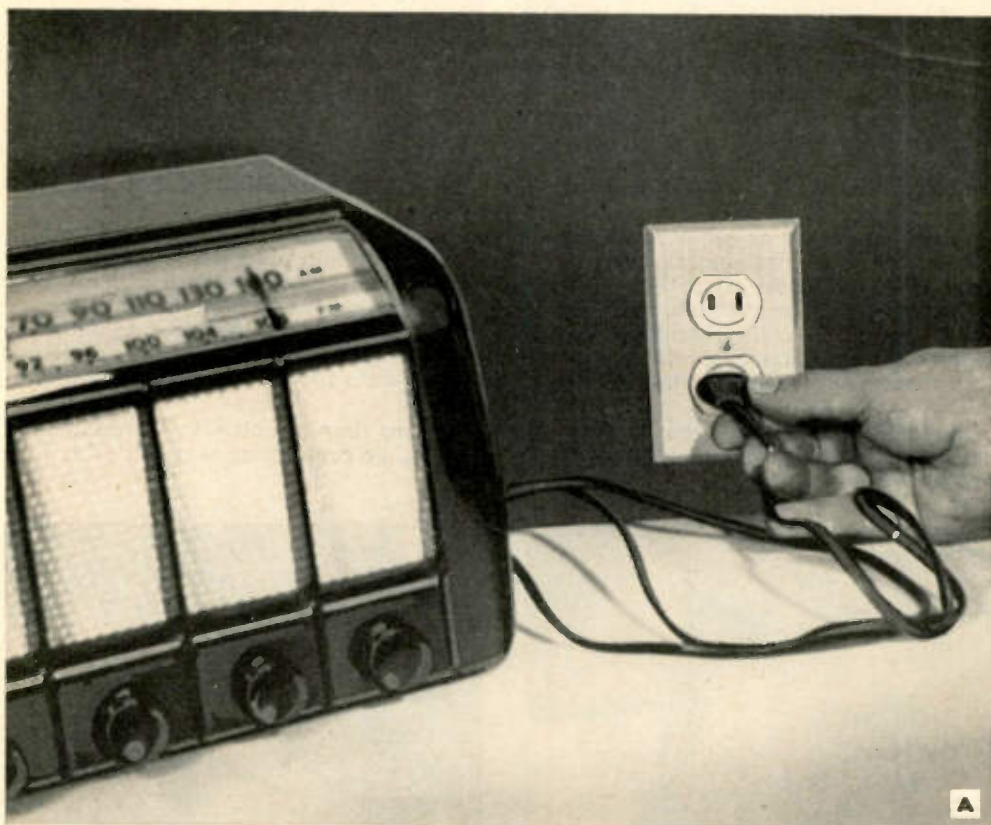

Photo Y—The metal prongs of a line-cord plug often become bent, with the result that they do not fit into the wall receptacle as they should, and the poor contact causes crackling noises in the set when the cord is moved. Most plugs can be temporarily repaired by straightening the prongs with a pair of pliers as shown; if this does not eliminate the trouble a new plug should be installed on the line cord.



Photo Z—Screw-type antenna terminals sometimes pull loose and may contact the metal chassis and kill reception. An emergency repair can be made by cutting the antenna lead inside the chassis and soldering on an additional length of insulated wire which is brought out through the screw terminal hole and terminated at a convenient length with a Fahnestock clip, or an old B-battery clip, as shown. Be sure to tape the connection made inside the chassis.

HOW TO REMOVE A RADIO CHASSIS FROM THE CABINET



FIRST DISCONNECT THE LINE PLUG FROM WALL OUTLET

HOW TO REMOVE A RADIO CHASSIS FROM THE CABINET

IT IS always necessary to remove the chassis from the cabinet of small portable and table-model receivers to make circuit checks and repairs. The first step is to unplug the receiver power cord from the wall outlet to prevent the possibility of a shock, as shown in photo A. Never attempt to remove or reinstall a chassis when the line cord is connected. The next step is to remove the antenna or ground wires, if any. Some models have loop antennas which must be removed. When doing this be careful not to break the small connecting wires.

Remove all control knobs which fit over the various control shafts. Some of these are held in place by friction and will pull off easily as shown in photo B; others have setscrews. In many cases there will be small felt washers behind each knob and they should be dropped into a box along with the knobs and screws. Most of the small table models in plastic cabinets have back covers that are held in position by means of snap fasteners. In wooden cabinets these cardboard or composition back covers are held with small screws. The snap fasteners are easily pried out with a screwdriver as shown in photo C. In many late receivers Phillips-type screws are used to hold the chassis in the cabinet. These screws have an indented cross on the top instead of the usual slot and require Phillips-type screwdrivers to remove them. These screwdrivers are available from all radio parts houses. Two handy sizes are illustrated in photo E. These or other screws may be at the back of the plastic cabinet as shown in photo D, or they may be in the bottom of the cabinet. To remove the chassis, first close the tuning condenser plates by setting dial pointer at 55. Then hold the cabinet and back of the chassis as shown in photo F, sliding the chassis out gently in order not to force the dial pointer or other parts which might bind.

Careful handling is important when removing a heavy chassis from a large table-model receiver cabinet, or from a console. Coils, wires and parts are easily damaged if the chassis is not removed correctly. The

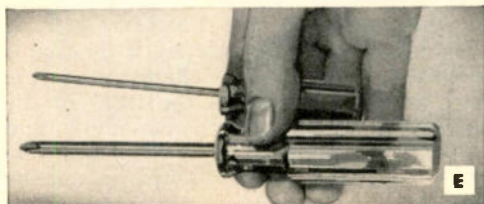
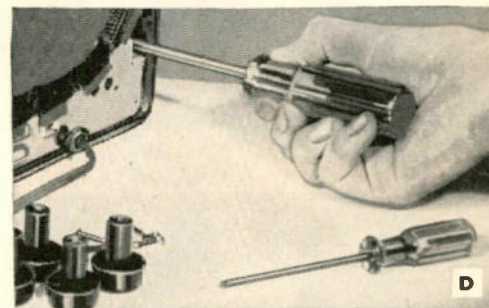
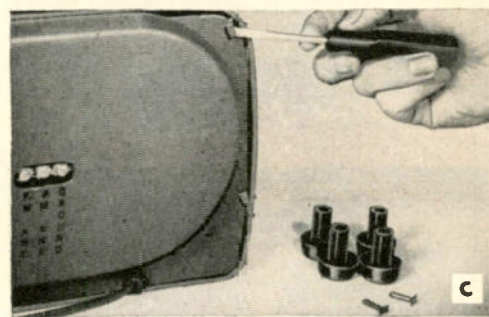
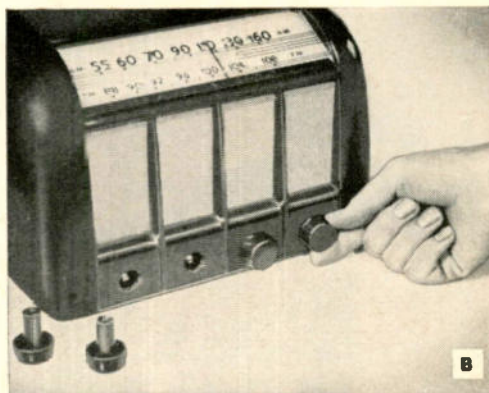

HOW TO REMOVE A RADIO CHASSIS FROM THE CABINET

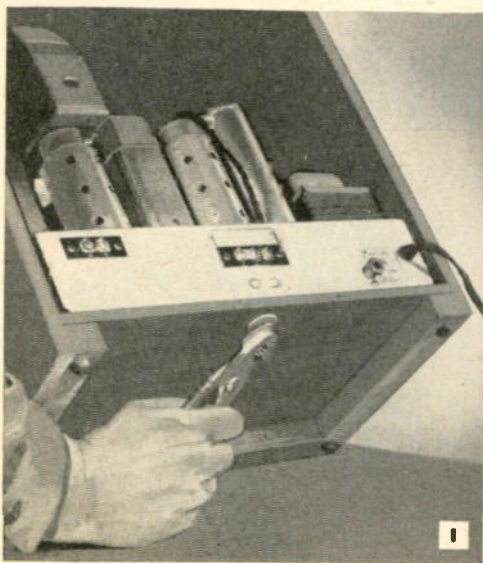
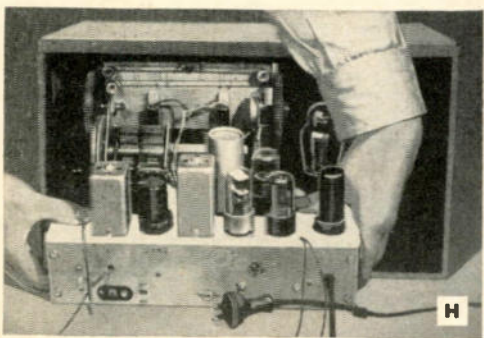
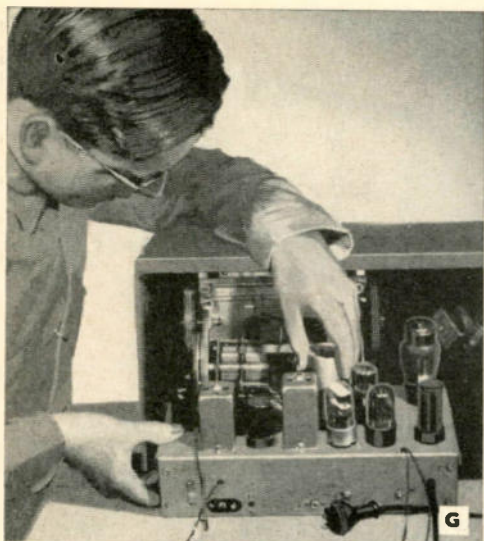

radio worker in photo G is definitely doing it the wrong way. He is lifting and pulling on an electrolytic condenser, which may loosen or damage such a condenser. Coils are also easily broken if they are used to support the weight of the chassis. Photo H shows the correct method—handling the chassis itself and not some mounted part. About the only mounted part that is strong enough to serve as a grip in removing a chassis base would be the power transformer, and in this case the set shown has no power transformer.

Many large receiver chassis bases are mounted in the cabinet by means of bolts or large machine screws and washers. Bolts are easily removed with a pair of heavy pliers as shown in photo I. In many cases there will be some provision for “floating” the chassis on soft rubber bushings. These should be carefully replaced when the chassis is reinstalled in the cabinet. When such rubber bushings are used, the chassis mounting screws are not drawn up tight, thus permitting the chassis to “float.” This cushioning is necessary in some types of radio receivers and P. A. amplifiers. If the loudspeaker is not connected to a cable terminating in a plug that fits into a socket mounted on the chassis, it is usually necessary to take out the mounting screws and remove the speaker from the cabinet. In some table-model sets the cable is long enough to permit the chassis to be removed temporarily without taking out the speaker. Sets that have inclined tuning dials, as in some console cabinets, have additional screws that must be removed as they hold the tuning mechanism in position. In console cabinets it is seldom necessary to remove the chassis to replace tubes, but the same precautions must be observed. Disconnect the power cord from the wall socket before touching the chassis or changing a tube. If the chassis must be removed, never cut cables that pass through holes in the cabinet. You will always find that there is a convenient plug at one end of the cable. When disconnecting such plugs be careful to note where each one goes and label them to avoid confusion. In some console receivers the dial pointer must be removed before the chassis can be taken out, as the operating mechanism extends through a hole in the cabinet. If the dial is mounted directly on the chassis base, it is also usually screwed to the front of the cabinet to strengthen the assembly and prevent vibration. In some cases brackets or wood strips are employed as chassis braces.

SERVICE HINTS FOR STUDENT EXPERIMENTERS

RADIO SERVICING is a profitable occupation and many experimenters become interested in its possibilities through working with their receivers and by building their own radio and electronic equipment. They may then take a good training course and attain real professional standing in their communities. The experimenter soon learns that what he saw when he first looked at the underside of a radio-receiver chassis was not just a jumble of strange-looking parts, but a well-planned electrical device which works according to known electrical rules. The commonly used radio parts illustrated in this book will become very familiar as you find them in radio receivers, amplifiers, television receivers and even tiny midget sets. They may vary in size, type and value, but they all belong to the same group.

Basic Radio and Electronic Parts

The main, or basic, parts of any radio receiver or electronic device are the coils, tubes, condensers and resistors. Any of these basic parts can become defective. Regardless of type, a radio coil is a continuous winding through which an electrical current flows. If the wire should break due to strain, corrosion or poorly soldered connections, current

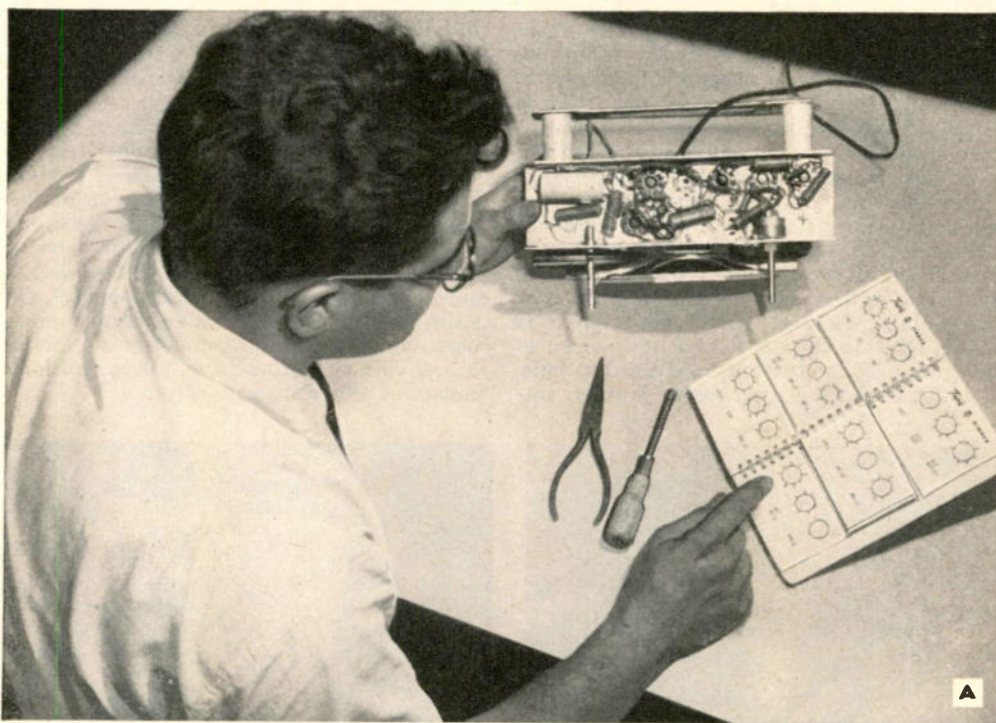

can no longer flow through the coil and the set is dead. A simple continuity test with a meter or a flashlight bulb in series with a dry-cell battery will indicate the "open" circuit very quickly. If the break is at a terminal it is a simple matter to resolder the connection; however, if it is under several layers of wire and cannot be seen, the obvious remedy in most cases is a replacement coil. Short circuits occur when insulation on the wires breaks down and there is contact between the bare copper wires, or layers of turns on the coil. This makes it possible for current to flow through the break, taking a "short cut" to the other wire or adjacent layer instead of following the intended number of turns of wire. Thus this short circuit changes the property of the coil so that the current is not flowing at its rated intensity. Moisture and changes in the spacing of the turns also change the electrical characteristics of coils and interfere with operation.

Radio receiver troubles follow a fairly well-defined trend; your set either does not play, or it operates incorrectly. Faulty operation includes hum, distortion, oscillation,

SERVICE HINTS FOR STUDENT EXPERIMENTERS

intermittent operation and weak signals. If the set is dead, first check to see if the glass tubes all light, and all tubes are tight in sockets; make certain the antenna connections are not defective. See that the speaker is plugged in, and that all tube caps are in position. If there is any evidence of heating, such as smoke coming from the chassis, disconnect the set immediately.

Most experimenters learn to make these checks very quickly. If none of these checks indicates the trouble, the next step is to check the tubes and make a complete circuit test, working back from the power tube to the antenna input of the set. The experienced worker will quickly isolate the defective stage in most cases by this method. Do not guess at tube-base connections, always keep a receiving-tube manual on the workbench. A handy reference booklet of tube-base diagrams is shown in photo A; this is known as the "Triple Pindex." It permits the worker to instantly locate and simultaneously study any three tube-base diagrams out of over 475 types. After locating the dead stage, check connections and parts for continuity with an ohmmeter. If new parts are required they should be of good quality and exactly as specified in the service manual for that particular receiver. After the repair is made, operate the set for an hour or so to be sure that no further trouble develops.

Trained service men agree that an im-

properly playing receiver often presents a more difficult problem than one that is dead. There is no definite or easy method that will show up the defect quickly. However, most well-trained service men and many experienced radio students locate such troubles in a surprisingly short time. They know just what parts in a circuit could cause the trouble indicated by the symptoms. If the set hums, the first thing to do is to check the filter system, especially electrolytic filter condensers. If a high-gain audio amplifier is used, it is a good idea to try new tubes even though the ones in the set check good in the tube tester. Cathode-to-heater leakage may not show up in the tester. If there is distortion in the set at a low setting of the volume control, excessive bias on some tube is indicated. If distortion occurs at a high setting, the bias on some tube is too low. In the service manual of the set, the schematic circuit diagram will show what could cause this, so these points are immediately checked.

Intermittent reception presents a problem for most service men. Poor contact between fixed condenser lugs and the foil in a coupling condenser is a common cause of this trouble, and the repair of course is a new condenser of the same capacity and voltage rating. Poor chassis ground connections, loose soldered connections, defective tubes and resistors are other common causes of intermittent reception.

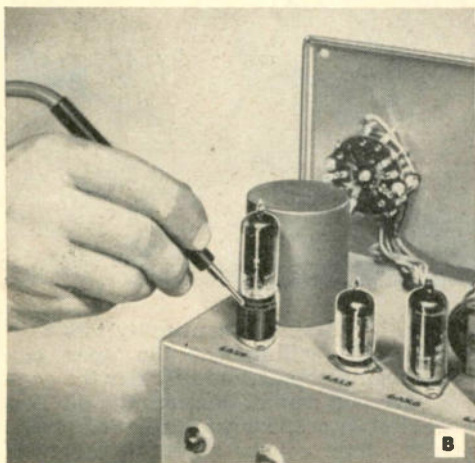

Photo B—Miniature tube test-point adapter permits tube-base tests to be made on tube side of radio chassis. Place adapter in tube socket and insert tube in top; under-chassis wiring and components need not be disturbed.

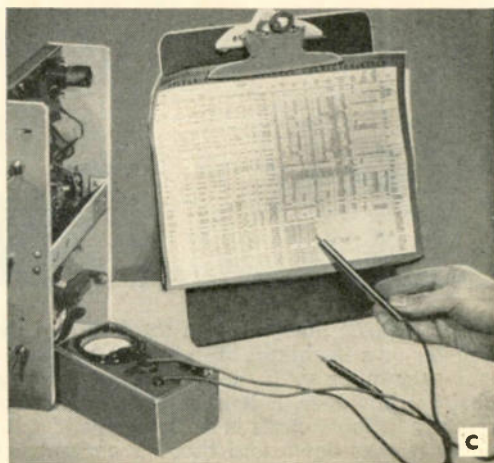

Photo C—A spring clip board will be found very handy for holding tube charts or diagrams. An improvised support may be attached to the back.

SERVICE HINTS FOR STUDENT EXPERIMENTERS

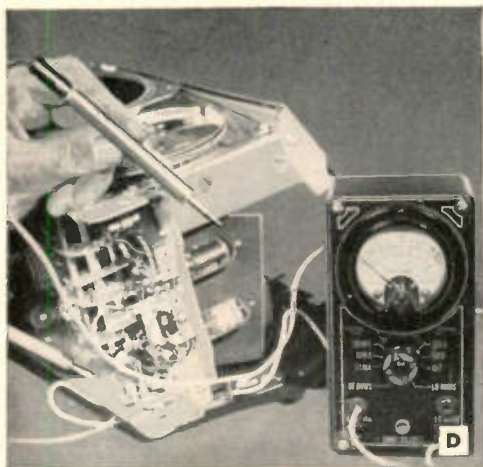

Photo D—Supporting the radio chassis while it is under test on the workbench presents a common problem, especially when the set employs fragile miniature-type tubes that must be protected. Ordinary rubber door stops, or a piece of hardboard can be used as shown. Adjustable chassis cradles are also available for this purpose.

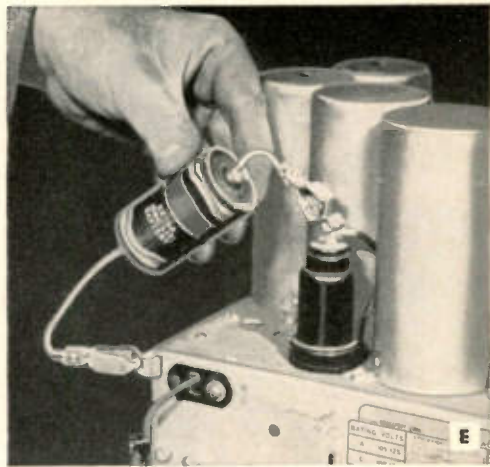

Photo E—A single 1½-volt flashlight cell may be used in the manner illustrated to aid in detecting the dead stage in a radio receiver. When the battery is clipped to the chassis and the positive terminal used in a make-and-break contact at the tube grid, a clicking noise should be heard in the speaker if the stages ahead of the tube are working. Clicking is caused by the change in grid voltage due to the temporary battery hookup.

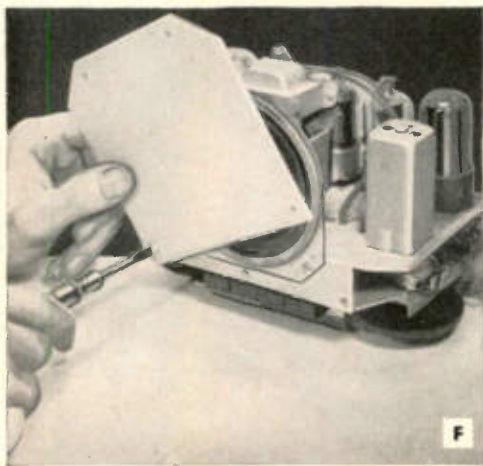

Photo F—When working on small table-model receivers that have the speaker mounted on the chassis, there is always danger of damaging the speaker cone when lifting the chassis, or by striking the cone with a tool. A temporary protective cardboard cover solves the problem as illustrated. Cut it large enough to cover the metal speaker frame and punch holes in the corners so that it can be fastened to the frame.

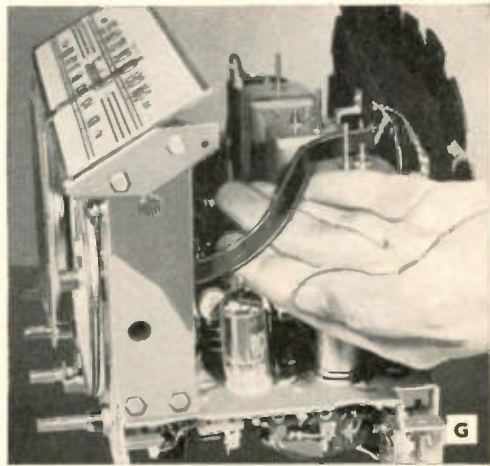

Photo G—When changing tubes or making repairs in FM receivers, or any high-frequency type of receiver which employs a flat two-conductor lead that is connected from the antenna terminals to the antenna coil, always check the position of this lead-in cable before moving it. Changing the position of this cable may result in unsatisfactory operation; if you move it, always see that it is put back in the original position.

SERVICE HINTS FOR STUDENT EXPERIMENTERS

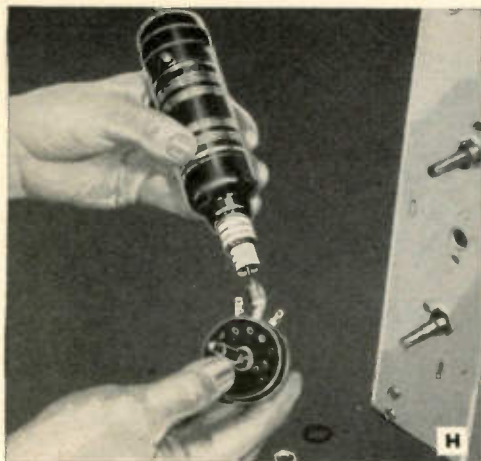

Photo H—A small electrically operated hand grinder makes a good tool for the radio workbench. It may be used to remove old solder from holes in the lugs of a volume control as illustrated. It is also useful for cleaning wires and terminals preparatory to soldering when replacing a radio part in a chassis. When soldered ground connections are made on chassis bases, the grinder may be used to clean a spot for a good connection.

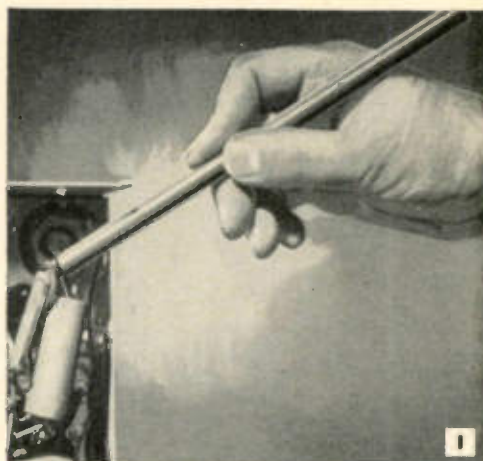

Photo I—Many times a poorly soldered joint, or a defective resistor or condenser may be located by probing gently around such parts. A good tool for this purpose is a piece of Bakelite or fiber rod, or an insulated aligning tool as illustrated. A piece of wooden dowel rod is also useful for this purpose. *Do not use a screwdriver for probing.*

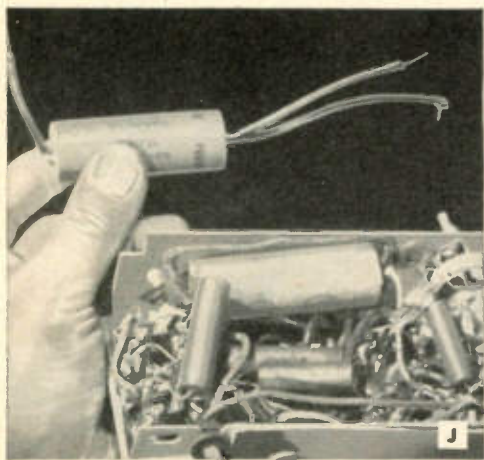

Photo J—Small a.c.-d.c. radios usually employ a double filter condenser of around 20-20 mfd. These filter condensers become inoperative in time due to deterioration, with the result that the set loses volume and becomes noisy. If the tubes in the set test satisfactorily it is well worth while to replace this dual-type filter condenser. Before removing it carefully note the polarity markings on the original. The common negative, usually the black lead, will go to the low voltage side of the circuit, while the positive is the high voltage side. The replacement condenser must have the same capacity and voltage ratings.



Photo K—New multirange d.c. voltmeters can be safely checked for accuracy with a fresh flashlight battery for $1\frac{1}{2}$ volts. This serves to show polarity of test leads and meter before connecting it to a higher voltage which might damage the meter.

SERVICE HINTS FOR STUDENT EXPERIMENTERS

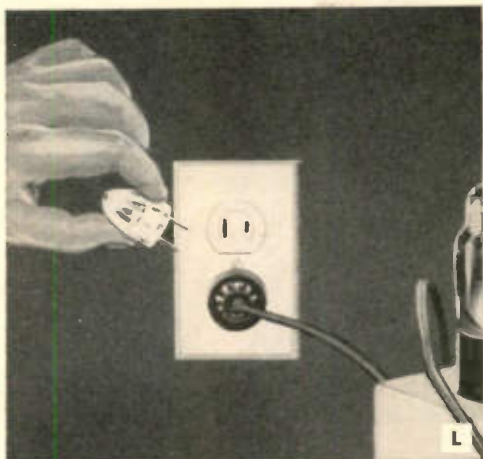

Photo L—Small glow lamps rated at $\frac{1}{25}$ or $\frac{1}{10}$ watt may be used to advantage on a radio test board, or in any double wall outlet as illustrated. Available in dime stores, these tiny glow lamps will give an indication or warning that the outlet is energized and may prevent equipment from being left connected when not required. They are also useful as indicating lamps in testing various stages in amateur transmitters.

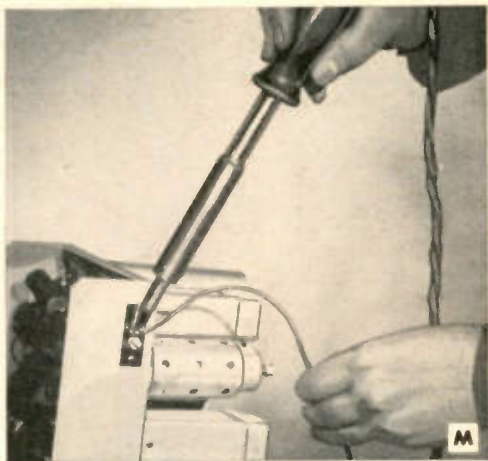

Photo M—Loose antenna and ground connections are always a source of noise in a radio receiver. If the threads are stripped on a screw terminal in the antenna-ground terminal strip on the rear of the chassis, solder a short length of wire directly to the defective terminal as shown and connect the lead to the short wire.



Photo N—On sets where the switch and volume control are combined an external snap-switch inserted in one side of the set power cord as illustrated saves waiting for the set to warm up when left on a certain station at the desired volume. With such an arrangement wear on the volume control is greatly reduced. This idea is also convenient when a replacement switch control is not available.

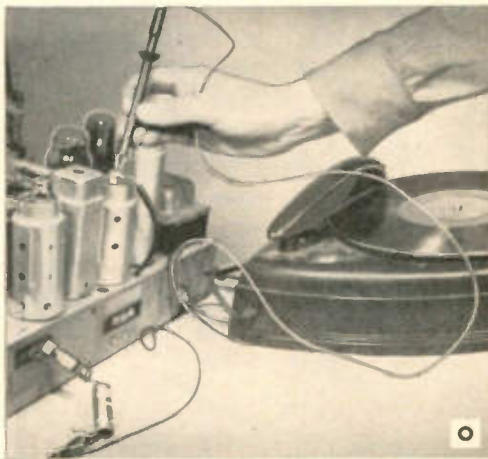

Photo O—A record player may be connected through test leads as shown to the audio section of a receiver to test for certain defects. Note that one lead from the pickup is connected through a .05 mfd. paper condenser to the radio chassis, while the other lead is attached to a probe and touched to the grid of a tube that is used as a combined detector and amplifier. Other checking points are possible, depending upon the circuit.

SERVICE HINTS FOR STUDENT EXPERIMENTERS

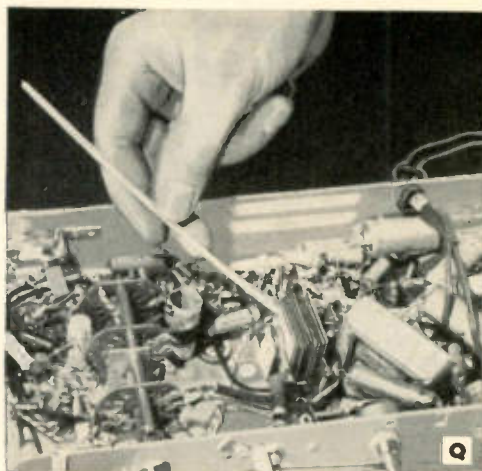
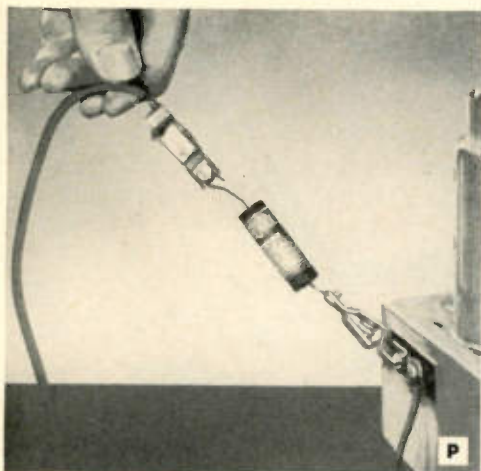

Photo P—Lack of sensitivity is sometimes due to an antenna that is excessively long. This condition can be checked by placing a .005 mfd. paper-type fixed condenser in series with the antenna lead-in as shown. If selectivity is improved the condenser may be left in position, or the antenna shortened. The total length of the antenna includes lead-in. In localities having a number of stations, good selectivity is important.

Photo Q—Selenium rectifiers of the type indicated are used in many modern radios in place of rectifier tubes. The active material on the plates of such rectifiers may be damaged by overheating. Therefore, other equipment should be kept in the clear. Openings in the chassis located directly above this rectifier should be kept free for ventilation.

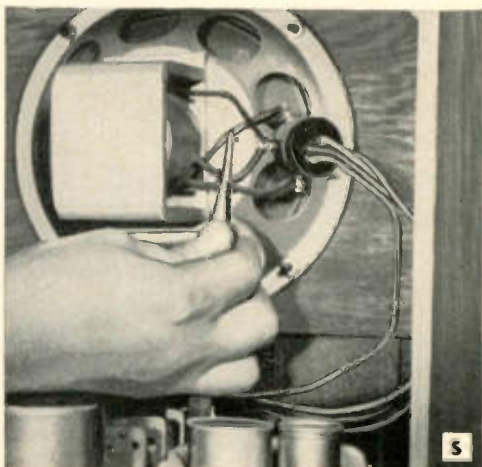

Photo R—Reception may sometimes be improved and hum reduced by grounding the loudspeaker frame to the chassis of the set. This may be checked by connecting a test lead to the chassis with a clip and touching the test prod to the speaker case.

Photo S—In certain dynamic speakers a hum-reducing coil is added on the form containing the field-coil winding. This hum-bucking coil is made up of a number of turns of wire and arranged to pick up a hum voltage equivalent to the hum voltage induced into the voice coil. It is necessary that this coil be connected in a certain manner to accomplish this purpose. If hum is excessive, check this winding to make sure that the leads have not been reversed at some time when repairs were made. Try reversing the leads as indicated; disconnect the set when reversing the leads.

SERVICE HINTS FOR STUDENT EXPERIMENTERS

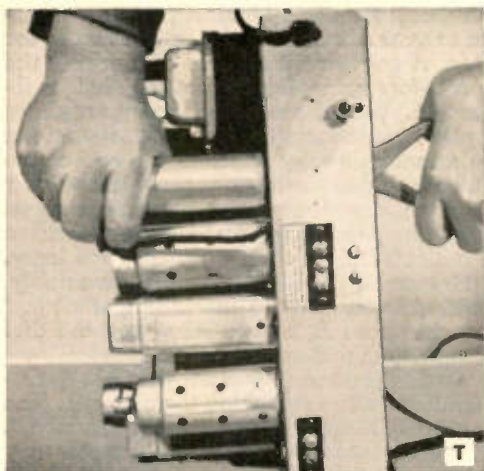

Photo T—Hum in a radio receiver may be due to a poor contact connection where the metal can of the electrolytic filter condenser is grounded on the chassis. First disconnect the set line cord from the wall outlet; the metal can may be held by one hand and the other hand used to tighten the holding nut under the chassis as illustrated. Care must be taken not to damage the insulation on any wires under the chassis.

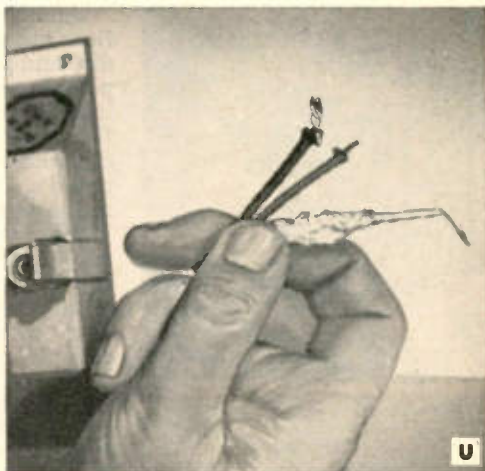

Photo U—Older receivers that use a line-cord resistor sometimes become inoperative due to the resistor lead grounding on the chassis. As may be noted in the photo, this resistor carries an asbestos covering that is easily damaged. Carefully insulate this resistor under the chassis and see that it does not move when the line cord is pulled.

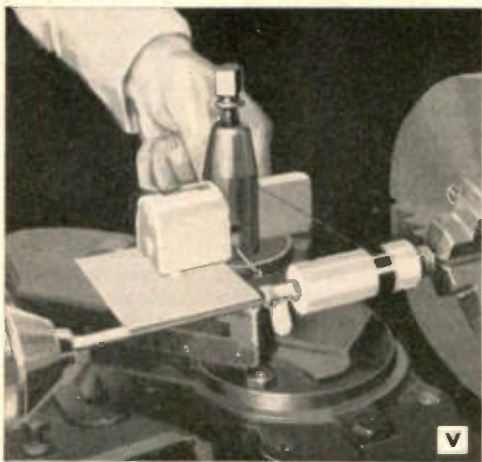

Photo V—Although radio experimenters usually wind coils by hand, some who are fortunate enough to own a lathe and winding counter rig a winding setup like the one illustrated. The coil shown is being wound on a dry wooden form gripped in the chuck by means of a threaded rod passed through the form and held by nuts at each end. At the outboard end of the rod is a small "dog" which is also clamped in place by a nut. The "dog" rotates with the form and trips the counter, recording each revolution. Bakelite coil forms may be wound by clamping a wooden cone in each end of the form.

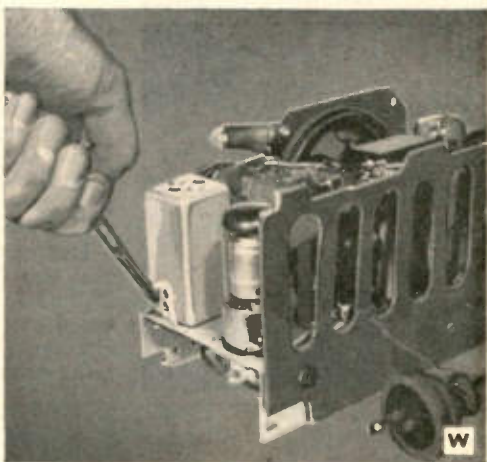
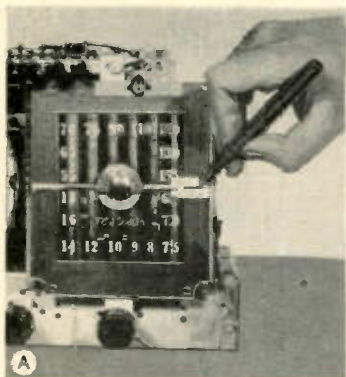

Photo W—Many coil shields have spring clips which place a tension between the shield and chassis for good contact. Such contacts may loosen and cause fading or oscillation. Adjust the spring clips with pliers as illustrated to reestablish good contact.

SERVICE HINTS FOR STUDENT EXPERIMENTERS



Tuning dial repairs are not difficult if proper precautions are taken to avoid disturbing the calibration of the dial and pointer. A convenient method of marking the pointer position before removing it from the shaft is illustrated in photo A. With the variable condenser plates fully meshed, place a small strip of adhesive tape on the dial and make a mark directly opposite the end of the pointer. It is then a simple matter to replace the pointer in the same position after the repairs have been made.



After removing the pointer and dial plate a new drive cable may be indicated if it is badly worn or too loose. If so, make a diagram of the dial-drive cable assembly, tracing the cord wrapped around the tuning shaft and drum as shown in photo B, before removing the dial cord; this will save time and avoid errors.

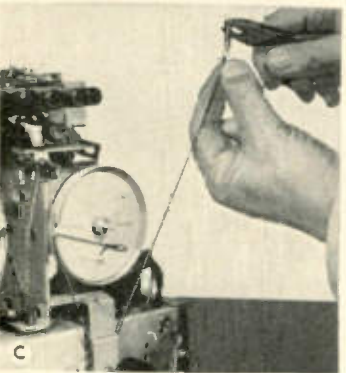

Even if the cord is broken it is often possible to determine its operation before removing the old cord. The system shown is fairly simple; others are more involved. If the dial cord merely is loose and slipping, a repair may sometimes be made by cutting off a small portion of one of the springs as indicated in photo C. When this spring on the end of the cord is reconnected to its hook on the dial drum, more tension will be placed on the cord. Another temporary repair is to apply rosin or a kitchen cleanser powder to the cord. Heavy fishline will often make an emergency cord or cable repair if standard dial cable is not available. Some receivers use special stranded phosphor bronze cable, others heavy linen cord. Permanent repairs on such receivers can be made by any well equipped experimenter or radio service man.

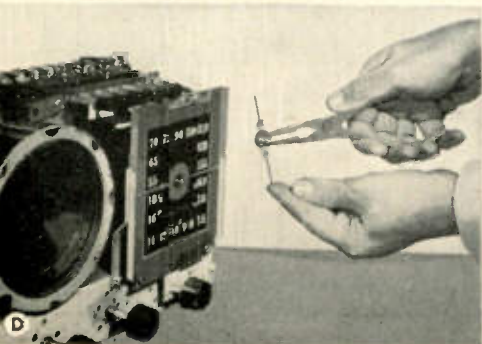

Loose dial pointers or indicators may be repaired by bending the clasps which fit over the shaft with a pair of long-nose pliers, as illustrated in photo D, to obtain a tight fit. Sometimes a light application of service cement, of the type used to repair speaker cones, is necessary, as indicated in photo E. In all cases when the pointer is replaced on the shaft make certain that the condenser plates are fully meshed and that the pointer is lined up with the guide mark. Install the set in its cabinet carefully and make sure that all chassis mounting screws under the cabinet are replaced correctly.

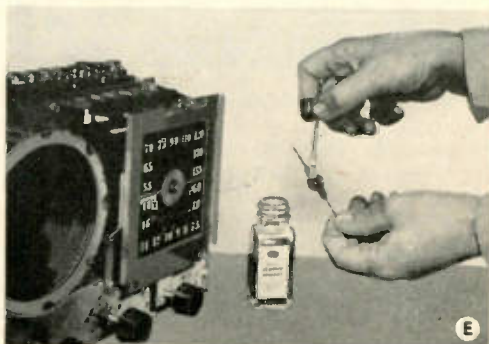

Before tightening these mounting bolts check to see that the dial is properly centered in the cabinet opening; also that the shafts of the various controls are centered in the holes in the front of the cabinet. If the chassis "floats" on soft rubber bushings the mounting bolts should not be fully tightened.

HOW TO REPLACE VOLUME CONTROLS

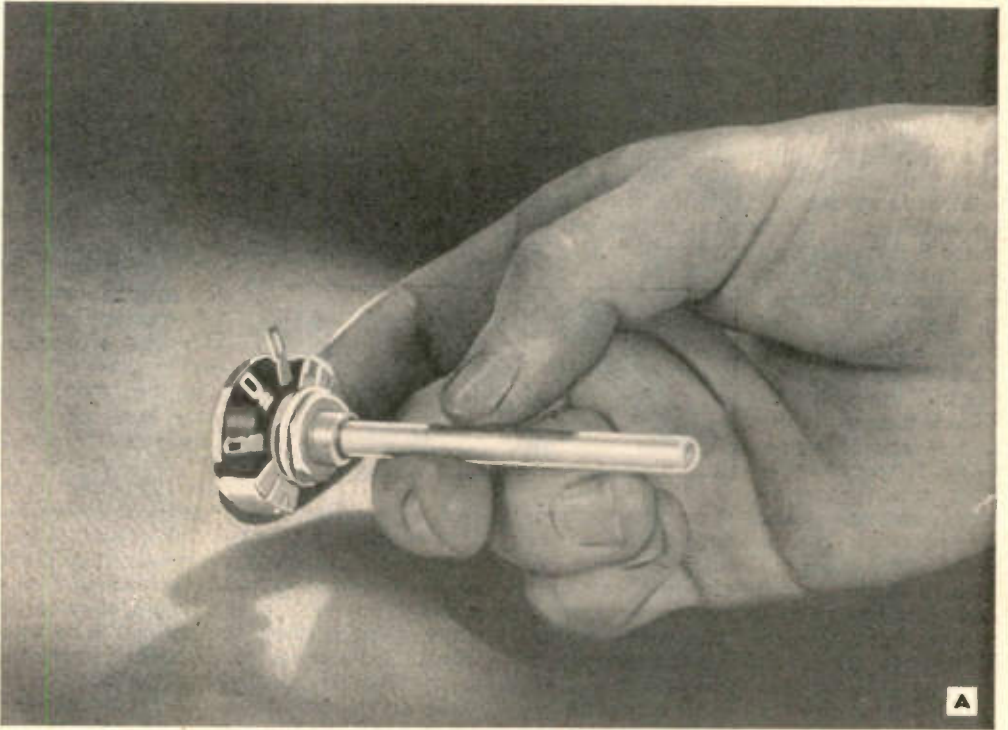

VOLUME AND TONE CONTROLS ARE SUBJECT TO WEAR AND ARE A COMMON CAUSE OF NOISE

HOW TO REPLACE VOLUME CONTROLS

VOLUME controls and tone controls, photo A, employ a movable contact that slides over a resistance element. Owing to constant friction, this element becomes worn and eventually it must be replaced. In certain types of controls poor contacts may occur between the connecting terminal and the rotating arm. If a defect occurs that would cause excess current to flow through the resistance element it would burn out like any other resistor.

Defective controls are very easy to check as a good volume control should be smooth in action, increasing and decreasing the volume without adding any noise, and without any sudden changes. Volume controls are subject to the most wear and are a common source of noise. If the receiver is noisy when you turn the volume control or when you pull or push the knob, the control is evidently defective and should be replaced. If the control is rotated and there is no effect on the volume, it is quite possible that there

is a break or open in the resistor element near one of the terminals. Should the volume take a sudden jump as the control is rotated, it would definitely indicate a

worn resistance element or other internal defect; such controls are usually very noisy. Obviously no meter or other set-testing device is required to check noisy controls, however an ohmmeter may be used by the experienced worker if desired. By connecting the ohmmeter probes to the moving arm terminal and one of the end terminals on the resistance strip, the operator can quickly check the contact between the arm and the resistance element. To do this the set should first be disconnected from the power line; then the circuit leads should be unsoldered from the volume control terminals to avoid having any shunt paths that would give you a false reading. The resistance, as indicated by the ohmmeter, will vary smoothly as the volume control is rotated and the needle will not jerk or jump if the control is in good condition. If the resistance of the control changes slowly over a portion of the control range and swiftly over the balance of the control range, the change of speed is due to the "taper" of the resistor and it does not mean that the control is defective. However, if the resistance varies back and forth over the range as the con-

trol is rotated, it will definitely indicate that there is a poor contact between the rotor contact and the resistance strip, and a new control should be installed. The student or experimenter should always make a drawing of the volume control and its connections before removing it from the chassis base. Indicate the color of each lead. A pictorial drawing will help to prevent wrong connections when the new volume control is installed. To obtain the proper replacement control, give the radio parts house the make and model number of your receiver. If the set is a standard make, an exact duplicate replacement or a general-purpose unit will be available. Detailed material lists for student-type receiver models and other radio and electronic construction articles should always be filed and kept available for such emergencies. If the original control has a switch, be sure to order the switch with the replacement unit. Replacement guide books

are published by the manufacturers of controls for standard commercial receivers.

In replacing volume controls it is important to check the moving arm on the defective control,

especially in older sets, to determine if it is grounded or not. Of course if you have the circuit diagram it will show if the center terminal should be grounded. Some controls have this ground connection made automatically when the control is mounted on the chassis base. There are, however, many replacement controls designed to be used on several types of receivers, and some sets have the contact arm of the volume control insulated from the mounting stud. To determine if the center arm is connected to the mounting stud, use either an ohmmeter or a flashlight bulb connected in series with a dry-cell battery to make a continuity test. If you find continuity between any terminal and the shaft of the old control, it will be necessary to provide a ground connection between that terminal and the set chassis. Be sure to add this connection to your pictorial sketch. Of course, if you use an exact duplicate control it will have this internal connection, but the general replacement unit will not.

When mounting the new volume control on the chassis, tighten the holding nut as much as possible to prevent the control

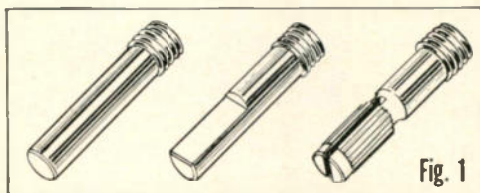
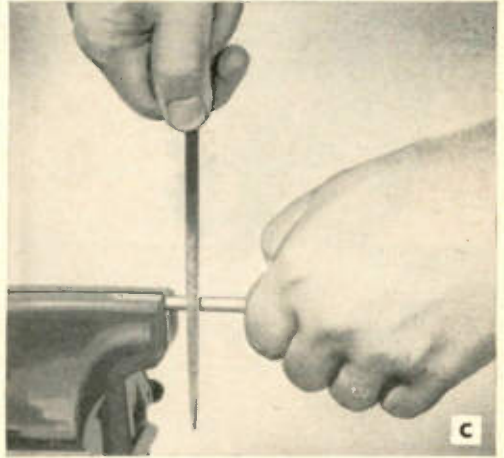
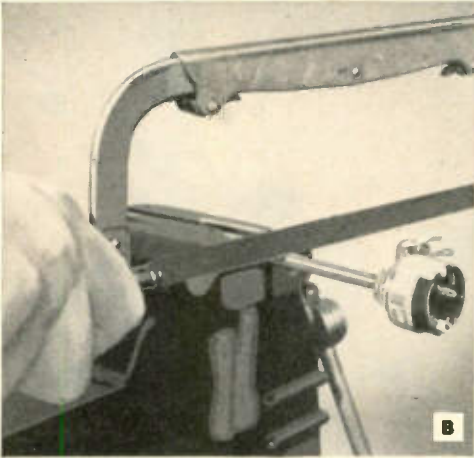

Fig. 1

HOW TO REPLACE VOLUME CONTROLS



unit from turning in manual operation. If loose, the entire control will turn with the knob and probably break off the control leads. Some volume controls have tiny metal or fiber tabs that fit into a small hole in the chassis base to keep the control in the proper position. If so, be sure that this projecting tab is in its hole before tightening the holding nut in the final mounting operation.

General replacement controls have the same resistance value as the original, but they may differ in physical size. In case it should be larger than the original control unit, make certain that there is sufficient room to mount it. If not, you may have to shop around a bit for one having the same dimensions as the original. Volume-control

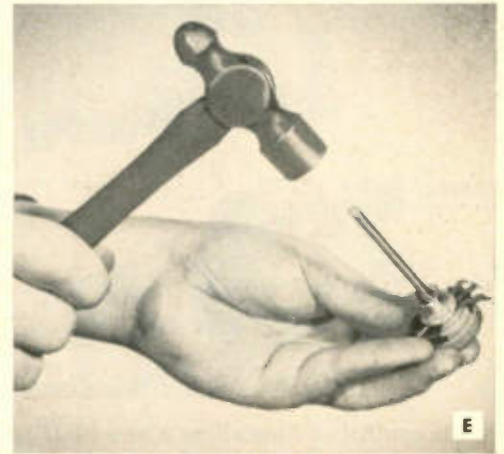
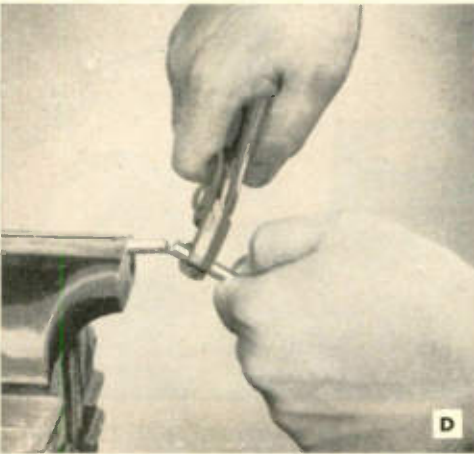

shafts are either round, slotted or half-round as illustrated in Fig. 1. As the general-replacement control is designed to fit many different types of receivers, the control shaft is extra long and must be cut to proper length. Care must be taken in doing this so as not to damage the new unit. The safest method is to measure the shaft of the old control and cut the new one accordingly, holding it in a vise and using a hacksaw as shown in photo B. Some control shafts are of soft material which may be filed at the proper spot as illustrated in photo C and then broken off as shown in photo D. Certain controls have separate "tap in" shafts that are to be driven into the control unit before it is installed as shown in photo E. These universal-type controls are handy for the service man and experimenter as a variety of shafts is available for them so that it is a simple matter to supply the type of shaft that will match the others on the set, and use the same knobs that may be either setscrew types or the push-on variety.

HOW TO REPLACE VOLUME CONTROLS

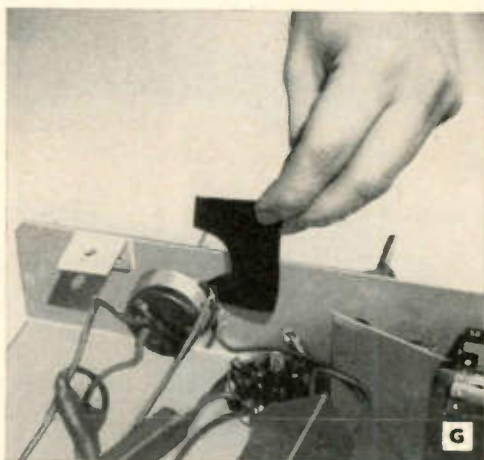
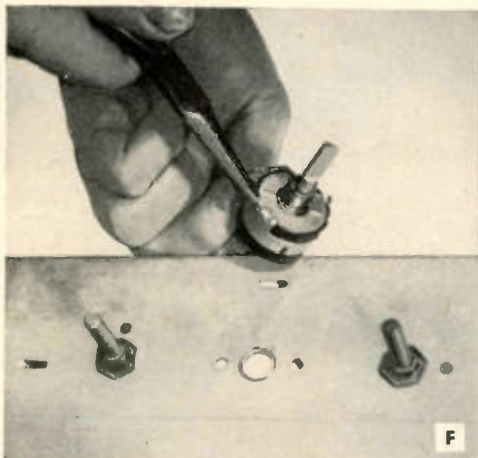

Volume control tapers are identified by numbers or letters in parts-house catalogues; for audio and antenna shunt circuits the taper is No. 1; for series circuits or cathode voltage controls the taper is No. 2; taper No. 3 is for combination antenna shunt plus bias circuits. The linear taper No. 4 is specified where voltage is proportional to the degree of rotation. The type commonly specified in the average student construction article is the audio-taper No. 1. Very few general-purpose replacement controls have switches on them. However a switch can be added simply by removing the back plate

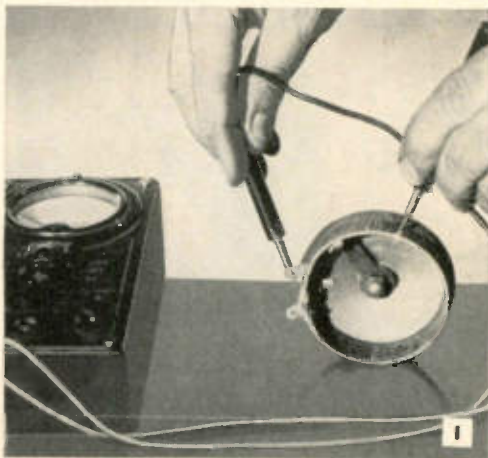
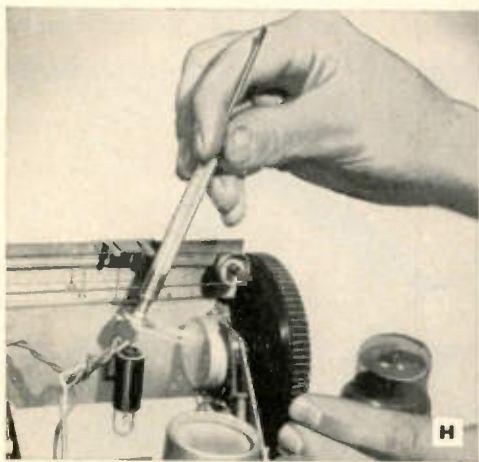

of the control and installing a new plate which has the switch mounted on it. The switch plate can then be attached permanently by bending the holding clips over as indicated in photo F.

Where the terminals of the volume control are very close to the chassis or other parts, a piece of insulating material known as varnished cambric, cut as shown in photo G, can be slipped in front of the unit between the terminals and the chassis, to prevent possible shorts. An emergency hint for temporarily quieting some noisy controls is illustrated in photo H. The receiver is disconnected from the wall outlet, and the volume control case is tapped lightly while moving the control knob slowly back and forth. An emergency hint to determine the original resistance value of a burned-out wire-wound control is shown in photo I. This is useful in repairing old sets for which the parts specifications are not immediately available. The resistance is measured by means of an ohmmeter from each terminal lug to the break or open point in the winding, and then these resistance values are added to determine the approximate original total resistance.

HOW TO MOUNT PARTS AND WIRE CIRCUITS



MARKING CHASSIS BASE TO IDENTIFY TUBE SOCKETS

HOW TO MOUNT PARTS AND WIRE CIRCUITS

CORRECT LAYOUT of parts is important no matter what type of radio or electronic unit you are building, as a poor arrangement can cause the equipment to function incorrectly. Of course, in some cases the layout is more critical than in others. When you are following a pictorial wiring diagram the parts are shown carefully arranged, especially the tube sockets. Place your sockets in the positions as indicated by the center keys. When this is done it will insure the shortest possible leads necessary to prevent undesired oscillation, or in other words, squeals instead of clear signals.

For example: in Fig. 1 you will see that both tube sockets are placed in the same position, and a fixed condenser has been connected between terminal 3 of one tube socket and terminal 5 of the other. This is about the shortest connection that can be made without crossing over other terminal lugs. Now by merely rotating one of the tube sockets to the position shown in Fig. 2, the lead is reduced in length and thus the connection is more direct. It is not always possible to actually show short lead wires in pictorial wiring diagrams as it would be necessary to cross over too many other leads and parts on the drawing. However, the parts are arranged to permit short leads and the builder should make his leads, especially those for the tube grid and plate connections, as direct as possible. The use of insulated hookup wire, or varnished-cambric tubing known as "spaghetti," over bare wires will prevent possible shorts in crowded spots.

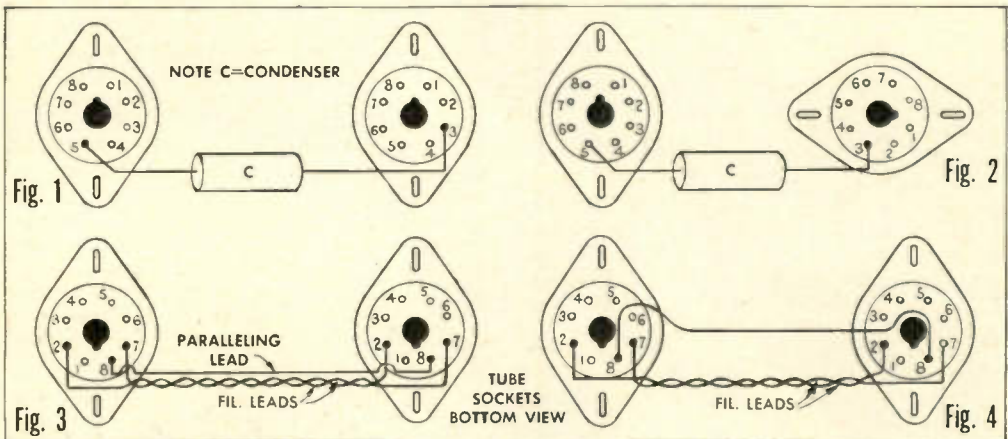

Avoid Hum Pickup

In some cases running direct leads is not the best procedure, and should be avoided. Grid and plate leads should not be paralleled; also there are other cases where leads should not parallel. For example: in Fig. 3 a lead is run between terminal 8 of one tube socket and terminal 8 of another socket. The lead is reasonably short, but it lies parallel to the tube filament leads and in some cases this would mean that considerable hum would be picked up. The experimenter may find that running this lead on a less direct route, as indicated in Fig. 4, will prove to be more satisfactory. Actual experimenting with the particular circuit you are wiring is the best method of determining this. The main reason for the pictorial diagram is to show the physical layout of the parts and to identify the leads running to them. As a rule filament leads do not have to be short, they can be formed around the inside edge of the chassis base in many cases.

In circuit wiring a good method to follow is to wire the filament circuit first; then connect the various condensers and resistors. Most fixed resistors and fixed condensers are provided with "pigtail" wire leads, and are thus self-supporting. Low-capacity fixed condensers are usually of the flat rectangular "mica" type; they consist of tin foil or sheet-brass plates with thin sheets of mica for the dielectric, and have a Bakelite or similar covering to protect them from moisture. A tubular "paper-type" fixed condenser has greater capacity and consists of a strip of waxed paper between two strips of tin foil. The black ring, or foil end, commonly goes to the ground side of the circuit.

When Polarity is Important

An electrolytic condenser is usually larger than the paper type; it consists of a fixed condenser in which the dielectric is a thin film of gas formed on the surface of one aluminum electrode by a liquid or paste electrolyte. It is always necessary to observe the polarity of electrolytic condensers when wiring them into the circuit. A black lead is usually negative, and the positive is red. These electrolytic condensers are always marked positive and negative. In the multiple-section types the capacity values and terminal code for the various leads appear on the condenser unit. Some are in cardboard cases, and other tubular types are in metal cases that are mounted upright on the chassis base.

Variable condensers that are used to tune receivers commonly have plates of aluminum in two or more sections. One plate is stationary and the other rotates so that the area of the plates facing each other may be changed; thus the capacity of the condenser to store electrical energy may be varied. The rotary set of plates is called the rotor, and this is usually electrically and mechanically common with the frame. The stationary section, or sections, of plates is called the stator; it is indicated in many circuits by the letter S. Air is usually the dielectric in variable condensers. A trimmer condenser is a semi-variable type usually adjusted with a screwdriver. The capacity rating of modern variable condensers is always stated by the manufacturer; it cannot be determined by counting the number of plates.

Arrangement of Parts

If no pictorial wiring diagram is available for the particular unit you want to build, you should study the photos of the completed instrument and note carefully how the parts are arranged on the chassis base. This will help you work out your layout as far as the parts such as the coils, transformers and chokes on the base are concerned; also the placement of the on-off switch, volume and tone controls. If two transformers, chokes or coils are mounted on a chassis base in the position shown in photo B, a bad hum can be picked up by one coil which is influenced by the magnetic field of the other. This can happen in either radio-frequency (r.f.) or audio-frequency (a.f.) circuits. To avoid this condition you will always find that a good parts layout will show units mounted at right angles as indicated in photo C. It is important to follow specifications closely in

building any radio or electronic device as the parts have been carefully selected to meet the particular requirements of the circuit under construction. For example, if the builder purchases a power transformer that supplies higher or lower voltage than specified, in some cases it will not be a critical departure and the instrument will work. On the other hand it may result in distortion, oscillation and unearthly squeals, or, the silence of inoperation. This applies to other parts such as volume controls, resistors, chokes, condensers and other components.

If you are building from a construction article where the diagrams and specifications have been properly prepared for the beginner, the plans will include photos, layout, pictorial and schematic wiring diagrams made directly from the original tested model. If you are working from such a construction article you will have very little to worry about provided you use the parts specified and follow the directions carefully. Many beginners, and also experienced builders, find it a good idea to use a colored pencil and cover each lead on the diagram as the wiring progresses. In this manner no lead is omitted. If you are stumped at any point consult an experienced builder; do not wire blindly. Check your actual wiring with the schematic circuit diagram by picking out the particular tube or portion of the circuit involved, and you will be surprised in many cases to find that you can solve your own problem.

Mark Tube Locations on Chassis

A common cause of wrong connections when wiring under a chassis base is becoming confused in the location of the various tubes. To solve this problem and speed up the process of wiring, mark the chassis base near each tube socket to identify the tube. The tube number should be marked on both the top and bottom of the chassis base adjacent to its socket. You can use a pencil, or scratch the number in with an ice pick. A vibrating-type engraving tool may also be used for this purpose as shown in photo A. Intermediate-frequency transformers and other radio parts can be identified in the same manner. Such markings are also of help in later checking of circuits and making repairs. The tube sockets will usually be bottom views in both the schematic and pictorial wiring diagrams unless otherwise specified. In *Popular Mechanics Magazine* and in this book the tube-socket terminals are numbered in the same manner in both the schematic and pictorial wiring diagrams; coil and transformer termi-

HOW TO MOUNT PARTS AND WIRE CIRCUITS

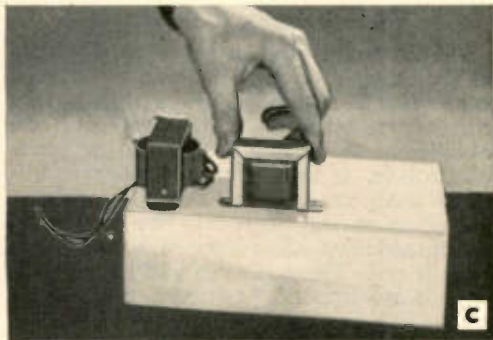
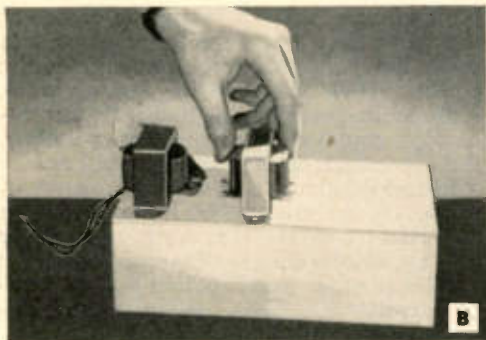

nals are also identified with corresponding numbers in both diagrams. This eliminates guessing and simplifies circuit checking. The polarity of fixed condensers is always shown in both diagrams, except in cases where polarity is not important. Mica fixed condensers of the common variety do not have to be polarized, they can be connected either way. This is also true of common carbon-type fixed resistors.

Connections to variable tuning condensers often puzzle beginners. The stator, or fixed-plate section, terminals are insulated from the frame of the condenser by either ceramic, Bakelite or similar high-dielectric insulating material. Sometimes the terminal lugs to the stator plates are brought out only on one side of the condenser; in other makes there is a connecting lug to the same stator section on both sides of the condenser for convenience. Therefore stator connections can be on either side. As the condenser frame is common with the rotor in most standard variable tuning condensers, the common rotor connection can be made at a single point on the frame for either single-section or for ganged condensers, which may have several independent stator sections and a common rotor. Many variable tuning condensers have a small, screwdriver-adjusted trimmer condenser across each section. These trimmers are independently adjustable for certain preliminary tuning and aligning purposes. No external circuit connections are made to these trimmers; in other words, they provide for vernier adjustments and are a built-in part of each condenser section.

Learn to Read Color Codes

To identify the various values and leads of standard radio parts such as fixed resistors, fixed condensers, transformers, chokes and similar components, the Radio Manufacturers Association (R.M.A.) has adopted a standard color code. The identi-

fying colors for fixed resistors and mica condensers are represented by numbers; these charts are easy to read, and they are shown in the appendix. The color code for resistors employs three colors to identify the resistance value of each resistor. In older types the "body" color represents the first figure of the resistance value; one "end," or "tip," is colored to represent the second figure. A colored "band" or "dot" near the center of the resistor indicates the number of zeros following the first two figures. Most new carbon or composition-type fixed resistors are now marked with colored bands to identify the resistance value of each resistor as shown in chart Fig. 6. The band nearest the end represents the "body" color; the next band the "tip" or "end" color, and the third band is the "dot" color. The fourth, gold or silver, band indicates the tolerance plus or minus; when there is no fourth band the tolerance is 20 percent plus or minus. Referring to resistor color-code chart Fig. 6, for example: if the first band on the resistor is green, the second band blue, and the third band red, the value would be 5600 ohms. If the resistor is color-coded by the old "body," "end" and "dot" method the same code numbers apply; the "body" color representing the first figure 5 would be green; the "end" would be blue for second figure 6; and the "dot," or center color, would be red to represent the number of zeros following the first two numbers.

The fixed carbon-resistor values given in all construction articles are now subject to the new R.M.A. standard. Select the nearest preferred R.M.A. standard value to the one specified. For example: the nearest value to 50,000 ohms is 47,000 ohms, etc., as will be noted in the preferred R.M.A. values chart. Sometimes the value will be slightly above rather than below the original specified; these slight differences do not affect the efficiency of any circuit.

HOMEMADE SET TESTERS AND TEST BENCH

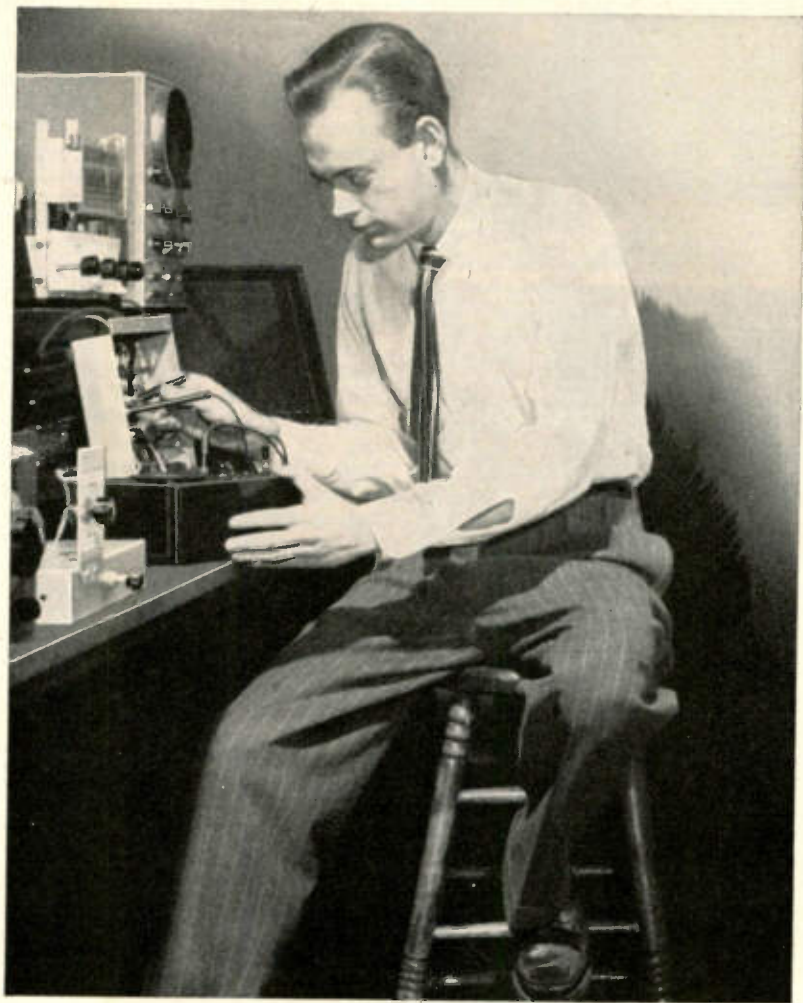

"TROUBLE SHOOTING" WITH A VOLT-OHMMETER

HOW TO BUILD AN INEXPENSIVE

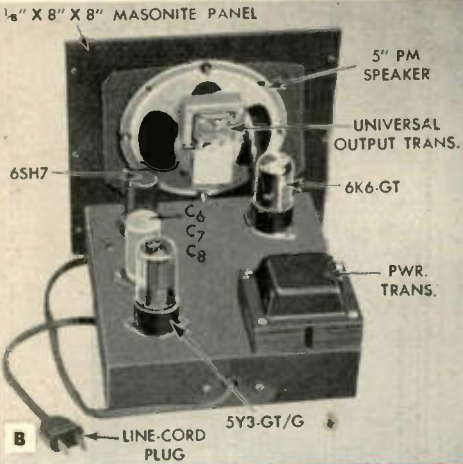

SIGNAL tracing means to sample or examine the signal at any specified point on its journey through the various stages in a receiver to the loudspeaker. It is a modern method of servicing radio sets; when you pass from a point of normal signal to the point at which this "electronic bloodhound" verifies or confirms the complaint, you have just passed into or through the defective stage. In other words, this signal tracer will quickly enable you to locate the defective stage and, in many cases, the defective part itself. It also enables you to listen to the actual signal as it is traced through the set and provides a means for checking the quality of the signal at each sampling point. This approved method of set servicing is in common use.

It is easy to build and simple to use as it is merely an audio amplifier with a built-in power supply and a nonlinear detector in the form of a probe. The unit illustrated consists of two amplifying stages employing one 6SH7 tube and one type 6K6-GT tube. The nonlinear detector probe, which is housed in a short length of Bakelite tubing, is connected to a 6-ft. length of 3-conductor cable, in which one lead is shielded. It employs a 6C4 tube; the cable terminates in a type P-303-CCT Jones plug. Since this is a grid-leak type of detector, it also adds considerably to the signal amplification. A 5Y3-GT/G tube is used in the conventional built-in power supply, with the additional condensers C11 and C12 employed to take

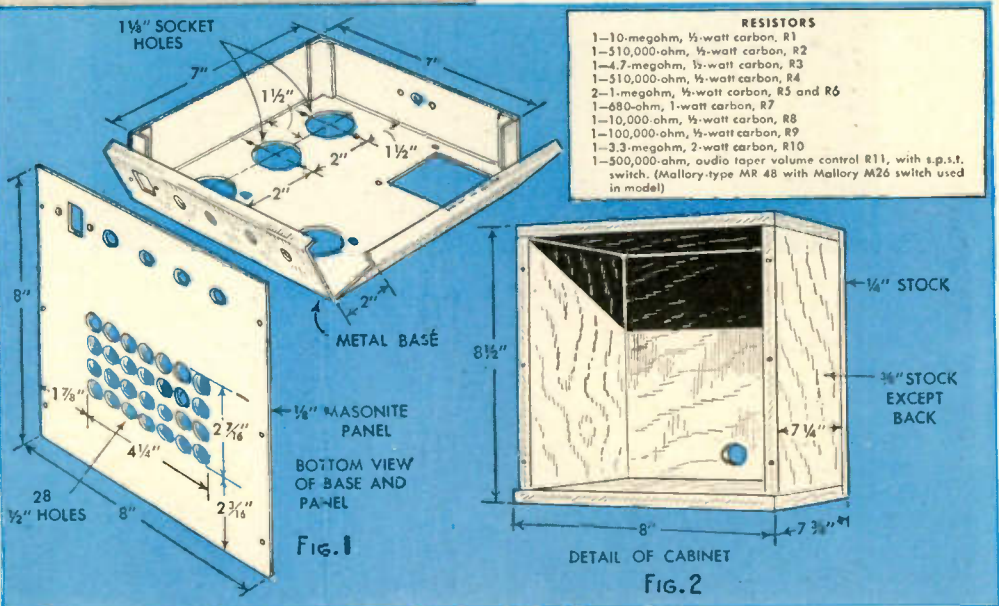

- RESISTORS**
- 1—10-megohm, 1/2-watt carbon, R1
 - 1—510,000-ohm, 1/2-watt carbon, R2
 - 1—4.7-megohm, 1/2-watt carbon, R3
 - 1—510,000-ohm, 1/2-watt carbon, R4
 - 2—1-megohm, 1/2-watt carbon, R5 and R6
 - 1—680-ohm, 1-watt carbon, R7
 - 1—10,000-ohm, 1/2-watt carbon, R8
 - 1—100,000-ohm, 1/2-watt carbon, R9
 - 1—3.3-megohm, 2-watt carbon, R10
 - 1—500,000-ohm, audio taper volume control R11, with s.p.s.t. switch. (Mallory-type MR 48 with Mallory M26 switch used in model)

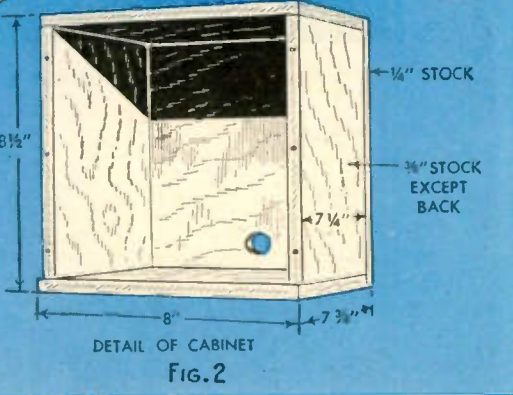

SIGNAL TRACER FOR RADIO SERVICING

out line noises which might appear in the signal tracer, because of its high amplification. Photos A, B, F, G and H show various views of the completed instrument. The metal chassis base, Masonite panel, and cabinet are all carefully detailed in Figs. 1 and 2. A complete schematic circuit diagram is given in Fig. 3. Pictorial wiring diagrams of the 6C4 tube socket, probe and cable connections are shown in Figs. 3-A and 3-B. Condenser C1, resistor R1 and the 6C4 miniature tube are all contained within a 1½-in.-dia. piece of Bakelite tubing which is closed at each end with a disk of ¼-in. polystyrene. This is a clear plastic insulating material that is available from all radio-parts houses. Condenser C1 consists of two pieces of insulated hookup wire 1¼ in. long twisted together to provide a necessary small capacity; note that only one end of each wire is connected, as indicated in Fig. 3-B. Photos D and E show the completed probe and cable. The banana plug is the actual probe which is used to contact the various parts of the receiver. It picks off either an r.f., i.f., or audio signal. For r.f. or i.f., the signal can be

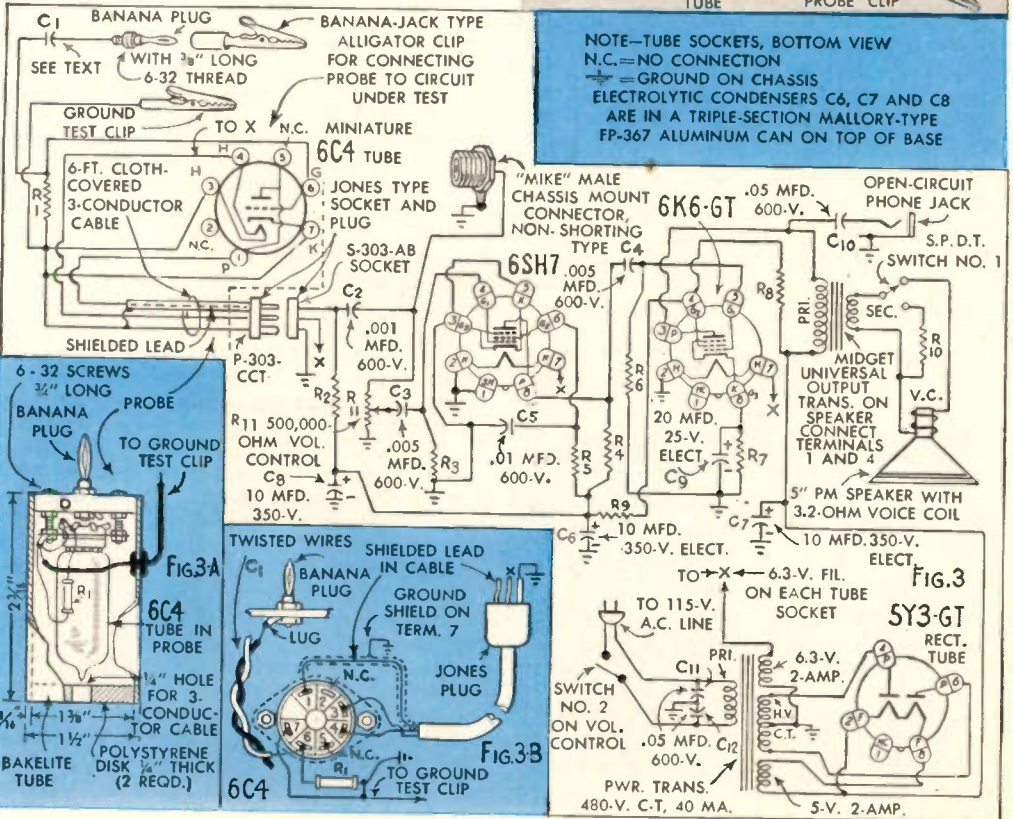
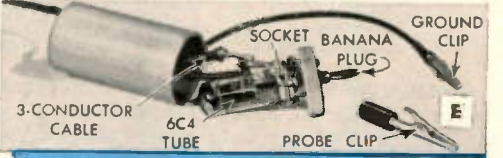

SIGNAL TRACER FOR RADIO SERVICING

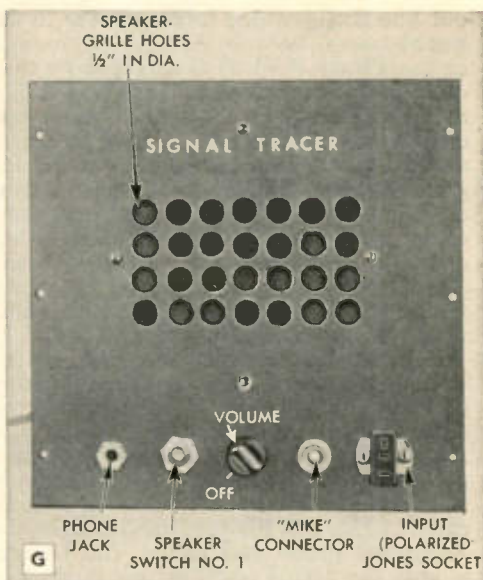
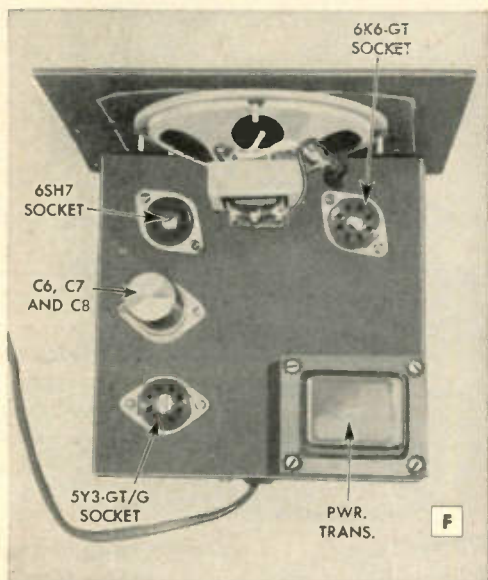

detected in the 6C4 tube and converted to audio where it is further amplified in the other two tubes for operating either a loudspeaker or a set of headphones. Switch No. 1 cuts in dummy load when phones are used. With the microphone connector you have a 2-stage public-address amplifier should the emergency ever arise.

When arranging the parts on the chassis base, mount them so as to make all connections between the various terminals as short as possible. All "hot" wires associated with the output circuit, such as the plate side of the 6K6-GT, must be well separated from any wires associated with the input or grid side of the 6SH7 tube. Leads and components connected to grids or plates of either tube should have the shortest possible length; clip the pigtailed of resistors and condensers where necessary to keep these leads short. In common practice, the signal tracing procedure is to work backwards from the loudspeaker towards the antenna circuit. Always guard against possible shock by disconnecting the receiver from the power line and use the alligator clips to make the necessary circuit connections each time the probe is moved. Assuming that you have a "dead" receiver but your meter indicates plate and filament voltage to the tubes, you begin with your signal tracer by connecting the ground clip to the chassis of the set and

check at the speaker voice-coil leads. Then go to the plate terminal of the output stage and next to the grid terminal of the output stage, etc., until something is heard in the loudspeaker of the signal tracer. The best points of contact are usually the grids or plates of each of the tubes (except the power-supply rectifier tube), checking every tube all the way back down the line until the signal is heard. When the signal is heard, this is your indication that immediately following this point, there is a failure in the receiver itself. Thus, by process of elimination, you are able to find the cause of the trouble. The instrument is light and easily portable. A chrome drawer-pull handle can be mounted on the top of the case. The rugged case as detailed in the diagram Fig. 2, will stand up under rough handling. See page 155 for detailed material list.

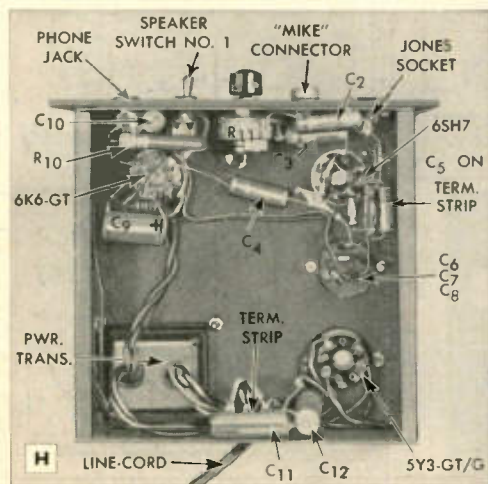

UTILITY VOLT-OHM CHECKER

THE MOST useful test instrument for the student and experimenter is a volt-ohm checker. The volt-ohm-milliammeter in photos A and B was built by students as a class project.

A two-deck 12-point rotary-type switch is used for selecting the various positions. A small Bakelite plate, $1\frac{3}{4} \times 2$ in., with the fixed resistors attached is mounted on the back of the rotary switch, and the wiring is quite simple. All parts values are identified in the diagrams; the fixed resistors are all $\frac{1}{2}$ -watt carbon types except the special resistors .505-ohm and .05-ohm marked by stars in Fig. 1. These special resistors were assembled by using two $1\frac{1}{2}$ -megohm resistors for the forms. Resistance wire was wound on these forms and measured on a bridge to obtain .05 and .505 ohm. About 2 in. of No. 16 resistance wire was used for .05 and about 2 in. of No. 26 for .505. The wire was then soldered to the resistor leads, actually placing the two resistances in multiple, but due to their high value no difference would be observed in the smaller values. The 5.55-ohm resistor was made by connecting two 11-ohm carbon resistors in parallel; the 5000-ohm variable resistor is a midget linear-taper type. Two pointer-type dial knobs, a set of test prods and a 0-1 milliammeter complete the assembly which is made in a metal case $3\frac{1}{2} \times 4 \times 5$ in. deep. The meter is mounted in the lid. If the builder prefers to make a wooden case, it can be built of $\frac{1}{4}$ -in. plywood.

The case is large enough to house the $1\frac{1}{2}$ -volt flashlight cell and a Burgess type U-10-E, or similar, 15-volt battery. Dial scale for the switching points,

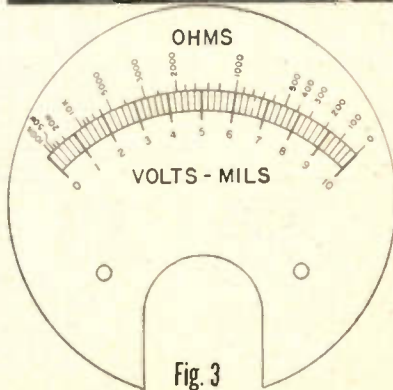
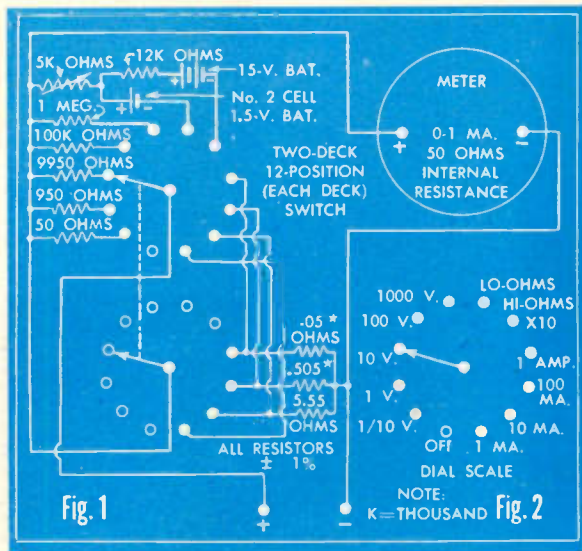
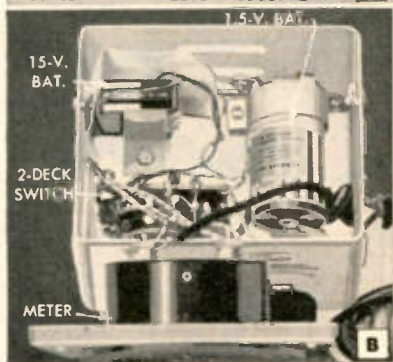
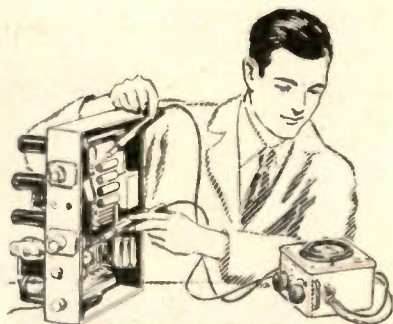

Fig. 2, and the zero adjustment arrow may be made on a strip of paper and pasted on the case as indicated in photo A. The meter-dial scale, to replace the original scale on the 0-1 milliammeter, is shown in Fig. 3 if you are using a 2-in. meter. If your meter is larger, make a photostat enlargement to the required size. If the resistor values are as specified, no alterations in the scale will be necessary.

"POPCORN CAN"



HERE is a simple a.c.-d.c. oscillator constructed from inexpensive parts to meet student needs. It provides a practical means for obtaining modulated or unmodulated signals for classroom work and emergency home set servicing. These signals may be employed for lining up i.f. transformers in superheterodyne receivers, for "ganging" condensers on supers and t.r.f. sets and provides usable harmonics down to 14 megacycles for calibrating receivers from the harmonics of broadcasting stations.

This unit will hold its calibration quite accurately for rough and ready work on the test bench. Housed in a tin popcorn can, it is thoroughly shielded; any similar can about 6¼ in. wide and 8 in. high may be used. The oscillator covers a band of from 550 to 1500 kilocycles by means of three plug-in coils. All coils overlap sufficiently so that there will be no gaps in the tuning range if any old variable condenser having a total of 20 or more plates is used.

The 7A7LM loktal-type tube is interchangeable with 7A7 and will be found in most dealers' stocks. Students may substitute a 6K7-GT or a 6J7 tube with simple socket changes. A 6C5-GT, or GT/G tube is employed as a rectifier.

The schematic circuit diagram is given in Fig. 1 and the simplified wiring diagram with parts values in Fig. 3. Photos A, B and C show various views of the completed unit.

Provide room for the variable condenser so that the rotor plates

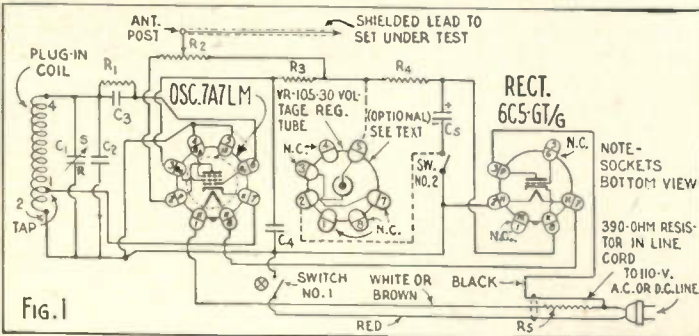
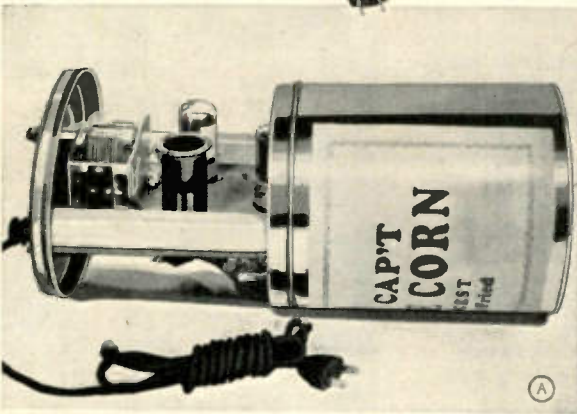
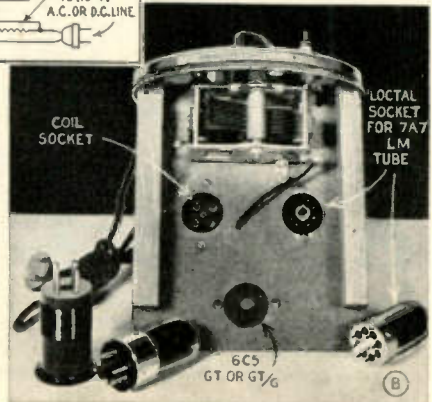
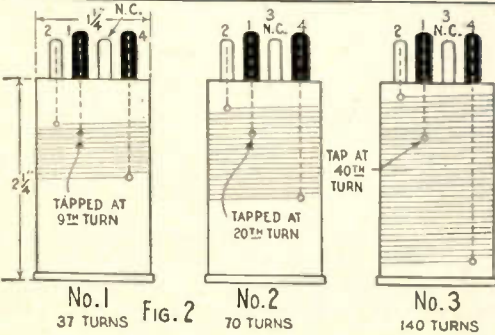

FIG. 1



SIGNAL GENERATOR lines up receivers

will clear the can when fully open. Any flexible No. 18 or 20 insulated hookup wire may be used for the circuit, and either No. 28, 30 or 32 enamel, silk or cotton-covered wire for the coils, Fig. 2. These are all close-wound on standard 4-prong coil forms. Solder leads carefully in each coil prong. To test the oscillator, plug in coil No. 2, turn on switch No. 1, and tune in a station on your receiver. Rotate (C_1) until you hear a sharp whistle in the set. The oscillator can be calibrated for the broadcast band by tuning in a number of stations of known frequency and then plotting a curve, or chart, of the dial settings; make a chart for each coil. Coil No. 3 tunes from 550 kc. to roughly 400 kc. thus covering the standard 456 kc. i.f. frequency. Ground the shield on the connecting antenna-post test lead to the ground post or chassis of the receiver which is under test.

To line up tuning condensers, tune to the "high" end of the band; switch No. 2 throws filter condenser C_5 out of the circuit to give a modulated tone. Adjust condensers for maximum output with this tone signal. With oscillator set for 456 kc., line up i.f. stages by direct grid connections. To calibrate short-wave receivers, the oscillator is tuned to broadcast stations of known frequency and then the harmonics are picked up in the short-wave bands. There will be strong harmonics down to 14 megacycles. Although the circuit is quite stable even under varying line voltages, some students may desire even more stability and can obtain it with the "optional" voltage regulator tube connected as indicated in Fig. 1. It can be mounted on the base panel near the 6C5-GT tube. See page 155 for detailed material list.

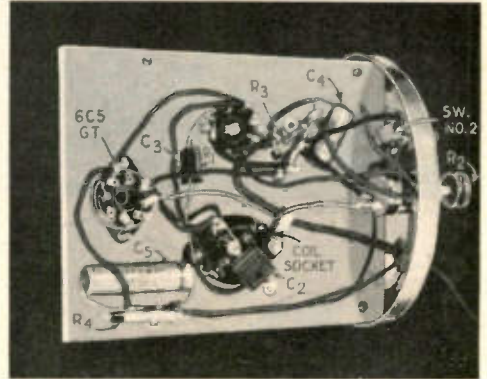

Above, pressed wood base panel mounted on wood strips screwed to under side of can lid

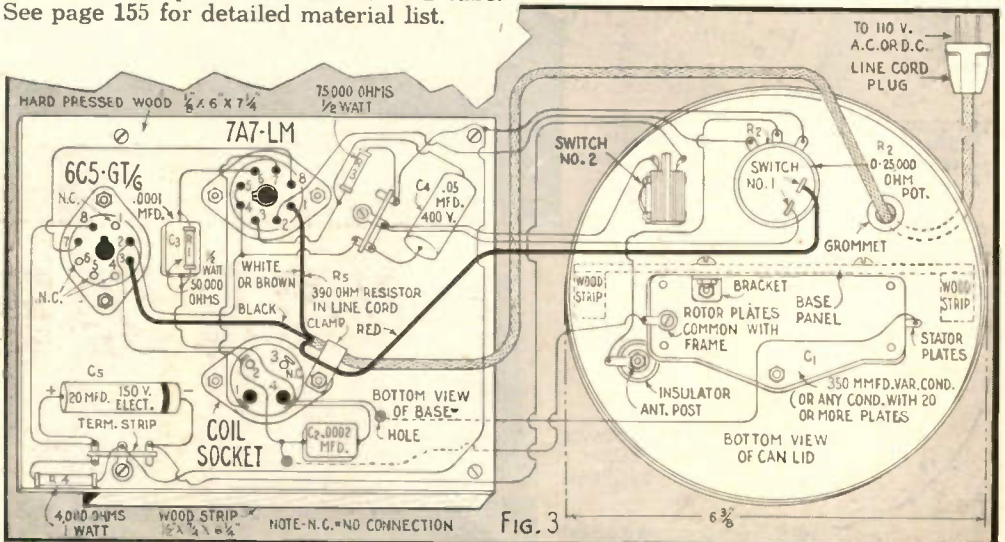

LOW-COST THREE-UNIT

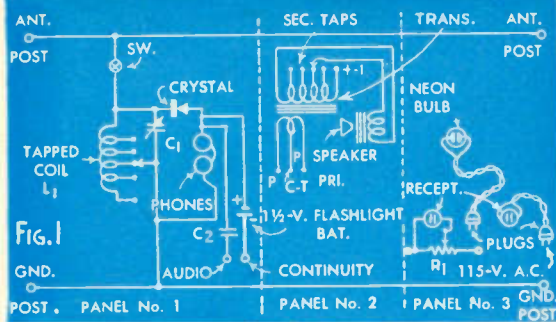
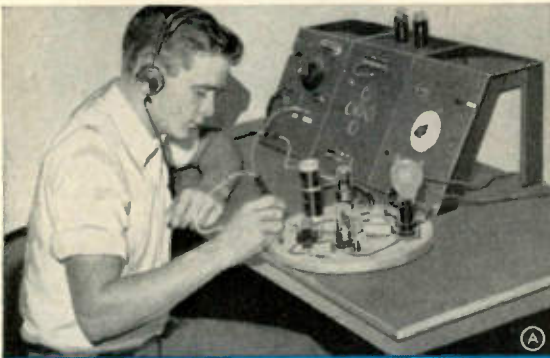

TOP PANELS ARE 5 1/2" X 9" 3 REQD.

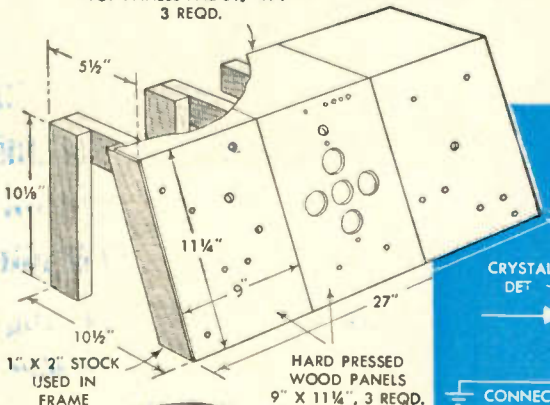

FIG. 2

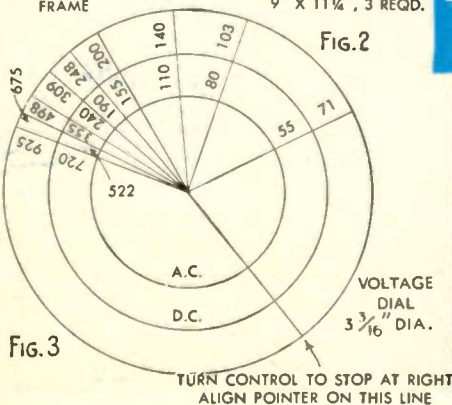
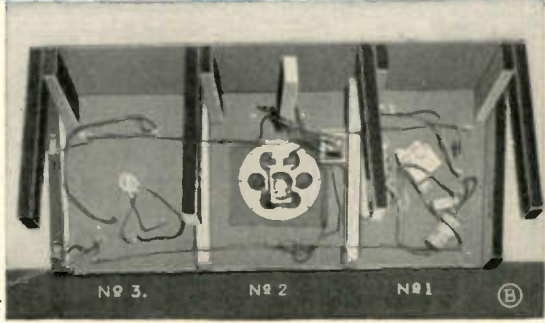
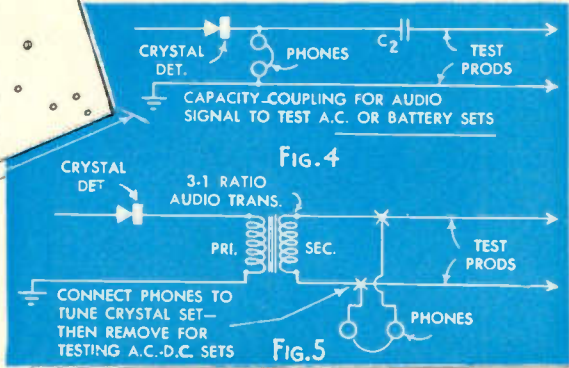

FIG. 3

NO METERS are required in the construction or operation of these useful set-testing units which are assembled in handy bench form for radio and electronic students and experimenters. Beginners will find these inexpensive units easy to build. The combination includes: a continuity checker to test for open circuits and for tracing wiring; an audio signal generator for testing amplifiers and checking the audio stages of receivers; a simple neon-bulb voltage reader which will give approximate voltage readings from 55 to 720 volts a.c., and from 71 to 925 volts d.c. The loudspeaker panel No. 2 is provided with a tapped universal matching transformer so that it can be used to meet any receiver or amplifier requirements.

Although complete for beginners as shown in photos A, B and C, a separate oscillator-type signal generator can be added later for testing receivers by the popular "signal tracing" method, if desired. Suitable portable-type set-testing units are to be found in this book.

The schematic circuit diagram for the three-panel assembly appears in Fig. 1. Simplified rear-view pictorial



TEST BENCH FOR BEGINNERS

wiring diagrams for each panel are shown below the front view photo C. The test bench proper can be an inexpensive wooden table. All panels and their supporting framework are detailed in Fig. 2; each slanting panel is a separate unit and the assembly is designed so that additional panels can be added; the top panels provide a handy shelf for plug-in coils, etc.

Panel No. 1 consists of a good crystal receiver that is to be tuned to a strong local station, the signal from which becomes available at the jack on the panel. From here it can be fed by means of a test prod to either the output stage or the first audio stage of a receiver to determine if the audio portion of the set is working properly. The cardboard tube coil form is wound with No. 26 D.C.C. wire. Fig. 4 shows the capacity-coupled method employed to provide the audio signal; Fig. 5 shows transformer coupling to keep hum at a minimum when testing a.c.-d.c. sets. The continuity checker on this panel consists of a single 1½-volt flashlight cell and the headphones; the test prod is used in the proper jack on the panel, and the ground post is connected to the other side of the circuit. A closed circuit is indicated by a click in the headphones. The voltage checker on panel No. 3 operates on the well known principle that the extinction voltage of a Mazda neon bulb is both critical and constant. After being warmed up for about 30 seconds, by plugging into the 110-volt line receptacle, the neon bulb is then plugged into the receptacle connected to the volume control (R_1), which serves as a voltage divider. The control is then adjusted to the point on the dial where the bulb goes out; the point on the dial at which this occurs depends upon the total volts across the pin-type test jack terminals connected to the volume control. Details for making the original calibrated paper dial used in this model appear in Fig. 3; when this dial is enlarged to a diameter of $3\frac{3}{16}$ in. the results are accurate enough for all practical purposes. For this original dial, the neon bulb and potentiometer R_1 must, of course, be as specified. The dial is mounted directly on the panel over the shaft of R_1 and a pointer knob is used. Your particular dial may be more accurately calibrated by setting up the different voltages by means of a suitable transformer, if desired. The transformer, of course, must have the necessary secondary voltages available. See page 155 for detailed material list.

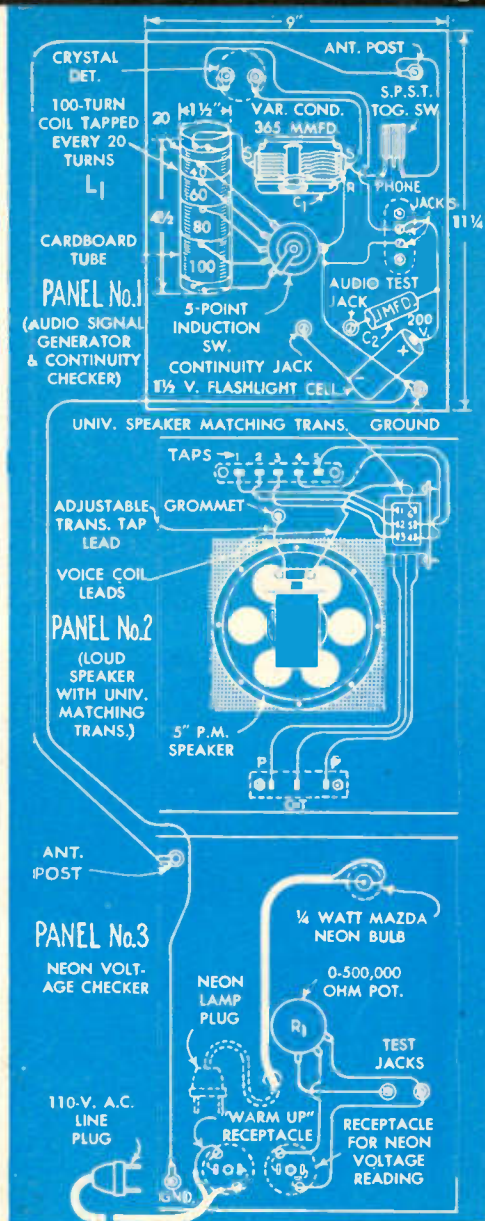

AUTO-RADIO SERVICE HINTS



(A) Loose or corroded rod antenna connections in mounting insulators may cause weak reception. A simple test for this condition is to substitute a temporary antenna; a short length of No. 12 rubber-covered wire is taped along the side of the car and clipped directly to the set antenna terminal

(B) When opening the set for repairs, mark the case covers before removing, as usually only one correct position will prevent shorting of the terminals

(C) After making repairs, such as soldering loose connections or replacing defective parts, shake out all loose particles of solder by jarring the set gently on the workbench as illustrated

(D) Intermittent reception often is caused by the shorting of tube grids to cover plate or speaker housing if attached to lid. Adhesive tape over tube-shield tops will solve this problem

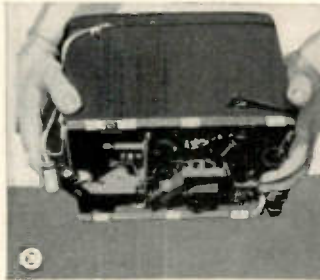
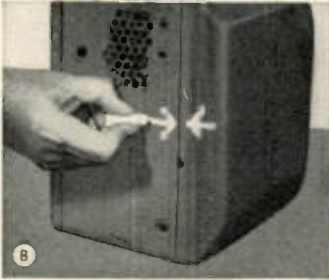

(E) When replacing fixed condensers or other parts having flexible leads, all exposed terminals should be taped to prevent any possible contact with the bottom cover

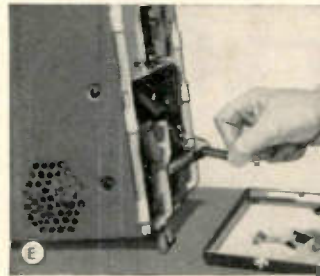

(G) Emery cloth is used to remove rust spots on cover plates, as the inside edges of these plates must make good contact with the case to avoid noise

(F) Tighten all screws in shielding compartments after working on any auto radio as vibration loosens such screws and is a cause of troublesome humming noises

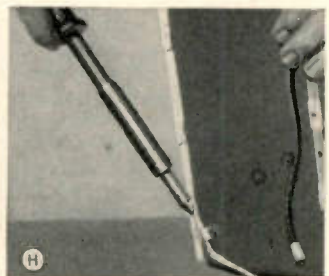
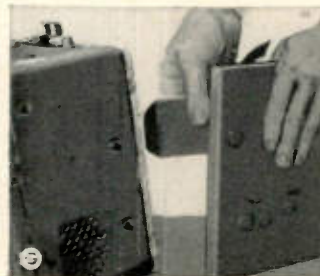

(H) To prevent ignition noises all grounded connections must be good. Shielded cable with metal braid bonded to the case often becomes loose; clean and resolder

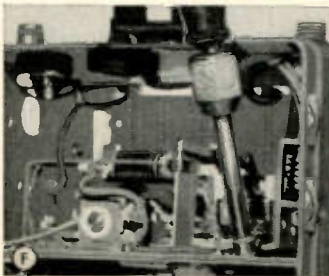

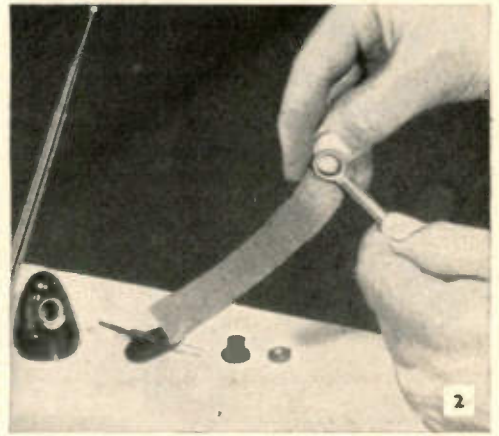
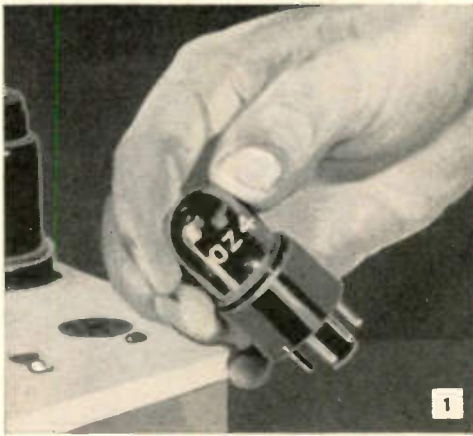

Auto-radio sets differ from the ordinary home radio in many respects. They are ultracompact, completely shielded and operate from a self-contained vibrator-type power pack, on the 6-volt car battery. As a rule the set is rather difficult to get at for repairs and tube replacements. Although auto-radio service is definitely not for the beginner, the average experimenter and student radio worker can make certain checks.

The illustrations on this page show some common faults that can be corrected in the radio chassis and antenna system in emergencies. Photo No. 1 shows a type OZ4 gas-filled rectifier tube that is in common auto-radio use. This is the first tube that should be checked when it is noted that the radio signals are very weak until the engine is speeded up. When this tube is in poor condition it is easily detected as it appears to improve with the higher voltage from the battery when the engine is raced.

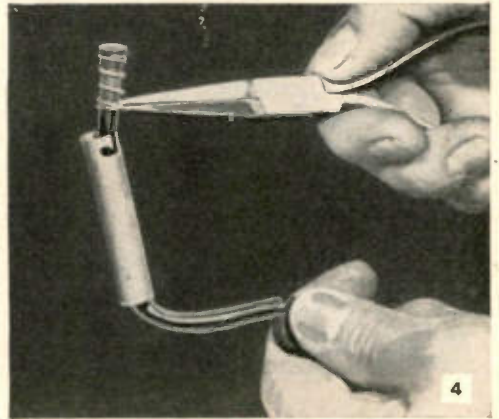
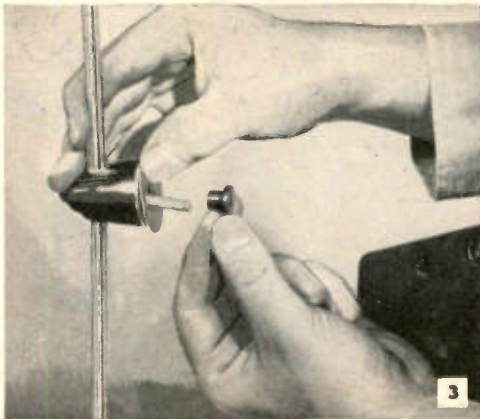

Another cause of poor reception in car radios is to be found in the corrosion of the lug which connects the antenna lead-in wire to the vertical "whip." Anyone can dismantle the insulator and lug assembly and clean the lug, nuts and washers with emery cloth as illustrated in photo No. 2. Before reassembling look for broken insulator bushings.

The small bushing shown in photo No. 3 if broken and not replaced, will permit the antenna to short on the car frame and cause a dead or intermittent radio. Photo No. 4 illustrates poor contact in the fuse sleeve which connects the battery to the radio. This will cause crackling noises and intermittent operation. To correct, extend the spring with a pair of pliers for more tension.

AUTO-RADIO SERVICE HINTS

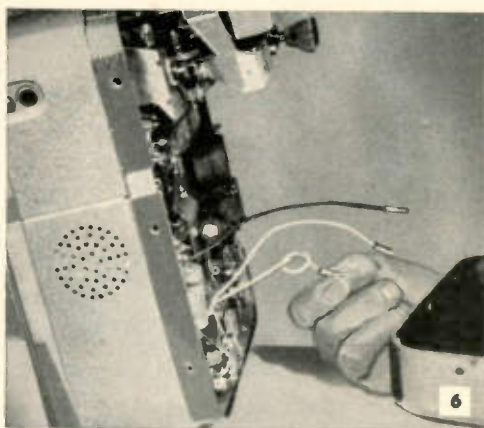
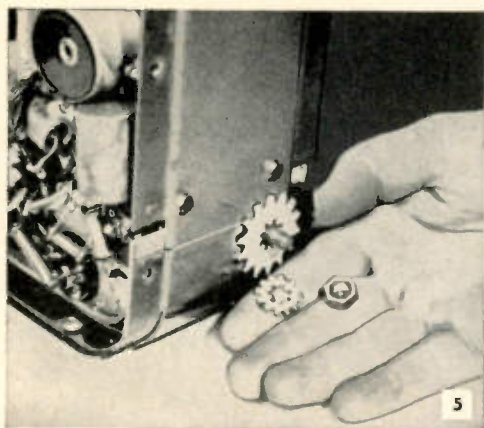

When it is necessary to remove the radio from the car, both time and money will be saved by keeping loose locknuts and washers on the radio-chassis bolts as illustrated in photo No. 5. Other nuts and bolts should be placed in a small box for the same reason. One lost nut or other part can cause troublesome delay.

Photo No. 6 illustrates a very important step in removing the radio speaker from the case. Be sure you know the proper sequence in connecting the wires before disconnecting any lead. Either tag them for identification, or tie loose knots in the leads and use pencil markings on the speaker unit to make certain that each connection is replaced in its original location. Daubs of variously colored paints on the leads and speaker unit will serve the same purpose. If soldered connections are to be made, see that each



one is mechanically and electrically strong, as auto radios are subject to more vibration than ordinary home receivers.

While the speaker is out of the case it is a very good idea to give it a cleaning with the suction hose of a vacuum sweeper as shown in photo No. 7. This will remove road dust and may save future trouble. This is also a good time to check up on the dial mounting screws and other bolts that may require tightening. Care should be taken not to damage the speaker cone.

If the soft rubber gasket, or vibration buffer, on the speaker unit shows signs of loosening, use rubber cement as shown in photo No. 8 to remount it in its original position. If it is not in good condition replace it with a new one.

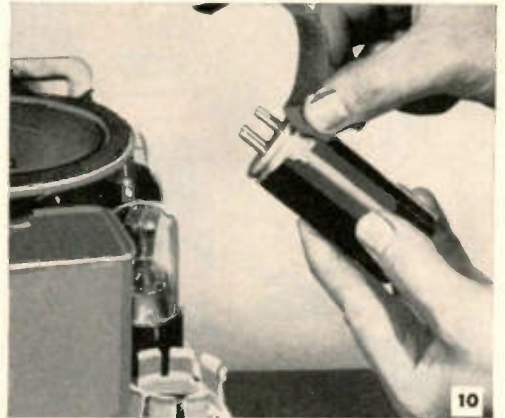
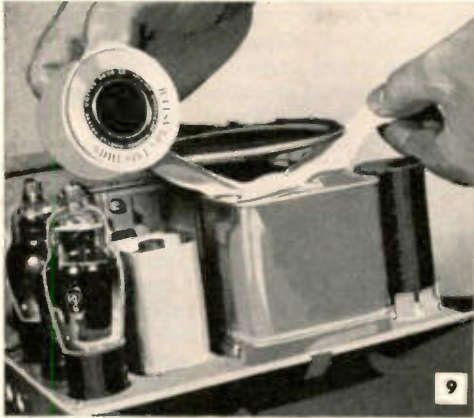

Owing to the compact design of auto radios the various parts are often quite close together in the final assembly. Rattling noises of a certain pitch are often caused by the speaker supports or the speaker frame striking a metal can or transformer case and vibrating with the frequency of the note received. Adhesive tape placed between the metal parts as shown in photo No. 9 will provide a barrier and stop this source of trouble. Tube shield cans and any other parts subject to vibration must be in the clear, and tightened down, also see that each tube is inserted firmly in its socket.

A constant buzzing noise of annoying volume which comes from the vibrator in the power-supply section of the receiver may often be reduced in volume by providing a better contact between the metal vibrator case and mounting contact fingers, or clips. Buffing the point of contact on the vibrator can with a piece of emery cloth as shown in

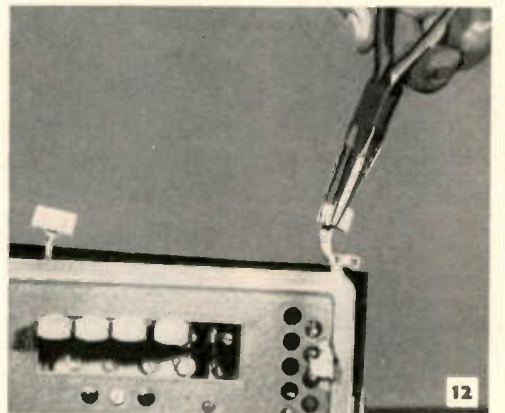
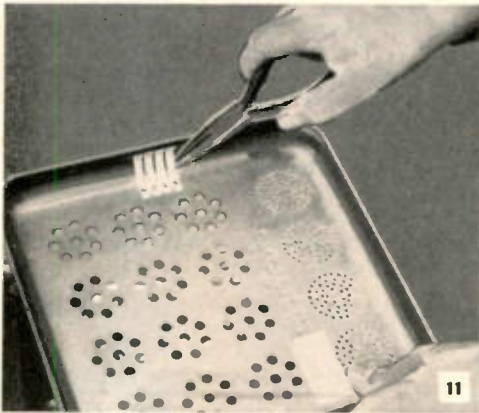
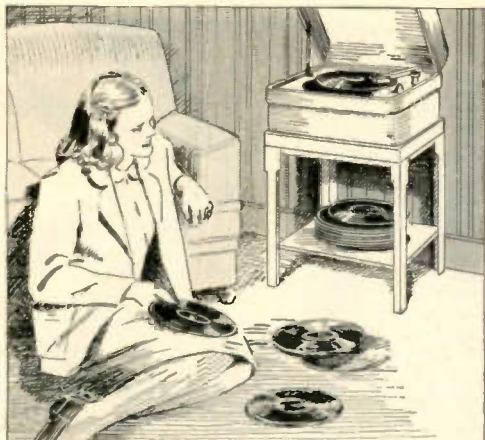

photo 10, and also bending in the contact fingers to provide a tighter grip will result in less buzz and better reception.

Bonding clips, or springs, on the radio chassis case indicated in photo No. 11, will not perform their intended function of keeping down ignition radiation noises if they are loose. Make sure that they are making good contact by adjusting them with a pair of pliers.

Another type of chassis bonding clip is shown in photo No. 12. These clips are attached to lengths of flexible woven-wire tape soldered to the chassis and are easily clipped to the case where they must make good contact. If they do not clip on tightly pinch them together with a pair of pliers as shown.

HOW TO CARE FOR YOUR RECORD PLAYER



ALTHOUGH usually built to withstand rough handling, your record player, like any other precision instrument, must have occasional attention if maximum service is to be maintained. Separate record players designed to play through the audio stages of your regular broadcast receiver require more attention than those built into combination phono-radio consoles or table-top cabinets. However, the following service hints apply to all types.

When the wires under the pickup arm leading to the crystal cartridge become loose, as illustrated in photo A, they will drag on the record and cause noise. In the case of a separate record player, the bottom plate may be removed and the slack pulled out, after which the wires may be secured with a piece of adhesive tape. In combination phono-radio sets these wires may be reached, in most cases, from the rear of the cabinet.

If the record player does not operate, the pickup cartridge may be defective. Check the cartridge by grasping the needle as shown in photo B; if the needle holder may be moved back and forth to any extent, it usually means that the pickup has been damaged and a new cartridge is necessary.

Dust particles scratch records on the side in contact with the cloth covering on top of the turntable. A small brush should be used at regular intervals as indicated in photo C. The bearing of phonograph turntables in constant use may require an occasional oiling. Where the motor has a felt packing as in photo D apply a light application of oil with an eyedropper; in some motors it may be necessary to use a drop of oil on a wire to reach the bearing. Crystal pickups are fragile and should be kept tightened in their arm mounting bracket as illustrated in photo E.

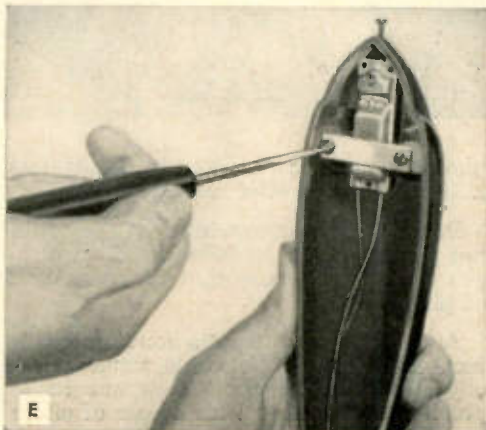
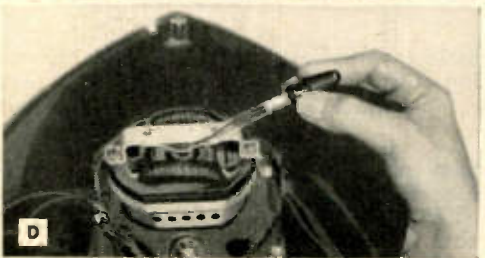
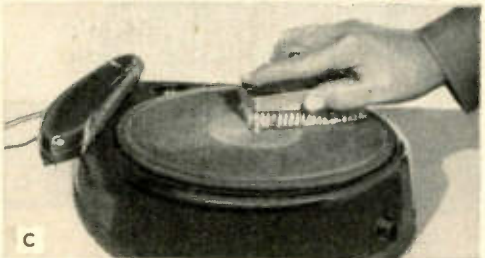

HOW TO CARE FOR YOUR RECORD PLAYER

Pickup arms vary in shape; a common type is illustrated in sketch F. With an arm of this general shape it is an easy matter to make a dust collector by slipping a piece of soft felt over the end of the arm as shown; this acts as an automatic wiper. It sweeps the record as it revolves and holds back some of the dust particles that would otherwise pile up around the tip of the needle and reduce the quality of reproduction. Cut the opening in the felt slightly under-size so that it will stay in place on the pickup arm. There should be enough material under the arm so that it will bend forward as it contacts the surface of the record, as indicated in the sketch.

Noise in radio-phonograph combinations, and also in separate record players that are plugged into phono-input jacks in radios, is often the result of an oxidized phono plug that needs cleaning. To clean the plug, use a piece of light emery cloth in the manner shown in photo G; this will usually clear up the trouble. If it ever becomes necessary to replace a crystal pickup cartridge, never solder the leads directly to the cartridge terminals. The crystal cartridge is very fragile and easily damaged by the heat of a soldering iron. The leads should be sol-

dered to slip-on clips as illustrated in photo H. The clips are then easily pushed on the cartridge terminals by hand. More phono needles are damaged by dropping the pickup arm on the turntable or the cabinet accidentally than in any other way. A piece of art gum may be used as shown in photo I without damaging the needle. The block of art gum acts to keep the arm from sliding if it is removed from its rest and protects the needle if the arm drops off accidentally. Wires in combination record players often become entangled with the turntable gears if carelessly installed. Such wires may be held in place with a thumbtack, photo J.

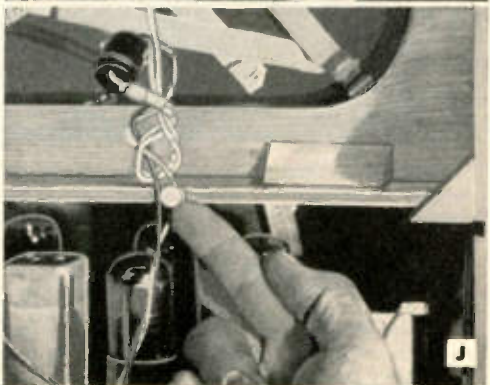
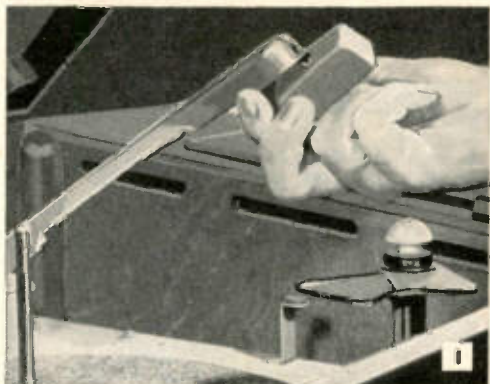
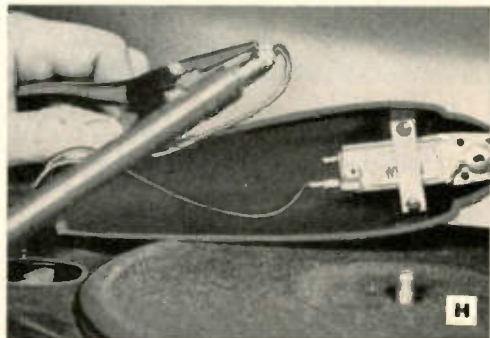
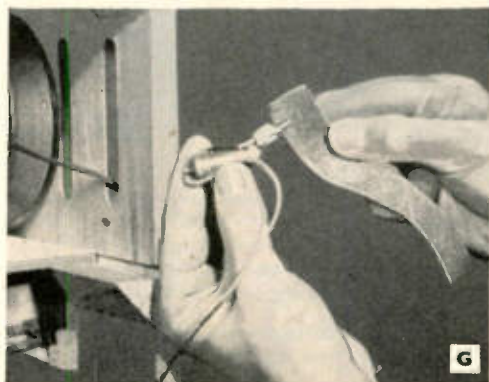
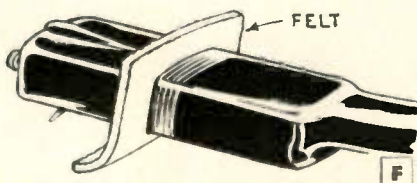

HOW TO CARE FOR YOUR RECORD PLAYER

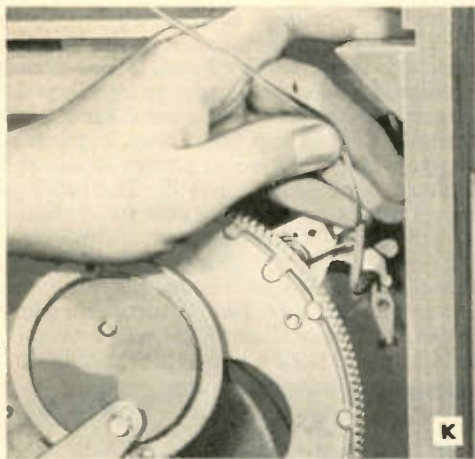

Photo K—The shielded cable indicated, leading from the pickup to the input of the audio amplifier, must be kept clear of all moving parts, but it must not hamper the pickup movement by placing a tension on the pickup arm. Keep this lead dressed, or secured, in its original position with either cellulose tape or rubber bands. If this shielded lead is broken or damaged in any manner it must be replaced with another of the same type and length, and the woven-wire shield should be grounded at the same points. Use a small soldering iron and apply it carefully using only just enough heat to make the rosin-core wire solder flow to form a good connection.

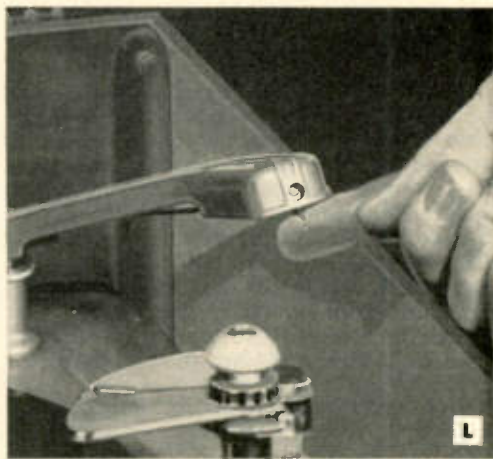

Photo L—Touching the finger to the needle as shown should produce a slight noise in the loudspeaker if all parts are in operating condition. This check is often helpful in phono-radio combinations for checking inoperation—particularly where the audio system may be tried by switching to "radio."

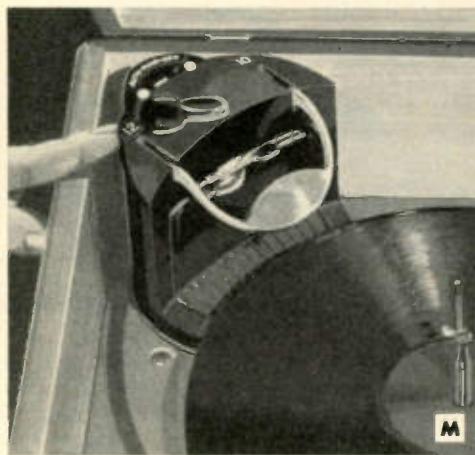

Photo M—This calls attention to the device used to adjust the player for the size of record to be played. If the needle does not land in the proper position on the record, check to see if it is set correctly for the size of records you wish to play. If you have a new automatic record changer and you are not familiar with its operation, do not touch the pickup arm while it is in cycle. First read the instruction sheet that the manufacturer supplies with the instrument, and you may avoid unnecessary service calls.

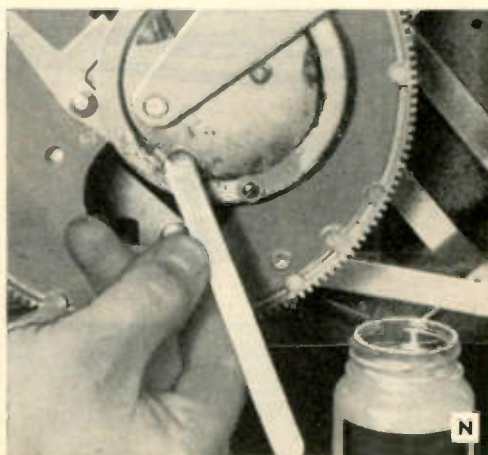

Photo N—Proper lubrication is important. Special lubricants are sold for the turntable and gears. Petroleum jelly may be applied sparingly to moving parts and gears when necessary as illustrated.

HOME recordings, or "snapshots in sound" as some prefer to call them, make permanent records of your baby's first words, birthday greetings and "letters" of spoken words to mail to distant friends and relatives. Similar recordings are made in teaching music and speech.

Owners of home recording apparatus, and phono-radio combinations with built-in record-making facilities sometimes encounter difficulties through lack of proper instruction, as they usually depend on short demonstrations given by the dealer.

The blank recording disks come in various sizes and thicknesses, coated and ready for cutting. A magnetic recording head is shown in Fig. 1; the armature is suspended in rubber with a stiff bearing at the bottom and a flexible damping block at top. Motion is imparted to the stylus as the armature vibrates in response to the alternating current in the coil. It is a delicate cutting tool and must be adjusted correctly. See that the stylus is inserted all the way into the cutting head with the flat side of the shank facing the thumbscrew. The cutting face of the stylus must be perpendicular to the disk, Fig. 2. Figs. 3, 4 and 5 illustrate and explain typical troubles.

Actually, a recorder can be compared to a fine lathe, as it consists of a similar true-running and perfectly balanced cutting mechanism. In a recorder it is important that the record be turned at an unvarying known speed, since sound is based on frequency and frequency is directly related to speed. The motor that turns the turntable must be kept in good running order, and the speed should be checked from time to time by means of a simple "stroboscope" disk available from radio parts houses and music firms. Unvarying speed is important both in recording and reproduction. Speed regulation that is below standard is the cause of "wows" which are audible to trained musical ears. Momentary changes in speed cause these audible changes in pitch. Read any instructions that come with your recorder.

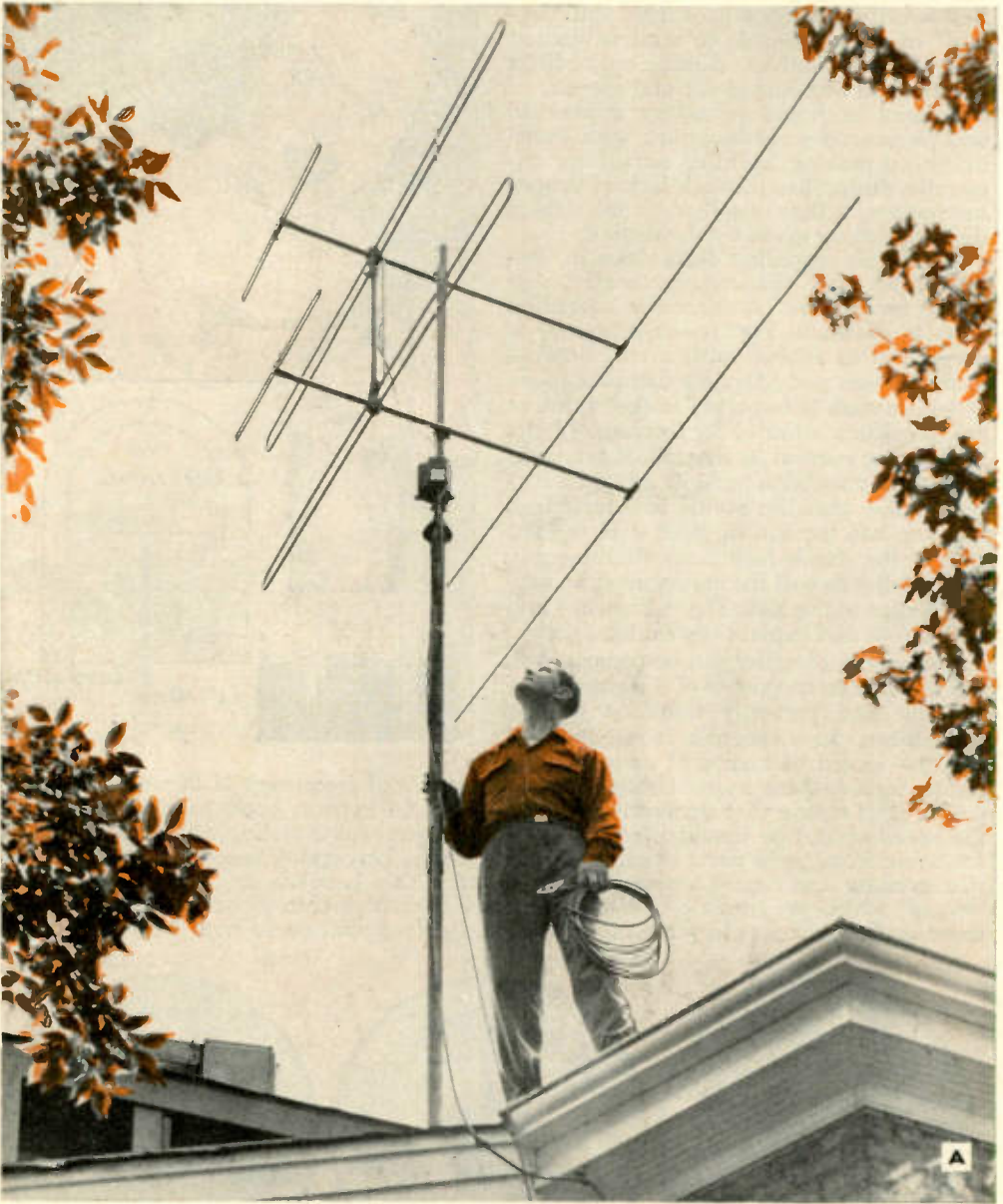

FIG. 3
Bent or misshapen recording blanks sometimes produce a "skip" pattern when the recording head is unable to cut a "low" area after bouncing upward over "high" portion of a disk

FIG. 4
Vibrations in the recording machine produce a "moire" pattern. Other causes may be hum in the amplifier, dirt in the cutting mechanism, worn drive wheels or overloaded motors

FIG. 5
Another "imperfect" pattern to watch for is the "spoke" design. The cause of this difficulty can usually be traced to overloaded motors or vibrations due to worn parts in the drive gear

TELEVISION IN THE HOME



HIGH-GAIN TV ANTENNA WITH MOTOR-DRIVEN ROTATOR

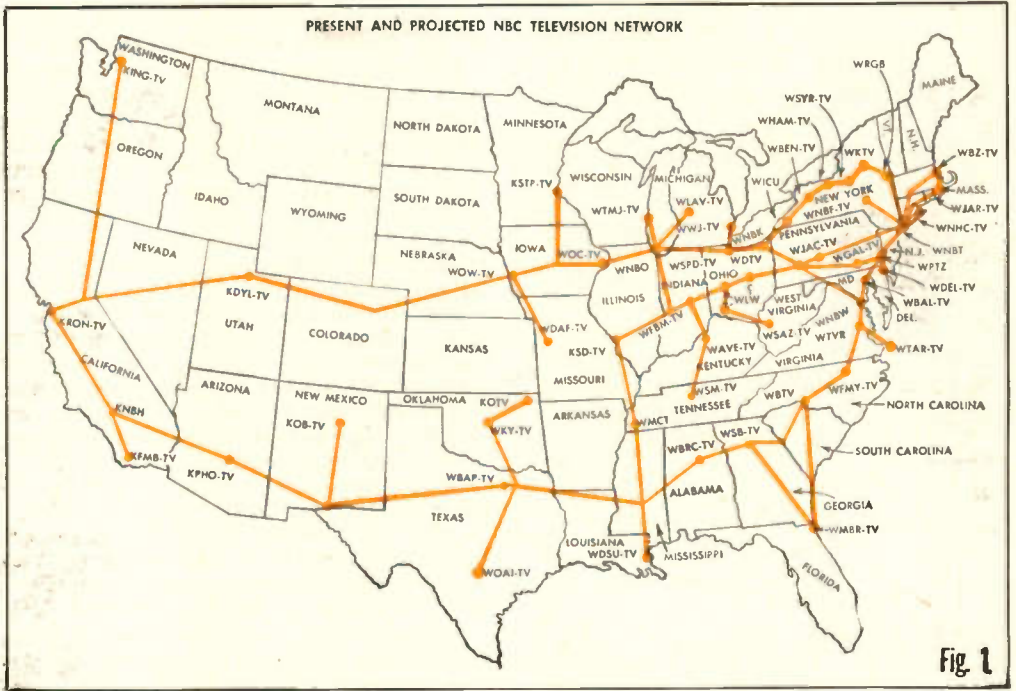

TELEVISION, combining FM sound with pictures, or actual images of life and action on a viewing screen, is complete entertainment as it provides both sight and sound. It brings events into your home as they happen, and it also reproduces sound movies. The sound and picture signals are transmitted simultaneously like a beam of light. Exactly like a ray of light, they are reflected by intervening buildings, hills or similar surfaces. TV transmission and reception are practically "line-of-sight" or quasi-optical in character. The signals do not follow the curvature of the earth; therefore the farther the receiver is from the transmitting station the higher the receiving antenna must be to receive the signals.

Each transmitting-station antenna is erected as high as possible so that it can cover the maximum territory or range. At the present time the practical useful range from

television transmitters, without any special gadgets or "boosters" at the receiver and without using extra-high receiving antennas, is limited to about 40 or 50 miles. This range, of course, depends upon local television receiving conditions where there are no unusually high hills or tall buildings intervening. Satisfactory reception of TV programs is possible at much greater distances, and fringe areas are greatly extended when high-gain specially designed, directional-antenna systems are used. A special-purpose Amphenol stacked antenna array of this type is illustrated in photo A and described in the following pages; height is an important factor. On the other hand, for receiving local television or FM programs in metropolitan areas such as Chicago, New York, Philadelphia, Los Angeles and other cities it is possible to employ very simple outdoor or indoor

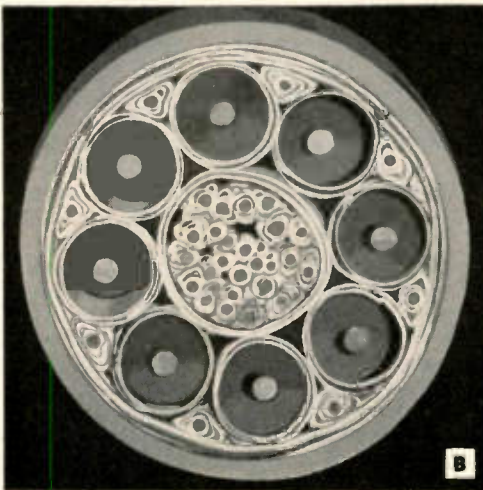

TELEVISION IN THE HOME

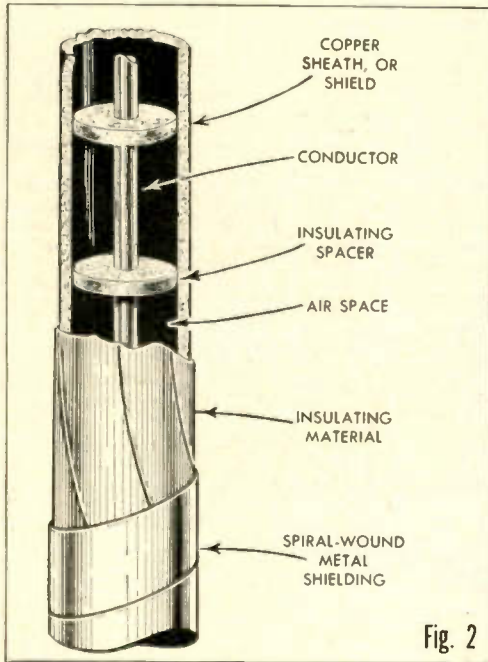

antennas, or in some cases receivers having built-in-antennas. However, there are exceptions in certain parts of such metropolitan areas and even the best of outdoor antenna systems must be properly installed to give satisfactory results. The importance of a trial demonstration in your particular home is obvious, especially for city dwellers who live in apartment buildings where some landlords bar the installation of rooftop antennas.

The growth of television was rapid following the first television broadcasts permitted after World War II. By late 1950, there were more than 100 television stations operating in the United States in areas with a total population of about 95 million people. Trade experts estimated there were about nine million TV receivers and the number of sets and stations was expected to increase steadily. The NBC network, with projections, is shown in Fig. 1.

It is not possible to set up television networks as simply as those commonly used for AM radio networks. Ordinary telephone wires employed to carry AM radio broadcast programs cannot be used for transmitting television sight and sound signals because the transmission of the high frequencies these signals require is not possible over ordinary telephone lines. However this plus the limitations of line-of-sight transmission is rapidly being

overcome with the Bell system of coaxial cables, and with ultra-short-wave relays.

A cross section of the specially developed American Telephone and Telegraph coaxial cable is shown in photo B. This eight-tube coaxial cable is a marvel of efficiency; each tube is capable of transmitting about 600 telephone conversations simultaneously or a single television program. Only six of the tubes are commonly employed in active service (two are reserved for emergencies), thus six TV programs can be handled at one time. Each tube consists of an inner conductor insulated from an outer shield of copper tubing with ceramic spacer disks as illustrated in the sketch, Fig. 2. The coaxial tubes are further insulated, shielded and arranged around the inner core of insulated multi-purpose control wires to make up the complete underground cable which is encased in lead, as illustrated in photo B. These cables are rented by the networks and television stations and now connect most of the cities in which the stations are located.

If you live in a so-called "fringe" area some distance from a TV transmitting station where you may encounter weak signals, or in any location where you might have difficult receiving conditions and hesitate to purchase a TV receiver for these reasons, there are several things that you can do to help you come to a decision. If television has recently arrived in your area you may have to do some pioneering, or insist on a demonstration by a reliable dealer. Your investment is going to be more than one hundred dollars and probably much more, so you want to be sure of best results. If TV has been available in your locality for some time the solution of your problem is quite simple. You can visit your neighbors, inspect their antenna installations and their receivers, and arrive at a pretty definite decision as soon as you see the results on their screens. You will thus avoid the pitfalls of pressure salesmanship, as you will have established a basis for comparison and can be guided by your personal requirements as to size of screen, make and style of set.

All television receivers employ extremely high operating voltages compared to those used in ordinary radio receivers. The owner should never attempt to make adjustments inside the set as dangerous high-voltage shocks can occur, even though the amperage is low. Experienced servicemen have to be careful in servicing TV receivers as shocks can be encountered even though the set is disconnected from the

power line, or protected by interlock switches. Large condensers and certain picture-tube surfaces can retain charges that have to be discharged to ground before the chassis is safe to handle. But the television set of today is perfectly safe for the owner to operate and handle in the ordinary manner. Also, it is simple to tune and all necessary tuning adjustments are provided for with the external controls.

FM, employed for sound with television programs, is capable of excellent sound quality provided that a suitable audio-amplifier circuit and speaker are used. The reputation of the manufacturer is a guide in this respect. A television receiver is really two large receivers in one, and therefore the most common service charge will be for tubes. From 20 to 30 or more tubes are employed in your TV set. The most expensive tube is the picture tube, and the cost advances with the size of the tube. The useful life of a TV picture tube varies. Designed for approximately 2000 hours of service, they often give more, and sometimes less. Certain limited guarantees and dealer's service insurance policy arrangements protect the owner in most cases.

A console model should be located where all can watch in comfort, but do not place it in front of a window, or between two windows. A table-model TV receiver should be placed on a table at the correct eye height for viewing when seated 8 or 10 feet in front of the screen. Never operate a TV receiver in a totally dark room; however, light should not shine directly on the screen. Side lighting from a window as in Fig. 3 is desirable. A single lamp placed 6 or 8 feet either side of the screen or behind the viewers will relieve eye strain. A good location for any TV set is at one end of a long room. Viewing distance will vary depending upon the size of the screen and individual requirements. The ideal viewing distance is 10 times the height of the picture. Special television tables of the correct height are available in woods to match standard table-model TV receivers. Do not place your TV set too near the wall, always leave air space for ventilation. For a good view, and to avoid fatigue, the viewer should sit on eye level with the screen and not more than 35 degrees away from the side of the screen. If you have a large family, and limited room space, the set can be placed in a corner to good advantage. The viewing angle is usually good with this arrangement and it does not necessitate shoving the furniture around. Do not worry about it being in a dark corner, as you can

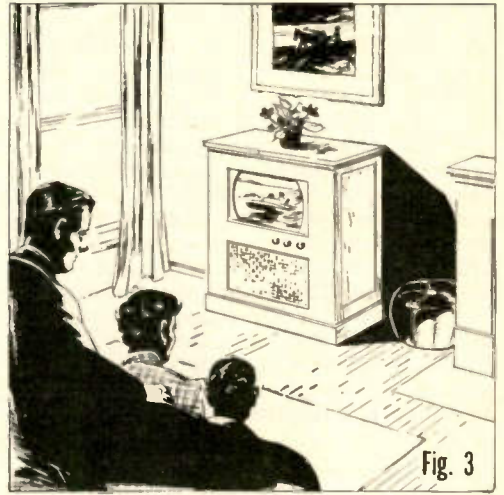

arrange the necessary lighting; corner placement usually avoids glare from multiple window lighting.

TV tables with rotating tops are available and they provide a convenient means for viewing a 16-inch-screen table-model set in several rooms from a central location if the floor plan of your house is open. For example, it can be swung around to face either the living room, kitchen, porch or dining room. On the other hand, if television viewing is becoming a juvenile problem, some owners with children have to install the set where it cannot dominate family life.

Owing to the high voltages employed, and the necessity for lock-in sweep oscillators, and completely wired and tested front-end tuners, the average experimenter is not advised to attempt home TV-set construction except with a specially engineered commercial television set in complete kit form. In these kits precautions have been taken to provide safety interlocks and all critical unit wiring and testing have been completed. The average student experimenter is not equipped with the necessary instruments for assembling and testing such stages. Such kits are possible only under specialized manufacturing and laboratory-testing conditions. However much experimenting can be done with special antenna systems, especially in fringe areas and in locations of low signal level. Such experimenting offers the TV set owner many interesting possibilities for improving reception. The results in most cases have been highly satisfactory.

Instructions for installing TV antenna systems will be found in following pages.

The Iconoscope Tube

ALTHOUGH television as we see it in our homes today has only been out of the laboratory a very few years, it is now a lusty billion-dollar infant industry. However the idea of scanning pictures, which is basic to all television, began with several very primitive devices. Paul Nipkow's original spinning perforated disks of the 1880s were used by television engineers in the 1920s at both the transmitting and receiving positions. The system was not satisfactory because of mechanical limitations, bulk, lighting problems, difficulty in synchronizing and its inability to give a sharp picture. After a long "incubation" period in several laboratories, electronic television

has finally solved the mechanical problems.

Dr. Vladimir Zworykin's iconoscope camera tube and kinescope picture tubes used the principle of magnetic deflection of an electron stream to scan an optical image in both tubes. Picking up the scene and converting it into an electrical signal, the electromagnetic deflection-type RCA iconoscope "camera" tube illustrated is the special cathode-ray tube that made modern TV transmission practical. As in many advanced developments in sight and sound engineering, Dr. Zworykin made good use of tips provided by nature, and in this case the eyes provided the clues. The "camera" tube "looks" at individual points on the object at different intervals of time and the impulse received from each point is transmitted separately.

The tube contains a mosaic plate covered with miniature photoelectric cells. These individual cells consist of cesium-oxide coated silver sheet particles that are deposited on a mica sheet which is mounted on a metal plate. Each tiny particle, mica dielectric and the metal plate form a miniature condenser. When this mosaic plate is mounted in the vacuum tube these tiny condensers are charged by the photoelectric effect when the tube is connected in the pickup "camera" shown in the conventional circuit diagram, Fig. 4. Pictorially exaggerated in the mosaic sketch (a), these individual cells are charged in varying degree according to the amount of light picked up by the mosaic elements; these are discharged by the vertically and horizontally controlled sweeping beam from the electron gun, through the resistor, thus producing a signal. Each cell recharges instantly. A view of the electron gun assembly appears at (b). Today a television picture consists of 525 lines of top to bottom "looks" at the object repeated 30 times per second. These transmitted signals picked up by your TV antenna are fed to your TV receiver and a flying spot of light is created by the swift movement of the deflected elec-

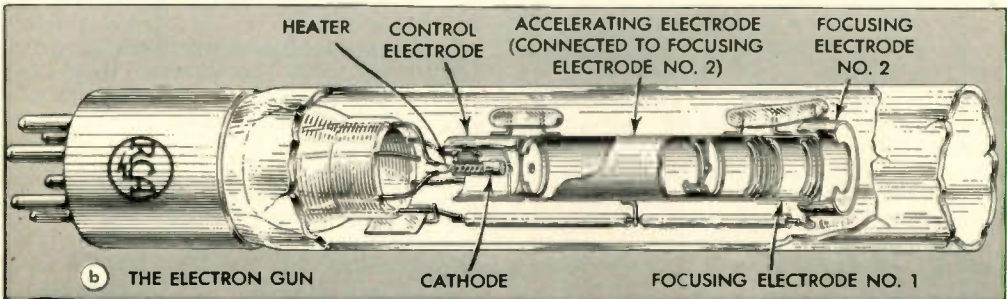
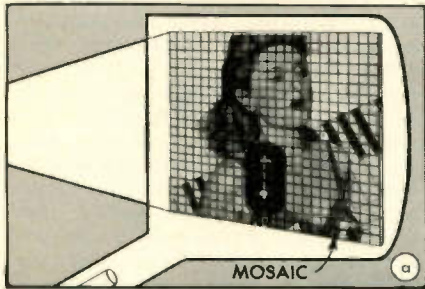
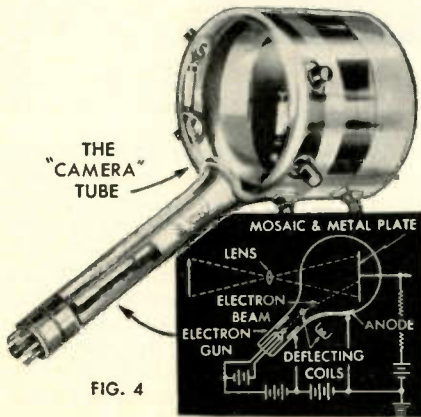

tron beam when it strikes a fluorescent coating on the inner surface of your kinescope picture tube. Traversing the 525-line surface of the kinescope screen 30 times a second, it forms a raster, which is modulated to recreate the picture. A raster is a predetermined pattern of scanning lines which provides substantially uniform coverage of an area. The fluorescent coating in the picture tube is composed of phosphors, materials which glow under electron impact. Special mixtures of these phosphors from various ores, produce a uniform, sharp picture on the tube face.

The Image Orthicon

The iconoscope "camera" tube is still in use in TV broadcasting stations, especially for use in telecasting film programs. In wider use is the ultra-sensitive image-orthicon "camera" tube illustrated in photo C. This more efficient pickup tube, now used by all TV broadcasting stations, has the keen "eyesight" necessary to match the sensitivity of the human eye under varying lighting conditions. The tube automatically adjusts pickup sensitivity to include extremely low light levels. This explains how the mobile-unit TV pickups give us such excellent telecasts of special "on-the-spot" news events at night under comparatively poor lighting conditions. "Live" TV shows are now telecast with greater brilliancy on the home-set TV screen, with less discomfort to the personnel at the studio because of this higher efficiency "camera" tube. This image orthicon retains all the good features of the iconoscope and adds several more. It is really three tubes in one as it combines image, scanning and multiplier sections as indicated in Fig. 5, below. The kinescope, or picture tube, in the home

TV receiver reverses the scanning process in re-creating the original optical image.

The built-in electron multiplier in the image orthicon tube, multiplies the modulated stream of electrons that is returning from the "target" before feeding the output signal into the "camera" amplifiers, as illustrated in diagram Fig. 5. The two-sided "target" for higher photo-sensitivity permits the charge pattern to be formed on one side while scanning takes place on the other. The tube in photo C is an improved type introduced in 1950 for studio pickup.

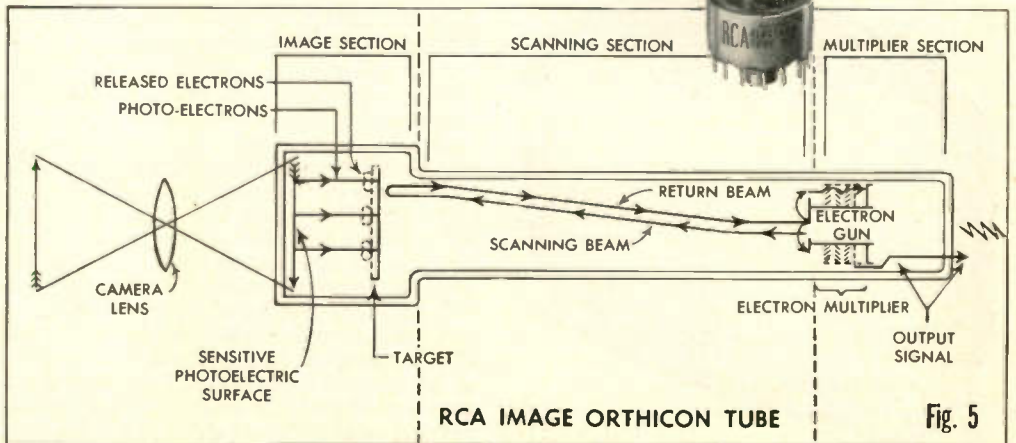
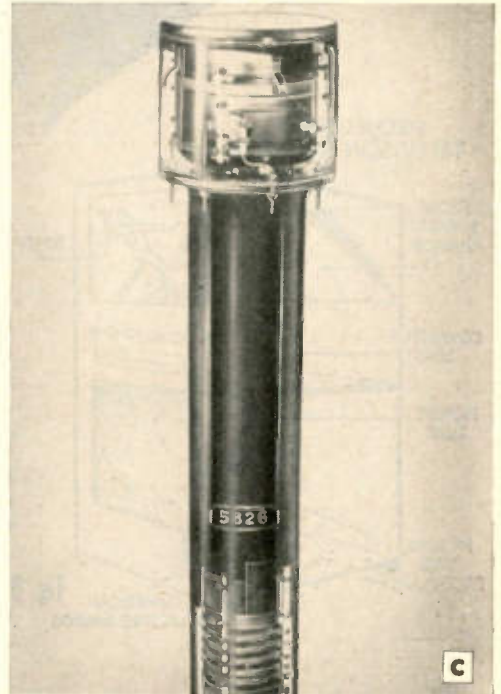

Fig. 5

Types of Picture Tubes

PICTURE SIZE is determined by the tube size in most television receivers which are of the direct-view type—where one looks directly at the face of the picture tube. In projection television, greatly enlarged pictures are obtained from a relatively small projection picture tube, operated at very high voltage.

The picture tube shown in photo D is a short, directly viewed, 16-inch metal-cone type. A rounded-end picture 11 by 14½ inches is obtained by utilizing the full screen diameter. Commonly used picture tubes come in both glass and metal-cone types and range in size from 10 to 20 inches. The advantages of the direct-view tube are: brightest picture, as no light is lost; picture can be viewed under normal room conditions; maximum contrast between light and dark areas, resulting in sharper and better defined pictures. The only limitation is size. The only advantage of the projection-type receiver is that it produces a larger picture than can be obtained in any other way. The limitations are: some loss of light and contrast; some loss of detail; owing to design it is somewhat more expensive. As a directional viewing screen is used in order to get needed brightness, the viewing angle is a little more limited.

The projection-type TV receiver operates in the manner illustrated in the sketch, Fig. 6. The small picture tube operated at high voltage provides a very brilliant image on the end of the tube. The bright image is necessary as the picture is projected through the system of mirrors and lenses onto a screen and in the process some light is lost. However with such a system it is possible to project an image up to the size of a motion picture screen used in movie theaters. This Schmidt-type optical system was borrowed from astronomy.

Another picture tube is the rectangular 16-in. type shown in photo E. This direct-viewing tube receives all of the rectangular picture just as it is broadcast by the TV transmitting station, and other advantages are claimed by the tube manufacturers. The advantage a console-model TV receiver has over a table model is the fact that a larger speaker can be used. Most manufacturers are now using larger speakers than they employed in earlier consoles and table models. Television sound is FM, and is capable of excellent reproduction with proper audio amplifiers and loudspeakers of suitable size. Some models appearing on the market stress these features.

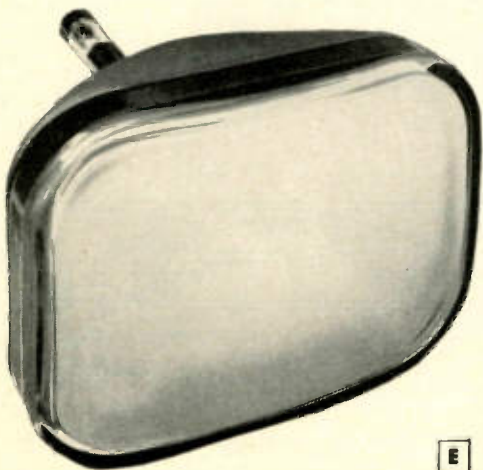
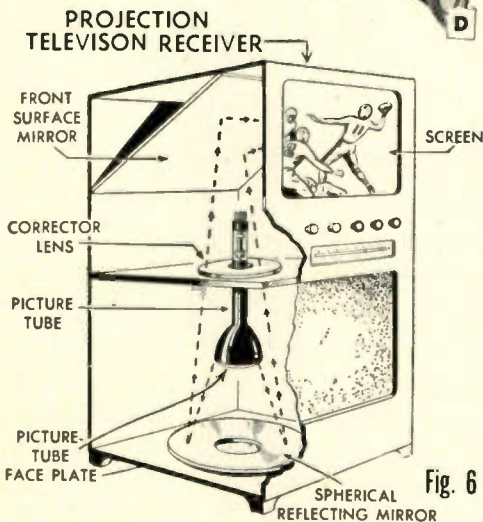
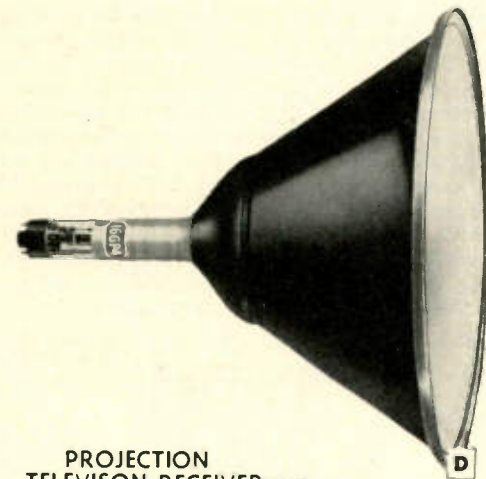

TELEVISION-receiver front-end tuning systems are of two types. The continuous-type tuner covers the 12 channels, or, in some cases, it covers the TV channels plus all FM bands in between including the commercial FM broadcasting bands. The second type is the preadjusted channel tuner, which may or may not have a vernier or "fine tuning" adjustment. It is pretuned to all 12 channels, or pretuned to a selected number of channels. The dealer's service adjustment is necessary to tune such a set to other channels.

The improved 12-channel TV tuner, photo F, was introduced in 1950 by RCA; it featured printed-circuit coils and rotary-turret switching.

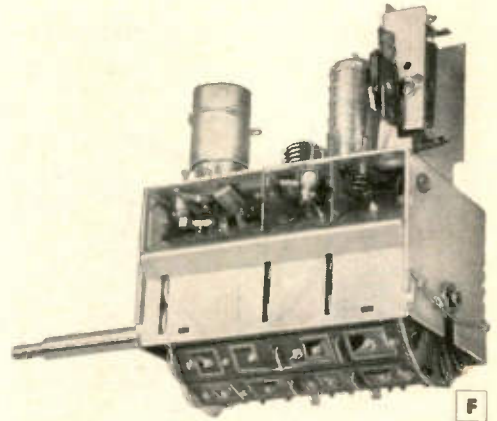

Color Television

Color television has to meet the standards set up by the Federal Communications Commission. In the beginning, compatibility requirements prevented any manufacturer from marketing sets that would obsolete standard black-and-white TV receivers. In other words, it was necessary that the color TV telecasts be received in good black-and-white, or monochrome, on regular black-and-white receivers. CBS introduced the mechanical system of spinning color wheels shown in Fig. 7. The transparent color wheels consist of segments of television's three primary colors, red, green and blue. The color wheel revolves in front of the TV "camera" at the broadcasting station. As each segment comes between the scene and the TV "camera" the lens picks up chiefly that particular color. For example: when green comes up the greens in the scene predominate. The same effect is produced with the other two colors. A similar whirling color wheel at the receiver, when synchronized with the one at the transmitter, produces the same effect on the TV picture-tube screen. The successive colors are flashed to the viewer at the rate of about 144 per second and the retentivity of the optic nerve—or persistence of vision—blends the colors into a full-color picture. The number of scanning lines used by CBS in early color-TV demonstra-

tions was 405 instead of the standard black-and-white 525 scanning lines per picture. There were 48 complete pictures of 144 fields of color each second, but with 405 scanning lines instead of 525 as in the ordinary black-and-white receivers the system could not meet the compatibility requirements. This difference in the number of scanning lines was necessary to meet the standard bandwidth of 6 megacycles. A slight alteration of the sweep circuits in the black-and-white receivers was necessary to receive pictures in both color and black-and-white.

Other color-television systems proposed to the FCC included General Electric's frequency interlace system; the NBC/RCA electronic system; the CTI (Color Television Inc.) of San Francisco system; the Charles W. Geer (University of Southern California) system; the Dr. E. N. Muller (of Luxembourg) system; the Dr. Leon Rubinstein (of New York City) system; the Prof. A. B. Bronwell (Northwestern University) system; the DeForest system, and the Sightmaster Corporation (New York City) system. Research extended over a period of many years, and the various laboratories have spent millions in developing color television, improving black-and-white and experimenting with three-dimensional television. Space in this book is not available to review all of the various proposed systems and preliminary development work.

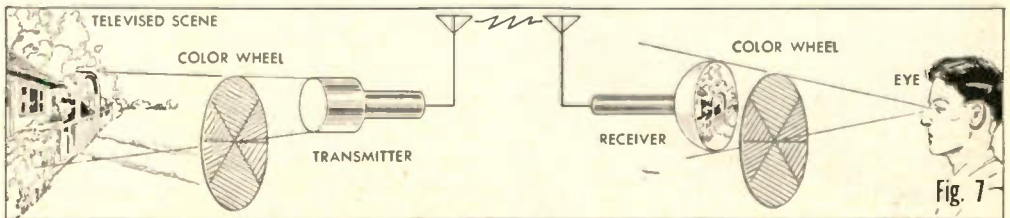

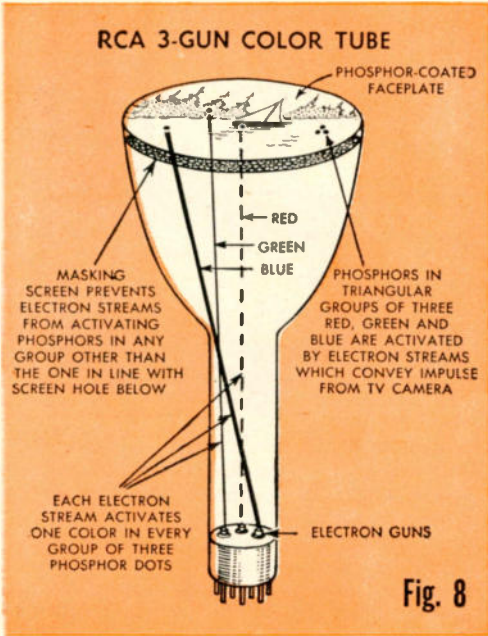

RCA has employed the all-electronic color-television system that eliminates mechanical devices. Beginning with a TV "camera" with three lenses and three electronic systems, or in other words three TV "cameras" combined in one, each unit picked up one of the red, green and blue colors and transmitted them in turn. On March 29, 1950, they introduced two improved types of color-TV tubes. One employed a single electron gun to "paint" the pictures. The other used three electron guns, each of which had an electron beam geared magnetically to actuate each of the television's three primary colors on the face of the tube and blend them true to the original scene being telecast.

Two color receivers were used in the demonstration, one with the three-electron gun tube, Figs. 8 and 9, and the other with the single electron gun tube. At the time that this demonstration was made the pictures measured 9 by 12 in. on the face of the tubes, and the tubes were of the standard metal-cone type. Both tubes produced color pictures when color signals were broadcast, and reproduced the pictures in good black-and-white when the received signals were in monochrome. The photo at lower left shows the demonstration model of the RCA tri-color all-electronic television receiver.

BEAM ANGLE DETERMINES COLOR

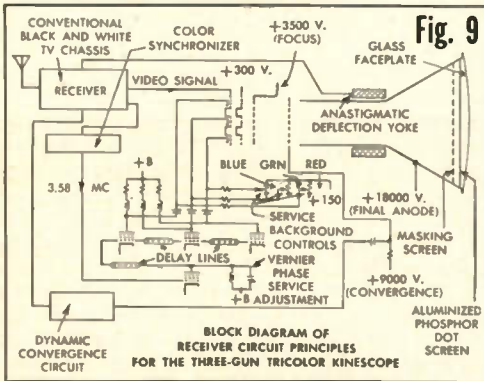

The face of each color tube was coated on the inside with a multiplicity of dots of color phosphor. The dots were arranged in triangular groups of three—one red, one green and one blue. There were 117,000 dots of each color making a total of 351,000. Behind the tube face there was a metal masking screen containing 117,000 holes approximately the same size as the dots of color phosphor. The holes were so placed that they overlapped equally each red, green and blue dot of a triangular group. The electron guns that "fire" narrow beams of electrons at the fluorescent-coated tube face are controlled by the video picture signals. These signals contain the necessary information regarding the color detail of the object or scene being televised. The simplified sketch of the three-gun tube, Fig. 8, illustrates the action that takes place. The images are made to appear on the face of the tube by the pencil-like beams of electrons that activate the fluorescent dots that represent the three primary colors. Although the three beams all operate simultaneously through the narrow glass neck of the same picture tube, they are controlled so that their actions are masked from interfering with each other.



ONE OF THE SMALLEST and simplest TV systems ever devised for non-broadcast industrial television has been demonstrated in the RCA laboratories. It was based on a remarkably small and sensitive pickup "camera" tube known as the Vidicon, and operated on the principle of photoconductivity instead of employing photoemissive cells. The system consisted of two units—the TV "camera" about the size of a 16-mm. home movie camera and a portable master control unit, photo A. The relative size of the broadcast-station image orthicon and the Vidicon "camera" tubes is indicated in photo B.

Projecting scenes over a coaxial cable up to 500 feet long, this comparatively inexpensive closed-circuit TV system had many possible applications in science, medicine, industry and education. Operating at normal light levels, it produced excellent black-and-white pictures, and could be adapted to produce pictures in natural colors and three-dimensional effects.

The Vidicon tube construction and operating details are shown in Fig. 1 and Fig. 2. Light, representing elements in the picture being picked up, passes through the glass face of the tube, then through a transparent conducting coating on the inside of the tube which forms the signal plate as indicated in Fig. 2. The light then strikes the photoconductive target which, on the side next to the signal plate, carries a positive charge of from 10 to 30 volts. The inside surface of the target is maintained at zero voltage. Because the target material is an insulator, very little current flows while it remains dark. When light strikes the target, it increases the conductivity of the material sufficiently to permit a charge to flow across the target and to charge the light-struck area a volt or two positive in the $\frac{1}{50}$ of a second between successive scans. The scanning beam generates the video signal, which is taken off the Kovar metal ring attached to the signal plate.

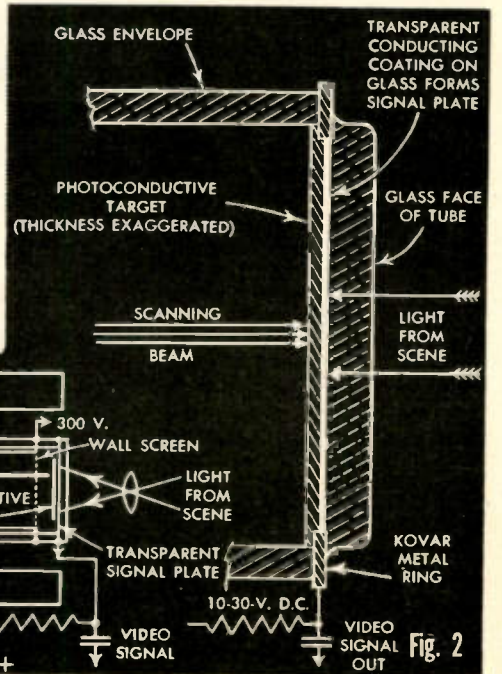
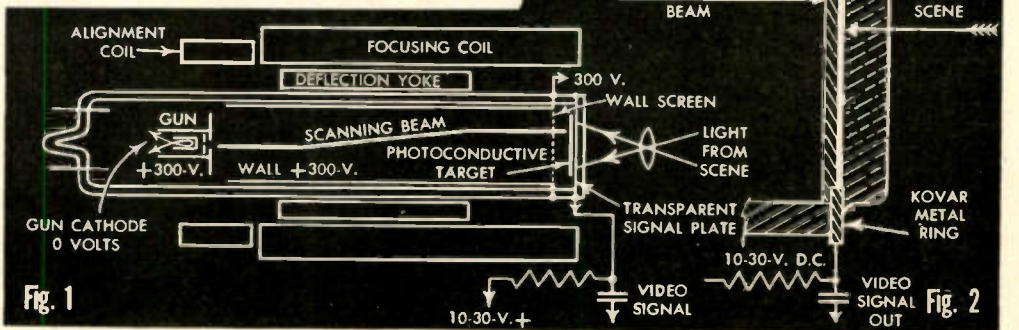
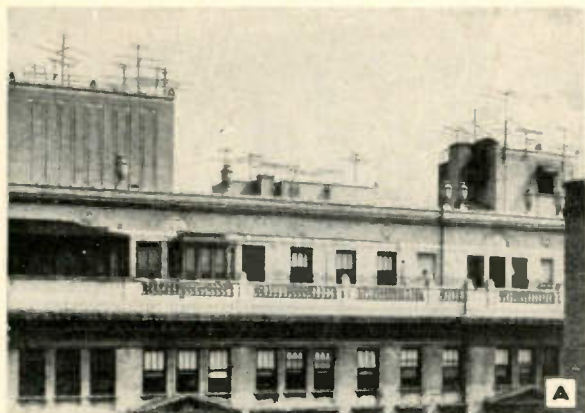

Fig. 1

Fig. 2

MASTER TV ANTENNA FOR APARTMENTS AND HOTELS



TELEVISION reception in apartments and hotels has presented problems to some managers of these properties in metropolitan areas. Tenants discover that various types of indoor TV antennas are not practical in their particular locations. In other locations roof antennas are necessary because the building is in a weak-signal area.

When the tenant finds he has a TV problem his first action is to request permission to install a roof antenna. The manager desires to please the tenant and, if he gives his consent, the result may look like the antenna jungle on the roof of the prominent Chicago building shown in photo A. The answer to this problem is a master TV-antenna system designed to accommodate a large number of TV receivers within a single building, or a number of buildings in a block. The Jerrold Mul-TV system illustrated in photos B, C and D employs a master amplifier (photo C), which amplifies each TV channel separately, from a minimum number of roof antennas. Photo B shows the roof of another building after the installation of this system. Type ADO-8 distribution units, photo D, each serve eight different apartments by means of coaxial cables from the master amplifier.

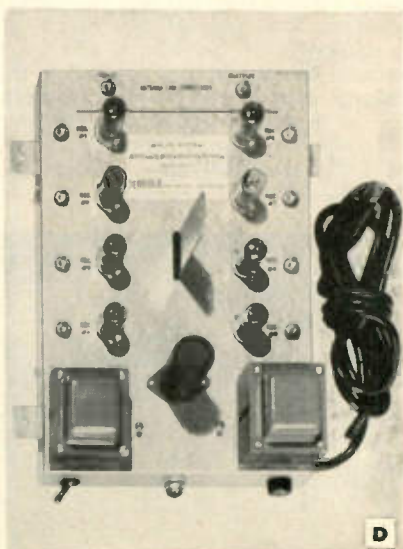
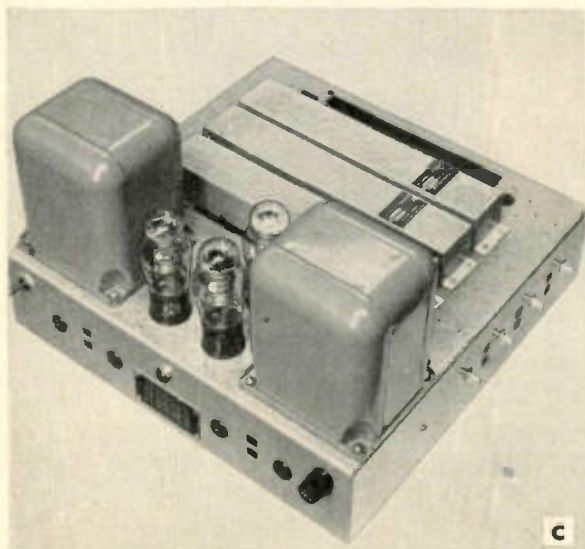

HOW TO INSTALL TV AND FM ANTENNA SYSTEMS

UNLIKE the ordinary radio receiver, for which any handy metallic object will act as an antenna, TV receivers combine two completely different receivers in one. The sound is received on an FM section, and the picture, or video, signals are received from a transmitter operating on AM. Both of these signals are in the high frequency range between 54 and 216 megacycles, as shown in the chart at the bottom of the following page.

The antenna is an important factor in obtaining good TV reception. Check various reception conditions in your area such as: directions and distances of the TV-transmitting stations; possible interference conditions such as nearby high buildings or intervening hills that might cause the appearance of troublesome "ghosts" or multiple images. These "ghosts" are caused by reflected signals that arrive at your antenna at fractional time differences in the manner illustrated in sketch Fig. 1 below. The secondary signal produces the "ghosts," which are out of register with the direct signal. This effect is clearly illustrated in the photo that appears in the TV-receiver picture-tuning instructions on page 75, Fig. 5. High-frequency television picture signals travel in straight lines similar to light waves, until some object blocks their path. An ideal condition would exist where the antenna of the television broadcasting station could be seen at the site of the receiving antenna. Fortunately reception is fairly good even when the direct signal is

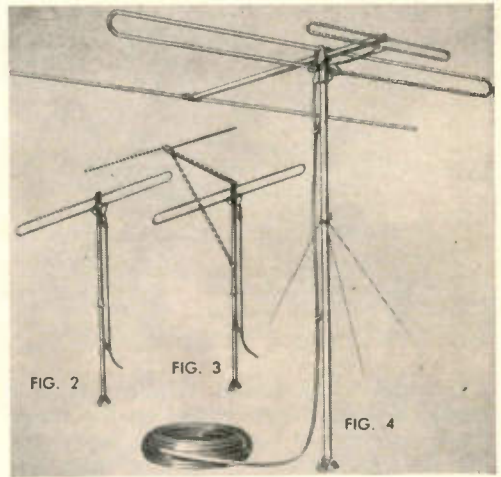

partially obstructed by large reflecting surfaces. As the TV signals are radiated in all directions from the transmitting-station antenna simultaneously, the receiving antenna must be highly directional or it will receive both the direct and multipath-reflected signals. These undesired reflected "ghost" signals can be eliminated with directional antenna systems. Three basic types of TV receiving antennas are shown in Figs. 2, 3 and 4 illustrated above.

The folded-dipole antenna, Fig. 2, is satisfactory under favorable receiving conditions; for example where there is only one

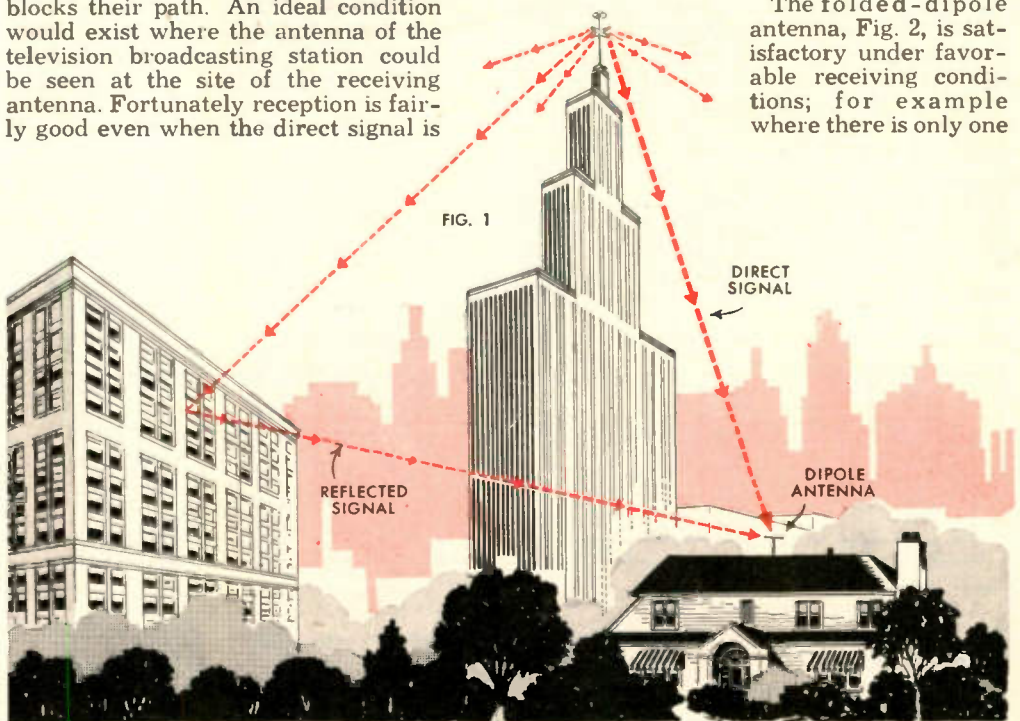

HOW TO INSTALL TV AND FM ANTENNA SYSTEMS

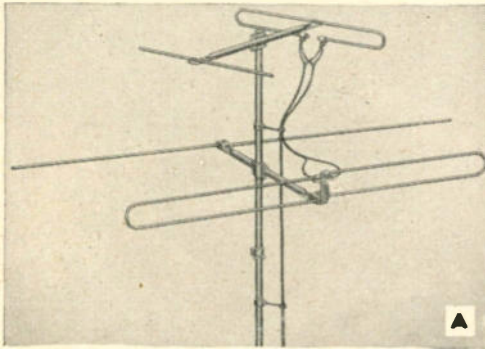

TV broadcasting station within receiving range. It is an improvement on the single dipole commonly used several years ago. Fig. 3 is a folded dipole with a reflector element about 10 percent longer, and about $\frac{1}{4}$ wavelength behind it. This is designed for use in low signal areas. Fig. 4 includes a high-band folded dipole at front. FM antennas are similar in construction to Figs. 2 and 3 but are cut to include all of the FM broadcast-band frequencies; their installation is the same.

Where there is only one TV transmitting station in a locality, the antenna problem is not serious. Trouble begins when other TV stations go on the air in different locations in the area and operate on widely different frequency channels. This situation calls for specially designed antenna systems with high and low-frequency sections that can be separately oriented. The Amphenol "Piggyback" type illustrated in photo A solved this problem. It was designed to receive on all 12 TV channels, using one common 300-ohm transmission line leading down to the TV receiver. It consists of a high-band folded dipole with a reflector in one plane, and a low-band folded dipole with a reflector underneath.

With this arrangement it can "look" in two directions at once in order to receive the maximum signal in both the high and the low TV bands. Otherwise the separate elements would have to be mechanically rotated to accomplish the same result on each station. All standard-type TV and FM antennas are available from dealers and radio parts houses in kit form; they are easily assembled and installed.

The first step in TV-antenna installation is to survey your location and decide where you want the receiver. You should keep in mind that the length of the 300-ohm transmission line should be kept to a minimum for low losses. If you have to cross any water pipes, metal air ducts or gutters, do so at a sharp angle, do not parallel them. Use twin-lead stand-off type insulators; twisting the twin-lead helps to cancel out noise pickup. If the TV transmitting station is west of the receiver location and you are using a folded dipole with a reflector, orient the antenna as shown in Fig. 5 for maximum pickup from the west. In other words, the best pickup is always broadside to the TV or FM antenna. With a single dipole and no reflector the antenna would be bi-directional, picking up the signal from both the west and east. The reflector makes it unidirectional.

TV receivers are available with or without antenna installation and service. There is usually an extra charge for these serv-

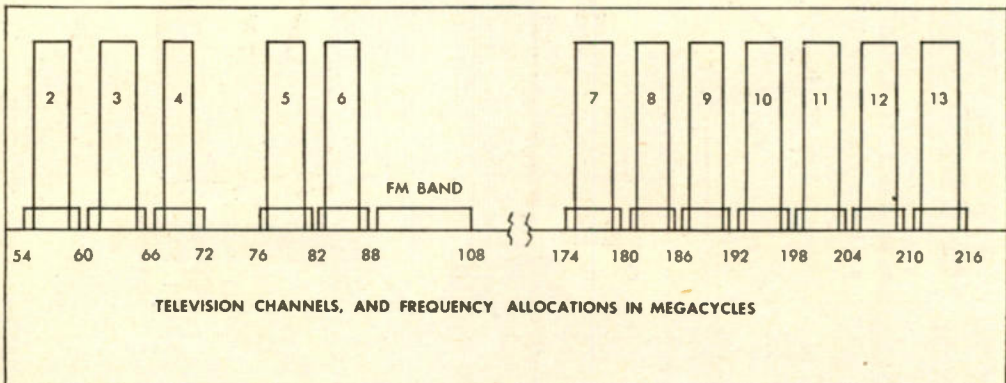
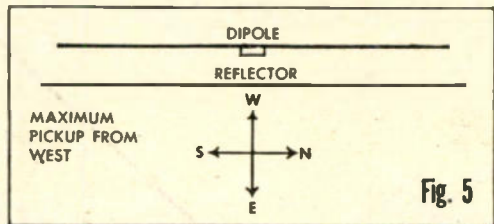

HOW TO INSTALL TV AND FM ANTENNA SYSTEMS

ices, but they are very desirable for those who are not able or do not wish to install their own rooftop antenna. In some cases in areas of strong TV signals, and where there are no interference problems, all you need is a TV receiver with a built-in antenna, or, you can use one of the handy adjustable portable indoor types.

If your location calls for a rooftop antenna, there are a few things of importance that should be taken into consideration, especially if you do the installing yourself. Auto-ignition noises from passing cars may cause troublesome interference; therefore the antenna should be as high as possible, and away from the street. A lightning arrester should be included in an outdoor TV or FM antenna installation to protect the set. Numerous questions have been raised regarding the positioning of lightning arresters on TV and FM antenna systems. The right and wrong methods are illustrated in Fig. 6. A standard twin-lead ar-

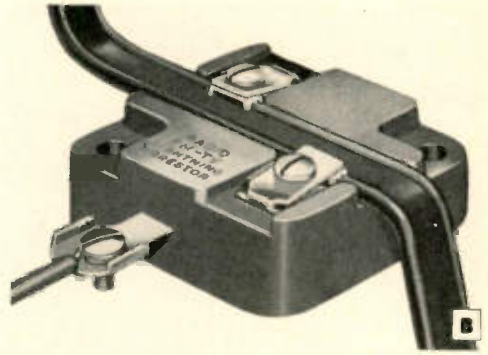

restor is shown in photo B; contact to the transmission-line conductors is made through special contact teeth. It is easily installed and this Amphenol 155-338 type combines the advantages of the resistor-type lightning arrester with the safety of the heavy-gap type. The antenna system is constantly grounded through a high-resistance network which has no effect on signal reception. Minor static discharges are carried to ground before the voltage can build up to a level which will cause interference in the receiver; a heavy discharge is passed directly across the gaps to ground. Instances of a direct lightning strike on the television antenna are extremely infrequent. The antenna supporting mast must have a direct connection to an external ground as indicated, to carry the major portion of the discharge to meet the requirements of the National Electrical code.

A chimney usually provides a good mounting base for the ordinary TV or FM-antenna installation, as illustrated in photo C. The chimney mount is adjustable and is available from all radio parts houses.

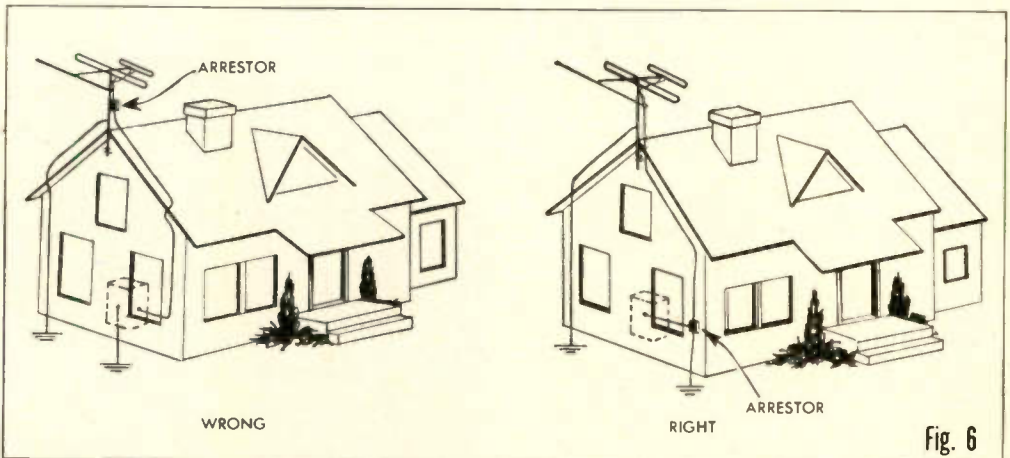

HOW TO INSTALL TV AND FM ANTENNA SYSTEMS

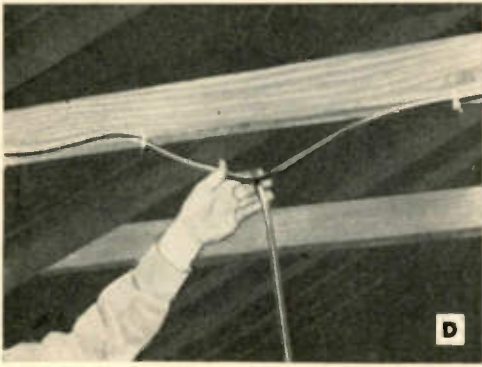

HOMEMADE emergency indoor TV and FM dipole antennas can be made from 300-ohm twin-lead as shown in Figs. 7 and 8. Such indoor antennas are not highly efficient but they often serve in emergencies, especially in areas of strong TV and FM signals, when a receiver must be moved to a sickroom or other temporary location. The twin-lead from the dipole can be any length up to 100 ft. or more. The flat, flexible polyethylene-plastic tape, in which the paralleled conductors are spaced to provide a 300-ohm transmission line, is easily cut and the conductors are soldered at the points indicated to form a dipole. The dipoles shown are cut to such length as to hit the approximate center of the TV and FM bands. About 1 in. of extra twin-lead will provide sufficient wire at the ends so that the wires can be bared, twisted together and soldered. The lower wire is then cut

at the center for connecting the twin-lead transmission line to the receiver, as indicated in Figs. 7 and 8.

The completed flat-tape twin-lead dipole antenna can then be placed under a rug, fastened to picture molding by means of thumbtacks, or installed in the attic on a collar beam as illustrated in photo D. Practically any commercial type of TV or FM dipole antenna can be installed in the attic. The "Telrex" type shown in photo E was specially designed for this purpose. It overcomes the landlord's and homeowner's opposition to rooftop TV or FM-antenna installations. Light in weight, it is self-supporting on a floor or it can be suspended from beams or rafters.

To orient any directional television antenna correctly for the desired stations it is usually necessary to do some experimenting. You cannot always be guided by the way your neighbor's antenna is installed, especially in crowded locations, where sometimes your best signal will be a reflected one. Out in fringe areas where you are on your own a simple method is to use a small pocket compass and a map of the city or area. If the stations are widely separated it will be necessary to experiment in orienting the high and low-frequency element sections in order to obtain maximum results. If your antenna is not a type with adjustable high and low sections, merely rotate the mast to the best position before tightening the mounting clamps. Delegate a member of your family to act as a viewer at the TV receiver while you orient the antenna on the roof. Self-powered hand telephones are used by service men for this purpose. You can get the same results by calling back and forth, or, by placing one or two other persons at intermediate points to relay information.

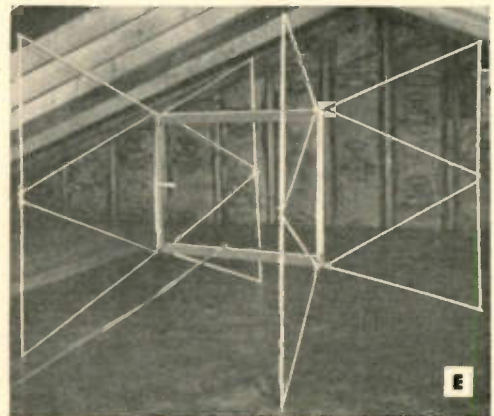
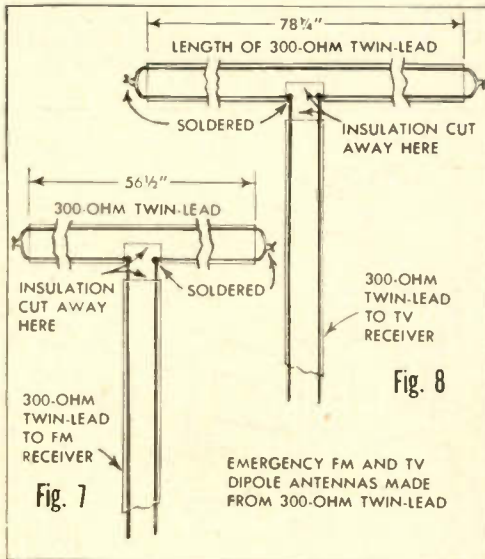

SPECIAL-PURPOSE TV ANTENNA SYSTEMS

SPECIAL-PURPOSE television antenna systems are making good picture reception possible in extreme fringe areas and in remote locations ordinarily beyond the expected range of TV transmitters. In these remote locations, height above ground becomes very important. Added sensitivity or gain is also necessary and this is obtained by stacking two or more bays, or sections, of antenna units together. The result is greatly increased gain that overcomes signal losses due to distance and absorption.

The height problem is easily solved by the use of specially designed, self-supporting aluminum-alloy towers of the type shown in photo A. Extremely light in weight and available in various heights, they are easily installed in yards and on house tops. The tower shown supports an Amphenol two-bay stacked array, and this installation gave excellent results on Chicago TV stations over a distance of 60 miles. The height of the array from the ground was 75 feet. A close-up of the two-bay array is shown in photo C. One common twin-lead is used and it can be either the standard flat 300-ohm line, Fig. 1, or the Amphenol tubular 300-ohm twin-lead, Fig. 2. This tubular-type twin-lead is claimed to reduce wind resistance and losses due to dirt and moisture, an important consideration in long runs or in locations of low signal strength. The fact that it retains its low loss efficiency in wet weather makes it ideal for the critical fringe-area antenna installations.

Another special-purpose type of TV antenna is the Taco "Twin-Driven Yagi,"



FIG. 1



FIG. 2

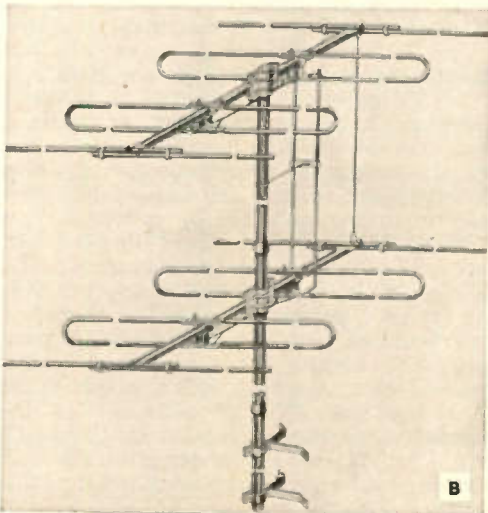

Two-bay stacked array with motor-driven rotating device to turn the TV antenna in any direction

SPECIAL-PURPOSE TV ANTENNA SYSTEMS

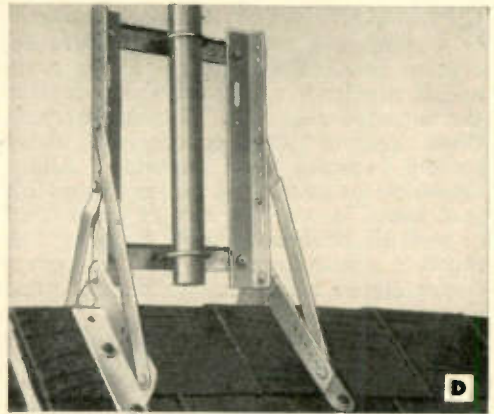
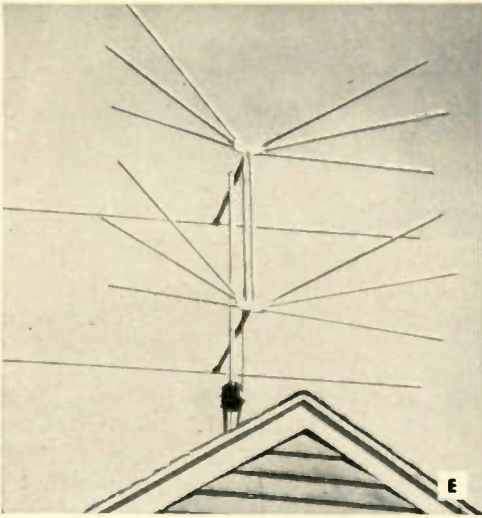
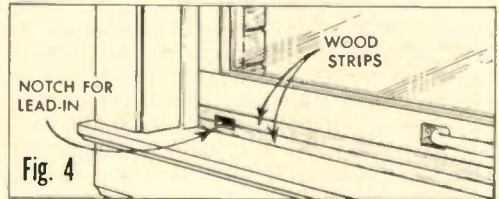
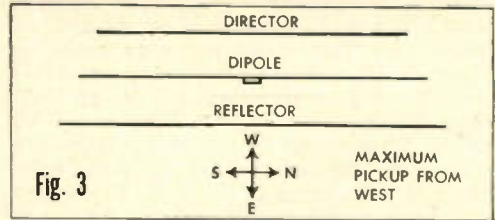

photo B. The Yagi, well-known to amateur radio operators, is a multiple parasitic-element array that has an exceptionally high-ratio front-to-back gain in any single specified band for which it is cut. With this "Twin-Driven" stagger-tuned "Yagi" array it is possible to achieve high gain in both TV channels 4 and 5. Heretofore it was only possible in one channel. In weak fringe areas or weak signal locations, this antenna is claimed to give excellent results. Large metropolitan areas, such as Chicago, Cleveland, New York, Washington, Los Angeles and San Francisco, have stations operating on channels 4 and 5. The original Yagi antenna is a multiple-element antenna system employing a director, dipole and reflector as shown in diagram Fig. 3. The reflector element is about 10 percent longer than the dipole, or driven element, and is located about $\frac{1}{4}$ wavelength behind it. The director is about 90 percent of the length of the dipole and is located about $\frac{1}{4}$ wavelength in front of it. This combination gives increased gain and directivity in critical locations.

A good directional receiving antenna is one that gives very little response in any but the desired direction. In all critical TV-antenna installations the twin-lead transmission line should be held to the side of the house with suitable stand-off insulators. If the line is slack and permitted to swing and sway in the wind, poor reception will result. When bringing the TV-antenna lead into the home, do not lay it on a window sill and clamp the window down on it, as you would an ordinary window-strip connector. This is bad practice and



will result in poor reception very quickly. A simple method is to provide two thin strips of wood the width of the window and notch them to pass the twin-lead line as illustrated in Fig. 4. A multipane window offers a simple solution as a pane of clear plastic can be substituted for the glass.

In TV-antenna installations it is often necessary to mount the antenna at a certain point on the building in order to get away from auto-ignition interference, or to clear intervening buildings. In this case the chimney mounting may not be practical. The "all-position" antenna mount illustrated in photo D will solve most any mounting problem as it may be adjusted to any position on the roof, parapet, side wall or corner of the building. An all-channel special-purpose TV antenna of the combined X and conical-effect type is shown in photo E. This high-gain "Tri-X" antenna was designed to emphasize channel 11, 12 and 13 reception; the apex arrangement is claimed to overcome an inherent weak point of the X-type antenna.

PICTURE DEFECTS AND CORRECTIONS USING TEST PATTERN

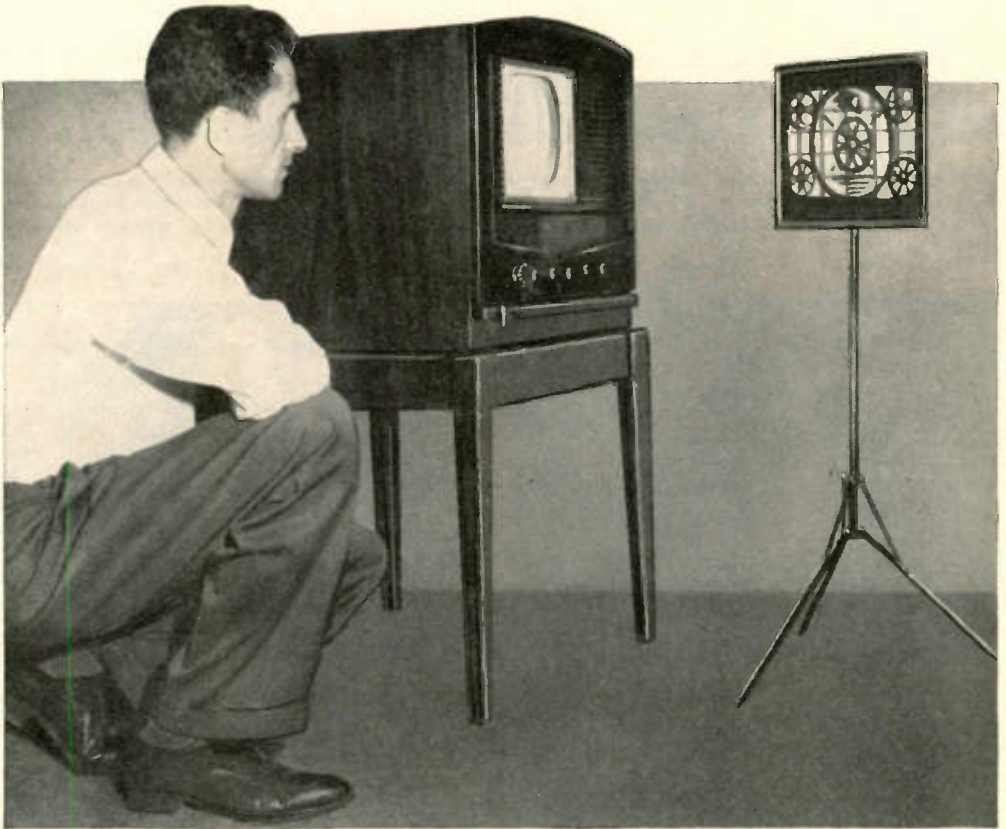

MAKING TV PICTURE CORRECTIONS USING TEST PATTERN REFLECTED BY A MIRROR

PICTURE DEFECTS AND CORRECTIONS USING TEST PATTERN

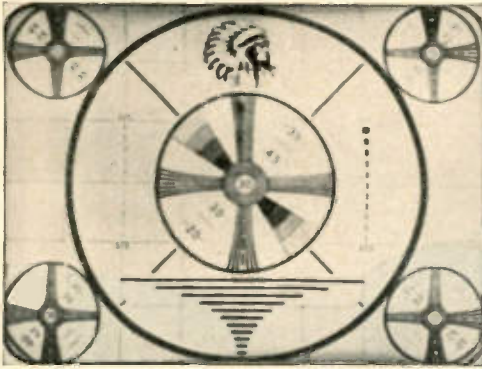

NORMAL PICTURE—Should be in sharp focus, with a good contrast between black and white picture elements with intermediate shades of gray; steady image

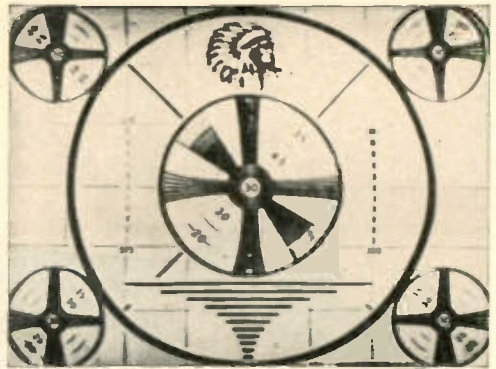

TOO MUCH CONTRAST—Intermediate shades of contrast are dark and do not contrast with black elements. Turn contrast control back, or advance brightness

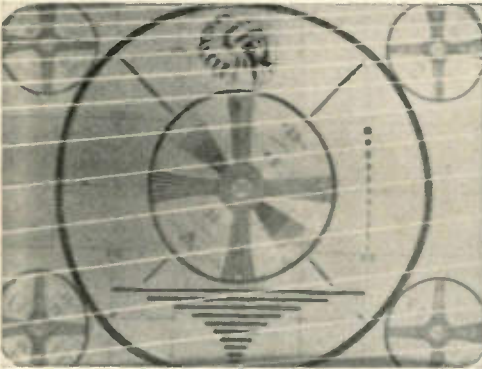

TOO LITTLE CONTRAST—Picture seems to be composed entirely of grays. Turn contrast control clockwise and brightness control counterclockwise to clear

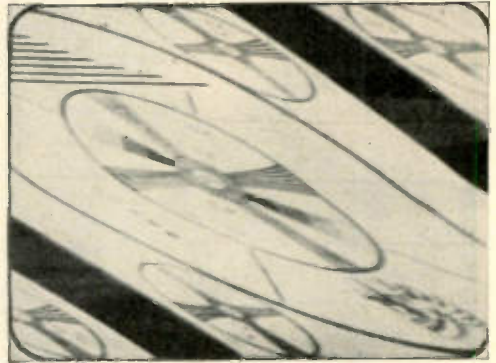

PICTURE TILTS OR MOVES SIDWAYS—Adjust horizontal hold until picture straightens up and locks into position so that there will be no sideways motion

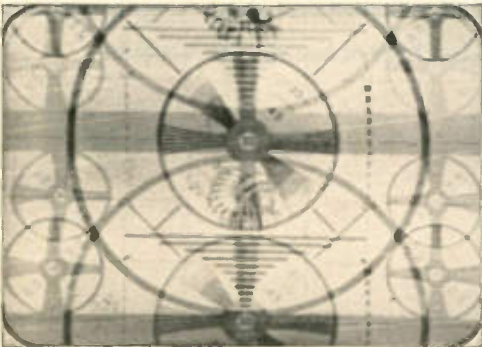

PICTURE MOVES UP AND DOWN—This is a rather common condition and is easily remedied by adjusting the vertical control to stop the rolling picture. No other control need be touched to correct this

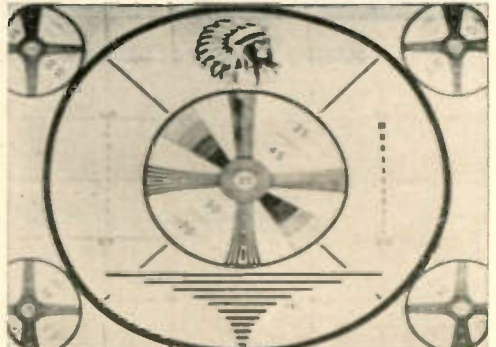

PICTURE TOO WIDE—Adjust the horizontal-size control so that the right and left picture edges are just covered by the mask and centered as shown. The width control is a screen-voltage control

PICTURE DEFECTS AND CORRECTIONS USING TEST PATTERN

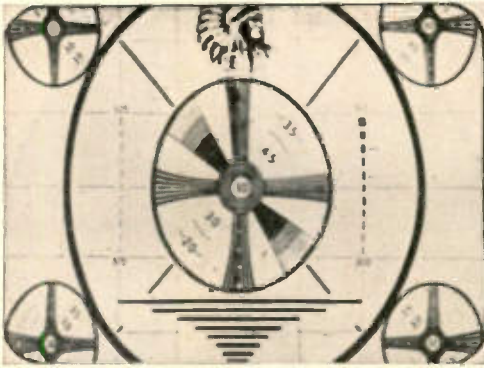

PICTURE TOO TALL—Adjust the vertical-size control so that the top and bottom picture edges are just covered by the mask so that it is centered on screen

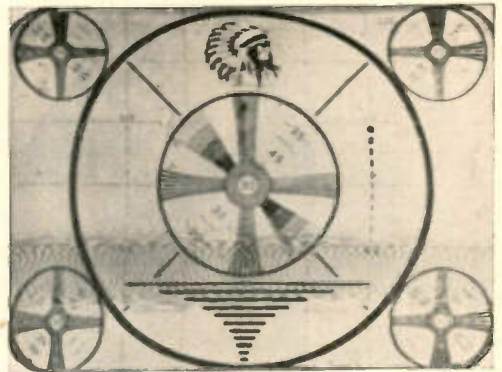

INTERFERENCE FROM DIATHERMY APPARATUS — A broadcasted type of interference that is picked up by the antenna. No receiver adjustment will eliminate it

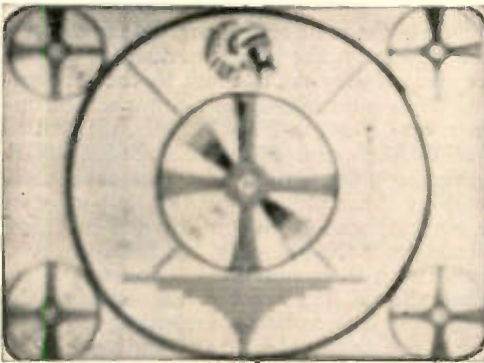

BLURRED PICTURE—This condition indicates that the picture is very definitely out of focus. Adjust the focus control until the picture detail is sharp and clear

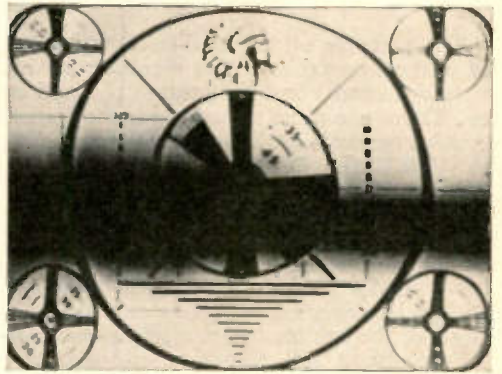

INTERFERENCE DUE TO HUM PICKUP IN SET—This can also be due to diathermy interference of greater intensity. To correct set hum TV service is indicated

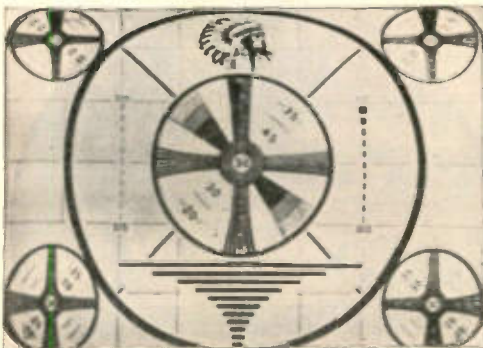

PICTURE ELONGATED VERTICALLY—Adjust the vertical linearity control so that the vertical radii from top to center and center to bottom are equal. This adjustment may slightly alter the vertical size

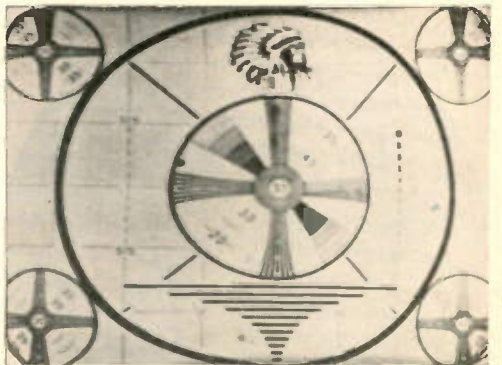

PICTURE ELONGATED HORIZONTALLY—Adjust horizontal linearity control so that the horizontal radius from center to left side is equal to radius from center to right side (this may alter the horizontal size)

TV PICTURE-TUNING PROCEDURE AND ADJUSTMENT



1

CORRECT



2

TOO BRIGHT

The pictures on this and following pages illustrate the results of incorrect adjustment of various controls on the receiver and also the effects on the actual picture of certain external conditions. Suggested corrections are given if they can be made by the set owner. There are some adjustments that must be made by a television service man. The operating controls are those on the front of the receiver. In some TV sets these are limited to **VOLUME, ON-OFF, BRIGHTNESS, CONTRAST** and **STATION SELECTOR**. The brightness control is used to adjust the brilliance of the picture; the contrast control varies the contrast between light and dark portions of the picture. The station-selector knob tunes the set to the desired channel (or station) and it may be turned in either direction. The controls at the rear of the set should be adjusted only by someone who has owned a TV set for some time and is familiar with their functions. Otherwise they should be adjusted by a service man. In no case should a TV set owner remove the back of the set for interior adjustments as extremely high voltages are employed in all TV receivers. All necessary adjustment controls are external at front and rear. The **WIDTH** control changes the size of the picture horizontally and does not affect the vertical size. The **VERTICAL HOLD** stops the picture from moving vertically; the **HEIGHT** control changes the size of the picture vertically and does not affect the horizontal size. The **FOCUS** control focuses the picture sharply on the face of the picture tube; the

HORIZONTAL MOVEMENT

VERTICAL MOVEMENT

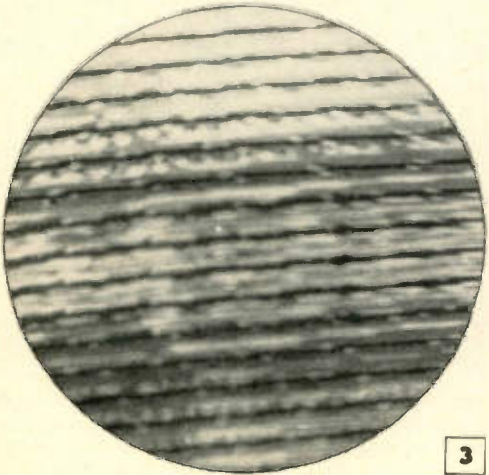

3

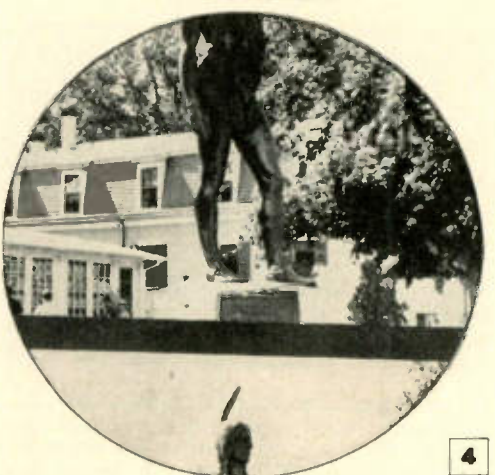

4

TV PICTURE-TUNING PROCEDURE AND ADJUSTMENT

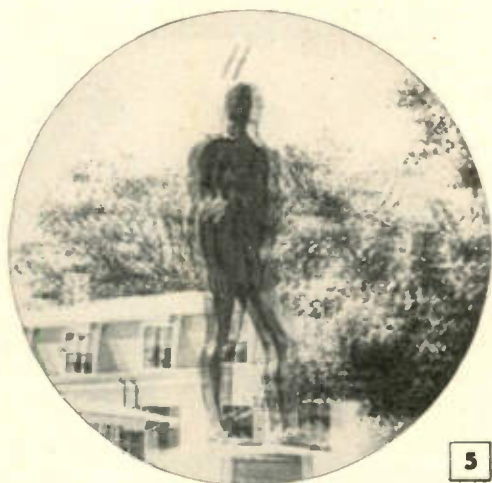

MULTIPLE IMAGES

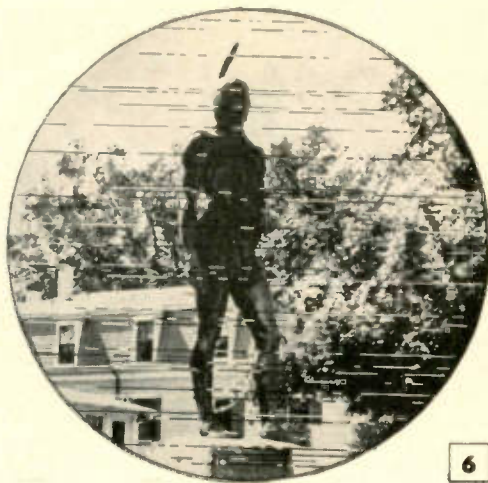

IGNITION INTERFERENCE

VERTICAL-LINEARITY control provides correct vertical distribution of the TV picture. When you have become familiar with the controls on the front of your TV set it is a simple matter for anyone to tune in a television program. You can learn to do this in a very few minutes after your set is installed. In fact, it is no more difficult to tune than most radio receivers. A common procedure is as follows: turn the set on and permit it to warm up for about 30 seconds. Now rotate the **STATION-SELECTOR** knob to the station (or channel) for the program that you wish to receive. All newspapers in areas where television programs are available publish a daily list of programs and give the time and channel number of each station in the area. The second step is to turn the **CONTRAST** control fully counterclockwise; next turn the **BRIGHTNESS** control fully counterclockwise and then turn it slowly clockwise until the face of the picture tube is illuminated. Now adjust the contrast control until you obtain the proper contrast between blacks and whites. The **VOLUME** control can then be set for the desired sound level. You now have your TV receiver in correct operating condition and you can switch from one station to another without retuning. However it may be necessary to readjust the **CONTRAST** control and the fine-tuning control which is combined with the **STATION-SELECTOR** knob in a dual assembly. Photo No. 1 shows proper picture quality—clear and steady with **CORRECT** contrast between black, white and gray

TOO MUCH CONTRAST



OUT OF FOCUS

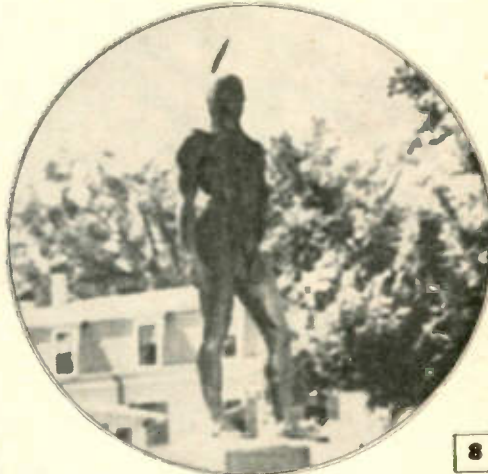

TV PICTURE-TUNING PROCEDURE AND ADJUSTMENT



ADJUST WIDTH

9



ADJUST HEIGHT

10

shades. No. 2 is **TOO BRIGHT**—back off contrast and brightness controls; advance brightness slowly, then adjust contrast. No. 3 shows **HORIZONTAL MOVEMENT**—adjust horizontal hold control slowly, until picture is steady. No. 4 shows **VERTICAL MOVEMENT**—when pictures move up and down rapidly, adjust vertical hold for steady picture. No. 5, **MULIPLE IMAGES**—"ghosts" due to signals reflected from tall buildings, mountains, etc.—these may be minimized by proper antenna orientation. No. 6, **IGNITION INTERFERENCE**—caused by automobiles or by electrically operated or motor-driven equipment in your immediate vicinity. No. 7, **TOO MUCH CONTRAST**—adjust same as for "too bright"; then adjust fine tuning and volume if necessary. No. 8, **OUT OF FOCUS**—adjust focus control for sharpest picture (seldom requires resetting). No. 9, **ADJUST WIDTH**—shows "side clipping." To correct, adjust width control until picture fills the screen horizontally. No. 10, **ADJUST HEIGHT**—This is "top and bottom clipping." Adjust height control until picture fills screen vertically. No. 11, **R. F. INTERFERENCE**—caused by high-powered radio equipment in the vicinity. May be minimized or eliminated by traps, shielding and line filtering. No. 12, **DIA-THERMY INTERFERENCE**—due to certain electrically operated medical equipment; the transmitted "herringbone" pattern may move vertically or remain stationary.

R. F. INTERFERENCE



11

DIATHERMY INTERFERENCE

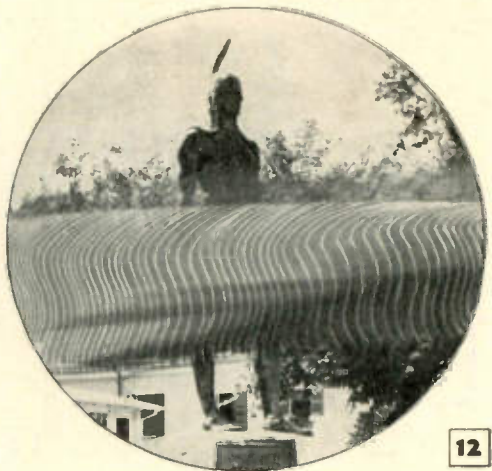

12

HINTS FOR TV SET OWNERS

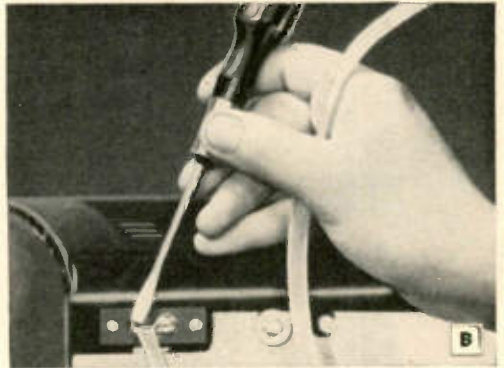
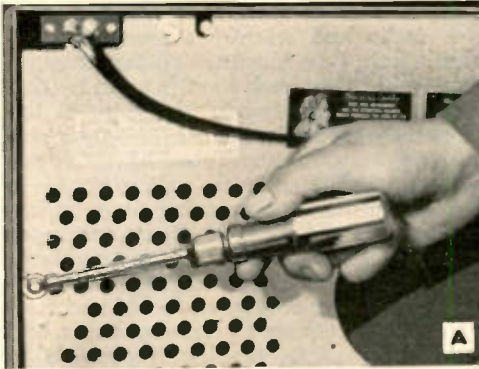

Photo A—Most television receivers have a caution label on the back cover advising that: "protection against dangerous electrical shock is provided by an interlock switch which opens the power-supply circuit when this cover is removed." Such an interlock device often consists of a metal strip attached to the cover which closes a switch inside the cabinet when the cover is tightened down. Unless the cover bolts are tight this clip will not make good contact and may cause the picture to move under vibration. DISCONNECT the set from the wall socket before touching, or tightening, any screw or bolt.

Photo B—Poor antenna connections at the TV set are a common cause of trouble. The small wires in the twin-lead antenna-connecting line are easily broken when merely twisted around the terminal screws, as shown. Small spade-type terminal lugs should be soldered to these leads to insure good connections.

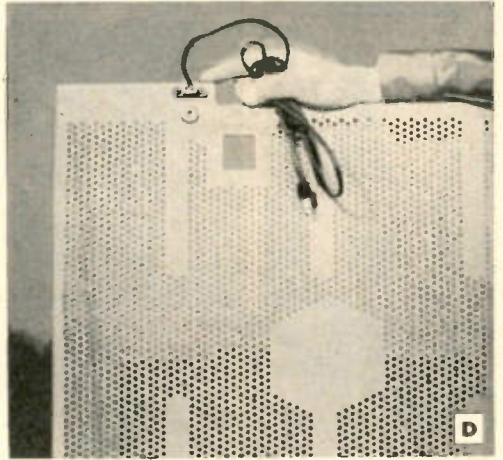
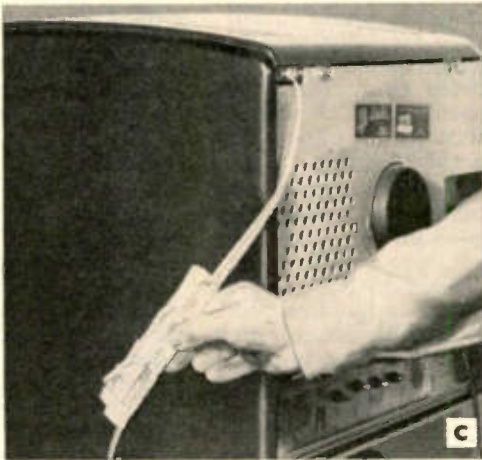

Photo C—In some cases where there is a problem of antenna mismatch which causes a poor picture on one certain channel, a piece of tinfoil from 3 to 5 in. long, folded over the twin-lead line near the receiver, will add a necessary capacity and result in considerable improvement of the picture. Slip the folded tinfoil along the lead-in, as shown in the photo, until the best picture is obtained. At this point the tinfoil may be fastened in position with rubber bands; it will not affect reception on other channels.

Photo D—Another type of safety interlock consists of a two-prong plug and line cord arrangement mounted on the cover. This plugs into a socket in the set which completes the power circuit when the cover is in position. Careless handling during service operations may damage this plug. Noisy sound reproduction, or moving of picture may result if there is a poor contact. If the plug is not defective, good contact may be obtained by tightening the bolts that hold the cover near the interlock or by pushing in on the plug.

MINIATURE RADIO TUBES



MINIATURE tubes make ultra-compact radio and television receivers possible. These tiny tubes weigh less than an ounce and range from 1 to $2\frac{1}{8}$ in. in height; they require one fourth the space of the tubes they are replacing. Besides their size and weight, miniature tubes have the advantage of shorter leads, which improves their performance by making them an immediate part of the circuit. Radio engineers point out that the miniatures are valuable especially when used with high frequencies, such as are employed in FM and television. They require no Bakelite bases, and have fewer parts, making it possible to build them faster and more cheaply.

The miniature radio tube, displayed by the young lady in photo A, is contrasted with the conventional-size tube which it replaces. As these tubes are more fragile than the older types they must be handled with care, especially when inserting and removing them from their sockets. The pins are comparatively small and easily bent out of line. A metal pin straightener of the type shown in photo B costs only about 50 cents. The pins can be straightened by using a pair of tweezers, as illustrated in photo C, but this must be done very carefully, as the loss of just one tube would equal the cost of the straightener twice over. The straightener has fluted openings which permit the delicate pins to start easily. They are then forced into proper position.

If it is necessary to carry a set of these tubes to a service shop for testing, it is a good idea to bind the tubes together with adhesive tape, keeping the tips free, as indicated in photo D. The glass bulbs are drawn to fine tips which are easily broken if the tubes are carried loose in a bag. When inserting new tubes, seat them firmly in their sockets in the vertical position shown in photo E and be very careful not to damage the delicate prongs or tip. In photo F, an old-type tube socket is shown in comparison with the new one required for miniature tubes. These small sockets fit into $\frac{5}{8}$ -in. chassis holes; they simplify chassis construction for students and experimenters as small drill holes may be enlarged with a tapered reamer. A toy muffin tray makes a good safe holder for these tubes on the workbench, as illustrated in photo G. The entire set of tubes for one of the new table-model receivers is in the toy tray; all but one are miniatures. A selenium rectifier was employed in this set. The useful life of miniature tubes is comparable to that of the older types.

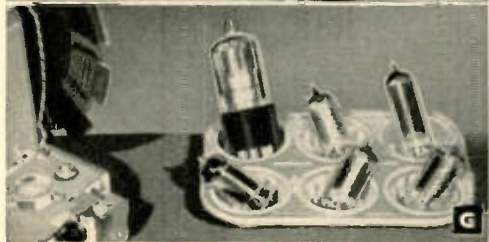
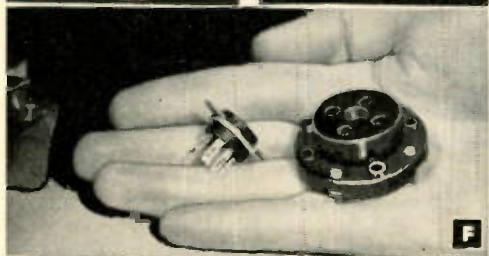

CONTROLLING the flow of current through an electrical circuit as a valve regulates the flow of water through a pipe, the electronic tube is actually an electrical valve. Unlike the water valve, the electronic tube has no moving parts; its action is completely electrical, therefore it operates at the speed of light. Some tubes smoothly regulate the current flow, others can instantly stop or start it.

All electronic tubes are basically the same; the General Electric "thyatron" is a commonly used type. Fig. 1 shows its heater that heats the cathode which gives off electrons, as illustrated in Fig. 2; the dot indicates a gas-filled tube. The anode (plate) is the other end of the conductor in the tube; when a positive voltage is applied to it, the plate attracts billions of electrons that are "boiled" off the cathode as in Fig. 3, and current then flows through the tube. Fig. 4, negatively charged, the plate cannot attract electrons. Fig. 5 symbols illustrate what the grid (control electrode) does: (1) when more than a certain critical value of negative voltage is applied to the grid, electrons cannot reach the plate; (2) when negative voltage is reduced, electrons flow to the plate; (3) flow stops when plate voltage becomes negative; then cycle repeats. Fig. 6 illustrates ionization: (1) an electron is knocked out of a neutral gas molecule; (2) a molecule having lost an electron is positive; (3) these positive molecules are called ions; (4) when enough ions form they neutralize the negative field, thus permitting more electrons to reach the plate for greater current-carrying capacity.

These are the fundamental principles of the electronic tube. These principles, carried out in various ways in hundreds of special-type tubes, are used in radio-television, industry and laboratory electronics.

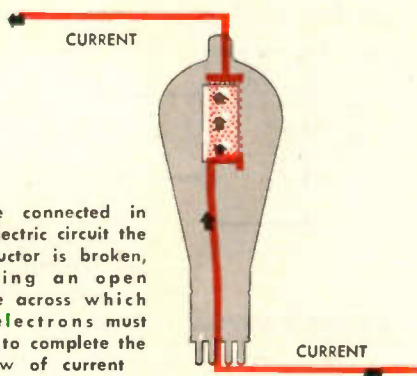

While connected in an electric circuit the conductor is broken, leaving an open space across which the electrons must pass to complete the flow of current

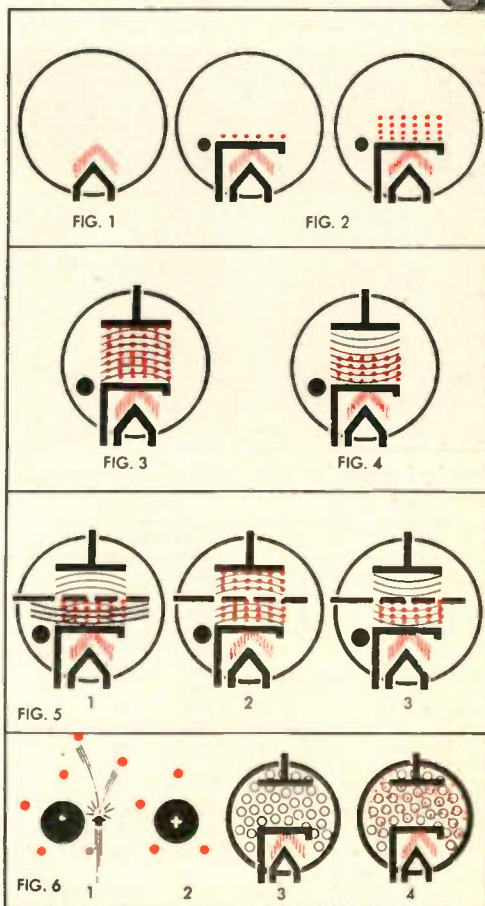

GERMANIUM CRYSTALS

THE CRYSTAL DETECTOR has been popular since the early days of wireless. Many enthusiastic adults and youngsters have constructed crystal sets and picked up signals with them, and the fascination of the crystal seems to be endless. With the advent of vacuum tubes at prices where the experimenter could afford them in numbers, the crystal came to be looked upon as a fragile novelty with few practical applications outside the toy radio receiver field.

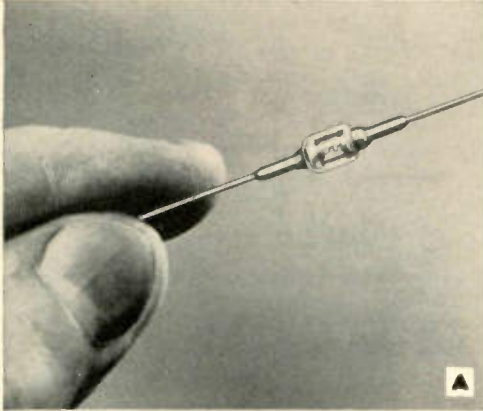

Germanium crystal diode, Sylvania type 1N34A in a moisture-proof hermetically sealed glass cartridge

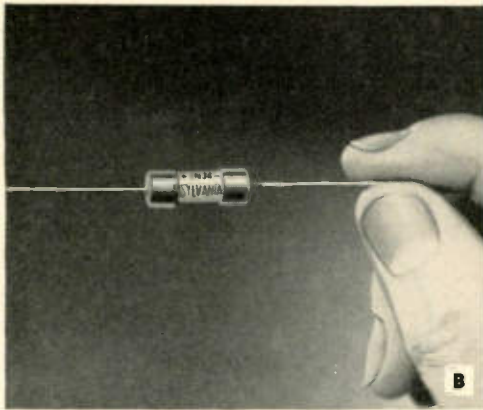

Standard germanium crystal diode, Sylvania type 1N-34 commonly used as a detector in modern crystal sets

Immediately after World War II, however, the highly stable germanium crystal diode became available to students and experimenters. They made highly efficient fixed-crystal detectors, and many useful tubeless circuit devices are now constructed around these crystal diodes. This germanium crystal diode typified by the popular Sylvania Electric 1N34, two varieties of which are shown in photos A and B, has restored the crystal to a position of importance in the electronics field. Employed during the war in radar equipment, they are now used to replace certain tubes in television receivers. They are employed as video detectors, discriminators and d.c. restorers. The electrical features include long life and the ability to work into a low resistive load with good efficiency. Type 1N34A shown in photo A is a general-purpose moisture-proof diode hermetically sealed in a glass cartridge. The common Sylvania 1N34 type illustrated in photo B is ideal as a crystal detector and is very popular with beginners and experimenters. Fig. 1 shows a typical experimental crystal receiver circuit. The coil can be any standard broadcast-band antenna coil. Under ordinary conditions, the range of any crystal receiver will not be greater than 25 or 30 miles. Beginners will find complete instructions for building a very good crystal set which makes use of a Sylvania type 1N34 crystal on page 82.

The use of a vacuum tube audio amplifier with a crystal set merely increases the volume of the signal picked up by the crystal; it does not increase the range.

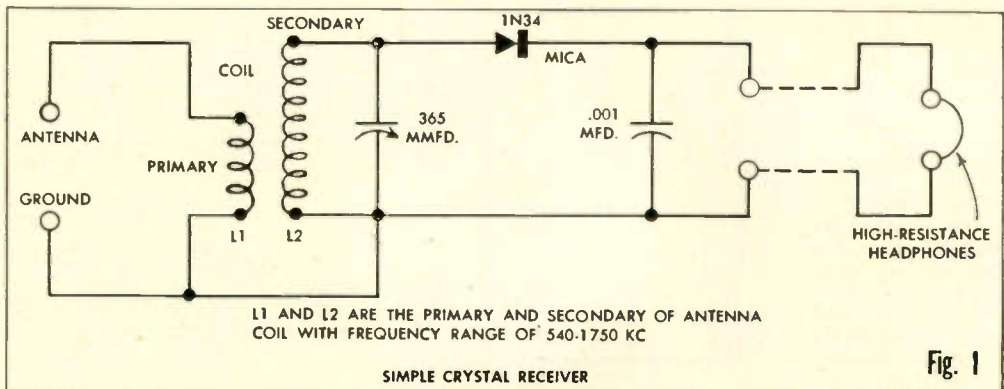

L1 AND L2 ARE THE PRIMARY AND SECONDARY OF ANTENNA COIL WITH FREQUENCY RANGE OF 540-1750 KC

SIMPLE CRYSTAL RECEIVER

Fig. 1

RADIO RECEIVERS AND TUNERS YOU CAN BUILD



IT'S FUN TO LEARN BY ACTUAL CONSTRUCTION

TAPPED-COIL CRYSTAL RECEIVER AND



A

SINCE a crystal set is the simplest form of radio receiver, it is the logical starting point for the student or junior experimenter. Unlike other types of receivers a crystal set uses no batteries or power-line supply, therefore the sound that emerges from the headphones is derived entirely from radio energy picked up by the antenna. Use a long, high antenna and a ground connection to a cold-water pipe.

The selective tapped-coil crystal receiver illustrated in photos A and B employs adjustable loading in a simple tuning arrangement that is very effective when used with a good sensitive pair of headphones. A schematic circuit diagram and the coil-winding details appear in Fig. 1; pictorial wiring diagram in Fig. 2 shows all connections clearly.

The 2-gang variable-condenser stator plates (S), are connected in parallel; the rotor plates (R) are common with the frame. This lead goes to the lever of switch No. 1; the lever of switch No. 2 is connected to one side of the 1N34 germanium crystal, and the headphones are in series.

When winding the coil, place a toothpick or

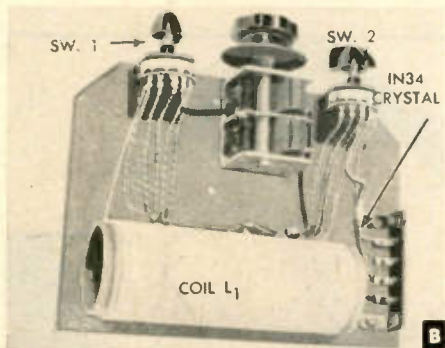

B

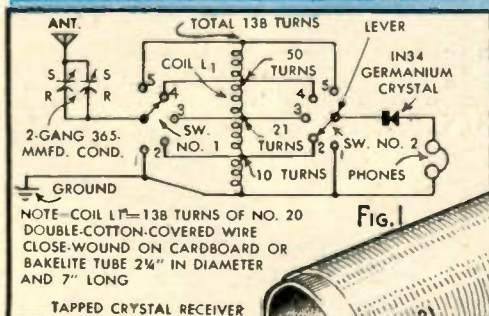

Fig. 1

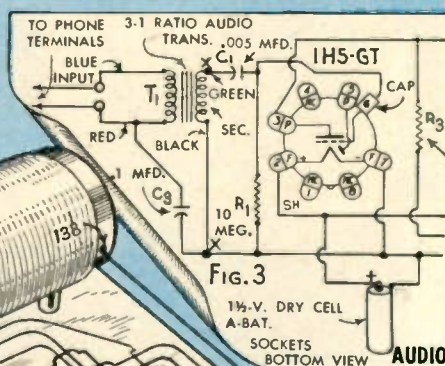

Fig. 3

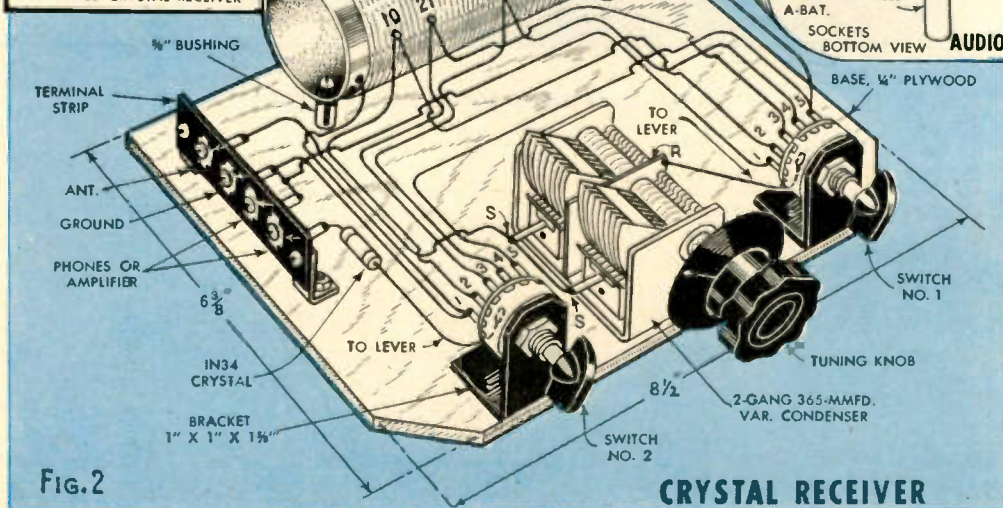
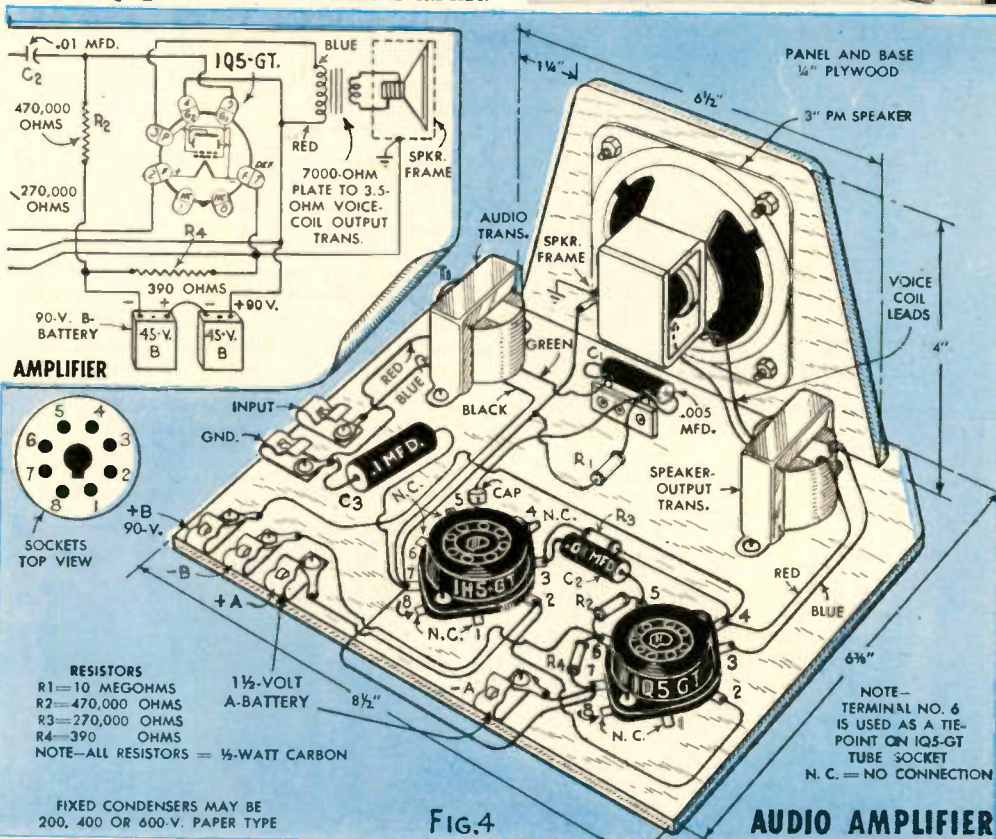
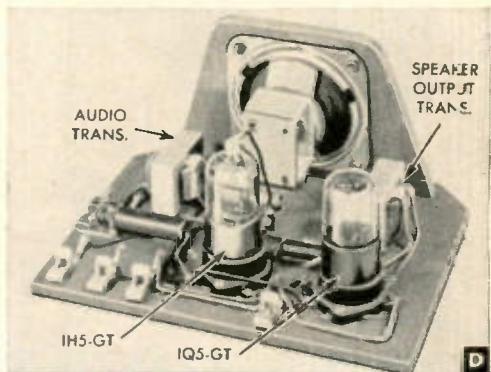

Fig. 2

CRYSTAL RECEIVER

BATTERY-OPERATED AMPLIFIER

matchstick under the turns which are to be tapped; this aids in the removal of the insulation where the leads are to be soldered for switch points at 10, 21 and 50 turns. Later, if you wish to discard the headphones and use a small loudspeaker you can do so by adding the 2-tube audio amplifier shown in photos C and D. The schematic circuit diagram is given in Fig. 3. All construction details for this amplifier unit are shown in the pictorial wiring diagram in Fig. 4. When connecting the units together, the grounded phone terminal on the crystal set connects to the ground clip on the audio amplifier; the insulated phone terminal on the crystal set is then connected to the input-terminal clip on the amplifier. The antenna and external ground leads on the crystal set remain the same. To turn the amplifier "on" and "off" either disconnect the positive (+) A-battery lead, or insert a large s.p.s.t. toggle switch in this lead. The switch was omitted here to keep cost down to minimum. Two 45-volt B-batteries and a large 1½-volt dry cell A-battery provide power. No volume control is used. See page 155 for detailed material list.



LOW-COST PROGRESSIVE RECEIVER

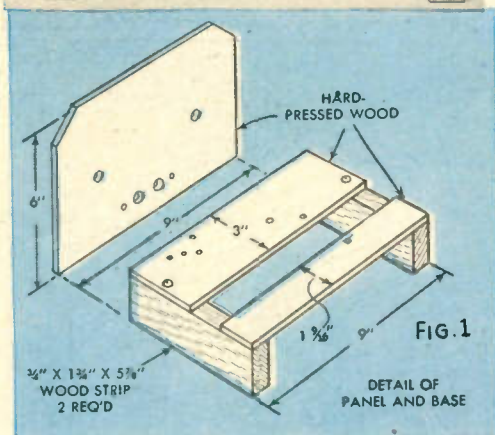
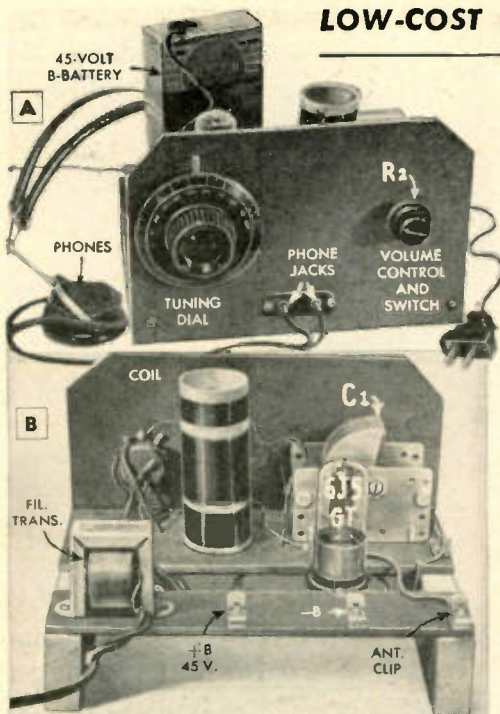

SPECIALLY planned for the beginner, this 1-tube set is easy to build and simple to operate. It employs a type 6J5-GT tube and has sufficient sensitivity to give good headphone reception on standard broadcast stations up to about 400 miles at night. In addition to being an excellent 1-tube receiver in its own right, this little set can be easily converted to a 4-tube a.c. three-band receiver without wasting parts or even making any extensive changes in the layout, other than adding additional sockets, coils and parts. The 4-tube set which is described beginning on page 86 tunes the short-wave bands as well as the broadcast band and has sufficient volume to operate a magnetic speaker at good output. Each set is a complete construction article.

Various views of the first set are shown in photos A, B, C and D; the base and panel details are given in Fig. 1. This set is built up in a semibreadboard layout on a chassis made of pressed wood, with two wooden strips which support the base. Note that the chassis is made in two pieces which permits the tube socket to be mounted without drilling large holes. The schematic circuit diagram appears in Fig. 2, and the simplified wiring diagram in Fig. 3.

The coils are close-wound on the cardboard tube with the number of turns indicated. Punch holes as shown in Fig. 3 so that the start and finish ends of each coil may be threaded in and out to anchor the winding, leaving sufficient wire at each end for the circuit connections. The finished coil is mounted with ordinary china cement. An octal-type tube socket having a metal mounting plate is mounted across the space between the hard-pressed-wood strips. Care must be taken that all tube

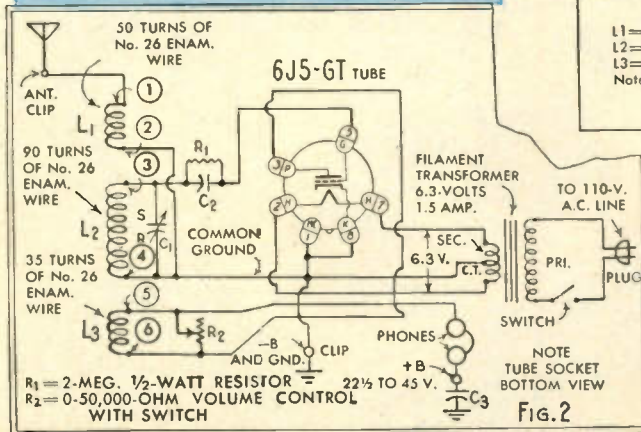

COIL WINDING DATA
 L₁—50 turns of No. 26 enameled wire
 L₂—90 turns of No. 26 enameled wire
 L₃—35 turns of No. 26 enameled wire
 Note—All coils are wound clockwise on a cardboard tube 1 1/2 in. in diameter and 4 in. long.

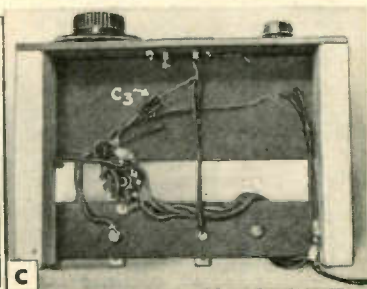

LOW-COST PROGRESSIVE RECEIVER

socket connections are made just as shown. A short metal strap is used to tie down the power cord running to the 6.3-volt filament transformer. Either a 22½ or 45-volt B-battery may be used to supply the plate voltage. The 6.3-volt filament transformer is an inexpensive 1.5-amp., or higher, type listed in all radio parts house catalogues. This is mounted on the rear strip which also carries the Fahnestock clips for the B-battery, ground and antenna leads. The "S" or stator connections on the variable condenser are common lugs on each side; the "R" or rotor lug is directly on the frame. This variable condenser can be any capacity between 350 mmfd. and 500 mmfd.

To test the set, be sure that your line supply is a.c., then plug the line cord into a wall socket; switch on the volume control and turn up this control until you hear a soft "plop" in the headphones. Next rotate tuning condenser C₁ until you hear a whistle, indicating a station. Now back off the volume control until the station comes in clear and loud. An indoor antenna will receive strong local stations but best results will be obtained with a good, high, outdoor antenna. The external ground connection at the negative-B clip can be made on a cold-water pipe or any convenient ground. See page 155 for detailed material list.

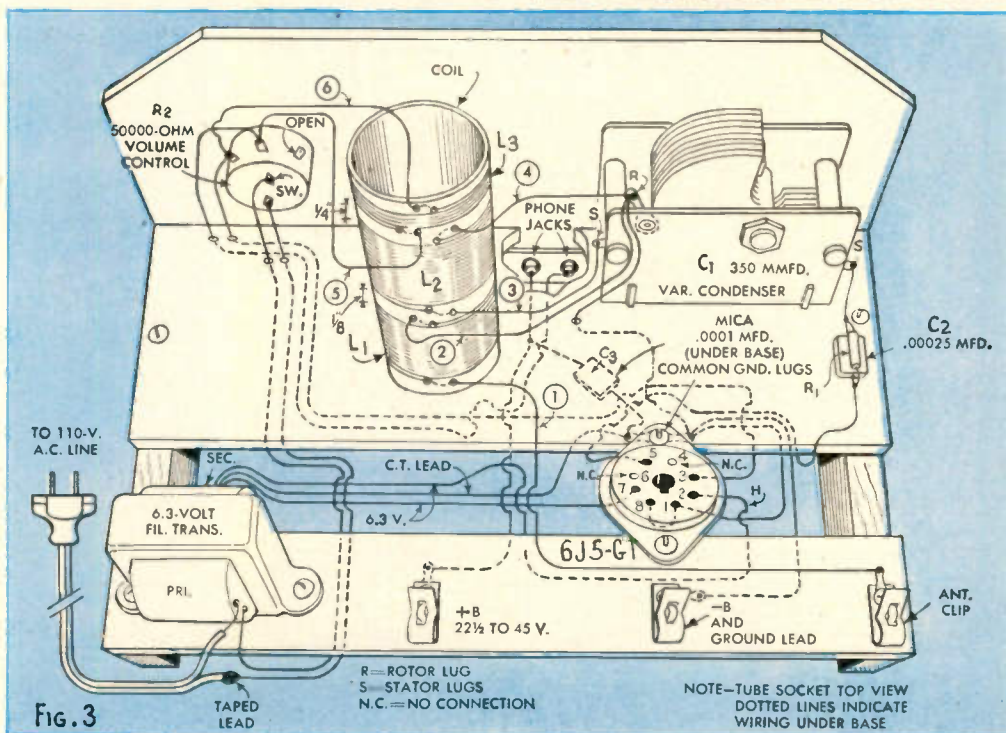
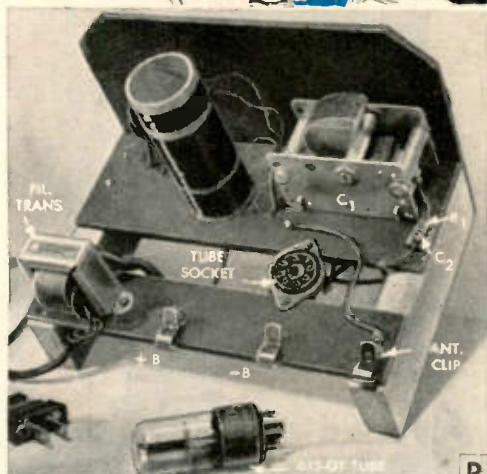

FOUR-TUBE PROGRESSIVE RECEIVER

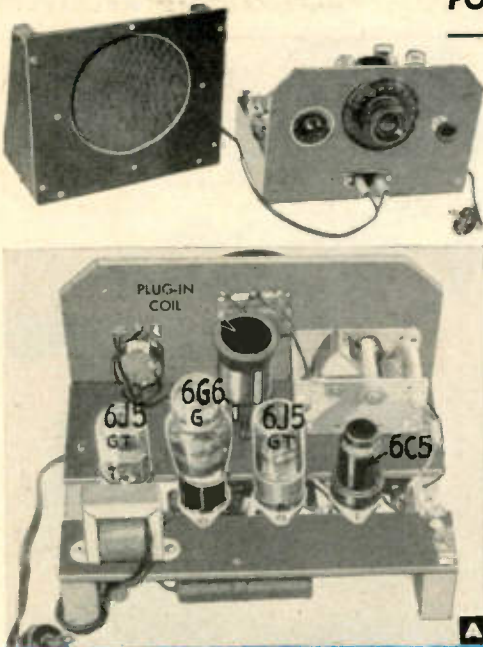

ALTHOUGH primarily designed for beginners, this low-cost unit is not intended to be easy. It is entirely different from the one-tube receiver previously described and employs 3 plug-in coils that tune from 550 to 18 meters, or, in other words, from about 545 to 16,670 kilocycles. All parts used in the 1-tube set are renumbered and again specified, except for the coil. The chassis base and panel details are exactly the same. Therefore, those who built set No. 1 will need only the additional tubes, audio transformer, speaker, plug-in coil forms and small parts.

Self-powered by using a 6J5 as a rectifier tube, no B-battery or external ground is used and the set has sufficient audio output to operate a loudspeaker. On the short-wave bands it is an excellent performer, bringing in stations at surprising distances. Placement of parts is not critical but, in order to prevent confusion in wiring, the builders of the 1-tube receiver are advised

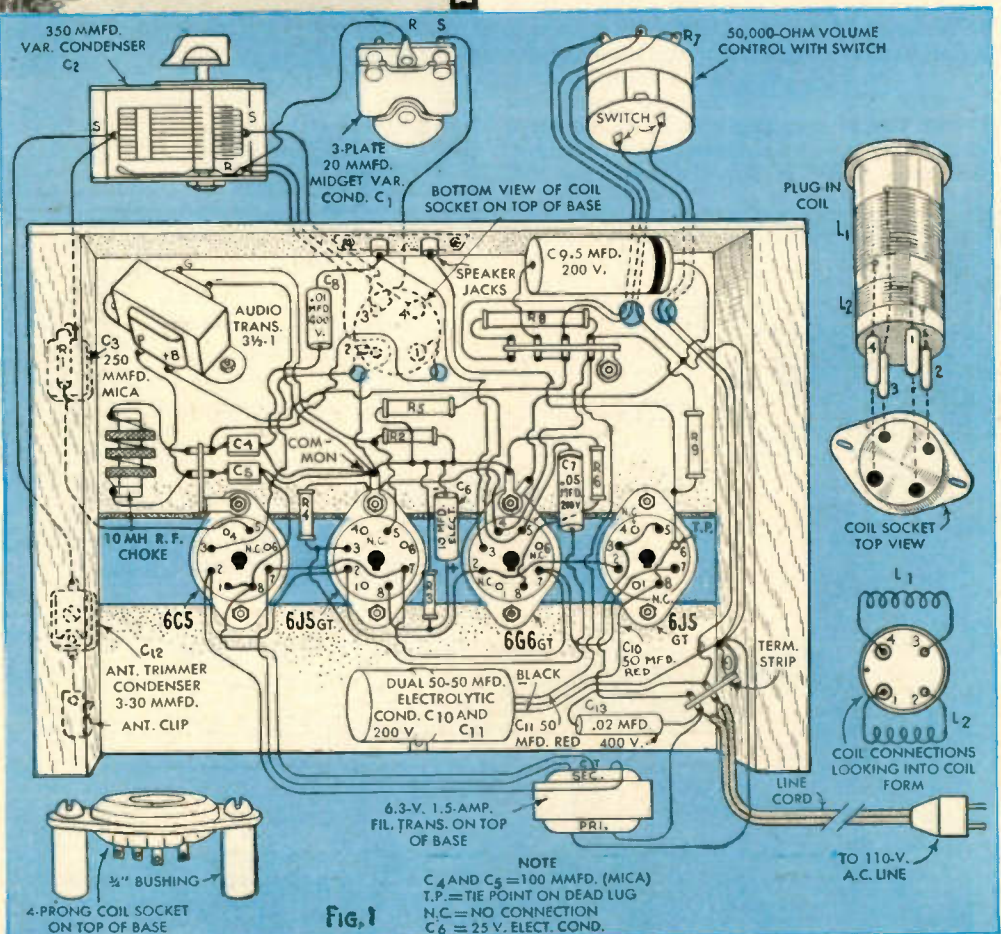

Fig. 1

FOUR-TUBE PROGRESSIVE RECEIVER

to remove all of the No. 1 set wiring and make a fresh start. The variable condenser, volume control and 6.3-volt filament transformer remain in the same positions.

The separate speaker unit is a 6-in. permanent-magnet type and a universal output transformer is mounted on the speaker. Voice coil connections are made on transformer taps Nos. 1 and 4.

When wiring the set, check each lead with pictorial diagram, Fig. 1, and schematic circuit diagram, Fig. 2. The 3 coils are wound on standard 4-prong plug-in coil forms, and overlap to cover the short-wave radio bands. The hardboard speaker baffle is $\frac{1}{8}$ in. by 7 in. by 8 in. For receiving local broadcasting stations a 10-ft. indoor antenna is best for selectivity; an outdoor antenna is best for distance. Condenser C2 is for the broadcast band; it also acts as a band-set condenser for short waves, and is set for the approximate frequency. All fine tuning is done with the small band-spread condenser C1.

See page 156 for detailed material list.

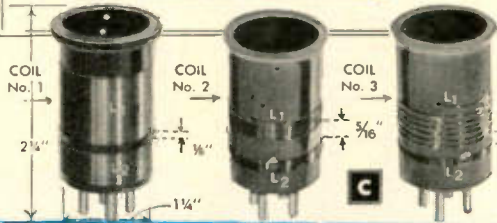
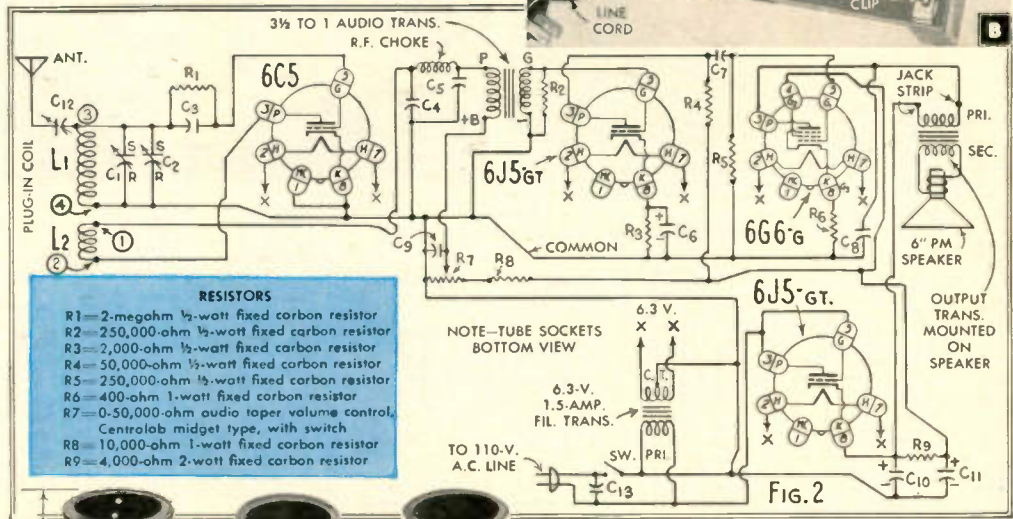
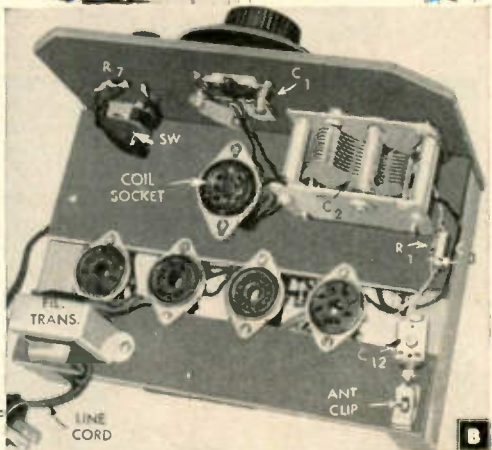

COIL WINDING CHART

- Coil No. 1—L1=95 turns No. 30 enameled wire (close wound)
 - L2=45 turns No. 30 enameled wire (close wound)
 - Coil No. 2—L1=14 turns No. 26 enameled wire (close wound)
 - L2=9 turns No. 26 enameled wire (close wound)
 - Coil No. 3—L1=6 turns No. 26 enameled wire (space wound)
 - L2=5 turns No. 26 enameled wire (close wound)
- Note—Turns for L1 are spaced $\frac{1}{16}$ in. on this coil. All coil are wound clockwise, and the windings are anchored with Duco household cement.

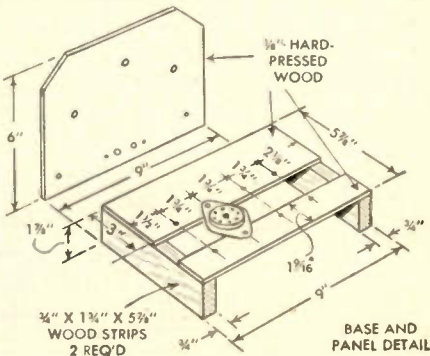

T.R.F. DUAL-PURPOSE RECEIVER



ALTHOUGH simple enough for the beginner, the unusual performance and flexibility of this 4-tube tuned-radio-frequency broadcast-band receiver will interest any experienced builder. The set includes a phono-input jack and may be used as an amplifier for a record player. Furthermore, it makes an excellent AM tuner for a public-address system, or for use with any large audio amplifier and separate speaker. When tested in *Popular Mechanics* radio laboratory, the fidelity and sensitivity were highly satisfactory considering the low cost and simplicity of design.

The most expensive parts are the tuning-dial assembly and the 6-in. PM speaker. An inexpensive 3 or 3½-in., 0-100 flat cir-

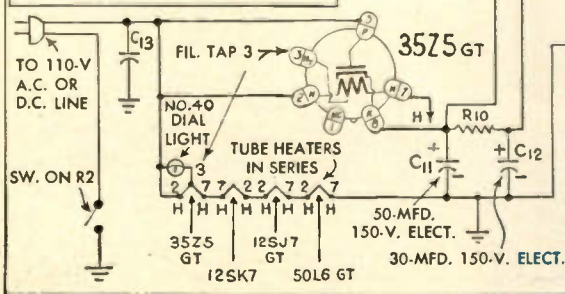
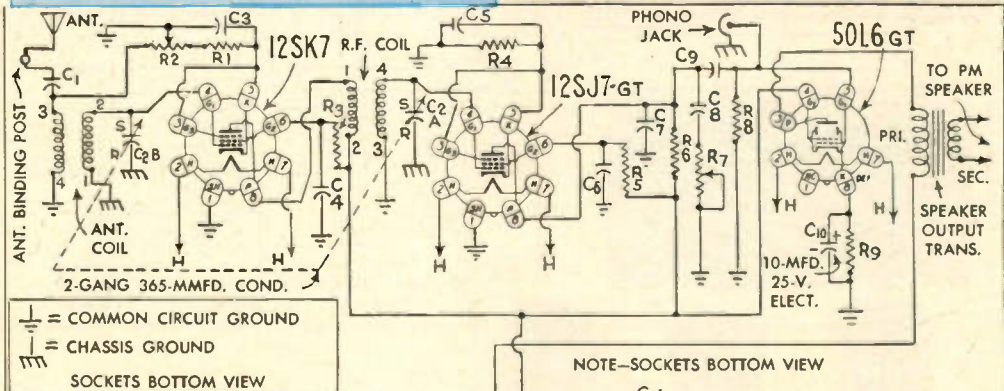
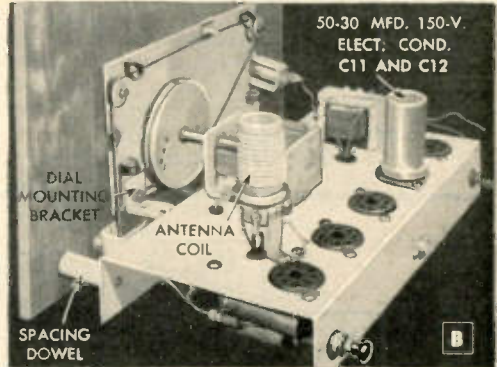
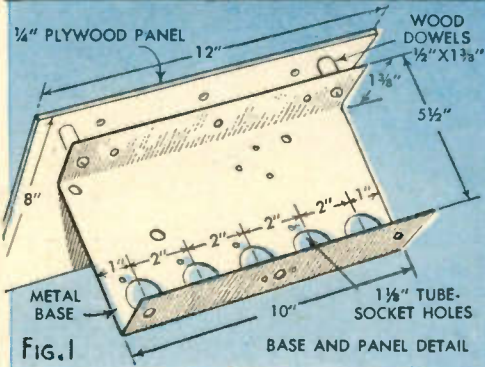
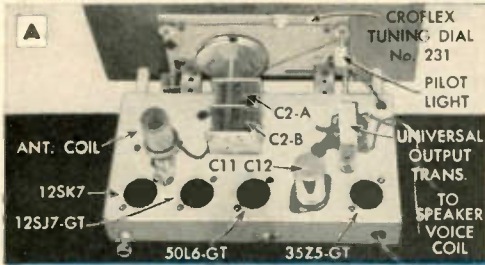

- NOTE—SOCKETS BOTTOM VIEW
- RESISTORS**
- R1 = 330-ohm, 1-watt carbon
 - R2 = 25,000-ohm volume control audio taper, with switch
 - R3 = 22,000-ohm, ½-watt carbon
 - R4 = 47,000-ohm, ½-watt carbon
 - R5 = 2.2-megohm, ½-watt carbon
 - R6 = 470,000-ohm, ½-watt carbon
 - R7 = 250,000-ohm potentiometer for tone control
 - R8 = 470,000-ohm, ½-watt carbon
 - R9 = 150-ohm, 1-watt carbon
 - R10 = 12,000-ohm, 1-watt carbon
 - R11 = 220,000-ohm, ½-watt carbon

T.R.F. DUAL-PURPOSE RECEIVER

cular-type tuning dial may be substituted for the Croflex No. 231 tuning-dial assembly; both are listed in parts-house catalogues. The 6-in. PM (permanent magnet) speaker is a good size for this set; however, any 4-in. to 8-in. PM speaker that the builder has on hand may be used. The speaker should be mounted on a fairly large baffle in order to obtain good tonal quality. Speaker cabinets and enclosures are available in all standard sizes. Many students and experimenters prefer to construct their own. All parts specified and used in the model are of high grade and were carefully selected to insure good service.

Those who wish to make their own chassis base will find the construction details in Fig. 1. This sheet-metal base may be bent to shape by clamping the metal sheet between two blocks of wood in a vise and using a wooden mallet. The standard-size chassis base supplied by parts houses is 1½ x 5 x 9½ in. These blank bases are available in either 20-ga. steel or in .005-in.-thick aluminum. The location of the parts on the chassis base is not critical but

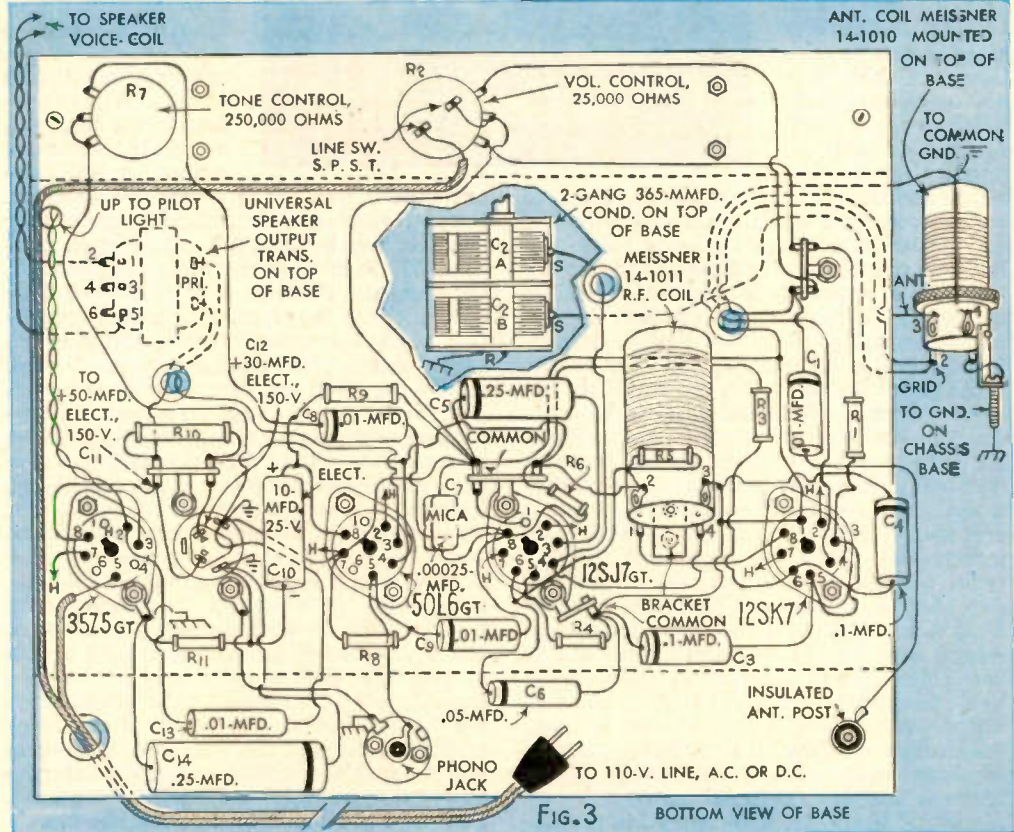
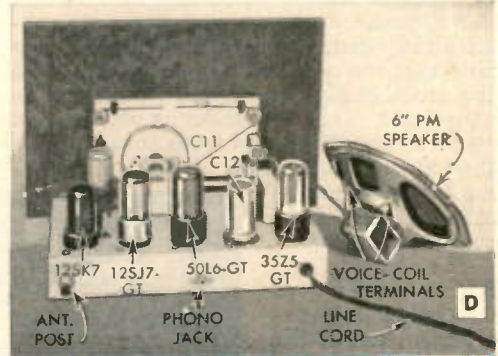
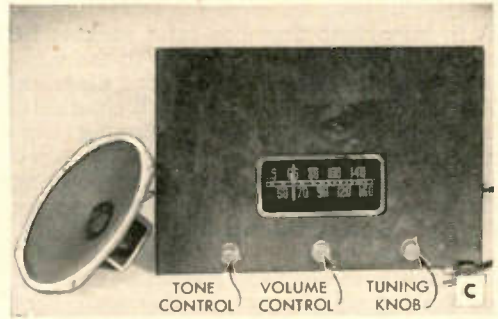

T.R.F. DUAL-PURPOSE RECEIVER

it is important that the tube sockets be mounted with the center keys in the position shown in the pictorial wiring diagram, Fig. 3. Photos A, B, C, D and E should be carefully studied before beginning construction. All parts are clearly identified in these photos and in the pictorial wiring diagram. Unmarked fixed condensers are 400 volt. Schematic circuit diagram, Fig. 2, carries the same coil-terminal key numbers and both diagrams should be checked as the wiring progresses. Use rosin-core wire solder and make certain that all soldered connections are neat and both mechanically and electrically strong. Please note that the common circuit grounds and the actual chassis grounds are clearly indicated and must be made as shown. No common circuit ground leads should touch the chassis. This entails a little extra wiring but it keeps the metal chassis from ever being "hot."

The antenna and R.F. coils are placed one below and the other on top of the chassis base and they are mounted at right angles to each other so that their corresponding fields will not cause oscillations. It will be noted that the antenna and the R.F. coil grid leads return to common ground while the variable-tuning condenser is to chassis ground; this also helps to prevent oscillations. If the Croflex tuning-dial assembly is not used, it will be necessary to mount the variable tuning condenser on the chassis so that the substituted circular dial will be centered on the front panel. In this case, the small tuning knob shown in the model will not be used. Therefore, the volume control can be shifted to its position to keep all the controls uniform on the 1/4-in. walnut-finished plywood front panel. The dial-light bracket and socket are supplied with the Croflex tuning-dial assembly; therefore, if this type of tuning dial is not used, it will be necessary to purchase a dial-light bracket with a screw-base socket and jewel and mount it on the plywood front panel at any convenient point. A good location would be at the upper left-hand corner when facing the panel. If the Croflex dial is used, the builder will find that complete assembly instructions come with it. The Meissner antenna and R.F. coils are provided with mounting brackets; when they are mount-

ed in the positions indicated, their terminal-numbering arrangement is as shown in the pictorial wiring diagram, Fig. 3. These standard coils are highly efficient, readily available, and should be used. The antenna coil is No. 14-1010 and the R.F. coil is No. 14-1011. The universal speaker-output transformer is a Stancor No. A-3856; the speaker voice-coil connections are made to secondary terminals 2 and 5 as the 50L6 tube should have a load impedance of about 2000 ohms.

If oscillations occur on the high end of the band when lining up the set after it is completely wired, it may be necessary to remove the "gimmick," which is a single-turn wire connected to the primary and wound around the secondary of the antenna coil. Merely clip it off where it is connected to the primary. When aligning

the set, adjust the trimmers on the variable-tuning condenser C2-A and C2-B on a station at the high end of the broadcast band for maximum output. Then adjust them at the low end of the band for maximum output. Again return to the high end to see if maximum output is still obtainable.

If not, reach a medium between the high and low ends. An indoor or outdoor antenna may be used depending upon location. Where there are a number of powerful broadcasting stations, a 15 or 20-ft. indoor antenna may be used. For distant reception, a good outdoor antenna will give the best results. No external ground wire should be used on this a.c.-d.c. receiver.

If the set is to be used as a tuner in connection with a large amplifier and speaker, turn the set volume control to maximum to keep hum level at the lowest possible point. Volume is then controlled at the larger amplifier in the usual manner. Also when you use this receiver as a tuner in connection with a larger amplifier and speaker, remove the set speaker and replace it with a 5-ohm, 5 or 10-watt wire-wound resistor. Use a shielded connecting lead with a phono plug and ground the shield on the plug cap. Connect this lead to the phono jack on the set and to the input of the large amplifier. Adjust the set volume control and the amplifier volume control for the desired volume and lowest possible hum level. See page 156 for detailed material list.

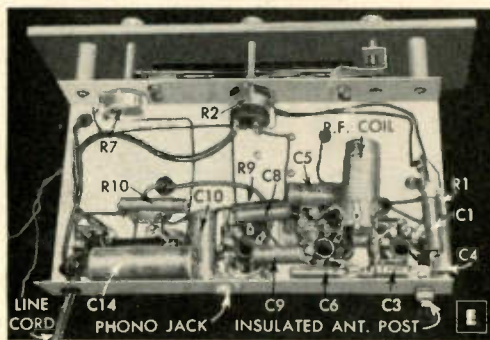

THREE-WAY PORTABLE SUPER

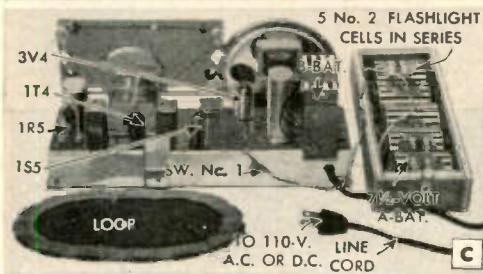
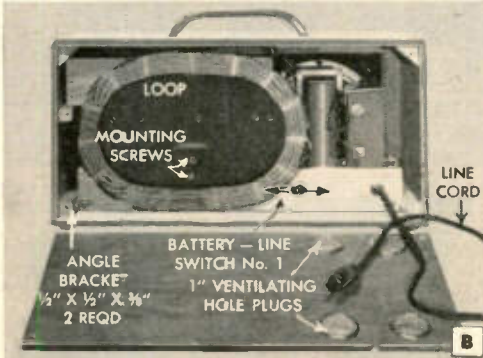

FULL 5-tube performance is obtained with this versatile 4-tube portable receiver because no rectifier tube is employed. A 100-ma. Federal selenium 5-plate rectifier converts a.c. to d.c. when operating from 110-volt lines. The switching circuit from battery to a.c.-d.c. operation is quite simple. It is done by means of a double-pole, double-throw toggle switch located on the rear of the chassis base. No special parts are used and all the components are available from radio parts houses for this compact 3-way portable vacation receiver.

Although definitely not designed for beginners, construction is not difficult if the builder uses care in placing the major component parts in the proper positions on the base so that all leads may be kept as short as possible. The miniature i.f. transformers are provided with color-coded lugs on the bottom. A red dot indicates a "B plus" connection, a blue dot the plate, a green dot the grid or diode-plate connection. A black dot identifies the ground or AVC terminal lug. The miniature tube sockets are 7-pin Amphenol No. 147-500 type. A metal shell in the center of each socket acts as a shield and may be used for a common ground tie

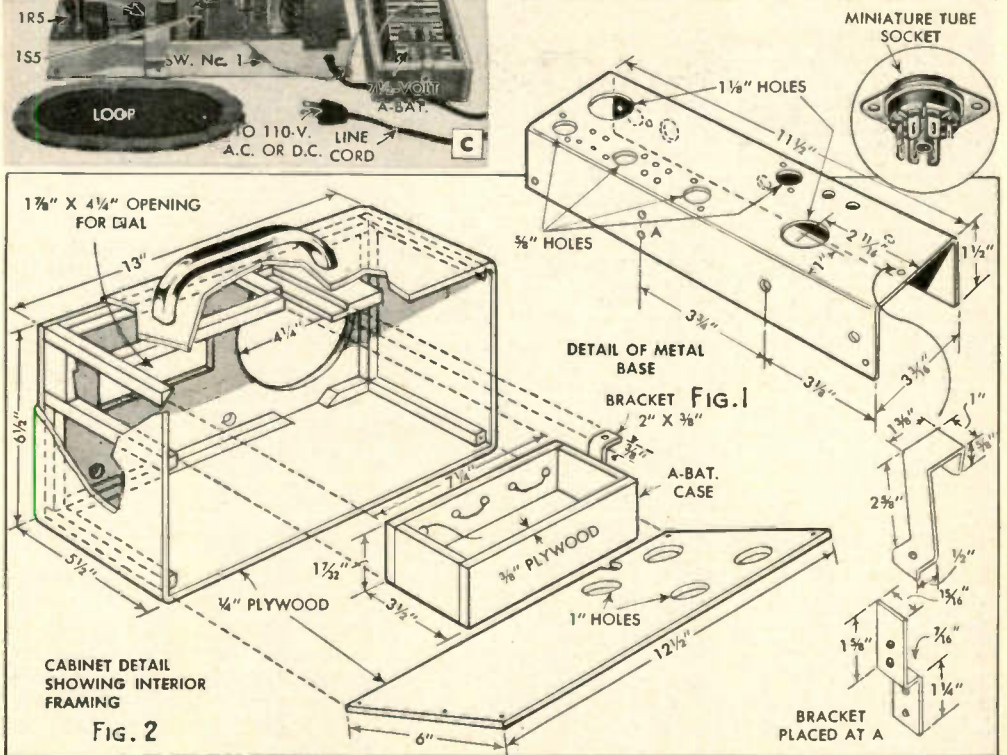

THREE-WAY PORTABLE SUPER



point. The $\frac{1}{10}$ -in. sheet-aluminum chassis base is detailed in Fig. 1. This base is quite simple and may be formed over a block of wood clamped in a vise. The brackets are cut from the same material. Photos A, B, C, D and E show various views of the completed set.

Wire the filament circuit and filament supply first, and keep all wiring short and as close to the chassis as possible. Leave the tubular paper condensers and resistors

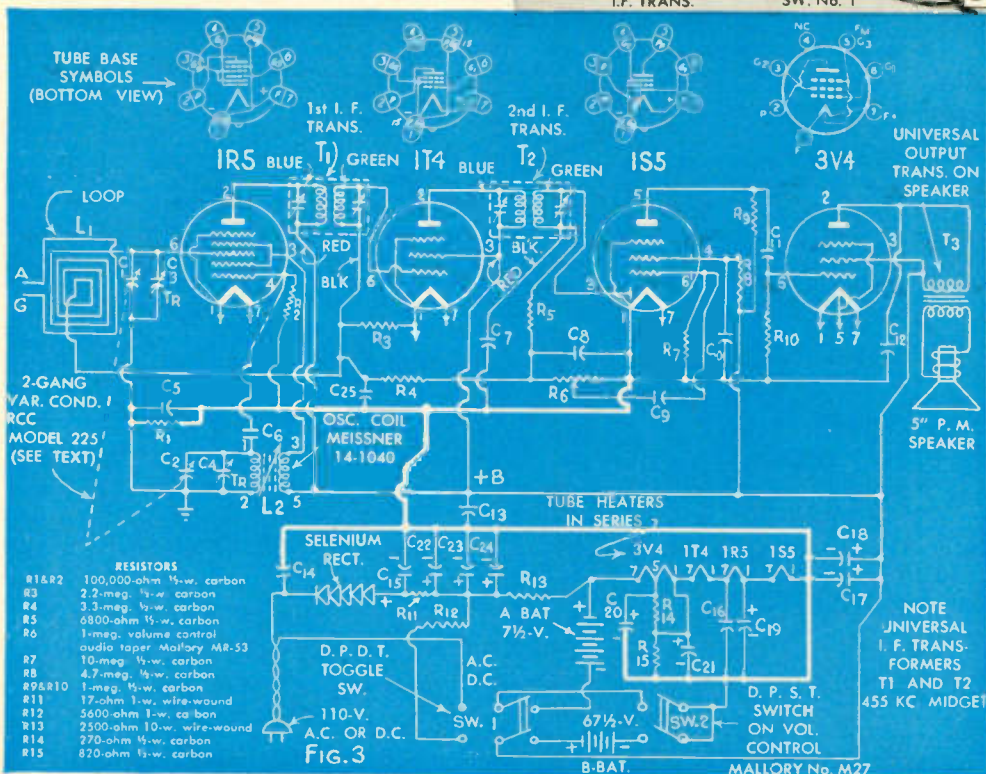
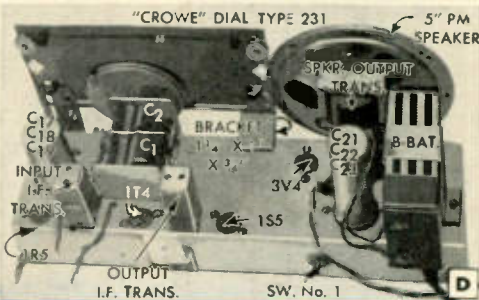

THREE-WAY PORTABLE SUPER

until all other wiring is completed. The schematic circuit diagram appears in Fig. 3. Use No. 20 or smaller hookup wire and rosin-core wire solder for the circuit. As the terminals on the tube sockets are small and may require several connections, care must be taken in soldering. Be careful that excess solder does not run down the terminals, touch another terminal or the chassis to cause a short. Always connect the outside foil of paper-type condensers to common ground when they are used as screen by-pass or AVC filter condensers; for fixed condenser values see Fig. 4. The Crowe dial comes with complete instructions for stringing the dial and cutting the panel hole in the cabinet. Complete details for the cabinet and A-battery case are given in Fig. 2. The cabinet is constructed of $\frac{1}{4}$ -in. plywood and strips of $\frac{1}{2}$ by $\frac{1}{2}$ -in. pine. All joints are glued and nailed with brads. The cabinet is given a thin coat of shellac, then stained any desired color. The final finish coat is a flat lacquer which is later polished with a heavy coating of paste floor wax. The handle is a dime-store chrome drawer pull. The A-battery case must slide easily in and out of the cabinet to prevent injury to the dial mechanism. Five $1\frac{1}{2}$ -volt No. 2 flashlight A-batteries are connected in series either by directly soldered connections, or phosphor-bronze spring clips, if preferred. To change the A-batteries, remove the two control knobs on the front and the two small angle brackets at the back of the chassis and pull the receiver partially out of the cabinet. Have the A-battery leads long enough to remove the case and be careful that they do not short on the chassis or any other wires or terminals in the set. Snap-clip leads are used on the $67\frac{1}{2}$ -volt B-battery. All tubes must be in their sockets when this set is operated on the 110-volt line. The A and B-batteries need not be in place but tape their leads to prevent shorts. To place the set in operation, throw switch No. 1 to the position for the type of power used and then turn on switch No. 2. The set will begin to play as soon as a station is tuned in. Very little adjustment of the i.f. transformers is required as they are pre-tuned at the factory. Tune the set to a station at about 600 kc. and adjust the i.f. trimmer condensers for maximum volume. Loosen the dial drum on the variable-condenser shaft and move the dial pointer so that it reads the frequency of the station tuned in. Now tighten the dial drum and tune in a station at about 1400 kc. and check the frequency of the station on the dial. If it is not correct, adjust trimmer C4 and the 19-plate

CONDENSERS (Fig. 4)

- 1—Two-gang variable condenser with cut-plate oscillator section Radio Condenser Corporation model 225, type CN825171 C1, C2 and trimmers C3, C4
- 7—.05-mfd. 400-v. paper-type condensers C5, C10, C13, C14, C15, C16 and C25
- 1—50-mmfd. mica-type condenser C6
- 2—100-mmfd. mica-type condensers C7 and C8
- 2—.01-mfd. 400-v. paper-type condensers C9 and C11
- 1—.005-mfd. 400-v. paper-type condenser C12
- 1—Mallory-type FP302 electrolytic condenser unit: 15-15 mfd. 150-v. C17 and C18; 1000-mfd. 2-v. C19
- 1—50-mfd. 25-v. electrolytic condenser C20
- 1—Mallory-type FP309 electrolytic condenser unit: 100-mfd. 25-v. C21; 50-mfd. 150-v. C22; 30-mfd. 150-v. C23. Note—both Mallory units have 3 sections
- 1—50-mfd. 150-v. electrolytic condenser C24

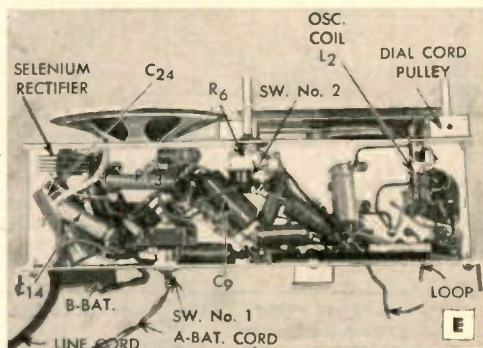

170.7 to 8.7-mmfd. oscillator section C2, until the reading is correct. The oscillator coil has a powdered iron-core slug that will now have to be adjusted with a small screwdriver to secure the proper dial readings in the middle of the dial. These last adjustments may have to be repeated several times to insure proper tracking over the entire dial. Finally adjust trimmer condenser C3 on section C1 of the 2-gang condenser for maximum volume; the capacity of the 27-plate section C1 is 431 to 11 mmfd. Terminals A and G on the loop antenna are for external antenna and ground connections if required in remote locations. Two short machine screws are used to mount the loop on the rear chassis bracket. This makes an excellent three-way superheterodyne portable receiver for the experienced builder, and it is ideal for advanced radio classes working under supervision of an instructor. If parts specified are used, and care is taken in construction and wiring, the receiver will be highly satisfactory. See page 156 for detailed material list.

TWO-TUBE "POCKETTE" PORTABLE

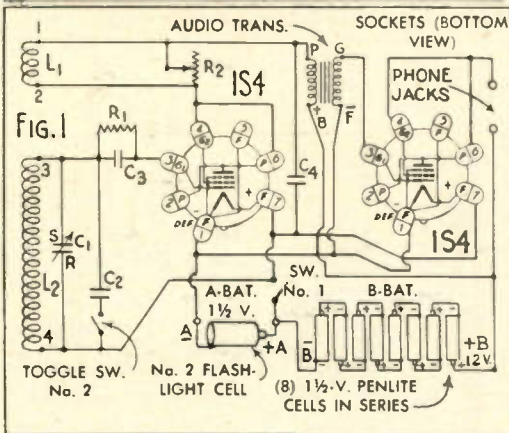
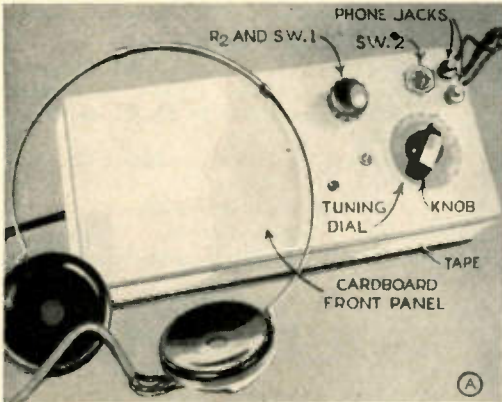

R1=2 meg. 1/2 watt resistor
 R2=0-10,000-ohm vol. control
 C1=350 mmfd. var. condenser
 C2, C3 and C4=.00025 mfd.
 mica or paper type

L1=15 turns No. 24 d.c.c.
 wire
 L2=20 turns No. 24 d.c.c.
 wire
 Note—Either No. 22, 24 or
 26 wire may be used

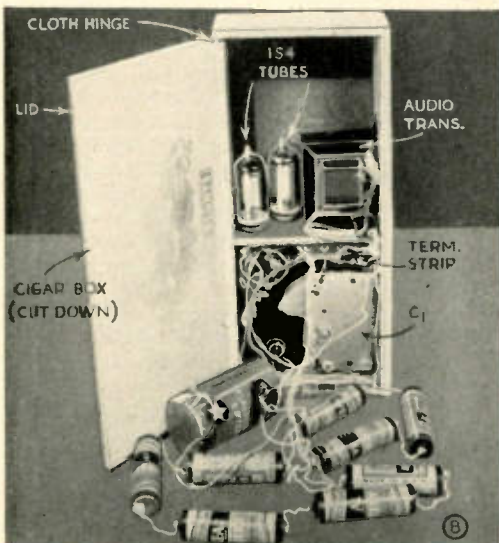

ALTHOUGH slightly larger than some of the new subminiature-tube pocket receivers, this two-tube personal-type receiver is still small enough to slip into your coat pocket, with just enough extending out the top for tuning purposes. Using a built-in loop antenna and operating without external connections this pocket set brings in local broadcasting stations with excellent volume and clarity for a small portable 2-tube receiver. It also includes a high-low switch and fixed-condenser tuning arrangement with the result that it tunes all of the broadcast band with an additional range on both ends of the dial.

Designed for the student experimenter and built from odds and ends of spare parts, it is easy to duplicate. All parts specified are to be found in any radio catalogue. The variable condenser C1 is a midget type that can be any capacity from 350 to 500 mmfd. Despite its small size this set employs a tiny chassis base or tube-mounting panel of hard-pressed wood. This helps to keep the leads short and supports the tube sockets firmly. The schematic circuit diagram, Fig. 1, and simplified wiring diagram, Fig. 2, show all construction details. The builder should check each wiring detail with both diagrams in order to avoid errors.

Two type 1S4 miniature tubes are employed in a standard regenerative circuit. It consists of a regenerative detector transformer-coupled to a single audio output stage. The outstanding feature of the "pockette" set is the coil, which consists of two windings made directly on the outside of the wooden case. This coil provides a loop antenna for reception and, like all loops, it is directional. Although No. 22 cotton-covered wire is preferred, any small wire such as No. 24 or No. 26 may be used. In this model No. 24 d.c.c. wire was used for the coil and practically all of the circuit connections. Please note that the A and B-battery leads are soldered directly to the positive and negative ends of the flashlight cells. Battery clip arrangements are not advised as they usually fail to make good mechanical and electrical contacts. Eight "penlite" cells connected in series provide 12 volts for the B supply. The A-battery consists of a single standard-size (No. 2) flashlight cell. In this compact pocket set no attempt is made to cable the battery leads; all other circuit leads should be kept as short as possible.

Photos A, B and C clearly show how the

TWO-TUBE "POCKETTE" PORTABLE

various controls and parts are arranged. The tube-mounting panel is supported on the back of the cardboard front panel by means of a small angle bracket and a short machine screw so that the bottoms of the miniature tube sockets will just clear the combination midget volume control and switch No. 1. The audio transformer should be an open-frame single-plate to single-grid midget type. This is mounted by means of a short 6-32 machine screw, the mounting lug extending through the notch cut in the end of the tube-socket panel. The case is made by cutting down a cigar box to the dimensions given in Fig. 2. The depth may be increased slightly depending upon the size of your parts. Do not change the width or length dimensions or the loop antenna coil will not function properly with the midget variable condenser specified. Both coils are close-wound in the same clockwise direction, and are spaced $\frac{1}{8}$ in. apart.

When the set is completed and working, the coils should be completely covered with adhesive tape; the entire cabinet may be covered with black oilcloth or other material if desired. In doing this be careful no moisture reaches the coils; this is important. With switch No. 2 thrown to the position that adds fixed condenser C_2 to the circuit the set tunes from approximately 530 kc. to about 900 kc. With C_2 switched out of the circuit the receiver tunes from 900 kc. to approximately 1600 kc. For distant stations an external antenna wire can be attached to stator (S) on condenser C_1 . See page 156 for detailed material list.

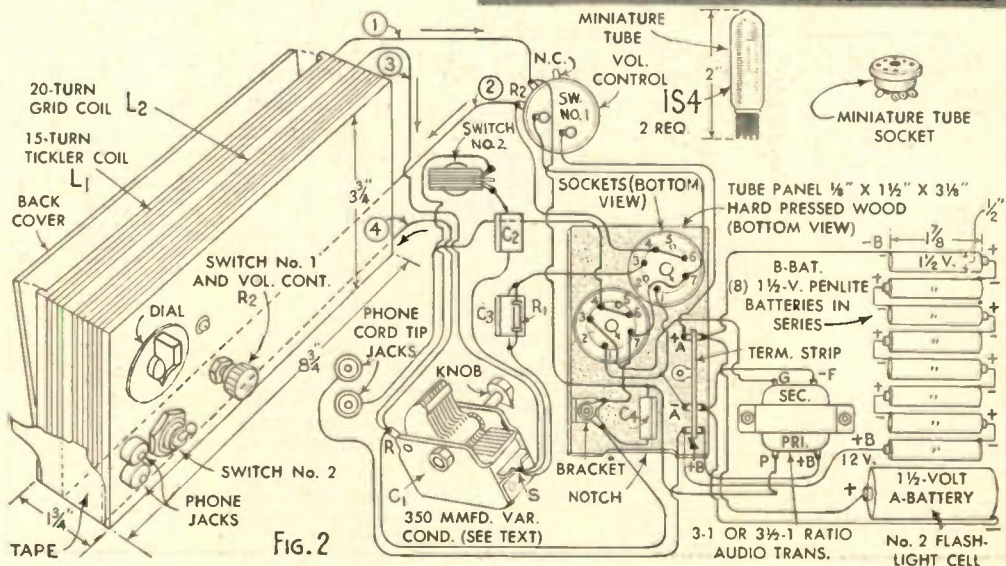
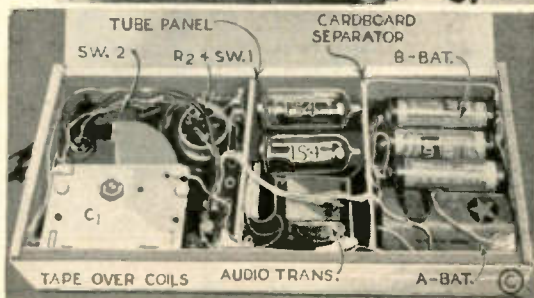

"HANDI-TALKIE" EMERGENCY RECEIVER

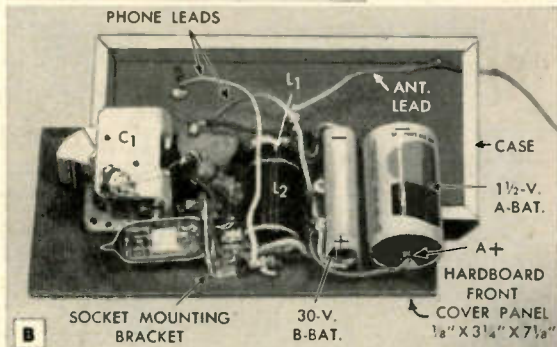
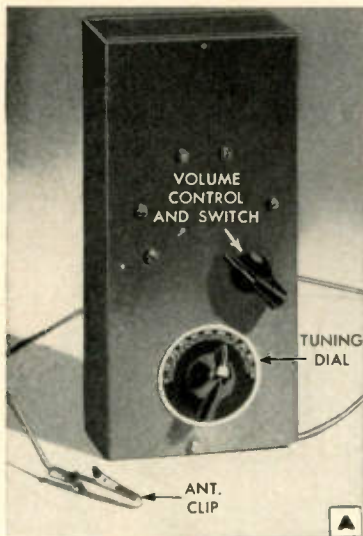

ONLY ONE miniature tube is used in this "handi-talkie" type battery-operated receiver. It is ideal for use during power-line failures, blackouts, hurricanes and similar emergencies. Small enough to slip into a coat pocket, it will bring in local broadcasting stations with only an emergency antenna. The short antenna lead shown in photo A terminates in a clip that can be clipped to the finger stop on a dial telephone, a metal lamp base, as shown in photo C, a metal window screen or any other metallic object in the home. Outdoors, any metal railing, wire fence or other large piece of metal provides an emergency antenna.

All parts are inexpensive standard materials. The case is made of 1/4-in. pine or plywood and the top and bottom covers are made of 1/8-in. hardboard. The over-all dimensions of the case are given in photo D. Most of the parts are mounted directly on the hardboard front panel as shown in photos B and E. The single earphone, which is from a 2000-ohm headset, should be a type that has outside terminals. It is mounted on the back panel by means of its terminal screws.

The coil for the set is hand-wound on a cardboard case from a "C"-size flashlight cell, as in Fig. 3. Coils L1 and L2 are both close-wound in the same clockwise direction as shown in pictorial diagram Fig. 1 and diagram Fig. 3. Two small holes are punched in the cardboard form to anchor the wire at the start and finish end of each coil. The schematic circuit diagram appears in Fig. 2; No. 18 or 20 flexible insulated hook-

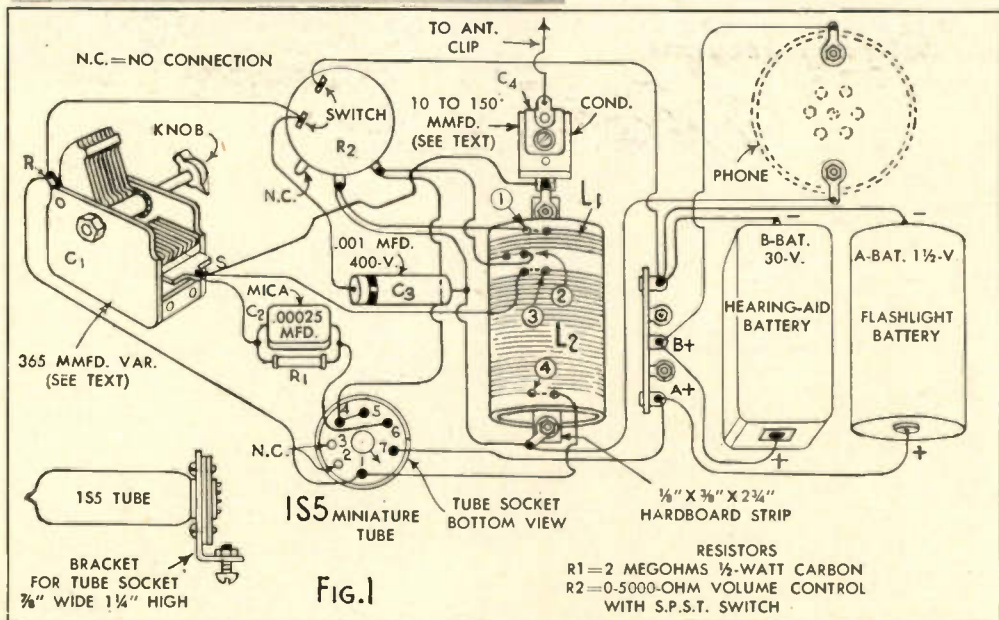

"HANDI-TALKIE" EMERGENCY RECEIVER

up wire is used for all connections except those to the coil, which are made with the coil wire ends. Be careful when wiring the terminals of the tube socket as a wrong connection here can result in a blown-out tube. The rotor plates of condenser C1 are common with the condenser frame; this is the terminal R. Power for the set is provided by one No. 2 standard-size flashlight cell and a 30-volt hearing-aid battery. Battery drain of the miniature 1S5 tube is very low.

Test the set first with a standard outdoor antenna or a long indoor wire. Assemble it in the case temporarily; open the setscrew on the small trimmer condenser C4 as far as it will go. The on-off switch is combined with the volume control. Turn this control "full on" and rotate the variable condenser until you hear a whistle indicating a station. Now back off the volume control very slowly until the whistle disappears and the station comes in clear. After the set is in working order with the standard antenna, connect it to any convenient emergency antenna such as the lamp base, or the stop on a dial phone, and adjust condenser C4 to be as far closed as possible without eliminating the oscillation whistle at the low (550 kc.) end of the band. The case cover is now closed with two small brads. This emergency set is designed for local stations; it is not intended for distant reception. Case may be stained and varnished if desired.

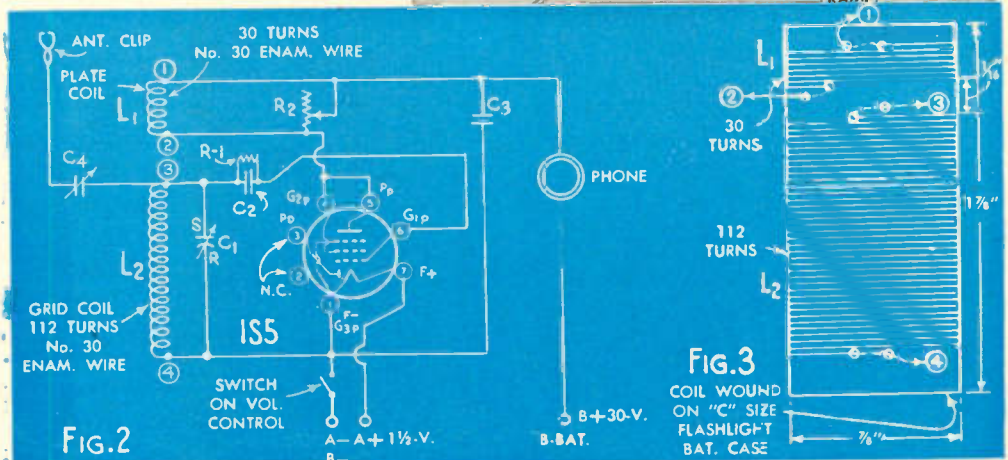
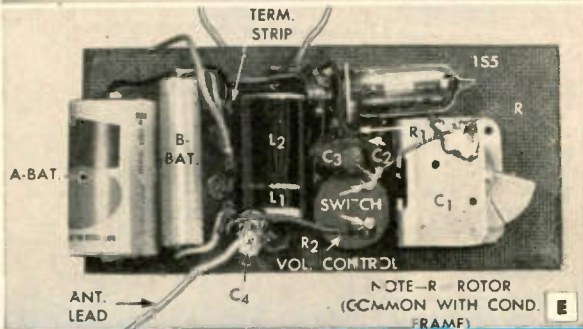
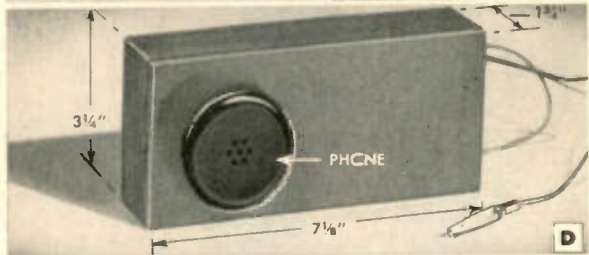

FOUR-TUBE SUPER BROADCAST TUNER

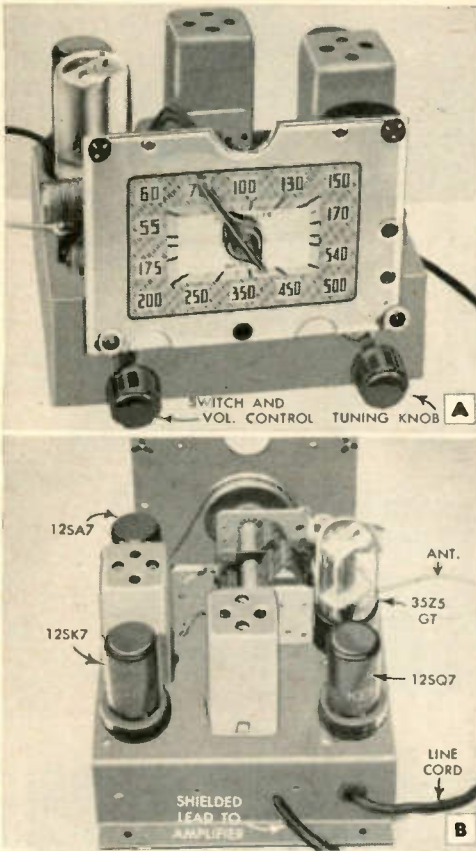

UNUSUALLY compact and highly efficient, this AM super tuner will provide the owner of any public-address system with a means for supplying "on the spot" radio music, news and public events at picnics, ball games, meetings or wherever PA systems are used. It also makes an ideal addition to sound installations of the type used in industrial plants for playing recordings for employees. It may be employed as a remote tuner for any radio receiver that is equipped with phono input jacks or with any audio amplifier. The antenna coil is a Carron No. S407 or any small universal type; the intermediate-frequency (i.f.) transformers and oscillator coil are all Meissner types. Note in photo C that the antenna coil is mounted horizontally above the base by soldering its ground terminal, No. 4, directly to the front of the

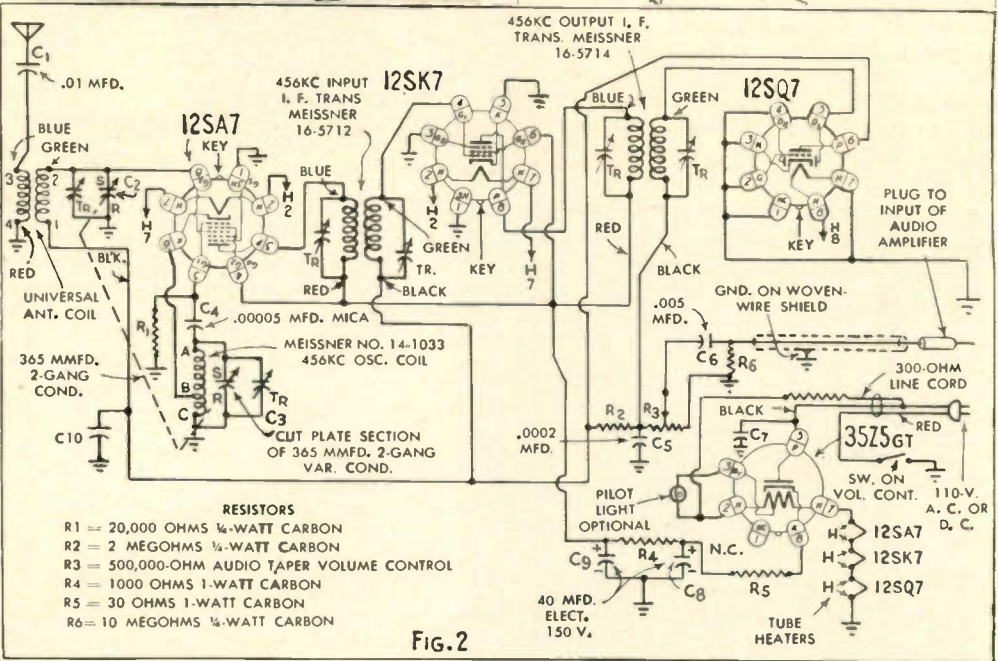
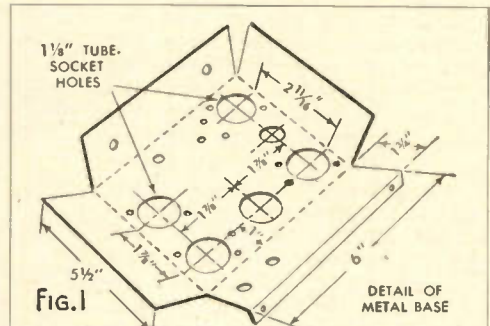

FOUR-TUBE SUPER BROADCAST TUNER

variable condenser frame. This connection is indicated with a wire lead in Fig. 3.

To balance the tuner unit, connect the antenna and audio amplifier; tune in a station at about 670 kc. The i.f. transformers are factory peaked and require very little adjusting—just a slight trimmer adjustment to bring in the station at maximum volume. While still tuned to this station, adjust the trimmer on C3, the oscillator cut-plate section, to bring in the station at the proper dial reading. Now tune in a station at about 1400 kc. and adjust trimmer C2 on the antenna-tuning condenser section until station comes in at maximum volume.

This is one of the simplest and most useful general-purpose superheterodyne broadcast-band tuners used in *Popular Mechanics* radio and electronics laboratory. See page 157 for detailed material list.

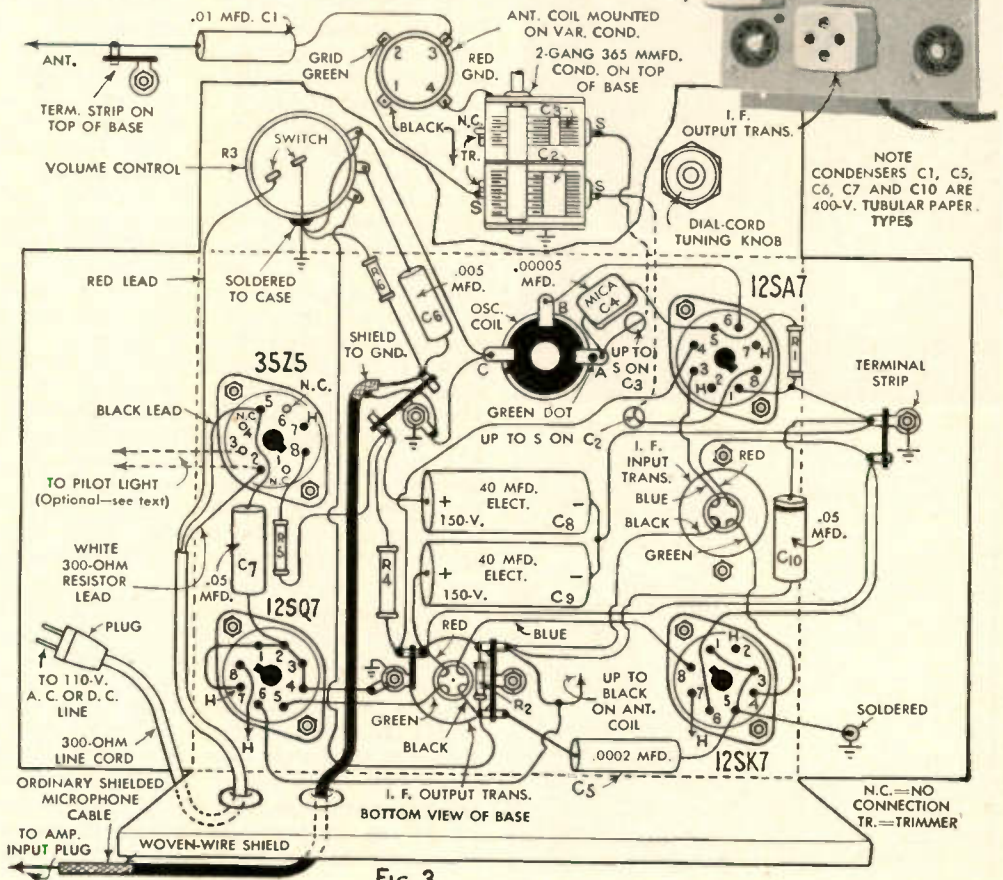

HIGH-FIDELITY FM TUNER UNIT

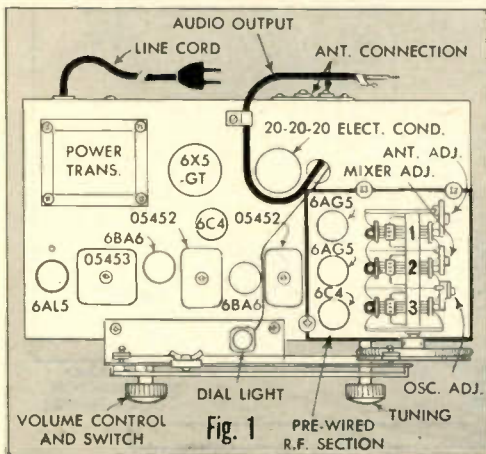
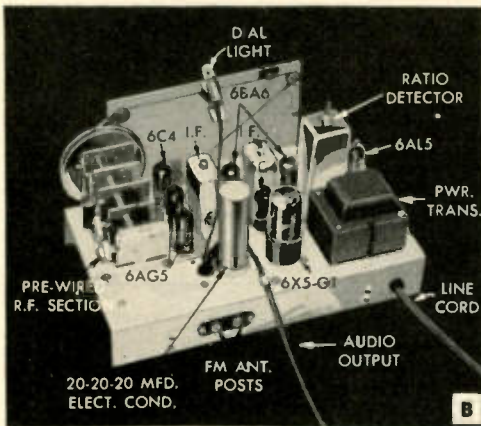

HERE IS an excellent FM tuner of advanced design that can be used with any good audio amplifier. It is easy to build as the r.f. front end is assembled and the i.f. coils are prealigned. This r.f. section comes in a compact prewired unit that mounts on the chassis base which is available cut, drilled and ready for mounting all parts just as shown in the photos.

The parts are available in complete kit form from radio-parts houses and are standard in every respect. Although not intended for beginners, the construction is not difficult for experienced builders, and the results when used with a good audio amplifier are highly satisfactory even to critical music lovers. Photo A shows the completed tuner connected to an audio amplifier and a good loudspeaker in an adequate enclosure. Photo B is a rear view of the chassis showing the binding post strip for an FM dipole antenna, and the audio output cable which is fastened to the chassis base by means of a clamp. A front view of the completed FM tuner appears in photo C. It may be housed in a standard stock cabinet or installed in a custom-made or home-built console combination. The chassis layout is shown in Fig. 1 and the dial-string detail in Fig. 2. A complete schematic circuit diagram appears in Fig. 3. All coils are of the reliable Meissner type, and every part is carefully selected to insure maximum results. Very little leeway in specifications can be tolerated in high-frequency FM circuits and the parts specifications given in Fig. 3 are those that are supplied in the complete kit shown in photo D. Those who do not wish to purchase the complete Meissner T-8CK kit shown in photo D can buy foundation parts which consist of the essential Meissner units. These are as follows: FM tuning assembly (catalogue number 13-7628) with dial parts and hardware; main chassis base (No. 05965-A); power transformer (No. 29501); FM-i.f. transformers (No. 05452), and the ratio detector coil (No. 05453). The i.f. coils and the ratio detector, when supplied separately, are not prealigned.

A bottom view of the completed FM tuner unit is shown in photo E. Before the operation of an FM receiver is described, it is well to review briefly the theory of FM transmission. Unlike amplitude-modulated (AM) transmission in which the r.f. wave varies in amplitude to correspond with the impressed audio signal, frequency-modulated transmission does not affect the amplitude of the wave. It permits the wave amplitude to remain constant but varies

HIGH-FIDELITY FM TUNER UNIT

wave frequency in accordance with the modulated signal, as illustrated in Fig. 4. If the carrier frequency of an FM broadcast station is, for example, 88 megacycles, its frequency under modulation may shift as high as 88,075 kc. and as low as 87,925 kc., a swing above and below 88 megacycles (88,000 kc.) of 150 kc. From this it can be seen that a single FM broadcasting station may cover a band width in the radio-frequency spectrum of as much as 150 kc. This is why FM broadcasting stations are located in the ultra-high-frequency bands where there is a great deal more room for wide-range high-fidelity transmission than in the regular broadcast band.

Designed by well-known radio engineers especially for students and experimenters, this FM tuner circuit employs a double converter system which greatly reduces image response. The detector circuit, built around the 6AL5 tube, is called a "ratio detector." It develops an audio voltage that is proportional to the ratio of the swing in frequency above and below the average frequency, during frequency-modulation (FM). It responds only to FM signals, not to amplitude-modulated (AM) signals and, since static and other electric disturbances

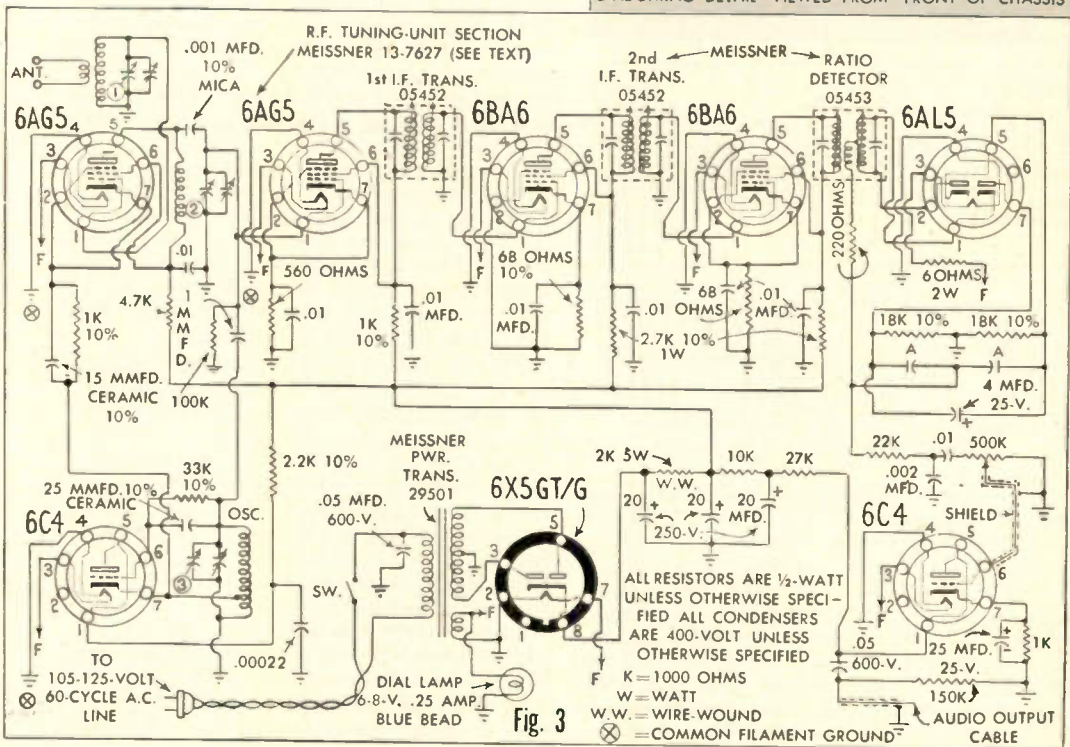
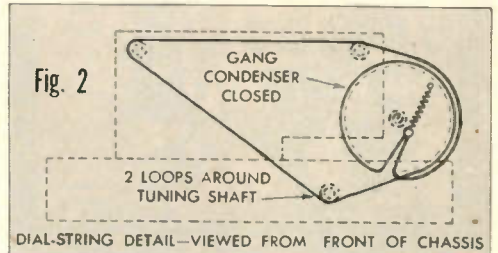
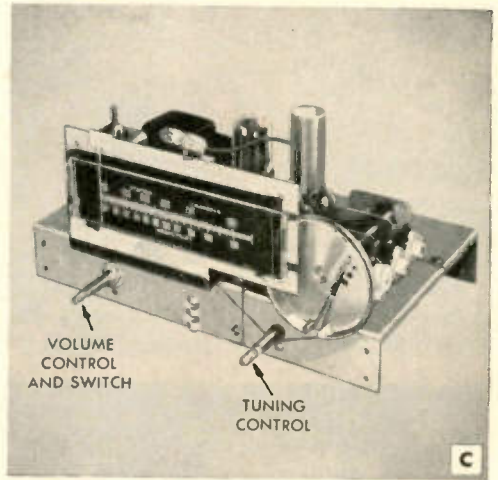

HIGH-FIDELITY FM TUNER UNIT

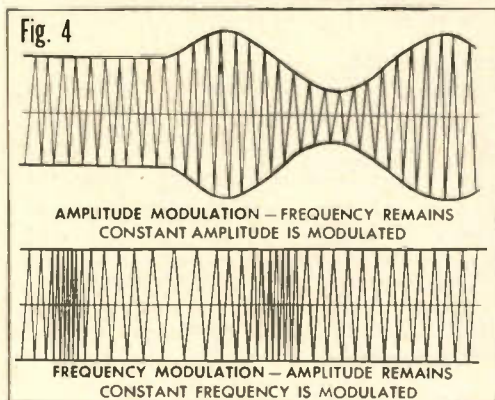
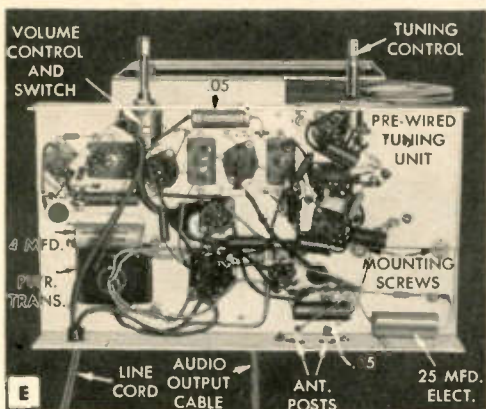
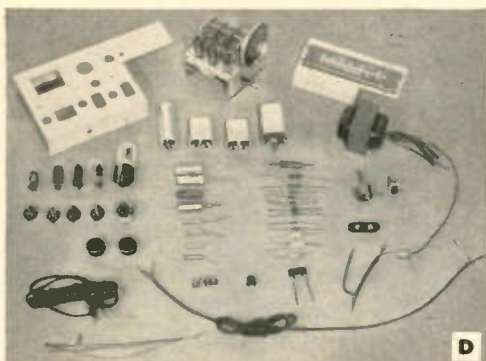

are principally amplitude modulated, they are not reproduced, thus the performance of the FM receiver is noise-free.

The input or antenna coil tunes the entire FM band from 88 to 108 megacycles. The oscillator involving the 6C4 tube, shown at lower left in the circuit diagram, beats with the incoming signal to produce a lower frequency signal. The oscillator voltage is fed into the main receiver circuit at two points, in series with the cathode of

the first 6AG5, and in shunt with the input grid of the second 6AG5 tube. After the second 6AG5, the signal is at 10.7-megacycle frequency and is amplified by the two following 6BA6 i.f. tubes.

Just above and to the left of the 6C4 audio-amplifier tube, shown at lower right in the circuit diagram, is a 22,000-ohm resistor and a .002-mfd. condenser. This is the de-emphasis circuit of the FM receiver. FM signals are transmitted by the station with the higher frequencies accentuated. At the receiver these higher frequencies must be attenuated to provide a perfectly flat response. Any noise in the circuit is also reduced at this point.

A full-wave rectifier is employed in the a.c. power supply, and the filter circuit is a resistor-condenser type. The output of the 6C4 amplifier tube is approximately 7 watts maximum. This is just right for use with any phono amplifier, power amplifier or good radio set having phono input terminals. Because of the high frequencies involved in FM reception, it is desirable to use a standard outdoor FM antenna, which should be mounted as high as possible. Those who wish to make an indoor FM dipole antenna that will give good results in strong FM signal areas can do so by using a short length of 300-ohm Amphenol twin lead. This is the same transmission-line material that is used for both FM and TV antenna lead-ins. Cut off a 57-in. length of the twin lead and bare the wires at each end just enough to twist them together and then solder these ends. Then lay the twin lead out flat and cut the lower wire in the exact center; bare the ends of this wire about $\frac{1}{2}$ -in. and tin them for soldering to the twin-lead transmission line to the receiver. This transmission line can be any length up to about 100 ft. You can fasten the antenna to any table or baseboard with the dipole broadside to the station.

This is often a good solution for the antenna problem when a roof installation is not practical; the twin-lead dipole can be tied with string to a horizontal collar beam in the attic. A twin-lead dipole of this description makes a good emergency FM antenna in an apartment house where roof antenna systems are not permitted. Merely fasten it to the picture molding with thumbtacks on the wall of the room that is broadside to the FM station. In some cases on upper floor apartments it can even be placed under a rug if there are powerful FM stations broadcasting in the vicinity. The length of the dipole is cut to 56 $\frac{1}{2}$ in. as this is about the center of the FM band.

HOW TO BUILD A LOW-COST INTER-ROOM PHONE SYSTEM

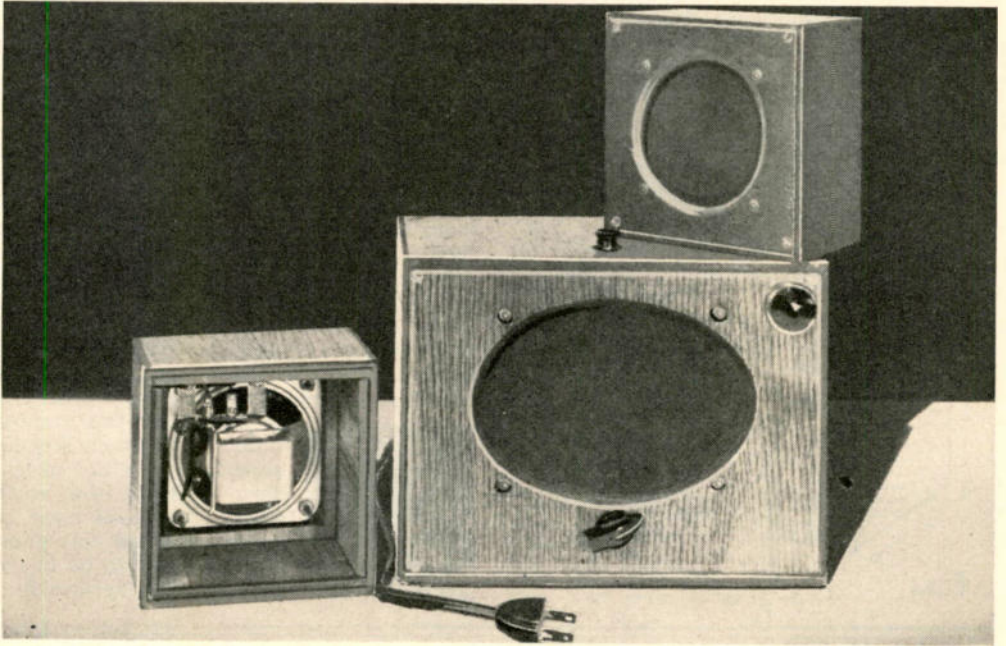

GENERAL-PURPOSE INTER-ROOM COMMUNICATION SYSTEM

LOW-COST PHONE SYSTEM

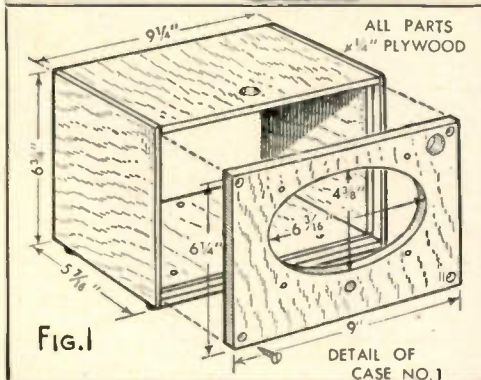
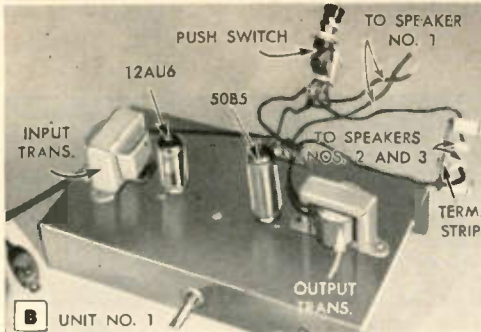
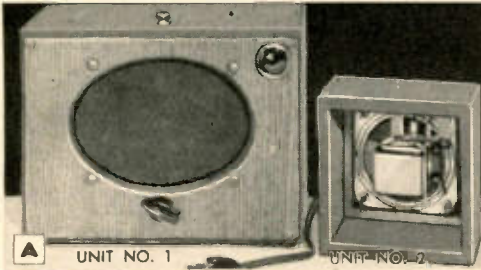

ONLY TWO miniature tubes are employed in this simple and inexpensive intercommunication system that provides two-way phone service between master station and other rooms, garage or workshop. It may also be used as an electronic nurse by locating one of the remote speaker units in the nursery and the master station in the living room. The baby's cry or other sounds will be picked up, amplified and reproduced at the master station.

The system consists essentially of a high-gain amplifier and two speakers that are connected with the master-station unit. The circuit is so arranged that one speaker is used as a microphone. A switching circuit switches the order of use. When the push button on the master station is in the "listen" or up position, the speaker at each remote station is connected to the input of the amplifier, and the speaker of the master station to the output. Thus a person can talk into the speaker at the remote point, and he will be heard in the speaker at the master unit. When the switch is pressed, as indicated in photo D, to the "talk" or down position, the speaker at the master unit, No. 1, connects to the input of the amplifier, and the speaker at the substation to the output. The person operating the master station then talks and

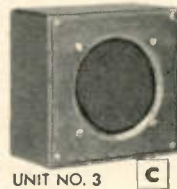

is heard at the remote point. The system is quite sensitive; it is not necessary to raise the voice above the level used in ordinary room conversation in order to be heard clearly. The system fea-

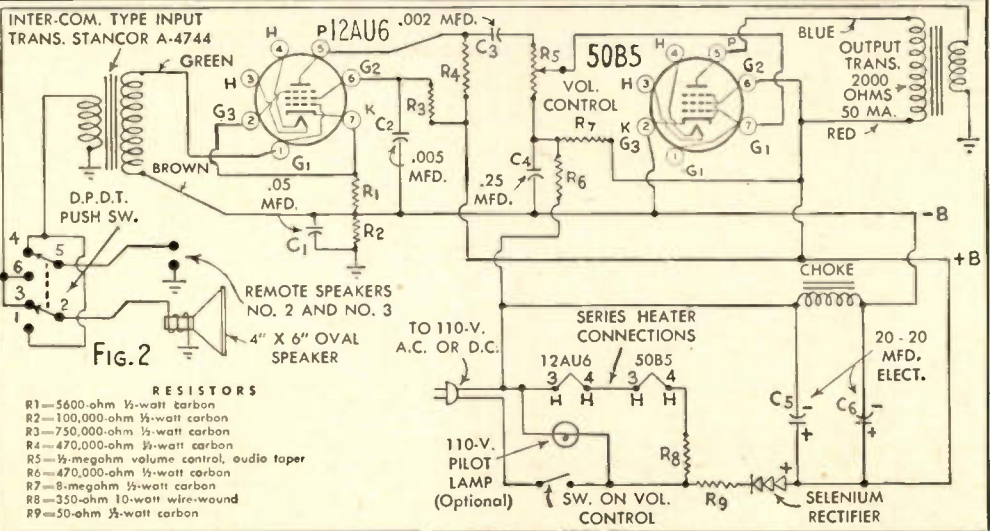

ALSO SERVES AS AN ELECTRONIC NURSE

tures a long-life selenium rectifier, a 12-AU6 tube as a voltage amplifier and a 50B5 beam-power amplifier with its high-power sensitivity. The unusual circuit with the choke in the negative-B side of the filter is to supply the steady fixed bias to the 50B5 tube and is used with the 8-meg. resistor from positive-B to furnish the proper bias voltage. This is a distinct advantage over the customary cathode-bias arrangement where the signal causes changes of the bias.

Construction should start with the chassis base of unit No. 1. Mount the tube sockets in the positions shown in the pictorial wiring diagram, Fig. 3; then mount the input and output transformers, the filter choke and selenium rectifier, and finally, all tie-point strips and soldering lugs. Wire one circuit at a time. For example, using rosin-core wire solder, wire all tube heater connections which are connected in

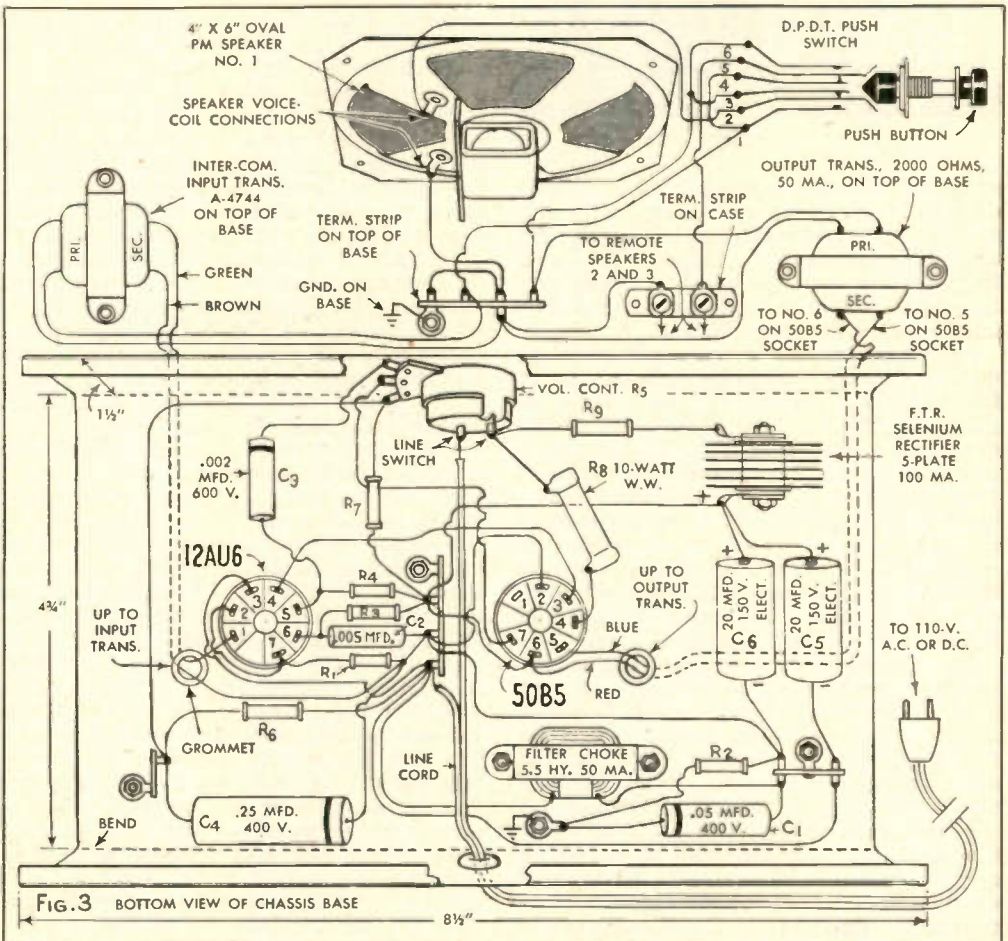

LOW-COST ELECTRONIC PHONE SYSTEM

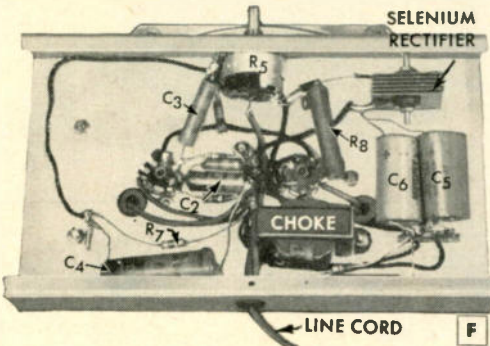
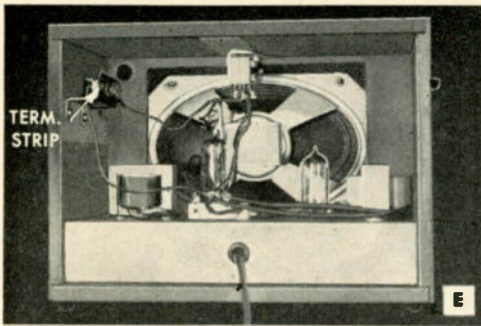

series as indicated in the schematic circuit diagram, Fig. 2, before going on to the next. It is a good idea to check off each part of the diagram as it is completed. An extra few minutes spent in careful wiring and thorough checking always save time and later possible trouble shooting.

After the chassis wiring is completed, wire the push switch in its normal position following the numbered terminals as shown in Fig. 3; these correspond to the numbers indicated in Fig. 2. The push switch is mounted in the top of the cabinet detailed in Fig. 1. The remote-station cabinets are detailed in Fig. 4, and the speakers are mounted as shown by means of rosette-head screws. The speaker opening in each case is backed with brown-flocked, metal grille screen. Photos A, B, C, D and E show views of the completed units.

To test the system, connect one of the remote-station units to the terminal strip mounted inside the master-station cabinet at the point indicated in photo E. The two-conductor line can be any insulated wire not smaller than No. 18 and lengths up to 500 ft. may be used. Plug in the master set, turn it on and let it warm up a few minutes. Have someone call on a remote station; push the switch and call back. If excessive hum is heard, reverse the position of the line plug in the wall socket. If

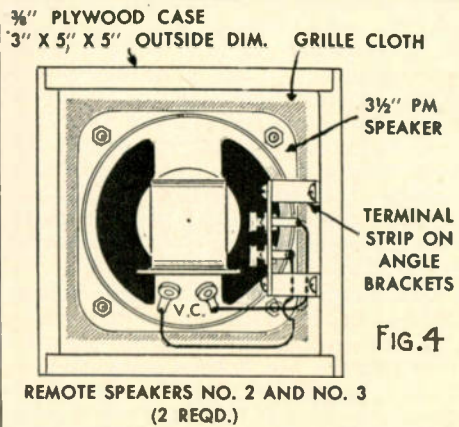

howling is encountered, it is due to acoustic feedback resulting from the proximity of the two stations. Try lowering the volume, or separate the two stations as far as possible. Remote-station unit, No. 3, may be connected in parallel at the terminal strip in the master station.

The plywood cabinets shown were homemade and very easy to build as detailed in Figs. 1 and 4. Any similar wood or metal cases may be used. Circular holes for speakers Nos. 2 and 3 are not difficult to cut, but the oval opening for the speaker in the master unit does present a problem. This is easily solved by using the speaker rim as a template for a cardboard pattern. The cutout can then be made with a bandsaw or keyhole saw. Sand all edges and assemble the cases with glue and small nails or brads. Fill in all cracks with plastic wood and sand and finish with a mahogany or walnut stain.

Both remote-station units should be provided with protective back covers; these can be made from 1/8-in. hardboard or 1/4-in. plywood. The master station should have a back cover in which a number of holes should be drilled to provide necessary ventilation. During continuous operation of this unit the tubes and rectifier will, of course, generate some heat like a small a.c.-d.c. receiver; therefore some ventilation is required. It is a good idea to drill several holes in the bottom of the cabinet directly below the selenium rectifier unit, also one in each end of the cabinet about 1 in. from the bottom for cross ventilation. Mount the cabinet and remote-speaker cases on small rubber feet. It is not practical to try to use more than two remote station units, however this number will meet all ordinary needs. See page 157 for detailed material list.

PHOTOTUBE RELAY AND OTHER ELECTRONIC DEVICES

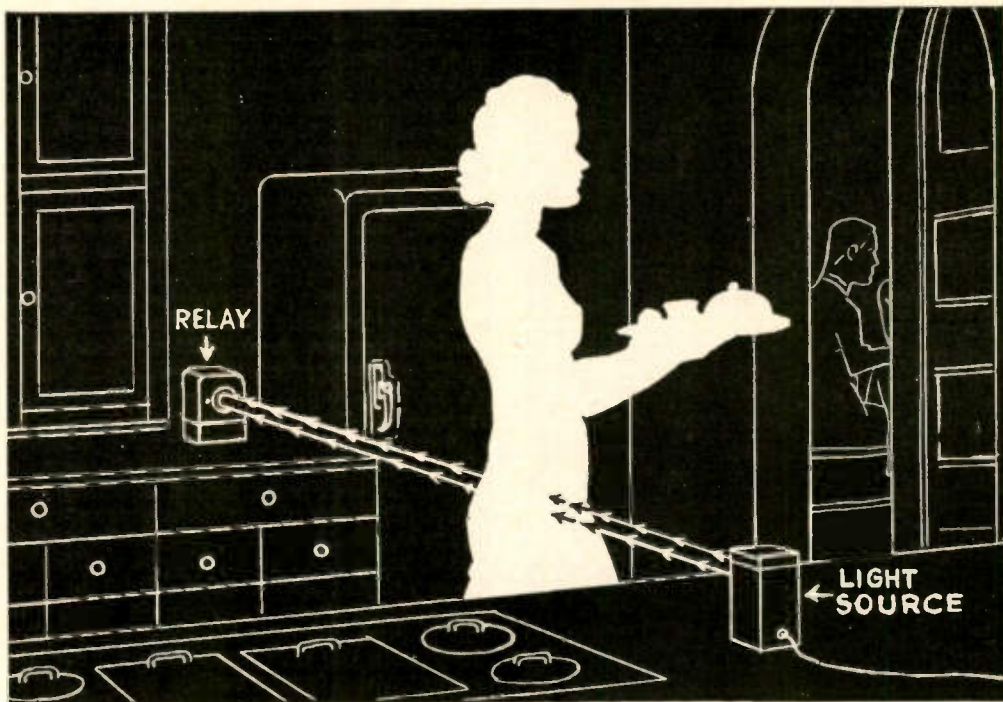

PHOTOTUBE RELAYS SERVE MANY USEFUL PURPOSES

HOW TO BUILD A MULTI-

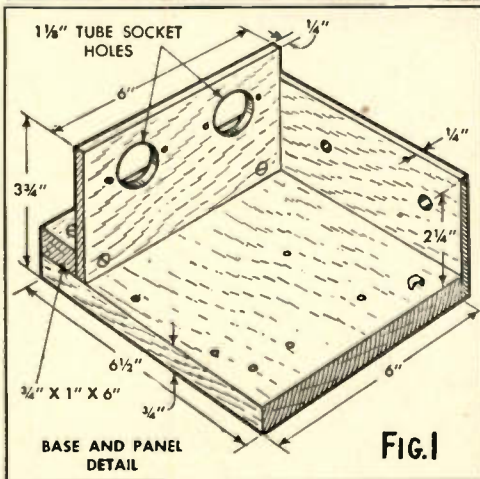
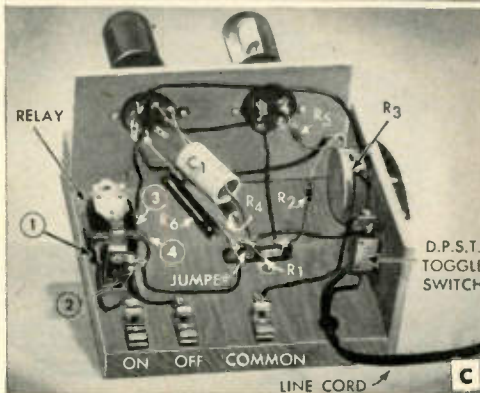
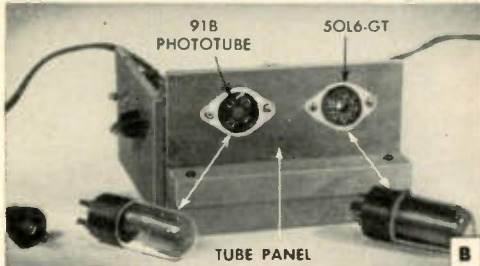
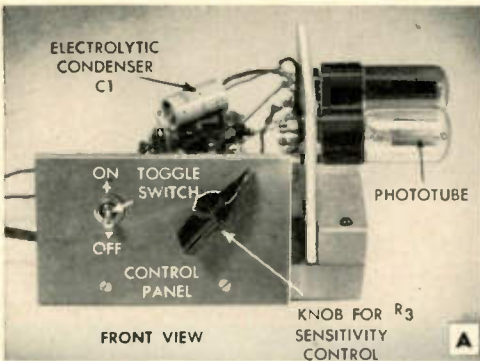

THIS modern phototube circuit will permit you to turn your lights or other electrical appliances on or off by either shining a light beam onto the phototube, or breaking a light beam that is shining on the tube. It has many applications, such as counting items going down a conveyor belt, announcing the entrance of a customer passing through a doorway, etc. By adding an infrared filter, available from any photographic supply house, to the light source, it can be converted into an efficient "black light" burglar-alarm system. The unit may also be made into an intermittent, electronic light flasher.

A sensitive s.p.d.t. relay is employed in the plate circuit of a 50L6-GT tube. The type-918 RCA phototube anode and cathode are connected in the grid circuit of the 50L6-GT tube in such a way that it causes the grid voltage to vary with light that falls on the phototube. Decrease of negative bias on the 50L6-GT causes a flow of plate current in that tube. Plate current in the 50L6-GT tube flows through the relay and closes the armature. The contacts on the armature supply 115 volts a.c. to a light or other appliance, or disconnect the a.c. from it, depending upon the terminal connections that you make on the unit.

Photos A, B, C and E show various views of the completed relay, while the simple base and panel construction is detailed in Fig. 1. The use of a double-pole, single-throw toggle switch disconnects the entire circuit from the house line, regardless of the polarity of the line plug. While the unit is operating precaution should be taken not to touch any of the unit wires or clips. Disconnect the unit from the wall socket, or throw the toggle switch to off before making connections to the clips. The sensitivity control is a 4-watt wire-wound potentiometer. The phototube, or photo-cell, always faces the direction of the light source, photo A. Schematic circuit diagram is given in Fig. 3; Fig. 2 shows pictorial bottom views of the tube sockets. Use rosin-core solder for all connections, and be sure to observe the polarity of the electrolytic condenser C1.

After completing the wiring, experiment with proper sensitivity control by playing a flashlight beam across the phototube. The click of the relay will indicate proper action as it closes and opens. Adjustment of the sensitivity control is determined by experience, and it will vary depending upon how feeble the light is, or how far away it is. A slight adjustment of the relay spring may be necessary. A good source of light can be made with an

ELECTRONIC PHOTO-PRINT TIMER

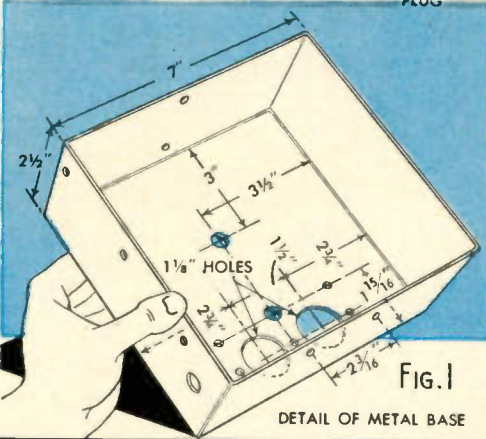
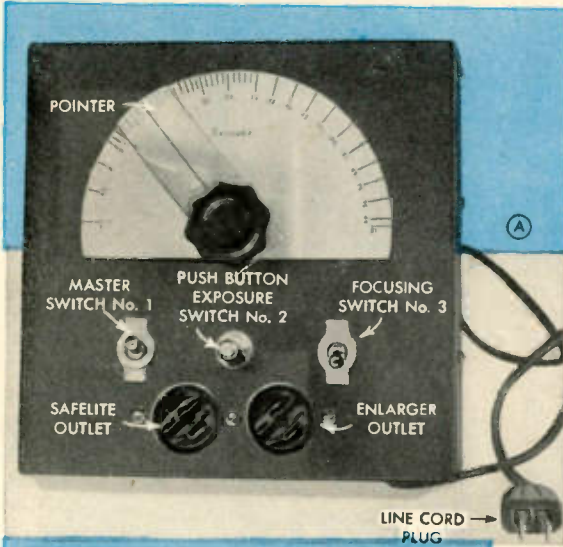

FIG. 1

DETAIL OF METAL BASE

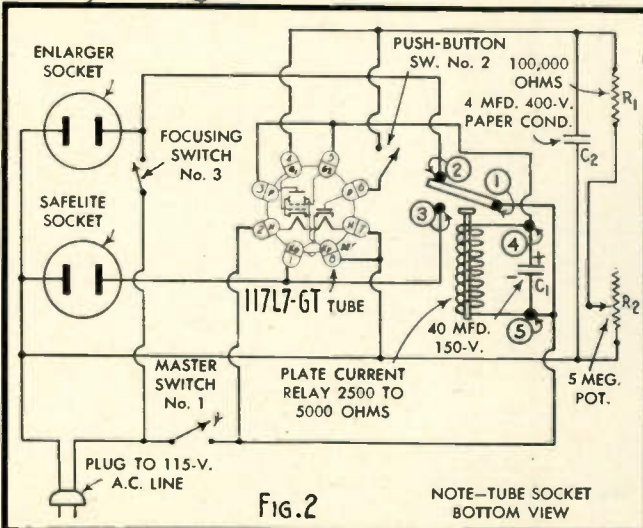
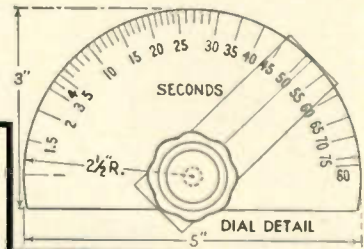
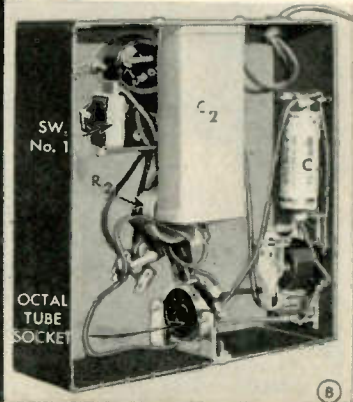

FIG. 2

NOTE—TUBE SOCKET
BOTTOM VIEW



DIAL DETAIL



B

ACCURATELY controlled timing enables the busy photographer to make uniform prints. This is especially important when making a large number of duplicate prints, such as personalized Christmas cards and similar printing of favorite snapshots. This electronic timer is easily calibrated by means of any self-starting electric clock, with a sweep second hand, plugged into the "enlarger" socket. The time range is from 1 to 80 seconds and the unit will control any electrical appliance or lamp that does not draw more than 250 watts. The relay winding is in the plate circuit of the triode-connected portion of the 117L7-GT tube which, when heated, draws plate current and closes the relay. The "safelite" is on all the time except during the exposure-timing period.

The sheet-metal base is detailed in Fig. 1 and the schematic circuit diagram is given in Fig. 2; a simplified pictorial wiring diagram appears in Fig. 3. Switches 1 and 3 are ordinary s.p.s.t. toggle types. Photos A, B and C show various views of the completed unit.

In operation, during the warm-up period with master switch No. 1 on, the enlarger or printer lamp will light, but as soon as the initial warm-up period is complete it

ELECTRONIC PHOTO-PRINT TIMER

will automatically go out unless focusing switch No. 3 is thrown on for focusing purposes. Keep switch No. 1 on while focusing. Select the time desired by varying control R_2 (dial knob), then press push-button exposure switch No. 2. Switch No. 2 is a s.p.s.t. normally open, push-to-close momentary type. When it is pressed, condenser C_2 charges; this places a high negative bias on the control grid of the tube, reducing its plate current immediately to the point where the relay drops out. C_2 must be an oil-filled paper type. The time required for the plate current to build up again to the point where the relay is actuated is the timing period of printing. It is important that C_2 be a high-grade low-loss 400 or 600-volt oil-filled paper type, in order to obtain stable operation.

To calibrate your timer, secure the white paper dial on the chassis under pointer R_2 . The pointer is made from a strip of clear plastic $\frac{1}{16}$ by 1 by 3 in. Mark the seconds on the dial as indicated by the sweep second hand of the clock; where the various seconds come in on your enlarged dial scale will be approximately at the points shown. The unit should be warmed up for 20 to 30 minutes before calibration, and before using. See page 157 for detailed material list.

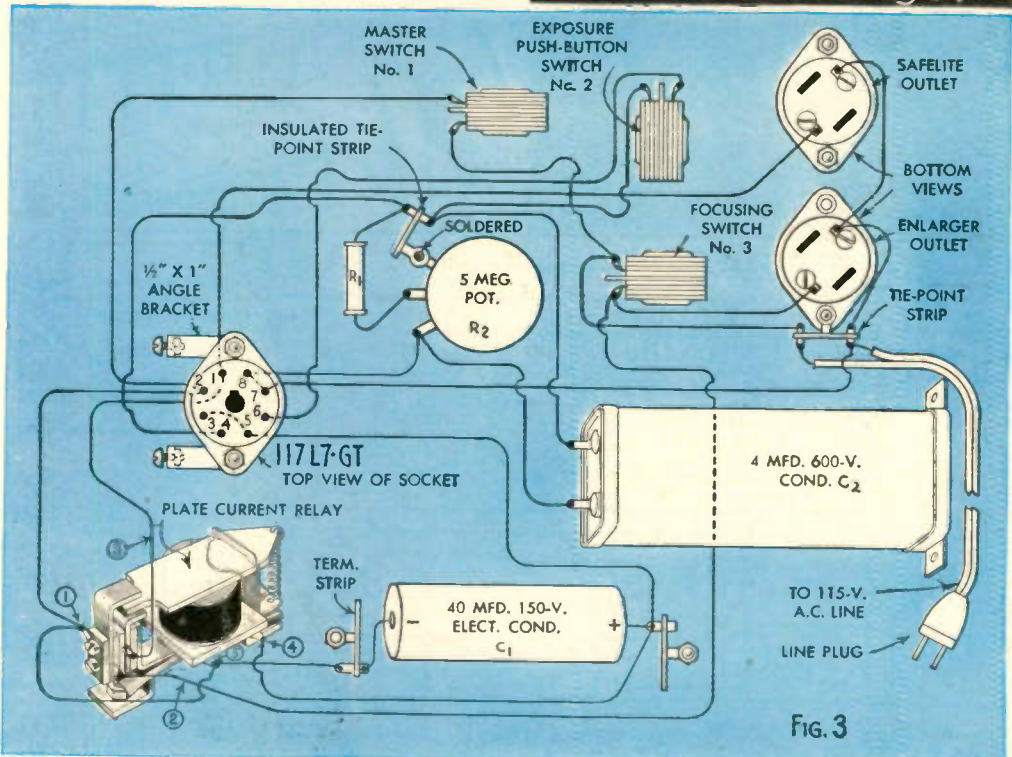
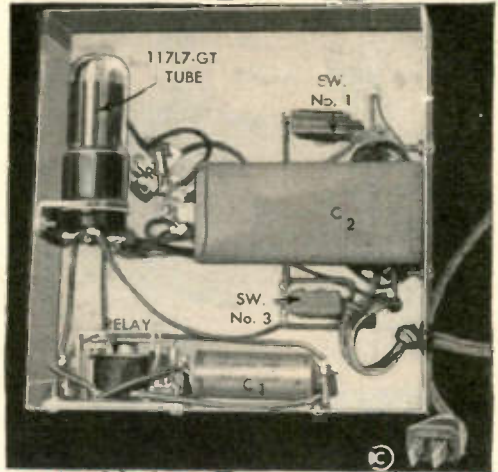
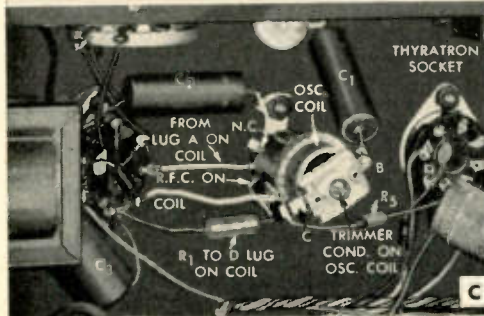
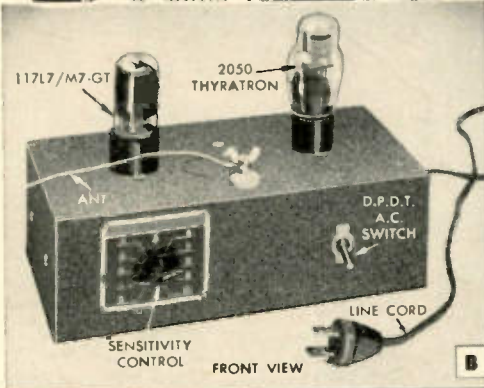

FIG. 3

HOW TO BUILD A SENSITIVE



THIS HIGHLY sensitive capacity-operated electronic relay has many useful applications around the home and in industry. It is easy to construct with ordinary radio and electronic parts that are available from all parts houses. The approach of a person to an antenna wire attached to this unit operates a 110-volt a.c. relay that may be used to turn on a light or start model trains or electrically operated appliances in sketch A. Passing persons merely place their hand near a 5 or 6-in. metal disk to which the antenna wire is fastened on the inside of the window. As a burglar alarm, it is ideal for turning on floodlights, or ringing a bell, for the protection of persons or property as illustrated in sketches D and E. The antenna or "alarm wire" can be concealed around a window frame or door, or attached to a sheet-metal plate under a walk.

The instrument can be plugged into any convenient 110-120-volt a.c. outlet in the

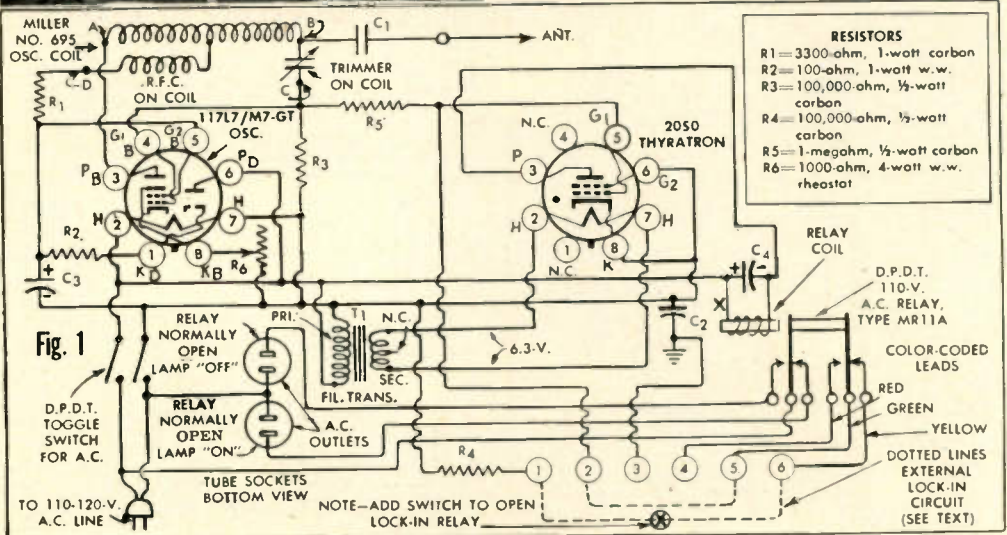

CAPACITY-OPERATED SWITCH

store, home or garage. The remote floodlight, alarm bell or other appliance to be operated is then merely plugged into one of the relay outlets mounted on the rear of the unit. Based on simple electronic principles, this capacity-operated switch shown in Fig. 1 consists of a free-running oscillator connected to an antenna wire. When a person or object comes close to this antenna wire, the additional loading to the oscillator circuit causes a drop in voltage across the grid-peak resistor. This voltage change is transferred to the 2050 Thyatron tube, which operates the relay closing the contacts that supply line current to the devices to be operated. The oscillator tube is the tetrode section of the dual-purpose 117L7/M7GT tube, the diode section being used to rectify the a.c. and convert it into d.c. for more sensitive operation of the oscillator circuit. Antenna wire lengths of about 10 ft. will operate nicely with this unit but the longer the wire the more the wire itself loads the oscillator, and the less relative effect

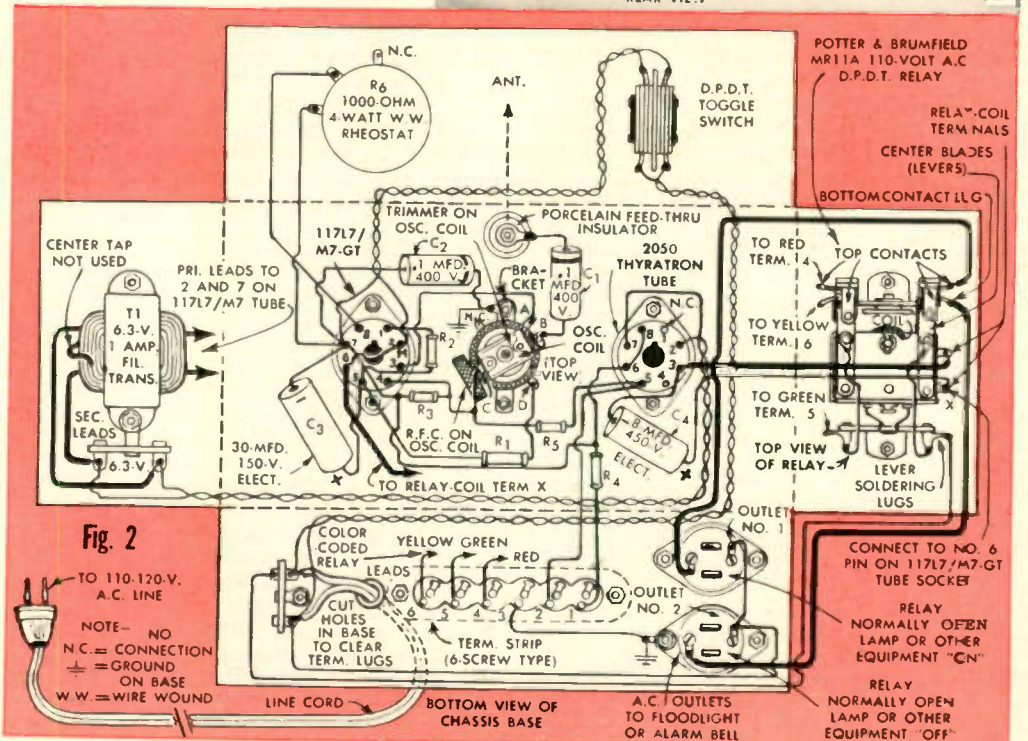
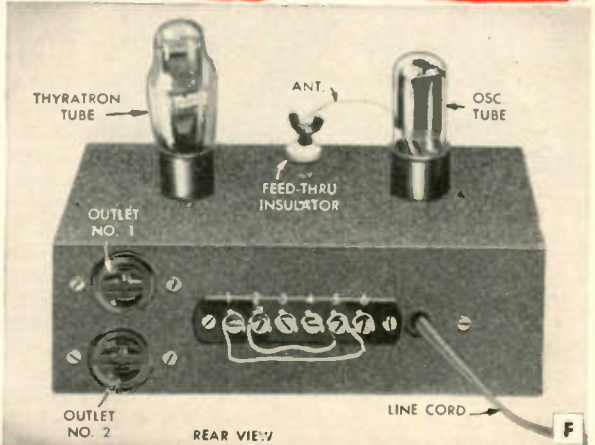

AUDIO AMPLIFIERS, RECORD PLAYERS AND HEARING AID



PORTABLE CHANGER AND AMPLIFIER FOR 45 R.P.M. RECORDS

TEN-WATT PHONO-RADIO AMPLIFIER

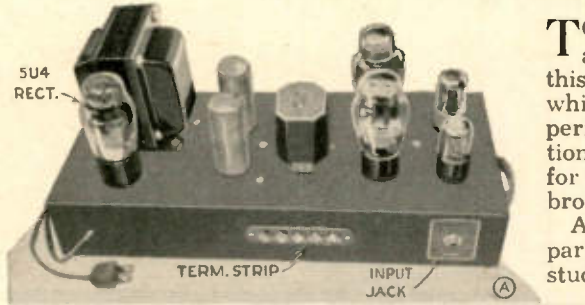

TONE quality often sought and seldom attained is an outstanding feature of this electronic power-amplifier unit which has been designed for critical experimenters interested in the reproduction of high-grade recorded music, and for use with FM as well as standard AM broadcast tuners.

Although the materials specified are parts that almost any advanced radio student or experimenter has on hand, they should be of good quality. Bass reproduction is built into the unit and is not obtained by the usual type of treble attenuation which results in a booming unnatural tone. With filament adjustment either 2A3 or 6A3 tubes may be employed in the push-pull resistance-coupled circuit, which includes phase inverter, and a simple form of feed back that prevents distortion and reduces hum level to a minimum.

The sheet-metal chassis base is detailed in Fig. 1; many experimenters will have salvaged metal bases that will meet the requirements. A schematic circuit diagram appears in Fig. 2, and a simplified pictorial wiring diagram in Fig. 3. Check both diagrams for parts values. The unit is not difficult to build as all mechanical and electrical details are clearly shown in Fig. 3 and photos A, B and C. A large permanent-mag-

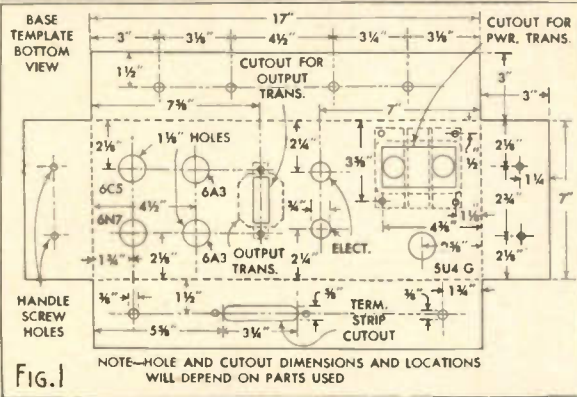

FIG. 1

NOTE—HOLE AND CUTOUT DIMENSIONS AND LOCATIONS WILL DEPEND ON PARTS USED

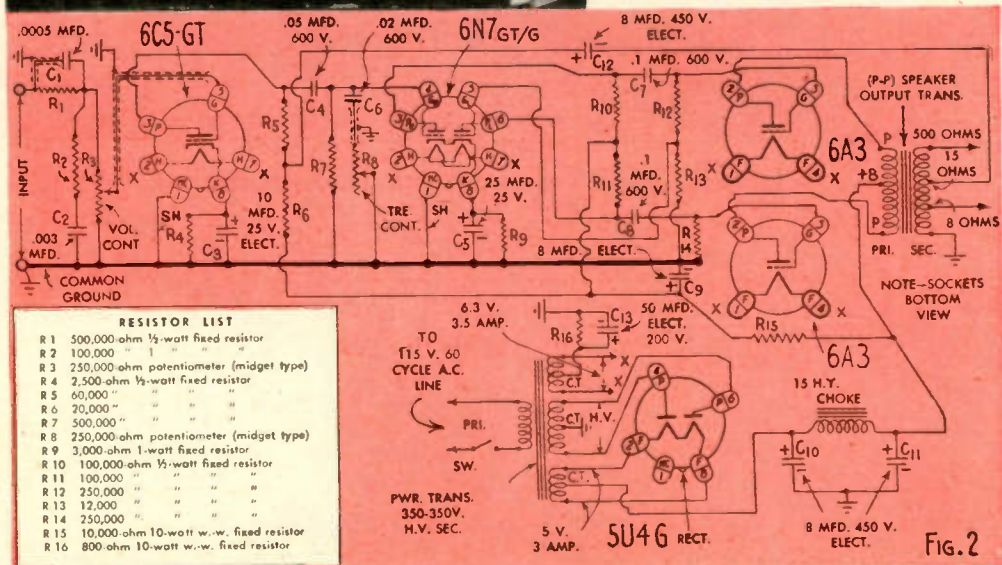
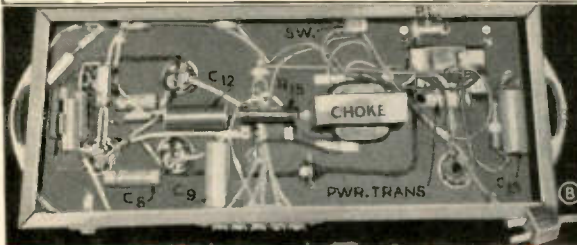

FIG. 2

TEN-WATT PHONO-RADIO AMPLIFIER

net loudspeaker should be used for best results. The speaker output transformer shown happened to be a type with terminals out the bottom. Yours may have a different terminal arrangement that may necessitate bringing the leads down through the top of the base to the terminal strip shown at rear. The electrolytic filter condensers C_6 and C_7 can be of higher capacity if line hum should be present. Any capacity up to 20 mfd. may be used; working voltage must be 450 volts or higher. Resistor R_{15} is mounted directly across the speaker output-transformer terminals, as shown in Fig. 3. The 8-ohm secondary tap is directly below this resistor.

As in any electronic device, all connections should be well soldered. Use shielded single-conductor wire where specified, and make all soldered ground connections to the metal shield just as indicated. The feed-back loop from the 15-ohm secondary tap on the 5000-ohm P-P speaker output transformer flattens out the frequency-response curve, but it can be omitted for greater gain. Short lead with arrow must go up to 15-ohm terminal. See page 157 for detailed material list.

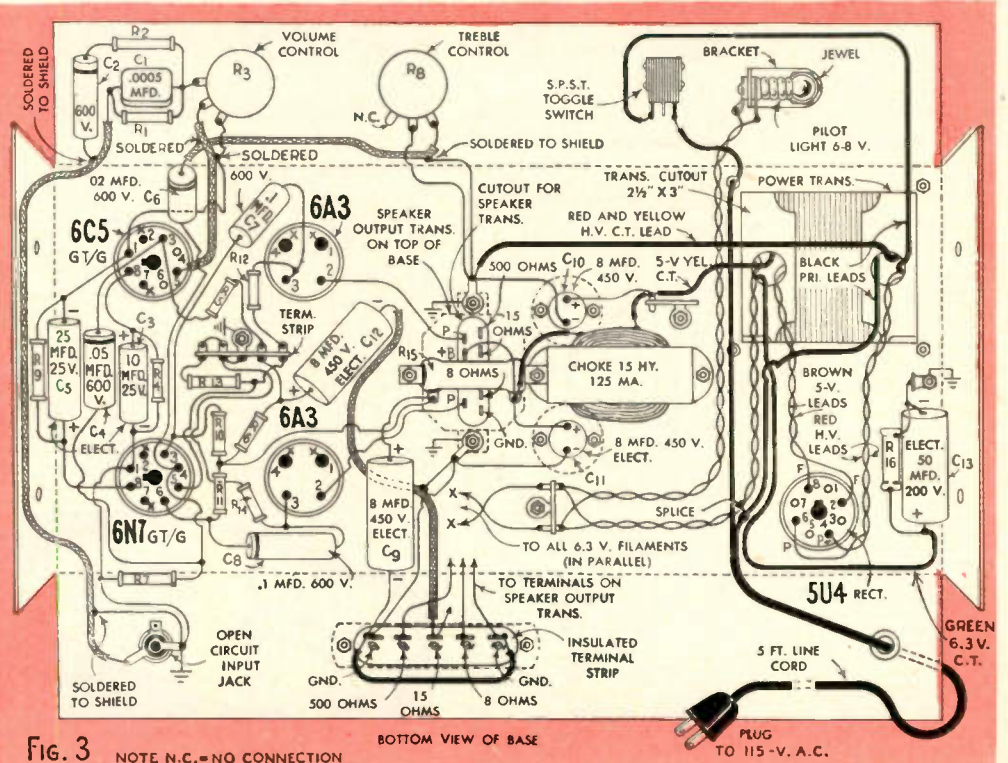
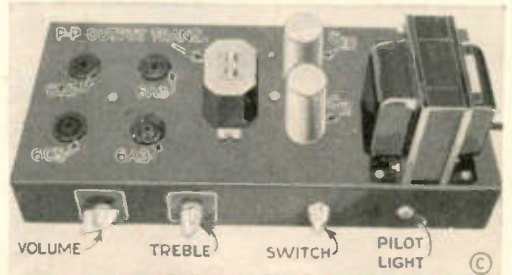
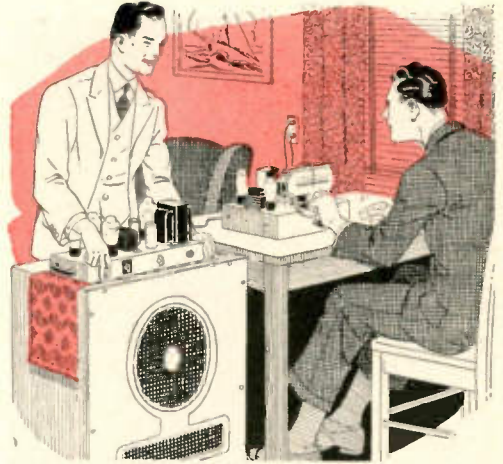
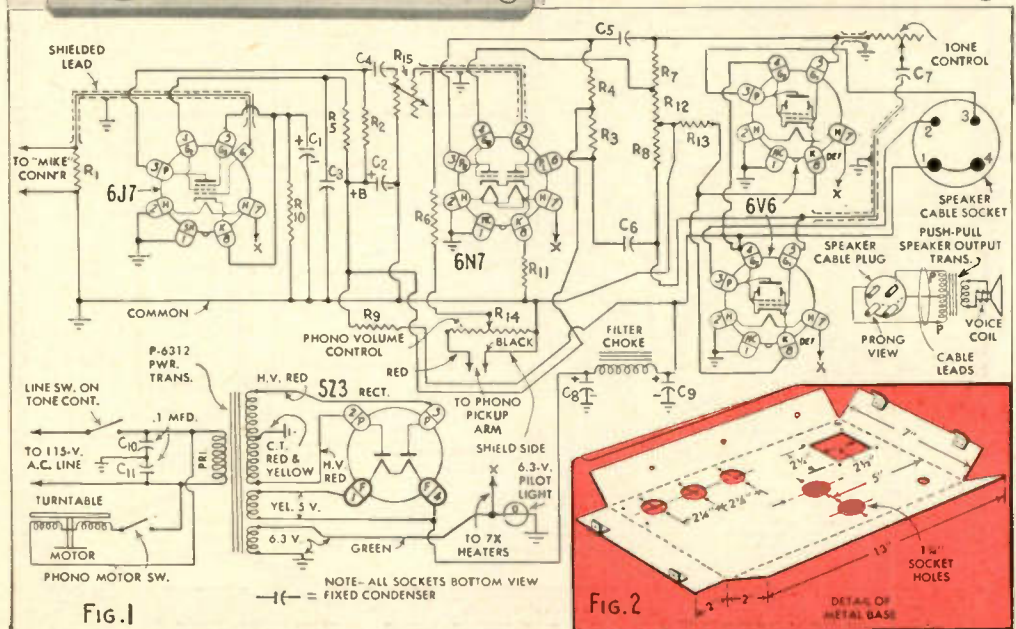
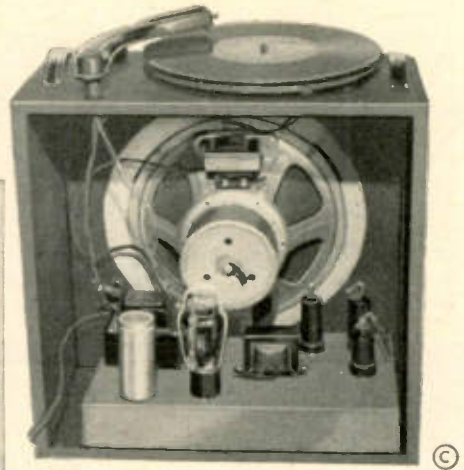
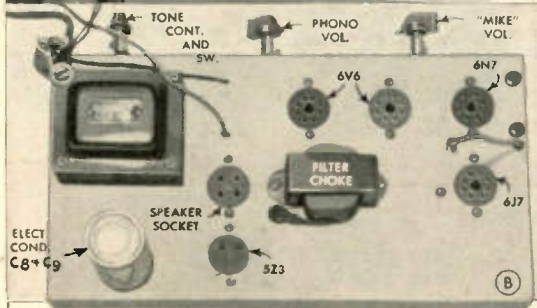

FIG. 3 NOTE N.C. = NO CONNECTION

UTILITY P.A. AMPLIFIER SYSTEM



THIS compact unit is a self-contained amplifier with speaker and record player combined within a wood or metal case which also acts as the speaker baffle. The utility of such a piece of electronic equipment is immediately apparent as it is unnecessary to run speaker cables or connect a separate record player. All you have to do is plug into a 115-volt outlet and you are ready to operate. A microphone channel is provided and separate controls adjust the volume of "mike" and phono channels individually; a tone control is also included. Push-pull 6V6 beam power output tubes provide excellent quality and sufficient



UTILITY P.A. AMPLIFIER SYSTEM

volume for dancing parties or audiences up to 500 without distortion. The amplifier chassis, phono motor and pickup are "float" mounted on soft rubber bushings.

Photos A and C show front and back views of the completed unit and it will be noted that a heavy duty 10-in. PM speaker is employed. A top view of the amplifier chassis appears in photo B and the schematic circuit diagram is given in Fig. 1. Fig. 3 shows the "mike" connector assembly which is mounted on the front panel. The wood or metal cabinet is 16 by 16 in. and 8 in. deep; any a.c. phono motor and 9-in. turntable may be used. Wiring details and specifications are shown in the pictorial diagram, Fig. 4. The power transformer has a 600-volt, 90-ma. center-tapped secondary winding.

This highly efficient unit also may be used with a pickup microphone for amplifying stringed instruments. It is important that shielded leads be used where they are indicated in the diagrams, and they must be grounded just as shown in Fig. 4. See page 158 for detailed material list.

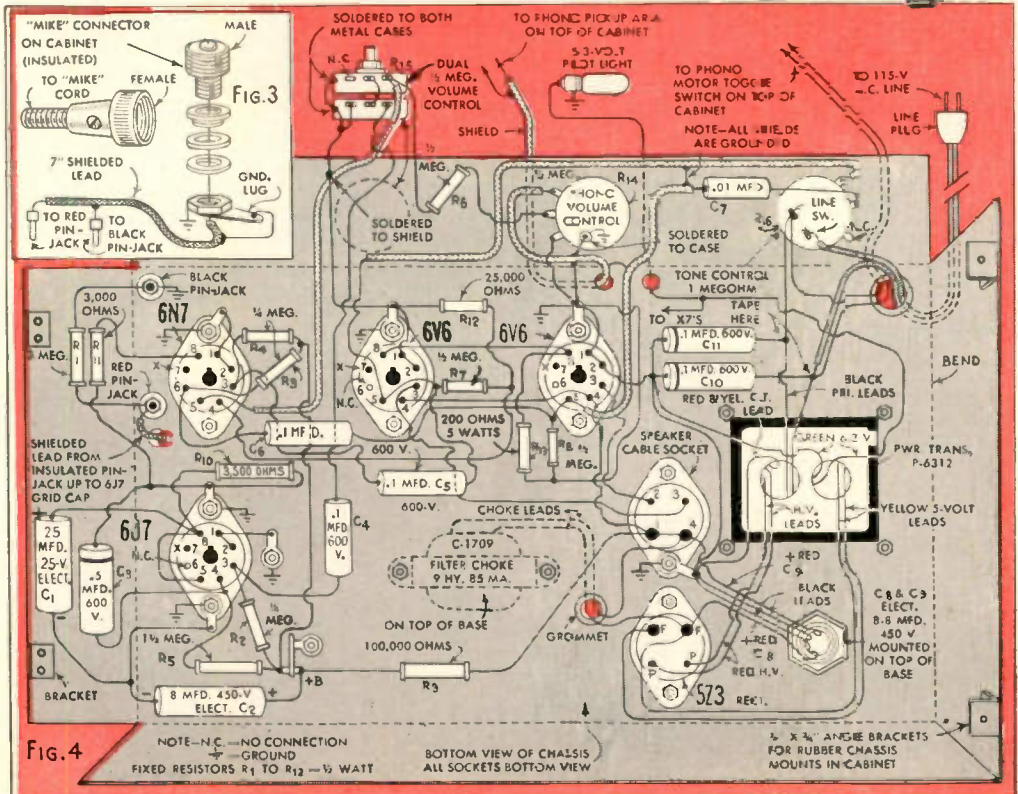

AMPLIFIER FOR 45 R. P. M. PORTABLE RECORD CHANGER

unit used. The record changer requires only a 3½-in. space above the base plate and 3¼ in. below. The cabinet shown is designed to house the amplifier on a metal chassis supported on the back of the plywood control panel. This chassis base is detailed in Fig. 2. The cutout section allows clearance for the 5-in. PM loudspeaker.

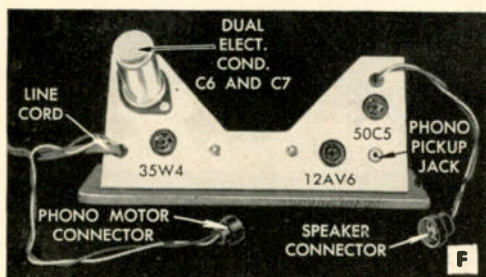

Good ventilation is provided for by means of ventilating hole plugs and these should not be omitted. These plugs have a fine wire screen inset in a ring with spring flanges, and are to be found in radio-parts catalogues. The loudspeaker hole also should be backed with wire screen to protect the speaker cone.

Before starting construction of the amplifier or portable case, it is a good idea to study the various diagrams and photos carefully. Photo A shows the completed unit in the case ready for carrying; in photo B, the lid is raised to show the controls. The lid is conveniently detachable as indicated in photo C; this photo also illustrates the method of stacking the records.

The schematic circuit diagram for the amplifier appears in Fig. 3, and a pictorial wiring diagram is shown in Fig. 4. This pictorial diagram is a detailed underside view of the amplifier chassis shown in photo D, and the chassis base has been flattened out to show each part clearly. Top views of this base appear in photos E and F. A polarized connector is employed to connect the record-changer motor to the line supply; a similar plug and socket connect the output of the audio amplifier to the primary of the output transformer which is mounted on the speaker. With this arrangement, it is a simple matter to remove the amplifier chassis and the record changer from the case without having to unsolder any connections. A type 12AV6 duodiode miniature tube is used in the input stage of the amplifier, and a new type 50C5 miniature pentode tube is employed in the output.

Although the circuit is conventional it is highly efficient for so compact a unit.

The rectifier used is a miniature 35W4 half-wave type. Wire the circuit carefully and check your wiring with both circuit diagrams. Use rosin-core wire solder and No. 18 or 20 hookup wire with push-back insulation. This excellent little amplifier includes volume and tone controls, and the output is sufficient for a large room. These

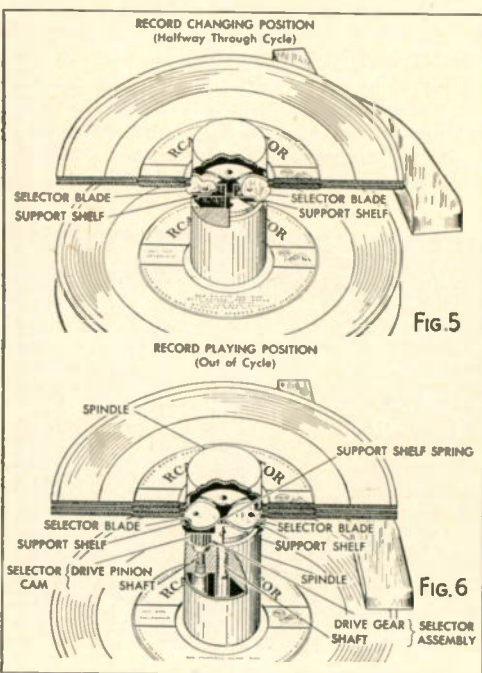

midget controls include the s.p.s.t. switches; the master switch is on the tone control. When operating the unit, this switch is turned on first to permit the amplifier to warm up. When the tubes have warmed up, turn on the volume control which also closes the motor switch. The control can then be advanced to the desired volume.

When stacking the records over the center post for automatic operation, place the desired selections upward, the last record to be played on top. Turn on the volume control and motor-drive switch; then push the "start-reject" knob on the changer plate to "start" and let go. The mechanism will then automatically play in sequence one side of each record stacked on the separator shelves. To reject a record being played push the "start-reject" knob to "reject." At conclusion of playing, and as the last record is being repeated, lift the tone arm and place it on the rest and turn off the motor switch. See page 158 for detailed material list.

INDOOR A.C.-D.C. AMPLIFIER

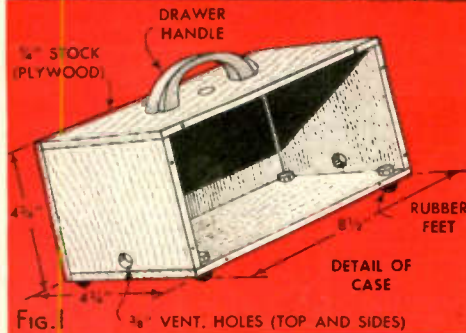
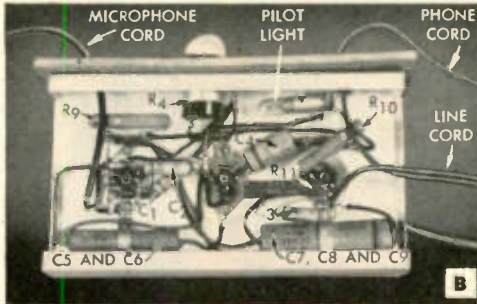
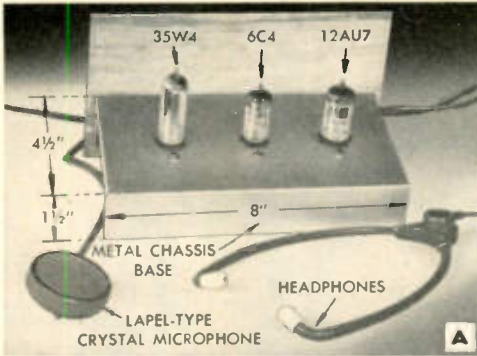

FIG. 1 3/8" VENT. HOLES (TOP AND SIDES)

WHERE a hearing aid is intended for indoor use only, it may be designed to operate directly from the ordinary 110-volt house-lighting outlets, thus saving the cost of batteries. The one illustrated and described consists of a simple a.c.-d.c.-type amplifier that is easy to build from parts that are available from all radio supply houses. Designed for high gain, which is necessary when a crystal microphone is employed, this 3-tube amplifier is unusually sensitive and highly efficient. Three miniature-type tubes are used to keep the size at a minimum; however, a slightly oversize chassis was used so that the parts are well spread out to simplify wiring.

A type 12AU7 tube, which is a twin-triode amplifier, is used in this circuit with the two triodes in cascade. This, plus the 6C4 tube, which is the output amplifier, provides three stages of amplification. The rectifier is a type 35W4. The crystal microphone used is of the lapel type which is small, light in weight and has much better frequency response and quality characteristics than the cheaper carbon types. The output of the amplifier may be used to drive any type of high-impedance magnetic headphones of 2000 ohms or higher, or crystal headphones. The simple plywood case is detailed in Fig. 1; the 1/4-in. plywood front panel is 4 3/4 in. high and 8 1/2 in. long.

The sheet-metal chassis-base holes for the miniature tube sockets are 5/8 in. in diameter. The schematic circuit diagram is

RESISTORS

- | | |
|--|----------------------------------|
| R1 = 1 megohm, 1/2-watt carbon | R6 = 47,000 ohm, 1/2-watt carbon |
| R2 = 820 ohm, 1/2-watt carbon | R7 = 47,000 ohm, 1/2-watt carbon |
| R3 = 47,000 ohm, 1/2-watt carbon | R8 = 1,500 ohm, 1/2-watt carbon |
| R4 = 50,000-ohm, audio-taper, volume control with switch | R9 = 10,000 ohm, 2-watt carbon |
| R5 = 47,000 ohm, 1/2-watt carbon | R10 = 10,000 ohm, 2-watt carbon |
| | R11 = 400 ohm, 10-watt W. W. I. |

NOTE—SEE TUBE HEATER CONNECTIONS BELOW

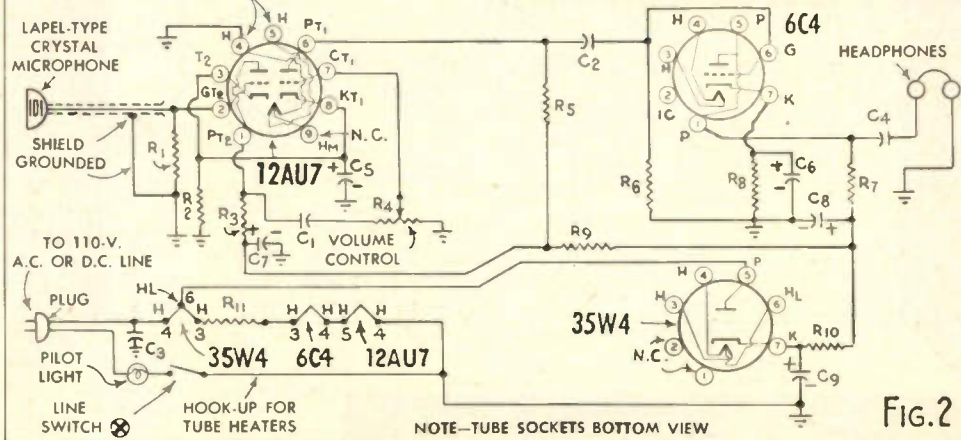

NOTE—TUBE SOCKETS BOTTOM VIEW

FIG. 2

INDOOR A.C.-D.C. AMPLIFIER FOR THE HARD OF HEARING

given in Fig. 2. The approximate parts positions are clearly shown in the underside photo B and the pictorial wiring diagram, Fig. 3. All paper-type tubular condensers used were of the midget variety.

In order to keep hum at a minimum, the chassis base is part of the a.c. circuit and must not be exposed. That is why plugs and jacks were not used in this amplifier, and it is also the reason the microphone and headphone cords were run into the amplifier and permanently wired. The unit must be housed in a wooden case and not in a metal cabinet. The microphone is on a long cord so that it may be handed to other persons for conversation, or placed near the radio or TV set. When connecting the microphone cord in the circuit, strip the woven-wire shield back far enough so that you can solder the shield directly to the ground lug which is placed under the 12AU7 socket-mounting screw. This will prevent breakage due to the strain on the long cord. Care should also be taken when soldering the headphone cord terminals permanently in the circuit. In ordinary headphones, the black lead goes to the ground side. See page 158 for detailed material list.

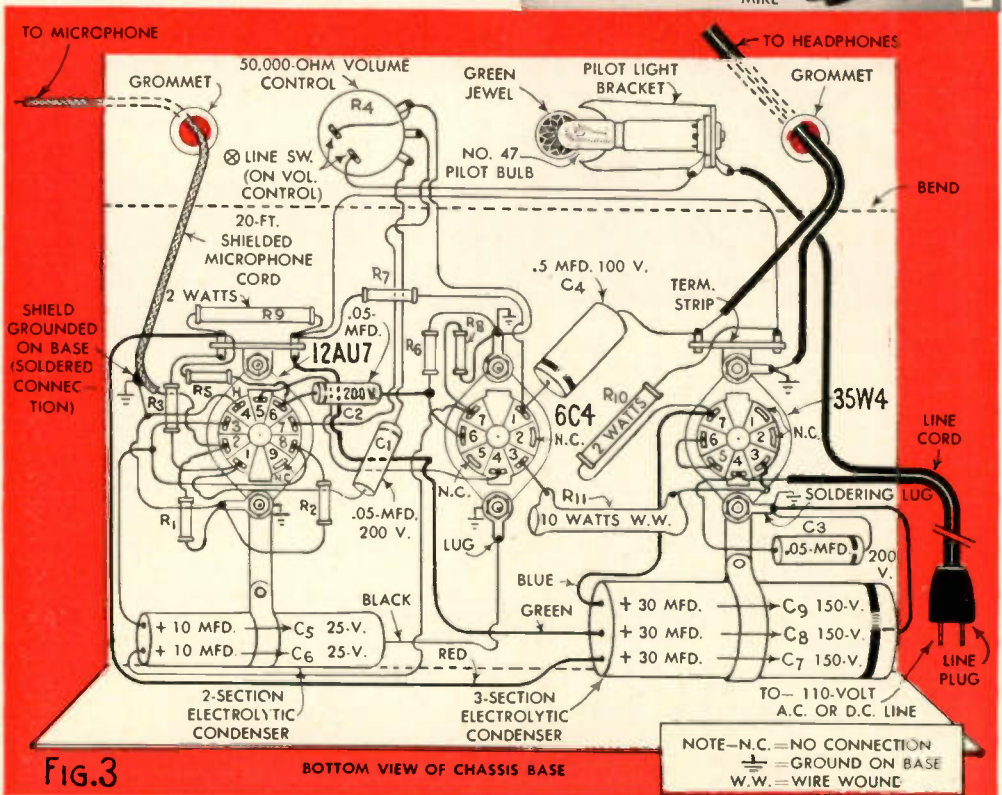
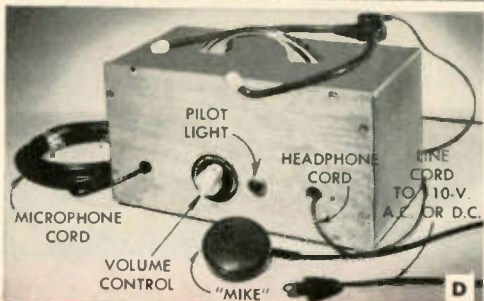

HOW TO ADD EXTENSION SPEAKERS

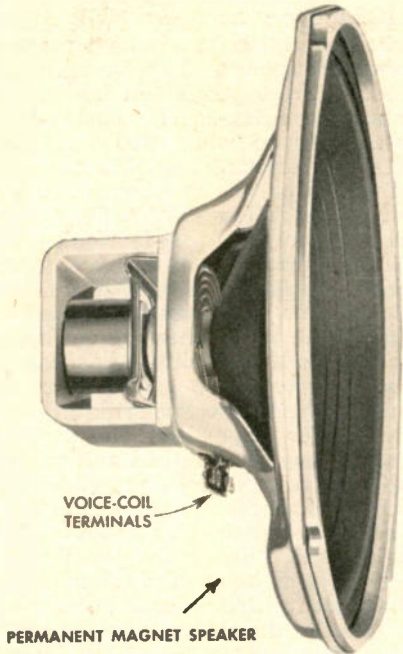

AUXILIARY speakers may be added to any standard-size table model or console-type receiver to serve additional rooms in the home. They should be installed in a large cabinet or speaker enclosure, or mounted on an adequate baffle, in order to obtain good tonal quality. The volume can be adjusted either at the broadcast receiver or the remote speaker, or speakers. Switches are easily provided to disconnect the extension speaker when not required.

Permanent-magnet (PM) type speakers are ideal for this purpose. They are self-powered and are available in all standard sizes from radio parts houses. As the voice coil of a PM speaker has a low impedance, it may be connected without the use of blocking condensers, as shown in Fig. 1. When the single-pole, single-throw toggle switch (Sw. No. 1) is thrown "down" the radio speaker will be in operation. When the switch is thrown "up" the set speaker is dead. Switch No. 2 cuts in the extra speaker, which may be located at any remote point such as in a bedroom, kitchen or in the basement recreation room.

For the experimenter or set owner who only wants the extra speaker cut "off" and "on," leaving the set speaker in operation, the simplified hookup Fig. 2 may be used. With the voice-coil connection shown in these diagrams it makes no difference if the output stage is single-ended or push-pull, as no d.c. voltage is present.

Extension speakers can be mounted in neat special wooden cabinets of various types and sizes available from radio supply houses. They can be installed on shelves or mounted on wall brackets. Some are designed for corner wall installations. In some cases they are flush-mounted in walls with decorative grilles and frames. Other installations are made in bookcases and closet doors. In all cases the wires to the speaker should be sufficiently long to permit easy removal of the speaker for repair or replacement purposes. Ordinary bell cord, or lamp cord, can be used to connect the remote speaker to the radio receiver or amplifier. The extension leads from the voice coil of the set speaker should be brought out to a jack and switch panel mounted by means of angle brackets inside the radio cabinet or console. The cable from the extension speaker can then be terminated with a phone plug. Bass-reflex enclosures for extension speakers are well-worth-while projects for radio experimenters and music lovers with critical ears for high quality reproduction of good music; see article on page 127.

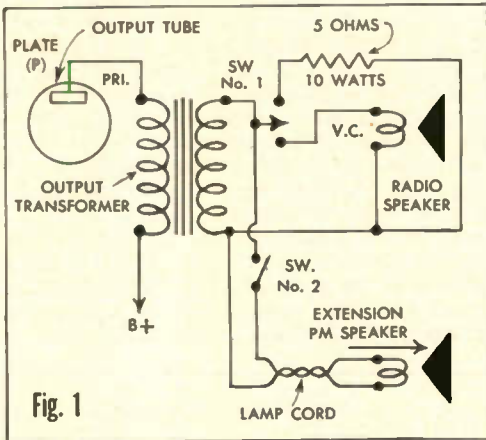

Fig. 1

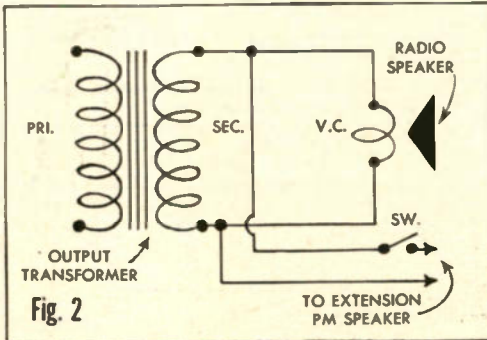

Fig. 2

HOW TO ADD EXTENSION SPEAKERS



ALMOST every home has at least one suitable location for a built-in receiver to service extension wall speakers in various rooms. These permanent built-in receiver and extension-speaker installations are often planned when building new homes, or when remodeling. However, they can be worked out by any homeowner.

Combination AM and FM radio receiver chassis units are available for built-in installations; several of the receivers, tuners and audio amplifiers described for construction in this book may be adapted for the purpose. A radio chassis may be installed on a shelf in a built-in bookcase as illustrated in sketch Fig. 1. Decorating the set control panel or speaker grille offers an opportunity for originality. The plywood front panel may be designed and painted to simulate a row of books as indicated in Fig. 2. Proper ventilation is necessary and Fig. 1 shows the method by which it is obtained; the space above the panel and a number of 1½-in. holes in the shelf permit the heated air from the chassis to escape.

All wiring to the chassis must be of the approved type and concealed for appearance. When several remote speakers are employed, a simple selector switch is used as indicated in diagram Fig. 3. If several speakers are to be used simultaneously, a universal output matching transformer is employed as shown in Fig. 4. If your speaker impedances are unknown, try several different output taps for best results. Fig. 5 shows an idea for connecting several speakers without a matching transformer. To control the volume of any remote speaker at the speaker itself, use an "L" pad as shown in the diagram, Fig. 6. The "L" pad must have the same impedance rating as the controlled speaker voice coil.

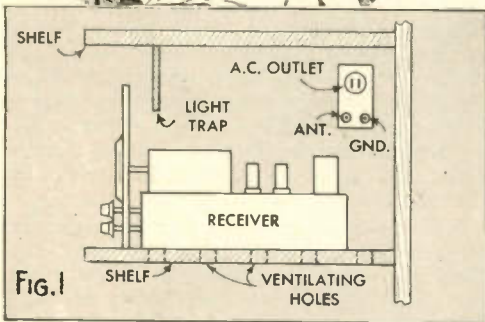

Fig. 1

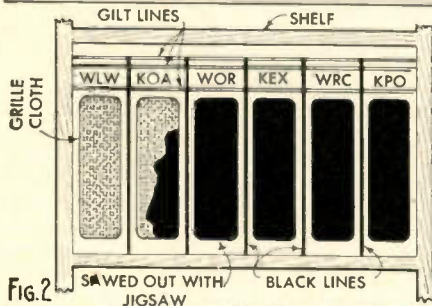

Fig. 2

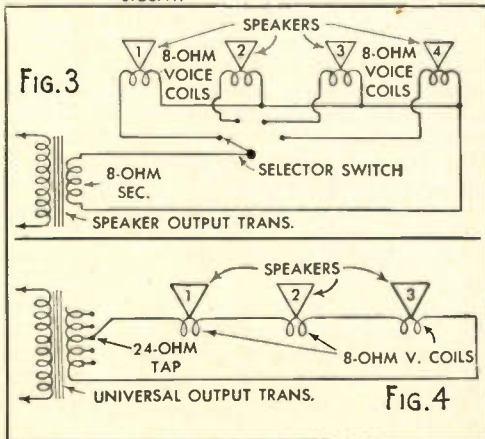

Fig. 3

Fig. 4

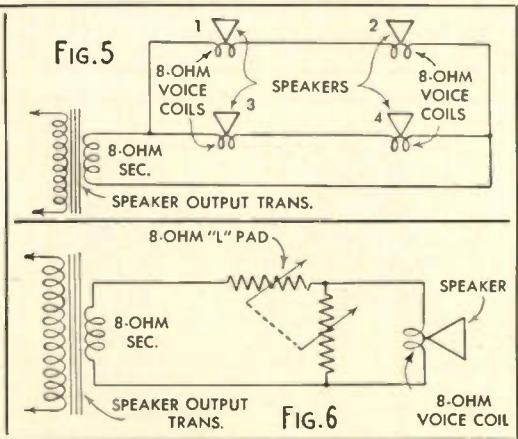

Fig. 5

Fig. 6

BASS REFLEX SPEAKER ENCLOSURE

BRING OUT those colorful bass notes without boom or objectionable resonance, with this homemade bass reflex speaker enclosure. Made from $\frac{3}{4}$ -in. stock plywood, this simple cabinet can be given a stain and finish to match other room furnishings. All inside dimensions are given in the chart below. (A) is the speaker aperture; (B) depth of cabinet; (C) width of cabinet; (D) height of cabinet. (E) is the length of the lower port and (F) is the height of the lower port. In the dimensions chart, B, C and D are minimum sizes for the listed speaker sizes. The larger the enclosure, the better will be the low-frequency response.

Horizontal braces should be used on the back and front (inside) to keep the cabinet from vibrating at its mechanical resonance frequency. Pad all interior walls (except the front wall on which the speaker is mounted) with two layers of $\frac{1}{2}$ -in. "Aerocore" Fiberglas pads available from radio parts houses, or "Ozite" under-rug padding. Back the speaker aperture and lower port



with flocked grille screen. Speaker opening (A) may be centered with respect to width but not in respect to height; locate the speaker about $\frac{1}{3}$ of the height distance down. Keep the lower port as close to the speaker opening as possible consistent with secure loudspeaker mounting. Enclosures of this type are ideal for testing high-fidelity AM and FM tuners and audio amplifiers.

DIMENSIONS CHART

Note: All dimensions are inside measurements.

Speaker Size	A	B	C	D	E	F
15"	13 $\frac{3}{4}$ "	12"	23 $\frac{3}{4}$ "	31 $\frac{7}{8}$ "	12 $\frac{3}{4}$ "	5 $\frac{1}{8}$ "
12"	10 $\frac{3}{4}$ "	11"	22"	28 $\frac{7}{8}$ "	10 $\frac{3}{8}$ "	5 $\frac{1}{8}$ "
10"	8 $\frac{3}{4}$ "	10 $\frac{1}{2}$ "	19 $\frac{3}{4}$ "	26 $\frac{1}{4}$ "	8 $\frac{3}{8}$ "	4 $\frac{1}{4}$ "
8"	6 $\frac{7}{8}$ "	9 $\frac{1}{2}$ "	16"	22 $\frac{1}{8}$ "	6 $\frac{1}{2}$ "	3 $\frac{3}{4}$ "

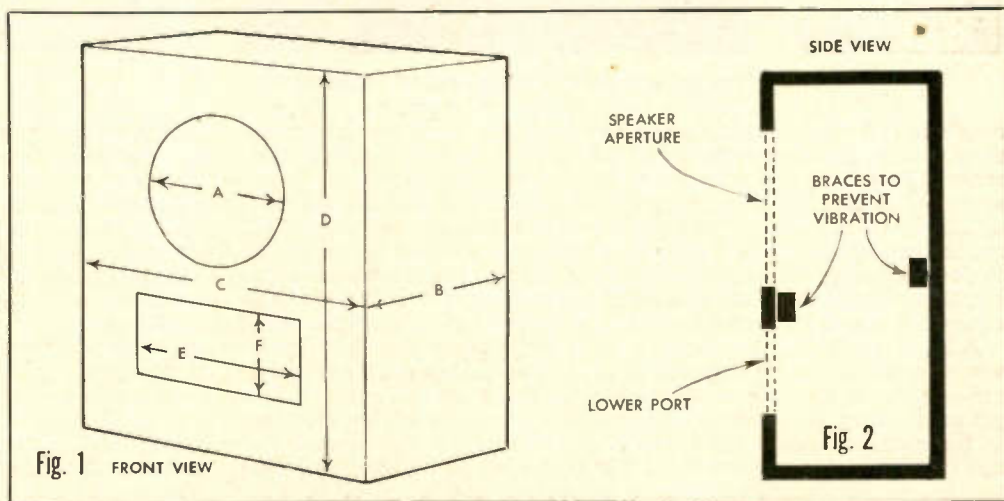

Fig. 1 FRONT VIEW

Fig. 2

HOW YOU CAN BECOME A HAM

IF YOU ARE a good citizen you can become a licensed amateur radio operator and join the thousands of active radio hams like the one in photo A who are now on the air in this country and practically every country on the globe. All you need is the desire—plus a little effort. The desire usually dates from your first visit to some friend's "ham shack." A ham shack is any place where a radio amateur has his receiver and transmitter. It may be in a basement, an attic or in one of the rooms in the home; regardless of where it is located it is known as the "shack" and it is here that the amateur makes friends by the hundreds in near-by and far-away places. In some cases where the man and his wife are both licensed amateur operators, the radio shack is in the best room in the house. No large amount of money or unusual intelligence is required to become a licensed



ON THE AIR WITH A SIMPLE PHONE TRANSMITTER

amateur and operate a station. There is no fee for the examination, and the equipment need not be expensive. Hams are of all ages and both sexes, and it does not take any more of your time and money than you are willing to give it. Even handicapped persons such as the blind or shut-ins often qualify for licenses despite their handicaps. The writer knows of many such cases in the United States and several in foreign countries. The reader can imagine how many happy hours and good friends this activity has brought to such persons. Ham radio keeps boys off the street and gives them a worth-while hobby. Newcomers are always welcome in the ham fraternity. Many licensed amateur radio operators are to be found in the Boy Scouts and in grammar and high schools.

A large number of the nation's hams are either college graduates or presently in school working toward their degrees. It is estimated that nearly 80 percent of all hams choose radio, science or mathematics for their major school subject. Understanding this, it is perhaps not so startling to find that more than 33,000 licensed hams are now employed in the communications and television industries in the United States. About half of the nation's hams are more than 31 years of age. Many are well-known doctors, lawyers, writers, businessmen, clergymen, educators, actors and officers in the Army, Navy and

HOW YOU CAN BECOME A HAM

Air Force. Freeman S. Gosden, W6QUT, of the famous Amos and Andy radio team; Tex Beneke, W2CKD, the band leader, and his wife Marguerite, W2EHR; Herbert Hoover, Jr., W6ZH, son of ex-President Herbert Hoover; George Edward Sterling, W3DF, the first and only ham to reach the bench of the F.C.C.; and Richard M. Purinton, W9SZ, vice-president of the American Phenolic Corporation, are just a few who come to mind at the moment. Sterling is pictured in his station in photo B.

What Is Ham Radio?

Amateur radio is a hobby pure and simple, but it does have a definite useful purpose that is recognized by all of the governments that issue the licenses to those who qualify under international laws and regulations. Examinations are held by the Federal Communications Commission (F.C.C.) in 65 cities in the United States, Hawaii and Alaska at stated periods and may be taken without cost by any law-abiding citizen. As of September 1950 there were 85,751 licensed radio hams in the United States and approximately 46,726 in foreign countries.

Ham radio provides the nation with thousands of self-trained and self-equipped expert radio operators in time of local or na-

tional emergency. Many thousands served in both world wars as teachers and operators on land, sea and in the air. Back in civilian life they are "hamming" again, meeting their old friends on the air, and lending a hand in training the newcomers who are always welcome. Ham radio, like many other hobbies, has its own slang, or "lingo," that is a part of the game and is recognized and used by hams in all countries. Many of the terms and time-saving abbreviations can be traced to land-line Morse telegraphy. Hams use both key code and voice, the code (c.w.) system being International Morse. In voice work over a microphone abbreviations are, of course, not necessary and should be avoided; however, they are sometimes very helpful in overcoming language difficulties in making contacts with ham friends in foreign countries.

The "Chief Op." is the licensed ham who owns and operates the station; the "YL" is the young lady friend, and, in some cases she may also be a licensed operator and owner of a station. The "XYL" is the wife who, in a surprising number of cases, is a licensed operator with her own call letters. The "Junior Op." is the son or daughter who hopes to get a "ticket" some day—and many do in their early teens.



HOW YOU CAN BECOME A HAM

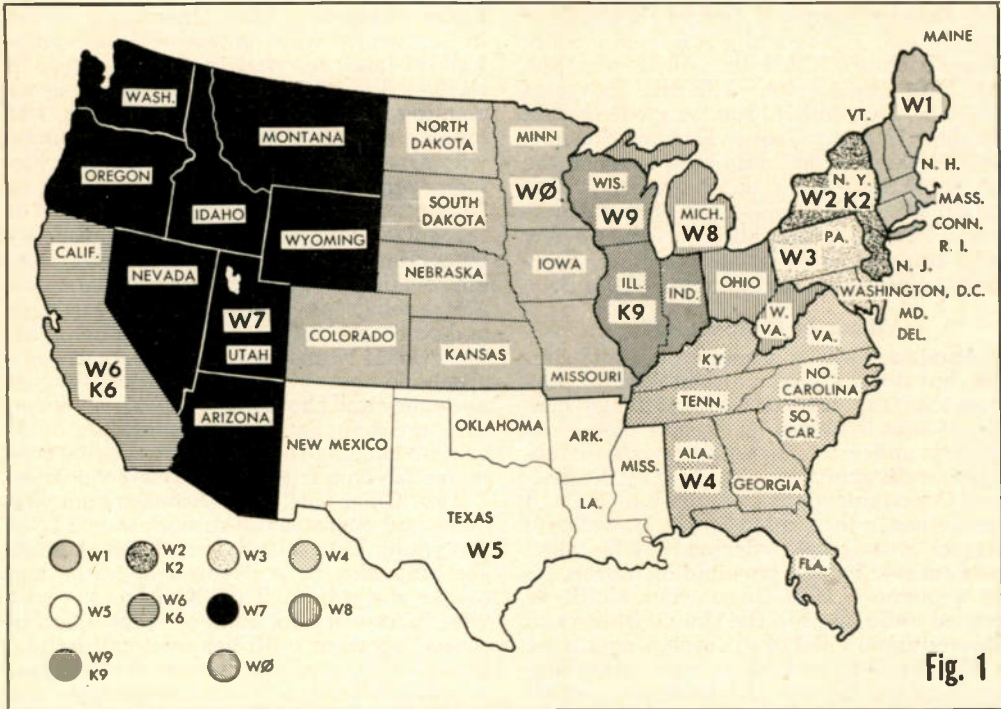

Fig. 1

If you tune in the short-wave amateur bands on your home receiver you can often hear hams calling "CQ" and giving their call letters. "CQ" indicates a general call and it is simply an invitation to talk issued to any amateur station listening. After several such calls the amateur turns off his transmitter, switches on his receiver, tunes over the band and listens for a reply. His call may be answered by some local amateur, one several hundred miles away, or, perhaps one halfway around the globe. Even the oldtimers get a keen thrill when the reply comes from some ham friend in South America, Europe or Africa. The conversation usually ends with "73," which indicates "with best wishes."

Call Letters Assigned

The United States is divided into ten amateur districts as shown on the map, Fig. 1. The prefix to the ham's call letters (W9, K9, etc.) indicates his district and general location. When calling "CQ" or replying to a call the amateur usually adds further information such as the name of his city, etc., to identify his location. In the United States the call will start with the letter W or K followed by the number of the district and the call letters of the station. In England the prefix is G; in France it is F, etc. In most

countries the prefix consists of two letters followed by their district number. For example: the prefix XE indicates Mexico; VE, Canada; GM, Scotland; SM, Sweden; ZS, South Africa; VK, Australia, etc. The *Radio Call Book Magazine*, published four times a year in the United States, is a complete directory and lists practically all of the licensed hams in the world, giving their international prefixes, call letters, names and addresses.

Hams divide themselves up into several classes, or groups, depending upon their personal interests in the various activities in amateur radio. Some join government sponsored ham club "traffic nets" for the purpose of relaying messages to and from persons and similar groups; this is done for practice and combines emergency training with fun. No money can be accepted for any amateur-radio message handling. Traffic nets are extremely useful in time of local floods, fires, explosions, blizzards and hurricanes. Radio amateurs have won the gratitude of the nation for their heroic performances in times of such disasters when all other forms of communication were out of service.

Isolated persons on land and sea have been able to contact hams for needed help in sickness and other serious situations, as

you have no doubt read in the many newspaper accounts. Of course, no radio amateur need belong to an organized "traffic net" to give help in such emergencies. Every amateur-radio station is a potential life-saving station. All amateurs stand ready at any hour of the day or night to cooperate in every way with local authorities, the Red Cross and the American Radio Relay League, by relaying messages for needed supplies, locating relatives and assuring inquiring relatives of the safety of their loved ones. When wires are down and traffic is at a standstill, radio amateurs operating on auxiliary power supplies get the messages through without delay.

Choice of Code or Phone

Some hams prefer to use c.w. exclusively, or, in other words, send messages by key in Continental Morse code; others use both c.w. and phone, and some phone exclusively. Some are satisfied to contact local ham friends and stations within a few hundred miles, others will obtain the most enjoyment in trying out ultra-high-frequency transmitting and receiving equipment of comparatively short range, but with highly

interesting possibilities. Some will prefer mobile operation in cars and boats. Many try for maximum distance (DX) with the lowest possible power on the 10, 20, 40 and 80-meter ham bands and make surprising DX records. The secret in most cases of records made on low power is an exceptionally good antenna system, and a favorable location. Of course, such records are only possible when QRM (interference from other stations), and QRN (static) or atmospheric conditions are not troublesome. With more power the contacts are made easier through such interference. An efficient directional-antenna system can increase the effective power several times and will minimize your interference with other stations.

The "DX Hound," as he is known to his fellow hams, is the one who gets the biggest thrill out of exchanging conversation (having QSOs) with hams thousands of miles away. These ambassadors of good will have friends all over the world. They may be handicapped by limited pocketbooks, but by careful buying of parts and by study and experimenting they manage to construct highly efficient transmitters and directional-antenna systems. As a rule most

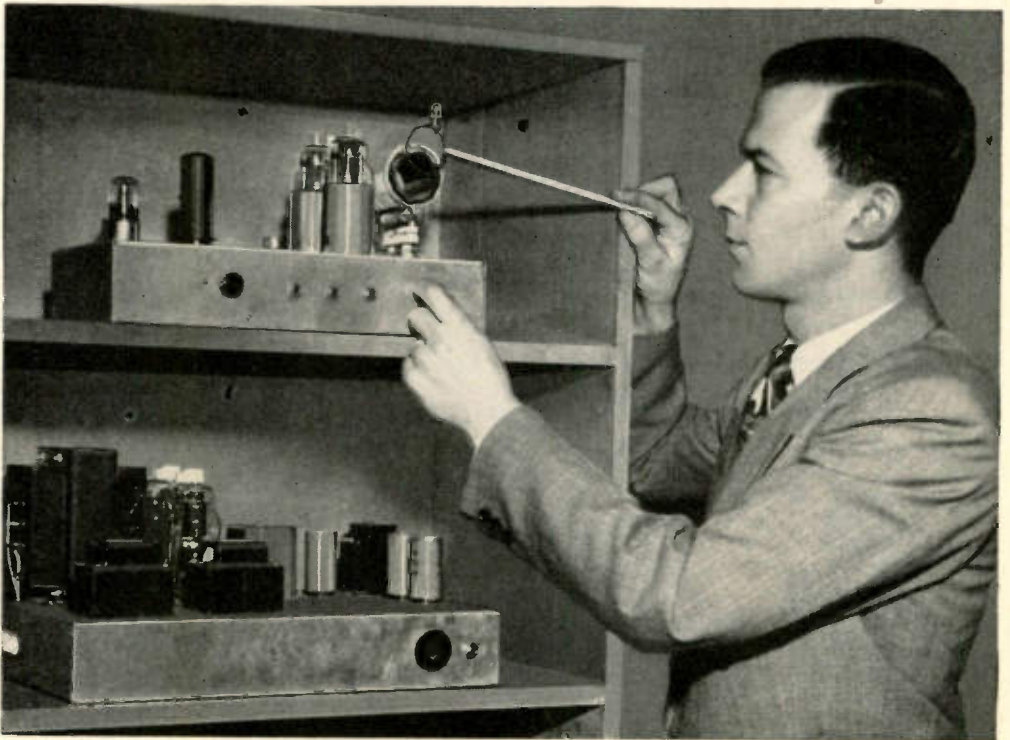

TUNING A TYPICAL HAM TRANSMITTER

HOW YOU CAN BECOME A HAM



Above, operating position at W9DCX; the direction indicator unit for monitoring the position of the beam antenna is on the desk slide arm. A 400-watt, 10-meter phone and c.w. transmitter is located at the right. Below, left, rotary beam antenna operated by remote control. Lower right, 1-kw. 20-meter phone transmitter

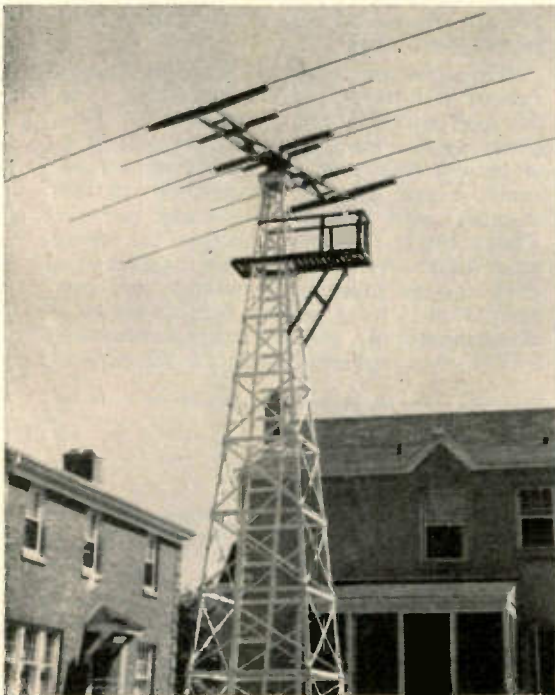

HOW YOU CAN BECOME A HAM



When you have made up your mind that you want to become a ham radio operator, the first thing you have to do is master the code. You will need an inexpensive buzzer set, or a code-practice oscillator, and key. Circuit diagram for a simple buzzer is shown in Fig. 2. The buzzer should be a high-frequency 3-volt type; the phones are connected across the buzzer coil with a small fixed condenser in series. Assembly is made on a small wooden baseboard. Code-practice oscillator units that operate directly off the 110-volt a.c. or d.c. house-lighting line and include a small loudspeaker, are available from parts houses. They may be used for group code practice as shown in the sketch.

The correct position for the hand and fingers for good transmitting with a key is illustrated in sketch Fig. 3 below. The code chart is shown on the following page. You can memorize this entire code alphabet in a few evenings. If two or more persons study code together, sending and receiving in turn, they can master it in a much short-

er time. Have your friend send each letter plainly, with long enough spaces between so that you can easily identify the letters and write them down. Take five or six letters in sequence at a time and learn them well. Then learn the next group, etc. Then practice on mixed letters, after which slowly send complete words and sentences. The sending should be at a slightly faster rate than you can copy easily. Never try to write down the dots and dashes, write down the letters you recognize and do not worry if you miss a few. With a little patience you will soon be getting every letter correctly.

Each letter has a rhythmical sound that you soon learn to identify. These sounds can be imitated by the spoken-word, or "dit-dah," method shown in the code chart. You learn the code by listening to it. Don't worry about speed as you will gain that by practice. When using the "dit" and "dah" method, the letter A would be "didah" as the "t" can be dropped in such combinations. The sound "di" should be staccato; for example the letter S would be "dididit," spoken like a small boy imitates the sound of a machine gun. Each "dah" should be stressed equally, slightly accented and drawn out. For example; in the letter A, "didah," or the letter C, "dahdidahdit," etc. As you progress it is a good idea to listen in on code transmissions with a short-wave receiver, and copy all you can. Some commercial operators send very slowly and usually repeat each word.

When you can receive 13 words a minute (about 65 letters), practice receiving code groups rather than written text. This prevents the student from recognizing a word and "filling in" before the letters are really heard. Finally concentrate on the numbers and punctuation—right here is where many applicants taking the code examination fall down, as they neglect this part of code practice. Now that you can copy from 13 to 15 words a minute without making an error, you are ready to pass the FCC code speed requirements. When you

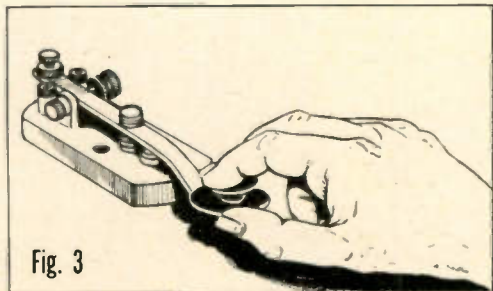
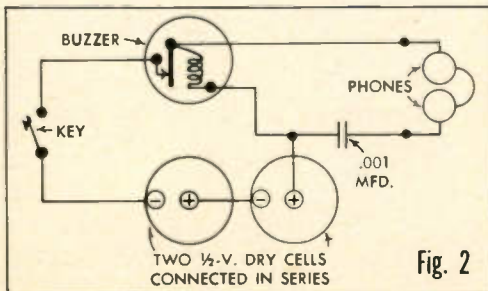

HOW YOU CAN BECOME A HAM

have demonstrated your ability to do this you will be permitted to take the written examination for your license.

Do not try to anticipate words and characters. Try to copy at least two letters behind the sender; write down the complete word immediately after it has been sent if possible, instead of one letter at a time. A good way to increase code speed is to copy special weather station broadcasts.

The American Radio Relay League is a good source of code-practice transmission information. The A.R.R.L. is an organization of hams. The group publishes schedules in their official monthly magazine, QST; this is the official organ of the International Amateur Radio Union. These WWV-WWVH code-practice schedules are for the benefit of amateurs and other interested groups. The National Bureau of Standards maintains this service of technical radio broadcasts over WWV, Beltsville, Md., and WWVH, Maui, T. H. The services from WWV include standard amateur-radio frequencies, time announcements at five-minute intervals by voice and International Morse code, and other valuable information. Remember that speed comes

from practice. Proceed slowly and do not practice when you are tired.

The beginner must have a reasonably good general knowledge of radio principles in order to build and operate his equipment and to pass the FCC written examination. No engineering training in the subject is required, but it does mean that the individual must spend some time and application in acquiring an understanding of the basic principles and the laws governing amateur radio service. While learning the code the beginner should study the specially prepared text books that are published by the American Radio Relay League, West Hartford, Connecticut. These booklets are listed in all radio parts house catalogues. One is the "Radio Amateur's License Manual," and the other is "How To Become a Radio Amateur." They are only 25c each and contain all the required simple technical information and laws. When you are ready to take your examination go, or write, to your nearest FCC office (see page 154 for list) for information as to when the next examination is to be held. If you fail on the first attempt, you can take the examination again within a short time.

CONTINENTAL (INTERNATIONAL MORSE) CODE

A	● —	dit-dah
B	— ● ● ●	dah-dit-dit-dit
C	— ● — ●	dah-dit-dah-dit
D	— ● ●	dah-dit-dit
E	●	dit
F	● ● — ●	dit-dit-dah-dit
G	— — ● ●	dah-dah-dit
H	● ● ● ●	dit-dit-dit-dit
I	● ●	dit-dit
J	● — — —	dit-dah-dah-dah
K	— ● — ●	dah-dit-dah
L	● — ● ●	dit-dah-dit-dit
M	— —	dah-dah
N	— ●	dah-dit
O	— — —	dah-dah-dah
P	● — — ●	dit-dah-dah-dit
Q	— — ● —	dah-dah-dit-dah
R	● — ●	dit-dah-dit
S	● ● ●	dit-dit-dit
T	—	dah
U	● ● —	dit-dit-dah
V	● ● ● —	dit-dit-dit-dah
W	● — —	dit-dah-dah
X	— ● ● —	dah-dit-dit-dah
Y	— ● — —	dah-dit-dah-dah
Z	— — ● ●	dah-dah-dit-dit

1	● — — —	dit-dah-dah-dah-dah
2	● ● — —	dit-dit-dah-dah-dah
3	● ● ● —	dit-dit-dit-dah-dah
4	● ● ● ●	dit-dit-dit-dit-dah
5	● ● ● ● ●	dit-dit-dit-dit-dit
6	— ● ● ● ●	dah-dit-dit-dit-dit
7	— — ● ● ● ●	dah-dah-dit-dit-dit
8	— — — ● ● ●	dah-dah-dah-dit-dit
9	— — — — ● ●	dah-dah-dah-dah-dit
0	— — — — —	dah-dah-dah-dah-dah

Period	● — — — ● — — —
Comma	— — — ● — — — — —
Question mark	● ● — — — — ● ●
Error	● ● ● ● ● ● ● ●
Double dash (BT)	— — ● ● ● ●
Wait (AS)	● ● ● ● ● ●
End of message (AR)	— — — — ●
Invitation to transmit	— — ● ●
End of work (SK)	● ● ● — — —

Period	dit-dah-dit-dah-dit-dah
Comma	dah-dah-dit-dit-dah-dah
Question mark	dit-dit-dah-dah-dit-dit
Error	dit-dit-dit-dit-dit-dit-dit-dit
Double dash	dah-dit-dit-dit-dah
Wait	dit-dah-dit-dit-dit
End of message	dit-dah-dit-dah-dit
Inv. to transmit	dah-dit-dah
End of work	dit-dit-dit-dah-dit-dah

HIGH EFFICIENCY TRANSCEIVER FOR 2-METER HAM BAND

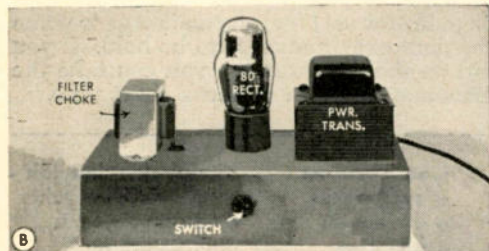
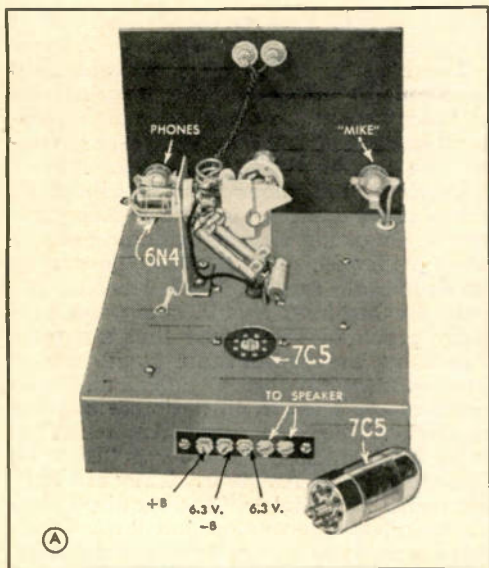

DESIGNED around a high-frequency tube ideal for the 2-meter ham band, this combination transmitter and receiver provides the newcomer as well as the experienced licensed amateur with an efficient means of getting on the air for local contacts, and an opportunity to try out ultra-high-frequency transmitting and receiving equipment. It also may be used for mobile operation in a car with one of the vibrator-type power supplies.

The 6N4 tube is a miniature triode self-controlled r.f. power oscillator and it is modulated with a type 7C5 loktal audio power tube in the "transmit" position. In the "receive" position the 6N4 is a super-regenerative detector and the 7C5 acts as an audio amplifier. All r.f. leads are extremely short; photos A and D show the compact construction.

A separate 300-volt a.c. power supply unit is detailed in Figs. 1 and 2. All circuit details and specifications for the transceiver appear in Fig. 3 and the photos. The 6N4 tube socket is a ceramic miniature type, mounted with terminals 1 and 7 at the bottom; terminals 4 and 6 are connected and grounded on the bracket. A National XP-6 "button" insulator is used to mount the bracket for tuning condenser C1. Small rubber grommets act as shock absorbers for the tube and choke assembly bracket which is grounded with a short piece of

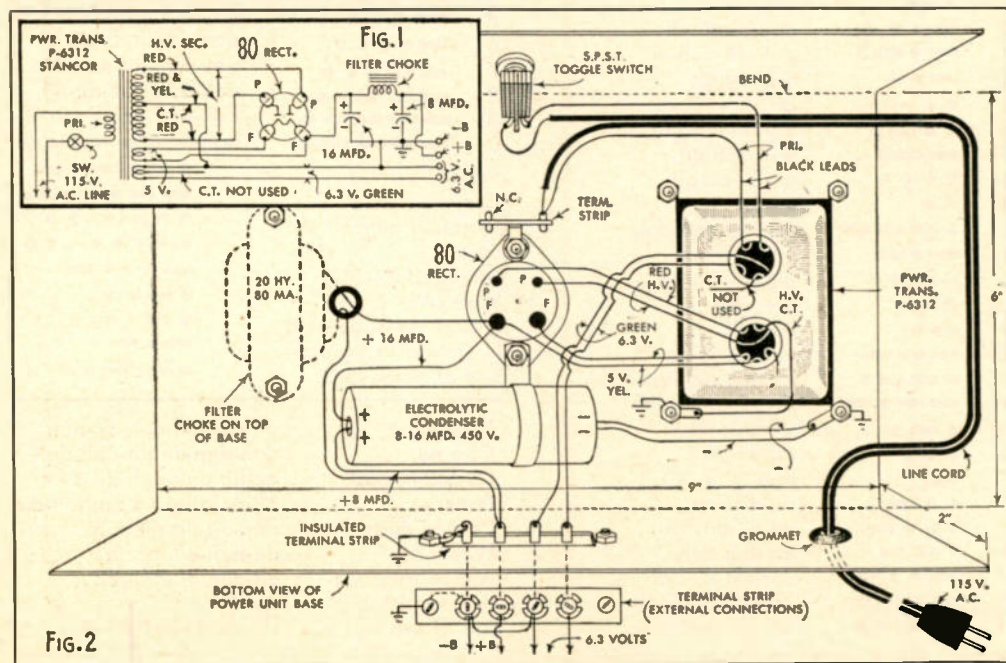

HIGH EFFICIENCY TRANSCEIVER FOR 2-METER HAM BAND

heavy braided wire. Coil L1 is soldered to the variable condenser terminals as closely as possible. Fixed condenser C2 is a 50-mmfd. Centralab or similar tubular ceramic type. Headphones are of the high-impedance type.

The folded dipole antenna is shown in Fig. 4. It can be tacked or tied to a "T" support made of 1 by 1-in. wood strips and inserted in a short length of pipe threaded into a deck flange for manual rotation if desired. This support can be 6 or 8 ft. high, and the pipe about 18 in. long for a temporary installation.

If heavy wire is used, the dipole spacing may be 1 in.; the feeders are made with "Amphenol" 300-ohm twin-lead transmission line, as shown in photo C. The entire antenna may be made with twin-line material by cutting it to length for the dipole and connecting the dipole ends. To operate, listen for another station and adjust sensitivity control for loudest signal. The rushing sound disappears when the station is tuned in. Adjust the two-turn pickup link coil L2 in coil L1, at the same time readjusting the sensitivity control for best reception; this coupling adjustment also is correct for transmitting. Any single-button carbon "mike" may be used; close talking is necessary for full modulation. For mobile operation you can use a 250-volt, 100 ma., 6-volt vibrator-type power unit for the power supply. See page 158 for detailed material list.

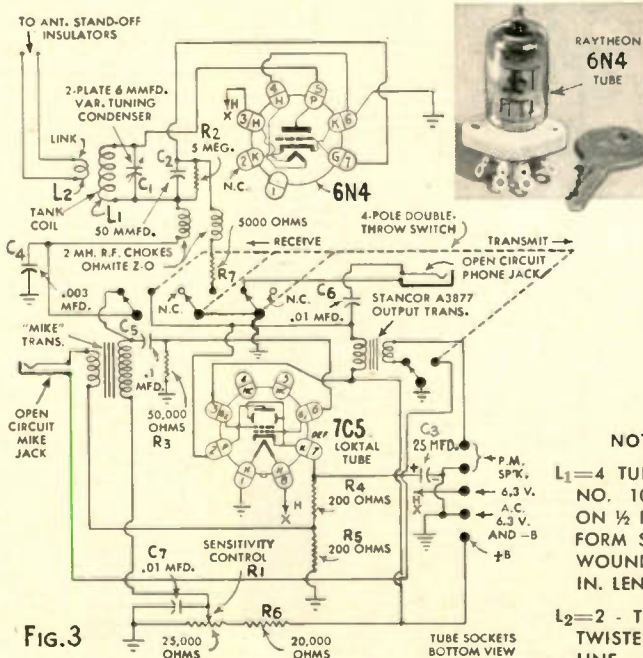
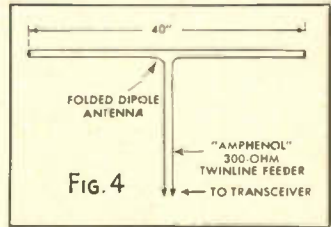
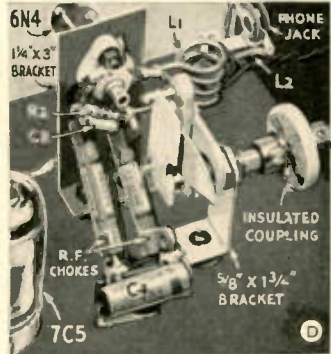

NOTE
 L₁ = 4 TURNS OF NO. 10 WIRE ON 1/2 IN. DIA. FORM SPACE-WOUND TO 3/4 IN. LENGTH
 L₂ = 2 - TURN TWISTED LINK LINE



FIG. 3

E

FIFTY-WATT TEN-METER TRANSMITTER FOR BEGINNERS

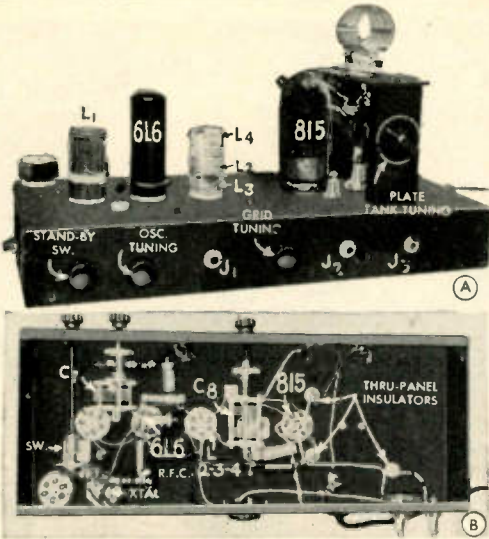

ALTHOUGH only four tubes are used in this two-unit c.w. transmitter, it is capable of approximately 50 watts output on 10 meters—enough to give a c.w. transmitting range of 2000 to 4000 miles or more when connected to an efficient antenna.

Designed primarily for operation on 10 meters, it also makes a useful foundation unit for a larger transmitter on other bands, as the beginner progresses. This provides a good flexible rig for the newcomer with his brand-new ham ticket; it is also a keen performer that will please any amateur radio operator. A schematic circuit diagram of the "twin" power unit appears in Fig. 1, and the 2-tube transmitter unit circuit diagram is given in Fig. 2. This transmitter uses a 6L6 tri-tet oscillator and the type 815 dual-beam tube as a class C amplifier; the 815 tube requires very little neutralizing even on 10 meters. The circuit

is simple and employs a minimum of parts, as will be noted in photos A, B, C and E. The 2-tube power unit appears in photo D.

A black crackle-finish chassis base is used for the transmitter. This is a standard size chassis 2 in. high, 7 in. wide and 17 in. long; it can be used in a relay rack later if desired. A chassis base of similar size is employed for the power unit. It will be

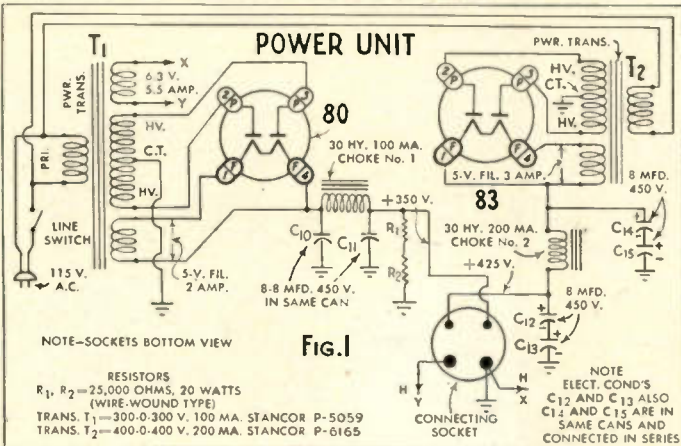

Fig. 1

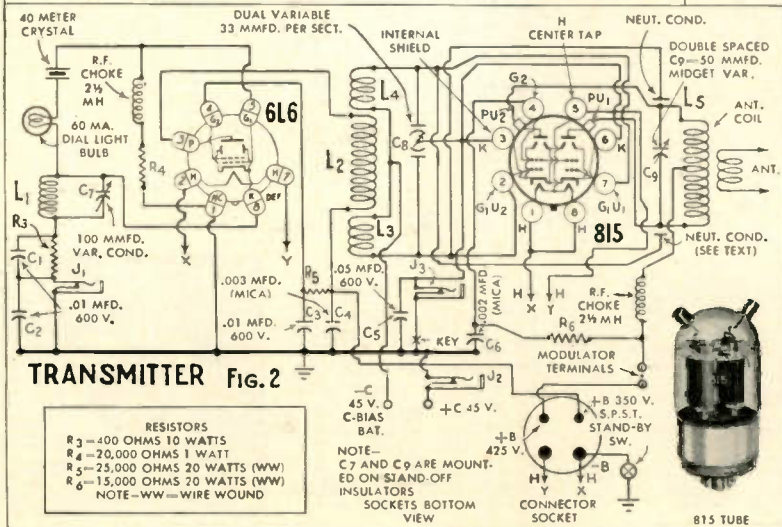

Fig. 2

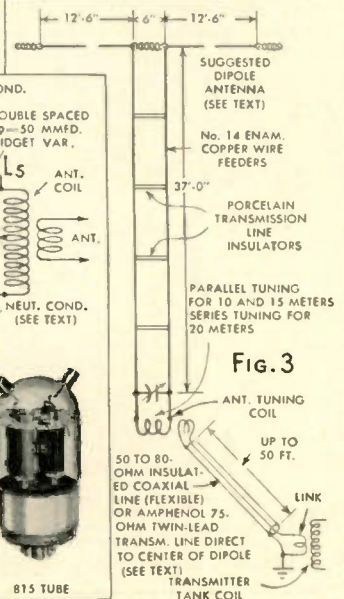

Fig. 3



815 TUBE

FIFTY-WATT TEN-METER TRANSMITTER FOR BEGINNERS

noted that insulated shaft couplings are used on variable condensers C₇ and C₈, also on the final tank tuning condenser C₉ that is mounted between the upright wood supporting blocks on top of the chassis base. The extension shafts are short lengths of 1/4-in. Bakelite rod; the stand-by switch is a s.p.s.t. rotary type in series with the negative B lead. It is mounted on a bracket near the crystal socket, with a bushing and extension shaft brought out to a control knob at front. Coils L₁, L₂, L₃ and L₄ are hand wound—see material list for turn data.

Coil L₅ is a Barker-Williamson 50-watt 10-meter plug-in center-tap type with center link fitted with a standard five-prong steatite base. This coil fits into a ceramic five-prong tube socket.

When all wiring is completed, the oscillator should be tested first. A flashlight bulb connected to a small loop of wire should glow when coupled to the combination oscillator plate coil and amplifier grid coil when the latter is tuned to 10 meters. In order to obtain maximum output from the oscillator, it may be necessary to experiment with the number of turns on coil L₁.

A small neutralizing capacity is provided by short lengths of No. 14 wire mounted on feed-thru insulators on each side of the 815 tube socket and connected to tube grids 2 and 7; capacity is varied by moving the wires closer to or farther from the plates of the tube. Once the oscillator is working properly, plate voltage can be applied to the amplifier section. A 0 to 200-mil. meter should be plugged into jack J₃ to check cathode current. The key is cut in at X or may be plugged in at either J₁ or J₃. The modulator terminals are for possible phone use and are shorted, of course, when this rig is used for c.w. With the key down, the cathode current should be about 40 ma. with meter in J₃. Cathode current will rise to 175 mils with antenna coupled to final tank. Grid measured in jack J₂ should be 6-10 mils. See page 159 for detailed material list.

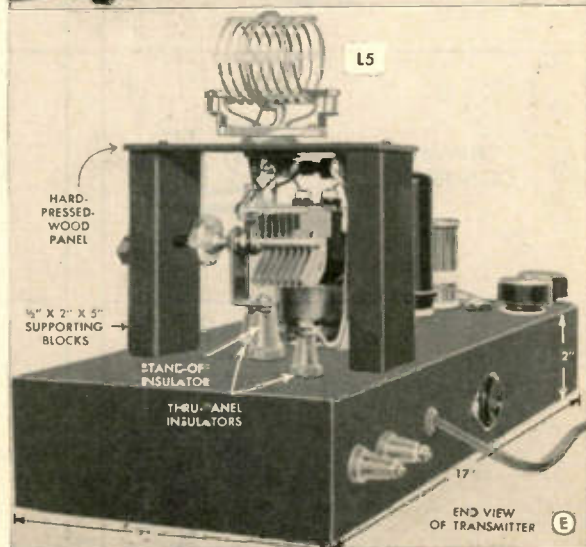
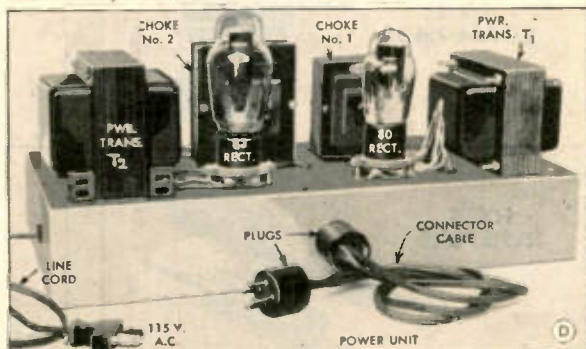

COMMONLY USED RADIO PARTS

PM SPEAKER

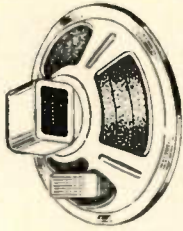

SINGLE-SECTION VARIABLE CONDENSER

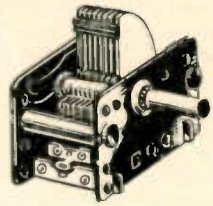

TUBULAR PAPER CONDENSER



2-GANG VARIABLE CONDENSER

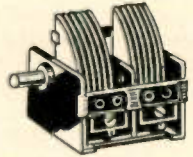

MICA FIXED CONDENSERS

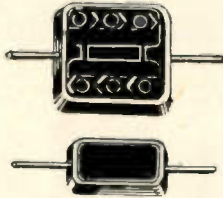

MIDGET VARIABLE CONDENSER

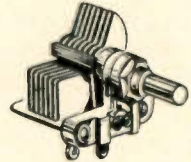

FIXED RESISTORS

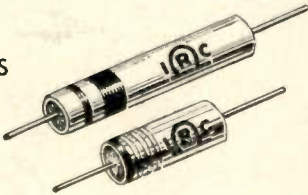

TUNING DIAL



TRIMMER CONDENSER

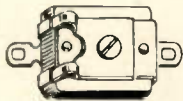

HEADPHONES



CHASSIS PUNCH FOR TUBE-SOCKET HOLES



PHONO PLUG AND JACK

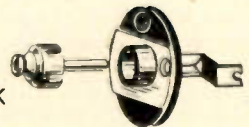

COMMONLY USED RADIO PARTS

**TUBE SOCKET
WITH
MOUNTING
PLATE**



**WIRE-WOUND
RESISTOR**

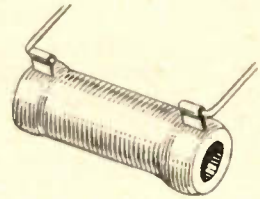

**MINIATURE TUBE SOCKET
RETAINER RING TYPE**

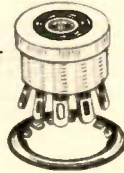

**WIRE-WOUND
CONTROL**

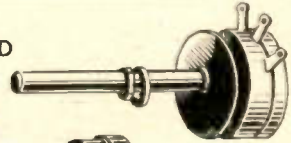

**ATTACHABLE
SWITCH**



**BAKELITE
SOCKET
FOR BREADBOARD
OR SUB-PANEL MOUNTING**

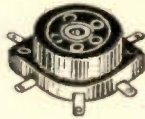

**TUBULAR
DRY
ELECTROLYTIC
CONDENSER**



**OSCILLATOR
COIL
(UNSHIELDED TYPE)**

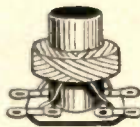

**R.F.
CHOKE
COIL**



**SHIELDED
ANTENNA AND
R.F. COILS**



**MINIATURE
SELENIUM
RECTIFIER**

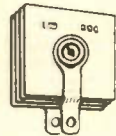

**AUDIO
TRANSFORMER
(UNSHIELDED TYPE)**

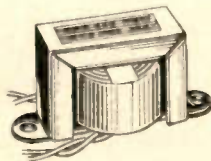

**INSULATED MOUNTING STRIP
(TERMINAL STRIP)**



COMMONLY USED RADIO PARTS

**UNIVERSAL
OUTPUT
TRANSFORMER**
SINGLE OR PUSH-PULL
PLATES TO
SPEAKER VOICE COIL

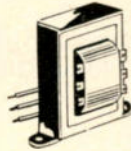

**FIXED
OUTPUT
TRANSFORMER**
SINGLE OR PUSH-PULL
PLATES TO
SPEAKER VOICE COIL

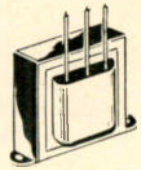

**POWER
TRANSFORMER**
COMBINATION
PLATE AND FILAMENT-
SUPPLY TYPE

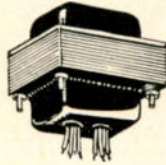

**FILAMENT
TRANSFORMER**
AVAILABLE WITH
SINGLE OR
MULTIPLE SECONDARY

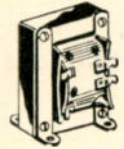

**HEAVY DUTY
PLATE
TRANSFORMER**



**FILTER
CHOKE**

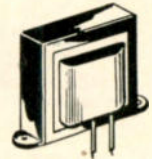

**CODE-
PRACTICE
KEY**



**RIBBED
PLUG-IN
COIL FORM**

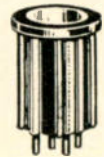

MIDGET JACK
AVAILABLE IN
CLOSED AND OPEN-
CIRCUIT TYPES

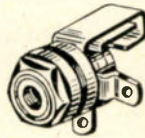

**PILOT-LIGHT
SOCKET AND
BRACKET WITH
JEWEL**





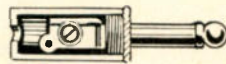









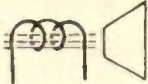

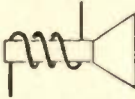

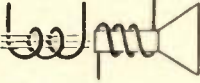

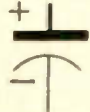

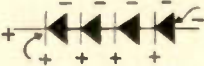
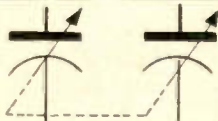
PHONE PLUG
(WITH SCREW CONNECTIONS)

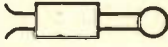
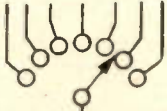

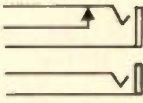

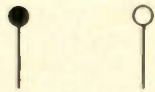

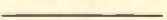





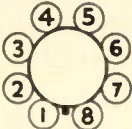
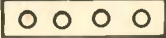
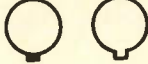

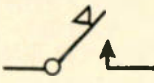

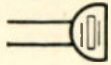
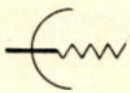
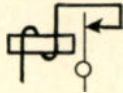



FAHNESTOCK CLIPS



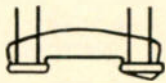

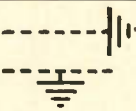

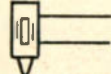

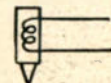



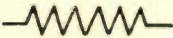

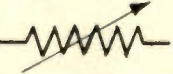

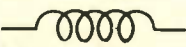

SCHEMATIC SYMBOLS USED IN CIRCUIT DIAGRAMS

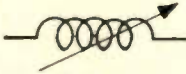
PART	SYMBOL	PART	SYMBOL
HEADPHONES		CONNECTED WIRES	
MAGNETIC SPEAKER		CROSSING WIRES NOT CONNECTED	
PERMANENT MAGNET SPEAKER (PM)		FIXED CONDENSER	
ELECTRO-DYNAMIC SPEAKER		VARIABLE CONDENSER	
PIEZOELECTRIC CRYSTAL		ELECTROLYTIC CONDENSER	
CRYSTAL DETECTOR		SHIELDED FIXED CONDENSER	
SELENIUM RECTIFIERS		GANGED VARIABLE CONDENSERS	
PILOT LAMP		PLUG	
ROTARY SWITCH		TWISTED LEADS	
JACKS CLOSED CIRCUIT OPEN CIRCUIT		SHIELDED LEAD	
TERMINALS		SHIELDING (GENERAL)	
CONNECTING WIRES (CONDUCTORS)		SOCKET SHELL (SHIELDING IN DOTTED LINES)	

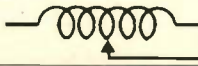
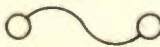
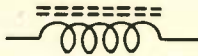
SCHEMATIC SYMBOLS USED IN CIRCUIT DIAGRAMS

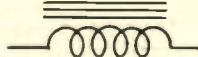
PART	SYMBOL	PART	SYMBOL
OCTAL TUBE BASE BASE BOTTOM VIEW		TERMINAL STRIP	
SOCKET ALIGNING KEY		LIGHTNING ARRESTER	
FILAMENT (FIL)		KEY	
CATHODE (K)		CRYSTAL MICROPHONE	
GRID (G)		BUZZER	
PLATE (P)		SINGLE-BUTTON CARBON MICROPHONE	
TRIODE VACUUM TUBE		DOUBLE-BUTTON CARBON MICROPHONE	
VOLTMETER		COAXIAL CABLE	
GALVANOMETER		HANDSET TELEPHONE	
AMMETER		GROUNDED SHIELDS	
MILLI-AMMETER		CRYSTAL PHONO PICKUP	
WATTMETER		ELECTRO-MAGNETIC PICKUP	

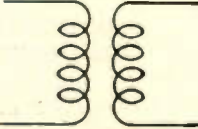
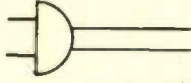
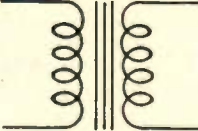
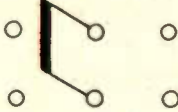
SCHEMATIC SYMBOLS USED IN CIRCUIT DIAGRAMS

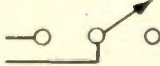
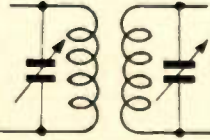
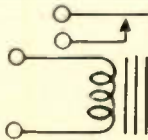
PART	SYMBOL	PART	SYMBOL
FIXED RESISTOR		LOOP ANTENNA	
VARIABLE RESISTOR		ANTENNA	
RESISTOR ADJUSTABLE IN STEPS		DRY CELL OR BATTERY (POSITIVE IS LONG LINE)	
AIR-CORE CHOKER COIL		GROUND TO CHASSIS BASE	
VARIABLE INDUCTANCE COIL		COMMON CIRCUIT GROUND	
INDUCTANCE COIL ADJUSTABLE IN STEPS		FUSE	
COIL WITH POWDERED- IRON CORE		SINGLE-POLE SINGLE-THROW SWITCH (S.P.S.T.)	
CHOKER COIL WITH IRON CORE		RECEPTACLE	
(R.F.) AIR-CORE TRANSFORMER		PLUG FOR POWER OUTLET	
(A.F.) IRON-CORE TRANSFORMER		DOUBLE-POLE DOUBLE-THROW SWITCH (D.P.D.T.)	
LINK-COUPLED INDUCTORS		SINGLE-POLE DOUBLE-THROW SWITCH (S.P.D.T.)	
TUNED AIR-CORE TRANSFORMER		RELAY	

HOW TO READ STANDARD COLOR CODES

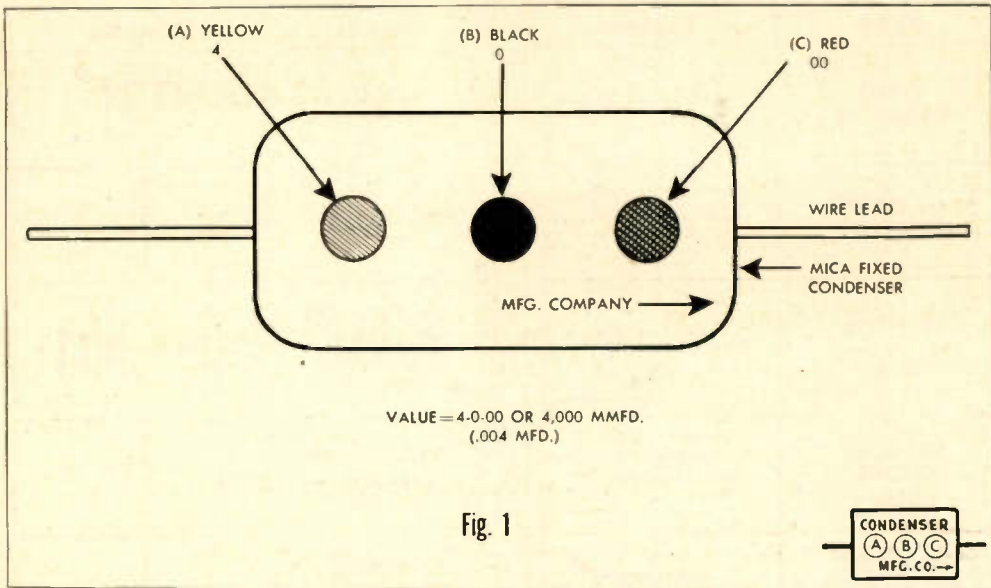

Fig. 1

R. M. A. COLOR CODE FOR MICA FIXED CONDENSERS

UNIT:—MICROMICROFARAD

A FIRST DOT	B SECOND DOT	C THIRD DOT
BLACK 0	BLACK 0	
BROWN 1	BROWN 1	BROWN 0
RED 2	RED 2	RED 00
ORANGE 3	ORANGE 3	ORANGE 000
YELLOW 4	YELLOW 4	YELLOW 0000
GREEN 5	GREEN 5	GREEN 00000
BLUE 6	BLUE 6	BLUE 000000
PURPLE 7	PURPLE 7	PURPLE 0000000
GRAY 8	GRAY 8	GRAY 00000000
WHITE 9	WHITE 9	WHITE 000000000

NOTE — IN DETERMINING CAPACITY OF A CONDENSER FROM ITS COLOR CODE, THE DOTS ARE READ FROM LEFT TO RIGHT WITH THE CONDENSER HELD SO THAT THE TRADEMARK IS IN A NORMAL READING POSITION

Fig. 2

R.M.A. COLOR CODE FOR LOUD-SPEAKER VOICE COILS

GREEN—finish BLACK—start

R.M.A. COLOR CODE FOR LOUD-SPEAKER FIELD COILS

BLACK and RED STRIPED—start
YELLOW and RED STRIPED—finish
SLATE and RED STRIPED—tap (if any)

PHONO MOTOR FREQUENCY IDENTIFICATION COLOR CODE

NO MARK.....60 cycles
GREEN SPOT.....50 cycles
WHITE SPOT.....25 cycles

BATTERY CABLE LEADS

Red A+ White B+ Intermediate
Black A- Brown C+
Blue B+ Orange C- Intermediate
Yellow B- Green C-

SPEAKER LEADS AND PLUG CONNECTIONS

NOTE—Color code and connections for wiring electro-dynamic speakers follow plan shown in Fig. 3. In all cases the start, tap, and finish of all windings are in clockwise sequence around the plug pins when viewing with pins toward you. All two-color leads have striped designs.

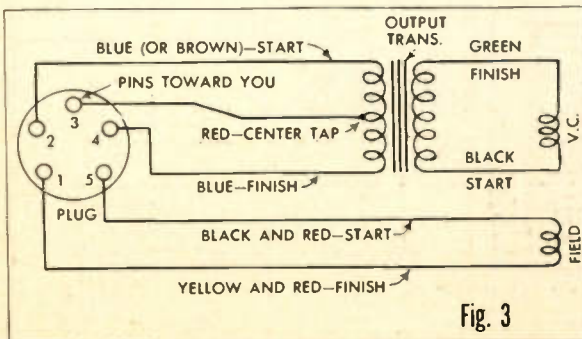
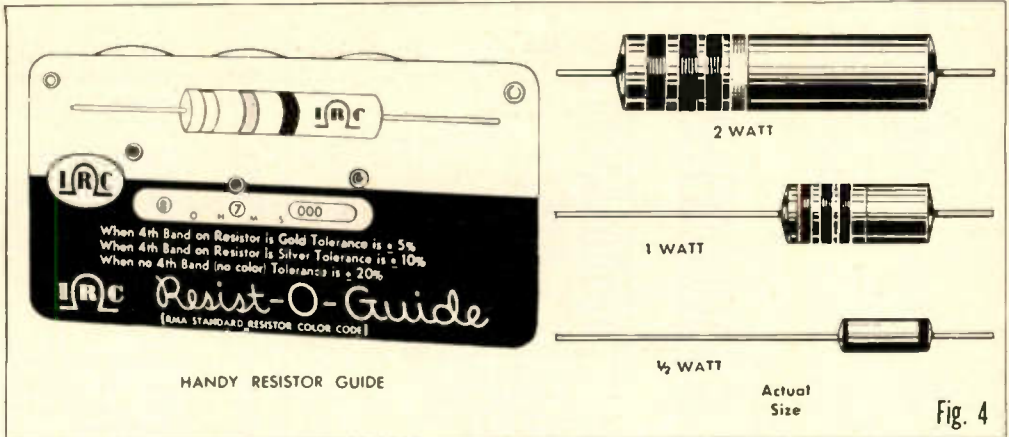

Fig. 3

HOW TO READ STANDARD COLOR CODES



PREFERRED R.M.A. VALUES FOR FIXED RESISTORS

Ohms	Ohms	Ohms	Ohms	Ohms	Ohms	Ohms	Ohms	Ohms
0.47	3.9	33	270	2,200	15,000	100,000	560,000	3.9 meg.
0.56	4.7	39	330	2,700	18,000	120,000	680,000	4.7 meg.
0.68	5.6	47	390	3,300	22,000	150,000	820,000	5.6 meg.
0.82	6.8	56	470	3,900	27,000	180,000	1.0 meg.	6.8 meg.
1.0	8.2	68	560	4,700	33,000	220,000	1.2 meg.	8.2 meg.
1.2	10.0	82	680	5,600	39,000	270,000	1.5 meg.	10 meg.
1.5	12.0	100	820	6,800	47,000	330,000	1.8 meg.	12 meg.
1.8	15.0	120	1,000	8,200	56,000	390,000	2.2 meg.	15 meg.
2.2	18.0	150	1,200	10,000	68,000	470,000	2.7 meg.	18 meg.
2.7	22.0	180	1,500	12,000	82,000	510,000	3.3 meg.	22 meg.
3.3	27.0	220	1,800					

Fig. 5

CHART A— R. M. A. COLOR CODE FOR FIXED RESISTORS

UNIT:—OHM

BLACK -0	BLACK -0	BLACK -
BROWN -1	BROWN -1	BROWN -0
RED -2	RED -2	RED -00
ORANGE -3	ORANGE -3	ORANGE -000
YELLOW -4	YELLOW -4	YELLOW -0000
GREEN -5	GREEN -5	GREEN -00000
BLUE -6	BLUE -6	BLUE -000000
VIOLET -7	VIOLET -7	GOLD -MULTIPLY BY .1
GRAY -8	GRAY -8	SILVER -MULTIPLY BY .01
WHITE -9	WHITE -9	

TOLERANCE
 GOLD = 5%
 SILVER = 10%
 NO BAND = 20%

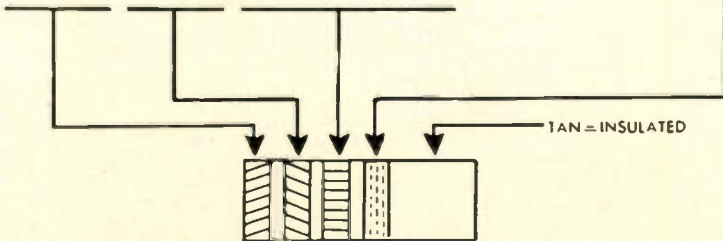

R M A COLOR CODE

Fig. 6

HOW TO READ STANDARD COLOR CODES

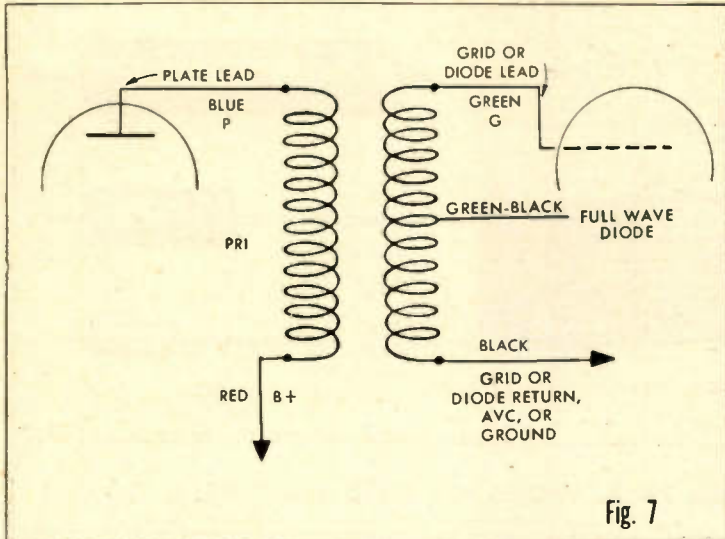

FIG. 7

R.M.A. color code for intermediate-frequency (I.F.) air-core transformer

NOTE—If the secondary is center-tapped, the second diode plate lead is green and black striped, and black is used for the center-tap lead.

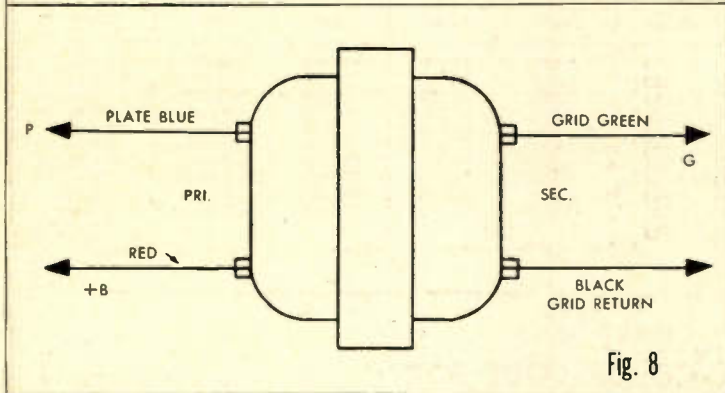

FIG. 8

R.M.A. color code for single-plate to single-grid audio-frequency (A.F.) transformer

NOTE—If the primary is center-tapped the plate starting lead is brown, and the finish plate lead is blue. The positive B lead is red whether the primary is plain or center-tapped. If the secondary is center-tapped, yellow will be the grid starting lead. Green is the grid finish lead. Black is the grid return lead whether the secondary is plain or center-tapped.

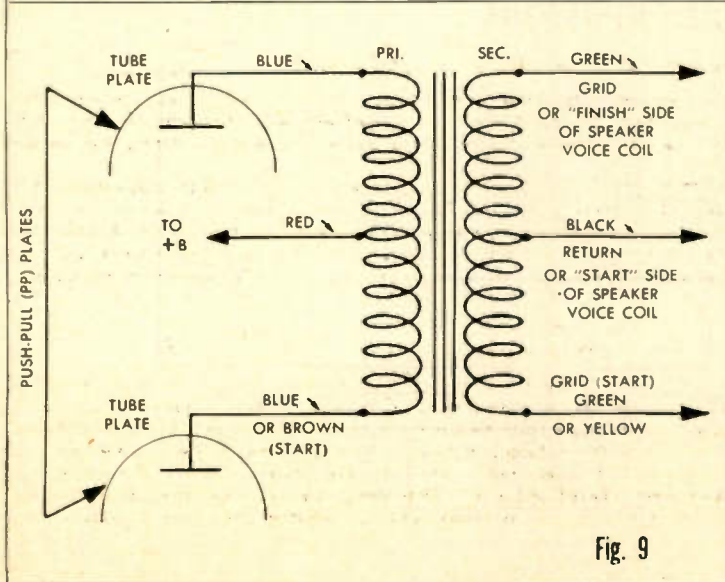
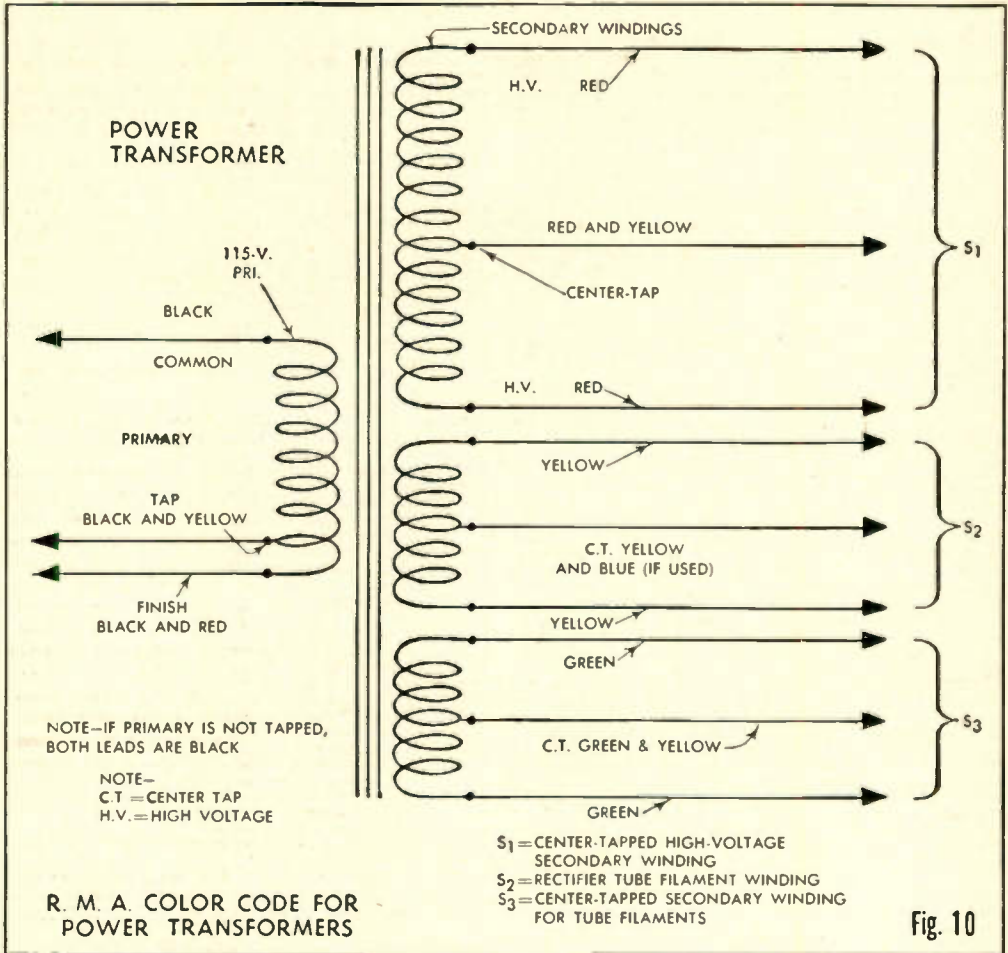

FIG. 9

R.M.A. color code for push-pull plates to single or push-pull grids (A.F.) audio transformer (Interstage or output type)

NOTE—
BLUE—Plate (finish lead of primary)
RED = B-positive lead (for either plain or center-tapped primary)
BROWN—Plate (start lead on center-tapped primary); Blue may be used if polarity is not required
GREEN—Grid (finish lead of secondary)
BLACK—Grid return (this applies to either plain or center-tapped secondary)
YELLOW—Grid (start) lead on center-tapped secondary. Green may be used if polarity is not required
 (In case of speaker-output transformers, black is start of secondary)

HOW TO READ STANDARD COLOR CODES



COLOR CODE HINTS FOR BEGINNERS

Normally the color code colors on fixed resistors, condensers and transformers are easy to read. However, the flexible color-coded leads on transformers and chokes are often covered with wax or paraffin and the colors are faint and difficult to identify. The colors can be brought out by applying a warm soldering iron on the insulation for an instant.

Some small ceramic fixed condensers are now made tubular in shape and from outward appearance it is sometimes rather difficult to distinguish them from small carbon-type fixed resistors. However the manufacturer's name is usually stamped on the part and the value given in either mfd. or mmfd. Reading the fixed condenser codes is just as easy as reading the resistor codes after the first color dot or band is identified. The remaining ones can be read in sequence. The code values are always expressed in micromicrofarads (mmfd.).

TUBE MANUALS

Every radio student and experimenter should have a tube manual. No engineer, radio service man, technician or radio amateur would be without one. No one can memorize all tube-base symbols or tube characteristics. The RCA Tube Manual is available from all radio parts houses for about 50c. It contains full technical data on all current receiving tubes, and typical circuit diagrams showing their application in FM and AM receivers and amplifiers. Complete descriptions of RCA tubes used in television receivers are included. The socket-connection diagrams are bottom views, clearly keyed and easily understood. Electron-tube applications include amplification, rectification, detection, automatic volume control (AVC), oscillation, frequency conversion and automatic frequency control.

COMMON RADIO AND ELECTRONIC TERMS

AMMETER. An instrument for measuring the current flow in amperes in a circuit.

AMPERE. The practical unit for measuring flow of current. When a one-ohm resistance is connected to a one-volt source, one ampere will flow.

ANODE. The radio-tube electrode to which the main electron stream flows. It is commonly called the plate, and is identified by the letter P.

ANTENNA. An arrangement of conducting wires or metal rods used for picking up, or radiating, radio waves. Also called an aerial.

AUDIBLE. Sound capable of being heard by the human ear.

AUDIO AMPLIFIER. Any vacuum-tube device which increases the voltage and power of an audio-frequency (a.f.) signal. It may be a separate unit, or the audio section of a radio receiver.

AUDIO FREQUENCY. A frequency corresponding to an audible sound wave. The extreme limits vary with individuals; range is from about 20 cycles to about 20,000 cycles per second.

AUDIO TRANSFORMER. An iron-core transformer used for coupling two audio-amplifier circuits together, or, for changing values of audio signals.

AUTOMATIC VOLUME CONTROL. A radio circuit which automatically maintains the output value of a radio receiver constant within certain limits while the carrier signal picked up by the antenna varies widely in amplitude.

BACKGROUND NOISE. Undesired noise heard along with received radio programs. Due to circuit conditions, or atmospheric interference.

BAFFLE. A flat surface of wood or metal used with a loudspeaker to increase the length of the air path from the front to the back of the loudspeaker diaphragm, thus reducing interaction between sound waves produced simultaneously from the front and back surfaces of the diaphragm. Also directs sound, and improves the fidelity of reproduction.

BAKELITE. A phenolic compound having high electrical resistance. Used as an insulating material in the construction of radio parts and panels.

BANDSPREAD TUNING CONTROL. A small variable condenser connected in parallel with the main tuning condenser of a short-wave receiver for the purpose of finer or more accurate tuning.

BAND SWITCH. A switch which simultaneously changes all tuning circuits of a radio receiver or transmitter to other desired predetermined bands.

B-BATTERY. A battery having many small cells connected in series, used for supplying d.c. plate and screen voltage to radio tubes in battery-operated radio and electronic equipment.

BEAM POWER-AMPLIFIER TUBE. A special type of vacuum tube for use in the output stage of a radio receiver. Deflecting electrodes concentrate the electrons into beams to give high power output with good quality.

B-ELIMINATOR. An a.c. power pack which is designed to convert a.c. power-line voltage to d.c. voltages of correct plate and screen values for tubes in circuits formerly supplied by B-batteries.

BIAS. The fixed negative grid voltage (commonly called grid bias) for an electron tube.

BLOCKING CONDENSER. Any condenser used in a radio circuit to block the flow of current while permitting a.c. signal currents to pass.

BY-PASS CONDENSER. Any condenser used to provide a low-impedance path for radio or audio signals to pass around a resistor or between a circuit terminal and ground.

CAPACITIVE COUPLING. Coupling in which a condenser provides a direct path for signal energy between two circuits.

CAPACITOR. Condenser of any type.

CAPACITY. The electrical size of a condenser, determining the amount of electrical energy which can be stored in a condenser by a given voltage. Capacity is measured in microfarads (mf.) and micromicrofarads (mmfd.). Note—1 mfd. is equal to 1,000,000 mmfd.

CARBON RESISTOR. A resistor made of carbon particles and a ceramic binder molded into a cylindrical shape, with wire connecting leads at each end.

CATHODE. The negative pole or electrode of an electrolytic cell, vacuum tube, etc. Identified by the letter K.

C-BATTERY. A battery used for supplying a negative C-bias to the control grid of a vacuum tube.

C-BIAS. An applied voltage used to make the control grid of a vacuum tube negative with respect to the cathode.

CHASSIS. A metal framework on which the parts of a radio receiver or any radio or electronic device are mounted.

CHOKE COIL. A coil used to limit the flow of alternating current while allowing direct current to pass. R.f. choke coils have air cores; a.f. choke coils have iron cores.

COAXIAL CABLE. A two-conductor cable in which one conductor is a flexible or non-flexible metal tube and the other is a wire supported in the center of the tube by insulators.

COLOR CODE. A system of colors used to specify the electrical value of a radio part, or to identify terminals and leads. R.M.A. code is standard.

CONDENSER. A device having the ability to receive and hold an electrical charge in two conductors separated from each other by insulation, called the dielectric, through which the two conductors, or plates, exert an inductive effect. The dielectric may be air, mica, oil, ceramic or a plastic material.

CONDUCTIVITY. The ability of a material to carry electric current.

CONDUCTOR. A wire or other metallic structure which provides a path for electric current between two points. A good conductor offers little opposition to the continuous flow of electric current.

CONTINENTAL CODE. Same as International Morse Code. Universally used for radio telegraphy.

CONTROL GRID. The electrode in a vacuum tube which has the most effective control over the plate current passed by the tube.

COULOMB. A measure of the amount of an electric current, being the quantity transferred in one second by a current of one ampere.

CRYSTAL CONTROL. Use of a quartz crystal to maintain operation of a radio station at its assigned frequency within the limits prescribed by law. The quartz crystal is ground to a size which will vibrate naturally at a desired radio frequency and generate that frequency when it is set into vibration.

CRYSTAL DETECTOR. A detector of radio signals utilizing a crystal such as silicon or galena in contact with a pointed wire to rectify an incoming radio signal. Used in crystal receivers.

CRYSTAL PICKUP. A type of phonograph pickup in which the needle movements bend a quartz crystal and cause the crystal to generate an audio-frequency voltage corresponding to the recorded sound waves.

CURRENT. The movement of electrons through a conductor. Current is measured in amperes, in milliamperes and in microamperes.

CUTTING HEAD. The part of a sound recorder which cuts the irregular grooves on a blank record disk, corresponding to the wave form of the sounds being recorded.

CYCLE. One complete reversal of an alternating current, including a rise to maximum in one direction, a return to zero, the rise to maximum in the other direction, and another return to zero. The number of cycles occurring in one second is the frequency of an alternating current.

DIELECTRIC. The insulating material between the plates of a condenser.

DIODE. A vacuum tube with a cold anode and a heated cathode, serving as a rectifier.

DROP. The voltage drop that occurs across a resistor due to current flow through the resistor.

DX. A slang expression for distance, used chiefly in connection with the reception of distant radio stations.

DYNAMIC LOUDSPEAKER. Any loudspeaker in which the diaphragm or cone is attached to a small coil mounted so that it can move within a constant magnetic field. Audio-frequency currents flowing through this "voice" coil make it move in and out, thereby causing the diaphragm to reproduce sound waves. In permanent-magnet (PM) speakers, the magnetic field is produced by a permanent magnet; and by an electrodynamic speakers.

ELECTRIC FIELD. A region in space surrounding a charged object. Lines drawn to represent the direction in which the electric field will act on other charged objects are called electric lines of force.

ELECTROLYTE. The liquid or chemical paste which is used between the electrodes of a dry cell, storage battery or electrolytic condenser.

ELECTRON. The most elementary charge of negative electricity; the electrical opposite of the proton.

ELECTRONICS. A broad field of electricity covering work with all types of apparatus employing electron tubes for industrial applications. Radio and television are major branches of the electronic field.

COMMON RADIO AND ELECTRONIC TERMS

ELECTRON TUBE. Any partly evacuated, completely evacuated or gas-filled tube used to control the flow of electrons in a circuit. Vacuum tubes, phototubes, mercury-vapor rectifier tubes and cathode-ray tubes are all electron tubes.

FACSIMILE. A system of radio communication in which photographs, drawings and printed matter of any kind are transmitted to receivers which feed into facsimile recorders.

FACSIMILE RECORDER. An instrument which reproduces on paper the illustration, writing or printed matter being transmitted by a facsimile system.

FAHNESTOCK CLIP. A spring-type terminal to which a temporary connection can be easily made.

FARAD. The unit of electrical capacity; the capacity of a condenser which, charged with one coulomb, gives a difference of potential of one volt.

F.C.C., OR FEDERAL COMMUNICATIONS COMMISSION. A commission appointed by the President of the United States and given licensing and regulating authority on matters dealing with wire and radio communication in the United States and its possessions.

FILAMENT. The resistance wire through which the filament current is sent in a vacuum tube to produce the heat required for electron emission.

FILTER CHOKE. A coil used in a filter system to pass low-frequency currents or direct current while limiting, or blocking, the flow of higher frequency alternating or pulsating currents.

FILTER CONDENSER. A condenser used in a filter system to permit passage of higher frequency currents while limiting, or blocking, the flow of lower frequency currents and direct current.

FIRST AUDIO STAGE. The first stage in the audio amplifier of a radio receiver. Audio signals are fed into this stage by the detector of a T.R.F. (tuned-radio-frequency) receiver; and by the second detector of superheterodyne receiver.

FIRST DETECTOR. That stage in a superheterodyne receiver in which the incoming modulated r.f. signal and the r.f. signal from the local oscillator are combined to produce the i.f. (intermediate frequency) signal.

FULL-WAVE RECTIFIER. A radio tube or other device which rectifies an alternating current in such a way that both halves of each input a.c. cycle appear in the pulsating rectified output. A full-wave rectifier tube employs two separate diode sections, one passing current during one alternation, and the other passing current during the opposite half-cycle.

GANGED TUNING CONDENSER. Two or more variable tuning condensers mounted on the same shaft and operated by a single control.

GRID. An electrode mounted between the cathode and the anode (plate) of a radio or electronic tube to control the flow of electrons from cathode to anode.

GRID CLIP. A spring clip used to make a convenient and easily-removed connection to the cap terminal located on the top of some types of radio tubes.

GRID CONDENSERS. A small fixed condenser inserted in the grid circuit of a vacuum tube.

GRID LEAK. A high-value resistor used to connect the control grid to the cathode, in a grid leak condenser circuit.

GRID RETURN. The connection or lead that provides a path for electrons from the grid circuit, or C-bias battery, to the cathode.

GRILLE CLOTH. A loosely woven cloth stretched behind the loudspeaker grille of a radio receiver to keep dust and other foreign particles out of the loudspeaker; and also to conceal the loudspeaker cone.

GROMMET. A rubber insulating washer used to prevent a wire from touching the sides of a chassis hole through which the wire passes.

GROUND CLAMP. A metal strap or clamp that is adjustable for making a good electrical connection to any ground rod or grounded pipe. The clamp has a screw terminal or soldering lug to which the ground wire is attached. A good ground is important if it is specified for your receiver.

HALF-WAVE RECTIFIER. A radio tube, or other device, which converts alternating current into pulsating direct current by allowing current to pass only during one half of each alternating-current cycle. A half-wave rectifier contains only one diode section.

HEADPHONES. Small telephone receivers held against the ears by a clamp passing over the head.

HEATER. A filament used in a vacuum tube only for the purpose of supplying heat to an indirectly heated cathode.

HEAVYSIDE LAYER. A layer of ionized gas which scientists believe exists in the region between 50 and 400 miles above the surface of the earth, and which reflects radio waves back to earth under certain conditions. It is also known as the Kennelly-Heaviside layer.

HENRY, OR HY. The practical unit for measuring inductance.

HOOKUP. A diagram giving circuit connections for a radio receiver, transmitter, or any electronic device.

HUM. A low and constant audio frequency, usually either 60 or 120 cycles. A defective filter condenser in an a.c. power pack is the usual cause of objectionable background hum in receivers.

IMPEDANCE. The total opposition which a radio part or circuit offers to the flow of alternating, or pulsating direct current at a particular frequency. Impedance is a combination of resistance and reactance, and is measured in ohms.

INDUCTANCE. That property of a coil or other radio part which tends to prevent any change in current flow. Inductance is effective only when varying or alternating currents are present; it has no effect on the flow of direct current. Inductance is measured in henrys.

INDUCTIVE COUPLING. A form of coupling in which energy is transferred from a coil in one circuit to a coil in another circuit by induction. There is no electrical connection between the coils; the coupling is produced by magnetic lines of force.

INTERMEDIATE FREQUENCY. In a superheterodyne receiver, the frequency to which all incoming carrier signals are converted before being fed into the intermediate-frequency amplifier.

INTERMEDIATE FREQUENCY AMPLIFIER. That section of a superheterodyne receiver which is designed to amplify signals with high efficiency at a predetermined frequency called the intermediate frequency of the receiver.

INTERMITTENT RECEPTION. A type of radio receiver trouble in which the receiver performs normally for a time, then becomes dead or distorts the signals, with the process being repeated at intervals.

LEADIN. A wire which serves to connect the outdoor signal pickup portion of an antenna system with the antenna terminal on the receiver.

LIGHTNING ARRESTER. A protective device used to divert directly to ground a discharge of lightning which strikes an antenna.

LINE CORD. A two-wire cable terminating in a two-prong plug used to connect a radio receiver to an a.c. or d.c. wall outlet.

LINE FILTER. A device inserted between the line-cord plug of a radio receiver and the power line to filter out noise signals that might enter the receiver from the power line. It consists of one or more choke coils and fixed condensers.

LOKAL TUBE. A small glass-type radio tube with special base construction which locks the tube firmly in the corresponding special eight-prong loktal socket. These tubes are used in auto radios and some a.c.-d.c. midget receivers.

LUG. A small strip of metal for placing under a terminal screw to provide a convenient means of making a soldered wire connection.

MAN-MADE STATIC. High-frequency noise signals produced by sparking in electrically operated apparatus, or power lines, and picked up by the receiver, interfering with a desired radio program.

MANUAL TUNING. Tuning a radio receiver by rotating the tuning control knob by hand.

METAL-TYPE TUBE. A vacuum tube having a metal envelope, with electrode connections being made through glass beads fused into the metal envelope. Usually called an all-metal tube.

MICROPHONE. A device which converts sound waves into corresponding audio frequency electrical energy. It contains some form of flexible diaphragm which moves in accordance with sound wave variations. This movement generates a minute voltage which is fed to the input of an amplifier where it is amplified many times.

MILLIAMMETER. A measuring instrument which measures current flow in milliamperes.

MOTORBOATING. Regeneration occurring at audio frequencies in a radio receiver or audio amplifier, resulting in "putt-putt" sounds resembling those made by a motorboat.

NEUTRON. Having neither positive nor negative charge. An uncharged particle of nearly the mass of the proton.

COMMON RADIO AND ELECTRONIC TERMS

OCTAL BASE. A type of tube socket having eight equally spaced prongs and a central aligning key. When some of the prongs are not required they are omitted without changing the positions of the remaining prongs.

OHM. The practical unit of electrical resistance, being the resistance of a circuit in which a potential difference of one volt produces a current of one ampere.

OHMMETER. A test instrument for measuring resistance.

OSCILLATION. A condition whereby high-frequency currents are generated in a circuit.

OSCILLATOR. The stage in a radio receiver, transmitter or other apparatus in which a vacuum tube and associated components generate alternating-current energy when fed with direct-current energy.

PADDER CONDENSER. In a superheterodyne receiver, this trimmer condenser is connected in series with the oscillator tuning circuit to control the receiver calibration at the low-frequency end of the tuning range.

PARALLEL CONNECTION. A connection in which current divides between two or more parts, as contrasted to a series connection in which the same current flows through all parts. Batteries are connected in parallel by connecting the positive terminals together, and then connecting the negative terminals together.

PENTODE. A vacuum tube having five electrodes. Ordinarily these will be the cathode, control grid, screen grid, suppressor grid and anode (P).

PERMANENT MAGNET. A piece of hardened steel or other magnetic material which has been artificially magnetized and retains its magnetism.

PHILLIPS SCREW. A screw having an indented cross on its head instead of the conventional slot.

PHOTOELECTRIC CELL. A device which converts variations in light into corresponding variations in voltage or current.

POLARITY. In a radio circuit or part, the quality of having two opposite charges, one negative and the other positive.

POTENTIOMETER. A variable resistance unit having a rotating contact arm which can be set at any desired point on the resistance element. The volume control in a radio receiver or audio amplifier is generally a potentiometer.

PROTON. Nucleus of the atom of the light isotope of hydrogen, constituting the principal part of its atomic mass and exhibiting a unit positive charge of electricity.

PUSH-BACK HOOKUP WIRE. Tinned copper hookup wire covered with cotton insulation that can be pushed back from the end of a wire length to expose sufficient wire for a connection.

PUSH-PULL CIRCUIT. A two-tube audio output circuit so designed that both tubes operate simultaneously and their individual audio-frequency plate currents add in the common load to give twice the output of a single tube.

PUSH-PULL TRANSFORMER. An iron-core a.f. transformer designed for use in a push-pull amplifier circuit. If it is the input transformer, it will have a center-tapped secondary winding. If it is the output transformer it will have a center-tapped primary winding.

RADIO FREQUENCY. Any frequency in the radio spectrum above the highest audible frequency, which is about 20,000 cycles. Abbreviated as r.f.

RADIO FREQUENCY AMPLIFIER. A vacuum-tube amplifier stage to provide amplification at radio frequencies. In a tuned-radio-frequency (t.r.f.) receiver all stages ahead of the detector are r.f. amplifier stages.

RADIO FREQUENCY TRANSFORMER. An air-core, or powdered-iron core, transformer used in r.f. circuits.

REACTANCE. Opposition offered to the flow of alternating current by the inductance or the capacity of a part.

RECTIFIER. A device that changes alternating current into pulsating direct current. It may be a vacuum tube, gaseous tube, crystal, vibrator, or a selenium rectifier device.

REGENERATION. The process by which a part of the output power of an amplifying device reacts upon the input circuit in such a way as to reinforce the initial power, thus increasing the amplification. It is sometimes referred to as "feedback."

RESISTANCE COUPLING. A type of coupling in which a resistor and a condenser provide a path for signal energy between two circuits.

RESISTOR. A resistance unit, or "package" of resistance, employed in the control or operation of electrical devices or for their protection from overload.

RESONANCE. In a circuit containing both inductance and capacity, a condition in which the inductive reactance is equal to and cancels out the capacitive reactance at a particular frequency.

RHEOSTAT. A variable resistance unit to control the flow of current.

SCHEMATIC DIAGRAM. A diagram which shows electrical connections of a radio or electronic device by means of symbols which are used to represent the various radio parts.

SENSITIVITY. A measure of the ability of a radio receiver to reproduce weak signals with good volume.

SELECTIVITY. The degree to which a receiver is capable of reproducing the signals of one station while rejecting signals from all other stations.

SHIELD. A metal can or housing placed around a radio part to prevent its electrical and magnetic fields from affecting nearby parts, or to prevent other fields from affecting it.

SHIELDED WIRE. Insulated wire having around it a shield of tinned braided copper wire.

SHORT CIRCUIT. A low-resistance connection, usually accidental, occurring between the two sides of a circuit, or between any two circuit terminals. It often results in excessive current flow and damage to parts.

SHORT WAVES. Wavelengths shorter than those included in the broadcast band. In other words, waves shorter than 200 meters. Short waves correspond to frequencies higher than the highest broadcast-band frequency of 1600 kilocycles.

SIGNAL GENERATOR. A test instrument used by radio service men and experimenters to produce a modulated or unmodulated r.f. carrier signal having a known radio-frequency value. It is used as a signal source during the alignment of a radio receiver and when checking for a defective part in an improperly working receiver.

SIGNAL TRACING. A radio receiver servicing technique which involves tracing the progress of a radio signal through an entire receiver, stage by stage, while the set is in operation.

SPAGHETTI TUBING. Heavily varnished cloth tubing used to provide additional insulation for radio circuit wirings.

SPIDER. A flexible fiber ring which serves to center the voice coil of a dynamic loudspeaker without hindering the in-and-out motion of the voice coil and its attached diaphragm.

SPLICE. A joint between two wires which possesses mechanical strength as well as good electrical conductivity.

STAND-OFF INSULATOR. An insulator used to support a wire or part at a desired distance away from the building or other support on which the insulator is mounted.

STATIC. Interfering noises heard in a radio receiver due to radio waves created by atmospheric electrical disturbances.

STATOR. The fixed plates in a variable condenser.

STEP-DOWN TRANSFORMER. A transformer in which the secondary winding has fewer turns than the primary, so that the secondary delivers a lower voltage than is applied to the primary.

STRANDED WIRE. A wire which consists of a number of finer wires twisted together.

TEST LEAD. A flexible insulated lead used chiefly for connecting meters and test instruments to a circuit under test.

TEST PROD. A sharp metal point provided with an insulated handle and means for connecting the point to a test lead. Used for making a touch connection to a circuit terminal.

TETRODE. A four-electrode vacuum tube. Ordinarily, these electrodes will be the cathode, control grid, screen grid and anode (P).

TOGGLE SWITCH. A small switch operated by means of a lever.

TONE. The general character of a reproduced radio program as it affects the human ear.

TONE CONTROL. A circuit control on a radio receiver which permits the operator to strengthen the response at either low or at high audio frequencies at will, so as to make the reproduced program pleasing.

TREBLE. A term sometimes used to designate high audio frequencies.

TRIODE. A three-electrode vacuum tube, usually having a cathode, control grid and anode (P).

TUNGAR BULB. A gaseous diode rectifier used in battery chargers.

TUNING. The process of setting all of the tuning circuits in a radio receiver simultaneously to a desired frequency by rotating the tuning dial.

COMMON RADIO AND ELECTRONIC TERMS

UNIVERSAL OUTPUT TRANSFORMER. An iron-core a.f. output transformer having a number of taps on its windings to permit its use in practically any average radio receiver (matches any output tube).

VACUUM TUBE. A device consisting of a number of electrodes mounted in an envelope, or housing, from which practically all air has been removed. Also called a radio tube or an electron tube.

VOLT. The unit of electromotive force which, steadily applied to a conductor whose resistance is one ohm, will produce a current of one ampere.

VOLTAGE REGULATOR TUBE. A two-element gaseous tube used in a.c. radio receivers to keep the input a.c. voltage to the receiver power pack constant despite wide variations in the line voltage.

VOLTMETER. A meter used to measure electrical pressure in volts.

VOLT-OHM-MILLIAMMETER. A test instrument having provisions for measuring voltage, resistance and

current. It employs a single meter having the necessary number of scales, and a switch which places the meter in the correct circuit for a particular measurement.

VOLUME CONTROL. A variable resistor which varies the a.f. output of a receiver or public-address (PA) amplifier, thereby changing the volume of the sound produced by the loudspeaker.

WATT. The practical unit of electrical power. One watt is the power produced by a current of 1 ampere at a pressure of 1 volt. In a d.c. circuit the power in watts consumed by a device is equal to the applied voltage multiplied by the current in amperes.

WIRE-WOUND RESISTOR. A resistor which is made by winding a high-resistance wire on an insulating form, usually ceramic; it may or may not be covered with a ceramic insulating layer.

ZERO BEAT. A condition where two frequencies are exactly the same.

COMMON TELEVISION TERMS

BRIGHTNESS CONTROL. The manual bias control of a picture tube. The brightness control affects both the average brightness and the contrast of the picture.

CAMERA TUBE. An electron-beam tube in which an electron current or charge-density image is formed from an optical image and scanned in a predetermined sequence to provide an electrical signal.

CARRIER. A wave suitable for modulation by a modulated wave. Lights up screen before picture comes on.

CONTRAST. The ratio between the maximum and minimum brightness values in a picture.

CONTRAST CONTROL. The manual gain control for the picture signal. The contrast control affects both the brightness and the contrast of the picture.

FOCUSING. The process of controlling the convergence and divergence of an electron beam.

FRAME. The total area occupied by the picture which is scanned while the picture signal is not blanked.

GHOST. The spurious image resulting from an echo.

HORIZONTAL HOLD CONTROL. The control which varies the free-running period of the horizontal deflection oscillator.

ICONOSCOPE. A camera tube in which a high-velocity electron beam scans a photoactive mosaic which has electrical storage capability.

KINESCOPE. RCA picture tube.

LINE FREQUENCY. The number of times per second that a fixed vertical line in the picture is crossed in one direction by the scanning spot. Scanning during vertical return intervals is counted.

MAGNETIC FOCUSING. A method of focusing an electron beam by the action of a magnetic field.

NUMBER OF SCANNING LINES. The ratio of line frequency to frame frequency.

ORTHICON TUBE. A sensitive camera tube in which a low-velocity electron beam scans a photoactive mosaic which has electrical storage capability.

PICKUP TUBE. See camera tube.

PICTURE SIGNAL. The signal resulting from the scanning process.

PICTURE TUBE. A cathode-ray tube used to produce an image by variation of the beam intensity as the beam scans a raster.

RASTER. A predetermined pattern of scanning lines which provides substantially uniform coverage of an area.

SCANNING. In television, the process of analyzing or synthesizing successively, according to a predetermined method, the light values of picture elements constituting a picture area.

SCANNING LINE. A single continuous narrow strip which is determined by the process of scanning. Note—In most television systems, the scanning lines which occur during the return intervals are blanked.

SCANNING SPOT. The area with which the scanned area is being explored at any instant during the trace interval.

SYNCHRONIZING SIGNALS. The signals employed for the synchronizing of scanning.

TELEVISION. The electrical transmission and reception of transient visual images. In other words: the transmission and reception of a rapid succession of images by means of radio waves traveling through space.

TRACE INTERVAL. The interval corresponding to the direction of sweep used for delineation.

VERTICAL HOLD CONTROL. The control which varies the free-running of the vertical deflection oscillator.

VIDEO. A term pertaining to the band width and spectrum position of the signal resulting from television scanning. Note—Commonly used in referring to the picture signal, and to parts and circuits which handle picture signals. Video is a Latin word meaning "I see."

COMMON ABBREVIATIONS

a.c.	alternating current	gnd.	ground	pri.	primary
a.f.	audio frequency	H	heater	R	resistor
AM	amplitude modulation	h.f.	high frequency	rect.	rectifier
amp.	ampere	h.v.	high voltage	r.f.	radio frequency
ant.	antenna	hy.	henry (unit of measurement for inductance)	r.f.c.	radio frequency choke
a.v.c.	automatic volume control	I	symbol for current in amperes	sec.	secondary
C	condenser (also cond.)	i.f.	intermediate frequency	SG	screen grid
cap.	capacity	K	cathode	s.p.d.t.	single-pole, double throw (switch)
ch.	choke	kc.	kilocycle	s.p.s.t.	single-pole, single-throw (switch)
cont.	control	kw.	kilowatt	super	superheterodyne (also superhet.)
c.r.	cathode ray	L	inductance (coil)	S-W	short wave
c.t.	center tap	LS	loudspeaker	sw.	switch
c.w.	continuous wave (code transmission)	ma.	milliamperes	T	transformer
DB	decibel (unit of measurement for sound)	mc.	megacycle	tp.	tiepoint
d.c.	direct current	meg.	megohm	tr.	trimmer (condenser)
d.p.d.t.	double-pole, double-throw (switch)	mf.	microfarad	t.r.f.	tuned radio frequency
d.p.s.t.	double-pole, single-throw (switch)	mh.	microhenry	u.h.f.	ultra high frequency
DX	long distance	mike	microphone	v.	volt
e.c.o.	electron-coupled oscillator	ml.	one-thousandth	var.	variable
elect.	electrolytic (condenser)	mmfd.	micromicrofarad	vol.	volume
EMF	electromotive force (voltage)	P	plate	v.h.f.	very high frequency
FIL	filament (also F)	PA	public address	w.	watt
FM	frequency modulation	pe.	photoelectric	w.w.	wire-wound
G	grid	ph.	phone (headphone)	X'mitter	transmitter
		phono	phonograph	X'tal	crystal
		PM	permanent magnet (speaker)		

FCC ADDRESSES

(FOR INFORMATION REGARDING AMATEUR RADIO LICENSE EXAMINATIONS ADDRESS FCC ENGINEER IN CHARGE)

- | | |
|---|---|
| 1600 Customhouse, Boston, Mass. | 801 Federal Office Bldg., Seattle, Wash. |
| 748 Federal Bldg., 641 Washington St., New York, N.Y. | 521 New Customhouse, Denver, Colo. |
| 1005 Customhouse, Second and Chestnut Sts., Philadelphia, Pa. | 208 Uptown Post Office Bldg., St. Paul, Minn. |
| 508 Old Town Bank Bldg., Baltimore, Md. | 838 U. S. Courthouse, Kansas City, Mo. |
| 402 Federal Bldg., Norfolk, Va. | 246 U. S. Courthouse Bldg., Chicago, Ill. |
| 411 Federal Annex, Atlanta, Ga. | 1029 New Federal Bldg., Detroit, Mich. |
| 312 Federal Bldg., Miami, Fla. | 328 Federal Bldg., Buffalo, N.Y. |
| 400 Audubon Bldg., New Orleans, La. | 609 Stagenwald Bldg., Honolulu, T.H. |
| 324 U. S. Appraisers Stores Bldg., Houston, Texas | (For Territory of Hawaii and outlying Pacific possessions except Alaska and adjacent islands) |
| 500 U. S. Terminal Annex Bldg., Dallas, Texas | 323 Federal Bldg., San Juan, P.R. (Puerto Rico & Virgin Islands) |
| 539 U. S. Post Office and Courthouse Bldg., Los Angeles, Cal. | 7 Shattuck Bldg., Juneau, Alaska (Territory of Alaska & adjacent islands) |
| 323-A Customhouse, San Francisco, Cal. | |
| 406 Central Bldg., Portland, Ore. | |

OHM'S LAW

This is a fundamental electric law which expresses the relationship between voltage, current and resistance in a direct-current circuit. It also is used to express the relationship between voltage, current and impedance in an alternating-current circuit. The three forms of this law are expressed as follows:

$$I \text{ (amperes)} = \frac{E \text{ (volts)}}{R \text{ (ohms)}} \quad E = I \times R \text{ or } (IR) \quad R = \frac{E}{I} \text{ (D.C. form)}$$

E is the pressure in volts or electromotive force (E.M.F.)

I is the current in amperes

R is the resistance in ohms

Z is the impedance in ohms (A.C. form)

This law was named after its discoverer, George Simon Ohm, in the early part of the nineteenth century. Ohm, the unit of resistance, was also named in his honor.

ELECTRICAL PREFIXES

Kilo = a quantity one thousand times greater than the unit
 Mill = a quantity equal to one-thousandth part of the unit
 Micro = a quantity equal to one-millionth part of the unit

Meg = a quantity one million times as great as the unit

For example: 1,000,000 ohms = 1 megohm
 1,000 cycles = 1 kilocycle
 1,000,000 cycles = 1 megacycle

CONVERSION TABLE

MULTIPLY	BY	TO OBTAIN	MULTIPLY	BY	TO OBTAIN
Amperes	× 1,000,000	Microamperes	Microfarads	× .000001	Farads
Amperes	× 1,000	Milliamperes	Microhenrys	× .000001	Henrys
Cycles	× .000001	Megacycles	Micro-ohms	× .000001	Ohms
Cycles	× .001	Kilocycles	Microvolts	× .000001	Volts
Farads	× 1,000,000,000,000	Micromicrofarads	Micromicrofarads	× .000000000001	Farads
Farads	× 1,000,000	Microfarads	Milliamperes	× .001	Amperes
Henrys	× 1,000,000	Microhenrys	Millihenrys	× .001	Henrys
Henrys	× 1,000	Millihenrys	Milliohms	× .001	Ohms
Kilocycles	× 1,000	Cycles	Millivolts	× .001	Volts
Megacycles	× 1,000,000	Cycles	Volts	× 1,000,000	Microvolts
Microamperes	× .000001	Amperes	Volts	× 1,000	Millivolts

WAVELENGTH-FREQUENCY CONVERSION

WAVE = any continually varying quantity, such as an alternating current, radio wave or sound wave.

RADIO WAVES travel at the same speed as light—300,000,000 meters, or about 186,000 miles a second.

WAVE LENGTH = the distance traveled in a time of one cycle by an alternating current, radio wave or sound wave. This is the same as the distance between successive peaks having the same polarity in the wave. For wave motion in ether (radio waves) the wavelength in meters is equal to the approximate number 300,000,000 divided by the frequency in cycles per second. The radio-wave velocity figure of 300,000,000 meters per second is commonly used for convenience. The exact number is 299,820,000 meters per second. The relationship between wavelength and frequency is shown by the formulas

$$\text{WAVELENGTH (in meters)} = \frac{300,000,000}{\text{frequency in cycles per second}}$$

or

$$\text{WAVELENGTH (in meters)} = \frac{300,000}{\text{frequency in kilocycles}}$$

or

$$\text{WAVELENGTH (in meters)} = \frac{300}{\text{frequency in megacycles}}$$

Example: the wavelength in meters corresponding to a frequency of 3650 kilocycles is

$$\text{WAVELENGTH (in meters)} = \frac{300,000}{3650 \text{ kilocycles}} = 82.2 \text{ meters}$$

Frequency is most commonly dealt with as it can be measured more accurately than wavelength. However, wavelength is used interchangeably with frequency in describing antennas, complete transmitters, tuned circuits and receivers.

SIGNAL TRACER FOR RADIO SERVICING

Resistors: see chart in Fig. 2. Condensers: C1 consists of two pieces of insulated hookup wire $1\frac{1}{4}$ in. lons, twisted together as shown in Fig. 3-B; one Sprague TM21 .001 mfd. 600 volts (C2); two Sprague TM25 .005 mfd. 600 volts (C3 and C4); one Sprague TM11 .01 mfd. 600 volts (C5); one Mallory-type FP 367 three-section electrolytic condenser 10-10-10 mfd. 350-volt d.c. (C6, C7 and C8); one Cornell-Dubilier type BR 202-A, 20-mfd. 25-volt electrolytic condenser (C9); Sprague TM15 .05-mfd. 600-volt (C10); two tubular paper-type .05-mfd. 600-volt condensers (C11 and C12). Tubes: one 5Y3-GT; one 6K6-GT; one 6SH7; one 6C4. One piece of Bakelite tubing $1\frac{1}{2}$ in. in diameter and 2-3/16 in. long. Two $\frac{1}{8}$ -in. polystyrene disks $1\frac{1}{8}$ in. in diameter (cut from sheet stock); 6 ft. of three-conductor cable with one conductor shielded (Belden No. 8734 used); one 5-in. PM speaker with 3.2-ohm voice coil; one universal midget-type output transformer, one power transformer, 480-volt secondary center tapped, 40 ma.; with 5-volt, 2-amp. secondary, and a 6.3-volt 2-amp. secondary; one s.p.d.t. toggle switch (switch No. 1); one line cord and plug; one Jones plug type P-303CCT; one Jones S-303-AB socket; one banana plug with $\frac{3}{8}$ -in. long 6-32 thread; two Mueller-type alligator clips type 608; three Amphenol octal sockets No. 77MIP-8; one Amphenol socket type 75-PC-1M; one seven-pin Amphenol miniature-tube socket; one male chassis-mount connector, non-shorting type; one Mallory-type A-1, or similar, phone jack; one terminal strip, Jones type No. 20-003, or similar; one terminal strip Jones type No. 2004, or similar.

"POPCORN CAN" SIGNAL GENERATOR

One piece of $\frac{1}{8}$ -in. Masonite, 6 in. wide and $7\frac{1}{4}$ in. long; two wood strips $\frac{1}{2}$ by $\frac{3}{4}$ by $6\frac{1}{4}$ in.; two three-lug terminal strips; one octal socket; one loktal socket and one four-prong socket; three four-prong plus-in coil forms, $1\frac{1}{4}$ by $2\frac{1}{4}$ in. see Fig. 2. (These coils may be close-wound with either No. 28, 30 or 32 wire having either enamel, cotton or silk insulation); one variable condenser 350 mmd. (Note—any variable condenser from 350 to 500 mmd. may be used); one 25,000-ohm potentiometer (R2) with switch; one s.p.s.t. toggle switch (SW2); one 50,000-ohm resistor $\frac{1}{2}$ -watt (R1); one 75,000-ohm resistor $\frac{1}{2}$ -watt (R3); one 4000-ohm resistor 1 watt (R4); one line-cord resistor (built into cord) 390-ohms (R5); one fixed condenser .0002 mfd. (C2); one .0001 mfd. (C3) (Note—these should be mica types if possible, if not use 400-volt tubular paper types; one .05-mfd. tubular paper-type 400-volt (C4) and one 20 mfd. 150-volt tubular-type electrolytic condenser (C5); one small porcelain "thru-panel" insulator; one rubber grommet; one pointer knob; one $1\frac{1}{4}$ -in. round dial plate 0-100; one small knob; one 1 by 1 in. bracket; one clamp for line cord, made from short strip of metal; six $\frac{3}{4}$ in. round-head wood screws; seven 6-32 machine screws $\frac{1}{2}$ in. long, with hex nuts to fit. (Note—the wire for the circuit can be any wire of suitable insulated type; wind all three coils in the same direction, and take off the tap at the number of turns indicated from the bottom of each coil.)

LOW-COST THREE-UNIT TEST BENCH

Materials for all panels: three Masonite panels $\frac{1}{2}$ by 9 by $11\frac{1}{4}$ in. (front panels); three Masonite panels $\frac{1}{2}$ by $5\frac{1}{2}$ by $11\frac{1}{4}$ in. (top panels); four pieces of 1 by 2-in. wood stock $10\frac{1}{2}$ in. long; four pieces of 1 by 2-in. wood stock $5\frac{1}{2}$ in. long; four pieces of 1 by 2-in. wood stock $11\frac{1}{4}$ -in. long (Note—wood screws are used for construction).

Materials for panel No. 1: one variable condenser 365 mmd. (any broadcast type 350, 360 or 365 mmd.); one cardboard coil form $4\frac{1}{2}$ in. long and $1\frac{1}{2}$ in. in diameter; one fixed crystal detector; one five-point induction switch or any similar tapped switch arrangement (Note—ordinary roundhead machine screws can be mounted on the panel so that the heads serve as contact points. A switch lever and knob will complete the assembly); one phone-jack strip; two cord-tip jacks; two binding posts; one .1-mfd. 200-volt tubular paper-type fixed condenser; one $\frac{1}{2}$ -volt flashlight cell; one s.p.s.t. toggle switch; two 6-32 machine screws and nuts; sufficient cotton-covered wire (No. 26 or No. 28) for coil (Note—hookup wire can be any ordinary insulated type No. 18 or 20 for all connections on the three panels. The coil is close-wound clockwise and is tapped every 20 turns. To tap the wire insert a matchstick or toothpick under the wire turn, scrape off the insulation and solder tap wire in position).

Materials for panel No. 2: one 5-in. PM speaker (a slightly larger speaker may be used if desired); one universal speaker-output transformer (mount on wood strip as shown); one five-terminal (screw-type) terminal strip; one three-terminal (screw-type) terminal strip; one rubber grommet for flexible tap lead for speaker transformer (Note—this is the lead that is brought out to the terminal strip at front, just above the speaker); four 6-32 machine screws and hex nuts.

Materials for panel No. 3: one $\frac{1}{4}$ -watt Mazda neon bulb (type with candelabra base); one porcelain candelabra base for above neon bulb; one 500,000-ohm potentiometer (R1); two cord-tip jacks; two panel-mounting type 115-volt receptacles; two binding posts; two line plugs with 5-ft. lamp cords (Note—cut neon lamp cord to convenient length); four 6-32 machine screws and hex nuts; one cardboard "voltage reading dial"—see Fig. 3 for details. The original dial was cut from "bristol board" and is 3-3/16 in. in diameter.

TAPPED-COIL CRYSTAL RECEIVER

One $\frac{1}{4}$ -in. plywood base; see Fig. 2 for dimensions; one Sylvania 1N34 germanium crystal; two single-pole five-position switches (Mallory No. 3115J type used); one Bakelite or cardboard tube $2\frac{1}{4}$ in. in dia. and 7 in. long; one small spool of No. 20 d.c. (double cotton covered) magnet wire; one terminal strip with four insulated lugs; one two-gang 365-mmd. variable condenser; one tuning knob; two pointer knobs; two $\frac{3}{8}$ -in. bushings; two angle brackets 1 by 1 by $1\frac{1}{8}$ in. for mounting switches; one pair of 2,000-ohm headphones; eleven flathead 6-32 machine screws $\frac{1}{2}$ in. long, with hex nuts to fit; four rubber bumper feet with 6-32 screws.

Audio-amplifier parts: one $\frac{1}{4}$ -in. plywood base and speaker baffle (See Fig. 4 for dimensions); fixed condensers, .005 mfd. C1; .01 mfd. C2; .1 mfd. C3 (all 400-volt paper type); fixed resistors, see chart, Fig. 4; one 3-to-1 or $3\frac{1}{2}$ -to-1 ratio unshielded-type audio transformer (T1). (Note—this is a single-plate-to-single-grid type); one output transformer (7000-ohm plate to 3.5-ohm voice-coil type); two octal above-chassis-type tube sockets; one 3-in. PM loudspeaker, with square metal frame; one tie-point strip with two insulated lugs. Tubes; one 1H5-GT; one 1Q5-GT; six Fahestock clips. Hardware, seven No. 6 soldering lugs; four 6-32 ornamental-head screws; four 6-32 $\frac{1}{4}$ -in. hexnuts; eleven No. 6 gimlet-point self-tapping screws $\frac{1}{4}$ in.; four No. 6 gimlet-point self-tapping screws $\frac{1}{2}$ in.; three No. 6 gimlet-point self-tapping screws $\frac{3}{8}$ in.; four rubber bumper feet with 6-32 screws; Batteries, two 45-volt B-batteries; one $1\frac{1}{2}$ -volt A-battery (any No. 6 ignition type).

BEGINNER'S LOW-COST PROGRESSIVE RECEIVER

One Masonite panel and chassis base supported with wood strips (see Fig. 1. The panel and base material is $\frac{1}{2}$ -in. thick); one type 6J5-GT tube; one Amphenol type MIP8 octal socket, or similar socket with mounting plate. (Note—Use rosin-core wire solder for all circuit connections); one 350-mmd. variable condenser (C1); one .00025-mfd. mica-type fixed condenser (C2); one .0001-mfd. mica-type fixed condenser (C3); one 2-meg. $\frac{1}{2}$ -watt fixed resistor (R1); one 50,000-ohm audio-taper-type volume control (R2); one filament transformer 6.3 volts, 1.5 amperes with center-tapped secondary (primary for 115 volts, 50-60 cycles. This is an open-frame transformer listed in parts-house catalogues); one 3-in. tuning dial 0-100; one knob for volume control; one cardboard tube $1\frac{1}{2}$ in. in diameter, and 4 in. long (Note—this can be cut from an ordinary cardboard mailing tube, or, the cardboard tube from toilet tissue. This form can be coated with shellac and dried in the oven if the set is to be used in a damp climate. All three coils are wound clockwise on this form with No. 26 enameled copper wire. See article for all coil-winding details. Be sure to space each coil just as indicated in Fig. 3; the coils are close-wound tightly and will stay in position with ordinary handling. "Coil dope" may be used to hold the windings if desired); one 5-ft. line cord with plug; one twin tip-jack strip for headphones; three Fahestock clips; eight 6-32 roundhead machine screws $\frac{1}{2}$ in. long with hex nuts to fit; six roundhead wood screws $\frac{3}{8}$ in. long; three round-hole soldering lugs. When mounting the parts on the base, follow the layout closely and keep the filament transformer on the rear strip at extreme left, as shown in Fig. 3. Use No. 18 or 20 hookup wire with push-back insulation for the circuit and make all socket connections just exactly as shown. A 45-volt

DETAILED MATERIAL LISTS

B-battery will give the best results. (Note—Variable condenser C1 can be any capacity from 350 mmfd. to 500 mmfd.)

FOUR-TUBE PROGRESSIVE RECEIVER

One Masonite chassis base. See Fig. 1; Tubes: one type 6C5; two 6J5-GT; one 6G6-G; four Amphenol-type MIP8 octal tube sockets, or, similar sockets with mounting plates; one four-prong wafer-type socket for the plug-in coils. Condensers: one 350-mmfd. variable condenser (C2), may be 350 to 500 mmfd.; one 20-mmfd. midget variable condenser (three-plate type) any make (C1); one 250-mmfd. mica-type fixed condenser (C3); two 100-mmfd. mica-type fixed condensers (C4 and C5); one 10-mfd. 25-volt (or higher) electrolytic condenser (C6); one .05 mfd. 200 or 400-volt tubular paper-type fixed condenser (C7); one .01-mfd. 400-volt tubular type fixed condenser (C8); one .5-mfd. 200 or 400-volt tubular paper-type fixed condenser (C9), one dual 50-50-mfd. tubular electrolytic condenser, 200 volts, or 40-40-mfd. type, 150 volts (C10 and C11); one 3-30-mfd. (or approximate) trimmer condenser (C12); one .02-mfd. 400-volt tubular paper-type fixed condenser (C13). Resistors: see chart in Fig. 2. Three standard four-prong plug-in coil forms 1½ in. in diameter and 2¼ in. high. (See coil-winding chart for winding details. A small spool of No. 30 enameled wire and a small spool of No. 26 enameled wire are required); one r.f. choke 10-mh. (Note—this choke can be any 10-mh. receiving type); one 3½-to-1 ratio audio transformer (or 3-to-1 ratio); one universal speaker output transformer (taps 1 and 4 used); one 6-in. permanent-magnet dynamic-type speaker, any good PM type (Note—this speaker is mounted in a small wooden frame on a hard-pressed wood baffle; dimensions are given in article); one 6.3-volt 1.5-amp. (or higher) filament transformer with center-tapped secondary; one 3-in. dial 0-100; one midget dial plate 0-100; two pointer knobs; one Fahnestock clip; two 2-lug and one 4-lug terminal strips; one 5-ft. line cord and plug; 17 half-inch 6-32 machine screws; six wood screws, ¼ in.; one twin-tip jack strip; two ¾-in. bushings; two 1-in. 6-32 machine screws with hex nuts; six round-hole soldering lugs.

T.R.F. QUAL-PURPOSE RECEIVER

One sheet-metal chassis base, as detailed in Fig. 1; one plywood front panel ¼ by 8 by 12 in. (the panel is given a walnut stain, rubbed down, and then waxed with any good floor wax); two wooden dowels ½ in. in diameter and 1¾-in. long; one Croflex tuning-dial assembly No. 231; one No. 40 dial light bulb; one Meissner antenna coil No. 14-1010 (mount this on top of the base); one Meissner r.f. coil No. 14-1011 (mount under base as shown in Fig. 3, bend the mounting bracket so that coil will be horizontal with chassis); one speaker output transformer. (Stancor No. A-3856 universal type is used in the model. The center red and outside brown primary leads are used; and the third primary lead is cut off, or taped, as this transformer is for either single or push-pull plates. Any similar single-plate universal speaker transformer may be used, or any output transformer that will provide a 2000-ohm load); one variable two-gang tuning condenser 365 mmfd., with trimmers (C2A, C2B). Note—this is a counterclockwise type for T.R.F. sets. (Defiance or similar); one dual 50-30-mfd., 150-volt electrolytic condenser, solar-type DY "twist prong" mounting type, or any similar type in metal case with mounting plate (C11 and C12); one 10-mfd. 25-volt electrolytic condenser C10 (any good tubular type); two .25-mfd. 400-volt tubular-type paper condensers, C5 and C14; two .1-mfd. 400-volt tubular-type paper condensers, C3 and C4; one .05-mfd. 400-volt tubular-type paper condenser, C6; four .01-mfd. 400-volt tubular-type paper condensers, C1, C8, C9 and C13; one .00025-mfd. mica-type 400-volt condenser C7. Resistors: see chart in Fig. 2. Tubes: 12SK7, 12SJ7-GT, 50L6-GT, 35Z5-GT; one 6-in. permanent-magnet (PM) speaker; four octal tube sockets; one line cord and plug; one phono-tip jack and plug; Miscellaneous: three terminal strips with two insulated lugs; one terminal strip with single insulated lug; five 5/16-in. rubber grommets; one insulated antenna binding post; seventeen 6-32 round-head machine screws ¾-in. long; seventeen ¼-in. 6-32 hex nuts; three small pointer-type knobs; three round-hole soldering lugs; rosin-core wire solder; 25 ft. of No. 20 flexible hookup wire with push-back insulation.

THREE-WAY PORTABLE SUPER

One sheet-metal chassis base—see Fig. 1; one plywood cabinet and A-battery box—see Fig. 2. Resistors: see

chart in Fig. 3. Condensers: see Fig. 4. Batteries: one A-battery, 7½ volts (this consists of five No. 2 flashlight cells connected in series); one B-battery, 67½-volt miniature portable type (Burgess XX45 or similar). Coils and transformers: one replacement-type loop antenna (any broadcast band type); one universal cut-plate oscillator coil (Meissner 14-1040) (L2); two 455-kc. midget i.f. transformers (Stanwyck SM-107B) (Note—these i.f. transformers are interchangeable for input or output stages in T1 and T2. Meissner No. 16-6758 "slug-tuned" midget i.f. transformers may be used); one speaker output transformer 10,000-ohm plate to 3.5-ohm voice coil, or any good universal-type output transformer (T3). One d.p.d.t. two position toggle switch (H&H No. 20905Z) SW. 1; one d.p.s.t. switch mounted on volume control (Mallory No. M27) SW. 2. Tubes: one each 1R5, 1T4, 1S5 and 3V4. One 100-ma. selenium five-plate rectifier (Federal Telephone & Radio Corp. No. 403D2625); four seven-pin miniature-tube sockets (Amphenol No. 147-500); one 7½-ft. line cord and plug; two battery clips, snap-on type (one male and one female); one 5-in. permanent-magnet (PM) speaker; one 4-in. tuning-dial assembly (Croname type 231); one horizontal dial scale (Croname type 36420); two 1-in. walnut knobs; one flocked grille screen (brown) 5½ by 5½ in.; one chrome drawer pull 5½ in.; two rubber grommets (for mounting speaker on chassis base); four rubber feet for bottom of cabinet; eight 4-36 by ½-in. machine screws with hex nuts to fit for mounting tube sockets; two 8-32 by ¾-in. machine screws with hex nuts for mounting speaker. Miscellaneous: soldering lugs; 3-2 by 5/16 machine screws and nuts; No. 6 by ¾-in. sheet-metal screws; No. 20 hookup wire; rosin core wire solder.

TWO-TUBE "POCKETTE" SET

One wood case 1¾ in. deep, 3¼ in. wide and 8¾ in. long. This was made by cutting down a cigar box, retaining a portion of the lid for the back cover. The case dimensions may be altered slightly depending upon the size of your parts. However, these changes must be in the depth of the case and not in the length and width so as not to alter coil dimensions. The front panel is of heavy bristol board or similar cardboard. Pebbled photo-mounting board was used in the model. Coils: L1 consists of 15 turns of No. 24 d.c.c. wire close wound; L2 consists of 20 turns of No. 24 d.c.c. wire close wound. (Note—both coils are wound in the same clockwise direction, and are spaced ½ in. apart). One 2-meg. ½-watt carbon resistor (R1); one 0-10,000-ohm volume control (R2), with switch (Note—this variable resistor should be a midget type); one 350-mmfd. midget-type variable condenser (C1) (Note—this may be any capacity from 350 to 500 mmfd.); three .00025-mfd. mica or paper-type fixed condensers (C2) (C3) and (C4); one piece of Masonite ¼ by 1½ by 3½ in. for tube panel; two type 1S4 miniature tubes; two sockets for miniature-type tubes (Amphenol or similar); one toggle switch (s.p.s.t. type) for switch No. 2; one dial plate (midget type) 0-100, 1½ in. in diameter (cement to panel); one pointer knob; two phone-tip jacks; one knob for volume control; one terminal strip with three insulated lugs; one single-plate to single-grid midget-type audio transformer, 3-1 or 3½-1 ratio; eight Penlite cells and one No. 2 flashlight cell. (Note—these can be Ray-O-Vac, Eveready, Burgess or similar standard flashlight cells); one pair of 2000-ohm sensitive headphones.

ONE-TUBE "HANDI-TALKIE" EMERGENCY SET

One ¼-in. plywood or pine case (see photo D for dimensions. The back and front panels are made of ¼-in. Masonite); one variable condenser, any midget "single" type 365 mmfd. to 500 mmfd. C1, one .00025-mfd. mica fixed condenser C2; one .001-mfd. 400-volt paper-type, C3; one 10-150-mmfd. trimmer (or padder) condenser, C4. Resistors: one 2-megohm ½-watt carbon R1; one 0-5000-ohm volume control with switch, R2. One headphone (approximately 2000-ohms, type with outside terminals); one socket for a type-1S5 miniature tube; one type-1S5 miniature tube; one bracket for miniature-tube socket (see Fig. 1); one tie-point terminal strip with three insulated lugs; one cardboard tube for winding coil (see Fig. 3); one thin Masonite strip ¼ by ¾ by 2¼ (for mounting coil on front panel); one 30-volt B-battery, hearing-aid type (Eveready No. 413 used); one Eveready size D 1½-volt flashlight battery (or similar). Miscellaneous: small coil of No. 30 enameled wire (for coils L1 and L2); No. 18 or 20 flexible hookup wire with pushback insulation; one alligator-type spring clip; two pointer knobs; one

midget circular dial plate 0-100; five 6-32 machine screws $\frac{1}{2}$ -in. long, with hex nuts to fit. See article text for coil-winding data.

FOUR-TUBE SUPER A.C.-D.C. BROADCAST TUNER

One sheet-metal chassis base, as detailed in Fig. 1; one Meissner No. 14-1033, 456-kc. oscillator coil (mounted under base); one Meissner No. 16-5712, 456-kc. i.f. input transformer; one Meissner No. 16-5714, 456-kc. i.f. output transformer; one Carron No. S407 antenna coil, or any small universal broadcast type; one two-gang 365 mmfd. to 500 mmfd. midget type variable condenser with cut-plate oscillator section, and trimmer condensers on each section C2 and C3; one tuning dial, counterclockwise type, $4\frac{1}{2}$ in. long and $3\frac{1}{4}$ in. high (Note—this can be any standard type, either direct or cord drive. A cord-driven type was used, and the tuning knob is mounted on the base. In the model, the dial is mounted on the base by means of two metal bushings $\frac{3}{8}$ in. long, and two 1-in. long 6-32 machine screws); one 500,000-ohm audio-taper volume control with switch (R3); one 20,000-ohm $\frac{1}{4}$ -watt carbon fixed resistor (R1); one 2-meg. $\frac{1}{4}$ -watt carbon fixed resistor (R2); one 1000-ohm 1-watt carbon fixed resistor (R4); one 30-ohm 1-watt carbon fixed resistor (R5); one 10-meg. $\frac{1}{4}$ -watt carbon (R6); one .01-mfd. 400-volt tubular paper-type fixed condenser (C1); one .00005-mfd. mica-type fixed condenser (C4); one .0002-mfd. 400-volt tubular paper-type fixed condenser (C5); one .005-mfd. 400-volt tubular paper-type fixed condenser (C6); one .05-mfd. 400-volt tubular paper-type fixed condenser (C7); two 40-mfd. 150-volt electrolytic condensers (C8 and C9) (tubular type); one .05-mfd. 400-volt tubular paper-type fixed condenser (C10). Tubes: one 12SA7, one 12SK7, one 12SQ7; one 35Z5-GT. Four Amphenol octal sockets "Mip" type with mounting plates; one 3-ft. length of shielded single-conductor rubber-covered cable (Note—this can be ordinary microphone cable). Miscellaneous: one plug for input to audio amplifier; three tie-point terminal strips with one insulated lug; one tie-point terminal strip with two insulated lugs; two knobs; twelve 6-32 machine screws $\frac{1}{2}$ in. long, with hex nuts to fit; one 300-ohm line cord with plug; one pilot-light bulb No. 47 and one bayonet-type clip-on pilot-light bracket (pilot light is optional).

LOW-COST INTERROOM PHONE SYSTEM

One sheet-metal chassis base $4\frac{1}{2}$ in. wide, $8\frac{1}{4}$ in. long and $1\frac{1}{2}$ in. high; three plywood cases as detailed in Figs. 1 and 4. Tubes: one 12AU6 and one 50B5 (miniature types), Amphenol or similar. Resistors: See chart, Fig. 2. Condensers: one .05-mfd. 400-volt tubular paper type (C1); one .005-mfd. 600-volt tubular paper type (C2); one .002-mfd. 600-volt tubular paper type (C3); one .25-mfd. 400-volt tubular paper type (C4); two 20-mfd. 150-volt tubular electrolytic (C5 and C6). One "Intercom" input transformer (Stancor A-4744); one output transformer 2000 ohms, 50 ma. open-frame type (any good make); one filter choke 5.5 hr., 50 ma.; two $3\frac{1}{2}$ -in. permanent-magnet (PM) speakers (3.2-ohm voice coil, Alnico V); one 4-in. by 6-in. oval (PM) speaker (Cinaudograph Model P-46A1, Alnico V); one push-pull switch, d.p.d.t. (Mallory type 2006); one selenium rectifier PTR five-plate, 100 ma.; one 5-ft. line cord, with plug; two three-terminal tiepoint lugs; one single-terminal tiepoint lug, and one two-terminal tiepoint lug. Miscellaneous: one soldering lug; eight 6-32, $5/16$ -in. machine screws; one 6-32 $\frac{1}{2}$ -in. machine screw; nine 6-32 $\frac{1}{4}$ -in. hex nuts; four 4-36 $\frac{1}{2}$ -in. machine screws; four 4-36 $\frac{1}{4}$ -in. hex nuts; three rubber grommets $5/16$ -in. inside diameter; three two-terminal connecting strips with mounting brackets.

MULTI-PURPOSE PHOTOTUBE RELAY

One base and panel (see Fig. 1 for details). Resistors: one 4700-ohm, $\frac{1}{2}$ -watt carbon (R1); one 10,000-ohm, $\frac{1}{2}$ -watt carbon (R2); one 500-ohm wire-wound 4-watt potentiometer (Mallory M-500-P) (R3); one 20,000-ohm, or 22,000-ohm, 1-watt carbon (R4); one 4.7 or 5-meg-ohm $\frac{1}{2}$ -watt carbon (R5); one 500-ohm, 10-watt wire-wound (R6). One 4-mfd. 250-volt electrolytic condenser (C1); one Potter and Brunfield L55 2500-ohm s.p.d.t. relay; one d.p.s.t. toggle switch; one four-prong socket for phototube (Amphenol Mip type); one octal tube socket, same type (both with mounting plates); one line cord with plug; one three-terminal tie-point strip; three Fahnestock clips; one bar knob; one RCA 918 phototube; one 50L6-GT tube. Miscellaneous: wood

screws; rosin-core wire solder; No. 18 or 20 flexible insulated hookup wire; one 115-volt light bulb; one porcelain base-mount socket for light bulb (light bulb used for test, see text).

ELECTRONIC PHOTOPRINT TIMER

One metal chassis base, 7 by 7 by $2\frac{1}{2}$ in. (see Fig. 1); two s.p.s.t. toggle switches, with "off-on" plates (Note—These are switches Nos. 1 and 3); one s.p.s.t. push-button switch, of the momentary "make" and normally "open" type (this is switch No. 2); two Amphenol 110-volt panel-type receptacles; one large dial knob; one piece of 1/16-in. clear plastic 1 in. wide and 3 in. long for pointer (Note—etch a line down the center of the pointer with an ice pick or other pointed tool and fill in with black ink. This pointer is drilled to mount directly on the shaft of the potentiometer R2); one piece of heavy white drawing paper 3 in. by 5 in. (for making dial scale); one 5-ft. 110-volt line cord and plug; one rubber grommet for line-cord hole in metal chassis base; one dozen roundhead 6-32 by $\frac{3}{8}$ -in. machine screws, with hex nuts; one octal-type tube socket; one type-117L7-GT tube; two angle brackets $\frac{1}{2}$ in. wide by 1 in. by $\frac{1}{2}$ in. (for mounting tube socket); one fixed carbon resistor, 100,000 ohms, $\frac{1}{2}$ watt (R1); one potentiometer, 5 meg. linear taper (any good make, R2); one 40-mfd. 150-volt tubular-type electrolytic condenser (C1); one 4-mfd. 400-volt paper oil-filled-type condenser (C2). Note—this can be either a 400 or 600-volt type, but it must be high grade, with no leakage. This is important for proper operation); one relay, 2500 to 5000 ohms, plate current type (this is a common type available from all radio parts houses, with a single-pole, double-throw switch, and a coil of 2500 to 5000 ohms for plate current operation); two tie-point terminal strips (with one insulated lug); one tie-point terminal strip (with two insulated lugs).

SENSITIVE CAPACITY-OPERATED SWITCH

One sheet-metal chassis base as detailed in Fig. 3. This is a standard 5 by $9\frac{1}{2}$ by 3-in. base available from radio parts houses. Tubes: one type 117L7/M7GT and one type-2050 Thyratron. Resistors: see chart in Fig. 1. Condensers: two .1-mfd. 400-volt tubular paper type (C1 and C2); one 30-mfd. 150-volt electrolytic (C3); one 8-mfd. 450-volt electrolytic (C4). One Miller No. 695 oscillator coil (Note—this oscillator coil comes complete with the trimmer condenser and the r.f. choke as shown. Available from Allied Radio Corp., 833 West Jackson Boulevard, Chicago 7, Illinois. Make connections just as indicated in Fig. 2). Sockets: two octal tube sockets; two female a.c. outlet sockets. One six-screw terminal strip; one Potter and Brunfield MR11A 110-volt a.c. d.p.d.t. relay; one 6.3-volt 1-amp. filament transformer; one line cord and plug; one small porcelain feed-thru insulator (Johnson or similar); one knob for rheostat; one control plate, numbered 0 to 10 (for sensitivity control). Miscellaneous: two two-lug tie-point strips; 18 6-32 roundhead machine screws $\frac{1}{2}$ in. long, with hex nuts to fit; insulated hookup wire No. 20; rosin-core solder; one d.p.s.t. toggle switch.

TEN-WATT PHONO-RADIO AMPLIFIER

One sheet-metal chassis base (see Fig. 1 for details); two metal drawer-pull handles (dime store variety), optional; three octal sockets and two four-prong sockets (any standard type); one 15-hy. 125-ma. filter choke; one 5,000-ohm impedance push-pull output transformer with secondary tapped for 500, 15 and 8 ohms (any good make); one power transformer (any good make with a 350-350-volt high-voltage secondary; one 6.3-volt 3.5-amp. secondary; and a 5-volt 3-amp. secondary; one five-terminal Bakelite terminal strip (screw and collar terminals); one four-terminal insulated tie-point strip; also one single and one two-terminal strip; one 5-ft. line cord and plug; one s.p.s.t. toggle switch; three pointer knobs; one "gain" and one "tone" dial plate (0-10) $2\frac{1}{4}$ in. by 1-11/16 in.; one 10-inch PM speaker (housed in a separate baffle case or cabinet); one open-circuit phono jack (midget type) label "record" or "input." Tubes: one type 6C5; one 6N7; two type 6A3 and one type 5U4-G. One Jewel pilot-light bracket and 6-8-volt bulb. Resistors: see chart in Fig. 2. Condensers: one .0005-mfd. mica-type fixed condenser (C1); one .003-mfd. 600-volt tubular paper-type fixed condenser (C2); one 10-mfd. 25-volt tubular electrolytic condenser (C3); one .05-mfd. 600-volt paper-type fixed condenser (C4); one 25-mfd. 25-volt tubular electrolytic condenser (C5); one .02-mfd. 600-volt tubular paper-type fixed condenser (C6); two

DETAILED MATERIAL LISTS

1-mfd. 600-volt tubular paper-type fixed condenser (C7 and C8); two 8-mfd. 450-volt tubular-type electrolytic condensers (C9 and C12); two 8-mfd. 450-volt upright can-type electrolytic condensers (Note—these are C10 and C11 and can be of higher capacity and voltage rating 12 mfd. each at 600 working volts); one 50-mfd. 150-volt or 200-volt tubular-type electrolytic condenser (C13). Hardware: 24 6-32 machine screws $\frac{1}{2}$ in. long with hex nuts to fit; 24 in. of shielded single-conductor hookup wire; hookup wire with pushback insulation; one rubber grommet, rosin-core wire solder; soldering lugs. Note—use shielded wire where specified and make all soldered connections to the metal shield as indicated. The voltage returned in the feed-back circuit must be of the correct phase for degeneration. If the polarity is incorrect, the amplifier will oscillate—in that case merely reverse the primary leads to the plates of the 6A3s.

UTILITY P. A. AMPLIFIER WITH RECORD PLAYER

One sheet-metal chassis base, 7 by 13 by 2 in. (see Fig. 2 for details. Note—this is a standard size available from all parts houses); one Stancor-type P-6312 power transformer secondary 580 volts center-tapped, 90 ma.; 5-volt secondary at 3 amps.; 6.3-volt secondary at 2.8 amps.; primary 115 volts, 60 cycles (Note—any similar 580 or 600 volt power transformer may be used); one Stancor No. C-1709 filter choke 250 ohms d.c., 9 hy. at 85 ma.; one Alliance, or similar type, phono motor with 9-in. turntable (78 r.p.m. self-starting type, will take both 10 and 12-in. records); one Shure "Gilder" crystal-type pickup; one metal speaker case 16 by 16 by 8 in. (Note—Any wood or metal case of similar size may be used); four eight-prong octal tube sockets; two four-prong wafer-type sockets; one s.p.s.t. toggle switch, with on-off plate; one grid cap for the 6J7 tube; four large soft-rubber chassis mounts; three small soft-rubber grommets; one pin jack (black); one pin jack (red) with insulating washers. Resistors: one fixed carbon resistor 3 meg., $\frac{1}{2}$ watt (R1); three fixed carbon resistors $\frac{1}{2}$ meg., $\frac{1}{2}$ watt (R2, R3 and R4); one fixed carbon resistor 1 $\frac{1}{2}$ meg., $\frac{1}{2}$ watt (R5); three fixed carbon resistors $\frac{1}{2}$ meg., $\frac{1}{2}$ watt (R6, R7 and R8); one fixed carbon resistor 100,000 ohms $\frac{1}{2}$ watt (R9); one fixed carbon resistor 3,500 ohms $\frac{1}{2}$ watt (R10); one fixed carbon resistor 3,000 ohms $\frac{1}{2}$ watt (R11); one fixed carbon resistor 25,000 ohms $\frac{1}{2}$ watt (R12); one fixed carbon resistor 200 ohms 5 watts (R13). One 500,000-ohm ($\frac{1}{2}$ meg.) potentiometer, audio taper (phono volume control (R14)); 2 $\frac{1}{2}$ ft. of shielded hookup wire; one dual 500,000-ohm ($\frac{1}{2}$ -meg.) dual volume-control potentiometer (R15); one 1-meg. tone-control potentiometer, with s.p.s.t. switch (R16). Condensers: one dual 8-8-mfd. 450-volt electrolytic condenser (base mounting type, C8 and C9). Note—this may be a 550-volt type; do not use one rated for less than 450 volts. One 25-mfd. tubular-type electrolytic condenser, 25 or 35 volts (C1); one 8-mfd. tubular-type electrolytic condenser 450 volts (C2); one .5-mfd. 600-volt paper-type by-pass condenser (C3); five 1-mfd. 600-volt paper-type by-pass condensers (C4, 5, 6, 10 and 11); one .01-mfd. 600-volt paper-type by-pass condenser (C7). One line cord and plug; 2 ft. three-wire cable for connecting speaker; one Jensen 10-in. PM speaker No. P10-Q (stock No. ST676) with a No. Z-3327 Jensen push-pull output transformer (Note—transformer is mounted on speaker); one jewel pilot-light bracket with a 6.3-volt lamp bulb; one four-prong plug (Amphenol or similar cable plug); one rubber grommet. Tubes: one 6N7, two 6V6, one 6J7, one 5Z3 rectifier tube. One tie-point terminal strip with insulated lug; four 8-32 machine screws $\frac{1}{2}$ in. long with washers and hex nuts; 26 6-32 machine screws $\frac{1}{2}$ in. long with hex nuts to fit; one Amphenol "mike" connector type MCIF-Female and one No. MCIM-Male; three dial plates—mike, phono and tone; three pointer knobs; two I.C.A. chrome handles or ordinary chrome drawer pulls; three shaft extenders. Note—The mike and pickup are crystal types. The chassis base is "float"-mounted on soft-rubber bushings. The phono motor is mounted on top of the cabinet by means of three soft-rubber grommets. The machine screws that go through these bushings should not be screwed down tight as they must permit the units to "float." A piece of $\frac{1}{8}$ -in. soft-pressed wood with cutout for speaker is mounted on the inside of the case directly back of the grille.

AMPLIFIER FOR 45 R.P.M. RECORD CHANGER

One portable case as detailed in Fig. 1 (or any similar manufactured case); one metal chassis base, as detailed

in Fig. 2; one 5 in. permanent-magnet (PM) speaker. Tubes: one 12AV6; one 50C5; one 35W4. Two male and female polarized connectors, Cinch or similar type; three Amphenol seven-prong miniature-tube sockets, type 78-7P or similar; one Stancor-type C-1707, or similar, filter choke (7 hy. 50 ma.); one universal-type speaker output transformer, or any output transformer to match a type 50C5 tube. Resistors: see chart above Fig. 3. Condensers: one .01-mfd. 400-volt tubular type (C1); one .002-mfd. 400-volt tubular type (C2); one .004-mfd. 400-volt tubular type (C3); one 20-mfd. 25-volt electrolytic (C4); one .02-mfd. 400-volt tubular type (C5); one Mallory-type FP dry electrolytic condenser (in can) 50-50 mfd. 150 volts (C6 and C7); one a.c. line cord with plug; two knobs (for volume and tone controls); one RCA phono jack and plug; two rubber grommets. Miscellaneous: rosin-core wire solder, insulated hookup wire, machine screws, and hardware for the portable case; one 45-r.p.m. record changer RCA or any similar type listed in radio parts catalogues (model used was No. C6-A1 made by Crescent Industries).

INDOOR A.C.-D.C. HEARING-AID AMPLIFIER

One sheet-metal chassis base $1\frac{1}{2}$ in. high, $4\frac{1}{2}$ in. wide and 8 in. long. One cabinet made of $\frac{1}{4}$ in. plywood; see Fig. 1 for details. The plywood front panel is $\frac{1}{4}$ by $4\frac{1}{2}$ by $8\frac{1}{2}$ in. Resistors: see chart above Fig. 2. Condensers: three .05-mfd. paper (midget) 200 volts (C1, C2 and C3); one .5-mfd. 100-volt or higher paper (midget) (C4); one dual-type tubular electrolytic 10-10-mfd. 25-volt (C5 and C6); one triple-type tubular electrolytic 30-30-30 mfd., 150 volts (C7, C8 and C9). Sockets: two seven-pin miniatures and one nine-pin miniature. One drawer-pull chrome handle for case; four rubber feet for case; one volume-control knob; one volume-control indicator plate; one Telex under-chain headset, or any good high-impedance headphones; two tie-point terminal strips with two insulated lugs; one line cord and plug; one pilot-light bracket; one No. 47 pilot-light bulb. Tubes: one 12AU7, one 6C4, and one 35W4. One crystal lapel-type microphone Shure No. 76B with 20 ft. cord; or Electro-Voice crystal microphone No. 915. Miscellaneous: hardware; wood; rubber grommets; rosin-core wire solder; wood screws for cabinet; eight 6-32 roundhead machine screws $\frac{1}{2}$ -in. long with hex nuts to fit; soldering lugs; No. 20 hookup wire with pushback insulation.

TWO-METER TRANSCEIVER

One sheet-metal chassis base for transceiver 7 by 7 by 2 in. Condensers: one 6-mmfd. midget variable condenser (Bud MC-327) (C1); one 50-mmf. Centralab or similar ceramic condenser (C2); one 25-mfd. 25-volt electrolytic tubular-type condenser (C3); one .003-mfd. 400-volt tubular fixed condenser (C4); one 1-mfd. 400-volt tubular fixed condenser (C5); two .01-mfd. 400-volt tubular fixed condensers (C6 and C7). Resistors: one 25,000-ohm potentiometer, carbon linear type (R1); one 5-meg. $\frac{1}{4}$ -watt carbon resistor (R2); one 50,000-ohm $\frac{1}{4}$ -watt carbon resistor (R3); two 200-ohm $\frac{1}{2}$ -watt carbon resistors (R4 and R5); one 20,000-ohm $\frac{1}{2}$ -watt carbon resistor (R6); one 5000-ohm $\frac{1}{2}$ -watt carbon resistor (R7). Two r.f. chokes 2 mh. (Ohmite type Z-O or new Z-144 preferred; one mike-to-grid transformer (single button); one output transformer (Stancor A3877); one ceramic miniature-tube socket (Johnson No. 287); one loktal wafer-type tube socket; one National XP-6 "button" type insulator; two porcelain feed-thru insulators (Johnson No. 44); one Johnson No. 256 bearing assembly; one Johnson flexible insulated coupler; one four-pole, two-position rotary switch (Mallory 1312L); two open-circuit phone jacks; one large knob dial, 0 to 100; two small pointer knobs; one five-terminal screw-type terminal strip; one five-terminal insulated tie-point strip; 18 6-32 $\frac{1}{2}$ -in. machine screws with hex nuts; one 6-32 machine screw 1 in. long with hex nut to fit. Miscellaneous: rosin-core wire solder; large round-hole soldering lugs; No. 18 hookup wire with pushback insulation (Note—the 2-turn L2 twisted-link line can be made with this); one bracket $1\frac{1}{4}$ in. wide and 3 in. long; one bracket $\frac{3}{8}$ in. wide and $1\frac{3}{4}$ in. long; No. 10 bare tinned copper wire for Coil L1; two rubber grommets. Tubes: one type 6N4 Raytheon or Tung-sol; one type 7C5 loktal. Note—C1 can be either 5 or 6 mmfd.

Materials for a.c. power supply unit: one sheet-metal base 9 in. long, 6 in. wide and 2 in. high; one Stancor power transformer type P-6312 (Note—580-volt center-tapped H.V. secondary @ 90 ma.; 5-volt secondary @ 3 amps.; 6.3-volt secondary @ 2.8 amps. center-tapped,

but tap is not used. Primary 115 volts 60 cycles; one 20-hy, 80-ma. filter choke (Note—this can be any good 250-ohm open-frame type such as Allied No. 62-002 or similar); one type 80 tube; one 5-ft. line cord with plug; one four-prong socket; one electrolytic condenser tubular-type 8-16 mfd. 450 volts; one s.p.s.t. toggle switch; two rubber grommets.

FIFTY-WATT, TEN-METER C.W. TRANSMITTER

Two sheet-metal bases 2 in. high, 7 in. wide and 17 in. long. Note—these are standard-size chassis bases. One power transformer, 300-0-300 volts, secondary rated at 100 mls or better. This transformer also has a 5-volt and a 6.3-volt winding (T1). Note—the Stancor P-5059 may be used: 337.5-0-337.5 volts, 200 ma.; 5 volts @ 3 amp.; 6.3 volts @ 5 amps. One power transformer 400-0-400 volts, 200 ma., with 5-volt filament winding (T2). Note—the Stancor P-6165 may be used. 400-0-400 volts, 200 ma.; 5 volts @ 4 amp. One filter choke 30 hy., 100 ma.; one filter choke 30 hy., 200 ma. Condensers: three .01-mfd. paper-type 600-volt fixed condensers (C1, C2 and C3); one .003-mfd. mica-type fixed condenser (C4); one .05-mfd. paper-type 600 volt fixed condenser (C5); one .002-mfd. mica-type fixed condenser (C6); one 100-mmfd. variable condenser (C7); one dual variable condenser 33 mmfd. per section (C8); one 50-mmfd. double-spaced midget variable condenser (C9); three National insulated shaft couplings (Note—These are used on variable condensers C7, C8 and C9; the extension shafts being short lengths of 1/4-in. Bakelite rod); one dual 8-8-mfd. 450-volt electrolytic condenser (C10 and C11); one dual 8-8-mfd. 450-volt electrolytic condenser (C12 and C13) in series; one dual 8-8-mfd. 450-volt electrolytic condenser (C14 and C15) in series (Note—these electrolytic condensers are Aerovox double-section compact universal mounting units, type 2E, and are mounted horizontally under the power unit). One standby switch (this is a s.p.s.t. rotary

type in series with the negative B lead. It is mounted on a bracket on the underside of the transmitter chassis base near the crystal socket, with a bushing and extension shaft brought out to a control knob next to the oscillator tuning-control knob); five four-prong tube sockets; one octal "steatite" socket for the 6L6 tube; three five-prong Amphenol "steatite" sockets; one six-prong "steatite" socket; one four-prong Amphenol "steatite" socket for coil L1; one Amphenol or similar type "steatite" large eight-pin octal socket for 815; two small metal caps for 815 tube; three control knobs; one s.p.s.t. toggle switch (for power unit); three jacks, circuit-closing type (J1, J2 and J3); two four-prong cable plugs (Note—these were made from the bases of old tubes. Coil L1 consists of eight turns of No. 22 d.c.c. wire close-wound on a 1 1/4-in. diameter four-prong coil form). Coil L2, L3 and L4 (this coil consists of three windings on a 1 1/4-in. dia. Amphenol No. 24-6P standard six-prong Polystyrene coil form). Coil L2 consists of 5 turns of No. 22 d.c.c. wire spaced to occupy 1/2 in. on the center of the coil form. L3 and L4 are each three turns of No. 22 d.c.c. wire spaced to occupy 1/4 in. and are wound on either side of L2 and spaced 3/16 in. from it). One Barker and Williamson Junior inductor, 10-meter plus-in coil type 10-JCL, center-tap type with center link, mounted on a five-prong steatite base (L5). Two 2 1/2-mh. r.f. chokes; six "thru-panel" insulators; one stand-off insulator; one 60-ma. dial-light bulb; one 40-meter crystal; one 45-volt C-bias battery. Hardware: brackets, bushings, etc. Tubes: one type 80 rectifier; one type 83 rectifier; one type 6L6; one type 815. Two wood supporting blocks 1/2 by 2 by 5 in. and one strip of Masonite 1/2 by 2 by 6 1/4 in. These supporting blocks and the strip are employed to mount the final tank coil. It will be noted that the insulated shaft of the final plate-tuning condenser C9 extends through one of the wood uprights. For resistors see chart in Fig. 2.

INDEX

- | | | | | | | | |
|--|---|--|--|--|---|--|--|
| <p>A</p> <p>Abbreviations, 153</p> <p>Amateur radio, 128-135</p> <p>American Radiq Relay League, 135</p> <p>Amplifier—</p> <p style="padding-left: 20px;">hearing-aid, 123-124; material list, 158</p> <p style="padding-left: 20px;">phono-radio, 116-117; material list, 157-158</p> <p style="padding-left: 20px;">public-address, 118-119, material list, 158</p> <p style="padding-left: 20px;">record-changer, 120-122; material list, 158</p> <p style="padding-left: 20px;">record-player, 88-90; material list, 156</p> <p style="padding-left: 20px;">two-tube battery-operated, 83; material list, 155</p> <p>AM tuner, 88-90, 98-99; material lists, 156, 157</p> <p>Anode, 79, 150</p> <p>Antenna—</p> <p style="padding-left: 20px;">connections, 10, 77</p> <p style="padding-left: 20px;">repair, 25, 46, 47</p> <p style="padding-left: 20px;">terminal repair, 17</p> <p style="padding-left: 20px;">TV and FM installation, 65-69</p> <p style="padding-left: 20px;">TV mismatch, 77</p> <p style="padding-left: 20px;">TV orientation, 68</p> <p style="padding-left: 20px;">TV special-purpose, 69-70</p> <p>Auto-radio repairs, 46-49</p> | <p>B</p> <p>Bass-reflex speaker enclosure, 127</p> <p>Battery-cable code, 146</p> <p>Broadcast-band tuner, 98-99; material list, 157</p> <p>Built-in speaker, 126</p> <p>Burglar alarms, 108-109, 112-114; material lists, 157</p> <p>Buzzer, code-practice, 134</p> | <p>C</p> <p>Cabinet repair, 16</p> <p>Cabled-lead connections, 9</p> <p>Capacity-operated switch, 112-114; material list, 157</p> | <p>D</p> <p>Cathode, 79, 150</p> <p>CBS color television, 61</p> <p>Channels for television, 61</p> <p>Chassis—</p> <p style="padding-left: 20px;">cradles, 23</p> <p style="padding-left: 20px;">removal, 19-20, 48</p> <p>Circuit—</p> <p style="padding-left: 20px;">connections, 6, 8, 36</p> <p style="padding-left: 20px;">symbols, 143-145</p> <p style="padding-left: 20px;">testing, 21</p> <p style="padding-left: 20px;">wiring, 33-36</p> <p>Coaxial cable, 56</p> <p>Code practice, 134-135</p> <p>Coil—</p> <p style="padding-left: 20px;">shield repair, 27</p> <p style="padding-left: 20px;">winder, 27</p> <p>Color—</p> <p style="padding-left: 20px;">codes, 36, 146-149</p> <p style="padding-left: 20px;">television, 61-62</p> <p>Common radio and electronic terms, 150-153</p> <p>Condenser—</p> <p style="padding-left: 20px;">color codes, 146</p> <p style="padding-left: 20px;">filter replacement, 24</p> <p style="padding-left: 20px;">uses and repairs, 15, 17, 24, 35, 36</p> <p>Confirmation cards, 132</p> <p>Continental Morse code, 135</p> <p>Conversion tables, 154</p> <p>Crystal—</p> <p style="padding-left: 20px;">detector, 80</p> <p style="padding-left: 20px;">germanium diode, 80</p> <p style="padding-left: 20px;">receiver, 82-83; material list, 155</p> | <p>E</p> <p>Electrical prefixes, 154</p> <p>Electron—</p> <p style="padding-left: 20px;">gun, 58</p> <p style="padding-left: 20px;">multiplier, 59</p> <p>Electronic—</p> <p style="padding-left: 20px;">flasher, 108-109; material list, 157</p> <p style="padding-left: 20px;">parts, basic, 21</p> <p style="padding-left: 20px;">photoprint timer, 110-111; material list, 157</p> <p style="padding-left: 20px;">relay, 112-114; material list, 157</p> <p style="padding-left: 20px;">terms, 150-153</p> <p style="padding-left: 20px;">tube, 79</p> <p>Emergency—</p> <p style="padding-left: 20px;">receiver, 96; material list, 156, 157</p> <p style="padding-left: 20px;">services of amateurs, 130</p> <p style="padding-left: 20px;">twin-lead TV and FM antennas, 68</p> <p>Extension speakers, 125-127</p> | <p>F</p> <p>FCC—</p> <p style="padding-left: 20px;">license examinations, 129</p> <p style="padding-left: 20px;">office addresses, 154</p> <p>Fixed-resistor color code, 147</p> <p>FM tuner-unit kit, 100-102</p> <p>Folded-dipole TV antenna, 65</p> <p>Four-tube progressive receiver, 86-87; material list, 156</p> <p>"Fringe" area of television, 56</p> | <p>G</p> <p>Germanium crystals, 80</p> <p>"Ghost" TV signals, 65, 76</p> <p>Glossary, 150-153</p> <p>Glow lamps, 25</p> <p>Grid electrode, 79, 151</p> <p>Ground connections, 10, 151</p> | <p>H</p> <p>Ham radio, 128-135</p> <p>"Handi-talkie" emergency receiver, 96; material list, 156-157</p> <p>Hearing aid, 123-124; material list, 158</p> |
|--|---|--|--|--|---|--|--|

INDEX

- High-gain television antenna, 54, 55, 65-69
Home recorder care, 53
Hum—
 in radio, 15, 26, 34, 35, 46
 reducing coil, 26
- I**
- Iconoscope tube, 58
Identifying tube sockets, 35-36
Ignition noise in auto radio, 46, 49
Image orthicon television tube, 59
Indoor AC-DC hearing aid, 123-124;
 material list, 158
Industrial television, 63
Insulation stripping, 7
Interlock switch, 77
Intermittent reception, 22, 46
International Morse code, 135
Inter-room communication system,
 104-106; material list, 157
Ionization, 79
- K**
- Kinescope, 58, 59, 153
- L**
- Lightning arrestors, 11, 67
Line-cord repair, 15, 17, 27
Loudspeaker repair, 14, 16, 48
Low-cost progressive receiver, 84-85;
 material list, 155
Lubrication of record player, 52
- M**
- Master television antenna, 64
Miniature tubes, 78
Mounting parts, 33-36
Multiple images, 65, 76
- N**
- NBC television network, 55
Noise—
 in radio, 11, 12, 14-16, 21, 22, 26,
 35
 in record player, 49, 50
- O**
- Ohm's law, 154
One-tube progressive receiver, 84-
 85; material list, 155-156
Open-circuit test, 21
Orientation of TV antenna, 68
Oscillator, 42-43, 152
- P**
- P. A. amplifier, 118-119; material
 list, 158
Parts—
 mounted, 33-36
 salvaged, 4
Phone system, inter-room, 104-106;
 material list, 157
Phono—
 motor frequency color code, 146
 plug care, 51
 radio amplifier, 116-117; material
 list, 157
Photoprint timer, 110-111; material
 list, 157
Phototube relay, 108-109; material
 list, 157
- Pickup arm, 50-52
Picture tube, 57, 60
"Piggy-back" TV antenna, 66
Pocket receiver (two-tube), 91-93;
 material list, 156
Polarity of electrolytic condenser,
 35, 36
Portable receiver (three-way), 91-96;
 material list, 156-157
Projection TV receiver tube, 60
- Q**
- QST (magazine), 135
- R**
- Radio Call Book Magazine, 130
Radio—
 parts, basic, 21
 parts, pictorial, 140-142
 terms, 150-153
Radio receivers—
 crystal set, 82-83; material list,
 155
 four-tube progressive, 86-87; ma-
 terial list, 156
 "handi-talkie" emergency porta-
 ble, 96-97; material list, 156-157
 one-tube progressive, 84-85; ma-
 terial list, 155
 pocket portable, 94-95; material
 list, 156
 portable super, 91-93; material
 list, 156
 t.r.f. dual-purpose, 88-90; mate-
 rial list, 156
RCA—
 color TV system, 62
 television tuner, 61
Reception noise—
 radio, 12, 15
 television, 73
Record-changer amplifier, 120-122;
 material list, 158
Record player—
 care, 50-53
 testing, 25
Relay—
 capacity-operated, 112-114; mate-
 rial list, 157
 phototube, 108-109; material list,
 157
Resistor, R.M.A. color codes and
 preferred values, 147
- S**
- Schematic symbols, 143-145
Selectivity check, 26
Sensitivity check, 26
Short circuits, 21
Signal—
 generator, 42; material list, 155
 tracer, 38-40; material list, 155
Soldering, 5-9
Speaker—
 bass-reflex enclosure, 127
 built-in, 126
 color codes, 146
 cone repaired, 14
 extensions, 125-127
 leads and plug connections, 146
 repairs, 14, 16, 48
- Stripping insulation, 7
Superheterodyne broadcast tuner,
 98-99; material list, 157
- T**
- Television—
 antenna systems and installation,
 54-56, 64-70
 channels, 66
 coaxial cable, 55, 56
 color, 61, 62
 growth, 56
 hints for set owners, 56, 57, 77
 industrial, 63
 network map, 55
 picture tuning, 74-76
 set selection and installation, 56,
 57
 sound, 60
 terms, 153
 test patterns (defects and correc-
 tions), 71-73
 transmission, 55
 tubes, 58, 59, 60-63
 tuners (front-end systems), 63
Test bench, 44-45; material list, 155
Three-way portable receiver, 91-93;
 material list, 156
Thyratron, 79
Tools—
 essential, 4
 special, 24
Transceiver, 2-meter band, 136-137;
 material list, 158
Transformer color codes, 148-149
Transmitter, 10-meter c.w., 138-139;
 material list, 159
T.r.f. receiver, 88-90; material list,
 156
Tube—
 changing, 13, 15
 check, 12, 22, 47
 grid clips removed, 15
 manual, 149
 miniature, 78
 pins straightened, 78
 principles, 79
 shields replaced, 13
 shields tightened, 12
 tests, 10, 11
 TV picture, 60
Tuning-dial repair, 28
Twin-lead lightning arrestor, 67
Two-way inter-room phone system,
 104-106; material list, 157
- U**
- Utility P. A. amplifier, 118-119; ma-
 terial list, 158
- V**
- Vidicon television tube, 63
Volt-ohm checker, 41
Volume control—
 hints, 12, 32
 replacement, 30-32
- W**
- Wavelength-frequency conversion,
 154
Wiring circuits, 33-36
- Y**
- Yagi TV antenna, 69, 70

Popular
Mechanics



PLANNING YOUR Home Workshop

Edited by SAM BROWN

Only Sam Brown and Popular Mechanics could give you such a book as "Planning Your Home Workshop," for these are magic names in the world of craftsmanship. Brown is a recognized authority and author of many articles and books on home workshops, advisor to power tool manufacturers and a man who has worked with every type of power tool, with all kinds of materials, and has a world-wide reputation for excellence in fine craftsmanship.

Planning Your Home Workshop is a "must" for the beginner and the experienced home shop worker, for no other book gives such complete information on shop layout and maintenance.

Your Shop—Layout—Equipment and Practical Shop Maintenance

This book shows how to set up a shop on a limited budget, how to avoid costly mistakes by buying the right tools, where to get the tools you need and want, what size and type to select, the basic "big-six" power tools, what hand tools to buy, floor plans and layouts to suit available space and facilities, the best use of electric motors, shop furniture you can build, hobbies for the home workshop, a selection of projects, and many other subjects. It contains 128 pages with more than 250 photos and 100 detailed scale drawings, many in colored line.

Cloth Binding \$2.50

Helps You Get the Right Shop at the Lowest Cost

Planning the Home Workshop
Catalog of Tool Buying Information
Hand Tools—to Start—to Add
The Basic Big Six Power Tools
Types of Shop—Wood—Machine—Art Metal—Plastic
Shop Layouts—Basement—Spare Room—Attic—Shops in Small Apartments
One-Motor Shops
Wiring and Lighting
Shop Furniture
Hobbies and "What to Make" Suggestions
Workshop Care and Maintenance

Popular Mechanics CRAFTSMAN'S Library

Planning Your Home Workshop is the first volume in the new Popular Mechanics Craftsman's Library. This will be the most practical and helpful series of publications ever to be issued in this field. Watch for forthcoming announcements.

Helpful Books for Trades, Home Workshop, Farm, Spare Time Work and Hobbies

Tells How to Make Hobbies Pay Their Way

There's double fun in a hobby when you can make it pay its own way and even produce a profit, and here is a fascinating and practical new book that shows you how to do it. Money Making Hobbies is a selection by Popular Mechanics Editors of helpful arts and crafts articles, written by widely known, expert craftsmen, and designed to produce extra income as well as pleasure and recreation. In all, it contains 46 comprehensive projects (132 different things to make!), featuring basic techniques for the beginner and more advanced work for the experienced craftsman.



Make Extra Money While Having Fun--With

MONEY MAKING HOBBIES

ONLY \$2.00



158 Pages of Instruction and Pictures You Can Use Every Day

HOBBIES IN METAL

Modeling in Sheet Metal, Simplified Brass Engraving, Novelty Jewelry You Can Make, Ketch II, You Can Spin It, High-Grade Cutlery From Hackawag Blades, Pictures "Embroidered" in Wire, Tin-Can Craft, Five "Keweenaw" Projects.

HOBBIES IN WOOD

Chip carving, Sculpturing in Wood, Scrollwork for Everybody, To Make or Repair a Bilar Pipe, Picture Carving in Relief, Hand-Carved Luppellers.

HOBBIES IN CERAMICS

Introduction to Ceramics, Ceramics Can Be a Family Affair, Decorative Wall Plaques From Modeling, Clay Patterns, Plaster Casting, Modeling Your Face in Plaster.

HOBBIES IN PLASTICS

There's Money in Heat-Forming Plastics, Colorful Desk Set From Plastics, Electric Open for Heat-Forming Plastics, It's Easy to Cement Plastics, Use Your Plastics Any Color, Edge-Lighted Signs in Plastics.

HOBBIES IN LEATHER

Leathercraft, Tool in Leather for Fun and Profit, Bookbinding for Fun and Profit.

HOBBIES IN TEXTILES AND FIBERS

Weaving Bags Into Bags, Make Weaving Your Hobby, Useful Baskets Woven From Rattle Materials, Things to Make From Raffia, Coraques of Oilcloth, Felt and Raffia, Try Your Hand at Climp Braiding.

HOBBIES IN GEMS

Start a Gem Collection, Gem Cutting—A Double Hobby.

HOBBIES IN GLASS

Plus Your Own Glassware, A Simple Way to Etch Glass.

HOBBIES IN FLOWERS

Urethra Grown at Home, Carlin All-Season House Plants, Winter Bouquets From Your Summer Garden, Miniature Gardens in Trays, Bowls and Well Sieries.

HOBBIES IN PAPER

The Sturdiness of Paper Will Surprise You, Mailing Tube Novelties, "Spotterprint" Silhouettes.



POPULAR MECHANICS PRESS, 200 E. Ontario St., Chicago 11



A Famous Family of "How-to" Books

YOUR HOME AND HOW TO BUILD IT YOURSELF. Step-by-step instructions for building the famous Popular Mechanics frame house! Clear photographs and diagrams. Complete material list. \$3.00.

40 POWER TOOLS YOU CAN MAKE. This amazing book tells how to make homeshop tools, including lathes, drill press, jigsaw, band saw, circular saw, sanders, etc., from castaway material. \$1.50.

PHOTO HANDBOOK. The complete guide to photography. Help you select the proper camera, shows you how to take pictures and develop, enlarge and print them yourself. Hundreds of photo kinks. \$2.00.

FARM MANUAL. Veteran farmers find valuable time and money-saving hints among the hundreds of articles in this book. How to make and maintain farm equipment, care for livestock. \$3.00.

CONCRETE HANDBOOK. The all-around book on working with concrete for home owner, handyman and construction worker. How to make walks, driveways, foundations, steps, benches, pools, ornaments. \$2.00.

WELDING, BRAZING AND SOLDERING. All the secrets of arc and spot welding, brazing and heat-treating of metals. \$1.75.

GARDEN BOOK. Make your garden a show spot of the neighborhood. Tips on growing better flowers and vegetables. Plans for making your own trellises, arbors, lawn furniture, ornaments. \$1.50.

PAINTING, FURNITURE FINISHING AND REPAIRING. A book for home craftsmen, furniture repairmen and finishers. Includes brush and spray painting techniques, antique work. \$1.50.

BUILD A BOAT FOR PLEASURE OR PROFIT. Plans and full instructions for building motorboats, sailboats, rowboats. \$2.00.

MOTORIST'S HANDBOOK. Keep this in your garage for hundreds of repair and maintenance hints. Get the most out of your car. \$2.00.

OUTDOOR SPORTS MANUAL. Make yourself at home in the great outdoors with this collection of 220 helpful articles and hints for fishermen, hunters, campers, trappers, boatmen and archers. \$2.00.

WHAT TO MAKE—11 VOLUMES. An annual selection of best craftsman projects—furniture, games, toys, gifts. You'll never be at a loss for something to make. Singly, \$1.75. Complete set, \$16.50.

THE BOY MECHANIC. Watch your youthful handyman get to work on these exciting projects for boys. Easy-to-understand instructions, hundreds of pictures and diagrams, \$2.00.

WHAT TO MAKE FOR CHILDREN. A book for the whole family. 175 projects to make from discarded or inexpensive materials—toys, dolls, doll-houses, playground slides, seesaws, etc. \$2.00.

THE YOUNG CRAFTSMAN. A wonderful book for energetic young fellows. How to make 450 projects with ordinary tools. \$2.00.

**4 NEW BOOKS
—RECENTLY ISSUED!**

CONCRETE BLOCK HOUSE. Anyone can make the famous Popular Mechanics five-room modern house from the instructions and plans given in this amazing book. \$2.00.

PLANNING YOUR HOME WORKSHOP. Sam Brown edited this for veteran craftsmen and beginners. All about the setup and operation of power tools. \$2.50.

MONEY-MAKING HOBBIES. 132 saleable projects you can make and sell—plus the pleasure of woodworking, metalcrafts, plastics, weaving, leathercraft, gem cutting, etc. \$2.00.

CHRISTMAS HANDBOOK. Solves your holiday gift and entertainment problems. Gifts and toys you can make for all the family, hints on lights, decorations. \$2.00.

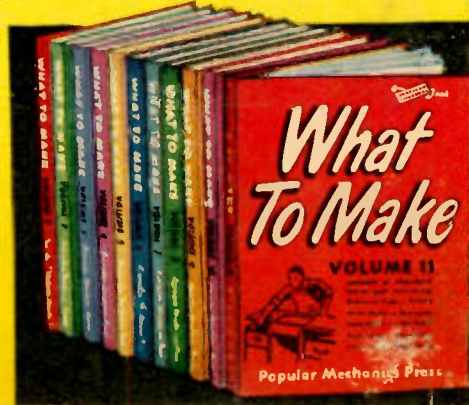

Order From Your Bookseller Or
POPULAR MECHANICS PRESS • 200 E. Ontario St., Chicago 11