

1958 POPULAR ELECTRONICS'

\$1.00

HI-FI

Guide & yearbook

top 57 discs & tapes

by edward tainall canby

how to go stereo

list of FM stations
free hi-fi booklets





YOUR high-fidelity equipment... Here's how the B.I.C. GROUP lines up

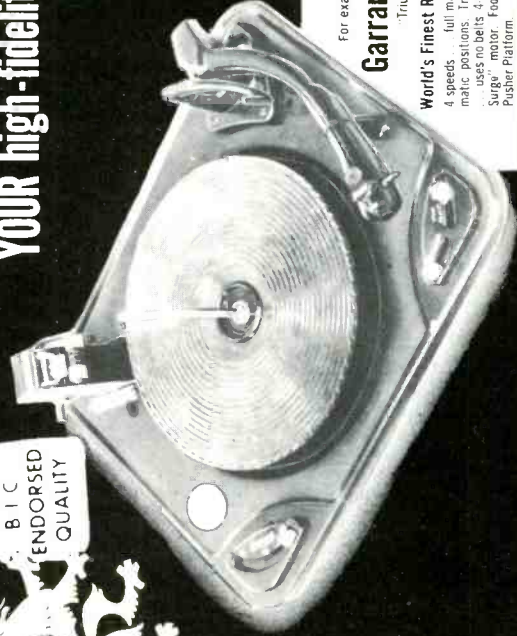

For example **New!**
Garrard RC 88
 "Triumph II"
World's Finest Record Changer
 4 speeds, full manual and automatic positions. True turret drive uses no belts, 4-pole induction surge motor. Footprint: Garrard Pusher Platform. \$55-50 net.

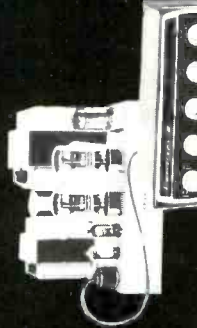

For example **New!**
LEAK "TL 50 PLUS"
 Brian's First Amplifier. Sets a new world standard in quality and circuitry. Full harmonic distortion, 100 db dynamic range, 1000 Hz. 100 watt (25 watt and 12 watt models also available) with **VARISLOPE III** Preampifier. Only preamp. in the world featuring a variable frequency response in midrange. Variety of options: \$79.00 net (also "Point One Plus" preamp!)



For example
Wharfedale Super 12 FS AL
 12" full-range Loudspeaker designed by world renowned G. A. Briggs. Remarkably level response over entire range. Especially full bodied, non-strident tone. Unique foam suspension and felt buffer in voice coil. 2850 Hz. 100 watt. Ohm load. 12" x 12" x 4 1/2" deep. Treble: from \$22.50 to \$79.50



For example **New**
R-J Floor Model R-1/12F
 The original small space loud speaker baffle. Patented* R-J design principles assure full smooth bass unobstructed highs. R-1/12F (for 12" speaker) Unfinished. \$45.00 Mahogany, Walnut, Blonde. \$56.00 (R-J 15" floor model for 15" speaker) *Pat. #2659462 and #2659463

Today you can assemble your entire high fidelity phonograph with B.I.C. quality endorsed components each the finest fully guaranteed uniformly better, yet priced competitively with ordinary components. Your continuing satisfaction is assured by really complete spare parts and service facilities.



New!
GARRARD 301
 "Professional" Transcription Turntable. Supreme in its class! All speeds variable and adjustable. Each machine tested perfect, with individual written inspection report on wow, rumble, flutter... \$89.00 net.



New!
GARRARD RC 121 "Renown"
 4-speed Mixer Changer. Garrard's most comprehensive manual changer. Includes cabinet, Simpo-Mix Oper. atom. permits stacking all record sizes together. 4-pole motor. Manual stop. \$42.50 net.



New!
GARRARD T-Mark II Manual Player. The answer for a quality budget system. Incorporates all record playing features of the Garrard automatic changers. 4-pole motor, automatic stop. \$32.50 net.



Genalex... Finest Audio Tubes
New! KT88 high power low distortion amplifying triode. \$4.50 net.
The original KT66 power amplifying triode. Fits same socket as U.S. #6L6. \$3.50 net.
The original 2Z79 low hum input tube. \$2.99 net.



New!
Wharfedale
 Briggs-designed 3-way Speaker System in Sand-Blast Baffle Ready to Play

SFB3 "Deluxe" \$249.00
SFB3 "Custom" \$199.00
OTHER WHARFEDALE SYSTEMS AND ENCLOSURES



R-J Shell-model Loudspeaker
 Maximum Bass. Minimum Space. Thrilling performance from any loud speaker in cabinet only slightly larger than the speaker itself. Single shelf and double shelf models and R-J Super 8 Unit. (complete with Wharfedale Super 8 FS AL Speaker) \$28.50 to \$59.50.

Customized Cabinets and "Do-It-Yourself" Kits by River Edge
 29 models; 10 finishes. Equipment and loud speaker cabinets to fit components of all major cabinets and lineups. Give unpainted kits.

W/AF/1 Two Speaker System \$129
W/AF/2 Two Speaker System \$159
C-500 Briggs Sand Blast 3-Way System Corner Enclosure \$115

For literature, write Dept. AY-198 Please specify product.

BRITISH INDUSTRIES CORPORATION • Port Washington, New York

1958

HI-FI

GUIDE & YEARBOOK

contents

Introduction	4
Yearbook	5
Guide, Part 1 <i>Improving Your Hi-Fi</i>	59
Guide, Part 2 <i>Tape Recording</i>	91
Guide, Part 3 <i>Stereo Hi-Fi</i>	119

Oliver Read, *Publisher*

Charles Tepfer, *Editor*

Art Fitzthum, *Art Editor*

Furman Hebb, *Assistant Editor*

John A. Ronan, Jr., *Advertising Director*

ZIFF-DAVIS PUBLISHING CO., 366 Madison Ave.,
New York 17, N. Y. William Ziff, President; H. J.
Morganroth, Vice President; Michael H. Froelich,
Vice President; Michael Michaelson, Vice President
and Circulation Director; Albert Gruen, Art
Director.



Cover Photo by Seymour Zweibel Productions
Copyright © 1958 by Ziff-Davis Publishing Company
All rights reserved.



introduction

THIS Guide & Yearbook is unlike any other publication dealing with high fidelity in that it is meant to be used constantly all year round. Whether the reader tunes in on his good music by FM, or whether he spins a disc to get his syncopation, he can use this yearbook. Here is a thoroughly checked list of FM stations, perhaps you've been missing one in your locality? Cut out the strobe disc and test the speed of your record player. Want some interesting new recordings? Choose them from the list given here. If your hi-fi set is acting up you may save some money by checking some of the most usual sources of trouble yourself before you call a serviceman. Read the article on page 53. There's much more for you in the yearbook section of this book irrespective of whether you are a beginner at hi-fi or an old hand.

The guide section this year spotlights three areas in hi-fi that are of greatest interest to the widest number of hi-fi fans. The first part helps you improve the hi-fi set you now have. It tells you how to add another speaker to your system, how to get "presence," how to take care of your phono pickup, and more. Part 2 tells you all about tape recording: how to splice, how to tape programs off the air, etc. You've heard of stereo, perhaps you've wondered about getting it? Read part 3. This is probably one of the most complete roundups of stereo information in print.

This is a Popular Electronics book. Many of the articles printed here first appeared in that magazine. To keep up with the rapid advances in high fidelity in a technically accurate and easily readable format, read Popular Electronics monthly.

Charles Tepfer

YEARBOOK

Trends in Hi-Fi	6
Hi-Fi Shows in '58	12
Hi-Fi Literature	14
Standout Discs & Tapes of 1957	18
Hi-Fi on the Air	22
FM Stations in the U.S. & Canada	27
Tape Recording in 1958	35
Stroboscope Disc	37
Test Records	38
The Fourth Speed	39
Rolloff and Turnover Settings	43
Hi-Fi Bookshelf	45
Record and Tape Clubs	48
Hi-Fi Shoptalk	50
What to Do Before Calling the Serviceman	54

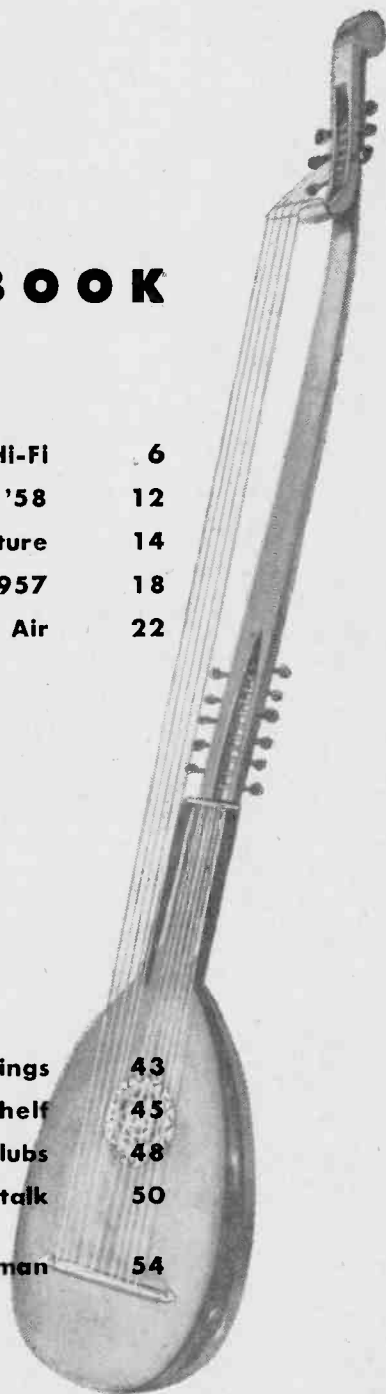

t r e n d s

i n h i - f i

by **John Milder**

FOR HI-FI FANS, 1957 was a year of exciting promises and steady improvement. The development and marketing of modestly priced equipment for reproducing music stereophonically in the home was of greatest interest.

There can no longer be any doubt that stereo, in one form or another, will be bought by many seekers of hi-fi. Every maker of tape recorders is now producing at least one stereo model, and there is virtually no audio shop without some selection of stereo components.

The last great obstacle for the widespread acceptance of stereo—the production of practical stereo records, has all but been demolished. Three separate processes have now appeared for the production of single-groove stereo disc recordings. These are “compatible” systems, i.e.; when played on a machine with a special stereo pickup, two separate music channels result. Using a conventional pickup yields a single output for reproduction through a normal preamp-amplifier-speaker system. More about this in the chapter on stereo.

We can all take comfort at the apparent determination of the recording industry to perfect and market only one kind of stereo disc and avoid the kind of battle which we witnessed a while ago between 33 $\frac{1}{2}$ LP's and 45's.

In the meantime, the manufacturers of stereo tape and tape playback equipment are losing little time in taking advantage of their lead over discs. There seems to be no reason to doubt that both tape and disc will find their proper share of the hi-fi market but, for the present, tape is far ahead. Tape equipment now ranges from such intelligently-designed economy units as the *Bell* and *Viking* tape decks to complete “cost is no object” systems by *Ampex*, *Berlant-Concertone* and others. By the beginning of 1958 virtually every major recording company will be issuing stereo tapes, and it is likely that the price of tapes will drop somewhat.

For those inclined to experiment a bit, a new stereo technique pioneered by Paul Klipsch and others seems to hold great promise. This new practice involves mixing part of both stereo channels in a third speaker located between the two now generally in use for stereo reproduction. The effect of this process is to fill in the void which sometimes becomes apparent between two sound sources in stereo reproduction. This method simulates a third or center channel without adding the great

expense and complexity which an actual third channel would involve. The only real cost of this system for most stereo fans would be for an additional speaker of acceptable quality to reproduce the "phantom" channel.

Pickups and Tone Arms

Although stereo tape seems to have dominated most of the audio conversations of 1957, the record and phono cartridge were still the sources from which most of our music flowed, and the year evidenced two divergent trends in pickup design.

The argument that tone arms and cartridges should be designed specifically for each other gathered strength with the introduction of designs such as the *Pickering* "Unipoise" and the *Shure* "Dynetic."

The "Dynetic" probably incorporates more unusual features in design than any pickup since the *Weathers* FM system. Like the *Weathers*, the *Shure* is designed specifically for a one gram tracking force. The cartridge is a magnetic one in which the magnet itself is the moving element rather than the coil as in most other high quality magnetics. The tone arm is designed only for lateral movement, with all vertical movement taking place at the head assembly, and employs jeweled bearings for both vertical and lateral movement. The stylus bar, rather than the head

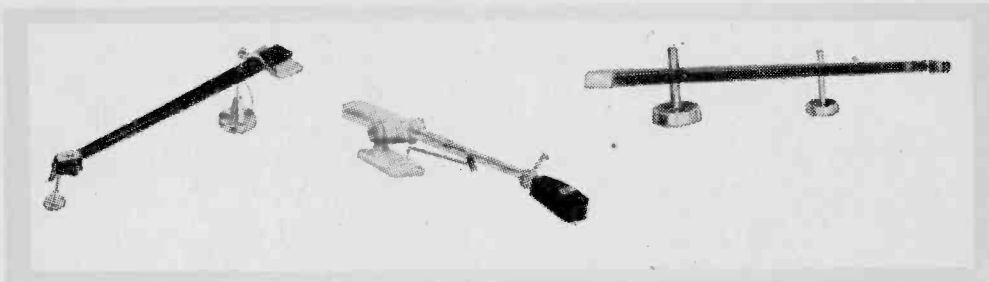

The *Pickering* "Unipoise," the Garrard TPA/10, and the *Shure* "Dynetic."

assembly, is offset and the stylus itself has a 0.7 mil tip for improved high frequency transient response and tracking of inner record grooves.

At the opposite pole of cartridge design is the new *Grado* moving coil pickup which is designed to work with any good tone arm. Although the *Grado* features higher lateral compliance (15×10^{-6} cm/dyne) than any other magnetic, this compliance is maintained only through a few degrees of lateral movement so that the great amount of side thrust involved in tripping a record changing mechanism will not deform the stylus cantilever. This enables the *Grado* to operate in any good record

changer at a stylus force as low as three grams. Further unusual design features include a plastic stylus cantilever and a unique method of preventing vertical movement of the coil, features which result in extremely good vertical compliance without spurious vertical response from "pinch effect" and other sources.

Opposite in design as they may seem, both the *Grado* and the "Dynetic" succeed in producing extremely transparent sound with a minimum of record wear.

General Electric chose 1957 to revamp its RPX series of variable reluctance cartridges. The new *G-E*, known as the VRII, has an improved high frequency response and higher lateral compliance.

A new idea in tone arm design was introduced by *Garrard*. The *Garrard* TPA/10 tone arm is unique in that its length may be varied from 12" to 16" to suit installation requirements.

Dealers report that one of the hottest items in the past year was the Audax tone arm kit. Made by *Rek-O-Kut*, this arm is furnished in both 12" and 16" lengths. A minimum of mechanical skill is necessary to complete its assembly.



Two of 1957's new pickups were the *Grado* (above left) and the *G-E* VRII (above right).

Amplifiers

The trend in amplifier design continues toward simplicity in preamplifiers and high power in power amplifiers. Among preamps, new designs proceed with the assumption that the buyer is going to use them in a system of overall high quality, thus minimizing those features intended to make up for possible defects in the rest of a hi-fi system. The emphasis instead has been placed on straight-forward design with the minimal amount of record equalization. This trend is likely to continue, although there will always be preamps designed to cover any eventuality that the audiophile may conceivably meet.

Among power amplifiers, simplification does not seem to be the order of the day. A few of the higher priced amplifiers include provisions for checking on tube condition and other factors, and variable damping controls are very popular. Much of the improvement in current amplifier circuits stems from the use of improved output tubes such as the EL34, EL84, and KT88, and improved transformers. These have quietly produced pretty much of a revolution in amplifier design.

The power controversy seems to have died down for the moment. For one thing, 50 and 60 watt amplifiers today cost no more than a 25 watt job did a few years ago. Also, so many people need the higher-powered amplifiers for their low efficiency speakers. One heartening fact is that there now seem to be many more lower-powered amplifiers which will cleanly produce the full audio range at points near their full rated output. This has not been common by any means, and it is certainly more than welcome.

Amplifier kits have come into even greater prominence. The familiar *Heathkit* line now provides models ranging from eight to seventy watts in power, and *EICO* is represented by various combinations from twelve to sixty watts. The *Dynakit* fifty-watt amplifier has been joined by a sixty-watt unit. *Acrosound*, *Regency*, and *Printed Electronic Research, Inc. (PERI)* have also entered the high power class with fifty and sixty watt models. The increasing use of printed circuitry has reduced kit building to a very easy process, and the audiophile who is willing to spend a few hours at it can produce professional results with no strain on his nerves or his wallet.

Transistor Hi-Fi

Transistors continue to exhibit great promise. *Madison Fielding* and *Regency* have produced transistorized preamps with full control facilities and fixed RIAA record equalization. An experimental preamp was exhibited recently incorporating eight transistors in an extremely conservative circuit with full record equalization and a totally inaudible noise level. One transistorized preamplifier has made its appearance. This is produced by *Video Instrument Co. (VICO)*. More can be expected. In general, however, transistors have not found their way into audio circuits as rapidly as some people anticipated, although their cost has dropped considerably.

Turntables

The long standing trend in turntable design toward increasingly heavier units for speed constancy and quiet operation has been challenged by a new product from *Weathers*. This is an extremely light single speed unit with a small hysteresis motor. The turntable is rim-driven by a gelatin idler wheel and is mounted on its base in an extremely free floating suspension. The theory of its inventor is that the light tracking force employed in modern pickups does not require a heavy motor for maintaining speed stability, and that careful design can produce a light

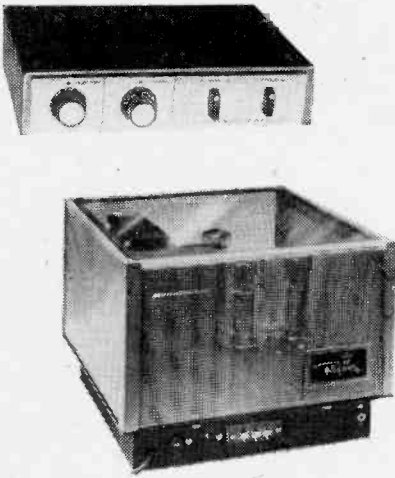

Representative of current amplifier design trends are the new Fairchild preamp (top) and the Regency power amplifier, a fifty-watt unit (below).

turntable which is not susceptible to rumble and other factors. Since its only appearance so far was at the New York High Fidelity Show, where it is virtually impossible to judge such matters as rumble and flutter, all that can be said with any certainty is that the turntable seems extremely impervious to vibration, ignoring attempts by its inventor to disturb it by pounding its supporting table with a heavy mallet.

Another departure in design was developed by *Fairchild*, in which turntable speed is changed and maintained electronically by means of an associated power amplifier, rather than by the conventional mechanical means. Speed constancy of the new unit seems to be virtually absolute, and the dual belt drive system employed is said to produce extremely quiet operation.

Loudspeaker Systems

The trend toward loudspeaker systems which are scaled to the size of the average living room continued stronger than ever. The acoustic suspension principle employed in the original AR-1 system has been used in several systems designed by the *KLH Corporation*. These speakers are primarily intended for use with electrostatic tweeters. Less conventional is the return of G. A. Briggs of *Wharfedale* to the use of a open-back baffle for a three way system. The new system is claimed to be totally non-resonant, employing a rigidly braced sand-filled panel, and gives usable bass response to thirty cps in a room corner. Would-be experimenters with this new-old idea should beware, however, for the speakers used are designed specifically for their purpose, and attempts to reproduce Mr. Briggs' results probably will not be very successful.

A new three-way speaker system for *EICO* employs a conical horn which terminates in a narrow rectangular slot. An eight-inch driver is used for bass and mid-range and a unique "free floating" horn-loaded tweeter unit points upward for wide dispersion of highs. The unit occupies little more than a square foot of floor space and stands slightly over three feet in height. Its inventor, Stuart Hegeman, has also developed a larger multi-speaker unit of similar design with a claimed flat frequency response down to 20 cps.

These and many other designs give the distinct impression that there's lots of good sound left in the moving coil speaker. *JansZen*, who in 1956 displayed a

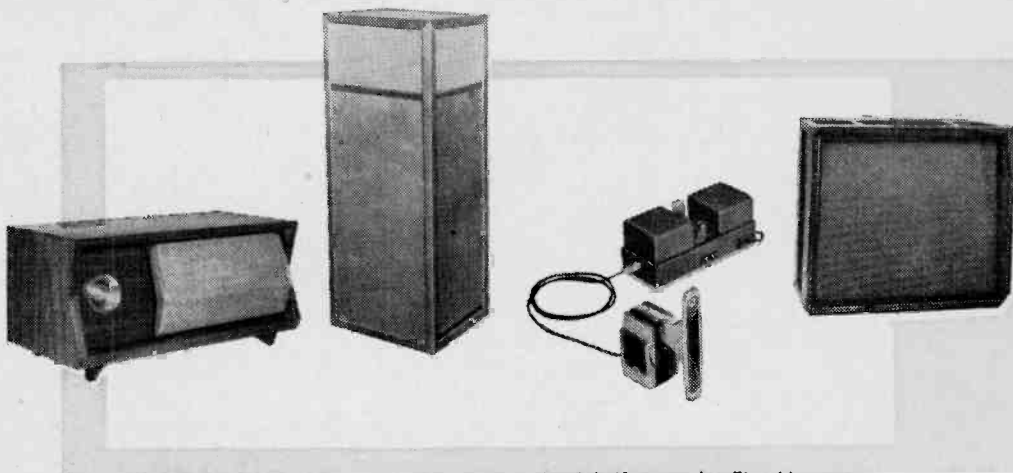

From left to right: a new Jim Lansing bookshelf unit, the Eico-Hegeman, the Electro-Voice "lonovac" tweeter, and the Wharfedale "Windsor DeLuxe."

full-range electrostatic speaker, this year introduced a moving coil unit of his own design for the bass range, as has Harold Leak in England. While the electrostatic speaker remains a highly-respected tweeter unit, it will be some time before full-range units threaten the reign of the moving coil speaker.

In the meantime, basic research in speaker design turned in many directions. H. A. Hartley, long an exponent of the single wide-range speaker, produced a ten-inch speaker with an entirely new kind of cone. Made of polymers, it is suspended in a cast plastic frame, and combines lightness for high frequencies with an extremely stiff piston action for bass response. Like the electrostatics, it seems to be free of any coloration. Whatever develops from this new concept, Mr. Hartley,

who has been working on speakers since the mid 1920's, has certainly contributed to the defense of the moving coil unit.

Probably the first attempt to use wartime-born servo mechanisms and automatic feedback correction in speaker design was announced by the *Integrand Corporation*. This new system, for monaural or stereo use, combines two three-speaker systems with each speaker driven by its own transistorized amplifier. Automatic feedback correction is employed for irregularities in speaker response due to room acoustics, speaker action, and other conditions. All crossovers are electronic and transistorized. No public demonstration of this new unit has taken place up to the present time, however.

Two other units, having a slight resemblance to each other, have made an initially promising appearance. One, a diaphragmless tweeter which makes use of an "ionic cloud" developed by the corona discharge of a quartz cell to produce sound is called the "Ionovac" and is now being marketed by *Electro-Voice*. Its stated frequency response is from 2,000 to 40,000 cps \pm 2 db, and its sound seems very similar to that of a good electrostatic tweeter. Its distant cousin, the corona loudspeaker, using a similar "corona wind" principle through a complicated system of electrodes, has been exhibited only experimentally. Even in its early rudimentary stages the corona speaker has many advantages—it has no audible bass resonant frequency and no moving parts—which suggest limitless possibilities. It is nowhere near the production stage, however, and probably will not be introduced commercially for some time.



The Norelco tape recorder offers three speeds.

Tape Recorders

The one imposing trend in tape recorders was the almost universal incorporation of stereo *playback* facilities, with an increasing number also furnishing stereo *recording* provisions. The growing number of "semi-professional" tape machines was swelled by the imported *Norelco* and *Revox* recorders, the former featuring among its three speeds a 1 $\frac{7}{8}$ ips speed for voice recording. There now is a large selection of records for those who want something more than the average home recorder provides but do not need all of the refinements offered by fully professional equipment. It is also worth noting that many more of the inexpensive home recorders now provide outputs for connection to high fidelity systems, although this feature often points up their deficiencies in performance.

Tuners

The 1957 crop of tuners seemed to reach the theoretical limits of signal sensitivity with such units as the *Fisher*, *Scott*, and *Sherwood*. Many city dwellers now find that their problem is too much, rather than too little sensitivity. The very latest of the new tuners have begun to make use of sensitivity controls to overcome this complaint, and it is a good bet that next year's models will continue this trend and reflect more preoccupation with other kinds of circuit refinements. Also likely to continue is the trend toward combining tuners and amplifiers on one chassis, which has proved both popular and practical.

Components or "Packaged" Hi-Fi?

Continuing and gaining is the number of component manufacturers who are marketing "packaged" or console hi-fi units. This trend must interest not only the newcomer to hi-fi who must decide whether he will buy a component installation or a console, but also those constantly seeking to improve what they already have. This seems a good time to review the merits of using separate component systems against those of factory-assembled systems. Component high fidelity caught on because of its instantly audible superiority to most commercial sets and because

of the flexibility and almost infinite variety of choice it offered. The great increase in component sales figures in recent years has been made possible by the flexibility and reasonable cost of such installations. Component hi-fi systems are obtainable in a range from approximately \$150 to \$3000 or more.

It nonetheless became evident that there was also a substantial number of people who wanted the convenience of factory-assembled consoles. There were several responses to this demand for complete hi-fi consoles. Some of the older console manufacturers responded by slightly changing the appearance of their radios and phonos and labeling them high fidelity. Some even used slightly larger speakers (they called them "wide range," of course).

Another answer was a custom installation provided by well-equipped audio salons, complete with modern or traditional cabinet work and ingenious concealment of individual components. However, most audio shops were unable to display actual samples of this kind of installation, even for the few people who were aware that it was available at all.

Just about this time, the U. S. was subject to an influx of radios from such manufacturers as *Telefunken*, *Grundig*, and *Blaupunkt* in Europe. These units, while not approaching the genuine high fidelity performance of component systems, nonetheless looked and sounded more substantial than most commercial radio sets, and inevitably benefitted from the general interest in hi-fi. There is no reason to doubt that they helped for a while to fill a legitimate need, but by now their advertising claims seem to have far

outrun their actual performance.

The past eighteen months have finally brought two major developments in packaged hi-fi. The more radical one was the decision by component manufacturers to market complete console units which used their own equipment as far as possible, matched by components of similar quality from other manufacturers. This idea had been used to some extent much earlier, but mostly in deluxe consoles in which cost was no object. The newer units were aimed directly at anyone who wanted console convenience. *Pilot*, who has been a pioneer in this direction, *Radio Craftsman*, *Harmon Kardon* and others produced complete systems in a single cabinet, using their own amplifiers and tuners with record changers and speakers from other sources. *Gray Research*, emphasizing the older hi-fi practice of keeping speakers separate from the rest of the system, combined its own turntable, tone arm, preamp and amplifier with *Bozak* speakers mounted in a separate cabinet. *Fisher* marketed consoles in all price ranges, modest to luxurious; *Ampex* produced console units which emphasized stereo tape facilities as the chief attraction.

In the meantime, the larger commercial radio and record companies finally began to market units which were significant improvements over their older consoles. Probably the most sweeping entrance into the field was by *Columbia*, with a wide

range of units from phonographs to elaborate models incorporating stereo tape provisions. Many consoles from both radio and component manufacturers could now justifiably claim to be hi-fi, although many of the small single-cabinet models had relatively little true bass response and others demonstrated acoustical feedback and other disturbances.

The new and unusual products developed during 1957 will soon be appearing in the neighborhood audio shops. In the meantime, we can all wait for the surprises that 1958 will bring. With such items as stereo discs on the horizon, it looks like another good year for audiophiles.



The Pilot PT-1050 radio-phonograph console unit.

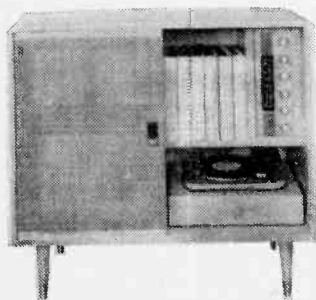

The Radio Craftsman "Music Master" radio-phono console.

hi-fi shows in

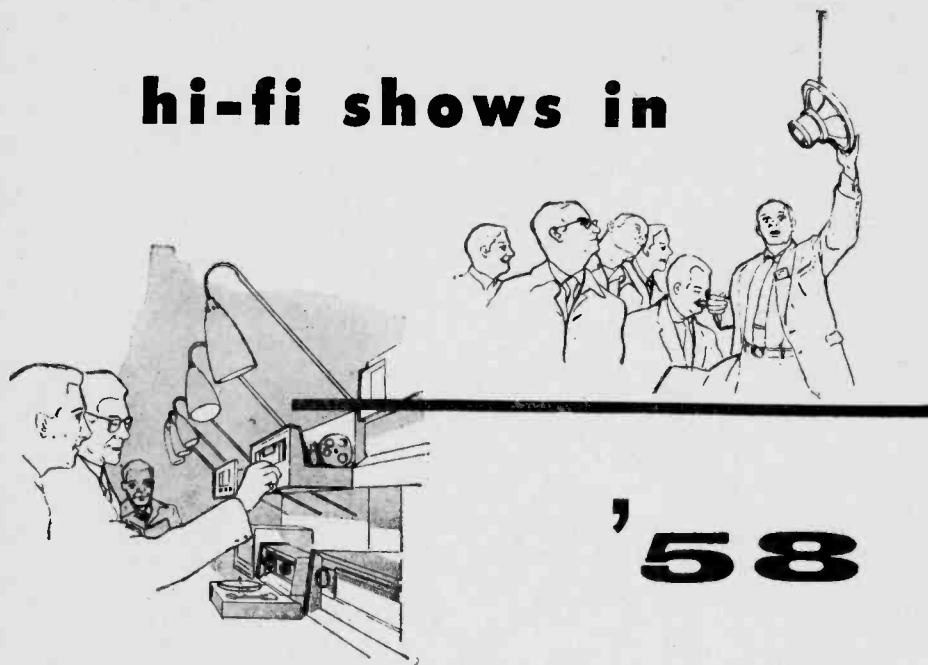

'58

Hi-Fi has finally graduated to the status of "big business." Retail sales of hi-fi components have jumped from a total of \$12,000,000 in 1950 to an estimated total of more than \$200,000,000 in 1957. And this is by no means the final sales goal; some industry people feel that sales will go over the half-billion mark in 1958. An important tool in developing the country's hi-fi potential in an effort to reach this sales figure is the hi-fi show. Such shows have been enthusiastically received by the public, with the ones in New York and Los Angeles, in particular, having drawn in close to 50,000 visitors.

The main attraction offered by the hi-fi shows is the opportunity given prospective buyers to see, hear, and compare all the hi-fi equipment on the market. This type of comprehensive comparison isn't possible at the average hi-fi dealer's store because his stock is necessarily limited by factors of storage space and, more important, capital. The average dealer can't possibly carry everything. He constantly walks the tight rope between carrying a representative line of products for all price ranges and, at the same time, trying to keep up with "off beat" items. At the hi-fi show on the other hand, the prospective hi-fi purchaser has the entire world of hi-fi components for his inspection. He has a chance to listen to the different amplifiers, speakers, and cartridges that he's been reading about. He can compare the various hi-fi systems, components and packages, in all price ranges and decide which system best suits his taste and pocketbook.

The shows are generally held in large hotels, with each exhibitor having one or more rooms for his exhibit. The demonstrations seem to be tending toward a more formal type of presentation. Many times, lectures are given, with some companies offering demonstrations at regularly scheduled intervals. This is in contrast to the previously accepted idea that the way to get people into an exhibit was to blast some music out of the door louder than the exhibit next door did. The exhibitors at the shows in recent years have distributed great quantities of advertising and helpful literature and usually have some of their engineering staff on hand to answer the hundreds of questions from interested visitors.

Special records and tapes are still favored for demonstration purposes, but they are less "gimmicky" than in former years. The sounds of hammers, saws, and freight trains are going out of style. It seems that music is winning out.

The leading producers of hi-fi shows are the *Institute of High Fidelity Manufacturers Inc.*, *Rigo Enterprises, Inc.*, and *International Sight and Sound Exposition, Inc.* Smaller shows over the country are organized by local retailers and distributors.

The *Institute of High Fidelity Manufacturers* was created in 1954 by representatives of the major manufacturers of hi-fi equipment. The purpose of the *IHF* is to promote

the hi-fi components industry in all possible ways, chief among these being the sponsorship of hi-fi shows. Only manufacturers or, in the case of foreign manufacturers, their U.S. sales agencies, may exhibit in *IHF*M shows. Admission to these shows is not free. The admission charge to hi-fi fans varies from 50 cents to 75 cents. Despite this, over 100,000 music lovers plunked down the cash to hear the latest in hi-fi at *IHF*M shows in 1957.

Because of the tremendous country-wide interest in hi-fi, a private company, *Rigo Enterprises, Inc.*, was formed to produce hi-fi shows. *Rigo* produces shows in smaller cities than the *IHF*M can economically go into and invites retailers, as well as manufacturers, to participate. *Rigo* has conducted twenty-two shows in nineteen cities over the entire nation within the past fifteen months. Henry Goldsmith, the president of *Rigo*, is optimistic about the future of hi-fi and the future of *Rigo* along with it. Mr. Goldsmith says the demand for hi-fi shows is seemingly insatiable, and *Rigo* has already booked thirteen shows for 1958. The admission charge for the *Rigo* shows is fifty cents.

The *International Sight and Sound Exposition, Inc.*, is the oldest organization producing hi-fi shows. Preparations for its seventh annual September presentation of the Chicago High Fidelity Show at the Palmer House are being made by its president, S. I. Neiman. The Chicago show has come a long way since 1952. The crowds at the last few annual shows at the Palmer House now threaten to make necessary the installation of an auxiliary escalator system. Mr. Neiman also has plans underway for two other hi-fi shows in 1958, one in Los Angeles, and one in New York City.

The smaller, independent shows around the country are usually sponsored by local or regional distributors and retailers. These shows have on occasion drawn heavy crowds and have brought the benefits of hi-fi shows to areas not covered by the larger exhibitions. These local shows, unfortunately, are not booked far enough in advance for inclusion in our show guide. For information about this type of show, keep in contact with local hi-fi salons and distributors.

hi-fi show calendar

(Most of these dates are tentative, subject to change by the sponsoring organization)

jan.	10, 11, 12 Minneapolis, Minn. Hotel Dyckman Rigo	17, 18, 19 Indianapolis, Ind. Hotel Antlers Rigo	24, 25, 26 Buffalo, N. Y. Statler Hotel Rigo		
feb.	7, 8, 9 Denver, Col. Hotel Cosmopolitan Rigo	14, 15, 16 San Francisco, Cal. Whitcomb Hotel IHF	21 Los Angeles, Cal. Int'l. Sight & Sound	26, 27, 28 Los Angeles, Cal. Biltmore Hotel IHF	
mar.	1, 2 Los Angeles, Cal. Biltmore Hotel IHF	7, 8, 9 Pittsburgh, Pa. Hotel Penn-Sheraton Rigo	21, 22, 23 Newark, N. J. Hotel Robert Treat Rigo	28, 29, 30 Baltimore, Md. Lord Baltimore H. Rigo	
sept.	5, 6, 7 Memphis, Tenn. Hotel Peabody Rigo	12, 13, 14 Chicago, Ill. Palmer House Int'l. Sight & Sound	19, 20, 21 Louisville, Ky. Hotel Seelbach Rigo	26 New York, N. Y. Int'l. Sight & Sound	30 New York, N. Y. Trade Show Bldg. IHF
oct.	1, 2, 3, 4 New York, N. Y. Trade Show Bldg. IHF	24, 25, 26 Seattle, Wash. Hotel New Washington Rigo	Montreal, Canada Dominion High Fidelity Association		
nov.	1, 2 Kansas City, Kansas University of Kansas City & Midwest High Fidelity Guild	7, 8, 9 St. Louis, Mo. Hotel Statler Rigo	Toronto, Canada Dominion High Fidelity Association		

hi-fi literature

most is free, some costs a nominal sum



THE BROCHURES, BOOKLETS, AND PLANS listed and described on the following pages are not primarily product advertisements or catalogues. Every manufacturer is glad to furnish a catalogue or folder describing his products. The listed literature that follows, however, is not just material "plugging" different products. Although it is prepared and distributed by hi-fi manufacturers and dealers, this material is published mainly for the purpose of spreading information about hi-fi in general. The manufacturers and dealers that participate in this type of program hope to broaden their markets and thus sell more units.

Manufacturers in the hi-fi component field are especially active in spreading the gospel of the component way to hi-fi. They do this partly to counteract the vague and many times unfounded claims of the hi-fi package unit merchandiser.

Among the literature listed will be found specific information to suit the immediate purposes of any hi-fi fan, whether he plans to build his own speaker enclosure, put together a complete hi-fi system, or merely to learn hi-fi terminology.

The literature is free unless otherwise noted. To receive copies of any of the booklets, just fill out the coupon on page 17.

High-Fidelity Systems

What Is High Fidelity?

A basic explanation of the what, how, and why of high fidelity in everyday language.
The Gray Manufacturing Co.

1

Temples of Tone

A discussion of music and electronics and their place in the field of hi-fi. Descriptions of all types of hi-fi components.
Electro-Voice, Inc.

2

What You Should Know About Hi-Fi

Reprint of a question-and-answer type article that appeared in *Coronet* magazine. Written in layman's terms by Ralph Bass.
Fisher Radio Corp.

3

The How and Why of High Fidelity

A very handsome 48 page booklet. Contains valuable information and points out advantages of building hi-fi kits at home. \$25.
Heath Company.

4

5

This Is High Fidelity

Practical advice on the selection and installation of high fidelity music systems for home use at minimum cost. Sixteen-page booklet. \$10.
Allied Radio Corporation.

Planning Built-in Hi-Fi Systems for the Home

Helpful suggestions for adding a built-in entertainment center in present homes, or including one in a new home. Cabinet construction and electrical wiring plans are given. Fifteen-page booklet. \$10.
Allied Radio Corporation.

6

A Frank Statement of High Fidelity Facts

A sixteen-page booklet outlining Altec Lansing's philosophy of high fidelity component design.
Altec Lansing Corporation.

7

Understanding High Fidelity

Written by Louis Biancolli and Lester H. Bogen. Excellent introduction to hi-fi with a section concerning the selection and installation of hi-fi equipment. Fifty-six pages. \$25.
David Bogen Co., Inc.

8

Hi-Fi Is for Everybody

Attractive thirty-two-page booklet which describes how to choose and install your hi-fi system. Includes sections on concealed and built-in installations.
Newcomb Audio Products Co.

9

High Fidelity in the Home—A New Approach by Pilot

Describes the history and development of hi-fi to the present day. Discusses the design and performance of the Pilot line of console units.
Pilot Radio Corporation.

10

Hi-Fi and Your Budget

Useful six-page booklet outlining the necessary ingredients of a hi-fi system and how to assemble them most economically.
Thorens Company.

11

Phono Equipment

Technical Bulletins 1-4

Articles covering "Design principles of a high fidelity phonograph reproducer," "High frequency distortion in record reproduction," "True bass response," and tips on cartridge and record care.
Electro-Sonic Laboratories, Inc.

12

The How & Why of Phonograph Cartridges

Describes in simple non-technical language, how various phono cartridges are constructed and advantages of each type. 1957 Edition.
Fairchild Recording Equipment Company.

13

How Good Is Your Arm?

Semi-technical bulletin describing design problems involved in construction of high quality transcription arms.
Fairchild Recording Equipment Company.

14

Turntable or Record Changer . . . which shall I buy?

Discussion of the relative advantages of turntables over record changers. Free strobe disc available on request.
Rek-O-Kut Co., Inc.

15

Phonograph Modernization Manual

A very complete and well-written booklet describing the design features and advantages of ceramic cartridges. Eleven pages. \$10. Also available is a reprint of an Audio League report concerning ceramic cartridges.
Sonotone Corp.

16

HDYBSYCS

Little folder discussing the perils of buying so-called "bargain" diamond styli.
The Tetrad Co., Inc.

17

18

Hi-Fi Facts and Record Care

Interesting leaflet dealing with the phonographic aspects of hi-fi. Emphasis on cartridges, tone arms, and record care.
Weathers Industries, Inc.

19

Electronic Phono Facts

Written by Maxmilian Weil, this twenty-one-page brochure answers hundreds of questions about hi-fi and is equally useful for hi-fi experts and amateurs. \$25.
Rek-O-Kut Co., Inc.

Loudspeakers and Enclosures

20

Principles of the Acoustic Suspension Speaker
Reprints of four articles that appeared in various audio publications. Interesting reading for amateur and "pro" alike.
Acoustic Research, Inc.

21

Construction Plans for Bass Reflex Speaker Cabinets (39 K 013)
Booklet explains planning and building of bass reflex enclosure for use with 15-inch speaker—a 12-inch adapter board is included in plans to permit use with 12-inch speaker.
Ten-page booklet. \$10.
Allied Radio Corp.

22

Resume of Loudspeaker Enclosures
Detailed Construction Drawings of Altec Enclosures. An essay, by Alexis Badmaieff, setting forth the Altec on enclosure design. Detailed construction data is available for the 606, 607, 609, 825, and 827 enclosures.
Altec Lansing Corp.

23

Bozak Enclosure Plans
Bozak will furnish information and construction plans for enclosures to house Bozak speakers. Requests for information must specify which Bozak speakers will be used and also must give details concerning room shape, etc.
R. T. Bozak Sales Company.

24

The How and Why of Hi-Fi, and other articles
Reprints of two technical reports and an exposition of the theory behind an unusual type of loudspeaker enclosure.
Bradford and Company.

25

The Ultimate in Fidelity of Music Reproduction
A very attractive booklet explaining the principles of the folded horn types of loudspeaker enclosure. Also available, for twenty-five cents each, are reprints of six articles written by Mr. Klipsch.
Klipsch and Associates.

Enclosure Plans

Plans for building Jim Lansing enclosures. Plans available for Model S 31, 34, 35, 36, 37, and 38.
James B. Lansing Sound, Inc.

26

An Electrostatic Loudspeaker Development
Reprint of the technical paper written by Arthur Janszen in the AES journal. Outlines the type of construction and advantages of the electrostatic speaker.
Neshaminy Electronic Corp.

27

You Can Build Your Own Hi-Fi Speaker Systems

Eighteen simplified plans for building self-contained or built-in single speaker, two-way, or three-way systems. Includes complete parts list and speaker data for all types of Jensen enclosures. \$50.

28

Four Enclosure Designs Tested in the Racon Laboratory
Four-page leaflet covering the design of four typical enclosures for hi-fi loudspeakers. Suitable for use with any well designed speaker.
Racon Electric Co., Inc.

29

30

Speaking about Loudspeakers

Very readable explanation of loudspeaker design factors making use of many helpful pictorial illustrations. \$10.
University Loudspeakers, Inc.

Tapes, Tape Recorders, and Microphones

31

Tape It Off the Air
Informative article about how to make home recordings from your tuner or radio. Tape timing chart also available.
ORRadio Industries, Inc.

32

"ABC's of Microphones"
Covers the basic types of microphones, generating elements, the selection of the correct mike, application data for a wide range of uses, and catalogue information on the full E-V line.
Electro-Voice, Inc.

33

What You Can Do About Magnetic Head Wear
Four-page article by Charles Westcott pointing out methods of reducing tape recorder head wear.
EMC Recordings Corp.

34

Ninety-nine Tape Recording Terms
A twelve-page booklet of tape recorder terms and their meanings. Much valuable incidental information is also given.
Minnesota Mining and Manufacturing Co.

35

Audio Head Demagnetizer
Explanation of how to use a tape recorder head demagnetizer and the reasons why it should be used.
Audio Devices Inc.

36

How to Edit Tape Recordings
Three-page article giving suggestions as to the easiest and best editing techniques. Enclose self-addressed, stamped envelope.
Ercona Corp.

37

Tape It Off the Air

Informative article about making home recordings from your tuner or radio. *Reeves Soundcraft Corp.*

38

Technical Information on Condenser Microphones

Technical explanation of how condenser microphones work. *Capps and Co.*

39

Theory and Operation of the Ultra-Linear Circuit

Twenty-two page booklet giving a detailed technical explanation of the Ultra-Linear circuit. \$.25. Also available is a sixteen-page catalogue which gives circuit diagrams for different types of output tubes, all using the ultra-linear principle. *Acro Products Co.*

40

Why Stereo

Furnishes the reader with accurate and detailed information regarding stereo and binaural reproduction. \$.25. *Radio Kits, Inc.*

Other Hi-Fi Topics

41

It's not Hi-Fi without FM

Explains the need for an FM antenna to provide sufficient signal to the tuner to attain full limiter action. *Technical Appliance Corp.*

42

All About FM Antennae and Their Installation

Excellent authoritative booklet on FM antennas and their selection. Includes FM station listing. Recommended for any owner of an FM tuner. \$.25. *Apparatus Development Co., Inc.*

43

Lost Instruments

Amusing but interesting sixteen-page booklet about features to look for when buying amplifiers. *McIntosh Laboratory, Inc.*

44

Recorded High Fidelity

Written by Kurt List, the musical director of Westminster records. Very interesting fifty-three page booklet outlining the techniques used in producing Westminster records. \$.25. *Westminster Recording Co., Inc.*

Catalogues

The following companies publish free catalogues which should be of interest to the average hi-fi fan.

45

Allied Radio Corp.
100 N. Western Ave.
Chicago 80, Ill.

46

Burstein-Applebee Co.
1012-14 McGee St.
Kansas City 6, Mo.

47

Harvey Radio Co.
103 West 43rd St.
New York 36, N. Y.

48

Heath Company
Benton Harbor, Mich.

49

Lafayette Radio
165-08 Liberty Ave.
Jamaica 33, N. Y.

50

McGee Radio Co.
1903 McGee St.
Kansas City, Mo.

51

Musicraft
48 East Oak St.
Chicago 11, Ill.

52

Newark Radio
223 West Madison St.
Chicago 6, Ill.
or
4736 W. Century Blvd.,
Inglewood, Calif.

53

Olson Radio
Warehouse
South Forge St.
Akron 8, Ohio

54

Radio Shack
167 Washington St.
Boston 8, Mass.

HI-FI LITERATURE

Please encircle the key number of each booklet you wish to receive. Be sure to inclose correct amount.

1 2 3 4 5 6 7 8 9 10 11 12 13 14 15 16 17 18
19 20 21 22 23 24 25 26 27 28 29 30 31 32 33 34 35 36
37 38 39 40 41 42 43 44 45 46 47 48 49 50 51 52 53 54

Mail to: Hi-Fi Guide and Yearbook, Box 1791
Church Street Station, New York 8, N. Y.

Name (Please Print)

Address

City..... Zone..... State.....

Enclosed

\$

No. of Booklets

standout discs & tapes of

'57

by *edward tatnall canby*

SURELY the most important factor in the field of records in 1957, was the continued issuing of thousands and thousands of new discs (and tapes), carrying on into another year the huge expansion of the record catalogues that began with the introduction of the LP record back in 1948. Without this continuing dynamic activity, nothing else would be of interest.

In 1957, virtually all records carried the indispensable label "Hi-Fi"—even reissues of older recordings. But even so, hi-fi did advance notably during the year on a good many fronts. First, under the general category of quality control, our 1957 records were better pressed, with less surface noise and less warping and off-center pressing than in any earlier year. Second, the use of plastic protective bags spread widely, and virtually all records were protected at least by paper envelopes inside the cardboard sleeves or in the boxed albums. These more careful packagings made the factory-sealed disc a less urgent matter than it had seemed in previous years and most brands were able to continue unsealed without rousing too much ire among the hi-fi customers.

Hi-fi sound advanced in two basic ways in addition to this. First was a gain in the "fi" itself, in pure, undistorted, faithful sound in the record groove, mainly thanks to new and improved cutters, including models imported from Denmark, where superb pickups and disc cutters have been designed. A number of record labels quietly shifted over to improved cutting equipment during the year. Similarly, new types of microphones were widely used during 1957. Several imported types from Germany and Austria, in particular, supplemented the widely known Telefunken microphones. Though no Russian innovations have been reported, our technology ran up a further debt to the Old World in 1957.

"Hi-fi sound" made great strides in 1957 through continued experiment in recording sessions with close-up, accentuated sound, bathed in a big echo—often artificially added. Multiple recording was almost commonplace in popular music and was also used in serious music for many compound recordings assembled from various tapes. In 1957 it became fairly clear that our taste has changed, and will change further, as to the sound we want on our records—even for Bach and Beethoven. In 1957 the old "dry" type of popular recording was almost entirely ousted by the new big-echo style, putting popular music on the opposite side of classical in this respect as compared to earlier years. This was the year of the big echo. Stereo tapes finally came into their own after several years of fitful beginnings. Most major companies did all recordings in stereo as well as monaural forms and most issued, at least, limited catalogues of stereo tape by the year's end. Home stereo tape equipment was announced far and wide in the fall publicity for new models. Most stereo equipment involved optional extras not included in the featured price. This was clearly a transitional year for stereo; the introduction of inexpensive stereo discs and disc playing equipment became a strong probability with the demonstration of two stereo disc systems in the late summer of 1957 and it seems likely that 1958 will be the year of fruition for these new developments.

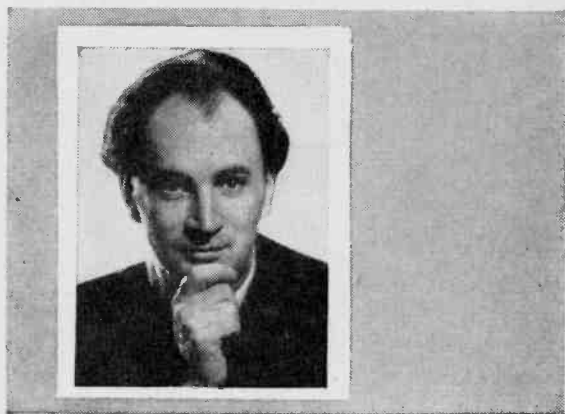

Rafael Kubelik conducts Brahms and Dvorak.

As to actual recordings, a number of interesting trends occurred in the year.

1. There was a sharp increase in the number of really top quality hi-fi recordings of jazz and folk specialties as well as popular Latin American types of music, and organ music, both theatre organ and electric organ. A large number of small record labels devoted effort to this category of hi-fi recording. Lines worth investigating were issued by *Hi-Fi Records* (and *Hi-Fi Tapes*), *Golden Crest*, *Tradition*, *Audio Fidelity*, *Contemporary*, *Dawn* and many others. Some of the materials had no great musical interest but the jazz recordings and some of the folk-type material were highly worthwhile musically.

2. Grand opera languished in this country with few new major recordings appearing. But European opera recording was never more active and a vast number of superb opera albums appeared in 1957, all of them with complete libretti and accompanying notes. The "fi" of most of them was at a new high.

3. Speech recording flourished in many fascinating areas during 1957. The pioneer *Caedmon* label poured out hi-fi speech with Carl Sandburg, readings from the Bible by Judith Anderson, and the Molly and Leopold Bloom soliloquies from James Joyce's "Ulysses." Superb Irish plays came from *Angel*; French drama with music from *London*; Shakespeare from *RCA Victor* and—with three actors for each part—the Baylor Theatre "Hamlet" on the *Word* label. Documentaries were increasingly important; Yale University put out a survey of the election speeches of 1956, ("Campaign 56"), Mrs. Roosevelt and Adlai Stevenson were interviewed at length on records (Arnold Michaelis).

4. Concert tour tie-in recordings are being issued more and more nowadays. It has been pretty well demonstrated that advance reputation via recordings can help a new musical artist who is about to tour this country. The thought has not been lost on the record companies, who in 1957 went out of their way to issue recordings in advance of numerous major concert tours. In retrospect, tie-ins are not of much importance to the record collector except to indicate that there is still, after all, a relationship between live music and recorded performances.

5. Contemporary classical music was heavily recorded in 1957, in part thanks to extensive foundation support of various recording projects. No longer can there be the complaint that contemporary music is neglected by recording companies! Major series included the one commissioned by the Louisville Orchestra, conducted by Robert Whitney and issued on a subscription basis. Others are the M-G-M series, in 1957 largely under the direction of Carlos Surinach, the new Epic series, promoted by the Fromm Music Foundation, and the CRI (Composers Recording, Inc.) series. Unlike some earlier high-minded attempts at modernism, these recordings were almost universally of top audio quality and therefore offer considerable interest to the hi-fi collector, though the intention is not primarily to please the hi-fi audience.



Judith Anderson shown recording Bible passages.

6. The noise aspect of audio was well documented in 1957, including such excellent hi-fi items (see the accompanying list) as Peter Bartok's beautifully edited "The Automobile—Sounds of 50 Years" (*Unicorn*) and O. Winston Link's "Sounds of Steam Railroading," a worthy rival to the famous *Cook* "Rail Dynamics" of some years back. The rash of "Giant Wurlitzer" organ recordings continued, as did the recording of ancient music boxes and other mechanical music-makers of the past. The LP catalogue now includes, from *Audiophile*, a record entitled "Adventures in Cacophony—Miscellaneous Sounds," which this writer has not heard. Assorted "Studies in High

Fidelity" continued to be marketed, with no great improvement over earlier forays into sound demonstration.

7. Stereo publicity led to numerous stereo sampler recordings and to more of the now-familiar jet plane and railroad train type of "side-to-side" demonstrations in stereo. But this type is passing thanks to a better understanding of stereo's less noisy values. More important, stereo recording technique was the subject of intense experiment in 1957. New techniques of two major sorts are being used: (a) three-track recording, for transferral to commercial two-track tape, pioneered by *RCA* and *Mercury* and (b) the revolutionary double microphone technique that makes both stereo and monaural recordings from a single point over an orchestra, used first on the continent and by *British EMI*.

8. Significantly improved reissue LP records were of great importance and interest in 1957, ranging from complete Toscanini operas, as broadcast in the past, to the famous Rachmaninoff series of recordings, now being reissued on both *RCA Victor* and *Camden* lines. *Westminster* launched a major reissue of most of its large earlier catalogue, renumbered and recut to the RIAA curve, the records making an excellent comparative documentation of progress in the five or six years since the originals were issued. Private imports of European reissues on LP began to appear, notably the *His Master's Voice* LP reissues from England.

9. Complex licensing arrangements brought more European classical recordings than ever to American distribution, mostly in exchange for American jazz and "pops" recordings going the other way. *London*, *Westminster* and *Vox* issued collections of named foreign-label imports (*Ducretet-Thomson*, *Vega*, *Nixa*, *Telefunken*, *Polydor*, etc.) and the major imports by *Epic* (*Phillips*), *London* (*English Decca*), *Decca* (*Deutsche Grammophon*), *Angel* and *Capitol* (*British E.M.I.*) continued.

The following list is a selection from 1957 record and pre-recorded tape releases in many areas, chosen for combined excellence in the musical content (or the recorded sound), and the technical hi-fi quality. The discs and tapes are not necessarily the best of their types and, if space allowed, other categories could be represented to expand the listings almost indefinitely.

Some outstanding stereo tapes have been included. These are noted as (ST). Many of the listed recordings are units in a series of similar records or tapes and are marked with an asterisk; any record dealer can suggest others in these groups. The number of records in an album, where there are more than one, are noted within a parenthesis.

The Automobile—Sounds of 50 Years. Unicorn UDS 1

Bach: Concerti for 3, 4 harps. (Ansbach Festival) London LL 1446

**Bach*, Cantatas (assorted). (Berlin Motet Choir, Philharmonic, etc., Lehmann) Archive ARC 3065, etc.

Bach, Brandenburg Concerti. (Boyd Neel Orch.) Unicorn UNLP 1040



Three albums of unusually interesting records issued during 1957 are shown.

- Bartok, Concerto for Orchestra.* (Berlin Radio Symphony, Fricsay) Decca DL 9951
- Beethoven, Works for Cello and Piano.* (Nelsova, Balsam) London LLA 52 (3)
- Beethoven, Symphony #3.* (Eroica) (Cleveland Orchestra, Szell) Epic LC 3385
- **Beethoven, Symphony #7.* (Philharmonia, Klemperer) Angel 35330
- Berlioz, Symphonie Fantastique.* (N. Y. Philharmonic Mitropoulos) Columbia OMB 6 (ST)
- **Bizet, Carmen Suites #1 and #2; L'Arlésienne Suite #1 and #2.* (Philharmonic Symphony London, Rodzinski) Westminster XWN 18230
- Bizet-Daudet, L'Arlésienne.* (Complete play with music) London LL 1489/90
- Brahms: German Requiem; Mahler, Kindertotenlieder.* (Fischer-Dieskau, St. Hedwig's Cath. Choir, Berlin Philharmonic, Kempe) RCA Victor LM 6050
- Brahms, Alto Rhapsody; Tragic Overture.* (Hoffman, North German Philharmonic Orchestra and Chorus, Bamberg) Concert Hall HX39 (ST)
- Brahms, Symphony #2.* (Vienna Philharmonic, Kubelik) London LL 1699
- Cast the First Stone.* (Documentary) (Murtagh, Sara Harris) Dolphin Doc. 1
- Cistercian Chant.* (St. Joseph Abbey Choir) Cambridge 402
- **Columbia World Library Folk and Primitive Music, Vols. XV, XVI, Italy, the Islands* (edited by Alan Lomax) Columbia KL 5173/4
- Debussy, Pelléas et Mélisande.* (Los Angeles, Fr. Nat. Radio Orchestra, Cluytens) Angel 3561 C/L (3)
- Delibes, Coppelia—ballet.* (Complete) (L'Orch. Su. Romande, Ansermet) London LL 1717/18 (2)
- **Anton Dermota—Operatic Recital.* Telefunken LGX 66048
- Dinu Lipatti—His Last Recital.* (Angel 3556 B) (2)
- Marcel Dupré—Playing the Cavallé-Coll Organ, St. Sulpice, Paris.* Overtone 13, 14
- **Dixieland Goes Progressive.* (Carey, Plonsky) Golden Crest CR 3024
- Dvorak, Symphonies #2; #5.* (New World) (Vienna Philharmonic, Kubelik) London LL 1606/07
- Dvorak, Serenade.* (Los Angeles Woodwinds, Raksin) Stereotape 8 (ST)
- English Keyboard Music* (Paul Wolfe, harps.) Exp. Anon. EA 0013
- Flamenco.* (Vicente Escudero, guitar, voice, dance) Columbia CL 982
- Telemann, Handel, Honegger, Hindemith—Four First Recordings.* (Sonatas for Two Violins) (Gerald and Wilfred Beal; Harriet Wingreen, pf.) Monitor 2008
- Franck, Pièce Héroïque; Three Chorales.* (Ed. Commette, organ) Angel 35369
- Gilbert & Sullivan, The Gondoliers.* (Glyndebourne Festival) Angel 3570B/L (2)
- Gluck, Orpheus and Euridice.* (Orig. French version w. tenor) (Danco, Simoneau, etc. Lamoureux Orchestra, Rosbaud) Epic SC 6019 (2)
- Gluck, Alceste.* (Orig. Italian version) (Flagstad, Jobin, etc.) London XLLA 49 (4)
- Haydn, Trumpet Concerto; Italian Overture #4.* (Vienna Philharmonica) (Swarowsky; Holler, tp.) Urania UST 1203 (ST)
- Highland Pageantry.* (Regimental Band, Pipes, Drums of the Black Watch) RCA Victor LM 1525
- **A Hi-Fi Carnival with Strauss.* (Vienna State Opera Orchestra, Paulik) Vanguard VRS 498
- Holst, The Planets.* (Los Angeles Philharmonic, Roger Wagner Chorus, Stokowski) Capitol P 8389
- **Hindemith Symph. in B-Flat; Schoenberg, Th. & Vars Op. 43a; Stravinsky, Symphonies of Wind Instrs.* (Eastman Wind Ens., Fennell) Mercury MG50143
- Honegger, Pacific 231, Rugby, etc.* (Philharmonic Symphony of London, Scherchen) Westminster XWN 18486
- **Hovhaness, Saint Vartan Symphony.* (M-G-M Chamber Orchestra, Surinach) M-G-M E3453
- **Italian Songs for Solo Voice.* (Alfred Deller w. lute, harps.) Vanguard BG 565
- **Jacobean Consort Music.* (Jacobean Ens., Dart) London OL 50133
- Jazz for Hi-Fi Lovers.* Dawn DLP 1124
- Mendelssohn, Cello Sonata in D; Strauss, Cello Sonata in F.* (Navarra, cello, Lush, pf.) Capital P 18045
- Mendelssohn, Vars. Sérieuses; Schumann, Three Romances; Schubert, Sonata in A Minor.* (Soriano, pf.) Boston B 303
- **Milhaud, Le Pauvre Matelot.* (Opera, conducted by composer) Westminster OPW 11030
- **Mozart, Violin Sonatas.* (Grumiaux, Haskil) Epic LC 3299
- Music for Hi-Fi Bugs.* (Pete Rugolo) Mercury MDS 3-1 (ST)
- Panorama of Musique Concrete, vols. 1, 2.* (France) London DTL 93090, 93121
- Poetry Readings in the Cellar.* (K. Rexroth, L. Ferlinghetti, Jazz Quintet) Fantasy 7002



Jacqueline Brumaire, soprano in Milhaud's opera. On the right, the late **Dinu Lipatti**, pianist.

high fidelity



on the air

HI-FI MUSIC has been on the air since 1936. In that year, WQXR in New York City began using the first AM antenna ever engineered to transmit the full range of audible frequencies. WQXR, or W2XR, as it was then called, was known as "The High Fidelity Station" even at that early date. Unfortunately, few receiving sets of the day came up to the hi-fi standards of the transmitter. The benefits of high fidelity were, for the most part, unknown and unappreciated.

With the birth of FM broadcasting, music broadcasting on a true hi-fi basis became possible. For the first time, the complete dynamic and frequency ranges of music could be broadcast with negligible background noise and interference by static. Still, however, because of the generally poor quality of home receiving equipment, a really accurate reproduction of the transmitted signal was not possible for most listeners.

About 1951, or roughly four years after the introduction of the LP record, a period of top-notch musical programming began. The public suddenly became hi-fi conscious and began buying hi-fi components and systems. The home listener at last had the equipment to benefit from the hi-fi capacities of FM broadcasting. As the number of FM sets increased, good music programming prospered. In the last three years, another important upsurge in FM music programming has taken place. Although the number of FM stations has remained at an almost constant level, musical programming has made tremendous gains.

The success of music programming on FM is due to several factors. A primary reason is that FM is inherently an ideal medium for music broadcasting because of its wide frequency range and low-noise characteristics. These are FM's greatest assets and selling points. But FM and music were suited to each other for another reason. When the country started "going hi-fi" in 1951 or so, FM, could offer music broadcasting as a free source—in addition to phonograph records—of hi-fi program material. Moreover, at a time when records were selling for six dollars apiece, FM provided an opportunity for the listener to audition the new records before actually buying them. The "classical disc jockey" musical programs were always very popular.

The success of musical programming is due also to economic reasons. Advertisers have come to realize that the market represented by serious music listeners is generally upper-class and upper-income, and this market offers a select consumer group for specialized types of advertising. The great majority of advertisers that use the stations as a medium appreciate the value of the "soft-sell" approach. Consequently, as a result of FM's intrinsically hi-fi capabilities and the tasteful use of commercial time, FM music broadcasting today provides the music listener with a convenient source of free musical entertainment that is practically boundless.

A number of stations print program guides which furnish advance program information for use by their listeners. These guides are usually published monthly

and are available on a yearly subscription basis with rates ranging from twenty cents or so to five dollars a year. These list in detail all of the programs to be broadcast during the period covered with specific record company name and catalogue number. Many list, by composer, the records and other music to be played. These booklets allow the listener to plan his musical evenings well in advance. The program guide of WFMT in Chicago is a most ambitious and elaborate one, listing not only its own radio programs but almost all other cultural events in the Chicago area.

Networks

Partly as a result of radio's reappraisal of its basic commodity—good sound—and also as a result of the loss to TV of a large part of its old audience, the major radio networks are finding it good business to place emphasis on sound quality in general and hi-fi in particular.

American Broadcasting Company

The most ambitious steps in the direction of better quality music programming are being taken by the *American Broadcasting Company*. Under the direction of Robert Eastman, ABC is rapidly changing to all-live programs for its daytime weekday schedule. This switch from soap-operas and disc jockeys to live variety entertainment is being made despite its necessitating a fifty percent increase in overhead costs. The ABC shows stress the personality of the star of each show who is backed up by singers, vocal groups, and a staff band of sixty-five. These new programs feature currently popular music and are being scheduled for four hours daily.

The ABC network is still presenting the Saturday afternoon broadcasts of the Metropolitan Opera direct from the opera house in New York City. This distinguished series, sponsored by *Texaco*, continues to honor everyone concerned with its production. To originate these broadcasts, ABC uses a technical staff of three engineers and a total of eleven microphones. The mikes are distributed as follows: four to pick up the orchestra, four hidden in the footlights to pick up voices, one suspended high above the stage, one hung from the center chandelier to pick up applause from the audience, and one for the commentator, Milton Cross.

The Metropolitan Opera broadcasts have an essentially flat range from 50 to 15,000 cps on FM, and to 8,000 cps on AM. These specifications, unfortunately, hold true only for listeners in the New York City area because the use of telephone lines necessary for country-wide distribution limits the high frequency range to about 5,000 cps. However, anything lacking in fidelity is more than made up by the excitement and sense of immediacy associated with a live broadcast of an actual performance.

National Broadcasting Company

NBC is undergoing a whole new program of re-evaluation of its musical structure. This is evidenced by the creation of a new company post, that of musical coordinator. This position has been filled by Robert Sadoff, who acts as a kind of musical efficiency expert. He is currently reorganizing all of RCA's musical radio shows for maximum auditory effectiveness. Mr. Sadoff, who is well-known as a musician and conductor, is in charge of all phases of RCA radio's musical programming from choice of theme music to the physical placement of microphones.

Metropolitan Opera Broadcasts for 1958

	1	"Vanessa" by Barber
	8	"Gianni Schicchi" by Puccini
FEB		"Salome" by Strauss
	15	"La Boheme" by Puccini
	22	"La Traviata" by Verdi

	1	"Tristan Und Isolde" by Wagner
	8	"Otello" by Verdi
MAR		"Tosca" by Puccini
	22	"Der Rosenkavalier" by Strauss
	29	"Madame Butterfly" by Puccini

	5	"Lucia di Lammermoor" by Donizetti
APR		"Samson et Delila" by Saint-Saens

Columbia Broadcasting Network

CBS produces two programs, both on Sunday afternoon, of special interest to the hi-fi listener: the live broadcasts of the New York Philharmonic Symphony Orchestra, and the live semi-classical music program, "The Best in Music," which features Percy Faith and his orchestra. These, again, are hi-fi meat for those in the New York City neighborhood, but the sound quality suffers from loss of high frequencies in the process of being transmitted via telephone wires over the country.

The Independents



Mr. Ronald Schmidt, program director of KPRC-FM in Houston, Texas, gingerly places his pickup on a hi-fi record. KPRC, one of the Southwest's outstanding FM stations, uses the Weathers arm and pickup; two Rek-O-Kut B-16H turntables; and also two stereophonic tape recorders.

The independent local FM stations are the richest and most rewarding source of hi-fi music on the air. One of the intrinsic disadvantages of FM radio—its limited distance range—may almost be said to have become an asset. Since there are no national hookups, there can be no nationwide programming and nationwide sponsorship. Consequently, the program level need not be kept at the "lowest common denominator" level of nationwide entertainment standards. As a result, the lucky listener has at his fingertips "dream-stations" like WQXR, WNYC, and WBAI in New York, WFMT in Chicago, and KFAC and KPOL in Los Angeles.

In addition to topnotch programming and quality of transmission, the independent FM stations usually have high standards of taste to which their sponsors must conform.

FM From Coast to Coast

Since radio is able to reach such an immense and varied audience, music broadcasting has become a major influence on the musical culture of our country. In the pre-radio days, the only person who would go to the bother and expense of attending a symphony or opera would be someone who had at least a little familiarity with those fields. Today a person can sample anything in the world of music, in his home and completely free, at the flick of a switch. The stations which make this vast musical world accessible are actually helping to widen the range of American musical taste.

Although there are over five hundred FM stations in the United States, (see the list on succeeding pages) some maintain especially outstanding musical programming. It is impossible, unfortunately, to mention all deserving stations; however, some of the most outstanding should be pointed out.

The senior hi-fi station in New York City is WQXR. It has been an enthusiastic promoter of hi-fi for over twenty years. WQXR plans its programming, however for musical value, not just a collection of sounds for the hi-fi enthusiast who may be more interested in sound than he is in music. One of WQXR's most praiseworthy efforts is the transmission of three hours of AM-FM stereophonic broadcasts each week. These programs include live pickups of music for duo-piano and also for string quartet.

Station WNYC, which is municipally owned, has for years furnished an exciting program of lectures, municipal information and good music to New York City listeners. WNYC has a staff of nine music commentators, more than any other station in the country. WNYC presents a yearly "Festival of American Music" during which little-known and standard works by American composers are played both live and on records.

The operation of many other independent FM stations in the New York City area, including several university-affiliated educational stations, makes an FM tuner mandatory for any music lover living in this area.

Chicago is also fortunate to have available the services of an outstanding station, WFMT. WFMT covers four states with a continuous program of cultural entertainment. No popular or semi-classical music is included in WFMT's pro-

gramming schedule. All works, whether music, plays, or talks, are presented in their entirety and are never interrupted for commercials or station breaks. No musical commercials or transcriptions may be used; all commercials must be read by the regular announcer. The WFMT "Fine Arts Guide" is not only a program guide, but is a guide to the entire cultural life of Chicago; it covers concerts, theater, films, etc., and is probably the most ambitious publication of its kind.

Down Texas way, the center of FM activity is Houston. The Houston area is covered by four stations; outstanding among these is KPRC, which broadcasts classical and light classical music each evening from five to eleven o'clock. KPRC also broadcasts stereophonically four nights every week. The city of Dallas has the services of six FM stations, including KIXL, which is now in its tenth year of hi-fi broadcasting. KIXL features mainly "pop" or light music. For those with a taste for more serious music, KSFM, in Dallas, offers an around-the-clock schedule of exclusively classical selections.

Moving on out to California, we find one of the largest and most prosperous hi-fi markets in the country. The Los Angeles area has an extremely high concentration of FM receivers, with estimates placing the total number of sets somewhere between one and one-and-one-half million. In the area are fourteen full-time commercial stations; five more offer duplicate programs from AM sister stations; and one is an educational station. Four outstanding music stations in Los Angeles are KFAC, KPOL, KGLA, and KBMS. KFAC is a "concert music station," transmitting classical music twenty-four hours per day; technical quality of records, reproducing equipment, and transmission is always a primary concern. KPOL schedules on a middlebrow level, featuring hi-fi records of showtunes, standards, and mood music twenty-four hours a day. KGLA and KBMS are mainly "pop" stations with KBMS devoting 125 hours per week to "pop" music. KBMS, in addition, finds time to program thirty-two hours of classical music per week, including eleven hours of live pickups. In nearby Long Beach, KNOB claims the distinction of being the world's first all-jazz station, and still maintains an all-jazz format.

The FM station of Pomona College, KSPC, programs at a consistently high cultural level, scheduling about ten hours of live classical music weekly. Operating from Fresno, KRKM devotes its facilities exclusively to fine music consisting of forty-eight hours of classical music and thirteen hours of mood music per week. San Francisco has five FM stations currently in operation with four more under construction. One of San Francisco's outstanding stations is KEAR; it feathered its cap this fall by the production of a series of programs recorded at the 1957 Salzburg festivals. KEAR makes available to its listeners a program guide.

The Educational Station

A special category of FM station that should be mentioned is the educational station. These are usually stations operated under the sponsorship of universities and colleges, their primary function being to provide practise facilities for students majoring in broadcasting, engineering, and allied subjects. The coverage area of these stations is generally limited, but the high quality of programming makes them of interest to those music listeners living nearby. The educational stations, as a rule, have no commercials; this is another contributing factor to their popularity.

Three live AM-FM stereo programs each week are transmitted by WQXR in New York City.

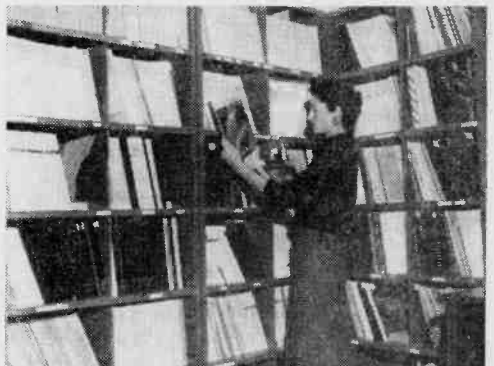

At KRKM in Fresno, California, Judy Faux examines a record from KRKM's LP library.

Multiplex

We can look forward to more AM-FM stereo transmission, and, even more intriguing, there will undoubtedly be a continuing expansion in multiplex operations. This will mean that one station can transmit two signals on its single carrier frequency; these two signals may be detected independently for monaural reproduction or simultaneously for stereo purposes. In the multiplex installations to the present, stations that use multiplex transmission generally employ the second channel as a background music source for use in restaurants, supermarkets, etc. The station then makes an income from the rental of special fixed-frequency receivers to its subscribers.

One of the pioneering companies in the multiplexing field is *Multiplex Services Corporation* in New York City. *MSC* has completed twelve transmitter installations, seven having been in continuous operation for over a year. At two of these stations, two subchannels will soon be in operation. These stations, *WGHF* in Brookfield, Conn., and *WAAT* in East Orange, N. J., have a main channel, which operates as any other FM station, a *first* subchannel, for broadcasting background music to commercial establishments, and a *second* subchannel, which will be used as a second channel for stereo or for other commercial communications purposes.

Because of design requirements, the multiplex transmitter must be practically distortionless to avoid crossmodulation between the main channel and the subchannel. This necessity for extremely low distortion will be of great value to the hi-fi listener when multiplex tuners become commercially available. Multiplex tuners which may be used for receiving both the main channel and the subchannel are reported to be in the works. With an eye toward the future and also as an extra selling point, several of the leading FM tuner manufacturers have been incorporating into their latest models special multiplex outputs for future use with separate multiplex adapters. Experimental adapter units which promise to give satisfactory results are now being tested by several manufacturers; some of these adapter units will probably be appearing on the market in early 1958.

It is doubtful that there will be an overnight country-wide expansion of multiplex; FM itself sputtered for a number of years before getting on a firm economic footing. The hi-fi music listener has no grounds for complaint, however; FM is now safely and securely established in practically every section of the country.

The FM stations currently in operation in the United States, its possessions, and Canada are listed on these and the following pages. Noted also are outstanding musical programs and, for most stations, the average weekly hours of both "pop" and classical music programming.

CITY	FREQ. STATION (in mc.)	WEEKLY HRS.	
		"pop"	classical
ALABAMA			
Albertville	105.1 WAVU-FM	60	10
Alexander City	106.1 WRFS-FM		
Andalusia	98.1 WCTA-FM		
Anniston	100.5 WHMA-FM		
Birmingham	99.5 WAFM		
	104.7 WJLN-FM		
Clanton	100.9 WKLF-FM	30	4
Cullman	101.1 WFMH-FM	60	0
Decatur	92.5 WHOS-FM		
Lanett	102.9 WRLD-FM		
Mobile	99.9 WKRG-FM		
Talladega	97.1 WHTB-FM	49	0
Tuscaloosa	91.7 WUOA	0	37
	95.7 WTBC-FM		
ARIZONA			
Globe	100.3 KWJB-FM		
Mesa	104.7 KTYL-FM		
Phoenix	88.5 KFCA		
	95.5 KELE		
Tucson	99.5 KTKT-FM		
ARKANSAS			
Blytheville	96.1 KLCN-FM	12	0
	"Music in Hi-Fi" 5 P.M.-9 P.M. daily		
Jonesboro	91.9 KASU	25	5
	101.9 KBTM-FM		
Mammoth Spg.	103.9 KAMS		
Pocahontas	97.7 KPOC-FM		
Siloam Springs	105.7 KUOA-FM	15	30
CALIFORNIA			
Bakersfield	94.1 KERN-FM		
	101.5 KQXR	110	16
Berkeley	89.3 KPFB		
	94.1 KPFA	0	65
	102.9 KRE-FM	52	0
Claremont	90.7 KSPC	14	39
	Ten hours weekly live classical music		
Eureka	96.3 KRED	119	11
Fresno	93.7 KRFM	13	48
	97.9 KMJ-FM		
	101.9 KARM-FM	100	
Glendale	101.9 KUTE	84	84
Hollywood	94.7 KRHM	69	21
	101.1 KHJ-FM		
Long Beach	88.1 KLON	0	12
	102.3 KFOX-FM		
	103.1 KNOB	112	0
	All jazz 16 hours daily		

F M stations in the U.S. & Canada

CITY	FREQ. (in mc.)	STATION	WEEKLY HRS.		
			"pop"	classical	
Los Angeles	88.7	KXLU			
	91.5	KUSC			
	92.3	KFAC-FM	0	168	
	93.1	KNX-FM			
	93.9	KPOL-FM			
	<i>Light classics 24 hours daily</i>				
	95.5	KABC-FM	5	13	
	96.3	KRKD-FM			
	97.1	KFMU			
	<i>Hi-fi programming 24 hours daily</i>				
	98.7	KCBH			
	99.5	KHOF			
	<i>Sacred music 80 hours weekly</i>				
	100.3	KMLA	120	0	
<i>Daily stereo program</i>					
103.5	KGLA-FM	100	5		
104.3	KPLA				
105.9	KBMS	125	32		
Marysville	99.9	KMYC-FM			
	103.3	KBEE-FM	96	2	
Modesto	<i>"Journey Into Hi-Fi" 18 hours weekly</i>				
	104.1	KTRB-FM	62	0	
Ontario	93.5	KEDO	68	0	
	89.3	KPCS			
Pasadena	95.3	KJML			
	96.1	KCRA-FM	16	81	
Sacramento	96.9	KFBK-FM			
	100.5	KGMS-FM	96	30	
<i>Hi-fi mood music 11P.M.-1A.M. nightly</i>					
107.9	KXOA-FM	54	0		
San Bernardino	91.9	KVCR			
San Diego	88.3	KSDS	18	2	
	94.1	KFSD-FM	25	28	
San Francisco	104.7	KDFR			
	91.7	KALW			
	97.3	KEAR	21	100	
	98.9	KCBS-FM			
	99.7	KNBC-FM			
103.7	KGO-FM				
San Jose	95.3	KSJO-FM	112	0	
Santa Ana	96.7	KWIZ-FM			
Santa Barbara	97.5	KROW	20	32	
Santa Clara	90.1	KSCU	0	32	
Santa Monica	89.9	KCRW			
Sausalito	102.1	KDFC			
Stockton	91.3	KCVN	4	5	

COLORADO

Boulder	97.3	KRNW		
	90.5	KSHS	4	4
Colorado Spgs.	91.3	KRCC	10	10
	105.1	KTGM	11	45
Denver	<i>Telephone-request programs 37 hours weekly</i>			

CITY	FREQ. (in mc.)	STATION	WEEKLY HRS.	
			"pop"	classical
Golden	98.5	KFML-FM		
Manitou Spgs.	102.7	KCMS-FM	40	58
	<i>Stereo 10 hours weekly</i>			
CONNECTICUT				
Brookfield	95.1	WGHF	62	22
	98.3	WLAD-FM	0	30
Danbury	96.5	WTIC-FM		
	93.7	WHCN	70	56
Meriden	95.7	WMMW-FM		
	99.1	WNHC-FM	12	6
New Haven	96.7	WSTC-FM		
Stamford	90.5	WHUS		
Storrs				

DELAWARE

Dover	94.7	WDOV-FM		
Wilmington	93.7	WDEL-FM	13	40
	99.5	WJBR	20	40

DISTRICT OF COLUMBIA

Washington	93.9	WRC-FM	50	2
	96.3	WTOP-FM		
	97.1	WASH	20	90
<i>"In the Concert Hall" 6-12 P.M. nightly</i>				
	98.7	WOL-FM		
	100.3	WFAN		
	101.1	WWDC-FM	126	
	103.5	WGMS-FM	31	90
	107.3	WMAL-FM	80	35
<i>"Milton Cross Presents" 18 hours weekly</i>				

FLORIDA

Daytona Beach	94.5	WNDB-FM		
Gainesville	104.1	WRUF-FM		
Jacksonville	95.1	WJAX-FM		
	96.1	WMBR-FM		
	96.9	WZOK		
Miami	91.7	WTHS	0	3
	93.9	WAHR-FM		
	96.3	WGBS-FM		
	97.3	WCKR-FM		
	99.9	WINZ-FM		
	101.5	WWPB	68	41
Miami Beach	93.1	WKAT-FM		
Orlando	92.3	WDBO-FM	28	6
	96.5	WHOO-FM	125	5
	100.3	WORZ	84	6
Palm Beach	97.9	WQXT-FM	89	35
Panama City	98.9	WDLP-FM		
Tallahassee	91.5	WFSU-FM	8	25
<i>Hi-fi programming 16 hours weekly</i>				

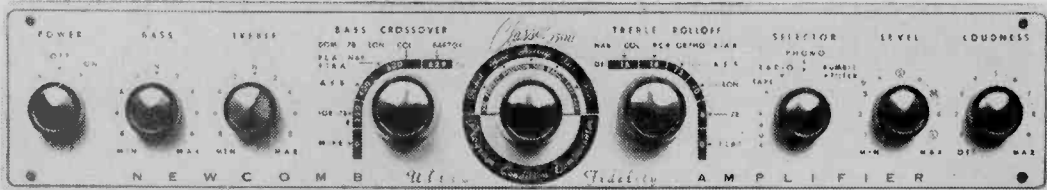

The Newcomb Classic 2500 Amplifier with integral preamplifier and control unit was designed in the belief that perfection is ageless. Distortion so low as to be scarcely measurable... Hum virtually undetectable... Superb volume controls designed to give maximum boost where most needed... Flexible, easy to use separate bass and treble compensation... Precision loudness contour control... These features and the specification figures that describe them have never been bettered by Newcomb or any other manufacturer. The Classic 2500 has indeed become a "classic" in every sense of the word. Newcomb was among the

first to build high and low cut-off filters into their units. Newcomb introduced "Audi-Balance"—still an exclusive feature in the Classic. Far more than a simple hum control, Audi-Balance permits the Classic owner, through a simple occasional adjustment, to hold distortion to an absolute minimum throughout the aging of the output tubes. Newcomb's patented "Adjust-A-Panel" innovation permits simple, easy mounting on a panel of any standard thickness. Although not available to every dealer, the Newcomb Classic 2500 is consistently found in elaborate custom installations where the only limiting stipulation is: "The finest made."

NEWCOMB

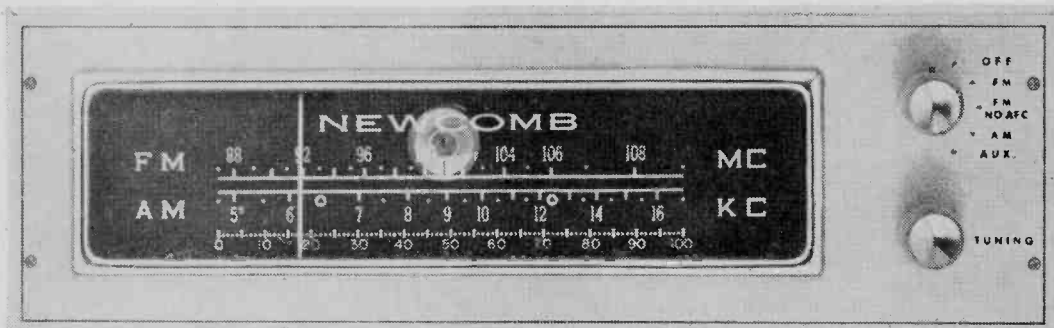

DURABILITY

The Newcomb Compact 200 AM-FM radio tuner becomes an ideal partner in perfection with the Classic 2500. In achieving a balance between stability, sensitivity, dependability, and ease of operation the Newcomb 200 has no equal. The 200 is designed to be a constant companion for those to whom music listening is a serious avocation. Snap-in AFC and temperature controlled oscillators give the 200 a rock-solid stability. The Newcomb Compact 1020 is an all-in-one power amplifier, preamplifier, and control unit complete with handsome case. The 1020 is designed to bring Newcomb standards of excellence to the critical listener

who requires maximum quality in minimum space. Conservatively rated at 20 watts, as its peak rating of 50 watts indicates, the Newcomb 1020 has separate bass and treble compensators for 36 different playback curves, wide ranging tone controls, and the superb Newcomb loudness contour control. High-keyed, gold-toned, yet conservative styling makes the Newcomb Compacts suitable for timeless, harmonious association with the most tasteful furnishings. Write for free data folders and the name of the Selected Newcomb Audio Specialist nearest you.

NEWCOMB AUDIO PRODUCTS CO. • 1st in sound since 1937 • 6824 Lexington Avenue, Hollywood 38, California

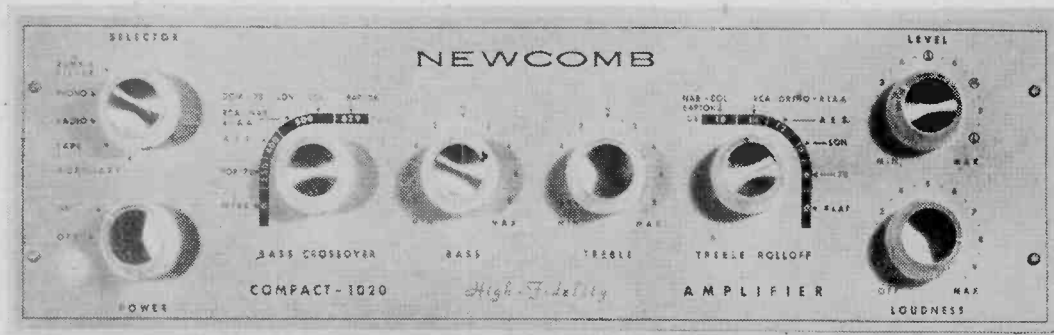



CITY	FREQ. (in mc.)	STATION	WEEKLY HRS.	
			"pop"	classical
Tampa	88.9	WTUN	6	20
	93.3	WFLA-FM	42	0
	100.7	WDAE-FM		
	104.7	WPKM	86	36
Winter Park	91.5	WPRK	5	15

GEORGIA

Athens	99.5	WGAU-FM		
Atlanta	90.1	WABE		
	92.9	WGKA-FM	0	100
	<i>"Audition" 3-4:30 P.M. Saturdays</i>			
	98.5	WSB-FM	84	10
<i>Hi-Fi program 11:30 P.M. nightly</i>				
Augusta	103.3	WAGA-FM		
	103.7	WBBQ-FM		
	105.7	WAUG-FM		
Columbus	93.3	WRBL-FM	60	3
	<i>"Stereo Serenade" and "Concert Hall"</i>			
Gainesville	103.9	WDUN-FM		
La Grange	104.1	WLAG-FM	12	6
Macon	99.1	WMAZ-FM		
Newnan	96.7	WCOH-FM		
Savannah	97.3	WTOC-FM		
Toccoa	106.1	WLET-FM	40	2

ILLINOIS

Bloomington	101.5	WJBC-FM		
Carmi	97.3	WROY-FM		
Champaign	97.5	WDWS-FM	35	4
Chicago	91.5	WBEZ	4	3
	94.7	WENR-FM		
	96.3	WBBM-FM	31	15
	97.1	WNIB	0	21
	97.9	WEHS	21	
	98.7	WFMT	0	125
<i>"The Hi-Fi Recordings" 7-8 P.M. Wednesdays</i>				
	99.5	WEFM		
	100.3	WFMF	0	125
	101.1	WMAQ-FM	63	5
	101.9	WCLM	4	14
	104.3	WSEL		
Decatur	102.1	WSOY-FM		
De Kalb	91.1	WNIC		
Effingham	95.7	WSEI		
Elgin	88.1	WEPS		
Elmwood Park	105.9	WXFM		
Evanston	89.3	WNUR		
	105.1	WEAW-FM	0	126
Harrisburg	99.9	WEBQ-FM		
Jacksonville	100.5	WLDS-FM		
Mattoon	96.9	WLBH-FM		
McComb	91.3	WWKS		
Mt. Vernon	94.1	WMIX-FM	66	0
<i>"Adventures in Hi-Fi" 6 P.M.-7 P.M. daily</i>				
Oak Park	102.3	WOPA-FM	110	30
<i>"High Fidelity Hall" and "Magic of Sound" Sundays</i>				
Olney	92.9	WVLN-FM	55	1
Paris	98.3	WPRS-FM	36	0
Peoria	92.5	WBMD-FM	51	6
<i>"Nightwatch" 10:30-11 P.M. weeknights</i>				
Quincy	99.5	WTAD-FM		
	105.1	WGEM-FM		
Rockford	97.5	WROK-FM		

CITY	FREQ. (in mc.)	STATION	WEEKLY HRS.	
			"pop"	classical
Rock Island	98.9	WHBF-FM		
Springfield	103.7	WTAX-FM	0	5
Urbana	90.9	WILL-FM	4	21

INDIANA

Bloomington	103.7	WFIU	14	23
Connersville	100.3	WCNB-FM		
Crawfordsville	106.3	WBBS	0	1
Elkhart	95.1	WCMR-FM		
	100.7	WTRC-FM	62	0
Evansville	90.7	WPSR		
	91.5	WEVC	9	6
	104.1	WIKY	81	2
<i>Stereo 6 hours weekly</i>				
Gary	88.1	WGVE		
Greencastle	91.7	WGRE	7	6
<i>"New Hi-Fi Recordings" 8-10 P.M. Mondays</i>				
	92.3	WJOB-FM		
Hammond	91.9	WHCI		
Hartford City	91.9	WVSH		
Huntington	90.1	WIAN		
Indianapolis	95.5	WFMS	112	14
	104.5	WAJC-FM		
Jasper	104.7	WITZ-FM	30	6
<i>"Hi-Fi Dinner Music" 5-6 P.M. weekdays</i>				
Madison	96.7	WORX-FM	57	0
Marion	106.9	WMRI-FM		
Muncie	91.5	WWHI		
	104.1	WMUN		
New Albany	88.1	WNAS		
New Castle	91.1	WYSN		
	102.5	WCTW	20	2
Terre Haute	99.9	WTHI-FM	55	0
Wabash	91.3	WSKS		
	97.5	WAIU-FM		
Warsaw	107.3	WRSW-FM		
Washington	106.5	WFML	40	2

IOWA

Ames	90.1	WOI-FM		37
Boone	99.3	KFGQ-FM		
Clinton	96.1	KROS-FM		
Davenport	103.7	WOC-FM		
Des Moines	88.1	KDPS	0	7
	100.3	WHO-FM	84	0
Dubuque	103.3	WDBQ-FM	120	0
Iowa City	91.7	KSUI	15	35
<i>"Fine Music Hour" 7 P.M.-8 P.M. nightly</i>				
Mason City	101.1	KGLO-FM		
Muscatine	99.7	KWPC-FM		
Storm Lake	101.5	KAYL-FM		
Waverly	89.1	KWAR	20	15

KANSAS

Emporia	88.7	KSTE		
Lawrence	91.5	KANU		
Manhattan	88.1	KSDB-FM		
Ottawa	88.1	KTJO-FM		
Wichita	89.1	KMUW	15	23
	100.3	KFH-FM	65	3

KENTUCKY

Ashland	93.7	WCMI-FM		
Bowling Green	101.1	WLBj-FM		

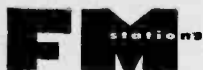

CITY	FREQ. (in mc.)	STATION	WEEKLY HRS.	
			"pop"	classical
Central City	101.9	WNES-FM		
Fulton	104.9	WFUL-FM	35	18
Henderson	99.5	WSON-FM	25	1
Hopkinsville	98.7	WHOP-FM		
Lexington	91.3	WBKY	6	10
	94.5	WLAP-FM		
Louisville	89.3	WFPL	0	35
	91.9	WEPK	0	54
Madisonville	93.9	WFMW-FM		
Mayfield	94.7	WNGO-FM		
	107.1	WKTM-FM		
Owensboro	92.5	WOMI-FM	40	2
	96.1	WVJS-FM		
Paducah	93.9	WKYB-FM		
	96.9	WPAD-FM		

LOUISIANA

Alexandria	96.9	KALB-FM		
Baton Rouge	98.1	WBRL		
	104.3	WAIL-FM		
Monroe	104.1	KMLB-FM		
New Orleans	95.7	WWMT		
	97.1	WRCM		
	105.3	WDSU-FM		
Shreveport	94.5	KWKH-FM	10	5
	96.5	KTBS-FM		
	101.1	KRMD-FM		

MAINE

Brunswick	91.9	WBOR	22	18
		"Webcor Music Hall"		
Caribou	97.7	WFST-FM	70	7
Lewiston	93.9	WCOU-FM	82	20

MARYLAND

Annapolis	99.1	WNAV-FM	120	0
Baltimore	88.1	WBIC	8	29
		"European Concert Hall"		
	102.7	WCAO-FM		
	104.3	WITH-FM	0	55
		"Sounds of our Times"		
Bethesda	106.3	WUST-FM		
Cumberland	102.9	WCUM-FM		
Hagerstown	104.7	WJEJ-FM	59	5
Oakland	95.5	WRNC		
Takoma Park	91.9	WGTS-FM		

MASSACHUSETTS

Amherst	89.5	WAMF		
	91.1	WMUA	36	7
Boston	88.9	WERS	20	32
	89.7	WGBH-FM	2	25
	90.9	WBUR	10	26

"High-Fi Fair," "Hi-Fi Classics," "Audio Spectrum," "Dimension in Sound"

	94.5	WHDH-FM	100	5
	96.9	WXHR	0	126

"WXHR Record Review," "Critics Choice," "High Fidelity Music Hall"

	98.5	WRKO		
	100.7	WCOP-FM	133	0
	103.3	WEEL-FM		
Brockton	97.7	WBET-FM	71	8
Cambridge	107.1	WHRB-FM		
Greenfield	98.3	WHA1-FM	35	12

CITY	FREQ. (in mc.)	STATION	WEEKLY HRS.	
			"pop"	classical
Lowell	99.5	WLLH-FM		
New Bedford	97.3	WBSM		
	98.1	WNBH-FM		
Pittsfield	94.3	WBEC-FM	37	12
South Hadley	88.5	WMHC		
Springfield	93.1	WHYN-FM	50	0
	94.7	WMAS-FM	50	5
		"Adventures in Hi-Fi" 3-5 P.M. Sundays		
Waltham	102.5	WCRB-FM	0	120
		Stereo 5 hours Sunday and Monday		
W. Yarmouth	94.3	WOCS-FM	35	16
Williamstown	90.1	WCFM	40	26
Winchester	91.9	WHSR-FM	2	1
Worcester	96.1	WTAG-FM	37	8

MICHIGAN

Ann Arbor	91.7	WUOM	0	40
		"Music of the Masters", "Musical Grab-Bag"		
Benton Harbor	99.9	WHFB-FM		
Coldwater	98.3	WTVB-FM	7	7

Hi-Fi programming 8-11:45 P.M. nightly

Dearborn	100.3	WKMH-FM		
Detroit	90.9	WDTR		
	93.1	WJBK-FM	168	0
	96.3	WJR-FM	55	6
	97.1	WWJ-FM	50	47
	97.9	WJLB-FM		
	101.1	WXYZ-FM		
	101.9	WDET-FM	6	26
	103.5	WMUZ		
East Lansing	90.5	WKAR-FM	15	32
Flint	95.1	WFBE		
	107.1	WFUM		
Grand Rapids	93.7	WJEF-FM		
	96.9	WLAV-FM	76	20

"The Voice of Hi-Fi" weeknights

Highland Park	88.1	WHPR	9	10
Kalamazoo	102.1	WMCR	10	18

"Fireside Philharmonic" 8-10:30 P.M. weeknights

Oak Park	95.5	WLDM		
Royal Oak	89.3	WOAK		
	104.3	WOMC	90	0
Saginaw	98.1	WSAM-FM		
Sturgis	103.1	WSTR-FM	55	3

MINNESOTA

Mankato	103.5	KYSM-FM		
Minneapolis	97.1	KWFM		
	98.5	KTIS-FM	0	5
	99.5	WLOL-FM	14	50
		Jazz and hi-fi 7-12 P.M. nightly		
St. Cloud	104.7	KFAM-FM	60	2
Winona	97.5	KWNO-FM	26	2

MISSISSIPPI

Gulfport	101.5	WGCM-FM		
Jackson	102.9	WJDX-FM		
Meridian	88.1	WMMI		

MISSOURI

Clayton	99.1	KFUO-FM	8	35
Jefferson City	98.5	KWOS-FM		
Joplin	96.1	WMBH-FM		
Kansas City	94.9	KCMO-FM	77	24



CITY	FREQ. (in mc.)	STATION	WEEKLY HRS. "pop" classical	
Kennett	98.9	KBOA-FM		
Poplar Bluff	94.5	KWOC-FM		
St. Louis	91.5	KSLH		
	93.7	KCFM	78	30
Springfield	94.7	KTTS-FM		
West Plains	93.9	KWPM-FM		

NEVADA

Reno

95.5 KNEV

NEW HAMPSHIRE

Berlin

103.7 WMOU-FM

Claremont

106.1 WTSV-FM

Manchester

95.7 WKBR-FM

Nashua

106.3 WOTW-FM

65 0

NEW JERSEY

Asbury Park

94.3 WJLK-FM

52 10

Bridgeton

98.9 WSNJ-FM

48 24

"Concert Cameos" 8-9 P.M. weeknights

Newark

88.3 WBGO

94.7 WAAT-FM

126 0

102.7 WHFI

New Brunswick

98.3 WCTC-FM

140 2

"Stardust Melodies" 7:30-10:30 P.M. Mon-Sat.

Paterson

93.1 WPAT-FM

100 26

Princeton

103.9 WPRB

72 24

Red Bank

100.3 WFHA-FM

So. Orange

89.5 WSOU

8 16

Trenton

97.5 WTOA

Zarephath

99.1 WAWZ-FM

0 10

Symphony concert 7:30-8:30 P.M. weeknights

NEW MEXICO

Albuquerque

89.1 KANW

1 2

96.3 KHFM

Los Alamos

98.5 KRSN-FM

38 21

NEW YORK

Allegheny

95.7 WHDL-FM

70 10

Auburn

96.1 WMBO-FM

Binghamton

95.3 WKOP-FM

90 30

98.1 WBNF-FM

28 15

Brooklyn

91.5 WNYE

1 4

Buffalo

92.9 WBNY-FM

Background music 19 hours daily

103.3 WILY

28 14

104.1 WWOL-FM

106.5 WBEN-FM

10 10

Hi-fi programming 6:30-10 P.M. weeknights

Cherry Valley

101.9 WRRC

Corning

106.1 WCLL-FM

Cortland

99.9 WKRT-FM

90 5

De Ruyter

105.1 WRRD

Floral Park

90.3 WSHS

3 3

Hempstead

98.3 WHLI-FM

49 18

Hornell

105.3 WWHG-FM

44 13

Ithaca

91.7 WITJ

10 4

"Holiday with Music" weeknights

97.3 WHCU-FM

103.7 WRRA

CITY	FREQ. (in mc.)	STATION	WEEKLY HRS. "pop" classical	
------	----------------	---------	--------------------------------	--

Jamestown

93.3 WJTN-FM

52 26

Messena

105.3 WMSA-FM

New Rochelle

93.5 WNRC-FM

60 3

New York

89.9 WKCR

15 25

90.7 WFUV

0 35

92.3 WHOM

60 0

Background music

93.9 WNYC

5 80

"Masterwork Hour" daily

95.5 WABC

117 4

96.3 WQXR

10 67

"Adventures in Sound" and

"Frontiers of Sound"

97.1 WRCA-FM

50 27

"Music Through the Night"

97.9 WEVD

20 50

98.7 WOR

40 2

"Music from Studio X" four hours daily

99.5 WBAI

40 52

"Accent on Sound" 9-10 P.M. weeknights

101.1 WCBS

50 42

"Music Til Dawn" 11:30-5:30 A.M.

101.9 WBFM

140 0

Background music

104.3 WNCN

138 30

"DeMatte Concert Hall" 6-8 P.M. Sundays

105.1 WRFM

77 28

"Operation Hi-Fi"

Niagara Falls

98.5 WHLD-FM

54 66

"Concert Hall" 12 noon-12 M. Sundays

Patchogue

97.5 WALK-FM

80 20

"Masterworks Hour" 10-11 P.M. weeknights

Poughkeepsie

104.7 WKIP-FM

Rochester

98.9 WHFM

54 12

Schenectady

99.5 WGFm

23 3

S. Bristol Twp.

95.1 WRRE

8 5

Springville

88.1 WSPE

14 28

Syracuse

88.1 WAER

"FM Hi-Fi Concert" 8-10 P.M. weeknights

93.1 WDDS-FM

112 0

94.5 WSYR-FM

20 0

Troy

92.3 WFLY

12 105

Utica

105.7 WRUN-FM

Wethersfield Twp.

107.7 WRRL

White Plains

103.9 WFAS

30 60

NORTH CAROLINA

Asheboro

92.3 WGWR-FM

Asheville

104.3 WLOS-FM

68 5

"Million Dollar Ballroom" weeknights

Burlington

93.9 WFNS-FM

101.1 WBBB-FM

Chapel Hill

91.5 WUNC

1 20

Charlotte

103.5 WSOC-FM

36 3

Clingsman Pk.

106.9 WMIT

Durham

105.1 WDNC-FM

50 1

Elkin

100.9 WIFM-FM

Fayetteville

98.1 WFNC-FM

Forest City

93.3 WBBO-FM

Gastonia

101.9 WGNC-FM

Goldsboro

96.9 WEQR-FM

Greensboro

89.9 WGPS

Greensville

91.3 WWWS

40 10

Henderson

92.5 WHNC-FM

83 4

"Hi-Fi" programs 19 hours weekly

CITY	FREQ.	STATION	WEEKLY HRS.	
			(in mc.)	"pop" classical
High Point	89.3	WHPS	12	9
	95.5	WHPE-FM		
	99.5	WMFR-FM	70	3
Laurinburg	100.3	WNOS-FM		
	96.5	WEWO-FM	45	11
Leaksville	94.5	WLOE-FM		
Lexington	94.3	WBUY-FM	84	7
Raleigh	94.7	WPTF-FM	0	7
	96.1	WKIX-FM	91	3
	101.5	WRAL-FM		
Reidsville	102.1	WREV-FM	35	7
	<i>"WREV Concert Hall" 8-10 P.M. Mondays</i>			
Rocky Mount	92.1	WEED-FM		
	100.7	WFMA		
Salisbury	106.5	WSTP-FM	16	1
	<i>Stereo program 10 P.M. Sundays</i>			
Sanford	105.5	WWGP-FM		
Shelby	96.1	WOHS-FM	100	3
Statesville	105.7	WSIC-FM		
Tarboro	104.3	WCPS-FM	65	3
	<i>"House of Music" 7-9 nightly</i>			
Thomasville	98.3	WTNC-FM		
Winston-Salem	93.1	WAIR-FM		
	104.1	WSJS-FM	28	8

OHIO

Akron	89.1	WAPS		
	97.5	WAKR-FM		
Alliance	101.7	WFAH-FM	140	8
Ashland	101.3	WATG-FM	40	23
Ashtabula	103.7	WICA-FM		
Athens	91.5	WOUI	85	16
Bellaire	100.5	WTRX-FM		
Bowling Green	88.1	WBGU	4	6
Canton	94.1	WHBC-FM	53	11
	<i>"Hi-Fi Time" 7:30-10 P.M. Sunday</i>			
Cincinnati	101.9	WKRC-FM		
	102.7	WSAI-FM		
	105.1	WCPO-FM		
Cleveland	90.3	WBOE	0	10
	98.5	WERE-FM	2	12
	99.5	WGAR-FM	55	16
	<i>"Henry Pildner Entertains" 7:45-11 P.M. weeknights</i>			
Cleveland Hts.	100.7	WHK-FM	22	8
	<i>"Midday Symphony"</i>			
	102.1	WDOK-FM		
	104.1	WJW-FM	65	0
	105.7	KYW-FM		
	95.3	WSRS-FM		
Columbus	89.7	WOSU-FM	0	60
	90.5	WCBE		
	92.3	WCOL-FM		
	94.7	WVCO-FM	60	5
Dayton	99.1	WHIO-FM		
Delaware	91.1	WSLN	7	11
Elyria	107.3	WEOL-FM		
Finlay	100.5	WFIN-FM	75	5
	<i>Hi-fi programming 7-9 P.M.</i>			
Fostoria	96.7	WFOB-FM		
Fremont	99.3	WFRO-FM		
Kent	88.1	WKSU-FM	6	16
Lima	102.1	WIMA-FM	90	4
	<i>"Sunday Best" 8-11 P.M. Sunday</i>			
Marion	106.9	WMRN-FM		

CITY	FREQ.	STATION	WEEKLY HRS.	
			(in mc.)	"pop" classical
Mt. Vernon	93.7	WMVO-FM		
Newark	100.3	WCLT-FM		
Oxford	88.5	WMUB	10	10
Portsmouth	104.1	WPAY-FM		
Steubenville	103.5	WSTV-FM		
	91.3	WTDS	0	4
Toledo	<i>"Making Friends with Music"</i>			
	92.5	WMHE		
	99.9	WTOD-FM		
	101.5	WSPD-FM	21	0
	104.7	WTOL-FM	113	15
	<i>"Hi-Fi Music Hall" 8-10 P.M. weeknights</i>			
Wooster	104.5	WWSST-FM		
Youngstown	98.9	WKBN-FM	40	2

OKLAHOMA

Norman	90.9	WNAD-FM	1	18
Oklahoma City	88.9	KOKH	2	5
Stillwater	91.7	KAMC-FM		
	93.9	KSPI-FM		
Tulsa	90.5	KWGS	12	15

OREGON

Eugene	91.1	KWAX	6	12
	91.9	KRVM	5	15
<i>"Music of the Masters," "Concert Hall"</i>				
Grants Pass	99.1	KUGN-FM		
	96.9	KGPO		
Oretech	88.1	KTEC		
Portland	92.3	KEX-FM		
	97.1	KPFM	68	46
<i>Stereo 9 hours weekly</i>				
	98.7	KPOJ-FM		
	100.3	KQFM		
<i>Background music</i>				
	101.1	KOIN-FM		
<i>Live music 17 hours weekly</i>				

PENNSYLVANIA

Allentown	100.7	WFMZ		
Altoona	100.1	WVAM-FM	84	1
Bethlehem	95.1	WGPA-FM	36	6
	<i>"Hi-Fi Showcase," "Adventures in Hi-Fi"</i>			
Bloomsburg	106.5	WHLM-FM		
	97.7	WBUT-FM	20	2
<i>Hi-fi programs 20 hours weekly</i>				
Chambersburg	95.9	WCHA-FM	30	0
Clauderport	96.7	WFRM-FM		
Dubois	102.1	WCED-FM	30	2
Easton	98.3	WEEX-FM		
	107.9	WEST-FM		
Erie	99.9	WERC-FM		
Harrisburg	97.3	WHP-FM		
Havertown	89.3	WHHS		
Hazleton	97.9	WAZL-FM		
Johnstown	92.1	WARD-FM		
	95.5	WJAC-FM	50	8
Lancaster	96.9	WLAN-FM	0	65
	101.3	WGAL-FM		
Lebanon	100.1	WLBR-FM		
Meadville	100.3	WGMW-FM		



CITY	FREQ. (in mc.)	STATION	WEEKLY HRS.			
			"pop"	classical		
Philadelphia	88.9	WXPN	45	28		
	90.1	WRTI-FM	5	5		
	<i>Opera programming 5 hours weekly</i>					
	90.9	WHYY	0	21		
	91.7	WPWT	6	15		
	93.3	WIP-FM	126	4		
	94.1	WIBG-FM				
	95.7	WFLN	0	119		
	<i>"Showcase of New Records" 2-5 P.M. Sat.</i>					
	98.1	WCAU-FM	120	48		
	102.1	WFIL-FM	1	12		
	102.9	WPEN-FM	12	122		
	105.3	WHAT-FM	160	0		
	Pittsburgh	91.5	WDUQ	0	10	
		92.9	KDKA-FM	63	56	
		<i>Hi-fi music 4 P.M.-Midnight</i>				
		93.7	WKJF	110	3	
		94.5	WWSW-FM			
		99.7	WJAS-FM	79	0	
<i>"Stereo Spectaculars"</i>						
Pottsville		101.9	WPPA-FM			
		89.9	WUSV	10	38	
Scranton		101.3	WGBI-FM			
	102.9	WPG-FM				
Sharon	91.1	WDFM	12	14		
	<i>"Hi-Fi Open House" 7-9 P.M. Sat.</i>					
Sunbury	94.1	WKOK-FM				
	92.3	WRRN-FM	54	19		
Warren	104.3	WJPA-FM				
	98.5	WBRE-FM				
Wilkes-Barre	100.3	WRAC-FM	56	6		
	105.1	WLYC-FM	30	21		
Williamsport	<i>"Music in the Evening" 8-10 P.M. nightly</i>					
	105.7	WNOW-FM	98	10		
RHODE ISLAND						
Providence	92.3	WPRO-FM	22	8		
	95.5	WPFM	0	122		
	101.5	WXCN	3	119		
	105.1	WPJB-FM				
Woonsocket	106.3	WWON-FM	80	6		
	SOUTH CAROLINA					
Anderson	101.1	WCAC	12	3		
	<i>"Hi-Fi For You" 8-11 P.M. Sundays</i>					
Charleston	95.1	WTMA-FM				
	96.9	WCSC-FM				
Columbia	89.9	WUSC-FM	18	27		
	97.9	WCOS-FM				
Dillon	92.9	WDSC-FM				
	92.5	WESC-FM	13	3		
Greenville	93.7	WFBC-FM	66	12		
	95.7	WCRS-FM				
Greenwood	102.7	WORG	35	7		
	98.3	WRHI-FM				
Rock Hill	98.1	WSNW-FM				
	98.9	WSPA-FM				
Spartanburg	100.5	WDXY-FM				
	TENNESSEE					
Bristol	96.9	WOPI-FM	20	5		
	<i>"Hi-Fi Music" 6:30-7:30 P.M. weeknights</i>					
Chattanooga	96.5	WDOD-FM	54	2		
	94.9	WGRV-FM				

CITY	FREQ. (in mc.)	STATION	WEEKLY HRS.	
			"pop"	classical
Jackson	104.1	WTJS-FM	88	6
Johnson City	100.7	WJHL-FM	40	2
Kingsport	98.5	WKPT-FM		
	91.1	WKCS	8	1
	91.9	WUOT	0	28
	93.3	WBIR-FM	108	5
Knoxville	99.7	WMCF	48	3
	<i>"Finest Music on Earth" Sunday P.M.</i>			
Memphis				
Nashville	105.9	WFMB	54	58
TEXAS				
Abilene	91.9	KACC-FM	25	11
Austin	98.3	KHFI	25	48
	<i>"Adventure in Hi-Fi" 8 P.M. Sat.</i>			
Baytown	92.1	KREL-FM		
Beaumont	97.5	KRIC-FM		
Cedar Hill	107.9	KDFW	77	52
Cleburne	94.3	KCLE-FM	80	3
	<i>"Music in Hi-Fi" 8-9 P.M.</i>			
Corpus Christi	95.5	KDMC	6	45
Dallas	88.1	KNER	5	6
	89.3	KSMU-FM		
	91.7	KVTT		
	92.5	KRLD-FM		
	101.1	WRR-FM	144	21
	104.5	KIXL-FM	116	7
	105.3	KSFM	0	126
<i>"Music of Other Lands," "Early Hi-Fi Records," "Chamber Music Hour"</i>				
Denton	106.3	KDNT-FM	70	20
El Paso	88.5	KVOF-FM		
Fort Worth	96.3	WBAP-FM	6	6
Houston	91.3	KUHF	27	27
	101.1	KTRH-FM	0	61
<i>"Audio Fare" 8:30-10 P.M. Sat.</i>				
	102.9	KPRC-FM	42	42
<i>Stereo 4 hours weekly</i>				
Nacogdoches	100.1	KELS		
Plainview	88.1	KHBL		
San Antonio	92.9	KONO-FM	52	17
	97.3	KITE-FM		
	99.5	KISS	0	56
Texarkana	98.1	KCMC-FM	70	4
UTAH				
Ephraim	88.9	KEPH		
Logan	88.1	KVSC	10	5
Salt Lake City	98.7	KDYL-FM		
	100.3	KSL-FM		
VIRGINIA				
Arlington	105.1	WARL-FM		
Charlottesville	91.3	WTJU	3	20
	95.3	WINA-FM		
Crewe	104.7	WSVS-FM		
	91.7	WEMC		
Harrisonburg	100.7	WSVA	55	3
	100.1	WWOD-FM	0	42
Martinsville	96.3	WMVA-FM		
Newport News	97.3	WGH-FM	28	56
Norfolk	90.5	WFOS	15	5
	91.5	WMTI		
	102.5	WRVC	24	95



CITY **FREQ. STATION** **WEEKLY HRS.**
(in mc.) "pop" classical

Richmond	94.5	WRVA-FM	29	30
<i>"Hi-Fi with Frank Brooks" 3-4:30 P.M. Sundays</i>				
	98.1	WCOD		
	102.1	WRNL-FM	70	10
Roanoke	94.9	WDBJ-FM	36	5
	99.1	WSLS-FM	50	50
Winchester	92.5	WRFL	90	0

WASHINGTON

Seattle	90.5	KUOW	11	16
	98.1	KING-FM	94	3
	99.9	KISW	0	105
<i>Hi-Fi Programs Tues. & Sat.</i>				
	100.7	KIRO-FM	33	3
<i>"The Jazz Show" 8-9 P.M. nightly</i>				
Spokane	92.9	KREM-FM	100	3
<i>"Treasures in Sound" 8-11 P.M. Sunday</i>				
Tacoma	90.9	KCPS		
	91.7	KTOY	10	5
	97.3	KTNT-FM	80	
<i>"Hi-Fi" 6-8 P.M. Monday-Saturday</i>				

WEST VIRGINIA

Beckley	99.5	WBKW	28	28
<i>"The Hi-Fi Show"</i>				
Charleston	97.5	WKAZ-FM	24	3
Huntington	100.5	WHTN-FM	56	14
<i>"Hi-Fi Concert" 8-10 P.M. Sun.-Fri.</i>				
Logan	103.3	WLOG-FM		
Martinsburg	94.3	WEPM-FM	75	3
<i>"Sunday with the Classics" 9:30-11 P.M.</i>				
Morgantown	99.3	WAJR-FM		
Oak Hill	94.1	WOAY-FM		
Parkersburg	106.5	WAAM-FM	12	2
Wheeling	97.3	WKWK-FM		
	98.7	WVVA-FM	31	0

WISCONSIN

Appleton	91.1	WLFM	4	18
<i>"Hi-Fi Concert" 7-9 P.M.</i>				
Chilton	89.3	WHKW		
Colfax	88.3	WHWC		
Delafield	90.7	WHAD		
Eau Claire	94.1	WEAU-FM		
Glendale	96.5	WFMR	20	60
Greenfield	94.9	WWCF		
Highland	91.3	WHHI		
Highland Twp.	89.9	WHSA		
Holmen	90.3	WHLA		
Janesville	99.9	WCLO-FM	68	7
<i>"Hi-Fi Concert" Sat. and Sun. nights</i>				
Madison	88.7	WHA-FM	0	50
	98.1	WISC-FM		
	104.1	WMFM	70	15
<i>Hi-Fi programming 20 hours weekly</i>				
Marshfield	103.9	WDLB-FM		
Merrill	100.7	WLIN		
Racine	100.7	WRJN-FM		
Rice Lake	96.3	WJMC-FM		
Sheboygan	100.3	WHBL-FM	70	1
Wausau	91.9	WHRM		
Wisconsin Rap.	103.3	WFHR-FM	90	3

CITY **FREQ. STATION** **WEEKLY HRS.**
(in mc.) "pop" classical

HAWAII

Honolulu	88.1	KVOK	12	0
	90.5	KUOH		
	95.5	KAIM-FM	43	39
<i>"Music Hall" nightly; daily stereo programs</i>				

PUERTO RICO

Mayaguez	97.5	WORA-FM	15	5
Ponce	104.7	WPRP-FM		

ALBERTA, CANADA

Edmonton	98.1	CKUA-FM	30	30
	99.5	CJCA-FM		
	100.3	CFRN-FM		

BRITISH COLUMBIA, CANADA

Vancouver	105.7	CBU-FM		
Victoria	98.5	CKDA-FM	100	8

MANITOBA, CANADA

Winnipeg	103.1	CJOB-FM		
----------	-------	---------	--	--

NOVA SCOTIA, CANADA

Halifax	96.1	CHNS-FM	48	2
Sydney	94.9	CJCB-FM		

ONTARIO, CANADA

Brantford	92.1	CKPC-FM	70	
<i>"Music by Moonlight" 10-11 P.M. Mon-Sat.</i>				
Cornwall	104.5	CKSF-FM		
Fort William	94.3	CKPR-FM		
Kingston	91.9	CFRC-FM		
	96.3	CKWS-FM	112	3
	99.5	CKLC-FM	105	18
Kitchener	96.7	CKRC-FM	70	6
London	95.9	CFPL-FM	100	0
Ottawa	93.9	CFRA-FM		
	103.3	CBO-FM		
St. Catherine	97.7	CKTB-FM		
Timmins	94.5	CKGB-FM		
Toronto	91.1	CJRT-FM		
	98.1	CHFI-FM	40	18
<i>"Hi-Fi" 15 hours weekly</i>				
	99.1	CBC-FM	50	13
	99.9	CFBR-FM	80	5
<i>"Starlight Serenade" 10-11 P.M.</i>				
Windsor	103.9	CKLW-FM		

QUEBEC, CANADA

Montreal	95.1	CBF-FM		
	100.7	CBM-FM		
	106.5	CFCF-FM	90	10
Quebec	98.1	CHRC-FM	10	14
Rimouski	101.5	CJBR-FM		
Verdun	96.9	CKVL-FM		

tape recording in 1958

by **irving rossman**

president, magnetic recording
industry association

OUT OF EVERY dollar spent on hi-fi equipment in 1958, thirty-five cents will go for tape recorders, tape, microphones, and related recording equipment. The tape recorder, which used to be an accessory to a hi-fi system, is today the cornerstone of many hi-fi systems. About two million people in industry, government, science, and at home find the tape recorder an important adjunct to their daily activities. This is in contrast to less than one million units in use only four years ago. The public demand for tape recorders has already attracted major mass-producers of electronic goods, such as *Sylvania*, *Philco*, *Columbia*, *Magnavox*, to mention only a few. Others, such as *Admiral* and *Motorola*, have not yet introduced recorders under their own brand name, but the further development of this trend seems probable. The firms supplying recorders, microphones, blank tape, and recorded tape for business or home use have ambitious plans for 1958 and the immediate future. There are now more than thirty companies in the United States manufacturing some four hundred different tape recorders to satisfy every consumer or industrial need.

What does this avalanche of equipment mean to the prospective buyer? It means there is the widest possible choice of recording equipment for all needs. Today, you can purchase tape recording

machines at all prices with an unnumbered variety of special applications. Whether your problem is recording a TV program for delayed transmission, teaching French to high school students, or preserving special radio broadcasts, there is a machine designed to meet your requirements.

Mr. Rossman, as president of the trade association that includes almost every manufacturer of tape recorders, recording tape, and prerecorded tape in this country, recently completed a survey of the industry. He points out some of the accomplishments of the tape industry and indicates current trends, new products, and basic developments now taking place. Mr. Rossman is also president of the Pentron Corporation, one of the largest manufacturers of tape recorders.

Home Recording Units

In home recorders, there is a wide variety of monaural and stereo combinations to choose from. Our recent survey indicated that eighty percent of the recorders manufactured in 1958 will have provision for stereo playback. There are machines operating at one, two, or three speeds, ranging from 1½ to 15 inches per second. Weight varies from a miniature hand-held, battery-operated device to professional units weighing one hundred pounds or more.

The most popular type of unit at present is the monaural record—stereo playback combination with speeds of 3¾ and 7½ inches per second. These units record half track and provide satisfactory reproduction of voice and music.

(Continued on page 118)

FOR A NEW HIGH IN HI-FI PERFORMANCE:



new G-E VR II magnetic cartridge

New PA-20 amplifier and preamplifier



● Smooth, clean response with a power output of 20 watts. ● Five separate inputs, three outputs and seven controls satisfy every home audio need. ● Incorporates unusual L-C tuned circuit in rumble filter for sharp low-frequency cutoff of 12 db per octave below 40 cycles. ● Ask for a demonstration.

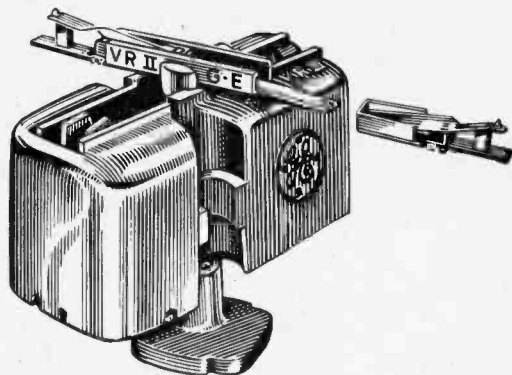

New Full-Range Reproduction. General Electric's new VR II Magnetic cartridge makes possible faithful reproduction from 20 through 20,000 cycles.

New 4-Gram Tracking Force. Lateral compliance has been extended to 1.7×10^{-6} cm per dyne, permitting a tracking force of only 4 grams to minimize record and stylus wear.

Instant CLIP-IN-TIP Stylus. You can replace a stylus instantly at home, without removing cartridge from tone arm.

New Electrostatic Shielding. Prevents pick-up of electrostatic interference; grounds stylus assembly to eliminate build-up of charges from record surface.

New Lightweight Construction. Microscopic precision and strong, lightweight construction assure your continued pleasure.

Hear the difference! Ask for a demonstration at your dealer's.



12" GOLDEN CO-AX Speaker

- 12" woofer, 2 3/4" tweeter
- Built-in crossover network
- 25-watt power rating

8" Speaker Enclosure

Features "Distributed Port" design for outstanding power handling ability and consistently smooth response.

High Fidelity Components Cabinet

Mounts amplifier, tuner, changer or turntable, and accessories. Storage space for records.

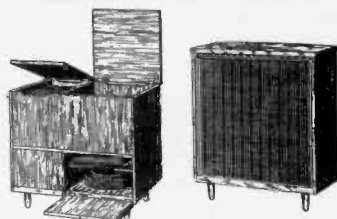

"Distributed Port" Speaker Enclosure

Provides effective damping and loading at low frequencies. In mahogany, cherry or blond.

G-E "Baton" Tone Arms Strong, lightweight aluminum with sealed ball-bearing mountings. "Pivot-tilt" head.



GENERAL ELECTRIC

General Electric Company
Specialty Electronic Components Dept.
Section HFGY58, West Genesee Street
Auburn, N. Y.

Please send me information on integrated G-E components:

Name _____

Address _____

City _____ Zone _____ State _____

CHECK UP

on your turntable



THE "HI-FI" STROBE DISC shown above can be used to check the speed of your turntable. There are three circles of dots, one row for each of the popular turntable speeds. To use the disc, cut it carefully from the page and paste on cardboard for support. Use a sharp knife or razor blade to cut out the black center portion of the disc. This must be done accurately for proper operation of the disc. Cut around the edge of the black area to make the hole just large enough to fit over the turntable spindle.

In use, the disc is placed on the turntable and the rotating turntable is viewed by incandescent or preferably fluorescent light. If the turntable speed is correct, the circle of dots for that speed should appear to stand still. If the dots appear to rotate in the same direction as the turntable, the speed is too high. If the dots move in the reverse direction, turntable speed is too low.

hi-fi test records

THANKS TO THE ingenuity of recording engineers, discs are available for making home checks on your phono system. Designed strictly for checking how well your hi-fi system is doing its job, the hi-fi test record has in its grooves various beeps and sweeps, all of which are full of meaning when properly evaluated. Although most test records necessitate the use of test equipment, some may be used profitably without any test equipment at all.

Record	What It Does	Instruments Needed
COOK		
<i>Series 10</i>	Permits frequency and distortion measurements, determination of arm resonance, tracking error, etc.	Requires at least an a.c. volt meter and preferably a distortion meter.
<i>Series 20</i>	Allows comparison of wide-range white noise (the noise between FM stations) with restricted-range white noise.	No test equipment necessary.
<i>Series 50</i>	Checks the IM distortion of the entire system.	No test equipment necessary.
DUBBINGS		
<i>The Measure of Your Phonograph's Performance (D-100)</i>	Tests stylus pressure, frequency response, rumble, flutter and wow, arm tracking, cartridge compliance, etc.	No test equipment necessary.
<i>The Measure of Your Phonograph's Equalization (D-101)</i>	Allows precise adjustment of tone controls to achieve exact playback equalization.	Requires a.c. voltmeter or Dubbings Test Level Indicator.
FOLKWAYS		
<i>Sounds of Frequency (FPX-100)</i>	Includes tones from 15.6 cps to 22.5 kc, square waves, demonstrations of high frequency loss, equalization runs, etc.	Requires use of a.c. voltmeter and oscilloscope.
CLARKSTAN		
<i>Audio Sweep Frequency (102M)</i>	Sweeps from 70 cps to 10 kc at a frequency of 20 sweeps per second.	Requires the use of an oscilloscope.
WESTMINSTER		
<i>TRC Check and Double Check</i>	Spot frequencies from 30 cps to 15 kc; slow sweep from 30 cps to 15 cps. Selections from "Lab" Series.	Best used with voltmeter.
ELECTRA		
<i>Playback System Calibration Record (EKL 35)</i>	Three bands of glide tones from 18 cps to 20 kc with identifying pauses along the way.	Best used with voltmeter.
LAFAYETTE RADIO		
<i>Hi-Fi Test Record</i>	Checks rumble, cartridge and stylus wear, hum, tonearm resonance, etc. Has repeated glide tone from 20 cps to 300 cps for tuning bass reflex enclosures.	May be used without instruments but is more useful when used with a voltmeter.
COMPONENTS CORP.		
<i>Wow and Flutter Too</i>	Checks turntable performance.	No test equipment required.
<i>How's Your Stylus?</i>	Checks stylus wear.	No test equipment required.
<i>Quiet, Please</i>	Checks turntable rumble.	No test equipment required.
<i>Tracking Special</i>	Checks tone arm resonances and tracking.	No test equipment required.
<i>Vertical/Lateral Response</i>	Auditory method of determining the vertical/lateral response of a phono cartridge.	No test equipment required.
<i>What—No Hum?</i>	Checks hum level of phono system.	No test equipment required.

the
fourth
speed

16 $\frac{2}{3}$
r p m

by *norman eisenberg*

After just "going in circles," 16-rpm discs take a slow turn into popularity for the record fan.

WHEN Chrysler announced, not so long ago, that its cars would be equipped with "highway hi-fi"—made possible by a new 16 $\frac{2}{3}$ -rpm record and player—audio enthusiasts drew their breaths in anticipation that this might have repercussions in hi-fi for the home.

What ensued, however, was not the expected sonic bonanza but a flabby fizz like a damped oscillation. The fact is that the 16-rpm speed—though detoured on the highways—never came to a dead stop for home audio.

The facts are: Aside from the dashboard version of 16 rpm, there is a growing library of these records available to the public. More and more record players are incorporating 16 rpm as a fourth speed. As "Talking Books," these discs are a boon to the blind—"The Lighthouse" of the New York Association for the Blind distributes them widely. Music, too, is now available on 16 rpm's. Vox Productions, Inc., well-known record company, has just issued some 16-rpm records in the 12-inch size that are especially interesting in that they present complete "programs" of classical or mood music—up to 100 minutes!

Biblical Turn

The Audio Book Company of St. Joseph, Mich., started the 16-rpm project way back in 1951. For a whole year they tried all kinds of slow speeds, as low as 4 $\frac{1}{2}$ rpm! In the fall of 1952, 16 rpm was picked as most practical because it would play on existing equipment.

The first "Talking Book" was a recording of the complete New Testament in the King James version, introduced in May, 1953, at department stores in California and New York. It took over a hundred auditions to find a "voice" for the Bible. The final choice was none other than Marvin Miller, known as the narrator of movie cartoon *Gerald McBoing-Boing* and other UPA features.

The talking book idea is not new. As far as the phonograph is concerned, it is literally true that "in the beginning was the



Two of the new 16 $\frac{2}{3}$ -rpm hi-fi music records issued by Vox Productions, Inc.

word." Thomas A. Edison, in the 1870's, dreamed of putting literature on records. "Mary Had a Little Lamb" was, in fact, the first recording ever made when Edison

at last put his new invention to the test. The Library of Congress had, for years, offered recorded books for the use of the blind—but not in the convenient, lightweight, and inexpensive form of 16-rpm discs.

Coming to the Point

Recently, Audio Book introduced music on "compatible" 16-rpm records. "Compatible" means that the new 7" discs can be played on any phonograph having the fourth (16-rpm) speed; no special stylus is needed. They can be played with a 1-mil (0.001") stylus, the same kind you use for regular microgrooves. Previously, music recorded at the fourth speed could be played only with a ½-mil (0.0005") stylus, as on the special equipment used in cars.

These "compatible" 16-rpm's contain a full 40 minutes of playing time on each 7" disc and list for \$1.69 per record. When more than one record is included in an album of a longer work, the price per disc is lower. This relatively low cost, combined with a widening repertory, will probably earn for these records growing popularity.

To clinch matters, this company has developed a speed-reducing adapter which fits—like a 45-rpm spindle adapter—over any 33⅓-rpm phono-player. Selling for \$1.95,

The four discs currently available from *Prestige* retail at \$7.98 and are aimed at the jazz fan. These feature such artists as the Billy Taylor Trio, Thelonious Monk, and the Concorde Modern Jazz Quartet. These also are the 12" size, averaging forty minutes on each side—equivalent to both sides of a conventional 33⅓ disc.

Reducing the speed of phonographs to gain playing time has always been an accepted and legitimate interest of audio technicians. Edison's first recording of the nursery rhyme was made at about 100 rpm. The high speed was necessary because of the narrow diameter of Edison's cylinder.

After Emile Berliner's invention of the flat disc with spiral groove, the turntable speed was internationally standardized at 78 rpm. This standard was observed for nearly half a century and the first great library of recorded sound was created at that speed—at a maximum of 4½ minutes playing time per side.

By 1948, searching for longer and uninterrupted play, Dr. Peter Goldmark of Columbia Records had developed the technique of cramming the full range of sound into narrower grooves. This new "microgroove" technique permitted discs to turn more slowly without losing high-frequency



Through the "talking book," classics of literature have joined those of music in the recorded medium.

this adapter not only accommodates the 1½" center hole—it also converts 33-rpm, to 16-rpm speed.

So far as music on 16-rpm discs is concerned, only two music record companies have, at the time of this writing, entered the field. These are *Vox Productions, Inc.* and *Prestige Records*. *Vox* has issued five 12" "extended long play" records, the VXL series, which list at \$6.95 each. These contain complete programs such as would be presented during an evening in a concert hall. One record, the VXL-1, for example, contains the *Romeo and Juliet Overture Fantasy*, the *Symphony No. 6* and the *Piano Concerto No. 1 in B Flat Minor*, all by Tchaikowsky.

response. Columbia's LP's thus set the new standard at 33⅓ rpm.

RCA Victor, concerned over having been "scooped," refused Columbia's generous invitation to jump aboard the LP bandwagon. Some years later they did so anyway—but not before they had involved the public in a "speed war" in which they pitted their own new 45-rpm doughnuts against Columbia's LP's. After years of bewilderment and industrial "warfare" (at the record buyer's expense), RCA's management then agreed to a policy of "coexistence" by which all record speeds were allowed to survive—each serving the particular needs for which it is best suited.



Hi-fi turntables featuring the fourth speed include (reading from top to bottom): the Fairchild Model 412-4, built to precision standards, with a hysteresis motor whose speed is controlled by a continuously variable frequency electronic oscillator; the Bogen B50 and the Metzner "Starlight," both featuring continuously variable speed adjustments over a mechanical transmission. The Garrard Model T "Mark II" and the Miraphon Model XM-110A turntables and the Collaro RC-456 automatic changer shown below are among the first low-priced equipment to feature 16 rpm.

Variable margin control, a recent electronic advance which allows each groove on the record only as much radial space as it needs—but no more, permitted closer "squeezing" of the soft passages without limiting the fullness of the loud ones. The space saving paid off in longer playing time per-unit-diameter and made it possible to get up to 10 minutes of music on a single side of a 45-rpm disc. In terms of cost per minute of music, this made the 45-rpm record comparable with the 33-rpm LP. Yet, in terms of hi-fi and musical possibilities, the 33-rpm disc is still the favored choice because its inherently longer playing time permits major works to be transcribed on a single disc without interruption.

On one point at least—that of playing time—the 33-rpm record is now rivaled by the 7" 16-rpm record, which provides comparable playing time at half the size (and cost) of a 12" record. The 7" 16-rpm record runs at least 20 minutes per side. For this reason it is sometimes advertised as "ultra-microgroove," but this term is misleading because it implies grooves narrower than the 1-mil used on regular LP's. As stated before, only the 16 rpm's made for Chrysler cars used grooves narrower than 1 mil; the newer "compatible" 16 rpm's can be played with a standard 1-mil stylus.

Time vs. Fidelity

While the 16-rpm record certainly makes good the claim of "longer long play," it cannot aspire to "higher hi-fi"—at least not at the present state of the recording art. Many people have the mistaken idea that long



play in itself means hi-fi. The truth is: all other things being equal, the greater the speed of a record, the greater the recordable frequency range—just as with tapes. In the case of tapes, narrow-gap magnet heads and tapes with homogeneous oxide layers can provide wide range at the relatively slow speed of 7.5 ips. So it is with discs—the groove dimensions as well as the surface properties of the vinylite material permit wide range *despite* slower speeds—not *because* of them.

True Hi-Fi at 16 rpm?

In the case of 16 rpm's, the question arises as to what extent this slowest of slow speeds (actually twice as slow as 33 rpm) impairs the sound. Most listeners agree that the new 16-rpm discs do not sound as good as top-quality 33-rpm or 45-rpm discs. However, as one company spokesman puts it: "There is no question but that improvements will be made. In the foreseeable future, a hi-fi record at 16 rpm will be a reality."

Design Problems

Another hurdle that 16-rpm records must clear is playback equipment. How will such records sound on conventional phono players? At a speed as slow as 16

Playing Speed (rpm)	Average Playing Time (minutes)		
	12"	10"	7"
78	4 1/2	3	2
45	—	—	4 1/2
45 EP	—	—	9
33	25	15	10
16	40	30	20

Average maximum playing time per side of records with different speeds, size.

rpm, the average record player—although adequate for 33 rpm—runs the risk of increased flutter and wow. Small defects in motor or drive system, which may go unnoticed at 33 rpm, could become magnified at 16 rpm into marring noise.

Turntable manufacturers have thus found a new problem-child in their lap. For their new models, they have had to make good mechanisms better and include provisions for the fourth speed with no appreciable price rise. A phono player that features the fourth speed now needs a fourth transmission wheel added to a mechanism that previously had only three. As you select the fourth speed, the appropriate wheel snaps into position to engage the idler wheel which spins the turntable.

It sounds simple, but new product design is involved, as well as premature obsolescence of existing models. And they're still not sure of how well these units will handle 16 rpm.

Units Providing 16 rpm

Yet uncertainty never deters an industry which evidently regards any question mark as a prod to go ahead, seek new ways, make new things, and generally succeed. Many "package" phono systems (including those decidedly low-fi) feature the fourth speed. Some hi-fi component firms also include it in new equipment. The *Garrard* Mark II manual player and RC-88, RC-98 and RC-121 changers incorporate it. Similarly, it appears in the *Collaro* RC-440, TC-340, TC-540 and RC-456 changers, *Bogen's* B50 and B20 manual players, the *Metzner* "Starlight" turntable, and the brilliantly engineered new *Fairchild* Model No. 412-4. Other changers and turntables incorporating the new fourth speed are the *Glaser-Steers Corp.* model GS Seventy-seven changer, the *Thorens* TD-124 turntable, the *Lafayette Radio* PK-180 turntable, the *D&R Ltd.* DR-12B turntable, the *Components Corp.* "Professional Junior" turntable, the *Miracord* XA-100 changer and the *Miraphon* XM-100A turntable.

With components in this class, it is safe to assume that wow and flutter at 16 rpm are pretty well licked. It also means that, for better or worse, 16 rpm is here to stay. The growing catalog of recorded material and new playback equipment in all price ranges proclaim that the tide may yet turn to 16 rpm and roll into the arena with quite a splash.



Adapter for 16 rpm fits over the spindle of any standard turntable. Made by Audio Book Co., this device costs \$1.95.

rolloff and turnover settings

AS THE LOW END of the audio band is restricted in amplitude on a record, so is the high end artificially boosted. At high frequencies, the magnetic cutter would produce grooves of such tiny amplitudes that the desired signal would be overwhelmed by noise—high-frequency noise from the cutting process itself and from the very structure of the record surface material. To obtain the added signal strength needed by the highs in order to ride over the noise, the recording engineer forces the cutter to describe grooves whose amplitudes are somewhat greater than they would be “normally.”

The additional amplitude for these grooves is obtained by treble boost or “pre-emphasis” in the recording process. Frequencies above a certain point in the audio range (the treble “roll-off” point) are actually recorded with more intensity than frequencies below that point. To hear them correctly, some kind of high-frequency reduction, or cut, or “roll-off” must be provided on playback.

As a result of these bass and treble tricks employed during the cutting of the record, the frequency curve impressed on the disc is anything but “flat.” Such a curve, played back with no equalization, would produce very weak bass and screechy treble.

For proper playback, the bass must now be boosted, and the treble cut. The recording characteristic curve must be matched by its exact opposite—or inverse—curve. This curve, called the “playback equalization curve,” is obtained from fairly simple circuits which are inserted after the cartridge in a playback system. Such circuits are invariably incorporated in all modern amplifiers.

Record Equalization Chart

The settings listed below apply to records made before 1955. Most present-day records are recorded according to the RIAA curve and should be played accordingly.

MANUFACTURER	LOW FREQUENCY TURNOVER	TREBLE ROLL-OFF AT 10 Kc	MANUFACTURER	LOW FREQUENCY TURNOVER	TREBLE ROLL-OFF AT 10 Kc
ALLEGRO	LP	NARTB	KAPP	RIAA	RIAA
AMERICAN REC. SOC.	AES	NAB	LONDON	RIAA	RIAA
ANGEL	NARTB	AES	LYRICORD	NAB	NAB
ATLANTIC	NARTB	NARTB	MCINTOSH	RIAA	RIAA
BACH GUILD	LP	NARTB	MERCURY	RIAA	RIAA
BARTOK	AES	AES	MGM	NAB	AES
BETHLEHEM	RIAA	RIAA	MONTILLA	RIAA	RIAA
BLUE NOTE	AES	AES	NEW JAZZ	RIAA	RIAA
BOSTON	LP	NAB	OCEANIC	LP	NAB
CAEDMON	NARTB	NARTB	L'OISEAU LYRE	RIAA	RIAA
CAPITOL	AES	AES	OVERTONE	RIAA	RIAA
CAPITOL-CETRA	AES	AES	OXFORD	LP	NAB
CETRA-SORIA	LP	NARTB	PERIOD	NARTB	NARTB
CLASSIC EDITIONS	RIAA	RIAA	PACIFIC JAZZ	RIAA	RIAA
COLOSSEUM	RIAA	RIAA	PHILHARMONIA	AES	AES
COLUMBIA	RIAA	RIAA	POLYMUSIC	NAB	NAB
CONCERT HALL	RIAA	FFRR	PRESTIGE	RIAA	RIAA
COOK	NAB	AES	RCA	RIAA	RIAA
CORAL	NAB	NAB	REMINGTON	NAB	NAB
DECCA	NAB	NAB	RENAISSANCE	LP	AES
ELEKTRA	RIAA	RIAA	RIVERSIDE	RIAA	RIAA
EPIC	RIAA	RIAA	SAVOY	RIAA	RIAA
ESOTERIC	RIAA	RIAA	TEMPO	NAB	NAB
FOLKWAYS	LP	LP	URANIA	NAB	NAB
GOOD-TIME JAZZ	RIAA	RIAA	VANGUARD	RIAA	RIAA
HAYDN SOCIETY	LP	LP	VOX	RIAA	RIAA
HMV	RIAA	NAB	WALDEN	RIAA	RIAA
			WESTMINSTER	LP	LP

high fidelity

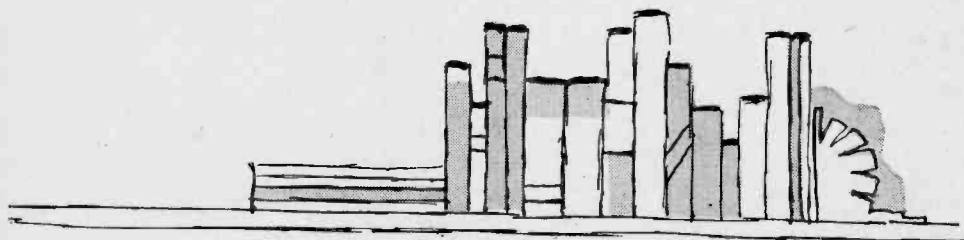

bookshelf

THE SUDDEN entrance of hi-fi into the thoughts and homes of millions has prompted the publication of many books on the subject. The best of these are lucid explanations of the objectives of high fidelity home music reproduction and practical guides on how to attain these objectives. The following list of currently available books, with comments on each, is meant to direct the reader toward those books which are informative, original, and readable.

Books concerning hi-fi break down, in the main, into three categories: those encompassing the general field, those about tape recorders, and those about speakers and enclosures. On the general subject of hi-fi, there is a further loose division: books of a basically introductory nature, directed at the consumer with no technical background, and books at a semi-technical to technical level for the seasoned audiophile or audio professional.

There are a number of hi-fi books available written on the layman's level. These books are the best possible means for the non-technical person to get some solid information about hi-fi. They help clear up the confusion and misconceptions that have arisen concerning the hi-fi field. The musical and electronic aspects of hi-fi are explained in non-technical terms, and usually special emphasis is placed on one of the most pressing problems in hi-fi—how to achieve it at lowest cost and still get good quality.

The following books will generally be found in bookstores, but in the event they can't be located in retail stores, they may be ordered directly from the publisher.

The Layman's Hi-Fi

The Saturday Review Home Book of Recorded Music and Sound Reproduction. Second Edition, by Canby, Burke, and Kolodin, published by Prentice Hall, Inc., New York, N. Y., 1956, 339 pages, \$4.95. Three different sections on records, reproducing equipment, and music appreciation with each author expertly handling his particular field. Interesting and pleasant reading.

Home Music Systems, Revised Edition, by Edward Tatnall Canby, published by Harper and Bros., New York, N. Y., 1955, 300 pages, \$3.95. A fine approach to hi-fi for the layman. Mr. Canby is one of the most informative and entertaining writers around. Very lively, clear, and interesting.

High Fidelity Home Music Systems, by W. R. Wellman, published by D. Van Nostrand Co., Inc., New York, N. Y., 1955, 177 pages, \$4.50. Suffers from attempting to cover too much ground. Rather superficial presentation of material that is by no means new.



High Fidelity—A Practical Guide, by Charles Fowler, published by McGraw Hill Publishing Co., Inc., New York, N. Y., 310 pages, \$4.85. Clear, intelligent discussion of the entire hi-fi field in non-technical language. Readable and informative.

Basic Audio Course, by Donald Carl Hoefler, published by Gernsback Publications, Inc., New York, N. Y., 1956, 223 pages, \$2.75, cloth cover, \$5.00. A good semi-textbook approach to hi-fi by one of the country's most experienced hi-fi writers.

The New High Fidelity Handbook, Revised Edition by Green and Radcliffe, published by Crown Publishers, Inc., New York, N. Y., 1956, 193 pages, \$4.95. A good basic book with excellent sections on hi-fi cabinetry.

The High Fidelity Reader, edited by R. H. Hoopes, Jr., published by Hanover House, Garden City, N. Y., 1956, 254 pages, \$3.50. A collection of articles that originally appeared in *High Fidelity* magazine.

High Fidelity Simplified, Third Edition, by H. D. Weiler, published by John F. Rider, Publisher, New York, N. Y., 1957, 202 pages, \$2.50. A good general book that explains most of the semi-technical aspects of hi-fi in everyday language. Soft cover.

Hi-Fi Handbook, published by Howard W. Sams & Co., Inc., Indianapolis, Ind., 240 pages, \$3.00. A good introductory book on hi-fi. Soft cover.

Hi-Fi Handbook, Revised Edition, by William J. Kendall, published by Thomas Y. Crowell Co., New York, N. Y., 1956, 174 pages, \$2.95. On an elementary level with little that is fresh or original.

Hi-Fi, by Martin Mayer, published by Random House, Inc., New York, N. Y., 1956, 144 pages, \$2.95. A very attractive and well-organized book. Contains an unusual amount of useful information on hi-fi along with specific component recommendations.

Hi-Fi Directory and Buyer's Guide, 1958 Edition, published by Ziff-Davis Publishing Co., Inc., 1957, 170 pages, \$1.00. Includes descriptions, technical specifications, prices, and illustrations of every hi-fi unit on the market. Invaluable for anyone interested in the hi-fi field. Special articles on how to choose hi-fi components. Soft cover.

How to Plan and Install Hi-Fi Systems, by Irving Greene, published by Fawcett Publications, Inc., New York, N. Y., 1957, 112 pages \$0.50. An introduction to hi-fi on an elementary level with many illustrations of current equipment. Good section on planning custom installations. Soft cover.

Low Cost Hi-Fi, by Donald Carl Hoefler, published by Fawcett Publications, Inc., New York, N. Y., 1957, 144 pages \$0.75. A book of interest to the kit-builder and the do-it-yourselfer. Soft cover.

Mechanix Illustrated Hi-Fi Guide, by Donald Carl Hoefler, published by Fawcett Publications, Inc., New York, N. Y., 1956, 144 pages \$0.75. Written primarily for the kit-builder and person interested in electronic "puttering." Soft cover.

Home Music Systems, published by Trend, Inc., Los Angeles, Cal., 1955, 128 pages, \$0.75. A book devoted to showing pictures of custom hi-fi installations. Soft cover.

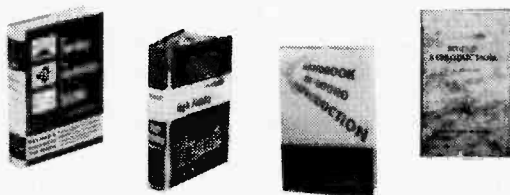

The Technical Side

The following books are on a higher technical level and are of value to the person with at least a knowledge of basic electronic circuitry. Some of them are, in effect, required reference books for hi-fi equipment designers.

Recording and Reproduction of Sound, Second Edition, by Dr. Oliver Read, published by Howard W. Sams and Co., Inc., Indianapolis, Ind., 1952, 800 pages, \$7.95. The

standard reference book on hi-fi written by one of the top authorities. Detailed descriptions of equipment, circuits, and methods. Dated but one of the classics in this field.

Guide to Audio Reproduction, by David Fidelman, published by John F. Rider Publisher, Inc., New York, N. Y., 1954, 240 pages, \$3.50. A well-written book with a great deal of detail on circuitry. A little dated but still serviceable. Soft cover.

Handbook of Sound Reproduction, by Edgar M. Villchur, published by Radio Magazines, Inc., Mineola, N. Y., 1957, 218 pages, \$6.50. One of the newest and finest books yet written on hi-fi by a well-known authority and speaker system designer. Taken from the series that appeared in *Audio Magazine*.

Sound Reproduction. Third Edition, by G. A. Briggs, published by Wharfedale Speakers, British Industries Corporation, Port Washington, N. Y., 1953, 368 pages, \$3.50. A very fine book written by the designer of the Wharfedale speakers. A fund of information for speaker and enclosure designers.

Maintaining Hi-Fi Equipment, by Joseph Marshall, published by Gernsback Publications, Inc., New York, N. Y., 1956, 223 pages, \$2.90, cloth cover, \$5.00. A good book that covers its subject clearly and concisely.

High Fidelity Techniques, by John H. Newitt, published by Rinehart and Co., Inc., New York, N. Y., 1953, 494 pages, \$7.50. A little dated, but still valuable and interesting reading. Emphasis on circuitry for design and reference work.

Repairing Hi-Fi Systems, by David Fidelman, published by John F. Rider Publisher, Inc., New York, N. Y., 1957, 203 pages, \$3.90. An excellent comprehensive book on hi-fi repair for the radio-TV serviceman and technically-minded audiophile. Soft cover.

Stereophonic Sound, by Norman H. Crowhurst, published by John F. Rider Publisher, Inc., New York, N. Y., 1957, 117 pages, \$2.25. A most complete survey of the stereo field. Profitable reading for anyone considering going into stereo. Soft cover.

Hi-Fi Annual and Audio Handbook, 1958 Edition, published by Ziff-Davis Publishing Co., Inc., New York, N. Y., 1957, 138 pages, \$1.00. A compilation of the best articles on hi-fi from *Radio and TV News*. Includes the excellent ten-part series by H. A. Hartley, the well-known British authority on audio. Soft cover.

High Fidelity, published by Gernsback Publications Inc., New York, N. Y., 1953, 128 pages, \$1.50. Dated and of relatively little interest or value today. Soft cover.

The 3rd Audio Anthology, edited by C. G. McProud, published by Radio Magazines, Inc., Mineola, N. Y., 1956, 124 pages, \$2.50. A selection of the best articles originally appearing in *Audio magazine*. Soft cover.

High Fidelity Circuit Design, by Crowhurst and Cooper, published by Gernsback Publications, Inc., New York, N. Y., 1957, 304 pages, \$5.95. Reference book for the builder and experimenter.

Tape Recorder Books

Record players, amplifiers and speakers are familiar to most people through experience with radio sets. The tape recorder, though, is still relatively new. Since it's only been around some ten years or so, most people haven't had time to acquire experience with it. Consequently, there is probably more confusion and less understanding about the tape recorder than any other class of hi-fi component. To provide information from a number of different viewpoints, there exists a wide selection of books on purchasing, using, and repairing tape recorders.

Tape Recorders and Tape Recordings, by Harold D. Weiler, published by Radio Magazines, Inc., Mineola, N. Y., 1956, \$2.95. Clearly written general summary of the tape recorder field, with excellent sections on using tape recorders in the home. Soft cover.

Your Tape Recorder, by Robert and Mary Marshall, published by Greenberg Publishers, New York, N. Y., 1955, 288 pages, \$4.95. Elementary presentation of little new material.

How to Make Good Tape Recordings, by C. J. LeBel, published by Audio Devices, Inc., New York, N. Y., 1956, 150 pages, \$1.50. A very good little book by one of the



top authorities. Explains clearly and concisely how to make top quality home recordings. Soft cover.

Magnetic Recording, by S. J. Begun, published by Murray Hill Publishers, Inc., New York, N. Y., 1953, 242 pages, \$5.00. A good comprehensive reference book on the history, theory, and applications of the tape recorder, written by an outstanding tape recorder engineer.

Elements of Magnetic Tape Recording, by N. M. Haynes, published by Prentice Hall Inc., New York, N. Y., 392 pages, \$7.95, 1957. A new and very comprehensive book for professionals or advanced audiophiles by a well-known designer of tape recorders.

How to Use a Tape Recorder, by Hodgson and Bullen, published by Hastings House Publishers, New York, N. Y., 1957, 216 pages, \$4.95. A book mainly devoted to listing some rather farfetched commercial and parlor game uses for the tape recorder.

Ribbons of Sound, by Karl A. Barleben, published by U. S. Camera Publishing Corp., New York, N. Y., 1956, 151 pages, \$2.50. Introduction to tape recorders for the beginner. Soft cover.

Tape Recorders—How They Work, by Charles G. Westcott, published by Howard W. Sams and Co., Inc., Indianapolis, Ind., 176 pages, \$2.75. Covers the tape recorder field at an elementary level. Soft cover.

How to Select and Use Your Tape Recorder, by David Mark, published by John F. Rider Publishers, New York, N. Y., 1956, 148 pages, \$2.95. An elementary level book. The buyer's guide section is, for the most part, obsolete now. Soft cover.

How to Service Tape Recorders, by C. A. Tuthill, published by John F. Rider Publisher, New York, N. Y., 1954, 176 pages, \$2.90. A little outdated now. Soft cover.



Speakers and Enclosures

On the subject of speakers and enclosures, two of the top authorities, Briggs of Wharfedale and Cohen of University, each have written extremely interesting and readable books. Either of these is highly recommended.

Loudspeakers, Fourth Edition, by G. A. Briggs, published by Wharfedale Speakers, British Industries Corp., Port Washington, N. Y., 1955, 92 pages, \$1.60. An excellent and well written book by one of the world's foremost authorities on speakers and enclosures. Soft cover.

Hi-Fi Loudspeakers and Enclosures, by Abraham B. Cohen, published by John F. Rider Publisher, New York, N. Y., 1956, 360 pages, \$5.50, \$4.60 paperbound. A complete study of all phases of loudspeakers and enclosures. The best and most detailed book on loudspeakers available. Authored by the chief engineer of University Loudspeakers, Inc.

Hi-Fi Magazines

Audio, published monthly by Radio Magazines, Inc., Mineola, N. Y., \$.50. For the engineer and technician.

Audiocraft, published monthly by The Billboard Publishing Co., New York, N. Y., \$.35. For the home builder and hobbyist.

High Fidelity, published monthly by The Billboard Publishing Co., New York, N. Y., \$.60. For the music lover and hi-fi listener.

Hi-Fi Music at Home, published bi-monthly by Sleeper Publications, Inc., New York, N. Y., \$.50. For the music lover and hi-fi listener.

Hi-Fi and Music Review, published monthly by Ziff-Davis Publishing Co., Inc., New York, N. Y., \$.35. For the music lover and hi-fi listener.

Popular Electronics, published monthly by Ziff-Davis Publishing Co., Inc., New York, N. Y., \$.35. For the semi-technical hi-fi fan.

Radio and TV News, published monthly by Ziff-Davis Publishing Co., Inc., New York, N. Y., \$.35. For the technically oriented hi-fi listener.

Radio Electronics, published monthly by Gernsback Publications, Inc., New York, N. Y., \$.35. For the technically oriented hi-fi fan.

record clubs

cut

record costs

MMUSIC LOVERS and audio fans have reaped the benefits of microgroove vinylite records in more ways than one. In addition to their long-play, wide-range features, LP's are non-breakable and light in weight—which means that they can be sent safely through the mails.

Taking advantage of this fact, mail order record clubs have put hi-fi into millions of homes. Wide mail distribution has lowered prices and boosted subscription sales to the tune (no pun intended) of 20 million dollars a year. One outfit alone—the Concert Hall Society—boasts a membership of about 500,000. A recent analysis made by the Society reveals that the majority of its members did not buy records regularly before joining.

While the clubs listed in the table are the major ones operating now, they are not the only outfits that sell music through the mails. Many smaller groups, specializing in certain types of records, enjoy a brisk trade. One enterprising musical organization has gone into the business, too—the Louisville Symphony has placed its recordings on a subscription basis.

The great advantage of buying records from clubs are the convenience and savings involved. A limiting factor is in the choice of records. As compared with going into a store, listening to, and buying what you want, the club method limits the choice to a narrow selection.

From a business viewpoint record clubs are thriving. CHS has mushroomed from its modest beginnings ten years ago to an outfit that employs more than 200 people. Two floors of a large office building, plus two shipping plants and batteries of automatic tabulators are needed to handle shipments, payments, accounts, cancellations, and correspondence.

Comparative highlights of the major clubs are shown in the accompanying chart. Free literature is available on request from any of the clubs listed.

For the stereo enthusiast, the Stereo Tape Exchange Club, % Magnetic Recording Co., 344 Main St., Paterson, N. J., will provide another stereo tape in exchange for an unwanted tape and a small service fee.

CLUB NAME AND ADDRESS	RECORD PRICE	BONUS	HOW IT WORKS	WHAT YOU GET
Jazztone Society 43 W. 61st St. New York 23, N. Y.	\$2.75	Introductory record for \$1.00. Free booklet on jazz.	No minimum purchase required. You receive advance notice of selection. Records are sent on approval, may be returned after playing.	The best in old and new jazz performed by top ranking musicians.
LP Record Club c/o Columbia Records 799 Seventh Ave. New York 19, N. Y. (or through local record retailers)	Regular Columbia list prices: CL 12" series, \$3.95; ML 12" series, \$4.98.	Free record when you join; bonus record for each two you buy.	Minimum purchase is four records a year. You receive advance notice of selection, may reject record or choose alternate by mailing back form by certain date.	All types of music; classical, show tunes, swing, etc., performed by leading Columbia artists.
Music-Appreciation Records c/o Book-of-the-Month Club 345 Hudson St. New York 14, N. Y.	\$3.60 for 12" discs; \$2.40 for 10" discs.	Introductory record free. Included with first purchase is album for holding 10 records and glossary of musical terms.	No minimum purchase required. You receive advance notice of selection, may reject record by mailing back form by certain date.	Standard classical works performed by leading ensembles; analyses narrated by well-known critics and musicologists.
Musical Masterpiece Society 43 W. 61st St. New York 23, N. Y.	\$1.65	Two introductory 10" records for \$1.00. Free booklet by Olin Downes.	Same as Jazztone Society	Classical works (standard plus some rarely heard) performed by first-rate ensembles.
Opera Society 45 Columbus Ave. New York 23, N. Y.	\$2.95	Introductory record for \$1.00.	Same as Jazztone Society	Operas (standard plus some rarely heard) sung and played by outstanding artists.

hi-fi shoptalk

a glossary
of most used
hi-fi terms



illustrations by *rodriguez*

DO YOU draw a blank when you hit phrases such as "IM distortion," "cathode follower," and "damping factor"? Perhaps the easiest way to gain an introduction to a new field is to understand its jargon. In the following glossary of the most common hi-fi terms, we have tried to be as concise as possible, both in the actual number of terms and in the definitions. This glossary is intended to put you at ease in the semi-technical world of hi-fi and should also be of help when planning a hi-fi purchase. If you know exactly what salesmen and advertisers mean when they start using hi-fi-ese, you stand a better chance of getting your money's worth and not being misled by meaningless terms such as "mellow-tone" and "full-fidelity."

AB Test—a method of instantaneously switching from one component to another while a hi-fi system is in actual use, for purposes of determining which component being switched is the more satisfactory.

Acoustic Feedback—the transfer of vibrations from the speaker to the phonograph pickup. This, in turn, is amplified and fed back to the amplifier again until the sound begins "breaking up." This also sometimes happens when a microphone picks up vibrations from its speaker, causing "howling."

AM—a method of radio broadcasting by which the carrier is amplitude modulated.

Attenuate—to decrease or make less prominent. A volume control is an attenuator.

Audio Frequency—the band of frequencies or sounds, audible to the human ear. The audible frequency range varies with the individual, but is usually from about 20 to 20,000 cps.

Aural Compensator—see "Loudness Compensation."

Automatic Frequency Control (AFC)—a circuit which acts as a semi-automatic tuning device, making tuning relatively uncritical and preventing drift.

Baffle—a housing or enclosure for a speaker.

Bass Reflex—a type of enclosure in which the sound from the rear of the speaker reinforces the sound from the front of the speaker via an opening in the enclosure called a "port."

Binaural—a system of recording through two microphones onto two separate sound tracks, then reproducing the two tracks individually through separate systems, and using headphones instead of loudspeakers. In the process of recording, the microphones are ideally a heads-width apart; when reproduced through earphones, great realism is possible because of differences of the sound track in volume levels, directionality, and phase.

Cartridge—that part of a record player assembly that translates the wiggles of the stylus in the record groove into an electrical voltage. This voltage is then fed to a preamplifier or amplifier.

Cathode Follower—a type of electronic circuit used in the output stage of tuners and control units to permit the use of long interconnecting cables without causing a loss of high frequencies.

Coaxial Speaker—a type of loudspeaker that contains a separate tweeter mounted within the frame of a woofer.

Compensation—see "Equalization."

Control Unit—a preamplifier with knobs for controlling tonal balance, volume, on-off, and function selection. Generally located remotely from the main amplifier.

Corner Horn—a horn-type speaker enclosure which is designed for placement in the corner of a room. The corner acts as the final extension of the horn.

CPS—"cycles per second," the unit of frequency measurement. The greater the cps, the higher the pitch of the sound.

Crossover Network—a device installed between power amplifier and speakers that separates different bands of frequencies and feeds them to the specially designed speaker for each frequency range.

Crystal—a natural or artificially produced slab of mineral material which generates an electrical voltage when it is mechanically deformed. Crystals are used on phonograph cartridges, microphones, and earphones to transfer mechanical motion into electrical signals or vice versa.

Cut—decrease

Cycle—one complete reversal of an alternating voltage. Sometimes used instead of "cycles per second," in which case it is an expression of frequency.

Damping—the resistance of a mechanical or electrical system to spurious vibrations, or oscillations. Usually concerns cartridges, tone arms, or loudspeakers. Common damping materials are special types of rubber, silicone compounds and resins.

Damping Factor—a measure of an amplifier's ability to stop spurious speaker vibrations. The numerical value of the damping factor is determined by the ratio of the impedance at the speaker terminals, such as 4, 8, or 16 ohms, to the internal impedance of the amplifier. The lower the internal impedance, the higher the damping factor and the greater is the amplifier's ability to minimize unwanted speaker vibrations.

Decibel—a unit of sound intensity measurement. Used in audio work mainly because it corresponds closely with the loudness perception patterns of the human ear. A change of one decibel, or "db," is a barely perceptible difference in sound level. A 3 db change is usually considered to be

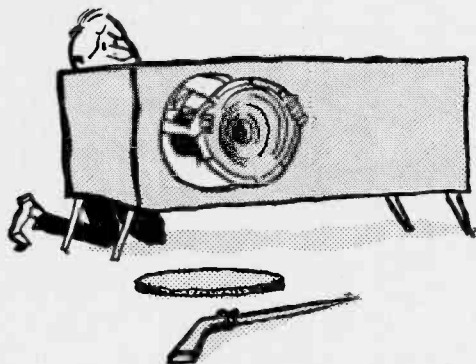

"high compliance system"

the smallest significant variation in volume. Each 3 db increase in volume requires twice the previous output power that was being used.

De-emphasis—the process, in reproduction, of compensating for pre-emphasis (see "Pre-emphasis").

Detector—the electronic circuit that converts the modulated radio frequency waves transmitted by the broadcasting station into audible frequencies.

Discriminator—a type of detector used in FM tuners. It is usually considered the most efficient and desirable type of detector, but it involves additional construction expense.

Distortion—any deviation of the reproduced signal from the original signal.

Drift—the effect as a tuner warms up of the station's apparently moving to one side of the original dial setting.

Electrostatic Speaker—a type of speaker that operates on the principles of static, rather than magnetic, electricity. Thus far, electrostatic speakers have been used almost exclusively as tweeters since physical construction problems raise obstacles to their use as full-range speakers.

Equalizer or Equalization—a circuit that compensates for the frequency boosts and cuts that are necessary in the production of a record master.

Exponential Horn—a type of horn speaker enclosure in which the mouth opening increases in size at an increasing rate according to exponential mathematics.

Feedback—a circuit that feeds back part of the output signal to the input in order to reduce distortion and increase the damping factor (see also "Acoustical Feedback").

Filter—a circuit designed to screen out a band of unwanted frequencies.

Flat—the reproduction of a band of frequencies with no accentuation or attenuation at any frequency.

Flutter—a periodic change of speed in a turntable or tape recorder occurring at a relatively rapid rate causing a warbling effect.

FM—a method of radio broadcasting with the carrier being frequency modulated rather than amplitude modulated, as in AM radio. It is capable of better quality and less noise than AM, but does not have as extended an operating range.

Folded Horn—a horn-type enclosure with the horn being internally convoluted rather than straight. (see "Horn").

Frequency Response—the ability of a component to reproduce a certain range of frequencies.

Hangover—the blurred effect caused when a speaker continues to vibrate after the original impulse has ceased.

Harmonics—harmonics are tones at intervals of one octave which are generated along with fundamental tones. The frequency of each harmonic is a multiple of the fundamental frequency. Generally the second harmonic, or that tone which is one octave higher, is the strongest harmonic tone, with higher multiples, or octave tones, also being present. The relationship between the intensity of all the harmonics in combination with the fundamental tone accounts for the differences in timbre of the different musical instruments.

Harmonic Distortion—the reproduction of a signal with an unnatural content of harmonics being generated in the reproducing equipment.

High Fidelity—the exact reproduction of sound.

Horn—a type of speaker enclosure with an expanding throat much like one of the brass family of musical instruments.

Hysteresis Synchronous Motor—a motor in which the speed is controlled by the frequency of the operating current.

Impedance—the total resistance, both a.c. and d.c., presented by an electrical or mechanical circuit. When two circuits are coupled together, they should have the same value of impedance for maximum transfer of power from one circuit to the other.

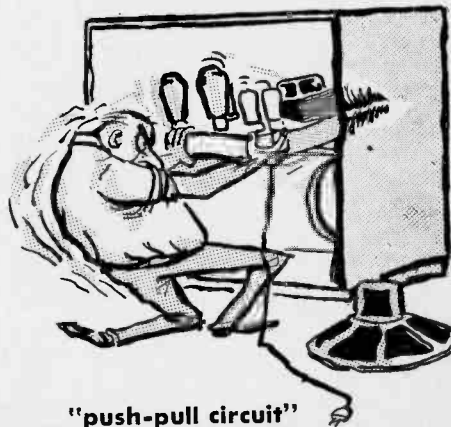

"push-pull circuit"

Infinite baffle—ideally an infinitely large totally enclosed volume. Generally refers to a speaker enclosure which is completely enclosed except for the speaker opening.

Intermodulation Distortion (IM)—a form of distortion whereby low frequencies distort the waveshape of high frequencies. This causes the high frequencies to lose their clarity and assume an unpleasant jangled sound.

IPS—"inches per second," the speed at which the tape travels in a tape recorder. Generally, the faster the tape speed, the wider the frequency range possible.

Limiting—a stage in an FM tuner which is designed to reduce noise and static picked up in transmission.

Linear—see "Flat."

Loudness Control (Loudness Compensation)—a type of volume control that automatically boosts the low frequencies as the volume level is decreased. This is done to compensate for the human ear's loss of sensitivity to the bass frequencies at low volumes.



"input impedance"

Multiplex—a method of FM broadcasting whereby two signals may be imposed on one carrier. This makes possible stereophonic transmission by one FM station.

Noise Suppressor—a circuit that reduces record scratch and tape hiss. A Dynamic Noise Suppressor operates only during soft passages since during loud passages no suppression is necessary because the noise is masked by the program material.

Phasing—the orientation of two or more units, either physically or electrically, so that each augments the other. Generally used in connection with loudspeakers. All speakers in a system should be pushing the air together.

Pickup—see "Cartridge."

Power Supply—a circuit which provides the necessary operating voltages for associated electronic equipment.

Preamplifier—a circuit used to boost the signal level from low-output cartridges, microphones, or tape heads. This signal is then fed to a main, or power, amplifier.

Pre-emphasis—the process, in FM broadcasting, of accentuating the high frequencies in order that the high frequencies may be attenuated at the receiver, with a consequent decrease in noise and static, thus yielding a better signal-to-noise ratio.

Push-pull—a type of amplifier output circuit characterized by low harmonic distortion.

Quieting—the measure of a tuner's ability to minimize noise and static.

Resonance—the natural tendency of a mechanical or electrical system toward vibration.

Rolloff—the reduction of the high frequencies in playback to compensate for their having been boosted in the process of producing a master record.

Rumble—in record reproduction, mechanical noises from the motor and driving elements are sometimes transmitted to the record, picked up by the cartridge, then reproduced through the entire system.

Selectivity—the ability of an FM tuner to separate two adjacent stations.

Sensitivity—the ability of a tuner to pick up distant stations.

Stereo or Stereophonic—a method of recording or broadcasting through two microphones at a distance apart, making two separate sound tracks, then reproducing each track through separate system with the speakers ideally the same distance apart as the original microphones.

Stylus—fancy word for needle.

Tracking Error—the difference between the perfect 90 degree tangency of the grooves of the phonograph record to the center of the record and the angle of the playback stylus to the center of the record.

Transient Response—the ability of a hi-fi system to faithfully reproduce the very abrupt beginnings and endings of sounds.

Turnover—the accentuation of the low frequencies in playback to compensate for their having been attenuated in the process of cutting a master record.

Tweeter—a speaker designed specifically for the high frequency range.

Ultra-linear—a type of amplifier output circuit characterized by high power and low distortion. It requires the use of a special type of output transformer which provides partial screen loading.

Watt—the unit of electrical power. The electrical watt is the power that is presented by the amplifier to the speaker. The acoustical watt is that loudness volume, or power, actually produced by the speaker. Therefore, the acoustical watt may be calculated by multiplying the electrical watts to the speaker times the efficiency of the speaker.

Woofer—a speaker designed specifically for the low frequency range.

Wow—a periodic fluctuation of turntable or tape recorder speed occurring at a relatively slow rate.



"stylus pressure"

(Continued from page 21)

- Prokofieff, *Symphony #7; Symphony #1*. (Classical) (Philharmonia, Malko) RCA Victor LM 2092
Sessions: *Idyll of Theocritus*. (Soprano & orchestra) (Louisville Orchestra) Louisville 57-4
Shakespeare, Hamlet—Baylor Theatre Prod. (dir. Paul Baker) Word 6002 (3)
Sibelius, *Symphony #7; The Oceanides; Pelléas et Mélisande*. (Royal Philharmonic, Beecham) Angel 35458
Sounds of Steam Railroading. (O. Winston Link) Railway Productions
*Stokowski—*The Orchestra*. (Leopold Stokowski) Capitol H 8 (ST)



Alan Lomax is shown making an on-the-spot recording of authentic folk music. His work in this field has been outstanding.

- Soviet Army Chorus and Band. Monitor MP 520
Strauss, *Fledermaus Ov.; Tales of the Vienna Woods; Blue Danube*. (Hallé O., Barbirolli) Merc. MDS 5-4 (ST)
*Strauss, *Le Bourgeois Gentilhomme; Suite*. (Chicago Symphony, Reiner) RCA Victor DCS 43 (ST)
Strauss, *Die Frau Ohne Schatten*. (Solos, Chorus, Vienna State Opera, Böhm) London XLLA 46 (5)
Stravinsky, *L'Histoire du Soldat*. (Ars Nova) Westminster Lab 7049
*Stravinsky, *The Rite of Spring*. (Paris Conserv. O., Monteux) RCA Victor EGS 67 (ST)
Stravinsky, *Petrouchka; Fire Bird Suite*. (Paris Conservatory Orchestra, Monteux) RCA Victor LM 2113
Synge, *The Playboy of the Western World*. (Complete play) (Cusack, McKenna, etc.) Angel 3547 (2)
Tchaikowsky, *Swan Lake Ballet*. (Complete) (Philadelphia Orchestra, Ormandy) Columbia ML 5201
Tchaikowsky, *The Queen of Spades*. (Complete opera) (Belgrade Nat. Opera) London XLLA 44 (4)
Toch, *Symphony #3*. (Pittsburgh Symphony, Steinberg) Capitol ZF 7 (ST)
The Use of History; *Our Heritage of History*. Prof. Preston Slosson. Spoken Arts 702
Wagner, *Die Götterdämmerung*. (Flagstad, Svanholm, Oslo Philharmonic) London XLLA 48 (6)
Webern, *The Complete Music*. (Dir. Robert Craft) Columbia K4L 232 (4)
The Weavers at Carnegie Hall. Vanguard VRS 9010
Weill, *The Seven Deadly Sins*. (Lotte Lenya, etc.) Columbia KL 5175

Demonstration Records

A HI-FI SYSTEM can be shown off without using the sounds of train whistles, sports cars, or leaky faucets. There are many records which are outstanding sonically and have musical value too. Some of these are listed below. The list is in no particular order of preference and makes no claims to completeness.

- Strauss: *Der Rosenkavalier* (Schwarzkopf, Karajan, Phil. Orch.) Angel 35492/5.
Tchaikowsky: *Swan Lake* (Ormandy, Phil. Orch.) Columbia ML-5201.
Bartok: *Concerto for Orchestra* (Dorati, Minn. Symphony) Mercury 50033.
Vaughan Williams: *Job* (Boult, London Philharmonic) London LL-1003.
Mozart: *Divertimenti* Vanguard VRS-482.
Bach: *Concerto for Oboe and Violin* Vanguard VRS-562.
Shostakovitch: *Symphony #5* (Rodzinsky, London Phil.) Westminster 108001.
Kodaly: *Hary Janos* (Dorati, Minn. Symphony) Mercury 50132.
Strauss: *Music of Johann Strauss* (Bruno Walter) Columbia ML-5113.
Respighi: *The Birds* (Caracciolo, Scarlatti Orch.) Angel 35310.
Mozart: *Piano Concertos #21 and #27* (Serkin-Schneider) Columbia ML-5013.
Haydn: *Symphony #100* (Scherchen, Vienna Symphony) Westminster 18325.
Debussy: *Iberia, La Mer* (Paray, Detroit Symphony) Mercury 50101.
Prokofiev: *Symphony #5* (Schippers, Philadelphia Orch.) Angel 35527.
Copland: *Appalachian Spring* (Ormandy, Philadelphia Orch.) Columbia ML-5157.
Tchaikowsky: *Serenade for Strings* (Ormandy, Phil. Orch.) Columbia ML-5187.

what to do before calling the serviceman

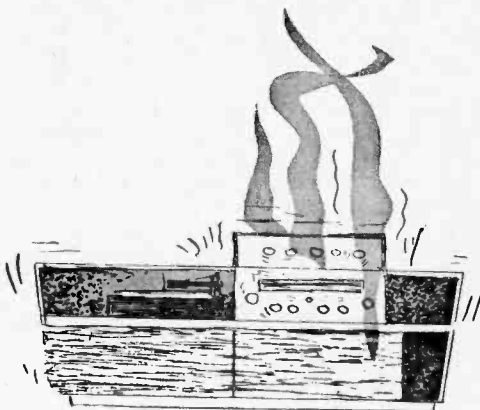

by furman hebb

HAS IT EVER happened that your hi-fi system developed some "bugs" and, because of lack of technical background, you were completely at a loss? The usual procedure is to call a serviceman, twiddle your thumbs, and glare at the finicky thing. However, before the serviceman can get to you, several days may pass. And most disgusting of all, hi-fi troubles have a habit of happening just before you want to show off your system to friends or when one of your favorite artists is to be on FM. Then to top it all off, when the serviceman finally makes his appearance, he glances around and says, "Well, of course it won't work like this." And after he makes a few little adjustments, the set is working fine again. You have not only been inconvenienced by losing the use of the set but you are also obliged to pay for the service call.

Fix It Yourself and Save Money

Some hi-fi troubles are definitely curable by the hi-fi listener who has a minimum of mechanical aptitude. The following simple checks should enable you to correct minor troubles that can disturb the operation of a hi-fi system. Even if you cannot make the actual repair of the set, you can at least localize the trouble to a particular component. If one unit can be pinned down as being the guilty party, then it can be taken to the repair shop. This saves the price of a serviceman's trip to your house.

This information is on a very basic level and is meant for the average person who, when the set doesn't work right, immediately heads for the telephone, calls the serviceman, and gets out his checkbook.

The reader will notice that many troubles which sometimes beset hi-fi sets are not included in this article. Such troubles as amplifier distortion, high noise level, jammed record changers, etc., require the services of an experienced technician.

General Complaints

Dead set (dial doesn't light up)—Make sure the a.c. plug of the equipment is plugged into the wall socket. If the wall plug is secure, remove the main fuse of the set and check to see if it has burned out. The main fuse is usually located in a screw-out receptacle which is installed on the amplifier chassis. If a new fuse should blow out immediately, the unit is in need of professional service.

Amplifier dial lights up but tuner doesn't (or vice versa)—Check line cords and a.c. plugs of all equipment. Inspect fuses to make sure they aren't burned out.

Dial lights come on but no sound, not even hum, with controls at maximum—Check at the amplifier and at the speaker that the twin speaker wires are connected and are not touching each other. Look to see that all the tubes are glowing. If one tube is not glowing, replace it with another tube of the same type. Many drug stores or supermarkets offer facilities for testing doubtful tubes.

Dial lights come on but no music comes through (slight hum through speaker with controls at maximum)—Check for tubes that are not glowing. Try tapping tubes with a pencil; if the tapping induces a tube to work intermittently, replace it. Ascertain that the connecting audio cable is securely plugged in. If the input cable to the main amplifier doesn't cause a loud hum when it is partially unplugged, the main, or power, amplifier is defective. If a loud hum is obtained, then the preamplifier or some of the connections are defective.

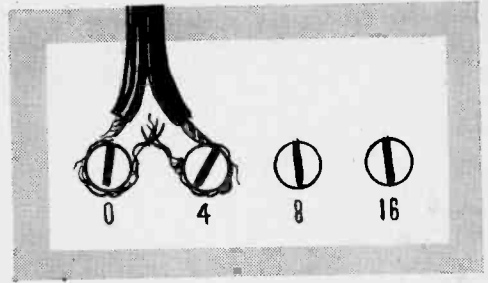

Speaker wires are shorted out, or touching each other at the amplifier terminals. This can cause extreme distortion or loss of sound altogether.

Constant low hum on all inputs—Try reversing the line plug in the wall socket. If the amplifier has a hum control, readjust it for minimum hum. If hum continues when the audio cable to the preamplifier is disconnected, the hum is from the basic amplifier; if the hum stops, the hum is from the preamplifier.

Very loud hum on all inputs—Inspect and wiggle all interconnecting cables; all must be in good condition around the connector and securely plugged in. In a complaint of this kind, the trouble is almost always caused by faulty audio cable connections.



The metallic element in this fuse is burned out and must be replaced. The replacement must be of the same current rating as the original.

loudness control and damping controls are properly adjusted; some controls cause extreme muddiness when turned up too far.

Distortion on both tuner and phono—

Try tapping tubes with a pencil; if the sound becomes clear as a result of this, replace the tube. Make sure that the double wires to the speaker are not touching each other either at the amplifier or at the speaker. Check that the

Phono Troubles

Turntable turns and dial lights are on but no sound from record—Something is either dead or not connected. First, make sure that all the connections from the cartridge to the amplifier are in good order. Check that the stylus is actually contacting the record properly. When the input plug to the preamplifier is partially unplugged, there should be a loud hum from the speaker; if there is not, then the trouble is in the preamplifier or amplifier and is best handled by an experienced technician.

Constant background hum on phono—This is usually caused by one of three things: (1) the phono cartridge is picking up hum from a nearby transformer, (2) the record player mechanism is not properly grounded to the amplifier, and (3) the preamplifier section of the amplifier is faulty. The first two of these can usually be

In this illustration the audio connector isn't completely plugged in. This will result in a hum.

If the frayed shielding to the audio connector should be broken, a very loud hum will be caused.

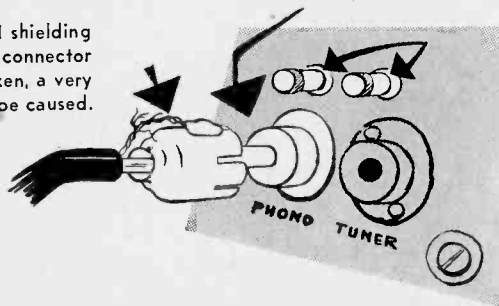

Level controls should be rotated to a maximum clockwise position when testing an amplifier or a preamplifier.

remedied by the layman. To prevent the cartridge from picking up transformer hum, try moving the record player farther away from the amplifier or, if this is impossible, try placing the two units at a different angle to each other; there may be an exact angle of rotation where a sharp reduction of hum level will be effected. To ground the record player to the amplifier, connect a wire from the chassis of the amplifier to the mounting plate or motor of the record player. Hum problems arising from preamplifier difficulties are a little tough for a novice and should be referred to a qualified serviceman.

Very loud hum on phono—This is usually caused by a broken connection. Check all connections from the pickup output to the preamplifier input.

Distortion on phono only—Check for bent or off-center stylus. The *G-E* cartridge is prone to develop this condition if roughly handled. If the stylus of a *G-E* cartridge is off-center, gently bend the arm holding the stylus until the stylus is midway between the two side pieces. To make sure the stylus is not worn, have it checked under a microscope. Some cartridge manufacturers will recondition their cartridges at no charge. Owners of *Pickering*, *Fairchild*, and *ESL* cartridges should have their pickups inspected and adjusted by the manufacturer at least every two years.

Arm skips grooves—Usually caused by worn or chipped stylus. Check the stylus for wear with a microscope. Make certain that the tone arm is tracking at the proper weight; if the arm is too light, it will have a tendency to skip grooves. If the lateral movement of the arm is not absolutely free, it will tend to play the same groove over and over again. A poorly designed arm that resonates severely at certain frequencies will sometimes jump grooves.

Low rumbling sound when arm is put on record—This is mechanical noise from the player being picked up by the cartridge. Check the physical mounting of the turntable. See that the support springs or other mechanical isolation elements are in good condition and have the correct amount of tension. For the solution of rumble problems, it is usually necessary to seek professional help.

Tuner Troubles

Dial lights come on but no sound from tuner—Try tapping tubes with a pencil. If possible, have tubes checked on a tube-tester. Make sure that the audio cable from the tuner to the amplifier (if the tuner is separate from the amplifier) is connected and is in good condition.

Tuner only picks up two or three stations—Make sure that the antenna is connected to the antenna input terminals of the tuner. If an external antenna is used, check for physical faults such as bent or broken elements, poor connections, and broken lead-in wire.

Speaker Troubles

Rattles from speaker—First of all, determine whether it's the speaker or the furniture rattling. Check the lamps and window frames for vibrations. If the enclosure is rattling or vibrating internally, it must be taken apart and braced internally. Many times an apparent speaker rattle is caused by faults of the cartridge being used. A cartridge with damping material that has deteriorated or with an off-center stylus can cause bad rattling sounds. A true speaker rattle is a little difficult to discern, and if the above suggestions don't remedy the situation, an experienced audio repairman should be consulted.

Set sounds too shrill or bassy—Try adjusting the tweeter level control on the speaker. Many times a set that "doesn't sound right" is taken care of by readjustment of the various tone controls.

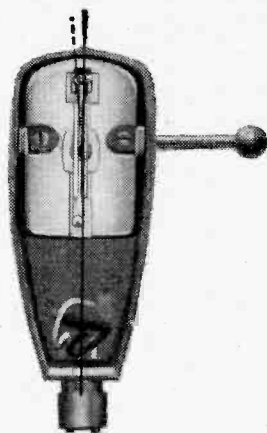

Stylus of General Electric cartridge is off-center and will cause distortion. Always check that the stylus is centered between the pole pieces if you have the GE cartridge and are getting distortion.

REK-O-KUT

leading high fidelity manufacturer... tells you

HOW TO AVOID A COSTLY MISTAKE IN YOUR HIGH FIDELITY SYSTEM

Here are three decisions you must make — wisely — if you are building a high fidelity system.

1. Shall I buy a changer or a turntable? No matter what other components you choose, you cannot hope to achieve high fidelity reproduction unless your records are played on a quality turntable. The eight reasons why this is so are discussed and illustrated in our new colorful booklet offered in the coupon below. Get a copy — you'll find it helpful.

2. Which make turntable shall I choose? Check all the specifications, features and the reputation of every brand. Then listen to a Rondine at your dealer! You'll find that Rek-O-Kut Rondines are unquestionably ahead on every count. For the art of crafting a turntable as enduringly silent as Rondine — is enjoyed by Rek-O-Kut alone — and acquired as the result of being the leading designer and manufacturer of equipment for broadcast studios.

3. Which Rondine model shall I choose? — The Rek-O-Kut Catalog tells you how to select the Rondine turntable suitable for your particular system. Whether you choose the Rondine, Rondine Deluxe or Rondine Jr. — You can be sure of lasting satisfying performance!

Rondine Jr.—2-speed and custom Rek-O-Kut motor.
\$59.95
Model L-34—33-1/3 & 45 rpm
Model L-37—33-1/3 & 78 rpm



from **\$59.95**

Rondine Deluxe, Model B-12H—3-speed and hysteresis synchronous motor. **\$129.95**

Rondine, Model B-12—3-speed and custom Rek-O-Kut induction motor. **\$84.95**

The famous Rek-O-Kut turntable arm.



12" Arm—\$26.95 16" Arm—\$29.95

The closest approach to free cartridge suspension!... Provides better compliance... finer tracking... and lower resonance than any other tone arm available today! Micrometer gramweight permits adjustment for correct stylus pressure without use of a scale!

Rek-O-Kut bases available in Walnut and Blonde.

THESE AIDS FREE, SEND COUPON!

- Strobe Disc
 Booklet — Turntable or Record Changer... which shall I buy?
 Catalog

REK-O-KUT COMPANY, INC.

38-19 108th Street, Corona 68, New York

Name _____

Address _____

City _____ Zone _____ State _____

make the most of your work... use a high precision **JBL LOUDSPEAKER!**

You will put many hours into learning the fundamentals, and then the fine points of high fidelity. You will spend your time and energy freely in building the very finest sound system you know how. Remember this when choosing your loudspeaker. Get a speaker of the highest precision—one that bears the symbol "JBL"—one that is worthy to demonstrate your own best efforts. JBL precision and advanced design are responsible for JBL efficiency—highest in the world. JBL efficiency gives you the smoothest, cleanest, most realistically lifelike sound you can get.

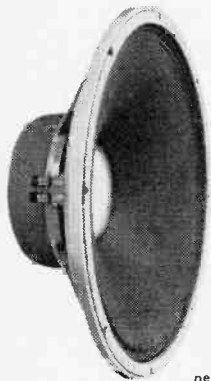
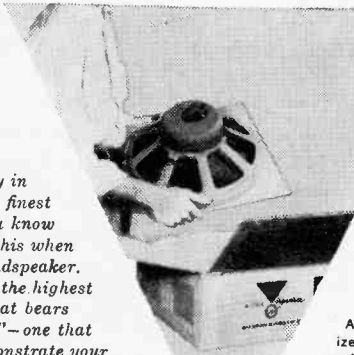

MODEL D130 15" EXTENDED RANGE LOUDSPEAKER

The only speaker of its kind... only one made with a 4" voice coil... only single unit speaker to give you complete, true high fidelity coverage of the entire audio spectrum. Your basic speaker. Use alone at first, later add JBL high frequency unit and dividing network for supreme excellence of JBL 2-way system.

MODEL D123 12" EXTENDED RANGE LOUDSPEAKER

An outstanding value, the D123 at first glance is most unusual because of its shallow structure—only 3 1/2". More unusual is the crisp, clean bass it generates. Listening will develop great respect for the D123's smooth response, excellent handling of transients, and pleasingly lucid highs.

MODEL D208/D216 8" EXTENDED RANGE LOUDSPEAKER

A thrilling piece of miniaturized precision craftsmanship. As perfect in its details as larger JBL units. A true precision transducer in every sense of the term. Properly enclosed, the D208 (eight ohms, D216 is 16 ohm model) gives impressive, rich, full range coverage of audio frequency range.

MODEL 075 HIGH FREQUENCY UNIT

Exciting to behold, the precision-machined 075 embodies a new concept in high frequency reproduction. A ring, rather than a diaphragm, radiates sound energy into the annular throat of an aluminum exponentially tapered horn. Above 2500 cps, 075 sets a new standard for linear reproduction.

MODEL 175DLH HIGH FREQUENCY ASSEMBLY

The finest of high precision drivers designed for 1200 cycle crossover is combined with a machined exponential horn and acoustical lens for optimum sound reproduction in the home. The lens, an exclusive JBL development, acoustically illuminates a 90° solid angle with equal intensity regardless of frequency.



Only a few of the many precision JBL products are shown on this page. Whatever your needs, you will find exactly the right system or unit for you in the complete, free JBL Signature catalog. Send for your free copy. A limited number of technical bulletins are also available. Please ask only for those in which you are vitally interested.

Please send me the following:
 Free Catalog of JBL Signature Products
 Name and address of Authorized JBL Signature Audio Specialist in my community

TECHNICAL BULLETINS ON:
 D130 D123 D208
 175DLH 075

NAME _____

ADDRESS _____

CITY _____ ZONE _____ STATE _____

MODEL 086 KIT DF PROFESSIONAL CDMPONENTS

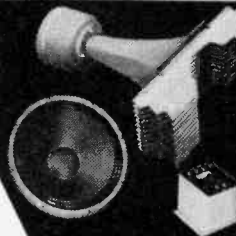

The finest speaker complement made. Designed for theaters, used in the Hartsfield, available for other applications to industry and the serious high fidelity enthusiast.

"JBL" means **JAMES B. LANSING SOUND, INC.** 3249 Casitas Avenue, Los Angeles 39, California

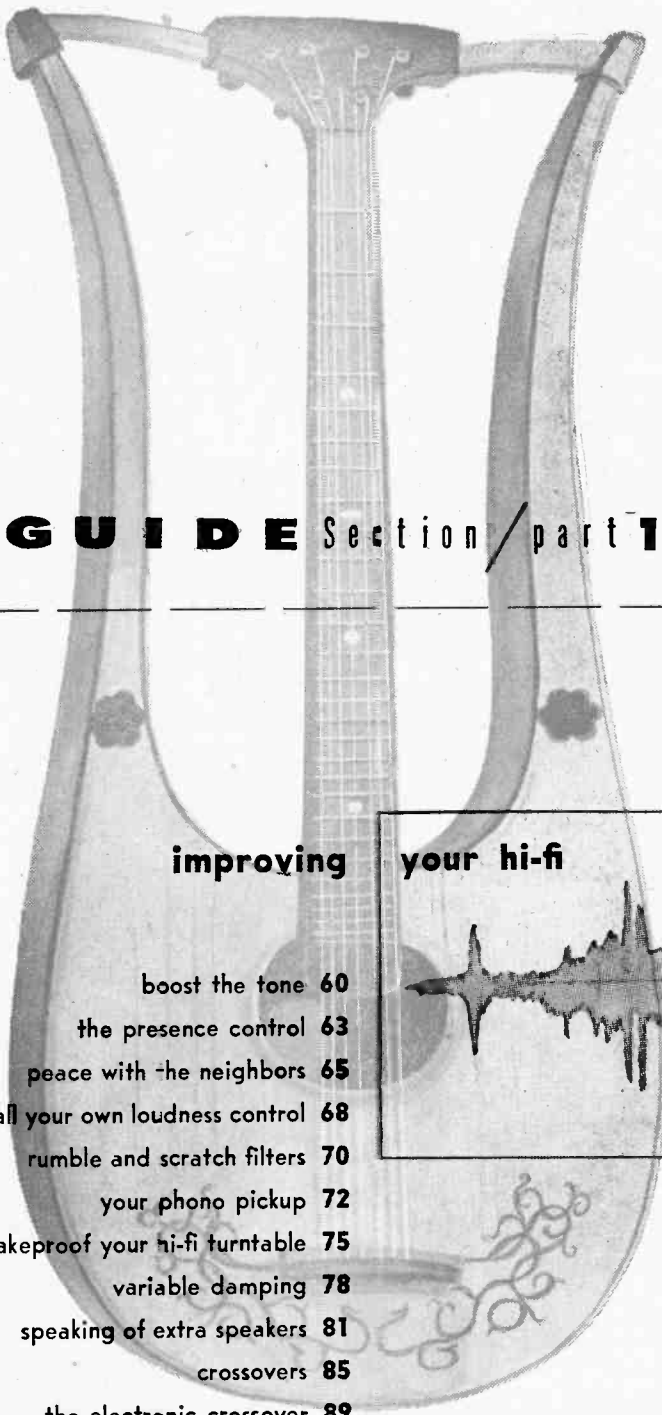

GUIDE Section / part 1

improving your hi-fi

- boost the tone 60
- the presence control 63
- peace with the neighbors 65
- install your own loudness control 68
- rumble and scratch filters 70
- your phono pickup 72
- shakeproof your hi-fi turntable 75
- variable damping 78
- speaking of extra speakers 81
- crossovers 85
- the electronic crossover 89

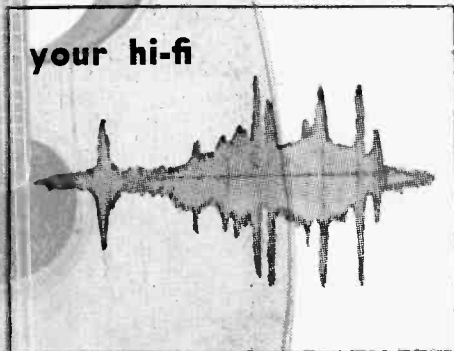

boost the tone

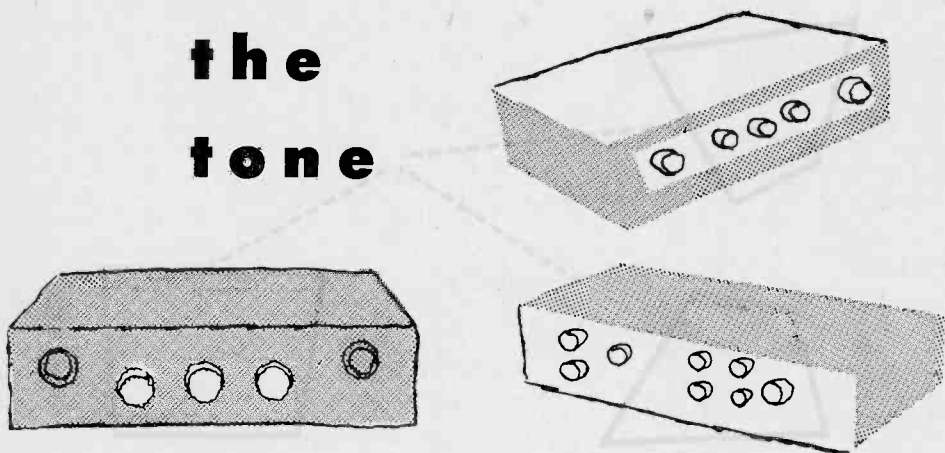

by *leon fields*

Tone controls can match the output of your hi-fi
to room acoustics and to your listening tastes

ANYONE WHO HAS ever read a set of specifications describing a hi-fi amplifier has, at one time or another, done a double-take when confronted with the following typical statements: (1) the amplifier is flat from 20 cps to 30,000 cps \pm 0.1 db, and (2) separate bass and treble controls provide as much as 20 db of boost or attenuation at low and high frequencies respectively.

"Why," inquires the hi-fi'er, "does the manufacturer go to such lengths to achieve uniform amplifier response, only to allow the 'uneducated' customer to upset it by the use of tone controls? Aren't we defeating the whole concept of high fidelity by incorporating these 'continuously variable amplitude-distorting' knobs?"

The question is a legitimate one and must be answered. After all, high fidelity does mean "faithfulness of reproduction," and it is highly doubtful that the first bassoon player of the Philharmonic Symphony has a "bass-boost" knob on his instrument. Your amplifier does have one, and a treble control as well. And they're designed for your use. More than mere gadgets, they can serve you well in increasing your hi-fi enjoyment.

"Mellow Like a Cello"

The history and development of tone controls parallels the changing public taste for reproduced music. It also follows the fidelity and flexibility of music that is broadcast and recorded. Early "tone controls" in the better console radios consisted generally of a simple treble-cut adjustment.

Turning the control knob of such a circuit may give the illusion of scaling from the depth of bass to the heights of treble, but to the ear trained to appreciate live music or initiated in the wide range afforded by hi-fi reproduction, such a "tone control" is practically worthless. At its best, it provides a limited kind of treble attenuation—and absolutely no bass boost. Used originally in radio receivers that were decidedly "un-hi-fi," its action was inherently limited to the relatively thin audio produced by such sets. Cutting the highs is not a real way of getting better bass.

Nevertheless, such a control could often be used to bring into balance the over-all

audio spectrum. This balance, often disregarded in the broadcast studio and completely unstandardized in the record industry until recent years, had to be achieved somehow in the home listening situation. Then, too, up to the advent of hi-fi, a great many people preferred so-called "mellow music."

Muted trombones and alto saxophones seemed to have had the most say in pre-war popular music. And in "classical" music, cellos whose overtones were clipped off and tympani with an anonymous thud but no "bite" filled the air in the homes of serious music lovers. An entire generation was weaned on this kind of listening, whose "hangover" effect is still evident in the opinion expressed now and then by newcomers to hi-fi that "it sounds too shrill." As a matter of fact, discounting those who had the opportunity to attend live concerts, relatively few "music lovers"—even those with extensive record collections—ever really knew what a live violin sounded like before the advent of hi-fi.

In such a reproducing and listening context, the simple treble-cut control had a justifiable, if not spectacular, role. There is still valid reason for its use in low-priced AM receivers and in applications where voice communication is the main thing. Despite recent advances in AM broadcasting, this type of transmission is still subject to static interference, especially in remote areas and during electrical storms. Most of the static heard is contained in the high-frequency portion of the audible spectrum. Since AM broadcasting is generally limited to a tonal range well below 10,000 cycles, it would seem pointless to run a sound system "wide-open" only to allow annoying noise and static to get through with no particular improvement in program content.

A second justification for treble cut lies in the fact that tastes in living room decor differ considerably. A relatively bare-walled, hard-floored "live" room seems to have more treble bouncing around than does a thickly carpeted, heavily draped room. In the former, the treble tones may sound too exaggerated despite the fact that the electronic system itself has perfectly flat response. In such a situation, cutting the treble by means of a convenient control would certainly be apropos.

Why Bass Boost?

FM broadcasting and LP records and the better equipment to go along with these recent program sources have brought the highs into the living room—sometimes with a vengeance. Usually, a hi-fi enthusiast passes through two initial stages upon being exposed to the new medium. First, he may be impressed by the presence of high frequencies in the reproduced sound. Violins, flutes, piccolos and brass choirs take on a new crispness and clarity of tone. Certain notes, like those struck on the triangle, may be heard for the first time. Everything is articulated more clearly and distinctly. The highs have been discovered!

Some time later, the listener reaches a more advanced state of aural sophistication in which he realizes that something is wrong—the bass tones aren't all there! After checking all the components of the system and re-reading their specifications, the

Separate treble and bass tone controls are standard items on hi-fi equipment and are indispensable to maximum enjoyment of hi-fi. They may be found on any of three types of components, representative examples of which are shown here. At upper right is the Lafayette Radio "LA-40" 15 watt amplifier containing a preamplifier and power amplifier on one chassis. Below left is the Newcomb "Compact Royal 712", a combined tuner, preamp and amplifier. Below right is the Eico "HF-61" control preamplifier which contains level and tone controls, input selector and rumble and scratch filters. Control-preamplifiers are usually used with separate power amplifiers.



listener concludes that either the components manufacturers are making overly extravagant claims or that he, the listener, isn't hearing right.

In this case, the latter conclusion happens to be true. He *isn't* hearing right! It's a fact that human hearing does not respond uniformly to all tones at all levels. To put it another way: if you listen to a live concert, your ears respond in a certain manner to all the sound heard. If you play a recording of that concert in your living room at reduced volume, the low tones will seem to be reduced *more* than the middle and high frequency tones.

To restore the music to its relative tonal balance at high settings of the volume control (where we are closer to the original "loudness level" of the live sound), the circuit provides no bass boost action. As the volume control is lowered, the circuit may be used to increase the level of bass tones.

Knobs and More Knobs

Often, in listening situations, tone control may be required which has the opposite effect of that just discussed. We might need a means of reducing bass and boosting treble. Bass attenuation may be desirable, for example, in a multiple speaker system in which the woofer is more efficient than the other elements of the system. Treble boost, on the other hand, might be needed to some degree because at the extreme high end of the audible spectrum human hearing undergoes somewhat the same deterioration that is experienced with low frequencies at subdued listening levels (though to a lesser degree as a rule). Treble boost might also be required to add highs for tonal balance in a relatively "dead" room. This, of course, is largely a matter of personal preference, the kind of thing that could require different control settings to suit different moods as well as room acoustics.

Then, too, components other than the amplifier may not have perfectly flat responses. It is by no means an insult to a phono pickup to say that it is "down 3 db at 15,000 cps." Neither can a speaker be deemed inferior because its response curve "drops several db below 50 cycles." A small amount of treble and bass boost respectively can restore the entire system to virtually flat response.

Offhand, it would seem that two more knobs would be required, winding up with a total of four tone controls: bass boost, bass cut, treble boost, and treble cut. Thanks to the ingenuity of hi-fi designers, the number of controls has been held to two—which provide all the tonal adjustment required. "Continuously variable" controls—one for bass cut and boost, the other for treble cut and boost—are now the rule in hi-fi amplifiers. Given a pair of such controls, the listener becomes a virtual conductor of his own orchestra, and can add such coloration and emphasis (or de-emphasis) as he deems necessary for over-all tonal balance.

Generally accepted procedure for correct use of tone controls is to start by leaving them in the "flat" or uniform response position. This is usually the center position on the knob. As the listener becomes more perceptive, and more sensitive to the peculiar aspects of his own listening area, he may find that moderate amounts of boost or cut may be used until the system sounds "just right." Cranking up both treble and bass controls as far as they will go proves nothing about the fidelity of the system and generally results in jarred nerves.

Baxandall Tone Controls

While great flexibility and range of control is afforded by the system just described, it has what many consider a slight drawback. The point in the frequency spectrum at which boost or attenuation begins is always approximately the same, about 800 cps. Thus, if 6 to 8 db of boost is really needed at 50 cycles to bring a particular speaker system into line, it can only be achieved by including about 3 db of boost at 300 cps. But no boost at all is really desired at 300 cps—it would lend a boomy quality to the sound, particularly to male voices.

This difficulty is overcome by a recent type of universal tone control system which uses feedback. Both boost and attenuation, as well as the point at which these effects begin, are made completely variable, depending on the control setting. For this reason, it is known as a "variable crossover" tone control, as well as by the name of its designer, P. J. Baxandall. This type of control system is considered by many to provide more pleasing results and flexibility. As a result, it has gained favor with many manufacturers in recent years. The prospective buyer should try the action and listen to the results of the various systems. Don't ignore tone controls and the importance of using them correctly. The proper use of tone controls can pay off in years of pleasurable listening.

the presence control



by leonard feldman

EVER NOTICE how the soloist seems to “stand right up front” in some pop records? The soloist isn’t *louder* than the orchestra, yet the three-dimensional feeling prevails—the singer almost seems to be “present” in your living room. Part of this effect is achieved by microphone placement during the recording session. But there’s another—even more important—engineering gimmick sometimes used to achieve the feeling of “presence.”

The sound we hear spans a musical range of about nine octaves or, to put it in hi-fi terms, a frequency range from about 20 cps to 15,000 cps. That includes everything from the big bass drum to the shrill notes of the piccolo. The human vocal range, however, comprises just the *central portion* of that over-all range. What’s more, the tones which help us “place” the sound lie mostly between 2000 and 5000 cps. They’re the tones that add crispness to human speech and to solo instruments such as the violin. A radio playing in the next room or apartment sounds dull because these very same frequencies aren’t “getting through” the intervening walls.

Recording engineers get that elusive quality of presence by boosting mid-range frequencies above the level of high and low frequencies. In other words, a deliberate “bump” is inserted electronically so that all tones contained in the region from about 1000 to 5000 cps are accentuated to a small degree. The effect has to be used in moderation. To overdo it would create a noticeable unbalance in the over-all recording.

In recording studios, special consoles costing hundreds of dollars are required to do this job, and not every studio does this type of frequency “bumping.”

You can achieve very much the same results in your hi-fi setup. The presence effect can be achieved by loudspeaker manipulation, or by electronic control. Let’s take the speaker method first.

In a three-way speaker system, the woofer usually handles frequencies below 600-800 cps. The mid-range speaker takes over from about 600 to 4000 cps, and the tweeter carries on from there. Normally, the three elements are arranged so that

they produce *equal* sound in their respective frequency regions. Furthermore, the crossover networks associated with the speakers are arranged so that as one element starts to "give up," the next one starts to "give out."

The result is flat or uniform response over the whole audible range of tones. Now, if you could readily increase the output of the mid-range speaker without affecting the output of the other two elements, or if you could decrease the sound output from the other two and leave the mid-range output unchanged, you'd be emphasizing just those frequencies which create the presence effect that helps make a soloist "stand out."

Speaker Level Controls. All you need to add this flexibility to your system are three speaker level controls, known as L-Pads. The L-Pad controls volume at the speaker (see diagram given below). Individual L-Pads may be connected at each speaker in the three-way system. As a first trial, set the woofer pad and tweeter pads about halfway counterclockwise from the maximum volume setting. Listen to some program material containing either a vocalist or an instrument solo and rotate the mid-range speaker pad from halfway to fully clockwise. Notice how the soloist seems to take on a prominent position in the over-all sound picture. If you end up with the mid-range control fully clockwise, the total response of your system will be a very close approximation of the "presence bump" used by some recording companies.

Of course, you can vary the effect to suit your taste by experimenting with the pads until you find the over-all balance which pleases you most. Remember that woofer and tweeter pads should be turned up about halfway. Then the mid-range pad is played against the other two for the most natural, lifelike effect.

Electronic Presence Control. Nearly two years ago, the Electro-Voice Company of Buchanan, Mich., designed a circuit into its Model PC-1 "Music Control Center," which accomplishes the same presence effect electronically. This control is part of the preamp circuitry. The E-V engineers, after considerable experimentation, decided that the optimum frequency of the "bump" should be centered at about 4500 cps and that the control should vary from totally flat response to a maximum of 10 decibels of boost at the presence frequency. The amount of presence effect is continuously variable depending upon the setting of a variable resistor.

If you already have a preamplifier not equipped with a presence control, you can incorporate a similar control into your system by building the "outboard" presence control described in the article starting on the next page. This control requires no power supply and can be "patched in" directly between your preamplifier and power amplifier without even removing a screw from either of your present units.

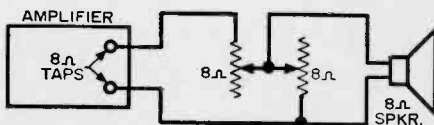

L-Pad, inserted between amplifier and speaker, can serve as level control to regulate output from speaker. Used in three-way speaker system, such controls can provide presence effect.

Graph shows response curve of three-way speaker system in which L-Pads are used to regulate the output from each reproducing unit. Mid-range unit provides presence.

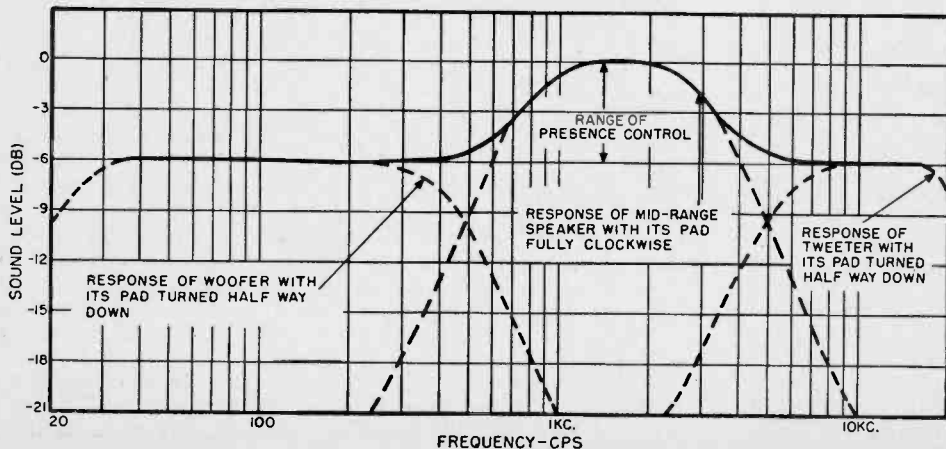

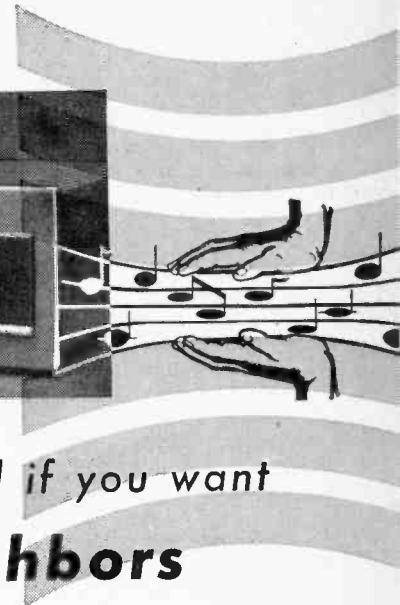
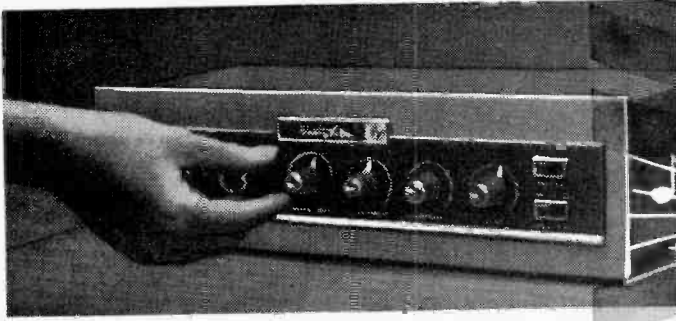

reach for the loudness control if you want **peace with the neighbors**

"HI-FI IS SWELL, but why do you have to play it so loud?"

This used to be a common—and fairly legitimate—complaint regarding the listening level of most hi-fi enthusiasts. Playing the system "wide open" was necessary to hear the entire frequency spectrum. It is a fact that our hearing falls off at the high and low ends of the audio band. In other words, it is actually harder for us to hear lows and highs than it is for us to hear the mid-range, assuming the same sound intensity throughout the frequency range.

A simple way of illustrating this fact is to ask a hi-fi owner to demonstrate the response of his system. Out comes an audio oscillator, test record, and scope or meter. Then follows a series of tonal grunts and squeals which, you are told, comprise the entire audible spectrum from "practically" zero cycles all the way to supersonic "dog" frequencies. All the while, the indicating device hooked across the loudspeaker terminals remains motionless, indicating that the response of the electronic part of the system is, indeed, flat within the prescribed limits of a high-quality sound-reproducing system.

It is quite obvious during such a test that not all the tones *sound* equally loud to you, the listener. The low notes may sound faint; the very high tones seem somewhat less intense than the middle frequencies.

Keeping the correct tonal balance at all volume levels is the job of the loudness control. Above, the Electro-Voice PC-1 preamp uses a stepped control for differing degrees of compensation. Right, the McIntosh C-3 audio control has an "aural balance" switch which permits five positions of loudness compensation. The Sherwood S-100011, a combined preamp and 36-watt amplifier, uses a simple combination loudness-volume control.

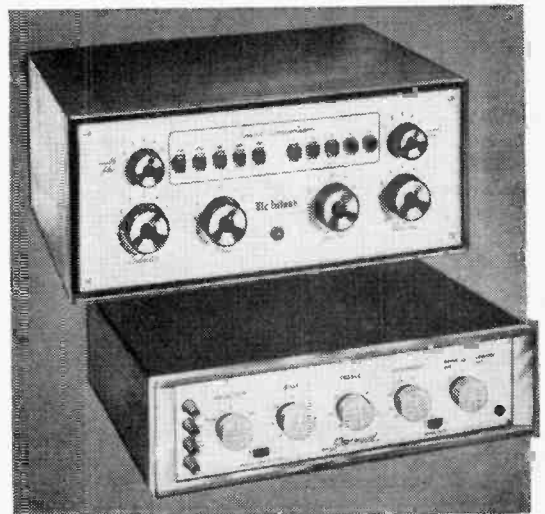

These audibility effects were investigated in detail by Harvey Fletcher and W. A. Munson in 1933—some time before high-quality sound invaded the living room. The curves in Fig. 1 summarize their intensive research and are now popularly referred to as the Fletcher-Munson curves. They point out what you have suspected all along—that human hearing response is anything but “flat.” In fact, if you saw curves such as these on a commercial amplifier, you wouldn’t even bother to give it a listening test.

At this point you’re probably ready to pounce upon the author with the following questions: “So what if we don’t hear all tones equally loud? After all, that’s how we’re used to hearing sounds, that’s how we hear live sounds in the first place. It wouldn’t be right to ‘doctor up’ our hi-fi systems by introducing ‘unnatural’ tone compensation gimmicks, would it?” Therein lies the whole argument for and against “loudness controls.”

If we listened to *all* recorded music at exactly the same level at which it was recorded (or, in other words, placed ourselves in the same hearing position that the microphone occupied during recording), the argument would cease to exist. Unfortunately (or fortunately for our neighbors in the next apartment), it is rarely possible to play a recording of a full symphony orchestra at such a level. First, the room in which you listen at home is considerably smaller than a symphony concert hall. Secondly, there are times when you may want the music as background to other activities, in which case extremely *low* level is desirable.

Why a Loudness Control?

Let’s take a detailed look at Fig. 2. Suppose the average level of a symphony orchestra corresponded to 80 decibels as heard from a good center-orchestra seat. The frequency response of your hearing mechanism is as shown in Fig. 2. Notice that at 50 cycles your “mental amplifier” is down about six decibels. Of course, while you are sitting at the concert, this fact makes no difference at all because that’s the way music has *always* sounded at this particular level.

Suppose you enjoy a particular selection and rush right out to the record shop after the concert to purchase the piece. You place it on the record changer, adjust the volume control and settle down for a repeat performance—with one major exception. That volume control was adjusted to play back the selection at an average level of only 50 db, because it is now late in the evening and everyone else but you is asleep. At this level, your hearing has a response characteristic like that shown dotted in Fig. 2. You will note that the response at 50 cycles is now down some 25 db, or about 50 db *lower* than during the actual performance (three-eighths as loud to your ear).

Other low and high notes are similarly displaced in relation to their original “live” intensity. This effect is pretty apparent even to the inexperienced listener. All you have to do is vary your volume control from fairly loud level to quiet “background level” and notice what seems to happen to the bass tones. They all but disappear.

There are two good reasons why ordinary tone controls aren’t adequate to compensate for these effects. In the first place, you can never be sure *how much* to compensate or boost the controls unless you have some absolute reference. Secondly, the amount of required correction at the “low frequency” end is often very great. If you were to boost the bass by the required amount—using your bass tone control—you wouldn’t have much “bass boost” left with which to compensate for *other* deficiencies in the system, such as acoustics of the room, speaker enclosure, etc. However, the loudness control takes care of these needs conveniently and simply—and you don’t have to be a mathematician to use it properly.

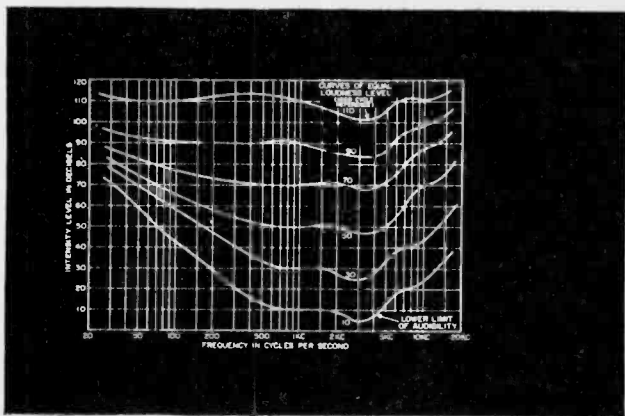

Fig. 1. Chart illustrating the human ear's increasing loss of sensitivity to both the high and low frequency ranges when the volume level decreases.

How It Works.

All commercially designed loudness controls are basically the same as tone control circuits, except that the amount of boost of both treble and bass tones is automatically adjusted as the volume control is varied. From the explanation of our hearing process given above, it follows that *the louder the music you're listening to, the less correction you need.*

And that's exactly how one popular form of loudness control works. If the control is at maximum (highest volume), the response of the circuit remains flat. As the control is rotated to decrease the volume level, more and more compensation is introduced.

Some controls apply correction at both low and high frequencies, while others only compensate for the more serious bass region deficiency. In either case, there is one more requirement for setting up the control to work properly. Somewhere else in the system there should be another common level or volume control. It may be on the same amplifier, at the input jack to the amplifier, on the tuner chassis (if it contains the preamplifier and selector switch of the system), or on a separate preamplifier-circuit unit.

Using the Control.

In setting up a loudness control to work properly, one point should be emphasized. Not all people have exactly the same hearing response. In fact, the Fletcher-Munson curves are actually *average* results of hearing tests given to hundreds of people. Therefore, the instructions to follow are, at best, an approximation. Slight variations in preference are to be expected in individual cases.

Start by rotating the loudness control to maximum. The volume control in the system should then be increased gradually from minimum, causing the music to sound louder and louder until, in your judgment, it is as loud as it would be if you were sitting in a choice orchestra seat at a concert. (This is a lot louder than you would at first believe.

Think back on the last concert you attended—or better still, attend another one with these thoughts in mind!) Now, reduce the volume to a comfortable "living-room listening level" by means of the loudness control, leaving the original volume control permanently set.

Regardless of how high or how low you set the loudness control, the correct amount of tonal compensation will take place automatically, lending realism never before possible at all listening levels. It would be ideal if that's all there was to it, but not all recordings are made with the same average amplitude. Thus, it may be necessary to repeat this process for different types of music and for particular recordings.

For example, a piano recording may often be heard as loudly as it was played during the original performance. In such a case, no compensation would be necessary. That would mean that the loudness control should be set at maximum, and

and adjusting of room listening level would then be done with the volume control.

Some commercial loudness controls have a switch with which the compensation effects can be turned off at will. Still others go a step further and provide as many as six so-called "contour" positions on a switch, for those people who don't happen to have the same hearing as Mr. Fletcher and Mr. Munson's "listeners."

These refinements are handy, but not essential, because it's always possible by working back and forth between the loudness control and volume control to set up conditions that suit your ears perfectly.

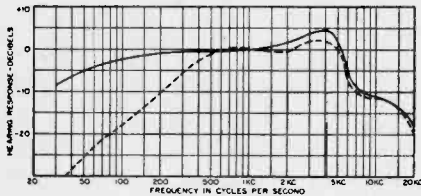
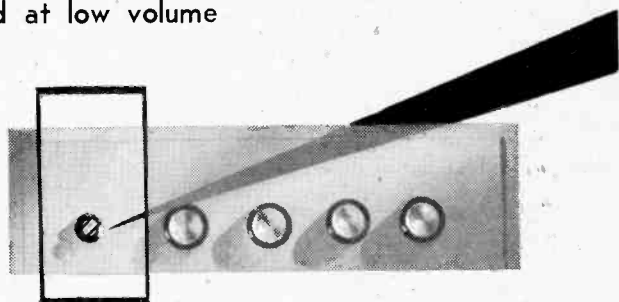

Fig. 2. Solid line is frequency response of the ear at 80 db level (full orchestra). Dotted line is the response of the ear at 50 db level.

install
your own
loudness control

Easily assembled kit added to amplifier gives
hi-fi sound at low volume



OUR EARS often play tricks with frequency response—particularly at low listening levels. They seem to hear middle frequencies better than they do bass tones or—to a lesser extent—very high pitched tones. Therefore, some tonal compensation is needed to restore an over-all balance to music reproduced by a sound system. A loudness control provides this compensation automatically, and makes it possible to enjoy wide-range reproduction at relatively low listening levels.

Amplifiers not equipped with such a control can be fitted with one quite readily. A loudness control in kit form—Model 02-200 “Compentrol”—is made by the *Centralab Company* of Milwaukee, Wisconsin. Included in the kit are all the parts needed for assembling one’s own loudness control. This kit costs \$4.75 and is carried by most electronic parts dealers.

The loudness control replaces the regular volume control. Before making the change, however, determine whether or not the regular volume control also serves as the power “on-off” switch. If it does, you will need one more part—*Centralab* “Fastatch” switch, Model KB-1, which costs an additional 50 cents. If your power “on-off” switch is separate and not part of your volume control, KB-1 will not be required.

Making the Change

Exact wiring and assembly instructions are furnished with the kit. Here are a few hints for assuring best results. For example, when you disconnect the old volume control, the leads wired to it should be left in their same relative positions, or labeled to facilitate reconnecting them to their proper terminals on the Compentrol.

Note also that three printed-circuit plates are supplied. One provides bass compensation and is the mainstay of the loudness control. The other two (PC-60 and PC-61) provide varying amounts of treble boost and you should use the one that best suits your tastes and needs. If your system has always been somewhat deficient in highs, try PC-61; this unit provides more treble boost than PC-60 does. On the other hand, if you have a multiple speaker system with separate tweeter, you’re more apt to find that PC-60 is just right for your system (less treble correction). Another thing—you can always clip one of these two printed-circuit plates out and substitute the other—or a simple direct wire if you feel you need no treble correction.

The shafts supplied with the kit are oversized, to permit trimming them down to

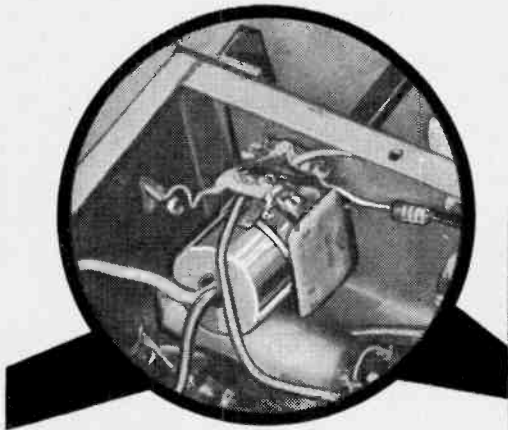

The control is mounted behind the front panel as shown above. This particular installation contains an on-off switch on the unit. The various parts included in the kit are shown on the right.

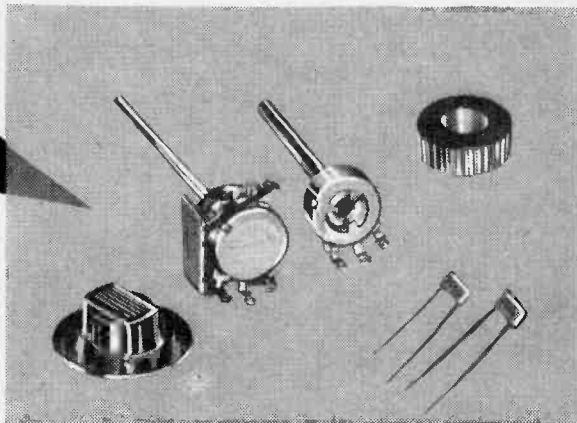
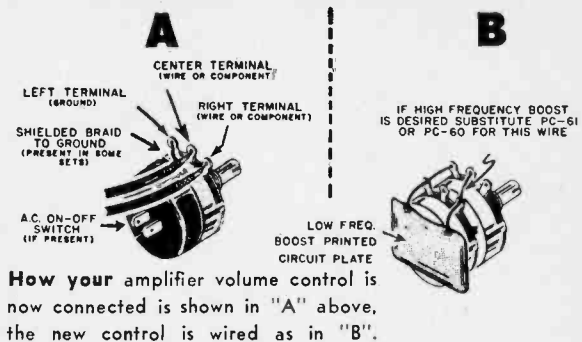

any required length for neat and proper mounting. A simple hacksaw will cut these shafts effectively.

The Compentrol is a dual control and requires two concentrically fitted knobs. These are supplied with the kit. If you find that their appearance conflicts with other knobs on your equipment, you may be able to get a set of dual knobs that match the other knobs. Another alternative is to get an entirely new set of knobs for all controls on your set. Most parts jobbers stock a wide variety of control knobs for you to choose from. In any case, the audible improvement in the system's sound will far outweigh any "knob problems."

Using the Control

Probably the nicest thing about the loudness control is that you can set it up to suit your own personal listening tastes. As a rule, once set up, it needs no further adjustment and can then be used as if it were a volume control. It is important, therefore, to make the following adjustments exactly as outlined.

Turn the small knob fully clockwise. With music (preferably full orchestra) as the program source, gradually turn the rear (larger) knob clockwise until what you hear is as loud as you would ever want it to be. Now, to lower the volume to more reasonable "living-room" proportions, use only the forward (small) knob which—from now on—is the only knob with which you need be concerned.

If, for some reason, you should want to cancel the compensating effects of the loudness control even at low volume settings (as, for example, when listening to a speaking voice or a normally soft solo instrument), simply turn the forward knob fully clockwise and work with the rear knob as your level control. When this is done, no compensation is afforded, and conventional volume control action is restored.

It will probably take you a while to get ideal settings of the two knobs to suit all listening conditions. The dots on the knobs are for convenience in noting what optimum settings you finally arrive at for different types of program material. You may want to make a list of these settings, as for example: "Symphony Orchestra, rear knob 3 o'clock, forward knob 12 o'clock," etc. With a little patience, this new control can provide a flexible means of bringing you closer to the hi-fi goal of lifelike reproduction of music in your home.

rumble and scratch filters

noises from records
can be reduced by
sharp cutoff filters



In addition to bass and treble controls, the Scott 121-C preamp-control unit features continuously variable dynamic noise suppression for both rumble and scratch, plus independent subsonic filter.

A FRIEND heard that we had a hi-fi system second to none, and decided to bring over some of his old, treasured 78-rpm records. He had been told that hi-fi could practically bring Caruso back to life. We started one of the ancient discs, and there followed a combination hiss-static effect that all but masked the great tenor's tones. "If that's hi-fi," said our friend, "I'm going back to my old model phonograph. I never heard any of that noise before!"

Those who have tried to play old records on new hi-fi systems have probably had a similar experience. The reason for it is simple. High fidelity, with its wide frequency response, does bring out the brilliance of high-pitched musical tones. But—at the same time—it reproduces record surface noise much more than a limited frequency range or "lo-fi" phono ever did. And there is plenty of noise on the older shellac recordings—caused by the manner in which they were made, the material of which they were made, and the type of heavy and often blunted pickups which were employed previously to play the records.

Still, many listeners own quite a collection of such discs. The question facing them is how to hear the music on those records but not the accompanying noise.

What Is Scratch?

What we call "scratch" is not a single tone, but a mixture of tones of varying intensity and pitch. The only sure thing about "scratch" is that it consists mostly of high frequencies. Hi-fi equipment, noted for its ability to reproduce musical overtones, will reproduce the high-frequency noise spectrum as well.

Now, at the other end of the frequency band are the low-frequency noises, caused chiefly by rumble from an imperfect record changer. In "lo-fi" systems using less expensive amplifiers, this rumble may go unnoticed because the amplifier and/or speaker is incapable of reproducing it. With better equipment, however, the rumble becomes a nuisance, especially during quieter passages of music.

Even when the rumble is so low-pitched that you can't hear it, it can still add distortion to the music. The speaker cone may vibrate very slowly, due to the rumble signal, while the regular program material is being superimposed on it. As a result, certain musical notes are reproduced by a distended speaker cone, causing subtle distortion which can give rise to "listener fatigue."

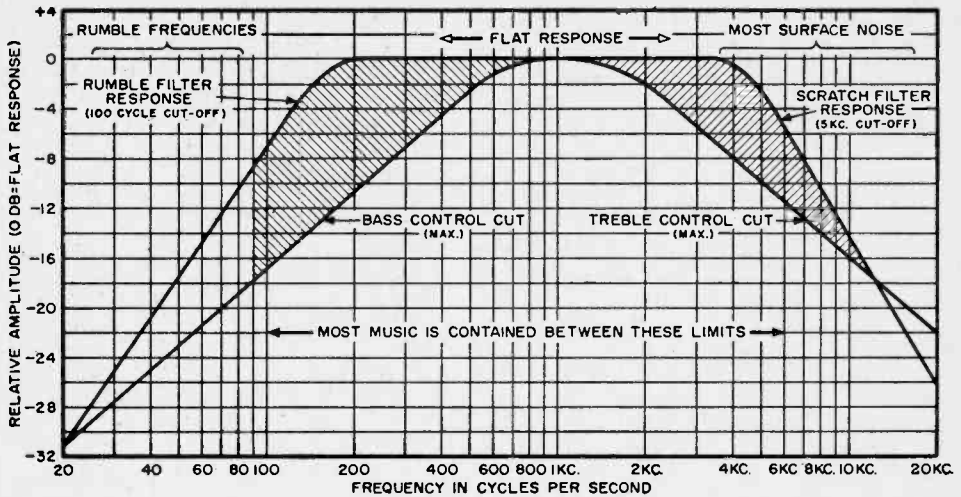

Graph shows comparison between the action of tone controls and that of properly designed filters for reducing noise caused by scratch and rumble. Note how much useful program material (represented by shaded areas) is lost when using tone controls for this purpose.

Tone Controls and Noise.

Ideally, it would be nice if we could filter out the noises without filtering out any of the music along with them. Practically, this is not possible. Although we can design circuits to get rid of any frequency or group of frequencies, those circuits have no way of knowing whether they are blocking out musical tones or extraneous scratch and rumble.

Nearly all tone controls have a slow rate of attenuation. In other words, to get a substantial decrease in intensity of tones at around 10,000 cycles, the control is so arranged that some decrease of intensity is already taking place at frequencies as low as 1000 or 2000 cycles. This is an ideal arrangement where tone controls are being used to compensate for the differences in room furnishing, loudspeakers, etc., for anything other than a gradual change of response would sound artificial. But when surface noise is the problem, tone controls just don't act as "steeply" as they should.

The same situation applies to the bass tone control which might, at first glance, seem like the way to combat turntable rumble. Again, the rumble will be eliminated or reduced, but so will the sonorous tones of the bass fiddles and the thundering crash of the kettle drums.

Filters Cut Sharply.

There are two basic differences between filters and tone controls. The former circuits have relatively flat or uniform response up to a given frequency, known as the cutoff point in the case of low-frequency rumble filters. As a result, *most* of the program content (which occupies the middle frequencies primarily) is retained in its entirety, while the extremely high noise and low rumble frequencies are rapidly and substantially blocked out. The graph illustrates the expected action of a pair of filters and illustrates how much program content would be lost if the same thing were attempted using conventional tone controls.

Actually, in the case of old 78-rpm recordings, there was very little program content above 5000 cycles in the first place, so practically nothing is lost by introducing such filters except the scratch itself.

Commercial record scratch filters usually have three or more settings (including a "flat response" setting). This means that the new, better grade recordings can be played "wide open," while older discs can be reproduced with just a slight amount of filtering to remove that edge of hiss. The very old "collector's items" can be played with maximum filtering to cut out all the old scratch and noise.

Similarly, rumble filters have several settings to take care of different degrees of rumble. The idea is to use the least amount of filtering necessary for pleasant reproduction in both cases.

your phono pickup

make it a strong link

by **hans h. fantel**

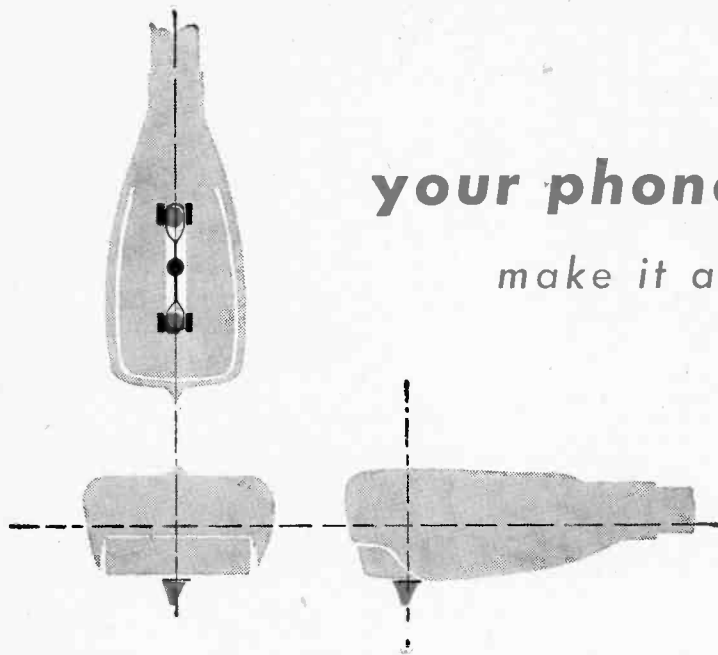

MANY ELECTRONIC SYSTEMS start with a mechanical action. Such is the case with hi-fi. The phono pickup must shiver and shake its way through the tortuous trail on the disc with as much accuracy as a train on its tracks—too much swing and the crash is deafening! There is tremendous pressure on the stylus to develop mechanical troubles and when it does succumb, it often takes a good record with it. You can keep it on the groove by applying some first aid in time to prevent costly damage to your record collection.

In fuzzy phonographs, you can usually trace trouble right to the source: the record or the stylus. Nothing can be done about worn and noisy records, except to expound what an ounce of prevention is worth where care is the only cure. But for the stylus there are several handy remedies. Styli can suffer five kinds of infirmity: (1) old age; (2) disorientation; (3) overweight; (4) arthritis and (5) plain dirt.

Old Age

Old age simply shows up as wear around the edges. Hard work in the groove gradually grinds down the youthful smoothness of your stylus until its face falls into sharp crags. The old stylus then takes savage revenge on the records that led it such a strenuous life by biting into them whenever they go for a spin and try to get another wiggle out of the old jewel.

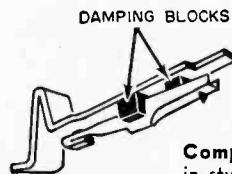

Compliance of damping blocks in stylus assembly (left) can be roughly checked by thumb-nail test shown above.

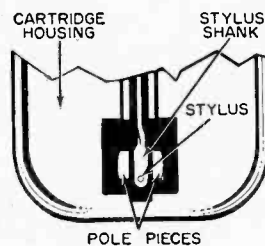
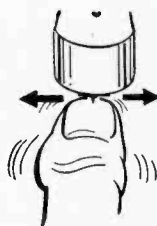

Stylus shank on G.E. cartridge must be exactly centered between pole pieces.

Of course, old age is always a fatal ailment. In this case, it is best diagnosed under the microscope, where the sharp lines in the formerly round stylus face show up clearly under sideways light. If you haven't got a microscope, your hi-fi dealer has, and he'll gladly let you see for yourself (and without charge) the ravages of time.

Such inspection tells you when to replace the worn stylus. As a rule, sapphires last 40-50 playing hours. Diamonds keep up the whirl for about 1-2 years.

Yet if you have friends, relatives, children or dogs within reach of your phonograph it's a good idea to check more often. Any one of them might have dropped the pickup on the turntable when you weren't looking, splitting a chunk right out of that precious point. You may never suspect this catastrophe until you look at your needle in the microscope and see something like an utterly abandoned quarry. Meanwhile, your records are reamed by a chisel edge. For this reason alone, a periodic peek is a good idea.

Disorientation

Disorientation in styli is a simple case of being off center and out of line. For instance, in the popular *G.E.* magnetic cartridge, the stylus must nestle exactly halfway between the two magnet poles so that equal swings to either side produce equivalent signals. Otherwise, one half of

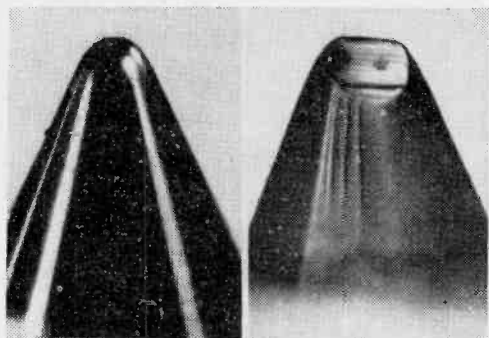

Most hi-fi shops use a microscope to distinguish smooth stylus (left) from battle-scarred ruin (right). Check your stylus to protect your favorite records.

the sound wave "outshouts" the other—and your ears lose the argument.

Sometimes the metal piece holding the stylus is bent so far out of shape that the stylus hits the pole piece on a wide swing. The weird acoustic results of such miniature "crashes" occurring at the rate of thousands per second can give you a real—not at all metaphoric—headache. Plastic surgery quickly sets things aright; a gentle nudge on the delicate stylus suspension usually brings the stylus back into the center of the gap, where it belongs. It's always a good idea to remove the stylus assembly before this operation.

Just as important as lateral centering of the stylus in a *G.E.* type cartridge is its vertical alignment. By this we simply mean that the stylus must come straight

down on the record; its center axis must be downright plumb. If it leans over to one side, it will wear that side of the groove faster than the other and pick up an unsymmetrical signal. The fault of such vertical slanting may be in the tone arm or in the stylus suspension itself. In the latter case, remove the stylus, and gently correct the bend in the metal strip holding the jewel point. If the stylus is non-removable, this adjustment must be made at the factory. *Never* twist a stylus permanently attached to the pickup mechanism (e.g., in a moving coil pickup). This would certainly ruin the entire delicate assembly.

Overweight

Overweight is a real killer. The time of life runs out fast on stylus and record alike if excess weight bears down on them. Of course, if you have a professional-type counterbalanced tone arm, you can quit worrying. Once adjusted, the pressure stays put.

Yet in spring-loaded tone arms, the spring gradually tires and pulls less strongly against the weight of the arm. The arm then rests more heavily on the stylus. But fortunately, most of these arms have a spring tension adjustment where a few turns of the screw make up for the gradual weakening of the spring. A quick check every few months with a stylus pressure gauge will let you keep the tone arm weight near its optimum. For most popular hi-fi cartridges, it should be 4-7 grams, while 2-3 grams suffice for professional pickups.

Arthritis

Arthritis, manifest in a certain stiffness of joints, comes naturally to aged pickups. After years of strenuous ups and downs and musical hi-jinx at every turn, the pickup loses its youthful springiness and can no longer follow the rapid dance of life in a record groove. The little plastic or rubber damping blocks that make stylus movement so easy and supple have hardened with time. No longer able to join the merriment of the fast musical vibrations, the old stylus leaves the accustomed furrow—and as it jumps out of the groove, you jump out of your chair. "Loss of compliance," says the expert after sage consultation.

Fortunately, the disease is rare. In most cases, the stylus itself will wear out before its moorings start to stiffen. And every time you replace the stylus, you automatically get a brand-new set of damping blocks. But if your record player jumps grooves and you know for sure that every-

thing else is all right (your turntable level and your stylus pressure are correct), you may have reason to suspect lack of compliance.

No accurate, sensitive test for compliance is available for home use. To meas-

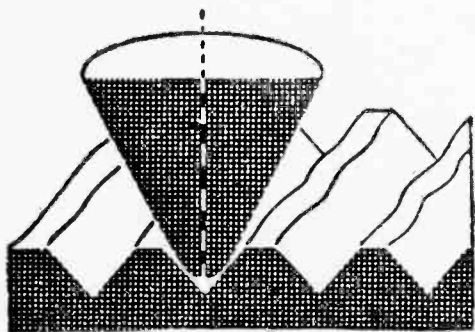

No slant on fidelity. Stylus must sit straight in groove. Check vertical axis.

ure such small forces as affect the sideways motion of a phono pickup takes rather fancy machinery. But you might try this rough "rule of the thumb." Let the stylus rest on the crest of your thumb nail. Then gently wiggle your thumb back and forth a small fraction of an inch—no further than the width of a record groove. If the stylus follows this short motion, chances are that its compliance is all right. It will then follow the undulations of the record groove with equal ease. But if the stylus remains ramrod while your thumb slides under it, ask your dealer about it. He may advise you to replace the stylus assembly, or if you use a moving coil pickup, to send it to the factory for fitting a new stylus.

Dirt

Dirt, plain or otherwise, is as natural to a stylus as to a pig. They just dig it up. Yet while pork is none the worse for it, music is. During the play of a single 12-inch LP side, the stylus literally sweeps up about 2½ miles of groove—the curviest, nookiest dust-catcher you ever saw. Mounting in miniature heaps and forming pin-head balls around the stylus shank, the

caked dirt clogs the free motion of the stylus. Besides, the magnet poles always seem to find some metal filings to clasp to their bosoms. Result: distortion and muffling of the highs.

Again the home remedy is simple and effective. During your regular "head examination," just pry loose these little pads of dirt. Do it gently with a pin, and don't bend the stylus shank. Don't use alcohol, carbon tetrachloride or similar solvents. These might attack the small rubber damping blocks of the stylus suspension and bring about premature arthritis. In that case, the cure may be worse than the disease. So keep it dry.

A more or less regular "head check" along these lines is a fine prophylactic for audio complaints. When there's trouble in the head, it won't help you to drag out your signal tracers, oscilloscopes, and what-have-you. They'll give you no clue. A defective phono pickup head poisons your music at the source, where no signal tracer can reach it. In a high percentage of hi-fi ailments, you will save yourself a futile run-around by going right to the head!

Checking stylus pressure, the Scherr precision gage indicates exact readings on clearly legible dial. An extra hand marks the maximum weight and keeps its position on the dial after the measurement is completed. An automatic record of the stylus pressure is thus retained.

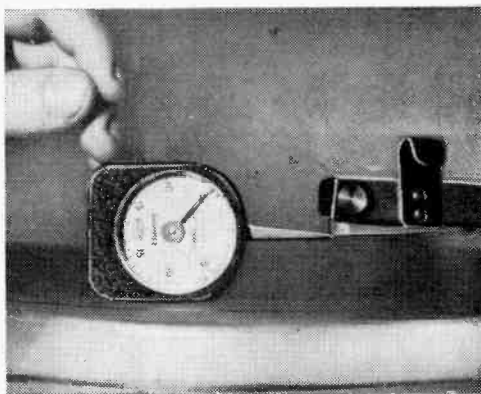

Stylus Replacement Chart

Stylus	Playing Time	Replacement
Diamond	as many hours per day as desired	must inspect after 1 year; may not be worn
Sapphire	1 hour per day	after 40 days
Osmium	1 hour per day	after 18 days

shakeproof

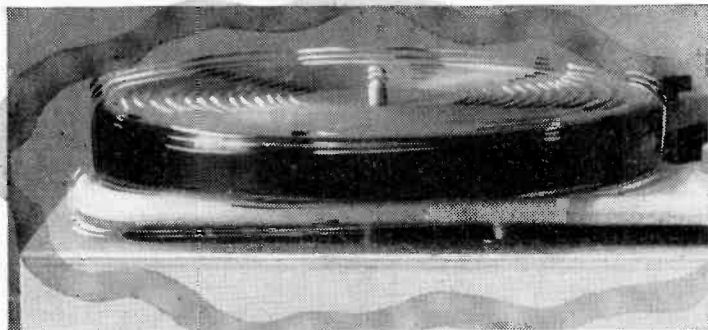

your hi-fi turntable

by robert sampson

DO YOU have to tiptoe across the room when your phonograph is going to keep from bouncing the pickup? Does your rig spit out the music in broken bits, like a fast and furious stutter, every time you move a muscle? Does the bouncing pickup dig bomb craters into your discs while emitting grim noises of battle?

Such things can happen on even the finest equipment unless your turntable is properly mounted. Here's how you can fix those shivers in two shakes.

To understand why control of vibration is so important in a turntable, think of your whole sound system simply as a vibration detector. If the surface of the turntable shakes with the stylus in the groove, the tip of the stylus shakes with it. Whenever the stylus tip moves at a frequency within the band pass of the system, whether the motion comes from outside vibration or from the music in the record groove, an electrical pulse is sent into the amplifier that finally emerges from the speaker as sound.

"Earthquake" Spotter

A tiny shake can produce a mighty big noise. The tip of your stylus has to be a fantastically sensitive vibration detector—like the instruments used for detecting distant earthquakes. After all, the system must produce the whole range from *pianissimo* to *fortissimo* from twists in the groove that measure only thousandths—even millionths—of an inch. This is fine as long as all the vibration comes from the groove of the record. Yet if the turntable itself shakes back and forth as little as a hundred-thousandth of an inch, you may get a noise out of your speaker that completely bedevils the music and frazzles your temper.

In most cheap phonographs, vibration of larger dimensions than this is common, as a result of haphazardly made rotating parts. The rough running principally accounts for the well-known "rumble" where the music is always accompanied by what sounds like a passing truck or subway train. The only remedy other than a makeshift "rumble filter" is to trade your jerry-built turntable for a precision-made job.

In the finer turntable motors built for high fidelity, this internally produced vibration has been brought down to the extremely low levels required for high-quality disc reproduction. But even the best turntable assembly is vulnerable to vibration reaching it from "outside," from the floor of your room and through the cabinet, if it is not properly installed. This article tells how to avoid such room-size "earthquakes" from jiggling your pickup.

Besides audible noise, there are several other ways that the external shakes can knock the spots out of fidelity. Suppose the vibration of the turntable surface is at a

frequency so low that you can't even hear it, say a bit below 20 cycles per second. Modern pickups and amplifiers, reaching further and further downward, are sensitive to such sub-bass frequencies as far down as 10 cycles per second—far below the hearing range of the human ear.

Now it happens that when a turntable shakes at a very low frequency, nine times out of ten it is a very hefty shake. Hence we get a tremendous electrical current pouring out of the pickup. By the time this surge reaches the output stage of the amplifier, it has been blown up into a sort of electric avalanche shoving the output tubes right into the distortion region. Then it tries to tear the speaker apart.

But you still can't hear it! The sound is below the frequency range of the ear. Yet the music playing at the same time will be mangled by the inaudible overload. The amplifier just can't handle the music, being too busy with the sub-audible noise.

The best test for such "sub-basement" ruckus is to touch the speaker cone very lightly with the tips of your fingers while a record is playing. If the cone keeps fluttering heavily like a flag in a high breeze, even when there are pauses in the music, you have a case of low-frequency shakes.

Another vibration difficulty is the one mentioned before: the pickup bouncing out of the groove. The latest pickups, with stylus pressures as low as 1 to 3 grams, rest on the record as lightly as a feather. This is dandy for low record wear and high fidelity, but it does mean that the pickup is easily jarred out of the groove by a heavy foot on the floor, a bus on the street outside, or dancing in the room. Shakeproof installation will also remedy this trouble.

Built-In Banshee

The last vibration difficulty we want to talk about is a real horror, if you happen to have it—acoustic feedback. Sound from the speaker, traveling through the air or through the floor of the room, shakes the turntable. This sends a new signal through the amplifier, which emerges from the speaker, shakes the table some more, goes through the amplifier, the speaker, back to table shaking, et cetera ad infinitum, like a dog chasing its tail.

With plenty of power being supplied by the amplifier, this high-gain audio tail-chasing can build up into a steady roar or scream that may well damage your amplifier or speaker. Or the feedback may occur only on loud notes of a certain frequency, which means that those notes will turn into banshee howls.

Acoustic feedback is most likely to occur when the speaker and turntable are mounted close together in the same cabinet, so the wood panels of the cabinet can transmit strong vibration directly from speaker to table.

One way to eliminate acoustic feedback is to set the turntable far apart from the loudspeaker. However, shakeproof mounting makes it possible to bring speaker and turntable closer together without drastic mishaps.

Shakeproofing forestalls all the various troubles recounted here. Just follow three

Many turntables come equipped with mounting springs. The Garrard Model T Mark II turntable shown here in an underside view has three mounting springs which are forced through holes in the wooden base designed for this unit.

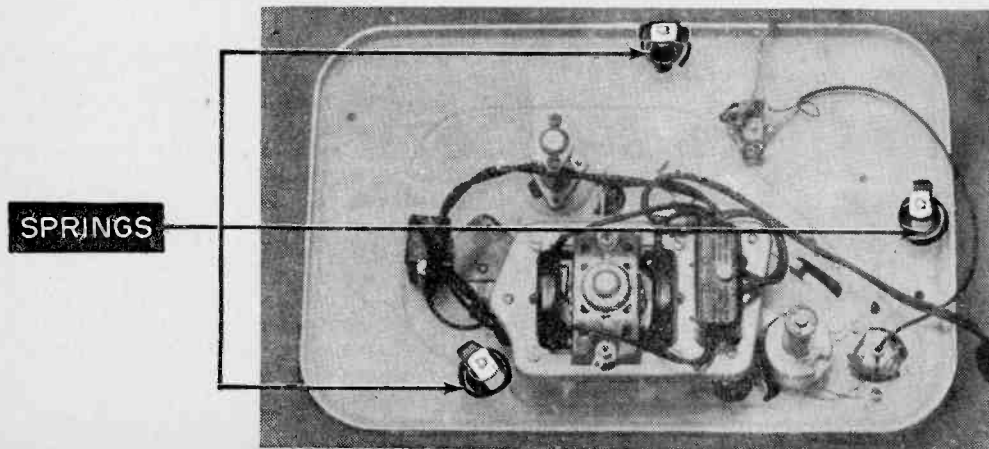

main principles.

(1) The first principle of proper installation is a very rigid connection between pickup and turntable. What we are trying to avoid is relative motion between pickup and table surface. So use a heavy motor-board, at least $\frac{3}{4}$ " plywood or the equivalent, with both pickup arm and turntable assembly tightly fastened to it. We are not talking here, of course, about the *motor*, but about the table itself. In the better assemblies, the motor is isolated by separate springs.

This principle has already been observed in some of the top-quality turntable assemblies now on the market. The turntable and pickup are on one rigid unit.

(2) The second principle is the isolation of the whole motorboard from the cabinet, and thus from the room. Put the whole assembly on springs supports, preferably rather soft steel springs. Rubber can be used, but it is usually hard to get a rubber mounting that does not collapse too far under the weight and at the same time is "soft" enough.

(3) This brings us to the third and most important principle of all. When you put a motorboard on springs, you have a system that can vibrate on its own. It has mass (the weight of the whole assembly) and compliance (the "give" of the springs). Thus it has a resonant frequency, at which the whole motorboard will tend to bounce up and down on the springs with only a small push from outside vibration.

Slow Bounce Okay

The real trick for success in the installation is to get this resonant frequency, or "period," below 8 cycles per second, and the lower the better. This makes the whole unit highly resistant to external vibration at other frequencies. The bottom ends of the springs may shake, but the vibration doesn't reach the top. The motorboard just "sits there."

How do we determine the period of the motorboard and springs? Push down on one corner, depressing one of the springs, and then let go suddenly. If you can easily count the ups and downs as the board bounces, the period is very low, no more than a few times per second. If the board takes off in a fast vibration, you are in trouble.

To lower the period, you can add weight to the motorboard, or make the springs "softer," or both. The quickest way, if the springs will carry the additional weight, is simply to fasten a chunk of lead to the underside of the board. Remember that you will need a weight not too much smaller than that already resting on the springs to lower the period substantially.

In addition to the low period, it is helpful to have "snubbers" in the springs, which act very much like the snubbers on the wheels of a car. If you use coil springs, you can stuff the insides of the springs tightly with cloth so that even if the assembly does start to bounce, it will be slowed to a stop after one or two motions.

Now—you have your unit on proper springs, it has a low period, it has good snubbers. Start a record and put a pickup in the groove. Jump up and down as hard as you can in the middle of the floor. It's nice, isn't it, to see that pickup go right on about its business, as though you weren't there hopping around like a jerk!

When the Model T turntable is mounted on its wooden base, a leaf spring prevents the turntable from pulling away from the base as a result of rough treatment. The correct spring position is shown at left; incorrect at right.

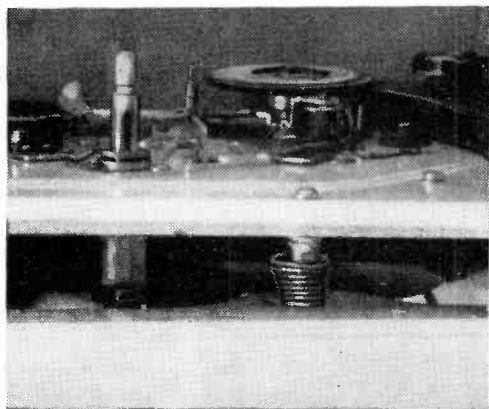
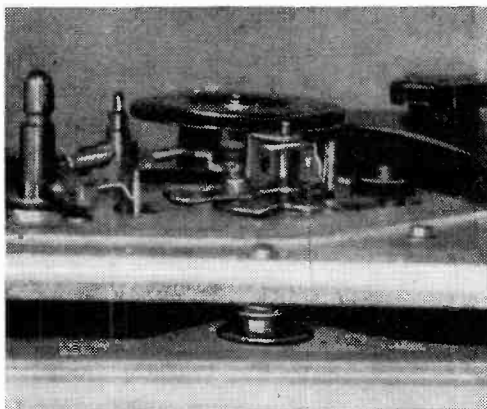

amplifier damping

By *leonard feldman*

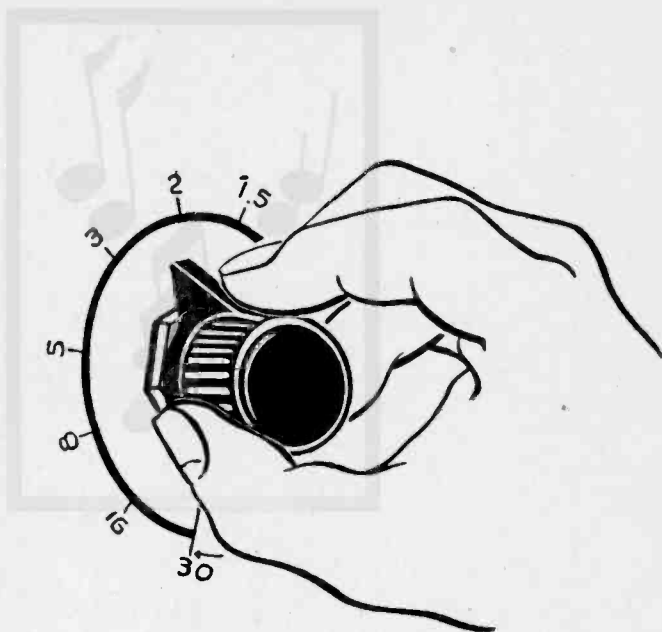

Sound may be soggy or crisp—damping can make it so

AS AN AUDIO FAN, you may still be damp behind the ears unless the music you play is damped BEFORE it reaches your ears. "Damping" is the term used to describe the method by which audio components are made to follow the signal without "taking off" on their own.

The trick is to prevent the loudspeaker cone from overshooting its mark or continuing to jiggle back and forth after a sudden burst of sound. Good damping keeps the speaker motion strictly equivalent to the signal waveform. It keeps the speaker from distorting the signal by random and unrelated movements of its own. In a way, damping does for your speaker what shock absorbers do for your car: in either case, the tendency to fly off at the bumps must be counteracted.

Without damping, loudspeakers "run wild" and do strange things to music. By continuing to shuttle back and forth after a sharp drum beat, an undamped speaker changes the crisp impact of the stick on the tight drum skin into a hollow, gong-like sound. The same thing happens to the plucking sound of string instruments, the strumming of a guitar, the tonguing of brass and woodwinds—until the instruments lose their character in reproduction and run together into a soggy mess. Proper damping keeps the sounds separate and distinct. You can then listen to details without having to strain to hear them.

Speaker "Brakes"

A certain amount of damping is engineered right into loudspeakers, particularly the better ones. It acts as brakes on a "runaway" speaker cone. Additional damping is accomplished by mounting a speaker in a properly designed enclosure; this, incidentally, is a good reason why speakers and enclosures should never be considered separately, but always in terms of what each will do for the other. Usually, these two methods of correction do not provide adequate damping, and the free-swinging loudspeaker still needs help from the amplifier "to get control of itself."

Fortunately, the misbehaving loudspeaker itself contributes the reins by which the amplifier can hold it in check. When it keeps jiggling beyond the duration of the actual signal, it acts as an electric generator. A "back" voltage is induced in its voice coil moving within the field of the surrounding magnet (see page 79), which sends a current back into the amplifier.

As in the case of any generator, the more power drawn from it, the harder it is to turn the generator. If the load resistance (in our case the impedance "looking into the amplifier") were low enough, this voice-coil "generator" would be constrained in its movement because of the current in the coil due to the "back" voltage. Hence, the overshoot would be reduced and, ultimately, eliminated.

Tap Test

One of the most startling experiments confirming this fact requires only a loudspeaker (preferably 12" or larger in cone diameter) and a small piece of wire. Hold the loudspeaker in one hand, grasping it by its rear housing. Have nothing connected to the two speaker terminals. Then gently tap the surface of the paper cone with your finger. Note the hollow quality of the dull thud that echoes from the cone.

Next, with no electronic equipment of any kind connected to the speaker, simply connect a short piece of wire between the two terminals of the unit, thereby shorting out the voice coil. Repeat the finger tapping and notice what happens to the sound. Now the sound has become sharp and crisp. The reason, of course, is that you have placed a short circuit (i.e., almost no resistance at all) on the voice coil "generator"

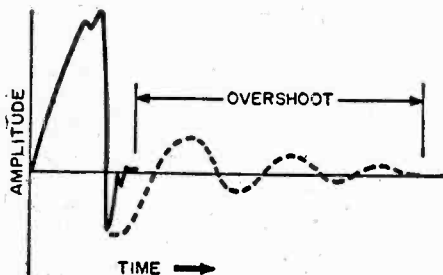

Showing damping problem graphically, the solid line represents the signal of a sharp sound burst (for instance, a drum beat). Improperly damped speaker keeps jiggling (dotted line) after actual sound stops. Extra undulations, called "overshoot," muddy the tone.

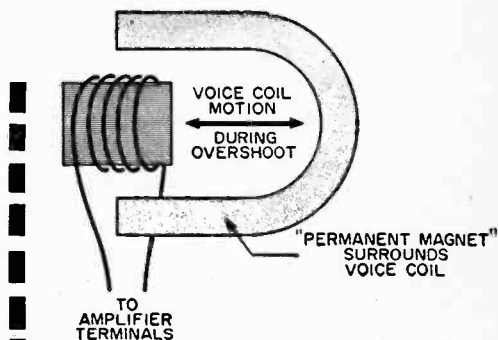

Loudspeaker coil moving against stationary magnet during "overshoot" acts as electric generator, causing current to flow back to amplifier. With proper damping, this current itself helps to check the overshoot, resulting in better speaker transient response.

and it cannot move freely under these conditions. Since the cone is now stiffly "damped," the thudding echo previously heard has disappeared.

In actual operation, the speaker terminals are connected to the amplifier output terminals. The lower the resistance that the speaker coil "sees" at the amplifier terminals, the more highly damped it will be. In fact, if the amplifier could be made to "look" like a short circuit to the speaker, we would have almost maximum damping. If we could make the amplifier look like a *negative* resistance, we could come up with maximum damping. All these things are possible, electronically. The question is, how much damping is necessary?

Damping Factor

Loudspeaker manufacturers have recently begun to specify the optimum electrical damping that an amplifier should have to match a particular speaker properly. This "damping factor" is expressed as a number, obtained by dividing the rated loudspeaker voice-coil impedance (usually 4, 8 or 16 ohms) by the "internal resistance" of the amplifier in question.

Thus, if an 8-ohm loudspeaker is to be connected across the 8-ohm taps of an amplifier output strip and the internal resistance measured across these taps is $\frac{1}{2}$ ohm, the amplifier is said to have a damping factor of $8:\frac{1}{2}$, or 16.

The so-called "output impedance" of an amplifier, as marked on the output terminal strip, actually refers to the impedance that a loudspeaker should have when connected to those terminals to assure maximum power transfer between amplifier and speaker.

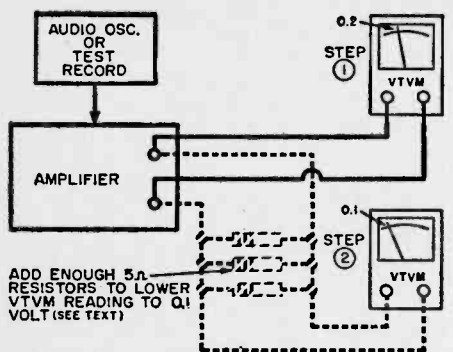

- STEP ①: VTVM READS 0.2 VOLT (BY ADJUSTING VOLUME CONTROL)
- STEP ②: VTVM NOW READS 0.1 VOLT BY ADDING 5-Ω RESISTORS IN PARALLEL ACROSS OUTPUT OF AMPLIFIER
- STEP ③: DIVIDE NUMBER OF RESISTORS USED INTO 5 TO GET AMPLIFIER INTERNAL RESISTANCE
- STEP ④: DIVIDE AMPLIFIER INTERNAL RESISTANCE INTO SPEAKER IMPEDANCE TO GET DAMPING FACTOR

Schematic setup for measuring the damping factor as explained step-by-step in text.

You can readily measure the damping factor of your present amplifier, to determine how closely it meets the recommendations given for the particular loudspeaker you plan to purchase. All you need is a dozen or more 5-ohm, ½-watt resistors and an audio oscillator. If you have no oscillator, use instead a test record having a sustained tone of 1000 cycles or 400 cycles. An a.c. voltmeter having 0-1 volt as its lowest range completes the necessary equipment.

Disconnect the loudspeaker from the amplifier output. Hook up the voltmeter to the correct output terminals of the amplifier (depending on the impedance of the proposed speaker). Then apply a signal to the amplifier either from the audio generator or the test record. Adjust the volume until the meter reads about 0.2 volt. Now place across the output terminals as many of the 5-ohm resistors as are necessary to reduce the meter reading to 0.1 volt. In adding resistors in parallel, make

certain to solder each one across the other, because even a fraction of an ohm of contact resistance will throw off this measurement.

After obtaining a reading of 0.1 volt, count the number of resistors used and divide this number into 5 to obtain the internal resistance of the amplifier. Next, divide the internal resistance into the impedance of the speaker to obtain the damping factor. The schematic on the left illustrates the procedure.

Optimum Matching

Having determined the damping factor of your amplifier, what can you do about it? If you should find that the damping factor is just about right for the speaker of your choice, let it go at that. On the other hand, if the damping factor exceeds the amount required for your loudspeaker, it is very simple to lower the damping factor externally.

Suppose an 8-ohm loudspeaker has a recommended damping factor of 4. That means that the loudspeaker, "looking back towards the amplifier," should see 2 ohms of resistance. Suppose then that the internal amplifier resistance, as measured by the procedure given above, is only 1 ohm. Simply add an external 1-ohm resistor (having at least a 2-watt rating if you play your music very loud) in series with one of the speaker leads, and you have met the requirements of the speaker manufacturer. The result will be a distinct—if subtle—difference in the sound you hear.

The situation is less simple if you find that your amplifier does not provide sufficient internal damping for the loudspeaker you want to use. There is very little you can do about it without making elaborate circuit changes. Your best bet is to find a more compatible speaker—or amplifier.

Variable Damping

A good many amplifiers are now equipped with a variable damping factor control. This lets you match the damping factor of the amplifier to a wide variety of speakers. More important, such controls enable the user to set the damping factor at a point most pleasing in terms of over-all sound, taking into account the vagaries of speaker enclosures, listening rooms, furnishings, etc. While some of these controls are labeled by various trade names, they all amount to pretty much the same thing, differing only in the provided range of control. With such a control, you can "crisp" music to your taste—dry, soggy, or in-between—just like bacon.

WHAT DAMPING DOES FOR YOUR SPEAKER

	Good Damping	Poor Damping
Distortion	If present, greatly decreased	If present, it goes unchecked
Bass	Flattens false peaks	Boomy due to uncontrolled resonance
Treble	Tends to be flat	Tends to shrill peaks
Transients	Sharp sounds clean and crisp	Sharp sounds blurred

THE HI-FI SALESMAN who sold you your high-powered amplifier probably made a very good point. "Just think," he said, "with this one investment, you're on your way towards music in *every* room of your mansion. All you have to do is keep adding speakers. This twenty-watter will handle four and possibly more!"

"Good," you thought, "after I learn the quirks of all these watts and db's, I'm going to scrap all those 'kitchen model' four-tube midgets, mount a few speakers here and there, and pipe the classics around as they do in the elegant restaurants."

Well, perhaps the time has come. Perhaps your ears have become so attuned to clean and faithful reproduction that you just can't tolerate inferior radios in the bedroom or den. The problems confronting you at this point are twofold. First, how do you arrange your switching so that you can pipe the music where you want it. Second, what sort of speakers should you choose for those "secondary" outlets? Since the second problem is a bit more personal, let's deal with it first.

Outdoor Speakers

The first prerequisite for any outdoor speaker installation is that it be thoroughly waterproof. There is absolutely no way to protect a conventional paper-cone speaker from the elements and still have it couple sound to the air! The only solution, then, is to employ a good quality metal or plastic "trumpet" with a suitable driver system designed for outdoor use. Anyone who has ever seen an outdoor sporting event or concert will recall the type we mean. These systems are generally classified as Public Address speakers, but be careful. Most p.a. speakers do not have a frequency response even remotely consistent with hi-fi requirements. A typical p.a. speaker we found listed in the catalog has a response of only 300 to 10,000 cycles. Actually, it's a fine speaker for voice paging—not musical reproduction.

Two acceptable units manufactured by *University Loudspeakers* are: Model BLC, which claims response from 70 to 15,000 cycles and sells for around \$50.00; and a much larger version of the same job, Model WLC, which sells for about three times that figure but goes down to 50 cycles. *Electro-Voice's* Model 848 claims good response from under 100 cycles to about 10,000 cycles, handles 25 watts and sells for under \$50.00. *Jensen's* Model VH-24 is recommended for music, handles

Speaking of EXTRA SPEAKERS

By
LEONARD FELDMAN

25 watts and claims fairly uniform response from 110 cycles to over 6000 cycles; it can be purchased for a little more than \$50.00.

Do not be alarmed at the seemingly conservative claims for bass frequency response of all these systems. Outside listening simply can't provide low bass, even if the speaker were capable of reproducing it, because of the missing room acoustics. There are no walls to bounce the bass around. The important things to listen for are "clean" reproduction and wide-angle coverage, so that you don't have to sit right in front of the speaker to get most of the music.

Kitchen Units

A lot depends on just how far you want to go and how much room you have. Actually, a kitchen is seldom as large as a living room, and is hardly a perfect acoustic

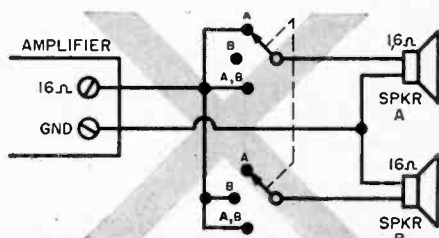

Fig. 1. A common but incorrect way of using two speakers separately or both together.

chamber with its hard floor and walls, ceramic surfaces, etc. Furthermore, to our way of thinking, you're not going to do much serious listening in the kitchen, but will probably use your speaker for pleasant background music. For these reasons, it would probably pay to go easy here and settle for an 8" or 10" speaker in an attractive wall baffle. Virtually all speaker manufacturers have models in this category. Of course, even in these surroundings, you are still better off mounting the speaker itself right into the wall, which affords a true infinite baffle and much-improved frequency response.

The All-Important Den

If you have a den, and if you equip it with hi-fi, you'll find that you're spending a lot more time there than you did previously. Usually, a den is furnished in somewhat the "soft" manner of a living room, and so compares favorably acoustically with the more formal room. Lots of enthusiasts we know find it difficult to decide whether to put the "primary" or "show" speaker in the living room or den.

If your den happens to be in the basement, you will generally find plenty of wall surface separating the den from the utility room or garage, and such wall surfaces are, again, ideal for speaker mounting. If the room is of generous proportions, a 12" or 15" woofer is recommended. However, if you must resort to the added expense of a furniture enclosure, be certain to hear the speaker in the particular enclosure before you make up your mind. This is an excellent rule to follow in choosing *any* speaker system and enclosure.

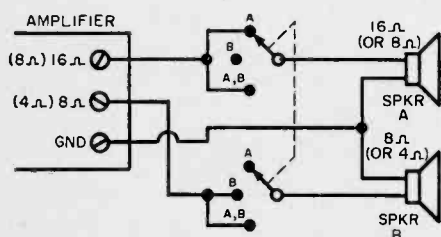

Fig. 2. This is the correct way to hook up two speakers which have different impedances.

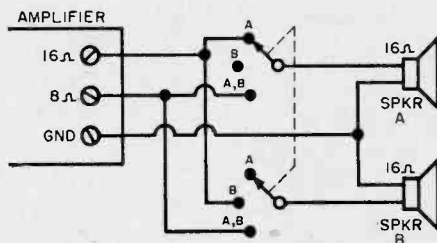

Fig. 3. Illustration of the correct hookup for two speakers of 16 ohms impedance each.

The Bedroom

Here, too, the requirement is mostly for background music rather than extended serious listening. Ideally suited to these requirements are the small, bookcase-type enclosure-speaker combinations which have become so popular. The *Heath SS-1*, the *University "Companionette,"* the *R-J S8U*, the *"Hartsdale,"* and many more of similar size, have found homes in headboards and night tables.

Incidentally, you can avoid jumping out of bed on wintry nights to turn off the hi-fi set by investing in one of the many types of appliance-timers available. They'll do the job at a preset time and spare you a set of frozen toes.

Speaker Volume Controls

Chances are you will end up with loudspeakers having different degrees of efficiency. That is, speaker *A* may sound quite loud with the volume control of your amplifier turned up halfway, while speaker *B* may be just above a whisper. There's nothing wrong with either of them—it's just a question of how they were designed. Then, too, in different rooms, different levels of sound may be required.

It's a good idea to equip each speaker with a level control, located right at the speaker in question. An ordinary volume control should not be used for this type of application. Its variations in impedance at different settings will create a mismatch, thus causing a power loss and, sometimes, serious distortion. Recommended instead is a constant impedance control.

These "pads" are available commercially either from *Labtronics Corporation* or *P. R. Mallory Corporation*. Be sure to specify 4- 8- or 16-ohm types, depending upon the impedance of the speaker you wish to control.

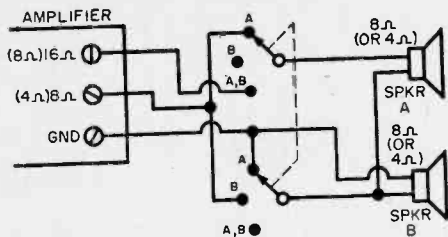

Fig. 4. Hookup for equal-impedance speakers.

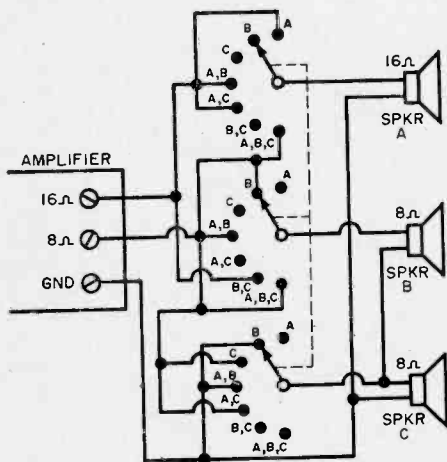

Fig. 5. Hookup for one 16-ohm and two 8-ohm speakers in every possible combination.

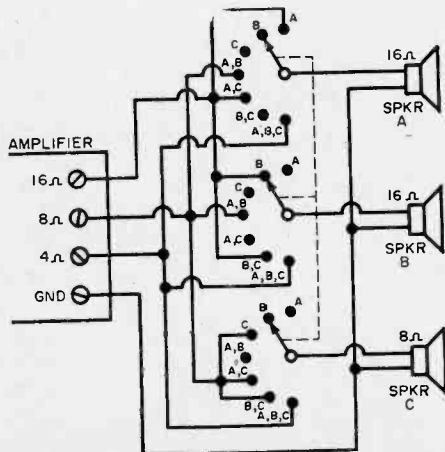

Fig. 6. Two 16-ohm speakers, one 8-ohm speaker.

Switching Choice

The biggest pitfall of all multiple speaker installations is found right at this point. Don't fall into it! A 16-ohm speaker belongs across the 16-ohm terminals of your amplifier. If the amplifier is to perform correctly, provide the most usable, undistorted power, proper damping, proper feedback and other criteria essential to hi-fi, there *must* be a correct impedance match between amplifier and speaker.

Yet, many multiple speaker fans think nothing of slapping a second or even a third 16-ohm speaker across the same terminals of the "amp" when they wish to have all three playing at the same time in different rooms. Two 16-ohm speakers in parallel look like an 8-ohm impedance to the amplifier (just as two 16-ohm resistors in parallel add up to 8 ohms). With only two speakers connected this way, a 2-to-1 mismatch exists between amplifier and speaker systems. Distortion occurs at much lower power levels and considerable power is wasted.

Okay, you say, hook the pair of speakers across the 8-ohm terminals of the amplifier and everything will be fine. It will, so long as you listen to both at once. But if you open one up in the course of your switching hookup, you'll now have a 16-ohm impedance across the 8 ohms, still a mismatch of 2 to 1. Figure 1 shows a typically incorrect switching arrangement.

Mixing Speakers

There is a way of switching two and even three speakers of different impedances in and out of a system and maintaining virtually perfect impedance match at all times. After all, your amplifier has several output impedance taps, and there's no reason why you can't use more than one in your proposed switching setup.

As one of the common "mixed setups" probably consists of one 16-ohm main speaker and one 8-ohm secondary system, let's consider this hookup first (Fig. 2). You'll notice that when speaker B is used, it's connected across the 8-ohm taps on the amplifier. When speaker A is used, it's connected across the 16-ohm terminals. And, finally, when both are in use, each is connected to its proper impedance. While it is true that the presence of a speaker across part of the output transformer secondary winding alters the total impedance of the winding slightly, the effect is much more negligible than would be the case when just paralleling the two speakers.

Figure 3 gives a correct hookup for two speakers having equal impedances of 16

ohms. It is similar to Fig. 1 in that each individual speaker, when used alone, is hooked up to the 16-ohm terminals of the amplifier. But in the third position of the switch, both speakers are hooked up in parallel and at the same time flipped over to the 8-ohm terminals of the amplifier, maintaining a perfect impedance match for every setting of the switch.

Shall We Try For Three?

Having gone this far, we decided to do something about our own "spider web." You see, our hi-fi can be piped to any one of three locations: the living room system (8-ohm impedance), the basement (16-ohm coax job) and the upstairs bedroom (8-ohm wall baffle system). Previous to this effort, our control panel resembled something out of a science-fiction rocket dispatching center, with knife-switches mounted in liberal profusion.

We decided right off that four switch settings (A, B, C and ABC) wouldn't do because there'd always be the case of friends in the living room and basement den, eager to partake of much fidelity, plus some "spoil-sport" in the upstairs bedroom trying to grab forty winks. A good switching system involving three speakers should, therefore, work as follows: A, B, C, AB, AC, BC, and ABC, or a total of seven positions.

The circuits of Figs. 5, 6 and 7 all utilize a special switch (Mallory, part number 1231L, or the equivalent) which consists of three sections, adjustable from two to eleven positions. Since there are

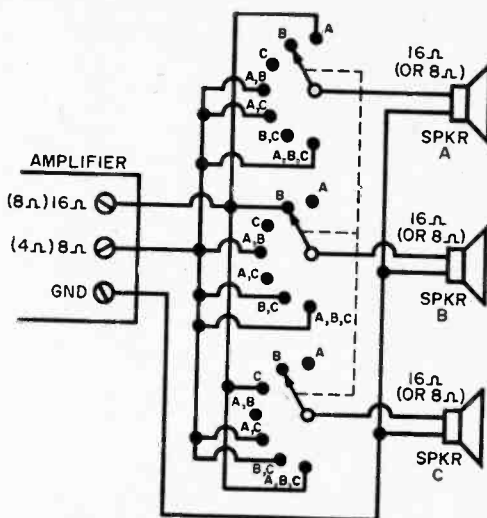

Fig. 7. Flexible switching arrangement for three 16-ohm speakers for single or simultaneous use.

many non-used switch lugs, however, you may find any number of ways of conveniently wiring up any one of the three circuits just by following the schematics themselves.

The most practical place for mounting your new switch is probably at or near the equipment, but there is no reason why it cannot be mounted anywhere you find it convenient. Mounted in a wall or in your equipment cabinet, the over-all effect is one of simplicity and professional "customized" wiring.

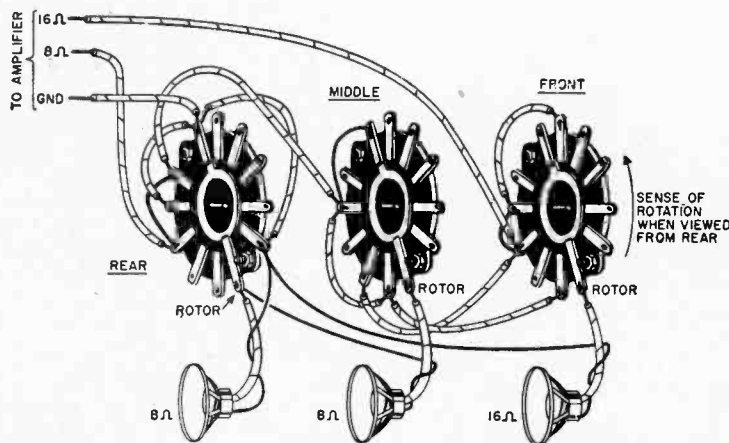
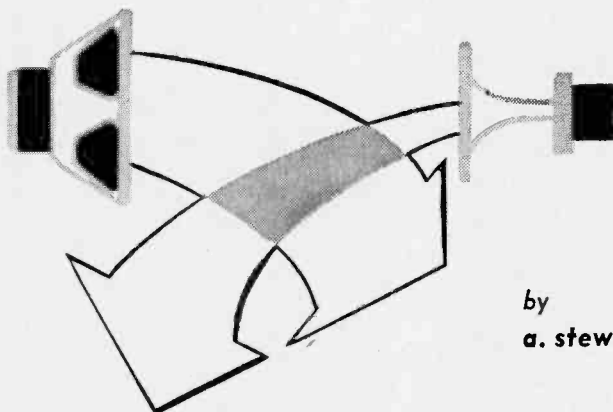

Fig. 8. Wiring layout for two 8-ohm speakers and one 16-ohm speaker (see circuit in Fig. 5). All decks shown are viewed from the rear. The lug marked "rotor" in the diagram may be placed differently on various manufacturers' switches. The Mallory switch which is described in the text has the rotor positioned on the reverse side of each deck. It may be necessary to reposition the wiring if the switch differs too radically from the diagram.

crossovers



by
a. stewart hegeman

Get the most out of your speakers with these
simple network circuits

IF YOU HAVE a single loudspeaker in your hi-fi system, you can safely bet that it clogs up the frequency response. No single unit speaker can efficiently cover the whole spectrum of musical sound. It suffers from having to stretch its range both high and low, like a tenor trying to sing soprano, bass, and everything in between all at once. The result is a brave compromise—some treble and some bass must be sacrificed.

Yet it is just those shimmering highs and throbbing lows, flashing like highlights on a clear stream of music, that put the thrill into real hi-fi. To catch these elusive extremes of the frequency range, serious hi-fi fans rely on separate woofers for bass and tweeters for treble. Such speakers don't need to compromise. They are built especially for the particular range they cover. They don't need to stretch beyond it.

Sometimes even a separate mid-range unit is added to make a three-way system, in which each speaker specializes even further, each covering only a fairly narrow frequency band, with greater clarity and efficiency. But before any multiple speaker system can be hooked up to the amplifier, one more component is needed: *the crossover network*.

Sound Splitting

Without a crossover network, part of the music would go to the wrong address. Heavy bass would run right into the delicate tweeter and tear it apart, or at least make it howl with anguish. At the other end, the rapid treble oscillations would feed into the heavy woofer, which, unable to swing fast enough, would simply convert them into heat. The tonal leftovers from such a mismatch would be a definitely low-fi hash.

To prevent such a log jam of frequencies, the crossover network acts somewhat like a traffic cop directing heavy trucks into one lane and light vehicles into another. It takes the output of the amplifier and splits it into separate channels for bass and treble, leading each to its proper speaker. For this reason, the crossover network is also known as a "frequency dividing network" or sometimes simply as a "frequency divider."

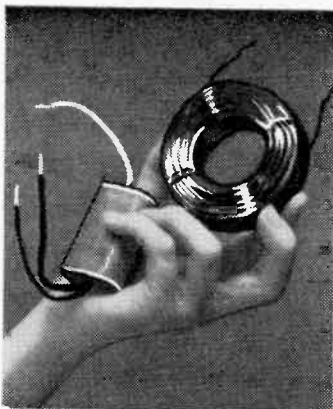

The simple handwound coil and inexpensive paper capacitor shown here together make up a crossover network which cleans up the highs and unmuffles the bass frequencies.

Under the Lid

To many hi-fi fans, the crossover network is just a mysterious box connected between the amplifier and the speaker system. But once the lid is lifted from this box, the simple logic of its design is readily apparent even to the novice.

All we need to remember is that a certain size of coil passes low frequencies while it inhibits highs, and that with a certain value of capacitor, it's the other way around. Thus, by combining a coil and a capacitor into an elementary filter network, you can make the bass go one way and the treble another. Four factors affect the performance of a crossover network: (1) crossover frequency; (2) operating impedance; (3) attenuation slope; (4) insertion loss. A definition of each term will clear up any possible confusion caused by such hi-fi shop-talk.

Crossover frequency. This is the frequency where the woofer leaves off and the tweeter takes over. The network must be designed to split the whole tonal range into an upper and lower channel at precisely that point. Choice of the crossover frequency therefore depends on the response range of the loudspeakers used in the system.

If woofer and tweeter ranges overlap, there is a certain amount of freedom in the choice of crossover frequency. Where a separate mid-range unit is added to form a three-way system, we need two crossover frequencies to separate the three speakers in the system. Choice of a frequency affects the over-all sound. Some designers feel that naturalness in the reproduction of string instruments and the human voice is best achieved when both the fundamental tone and the first two harmonics are generated by a single loudspeaker. These designers prefer their crossover frequencies

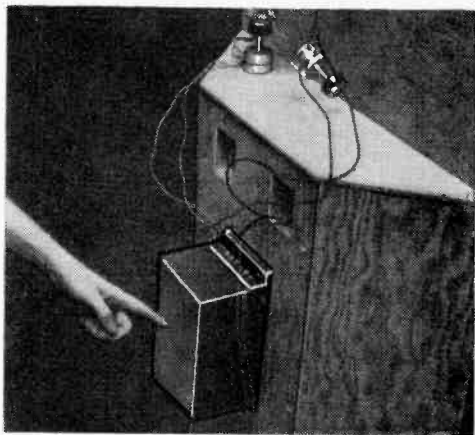

Crossover network on back of woofer enclosure with level controls hooked up experimentally.

very low (e.g., around 200 cps for mid-range crossover) or very high (e.g., 5000 cps for the tweeter) and avoid crossing over in the middle range. However, this is not a hard-and-fast rule. Well-balanced systems have been designed with crossover frequencies anywhere in the spectrum. Other factors being equal, a low crossover frequency for the woofer usually produces cleaner sound since it keeps higher frequencies away from the woofer and thus prevents their intermodulation with the bass.

Operating Impedance. For most efficient circuit operation, the crossover network must match the impedance of the signal source (i.e., the amplifier) to the impedance of its load (i.e., the speakers). In other words, a 16-ohm network should be driven from the 16-ohm terminals of the amplifier and should feed into 16-ohm loudspeakers. If the operating impedance of the network is not matched by the amplifier and speakers connected to it, the crossover frequency will shift from its proper value.

Impedance mismatch between crossover network and speakers can be corrected by

adding shunt or series resistors. If this is done, however, part of the energy going to the speaker will be silently burned up in the corrective resistors. That makes uphill work for the amplifier, taxing its power reserve and possibly driving it to distortion. Picking matched components in the first place avoids such wasteful makeshifts.

Attenuation Slope. Actually, the crossover frequency is not a sharp cutoff. The woofer signal doesn't simply "stop short" to avoid entering the tweeter range. Neither does the tweeter "slam on the brakes" to keep from sliding over into the woofer's "territory." Instead, both high and low range taper off gradually in the middle with plenty of overlap. The rate of this taper and

tain units. For instance, if a tweeter is not supposed to receive much energy below its cutoff point (say 2000 cps), the crossover network should cut the response sharply at that point rather than let it gradually slope off with plenty of overlap.

Insertion Loss. Since there are no perfect conductors, any coil or capacitor offers some resistance to the flow of current. Because the crossover network operates at low voltage and high current, there is bound to be some energy loss due to the resistance in the coils. By winding the coil with heavier gauge wire (No. 16 or larger), the power loss resulting from insertion of the network into the hi-fi system can usually be kept down to 10% of the total amplifier output

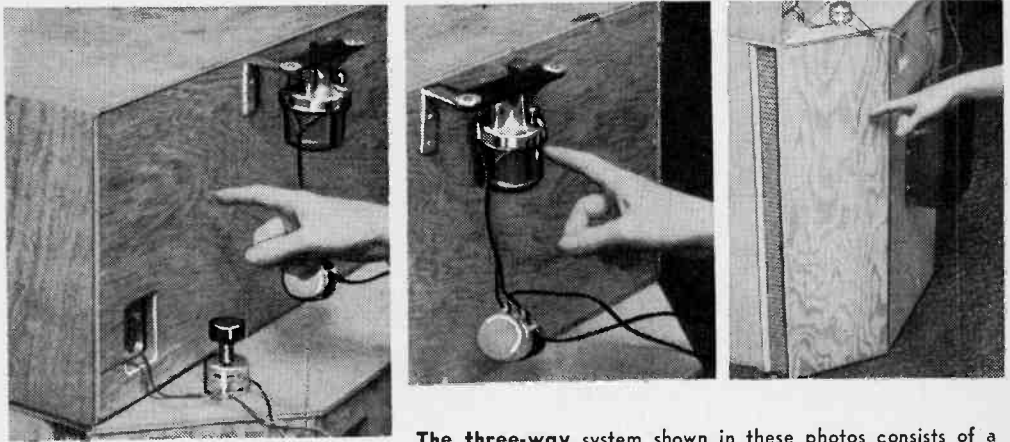

The three-way system shown in these photos consists of a tweeter pointed toward the ceiling for maximum dispersion mounted on the back of a midrange enclosure (left), all sitting on a woofer corner enclosure (right). Note that both tweeter and midrange units have level controls for "balancing out" the three separate speakers.

hence the area of overlap define the sharpness of separation between treble and bass.

With a single coil and capacitor in each speaker line, treble and bass response fall off at the rate of 6 db per octave, counted from the crossover point. Networks with two coils and two capacitors squelch "out of bounds" frequencies at the rate of 12 db per octave.

Sharp separation is not necessarily an advantage. Where woofer and tweeter themselves overlap in their frequency response, the lower attenuation rate of 6 db per octave seems preferable to many listeners. It makes the sound source seem more unified, avoiding the feeling that the sound is split, with treble and bass coming from different locations. However, the most important consideration in choosing between a 6-db or 12-db network is the frequency limits of the loudspeakers to be fed by the network. No speaker should receive large amounts of energy beyond its response limit. A sharp cutoff is therefore recommended with cer-

(= 1 lb.) Since most hi-fi installations can get along very well on the remaining 90% of their power, this loss is not critical. Only air-core coils should be used in crossover networks; iron cores produce hysteresis and magnetic losses which upset the power and frequency response of the network.

Level Controls

The crossover network itself splits the available energy equally between treble and bass channels. Yet the woofer and tweeter may not be equally efficient in converting this electrical energy to actual sound. The resulting difference will cause the tweeter to "out-shout" the woofer or vice versa. For this reason, a level control should be provided with the crossover network to balance the sound between the high and low end. Such a control also lets you compensate for the acoustics of the listening room, which may either reflect a lot of treble or swallow it up.

The level control on fancier networks is a so-called "T-pad" or "H-pad," with constant impedance at all settings. Yet in lower priced crossover networks, ordinary potentiometers are used without ill effect.

Damping Problems

Speaker impedance variations at different frequencies reflect back into the network, causing slight tonal changes.

Most of us have come to accept these little inconsistencies of tone color without even noticing them. Yet those whose keen ears remember what music *really* sounds like won't stop short of perfection. Several pioneer designs have come up with an answer to this impedance and damping problem make the crossover before rather than after the amplifier and then use a dual-channel amplification system.

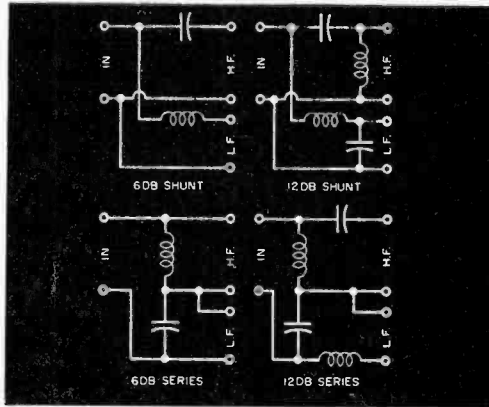

Simple crossover circuits consisting of coils and capacitors in series or parallel depending upon the attenuation rate desired. Two coils and two capacitors give 6 db more attenuation.

make your own crossover

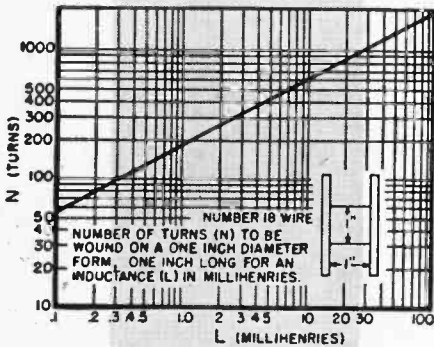
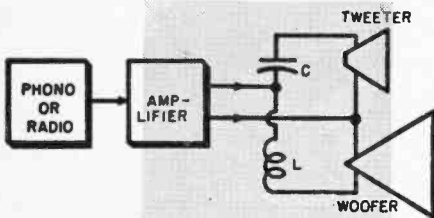

The simple circuit shown above makes an adequate crossover. Use the chart to wind your own coil.

THE SIMPLE CIRCUIT shown above will make a satisfactory crossover network for a two-way speaker system with separate tweeter and woofer, and takes only a few minutes to assemble. Capacitor *C* passes

the treble to the tweeter but blocks the bass, while coil *L* admits bass to the woofer but excludes treble.

To choose the right values of *C* and *L* for your particular installation, simply follow this procedure:

(a) Check the impedances of woofer and tweeter. They are usually marked on the speaker or appear in the manufacturer's specifications. If not, you can approximate each impedance by simply measuring the d.c. resistance of the voice coil with an ohmmeter.

(b) Pick a crossover frequency somewhere between 600 and 2000 cps, depending on the response range of your woofer and tweeter.

(c) To determine *C*, multiply the tweeter impedance by the crossover frequency and divide the product into 159,000.

(d) To determine *L*, multiply the woofer impedance by 159 and divide the product by the crossover frequency.

(e) To wind the coil yourself, you must know how many turns to wind on a 1"-long, 1"-diameter form. You find the number of turns by multiplying the square root of *L* by 180, or by consulting the chart at left. (Use No. 18 copper wire.)

(f) To obtain *C*, either buy a paper capacitor of the proper size, or buy two electrolytic capacitors (such as those used in a.c.-d.c. radios as filter capacitors) of *twice* the needed capacitance and connect them back to back as shown below. — *John J. Dougherty*



If electrolytic capacitors are used in a crossover, two are needed, each twice the desired capacitance.

the electronic crossover

frequency division before amplification results in cleaner sound

CROSSOVER NETWORKS—if properly matched to carefully chosen speakers—can make for excellent response. Some of the finest-sounding speaker systems use them. But dividing networks have certain drawbacks.

First, there is the “noise” that may be introduced eventually by less-than-top-quality components. For instance, high-value capacitors of the paper variety are very expensive and not always used. Electrolytics can be substituted if selected with an eye toward possible deterioration and leakage. A defective electrolytic, however, may not only introduce noise but shift your crossover frequency from one that provides a correct balance to one that can throw off the speaker system.

Secondly, networks made up of coils and capacitors must introduce some audio signal loss. Part of the total output of the amplifier is eaten up by the network as “payment” for the job it does. This is known as “insertion loss.” Neither the amount of noise nor the degree of insertion loss may be, in itself, very serious. The setup may still sound good. But there is a third network bugaboo that *can* become a serious limitation on sound quality and impair your enjoyment of programs.

The Damping Problem

By “damping,” we mean the ability of the amplifier to keep tight reins on the speaker. For sound faithful to the original, the cone must neither overshoot its mark nor keep jiggling after a sharp and sudden excursion. Good damping keeps the speaker motion strictly in step with the electric waveform arriving from the amplifier. Musically, this means clear definition of every sound—no blur, no crackling—and sharp, exciting transients.

Damping depends partly on the design of the speaker itself and partly on the interaction between speaker and amplifier. The amplifier effectively “puts on the brakes”

whenever the speaker cone zooms out of control. With a crossover network inserted between amplifier and speaker, the insertion loss of the network hinders the action of this self-correcting “feedback brake.” In other words, it lessens the damping. But, once again, this drawback may be more than offset by the advantage of the multiple loudspeakers made possible by the crossover network.

A more serious damping difficulty stems from the fact that the speaker itself changes impedance with changes in frequency. Air loading and springiness of the cone suspension differ at low and high notes. These variations reflect back into the voice coil circuit in the form of impedance variations. This affects the damping and thus changes the tone quality of the speaker. The impairment is most pronounced at bass frequencies which need greater surges of undistorted wattage in order for them to be faithfully reproduced.

Introducing the ECU

For many listeners, the above considerations are not worth bothering about. But designers with ultra-critical listening tastes and an approach that puts no ceiling on hi-fi perfection have come up with a system that sidesteps the damping problem.

Instead of using one power amplifier to feed a network and thence the speaker system the new approach uses *two separate power amplifiers*—one feeding a woofer, the other a tweeter. Frequency division is made *before* the sound enters either power amplifier. What’s more, instead of using an *RLC* network, this system uses an electronic crossover unit (ECU) to separate highs from lows.

An ECU resembles an amplifier and has no signal insertion loss. Also, the ECU does not disturb the feedback setup between power amplifier and speaker. Thus, it permits optimum damping.

(Continued on page 111)

the new dimension in sound...

tandberg stereo

plus everything else you would
want in a complete tape system

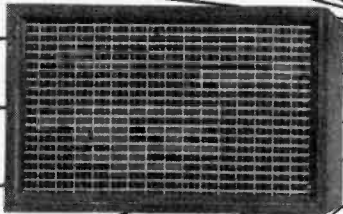

stereo-trio a complete
home music system—perfectly matched.
The Tandberg stereo-trio including model
3-Stereo recorder/reproducer and two perfectly
matched 266 speaker systems furnished
in the same fine grain mahogany as the model
3-Stereo cabinet. Comparable to the finest
—at almost half the price. \$469.95.

Designed for the highest of reproduction standards . . . Scandinavia Styled from fine grain mahogany.

STEREO 3-Speed Tape Phonograph and Tape Recorder—Tandberg Model 3-Stereo—for at home listening pleasure . . . or conveniently portable in luxury-styled luggage type carrying case for traveling enjoyment.



For the finest in sound reproduction, two extremely well-balanced power playback amplifiers are built-in with such efficiency of design that the distortion of each amplifier is under 1%. A specially manufactured in-line stereo head, unique in design and construction, provides a clarity of reproduction and a range of response heretofore unattainable.

The model 3-Stereo weighs 27 pounds, and is priced at \$369.50. Complete with microphone and carrying case.

3-Speed Versatility—Records half track . . . plays back half-track, full track and stereophonic tapes. Frequency response at 7½ i.p.s. is within ± 2 DB from 30 to 17,000 cycles (\pm DB from 50 to 10,000 cycles).

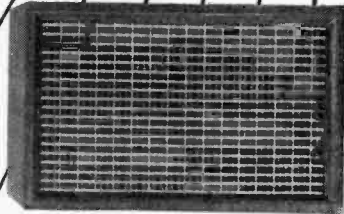

Hear and See the
Tandberg Stereo-Trio
or write for full
information to

Tandberg

10 E. 52nd St., New York 22, N. Y.



GUIDE Section / part 2

tape recording in the home

how to make good tape recordings 92

tape it off the air 97

splicing 101

do your tapes sound "real pro"? 107

getting the most out of tape 112

reel tricks for tape recordists 114

check the tape head 116

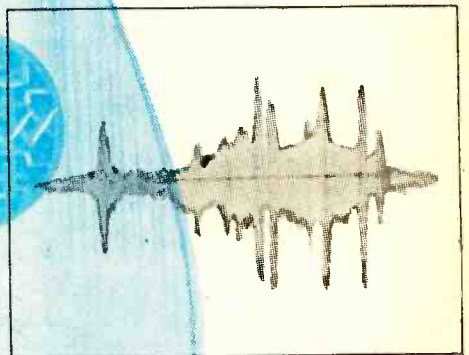

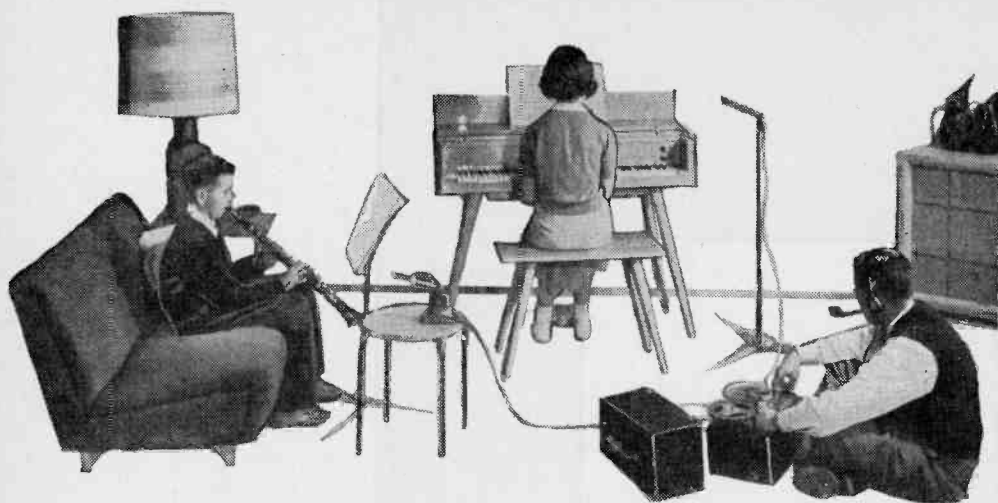

The professionals have no hidden secrets,
your tapes can be good too

RECORDING ON TAPE is more than a matter of pushing buttons if you want to have tapes that are as "high-fidelity" as your equipment can make them. Tapes should be a source of pride and enjoyment. It is sheer waste to spend hundreds of dollars on equipment, then mis-use it and get "dime-store" results.

Well, what's to be done? We assume that you have gone through the instruction manual which came with the recorder, and have acquainted yourself thoroughly with all of the controls. Does this sound too elementary? You'd be surprised at the number of people who just don't bother to do it. Take the time to orientate yourself fully in the workings of your recorder. It will be worth your while.

The best way to defeat the gremlins that bedevil recordists—and have fun doing so—is to make a *sample recording*, as outlined below. This recording will not only serve as a training session for you, but will show up many of your machine's defects which can be eliminated by adjustment.

Buy first-quality plastic-backed tape even for your very first recordings. You can always erase and re-use the tape, so why take chances? Using old paper-backed tape "until you get the hang of things" is a waste; you won't know what to blame if the recording turns out poorly.

Always place your tape recorder on a level, firm surface to prevent mechanical vibrations from influencing the quality of the recording. Leave air space around the

recording hints

Re-wind tape before using to "limber up" a new reel and prevent sticking.

Never re-wind past the tape heads.

Check tape feed reel to see that it is tightly packed.

Check program source to be recorded to determine whether it needs "tone correction."

Use a microphone stand, either floor or desk type, for added stability.

Make sure tape heads are clean, and properly oriented with respect to the tape.

"Ride the gain" as needed to maintain desired level during recording.

how to make good tape recordings

by jeanne hickam

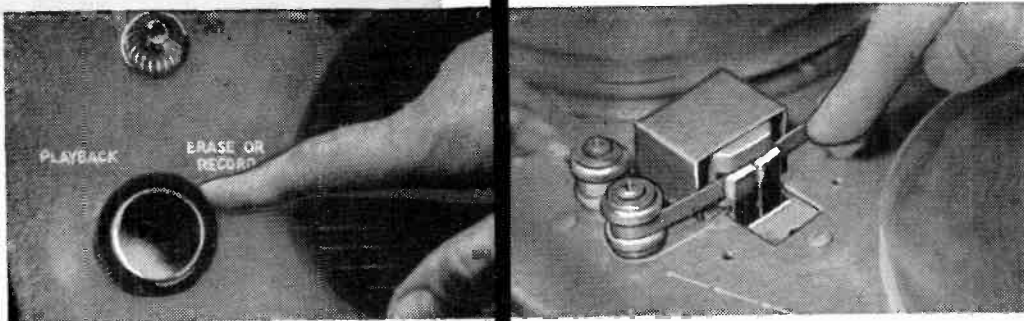

Proper setting of all operating controls is of prime importance. In addition to the "Playback-Record" switch, many recorders have controls for adjusting speed, as well as equalization for a particular speed. These items may seem obvious, but can ruin your recording if neglected.

Part of the head cover has been removed at right to show how the pressure pads hold the tape in contact with the recording head during operation. Worn pads, or springs on which they are mounted, will not hold tape in correct contact with head, resulting in low, or spotty volume.

recorder's ventilation port (generally on the bottom of the recorder) so that it will not overheat. As thick rugs, blankets, foam rubber sofas, etc., will frequently block this port, be prepared to place "props" of some sort under the legs or feet of the recorder. This will lift it an inch or so to enable air to enter the port.

Setting up to record

The microphone should be supported firmly. A mike stand is best. If one is not available, set the mike on a table. Hold it in your hand *only as a last resort*.

When recording from your radio, tuner, TV, or phonograph, pick up your sound from the volume control of this other source, or use a jack at the output of your hi-fi amplifier.* Less desirable, but workable, is to connect the recorder input to the speaker terminals of the other set. The poorest method is to record from the air with a mike placed in front of the loudspeaker; do *not* expect good results from this method.

Make sure of your connections and turn on the recorder. Allow sufficient time for warm-up. Check the tape threading. Almost all recorders use tape which is wound by the manufacturer with the oxide *in* (toward the hub of the reel). Most tape reels are already wound that way. In any case, the coated (dull) side of the tape must face the recording head. If necessary, rewind the tape.

Choose Right Tape Speed

Generally, the greater the tape speed, the better the fidelity. The highest speed on most home recorders is $7\frac{1}{2}$ ips (inches per second), and—unless yours offers one higher—this is the logical choice for taping music. If the selection you wish to record is more than 30 minutes long (the playing time of a standard 7" reel of tape at $7\frac{1}{2}$ ips), use one of the extended-play tapes (such as "Irish" long play, "Scotch" extra-play, etc.) rather than resorting to a lower speed and less fidelity to "make it fit on the reel."

A speed of $3\frac{3}{4}$ ips will give satisfactory results with most spoken material you wish to preserve. And $1\frac{1}{2}$ ips may be used for office dictation, records of business meetings, and the like; it will preserve the *words*, but will not faithfully reproduce individual *voices* because of its narrow frequency range.

Make a sample recording of the type of material to be taped. If "live," have your subject practice using the microphone. If off the air or from a phono player, set the volume control on the program source to the level to be used at recording time. Perhaps your recorder has an equalizer control which must be set manually when the tape speed is changed—be sure that this adjustment has been made.

During the trial run, set the volume control on the recorder so that the volume indicator, in conformance with the instruction book, shows that the machine is neither overloaded nor under-amplified. Try to record your program material "flat." You can adjust the treble-bass balance to your taste during playback.

Sometimes, you might want to "gimmick" frequency response during recording, as, for instance, in certain popular music with heavy bass underlining, which might benefit by the addition of a bit of accent on the treble side. Experiment with both flat and adjusted settings before doing this on a recording you want to preserve.

During the Test

If either the take-up or supply reel squeaks or rumbles, check to be sure it is firmly mounted on its spindle. Look also for warping, which will cause the reel to brush against the recorder. If the tape feeds unevenly, check the threading of the recorder again; improper splices in used or second-grade tape can also cause this trouble.

Some electrical appliances may cause fluctuations in the 117-volt a.c. line when they automatically turn on or off. If you can't disconnect the appliance, note where the deviation occurred in the recorded material, and remember that there will be a slight wow at that point during playback.

Irregularities in the winding of tape on the supply reel may cause variations. If this seems to be your trouble, try running the tape through your recorder at the fast forward or rewind speed (not past the recording head, please!) and then see how it behaves. Many recordists make this standard practice, maintaining that the tape feeds better when it is "limbered up."

If one reel fails to turn evenly, check your instruction book again. On many recorders, definite manual controls must be positively engaged. New recorders should be returned to the company from which they were obtained for adjustment if still under guarantee. If not, and if your recorder has a neoprene drive belt, look for slippage in this area. Do-it-yourself'ers can replace such belts in most instances, but don't try to hurry the job. And *don't oil a recorder* unless you are

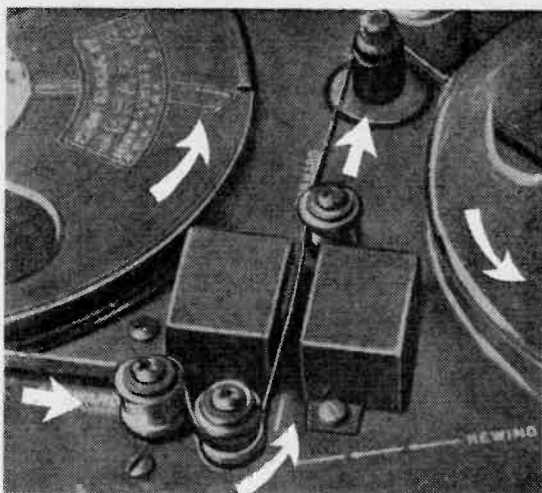

Arrows show path of tape from feed to take-up reels during recording. Note that on this particular machine an alternate path is required for rewind of tape. Each roller and its pad, around which tape passes, must be in good working condition.

sure you're doing exactly what the manufacturer recommends. One drop of oil in the wrong place can easily cause a drive belt to slip.

Checking Results

Stop recording and rewind your tape (not past the recording head, as this serves no useful purpose and merely dirties the head). Now, play it back.

Listen carefully for wow or flutter not caused by visible variation in the tape transport. Be sure that this is in the recording and not in the playback, where splices or voltage variations can produce the same ill effects. Play the test tape over a couple of times if in doubt.

Next, play the test back again at both lower and higher volumes than you anticipate using normally. Listen carefully for distortion caused by overloading the tape (recording with too much volume) or by over-amplification of the bass. Occasionally a volume indicator is not completely accurate; often a novice, or someone unaccustomed to a different type of indicator, will set the volume control incorrectly. If the over-all volume is too loud or too soft, try another test with an altered setting.

If your trouble is still lack of volume, look for the following causes: (1) defective idlers and springs that hold them; (2) weak tube or tubes—have them tested; (3) incorrect threading—the oxide (dull) side of the tape must contact the recording head(s); (4) dirty recording head(s)—clean with a Q-tip or pipe cleaner, moistened very slightly in *carbon tet* if absolutely necessary. Dry the head after using carbon tet, and allow another few minutes' time for further drying before rethreading. Run a second test, if necessary (or if you want to experiment with a different speed, volume, or treble-bass adjustment).

Now, Record

Trial run over, you are ready to make your first semi-professional recording. A little advance planning at this point will pay off in better results. Here are a few suggestions.

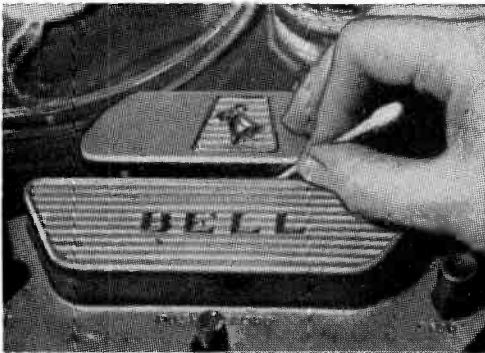

Clean heads regularly with cotton "Q-tip" or pipe cleaner dipped in carbon tetrachloride. Note that better grade tapes deposit less dirt and oxide particles on heads.

1. A series of spoken selections deserves an introduction on the tape itself, as does a taped version of a favorite radio program. Why not put this on the tape before making the recording, rather than splicing it on later?

2. When recording a series of musical selections (other than classics or opera), you will find that the finished results make more pleasant listening if you use the volume control during actual recording to "bring up" the music at the start of each selection and "fade out" at the end of it; this prevents a jar to the listener's nerves when the music starts suddenly after an interval of silence.

3. Some recorders leave an audible click on the tape when turned off. In recording a series of selections, you can eliminate this annoyance by pulling about an inch of tape back to the supply side manually each time you stop the recorder. When you start recording again, the click will be erased.

4. Remember that the ear and brain are selective: we hear only what we wish among a number of simultaneous sounds. The microphone has no such ability—if an automobile horn sounds outside your open window, or if you strike a match or pour a glass of water during a recording, you will hear the sound reproduced during playback. Use your mike where it is as quiet as possible, and do all you can to prevent extraneous noise.

All this may seem like a lot of bother but after you do it a few times, it will become as simple and automatic as the preparation you go through to take good photographs. And the results are well worth the effort.



What the name Norelco® means in a tape recorder

New Norelco 'Continental' Model EL3516

THE THREE-SPEED dual-track Norelco 'Continental' was specifically designed by Philips of the Netherlands, world's largest electronics concern outside of the United States, to be the finest self-contained, portable tape recording and playback system ever offered to recordists, high-fidelity enthusiasts and music lovers.

Nothing has been spared by the world-renowned Philips engineering teams to make the 'Continental' the most advanced and versatile instrument of its kind in mechanical design, electronic circuitry and construction. Three speeds, rather than just the conventional two, have been incorporated to insure maximum versatility and economy in both speech and hi-fi music recording. At each speed—1½, 3¾ and 7½ inches per second—the Norelco 'Continental' compares favorably in performance with other machines operating at the next higher speed. This is due primarily to the Philips magnetic head with an air gap of only 0.0002 inches, which makes possible extended high-frequency response even at the slower speeds.

Impressive as its specifications may be, the Norelco 'Continental' was designed, however, to be used and to be listened to—not to be read about. Its actual numerical specifications were determined by measuring it after it sounded good enough, handled tape gently enough, and ran smoothly and reliably enough to satisfy the uncompromising Philips engineers.

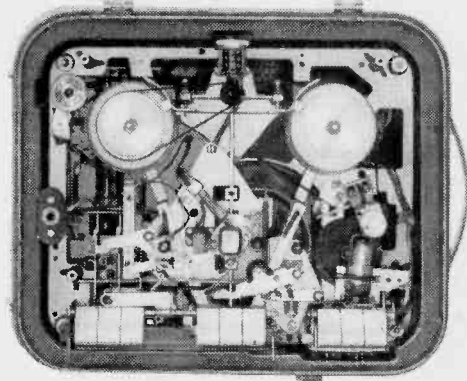

This is the way a great tape recorder is built!

The data below are therefore offered as examples of factual description and painstaking, conservative laboratory measurement, rather than advertising claims. Read them, if you are interested—but better yet, operate and listen to the Norelco 'Continental' for a while, and forget about specifications. Five minutes of actual use will demonstrate to you more forcibly than five pages of decibel figures and intermodulation percentages how a Norelco tape recorder is built!

For the name and address of your nearest Norelco 'Continental' dealer, write directly to Dept. G, North American Philips Co., Inc., High Fidelity Products Division, 230 Duffy Avenue, Hicksville, L. I., N. Y.

Specifications of the 'Continental' show exceptional electrical characteristics and ultra-stable tape motion. The machine is fully pushbutton-controlled and comes with built-in Norelco twin-cone speaker, magic-eye volume indicator and a remarkably fine high-impedance dynamic microphone.

Tape Speeds:	7½, 3¾ and 1½ inches per second
Tracks:	Dual
Frequency Response:	40 to 16,000 cps at 7½ ips; 50 to 8,000 cps at 3¾ ips; 60 to 4,500 cps at 1½ ips
Signal-to-Noise Ratio:	54 db
Wow and Flutter:	0.15% at 7½ ips; 0.2% at 3¾ ips; 0.35% at 1½ ips
Fast Forward and Reverse:	Less than 2 minutes for 1200' of tape
Automatic Stop:	At end of reel with metalized tape
Inputs:	1 radio/phone; 1 microphone
Outputs:	1 for external speaker; 1 for external amplifier
Tubes:	EF-86, ECC-83, EL-90, EZ-90, EM-81 (one of each)
Line Voltage:	110 volts AC (can be connected for 127-220-245 volts AC)
Power Consumption:	55 watts
Dimensions:	15¼" x 13" x 8"
Weight:	Approx. 30 lbs.

tape it off the air

by robert sampson



Catch and keep your own collection of music and plays.

OUT OF your radio loudspeaker old Sidney Bechet comes riding his reed like a wild man on a rocket, soaring on high notes to the ceiling, dropping to the floor with a growl. What a ride the old man does give! Lots of times before, you have listened to Sidney via your radio, and every time has been fresh and exciting.

But this time something very special has been added. When the program is over, you go to your radio, take a few minutes with preparations, then sit down. In a few seconds, here comes Sidney again out of your speaker, with that very same rush to the top of the clarinet range to start things off! You listen through the same driving set of tunes a second time. No doubt about it, you caught the old man on one of his best days. And you caught him for good! You "wrapped it up"—as they say in the lingo of recording engineers.

You've got him on magnetic tape, of course. The use of tape to put radio programs away in the locker, for re-use any time the owner feels like it, is one of the fastest-growing indoor hobbies. Symphony concerts, jive sessions, song recitals, historic speeches, any unique radio happening, can be added to your own personal collection of recordings for future enjoyment as long as you like. And you will get a kick out of editing and putting together special programs of items picked out by yourself for your family and friends.

Keep Out of Jail

Before describing the simple procedures for making good off-the-air recordings on magnetic tape, we must first issue a warning. Toss overboard right here and now any brainburst you may have had about selling copies of your off-the-air recordings. The right to make money out of the production of any professional entertainer or out of most other kinds of material you hear on the radio is carefully protected, as it should be.

So invite your friends in to hear your own recording of Satchmo or Menuhin, in your living room—yes. But don't try to sell the recording or charge admission to hear it, or you will have legal beagles baying at your heels. This applies not only to original performances on radio, but to any broadcasts of commercial recordings. Taping material off the air is strictly for fun—and fun only.

Simple Setup

Now—what equipment should you have to put the radio programs you want on tape? Basically, all you need is a radio receiver and a tape recorder. Good recordings can be made with just these two instruments. But if you have a separate radio tuner feeding into a hi-fi amplifier with a flexible control system, you can do the job with greater ease. We will describe both methods of recording.

Suppose you have a standard-model radio receiver, any make, and a portable tape recorder. The first rule is: the signal should be transferred from radio receiver to tape recorder in electrical form—not acoustically by putting the microphone in front of the loudspeaker. If you use the speaker-microphone method, you pick up the distortion inherent in these two units and also add room echoes and noises to your recording.

The easiest way to get a signal from the radio receiver to the tape machine is by putting alligator clips on one end of a length of lamp cord and a plug that fits your tape machine input on the other end. Clip the alligator "jaws" to the voice-coil terminals of your radio speaker and plug the other end into your tape machine, as is shown in the drawing on the next page.

This apparently haphazard procedure has some neat advantages. Because the voice coil has a very low impedance, usually less than 20 ohms, the cable will be insensitive to hum and usually won't need shielding. For the same reason, there will be no loss of high frequencies in the cable.

But the tape machine input is high impedance, 100,000 ohms or more. Hence, you will draw practically no power from your radio, and can listen to it in the ordinary way while recording.

Volume Level

The one adjustment that makes the biggest swing between a dandy recording and a miserable one is getting the right strength of signal into the recording head.

Too much signal on the tape, and you overload the tape. Harsh, fuzzy sound will screech at you as the intermodulation distortion rises rapidly. Too little signal, and the softer passages will drown in the background noise which is always present in any electronic sound reproduction system. The volume indicator on your recorder lets you steer clear of the twin pitfalls of distortion and noise.

The loudness difference between the top signal level that is within allowable distortion limits and the noise level is what is known as the "signal-to-noise" ratio. On tape, 3% intermodulation is usually taken as the maximum allowable distortion. Obviously, you will have the most "spread" for the music to rise and fall in loudness if the peaks just reach the "top" on your volume level indicator.

Every good tape machine has a volume indicator that tells you when you have set the incoming signal so that the peaks just hit the top. On the peaks, a neon bulb flashes, or an electronic eye just closes, or a VU meter—the most convenient and accurate of all to use—just swings up to "zero" at the peak allowable audio signal.

Volume indicators of three different types are used on tape recorders. In the top picture is the professional-type VU meter which monitors the level of every sound entering the machine. The "electronic eye" used on the recorder in the center photo serves the same purpose. The machine at the bottom has a neon bulb which flashes overload warnings but cannot indicate intermediate values of signal level. Some recorders use two neon bulbs with the second bulb arranged to flash at minimum recording level.

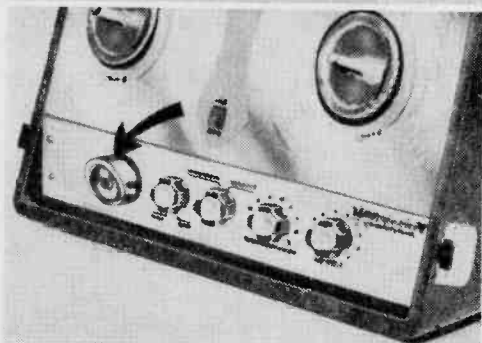
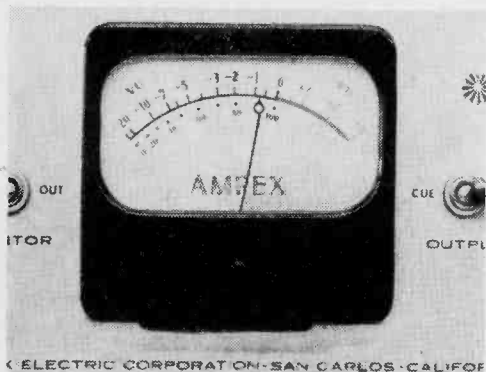

To get the signal level set right, turn on your equipment about 15 minutes before the program you want is scheduled to go on the air. That will allow sufficient warm-up to assure constant gain by the time your program comes on. Tune in the station the program will come from, and set the volume according to the *preceding* program. If this is music, you won't be far off when *your* music comes along. If it is speech, you will probably have to change the level a little when music comes along. But you are bound to be within shooting range of the "right" volume setting, and will need only a small final adjustment.

With a radio receiver feeding a tape machine as described, you have two volume controls located in the signal path. You can get the same level at the tape with different combinations of the two controls, by turning one up while you turn the other down. The right combination is with both controls somewhere near the same setting, and *not* with one all the way up and the other almost off.

This "no loafing" method avoids two bad extremes: (1) a signal out of the radio so strong that the first amplifier stage in the tape machine is overloaded, causing distortion (which would be the case with the radio control way up and tape recorder control way down); and (2) a signal out of the radio so low that the soft passages are down near the noise level (radio control way down and the recorder control nearly all the way up).

You can save a lot of agony by making a short "dry" test-run during the warm-up period. Suppose you wait until Satchmo starts to blow his horn to get your tape machine moving for the first time. *Then* you find out that you have a gremlin in your take-up reel, or a shorted recording head, or some other crippling defect. Then it's too late, old boy; Satchmo has escaped for good with that particular dish of jive.

Record a few minutes of the preceding program, and listen to it carefully. Harsh, distorted quality means too high a signal level unless there is something wrong with

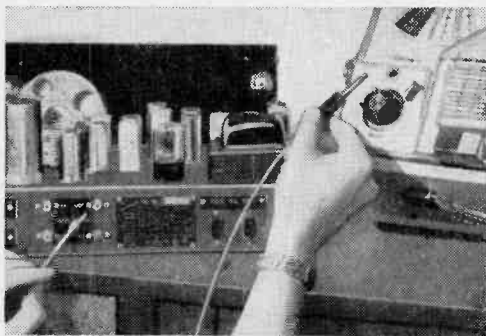

For best quality tape recordings, the tape machine input should be connected to the output of a hi-fi tuner as shown in the photograph above. For a simple take-off from any radio or television set, just clip the tape recorder's input leads to the voice-coil terminals of the loudspeaker as shown in the drawing. If an a.c./d.c. receiver is used as a recording source, an isolation transformer should be connected between the radio and recorder to prevent the possibility of a "hot" recorder chassis and a chance of a shock.

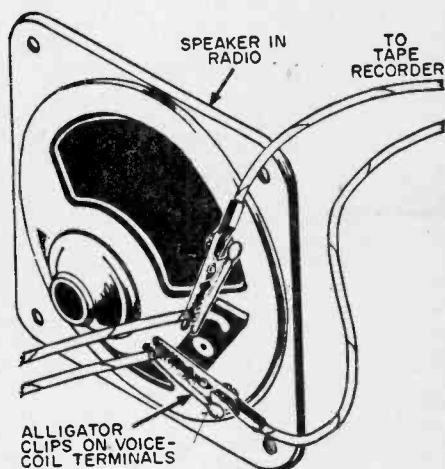

your amplifier. A muffled quality, with highs heavily attenuated, probably means a tiny piece of dirt on the recording head. Clean the head carefully. You will be able to correct many troubles if you discover them about 15 minutes *before* you "go on stage."

After actual recording starts, don't keep changing the volume setting; leave it strictly alone unless it turns out to be radically wrong. A recording on which the volume level is frequently changed sounds "broken up" and loses much of its impact in the volume waver caused by your knob twisting. It is the mark of a good recordist to set the level carefully, but then leave it set.

Begin to record about 20 seconds before your program goes on and *don't* start and stop the recorder to edit out short stretches you think you don't want. Let it run through everything. It's much better to edit out what you don't want *after* the recording is made. The tape can always be re-used—and you get a proper chance to

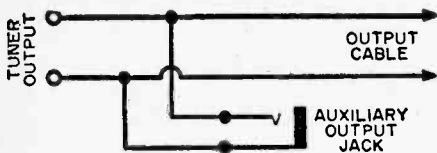

If your tuner has no separate output for a tape recorder, you can easily make one by connecting an extra jack across the regular tuner output, as shown in diagram above, to monitor as you record. If your preamp already has a "tape out" jack, use the over-all system hookup shown below.

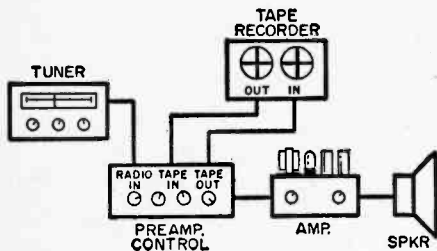

decide for sure—at your leisure—what you want to keep. If you missed something in the original recording that turns out to be necessary for good continuity, it's lost for good.

These instructions hold true for any kind of setup used in off-the-air recording. So far, we have assumed that you get your signal from the loudspeaker terminals of your radio by means of alligator clips. However, you can feed your recorder a somewhat cleaner signal if you tap it off somewhere ahead of the output stage of the receiver.

Fancy Hook-ups

The best way to get a top-quality signal off the air and into your tape machine is to employ a separate radio tuner, such as is used in high-fidelity systems. The best quality is, of course, obtainable only from FM.

The output of the tuner is usually a low-impedance line—just what you need for plugging into a tape machine. There are two main connecting methods. The choice between them depends on whether or not the preamplifier of your hi-fi has a "tape out" connection.

If there is no "tape out" on your preamp, you must unplug your tuner from the preamp and plug it into the tape machine, as shown on page 99. If you're in luck, your tape recorder has a "monitor" jack. This jack enables you to take the signal that's being taped and feed it back into

your amplifier or preamp so that you can hear the program as you record it.

If your recorder has no "monitor" output, you will not be able to listen to the radio program while it is going onto the tape. It is then more important than ever to have a warm-up period to set levels, and make a test run. After the program starts and you are plugged into the tape machine, you will hear nothing. But watching the volume indicator wiggle gives you assurance that the sounds you want are actually going onto the tape.

One way to improve this arrangement would be an extra output jack on your radio tuner, wired in parallel to the regular one, allowing you to send the radio signal simultaneously to the preamplifier and to the tape recorder. This extra output jack allows you to "monitor" the radio signal while recording—actually hear it as it goes on the tape.

If your preamplifier has a "tape out" connection, as well as a tape input, the whole job becomes simply one of throwing switches. The preamplifier "tape out" goes to the input of the tape machine. The output of the tape machine goes to "tape input" on the preamp, completing a head-to-

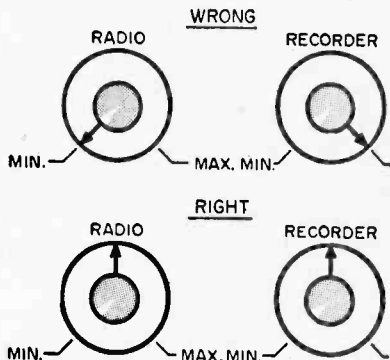

Right and wrong volume control settings on radio and tape recorder, as explained in text.

toe loop. Now any program—radio, phonograph, or microphone—that comes into your preamp can be recorded with the greatest of ease and under excellent electrical conditions. And you can listen as you record.

To get a radio signal onto tape, you simply have to switch your preamp selector to "radio," tune in the station, set the volume, and start the tape moving. To listen to what you have recorded, you just switch your preamp selector to "tape"—after rewinding the tape, of course.

By following the simple rules outlined here, you can start your own collection of "memorable moments."

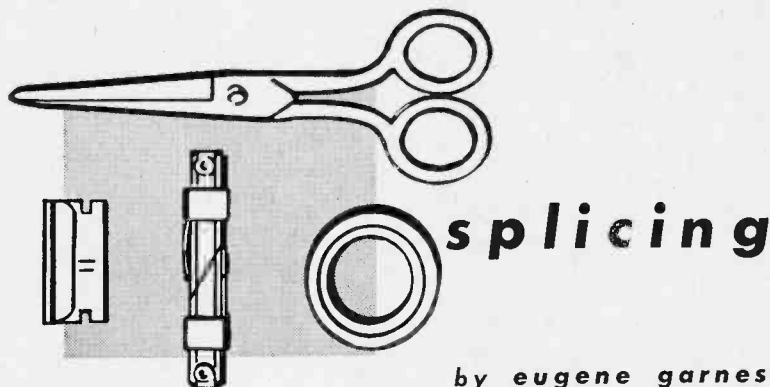

by eugene garnes

Combine reels, cut out noise and bloopers
with the techniques shown here

"THE FACE on the cutting room floor" is an old adage of movie-making that has turned many a dull film into a masterpiece. Like the movie-maker, the tape recorder fan can turn his noisy, stumbling reels into gems by some judicious cutting.

It's easy, and you should wind up with a perfect splice. The diagrams below show what correct and faulty splices look like.

All you need is a splicing block (\$2 or so), single-edge razor blades, $\frac{3}{4}$ " splicing tape and a good scissors. Ordinary cellophane tape is not satisfactory as it will creep with age and cause sticking. Stable, pressure-sensitive adhesive is used with professional tape equipment. Be very certain that neither the blade nor the scissors is magnetized, since that can cause an audible thump in playback. A head demagnetizer will also demagnetize tools.

The popular diagonal splice will give a strong, durable junction which should last the life of the tape. This is used to remove fairly large sections. The vertical splice gives a weaker bond, is used when short syllables are to be removed. It is made in the same way but with a vertical slice.

The mechanical segue, which is a smooth "dissolve," akin to the dissolve from one scene to another in the movies, is a form of diagonal splice. It provides a smooth transition point rather than an instantaneous one. With a long diagonal cut, 12" or so, the head begins to contact less and less of one tape's pickup surface, reducing the volume accordingly, and more and more of the other, increasing its volume in the same proportion. Result, a smooth dissolve.

Follow the drawings on the next two pages for perfect results . . .

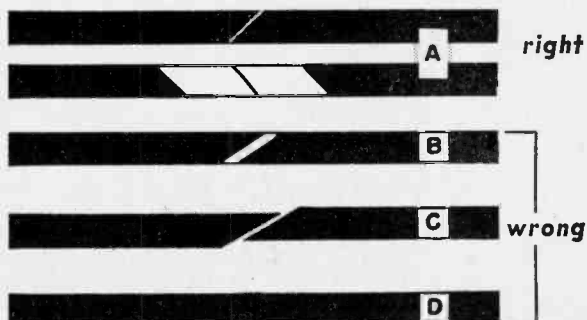

how to edit

When working closely with material such as interviews, you must be able to jockey the tape back and forth while in contact with the playback head and yet not have the driving mechanism engaged. All professional machines provide this feature. You can get the same result with many home machines by cocking the *Forward* control about halfway between off and "full on." This is generally impossible with push-button machines, however.

Now let's assume that we wish to edit an "Ah" from the start of a phrase. We "see-saw" the tape, beginning just ahead of the "Ah" up to two or three words of the phrase. After doing this a few times, we get the feel of the phrase, with a pretty good idea as to where to make the cut. By jockeying the tape slowly, the individual sounds that make up the words can be recognized and the undesirable sound pin-pointed.

If there's a definite break between the wanted and unwanted sounds, it should be easy to make a clean vertical cut there. However, if the sounds run into each other, as in the case of "Ah, yes," where there is no perceptible break, we have to jockey the tape slowly to determine where the "Ah" leaves off and the "yes" begins. If it is difficult to locate the exact spot, it may be wise to cut a little on the "Ah" side. Then if that's not satisfactory on playback, you can peel the tape and cut another 1/16-inch or so, resplice and check again, until you get exactly what you want.

In the above case a diagonal splice is recommended, since it will give a very rapid fade-in. This helps to create an effect not unlike that of the voice, which needs a few microseconds to reach full normal output when starting from a quiet state. In editing excess syllables, of course, the vertical splice must be employed.

When non-professional equipment not designed for editing is used, the playback head may not be visible, making it impossible to do close work. In such a case, place a reference mark on the head cover, directly above the head gap, and work from that.

There are certain limitations. You can edit only single-track tape, or dual track tape where only one track has been recorded. Stereo tape can be spliced provided that it is of the stacked-head type.

The tape is placed plastic (shiny) side up in the splicing block. The tape is then carefully cut with a sharp razor blade by following the diagonal slot milled into the splicer. The section containing the desirable material remains in the block. The section to be deleted is removed. Next, the section of tape to be joined to the first is placed in the block from the opposite end. In exactly the same way, you should then cut this piece. Now you will have the two diagonal cuts of the pieces to be joined facing each other, ready to be spliced.

A

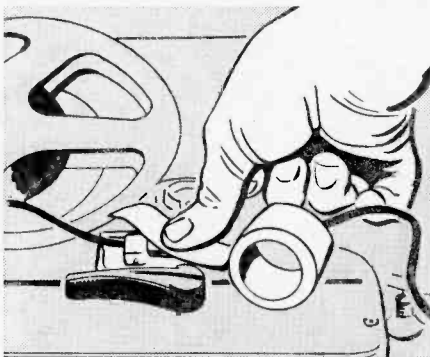
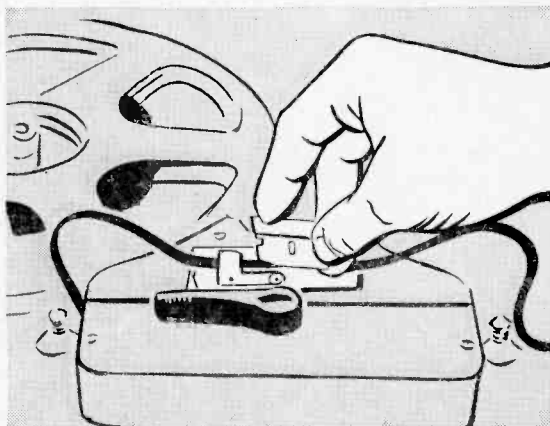

The next step is probably the most important in the whole operation. Very carefully adjust the tapes so that the ends butt perfectly. Now cut a piece of splicing tape about two inches long and press the sticky side down directly over the joint with the ball of your thumb. Make sure the sides of the splicing tape are parallel to the diagonal cut. With care, press the splicing tape on firmly, working away from the center. Now pick up the recording tape by the ends of the splicing tape and place it on a flat surface. Again apply firm pressure over the entire splice area to insure that the tape edges are bonded to the adhesive. Use scissors to trim off excess splicing tape, cutting slightly into the recording.

Now that you've made your first diagonal splice, you might want to try a mechanical segue. The procedure is essentially the same as in the previous steps. Put the first section of tape on a flat surface, preferably a wooden cutting block. Carefully place a ruler on the tape for the long diagonal cut—a 12" length might be good for your first try. Cut the tape cleanly in one stroke. Then place the second piece of tape in the same position, and measure off the exact same length. This time, however, make the cut in the opposite direction, so that the two cuts match. The next step is shown at right.

The first piece of recording tape is held in position by squares of masking tape applied at each end of the cut. Very carefully line up the second piece of tape so that the diagonal cuts butt and match. Anchor the second piece of tape in position with additional masking tape. Next, cut a 14" length of splicing tape and place it over the splice area. Apply the tape at the center of the splice only and work the splicing tape toward each end, being careful not to separate the butted cuts. You can check on this since the splicing tape is translucent. If they separate, you must start over.

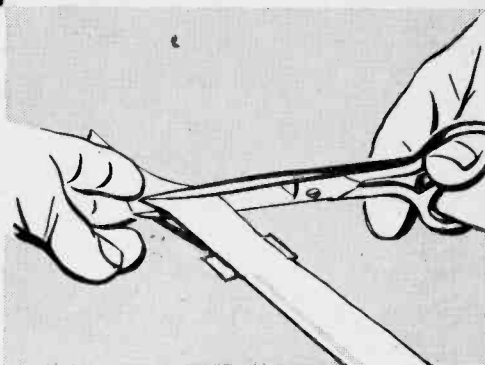
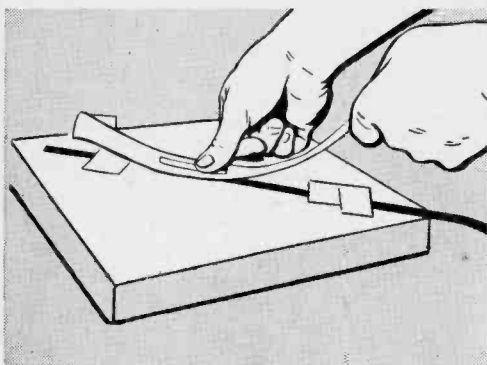
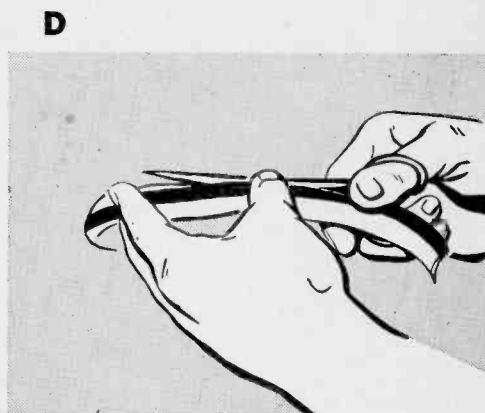
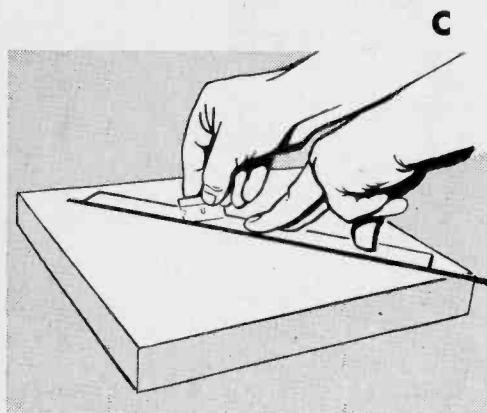

Before reaching the ends of the splicing tape, cut off about a half-inch diagonally. This will allow for smooth passage during playback. Complete the application of splicing tape, pressing it out all the way to the ends. When you reach the masking tape supports, it will be safe to remove them, since the already applied splicing tape will offer sufficient support. Make certain, however, that you don't disturb the butt as you pull off the masking tape, or you'll have to begin all over again. Press it down firmly.

Pick up the spliced tape and cautiously trim the excess splicing tape, cutting slightly into the recorded tape. This completes your mechanical segue which—if properly made according to the preceding steps—will result in a smoothness equal to the most skillful mechanical segue of professional engineers. This method is best for slower tape speeds, $7\frac{1}{2}$ and $3\frac{3}{4}$ ips being ideal. At the latter speed a 12" splice will give a four-second segue, while at the former speed the segue will last two seconds.

NEW! REG. U.S. PAT. OFF. **SCOTCH** BRAND Tensilized Double-Play
a **NEW** tape that

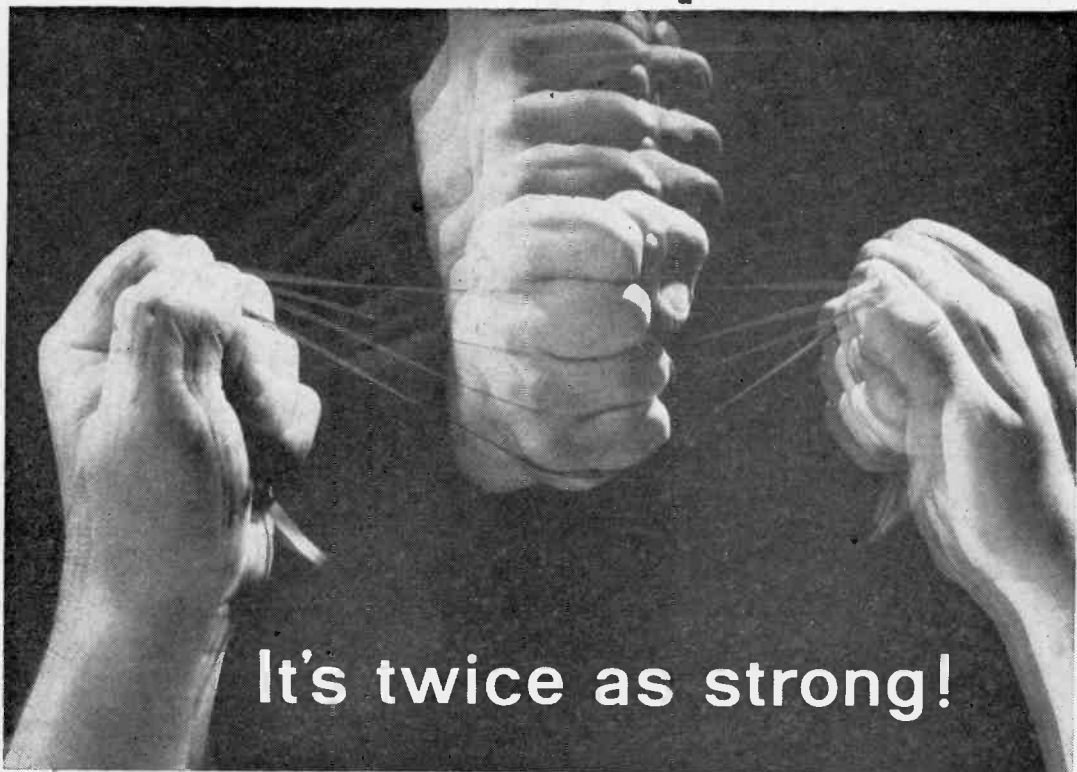

It's twice as strong!

There's never been an extended play tape as tough as new "Scotch" Brand Tensilized Double-Play Tape. It's twice as strong as ordinary magnetic tapes with the same playing time. Invisible "muscles" of Polyester, conditioned by a new unique process, give new Tensilized Double-Play

Tape super-strength. What's more, it's definitely stretch-resistant! Here's a long, long playing tape that will give you years of trouble-free use on any recording machine—home or professional. Don't pamper it . . . "Scotch" Tensilized Double-Play Tape is made to take it. Better buy a reel today!

Minnesota Mining & Mfg. Co.
Magnetic Products Div., Dept. QB-8
900 Bush Ave., St. Paul 6, Minn.

Rush me a copy of the free tape test kit:

Name _____

Street _____

City _____ Zone _____ State _____

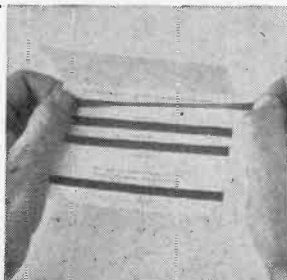

**Test its strength
for yourself**

Mail this coupon for your free test kit with sample lengths of all four extended play tapes. Pull each tape . . . hard! See . . . only "Scotch" Tensilized Double-Play Tape can stand the strain, just as it will even after years of use on your recorder.

Magnetic Tape

has everything!



Plays twice as long!

Like having two reels of tape on one! That's the miracle of new "Scotch" Brand Tensilized Double-Play Tape. A single reel of this remarkable super-thin magnetic tape actually gives you as much recording time as two reels of conventional tape. 100% more tape on a standard 7" reel. Enough to

record an entire opera, radio concert or business conference on a single reel—without interruption! Right now your dealer has new super-strong "Scotch" Double-Play Tape in limited supply only — but more's on the way and well worth its slight extra cost. Look for it in its new, bright blue carton.

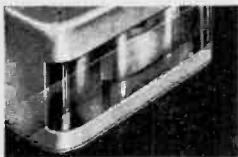

Enjoy "Scotch" Brand's built-in dry silicone lubrication

New "Scotch" Tensilized Double-Play Tape protects your recorder's head from wear with built-in silicone particles. Only "Scotch" Brand performs this vital lubricating job for you — reducing recorder head abrasion and eliminating tape squeal.



MINNESOTA MINING AND MANUFACTURING COMPANY

... WHERE RESEARCH IS THE KEY TO TOMORROW



The term "SCOTCH" and the plaid design are registered trademarks for Magnetic Tape made in U.S.A. by MINNESOTA MINING AND MFG. CO., St. Paul 6, Minn. Export Sales Office: 99 Park Ave., New York 16, N.Y.

© 3M CO., 1958

Where to get ALL the facts on ALL Hi-Fi equipment—for only \$1



For the first time, complete information on every hi-fi product is presented in one book — 864 hi-fi units and components illustrated and listed according to price, manufacturer, specifications, dimensions, features, model numbers, even shipping weights — in the new 1958

HI-FI DIRECTORY & BUYERS' GUIDE

If you're shopping for hi-fi equipment . . . if you're a "do-it-yourselfer," or want a whole system installed in your home . . . if you want to save time and money, send for your copy of the 1958 *Hi-Fi Directory & Buyers' Guide* now.

Its 170 pages describe in detail the latest AM and FM tuners, amplifiers, preamps, record changers, phonographs, styli, turntables, speakers, enclosures, cabinets, tape recorders, speaker systems, stereo units and consoles. On page 45, for example, you find an 80-watt amplifier for \$229.95. Underneath it is another amplifier for \$109.50. Why is one more than twice the price of the other? On page 134 is a speaker of radical new appearance. What are the 25 essentials of a good tape recorder? Pages 72-73 tell you. Why do some tuners have a "local-distant" switch? Why aren't ball bearings used very much in record players? Who makes tape splicers? What's the importance of bias adjustment in home recording?

You'll find the answers to these and thousands of other questions in the new *Hi-Fi Directory & Buyers' Guide* — a giant reference that belongs in your hi-fi library! It's a treasury of hi-fi values and practical guidance . . . even includes 47 records recommended by Eugene Ormandy . . . and a full list of hi-fi dealers in the U. S.!

Let the world's first complete Buyers Guide help you select the right hi-fi equipment for your needs.

Pick up a copy at your newsstand or hi-fi salon today
Or mail coupon below:

HI-FI DIRECTORY & BUYERS' GUIDE, Dept. HFG
64 E. Lake St., Chicago 1, Ill.

Please send me a copy of the 1958 *Hi-Fi Directory & Buyers' Guide* for which I enclose \$1, plus 10c to cover postage and handling.

Name _____

Street _____

City _____ Zone _____ State _____

do your tapes sound

'Real Pro'?

by *william h. o'brien*



A little care for your home recorder
helps it sound like a studio model

YOU'VE propped up your tape recorder before the high school band, being careful about mike placement to avoid the tonal fog spread over the bright blare of the brass by the acoustics of the old gym. Or, recording your Wednesday night chamber music group, you monitored for balance between the instruments and for the intimate detail that distinguishes such music. Yet, despite all this care in your recording setup, the tapes somehow don't sound like professional products. Perhaps you accept this lack of quality as inevitable, blaming it on the quality of your small home tape recorder.

The reason for better quality in the professional's end product is not only the equipment utilized but the way he goes about the job, so you might be doing your machine an injustice. Your home tape recorders are capable of far more "professional-sounding" results than you obtained in the past. Devote the same care to your machine that a professional lavishes on his and you may be surprised how closely your taping resembles professional sound.

where to get it

You can obtain information on the tape recorder accessories mentioned in this article and names of retail suppliers by writing to the following manufacturers:

Head Cleaner

Long Life Fluid	Audio Devices, Inc.
EMC Recording Corp.	444 Madison Ave. New York, N. Y.
806 E. 7th St. St. Paul 6, Minn.	

Tape and Clutch Lubricant

Long Life Fluid
EMC Recording Corp.
806 E. 7th St.
St. Paul 6, Minn.

Head Demagnetizers

Ampex Corp.	Audio Devices, Inc.
Redwood City, Calif.	444 Madison Ave. New York, N. Y.
Int'l Pacific Recording Corp.	
860 Vine St. Los Angeles, Calif.	

4"-Hub Tape Reels

EMC Recording Corp.	Samuel Candler Enterprises
806 E. 7th St. St. Paul 6, Minn.	1050 Ponce de Leon Ave., N.E. Atlanta, Ga.

These accessories permit the tape recording amateur to give his equipment the same routine maintenance as is employed in professional sound studios.

We won't tell you here how to make a recording. Choice and placement of microphones, acoustic preparation of the recording room, etc., are another story. We are concerned with only one thing: how to assure peak performance of your recorder before you even start to spin the reels.

Pad, Clutch and Tension

The first step is a professional-style pre-recording check of the machine's operation. Take a close look at the pressure pad holding the tape against the recording head. If it is not pressing firmly enough against the head, high frequencies will be lost. Pressing too tightly, the tape will slow down. Gently but firmly is the rule. Don't be afraid to adjust the pad.

Now let's check the clutch take-up for tension. An overly tight clutch can spoil a recording by "overpowering" the capstan. The clutch starts to pull the tape instead of the capstan, producing noticeable wow and flutter.

Here is a simple test for clutch tension which can be used on most small home tape recorders. Place a pencil against the tape at a point just beyond the capstan. If the tape *readily* "bows" out, you have correct tension. If not—if the tape skews out of

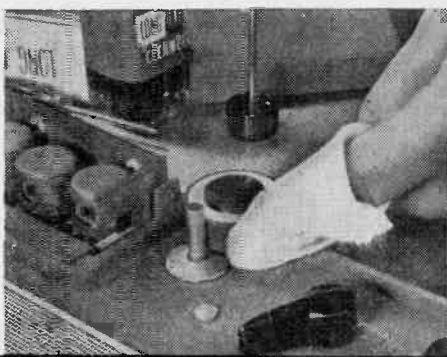

Cleaning the pressure pad of the recorder, the pressure roller and the capstan is a simple remedy for slow-running machines where dirt creates a mechanical hindrance.

Running tape through a pad soaked with lubricating fluid removes abrasive particles that accumulate on heads and guides, causing wear and impairing quality of recordings.

Recording heads may be cleaned with a special cleaning fluid which dissolves binder and oxide deposits that build up near the magnet gap. Despite its solvent quality, the fluid doesn't attack metal or plastic parts of the recording head.

away from the head. Be careful to avoid any abrupt motion, or the head will not be completely demagnetized. It is not necessary to demagnetize the erase head of the machine.

line only by exerting pressure—there is too much tension on the clutch.

The most inexperienced amateur should not hesitate to adjust the clutch. In all likelihood, your home tape recorder has a setscrew or nut to loosen or tighten the felt clutch pad and spring device. Make the necessary adjustment, using the "pencil test."

"Greasing" the "Skids"

Smooth operation of the clutch, as well as correct tension, is essential for maximum performance of your machine. It's a good idea to lubricate the felt clutch pad. Remove the part containing the pad from the clutch assembly and saturate it with silicone lubricant. Long Life lubricant is one brand used by professional tape recording engineers. The saturated felt pad should be left out all night; the fluid will evaporate, leaving the silicone behind to form a smooth surface on the pad, reducing friction to a minimum and eliminating any tendency for jerky action.

Caution: Under no circumstances use any kind of lubricating oil or similar product (common machine oil) on the clutch, unless the manufacturer of your recorder expressly specifies it for use. The heat produced by the machine in operation causes petroleum products to break down and, instead of lubricating, create friction.

Clear Heads

Magnetized heads have a bad habit of erasing the very high frequencies on your recorded tapes. It is a good practice to demagnetize the recording and playback heads of your machine before every use. Head demagnetizers are manufactured by a number of companies and can be purchased for approximately \$10. Before using the demagnetizer, cover the pole pieces of the recording head with a double layer of Scotch Brand cellophane tape. This will protect the head from scratches or other damage. The cellophane tape also acts as a "buffer" between the head and the demagnetizing field, helping to maintain even distribution of the field, and enables you to withdraw the demagnetizer in such a way as to assure complete demagnetization. Make two or three passes up and down the length of the pole pieces with demagnetizer, moving it slowly and steadily and gradually raising it upward and

away from the head. Be careful to avoid any abrupt motion, or the head will not be completely demagnetized. It is not necessary to demagnetize the erase head of the machine.

Smooth Travel

Correct speed and even tape travel are of primary importance in getting peak performance from your tape recorder. When playing back recordings made on the same machine, correct speed is not particularly important. But when playing back tapes recorded on professional equipment which maintained exact speed, a speed variation in your machine will seriously impair fidelity by noticeably changing the pitch of music and voice. To get full enjoyment from the many fine pre-recorded tapes now on the market, you will naturally want to obtain accurate reproduction.

Here's how you can check the speed of your machine the way the professionals do

with a timing tape manufactured especially for this purpose. Such tapes display a printed pattern which repeats itself with complete assurance every 15 inches. At 7½ ips, the pattern will appear once every two seconds; at 3¾ ips, every four seconds. Count out 56 consecutive 15-inch segments of the timing tape. Then, with a red wax crayon, make a mark at a point three segments in from each end. This leaves 50 segments between the two red marks. Thread up the timing tape, setting the first red mark right next to the capstan, and start the machine.

Note the time in seconds that it takes for the second red mark to appear at the capstan. If a machine is running at exactly 7½ ips, it will take 100 seconds; at exactly 3¾ ips, 200 seconds. Don't expect to hit this reading on the nose. If your machine times out at 98 or 102 seconds, it is satisfactory. Most home tape recorders of good quality will be within plus or minus two per cent of the rated speed. If the machine falls within these limits, there's no problem.

A slow machine probably means that the capstan is slipping. Correct by cleaning the capstan with Long Life cleaning fluid. Once the capstan and rubber pressure roller have been thoroughly cleaned, the machine should speed up to its correct rate. The top photo on page 108 shows how to clean the capstan and pressure pad.

A machine consistently running at excessively slow or fast speeds should be returned to the manufacturer.

Tape Treatment

All of the major brands of tape will give completely satisfactory results on home tape recording equipment. Just the same, recording tape does need some special attention if you are aiming at maximum performance. Here's why that's so.

All magnetic recording tape is manufactured in wide rolls and then slit into ¼ widths, giving it jagged edges. Passing through the machine, these jagged edges cause a build-up of binder and oxide deposit to accumulate on the heads and guides. Like a fine rouge abrasive, these particles gradually wear away the laminated metal of the head. The harmful effects aren't noticeable at once. A single roll of tape will not do any immediate damage, but in time a definite loss of recording quality will result.

Fortunately, it is easy to prevent this type of damage by removing the abrasive particles from the edge of the tape. Saturate a wad of cotton with the same fluid that you used to lubricate the clutch. Squeeze out excess fluid until the cotton is wet but not "drippy." Holding the cotton between your thumb and forefinger, grasp the tape lightly and run its entire length at fast forward or rewind as shown on page 108. When you've finished, take a look at the cotton. You'll be amazed at the amount of oxide and particles that has been removed.

Be sure to rewind the tape after completing this treatment. It is under tension from being wound while under the pressure of your fingers and, if stored in this condition, it will be damaged.

The treatment will also give the tape a uniform layer of silicone to reduce friction and promote more intimate contact between head and tape with less noise and tendency to "drop out."

Tape Thickness and Reel Size

Two factors often overlooked by the home recordist are tape thickness and reel size. Professional engineers favor tape with the oxide coat on 1-mil backing. Thinner than standard tape (1½-mil backing), it is more compliant and makes closer contact with the head; yet it is not so thin that it will stretch or break, as occasionally happens with the extremely thin ½-mil tapes.

Another problem of recording on either amateur or professional equipment is keeping the ratio between the outside diameter of the reel and the hub diameter at a minimum. If a considerable ratio exists, the difference in tension between a full reel and an almost empty one can cause a speed variation from the beginning to the end of a recording. A special 7-inch reel has been introduced which holds 1200 feet of 1-mil tape and yet has a hub diameter of four inches. With this larger hub, there is little or no danger of distortion on the layers of tape next to the hub, a mishap prevalent with small hubs and the cause of many poor tape recordings. So, before you make your recording, it's a good idea to remove your tape from the original reel and rewind it onto a reel with a 4-inch hub. It is also recommended that you use the same type of reel for take-up.

The maintenance and operational procedures described here require a great deal of time. However, by employing these techniques, you will obtain better, more professional results and derive greater pride and satisfaction from your hobby.

(Continued from page 89)

Typical Setup

In operation, the ECU is connected directly after the preamp-equalizer. The input signal is divided and fed to individual power amplifiers. Each power amplifier, in turn, drives its own speaker—one for lows, the other for highs.

Such a setup permits great flexibility in adapting individual speakers to handle their correct frequency ranges. Highs and lows are amplified separately and reproduced separately. This means that inter-modulation distortion is virtually licked. Unstable loading conditions and problems of impedance matching are solved. The variety of crossover points provided by the ECU permits experimenting with whatever speakers you have until the best possible combination is achieved.

Further Refinements

An ECU can also be used as the basis for a three-way speaker system. One method would be to use two ECU's cascaded. A cheaper, but effective, method would be to combine the ECU with an LC network. The ECU makes the first frequency division into bass and treble. The treble is then further split into two channels (mid-range and high) by the network.

To use the ECU in such a system, select a fairly low bass crossover point, say, 400 cycles. Everything below 400 cps is then fed to the woofer. Everything above 400 cps is fed to an external dividing network. The network then makes another division into mid-range and highs with a likely crossover at, say, 4000 cps, depending on the particular tweeter used.

Such a system makes the best use of the natural advantages of both an electronic crossover and the LC network. By taking over the demanding job of bass crossover, the ECU delivers maximum undistorted power to the woofer for best bass reproduction. The network, designed to operate at about 4000 cps, can be built from relatively low-value and inexpensive capacitors. As a high-pass filter, it will not be called upon to handle excessively high wattages, but will deliver plenty of highs to a tweeter and help put a tonal sheen onto the sound you hear.

Whether your hi-fi needs lead you to the ultimate in sound systems or to one of the more modestly priced units described, you'll find that an electronic crossover can furnish you with a new measure of thrilling, realistic sound.

At last! A practical answer to your cost problem. The World's Largest Tape Recorder Outlet and Service Lab now brings you a Money Saving . . .

STEREO TAPE EXCHANGE

Count these advantages and you'll see why we positively must limit our membership to 2500 for the entire United States and Canada. There are an estimated 2 million tape recorders in use, so this means that only 1 out of every 800 users may be enrolled, on a first come first served basis . . .

1. EXCHANGE \$50 WORTH OF STEREO TAPE FOR ONLY \$1.35 PER REEL.
2. RENT STEREO TAPES FOR ONLY \$1.45 EA.
3. FREE! A TERRIFIC \$9.95 STEREO PARTY TAPE.
4. FREE! 4 STEREO CATALOGS.
5. BUY STEREO TAPES, BLANK TAPE, ACCESSORIES & HI-FI COMPONENTS AT MAXIMUM SAVINGS.
6. HIGHER TRADE-IN ALLOWANCES. Our huge service lab and facilities for converting recorders to stereo, plus our 10 showrooms enable us to rebuild and resell recorders in quantity. This means the highest possible trade-in allowances to you. You need wait no longer for the thrill of stereo in your home. Enjoy the living presence now possible on such fine (stacked head) units as BELL and PENTRON, best in the lower price range. Or, for only a little more, you may own a system of amazing quality, ruggedness, durability, and ease of operation, the TANDBERG STEREO. And for those who want only the very, very best, the stereo leader of the world, the professional machine now at a price you can easily afford . . .

**AMPEX ONLY 10% DOWN
24 MONTHS TO PAY**

Magnetic Recording Co. climaxes its 10th year as tape recorder specialists by bringing you this amazing money-saving club.

MEMBERSHIP LIMITED

Write at once for full details.

Stereo Tape Exchange

c/o Magnetic Recording Company
344 Main Street
Paterson, New Jersey

Karlson

announces

THREE MAJOR "BREAK-THROUGHS" IN PRECISION ACOUSTICS

★ Karlson Enclosures* for 8", 12", 15", 18" Speakers
Now Patented** and accepted as a superior musical instrument
— designed to improve the performance of any Hi-Fi speaker.
(not just a box!)

★ Pre-recorded Stereo Tapes
Recordings made for the first time with the sensational new Karlson microphone having dynamic range equivalent to that of the human ear (120 DB); frequency range from 0-40,000 C.P.S.

★ Karlson "Recorder-Mate 8" Patented** Speaker-Transducer

Stereo perfect — low cost — portable — compact — superior to more costly systems.

**Pat. No. 2,816,619 ©1958

for further information
fill out coupon

KARLSON ASSOCIATES, INC.
Dept. HFB, 1610 Neck Road, Brooklyn 29, New York

Enclosure Stereo Tapes Recorder-Mate 8"

Name.....

Address.....

City..... State.....

getting the most out of tape

ARE YOU completely satisfied with your tapes? Do you feel you're getting the most in sound quality for the money you invest in equipment and tape? Maybe! Here are a couple of tips which make you change your mind.

First, how about the speed of your recorder? If your machine is running fast or slow, chances are that you've never noticed it. But if you run someone else's tapes on your recorder, or your tapes on another machine, you can be sure it'll be evident in a change of pitch or tempo. A simple way to determine the actual speed of the recorder is as follows:

Carefully cut a piece of blank tape five times the length of the rated speed of the machine, adding a quarter inch for splicing. (For instance, a 7.5-ips speed takes a length of $37\frac{1}{2}$ " plus $\frac{1}{4}$ ", for a total of $37\frac{3}{4}$ ".) Square both ends, overlap a quarter inch, make a diagonal cut, and splice in the usual way. Thread the loop into the recorder so that it can run continuously without interruption. Then switch to record and turn the gain up half way. Thump the mike once with your finger and stop, so it won't be erased on the next turn. Now

switch to playback and count the total number of thumps in 120 seconds.

The number of thumps divided by Factor A gives the actual speed of your recorder; for a rated speed of 15 ips, Factor A is 1.6; for 7.5 ips, 3.2; for 3.75 ips, 6.4; for 1.875 ips, 12.8. Assuming a rated speed of 7.5 ips, you should count 24 thumps in 120 seconds at true speed (24 divided by 3.2, which is Factor A for that speed). One thump more or less shows a 5% deviation in speed, usually detectable only by the critical listener. If the variation is more than that, it should be corrected.

Secondly, recording tape is available in a wide variety of brands and price ranges: the following is a simple comparative test which demonstrates the relative output of any two tapes, and will help determine which is more suitable.

Splice two sample lengths (3' to 5') of any two brands, after marking them for identification. Run this sample through with a steady signal at the input—or vary it by using a voice or music passage. Splice the free ends to make a loop. Then put it in the machine and play it back. When measured with an oscilloscope or a VTVM, the relative outputs of the two tapes can easily be compared. You can also determine the frequency response of the tapes and your recorder.

Even without these devices, you can judge fairly critically by ear. You may, perhaps, whistle a steady note into the mike and listen carefully to the playback. Of course, your own judgment will be the critical factor in this case, but since you are doing it for yourself, that's the only thing that counts.

One or both of these tape "tricks" should increase your listening pleasure manifold.

—Warren J. Smith

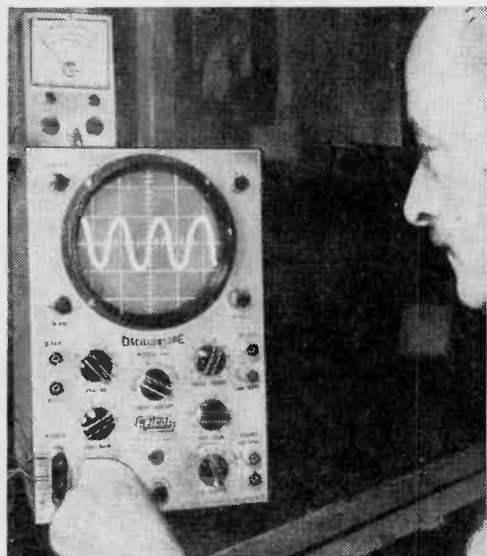

Use an oscilloscope after splicing two brands or grades of tape to find which one has better quality.

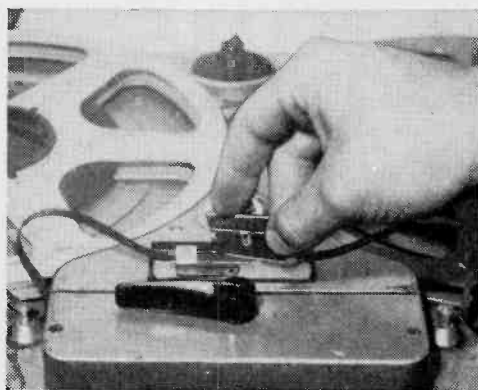

Use a splicing block to make loop of tape to determine exact speed of your recorder. It may be in error.

7 KEYS TO PERFECT SOUND

In the complete Audiotape line there's a tape that's right for every job — all with the same consistent uniform quality that means top performance on any tape recorder

PLASTIC-BASE AUDIOTAPE on 1½-mil cellulose acetate meets the most exacting requirements of the professional, educational and home recordist at minimum cost. Known the world over for matchless performance and consistent uniform quality. Series 51, in the red box.

AUDIOTAPE ON 1½-MIL MYLAR*—a premium-quality professional tape with maximum mechanical strength and immunity to heat and humidity. Will not dry out or embrittle with age. Series 71, in the green box.

"LR" AUDIOTAPE ON 1-MIL "MYLAR"—50% more recording time per reel. Strong, super-durable polyester film base assures trouble-free operation even under extreme heat and humidity. Series 61, in the black-and-red box.

PLASTIC-BASE "LR" AUDIOTAPE provides 50% more recording time on low-cost 1-mil cellulose acetate base, affording maximum economy where high strength is not required. Series 41, in the blue box.

SUPER-THIN AUDIOTAPE on ½-mil "Mylar" gives twice as much recording time per reel as standard plastic-base tape. For long-play applications where tape tension is not excessive. Series 31, in the yellow box.

MASTER LOW PRINT-THROUGH AUDIOTAPE on plastic base — reduces print-through (magnetic echo) by 8 db. The finest, professional-quality recording tape. Base material, 1½-mil acetate. Maximum fidelity, uniformity, frequency response and freedom from noise and distortion... Series 51M, in the red-and-gold box.

MASTER LOW PRINT-THROUGH AUDIOTAPE on 1½-mil "Mylar"—print-through (magnetic echo) is reduced by 8 db. A super durable tape that meets the highest standards of performance. Withstands extreme temperatures and is virtually immune to humidity. Has maximum life under any conditions... Series 71M, in the green-and-gold box.

*DuPont Trade Mark

audiotape
TRADE MARK
it speaks for itself

AUDIO DEVICES, INC., 444 Madison Ave., N. Y. 22, N. Y.
In Hollywood: 840 N. Fairfax Ave. • In Chicago: 5428 Milwaukee Ave.
Export Dept.: 13 East 40th St., N. Y., 16 • Cables "ARLAB"
Rectifier Division: 620 E. Dyer Rd., Santa Ana, Calif.



reel tricks for tape recordists



■ The first step in making a tape album is to glue two tape cartons front-to-back. Recommended method is to spread rubber cement on both surfaces to be bonded. Wait until they are almost dry, or "tacky"; then place them together firmly and hold tightly for about 30 seconds. Any number of empty tape cartons can be attached to each other in this manner.

homemade tape album



■ ■ Next, add a binding hinge. This piece helps keep the cartons together, and permits them to be turned so that they lie flat, exactly like sections of a record album. Suggested material for hinge is colored plastic, available in rolled strips. This material has high adhesion, is strong, and looks very "professional."

■ ■ ■ Final step in making tape album is to add an appropriate label (right). This may be hand-lettered, cut from a magazine advertisement, etc. A similar label across the binding hinge will help identify selection when album is placed on shelf next to its mates. You can color-code albums, according to type of program material, by using different colors of plastic tape for binding and labels.



SOME OF THE FUN of tape recording lies in the little things which are by-products of your main hobby and which can add to the enjoyment of recording at home. One of these is making your own album to store recorded tapes. Another is to devise an "endless" tape recording—useful for repeating messages at regular intervals. These photos and captions tell you how to do both quickly and inexpensively.

Ron Anderson



Endless Tape Recording

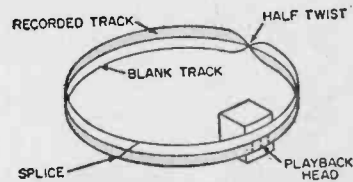

To repeat message, with silent period interspersed, use method shown above. Before splicing the two ends of your tape segment, put a half twist in it. When the tape plays, the message will be heard the first time around. When the splice passes the head, the tape will be turned around and the blank area will pass the head causing silent period.

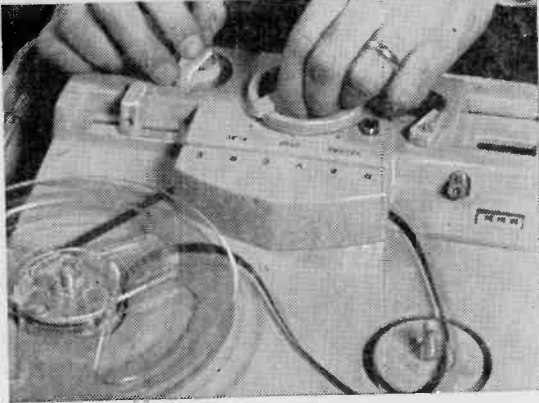

Messages of moderately long duration are put on continuous tape. Run tape over edge of table and hang empty reel on it. This provides enough weight to keep tape running smoothly.

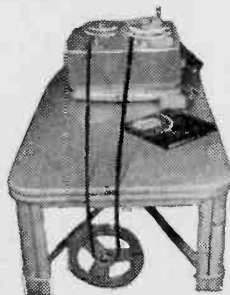

A continuous loop of recorded tape can be made in many sizes to suit different purposes. If the message you want to repeat is to be short, you can run the tape around one of the reels, or possibly around both, as shown in the photo at left. All you need do in this case is to splice the ends of a segment of tape of the desired length. A method for making a longer continuous tape is illustrated below, left. Still another method—and one that provides much longer messages because more tape can be used—is to let the tape spin off into a plastic bag fastened to your recorder. Just let the tape pile up hodge-podge in the bag and it won't snarl or tangle.

check the tape head

by h. h. fantel

SHOOTING trouble in the head may sound a bit radical, but it's a simple and effective way of curing most tape recorder complaints. Tape recording and playback heads are afflicted by minor ills. For this reason, make sure your heads are (1) straight, and (2) clean.

Problems may come to a head when there is a screw loose somewhere. In that case, the head forgets which end is up and leans over a little to one side. To retain the full advantage of wide-range tape recording, the head must always be proudly erect at strictly right angles to the direction of tape travel. In other words, as the tape travels sideways, the head posture must be straight up and down.

You can improvise your own test of head alignment by simply carefully skewing the tape (first in one direction, then in the other) as it runs past the head (see photo, above right). If the music brightens up with added highs as you deflect the tape, you know that your head is on crooked. But that's nothing that a small screwdriver won't fix. Adjustment screws are provided for this purpose.

For this test, you can't use tape recorded on your own machine—because the error in recording cancels the error in playback. Result: you still don't know whether or not your head needs fixing. For a valid test, you must use "pre-recorded" tape made on a perfectly aligned "professional" machine. Pre-recorded tape from reputable manufacturers is suitable for the purpose, but special alignment-check tapes are available. Play this tape while you adjust the inclination for maximum sonic brilliance. When you get that angle straight up, you're a lot closer to being up on all the angles of hi-fi tape recording.

As miles of tape file past the recording and playback heads, friction between tape and head files away oxide particles and dust from the tape. After a while, a sticky mess of such hi-fi dandruff gums up the straight and narrow gap, which is the business end of the tape machine. The accumulated dirt prevents close contact between the magnetic gap and the tape, resulting in considerable loss of high-frequency response. For instance, if a welt of dirt on your head pushes the tape away by as little as seven-thousandths of an inch, all frequencies above 5000 cycles will drop 30 db. That's about as good as being lost altogether.

The remedy is simple: just dab the tape recorder heads with a soft cloth soaked in carbon tet, and the gummy dandruff comes right off. The carbon tet won't attack the rubber parts of your machine, but be sure it's all dried off before you run tape over the freshly cleaned head.

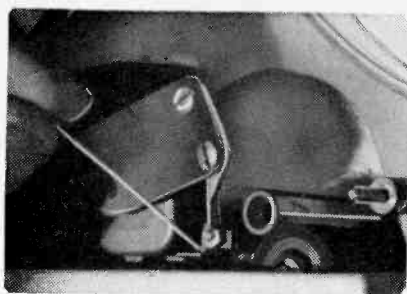

Wiggle a toothpick slowly back and forth against tape near the playback head. If highs improve at any point, align tape head.

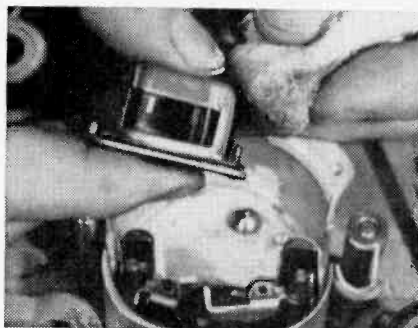

Cleaning head with carbon tet assures better tape contact.

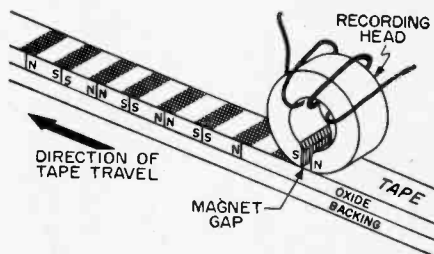

Magnet gap in recording head must cross tape at right angle.

for high fidelity...today...and for years to come...

ONLY SOUNDCRAFT TAPES...

**ONLY SOUNDCRAFT
MICROPOLISHES TAPE!**

Friction between recorder heads and non-polished tape surfaces is produced by tiny nodules... *microns* in size... which cause a loss of high frequency signals in recording, and even further loss in playback. Unless your tape surface is perfectly smooth when new... *you've lost high frequency response before you start!* Friction also causes dangerous head wear because recorder heads are forced to act as polishing surfaces! A truly smooth surface *must* be polished... and *no other tape...* ONLY SOUNDCRAFT TAPE is polished... MICROPOLISHED to guarantee high fidelity reproduction... to reduce head wear... *to save the quality of the sound!*

**ONLY SOUNDCRAFT
OXIDE FORMULATION
IS PLASTICIZER-FREE!**

Plasticizers, chemical agents used in other tapes to provide pliancy, eventually migrate into the atmosphere, leaving tape dry and brittle... *old before its time!* It is the oxide formulation on tape that carries the sound... and ONLY SOUNDCRAFT TAPES have the remarkable oxide formulation which eliminates antiquated plasticizers! You get *complete tape stability... unequalled protection for your recordings!* And when you buy SOUNDCRAFT TAPE on MYLAR* base you have double protection... *lifelong preservation of your recordings...* ONLY ON SOUNDCRAFT TAPE!

*T.M. for Dupont's plasticizer-free Polyester film

PROFESSIONAL (Acetate)... professional applications—uniformity guaranteed. 7" reel—1200 feet.

RED DIAMOND (Acetate)... long, hard usage, economy. 7" reel—1200 feet.



**ONLY SOUNDCRAFT
OXIDE FORMULATION IS
"UNI-LEVEL" COATED!**

Variations in thickness of oxide coating cause distortion of low frequencies... a condition all the more dangerous because you can't see the variation. To insure faultless low frequency response through positive coating uniformity... *insist on SOUNDCRAFT TAPES...* the only tapes with oxide coating applied by the exclusive UNI-LEVEL process... *you can hear the difference!*

Because of these exclusive features, all SOUNDCRAFT TAPES offer complete uniformity... within a reel and from reel to reel... and can be freely interspliced without changes in volume!

PLUS 50 (Mylar)... long play, strength, long term storage. 7" reel—1800 feet.

PLUS 100 (Mylar)... extra-long play—ultimate in double-length tapes. 7" reel—2400 feet.

LIFETIME (Mylar)... utmost strength, professional fidelity, permanence, accurate timing—lifetime guarantee. 7" reel—1200 feet.

REEVES SOUNDCRAFT CORP.

10 E. 52nd Street, New York 22, N. Y. • West Coast: 342 N. La Brea, Los Angeles 36, California

FOR EVERY SOUND REASON...REFUSE LESSER QUALITY...BUY ONLY SOUNDCRAFT TAPES!

Tape Recording in 1958

(Continued from page 35)

Prices range from less than \$100 to more than \$2000 for the elaborate professional stereo recorders featured in the advanced audiophile's hi-fi system. The lower-priced units include, in most instances, an audio amplifier and speaker mounted in a single carrying case. The stereo units can often be purchased with matching sets of portable speaker enclosures.

There has been a growing trend during the past several years for manufacturers of the popular-priced tape recorders to emulate the practice of manufacturers of professional equipment, in making separate tape decks and preamplifiers available. Conversely, the more expensive recorders sold by *Ampex*, *Berlant-Concertone* and *Magnecord* are now available in single packages.

The whole industry has seen an increasing demand for better quality and more expensive recorders. Consumers are willing to pay substantial sums to hear true hi-fi in their homes. Stereo has generated more excitement and interest in home recording than any previous development.

Many major companies have entered the tape recording business during the past several years. The *David Bogen Co., Inc.* is marketing a \$385 professional type recorder with three motors, VU meter, and 10½" reels. Playback preamplifier is separate. *Graflex*, a firm well-known in the camera field, took over the *Ampro* line in 1957. The *Ampro* 758, priced at \$249.95, has been a popular model in the medium-priced field. Mr. H. A. Schumacker, vice president of *Graflex*, states that several radio-TV manufacturers are considering the use of the *Ampro* tape deck in their hi-fi furniture units this year. *Bell and Howell*, another firm identified with the camera business, made significant contributions to the concepts of tape recorder styling. Their portable units drew praise from the architectural and decorator trades last year.

Bell Sound Systems this year offers a three-motor, monaural record-stereo playback unit priced under \$250. *Bell* sells through distributors to appliance, TV, music, and department stores and expects substantial sales increases in 1958.

The *Wollensack* recorder employs a new idea in tape recorder design. This unit is extremely compact and features a lightweight metal frame. *V-M* and *Webcor* also introduced new models in 1957. Mr. H.

R. Letzer, vice president of *Webcor*, predicts that the combined sales of phonographs and tape recorders will achieve a level of \$500 million at retail within two years.

One new development that lends itself to making stereo listening more enjoyable is the remote control accessory for adjusting speaker volume. Remote controls have long been a feature of tape recorders for starting, stopping, and fast rewind of tape. In 1958, *Webcor* will be promoting a new "Aural Balance" remote control for adjusting the audio levels of both speakers from anywhere in the room.

Both *Magnecord* and *Berlant-Concertone* introduced new recorders at the fall and winter hi-fi shows. The *Concertone* series 60 models feature 10½" reels, push-button controls, VU meter, three motors, and speeds of 7½ and 15 ips. The *Magnecord* "Courier" also features 10½" reels, three motors, push-button controls, and a playback amplifier with bass, treble, loudness, and inter-channel balance controls.

Imported Tape Recorders

The tape recorder buyer in 1958 will be confronted with a wide assortment of new brands from foreign manufacturers. *Grundig* is planning a daily production of one thousand recorders from its new Bayreuth plant. *Grundig* expects to produce 260,000 machines annually for worldwide distribution.

A complete stereo record and playback system, the "Sterecorder" was introduced this year by *Superscope*. The tape deck is manufactured by *Sony* of Japan, one of the five largest manufacturers of transistors in the world. The "Sterecorder" is priced at \$525, or \$700 with a set of matching speakers.

Norelco of Holland, *ReVox* of Switzerland, *Ferrograph* of Great Britain, *Tandberg* of Norway, and *Fen-Tone* of Germany all offer tape recorders for the U. S. market. *Fen-Tone* plans the introduction of several new units, including a tape deck kit, a stereo unit, and a recorder with provisions for 10½" reels.

Prospects for the Future

What will happen in 1958 will be an amplification of the dramatic impact of stereo sound on tape, the increased use of the tape recorder for home entertainment, and a growing demand for all types of specialized recorders for use in industry. Video recorders and playback units, while still too bulky and expensive for home use, will be the subject of intensive research to find ways to eventually get these units into the American home.



GUIDE Section / part **3**

stereo

- going stereo **120**
- stereo in the home **135**
- how stereo tapes are made **142**
- convert to stereo **146**
- stereo equipment roundup **150**

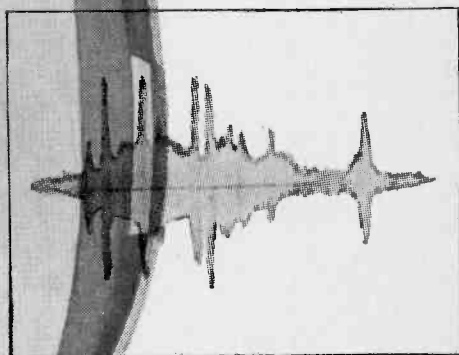

going stereo?

by norman eisenberg

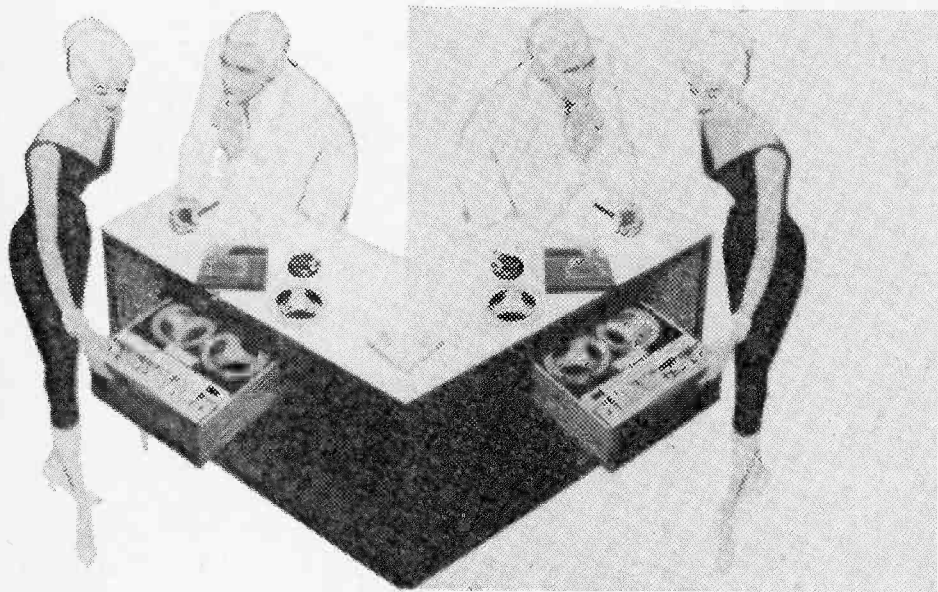

IF YOU'RE A HI-FI ENTHUSIAST who now owns a going system, you may as well accept the inevitable: sooner or later you'll want your "going system" to be "going stereo." A stereophonic system, as you probably know by now, helps get that "third dimension" into the music you hear at home—a sense of depth and spaciousness and realism that a single-channel, or monaural system, cannot quite achieve. In fact, for some listeners, stereophonic sound represents as dramatic an advance over monaural hi-fi as did hi-fi over low-fi.

Despite this difference, the "going stereo" process for one who now owns a hi-fi system need not be a revolution; it can be a reasonable sort of conversion. If you want to go into stereo, it does not mean that your present hi-fi rig has become obsolete; it means, on the contrary, that you already have the beginning portion, somewhat more than one-half, of a future stereo system.

Fortunately, the equipment needed to complete your stereo system need not be a literal replica of your present rig—and indeed, sometimes it should *not* be. Certain avenues of approach to the question of assembling stereo, based on currently available components can be suggested. Before we begin let's agree on a few definitions. In a field as relatively young as stereo, particularly in tape stereo, industry-wide (and hobbyist-wide) agreement on terminology has not yet crystallized. For our purposes, for example, a "tape deck" refers to the tape transport mechanism and tape heads—without "electronics," i.e., without preamplifier-equalizer or power amplifier. A "tape record-playback preamp" designates a preamplifier that provides both gain and equalization for either recording onto tape or for playing from a previously recorded tape. A preamp that does not provide the recording function will be labeled a "tape playback preamp." The term "preamp," by itself, will refer to a conventional preamplifier-equalizer with controls. A "power amp" is, of course, the unit that delivers driving power to the speaker. When both preamp and power amp functions are combined on a single chassis, the unit will be termed a "complete amp." "Channel 1" will refer to your present hi-fi system; "Channel 2," to the second channel to be added for stereo.

Stereo Program Sources

Present sources of stereophonic program material, available for home listening, include prerecorded stereophonic tapes and—in some areas—stereophonic or binaural broadcasts in which one program channel is transmitted via AM, while the other is sent out simultaneously over FM. A type of all-FM stereo, in which both channels are sent out on FM, utilizing two different carrier frequencies, is known as “multiplexing.” Such broadcasts are not yet generally available, although recent experiments by a few broadcasters indicate that they may be on the way. Finally there are stereo discs—conventional looking LP platters whose grooves harbor two distinct sound channels for stereo playback. These records, too, are still in the developmental stage, but, if all goes well, a selection of such records, and new stereo pickups to track them, should be on the market before the end of 1958.

While most of us must compromise with budget, we do not have to compromise too much, or at all, with end results. There are several paths for anyone going stereo—and they can be as painless as they are sonically rewarding.

AM-FM Stereo Broadcasts

Listeners fortunate enough to live in areas where AM-FM stereo broadcasts are available can get a taste of stereo simply by listening to the AM and FM transmissions simultaneously. To do so involves the use of two separate receiving systems. For most listeners this has meant hearing the FM portion over the existing hi-fi system (FM tuner to amplifier to speaker), and pulling in the AM by dusting off the old AM set and re-installing it in the living room—generally about six to eight feet from the speaker of the hi-fi system (*Fig. 1*). Because of AM's limited frequency range and high signal-to-noise ratio, there's no denying that such a stereo system is a compromise—but it does provide some stereo. It also demonstrates that stereo can be realized even with equipment that is not “matched,” i.e., identical in quality.

Enthusiasts who have monaural systems and are fortunate enough to have a spare speaker system can hook up one of their speakers to the AM radio. Such a rig will provide better reproduction from the AM side and enhance the stereo effect (*Fig. 2*). Carrying this approach a few steps farther, the ideal system for listening to stereo broadcasts would be a completely separate hi-fi AM channel in addition to the hi-fi FM channel. This involves an AM tuner, a second amplifier, and the second speaker (*Fig. 3*). In such a system, the AM section of most “AM-FM” tuners is unusable—unless the tuner is specifically designated as a binaural or stereo tuner. Stereo tuners are actually two separate tuners (AM and FM) on one chassis; each can be operated independently of the other, as well as simultaneously. They share nothing but the chassis itself and a common power supply. Examples of such tuners are the *Electro-Voice* model 3304 (about \$240) and model 3303 (about \$280, and including a built-in preamp); the *H. H. Scott* model 330-C (\$225) and 331-C (\$290, and including a built-in preamp); and the *Madison-Fielding* model 333 stereo tuner (\$149.95). For kit fanciers, there is the *Arkay* ST-11 (\$47.95); the *Lafayette* KT-500 (\$69.50); and the *Telematic* KB-402 (\$69.95). The hi-fi enthusiast who has no tuner at present but who anticipates listening to stereo broadcasts would do well to consider a stereo tuner, of which the above models are examples of what is currently available. Listeners with a good FM tuner might consider a hi-fi AM tuner (there are several on the market,

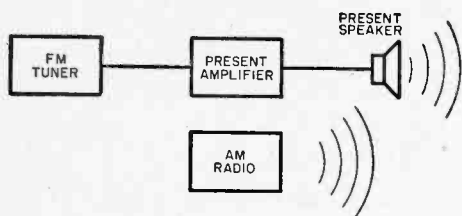
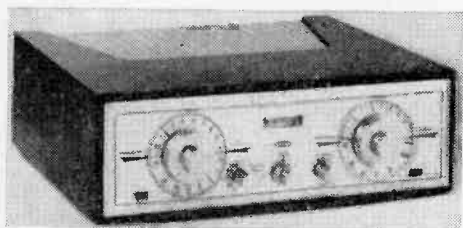

Fig. 1. Simple low-cost way to get broadcast AM-FM stereo is to use home AM radio simultaneously with FM tuner in present high-fidelity sound system.



Stereo tuner model 3304 made by Electro-Voice can replace separate AM and FM tuners in systems for receiving broadcast AM-FM stereo.



Tuner incorporating completely separate AM and FM receivers on one chassis for stereophonic reception. This unit made by H. H. Scott includes preamplifier-equalizer.

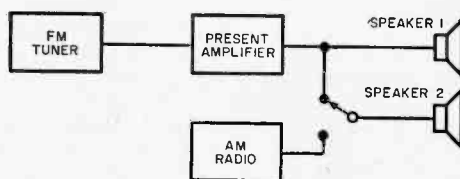

Fig. 2. Improved version of set-up in Fig. 1 uses second speaker of hi-fi system to improve sound quality of AM radio. Switch permits connection to amplifier for monaural listening.

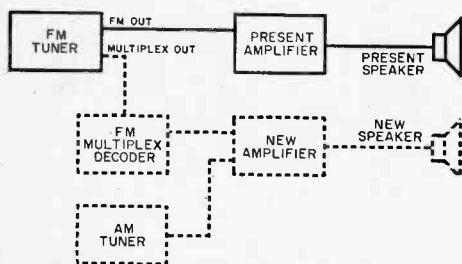
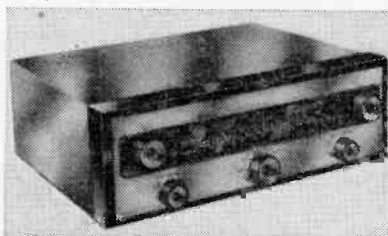

Fig. 3. Ideal system for reception of stereophonic AM-FM broadcast as well as FM-multiplex stereo can be added to monaural system.



Kit stereo tuner from Lafayette Radio has separate AM and FM outputs. This unit is also available in assembled form.

including models by *Fisher* and *Bogen*).

Multiplex FM is being used in a restricted sense—largely to provide “background music” for certain business establishments who subscribe to the service. It has not, as yet, been used for stereo broadcasts to the general public. In any case, to receive the multiplexed channel, you must have a multiplex output on your regular FM tuner, from which the multiplex signal is then fed to a special multiplex decoder, and thence to an amplifier and speaker. Multiplex decoders are not presently being offered for sale but are anticipated to be on the market in late 1958.

Combination AM-FM tuner made by Madison-Fielding provides multiplex output for attachment of decoder to permit reception of FM-multiplex.

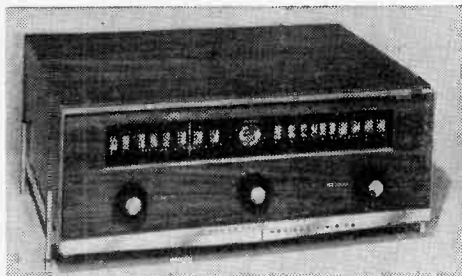
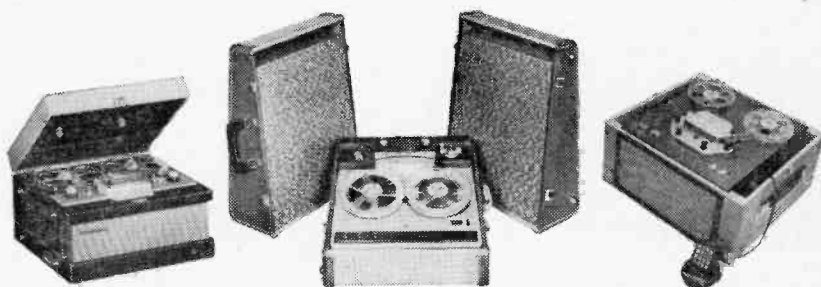
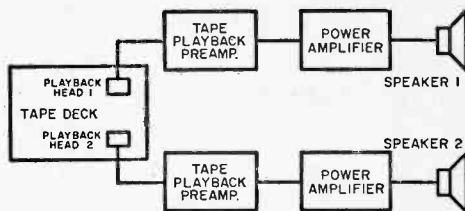

Fig. 4. Basic setup for stereo tape playback. Exact method used can be varied as described in text depending on equipment you have available.



Tape recorders available for playback of prerecorded stereophonic tapes include the V-M model 711 at left, Webcor BP2827 "Imperial" at center, and the Bell Stereophonic at right.

Stereo Tapes

The most widely used source of stereo program material is, at present, prerecorded stereophonic tapes. To play stereo tapes, a tape machine must have two playback heads, one for each track recorded on the tape. Each playback head feeds its own playback preamp, power amp, and speaker (Fig. 2A). Many existing tape recorders can be converted for such playback, using special stereo adapter gear put out by tape machine manufacturers—such as *V-M*, *Revere*, *Pentron*, etc. for their respective models. Such an adapter package usually includes the second playback preamp as well as the stereo heads. A "universal" adapter, the *Dactron*, is reported to be capable of fitting a second head onto any make of tape recorder. *Dactron* also makes available a transistor type preamp for under \$20. This second playback preamp may not always be needed, depending on what other equipment you own, or plan to get. Separate heads, minus preamps, are available from such companies as *Shure*, *Dynamu*, and *Brush*. Installing one of these heads is probably a job, though, for the professional—assess your own ability and technical know-how before tackling such a job. In any case, check with the manufacturer of the machine you plan to convert, as well as with the manufacturer of the conversion package or playback head.

Summarizing, then, the possible hookups shown in *Figs. 4, 5 and 6*: basic requirements for a stereo tape playback system are shown in *Fig. 4*. Your present tape equipment may include one or more of the basic blocks of such a system. If you have a "complete" tape recorder, i.e., one that includes complete playback facilities for one channel, you may use that channel for tape playback head 1. Playback from head 2 may then be accomplished by feeding it directly into an external complete amplifier (*Fig. 5*) if it has the correct input (more of this later). If your present tape equip-

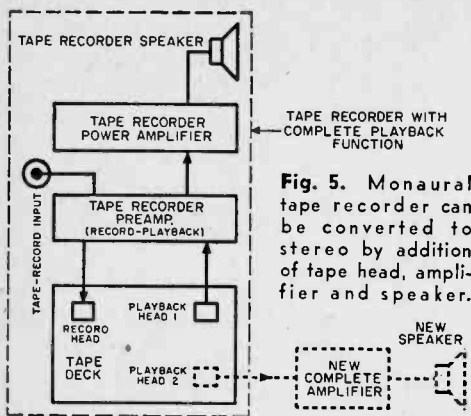

Fig. 5. Monaural tape recorder can be converted to stereo by addition of tape head, amplifier and speaker.

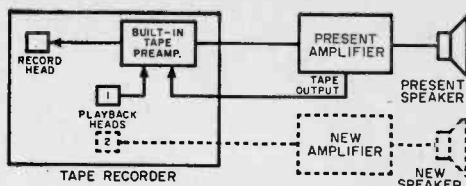

Fig. 6. Recorder in single channel hi-fi system can be converted to stereo. Channel 1 remains same as in original monaural hi-fi system. Channel 2, using added playback head feeds second amplifier. It is desirable for second amplifier to have tape head input that will give proper equalization for second stereo sound channel.

ment does *not* include a playback power amp, but *does* include a built-in tape preamp, you will need *two* external amplifiers for stereo playback (Fig. 6).

If your present hi-fi system does not include any tape equipment, your problem is not one of conversion, but of initiation—and the initiation fee can vary considerably, depending on what equipment you choose. From the relatively low priced decks and associated electronics made by such companies as *Viking*, *Pentron*, *Bell*, and *Fen-Tone*, the gear ranges upward through such names as *Revox*, *Berlant-Concertone*, *Ferrograph*, *Crown*, and *Ampex*. It is quite likely that a higher initial investment will bring greater returns in terms of longer wear and satisfactory performance. Despite this, budget-minded stereo tape fanciers need not feel left out of things; modestly priced tape equipment can be quite satisfactory if enough care goes into its design and construction. It is quite possible to purchase a decent tape deck, with stereo heads, for less than \$115.

Once past the tape heads, the electronics routes are varied but they all reach the goal of stereo sound. What route to take depends largely on what you presently own, and care to keep in the future. Let's explore the possibilities of the different kinds of set-ups possible on each major route.

Present System Uses Separate Preamp and Power Amp

Possibility "A" would be to get a second power amp, and use one external tape playback preamp—either the one included with the tape deck, or one purchased separately (Fig. 7). If your system's preamp-equalizer has an input expressly made for signals from a tape playback head, you can feed either channel to it, and the other channel to the tape playback preamp. If your original preamp has no such input,

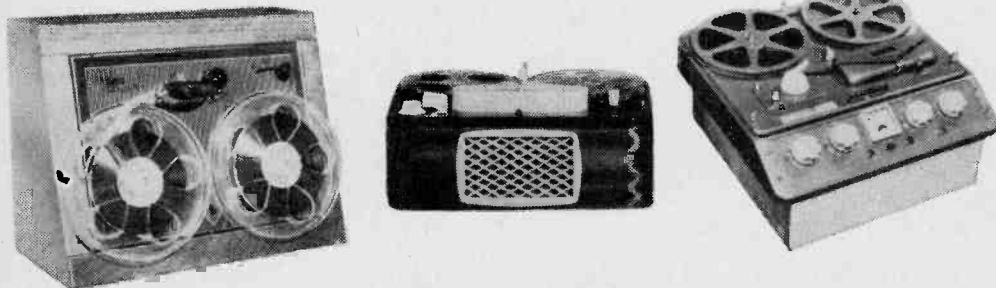

Tape equipment suitable for installation in stereophonic hi-fi systems range from the relatively low-priced Viking tape deck at left, to higher priced units such as the Tandberg, center, and British made Ferrograph tape recorder at the right.

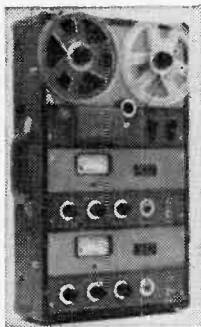

Ampex model 601-2 uses a type 601 tape transport with two pre-amplifiers for stereophonic recording and playback. Recording heads are of the stacked type with a full track erase head that erases both channels simultaneously.

you may get away with using the low level phono input and equalizing for the old NAB curve which comes fairly close to the curve needed for correct tape playback equalization. Strictly speaking, this is not the cricket way to do things—but pending the purchase of a second tape playback preamp, it can be done and it will work. The second power amp can also be used for the AM side of a stereo broadcast, if you care to feed it from an AM tuner. Since power amps do not come equipped with input selector switches, you'll have to rig one yourself; a simple double-throw switch will do the trick. It can be mounted on the power amp chassis.

Possibility "B" would be to get the second power amp and *two* tape playback preamps. This assures precisely correct equalization for both channels on playback. Coming out of tape playback preamp 1, the signal goes into a suitable high level input on the original hi-fi system preamp; from tape playback preamp 2, the signal goes directly into the second power amp. As a matter of fact, the signal from tape playback preamp

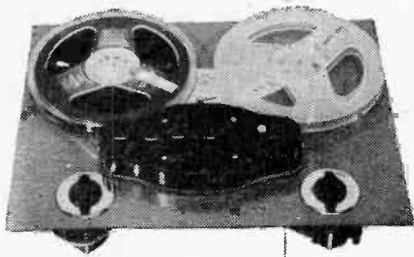

The Fen-Tone Brennel tape deck designed for custom installation in existing high-fidelity systems is available with staggered stereo playback heads.

1958 Edition



Why Buy?

Twice the RUMBLE
Twice the FLUTTER
Twice the WOW for
Twice the PRICE



Half the RUMBLE
Half the FLUTTER
Half the WOW for

HALF THE PRICE

For exceptional performance, choose either of these professional quality Component turntables:

The Duo-speed . . . a two-speed, belt-driven turntable . . . \$49.50

The Professional Junior . . . a single speed, belt-driven turntable . . . \$39.50

For full details and name of dealer write:

COMPONENTS
 CORPORATION, Dept. PE-10



DENVILLE,

NEW JERSEY

I could go directly into the original hi-fi system power amp since the controls on the two tape playback preamps would be quite sufficient for regulating volume and tone. The only trouble with plugging directly into the original system power amp is that it would require unplugging the audio cable from the system preamp which has other program sources (tuner, phono) feeding into it. In short, using the original system preamp is a convenience, *but nothing more*. As mentioned before, you could install a two-position selector switch on your system's original power amp; one position would select the output from the tape playback preamp and the other would select the output from the system preamp. A very satisfactory commercial unit incorporating two tape playback preamps and a power amp is made by *Bogen*. This unit, the *ST-10*, is about \$60 complete with cage and legs.

Possibility "C" brings us back to using only one tape playback preamp—and buying a new complete amplifier to round out the stereo system. Many recent complete amplifiers have an input for signals from a tape playback head, an input that provides correct equalization for tape playback without the need for a separate tape playback preamp. The advantages of such an amplifier are its convenience (eliminating the need for outboard switches or having to push and pull plugs) as well as having the additional "front end" controls provided for potential use with other stereo program sources. The complete amplifier also serves as a standby or spare amplifier for the original system in the event of temporary breakdown.

Possibility "D" eliminates the need for any tape playback preamp. Get a new complete amplifier—one that has an input for signals from a tape playback head. Then feed one tape channel to this amplifier and feed the other tape channel to your system's original preamp (Fig. 8).

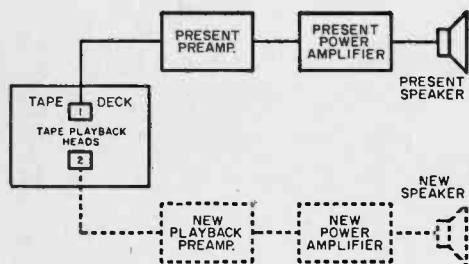
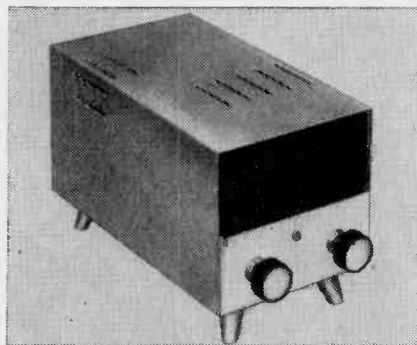
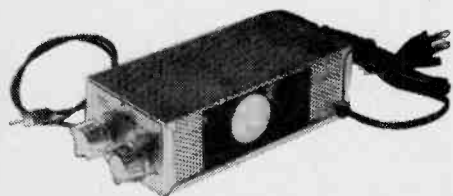

Fig. 7. Possibility A, described in text, uses new playback preamplifier, power amplifier and loud-speaker to get stereo operation.



Stereophonic tape preamp-amplifier made by David Bogen has 10 watt output with 1% harmonic distortion. Output is flat within ± 2 db from 20 to 20,000 cps.



Playback preamplifier made by Viking provides NARTB tape equalization. Controls permit variation of output level and equalization.



Record and playback amplifier for Viking tape deck provides NARTB equalization for both record and playback functions.

Present System Uses Complete Amplifier

If your present hi-fi system is built around a complete amplifier, i.e., one in which preamp and power amp are combined on one chassis, you are faced with pretty much the same alternatives as described for systems using a separate preamp and power amp. First, determine whether your present amplifier can accommodate the signal from a tape playback head. If it can, then you need get only one tape playback preamp and a new power amp. If it cannot, you can try

the approach described above under Possibility "A," or you can buy the two tape playback preamps and a new power amp (Possibility "B"). Again, if your present system amplifier *does* accept signals from a tape head, you might want simply to duplicate it—just get another identical amplifier. As in the case of Possibilities "C" and "D" above, this provides you with two sets of controls—one for each channel of your stereo system (Fig. 9).

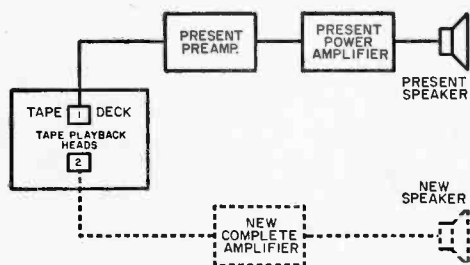

Fig. 8. Accomplishing tape playback without use of special tape preamplifiers is described in text as possibility "D" for converting to stereo. Channel 1 is fed to system preamplifier and channel 2 goes to new amplifier-speaker system.



Dual channel Pentron CA-15 playback preamplifier has separate equalization for each channel. Output is 1 volt rms with signal to noise ratio of 50 to 60 db. Total harmonic distortion is less than 1%.

- Green Dot Controls
 - 22 Watts Undistorted Power Output
 - 5 Position Record Equalizer
 - Tape, Tuner and TV Inputs
 - Separate Rumble and Scratch Filters
 - Speaker Selector Switch
 - Tape Recorder Monitor Switch
 - Volume-Loudness Switch
 - 2 Magnetic Inputs with Selector Switch on Front
 - NARTB Tape Playback Preamp
 - Separate Tape Outputs for Recording and Monitoring
 - Separate Bass and Treble Tone Controls
 - Beautiful Accessory Mahogany Case
 - Compact
- Only 15½" x 5" x 12½"



*All prices slightly higher west of the Rockies.

Plan your Hi Fi system around the H. H. Scott '99' . . . your Best Buy at \$109.95

There are many reasons for building your system around the H. H. Scott '99' This control and power center is expertly engineered. It's easy to install and connect, easy to play. Have your dealer demonstrate H. H. Scott amplifiers, tuners and turntables before you choose your components.

BEFORE YOU PLAN YOUR SYSTEM WRITE FOR H. H. SCOTT'S FREE CATALOG AND HI FI GUIDE

H. H. Scott, Inc., 111 Powdermill Road, Maynard, Mass.
Export - 36 W 40th St., New York City, Dept. YB
Rush me your new catalog YB showing the complete H. H. Scott line, including the question and answer section explaining hi-fi.

NAME _____
ADDRESS _____
CITY _____ STATE _____

Fig. 9. For system using complete amplifier for tape playback a second complete amplifier would be a convenient choice. This will not provide recording function but will permit playback of pre-recorded stereo tapes.

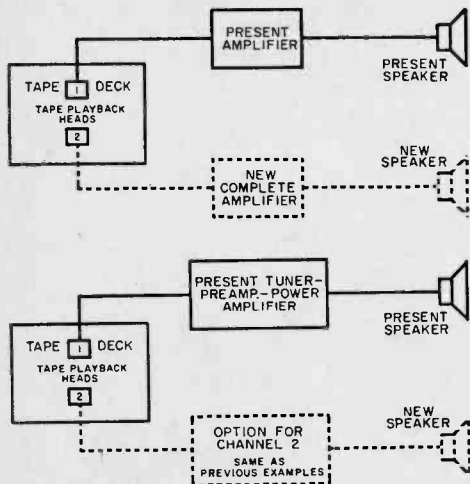
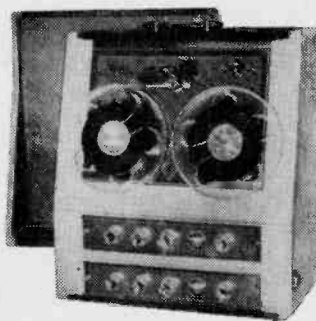
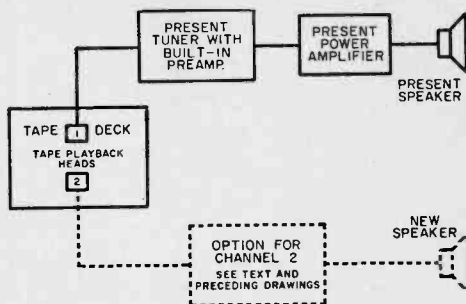

Fig. 11. Recently developed chassis with tuner preamp-amplifier can be used in stereo system.

Viking stereo tape unit has two separate record and playback preamps in a portable carrying case.

Fig. 10. System for adapting monaural tape system to stereo can use present tuner with built-in preamplifier for one channel and added amplifier and speaker for channel 2.



Present System Uses Tuner with Built-In Preamp

Many a fine monaural system uses a tuner which includes a built-in preamplifier-equalizer, with all "front end" controls (*Fig. 10*). By definition, such a system must use a separate power amp to drive the loudspeaker. The possible approaches to stereo would be the same as those described for systems using separate preamps and power amps—except for one thing: most of the older tuner-preamp units are not likely to have inputs for tape head signals, and the two tape playback preamps approach may be the best solution.

Present System Uses Combination Tuner-Preamp-Power Amp

If you own the relatively recent kind of hi-fi unit in which the tuner, preamp, and power amp are all combined on one chassis, you must first determine what low level signals it will accommodate. If it is a unit like the Fisher 500, with a tape head input, you can use it for one of the stereo channels. You then must get one more tape playback preamp and additional power amp, or a new complete amplifier that has a tape head input (*Fig. 11*).

What About Making Your Own Recordings?

In a sense, what we have been saying so far is that you can play stereo tapes without using two separate tape playback preamps—but rather by taking advantage of the facilities provided on general hi-fi amplifiers. This concept is of particular importance to the listener who is interested in tape playback only, or in using a tape transport deck in much the same manner as he uses a phono player—for listening

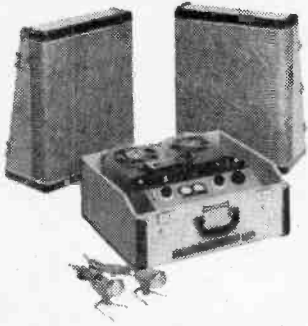

Portable stereophonic record/playback unit by Sony has stacked heads and hysteresis capstan motor.

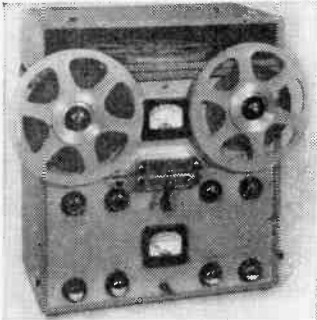

Stereo tape system designed by Crown has built-in preamplifiers and 20-watt power amplifiers for each channel, allowing both stereo record and playback.

to music that has been previously recorded. If you already own a tape recorder that has built-in provision for monaural playback, then—you already own one tape playback preamp; if so, your conversion to stereo still may proceed along the lines outlined above, but keep in mind that where it says "get one tape playback preamp"—you already have that unit.

If you own, or are planning to get, a tape transport—with the preamps optional, you will find that to do any of your own recording onto tape, you will need a record preamplifier. In equipment presently available, preamps used for recording onto tape invariably are used for the playback function too. Which means you automatically get one playback preamp with the preamp you buy in order to record. On the other hand, units designed for tape playback *only* have no record amplifier. The question, for many, will be: do I need two such units (record preamp *and* playback preamps)? The answer is yes—if you plan to make your own stereo recordings. Regardless of what kind of hookup you can use for two channel playback, you *must* get both record and playback preamps for recording your own tapes. In most separate tape preamps, both functions are combined,

the Hi-Fi experts say:

the BEST BUYS are **EICO**



NEW FM TUNER HFT-90
Kit \$39.95* Wired \$65.95*
*less cover, excise tax incl.
Cover \$3.95

Pre-wired, pre-aligned, drift-free, ready-to-use front end—advanced circuitry and temperature-compensated components eliminates need for AFC. Sensitivity 1.5 uv for 20 db quieting. Output 1 v for 10 uv input. Response 20-20,000 cps \pm 1 db. Drift less than 2 parts in 10,000 from cold start.

"... performance rivals that of the most expensive preamps." — says Joseph Marshall, AUDIOCRAFT, April, 1957, of the



HF61-A PREAMPLIFIER
Kit \$24.95
Wired \$37.95

HF61 (with power supply) Kit \$29.95, Wired \$44.95

"... one of the best-performing amplifiers extant; obviously an excellent buy." AUDIOCRAFT Kit Report, July 1957, on the

HF60 60-WATT Ultra-Linear Power Amplifier with Acro TO-330
Output Xfmr:

Kit \$72.95, Wired \$99.95.

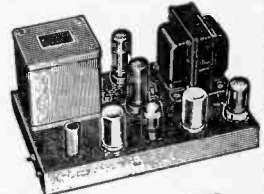

NOTE! these 2 similar **EICO** BEST BUYS:

HF50 50-WATT Ultra-Linear Power Amplifier with extremely high quality Chicago Standard Output Transformer. Identical in every other respect to HF60 and same specifications up to 50 watts. Kit \$57.95; Wired \$87.95.

HF52 Integrated 50-WATT Ultra-Linear Amplifier and Preamplifier-Control Section on one chassis. All preamp features of HF61 less scratch and rumble filters. Power amplifier section essentially identical to HF50. Kit \$69.95, Wired \$109.95.



"well-engineered yet inexpensive"—says Wm. A. Stocklin, Editor, RADIO TV NEWS, of the

HF20 20-Watt Integrated Amplifier complete with Preamplifier, Equalizer & Control Section all on one chassis.
Kit \$49.95. Wired \$79.95



"... produces sound that to my musical ears rates as excellent, from high top to clean low bottom." — says Edward Tatnall Canby,

AUDIO Magazine, about the **NEW STANDARD SPEAKER SYSTEM HFS2**, which creates "open" natural sound, fine balance and true aural perspective unapproached by any commercially available system—and in only one square foot of floor space. HWD: 36" x 15½" x 11½". **\$139.95**



TWO-WAY SPEAKER SYSTEM HFS1

Complete with factory-built bookshelf size cabinet. Jensen 8" woofer, matching Jensen compression-driver Hypex horn tweeter. Smooth bass, crisp highs, all free of coloration. Response 70-12,000 cps \pm 6 db. HWD: 11" x 23" x 9". Wiring time 15 min. Impedance 8 ohms. **\$39.95**

EICO 33-00 Northern Blvd., L.I.C. 1, N.Y.

Please send FREE catalog & name of distributor

NAME.....

ADDRESS.....

CITY.....ZONE.....STATE.....

Prices 5% higher on West Coast HG-58

KEEP POSTED ON HI-FI EACH MONTH BY SUBSCRIBING TO ONE OF THESE AUTHORITATIVE PUBLICATIONS!

Special Introductory Offer for Readers of the 1958 Hi-Fi Guide and Yearbook

Choose any Ziff-Davis electronics monthly at the special rate of...
18 Months for only \$3.85
(the equivalent of 6 months free!)

JUST FILL OUT AND MAIL THE CARD OPPOSITE THIS PAGE!

Whether you're a beginner in hi-fi or an old pro, you're sure to profit from the high fidelity know-how and guidance to be found in Ziff-Davis electronics magazines. Right now, you can choose any one or all of these fine magazines at a special rate of less than 22¢ per copy!

FOR BROAD, INFORMATIVE COVERAGE OF HI-FI MUSIC AND SOUND...

Read HI FI & MUSIC REVIEW, America's newest, most complete high fidelity magazine. Each month you'll enjoy more than 20 pages of record and tape reviews...entertaining picture features on concert and jazz personalities...helpful articles on selecting a system best suited to the acoustics of your home...basic info on installation, equipment, buying, stereo, new developments and techniques.

FOR DO-IT-YOURSELF HI-FI CONSTRUCTION PROJECTS AND ADVICE

Subscribe to POPULAR ELECTRONICS, the world's largest-selling magazine for electronics experimenters and hobbyists. Edited by the same staff who turned out the *Hi-Fi Guide and Yearbook* you are now reading, POPULAR ELECTRONICS devotes an entire section to hi-fi projects each month. You'll learn how to build your own rig, save money on construction of hi-fi components as well as dozens of other practical electronics devices. What's more, you'll keep posted on the whole exciting electronics world...from computers to radar, short wave listening to career opportunities.

FOR TECHNICAL HI-FI GUIDANCE FOR ADVANCED FANS...

Don't miss RADIO & TV NEWS, the nation's oldest and most widely read technical electronics magazine. If you can follow a schematic and want expert guidance on building or servicing high fidelity equipment, here's your publication! In RADIO & TV NEWS, you'll enjoy articles on measuring tape wow and flutter, ultra-linear speaker systems, crossovers, stereo adaptations PLUS features on servicing radio and TV, test equipment, ham radio and communications and news of the electronics industry.



Act Now! 18 issues for only \$3.85



Regularly, any one of these Ziff-Davis electronics publications would cost you \$4.00 for a 12-month subscription. But act right now and you receive 18 months for less than the regular cost of 12... actually get 6 extra issues at no extra cost. Use postage-paid envelope opposite this page today!

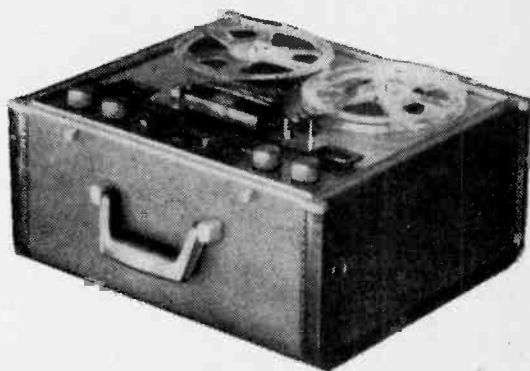
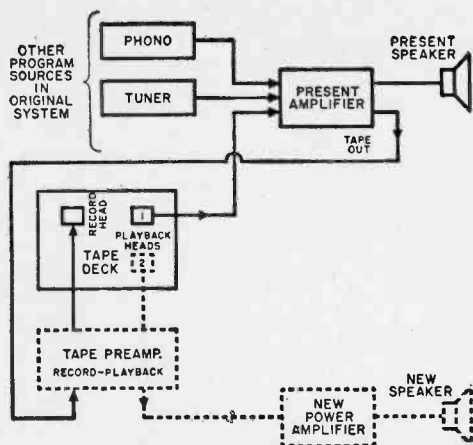

Fig. 12. Stereo playback-monaural record system, Stereo playback Ampex unit records monaurally.

however. Most audiophiles—regardless of their involvement in stereo playback—stick to monaural tape recordings (Fig. 12). However, there is considerable talk about making original stereo recordings; a few words here to suggest what is involved may be in order.

First of all, what is there for you to record stereophonically? Possibly, off-the-air stereo AM-FM broadcasts; possibly some live stereo that you might want to stage yourself (assuming you have at least two microphones and the willing participants); possibly, as they become available, stereo discs; possibly too, prerecorded stereo tapes borrowed from someone else! In any case, for any kind of stereo recording you'll need *two* recording heads, each fed by its own record preamplifier. If this is your aim, then you must get two record-playback preamps, simply because no record-only preamp is commercially available. A likely system for stereo recording and playback—of tapes, discs, and broadcasts—is blocked out in Fig. 13.

Stereo Disc Playback

The release of the first stereophonic disc was made in late 1957. More are expected in 1958. Such a record physically resembles a regular LP disc, but its grooves contain two independent sound channels. When played simultaneously, they produce stereophonic sound. In all likelihood, new stereo pickups will be appearing shortly. The stereo disc pickups will be capable of tracking both sets of groove modulations, developing two separate electrical signals. These signals will then go to two separate phono preamp-equalizers, thence to two separate power amplifiers, and finally to two

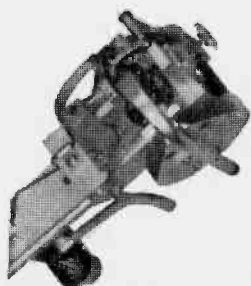

Head of Westrex 3A stereo cutter.

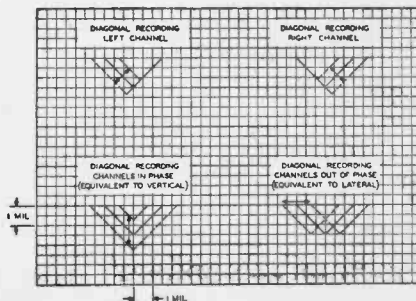

Stylus motion in Westrex stereo recording system.

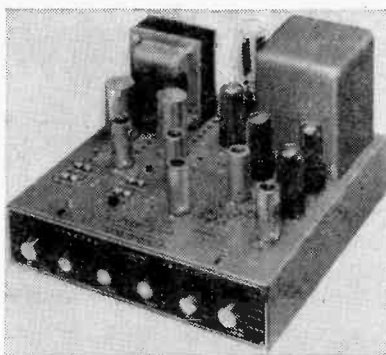
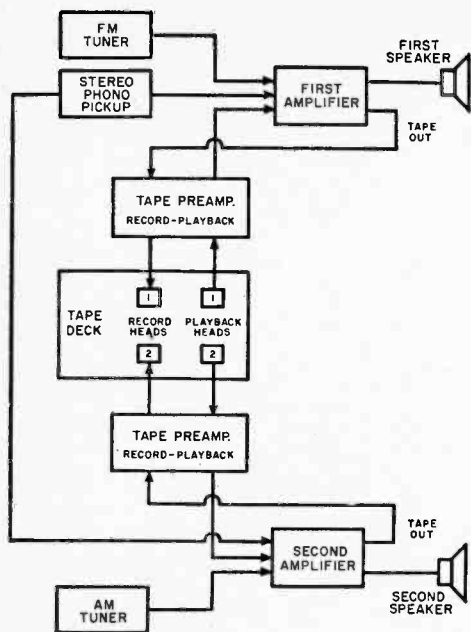

Newcomb two-channel 25-watt amplifier with built-in preamplifiers has control panel permitting balancing of speakers with master bass-treble and volume controls. Each channel has 12½ watt output.

Fig. 13. Complete system for stereo recording and stereo playback from all stereo program sources. Possible addition in future would be FM-multiplex decoder between tuner and second amplifier.

separate speaker systems. Again, your present phono system—in the context of stereo discs—represents more than half of the projected stereo phono system. The only thing likely to be made obsolete by stereo discs is your present pickup; it certainly will not be capable of tracking *both* channels on the new stereo disc, and it is uncertain at this point whether it will be able to track even one of them without damaging the grooves of a stereo disc. What is highly probable is that the new pickups for playing stereo discs will also be capable of playing your present records.

Additional Equipment for Stereo Discs

As for the necessary additional equipment for such a system—again, much hinges on your present line-up of equipment, particularly in what unit the present phono-preamp-equalizer is contained. The cheapest approach for stereo discs would be to buy, or build, an “outboard” preamp-equalizer and then plug in to whatever power amplifier and speaker you have at hand—even the audio section of a decent AM radio might do, in a pinch. This may not be “hi-fi” but it could provide a measure of the stereo effect. Probably the wisest choice would be a second complete amplifier—one which can take any signals you may want to throw into it, including those from low and high-level phono pickups as well as tape heads, microphones, and tuners. As interest mounts in the increasing forms of stereo, so will the flexibility and adaptability of the equipment made by the audio industry. Keeping in mind the basic needs of a stereo system, study carefully the specifications of available equipment, paying special attention to what is provided in the way of inputs and outputs. Try not to shortchange your system by leaving something out—and at the same time don’t overload your system with unnecessary duplication of controls and functions. It almost seems as if there may be little point in buying two *tape* playback preamps now when you may want to buy another preamp eventually for stereo phono. Perhaps it would be better to get both tape and phono playback in a complete amplifier unit.

The Second Speaker

We have said a good deal, so far, about the second channel as regards program material and playback amplifier. (It should be understood that wherever the “second



Stereo tape system designed by Ampex for home installation consists of tape recorder and two matching amplifier-speakers.

amplifier" has been mentioned, the "second speaker" was also implied). Now what about that second speaker? The subject of speaker selection and placement, for stereo, is one of the most complex and controversial in all of audio—and many of the highlights are amply treated elsewhere in this volume. A few general thoughts may help to clarify some of the fog surrounding this final stop on the road to stereo.

Ideally, the theoretical goal is matched speakers—identical from top to bottom, including drivers, enclosure, down to the last capacitor in the crossover network. Most aficionados agree that while such a set-up *should* be used, it need *not* be. Often, the *placement* of the speakers, with respect to each other as well as the listening room, is as critical, if not more so, than the actual speakers themselves. Consequently, a modest bookshelf-type speaker system can, in many cases, make a very satisfactory reproducer for the second channel. Many experts in fact, maintain that two speakers of less than top quality will sound better than one speaker of top quality—on single channel music as well as on stereo. Assuming then, that you are not planning to duplicate your present speaker system for stereo, you would do well to consider a lesser reproducer for the second channel. Listen, if you can, to comparisons of two modest speakers as against the single behemoth—for single-channel reproduction and stereo both.

As for placement of the speakers for stereo, some revision of monaural speaker placement concepts may be in order, especially the one about corner placement being best. For monaural systems, the corner spot is still considered best for the speaker—but this doesn't mean that the opposite corner is best for the second speaker when going stereo. If you already own a corner speaker system, you may find that the second speaker works out best when it's positioned flat against the wall, say, about six to eight feet from the original speaker—and not necessarily against the "short wall" either. In fact, the "long wall" of the room is now regarded as the best place

Master control amplifier for Bell Stereophonic hi-fi system controls balance, tone and volume level in both channels. Loudspeakers are mounted in bookcases at either side of window. Tape recorder is at right rear. Entire system can be installed with minimum of work since all units are individually housed.



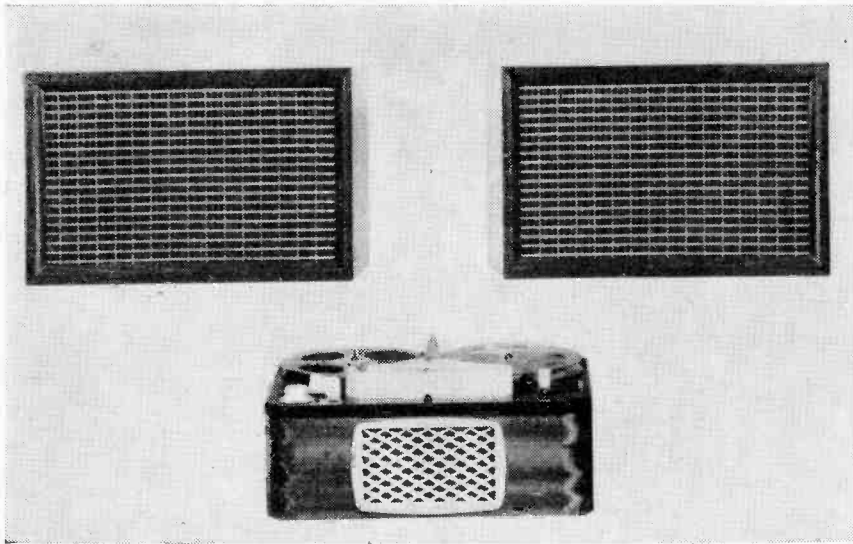

Compact stereo system by Tandberg includes two $3\frac{1}{2}$ watt amplifiers and matching loudspeakers.

for stereo speakers. If your present speaker system is not a must-be-in-a-corner type, spot it against the long wall of your room about one-third of the way in from either corner; then place the second speaker at the same relative distance from the other corner (*Fig. 14*). A little shifting and adjusting, and you'll wind up with maximum stereo spread and sonic effectiveness.

Of course, if you want to avoid the whole problem of loudspeakers and keep the stereo all to yourself, you can use a pair of headphones—but who ever knew a stereo fan who could resist letting the whole neighborhood know about the glories of stereophonic sound?

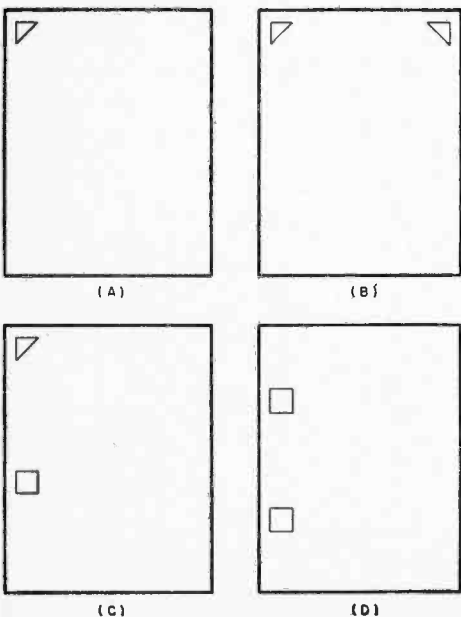

Fig. 14. Although most experts agree that corner placement (A) is best for a single channel system, the double corner system (B) is not considered best for stereo. Placement as shown in (C) is generally preferred but sometimes better results are obtained when speakers are arranged as shown in (D).

stereo in the home



by **charles tepfer**

AS FINE as high fidelity equipment has become, it is a delusion to contend that the experience of listening to music at home is the same as listening to it in a concert hall. At best, in conventional setups, the sound from a home music system issues from a corner of the living room. In a concert hall the entire shell-like stage vibrates with sound.

Until recently, it was necessary for music lovers to listen to records at home with their imaginations as well as their ears. In listening to an opera recording the listener recreated in his mind's eye the scenery and stage business as he remembered them if he had been lucky enough to attend a live performance. Similarly for other types of music, listening via records was 50 per cent hearing and 50 per cent imagining. Now, however, with stereophonic sound, listening to records at home can be a more complete experiencing of the music.

Stereo Realism

It is possible with stereo high fidelity reproducing equipment to present a wall of sound; but, experimentation has proven that this is not really necessary to create realism in the home. When a string quartet is performing on the stage, it appears to the listener in a concert hall that the music is coming from the whole stage rather than from the individual performer. This, of course, is a matter of stage acoustics and sound projection. There is, however, also a sense of sound *direction*. In other words, even though the complete sound is issuing from a broad area, the cello's mellowness may be coming from the right side of the group—the violin's trills may be coming from the left. Ideally then, to reproduce the string quartet in a living room would require four speakers, one for each of the instruments. Of course, each speaker would have to be backed up by a clear channel straight to the instrument itself. These four speakers arranged like a quartet would produce the sound distribution and, at the same time, the sense of direction that obtains at live performances.

Whereas this might be feasible for a quartet, it would get out of hand when reproducing orchestral music—we certainly can't have a speaker for each performer. The alternative then is to effect a compromise, to use that number of speakers and sound channels that will give the illusion of spaciousness and direction.

In the theater or at concert hall hi-fi demonstrations, several channels are generally used. The movie "Around The World In 80 Days" utilizes seven channels, each channel backing up a specific portion of the movie screen. For the home, experimentation has indicated that two channels feeding two separate speaker systems spaced a fixed distance apart, will perform adequately, although three channels are more desirable. Unfortunately, the equipment necessary to obtain three-channel reproduction in the home would make such installations quite expensive. A compromise has been worked out that of mixing the signals from two channels and feeding the result to a third speaker located between the other two. But this has not yet been adequately tested. One of the problems, of course, in producing stereo at home is the source—where will you get stereo to reproduce?

Stereo Sources

Until recently there were only two sources for stereo music and one of these was available only infrequently in certain localities. These two sources were prerecorded tape and broadcasting stations. Now, however, stereo records are bursting out of the laboratory. These promise to introduce stereo into more homes faster than either of the other two sources could have done.

At the present time a few select broadcasting stations are transmitting a limited number of music programs simultaneously over their AM and FM outlets. In the studio, two microphones are used. One microphone picks up the right hand side of the performing group and the other mike, about seven feet away, picks up the left. The sound from each microphone is passed through separate amplifier systems and is broadcast completely separate. In the home, two receivers must be used: one AM and one FM. These receivers should be placed along one wall, spaced five to seven feet apart. The listener sits an equal distance from them in the room. The room layout is shown in the accompanying diagram. Listening to stereo by this method has several severe limitations. You can only get stereo when the station is broadcasting it, the type of music broadcast is generally limited to works performed by small groups, and the quality of the reproduction in the home depends upon the AM receiver used. Since the FM receiver is usually much superior to the AM radio which often is a small table

model, the disparity in sound between both sources is often more pronounced than the stereo realism. However, when two closely matched reproducers are used, the stereo effect is rewarding.

A much more effective method for obtaining stereo music in the home is to use prerecorded tape. With a foresight that is laudible, most record and prerecorded tape companies have been recording all of their music on stereo tape for some time. The actual records and prerecorded tapes made from the original tape have been of the conventional monaural variety. With the advent of stereo equipment for the home, however, the prerecorded tape companies decided to duplicate their original stereo

tapes for general sale. Thus, the high fidelity listener who has stereo equipment can now buy a wide variety of stereo tapes. Of course, this requires that the listener own a stereo tape playback machine. Fortunately, these are widely available in a variety of prices and quality. But more of this later.

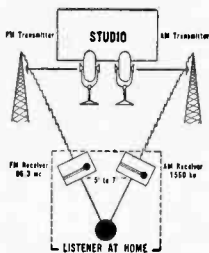

Stereo Discs

Since the majority of music listeners buy their selections on records, this type of music carrier has received the greatest attention in the laboratory of stereo development. As early as 1930 laboratories in this country were working on methods to cut two channels in every groove on the record. In the late 1940's, records that had two separate sets of grooves, one set for each channel, were made available in this country. This required a specially-designed pickup arm which looked like a two-pronged fork,



The first prototype stereo disc was cut with the "45-45" system and released by Audio Fidelity, Inc.

each prong holding a pickup and stylus. These were uneconomical and of limited interest.

With the increased interest in stereo reproduction, and in particular, with the inroads made by prerecorded tape into the field, the record companies and their suppliers renewed their research in this direction. In the year just passed, three industry representatives announced developments of great interest to record collectors. All three claim that they have produced stereo records and have in fact demonstrated them. These records contain two-channel sound in a single groove and what is even more important, require a single pickup that can be produced relatively cheaply.

At the present time, virtually all record companies are investigating these systems. It is to be hoped that one will be adopted universally so that the investment required by the record buyer for reproducing stereo via records will be minimized. From industry reports it appears that the method developed by the *Westrex Corporation* has the inside track. This company is the producer of a disc recording system that is widely used throughout the record industry. The most startling feature of the *Westrex* "StereoDisk" is that a single conventional monaural pickup may be used on this disc to give conventional monaural sound through a single preamplifier-amplifier and speaker. Thus, the way is clear for all record companies to issue nothing but stereo discs in the future. The buyer who has monaural equipment can play back this record on his conventional setup. The buyer who has stereo equipment can use this disc for stereo. This will allow the cost of such records to be relatively low or even equal to that of present records since they can be pressed with mass production techniques in the greatest quantity.

NEW FAIRCHILD



ELECTRONIC TURNTABLE



surpasses all
industry
performance
standards

*sensational 33 $\frac{1}{3}$ rpm single
speed turntable easily
converts to 4-speed operation*

FAIRCHILD Recording Equipment Co.
10-40 45th Avenue, Long Island City 1, N. Y.

Please send complete information about the following new Fairchild Turntables:

- Convertible 33 $\frac{1}{3}$ rpm
- Complete 4-Speed E/D

Name _____

Address _____

City _____ Zone _____ State _____

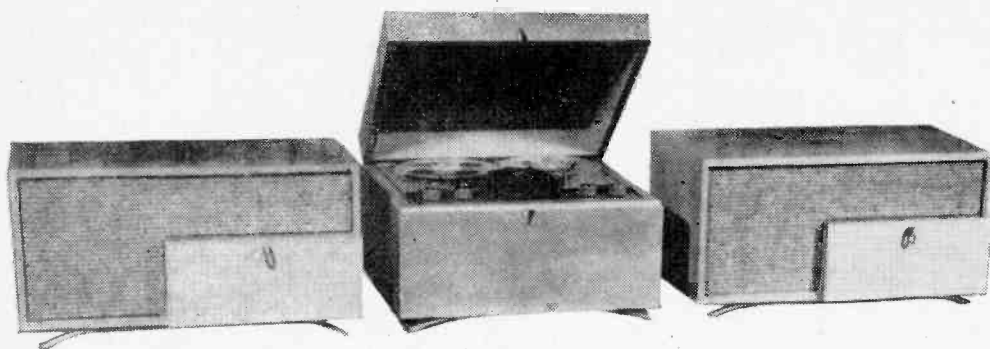

Stereo playback system for home installation designed by Ampeg. Each speaker housing also includes associated amplifier and balance controls mounted in drawer at lower right of cabinet.

Almost all pickup companies now have in their laboratories working models of pickups designed for this new disc. Some are even now available on limited order. Whether these pickups and discs are available immediately or not, the music lover who desires to buy a hi-fi system now can prepare for stereo with every purchase.

Buying Stereo

Elsewhere in this chapter the topic of converting a single channel hi-fi system to stereo is covered. This article may be read profitably by anyone who is setting out to start a hi-fi system. It is practical to buy a single channel system now and convert it to stereo later. If you decide to do this, make certain that the individual components that you buy contain the flexibility to allow them to be integrated into a stereo system. For example, the preamplifier should have a tape head input with enough gain to operate directly off most popular tape heads. If you are buying a tuner it is advisable either to buy a unit that has FM only or, an AM-FM tuner in which the AM and FM channels are completely separate and may be used simultaneously. It is advisable to buy amplifiers which have level or gain controls so that the volume of both channels may be equated. Other precautions are given in the article on converting to stereo.

One important factor to consider, however, is the speaker enclosure. For single-channel equipment the emphasis has been on corner placement of the speaker enclosure. In this way, the walls of the room itself function as an extension of the cabinet for the widest dispersion of the sound and for the most efficient coupling of the sound from the loudspeaker to the air in the room. This does not hold for stereophonic installations. If we use corner placement of both speakers we will lose the sense of direction inherent in stereo. Therefore, when buying a speaker enclosure for a single channel system with the intent of converting to stereo, it is advisable to buy an enclosure which does not need to be placed in a corner of a room.

If the reader desires, however, to start right off in stereo there are many units available to him at many price ranges. Starting with the least expensive unit, the listener may buy a tape recorder with stereo playback heads and preamplifiers with a single amplifier and speaker for about \$225. An additional amplifier and speaker unit designed for use with this recorder is furnished for about \$90. This outfit is sold by *Bell* and is shown in the accompanying photograph. *RCA*, *Columbia*, *Webcor* and almost all other tape recorder manufacturers make similar units available.

Another way of getting into stereo in a modest way is to buy a tape deck or tape transport mechanism only, with stereo playback heads. Such mechanisms are available from *Pentron*, *Viking*, *Ferroglyph*, *Fenton*, *Bell* and some others. To this basic mechanism may be added a wide variety of playback preamplifiers and amplifier and speaker systems of whatever price range and quality the buyer desires. For example, a *Viking* tape deck for stereo playback is available at \$99. A single playback preamplifier is also available from *Viking* for \$29.50. Or a more elaborate preamplifier may be bought from any of the many preamplifier manufacturers.

A top quality stereo tape playback system such as that made available by the *Ampeg Corporation* can cost from \$950 on up. The *Ampeg* system shown includes two speakers, an amplifier and the stereo tape playback mechanisms.

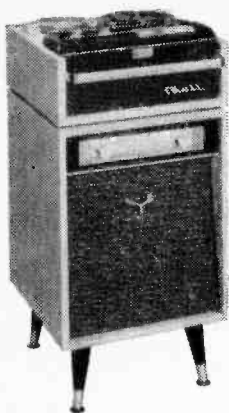

Stereo tape playback unit with monaural recording facility can be obtained with cabinet type amplifier speaker unit from Bell Sound Systems.

Stereo Consoles

Many stereo tape playback units are available in well-designed beautifully-finished consoles at a higher price, of course. The *AmpeX* "Crescendo" console pictured on the following page sells for about \$1800. In addition to the tape playback facilities, this also includes a four speed record changer and an AM-FM tuner. Other *AmpeX* consoles designed to fit with various types of period furniture are also available. The *Fisher Radio Corporation* also has a wide line of stereo consoles. A top view of their "Executive" model is on page 140. The selling price for this complete unit is \$1600 and includes a four speed record changer, an AM-FM tuner, a stereophonic tape recorder, a two channel stereo amplifier, a stereo master audio control center and four speakers in two enclosures. As the photo shows, the speaker enclosures are located at opposite ends of the console, far enough apart to assure spatial distribution of the sound from both channels. A more expensive console by *Fisher* is the "President" which sells for about \$2500.

Another elaborate console group designed for stereophonic reproduction is made available by *RCA* and can be in your living room for \$2000. In this particular system the speaker enclosures are separate from the cabinet containing the tape recorder, record changer, tuner and amplifiers. Such units are available also from other manufacturers of high fidelity equipment.

For those hi-fi enthusiasts who want the best, can afford to pay for it, and desire component systems rather than complete consoles, there are many choices available. The components for one particular installa-

for everything in hi-fi

GET THE MONEY-SAVING 1958

ALLIED CATALOG

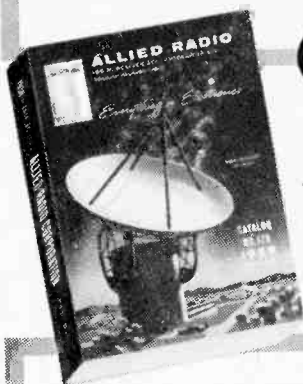

FREE!



featuring the world's largest selection
of HI-FI SYSTEMS & COMPONENTS



Here's your complete money-saving guide to *everything* in Hi-Fi. Own a fine custom quality Hi-Fi music system at no more than the cost of an ordinary phonograph. See dozens of ALLIED-recommended complete Hi-Fi Systems, plus the world's largest selection of components, including amplifiers, tuners, changers, speakers, enclosures, stereophonic units, recorders and accessories. Make your money-saving selection from the ALLIED Catalog—get the best in Hi-Fi for less!

KNIGHT SUPER-VALUE HI-FI: You'll save most on ALLIED'S KNIGHT Hi-Fi components and complete matched systems—equal to the finest, yet far lower in cost!

BUILD YOUR OWN HI-FI AND SAVE! It's easy with ALLIED KNIGHT-KITS. You do the simple assembly and get professional performance and looks at up to 50% savings. See our complete selection of KNIGHT-KIT amplifiers, tuners, speakers and enclosures. SAVE MONEY AT

America's Hi-Fi Center

Our 37th year



ALLIED RADIO

send for
FREE
Catalog

ALLIED RADIO CORP., Dept. TT-8
100 N. Western Ave., Chicago 80, Illinois

Send FREE 1958 ALLIED Catalog

Name _____

Address _____

City _____ Zone _____ State _____

tion are shown below. These consist of a *Madison Fielding* "Series 333" AM and separate FM tuners in one chassis, a *Madison Fielding* "Series 320" stereophonic pre-amplifier amplifier, a *Berlant Concertone* "Model 33" stereo tape recorder for recording and play-back, and *Bozak* "B-304" speaker system. Admittedly, this is a very high priced installation, but any of the components may be used without the other and with other components to make up systems that are less expensive.

Component stereo hi-fi systems can be made up to fit every budget and can use components from almost any manufacturer. One of the first steps in making up a good stereo system is to find a reputable hi-fi dealer in your locality. Tell him the features you want, and as honestly as you can determine, the budget you have to

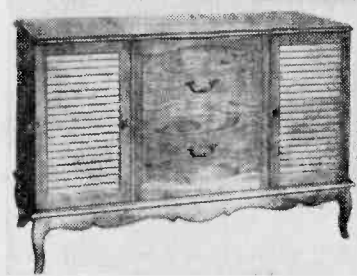
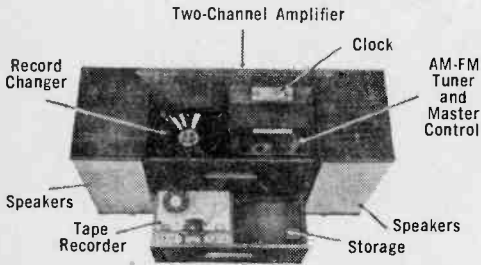

Radio, phonograph and tape stereophonic console made by Fisher has two 4-speaker systems fed by separate power amplifiers. For monaural listening "The Executive" uses all eight speakers.

The Ampex Crescendo console features the Ampex stereo tape recorder, two separate speaker-amplifier systems, AM-FM tuner, four-speed changer, and microphone—plus beautiful cabinet work

work with. He in turn will guide you through the hundreds of components available to those most suitable for you.

If you yourself feel competent to assemble a complete system and make your own selections, you can save an appreciable amount of money by purchasing hi-fi kits from reputable kit manufacturers.

Stereo hi-fi is dramatic when properly reproduced. Good stereo can make average recordings sound better and very good recordings sound quite real. It would seem that the hi-fi enthusiast who buys hi-fi equipment with no allowance for stereo reproduction is cheating himself. Why settle for two dimensions in sound when you can experience the reality of three?



Speaker enclosure designed to fit a provincial setting houses two three-way speaker systems. Each channel of the \$820 Bozak "Stereo Fantasy" enclosure can handle 30 watts. Both channels can be used together for monaural listening.

AM-FM stereo tuner and amplifier system by Madison-Fielding has provisions for addition of multiplex unit for FM stereo in future.

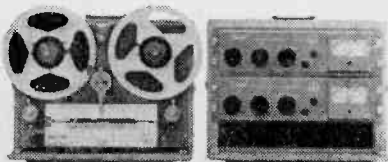
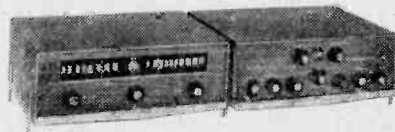

Professional-type stereo tape recorder made by Berlant operates at tape speed of 7½ or 15 inches per second. A hysteresis synchronous motor is used for capstan drive, providing flutter and wow specifications of less than .1 per cent at 15 ips.



**60 NEW PROJECTS FOR
"DO-IT-YOURSELFERS"**

in the NEW EDITION of the
**ELECTRONIC
EXPERIMENTER'S
HANDBOOK**

ADVANCE NOTICE: This new 1958 Edition of the *Electronic Experimenter's Handbook* will go on sale March 27. If you like to build useful, profitable electronic devices, reserve your copy of the new *Handbook* now. Last year's edition sold so fast many hobbyists, experimenters and students couldn't buy a copy . . . and this year's *Electronic Experimenter's Handbook* contains even *more projects, more pictures, more guidance!* Each device has been pre-tested and operated by readers of *Popular Electronics*. You'll find step-by-step instructions, hundreds of photos, drawings and unique "pictorial diagrams."

**60 Devices . . . Nearly 200 pages . . . a Practical "File"
of Electronics Ideas and Information**

FOR YOUR HI-FI. Presence control. Hi-fi crossover. Filter. Electrostatic speaker system. Mixer equalizer. Spare amplifier. \$5 coax. 3-way speaker system. Junior hi-fi. Crossover with brilliance.

RECEIVERS. Shirt pocket transistor superhet. Vokar receiver. Superegen unit. Miniature VHF ear. Junkbox BC receiver. Etched circuit two-tuber.

FOR YOUR HOME. Invisible light door opener. Electronic brain to control house lights. DC supply for AC/DC motors. Power transistor for pocket radios. Light-operated relay. Transistorized intercom. Radio intercom. Electronic Christmas bells.

FOR YOUR DARKROOM. Audio photometer. Transistor slave flash unit. "Varistrobe." Light distributor. Darkroom timer. Enlarger exposure meter.

FOR YOUR HAM SHACK. Simple shortwave receiver. VHF explorer's receiver. 70-watt transmitter. Double your Heathkit AT-1 output. Code practice set. Antenna tuner. Transistor 10-meter receiver.

FOR YOUR WORKSHOP. Economy tube tester. Heat-controlled solder stand. Economy signal generator. Simple oscilloscope calibrator. \$14 signal tracer. Transistor checker. Capacitor meter. Low-cost multimeter. Transistorized signal tracer.

FOR THE KIDS. IQ tester. Electronic worm digger. Model spaceship. Game computer. Transistorized phonograph amplifier.

SPECIAL PROJECTS. Solar battery experiments. Electronic anemometer. Picture tube rejuvenator. Detectorscope. Simplified etched circuits. Geiger gun. Frost sentinel. Vibrato for an electric guitar.

COMING SOON - Only \$1

Reserve Your Copy Today at Your
Newsstand or Radio Parts Store



ZIFF-DAVIS PUBLISHING COMPANY, 64 East Lake Street, Chicago 1, Illinois



how stereo tapes are made

STEREOPHONIC TAPE recordings are undoubtedly one of the hottest items in the field of high fidelity sound today. If you've heard stereo, you know why. If you haven't heard it, you're missing something!

A stereo fan will tell you that stereo brings "presence," "depth" and "feeling" to recorded music like it's never had before. It's almost like listening to music with two ears, after a lifetime of listening with only one. Or like actually sitting in front of a live orchestra instead of listening to the same orchestra through a hole in the wall.

Like all fans, stereo fans may be prejudiced. But even the experts—who were hi-fi fans 20 years ahead of their time—with years of listening experience and vast collections of disc recordings—tend to agree that stereo will be the music of the future. But the significant thing to the hi-fi fan is that stereo is here today and it's growing by leaps and bounds. Virtually all tape recorder manufacturers offer stereo tape

players and all the major record companies, as well as a host of the smaller labels and strictly tape companies, have put a considerable range of stereo selections on the market.

What's more, they're going full blast to build up their libraries so that eventually almost anything available on disc will also be available on tape. This situation may not be so hard to come by, either, since for the past 10 years virtually every disc that has been made was originally recorded on tape. And, pertinent to stereo, many of the major recording companies have been taping their recording sessions stereophonically for several years.

Basic difference between stereo recording and monaural is that in stereo, two (and sometimes three) separate sound tracks are recorded simultaneously and side by side on a magnetic tape. To be genuine stereo, each of the recordings must be independent of the other. A stereo recorder is actually two complete tape recorders in one using only a common tape drive mechanism.

For three channel stereo, which is recorded on half-inch tape rather than conventional quarter-inch, the tape recorder must be three machines in one. In the case of three-channel recorders, the third channel is subsequently mixed into the basic two in producing finished stereo tapes for home use.

A further complicating factor not encountered in monaural machines appears in the head design of stereo recorders. Stereo recorders, by and large, use "in-line" or "stacked" heads so that the stereo recording can be spliced and edited easily. But in stacking the heads, the magnetic fields surrounding each of them cause problems in the form of interference and cross-talk between the recorded channels. Professional stereo machines are engineered to eliminate this problem, but such engineering comes with high price tags.

Most recording engineers will probably agree that, because of the psychological advantage of the stereo effect, it's easier to make good stereo tapes than a good monaural recording. Sometimes even "poor" stereo can sound pretty exciting. Then, too, most of them seem to be champing at the bit, waiting for the novelty effect of stereo to wear off so that it will be judged and appreciated for what it really is—simply the best possible reproduction of music. But there's a considerable amount of feeling that the listening public is still all wrapped up in stereo per se: music with a left and a right side to it. As a result the "ping-pong ball" emphasis in some stereo may be around for a while.

Originally it was thought that the full-dimensional quality of stereophonic sound could be reproduced by using microphones as if they were human ears. The reason seemed obvious enough, for as everyone knows, we hear depth and direction in live sound because the sounds that reach one ear are subtly different from those that

An actual stereo recording session by Stereophony, Incorporated. The two microphones are suspended about six feet apart, slightly above and some distance out in front of the different band instruments.

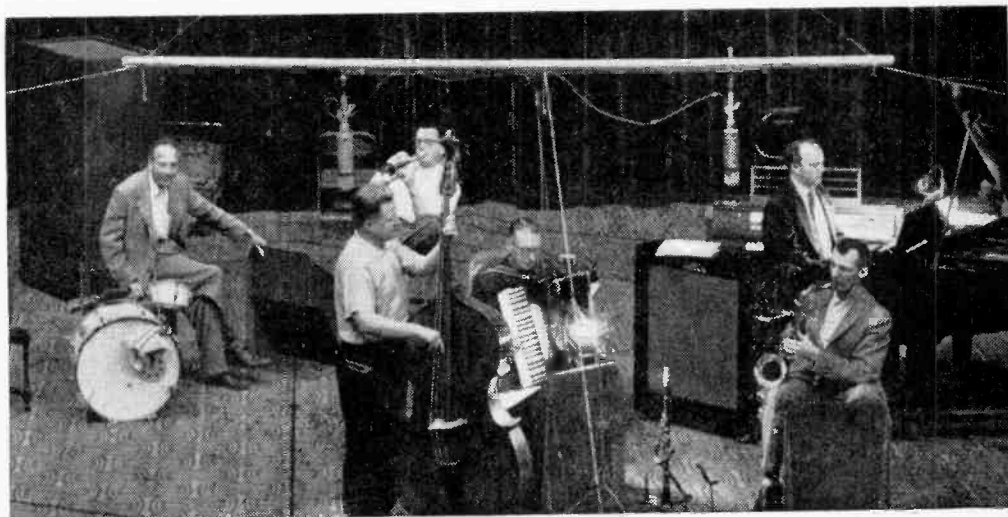



Dr. Kurt List, musical director of Westminster, is shown here with his assistant, Ursula Stenz, working in the Westminster-Sonotape laboratory.

travel around to the other. It therefore appeared that realistic stereo could be recorded by separate-track microphones placed on opposite sides of a dummy head.

But to the surprise of many logical thinkers, this method never seemed to work out quite right. And after they thought about it a bit, the reason for this also seemed obvious. For what these two ear-spaced microphones recorded on two magnetic-tape tracks was the way an individual listener in a concert hall might hear the live sounds—not the way they actually originated across the full width of the stage. In other words, the two-eared system captured the end rather than the beginning of the sound.

To correct for this deficiency, two other approaches have been worked out. The first of these entails using more than two microphones and then mixing the outputs of the microphones until two balanced stereo channels are on the final master tape. The second involves nothing more than using a separate microphone for each channel. Both are currently in use among commercial stereo recordists; highly lifelike tapes have been obtained by both methods, and the choice is largely one of personal preference.

The first of these methods derives very largely from motion picture sound. Some of the more elaborate stereo systems used with films make use of six or more individual sound tracks. Each is fed by a separate mike, and during the recording operation, these are spaced over a wide horizon. In the theater these sounds are reproduced by an equal number of amplifiers and loudspeakers arranged in a corresponding panoramic sweep. Thus when a locomotive steams across the screen, its sound starts on one side of the house and travels with it to the other side.

The success with which multiple mikes and sound tracks is able to recreate depth, direction, motion, and perspective has convinced many recording engineers that stereo sounds best when it is picked up by anywhere from four to ten microphones spaced across a stage.

Unlike theater systems, however, home-type stereo players are limited (as a purely practical matter) to two tape tracks and amplifier-loudspeaker systems. So even when sound is master-recorded on a large number of tracks, it has to be mixed for final release on two.

Engineers who favor the two-microphone system argue that since playback is restricted to two tracks, the recording doesn't need more. They also insist that the proper placement of the two recording mikes must be determined by actual listening tests. Good microphones and tape machines are essential, but when they're directed by engineering formulas alone, they still can't capture that all important *illusion* of reality. As always, truly fine recordings still need the artist's touch.

A proponent of the two-channel, one-mike-per-channel technique is Larry C. Lueck, vice president and technical director of *EMC Recording Company* of St. Paul, Minn., whose stereo tapes are distributed under the *Stereophony, Incorporated* label.

"Good stereo should re-create as faithfully as possible the effect of a live performance," Lueck says. "To achieve this effect, we limit ourselves to one microphone per channel with no mixing whatsoever. The two microphones are hung out in front of the orchestra and above—one to the left and one to the right. The pieces in the orchestra are then arranged for best overall perspective. By keeping the microphones a little distance away from the orchestra, each picks up not only the sound from its side, but also some of the sound from the other side. The result is an overall blend of sound. You don't hear just the right and the left, but also the man in the middle."

An opposite technique is to use several microphones—one for each section of the

orchestra. In recording, the sound picked up by all the microphones on the left side is mixed into the right channel.

Still another point of view is offered by Russ Molloy, vice president of *Bel Canto Magnetic Recorded Tapes*, Los Angeles. He says that two channels are usually sufficient for recording smaller groups, but that for large orchestras of 50, 100 or 150 pieces, a three channel tape is essential with at least three microphones.

"Two microphones are placed out in front to pick up the orchestra and feed to the right and left channels on the tape while the third channel is used to pick up the soloist," Molloy says. "That way the soloists don't get lost in the crowd and yet the overall orchestral balance is preserved. In reducing the three tracks to two for home use, the soloist channel is later mixed in."

Another technique used by *Bel Canto* is described by Molloy as "phantom stereo" in recording small, five or six piece bands which sometimes ultimately sound a bit "thin" in stereo—especially when the stereo loudspeakers in the home are spread farther apart than the band itself may have been. Two microphones are set up in front and a short distance apart. Then a third microphone is suspended in the center and high above the orchestra. The gain of this microphone is turned up just enough so that it "bleeds" to both channels providing a more realistic measure of "fullness" which might otherwise be missing with a small group.

Tape Duplication

Professional tape duplicating equipment used for turning out stereophonic tapes operates at a standard speed of 60 inches a second. At this speed, a tape which will be played at $7\frac{1}{2}$ ips and will last for 30 minutes can be turned out in only $3\frac{3}{4}$ minutes.

To produce stereo tapes with a top frequency response of that of the submaster—usually 15,000 cycles per second at $7\frac{1}{2}$ inches per second—tape duplicating machines must have a high frequency range which seems pretty fantastic compared to home recorders. If a $7\frac{1}{2}$ ips tape is duplicated at eight times normal speed, or 60 ips, the high frequency range must also be extended eight times from 15,000 cps up to 120,000 cps.

This is not as difficult as it sounds since, all other things being equal, the faster a tape recorder is run, the higher the upper limits of its frequency response. However equalization is a problem and special amplifier circuitry is utilized.

1958 Edition

**DO YOU
HAVE the
EARS**



for EASY LISTENING?

**NOW YOU CAN HAVE EASY
LISTENING at a LOW COST**

Easy listening—velvet smooth response over the entire audio range—that's what you get in a new Utah Unidrive Coaxial High Fidelity Reproducer.

Engineered for exceptionally fine frequency extension of both the bass and extremely high registers—a Unidrive will give you unsurpassed tonal quality—with minimum distortion—a velvet smoothness that is a revelation and a real pleasure to hear.

The Utah Unidrives are unique in design and assembly technique. A single, high efficiency magnet drives two perfectly matched and balanced high and low frequency cones with mechanical crossover, to achieve an efficiency heretofore unattainable in conventional designs. A newly developed skiver roll cone treatment immeasurably increases speaker lifetime.

See and hear the new Utah Unidrives at your dealers today. Available in six models and five sizes—6 X 9", two 8", two 12" and 15". Starting at the unbelievably low price of only \$15.95.

utah RADIO PRODUCTS CORPORATION
HUNTINGTON, INDIANA

Expt. Dept. Fidevox International, Chi., Ill.

convert to stereo

by ernest wayland

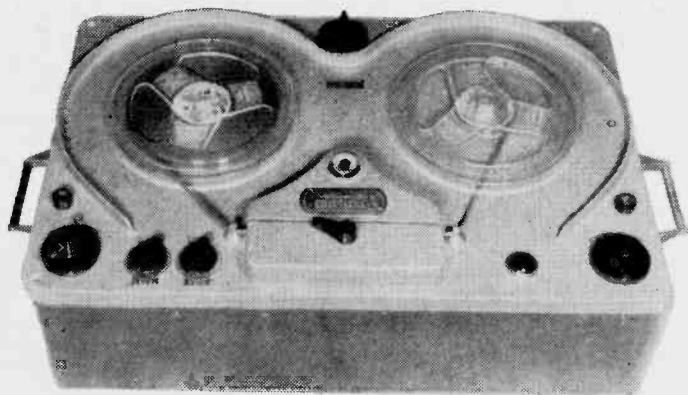

STEREOPHONIC high fidelity is available today! And its thrilling realism can be enjoyed inexpensively in your own home on your own tape recorder. Dozens of new stereo tapes are being released monthly. The major companies with few exceptions are doing all their recording with dual microphones for eventual stereo release. Many a monaural record or tape which you are playing today has a stereo master in the vaults ready for release in stereo form tomorrow.

The quality of the recorded stereo tapes is improving constantly: they are quieter, with less background tape noise; they have a wider dynamic range; and by and large, they evidence a surer grasp of the problems of microphone placement and control room technique.

Not only are the technical problems of stereo tape production gradually disappearing, but, possibly as a result of the engineering advances, prices are coming down to a more rational level. The stereo tape selling at \$12 will probably soon be a thing of the past, extinct as the 78 rpm record.

Conversion Kits

Do you have the uneasy feeling that you have been "stuck" with an expensive *monaural* tape player? If so, cheer up! It's not necessary to trade in your old tape player in order to reap the joys of 3-D tape listening. And you needn't despair because the manufacturer of your particular machine does not supply a stereo conversion kit. For although the manufacturer's com-

ponents are almost always preferable, much can be done for the tape recorder which is worth converting but has no specific conversion kit designed for it.

A case in point is the *Concertone* Model 1401. After unsuccessfully searching the parts catalogs and haunting the hi-fi salons for conversion information, material concerning the subject was obtained from the *Dactron Company*. The *Dactron Company* makes an "outboard" adapter suitable for converting *any* tape recorder to in-line stereo playback.

Since the *Dactron* Steradapter subsequently became available locally, one was purchased for the modest sum of \$22.50. The instructions in its box informed one that the *Dactron* adapter could be attached (by means of a simple clip-in mount provided) to the front or side of any tape recorder. And sitting there unobtrusively, it will play, with the aid of an additional tape head pre-amplifier and a few simple interconnections, *any* of the currently available stacked-stereo tapes.

Mounting Methods

The mounting recommended by *Dactron*, is at the *side* of the recorder cabinet. However, the physical layout of the *Concertone* does not permit the suggested "side-saddle" mounting. If a similar situation prevails with your recorder, then a certain amount of ingenuity must be brought into play. It is necessary that the adapter guides line up vertically with the tape reel and feed the tape to the capstan with a minimum of twist and turn. Hence, be-

fore screwing the Steradapter bracket down to any specific position, feed the tape by the adapter guides and then thread it through the machine and to the take-up reel as in normal operation. A little juggling about should enable you to determine the optimum mounting position for the Steradapter.

When choosing a mounting position, the following precautions should be observed;

the tape, when taking its new path from the feed reel should not directly encounter any *steel* plates, guides, etc., as magnetization of these parts may cause a rise in the tape noise level. Right angle turns in the path of the tape should be kept at a minimum to avoid possible strain or breakage. And lastly, always remove the tape from the adapter when using the rewind or fast forward position.

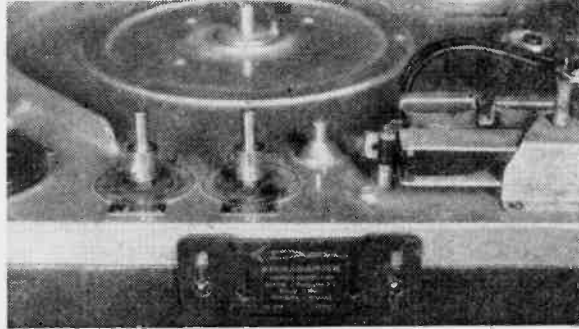

The Steradapter mounting plate is shown screwed into place on the front panel of the Concertone 1501. Note that front mounting requires using extension shafts on the controls.

The Electronic Conversion

Once the mounting of the adapter has been accomplished, we are set to tackle the electronic part of the conversion. And here there's a multitude of possibilities. Basically, what will determine the exact setup used will be the components and characteristics of your *present* hi-fi system and tape recorder.

Most modern preamps and integrated amplifiers have a jack on the rear panel and a switch position on the front panel labeled "Tape." In the majority of cases, this input is meant to accommodate the output of a tape *preamplifier* and do not in themselves have enough gain to provide a high enough output to an amplifier when connected directly to a tape head. Check your instruction manual or your hi-fi salesman if in doubt as to what type of tape input is in your unit.

If you *do* have the necessary tape-head preamp input in your amplifier, all that needs to be done is to run one shielded lead from the Steradapter to it, and the other to your tape recorder's playback head input.

With reference to the problem of "getting into" the playback head preamplifier of your recorder, *Dactron* recommends a simple procedure. Remove your recorder's capstan cover and drill a hole in it

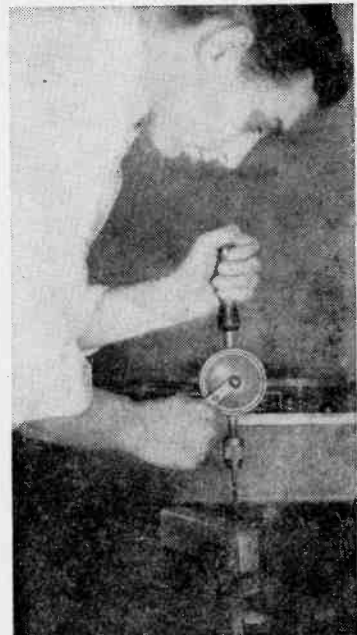

The capstan cover may be easily drilled with either an electric drill or with a hand drill, as shown. Be certain the hole exactly fits Telex plug.

which, when the cover is in place on the recorder, will be located as close as possible to your original playback head. A *Telex* miniature closed-circuit phone jack should be installed in this hole and wired as per *Dactron's* instructions. The hole should be located so that the rear contacts of the jack, when mounted, do *not* make contact with any components enclosed by the shield. Using the *Telex* con-

nectors, whenever the matching plug is inserted in the jack, the internal head of your record will be switched *out* of the playback circuit and one channel of the Steradapter head will play through the preamplifier of your present tape recorder.

To play the *other* channel another tape-head preamp is needed. If your control unit does not incorporate a *tape-head* preamplifier, a separate "outboard" preamp

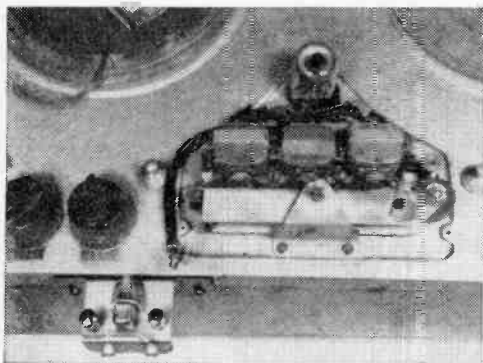
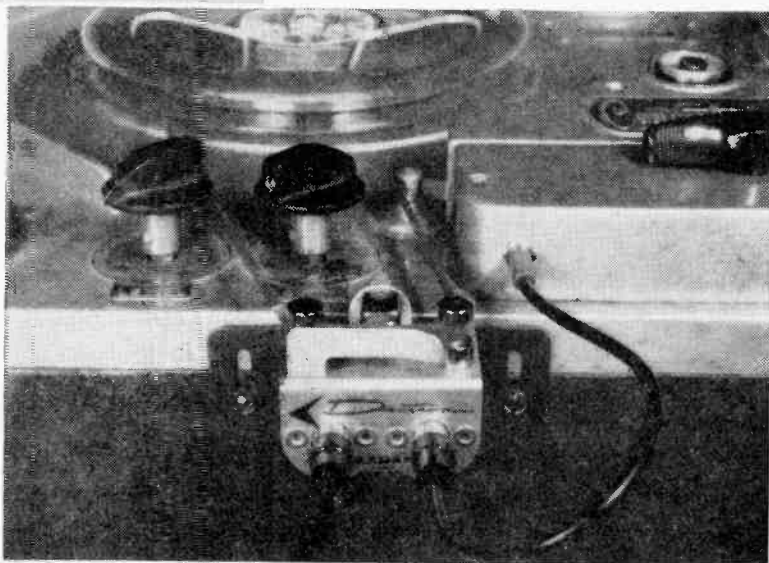
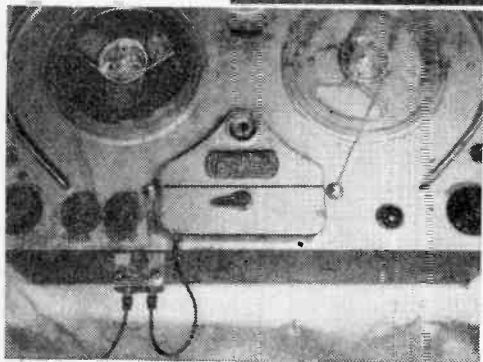

Photo at left shows recorder with Steradapter in place and with connections to the recorder pre-amplifier already made. Following the Steradapter instructions, the cable to the preamplifier of the recorder is wired to permit the use of the recorder's preamplifier for one stereo channel when connected to the Steradapter and yet permit normal monaural playback when it is not connected for stereo.



Steradapter completely installed and ready to play is shown above and at left. Although front mounting is not recommended by *Dactron*, no wow or flutter were audible in playback. However, right angle turns in tape path should be avoided if possible. Note that Steradapter is connected to play back one channel through *Concertone* and the other through a separate amplifying system.



unit will be necessary. Several tape recorder manufacturers have outboard tape preamps available. Prices range from about \$18 for the *Dactron* one-channel transistor unit to \$80 for the *Pentron* two-channel playback preamp.

Proof of the Pudding

Since a variety of equipment could be borrowed from friends with hi-fi rigs, sev-

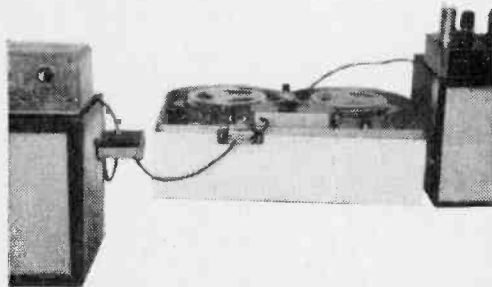

Stereo playback system using recorder's preamplifier. One channel goes through recorder preamplifier, ten-watt amplifier, and bookshelf type speaker. Second channel feeds through *Dactron* transistor preamplifier to original hi-fi system.

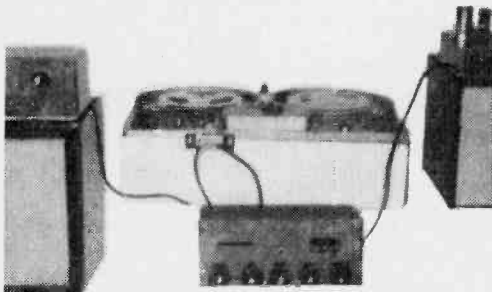

Stereo playback system using *Pentron* dual channel preamplifier. One channel feeds through one preamp channel to original hi-fi system and the second goes through the other preamp channel and then to auxiliary system. Dual preamp is highly flexible.

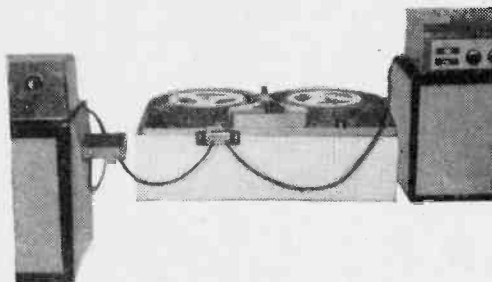

Stereo playback system using *Dactron* transistor preamp and original hi-fi system for one channel, and *Lafayette LA-40* amplifier with tape head input for the second channel. If amplifier with tape head input is used, no rewiring is necessary.

1958 Edition

for Ultimate Fidelity

SHERWOOD*

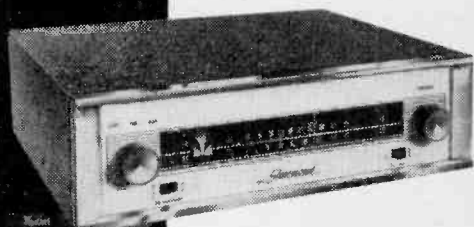

*outstanding honors bestowed, unsolicited, by most recognized testing organizations

No matter where your music comes from—FM, your own discs, or tape—you will enjoy it at its best coming from Sherwood's complete home music center . . . most honored of them all! Sherwood tuners for example . . .

First to achieve under one micro-volt sensitivity for 20 db FM quieting increases station range to over 100 miles. Other important features include the new "Feather-Ray" tuning eye, automatic frequency control, fly-wheel tuning, output level control and cathode-follower output.

Model S-2000 FM-AM Tuner \$139.50 net
Model S-3000 FM (only) Tuner \$99.50 net

For complete specifications, write Dept. ZY-58

SHERWOOD

ELECTRONIC LABORATORIES, INC.

2802 West Cullom Avenue, Chicago 18, Illinois

The "complete high fidelity home music center."

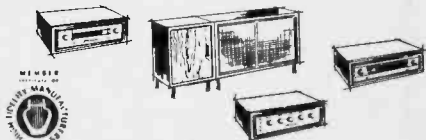

In New York, hear "Accent on Sound" with Skip Weshner, WBAI-FM, week nights, 9 P.M. In Los Angeles, KRHM-FM, 10 P.M.

eral different ways of hooking up the two channels from the *Dactron* head were tried. All worked well; the photographs show the various combinations tried. The *Sonotape* audio show stereo tape was used to check out the Steradapter. After obtaining the proper volume balance on the amplifiers, the orchestra seemed to come to life. Although the monaural system had always seemed satisfactory, the sound now had taken on a different aspect. New clarity and body were immediately apparent, but even more important was a feeling of dimension. The orchestral instruments seemed to be located along the side of the room where the speakers were. And, best of all, even with the unorthodox side mounting of the Steradapter, there was no perceptible increase in wow or flutter.

Try It Out

The hi-fi salesman greeted the advent of stereo with joy and an expansion of facilities. Ha, they thought to themselves, we are going to sell two of everything! Well, although events have not quite supported their expectations, they still maintain a warm spot in their bosoms for those adventurous souls taking the stereo plunge. They are sometimes willing to make available on a tryout basis their smaller speaker systems and integrated amplifiers.

Take everything the salesman is prepared to let you try out for your extra channel. Your dealer knows he's going to sell you *something*, and hence you have the possibility of a fine relationship with him. Start small; it might be difficult to argue the loan of an Electrovoice Patrician on a tryout basis. Try something like the little Hartsdale speaker system and drive it by a 10-15 watt amplifier. Try shifting the speakers in relation to each other, and to the listening area. The problem of stereo speaker placement is not easily solved, but an optimum arrangement can be worked out for your specific listening room.

The deluxe stereo system requires no electronic modification or rewiring your tape recorder. Either two separate preamps or one dual channel preamp is used; the internal amplifier of your present tape recorder is not used. Two complete hi-fi amplifiers and two complete speaker systems are also required. The advantage of such a system is found in its flexibility and ease of balance; the disadvantage is its cost. Try more expensive second channel equipment by all means, but when you hit the point of diminishing audio returns, for goodness sakes, stop! Remember your pursuit is high fidelity—not bankruptcy or divorce.

stereo

AMPEX CORP.

A-122

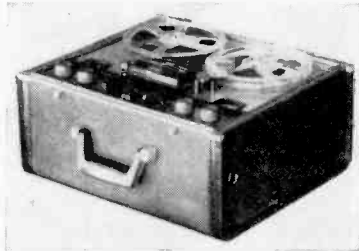

Dual track, two speed ($3\frac{3}{4}$ and $7\frac{1}{2}$ ips) portable; frequency response at $3\frac{3}{4}$ ips: 30-7,500 cps, ± 2 db 50-5,000 cps, at $7\frac{1}{2}$ ips: 30-15,000 cps, ± 2 db 50-10,000; flutter and wow under 0.3% at $3\frac{3}{4}$ ips, under 0.25% at $7\frac{1}{2}$ ips; signal-to-noise better than 50 db at $7\frac{1}{2}$ ips and better than 45 db at $3\frac{3}{4}$ ips; VU meter; 7" reels; $9" \times 17\frac{1}{2}" \times 15"$; 31 lbs.

A-122 (Monaural record, stereo playback) . . \$449.50

Stereo System

Consists of one A-121 record-playback tape unit and two A-621 amplifier-speaker systems; A-121 has



same mechanism and specifications as A-122; A-621 has 10 watt amplifier; flat response 65 to 10,000 cps; hum and noise -70 db; volume control; equalization control; input selector for tape, TV, tuner, and phono; in matching blonde or mahogany cabinets; recorder is $10\frac{1}{2}" \times 16" \times 17\frac{1}{4}"$; amplifier-speaker is $9\frac{1}{2}" \times 11" \times 21"$.

Complete stereo system \$895.00
A-121 only \$495.00
A-621 only \$229.50

Model 601-2 Stereo Tape System

Stereophonic tape recorder using Model 601 tape transport and two Model 601 electronic chassis for stereo record/playback; full track erase head; stacked record and playback heads; $7\frac{1}{2}$ ips; frequency response: 40 to 15,000 cps, 40 to 10,000 cps ± 2 db, no more than 4 db down at 15,000 cps; wow and flutter under 0.17% rms; signal-to-noise ratio: full track, over 55 db below peak recording

equipment roundup

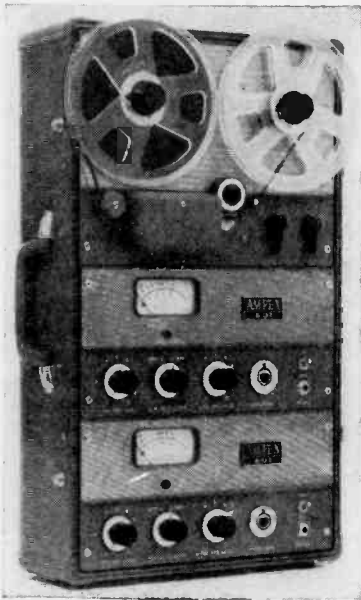

level at 3% total harmonic distortion; half track, over 50 db; VU meter; separate record and playback preamplifiers; reel size: 7"; timing accuracy: ± 3.6 seconds in 30 minute recording; microphone and high level inputs with full mixing provisions; vertical or horizontal operation; separate playback preamps permit instantaneous comparison between incoming program material and actual recording; headphones jack; output: 1.23 volts into 600 ohm load from tapes recorded at program level: 8"x13"x24 1/2"\$995.00

APPROVED ELECTRONIC INSTRUMENT CORP.

Model A-380 Binaural Amplifier Kit

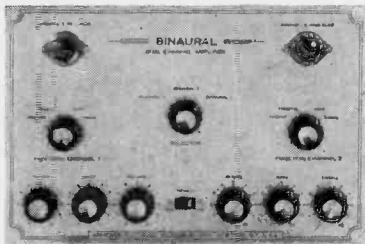

Separate preamps and power amplifiers; maximum output (each channel): 4 watts; frequency re-

sponse: 40 to 12,000 cps ± 1 db; hum level 78 db below rated output; bass and treble controls supply 12 db maximum boost; function selector for monaural or binaural use; inputs: magnetic, crystal, tape, radio; maximum gain on phono inputs 35 db; output indicators; output impedances: 4, 8, 16 ohms; tubes: Channel 1, 2-6F5, 6V6GT, 1629; Channel 2, 2-6F5, 6V6GT, 1629, both channels; 6SC7, 5Y3GT; gold finish; 13"w x8 1/2"h x9"d.\$39.95

ARKAY RADIO PRODUCTS

ST-11 AM-FM Binaural Tuner Kit



AM and FM completely separate and independent; FM specifications: sensitivity 4 microvolts for 20 db quieting, bandwidth 200 kc at 6 db down, image rejection 30 db minimum, frequency response ± 5 db 20 to 20,000 cps, hum level -65 db, AFC, cathode follower output; AM specifications: sensitivity 3 microvolts for 20 db signal-to-noise, frequency response 20 to 8,500 cps, two bands—narrow and wide, whistle filter, cathode follower output; self powered; weight 12 lbs.; tubes are 3-12AT7, 4-6BA6, 6AU6, 6BE6, 6AL5, plus selenium rectifier.\$47.95
Factory wired\$69.95

SA-25 Stereo Preamplifier-25 Watt Amplifier Kit

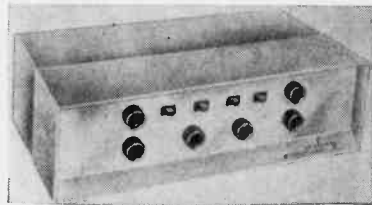

Channel 1 drives a 25-watt amplifier, fixed equalization for LP-RIAA-EUR magnetic phono, inputs for NARTB (tape head), tuner, and auxiliary equipment; Channel 2 is a preamp with cathode follower output, has input and equalization identical to Channel 1, may be used to drive any amplifier to provide stereo-binaural playback; both Channels 1 and 2 are regulated by a single-ganged volume

control; tone control for bass is ± 16 db at 60 cps, for treble ± 16 db at 10,000 cps; low cut filter is -6 db and -12 db, high cut filter is -6 db and -12 db; loudness control; IM distortion 1.8% at 20 watts; hum -90 db; tape -70 db; frequency response at 20 watts 20 to 35,000 cps, ± 2 db; eight tubes: 2-6L6GB, 5U4/GZ34, 2-12AX7/ECC83, 12AT7/ECC81, 12AU7/ECC82, 6C4; 29 lbs.. \$59.95
 Factory wired.....\$89.95

SP-6 Stereo Preamplifier Kit

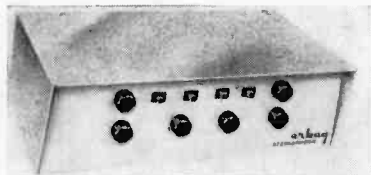

Two sets of inputs for tape deck, magnetic phono, tuner, and auxiliary; single volume control knob for both channels; individual input level controls for each input channel; two .5-volt cathode follower outputs; bass control gives ± 16 db at 60 cps; treble ± 16 db at 10,000 cps; hi and low filters each have three positions, 0, -6 db, -12 db; equalizations are LP, RIAA, EUR; variable loudness control; frequency response from 20 to 40,000 cps, ± 5 db; d.c. filaments; left and right balance controls; 15 lbs.....\$34.95
 Factory wired.....\$47.95

AMERICAN ELECTRONICS, INC.

Concertone 61, 62, and 63

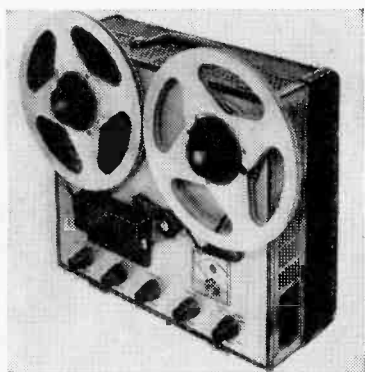

Speeds are $7\frac{1}{2}$ ips and 15 ips; frequency response 40 to 12,000 cps ± 2 db at $7\frac{1}{2}$ ips and 30 to 15,000 cps ± 2 db at 15 ips; signal-to-noise ratio 45 db at $7\frac{1}{2}$ ips and 55 db at 15 ips; flutter and wow .15% at 15 ips and .25% at $7\frac{1}{2}$ ips; three motors with hysteresis synchronous capstan motor; push button operation; VU meter; facilities for monitoring; takes up to $10\frac{1}{2}$ " reels; weight 35 lbs.; $16\frac{1}{2}$ "h x $15\frac{1}{2}$ "w x $5\frac{3}{4}$ "d.

Model 61 (half track record and playback).....
\$495.00 (\$555.00 with case)
 Model 62 (half track record with half track, full track and stereo playback).....
\$595.00 (\$655.00 with case)
 Model 63 (stereo record and playback).....
\$695.00 (\$755.00 with case)

Berlant 33

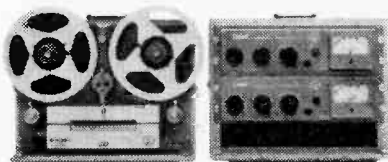

Dual speed ($7\frac{1}{2}$ and 15 ips) stereo record-playback; frequency response 50 to 15,000 cps ± 2 db at 15 ips and 50 to 12,000 cps ± 2 db at $7\frac{1}{2}$ ips; signal-to-noise ratio better than 55 db; flutter and wow less than .1% at 15 ips and less than .2% at $7\frac{1}{2}$ ips; three motors with hysteresis synchronous capstan motor; shipping weight 77 lbs.\$995.00

BELL SOUND SYSTEMS, INC.

Model RT-205



Dual track; speeds are $3\frac{3}{4}$ and $7\frac{1}{2}$ ips; three heavy-duty 4-pole motors; frequency response is 30 to 12,000 cps at $7\frac{1}{2}$ ips; flutter and wow are less than $\frac{1}{4}$ of 1% at $7\frac{1}{2}$ ips; neon light level indicator; uses 7-inch reel; contains playback pre-amp, 5-watt amplifier and 6" speaker; outputs for external amplifier or speaker; tape lifted from heads during wind and rewind; $17\frac{1}{2}$ "d x $15\frac{1}{4}$ "w x $7\frac{3}{4}$ "h.

- RT-205 1B monaural record/erase with stereophonic playback, inline heads\$224.95
- RT-205 OB monaural record/erase with stereophonic playback, offset heads\$209.95
- 302-D portable amplifier-speaker; 5-watt amplifier, 6"x9" woofer, 3½" tweeter.....\$69.95
- 305-D cabinet type amplifier-speaker; 5-watt amplifier with 60 to 15,000 cps response; volume and tone controls\$89.95

Model T-203



Available in several monaural-stereo combinations; stereo units may be used for both inline and offset arrangements; specifications with Bell accessories: frequency response 40-10,000 cps; ±2 db; 20-15,000 cps ±4 db (record and playback); speeds are 7½ and 3¾ ips; flutter less than .25% at 7½ ips; over-all distortion less than 1% at maximum recording level; signal-to-noise better than 50 db for a recording having 3% third harmonic distortion; tape lifter removes tape from heads during stop and wind-rewind; up to 7" reels; three 4-pole motors; electro-dynamic braking, no belts, pulleys, clutches or mechanical brakes; 15¾" w x 13½" h x 5½" d; may be mounted vertically or horizontally; weight 21 lbs.

- Model T-201 (monaural and stereo inline-offset playback)\$119.95
- Model T-202 (monaural erase/record playback; stereo inline-offset playback).....\$129.95
- Model T-203 (monaural erase/record playback; stereo inline-offset erase/record playback)\$149.95
- Model T-206 (Model T-202 tape transport, Bell P-100 preamplifier, and Bell RP-120 recording-playback preamplifier in 200 CC portable carrying case, 8¾" h x 17¼" w x 16½" d.) . \$259.95

Model 3 DTG

Two channel amplifier for stereophonic applications; power output 12 watts each channel with less than .5% distortion; response 20-20,000 cps ±½ db; hum 70 db below rated output; dual inputs for magnetic phono, radio, tape heads, and aux.; bass control +17 db, -18 db at 40 cps on both channels; treble control +16 db, -17 db at

**140 Pages!
262 Photos,
Drawings,
Diagrams,
Charts!
7 Chapters!**



**TAPE
STEREO
SPEAKERS
PREAMPS
TRANSISTORS
AMPLIFIERS
CONTROLS
CARTRIDGES
ENCLOSURES**

YOUR BEST GUIDE TO HI-FI CONSTRUCTION!

The 1958 *Hi-Fi Annual & Audio Handbook* is the most authoritative guide to hi-fi construction, circuits, systems, developments, maintenance and components ever published! In it you'll find a 10-part article on speakers and baffles that's been called a "classic" . . . complete details on building a simple pre-amp . . . and more than 30 other practical, profitable articles.

A TREASURE OF PROFESSIONAL GUIDANCE

- Room Acoustics * Baffles & Enclosures *
- Volume Expander * Damping * 2-Tube Binaural Speaker * Build a Tape System *
- Transistor Preamp * Measuring Amplifier Damping * Dual-Cone Units * "Presence" Equalizer * 3-Channel Amplifier * Stereo Ionic Cloud Tweeter * "3-D" Converter * Tone Compensator * Ceramic Cartridges * And much more.

GET YOUR COPY TODAY!

Available at your newsstand or radio parts store . . . or use this coupon to order by mail.

RUSH COUPON NOW!

Hi-Fi Annual & Audio Handbook
Dept. HFG, 64 E. Lake Street
Chicago 1, Illinois



Please rush me the Hi-Fi Annual & Audio Handbook. I enclose \$1.00, plus 10¢ to cover postage and handling.

Name

Street

City..... Zone... State.....

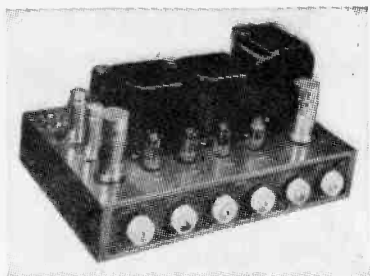

15,000 cps on both channels; master gain and balance controls; dual outputs for 4, 8, 16 ohms, and high impedance outputs for recorder; three a.c. convenience outlets; tubes are 6-ECC83, 4-6V6, 5U4G; 11"x15"x8"; 26 pounds.....\$149.95
Complete with metal cover.....\$159.95

DAVID BOGEN CO., INC.

Model ST-10

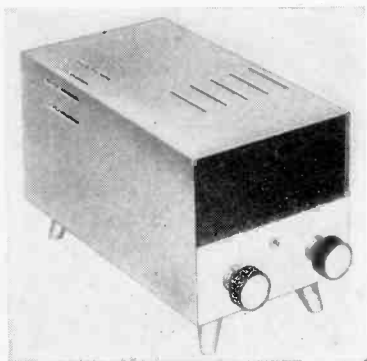

Stereophonic tape preamp-amplifier; 10-watts output; 20 to 20,000 cps, ± 2 db; harmonic distortion 1% at 10 watts; gain in "Tape 1," 140 db, "Tape 2," 54 db; noise level -80 db; sensitivity for Tapes 1 and 2 is 0.45 millivolt; seven tubes; with cage and legs 5 $\frac{3}{4}$ "x12"x6 $\frac{1}{2}$ " h.

ST 10 (chassis only)\$52.50
ST 10G (with cage and legs)\$59.50

BRENELL (Fen-Tone Corp.)

Brenell Pro-2 Tape Preamplifier

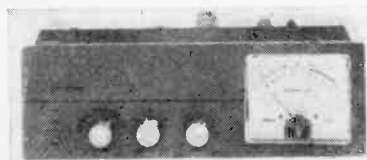

Tape record/playback preamplifier designed for use with Brenell tape deck; NARTB playback equalization for 3 $\frac{3}{4}$, 7 $\frac{1}{2}$, and 15 ips; RIAA record equalization; VU meter; frequency response: 30 to 17,500 cps ± 2 db; signal-to-noise ratio: 60 db; inputs:

high impedance microphone, magnetic phono (10 millivolt sensitivity), high level; output: 1 volt.
\$111.50

Brenell Model Mark IVB Tape Deck

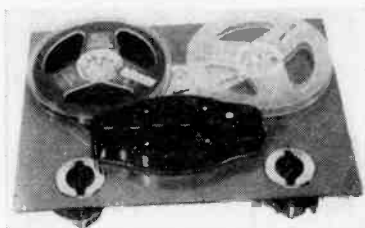

Tape deck chassis; dual track; takes up to 4 heads for record, playback, and erase; 3 speeds; 3 motors; frequency response: 3.75 ips, 50 to 6000 cps; 7.5 ips, 50 to 12,000 cps; 15 ips, 30 to 15,000 cps (all ± 3 db); flutter and wow less than 0.2%; tuning eye level indicator; dual track operation for up to 7" reel; requires preamp and amplifier; speed change by screw-on 2:1 ratio capstan sleeve and slow-fast stepped flywheel and motor pulley assembly; mumetal heads; mechanical brakes; 2 knob control, interlocked; digital counter; fast rewind; size 15"x11 $\frac{1}{2}$ "x3 $\frac{3}{4}$ "d; mounting: from horizontal up to 85° slant.

Mark IVB, 1 upper, 1 lower track erase head; 1 upper, 1 lower track record/playback head; (staggered stereo).....\$182.87

ELECTRO-VOICE, INC.

Model 3304 AM-FM Tuner

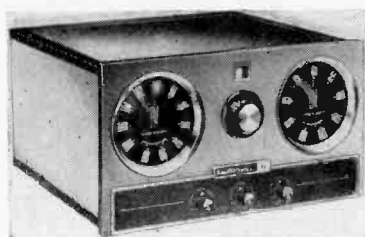

Independent AM and FM sections for stereo operation; FM circuit uses cascode r.f. amplifier, triode-pentode mixer oscillator, two stages of i.f., two stages of Armstrong limiting with Foster-Seeley discriminator; sensitivity: FM, 1 microvolt for 20 db quieting, 2 microvolts for 30 db quieting; AM, 1 microvolt for 6 db quieting; variable AFC; tuning eye for FM with separate signal strength meters for AM and FM; i.f. bandwidth: FM, 180 kc flat; AM, 11 kc to 6 db down points; separate low impedance outputs with balance control for stereo operation; variable squelch circuit; two a.c. convenience outlets; tubes: 2-6BA6, 6BE6, 2-6AU6, 2-12AT7, 6BK7A, 6U8, 6AL5, 6AL7, 12AX7, 5Y3GT; 3-1N294 diodes; 15"w x8 $\frac{1}{4}$ "h x15 $\frac{3}{4}$ "d.\$239.50

Model 3303 AM-FM Tuner—Preamplifier



Independent AM and FM sections for stereo use; Armstrong FM circuit with Foster-Seeley discriminator; sensitivity: FM, 1 microvolt for 20 db quieting; AM, 1 microvolt for 6 db quieting; variable AFC; tuning eye for FM with separate AM and FM signal strength meters; i.f. bandwidth: FM, 180 kc flat; AM, 11 kc to 6 db down points; variable squelch circuit; 10-position record equalization; bass control: 20 db boost and 15 db cut at 50 cps; treble control: 15 db boost and 20 db cut at 10,000 cps; 3-position loudness compensation and presence rise controls; frequency response: 20 to 40,000 cps ± 1 db; harmonic distortion less than 0.2% at rated output; IM distortion less than 0.3% at rated output; hum 75 db below rated output at maximum volume control setting, 60 db on magnetic phono input; inputs: magnetic phono (8 millivolt sensitivity), ceramic phono, tape, TV, aux; output: 1.25 volts rated, 15 volts max; low impedance main output, high impedance recorder output; detector outputs on AM and FM sections; tubes: 2—6BA6, 6J6, 6BE6, 2—6AU6, 3—12AT7, 6BK7A, 6U8, 6AL5, 6AL7, 2—12AX7, 12AD7, 5Y3GT; three 1N294 diodes; 15" w x 8 1/4" h x 15 3/4" d. \$279.50

EMC RECORDING CORP.

Model 2000

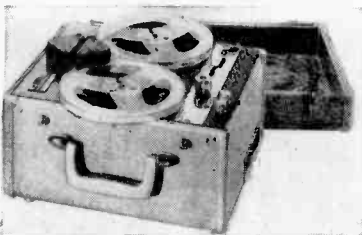

Portable monaural record stereo playback tape recorder; full track or half track; inline or staggered heads for stereo playback; Maico dynamic ultra-linear heads; tape speed 7 1/2 ips; frequency response from cathode follower 40 to 12,000 cps ± 3 db, 30 to 15,000 cps ± 5 db; frequency response from output transformer 60 to 12,000 cps; flutter and wow less than 0.25%; noise at least 55 db below 3% distorted signal; 7-inch maximum reel size; contains playback preamp, 3-watt amplifier, 5" woofer and 4" tweeter; two cathode follower outputs for connection to external amplifier; external speaker connection for built-in amplifier; single lever tape control; instant braking; dust-tight portable samsonite case; 13 1/2" x 9 1/2" x 8 3/4"; 20 lbs. Model 2000. \$189.95 Net

1958 Edition

ERCONA CORP.

Ferrogaph Stereo 77 and Stereo 88

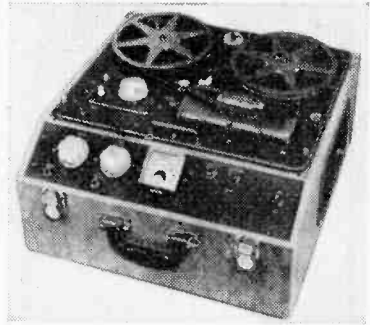

Stereo 77 is monaural record and stereo playback (3 3/4 and 7 1/2 ips); Stereo 88 is stereo record and stereo or full track monaural playback (7 1/2 and 15 ips); three motors with hysteresis synchronous capstan motor; frequency response 50 to 6,000 cps ± 3 db at 3 3/4 ips; 50 to 10,000 cps ± 2 db at 7 1/2 ips, 40 to 15,000 cps ± 2 db at 15 ips; wow and flutter less than .2% at 7 1/2 ips; signal-to-noise better than 50 db; weight 45 lbs.; 18 1/2" x 17 1/2" x 9".

Stereo 77. \$545.00
Stereo 88. \$595.00

LAFAYETTE RADIO

Tancordex Stereo Tape Recorder



Monaural and stereo playback unit with provision for adding single or dual recording preamplifiers; 7 1/2 ips; three capacitor induction motors; 3 heads: erase, record, and playback; frequency response: 40 to 15,000 cps; flutter and wow less than 0.17%; push-button and level controls; cabinet finished in blonde or mahogany with removable lid; 25 1/2" w x 15 3/4" d x 12" h. \$495.00 Net

Model KT-500 Stereo Tuner Kit

AM-FM tuner kit with independent AM and FM sections for stereo use; Armstrong FM circuit; sensitivity: FM, 2 microvolts for 30 db quieting; AM, 5 microvolt terminal sensitivity; AFC with defeat provision; tuning eye; frequency response: FM, 20 to 20,000 cps ± 0.5 db; AM, 20 to 5,000 cps ± 3 db; harmonic distortion under 1% on FM, under 1% on AM for up to 80% modulation; hum 60 db

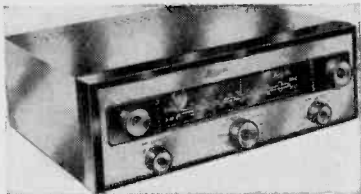

below 100% modulation; bandwidth: FM, 200 kc, 6 db down; AM, 8 kc, 6 db down; IF rejection: FM, 70 db; AM, 50 db; image rejection: FM, 40 db; AM, 30 db; FM drift: ± 5 kc max; AM whistle filter; two cathode follower outputs; output level; FM, 2.5 volts for 100% modulation; AM, 1 volt average; tubes: 4—6BA6, 2—6AU6, 1—6BK7A, 1—ECC85, 1—6AL5, 6—BE6, 1—12AU7, 1—6U5; selenium rectifier; $13\frac{3}{4}$ "w x $10\frac{3}{8}$ "d x $4\frac{1}{2}$ "h.
 Model KT-500 (Kit form) \$69.50 Net
 Model LT-50 (Assembled) \$114.50 Net

Model LT-30

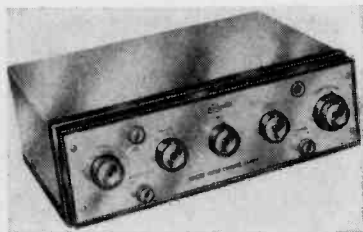

Preamp-control unit, uniformly flat frequency response over the entire audible range; less than .09% IM and .07% harmonic distortion at 1 volt output; 7 position function selector: radio, aux, tape and four phono turnover positions; 6 position rolloff control; bass control gives 16 db boost and 18 db cut at 30 cycles, treble gives 11 db boost and 18 db cut at 10,000 cps; separate volume and loudness controls; tape monitor switch; rumble filter switch; inputs are radio, tape, aux, magnetic phono, crystal phono, tape head and separate high level input for second channel of binaural system; two cathode follower outputs, one for second channel of binaural system, operating from second high level input; sensitivity 2 millivolts for 1 volt output on magnetic phono, .2 volts for 1 volt output on high level inputs; hum and noise 80 db below 3 volts at full gain on high level inputs, better than 60 db below effective program level at full gain with 10 millivolts input on phono or tape; 3—ECC83 and 2 selenium rectifiers; d.c. supply on all filaments; printed circuit construction; three a.c. outlets; $12\frac{3}{4}$ "w x $3\frac{3}{4}$ "h x $9\frac{1}{8}$ "d.
 LT-30 \$59.59 Net
 KT-300 (kit form) \$39.50 Net

MADISON FIELD CORP.

Series 320 Stereo Amplifier

Two complete amplifiers on one chassis, individual controls for each section as well as master volume



control for adjusting stereo program levels; power response constant at 20 watts per section 20-20,000 cycles plus or minus 1 db; frequency response uniform 20-20,000 cps within .5 db; hum and noise down 55 db at full output in phono position, better than 75 db in high level positions; inputs (each channel) two high level, one low level; outputs (each channel) 4, 8 and 16 ohm speakers and tape recorder monitoring \$169.95

FM-AM-Multiplex Tuner Series 333

AM and FM tuners can be used individually or for stereo; multiplex output; dual tuning indicator; cathode follower outputs; individual level set controls on AM and FM; FM Section: sensitivity 0.9 μ v for 20 db quieting; frequency response uniform within 1 db, 20-20,000 cycles. Less than 20 KC drift from cold start, completely stable after 1 minute. AM Section: sensitivity 15 μ v per meter loop sensitivity; 3 μ v with direct antenna connection; AVC; tuned RF stage; for maximum selectivity. \$149.95

NEWCOMB AUDIO PRODUCTS

Model 3D12 Stereophonic Preamp-Amplifiers

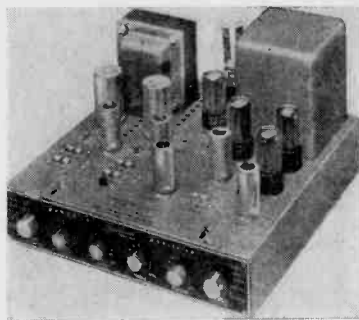

Two channel amplifier; 25-watt (total) output; built-in preamps; frequency response: 20 to 20,000 cps ± 1 db; hum and noise 80 db below 12 watts; distortion less than 2% at 25-watt output; bass control: 0 to +18 db; treble: -24 to +13 db; 5 position phono compensation control; loudness control (volume); 5 inputs: tuner, high and low level magnetic phonos, crystal phono, tape; outputs (paired): 8, 16 ohms (to speakers), two tape outputs; separate hum balance on each channel; correction switch for inside track of Cook and similar binaural recordings; focus control for stereo speaker balance; 5 position channel selector: stereo, reverse, A-only, B-only, monaural (both channels); twin speaker strips on rear of chassis; size: $12\frac{1}{8}$ " x $12\frac{1}{2}$ " x $7\frac{3}{8}$ "; weight: 19 lbs. \$179.50 Net

THE PENTRON CORPORATION

Model CA-15

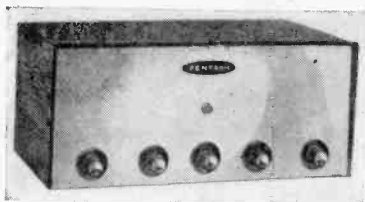

Stereo dual channel, playback preamplifier with separate equalization for each channel; two phono jack outputs; 1 volt rms output level; signal-to-noise ratio 50-60 db; frequency response 20 to 20,000 cps; distortion 1% total harmonic; NARTB equalized; volume and equalization control for each channel; power on-off master gain control; hum adjusting control; tubes are: 2—12AY7, 2—12AU7, 6X5; gold panel with black perforated cage; size 11 $\frac{1}{16}$ " x 5" x 8"; shpg wt 6 lbs. \$79.95 Net
Models TM-1, TM-3, TM-4 Tape Decks

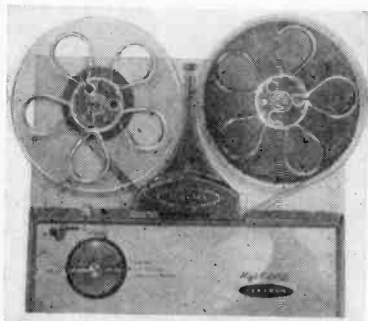

Portable tape mechanism offered with three different head arrangements: TM-1 half-track combination record/play/erase head for monaural, TM-3 two half-track combination record/play/erase heads for stereophonic (staggered) recording and playback (may be used for monaural using one head), TM-4 half track combination head and stacked (in-line) stereo head, for monaural and stereo recording and playback; (fresh or bulk-erased tape must be used when recording stereo); combination head; track width .093", gap 1/4 mil, impedance of record section 6,000 ohms, inductance of erase section 60 mh, easily changeable pole pieces; stacked head: track width .08", gap width .15 mil; impedance 3500 ohms; frequency response 40 to 14,000 cps properly equalized; signal-to-noise ratio 50-55 db; flutter less than 0.4% at 7 1/2 ips, under 1% at 3 3/4 ips; harmonic distortion less than 2% with NARTB tape and preamp; up to 7" reels; single rotary control for play, record, fast forward, fast rewind; induction type 4-pole shaded motor; shock mount brackets for vertical, horizontal, angle mounting; kit available to add digital reset counter; carrying case will mount 2 CA units in addition to mechanism; azimuth head assembly for accurate, screwdriver controlled azimuth and other head orientation; capstan drive, idler driven; idler disengaged in neutral; 4 pin jack outputs; 2 a.c. outlets;

1958 Edition



WHAT ABOUT FM ANTENNAS

Dollar-for-dollar, a Taco FM antenna is your best buy of all equipment in an FM hi-fi system. A Taco FM antenna will bring out the best in your tuner, amplifier and speaker.

Taco, world's largest manufacturer of fine antennas, offers FM antennas for every need, as well as complete, easy-to-install antenna kits.

WRITE for free copy of FM antenna data, or ask your dealer . . .



A COMPLETE HIGH FIDELITY PHONO SYSTEM WITH AMPLIFIER AND ENCLOSURE IN EASY TO BUILD KIT FORM! YES, THRILLING LIVE PERFORMANCE QUALITY CAN BE YOURS WITH THESE SUPERB CUSTOM COMPONENTS, OFFERED FOR THE FIRST TIME AT THIS SENSATIONAL PRICE.

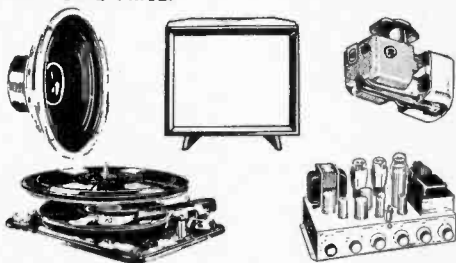

SYSTEM INCLUDES: The famous Bogen DB20 in kit form; the finest 20 watt amplifier of 3 dozen brands tested by a leading consumer testing organization. Features control center and 20 watt amplifier on one chassis, frequency response plus or minus 1 db, 20 to 20,000 cycles at full rated output; 1M distortion 0.3% at 20 watts and a full set of controls are among its many features. No guesswork, no errors; what's more, no experience is needed to build it. All parts are included with step by step instruction. Miracord's new XA100 4 speed automatic and manual changer features push button operation with no wow and flutter. Just a touch of your fingertip and it starts, stops, pauses between records, repeats, and filters. Plays 10" & 12" records intermixed; includes "Magic Wand" spindle. The cartridge is General Electric's VR1 4G052 with diamond and sapphire styl. For rich, smooth, quality sound, the Electro-Voice SP12B 12" radax speaker is offered. You'll also enjoy building the Electro-Voice KD5 "Empire" enclosure kit; a folded horn type, it features Klipsch design with a bass response down to 40 cycles; will fit any home and decor; all parts pre-cut and sanded with easy to follow instructions.

STOCK #G102A. Your Price \$189.00.
All units are brand new and in the original factory sealed cartons with the mfg's full warranty. Terms are full payment or 25% deposit, balance C.O.D. All shipments are F.O.B., N.Y.C.
Unhappy with "HI" HI-FI Prices? Unusual discounts on all your needs. Write now and save.
SEND FOR DISCOUNT CATALOG A-9 BEFORE YOU BUY ANY HI-FI. YOU'LL BE GLAD YOU DID.

KEY electronics company
120 Liberty St., N. Y. 6, N. Y.
PHONE: Evergreen 4-6071

gray and gold finish; size 10 $\frac{3}{32}$ "x13"x7"; shpg wt 14 lbs.

- Model TM-1 \$ 84.50 Net
- Model TM-3 \$ 95.00 Net
- Model TM-4 \$109.95 Net

Model CA-13



Self-powered playback record amplifier; 2 inputs, one microphone, one radio-phono; one volt output to power amplifier; noise ratio 50-55 db; frequency response 40 to 40,000 cps; distortion 2% total harmonic; modified NARTB equalization; sensitivity: .001 volt high impedance on microphone input; 0.5 volt high impedance on radio-phono input; record/play switch; power on-off gain control; interlock button; hum adjusting control; illuminated VU type meter; tubes are 12AX7/ECC83, 2—12AU7, 6C4, 6X5; gold front plate with black perforated cage; size 11 $\frac{5}{16}$ "x5"x8"; shpg wt 6 lbs. \$79.95 Net

Model NL-1S "Mercury"



Portable, half track or full track, dual-speed (3 $\frac{3}{4}$ and 7 $\frac{1}{2}$ ips) complete tape unit; one head, replaceable pole piece; balanced 4-pole shaded induction type motor; frequency response 40 to 11,000 cps at 7 $\frac{1}{2}$ ips, 40 to 7,000 cps at 3 $\frac{3}{4}$ ips; flutter under 0.4% at 7 $\frac{1}{2}$ ips, under 1% at 3 $\frac{3}{4}$ ips; signal-to-noise ratio 45 db; neon bulb level indicator; up to 7" reels; 4 watt amplifier; 6" extended range speaker; single rotary control for play, record, fast forward, fast rewind; interlock button prevents accidental recording or erasure; speed change level; volume control; tone control with on-off switch; high impedance low gain input; high impedance high gain input; high and low impedance outputs; may be used as PA system; tubes are 6J7, 6SL7, 6X5, 6V6; size 14"x17"x11"; shpg wt 29 lbs; complete with crystal mike and empty reel of tape.

Model NL-1S (stacked stereo head, and preamp for second channel) \$139.95 Net

Model NL-2S "Champion"



Portable; half or full track, dual speed (3 $\frac{3}{4}$ and 7 $\frac{1}{2}$ ips) complete tape unit; one head, replaceable pole piece, $\frac{1}{4}$ mil gap; balanced 4-pole shaded induction type motor; frequency response 40 to 13,000 cps at 7 $\frac{1}{2}$ ips, 40 to 7,000 cps at 3 $\frac{3}{4}$ ips; signal-to-noise ratio 48 db; tuning eye level indicator; 5 watt amplifier; 6" woofer and 4" tweeter with crossover network; special on-off switch cuts out motor while amplifier is on phono or PA; digital type counter with manual reset; tubes are 6J7, 6SL7, 6X5, 6V6, 6ES5; size 14"x16 $\frac{3}{4}$ "x10 $\frac{3}{4}$ "; shpg wt 33 lbs. Identical to Model NL-1S in all other specifications.

Model NL-2S (with stacked stereo head, plus preamp for second channel) \$179.95 Net

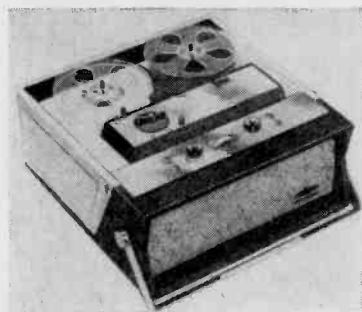

Model NL-3S "Aristocrat"

Frequency response 40 to 15,000 cps at 7 $\frac{1}{2}$ ips, 40 to 7,500 at 3 $\frac{3}{4}$ ips; signal-to-noise ratio 50 db; illuminated VU meter level indicator; 10 watts push-pull output; 4 speakers: two 6" woofers, 6" mid-range, tweeter, network with crossovers at 600 and 2,000 cps; tubes are 6J7, 6SL7, 6X5, 6V6, 12AU7, 2—6AQ5; automatic switch stops drive motor on tape break or end of tape automatic idler disengagement; size 17 $\frac{1}{8}$ "x17 $\frac{3}{4}$ "x11"; shpg wt 38 lbs; identical to model NL-2S in all other specifications. Model NL-3S (stacked stereo head, and preamp for second channel) \$219.95 Net

H. H. SCOTT

Model 330-C Stereophonic AM-FM Tuner

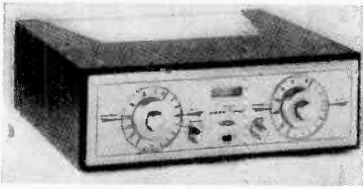

Completely separate AM and FM sections for stereo operation; sensitivity: FM, 2 microvolts for 20 db quieting; AM, 1 microvolt for usable audio output; illuminated signal strength meter; FM Section; 150 kc i.f. passband, 2 megacycle detector 80 db rejection of spurious cross-modulation response, AGC compensates for variations in signal strengths two stages of limiting; AM Section; three position adjustable i.f. bandwidth for wide range, normal, and distance reception, 10 kc whistle filter, 4 volt output for 100% modulation; separate AM and FM level controls on rear panel; separate output jacks for stereo operation and tape recording; FM multiplex output; tubes: 6BQ7A, 6U8, 4-6AU6, 6BE6, 6BA6, 2-12AX7, 6X5, 6AL5; 2-CK705A diodes; 15 1/4" w x 12 1/2" d x 4 3/4" h; 15 lbs.

Model 330-C \$224.95
 Plasti-leather accessory case \$ 9.95
 Wood accessory case \$ 19.95

Model 331-C Stereophonic AM-FM Tuner with Controls

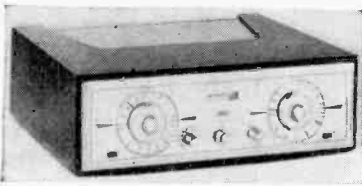

Incorporates AM and FM sections of Model 330-C tuner with addition of preamplifier-equalizer; five record equalization positions; NARTB tape-playback equalization; bass control; 17 db maximum boost at 30 cps; treble control: 19 db maximum boost at 20,000 cps; subsonic rumble filter; loudness compensation switch; inputs: 2 magnetic phono, 2 high level; outputs: main, tape recorder, separate AM and FM for stereo; tubes: 6BQ7, 6U8, 4-6AU6, 6BE6, 6BA6, 6AL5, 2-12AX7, 6X5, 12AU7, 2-CK705A diodes; dimensions in accessory case; 15 1/4" x 4 3/4" x 12 1/2"; 17 lbs.

Model 331-C \$289.95
 Plasti-leather accessory case \$ 9.95
 Wood accessory case \$ 19.95

1958 Edition

SUPERSCOPE, INC.

Sony Model-555 "Stereocorder"

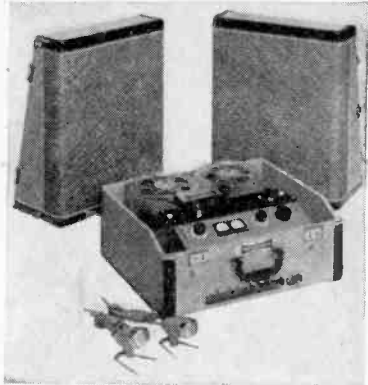

Portable stereophonic record/playback unit; stacked (in-line) erase and record/playback heads; hysteresis synchronous drive motor; separate amplification and preamplification for each channel with independent controls; 2 high impedance dynamic microphones; 4"x6" monitor speaker; switch for monaural operation; separate speaker outputs; automatic tape lifter; leather and vinyl portable case. Model 555.....\$525.00

Also available: two matching speaker enclosures with James B. Lansing D123 speakers; enclosures combine to form one portable case.

With speakers.....\$175.00
 Enclosures only.....\$ 60.00

TANBERG

Stereo 3



Three speeds, 1/8 ips, 3 3/4 ips, and 7 1/2 ips; wow and flutter below .2% at 3 3/4 ips and below .25% at 1/8 ips, .1% at 7 1/2 ips; frequency response 50 to 8,000 cps ± 2 db at 3 3/4 ips, 50 to 4,000 cps ± 2 db at 1/8 ips; 30 to 16,000 cps ± 2 db at 7 1/2 ips; signal-to-noise -60 db at 7 1/2 ips; provision for playing back stereo tapes; built-in twin amplifiers, each with 3 1/2 watts output; amplifiers connected in parallel for monaural tape playback giving 7 watts output hand rubbed furniture cabinet; 15"x11"x6"; 27 pounds with case.....\$369.50

Model 3-266-stereo system consists of Model 3 stereo recorder and two matching Model 266 or CS-40 speaker systems (each 14"x10"x22"). \$469.95

159

VIKING OF MINNEAPOLIS

FF75 Series Tape Decks

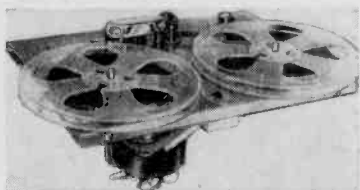

All Viking decks use "Dynamu" heads and have response of 30 to 14,000 cps at $7\frac{1}{2}$ ips and 40 to 7,000 cps at $3\frac{3}{4}$ ips; signal-to-noise 55 db or better; flutter .2%; 7" maximum reel size; 4-pole 60 cycle motor; mechanically actuated supply and takeup reel brakes; head gap width of .00015"; $14\frac{5}{8}$ "x $9\frac{3}{8}$ "x $5\frac{1}{8}$ "; 11 pounds.

FF75SU universal stereophonic playback unit, in-line and staggered heads; consists of transport, head bracket, in-line head assembly, standard half-track record/playback head, tapelifter and pressure pads; (can be used for recording if previously recorded tapes are bulk erased) \$106.00 Net

FF75SR in-line stereophonic playback unit plus half-track erase record/playback functions; consists of transport, head bracket, in-line stereophonic head, half-track erase head, half-track record/playback head, and tapelifter and pressure pad; (can be used for in-line stereophonic recording if each half-track of previously recorded tapes is erased separately, or bulk erasure is used.) . . . \$113.00 Net

FF75S in-line stereo unit; consists of transport, head bracket, in-line head assembly, tapelifter and pressure pad. \$99.00 Net

PB60

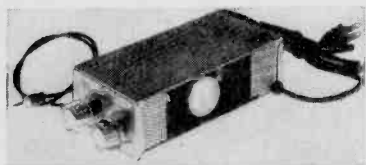

Self-contained NARTB tape playback equalized pre-amplifier for use with any Viking deck; provides nominal one volt output at medium high impedance; variable level and equalization controls; built in power supply with on-off switch mounted on level control; switched a.c. receptacle for auxiliary equipment; hum balancing adjustment; 115 volts 50-60 cycles a.c.; dimensions 3 "w x $2\frac{1}{4}$ "h x $6\frac{1}{2}$ "d. \$29.50 Net

RP61



Record/playback amplifier; consists of recording amplifier, erase-bias oscillator and playback pre-amplifier for use with any Viking deck; provides for full fidelity recording from low output microphone,

phono, radio or tape inputs; frequency response in playback 30 to 14,000 cps ± 2 db, in record-playback cycle 30 to 12,000 cps ± 3 db; signal-to-noise 60 db; tube complement: 12AX7, 12AU7A, 12AV7, 6X4, 6E5; separate recording and playback level controls provided, and variable equalization control; completely self-contained, switched a.c. receptacle for auxiliary equipment; 110 volts 50-60 cycles a.c.; dimensions: 11 "w x $2\frac{1}{4}$ "h x $6\frac{3}{4}$ "d.

\$77.50 Net

Rack-mounted RP61; available complete with VU meter; 6E5 indicator tube replaced by a conventional VU meter amplifier; unit is identified by the suffix VU after the type number and is capable of professional recording and playback preamplifier performance. \$119.00 Net

Stereo Pro Recorder



Complete portable stereophonic recording unit consisting of stereophonic deck, RP61 record/playback preamplifier, and RP61S stereophonic record/playback amplifier mounted in a portable case; dimensions 16 "w x $17\frac{1}{2}$ "h x 10 "d. \$299.00 Net

V-M CORP.

Model 750 Stereo Tape Recorder

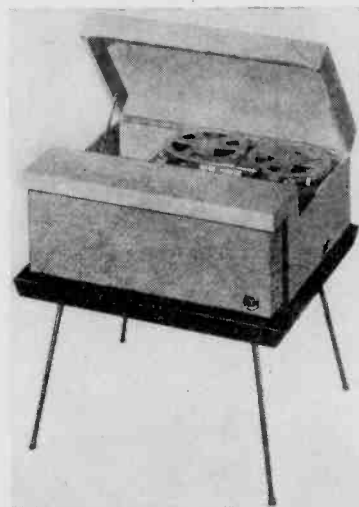

Monaural record; stereophonic playback; signal-to-

HI-FI GUIDE & YEARBOOK

noise —45 db; wow .4%; two 8" woofers and one 3.5" tweeter; external speaker jack; push button controls; "Normal" and "Distort" lights for indication of proper recording level; tape index counter; automatic shutoff at end of reel; 3¾ ips and 7½ ips; 5-watt amplifier; tone control; pause button permits stops while recording or playing; external amplifier and speaker jacks; large storage compartment; records from crystal or dynamic mike, radio or TV, or any crystal, ceramic, or magnetic pickup; tape index counter; 10¾"x19½"x22¾"; in blonde or mahogany.....\$259.95

Model 711 Stereo Tape Recorder

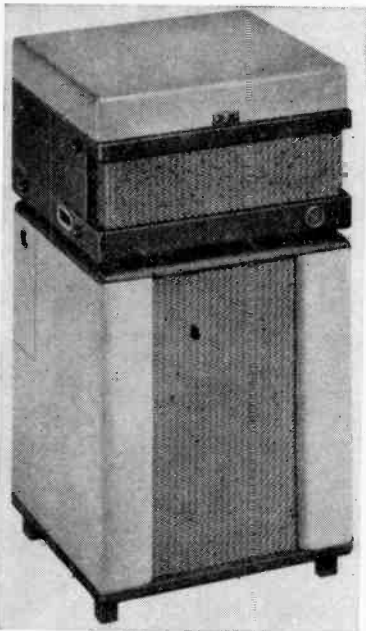

Monaural record; stereophonic playback; signal-to-noise —45 db; wow and flutter .4%; 6"x9" woofer and 3.5" tweeter; push button controls; "Normal" and "Distort" lights for indication of proper recording level; tape index counter; automatic shutoff at end of reel; dual speed—3¾ ips and 7½ ips; 5 watt amplifier tone control; pause button permits stops while recording or playing; large storage compartment; external amplifier and speaker jacks; records from any sound source; 9½"x14½"x16".....\$209.95 List
Model 25A Speaker.....\$49.95 List

Model 165 Amplifier-Speaker System

"StereoVoice" speaker system composed of two 8" woofers and a 3.5" tweeter; bass-reflex enclosure; ideal for bookcase installation; optional brass or black legs; 6-8 ohms; 9¼"h x 12½"d x 24"w; amplifier is 5 watts; less than 2% distortion; 30 to 20,000

ADVERTISERS INDEX

1958 Hi-Fi Guide & Yearbook

ADVERTISER	Page No.
Allied Radio Corp.	139
Audio Devices Inc.	113
British Industries Corp.	Second Cover
Columbia L. P. Record Club	49
Components Corporation	125
EICO	129
Electro-Voice, Inc.	Third Cover
Electronic Experimenter's Handbook	141
Fairchild Recording Equipment Co.	137
General Electric Company	36
HiFiAnnual & Audio Handbook	153
HiFi Directory & Buyers' Guide	106
Karlson Associates, Inc.	111
Key Electronics Company	157
Lansing Sound, Inc., James B.	58
Magnetic Recording Company	111
Minnesota Mining & Manufacturing Company	104, 105
Newcomb Audio Products Co.	28
North American Philips Co., Inc.	96
Orradio Industries, Inc.	Fourth Cover
Reeves Soundcraft Corp.	117
Rek-O-Kut Company, Inc.	57
Scott, Inc., H. H.	127
Sherwood Electronic Laboratories Inc.	149
Tandberg	90
Technical Appliance Corporation	157
Utah Radio Products Corporation	145
Ziff-Davis Electronics Publications	130

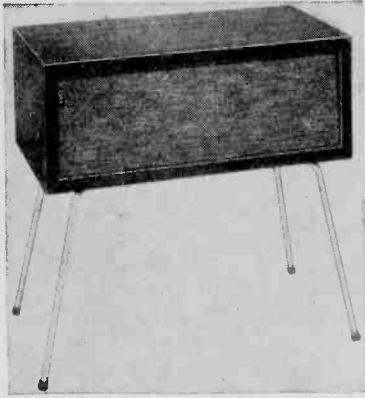

cps ± 2 db at 5 watts; bass, treble, and volume controls; output 8 ohms; $7\frac{1}{4}$ "x $6\frac{3}{4}$ "x $3\frac{3}{8}$ "... \$85.00 List

Model 166 StereoVoice Amplifier-Speaker

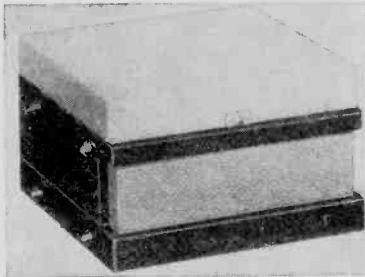

Amplifier-speaker to match V-M tape recorders; speaker section has 6"x9" woofer and 3.5" tweeter; response 40 to 15,000 ± 5 db; 5 watt amplifier, less than 2% distortion; 30 to 20,000 ± 2 db at 5 watts; volume, bass, and treble controls; $9\frac{1}{2}$ "x $14\frac{1}{2}$ "x 16 ". \$75.00 List

WEBCOR, INC.

Model 2821 "Royal"



Monaural tape recorder with monaural and stereophonic playback; $3\frac{3}{4}$ and $7\frac{1}{2}$ ips; frequency response: 70 to 7,000 cps at $3\frac{3}{4}$ ips, 50 to 12,000 cps at $7\frac{1}{2}$ ips; wow and flutter less than .4%; signal-to-noise ratio: 45 db; tuning-eye record level indicator; 5-watt peak power amplifier; two speakers; two 4-pole motors; tape counter; ebony and white finishes; $10\frac{1}{8}$ "h x $17\frac{1}{2}$ "w x $16\frac{1}{2}$ "d.

Model 2821..... \$239.95

Model BP2827 "Imperial"

Monaural tape recorder with monaural and stacked heads stereophonic playback; $3\frac{3}{4}$ and $7\frac{1}{2}$ ips; frequency response: 50 to 10,000 cps at $3\frac{3}{4}$ ips, 40 to 15,000 cps at $7\frac{1}{2}$ ips; wow and flutter less than

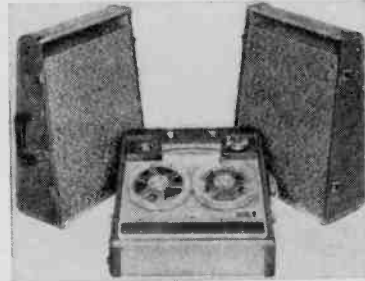

.4%; signal-to-noise ratio: 45 db; tape counter; built-in 8 watt amplifier; monaural record and playback without reel turnover; 3 speakers in detachable case; separate speaker system (Model BP-4827) available at extra cost, consisting of 8", 6", and 4" speakers with additional amplifier for stereo use; ocean blue and gray finish; $16\frac{3}{8}$ "w x $9\text{-}5\text{-}16$ "h x $19\frac{7}{8}$ "d.

Model BP2827..... \$319.95

Model BP2897 (with AM radio)..... \$359.95

Model BP4827 (speaker system only)..... \$119.95

Model 2822 "Royal Coronet"

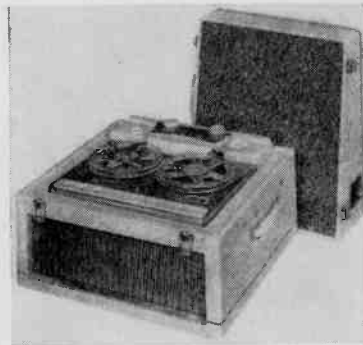

Monaural tape recorder with monaural and stereophonic playback; stacked stereo heads; $3\frac{3}{4}$ and $7\frac{1}{2}$ ips; two 4-pole motors; frequency response: 50 to 10,000 cps at $3\frac{3}{4}$ ips, 40 to 15,000 cps at $7\frac{1}{2}$ ips; wow and flutter less than .4%; signal-to-noise ratio: 45 db; tape counter, tuning eye recording level indicator; 8-watt peak power amplifier; 3 speakers; Model 4820 available as second channel amplifier and speaker system for stereo operation; output jack for connection to external power amplifier; one a.c. convenience outlet; ebony or white finishes; 19"w x 11"h x 19"d.

Model 2822..... \$289.95

Model 4820 (speaker system only)..... \$79.50

**Here's the
EASY WAY
to get ALL the Facts
on Electro-Voice
"do-it-yourself"
Hi-Fi**

Now, you can have the very best in hi-fi without spending a small fortune . . . the Electro-Voice do-it-yourself Way! You don't have to be an electronic genius, either. It's easy with the lucid, step-by-step E-V instructions.

Electro-Voice® ELECTRO-VOICE, INC.
BUCHANAN, MICHIGAN

Export: 13 East 40th Street, New York 16, U. S. A. Cables: ARLAB

Send me all the facts about...



The Electro-Voice Aristocrat Folded-Horn Corner Enclosure, ONE of many outstanding E-V speaker enclosures, finished and assembled. All you do is install speakers. \$45 and up.

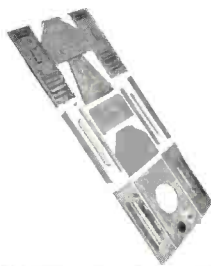

The Electro-Voice Do-It-Yourself Enclosure Kits, seven famous E-V speaker enclosures that are easy to assemble, and economical, too. \$26 to \$118.



The Electro-Voice Speaker-Enclosure Construction Books. Each book provides simple, step-by-step details on how to make one of the seven E-V hi-fi speaker enclosures with materials from any lumber yard or hardware store. \$.75 to \$1.50.

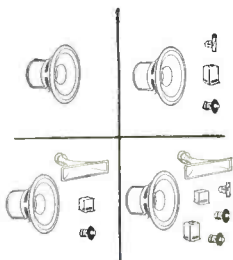

The Electro-Voice Speaker Building Block Systems that let me expand from a single speaker to a multi-way high-fidelity speaker system in easy, economical steps, as my budget permits. \$37.00 and up.

ELECTRO-VOICE, INC.
Dept. PEA-8
Buchanan, Michigan

NAME.....

ADDRESS.....

CITY.....

STATE.....

**Just fill out
the Coupon,
Clip and
Mail Today!**

Did Someone Say "Switch?"



When the art of recording was just taking shape
And it seemed to the experts that tape was just tape,
It made sense to try switching from this brand to that—
Until **irish** pulled **FERRO-SHEEN** out of the hat!

Now the **FERRO-SHEEN** process, the experts agree,
Has made **irish** tape different in *kind*, not degree,
So there's no earthly reason for switching your brand,
Save from Long Play to Double, or Brown to Green Band!



...if you are using
irish BROWN BAND

(an inexpensive general-purpose
tape of excellent characteristics)
... and want all the advantages of
FERRO-SHEEN ...



...switch to
**irish
FERRO-SHEEN GREEN BAND**

(it costs no more than old-
fashioned coated tape)
... if you then want 50% more play-
ing time on the same size reel ...



...switch to
**irish
FERRO-SHEEN LONG PLAY**

(on 1-mil Mylar or acetate base)
... if you then want twice the
normal playing time on the
same size reel ...



...switch to
**irish
FERRO-SHEEN DOUBLE PLAY**

(made on 1/2-mil Mylar base and
available on 5" and 7" reels)
There's an **irish** tape
for every recording purpose!



Available wherever quality tape is sold.

ORRadio Industries, Inc., Opelika, Alabama

Export: Morhan Exporting Corp., 458 Broadway, New York 13, N.Y., U.S.A.

Canada: Atlas Radio Corp., Ltd., 50 Wingold Ave., Toronto 10, Ontario