

1982

POPULAR ELECTRONICS

\$2.95

# INVITATION TO ELECTRONICS

**COMPLETE GUIDE TO HOME ELECTRONIC PRODUCTS**

- \* PERSONAL COMPUTERS \* PROJECTION COLOR TV
- \* VIDEOCASSETTE RECORDERS \* ELECTRONIC CAREERS & EDUCATION \* HOME TV EARTH STATIONS
- \* ELECTRONIC KIT BUILDING \* HOBBY COMMUNICATIONS





# Improve your video image

Does what looked good on two-hour look not-so-good on six? Or what looked great on your original videotape end up hard-to-look-at when you dub a copy? Maybe the picture's a little soft; or smeary; lacks contrast; or the color's a little off. You may not even be sure what it is — it's just not up to snuff.

But you live with it. Because six-hour is more economical and more convenient than two-hour. Because a mediocre copy is better than no copy at all.

All the same, wouldn't it be nice if you could somehow improve the quality?

At Vidicraft, improving video quality is our business. Our video processing components are to video what graphic equalizers and metal tape are to audio. They help you get the most out of your system.

Take the Detailer II image enhancer, for instance. By amplifying high frequency picture information, the Detailer II can actually increase apparent resolution. Translated, that means improved sharpness and greater picture detail. A crisper, more lifelike image. Better dubs. Better original recordings. Even better playback of programs you already own.

Basic features include individual controls for detail and sharpness, plus Vidicraft's exclusive VNX™ control for enhancement noise reduction. For convenience, we've also included three switchable inputs and a four-output distribution amplifier — for interconnecting multiple VCRs, as well as other video components. And for making multiple copies.

The Proc Amp is another example. It gives you the ability -electronically- to regulate chroma level and phase, and overall luminance level. This means you can correct color saturation and hue for greater color accuracy. And adjust overall video signal level for optimum contrast and brightness. Not simply upon playback - where it may be too late - but in making the recording itself.

That's not to mention some of the small things you can do with our Proc Amp. Like eliminate color all together - to rid a black and white program of color fringing, for example. Or create fade outs and fade ins - to make nice, smooth, professional looking transitions.

Features include center-detent controls, a luminance level meter, and a four-output distribution amplifier.

A bypass feature is also provided - both on the Proc Amp and Detailer II - to give you instant picture-before and picture-after comparisons. So you can accurately judge the results.

Even a small touch like that can be an important consideration in getting the best image.

For a close look at what we mean, visit your Vidicraft dealer. Where you can see our complete line of video components. For the location nearest you, dial toll free: 1-800-547-1491.



# vidicraft

# Digital Watch Radio



*When people see you plug stereo headphones into your digital watch, they may wonder. Walkman, move over.*

*The samarium headphones and the Digital Watch Radio produce a strong sound you'll find hard to believe.*

It all makes sense. If you wear your digital watch most of the time just adding an alarm, a chronograph, and even an hourly chime might make it more appealing. But adding a radio, that tops it all.

The Advance Digital Watch Radio is exactly that—a full-featured digital watch with a built-in AM radio that lets you listen to music, news and sports anytime, anywhere—all with a sound so powerful that you'll shake your head in disbelief.

Remember your surprise the first time you listened to a Sony Walkman or to one of the new headphone radios? Remember the sound quality, the deep bass response and the crystal clear highs? That's what you'll discover from that little sound package on your wrist. But wait, there's more.

## NO EASY TASK

Keeping the radio small and powerful was no easy task. It involved new technology and some pretty clever thinking. For example, the volume control is located on the headphones and there is no on/off switch. Just plugging in the headphone jack turns on the radio.

The 2 milliamp circuit gives you over 100 hours of play from your radio—all from just one commonly available silver oxide battery. A separate battery runs your watch for over a year. But the features don't stop there.

The AM radio tuner is attached to a thin flat disc that you turn with your thumb. Stations come in clear and crisp and despite the tuner's small size, the stations are easy to fine tune thanks to a highly directional Hitachi radio antenna which has a low signal-to-noise ratio. But what about the watch?

## FULL-FUNCTION WATCH

The Watch Radio is a full-function LCD digital alarm, chronograph timepiece with hourly componentry. The watch is an impressive product that could alone be worth \$49.95.

Now, when you add the powerful AM radio and a set of samarium cobalt high fidelity headphones, only then can you appreciate the real value of the Watch Radio. Samarium cobalt, a space-age material, reduces the weight of the headphones, provides outstanding frequency response and replaces the need for the bulkier iron magnet traditionally used in today's smaller headphones. The combination

of both the samarium cobalt headphones and the unique circuitry is one of the breakthroughs that has made this product possible.

With the lightweight headphones, you also get a small ear plug headphone which lets you monitor your radio without drawing too much attention to it. It's really a cheap listening device that makes a perfect accessory because you can easily carry it with you in your pocket or purse.

Now you can jog or play most sports without having to lug a cassette recorder or AM radio around. Just plug the long headphone wire into your watch and select your entertainment. At sporting events, while walking your dog,

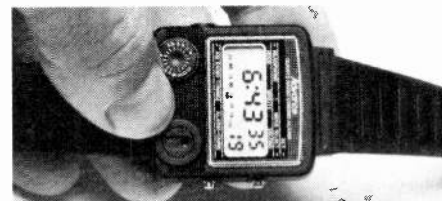
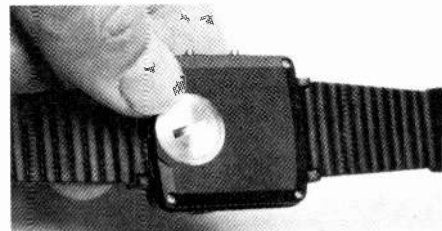

*You can easily change the battery after 100 hours of use. The small opening to the right of the dial (shown in the photo at the bottom) is a sound port for the watch chime and alarm.*

riding your bicycle or even waiting in line at the checkout counter, you've always got your entertainment with you. Think of it. Now to check the weather you can use your watch.

We suggest you order an Advance Digital Watch Radio on our 30-day, no obligation trial. We realize that it is impossible for you to imagine the incredible sound and the watch quality until you personally wear and use it. So, when you receive it, give it a real work out. Use it while you shop, work or play. Take it with you on a trip. See how handy it is when you want to check the weather or sports results.

But the most fun is watching the reactions of people who see you listening to your digital watch or seeing their expressions after they hear its powerful sound on your headphones. It's a product that people will find hard to believe—even in today's electronic revolution.

If after your testing you're not convinced that the Advance Digital Watch Radio is even more than we've described, no problem. Return your watch and headphones for a full refund including your \$3.00 for postage and handling.

## GREAT VALUE PACKAGE

But with all its advanced technology and sophisticated electronics, the Advance Digital Watch Radio is probably one of the greatest values we've ever offered in one complete package. A digital watch, a built-in radio, a handsome set of samarium cobalt headphones, a cheap ear plug headphone plus the batteries—all for \$49.95. Each watch comes complete with a one-year limited warranty and all batteries. Just open up your package, plug in the headphones and you're ready to go.

The Watch Radio offers us the opportunity to add some fun and everyday practicality to our life—all at a very reasonable price.

Technology keeps marching on. So, we wouldn't be surprised if the Advance engineers are working on the TV version of their new watch. And you won't be too surprised either—once you personally hear the phenomenal sound from their radio. Order your Digital Watch Radio at no obligation, today.

To order send a check or money order to the address below or credit card holders call toll-free 800 228-5000 (In Nebraska call 800 323-6400). When ordering, please use order number (shown in parenthesis) for faster service. Please add 3.00 for postage and handling and Illinois residents add 6% sales tax. Digital Watch Radio \$49.95 (2040IE01) Send \$1 for the new JS&A catalog

**JS&A** PRODUCTS  
THAT THINK

One JS&A Plaza, Northbrook, Ill. 60062  
(312) 564-7000 © JS&A Group, Inc., 1982

# INVITATION TO ELECTRONICS

<b>Invitation To Electronics</b> .....	<b>4</b>
<b>The World of High-Fidelity Sound</b> .....	<b>8</b>
<i>The ins and outs of putting together a stereo system.</i>	
<b>Tune In On the Video Revolution</b> .....	<b>33</b>
<i>How you can turn your TV set into a complete home-entertainment system with videocassette recorders, video-disk players, and satellite TV reception.</i>	
<b>Getting Started In Personal Computers</b> .....	<b>46</b>
<i>How to understand and join the computer revolution at home and at work.</i>	
<b>Glossary Of Technical Computer Terms</b> .....	<b>76</b>
<i>Helps you understand the buzz words used by computerists.</i>	
<b>Hobby Communications For Fun &amp; Safety</b> .....	<b>78</b>
<i>Getting started in shortwave listening, Public Service listening, CB, marine, and ham radio.</i>	
<b>Getting Acquainted With Electronic Circuits</b> .....	<b>94</b>
<i>Tells you what you need to know to be able to build electronic kits and projects.</i>	
<b>Learn More To Earn More</b> .....	<b>122</b>
<i>Advance your career with continuing education.</i>	
<b>They're Wooing You In Electronic Land</b> .....	<b>126</b>
<i>Electronic career information.</i>	
<b>Glossary of Audio Technical Terms</b> .....	<b>128</b>
<i>What the technical jargon and specifications mean.</i>	

COVER PHOTO BY STEVEN HUNT PHOTO DESIGNS

**ARTHUR P. SALSBERG**  
Editorial Director

Editorial and Executive Offices  
One Park Avenue  
New York, New York 10016  
212 725-3500

Ziff-Davis Publishing Company  
Richard P. Friese  
Albert S. Traina

President  
President, Consumer  
Magazine Division  
Executive Vice President  
Senior Vice Presidents

**ALEXANDER W. BURAWA**  
Managing Editor

Publisher  
Joe E. Mesics  
212 725-3568

Furman Hebb  
Phillip T. Heffernan  
Sidney Holtz  
Edward D. Muhlfeld  
Philip Sinc  
Robert Bavier  
Baird Davis  
George Morrissey  
Jerry Schneider  
Selwyn Taubman  
Bertram A. Abrams

Vice Presidents  
Vice President, Annuals  
Treasurer  
Secretary

**JULES GILDER**  
**LOU FRENZEL**  
Contributing Editors

New York Office  
Advertising Director:  
Richard Govatski, 212 725-7460  
Sales:  
Tom Ballou, 212 725-3578  
Ken Lipka, 212 725-3580

COPYRIGHT © 1982 BY ZIFF-DAVIS PUBLISHING COMPANY. ALL RIGHTS RESERVED.

**EDWARD I. BUXBAUM**  
**LESTER FRIEDMAN**  
Art Directors

Midwestern Office  
Suite 1400, 180 N. Michigan Ave.  
Chicago, IL 60601; 312 346-2600  
Sales: Ted Welch

PERMISSIONS: Material may not be reproduced in any form without permission. Requests for permission should be directed to John Babcock, Rights & Permissions, Ziff-Davis Publishing Co., One Park Ave., New York, NY 10016.

**JOE MESICS**  
Publisher

Representation In Japan  
J.S. Yagi  
Iwai Trading Company, Ltd.  
603 Ginza Sky Heights Bldg.  
18-13, Ginza 7-Chome  
Tokyo, Japan

1982 INVITATION TO ELECTRONICS is published annually by Ziff-Davis Publishing Company, One Park Avenue, New York, NY 10016. Also publishers of Popular Electronics, Stereo Review, Electronic Experimenter's Handbook, Tape Recording & Buying Guide, and Stereo Buyers Guide.



MOST POWERFUL

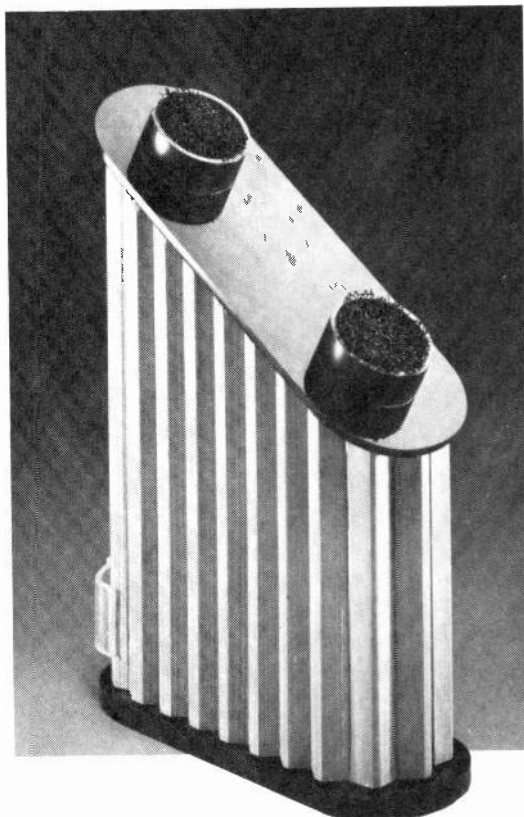

# Fresh Air Bubble

TRADE MARK

*Surround your body or your work place with ion-controlled fresh air in America's first bipolar electrostatic home precipitator.*

*The unit measures only 2" x 4" x 7" and its black and wood grain styling will fit into most decor.*

There's a danger. And this invisible menace will affect nearly everybody reading this ad.

The danger is pollution—but not the ordinary kind. In fact, ten years ago, we didn't have this new kind of pollution. Let us explain.

Ten years ago, cars didn't have catalytic converters. Today, these catalytic converters "grind up" the car exhaust into particles so small they form micron soot, and micron soot is so fine, it can be easily absorbed into your lungs. Even the EPA has stated, "Because it is so fine, such soot particles stay longer and cause more damage in the respiratory tract."

Ten years ago, homes were able to "breathe" or exchange air between the outdoors and indoors four or five times a day. Today, with our well-insulated energy-conscious buildings our homes literally create and trap pollution that we breathe unwittingly.

## OTHER PROBLEMS

There are other problems too. Add the daily soot, dust, smoke and other impurities in the air and you've created pollution problems even worse than they were ten years ago—so bad in fact that environmental groups are especially concerned over this new "time bomb" lurking in our environment.

But American ingenuity hasn't been sitting still. A rash of small devices containing charcoal filters with fans and selling for around \$30 have literally flooded the market. The problem is that these devices only remove particles 5 microns or larger. Today's micron soot is one micron or smaller. Cigarette smoke for example is 2 to 3 microns or smaller.

## 70,000 UNITS SOLD

In 1978, JS&A introduced the negative ion generator in a national advertising campaign and sold over 70,000 units. It was a device that cleaned the air by electrostatically removing particles even smaller than one micron. Hospital burn centers soon began using commercial versions of the negative ion generator.

Removing sub micron particles from the air was very important, but there was also a surprising second benefit. The unit added negatively charged ions to the air.

We've all felt the effects of negative ions after a thunderstorm. When you take a deep breath, the air smells good and you feel good.

The opposite is true of positive ions which can be found in polluted environments, air conditioned office buildings and in automobiles. Many scientists believe that positive ions make you feel moody, depressed, irritable and restless. A negative ion generator cancels out the positive ions and fills the air with negative ions.

## AN EXPERIMENT

When you blow smoke into an inverted glass bowl and put it over an ion generator, the smoke immediately vanishes. Or if you place the ion generator in an odor-filled room, the room soon smells fresh.

It was these experiments that really convinced the public that the JS&A ion generator was a valuable new home appliance. Soon the market was flooded with competitive ion generators. Many were not as efficient as JS&A's first model. Some emitted very few ions and one actually emitted dangerous levels of ozone. JS&A conducted independent laboratory tests and publicized the results which showed that JS&A's unit was indeed the best.

That's the history. But like any new technology, there's sure to be improvements. The first ion generator produced negatively charged ions which attached themselves to the pollutants and then fell to the ground. You ended up with clean, fresh air but also dirty rugs and walls.

In winter, the units created electrostatic discharges which can be uncomfortable when touching a doorknob or someone else.

## CONTROLLED ION ENVIRONMENT

So American scientists created an ion generator using a bipolar emitter which emits a balanced amount of negative ions to create a controlled ion environment. One emitter produces negative ions and the other controls and shapes those ions to create an ion bubble.

The end result is a unit which leaves just the right amount of negative ions in a large room, attracts the pollution particles and deposits

them on a beautiful wooden collector while keeping your floors and walls free of dirt. You're actually placed in a fresh air bubble while you work, sleep or relax and with no uncomfortable electrostatic charge. But wait, there's more.

We'll enclose with each unit, a white paper filter which you can place over the wooden collector. If the white paper is not blackened with micron soot after only ten days, please send your unit back for a full refund and we'll also refund your \$4.00 postage and handling. And you can make that test anytime within 30 days after you receive your unit.

The white filter test will prove just how dirty your environment really is and it will also prove the effectiveness of the Fresh Air Bubble—the most powerful ion product sold today.

We urge you to try the Fresh Air Bubble in your home or office. Put one on your desk or in any smoke-filled room. Notice the refreshing difference in your work environment. Take it home and plug it in next to your bed. Chances are, you'll want to buy another one before our 30-day trial period ends.

When you order the unit, we'll send you the Fresh Air Bubble complete with instructions and a one year limited warranty. Then plug it in and leave it run all day and night. The cost to run the unit is only a few cents per day.

The era of the bipolar electrostatic precipitator as a home appliance is here. Order the best unit available at no obligation, today.

To order, send a check or money order to the address below or credit card holders call toll free **800 228-5000**. (In Nebraska call **800 323-6400**.) When ordering, please use the order number (shown in parenthesis) for faster service. Please add \$4.00 for postage and handling and Ill. residents add 6% sales tax. Fresh Air Bubble **\$89.95 (7050IE01)**

**JS&A** PRODUCTS  
THAT THINK

One JS&A Plaza, Northbrook, Ill. 60062  
(312) 564-7000 © JS&A Group, Inc., 1982

# INVITATION TO ELECTRONICS

*cordially welcomes you to its debut issue  
covering the whole area of  
entertainment and functional electronics  
in the home.*

The program is designed to give you a basic understanding of electronic products that spice our everyday lives. Doubtlessly you are already living with some of these present-day marvels and are considering adding or replacing some in your home. INVITATION TO ELECTRONICS will de-mystify how these products work so that you will be more comfortable when using them and understand what to look for when buying them.

In the following pages you will meet the world of stereo hi-fi component equipment that has captured the imagination and thrilled so many people over the years with sonic realism. This will be followed by introducing you to video equipment that has added a new dimension to home entertainment. Vidiocassette recorders... video disc machines... satellite TV stations... color TV receivers, both direct-view and projection systems.

You won't want to miss the section on computers, of course. Find out what they are and why millions of people have already bought them for personal use. Familiarize yourself with computer jargon that is becoming more and more commonplace as computers encroach on our everyday lives. Here you will get a better idea of what's in the computer retail marketplace and how you might adopt one for fun, improved efficiency, education, and business.

In another section, you will be introduced to the basics of electronic components and circuits so that you have a better understanding of what's behind the miracle of today's electronic

products. Moreover, you will learn how to make your own electronic products when plans are supplied by magazines such as the monthly Popular Electronics and kit suppliers such as the Heath Company. Aside from the pride of "rolling your own," this approach to acquiring electronic products can save you money and often enable you to have equipment that is not available in assembled form.

And in another section you will see how radio communications can expand and fulfill your lives. For example, two-way communications equipment, which includes CB Radio and Amateur (HAM) Radio, enables one to talk to other people while at home or on-the-move in an automobile. Special receiving-only equipment allows you to listen in on broadcasts that cannot be picked up by ordinary AM or FM tuners. For instance, a Public Safety receiver gives you a front seat where the action is, enabling you to hear police, fire, marine radio, aviation, and other such radio conversations. With a shortwave broadcast receiver, you will hear programs (many in English) from other countries. This includes news with a foreign slant, music, even radio theatre.

And finally, there is a section on careers and education in electronics in the event that you wish to pursue the field further for avocational or professional reasons.

There is no end to electronics phenomena, so the conclusion of Invitation to Electronics is really the beginning of your fun and fascination with electronic products. Welcome to a new age.

The Editors



**Finally  
you can afford  
to satisfy  
your lust for  
power.**

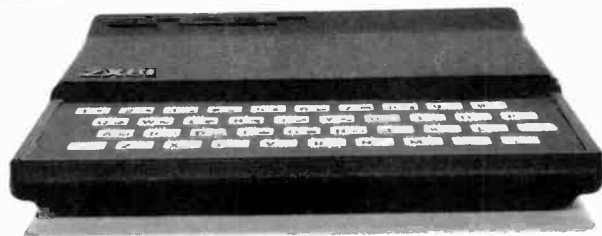

ZX81





# For \$99.95 you can have a full powered personal computer.

Most people know by now that the ZX81 from Sinclair Research is the lowest priced personal computer in the world.

But serious programmers are looking for more than a low price. They're looking for true computer power. And that's where the ZX81 surprises a lot of people.

Just look at the keyboard and you'll get some idea of the ZX81's power. It has more than 60 BASIC commands, 20 graphic symbols, and complete mathematical functions. And there's even more power that you can't see.

**A breakthrough in personal computers.** The ZX81 offers features found only on computers costing two or three times as much.

- Just look at what you get:
- Continuous display, including moving graphics
  - Multi-dimensional string and numerical arrays
  - Mathematical and scientific functions accurate to 8 decimal places
  - Unique one-touch entry of key words like PRINT, RUN and LIST
  - Automatic syntax error detection and easy editing
  - Randomize function useful for both games and serious applications
  - Built-in interface for ZX Printer
  - 1K of memory expandable to 16K
  - A comprehensive programming guide and operating manual

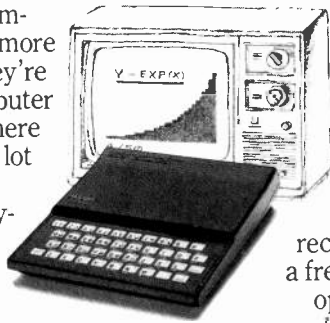

**Sinclair programs are available**

The ZX81 is also very convenient to use. It hooks up to any television set to produce a clear 32-column by 24-line display. And you can use a regular cassette recorder to store and recall programs by name.

**What you get.** When you order your ZX81, you get everything you need to start programming.

It comes with connectors for your TV and cassette recorder, an AC adaptor, and a free programming guide and operating manual that completely documents the capabilities of the ZX81.

**Options and add-ons.** Like any full-powered computer, the ZX81 can be expanded and upgraded.

Its 1K memory can be expanded to over 16K just by plugging the Sinclair Memory Module onto the back of the unit. The cost is only \$49.95.

Sinclair has also published pre-recorded programs on cassettes for your ZX81. We're constantly coming out with new programs, so we'll send you our latest software catalog when you order your computer.

**How did we do it?** The question most often asked about the ZX81 is, "How can so much computer power cost so little money?"

The answer is that Sinclair Research simply took a different approach. Our only goal was to make programming power as affordable as possible. So we developed a radical new design that cuts costs dramatically without cutting computer power. For example, our unique Master Chip replaces as many as 18 chips used in other personal computers.

The success of the ZX81 speaks for itself. It is now the fastest-selling personal computer in the world. And we stand behind our product. If anything goes wrong in the first 90 days, we'll repair or replace your unit free of

charge. Even after that, you can take advantage of our national service-by-mail facilities for a minimum fee.

**Order now and try it out for 10 days.** Simply send the coupon along with a check or money order. For faster delivery, call our toll-free number and use your MasterCard or VISA.

You have 10 days to try out the ZX81. If it isn't all we say it is, just send it back and we'll refund your money.

Why wait any longer? With the Sinclair ZX81, you can finally afford to have the computer power you've always wanted.

**Call toll free 800-543-3000.** Ask for operator #509. In Ohio call: 800-582-1364; in Canada call: 513-729-4300. Ask for operator #509.

Phones open 24 hours a day, 7 days a week.

Have your MasterCard or VISA ready.

These numbers are for orders only. If you just want information, please write: Sinclair Research Ltd., 2 Sinclair Plaza, Nashua, NH 03061.

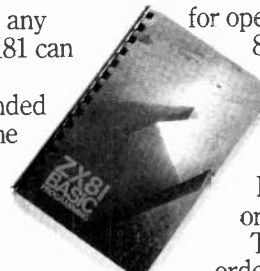

**Free guide to programming**

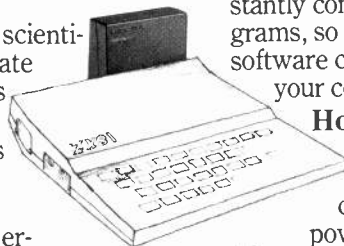

**16K Memory Module**

**To order call toll free: 800-543-3000.**

AD CODE 051E	MAIL TO: Sinclair Research Ltd., One Sinclair Plaza, Nashua, NH 03061.		
	PRICE*	QTY.	AMOUNT
ZX81	\$99.95		
16K Memory Module	\$49.95		
Shipping and Handling	\$4.95		\$4.95
*U.S. dollars	TOTAL		
Name			
Address			
City		State	Zip

Sinclair technology is also available in Timex/Sinclair computers under a license from Sinclair Research Ltd.

**sinclair**

# THE WORLD OF HIGH FIDELITY SOUND

**MUSIC HAS BEEN** a source of listening pleasure since long before the dawn of recorded history. Throughout most of this time, however, anyone who wanted to hear and enjoy music had to be at live performances. For the great majority of people, then, music could be enjoyed only on special occasions, such as at fairs and carnivals. Being able to

hear music on demand has been possible for only about 100 years or so. It began with the introduction of the phonograph player in the late Nineteenth Century and was reinforced with radio broadcasting of music in the third decade of the Twentieth Century.

We're fortunate today to be able to listen to almost any type of music we

wish to hear whenever we wish and wherever we happen to be. Thanks to high-quality electronic equipment, the music we can listen to today can have all the sonic qualities of the original performances.

Sooner or later, everyone wants to put together a hi-fi system to listen to music. To be able to do so intelligently, however, one must know something about the various hi-fi components on the market. In the following pages, we'll describe the components needed to assemble a hi-fi system and give hints on what to look for in terms of performance.

**Hi-Fi Vs. Stereo.** Among many newcomers to audio, the terms *hi-fi* and *stereo* are frequently confused. Many people believe the two mean the same thing; they don't. Each term describes a different aspect of the sound system.

Hi-fi, a contraction of "high fidelity," refers to the *quality* of the reproduced sound, or how faithfully the sound reflects what's available from the program source (phono, tape, tuner, etc.). The closer the reproduced sound comes to the original source signal, the higher the fidelity. For a system to qualify as being high in fidelity, *every* component in it, from source to speaker systems, must be able to reproduce virtually every nuance of the source signal with a minimum of distortion and noise. The higher the fidelity, therefore, the more faithful the reproduction. Fidelity is a measure of a component's frequency response, distortion figure, and the noise content it adds to the program.

The term "stereo," on the other hand, refers to the system's ability to reproduce two distinct channels of sound from two-channel sources. (If the source is single-channel mono, as in AM reception, the same sound will be reproduced in both stereo channels.) Obviously, then, for true stereo sound, with different program information in each channel, there must be two relatively independent channels at the source, two amplifier channels, and two speaker systems. Furthermore, to obtain proper stereo perspective in which the sounds of



PHOTO COURTESY OF AKAI AMERICA, LTD.



Sinclair  
ZX81

# SOFTWARE

BOOKS  
CASSETTES

## GAMES PACKS

**1** for 1K ZX81 & 8K ROM ZX80. Eight fantastic programs for the unexpanded ZX81  
**\$9.95** (\$12.95 in Canada)

**2** for 16K ZX81. Four programs written in BASIC for the expanded ZX81. PONTOON, FRUIT MACHINE, OXO, and BIO— RHYTHMS.  
**\$9.95** (\$12.95 in Canada)

**3** for 16K ZX81 and 8K ROM ZX80. Two programs for expanded ZX81 to keep you entertained for hours! 3-D OXO is written in machine code and is hard to beat. MARS RESCUE is a compulsive adventure game.  
**\$9.95** (\$12.95 in Canada)

**4** for 16K ZX81. ZOMBIES — escape as they chase you around Zombie Island. Lure them into the pits, but don't fall in yourself. MOUNT MAYHEM — can you reach the 20,000 foot summit? Look out for Yetis and other hazards!  
**\$9.95** (\$12.95 in Canada)

## DICTATOR

Fantastic new adventure game for 16K (or greater) ZX81. You have just become 129th ruler of Ritimba with a single goal in mind: take full advantage of the situation for your own good. You have to deal with a handful of factions: unruly army, downtrodden peasants — but you have the secret police on your side.  
Requires 16K.

**\$14.95** (\$17.95 in Canada)

## CONSTELLATION

Turn your ZX81 into a telescope with this amazing 16K program. Produces a simulation of the night sky as seen from any position on Earth at any chosen time this century. You may point your telescope in any direction, move it up, down, left or right, zoom in or out. Stars may be displayed by magnitude or constellation  
**\$14.95** (\$19.95 in Canada)

## STAR TREK

The classic computer game in which you trek across the galaxy in search of Klingons to zap with your phasers and photon torpedoes. You have long and short range scanners to help you find them, Starbases to refuel your ship at and, of course, various witty comments from the crew. 16K.

**\$9.95** (\$12.95 in Canada)

## ZX81 CHESS

A challenging chess programme, written in machine language, designed to operate in the ZX81 fast mode. ZX Chess allows you to select from 6 levels of play, choose either black or white, and enables castling and en passant moves. Unique "self-running" feature: you start the tape and when the chess board appears on the screen, start your game. 16K  
**ZX CHESS \$24.95** (\$29.95 in Canada)

HOME BUDGET ANALYSIS					
INCOM	2000	2000	2000	2000	
HTGE	450	450	450	650	
AUTO	250	250	250	250	
UTILTY	30	32	34	36	
MISC	300	330	363	399.3	
SAVED	970	938	903	714.7	

## VU-CALC

VU-CALC. Constructs, generates, and calculates large tables for analysis, budget sheets and projections. Up to 26 columns of figures or data can be entered, plus user definable formulae capable of relating any one or more position in the table to any other defined position.

**\$24.95** (\$29.95 in Canada)

```

MULTIFILE
PROGRAM (C) 1981 BUS-E-TE
MENU
1 SET UP FILE PARAMETERS
2 CREATE FILE
3 MODIFY FILE
4 SEARCH FOR FILE
5 STEP THROUGH FILES
6 SUM NUMERICAL FILE
7 SECURITY LOCK
8 SAVE FILES ON TAPE
ENTER YOUR CHOICE (1-8)

```

## MULTIFILE

### Data Storage System

An amazingly versatile multi-purpose filing system for the 16K ZX81. The program is menu-driven, and number, size and headings of files are user-definable. Both string and numerical files are catered for. Files may be created, modified, replaced, and searched, and are protected by an ingenious foolproof security system. Output to the ZX printer is also provided. The program comes on cassette, together with three quality data cassettes for file storage, and comprehensive documentation, describing a host of applications for both business and personal use. Supplied in an attractive storage case. If your ZX81 is bored with playing games, then this program will give it plenty to think about!  
**\$29.95** (\$39.95 in Canada)

## ZX81 COMPLETE BASIC COURSE

**\$34.95**



At last, a comprehensive text for your Sinclair ZX81! The complete BASIC Course is a manual which will immediately become an indispensable work of reference for all your ZX81 programming.

The Complete BASIC Course is designed to teach you to write and develop BASIC programs for the Sinclair ZX81 — no other books or aids are necessary. All is revealed in our easy step-by-step guide with programs and test yourself exercises all the way through.

### NUMEROUS EXAMPLES:

The Complete BASIC Course contains over 100 programs and examples! These programs illustrate the use and possibilities of the Sinclair ZX81.

- Home use
- Financial analysis and planning
- Educational applications
- Games
- Mathematical applications
- Displays of Artificial Intelligence

### EVERY FUNCTION COVERED:

No matter what your application, what your confusion about, any function you will find it covered in the Complete BASIC Course.

A full and detailed discussion is included of even traditionally taboo topics such as USR, PEEK and POKE.

### A PERMANENT WORK OF REFERENCE:

The Complete BASIC Course is an excellent reference work for experienced programmers (including tips on using special techniques) as well as a comprehensive step-by-step guide for complete beginners.

The Complete BASIC Course has over 240 pages filled with information in an attractive durable ring binder — this is a lay-flat work of reference that deserves a place next to every Sinclair ZX81 microcomputer.

### BASIC Course Programs on Cassette

All major programs in the BASIC Course are available pre-recorded in this set of cassettes. This is a valuable adjunct to the Course, saving you time and effort.  
**\$7.50** (\$9.95 in Canada)

## GLADSTONE ELECTRONICS

Phone Orders  
(716) 849-0735

Mail to:

**GLADSTONE ELECTRONICS**  
901 FUHRMANN BLVD.  
BUFFALO, New York 14203

Name \_\_\_\_\_

Company (if applicable) \_\_\_\_\_

Address \_\_\_\_\_

City \_\_\_\_\_ State \_\_\_\_\_ Zip \_\_\_\_\_

Please indicate method of payment —

Check money order (no cash please) \_\_\_\_\_ Date \_\_\_\_\_

Charge to \_\_\_\_\_

VISA/BankAmericard  Mastercharge

No. \_\_\_\_\_ Exp. date \_\_\_\_\_

Signature \_\_\_\_\_

WRITE FOR OUR FREE ZX81 SOFTWARE CATALOGUE.

Please rush me:

Qty	Title	Price
Shipping & handling (see below)		
<b>TOTAL</b>		

Shipping & handling: add \$1.50 for first item, 50 cents for each additional item. Cassettes guaranteed perfect, or replacement will be made free of charge. All materials copyright. In Canada: Mail to 1736 Avenue Rd., Toronto, Ont., M5M 3Y7.

Note: Allow two weeks for personal checks to clear.

CIRCLE NO. 7 ON FREE INFORMATION CARD

instruments and vocalists are spread from left to right across a "stage," the speaker systems must be separated from each other by a certain minimum distance. With proper speaker system placement, a true stereo image is obtained and the only factor that determines how effectively the stereo image is generated is the *separation* figure for the source and amplifying system.

Always keep in mind that not all stereo systems are capable of high-fidelity sound reproduction, and vice-versa. Some very inexpensive no-name brand systems may, indeed, be stereo systems but have fidelity capabilities no better than that obtainable with a good-quality restricted-frequency-response AM table radio. By the same token, an expensive, well-designed mono system can and usually does reproduce excellent hi-fi sound but lacks the directional capability of stereo equipment, even if a second speaker system is added.

It's also possible to have a system in which all but one of the basic components qualifies as truly high fidelity. For example, if you were to feed a true hi-fi source to a true hi-fi amplifying system that, in turn, drives low-quality speaker systems, you couldn't expect the sound you hear to be a true representation of the program source signal. In a case like this, using restricted frequency response speaker systems that have very irregular response curves, the fidelity of the sound you hear will be only as good (or as bad) as the speaker systems, regardless of how good the quality of the other components in the system. System fidelity will suffer until good-quality speaker systems are used.

high enough power level to drive speaker systems. Anything else an amplifier is



Carver M-400 basic power amplifier.

made to do is incidental to the component's basic purpose. In essence, then, the amplifier provides the system's "muscle power."

In its most elementary form, the audio amplifier is a *basic power amplifier*, whose only purpose is to develop the power needed to drive the speaker systems. This type of component typically has no volume or tone controls, source-program selection facilities, etc. In fact, the great majority of basic power amplifiers sold today have little more than a switch for turning on and off power and a second switch that permits selection of either or both of two pairs of stereo speaker systems.

part in the basic amplifying function of the component. In some cases, as with amplifiers rated at 100 or more watts per channel (W/ch), the peak-power displays are accompanied by a switch that's used to select either of two full-scale ranges. Setting the switch to one position allows the displays to indicate the full power at which the amplifier is rated. Setting the switch to the alternate position allows the displays to indicate only a fraction (for example, one-tenth) of the amplifier's rated output power full-scale, on an expanded scale. With this type of power monitoring arrangement, one can keep an eye on the amount of peak power delivered to and adjust listening volume to a safe level for the speaker systems used.

Basic power amplifiers are available in a wide range of rated maximum power-delivery capabilities, from a low of about 35 to a prodigious 400 or more watts per channel.

To be able to drive a basic power amplifier to its full rated power, input signal level (amplitude) must be between 0.75 and 1.5 volts peak-to-peak, depending on the amplifier. Few program sources—even so-called "high-level" sources, such as tuner and tape—are capable of developing the input levels required to effectively drive basic power amplifiers. (The typical tuner and tape deck rarely develop more than 0.5 volt peak-to-peak output, while a phono cartridge's output might be no greater than a few thousandths of a volt.) It's necessary, therefore, to use a *preamplifier* between the basic power amplifier and source. It then becomes the task of the preamp to develop a signal of sufficient level to effectively drive the basic power amplifier to full rated power.

Most modern stereo preamps do a great deal more than just amplify low-level signals. They are also designed to serve as the main control center for the stereo system. As such, the typical stereo preamp is more accurately titled a "*preamplifier/control center*." This is the component that has the various input jacks, switches, controls, and indicators needed to conveniently operate the sound system.

The preamp's input section may contain facilities for a turntable/cartridge system, two or more tape decks, an AM tuner, an FM tuner, and at least one high-level AUX (auxiliary) input. AUX inputs can be used to pipe in the sound output signal from a TV receiver or videocassette recorder or video-disc player to obtain better-quality sound. Needless to say, for a preamp to be of practical

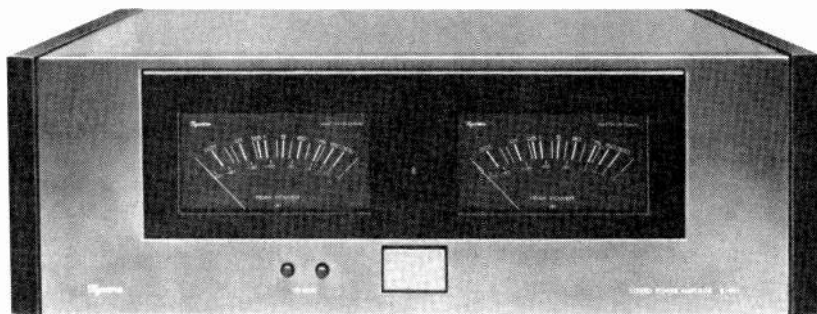

Cybernet "Kyocera Series" 150-W/channel basic power amplifier with meters.

**Amplifiers.** Every audio system must contain an amplifier. The basic task of this component is to boost low-level, low-power signals from phono, tape, tuner, and other program sources to a

Meters or LED (light-emitting diode) bar-graph displays are frequently built into basic power amplifiers to permit visual monitoring of peak power delivered to speaker systems. They take no

benefit to a stereo system, it must have a sufficient number of input jacks to accommodate all program-source components. It must also have a sufficient number of program source settings on its input selector.

A power switch and power-on indicator light must also be included. On the rear apron of the preamp should be both switched and unswitched accessory ac outlets into which the various system components can be plugged. These convenience outlets relieve the user of the need to have a multiplicity of wall outlets available to accommodate all of the components that might be used in a stereo system. More importantly, the switched outlets on the rear apron of the preamp, operated from the preamp's power switch, make it possible to control

loudness control is a variation of the volume control. At low listening levels, where the human ear is less responsive to low-frequency bass sounds, the loudness control's circuit reduces the amount of bass attenuation, compared to the midrange and treble attenuation, to prevent the low-frequency loss effect.) When an ordinary volume control is provided, a loudness switch is almost always included to maintain less bass attenuation at low listening levels. Also on the front panel may be a mode selector that allows the user to switch from mono to stereo as desired, while a separate switch might be included to allow the connections to one of the speaker systems to be reversed to correct for misphasing during hookup.

Bass and treble controls on the front

that removes the tone controls from the circuit in a single operation that doesn't disturb the settings of the tone controls themselves.

Inclusion of a balance control permits the relative output from each speaker system to be balanced with regard to the listening position and to compensate for unequal amplification between channels in the system. With this control, a listener can place himself psychoacoustically stage-center, even if he's listening from a location nearer one than the other speaker system.

Some preamps also feature rumble and scratch (low- and high-cut) filters. A rumble filter is used to remove low-frequency noise from a poorly designed or faulty turntable, while a scratch filter is used to reduce or eliminate the sound of scratches and surface noise when playing damaged and old records. Since use of rumble and scratch filters clip off the low and high frequencies, respectively, sound heard when they're switched into a circuit will be dramatically altered as a result of the resulting restricted frequency response. Consequently, it's recommended that these filters be used judiciously and only when they're really needed.

More elaborate preamp/control centers might have additional control facilities, such as: a multiple-band equalizer that replaces the traditional tone controls; switches that permit selection of the best load capacitance and resistance for a given phono cartridge; and possibly even a signal processor, such as a noise-reduction unit for taping or a "space expander" that simulates concert-hall sound in much smaller listening rooms.

Traditionally, preamps were designed to be used with moving-magnet phono cartridges and, as a result, contained a relatively simple phono preamplifier stage for boosting phono signals to the



Kenwood "Purist Group" L-07CII high-speed control amplifier (preamp).

power for the entire system with a single operation. The switched outlets permit all components, *except* the turntable, to be switched on and off with the preamp's power switch. The unswitched outlet is used for the turntable, which should never be switched off unless its tonearm has returned to its rest position, at which point, it will automatically shut the power off.

On the rear apron or the underside of the preamp will be a set of controls, usually located near the input jacks. These controls permit the levels of the various inputs to be adjusted so that all program sources are at the same relative level, obviating the need to constantly readjust volume when switching from phono to tuner to tape, etc. Rounding out the rear-panel facilities are input and output jacks for at least one and more frequently tape decks.

On the preamp's front panel will be a volume or loudness control. In some preamps, there are separate volume controls for the left and right channels. (A

panel allow the low and high ends of the amplifying system's frequency response to be boosted and/or cut to tailor the sound to individual tastes or to adjust for speaker-system deficiencies and different listening room acoustics. More and more frequently these days, a midrange tone control is also provided. In

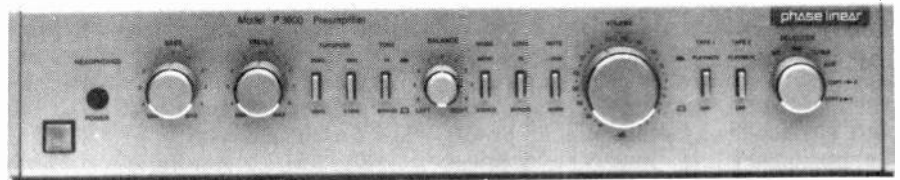

Phase Linear Model P 3600 Stereo preamplifier/control center.

their center (neutral) positions, the tone controls are effectively out of the circuit to give flat, unaltered response. Many preamps also have a tone-bypass switch

level of tuner and tape signals. Recently, moving-coil cartridges, whose outputs are on the order of tenths of a thousandth of a volt, have placed additional



amplifying demands on the audio system. Ordinarily, use of a moving-coil cartridge demands that an external pre-amplifier be used to boost signal level to that of the moving-magnet cartridge. Some of the preamps currently being sold have this pre-pre-amplifier built into them for user convenience.

The basic power amplifier and preamp/control center are frequently combined into a single *integrated amplifier*. This combination component has most of the features and functions usually obtained with two separate components, but in a more convenient packaging arrangement. The integrated amplifier needs only one or more sources (turntable, tuner, tape deck, etc.) and a pair of speaker systems to make it into a full-fledged stereo sound system.

Building a sound system around an integrated amplifier brings certain benefits. One of these is the reduced demand for space with the single component, which can be an important consideration to apartment dwellers and students residing in college dorms. A second advantage is that the price of an integrated amplifier is usually less than the combined price of separate components. A third advantage is that the integrated amplifier relieves the user of the need to match separate preamp and power amp to obtain a balanced amplifying system and reduces the number of cables and ac line cords with which one must contend.

Of course, opting for an integrated amplifier also has its disadvantages, most of which are relatively minor. The major disadvantage is the need to replace the entire amplifying system even if it's desired to upgrade to, say, greater control/input flexibility while retaining the same amount of output power capability. With separate components, one can relatively inexpensively replace only the component it's desired to upgrade. A second disadvantage is that most stereo integrated amplifiers usually offer fewer inputs and program source selectors than are commonly available with separate preamp/control centers. This is an important consideration only if a system calls for more phono, tuner, tape, and AUX sources than there are facilities to accommodate them. Finally, if an audiophile's needs exceed more than about 150 W/ch, he'll have no alternative but to use separate components. (Output delivery capability rarely exceeds about 150 W/ch for integrated amplifiers.)

Features and output power capability for integrated amplifiers vary over a wide range. As a general rule, the more

features and/or power available in a given series of integrated amplifiers, the greater the cost. At the low end of the price range are models with minimum input facilities, which might include jacks for one each phono, tuner, tape, and AUX source; only the most essential controls, such as volume, balance, bass and treble tone, and perhaps low- and high-cut filters; and output power ranging as low as 15 W/ch. More expensive

FM-stereo tuner, open-reel and cassette tape decks, and the new crop of high-quality-sound video equipment. Let's take a look at each of the audio-only sources in turn.

• *Record Players*. This component is really a system of integrated sub-components. Its only purpose is to accurately convert audio information on phonograph records into electrical signals that can be amplified for delivery to speaker



Pioneer PL-L800 linear-tracking turntable with up-front controls.

models frequently add an extra phono input and another tape-monitor/dub loop to permit dubbing from one tape deck to another; a peak-power monitor display, such as found on many basic power amplifiers; and power ratings up to about 100 W/ch. High-end models might offer moving-coil phono pre-amplifiers; selectable cartridge loading capacitance and resistance; and power ratings of from about 90 to 150 watts per channel.

**Program Sources.** An amplifying system has relatively little value unless it has sources from which programs can be selected. In modern home-entertainment, there's no dearth of sources from which programs can be obtained. The traditional sources are turntable/phono-cartridge system (record player), AM/

systems. The basic elements of the record playing system are: a motor-driven platter (the actual turntable), a phono cartridge, and a tonearm on which the cartridge is mounted. (The term "turntable" is frequently used as the name for the entire record playing system. In this article, we'll use the two interchangeably.)

There are basically two different types of record players—single play and multiple play. The latter is designed to automatically cycle from one record to the next at end of play. Within the single-play category are two versions. The fully automatic version automatically lifts the tonearm from its rest, indexes it over the record's lead-in grooves, and drops the tonearm into the play position on the record with a single operation of the PLAY switch. At end of play, the

# Explore the excellence of your ZX81 with a

MEMOPAK

MEMOPAK

MEMOPAK

MEMOPAK

MEMOPAK



## MEMOPAK 64k memory extension for \$179.95

Give your diminishing memory more byte.

### MEMOPAK 64K RAM \$179.95

The Sinclair ZX81 has revolutionized home computing. The MEMOPAK 64K RAM extends the memory of ZX81 by a further 56K to a full 64K. It is neither switched nor paged and is Directly Addressable. The unit is user transparent and accepts such basic commands as 10 DIM A (9000). It plugs directly into the back of ZX81 and does not inhibit the use of the printer or other add-on units. There is no need for an additional power supply or leads.

#### Description of memory

0-8K . . . Sinclair ROM  
8-16K . . . This section of memory switches in or out in 4K blocks to leave space for memory mapping, holds its contents during cassette loads, allows communication between programs, and can be used to run assembly language routines.

16-32K . . . This area can be used for basic programs and assembly language routines.

32-64K . . . 32K of RAM memory for basic variables and large arrays. With the MEMOPAK 64K extension the ZX81 is transformed into a powerful computer, suitable for business, leisure and educational use, at a fraction of the cost of comparable systems.

### MEMOPAK 16K RAM \$79.95

With the addition of MEMOPAK 16K, your ZX81 will have a full 16K of Directly Addressable RAM. It is neither switched nor paged and enables you to execute longer and more sophisticated programs and to hold an extended data base.

The 16K and 64K Memopaks come in attractive, custom-designed and engineered cases which fit snugly on to the back of the ZX81 giving a firm connection.

#### Free service on your MEMOPAK

Within the first six months, should anything go wrong with your MEMOPAK, return it to us and we will repair or replace it free of charge.

### Try MEMOPAK with no obligation

You can use our MEMOPAK in your home without obligation. After 10 days if you are not completely satisfied, simply return it for a full refund.

#### Coming soon . . . . .

A complete range of ZX81 plug-in peripherals:

- MEMOTECH Hi-Res Graphics
- MEMOTECH Digitising Tablets
- RS232 Interface
- Centronic Interface and
- Software Drivers

All these products are designed to fit "piggy-back" fashion on to each other and use the ZX81 power supply.

Further information forthcoming.

Memotech Corp. 7550 W. Yale Ave. Suite 220 Denver, Colo. 80227

Yes! I would like to try the Memopak. I understand that if I'm not completely satisfied, I can return it in 10 days for a full refund.

	Price †	Qty.	Amount
<input type="checkbox"/> Check	Memopak 64k RAM	\$ 179.95	
<input type="checkbox"/> Visa	Memopak 16k RAM	\$ 79.95	
<input type="checkbox"/> MC	Shipping and Handling	\$ 4.95	\$ 4.95
<b>Total</b>			

Act. No. \_\_\_\_\_ Exp. \_\_\_\_\_ † U.S. Dollars

Name \_\_\_\_\_

Street \_\_\_\_\_

City \_\_\_\_\_ State \_\_\_\_\_ Zip \_\_\_\_\_

**MEMOTECH**  
Memory Extension Specialists

Memotech Corporation  
7550 West Yale Ave., Suite 200  
Denver, Colorado 80227  
Ph. (303) 986-1516

tonearm automatically lifts and returns to its rest position, shutting off the player. Semiautomatic versions require the tonearm to be manually cued to start play but automatically return the tonearm to its rest position at end of play. In both cases, turntable start-up occurs as

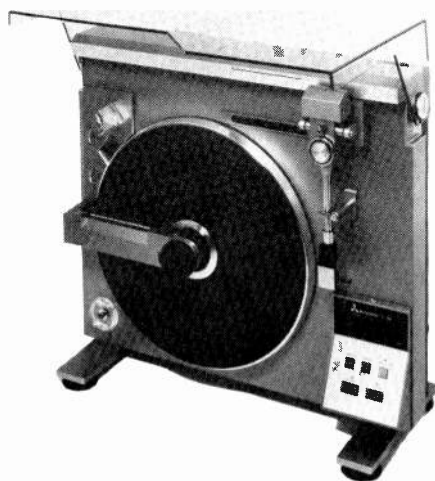

Mitsubishi LT-5V vertical linear-tracking turntable with dust cover.

soon as the tonearm is moved from its rest position.

The turntable platter mechanism might at first appear to be a simple device. While it's true that its only function is to rotate a record, either directly or via a belt, its speed must be accurately maintained, and the platter must be isolated from mechanical vibrations. Any vibrations transmitted to the platter will be picked up by the phono cartridge and amplified along with the program material and will be heard as low-frequency *rumble*. Any variations in speed will cause the pitch of the reproduced sound to be heard as disturbing *wow* and *flutter*.

Turntable rumble is minimized by using a smoothly rotating motor, precision



Crown FM Two digital FM tuner with station presets and rack handles.

manufactured parts, and rubber shock mounts. Wow and flutter are minimized with specially designed motors. With higher-quality turntables, a crystal or phase-locked-loop (PLL) circuit is used in conjunction with the motor to maintain precise speed.

Although multiple-speed record changers are still available, especially for all-in-one compact stereo systems, the current trend is toward use of two- or single-speed (33 $\frac{1}{3}$ - and 45-rpm or 33 $\frac{1}{3}$ -rpm only) single-play turntables. Few people still play older 78-rpm records, and the 45-rpm disc seems to have lost its appeal as a major medium for hi-fi recordings.

Contrary to popular belief, turntable platters don't have to be heavyweight castings to maintain constant speed and smooth rotation by flywheel effect. Many new designs stress lightweight platters as the means to achieve lower vibration. Both designs have yielded excellent record playing systems.

The *tonearm* is more than just a device from which to hang a phono cartridge. It's a critical element in the record-playing system, responsible for guiding the cartridge smoothly and with minimal drag across a record being played. It must also apply just the right amount of pressure (*tracking force*) to the cartridge's stylus as it rides in the record grooves, and it must isolate the cartridge from mechanical vibrations. Finally, the tonearm must hold the stylus as close as possible to tangency to the record grooves as it sweeps across the record's surface. With standard pivot-type tonearms, perfect tangency isn't physically possible at all times, since the tonearm can't move radially across the record's surface. Any departure from true tangency is referred to as *tracking error*. With properly designed pivot-type tonearms, tracking error is usually limited to only a very small percentage figure. Of course, to remove the problem altogether, one can use a tangential or so-called "linear-tracking" tonearm.

*Phono cartridges* are transducers that convert mechanical vibrations of the stylus as it moves in the record's groove into an electrical signal voltage that can be electronically amplified. Cartridge performance is a function of how accurately the stylus follows the complex mechanical modulation in the groove walls. Any deviation in accuracy results in distortion.

Different designs and different mountings make it possible to find a cartridge for every type of tonearm and detachable headshell on the market.

Among the factors of importance in phono cartridges are electrical output, compliance, tracking force, and dynamic mass.

Of the three basic types of phono cartridges in popular use—crystal, ceramic,

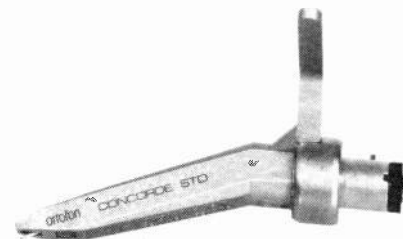

Ortofon "Concorde STD" headshell/stereo phonograph cartridge.

and magnetic—only the magnetic variety is of concern for high-quality sound reproduction. Crystal and ceramic cartridges, although high in electrical output, lack the frequency response for hi-fi applications. They're generally used in low-cost stereo and mono systems.

The output of the typical magnetic cartridge is quite low, on the order of about 3 mV (0.003 volt), which accounts for the need for a separate phono preamplifier in the amplifying portion of the stereo system. Since a magnetic cartridge is sensitive to hum pick-up, it's important that the motor used to rotate the player's platter be well shielded.

The compliance of a phono cartridge is a measure of how easily the stylus moves in the record grooves. The higher the compliance, the more accurate the reproduction of the recorded music and the lower the distortion. Also higher compliance allows one to apply less tracking force to the stylus for accurate reproduction, extending stylus and record life. A typical high-compliance cartridge can track with only 1 gram (about 0.03 oz) of force. By contrast, tonearm/cartridge combinations in low-cost record changers usually require tracking forces of 3 or more grams.

Dynamic mass is a measure of the weight of the moving parts in a cartridge. With low mass, the stylus can follow the rapid variations impressed in record grooves. A better-quality cartridge will have a dynamic mass of 1 mg (a thousandth of a gram) or less.





# TOOL & SOLDER STATION

## Model SK-25



- Holds Soldering Iron safely
- Sponge pad cleans tip
- Organizes Solder, Tools, Accessories
- For Factory, Lab or Home

\*Tools not included. Available separately

# SOLDER AID

**OK Machine & Tool Corporation**  
3455 Conner St., Bronx, N.Y. 10475 U.S.A.  
Tel. (212) 994-6600 Telex 125091

CIRCLE NO. 15 ON FREE INFORMATION CARD

Because of where and how it's used, the stylus is a vital element in the record-playing process. Although it's made from diamond, the hardest substance known to man, it's subject to wear as it rides in the grooves of a record. A worn stylus, unable to accurately follow record groove variations, will produce distortion. More importantly, it will greatly accelerate record wear. Viewed under a microscope, the tip of an unworn stylus isn't as sharply pointed as it might appear to be to the naked eye. It's actually rounded, with a radius of 0.3 to 0.5 mil (0.003 to 0.005 in.). The popular elliptical stylus has a width of 0.7 mil and an end radius of 0.2 mil, which allows it to follow the groove more closely than a conical stylus. Stylus wear appears as a flattening of the surface and may be unequal on opposite sides of the stylus.

Controls for operating turntables are



Shure V15 Type V phono cartridge has integral dust/destaticizer brush.

designed for both user convenience and to protect delicate records and cartridges. Two controls always found on hi-fi-quality turntables are stylus pressure and antiskating force adjustments, both concerned with the tonearm assembly. The stylus pressure control, usually applied with a spring or weight, is almost always calibrated over a range from 0 to about 3 grams, in line with the requirements for today's high-compliance cartridges. For pivot-type tonearms, the antiskate control permits pressure exerted by the cartridge stylus to be balanced for the left and right groove walls. Antiskating pressure is usually obtained with a spring, but it might be from a weight-and-pulley mechanism in high-quality tonearms.

Speed selector, cueing, and stop controls are featured in virtually all hi-fidelity single-play turntable systems. For belt-driven turntables, separate pitch controls are provided for each speed to permit the rotation speed of the platter to be adjusted over a  $\pm 3\%$  range. Pitch controls are used in conjunction with stroboscope markings on the platter and a strobe light built into the base of the player. The viscous-damped cueing control gently raises and lowers the tonearm. When activated, the stop control automatically lifts the tonearm from the record's surface during play and returns it to its rest position. Only fully-automatic single-play systems have a PLAY, or similarly labeled, control to initiate the playing sequence.

Operating controls for record changers are almost always fewer than for single-play models. In addition to stylus-pressure and antiskate-force controls, record changers feature record-size selectors for proper indexing of the tonearm over the lead-in grooves, and OFF/PLAY/REJECT levers. If the platter is belt driven, a pitch control is normally provided, along with a stroboscope setup for accurately trimming speed.

A flip-up dust cover is an important item to include in a record-playing system. As its name implies, the dust cover is used to protect the turntable's mechanisms from airborne dust and dirt. Except when placing records on and removing them from the turntable platter,

the dust cover should always be lowered even when playing records. Modern single-play hi-fi turntables take this into account and have their operating controls (not stylus pressure and antiskating) accessible on the front apron.

• *Tuners.* Second only to the turntable in popularity as a source of high-fidelity programs is the FM tuner. Unlike ordinary portable and table-model FM radios, the tuner has no power amplifier or speakers. It doesn't need them, since it's designed to serve as only a source of programs that are amplified and acoustically reproduced by the sound system's amplifier and speakers. Also unlike ordinary portable and table radios, hi-fi tuners are critically designed to extract all of the audio signal transmitted over the airwaves with as faithful fidelity as possible.

FM is the medium commonly used today for broadcasting high-fidelity sound signals. The basic reasons for this are that FM is currently the only medium with sufficient bandwidth to handle virtually the entire audio frequency range (up to 15,000 Hz) and is much more immune to electrical noise and interference than AM. The AM section in high-quality tuners sold today is usually much better designed than its portable and table radio counterparts to provide the best possible sound, although the sound itself lacks the quality available from the FM section.

Every tuner used in a hi-fi system

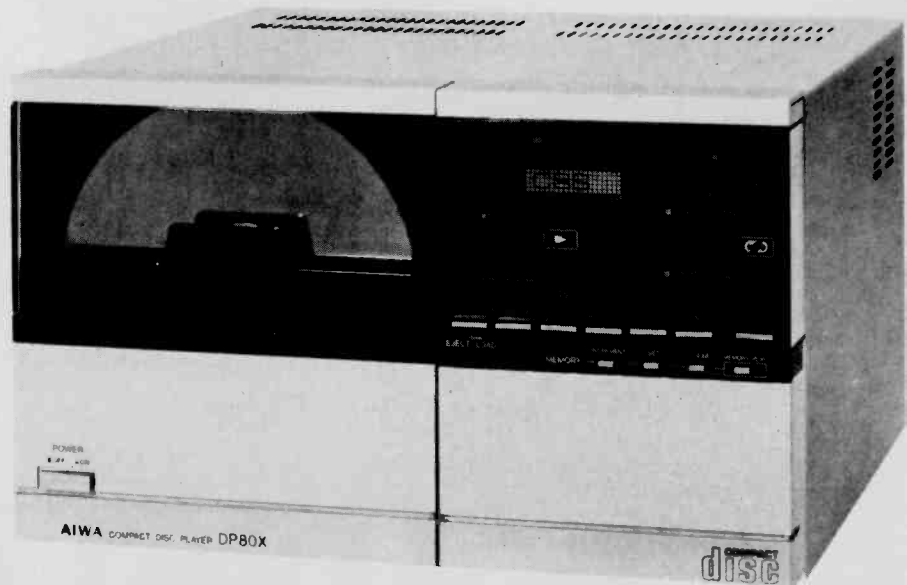

Aiwa digital disc player may signify wave of the future in record playing. It has most of the special features to be found in video-disc players.



Introducing incredible tuning accuracy at an incredibly affordable price: The Command Series RF-3100

31-band AM/FM/SW receiver.\* No other shortwave receiver brings in PLL quartz synthesized tuning and all-band digital readout for as low a price.† The tuner tracks and "locks" onto your signal, and the 5-digit display shows exactly what frequency you're on.

There are other ways the RF-3100 commands the airways: It can travel the full length of the shortwave band (that's 1.6 to 30 MHz). It eliminates interference when stations overlap by narrowing the broadcast band. It improves reception in strong signal areas with RF Gain Control. And the RF-3100 catches Morse

communications accurately with BFO Pitch Control.

Want to bring in your favorite programs without lifting a finger? Then consider the Panasonic RF-6300 8-band AM/FM/SW receiver (1.6 to 30 MHz) has microcomputerized preset pushbutton tuning, for programming 12 different broadcasts, or the same broadcast 12 days in a row. Automatically. It even has a quartz alarm clock that turns the radio on and off to play your favorite broadcasts.



RF-6300 8-band AM/FM/SW

The Command Series RF-3100 and RF-6300. Two more ways to roam the

globe at the speed of sound. Only from Panasonic.

\*Shortwave reception will vary with antenna, weather conditions, operator's geographic location and other factors. An outside antenna may be required for maximum shortwave reception.

†Based on a comparison of suggested retail prices.

## This Panasonic Command Series™ shortwave receiver brings the state of the art closer to the state of your pocketbook.



With PLL Quartz Synthesized Tuning and Digital Frequency Readout.

**Panasonic**  
just slightly ahead of our time.



must include a section that can tune in the 88-to-108-MHz standard FM broadcast band. Furthermore, it must contain a stereo decoder (demultiplexer) to be able to extract two separate audio signal channels from stereo FM broadcast programs.

A wide variety of tuner models available offer different features and functions at prices that range from as low as \$100 to well in excess of \$1500. There are FM-only and AM/FM tuners, tuners with numeric displays instead of the usual analog slide-rule dial, and even tuners that remember selected station frequencies for one-touch instant recall. The more one pays for a tuner, of course, the better its performance and/or the greater its range of features. Oddly enough, some of the most expensive tuners on the market, those ranging from \$750 on up, usually feature FM-only reception capabilities, concentrating more on quality and special functions than on flexibility.

At the very minimum, any tuner, regardless of type, must provide a power switch, tuning control, tuning dial or other indicator of frequency, a STEREO indicator that lights up when an FM-stereo station is being received, separate right- and left-channel outputs, and a meter or some other device to aid in tuning. If it's a combination AM/FM tuner,

it must also have a switch for band selection. Even relatively inexpensive tuners nowadays offer such additional niceties as a stereo/mono mode selector

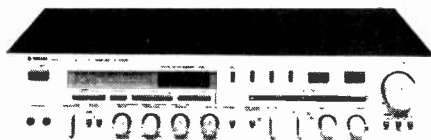

Yamaha AM/FM-stereo receiver with digital tuning and station presets.

for FM; a blend switch for clearing up noise due to noise and signal fading on FM; and both signal-strength and center-channel tuning aids. Signal-strength tuning aids work on both AM and FM, while the center-channel aid is for FM-only tuning.

The traditional "slide-rule" tuning dial across which a pointer moves as the tuning control is operated is rapidly becoming a thing of the past, even for low-end tuners. Modern tuners are more frequently than not featuring numeric displays that indicate the exact frequency or FM channel tuned without ambiguities or the need to interpret and cor-

rect for misadjusted dials. In many moderate and high priced tuners, the display is unaccompanied by a tuning meter, since all one need do is roughly tune a station or channel and let an internal circuit "pull" it precisely on frequency. As the internal circuit locks onto a channel, a LOCKED indicator on the front panel lights up.

Tuning with digital numeric display systems can be accomplished in any of several ways, depending on the design of the tuner. One way is with a traditional manual rotary-type tuning control knob. As the knob is rotated to search for a desired station, the display's numbers



Denon DA-401 universal tonearm.

change. With this type of system, tuning is very similar to that for slide-rule dial schemes. When one tunes to the end of the band, control motion stops and must be reversed to continue tuning.

**GUIDE TO POWER-AMPLIFIER REQUIREMENTS  
FOR SPEAKER EFFICIENCY AND ROOM SIZE**

Highest Sound Pressure Level (in dB) Possible for a Room of Indicated Volume (in cu. ft.)

Amplifier Power (Continuous Watts per Channel)	Low-Efficiency Systems			Medium-Efficiency Systems			High-Efficiency Systems		
	2000 Cu Ft	3000 Cu Ft	4000 Cu Ft	2000 Cu Ft	3000 Cu Ft	4000 Cu Ft	2000 Cu Ft	3000 Cu Ft	4000 Cu Ft
10	94 dB	92 dB	91 dB	97 dB	95 dB	93 dB	102 dB	101 dB	100 dB
20	97 dB	95 dB	94 dB	100 dB	98 dB	96 dB	105 dB	104 dB	103 dB
35	99.5 dB	97.5 dB	96.5 dB	102.5 dB	101.5 dB	98 dB	107 dB	106 dB	105 dB
50	101 dB	99 dB	98 dB	104 dB	102 dB	100 dB	109 dB	108 dB	107 dB
75	103 dB	101 dB	100 dB	105 dB	103.5 dB	101.5 dB	110.5 dB	109.5 dB	108.5 dB
100	104 dB	102 dB	101 dB	107 dB	105 dB	103 dB	112 dB	111 dB	110 dB
125	105 dB	103 dB	102 dB	108 dB	106 dB	104 dB	113 dB	112 dB	111 dB

Numbers given are for "average" room furnishings—neither too reflective nor too absorptive. Rooms having heavy draperies, rugs, and much upholstered furniture may require somewhat more power to achieve the sound levels shown. Overly "live" rooms may require a bit less power for the same results.

CAUTION: Not all speaker systems can safely accept all power levels shown. Check with the manufacturer regarding maximum power permissible.

TYPICAL SPECIFICATIONS OF HI-FI COMPONENTS

	LOW	MEDIUM	HIGH
<b>TUNER (OR TUNER SECTION OF RECEIVER)</b> IHF Sensitivity $\mu$ V (dBf) (mono)	3.0 (14.7) or lower	2.0 (11.2) or lower	1.8 (10.3) or lower
50 dB quieting sensitivity $\mu$ V (dBf), mono/stereo	10(25.2)/50/(39.1)	5(19.2)/40(37.2)	3(14.7)/30(34.7)
S/N (dB); mono; stereo	60/50	68/60	70/65
Selectivity (dB)	50 or more	60 or more	80 or more
Capture Ratio (dB)	3.0 or less	2.0 or less	1.3 or less
THD (%) (1 kHz, mono/stereo)	1.0/1.5 or less	0.5/0.8 or less	0.2/0.3 or less
Stereo Separation (dB, 1 kHz)	30 or more	35 or more	40 or more
AM Suppression (dB)	40 or more	50 or more	60 or more:
<b>AMPLIFIER (OR RECEIVER AMP)</b> Power Out/Channel (Continuous watts)	10-30	30-100	over 100
Rated THD (at full output) (%)	1.0 or less	0.5 or less	0.2 or less
Rated IM Distortion (%)	1.0 or less	0.5 or less	0.2 or less
Damping factor	10 or more	30 or more	50 or more
Phono Hum (dB below 10 mV input)	60 or more	65 or more	70 or more
Aux Hum (dB below rated output)	70 or more	75 or more	80 or more
<b>TURNTABLE SYSTEMS</b> Wow and Flutter (% Wrms)	0.15 or less	0.10 or less	0.05 or less
Rumble (dB, per DIN B)	55 or more	60 or more	70 or more
<b>CASSETTE DECKS</b> Frequency Response (Hz: 3dB)	50-12,000	30-15,000	20-18,000
Wow and Flutter (% Wrms)	0.2 or less	0.12 or less	0.1 or less
S/N (dB, less Dolby)	45 or more	48 or more	50 or more
<b>OPEN-REEL DECKS</b> Highest Speed (ips)	7 1/2	7 1/2	15
Freq. Response at highest speed (Hz + dB)	40-15,000	30-20,000	20-21,000
S/N (dB)	50 or more	55 or more	60 or more
Wow and Flutter (%)	0.15 or less	0.1 or less	0.07 or less

A more flexible and direct approach to tuning is accomplished with an electronic scan tuning system. In this scheme, touching UP and DOWN touchplates or buttons causes the scan system to seek the next higher or lower active frequency. Continuous touch causes the scan function to operate continuously, slowly at first and then picking up speed, until the touch is removed. There are no moving parts in the scan-tune system as there are in the rotary system described above. All tuning is accomplished electronically with a phase-locked-loop (PLL) frequency synthesizer circuit. Consequently, when the scan reaches the extreme end of the band, tuning automatically jumps to the opposite end of the band and continues in the same direction. A manual tuning mode is also included.

Finally, the most direct approach to station tuning is accomplished with a random-access preset scheme. A specific station can be instantly accessed with a single touch of a preset button, eliminat-

ing the need to cycle through all intermediate stations. Random-access tuning works in conjunction with scan tuning systems. Before it can be used, one must first tune desired stations using the manual tune mode and then store them in a memory system. Only then can a stored station be recalled. Stations stored in memory remain there until changed or power to the tuner is interrupted. (The preset memory section is always powered, sometimes by a battery, as long as the tuner is connected to



JVC DD-9 cassette deck with soft-touch controls and Dolby/ANRS noise-reduction systems.

the ac line.) The number of station presets available is usually 5 or 6 for FM-only tuners and 6 or 7 each for the AM and FM bands for AM/FM tuners.

Recently, a number of extras have begun to appear in modern AM/FM and FM-only tuners. Among these are both digital-numeric frequency displays and analog dial scales. More often than not, the latter isn't a conventional purely mechanical dial-and-pointer mechanism; rather, it's usually composed of a calibrated slide-rule scale with LEDs (light-emitting diodes) that successively wink on and off as tuning passes through the location of each on the dial. Traditional meter movements for the tuning aids are giving way to LED arrays, sometimes in two colors. Some tuners even feature wide/narrow bandwidth selectors for optimizing performance under different reception conditions.

Tuners are best compared by how well they perform the functions for which they are designed. Viewed from this perspective, inputs and outputs become

very important. Since a tuner's "front end" must be able to process very weak radio signals and be able to discriminate between signals very close to each other in frequency and sometimes on the same frequency in congested areas, *sensitivity* and *selectivity* are very important parameters. Sensitivity is a measure of how well a tuner can bring in weak and/or distant stations. Selectivity, on the other hand, is a measure of how well a tuner can tune in one station while rejecting all others on different frequencies. Capture ratio is the parameter that defines the effectiveness of a tuner's ability to lock onto only the stronger of two stations on the same frequency without introducing interference by-products that can be heard from the speaker systems. There are more than a dozen other parameters needed to fully describe a tuner's r-f performance, some of which we'll discuss later.

Once a tuner extracts all the audio information from a broadcast, including separating it into two separate stereo channels, the audio portion's parameters become important. As in the case for preamps, the tuner's audio circuits must be capable of amplifying the extracted audio with little or no locally introduced distortion or noise. Therefore, frequency response figures and signal-to-noise (S/N) ratio must be in line with the highest quality one would normally expect from audio equipment.

• *Tape Decks.* The final audio-only program-source component we'll discuss is the tape deck. Actually, tape decks are input and output devices. Like the tuner, the tape deck isn't designed to be used as a stand-alone component. It has no built-in power amplifier or speakers.

Until a few years ago, there were three basic types of tape decks used routinely by audiophiles: open-reel, cassette, and 8-track cartridge. At the present time, however, the cassette deck is the overwhelming choice, sales of which outnumber the other two types of decks by hundreds to thousands to one. From all indications, the cassette deck will continue to be the almost exclusive choice for many years to come, basically because it offers the best combination of features and functions for the prices demanded. Open-reel decks, thanks to spiraling prices, have become more or less professional machines for taping live performances, though they're still used by a small, select group of critical listeners. The 8-track cartridge deck, once very popular in car hi-fi systems and then later on in the home, has all but lost its appeal. There are very few new model 8-track deck introductions each year and old models are rapidly being phased out in favor of cassette decks. As a result, 8-track cartridge decks have become a relative rarity in new hi-fi systems.

Two distinct advantages of the tape

medium make tape decks attractive to modern audio enthusiasts. Firstly, playing tapes causes hardly any tape wear, even after dozens of plays. (Every time a

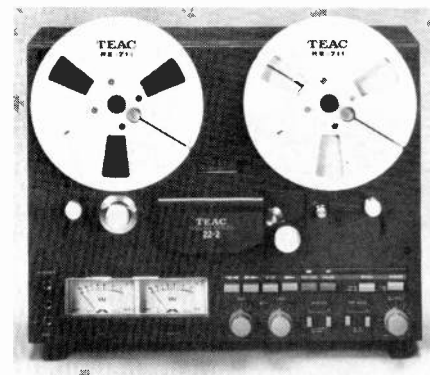

Tascam by Teac Model 22-2 open-reel 10 1/2-in. recorder/reproducer.

record is played, some wear results, giving the phonograph disk a shorter playing life than the tape medium.) For this reason, many users tape all their records and then store them away, playing only their tapes. Secondly, the tape medium permits one to record as well as play back selections. With this capability, it's a lot more economical to record selections off the air and from other peoples'

### FM TUNER FEATURES

FEATURE	PRICE RANGE			PURPOSE OR ADVANTAGE
	LOW	MEDIUM	HIGH	
Twin Tuning Meters		X	X	Permits more accurate tuning (and therefore lower distortion) in FM.
FM Muting	X	X	X	Eliminates interstation noise when tuning between FM signals.
Selectable I-F Bandwidth			X	Lowest distortion reception for uncrowded dial conditions; reduced interference from adjacent signals in crowded signal areas.
"MPX" Blend Switch		X	X	Reduced background noise when listening to weak-signal stereo FM stations.
Touch-Sensitive AFC Tuning Knob		X	X	Goes by various trade names, but assists in achieving center-tune accuracy; and reduces tuning error and possible long-term station drifting.
Variable Muting			X	Lets you set muting threshold level for reception and noise conditions.
Station Pre-Select Switches			X	Permits pre-programming of favorite stations and selection of them at the push of a single button.
Dolby FM (built in)		X	X	Useful for noise reduction in FM listening if some stations in your area use the Dolby system when broadcasting.



records than to buy expensive records to build up a library of recorded music. And when one no longer wants a selection, it can be erased and replaced by another selection.

Different types of tape decks may have differences in operation, design, and performance. But they also share some common operating principles. For example, they're all designed to use the same or similar magnetic tapes as the recording and playback medium. This tape usually consists of a polyester or acetate base material, one surface of which is coated with fine crystalline iron oxide or chromium-dioxide (CrO<sub>2</sub>) or fine metallic particles.

Open-reel tapes for home-entertainment decks are generally 1/4 in. wide and are designed to easily accommodate four signal tracks (two stereo tracks in each direction) without crowding. Cassette tapes are 1/8 in. wide and accommodate four signal tracks in the same format as open-reel tapes, but in a more crowded manner. Tapes in 8-track cartridges, although 1/4 in. wide are designed to accommodate eight signal tracks, arranged in four stereo pairs, in only one direction. Consequently, 8-track tapes share some basic similarities with both open-reel and cassette tapes but have significant differences of their own. From the foregoing, it's fairly obvious that there's no compatibility between the different types of tape media.

Open-reel and cassette decks handle the tape in much the same manner. Tape is pulled from one reel across the record/playback head assembly by a motor-driven capstan and pinch-roller assembly and onto a motor-driven take-up reel. For open-reel decks, the feed and take-up reels are two completely separate items that must be individually loaded onto the deck, and the tape must be manually threaded from reel to reel. Although two separate reels are also used in cassette decks, they're both mounted inside the same cassette housing, and the ends of the tape are permanently fixed to them. To load a cassette deck, one simply drops the cassette, in the proper direction, into the cassette well, close the door, and press the operating controls, following which, tape threading is automatic.

At end of play, both the open-reel and cassette decks automatically shut off. To be able to play the other sides of the tapes, it's necessary to turn them over. With open-reel decks, the two reels must be interchanged and the tape must be manually rethreaded. With cassette decks, it's necessary only to remove the

cassette from its well and turn it over before replacing it.

Because of the single feed/take-up nature of the 8-track cartridge, the scheme used in 8-track is completely different from that used in open-reel and cassette decks. Although the same type of driven capstan/pinch-roller assembly is used, there are no separate feed and take-up assemblies. Tape inside the cartridge is wound in a single continuous loop onto a single reel. The tape-drive mechanism pulls tape from the inside of



*Koss CM/1030 four-way, dual-port floor-standing speaker system.*

the reel across the tape heads and back onto the outside of the reel. At end of play for any given pair of tracks, play automatically proceeds to the next pair. This is accomplished with the aid of a length of metallic foil between the beginning and end of the tape loop and a solenoid.

Tape drive mechanisms, called *transports*, use capstans and pinch rollers to pull the tape across the deck's heads at a steady speed. Some open-reel and cassette drive arrangements use a single motor and belt-and-pulley arrangement to rotate the capstan, take-up reel, and feed reel. Other schemes use one motor for capstan drive and another motor to handle the feed and take-up reels. More expensive decks may assign separate motors to the capstan, take-up reel, and feed reel mechanisms. A single-motor scheme is almost always used in 8-track cartridge decks. (Because 8-track cartridge decks have virtually disappeared

from the marketplace, we'll limit our discussion from this point on to only open-reel and cassette decks.)

Depending on design, an open-reel deck can accommodate 7- or 10 1/2-in. metal or plastic reels. If 7-in. reels are used, they're loaded onto the deck directly; for 10 1/2-in. reels, however, a special EIA (Electronic Industries Association) or NAB (National Association of Broadcasters) hub must be used to load and lock reels into place. The amount of tape on a reel is specified by footage, rather than playing time. The reason for this is that almost all open-reel decks offer a choice of different tape speeds. Since the tape can be used at any of the available speeds, it has become the common, but not exclusive, practice to specify tape quantity by footage. If a deck that offers 15, 7 1/2, and 3 3/4 ips (inches per second) speeds and a 2500-ft reel were to be used, record/play times obtained would be slightly more than 30, 60, and 120 minutes per side, respectively. Open-reel tapes are

## THE NEW 1982 FREE AUDIO/VIDEO CATALOG!

- 240 Pages.
- Greatest Discounts on **EVERY MAJOR BRAND.**
- Latest Audio & Video Product Listing Available.
- **MULTI-MILLION DOLLAR** Factory Fresh Inventory.
- **EXCLUSIVE "J&R EXPRESS MAIL ORDER SERVICE".**

**Call Toll Free:**

**(800) 221-8180**

In New York Call: (212) 732-8600

Dealers & Institutional Inquires Welcome

**J&R MUSIC  
WORLD**

**23 PARK ROW, N.Y.C., 10038**

CIRCLE NO. 12 ON FREE INFORMATION CARD

available in 1200- and 1800-ft lengths on 7-in. reels and in 2500- and 3600-ft lengths on 10½-in. reels.

An open-reel deck for home-entertainment use should provide speeds of 7½ and 3¾ ips to give a good compromise in frequency response and economy in tape usage. (Frequency response is a measure of the deck's fidelity and is almost wholly a function of tape speed. The faster the speed, the wider the frequency response and the higher the fidelity. A typical deck might have a frequency response of 30 to 20,000 Hz at 7½ ips but only 30 to 12,000 Hz at 3¾ ips. In a case like this the response at 7½ ips will handle the entire 20-to-20,000-Hz audio range. For less critical listening, the lower-fidelity 3¾-ips speed will still provide passable reproduction.) Of the three types of tape decks available, the open-reel variety offers the best in hi-fi capabilities, including the widest frequency response, lowest inherent noise, and least amount of distortion

without special processing of signals.

Reflecting the essentially professional nature of these machines, open-reel tape deck features are designed to provide maximum signal-handling flexibility. All feature at least a two-motor, many a three-motor, transport design in which heavy-duty precision motors are used. Record-level controls, separate for each channel and usually for microphone and line inputs, are teamed with meters or digital-type displays that have professional VU ballistics. Peak-hold signal level indicators are almost always provided for simplifying setting the proper recording levels.

Other more or less standard features include: a source/tape monitoring facility that permits a user to listen to music as it enters the deck from the program source or to hear what's been recorded on tape, just after it has been recorded; separate precision, long-life erase, record, and playback heads; features for adding an optional noise-reduction ac-

cessory (some models have these built in); tape counter; and an indicator that lights when the record function has been engaged.

A number of models offer special features. Two such are sound-on-sound and sound-with-sound recording. Sound-on-sound allows one to record over existing signals, without erasing the previously recorded information. Amateur and professional musicians and vocalists will find this feature useful, since it permits them to add their playing or singing to a professional group's numbers. Sound-with-sound can be used to record a voice signal on one channel, using a microphone, while using a line source to record music on the other channel. A few models feature automatic reversing at end of play but not record. Some even offer remote-control facilities, while others provide a control for precisely trimming speed.

Transport controls used to effect all mechanical and some limited electronic

PREAMPLIFIER/CONTROL SECTION FEATURES

FEATURE	PRICE RANGE			PURPOSE OR ADVANTAGE
	LOW	MEDIUM	HIGH	
Phono 1 & Phono 2 Inputs		X	X	Permits use of two separate record players
1 Tape Monitor Circuits & Switching	X			Add a Tape Deck or another audio accessory
2 Tape Monitor Circuits & Switching	X			Add two tape decks or one tape deck plus an audio accessory
Tape Dubbing		X	X	Copy tapes from one connected tape deck to another
Bass and Treble Tone Controls	X	X	X	Adjust response of system to compensate for other components, or to suit personal taste
Mid-Range Tone Control			X	Aids in emphasizing vocal music. Affords greater degree of control.
Selectable Bass & Treble Frequency Turnover Points			X	Permits trimming response at frequency extremes without affecting important mid-range frequencies
Low-Cut Filter	X	X	X	Reduces effects of turntable vibration, noise and rumble
High-Cut Filter	X	X	X	Reduces FM hiss, and tape and record noise with minimum effect on musical reproduction
Audio Muting			X	Fixed reduction of loudness, used when listening is interrupted by phone call, doorbell, etc.
Loudness Control	X	X	X	Improves sound quality and balance when listening at low, "Background Music" loudness levels
Microphone Input		X	X	Lets you add voice sounds to other program sources
Pre-Amp Interconnections		X	X	Permits separate operation of these sections, or connection of accessories (e.g., equalizer, noise reduction unit etc.) between them

operations are usually solenoid operated, with logic control circuits. With this type of control system, it's possible to punch in one conflicting command after another, such as play and then rewind, without having to go through stop first. With ordinary mechanical controls, hitting a sequence like this would place tremendous opposing forces on the tape, causing it to snap and its free ends to be chewed up. The solenoid/logic system will automatically jump to stop, wait for tape motion to cease, and then go into rewind, all automatically and without tape stress or damage.

very restrictive frequency response. In fact, when the cassette medium was first introduced, its fidelity made it suitable for only voice dictation. Intensive development over the years in electronics, tape-head design, and tape technology has increased the medium's audio performance to the point where it's almost the equal of the open-reel deck's. Highest-quality decks, using the new metal tape formulations, often yield overall performance that's almost indistinguishable from that of open-reel decks.

Another problem inherent with slow operating speed and narrow tape width is noise. By nature, cassette reproduction is much noisier than playback from the typical record player. (Tape playback from *any* type of deck is, as a rule, noisier than record-disc playback.) This noise can be discerned as a high level of hiss in low-quality portable cassette recorder/players. To reduce noise to almost inaudible levels in even relatively inexpensive cassette decks, the current trend is to build into them one or more noise-reduction systems. The most common are those developed by Dolby Laboratories and dbx, Inc., though these aren't the only ones in use. These noise reduction systems can be switched in and out at the user's option.

Availability of different tape formulations and in-deck facilities to optimize performance for each allows cassette-deck users to capitalize on a means other than faster speed to improve on frequency response. Since a wide frequency response is required for high-fidelity sound reproduction, it's obvious that better-quality tape is preferable as the need for critical recording/reproducing increases.

For general-purpose recording of music, ferric-oxide tape is most frequently used. This tape formulation yields frequency responses ranging from 25 or 30 Hz on the low end to 14,000 to 16,000 Hz on the high end, depending on the cassette deck used. Some very expensive tape decks even extend the high end out to 20,000 Hz, the limit of the audio spectrum. Most music can be successfully recorded and played back, with only a small loss in high-frequency content, using ferric-oxide tape and even an economy-priced cassette deck today.

Chromium-dioxide, or CrO<sub>2</sub>, tape is preferable for more critical response requirements. Frequency response at the top end can be extended typically 15,000 to 19,000 Hz with CrO<sub>2</sub> tape, which is sufficient for recording and playing back almost any type of music. Premium-quality metal tape offers

the highest possible sonic quality from any cassette deck designed to use it. Metal-particle tapes almost routinely provide a high-end response out to 18,000 Hz or more and are capable of capturing just about any musical note and its overtones and play them back. A number of cassette decks described as "metal compatible" aren't really designed to take full advantage of the record/play characteristics of metal tapes. In cases like this, the high-end response might be limited to about 16,000 Hz, the metal-tape-handling ability included more or less as a convenience to allow prerecorded metal tapes to be played on these decks.

For any given tape deck to be able to use different tape formulations, the deck's electronics must include adjustable bias and equalization to optimize



*Bose 601 Series II floor-standing direct/reflecting speaker system.*

Because open-reel tape decks are designed more for professional use, the better choice for home-entertainment system installations is the cassette deck. By comparison, cassette decks are much easier to physically and electrically integrate into the typical home system. Because of their intended use, cassette decks are usually easier to use than open-reel decks. They're also, as a rule, considerably less expensive.

Like the open-reel deck, the cassette deck feeds tape from one reel, across the tape heads, to another reel. This is where the similarity ends, however. The major difference is that almost all cassette decks feature only one speed, a very slow 1 $\frac{7}{8}$  ips. A few models feature selectable 1 $\frac{7}{8}$ - and 3 $\frac{3}{4}$ -ips operation to give users the opportunity to take advantage of the better frequency response possible at 3 $\frac{3}{4}$  ips, but at a penalty of twice the consumption of tape.

Operating at only 1 $\frac{7}{8}$  ips and using narrow  $\frac{1}{8}$ -in.-wide tape, the cassette medium would ordinarily suffer from



*Speakerlab S-50 four-way bi-amplified acoustic-suspension speaker system.*

## ...High Fidelity...

performance for each type of tape. The usual procedure is to equip a deck with switches that have normal, CrO<sub>2</sub>, and metal positions for simultaneously setting bias and equalization for ferric-oxide, chromium-dioxide, and metal tapes, respectively. With each setting, fixed bias and equalization are applied. Better-quality cassette decks provide continuously adjustable bias and equalization controls and facilities for their proper use to allow a user to exactly optimize deck/tape performance.

Different tape formulations offer different noise characteristics. As one moves from ferric-oxide to chromium-dioxide to metal-particle tape, the amount of noise compared to signal level (called *signal-to-noise* ratio and abbreviated S/N) decreases. Improvement may be only minimal in some decks, but it can be significant in others, depending on deck design.

Since cassette decks are usually single-speed-only machines, it's reasonable

record/play time. C120 cassettes aren't very popular for serious hi-fi use, basically because the extremely thin base material usually isn't very durable.

All modern hi-fi cassette decks feature front-loading mechanisms. In the great majority of cases, the cassette loads into a flip-out door over the cassette compartment. Once the cassette's

those for the mechanical transport and those for the electronics portion. Every cassette deck must have a certain minimum of transport controls, which include: STOP, PLAY, RECORD, FAST FORWARD, REWIND, and EJECT. The EJECT control can be either completely separate from the other transport controls or be activated by pressing the STOP control

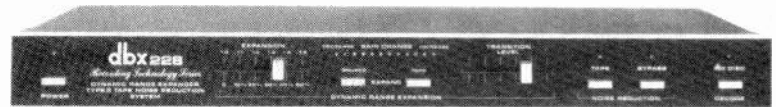

*dbx® dynamic range enhancer/type II tape noise-reduction system.*



*Technics SH-8040 ambience and echo space dimension controller with display.*



*Koss K/6ALC stereo headphones with balance control and coiled cord.*

for manufacturers to specify tape length by playing time, rather than footage. This being the case, manufacturers years ago adopted a universal specification convention as follows: C46 stands for 46 minutes of record/play time for *both* sides of the cassette, C60 for 60 minutes, C90 for 90 minutes, and C120 for 120 minutes. A typical C46 cassette will be able to accommodate all the music normally recorded on both sides of a single-disc 33 $\frac{1}{3}$ -rpm LP album. Most audiophiles, however, prefer to buy C60 and C90 cassettes because they're more economical for the amount of money spent for each minute of

loaded, the door is manually closed to put the cassette in the proper position for recording and playing back. An alternative is the doorless direct-load mechanism in which the cassette loads directly and locks into place. Each approach has its own advantages and disadvantages.

Door-type mechanisms offer superior protection from airborne dirt to the tape, tape heads, and moving parts of the transport. On the other hand, the direct-load mechanism leaves the entire cassette open to view, allowing users to more easily keep tabs on how much tape remains on the feed reel during a taping session. By backlighting the cassette compartment in door-type mechanisms, however, it can be almost as easy to monitor remaining tape.

Doors on cassette compartments in economy-priced cassette decks may be simply spring loaded to instantly pop open when the eject control is operated. In more expensive decks, the door is damped so that opening is gentler and more controlled. Also, the door itself is removable to permit easy access to tape heads, tape guides, and the pinch-roller/capstan assembly for required periodic cleaning.

There are two sets of controls on every cassette (as well as open-reel) deck—

twice, depending on deck design. Normally added to this minimum complement is a PAUSE control that's used to temporarily suspend tape motion in record and playback, but not for fast forward and rewind.

The mechanical functions of the cassette deck's transport can be effected by any one of three basic mechanisms. In economy decks, the mechanism is usually a strictly mechanical system operated by so-called "piano keys." In medium-price decks, a "feather-touch" system is frequently used. With this system, the mechanism is similar to the piano-key system, but it features power assist from solenoids. All premium and many medium-priced cassette decks utilize a full-logic control system similar to that used in open-reel decks.

All cassette decks feature a mechanical or electronic tape counter. This device is used to monitor the numerical location of each selection as it's recorded on tape. By keeping a record of each location, it's a simple process to locate any given selection using the fast-forward or rewind functions of the transport. Accompanying the index counter is a RESET button that permits resetting the number display to 000 so that the same starting point can be used for every cassette.





Minimum control lineup for the electronic functions of the cassette deck include: separately adjustable left- and right-channel record level controls (in rare cases, a single control is provided for setting record levels simultaneously in both channels, while a separate control is provided for balancing the channels); a tape selector switch or switches for setting bias and equalization for several different tape formulations; a switch that turns on and disables any built-in noise-reduction system; a line/microphone source selector; and a power on/off switch.

Other more or less standard features to be found in cassette decks include: meters or bar-graph displays that give visual indication of record and playback levels; peak signal indicators to aid in accurately setting recording levels; separate line inputs on the rear apron and microphone inputs on the front panel for each channel; and a headphone jack through which the stereo recordings can be monitored. A REC (record) MUTE switch that inserts a minimum-duration, usually 3-second, blank space between selections to permit easy location of the start of each selection with any of a number of automatic memory systems is frequently provided. With tape decks that feature user-adjustable bias and equalization, controls for these are provided. Two speed decks include a 1 7/8 and 3 3/4 ips selector.

To make cassette decks as useful as possible, manufacturers often include extra features. For example, many decks have built into them MPX (multiplex) filters that can be switched in to remove any residual interfering signals that result from FM-stereo demodulation and might otherwise cause "birdies" to be heard in the recording. Also, most decks have facilities for automatic unattended recording with an optional timer accessory. Optional remote-control capability is offered with some models. And some decks even offer automatic reverse play, using two capstans, while others might offer automatic play after rewind.

Built-in computer facilities in some very sophisticated decks can greatly simplify overall operation. Such a deck will normally use its computer facilities to test each tape to be recorded to determine its bias and equalization requirements and switch in exactly what's needed, all without human intervention. Additionally, the computer can be used to play selections recorded on a tape in a user-programmed random order.

Cassette decks usually offer only two tape heads, one for erasing and the other

# FREE!



## THE IMPORTANT CATALOG FOR THE ACTIVE HAM

### Hi-Tech Stations:

Amateur Radio's hottest ideas come from the Ham-licensed engineers at Heath. We have a *complete* line of world-famous gear you can build from proven kits for unparalleled performance, value and reliability. *There's more for the Ham at Heath!*



### Computer Operation:

"Micro"-enhanced ham shacks are the wave of this hobby's future. Pacesetter Amateur Radio enthusiasts are using computers to design antennas, plot beam headings, track OSCAR and transmit RTTY. Heath and the Ham, once again, are the perfect partners in this new adventure.



### Guaranteed Courses:

Heathkit/Zenith Educational Courses are the low-cost, time-saving way to learn. We have comprehensive programs to help earn your Novice, General or Advanced Class licenses. You can't fail - Heath guarantees that you will pass! - or we'll refund the purchase price.

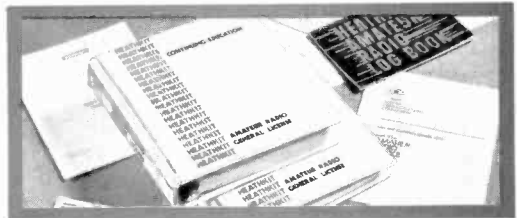

### Service and Accessory

**Equipment:** Whether you need a test instrument for electronics service work, manufacturing and design or hobby applications, see us. All Heathkit instruments are units of high-professional quality offering our extra-value capability. Like our 20 MHz dual-trace portable oscilloscope, they're built to last and give you reliable results every time.

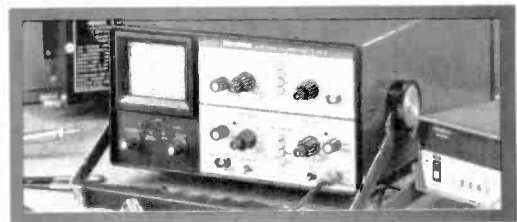

**SEE IT ALL IN THE BIG, NEW HEATHKIT CATALOG** and read about our entire line of electronic kits.

**SEND FOR YOURS TODAY!**

If coupon is missing, write:  
Heath Company,  
Dept. 062-893,  
Benton Harbor,  
MI 49022

In Canada: Heath Co.,  
1480 Dundas St. East,  
Mississauga, ONT  
L4X 2R7

## Heathkit FREE CATALOG!

Please send my free Heathkit Catalog. I want to "build in" the quality difference.

Send to: **Heath Co., Dept. 062-893  
Benton Harbor, MI 49022**

Name \_\_\_\_\_

Address \_\_\_\_\_

City \_\_\_\_\_ State \_\_\_\_\_

AM-424R1 Zip \_\_\_\_\_

for alternately recording and playing. More sophisticated decks feature three heads, using separate heads for the record and playback functions. With this arrangement, it's possible to monitor the input signal as it's being recorded or the signal recorded on the tape itself. Consequently, a SOURCE/TAPE switch would be provided to allow a user to select which he wishes to monitor.

**Receivers.** Before we get to the actual reproducers of the sound, the speaker systems and headphones, one more component deserves mention. This is the stereo receiver, a single component that combines all the functions of tuner, preamp/control center, and power amplifier in the same package. Some receivers also include a good-quality cassette deck and are called "casseivers."

Choosing a stereo receiver is the simplest way to put together a hi-fi system. Because it contains three or four basic elements in one package, the receiver relieves the buyer of having to choose from a frequently bewildering variety of competing separate components. This relief is carried further in that there's no need to integrate components into a working system, since each element is already integrated and internally interconnected by the manufacturer. Consequently, cable requirements with a receiver or casseiver are reduced to an absolute minimum. Finally, the cost of the typical receiver or casseiver is usually considerably less than one would have to pay for a similarly configured system consisting of separate components.

Until a few years ago, the view that the facilities available in and performance levels of receivers were far from adequate for serious hi-fi listening might have been valid. This is no longer the case. Many of today's better-quality receivers can deliver levels of performance the equal of many separate components, in a much easier to use setup. Nor is there any real justification to the complaint that receivers lack the "muscle" to adequately drive inefficient high-quality speaker systems. At least one receiver on the current market is capable of delivering 200 W/ch and many are rated to deliver 100 to 150 W/ch, which should prove to be more than adequate to drive just about any speaker systems, no matter how inefficient. For more modest needs, there are also receivers rated to deliver as low as 10 watts per channel.

Almost every special feature that can be found in separate-component tuners can be found in the tuners used in

receivers. Examples are: up/down scan tuning with random-access, instant-recall station presets; digital-numeric frequency displays with PLL synthesized tuning; bar-graph type displays to aid in proper tuning; wide/narrow i-f bandwidth selection; and even built-in FM Dolby noise-reduction systems.

The amplifying portions of most receivers, viewed as integrated rather than individual-component amplifiers, offer a host of operating conveniences. Depending on the model selected, one can find bar-graph peak output power level displays; bass, treble, and often midrange tone controls; multiple-band graphic equalizers that replace tone controls; loudness switches or controls; high- and low-cut filters; moving-coil and moving-

Since the receiver represents a fully integrated component, it leaves the user no opportunity to upgrade only a portion of the system. If a user desires to upgrade, the entire receiver must be replaced. The other shortcoming is in the number and/or variety of inputs the receiver usually accommodates. As a general rule, fewer input facilities are available with receivers than are normally provided with a sophisticated preamp/control center.

On the plus side, receivers and casseivers have the edge over separate components when it comes to space requirements and interconnecting cable needs and price. Many repeat equipment buyers select all-in-one receivers for any or all of these reasons.

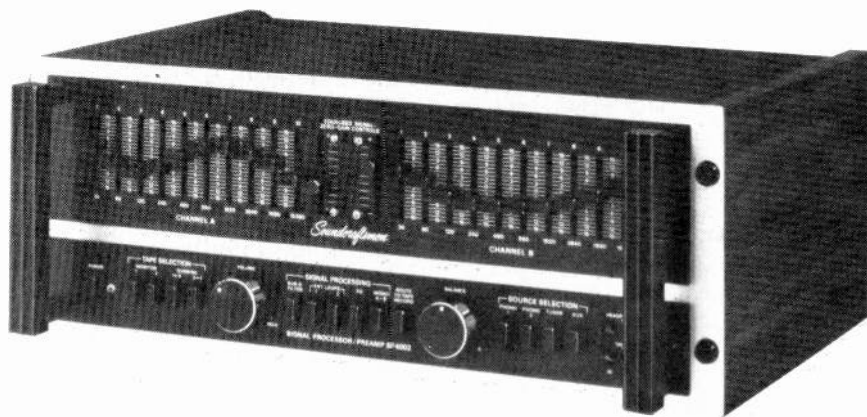

Soundcraftsmen SP 4002 signal processor/preamp with graphic equalizer.

magnet phono inputs; and facilities for at least two tape decks.

Cassette decks built into casseivers generally reflect the current trends in component-deck philosophy. For example, all casseiver decks feature bias and equalization selectors for ferric-oxide, chromium-dioxide, and metal-particle tape formulations. The quality of the decks are vastly superior to those found in typical department-store compact stereo systems. The casseiver's transport system is generally operated via solenoid-assisted soft-touch controls. All in all, overall cassette deck quality in casseivers is about on a par with medium-priced separate-component decks.

There are basically two areas in which a receiver or casseiver falls short of the capabilities available with separate component systems. One is flexibility.

**Speaker Systems** All electrical and electronic portions of a hi-fi system, from program source to the output of the power amplifier, are used to meet only one objective. That is to ultimately drive the speaker systems that generate the audible stereo sound. True high-fidelity speaker systems generally consist of at least two loudspeakers mounted in a specially designed cabinet and interconnected with each other and the driving amplifier with a crossover network. (Note: The terms "speakers" and "loudspeakers" are frequently—and erroneously—used to refer to speaker "systems" consisting of loudspeakers, crossover networks, and cabinets. To be technically correct, these terms should be used to refer to only the drivers used in a system, not the entire system.)

No single loudspeaker (driver) can

handle the entire audio spectrum from the lowest bass to the highest treble. Even if so-called "full-range" speakers could cover the entire range, they would exhibit large-amplitude peaks and dips in response that would seriously "color" the reproduced sound. For a hi-fi system to cover all or most of the audio range, with few reasonably small amplitude peaks and dips, the usual approach is to use two or more different *types* of drivers. Each type of driver selected is responsible for providing fairly flat re-

er. Such an approach would yield a three-way speaker system. In some very elaborate four- and five-way speaker systems, additional upper-bass woofers and/or upper-midrange drivers may be used. As one goes from the bass to the midrange to the treble, the drivers used decrease in size (diameter), reflecting the fact that less air must be moved to

Two basic types of enclosures are popularly used in modern speaker systems—sealed (also known as acoustic suspension) and ported. The purpose of the enclosure goes far beyond simply providing a convenient means for mechanically supporting loudspeakers and protecting them from damage. In fact, its primary purpose is to prevent sound

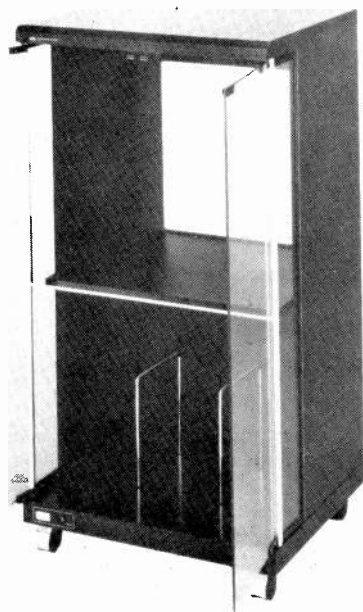

Sansui's GX-155 is fairly typical of compact roll-around equipment cabinets.

sponse over only that portion of the spectrum for which it's designed.

Low-frequency signals that require a lot of power to move the large volume of air needed for bass-note reproduction are handled by large-size *woofers*. High-frequency signals that require considerably less power to move the small volume of air to reproduce treble notes, on the other hand, are handled by small cone- or dome-type *tweeters*. An arrangement in which a woofer and a tweeter are used is termed a two-way system. In a case like this, the two drivers would each have a relatively wide range of frequencies they must handle.

A third, intermediate-size, loudspeaker called a *midrange driver* can be used to cover middle frequencies and relieve the design burdens of woofer and tweet-

reproduce the higher-frequency notes.

It would be incorrect to assume that the greater the number of drivers used in a speaker system, the better the sound. Some two-way systems provide as good sound as many three-way systems. By the same token, many three-way systems can equal or better the sound quality available with more elaborate multi-way systems.

Crossover networks in multi-way speaker systems are used to transfer drive power from loudspeaker to loudspeaker, according to the frequency content of the music being played. A deep-bass pedal note from an organ would be reproduced by the woofer, middle-register piano notes by a midrange driver, and high-frequency violin notes by both midrange driver and tweeter. Transfer of signal power from driver to driver isn't sharp. Rather, drivers are selected so that portions of their range overlap those of any drivers designed to handle lower and higher frequencies.

Another approach to providing full audio-spectrum coverage is to use a compact full-range speaker system supplemented by a separate sub-woofer for very-deep-bass reproduction and a pair of supertweeter add-ons to handle very-high-frequency notes. The sub-woofer would be driven by its own separate power amplifier, the tweeters by the same amplifier used for the full-range speaker systems.

from the rear of the loudspeaker from cancelling some of the sound radiated from the front and reducing bass response. With the ported design, radiated sound exiting through the port is in-phase with and thus reinforces the sound coming from the front of the woofer. The result is an overall improvement in bass response.

Numerous approaches to ported enclosures have been implemented over the years, including use of internal tubes and rectangular ducts to route sound from the rear of the woofer through the port and internal baffling to smooth bass response. The designs control the resonance of the enclosure and aid in coupling the sound energy from the driver to the listening room. Sealed enclosures, on the other hand, operate on the principle that the speaker box is nonresonant and doesn't contribute to distortion in the sound output.

Since it's preferable to have sound fill a room, rather than be radiated in a narrow beam toward one area, a speaker system should disperse sound energy as uniformly as possible. By nature, woofers are basically nondirectional and present no problems. Where the problem usually exists is with the tweeter, which can be very directional, depending on design. A simple way to test dispersion is to stand on-axis with the drivers in a speaker system while music is being played. Then move first to one and

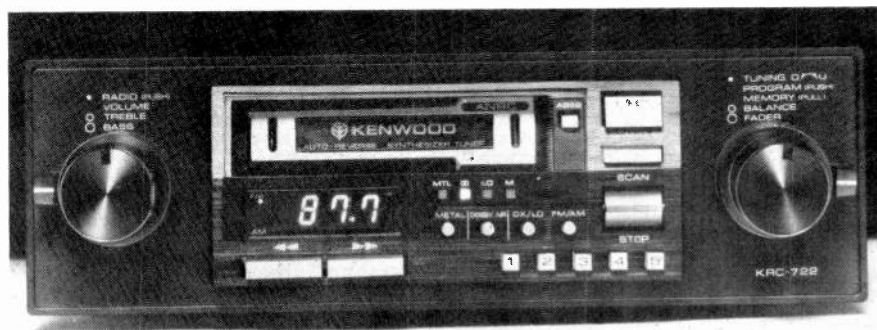

Kenwood KRC-722 in-dash AM/FM-stereo/cassette player has digital tuning dial.

then to the other side of the speaker system. If as you move from side to side the intensity of the high notes tends to drop off rapidly, the tweeter is highly directional. Small dome-type tweeters disperse high-frequency sounds over an area contained within about an 80-degree arc vertically and horizontally. Cone-type tweeters are usually much more directional.

A very important way to grade a speaker system is by efficiency. Being electromechanical devices, all speaker systems are relatively inefficient. That is, they require a considerable amount of power to drive them to relatively high listening levels. Keep in mind that efficiency figures (almost never published) for speaker systems are very low. A highly efficient speaker system, for example, may have an efficiency figure of less than 10%; a more average figure would be more like 3% and may be as low as 1%. Ported speaker systems are, on the average, considerably more efficient than acoustic-suspension systems.

Speaker systems in which more than one loudspeaker are used normally come

icant. Minimum recommended power defines the least amount of amplifier power required to drive the speaker system to listening sound levels. Maximum or peak power is an indication of how much amplifier power a speaker system can handle without damage. Needless to say, then, power rating for a speaker system and output power rating for an amplifier are intimately related. Both must be carefully considered when choosing components for a stereo system. Too much amplifier power can damage the speaker system; too little power will produce too low a listening level and can contribute distortion if the volume control must be turned up to its maximum position.

How well a given speaker system will perform in a home-entertainment stereo system depends on a number of factors. Power and frequency response figures can give only a general idea of the design parameters for the system. Room size and appointments must be taken into account. A room with relatively bare walls and floor and minimal furnishings will make the sound appear

ners of a room or against a wall. For stereo setups, speaker systems should be spaced 8 to 10 feet apart and located so that they face the longer rather than the shorter dimension of a rectangular room, if at all possible. Although bass response may be greater with the speaker systems resting on the floor, it may be preferred to have them up high on a bookshelf so that the sound originates at ear level.

Since the listening room is a critical component in a stereo system, it's advisable that you experiment with speaker-system placement to obtain the most satisfactory arrangement.

**Headphones.** Two distinct advantages are derived from listening to stereo music through headphones rather than speaker systems. With headphones, you can listen to what you want to hear, at the loudness level you desire, and when you wish to listen without disturbing anyone else in the same room. Secondly, headphones are completely independent of room acoustics.

It's surprising to many people to discover that headphones routinely deliver frequency responses ranging from 20 to 20,000 Hz, when most speaker systems are hard pressed to provide a range of from 30 to 18,000 Hz. The reason for the headphone's ability to deliver a full-spectrum response lies in the fact that there's a very small volume of air that must be moved between the drivers and your ears. With the headphones pressed tightly to one's head, that volume of air remains constant. It becomes a relatively simple matter, then, for the headphone and its drivers to be designed to work efficiently and provide the widest frequency response in this known-volume environment.

A stereo headphone system consists basically of two small and efficient drivers contained in separate earcups fitted with resilient cushions to provide the phones-to-head seal. (Some two-way headphones have separate woofers and tweeters in each earcup.) The earcups are mounted on an adjustable spring-loaded headband that presses them against the head. For user convenience, many models feature volume controls for the left and right earcups or a single balance control for adjusting sound to the same level in both earcups.

Headphones might be equipped with full-isolation head seals that exclude outside sound from entering and mixing with the program sounds. Alternatively, the seals can be made from an open cellular material designed to permit out-

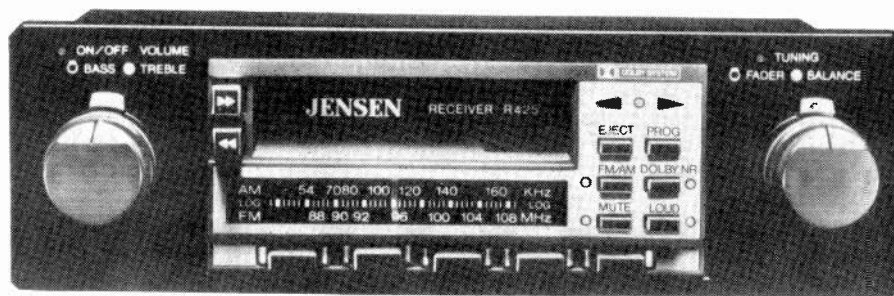

Jensen R425 in-dash AM/FM-stereo/cassette player with analog tuning dial.

with one or more controls that the user can adjust to contour the sound produced to his tastes or to compensate for listening-room acoustics deficiencies. In two-way systems, a control for adjusting the output level of the tweeter might be provided, while in three-way systems separate controls might be provided for the tweeter and the midrange driver.

Speaker systems come in a host of sizes, ranging from massive floor-standing furniture-size models to ultracompact models that can be unobtrusively tucked away on a shelf. There is, on the whole, at least one speaker system model to suit every listening-room need.

When a speaker system is rated according to power, two figures are signif-

“bright.” The same room with heavy draperies and tapestries, a thick rug on the floor, and large overstuffed furniture will make the sound appear to be “dull.” A speaker system that sounds great in a showroom may sound completely different at home, due to the differences in listening-room acoustics.

Placement of speaker systems in a listening room also has a direct bearing on the sound reproduced. Omnidirectional speaker systems that have drivers mounted on the sides as well as the front of the enclosures should always be positioned as recommended by the manufacturer. Speaker systems with all drivers facing only one way will deliver better bass characteristics if placed in cor-



side sounds to enter the listening environment, allowing one to hear the ringing of a telephone, door chimes, etc.

Materials used in almost all modern stereo headphones are selected to produce lightweight listening devices. Most headphones weigh in at between 7 and 12 ozs, but a few ultra-lightweight phones that weigh in at 2 to 4 ozs are also available. These weights are, of course, exclusive of cord, which is usually 6 to 12 ft long and terminated with a standard stereo phone plug to mate with the standard phone jacks on many stereo components.

While light weight makes for good user comfort, headphones shouldn't be thought of as replacements for speaker systems. Actually, headphones should be viewed as supplements to speaker systems, available for use under particular conditions, such as for private listening or to shut out ambient sounds.

Bear in mind that, like speaker systems, each headphone model has its own distinctive sound-reproduction "character." Some phones sound brighter than others, while others may have a heavier bass response. So, before you buy, it pays to compare several different models. Check not only for sound characteristics, but for user comfort as well.

**Accessories.** Once a basic stereo system has been operating for a time, many audiophiles see the need for accessory add-ons that will in some way improve the sound they hear. For example, one might want to add a graphic equalizer, a dynamic range expander, or a device to synthesize large concert-hall sound in a confined space.

A critical listener might find it necessary to be able to adjust tonal response of his system at various points of the frequency spectrum to compensate for variations in equipment performance and in room acoustics. To obtain a roughly flat *audible* response from speaker systems, for example, it may be necessary to boost or attenuate response at a number of points in the response curve. Ordinary bass, midrange, and treble tone controls built into most amplifiers and preamps might not provide sufficient control capabilities to affect the frequencies that need tailoring. Obviously, then, some other component is needed to accomplish this task—a *graphic equalizer*.

A graphic equalizer may contain from five to 20 slide-type controls for each stereo channel. Each control is assigned a small portion of the audio spectrum. A typical 10-band graphic equalizer might have control center frequencies of 31,

62, 125, 250, 500, 1000, 2000, 4000, 8000, and 16,000 Hz, covering almost the entire audio band of frequencies in roughly octave steps. (An octave is defined as a doubling of frequency, such as 31 to 62 Hz, 250 to 500 Hz, and 8000 to 16,000 Hz, each representing a single octave jump.) The greater the number of bands into which an equalizer divides the spectrum, the more precise the control over the response curve.

Each control is normally adjustable over a  $\pm 12$  dB range, which is usually more than sufficient to cover any response tailoring task one is likely to encounter with modern hi-fi equipment. To be most effective, adjustment of any one control should cause very little or no interaction with frequency bands outside its control range.

Graphic equalizers are named for the manner in which the slide controls are arranged and used. As each control is adjusted, it occupies a certain point on a vertical scale. Since all scales are located side by side, when all adjustments

are finally completed, one can see at a glance a graphic representation of the equalized response curve.

Once all equalizer controls are adjusted, they're normally not touched again unless a component is replaced, the speaker systems are relocated, or the furnishings in the listening room are changed. Bear in mind that proper use of a graphic equalizer is no easy task. To be able to exactly set the controls, one needs a special calibrated microphone and a spectrum analyzer. Normally, these items aren't supplied with the equalizer and must be obtained separately. A very few equalizer models have them built in, and at least one model is able to automatically adjust the controls, under microprocessor control, for listening-room conditions and can even store several different response settings to meet different likes.

Another accessory frequently used in hi-fi systems is a device known as a *dynamic range expander*, which is used to restore the dynamic range of live per-

## Shelf Conscious?

Now you can organize your copies of **Popular Electronics**

Now your magazines can be a handsome addition to your decor, well organized, and easy to find, thanks to these durable library-quality cases or binders. They're made of luxury-look leatherette over high-quality binders board. And both styles are custom-designed for this or any magazine you save, with size, color, and imprint selected by the publisher. FREE transfer foil included for marking dates and volumes.

### Magazine binders



hold a year's issues on individual snap-in rods, combining them into one volume. \$7.95 each; 3 for \$22.50; 6 for \$42.95. Mixed titles OK for quantity prices.

### Open-back cases

store your issues for individual reference. \$6.95 each; 3 for \$19.75; 6 for \$37.50. Mixed titles OK for quantity prices.



CHARGE ORDERS ONLY—  
for your convenience PHONE 24 HRS.  
TOLL FREE 800-345-8112  
In Pennsylvania only 800-662-2444

**Popular Electronics**, P.O. Box 5120,  
Philadelphia, PA 19141

Please send:  Cases  Binders

TITLE \_\_\_\_\_ QUANT. \_\_\_\_\_

Popular Electronics. \_\_\_\_\_

(Other): \_\_\_\_\_

ENCLOSED IS \$ \_\_\_\_\_ \* Add \$1.00  
per order for postage & handling. Outside USA  
add \$2.50 per unit ordered. Send U.S. funds only.

CHARGE (Min. \$10):  VISA  Master Charge  
American Express

Card # \_\_\_\_\_

Exp. Date \_\_\_\_\_

Signature \_\_\_\_\_

Print Name \_\_\_\_\_

Address \_\_\_\_\_

City/State/Zip \_\_\_\_\_

\*Residents of CA, CO, DC, FL, IL, MA, MI, MO, NJ, NY  
State, OH, SC, TN and VT add applicable sales tax.

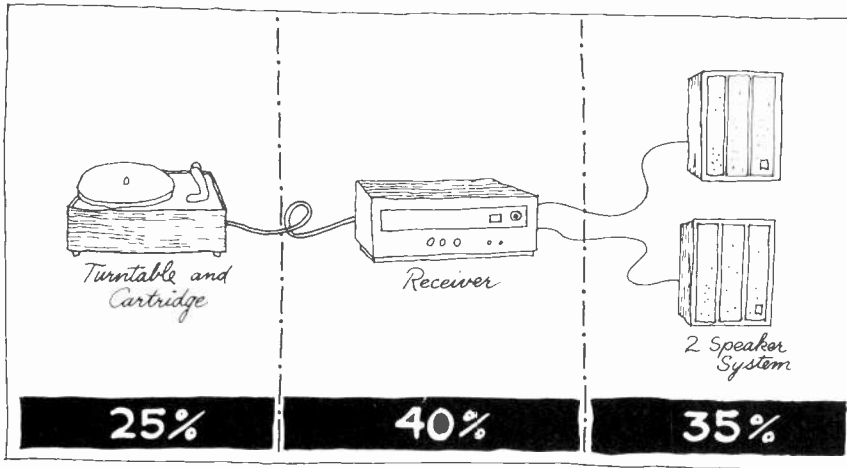

In simplest system, greatest dollar amount is apportioned to the receiver.

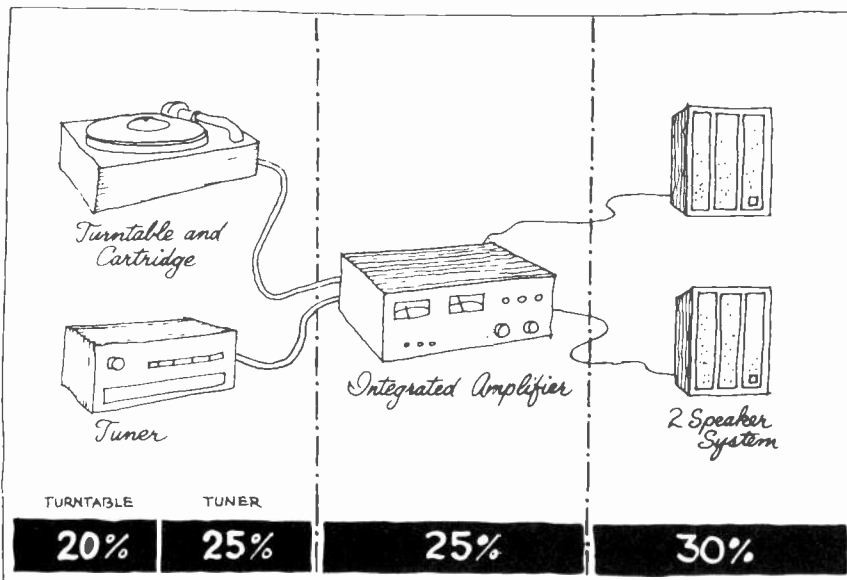

In intermediate system, more money should be apportioned to input devices.

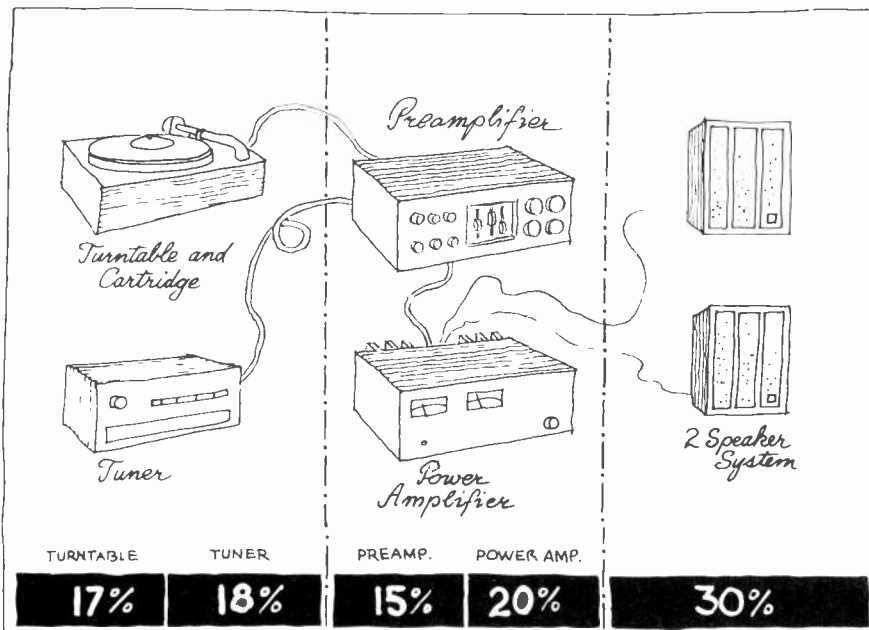

Component separates evenly distribute budget for inputs, amplifiers, speakers.

performances. During live performances, an orchestra's dynamic range may be as much as 100 dB between the softest and loudest passages. Limitations in recording techniques could produce significant distortion products if an attempt were made to record such an extreme dynamic range. Material on records and tapes and, by inference, FM broadcasts using recorded material, is compressed before recording to offset such problems. Unfortunately, the resulting sound lacks some of the liveliness that existed in the live session when the recording is played back. Dynamic range expanders reverse the compression and restore the high level of the loud passages to give the reproduced sound a character as near as possible to that of the live performance.

There are, of course, several other accessories that can be added to a hi-fi system to improve performance or/and bestow a desired character on the reproduced sound. Among the more popular of these are the various noise-reduction devices designed for tape recording and playback and playback only of records; concert hall-sound simulators, such as the Carver Sonic Hologram; digital delay systems; etc.

Accessories designed to be added to existing hi-fi systems are usually connected via one of the system's tape loops. In cases where separate component preamp and power amp are used, these accessories can be connected into the system between the two. A few integrated amplifiers and receivers also offer facilities that permit access to preamp-output and power-amplifier-input jacks for connecting these accessories into the system.

**Miniature Components.** Almost every component we've discussed thus far, with the possible exception of the open-reel tape deck, can be obtained in miniature form. There are even miniature speaker systems and turntables available, though the practical limit for the latter is determined by the physical size of the standard 12-in. LP phonograph record. Spurred on by Japanese hi-fi consumer demands and reinforced by the needs of apartment and college-dorm dwellers everywhere, manufacturers have begun to make individual components and entire systems that require little more than a square foot of shelf space. The move toward miniaturization began only a few years ago in Japan but has rapidly become a significant fraction of the hi-fi equipment market and is steadily growing.

## ...High Fidelity...

Minicomponents are, on the average, generally as good as their larger full-size counterparts in the same price ranges. They're available in the form of tuners, turntables, cassette decks, integrated amplifiers, preamp/control centers, basic power amps, and receivers. Speaker systems generally range from shoe-box size to slightly more than a cubic foot in volume; yet, they provide surprisingly good sound reproduction for their compact sizes. For user convenience, some manufacturers even offer such useful accessory options as remote-control systems and timers.

The trend toward miniaturization usually means that the various components are packaged as ready-to-go systems. Individual-component systems include a tuner, cassette deck, preamp/control center, basic power amplifier, and a pair of speaker systems. Other systems replace the preamp and power amp with an integrated amplifier, and still others are built around a receiver. Many components are available as separates, usually at the dealer's option.

Most minicomponents are designed to be stacked flat one atop the other and can be locked together to present a uni-

tized construction appearance. At least one brand of such components is designed to be either stacked flat or stood side by side on end like books.

One thing you're not likely to obtain with the current crop of minicomponents is prodigious amounts of power. The practical limit at this writing, even for basic power amplifiers, is about 60 watts per channel. This doesn't necessarily mean that minicomponent amplifiers are under-powered. You won't be able to use them to drive very inefficient floor-standing speaker systems, but in most cases, adequate power is available to drive the minispeaker systems which were designed to be used with these components.

Other than restricted power, almost anything else you can obtain in terms of features from full-size components can be had with minicomponents. Tuners and receivers frequently feature all-electronic PLL-synthesizer up/down scan tuning backed up with digital-numeric displays and multiple-station presets that can be randomly accessed. Cassette decks generally feature feather-touch transport controls, memory play functions, and normal/CrO<sub>2</sub>/metal tape capabilities. And power amplifiers in many cases have peak-power metering systems, using bar-graph displays.

**Car Stereo.** Listening to stereo sound isn't limited to the home. With the wide-ranging line of car-stereo components on the market, you can listen to stereo sound in your car, recreational vehicle, boat, etc. All you need is a source of 12-volt dc power to be able to use these usually very compact components.

Many of the components common to home-entertainment systems are available as car-stereo components, including receivers, cassette decks, power amplifiers, graphic equalizers, and speakers and speaker systems. Typically, car-stereo receivers mount in the dashboard in place of the ordinary AM/FM radio and the speakers are located behind the dashboard, in doors, or in rear-window shelves. Some components, such as power amplifiers and equalizers, are designed to be mounted under the dashboard or on transmission humps, usually in anti-theft mounting brackets.

The usual procedure for setting up a car-stereo system has an AM/FM-stereo receiver with built-in cassette player mounted in the dashboard. The audio output from the receiver/cassette player is then routed through a separate relatively high-power amplifier (also commonly known as a "power booster") to

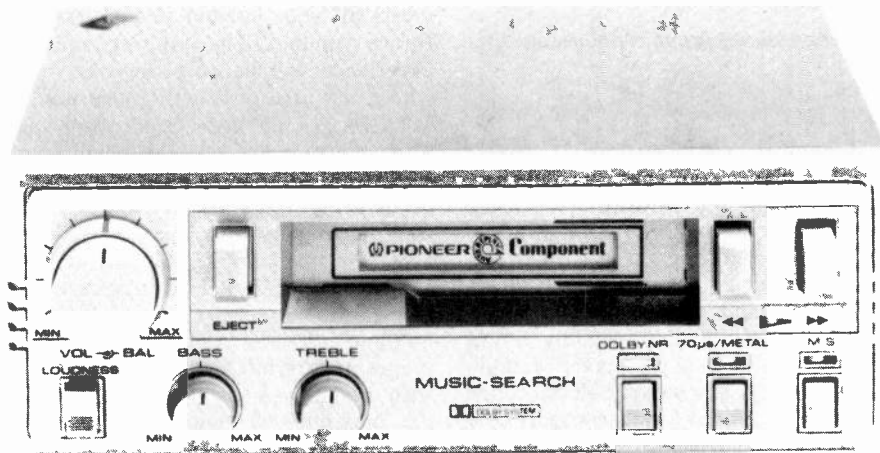

*Pioneer KP-404G under-dash component cassette deck with Dolby noise reduction.*

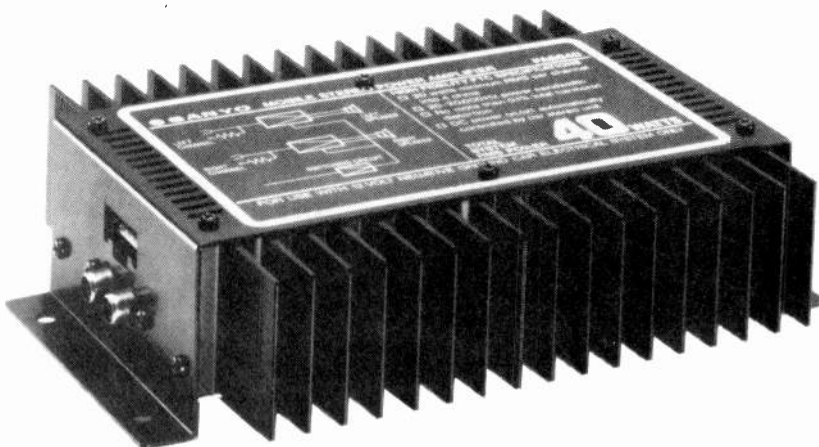

*Sanyo PA6040 40-watt mobile stereo power amplifier.*

drive often elaborate networks of speakers. Of course, one can opt for an in-dash AM/FM-stereo receiver and separate under-dash cassette player. Also, power boosters and graphic equalizers can be separate components or combined into a single convenient and compact component.

If one were to compare the perfor-

passengers. Furthermore, road safety rules dictate that the equipment be very easy to operate, to minimize possibly hazardous distractions while driving. For this reason, the control complements on car-stereo components are considerably abbreviated versions of those found on similar home-entertainment products.

sette eject at end of play or rewind, and feather-touch transport controls.

Power boosters used in car-stereo systems normally have no controls, relying on the volume and other controls in the receivers with which they're used for setting listening levels and contouring the sound. Graphic equalizers, whether components by themselves or integrated into power amplifiers, contain a minimum of five control bands.

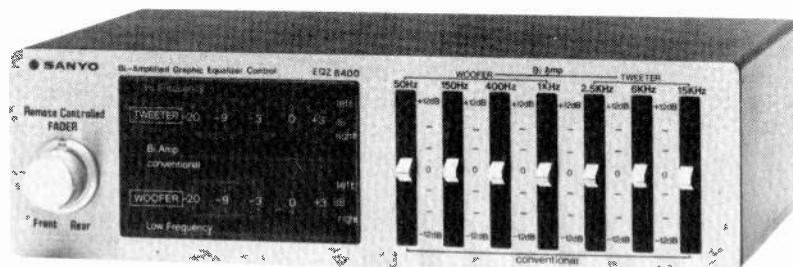

Sanyo Model EQZ-6400 bi-amplified seven-band car-stereo graphic equalizer.

**Listening Experience.** Putting together a stereo system can entail spending many hours and days poring over manufacturer literature and auditioning prospective components in dealer showrooms. But making comparisons between competing products can be well worth the effort if you end up with a well-integrated and flexible system that meets all your current and short-term future demands. The resulting listening experience will be only the start in a whole new area of listening pleasure.

mances of car-stereo and home-entertainment components in the home environment, the former might appear to lack some of the range of the latter. Also, car-stereo components generally have higher levels of residual noise than their home-entertainment counterparts. This isn't a reflection of poor design in car-stereo equipment; these components are to be used in normally very noisy environments and don't need as wide-ranging and noise-free design. High frequencies in the typical mobile environment are usually lost, while road noise will easily mask any residual equipment noise. So, instead of taking unnecessary pains in designing for full-audio-spectrum response and ultra-low-level noise, car-stereo component manufacturers concentrate on a more important area—durability of the equipment under extreme vibration and temperature conditions. The result is usually a happy medium of very durable equipment with performance capabilities far beyond the demands of the mobile environment.

The physical constraints of the mobile environment make it necessary for all car-stereo equipment to be very compact so that it won't interfere with drivers or

A typical AM/FM-stereo receiver/cassette-player combination component would have a control lineup that consists of little more than the minimum required for operation. In the tuner section, one would find a tuning knob, AM/FM band selector, local/distant sensitivity switch, and possibly a few AM and FM station presets for random-access tuning. The cassette-deck section would have all the usual transport controls, except record and pause, a switch for inserting and removing a built-in Dolby noise-reduction system, and a tape-formulation selector. Amplifier controls, usually concentric in two pairs or trios, include: on/off-volume, bass and treble tone, balance, and fader. Add to these stereo/mono and loudness switches. A few models even have controls for a built-in five-or-more-band graphic equalizer.

Frequency displays in modern car-stereo AM/FM receiver/cassette players can be either traditional slide-rule-dial-and-pointer mechanisms or digital-numeric readouts. PLL synthesizer AM/FM tuning circuits are commonly featured, as are automatic-reverse cassette deck mechanisms, automatic cas-

There can be little doubt from the foregoing that a good high-fidelity stereo system will open a whole new world of listening pleasure for you. At the start, having made a moderate to sizeable investment in the equipment, you can listen to no-cost FM broadcasts for your music pleasure. Then you can start building a record and tape library of program material. And don't forget that with a good hi-fi system you can obtain the maximum listening benefits from such wide audio bandwidth video products as videocassette recorders, videodisk players, and many of today's top-quality TV receivers.

Whether you go the separate-components route preferred by many audio purists or opt for an AM/FM-stereo receiver with turntable, cassette and/or open-reel tape deck, and speaker system, just make sure you'll be satisfied with the sound the system offers. It's not how much you pay for a system, or how fancy and elaborate its control complement, that counts. The only things that count are the quality of the sound and enough flexibility for your listening needs. ◇

**High-fidelity audio, like any other technical field has its own jargon, used by those in the know. To help you understand what knowledgeable people mean when they use these terms, refer to the "Glossary Of Audio Technical Terms" that begins on page 128.**



# TUNE IN ON THE VIDEO REVOLUTION



General Electric's "Widescreen 4000" rear-projection TV set in a single convenient cabinet operates like an ordinary TV set.

**W**ITH SOARING COSTS of admission to movie theaters, the legitimate theater, and sports events, plus the added expenses of dining out and travel, people are seeking substitute entertainment at home. To satisfy this quest, more and more people are turning to video as a major source of entertain-

ment. As a result, subscriptions to cable and pay TV are burgeoning. These services bring movies, sports events, and a variety of special shows into the home. Another alternative being pursued is the recording and playback of TV broadcasts with videocassette recorders (VCRs), and playing prerecorded video-

cassettes and video discs on a TV set.

In an effort to increase home-viewing options even further, some consumers are installing satellite TV receiving systems in their backyards. This type of hardware gives access to hundreds of programs distributed world-wide, on a multitude of topics and in a wide sprink-

ling of English and foreign languages. And as video entertainment delivered into the home grows, viewers are eying projection color TV systems to provide more life-like viewing, as well as to upgrade color TV receivers.

Here are details about video technology that you should know to be able to join and enjoy the video revolution that's changing many life styles today.

**Videocassette Recorders.** VCRs are firmly entrenched now as major home-entertainment electronic products in the U.S. Moreover, sales continue to skyrocket. There's good reason for this widespread popularity of VCRs. With a VCR, you can record TV programs during your absence from home or while asleep; record one program while viewing another, for later playback on your TV receiver; rent or buy prerecorded movies; displace your home movie camera, with the attendant advantage of not having to wait for film to be developed; and other benefits.

Adding a video camera to a VCR/TV receiver setup can help you to improve your golf swing or dance steps by allowing you to observe your faults when played back on your TV screen. Or you can rent VCR tapes prepared by pros to show you how to do it properly.

The two most popular types of home videocassette recorders are the VHS and Beta formats. They account for virtually all VCRs on dealer shelves. Sony Corporation introduced the first home VCR into the U.S. in 1975 under the name Betamax. The cassette-loaded Betamax uses 1/2-in.-wide tape.

A year after Sony's introduction of the Betamax recorder, Victor Company of Japan (JVC) introduced its VCR with a modified format, called VHS (Video Home Systems). Although VHS machines also use a cassette loaded with 1/2-in.-wide tape, the similarity between the two media ends here. The cassettes are housed in different-size plastic cases, and the machines operate in a different manner and at different speeds. Consequently the two competing systems are incompatible; VHS tapes can't be used to record and/or play back in Beta machines, and vice-versa.

**How VCRs Work.** It's axiomatic with tape machines that the faster the tape moves past tape heads, the higher the frequency it can produce. For example, an audio tape moving at 15 inches per second (ips) past a stereo cassette's tape heads might produce 20,000 Hz (20 kHz), while one running at half that

speed, 7 1/2 ips, may achieve only 15 kHz. To produce video, however, the tape must handle more than a 2-million Hertz (2-MHz) range!

Interestingly, a VCR achieves its required 2-MHz and higher frequency range as the video tape moves at a relatively low tape speed—as low as 0.44 ips for a six-hour video recording. Observ-

Two heads, spaced 180 degrees apart, are mounted on a drum that rotates at 30 revolutions per second, the same number of video frames per second used in the NTSC TV system used in the U.S. In the NTSC system, a picture is produced by one odd and one even "interlaced" or interleaved fields. The combination of both forms one frame or complete picture. Thus, as the tape rotates past the two heads 30 times per second, each head records one field to produce two fields, or one frame, per rotation of the heads.

The helical-scan format has the heads mounted on a wheel (disc or hub) that spins them diagonally across the tape to form a path similar to a helix. Also, to reduce interference or crosstalk from closely adjacent tracks, the head gaps are not perpendicular to the track as in audio recorders, but are slightly (and deliberately) misaligned 6 to 7 degrees. Each of the two heads is inclined in a direction opposite to the other, thus producing tracks 12 to 14 degrees displaced from each other. In the VHS system (used by Panasonic, RCA, JVC, Magnavox, and many others), 6 degrees is used, while 7 degrees is used with the Betamax scheme (used by Sony, Zenith, and Toshiba).

In basic operation, Beta and VHS machines operate similarly. The Beta VCR is somewhat more compact than VHS and uses a smaller-size cassette. The Beta 1/2-inch tape is stored on a two-hub cassette measuring approximately 6 in. X 4 in. X 1 in., compared to the 7 1/2 in. X 4 in. X 1 in. VHS cassette. Early Beta models operated at a tape speed of 1.5 ips and the cassette contained 500 feet of tape for one-hour playback. This speed, called Beta I or X1, is not used in new VCRs, although some Sony models include it to allow playback of older recordings. Today's Beta VCRs use Beta II at 0.79 ips, or Beta III at 0.53 ips. Beta II offers three-hour play time, while five hours is possible with Beta III.

The VHS cassette, slightly larger than the Beta-type, operates at slower speeds, thus offering the capability of longer playing time. VHS SP, at 1.31 ips, permits two-hour playback; VHS LP, at 0.66 ips, provides four-hour playback; and VHS ELP or SLP, at only 0.44 ips, extends playing and recording time to six hours. (Recently announced video tape that is thinner is said to extend play time to eight hours.)

Readers familiar with recording on an audio open-reel recorder are aware that the ear might detect changes in record-

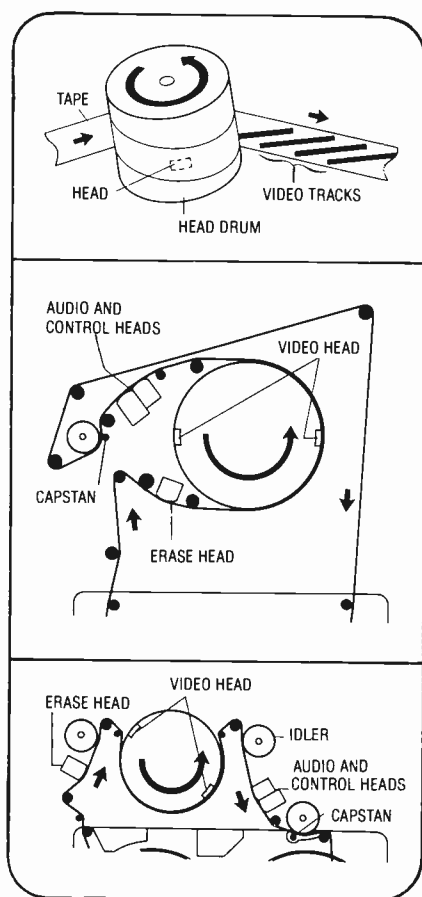

Head/drum details (top) and tape threading details for Beta (center) and VHS (bottom) videocassette recorders.

ing the tape through a window in the videocassette compartment, the tape hardly seems to move!

This "trick" is accomplished by using moving tape heads, whereas in audio tape machines, tape heads are stationary. Video tape heads, instead, are mounted on a cylinder or disk that rotates at 1800 rpm and sweeps across the tape surface. This technique, called helical scan, permits storage of high-frequency information on 1/2-in.-wide magnetic tape without requiring excessive tape, since the tape moves so slowly.

ing quality when speed is changed from 15 ips to 7 1/2 ips to 3 3/4 ips; the sparkling high notes drop out and sound quality is compromised. So too, do picture and audio quality deteriorate at lower video tape speeds. But picture and sound quality, even at the slowest speeds, are more than adequate in most instances. Where they are not, such as recording a poor picture or copying someone's tape, higher speed should be used. The advantages of slower speeds of movies are obvious: lower tape cost when six rather than hours of movies are put on one tape; convenience of having a lengthy movie on one tape rather than on one full tape and a portion of a second; and less storage space requirements.

Another major difference between Beta and VHS formats is the method of wrapping the tape around the recording drum. In the Beta machine, video tape is drawn around the drum as soon as the cassette is inserted and presses a small switch to activate the wrapping mechanism. The arrangement is called "U" loading, since the tape path resembles the letter "U."

In the VHS system, the PLAYBACK or RECORD button must be pressed to start the tape-wrapping process. The tape is pulled from the cassette by two parallel arms in a path that resembles the letter "M." Hence, the VHS system takes a few seconds after starting for the tape to be positioned (and therefore to record), while the Beta is ready instantly once the cassette is inserted. Actual threading time is faster with VHS, though.

The majority of Beta VCRs in the market today are two-speed, one for three hours and 20 minutes, and the other for five hours playback or recording time. VHS models are now available with two or three speeds. The two- and four-hour models are being replaced by two-four-six-hour models.

A number of newer VHS designs boast four recording heads rather than two. One pair of heads is used for the higher-quality, higher-speed two-hour mode, while another pair is generally used for four- or six-hour mode. Basically, the recording track width is different; slow-speed recordings require thinner diagonal tracks to accommodate the greater recording density. Use of four heads, rather than two, provides pictures with less noise or "snow" degradation since each set can be designed to work best with the hour-mode chosen.

Basic controls of VCRs include RECORD, PLAYBACK, PAUSE, REWIND, FAST-FORWARD, EJECT, and TRACKING. Many models include a 24-hour timer to per-

Courtesy Panasonic

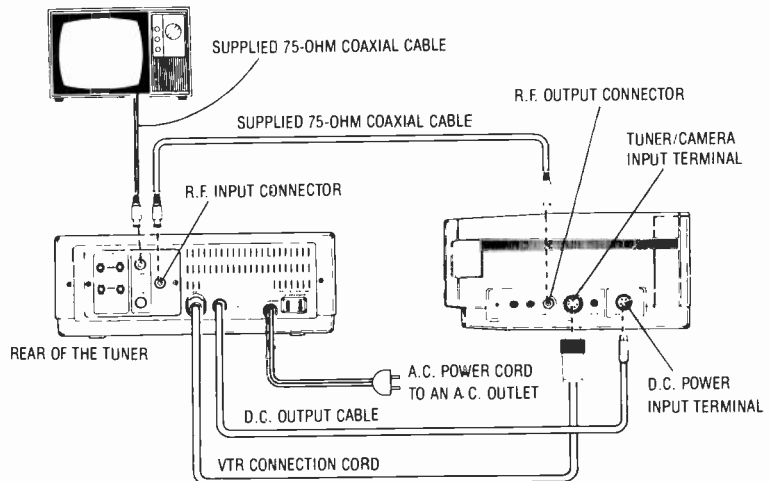

Typical in-home hookup of a two-piece portable system. For portable use, camera plugs into socket at side of recorder, which works with the tuner component. Tuner also serves as power supply/battery charger.

Courtesy Hitachi

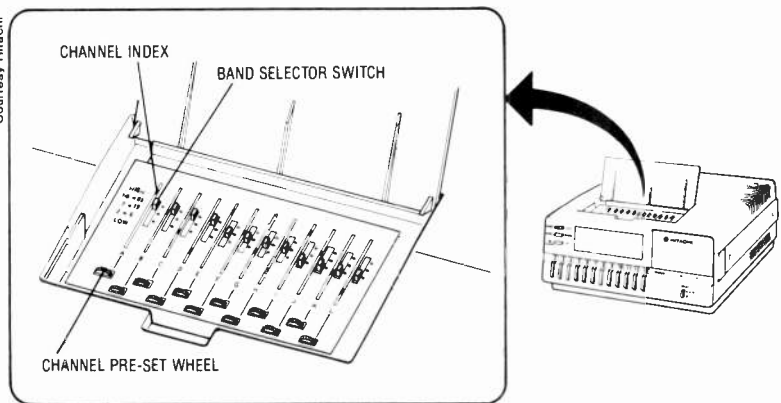

The fine-tuning controls are usually concealed in a separate compartment in those units that employ pushbutton tuning. Any channel can be assigned to any pushbutton, including UHF and, sometimes, cable channels.

Courtesy Magnavox

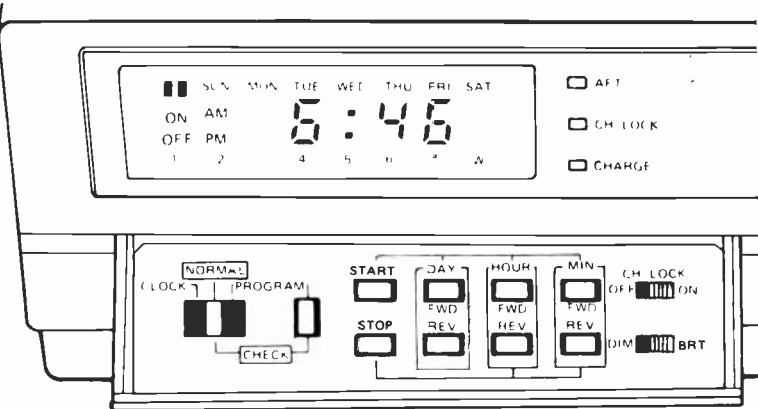

The flexibility of the programming available on different VCRs varies tremendously from model to model, but all have at least a one-day/one-event timer that makes unattended recording possible.

mit automatic recording of one program during a 24-hour period. But there are many additional options that appeal to today's consumer.

For those who are away from home for extended time periods, a decided advantage of the VCR would be the ability to record programs automatically for later replay. With the versatile microprocessor chip and availability of all-electronic Varactor tuning, VCRs now

cable or an infrared wireless unit, allows a user to conveniently stop the VCR when a commercial occurs during off-the-air taping. It also permits control over the fast-forward, rewind, and pause functions without leaving the armchair. On some units, channel changing and search capabilities are also available on the remote controller.

Some VCRs use microprocessor logic controls that work together with feath-

film and processing, plus the inability to reuse the film for new pictures, video-movie making is certainly an interesting consumer option. Whereas two hours of silent movie film might cost close to \$400 (40 rolls of three-minute film), video tape costs less than \$20. Moreover, video tape can be reused and is immediately available for viewing with sound since film processing is unnecessary. True, a color video camera is more costly than a photographic film 8mm movie camera, even with sound facilities, and a VCR is also more expensive compared to a movie projector and screen. But as a long-time investment, the video approach is less expensive and provides superior results and other recording and playback benefits.

Portable VCRs are generally marketed as two sections of a modular system. The basic portable VCR is lightweight (generally less than 12 pounds or so complete with battery pack) and does not include a tuner or programmable timer. A second matching unit, the tuner/timer, is offered as an optional add-on. Thus, the portable VCR owner can carry his self-powered portable VCR to capture his teenage son's first touchdown without the need to transport the tuner section. Back at home, he can quickly hook up the tuner/timer to convert the portable VCR to a table-top equivalent and tape TV programs.

There are a few types of portable VCRs that use other than the VHS and Betamax formats. These include models marketed by Technicolor Co. (made by Funari Electric) that feature 1/4-in. video tape in a compact housing resembling an audio tape cassette. The cassette itself weighs only two ounces, compared to about eight ounces for VHS or Beta cassettes. Forty-five minutes play/record time is achieved in the 1/4-in. format, which is, of course, incompatible with other machines. Its main advantage is light weight only seven pounds. As with



*Panasonic NV-8350 VHS VCR features Dolby noise reduction system for audio signals and wired remote controller.*

offer programming options that permit recording up to eight events, each within a specified length of time, over a period of two weeks. This means that the owner can go on a two-week vacation to Europe and record eight programs he otherwise would have missed, providing that all eight of them do not represent more than six hours of programming. (The maximum recording possible on a single cassette has been extended to eight hours, though the tape speed remains the same as that for six hours.)

With many hours of tape being recorded, how do you locate a particular segment on it without wasting lots of time? The least expensive models employ a simple tape counter to do this. More costly models use a memory rewind scheme with the digital counter to automatically locate the desired portion. These models also make use of fast-scanning forward and reverse (at speeds from two to 21 times faster than normal) to reach a desired segment quickly. Such speeds are used for program location, not for viewing.

Other options available include stop-action to lock one frame on the TV screen; variable slow speed to permit serious analysis of a professional golfer's swing; and frame-by-frame advance.

Remote control, using 10 to 25 feet of

er-touch controls. The advantages of this system are easier control handling and elimination of waiting time for one function to finish before another function can be activated.

For some people, it might be desirable to have cable midband and super-band channels in the built-in VCR tuner. If so, look for a 105-channel tuner instead of the usual 83-channel model.

Features cost money, of course. Therefore, it's important to evaluate what the extras will do for you and how often you will use them.

**Live Recording.** With a three-minute roll of movie film costing close to \$10 for



*Sony SL-500 Betamax VCR features front cassette loading and wired remote controller.*



the large machines, a separate matching tuner section is available. The company also offers an all-in-one system, too.

As portable VCRs become more popular, the appeal of video cameras grows. Further, one can use a video camera for nonportable models wherever an ac outlet is at hand. Interestingly, a recent study by a major VCR supplier revealed that one out of every five purchasers of VCRs bought or intended to buy a video camera. VCR cameras are not inexpensive, though. They parallel the cost of the videocassette recorder/player itself. This relates to color cameras, since purchases of black-and-white cameras constitute an extremely small market, for apparent reasons.

A video camera, simply stated, converts light and sound into electrical impulses or signals. These signals are then routed to the VCR, where the electrical signals are converted to magnetic signals and recorded for later viewing on a TV receiver.

There are some important factors to consider in selecting a color video camera. They include weight, type of viewfinder, lens quality and speed, zoom range, microphone performance, special effects, and price. Color video cameras on the market today range in weight from about three to 10 pounds. But some are more comfortable in balance than others that might be lighter. Before buying, play with your selected model for a few minutes to see how it feels as you aim and move.

Cheaper video cameras have optical viewfinders mounted on top or on the side of the camera. They can tell you approximately what the lens is viewing but not much more. They are limited to fixed-length lenses. Better-grade cameras incorporate zoom lenses for wide-angle and telephoto applications. All combine an audio microphone. Another type is the "through-the-lens" system that is familiar to owners of 35-mm single-lens reflex cameras. This viewfinder uses mirrors to allow the user to see, in color, what the lens is observing.

The most prevalent viewing arrangement (and most expensive) uses an electronic viewfinder. This is essentially a miniature 1 1/2-in. black-and-white TV monitor. With this type of viewfinder, the user sees exactly what is being filmed in black and white. At the end of taping a scene, the material can be immediately displayed on the tiny screen. If the user is unhappy with the results, he can re-shoot the scene within minutes (hardly possible with a conventional film camera).

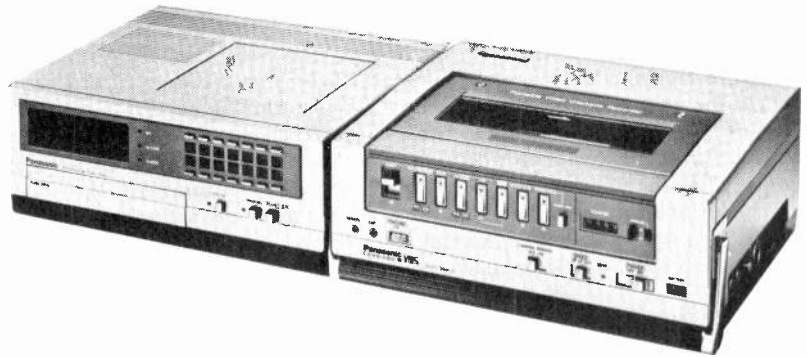

Panasonic PV-4510 portable VHS VCR (right) with companion tuner/timer (left).

The speed of a lens, or ability to function well with low-light levels, is rated by its f number. An f1.4 lens will have a larger maximum aperture and, thus, will admit more light than an f1.8 lens. Therefore, if low-light shooting is a major application, an f1.4 or f1.6 lens would be recommended over, say, an f2.0. When shopping for a zoom lens, check the range of focal lengths offered.

Low-cost lenses may have a zoom ratio of only 2 to 1 compared with the more common (and more useful) 6 to 1, the latter providing, for example, a 12- to 72- mm range.

Check the footcandles specification to determine how you can expect the camera to operate with minimum illumination. Fifty lux (5 footcandles) is a good rating at an f1.4 lens opening.

## IF YOU'RE NOT USING NORTRONICS VIDEO CLEANER YOU OUGHT TO HAVE YOUR HEADS EXAMINED.

Your video recorder has 5 to 7 magnetic heads and numerous intricate components. Dirt, dust, and tape oxide can build up inside your VCR and severely distort both picture and sound.

Nortronics VHS & BETA format Video Cleaning Cassettes are the only non-abrasive, drop-in wet system cassettes that clean all the heads and entire tape path using a continuously fresh-moving surface with each application.

For true color and sharp sound, see your local Nortronics dealer today. Available in 2000 electronics stores from coast to coast.

Nortronics Co., Inc.,  
8101 Tenth Avenue North,  
Minneapolis, MN 55427



**NORTRONICS**  
Recording Is Our Business

## ...Video...

Finally, video cameras are all equipped to include sound. Some models have a microphone built into the body of the camera. While this may be convenient, it is not the most efficient way of picking up sound. Other models use a boom-mounted microphone that allows the user to point the microphone in a direction other than where the camera is aimed, if so desired. Some deluxe models include a second microphone at the

veniently input all video devices and permit selecting the output directed to your TV set and/or VCR. With such devices, there is no need to plug and unplug jacks and terminals.

When a copy is made of a recorded tape, perhaps a movie, there is always some loss of quality. To overcome this, another VCR accessory—the signal enhancer—is often used to improve the apparent crispness of the new VCR

control to permit making readjustments in case the picture rolls or jitters. So “Copyguard” eliminators have become reasonably popular for perfectly legitimate purposes.

Small distribution amplifiers with multiple outputs are also popular devices. They enable one to feed video tape information to multiple TV sets that would otherwise receive signals with their strength too diminished for them to operate properly. If only two TV sets are used and the distance is not great, a low-cost signal splitter can be used.

**VCR Care.** Video equipment is rugged, but there are certain precautions owners should take to protect their investment. For example:

- Don't use sharp instruments, abrasive material, or questionable cleaning fluid to “clean” tape heads. There are special cleaning cassettes or other kits to accomplish this task.

- Be alert to possible problems that can arise when moving a VCR from a cold area to a hot area, perhaps near a radiator. Moisture can form and, as a result, your VCR can be damaged by the tape sticking to pulleys. However, VCRs incorporate a dew circuit to cut off operation if moisture is excessive (some units have an indicator light to show that the dew circuit is in operation). To be on the safe side, though, wait a few hours before using the machine when moving from one extreme temperature area to another.

- Dust can damage your VCR. So be sure to place a dust cover over the equipment when it's not in use.

- Don't point a video camera directly at the sun. You can ruin it!

- Don't maintain “still frame” too long, as rotating heads will cause tape material to clog the heads. The majority of VCRs today have an automatic circuit that switches the heads away after a predetermined amount of time (usually about five minutes).

**Video-Disc Players.** Video-disc

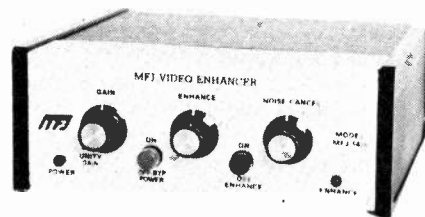

*MFJ Video Enhancer permits clean copying from one VCR to another.*

COURTESY GENERAL ELECTRIC TELEVISION

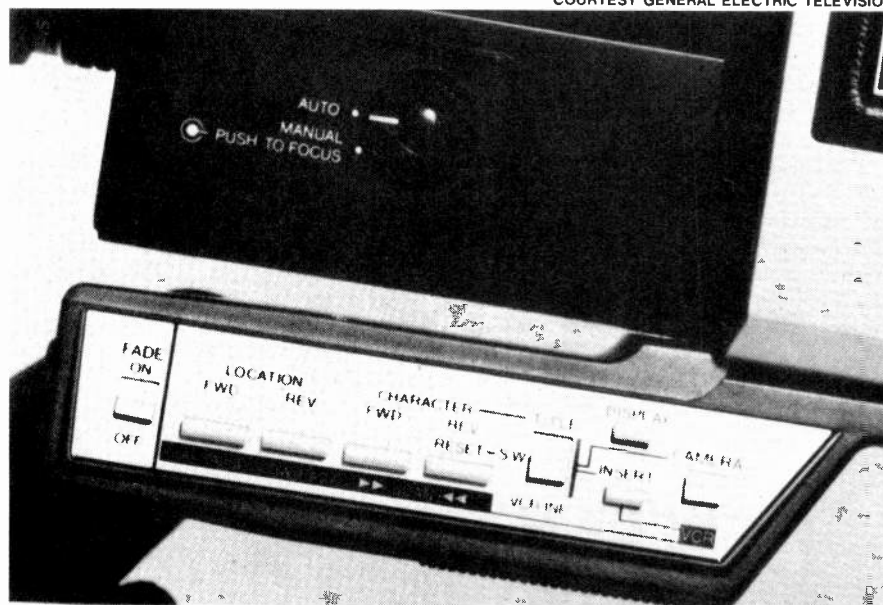

*Closeup of special controls used to operate VCR from video camera.*

rear of the camera to improve a user's ability to narrate or make comments as he shoots with less sound pickup of subjects. Additionally, many models include a jack to permit a remote microphone to be used, fade-in/fade-out special effect, power zoom, and so on.

Since a video camera represents a substantial investment, it is suggested that the shopper get the feel of the camera by evaluating its balance, ease of reaching controls, comfort, convenience of the viewfinder, etc., before buying. In short, make sure that he or she is compatible with the design of the product.

**VCR Accessories.** A jumble of wires and cables accumulates at the rear of the TV set as video equipment expands. Cables abound for a TV game, a video-disc player, a VCR, and perhaps even a home computer. In addition, more and more people are subscribing to cable or pay TV to further compound the confusion. To unsnarl the maze of wires, signal switcher boxes are available to con-

recording. The enhancer does this by extending the video range to capture missing high frequencies that influence picture resolution. To do this effectively, though, the enhancer should also contain a good video noise remover since adding more video high frequencies also increases noise or snow in the picture.

Another popular accessory is a “Copyguard” eliminator. Since companies which produce movies and other events on videotape want to prevent people from copying their work, which might sell for \$50, they generally insert a signal to distort the vertical sync pulse so that it causes picture rolling when trying to record it. It's not always effective simply because it cannot be too strong, which would upset the picture synchronization for people who are just playing it on their TV sets. Nonetheless, some TV sets do not have wide-range synchronization circuits to counter even the weak “Copyguard” signals. Moreover, some of the more recent TV sets don't even have a visible vertical-hold

players, unlike videocassette machines, cannot record. They do hold certain advantages over VCRs in some other respects, however. At least one type costs considerably less, they are much easier to use than VCRs, and prerecorded discs are less expensive (though there are fewer titles available at this time than on video tapes). Furthermore, there is much quicker access to whatever part of a recording one wishes to switch to. In other words, much of the same differences that exist between audio record players and audio tape recorders are present between video players and video recorders.

There are three different types of video-disc formats, none of which can play another's discs: optical or laser (LV), capacitance electronic disc (CED), and a forthcoming very high density (VHD) type of video disco.

The optical or LV type, introduced by Magnavox, has the most sophisticated design of the three. The player uses a low-power laser beam to "read" the video-disc's indentations without actually touching the disc. When playing a disc on a platter that rotates 1800 revolutions per minute, the laser beam is focused onto the surface of the rotating disc through a group of mirrors, a prism to split the laser beam, and a lens to sharply direct the beam.

When the beam of light hits an indentation, the light is scattered and its output is reflected back through the lens and prism to a photodiode. When the beam passes a section of the groove where a pit does not exist, the beam is bounced off the reflective coating and delivers a high light output to the photodiode. Thus, as the beam scans the rotating videodisc, a series of high and low light reflections appear at the photodiode, which converts these light impulses to electrical signals that correspond to the original TV picture and sound information.

Since the LV format disc rotates 30 times per second, the same number of frames displayed on a TV screen each second, it is possible to obtain a single frame, or freeze frame, by directing the laser beam at the same point as long as desired. Other features unique to LV systems permit the owner to conveniently select a particular frame. Each frame is identified by a reference number. When this number is punched on a keypad that's integrated with the machine, that frame will be quickly located and shown on the TV screen. It could be a closeup of a movie queen or a page from the Sears catalog (the latter has

been recorded in its entirety on disc.)

LV players that operate at 1800 rpm use discs that play one-half hour on each side. Discs that are capable of displaying one hour per side are available, too, but they do not have the freeze-frame capability. Also, the machine is switched to a slower speed in order to realize the longer play time.

The CED (Capacitance Electronic Disc) approach, called Selectavision by its creator, RCA, employs almost 10,000 disc grooves per inch on its 12-inch video-disc, offering one-hour-per-side playing time, with the disc spinning at 450 rpm. A thin electrode acts as a pickup stylus, and senses a change in capacitance as it travels in grooves of a plastic disc that conducts electricity.

A pit is a depression and, thus, there will be a difference in distance (and therefore capacitance) when the stylus rides along the groove where there is no pit and then suddenly encounters a pit. The fluctuations in capacitance correspond to the presence or absence of pits, providing an electrical signal corre-

sponding to the TV picture and sound.

Since dust and smudges from handling could seriously affect a CED video disc, sealed disc caddies are used. The user simply inserts the caddy into the CED player and withdraws the empty caddy. When play is completed, the caddy is inserted into the slot in the front of the player and the disk is returned to the caddy. In this manner, there are no fingerprint smudges to deteriorate video disc performance.

As the CED system operates at 450 rpm, with four TV frames per revolution, freeze frame is not possible. However, it is possible to locate a scene rapidly with fast-scan search controls that enable the stylus to skip grooves quickly. The stylus is rated for 500 plays and a home-user drop-in replacement costs about \$75. Companies that have joined the CED approach are Zenith, Sanyo, Toshiba, Hitachi, and Radio Shack, among others. Though stereo sound is possible, present models do not include this provision, whereas the laser-type does feature two-channel stereo sound.



*Go-anywhere convenience for video recording where no power is available is typified by this General Electric portable VCR and video camera with electronic viewfinder.*

An anticipated new video-disc entry called Very High Density (VHD) is interlinked with Matsushita Electric Co., parent company of Panasonic, and the Victor Company of Japan (JVC). The VHD system uses 10-inch video discs, which rotate at 900 rpm and offer one hour of viewing per side. As with the

which translate into electrical signals, while the adjacent tracks contain information to direct movement of the cantilever arm and stylus. This arrangement permits the stylus to repeat the same frame continuously and, thus, offer a freeze-frame feature.

The player also includes fast-forward,

ding a third supporter. At this writing, however, introduction of the machine has been delayed.

A shortcoming of all the video-disc machines is the relative dearth of discs or "software" for sale. This will likely be corrected in time.

**Home Satellite TV.** So-called TV earth stations can increase your viewing options by giving you access to television satellite reception. These signals are delivered by communications satellites sent up by RCA, AT&T, GE, Western Union, and the Canadian government, to name a few sources. RCA's SATCOM I, launched in 1975, devotes many of its 24 channels to the cable-TV industry, including Home Box Office (HBO). Similarly, GE's COMSTAR D-2 uses many of its transponders for programs on cable television.

Until a few years ago, the cost for an "Earth station" to receive satellite transmission was more than \$100,000. Today, typical systems are available for \$7000, with many selling for less.

**Uplink/Downlink Signals.** A communications satellite contains two sets of antennas: one to receive the signal beamed up to it from the earth, and the other to retransmit the signal back to earth over a wide area. To avoid inter-

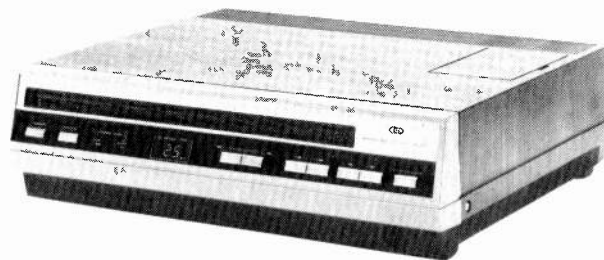

Sanyo VDR 3000 CED-type video-disc player.

CED system, the VHD approach uses a stylus to detect capacitance variations produced by tiny pits in the conductive plastic disc.

A major difference between this and the RCA system is that the VHD system does not utilize the grooves in which the stylus is physically moved. The stylus covers several spiral tracks instead of one, as it glides along the surface while held by a cantilever arm. One of the tracks provides capacitance variations,

reverse, and slow speed. In a sense, the VHD system provides some features available with an optical system, while basically operating as a CED system. In addition, the VHD scheme includes two-channel audio capability for stereo sound or bilingual provisions. And an Audio High Density (AHD) provision makes it ready for use with digital audio when it becomes available. A major asset for the VHD system was its endorsement by General Electric, ad-

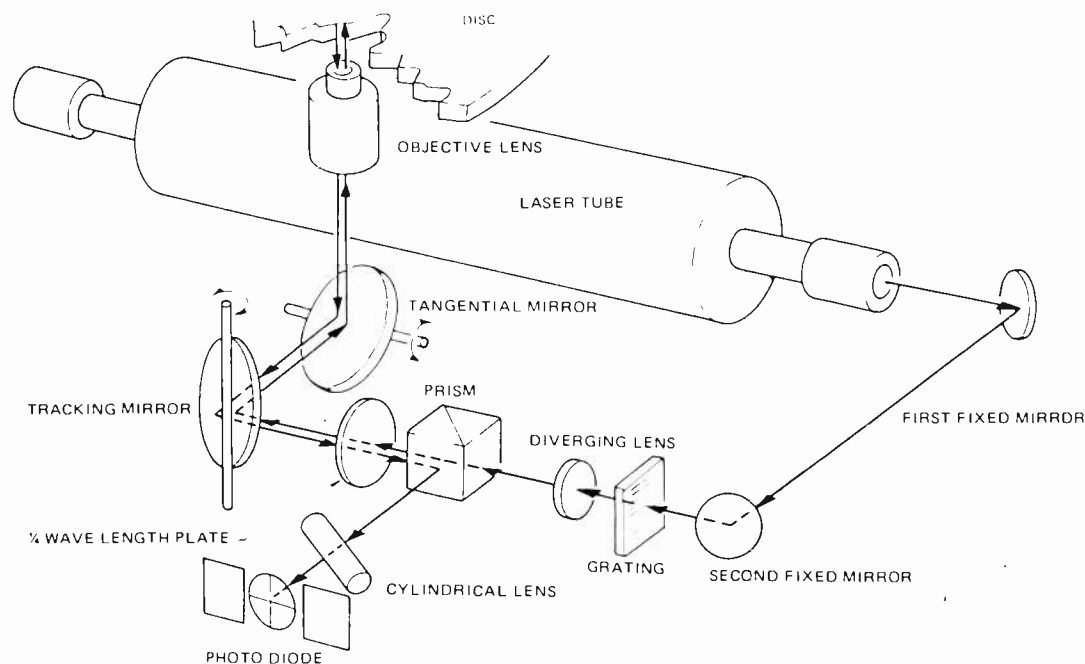

Laser beam is reflected onto disk and back again to photo diode in Pioneer VP-1000 optical video-disc player.



ference, the "uplink" signals sent up to the satellite generally extend from 5.9 to 6.4 GHz, a 500-MHz spread, while the "downlink" retransmitted signals extend from 3.7 to 4.2 GHz. This microwave frequency range is commonly referred to as C-band. Each satellite TV channel requires 40-MHz bandwidth and, thus, 12 channels are available with some frequency space left for satellite-to-ground command and beacon signals.

Those familiar with the typical vhf station bandwidth of 6 MHz may wonder why 40 MHz is required for a satellite TV channel. For terrestrial TV with line-of-sight distances of 40 miles or so, amplitude modulation (AM) is used to place the intelligence on (modulate) the TV carrier. A slight departure from single sideband (called vestigial sideband) allows the TV picture and sound information to fit within a 6-MHz allocation. Thus, on the ground, TV signal transmission consists of a combination AM/FM system with the picture being transmitted in the AM mode and the sound being transmitted in the FM (frequency modulated) mode.

In satellite TV systems, an FM/FM system is used, with both video and sound being frequency modulated. This means that a much wider bandwidth is required; fortunately, there is adequate spacing available at the high microwave frequencies. The advantage of FM over AM is the absence of noise or "snow," as

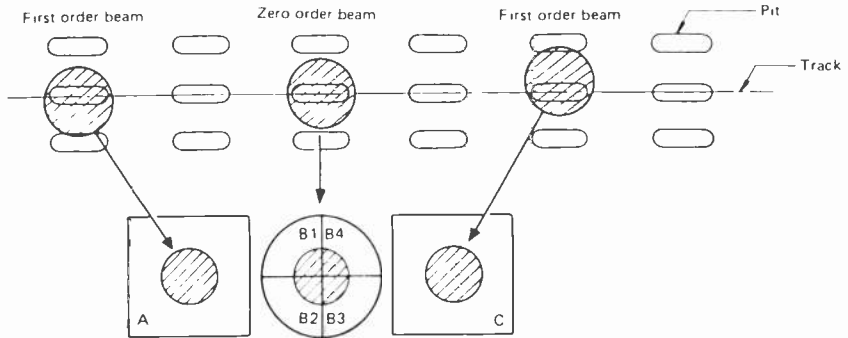

Optical information is converted into electrical signals for audio, video, and tracking systems in Pioneer's Model VP-1000 video-disc player.

long as the FM signal level exceeds a minimum specified threshold. AM transmission is more susceptible to noise, even at high signal levels.

In use, each satellite contains a number of transponders or channels with one TV channel assigned per transponder. However, some satellites, such as SATCOM I, use a dual polarization technique to double the number of channels from 12 to 24. This technique of reusing frequencies will find increasing application in future satellite designs.

Inside the satellite, 5.9-to-6.4-GHz uplink signals are amplified and then routed to a frequency converter stage, where they are changed to the downlink 3.7-to-4.2-GHz band. A fairly broadband transmitting antenna could be

used at the satellite to cover a very large portion of the earth's surface. However, the limited amount of power generated by the solar panels provides only five watts of transmitter input power, not the kilowatts available from earth-located stations. If a broadband antenna were used, signals received at ground stations would be very weak and receiver antennas might have to be as large as 30 or 40



Convenient storage for videocassette recorder and tapes behind glass doors, plus roll-around cart for TV receiver is typified in this Model 2510 cabinet from Gusdorf.

## AMAZING DEVICES

PHASORS

**PHASOR PAIN FIELD** — Patented and recently developed in our labs is being tested by Gov't for riot control. Soon to come under weapons restrictions as an infernal machine. Easily hand-held. Hazardous IF NOT USED WITH DISCRETION. \$15.00

PPF-1 PLANS (sold for animal control) \$15.00

**INVISIBLE PAIN FIELD GENERATOR** — Produces a directional field of moderately intense pain to back of head up to 50'. Cigarette pack size enclosure is easily hidden. \$129.50

IPG-3 PLANS \$7.00 IPG-3K KIT & PLANS \$44.50

IPG-30 (assembled for animal control) \$59.50

**PHASOR STUN/BURNING WAND** — Produces sufficient electrical energy capable of burning flesh. Intended as a personal defense device.

PSW-3 PLANS \$8.00 PSW-3K KIT & PLANS \$59.50

LASERS

**RUBY LASER RAY PISTOL** — Intense visible red, burns, hazardous, with parts sources. \$15.00

RUBY PLANS (includes all part sources) \$15.00

**CARBON DIOXIDE LASER** — Generates 20-40 watts of continuous power capable of burning, cutting, hazardous. (with all part sources) \$15.00

**LASER RIFLE** — Produces 200-3000 pulses of 30 watt optical energy. Portable and easily hand-held. \$10.00

LRG-3 PLANS \$10.00

LRG-3K KIT PLANS (minus diode) \$129.50

**POCKET LASER** — For the beginner, visible red optical version, non-hazardous. \$5.00

LHC-2 \$5.00 LHC-2K KIT & PLANS \$24.50

**HIGH POWERED PORTABLE ENERGY SOURCE FOR LASERS AND MAGNETIC WEAPONS** — Exploding wires, shockwave, etc. Miniature size. \$49.50

HPS-1 PLANS \$8.00 HPS-1K KIT & PLANS \$49.50

**PARTICLE BEAM WEAPON** — PLANS \$15.00

SECURITY

**INFINITY XMTR** — Uses telephone lines for selective home or office listening while away on business or vacation. \$15.00

INF-1 PLANS \$15.00

**SEE IN DARK** — Long range, total darkness. \$10.00

SD-4 PLANS \$10.00

**LONG RANGE WIRELESS MIKE** — Crystal clear quality — miniature. \$7.00

FBT-7 PLANS \$7.00 FBT-7K PLANS & KIT \$34.50

**WIRELESS TELEPHONE TRANSMITTER** — Long range, automatic. \$10.00

VWPM-5 PLANS \$10.00 VWPM-5K PLANS & KIT \$34.50

Send for FREE catalog description of above plus hundreds more plans, kits and completed items. We accept MC or Visa or when ordering, send check or money order. We pay shipping charges on orders over \$50.00, otherwise include 10% with remittance.

SEND TO: SCIENTIFIC SYSTEMS  
DEPT. Q1 BOX 716 AMHERST, NH 03031

feet in diameter.

Satellites use fairly narrow-beam, high-gain antennas to concentrate the emitted TV signals over a smaller area, such as the lower portion of the United States. The transmitted energy leaves the satellite antenna as a relatively narrow beam, but widens and disperses as it reaches the earth. The pattern, or strength of signal level at various geographic locations, is known as the "footprint" of the satellite. The shape of the "footprint" indicates the EIRP (Effective Isotropic Radiation Power) expressed in dBW (decibels per watt).

Earth stations designed to receive, not transmit, TV satellite signals are called TVRO (Television Receive Only) stations. Their basic components include a parabolic antenna—generally 10 to 15 feet in diameter, a low-noise amplifier (LNA) mounted on the antenna, and a microwave receiver. The sound and picture signals, after recovery from the microwave receiver, are fed to a high-quality monitor or, by means of an r-f modulator, to a standard television receiver for viewing.

Since the growing number of satellites operate in the same frequency band, it is necessary to allocate assigned positions for their geosynchronous orbit to avoid satellite collisions and signal interference. This task is handled by the International Telecommunications Union (ITU), which has designated "parking spots" for the "stationary" satellites. The locations range from 150-degrees to 70-degrees west longitude.

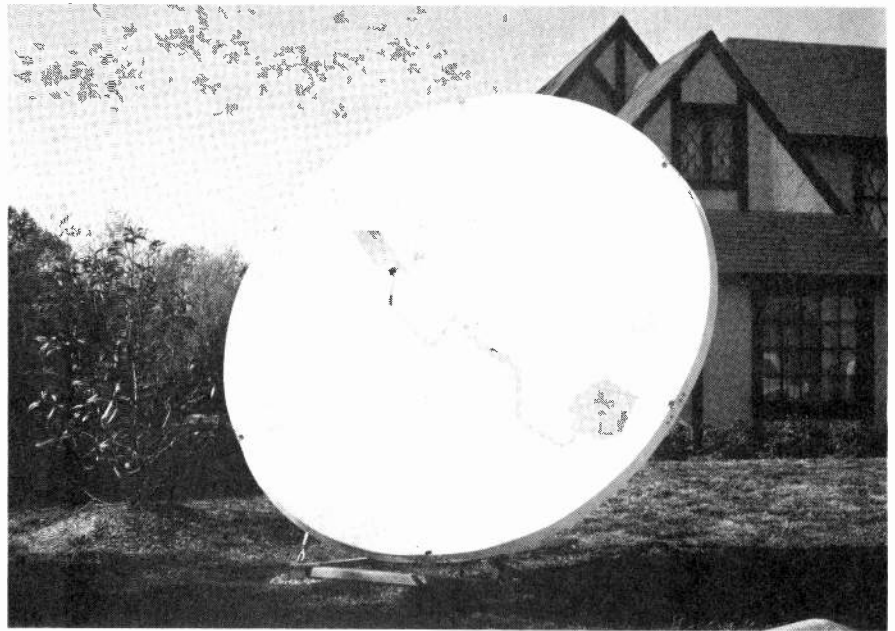

Heathkit SRA-8100-1 three-meter satellite TV receiving antenna by Scientific-Atlanta.

**Getting Started.** If you're ready to invest in your own TVRO, the first step is to investigate whether your community has zoning laws that prohibit the installation of potential eyesores in the neighborhood, which a large antenna might be construed to be. Then check "footprints" of the various satellites to determine signal strength (EIRP) in your area. Next, talk to a local supplier of TVRO equipment to make sure that

there aren't any government communications or radar stations, telephone company microwave links, or public service two-way radio systems that can seriously affect your reception.

If all inputs say "go" and you are ready to take the next serious step, decide where the antenna will be situated. Don't expect to mount a 10-foot parabolic dish on your rooftop alongside your TV antenna. The TVRO antenna may weigh more than 500 pounds and be exposed to excessive wind loads. An open area in the backyard, with a concrete pedestal to mount the antenna, is the proper location.

Since the signals routed from the antenna and the LNA are quite weak, it is advisable to avoid excessively long runs of cable between the antenna and the receiver in the house.

**Television Basics.** You must have a TV receiver, obviously, in order to enjoy video/audio equipment such as a video cassette recorder, video-disc machine, cable TV, etc. Here are some insights into how a TV set works, both black-and-white and color. Such information will also help you when shopping for a new television receiver.

To understand how a television receiver works, it's best to examine it in simple functional slices, starting with the broadcast signal arriving at the TV antenna. These minute radio-frequency (r-f) signals impinge on the antenna and



Heathkit SRA-8100-3 satellite TV receiver has built-in 24-channel tuner, digital channel and time displays, and convenient remote controller.

# free

## HEATHKIT CATALOG

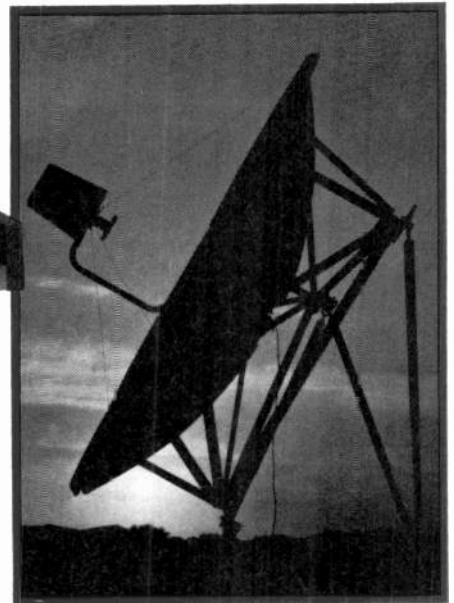

are led into the TV set's r-f tuner section through antenna wire. (If cable TV is used, the signal reaches the TV set through the cable-TV wire.) The tuner, or "front end," is used to select the frequency (channel) switched in by the user and amplify it.

The tuner also contains another section that combines with the amplified signals to produce a lower-frequency signal that's easier to handle. This is called an intermediate-frequency signal (i-f), which is further amplified as it moves toward the cathode ray tube (CRT) or picture tube.

At this point the signal, which contained all the video and sound information, enters a video detector stage. Here, the video and the audio are separated, each going to its respective destination: video to the picture tube to create images, and audio to the loudspeaker to produce the sounds you hear. Along the way, the carrier wave (think of it as a train or bus) is removed, and the respective signals (consider them to be cargo) are further amplified.

To keep the TV camera and the home TV receiver in step with each other, the TV station includes synchronization ("sync") signals with its transmissions. The TV receiver has a sync section to separate these broadcast control signals from the whole transmission, and routes them in a way that locks the picture to what the camera is producing. If something goes awry with the vertical sync control, the picture would likely roll; with a defective horizontal sync circuit, you might see the picture information going off on a slant.

To obtain light and a picture on a TV screen, a system called sequential scanning is used. This is a procedure that "paints" the picture information across the face of the TV picture tube in an interesting manner, as follows.

An electron beam is formed in the neck of the big glass TV picture tube. This beam is attracted to and focused onto the back-face of the picture tube screen, which is coated with phosphor that's charged positive by a very high voltage. When the beam of electrons strikes the phosphor, it causes a point of light to appear on the screen.

Around the neck of the tube are windings of wire, called a "deflection yoke," which carry voltage from vertical sweep and horizontal sweep to circuits that magnetically deflect the electron beam. The vertical section causes the beam to step down on the screen, while the horizontal section simultaneously moves the beam diagonally from top-left to bot-

Discover the newest in electronics for your home and business...

- Computer hardware and software
- Earth Station
- Self-study educational courses
- Precision test instruments
- Computerized weather instruments
- Complete Solar Hot Water Systems
- Automotive and home energy savers
- Color TVs and video accessories
- Fine stereo high-fidelity components
- Amateur radio gear

...all in easy-to-build, money-saving kits.

Send for the all-new, free Heathkit Catalog today!

104 pages describe over 400 exciting kits for your electronics hobby.

If coupon is missing, write Heath Company, Department 062-892 Benton Harbor, MI 49022

Please send my free Heathkit Catalog. I am not currently receiving one.

Mail to: Heath Co., Dept. 062-892 Benton Harbor, MI 49022

free

Name \_\_\_\_\_

Address \_\_\_\_\_

City \_\_\_\_\_ State \_\_\_\_\_

CL-754 Zip \_\_\_\_\_

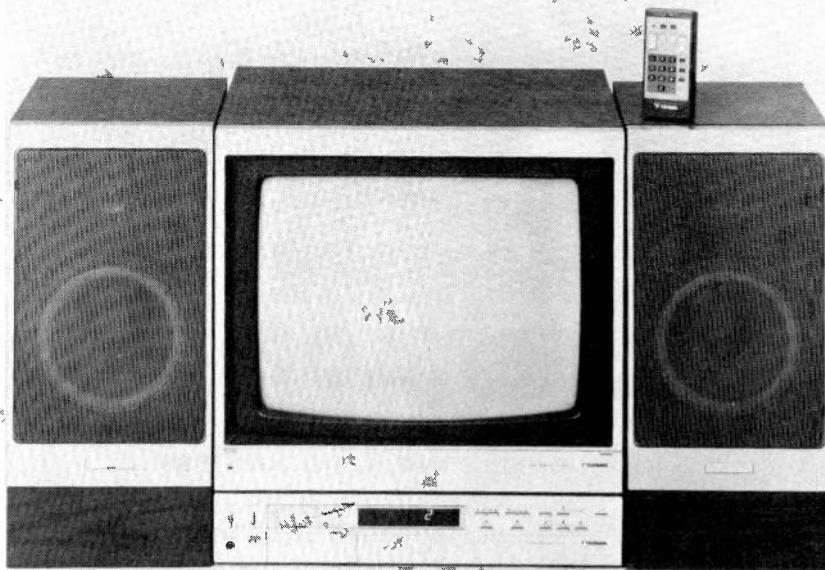

*Teknika Model ATV-19 audio/TV component system.*

tom-right of the screen (facing the viewer). Whenever the beam is shifted rapidly to the left to start another left-to-right diagonal scan line, this "retrace" line is "blanked out."

To avoid a flicker effect due to illuminated lines of light scanned at the top of the tube that fade out by the time the

scan reaches the bottom of the tube, an "interlace" system is used. This is a method that produces two fields every 60 seconds, with the second one using scan lines that fall between those of the first scan lines. Therefore, each scan consists of 262½ lines. Not many TV receivers have very good interlacing, which results in pairing of the scan lines. This reduces sharpness somewhat.

The light-through-dark picture elements incorporated in the video signal are reproduced by automatically varying the intensity of the electron beam as it scans the screen. This is how the actual picture is formed, creating varying light and dark areas. The eye doesn't detect all these broken-up light elements, just as it doesn't notice the dot structure that makes up a picture on a printed page in this magazine (unless you view the picture up close through a magnifying glass).

To develop a bright picture on the CRT requires 12 to 15,000 volts at a black-and-white picture tube anode. This is applied internally to the CRT, of course, while the glass envelope of the tube acts as an insulator. The high-voltage section accomplishes this task. Finally, a low-voltage power supply develops, the various direct-current (dc) voltages required at different sections of the set from the 117-volt alternating (ac) power line.

Combining all the foregoing sections into one receiver will produce a monochrome or black-and-white picture plus sound. To add color (or chrominance) to the monochrome picture requires additional stages and circuits, as well as a special picture tube.

**Color TV.** A color set is essentially a black-and-white set, with color TV circuit and picture tube added. Here's how

color video pictures are created.

A color picture, as seen on a color TV set, is actually three separately formed pictures that the eye resolves as one single picture in color.

Any color can be reproduced by combining the proper amounts of three primary colors; in a color TV system, red, blue, and green are the selected primary colors. Cyan is produced when blue and green are combined, with no red present. Magenta, or purple, is created when red and blue are combined. When proper amounts of all three primary colors are combined, white or shades of grey appear.

When a yellow flower is scanned, only the red and green cameras would produce electrical signal outputs (yellow is formed by adding red to green). The transmitter could send out signals representing the levels of output for green, red, and blue; at the receiver, a separate section could be designated for green, red, and blue, and amplified signals could be directed to three CRTs: one with a green filter in front of it, one with red, and one with blue. Finally, all three pictures could be optically projected onto a screen where the proper colors would then appear. That's a basic system that could work, but it will prove to be unacceptable.

First of all, the system would require lots of components and, thus, be very expensive and subject to excessive breakdown (the more parts, the higher the probability of defects). Second, the system demands considerable bandwidth or frequency space since three, not one, sets of signals are transmitted from one station (one for each primary color). And lastly, the system would not be compatible. This means, while an owner of a color set could view the resultant picture, the owner of a monochrome set could see the equivalent output of only one color transmitted. For example, if he received the equivalent of the blue video signal, he would see nothing on his monochrome screen when a yellow flower was shown.

The NTSC (National Television Standards Committee) system used in the U.S. and many other countries (not all countries have adopted the system) operates so that owners of color sets can view programs of color or monochrome (old films); similarly, all monochrome receivers can receive color transmission (in black-and-white, of course) with no modifications.

The NTSC system requires transmission of chrominance signals to carry the color information, and color sync signals

## projection television

THE  
NEW,  
ULTRA  
FAST  
f/1.45  
LENS  
KIT  
\$59.95

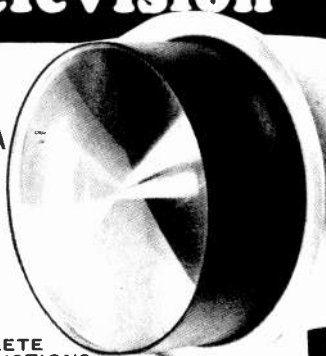

COMPLETE  
INSTRUCTIONS  
SUPPLIED IN KIT

8 1/4" Dia. x 1 1/4"  
12" Focal Length

**BUILD YOUR  
OWN GIANT SCREEN TV SET!**

Double-Element Fresnel Lens Kit now available. You get the two lenses, housing halves, diaphragm and mounting flange collar with complete instructions. Guaranteed or full lens price refunded!

3 1/2 TO 7 FOOT SCREENS STOCKED  
Send \$1 For 8-Page Instruction Book  
Or Write For Descriptive Brochure!

Dealer Inquiries Invited

**PROJECTAPIX, LTD.**

300 WEST 53 STREET  
NEW YORK, N.Y. 10019  
TELEPHONES: (212) 765-7869

CIRCLE NO. 28 ON FREE INFORMATION CARD



to convey proper frequency and phase timing of the color signals. In addition, a color receiver must include a color picture tube to recreate the color picture. A convergence section is also included to properly align or register the three closely-spaced pictures developed by the color CRT. Since the basic design of the color CRT offers poor electrical-to-light conversion, higher voltages are required than found on monochrome sets. Hence, 25,000 volts is common in most standard color TV receivers.

The shadow-mask principle has been used for color TV picture tubes for many years. There are three electron "guns" (as compared to one in a monochrome tube) at the rear of the single picture tube. The blue gun receives electrical signals corresponding to blue, the green gun a green signal, and the red gun a red electrical signal.

The front screen of a 21-inch color TV tube contains more than one-million red, blue, and green phosphor dots, each precisely located. The dots are arranged in groups of three or triads (one green, one red, and one blue) or more than 350,000 triads. A perforated metal plate, the shadow mask, is located slightly behind the phosphor dot screen, and is precision mounted so that each hole is centered over a triad. Now, when a scene is transmitted of a blue sky, the electrons leaving the blue gun travel through the shadow mask hole and strike only the blue phosphor, creating a blue dot on the screen; as the beam continues scanning, more blue dots occur. Since only blue is being viewed, there are no green or red electrical signals at the green or red guns; however, without the shadow mask, the electrons from the blue gun could hit the green and red phosphors, incorrectly coloring the picture. When a yellow flower is being viewed, the phosphor would light up for the red and green areas and the eye would resolve the combination as a yellow flower; actually there is one red and one green picture, not merely one yellow picture. When a white area such as a picket fence is viewed, all three phosphors would be energized, so the eye would see white.

It takes precision tube manufacturing and proper picture tube adjustment to produce a good-quality color picture. If the color tube has been poorly installed, you might see during a white scene that the bottom left of the screen has a purple tint over it; this indicates a "purity" problem or need for readjustment. Also, you might notice that a red (or blue or



*Mitsubishi VS-510UD projection system all-in-one unit closes up to give appearance of fine cabinet furniture.*

green) "ghost" or reflection is on the left of all images on the screen. It may appear as a second picture slightly displaced a quarter-inch or so from the main image. This is called a conver-

gence problem, and requires readjustment of components mounted around the neck of the picture tube. More recent color tubes use vertical stripes, rather than triads, to form the color picture, but the principle is still the same: three separate images are used (three primary colors) to produce a color picture from the chroma signal.

In a color receiver, the chrominance (or color) signal is combined with the luminance (or monochrome) signal to create the color picture. A monochrome receiver with the compatible NTSC system requires only the luminance signal for display of a black-and-white picture. Color information transmitted to a non-color TV set is not acted upon; only the mixed three colors (30% red, 59% green, 11% blue) that produce a black-and-white picture are used here.

**Projection TV.** There's a practical and economic limit to how large a glass TV

*(Continued on page 133.)*

## Computer & Electronics Books For Beginners

These handy books of programs and about programming are jammed with easy-to-understand info for beginners. Everything you need to know to get started programming TRS-80 Color Computer, PC-2, Sharp PC-1500, APPLE II.

**101 Pocket Computer Programming Tips & Tricks.** secrets hints short cuts. techniques from a master programmer for TRS-80 PC-2, PC-1, Sharp PC-1500, PC-1211 pocket computers 128 pages \$7.95

**Pocket Computer Programming Made Easy.** new fast easy read-and-learn way to make TRS-80 PC-2 PC-1, Sharp PC-1500 PC-1211, Casio FX-702P pocket computers work for you Learn BASIC quickly 128 pages \$8.95

**101 Color Computer Programming Tips & Tricks.** learn-by doing instructions, hints, secrets, techniques, insights for TRS-80 Color Computer 128 pages \$7.95

**55 Color Computer Programs for Home, School & Office.** practical ready-to-run software with colorful graphics 128 pages \$9.95

**101 APPLE Computer Programming Tips & Tricks.** secrets, hints, short-cuts, techniques, insights, for APPLE II, 128 pages \$8.95

**25 Easy-To-Build One-Night & Weekend Electronics Projects.** useful gadgets, readily-available parts, 96 pages \$4.95

**25 Electronics Projects for Beginners** 96 pages \$4.95

Send check, money order, or MasterCard or VISA  
Include \$1 shipping. Or write for free catalog. Mail to:

### ARCsoft Publishers

POST OFFICE BOX 132 D  
WOODSBORO, MARYLAND 21798

(301) 663-4444



# GETTING STARTED IN PERSONAL COMPUTING



How to understand and join the computer  
revolution at home and at work.

SINCE 1975, more than 3,000,000 personal computers have been sold. Who bought them? People from all walks of life, people like you. These people are already living in the world of the future, and you can, too. All you need is your own computer.

**BY NOW**, you've probably heard or read a lot about personal computers. You might even want one of these wonders of modern electronics, but have resisted buying one because you don't know enough to make an intelligent choice. Or perhaps technical computer buzz words, which you're convinced will never have any meaning to you, have put you off. Well, cheer up. All but a very small minority of personal computer owners were once in the same predicament when they got started.

The purpose of this section is to invite you to join the millions of people who are already entertained, educated, and helped by personal computers in their daily and business activities. With this in mind, we've assembled an overview of modern personal computing that will give you as much information as you need to get started, whether you want a computer for your home or business.

While it's true that we'll be introducing you to some of the technical jargon used in computing, we'll keep it to a minimum and explain it in language anyone can understand. And to help you along, we've included a Glossary of Technical Computer Terms at the end of this section.

**First Things First.** The purpose of a personal computer—or any other computer, for that matter—is to compute, whether it's used in a home or in an office. But if you think all personal computers are alike, think again. Different manufacturers design their computers to meet different goals, and not all computers designed to meet the same goals achieve them in the same way. Each manufacturer is free to select his own set of criteria to achieve what he considers

to be the best collection of features, functions, and capabilities for the products he offers. Most manufacturers do just that, resulting in a diverse and competitive personal computer market for the home and business.

Realizing that computers are the wave of the future, some toy manufacturers are marketing computers designed to expose very young children to the machines. A good example of such a computer is the MAC Mini Computer from Entex Industries, which has a user-programmable mode, a calculator mode, a game mode, and a music mode. Mattel, Inc. introduced a similar computer aimed at the 6-to-11 age group called "The Children's Discovery System."

Some personal computers are basically video games playing machines to which there is the option of adding devices that allow them to be used as computers. For example, Mattel's "Intellivision" promises to market such an expansion device soon in which the game mates with a computer keyboard. Astrovision's Bally professional "Arcade" video game has similar provisions with its 32-key computer section.

There are a number of ways by which personal computers can be categorized. One way is to group all color-capable computers in one category and all monochrome computers in another. A second way would be to list all general-purpose computers under one heading and all special-purpose computers under another heading. A third approach would be to group computers according to the microprocessors they use. Another view would be a division based on how the machines are sold (by store-front retailers, sales representatives etc.). None of these or any other such approaches, however, will fit every computer neatly into any one category without causing

confusion since there is considerable overlap.

**What Is a Computer?** Let's take a look at what makes a "computer" by definition. One thing you should know at the outset is that virtually all data-processing computers in use today are *digital* devices, including the personal computer. Therefore a computer can be defined as an enormous collection of basically simple circuits arranged so they can perform arithmetical and logical operations according to a precise set of rules set forth in a program.

A personal computer is like any other digital computer, except that it is compact, occupying little more than the area needed for a standard office electric typewriter. But don't let its diminutive size fool you into thinking that the personal computer's processing capabilities are limited to a few primitive operations. Far from it. In fact, the modern personal computer is actually *more* powerful and a great deal more flexible to use than the large computers that required entire rooms to house them 20 years ago.

No matter how large or small a computer is, it must contain no less than three elements for it to qualify as a "computer." These are a central processing unit (or CPU), a memory system, and a means for getting data and instructions into and the results of processing out of the computer.

The CPU can be thought of as the "brain" of the computer, since it's responsible for carrying out, or *executing*, all computing functions. In short, the CPU performs all desired logical and arithmetical operations, and also manages the memory system. The memory system is where the computer stores information until needed by the CPU. When any information is needed by you

*Typical computer setup might include the computer itself, a video display monitor, and one or more disk drives, such as the Apple Computer system shown on the opposite page.*

or a program, the CPU fetches, or *retrieves*, it from its location in memory. Finally, the input/output element, abbreviated I/O, provides the means by which an external device can be connected to the computer to permit entry of data and commands, and to obtain a visual (and sometimes audible) record of the results of processing operations.

The CPU in modern personal computers is often referred to as a "microprocessor." This integrated-circuit (IC) device gets its name from the microscopic-sized circuits within it that "process" data. Microprocessors contain thousands of logic circuits on a silicon "chip" that's small enough to be contained in a package measuring only  $2 \times 1 \times \frac{1}{4}$  in. Because these high-circuit-density ICs can be manufactured at a very low per-device cost, it was possible for the personal computer (also known as a *microcomputer*) to become a practical reality, affordable by just about everyone.

There are, of course, different types of microprocessors that are used in personal computers. Among the microprocessors that have appeared in personal computers over the years are such 8-bit devices as RCA's CDP1802; Intel's 8080, 8080A, and 8085; Motorola's MC6800; MOS Technology's 6502; and Zilog's Z80. At this writing, however, the overwhelming majority of personal computers on the market and in use are built around either the 6502 or the Z80 microprocessor.

The 6502 is the microprocessor used in the Apple II and III; Atari 400 and 800; Commodore PET, CBM, and VIC; and Mattel Intellivision personal computers. The Z80 microprocessor is used in the Radio Shack TRS-80 Models I, II, and III; Heath/Zenith H/Z89; Xerox 820; and the Osborne-1 personal computers, among others.

Not all personal computers are built around 8-bit microprocessors. For example, Heath's H-11A uses a KD11-HA microprocessor, which makes this personal computer identical to the Digital Equipment Corp. (DEC) PDP-11/03. And IBM in its Personal Computer uses the Intel 8088 microprocessor. Both the KD11-HA and 8088 are 16-bit microprocessors.

As a final note on microprocessor types, you should be aware that some computers are built around proprietary devices that are available from only one or just a few sources. Notable examples of these are the microprocessors used in Hewlett-Packard's HP-85 and HP-83 personal computers.

When we speak of 8 and 16 bits with

reference to microprocessors, we mean the number of pieces (bits) of information each processes at a time. Sixteen enables a computer to perform internal operations more quickly than 8 bits.

**Computer Intelligence.** Contrary to popular belief, computers and microprocessors have no real intelligence. Until you feed commands or programs into a computer, telling it what to do, how to do what you want, and even when to do it, the computer will do absolutely nothing at all. In fact, its entire communicating vocabulary consists of only two logic states, used to represent on/off, yes/no, true/false, high/low, go/no-go, or, more commonly, 1/0. Because they recognize and respond to only these two states, computers are said to be able to handle only *binary* data. Therefore, for a computer to be able to process data, that data must first be translated into a binary language, consisting of 1s and 0s.

Each 1 and 0 in the computer's lexicon is called a *bit*, which is an acronym for BInary digiT. Any 8-bit microprocessor, then, can handle eight binary digits of information at one time. When eight bits are placed together, they form a unit called a *byte*. (Sometimes *byte* and *word* are used interchangeably.) To complete our introduction of computer buzz words, half a byte, or 4 bits, is known as a *nybble*.

Since units of memory are designated in bytes, the computer's memory is arranged so that each addressable location stores one byte, or eight pieces, of

binary information. One byte of memory, therefore, can store one alphabetic, punctuation, special, or graphics character's binary code. Numeric characters, however, occupy only four bits, or a nybble, of any given location in memory, which means that a single memory address can store *two* numeral codes.

**Practical System.** Though it's true that only three elements are absolutely necessary to call a system of circuits a computer, at least two other key components are needed to make it into a practical data-processing system. These are an input device, which provides the means by which data is entered, and an output device, which lets you see data as it's being entered and the results of computer operations. Frequently, the input and output devices are combined in a single package called a "terminal."

In most personal computer systems, the input device is a typewriter-like alphanumeric keyboard, sometimes supplemented by a separate numeric keypad to simplify entry of numbers. (Computer trainers, however, usually have a calculator-like hexadecimal keypad with extra keys for issuing instructions as the only means of on-board entry.)

Some keyboards, like the one used for the Apple II computer, don't normally permit entry of lower-case alphabetic characters. Others, such as used with the Apple III, Radio Shack TRS-80 Model III, and Heath/Zenith H/Z89 computers, provide the means for entering lower-case characters. A few

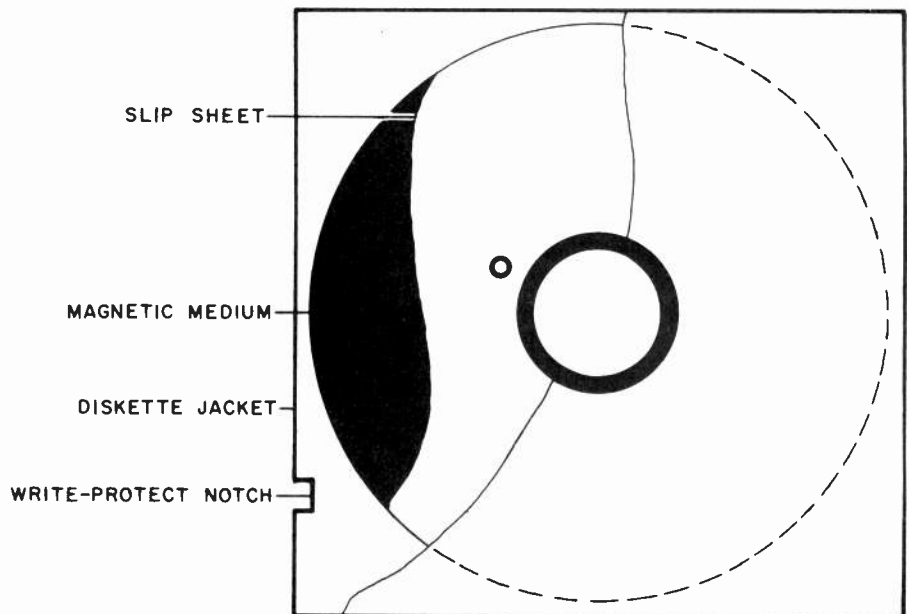

Cutaway view shows internal details of both 5.25- and 8-in. floppy disks.



# Now NRI takes you inside the new TRS-80 Model III microcomputer to train you at home as the new breed of computer specialist!

**NRI teams up with Radio Shack advanced technology to teach you how to use, program and service state-of-the-art microcomputers...**

It's no longer enough to be just a programmer or a technician. With microcomputers moving into the fabric of our lives (over 250,000 of the TRS-80™ alone have been sold), interdisciplinary skills are demanded. And NRI can prepare you with the first course of its kind, covering the complete world of the microcomputer.

## **Learn At Home in Your Spare Time**

With NRI training, the programmer gains practical knowledge of hardware, enabling him to design simpler,

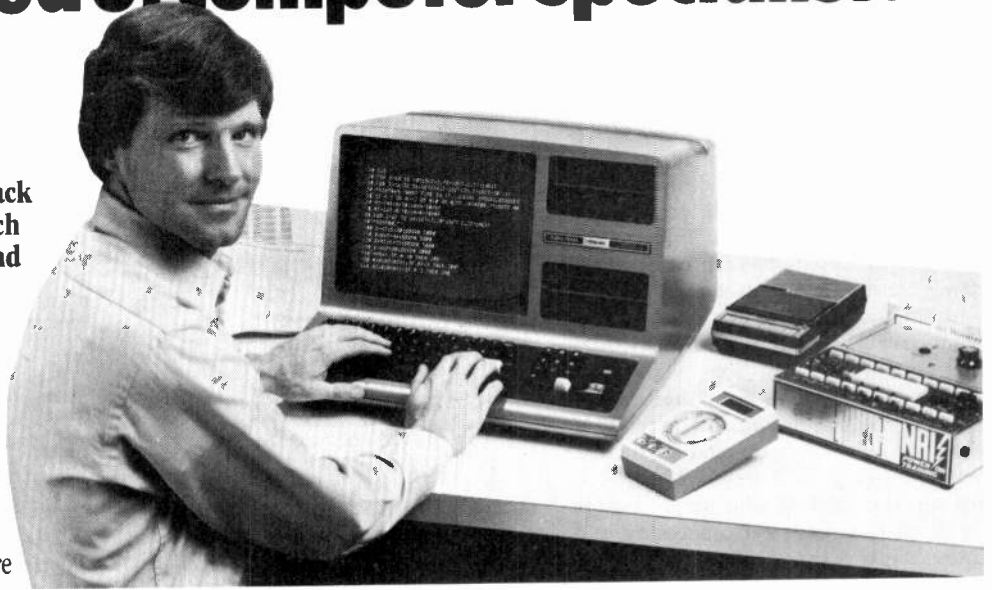

more effective programs. And, with advanced programming skills, the technician can test and debug systems quickly and easily.

Only NRI gives you both kinds of training with the convenience of home study. No classroom pressures, no night school, no gasoline wasted. You learn at your convenience, at your own pace. Yet you're always backed by the NRI staff and your instructor, answering questions, giving you guidance, and available for special help if you need it.

## **You Get Your Own Computer to Learn On and Keep**

NRI training is hands-on training, with practical experiments and demonstrations as the very foundation of your knowledge. You don't just program your computer, you go inside it...watch how circuits interact...interface with other systems...gain a real insight into its nature.

You also work with an advanced liquid crystal display hand-held multi-meter and the NRI Discovery Lab, performing over 60 separate experiments. You learn troubleshooting procedures

and gain greater understanding of the information. Both microcomputer and equipment come as part of your training for you to use and keep.

## **Send for Free Catalog... No Salesman Will Call**

Get all the details on this exciting course in NRI's free, 100-page catalog. It shows all equipment, lesson outlines, and facts on other electronics courses such as Complete Communications with CB, TV/Audio and Video, Digital Electronics, and more. Send today, no salesman will ever bother you. Keep up with the latest technology as you learn on the latest model of the world's most popular computer. If card has been used, write to:

**NRI Schools**  
McGraw-Hill Continuing  
Education Center  
3939 Wisconsin Avenue  
Washington, D.C. 20016.

**We'll train you for the good jobs!**



**Training includes new TRS-80 Model III microcomputer, 6-function LCD Beckman multi-meter, and the NRI Discovery Lab with hundreds of tests and experiments.**

(TRS-80 is a trademark of the Radio Shack division of Tandy Corp.)

computers, like the Commodore PET and Heath/Zenith H/Z89 even permit entry of preprogrammed graphics characters directly from the keyboard.

The most common way of getting output information from a computer into a readable form is by displaying it on the screen of a TV-like video device known as a *video monitor*. (Again, computer trainers approach the output display differently, most using light-emitting-diode, or LED, output displays.) Commonly used video displays are a standard TV receiver, connected to the computer through an r-f modulator, as is the case with Atari computers; video monitors, such as those used with Apple computers; and dedicated built-in video monitors, such as those used in the TRS-80 Model III, PET/CBM, H/Z89, and other computers.

Video displays can be either monochrome (black and white or green and black) or full color, depending on the computer being used and the software program provided. If your major use for a computer is for word processing and other word-intensive applications, a monochrome monitor would be the preferable choice. The reason for this is that display resolution (ability to display fine detail) is greater for monochrome TV monitors. Also, because monochrome monitors generally feature wider bandwidth than is possible with color monitors, they are better able to display much longer lines of text without suffering from serious degradation in resolution. The typical 13-in. monochrome monitor can easily display 24 lines of 80 characters per line, while the typical color monitor is usually limited to 8 or 16 lines of 32 characters each.

Color monitors are usually preferable if games playing is one of the primary reasons why you want a computer. Such a monitor will allow you to take full advantage of the color graphics that characterize most computer games.

If you've decided to buy a color-capable computer and a color monitor, bear in mind that picture quality will depend upon the type of monitor you use. Least crisp pictures result when a computer is connected to the antenna terminals of a color-TV receiver via an r-f modulator. A considerable improvement will be obtained if you feed the computer's composite video signal directly to the video input of a color-monitor-only display. Best picture quality, however, is obtained with a special RGB color video monitor, which has provisions for its red, green, and blue picture tube guns to each be "fired" by its own separate vid-

- 1 = DISKETTE JACKET
  - 2 = HUB DRIVE HOLE
  - 3 = INDEX HOLE
  - 4 = HEAD ACCESS SLOT
  - 5 = WRITE-PROTECT NOTCH
  - 6 = MANUFACTURER ID LABEL
  - 7 = USER-APPLIED LABEL
- BLACK AREAS = MAGNETIC MEDIUM

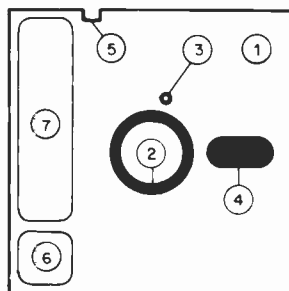

5.25" DISK  
(5.25" X 5.25" JACKET)

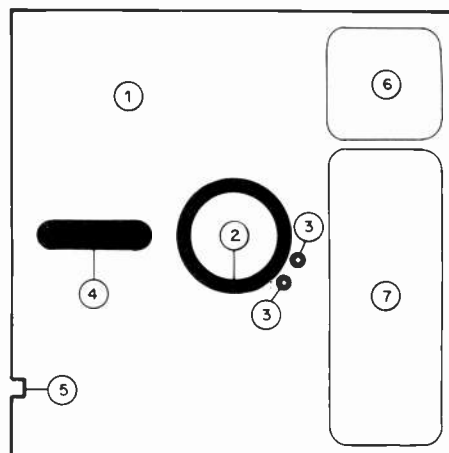

8" DISK  
(8" X 8" JACKET)

*Differences between 5.25- and 8-in. floppy disks, aside from size, are pointed up by location of write-protect notch with respect to head slot.*

eo signal. Unfortunately, few personal color computers provide the individual signals required to drive an RGB color monitor. Those that do are the Apple II, IBM Personal Computer, and NEC PC-8001 computers.

**Memory Makes It Possible.** As stated earlier, one of the three items every computer absolutely needs is memory. Without memory, the CPU would be virtually helpless because information would have to be fed in every time the computer needs it and you would have to write down intermediate results of calculations until they're

needed again by the computer. With sufficient memory, however, a computer can store program instructions, information to be processed, and temporary results of mathematical and logical operations performed.

Many different types of memory are used in modern personal computers. They range from semiconductor devices like RAM, ROM, PROM, and EPROM to magnetic devices like cassette tape, floppy disk, and hard disk.

Semiconductor devices make up the largest variety of memory available. Some types, like RAM (random-access memory), are designed to be used for

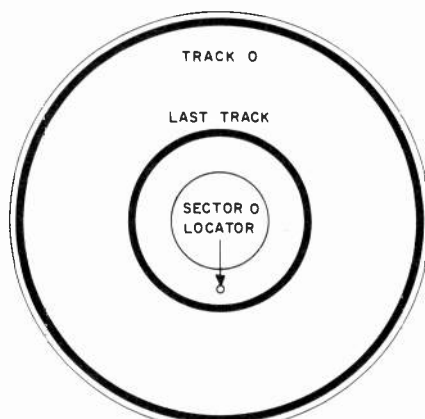

SOFT-SECTORED  
(SINGLE HOLE)

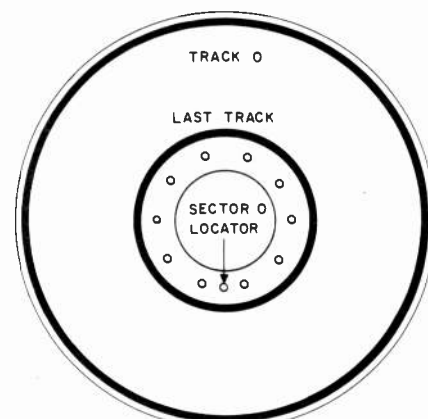

10-HOLE HARD-SECTORED  
(11 HOLES ACTUAL)

*With soft-sectored disks, single hole is used to locate only sector 0; multiple holes in hard-sectored disks allow rapid location of all sectors.*

# Free Heathkit Catalog

## featuring computers, peripherals and software for home and business.

**Build it yourself** and save up to 50%.

**Build it yourself** and learn – know your system from the inside out, grow as your skills grow, change as your needs change.

**Build it yourself** the easy Heathkit way – with step-by-step assembly manuals, friendly over-the-phone assistance and 65 convenient Heathkit Electronic Centers\* – selling and servicing our computers in the U.S. and Canada. See your telephone white pages for locations.

- Complete, integrated computer systems
- Peripherals – including video terminals, letter-quality printers, color graphics
- Disk storage systems, up to 12 megabytes
- Three operating systems, including CP/M
- Innovative software – including word processing, SuperCalc electronic spreadsheet and Peachtree business programs
- Self-instructing programming courses from Heathkit/Zenith Educational Systems
- Accessories and supplies

\*Heathkit Electronic Centers in the U.S. are units of Veritechnology Electronics Corporation.

temporary storage, with data in them able to be erased and replaced by new data as the need arises. Other types of semiconductor memory, like the ROM (read-only memory), are used for permanent, nonalterable storage. Still others, like PROM (programmable read-only memory) and EPROM (erasable programmable read-only memory), can be easily programmed by the computer manufacturer or even the knowledgeable computer owner and then be used as ROMs.

**Semiconductor Memory.** RAM is called random-access memory because it permits direct access to any desired cell in memory, which can then have data read from it or written into it. It is possible to write data into RAM and, when it isn't needed any more, to replace it with new data. Any data stored in RAM remains there until it's either erased or changed by operator command or power to memory is interrupted. If the latter occurs, all data in RAM is irretrievably lost. For this reason, RAM is "volatile" memory.

In certain cases, it's desirable to have a program, such as a BASIC language interpreter or the computer's operating system, available to the user as soon as the computer is powered up. For this application, the ROM is ideal, since whatever data is stored in it remains there permanently, even when power is interrupted. Also, no data in the ROM can be altered by the operator. Once a ROM is programmed, it's usually not reprogrammable.

**Mass-Storage Devices.** While semiconductor memory can be used to store limited amount of data (in most cases, up to 65,536 bytes, generally shortened to 65K), they aren't really practical for storing the hundreds of thousands and even millions of bytes of program data computer operators routinely have in their software libraries. Magnetic memory devices that use cassette tapes or disks are far more practical for storing such huge amounts of data.

When personal computers first appeared in the mid-1970s, the only ways programs could be saved for reuse was on punched paper tape or on audio cassette tape. Paper-tape readers and punches had several disadvantages, among them, high cost, slow read/write speed, and an electromechanical design that made them unreliable for repeatable results.

Owing to the shortcomings of a paper-tape system, a variety of schemes were



Send today for your  
**FREE HEATHKIT CATALOG**



If coupon is missing, write Heath Co., Dept. 062-891, Benton Harbor, MI 49022  
In Canada, write Heath Co., 1480 Dundas St. East, Mississauga, Ontario L4X 2R7



Please send my free Heathkit Catalog. I am not currently receiving one.

Send to: Heath Co., Dept. 062-891  
Benton Harbor, MI 49022

Name \_\_\_\_\_

Address \_\_\_\_\_

City \_\_\_\_\_ State \_\_\_\_\_

CP-207 \_\_\_\_\_ Zip \_\_\_\_\_

CIRCLE NO. 9 ON FREE INFORMATION CARD

developed to save data on audio cassettes. Unfortunately, each cassette scheme was incompatible with all others. The result is, to this day, that of all computer companies that have tape-storage capability—Apple, Atari, Commodore, IBM, and Radio Shack—none is compatible with any of the others. As a result, one cannot “trade” software. However, the one major advantage reaped by the cassette medium is a tremendous reduction in cost. The tape deck itself usually costs \$50 to \$100, and high-quality cassettes can be bought for as little as \$2.50. Because of this low-cost entry advantage, cassette storage is still available.

Incompatibilities between cassette re-

the one you want. A lot of time can be wasted in locating the program you want to load and run.

**Moving Up To Disk Drives.** Serious users of cassette-based computer systems quickly switch to disk storage systems as soon as they discover they need and can afford them. Switching to disk storage gives one the benefits of faster operation, more storage, and easier use.

Programs on a disk can be randomly accessed, which means that the disk drive's read/write head can get to any program on the disk without first having to pass through data stored on earlier tracks.

There are currently two major types of disk-based mass-storage systems in use in personal computer systems—hard disks and so-called “floppy” disks.

Originally introduced by IBM in the late 1960s, the floppy-disk medium began to become popular in personal computer systems in the mid-1970s when Shugart Associates introduced the relatively inexpensive 5.25-in. mini version. To this day, the 5.25-in. mini-floppy disk drive continues to be the most often used magnetic memory system used in personal computer systems. However, there are also quite a number of standard 8-in. floppy drives now in use. And Sony recently announced that a smaller 3-in. floppy-disk drive may soon be appearing on the market.

Floppy disks, the medium used in these drives, get their name from the flexible nature of the recording medium. The recording medium consists of a very thin disk-shaped piece of Mylar that is coated on both sides with a magnetic oxide material similar to that used on audio cassette and open-reel tapes. The medium is housed inside a square tough plastic protective jacket that is slightly larger than the diskette itself. Between both surfaces of the diskette and its protective jacket is a slip sheet made of a material that allows the diskette to freely rotate inside its jacket.

Several cutouts, each designed for a specific purpose, are cut into the protective jacket. The first of these are a pair of long slots, one on each side of the jacket and directly in line with each other, that provide a means for the disk drive's read/write head to contact the diskette on one side while intimate con-



*Personal Micro Computer's PMC-80 is similar in operation to the popular Radio Shack Model TRS-80 personal microcomputer.*

Recording systems go even deeper. For example, different manufacturers use different speeds to record data. Radio Shack has three speeds available on different models of its TRS-80 computer. The widely owned, no-longer-produced Model I has a speed of 300 baud (bits per second) for its Level I machines and 500 baud for its Level II machines. A work-a-like Model I machine from Personal Micro Computers, Inc. is available as PMC-80, with an advanced version called PMC-81. The new Model III offers selectable 500 and 1500 baud so that Models I and II tapes can be read by the Model III.

Aside from the annoyance of incompatibility, the cassette medium has an insurmountable shortcoming because data is stored on tape in a serial manner. If you wish to call, say, the fourth program on a cassette, you would have to wait until the computer passes over the first three programs before you get to

Speed is perhaps the most important advantage reaped by the switch to the disk storage medium. Consider that a standard C30 cassette that can store about 250,000 bytes of data requires 15 minutes per side to read. If you wanted to retrieve a specific program from this tape into your computer it could take many seconds or as long as 14 or more minutes to access it, depending on just where on the tape the program is stored. Under worst-case conditions, accessing any program on a floppy disk would require one or two seconds.

Continuing our comparison, once the desired program is accessed by both media, it must be transferred into the computer's memory. Data transfer rate for cassette systems ranges from 300 to 1500 baud, while baud rate for floppy-disk systems ranges from 15,600 to 31,000. Hence, the transfer rate for the disk system can be as much as 100 times faster than it is for the cassette.



*Sony's new 3.5-in. micro-size disk drive offers users a third alternative.*

tact is maintained between head and recording medium from a pressure pad on the other side. A small index hole is used to allow the drive to read any sector holes in the recording medium as they pass by, using an optical system. A large center hole in the diskette and a slightly larger hole in the jacket provide the means by which the drive's spindle can lock onto the diskette. Finally, there is a square write-protect notch that determines whether or not the drive can write (record) data from the computer onto the disk.

The write-protect notch serves the same purpose as the knock-out tabs on the back of a cassette housing. On floppy disks, the function of the notch changes with the size of the medium. For 5.25-in. diskettes, the write function of the drive is disabled when the notch is covered, preventing any possibility of accidentally writing data to or erasing data from the diskette. In this case, a write-protected diskette is a "read-only" (RO) device. To obtain the same write-protect feature with an 8-in. floppy disk, the notch must be uncovered. A disk that isn't protected against recording is known as a read/write (R/W) device. Physical location of the write-protect notch in the jackets is different for the 5.25- and 8-in. floppy disk.

The manner in which data is stored on a computer disk is similar to the way program information is stored on a phonograph record. However, instead of data being stored in grooves on a computer disk, it's stored on invisible tracks as magnetic variations in the disk's oxide coating.

Unlike the phonograph record, which has a single continuous spiral groove, the floppy disk has separate concentric tracks that are numbered consecutively upward, with track 0 near the outside rim of the disk, or farthest from the central hole. Depending on the storage format employed, floppy disks can have anywhere from 35 to 80 tracks on them. To simplify accessing the data on the various tracks of a floppy disk, each track is partitioned off into several sectors. The number of sectors per track varies with format from 10 to 26, and each sector can store 128 to 256 bytes of program or file data.

When a disk drive is called upon to read data into the computer from a disk, the drive must know where its read/write head is located and where the head is to be positioned for the desired read operation. Two main schemes are used to accomplish this. One is soft sectoring, wherein a blank diskette is formatted

with information that identifies each track and sector. This information must be written (formatted) onto each disk before it can be used.

With soft sectoring, each sector on a disk has a short "header" that contains the track and sector numbers and perhaps some additional information. Whenever the drive's head goes over any sector, it immediately knows where it is. Some soft-sectoring techniques ease the coding burden a bit by making use of the indexing hole near the drive hub of the disk to identify sector 0. Others, like that used in Apple disk drives, simply ignore the indexing hole.

While soft sectoring is versatile and allows for easy changing of data on a disk, it can be storage-space inefficient because as much as 20% of available space may be needed for recording of the track and sector information needed by the drive.

Greater storage efficiency is obtained with the hard-sectoring technique employed in many disk systems. Instead of having to store track and sector information on the disk, hard sectoring uses a series of small holes, arranged in a circle and equally spaced around the disk's hub hole. There is a separate hole for each sector, plus an additional hole spaced midway between the first and last sector holes that "tags" the beginning of sector 0.

Inexpensive disk-drive systems are usually termed "single sided, single density." This means that only one side of the disk is available for storage of data in a relatively uncluttered manner. There are a number of ways a given size floppy disk can be made to store more data, doubling or even quadrupling its storage ability. To be able to increase the storage capacity of a disk, it is necessary for you to use different drives. You can, for example, use double-sided drives that have two read/write heads facing each other that permit you to write data on *both* sides of a disk, doubling the storage capacity of the system. The same thing can be accomplished by using drives that are single sided but are rated double density. But for the greatest amount of storage capability, up to four times that possible with a single-sided, single-density system, you can move up to double-sided, double-density drives. (Any drive that is specified as "double sided"—no matter what the density—is treated as two separate drives by the computer and is accessed as two totally separate logical devices.)

If you find that moving up to 8-in. double-sided, double-density drives still

doesn't satisfy your storage requirements, you can move up to the big leagues by using a hard-disk drive.

**Hard Disks Are Tops.** When your data storage requirements exceed the 100,000-to-500,000-byte capabilities of floppy disks, it's time for you to consider investing in a hard-disk drive. As its name implies, the hard-disk drive uses a rigid medium that almost always is not removable from the drive. (Floppy disks are designed to be inserted and removed from their drives as needed.)

The main attraction of the hard-disk system is its ability to store millions of bytes of data on a single disk. You can get up to 5 megabytes (5,000,000 bytes) with a 5-in. hard-disk system, up to 12 megabytes with an 8-in. system, and up to 20 megabytes with a 10-in. system. Prices for hard-disk drives start in the \$3000-to-\$4000 range for the 5-in. mini. Contrast this to the \$350 to \$500 selling price of the 5.25-in. minifloppy and the \$500 to \$750 for the 8-in. floppy drive.

To gain this tremendous increase in storage capacity (a 5-in. drive can store on a single hard disk as much data as can be stored on as many as 35 5.25-in. floppy disks), storage density is increased from the 48 to 96 tracks per inch (TPI) common with floppy disks to as much as 500 TPI in hard disks. In addition, recording density, which is the number of bits that can be recorded per inch (BPI), has been dramatically increased. To top it all off, access time to data on the disk is typically two to six times faster than with floppy disks.

Most microcomputer systems in which a hard-disk drive is used also have at least one 5.25- or 8-in. floppy-disk drive as backup. With both types of drives available, it is possible to store constantly used software—like operating systems, a BASIC language interpreter, word processor, and business programs—on the hard-disk drive for instant on-line access, while less-frequently used software such as mailing lists, computer chess, etc., go on removable floppy disks that can be removed and replaced as needed according to program requirements.

**Printers.** Sooner or later, everyone who owns a personal computer decides he needs a printer to go with it. For the home user, the initial need may be no more than an urge to have something on paper to show people what he can do with his computer. For the business user, however, a printer can be a very real necessity for letter writing, ledger



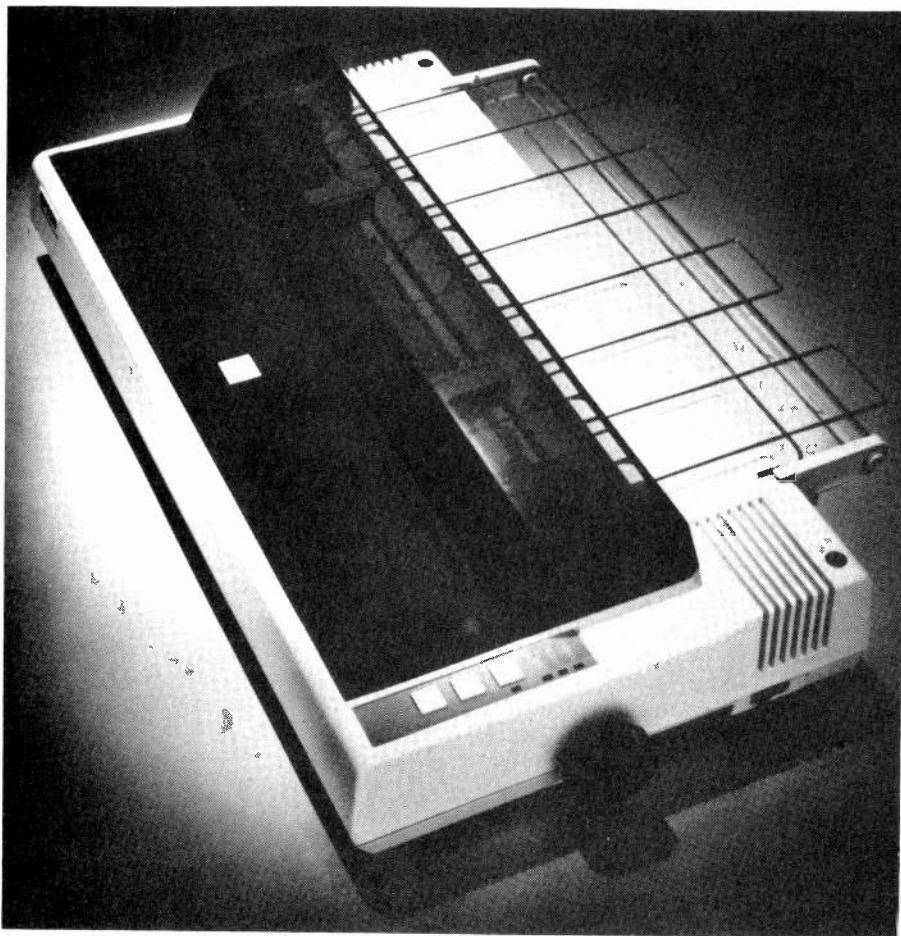

Popular Epson MX-100 dot-matrix impact printer.

keeping, billing, etc.

When we state "printer" here, we mean a print-only device that's designed to use 8½-in. (or wider) paper and can print up to 132 or a minimum of 80 characters per line. We don't mean a printing terminal that comes with a full typewriter-type keyboard, nor do we mean one of the variety of small printers designed to use adding-machine paper rolls and print only 20 characters per line. Although "calculator-roll" printers may have a legitimate place for some computer printing applications, they are by no means suitable for word processing, electronic-spreadsheets, or even the majority of run-of-the-mill computer-games and high-level-language program printouts.

A full-page-width printer is certainly one of the most useful peripherals you can add to a computer system. At the very least, the printer is more practical than a video monitor because it can "display" considerably more information on a single 8½ × 11-in. sheet of paper than can possibly be crammed onto a single video screen. In fact, it would take a minimum of three of the

usual 80-character by 24-line video screens to display all of the information that can be printed on *one* single-spaced 56-line page of standard stationery.

Since you can't make a single video screen display more than one screen of information at a time, you're limited to how much of a document you can view at any given time. This can be very restrictive if you should want to compare two or more similar letters or billing statements. If you had the information printed out on paper, however, you could set pages side by side and directly compare them to each other. With video-displayed copy, you'd have to trust to *your* memory information displayed on a previous screen while you scrutinize the current screen.

**Types of Printers.** For the home and business personal computer, the types of printers used nowadays are almost always of the impact variety. These printers transfer character images to paper in much the same manner as an ordinary typewriter does, by striking through an inked ribbon.

With impact printers, you can use

ordinary stationery (electrostatic and thermal printers require special, usually expensive, paper); reliable printing mechanisms and long-lasting print elements; and the ability to print more than one copy on a single pass, using carbon-paper-interleaved forms. In all, the switch to impact printers has brought many benefits. The only thing that has really been sacrificed is the ultra-quiet operation characteristic of nonimpact printers.

Among impact printers, there are two major categories: dot matrix and formed character. Each has its own features to recommend it and each is designed to fill a different set of needs.

As its name implies, the dot-matrix printer forms all characters by printing a fixed set of dots. The arrangement of dots from which any given character is formed is set by a fixed matrix of so many dots wide by so many high. These are created by automatically activated "wires" in the printhead that are caused to protrude at lightning speed. The matrix may be 5 × 7, 7 × 9, and a greater number of dots.

Since characters from a dot-matrix printer are made up of discrete dots, they aren't continuous and, therefore, may suffer from low legibility. However, many dot-matrix printers permit multiple-pass printing, which allows the printhead to be slightly offset on each successive printing pass to fill in the gaps. As a result, characters appear to be solid and continuous, though slightly ragged. Even so, legibility is vastly increased, resulting in so-called "correspondence-quality" printed copy. Another shortcoming of dot-matrix printers, though minor, is that typefaces (styles) aren't interchangeable. But with some printers, such as the Epson MX-80, among others, a variety of compressed and expanded type faces can be chosen, as well as graphics options.

To obtain "letter-quality" character printouts with a really professional appearance, it's necessary to use a formed-character printer. This type of printer has the advantage of allowing you to choose from a wide range of typefaces that can quickly and easily be interchanged as the need arises.

Within the category of formed-character printers, there are basically two types from which to choose. One is NEC Personal Computer Division's popular Spinwriter printer, which uses a plastic print element known as a "thimble," so-called because of its shape. The other is the "daisy-wheel" printer developed by Xerox and currently used by the company in its Diablo line of printers, Qume, and a number of other manufacturers of

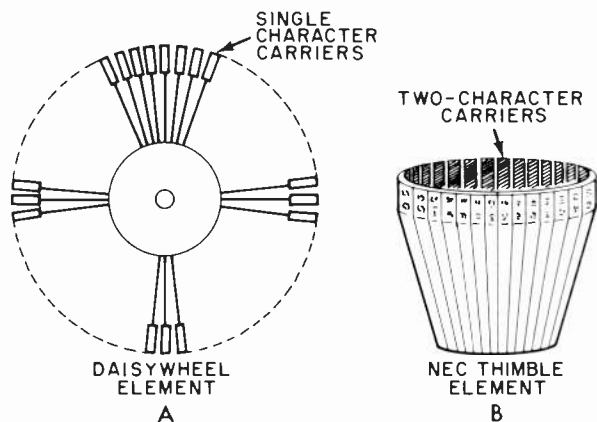

Examples of formed-character printing elements. The daisywheel element is popularly used in letter-quality printers made in the U.S. Thimble is currently used in only the NEC Spinwriter printer.

formed-character printers.

The NEC thimble is made up 64 print arms, each of which has two character slugs on it, yielding a total of 128 possible print characters. By contrast, the daisy-wheel printer uses a print element made up of a central hub from which 96 or more single-character-slug arms radiate, resembling the petals of the daisy flower.

For those people who don't want to tie up a lot of money in a typewriter-quality printer that will be used only a fraction of the time, the Typrinter 221 from Howard Industries is worthy of serious consideration. This fairly new device is basically an Olivetti 221 electronic typewriter that has been converted for use as a full-blown input/output computer terminal. When it's not being used as a terminal (or printer), it still functions as a standard electronic typewriter.

Formed-character printers are much more costly than dot-matrix types. The type of printer you select for use with your computer will depend on a number of factors. Let's take a look at the more important of these:

- **Printing Speed.** The speed at which a printer can type out copy may or may not be important to you, depending on your applications. If you plan to use your personal computer at home for occasional low-volume printing, speed won't be as important to you as it would be if you had a daily moderate-to-heavy printing volume.

As a general rule, dot-matrix printers are faster than formed-character models. Typical speeds range from about 40 to more than 200 characters per second (CPS), depending on how much you spend for the printer. In contrast, formed-character printers are generally much slower, producing as few as 15 to a maximum of about 80 CPS. With either

type of printer, the faster the speed, the more expensive the printer.

Keep in mind that speed for a dot-matrix printer is usually specified for single-pass printing. If you use multiple-pass printing, you should be aware that each pass will consume extra time that must be deducted from the specified figure. Therefore, the dot-matrix printer's speed advantage can be quickly eroded away, bringing actual printing speed down to a range competitive with that of formed-character printers.

Examples of formed-character and dot-matrix printing. Note difference in legibility.



As a rule, bidirectional printers, which can print in both directions, eliminating the time needed for a carriage return at the end of a line, are faster than single-direction models. Most modern printers have this capability.

- **Print Quality.** This is an area in which a buy decision will almost always have to be based on your printing requirements. If your computer is to be used primarily for word processing in which professional-quality printing is a prime requirement, a formed-character printer will be your only choice. On the other hand, if your applications don't require letter-quality printing—but instead are for printing mailing labels, home computing, etc.—you'll probably be better off with a dot-matrix printer

and put the money you save into getting more printing capabilities or something else you might want or need for your computer.

Remember that not all dot-matrix printers are created equal. Different printers in different price ranges offer different features. One of the first things to remember is that not all dot-matrix printers offer multiple-pass printing; with these, you won't obtain correspondence-quality copy. Too, not all printers can print lower-case alphabetic-character descenders, the "tails" on the g, j, p, q, and y that go below the base line of the other letters. An upper/lower-case (u/lc) printer that doesn't have true descenders will print these letters with the bottoms of their tails sitting on the base line. Of course, this may be acceptable for in-house business applications, but it can prove to be disconcerting in some cases.

Another thing dot-matrix printers may or may not be able to provide is true underlining (all formed-character printers offer this capability). Again, you may not consider this an important feature, but if your system is designed for extensive word processing, it's something to take into consideration.

There is one situation where selection

of a printer can be extremely complicated. That's when you need both fast printing speed *and* letter-quality copy. Unfortunately, you're not likely to find a low-to-moderate-priced printer that can provide both. However, if you need both features, but each in a different machine, you have the option of using a fast dot-matrix printer *and* a slower formed-character printer in the same system.

- **Versatility.** Both dot-matrix and formed-character printers are extremely versatile, each in its own special way. The major versatility attribute of the formed-character printer is that it's designed to allow you to quickly and easily change print elements to suit the copy you're printing. This opens the door for you to change type style and even size

(pica or elite) for highlighting, emphasizing, or just to suit a whim.

Another big plus for the formed-character printer is its ability to produce *proportionally spaced* copy to produce an effect indistinguishable from professional printing, like the copy you're reading. Proportional spacing means that the space width for each character is apportioned according to how much space the character actually needs. The letters *i* and *l* and numeral *1* are allotted less space and letters *M*, *W*, *m*, and *w* are allotted more space than the other letters and numerals. (Proportional spacing isn't offered, although it is possible, with matrix printers at this writing.)

As alluded to earlier, many modern dot-matrix printers allow you to choose and mix condensed, normal, and expanded characters with and without boldfacing, without having to change a printhead. Many dot-matrix printers also accommodate the graphics capability built into many computers, allowing you print out pictures that appear on the video display screen, mixing them with any alphanumeric text that might be included in the display, all on the same

sheet of paper. It's even possible to use the graphics capability to create custom character sets for foreign alphabets, math and science symbols, etc. Not all dot-matrix printers have this last capability, however.

• **Price.** Many first-time printer buyers make the error of placing price at the top of their lists of important factors to consider in the buy decision. While price is an important consideration, it should be placed far down on the list because it's too easy to let it lull you into making the wrong decision. Many people have used price as their yardstick for comparisons and ended up either buying a printer that couldn't fill their printing needs or unnecessarily spending money on "bells and whistles" they never needed or even used. The only realistic way of choosing a printer is to first make up a master list of the features and functions you now need and take into consideration your needs in the future and *then* look at prices to see what you can afford for what you need.

Having put price on its proper perspective, let's see what the market has to offer. Dot-matrix printers are usually

considerably lower in cost than formed-character models, ranging for as low as \$300 to a high in the neighborhood of \$1500. You won't find such "low" prices for formed-character printers, which start at \$2000 and can cost as much as \$4000 or more.

From the foregoing, it's obvious that printers are costly items, frequently as expensive as and sometimes more expensive than the computers with which they're used. Equally obvious, it pays to know something about printers to help you make an intelligent decision.

**Modems.** As mentioned earlier, it's possible to use a personal computer as an electronic mail station, to communicate with another remote computer, and to tie in with a data bank. To be able to do this, you'll have to attach your computer to a telephone line. To do this, you'll need a "modem."

The modem gets its name from what it does—MODulates digital data coming out of a computer into the analog signal required by the telephone line and DEModulates analog signals coming from the phone line into the digital form

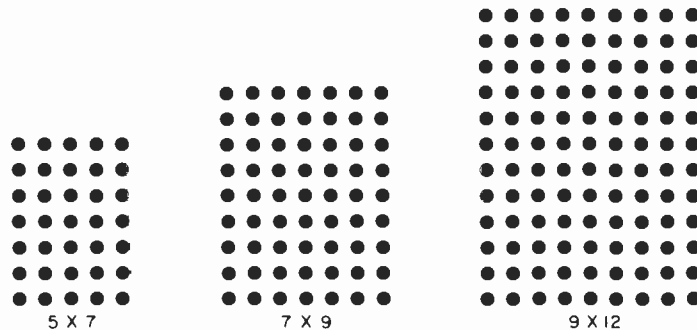

A  
TYPICAL CHARACTER MATRICES

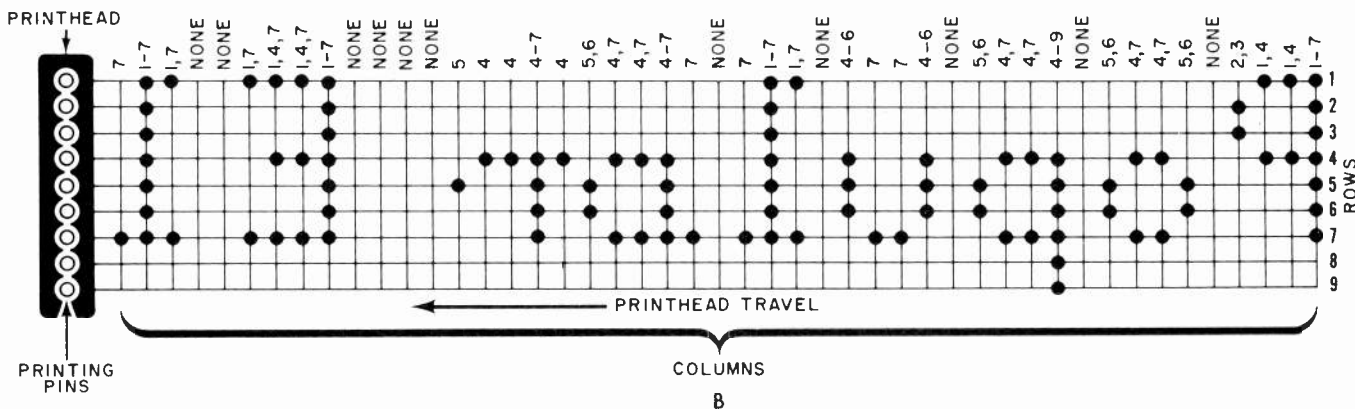

Dot-matrix printhead has a single vertical column of printing pins that are selectively "fired."

required by the computer. Modems can be classified as half-duplex or full-duplex devices. A half-duplex modem allows transfer of data in only one direction at a time. A full-duplex modem adds versatility, permitting data to be transmitted/received simultaneously.

Another way of classifying modems is by the way they connect to the phone line. The simpler and usually least expensive type of modem, known as an *acoustic modem*, makes no direct connection to the phone line. Instead, the modem has built into it a pair of "earmuffs" into which the handset of the telephone plugs. Contained inside one earmuff is a small speaker that feeds data into the handset's microphone,

connect type. The newest and most sophisticated modems, like the Hayes "Smartmodem," can cost up to \$300, but offer such features as Touch-Tone line compatibility, automatic dialing and answering, built-in audio monitor system, and a LED (light-emitting diode) display that allows you to check modem operating status.

**Window On The World.** With a modem, you have access to a whole new world beyond your computer. For example, you can dial up one of the information services—such as Reader's Digest's "The Source" or Compuserve's "Micro-net"—and access a huge data base of information on a wide variety of topics.

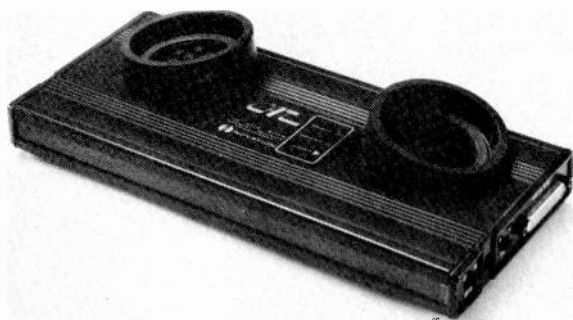

*Novation CAT is typical of acoustic modems used with personal computers. Other modems connect computers directly to telephone lines.*

while the other earmuff has a microphone that picks up data from the handset's speaker. The earmuffs, made from a rubber-like plastic, are designed for a tight fit around both ends of the handset and are virtually sound-proof to prevent external noise from entering the phone line.

About five years or so ago, *direct-coupled modems* began to come into widespread use. This type of modem has the advantage that it isn't susceptible to the interference and noise sometimes encountered with acoustic coupling. Also, the direct-coupled modem doesn't have to work within the mechanical response limits of speakers and microphones and, therefore, can transmit and receive data considerably faster than is possible with an acoustic modem. For comparison purposes, the maximum speed of an acoustic modem for telephone lines is 1200 bits per second (baud), while the maximum for the direct-connect modem is 9600 baud or more.

Suggested retail prices for modems usually start at about \$150 for an acoustic model like the Novation CAT and somewhere around \$200 for a direct-

Alternatively, you can use the electronic-mail facilities of these communication services to send information instantaneously across the country inexpensively.

If you're a news-buff, you can even get the latest news from around the country and around the world hot off the United Press International (UPI) wire before you hear it on radio or TV or read it in your daily paper. All you need do is dial The Source and select the UPI news service. Interested in only a portion of the news? Let the system do the weeding for you. Simply tell the computer/information service to search out and display only those news items in which a key name or word appears. You can even ask the system for last week's news.

Personal-computer-accessible data networks also offer you access to a powerful computer with a wide variety of programming languages from which to choose. Among the other items available are a travel service, a nationwide buying service, and a bulletin-board service, the last allowing you to post a message for every other subscriber to see.

A modem isn't limited to use on just

the large national networks. There are plenty of local electronic bulletin boards, usually set up by local computer clubs and computer stores, that offer useful bits of information for anyone who cares to dial up the service. And in many cities, you can even get the latest astronomy information from your local planetarium. Stock market reports, news reports, weather forecasts . . . the list of services being offered grows almost daily. And all you need to access them are a personal computer and a modem.

**Computers That Talk.** "Talking" can mean more than just a word used to indicate that one computer can communicate with another in their own silent binary language. Thanks to the rapid growth in semiconductor technology, computers can be made to actually converse with you, vocalizing words you can understand.

There are several different ways in which a computer can be made to talk. Some devices have a limited and fixed built-in full-word vocabulary, while others can be user programmed to generate human-like sounds by stringing together small bits of speech known as *phonemes* to generate recognizable words.

The phoneme approach has potentially an unlimited vocalizing flexibility. However, its vocabulary, like that of the fixed-word approach, is generally limited, due to the fact that a tremendous amount of memory is required to store each phoneme within the computer.

To use a phoneme system, a computer must be equipped with an external voice synthesizer accessory. Connected to this accessory is a microphone into which you speak the words you wish to have the computer vocalize, under program control. As the words are spoken, the computer *digitizes* them by breaking them up into many small pieces, assigning a digital code to each piece, and then storing each piece in its own separate location in memory. It's obvious, then, that memory can be quickly used up. Hence the limitation on the number of words that can be used. Even so, the phoneme approach has one major advantage over the fixed-word approach—it produces very natural-sounding speech.

**. . . And Listen.** If a computer can be made to talk, can it be made to listen as well? The answer to this question is a qualified "Yes." The qualification is necessary because the procedure for making a computer listen to the spoken

word is considerably more difficult than that for talking. To begin with, people from different geographical locations on the earth speak different languages. But even if recognition were to be limited to one language, such as English, there is a wide range of variations in word usage, pronunciations, and accents with which the computer would have to contend. Since the computer is a very literal device, it wouldn't be able to grasp that the same word pronounced slightly differently is indeed the same word.

Even though you can't make your computer recognize what everyone says to it, you *can* "train" it to recognize and differentiate between a few people who speak particular key words. Hence, one advantage to the hearing limitation is that voice recognition can be used to prevent unauthorized use of your computer.

A computer's voice recognition is accomplished by repeating five or 10 times into the microphone of the speech-recognition device the words to be recognized. A computer program (software) supplied with the device analyzes the analog signal created by the spoken words with each repetition and stores the digital code for the pattern in memory. This pattern code can then be recalled from memory at a later time.

As with the phoneme vocalizer mentioned above, the vocabulary, or number of words, that can be stored in memory is very limited.

**Up And Running.** To be able to easily use disk drives and other peripherals with a computer, the computer must know which devices are available, what they do, and how to use them. For this, the computer needs an "operating system," or, in the case of a disk-based computer, a "disk operating system" (DOS).

An operating system is responsible for the computer's "housekeeping." Stated simply, it is a program that interfaces between the user and/or software and the computer. All commands sent to the computer are executed by way of the operating system.

If the same operating system is used in a wide variety of computers, users of these computers are relieved of the need to have to learn more than a few simple basics to be able to operate any one of these machines. More importantly, software developed on one computer can be used on any other computer that uses the same operating system.

A relatively universal operating system is CP/M, which stands for control

program for microcomputers. Originally developed by Digital Research for the 8080 microprocessor, CP/M can also be used in any computer that uses a Z80 or 8085 microprocessor, since both contain the entire instruction set of the 8080 on which the operating system is based.

Recently, Digital Research released a new operating system for microcomputers that use the 8080, 8085, and Z80 microprocessors. Called MP/M, it is

ers often supply operating systems that work only in their computers and aren't compatible with the CP/M operating system. Examples of these are the Apple DOS and SOS supplied with the Apple II and III computers, HDOS (Heath disk operating system) offered for the Heath/Zenith H/Z89, and TRSDOS supplied with Radio Shack TRS-80 computers. Because Radio Shack doesn't license TRSDOS to outside ven-

Period	8	9	10	11	12	Period	Percent
Income	2000	2000	2000	2000	2000	Income	
Mortgage	600	600	600	600	600	Mortgage	0.31
Utilities	85	50	50	100	140	Utilities	0.04
Telephone	75	75	75	75	75	Telephone	0.04
Food	350	350	350	350	350	Food	0.18
Clothing	120	120	120	120	120	Clothing	0.06
Car Expen	80	80	80	80	80	Car Expen	0.04
Car Insur						Car Insur	0.01
Savings	150	150	150	150	150	Savings	0.08
Leisure	540	575	575	525	480	Leisure	0.22

On-screen video display of computer information. Note that characters can be either white on black or black on white (reverse video).

basically the same as CP/M, but it's designed to be used in systems in which more than one terminal is connected to the same computer. Because of its basic similarity, MP/M is fully compatible with software developed under CP/M.

Availability of CP/M has made it easier for new computers to be accepted as they're introduced. When Xerox introduced its personal computer last year, for example, CP/M was made immediately available for it, giving an almost instant base of programs for the owners to use.

Although CP/M is perhaps the most well-known operating system, it's not the only one in widespread use, especially not for 6502-based computers, with which it's not compatible. Manufactur-

dors, several different software houses have developed their own operating systems for the TRS-80 computer: LDOS from Lobo International, OS-80 from Percom Inc., and DOSPLUS from Micro-Systems Software Inc.

Since Apple computers are built around the 6502 microprocessor, users are not normally able to use the large software base written under CP/M. However, a recently introduced board from Microsoft that plugs into Apple computers provides Z80 emulation that allows a modified CP/M to be used in these machines. With this board installed in the computer and system operation under CP/M, Apple computers can run programs written under this popular operating system.



**Computer Languages.** If you decide to buy a personal computer for your home or business, be prepared to learn a new language. As you already know, computers do not converse in English or whatever human language you currently speak. Since the computer is unable to accommodate you, you'll have to accommodate the computer. This isn't as bad as it sounds, since most "high-level" computer languages written to make the user more comfortable with computers use English-language terms.

The most primitive language, termed "machine language," is the one the computer understands and responds to directly. This is a language you'll probably never use, since it's composed entirely of octal (base-8) or hexadecimal (base-16) numbers. (Octal uses the numerals 0 through 7, while hexadecimal uses the numerals 0 through 9 and letters A through F. To avoid confusion, octal numbers are tagged with a "Q" suffix, hex numbers with the letter "H.") Because machine language is very difficult to master, very few people ever get involved in using it. What makes machine language very appealing is that it executes programs much faster and requires considerably fewer steps in programming when compared to high-level languages.

Computerists who wish to write programs in machine language to obtain its benefits can use "assembly language," which substitutes English-like words and abbreviations for instructions to the microprocessor. Known as "mnemonics," these abbreviations are chosen by microprocessor manufacturers to help the programmer to more easily remember what particular action they initiate. For example, the mnemonic LDA stands for Load the Accumulator with a particular value.

As you might have guessed, there are many different assembly languages, a different one for each microprocessor in use. Fortunately, once you learn to program in one assembly language, it's a relatively easy task to pick up on another such language. Procedures for using each of these different languages generally follow the same rules. All that really changes is the form of the mnemonics.

Although assembly and machine languages are fast and concise, they aren't "user friendly" and, thus, not comfortable for human operators to use. Therefore, to increase operator efficiency, a number of high-level languages—so called because they're more human in nature—have been developed to simplify human/computer interaction.

Most common among high-level languages is BASIC, which is an acronym for Beginner's All-purpose Symbolic Instruction Code, if for no other reason than it is the most conversational and easiest to learn. BASIC was developed in 1965 at Dartmouth College under a grant from the National Science Foundation by a research team headed by John Kemeny and Thomas Kurtz.

From its humble beginnings, BASIC has grown into a major computer programming language.

Although much of the BASIC interpreters available to personal-computer users were written in a company named Microsoft, not all versions are the same. Some versions have features lacking in others. A typical example is the PRINT USING command in Radio Shack's version of BASIC, which makes it easy to format numbers for print-out. This command is absent in Apple and Commodore versions of Microsoft's BASIC.

Microsoft isn't the only software house supplying BASIC to computer users. Other software houses have their own versions of the language that aren't compatible with Microsoft BASIC. Examples include Atari, North Star, and Apple Integer BASICs. Some things are common to these three versions of BASIC. All three handle text in roughly the same manner, but this manner is completely different from the way Microsoft BASIC handles text. Some converting of programs from one version to another may present difficulties, however.

Much of the reason for the incompatibilities between different versions of BASIC, even when the languages are similar, can be attributed to differences in the way commands are written. PET and Apple BASIC, for example, have a GETS command that can be implemented in Radio Shack BASIC only by using the format INKEY\$.

Perhaps most frustrating is trying to get a program written in one version of BASIC to run in a computer that uses a different version that doesn't have one or more commands called for by the program. If you're able to load a program into your computer and it won't run, the BASIC interpreter will usually stop at each occurrence in the program where an error occurs and inform you which line in the program to check. You can then inspect each line and compare all statements in it against the list of possible commands in your BASIC manual to determine why.

BASIC is available for microcomputers in interpreter and compiler implementations. Interpreter BASIC is what

is usually distributed for personal computers. In this implementation, each line in a program is converted (interpreted) into language the computer understands *while the program is running*. What this means is that the computer must waste a great deal of time during interpretation that can better be used for computing. Consequently, interpreter BASIC's major disadvantage is that it is very slow.

The major advantage of interpreter BASIC is that it is *interactive*. That is, if an error is discovered within a program written under interpreter BASIC, it can be rectified and immediately tested. Some interpreter BASICs test each line as it's entered for correct format and instructions and return an error message if everything isn't okay in the line, permitting you to make immediate corrections without having to "debug" the program as it's running. Other BASICs skip this step and return error messages during program operation.

Compiler BASIC, also known as C BASIC, is much faster and uses less memory than interpreter BASIC, because it translates programs directly into machine language, using object codes that take up less memory than English-language-like words. Because compiled BASIC programs are already in a language directly usable by your computer, no time is wasted in interpreting during program execution.

One doesn't obtain the advantages of a compiler without having to sacrifice something. The penalty here is that compiler BASIC is a *noninteractive* programming language. Original programming errors won't be known to you until *after* you compile and run a program. If errors are detected during a compiler-run (CRUN) operation, the program will abort and you'll have to return to your original program listing (source code) to make the appropriate changes. Fortunately, when the program aborts, the compiler will tell you how many errors were detected and exactly where in the program to find them. Once a program has been edited to eliminate errors, it must be recompiled and run.

The manner in which interpreter and compiler BASIC are used is completely different. With interpreter BASIC, you load the language into your computer and, when the prompt (the word "READY," a blinking cursor, etc.) comes up on the screen of the video display, start typing in your program. You must give each consecutive line of your program a unique consecutive whole number code. Without the number code, the interpreter will remain at command

level and immediately execute typed-in instructions as soon as a carriage return is made. In the command mode, the results of the instructions will be displayed, but the instructions themselves will be wiped out of memory. Once the program is keyed in, you save it on disk (or tape), giving it a unique file name by which it can be recalled at any time in the future.

With compiler BASIC, you do things differently. Firstly, you don't load the compiler into your computer. Instead, you load the editor utility from CP/M or other operating system or a word-processing package like "WordStar" or "Magic Wand." When you write your program, you must be very careful to use only those commands available in C BASIC and the proper format (syntax), but you don't have to assign number codes to each line except under clearly defined circumstances. If you wish, you can use line numbers, but you aren't restricted to just whole numbers.

Once a program is keyed into a computer via a text editor, it is saved on disk as a *source-code listing* under a unique file name. Then, to compile the program, you invoke the compiler BASIC (CBAS) utility and tell it to compile the source-code listing. The compiler now converts the source code into the compacted *object code* and stores the now-compiled program on disk. Finally, to run the compiled program, you simply type in CRUN (for compiler run) and

*Atari 800 has facilities for installing extra memory and game and program cartridges. Disk drives, cassette deck are optional; color-TV receiver is user supplied.*



the file name for the program.

If you decide to do all your programming in BASIC, the ideal situation would be to have on hand both interpreter and compiler versions of the language. However, if you're new to computers and programming, and decide to use only one version, you'll probably be better off choosing an interpreter BASIC unless you know you'll be needing the compiler's speed when you initially put together your system.

**Other Language Choices.** Although BASIC is the most popular high-level language used in modern personal computers, it's by no means the only one. FORTRAN and COBOL, two languages that originated with large mainframe computers, have recently become available for microcomputers with only a few compromises.

FORTRAN, which is an acronym for FORMula TRANslation, was developed by IBM in the mid-1950s for use by scientists and engineers. It has now proven extremely popular with personal computer users who have a need for math-oriented programming capability. COBOL, which is an acronym for Common Business Oriented Language, is probably the most widespread language in use for business programs. Developed by the Department of Defense in 1960, COBOL has only recently become available in a form usable in personal computers.

Pascal is a rising new star on the personal computer scene. Named after the seventeenth century mathematician, Blaise Pascal, it was developed in 1970 by Dr. Niklaus Wirth of the Federal Institute of Technology, Zurich, Switzerland. Pascal is different from many other high-level languages owing to the fact that it requires that programs be written according to a very rigid format. For most people who are first introduced to Pascal, its rigid-structure format may appear to be overly cumbersome. However, the language works out very well when used to write long programs.



*Apple's top-of-the-line Apple III comes with business graphics software for displaying on-screen easy-to-read charts and graphs, optionally in full color.*

The reason for Pascal's rapid growth in popularity is hardly due to the fact that this is a great language. Its success is due mainly to the fact that it's being widely taught in colleges and universities.

The one characteristic that FORTRAN, COBOL, and Pascal share in common is fast execution time. All three of these programming languages are compiler based.

Lesser-known languages that are enjoying limited use in personal computers include FORTH, LISP, LOGO, and PILOT. However, for now, the big four prevail on the personal computer scene, with BASIC leading the way, followed by FORTRAN, COBOL, and Pascal.

**What's Available.** Now that you know something about computers and the peripherals and software that make them into practical systems, let's take a brief look at some of the more popular personal computers on the market.

Apple Computer Company's Apple II and Apple II Plus are good examples of general-purpose computers that have a large following. These 6502-based, high-resolution color machines can be used for just about anything a personal computer is capable of doing, from games playing to educating students to managing a small business.

In its standard configuration, the Apple II comes with an integral upper-case-only typewriter keyboard terminal; 48K (49,152 bytes) of user RAM; 16-color palette (for low-resolution graphics); seven slots for user expansion; composite video output; Integer BASIC; and cassette I/O facilities. The Apple II Plus is the same computer, except that it comes with Applesoft Floating Point BASIC.

Both Apple II computers are designed to be used with an optional color monitor or with an optional r-f modulator and a standard color TV receiver. As configured, these computers are capable of generating on-screen 24 lines of 40 characters per line.

Owing to their great popularity, these Apple computers are heavily supported with additional hardware and software by Apple and a number of outside vendors. Among the hardware items being offered as options are disk drives, printers, lower-case character generators in both 40- and 80-character line formats, sound synthesizers, light pens, Z80 emulator module (permits use of software written under CP/M), and lots more. Available software is no less impressive, ranging from dozens and dozens of

games to home finance to a wide variety of packages designed for business applications. There are also several high-level programming languages available, among them interpreter BASIC, Pascal, FORTRAN, and Pilot.

Apple also has a professional system, the Apple III, designed as a total system for the business user. This 6502-based color-capable machine comes with a number of peripherals and other items that are usually optional add-ons with other computers. In its normal configuration, the Apple III is supplied with 128K of user RAM; RS232C serial, Silentype™ printer, and external-sound interfaces; four expansion slots; several high-resolution graphics modes; integral

electronic spreadsheet; "AppleWriter III" word-processing package; Business Graphics package; Mail List Manager; "Access III," which allows the computer's smart terminal to access large main-frame computers; and an Apple II emulator that allows the Apple III to run most Apple II programs.

Atari, Inc., of video games fame, offers two 6502-based color computers, both with high-resolution graphics capability. The Atari 400, an entry-level computer, features a touch-sensitive (instead of the usual typewriter-style) keyboard, a slot for plugging in preprogrammed games and applications cartridges, and a 16-color palette. It's supplied with 8K of RAM, only 5K of

*Commodore's PET 2001 professional computer has built-in integral video display monitor, keyboard addressable graphics, and separate numeric keypad.*



typewriter-like keyboard with separate numeric keypad; and 140K-byte 5.25-in. minifloppy drive. Also included in the standard package is a black-and-green video display monitor that can handle the full upper-case character set in a 24-line by 80-character-per-line format.

Optional hardware for the Apple III include a 16-color graphics video monitor with RGB inputs; 5.25-in. minifloppy drives (up to three can be added to the system); 5M (5,000,000) byte hard-disk system; hard-copy printers; and modems. Not all of these items are available from Apple, however.

Software for the Apple III includes Apple's own Sophisticated Operating System (SOS); Business BASIC; UCSD Pascal; COBOL; "VisiCalc"

which is user accessible; 8K of ROM, which contains the system monitor (a type of operating system) and interpreter BASIC; four independent sound synthesizers; and a built-in r-f modulator. System RAM expansion is possible, but to only 16K, while ROM can be expanded to 16K, via plug-in ROM cartridges.

While the Atari 400 is, indeed, a computer by definition, it's basically a super games player with limited user programming capabilities. It might be adequate for the home user who has no need or desire to build a full-blown computing system, but it doesn't meet minimum requirements for serious business applications.

The Atari 800, on the other hand, is suited for very-small-business and professional applications, as well as for

## ...Computers...

home use. In its standard configuration, the 800 is basically the same machine as the 400, except that it has a standard typewriter-style keyboard and can be expanded for up to 48K of RAM.

Both the 400 and 800, designed to be used with a user-supplied standard color TV receiver, are capable of displaying on-screen 12 lines of 38 characters each. Optional peripherals for both machines include: cassette deck for mass storage; games controllers; an interface module to permit expansion; 40- and 80-character-line dot-matrix printers; and an acoustic modem. Additionally, the 800 can be equipped with up to four 5.25-in. minifloppy drives to provide a total on-line capacity of 370 K bytes.

*Commodore Business Machines* has a number of offerings for the personal computerist. At the low-price end is the VIC 20 color computer, a 6502-based machine that's designed to be used with any standard color TV receiver, via its built-in r-f modulator. The standard VIC 20 configuration offers 5K of user RAM; interpreter BASIC in ROM; programmable sound generator; joystick controller; paddles; light pen; and typewriter-style keyboard. A facility for accommodating plug-in games and applications cartridges is also provided. Display format is 23 lines of 22 characters per line, and display capability includes high-resolution graphics. User RAM can be expanded to a 32K bytes.

Commodore's PET 2001-8 and 2001-16 Personal Computers, both 6502-based machines, offer 8K and 16K of user RAM, respectively. While the 2001-8 comes with a built-in cassette deck, this is an optional external item with the 2001-16. Both come with integral dedicated monochrome video display monitor, capable of displaying 25 lines of 40 characters per line. Prices for the PET 2001-8 and 2001-16 are

The PET 2001 Professional Computer is basically the same as the 2001-8 and 2001-16, except that its typewriter key-

*Hewlett Packard's HP-85 computer has an integral 5-in. video display monitor, tape cartridge storage, 32-character-per-line printer.*

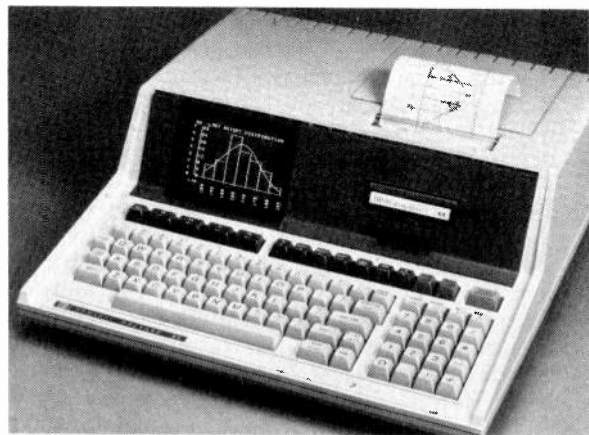

board is supplemented by a separate numeric keypad and programmed graphics characters are available from the keyboard. User RAM in this machine can be expanded to 32K, and an optional cassette deck is available.

Similar to the PET 2001 Professional Computer, the Commodore CBM 2001 Business Computer provides a 25-line by 80-character-per-line display capability. It also has an advanced operating system for managing computer operations and accessing optional peripherals and a screen editor that simplifies the user's task of operating the computer.

All PET and CBM computers come with 14K of ROM, which contains Microsoft interpreter BASIC. ROM expansion can be to a maximum of 22K bytes. These computers also come with their own integral dedicated monochrome video display monitors.

Commodore's final offering is the CBM 8096. This machine contains 96K of RAM, which permits operation under FORTRAN and COBOL and provides plenty of user memory for extensive-document word processing. In line with the computer's intended professional use, its display format, on its integral dedicated monochrome video monitor is

24 lines by 80 characters each.

A wide range of peripherals and software are available from Commodore and outside vendors.

The *Heath Company* offers the H89 "all-in-one" microcomputer in kit form for the professional and home user. Also available wired as the Z89 (from Heath and parent company Zenith Data Systems), this computer "system" contains the computer with 48K of user RAM; an integral dedicated monochrome (black-and-white or black-and-green) video display monitor; and single-sided, single-density 5.25-in. minifloppy drive, all housed in a terminal-size cabinet. In its standard configuration, the H/Z89 comes with a typewriter-style keyboard with separate numeric/control keypad and eight user-definable keys, CP/M capability, and three RS232C serial ports with built-in interfaces. User RAM can be expanded to a system maximum of 65K bytes.

In addition to providing upper-case and true-descender lower-case characters, the display can be in mixed standard and reverse video. Also built into the H/Z89 are 33 preprogrammed graphics characters that are accessible directly from the keyboard. Display format is 24 lines by 80 characters per line, and a software-controllable 25th line is available. Separate Z80 microprocessors are used in the computer and sophisticated terminal.

Hardware is available for expanding the H/Z89's on-line storage capability with extra 5.25-in. minifloppy and 8-in. standard floppy-disk drives, and a 5-in. Winchester hard-disk drive can put up to 12M bytes on-line. The system can also accommodate hard-copy printers and a modem. Software support is very extensive. Most of what Heath and Zenith have to offer are professional



*Heathkit H89 is the kit version of Zenith's Z89 all-in-one microcomputer. It features an integral smart terminal, video display monitor, 5.25-in. floppy-disk drive, 48K of RAM, and three I/O ports.*

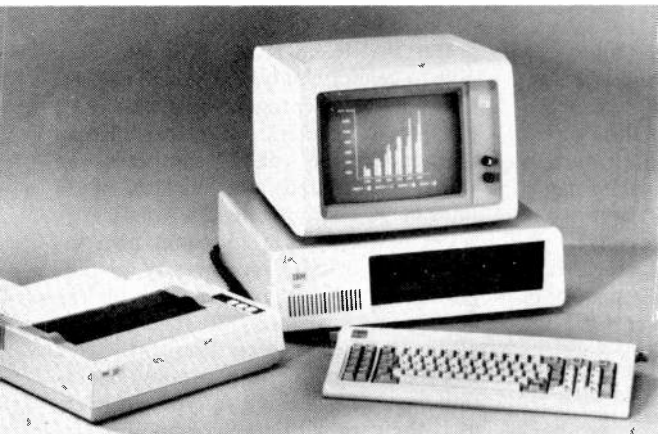

*IBM's Personal Computer is a 16-bit machine. Full system shown here consists of computer with detachable keyboard, dual disk drives, and video monitor.*

business software packages, but a wide range of home-user programs are available from the Heath User's Group (HUG). High-level languages include Heath's own Extended Benton Harbor BASIC interpreter; Microsoft interpreter BASIC-80; C BASIC; UCSD Pascal; Microsoft FORTRAN; and Microsoft COBOL-80. Other software includes: CP/M and HDOS (Heath Disk Operating System), "SuperCalc" electronic spreadsheet, Condor Data Base Management System, Peachtree's business management programs, and no less than three different word-processing software packages.

Hewlett-Packard offers a pair of personal computers, designed primarily for professional use by scientists, engineers, and business analysts. The HP-85 and HP-83 both use a proprietary microprocessor designed and manufactured by Hewlett-Packard and are the same basic computing machine. The two differ only in what they have to offer beyond the computer itself. Among the standard features to be found in both machines are: typewriter-style keyboard with separate numeric keypad and two banks of extra keys for user-defined and system control functions; integral dedicated 5-in. monochrome video display monitor; four I/O expansion ports; 16K of user RAM; high-resolution graphics mode with plotting capability; and upper/lower-case character set with true lower-case descenders. The whole is housed in a case smaller than most office electric typewriters.

User RAM in both H-P machines is expandable to 32K bytes, with optional plug-in modules. Display format is 16 lines of 32 characters each. However, up to 64 lines, stored in a display buffer, are available for viewing, accessible with up/down scrolling. An interpreter BA-

SIC in ROM also comes with the computers.

The HP-85 differs from the HP-83 in that, in addition to all the above features, it has a built-in thermal printer and tape-cartridge storage system. The bidirectional printer, which also operates in the graphics/plot mode and can print out anything that can be displayed on the monitor, has a 32-character line capacity and an underline capability. The tape cartridge drive uses proprietary magnetic tape cartridges, each of which can store up to 217K bytes of program data.

Both computers are designed to accept a variety of optional add-ons, via their expansion ports. Among the items available from H-P are floppy-disk drives, full-size hard-copy printers, and graphics plotters.

IBM, of mainframe computer fame, has a personal computer that's oddly enough called simply the IBM Personal Computer. This is a 16-bit machine, built around the Intel 8088 microprocessor. A color-capable computer, the Personal Computer's minimum system configuration consists of a detachable typewriter-style keyboard; 16K of user RAM; 40K of ROM, which contains the operating system and interpreter BASIC; a TV receiver adapter; and a cassette port for an optional cassette deck.

A full IBM Personal Computer system includes 64K of user RAM; a 12-in. monochrome video display monitor; two 5.25-in. minifloppy drives; and a full-size dot-matrix impact printer. Options for this computer include a full-color video display monitor and adapter, joysticks, and a light pen.

The computer's microprocessor-controlled keyboard has 83 keys, including 10 for numeric entry/cursor control and another 10 that can be user defined. The

keyboard can access a 256-character set, which includes full upper/lower-case alphanumeric, foreign-language characters, Greek and scientific symbols, and line graphics characters.

The disk drives in the IBM Personal Computer are single-sided, double-density units, each capable of storing up to 320K bytes of data.

The monochrome video monitor can display up to 25 lines of 80 characters per line, using upper-case and true-descender lower-case characters. Characters can be displayed against three background shades and can be blinking, underlined, displayed high intensity, and in standard and inverted video. There's also a nondisplay mode for security purposes. An optional add-on module is needed for using a color video monitor.

Available software for the IBM Personal Computer pegs this machine as a professional system. In addition to the disk operating system (DOS) on disk, the primary high-level programming language available is a fast Microsoft interpreter BASIC, but a Pascal compiler is also obtainable. Other professional software includes: "VisiCalc" electronic spreadsheet, "EasyWriter" word-processing package, Peachtree software, etc. By the time you read this, CP/M-86 (CP/M adapted for 16-bit microcomputers) will probably be available too.

NEC America, Inc. of Japan is marketing the Model PC-8001 personal color computer for both business and home use. This Z80-based machine features a typewriter-style keyboard with separate numeric keypad; 24K Microsoft interpreter BASIC in ROM; 248 displayable characters; and high-resolution RGB color video display monitor. It has an 8-color palette and can be expanded for up to 64K bytes of user RAM.

The displayable character set for the PC-8001 includes full upper-case and true-descender lower-case English alphanumeric characters, Japanese katakana characters, and graphics characters. The computer can display on-screen a maximum of 25 lines by 80 characters per line. However, the user has the option of selecting 80-, 72-, 40-, or 36-character lines by 25 or 20 lines deep. Display capabilities also include underlining, flashing characters, and mixed standard and inverted video.

Options for the PC-8001 include disk drives (up to four can be used in the system), printers, two RS232C serial ports, a parallel port, and an IEEE-488 bus.

Osborne Computer Corp.'s "all-in-





*Osborne Computer Corp. Osborne-1 is an all-in-one "computer in a suitcase." It has a detachable keyboard, a built-in 5-in. video display monitor, and two 5.25-in. floppy-disk drives. Optional 12-in. video display monitor is also shown at left.*

one" Osborne-1 personal computer requires addition of only a hard-copy printer and a modem to convert it into a full-blown computing system. This computer comes with a complete hardware/software "system" in a small overnight-case-size package that's truly portable. (It can even be powered from an optional battery pack when ac line power isn't available.) Everything needed to make this into a computing system (minus printer and modem, of course) is built in, including a full 64K of user RAM.

The Osborne-1's standard configuration consists of a Z80-microprocessor based computer with full maximum user memory; detachable typewriter-style keyboard with separate numeric keypad; integral dedicated 5-in. video display monitor "window;" and a pair of 5.25-in. single-sided, single-density minifloppy drives. In addition, the computer has an RS232C interface port, a parallel port that mimics the "Centronics standard" interface (IEEE-488 bus), and an external-video connector that permits use of a larger video display monitor.

Due to its small size, the 5-in. video display in the Osborne-1 is capable of displaying only 24 lines of 54 characters each. However, with up/down/left/right scrolling and use of 4K of RAM, it will let you view a full 32 lines of 128 characters per line. With an external 12-in. or larger monitor, you can tell the computer to display 24 lines by 80 characters. In both cases, the video screen can display upper-case and true-descender lower-case alphanumeric characters, and individual portions of the text can be highlighted by underlining or by mixing full and half-intensity characters.

Software supplied with the Osborne-1 at no extra cost represents a profession-

al/business package. It includes: CP/M operating system; Microsoft interpreter BASIC-80, C BASIC, full-implementation "WordStar" word-processing package; "Mail Merge;" and "SuperCalc" electronic spreadsheet.

Sinclair Research Ltd., a British company, has a very inexpensive, very compact personal computer you might want to consider if you don't want to tie up a lot of money. Called the ZX81, it's available factory wired for \$149.95 or in

*Sinclair Research's ZX80 microcomputer, no longer available, was forerunner of ZX81, currently available in both wired and kit forms. ZX81 features a pressure-sensitive keyboard, built-in TV interface, and one-key entry of common BASIC commands.*

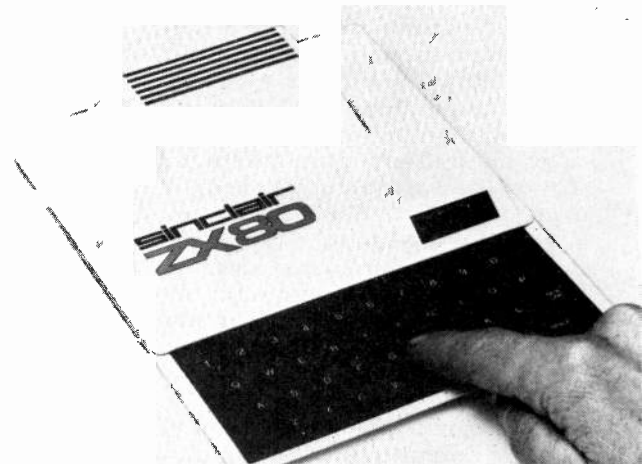

kit form for \$99.95; otherwise, both versions are identical.

As configured, without optional additions, the ZX81 comes with Z80A microprocessor, pressure-sensitive (not typewriter-style) keyboard, audio interface for a cassette deck, and an r-f modulator that connects to a standard TV receiver via a supplied TV/game isolation switch. Built into the computer are 4K of user RAM and an 8K extended inter-

preter BASIC in ROM. The system is able to generate only upper-case characters but has preprogrammed into it 20 graphics characters. On-screen display is monochrome (black characters on white background) and consists of 24 lines of 32 characters each.

On power-up, the computer goes directly into BASIC and is ready for programming. A unique feature of the ZX81 is its keyboard shift function that allows the user to key in frequently used BASIC commands in a two-key operation, instead of having to type out each, as is the case with other computers.

User RAM for the ZX81 can be expanded by 16K bytes, simply by plugging into a slot at the rear of the computer an optional RAM cartridge.

An optional 32-column printer is available for the ZX81. Anything that can be displayed on a video monitor (TV receiver) can also be printed out, including alphanumerics and graphics.

Tandy Corp., through its subsidiary, Radio Shack, is marketing a whole series of personal computers designed for virtually every business, professional, educational, and home need. Aimed at the home user, the TRS-80 Color Computer is the lowest-priced machine

in the line. This computer is built around a Motorola 8-bit MC6809E microprocessor. It comes with a minimum of 4K of user RAM; Color BASIC in 8K of ROM; typewriter-style keyboard; tape recorder interface; interface for two joysticks; RS232C serial interface; and a slot for plugging in games and applications cartridges.

Designed to be used with any standard color TV receiver, via its built-in

If you like to make things work...and then find out why they work—

# you could be getting paid for doing something you really enjoy!

Learn electronics...right on up to an Associate Degree...in your own home without giving up your present job or income.

People who really like their work get ahead faster. And, when your natural abilities match the job requirements, you have an extra advantage. When you use practical training to sharpen your skills, your odds are better for keeping your job even if others are losing theirs. So, if you find satisfaction and interest in making things work, a career in electronics may be for you.

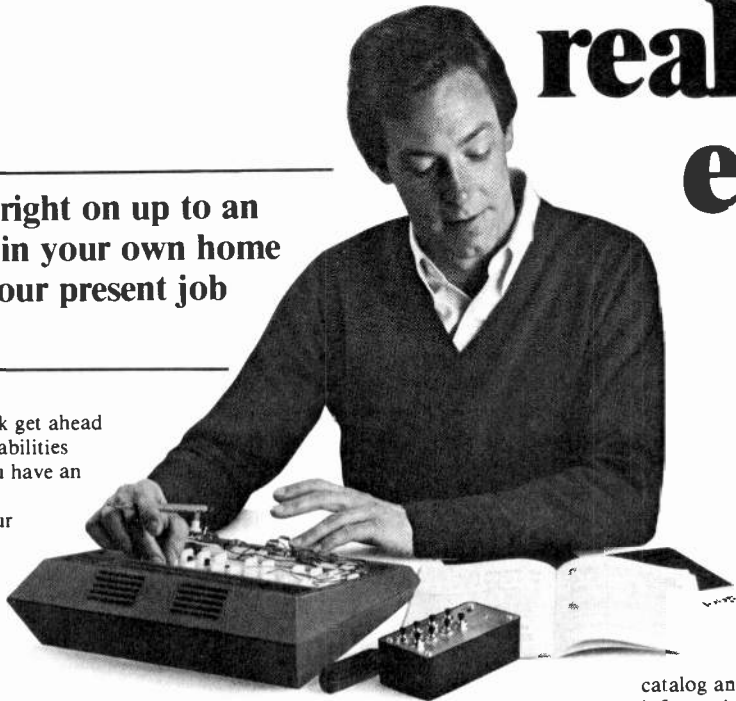

## START MAKING THINGS WORK FOR YOU

Send today for the CIE school catalog and complete package of career information. It's all FREE, and it will help you decide where you want to start and how far you want to go. For your convenience, we'll try to have a school representative contact you to review the various educational programs and assist in course selection. Just mail the postage-paid card or write, mentioning the name and date of this magazine. We want to help you make things work, so send for your FREE school catalog today!

## WHY ELECTRONICS IN THE 80's

### Opportunity.

The field of electronics simply offers more career opportunities — and more job security — than most other fields today. Take digital technology, for example. Much of the new telecommunications, data processing, and production equipment depends upon sophisticated microprocessors to receive, sort, and send digital signals in microseconds. Two of CIE's newest home study courses combine digital electronics theory with actual experience on digital equipment. Successful completion of either one of those courses is creditable toward CIE's Associate Degree program. That's right...you can earn an Associate Degree without attending a single class session.

## MAKING THINGS WORK

Many of CIE's Career Courses stress "hands-on" training. We believe textbook knowledge is important — but it's just as important to know to apply your book learning in practical situations. From basic circuitry in CIE's Personal Training Laboratory in several Career Courses, through the Microprocessor Training Laboratory, CIE helps channel your desire to "make things work" into skills you can sell.

## IN A CLASS BY YOURSELF

One of the great benefits of home study is the independence it gives you. You study where and when you want to. You move as fast as you can handle it. There's no classroom to go to because with CIE, the classroom comes to you! But, you're never alone. When you request help, the CIE electronics expert best qualified will personally respond in writing.

## SET YOUR OWN GOALS

CIE's wide selection of courses gives you many options. You start with a Career Course that suits your talents. Then, since more than half of CIE's courses include a series of optional lessons to prepare you to pass the government-administered FCC License exam, you can get an FCC License...a requirement for *some* electronics jobs and a credential for *all* electronics jobs. You may then go on and earn an Associate in Applied Science Degree in Electronics Engineering Technology. It's all up to you!

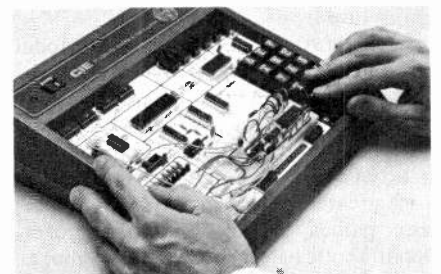

*CIE's Microprocessor Training Laboratory, an integral part of the Associate Degree program, lets the advanced student apply digital technology in many of the same ways electronics professionals do.*

**CIE** **Cleveland Institute of Electronics, Inc.**  
1776 East 17th Street, Cleveland, Ohio 44114  
Accredited School National Home Study Council

r-f modulator, the TRS-80 Color Computer has an 8-color palette and is capable of displaying on-screen 16 lines of 32 characters each of upper-case-only alphanumeric and graphics characters.

Available in both 16K and 32K RAM versions, as well as the basic 4K version, the TRS-80 Color Computer comes with extended color (interpreter) BASIC for machines with memory to support it. Optional equipment for the computer include a cassette deck, joystick controllers, a wide range of games and applications program packs, 5.25-in. minifloppy drives (up to four drives can be used), and hard-copy printers.

The TRS-80 Model III "all-in-one" personal computer is built around a Z80 microprocessor and can be tailored to suit user needs. In its minimum configuration, it contains 4K of user RAM; 4K Level I interpreter BASIC in ROM or 14K Model III interpreter BASIC in ROM; typewriter-style keyboard with separate numeric keypad; integral dedicated 12-in. black-and-white high-resolution video display monitor; cassette-deck interface; and internal expansion capabilities.

Any TRS-80 Model III can be fully expanded to include 48K of internal user RAM; up to four double-density 5.25-in. minifloppy drives, two in the computer housing and two external; a variety of hard-copy printers; and acoustic and direct-connect modems. Among the software items available for this computer from Radio Shack are TRSDOS disk operating system; disk interpreter BASIC; business applications and utility programs; "SCRIPSIT" and "SuperSCRIPSIT" word-processing packages; data base and management planning packages; and programs for home and family use.

Like the Apple II, the TRS-80 Model III is heavily supported by outside vendors. Just about every hardware peripheral that can be connected to a computer is available. And software support is just as extensive, including CP/M and other sophisticated operating systems, computer games, business and other professional applications software, and more.

Moving up to professional personal-computing systems, you'll find the TRS-80 Model II. This Z80A-based machine employs separate microprocessors for the computing and keyboard/terminal functions. It can be configured to contain a full 64K of user RAM (minimum supplied is 32K), up to four 8-in. double-density floppy-disk, and four 8.4-M byte hard-disk drives. Additionally, it can support a host of other peripherals,

including a choice of formed-character and dot-matrix impact printers, plotters, and modems.

The basic TRS-80 Model II consists of a detachable typewriter-style keyboard with separate numeric/control keypad and a video-display/disk-drive module. The 12-in. monochrome video screen can display 24 lines of 80 or 40 characters (selectable) per line of upper-case and true-descender lower-case alphanumeric characters, as well as 32 "Business Graphics" characters. The built-in drive is a standard 8-in. double-density floppy unit.

Software available for the Model II is highly business/professional-oriented. In addition to the TRSDOS operating system, Radio Shack offers interpreter and compiler BASIC, COBOL, and FORTRAN high-level programming languages. Program development and applications software focuses mainly on accounting and business needs and includes "SCRIPSIT" word-processing, "VisiCalc" electronic-spreadsheet, and filing packages. In addition, the Model II can be made to serve as an intelligent terminal that can access large main-frame computers via telephone lines.

Radio Shack's fastest and most powerful TRS-80 computer is the Model 16, a 16-bit machine that uses two microprocessors. All computing/memory-management functions in this computer are performed by a Motorola MC68000 16-bit microprocessor that's able to address up to 512-K of memory. House-keeping functions are taken care of by a separate Z80A microprocessor. The Z80A also assures compatibility with existing Model II software.

The Model 16 is a two-piece desk-top machine. It has a detachable typewriter-style keyboard with separate numeric/control keypad and a module that contains a monochrome (black-and-green) 12-in. video display monitor and room for mounting two 8-in. floppy-disk drives. The minimum system contains 128K of user RAM (expandable to 512K bytes on-board), one double-density 8-in. floppy-disk drive, and two serial and one parallel interface ports. Up to three more 8-in. floppy-disk and four 8.4M byte hard-disk drives can be added. One of the serial ports can also be used to communicate with large main-frame computers via the telephone line.

The operating system for the Model



Radio Shack TRS-80 Model II microcomputer with Line Printer III, external 8-in. floppy-disk drive system, and system desk.

16 permits multiple-user system configurations. All that need be added are one or more video display terminals. As many as three users can access programs in the Model 16 at any one time, without perceptible loss in performance.

Available hardware for the Model 16 includes a variety of formed-character and dot-matrix impact printers, plotters, digitizers, and modems. Software support is provided by the entire library of programs and languages written for other TRS-80 Models.

Texas Instruments is another company that offers a 16-bit machine to the personal computer market. Its Model 99/4 color computer, however, is designed for home use. Built around TI's own 16-bit TMS9900 microprocessor, the 99/4 offers: 16K of user RAM; 26K of ROM, which contains the system monitor routines and an interpreter BASIC language with color commands; a 40-key typewriter-style keyboard; and a slot for plugging in TI Solid State Software Command Modules.

As supplied, the 99/4 is designed to connect to a color video monitor. However, with an optional r-f modulator, it can be used with any standard color TV receiver. The computer features a cassette-deck interface, color graphics capability, and a programmable sound synthesizer. Optionally, it can be equipped with TI's solid-state speech synthesizer to generate-synthesized speech.

Owing to its 16-bit architecture, the 99/4 computer can address up to 72K bytes of mixed RAM and ROM memory. Up to 30K bytes of this can be optional plug-in ROM games and applications cartridges.

Software for the 99/4 is available on cassette tape, floppy disk, or in command modules that plug into the computer's cartridge slot. In addition to stock market analysis, home-finance, accounting, educational, and management modules, TI offers a variety of games modules that take advantage of the system's high-resolution color graphics and sound generator. Milton Bradley also offers games modules for the 99/4 computer.

Optional peripherals for the computer include 5.25-in. minifloppy-disk drives, a disk-drive controller module, thermal printer, modem, and an RS232C serial interface adapter.

Xerox, makers of photocopy equipment, offers its professional Model 820 to the personal computer market. This Z80-based machine is designed to be

*Xerox 820 personal computer is meant for basically the business user. It comes with dedicated 12-in. video display monitor, detachable keyboard, and dual 5.25-in. floppy-disk drive units.*

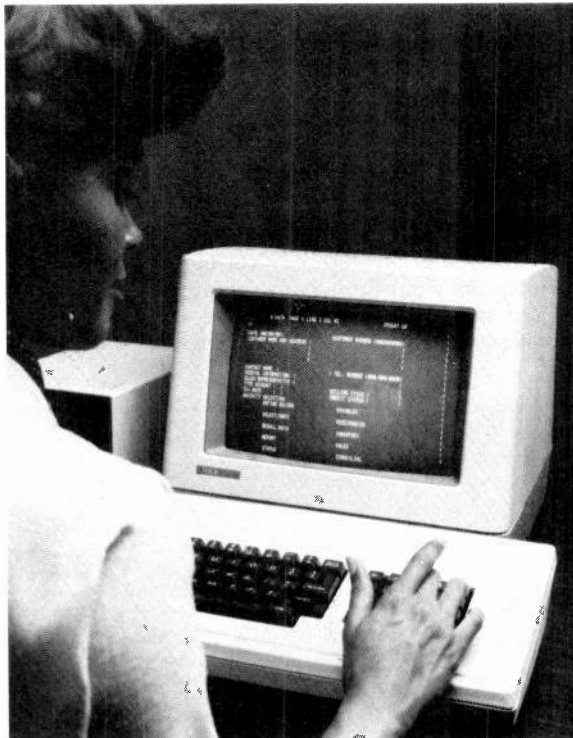

CP/M compatible, making virtually all software written under this popular operating system available to Model 820 users and owners.

The Xerox 820 features 64K of user RAM; 4K of system ROM; separate RS 232C serial and parallel ports; typewriter-style keyboard with separate numeric keypad; and 12-in. monochrome video display monitor. Also included in the system are two single-sided, single-density 5.25-in. minifloppy-disk drives. The video monitor can display 24 lines of 80 characters per line of upper-case and true-descender lower-case characters keyed in from the keyboard.

Options for the Xerox 820 reflect the office-use nature of this computer. They include a Diablo 630 daisywheel formed-character impact printer; 8-in. floppy-disk drives; CP/M operating system; "WordStar" word-processing package; "SuperCalc" electronic spreadsheet; Microsoft interpreter BASIC programming language on disk; compiler BASIC; COBOL-80; and "MSORT."

**Computer In A Pocket.** The personal computers described, all desktop units excepting the Sinclair, are certainly small, but they're far from the smallest available. True micro-size computers that can fit in a big pocket and operate

on self-contained batteries have begun to appear in the marketplace. True computing machines, these mighty mites have much of the computing capabilities of their desktop relations, but in a form that allows them to be used anywhere, anytime. They even interface with peripherals and can be expanded with more memory.

Typical pocketable computers have calculator-type keyboards with their keys arranged in a modified typewriter layout, alphanumeric dot-matrix liquid-crystal displays (LCDs), some small amount of user RAM, and interpreter BASIC in ROM. As such, they're virtually complete stand-alone computer/terminal systems. Their displays can contain 24 or 26 alphanumeric upper- and lower-case characters (though not with true lower-case descenders) for immediate view, but longer lines can be viewed via automatic scrolling.

These tiny computers use custom very-low-power microprocessors. To assure reasonably long battery life, the CMOS microprocessor is teamed up with CMOS RAM and ROM devices. Anything stored in RAM remains there, even when the power switch is set to off, until it is deliberately altered or erased.

Typical of the pocket computers currently available are the Radio Shack

TRS-80 Pocket Computer and TRS-80 Model PC-2. Though the two share the same TRS-80 family name, they're different machines. The first contains 11K of ROM programmed with the system monitor and interpreter BASIC and 1.5K of user RAM. The display can handle 24 characters. Peripherals for this computer include a dot-matrix printer and a cassette-deck interface.

The new TRS-80 Model PC-2 is a second-generation machine, slightly

expanded. Peripherals can be connected to the PC-2 via an I/O interface connector on the computer. In the works for this machine is an RS232C serial interface that will allow the tiny computer to communicate with other computers via a modem. Sharp Electronics Corp. offers similar models. Its new PC-1500 has an optional printer that's designed to mate side-by-side with the computer. It has four-color graphic capability, nine character sizes, x-y plotting, and has a

64K of ROM can be used with this machine, added in 16K blocks. Optional RAM modules permit maximum user memory to be expanded to 48K bytes. All keys on this computer can be user-redefined, and a built-in electronic secretary can be programmed to remind the user of appointments.

Although the HHC can be used as is as a stand-alone computer/terminal system, it appears to have been designed to serve as the foundation for a complete computing system that can be fit into an attache case. Available peripherals include a dot-matrix printer/cassette interface module, acoustic modem, color TV adapter that can be used to display up to 16 lines at a time in up to eight colors, and an RS232C serial interface. An attache case, specially designed to accommodate the HHC and its peripherals, is available from Quasar.

Other manufacturers promise to market pocketable computers, too.

**Micro-Mainframe Computers.** The foregoing personal computers have one thing in common: they're all structured according to the dictates of the *manufacturer*. There's little or nothing you can do to change the basic configuration of the computer to meet the needs required by special applications. You can't for example, restructure a monochrome-only computer to have it display color graphics. Also, a given computer is almost always the foundation upon which a manufacturer builds a total system in which only his or a very few outside vendors' peripherals can be used.

To be able to structure a computing system the way *you* want or need it, you'll have to look to the small number of micro-mainframes offered at personal-computer prices. Most of these machines are built around either the Z80 or the 8085 microprocessor and share a "standardized" S100 bus structure. (The S100 bus was developed by MITS for its Altair 8800 microcomputer, which started the revolution in low-cost personal computers when it was introduced through a cover story in POPULAR ELECTRONICS magazine's January 1975 issue.) Although there may be only a half dozen or so manufacturers supplying S100 micro-mainframe computers to the low-price market, there is certainly no shortage of suppliers of compatible hardware and software.

With a micro-mainframe computer, you can virtually design a computing system from the ground up. You start with a package that contains power sup-

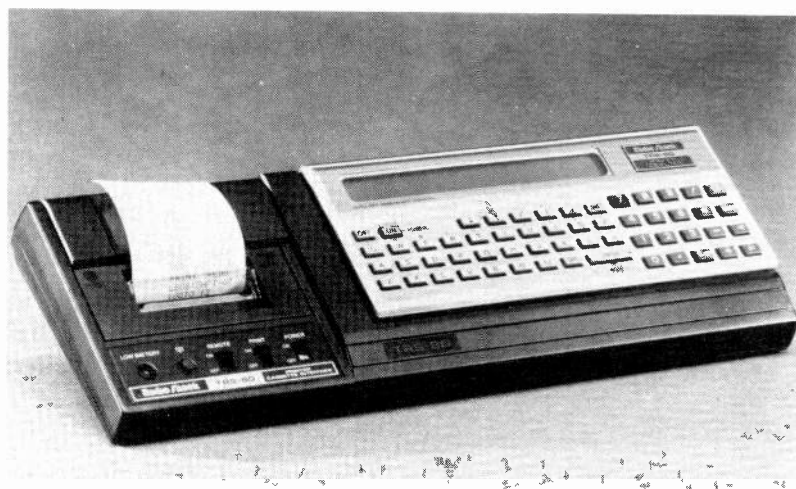

Radio Shack TRS-80 Pocket Computer with printer and interface.

larger and heavier than the TRS-80 Pocket Computer. It offers a 26-character display, 16K of ROM programmed with a more powerful extended interpreter BASIC programming language, and 1850 bytes of on-board user RAM. Memory can be expanded to a maximum of 16K of RAM via optional plug-in modules. Using intelligent peripherals, like the optional four-color printer-plotter/dual-cassette interface, the PC-2's BASIC command set can be

dual-cassette interface.

Quasar and Panasonic's HHC (hand-held computer) typifies the higher-price end of the pocketable computer market. This machine is slightly larger and heavier than the Radio Shack/Sharp computers and is tagged at a higher price than the TRS-80 Model PC-2. It features a 24-character display, 16K of ROM, 1.3K (optionally 3.3K) of user RAM, and slots for memory expansion and peripherals interfacing. A total of

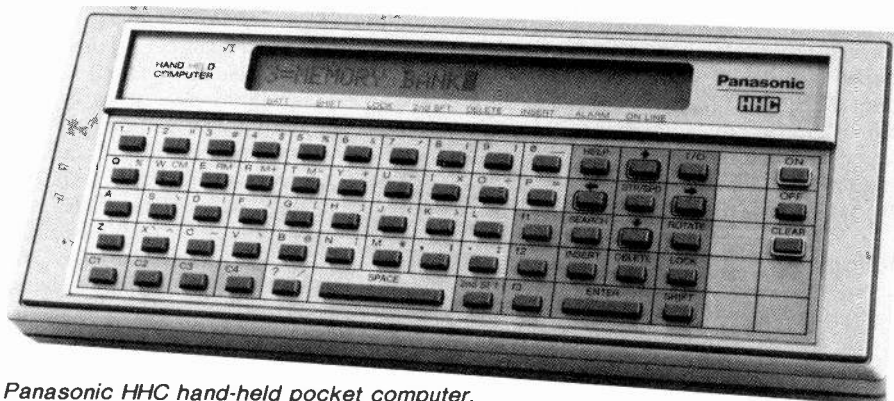

Panasonic HHC hand-held pocket computer.



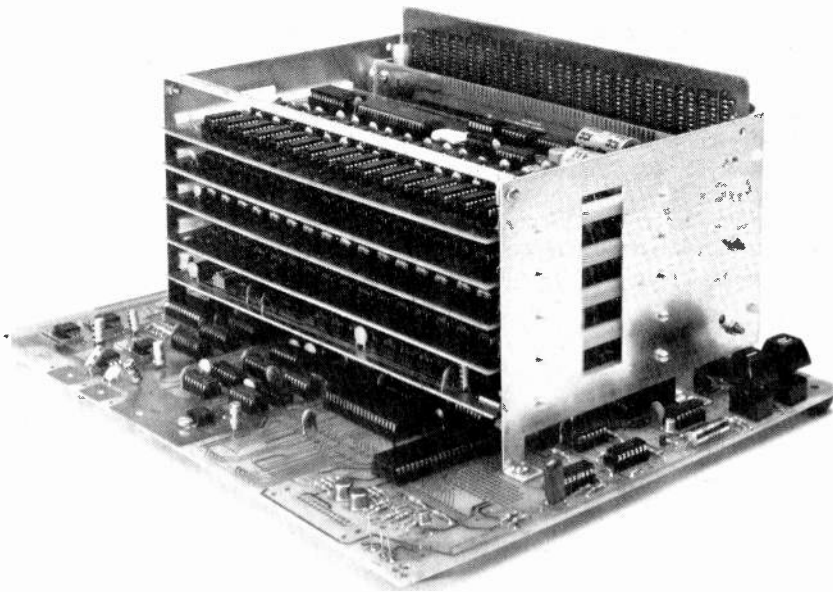

Netronics' Explorer 85 micro-mainframe computer is shown fully populated with plug-in circuit-board assemblies. This type of computer can be configured as the user desires with any choice of bus-compatible options.

ply, MPU (microprocessing unit) module, a motherboard bus, and perhaps a cabinet with cooling fan. The MPU module contains the CPU, system ROM, perhaps some small amount of user RAM, and bus drivers for communicating with other modules and peripherals. The motherboard is a printed-circuit board assembly with parallel copper traces that interconnect the MPU module with a number of edge connectors that serve as slots for add-on modules.

To the minimum computer can be added any combination of optional plug-in-modules, purchased from the manufacturer of the computer or any of a number of different manufacturers. You can choose to add dynamic and/or static RAM, each type accessed separately; ROM; serial and parallel interfaces; one or more disk-controller cards; a color-graphics generator; and any of dozens of special-purpose devices. As many cards can be added as there are motherboard bus connectors available and the power supply can safely handle. If more cards are needed, they can be added simply by installing a bus extender and extra power supply.

Once you've configured the computer as needed, you can add any type of hard-copy printer, terminal, disk drives, plotters, etc., you desire. As with the plug-in modules, each of these peripherals can be purchased from a different manufacturer.

Most S100 micro-mainframe comput-

ers are designed around the Z80 micro-processor, but at least one uses the 8085. Among the most popular Z80-based S100 computers are Cromemco's Z-2, Exidy's Sorcerer, North Star's Horizon, and Vector Graphic's MZ. The Explorer/85 from Netronics R & D Ltd uses an 8085 processor chip.

While micro-mainframe computers offer the advantage of full flexibility, they do have two disadvantages. Most important of these is that they require that you know something about computer hardware or work out your needs with the seller. Since computer and modules may not be obtained from a single manufacturer, all the parts to get a system working must be properly integrated. The second disadvantage is that a system will usually cost more to configure than if it were put together by a single manufacturer and sold as a package.

**Computer Trainers.** The last category of personal computers we'll touch on is the computer "trainer." These devices are designed to give the user a means by which to gain a thorough technical grounding in microcomputer/microprocessor hardware and assembly-language programming. They're not meant for the business user who needs a word-processing or accounting machine or the casual home user who wants to play prepackaged computer games and balance his checkbook. Moreover, they are generally available as kits that one must assem-

# WE TAKE YOU BY THE HAND!

You'll learn all about computers: how to build, program, service, even play TV games—without knowing the first thing about it!

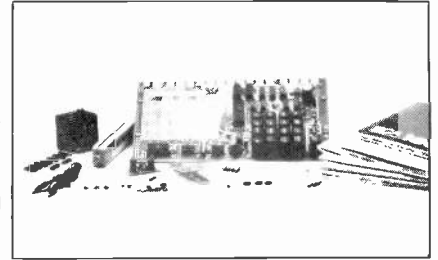

## The New ELF II "Beginners" Package

Your own expandable micro-computer kit, 5 diagnostic analyzers plus circuit, programming, diagnostic manuals, even games you can play on TV. All only \$139.95.

Even if you don't know bits from bytes, now it's easy and inexpensive to build your own micro-computer, learn how it works, program it, even play games with it on your TV! It's here in the New ELF II "Beginners" Package, only from Netronics. Only \$139.95. Here's the package: 1. your own micro-computer, the famous ELF II (featuring the RCA 1802 CMOS microprocessor) in kit form with step-by-step instructions on how to build it. Diagnostic Analyzers including 2. your own Logic Probe, 3. Pulse Catcher, 4. 8 bit Test Register, 5. Logic Analyzer, 6. Gate Arrays, 7. Non Technical Manuals on how to use analyzers, how to get into the guts of the computer, what makes it tick, how to service it, 8. Sample Programs that teach you machine language programming plus how to correct or "debug" any programming mistakes, 9. TV games you can play. If your TV set has no video input, an optional converter (RF Modulator), is available. Then, once you've got this "Beginners" Package under your belt, keep on expanding your ELF II with additions like the Typewriter Key Board, added RAM, Full Basic Interpreter, Electric Mouth Talking Board, Color Music, A/D/D A Boards for Robot Controls and much, much more. We'll take you by the hand with the New ELF II "Beginners" Package. Only \$139.95. Mail or phone in your order today and begin.

**Specifications ELF II "Beginners" Package**  
The computer features an RCA CMOS 1802 8 bit microprocessor, addressable to 64K bytes with DMA, interrupt 18 Registers, ALU, 256 byte RAM expandable to 64K bytes, Professional Hex keyboard, fully decoded so there's no waste memory with keyboard scanning circuits, built-in power regulator, 5 slot plug-in expansion BUS (less connectors) stable crystal clock for timing purposes and a double-sided plated through PCB Board plus RCA 1861 video IC to display any segment of memory on a video monitor or TV screen along with the logic and support circuitry, you need to learn even one of the RCA 1802 capabilities. The diagnostic analyzers aid in understanding and trouble shooting your ELF II, as well as other computer and microprocessor products.

Continental U.S.A. Credit Card Buyers Outside Connecticut

**CALL TOLL FREE 800-243-7428**

To Order From Connecticut or For Technical Assistance, Etc.,

Call (203) 354-9375

**NETRONICS R&D LTD.** Dept. IV  
333 Litchfield Road, New Milford, CT 06776

Please send the items checked below:

- ELF II "Beginners" Kit ..... \$139.95
- RF Modulator ..... \$ 8.95

Plus \$3.00 for postage, handling and insurance  
( \$6.00 Canada )

Connecticut Residents add sales tax

Total Enclosed \$ \_\_\_\_\_

- Personal Check     Cashier's Check Money Order
- Visa     Master Charge (Bank No. \_\_\_\_\_)

Acct. No. \_\_\_\_\_

Signature \_\_\_\_\_ Exp. Date \_\_\_\_\_

Print Name \_\_\_\_\_

Address \_\_\_\_\_

City \_\_\_\_\_

State \_\_\_\_\_ Zip \_\_\_\_\_

ble. This is part of the learning process.

Leading the way in microprocessor trainers is the Heath Company with its ET-3400A trainer and companion (optional) Heath/Zenith EE-3401 self-instruction microprocessor course. The 6800-based trainer features a 1K monitor in ROM, 256 bytes (expandable optionally to 512 bytes) of user RAM, a six-digit light-emitting-diode (LED) display, and a 17-key hexadecimal keypad. A number of electronic components supplied with the EE-3401 course allow the user to perform programming and interfacing experiments.

The Heath ET-3400 trainer can be upgraded to computer status with addition of an optional ET-3400A accessory. The ET-3400A can add up to 4K bytes of user RAM and features a terminal monitor in ROM; Heath/Pittman Tiny BASIC interpreter in ROM; cassette I/O port; and an RS232C serial interface. A video display terminal can be connected to the accessory via the serial interface to allow you to program and run programs in standard BASIC-language format.

Two other trainers worthy of note are the Elf II from Netronics R&D Ltd and the Super Elf from Quest Electronics. These very inexpensive machines both use RCA's CMOS CDP1802 microprocessor and are expandable to full computer status. And, like the Heath ET-3400/ET-3400A, both are supplied in kit form with manuals that tell how to build, program, and use them.

The Netronics Elf II comes with 256 bytes of RAM, a five-slot S100-type

expansion bus, system monitor in ROM, hex keypad, and video output. RAM can be expanded out to a full 64 K bytes. Available options include: an r-f modulator for connecting the computer to a standard TV receiver; typewriter-style keyboard; full BASIC interpreter programming language; "Electric Mouth" voice synthesizer module; color/music-synthesizer module; and analog-to-digi-

**Cost of Ownership.** Getting started in personal computing can be a relatively inexpensive or a very expensive proposition, depending on how elaborate a system you want. For as little as \$99.95, you can get the Sinclair MX80 computer kit, while for more than \$10,000, you can obtain a complete business computing system with floppy- and hard-disk drives, printer, modem, and a full library

*The Netronics Elf II is representative of bus-oriented computer trainers. It can accommodate many different types of plug-in circuit boards and can easily be upgraded to full computer status.*

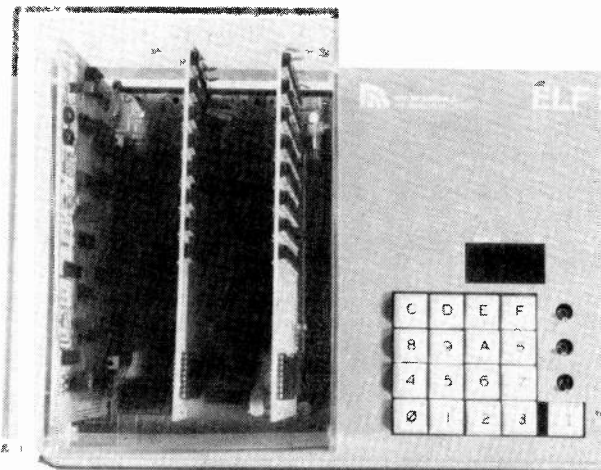

tal (A/D) and digital-to-analog (D/A) converters for robot control.

The basic Quest Super Elf is similar in design and capabilities to the Netronics Elf II. Available options for this computer/trainer include a cassette interface; color-video module; interpreter BASIC language; typewriter-style keyboard; S100 bus; hard-copy printer; floppy-disk drives; and an RS232C serial interface.

of software. Most first-time computer buyers can expect to spend in the neighborhood of \$1500 for a true computing system with basic software but minus disk drives, printer, and modem. With these additions, plus a more elaborate lineup of operating software, full system price will usually be in the neighborhood of \$3500 or more. Of course, if your initial interest is in being able to play any of the challenging computer games, your initial entry need be no more than about \$300, plus the cost of software.

**In Conclusion.** As you can see from the foregoing, personal computing is an extremely diverse, dynamic, and rewarding pursuit, both at home and on the job. It's constantly evolving to accommodate new hardware and software. In fact, in the less than 10 years time since it all began, personal computers have undergone tremendous changes, most notably in the simplification of hardware and the "humanization" of the software. Yet, we're really only at the beginning of a new technology. What's to come in the immediate and far future is anyone's guess.

One thing is certain: every one of us will soon be using personal computers as routinely as we now use the telephone. Needless to say, the faster you become familiar with computing, the less likely will you be a "future shock" victim. ♦



*Heath ET-3400A computer trainer is designed to help users learn assembly language programming. It can be optionally expanded to full computer status with more memory, BASIC in ROM, a terminal, etc.*

# INSTANT PC BOARDS

WITH

## E-Z CIRCUIT™ Pressure-Sensitive

by  Bishop Graphics, Inc.

## COPPER DESIGN PRODUCTS!

**NO Artwork! NO Photography! NO Screening! NO Etching!**

**And It's As Easy As 1...2...3...**

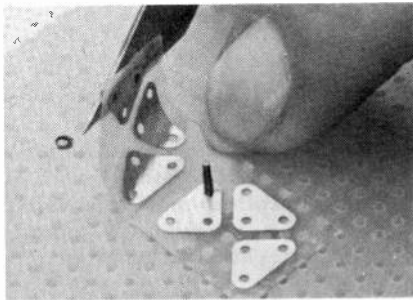

**1. APPLY COPPER MTG. CONFIGURATIONS**

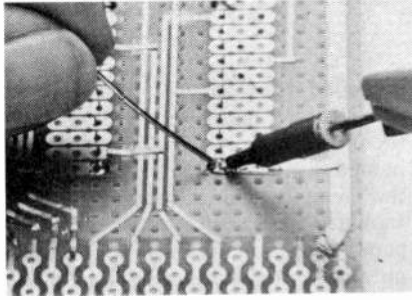

**2. SOLDER COMPONENT CONNECTIONS**

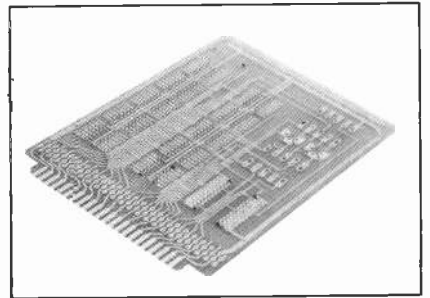

**3. IT'S READY TO USE!**

Now, thanks to this revolutionary new E-Z CIRCUIT concept, you can build professional quality printed circuit boards right in your own home or shop

- ... without messy chemicals
- ... without artwork
- ... without photography
- ... without screening or etching

Read What **RADIO-ELECTRONICS** Hobby Editor, "Doc" Savage Says About the E-Z CIRCUIT System!

"Those patterns are not for making artwork — they are *copper*. When you have pressed them down on a board, you are ready to mount the circuit components, solder them in place and turn on the power! *That* is what I call instant PC boards."

"Having used this E-Z CIRCUIT system, I can report that it is quick, easy and reliable. It is the best way I have found to make one or two-of-a-kind PC boards."

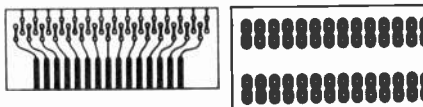

**The Secret? E-Z CIRCUIT's Unique Pressure-Sensitive COPPER Tapes & Patterns!**

Each E-Z CIRCUIT copper mounting configuration is made of super-thin, epoxy

glass with a special two-phase, adhesive on one side, and a one-ounce copper pattern laminated on the other. When applied to your PC board, these copper patterns work like the circuitry on a conventional *etched* printed circuit board. You solder the components directly to them.

**Make A Mistake? With E-Z CIRCUIT, You Won't Waste A Board!**

Thanks to E-Z CIRCUIT's special, two-phase adhesive, you have — within the first few minutes — the opportunity to reposition the copper patterns and tapes to make corrections, modifications and improvements ... *without* harming the appearance and performance of your board.

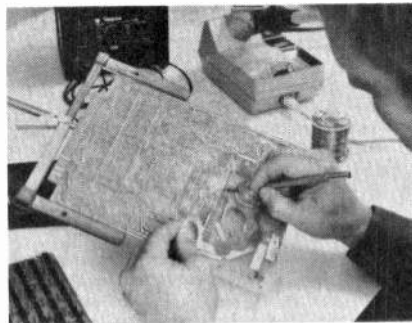

**Use Them For Repairing And Modifying Existing Circuitry, Too!**

Besides creating an actual, professional functioning circuit board, you can use E-Z CIRCUIT Pressure-Sensitive Copper PC design products to repair or modify existing circuitry.

**Unique E-Z CIRCUIT Technical Manual ... A "Gold Mine" of Usable, "How To" Information!**

We even show you how easy it is. The new E-Z CIRCUIT PC Copper Products Technical Manual & Catalog EZ-3001 leads you through every step with fully illustrated instructions written in clear, simple language to make it easy for you to produce a professional quality, PC board. It's packed with invaluable technical "How To" information that tells you:

- **How to build a PC board**
- **How to repair damaged circuitry**
- **How to solder professionally**

Send For Your **FREE** Copy Today To:

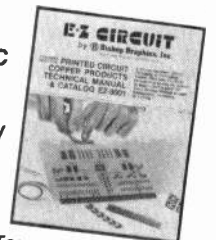

**E-Z CIRCUIT™**  
by  Bishop Graphics, Inc.

P. O. Box 5007ITE Westlake Village, CA 91359

Please send me a free copy of  
**E-Z CIRCUIT PC Copper Products  
Technical Manual & Catalog EZ-3001**

Name \_\_\_\_\_

Street \_\_\_\_\_

City \_\_\_\_\_ State \_\_\_\_\_ Zip \_\_\_\_\_

(DEALER INQUIRIES WELCOME) ITE

# GLOSSARY OF TECHNICAL COMPUTER TERMS

More than any other endeavor in the electronics area, computing—including personal computing—has perhaps the most extensive, not to mention intimidating, lineup of technical terms we call “jargon.” to help take the mystique out of this jargon and render it less intimidating, we’ve

compiled the following glossary of technical computer terms. Each entry in this abbreviated list is accompanied by a definition that reflects the term’s accepted common usage. Included here are only the terms in popular use among entry-level computerists, provided to help you under-

stand all but the deepest technical terms a computer salesman or an advanced computerist might use in describing a computer to you. For more in-depth coverage, you can obtain any of a number of “computer dictionaries” sold at computer retail outlets.

**Access time**—Time required to get a byte from memory.

**Acoustic coupler**—An electronic device for connecting a telephone handset to a computer. See also *modem*.

**Address**—A number that indicates the location of a byte in computer memory.

**Alphanumeric**—A set of all alphabetic and numeric characters.

**Alterable memory**—A type of memory that permits data to be stored in it under direction of the user. Also called “user memory.” See also *RAM*.

**ASCII**—Stands for American Standard Code for Information Interchange.

**ASCII keyboard**—A typewriter-like keyboard that contains keys for all characters in the ASCII character set.

**Assembler**—A program that converts the computer’s mnemonics into binary code for execution. Acts as a compiler for machine language. See also *compiler*.

**Assembly language**—A notation that represents program-data and machine-instruction mnemonic symbols that are easier than machine language for the human programmer to understand.

**BASIC**—Stands for Beginner’s All-purpose Symbolic Instruction Code; a popular high-level programming language. It is the easiest of all high-level languages to learn.

**Baud**—A measure of the rate at which digital data is transmitted in bits per second; typically ranges up to 19,200 baud (19.2K baud).

**Bidirectional printing**—A feature of some computer printers; indicates that a printer prints from left to right, line feeds with no carriage return, and continues from right to left. Procedure continues until entire document is printed. Speeds up the printing process.

**Bit**—Acronym for Binary digit; represents either of two binary states—1 or 0. Bits are usually grouped for easier operator manipulation. See

also *nybble, byte, and word*.

**BPI**—Stands for bits per inch and is used to specify the density of data that can be recorded on a magnetic disk or tape.

**Byte**—A group of bits, usually eight; universally used to represent a character. There are two nybbles in a byte.

**C BASIC**—A popular compiler BASIC language for 8080, 8085, and Z80 microprocessor computers. C BASIC is much faster in execution than the more popular interpreter BASIC. This high-level language is not interactive.

**Character set**—The total number of alphanumeric, special, and punctuation characters available on a terminal or printer.

**COBOL**—Acronym for COmmon Business Oriented Language; a high-level language with English-like words popular for business programming applications.

**Compiler**—A program that converts high-level language into the binary code required by the computer. Compiler instructions are known as the “object code.”

**Computer**—A general-purpose computing system whose minimum configuration is a CPU, memory, and input/output (I/O) capability.

**Computer system**—A complete computer setup, including CPU, memory, input and output (I/O) devices, and software.

**CP/M**—Abbreviation for Control Program for Microcomputers; a single-user operating system for 8080, 8085, and Z80 microcomputers.

**CPU**—Abbreviation for Central Processing Unit; part of the computer responsible for processing data and storing data in and retrieving it from memory. Often referred to as the “brain” of the computer.

**Daisy-wheel printer**—An impact printer whose printing element resembles a daisy flower, with its 96 or more single-character-slugs radiating from a central hub.

**Data-transfer rate**—The speed at which computer

data is transferred from one place to another, such as from computer to terminal, printer, or modem.

**Descenders**—The name given to that portion of lower-case characters g, j, p, q, and y that descends below the base line of other characters.

**Disk**—A flat, circular magnetic storage medium that is rotated like a phonograph record. To differentiate between the audio and computer media, spelling is different—disc for audio, disk for computers.

**Diskette**—A term used to identify a “floppy disk” magnetic storage disk.

**Display**—A computer output device designed to show alphanumeric and/or graphics data. In personal computing, the display is usually a TV-like video screen, but it can also be a printout from a hard-copy printer.

**Dot matrix**—A means by which alphanumeric, special, and control characters are formed using a matrix of small dots. The matrix is fixed and defined as so many dots wide by so many dots high. Typical matrices are 5 × 7, 7 × 9, 7 × 12, and so on.

**Double density**—A technique used to double the amount of data that can be stored on a magnetic medium.

**Double-sided disk**—Refers to a storage disk whose two sides are available for data storage.

**Dual intensity**—Indicates the ability of a terminal or printer to produce characters in regular and highlighted or bold formats.

**Editor**—A computer program used to permit entry of text into a computer system. The system under which the source code is written for compiling BASIC programs.

**EPROM**—Acronym for Erasable Programmable Read-Only Memory; a type of computer memory device that can be used to permanently store data within a computer for instant access. Can be erased by ultraviolet light and reprogram-

- med. A nonvolatile memory that retains programmed-in data even when no power is applied. See also *PROM* and *ROM*.
- Floppy disk**—The magnetic medium used for mass storage of data. Flexible disks are available in 8- and 5.25-in. sizes, hard- and soft-sector formats. This term is used to describe the magnetic disk medium and its protective jacket.
- FORTRAN**—Acronym for FORMula TRANslator, a high-level programming language developed for mathematical operations required by scientists and engineers.
- Full duplex**—A communication mode in which data can be transmitted and received simultaneously.
- Half duplex**—A communication mode in which data can be transmitted and received, but not simultaneously.
- Hard copy**—Output from a computer printed on paper.
- Hard disk**—A mass-storage disk medium that uses a rigid-material disk on which is deposited the magnetic medium. Usually nonremovable medium, hard-disk systems are faster and can store many times more data than is possible on same-size floppy disks. The disk itself is housed in a hermetically sealed enclosure, along with the read/write head, to insure against contamination that could cause read/write problems.
- Hard sectored**—A term used to describe a mass-storage disk in which the recording medium has been divided into nonalterable segments. Disks of this nature have a ring of sector-locator holes for easy location.
- Hardware**—Describes all items in a computer system that are not software: circuit boards, integrated circuits, transistors, discrete components, etc. See also *software*.
- Hexadecimal**—Frequently abbreviated "hex," this numbering system, popularly used in the computer world, uses a base-16 format. Hex numbers count up from 0 to 9 numerically and continue through the letters A through F to represent the full 16 numerals possible. Hex numbers are usually tagged with the suffix "H" to distinguish them from decimal and octal numbers.
- High-level language**—Any human-like programming language that is relatively easy for the computer user to learn and use. Examples include BASIC, COBOL, FORTRAN, Pascal, PL1, APL, etc.
- High resolution**—A term used to describe the ability of a video terminal to display highly detailed graphics.
- Impact printer**—Any printer in which characters are transferred to paper by striking through an inked ribbon.
- Index hole**—A hole punched through the floppy-disk medium that can be read by an electro-optical system in the disk drive to accurately locate the beginning of sector 0 on the disk.
- Instruction**—A single command within a computer program.
- Instruction set**—A list of the basic operations that can be performed by a CPU. Each CPU has its own unique instruction set.
- Interface**—An electronic or software device used to mate a computer with its peripherals and the outside world.
- Interpreter**—A translator program that converts high-level-language instructions and data into the binary machine language required by the computer. Unlike the compiler, the interpreter is interactive.
- I/O**—An abbreviation for input/output.
- Letter quality**—A term used to indicate professional-quality printing from a formed-character printer, such as the daisywheel and thimble.
- Library**—A collection of computer programs, usually on cassette tape or floppy disk.
- Listing**—A printout of a computer program.
- Load**—A term that indicates the transfer of data from a storage location, such as a disk or tape, into a computer for execution.
- Machine language**—A set of binary codes that the computer can operate on directly.
- Mass storage**—An external memory device, such as a disk or tape, used for storage of a long program or many small programs.
- Megabyte**—A term to indicate millions of bytes; 1-megabyte = 1,048,576 bytes or 1048 kilobytes (KB).
- Memory**—Describes a storage area for binary data and programs. Can be any mixture of RAM, ROM, PROM, and EPROM in the computer or external disk and tape drives.
- Microcomputer**—An integrated, complete small computer system built around a microprocessor (CPU), memory, and input/output interfaces and containing a power-supply. All personal computers are microcomputers.
- Microprocessor**—The CPU of a microcomputer.
- Minidisk**—A 5.25-in. floppy disk.
- Modem**—Acronym for MODulator/DEModulator; a device used to interface a computer with the telephone line, converting digital information into analog form and vice-versa.
- MP/M**—Abbreviation for Multiprogramming control Program for Microprocessors; a multiple-user version of the CP/M operating system. See also *CP/M*.
- Nybble**—A block of data representing half a byte, usually 4 bits.
- Number crunching**—Performance of complex numerical operations or arithmetic-intensive computation by a computer.
- Object code**—The binary code produced by an assembler or compiler program; it can usually be executed directly by the CPU when loaded into the computer. See also *source code*.
- Octal**—A numbering system in which only eight digits, 0 through 7, are used. Sometimes used in microcomputers. Octal numbers are usually tagged with the suffix "Q" to distinguish them from decimal and hexadecimal numbers.
- On-line**—A phrase used to indicate any device directly connected to a computer.
- Operating system**—A program or collection of programs used to manage the hardware and logical functions of a computer system.
- Overstriking**—The ability of a hard-copy printer to strike a character more than once to produce a boldface effect.
- Pascal**—A high-level programming language named after Blaise Pascal. This is a very rigidly structured programming language.
- Peripheral**—Any device that connects to and is controlled by a computer.
- Personal computer**—A low-cost, very compact computer designed for the individual user without requiring access to a large computer. All personal computers are stand-alone microcomputers.
- Program**—A list of user-specified instructions that tell a computer to perform a specific processing task. Programs can be written in machine language, assembly language, and high-level language.
- Programming language**—Any language used to write a computer program (see above).
- PROM**—Acronym for Programmable Read-Only Memory; a permanent storage device that can be programmed by the device manufacturer, supplier, or user. See also *EPROM* and *ROM*.
- Quad density**—A term used to specify the data storage density of a computer disk system. Quad-density systems can store up to four times the data that can be stored on single-density disks. Double-sided, double-density disks are quad-density disks.
- RAM**—Acronym for Random-Access Memory; a volatile type of temporary storage device that can be written to by the user. Any data byte stored in RAM can be directly retrieved simply by entering its address. Data stored in RAM is irretrievably lost when power is shut down.
- ROM**—Acronym for Read-Only Memory; a permanent data storage device that, once programmed, cannot be reprogrammed. The user can only read what is in ROM; he cannot write to it. This type of memory is nonvolatile. See also *EPROM* and *PROM*.
- Read/write**—A term used to indicate that the user can read data from and write data into memory, which can be RAM, tape, or disk.
- Reverse video**—A term used to indicate in some video terminals the ability to display black characters on a white (or green) background.
- Scrolling**—The ability to move text displayed on a video terminal's screen up and down (and in some cases left and right) by one or more lines.
- Sector**—A section of a storage disk's track. See also *hard sector* and *soft sector*.
- Serial data**—Data transmitted one bit at a time.
- Serial port**—An input/output port in a computer through which data is transmitted and received one bit at a time. In most cases in personal computers, serial data is passed through an RS232C serial interface port.
- Single-sided**—A phrase used to indicate that only one side of a disk is accessible by the disk drive for storage and retrieval of data.
- Soft sectored**—A technique used to format a magnetic storage disk so that the beginning of each sector is preceded by an identifying code. See also *hard sectored*.
- Source code**—A program written under an editor program in English-like words. This source program is then submitted to an assembler or compiler for translation into a form usable by the computer. See also *object code*.
- Syntax**—A set of grammatical rules that define how a programming language must be written to be properly executed in a computer.
- Tractor feed**—A mechanical device in hard-copy printers used to insure accurate positioning and moving of fan-fold paper through the mechanism. Sprockets in the printer engage the holes along the sides of the paper. A must-have item in high-speed printing, where accuracy in alignment is a necessity, such as in the printing of thousands of mailing labels.
- Volatile storage**—Refers to a memory device that loses data programmed into it when power is removed or interrupted. See also *RAM*.
- Word**—Another term for byte (see *byte*). A word can be composed of any number of bits, but in small computers is usually limited to 4, 8, or 16.
- Word processor**—A computer/software system designed for writing and editing letters, reports, and any other word-intensive document.
- Write protection**—A phrase indicating that data cannot be written onto or erased from a storage disk. For an 8-in. disk to be write protected, an adhesive tab must be removed from its protective jacket, while for a 5.25-in. disk, the tab must be placed on the jacket.



# HOBBY COMMUNICATIONS FOR FUN & SAFETY

## . . . LISTEN TO:

- *Police, fire, and other emergency & public-Safety broadcasts with a scanning monitor*
- *The world with a shortwave communications receiver*

## . . . LISTEN AND TALK TO:

- *Boaters with marine radio*
- *CB'ers with Citizens Band radio*
- *People from all over the world with ham radio*



**T**HIS IS A communications-oriented world in which millions of words, pictures, and computer data routinely link city to city and continent to continent every day over the airwaves. Some transmissions—like long-distance telephone calls and remote TV broadcasts—even reach deep out into space before arriving at their destinations.

Radio communications comes in very diverse forms. Two of the most familiar are the AM/FM radio and TV broadcasts to which we tune every day to be entertained and to be kept abreast of news, weather, and sports. Another familiar means of communication to a large segment of the population, Citizens Band (CB) radio, is used by more than 20-million motorists. With CB radio, we enter the world of two-way radio communication, which lets us listen to broadcast messages and respond to them over the air. Then, too, there are hundreds of thousands of Amateur Radio operators throughout the world who also use two-way radio to talk to each other. Boat owners can venture far from shore, confident that their vhf/FM marine two-way radios will bring help should it become necessary.

While communications by radio is a big business, it's also an exciting hobby (in some cases, as in marine radio, a necessity) that almost anyone can pursue. In addition to CB, Amateur, and marine radio, there are also listen-only aspects to the hobby. For example, there are many thousands of enthusiasts who listen to broadcasts from foreign lands, using general-coverage communications receivers. They can tune into Europe, Africa, Asia, and even Australia to hear music, news with different points of view, etc. Finally, there are the hobbyists who, using a scanning monitor receiver, listen to the police, fire department, and other emergency calls on the Public Safety bands.

Whether the activity is two way, with the hobbyist receiving and transmitting, or simple listen-only, radio communication is often exciting. So, if you're looking for a new activity to fill your leisure time, tune in the airwaves.

*Opposite page—Morse-A-Keyer from Microcraft Corp. automatically generates the proper Morse code dots and dashes for any alphabetic, numeric, or punctuation character typed in from the keyboard.*

**A Communications System.** There are two basic elements required to make a communications "system." They are a source (transmitter) of intelligence and a destination (receiver). Without both, no system exists.

The simplest radio transmitter consists of an oscillator, an antenna, and a source of power. The oscillator generates a radio-frequency (r-f) signal that is fed to an antenna that, in turn, radiates the signal energy into space, as shown in Fig. 1. If a receiver were to be tuned to the particular frequency of the transmitter, nothing would be heard, since there is no voice, music, or picture information present. Now, if the carrier were to be keyed on and off in a series of dots and dashes, such as used for International Morse Code, this code could be heard using a special CW receiver. An experienced communicator who knows the code could then copy the message being transmitted.

A steady carrier by itself conveys no information. It's the process of *modulation* that adds intelligence to a carrier. The carrier—or continuous-wave (CW)

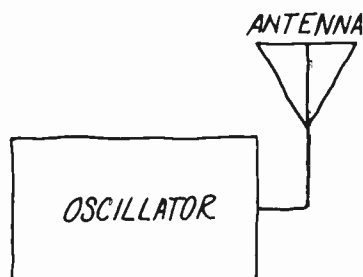

Fig. 1. Simplest transmitter diagram.

signal—can be modulated in a number of ways. The simplest approach is keying on and off the carrier (Fig. 2A). If, instead, a 1000-Hz signal that modulates the carrier were to be keyed on and off, the result would be a modulated continuous-wave (MCW) signal, as illustrated in Fig. 2B.

To convey voice, music, and video information, two other types of modulation are generally used. One is amplitude modulation (AM); the other is frequency modulation (FM). In amplitude modulation, the *amplitude* of the carrier

signal is varied by the audio signal (Fig. 2C). In frequency modulation, carrier amplitude is kept constant, while the *frequency* of the carrier is varied at the audio rate (Fig. 2D). A major advantage inherent in FM is its freedom from much noise and interference that can plague AM. Since electrical noise rides on the peaks of the carrier signal, where AM intelligence is carried, it can render the AM signal unintelligible. FM, on the other hand, relies solely on the variations in frequency to convey its information and, thus, is relatively immune to this problem—even if noise is riding the peaks of its carrier. Furthermore, FM offers the capability of wider frequency range, resulting in better fidelity by capturing high music overtones.

In AM and FM transmitting systems, another element must be added to combine the carrier and intelligence. This device is called a "modulator" (Fig. 3).

At the receiving end of a communications system, two items are needed: a receiver and an antenna. The antenna intercepts the broadcast r-f signal and routes it to the receiver. The receiver then amplifies the very weak r-f signal, demodulates it to recover the audio and/or video intelligence, and then amplifies the intelligence signal to a level sufficient to drive a speaker and/or TV picture tube.

Since it's the norm to have many transmitters, operating at different frequencies, in a given locality, the receiver must be able to discriminate between the desired signal while rejecting all others. This is known as "selectivity" and is one of the most important functions of the receiver.

In removing the intelligence from the r-f carrier during the recovery process, a demodulator is used. This demodulator does the exact reverse of the modulator in a transmitter. (The only purpose of the carrier is to "carry" the intelligence from the transmitter to a receiver over long distances. This done, the carrier is no longer needed and is eliminated by the receiver.)

**The Superhet Receiver.** Various receiver designs have been developed over the years for picking up radio waves. Among those that have achieved success were the tuned radio-frequency (TRF), regenerative, superregenerative, and

superheterodyne receiver. Each had its particular cost, parts count, or performance advantages to account for its success. During the past 25 years or so, however, the superheterodyne, or superhet, receiver has become firmly established as the most popular design because it offers the features most desired for general-purpose radio-communication reception.

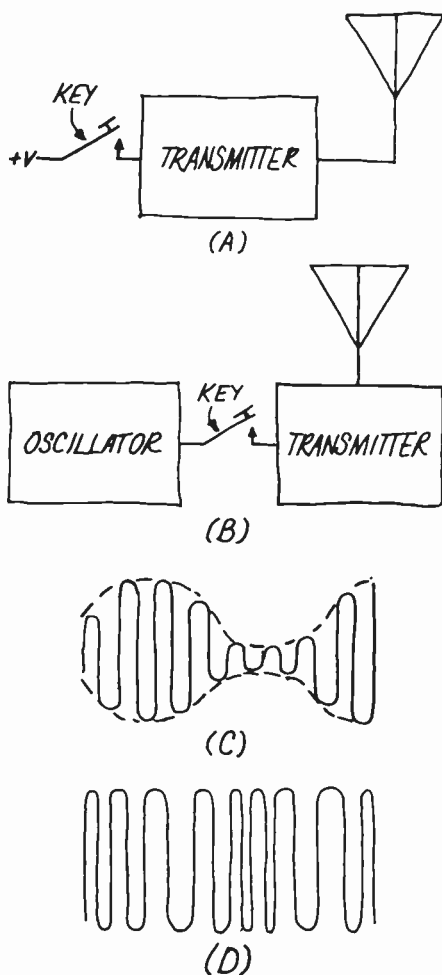

Fig. 2. Keyed-carrier (A) and modulated continuous-wave (MCW) transmitters (B); AM (C) and FM (D) radio signals.

A superhet receiver (Fig. 4) first amplifies the incoming r-f signal and then combines with it in a mixer stage a lower-frequency continuous-wave oscillator signal developed in another stage in the receiver. The result of this mixing is an intermediate-frequency (i-f) signal that's less costly in terms of circuit design to amplify further. By reducing

the frequency of the incoming signal, less complex circuitry is needed to provide high levels of amplification without excessive noise being introduced.

Higher amplification with fewer circuits, improved receiver stability, and better selectivity are hallmarks of the superhet receiver design.

Once the i-f signal in a superhet receiver has been amplified, it is then routed to a *demodulator* (also called a detector). This circuit recovers the intelligence by eliminating the carrier. The intelligence signal—audio or/and video—is then further amplified and, ultimately, delivered to a speaker or/and TV picture tube.

**About Antennas.** The function of an antenna is to either convert electrical energy into electromagnetic waves or to convert intercepted electromagnetic

tance is greater than 550 meters. Wavelengths between 200 and 550 meters are considered *medium wave*, while less than 200 meters is considered *short-wave*. Another method of describing radio waves is by frequency. The velocity of light (300-million meters per second) divided by the wavelength determines a radio signal's frequency. For example, for a 300-meter medium-wave signal, the frequency is  $300,000,000/300$ , or 1,000,000 Hz. This very large number is usually abbreviated as 1 MHz. (In electronics, a universally accepted shorthand is used to express very large numbers in brief form. Any number followed by an "M" must be multiplied by 1,000,000. Likewise, any number followed by the letter "k" must always be multiplied by 1000.)

Transmitter energy is radiated most effectively when the antenna is cut to a

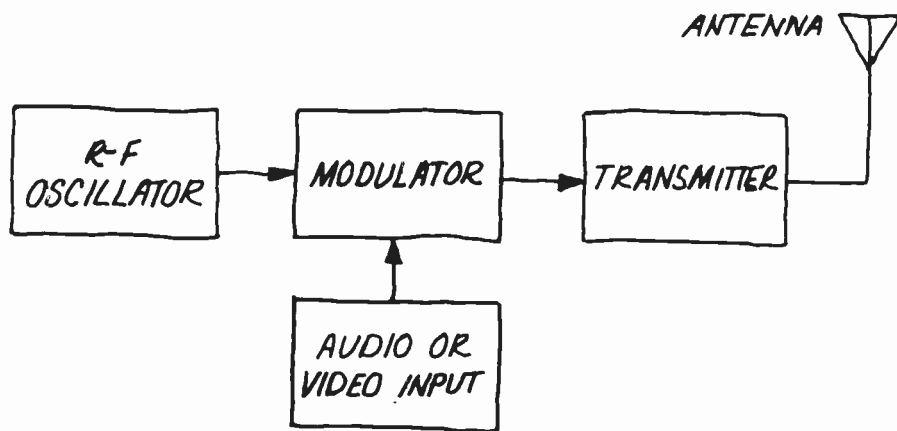

Fig. 3. Simplified block diagram of complete transmitter; modulator combines r-f carrier signal with audio/video input before amplification by transmitter.

waves into electrical energy. A transmitting antenna converts electrical energy from a transmitter into radio waves that easily radiate long distances through space. The receiving antenna, on the other hand, intercepts these radio waves and converts them into weak r-f currents that must be amplified by the receiver to be of any use.

The length of a radio wave is the distance between two peaks of a continuous series of waves (Fig. 5). A radio wave is considered to be *longwave* if this dis-

half wavelength. The physical length of the antenna, then, would be only half as long as the wavelength of the signal to be transmitted. If the antenna's length is too short or too long, transmission will be less effective, and transmitter power will be wasted. It's possible, however, to *electrically* lengthen an antenna that's physically shorter than halfwave to make it behave as though it's the correct physical length. This is typically done with mobile whip antennas used in Citizens Band radio to allow the antenna

## Super Scanner—the Ideal Base Antenna for Sophisticated Emergency Operations

For isolating and pinpointing the origin of emergency or commercial CB communications, there's nothing to compare with The Antenna Specialists' MS119 Super Scanner. This unique antenna is both a superb omnidirectional antenna with tremendous 5.75 dB gain and, with the twist of a knob, a high performance beam exhibiting 8.75 dB gain—like increasing your power seven times. It lets you search with the omni mode, then zero in for maximum range and clarity with the beam mode—all done instantaneously and electronically. The Super Scanner weighs just 17 pounds, is quite simple to assemble and is complete except for standard 50 ohm coax cable.

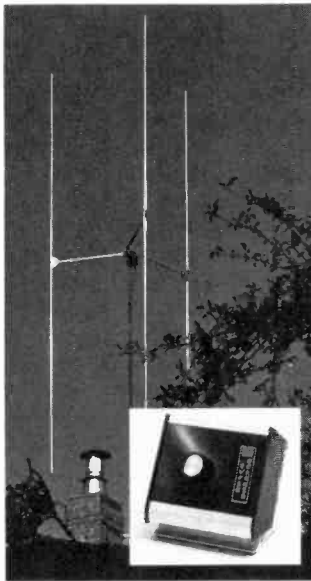

## A/S Tri-Band Antenna Helps Get the Most Out of Your Scanner

Many scanner operators, especially those who have a serious purpose for their equipment, have discovered that the built-in whip antenna furnished with the radio simply cannot provide the range necessary to cover all the land mobile stations in their area that might be vitally important to their network. This is especially true in suburban and rural areas, or where portable radios are widely used. The Antenna Specialists Co. offers a wide selection of special antennas for monitor use, both base and mobile. Although some professionals and hobbyists prefer to install separate antennas for VHF and UHF coverage, most find the MONR31 tri-band model entirely satisfactory and

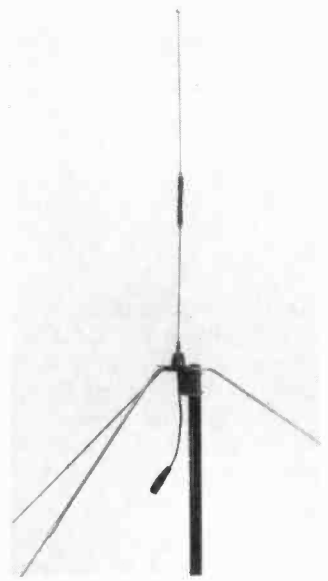

very easy to handle and install. This unit is a high performance professional grade antenna that covers not only low band, high band and UHF but the "T" band as well, through 512MHz. Both the whip and 65" radials are finest stainless steel construction, and the slim, durable phasing coil is weather-proof. It comes complete with SO-239 receptacle (coax cable not furnished).

## A/S Professional Antennas Just the Ticket for GMRS Applications

If you're into GMRS, you'll be interested in two models from The Antenna Specialists Company's extensive line of professional land mobile antennas that are especially suitable for typical

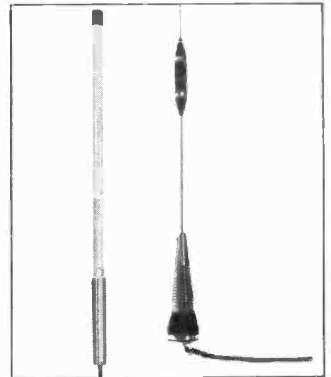

GMRS applications. The ASP-705 Super Base Commander® is a high performance UHF collinear fiber glass unit exhibiting a minimum of 10 dB gain (RS329) and accommodating 250 Watts RF power (500 Watts with optional pigtail). Bandwidth is 20 MHz (450-470 MHz). The antenna is wind rated at 128 MPH with a safety factor of 1.65. For mobile applications series ASPR660 is recommended for high performance, low profile configuration and lots of mounting options including roof, trunk lip, magnetic and cowl. Two precisely phased 3/4 wavelength collinear radiators provide 5 dB gain at the horizon.

**formula-1™**

**the antenna specialists co. presents the latest advance in high-performance antennas for professional CB communications**

A formula race car and A/S's new Model M-710 **Formula-1** are more alike than you'd guess. The engineering strategy is identical: continually refine a proven basic design, within a set of strict operating parameters such as electromagnetic propagation and transmitter power, with one objective: MAXIMUM POSSIBLE PERFORMANCE.

That's **Formula-1**, the direct descendant of A/S's original classic base-loaded low-band mobile police antennas, and the culmination of over 25 years of continuous design development. Born for performance, built to last. **Formula-1** is today's new state-of-the-art in mobile CB antennas.

- Precision-wound, water-proof "Big Momma" type coil. Cool running...x100 reserve power factor. Lifetime burnout guarantee.
- Factory tuned for general use, set-screw ultra-fine tuning.
- Longer whip for more reach.
- 17-7 PH stainless steel whip. Taper ground to minimize range-robbing wind deflection at highway speeds.
- Anti-static whip ball tip for less noise, better safety.
- New quarter-turn quick-disconnect. Life tested over 2,500 times.
- 17' pre-assembled cable. miniature in-line connector for easy installation.
- Contour-forming protective mounting gasket for finished appearance.
- Complete hardware for both roof-top or trunk-lip mounting.
- 5 year limited warranty.

**Formula-1** performs like a formula should...and overtakes anything else on the roads. Available now from your CB dealer.

**the antenna specialists co.**

**REACT** Support your local REACT Team... We do!

**AS** 100% Service of Quality  
a member of The Allen Group

12435 Euclid Avenue, Cleveland, Ohio 44106 • Canada: A. C. Simmonds & Sons, Ltd.

element to be of a reasonably short length, yet assure optimum transmission efficiency.

**Shortwave Listening.** Beyond standard broadcast AM and FM radio and vhf/uhf TV lies a whole uncharted world of radio listening for anyone who has never used a shortwave receiver. Not only is shortwave listening (SWL) an interesting and often fascinating hobby,

hour period. With such a receiver, you'll be able to hear news reports from *British Broadcasting Company (BBC)* and *Radio Moscow* in the English language. Turn the dial, and you'll probably pick up broadcasts from Africa, New Zealand, Greece, Bermuda, and just about every country on earth. You'll hear Amateur Radio operators chatting with each other in both voice and code, steel-band concerts from the Caribbean Is-

**Collecting QSL Cards.** The practice of collecting QSLs, or verifications of reception, is an exciting part of shortwave listening. The proud owner of a really "hot" SW receiver is usually anxious to learn what distant lands he can reach out to and bring into his listening station. When he picks up a distant station, he can jot down date and exact time of reception, frequency on which he heard the broadcast, some details on the

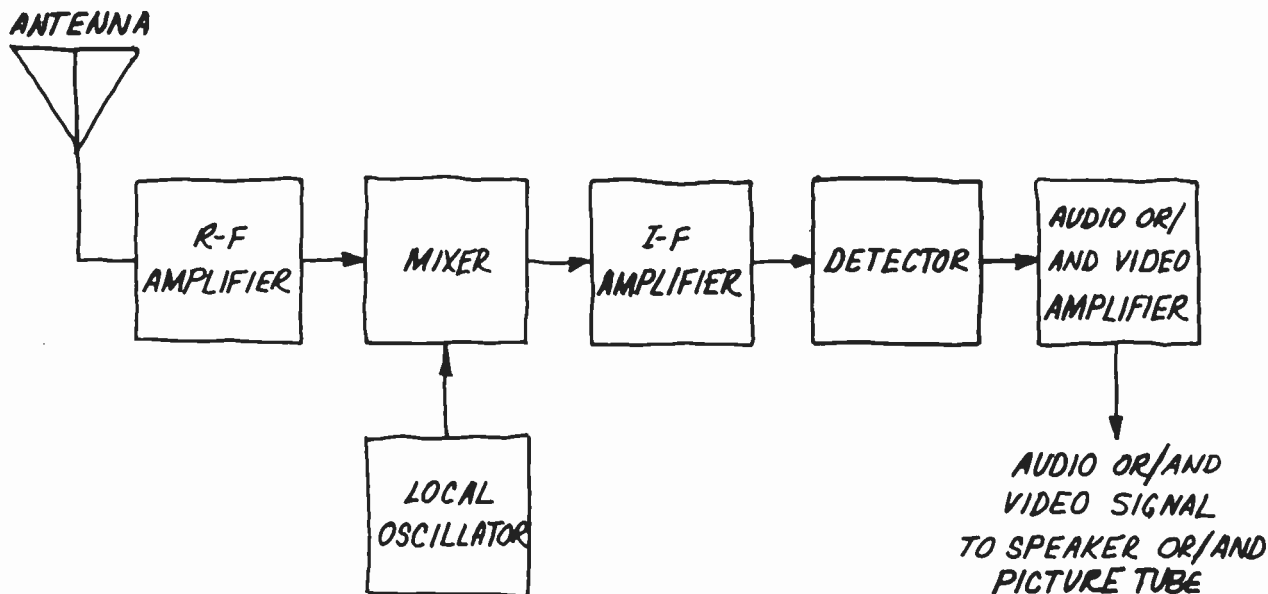

Fig. 4. Block diagram of the basic elements required in typical superheterodyne receiver.

it can be used to help learn another language, hear politics discussed from divergent points of view, and bring in music created and performed in foreign and exotic lands.

With a good SW receiver, it's possible to tune in more than 200 different countries that broadcast throughout each 24-

lands, and a whole lot more.

Foreign radio broadcasters are usually anxious to hear how their long-distance transmissions are faring and will usually respond to requests from SWLs with picturesque QSL cards and/or pennants that can be hung on a wall to dress up a listening station.

program monitored, and the quality of the reception. He'll then send this detailed report to the station that originated the broadcast, often including a souvenir, international reply coupons (available from the Post Office), or stamps as a small gift. In return, he'll usually get by return mail a QSL verification card, a letter with exotic stamps, or a pennant.

Some broadcasters, such as Radio Sweden, are very cooperative to comply with QSL requests. Others simply don't have the staff or the budget to respond. So keep this in mind when you make a request for a QSL reply.

When you write your report requesting a QSL, use Greenwich Mean Time (GMT), which is the standard used by all international broadcasters. (GMT is five hours ahead of Eastern Standard Time and eight hours ahead of Pacific Standard Time.) To avoid confusion between am and pm, GMT standard time-keeping is on a 24-hour clock, with mid-

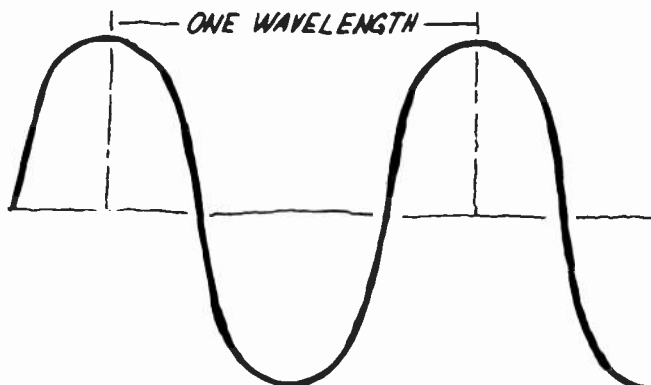

Fig. 5. One wavelength is the distance between any two identical points on a sinusoidal waveform.



night represented by 2400, 1 am by 0100, noon by 1200, 8:30 pm by 2030, and so forth.

Reception quality is generally denoted by a SINPO code, which is a useful shorthand method illustrated in an accompanying table.

**Selecting A Receiver.** If you were to shop for a shortwave receiver, you might be intimidated by the variety of different types on the market. Each type offers features that others don't and lacks features that can be found in other models. There is no one "best" receiver that will suit the needs of every SWL. So what's needed to make a good buying decision is to know something about SW receivers and your listening needs.

Ideally, one should acquire a good general-coverage communications receiver that has a tuning range of from

some only a few kilohertz apart, it's important for a receiver to have a high degree of selectivity to separate a desired station while rejecting others. The sharper the selectivity, the less the interference from adjacent channels. However, too sharp a selectivity can render tuning very difficult and can affect the quality of the sound in the received program. The better (and more costly) receivers that boast narrow selectivity include a selectable selectivity switch. For example, a two-position selectivity switch might allow the user to select the best bandwidth for the type of signal being monitored. For code (CW) signals that require only a 500-Hz bandwidth, narrow bandwidth would be chosen to make selectivity sharp and minimize or eliminate adjacent-channel interference. When a voice transmission is tuned, the switch would be set to wide bandwidth

to allow the receiver to accommodate, say, a 2.5-kHz bandwidth for voice transmissions.

When attempting to tune a station in a crowded SW band, a steady hand is required. To simplify tuning, most sensitive receivers have a bandsread tuning feature that operates in conjunction with the main tuning mechanism. This feature allows a much narrower bandwidth (500 kHz) to be handled without having to exercise a critically delicate touch. Digital-readout displays of frequencies are becoming very popular since they make it so easy to tune in the desired broadcast.

Since SW reception is often plagued by extraneous noise bursts that briefly override and obscure the main signal, receivers usually have a switchable automatic noise limiter (anl) or noise blanker built in. The latter is superior for this purpose. Either of these two devices can be switched in to clip the noise pulses and render them less objectionable to the ear.

While it may be a lot of fun to twiddle the tuning control to bring in a station, it would hardly be desirable to have to constantly retune to keep monitoring the broadcast. Hence, the receiver should have good frequency stability. All receivers warm up as they're operating, even though they are solid-state today. The heat sometimes causes changes in transistor characteristics and component values. The result is that the receiver will drift off frequency and require constant retuning.

Other features desirable to have to improve or make more flexible receiver performance include variable automatic



*Kenwood R-300 communications receiver has drum-type tuning and bandsread dials.*

550 kHz to 30 MHz. This covers the entire shortwave spectrum as well as some amateur-radio and CB bands, and the standard AM broadcast band. Key factors in equipment selection include sensitivity, selectivity, and tuning-ease provisions. Other important considerations are noise suppression, variable rf control, tuning accuracy, and a provision for a beat-frequency oscillator.

Sensitivity is the most important factor. This is a receiver's ability to pull in signals. The greater the sensitivity the better a receiver's ability to capture weak and distant stations. Most SW receivers on the market offer more than adequate sensitivity.

Since the SW bands are frequently very crowded, with many stations spaced close to each other in frequency,



*Panasonic RF-4900 communications receiver with direct-read digital dial.*

volume-control circuit, a signal-strength meter, and a beat-frequency oscillator. All receivers have a built-in automatic volume control (avc) circuit. This permits a receiver to automatically adjust audio volume as international broadcast signal strength wavers owing to propagation effects caused by the ionosphere.

maintain good reception probabilities.

**Public Safety Scanning.** Not all hobby radio listening is on the SW bands. Thousands of radio-listening hobbyists listen to the local Public Safety FM bands on which they can hear police, fire, and other emergency-service

are not transmitted on a steady, regular basis. An emergency call may occur on a particular frequency and last only a few seconds, giving you precious little time to spot it, much less listen to the message, without a scanning monitor. Using a scanner, however, you'll almost certainly hear the message because the receiver itself constantly scans through preselected channels and automatically stops on any channel on which activity occurs. The speed at which the scanner operates and locks onto an incoming signal is much faster than you could hope to match using manual scanning.

During normal operation, a scanner will constantly search through a number of predetermined channels (frequencies) at high speed. When it encounters a signal on any channel, it pauses in its search to permit the listener to hear the message. Then, when the transmission ceases, scanning resumes automatically, continuing until another live channel is encountered. At the listener's option, however, the scanning function can be suspended to allow continuous monitoring on a single desired channel.

Four different frequency bands are generally monitored by scanners. They are: low vhf on 30 to 50 MHz, high vhf on 150 to 174 MHz, uhf on 450 to 470 MHz, and uhf-T on 470 to 512 MHz. Low vhf is used by sheriffs, state-police, highway-patrol, and fire departments, where long-distance communication is



*Yesu FRG-7000 communications receiver with digital tuning display.*

With variable avc one can adjust the speed of such control. The signal-strength meter—or S meter as it's usually called—helps in tuning and monitoring the strength of the incoming signal. The beat-frequency oscillator, or bfo, is needed for reception of amateur radio's CW and single-sideband (SSB) transmitted signals.

calls, as well as marine radio telephone calls and 2-meter FM ham transmissions. Of course, you need a different type of receiver to be able to tune in these calls.

Most hobbyists who routinely monitor the Public Safety FM bands use a receiver called a "scanner" or "scanning monitor." Although there are a number

**DXing The SW Bands.** DXing, or reaching out to pick up broadcasts from distant lands, can be the most exciting part of the SWL hobby. Once a listening station has been set up, you can get on with your new hobby. But first you'll have to familiarize yourself with the procedures for using your new SW receiver most effectively.

Logging, or maintaining a logbook, is a voluntary activity almost every DX listener adopts. In the logbook is kept a record of every station picked up, the time of day for the reception, frequency, and location of the station. For example, if a station in Chile is picked up and you want to tune it in over a period of time, it's helpful to know where it's located on the dial. Keeping an accurate record of the initial reception will help you in locating a station at a later time. Also, a logbook will prove helpful when it comes time to request QSL cards from distant broadcasting stations you've received. Keep in mind that some SW broadcasters change their transmission frequencies a few times a year in keeping with nature's propagation characteristics to

of inexpensive band-switching public-service-band monitor receivers on the market that can tune in these emergency transmissions, scanners are the preferable choice because of the operating convenience they offer.

Public-service and emergency calls

essential between base stations and mobile radios. High vhf is also used by police and by marine, railroad, taxicab-dispatching, and mobile-telephone services. Uhf and uhf-T have become increasingly popular for police, fire, taxicab, and mobile-telephone use since,



*Radio Shack Realistic DX-300 synthesized communications receiver.*

at these high frequencies, a considerable amount of channel space is available.

Each channel is assigned a specific operating frequency. Since a scanner is basically a fixed-tuned receiver that scans a selected group of channels in discrete steps, it's necessary for you to know which services operate in your area and the frequencies they use. Some scanners require separate crystals for each channel you wish to monitor. The current trend, however, is the more expensive programmable scanning monitor in which a large number of channels can be preprogrammed by synthesizing their frequencies with just a few crystals instead of one for each.

Scanners are available in pocket-size battery-powered models with four-channel capability to desktop programmable models that are capable of searching through hundreds of channels. A typical scanner might be crystal controlled with 8-channel coverage of low vhf, high vhf, and low uhf.

Moving up to the most modern monitor receivers, we come to the programmable synthesizer scanner. Employing microprocessor circuits, the scanner can store frequencies of active channels you choose in its memory system for instant recall simply by pressing buttons on a keyboard.

A typical programmable scanner can access more than 6000 frequencies and allow any 16 to be stored for scan monitoring. Its features would include high selectivity to reduce or reject signals close to the desired frequency; variable scanning rate ranging from two to 10 channels per second; high sensitivity to bring in weak stations; and digital-numeric frequency display. With a programmable scanner, the listener merely keys in channel and frequency selections on the receiver's calculator-like keyboard.

Regardless of which type of scanner you use, you must know the exact frequencies of the services operating in your locality so that you can buy crystals for them or program them into your programmable scanner. Listings are published in the *Police Call Directories*, available from Radio Shack and stores in which you can buy Amateur Radio and other communications equipment. If aviation-communication monitoring is of interest to you, a scanner that covers the 118-to-134-MHz band will be needed. Likewise, if you want to listen in on the 2-meter Amateur Radio band, you'll need a 144-to-148-MHz vhf FM scanning monitor receiver.

If a scanner is bought to be used in an area where services to be monitored are

few, a low-cost crystal type will suffice. Since few crystals will be needed, overall cost may be considerably less than what you would have to pay for a sophisticated microprocessor-controlled programmable scanner. On the other hand, if you use your scanner while traveling long distances, a programmable scanner, which can be made to search out unknown frequencies, will be a better

investment by far.

The typical scanner comes with a small plug-in or attached antenna, which is adequate if your listening station is not too far from the transmitting stations, both fixed and mobile. There are better indoor antennas available, though. Best distant reception will be obtained with an outdoor antenna designed for the particular band or bands

## Reduce Your Electric Bill!

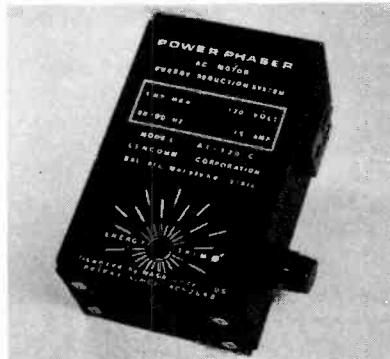

You'll be a little richer after building one of these...

Cut the cost of operating motor driven appliances and machinery AS MUCH AS 40%

**\$36.<sup>95</sup>** KIT

**FACTORY WIRED \$59.95**  
(3 for \$149.95)

- Reduces Your Electric Bill
- Save As Much As 40% on cost of operating Appliances & Machines
- Starts Paying For Itself as soon as it's installed
- Eligible for 15% Energy Tax Credit
- Appliances & Machines run quieter and cooler
- Protects Motors from Burn-out
- Simple Plug-in Installation
- Patented Solid State Electronics
- High Capacity 120 Volt 15 AMP, 1 HP Motor Rating
- Compact 3" x 5" x 2" Package
- Easy Assembly
- Typical Applications
  - Swimming Pool Filters
  - Furnace and Attic Fans
  - Clothes and Dishwashers
  - Freezers
  - Air Conditioners
  - Saws
  - Grinders
  - Any AC Motor Driven Device

**USED BY A NATIONALLY ACCREDITED TECHNICAL SCHOOL IN THEIR TRAINING PROGRAM**

Advanced SPACE AGE Technology now makes possible the ONLY electronic kit that PAYS FOR ITSELF and keeps on paying you a dividend by lowering your electric bill.

POWER PHASER is a patented, solid state analog mini-computer that constantly calculates the exact amount of power a motor requires to do work at any instant and automatically adjusts voltage to this precise level. Energy consumption is reduced, motor life is extended - MONEY IS SAVED.

**PHONE ORDERS - Credit card or C.O.D. customers call 301-272-2860**

**Lincomm Corporation/Advanced Technology Systems**

Dept. RE200 /415 W. Bel Air Avenue, Aberdeen, Maryland 21001

Send \_\_\_\_\_ Factory Wired POWER PHASER(S)-\$59.95 ea.

Send \_\_\_\_\_ POWER PHASER KIT(S)-\$36.95 ea.

Include \$2.00 Shipping & Handling. Maryland Residents add 5% tax.

\_\_\_\_\_ Check or Money Order enclosed

Charge to: \_\_\_\_\_ Mastercard \_\_\_\_\_ Visa

Card No. \_\_\_\_\_ Expires \_\_\_\_\_

Bank No. (Above your name Mastercard only) \_\_\_\_\_

**PLEASE PRINT CLEARLY**

NAME \_\_\_\_\_ ADDRESS \_\_\_\_\_

CITY \_\_\_\_\_ STATE \_\_\_\_\_ ZIP \_\_\_\_\_

of frequencies you intend to monitor on a regular basis, however.

In sum, it's a lot of fun listening to, say, a police dispatcher talking to an officer in a patrol car. Keep in mind, though, that the Communications Act prohibits you from discussing what you

or so, CB operators have also become active contributors to public safety during emergencies. Public-spirited CBers subscribe to REACT and ALERT, two very active nationwide CB emergency services. Teams of REACT volunteers around the country constantly monitor

when a distress call comes in, pull over to the side of the road and stop your vehicle. Then, using a pad and pencil (which you should have handy in your glove compartment), take down any facts pertinent to the situation. Write down the exact location of the person who needs help, the nature of the emergency, number and types of vehicles involved, number of people involved, and if there are any injuries. You may have to ask a lot of questions to get a complete report; so, keep calm and collected while soliciting information.

Once you have a complete report, relay the information immediately to the proper authorities—police, fire, Coast Guard, etc. If an ambulance is required, it will most likely be summoned by police or state troopers.

A key point to remember when using channel 9 to handle an emergency is to keep this emergency channel clear for other emergency traffic. Therefore, don't use it except for emergencies, and then use it as efficiently as possible, keeping your operations short. If possible, once you contact the emergency authorities or REACT or ALERT, switch to another clear channel to give any information germane to the emergency situation.

**Types of CB Radios.** The type of CB radio you buy will depend mostly on where you intend to use it and what type of communications you expect to need. There are, of course, different types of

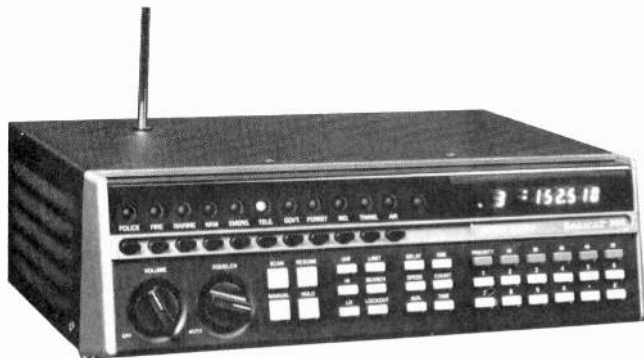

*Microprocessor-based Bearcat 3000 "Service Search" scanning monitor receiver for tuning in Public Safety Bands.*

heard with anyone (excepting Amateur Radio transmissions), and that a very few areas have local ordinances prohibiting use of these receivers by the general public.

**CB RADIO.** Citizens Band or CB radio is the means by which the ordinary citizen can participate in two-way radio communication inexpensively and without having to pass a test to get a license. You don't have to learn electronics and radio theory, or master Morse Code as Radio Amateurs do to become a CBER.

The 40 channels currently assigned to CB radio operations on the 27-MHz band are spaced 10 kHz apart, except those adjacent to class-C channels (Fig. 6). Channel 9, on 27.065 MHz, is reserved for emergency communications. It's also used to provide motorists with directions and information on lodgings. Channel 13 is generally used for marine communications, motorists and truckers usually use channel 19 to learn about road conditions and traffic congestion from other on-the-road CBers, while channel 10 is often used on local highways. Although it's not official, the custom is to reserve channels 16 and 35 through 40 for single-sideband (SSB) operations.

**Pitching In With CB.** There are many on-the-air activities in which CBers can participate, including social conversations, giving reports on road and traffic conditions, etc. During the past decade

channel 9, standing ready to offer assistance or to call for professional help for anyone who needs it.

This emergency service aspect of CB radio has, in fact, been so successful that many law-enforcement agencies monitor channels 9 and 19 to offer immediate aid when necessary. At sea, the Coast Guard listens in on channel 9 and is ready to render service to any small boat owner who sends out a distress call.

*Regency fully programmable "Touch M100" Public Safety Band scanning monitor receiver.*



While it's not part of the written rules, every CB owner should be ready to cope with an emergency call. If you should hear such a call, whether you're driving or monitoring from a base station, you can be in a very important position to help the authorities. If you're driving

CB rigs designed to meet different communication demands and installations. To this end, there are three basic types available: mobile radios for cars, trucks, recreational vehicles, etc.; base-station rigs for stationary home and office use; and lightweight and compact battery-

powered walkie-talkie rigs that can be used when you're on foot.

If you want a CB radio to communicate while you're on the road, a mobile rig is the obvious choice. It can be installed just about anywhere in a vehicle, including in a dashboard, under the dash, under a seat, or even in a trunk. For in-dash installations, you can obtain a CB radio that's part of a complete AM/FM-receiver/cassette-player/CB-radio system. Underdash CB radios can be either permanently mounted or set into a slide-out bracket for easy removal when you're not in your car. Under-seat and in-trunk mounting require special types of CB radios whose electronics package goes in a hidden location and whose microphone assembly has all operating controls mounted on it.

Mobile CB radios are designed to be powered from the electrical system of the vehicle in which they're mounted. However, inexpensive (\$20 or less) ac line-power driven power supplies are available to allow a mobile rig to be used in a home or office. Not only does the ac power supply allow you to use a mobile rig as a base station, it offers the benefits of greater communication range, using a roof- or tower-mounted antenna.

A base-station CB radio, designed for fixed locations where ac power is available, comes with a built-in ac power supply. As a rule, base-station rigs are larg-

er than their mobile counterparts, allowing them to offer additional features. Many base-station radios even come with a 12-volt input jack that permits them to be used in mobile communication environments.

Like the radio, the base-station antenna remains in a fixed location, usually on a mast or tower atop a roof, where it can be as much as 40 ft above the ground. Base-station CB antennas are much larger and heavier than the typical mobile CB whip antenna, owing to

and only the remaining sideband is used to recover the audio intelligence transmitted. For the receiver to be able to do this, its bandwidth must be at least 5000 Hz wide to allow it to accommodate both sidebands. Also, if the transmitter is delivering 4 watts of output power, with 2 watts of audio power, the effective talk power in each sideband is limited to only 1 watt.

Single-sideband (SSB) operation is also available on many CB radios. In an SSB system, the carrier and one side-

Radio Shack  
Realistic  
TRC-470 in-dash  
40-channel  
CB/AM/FM-  
stereo receiver.

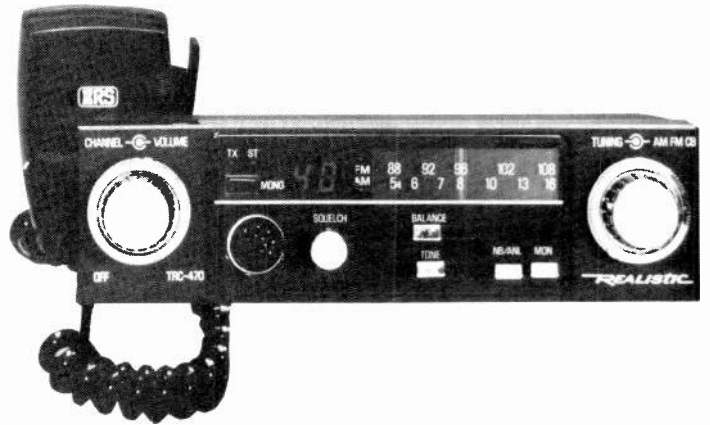

the fact that they're more critically designed to provide maximum transmit/receive efficiency.

A hand-held walkie-talkie type CB radio is ideal for hunters, fishermen, campers, backpackers, and others who don't ordinarily have access to line or mobile power systems. One pays for the convenience of these carry-along rigs in two ways. Firstly, range is limited by the considerably shorter antennas used with these radios. Secondly, operating time is relatively short, due to the limited amount of electrical power that can be stored in the radio's power pack. (Most CBers who use hand-held radios install rechargeable nickel-cadmium cells to obviate the need to be constantly replacing batteries.)

When an operator keys (turns on) his microphone, his AM CB radio generates a carrier and two mirror-image sidebands when voice modulation is applied. A signal of 2500 Hz applied to the transmitter produces a carrier on the selected frequency plus upper and lower sidebands spaced 2500 Hz above and below the carrier frequency.

When the AM signal is received, the carrier and one sideband are removed

band are removed *before* the signal is transmitted, concentrating all of the power in the single sideband transmitted. Now, if a 2500-Hz audio signal is transmitted on, say, SSB channel 14 (27.125 MHz), the upper sideband of 27.1275 MHz (27.125 MHz + 0.0025 MHz) would be sent out over the air and the SSB receiver's bandwidth would have to be only 2500 Hz wide—half that of an AM system's receiver—for it to properly receive the signal. Moreover, the SSB receiver's sensitivity would be improved and its input noise level would be reduced. Also, the 4 watts of allowable power concentrated in the single transmitted sideband would, in effect, result in 12 watts of peak envelope power (PEP).

Special circuits in the SSB receiver reinsert the carrier removed by the transmitter, making SSB systems more expensive to produce than AM systems and, thus, are considerably more expensive to buy. However, one gets more than just added talk power for the premium price he pays for an SSB CB rig. The bonus here is that there are three times the number of communication channels available to the SSB CBER. An



Fox BMP 10/60 programmable PSB radio.



SSB operator can select either upper sideband (USB) or lower sideband (LSB) on any of the standard 40 AM channels without interfering with someone else using the other sideband on the same frequency. This alone gives a choice of 80 channels, but it's not all, because SSB radios also allow operation as AM systems, giving an additional 40 channels. So, all told, the SSB CB radio can access 120 channels. Of course, when a CBER is operating on SSB, anyone else using an AM-only rig wouldn't be able to hear him, even if the two were on the same channel. All things being equal, the SSB'er will wipe out the AM'ers communications if both were on the same channel.

If your interest runs to just monitoring the CB channels and you have no desire to talk back, you don't need a CB transceiver. You can, instead, buy a communications receiver that covers the CB frequencies, an AM/FM/CB portable radio, or a CB converter that can be attached to an AM radio to allow it to bring in CB signals.

**Mastering The Controls.** Since CB radios aren't designed for technically trained users, the controls on them are easy to understand and master. Among the controls that can be found on a CB radio are: volume/power control; push-to-talk transmit switch; squelch control; CB/PA switch; ANL (automatic noise limiter) switch; channel selector; r-f gain control; and delta-tune control. An S meter is another item usually found on CB radios. Not all of the above controls can be found on all CB radios transceivers, however.

When a CB receiver is on, a certain amount of static-electricity-induced noise—sometimes called "hash"—will be heard, even when another CB station isn't transmitting on the channel to which the receiver is tuned. As a channel is being monitored, this static can become very annoying. To deal with this problem, CB radio manufacturers provide a squelch control in their products. As the setting of the squelch control is varied, it reaches a point where background sounds are quieted so that static and internal noises won't be heard. Only a signal of sufficient strength will override the squelch and be heard from the CB radio's speaker. When an incoming transmission ends, the CB receiver will become quiet again until another signal arrives and is detected.

Proper use of the squelch control may take a little practice. Too high a setting, for example, will lock out moderate-

strength signals, allowing only very strong signals to pass through the receiver. On the other hand, too low a setting won't be as effective in completely silencing background noise.

Sometimes even a strong CB signal that overrides the squelch circuit can be swamped with heavy atmospheric and/or ignition noise. To deal with this problem, an automatic noise limiter (ANL) circuit in the CB receiver can be switched in. When the ANL is switched in, the circuit clips (removes) the disturbing signals.

Many CB radios also provide a public-address (PA) facility that allows the radios to be used, in conjunction with a larger, more powerful external speaker as a paging system. Operation on either CB or PA can be selected via a switch on the front panel of the CB radio.

*Drawing shows details of how CB antenna is mounted to roof of a vehicle.*

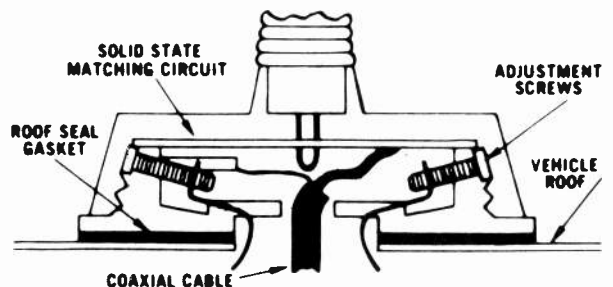

An S meter (the "S" stands for signal quality) enables the CB radio operator to monitor the relative signal strength of an incoming signal. The meter's scale is generally divided into equal segments numbered from 1 to 9. The higher the number to which the S meter's pointer swings, the higher the strength of an incoming transmission.

In an effort to provide usable reception of very weak signals, more expensive CB radios have built into them very efficient high-gain r-f (radio-frequency) amplifiers. Obviously, a receiver with additional r-f gain can overload when a strong nearby signal arrives. So, an r-f gain control is included to permit the amplification, or gain, of the r-f circuit to be adjusted to handle virtually any signal-reception condition.

Although crystals used in CB radios are quite precise in maintaining accurate operation at the frequency for which they're cut, a wide disparity between the actual crystal operating frequencies can result in distortion or poor voice quality. Such a situation might exist if two CB radios communicating

with each other have crystals that are operating on the extreme high and extreme low sides of the center-frequency design tolerance. Both CB radios would be operating within the FCC-specified tolerance range, making both good units, but communication intelligibility would suffer. To deal with this potential problem, most CB radios are equipped with a delta-tune control. This device usually has three positions—plus, median, and minus—to allow the CB operator to slightly adjust (trim or fine tune) the crystal frequency for clearer reception.

Among the desirable features to have in a CB radio is a channel-9 monitor. Since channel 9 is reserved for emergency situations, it's important to maintain contact with it. Some CB radios have a light that flashes whenever someone is

transmitting on channel 9. This light will flash even if an operator is tuned to a different channel. More sophisticated CB radios have circuits in them that route incoming channel-9 messages directly to the speaker, interrupting reception on any other channel being monitored at the time.

**CB Antennas.** The antenna is perhaps the most critical element in a CB radio system. Unless the antenna is properly tuned and installed, it can severely limit communication range by not allowing the maximum amount of power developed by a transmitter to be radiated.

An antenna can be a single vertical element, such as the whip used in mobile installations, or an elaborate collection of rods, wires, and coils, such as used in a base-station setup.

For optimum communication performance, antenna length must be closely related to the wavelength of the frequency the antenna is to handle. Since the 27-MHz CB band has a wavelength of 11 meters (36.6 ft), optimum performance will be obtained if an antenna

of this length is used. Obviously, such a long antenna would be impractical, especially for mobile use. Fortunately, multiples of this wavelength are also efficient. But even a quarter-wavelength antenna at 9-ft long, which might be fine for a base station, would be tall enough to be troublesome on the roof or bumper of a car. Most mobile antennas are, therefore, usually equipped with a coil of wire (called a "loading coil") and a less-than-2-ft-long whip that simulate a quarter-wave antenna at 27 MHz.

Antenna impedance, another important parameter, must match the impedance of the CB radio and connecting cable to assure maximum transfer of power to the antenna. Any mismatch will cause a portion of the developed power to be reflected back to the transmitter. Any energy reflected back subtracts from the transmitter's power and isn't available for radiation from the antenna. Since CB transmitters develop relatively low power to start with, it's essential to have as much as possible of this energy reach the antenna, with little or none reflected back.

You don't have to know all the technical details of impedance matching to be able to properly install and match a CB antenna. All you need is an SWR meter, which measures the standing wave ratio in a CB-radio transmitting system. Then, all you have to bear in mind is that the lower the SWR reading, the better the impedance match and the better the CB radio's performance for both reception and transmission.

After an antenna is installed, the SWR meter is connected between the antenna and the radio's transmitter output. Then the radio is set to a mid-band channel such as 20, and turned on. With the SWR meter set to FWD (forward), the microphone is turned on and the knob on the meter is adjusted until the meter's pointer is matched to a mark on the right side of the scale. After this, the meter's switch is set to REF (reflected) and the microphone is again keyed. If the meter's pointer drops to a reading of less than 1.5:1, impedance matching is good; if not, some antenna trimming is necessary. Most CB antennas have provisions for adjusting their length, while testing the SWR, to further reduce the SWR level or bring it down to a reasonably low level.

For a mobile installation, the antenna can be a full 9 ft long or the coil-loaded shorter equivalent. The antenna can be mounted in the center of a vehicle's roof, where its radiation pattern will be uniform and evenly distributed. Because

many car owners frown on drilling holes through the tops of their cars, rear-bumper and trunk-lip mount antennas are more common. Other alternatives include antennas that temporarily clip onto and are easily removed from a vehicle's rain gutter and magnetic-base antennas that firmly anchor to a vehicle's top or trunk lid, but also permit easy removal. In both these latter cases, the antenna cable is routed through an open window and connected to the CB radio's antenna input.

Antennas for base stations are generally more complicated, more expensive, and a great deal more efficient than the simple vertical whips used for mobile installations. In base-station applications, polarization (how the antenna is oriented), gain, and directionality become significant. A vertically polarized antenna (pointing straight up) is the usual choice here. Signals from such antennas are easily picked up by mobile CB antennas, which are almost always designed to be vertically mounted and, thus, are vertically polarized. However, these signals will be poorly received by an installation that has a horizontally polarized (parallel to the earth's surface) antenna. Some, but not many, base stations use horizontally polarized antenna systems.

An antenna can provide more effective radiated power (gain) if the transmitted radio waves are focused instead of being spread out. A focused beam antenna is very directional and will permit contact with a distant CB station if it's properly aimed. Only receiving antennas that lie within the focused beam pattern will pick up the signal; those that lie outside the beam pattern won't be able to pick up the signal well. Omnidirectional antennas, on the other hand, provide a uniform radiation pattern, which can be received by just about all CBers within a smaller-radius communicating area.

A typical base-station omnidirectional antenna is a 9-ft quarter-wave vertical element with a ground plane made up of three or four isolated radial rods. A more complicated, highly directional beam antenna concentrates its radiated signals in a single direction.

**On The Air.** If you've ever listened in on the CB channels or seen a motion picture or TV show about truckers, you know that CBers often use a special jargon. Much of this "language" revolves about the 10-code that was in existence long before CB radio became popular. The 10-code is a form of shorthand that

helps reduce talk time, each one with a unique and special meaning. Typical examples of 10-codes are: 10-4 for affirmative or message received; 10-6 for busy, please stand by; 10-7 for going off the air; 10-8 for ready to receive a call; 10-10 for transmission completed; and 10-20 for asking for and reporting locations of CBers on the air.

SSB operators tend to take their CB operating more seriously than do typical AM operators. They use Q signals similar to those used by Amateur Radio operators. Thus, instead of hearing 10-codes, you're more likely to hear such codes as QRM, QSM, QSL, and QRJ from SSB CBers. Here are the meanings: QRM—interference affecting transmission; QSM—repeat message; QSL—acknowledge receipt; QRJ—signal is weak.

Most CBers also have their own special jargon that can be confusing to the neophyte. But after a few weeks of being on the air, the newcomer will soon be understanding and using it himself.

**Marine Radio.** If you own or plan to buy a pleasure boat, chances are you'll want to assure safety in an emergency with reliable two-way communication. This can be accomplished with a CB radio, a vhf/FM marine radio, or both. A vhf/FM marine radio is preferred. Firstly, its communications range is greater. And a vhf/FM marine radio will let you contact commercial vessels, waterway control points, marinas, the Coast Guard; place and receive telephone calls; get weather reports, etc. It's illegal to use a marine radio for idle chatter with other boaters, however. So a CB radio is helpful here, if other boaters also have one.

Although 55 channels are set aside for vhf/FM marine operations, not all are available (or needed) for recreational craft. It isn't necessary, therefore, to install an expensive 55-channel two-way radio on a pleasure boat. In almost all cases, a less-expensive 12-channel radio will be sufficient.

Many 12-channel marine radios employ two crystals per active channel. Of the 12 channels selected, one or two are usually set aside for receiving-only of National Weather Service (NWS) transmissions on 162.40 and 162.55 MHz. The remaining channels might include a marine radiotelephone channel to enable placing and receiving regular telephone calls at sea on channel 26 or 28, depending on your area. Another channel should be channel 16 (156.80 MHz) for safety information, while yet

another would be channel 6 (156.3 MHz) for ship-to-ship safety communication, and so forth.

More sophisticated—and expensive—marine radios employ a phase-locked-loop (PLL) frequency synthesizer to give access to all 55 channels. Semiautomatic operation is also available with some models, using a microprocessor integrated circuit.

Marine radios are permitted to deliver up to 25 watts of output power to their antennas. However, a switch is usually provided for reducing output power to 1

reap these exciting benefits, one must be able to transmit and receive Morse code, and be familiar with the FCC Rules and Regulations—all of which must be demonstrated by passing tests administered by the FCC.

Aside from passage of tests to obtain a license, the only requirement for becoming a ham-radio operator is that one be a citizen or national of the United States. Age, sex, religion, or national origin have no bearing on eligibility. Licenses have been issued to children of less than

Although it's good for only two years, the Novice ticket can be renewed for another two years.

The Novice exam isn't given at an FCC field office, as is the case with the exams for all other levels of Amateur Radio licenses. This exam is administered by another ham who holds a General class or higher license and who is at least 18 years old and who is *not* related to the applicant.

Many people who become interested in ham radio for the first time are put off by the code-proficiency requirement. At first, the *dits* and *dahs* (dots and dashes) of the International Morse Code may sound way beyond their capabilities to learn, when in fact, code is really relatively easy to learn. All it takes is a bit of practice, first to distinguish between the *dits* and *dahs*, and then between character groupings. The code itself is arranged in a very logical manner, with the most frequently encountered letters assigned the simplest groupings.

To help the newcomer to Morse code achieve proficiency in reading, there are a number of records and cassette tapes that start at very slow speeds to help in familiarizing the listener with the *dits* and *dahs* and in picking up speed in recognition of character code groups. A good way to learn to copy code is to start with another neophyte who is also anxious to learn code, though a go-it-aloner should experience little difficulty in mastering the code with practice.

Beyond tapes and records, there is another excellent way to build up code-copying speed. If you have access to a communications receiver, you can tune just about anywhere but the broadcast band to pick up ham, military, and commercial CW signals that you can practice copying. Another alternative is to tune in the ARRL (American Radio Relay League) broadcast on W1AW, which transmits daily at various speeds. You can get a copy of W1AW's broadcast schedule by writing to American Radio Relay League, 225 Main St., Newington, CT 06111.

To learn how to send code, you'll need a code-practice oscillator (cpo) and telegraph key. These items are commonly available from most electronics parts stores and through mail-order suppliers. They're usually very inexpensive; a good-quality setup, including telegraph key and built-in speaker, should cost in the neighborhood of \$15 or less.

In recent years, the code test has been simplified, making it basically a message-content exam. You'll be expected to copy a 5-minute message and then



Yaesu CPU-2500 microprocessor-programmable 2-meter Amateur transceiver.

watt during close-proximity ship-to-ship communication and when in harbors.

Communication between two boats or between a boat and a shore station is accomplished with simplex operation, with transmission and reception on the same frequency. On the other hand, two-frequency half-duplex operation is used for the marine radiotelephone channel, with each station transmitting on one channel and receiving on another.

The antenna on a boat should be mounted as high as possible above the surface of the water to provide maximum communicating range.

**Amateur Radio.** Amateur Radio—or ham radio to its adherents—is the highest level of two-way radio operation to which the private citizen can aspire. Moving up to ham radio, one also moves up to greater transmitting power; local and long-distance communication; a choice of many different bands on which to operate; and a wide variety of modes of operation. Of course, to be able to

10 years of age and to golden agers well into their eighties.

**Becoming a Ham.** There are five classes of ham licenses. In ascending order of the advantages they bring, they are: Novice, Technician, General/Conditional, Advanced, and Extra Class. To qualify for a Novice "ticket" (a buzz word for license), one must pass a relatively simple test on basic radio theory and FCC Rules and Regulations and be capable of sending and receiving international Morse code at a rate of 5 words per minute (wpm).

Upon passing the Novice exam and receiving a Novice ticket, you can transmit Morse code (CW)—but not voice—from a transmitter rated at up to 250 watts output. To be permitted to operate phone (voice), plus being allowed to move up to higher transmitter power, you must pass the examinations for the next plateau upward.

The Novice ticket limits operation to the 80-, 40-, 15-, and 10-meter bands.

answer a 10-question comprehension test to determine whether or not you understand the message. So, even if you miss a few letters here and there, it should be possible to pass the code portion of the exam with flying colors.

There are many good books that can be used to prepare you for the written portion of the Amateur Radio licensing exam. A good place to start looking for them is your local electronics parts store. You'll need as a minimum books on electronics and radio theory and FCC Rules and Regulations. One excellent book that covers all phases of Amateur Radio is the *Radio Amateur's Handbook* published annually by the American Radio Relay League. Books devoted to Amateur Radio exams are particularly useful, since they can also serve as a reference guide to other books you'll need to help you to get a thorough grounding in the subjects needed for passing ham-radio licensing exams. These books are prepared in a question-and-answer format, using Q&As similar to those in actual FCC exams.

Another good way to prepare for all phases of Amateur Radio licensing exams and ham operations is to join a local ARRL group or ham radio club. Many high schools and colleges also offer ham radio license courses as part of their adult education programs, and a number of correspondence schools offer licensing courses.

If you're learning electronics and communications theory, and the FCC Rules and Regulations on your own, the best advice is: Take your time. Don't try to rush through a book in just a few days, and don't jump ahead of yourself or proceed to a new topic until you thoroughly understand topics on which new material is based. It's preferable to study for a half hour or so a day for several weeks at a leisurely pace than to try to cram everything into a very short period of time.

When you feel you're prepared to take your Novice exam (or any other level of ham radio exam, for that matter), request Form 610 from your local or closest FCC field office. Fill it out and return it; the FCC will then inform you when and where to take the exam. Amateur Radio licensing exams are generally given at FCC field offices on specific dates, except for the Novice exam, which is administered by a holder of a General class license at a location agreeable to both you and the ticket holder.

**Moving Up The Ladder.** Getting a Novice ticket is more or less an initial

tion to Amateur Radio. After serving an apprenticeship as a Novice, you'll want to upgrade to more transmitter power and be able to operate on more bands and/or be able to use voice or TV communications. To be able to do this, you'll have to take tougher licensing exams.

The Technician licensing exam involves a more technical written test—but the same 5-wpm code-copying proficiency—than that for the Novice ticket. This license is good for 5 years and can be renewed for another 5. Holders of Technician tickets can operate radiotelegraphy (CW or code) and radiotelephone (voice). Furthermore, they have access to operate on both the vhf and uhf Amateur Radio bands. The two-meter band is especially popular since there are many local clubs that have relay systems to extend range greatly.

To obtain a General-Class license, the next step up, you must demonstrate a code-copying proficiency of 13 wpm, but the written exam is the same as for the Technician ticket. To make things easy, Technician ticket holders simply have to pass the 13-wpm code-copying test to upgrade their licenses. They don't have to retake the written exam.

Going up another rung on the ladder, you come to the Advanced Class license, and at the top of the ladder is the Extra Class license. Each progressive step requires passing a more difficult exam, but opens up new frequencies you can use. One of the advantages of moving up to the Advanced and Extra Class licenses is the opportunity they give the holder to transmit TV pictures.

A holder of one class of license isn't obligated to upgrade to a higher class,

to a higher class of license, a simple rig can be upgraded with a modulator to provide voice-operation capability.

Most beginners are anxious to buy a commercial transmitter, which may cost several hundred dollars. Such transmitters generally cover the 80- through 10-meter bands and can accommodate both CW and voice modulation.

Although a Novice may be limited to CW operation, it would be shortsighted of him to buy a CW-only transmitter. While some newcomers do just this and trade up when they're ready, most who expect to upgrade their licenses invest in a transmitter that can be used for voice and SSB as well as CW. Also, just because a Novice is limited to 250 watts of transmitter power doesn't mean that he must buy a 250-watter. Less expensive 100-watt transmitters will provide sufficient power for long-distance coverage. Some Novices, expecting to graduate to higher-class licenses fairly quickly, buy higher-power transmitters that provide up to 1000 watts of power but are usually designed to operate at less than 250 watts when desired.

Finally, some hams who like challenges use transmitters that develop very low power—on the order of 2 watts or less—to make long-distance contacts. Such low-power transmitters are usually home-built from parts salvaged from radio and/or TV receivers.

**The Antenna.** Experienced hams know that doubling transmitter power isn't as effective in delivering a stronger signal as is using a more efficient antenna. It isn't uncommon, therefore, for a ham to include as a basic element of his

*MFJ Versa Tuner II simplifies selection of antenna and proper matching impedance.*



nor is there any minimum length of time he must remain at a given level.

A beginner can transmit with a low-power exciter variable-frequency oscillator (vfo), turned on and off as the transmitter is keyed, to produce *dits* and *dahs* (dots and dashes). With an efficient antenna and a bit of luck, he can communicate with distant hams located thousands of miles away. After moving

ham shack a rather complicated and massive antenna.

Antennas for ham radio operation range from simple dipoles to very elaborate directional arrays with lots of rods and wires. The simplest antenna, the dipole, consists of two equal lengths of wire arranged end to end and fed at the center. Another basic type of antenna is the vertical rod, or Marconi, antenna.

The dipole antenna has a bidirectional radiation pattern. Energy from this antenna is radiated equally in all directions perpendicular to the line of the wire.

Beam antennas are directional, concentrating the r-f energy delivered to them into a focused beam that's aimed in one specific direction. Typical examples of this type of antenna are Yagi and quad arrays, to name just two. Beam antennas are generally mounted on an antenna rotator that permits them to be aimed in any desired direction, using a control box located in the ham shack near the transmitter.

**Hams on FM.** Although it's certainly exciting to work DX, contacting far-dis-

tant stations, there can be just as much satisfaction in limiting communication to line-of-sight 2-meter operation on the 144-to-148 MHz Amateur band, using FM instead of AM. Availability of modestly priced hand-held and mobile FM transceivers, coupled with noise-free operation, has considerably changed the Amateur Radio hobby.

approach in modern rigs is to synthesize the desired frequencies using very few crystals to cover the entire band. A typical 2-meter FM transceiver for base or mobile installations can deliver 10 watts of power, is about the size of a cigar box, and draws less than 3 amperes of current from a 12-volt dc power supply or automotive electrical system. Hand-held rigs generally deliver 1 to 4 watts of output power, are small enough to be slipped into a large pocket, and can be operated for several hours from rechargeable nickel-cadmium batteries.

Repeater stations enable the 2-meter FM operator to contact other FMers via relay links. A repeater station is a combination receiver/transmitter system lo-

these pulses and produces printed characters on paper.

Although the receiver and transmitter used for RTTY are conventional in design, a keyer and receiving converter are required to make this type of operation possible. The keyer switches the transmitter on and off as pulses are generated by the originating teletypewriter. The receiving converter is responsible for converting the incoming RTTY signal into dc pulses that operate the destination teletypewriter.

**Slow-Scan TV.** Not only do hams talk to each other over the airwaves, they sometimes even see each other the same way, using ham TV transmissions. Two

A	••••	N	•••••	1	••••••••••
B	••••••••	O	••••••••	2	••••••••••
C	••••••••••	P	••••••••••	3	••••••••••
D	••••••••	Q	••••••••••	4	••••••••••
E	•••••	R	••••••••	5	••••••••••
F	••••••••••	S	••••••••	6	••••••••••
G	••••••••••	T	••••••••	7	••••••••••
H	••••••••••	U	••••••••	8	••••••••••
I	•••••	V	••••••••	9	••••••••••
J	••••••••••	W	••••••••	Ø	••••••••••
K	••••••••••	X	••••••••		
L	••••••••••	Y	••••••••		
M	••••••••	Z	••••••••		
WAIT (AS)	••••••••••	QUESTION MARK	••••••••••		
PERIOD	••••••••••	DOUBLE DASH (BREAK)	••••••••••		
COMMA	••••••••••	END OF MESSAGE (AR)	••••••••••		
FRACTION BAR (/)	••••••••••	INVITATION TO TRANSMIT	••••••••		
ERROR	••••••••••	END OF TRANSMISSION (SK)	••••••••••		

The International Morse Code used by professional communicators and Amateur Radio Operators.

tant stations, there can be just as much satisfaction in limiting communication to line-of-sight 2-meter operation on the 144-to-148 MHz Amateur band, using FM instead of AM. Availability of modestly priced hand-held and mobile FM transceivers, coupled with noise-free operation, has considerably changed the Amateur Radio hobby.

The 2-meter FM band is divided into specific frequencies or channels that are separated from each other by 30 kHz. Channel 1 is on 146.01 MHz, channel 2 is on 146.04 MHz (146.01 MHz + 30 kHz), and so on up to 147.99 MHz. Early-design 2-meter rigs used two crystals per desired channel, but the popular

repeater picks up signals from mobile and hand-held rigs and retransmits them on another frequency, from an antenna mounted high above the ground. This arrangement permits communication over long distances.

**Sending Printed Words.** In addition to CW and voice, hams can also transmit radioteletype messages. A RTTY message to be transmitted is originated on a teletypewriter, a typewriter-like machine that generates a set of coded pulses that are unique for each letter, numeral, and symbol. At the receiving end, another teletypewriter decodes

systems are currently in use by hams: slow-scan TV (SSTV) and live-action TV, known as Amateur TV, or ATV. With SSTV, still pictures are transmitted over thousands of miles. Fast-action TV permits transmission of moving pictures, but over much shorter distances than with SSTV.

In an SSTV system, a still picture is developed on the receiving TV screen as a beam of light scans 120 horizontal lines in about 8 seconds. Pictures aren't as sharp as with a commercial broadcasting system that uses 525 horizontal scanning lines.

If you were to listen to an incoming SSTV signal, you would hear a succes-



sion of audio tones that represent the light and dark portions of the picture. This arrangement permits SSTV to operate within the same narrow bandwidth used for normal voice transmission. (Most SSTV activity is on the 20-meter band, although some transmissions occur on 40 and 80 meters as well.)

Fast-scan TV, on the other hand, operates in the 3/4-meter uhf band, at approximately 440 MHz. Since home construction at these frequencies is critical, kits and home-brew equipment are quite rare. Fortunately, there are many low-cost surplus transmitters to be found on the market for relatively simple experimentation and conversion by hams. For reception of uhf TV pictures, a commercial uhf converter can be used if minor modifications are made to lower the TV Channel 14 tuning circuits.

**Ham in Space.** Shortly before Christmas 1961, a NASA Atlas Agena rocket carried a 2-meter beacon transmitter into space to orbit the earth. Called OSCAR, this was the first "ham" in space, transmitting a message back to earthbound hams. Although it lasted for only 3 weeks and developed only 0.1 watt of radiated power, its transmissions were heard by thousands of hams in more than 30 countries.

More OSCARS were lofted into space over the years. Notable was OSCAR 7, launched in 1975. This ham in space contained two repeaters, two telemetry beacons, and a control system that could be directed by commands from the ground. Powered by solar-cell panels, it was designed by hams from Germany, Australia, Canada, and the United States. Four 2-meter whip antennas aboard OSCAR 7 were used to receive signals transmitted by earthbound hams, while a 10-meter dipole antenna was used to transmit back to earth. For the first time in history, hams could communicate into space and back again to the earth.

**Ham Activities.** It's a rare Novice, who, getting on the air for the first time, isn't thrilled by his initial contacts. As time goes by, the wonder may diminish but will hardly disappear whenever a first-time contact is made. Each time a ham goes on the air becomes a new experience, because he never knows what to expect or who he's going to contact. It's not unusual for a Novice to contact a fellow ham in Europe, Africa, or even Australia.

Once the initial wonder of actually communicating over very long distances

diminishes and the hobby settles down to being just plain fun, a Novice may decide to begin collecting certificates of performance. He can, for example, obtain an RCC (Rag Chewers Club) certificate simply by showing proof that he's spoken with another ham station for at least 30 minutes. Then, after a few months of being on the air and contacting hams in many states, he may decide to selectively call hams in states not yet contacted. Having contacted and collected a full set of QSL cards from hams from every state, he can obtain a WAS (Worked All States) certificate. With a bit more diligence, perhaps with updated and better ham equipment, he can

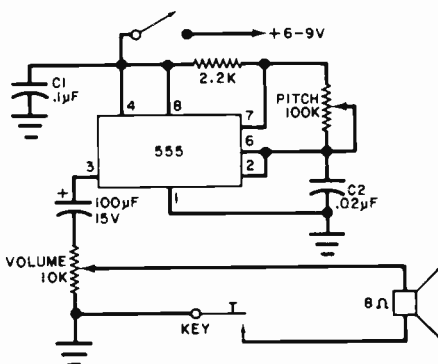

A code-practice oscillator you can build.

qualify for the WAC (Worked All Continents) certificate. Ultimately, after sufficient time on the air, he may accumulate confirmations to the effect that he's been in contact with hams from 100 or more countries, qualifying him for the prestigious DXCC (DX Century Club) certificate.

By nature, hams are sociable people, many sealing friendships that will last a lifetime, simply through over-the-air contacts. These friendships can and frequently do cross national borders, be between people who hold different political ideologies, etc. They're not forged by national pride; rather, they're the result of a kinship created by a common hobby-interest bond.

There are a number of off-the-air activities related to Amateur Radio in which a ham can participate. Perhaps the most popular of all is becoming an active member of a ham club. There are hundreds of ham clubs throughout the U.S., thousands the world over. The national organization for Amateur Radio enthusiasts in the U.S. is the American Radio Relay League, quartered in

Newington, CT. Any ham can become a member of the ARRL, the only requirements being an interest in ham radio and payment of \$12 annual dues. ARRL members receive a year's subscription to the organization's monthly magazine, *QST*, as part of their regular membership benefits.

Members of local ham clubs generally meet on a regular basis to discuss their hobby, plan club activities, elect new members, listen to guest speakers, etc. One of the activities that has become more or less traditional with ham clubs is the putting on of conventions and jamborees, where picnics are mixed with technical discussions and demonstrations of new equipment. A favorite feature of such meets is the ham flea market, where a long row of tables is piled with used equipment for sale and trade. Here's where hams who want to upgrade their equipment frequently find very good buys on what they need.

Other club activities might include code contests to determine who is the fastest at sending and copying code. The main objective of many hams who often travel far and wide to reach a club meet is to say hello to fellow hams they've met over the air but never in person.

In addition to the friendships developed among hams, the nationwide network of this radio group is often a blessing to the public in times of disaster. In situations where floods, hurricanes, storms, and forest fires put out of commission telephone lines and other communications equipment, hams have voluntarily kept lines of communication open. Over the years, hundreds of cases have been reported in which hams have been instrumental in saving property and lives by providing vital emergency radio service. Like CBers, hams have a national emergency-service organization, called the Radio Amateur Civil Emergency Service, or RACES.

**In Closing.** From the foregoing, it's not too difficult to see just how interesting and exciting radio communications can be. Locally, you can listen in on police, fire, and other public-safety broadcasts and ham radio operators on the 2-meter FM band. Reaching out for DX contacts, you can pull in broadcasts from virtually every location on the globe. And if listen-only isn't your cup of tea, you can even respond to other radio hobbyists by two-way communications. Whatever your interest, you'll find that radio communication is rarely boring, often surprising, and almost always exciting. ◇

# GETTING ACQUAINTED WITH ELECTRONIC CIRCUITS

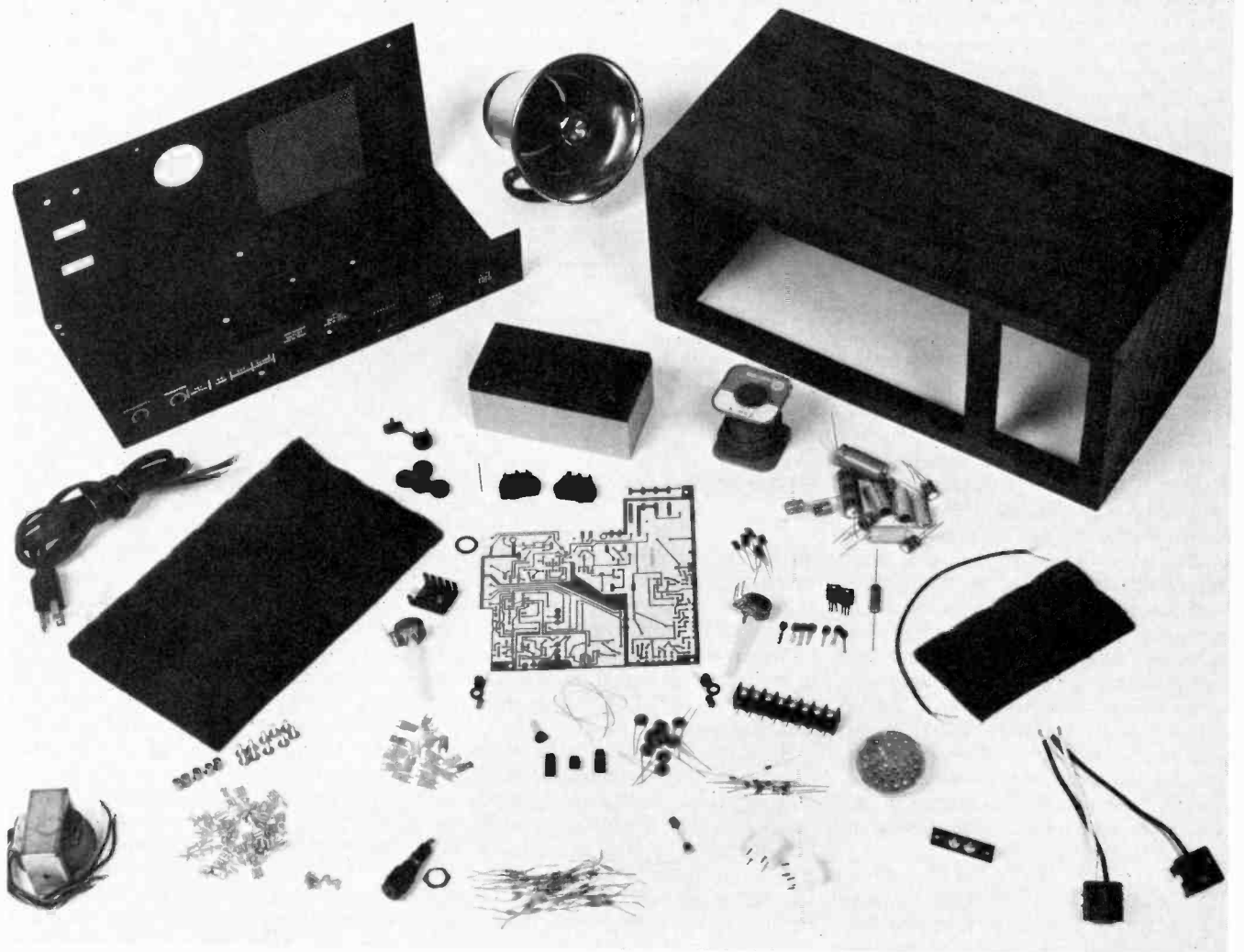

- How to identify components by physical configuration & schematic symbol.
- Tips on tools needed for kit and project building.
- How to make connections and properly solder them.
- Plus bonus intruder / burglar alarm you can build.

ONE OF THE most rewarding aspects of the electronics hobby is being able to build projects and kits. This ability to build things can not only be lots of fun, it can also save you money. A typical electronic kit of, say, a stereo receiver can save you 40% or more of what you'd have to pay for a factory-assembled version of the same receiver. Then, too, there are many useful projects published in electronics magazines and books that aren't even available as commercial projects. Many hobbyists build electronic kits and projects for the satisfaction of having built them, rather than for the money they can save by building them themselves.

For the newcomer to electronics, the variety of components used in even relatively simple projects can be overwhelming. For complex commercial products, such as a stereo receiver, color TV receiver, or microcomputer, this variety can be less overwhelming than the staggering number of individual components used. Fortunately, the variety really isn't as great as it might at first appear to be, since there are only about 20 basic types commonly in use. Each type can be easily identified by its schematic (electrical) symbol and physical configuration, as we'll point out here.

As for the number of components used, it would be safe to say that, once you can readily identify each type of component by sight, you could easily build an electronic project of, say, 1000 components in about the same time as it would take you to assemble a jigsaw puzzle of the same parts count.

Learning how to successfully assemble electronic kits and projects is far from difficult. All it really requires of you is to learn how to identify components by physical configuration and their schematic symbols, possibly be able to follow schematic diagrams, master the use of a few basic tools, and learn how to wire and solder. This sounds like a lot to have to absorb but really isn't. With a little practice, it won't be long before you're building projects and kits like a professional.

**Identifying Components.** To the uninitiate browsing through the parts department in an electronics store, the display racks can be confusing. In reality, the arrangement of the racks is general-

ly very logical to make it possible for a buyer to rapidly locate exactly what he wants without the aid of a salesperson. Each type of component is grouped in its own special section. For example, all types of resistors are usually grouped together. Capacitors, also grouped together, will be in a different location, transistors in still another location, and so forth.

Anyone who knows exactly what he wants and can identify it by sight will have very little difficulty finding it. So, your first task is to learn to identify different types of components.

**Resistors.** There are two basic types of resistors—fixed and variable. We'll discuss the fixed type first. This most basic of components is perhaps the easiest to identify. In its simplest form, the fixed resistor has a cylindrical body with wire leads extending axially from both ends. (Fig. 1). Even if a resistor's body has a square crosssection, its leads generally exit the body axially. In only a very few cases do the leads extend at right angles from a resistor's axis.

The most common type of resistor in use is the carbon-composition variety. The range of useful values for this type of resistor is from several ohms to several million ohms. (The unit of resistance is the *ohm*, named after George Simon Ohm. The ohm is represented in electronics shorthand by the Greek capital omega, "Ω.")

To handle very large numbers used for expressing resistance values, two prefixes are commonly used. The first of these is "kilo," which stands for thousands and is represented by the letter "k." Any number with the letter *k* following it, such as 1.5 k (read as 1.5 kilohms), must be multiplied by 1000 to express its value in units. Therefore, 1.5 k = 1.5 × 1000 = 1500 ohms. The second prefix is "mega," which stands for millions and is expressed by the letter "M." Hence, if you see a resistance value of 3.3 M (said 3.3 megohms), you know that its value is 3.3 × 1,000,000 = 3,300,000 ohms.

For the great majority of resistors on the market, you'll find that no value numbers appear on the bodies of the devices. Instead, a universal color code (Fig. 2) is used to express values. The color code appears as different color

bands around the bodies of the resistors. The bands are always grouped nearer one end than the other end of the resistor's body. The proper way to "read" the code is to hold the resistor so that the banded end is on the left; then the leftmost band is band 1, the next is band 2, and so on. To be able to properly identify a resistor's value using the color-code scheme, a minimum of three bands are necessary.

Here's how you read the color code: First, bands 1 and 2 identify the two significant figures (only two are used). Next, band 3 tells you the multiplier value. Finally, band 4 tells you the resistor's tolerance in percent. (Any resistor that doesn't have a fourth band automatically has a tolerance of ±20%.) Typical examples are:

	BAND 1	BAND 2	BAND 3	BAND 4
A)	red 2	violet 7	orange 1000	silver ± 10%
B)	green 5	black 0	gold 0.1	gold ± 5%

In example A, the value is 27,000 ohms (27 k), from 27 × 1000, with a tolerance of ±10%. Therefore, the resistor's actual value, taking into account the tolerance specified, can be anywhere from 24,300 to 29,700 (24.3 to 29.7 k). In example B, we have a value of 5 ohms, from 50 × 0.1, with a tolerance of ±5%, for an actual resistance range of from 4.95 to 5.05 ohms. As you can see, using the color-code chart is really a very simple procedure.

One of the most interesting things about most types of resistors is that value has little or nothing to do with how large a resistor is, since a 5-ohm resistor can have the identical size and shape package (body) as a 50-k or even a 3.3-M resistor. If you find two resistors banded with the same color code (or stamped with the same value) in two different size but same-shape packages, the difference between them is in the amount of power each can handle. As a rule, the larger the package, the greater the amount of power the resistor can safely handle. Carbon-composition resistors come in five sizes, each capable of handling up to a specific amount of power: 1/8, 1/4, 1/2, 1, and 2 watts.

Manufacturers don't normally include as a part of the color-code scheme a band to identify a resistor's power-

handling capability. However, since color-coded resistors come in only five sizes, it's a simple matter to keep in mind the power rating for any given size. (Note: a higher-power resistor can almost always be substituted for the same-value resistor, but not the other way around. Unless size is critical, such as on a crowded printed-circuit assembly, you can perform this substitution.)

Carbon-composition resistors are generally low-power devices, capable of handling up to about 2 watts of power. Higher-power-handling resistors can come in a variety of different body shapes, ranging from the tubular resistor, to a square cross-section, to a metal-jacketed body designed to be bolted to a metal chassis. (Typical configurations are shown in Fig. 1.) Power resistors generally have stamped on them values and power rating and sometimes tolerances. Values are given in numbers, not the usual color codes.

Another type of resistor that's becoming increasingly important in today's critical circuits is the *precision* resistor whose exact value—not color code—is stamped on it. These are generally cylindrical in design, with rounded rather than flat ends. Unlike the typical carbon-composition resistor, the precision resistor's value frequently has a direct bearing on physical size. Most precision resistors are low-power devices.

The schematic symbol for *all* fixed resistors, regardless of type, looks like a saw edge. It's shown to the right of the physical configurations in Fig. 1.

Not all resistors are manufactured to have a single fixed value like those described above. It's possible to produce variable resistors whose values can be changed at will. If you've ever turned up or down the volume on your TV receiver or hi-fi amplifier, you've handled one type of variable resistor.

All variable resistors commonly used in modern electronics are termed *potentiometers*, or "pots." Unlike fixed resistors that have only two leads, potentiometers have three. Two are attached to the beginning and end of the resistive element; the third attaches to a wiper that can be moved across the resistive element to vary the resistance between it and the other two leads. As the wiper is moved along the element, the resistance between it and one of the leads increases, while at the same time the resistance between the wiper and the other lead decreases. At any point, however, the two resistances added together will be equal to a value that's the same

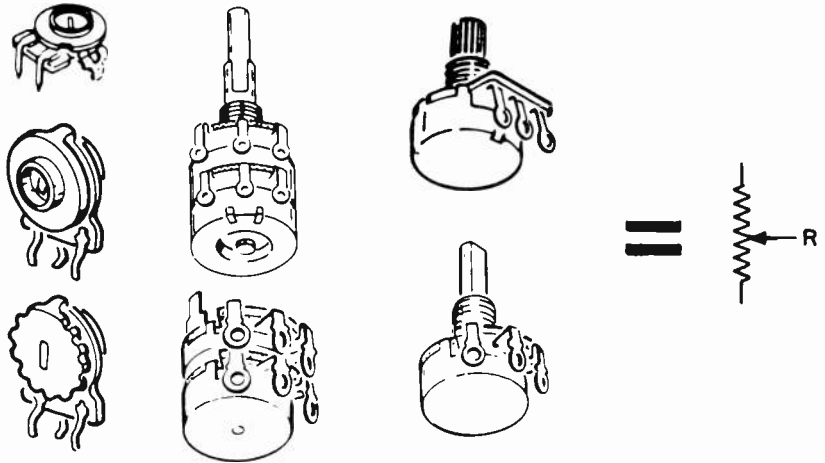
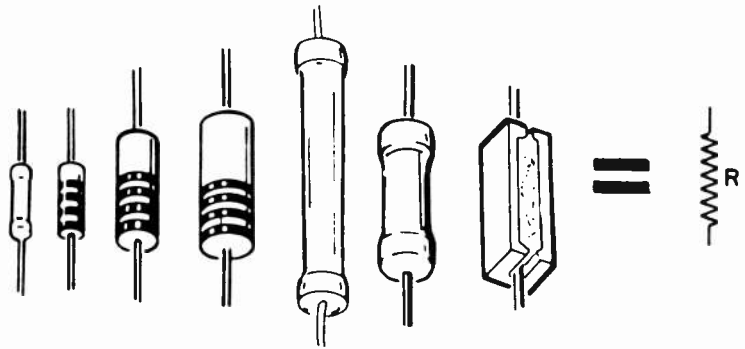

Fig. 1. Fixed (top) and variable (bottom) resistors are easy to identify.

### RESISTOR—COLOR—CODE CHART

COLOR	SIGNIFICANT FIGURE	MULTIPLIER	TOLERANCE IN %
Black	0	1	-
Brown	1	10	-
Red	2	100	-
Orange	3	1000	-
Yellow	4	10,000	-
Green	5	100,000	-
Blue	6	1,000,000	-
Violet	7	10,000,000	-
Gray	8	*	-
White	9	*	-
Gold	-	0.1	5
Silver	-	0.01	10
No color	-	----	20

\*Normally not used.

Fig. 2. Color-code chart makes it fairly easy to determine resistor values.

for every other point to which the wiper can be set (Fig. 3).

Pots are useful because they allow the voltage or signal level to be adjusted as needed. In the case of a TV receiver, the

pot allows the level of the audio signal to be raised or lowered to suit listening needs or tastes.

Volume controls are the most visible type of potentiometer used by most of us, but they aren't the only type by any means. Some pots are even designed to be adjusted by moving a lever in a straight line, such as those used for boost/cut controls on a graphic equalizer. Other types require use of a screwdriver for adjustment.

Most potentiometers used in electronics aren't even accessible or visible outside a product's or project's cabinet. They're usually adjusted to provide a certain level of circuit performance and

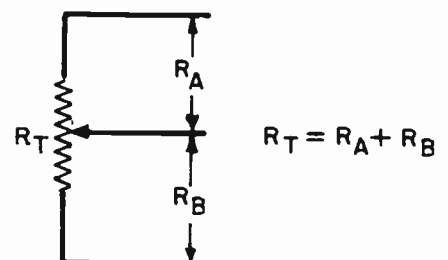

Fig. 3. Schematic of potentiometer.

# BUILD 20 RADIO AND ELECTRONICS CIRCUITS

## PROGRESSIVE HOME RADIO-T.V. COURSE

### Now Includes

- ★ 12 RECEIVERS
- ★ 3 TRANSMITTERS
- ★ SQ. WAVE GENERATOR
- ★ SIGNAL TRACER
- ★ AMPLIFIER
- ★ SIGNAL INJECTOR
- ★ CODE OSCILLATOR
- ★ No Knowledge of Radio Necessary
- ★ No Additional Parts or Tools Needed
- ★ Solid State Circuits
- ★ Vacuum Tube Circuits

**YOU DON'T HAVE TO SPEND HUNDREDS OF DOLLARS FOR A RADIO COURSE**

The "Edu-Kit" offers you an outstanding PRACTICAL HOME RADIO COURSE at a rock-bottom price. Our Kit is designed to train Radio & Electronics Technicians, making use of the most modern methods of home training. You will learn radio theory, construction practice and servicing. THIS IS A COMPLETE RADIO COURSE IN EVERY DETAIL. You will learn how to build radios, using regular schematics; how to wire and solder in a professional manner; how to service radios. You will work with the standard type of punched metal chassis as well as the latest development of Printed Circuit chassis. You will learn the basic principles of radio. You will construct, study and work with RF and AF amplifiers and oscillators, detectors, rectifiers, test equipment. You will learn and practice code, using the Progressive Code Oscillator. You will learn and practice trouble-shooting, using the Progressive Signal Tracer, Progressive Signal Injector, Progressive Dynamic Radio & Electronics Tester, Square Wave Generator and the accompanying instructional material. You will receive training for the Novice, Technician and General Classes of F.C.C. Radio Amateur Licenses. You will build Receiver, Transmitter, Square Wave Generator, Code Oscillator, Signal Tracer and Signal Injector circuits, and learn how to operate them. You will receive an excellent background for television, Hi-Fi and Electronics. Absolutely no previous knowledge of radio or science is required. The "Edu-Kit" is the product of many years of teaching and engineering experience. The "Edu-Kit" will provide you with a basic education in Electronics and Radio, worth many times the low price you pay. The Signal Tracer alone is worth more than the price of the kit.

### THE KIT FOR EVERYONE

You do not need the slightest background in radio or science. Whether you are interested in Radio & Electronics because you want an interesting hobby, a well paying business or a job with a future, you will find the "Edu-Kit" a worth-while investment. Many thousands of individuals of all

ages and backgrounds have successfully used the "Edu-Kit" in more than 75 countries of the world. The "Edu-Kit" has been carefully designed, step by step, so that you cannot make a mistake. The "Edu-Kit" allows you to teach yourself at your own rate. No instructor is necessary.

### PROGRESSIVE TEACHING METHOD

The Progressive Radio "Edu-Kit" is the foremost educational radio kit in the world, and is universally accepted as the standard in the field of electronics training. The "Edu-Kit" uses the modern educational principle of "Learn by Doing." Therefore you construct, learn schematics, study theory, practice trouble shooting—all in a closely integrated program designed to provide an easily-learned, thorough and interesting background in radio. You begin by examining the various radio parts of the "Edu-Kit." You then learn the function, theory and wiring of these parts. Then you build a simple radio. With this first set you will enjoy listening to regular broadcast stations, learn theory, practice testing and trouble-shooting. Then you build a more advanced radio, learn more advanced theory and techniques. Gradually, in a progressive manner, and at your own rate, you will find yourself constructing more advanced multi-tube radio circuits, and doing work like a professional Radio Technician.

Included in the "Edu-Kit" course are Receiver, Transmitter, Code Oscillator, Signal Tracer, Square Wave Generator and Signal Injector Circuits. These are not unprofessional "breadboard" experiments, but genuine radio circuits, constructed by means of professional wiring and soldering on metal chassis, plus the new method of radio construction known as "Printed Circuitry." These circuits operate on your regular AC or DC house current.

### THE "EDU-KIT" IS COMPLETE

You will receive all parts and instructions necessary to build twenty different radio and electronics circuits, each guaranteed to operate. Our Kits contain tubes, tube sockets, variable, electrolytic, mica, ceramic and paper dielectric condensers, resistors, tie strips, hardware, tubing, punched metal chassis, Instruction Manuals, hook-up wire, solder, selenium rectifiers, coils, volume controls, switches, solid state devices, etc.

In addition, you receive Printed Circuit materials, including Printed Circuit chassis, special tube sockets, hardware and instructions. You also receive a useful set of tools, a professional electric soldering iron, and a self-powered Dynamic Radio and Electronics Tester. The "Edu-Kit" also includes Code Instructions and the Progressive Code Oscillator, in addition to F.C.C. Radio Amateur License training. You will also receive lessons for servicing with the Progressive Signal Tracer and the Progressive Signal Injector, a High Fidelity Guide and a Quiz Book. You receive Membership in Radio-TV Club, Free Consultation Service, Certificate of Merit and Discount Privileges. You receive all parts, tools, instructions, etc. Everything is yours to keep.

Progressive "Edu-Kits" Inc., 1189 Broadway, Dept. 610-DJ Hewlett, N.Y. 11557

Please rush me free literature describing the Progressive Radio-TV Course with Edu-Kits. No Salesman will call.

NAME .....

ADDRESS .....

CITY & STATE ..... ZIP .....

### PROGRESSIVE "EDU-KITS" INC.

1189 Broadway, Dept. 610-DJ Hewlett, N.Y. 11557



Reg. U.S. Pat. Off.

Training Electronics Technicians Since 1946

### FREE EXTRAS

- SET OF TOOLS
- SOLDERING IRON
- ELECTRONICS TESTER
- PLIERS-CUTTERS
- VALUABLE DISCOUNT CARD
- CERTIFICATE OF MERIT
- TESTER INSTRUCTION MANUAL
- HIGH FIDELITY GUIDE & QUIZZES
- TELEVISION BOOK & RADIO TROUBLE-SHOOTING BOOK
- MEMBERSHIP IN RADIO-TV CLUB: CONSULTATION SERVICE, FCC AMATEUR LICENSE TRAINING
- PRINTED CIRCUITRY

### SERVICING LESSONS

You will learn trouble-shooting and servicing in a progressive manner. You will practice repairs on the sets that you construct. You will learn symptoms and causes of trouble in home, portable and car radios. You will learn how to use the professional Signal Tracer, the unique Signal Injector and the dynamic Radio & Electronics Tester. While you are learning in this practical way, you will be able to do many a repair job for your friends and neighbors, and charge fees which will far exceed the price of the "Edu-Kit." Our Consultation Service will help you with any technical problems you may have.

### FROM OUR MAIL BAG

Ben Valerio, P. O. Box 21, Magna, Utah: "The Edu-Kits are wonderful. Here I am sending you the questions and also the answers for them. I have been in Radio for the last seven years, but like to work with Radio Kits, and like to build Radio Testing Equipment. I enjoyed every minute I worked with the different kits; the Signal Tracer works fine. Also like to let you know that I feel proud of becoming a member of your Radio-TV Club."

Robert L. Shuff, 1534 Monroe Ave., Huntington, W. Va.: "Thought I would drop you a few lines to say that I received my Edu-Kit, and was really amazed that such a bargain can be had at such a low price. I have already started repairing radios and phonographs. My friends were really surprised to see me get into the swing of it so quickly. The Trouble-shooting Tester that comes with the Kit is really swell, and finds the trouble, if there is any to be found."

### SOLID STATE

Today an electronics technician or hobbyist requires a knowledge of solid state, as well as vacuum tube circuitry. The "Edu-Kit" course teaches both. You will build vacuum tube, 100% solid state and combination ("hybrid") circuits.

### PRINTED CIRCUITRY

At no increase in price, the "Edu-Kit" now includes Printed Circuitry. You build a Printed Circuit Signal Injector, a unique servicing instrument that can detect many Radio and TV troubles. This revolutionary new technique of radio construction is now becoming popular in commercial radio and TV sets.

A Printed Circuit is a special insulated chassis on which has been deposited a conducting material which takes the place of wiring. The various parts are merely plugged in and soldered to terminals.

Printed Circuitry is the basis of modern Automation Electronics. A knowledge of this subject is a necessity today for anyone interested in Electronics.



aren't touched again until performance degrades or something else goes wrong. Most such pots are mounted on printed-circuit assemblies.

Typical configurations of the various types of potentiometers commonly used in electronics are illustrated in Fig. 1. Also shown is the schematic symbol for every type of potentiometer. This symbol is similar to that for the fixed resistor, except it has an arrowhead for the wiper element.

**Capacitors.** Another component almost as frequently used as the resistor in electronics is a device known as a *capacitor*. Like the resistor, it's available in both fixed and variable forms and in a wide variety of physical configurations. Unlike the resistor, which can be used at virtually every voltage level, the capacitor is usually designed to be used at or below specific voltage levels.

Capacitors are found in all types of electronic equipment. You're probably most familiar with them as the control you use to tune in stations on your pocket radio. Capacitors are also found in electronic clocks and watches, noise filters, car ignition systems, radio and TV receivers, hi-fi gear, and a host of other familiar and not-so-familiar electronic equipment.

The basic task of the capacitor is to hold an electrical charge. How long it holds a charge depends on many things and is a measure of its tolerance. With most inexpensive capacitors, the charge leaks off fairly rapidly, making them unsuitable for timing circuits where a high degree of accuracy is required. In applications where charge retention is of critical importance, more expensive and more critically manufactured capacitors must be used.

Shown in Fig. 4A are the configurations of the most commonly used fixed capacitors. Note that there are two distinct groupings—polarized and nonpolarized.

Nonpolarized capacitors, such as the popular ceramic disc, can be installed in a circuit in either direction, without regard to which lead goes where. The schematic symbol, which consists of a straight and a curved line, reflects this nonpolarized characteristic. Although the symbol makes it appear that the capacitor must be installed in only one direction, without a plus sign (+) near the straight line, polarity is of no significance. Nonpolarized capacitors are generally used to couple audio and radio-frequency (r-f) signals from one stage to another in a circuit while at the

same time preventing dc voltage from passing through. (Capacitors are ac-only devices. They do *not* pass dc voltages; in fact, they block it.)

Polarized capacitors *must* be installed

identifies it as an electrolytic or polarized capacitor. This type of capacitor is used in power supplies, in audio circuits to pass low-frequency ac signals while blocking dc, and in timing circuits.

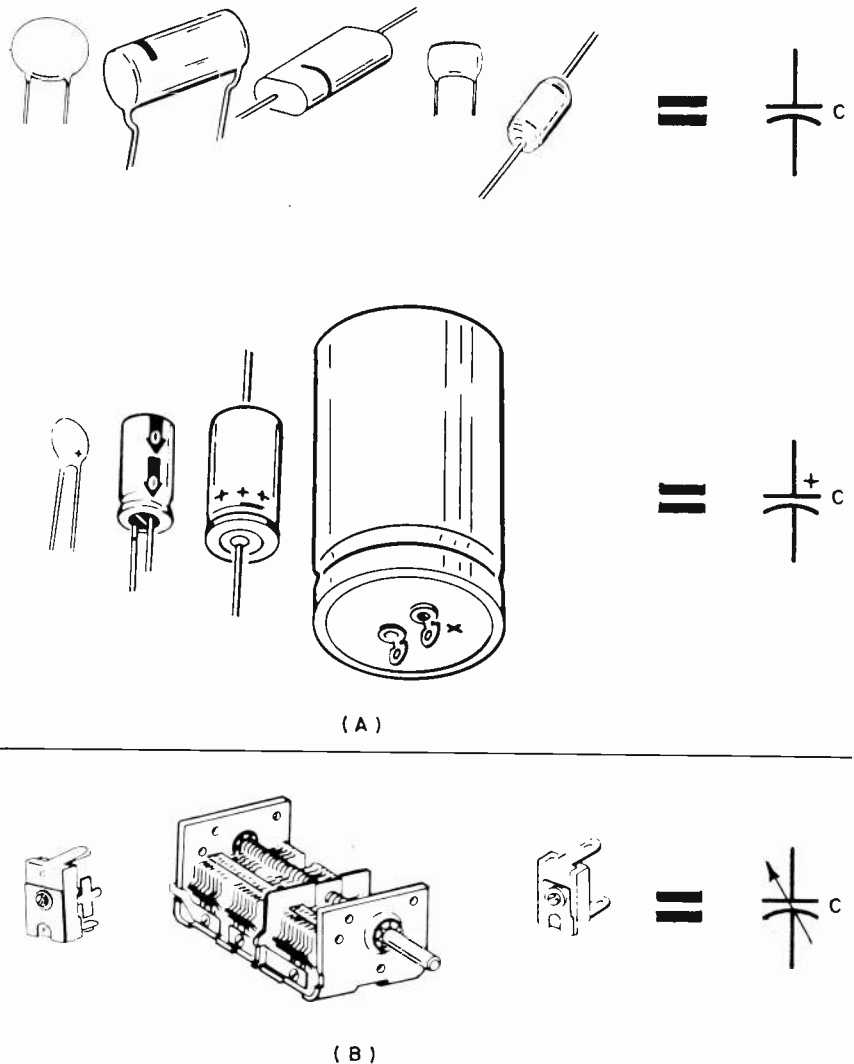

Fig. 4. Configurations and schematic representations of fixed nonpolarized and electrolytic capacitors (A) and variable capacitors (B).

in circuits in the proper direction, matching the + and - leads to the appropriate points in the circuit. To aid in proper installation, polarized—also known as *electrolytic*—capacitors always have at least one of their leads identified. In most cases, the identified lead has a + near it. Any capacitor symbol with a + near its straight line

As you can see in Fig. 4A, there's a greater variety of physical configurations for nonpolarized than for polarized fixed capacitors. The reason for this is that there's a greater variety of nonpolarized capacitor types. Leads for nonpolarized capacitors are almost always parallel to each other to make it very simple to mount these components on

printed-circuit boards and other components. Polarized capacitors are usually tubular in design and are much larger than the typical nonpolarized capacitor. Their leads can be axial or parallel, allowing either flat or upright mounting on printed-circuit boards. An exception to this is the tantalum electrolytic capacitor, which resembles the nonpolarized disc capacitor and has parallel leads. It's easy to identify the tantalum capacitor, however, since it has a + near its positive lead.

Variable capacitors range in size from the almost microscopic size used in digital wristwatches to the medium size used in radio receivers to the very large size used in radio transmitters. As shown in Fig. 4B, they can be adjusted with either a control knob or with an insulated screwdriver-like tool, depending on type. Those that are adjustable with control knobs are usually user-accessible from outside a project's cabinet, while those designed for screwdriver adjustment (called *trimmer* capacitors) are almost always internal set-and-forget devices. The standard schematic symbol used for variable capacitors is the same as for fixed capacitors, except that it has an arrow running diagonally through it.

The basic unit of capacitance is the farad, named after Michael Faraday, and is represented by the letter "F." Because capacitance in practical devices is always smaller—in fact, usually infinitesimally smaller—than a whole farad, an electronics shorthand notation has been adopted to allow the very small numbers to be written in a simplified, easy-to-read manner. Two prefixes are commonly used—*micro* and *pico*, represented by "μ" and "p," respectively. Micro indicates that a stated value is to be divided by 1-million to yield its value in farads, while pico indicates that a stated value is to be divided by 1-trillion. Under these rules, 1.5 μF and 330 pF become 0.0000015 and 0.00000000033F, respectively. As you can see, the farad values would be very unwieldy to write. More to the point, they would be very difficult to read.

Capacitors generally have stamped or printed on them their values, at least in numerals (the μF or pF may be absent). Fixed capacitors have printed on them a single value. Variable capacitors, on the other hand will have stamped into their frames or printed on their ceramic bases a value range, such as 3-30, which means 3 to 30 pF.

Commonly available values for nonpolarized fixed capacitors range from

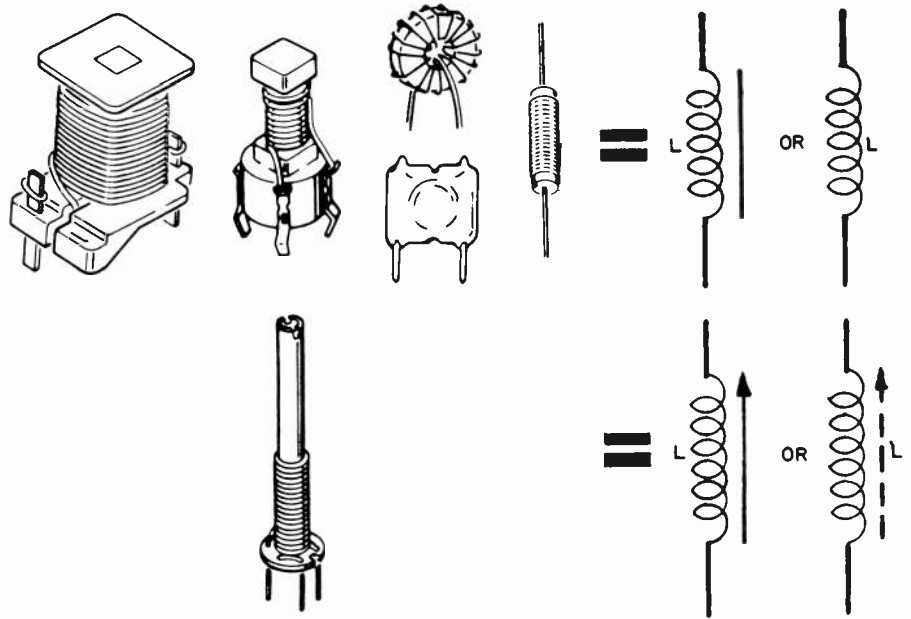

Fig. 5. Inductors come in many different physical configurations.

about 4.7 pF to about 0.1 μF. Electrolytic capacitor values range from 0.1 to about 35 μF for tantalums and from 1 μF to as high as 30,000 μF or more for standard electrolytics. Variable capacitors generally offer very low values ranging from a low of about 2 pF to a high of about 225 pF.

Some fixed nonpolarized capacitors and *all* electrolytic capacitors will have printed on them, in addition to values, a voltage specification. This voltage is expressed in WVDC (working volts dc) and specifies the *maximum* potential to which the capacitor should be subjected. You can substitute a capacitor with a higher working voltage rating, but not a lower rating.

A word of caution: When a project calls for a specific type of capacitor accompanied by the phrase "do not substitute," don't use a different type. In cases like this, the *type* of capacitor is critical, and any substitutions will have a direct effect on how the project performs. Most capacitor tolerances are very loose. In circumstances where a special type of capacitor is called for, there's a good reason, usually to maintain a high degree of value accuracy.

**Inductors.** Very popular in r-f and test-equipment circuits and to a lesser degree in video and audio circuits is a device known as an *inductor*. Consisting of a length of wire wound on a rigid plastic, plastic-impregnated paper, or ceramic form (some inductors need no form, being wound from relatively rigid wire that's self supporting), the inductor performs a task exactly the opposite that of the capacitor. That is, it readily passes dc voltages and low-frequency ac

signals but blocks higher-frequency ac signals.

An inductor may or may not be variable, depending on whether or not it has a tunable metallic slug in its core. Illustrated in Fig. 5 are typical fixed and tunable inductor configurations. A fixed inductor is schematically represented by a stylized coil drawing and is identified by the letter "L." Tunable inductors are represented schematically by the same drawing, this time accompanied by one or more dashed or solid lines that represent the slug; an arrowhead on any of the lines indicates that the slug is tunable. Dashed lines tell you that the core material is powdered iron that has been compressed into a solid slug and is held together with a binder. Solid lines tell you that the core is a solid piece of iron or brass.

The standard unit of inductance is the Henry, named after an American scientist of the same name and abbreviated "H." Useful values of inductance range from fractional parts of a microhenry (μH) to thousandths of a Henry (milli-henries, or mH) to several tens of Henrys, according to physical size.

**Transformers.** One type of inductor that's very popular in electronic equipment is a device known as a *transformer*. Actually, the transformer consists of two or more inductors located physically close to each other so that current passing through one will induce a current in the others.

The most frequently used type of transformer is the power transformer, which converts 117-volt ac line power to some other voltage required by a circuit. This type of transformer can be either a

step-up or a step-down device. If it's a step-up device, the output across the secondary winding is *greater* than the voltage applied to the primary winding (Fig. 6A). On the other hand, if it's a step-down transformer, the output voltage will be *less* than the input voltage (Fig. 6B). Some power transformers have multiple secondary windings to provide different output voltages (such as the

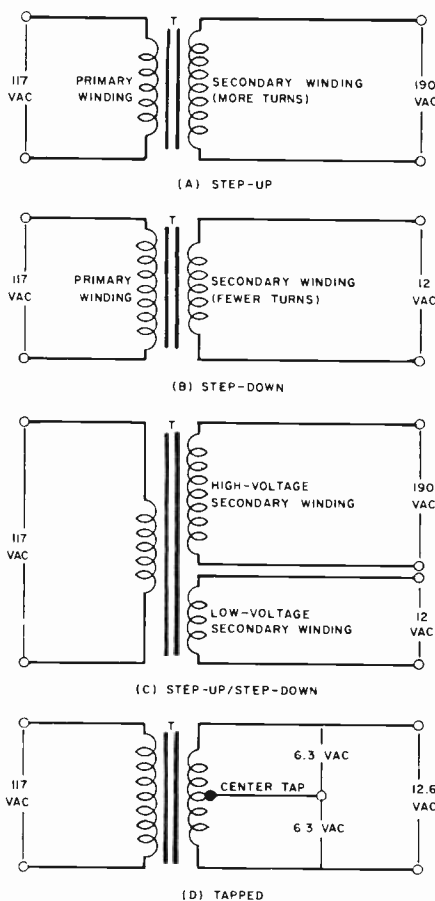

Fig. 6. Schematic representations of various types of iron-core transformers in common use in kits and construction projects.

step-up/down transformer shown schematically in Fig. 6C) or the same output voltage on more than one secondary, each isolated from the other. Finally, some power transformers have tapped secondaries (Fig. 6D) that provide a choice of two voltages for different needs or for use of a full-wave bridge rectifier assembly. The secondary winding of this type of transformer is treated as separate windings, as in the case of Fig. 6C, except that there's no isolation between the outputs.

Transformers used for power and in

the deflection circuits of TV receivers, to name just two, have their primaries and secondaries wound on the *same* core, which is usually laminated iron. This is done to assure maximum coupling efficiency so that maximum power is transferred from primary to secondary.

While most transformers familiar to electronics hobbyists have iron cores (which accounts for their heavy weight), an iron core isn't always necessary. Some transformers have powdered-iron cores and others even use air as their cores (Fig. 7). Air-core transformers are used in applications where it's not necessary to transfer a lot of current or voltage from primary to secondary. In cases like this, required coupling is accomplished by locating the primary and secondary windings physically close to each other for maximum efficiency.

Transformers are also used to isolate one portion of a circuit from another and to match the characteristics of an electronic circuit to those of a speaker or headphone. This type of transformer, like the type used for power, has a laminated iron core.

All transformers, regardless of application, are ac-only devices. Actually, they're ac-to-ac devices in which an ac voltage applied to the input produces a stepped-up, stepped-down, or the same ac voltage at the output.

Typical configurations of transformers are illustrated in Fig. 8. For schematic representations, see Figs. 6 and 7. The schematic identifier for the transformer is the letter "T."

**Switches and Relays.** Switches are very necessary components in electronic circuits. Not only are they used to turn on and off power safely, they're also used to direct voltages to different parts of a circuit at different times, allow selection of different components for varying circuit conditions, to direct signal flow where it's wanted, etc.

In its most basic form, the switch is a simple make/break (on/off) device, used to connect power to and disconnect power from circuits. Very elaborate switches can be used to perform a number of tasks simultaneously. An example of the latter is the switching arrangement used in some stereo receivers to select the program source. Such a switch might transfer source selection from an FM tuner to a phono input, extinguish the tuner's display and lighted panel legend, disable power to the tuner, and apply power to the phono preamplifier and light up its panel legend—all in a single switchoperation.

Switches come in many different physical configurations and sizes. Among the varied configurations in common use are toggle, slide, rocker, pushbutton, and rotary arrangements (Fig. 92). Some switches lock into each position to which they can be set; others are only momentary, returning to the position from which they were moved when released; and still others will lock in but automatically release when any other switch in the bank is pressed. Size depends on the amount of power (current) the switch is designed to handle and/or on how elaborate the switching arrangement. There are even micro-miniature switches, used mainly in computer circuits, that fit as many as seven or eight completely separate switches in a package no longer than 1 in. and less than 1/2 in. wide.

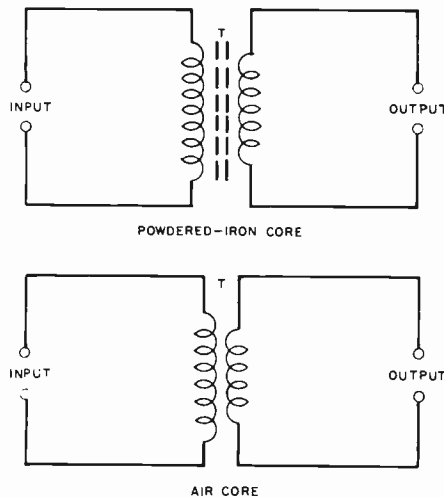

Fig. 7. Schematic symbols of powdered-iron and air-core transformers.

To understand how switches are specified, it's important that you become familiar with the terms *pole* and *throw*. These two terms are used to define the physical/electrical characteristics of any given switching arrangement. The number of poles specified for a switch refers to the number of switching stations (positions) available. By contrast, the number of throws refers to how many elements within a switch can be physically moved from pole to pole.

Typical switching arrangements (schematic representations) for commonly used switches are illustrated in Fig. 10. At the top is the most common, the single-pole, single-throw (abbreviated *spst*) toggle switch representa-

### 7400

SN7400N	.20	SN7472N	.29	SN74156N	.79
SN7401N	.20	SN7473N	.35	SN74157N	.89
SN7402N	.25	SN7474N	.35	SN74160N	.69
SN7403N	.25	SN7475N	.49	SN74161N	.89
SN7404N	.25	SN7476N	.35	SN74158N	.89
SN7405N	.29	SN7477N	5.00	SN74163N	.89
SN7406N	.35	SN7480N	.50	SN74164N	.89
SN7407N	.35	SN7482N	.59	SN74155N	.89
SN7408N	.29	SN7483N	.69	SN74166N	1.25
SN7409N	.29	SN7485N	.99	SN74167N	2.79
SN7410N	.29	SN7486N	.35	SN74170N	1.95
SN7411N	.29	SN7489N	1.75	SN74172N	4.95
SN7412N	.35	SN7490N	.49	SN74173N	1.39
SN7413N	.40	SN7491N	.59	SN74174N	.99
SN7414N	.49	SN7492N	.45	SN74175N	.79
SN7415N	.29	SN7493N	.45	SN74176N	.79
SN7417N	.29	SN7494N	.69	SN74177N	.79
SN7420N	.25	SN7495N	.69	SN74179N	1.49
SN7421N	.29	SN7496N	.69	SN74180N	.79
SN7422N	.45	SN7497N	3.00	SN74181N	2.25
SN7423N	.29	SN74100N	1.49	SN74182N	.79
SN7425N	.29	SN74104N	.89	SN74184N	2.49
SN7426N	.29	SN74105N	.89	SN74185N	2.49
SN7427N	.25	SN74107N	.35	SN74190N	1.25
SN7428N	.49	SN74109N	.35	SN74191N	1.25
SN7429N	.25	SN74116N	1.95	SN74192N	.89
SN7432N	.29	SN74121N	.39	SN74193N	.89
SN7437N	.25	SN74122N	.55	SN74194N	.89
SN7438N	.40	SN74123N	.59	SN74195N	.69
SN7439N	.25	SN74125N	.49	SN74196N	.89
SN7440N	.20	SN74126N	.49	SN74197N	.89
SN7441N	.89	SN74132N	.75	SN74198N	1.49
SN7442N	.59	SN74136N	.75	SN74199N	1.49
SN7443N	1.10	SN74141N	.99	SN74201N	1.25
SN7444N	.89	SN74142N	.49	SN74205N	1.95
SN7445N	.89	SN74143N	.49	SN7426N	.95
SN7446N	.69	SN74144N	.49	SN7427N	.79
SN7447N	.69	SN74145N	.79	SN7428N	1.49
SN7448N	.79	SN74147N	1.25	SN7429N	3.95
SN7449N	.20	SN74148N	1.25	SN74265N	3.95
SN7453N	.20	SN74151N	.69	SN74365N	.69
SN7454N	.20	SN74152N	.69	SN74366N	.69
SN7455A	.20	SN74153A	.69	SN74367N	.69
SN7456A	.20	SN74154A	1.25	SN74390N	1.49
SN7470N	.29	SN74155N	.79	SN74393N	1.49

### 74LS

74LS01	.29	74LS92	.75	74LS192	1.15
74LS02	.29	74LS93	.75	74LS193	1.15
74LS03	.29	74LS94	.75	74LS194	1.15
74LS04	.29	74LS95	.75	74LS197	1.19
74LS05	.35	74LS96	1.15	74LS221	1.19
74LS06	.35	74LS107	.45	74LS241	1.49
74LS08	.35	74LS109	.45	74LS242	1.49
74LS10	.35	74LS112	.45	74LS244	1.49
74LS11	.35	74LS113	.45	74LS245	2.95
74LS12	.35	74LS114	.45	74LS248	1.19
74LS13	.59	74LS122	.69	74LS249	1.19
74LS14	.59	74LS125	.59	74LS251	.99
74LS15	.59	74LS126	.59	74LS252	.99
74LS16	.59	74LS127	.59	74LS253	.99
74LS17	.59	74LS128	.59	74LS254	.99
74LS18	.59	74LS129	.59	74LS255	.99
74LS19	.59	74LS130	.59	74LS256	.99
74LS20	.59	74LS131	.59	74LS257	.99
74LS21	.59	74LS132	.59	74LS258	.99
74LS22	.59	74LS133	.59	74LS260	.69
74LS23	.59	74LS134	.59	74LS266	.69
74LS24	.59	74LS135	.59	74LS271	.69
74LS25	.59	74LS136	.59	74LS272	.69
74LS26	.59	74LS137	.59	74LS273	.69
74LS27	.59	74LS138	.59	74LS274	.69
74LS28	.59	74LS139	.59	74LS275	.69
74LS29	.59	74LS140	.59	74LS276	.69
74LS30	.59	74LS141	.59	74LS277	.69
74LS31	.59	74LS142	.59	74LS278	.69
74LS32	.59	74LS143	.59	74LS279	.69
74LS33	.59	74LS144	.59	74LS280	.69
74LS34	.59	74LS145	.59	74LS281	.69
74LS35	.59	74LS146	.59	74LS282	.69
74LS36	.59	74LS147	.59	74LS283	.69
74LS37	.59	74LS148	.59	74LS284	.69
74LS38	.59	74LS149	.59	74LS285	.69
74LS39	.59	74LS150	.59	74LS286	.69
74LS40	.59	74LS151	.59	74LS287	.69
74LS41	.59	74LS152	.59	74LS288	.69
74LS42	.59	74LS153	.59	74LS289	.69
74LS43	.59	74LS154	.59	74LS290	.69
74LS44	.59	74LS155	.59	74LS291	.69
74LS45	.59	74LS156	.59	74LS292	.69
74LS46	.59	74LS157	.59	74LS293	.69
74LS47	.59	74LS158	.59	74LS294	.69
74LS48	.59	74LS159	.59	74LS295	.69
74LS49	.59	74LS160	.59	74LS296	.69
74LS50	.59	74LS161	.59	74LS297	.69
74LS51	.59	74LS162	.59	74LS298	.69
74LS52	.59	74LS163	.59	74LS299	.69
74LS53	.59	74LS164	.59	74LS300	.69
74LS54	.59	74LS165	.59	74LS301	.69
74LS55	.59	74LS166	.59	74LS302	.69
74LS56	.59	74LS167	.59	74LS303	.69
74LS57	.59	74LS168	.59	74LS304	.69
74LS58	.59	74LS169	.59	74LS305	.69
74LS59	.59	74LS170	.59	74LS306	.69
74LS60	.59	74LS171	.59	74LS307	.69
74LS61	.59	74LS172	.59	74LS308	.69
74LS62	.59	74LS173	.59	74LS309	.69
74LS63	.59	74LS174	.59	74LS310	.69
74LS64	.59	74LS175	.59	74LS311	.69
74LS65	.59	74LS176	.59	74LS312	.69
74LS66	.59	74LS177	.59	74LS313	.69
74LS67	.59	74LS178	.59	74LS314	.69
74LS68	.59	74LS179	.59	74LS315	.69
74LS69	.59	74LS180	.59	74LS316	.69
74LS70	.59	74LS181	.59	74LS317	.69
74LS71	.59	74LS182	.59	74LS318	.69
74LS72	.59	74LS183	.59	74LS319	.69
74LS73	.59	74LS184	.59	74LS320	.69
74LS74	.59	74LS185	.59	74LS321	.69
74LS75	.59	74LS186	.59	74LS322	.69
74LS76	.59	74LS187	.59	74LS323	.69
74LS77	.59	74LS188	.59	74LS324	.69
74LS78	.59	74LS189	.59	74LS325	.69
74LS79	.59	74LS190	.59	74LS326	.69
74LS80	.59	74LS191	.59	74LS327	.69

### 74S

74S01	.45	74S124	3.25
74S02	.45	74S125	3.25
74S03	.45	74S126	3.25
74S04	.55	74S127	3.25
74S05	.55	74S128	3.25
74S06	.55	74S129	3.25
74S07	.55	74S130	3.25
74S08	.55	74S131	3.25
74S09	.55	74S132	3.25
74S10	.45	74S133	3.25
74S11	.45	74S134	3.25
74S12	.45	74S135	3.25
74S13	.45	74S136	3.25
74S14	.45	74S137	3.25
74S15	.45	74S138	3.25
74S16	.45	74S139	3.25
74S17	.45	74S140	3.25
74S18	.45	74S141	3.25
74S19	.45	74S142	3.25
74S20	.45	74S143	3.25
74S21	.45	74S144	3.25
74S22	.45	74S145	3.25
74S23	.45	74S146	3.25
74S24	.45	74S147	3.25
74S25	.45	74S148	3.25
74S26	.45	74S149	3.25
74S27	.45	74S150	3.25
74S28	.45	74S151	3.25
74S29	.45	74S152	3.25
74S30	.45	74S153	3.25
74S31	.45	74S154	3.25
74S32	.45	74S155	3.25
74S33	.45	74S156	3.25
74S34	.45	74S157	3.25
74S35	.45	74S158	3.25
74S36	.45	74S159	3.25
74S37	.45	74S160	3.25
74S38	.45	74S161	3.25
74S39	.45	74S162	3.25
74S40	.45	74S163	3.25
74S41	.45	74S164	3.25
74S42	.45	74S165	3.25
74S43	.45	74S166	3.25
74S44	.45	74S167	3.25
74S45	.45	74S168	3.25
74S46	.45	74S169	3.25
74S47	.45	74S170	3.25
74S48	.45	74S171	3.25
74S49	.45	74S172	3.25
74S50	.45	74S173	3.25
74S51	.45	74S174	3.25
74S52	.45	74S175	3.25
74S53	.45	74S176	3.25
74S54	.45	74S177	3.25
74S55	.45	74S178	3.25
74S56	.45	74S179	3.25
74S57	.45	74S180	3.25
74S58	.45	74S181	3.25
74S59	.45	74S182	3.25
74S60	.45	74S183	3.25
74S61	.45	74S184	3.25
74S62	.45	74S185	3.25
74S63	.45	74S186	3.25
74S64	.45	74S187	3.25
74S65	.45	74S188	3.25
74S66	.45	74S189	3.25
74S67	.45	74S190	3.25
74S68	.45	74S191	3.25
74S69	.45	74S192	3.25
74S70	.45	74S193	3.25
74S71	.45	74S194	3.25
74S72	.45	74S195	3.25
74S73	.45	74S196	3.25
74S74	.45	74S197	3.25
74S75	.45	74S198	3.25
74S76	.45	74S199	3.25
74S77	.45	74S200	3.25

### CA-LINEAR

CA3010H	.99	CA3089N	3.75
CA3013H	2.15	CA3096N	3.95
CA3023H	3.25	CA3100N	1.25
CA3035H	2.49	CA3100H	1.25
CA3039H	1.35	CA3100M	1.25
CA3046N	1.30	CA3100N	.59
CA3069N	3.25	CA3106N	3.50

### CD-CMOS

CD4000	.39	CD4098	2.49
CD4001	.39	CD4099	.75
CD4002	.39	CD4100	.99
CD4003	1.19	CD4091	1.49
CD4007	.25	CD4092	.99
CD4009	.49	CD4093	.89
CD4010	.49	CD4094	.89
CD4011	.39	CD4095	1.79
CD4012	.25	CD4096	2.95
CD4013	.49	CD4097	1.49
CD4014	1.39	CD4098	1.79
CD4015	1.19	CD4099	.89
CD4016	.59	CD4100	1.95
CD4017	1.19	CD4101	1.19
CD4018	.99	CD4102	1.79
CD4019	.49	CD4103	1.95
CD4020	1.19	CD4104	2.79
CD4021	1.19	CD4105	2.79
CD4022	1.19	CD4106	2.79
CD4023	.29	CD4107	2.49
CD4024	.79	CD4108	.45
CD4025	.49	CD4109	1.95
CD4026	2.95	CD4110	.49
CD4027	.69	CD4111	.49
CD4028	.89	CD4112	.89
CD4029	1.49	CD4113	.39
CD4030	.49	CD4114	1.35
CD4031	.49	CD4115	.55
CD4032	.49	CD4116	.39
CD4033	.99	CD4117	.39
CD4034	1.49	CD4118	.39
CD4035	.99	CD4119	.39

tion. Directly below this is the representation for the common momentary-action, normally-open (N.O.) pushbutton switch, also an spst device. The final spst switch arrangement shown is for the slide switch. Although three solid contact dots are shown, only two are used for the make/break action.

As more poles and/or throws are added to a switching arrangement, the abbreviations change as follows: dpst = double-pole, single-throw; dpdt = double-pole, double-throw; 3pst = triple-pole, single-throw; sp4t = single-pole, four-throw; etc. For rotary switches, the abbreviation convention is different. This type of switch is usually described by the number of positions to which it can be set and the number of sections (wafers) included. For example, a rotary switch that has 12 positions and three wafers is described in exactly these terms for convenience.

In most applications that call for multiple-position rotary switches, the switch from station to station is a simple make/break process. However, in some cases, it's necessary to use a switch that makes before breaks. In even rarer cases, you might need a switch that shorts together successive stations as the switch control shaft is rotated. Both types of switching arrangements are illustrated in Fig. 10.

Sometimes it's desirable to switch a high-power circuit using only a low-power switch. An example of where this

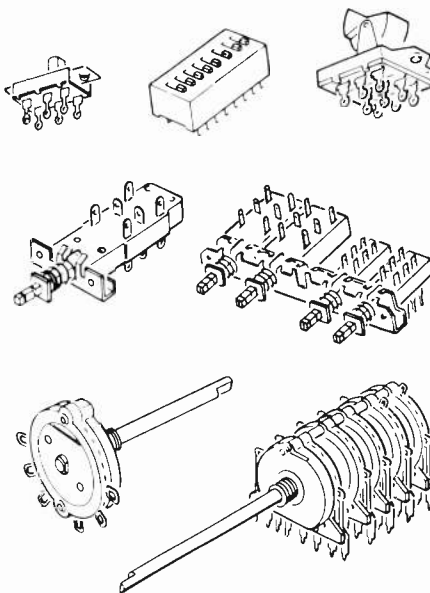

COURTESY THE HEATH COMPANY

Fig. 9. Typical switch configurations.

might be necessary is in a home intruder-alarm system, in which low-current-capacity door and window switches must be made to activate a high-current siren or bell. Obviously, trying to pass a high current through a low-current switch would cause irreparable damage to the switch. Of course, one way to circumvent the problem would be to substitute

high-current door and window switches. But this may not be possible. A better solution, however, would be to use a high-current-handling *relay* between the low-current switches and high-current siren or bell. Using this approach, a low current passing through the switches can activate the relay, whose high-current contacts, in turn, bear the alarm bell or siren load.

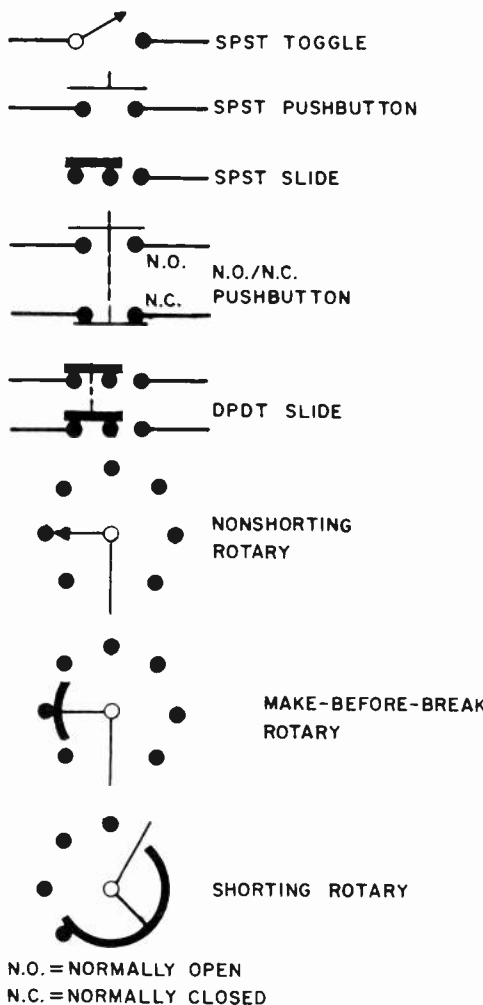

Fig. 10. Various types of switches.

Relays are actually special types of switches in which the contacts are moved magnetically. Every relay consists of two basic elements—an electromagnet and a set of switching contacts. The electromagnet assembly consists of many turns of wire wound on a solid iron core. When a current passes through the coil, it creates a magnetic field that's focused by the iron core toward the

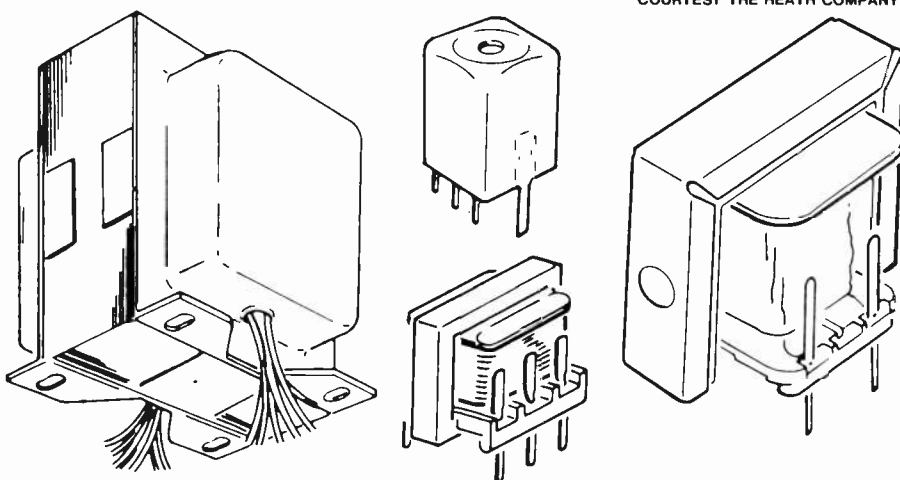

Fig. 8. Transformers come in many different physical configurations.



## ...Getting Acquainted...

switching arrangement. This magnetic field attracts the spring-loaded movable contact assembly (called an *armature*) toward the electromagnet. When this occurs, the contacts attached to the armature make contact with appropriate stationary contacts to complete a circuit. Frequently, when the armature moves toward its activate contacts, it breaks contact with other contacts.

When a relay has stationary contacts in both positions of the armature, each set of contacts can be specified as *normally open* (N.O.) or *normally closed* (N.C.). Therefore, when no current is passed through a relay's coil, the contacts to which the armature is positioned are normally closed, while the other contacts are normally open.

Relays are rated in two ways, according to the voltage or current required to activate their coils and the current-handling capacity of their contacts. The contact arrangement can be spst, dpst, dpdt, etc., in the same manner used for nonrotary switches.

Typical relay configurations are illus-

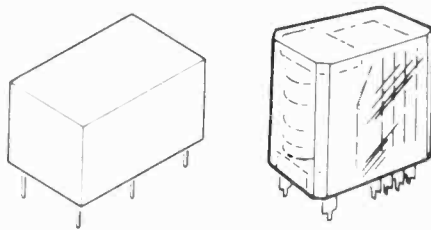

COURTESY THE HEATH COMPANY

Fig. 11. Typical relay packages.

trated in Fig. 11. Note that some relays are open-frame, others are enclosed in plastic cases, and still others are miniature *reed* devices. The last are usually housed inside metal or plastic containers. A few schematic representations for different types of relay/contact arrangements are illustrated in Fig. 12. Finally, the identifier for the relay can be either the letter "K" or the letters "RY."

**Diodes.** The simplest semiconductor device is the *diode*. Its schematic sym-

bol, shown in Fig. 13A, consists of an arrowhead and a bar. The bar indicates the negative or *cathode* end, the arrow the positive or *anode* end of the diode. (A useful hint to remember for any semiconductor device, including the diode, is that the arrowhead *always* points to a negative lead or terminal.)

The term "diode" doesn't refer to a single component but, rather, to a whole family of different devices. One of the most important of these is the *rectifier* diode, which is used to convert ac voltages into pulsating-dc voltages, as shown in Fig. 14. This rectification is made possible by the fact that the diode permits current to flow in only one direction.

Diodes used in voltage-conversion applications are often referred to as *power rectifiers*, especially if they're capable of passing from several to several hundred amperes of current.

Rectifier diodes are manufactured to operate below specific voltages and currents. Voltages usually range from a low of about 50 to 1000 volts or more, while

We accept VISA, MC, C.O.D., CHECK or M.O.

## FIRST QUALITY COMPONENTS - NOT MAIL ORDER "SECONDS"

Min. order \$10.00 - add 5% Shpg and \$1.00 Ins

### ARIES ZERO INSERTION FORCE SOCKETS



cam actuated, true zero insertion - tin plated solder tail pins - capable of being plugged into dip sockets, including wire wrap

Stock No	No Pins	1-24	25	50
11055	24	\$ 4.35	\$ 3.90	\$ 3.60
11056	28	4.50	4.05	3.75
11057	40	5.95	5.35	4.95
11058	64	10.50	9.45	8.70

### RESISTOR ASSORTMENT

82508 - 700 pcs (1 each below assortment) \$22.50

Stock No 82501 10 ea of 10-12-15-18-22-27-33-39-47-56 OHM  
 Stock No 83502 10 ea of 68-82-100-120-150-180-220-270-330-390 OHM  
 Stock No 82503 10 ea of 470-560-680-820-1K-1.2K-1.5K-1.8K-2.2K-2.7 OHM  
 Stock No 82504 10 ea of 3.3K-3.9K-4.7K-5.6K-6.8K-8.2K-10K-12K-15K-18K OHM  
 Stock No 82505 10 ea of 22K-27K-33K-39K-47K-56K-68K-82K-100K-120K OHM  
 Stock No 82506 10 ea of 150K-180K-220K-270K-330K-390K-470K-560K-680K-820K OHM  
 Stock No 82507 10 ea of 1M-1.2M-1.5M-1.8M-2.2M-2.7M-3.3M-3.9M-4.7M-5.6M-OHM

\$3.95 each for any assortment

### WILD ROVER

Touch switch capsule  
 Operating motion is .005" without the use of a levered arm. Extremely fast on and off with low noise. Normally operated 1.15 VAC, 1.6 amp, 30 million resistance. .615 radius by .160 thick



Stock No 119 10 25  
 12098 \$1.28 \$1.12 \$ .95

### 60/40 ROSIN CORE SOLDER

Stock No	Dia (feet)	Length (oz)	Price
50075	.062	9	\$3.28
50076	.062	25	4.36
50077	.062	50	6.02
50078	.032	33	1.5 4.08
50079	.032	88	5 4 5.16
50080	.032	175	8 6.82



### TI WIRE WRAP SOCKETS

Tin plated phosphor bronze contact - 3 wrap



Stock No	No Pins	1-24	25	100
11301	8	\$ 4.45	\$ 4.05	\$ 3.6
11302	14	66	59	54
11303	18	72	64	58
11304	18	82	73	66
11305	20	1.11	.99	.90
11306	22	1.25	1.12	1.02
11307	24	1.41	1.25	1.14
11308	28	1.71	1.52	1.38
11309	40	2.31	2.05	1.88

### TI LOW PROFILE SOCKETS

Tin plated phosphor bronze contact pins with gas tight seal

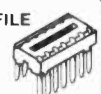

Stock No	No Pins	1-24	25	100
11201	8	\$ 1.5	\$ 1.3	\$ 1.2
11202	14	18	15	14
11203	18	21	18	16
11204	18	24	21	19
11205	20	27	24	21
11206	22	30	26	23
11207	24	33	30	25
11208	28	38	34	29
11209	40	53	45	40

### ELPAC POWER SUPPLIES - DC/DC CONVERTERS



SINTEC Stock No	ELPAC Part No	Input Voltage (VDC)	Output Voltage (VDC)	Output Current (mA)	Dimensions (inches)	Price
13825	CB3801	3.0-7.0	12.0-8	0.25	48.5x13.05 x 7.95	
13826	CB3811	4.0-7.0	12.0-8	0.25	48.5x13.05 x 7.95	
13827	CB3802	3.0-7.0	15.0-7	0.20	48.5x13.05 x 7.95	
13828	CB3812	3.0-7.0	15.0-7	0.20	48.5x13.05 x 7.95	
13829	CB3804	3.0-7.0	28.0-7	0.10	48.5x13.05 x 7.95	
13830	CB3814	3.0-7.0	28.0-7	0.10	48.5x13.05 x 7.95	

Stock No 13801 - "Floppy Disc" Power Supply For Winchester Drives \$109.00  
 13801-1 Data Sheet for 13801 \$ 25

### ELPAC POWER SUPPLIES - SOLV SERIES FULLY REGULATED

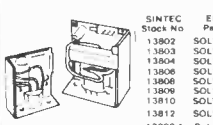

SINTEC Stock No	ELPAC Part No	Output Voltage	Output Current	Dimensions (inches)	OVP	Price
13802	SOLV15-5	5	3.0A	4.7-18x4x2	Fixed included	\$39.95
13803	SOLV15-12	12	1.5A	4.7-18x4x2	Fixed included	39.95
13804	SOLV15-15	15	1.2A	4.7-18x4x2	Fixed included	39.95
13806	SOLV15-24	24	0.75A	4.7-18x4x2	Fixed included	39.95
13808	SOLV30-5	5	6.0A	5.5-8x4.7-8x3-3/16	OVP-4	59.95
13809	SOLV30-12	12	4.0A	5.5-8x4.7-8x3-3/16	OVP-4	59.95
13810	SOLV30-15	15	3.3A	5.5-8x4.7-8x3-3/16	OVP-4	59.95
13812	SOLV30-24	24	2.0A	5.5-8x4.7-8x3-3/16	OVP-4	59.95

13802-1 Data Sheet for SOLV Series \$ 25

### Special of the Month!



**DIGITAL MULTIMETER**  
 Large easy to read 5 1/2 digit display-200 hours operating life with single 9v alkaline battery-low battery polarity indicators - Five functions (DC Volts, Ohms, DC mA, AC Volts, Diode and transistor junction check in circuit)  
 Stock No 82501 \$54.95  
 Stock No 82502 \$49.95  
 Kit Form with instructions

### MODUTEC

**Miniclamp AC Volt-Ammeter**  
 allows singling one conductor out of many without disarrangement  
 Stock No AC Amperes Price  
 13730 0-25A \$39.50  
 13731 0-50A 39.50  
 13732 0-100A 39.50

**ACCESSORY LINE SPLITTER**  
 allows fast readings of AC power consumption of plug in equipment without separation of leads.  
 Stock No. 13727 \$9.95

**POCKET SIZED BATTERY TESTER**  
 for all types of small batteries from 1.35v to 4.5v  
 Stock No. 13733 \$13.95

**VOLT-ICATOR**  
 automotive diagnostic meter plugs into lighter socket and indicates battery condition and charging rates.  
 Stock No. 13736 \$12.95

**AC VOLTAGE TESTER**  
 plugs into any 110v service receptacle to check time voltage over 50-150 VAC  
 Stock No. 13735 \$9.95

**VOM-MULTITESTER**  
 versatile Volt-Ohm-Milliammeter in small package  
 Stock No. 13729 \$13.95

### HUNTER TOOLS



8 Blades, sizes .050, 1/16", 5/16", 3/32", 7/64", 1/8", 9/64", 5/32"  
 STOCK NO 51002 \$3.45

7 most popular sizes - 3/16", 7/32", 1/4", 9/32", 5/16", 11/32", 3/8"  
**Nutdriver Kit** STOCK NO 51001 \$21.95

**CRIMPS** #10 - #24 wire STRIPS solid #12-22 and stranded #14-24  
**SCREW CUTTER** for 6 most common screw sizes. CUTTER and PLIERS  
 Stock No. 51005 \$12.95

**THE PIKE** 5 in 1 Tool  
 Stock No. 51005 \$12.95

**SINTEC** Drawer Q Milford NJ 08848-9990



**TOLL 800-526-5960**  
**FREE** in NJ (201) 996-4093

Send for Free Catalog - over 1100 parts.

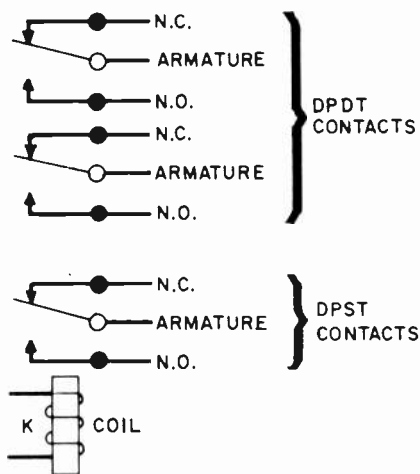

Fig. 12. Schematic representation of relay shown with two different versions of contact arrangements.

currents can range from a fraction of an ampere to several tens of amperes for hobby applications. As in the case of capacitors, you can substitute diodes with higher voltage or current ratings but never lower ratings.

Needless to say, when you select a rectifier diode, you must take into account the voltage and current at which it must operate.

There's also a special type of device known as a *bridge rectifier assembly* that greatly simplifies the building of many ac-powered projects. As shown in Fig. 13B, the bridge rectifier contains four separate rectifier diodes in a single package. The rectifier diodes come already prewired in the proper configuration for use in a full-wave power supply. As with individual rectifier diodes, selection of a bridge rectifier assembly must take into account both current and voltage requirements.

Not all diodes are used for power-conversion. Some are used for communications, such as the diodes used in transistor radios to recover voice and music from radio signals. This type of diode is often referred to as a *small-signal diode*, or simply *signal diode*, because currents that ordinarily pass through it never exceed a usually small fraction of an ampere.

By carefully adjusting the manufacturing process, it's possible to enhance certain characteristics that aren't normally used in diodes. One special diode, called the *zener diode*, is manufactured to enhance its voltage-regulating characteristic. Zener diodes can be manufactured to regulate from as low as 1 volt to

several hundred volts. For the average hobbyist, zener values of about 24 volts is the practical high-end limit. (Note: each zener diode is made to regulate at only one voltage. In cases where regulation is required at several different voltages, a different zener diode is used for each desired voltage.)

While the zener diode has the ability to regulate voltage, there's also a *current-regulating diode* that can prove to be extremely useful, especially in delicate test-equipment circuits.

The schematic symbols for both the zener diode and the current-regulating diode are shown in Fig. 13C and D, respectively. Note that for the ordinary rectifier and signal diode the symbol remains the same, but two different symbols are used for the zener and current-regulating diodes. For the zener diode, the bar is replaced by a "Z" on its side, while for the current-regulating diode the bar remains the same but the arrowhead is replaced with a black disc. Using different symbols makes it easy to identify different types of diodes at a glance when reading schematic diagrams.

Two more important types of diodes with which you should become familiar are the voltage-variable capacitance, or *Varactor*, diode and the *light-emitting*

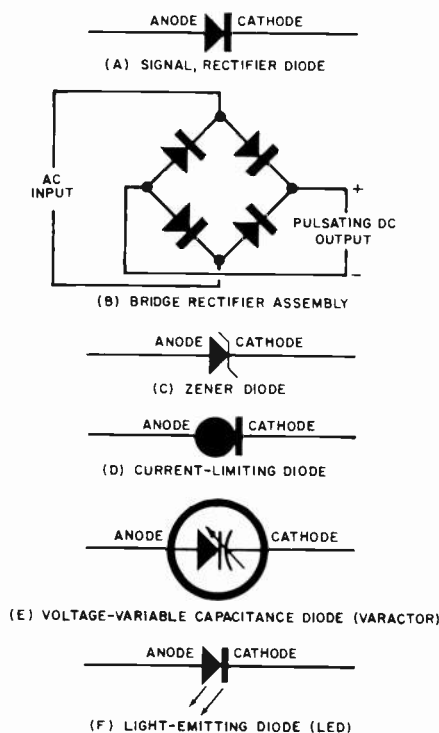
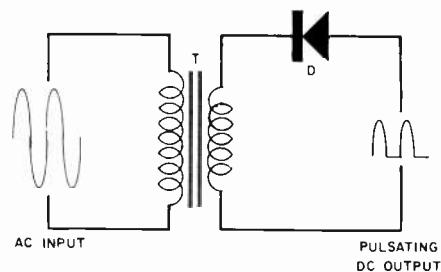

Fig. 13. Schematic representations of all types of diodes and the all-in-one bridge rectifier assembly.



Drawing illustrates how ac line voltage is stepped down and rectified to become pulsating dc.

diode, or *LED*. They're used not for their rectifier or regulating abilities, but for characteristics that are usually not related to diode functions.

The Varactor diode is a special type of device manufactured to enhance its variable *capacitance* abilities under changing dc-voltage conditions. It can be found in many modern TV receivers, where it's used as the main tuning element in vhf/uhf tuners. The schematic symbol for the Varactor diode (Fig. 13E) is a cross between the symbols used for ordinary diodes and variable capacitors and is almost always enclosed in a circle.

The light-emitting diode, as its name implies, is used to generate visible light. It's frequently used as a power-on indicator and can also be found in cassette tape decks to indicate peak recording levels and in hi-fi amplifiers to indicate relative output power levels, among other applications. LEDs are available in red, yellow, orange, and green, making it possible to use more than one color to indicate different things or conditions. The schematic symbol for the LED, regardless of color is the same as for the ordinary diode, except that it has a pair of parallel arrows pointing away from the arrowhead/bar junction to indicate light generation (Fig. 13F).

Unlike the other components discussed to this point, all of which have a single or at most two schematic identifiers, diodes have several. Most schematic diagrams use the letter "D" to identify all signal, rectifier, and regulator diodes, but some use the letters "CR" in the same way. Zener diodes are frequently identified by the letters "ZD." On the other hand, the term "LED" appears to be the universal identifier for light-emitting diodes.

Shown in Fig. 14 is a typical selection of physical configurations for all types of diodes and encapsulated bridge-rectifier assemblies.

CREATIVE COMPUTING PRESENTS...

# COMPUTER BOOKS!

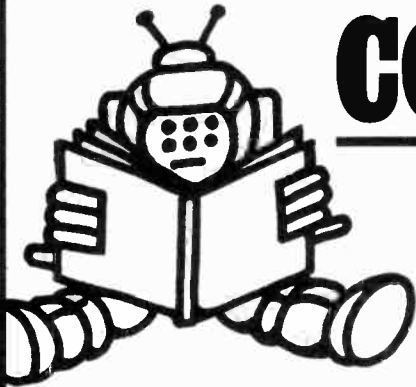

## Basic Computer Games

A complete anthology of 101 favorite games and simulations, each complete with sample runs, program listings and description. All games run in standard Microsoft Basic and are easy to use with any computer. There are games just for fun, to develop logic strategies, to teach environmental solutions, to simulate athletic competition, to play alone or with a group.

Edited by David Ahl with illustrations by George Beker. Large format paperback, 200 pages.

#6C... Basic Computer Games... \$7.95 (\$1.50)

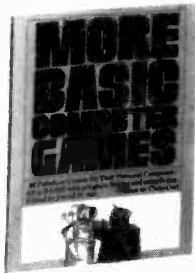
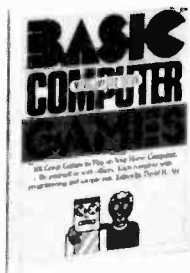

## More Basic Computer Games

Here are 84 new Microsoft Basic games to challenge you! Includes program listings, sample runs, and a Basic conversion table to make these games easy to use on any computer. Edited by David Ahl and Steve North, illustrated by George Beker. Large format paperback, 200 pages.

#6C2... More Basic Computer Games... \$7.95 (\$1.50)  
 #6C4... More Basic Computer Games/ TRS-80... \$7.95 (\$1.50)

## Computers for Kids

An easy-to-understand, step-by-step approach to programming for kids. Everything from what a computer is and how to create a flowchart to writing simple games and drawing pictures that move. Also a section of helpful hints for parents and teachers, and detailed lesson ideas. An excel-

lent elementary introduction. By Sally Greenwood Larsen. Large format paperback.



#12G... Computers for Kids/Apple \$3.95 (\$1)  
 #12H... Computers for Kids/TRS-80 \$3.95 (\$1)  
 #12J... Computers for Kids/Atari \$3.95 (\$1)  
 #12S... Computers for Kids/Sinclair \$3.95 (\$1)

## Computers in Mathematics

Whatever grade you teach you'll find plenty of ways to approach mathematical concepts in *Computers in Mathematics*. Here are 134 articles and applications written for *Creative Computing* by math teachers. Flowcharts, programs, and sample runs. Over 250 problems, puzzles and programming ideas on everything from simple binary counting to multiple regression analysis and differential equations. 224 pages, large-format paperback book.

#12D... Computers in Mathematics... \$15.95 (\$2)

## The Best of Creative Computing

Articles, learning activities, fiction, games, programs, reviews, cartoons and puzzles from *Creative Computing*. Volume 1 includes computer applications in education and recreation. Volume 2 includes languages, programming theory and artificial intelligence. Volume 3 includes features on technology, public access, medical applications and computers in music. 300+ pages per volume.

#6A... Vol. 1, Best of Creative Computing... \$8.95 (\$2)  
 #6B... Vol. 2, Best of Creative Computing... \$8.95 (\$2)  
 #12C... Vol. 3, Best of Creative Computing... \$8.95 (\$2)



**creative computing** Dept. E721 • 39 E. Hanover Avenue • Morris Plains, NJ 07950

Please send me the following books:

Book Number	Quantity	Title	Price Each	Total Price

Add postage and handling figures in parentheses ( ) following item price. Outside U.S.A., add \$3.00 per order

Subtotal\* \$

Postage and Handling \$

Total \$

Payment enclosed \$

\*(NJ Residents add 5% sales tax.)

Charge my:  American Express  MasterCard  Visa

(Charge and phone orders: \$10 minimum.)

Card No.

Exp Date

Signature

Mr./Mrs./Ms

(please print full name)

Address

City/State/Zip

CHARGE ORDERS: For your convenience, PHONE TOLL FREE: 800-631-8112. (In NJ only, 201-540-0445.)

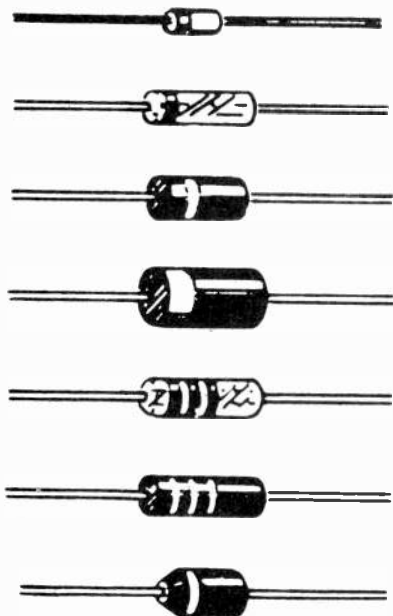

SIGNAL AND RECTIFIER DIODES

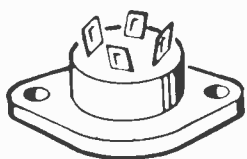
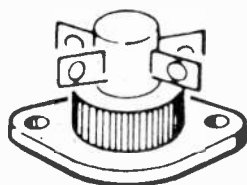

BRIDGE RECTIFIER ASSEMBLY

Fig. 14. Physical configurations for diodes and bridge rectifiers.

**Transistors.** As was the case with diodes, the term *transistor* applies to a whole family of different semiconductor devices. The most elementary of these is the *bipolar transistor*, shown schematically in Fig. 15A. This is a three-terminal device that comes in many different package configurations and sizes. There are two basic types of bipolar transistors—*npn* and *pnp*, the difference between the schematic representations being the direction in which the arrow points inside the circle.

The three terminals (or leads) on

every bipolar transistor are labeled *emitter*, *collector*, and *base*. It's easy to determine which is which, even if it's not indicated on a schematic diagram because the lead with the arrow is always the emitter, the lead connected to the bar is always the base, and the remaining lead is always the collector.

Moving along, we come to the next type of transistor, the *field-effect transistor*, or *FET*. There are two major types of FETs of interest to the hobbyist—the junction FET (JFET) and the metal-oxide-semiconductor FET (MOSFET), or insulated-gate FET (IGFET)—both of which are shown in schematic symbol in Fig. 15B and C, respectively.

FETs are of great interest because they have almost ideal characteristics for circuits in which it's necessary to make very sensitive measurements. They're typically found in test instru-

ments, high-quality FM tuners, and other electronic products.

The JFET was the earliest field-effect transistor device developed. Just as there are npn and pnp transistors, there are n- and p-channel FETs, the direction in which the arrow points identifying which is which. The terminals or leads for the JFET are labeled *source*, *drain*, and *gate*, which correspond to the emitter, collector, and base of the bipolar transistor.

The MOSFET or IGFET (the two are identical) is similar to the JFET in design, except that no direct connection is made from the gate to the semiconductor material. (Note the difference between the JFET and MOSFET in Fig. 15B and C.) Also, the MOSFET can have more than one gate electrode. Hence, while JFETs are three-terminal devices, MOSFETs can have more than three terminals.

COURTESY THE HEATH COMPANY

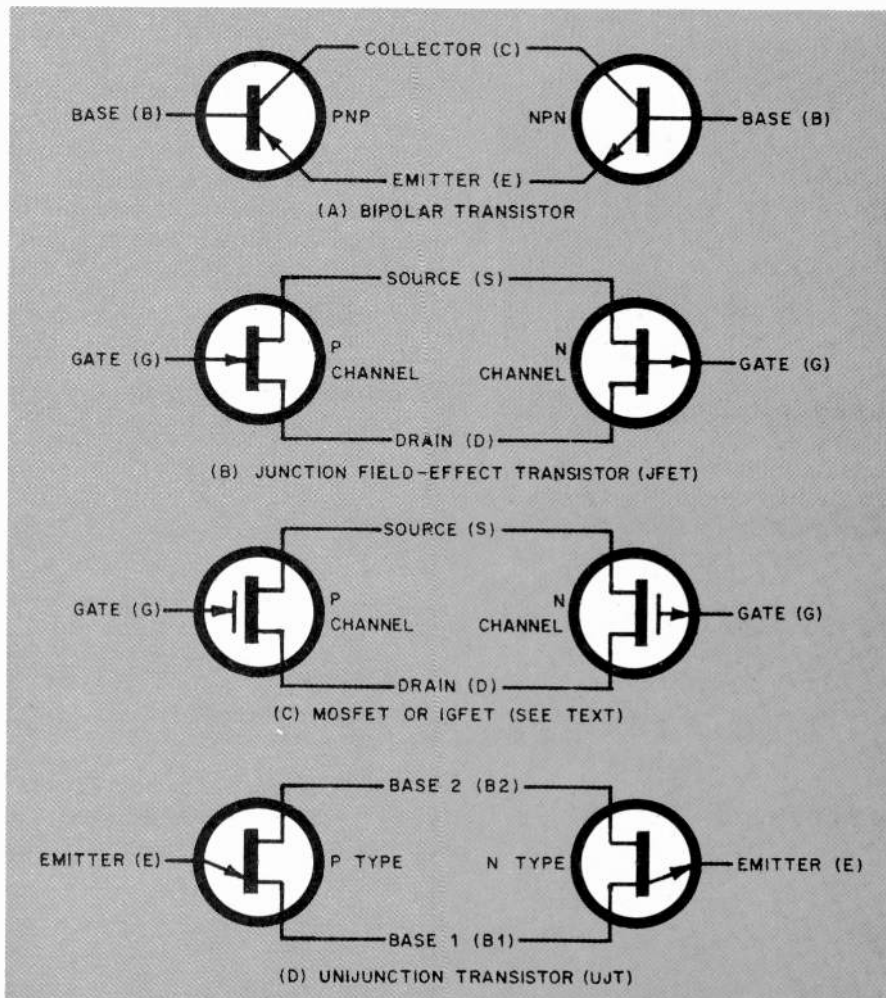

Fig. 15. Schematic identifier symbols for transistors.

The input impedance of the MOSFET, on the order of millions of megohms, is considerably greater than the few megohms to more than a thousand megohms of the typical JFET. This makes the MOSFET a great deal more sensitive, which accounts for its use in critical measurement applications, highly sensitive medical electronics equipment, and in high-quality FM and TV tuners.

A very handy semiconductor device, used for generating pulses, is the *uni-junction transistor*, or *UJT*. The schematic symbol for this three-terminal device is shown in Fig. 15D. Note its similarity to the JFET. To avoid confusion between the UJT and the JFET, however, the line that has an arrowhead on it is at an angle in the UJT. The UJT's terminals are labeled *base 1* (B1), *base 2* (B2), and *emitter* (E), which correspond to the source, drain, and gate in the JFET. The B1 and B2 terminals in a UJT are often interchangeable.

Typical examples of case configurations for all types of transistors are shown in Fig. 16. Smaller plastic-encapsulated cases are used for relatively low-power devices, while the larger metal-cased devices generally indicate high-power-handling ability.

The schematic identifier for the transistor, regardless of type, is usually the letter "Q." However, in some cases, particularly in foreign publications, the letters "TR" or "Tr" are used instead.

**Semiconductor Switches.** A special type of semiconductor device very popular in switching applications, is the *thyristor*, or semiconductor switch. This type of device has some of the characteristics of ordinary diodes and the physical

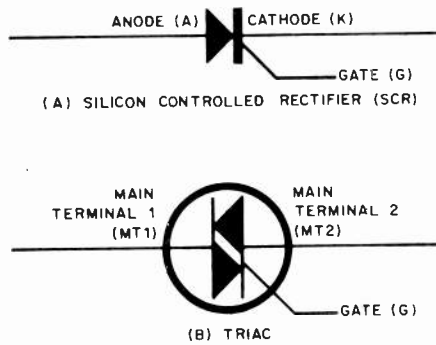

Fig. 17. Shown are the schematic symbols for the silicon controlled rectifier (A) and the triac (B).

appearance of a transistor. Like the transistor, it's a three-terminal device, yet the elements inside it are diodes. The case configuration for thyristors can be any of those illustrated for medium- and high-power transistors in Fig. 16, depending on the amount of power a given device is designed to handle.

The *silicon controlled rectifier*, or SCR, is one of the two types of thyristors commonly available to electronics hobbyists. When used to switch dc voltages, the SCR behaves like an ordinary diode in one direction, while in the other direction it acts like a diode in series with an electronic switch.

Like an ordinary diode, the SCR's schematic symbol consists of an arrowhead pointing toward a bar (Fig. 17A).

SCRs aren't limited to use in dc-voltage switching applications. When they're used to switch ac voltages, two SCRs are usually required, one each to handle the positive and negative alternations of the ac voltage.

In ac applications, the SCR turns itself off automatically as the voltage passes through zero. In dc applications, however, once an SCR is triggered on, it will remain on until a switch or other device briefly interrupts the flow of current through it. This latching characteristic makes the SCR an ideal switching component in alarm systems.

The other thyristor device of interest to the hobbyist is the *TRIAC* (an acronym for *trioded ac semiconductor switch*). The TRIAC is similar to the SCR in what it does, except that it's an ac-only switching device. Contained within the TRIAC are *two* SCR-like devices (Fig. 17B) connected in parallel but opposite directions, with only one gate terminal. This arrangement is similar to the two-SCR approach used for ac switching but is considerably more convenient and less expensive to use.

TRIACs are three-terminal devices. Their terminals are labeled *main terminal 1* (MT1), *main terminal 2* (MT2), and *gate* (G). If you study the schematic symbol for the TRIAC, you can readily see why the phrase "main terminal" is used instead of anode or cathode. Each main terminal is both an anode and a cathode, acting as one or the other on different alternations of the ac voltage.

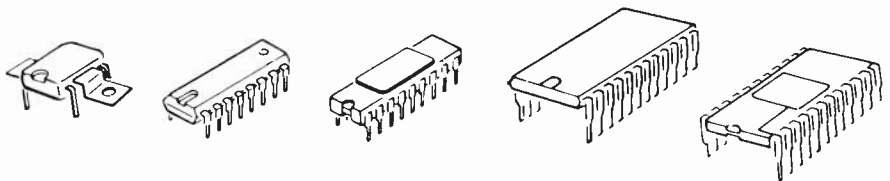

COURTESY THE HEATH COMPANY

Fig. 18. Typical case configurations for all types of integrated circuits.

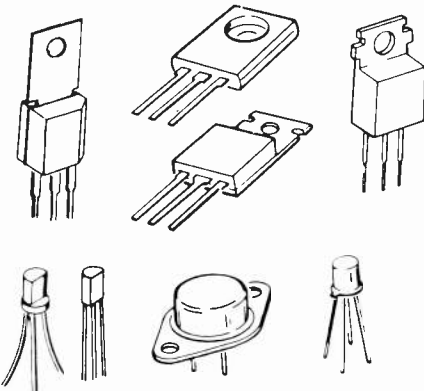

Fig. 16. Case configurations for all types of transistors, silicon controlled rectifiers, and triacs.

However, coming off the bar at an angle is a third electrode. Also like the diode, the SCR's arrowhead and bar are called the *anode* and *cathode* terminals, respectively, while the diagonal electrode is called the *gate*. The anode goes to the positive side of the supply voltage, the cathode to the negative side. The gate goes to some point in the circuit that can deliver a "trigger" voltage when a certain condition is met.

Any circuit or device to be switched by a TRIAC connects between either MT1 or MT2 and one side of the power source, while the other main terminal goes to the other side of the power source. Switching is then accomplished by a signal applied to the gate. Once triggered on, the TRIAC will remain on only as long as the trigger signal is applied to the gate. This makes the TRIAC ideal for use in solid-state light-



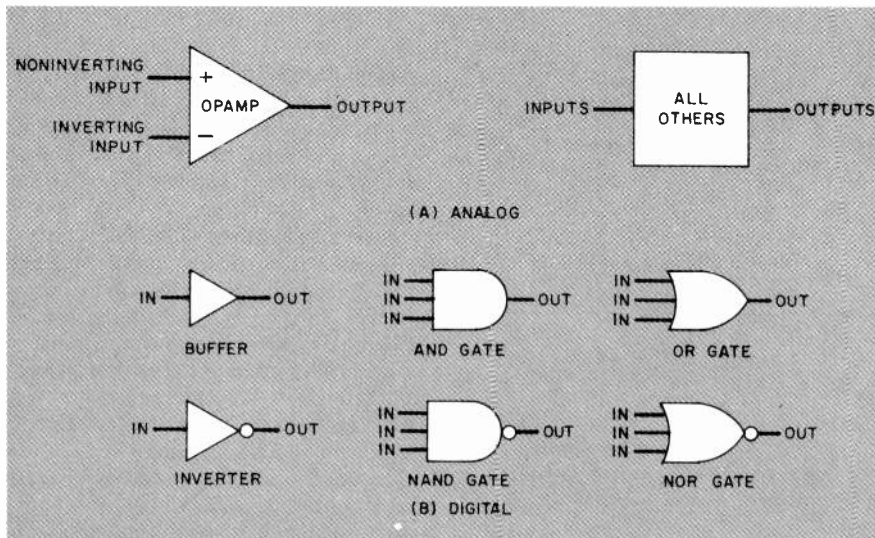

Fig. 19. Schematic and block diagram identifiers for all types of analog and digital integrated circuits.

dimmer and variable-speed motor controllers.

The schematic identifier for the SCR is simply "SCR." The identifier for the TRIAC, on the other hand, is almost always the same as for the transistor, the letter "Q" or "TR."

**Integrated Circuits.** Electronics technology has come a long way since the invention of the transistor. The invention and subsequent widespread use of integrated circuits, or ICs, typifies just how far it's actually come. Thanks to relatively low cost ICs, it's possible today for even a beginning hobbyist to build projects that only 15 years ago would have qualified as advanced construction jobs—if they could even have been built with components available at that time.

ICs aren't like the discrete components we've discussed up to this point. They're actually complete *circuits* that are reduced to microscopic size and housed inside miniature size packages (Fig. 18). While some ICs are housed inside packages whose configurations are virtually indistinguishable from those used for transistors, the typical IC package is a long, narrow shape with a multiplicity of pins arranged in two parallel rows. Such a configuration is termed a dual in-line package, or *DIP*. Some ICs, like transistors, are three-terminal devices. The great majority, however, have a minimum of four to as many as 64 or more pins, depending on how complex are the circuits contained in them.

Even the simplest IC can contain a dozen or more transistor stages, includ-

ing transistors, resistors, and capacitors. Some of the circuits contained inside IC packages are staggeringly complex. For example a single microprocessor or high-density memory IC used in a microcomputer can contain *thousands* of individual transistor stages, all wired together internally to produce a circuit that requires only a power supply and appropriate input to make it work. If a circuit as complex as either of these two ICs could be built from discrete transistors, it might cost tens of thousands of dollars to produce and would take up

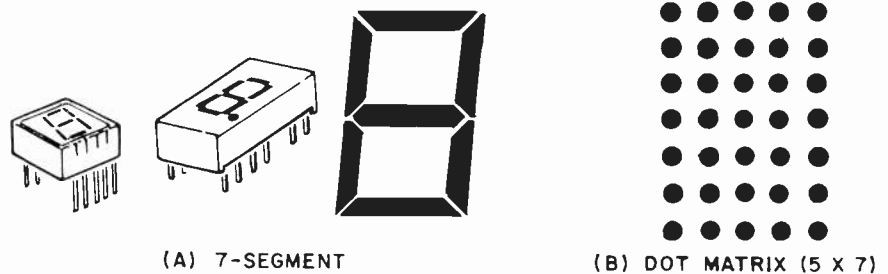

Fig. 20. Seven-segment displays can indicate all numbers, some letters; dot-matrix displays can indicate all alphanumeric and special symbols.

cubic yards of space. Yet, a microprocessor IC, for example, costs \$20 or less and is usually only about 1 1/2 in. long by 5/8 in. wide by 1/4 in. deep.

All integrated circuits fall into either of two general categories—*analog* or *digital*. Analog ICs are used in applications that deal with continuous signals, such as audio and r-f, while digital ICs

are used in applications that deal with pulses.

There are several basic types of analog ICs, including but not limited to amplifiers, voltage regulators, and phase-locked loops (PLLs). The schematic representations for these ICs are illustrated in Fig. 19A.

Two popular types of analog ICs in current use are the *operational amplifier*, or *opamp*, and the audio amplifier. Opamps are designed to have high input impedance and high gain (amplification). Ordinarily, they consist of an amplifier with separate inverting (−) and noninverting (+) inputs and a single output.

Perhaps the greatest strides in IC technology have occurred and are continuing to occur in the digital area. To meet different criteria, different families of digital ICs have been developed over the years. Perhaps the oldest in popular current use is the transistor-transistor logic (TTL) family. Circuitry in these ICs consists of ordinary npn and pnp bipolar transistor stages designed to operate at a regulated 5-volt dc power level. An improved member of this family is the Schottky TTL series, which is faster and can be used in higher-frequency applications. In addition, there are also low-power TTL and low-power Schottky devices designed to require less current while preserving the characteristics of TTL devices. Frequently standard, Schottky, and low-power TTL devices are mixed in the same circuit to

take advantage of each type's special characteristics.

Complementary metal-oxide semiconductor (CMOS) ICs have recently begun to eclipse TTL devices in popularity, basically because of their very low power requirements and the fact that they can operate over a 5-to-18-volt dc range. This family of digital ICs is built

around complementary n- and p-channel FETs.

MOS (metal-oxide semiconductor) ICs are also low-power devices, but they have the disadvantage of requiring multiple-voltage power supplies, typically +5, +12, and -12 volts.

The functions in all families of digital ICs are implemented by combining different combinations of three basic elements—NOT, AND, and OR gates. (See Fig. 19B.)

The NOT gate, or as it's more commonly called, the *inverter* is the most fundamental device. Its output is *not* the same as its input. If the input is high, the output is low, and vice-versa. A similar device, known as a *buffer*, gives the same output as the applied input. To schematically distinguish between the buffer and the inverter (NOT gate), the latter has a small circle at its output.

Both the AND and the OR functions work on two (or more) input signals to produce one output signal. For the AND gate, only if *all* inputs are high will there be a high output; otherwise, the output will be low. With the OR gate, if any one or more inputs are high, the output will be high; with no inputs, the output will be low.

By placing a small circle at the outputs of the AND and OR gate symbols, we identify these devices as NAND and NOR gates, respectively. This notation tells us that the outputs of these gates are the opposite of those for the same input conditions for the AND and OR gates. That is, the output from a NAND gate will be *low* if all its inputs are high. Likewise, if any one or more inputs to a NOR gate are high, the output will be low; otherwise the output will be high.

In schematic diagrams of circuits in which individual gates are used, the schematic symbols for each gate is shown. When these elements are combined to produce a prepacked logic-function block, such as with the JK flip-flop or decade counter, a square or rectangular box is used to simplify the representation and avoid confusion.

The schematic identifier for ICs isn't standardized. Most publications and manufacturers use the letters "IC" for *all* types of ICs. Others, particularly in the digital and computer industries, use the letter "U" for all or at least digital ICs.

**Digital Displays.** Numeric and alphanumeric displays are routinely used in a host of modern electrical and electronic products and projects. They can be found in such consumer items as digital

clocks and watches, microwave ovens, bathroom scales, thermometers, and calculators. They're also used in CB radios and TV receivers as channel indicators and in AM and FM tuners to indicate exact tuned frequency. They're even more extensively used in test instru-

ments to replace often ambiguous and difficult-to-read meter movements in volt/ohm/milliammeters and frequency/events counters. And they're *very* popular items in hobby electronic projects of all kinds.

Most modern numeric displays use an



Introducing . . .

## MAGNUM 'Power Sleuth'

**Tunable FM Antenna Amplifier For all FM Antenna Systems**

With fully controllable gain, the MAGNUM 95FM 'Sleuth' provides up to 30db of clean, crisp gain (boost) to your antenna's FM signal. Also, it will attenuate to -10db to relieve that annoying front end overload from strong, local stations. Continuously variable tuning provides a tight 600khz bandwidth, adding significantly to your tuner's selectivity and sensitivity. The Sleuth installs in minutes at the tuner end of your antenna lead-in.

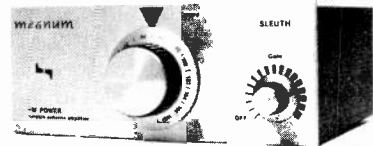

**Technical:** 3 rf stages, varactor tuned using noise-free, Gold CERMET control; Gain, variable +30 to -10db; Noise figure 4db; Tuning range 88 - 108mhz; Input/output 300 ohms; 110vac op'n @ 10 watts.

### TWO GREAT NEW FM ANTENNAS from GAM Electronics

The Stereo One is a revolutionary new vertical FM antenna that is fully omnidirectional and provides up to double (3db) gain over your present dipole ('T' or turnstile) antenna. Its unique vertical design is less susceptible to annoying multipath and it may be mast or windowsill mounted and even used indoors.

**Technical:** Gain 3db (approx.) @ 98mhz/300 ohms; Range 88 - 108mhz; Construction 2-section (S.S. whip & PVC transformer housing); Height 76"; Weight 12 oz.; Output 300 ohms; Mounting brkt. for mast or windowsill.

Introducing the GAM Stereo Two. Designed specifically for cramped mounting situations, such as balconies, windows, etc., the Stereo Two has already proven itself a high-gain alternative to 'rabbits ears' and wire dipoles. It has substantially\* the same great characteristics as its big brother, the Stereo One, yet it mounts neatly and unobtrusively on balcony rail or by a window. Its slender whip 'blends' nicely with hardly a hint that it's even there.

**Technical:** Gain 3db (approx.) @ 100mhz/75 ohms; Range 88 - 108mhz; Construction stainless steel whip with shielded base loading coil; Height 54"; Weight 12 oz.; Output 75 ohms; S.S. 'L' mtg. brkt. & 25 ft. cable ass'y. included.

\*Gain taken with lead-in cable 25 ft. maximum.

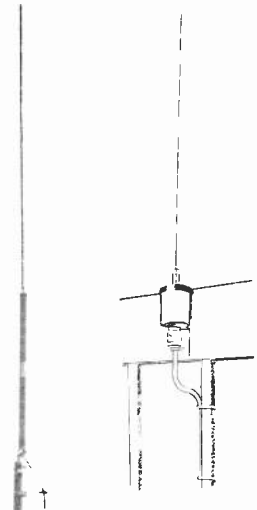

NOTE: MAGNUM and GAM products also available in automotive versions.

**Introductory Offer** (limited offer) Send check or money order to

MAGNUM 95FM Amplifier . . (reg. \$159.95) **\$139.95**  
 GAM Stereo One or Two . . . (reg. \$ 69.95) **\$ 59.95**  
 MAGNUM Amp  
 GAM Antenna . . . . . (reg. \$229.90) **\$189.95**  
 (N.Y. residents add 7% State Tax)  
 Please add \$3.50 shipping for one—\$2. ea. add'l. item.

**Castle Marketing**

Holland Street  
 P.O. Box 219  
 Alexandria Bay, N.Y.  
 13607

VISA & MASTER CARD buyers are welcome to call for FAST service (315) 482-2589.

arrangement of seven bars, or *segments*, to represent all numerals from 0 through 9 and some alphabetic characters (Fig. 20A). To display the full set of alphabetic and numeric (alphanumeric) characters, a display scheme consisting of 16 segments or an arrangement of dots in a matrix is used (Fig. 20B).

There are five basic types of numeric and/or alphanumeric displays in use today. These include: incandescent, fluorescent, gas-discharge, light-emitting diode (LED), and liquid-crystal displays (LCDs). Most of these are available in both 7- and 16-segment formats, while the dot-matrix format appears to be restricted to basically LED and LCD technology at this time. As a hobbyist, you need concern yourself only with LCD and LED displays. Rarely will a project call for any of the other types.

Digital displays are available in a wide variety of sizes, ranging from as small as 0.13 in. (used in calculators and watches) to 6 in. or more tall (used in public clocks and scoreboards). The almost universal identifier for this component are the letters "DISP."

**Miscellaneous Components.** In ad-

dition to all the above, there is a variety of other components frequently enough used in hobby electronics to demand your attention. Among the more frequently used are batteries, fuses, and connectors. Less frequently used items are lamps, meter movements, solar and photoelectric cells, and circuit breakers.

The most common type of battery is the disposable carbon-zinc variety. It's available in the following 1.5-volt cell sizes: AAA, AA, C, and D, in order of increasing size and current-delivery capability. The carbon-zinc variety is also available in prepackaged 9-volt transistor and 6- and 12-volt lantern battery forms.

A better battery to use for electronic projects, where long life is usually very important, is the alkaline type. Alkaline batteries are very similar in variety to carbon-zinc batteries, available in AAA, AA, C, and D cells and in prepackaged 9-volt transistor battery sizes. The major difference between alkaline and carbon-zinc batteries is that the

former can deliver two to ten times more useful life.

The best battery for electronic projects, of course, is the rechargeable nickel-cadmium variety, which eliminates the need to constantly replace spent batteries. Ni-Cd (sometimes called "Ni-cad") batteries are noted for their high-current capabilities, long cycle life, and good low-temperature performance. They're available in a wide variety of sizes and shapes to fit just about every possible need. Nickel-cadmium batteries cost as much as 10 times as much as the same-size carbon-zinc battery. However, since they can be recharged up to 1000 times, the initial high cost is more than off set by the per-use cost.

Shown in Fig. 21A are physical configurations of a representative collection of miscellaneous components commonly used in electronic projects.

Fuses (only the "bayonet" variety is used in hobby electronics) and circuit breakers are used as protective devices to prevent damage to circuits and/or components when an overload occurs. The two devices operate on different principles. Inside the fuse is a wire element that literally vaporizes (fuses) when too high a current is passed through it. Once blown, a fuse must be replaced with the *same type* fuse. The design of the circuit breaker is altogether different. It uses a bimetallic element that bends away from a contact when an excessive current is passed through it, breaking the circuit. A spring then keeps the bimetallic element from returning to the normally-closed condition until the circuit breaker is manually reset. Hence, circuit breakers are reusable.

There are two basic types of fuses, fast-action and slow-blow. Fast-action fuses are used wherever it's imperative that power be instantly disconnected when an overload occurs. Slow-blow fuses, on the other hand, are designed to easily handle brief surges of current without blowing but thereafter provide normal fuse protection. A slow-blow fuse will blow only if an excessive current flows through it for a predetermined period of time.

Fuses and circuit breakers are available in a variety of different ampere ratings, ranging from a few milliamperes to several amperes. Of course, fuses come in a much greater variety of ratings than do circuit breakers. Shown in Fig. 21B are the physical configurations for both. The schematic identifier for the fuse is the letter "F," while that for the circuit breaker are the letters "CB."

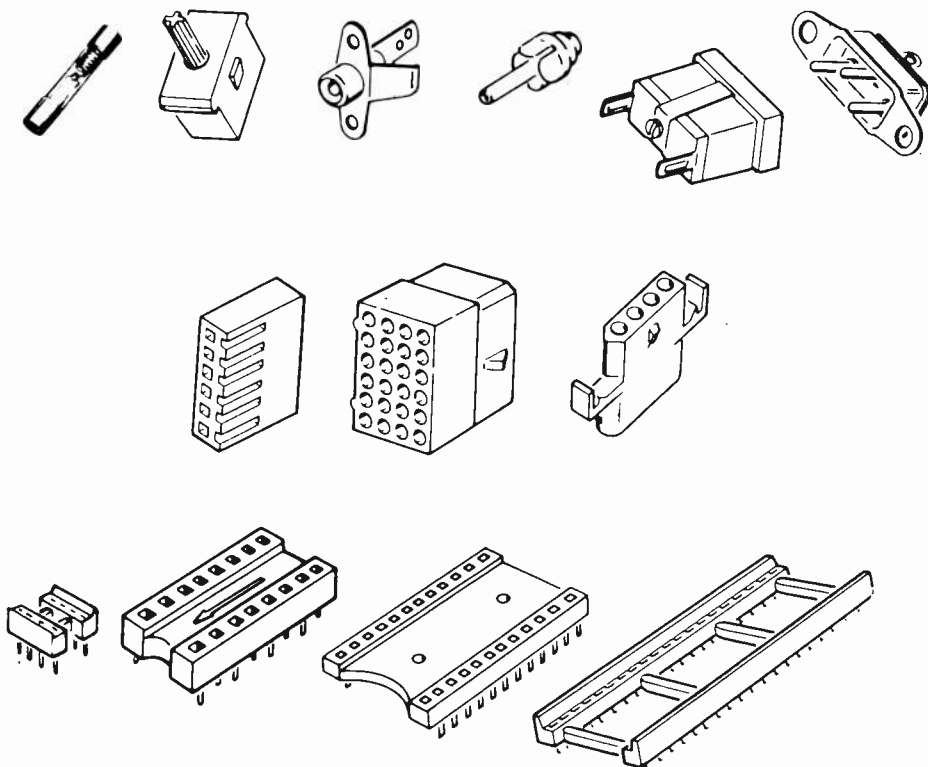
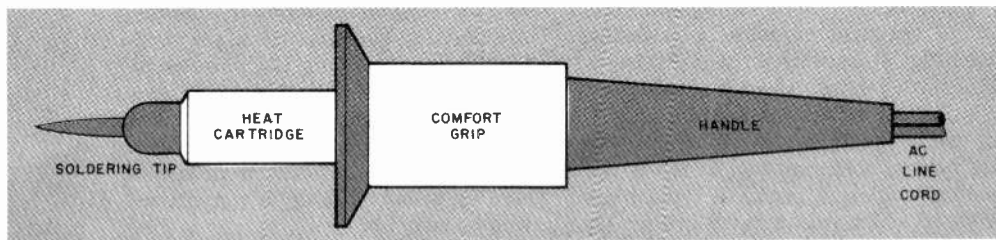

Fig. 21. Physical configurations for fuses and circuit breakers (top left), phono jack and plug (top center), ac receptacle and plug (top right); connectors (center); and integrated circuit sockets (bottom).

Fig. 22. Drawing identifies various elements that make up the typical soldering pencil. Soldering tip and heat cartridge can be changed to suit different soldering needs.



In addition to the LED, there are two basic types of indicator lamps commonly used in electronics. One is the miniature incandescent lamp, which is similar to the lamps used in flashlights. The other is the low-current neon lamp.

Special types of resistors are sometimes used in control applications. Among these are the light-dependent resistor (LDR), the temperature-dependent resistor (TDR), and the voltage-dependent resistor (VDR). These are shown schematically in Fig. 22D. Note that each is enclosed inside a circle and is accompanied by a legend that identifies its function.

Meter movements, once very popularly used in test equipment and radio gear, have in recent years given way to digital numeric displays. However, they're still used in many circuits to indicate voltage and current levels, signal levels, and trends. The schematic representation is a circle with stylized pointer. Our final entry for component identification is *connectors*, a designation that covers a wide range of devices. These devices aren't really "components" by the usual definition. Some of the more familiar connectors include the RCA phono jack and plug used in audio, the phone plugs and jacks used for headphones, and the vhf/uhf connector found on the backs of TV receivers. Add to this list the coaxial r-f connectors used in radio-communications gear; edge connectors used in all types of modular-design equipment; bus connectors used in computers; and power connectors. The list goes on and on. Fortunately, only a narrow range of the available connectors are of practical use to the electronics hobbyist.

A sampling of the more popular connectors, jacks, and plugs for hobby electronics are illustrated in Fig. 21. Beside each physical representation is shown the equivalent schematic symbol. Schematic identifiers are usually given to only jacks, plugs, and sockets. They're almost always represented by the letters "J," "P," and "SO," respectively.

**Soldering.** Anyone who plans to assemble an electronic kit or build a project

from scratch must first learn how to solder. To solder properly, a few basic rules must be observed. Once the procedure involved is mastered, the actual soldering operation is really very simple to perform and becomes automatic in time.

Solder is the means by which metal leads on components are bound into a circuit both electrically and mechanically. Solder itself is an alloy of specific proportions of lead and tin whose melting temperature is far below that of the metals it's to join together. The most commonly used solder alloy contains 60% lead and 40% tin, abbreviated 60/40 solder. The melting temperature of 60/40 solder is low enough to allow safe soldering of even delicate heat-sensitive solid-state components. Additionally, the low melting temperature allows use of inexpensive soldering tools.

During the soldering operation, heat from the soldering tool causes oxides to form on the surfaces of the metals being soldered. This occurs even if the metals are perfectly clean and free of oxides to start. These oxides (and any dirt and/or grease) will form a barrier that will prevent a good solder connection to be made. To combat the oxide (but *not* the dirt and grease) problem, most modern solders for electronics have a core of rosin flux that automatically cleans away oxides during the soldering operation. The best type of solder to use for electronics, therefore, is a 60/40 alloy with rosin core.

Keep in mind that not all solders are safe to use in electronic assembly work. Only those specifically labeled safe for electronics work should ever be used. Other solders may contain corrosive materials that will degrade the integrity of soldered joints in short order and cause a perfectly wired circuit to stop operating. Therefore, to be on the safe side, always make it a point to buy your solder from an electronic parts outlet. Unless you're absolutely certain about what you're buying, don't buy from your local hardware store. Most solders in hardware stores are okay for plumbing and sheet-

metal work but can prove to be disastrous for delicate electronic projects.

Solder is available in different diameters to meet different soldering requirements. For most electronics work, however, the best size to use is about 30 gauge. This very-thin-diameter solder is ideal to use on closely spaced printed-circuit pads (as between IC pins) because it's easy to control solder flow and avoid creating solder bridges.

**Soldering Tools.** The basic tool used for soldering is the soldering iron or pen-

**MICRO-PROFESSOR**  
MPP-1 USER'S AND EXPERIMENTAL MANUAL

Dear Electronic Enthusiast:  
Now let the Micro-Professor usher you into the microcomputer evolution.  
The Micro-Professor™ is the first really low cost learning system designed for personal use. It will truly become your Personal Computer.

Sincerely,  
*Chris Johnson*  
Chris Johnson, Customer Service

**only \$149.95**



**Z-80 BASED**

## MICROCOMPUTER

**A superb learning tool for students, instructors, hobbyists.**

Nothing else needed. Just plug in and start learning! Complete experimenters manual, easy instructions. 18 experiments., Fully expandable for Z80-CTC, Z80-PIO, EPROM, Breadboarding and prototyping. Invest with confidence. Now only \$149.95, two for only \$279.95. 2KB BASIC interpreter now available, only \$19.00. Full money back guarantee!

**Plus-FREE GIFT**

Check this box for FREE Z-80 Microprocessor Programming and Interfacing textbook when you order within 7 days. \$12.95 value.

**ETRONIX**  
Dept I E072  
14803 N.E. 40th  
Redmond, WA 98052

For immediate action call TOLL FREE:  
**1-800-426-1044**

NAME \_\_\_\_\_  
ADDRESS \_\_\_\_\_  
CITY \_\_\_\_\_ ST \_\_\_\_\_ ZIP \_\_\_\_\_  
 VISA     MSTCRD    EXP \_\_\_\_\_  
ACCT. NO. \_\_\_\_\_

CIRCLE NO. 21 ON FREE INFORMATION CARD

## ...Getting Acquainted...

cil. These tools are available in a variety of sizes, shapes, and wattage ratings. For all practical purposes, a soldering iron rated at between 25 and 50 watts will suffice for just about any soldering task likely to be encountered in modern kit and project building. Perhaps the best type of soldering tool to use is the modular soldering pencil, a typical example of which is illustrated in Fig. 22. This type of tool offers the greatest flexibility, allowing the user to choose from and interchange heat cartridges and/or soldering tips. Hence, with the modular pencil, the handle can be fitted with a 25-watt cartridge and needle-point tip for work on delicate printed circuits. Then, if a heavy-duty chassis lug must be soldered, the cartridge can be replaced with a 50-watt unit fitted with a massive conical or chisel tip.

Although most electronic wiring is performed in locations where ac power is

readily available, sometimes it's necessary to solder where no power is handy. For situations like this, there are cordless soldering irons (Fig. 23) powered by rechargeable batteries. Cordless irons aren't designed or meant for extended kit and project soldering. Rather, they're meant to be used in situations where up to only 100 or so connections are to be soldered.

Soldering irons require some preventive maintenance to keep them in proper operating condition. If a soldering iron is left powered for a long period of time, its tip can become pitted and worn away. To prevent this from happening, it's important to frequently clean away dirt and oxide build-up with a dampened sponge or cloth while the iron is hot. After the iron cools, its tip should be loosened about a half turn to prevent seizure that could, in turn, prevent it from easily being replaced or interchanged.

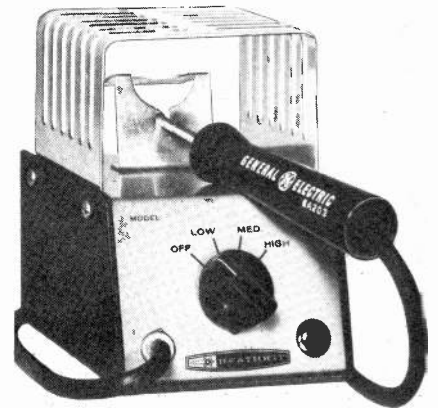

COURTESY THE HEATH COMPANY

Heathkit's Model GH-17 soldering iron kit is an example of an adjustable-heat soldering tool.

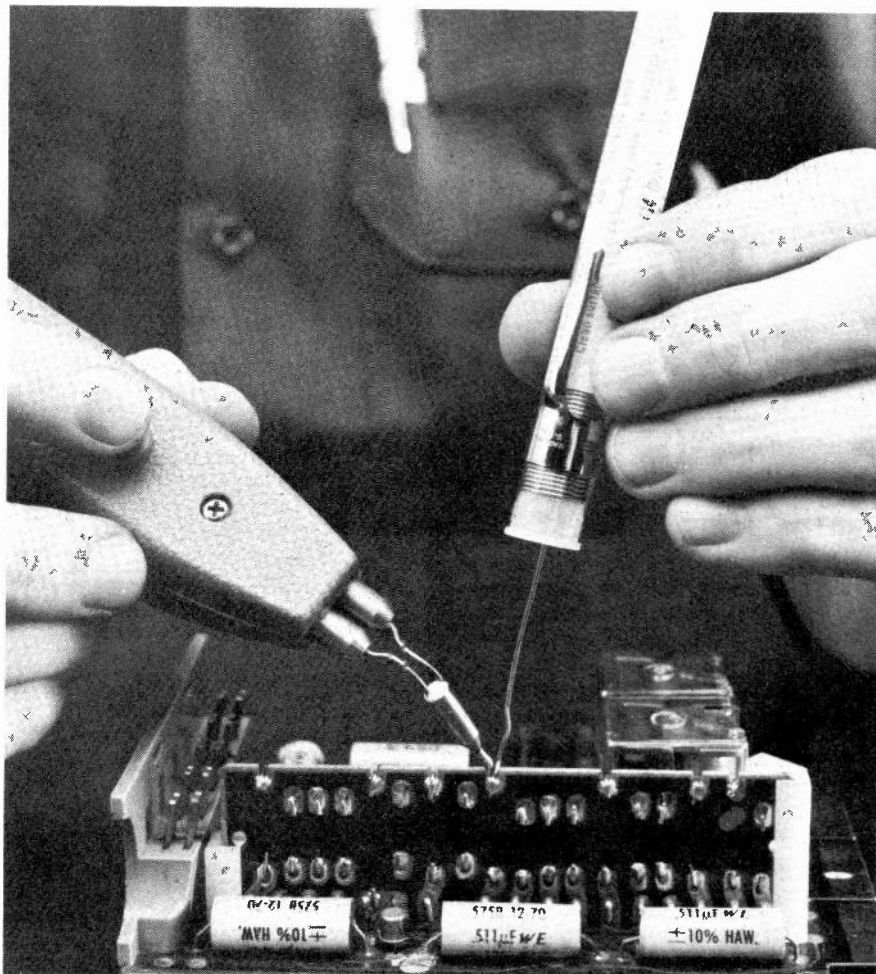

COURTESY EASTMAN CHEMICAL PRODUCTS, INC.

Fig. 23. Photo shows a cordless soldering iron in field use. Technician feeds solder to the connection from Kester Solder's "solder in a pocket."

When a new soldering tip is first installed on a soldering tool and is brought up to soldering temperature for the first time, it must be *tinned*. Tinning is necessary to protect the tip from succumbing to oxidation as a result of heat. A tip to be tinned must first be cleaned of all dirt, grease, and oxide. Then, when it's brought up to soldering temperature, solder is flowed over it until all portions of the surface are coated. This done, the excess solder must be removed with a damp sponge or cloth.

Soldering tips can be either solid raw copper or iron-plated copper. Raw copper provides the best heat efficiency but rapidly deteriorates as a result of pitting and oxide build-up. Although plated tips are slightly less efficient and cost two to four times more than equivalent raw-copper tips, they're worth the investment because they can last up to 10 times longer. Also, plated tips require considerably less maintenance to keep them in tip-top order.

In addition to the soldering iron, at least one other soldering-aid tool should be part of a soldering station. This is a wand-like device with a plastic body fitted at one end with a blunt-pointed aluminum probe and the other end with a slotted aluminum lead bender. The blunt point is a handy item to have for clearing circuit board holes of solder that's still liquid and to push out of the holes very short leads during desoldering operations.

When preparing to make a solder connection, remember one important rule: A good *clean* mechanical connection is essential, since the solder is expected to



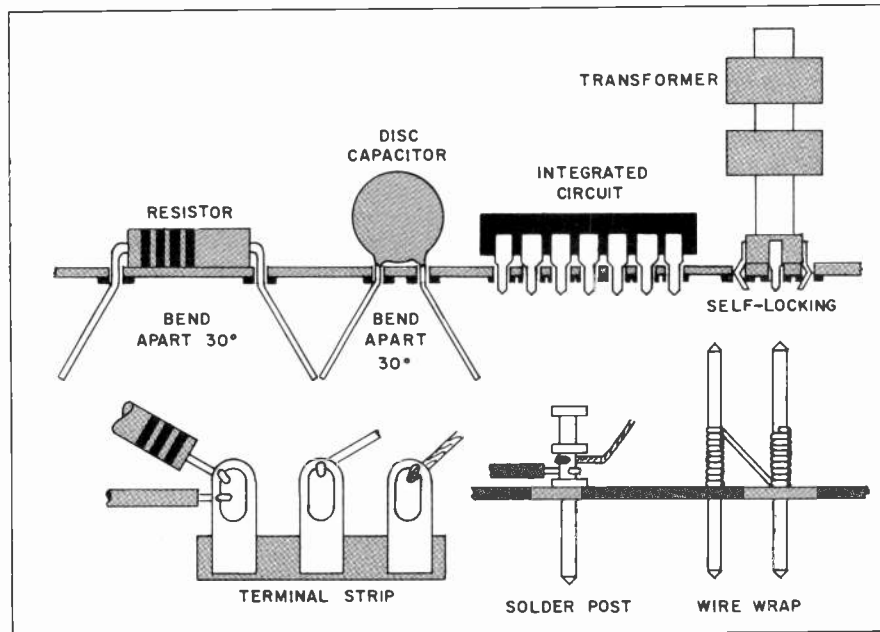

Fig. 24. Illustrated are methods of making connections on pc boards (top), terminal strips (bottom left), and solder and Wire Wrap posts (bottom right).

make electrical as well as physical contact. If you're using a printed-circuit board with raw copper conductors, it's a good idea to scrub the copper under running water with fine steel wool until it's burnished. Then, before installing resistors, capacitors, diodes, etc., rub their leads with *plain*, not soaped, dry steel wool to clean away all vestiges of oxide scale and dirt.

When you mount a component, make sure it's firmly anchored mechanically. Place the tip of the hot soldering iron against the joint and hold it there for a few seconds to heat it. Then sparingly feed solder between tip and joint, allowing only enough solder to flow into and lightly coat the connection. Don't feed excessive solder or try to fill a large lug hole. If you do, you'll only court trouble, because excessive solder can create bridges that short-circuit to other components in a circuit.

Once the solder flows into and coats a connection, immediately remove the solder feed and *then* the tip of the soldering iron from the joint. Allow the newly soldered connection to remain undisturbed for a few seconds until it cools and the solder solidifies. If a connection is moved while the solder is still in a liquid or plastic state, allow it to completely cool and then reapply heat only until the solder once again flows and becomes

liquid. Failure to do this can result in a "cold" solder connection that has a dull, grainy appearance when the solder fully sets. This connection will almost certainly lead to problems in the future unless it's rectified immediately.

Some electronic components, like ICs and other solid-state devices, are delicate and can't tolerate much heat. Even some resistors can succumb to heat damage. Therefore, it's often necessary to guard against heat damage by clipping a heat-sink to the component lead between the component itself and the point where heat will be applied. Do this with each lead of the component in turn. The heat will travel to and be dissipated safely by the heatsink instead of the component. (Three or four different sizes of heat sinks should be part of every electronics hobbyist's toolkit.)

**Desoldering.** There are times when it may be necessary to remove a soldered-in component from a circuit, either because of component failure or because of a wiring error. To be able to do this, you must remove as much solder from the connection in an operation known as *desoldering*.

When removing solder from a joint or connection, the two tools you'll use most are a soldering iron and a bulb- or plunger-type solder sucker. The task of

the latter is to suck up solder heated to a liquid state. Place the tip of a hot soldering iron against the connection to be desoldered and hold it there until the solder becomes liquid. (If the component is to be saved, don't forget to clip a heat sink to each of its leads as it's being desoldered.) With the solder in a liquid state, and while still heating the connection, suck up as much solder as possible. Don't apply the heat too long, especially on printed-circuit assemblies. It's better to work on a connection for no more than about 10 seconds, moving on to another connection while the first cools, than to risk heat damage. You can always return to the first connection later to resume the solder-removal operation.

The purpose of removing solder from a connection is to free the wires and wire leads of components so that they can be easily disconnected. With printed-circuit assemblies, this is rarely a problem, requiring at most that you use the pointed end of a soldering aid to push the lead stub free from its solder-pad

**Free!**

**Edmund Scientific Catalog**

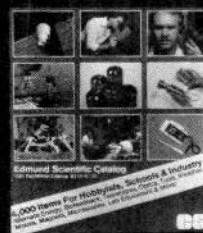

**4,000 Unique Items**

Astronomy, Microscopy, Biofeedback, Weather, Alternate Energy, Binoculars, Optics, Magnets, Magnifiers, Tools, Unique Lighting, Lab Equipment, and much more. Over 4,000 unique and fascinating products. Send for our **FREE**, colorful 1982 Edmund Scientific Catalog. . . Today!

**Rush me your free catalog!**

Name \_\_\_\_\_  
 Address \_\_\_\_\_  
 City \_\_\_\_\_  
 State \_\_\_\_\_ Zip \_\_\_\_\_

**Clip And Mail Coupon Today To:**  
 Edmund Scientific Co., Dept. 8211 BV12  
 Edscorp Bldg., Barrington, N.J. 08007

No. 3455 \*1982 Edmund Scientific Co.

hole. Connections made to control and switch lugs and other components that require hooked wires are frequently not so accommodating. After using a solder sucker, enough solder may still be left behind to prevent easy disconnection without damaging component leads or the lugs themselves. With this type of connection, you can take either or both of two approaches to free wires from the solder bond. First, you can use *solder wick* to remove all but a trace of the remaining solder. (Solder wick is a fine-mesh copper braid that absorbs solder with a spongelike action.)

To use solder wick, place it against the joint or connection and press the point of a hot soldering iron against it. As the braid heats up, wicking action will draw off solder, turning the braid from a bright coppery color to a bright silvery color. As the solder wick absorbs solder it becomes saturated, requiring that it be repositioned so that coppery color is always directly between the soldering-iron point and solder to be removed.

Sometimes, using solder wick alone may not be enough to free a wire lead from a joint. In this case, it becomes necessary to use the slotted end of the soldering aid to gently lift and pry away the lead wire, all the time applying heat to the joint.

Here are a few hints to keep in mind when desoldering. First, *never* apply heat for too long to any connection, no matter how delicate or massive. Secondly, always take care to prevent heat damage to a component to be saved or any other components connected to the same joint by using heat sinks. If you're working on a printed-circuit assembly, it's necessary to be very careful with your use of heat because excessive heat can cause the copper conductors to separate from the board material. Finally, you can use diagonal (wire) cutters to simplify the removal operation, by cutting away the body of a component that has failed and use longnose pliers to grasp and work loose the lead stubs. This last is particularly useful when

### PARTS LIST

- B1—6-volt lantern battery
- B2—Two 6-volt lantern batteries in series
- C1—0.1- $\mu$ F disc capacitor
- C2—47- $\mu$ F, 16-volt electrolytic capacitor
- D1—1N4001 rectifier diode
- I1—6-volt incandescent lamp
- K1—6-volt dc relay
- R1—56,000-ohm, 1/4-watt resistor
- S1—Key operated spst switch
- S2—Momentary-action spdt pushbutton switch
- Misc.—Lockable metal box large enough to accommodate circuitry and batteries; 12-volt dc alarm bell in its own locking metal box; normally-closed alarm trip switches (as many as needed); window foil; panel-mount socket for I1; perforated circuit board (plain); push-in solder posts; 6-station barrier block (optional); solid and stranded No. 22 insulated hookup wire; machine hardware; solder; etc.

COURTESY OK MACHINE & TOOL CORP.

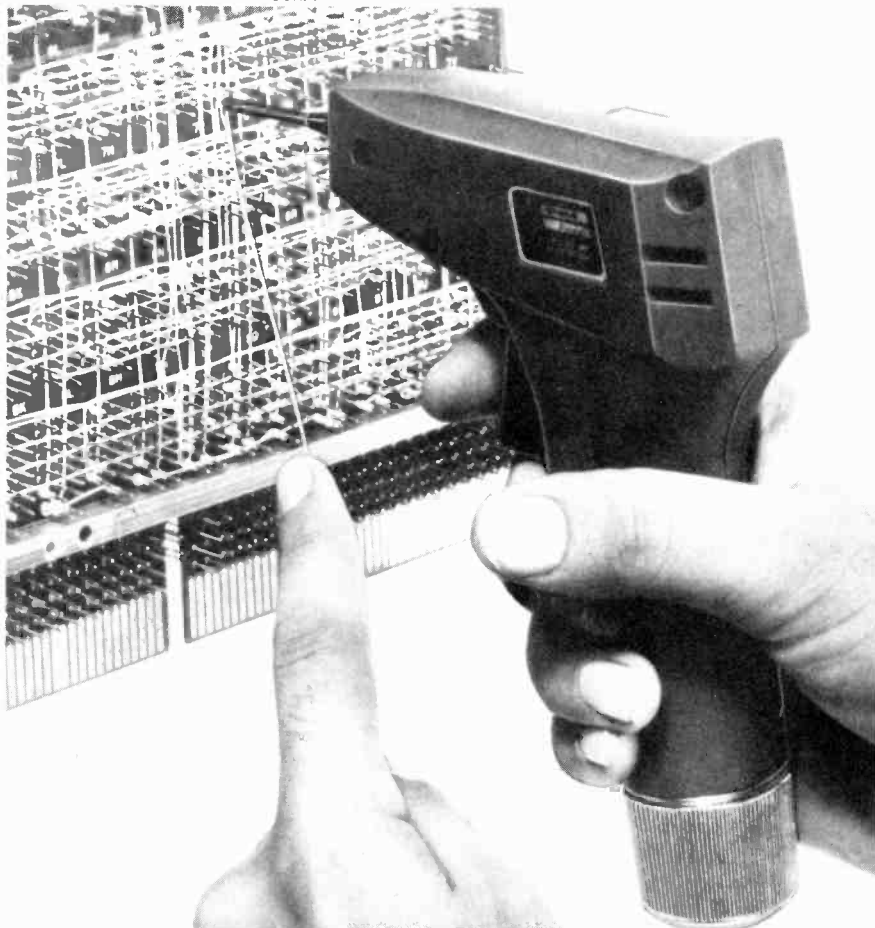

working on printed-circuit assemblies, where components are usually crowded together and mounted flush with the surface of the board.

It takes as much a knack to desolder as it does to solder properly. Needless to say, then, the best way to learn how to desolder properly is to practice.

**Making Connections.** The whole idea behind electronic project and kit building is to connect one component to another until an electronic circuit is complete. Everything else done to complete a project, including soldering and bolting together metal pieces and physically mounting components on their mechanical supports, is performed only to assist in maintaining the connections. Of course, to be able to make electrical connections, you must assure good mechanical connections as well.

There are different types of connections used in electronics assembly, each designed to meet a special need. The

*When it comes to major projects that require hundreds of Wire Wrap connections to be made, the battery-powered tool can't be beat.*

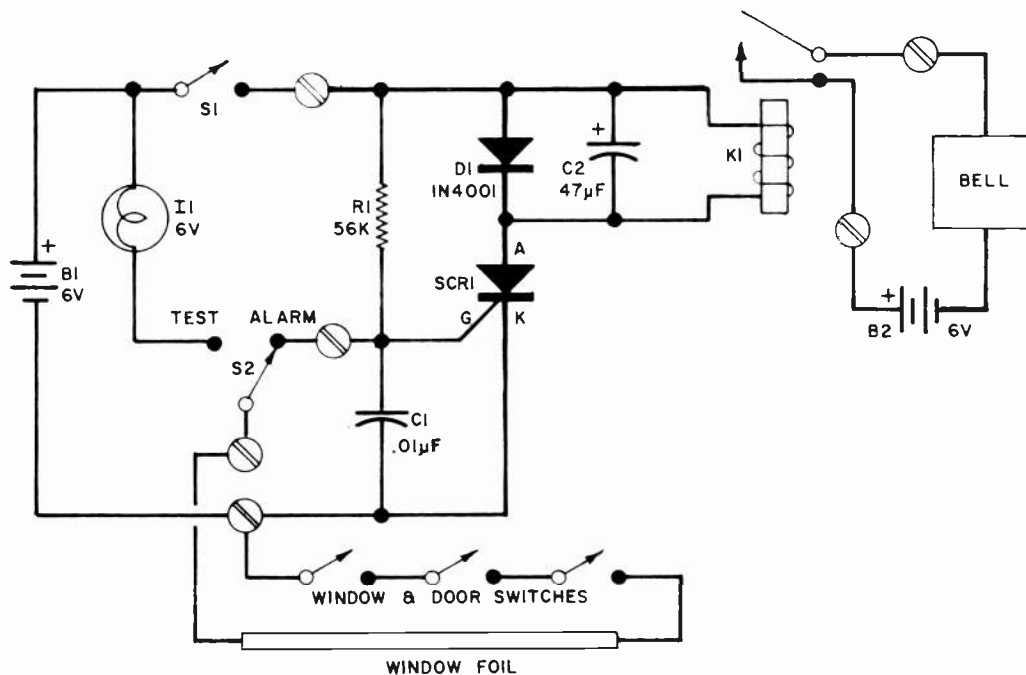

Fig. 25. Schematic diagram of a low-cost perimeter-protection burglar alarm.

simplest of these is the printed-circuit connection (Fig. 24A), in which one and only one component lead or wire end is inserted into each hole in the board. For components with up to four leads, such as resistors, capacitors, diodes, and transistors, leads are simply spread apart to hold components in place until they're soldered.

Components with more than four leads, like integrated circuits (or their sockets and multiple-pole/throw switches, must be held in place with a finger while at least two leads on opposite sides of the components are soldered. This done, finger pressure can be removed to complete the soldering operation. In some cases, as with some printed-circuit air-core and slug-tuned transformers and trimmer potentiometers, no leads need be bent or finger pressure be applied, since the leads themselves lock into place upon insertion into the holes of a pc board.

As can be seen in Fig. 24A, most wires and component leads soldered to pc-board pads are made from solid wire. Sometimes, however, it's necessary to use stranded wires, which require tinning. To tin stranded wires, the strands must be twisted together into a tight bundle and then heated to flow solder

into and slightly coat the bundle. When tinning, heat the bundled strands and feed the solder to the heated bundle—not the soldering tip. (Note: any time stranded wire is used in any type of connection, it must be tinned. This prevents one or more strands from separating from the bundle and shorting to other points in a circuit that can cause catastrophic results when power is applied to a project or kit.)

After each component lead or wire has been soldered to a pc-board, excessive lengths must be trimmed away as close as possible to the solder pads. Then each connection must be carefully inspected. Any suspicious connection must immediately be reheated until the solder flows and makes a good connection.

Other types of connections are illustrated in Fig. 24B. Note that in each case illustrated the wire or lead must be formed into a hook and then hung onto a lug or wrapped around a solder post and squeezed shut with longnose pliers. It's not necessary or even advisable to make more than one turn of wire; a simple crimped J hook will suffice as long as each connection is mechanically secure before it's soldered. When more than one wire or lead is to be connected to a lug or post, the connection should be sol-

dered only after the last one is crimped in place.

Up to this point, we've been discussing connections that require soldering. During the past five years or so, however, a type of connection that requires *no* soldering has assumed a high degree of importance, especially in the computer industry and among electronics experimenters and hobbyists. Called Wire Wrap, it has been used with a high degree of reliability in telephone company equipment and mainframe computers for many years.

Excellent electrical/mechanical Wire Wrap connections are achieved with special terminal posts, wire, and a simple-to-use tool. Wire Wrap terminal posts are square in crosssection, with sharp edges that bite into the wire as it's wrapped under tension (Fig. 24C). Depending on the type of tool used, wrap wires can be either stripped before wrapping or slit while being wrapped to expose the conductor to contact with the wrap post. In the latter case, the insulation remains on the wire when wrapping is complete.

A basic Wire Wrapping tool can be used to strip insulation from the wire and for wrapping and unwrapping, depending on which end of the tool is used.

# MATERIALS FOR PROJECT BUILDING

Kit assembly is a relatively easy and straightforward procedure, since kit manufacturers generally supply all the materials needed for putting together at least the entire circuit. Frequently, even the hardware and enclosure needed to complete the task are supplied. With project building, on the other hand, the burden of getting together all the items needed falls upon you, the builder.

Simple and even some complex circuits can be assembled temporarily on a solderless breadboarding socket, as shown in Fig. A. This ingenious device consists of a perforated plastic block with a matrix of holes into which component leads and wires are plugged directly, eliminating the need to crimp them around terminals and soldering to complete a connection.

The matrix of the typical solderless breadboarding socket is arranged so that when integrated circuits and other components are plugged in, four tie points are available for connecting external components to each pin of the IC or lead of a component. If additional connections are required to any given point, jumper wires can be connected to a free set of vertical socket holes to obtain an additional four tie points.

Above and below the main breadboarding area of the solderless socket

are double rows of holes that can serve as buses for power and signal flow. With four such buses available, one can assemble circuits on the breadboard that require plus (+), minus (-), and power ground (GND), as well as a separate signal ground when needed.

Solderless breadboarding sockets are convenient devices for final project assembly, as well as for "proofing" circuit designs. When circuit wiring is complete, it's a simple matter to mount the

socket assembly on a chassis and make all connections to such external components as controls, switches, digital displays, meters, etc.

For all but the simplest of projects, a printed-circuit, or pc, board is generally the preferred approach to circuit assembly. While some published project-construction plans might indicate a source from which kits or the pc board can be obtained, it's usually necessary for the builder to fabricate his own boards from

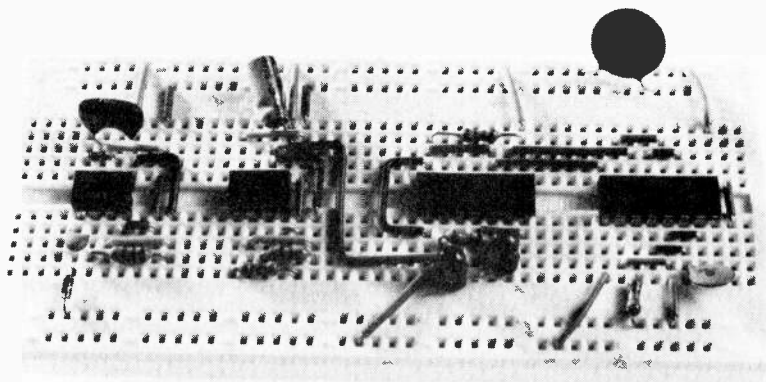

*Fig. A. This AP Products "Circuit Strip" is a typical example of a solderless bread-boarding block. Component and wire leads conveniently plug into the matrix of holes to form solid electrical contact. An assortment of prestripped wires comes in handy for quick circuit assembly and circuit alterations.*

To perform the wrap operation, the wire is slipped into a hole in the wrap end of the tool, which is then slipped onto the post and rotated up to eight times for each connection. As the tool is being rotated, it forcibly wraps the wire around the post to a single-layer tightly wound multiple-turn connection.

The tool used for making Wire Wrap connections can be a simple wand-like device that must be manually rotated to perform the wrap/unwrap operation. If

a great deal of wrapping is anticipated, a battery-powered tool can be obtained.

Wire Wrap posts are designed to be force fitted into plain (unclad) perforated circuit board. Some companies make hybrid circuit boards that have copper strips for conventional pc assembly and plain areas for installing Wire Wrap hardware and breadboarding solder posts. Such boards offer the user the convenience of printed circuit assembly for permanent circuitry, Wire

Wrap assembly for alterable circuitry, and conventional perf-board assembly for permanent wiring of components that can't be accommodated in the printed-circuit areas.

**Sample Projects.** Now that you know how to identify components by physical configuration and schematic symbol, let's put your knowledge to work. Presented here is a relatively simple and inexpensive intruder-alarm project you

etching-and-drilling guide artwork printed in the plans.

Printed-circuit board fabrication is a relatively complex procedure, requiring the use of art supplies, handling of caustic chemicals, and machining operations (cutting and drilling), in addition to actual circuit wiring. Also, there are a number of different procedures and techniques used for actually preparing the pc blank for etching (removing unwanted copper). Needless to say, we haven't the room here to provide step-by-step instructions for pc board fabrication. Fortunately, there's no dearth of information on this subject. Aside from definitive how-to articles published in magazines like POPULAR ELECTRONICS, all pc materials suppliers include in their kits usually explicit instructions that even beginners can follow for fabricating their own boards.

Printed-circuit artwork that appears in magazines and books usually consists of etching and drilling guides (Fig. B) and components-placement diagrams (Fig. C). The guide shown in Fig. B is in negative form for direct use with pc kits in which B-negative materials (the most popular variety) are supplied. A kit that contains positive materials would require that the artwork first be reversed (black on white) before it can be used.

The same guide shown in Fig. B appears "flopped" and reproduced in positive fashion in Fig. C to give a component-side view of the board. Except in cases where there are conductors on both sides, components always mount on the blank side of a pc board. Off-the-board connections to controls, switches, etc., are indicated by legends located around the perimeter and sometimes on the component-mounting portion of the artwork. Special instructions might appear as footnotes below the artwork, as shown in Fig. C.

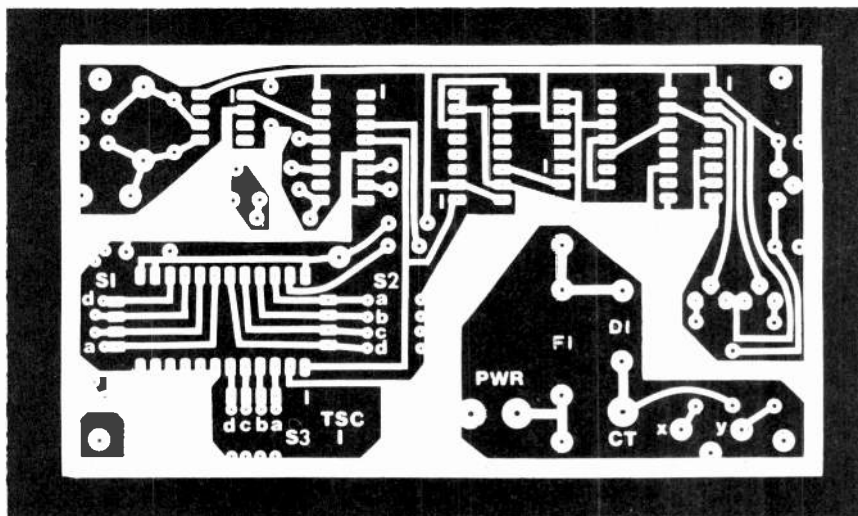

Fig. B. An example of an etching-and-drilling guide to be used with B-negative printed-circuit materials. For positive materials, lines must be black on white.

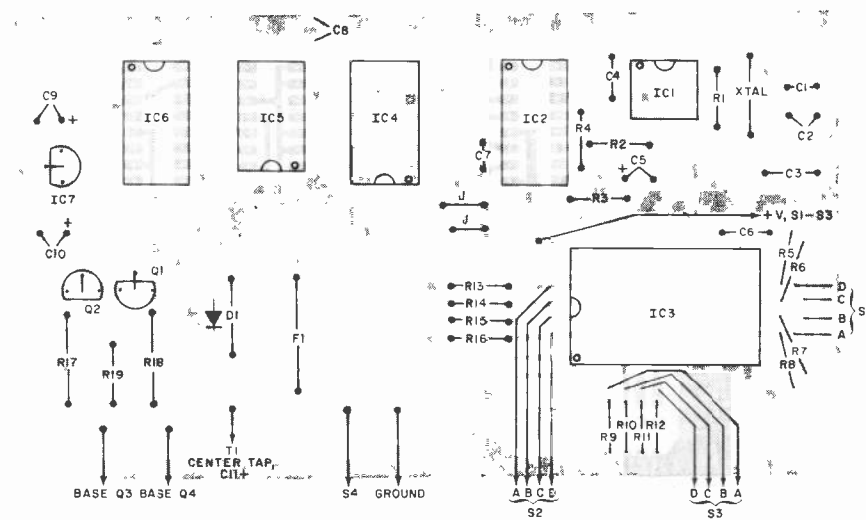

Fig. C. Component-placement guide for pc board shown in Fig. B. Note that here the guide is "flopped" for a component-side view of the board.

can build. It's practical too, since it can be used to protect your home from burglary and intruder entry.

The schematic diagram of the intruder alarm is shown in Fig. 25 along with its Parts List. This alarm is designed to use low-current magnetically operated door and window trip switches and window foil in a solid-state perimeter-protection system.

Represented in the component lineup are two different types of capacitors, a

resistor, a relay, a diode, a silicon controlled rectifier, an indicator lamp, two batteries, and two different types of switches.

The heart of the circuit is silicon controlled rectifier SCR1, which triggers on when an intrusion occurs and energizes relay K1. When the relay energizes and closes its contacts, it completes the bell circuit from battery B2 and the alarm sounds.

The alarm has two operating modes.

With S2 set to TEST, the circuit indicates, via indicator lamp I1, status of the perimeter-protection switches and foil. With all protected doors and windows closed and foil intact, the status of the sensor circuit is normally-closed and I1 lights. If any door or window is open or there's a break in the foil, I1 won't light because the circuit is incomplete. This condition must be rectified before the alarm can be armed.

Now, with S2 set to ALARM and key-



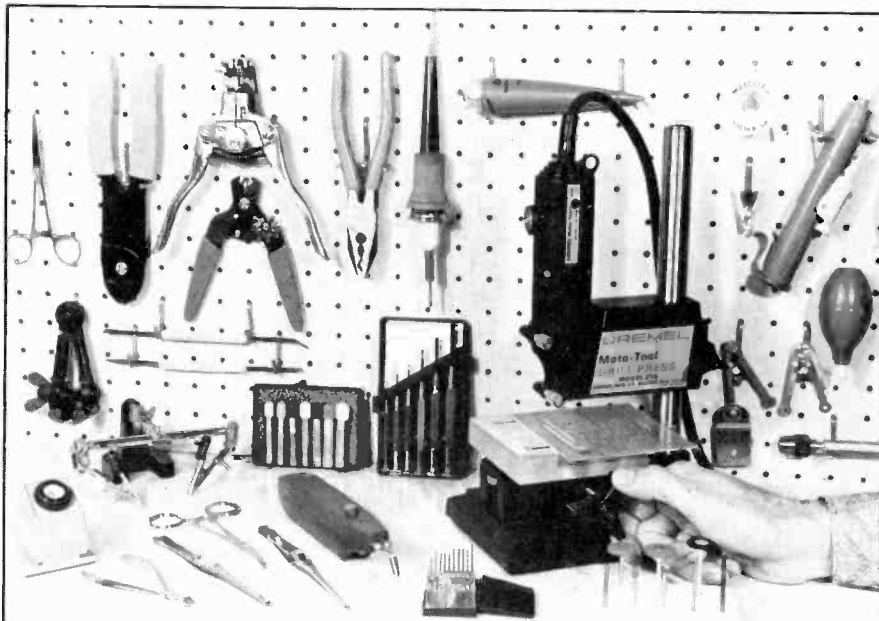

## TOOLS FOR ELECTRONICS

To be able to assemble electronic kits or build projects, it's necessary to have the proper tools to handle the tasks you'll be called upon to perform. If your interest runs to only assembling kits like those from the Heath Company, your tool requirements will be minimal. At the very least, however, the items you'll need include: longnose pliers, diagonal wire cutters, two or more sizes of slotted- and Phillips-head screwdrivers, adjustable wrench, slip-joint pliers, several heat sinks, and a 25- to 40-watt soldering iron or pencil.

If you're planning to build projects from scratch and many of the "bare-bones" kits that contain only the electronic parts but no enclosure or other hardware, your tool needs will be more demanding. In addition to all of the above, you should include a hacksaw, larger variety of screwdrivers, set of nut drivers, Allen wrenches, locking pliers, wire strippers, sheet-metal reamer, probes, and a desoldering tool or solder sucker. Of course, since you'll also have to house your projects and kits inside protective enclosures and possibly even fabricate your own printed-circuit (pc) boards, you'll also need a few machining tools. A 1/4- or 3/8-in. electric drill and an assortment of drill bits are musts for drilling component-mounting holes in

metal enclosures and chassis. A smaller, lightweight tool, like the Dremel Moto-Tool fitted with a pin chuck, is more practical for the delicate drilling required for pc-board fabrication. This type of tool can be equipped with any of a wide assortment of grinding, buffing, and cutting bits that make it serve as an all-around power tool.

While power drills are excellent for making small-diameter holes, special tools are required for cutting holes in excess of 3/8 in. in diameter. For this task, a Greenlee chassis punch set is ideal. And for making square, rectangular, and irregularly shaped cutouts in up to 16-gauge metal, a nibbling tool can't be beat.

As your project building grows to include elaborate and complex circuit designs, you should consider adding a small bench-top vise, high-intensity lamp, magnifying lens, and "third-hand" jig. The last conveniently holds circuit boards and small parts, leaving your hands free to use tools.

When shopping for tools, don't try to save a few dollars by buying inferior tools. Remember that top-quality tools will give a lifetime of hard use, returning your initial high-cost investment dozens of times over. And top-quality tools won't fail at a critical moment.

operated switch *S1* turned on (closed), power is applied to the *SCR1* circuit and the system is armed. As long as all switches are closed and foil is intact, current flows through them and bypasses capacitor *C1*. Under this condition, no trigger voltage is applied to the gate of *SCR1* and the alarm remains silent.

If any switch is opened or the foil is cut while the circuit is armed, even if only briefly, *C1* will no longer be bypassed and current flowing to it will trigger *SCR1*'s gate. Once this occurs, *SCR1* turns on and energizes *K1* to complete the bell circuit. The alarm bell will continue to sound, even if the normally-closed condition of the sensor circuit is restored, until power to *SCR1* is interrupted by opening *S1*.

Power for the alarm and bell circuits is supplied separately by batteries *B1* and *B2*. Battery *B1* is a single 6-volt lantern battery, while battery *B2* consists of two 6-volt lantern batteries in series. Current drain for the SCR circuit is very low in the armed but not tripped condition, assuring long life.

**Construction.** This simple circuit can be assembled on a piece of perforated circuit board with the aid of push-in solder terminals. The parts you'll need are detailed in the Parts List in Fig. 25. Components can be mounted on the board and wired as shown in Fig. 26. Be careful to observe the polarities of *C2* and *D1* and the lead identifications for *SCR1*. Interconnections between components, shown as broken lines, should be made with No. 22 insulated *solid* hookup wire on the underside of the board.

The 6-station barrier block shown at the left in the assembly drawing simplifies connections to the bell and sensor circuits, batteries, and alarm control switches *S1* and *S2*. If you wish, you can eliminate the barrier block.

The circuit-board assembly is best mounted inside a lockable metal box that's large enough to also accommodate the batteries and *S1* and *S2*. Before mounting anything in the box, however, drill mounting holes for *S1*, *S2*, *I1*, and the circuit board and for routing the wires to external devices. Then mount the circuit board assembly, using four 1/2-in. metal spacers and 6-32 × 3/4 or 1 in. machine hardware. Mount *I1*, *S1*, and *S2* in their respective holes and connect No. 22 *stranded* hookup from their lugs to the appropriate screws on the

(continued on page 134.)



**ATARI 800**  
 16K... \$669  
 32K... \$749  
 48K... \$779

410 Recorder	\$76.00
810 Disc Drive	\$449.00
822 Printer	\$269.00
825 Printer	\$629.00
830 Modem	\$159.00
820 Printer	\$269.00
850 Interface	\$169.00
New DOS 2 System	\$29.00
CX30 Paddle	\$18.00
CX40 Joy Stick	\$18.00

CX853 16K RAM	\$77.95
Microtek 16K RAM	\$64.95
Microtek 32K RAM	\$99.95
Ramdisk (128K)	\$429.95
INTEC 32K Ram	\$99.95
INTEC 48K Ram	\$199.95

One year extended warranty	\$70.00
481 Entertainer	\$69.00
482 Educator	\$130.00
483 Programmer	\$49.00
484 Communicator	\$344.00



**ATARI 400**  
 16K... \$329  
 32K... \$419  
 48K... \$519

Visicalc	\$179.00
Letterperfect	\$109.00
Ricochet	\$14.50
Crush Crumble & Chomp	\$24.00
Star Warrior	\$29.00
Rescue at Rigel	\$24.00
Datestones	\$16.00
Invasion Orion	\$18.50
Mission Asteroid	\$22.00
MouskATTACK	\$31.00
The Next Step	\$34.00
Softporn	\$27.00
Wizzard & Princess	\$29.00
K-BYTE Crazy Shoot Out (ROM)	\$39.00
Protector (Disk 32K)	\$24.00
Jaw Breaker (on line disk)	\$27.00
Ghost Hunter (cassette)	\$24.00
Ghost Hunter (disk)	\$30.00
PAC MAN	\$35.00
Centipede	\$35.00
Caverns of Mars	\$32.00
Synapse	
File Manager 800	\$69.95
Dodge Racer	\$19.00
Chicken	\$24.00
Siime	\$24.00
Nautilus	\$24.00
Disk Manager	\$24.00
Fort Apocalypse	\$24.00
Assembler	\$39.00

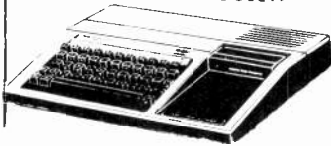

**TI-99/4A \$299**

R.F. Modulator	\$29.00
Telephone Coupler	\$169.00
PHP1200 Peripheral Box	\$199.00
PHP1220 RS232 card	\$143.00
PHP1240 Disk Controller	\$199.00
PHP1250 Disk Drive	\$319.00
PHP1260 32K RAM	\$229.00
Wired Remote Controllers(Pair)	\$31.00
PHP Printer Solid State	\$319.00
Home Financial Decisions	\$26.00
Personal Record Keeping	\$43.00
Mailing List	\$60.00
Checkbook Manager	\$18.00
Tombstone City 21st Century	\$34.00
Munch Man	\$34.00
TI Invaders	\$34.00
Car Wars	\$34.00

## Computer Covers

ATTRACTIVE COVERS FOR YOUR COMPUTER AND DISK DRIVE.

Atari 400	\$6.99
Atari 800	\$6.99
Atari 810	\$6.99
All Atari Covers are Beige.	
Commodore VIC-20	\$6.99
Commodore 8032	\$14.99
Commodore 8050/4040	\$10.99
All Commodore Covers are Royal Blue.	

## Monitors

Amdtek 300G	\$169.00
Color I	\$339.00
Color II	\$699.00
Color III	\$429.00
NEC 12" B&W	\$169.00
12" Color	\$339.00
TI 10" Color	\$349.00
Zenith ZVM 121 (Green)	\$119.00
BMC 12" Green	\$85.00

## Televideo

910	\$579.00
912C	\$699.00
920C	\$749.00
925C	\$749.00
950	\$939.00
802	\$CAll
802H	\$CAll
806	\$CAll
816	\$CAll

## Modems

Hayes Smart	\$239.00
Chronograph	\$199.00
Micromodem II	\$279.00
Micromodem 100	\$309.00
Novation Auto	\$239.00
D Cat	\$169.00
Cat	\$158.00

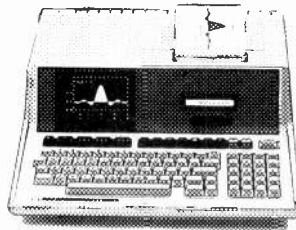

**HP-85 \$1899**

HP-86	call
HP-87	\$1769.00
HP-125	\$1999.00
HP-85 16K Memory Module	\$169.00
5 1/4" Dual Master Disc Drive	\$1769.00
Hard Disk w/Floppy	\$4349.00
Hard Disk	\$3440.00
80 Column Printer	\$799.00
"Sweet Lips" Plotter	\$1149.00
87 CPM	\$399.00
87 128K Memory	\$610.00
87 Visicalc	\$205.00
125 & 85 Visicalc	\$179.00

## HP41CV Calculator \$239

41C	\$189.00
11C	\$104.00
12C	\$114.00
34C	\$114.00
38C	\$114.00
HP-41 Printer	\$340.00
HP41 CALCULATOR PERIPHERALS	
IL Modul	\$104.00
Digital Cassette	\$449.00
Printer/Plotter	\$419.00
Card Reader	\$164.00
Optical Wand	\$99.00

## Apple

Call for availability and prices on all Apple computers and peripherals

## Printers

Smith Corona TP1	\$699.00
Centronics 739-1	\$519.00
Centronics 739-3	\$619.00
Diablo 630 Special	\$1799.00
Epson	
MX80 w/Graftrax	\$449.00
MX80FT	Call
MX100	Call
NEC	
8023	\$549.00
7730	Call
7720	Call
7710	Call
Okidata	
82A	\$499.00
83A	\$749.00
84	\$1129.00
Citih Starwriter	
F10-40 CPS	\$1469.00
F10-55 CPS	Call
Prowriter	\$479.00
Talley	
8024-L	\$1629.00
IDS	
Prism	\$CAll
MPC Apple Parallel Board & Cable	\$69.00
2 Meter RS232-RS232	\$29.95
Cables Available For Most Interfacing Purposes	



**8032 \$1039**

4032	\$969.00
4016	\$769.00
8096 Upgrade Kit	\$369.00
Super Pet	\$1599.00
2031	\$529.00
B250 (Double Sided D. Drive)	\$1899.00
5 Megabyte Hard Disk	\$2399.00
8050	\$1299.00
4040	\$969.00
8300 (Letter Quality)	\$1799.00
8023	\$769.00
4022	\$599.00
Pet to IEEE Cable	\$37.00
IEEE to IEEE Cable	\$46.00
Tractor Feed for 8300	\$240.00

SOFTWARE  
 Magis Professional Software  
 BPI Creative Software  
 Visicorp

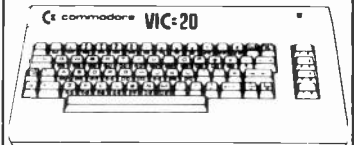

**VIC 20 \$239**

Call for price and availability of VIC-64

Commodore Catassette	\$69.00
Disk Drive	\$499.00
VIC Graphic Printer	\$339.00
3K Memory Expander	\$32.00
8K Memory Expander	\$53.00
16K VIC Expansion	\$99.00
RS232C Terminal Interface	\$43.00
VIC IEEE-488 Interface	\$86.00
VIC 20 Super Expander	\$53.00
Programmers Reference Guide	\$15.00
Introduction to Computing	\$18.00
Introduction to BASIC Programming	\$19.00
Household Finance	\$27.00
VIC Games	\$19.00
VIC Home Inventory	\$13.00
VIC Rec/Ed II	\$13.00
Terminal	\$13.00
Un Word	\$13.00
Grafix Managerie	\$11.00
VIC PICS	\$15.00
Ticker Tape	\$13.00
Banner Headliner	\$13.00
RS 232	\$39.00
Super Slot	\$23.00
VIC Avengers	\$23.00
Super Alien	\$23.00
Super Lander	\$23.00
Draw Poker	\$23.00
Midnite Drive	\$23.00

**east computer mail order west**  
**800-233-8950 CALL TOLL FREE 800-648-3311**  
**HOW TO ORDER:**

477 East Third Street  
 Williamsport, PA 17701  
 (717) 327-9575  
 Patricio Habla Espanol

In-stock items shipped same day you call. No risk, no deposit on C.O.D. orders. Pre-paid orders receive free shipping within the continental United States with no waiting period for certified checks or money orders. All prices shown are cash prices add 3% for Mastercard and Visa. NV and PA residents add sales tax. All items subject to availability and price change.

P.O. Box 6689  
 Stateline, Nevada 89449  
 (702) 588-5654  
 Franco Habla Espanol

## Continuing education can help to advance your career

**A** SINGLE decision can help you to do a better job at work, get promoted to higher paying managerial or marketing positions, or even get more enjoyment out of your hobby. That is the decision to pursue continuing education, a name for studies that follow completion of regular formal education.

A recent study indicates that about 60 million people in the U.S. are participating in some kind of post-secondary education. Of these, 14 million are en-

rolled in regular college, university or technical school programs. But 46 million are learning through other means.

Because of rapid changes in technology, electronics engineers and technicians risk becoming technically obsolete if their knowledge is not current. And technical obsolescence can make you less effective or even incompetent at your job. Besides keeping your training current, continuing education can provide new skills and knowledge in sub-

jects like writing, speaking, supervision, management and marketing that are so important to career advancement. It may even help you prepare for a career change. Moreover there is often some hobby-related interest—as a major part of any hobby is learning more about it.

**How to Get Started.** Continuing education can take many forms. These include magazines and newspapers, books, self-study programs, resident

BY LOU FRENZEL

**LEARN  
MORE  
TO  
EARN  
MORE**

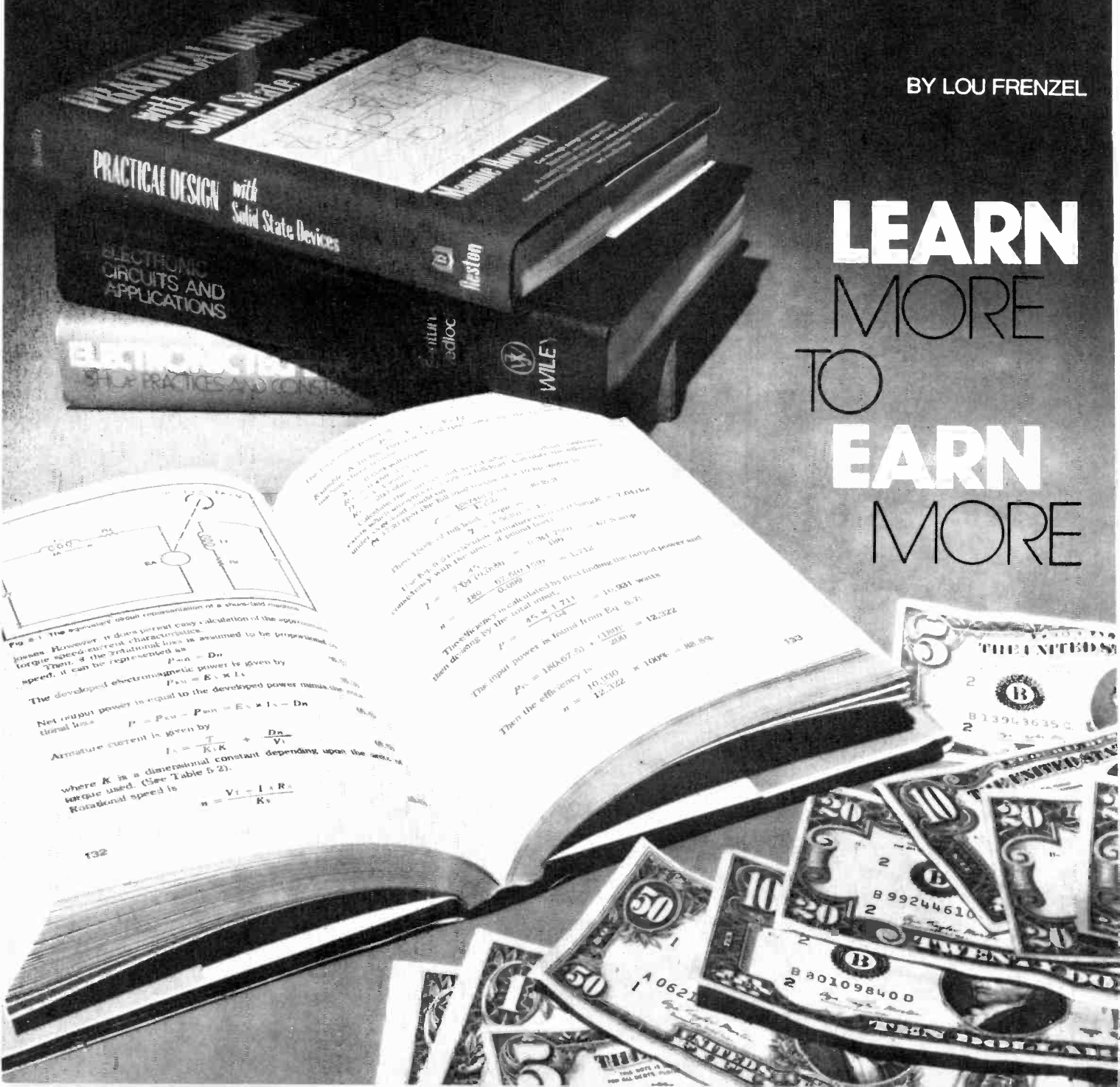

classes, home-study courses and even college degree programs. In addition, a good deal of learning comes from informal sources, such as manufacturers' literature and trade shows.

The particular strength of magazines is that they are usually published frequently, and can respond quickly to new technical developments.

Odd though it may seem, some of the most important sources of information in magazines are the ads. In electronics, some manufacturers on the leading edge of technology are particularly adroit at communicating and explaining it. And, in order to remain competitive, manufacturers are continually forced to adopt new technology. You can take advantage of this simply by reading their advertisements and obtaining their literature. Many companies supply volumes of data sheets, applications notes, catalogs, and newsletters. Most of these are free for the asking or available at a very modest price. Read the ads and write for manufacturers' literature that interests you; make liberal use of the "bingo" cards in the magazines.

Books are one of the most compact, efficient, and economical forms of education. They are an ideal complement to magazines since they provide greater length, depth, and breadth of coverage. Some electronics books may be too specialized for your local bookstores. But most electronics stores (Radio Shack, Heathkit Electronic Centers, etc.) also carry books.

An excellent and reasonably inexpensive way to get the books you want is through a book club. There are several aimed at those interested in electronics, computers and related subjects, and their regular announcements keep you informed as to what books are available. Table I lists some of them. Discounts range up to 15%.

You can also benefit from self-study courses, which are short, low-cost, formal learning programs covering a specific subject. These programs are designed for self-instruction and consist of printed text, audio cassettes, and often other media. Some also include experiments with various electronic components and circuits. Usually these courses sell from \$50 to \$700 and are available from a variety of sources. For example, Heath/Zenith Educational Systems, a division of Heath Company (Benton Harbor, MI 49022), specializes in courses in electronics, computers and related topics.

One of the oldest forms of continuing education is the correspondence course. There are a number of home-study schools providing college-level training

## TABLE I—BOOK CLUBS

**Electronic and Control Engineer's Book Club**  
McGraw-Hill Book Company  
1221 Avenue of the Americas  
New York, NY 10020

**Electronics Book Service**  
Box 42  
West Nyack, NY 10995

**Electronics Book Club**  
Blue Ridge Summit, PA 17214

**The Library of Computer and Information Sciences**  
Riverside, NJ 08370

## TABLE II—HOME STUDY SCHOOLS

**Cleveland Institute of Electronics**  
1776 East 17th St.  
Cleveland, OH 44114

**International Correspondence Schools**  
Scranton, PA 18515

**National Technical Schools**  
4000 South Figueroa  
Los Angeles, CA 90037

**NRI Schools**  
McGraw-Hill Continuing Education Center  
3939 Wisconsin Ave., N.W.  
Washington, DC 20016

## TABLE III—SCHOOLS OFFERING NONTRADITIONAL DEGREE PROGRAMS

**California Western University**  
Santa Ana, CA

**Century University**  
9100 Wilshire Blvd.  
Beverly Hills, CA 90212

**Clayton University**  
Box 16150  
St. Louis, MO 63105

**Grantham College of Engineering**  
Box 35499  
Los Angeles, CA 90035

**Nova University**  
3301 College Ave.  
Fort Lauderdale, FL 33314

**University of Beverly Hills**  
Beverly Hills, CA

**Upper Iowa University**  
107 Campbell Ave., S.W.  
Roanoke, VA 24034

for electronics technicians and engineers as well as complete career courses and shorter continuing education programs through these courses. Like self-study courses, home-study programs are designed for individual self-instruction. In contrast, though, the "student" works with a teacher through the mail. Lesson plans are sent and corrected; questions are posed and answered in this manner. Home-study courses are typically longer, more comprehensive and, of course, more expensive. Home study is a good way to review important fundamentals and gain new knowledge and skills. For additional information, contact the schools listed in Table II.

Many colleges and universities offer home study courses for college credit. You can complete up to one-half of the work toward a bachelor's degree this way. Contact the National University Continuing Education Association, Suite 360, One DuPont Circle, Washington, DC 20036, for more information on which colleges offer such programs.

**Resident Seminars.** There are workshops or short classroom courses that last anywhere from a day to a week. They usually concentrate on one specific topic and are often presented as a traditional classroom lecture (although some also include laboratory work). Many of these programs are conducted in the larger cities at local hotels where meeting facilities, meals and lodging are readily available. They cost from \$50 to \$700 (not including travel and lodging expenses).

Seminars are frequently conducted by manufacturers who wish to announce new components, circuits, equipment and techniques, and many of them are free. Some colleges and universities also offer resident seminars, and there are private companies specializing in various kinds of seminars. One such firm is Integrated Computer Systems (3304 Pico Blvd., Santa Monica, CA 90405) which offers courses in microprocessors, computer programming, speech synthesis and data communications. Professional organizations such as the Institute of Electrical and Electronic Engineers conduct them too.

**Trade Shows and Conferences.** Many people dismiss trade shows and conferences as a waste of time and money. Actually, they can be good sources of continuing education. You can learn a lot from the talks, papers, and exhibits covering the latest developments in components and equipment. You will also have an opportunity to check out the various competitive sources, exchange

ideas and information, and pick up the latest manufacturers' literature. Trade shows give you a perspective that you just can't get elsewhere. They provide a great source of knowledge, information, and talent—and many products—in one place.

**College.** Regular college programs leading to a bachelor's, master's, or other advanced degree are not usually regarded as continuing education. However, they can serve this purpose for some individuals who lack a degree. Determining whether or not you should work toward a college degree depends upon your own situation. Does the job you seek require a degree? Is a degree necessary or desirable for advancement? Do you need a degree to change jobs or careers?

You might want a degree simply for the additional knowledge and prestige that it brings. Often, even when you do not actually need a degree to do a job, the degree will help you get it anyway. For many supervisory or managerial positions, a degree is mandatory.

If you are working full time, your best source of a degree is a local college or university with an evening degree program. Such programs can take anywhere from 4 to 10 years to complete, depending upon your pace of study, the availability of required courses, and your work schedule.

If you already have a technical bachelor's degree, you may have considered going back for a master's. While nice to have, a master's degree may not help to ward off obsolescence or foster promotion. And some of the things you study in a master's program may already be familiar to you from your bachelor's courses. In most cases, you would do better spending your time and money on other forms of more specific continuing education.

There are a number of schools that offer college degree programs through extension work or home study. They evaluate your previous education and experience, regardless of the source, and award you college credit for it. Other institutions test you on various subjects and give you appropriate credit if you pass. Many programs will transfer credit from home-study courses, seminars, military training, or employer courses. And you can actually obtain a college degree by completing certain home-study courses or written projects. The quality of such programs varies widely so you should investigate each school carefully before initiating a program. But your own motivation plays the major role in any success. Some of the

schools that offer nontraditional programs are listed in Table IV. A good reference book and counseling service on this subject is offered by Dr. John Bear, Drawer H, Litterriver, CA 95456.

There are two specific programs that enable you to get credit without going to college. The first is sponsored by the American Council on Education (One DuPont Circle, Washington, DC 20036). ACE evaluates many kinds of noncollegiate courses—both resident and home-study—from sources such as industry, the military, and home-study schools. If the courses are college level and of sufficient depth and value, ACE will approve them and assign an appropriate amount of college credit. Such approved courses are then listed, in a quarterly directory. If you take or have taken any of the courses listed, you may receive college credit for them. Most colleges and universities are members of ACE and will consider giving credit for ACE-approved programs. But the ACE course must be the equivalent of a similar course at the college before credit is given. The decision is strictly up to the school and each case is considered individually.

Another college credit program is CLEP (College Level Examination Program). This is a testing program designed to help individuals get college credit for knowledge they have accumulated. To get college credit you sign up with CLEP for an appropriate exam, and if you pass, CLEP notifies the college or university of your choice. Most colleges and universities participate in the CLEP program and will automatically grant you college credit if you pass the exam. For more information, write to it directly at CLEP, Box 2815, Princeton, NJ 08540.

**Accreditation.** This is the process by which an independent agency investigates and evaluates the merit of a school and the quality of its programs. Accreditation indicates that the school meets certain minimum standards of quality and effectiveness. Basically, it is a guarantee that the institution is legitimate and that its courses will be of value to you. For the most part, continuing education programs are not accredited because they are offered from such a wide variety of sources. Usually, only schools are accredited. Organizations such as magazine and book publishers, seminar firms and manufacturers cannot be accredited. Therefore, when considering them, you must go by their reputation and the recommendations of others.

Home-study schools as well as colleges and universities do receive accredi-

tation. They are accredited by the National Home Study Council to which you can write at 1601 18th Street N.W., Washington, DC 20009, for a list of accredited schools. The NUCEA mentioned earlier also accredits college home-study programs. The Accrediting Board for Engineering and Technology (ABET, formerly the Engineer's Council for Professional Development), an organization that accredits engineering and technology degree programs, is considering the accreditation of continuing education programs for engineers and technicians.

Recently, a new organization known as the Council for Non-Collegiate Continuing Education was formed in an attempt to approve and accredit all continuing education programs from non-traditional sources. Information and a list of its accredited organizations can be obtained by writing to it at 6 North Sixth St., Richmond, VA 23219.

**The Continuing Education Unit (CEU).** The CEU is a unit of measurement used by companies, institutions, and professional associations in recognizing the completion of some form of noncredit adult continuing education. One CEU is defined as ten contact hours in some kind of formal education activity. Many organizations award CEUs for self-study courses, resident seminars and other various forms of continuing education.

It is important to note that continuing education units are not college credit. The two are not related. CEUs are simply a means of recognizing, accumulating, and recording your participation in continuing education programs. For more information on the CEU, write to the Council for the Continuing Education Unit, 13000 Old Columbia Pike, Silver Spring, MD 20904.

**Financing.** Most individuals pay for continuing education themselves. But, there are a number of sources that will finance continuing education.

Your employer is the first source you should consider. In many cases, a company will pay for books, magazines, self-instruction materials, and resident seminars. Often, all you have to do is convince your employer that you need a particular course, that it is job related, and that it will benefit both of you. In addition, most employers offer some kind of tuition reimbursement plan for people working on a college degree or engaging in other forms of job-related education. In such plans, you pay for your college tuition and books, and upon completing and passing the course, the



company will reimburse you from 50% to 100%. Check with your supervisor or personnel department for information.

The Veterans Administration continues to provide educational benefits for those who served in the armed forces. The VA pays up to 90% of the tuition for regular college degree programs and many home-study courses. Check with the institutions in question to verify the applicability of VA funding.

One recent study shows that over \$17 billion a year in educational funds is available from industry and government—most of it going unclaimed. And did you know that you can get a tax deduction for some kinds of continuing education? If you pay for this education yourself and it is used primarily to maintain your present job competence and skills, you may deduct the cost of such education and related expenses from your income tax. But continuing education that prepares you for an advancement or a new job is *not* eligible for the deduction. In any case, it is wise to check with the IRS.

**What to Study.** It is difficult to pinpoint which subjects you'll need, but we can make some suggestions that may be helpful. Today there is a revolution in the microprocessor and microcomputer fields, and sooner or later you can expect to encounter one of these versatile devices. For this reason, anything you learn about microprocessors, microcomputers and related topics will ultimately be helpful. Computer programming is another vital area. Programming in BASIC, FORTRAN or assembly language is a useful skill.

Keeping up-to-date on the latest components and circuits is also important. It is wise to keep your eye on new integrated circuit developments and applications. Some examples are op amps, active filters, phase-locked loops, dynamic and bubble memories, opto electronics, data conversion components such as A/D and D/A converters, and data communications devices like CODECS, modems and protocol controllers. Component advances such as CMOS, VMOS, VLSI and solid-state relays are important, as are developing technologies such as lasers, video discs, and fiber optics.

As an electronic engineer or technician you will probably find the technical courses of most value. But many non-electronics subjects are useful, too. For example, if you plan to move into management, you'll need to learn supervisory and management techniques, and people-handling skills. All of these can be helpful in broadening your professional skills and job opportunities. ◇

# the problem solvers\*

## in microprocessor technology

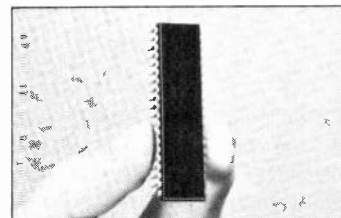

### The problem:

I need to learn microprocessor technology for my job.



## The Heathkit/Zenith Solution

**Effective learning:** Our Microprocessor Course provides a comprehensive background in the technology you need for your job. You progress at your own speed. Color visuals make the Course even more interesting. And audio cassettes let you see AND hear each concept.

**First-hand learning:** Hands-on programming and interfacing experiments, using our microprocessor trainer and parts, reinforce the concepts presented in the text and build on your prior electronics background.

**Cost-effective learning:** Our Microprocessor Course costs much less than other microprocessor courses.

**Heathkit/Zenith also offers complete courses** in Fundamental and Advanced Electronics including Optoelectronics, Microprocessor Interfacing, CMOS or Digital Techniques and Voice Synthesis. Write for details.

With the Microprocessor Course you learn about microprocessors, microcomputers, programming and interfacing in a fast, effective and inexpensive way.



\*Heathkit



## Educational Systems

Dept. 062-890, Benton Harbor, MI 49022

Contact the microprocessor educators today!

Write the above address for more information.

ED-162R1

CIRCLE NO. 11 ON FREE INFORMATION CARD

# THEY'RE WOOING YOU IN ELECTRONIC LAND!

**Y**OU might be planning to be an electronics engineer, computer professional, or electronic technician. You should know, then, that people holding these titles are in a seller's market with bright prospects for at least the next decade. In fact, the demand for people with such skills has never been higher.

A 1979 salary survey by the IEEE revealed that the mean income for respondents was \$31,680, with an average of 18.1 years of experience. With salaries rising in leaps and bounds, 1981 income in succeeding years is expected to be substantially higher. Naturally, a variety of factors influence income, such as level of responsibility, product area, and region of the country. For example, if your area of technical competence is in electronic devices, you are likely earning more than someone working, say, instrumentation (\$35.2M vs. \$32.1M in 1979). If you work in Philadelphia, you're probably earning much more than a counterpart in Florida (\$37.2M vs. \$29M in 1979).

Today, you don't even require experience to land a job in electronics. It's not unusual for freshly minted electronic engineers or computer science majors to start their first job in the low-\$20,000 bracket. Add a few thousand dollars per year for a master's degree. And you could look at a median starting salary of more than \$30,000 for Ph.Ds.

Not everything always comes up roses for electronic engineers, however. There are dips and rises in opportunity, of course, depending on the economic picture. As seasoned engineers know, supply and demand is cyclical. For instance, it wasn't too many years ago when there were not enough jobs to go around in the engineering field. The picture has changed, though, making recruiters' jobs tougher.

Engineering and computer sci people enjoy one of the highest starting salaries among degree holders. But ten years down the line, they fall behind as compared to incomes of the sales-marketing and accounting grads, you should know. Furthermore, there's career-maintenance time—keeping up with new tech-

nology—that is tougher to pursue owing to its complexities than in nontechnical fields. Nonetheless, career satisfaction is a large part of a person's drive to enter technical fields. For example, Frank Coss of Deutsch, Shea & Evans, Inc., NY, human resources consultants, concluded from a survey of programmers and systems analysts that they show more job satisfaction than any other group of workers they researched.

**Job Classifications.** In hardware, jobs may be broadly broken down into technicians, engineering technicians, engineering technologists, and engineers.

Engineers (BSEE) are generally involved in circuit and systems design, and research and development. Training generally requires graduation from an engineering course with the BSEE degree. One can specialize in a variety of areas, of course, such as computers, integrated circuits, communications, and so on. Moreover, some colleges or universities, such as MIT, emphasize underlying principles in electronics, while others lean more toward applications.

Following EEs are the BETs or engineering technologists. This training prepares students for circuit design, modifications and applications work, and a few become involved in research. There are proposals out at the IEEE to eliminate calling BET graduates "engineers," but they do indeed perform as engineers at work. A BET graduate pursues a four-year undergraduate course, while getting a BSEE is really a five-year regimen, often squeezed into four years.

An engineering technician does troubleshooting, circuit modifications and, in some instances, even circuit design. Formal training can be had at a two-year community college, a resident technical school, home-study school, or military. The highest certification would be an Associate Degree.

A technician is generally confined to troubleshooting, maintenance and repair. Work might be on consumer electronic equipment—TV receivers, marine radio, etc.—or in commercial areas such as two-way radios, medical elec-

tronic equipment, and so on. Training is most often through a resident technical school, home study school or military. Being lowest on the technical totem pole isn't too bad, though, since many such techs start their own businesses and can earn more than higher-level people in the electronics field.

People in the computer software area are a breed apart. One might be a graduate EE as a software engineer, another a two-year college grad as a computer programmer or systems analyst. More and more, though, are four-year college grads, either specializing in computer science or in information science. The latter leans to business computer applications, with more limited mathematics. Then, of course, one can be a major in math with some computer courses behind them, or a major in business with same, and break into the field without much trouble.

The computer field is the hotter-than-hot field now and in the foreseeable future. There are more than one-million computer systems operating today, a seven-fold increase in six years. And there's no end in sight. The Bureau of Labor Statistics indicates that there are 534,000 programmers and systems analysts today, which is an increase of 25% in only the past two years. *Business Week* notes that the need for programmers could reach 1.5 million by 1990!

With more than 1,000 computer languages around, one might ask which one should be studied. It's probably best to be proficient in two or three major languages, such as FORTRAN, COBOL, or APL, plus Assembly. Most important is a demonstrated ability to learn languages quickly and be able to program well. For example, RPG (Report Program Generator) is an important language for business computers, though few colleges teach it.

If you're planning to enter college in the pursuit of a computer or engineering career, you may be interested in seeking out a computer for counselling. If so, don't overlook "Siggy." This is an acronym for the System of Interactive Guidance and Information developed by the

**APPLICATION ENGINEERS  
INDUSTRIAL ROBOTS**

**PROGRAMMERS/  
ANALYSTS**

**Broaden YOUR Base**

If you see application variety as your route to professional fulfillment and career growth, PMI is for you. Here you'll find assignments in every conceivable type and size of business enterprise. And here you'll find a group of growth and advancement opportunities. Check your Thom...

New York  
P R  
C  
Boston

the worlds leading painting equipment welding controls and growing world trial robots

ve of becoming a technology robots. aggressive applica-

**DIGITAL  
DESIGN  
ENGINEERS**

**ENGINEERS  
TECHNICIANS  
COMPUTER SCIENTISTS**

Aerospace/Electronics/ & Mechanical Engineering Disciplines

**CALIFORNIA HI**  
Enjoy small town

**PROGRAMMER  
ANALYST**

**COMPUTER  
SYSTEMS**

**DATA PROCESSING MANAGER  
SALARY TO \$35,000**

AVP reporting to President of NY member International banking group & responsible for All data processing activities including implementation of recently acquired system designed to bank specifications

**BAL  
PROG/ANALYSTS  
\$28-\$38,000**

Relationship must have or computer environment. Program System c Supervisor. This is a g created depar Our present Basic for o w penphera the Person

**SR. SYSTEMS  
ANALYST**

**Reliability  
Engineers  
Military Electronics**

Career progress comes fast the indus

**COMPUTER  
SERVICE  
REPRESENTATIVE**

NYC area. Computer experience preferred necessary Tuesday. ppointin

**SENIOR  
DIGITAL  
ENGINEER**

as well as long range iner

**RELIABILITY  
DESIGN  
ENGINEERS**

ITT Avionics Div... expanding opera campus...

**Systems Engineer**

As innovative leaders in advanced Distributed Data Processing

**COBOL**

Worldwide industrial manufacturer has excellent opportunities in its Corporate Systems Group located in North ern N J. Positions require a minimum of 6 months to 2 years

Educational Testing Service of Princeton, NJ, and adopted by at least 26 colleges and universities plus junior and community colleges. Siggy's computer software helps people identify and explore their career options.

There are many different avenues you can travel in developing varied electronics experience and a career. Perhaps you are interested in the military electronics area, which is very dependent on how much money the government allocates. This is a traditionally good field for electronics and is expected to continue to be so. However, overall U.S. defense budgets for the coming year will not come close to keeping up with inflation. Electronics and communications research and development fare much better (+2.5%), though there will still be some slippage since inflation is expected to be 7% to 10%.

The federal government has computer jobs, too. And why not, since here's where some 20% of the computers are. Just check the Civil Service Commission hiring lists. One, Computer Specialists announcement #420, is a non-test exam that requires at least a substantial training background. Another is announcement #424 for computer specialists with engineering or math backgrounds.

**Making Your Move.** As electronics is applied to more and more areas of business, commerce, industry and the consumer marketplace, the demand for engineers and technicians will undoubtedly grow. You can cash in on the present and near-future opportunities by simply getting an education in electronics, upgrading your electronics knowledge industry training programs, or, if you're ready, changing jobs.

For the latter—changing jobs—look for very substantial real increases in income, at least 20 per cent. If a position in another part of the country interests you, do check out living costs in that area compared to your present location. Check the fringe benefits package before accepting the job to weigh what you will truly gain in added money. Find out about employee turnover in your area, too. Note, though, that in the computer field, job hopping is commonplace, and thus turnover is typically high. If you're investigating joining a company that depends on defense contracts, find out about the contracts in house. Long-term ones are better than short-term ones, of course.

So do peer outside to see if there's a much better world waiting for you. But don't simply jump into a new job without learning as much as you can about your future in the company.

# GLOSSARY OF AUDIO TECHNICAL TERMS

## AMPLIFIERS

**Decibel (dB):** A measure of the ratio between two power levels. Doubling or halving the power corresponds to a 3-dB change, and 10-dB corresponds roughly to the audible effect of doubling or halving the *loudness* of a signal (although it represents a power ratio of 10:1).

**Distortion:** An undesired change in the waveform of a signal. With a single frequency (sine wave) signal, distortion appears as harmonics (multiples) of the input frequency. The rms (effective a.c. point) sum of all harmonic distortion components, is known as *total harmonic distortion*, or THD. When a two-tone test signal is used, distortion components appear at frequencies which are sums and differences of multiples of the input frequencies. Their magnitude is expressed as *intermodulation (IM) distortion*, which is more distressing to hear than THD.

**Equalization:** An intentional departure from response flatness to compensate for complementary characteristics introduced elsewhere in the system (as with discs, tape, and FM broadcasting). Also used to correct for response deficiencies in speakers and other components.

**Filter:** A circuit that attenuates signals above or below a specific frequency without materially affecting signals in its pass-band.

**Frequency Response:** Always specified as a range, such as 50 to 15,000 Hz; but in order to be meaningful it must be further defined in terms of decibel variation from absolute flatness over a specified frequency range (e.g.,  $\pm 3$  dB from 50 to 15,000 Hz). An indication of a sound system's ability to reproduce all audible frequencies supplied to it.

**Hz:** The standard abbreviation of Hertz, the unit of frequency; one cycle per second.

**Integrated Amplifier:** A single component combining the functions and circuitry of a Power Amplifier and Preamplifier.

**Intermodulation (IM);** See *Distortion*.

**Loudness Compensation:** A form of equalization, coupled with the volume control, that progressively emphasizes low frequencies (and sometimes also high frequencies) relative to the middle frequencies as the volume is reduced. Intended to correct for the human ear's natural loss of hearing sensitivity at the frequency extremes when sound level is reduced.

**Noise:** Any unwanted signal unrelated to the desired signal and tending to obscure it. In audio, noise is usually heard as hiss (random noise) or as hum (the power line frequency and its harmonics).

**Power Output:** FTC rules require that amplifier power be measured with all channels operating, after a standard pre-conditioning period to bring amplifier components to their maximum working temperature. Advertised power must be

expressed in the form: "50 watts minimum rms per channel into 8 ohms with less than 0.3% harmonic distortion from 20 Hz to 20,000 Hz." The manufacturer is free to establish its own power, frequency, and distortion ratings, and implicit in the rating is the statement that rated distortion will not be exceeded at any power from 0.25 watts to rated power.

**Power Amplifier:** An amplifier driven by a relatively low voltage, low-power signal, of the order of 0.1 milliwatts or less, which delivers a substantial power output to low impedance speaker loads.

**Preamplifier:** Also known as control amplifier, or control center. A switching, amplification, and equalization component designed to select input signals, amplify them and deliver an output voltage to a power amplifier.

**Signal-to-Noise Ratio (S/N):** The ratio in dB between a reference power output (usually the amplifier's rated power) and the hum and noise power in the output of the amplifier.

**Tape Monitor:** An interruption in the signal path of a preamplifier, from which the selected input signal is supplied to an external tape recorder, and to which the playback output of the recorder is returned for further amplification and processing. Tape monitor circuits allow the owner of a recorder with separate recording and playback heads to listen to a tape as it's recorded, ensuring it is being recorded properly. They also allow the use of external signal-processing devices such as equalizers, noise reducers and expanders, and are sometimes known as "external processor loops" for that reason.

**THD:** See *Distortion*.

**Tone Control:** A circuit designed to increase or decrease the amplification in a specific frequency range, with little or no effect at other frequencies. Bass tone controls usually affect frequencies below a turnover frequency which may vary between 100 and 1,000 Hz. Treble tone controls are typically "hinged" to affect frequencies above 1,500 Hz. The range of a tone control (the maximum amount by which it can vary the amplification within its operating range) is typically about  $\pm 15$  dB, but may be as low as  $\pm 7$  dB or as great as  $\pm 20$  dB.

## TUNERS

**AM (Amplitude Modulation):** A process in which the program information is imposed on a carrier signal of constant frequency, by varying its amplitude in proportion to program level. Used on the standard broadcast band (550 to 1650 kHz), and on longwave and shortwave bands.

**AM Suppression:** The ability of an FM tuner to reject AM signals.

**Capture Ratio:** The minimum ratio between the strengths of two FM signals on the same frequency that will enable the tuner to suppress

the weaker by 30 dB.

**Deemphasis:** A form of equalization used in FM tuners, complementary to a pre-emphasis used in transmission. The purpose is to improve the overall S/N ratio, while maintaining a uniform frequency response.

**Dolby "B":** A noise reduction system, originally developed for tape recording, but now adapted to FM broadcasting as well.

**FM (Frequency Modulation):** A process in which the program information is imposed on a carrier signal of constant amplitude by varying its instantaneous frequency in proportion to the program level. Used on the FM broadcast band (88 to 108 MHz).

**i-f Rejection:** The ability of a superheterodyne AM or FM tuner's i-f circuits to reject external interference at the intermediate frequency.

**Image Rejection:** The ability of a superheterodyne receiver to ignore signals removed from the desired frequency by twice the intermediate frequency (10.7 MHz in home FM receivers, 455 kHz in home AM receivers).

**Multipath:** A condition in which a signal reaches the receiving antenna over two or more paths of different lengths. The resulting interference causes distortion in the receiver, as well as loss of stereo channel separation.

**Multiplex:** The system used to transmit two stereo program channels on a single FM carrier in such a form that the complete program (left plus right channels) can be heard on a mono FM tuner. A multiplex demodulator in the tuner converts the composite received program to its two channel form.

**Selectivity:** The ability of a tuner to reject unwanted signals on nearby channels.

**Sensitivity.** In FM, the signal strength a tuner requires in order to reduce noise and distortion to specified levels. "Quieting sensitivity" measures the input signal needed to reduce noise and distortion to 50 dB below the output audio signal level, a fairly listenable condition. "Usable sensitivity" defines the signal level needed to reduce noise and distortion to 30 dB below the audio output, a condition noisy enough to render "usable" a misnomer. Sensitivity is usually stated both in microvolts ( $\mu\text{V}$ ) of signal across the tuner's 300-ohm input (figures across the 75-ohm input would be lower) and in "dBf"—decibels above a signal level of one femtowatt ( $10^{-15}\text{W}$ ), equivalent to 0.55  $\mu\text{V}$  into 300 ohms. See chart.

**Synthesizer:** A system for generating a precise and stable frequency whose accuracy is determined by a quartz crystal oscillator, instead of inductance/capacitance tuned circuits.

## TURNTABLES

**Acoustic Feedback:** The pickup, by a turntable, of vibrations from the loudspeaker. If these vibrations reach the *cartridge*, they will be reamplified, causing noise (usually a rumble, but in extreme cases a howl) and/or distortion.

**Antiskating:** A system for neutralizing the lateral skating force developed with a tonearm having an offset cartridge angle. See *Skating Force*.

**Automatic Turntable:** A record player whose tone arm is positioned automatically for playing records when a control is operated, and which shuts off automatically at the end of play. See *Record Changer*.

## GLOSSARY...

**Cueing Device:** A lever or control that raises and lowers the tonearm without direct handling by the operator. Usually viscous damped for uniform rise and fall times, no matter how rapidly the control is moved.

**Direct Drive:** A record playing system whose motor is designed to turn at the record speed. No intermediate coupling devices are used, and the platter rests directly on the motor shaft. Direct-drive motors generally utilize *Electronic Speed Control*.

**Electronic Speed Control:** A system whereby a motor's speed is controlled by feedback from a frequency-sensing circuit attached to the device being powered.

**Flutter:** The audible effect of short-term record speed fluctuations, occurring at a low audio or an infrasonic rate (0.5 to 200 Hz). This causes a frequency modulation of the program material, heard as a wavering or roughness of the sound. It is described as a percentage of rated speed; the smaller this percentage, the less audible the flutter. The percentage is generally combined with wow. (See *Wow*.) It is often "weighted" (wrms) so that it corresponds to the average human hearing response.

**Pitch Control:** A circuit which permits a turntable's speed to be varied slightly.

**Radial Tonearm:** A tonearm that moves along a track parallel to the record radius, maintaining perfect tangency to the groove. Sometimes called *straight line tracking arm*.

**Record Changer:** A type of automatic turntable capable of playing a number of records (usually 6 to 10) in sequence.

**Rumble:** The audible effect of low-frequency vibration transmitted from the motor or other moving parts to the record or the tonearm. Heard (as a hum or rumbling sound) only when the pickup stylus is on a rotating record. Rumble is measured in dB below a specified signal level.

**Semi-Automatic:** Having automatic arm return and motor shut-off at the end of a record, but no automatic start and tonearm set-down at the beginning of play.

**Servo Control:** A technique by which the speed or position of a moving device is forced into conformity with a desired, or standard speed or position. The speed of a servo-controlled turntable is established by a precision voltage or frequency standard, to which it is compared and automatically adjusted to reduce the difference to a minimum (see *Electronic Speed Control*).

**Skating Force:** A frictional force between the pickup stylus and the record material, tending to move the pickup toward the center of the record. It is present only when the cartridge is offset at an angle to reduce tracking error. See *Anti-Skating*.

**Statically Balanced Arm:** A type of tonearm whose masses are first balanced about the pivot, then unbalanced to provide tracking force.

**Stroboscope:** A means by which a rotating object can be made to appear stationary, by illuminating it with a flashing light at the correct frequency. Many turntable platters carry a band of dots around their rims, or on their under surfaces, lit by a neon lamp. When the platter speed is adjusted to exactly 33 $\frac{1}{3}$  or 45 rpm, the dots appear to stand still.

**Tonearm:** The portion of a record player that supports the phono cartridge and maintains it in the correct relationship to the record surface and the spiral groove.

**Tracking Error:** The angle between the front-rear axis of the phono cartridge and a line tangent to the record groove. Ideally it should be zero, but can be maintained at less than 0.5 degrees per inch of playing radius in a well designed tonearm. Excessive error can cause increased distortion.

**Wow:** The audible effect of a low frequency flutter, occurring at a rate of 0.5 to 10 Hz. Most audible and objectionable on sustained tones. See *Flutter*.

## PHONO CARTRIDGES

**Biradial:** See *Elliptical*.

**Cantilever:** The rod, or tube, that supports the stylus at its free end, is pivoted at or near its other end, and transfers the stylus motion to the generating elements of the cartridge.

**Cartridge:** The device which holds the stylus (or "needle") and translates into an electrical signal the motions of the stylus as it tracks the wiggling modulations of the groove.

**Channel Separation:** The amount of stereo program material from one channel appearing in the cartridge output for the other channel. Expressed in decibels relative to the desired channel output, with values of 20 to 30 dB (the higher figure being preferable) through most of the audible frequency range being typical of good cartridges.

**Compliance:** The ease with which a stylus can be deflected by the groove wall.

**Damping:** The application of a mechanical resistance, such as a rubber or silicone material, to the cantilever pivot to reduce the amplitude of a resonance.

**Elliptical Stylus:** A stylus whose cross-section, as seen from above, is an ellipse placed across the record groove. Elliptical styli can more readily trace the finer high-frequency modulations of the groove than spherical styli can.

**Magnetic:** A type of cartridge which generates its signal from the relative motions of a magnetic field and a coil or coils (either the field or the coils may move, depending on cartridge design). The output is proportional to the velocity of the stylus motion.

**Mass (tip):** The combined effect of the mass of the diamond stylus, its mounting, the cantilever rod, and the generating elements, as seen by the record groove which must accelerate that mass.

**Moving-coil:** A type of magnetic cartridge in which the coils, connected to the stylus, move within a stationary magnetic field.

**Piezoelectric:** A type of cartridge whose generating element is a ceramic, crystal or electret which generates electricity when bent, twisted or stressed. The output of such cartridges can be fairly high. It is also proportional to the amplitude of the stylus motion, rather than stylus velocity.

**Shibata Stylus:** The first of several multi-radial stylus designs, with two flat facets forming a vee-shaped "prow" in front, and a blunter stern. The main claimed advantage is that the stylus's sharp edges can easily track ultra-fine, high-frequency modulations.

**Spherical Stylus:** A stylus whose shape is conical, with the downward-facing point of the cone rounded to a specified radius of curvature, usually 0.5 or 0.7 mil.

**Stylus:** The specially shaped jewel tip (normally a diamond) that rides in a record groove and follows the variations in groove shape and position. Its motion is transmitted through the supporting cantilever to the generating elements in the cartridge. Styli come in several shapes: see *Elliptical*, *Spherical* and *Shibata*.

**Tracking Force:** The vertical force (in grams) exerted by the stylus on the record groove. Must be high enough to keep the stylus in contact with the groove at all times.

**Transducer:** A device which converts information from one physical form to another. Examples include the phono cartridge (mechanical to electrical), loudspeaker (electrical to acoustical), and microphone (acoustical to electrical).

## TAPE MACHINES

**ANRS, Super ANRS:** A noise reduction system used by JVC. ANRS operates on principles similar to those used by the *Dolby system*. Therefore, there is a degree of compatibility between recordings made with either noise-reduction system.

**Bias:** A high frequency current which is combined with the signal being recorded. Necessary for low distortion and noise, and must be adjusted for the properties of the tape used.

**Bidirectional:** In open-reel or cassette recorders, the ability to play (and, in some cases, record) both stereo track pairs on a tape by reversing the tape's direction of motion without removing and replacing the tape reels or cassette from the tape deck.

**Capstan:** A shaft rotating at constant speed, which is pressed against the tape and moves it past the heads.

**Channel:** An independent signal path. Stereo recorders have two such channels, quadraphonic ones have four.

**Closed-loop drive:** A tape transport mechanism in which the tape's speed and tension are controlled by contact with a capstan at each end of the head assembly.

**Crossfield Recording:** A system in which the *Bias* is not applied to the tape by the recording head, but by a separate head on the tape's backing side, so that the bias signal will not partially erase high frequencies as they are being recorded.

**Cue Control:** A switch which temporarily disables a recorder's *Tape Lifters* during fast-forward and rewind, so the operator can judge what portion of the recording is passing the heads of the tape deck.

**dbx:** A noise reduction system by which the program is compressed before being recorded, and expanded upon playback to restore the original dynamic range.

**Dolby Noise Reduction:** A family of compressor-expander noise-reduction systems. *Dolby A*, the most elaborate was designed for professional tape recorders and gives 10 dB of noise reduction. *Dolby B*, also able to reduce noise by 10 dB is a lower cost system designed for cassette recorders and sometimes used in FM broadcasting as well. *Dolby C*, the newest system, is also meant for cassette decks but gives 20 dB of noise reduction.



## GLOSSARY...

**Dual Capstan:** See *Closed Loop*.

**Dynamic Range:** The ratio between the maximum recorded level (usually that which results in 3% playback distortion) and the playback noises from a tape recorded with no signal input. Expressed in decibels (dB).

**Echo:** A special recording effect, in which a portion of the recorded program is taken from the playback head, a short interval after being recorded, and mixed with the incoming program. Principally used at tape speeds greater than 3 $\frac{3}{4}$  ips, where the delayed signal is not heard as a separate sound.

**Equalization:** Different equalization characteristics are used in the recording and playback amplifiers of a tape recorder, to compensate for the magnetic characteristics of the tape and the heads. Playback equalization is standardized to give flat frequency response with any properly recorded tape, while recording equalization is a property of a particular machine, depending on its head design and the tape for which it was meant.

**Flutter:** A rapid pitch fluctuation, caused by uneven tape movement across the heads. Usually heard as a slight roughness, and in extreme cases as a "gargling" sound.

**Four Track (Quarter Track):** A tape format in which the width of the tape is recorded in four parallel magnetic tracks, separated by narrow unrecorded guard bands.

**Half Track:** See *Two Track*.

**Head:** A magnetic component containing a coil through which a signal current is passed, and a narrow gap in its pole structure against which the tape presses.

**Line:** A term used to denote a high level signal input or output circuit. Line level is usually of the order of a volt, as distinguished from the microphone level of the order of millivolts.

**Memory Counter (or Rewind):** A system which allows the tape to be rewound automatically to any predetermined point on the tape.

**Monitor Head:** A separate playback head on some tape recorders that makes it possible to listen to the material on the tape an instant after it has been recorded, and while the recording is still in progress.

**MPX Filter, Multiplex Filter:** Circuits to remove 19 kHz tones from a signal to be recorded, in order to prevent audible interference between the tape recorder's bias signal and the 19-kHz pilot tone in the output signal from a stereo FM tuner or receiver.

**Pause Control:** A feature of some tape recorders that make it possible to stop the movement of tape temporarily without switching the machine from "play" or "record."

**Peak Indicator:** An indicator, usually of the flashing-light type, showing when transient signal levels exceed a recorder's ability to handle them without distortion. Such indicators are often used to supplement *Recording-Level Meters*, which usually indicate average signal levels.

**Peak-Reading meter:** A type of *Recording-Level Meter* whose needle rises quickly and falls back at moderate speed, permitting the operator to judge the levels of transient peak waveforms.

**Quarter Track:** See *Four Track*.

**Recording-Level Meter:** An indicator on a tape recorder that provides some idea of the signal-levels being applied to the tape from moment to moment. It is intended as an aid in setting the recording levels to ensure that the tape is neither overloaded with excessive levels or "under-recorded" with too little signal, allowing hiss and other noise to intrude.

**Saturation:** An effect that occurs when a tape is fully magnetized, and further increase of signal input level does not produce a corresponding increase in recorded level. Saturation can also occur in the magnetic structure of the heads.

**Signal-to-Noise Ratio (S/N):** See *Dynamic Range*.

**Sound-on-Sound:** A process in which a program is recorded first on one track, then played back and re-recorded with added material on the other track.

**Sound-with-Sound:** A process by which a program is recorded on one track, then monitored as a second program is recorded on another track.

**Tension Arm:** An arm, or feeler, over which the tape rides as it enters or leaves the heads. It is lightly spring loaded to take up any tape slack and maintain a uniform tension, in order to reduce flutter. Should the tape end or break, the arm causes the transport to shut off.

**Track:** The path on the magnetic tape along which a single channel of sound is recorded.

**Two Track (Half Track):** A tape format in which the width of the tape is recorded in two parallel magnetic tracks, separated by an unrecorded guard band. As compared to *Four Track* recording, the two track system gives improved dynamic range and can be edited without loss of program, since the tape is passed in a single direction only.

**VU Meter:** A type of *Recording Level Indicator* which shows average signal levels in decibels relative to a fixed 0-dB reference level (and, often, in percent of maximum recommended modulation). While the term is frequently used for any level meter using this scale, it applies most strictly to meters having a specified, stan-

dard degree of damping; it is widely used in professional equipment in the United States, because the standardized damping allows the operator familiar with one VU meter to closely judge signal levels on any other true VU meter.

## SPEAKER SYSTEMS

**Acoustic Suspension:** A speaker system in which the woofer cone is loosely suspended, and its motion controlled to a great extent by the stiffness of the enclosed air. Noted for its extended, low distortion bass output and low efficiency.

**Coaxial:** Tweeters are sometimes mounted in front of woofers; since each driver fires along the same axis, they are said to be coaxial.

**Crossover Network:** A filter which passes low frequencies to a woofer, middle frequencies to a mid-range driver (in three-way systems) and high frequencies to a tweeter. Frequencies outside the range of each driver are attenuated at a rate determined by the network design (see *Slope*). A crossover frequency is a frequency at which each of two drivers is receiving half the amplifier's power; below or above that point, one speaker will receive more power than the other.

**Dipole:** A form of speaker which radiates in approximately equal amounts to the rear and the front.

**Dispersion:** The spread of a speaker's high frequencies, measured in degrees.

**Driver:** Any individual speaker within a system, such as the *woofer*, *tweeter*, etc.

**Dynamic:** A speaker drive principle using the interaction between the magnetic field surrounding a voice coil carrying a signal current and a fixed magnetic field to move the coil and the cone to which it is attached.

**Efficiency:** The percentage of the electrical input power to a speaker that is converted to acoustic energy. Varies from a small fraction of one percent to as much as ten percent or more, depending on the design of the speaker. Higher efficiency means that less electrical amplifier

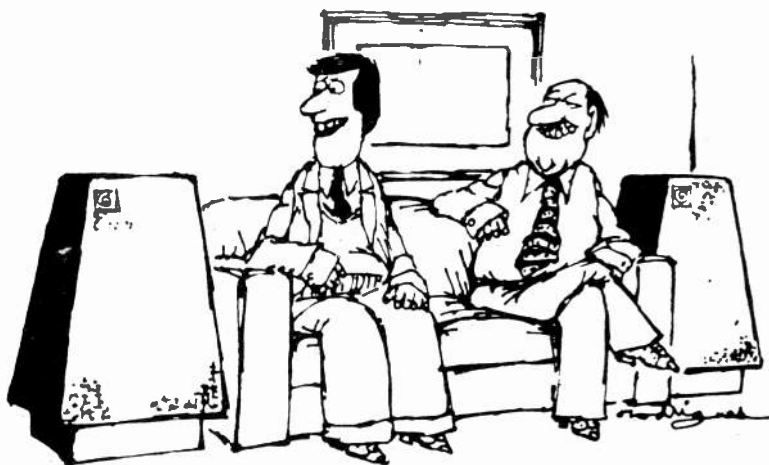

"From zero to 20,000-cycle response—say, those are good speakers, Floyd!"

# reprint series

POPULAR ELECTRONICS publishes a wide variety of important articles covering the broad field of electronics. Reprints of selected articles are now available for your reference, study or home-project needs.

## AUDIO

- 40855 How To Evaluate Tape Recording Specs (10/74)
- 40964 Build The Hi-Fi TV Audio Minder (4/77)
- 41097 Upgrading Your Old Stereo FM Tuner System & Expanders (9/77)
- 41098 Build An Audio Comander (11/77)
- 41099 How FM Tuners Work, Part I (12/77)
- 41100\* How FM Tuners Work, Part II (1/78)
- 41303\* Build A Super Filter (9/78)
- 41304 Build A Disco Preamp-Mixer (9/78)
- 41305 Build A Stereo Roto Blender (10/78)
- 50121 Parametric Equalizer (9/79)
- 50128 Clipping Indicator (11/79)
- 50138 Car Stereo Standards (3/80)
- 50241 Optimum Bias For Your Tape Recorder (10/80)

## COMPUTERS

- 40860 How To Select A Microcomputer (12/76)
- 40861 Ins & Outs Of Computers For Beginners (6/76)
- 40966 Introducing Speechlab—The First Hobbyist Vocal Interface For A Computer (12/78)
- 41306 Cassette Control For TRS-80 Computer (11/78)
- 41308 Computer Bubble Memories (2/79)
- 50117\* Ohio Scientific Computer (3/79)
- 50123 How To Add I/O Ports (10/79)
- 50125 Computer Printing (11/79)
- 50126 CP/M (11/79)
- 50130 Computer-Aided Morse Code (12/79)
- 50131\* TR-80 "Real Time" Timer (1/80)
- 50139\* TRS-80 Combination Lock (3/80)
- 50142 Extra Keyboards (4/80)
- 50144 Programming Microprocessors (5/80)

- 50243 Basics Of Computer Disc Systems (11/80)
- 50250 Binary, Octal & Hexidecimal Numbers (3/81)
- COSMAC "ELF" SERIES
- 40857 Low Cost Experimenter's Microcomputer (8/76)
- 40858 Experimenter's Microcomputer/With Hardware Improvements & More Programming Details (9/76)
- 40859 Microcomputer: How To Expand Memory, Plus More Programs (3/77)
- 40870 Build The Pixie Graphic Display (7/77)
- 41101 Expanding Elf II (3/78)
- 41307 Tic-Tac-Toe For Elf Computer (11/78)

## COMMUNICATIONS

- 40862 CB Specifications Made Easy (3/75)
- 40863 How To Choose CB Base Station Antennas (4/76)
- 40965 Build Morse-A-Letter (1/77)
- 50127 Radioteletype Reader, Part I (11/79)
- 50141 Radioteletype Reader, Part II (12/79)
- 50238 High Tech Gear For Hams & SWLS (8/80)
- 50246 PE Examines Cordless Telephones (12/80)
- 50247 Build A Morse-A-Keyer (1/81 & 2/81)
- 50249 A Look At Pocket Pagers (3/81)
- 50276 Direct Broadcasting Satellites (5/81)

## OTHER

- 40867 How To Design Your Own Power Supplies (6/75)
- 40868 The Care & Feeding Of NiCd Batteries (3/76)
- 40869 Build A Gas & Fume Detector (8/76)
- 40963 Six CMOS Circuits For Experimenters (4/77)

- 40967 Programming Calculators For Fun & Games (6/77)
- 41103 How To Design TTL Digital Systems (10/77)
- 41104 Build An Autoranging Digital Capacitance Meter (2/78)
- 41309 Use Low Cost Digital Equipment (11/78)
- 41310 Energy Leak Detector (10/78)
- 41311 An A/D Converter (9/78)
- 41312 Security Focus (2 Articles) (12/78)
- 41313 Universal Electronic Timer (1/79)
- 41314 Mph Car "Cruisealert" (2/79)
- 50124 NASA Motor-Control Circuit (2/79)
- 50132 A Personal Radiation Monitor (1/80)
- 50134 The New Digital Multimeters (2/80)
- 50135 Car Econometer (2/80)
- 50143 Motion-Detector Alarm (5/80)
- 50239 Build An Auto Windshield Wiper Controller (8/80)
- 50240 Check Heat Loss With A Degree-Day Meter (9/80)
- 50242 Build An Infrared Road Icing Alert (10/80)
- 50244 Inexpensive Auto Battery Tester (11/80)
- 50245 Build A Super Music Maker Microprocessor (11/80)
- 50248 Transient Protection For Automobile Circuits (2/81)

## LEARNING ELECTRONIC THEORY WITH CALCULATORS SERIES

- 40864 Basic Equations And Ohm's Law (7/76)
- 40865 Reactance, Time Constants And AC Calculations (8/76)
- 40866 RC Coupling, Basic Amplifier Calculations, And RLC Relationship (9/76)

## VIDEO

- 50237 Video Cassette Recorders (6/80)
- 50270 Wireless TV Commercial Killer (2/81)

DATE INDICATES ISSUE IN WHICH ARTICLE APPEARED.  
Reprints are \$2 each, \$1 for those marked with asterisk. Minimum order \$6.



**CHARGE ORDERS (Minimum \$10)—For your convenience PHONE TOLL FREE 800-345-8112. In Pennsylvania only 800-662-2444.**

POPULAR ELECTRONICS REPRINTS  
P.O. Box 278, Pratt Station  
Brooklyn, NY 11205  
Please send the reprints listed below:

Reprint #	Quan.	Reprint #	Quan.

Number of reprints ordered: \_\_\_\_\_  
TOTAL ENCLOSED (minimum order \$6): \$ \_\_\_\_\_  
U.S.A.—shipped First Class, add \$1 per order post. & hand.  
Outside U.S.A.—shipped Air Mail only, add \$2 per order.

CHARGE MY CREDIT CARD (minimum order \$10):

- American Express     Visa  
 MasterCard         Diners Club

Card No. \_\_\_\_\_ Exp. Date \_\_\_\_\_

Signature \_\_\_\_\_

Mr./Mrs./Ms. \_\_\_\_\_  
(please print full name)

Address \_\_\_\_\_ Apt. \_\_\_\_\_

City \_\_\_\_\_

State / Zip \_\_\_\_\_

Residents of CA, CO, DC, FL, IL, MA, MI, MO, NJ, NY State, OH, SC, TN, and VT add applicable sales tax.

## GLOSSARY...

power is required for a given listening volume, but is not directly related to sound quality.

**Electrostatic:** A speaker drive principle in which a thin plastic membrane, or diaphragm, is suspended in an electric field that is varied by the signal from the amplifier. This causes the diaphragm to move, propagating a pressure wave in the air.

**Impedance:** A speaker's opposition to the flow of an alternating current, which varies with frequency.

**Infinite Baffle:** A fully sealed box enclosing the speaker.

**Molecular Film:** A type of *piezoelectric* speaker.

**Motional Feedback:** Correction of a speaker's response by feeding information about its motion back to the amplifier. The amplifier then compares the speaker's motions with its own output and changes this output in such a way as to counteract any changes (distortions) created by the speaker.

**Moving-Coil:** See *Dynamic*.

**Omnidirectional:** Emitting sound equally in all directions. Frequently applied to speakers that are only "omni" in the forward or upward hemisphere.

**Piezoelectric:** A speaker drive principle using a ceramic element which expands or bends under

the application of a signal voltage. This deflection generates a sound output. Used in some tweeter designs.

**Polar Response:** The variation of output, at any given frequency, at different angles to the forward axis of symmetry of the speaker. In general, it will be different in horizontal and vertical planes, as well as with frequency. See *Dispersion*.

**Port:** An opening in a speaker enclosure, permitting the bass radiation from the back of the woofer cone to be combined with its forward radiation to enhance the total response.

**Ribbon:** A form of high-frequency driver using a light ribbon suspended in a magnetic field to generate sound when current is passed through it. In its basic form, a very high quality but fragile high frequency driver.

**Subwoofer:** A speaker designed only to handle very low frequencies, usually from a top of 100 Hz to a bottom below 20 Hz.

**Supertweeter:** A tweeter used only for extremely high frequencies; usually in 4-way or 5-way systems.

**Tweeter:** A high frequency driver.

**Two-way, Three-way:** Refers to the number of frequency bands into which a speaker's output is divided. A two-way system would divide the spectrum into two such bands, one of which would be handled by a woofer or woofers, the other by a tweeter or tweeters. A three-way system would have one or more woofers, midrange speakers and tweeters. Systems up to five-way have been marketed.

**Woofer:** A low-frequency driver.

## HEADPHONES & MICROPHONES

**Bidirectional:** Responding equally well to sounds from two opposite directions (a figure-8 pattern).

**Cardioid:** A heart-shaped polar response, with strong rejection to signals arriving from the rear.

**Circumaural:** A headphone in which the earpiece completely surrounds the wearer's ear, and is sealed to the head to provide tight bass coupling.

**Condenser:** A type of electrostatic microphone characterized by wide frequency range and low distortion.

**Dynamic:** A headphone driver using a voice coil in a magnetic field, driving a paper or plastic diaphragm as in a speaker.

**Electret:** A permanently polarized form of condenser microphone.

**Electrostatic:** A headphone drive system using a thin plastic membrane in a high voltage electrostatic field, whose variation by the signal voltage moves the entire diaphragm to create a sound pressure wave.

**Impedance:** See definition under *Speakers*.

**Moving Coil:** See *Dynamic*.

**Omnidirectional:** Responding equally to sounds arriving from any direction.

**Ribbon:** A type of microphone using a light metal foil ribbon in a powerful magnetic field. Widely used in studios.

**Self-Energizing:** A type of electrostatic phone which uses the stepped-up signal voltage to supply the d.c. polarizing voltage required for operation.

**Sensitivity:** A measurement of the electrical output of a microphone for a given sound pressure level at its diaphragm.

**Super-Cardioid:** Similar to cardioid (see above) but with a narrower response lobe.

## SIGNAL PROCESSORS

**Cx.** A compressor/expander noise-reduction system first introduced by CBS Records. Capable of 20 dB of noise reduction, it extends the dynamic range of phonograph discs to 80 to 85 dB. To realize this extension, the user must play the record back through a decoder, but the system is designed so that a record played without decoding is quite listenable.

**dbx:** A complementary compressor/expander system. See definition under *Tape Recorders*.

**Dolby "B":** A system for minimizing noise added to a program during recording. See definition under *Tape Recorders*.

**Expander:** A device used to restore natural dynamic range by counteracting the compression of dynamic range used in the making of recordings and in broadcasting.

**Graphic Equalizer:** A multi-band equalizer whose controls are sliders, so that their settings can be seen as a rough graph of their frequency response characteristics. See also *Equalization* under *Amplifiers*.

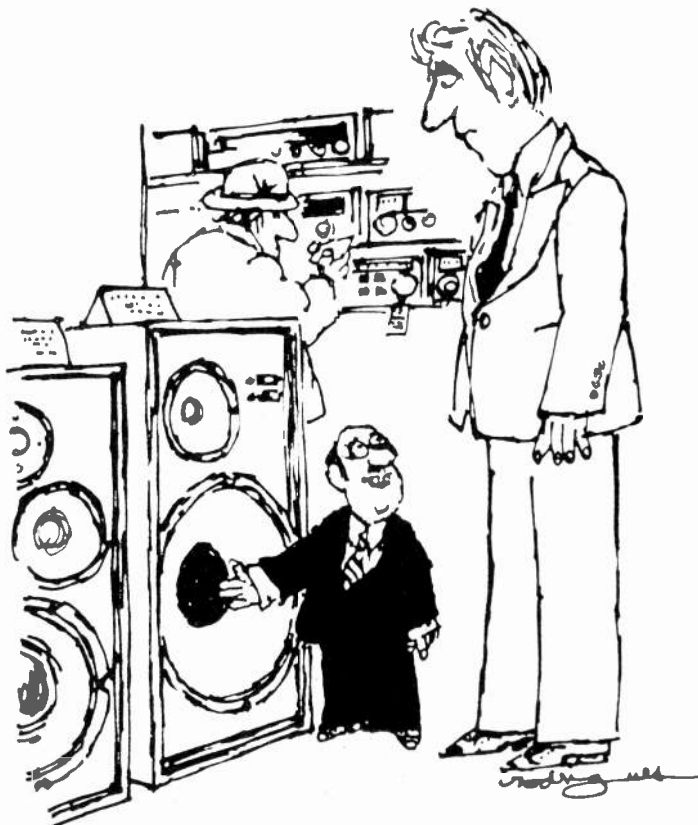

"For the money that is one helluva massive woofer, sir!"

(Continued from page 45.)

picture tube can be made. Not much more than a 2-ft diagonal measurement (25-in.) is on the market today. The dramatic visual impact of a larger viewing screen, however, can be obtained with an optical projection-type TV receiver. They vary from 4-ft to 6-ft screens,

casters to move it aside when not viewing, as the unit does not stand against a wall. A Kloss new system provides a 10-ft diagonal measurement directly on a wall—without a special screen.

Keep in mind that, for a 6-ft screen, you'll have to have 6 to 8 ft between the screen and the projector, and another few feet for the projection-TV cabinet itself. You would require at least a few feet more to accommodate the viewers, too. A rule of thumb is to view the screen no closer than two times the diagonal size of the screen.

All-in-one projection TV sets, which can be positioned against a wall, have become very popular owing to lower space demands. A 4-ft. diagonal screen measurement is standard. Instead of projecting the picture directly at a

system with a fixed screen. With this arrangement, the picture is projected to the side of the inside cabinet, where it is reflected onto the back of the screen.

Another important consideration for prospective buyers relates to the optical method used for a projection-TV system. There are single lens/magnifier designs that are attached, via an enclosure, to the face of a TV set. This is the least desirable (and lowest cost) method of projecting a TV image onto a screen that's substantially larger than the size of a large picture tube. Such a device is generally used in conjunction with a 13-in. color TV portable. To observe a good picture using this method requires viewing in a very low light room, owing to the system's brightness deficiency.

The better projection-TV systems employ three lenses, which increases the available light level to about five times that of the typical single-lens system. As a result, you can watch such a system with the lights on and see a fine picture. Each tube produces only one color (red, blue, or green), while mixing of the three light outputs takes place on the screen itself.

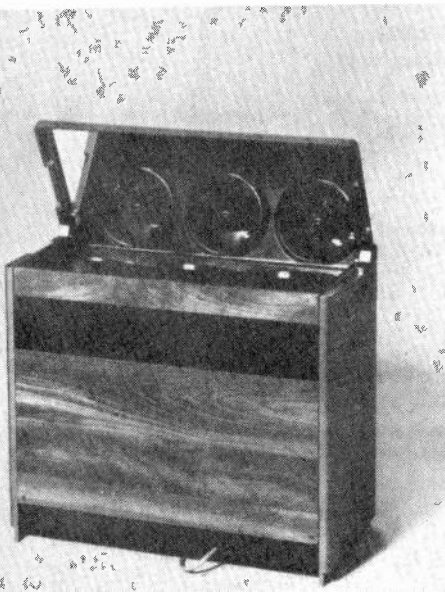

Kloss Novabeam® portable projection-TV with lid in "in use" position.



Sony FD-200 pocket TV set uses a liquid-crystal picture "tube".

depending on the type of projection systems used. Furthermore, different designs produce different levels of brightness. All the systems project the color TV picture (assuming the program is playing in color) onto a special screen made of material similar to that of a screen used to view camera slides or motion pictures.

To obtain an exceptionally large TV picture requires the use of a two-piece system. One section contains the TV receiver with projection lens optics, while the other section is a large, usually 6-ft screen that is supported on a stand or hung on a wall. Unless one has a sufficiently large room in which to view it, you will have to forego screens this large. The TV cabinet usually includes

screen, the picture is projected to a mirror, which reflects the image onto a screen that is part of the single, rather large cabinet. The screen can be folded down when not in use. In a variation on this all-in-one design is a rear-projection

**120VAC VARIABLE STROBE LIGHT KIT**  
Complete variable rate strobe light kit produces brilliant flashes of light. Operates from standard 120VAC. Reliable design—thousands of these are in use throughout the world. Overall size of completed board: 3 L x 2 W x 3 H. C3071 \$7.50

**3VDC ELECTRONIC WARNING FLASHER KIT**  
This portable battery operated device continuously emits bursts of intense light at a fixed repetition rate. Can be seen for great distances making it a great safety device. Features xenon flashtube. Operates on 3VDC (two 1.5V Batteries). Size of board: 2 1/4 L x 2 W. C3207 \$7.95

**FASCINATION STAR KIT**  
Produces an exploding star visual effect using 25 LEDs and IC-logic. The center LED lights first then the next group of LEDs light and then another set of lights until the outer edge of the star lights up. The process then reverses itself. Operates from 9V battery. C4432 \$18.95

**ELECTRONIC WHEEL OF FORTUNE KIT**  
Push the start button and a bright red ball (LED) appear to spin around ten numbers. When you release the button the electronic ball appears to slow down and finally comes to a stop on one number. As the ball spins a small speaker emits a locking sound in synchronization. Unit operates from 9V battery. Size of board: 2 9/16 x 2 6/16. C3806 \$9.99

**SOUND EFFECTS GENERATOR KIT**  
Exciting sound effects kit uses the popular T76477 chip to develop phasing, locomotive siren, tweezing, bird organ, Morse T etc. sounds. Uses dip switch for simple programming of the generator. Operates from 9V battery. Size of board: 3 25 x 2. C4422 \$12.95

**3CHANNEL COLOR ORGAN**  
Very popular 3 channel color organ causes lights of your choice to flash to beat of music. Features level control and 3 separate AC outlets to connect Christmas lights, lamps etc. Operates from 120VAC. Size of board: 3 x 5. C4330 \$8.50

**POPULAR ITEMS**  
GREEN HEONS same as NE2 but glows bright green) C4551 \$1.00  
3 750ma SOLAR CELL C4637 \$3.50  
3 6V 100ma NICAD (removed from new equipment) C4685 \$2.50  
KESTER 60 40 PC SOLDER 6 ft coil C4456 \$1.00  
C106B SCR 200V 4A C4426 .89  
100WS ROUND FLASHTUBE C4666 \$7.95  
PC 10 PC SYNC CORD C4667 \$2.00

**LED STEREO POWER METER KIT**  
Features attractive moving jumbo LED display with 20 LEDs (10 per channel) indicating RMS output of amplifier. Connects to speaker leads. Can be used with any amplifier from 1 to 200 watts. Size: 2 1/2" x 6 1/2". Requires 3VDC at 500 ma. C4662 \$17.95

**DUAL VOLTAGE POWER SUPPLY KIT**  
Power supply for above kit. Output: 8 VDC at 500 ma; output 120 VAC. Size: 2" x 2 1/2". C4663 \$5.95

Combination of both kits C4664 \$22.95

**CHANEY electronics inc.**  
P.O. BOX 27038  
DENVER, COLORADO 80227  
303-781-5750

Phone Orders: 303-781-5750  
Minimum AD Order \$9.00  
Please include \$1.50 for postage (UPS)  
VISA MC accepted  
Phone orders are welcome  
Send for our free catalog of unique items

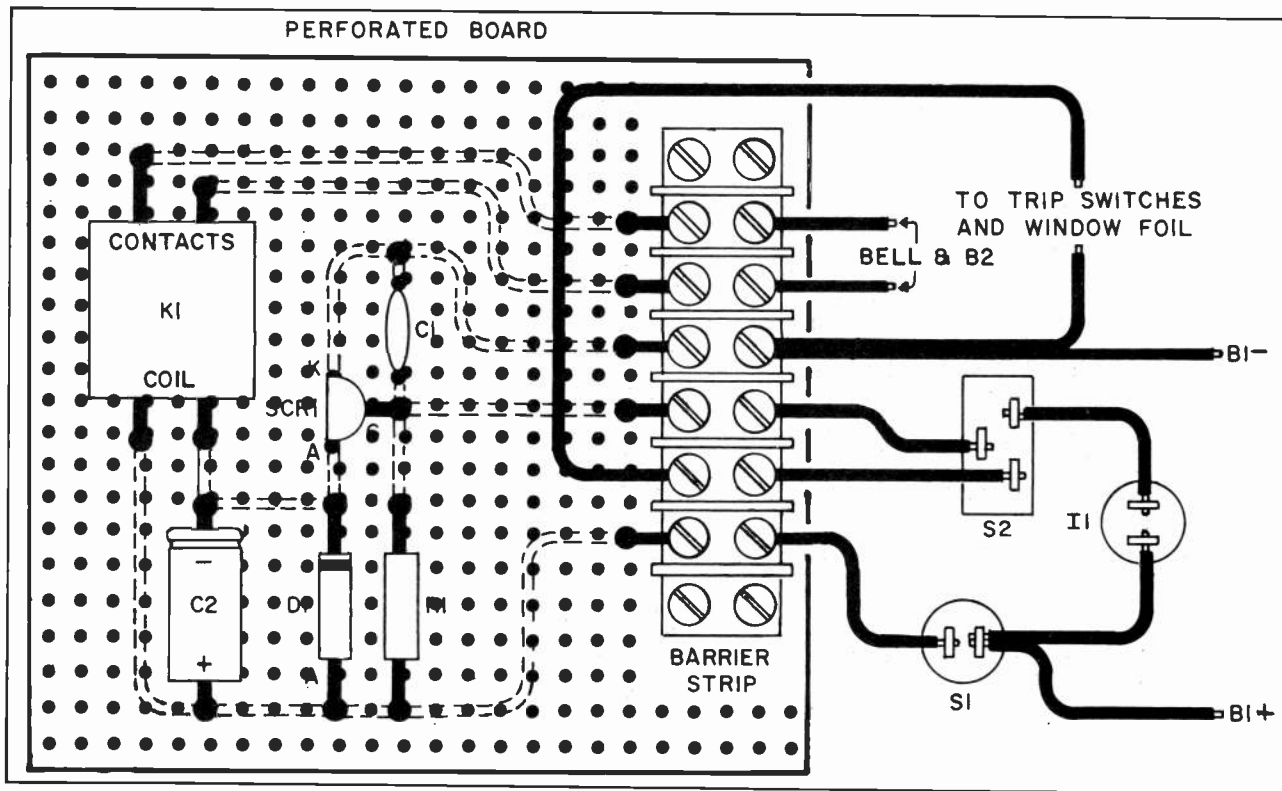

Fig. 26. Construction details for perimeter-protection burglar alarm. Circuit assembles on unclad perforated board, using solder posts to make all interconnections. Top-of-board wiring is shown solid black, while under-board wiring is shown phantomed.

barrier block. (Don't forget to pretin the wires after stripping away the insulation.) Solder the connections at the lugs but not at the barrier block.

Mount the bell and circuit boxes in a convenient location. It's best to bolt the two boxes together so that the wires can't be cut to silence the bell. Next, mount the trip switches and apply the foil to all doors and windows to be protected, following the instructions provided with these devices. This done, interconnect the switches and foils with stranded hookup wire, forming a continuous series run (see Fig. 28). Then route the wires along baseboards and door frames and connect them to the appropriate screws on the barrier block. (Again, don't forget to pretin the stripped wires.) Finally, install and interconnect the batteries to the barrier block.

**System Checkout.** With *S1* open (OFF), press *S2*. If all door and window switches are closed and the foils are intact, *I1* should light. If the lamp doesn't light, check the sensor switches and foils, closing any doors and windows that are open and replacing any foil that

has a break in it. Once you obtain the proper conditions, arm the alarm by setting *S1* to ON. If all is still okay, the bell won't sound.

Now open a protected door or window (don't cut any foil). The alarm should almost immediately sound. It should continue to sound even if you close the door or window. Reset the alarm by setting *S1* to OFF and then back to ON. This completes checkout and your alarm is ready to protect your premises.

**In Closing.** As you can see from the foregoing, electronics can be an exciting and rewarding hobby. There isn't really much you have to learn to be able to build electronic devices from kits and instructions supplied in magazines and books. And the investment in a minimal tool kit and time required to learn the basics can, in the long run, save you lots of money, since products that you can buy ready-to-go can be home built for far less money.

Perhaps the most important thing the electronics hobbyist gets from his hobby is the pride and satisfaction of knowing he built some piece of equipment. ♦

**Invitation to Electronics Advertisers Index**

RS no.	Advertiser	Page
2	Antenna Specialists .....	81
3	AP Products .....	Cv. 3
4	ARCsoft Publishing .....	45
25	Bishop Graphics .....	75
5	Castle Marketing .....	109
26	Chaney .....	133
	Cleveland Institute of Electronics .....	67-69
27	Computer Mail Order .....	121
	Edmund Scientific .....	113
21	Etronix .....	111
7	Gladstone .....	9
8, 9, 10, 11	Heath .....	25, 43, 53, 125
13	Jameco .....	101
12	J & R Music .....	21
	J S & A .....	1, 3
14	Lincomm .....	85
22	Memotech .....	13
	Netronics .....	73
20	Nortronics .....	37
	NRI Schools .....	49-51
15	OK Machine & Tool Co .....	15
16	Panasonic .....	17
17	Progressive Edu Kits .....	97
28	Projectapix .....	44
18	Scientific Systems .....	41
	Sinclair Research .....	5-7
19	Sintec .....	103
46	TDK .....	Cv. 4
24	Vidicraft .....	Cv. 2



**Be careful.  
Your hobby is  
about to  
become an  
obsession.**

**HOBBY-BLOX™**  
The modular, circuit  
building system for  
electronic hobbyists.



Until now, you had to buy "professional" solderless breadboards for your projects and pay "professional" prices. Now there's Hobby-Blox™, a totally new circuit-building system that's not only economically priced but offers many more advantages to the hobbyist.

At the core of the system are two expandable starter packs (priced under \$9.00), one for discrete component projects, the other for integrated circuit projects. Each comes with a number of Hobby-Blox modules that fit into a tray and an illustrated project booklet. In addition, the system includes 14 separate component packs you can purchase individually — terminal, distribution and bus strips, speaker panels, binding posts, etc. — priced from \$1.49 to \$4.29.

The Hobby-Blox system is easy to use because the modules are color-keyed and letter/number indexed. It's time-saving, because they're solderless. It's compatible with DIP's of all sizes and a wide variety of discrete components. And you save money, because the parts can be reused again and again.

How far can you go with the Hobby-Blox system? Take a look at the example above. Then you'll know why we say, "your only limit is your own imagination!"

**For a free catalog and the name of your nearest Hobby-Blox dealer, call Toll Free 800 321-9668. In Ohio call collect (216) 354-2101.**

Patents Pending  
© A P PRODUCTS INCORPORATED 1980  
Prices shown are current suggested U.S. resale.



A P PRODUCTS INCORPORATED  
9450 Pineneedle Drive  
P.O. Box 603  
Mentor, Ohio 44060  
(216) 354-2101  
TWX: 810-425-2250  
In Europe, contact A P PRODUCTS GmbH  
Bäumlesweg 21 • D-7031 Weil 1 • W. Germany





# A video cassette mechanism needs to be more than a package for your tape.



Your video cassette mechanism needs to do more than store and transport your video tape. Because a lot can go wrong with your picture that has nothing to do with your tape.

Our specially engineered cassette mechanism maintains proper tape tension, preventing jamming and snapped leaders so that your tape can have a longer life.

We also designed our mechanism for optimal tape-to-head contact to prevent skewing and

jitters. And we use stainless steel pins to support the guide rollers which provide better alignment and tape-edge protection than the plastic pins used by some manufacturers.

TDK maintains tolerances up to 2½ times tighter than industry standards. We even build our video cassette shell halves to micron tolerances for an exact top and bottom match.

We do everything we can to make sure that TDK Super Avilyn video tape and the TDK super precision mechanism will combine to give you the best

possible picture. That's why our video cassette mechanism is every bit as impressive as our video tape.



 **TDK**<sup>®</sup>  
The vision of the future.