

Howard
1956

HI-FI GUIDE

By Donald Carl Hoefler

- Setting Up a Hi-Fi Unit
- Improving Your Hi-Fi System
- Building From Kits
- Trouble Shooting and Maintenance
- Stereophonic Sound
- Adding Radio, TV and Tape Recorder
- Hi-Fi on the Highway



~

Special Section: The nation's top disc jockeys pick their favorite Hi-Fi records

DON'T BUY A CHEESE BOX

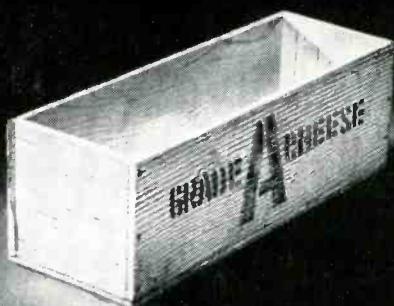

WHEN YOU BUY A "DO-IT-YOURSELF" SPEAKER ENCLOSURE KIT



Your speaker enclosure is not just a box. It's an important component of your Hi-Fi system. A "build-it-yourself" enclosure should be as good as the finest factory-assembled enclosure. When you "build your own" don't end up with a cheesebox . . . make sure that the kit you buy has all these features:

1. Full 3/4" Hardwood Cabinet Plywood used throughout. Select Grade White Birch used for all finishing surfaces.
2. All wood pre-shaped. Almost all assembly done with a screwdriver. Complete instructions supplied with each kit.
3. Flexible, speaker mounting board permits countless P.S.E. and multi-speaker combinations.
4. "Decor-Cooustic" design. A perfect union of the most advanced principles of acoustic baffling and interior decoration. A true corner-less-corner enclosure.

Only University "KwiKits" have all these important features. Don't forget, the difference between mediocre kits and the finest is only a matter of a few dollars. Don't jeopardize the quality of your whole system by a false economy.

Model KEN 15 — Same as Model EN-15 enclosure used in the "MASTER" Speaker System except for simplified frame. Baffle board is pre-cut for 15" speakers and supplied with adapter for 12" speakers. Adapters also supplied for most of the popular 2 or 3 way P.S.E. Speaker Systems. Completed enclosure measures 37" H x 28" W x 19 1/4" D.
KEN-15—\$49.75 Net.



KEN-15

Model KEN-12 — Similar to Model KEN-15 except that mounting board is pre-cut for all 12" speakers. Adapters also supplied for most of the popular 2 or 3 way P.S.E. combinations. Dimensions: 30" H x 21 1/2" W x 15 3/4" D.
KEN-12—\$39.75 Net.



KEN-12

Model EN-CB Unfinished-Utility Enclosure

A true folded self-contained exponential horn, operates with highest quality wherever placed independently of walls or floors. Complete in itself with all acoustically correct elements always in place. EN-CB is identical in design to the enclosure used in the famous "Classic" "Decor-Cooustic" system. Ideal for the do-it-yourself home decorator finishing is limited only by the imagination. Can be used horizontally or vertically. Fully assembled, constructed throughout of 3/4" Birch plywood with locked and mitre joints and braced with heavy glue blocks. Supplied unfinished, less base and frame, but with necessary hardware for mounting speaker. Recommended components are: Model CJ5W Dual Impedance Woofer, Model HF-206 Super-Tweeter, Model Cobreflex-2 Mid-range Horn with T-30 Driver, Model N-3 Network. 40" x 30" x 24". Shpg. Wt. 150 lbs. **\$120.00 Net.**

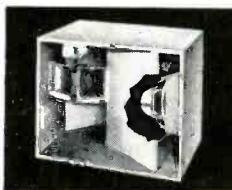

THE P.S.E. STORY

P.S.E.—Progressive Speaker Expansion plan (a concept first introduced by University) is the most revolutionary development in loudspeaker history.

University speaker components, enclosures and networks have been so uniquely designed that it is possible to start an excellent basic system at low cost and add to it later—while enjoying immediate listening satisfaction. P.S.E. makes possible building up to any fine system in successive, inexpensive steps using KwiKits and EN-CB enclosure. For the fascinating story of P.S.E. please send for FREE illustrated brochure.



LISTEN

University sounds better



UNIVERSITY LOUDSPEAKERS, INC., 80 SOUTH KENSICO AVENUE, WHITE PLAINS, N. Y.

Rise Stevens

Comments on
Diamond
Phonograph
Needles



"Nothing less than the best will suffice for those interested in hearing phonograph records played properly. My listening experience has convinced me that the diamond phonograph needle is superlative in terms of quality and economy."



Be sure your phonograph has a **DIAMOND**

PLAY SAFE
PLAY DIAMOND

TETRAD

WORLD'S LARGEST
MANUFACTURERS
OF DIAMOND STYLII

For further information write to: Dept. LC 62 St. Mary St., Yonkers, N. Y.

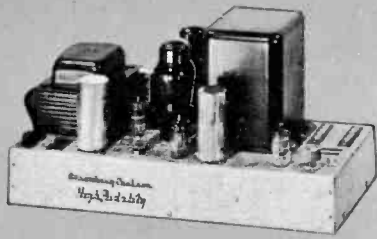

Mechanix Illustrated Hi-Fi Guide

by Donald Carl Hoefler

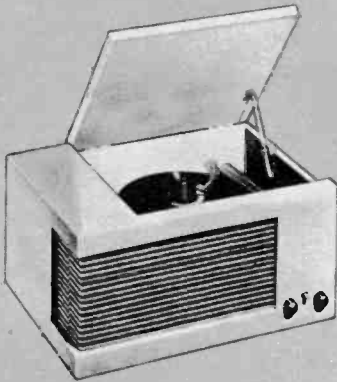

A FAWCETT BOOK • NUMBER 321
LARRY EISINGER • EDITOR-IN-CHIEF • FAWCETT BOOKS
GEORGE TILTON • MANAGING EDITOR

W. H. Fawcett, Jr. President
Roger Fawcett General Manager
Ralph Daigh Editorial Director
James B. Boynton Advertising Director
Al Allard Art Director
Ralph Mattison Associate Art Director

DAN BLUE EDITOR
Jean Galloway Associate Editor

HAROLD KELLY ART EDITOR
Silvio Lembo Associate Art Editor
Nick Carlucci Art Associate
Murray Cooper Art Associate
Harold E. Price Art Associate
Michael Gaynor Art Associate

Anne B. Ragno Production Editor
Phyllis Goodman Assistant Production Editor

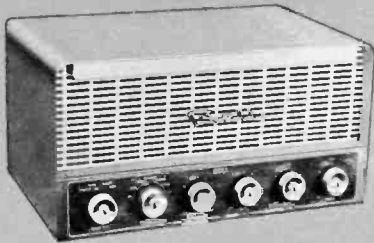

MECHANIX ILLUSTRATED HI-FI GUIDE, Fawcett Book 321, is published by Fawcett Publications, Inc., Greenwich, Connecticut. Editorial and Advertising Offices: 67 West 44th Street, New York 36, New York. General Offices: Fawcett Building, Greenwich, Connecticut. Gordon Fawcett—Secretary-Treasurer. Roscoe Fawcett—Circulation Director. Submissions should be directed to Managing Editor, Fawcett Books. Not responsible for lost manuscripts and photographs though every effort will be made to return unacceptable material if accompanied by self-addressed envelope with sufficient first-class postage. Trademark of Fawcett Publications, Inc. Printed in U. S. A. Copyright 1956 by Fawcett Publications, Inc.

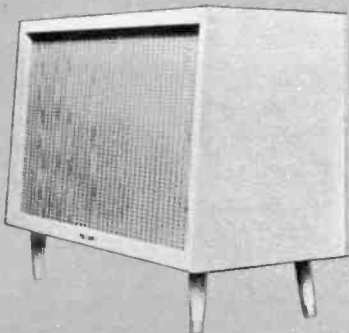

NOW! SAVE up to 50%

BUILD YOUR OWN

E-V HIGH FIDELITY Speaker Enclosure



EVERY PIECE PRECUT

in *Ready-to-Assemble* **KITS**

Now you can own an acoustically correct *Electro-Voice* high-fidelity folded-horn speaker enclosure for your home music system and *save up to one-half!* Build it yourself...seven models to choose from... wall types... corner types...for full range loudspeaker...for separate two, three and four-way speaker systems.

All parts are precut—ready to assemble. Exterior surfaces are clear-grained birch. Easy, step-by-step instructions show you how to “Do-it-Yourself.”

Beautiful furniture finish is easily obtained with an E-V Finishing Kit.* E-V Decorative Trim Kit* adds the final touch. (*Available separately.)



See your E-V Hi-Fi Distributor for Construction Books and K-D Kits —or write for Bulletin 211-FB

Electro-Voice®

ELECTRO-VOICE INC. • BUCHANAN, MICH.

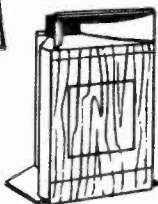

THE PATRICIAN IV KIT. An interior assembly kit for those desiring the finest. This augmented design of the Klipsch corner folded-horn bass section delivers an added full octave of bass. Designed for use with E-V Model 103C Patrician IV four-way driver components. For built-in installations or to be decorated as you choose. Finished size: 57½ in. high, 34½ in. wide, 26¾ in. deep. Shpg. wt. 150 lb.

Model KD1 Net, \$118.00



THE BARONET KIT. Phenomenal reproducer for such small size. This folded-horn corner enclosure is designed for use with E-V Model SP8B 8-in. Radax speaker. E-V T35 or T35B Super Sonax UHF driver can be added for a separate two-way system. Finished size: 23 in. high, 14 in. wide, 13 in. deep. Shpg. wt. 24 lb.

Model KD7 Net, \$26.00



THE ARISTOCRAT KIT. Folded-horn corner enclosure designed for 12-in. speakers and separate 2 and 3-way systems. For use with Electro-Voice SP12 or SP12B coaxial speakers, 12TRX or 12TRXB triaxial reproducers, and 10B, 111 2-way and 108A, 111A 3-way systems. Smooth reproduction down to 35 cps, with remarkable purity and efficiency. Finished size: 29¾ in. high, 19 in. wide, 15¾ in. deep. Shpg. wt. 37 lb.

Model KD6 Net, \$39.00

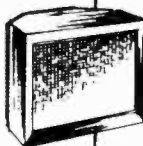

THE EMPIRE KIT. Economical, folded-horn enclosure for use in a corner or flat against one wall. Designed for 15-in. speakers and separate 2 and 3-way systems. Particularly effective when used with SP15B coaxial speaker, 15TRXB triaxial reproducer, or 116 2-way or 116A 3-way system. Recommended components for Regency kit may also be employed. Finished size: 29¾ in. high, 32 in. wide, 16 in. deep. Shpg. wt. 45 lb.

Model KD5 Net, \$51.00

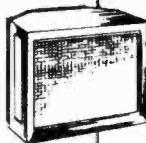

THE REGENCY KIT. Most popular low-boy style folded-horn enclosure that can be used in corner or flat against one wall. Improves the bass range and response of any 15-in. speaker. Makes an outstandingly efficient reproducer when used with E-V SP15 coaxial speaker, 15TRX triaxial reproducer or 114A 2-way or 114B 3-way system. Finished size: 29¾ in. high, 33½ in. wide, 19 in. deep. Shpg. wt. 70 lb.

Model KD4 Net, \$73.00

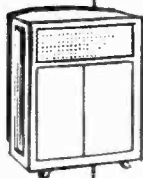

THE CENTURION KIT. Four-way system folded-horn, corner enclosure. Uses exclusive E-V “W” type single-path indirect radiator for propagation of extended bass. Sealed cavity behind 15 in. low-frequency driver cone promotes superlative transient response, subdues cone excursions, lowers distortion. For use with E-V Model 105 or Model 117 package of driver components. Finished size: 42½ in. high, 29 in. wide, 22½ in. deep. Shpg. wt. 75 lb.

Model KD3 Net, \$87.00



THE GEORGIAN KIT. An interior assembly kit that creates authentic Klipsch indirect radiator type corner folded-horn bass section for 15 in. 4-way speaker system. Exceeded in range only by the Patrician IV. For use with E-V Model 105 or Model 117 package of 4-way driver components. For built-in installations or to be decorated as you choose. Finished size: 38½ in. high, 26¾ in. wide, 22½ in. deep. Shpg. wt. 88 lb.

Model KD2 Net, \$65.00

CONTENTS

The 10-Year Hi-Fi Cycle	6
Hi-Fi for Everyone	11
Starting Off Right	16
Hi-Fi in a Package	22
Building From Kits	30
Adding Radio and TV	44
Adding a Tape Recorder	49
Expanding and Improving Your Hi-Fi System	58
Your Complete Hi-Fi System	68
Maintenance and Trouble Shooting	76
How Hi the Hokum?	86
Stereophonic Sound	90
Hi-Fi on the Highway	96
What About Loudspeakers?	100
The Best Hi-Fi Records	112
Free Items and Special Bargains	120

INTRODUCTION



WHILE HI-FI is hardly new to the American scene, it is now enjoying an unprecedented popularity. More people have hi-fi systems today than ever before, and millions of others are considering putting a hi-fi system into their home. Interest in this field is ever-growing.

WITH THIS growth has come many new hi-fi systems and products, and a need to evaluate them. Thus, this book has

been published to bring the public up-to-date on all the latest developments in the hi-fi field.

OUR AUTHOR, Donald Carl Hoefler, has counseled with all the leading manufacturers and engineers in the hi-fi field. The result of this research is the latest information, photographs, and illustrations of new hi-fi products. Of even greater value is his appraisal of this equipment.

HE HAS also included an entire section devoted to all the free information, booklets and gimmicks you can get by writing the hi-fi manufacturers. Also in the book is a survey of the top hi-fi records chosen by the nation's top disc jockeys.

MR. HOEFLER has written our two previous hi-fi best sellers, *Hi-Fi Manual*, and *Low Cost Hi-Fi*. He has been engaged in music and sound activities since high fidelity first created a flurry in America. One of the pioneer frequency-modulation broadcast engineers, he was for several years associated with Major Edwin H. Armstrong, the inventor of FM. Hoefler later designed and built FM stations, and served as Chief Engineer of the Continental FM Network. He is currently engaged as sound engineer for RCA Victor; in this field he has been responsible for a number of innovations in magnetic tape techniques. Thus, you can see that Mr. Hoefler was indeed the right author for this book. He speaks with the authority of broad experience gained throughout the United States and Europe.

Dan Blue Editor

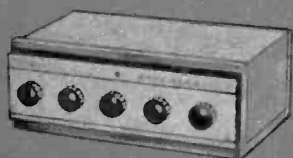
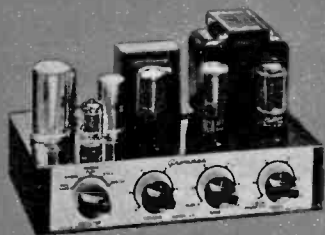

THE LOW DOWN ON HI-FI

EVERY MONTH IN

High Fidelity

THE AUTHORITATIVE HOME MUSIC MAGAZINE



RECORD REVIEWS

More than any other magazine . . . over 2,000 a year!



TESTED-IN-THE-HOME

Dependable equipment buying guide.



DISCOGRAPHIES

Complete, critical coverage of all long-play recordings by an individual artist or of an individual composer.



ARTICLES AND STORIES

. . . about people, places and activities in the exciting world of music and sound.



FAMOUS AUTHORS

Names like these appear in every issue: Jacques Barzun, Wm. Saroyan, Aaron Copland, E. Power Biggs, and C. G. Burke. John M. Conly is the Editor.

FREE!

Fill in coupon below for a free copy of latest issue.

HIGH FIDELITY, 4422 Publishing House, Great Barrington, Mass.

Please send me, **ABSOLUTELY FREE**, a copy of the latest issue of **HIGH FIDELITY**, and bill me for a three year subscription to start with the following issue. This is at your money-saving price of only \$13.50.

I prefer 2 years at \$10.00
(24 issues)

I prefer 1 year at \$6.00
(12 issues)

NAME _____

ADDRESS _____

Add \$1 per year for subscriptions outside the U.S. and Canada.

NO RISK GUARANTEE—If my free copy does not live up to expectations, I may cancel my subscription and pay nothing.

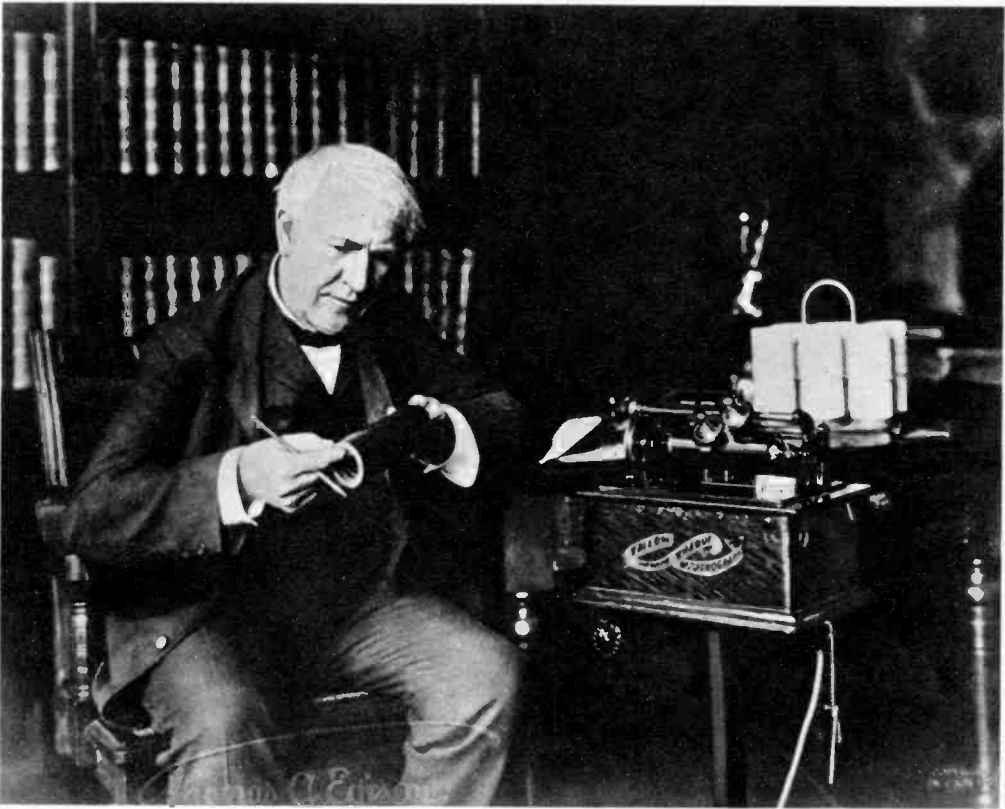

RCA Victor

THE HI-FI business dates back to Thomas A. Edison and his invention of the phonograph in 1877.

The 10-Year Hi-Fi Cycle

The passing of each decade has always brought forth new advances in this field.

THE very rapid growth of high fidelity during the past 10 years sometimes causes us to forget that the quest for audio perfection has been going on for many decades. It is interesting to note, in fact, that the passing of each decade has been the signal for another big step forward in the art.

Although much has been known of the physics of sound and music since the time of the ancient Greek civilization, the first known attempt at recording sound waves was made just a century ago, in 1857. Leon Scott invented his *Phonautograph* in

France, an instrument which traced a wavy spiral line on a rotating cylinder coated with lampblack.

It was not until exactly two decades later, however, that it became possible to reproduce sound as well. In 1877 Thomas Edison developed a device for both recording and reproducing sound, and this was the very beginning of the modern phonograph record industry. At the same time Alexander Graham Bell was perfecting his telephone, an instrument for collecting, transmitting and reproducing sound electrically over wires.

Attention Record Collectors!

Ask your record dealer for the 176-page
Schwann LONG PLAYING RECORD CATALOG

**A complete, accurate, well printed catalog of over
18,000 long playing records.**

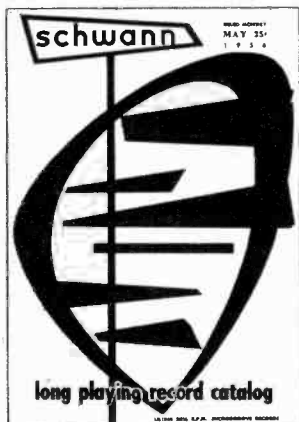

- ★ the selection on the back of the record clearly identified.
- ★ new releases of over 275 companies every month (starred).
- ★ composer, title, performers.
- ★ composers' dates of birth and death.
- ★ size of record, record number, number of records in sets.
- ★ classical records listed by composer.
- ★ popular, musical shows, children's, listed by title or artist.
- ★ operas, operettas, folk music, speech . . . all in **ONE** booklet.
- ★ complete price list.

If you are a real music lover you shouldn't be without SCHWANN LONG PLAYING RECORD CATALOG. Issued monthly, it lists and classifies *all* long play records of *all* companies. New releases as well as discontinued numbers are clearly marked for your convenience in making your selections.

Whether your preference is classical or popular—you'll find it in SCHWANN. The Schwann Catalog is available every month at more than 3400 record stores. Ask your regular record dealer for it. If he doesn't have it, send us his complete name and address as well as your own and we will send you a FREE copy of the Schwann Catalog.

SCHWANN LONG PLAYING CATALOG

137 Newbury Street
Boston 16, Mass.

Gentlemen:

Please send me a FREE copy of the SCHWANN CATALOG. I understand I am under no obligation.

MY NAME

DEALER'S NAME

STREET

STREET

CITY STATE

CITY STATE

HI-FI IN REVIEW

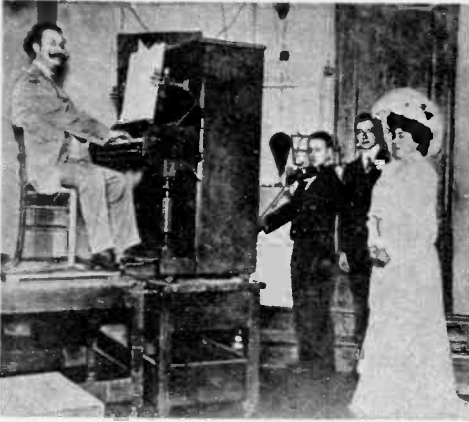

HERE IS famous singer Nellie Melba recording for Victor in a primitive studio of the early 1900's.



THIS IS what a broadcast studio of the Roaring Twenties looked like. Note box-shaped mikes.



AND HERE is the modern type tape recorder which has meant so much to the advance of hi-fi field.

Another 10 years passed, and then Emile Berliner introduced the first flat disc record, as opposed to Edison's cylinders. He also at the same time demonstrated the first practical method for duplication and mass production of records.

The end of the next decade, between 1896 and 1898, saw two more steps forward. Guglielmo Marconi invented radio, and Eldridge Johnson perfected a practical phonograph reproducer with a spring-wound motor. This instrument was the foundation for his Victor Talking Machine Company, which was soon to follow.

Exactly a half century after the *Phonograph*, in 1907, Dr. Lee DeForest earned the title "Father of Radio" when he demonstrated that sound could be transmitted over radio waves. Thus was born the radio broadcasting industry.

About 10 more years, and the world was involved in the greatest war it had ever known. A young major in the Army Signal Corps, Edwin H. Armstrong, while stationed in France invented a new type of radio receiver known as the superheterodyne. It exhibited greater sensitivity, selectivity and fidelity than previous types, and was so basically sound that it is still used in all radio and TV sets.

In another decade, 1927, the first electrical recordings were introduced to the public, and were a vast improvement over the acoustical type previously offered. That same year saw the beginning of the modern era of the sound-on-film motion picture. This type of recording soon came to be recognized as the highest state of the art.

Exactly 10 years later, in 1937, Major Armstrong again came to the fore with the introduction of Frequency Modulation. This development truly heralded modern high fidelity, with standards which even now are accepted as representing real hi-fi.

At the end of the next decade there appeared three new developments, each a tremendous advance in the art, and with them hi-fi really began to grow in earnest. These were tape recording, the long-playing record, and the variable-reluctance phonograph pickup. Now for the first time it became possible for everyone to have hi-fi in the home with only a modest investment.

And now another decade closes, with 1957 the 100th anniversary of the *Phonograph*. What wondrous new development may be before us this time? •

PIONEER ACHIEVEMENTS

1925 — the first "corner" speaker system... 1927 — the first multi-diaphragm system for highs and lows... 1928 — the first commercial electronic cartridge and tone-arm... 1935 — the first "radial-slot" speaker system, etc. ALL INVENTED BY MAXIMILIAN WEIL, who holds over 260 patents — and whose know-how created the new achievement described below:



NEW CONCEPT IN TONE-ARM ENGINEERING

NOW — the "Blue Chip" Compass-Pivoted Tone-Arm in KIT form —
and at **HALF price!**

• new superior performance - with any cartridge

AUDAX KT-12:

12" Tone-Arm KIT, \$14.55 NET...
Factory-assembled, \$24.00 NET

AUDAX KT-16:

16" Tone-Arm KIT, \$17.55 NET.
Factory-assembled, \$30.00 NET

You do-it-yourself with no tools other than a nail-file or small screwdriver.



The time-tested "Blue Chip" Audax HF-16 (\$30.00 Net) is acknowledged by all as the finest and most efficient tone-arm. Now the new KT-16 Tone-Arm — greatly superior to the HF-16 — is available to you in KIT form — at HALF price.

The new KT models are the crowning achievement of a quarter-century of constant refinement and re-engineering of the very first commercial electronic pickup arm (Audax 1928) ... to the *fewest possible parts*. It is this very *nth degree engineered simplicity* that makes the new KT Tone-Arms possible.*

Not only does this structural simplicity eliminate tone-arm distortion. But it is also the very reason why you yourself can assemble these arms in about 20 minutes. And — it is your *built-in assurance* that after assembly they will be, in EVERY respect, as fine as the factory-assembled units ... and save you 50%!

UTMOST SIMPLICITY OF CONSTRUCTION!

No springs to cause fatigue distortion, no spurious responses. You assemble it in about 20 minutes — you save 50% — and you are CERTAIN it is as RIGHT and FINE as the factory-assembled unit! See them at your dealer. (If shipped from New York City, add 25c). Write for FREE reference guide — fill out the coupon.

AMERICA'S LEADING CONSUMER TESTING ORGANIZATION

placed the leader predecessor HF-16 in the "Blue Chip" class. Now the new KT Tone-Arms are greatly superior.

Everything considered, no tone arm equals the new Audax KT—regardless of price!

AUDAX COMPANY, Att.: Mr. L.
500 Fifth Avenue, New York 36

*Send me FREE your \$1.00, 22-page, 1956 reference guide, "ELECTRONIC PHONO FACTS" — by pioneer Maximilian Weil.

Name.....

Address.....

City..... Zone..... State.....

Audax

Fine audio-electronic apparatus for 35 years

AUDAX COMPANY, 500 Fifth Avenue, New York 36, N. Y.

YOUR high-fidelity equipment... Here's how the B.I.C. GROUP lines up

B.I.C.
ENDORSED
QUALITY



For example—**New!**
Garrard RC 88
"Triumph II"
World's Finest Record Changer
Full manual and automatic positions.
True-turret drive, uses no belts, double
"Induction Surge" motor. Footproof
Garrard Pusher Platform. \$54.50 net

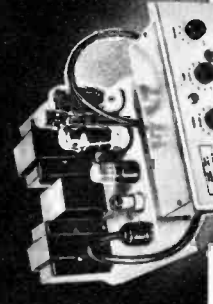

For example—
Leak TL/10
Britain's Finest Amplifier
with "Point one"
Remote Control Pre-amplifier.
B. B. C. standard setting!
Amazingly low 0.1% distortion
Four master control dials,
with exclusive plug-in tape
jacks on front panel.
\$109.50 net complete

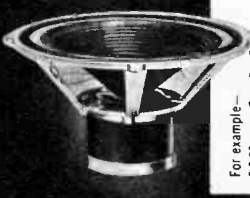

For example—
Wharfedale
Super 12 / CS/AL
12" full-range Loudspeaker.
Built under the supervision
of world renowned G. A. Briggs.
Remarkably level response
over entire range. Especially
full-bodied, non-strident
tone. Cone "floats" in
hand-lifted cloth rim. \$76.15 net

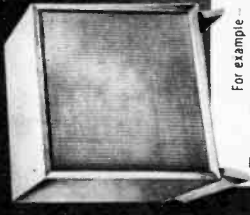

For example—
R-J Floor model
the original small-space
loudspeaker built on
Patented R-J design principles
assure full, smooth bass,
unobstructed highs.
Model F-12-M Mahogany \$52.50
Model F-12-B Korina \$57.50

Today you can assemble your entire high fidelity phonograph with B.I.C. quality-endorsed components... each the finest... fully guaranteed... uniformly better, yet priced competitively with ordinary components. Your continuing satisfaction is assured by really complete spare parts and service facilities. Write for literature Dept. S-686

New!
GARRARD RC 98
"Crown II"
Super Changer. All RC 88 features, including full manual positions + or - variable speed control on all 3 speeds. \$67.50 net

GARRARD 301
"Protes"
3-Speed Transcription Turntable. Supreme in its class! All speeds variable and adjustable. Each machine tested perfect, with individual written inspection report on wow, rumble, flutter... \$89.00 net

New!
GARRARD RC 121
"Renown"
Mixer Changer. Garrard's most compact, economical changer — fits any cabinet. Simpli-Mix Operation permits stacking all record sizes together. 4-pole motor. Manual position. \$42.50 net

GARRARD T "Crest"
3 speed Manual Player with automatic start and stop. Compact, efficient... incorporates all basic record-playing features of famed Model RC-80 changer. \$32.50 net

LEAK TL/12
Amplifier with unique VariSlope Pre-Amplifier. Amazingly low harmonic distortion of 0.1%. VariSlope Pre-amp actually permits control of taper for high frequencies!
TL 12 Amplifier \$149.50
VariSlope Pre-amp... \$69.50

Wharfedale Loudspeakers
Built under supervision of G. A. Briggs. Unique cloth suspension and felt buffer rim. Aluminum voice coils.
3" Tribe model, 8", 10", 12" full-range models: \$15.00 to \$75.00

R-J Shell-model Loudspeaker
"Maximum Bass, Maximum Space"
Tirring performance from any loudspeaker in cabinet only slightly larger than the speaker itself. Single shelf and double-shelf models; and R-J Wharfedale unit (complete with special Briggs designed speaker.) \$26.50 to \$60.00 net

Genalex... Finest Audio Tubes
The original KT66 pentode amplifying triode socket as U.S. #6L6... \$3.50 net
The original 2729... lowest hum, highest gain, audio pre-amplifier — equalizer tube... \$2.99 net

Customized Cabinets and "Do-it-Yourself" Kits by River Edge
29 models; 10 finishes
Equipment and loudspeakers to fit components. Finished cabinets and inexpensive unpainted kits.
"Do-it-Yourself" Kit
Finished cabinet

R-J Shell-model Loudspeaker
"Maximum Bass, Maximum Space"
Tirring performance from any loudspeaker in cabinet only slightly larger than the speaker itself. Single shelf and double-shelf models; and R-J Wharfedale unit (complete with special Briggs designed speaker.) \$26.50 to \$60.00 net

BRITISH INDUSTRIES CORPORATION • Port Washington, New York



David Bogen Co., Inc.

Hi-Fi for Everyone

You don't have to be a Ph.D. to enjoy hi-fi. All it requires is interest and some basic knowledge.

DON'T get me wrong, friend. I haven't any objection to members of the intelligentsia joining the hi-fi movement. I can't blame the high-class magazines for wanting to get some mileage out of the hi-fi bandwagon. It's not my worry if some of the hi-fi manufacturers want to limit their sales approach to a snob appeal. But when all this begins to add up to a hi-fi cult in the nature of a secret society, then I begin to get my dander up.

Because you don't have to know any secret passwords in order to become a hi-fi hobbyist, no more than you have to be a mechanical engineer to get full value out of an automobile. Most of the mumbo-jumbo about the hi-fi art you read nowadays is just exactly that. As the bopsters say, "Who needs it?"

Hi-fi is fundamentally concerned with the accurate reproduction of all types of sound, whether they be called noise, speech or music. Sound waves generated in air behave in somewhat the same manner as waves set up by dropping a stone

into still water. The waves or ripples move outward from the point struck by the stone, moving in concentric circles of increasing diameters until they finally reach the shore.

The number of waves breaking at a point on the shore in a given time—such as one second—determine the *frequency* of the wave motion. The distance between the waves, measured at common points, such as the crests, is known as the *wavelength*. The full outline of a wave, from crest to trough and up to the next crest, is called a *cycle*. As the waves radiate out they become smaller and we say that the *amplitude* diminishes.

Determining Pitch

The frequency and wavelength of sound waves in air determine their *pitch*. Thus, the bass tones are low in frequency, long in wavelength, and low in pitch. And the treble tones are high in frequency, short in wavelength, and high in pitch. When the frequency is exactly doubled and the wavelength halved, the sound is said to be raised in pitch by one *octave*.

The type of sound comprising only a single frequency is said to be a pure tone, but the sounds encountered in nature are ordinarily much more complex. A musical chord, for example, contains a number of tones of different frequencies.

More than that, we must consider that two different musical instruments playing

tones of the same frequency will sound markedly dissimilar. The distinguishing differences in the sounds are due to the shape of the waves produced. Thus each instrument is generating not only its basic pitch tone, known as the *fundamental*, but also a series of secondary vibrations known as *overtones* or *harmonics*. It is the specific combination of fundamental and harmonics which gives an individual instrument its *tone quality* or *timbre*.

The very first step in sound reproduction is the collecting of sound waves by means of a microphone. The "mike" has a sensitive diaphragm or ribbon which is set in motion by the wave disturbances in the air. This motion in turn generates a minute electrical voltage, whose waveform should be exactly like that of the original sound. This voltage must grow much larger in size, while at the same time retaining its identical shape, before it is useful for sound reproduction. The building up is the next step, accomplished by means of an *amplifier*.

The simplest amplifier—and according to many authorities still the best for audio use—is the three-element (or *triode*) vacuum tube. The three metal elements within the evacuated glass or metal bulb are commonly known as the *cathode*, *control grid*, and *plate*.

When the cathode is heated by means of an independent electric current, a large



number of electrons "bubble out" into the surrounding area. Since each electron is a tiny unit of negative electricity, it will be repelled by other negative charges, but attracted by a positive charge. Then if a fixed positive electric charge is placed on the plate, there will immediately be set up an electron flow from cathode to plate. This electron flow then actually constitutes an electric current moving through a vacuum.

Diode Tube

Without a grid present, such a vacuum tube is known as a *diode*, and is often found in amplifier power supplies. Since current will flow from cathode to plate, but not from plate to cathode, when an alternating current is applied to the input of this tube, there will appear at the output a pulsating direct current. This pulsating d-c then may be filtered and smoothed to constant d-c, and this in turn provides the operating voltages for the other tubes in the set. Instead of this rectifier power supply, however, we will assume for simplicity's sake that our one-tube amplifier is battery-operated.

The grid is a metallic mesh inserted in the path of the electron flow between cathode and plate. With no voltage on the grid, electron flow will continue almost as before, with most of the electrons passing through the openings and on toward the plate. But when a positive voltage is ap-

plied to the grid, less electrons will arrive at the plate, as some of them will be attracted to the grid instead. If a negative voltage is applied to the grid, once again the plate will receive less electrons, since many of them will be repelled by the grid and return to the cathode.

In usual practice a fixed negative voltage, known as *grid bias*, is applied to the control grid, and the incoming signal is superimposed on this bias. Then the grid voltage will become more or less negative with the variations in the incoming signal voltage. And the electron flow and the current in the plate circuit will vary in exact accordance with the signal on the grid.

The result of all this is that we have gained a tremendous electrical advantage, with the voltage appearing in the output plate circuit being many times that fed into the grid circuit. Now with a microphone generating the signal at the input circuit and a loudspeaker being driven by the output circuit, we have a rudimentary audio amplifier. The microphone first converts sound waves into minute electrical waves of the same shape. Then the triode tube amplifies the minute voltages into those great enough to energize the loudspeaker. The speaker then reconverts the voltages to sound.

If we replace the loudspeaker in our example with a record cutting head and stylus, we have the basic elements of a disc

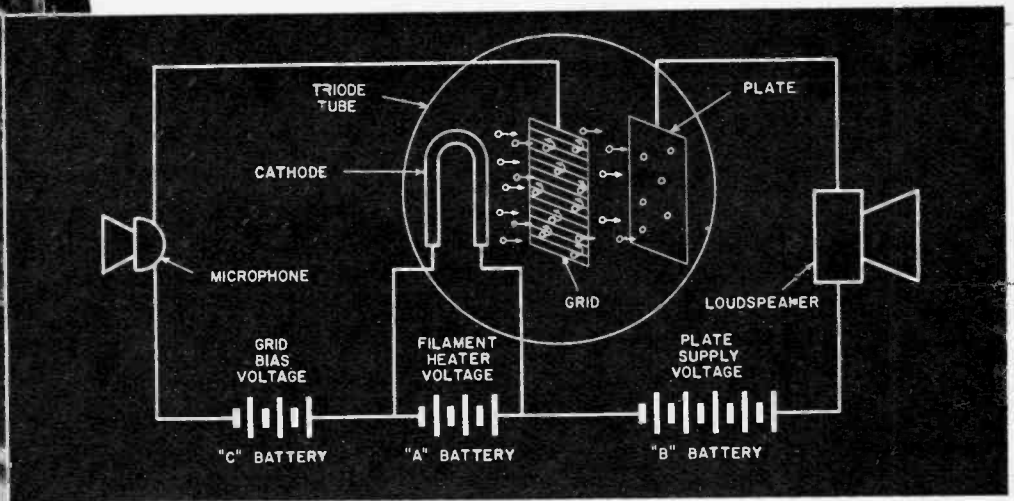

TWO BEAUTIES (photo left) in a lovely setting made for hi-fi listening. Speaker by Jim Lansing. Diagram above shows Triode Amplifier, basic hi-fi type. Note effect of grid on flow of electrons.



recorder. If we retain the speaker and replace the microphone with a phonograph pickup, we have the basic elements of a record player.

If the loudspeaker is replaced by a radio transmitter, we now have a fundamental broadcasting station. Returning the speaker to the plate circuit and putting a radio tuner in the grid circuit, we have assembled a receiving system.

When the loudspeaker is replaced by a magnetic record head, the result is the basis of a tape recorder. Leaving the speaker in place, but putting a magnetic playback head in the input, we now have the basis of a tape reproducer system.

Obviously, then, the audio amplifier is a versatile and indispensable element in every link of the hi-fi chain. This being true, the amplifier has been subjected to

the most intensive research and development, and is today well-nigh perfect. The electro-mechanical elements which go to make up the balance of the hi-fi system are not yet quite so advanced, but even they are capable of contributing to the reproduction of sound which is very high fidelity, indeed.

A final consideration which you will encounter wherever hi-fi is discussed is the matter of *equalization* or *compensation*. An equalizer is basically a tone control, which causes some sound frequencies to be either more or less prominent than they were in the original. Variable equalizers are quite commonly employed by recordists to provide certain desired sound characteristics, just as tone controls are sometimes necessary to provide a better acoustic balance in a hi-fi system which is set up in the home.

BEAUTIFUL CABINETS house these fine hi-fi units. Photo across page shows system created by designer Patricia Harvey for the Gregory Furniture Company. Hi-fi equipment includes Fisher Model 80-T AM-FM tuner. Photo below shows Lansing C39 unit, a handsome mahogany enclosure which complements the other office furniture in room. Many offices have installed hi-fi equipment.

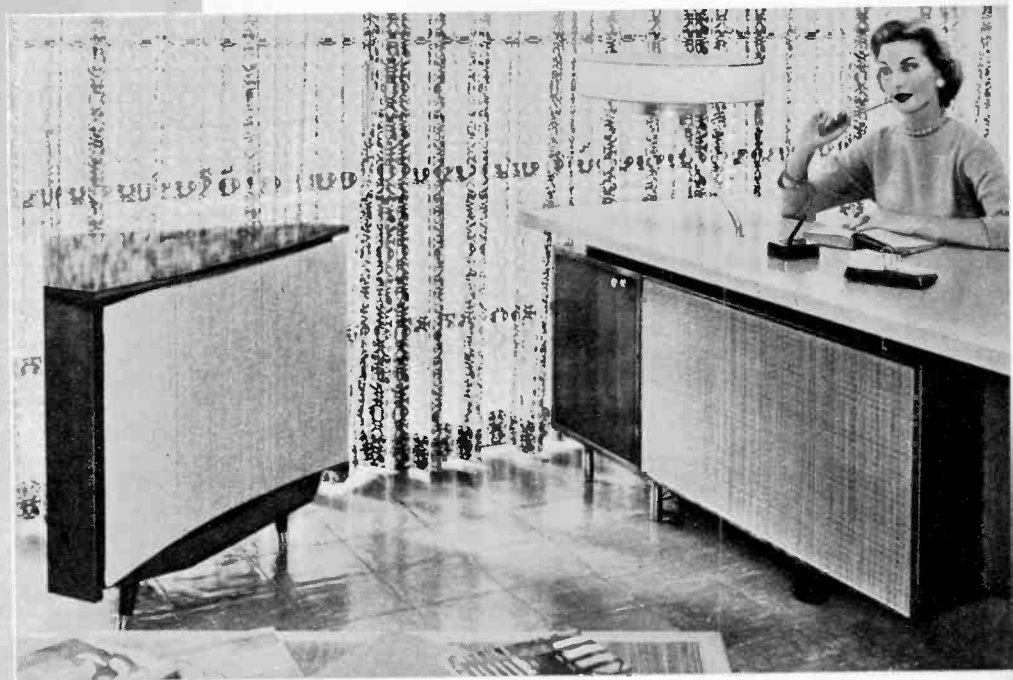

In addition to these, however, we often encounter fixed equalizers which deliberately and constantly alter the transmission characteristics of the system. In FM radio, for example, the higher frequencies are purposely pre-emphasized in the transmitter. Since a certain amount of hiss and other high-frequency noise is characteristic of radio transmission, "tipping up" the treble frequency range permits the sound signal to override the noise. Then in the receiver or tuner there is a complementary de-emphasis circuit which restores the original balance.

Record Compensation

The tape recorder similarly has pre-equalization built into its record circuit, along with a similar post-equalizer in the playback. Phonograph records not only

have a tipped-up treble range, but also a rolled-off bass range, this latter equalization being intended to prevent overcutting between adjacent grooves on the disc.

Now the hi-fi reproducer must be able to post-equalize or compensate with a characteristic just exactly opposite that of the recording system. Until the record manufacturers got together a couple of years ago and agreed on a standard, this was a real headache. Present playback compensators are relatively simple devices, however, and are ordinarily incorporated as an integral part of the reproducing system. More elaborate compensators are no longer necessary, except for those whose record collections include a lot of earlier material.

And that is the how-it-works of hi-fi. Now let's get on with how-to-do-it. •



Starting Off Right

Thorough planning is vital to setting up a hi-fi system because you'll probably build your system little by little rather than buy it all at once.

DEMONSTRATION ROOMS, such as this one at Harvey Radio Company in New York City, enables hi-fi fans to make accurate comparison auditions.

TABLE LOUDSPEAKER by Jensen demonstrates that hi-fi equipment need no longer be treated like an ugly duckling, is now handsome furniture piece.

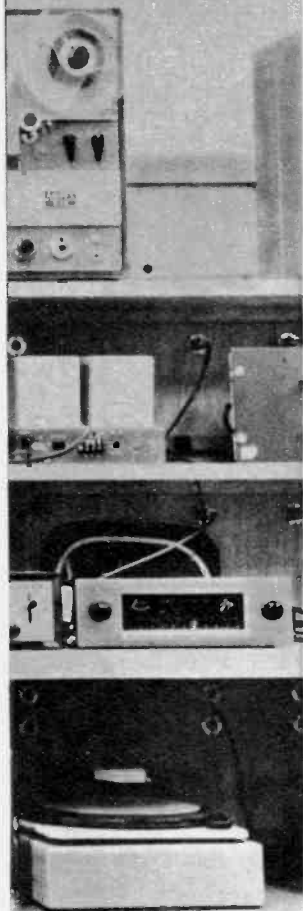

BEFORE you make any investment at all in hi-fi equipment, I cannot emphasize too strongly the importance of very thorough planning. In all likelihood you will build up your system as you go along, rather than buying everything at once.

Consider first, then, the various program sources available for hi-fi reproduction, and determine the relative importance of them to you. You have a choice of at least six possible sources, including AM radio, FM radio, phonograph records, recorded tape, television audio, and sound movies.

In all likelihood you probably have some kind of radio and TV reproduction already,

and if you have a sound movie projector, that, too, has gotten along without a hi-fi setup. So you'll probably begin with a system devoted exclusively to records or tape. Since the repertoire of records is so much greater than that available on tape, and since recorded tapes are somewhat more expensive, the most logical beginning for you will probably be a record-playing hi-fi system.

You will then begin with three basic units, consisting of a record reproducer, audio amplifier, and speaker system. The first reproducing element is the record turntable or changer, and already you must

make a choice. Personally I prefer the unadorned turntable, for reasons which I have detailed in *Hi-Fi Manual and Low Cost Hi-Fi*. There are good arguments for both sides of the question, however, and you should consider them carefully before you decide.

Whichever type you get, it should operate at all three standard speeds, and possibly you will want the newest speed of 16 $\frac{2}{3}$ r.p.m. as well. (See chapter on *high-way hi-fi*.) It should accommodate all sizes of records up to at least 12 inches, should rotate them at precisely the required speeds, without slippage and without contributing noise or rumble.

Basic Hi-Fi Pickups

The pickup should have a choice of the two common styli sizes, 1.0 mil and 3.0 mil, and both of these should be preferably made of diamond. There are two basic types of hi-fi pickups available today, one operating on magnetic principles, the other being the crystal or ceramic unit. There are excellent pickups in both types, but there are two factors which must be considered as they pertain to the equipment following.

In general the output of the piezoelectric (ceramic and crystal) types is much greater than that of the magnetics. This means that no preamplifier stage is needed. Since all of the other sources have outputs great enough to obviate the preamp, it may be possible to exclude this unit completely.

A few years ago this would have been a much more important consideration, when preamplifiers were almost always separate units. Today, however, the main power amplifier usually includes the necessary compensation and sufficient gain to handle input signals of any magnitude. This means that the separate preamplifier is obsolete anyway.

The waveforms of the voltages generated by the two types of pickups when tracking a record are considerably different. It is absolutely essential, therefore, that the equipment which follows the pickup has the correct type of record compensation for the pickup you intend using.

The main amplifier is the unit which receives the feeble voltages from any of the several signal sources and builds them up to the point where they can drive the loudspeaker efficiently. It is here that the various controls will usually, though not always, be found. Since we are discussing here the possibility of as many as six signal sources, this means that the amplifier must have six separate inputs. I don't know of any hi-fi power amplifier having such provisions, and if your contemplated rig

is to be this elaborate, perhaps you should consider the possibility of a separate audio control unit ahead of the amplifier.

The control unit will handle the switching, compensating, volume and tone adjustments for all six inputs, while the amplifier is "basic," being a fixed-gain device without any controls at all. Whichever method is used, or some other variant, it is very important to determine at the outset where your control center is going to be in the circuit, and to avoid future additions which will make for duplication of controls. Such duplication is not only wasteful, but it also makes for operational problems and is a potential source of distortion.

The amplifier itself must be virtually free of distortion, of course, although this is hardly a serious problem any more. The power rating of the amplifier chosen will depend somewhat upon acoustical requirements and also upon your personal desires. The amount of amplifier power necessary to fill the room with sound will be greater, of course, the larger the size of the room. Assuming a normal-sized living room or den, without an undue amount of highly-absorptive surfaces on the floors and walls, the amount of power necessary will seldom be more than 25 watts, and as little as 10 will often prove to be sufficient. If in doubt, you should definitely err on the high side. It is not possible to add on an additional power amplifier after the first to boost power at a later date, and trade-in deals in the hi-fi market are hardly worth the trouble.

Electronic Crossover

One way out of the dilemma, however, would be the Electronic Crossover, offered in kit form by the Heath Company. This is a system whereby the signals destined for the several loudspeaker elements are divided before amplification and then amplified separately. Since it is only the extreme bass frequencies which require tremendous power, it is possible to extend your system frequency response and power capabilities simultaneously. There will be more about this in the chapter on kits.

If you don't use the electronic crossover, then the usual dividing network must be placed between the amplifier output and the speaker input. It has long been known to hi-fi fans that the most efficient method of sound reproduction is one having a multiple speaker system. In this case there are one or more speakers for each part of the frequency range, the signal being divided among the speakers on the basis of frequency. The speakers are often radically different from one another in design, each unit being intended specifically for its defi-

how to connect cables for installation

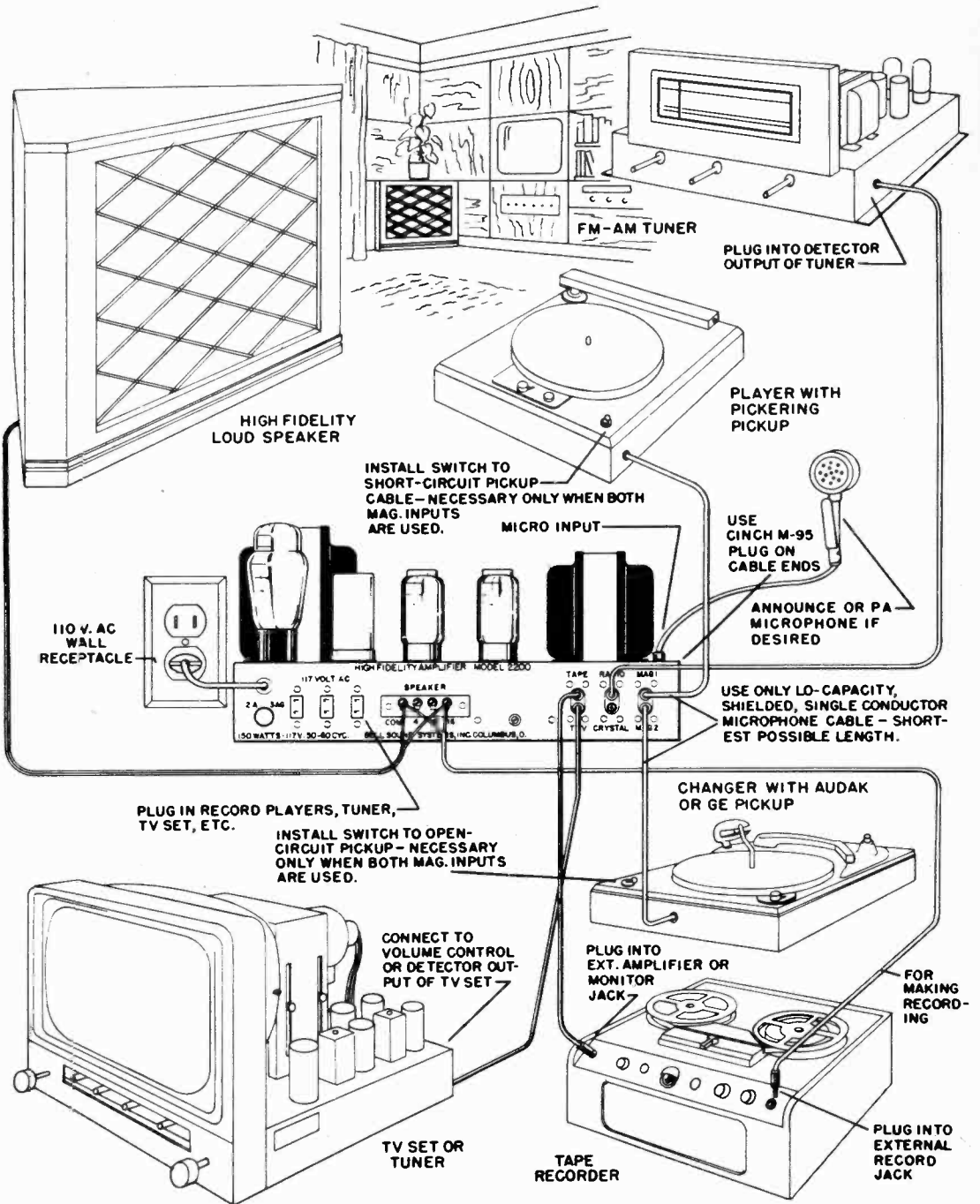

FLEXIBILITY is the keynote of an integrated hi-fi system. Heart of this installation is Bell amplifier.

nite assigned part of the audio spectrum.

Originally these multiple systems were all two-way only, with a large low-frequency speaker known as a *woofer*, and a smaller high-frequency unit called a *tweeter*. The terminology is presently rather confused, however, with the addition of "squawkers," "super-tweeters" and such. Today three- and four-way systems are quite common, although the principles are the same.

Here is one case where the hi-fi fan gets a break, for the building up of a complete speaker system in easy stages is quite simple and logical. Most manufacturers now provide for this, two excellent examples being the Progressive Speaker Expansion System of University, and the Heath Range Extending Speaker System.

Loudspeaker Enclosure

A proper enclosure is an integral part of good loudspeaker performance, and the manufacturer's suggestions should be followed for best results. And at this point I think that I should suggest that whatever manufacture of speaker you decide upon, you stay with it for the entire reproducer system. There is always the possibility that a type *A* high-frequency unit added to a type *B* woofer element will give absolutely phenomenal results. But since each of these units was designed specifically with others in the same line, it is far wiser to plan on getting a set of matched speakers. Then if performance is not up to par, and you are sure that your installation is correct, you certainly have the right to take it up with the one manufacturer involved.

Having now tentatively decided upon a complete "starter set" of components for a record reproducing system, it is time for a family conference on fitting the hi-fi system into the home decorating scheme. One question which must be decided is whether the system is to be "built-in" or "built-out." A very popular built-in arrangement places all of the components in a closet adjacent to the listening room, with the speakers and controls mounted through a door or wall. This setup causes perhaps the least disruption to the normal household functioning and furniture placement. It is neat in appearance, and requires only the simplest cabinet work. Another common built-in scheme employs existing book shelves, which are often deep enough to house the various components and a speaker enclosure as well.

If you intend using a cabinet, the question of decor assumes much greater importance. After you have decided on a general design which will harmonize with your decorative scheme, you can build your own, construct from one of the many available kits, or buy a finished cabinet

ready to house your various components.

Next, and still before acquiring any actual equipment, it is most important to consider the question of component size against available space. Failure to recognize this seemingly obvious point has been the cause of considerable grief to hi-fi constructors, but you can very easily avoid it simply by proper forethought and planning. Hi-fi components are now made in every conceivable size, shape and style, and it should not be difficult to find just the thing to suit your particular requirements.

It is a good plan now to begin drawing to scale a sketch of the mounting area or cabinet you intend using. Then lightly sketch in the components, showing how each may be fitted into place and mounted. Information on sizes will be found in the manufacturers' literature or distributor catalogs. Placement of the components is not too critical in the technical sense, although it is wise to hold the length of the interconnecting wiring to a minimum. At the same time adequate ventilation must be provided for longer life of tubes and parts, and the units should not be so close together that there will be serious interaction between them. There could possibly be inductive effects between units, which might be conducive to hum or other noises in the output. Most hi-fi equipment today, however, is of excellent construction and well shielded, so that interference effects can be practically ignored unless there is a specific caution in the instruction manual. And right now, of course, is the time to plan for the expansion of the system into its final form, by the addition of other program sources, range-extending speaker elements, and possibly remote controls or more power.

Which of the additional program sources you want, and in what sequence you will acquire them, is, of course, strictly a matter of personal taste. One of them will almost certainly be radio, for there are quite a few good shows on the air, which sound even better through a hi-fi system.

Radio Broadcasting

There are two types of radio broadcasting in common use, the older "standard" type being often referred to as AM, the newer improved type being called FM. The initials stand for the terms Amplitude Modulation and Frequency Modulation, and refer to two different methods of superimposing the audio-frequency signal upon the radio-frequency "carrier" wave.

FM is vastly superior to AM as a method of transmission, the frequency and dynamic ranges being much greater, and the inherent noise much less. But FM broadcasting has the practical limitation that it often lacks access to the same programs as are

produced for AM. And in many parts of the country, of course, there are simply no FM stations at all. Thus either an FM-only or AM-only setup leaves something to be desired for the hi-fi fan. I would therefore recommend that, unless FM is totally inaccessible to you, that you plan to have both in your complete hi-fi system. We'll talk about this in the chapter on radio and TV.

Tape Recording

Tape recording is the newest, and in some ways the most exciting development of all to arrive on the hi-fi scene. In the complete and ideal hi-fi system we have under discussion, your tape recorder will perform a variety of important functions. In addition to live recording, you should be able to record off the air broadcasts from FM, AM, and TV. You can also dub from phonograph records, or even re-record from another tape recorder. In short, anything which goes through your hi-fi system should be capable of recording on tape. Furthermore, in order to use more than a single microphone for live recording, it will be necessary to have a mixer preceding the recorder. This is simply a control panel which permits adjusting the volume of the several microphone or other input channels, and then combines them into a composite signal to be fed into the recorder in the usual manner.

In order to accomplish all this conveniently, without a lot of troublesome switching, readjustment, and a maze of wires running in every direction, there will have to be some careful design planning beforehand. For all but the live recording, the recorder input should be so connected that it receives whatever signal is passing through the hi-fi system. It should be connected across the output of the control amplifier or main amplifier, or at some other point common to all of the incoming signals. This is a little complicated, but it will increase the usefulness of the tape recorder tremendously, and is well worth the effort in working it out. There will be more on this subject in the chapter on tape.

I mention the idea of reproducing home movie sound track through the hi-fi system merely to suggest the possibilities. There is actually very little material on 8- or 16-mm film which can be called hi-fi, although the new magnetic recording method is much improved. Still it sounds better on a hi-fi system, so if you are a home movie fan with sound equipment and hi-fi as well, you should give some thought to combining the two.

Many of the problems of assembling a good hi-fi system can be avoided simply by buying it all in a package, as we will demonstrate in the next section. •

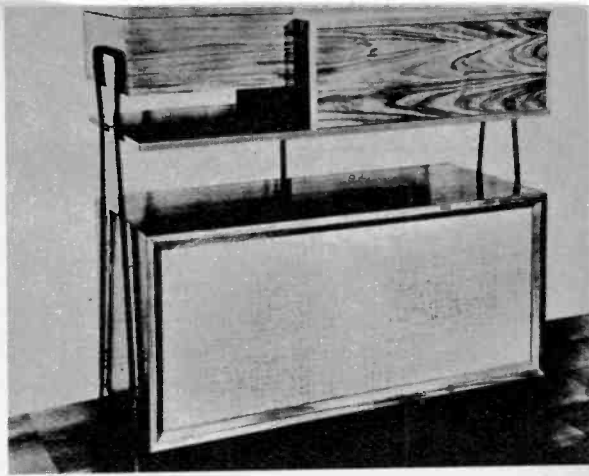

HANDSOME DESIGN combines with sound engineering in cabinets and enclosure by Jeff Markell.

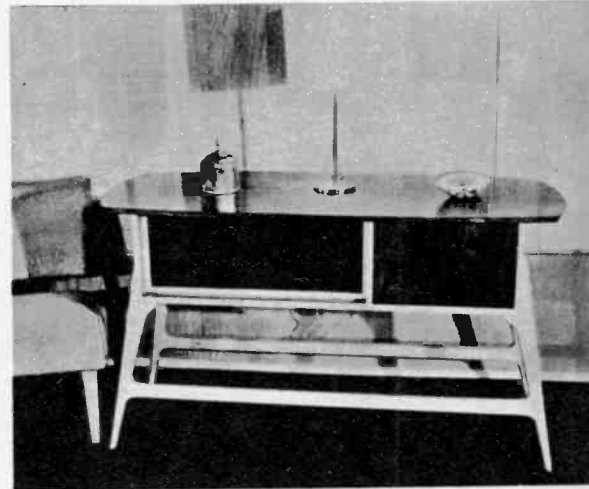

MODERN TREND is again in evidence in Jeff Markell equipment enclosure doubling as fine furniture.

TURNTABLE without changer is choice of avid audiophiles. Among best is Rek-O-Kut Rondine.

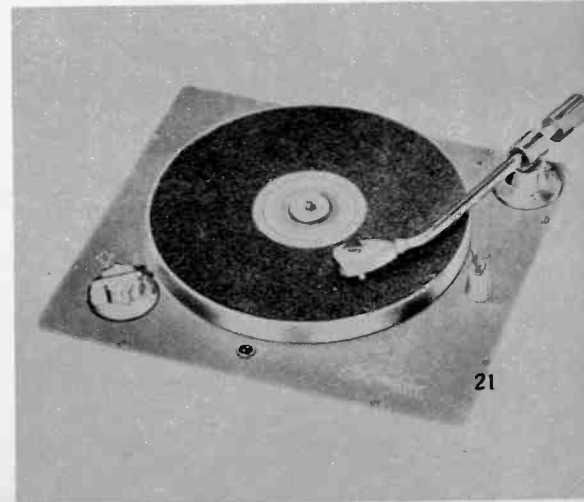

Hi-Fi in a Package

Today's manufacturers make it possible for you to buy a complete hi-fi unit already encased in handsome furniture.



FINE HIGH FIDELITY need no longer be confined to members of the screwdriver and soldering iron set. Handsome furniture is part and parcel of these Altec units.

COMPACTNESS IS KEYNOTE in hi-fi package shown across page. This system includes a phono-amplifier combination, tuner and two-way Jensen speaker.

THE concept of packaged hi-fi has undergone a rather marked change in recent seasons. Originally, the package idea had to do with the simultaneous purchase of a complete set of matched components, selected by the manufacturer or distributor and usually offered at a special price.

More recently the term has been used to refer to high fidelity components which are available in matching cabinetry, thus providing the easiest form of installation for those who have neither the time nor inclination to design their own component layout.

Package merchandise which is truly hi-fi therefore bridges the gap between the raw hi-fi components and the mass-produced low-fi home instrument. It permits anyone who wants good sound reproduction at home, but who doesn't want the work involved in a custom component installation, to buy hi-fi which he can take home, unpack, plug in the wall socket, and play.

These are certainly very important advantages to the hi-fi devotee who is not mechanically inclined, but the system also has its dangers. How can the non-technical person really be certain that what he is getting is genuine hi-fi? How can he guard against buying just one more junky radio-phono-TV combination? The answers to these questions are not always easy to find, but there are certain basic principles which will guide the package purchaser in his quest for quality.

One possibility of confusion arises in the case of the manufacturer



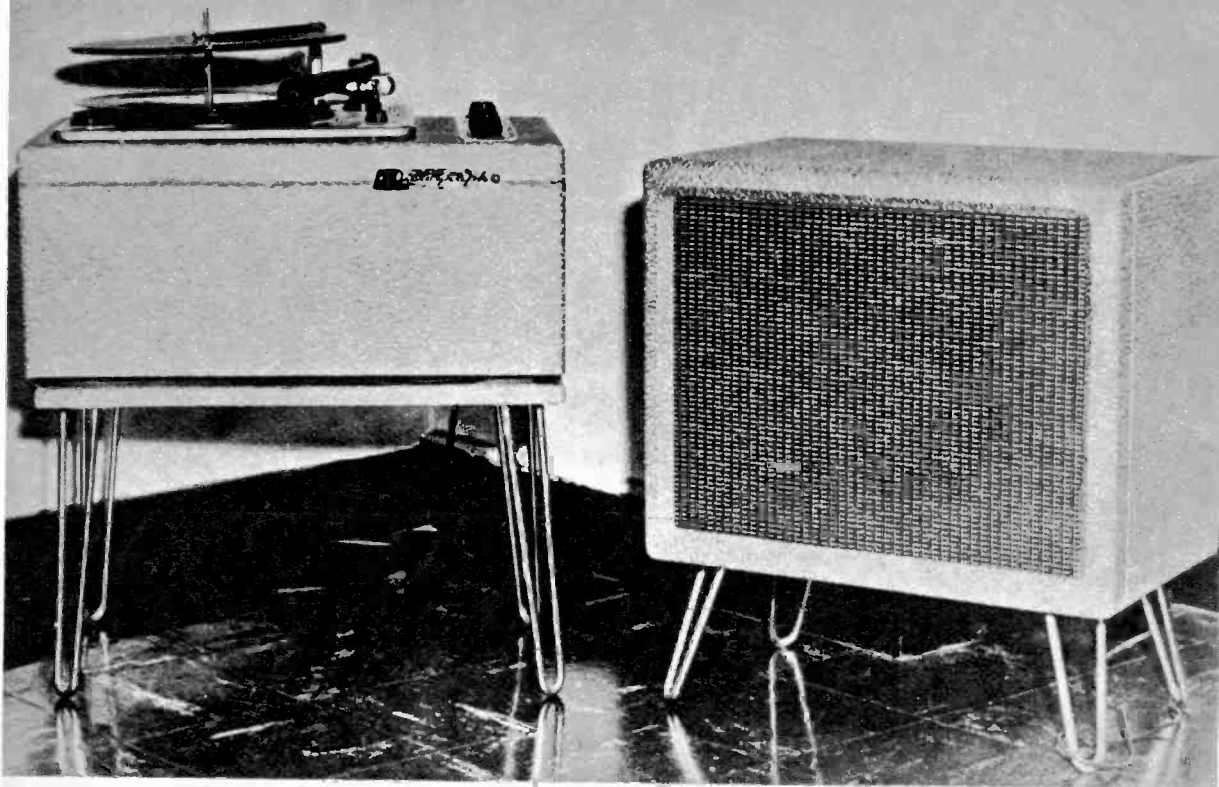

PACKAGED PHONO system by Dictograph includes changer, amplifier and two-way speaker.

who offers all three types of merchandise: components, packages, and conventional home instruments. It is essential then that his package line be made up of components from his hi-fi group, not from the home instruments. Just about the only way that the purchaser can be certain of what he is getting is to make direct visual check whenever possible. Look inside the cabinets and make a part-by-part comparison between the several types. The chassis in the average home instrument looks rather unlike that of the usual hi-fi amplifier. Differences in speakers, record players and controls are also readily apparent.

Beyond this there are five Hi-Fi Rules-of-Thumb, the strict observance of which will almost certainly prevent you from making any drastic errors. They describe five features, all of which the system must exhibit before it can be called truly hi-fi.

(1) *Separate speaker cabinet.* The loud speaker must be housed in an enclosure entirely separate from the amplifier and the record turntable. When all three are one cabinet, as they always are in low home instruments, the intense vibrations from the speaker are transmitted through the cabinet, or the close-coupled air within it, directly to the delicate phono pickup and the microphonic tubes of the amplifier.



HI-FI **ALTEC**
RULES-OF-THUMB
MUST HAVE...

- 1. Separate speaker cabinet**
- 2. Three record crossover selections**
- 3. Separate bass and treble controls**
- 4. Genuine two-way speaker**
- 5. At least two cubic foot speaker enclosure**

COMPACT AND ATTRACTIVE is the Dictograph housed in mahogany or oak wood cabinet.



CORNER SPEAKER used with Dictograph system improves bass response and sound dispersion.

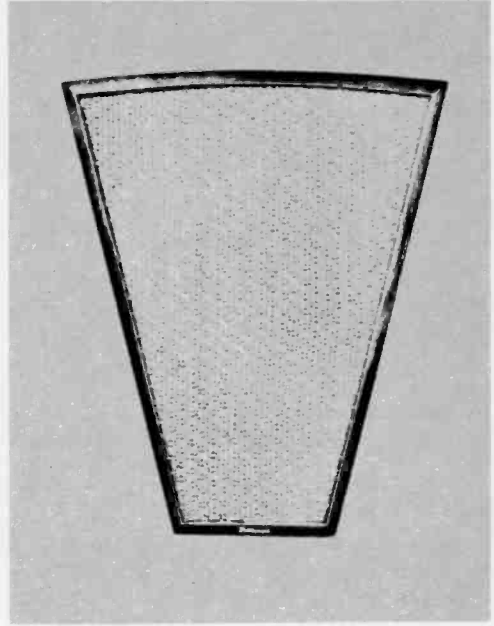

The result is feedback and intermodulation. Most home instruments are even deliberately designed to attenuate the powerful bass frequencies, so as to minimize this problem. Obviously such an arrangement can hardly be considered hi-fi.

(2) *Three record crossover selections.* Although the domestic record industry has now standardized fairly well on a single recording characteristic, this agreement has not been in effect for long, and any record library which is fairly extensive will certainly include many discs having other characteristics. Of utmost importance, of course, is the new standard curve, which on the control may be indicated as RIAA, NARTB, ORTHO, or RCA. Second in importance is an older characteristic which was used extensively in the late 40's and early 1950's. This may appear on a control position marked AES or LP. Usually, there should be compensation for 78-r.p.m. records, the sort of curve which is still used by some European companies. This might be marked FOR, EUR, etc. Even three such equalization characteristics as these involve some compromises, and they are therefore the bare minimum for hi-fi requirements.

Separate bass and treble controls. These are primarily for adjusting the sound

for the acoustics of the listening room, and for your personal taste. To a lesser degree they are useful in compensating for deficiencies in the equipment, records, or broadcast transmissions. If the controls are not independent of each other, and if they don't provide both boost and rolloff, they can't possibly do the job required of them.

(4) *Genuine two-way speaker.* This is one which has been kicked around unmercifully by the home instrument promoters. So much has been said about multiple speakers for hi-fi, that many of the build-it-down-to-a-price people are simply adding a couple more cheap 5-inch speakers to their rigs, and then blandly implying that they offer truly wide-range hi-fi, or even in some cases that such an arrangement is tantamount to stereo! The simple act of adding more speakers of the same kind to a system in the hopes of extending the range is sheer nonsense. The reason for multiple hi-fi speakers is the fact that no one speaker can reproduce all ten octaves which are audible to the ear. Two or more speakers are therefore used, but each one is specially designed to operate only in a designated range, and dividing networks are used to keep each out of the other's territory. Unless the package speakers comprise a *multirange* system,



MAESTRO SYSTEM by Radio Craftsmen features a loudness control and nine equalizer settings.

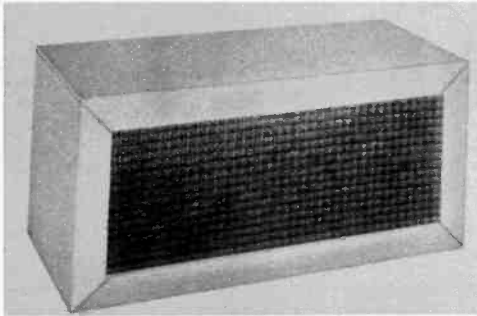

THREE-WAY speaker system encased in genuine woods completes reproducer of Maestro unit.



PLUGGING IN phono cartridge, usually packed separately, readies the combination for service.

with two or more different and specialized radiators, they cannot at this state of the art be regarded as truly high fidelity.

(5) *At least two-cubic-foot speaker enclosure.* The size of the speaker is one factor in determining its ability to reproduce bass tones. The two-cubic-foot figure is correct for an 8-inch speaker, while anything smaller than eight inches will be practically useless for low-frequency reproduction. In the case of the bass reflex enclosure, which is by far the most commonly used type, it is *not* true that the larger the cabinet the better. The fact is that there should be a rather close correlation between speaker size and the inside volume of the enclosure. For best results, the sizes should be within 10% of the following:

Speaker Diameter	Enclosure Volume
8 inches	3,530 cu. in.
10	5,980
12	7,690
15	9,990
18	13,900

Anyone can apply these five Rules-of-Thumb. You needn't be an expert. You will note that I haven't even mentioned the usual criteria of frequency response, distortion, power output or hum level. The trouble is that these factors are often the subjects of exaggerated advertising claims,

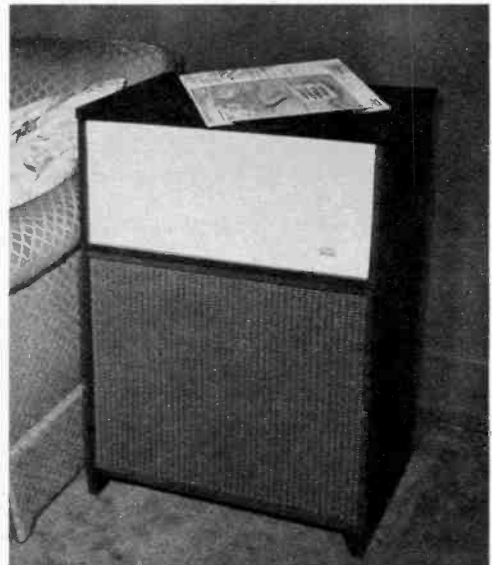

HEART OF Altec package line is Melodist, with changer, controls, amplifier, and optional speaker.

simply because the average person has no way of proving or disproving them. But if the hi-fi package satisfies *all* of these five rules, one can assume rather safely that it has been engineered to provide all of the other performance characteristics essential to true high fidelity reproduction.

Probably the outstanding low-cost system in which this is true is the Dictograph home music system. Since it does adhere to our five rules-of-thumb, let's skip over to examine some of the other design features which contribute to making this system a best buy in the field.

Good Low-Cost Systems

This is basically a phono system, but it includes built-in auxiliary inputs for tape, TV and radio. The reproducer is the G.E. variable-reluctance cartridge, a very fine all-around performer, equipped with two jeweled styli, the microgroove point being a genuine diamond. This feature is unique among both packages and components in the low-price range.

The changer is a Collaro 3-speed intermix, certainly among the better brands on the market. Although the manufacturers do not mention it as a feature, I think it important to note that it is possible with this changer to take the pressure off the idler wheel when the turntable is not operating, thus avoiding flat spots and wows. To do this, simply turn the three-position

speed control switch to a point *midway* between settings. That is, when turning off the power, cultivate the habit of simultaneously snapping the speed-change switch into the notch midway between 33 and 78, or between 78 and 45. You'll get better performance longer if you do.

The amplifier is a 7-tube Williamson type, very conservatively rated at 10 watts. This same amplifier, incidentally, under the trade name of its own manufacturer, has been widely acclaimed as a best buy in its own right.

The speaker system is a 2-element array, with excellent performance between 40 and 15,000 c.p.s. With the soft suspension typical of the European speakers it uses, the response is exceptionally smooth and mellow.

Although this basic system has provision for expansion to all the other sound sources, and for simultaneous operation of two separate speaker systems, some audiophiles might still feel that expansion to higher powers and larger speakers would be inhibited. I personally wouldn't let such considerations stand in my way, for the Dictograph is ideal as a *second* system.

It is relatively light and portable, and I have found it perfect for providing dance music at parties and for outdoor use on my patio. It should also be excellent for students away from home, servicemen, and doctors' or dentists' waiting rooms. Any-



OUTSTANDING FEATURES of Melodist amplifier are explained to author Don Hoefler by Marvin Kline of Altec Lansing Corporation. This unit is for those who wish to install changer or player separately.

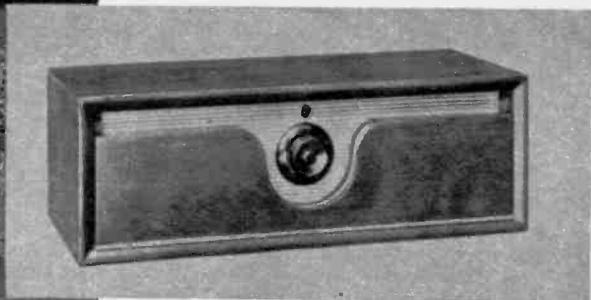

CONTROL PREAMPLIFIER at left has elaborate controls for adjustment in package unit by Altec.

CLOSED DOOR over secondary controls (above) improves looks, simplifies operation for others.

where that space is limited and mobility necessary, the Dictograph system is just the ticket.

A little more expensive, and less adaptive to portability, is the Maestro, recently introduced by the reorganized Radio Craftsmen group. This is likewise basically a phono system, housed in two separate units of wood, finished in genuine mahogany or limed oak.

The changer has four speeds, and is equipped with a variable reluctance cartridge with diamond stylus. Power output is 10 watts, with loudness control and nine effective record equalization positions. The input is designed to permit the substitution of a ceramic cartridge, and to accept signals from tape, TV and tuner.

Three-Way Speaker

The speaker system is three-way, with an 8-inch woofer, 8-inch midrange, and 3-inch tweeter. The enclosure is the bass reflex type, finished to match the phono-amplifier cabinet.

Probably the leading producer of an integrated package line of true high-fidelity equipment is the Altec Lansing Corporation, pioneers in motion picture theatre sound and home high fidelity reproduction. Altec was perhaps the first to attack the problem of achieving hi-fi in various types of furniture pieces, of restricted dimensions and suitable decor, to meet the taste and space requirements of various households.

They offer their regular catalog high fidelity components in a variety of furni-

ture pieces designed to meet various home-furnishing demands. All units in the package line are available in the most popular finishes, mahogany or blonde.

The basis of the system is the Melodist combination, consisting of a control preamplifier, power amplifier and Collaro changer housed in a single cabinet. The compensator has a choice of four characteristics, and the amplifier is conservatively rated at 10 watts, from 20 to 22,000 c.p.s. For those who have a separate changer, or who desire a different cabinet design, the Melodist control and power amplifiers are available alone in another enclosure.

If a more powerful amplifier is desired, it can be purchased from the component catalog, put out of sight in a closet, and the 440B control preamplifier and its cabinet installed in the listening room. Also available in matching cabinets are an FM-AM tuner, as well as an AM-only tuner.

There is a choice of several fine speakers in enclosures available for use with these units. The smallest is known as the Melodist, and is a two-way system having a 10-inch woofer and horn-type tweeter, with a crossover frequency of 3,000 c.p.s. Where budget or space requirements are important factors, this little speaker is ideal. Weighing only 30 pounds, and measuring but 23"x11"x10", it works fine in a bookshelf installation. Range is guaranteed from 70 to 22,000 c.p.s.

Higher up on the scale are the two iconic speaker systems. One known as the 824A uses a 12-inch woofer, and has a guaranteed

ICONIC SPEAKER at right is best system recommended for use with basic Melodist combination. It has a frequency response which is guaranteed as 35-22,000 c.p.s.



range from 50 to 22,000 c.p.s. The larger iconic, called the 826A, has a 15-inch woofer, and its range is guaranteed to be 35 to 22,000 c.p.s. All of these speaker systems reflect the Altec philosophy of a maximum of two speakers, mounted in a bass reflex enclosure. Their reasons for this are argued very convincingly in the chapter titled *What About Loudspeakers?*

Top-Ranking Package

The *ne plus ultra* of high fidelity package systems is the Fisher President, which sells for just five dollars less than a cool two thousand. This is a 32-tube instrument, constructed on five separate chassis, with separate FM and AM tuners for either stereo or monaural operation, two separate 60-watt power amplifiers, and a stereo master audio control center. Five meters are included for accuracy in tuning and stereo program balancing.

There is a three-speed changer with magnetic cartridge and two diamond styli, and a stereo and monaural tape phonograph. Storage facilities for both records and tapes are provided in the console.

Two completely separate three-way speaker systems are included, which may be operated split for stereo or simultaneously for monaural. In short, if this big job hasn't got it, you just don't need it!

This, then, covers the packaged hi-fi picture, from less than \$200 to just under \$2,000. The choice isn't nearly as wide as in the component field, but there is now good quality available for those who don't want any fuss or bother. •

PRESIDENT SERIES by Fisher is the ultimate in hi-fi packages. Size is 70 inches wide, 33 inches high.

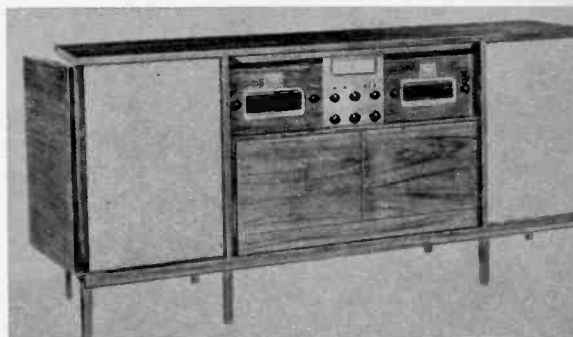

PULL-OUT DRAWERS provide easy access to tape phonograph, record changer and storage area.



Building From Kits

It's easy and lots of fun to construct your own hi-fi system. More than that, there's a tremendous personal satisfaction involved.

KIT BUILDING can be a family affair when father and son pitch in together, as in the photo at right. Electronic construction is not messy, so no workshop is needed.

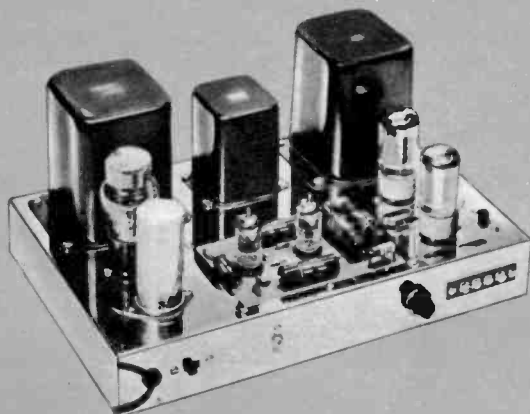

PRINTED CIRCUITRY is a feature of Knight amplifier, with straightforward design and construction.

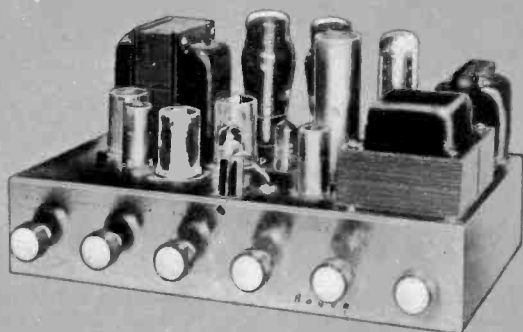

NEWEST KITS are those bearing well-known Bogen name. Model DB20 is now in do-it-yourself form.

I CAN imagine many reasons why one might want to construct his own hi-fi system rather than buy a package or a group of components. A fellow might be a student or experimenter who wants to increase his knowledge. Or he could be a music lover who wants just as much hi-fi as he can squeeze out of a limited budget. But I think the very best reason of all is the tremendous satisfaction one feels after

having done it all himself. I have built a complete Heathkit hi-fi system and I can tell you it is a truly gratifying experience.

Now perhaps you think it's a little out of place for an old pro, who has designed and built several broadcast stations, to be telling you of the delights in store for Mr. Joe Average when he builds his own. And you could be partly right. But while my experience might enable me to do this sort



of thing blindfolded, it also certainly would tend to take some of the sheen off my enthusiasm. Despite this I can still say that building from kits is just downright good fun.

There's something else about that, too. Anyone, by the time he has completed building his second Heathkit, is an "old pro" in his own right. This fact, while on the one hand it is very gratifying to the

manufacturers, is at the same time the source of a few headaches at the plant. The problems come when a new kit is developed and is ready for production.

In order to be absolutely certain that their kits are perfectly simple to assemble and that their instruction books are readable and accurate, they "test-hop" a few of them with non-technical personnel and friends. These human guinea pigs may be

CAUTION!!

DO NOT DISCARD ANY PACKING MATERIAL UNTIL ALL PARTS ARE CHECKED AGAINST THE PARTS LIST IN THE MANUAL

ALL PARTS of this Heathkit are carefully laid out preparatory to inventory by the constructor.

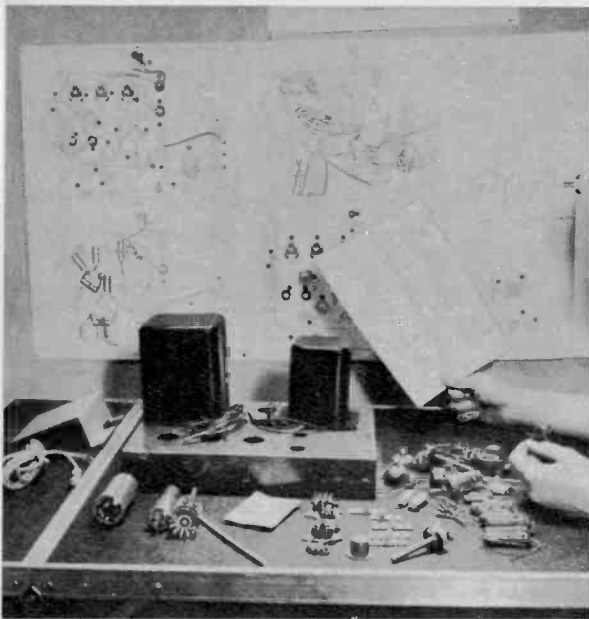

EACH PART is checked against parts list to find components possibly misplaced during unpacking.

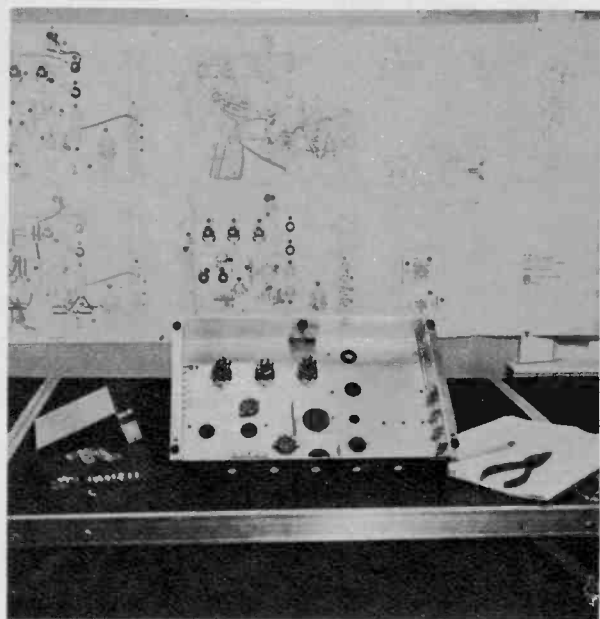

FIRST STEP in construction is mounting of hardware on chassis. Note instructions mounted on wall.

office girls, clerks, shippers, accountants, in fact anyone who can't tell a nut from a bolt, a tube socket from a transformer. They are then told to build the kit, following the instruction book precisely, and to report any difficulties encountered. The engineers digest all these reports and remove the "bugs," so that when the kit is placed on the market it is as simple and accurate as humanly possible to make it. Then they go on to the next project.

Becoming an Expert

And now is where the trouble begins. The Heath people have learned from long experience that, once one of their amateur constructors has built two kits, he or she is no longer useful as a criterion. He is already too sophisticated in the ways of electronics. He overlooks gaps in the instructions. He improvises around the mistakes. Since those gaps and mistakes are the things the manufacturer is looking for, so that they may be eliminated before the kit is offered to the public, such a person is no longer useful as a trouble-spotter.

This, then, is the point of my argument. If any rank amateur selected at random can become a real expert so quickly, then certainly you would experience no difficulty in building any or all of your own

hi-fi components. And the kick you'll get out of tuning in your first radio signal or playing your first record, on a system built with your own hands, is something you'll find in no other way. Then when you proudly show off your new system to friends and neighbors, the -fi will seem at least twice as high.

The only qualifications you need for assembling a well-designed kit are the ability to read and follow instructions, the knack of soldering an electrical joint, and the ability to use a couple of simple hand tools. Now the first qualification you obviously have, or you wouldn't have spent good money on this book. The other two qualifications are utterly simple, and if you don't have them now, just stay with me for a few more paragraphs and they shall be yours.

We'll begin our tips on soldering technique with the obvious truism that first you'll need a soldering iron and some solder. I suggest that after you have these items ready for use you practice with a few odd lengths of wire and a tube socket for a half hour or so.

Before that, though, you'll have to decide what type of iron to get. It should be electrically operated, of course, the best types for radio work being the 50-watt "pencil" type, the standard 60- or 100-watt

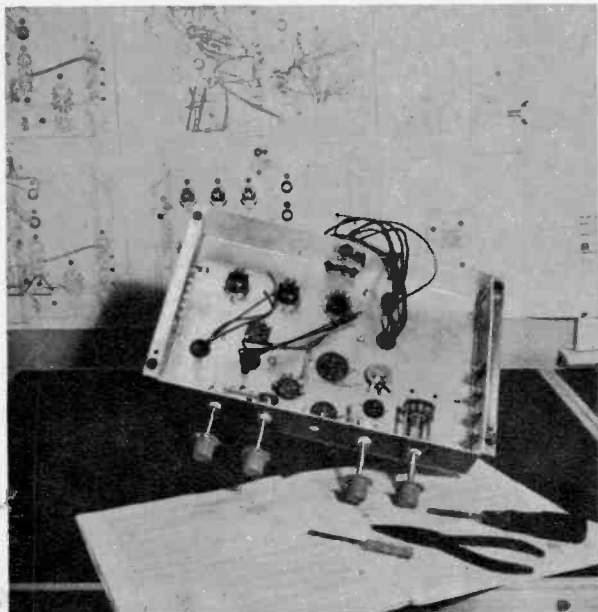

TRANSFORMERS and switches are installed next. Instructions are checked off as each step completed.

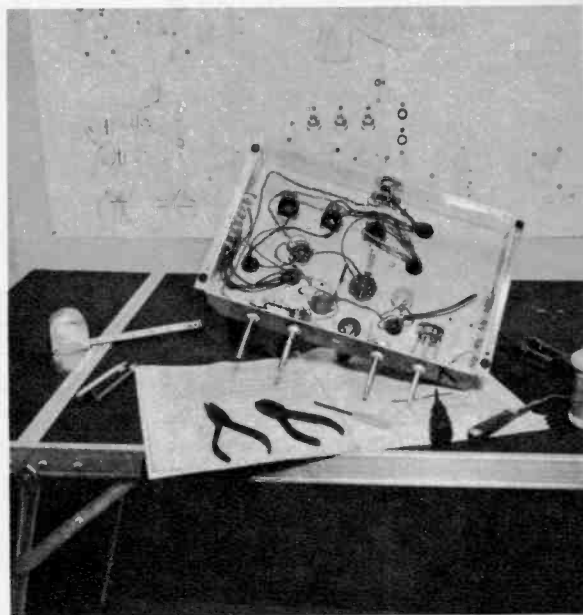

COMPLETION of first stage finds transformers and tube filament power circuits secured in place.

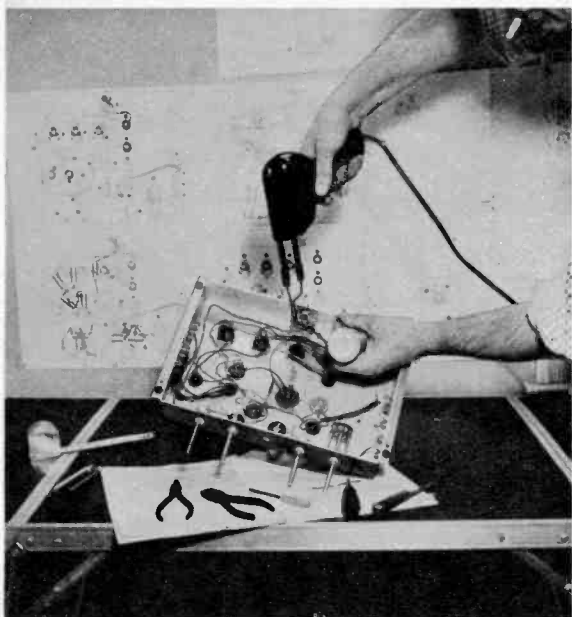

SOLDERING GUN is a safety plus for constructor with children. Tip is hot only as joint is made.

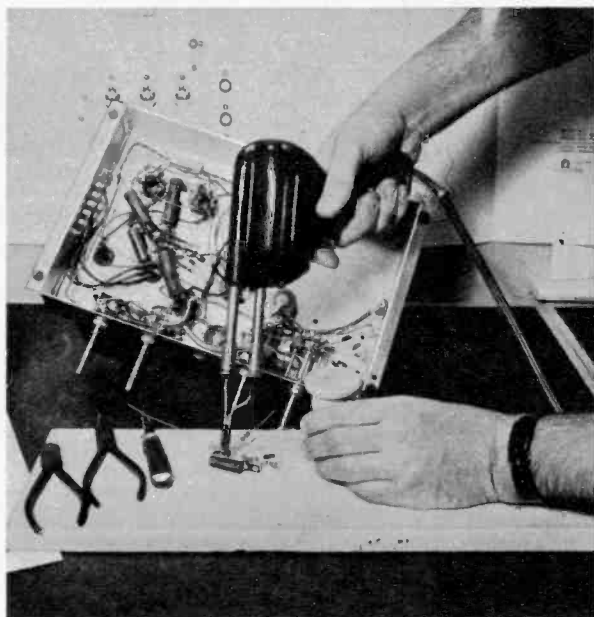

SUB-ASSEMBLIES prior to installation become common as work progresses, avoiding any mistakes.

irons, or the high-speed soldering "gun." Your best bet as a start for all-around work will be the 60- or 100-watt size.

The type of solder used is extremely important. The only kind acceptable is that marked *Rosin Core Radio Solder*. This type is an alloy of tin and lead, usually in the proportions 50-50 or 40-60. Running lengthwise through this wire-like material are one or more tubular holes, which are filled with a compound of rosin. This is known as *flux*, and acts as a cleaning agent in the operation. Never under any circumstances use a substitute for radio soldering, nor should you use any separate flux, not even the type claiming to be a "non-corrosive" paste. Corrosion, short-circuits and ultimate breakdown of the equipment are sure to result if these precautions are not observed.

The first step in preparing a new iron for use is known as "tinning." Begin by plugging the iron in and rubbing solder against the tip every few moments. The iron won't be hot enough to melt the metal at first, but continue the operation so that solder begins to flow the instant the heat is great enough. The purpose of this is to have the tinning accomplished before the copper tip gets a chance to oxidize. With molten solder flowing freely over both faces of the

tip of the iron, wipe off the excess with a rag rolled up into a ball, thus exposing a thin, shiny layer of tin covering the tip. Now you are ready to proceed with soldering operation. In time the tinning will become dull and flaked, and the tip may even become pitted. When this happens, simply file the tip faces down flat and tin again as before.

Soldering Preparation

You'll have no difficulty soldering as long as the terminals on which you're working are bright and clean, and the wire ends free of wax, frayed insulation or other foreign substances. A bit of sandpaper or a knife edge are useful in cleaning terminals when necessary. Do not use emery cloth or paper, however, as the abrasive is electrically conductive and may cause trouble later.

Now crimp or otherwise secure the wire (or wires) to the terminal, so that the joint will not have to rely upon the solder for physical strength. Then the well-tinned tip of a hot soldering iron is placed against the joint so that the terminal itself is sufficiently heated to cause melting of the solder. Solder is then placed against the joint and will immediately begin to flow. Melt only enough solder to cover the junc-

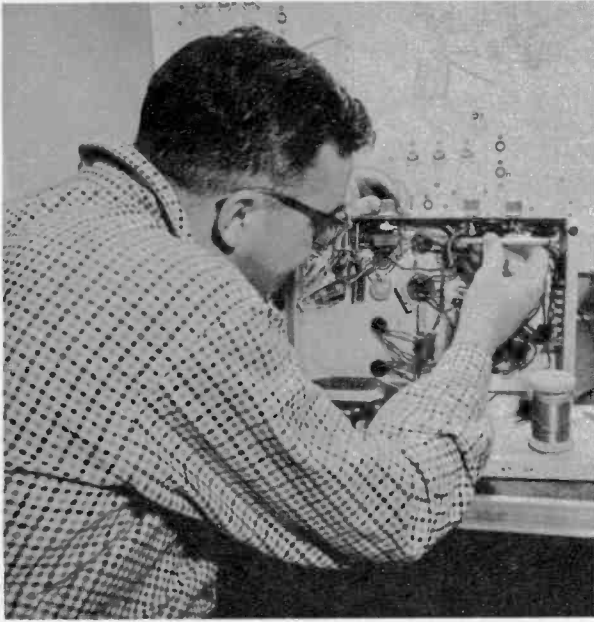

FINAL CHECK of circuit is made before power is applied. Trouble is thus avoided at the outset.

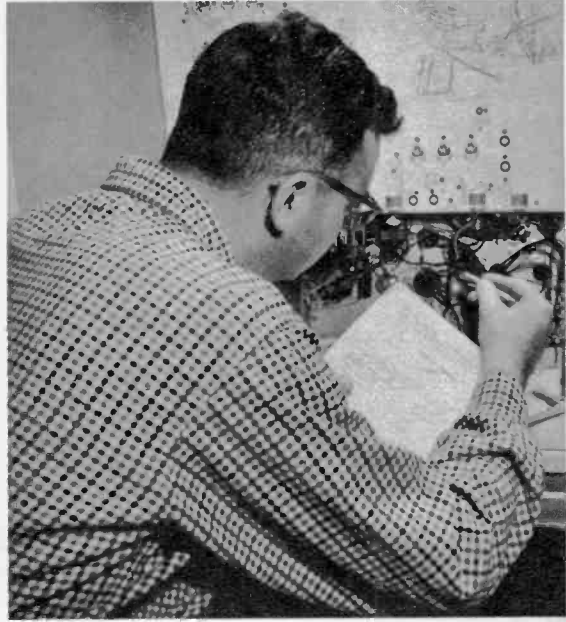

MISTAKE is found and safely corrected. Shielded wire was touching another circuit and shorting.

IT WORKS! Little daughter is almost as proud as father when Heathkit amplifier first performs.

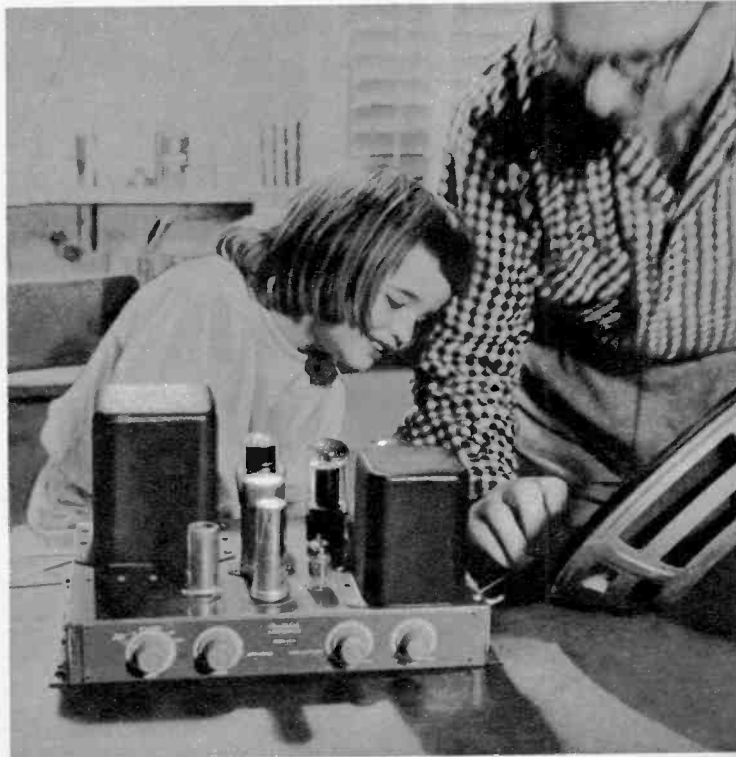



a system built entirely from kits

AMONG FIRST practical applications of old theoretical principle is new Electronic Crossover introduced in the Heathkit line. This system permits signal division at low level, prior to power amplification, rather than in crossover network usually between amplifier output and speaker input. Since most of the power requirement is at extremely low frequencies, the addition of a small low-power amplifier is sufficient for the treble region. Advantages include greater efficiency and flexibility, as well as lowered distortion, particularly in the very difficult crossover region.

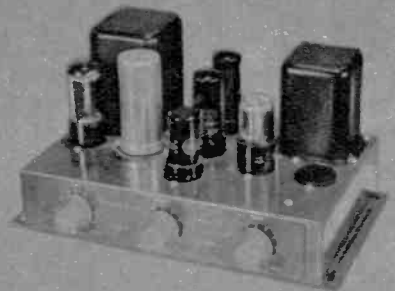
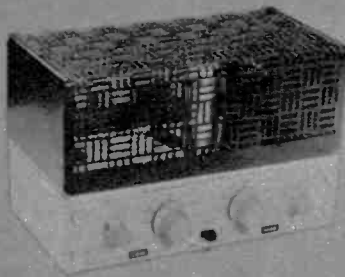

ELECTRONIC CROSSOVER (center above) features choice of seven different crossover frequencies, from 100 to 3,500 c.p.s., plus built-in high pass and low pass filters. Separate level controls are provided for each of the two outputs. **Small power amplifier** (above right) is sufficient for high frequencies.

tion. It is neither necessary nor desirable that the entire hole in the terminal be filled. Excess solder flowing into the contacts of tube sockets or switches may well ruin them. It is wise to position the work so that gravity will tend to keep the solder where you want it.

The quality of a solder joint can be readily told by its appearance. If the solder stands up in a blob on top of the connection, or has a crystalline or grainy texture on its surface, it is a "cold" joint and must be reworked. In a good solder joint the metal cools to a smooth, bright, well-rounded appearance, after having obviously been well melted and flowed. To sum up, soldering is really a quite simple process, and if you bear in mind one simple rule every soldered joint you make will be perfect. Just remember that the solder is *always* to be melted by the parts to be joined, *never* by the iron itself.

Necessary Hand Tools

The next common tool you'll require for your kit building is a screwdriver or two. The ordinary flat-bladed screwdriver is usually designated in terms of its blade length. Thus a 4-inch screwdriver has a blade four inches long. It is fairly important that the size screwdriver you use be one intended for the screws involved. Obviously an oversize tool is useless, but

one which is greatly undersize is difficult to work with and may damage the screw slots. For most electronic kit construction you'll probably never require anything larger than a 4-inch model, although wood cabinet kits may well call for something bigger.

Screws are of three basic types. Wood screws are intended for fastening wood or some other material to wood. They cut their own thread into the wood after an undersize starter hole has been drilled. In audio work this type of fastening is confined almost exclusively to cabinet work. In most kits, starter holes and countersink holes are already drilled. Thus the assembly is simple and obvious.

The next most common type of screw is the machine screw. This is used for fastening in or to metal. It does not cut a thread in the material into which it is screwed. If the screw is to go into a heavy piece of metal, that material must first have a thread cut with a tap in the sides of a drilled hole. This type of construction is not very common in audio work, however. Usually the screw passes completely through holes in the material which are just large enough to allow clearance, and a washer and nut are turned on at the end. With a screwdriver in the screw slot and a wrench on the nut, one or both of them is turned clockwise until snug. The only precautions to observe are to be sure to use the

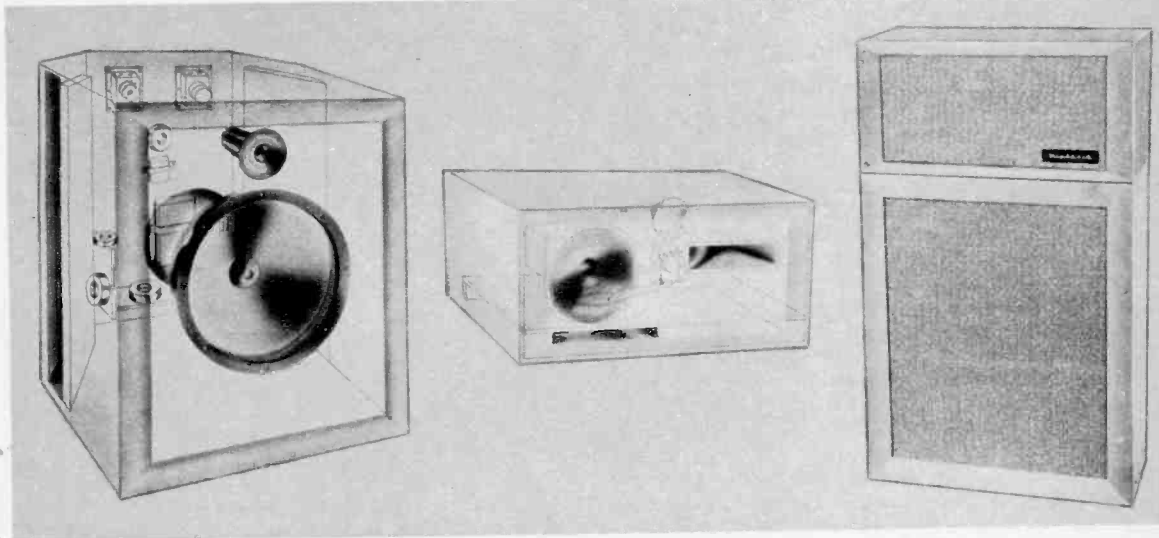

FOUR WAY speaker system is result of adding Heathkit range extending speakers to basic hi-fi unit. Ghost view of midrange unit (above center) shows cone speaker and horn in enclosure. Range extender (above left) adds large woofer and super tweeter. Combination is mounted as shown above at right.

screw size and washer type specified in the kit instructions, and not to turn the screws so tight as to strip the threads.

Wrenches are of several types, including end wrenches, socket wrenches and "finger" wrenches. A very small adjustable end wrench will usually suffice for most kit construction. A set of socket wrenches, of the type with a shaft and screwdriver handle, is easier to use but considerably more expensive. The little finger wrenches look something like thimbles with small openings protruding at one end. They are particularly useful for getting into inaccessible areas. In a pinch, however, you can probably forego the wrenches entirely and get along with just an ordinary pair of pliers.

But while the ordinary combination pliers are a useful multi-purpose tool, you should invest in a pair of long-nose pliers as well. These are handy for working in confined areas and for the finer detail in shaping wires to fit.

Another equally indispensable tool is the wire cutter, usually in the form of a pair of diagonal cutting pliers. Most components, particularly resistors, condensers and audio transformers, are supplied with long wire leads, often referred to as "pig-tails." Since a standard rule in electronic construction is to keep the leads as short as possible, it is necessary after installing a part in place to snip off the excess wire. This is done quickly and simply with a pair of diagonals, and no other tool will do nearly as well.

Use of Pocket Knife

Finally we come to another tool of many uses, the ordinary pocket knife. The most important application in audio work is in the preparation of wire ends for soldering. If the wire is insulated, it may be necessary to trim back the end of it for a quarter-inch or so to expose the metal. Some wires may have additionally a baked enamel coating. In the case of components, many of them are dipped in wax, including the pigtailed. All of this stuff must be cleaned off the part of the wire to be soldered, until clean, bare metal is exposed. One of the easiest ways of doing this is by scraping with a knife. The other, as I've indicated, is with a bit of sandpaper.

With these few simple tools and a good kit, you need only take the time and care to follow simple step-by-step instructions until you have built yourself a complete system of top-notch hi-fi components. There is only one organization at present, however, which offers anything approach-

knock-down kit becomes veneered furniture in two evenings

LOCK-MITER joints are secured by steel angles.

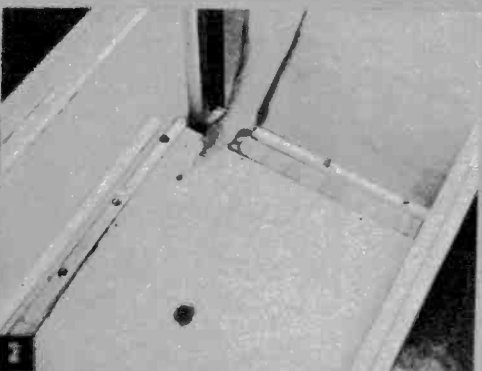
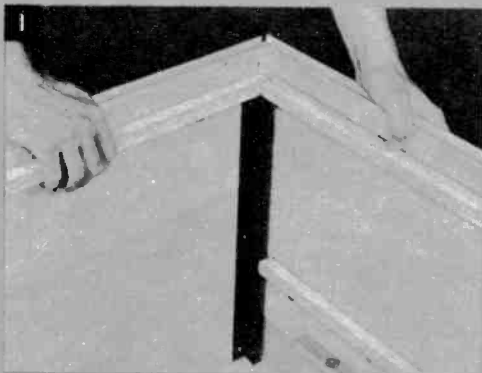

THIRD BAFFLE installed before remaining side.

FIRST BAFFLE of acoustic labyrinth installed.

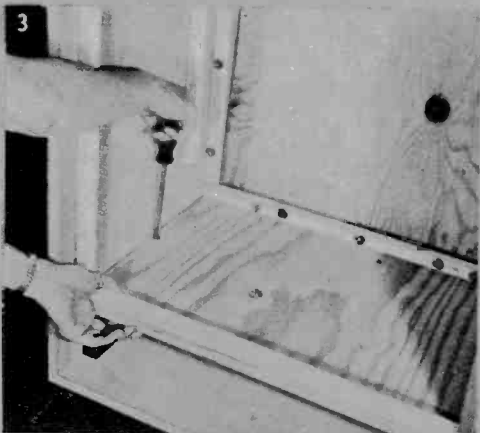

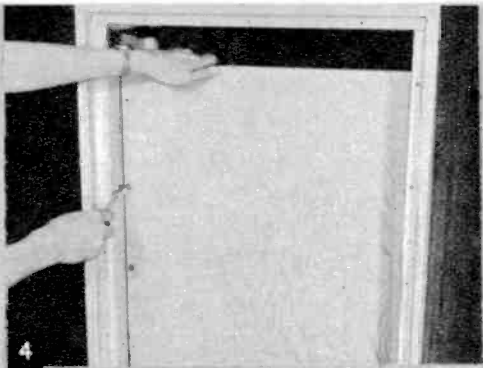

4
THIRD Baffle now aligned and screwed tight.
VOICE COIL lead lugs attached to back board.

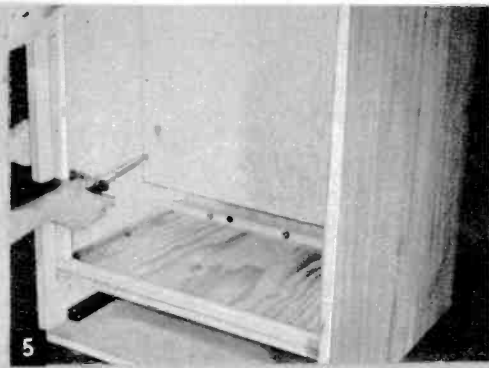

5
SECOND Baffle is the last one to be installed.
BACK INSTALLED with some machine screws.

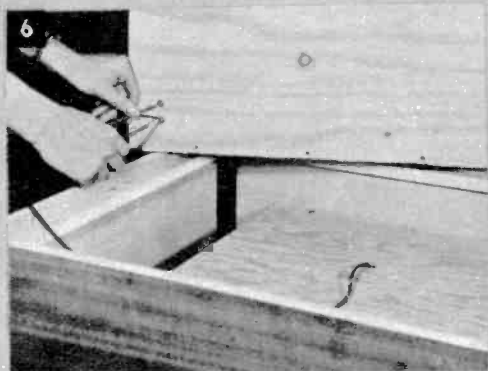

6
LOUDSPEAKER is next mounted on front panel.
GRILLE CLOTH installation completes assembly.

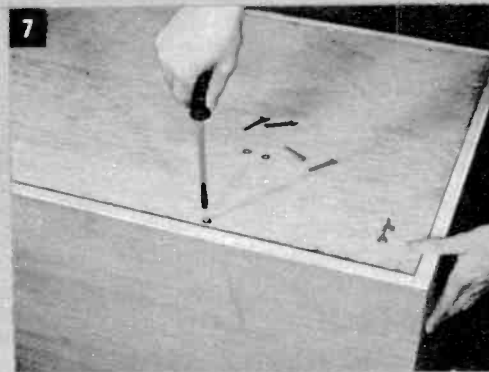

7
SPEAKER PANEL forms glue-free gasket joint.
ACOUSTI-MAGIC system is ready for veneering.

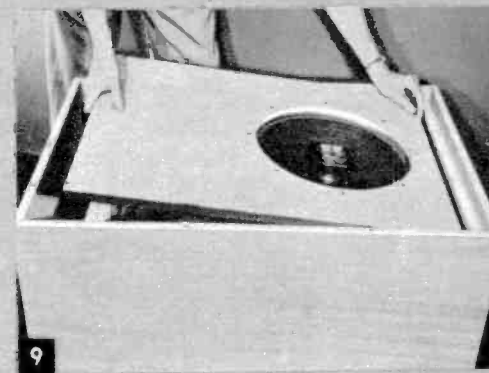
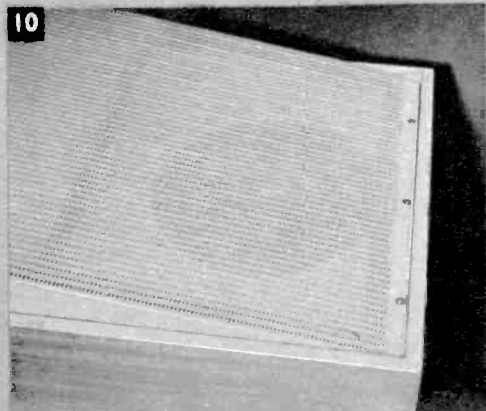

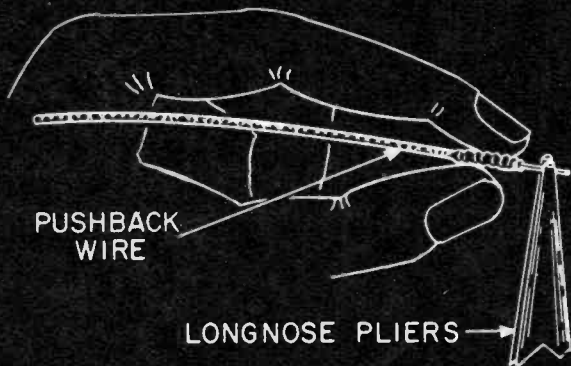

PUSHBACK WIRE

LONGNOSE PLIERS

PUSHBACK WIRE has soft insulation, can bare conductor without being removed.

CONTROL MOUNTING uses two hex nuts, lets shaft length adjust to knob requirements.

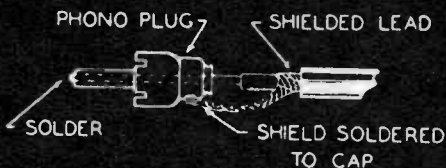

PHONO OR PIN PLUG is common hi-fi connector.

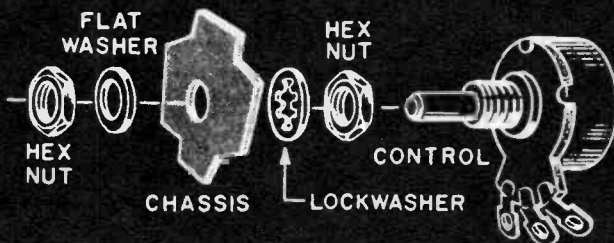

ing a complete system, and this is the Heath Company, which sells exclusively by direct mail. They offer everything from preamplifier-equalizer through to a splendid four-way speaker system. At the source end they have only a top-notch AM tuner and good FM tuner, although rumors continue to circulate that they may round out the line with a record reproducer and tape recorder system in kit form. I have the entire Heath system in my own home, and I'm extremely happy with it. I'll describe it to you in more detail, but first I think you may want to know some of the other sources of hi-fi kits.

Allied Radio, the big mail-order parts house in Chicago, has a couple of good amplifier kits. So do Eico and Tech-Master. Eico has a very complete line of test equipment in kit form, incidentally, while Tech-Master is a leader in the TV kit field.

Newest Amplifier Kits

A newcomer in the hi-fi kit field is a name well known to audiophiles. The David Bogen Company has announced that two very popular amplifier models, the DB110 and the DB20DF, are now available in kit form. Both of these amplifiers have repeatedly received excellent ratings from various consumer testing organizations, and the releasing of these two outstanding models as kits will prove a boon to many a budget-conscious hi-fi fan. Bogen suggests that their kits are appropriate for gift giving, with a new method of instruction

which enables even a youngster to assemble one with little or no supervision. Also included is a short course of instruction in audio theory, which will allow parents to impart the maximum educational values to the younger constructor.

All of the major loudspeaker manufacturers now offer complete speaker and enclosure systems in kit form, including University, Electro-Voice and Jensen. For those who want a custom job without a lot of construction bother, the University EN-CB is a logical answer. This is a folded exponential horn, completely assembled but without exterior finish. Since it does not depend upon floor or walls for its radiation, it can be placed in any location and positioned either vertically or horizontally. It can be used as part of a built-in, a room divider, or anywhere else it fits the decorating scheme. Similarly, any type of trim and finish may be selected to provide a truly custom piece of furniture.

One of my own kit systems is Heath, and I am exceedingly well pleased with it. I started off with the AM tuner, a real little honey which sells for less than 25 dollars. This tuner has exceptionally broad audio response along with good selectivity and sensitivity. If you know anything about radio theory you know that it takes a high order of engineering magic to come up with that combination. Another feature of this little job is an amazingly sharp rejection filter, tuned to 10 kc to minimize squeals due to adjacent channel interference.

My next effort was the FM tuner, Model

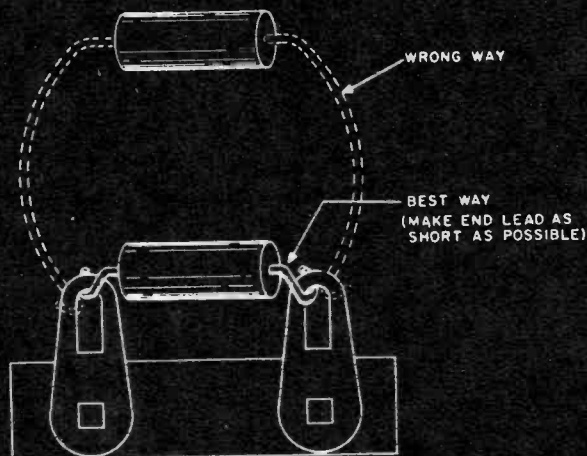

SHORT LEADS are rule in all electronic wiring.

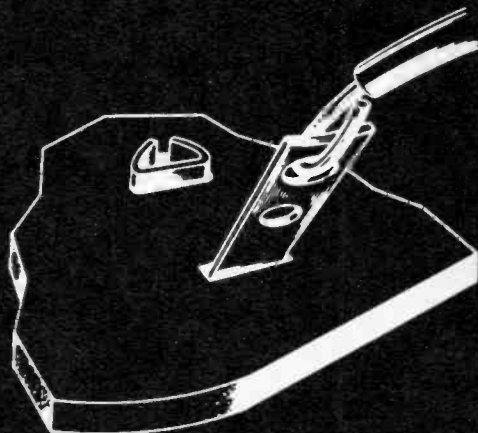

CRIMPED WIRE end permits strong soldered joint.

FM-3, and here I must admit I was rather skeptical. Having worked with Major Armstrong, I was thoroughly convinced that his limiter-discriminator system stood head and shoulders over the others. Not so many years ago I observed many big-name manufacturers bilking the public with junky imitations of FM, and that kind of thing isn't easy to forget. So when I saw that this Heathkit had a ratio detector, I was unenthusiastic to say the least.

FM Detection

Of course, I knew that one school of thought says that there's nothing wrong with ratio detection which a good limiter won't cure, but this job doesn't even have a limiter! Still, I wanted to build a matching all-Heath system, and besides I couldn't ignore the fact that this kit was priced at the same low figure as the AM tuner. So I built it. And I got the surprise of my life. No doubt about it, this little baby is really hot. The original FM system may be a little better, but practically the difference is academic.

I needed more flexibility in my input system, and with the WA-P2 preamplifier I got it for less than a twenty-dollar bill. It has five input positions, controlled by a selector switch, with individual level controls on each. My record collection is extremely varied, so I make good use of the two-section compensator control. One switch provides a choice of four different crossover frequencies, while the other provides any of four different rolloff charac-

teristics, a total of sixteen equalization curves. The tone controls are separate for bass and treble, and each offers either boost or rolloff. Finally there is a conventional volume control and a special hum-balancing control as well.

Since this preamp gets its operating voltages from the power amplifier, I decided to go ahead with that element as well, rather than to try to work it out with the amplifier I had been using. Heath has a rather wide choice of amplifier kits ranging from a little job of 7 watts up to a husky 25-watter. And although I've been telling you all along that ten watts are quite ample for most home applications, I decided that here would be an economical opportunity for me to experiment further with high power under controlled conditions. I therefore selected the big one, the 25-watt Williamson type, Model W-5M.

After living with this unit for some months I can testify that it is excellent in design and performance. As for the power, it comes down to your own personal choice, and whether you want to lay out the extra money for that last little bit of extra performance. Even the cost consideration is relatively unimportant here, however, for even the 25-watter is priced at less than sixty dollars.

The main advantage of additional power capability is the behavior of an amplifier on heavy peak signals, as well as its ability to deliver sufficient power to drive the bass woofer adequately. With less power-

handling in the amplifier, there will occasionally be a little distortion on instantaneous (and infrequent) peaks. Most persons can't hear this, however, and it happens seldom enough to be a rather minor problem anyhow. As for the bass end, if you have a big booming woofer, it will perform more efficiently and cleanly if there is plenty of reserve in the amplifier driving it.

I didn't have such a speaker system to begin with, but I intended to get it in due time to finish out my installation. The first building block consisted of the SS-1 unit, which is a two-way system in a ducted-port bass reflex enclosure. The speakers are special-design Jensens, built to Heath specifications especially for this unit. The low-frequency element is an 8-inch cone speaker, while the high-frequency unit is a compression driver with exponential horn.

Extending Speaker Range

This system works very smoothly over the middle range, but as you can guess from the 8-inch speaker size, the low end is a little anemic. Heath claims a range of 50 to 12,000 c.p.s. for this system, which seems justified, and while I didn't miss so much at the top end, I did feel the lack of that bottom octave.

So at the earliest possible moment I added the SS-1B, which Heath calls its Range Extending Speaker System. The description is apt, for the purpose of this unit is to cover only the extremes of the audio spectrum where the SS-1 is inadequate. This is also a bass reflex enclosure, much larger than the first 2-way unit, but similar enough in appearance to provide a matched combination.

Now I had a 4-way system, with a 15-inch woofer covering from 35 to 600 c.p.s., a lower mid-range unit operating between 600 and 1,600, an upper mid-range unit working between 1,600 and 4,000, and finally a super tweeter handling from 4,000 up to 16,000 c.p.s. As you can see, the range extenders also took over part of the job of the first unit, with the SS-1 now called upon to deliver only in the area from 600 to 4,000 c.p.s. According to Heath's published curves, the low end starts to roll off around 50 c.p.s. and is down 5 db at 35 cycles, which is the bottom of their claimed response. To my mind this is ultra-conservative. Although I've made no specific measurements, I do know that the bass response is clean and solid, and to my ear quite good even on the lowest tones.

Well, now my system seemed complete,

but like every other audiophile I am always looking for improvements. Luckily, Heath has something with which I've wanted to experiment for a long time, and I decided now to give it a try. It's an idea which has been under theoretical discussion for some time, and finally seems to be getting into successful practice.

Heath calls their version the Electronic Crossover, which is quite descriptive. The gist of the idea is the splitting of the audio spectrum by frequency at low level, ahead of the power amplifier, with separate amplification following for each band. Thus there is no conventional crossover network between amplifier and speaker; instead the electronic crossover does the dividing following the preamplifier stage, and there are then two power amplifiers after that, one for each band of frequencies. Each amplifier then drives directly its own associated speaker.

In my case, with a 4-way speaker system, ideally I would be dividing the signal into four bands following the preamp, with four power amplifiers driving four speakers. The Heath Electronic Crossover is not that elaborate, however, and is capable only of a 2-way split. So I adjusted it for a 700-c.p.s. crossover, as the manufacturer recommended, with the bass signal below that frequency fed into my 25-watt amplifier. Coming out of the power amplifier the signal goes directly into the 15-inch woofer, *without* using the old dividing network that had been there previously.

Another Power Amplifier

Now I needed another power amplifier for the remainder of the spectrum above 700 cycles, and to my surprise Heath recommended their little 7-watt job, the A-7D, as adequate. So building that was the next step, and when completed it was installed at the output of the high-frequency section of the electronic crossover. At the amplifier output is still the conventional crossover network for dividing up the signal among the remaining three speakers.

Frequency division takes place therefore at two points in the system. Coming out of the preamp we go into the electronic crossover and divide at 700 cycles, the low frequency component going into the 25-watt amplifier and the upper band going into the 7-watt unit. The big job drives the woofer directly, while the small one feeds the same old network. This crossover functions as before, with the exception of the bass, with splitting into segments of 700-1,600, 1,600-4,000 and 4,000-16,000 cycles.

Now aside from the novelty of this thing you may well be wondering just what's the good of it. Well, for one thing I've eliminated a 1-decibel insertion loss in the crossover network feeding my woofer. This may sound like peanuts until you consider that it was causing my 25-watt amplifier to act like 20 watts, simply because those other five watts were being dissipated in the network. Thus you see a loss of 1 db means a power decrease of 20%.

Furthermore, reproduction in the vicinity of the crossover is cleaner and more decisive. This is due to the fact that the characteristics and the frequency of the crossover are readily adjustable to individual speaker performance.

Finally, intermodulation distortion, which was already very low in this particular amplifier, is now practically nil. This phenomenon is the effect of high-power low-frequency signals reacting upon the higher frequencies. In my system, this component is completely isolated and is unable to cause trouble.

Rewards for the Constructor

Perhaps now you can understand my very great enthusiasm for my own hi-fi system, built over a period of time entirely from Heathkits. Not only was the building a lot of fun, but the outstanding results are more than ample reward for the effort. And not to be ignored is the great cost saving when you do it yourself. I now have a system which will rank up with the best of them, but which originally cost only around \$300, and I wouldn't part with it for three times the price. Now if Heath will just let loose with phono and tape kits. . .

And there you have the third and last way of assembling your own hi-fi system. The simplest, of course, is through the package plan. Next is the familiar system of component installation, where you do the customizing through your own finishing and furnishing. Finally we have the kit method just discussed.

Your choice will be the decision of just how much of yourself you want to put into it. The more you give in time and effort, the less you will give in money, and the more your system will seem to be a part of you. Each method has its adherents, and there are pro and con arguments for each. I have tried them all, and I'd be the very last to say that any of them is ideal for every person. I have given you the facts as best I know them. Now you must complete the equation by adding in the personal factors, and only then can you have the best solution for you alone. •

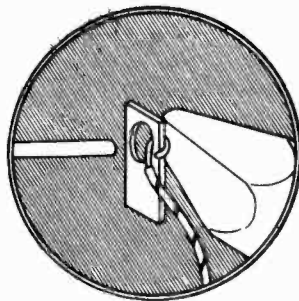

SOLDERING HEAT is applied directly to work, which in turn melts solder for stronger, neater joint.



COLD SOLDER joint (left) has obviously poor appearance as compared with correct joint (right).

CABINART ENCLOSURES are now available in kits with choice of pre-finished hand rubbed surfaces.

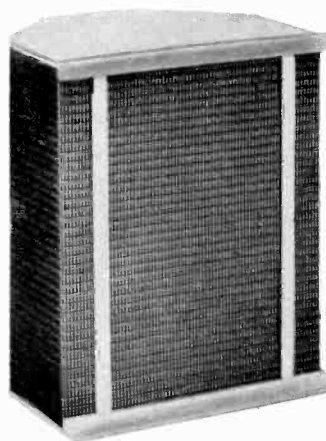

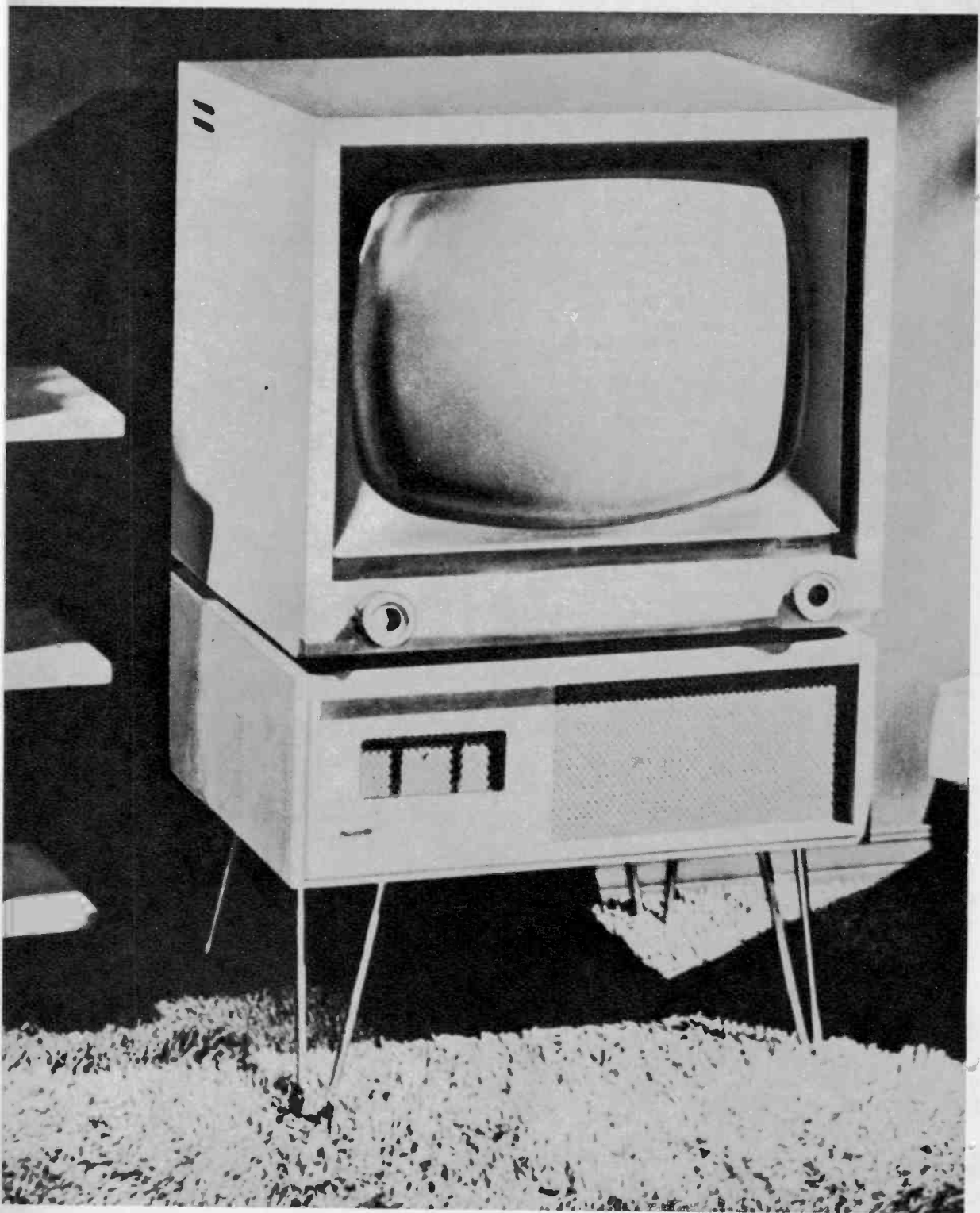

Adding Radio and TV

Until hi-fi tuners can be added, existing home instruments are readily adaptable to smoother high-fidelity performance.

RADIO and television are usually secondary additions to the hi-fi system, as nearly everyone begins his setup with record reproduction. Assuming, then, that you now have a good hi-fi record system, and that you also own some sort of ordinary radio and TV set, you probably want to take as much advantage as possible of your hi-fi reproducer using it in conjunction with these home instruments.

To determine just how much we can do to combine these several functions usefully, let's consider the course followed by sound signals in a receiving system. Whether the set be AM, FM, TV, or any combination of these, the general discussion which follows will apply. We will ignore completely the video portion of TV, however, as it in no way concerns our hi-fi setup.

We can say then that audio signals which have been superimposed on a carrier wave in a transmitter will then go through five separate operations in reception. The parts of the receiver we can denote in a general way as the antenna system, the front end, the detector, the audio amplifier, and the loudspeaker.

The antenna simply intercepts the signals and feeds them into the front end, where the desired one is selected or tuned and amplified. The detector then removes the audio from the radio carrier wave, which is discarded. The detector output is thus an electrical voltage varying at audio frequencies. This audio voltage is built up to considerable

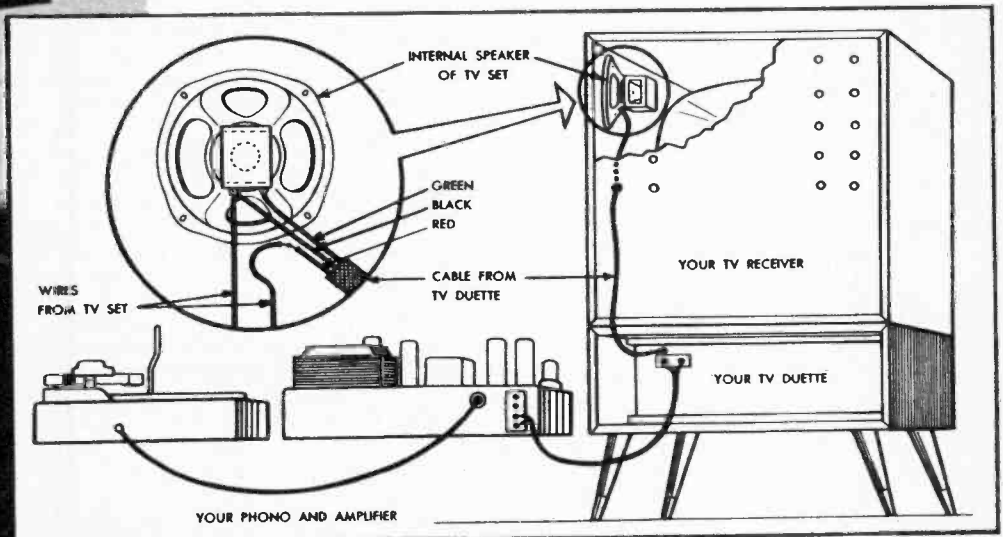

HI-FI CONVERSION for any television or radio set is feature of Jensen Duette, shown at left. With modern furniture design, this system makes handsome adjunct to an existing home instrument. With addition of phono and power amplifier, a well-rounded hi-fi system emerges from this very beautiful unit. Interconnection shown in the diagram above permits selection of hi-fi or set's own speaker.

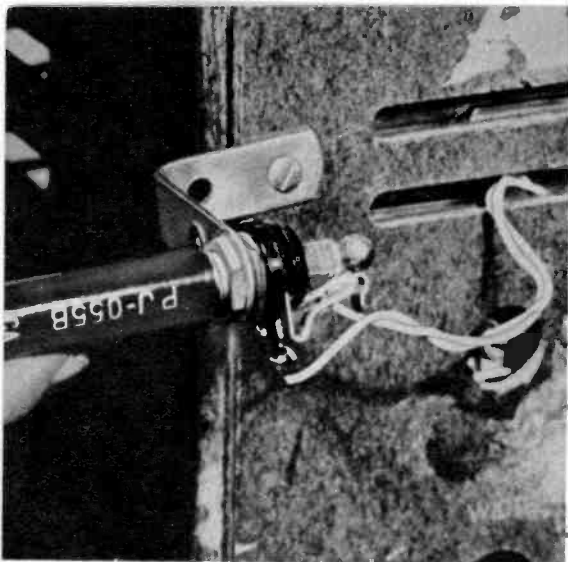

JACK CONNECTION at output permits normal set operation except when hi-fi speaker is plugged in.

JACK INSTALLATION between output transformer and speaker requires cutting wire, soldering leads.

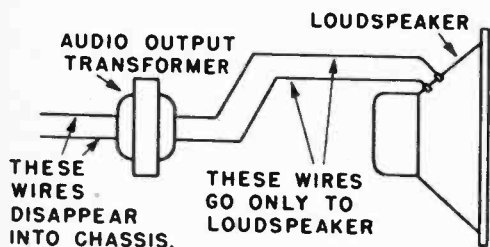

THESE WIRES GO ONLY TO LOUDSPEAKER

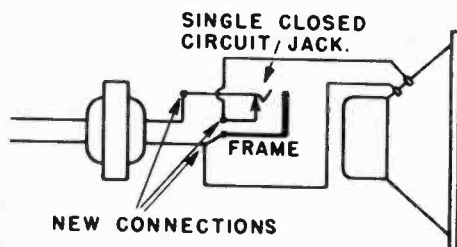
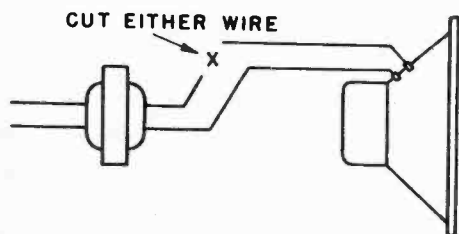

power in the amplifier, and finally fed into the loudspeaker system where it is reconverted to sound.

In the ordinary home instrument, however, the audio amplifier is small and weak, the loudspeaker is a cheap little thing, and the part of the cabinet housing the speaker is designed for appearance, not for sound performance. Now, since these three components are duplicated in our hi-fi system, we will obtain better results if we use them in place of those originally furnished. Even though the forepart of the receiver may be less than perfect in design—and in home instruments this is usually the case—we will improve reproduction considerably by working on these output components.

Better Speaker Enclosure

Improvement can be effected even by using the present system complete, but putting the speaker in a good separate enclosure. You can either buy or build an enclosure for whatever size speaker was supplied with the instrument. Later on in this book I'll tell you about several sources for free drawings and specifications for speaker enclosures.

The actual installation is then simple. But remember, whenever working on this project or any other involving parts removal or replacement in electronic equipment, *remove all power by pulling the plug out of the receptacle.* Simply turning off the switch in front is not sufficient. You can be certain all voltages are out of the set completely only if the plug is pulled.

When removing the speaker from its present small cabinet, just be careful not to poke a hole through the paper cone with the screwdriver. Remember also that parts of the speaker are strongly magnetic. Before completing the installation, make sure that no screws, nuts, washers or metal fragments are clinging to any of these parts. In some cases in small sets, the speaker is mounted to the set chassis rather than the cabinet. Removal is still simple and obvious, but the new mounting should be by means of screws through the appropriate holes in the frame at the mouth of the speaker. If the wires are not long enough for the new installation, cut each of them, splice in an additional piece of the required length, making sure that the new joints are well insulated.

Going a step further, let's assume that you already have a hi-fi speaker and enclosure, but want the existing amplifier in the set to drive them. Then you must connect from the amplifier output transformer to your speaker input. Since the old speaker

probably has a voice coil impedance in the neighborhood of 3-4 ohms and the new one is about 6-8 ohms, no very serious mismatching will result from such an arrangement. Although the audio amplifier is neither very powerful nor very hi-fi, a good new speaker will reproduce everything the amplifier can deliver.

The first problem now is the location of the output transformer. To do that, begin looking right at the old speaker itself. You will see a pair of fine flexible wires attached to the speaker near the apex of the cone. Now trace this pair away from the speaker and toward the set to find the transformer. In many cases you won't have far to look, for the transformer is often mounted directly on the speaker frame. Otherwise it will be mounted on the chassis.

Now we want to remove the connection between the secondary winding of the transformer and the voice coil of the speaker. This pair has usually one black wire and one green. Everything else must remain as is. You will see other wires running from a tube socket into the transformer. You might also see other wires going into the big magnet structure behind the speaker frame. These may be color coded black-red and yellow-red. None of this wiring should be disturbed.

Extension Speaker

The pair between transformer and voice coil must be opened up, either by disconnecting a pair of screw terminals, opening a pronged connector, breaking a couple of splices, or by physically cutting the wire. In any case the part going to the voice coil is disregarded, while a new long pair of wires is connected between the transformer output terminals and the input of the new hi-fi speaker. For greater flexibility, and with just a little more trouble, you can install a jack-and-plug arrangement, which will permit the old speaker to operate when the plug is not inserted, but which causes the signal to swing over to the hi-fi speaker whenever it is plugged in.

If you have a complete hi-fi system including amplifier, however, then your best bet is to use as much of that rig and as little of the home instrument as possible. You can't use the equalizer-preamp section, nor would you want to, but you should use the main power amplifier. In this case you want to pick up the audio signal from the radio or TV set immediately following detection.

The easiest way of locating this point is to go to the volume control. Since this control is nearly always inserted between detector and first audio amplifier, that is the

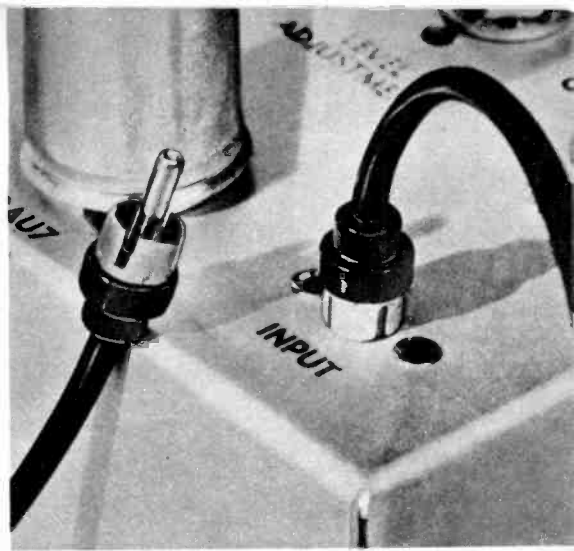

RADIO OR TV detector output is readily connected to hi-fi amplifier through standard phono plug.

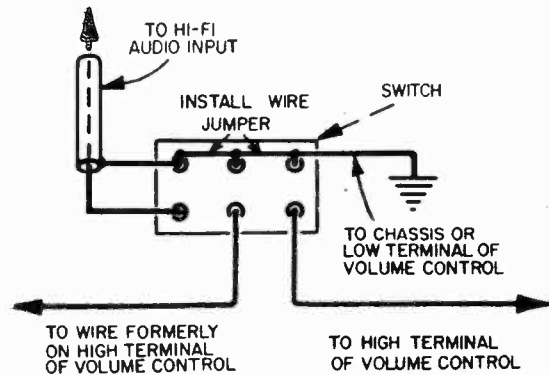

KNIFE SWITCH at right is basis of connection shown above. Detector output of radio or TV is picked up at volume control, switch sends to set or hi-fi system.

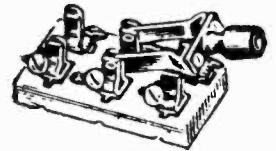

VOLUME CONTROL above is typical of those in radio, TV, hi-fi gear. When altering connections for addition of hi-fi, only two outer terminals are changed.

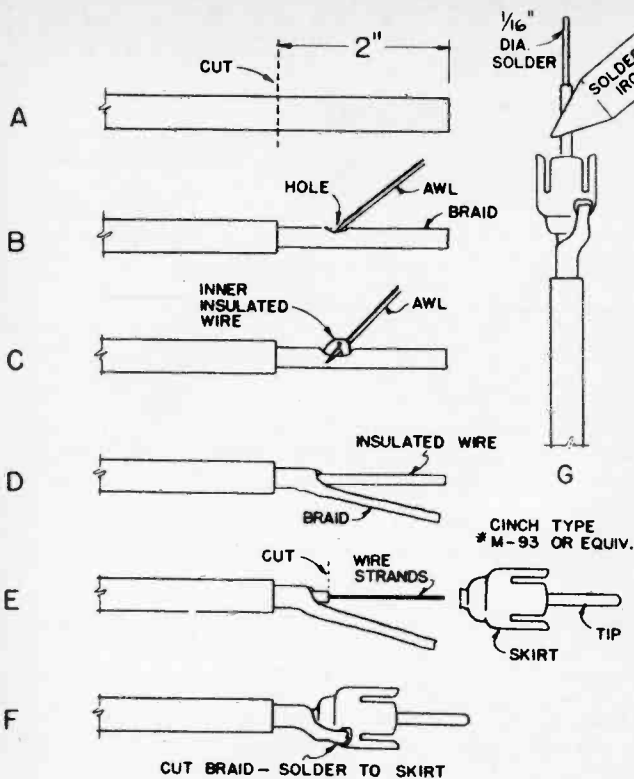

*The New High Fidelity Handbook
by Irving Greene & James Radcliffe*

THIS DRAWING shows method of connecting a phono plug to a shielded wire:

(A) Remove outer insulation from shielded wire exposing 2 inches of braid (shield).

(B) Push back the shield braid to loosen the weave. Use an awl or other sharp pointed tool to spread the weave and form an opening through which the inner wire can be very easily drawn.

(C) Use the awl, bend the inner wire and, inserting the awl tip under the bend, draw this wire out of the braid. Take care not to injure insulation of the inner wire.

(D) Strip about 1 1/4 inches of the insulation from the inner wire and twist the shield braid to form a second conductor.

(E) Tin both conductors with solder and insert the center wire into the plug.

(F) Solder the braid to the skirt of the plug and cut off surplus. Solder carefully.

(G) Holding the wire and plug upright, insert a piece of solder 1/16 inch in diameter into the center of the plug tine. Apply the iron tip and let the solder flow slowly into the tine. Carefully remove iron tip as soon as solder has run into the tine. Let cool slowly, do not jerk or move plug or else a cold joint will result.

best point to pick up the signal. You will note three terminals on the rear of this control, and of these three we are interested only in the two outside ones. The center one is left alone.

If your volume control also handles the on-off switching function, you will find a second pair of terminals just in front of the other three. Leave these alone also. And if you haven't already pulled that power plug, do so now, for otherwise those terminals will be charged with 110 volts.

In order to make your interconnection you will need some ordinary phono cable, which is single-conductor shielded wire. Running through the center of this cable is a single solid wire or a number of fine wire strands, together forming one electrical conductor. Surrounding the center conductor is insulated tubing, usually of rubber, cloth or plastic. The third layer surrounding is a stranded wire braid, known as the shield. Sometimes there is another layer of insulation outside of this.

Now you must prepare the ends of the cable for the electrical connection. The method is exactly the same as that for the pin plug, except that no plug is used at this end. You will note that one of the three terminals on the volume control is connected directly to the metal chassis of the

set. Carefully tin the braid of your phono cable and solder it to this same terminal.

Then ignoring the center terminal, unsolder and remove the wire from the third terminal. Twist this wire to the center conductor of your phono cable, solder the joint, and wrap it with tape. The total length of the cable should not exceed ten feet, to avoid high-frequency losses, and at the other end it is connected to the hi-fi power amplifier.

Your amplifier probably has receptacles for pin plugs, in which case a plug must be connected to the cable end. The amplifier connection must be at a point in the circuit following the preamp, so in the case of a simple power amplifier you'll just plug the cable into the input. If a preamp is included in the power amplifier chassis, then plug the cable into one of the high-level positions, such as one marked RADIO, TUNER, or TV. If you want a more flexible setup, wherein the radio or TV can play either through its own speaker or through the hi-fi system, then a simple jack or switching circuit may be installed.

Ultimately, of course, you will be rounding out your system with truly hi-fi tuners. But until you're ready for this, the simple installations described here will afford you many hours of more pleasant listening. •

The 7 Old-Fashioned Villains of Tape Recording

...and How

irish FERRO-SHEEN
BRAND

Foiled Them All

Once upon a time, 7 Old-Fashioned Villains like this  were wreaking endless woe on Decent People with Tape Recorders. The 1st Villain was Oxenscheid the Oxide Shedder.

He scraped away at the crumbly oxide coating of old-fashioned tape and gummed up tape recorders with the shedding particles. The 2nd Villain was Wearhead the Head Wearer.  He filed down the magnetic heads

with the abrasive coating of old-fashioned tape. The 3rd Villain was Frickenshaw the Frequency Discriminator.

 He dragged down the high-frequency response of old-fashioned tape through inadequate contact between the "grainy" coating and the head. The 4th Villain was Noysenhiss the Noise Generator.

He generated tape hiss and modulation noise  as a result of the random vibrations and irregular flux variations caused by the uneven magnetic coating of old-fashioned tape. The 5th and 6th Villains

were Dropofsky the Drop-Out Artist and Pringlethorpe the Print-Through Bug.  They

put nodules and agglomerates into the oxide emulsion of old-fashioned coated tape, causing "drop-outs" whenever these trouble spots lost contact with the record or playback head, and inducing "print-through" on the recorded

tape when the extra flux at the trouble spots cut through adjacent layers on the reel. The 7th Villain was Brattleby the Embrittler.  He dried out the plasticizers in old-fashioned coated tape and embrittled

irreplaceable recordings. Then: OCTOBER, 1954! That's when a very un-old-fashioned little man by the name of

F. R. O'Sheen  announced that he had developed the revolutionary new **irish FERRO-SHEEN** process of

tape manufacture and presto!  the 7 Old-Fashioned

Villains were sent a-scurrying with cries of "Confound it - Foiled again!" Yes, F. R. O'Sheen had made the new magnetic oxide lamination of **irish FERRO-SHEEN** tape so smooth-surfaced and non-abrasive, so firmly anchored

and homogeneously bonded to the base, so free from nodules and agglomerates, that the

7 Villains were evicted—for good! **Moral:** Don't let Old-Fashioned Villains do you out

of your hi-fi rights!  Just say "No, thanks" to ordinary coated tape and

ask for F. R. O'Sheen **irish FERRO-SHEEN**, that is! ORRadio Industries, Inc., Opelika, Alabama.



Build it yourself

Famous **BOGEN** DB20 Amplifier

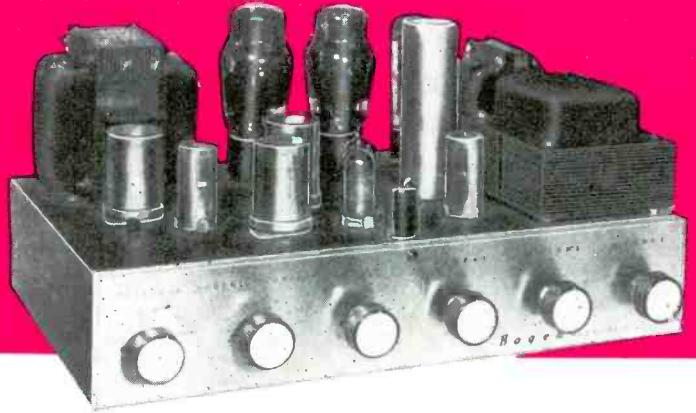

**anyone
can do it!**

Now in kit form for the first time!



BUILD THE BEST! Of 3 dozen hi-fi amplifiers ex- amined, a famous

consumer testing organization found the BOGEN DB20 to be the finest! Take a look at the specifications at the right and you'll see why. It's the ideal 20-watt amplifier for any home installation. Never before has BOGEN offered any kit. *Now you can do it yourself and save up to one third of the regular price!*

STEPpak* MAKES IT EASY.

All parts needed for each step are packaged together in a separate envelope. No guesswork. No mistakes.

No trouble identifying what goes where. Even the wires are pre-cut to the proper length. Detailed STEP-BOOK tells you and *shows* you exactly what to do every step of the way, and gives basic theory in non-technical language so that you understand *why* your amplifier works so much better than any other.

NO EXPERIENCE NEEDED.

No knowledge of electronics or hi-fi required. Anyone who can turn a screwdriver can build this DB20. A great do-it-yourself project. A gift that will always be remembered. Complete BOGEN guarantee. See your BOGEN dealer now.

DB20 SPECIFICATIONS

CONTROLS

Separate 5-position loudness contour selector; 4 input positions; 7 record equalization positions; continuously variable damping factor control; separate continuously variable bass and treble controls; volume control.

SPECIFICATIONS

0.3% distortion at 20 watts; peak 30 watts; response, 20-20,000 cps ± 0.7 db.

**See Your Dealer
For Price**

FOR THE SMALLER SYSTEM

BOGEN DB110 12-watt Amplifier Kit. Assemble this BOGEN DB110 at home. Only 0.65% distortion at rated 12 watts; response, ± 0.5 db from 15-30,000 cps. 4 controls: volume, separate continuously variable treble and bass controls, one control provides four input selector positions plus 3 record equalizer positions.

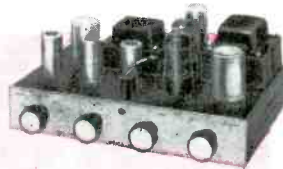

**See Your Dealer
For Price**

SEE YOUR BOGEN DEALER

— Or write to us today for his name & address.
David Bogen Co., Inc.,
P.O. Box 500, Paramus,
New Jersey.

component or kit... buy

Bogen

HIGH FIDELITY
because it sounds better

The 7 Old-Fashioned Villains of Tape Recording

...and How

irish FERRO-SHEEN
BRAND

Foiled Them All

Once upon a time, 7 Old-Fashioned Villains like this  were wreaking endless woe on Decent People with Tape Recorders. The 1st Villain was Oxenscheid the Oxide Shedder.

He scraped away at the crumbly oxide coating of old-fashioned tape and gummed up tape recorders with the shedding particles. The 2nd Villain was Wearhead the Head Wearer.

He filed down the magnetic heads with the abrasive coating of old-fashioned tape. The 3rd Villain was Frickenshaw the Frequency Discriminator.

He dragged down the high-frequency response of old-fashioned tape through inadequate contact between the "grainy" coating and the head. The 4th Villain was Noysenhiss the Noise Generator.

He generated tape hiss and modulation noise as a result of the random vibrations and irregular flux variations caused by the uneven magnetic coating of old-fashioned tape. The 5th and 6th Villains were Dropofsky the Drop-Out Artist and Pringlethorpe the Print-Through Bug.

They put nodules and agglomerates into the oxide emulsion of old-fashioned coated tape, causing "drop-outs" whenever these trouble spots lost contact with the record or playback head, and inducing "print-through" on the recorded tape when the extra flux at the trouble spots cut through adjacent layers on the reel.

The 7th Villain was Brattleby the Embrittler.

He dried out the plasticizers in old-fashioned coated tape and embrittled irreplaceable recordings. Then: OCTOBER, 1954! That's when a very un-old-fashioned little man by the name of F. R. O'Sheen

announced that he had developed the revolutionary new **irish FERRO-SHEEN** process of tape manufacture and presto!

the 7 Old-Fashioned Villains were sent a-scurrying with cries of "Confound it - Foiled again!" Yes, F. R. O'Sheen had made the new magnetic oxide lamination of **irish FERRO-SHEEN** tape so smooth-surfaced and non-abrasive, so firmly anchored and homogeneously bonded to the base, so free from nodules and agglomerates, that the

7 Villains were evicted - for good! **Moral:** Don't let Old-Fashioned Villains do you out of your hi-fi rights!

Just say "No, thanks" to ordinary coated tape and ask for F. R. O'Sheen **irish FERRO-SHEEN**, that is! ORRadio Industries, Inc., Opelika, Alabama.



Build it yourself

Famous BOGEN DB20 Amplifier

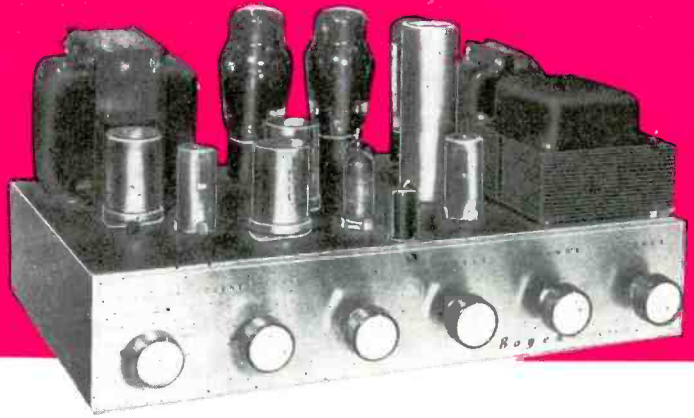

**anyone
can do it!**

Now in kit form for the first time!



**BUILD THE
BEST!** Of 3 dozen
hi-fi amplifiers ex-
amined, a famous

consumer testing organization found the BOGEN DB20 to be the finest! Take a look at the specifications at the right and you'll see why. It's the ideal 20-watt amplifier for any home installation. Never before has BOGEN offered any kit. *Now you can do it yourself and save up to one third of the regular price!*

STEPpak* MAKES IT EASY.

All parts needed for each step are packaged together in a separate envelope. No guesswork. No mistakes.

No trouble identifying what goes where. Even the wires are pre-cut to the proper length. Detailed **STEP-BOOK** tells you and *shows* you exactly what to do every step of the way, and gives basic theory in non-technical language so that you understand *why* your amplifier works so much better than any other.

NO EXPERIENCE NEEDED.

No knowledge of electronics or hi-fi required. Anyone who can turn a screwdriver can build this DB20. A great do-it-yourself project. A gift that will always be remembered. Complete BOGEN guarantee. See your BOGEN dealer now.

DB20 SPECIFICATIONS

CONTROLS

Separate 5-position loudness contour selector; 4 input positions; 7 record equalization positions; continuously variable damping factor control; separate continuously variable bass and treble controls; volume control.

SPECIFICATIONS

0.3% distortion at 20 watts; peak 30 watts; response, 20-20,000 cps \pm 0.7 db.

**See Your Dealer
For Price**

FOR THE SMALLER SYSTEM

BOGEN DB110 12-watt Amplifier Kit. Assemble this BOGEN DB110 at home. Only 0.65% distortion at rated 12 watts; response, \pm 0.5 db from 15-30,000 cps. 4 controls: volume, separate continuously variable treble and bass controls, one control provides four input selector positions plus 3 record equalizer positions.

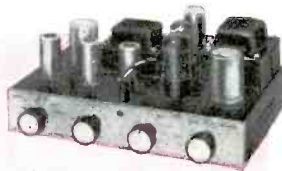

**See Your Dealer
For Price**

SEE YOUR BOGEN DEALER

— Or write to us today for his name & address. David Bogen Co., Inc., P.O. Box 500, Paramus, New Jersey.

component or kit... buy

Bogen

HIGH FIDELITY
because it sounds better



AMPEX MODEL 600 (and 601) is portable tape recorder which can be carried in case (photo above) or installed in home hi-fi unit (photo right). This tape recorder weighs only 28 pounds, has excellent frequency response at $7\frac{1}{2}$ ips.



Adding a Tape Recorder

Home hi-fi tape recorders are rapidly approaching the excellence of professional hi-fi tape machines.

THE tape recorder industry, which historically is at least 20 years behind the rest of the audio art, has been moving rapidly to close this gap. For several years I've been cautioning hi-fi fans to go slow on tape, unless cost was no object, but the day is not far off when this advice can be forgotten entirely.

The crux of the argument was simply that it was next to impossible to obtain tape equipment in the amateur class which would measure up in performance to the rest of the hi-fi rig. Putting it somewhat differently, the only difference between amateur and professional audio gear today—other than tape—is in ruggedness. Professional equipment is built to take a pounding hour after hour, day after day, while home hi-fi equipment is comparatively light

TAPESONIC model has push-button operation, fast forward and rewind mechanism, three motors and three speeds: 15, 7½, and 3¾ inches per second.

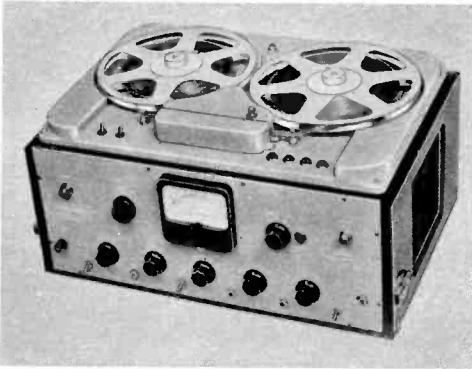

FERROGRAPH portable tape recorder was designed primarily for professional use, is British made, available to American market for first time.

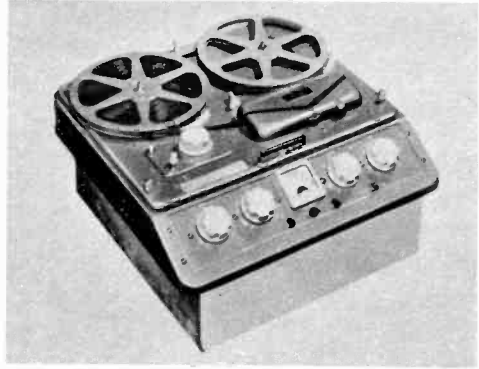

duty. But in performance the two are identical.

Until very recently, the same comparison could not be drawn with tape recording. This is not surprising when we consider that tape was unknown on these shores until after the war, and that many of the problems it presented were unique and had to be solved from scratch. Even after they were solved from an engineering standpoint there still remained the problem of bringing the cost within the range of the average consumer pocketbook.

Home Tape Recorders

In an amazingly short time there were home tape recorders on the market which did an adequate job on speech, but which left much to be desired when used for music. It still cannot be said in all honesty that tape recorders are available which will match other hi-fi equipment dollar for dollar in performance and value. But the trend is unmistakably in that direction, and there are now a number of good home tape recorders on the market. Prices still aren't in the bargain category, but it's no longer necessary to shell out several thousand for a pro model, either.

So this may be the time for you to consider adding tape equipment to your present hi-fi installation. If so, you'll find that the actual interconnection is extremely simple. But first you should know something about how it works, and what to look for when buying.

A common trick of boy experimenters consists of wrapping a coil of insulated wire around an iron nail and connecting the ends of the wire to the terminals of an electric battery. When this is done the nail almost

immediately becomes a permanent magnet. This basic principle of electromagnetism is employed in the making of a tape recording.

In a recorder, however, the audio currents are constantly varying, as opposed to the direct current from the battery in our experiment. Thus if we were to continuously magnetize the same section of tape, each succeeding change in the current would rearrange the magnetic pattern and obliterate what had gone before.

The tape would have been magnetized, but no permanent record would remain. Thus we must have another very important element to comprise a complete tape recorder. Something is necessary to keep the tape constantly in motion, with a fresh section of blank stock always in position to receive the magnetic impulse of the latest change in the audio current. And it is this something which has been the greatest deterrent to the development of home hi-fi tape recorders.

The device which pulls the tape through the machine is called the tape transport mechanism, and its method of operation is known as capstan drive. The capstan is a flat-sided metal or rubber cylinder mounted on the end of a motor shaft. A second pressure roller holds the tape against the capstan, whose rotation pulls the tape through with a sort of squeegee effect. The path of tape travel then is off the supply reel, past an erase magnet, past the record-reproduce head(s), through the capstan drive, and onto the takeup reel.

The need for perfectly constant speed in this transport mechanism is just about twice as critical as it is for a record turntable. For while the speed variation in a

DEJUR offers this typical stripped-down model for custom installations. Permanent mounting is therefore possible in furniture of one's choice

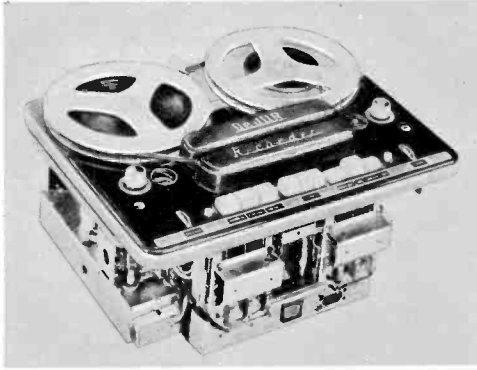

PRESTO model was designed for the area between the expensive professional model and the small home recorder. It has three motors, three heads.

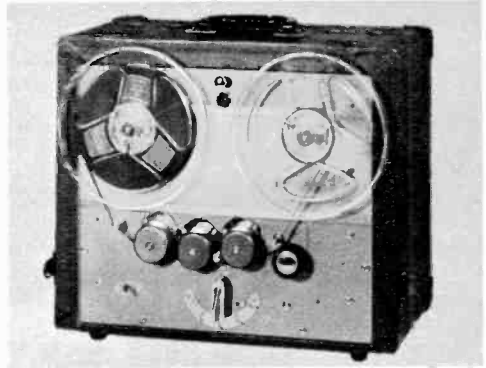

commercial record is negligible, any wow or flutter introduced in the making of a tape recording will be doubled when the tape is reproduced on the same machine.

It is no exaggeration to say that the percentage of speed variation can be regarded as the true "figure of merit" for a tape recorder. Specifically, the following figures are the ones to bear in mind. Nearly anyone can detect wow and flutter of 0.5%, but this is the figure you will find in manufacturers' claims for most amateur tape recorders. This isn't hi-fi, no matter what they say about frequency response and distortion, so forget it.

Professional Tape Recorders

Professional equipment, on the other hand, usually exhibits variations on the order of 0.1% or less. In between these two figures lie the characteristics of the semi-pro models. They usually exhibit variations on the order of 0.2 to 0.25%. In this category you will find such models as the Ampex 600, Magnecord, Pentron Dynacord, Tapesonic, Revere T-11, Viking, and Recordio Prest-Omatic. Prices on equipment with these specifications vary from about \$200 to \$500, depending upon the components and operational features.

Among the many advantages of tape recording is the ability of a tape to be played repeatedly without loss in quality. But when a given recording is no longer needed, the same tape may be used for recording again whenever desired. When the tape is to be reused, the old sound is removed from it just a fraction of a second before the new sound is recorded. This process of removing the existing sound is known as erasing, or more properly, *obliterating*.

DYNACORD model was designed for professional work, has three motor drive, three head construction, dynamic braking and push-button operation.



BERLANT model consists of two parts, the recorder drive mechanism and one or more recorder amplifiers. It has three speeds, fast forward, rewinding.

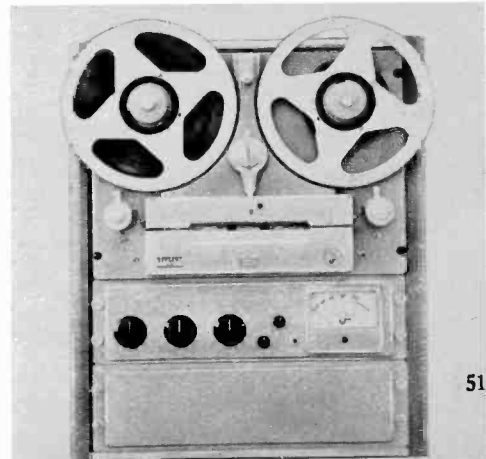

how magnetic tape is made

LABORATORY technician prepares for an experimental formulation in the laboratory grinding mill.



HUGE BATCHES of the magnetic coating lacquer are mixed in large 500-gallon mills like this one.



THE TAPE coating operation is extremely critical. It is performed on precision machines like these.

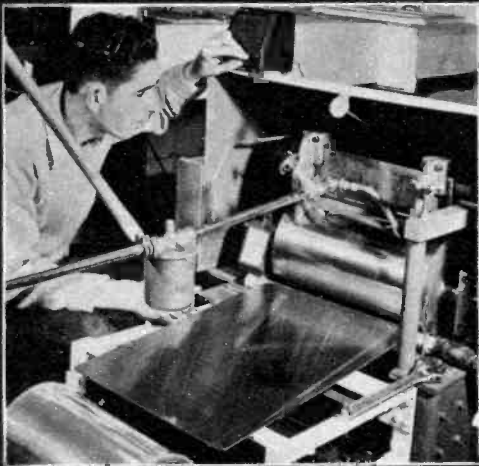

PRODUCING quarter-inch tapes from the large coated rolls is a responsibility of slitter operator.

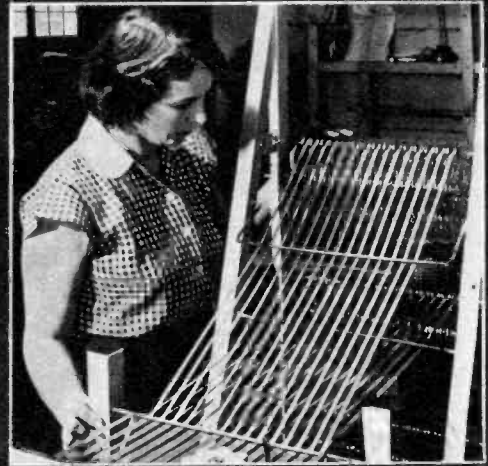

COMPLETE, thorough audio analysis is made on each production of the tape made by the factory.



FINAL visual inspection of the tape is made by skilled operators using fluorescent lighting boxes.

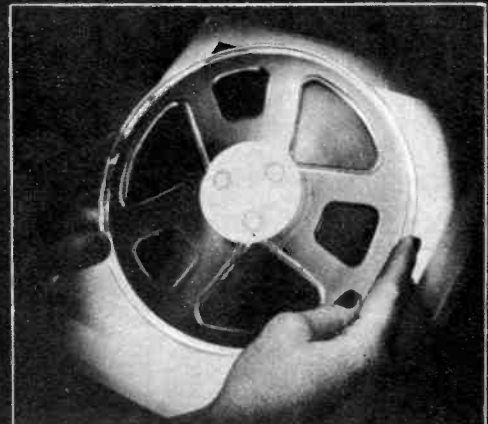

MASS production of the magnetic coating lacquer for tape is accomplished by huge grinding mills which are capable of delivering 500 gallons of coating. A slow and continuous grinding results in a uniform dispersion of the iron oxide particles in the lacquer-type base. Special wetting agents and highly effective lubricants are incorporated during the grinding process.

The precision coating of the magnetic lacquer on the plastic film is the most delicate step in the manufacture of magnetic tape. The coating machinery required for this operation is manufactured to watchmaker tolerances. This company's tape is coated to a tolerance of a half of 1/10,000 of an inch since a variation in thickness of even less than that may vary the amplitude of the audio output as much as a full decibel.

The next step in the operation is the production of tapes from coated rolls. This is done by the slitter operator who cuts the 12-inch coated rolls into 1/4-inch tapes and winds it on 1200-foot reels, the standard 7-inch reel of the industry.

After the tape is wound on the reels, it is subjected to a thorough audio analysis. Professional recording and test equipment is used for this operation. The tape is tested for frequency response, amplitude variation, signal output, and noise level.

The final step in the manufacturing process before shipment to distributors is the careful visual inspection of the tape. This is made under fluorescent lighting with the operator checking for inconsistencies in the winding and slitting of the tape and for fractures and molding imperfections in the reel.

The process is somewhat analogous to finger-writing in the sand, which is the reason engineers prefer the later term. If you should write your name in the sand with your finger, you don't actually make any permanent change in the sand itself. All you do is to rearrange some of the grains. And when you "erase" the writing by smoothing the sand over, you really only obliterate it. Once again the grains of sand are rearranged, with no distinguishable pattern.

Erasing or obliterating on a magnetic tape is somewhat similar. The microscopically tiny magnets which had previously been arranged in a definite pattern during recording are completely scrambled up so that no distinguishable pattern remains. The tape is then said to be blank and once again ready for recording.

While we have been comparing grains of sand to the billions of tiny magnets on a piece of tape, it should be understood that this magnetization occurs at molecular dimensions, and there is no change at all visible to the naked eye. It is therefore impossible to tell, simply by looking at a tape, whether or not it has any sound on it. The only way to be certain of what is recorded on a piece of tape, if anything, is to play it.

Tape Precautions

Whenever you are in doubt as to the condition of a tape, the safe thing to do is to audition it first. More than once an irreplaceable recording has been inadvertently destroyed by erasing and re-recording on a tape which was supposedly available for use. You can avoid this problem by labeling clearly all recordings as you make them, and by keeping your permanent tape library well separated from your usable stock. Just remember that all tape looks alike, and make it a habit to listen before you reuse a tape for recording.

All tape recorders contain an erase head, an electromagnet, or in the cheaper machines, a permanent magnet. The tape passes over this erase magnet before it reaches the recording head. Neither of these heads is activated, however, until the recorder control switch or button is placed into the "record" position.

Permanent magnet erase is not recommended for hi-fi applications, and it is advisable to check this element carefully before making a purchase. A rather large amount of power is necessary to energize the erase magnet for complete and quiet erasing. Some of the lower-priced machines just can't quite make the grade.



how to splice tape

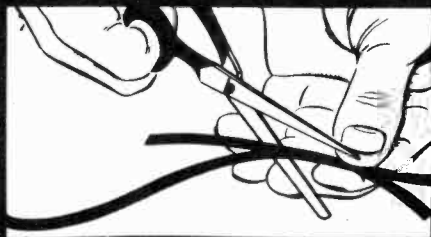

CUT tape at 60 degree angle with overlap so that ends line up, splice is unheard.

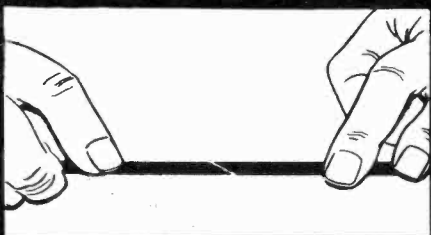

ALIGN tape so that the uncoated side is up. This side appears shiny on plastic tape.



COVER aligned ends with splicing tape. Make sure tape is even, secured tightly.



TRIM excess tape, cutting into backing slightly (dotted lines) to eliminate sticking.

Minnesota Mining & Manufacturing Co.

The erase function can be tested fairly well by ear if you have a recorded tape which is not to be saved. With the tape on the machine, start it in operation in the "record" position, but with the volume control turned all the way down. After a few minutes running time, rewind the tape and play it back, this time with the volume control turned up rather high. If the erased sound is still quite loud on the tape, or if the noise level is unduly high, you'd better scratch the machine off the list.

With erasing completed, a tape next passes over an adjacent record head. Here it is subjected to a strong magnetic field which varies with the audio signal fed into the record amplifier. The tape is thereby magnetized with this sound pattern and is immediately ready for playback.

Tape Reproduction

In the better machines there is a reproduce head adjacent to the record head, which permits listening to the recorded tape only a fraction of a second after recording. The lower-priced equipment, however, uses only one electromagnet as a combination record-reproduce head. With this arrangement it is necessary to wait until recording is finished before playing back.

Tape recorders have a built-in pre-emphasis-deemphasis characteristic for better signal-to-noise ratio, somewhat similar to the compensations employed for disc recording or FM broadcasting. Since the playback compensation is the complement of that in the record amplifier, the two cancel each other and the resulting reproduction is flat.

Until fairly recently the question of tape compensation was as much a mixup as used to prevail in phonograph records. Lately, however, just as the phono manufacturers got together, so now have the tape people. A standard characteristic has been adopted and is being incorporated in the new models. No longer will we have the weird results which we used to obtain when recording on a machine of one make, and then playing back on another type.

Tape costs were cut in half with the introduction of the ingenious system known as dual-track recording. In this method only a little less than half the width of tape is used for recording at a given time. Thus it is possible to record along the entire length of tape twice, once on each half. But this economy is not gained without certain disadvantages.

Since only half of the tape width is used for recording at any given time, the innate

noise in the magnetic coating becomes relatively more significant. The ratio of signal to noise, therefore, can never be as good as on an equivalent full-track system. Another problem is the dropout, a momentary reduction in volume or loss of high frequencies. This may be due to defects in the tape coating, or because of warp or weave of the tape as it passes the playback head. Whatever the cause, the result is much more noticeable on a half-track system. Finally, it is impossible to edit this type of tape without spoiling the adjacent track. Whenever parts of the tape are removed by cutting and splicing, both tracks are affected equally. If the opposite track is blank or has expendable material recorded on it, then, of course, the tape may be edited just as readily as the full-track type.

A modification of the dual-track system is now being employed widely for binaural or stereophonic recording. This employs two recorded signals, reproduced simultaneously through two separate systems. When the recordings are properly made and reproduced, the sound has a presence and dimension which has been achieved in no other way. We'll cover this in more detail in the chapter on stereophonic sound.

There are presently five different American manufacturers of magnetic tape, and each of them offers so many different types that the amateur may well find himself thoroughly confused. All tape, regardless of manufacturer or type, consists of a non-magnetic plastic base having a magnetic coating of some form of iron oxide. These are the two variables which go to make up the many different types of tape on the market.

Types of Plastic Tape

The first difference to consider is the composition of the base. Originally all of the plastic tape was made of a compound known as cellulose acetate. More recently there has been introduced a polyester film, usually sold under the DuPont trade name "Mylar." The advantages claimed for the polyester type are greater stability with respect to temperature and humidity, and much greater strength and resistance to shock.

The greater strength may often prove to be a disadvantage, however, for tape of this type will stretch considerably before breaking, while the acetate type is much more likely to snap under strain. A broken tape can be repaired readily with a simple splice, but a stretched tape is virtually hopeless. The other disadvantage of poly-

how to insert strip of leader

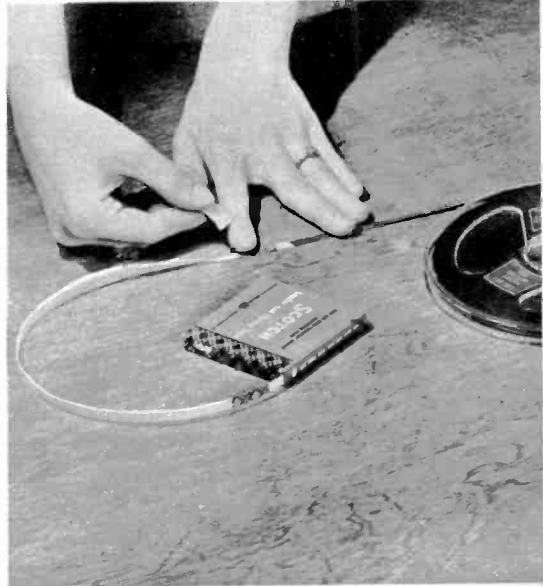

LEADER splicing is same as for magnetic type. Marker bars are for precise timing.

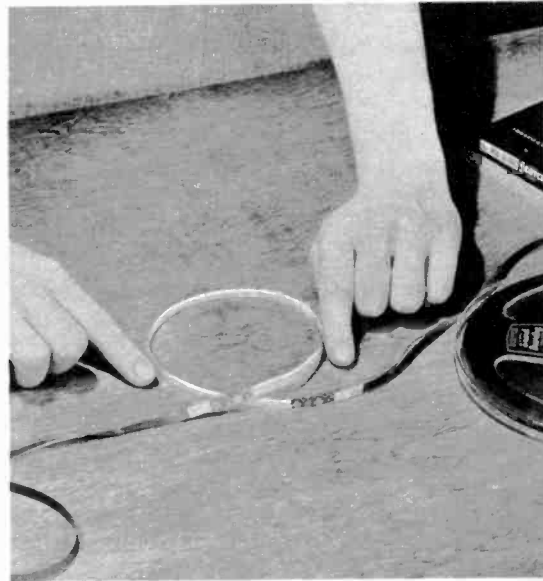

LEADER insertion between two magnetic sections provides the desired interval of silence.
Scotch Brand Tape

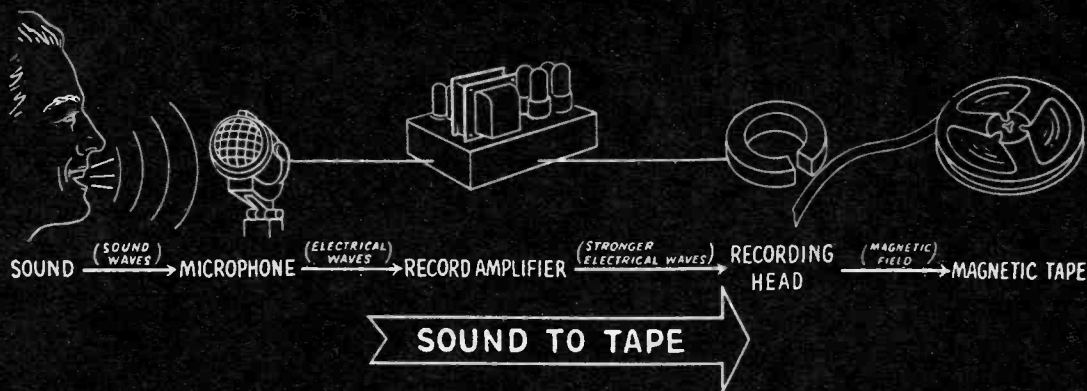

ester to the budget-wise hi-fi fan is its greater original cost.

The second important variable in the tape base is its thickness. The original acetate tape was 0.0015 inch thick, this dimension being commonly referred to as 1½ mils. With the advent of polyester film, however, along with more sensitive coating formulations, the "Scotch" tape people introduced their type 190, which has a 1.0 mil base and somewhat thinner coating, resulting in a 50% increase in playing time. More specifically, it is possible to get half again as much tape on the same size reel.

Most of the manufacturers now offer similar types, Irish Tape being labeled "Long Playing," while the Audiotape version is dubbed "Longer Recording."

Double Play Tapes

Not content with this development, the Irish Tape people carried it a step further and introduced their "Double-Play" tape on a 0.5 mil Mylar base. As its name implies, this tape permits double the playing time, with 2400 feet of tape on the 7-inch reel which formerly held 1200 feet. It is also available in the 1200-foot length on a 5-inch reel. It isn't likely that tape will get much thinner, as we are now very close to the minimum limit for mechanical strength, as well as the problem of "print-through," where adjacent layers of recorded tape magnetize one another. There are also many more manufacturing difficulties when working to such close tolerances. As a consequence, other manufacturers have shied away from this item, although Audiotape has now taken the plunge with the introduction of its "Super-Thin" line.

The other basic difference in tape types

is in the coating. The magnetic material in the coating is iron oxide, held together and adhered to the tape by a suitable binder. Although black oxide was used for a time in earlier tapes, the red type is now used almost exclusively. More recently there appeared a green oxide under the Scotch trade name of "High Output." This is not to be confused with the colored Audiotape, which is offered with a base dyed blue or green for both cueing and coding.

In HO tape the color is actually in the oxide itself. Researchers have known for some time that certain elements, when added to iron oxide, will alter its magnetic properties. The addition of zinc, for example, will yield a tape which is considerably less sensitive. The people at Minnesota Mining and Manufacturing, however, have discovered an additive which makes the oxide more sensitive. Just what that additive might be is a closely guarded secret, which competitors have apparently not discovered. The result is a tape which affords over 8 decibels increase in output level for the same record level, for which 3M claims better signal-to-noise ratio, less distortion and greater dynamic range.

The question of tape life is a matter for some conjecture. It is true that tapes have been played well over ten thousand times in laboratory tests, which is certainly more than can be said for any phonograph record. But at this stage any claim that tapes will last forever is at best a considerable exaggeration. The fact is that no one yet has devised a reliable accelerated aging test, and so there is just no way of knowing what will happen to a tape with the passage of a few more decades.

Although we don't know how long tape will last, we do know some precautions

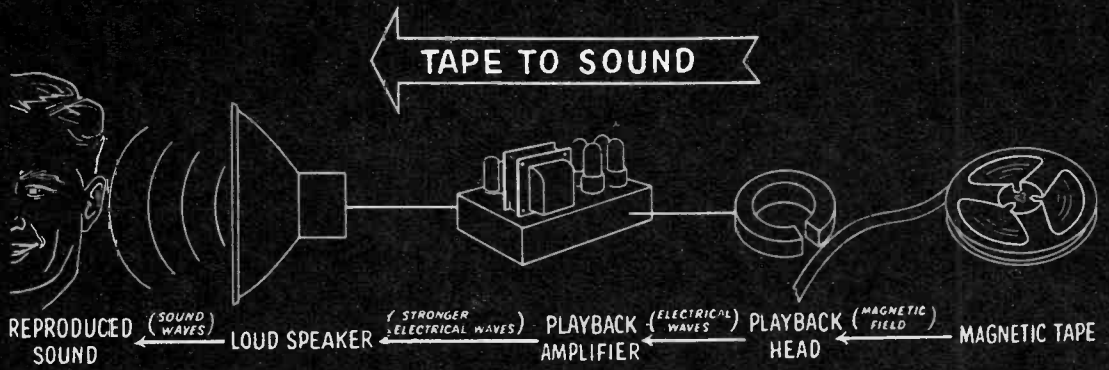

which will prolong its life. When storing tapes the hi-fi fan would be well advised to observe these practices. There is a tendency for recorded tape to print through while in storage, an effect which is aggravated by excessive signal level or high temperatures.

Tapes should therefore be recorded at a low enough level that peak distortion is less than 2%, and the temperature of the storage place should be preferably between 60 and 70 degrees F., with a relative humidity of 40 to 60%. They should also be kept well away from any magnetic fields, such as those from motors, power lines or magnets.

Minimizing Print-Through

Both print-through and stretching can be further minimized if the tape is wound rather loosely on the reel. The edges of the wound tape should form a fairly flat surface, as a few layers protruding will almost certainly become bent over and mashed.

An excellent storage container for the tape is the aluminum can sold for home movie film. This provides some magnetic shielding, it has space for a drying agent, and its edges may be sealed with water-proof tape.

Blotting paper is a very good drying agent to place in the cans, provided it is thoroughly dry itself. It can be dried by placing it in an oven under a low heat with the door open. After cooling, the paper is cut to fit the can, with a piece going on each side of the tape reel. When the tapes are stored for long periods of time, they should be rewound occasionally to loosen up any stickiness between layers. These procedures were developed by professionals, but are applicable for audiophile use. •

THESE DRAWINGS, above and on the opposite page, show the similarities and differences in tape recording and reproduction. Note single amplifier used to perform both functions, with an electromagnet at input or output as required.

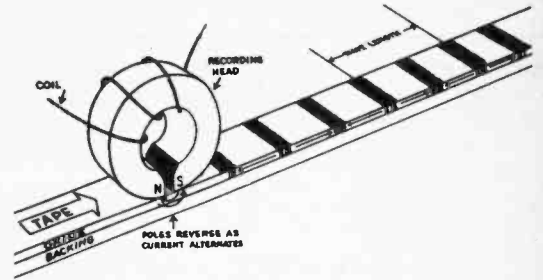

THIS SHOWS in exaggerated form how bar magnets are laid down on tape as it passes the head. The wave length of the sound can be measured as shown on the diagram. Also note the arrangement of the magnetic poles of the signal pattern.

SINGLE TRACK



DUAL TRACK



THIS SHOWS recording methods. In single track recording, the entire tape surface is magnetized by the signal from the record head. In dual track, one half is magnetized in one direction, then the other half is recorded in the opposite direction.



Expanding and Improving Your Hi-Fi System

Here are some worth-while suggestions about the kinds and makes of equipment you can buy in order to make your hi-fi system really complete and first-class.

KORINA WELDWOOD Music Unit (photo left) contains entire hi-fi system, makes beautiful piece of furniture. Note long shelf above unit to hold records.

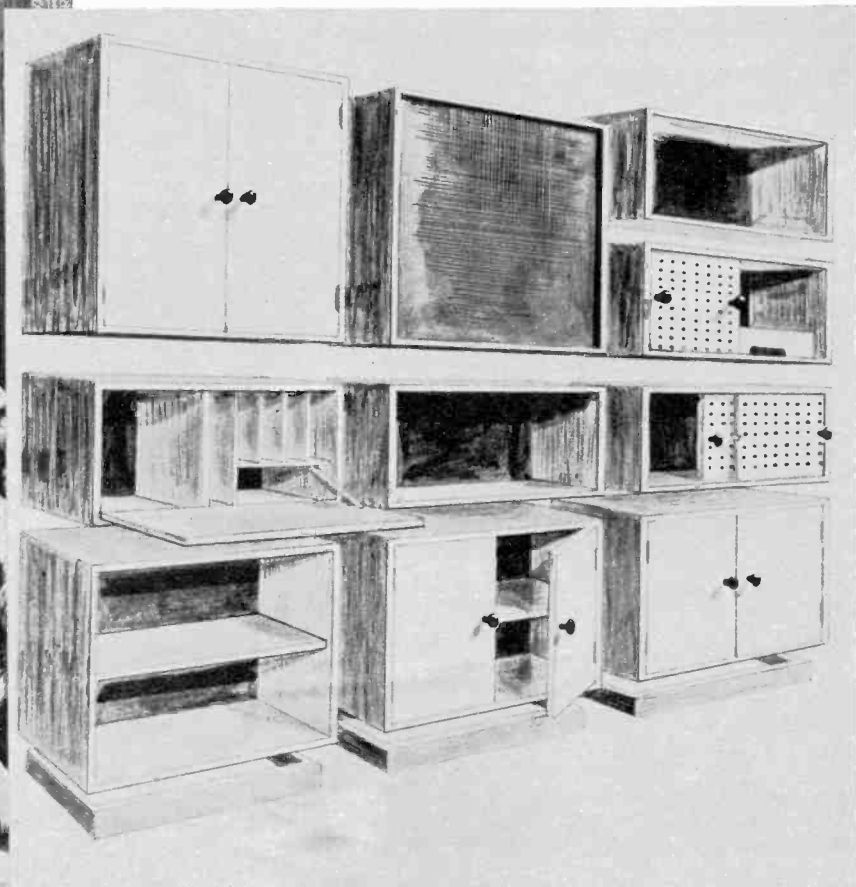

CABINART UNIT (photo above) is a build-it-yourself hi-fi unit in ten parts—nine cabinets and a base. Cabinets may be purchased singly, fit to space.

ONE of the beauties of the component method of hi-fi installation is the ease with which one can plan, finance and install his system. As your ideas become more defined and as your finances permit, you can add accessories and improvements to your basic system, always increasing your enjoyment of your hobby in a logical step-by-step fashion.

A better phono-pickup will improve any system, even the old-fashioned, mass-produced home instrument. Ever since the introduction of the variable-reluctance pickup, which was truly a landmark in the progress of hi-fi, the magnetic type units have held sway in most hi-fi systems, and

the older crystal types almost overnight had become passé. But more recently there have been some rather startling developments in this field, and the newer type of crystal cartridge known as the *ceramic* now appears likely to turn the tide in the opposite direction.

Ceramic cartridges have the advantages of being insensitive to hum induction, and freedom from magnetic attraction between pickup and turntable. Their output is considerably higher than that of the magnetic cartridge, and they very readily can be equalized to standard record compensation characteristics.

For those who are now using magnetic

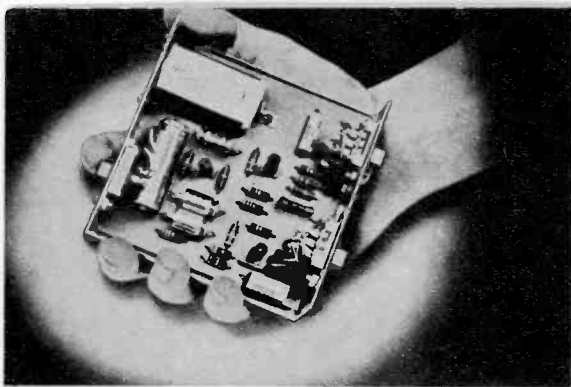

UNDERSIDE view of the Fisher All-Transistor Pre-amplifier-Equalizer shows construction of unit.

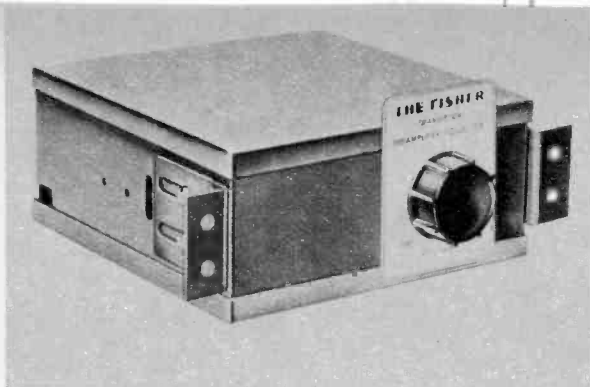

HERE IS the same Fisher preamp in its case. Unit is the first all-transistor product in hi-fi field.

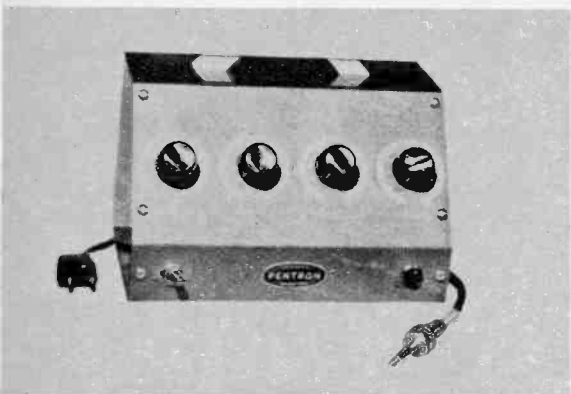

PENTRON microphone mixer allows for mixing microphones, or mike with radio or phonograph.



FLEXIBILITY is the keynote of Scott Equalizer-Preamplifier, including noise suppression at will.

pickups and contemplating a conversion to the ceramic type, a good possibility is the Shure Music Lovers cartridge. This unit comes provided with an electrical network, which permits direct connection to an amplifier designed for magnetic pickups. It is therefore possible to improve a system with this unit without complicated changes in circuitry, and while retaining one's present compensator.

Other leading manufacturers of high fidelity ceramic cartridges include Sonotone, Electro-Voice and Astatic. Replacement with these cartridges is simplicity itself, requiring in most cases nothing more than a small screwdriver.

Magnetic Cartridges

Perhaps in answer to the recent ceramic upsurge, there has been continuing progress in magnetic development as well. One of the more outstanding new cartridges is the Pickering Fluxvalve, which has unusually high compliance and low tracking force. A new wrinkle being recommended for this cartridge is the half-mil stylus, with

a tip radius just half that ordinarily regarded as optimum for microgroove recordings. The manufacturer claims better high-frequency response by virtue of better tracking over sharply curving high-frequency groove displacements.

A corollary advantage may appear when playing badly-worn records. If the groove damage was caused by a 1-mil or larger stylus, the new half-mil tip will ride below this, on a part of the groove walls never before touched by the stylus. This principle has been employed for years by professional recordists, who also know that it is not a perfect cure-all. It should be remembered that all microgroove recording, processing and quality testing is predicated on the use of a 1-mil playback stylus. What happens near the bottom of the groove is not so important to record manufacturers. Imperfections might exist which under ordinary circumstances would be inconsequential, but with a smaller stylus might become glaringly apparent.

Perhaps your need is for a better tone arm. There are now literally dozens on

the market, but one of the oldest and most trusted designs, the Astatic Model 400, is still going strong. One of the newest and most revolutionary, on the other hand, is the Orthosonic V/4. This is the commercial realization of an idea which is as old as recording itself.

New Tone Arm

Engineers have been attempting unsuccessfully for many years to perfect an arm which will move the reproducing stylus in a straight line across the record, this being the path followed by the original cutting stylus. When the playback does not occur along this path there is said to be *tracking error*. Various approaches have been tried in attempting to minimize this, such as very long tone arms, curved arms, offset cartridges and jointed parallelogram arms. But none of them has ever done the job perfectly.

The design problems here are obvious. In addition to a straight-line movement, it is essential that this movement be virtually frictionless. And it was with this latter re-

quirement that most designers have had to admit defeat. Now, however, the developers of the Orthosonic claim to have licked the problem, and the preliminary evidence would indicate that the claims are well founded. If so, they have absolutely nothing to worry about. If it lives up to its promise, the Orthosonic arm will make pivoted tone arms as dead as the dodo bird.

Perhaps your next move will be the acquisition of something new to spin your discs. Rek-O-Kut and Presto offer the finest in turntable products, but if it's a changer you have in mind you'll have to look elsewhere. My own aversion to changers is well known, and although I readily admit their convenience, I have yet to see one which compares in quality with the two makes of turntables just mentioned. But I must admit, on the other hand, that changers are constantly being improved and when I find one which meets my standards I'll be the first to toss the old one-play job into mothballs.

That day hasn't arrived yet, but I can see it's coming closer when I examine the

MASTER AUDIO CONTROL by Fisher closely resembles broadcast mixing console for home use.

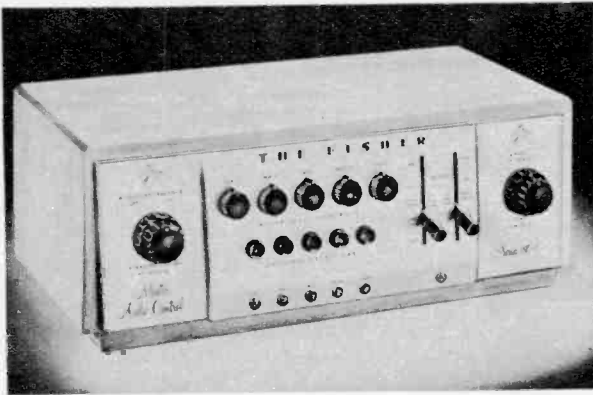

HI-LO FILTER system, also by Fisher, affords wide choice of noise elimination characteristics.

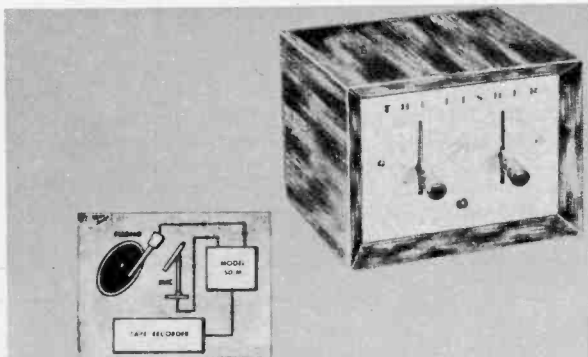

PREAMPLIFIER-EQUALIZER has simple controls for record reproduction in small, handsome case.

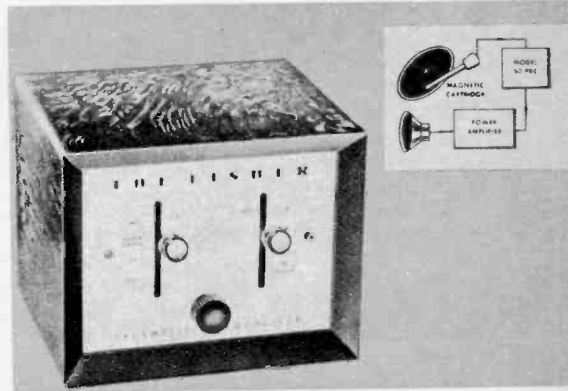

MIXER-FADER permits combination of two signals with separate faders for each plus master volume.

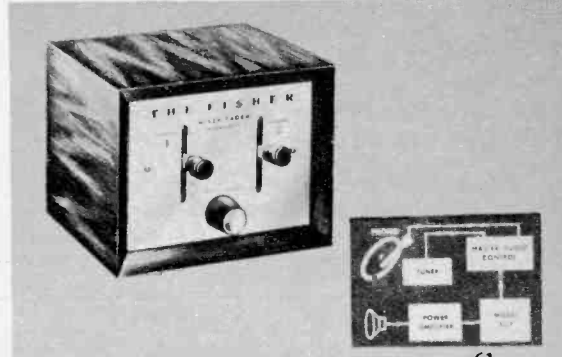

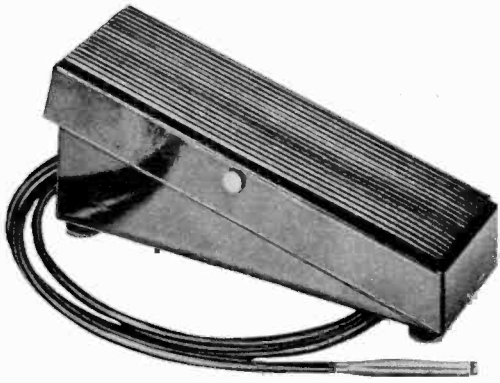

REMOTE CONTROL of tape recorder with foot switch by Pentron lets recordist get into the act.

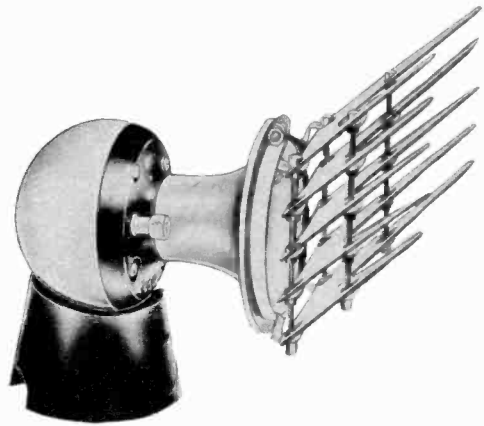

ACOUSTIC LENS tweeter, sold by Lafayette, has uniform dispersion of higher sound frequencies.

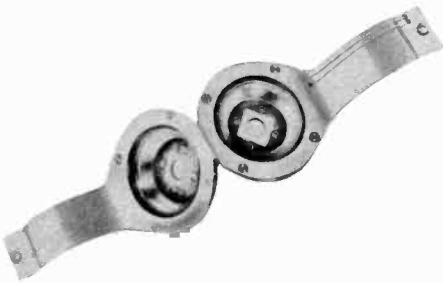

BI-AXIAL TWEETER assembly by Lorenz features twin bracket for mounting on existing woofer.

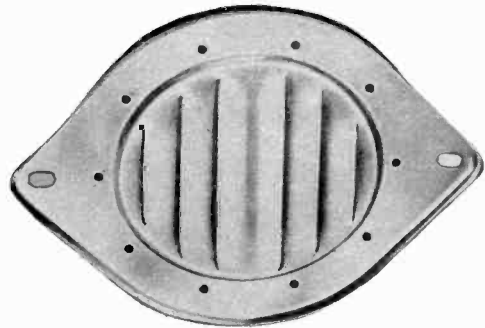

ELECTROSTATIC TWEETER provides better high frequency response at a very reasonable cost.

Miracord XA-100, an imported job. This baby has a fancy set of push-button controls and it really is gentle in its handling of records. Even a scratch filter can be switched in if you like such gadgets. Now if they can just get the wow, flutter, and rumble down a tiny bit more. . .

Preamplifier-Equalizer

If you should need a good preamplifier for your magnetic cartridge, and the pioneer spirit surges within your breast, you can now have the very first piece of hi-fi gear whose principles will unquestionably be in universal use a few years from now.

I refer to the Fisher TR-1 preamplifier-equalizer, the first hi-fi equipment to use transistors and printed wiring throughout.

It draws its power from a tiny self-contained battery, with a consumption so low that the operating life of the battery is nearly as great as its shelf life.

This thing is no gimmick, and not all of its advantages are economies in manufacturing. Noise and hum level are below those even theoretically possible for a rectifier-supplied vacuum-tube amplifier. The unique design, furthermore, permits an output cable length of even up to 200 feet. Thus the phonograph or microphone can be separated from the main amplifier by considerable distance without ill effect. You'll be hearing a lot more about transistors in hi-fi, so keep your eye on this one.

For the more conventional minded,



CONE-TYPE TWEETER by Lafayette is another low-cost approach to high frequency improvement.



DIVIDING NETWORK, Lafayette AR-28, has simple screw-terminal installation, balance control.

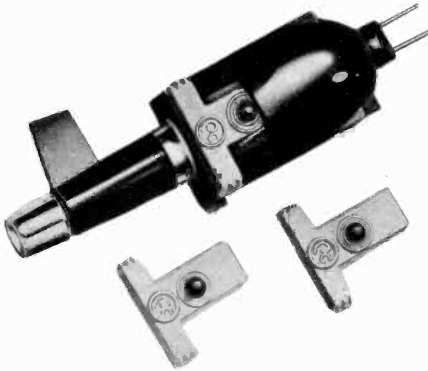

FLUXVALVE CARTRIDGE by Pickering has three styli sizes: conventional 1 and 3 mils, new half-mil.

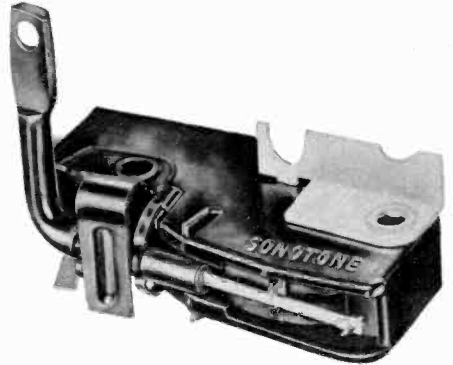

CERAMIC CARTRIDGES such as Sonotone 3T have higher output, lower hum and simple compensation.

Fisher offers its Series 50 audio accessories, each interesting and useful. The 50-PR-C audio control is actually a preamplifier-equalizer, with a wide range of compensation characteristics. Four crossover frequencies are available, as well as four high-frequency rolloff curves.

Noise Filter

The 50-F filter system is especially recommended for those who have extensive libraries of old and noisy records. It is also useful for noisy radio broadcasts, such as those heard from overseas. In addition to a flat response, the filter will cut off below 30, 70 or 120 cycles, at a rate of 10 db per octave. It also provides high frequency cut-offs above 3, 6, 10, or 20 kc, tapering

rather steeply at a rate of 20 db per octave. The mixer-fader, Model 50-M, permits the combining two signal sources, such as two turntables, a turntable and microphone, or any other pair in a single output. Individual level adjustment of each signal is provided. Mixers are particularly useful for recording or for home movie presentations. They are used extensively in recording, radio, TV, and motion pictures, but small portable models for amateur use are exceedingly scarce.

A somewhat more elaborate mixer, which does a sweet job, is the Pentron Model MM-4. This has six channels in all, four for microphones and two for phono, tape reproducer or tuner. Only the mike channels have faders, as the other sources

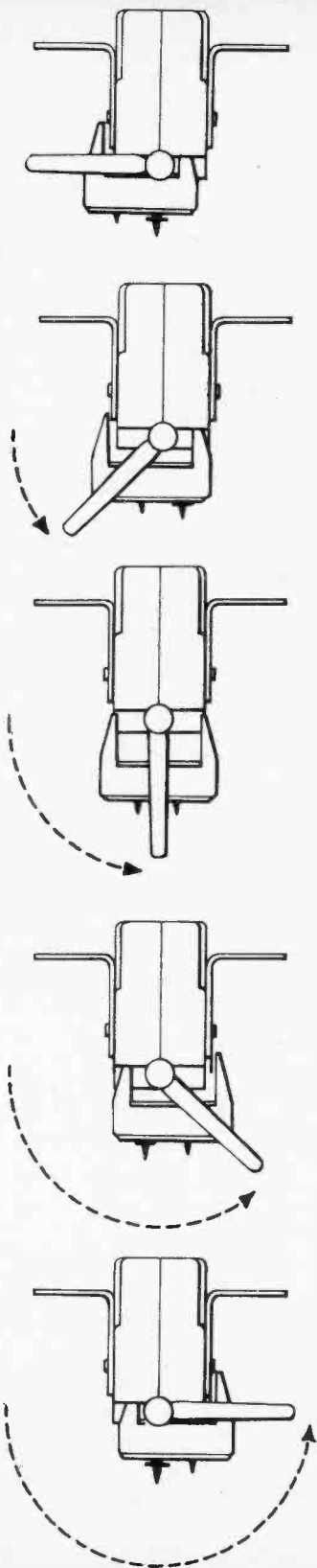

ORTHOSONIC V/4 tone arm moves cartridge in a straight line, reduces tracking error to zero.

SCOTCH BRAND write-on labels ease identification of tapes. Date, reel number, subject are listed.

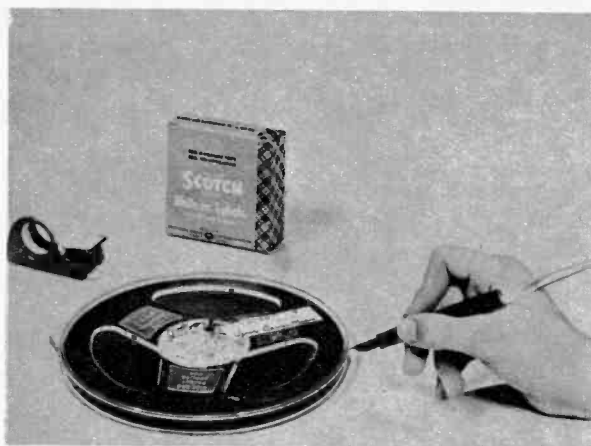

will have their own volume controls. This unit can be used to good advantage directly through the sound system, or into a tape recorder or magnetic motion-picture recorder.

Closely related to the mixer, but more elaborate and more flexible is the audio control center, such as the Fisher 80-C or the Scott 121-C. The basic purpose of such a unit is the combination of all the available signal sources, which may include

MUSIC LOVERS cartridge by Shure has "needle shift," eliminates turnover of needle or cartridge.

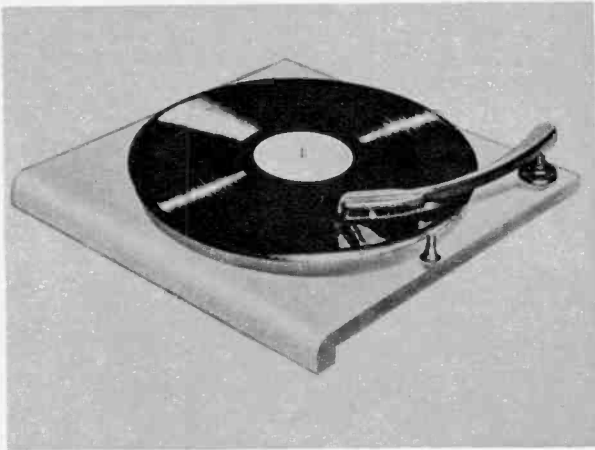

TRANSCRIPTION ARM Model 400 by Astatic is long-time favorite of hi-fi fans, still good performer.

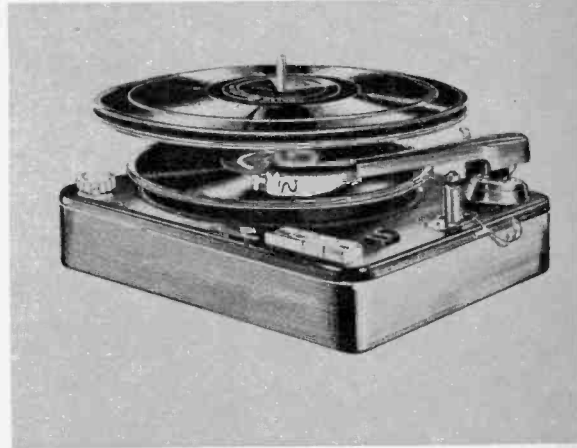

IMPORTED CHANGER by Miracord has push-button controls, optional scratch filter, quiet operation.

AUDIO DEVICES identification labels have adhesive backs, are pressed in place, can be peeled off.

ORRADIO has these reel tabs to identify reels. Tabs fit beneath edges of any 7-inch plastic or metal reel.

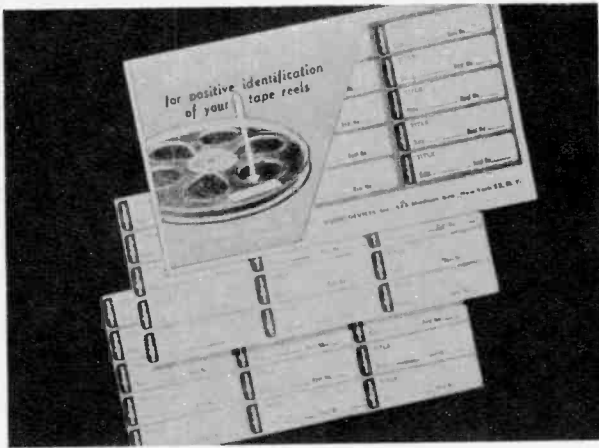

record players, tape players, tuners, TV sets, microphones and others. Here is provided correct termination for the various devices, with necessary switching and control apparatus. With a setup such as this it is possible to feed into the main amplifier and speaker, and a recorder as well, any signal or combination of signals desired. At this point also the various levels are controlled, usually with a choice of either loudness or volume control. Record equalization is also provided, as well as tone controls and, sometimes, filters. The Scott also includes the well-known dynamic noise suppressor. Units of this type are

not necessary to the basic hi-fi system, but they are indispensable to the advanced amateur and sound experimenter who really knows what to do with them.

In your initial hi-fi system you will probably have a loudspeaker which is adequate over most of the audible range, but perhaps somewhat deficient at the extremities. These shortcomings can be corrected by augmenting your present system with a good tweeter, and finally a better bass speaker. It is advisable, but not absolutely essential, that you stay with the manufacturer of your mid-range speaker, so that the additional components will be matched

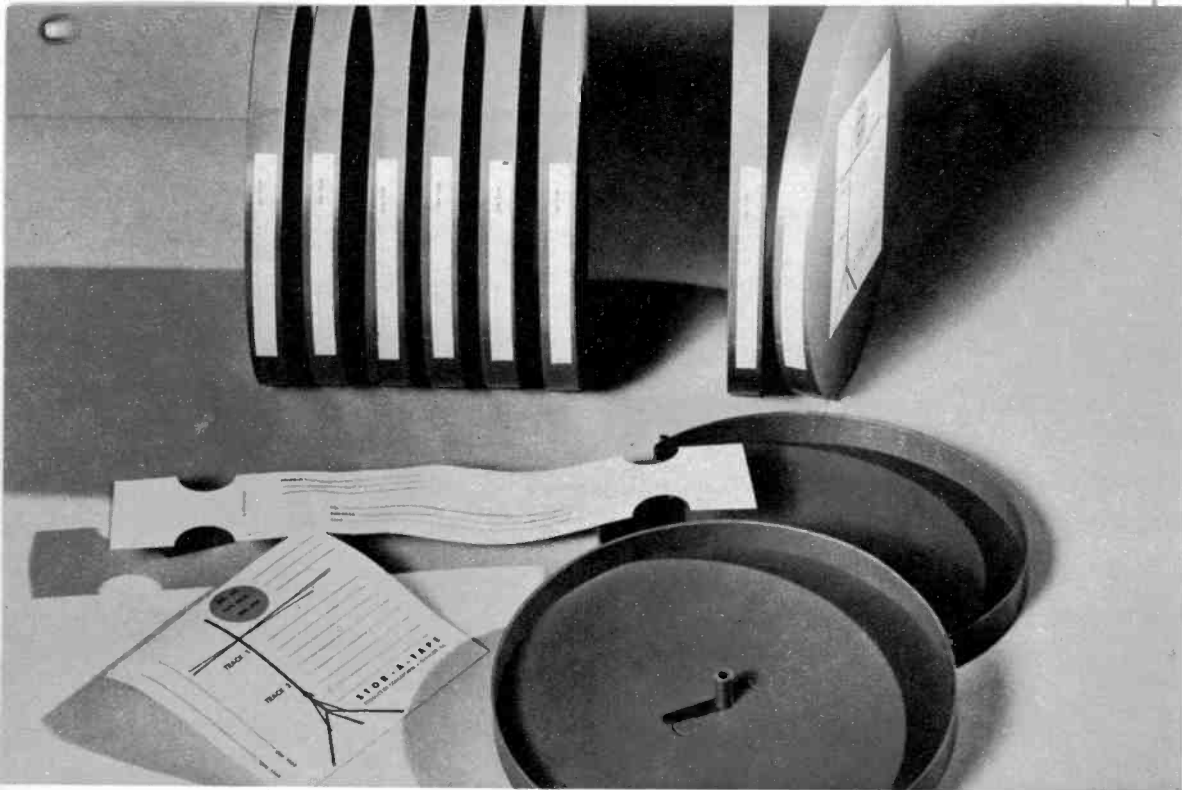

STOR-A-TAPE containers provide safe identification and storage of precious tape recordings. This Con-cortape product holds tape intact on center post, stands on edge to save space, as shown above.

to it. Since balancing controls between the elements are now so common, however, you may get just the result you want by mixing it up a little.

Since tweeters are far less expensive, your first step in expansion will probably be in the direction of more highs. If you are short on cash and looking for bargains, the mail order houses should be one of your first considerations. Lafayette, for example, has a little tweeter, Model HK-3, which is good to 16,000 cycles for around \$6. Another model, HW-7, has an acoustic lens and is good to well above audibility. This one sells for around fifteen dollars. In both cases a crossover network is additional, and the Lafayette AR-28, at around \$9, will do the job nicely.

Imported Equipment

The Lorenz line, which is imported, includes several items of interest. The electrostatic tweeter, SKL 100, provides a very inexpensive means of extending the upper range, and has been quite popular among audiophiles. The LP65 horn-type tweeter has an interesting plastic cone design, and brackets are available for mounting one or two coaxially within an existing 12-inch speaker.

The shape, stiffness and mounting suspensions of most European speakers are quite different from those in the United States, tending to give a softer, rounder tone. This is another reason for advising caution when combining speakers of several origins. The sound of the imported speakers is quite pleasant, however, and if this is your preference you might well consider using one such as the Lorenz LP312 as a woofer.

Another approach to this problem, if you are a constructor, is the range extending system of Heathkit, which was described in detail in an earlier chapter. Certainly one of the most common-sense approaches for the novice who may be completely in the dark is the Progressive Speaker Expansion plan created by University. This is a logical, clear-cut solution from a manufacturer whose product excellence is well known. In the chapter on Free Items and Special Bargains we'll describe how you can get all the necessary data free of charge.

I've said many times that careful planning in advance is essential, and nowhere is this more true than in the question of how and where to install the equipment. The answers have been wrapped up very neatly by Cabinart in their ST series. Ten

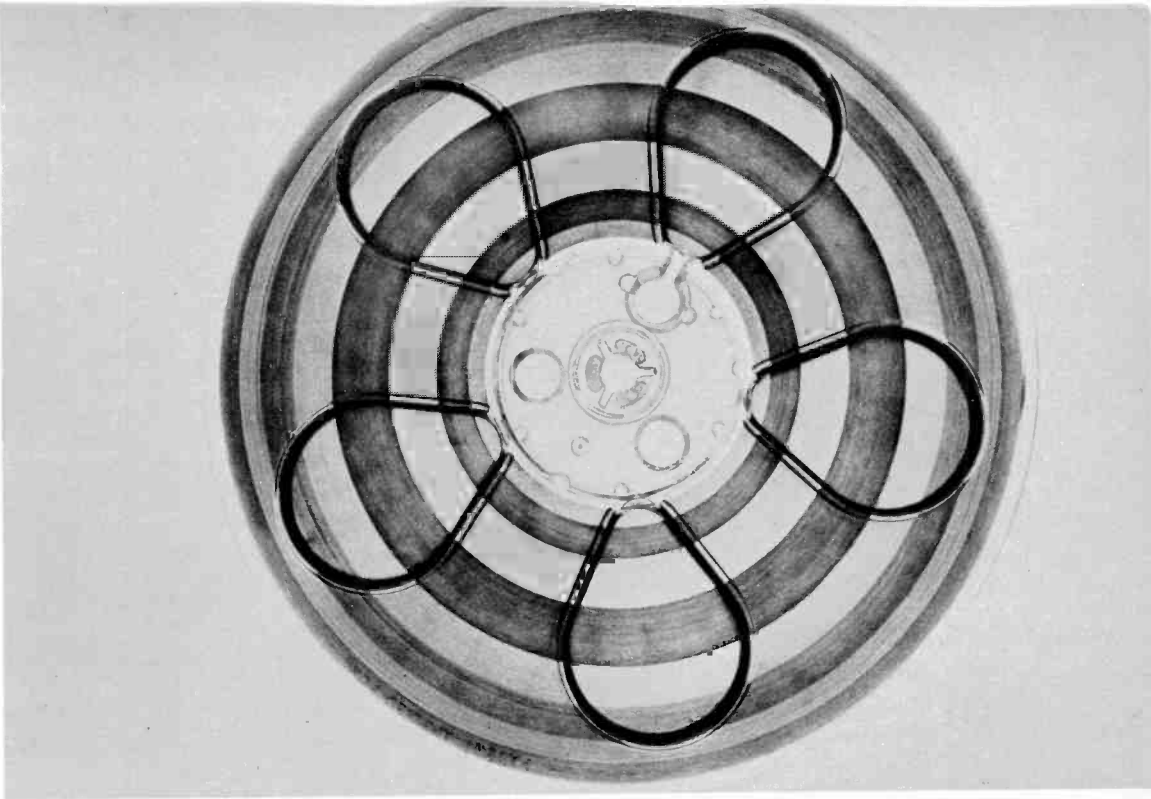

COLORED AUDIOTAPE shows clearly various hues when several colors are spliced on single reel. This system permits easy identification and cueing of desired selections or takes in few moments.

modular units are available, in either assembled or kit form. Since they may be purchased separately, the cabinet work may grow as the system grows, but with all shapes and dimensions known in advance.

A number of accessories worthy of mention are available to the tape recordist. One of the most obvious problems is a means of identification for the tapes themselves. Although all manufacturers allow sufficient space on the tape boxes for written identification, this becomes meaningless if the reel and the box become separated. The most positive identification of all is a spoken announcement recorded on the tape itself. The next best answer is written titles on paper leader spliced to the tape. The next best is the adhesive label stuck on the reel. Both Audio and Scotch offer these. Irish offers an identifying tab which may be slipped under the reel edges. In the final chapter we'll tell how to get a supply of these free.

Other Supplies

Audiotape also supplies corrugated boxes for mailing tape, and colored reels for classifying your tapes by artist, musical type, or other chosen categories. Pentron makes a foot pedal attachment, which per-

mits remote switching on and off of a tape recorder, extremely useful when the recordist is also the performer.

As you become more advanced as a tape editor, you will soon tire of the scissors and want some type of tape splicer. A really top-notch splicer is yet to be developed, in my opinion, but meanwhile you can find available a variety of types at prices ranging from around five dollars up to around a hundred. Since there's so much room for improvement in this field, I'd suggest you get the cheapest thing you can find which will do a satisfactory job for you.

I hope you'll regard these suggestions as thought-starters and ideas for future planning. Not nearly all of the possibilities have been explored in these few pages, nor is everything mentioned here ideally suited to every situation. It all gets back to my favorite theme song entitled *planning*. If you buy your accessories and improvements on impulse, you're almost certain to end up with a rat's nest of wiring, duplicated functions, incompatible components, and wasted money. I can give my personal recommendation to all of the products mentioned here, but *please* don't go out tomorrow and buy out the store. •

INSTALLATION in wall of recreation room has speaker mounted behind sound-transparent picture. System below is installed in gracious living room of Chicago's Gold Coast, overlooking Lake Michigan. Both installations were done by Allied Radio.



Your Complete System

Selection of hi-fi components from wide variety available often confuses the audio novice. Here are five suggested systems in five price ranges.

THE beginner in hi-fi, after absorbing reams of literature on the technical principles of the art, along with equal amounts of seemingly conflicting advertising copy, still is confronted with a fundamental problem. To get started on the right foot, just what should he buy? Many of the letters I receive from interested readers indicate that most of the books and magazines fall short of the mark, for they fail to give specific suggestions about component purchases.

Perhaps the other writers have steered clear of this area, realizing that hi-fi is such a personal sort of hobby, and remembering the old axiom about not being able to please all of the people all of the time. Nevertheless, because I have been repeatedly asked to do so by readers, I have conducted my own personal shopping tour, as if I were in the market for five different hi-fi systems in five different price ranges.

What follows, then, is simply my own personal opinion of what's good on the market today. Undoubtedly there will be many who will disagree with me. Some readers will feel that my selections don't quite suit their needs. Many manufacturers will berate me for having overlooked them. I should make it abundantly clear, therefore, that my failing to mention a given product here does not automatically relegate it to the junk class. There are many good products on the hi-fi market today, and although I know of nearly all of them, I could never find space to discuss them all. With these reservations and qualifications, and with a deep breath, I tell you what I would do if I had need of five systems, along with the necessary coin of the realm.

GROUP ONE—UNDER \$160

Knight "Uni-Fi" Tuner Amplifier (AM-FM with 10-watt amplifier)
Webcor 1631-27 Automatic Record Changer
Electro-Voice SP-12B 12" Radax Speaker

This group, which I think is an exceptional buy, is available from Allied Radio Corporation, Chicago, Illinois, for \$159.95. This includes the basic components listed, as well as a G.E. RPX-050 cartridge with sapphire styli.

As a start, the speaker system may be placed in any sort of simple box baffle or available cabinet. As soon as finances permit, however, the first add-on should be the enclosure designed for the speaker. The *Aristocrat*, which permits expansion of the speaker system at a later date, may be acquired in any of three ways:

(1) Build it yourself from plans available from Electro-Voice, Buchanan, Michigan, or Allied Radio in Chicago. Ask for plans for model KD-6, priced at \$1.00.

(2) Assemble the *Aristocrat* from a kit, for \$35.28.

(3) Buy the *Aristocrat* ready built, at \$64.68 in mahogany, slightly more for blonde finish.

The next step would be the replacement of the 1-mil micro-groove sapphire stylus with one of diamond. The diamond point for the G.E. cartridge is known as RJP-01D, and is \$16.17.

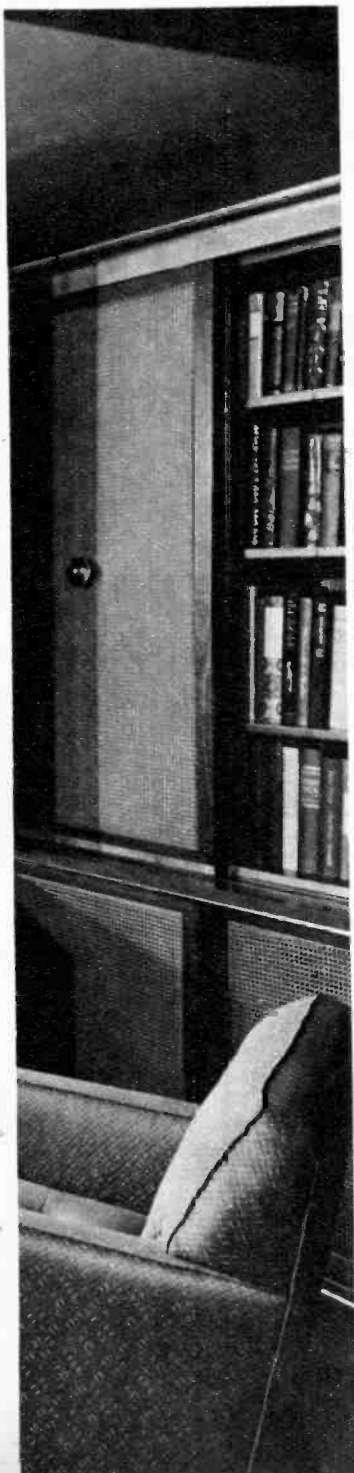



CHANGER by Garrard, Model RC-121, is recommended as most economical by manufacturer.

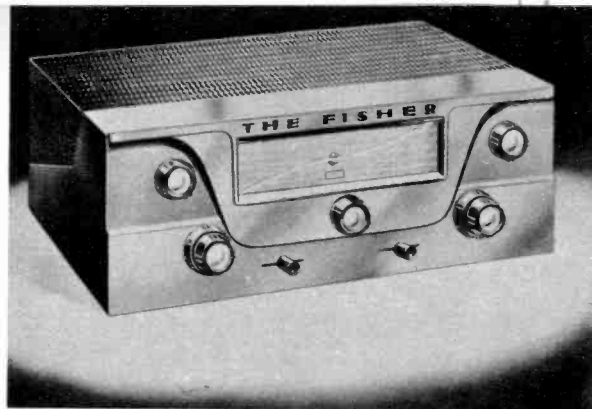

MASTER CONTROL AMPLIFIER by Fisher features the Tonescope, graphic picture of control settings.

At this stage, the additional expenditure of time and money should be confined to the installation. The furnishing and decorating angles should be considered in determining the permanent mountings for the tuner-amplifier and changer.

Finally the high-frequency response may be improved by using the tweeter cutout in the enclosure and adding the Electro-Voice T-35B Super Tweeter, AT-37 Level Control, and X-36 Crossover Network, the total cost for all three being \$32.24.

GROUP TWO—UNDER \$300

Fisher CA-40 Master Control Amplifier (25 Watts).....	\$139.50
Garrard RC-121 Automatic Record Changer.....	41.65
G.E. RPX-050A Cartridge, Sapphire Styli.....	8.20
Electro-Voice 108 Speaker System.....	102.32
	<hr/>
	\$291.67

To meet initial budget requirements, this system provides high-quality record reproduction, using superior components while retaining moderate cost. Tuners and a tape system can be added at a later date as finances permit. The stripped-down components may be employed in a bookshelf or tabletop installation temporarily, or may be installed in an existing piece of furniture.

The first step in adding on to make an acoustically correct system will be the acquisition of a suitable enclosure. This speaker arrangement is the same as the completed one in Group One, with super tweeter, and the *Aristocrat* enclosure is recommended. It may be added in any of the three ways described in the Group One listing. The next step is also the same as in Group One, namely, to get rid of the

sapphire tip and replace it with a diamond.

Installation will depend upon your decor and individual requirements. Much of the fun of the hi-fi hobby lies in that fact that you can do just about as much or as little of the electronic construction and cabinet crafting as you wish. In the components selected here, no electronic work is required except for simple interconnection between the units. As for the woodcrafting, here the sky is the limit—or on the other hand you can simply throw all of the stuff out of sight in a closet. In either case, be sure to allow for future expansion with tuners, and possibly tape.

Finally, finish up with the addition of a Fisher FM-40 FM tuner at \$99.50, or a Bogen R660 FM-AM tuner for \$119.50.

GROUP THREE—UNDER \$450

Bogen R710 FM-AM Tuner.....	\$126.50
Bogen DO-70 Amplifier (70 Watts):	129.50
Bogen B50-16X Record Player, G.E. Cartridge)	48.65
Bogen PB5 Record Player Base.....	4.80
University <i>Senior</i> Speaker Components	109.00
	<hr/>
	\$418.45

This selection represents a moderately priced hi-fi system for records and FM-AM radio, plus provision for the addition of tape at a later date. Each of the electronic components has its own metal enclosure, and a base is provided for the record player, so that the system as is may be used in an existing-furniture or bookshelf installation. If the system is to be customized at the outset, the enclosures and base may be omitted.

I have selected in this instance a record player rather than a changer, thus getting greater quality in the elements of impor-

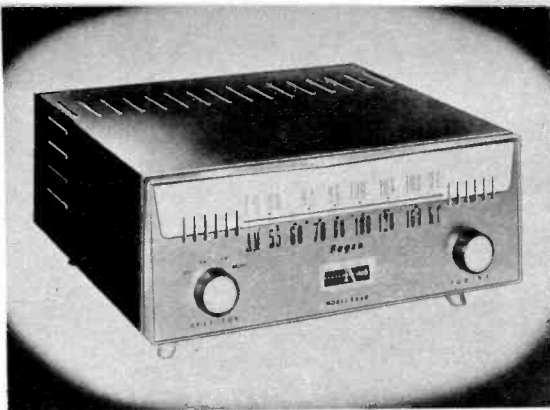

TUNER R660 by Bogen has high sensitivity and selectivity, dual FM noise suppression limiters.



BOGEN B50-16/X player has continuously variable speed selector for precise pitch adjustment.

tance instead of in a complex changing mechanism. If a changer in the same price range is an absolute must, however, then I'd recommend the Garrard RC88 at \$53.41. In either case, one of the first steps should be the addition of an RPJ-01D diamond at \$16.17.

As with the speaker enclosure in the lower groupings, this system also may be acquired by a choice of methods:

(1) Build it yourself from plans available free of charge from University Loudspeakers, White Plains, New York. Write Mr. Larry Epstein at that address, asking for Technigram No. 13.

(2) Assemble the University Kwi-Kit, Model KEN-12, priced at \$39.75.

(3) Buy the EN-12 enclosure ready built, at \$75.00 in mahogany, slightly more for blonde finish.

GROUP FOUR—UNDER \$750

Fisher 80-R FM-AM Tuner	\$169.50
McIntosh C-8 Compensator Control	88.50
McIntosh MC-60 Amplifier (60 Watts)	198.50
Miracord XA-100 Automatic Record Changer	66.15
Miratwin MST-2D Cartridge, Diamond LP Stylus	44.10
University <i>Classic</i> Speaker Components	173.00
	<hr/>
	\$739.75

This system is very nearly tops in high fidelity, with nothing to add except a speaker enclosure and tape recorder. The components are designed for a custom-furniture installation or a built-in wall unit.

Although the speaker system will perform excellently in the infinite baffle usually employed in wall built-ins, it will

deliver the finest when used with the horn enclosure designed for it. Although the *Classic* system is available ready-built, with all components in a finished horn enclosure, this doesn't leave much room for self-expression in individual decor. I would therefore recommend the basic unfinished horn.

The horn enclosure may be built at home from plans available free of charge from University Loudspeakers, White Plains, New York. Write Mr. Larry Epstein at that address, requesting Forms 78A9 and 78A10.

For those with less time, or who lack the facilities for such an extensive construction job, the completely assembled but rough-finished horn, known as the University EN-CB, may be used as a basic shell for building into a wall or room divider. It is priced at \$120.

If a unit of furniture is desired, the EN-CB may be surfaced with Formica or Micarta, even in one's own living room. A picture story showing just how simple the process can be, will be found in the chapter titled *What About Loudspeakers?*

GROUP FIVE—ABOUT \$800

Fisher 80T FM-AM Tuner with Audio Controls	\$199.50
Fisher 90A Amplifier (90 Watts)	229.50
Rek-O-Kut B12H Turntable	119.95
Rek-O-Kut A-120 Tone Arm	26.95
Pickering Fluxvalve Cartridge, Diamond LP Stylus	49.50
Jensen <i>Imperial</i> Speaker Components	184.50
	<hr/>
	\$809.50

This is my "dream" system, representing in my opinion the very last word in hi-fi today, regardless of price. Here is professional quality every step of the way, and

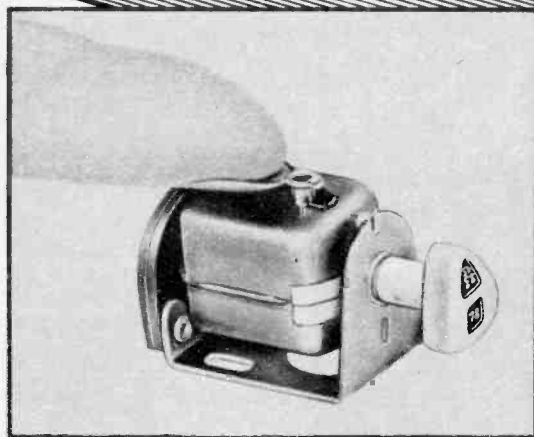
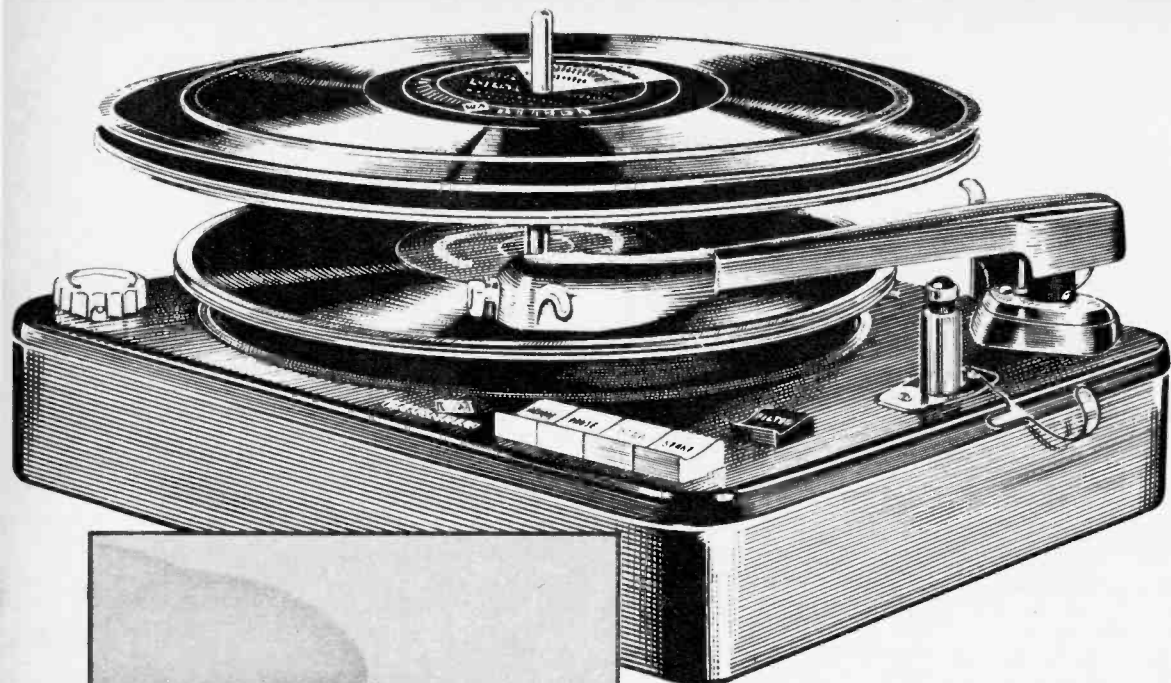

CHANGER by Miracord (above) features "Magic Wand" drop mechanism, without pusher arms or stabilizers. Miracord cartridge (left) is two pickups in one unit.

sufficient audio power to set up any desired arrangement of extension speakers throughout the house.

Once again a few additional words are necessary concerning the loudspeaker system. The Jensen *Imperial* system, in my judgment the best that has ever been made, is available from the factory in a finished enclosure. But to purchase it this way would increase the basic price of the entire system by 50%, or up to around \$1200. Furthermore, the same comments apply here as in the case of the Group Five speaker system. But with the do-it-yourself approach it is possible to save several hundred dollars. Here's how:

(1) Build it yourself from plans in Jensen Manual 1060, available for 50 cents from most hi-fi dealers or from Jensen Manufacturing Company, Chicago 38, Illinois.

(2) Assemble the *Imperial* from a kit available from Cabinart, Brooklyn, New

York. This is a basic shell which can be used for wall built-ins and room dividers, priced at \$89.

(3) For a piece of furniture, get a finishing kit for \$54, also from Cabinart. This contains pre-cut and pre-finished surface sections of mahogany or korina, as well as all accessories such as grille cloth and hardware.

And there you have the story of how I would budget my money for component systems in several typical price ranges. Please remember that I am only telling how I would spend my money, not necessarily how you should spend yours. It may well be that somewhere here you may have found just the information you were looking for, and on the other hand none of these may suit your requirements for any number of reasons. At any rate, I hope you've gained some useful ideas. Now pardon me while I get ready to dodge the brickbats. •

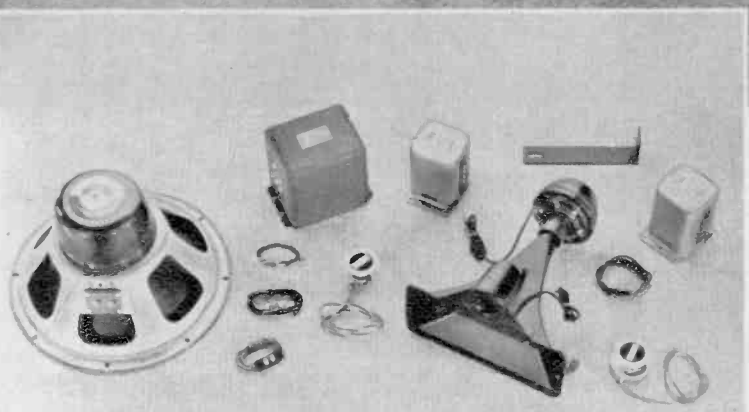

JENSEN Imperial speakers provide the sound in unit above. Three-way system components are shown left. Crossover frequencies are 600 and 4,000 c.p.s. With grille removed (below left) speaker placement is very clearly indicated.

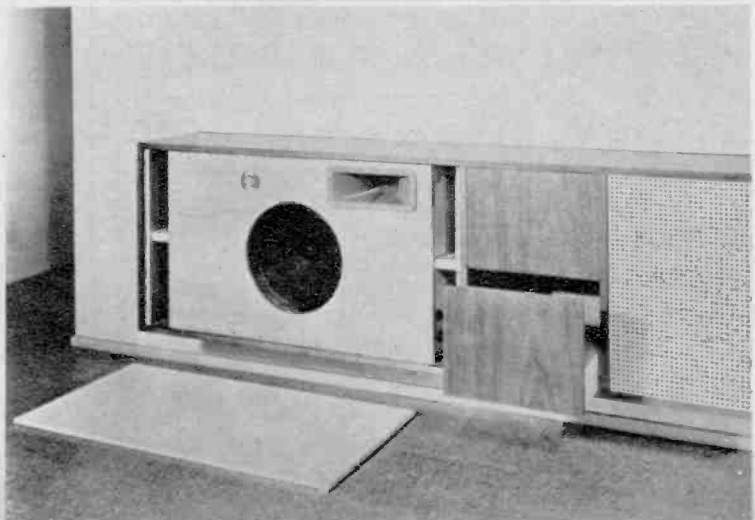



BOOKSHELF INSTALLATION above makes striking use of knotty pine to enhance Bogen components.



MODERN DESIGN is everywhere evident in unique Allied Radio bookshelf installation shown at left.

WALL-HUNG CASE below provides Bogen system with acoustic and decorative advantages.

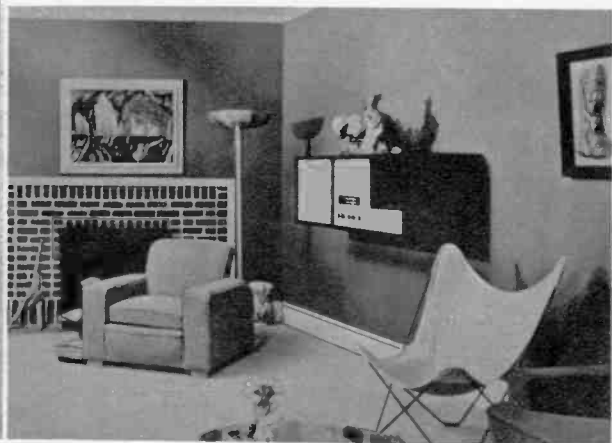

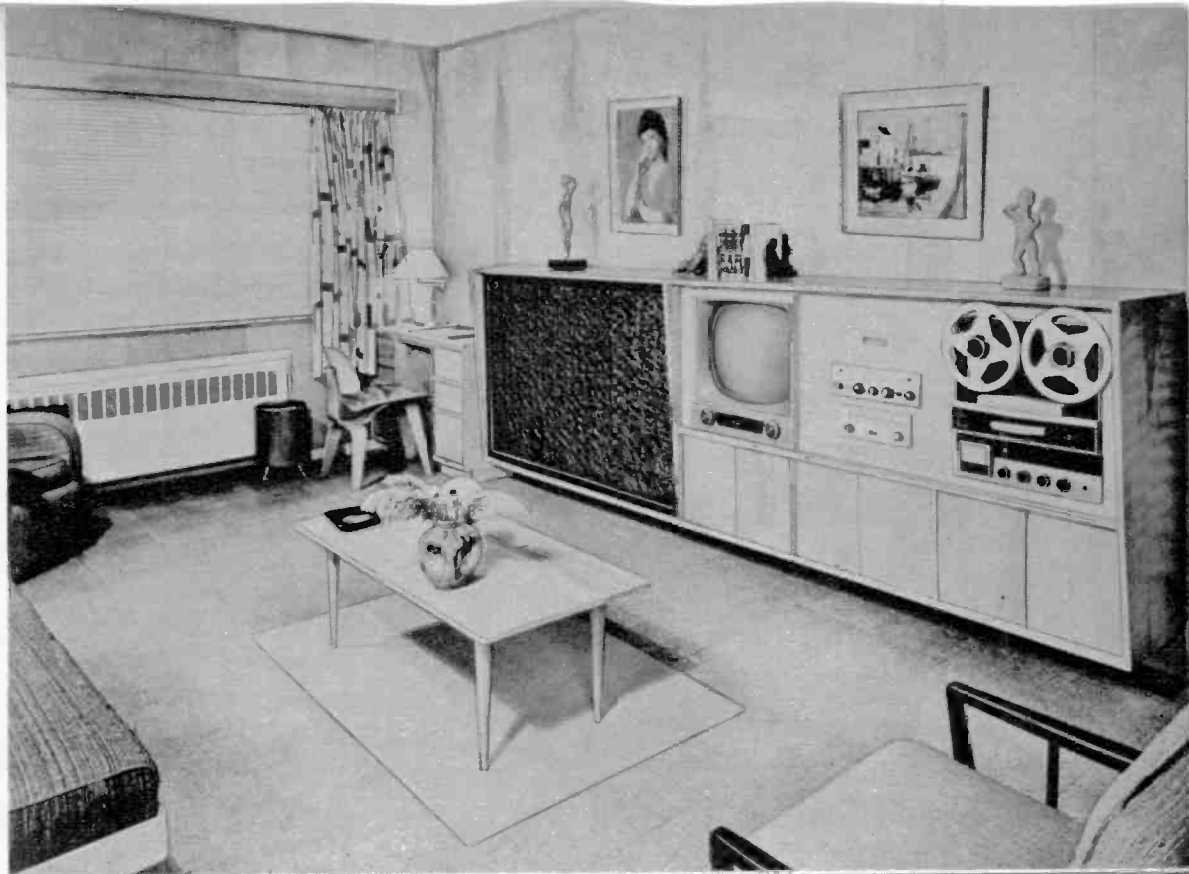

DECORATIVE USE of matching woods provides handsome housing for Bogen system shown above.

SLIDING DOOR conceals home entertainment center at right when not in use. Hi-fi by Fisher Radio.

HI-FI and dining provide happy combination in Bogen installation below. Note overhead speaker.



EQUIPMENT MAINTENANCE is easy when a tube checker is close as the corner drugstore. This one is in Jomar Chemists, Flushing, N. Y.



CONNECTORS often include phone plug, pin plug, Jones plug and Amphenol screw-on. In hand is pin-to-phone plug adapter.

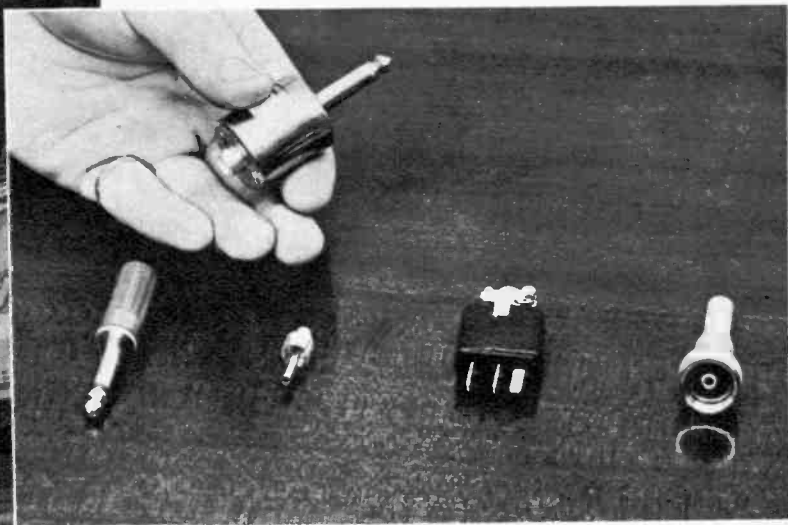

Maintenance and Trouble Shooting

Most of the troubles you'll encounter in your hi-fi system are the kind you can fix yourself.

WHEN I first came out of engineering school I was the original eager beaver, ready to take over the electronic world. Whenever confronted with a malfunctioning piece of electronic equipment, I would sit down, armed with all my new-found knowledge and reasoning, come up with dozens of the most complex, abstruse causes for the difficulty. Then I'd examine the set, eliminate these possibilities one by one, and finally discover to my intense sorrow that the cause of the trouble was a blown fuse, burned-out tube, frayed power cable—or just a switch turned off.

I had to learn that lesson the hard way, but the statistics are still the same today. At least 80% of the trouble you'll encounter in your hi-fi system are of this simple everyday garden variety, and there's no reason at all why you can't be your own serviceman on these cases. And even these problems will be fewer and farther between if you'll observe a few simple precautions.

Much of your hi-fi gear generates considerable heat, and you'll hold your equipment troubles to a minimum if you permit that heat to escape. This means adequate ventilation is an absolute necessity. Don't install equipment in an enclosed box where air can't circulate freely.



TUBE TESTER by Eico performs variety of checks. Eico instruments available as kits or assembled.

VACUUM TUBE VOLTMETER reads accurately on complex waveforms encountered in audio work.

Punch vent holes in the sides and bottom where they won't mar the external appearance. If that's not enough, remove the back. If you're afraid of injury to curious little hands, tack pieces of screening over the vent openings. Even set up a small fan if necessary, but keep the equipment cool. You'll prolong its life, cut down servicing and reduce costs.

Many of the components also have associated electrostatic and magnetic fields, and these attract dust and dirt particles. This then means that frequent periodic cleanings are an absolute must. If you haven't been in this habit, look right now into the back of your equipment. If you don't have a hi-fi system yet, look into the back of your radio or TV set. If it's more than a few months old I can guarantee you one of the dirtiest messes you ever saw.

Cleaning Tools

Probably the best device for the preliminary cleaning is the lowly vacuum cleaner. The small round dusting brush and the crevice cleaning attachment are particularly useful! Use the vacuum function, of course. Merely blowing the dust out into the air will permit it to be attracted right back to the set in a matter of hours. And to be absolutely safe, be certain that all power cords to the hi-fi equipment are pulled out from the wall plugs.

Be particularly careful on the underside that no wiring is disturbed, which might cause shorts or open circuits. Finally, work on any missed spots with a soft dry rag. When finished, inspect all tubes and other plug-in devices to be sure they are firmly seated in their sockets.

Tape recorders require additional and frequent cleaning. Despite every precaution, small fragments of oxide and binder will continually wear off the tape and cling to the heads, rollers and guides. The housing should be removed from over the heads and the entire top deck then carefully vacuum cleaned. The scale worn off the tape coating is more stubborn, however, and must be loosened with a little solvent and rubbed off. A small cotton swab, such as a Q-tip, dipped in a little carbon tetrachloride will do nicely. Use only as much pressure as necessary, and as little solvent as possible. Wipe off any excess solvent when finished, and allow a few minutes for the surfaces to dry thoroughly before playing tapes. Performing this routine frequently will reduce wear and tear on both tape and machine, and will prevent impaired frequency response due to beclouded heads.

Cleanliness is vitally important in the care and use of phonograph records, especially the microgroove types. To appreciate fully just what a little dust and dirt can do to your precious records, just con-

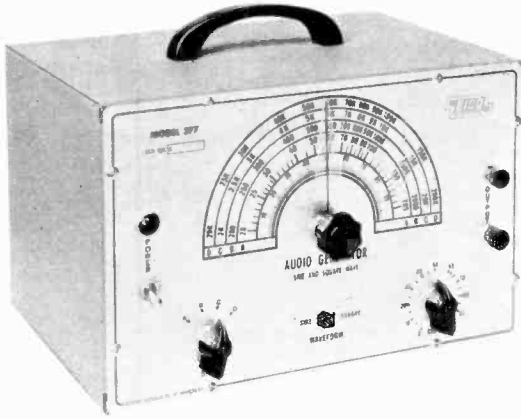

AUDIO GENERATOR is indispensable for response and distortion measurements on hi-fi equipment.



OSCILLOSCOPE is useful not only for visual check of audio waveforms, but also for trouble shooting.

sider the real agony you sometimes go through when you get the tiniest speck in your eye. The mere fact that an object is almost too small to be seen does not mean that it cannot be rough, jagged and brutal. If you still doubt me, next time you have a painful mote removed from your eye, examine it under a microscope. What you'll see will send chills up and down your spine.

Then consider what happens when such a microcosmic monster becomes trapped between stylus and record, with tons of pressure forcing it against the soft plastic groove walls. The record gets chewed up unmercifully and irreparably, and the stylus, too, takes a beating and in time is worn flat. Obviously, when laying out up to six bucks a copy for discs, it's foolhardy not to keep them exceptionally clean.

Cleaning Records

The very best method I know for cleaning records, and the one invariably used in professional installations, is compressed air. Unfortunately, not many of us have a tank of the stuff lying around the house, but most of us do have a small air compressor which will work fairly well. When a vacuum cleaner hose is connected to the exhaust or blower end, and the crevice tool attached to the other end, a fairly decent pressure can be built up. You can increase the pressure even more by closing off part of the crevice tool opening with some ad-

hesive tape wrapped over the end. The cleaner itself must be reasonably free of dirt, with the filter installed, or it may just blow more dirt onto the record.

But I realize that all this is a lot of bother, and you may think I've wasted my time and yours even mentioning it. So we'll go on to the next best method, which involves wiping the disc with a slightly damp cloth or plastic foam sponge. Most authorities recommend placing the record on a spinning turntable for this job, but I don't agree. You really can't apply enough pressure this way without putting an undue strain on the motor and power train in the table. I prefer holding the record flat, with one edge against the chest and the opposite edge with one hand held vertically. Then with the other hand apply the sponge, rubbing gently but firmly in a circular motion. Since this usually releases the static charge built up on the disc, any visible specks remaining can be blown off by mouth.

Of course, the records should be stored vertically in their jackets when not in use, well away from direct sunlight or interior heat sources. The groove area should *never* be touched with the hands, and the records should *never* remain in stacks, especially not after a bunch has finished playing and lies on a changer turntable.

And speaking of changers, these are such complex devices that there is little one can



CLEANER for carbon-type variable controls is a special solvent. Apply it with an eye dropper.



REMOVE KNOB, tilt set slightly backward, let fluid run down the shaft. Work in by rotating shaft.

do with them in the home other than frequent cleaning and occasional oiling and greasing of moving parts. The stylus and pickup assembly should always be kept scrupulously clean, of course, for cleaning the record means nothing if the pickup assembly drops a lot of dirt on it as soon as the arm comes down. An excellent tool for this cleaning is a small mascara brush.

There are, however, several changer adjustments which are often needed and which can be performed by you. There is nothing quite so annoying as a changer which is maladjusted for the stylus landing point. Either the thing starts playing a few bars into the music or it lands outside the record area and must be placed in the lead-in groove by hand. Both these problems can be easily corrected.

When you raise the tone arm up to a vertical position and examine it at the pivot end, you will note some sort of screw adjustment which determines the position of the arm mounting on the axle. Now put a 7- or 10-inch record on the table and cycle the changer by actuating the "Reject" switch. Then, when the arm has begun its descent and is about a half-inch from the top of the record, turn off the power and stop the rotation.

Raise the tone arm again manually and begin adjusting the set-down screw. Then drop the arm back down gently to determine the results of your adjustment. Continue adjusting until the set-down point is midway between the outer edge of the record and the first sound groove. Finally turn on the power again and cycle the changer. Check the landing points on 7-, 10- and 12-inch records. Since the distance between these three points is fixed by the changer design, no separate adjustment of each is possible. Thus if any one of them

is still not right it will be necessary to make further adjustment until a compromise point is found where all three landings are acceptable.

Occasionally it is necessary to adjust the tone arm height. This becomes necessary if the arm fails to clear either its rest, or the top of a full record stack on the turntable, or the bottom of a record on the drop shelf above. Correction is made by the height adjustment screw, usually a threaded stud protruding downward from the bottom of the arm, an inch or two in from the pivot. This is usually accomplished from the underside by means of a small wrench, although in some types it may be done through a hole in the arm, using a screwdriver.

Tone Arm Height

To prepare for the adjustment, place a full stack of the maximum number of records recommended by the changer manufacturer onto the turntable. Then cycle the changer automatically by actuating the *Reject* switch. Adjust the height screw until the arm raises straight up about $\frac{1}{4}$ inch above the top of the stack.

Another important changer adjustment is in the matter of stylus pressure. If the spring counterbalance gets tired or is out of adjustment, your records are bearing the brunt of it. Furthermore, changers are usually adjusted at the factory for pressures in the neighborhood of 8 to 12 grams, rather than the 5 to 8 grams recommended for microgroove recordings. I would therefore advise every changer owner to get a good stylus pressure gauge, and adjust that spring for the lightest possible force consistent with satisfactory changer operation.

Electronic troubles can be exceedingly



SHIELDS in preliminary stages must be twisted and removed before tubes can be taken out.

complex, but as I've already observed they are usually very simple. Let's begin with the cases of complete inoperation. First determine if you have a source of power. Perhaps there is a fuse or breaker blown in your house power line. Maybe the plug isn't in the wall. Perhaps the cord is cut or broken. If you are certain power is getting into the chassis of the system, the next element to suspect is a fuse in the equipment.

You should know in advance the location and rating of every fuse in your system. In hi-fi systems they are usually of the little glass cartridge type, and a simple visual check will normally show if the link is discontinuous and must be replaced. The fuse holder is most often of the panel-mounted variety, with either a knurled-knob or screw-top cap for removal. System power should be removed when checking fuses, preferably by pulling the AC cord.

If the fuse is burned out, it should be replaced by one of *identical* value, and power again turned on. If the set lights up, you can assume that the trouble was a momentary overload and not serious. But if fuses continue to blow, then trouble must lie elsewhere.

Many causes of blown fuses can be detected with a visual inspection. Frayed power cords, misplaced or dangling wires, and even some internal shorts, will be obvious by the black marks on them from arcing or sparking. Any such faulty component will simply have to be replaced or repaired.

Another possible cause of inoperation is the failure to get power from an interconnection. Many pieces of equipment now include auxiliary power outlets, into which other apparatus may be plugged. In some

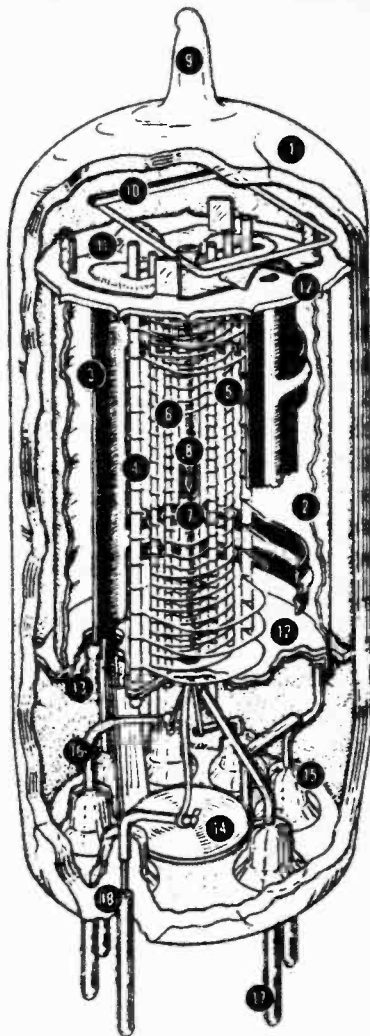

tube construction

CUTAWAY DRAWING by RCA shows internal construction details of typical "miniature" glass tube used in television receivers. Sketch is 2½ times actual size, and component parts are as follows:

- | | |
|--------------------------------|--------------------------------|
| 1 Glass Envelope | 10 Getter |
| 2 Internal Shield | 11 SpacerShieldHeader |
| 3 Plate | 12 Insulating Spacer |
| 4 Grid No. 3
(Suppressor) | 13 Spacer Shield |
| 5 Grid No. 2 (Screen) | 14 Inter-Pin Shield |
| 6 Grid No. 1
(Control Grid) | 15 Glass Button-Stem
Shield |
| 7 Cathode | 16 Lead Wire |
| 8 Heater | 17 Base Pin |
| 9 Exhaust Tip | 18 Glass-to-MetalShield |



FOUR-PIN

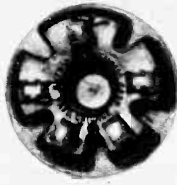

FIVE-PIN



FIVE-PIN TOP-OF-CHASSIS TYPE

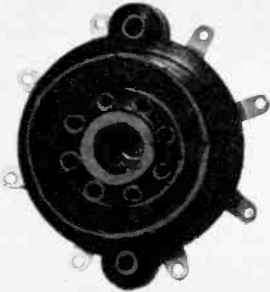

OCTAL UNIVERSAL MOUNTING TYPE



OCTAL (NOTE KEYWAY)

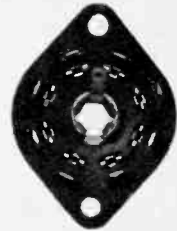

LOCTAL

cases these receptacles are "hot" only when the supplying equipment is turned on. Thus if your tuner gets its power from a receptacle on your tape recorder, it is possible that the tuner won't operate unless the recorder is turned on. An arrangement of this sort may be very handy, since one main piece of equipment can act as the master switch for all of the others, thus obviating the need for turning on a number of switches and adjusting controls whenever starting the system. But if it causes inconvenience, then you should draw your power directly from a house receptacle.

The next likely source of trouble would be a tube. If you are unable to see any light in a glass tube, or if a metal type doesn't feel even slightly warm, chances are the filament is burned out and the tube must be replaced. It is exceedingly important that the identical type be used for replacement, but the manufacture is not very critical. A type 6SN7-GT for example, is a 6SN7-GT, regardless of which

reputable manufacturer makes it. Prices and quality in vacuum tubes vary but slightly.

But while a burned-out filament indicates tube failure, a lighted filament does not necessarily mean the tube is all right. Tubes can also be open, shorted, gassy, or just weak. The simplest and most accurate means of detecting a bad tube is to replace it with a good spare and note the results. If the trouble clears, throw the old tube away. If it doesn't, return the old tube to its socket and go on to the next one. Lacking a set of spares, you'll have to test the old ones on a tube checker, which means removing all of them from the set and finding a friend or local dealer who has such an instrument. This is still not quite as accurate as a substitution test under your own operating conditions, however, and I'd therefore advise that you keep a spare kit of tubes on hand.

Whichever method of tube checking you employ, however, you must be quite care-

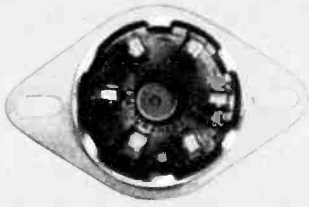

SIX-PIN

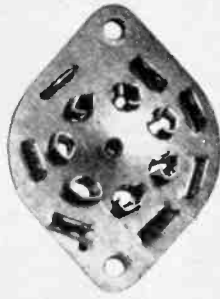

SEVEN-PIN



SEVEN-PIN MINIATURE



NINE-PIN NOVAL

SHOWN ON this panel is an assortment of standard tube sockets. All are labeled for identification. All except the five-pin and octal universal are shown from the bottom.

DELICATE PINS of miniature tubes may sometimes be fixed with 7-prong, 9-prong pin straightener.

TUBE TYPES found in hi-fi work include glass octal, metal octal, miniatures in and out of socket.

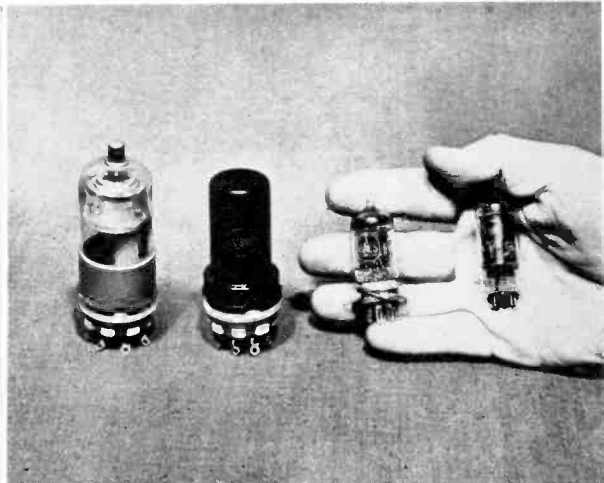
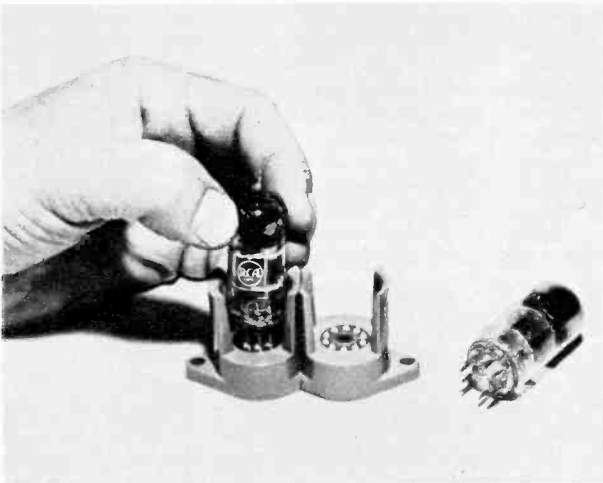

seven ways to remove needles

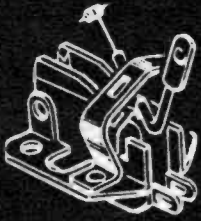

1-Release spring-
pull needle out.

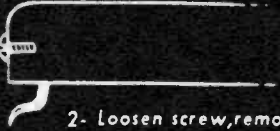

2- Loosen screw, remove needle.

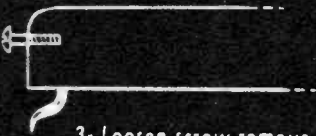

3- Loosen screw, remove needle.



4-Loosen screw, remove needle.

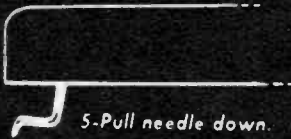

5-Pull needle down.

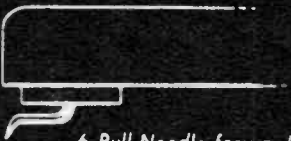

6-Pull Needle forward.

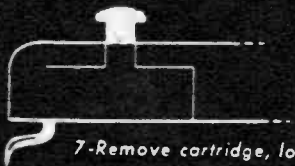

7-Remove cartridge, loosen nut,
C-washer, pull needle out.

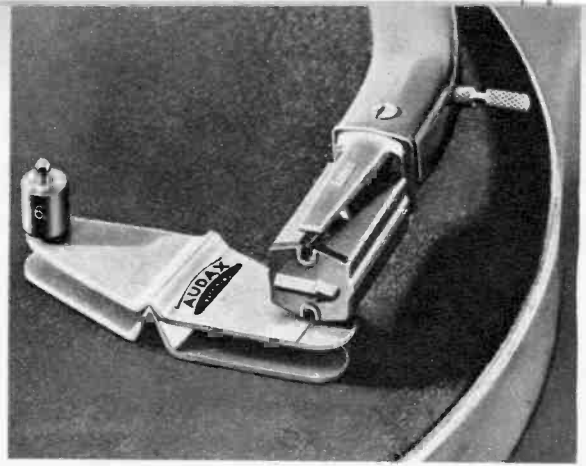

STYLUS PRESSURE is best measured by a balance, such as the one shown above made by Audax.

ful in their removal and replacement. You will turn the power off, of course, but you still must be wary of burns if the set has been operating for a while, and at the same time avoid dropping and damaging the tube.

Removal and replacement of octal and loctal type tubes is fairly simple, as they locate themselves through a keyway in the base which fits a notch in their socket. Since all such sockets are identical, however, many different tubes will fit them, and one must be certain which type goes in what socket. If the types are not clearly marked on the chassis, or if you don't have a tube-location diagram, then I earnestly suggest that you make one. No matter how good you think your memory to be, you can get yourself into a hopeless jumble, with the set refusing to operate and possibly some tubes ruined.

Handling Miniature Tubes

The difficulties are compounded in the case of miniature tubes. They are extremely fragile and subject to damage. Furthermore they have no guides, such as the keyway and notch arrangement. When removing a miniature tube from its socket, pull it straight up and out. If it resists you may have to rock it *slightly*, but hold this rocking to a minimum, as the small wire prongs bend all too readily.

Replacing one of these little nothings into its socket is the real fun, though. Since there is no keyway, you must use the pin spacing as your only guide. Don't try to force the tube, and don't try to feel your way by rotating the tube against the socket. Either practice is almost certain to win you some bent or broken pins.

The job will be easier, though, if you have plenty of light and use a small mirror. A dental mirror is perfect; lacking

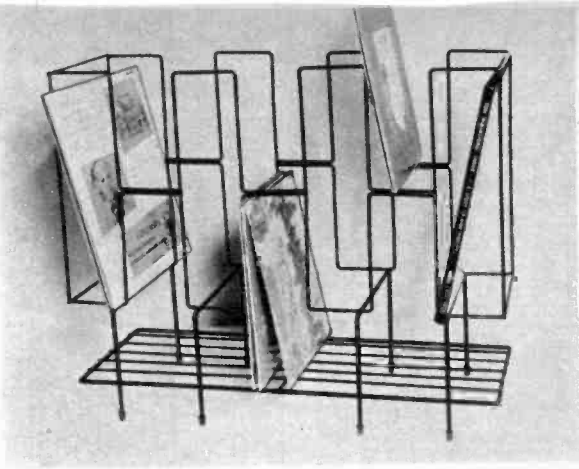

RECORD STORAGE with discs correctly vertical is feature of this rack by Leslie Creations.

this you can use a small pocket mirror. Angle the mirror so that you see both the tube pins and the socket holes, and you can't miss.

All of the tests I've described so far can be performed without your getting into the set with power on. These are the safest, and if you have any doubts about your abilities I suggest you leave anything further to a professional serviceman. Whenever working on equipment with power on, no matter how experienced you are, it is always wise to *keep one hand behind your back*. Better yet, keep it in your pocket. There's nothing "sissy" about this; it's just good common sense. As long as only one hand is in the equipment at a time, the worst that can happen is an electric shock through that hand. But if you provide a path for current to pass from hand to hand through the body, this could be serious. So play it safe.

If you follow instructions precisely on this test, however, there is almost no chance of your getting into trouble at-all. It is known as the shock test, although no pun is intended. It is based on the idea that tubes which malfunction intermittently can be deliberately caused to misbehave when subjected to mechanical shock. Similarly, conditions of tubes which are going sour can often be aggravated by this method. In either case the offender is readily singled out and replaced.

With power turned on and the back off the set, tap the tubes one by one, rather sharply with the rubber end of a pencil. Then observe the effect on the output. If the sound becomes noisy or distorted, squeals or goes dead, the tapped tube is at fault and should be replaced. Similarly, if the tube itself sparks, or exhibits a blue vapor, or its elements become red hot, it must go. •

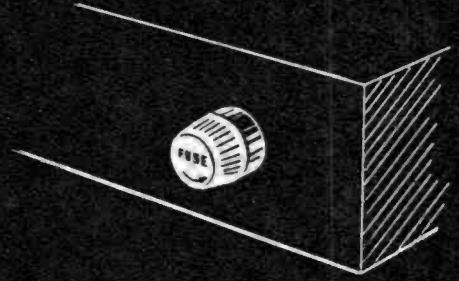

PANEL MOUNTING of fuses is typical in hi-fi equipment. Removal is accomplished by unscrewing the holder.

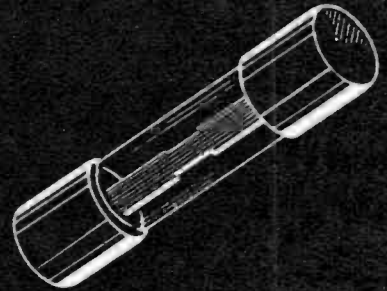

TYPICAL FUSE found in hi-fi systems. If metallic element is broken in middle, bad fuse must be replaced.

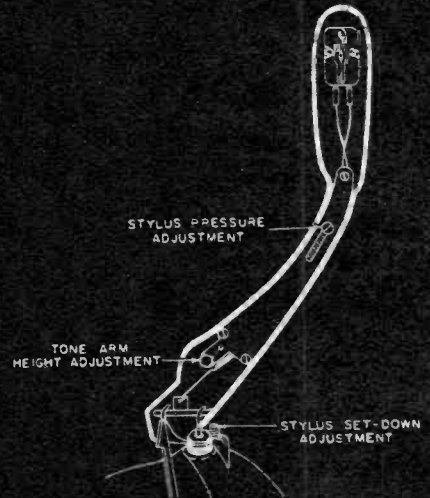

TONE ARM ADJUSTMENTS on this V-M changer are simple and typical. Other makes are generally similar.

THIS DRAWING takes to task the hi-fi fan who purchases far more equipment than he could ever use.

How Hi The Hokum?

Let's take an intelligent look at the barbs hurled at hi-fi enthusiasts by their critics.



I CAN take a joke as well as the next guy, I think, but this time I'm mad! I don't know how you feel about it, friend, but it seems to me that too many jokers have been getting too many yocks at the expense of us audiophiles. Nobody pokes fun at stamp collectors. Nobody ridicules camera bugs. But every barbed wit in the business seems to regard the hi-fi hobby as fair game.

So all right, we do have our foibles, just like anyone else. But we're surely not the bunch of screwballs that certain funny-men would have you think. So right here and now, let's get the fiction separated from

the fact, and let's put the arguments of our self-styled critics back into their true perspective.

Every autumn, as surely as the leaves do fall, we will read once again the hilarious story of the confusion and cacaphony at the several audio shows and hi-fi exhibitions. Now I ask you, was there ever a sizable public gathering which was not even a little bit noisy and disorganized? Why should a hi-fi show be any different?

It does serve its purpose, and rather well, I think. It permits audiophiles to see the new products as soon as they are put on sale, and to hear their performance in com-



parison with their competitors. So perhaps this is not as good as an A-B test under laboratory conditions. But if there is a better way to learn as much about as many different systems in so short a time, I'm sure that the hi-fi industry would be most happy to know of it.

Too Much Equipment?

Hi-fi fans have also often been criticized for overbuying, for getting more than they could ever possibly use. As one well-known critic put it a few years ago, "Putting today's hi-fi equipment in the home is like using a Cadillac to haul coal." The

gist of the argument was that hi-fi equipment was capable of reproducing more than any record or radio program was capable of giving.

At the time that statement was made, it was not a very great exaggeration. After the many years of truly horrible home instruments, now suddenly hi-fi equipment was available which really *was* better than the records and radio shows it was used to reproduce. But this seeming incongruity actually had a very beneficial effect.

For the first time many home listeners realized how dismal were many of the offerings of the broadcasters and recorders.

how the critics see it...

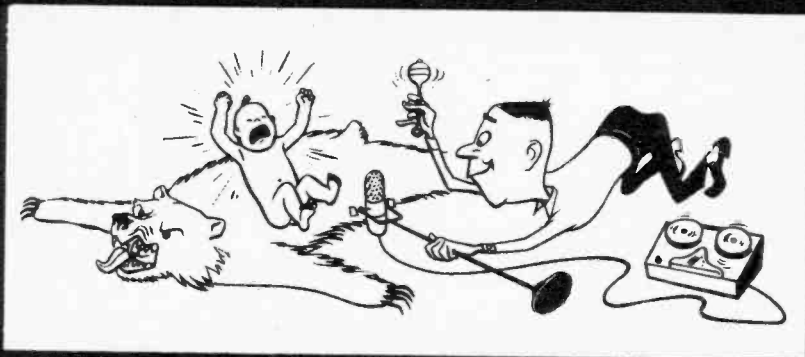

A number of small record companies sprang up almost overnight to meet the quality demands of discriminating audiophiles. As the old established companies saw their markets evaporating, they finally had to huff and puff pretty hard to catch up. As a result, all records today are truly much better than ever before. Even the sagging radio business had to recognize the demands of this movement and provide better program fare. These benefits are now available to all the public, and they are largely due to the incessant demands of the small but extremely vocal group of hardy hi-fi pioneers.

Too Much Power?

The critics go on to say that hi-fi bugs install equipment which is impossible to utilize fully in the home, with powerhouse amplifiers, gigantic speaker systems, and frequency ranges far beyond the limits of human hearing. This is a subject which is discussed in some detail in another Fawcett Book, *Low Cost Hi-Fi*, and from this we see that there is some basis for the argument.

There undoubtedly are some hi-fi installations which will never be called upon to perform up to their full potential. There are also a lot of fishtail sedans sold every year to people who are buying prestige, while as a practical matter they might be much better off with a motor scooter. But does anyone have the temerity to say that all Caddy owners are nuts?

Another favorite bleat of the hi-fi detractors is that audiophiles aren't happy unless their loudspeakers are waking babies, blowing out matches, and shatter-

ing glassware at fifty paces. Simply, they just play the things too loud!

We can't deny that some dyed-in-the-wool addicts mistake their hi-fi systems for public-address systems, and try to serenade their entire neighborhoods. This admittedly may be extremely annoying to the guy next door or in the apartment downstairs, especially if he's trying to grab some shuteye, but there is some method to our audiophile's madness.

This has to do with the response of the human ear, or more broadly, the entire physio-psychological experience of music listening. It's a well-known fact, for example, that the ability of the ear to discern extremely high and low frequencies falls off rapidly as the intensity is reduced. One approach to compensating for this in the hi-fi system is the amplifier loudness control, which favors the highs and lows increasingly as the volume is decreased.

But the fact remains that the only way to approximate the psychological impression of listening to a symphony orchestra is to have the hi-fi system radiating acoustic powers on the order of those generated by the orchestra itself. Otherwise the effect is about the same as looking at a postcard-size reproduction of a great painting. Whether it is practical or even desirable to have the sound of a full symphony orchestra in one's living room is not for me to say. But for true high fidelity a full frequency range is not enough. The sound intensities must also approximate those of the original.

Hi-fi addicts are often berated for waxing ecstatic over the passionate breathing of the violin virtuoso, the rosin noise of bow on string, the rustle of music pages



being turned. All true, I suppose, but strictly for those for whom the novelty of a brand-new hi-fi set has not yet worn off.

This admittedly hasn't very much to do with listening to music, but I don't think that the newcomer to hi-fi can be criticized too severely for his interest and curiosity about sounds he has never before heard. In fact it probably gives him the feeling of being closer to the great artists than he ever was even in the best seat in Carnegie Hall.

Too Many Experts?

The recording engineers, in their microphone placement, strive for a pickup which will provide the listener with the truest perspective. They must therefore consider the combined effects of the distance between performer and microphone, and between loudspeaker and listener. He must also consider not only the studio acoustics, but the conditions in the listening room as well. The final adjustments, however, are made by the hi-fi listener himself. And he soon learns to set the controls for the most realistic music listening. When he matures to this point, his hi-fi system becomes the fine instrument it was designed to be, and its trick and gimmick aspects fade into limbo.

It has also been said that all members of the hi-fi cult are either engineers who are frustrated musicians, or musicians who are frustrated engineers. In either case they are way over their heads in areas where they are almost totally ignorant.

In a very general way this description was somewhat apt when applied to the early hi-fi pioneers. Since then they have

been joined by people in all walks of life, including many other professionals, such as physicians, dentists, lawyers and educators. It isn't likely that *all* of these people need the help of a psychoanalyst.

It happens that I have had considerable training and experience in both music and engineering, and I do know this much: One doesn't have to be an engineer to operate and maintain a hi-fi system, nor a musician to appreciate and enjoy music.

But the early interest of the musicians in the hi-fi movement was a very good thing. They often got the engineers to throw off their textbook shackles and proceed to do the theoretically impossible. And the engineers were able to present knowledge about sound, acoustics and the physics of music which even most musicians didn't know. Complementing each other, they were able to make tremendous strides in the advancement of the high fidelity field.

Not to be forgotten, either, are the experimenters whose training may have been in quite different fields. Like all experimenters and inventors, they have hit a lot of foul balls. But they have also come up with some of the most significant hi-fi developments, and many of the highly respected products of today originally came out of someone's home workshop.

And so high fidelity is a most wholesome and worthwhile hobby. If you are a part of it, or are contemplating joining us, you are in good company. There certainly is nothing to be ashamed of, the brickbats of a few cynics notwithstanding. After all, they can't lick us; sooner or later they'll be joining us, too. •



Stereophonic Sound

This newest form of audio reproduction makes use of two or more separate audio channels.

THE illusion of depth and perspective in sound reproduction is a challenge which has intrigued audio engineers nearly as long as 3-dimensional pictures have engrossed photographers. And just as stereo photography has developed using two pictures, one for each eye, so stereo sound uses two or more separate audio channels.

"Stereophonic sound" is really a redundant term, for the word *stereophonic* alone comes from two Greek words meaning *solid sound*. This term is just about perfect in describing the sensation of hearing the newest form of audio reproduction.

To understand the full meaning of stereo sound, and the reasons behind the enthusiasm hi-fi enthusiasts have for it, we'll have to give some consideration to the human hearing process. First of all, remember that your two ears are only a part of your sense of hearing, and that your brain also plays an active part in the process.

Although the ears collect all of the sound in the air surrounding them, the brain is actually able, within limits, to select only those sounds it wishes to hear. Thus you can actually carry on a conversation on a noisy street corner, or in a

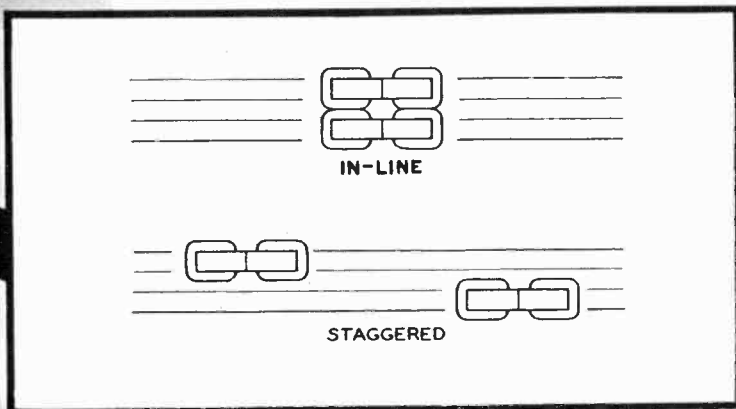

SYMMETRY of Bell stereo installation (left) poses few decorating problems. Two types of head alignment (above) require careful selectivity in buying recorded tapes.

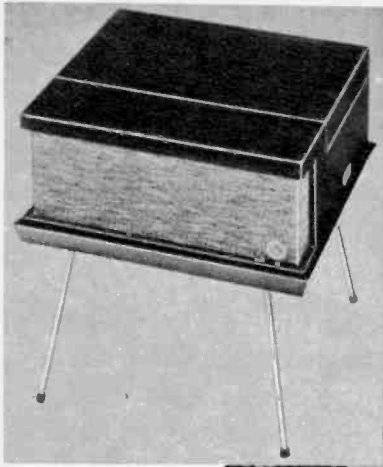

CELESTE MODEL by VM is monaural tape recorder, stereo reproducer when second amplifier and speaker is added.



crowded room can pick out the voice of one person even when everyone seems to be talking at once.

The physical reason for this is simply that you have *two* ears, or what is known as a *binaural* sense of hearing. Sounds reaching your two ears are minutely different in loudness and time, and you can therefore identify quite accurately the location from which a given sound emanates.

The ordinary recording or broadcasting system, however, has no such discretion. The microphone picks up and transmits everything within its range indiscriminately. Even if several microphones are employed, all of their signals are combined in a mixer and fed to a single channel. The result then is effectively one-eared, or *monaural*.

Early Stereo Systems

Numerous and varied attempts have been made toward developing a truly binaural sound reproducing system, and some of them have been quite successful from an engineering point of view. But it has only been in the past few years, since hi-fi has caught the public fancy, that binaural and stereo systems have gained impetus.

As early as the turn of the century, when all recorded sound was of the acoustical variety, the *Polyphone* used a dual system

of styli, diaphragms and horns for a stereo effect. In 1925, when radio broadcasting was still in its infancy, WPAJ in New Haven, Connecticut, was operating two transmitters simultaneously in a binaural system.

The Bell Telephone Laboratories were also hard at work on the problem in the 1930's, and demonstrated their perfected system at the New York World's Fair. Around the same time the National Broadcasting Company performed similar experiments with a pickup technique employing a dummy human head with a microphone placed in each ear. The mikes fed completely separate sound channels up to the ultimate listener, who had a split pair of headphones, one for each channel. This system has the very striking effect of actually seeming to place the listener at the location of the dummy microphone head.

The two-mike technique with the dummy head is truly a binaural system, and most authorities now agree that this is the only one properly described as *true binaural*. Although the true binaural system provides tremendously exciting results, it does absolutely require the use of headphones, which most people regard as a nuisance.

For this reason, all of the notable recent development work toward realism in sound

ADDING STEREO to existing system is simple with two preamps and one power amplifier by Bogen.

STEREO TAPE player by Pentron has two preamplifiers, plays either in-line or staggered tapes.

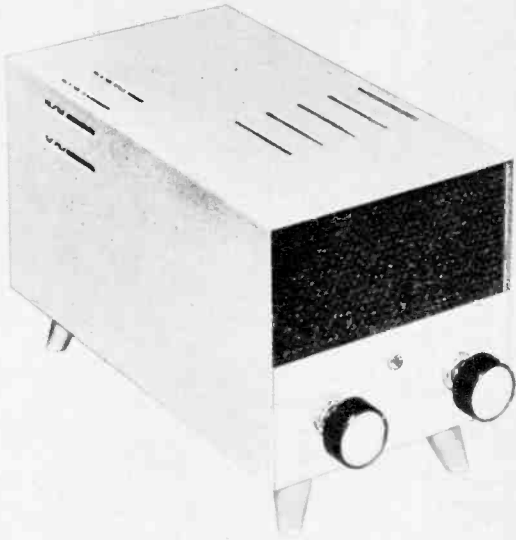

has been aimed at the use of two or more loudspeakers. All of these systems are now lumped under the general term *stereophonic sound*, while the older term *binaural sound* is reserved strictly for the dummy head-and-earphone system.

Immediately prior to the entry of the United States in World War II, there were announced two quite dissimilar 3-channel systems of sound film recording. One of them was *Fantasound*, used in the Walt Disney Picture, "Fantasia." As its name implies, this system was intended more for tricky and sensational effects than for realism.

Stereophonic Sound-Film

Concurrently the Bell Telephone Laboratories were demonstrating *The Stereophonic Sound-Film System*, in which the sound also was photographically recorded on three separate tracks of a single strip of motion picture film, and reproduced on three loudspeakers. This was not employed for motion pictures, as it had the same economic disadvantage as *Fantasound*, namely, that a whole separate length of film was required in addition to the picture film.

In the postwar *Cinerama* system, however, this disadvantage was not quite so apparent, as three separate films were used for the picture anyway, and a fourth for the

sound didn't seem so illogical. Meanwhile, too, magnetic recording had been perfected, and the *Cinerama* system therefore used magnetic sound film, with seven channels. In a *Cinerama* presentation there are five loudspeakers behind the wide concave screen, along with two more "surround" speakers further out along the sides of the theater.

The motion picture industry didn't feel that such an elaborate system was feasible for routine work, and so with the leadership of 20th Century-Fox and the *Cinemascope* system, stereo sound and movies on a single film became a reality. This is also a 3-channel system, similar in theory to the Bell method of 1941, but now using magnetic track. Just about all of the film area which is not occupied by picture or sprocket holes is coated with magnetic oxide for recording.

The introduction of *Cinerama* and *Cinemascope* has certainly heightened tremendously the public interest in stereo sound and its possible application in the home. Sensing this potential demand, many researchers in the audio field have been busily attacking the problem of adapting stereo to the hi-fi system. Stereo on disc and tape is now readily available, and in some areas there are regularly scheduled stereo broadcasts as well.

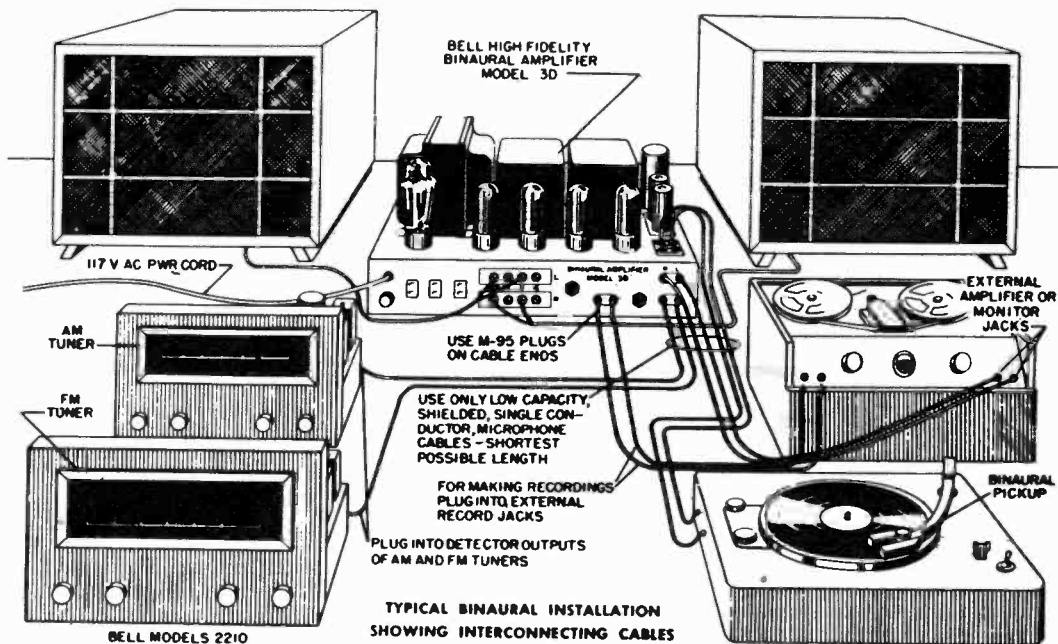

THREE TYPES of stereo reproduction are provided in this complete Bell system, including tape, AM-FM simulcasts, and Cook binaural discs. Note that this system is little more complex than monaural.

In New York City, for example, station WQXR broadcasts at specified times live music by a stereo method, using their AM transmitter for one channel, and the FM transmitter for the other. In Washington, D. C., two separate FM stations have worked co-operatively in experimental presentations of stereo broadcasts.

The AM-FM method has the usual AM limitations, however, including limited frequency range, susceptibility to static noise, and adjacent-channel interference. In both the AM-FM and FM-FM systems there is also the economic factor involved in the operation of two completely separate systems. It would obviously be very desirable to be able somehow to put both signals of a two-channel system on a single radio carrier.

Stereo On FM

During the late war there was a system widely used in military communications known as *multiplexing*. This permitted the sending of a number of messages simultaneously on a single radio channel. An adaptation of this idea has since been demonstrated in stereo sound broadcasting on a single FM station. This system is entirely compatible, in that the listener with a single FM set may hear the program monaurally

without any interference from the second signal. This system holds great promise for the future, and with the many stereo reproducers now in use, it should be highly successful.

There have been several attempts since the Polyphone at developing a stereo disc system. The Bell Labs experimented extensively with a complex groove, in which one signal was recorded laterally in the conventional manner, while a second appeared in the vertical or "hill-and-dale" modulation of the same groove. There has also been proposed a system in which both sides of the disc are recorded and then played simultaneously, using two pickups, and one groove spiralling counterlockwise, of course, while the other rotates in the clockwise direction.

The only stereo disc system which has been employed commercially, however, is that due to Emory Cook. In his method the outer half of the recorded surface comprises one track, while the second track begins in the middle of the playing surface and continues to the label edge. Then two pickups on a single arm, spaced side-by-side by the exact distance between the starting grooves of the two bands, are used to feed each of the two reproduce channels.

By far the most popular means of ob-



TABLETOP SYSTEM by Ampex features stereo tape reproduction as well as playback of both half-track and full-track monaural recorded tapes. A two-speed half-track tape recorder is included in system.

taining stereo reproduction in the home, however, is through magnetic tape. Very soon following the advent of modern magnetic recording there was introduced the dual-track system, which was already described in the chapter on adding tape to your system. If this idea was good for two separate sequential recordings on a single tape, it was reasoned, why not use the two tracks simultaneously for stereo sound?

Stereo tapes are now exceedingly common and readily available. When RCA Victor crashed the field with new stereo recordings of big-name artists, it was obvious that a new industry was being born. There are now literally dozens of companies in the recorded tape field, and most of them offer stereo.

Tape Head Alignment

It appears that every new industry is plagued by lack of standards, however, and this one is no exception. The inconsistency is in the matter of reproduce head alignment. In some tape reproducers, the two playback head gaps are directly over one another and said to be *in-line*. In other cases the heads are somewhat separate and said to be *staggered*. Obviously *in-line* tapes must be played back on similar equipment, while *staggered* reproducers

can be used only on tapes made that way. A few tape machines are adjustable to either type. But unless you have one of these, or until standards are adopted, you must be careful that your tapes and reproducers are of the same type.

It should also be obvious that a multiplicity of speakers alone does not necessarily constitute a stereo system. You can have stereo only when the recorded or broadcast material is specifically stereo, and when you have two completely separate reproducing channels. This does not mean that your present system is obsolete, however, but only that additional equipment is necessary for stereo reproduction.

The additions are not as extensive as you might think, either. If you have both an AM and an FM tuner, you have the beginning of an AM-FM stereo receiving system. A simple adapter is available for adding the second pickup for the Cook stereo disc system. Modification kits are available for some makes of tape recorders, converting them from single- or dual-track to stereo. All that you really need, then, is an additional power amplifier and loudspeaker. But once you have heard stereo sound properly reproduced, you won't rest until you have augmented your old 2-d stuff with modern stereo sound! •

Hi-Fi on the Highway

New improvements in the field of high fidelity now make it possible to enjoy good music in your car.

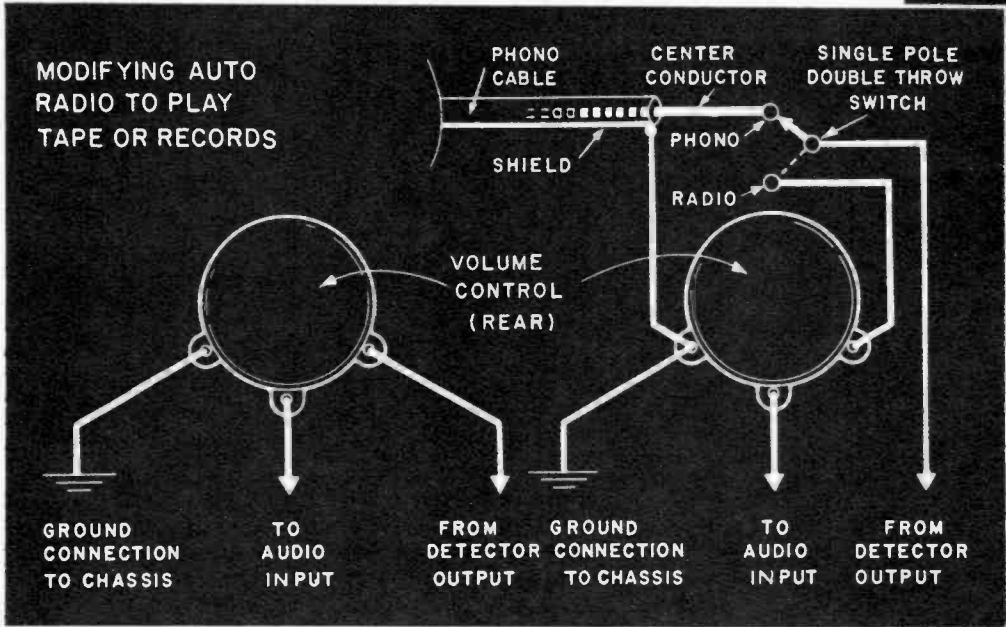

SIMPLE CHANGE of radio volume control (above) permits adding other sound sources. Highway Hi-Fi system (right) is latest development for audiophiles on the move.

WHEN the call of the open road beckons today's audiophile to the wide open spaces, one of the comforts of civilization he can take right along with him is the enjoyment of high fidelity music. But in a sense, hi-fi has been with us on the highway even longer than in the home.

I remember well some twenty years ago, back in the neolithic era of hi-fi, a friend of mine rescued a *Sonomatic* auto radio from a wrecked Buick and converted it to AC for use in his home. He said that it was better than any audio amplifier he could buy at the time. And I had to admit it sounded pretty doggone good.

Auto radios have always had to exhibit greater sensitivity, selectivity, and noise rejection than home sets, and consequently have had much better quality built in. Furthermore, they never became embroiled in the price cutting rat race. There

never was an auto radio equivalent of the \$9.95 table model.

The basic auto radio, then, is usually a very fine instrument, and there is much that the hi-fi fan can do with it to afford himself nearly as much musical enjoyment as he has at home.

One thing he can do is take a record player along and literally be his own disc jockey. The simplest approach to this is the Highway Hi-Fi system, developed by CBS and first introduced with the 1956 line of Chrysler cars. This system plays through the speaker of the car radio and uses the audio system of the receiver.

The turntable is located in a shock-proof case, mounted just below the center of the instrument panel. The tone arm houses a ceramic pickup with sapphire stylus. Beneath the turntable is a storage shelf with room for a half-dozen records.

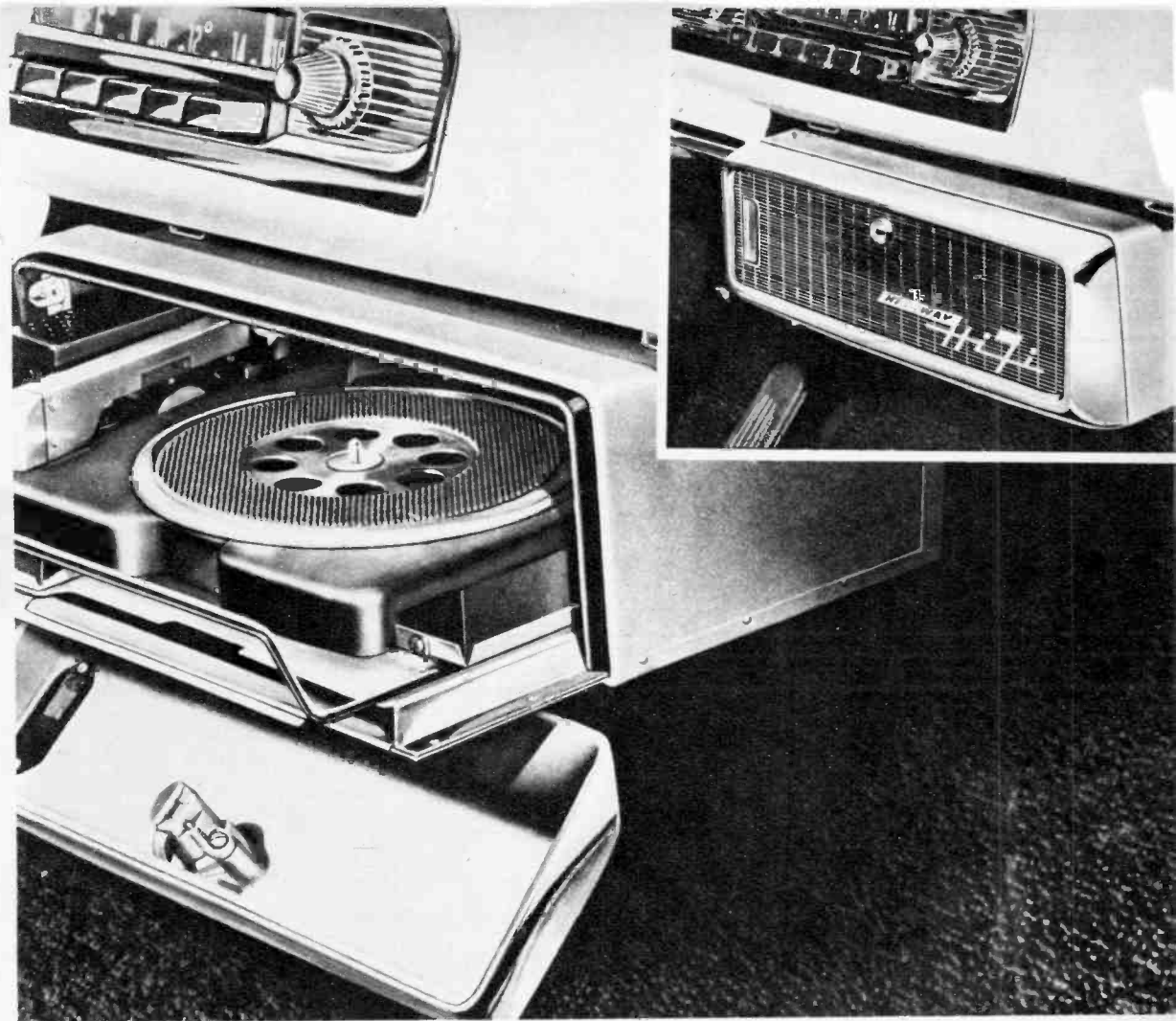

The records themselves are 7 inches in diameter, double faced, and rotate at $16\frac{2}{3}$ r.p.m. This slow speed, plus extremely fine grooving, permits a playing time of up to 45 minutes of music or a full hour of speech on each side.

Special Highway Records

With such extensive playing time, it becomes a little more obvious why storage space for only six records is adequate. The six discs included with the player at the time of installation contain all of the following: Tchaikovsky's *Sixth Symphony*, Borodin's *Polovtsian Dances*, Ippalitev-Ivanov's *Procession of the Sardar*, the original cast album of *Pajama Game*, Walt Disney's *Davey Crockett*, *Gene Autry and Champion*, *Romantic Moods* by Percy Faith, *Quiet Jazz* by Paul Weston, *Music of Cole Porter* and *Victor Herbert* by Andre

Kostelanetz, and readings from *Don Juan in Hell*.

The Highway Hi-Fi experiment has evidently proved quite successful, for trade rumors in Detroit and New York indicate that other automobile manufacturers and other record companies are quietly preparing to enter this field themselves. All of them, however, are years behind some audio enthusiasts, who have installed the little RCA 45-r.p.m. players in their auto glove compartments.

It seems a little incredible that the playing of a record in a car would be unaffected by the car angle, highway speed, or severe cornering. But the Chrysler Corporation reports that it is extremely difficult to jar the arm off the record or even to make the stylus jump a groove. Owners of 45-r.p.m. auto installations report similar results after shock mounting, and furthermore

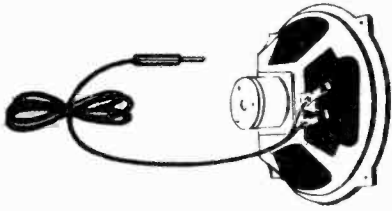

UPON ARRIVAL. simplest connection is by means of alligator clips to deck speaker, as shown.

they boast of longer playing times and better quality of reproduction.

There are two basic problems encountered when attempting to use home equipment, such as a 45-r.p.m. player or tape recorder, in conjunction with an auto radio. One is the source of power, and the other concerns the connection to the audio input of the radio.

The power problem concerns changing the 6 or 12 volts DC supplied by the car battery to 110 volts AC, the common supply available in homes. If we can get 110 v. AC in the car, then the operation of our equipment is just as simple as plugging into the wall socket at home. The device which accomplishes this is known as an inverter or converter, of which there are two general types.

Types of Converters

The commoner type of converter is known as a *vibrator*, and there is very likely one of these in your present car radio. This has a set of vibrating contacts, something like an ordinary doorbell, which interrupt the DC from the battery and thus cause a rough AC wave to be induced in a transformer connected to it. The better types will also include some form of noise filtering.

Vibrator converters, such as the Trav-
Electric, are available in a variety of sizes, and the only question in selecting one is to be sure that the capacity is somewhat greater than the requirements of the device. Suppose, for example, that you own a DeJur TK 820 tape recorder, which has a power requirement of 100 watts. The converter then should be rated for at least 100 watts continuous service and 120 watts intermittent operation. The connection is sheer simplicity. The cord from the converter is plugged into the cigarette lighter receptacle on the car, and the tape recorder or record player is plugged into the receptacle on the converter.

When more power is required, a motor-generator is used, this type being known variously as a genemotor, dynamotor, rotary converter or M-G set. This is simply a combination of a DC electric motor, operating at 6 or 12 volts, plus an AC electric generator which delivers 110 volts at 60 cycles. These are commonly used in professional mobile service, such as police, aviation and marine communications, but they are also used by radio amateurs and hi-fi fans who want an abundance of power in their cars. They are normally mounted in the trunk or under the hood, and the input connection is directly across the battery rather than through the cigarette lighter receptacle.

Connecting to Radio

With one of these power sources in your car you can operate almost any piece of hi-fi equipment. If the unit you are using, such as a tape recorder, has its own amplifier and speaker, chances are it also has a low-level high-impedance output jack for connection to an external amplifier. If it does not, reference to the *Radio-TV* chapter will show you how to pick up such a signal off the volume control. The only question remaining now is how to get it into the audio system of your car radio.

Since auto radios don't normally have receptacles for external signal sources, it will probably be necessary to remove the electronic portion from the car. A simple connection with a selector switch at the input of the volume control is all that is necessary. Better yet, a shorting type jack, such as that shown in the *Radio-TV* chapter for adding a hi-fi speaker may be used.

Something else we can now have in our cars is FM reception, by means of the Hastings FM broadcast tuner for cars. Designed for underdash mounting, the tuner alone works in conjunction with the audio

of the regular AM car radio, or a separate 8-watt amplifier and power supply may be added. As compared to the best AM car reception, it is claimed that with the Hastings tuner there are no dropouts when bridges or underpasses are encountered, nor noises when running parallel to high tension lines. Instead, the FM signal holds steady and unchanging over long distances, even long after AM stations in the same area fade out and disappear.

If you want something which can be used both on the road and outside the car after you arrive, then a good portable is the thing for you. The recent American trend in portables has been toward small transistorized models, which are low in power and equally low in fidelity. There is a German Telefunken model, however, which offers both FM and AM of good quality in a portable, and which works well both inside a car and out.

One of the most versatile units to come along is the Bell Mobile Amplifier, which operates on *either* regular house current or 6-12 volts DC. When used for mobile operation, it has its own shock-mounted vibrator power supply, for connection directly across the car battery.

Mobile Amplifiers

This amplifier has an output of 25 watts, and is available separately or with single- or three-speed record player mounted on top of its case. The record player has a ceramic cartridge, and there is a separate input for other signal sources such as second phono, tape, tuner or microphone. At the output there is a variety of loudspeaker impedance connections. If you want a single unit which will operate just about anywhere, this one merits serious consideration.

Now we have seen that we can have in our cars just about all of the hi-fi comforts of home, including recorded tape, phonograph records at four different speeds, and either FM or AM radio. But what about after we get where we're going? The auto speaker mounted in the instrument panel isn't going to be of much use unless we stick pretty close to the car. We can lick that, too, if we bring along a portable extension speaker which can be connected to the car radio output.

One version of the Jensen Duette, for example, comes in a leatherette bound carrying case with handle, just the thing for the picnic or camp ground, beach or patio. The best method of connection to the car radio is that shown in the *Radio-TV* chapter. A less complicated alternative, if you have a

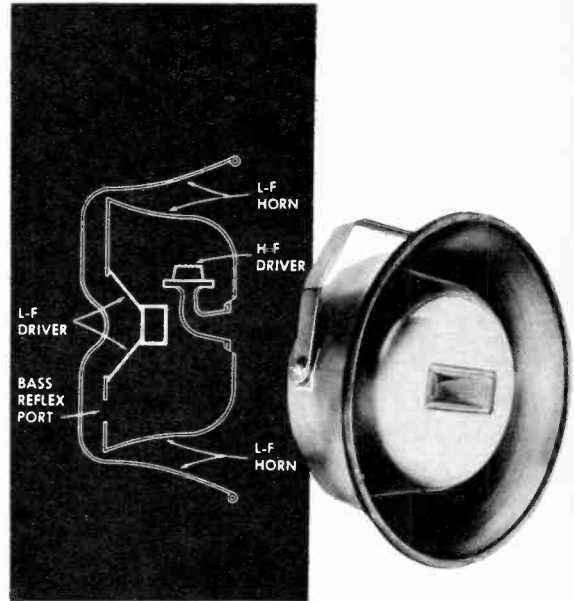

WEATHERPROOF speaker by Jensen will withstand the elements while delivering the best hi-fi.

rear deck extension speaker, is simply to connect a pair of leads across the voice coil of this unit.

All fine and dandy, you say, but what about the weather? What happens if my expensive hi-fi speaker stands out in the hot sun all day, or in the salt air, or gets drenched in a sudden downpour? The answer is absolutely *nothing*, provided you have a weatherproof speaker.

Weatherproof Speakers

The Jensen HF-100, as an example, is a true hi-fi radiator, with smooth response from 60 to 15,000 c.p.s. It is a two-way system, employing a patented bass reflex within a horn. The tweeter horn has a 90° bend in it, thus placing the driver at the top of the unit and providing self-draining. It is virtually impossible for rain, sleet or snow to reach the driver.

The special moisture-protected woofer is likewise protected from direct access to weather. A plastic inner section reinforced with glass fiber, mounted in a spun aluminum outer horn provide mechanical protection. The finish is a weather-resisting baked enamel. There are many other outdoor speakers, of course, although not nearly all of them are high fidelity, so you must exercise care in making your choice. •

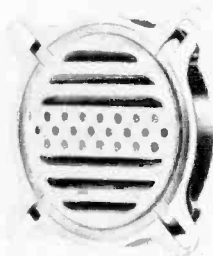
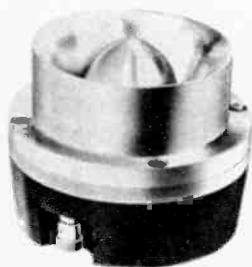
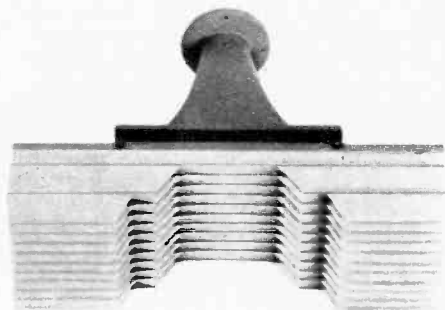
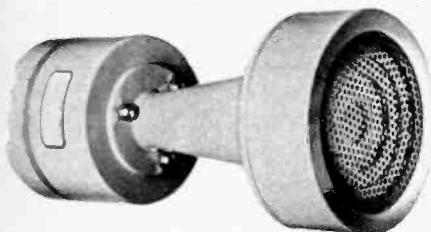
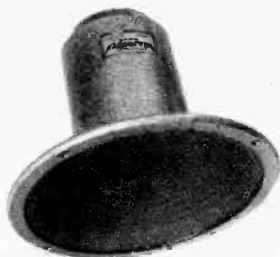

THE most confusing problems facing hi-fi fans, both neophytes and old-timers alike, have to do with loudspeakers. My everyday conversations and the majority of my mail from readers indicate overwhelmingly that this is the area of greatest uncertainty and confusion. In hopes of clearing the air somewhat, I have gone directly to the leaders of the industry with a group of tough questions, and have asked opinions of their top technical experts. The answers are those of conservative engineers, not hyperthyroid promotion men. While they are obviously not always in complete agreement, their statements should do much to clarify the issues.

Participants in this discussion are:

MR. KARL KRAMER, Manager of Technical Services, Jensen Manufacturing Company, Chicago, Illinois. He holds the degree of Master of Science in Electrical Engineering from Ohio State University, where he studied with the famous Professor Everitt. He is a Senior Member of the Institute of Radio Engineers, and a member of the American Institute of Physics and Acoustical Society of America.

MR. ABRAHAM COHEN, Engineering Manager, University Loudspeakers, Inc., White Plains, New York. A graduate of Northeastern University, majoring in Electrical Engineering, Mr. Cohen was also concertmaster of the Boston School Symphony Orchestra and first violinist of the

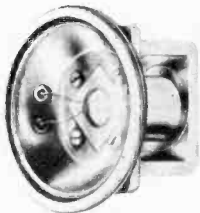
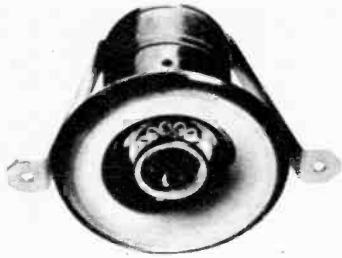

What About Loudspeakers

Top experts discuss one of the most confusing areas in hi-fi.

WIDE VARIETY of loudspeaker types on the market today is extremely perplexing to the uninitiated.

Boston Civic Symphony Orchestra. He is author of an outstanding book on this subject, *Hi-Fi Loudspeakers and Enclosures*.

MR. ALEXIS BADMAIEFF, Chief Engineer, Transducers, Altec Lansing Corporation, Beverly Hills, California. Educated at the Warsaw Polytechnic Institute in Poland, Mr. Badmaieff is the holder of 26 patents in the fields of electronics, mechanics, acoustics and optics. Well known for his many technical papers and articles, he is a Fellow of the Audio Engineering Society and an active member of the Society of Motion Picture and Television Engineers.

COL. PAUL KLIPSCH, Owner-Manager, Klipsch and Associates, Hope, Ar-

kansas. Best known to audiophiles for his famous "Klipschorn", Col. Klipsch typifies the rugged individualism and pioneering spirit which have contributed so much to this industry. A man of strong convictions, he has a venerable record of achievement to support his opinions.

MR. HOEFLER: Much has been said about the number of elements in a loudspeaker system. One school holds that the theoretical ideal would be a single radiating element which operates with equal efficiency over the ten or more octaves audible range. At the other extreme are those who feel that a large number of specialized speakers, each operating over

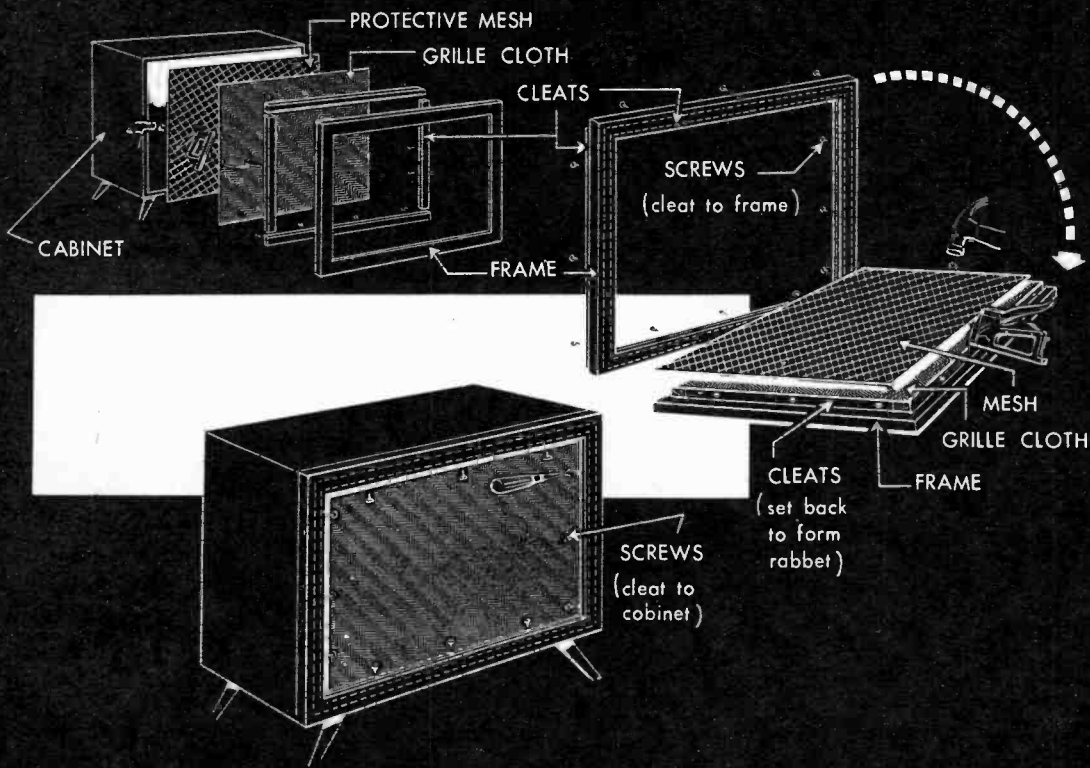

University Loudspeakers, Inc.

a restricted range, is the better approach. What is your opinion about the number of speaker elements and their configuration?

MR. BADMAIEFF: A single radiating element is the theoretical ideal for sound reproduction. However, at the present time there is no single loudspeaker capable of efficiently reproducing the entire range of the human ear. In multiple element systems there are the problems of crossover and acoustic phasing. Since these problems are inherent and their duplicity greatly increases the difficulties, crossover should be kept to a minimum. This is the reason why nearly all professional sound systems are limited to two sections, one for low frequency propagation and one for high frequencies.

MR. COHEN: This question may best be resolved by analogy between the loudspeaker system and a modern orchestra. Here we find not merely one single instrument producing all the tones of the audible spectrum, but a "choir" of instruments, each designed to produce that band of

frequencies required of it. It would be fantastically difficult to overcome the laws of Mother Nature in devising one instrument to do the work of all these. It is dubious if a "theoretical ideal" could be postulated for such a single instrument, even if we limit ourselves only to matters of efficiency, for we know well that even when instruments play tones of the same pitch, they still differ in timbre.

In line with these thoughts, the theoretically ideal speaker system might be one with a single speaker for each instrument of the orchestra, this speaker being called upon to reproduce only those tones originally created by that instrument. This ideal, of course, is a far call into the future, the peak of stereophonic reproduction, perhaps. In our present modest approach to this perfection, a typical multi-speaker system having a large woofer for the deep bass notes, a broad mid-range unit for the overall body of the orchestra, and a treble tweeter to top off with the natural brilliance of the original performance, is a first approach to "orchestrating" the reproducing system.

IN KEEPING with the clean, modern lines of the completed University EN-CB enclosure, the front frame and grille is constructed of simple design. The frame is made of four sections of 2-inch birch hardwood cut to size and mitered. The frame is mounted to enclosure from front by means of screws through a cleat. Since cleat is recessed and screw holes countersunk, the mounting screws are not visible from front of the enclosure. The front frame and grille assembly is easily constructed in four simple steps: (1) Using 2 1/4 x 3/4-inch birch hardwood, cut four strips to length. Cut a 45° miter on each end of the strips and join with spline fasteners and glue. Finish in the color of the Formica or Micarta used to surface the enclosure. (2) Make the cleat from four strips of 3/4 x 3/4 inch poplar or bass hardwood. It is not necessary to miter the edges of these sections. Position the pieces on the back of the frame 3/4 inch from the outside edge, and secure cleat to frame with one-inch No. 8 flat-head wood screws and glue. (3) Cut the grille cloth to size and stretch over the cleat. Fasten with staples or tacks. To ensure a proper fit into the front opening, do not overlap the cloth around the sides of the cleat. (4) Using a piece of protective mesh, fasten to assembly with "U" nails or staples. Photos which follow show process of finishing.

It is true that multi-speaker systems, because of the dividing networks, may introduce some phase distortion. But the effects of such distortion are very debatable, and in some quarters held to be nonexistent. On the other hand, intermodulation distortion is a very real and disturbing factor to be dealt with. Because of the band separation in multi-speaker systems, such intermodulation is reduced to a minimum and the individual loudspeakers may be designed to perform most efficiently within their bands, resulting also in improved power performance from the amplifier.

COL. KLIPSCH: It is a matter of fact, not opinion, that a single direct radiator of small size will give a more nearly flat response over a wider range than some larger and more complicated systems. But likewise it is a fact that a small direct-radiator speaker, say six inches in diameter, would have to perform an excursion of several inches to produce a barely audible fundamental output at a few feet distance at some low frequency like 60 cycles, which, even if possible, would re-

sult in distortion many times the fundamental output. It is also a fact that when two or more frequencies are mixed in a single piston radiator, the lower frequency amplitude will modulate the upper one, which causes the oft-referred-to intermodulation distortion. The result of recognition of these facts is that the best loudspeaker systems now employ at least two loudspeaker elements. The design problems entail minimizing the frequency anomalies and interferences between a pair of speakers radiating the same frequency near a crossover point. At present, only multiple speakers have been capable of duplicating the sound to a high degree of accuracy.

MR. KRAMER: This question is strictly academic, since no single radiating element has ever been designed which operates with equal efficiency over the entire range. Even if such a device were available, there is no good reason to believe it would be superior to multiple-channel systems which are now commercially available. The design requirements at opposite ends of the pass band are in direct conflict, and therefore the narrower this band the less the compromise that must be made. In general the more channels the better, but the three-way system has about reached the point of diminishing returns. Excellent systems of this type are commercially available in several forms; unitary assemblies of multiple units and those with separated units give essentially identical performance. Also, the use of more than one loudspeaker system will result in far greater realism of reproduction than the most "perfect" single speaker system for most types of music reproduction. Remember that the orchestra is spread over a very large area and the sound does not emanate from just a single point.

MR. HOEFLER: Other than assuring the proper impedance connection between the output transformer of an amplifier and the input circuit of a speaker system, what other precautions may the home hi-fi listener observe to be certain of optimum damping and minimum transient distortion?

COL. KLIPSCH: The subject of optimum damping is one which could fill a book. In my opinion the safest procedure beyond proper impedance matching is to use an amplifier with an internal impedance between the limits of about $\frac{1}{16}$ and $\frac{1}{2}$ the nominal impedance, without any ap-

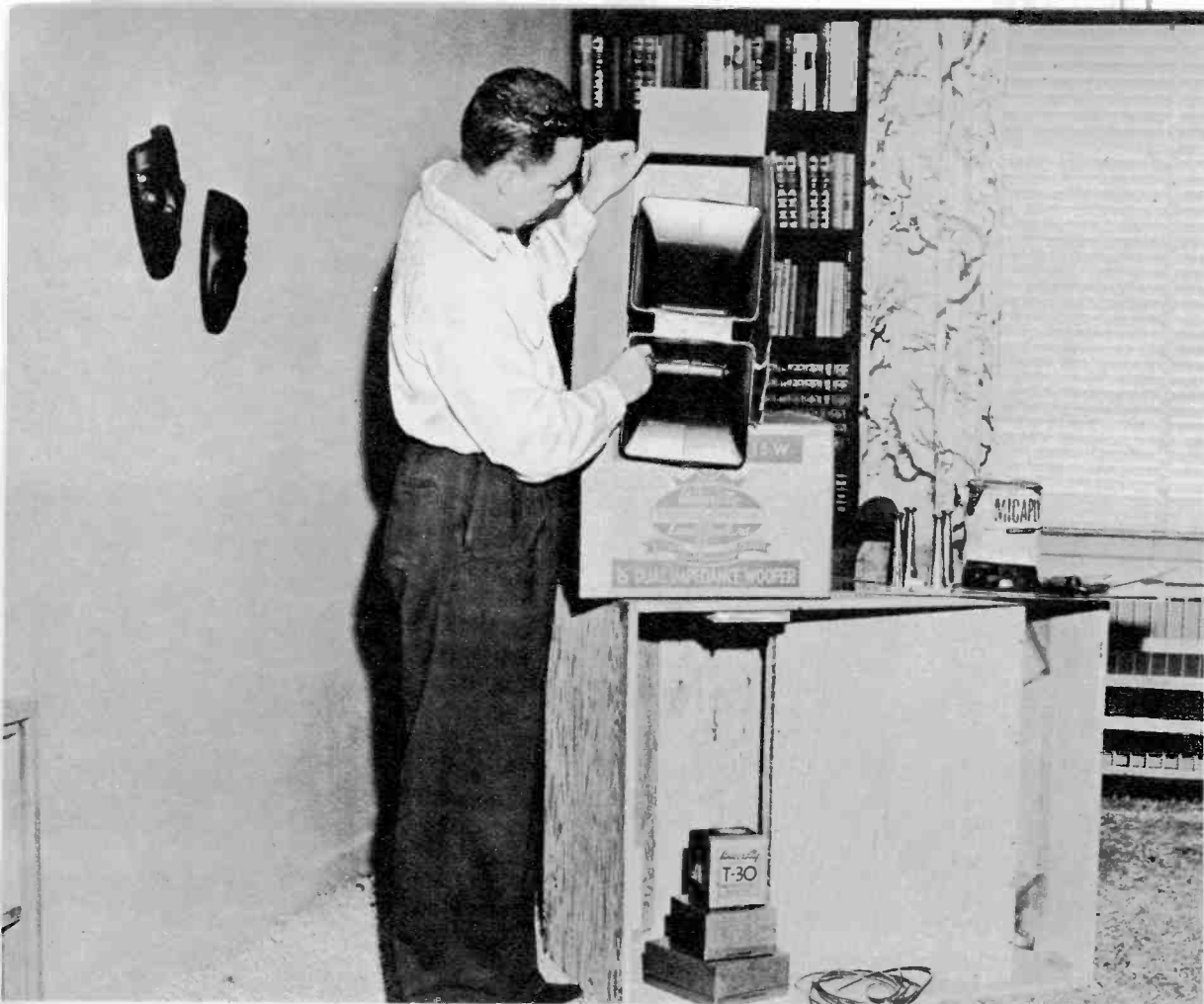

plication of variable damping. This is expressed as an opinion rather than a universal fact, as there are exceptions.

MR. BADMAIEFF: In order to assure the full realization of quality from a good loudspeaker, it is necessary that the speaker be housed in an enclosure designed specifically for its characteristics, and that it be connected to an amplifier having not only the proper output impedance but also the proper source impedance. The best way to assure this is to follow the manufacturer's recommendations for enclosures and to use an amplifier matched to the manufacturer's loudspeakers. For the greatest quality use an amplifier and speaker system of the same manufacture.

MR. KRAMER: Transient distortion in the upper frequency ranges is a far more important consideration than that which occurs in the low frequency range. Such distortion is in no way related to the ampli-

fier damping. To eliminate it the loudspeaker must be free of spurious modes of vibration which cause response variations, or these modes must be damped within the loudspeaker itself. Even transient distortion near the low frequency resonance points is not nearly as serious as many believe. Obviously the enclosure is an important factor; good loudspeakers with suitable coordinated enclosures are not sensitive to amplifier damping characteristics. The adjustment of damping controls on the amplifier can easily be made to yield the best listening quality.

MR. COHEN: The question of optimum damping is perhaps the least understood aspect of loudspeaker performance by the average hobbyist. As far as the home high fidelity listener is concerned, he can do very little other than accept performance of his complete system as installed for him, or as purchased complete, and hope that the designers of the various equipments



CLASSIC SPEAKER system is easily installed in enclosure and surfaces finished. All components, parts and necessary tools are shown at left. Author Don Hoefler is just unpacking the midrange horn. First step (above) is attaching decorative metal legs with wood screws. At right, special cement is applied to cabinet with serrated tool. After plastic veneer is also cemented, it is applied to both sides and to the top.

have come up with the proper damping for the entire system. There is very little the end user can do to alter the damping characteristics of the speaker system, but where he has damping controls available on his amplifier, he might make some simple listening comparisons of a recording whose characteristics he knows well, adjusting the damping control to the point where he hears a cleaner strike of the piano, the sharpest pluck of the guitar and the tight drum blow of the tympani rather than a muddy barrel tone. Yet in making these adjustments, the experimenter may find no difference at all, due to the fact that the speaker system itself is already so critically damped that further damping still tends to do nothing but reduce the acoustic output rather than to improve the transient response.

Too often overlooked is the effect of frequency response upon the transient response. It should be remembered that a sudden impulse of signal is essentially

composed of a host of waveforms—a fundamental and a series of mathematically related harmonics. When some of these harmonics become lost, the steep wavefront of the original signal deteriorates. One may therefore expect optimum results from a system wherein the amplifier has flat frequency response from the lowest usable frequency, such as 30 c.p.s., up to perhaps 50,000 c.p.s., and where the speaker system is flat up to 15,000 c.p.s. at least. Then one may be reasonably sure that all the harmonic content of the original impulse tone will be reproduced in the final output, with as sharp a wavefront as originally created by the instrument itself, thus in essence providing proper transient response.

MR. HOEFLER: The number of enclosures now on the market, each with its own claims of excellence in design and performance, has many prospective hi-fi hobbyists thoroughly confused. Is there

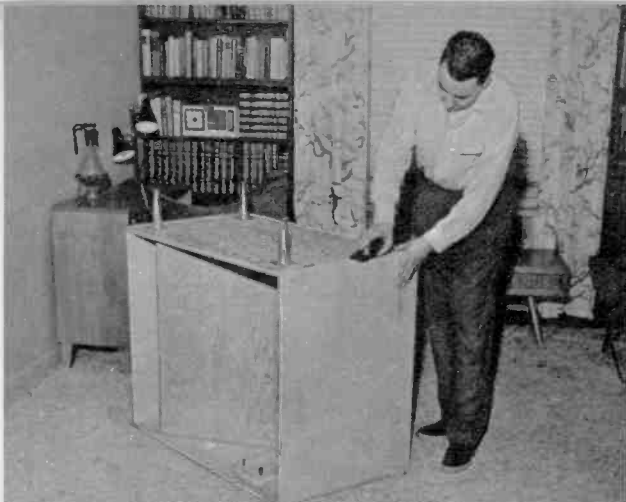

EXCESS FINISH of Formica or Micarta is trimmed away with plane or fine-tooth saw, then touched up with sandpaper. In these simple steps surfaces are finished and installation begins.



WOOFER AND TWEETER already in, the crossover network and screw terminal strip are installed with wood screws. Unit must be set back sufficiently to leave room for clearance of midrange horn.

MIDRANGE HORN is mounted last, fitting over bolts which are factory-installed in enclosure. Final procedure inside cabinet involves installing connecting cables between each of three speakers and crossover terminals.



any one type which you feel is outstanding? Are there any basic principles which you can suggest to guide the prospective purchaser?

MR. KRAMER: There are literally hundreds of loudspeaker enclosure designs, many originating out of dubious theories and crude experimentation. No enclosure can improve a poor loudspeaker! Loudspeaker enclosures logically fall into two categories, namely, horns having large actual or effective mouth size, and the numerous smaller enclosures which are variants of the basic bass reflex design. It is important to note that unless the mouth, and therefore the overall size, is quite large, horn type enclosures do not act as such but rather fall in the second category. Perhaps it is an oversimplification to class all others as variants of the bass reflex but their performance characteristics make this a valid conclusion. Note, for example, that the infinite baffle enclosure is simply a bass reflex with the port blocked; in many cases the port is duct loaded and often additional cavities are coupled to the basic enclosure. The Jensen Manufacturing Company recognizes the enclosure problem as one of the important ones facing the consumer, and they have issued a technical manual showing structural details for loudspeaker enclosures in various sizes for typical loudspeaker systems. It is important to recognize that the loudspeaker system and the enclosure must be carefully correlated for best results; there is no one enclosure design suitable for all types and sizes of speakers.

MR. BADMAIEFF: It is desirable for an enclosure to provide a certain amount of bass reinforcement for the loudspeaker. In doing this, however, dips in the frequency response of the speaker due to cabinet phasing are often created, and in the most extreme cases the enclosure severely limits the radiation of the loudspeaker above 500 c.p.s. The only type of enclosure where this is not true is the bass reflex. It does not provide as great a bass reinforcement as other types, such as the folded horn, but neither does it introduce the deficiencies in frequency response associated with them. For this reason, a bass reflex enclosure provides the most truthful reproduction.

COL. KLIPSCH: Being a designer of horns, I feel justified in a strong prejudice for them in preference to enclosures. Experience with enclosures since 1938 indi-

cates the closed back box as providing the best enclosure from the standpoint of lowest distortion. The enhanced bass of various ported boxes seems to be in the form of peaks which are in the wrong places. Note the distinction here between a "box" or "enclosure" and a "horn." The former is a means of isolating the front from the back of a cone radiator. A horn, on the other hand, provides a transformer action, like the gear box on a car (or, if you can't remember that far back, think of it functionally as a torque converter). With it, the diaphragm excursion and consequently the distortion may be reduced for a given output power.

MR. COHEN: Perhaps the most important principle to guide the prospective purchaser of an enclosure is that it cannot be considered as separate and apart from the speaker which it is to house. The type of enclosure will be dictated by the components chosen, and may be of the direct-radiator type or of the horn-loaded variety. In this respect then there is no ideal enclosure, other than in matters of compatibility with its component speakers. These two broad categories thus have their own specific adaptabilities to chosen components.

The more versatile enclosure, one that lends itself to many types of systems, from the single extended range type to complex multi-speaker layouts, as well as being the easiest for the home constructor to assemble, is the general bass reflex type, of which there are many variations. The true compression-driven horn enclosure, on the other hand, offers distinct advantages of cleaner and more efficiently reproduced low frequencies. To achieve these advantages one must immediately adopt the multi-speaker philosophy, for the bends and twists of the folded horn entirely mitigate against the transmission through it of any but the lower end of the acoustic spectrum. It is imperative that with the bass woofer there be used the necessary complement of mid-range reproducer and treble tweeter.

Basically, the loudspeaker and enclosure work as a team, and the enclosure must be as rigidly built as the loudspeaker. The purpose of the enclosure is to hold the loudspeaker so that it may vibrate the air external to it. Should the enclosure itself vibrate, this is acoustic energy wasted. To circumvent such loss, the enclosure should be built from heavy inflexible panels, well screwed and glued in the best manner of fine furniture. It will then provide the

proper boundry for the vibrating air masses, without itself being vibrated.

MR. HOEFLER: The dynamic speaker has been in common use for so long that we sometimes forget that development in this area has included many other types such as balanced armature, inductor driver, iron diaphragm, electrostatic and crystal units. Now the electrostatic speaker is enjoying a resurgence and there is much discussion about the ionic speaker. Do you feel that there is any speaker type, either now in production or in someone's ivory tower, which will supplant the dynamic system?

COL. KLIPSCH: What form of driving mechanism for the loudspeaker diaphragm will emerge as best would require a crystal ball. Currently there are several new products advertised as "new in principle." They sound different, all right, including a strong difference from the original sound. One speaker of low excursion capability exhibits such high distortion at very low levels as to attribute the "brilliance" to this cause. For now, these devices are for sound effects rather than sound reproduction. One electrostatic tweeter showed over 400 per cent distortion at 5,000 c.p.s. at an output corresponding to that of a dynamic unit with an input of a small fraction of a watt.

MR. BADMAIEFF: At the present state of the transducer art the moving coil or dynamic speaker is still superior in efficiency, freedom from distortion and smoothness of frequency response. The electrostatic speaker suffers from internally generated hissing, extreme directivity, and an efficiency so low as to require an unreasonably high-powered amplifier. In addition, electrostatic speakers are severely limited in the amount of sound power which they can generate regardless of the amplifier power available.

MR. COHEN: The electrostatic speaker and the ionic loudspeaker have their origins in the "singing condenser" and the "singing arc" of yesteryear. These phenomena, which were actually defects in component parts of those days, whetted someone's imagination and the defects were turned into attributes of a limited scope at that time. The apparent newness of the electrostatic speaker has attracted to its ranks those people who must have the newest and most glamorous things in life, and for them it serves a purpose. But

it may be said with assurance that, for utter simplicity of installation and operation, with outstanding performance and reliability, the present day dynamic speaker is hard to beat. Intensive research continues in our laboratories on projects to improve the quality of performance of the dynamic speaker, to raise its level of efficiency, and to refine production techniques toward the end that the consumer may obtain the most of his high fidelity dollar. What trade secrets may exist in somebody's ivory tower we may know only when they come down from that tower.

MR. KRAMER: There is no loudspeaker type in production or in the research and development laboratories which we feel offers a serious or immediate threat to the moving coil loudspeaker in common use today. Of course, there is no reason to believe that some new type might not be devised in the future which may alter this situation.

MR. HOEFLER: There has been so much dramatic improvement in amplifier design in recent years that the loudspeaker system is now frequently criticized as being the weakest link in the hi-fi chain. Do you feel that such criticism is justified? Do you feel, as a practical matter, there is much room for improvement in loudspeakers? Just what are the toughest design problems faced by the loudspeaker engineer?

MR. COHEN: Despite the high order of performance of today's speakers, it must be said that the acoustic system, comprised of the speaker and enclosure, is the soft spot that needs shoring up. Much work remains to be done, both by the engineer and the acoustic psychologist, to resolve the matter of loudspeaker performance on an objective basis that will be consistent with psycho-acoustic results and objective measurements. Presently it is not uncommon for the ear to pick one loudspeaker over another despite measured characteristics to the contrary. Meanwhile the design engineer does his utmost to obtain the optimum measured performance on an economical basis, with maximum life expectancy and stability of the speaker for the user.

In a general sense, the toughest design problem faced by the loudspeaker engineer is in matters of how little of one necessary performance characteristic he will be forced to sacrifice to obtain an alternate desired result: How much loss of efficiency

CUTAWAY VIEW of enclosure shows three speaker elements mounted in place. Note that woofer is completely enclosed and acts as driver of folded horn formed by the internal configuration of the cabinet. When enclosure is to be used in vertical position, tweeter and midrange are remounted.

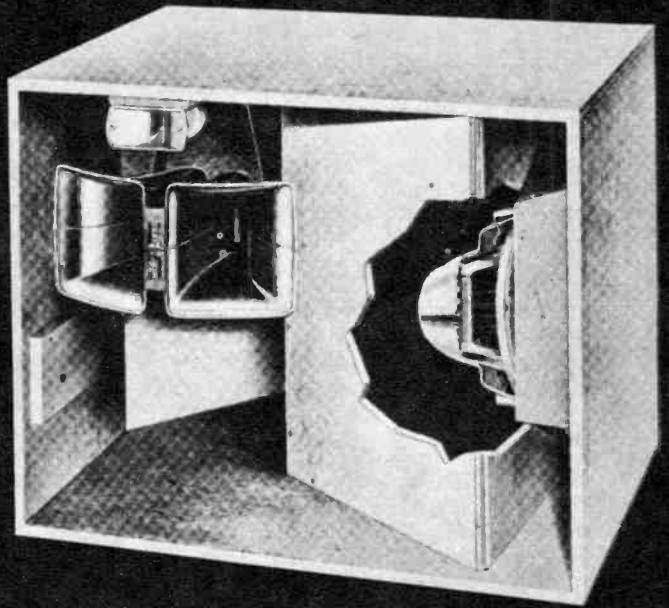

PLAN VIEWS of enclosure show internal cabinet construction. Dotted lines in top view are sound path in folded horn.

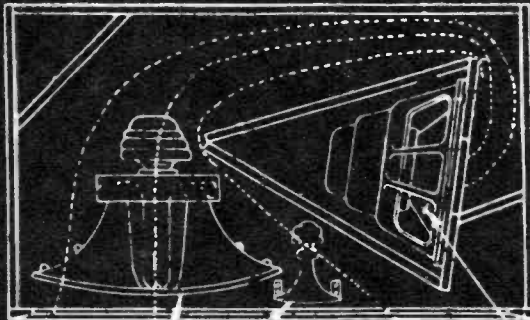

UNIVERSITY MODEL
COBREFLEX 2

UNIVERSITY MODEL
HF-206

UNIVERSITY MODEL
C 15 W

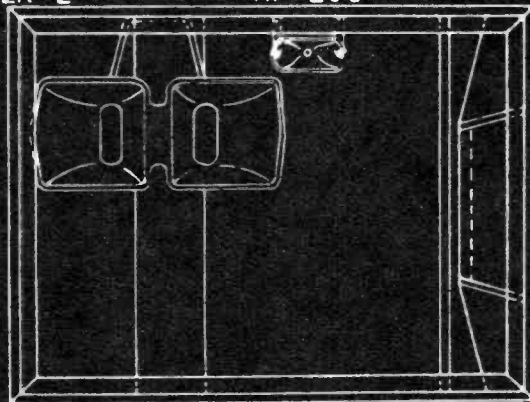

3 1/2

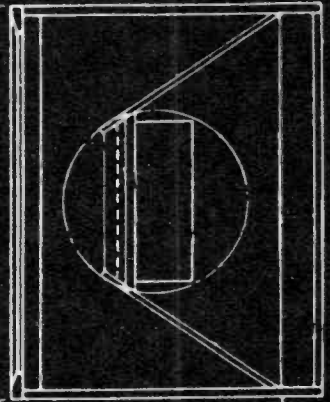

40 5/8

23 3/4

may we tolerate in a particular design for the sake of improved linearity, and how may this loss be overcome? How much reduction in high frequency response shall we accept from a single extended range speaker when we want simultaneously to achieve good, stable diaphragm piston action for low frequencies, and how can we minimize this loss with new pulp materials? How shall we continually improve the power capacity of the speaker to keep in step with increasing amplifier ratings, without deteriorating its acoustic performance? How can we best design a uniformly compatible line of specialized loudspeaker components to make selection simple, straightforward, and easily understood by the layman? These are typical everyday concerns of the engineer, and each one in turn gives rise to dozens of others. The excitement and exhilaration in this field lie in pinning down, one after another, the solutions to these problems.

MR. BADMAIEFF: It is true that amplifiers can be designed which are for all practical intents perfect. Loudspeakers, however, must transform electrical energy to mechanical movement, and mechanical movement into sound. This triple transition of energy is difficult to control, and although loudspeakers have today reached the point where a trained ear is required to differentiate between their reproduction and the original sound, they are by no means perfect. There is room for improvement, and it will continue to be made as the art advances.

COL. KLIPSCH: The dramatic improvement in amplifiers is largely in the minds of the advertising managers. There is, currently, a plethora of mediocre amplifiers on the market, and the good ones capable of 30% of their rated output at 10 c.p.s. can be counted on the fingers of a couple of cow's hoofs. Even so, the electromechanical transducers (speakers, pickups, microphones) remain subject to more forms of distortion than even some of the "just fair" amplifiers. The tough problem in a speaker remains that of producing an undistorted pressure in an imponderable medium like air, with a piston made of a material with a specific gravity over 1,000 times that of air.

MR. KRAMER: In most high fidelity systems, significant improvement in the performance can be realized by using better loudspeaker systems. Modern speaker systems, where cost and size are not limiting factors, can provide perform-

ance superior to many other components in the better high fidelity systems. Perhaps the one factor which destroys the realism of music reproduction more than any other is the presence of background noise; certainly this is not in any way a fault of the loudspeaker system. All large, reputable loudspeaker manufacturers, however, carry on active development and research programs, and we certainly expect refinement of present designs as a result.

MR. HOEFLER: Are there any other comments you would care to make about loudspeakers: design, manufacturing, merchandising, application?

MR. BADMAIEFF: Many people today have been building speaker systems consisting of components of a variety of manufacturers. The possibility of such a system performing well is very small, since the low frequency unit, network, and high frequency unit must be engineered to provide the compatibility required for a smooth frequency response.

MR. KRAMER: The proper choice of loudspeaker equipment is an important problem facing the consumer. He must be aware of the product which by some magic solves all problems. Basic acoustical problems are not solved by trick methods but rather by good, clean, sound engineering design. The consumer would do well to spend his efforts in evaluating loudspeakers rather than to demand certain design details which may actually defeat the purpose. A good loudspeaker imparts no characteristic of its own to the reproduction, and any coloration of this kind can be detected by listening carefully to several types of reproduced music. Since there are no accepted standards at the present time, the usual specifications and response curves are valueless.

MR. COHEN: Loudspeakers do not serve their intended purpose unless they function properly in their surroundings. Although we do not all have living rooms that are miniature concert halls, there is much we can do to the ordinary listening room to improve its acoustic performance. In general, a very bare room will be reverberant, with a rolling and echoing of sound that produces confusion and indistinctness. On the other hand, a very overstuffed room will be dry, with a feeling of dullness and impaired brilliance in the reproduction. Somewhere in between these extremes is an optimum condition that will impart to the reproduced sound the right

amount of reverberation to make it live and lifelike. Placement of the enclosure in the room is also important, in determining system performance. Corner locations not only help to reinforce the low frequencies, but angularly span most of the listening room and consequently produce improved high frequency coverage.

COL. KLIPSCH: There are some speakers, boxes, and speaker box combinations for which their makers advertise the most fantastic claims, such as 16 c.p.s. and lower response from radiators of only one foot diameter. It could be granted that any small speaker could radiate any wavelength, but the fundamental radiated by a 10-inch piston at a distance of ten feet in free space at 30 c.p.s. is demonstrably below the threshold of audibility. The "reports of independent laboratories" on such devices, as quoted, could stand a lot of revision in the interest of practical accuracy. Many of these speakers are good within the size and price bracket, but the advertising claims are so exaggerated as to be ludicrous to the experienced worker, but still capable of sucking in that part of the public which is too inexperienced to know the limitations of fundamental physics, or which actually likes to be fooled. The high fidelity art could stand

some illumination of the quackery which pervades every new art.

Even some of the reputable manufacturers have been beguiled or trapped into exaggerations of both performance and claims. Some very fine speakers are deliberately designed with peaks (usually about 50 and 8,000 c.p.s.) to exaggerate the "high fidelity" effects; some less than fine systems make up the loss in advertising specifications. The little single 12-inch speaker with "response to 20 cycles" may be demonstrably responsive to this frequency in laboratory test, but the fact remains that at tolerable excursions (from distortion standpoint) the power response of a 12-inch speaker is only 0.0005 watt at 30 c.p.s. This would give a 60 decibel intensity at about nine feet, which is some 4 db below the 64-decibel threshold of hearing. Considering the 80 to 110 db levels encountered in recording, it is readily seen how far short of any useful response the small radiator must necessarily fall.

There you have the considered opinions of four of the top technical men in the loudspeaker field. While their views are sometimes conflicting, they are every one based on sound engineering logic. And it is interesting to note that in several cases they have unanimously exploded certain widely held loudspeaker myths. •

CONSTRUCTION COMPLETED. the author and his children enjoy their new Classic loudspeaker system.

Photos by Joseph Wayne



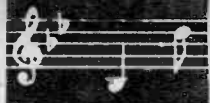

The Best Hi-Fi Records

Compiled by Lyle Kenyon Engel

The nation's top disc jockeys select their favorite records and albums, and suggest these as a basis for a really fine hi-fi collection.

THE American disc jockey is entrusted with a tremendous job. He receives thousands of record releases every month from hundreds of record companies throughout the nation, and he must sift through these releases to select records of particular interest to his public.

Anyone can select records that appeal to him, but the disc jockey has a particular problem: In order to keep his rating with the people in his area he must maintain constant checks on his programming material to see that he is giving the people what they want.

The average top disc jockey receives over 2,000 single records every month. Since each record will average about three minutes, just to listen to these for the first time will take 100 hours alone. This does not take into consideration the albums he receives and the fact that everything has to be rated for use and then filed.

The disc jockey is also very important to the American economy. His selection of records will be played to millions of people and stimulate them into purchasing some \$250,000,000 worth of recordings per year.

We have asked a cross section of top disc jockeys to select their favorite hi-fi record selections in both singles and albums. Here are their choices to help you in building up your home library. •





BILL BALLANCE of KNX, Los Angeles, is typical of the hundreds of disc jockeys who play an important part in the music of America. On the following pages you'll find the favorite hi-fi records of disc jockeys.



CAL MILNER AND LARRY BROWN, WPEN,
Philadelphia, Pennsylvania

FAVORITE HI-FI RECORDS:

Somebody's Gotta Lose (Hi-Fi)
That's Right (Mills Brothers) (Hi-Fi)
Canadian Sunset (Hugo Winterhalter) Victor

FAVORITE HI-FI ALBUMS:

Harry James In Hi-Fi. Capitol
Songs I Wished I'd Sung (Bing Crosby) Decca
Songs For Swingin' Lovers (Frank Sinatra) Capitol



BOB CHAMBERS, WKXY, Sarasota, Florida

FAVORITE HI-FI RECORDS:

Mack The Knife (Louis Armstrong) Columbia
Mr. Wonderful (Sarah Vaughan) Mercury
Moonglow and Theme from Picnic (Morris
Stoloff) Decca

FAVORITE HI-FI ALBUMS:

Music For Sleepwalkers Only
(Murray McEachern) Key
Blue Rose (Rosemary Clooney, Duke
Ellington) Key
Songs For Swingin' Lovers (Frank Sinatra) Capitol



ART ROBERTS, WXLW, Indianapolis, Indiana

FAVORITE HI-FI RECORDS:

Simonetta (Werner Muller) Decca
This Love of Mine (Tommy Dorsey) Decca
Love of Genevieve (Nelson Riddle) Capitol

FAVORITE HI-FI ALBUMS:

Recipes For Romance (Spencer-Hagen) "X"
Arthur Murray's Dance And Dream Time. Capitol
Mood For Twelve (Paul Weston) Columbia



CARL "TINY" THOMALE, WHAS,
Louisville, Kentucky

FAVORITE HI-FI RECORDS:

Moonglow and Theme from Picnic (Morris
Stoloff) Decca
Somebody Up There Likes Me (Perry Como) Victor
If You Don't Want My Love (Jaye P. Morgan) Victor

FAVORITE HI-FI ALBUMS:

Under Glass (Hi Lo's) Starlite
Sweet and Hot (Ella Fitzgerald) Decca
Manhattan Time (Art Van Damme) Columbia

JOE MITCHELL, KPOJ, Portland, Oregon

FAVORITE HI-FI RECORDS:

Haunted Guitar (The Three Suns) Victor
To Love Again (Marc Fredericks) Dot
Summit Ridge Drive (Jimmy Palmer) Mercury

FAVORITE HI-FI ALBUMS:

Concert by the Sea (Erroll Garner) Columbia
Escapade in Sound (Al Nevins) Victor
Dave McKenna Solo Piano. ABC-Paramount



GENE WHITAKER, WNCA.

Siler City, North Carolina

FAVORITE HI-FI RECORDS:

Kiss Me Again (Mantovani) London
Dream Along With Me (Perry Como) Victor
Now You Has Jazz (Armstrong, Crosby) Capitol

FAVORITE HI-FI ALBUMS:

The Popular Gershwin. Victor
The Great Benny Goodman. Columbia
High Society (Movie Cast) Capitol



JERRY MARSHALL, WNEW, New York, N. Y.

FAVORITE HI-FI RECORDS:

Cue Sera Sera (Doris Day) Columbia
Allegheny Moon (Patti Page) Mercury
Somebody Up There Likes Me (Perry Como) Victor

FAVORITE HI-FI ALBUMS:

Songs For Swingin' Lovers (Frank Sinatra) Capitol
Cole Porter Songbook. Verve
Your Musical Holiday in New York (Werner Muller)
Decca



JERRY & JIMMA STRONG, WMAL.

Washington, D. C.

FAVORITE HI-FI RECORDS:

Street of Dreams (Vic Damone) Columbia
Moonglow and Theme from Picnic (Morris
Stoloff) Decca
You Don't Know Me (Jerry Vale) Columbia

FAVORITE HI-FI ALBUMS:

Ella Fitzgerald Sings Cole Porter. Verve
Hefti Hot'n Hearty (Neal Hefti) Epic
Solo Mood (Paul Weston) Columbia





MIKE WOŁOSON, WNOR, Norfolk, Va.

FAVORITE HI-FI RECORDS:

Allegheny Moon (Patti Page) Mercury
If You Can Dream (Four Aces) Decca
A Fine Romance, Columbia

FAVORITE HI-FI ALBUMS:

Oklahoma (Original Cast) Capitol
Ella Fitzgerald Sings Cole Porter, Verve
Swingin' On Campus (Ray Anthony) Capitol



GIL HENRY, KING, Hollywood, California

FAVORITE HI-FI RECORDS:

Doddletown Filers (Sauter-Finnegan) Victor
Skinned Deep (Woody Herman) Capitol
Man With The Golden Arm (Billy May) Capitol

FAVORITE HI-FI ALBUMS:

Les Brown at Hollywood Palladium, Coral
Escapade (Art Nevens) Victor
Pines of Rome—Fountains of Rome
(Arturo Toscanini) Victor



NOEL BALL, WSIX, Nashville, Tennessee

FAVORITE HI-FI RECORDS:

True Love (Bing Crosby, Grace Kelly) Capitol
Melody of Love (Billy Vaughn) Dot
Canadian Sunset (Hugo Winterhalter) Victor

FAVORITE HI-FI ALBUMS:

The Golden Instrumentals (Billy Vaughn) Dot
Music For Lovers Only (Jackie Gleason) Capitol
Love Is A Many Splendored Thing
(Richard Hayman) Mercury



LARRY GENTILE, WXYZ, Detroit, Michigan

FAVORITE HI-FI RECORDS:

Dream Rhapsody (Les Baxter) Capitol
Blue Mirage (Frank Chacksfield) London
Arrivederci Roma (Three Suns) Victor

FAVORITE HI-FI ALBUMS:

The Golden Instrument (Billy Vaughn) Dot
My Fair Lady (Broadway Cast) Columbia
Songs For Swingin' Lovers (Frank Sinatra) Capitol

HARRY DOWNIE, WICC, Bridgeport, Connecticut

FAVORITE HI-FI RECORDS:

All My Love (Werner Muller) Decca
Moonglow and Theme from Picnic (Morris Stoloff) Decca
Marimba Charleston (David Carroll) Mercury

FAVORITE HI-FI ALBUMS:

Ted Heath, Volume 4, London
Harry James In Hi-Fi, Columbia
Benny Goodman In Hi-Fi, Columbia



JIM AYLWARD, WHIL, Boston, Massachusetts

FAVORITE HI-FI RECORDS:

Havana (Les Baxter) Capitol
Italian Theme (Cyril Stapleton) London
Cry Me A River (Julie London) Liberty

FAVORITE HI-FI ALBUMS:

Me And My Shadow (Ted Lewis) RKO-Unique
King And I (Movie Cast) Capitol
The Most Happy Fella (Original Cast) Columbia



HARRY NIGOCIA, WJBW, New Orleans, Louisiana

FAVORITE HI-FI RECORDS:

Monte Carlo Melody (Werner Muller) Decca
Lola's Theme (Steve Allen) Coral
Bistro (Werner Muller) Decca

FAVORITE HI-FI ALBUMS:

Dee Most (Lenny Dee) Decca
Songs I Wish I Had Sung (Bing Crosby) Decca
Your Musical Holiday In New York, Decca



CHUCK THOMPSON, WALA, Mobile, Alabama

FAVORITE HI-FI RECORDS:

Hell's Bells (David Carroll) Mercury
Ziguener (Billy Regis) Victor
Perdido (Three Suns) Victor

FAVORITE HI-FI ALBUMS:

Harry James In Hi-Fi, Capitol
Jazz (Dave Brubeck Quartet) Columbia
Music For Sleepwalkers Only (Murray McEachern) Key





JOE MARTIN, WOW, Omaha, Nebraska

FAVORITE HI-FI RECORDS:

To Love Again (Carmen Cavallaro) Decca
Canadian Sunset (Hugo Winterhalter) Victor
Lazy Gondalier (Mantovani) London

FAVORITE HI-FI ALBUMS:

Moonglow and Theme from Picnic (Morris Stoloff) Decca
Songs of Love (Robert Shaw Chorus) Victor
Wagon Wheels (Morton Gould) Columbia



**DONN TIBBETTS, WGIR,
Manchester, New Hampshire**

FAVORITE HI-FI RECORDS:

Canadian Sunset (Hugo Winterhalter) Victor
Theme from Proud Ones (Nelson Riddle) Capitol
When the White Lilacs Bloom Again
(LeRoy Holmes) MGM

FAVORITE HI-FI ALBUMS:

My Fair Lady (Percy Faith) Columbia
Gaité Parisian (Boston Pops) Victor
Passport to Romance (Percy Faith) Columbia



PAUL BRENNER, WAAT, Newark, New Jersey

FAVORITE HI-FI RECORDS:

Flaherty's Beguine (Hugo Winterhalter) Victor
Autumn Leaves (Roger Williams) Kapp
Malaquena (Ted Heath) London

FAVORITE HI-FI ALBUMS:

Overture of 1812 (Minneapolis Symphony) Mercury
La Danza! (Hollywood Bowl Symphony) Capitol
Lonely Spell (Bob Manning) Capitol



JON FARMER, WAGA, Atlanta, Georgia

FAVORITE HI-FI RECORDS:

How Little We Know (Frank Sinatra) Capitol
Portuguese Washerwoman (Joe Fingers Carr) Capitol
Moonglow and Theme from Picnic (Morris Stoloff) Decca

FAVORITE HI-FI ALBUMS:

Eddy Duchin Story (Original Cast) Decca
Benny Goodman Story (Original Cast) Decca
King and I (Movie Cast) Capitol

JACK DENTON, WISN, Milwaukee, Wisconsin

FAVORITE HI-FI RECORDS:

Hi-Fi Drums (Herman, Rich) Capitol
Tinnin' In (Georgie Auld) Mercury
Love Is Just Around The Corner (Georgie Auld)
Mercury

FAVORITE HI-FI ALBUMS:

Harry James In Hi-Fi. Capitol
Music For Sleepwalkers Only (Murray
McEachern) Key
Rain Or Shine (Dick Haymes) Capitol



RAY PERKINS, KIMN, Denver, Colorado

FAVORITE HI-FI RECORDS:

Malaquena (Boston Pops) Victor
Old Man River (Bing Crosby) Decca
Sicilian Tarantella (Henri Rene) Columbia

FAVORITE HI-FI ALBUMS:

Beethoven's Ninth Symphony (Arturo
Toscanini) Victor
Roman Carnival Overture (Arturo Toscanini) Victor
La Danse (Hollywood Bowl Symphony) Capitol



ART HELLYER, WCFL, Chicago, Illinois

FAVORITE HI-FI RECORDS:

Cry Me A River (Julie London) Liberty
He (McGuire Sisters) Coral
That Old Feeling (Frankie Laine, Buck Clayton)
Columbia

FAVORITE HI-FI ALBUMS:

Folk Songs of the Frontier (Roger Wagner
Chorale) Capitol
Julie Is Her Name (Julie London) Liberty
The Great Benny Goodman. Columbia



LOU EMM, WHIO, Dayton, Ohio

FAVORITE HI-FI RECORDS:

Canadian Sunset (Hugo Winterhalter) Victor
Quiet Village. Hi-Fi Record
Tone Poems of Color (Frank Sinatra) Capitol

FAVORITE HI-FI ALBUMS:

My Fair Lady (Broadway Cast) Columbia
King and I (Movie Cast) Capitol
Cinerama Holiday (Jack Shaindlin) Mercury



Free Items and Special Bargains

Here are various consulting services, detailed building plans, magazines, manuals and references now available to hi-fi fans.



ONCE again my publishers and I have scouted the entire hi-fi field looking for useful items, services, and helpful publications, which are made available to our readers free of charge or at nominal cost. All manufacturers offer catalogs, price lists, and the usual sales literature, but many go further and provide interested parties with something which they can really use. All of the items mentioned here are truly worthwhile, but nevertheless absolutely free, unless a small service charge is specifically noted. We believe that the list which follows is the most complete ever published, and hope that our readers will find its use both helpful and profitable.

Typical Installation Diagrams

A beautiful book, showing drawings of typical hi-fi installations, necessary components and their interconnection. Included are a number of color photos of tape recorders and amplifiers in typical surroundings. Ask for Catalog No. 101. Write to Bell Sound Systems, Inc., 555 Marion Road, Columbus 7, Ohio.

Audiocraft Magazine

This is the new how-to-do-it magazine of home sound reproduction. Regularly features articles on electronic construction, sound servicing, woodcrafting, and system design. This magazine sells everywhere for

FOR REPAIRING RADIO AND TV

Superior's New Model 670-A

SUPER METER



A COMBINATION
VOLT-OHM MILLIAMMETER
PLUS CAPACITY REACTANCE
INDUCTANCE AND DECIBEL
MEASUREMENTS

ADDED FEATURE:

Built in ISOLATION TRANSFORMER reduces possibility of burning out meter through misuse.

SPECIFICATIONS:

D.C. VOLTS: 0 to 7.5/15/75/150/750/1,500/7,500 Volts
A.C. VOLTS: 0 to 15/30/150/300/1,500/3,000 Volts
OUTPUT VOLTS: 0 to 15/30/150/300/1,500/3,000 Volts
D.C. CURRENT: 0 to 1.5/15/150 Ma. 0 to 1.5/15 Amperes
RESISTANCE: 0 to 1,000/100,000 Ohms 0 to 10 Megohms
CAPACITY: .001 to 1 Mfd. 1 to 50 Mfd. (Good-Bad scale for checking quality of electrolytic condensers.)
REACTANCE: 50 to 2,500 Ohms 2,500 Ohms to 2.5 Megohms
INDUCTANCE: .15 to 7 Henries 7 to 7,000 Henries
DECIBELS: -6 to +18 +14 to +38 +34 to +58

The Model 670-A comes housed, in a rugged crackle-finished steel cabinet complete with test leads and operating instructions.

28⁴⁰

Superior's New Streamlined Model TC-55

TUBE TESTER



QUICKLY AND EFFICIENTLY TESTS RADIO AND TV TUBES INCLUDING: SEVEN PIN MINIATURES; EIGHT PIN SUBMINARS, OCTALS AND LOCTALS; NINE PIN NOVALS

YOU CAN'T INSERT A TUBE IN THE WRONG SOCKET.

It is impossible to insert the tube in the wrong socket when using the new Model TC-55. Separate sockets are used, one for each type of tube base. If the tube fits in the socket it can be tested.

"FREE-POINT" ELEMENT SWITCHING SYSTEM.

The Model TC-55 incorporates a newly designed element selector switch system which reduces the possibility of obsolescence to an absolute minimum. Any pin may be used as a filament pin and the voltage applied between that pin and any other pin, or even the "top-cap."

CHECKS FOR SHORTS AND LEAKAGES BETWEEN ALL ELEMENTS. The Model TC-55 provides a super sensitive method of checking for shorts and leakages up to 5 Megohms between any and all of the terminals.

ELEMENTAL SWITCHES ARE NUMBERED IN STRICT ACCORDANCE WITH R.M.A. SPECIFICATION.

One of the most important improvements, we believe, is the fact that the 4 position fast-action snap switches are all numbered in exact accordance with the standard R.M.A. numbering system.

Thus, if the element terminating in pin No. 7 of a tube is under test, button No. 7 is used for that test.

The Model TC-55 comes complete with operating instructions and charts. Use it on the bench—use it for field calls. A streamlined carrying case, included at no extra charge, accommodates the tester and book of instructions.

26⁹⁵

FOR REPAIRING ALL ELECTRICAL APPLIANCES MOTORS AND AUTOMOBILES

Superior's New Model 70 UTILITY TESTER



As an electrical trouble shooter
the Model-70:

- Measures A.C. and D.C. Voltages, A.C. and D.C. Current, Resistances, Leakage, etc.
- Will measure current consumption while the appliance under test is in operation.
- Incorporates a sensitive direct-reading resistance range which will measure all resistances commonly used in electrical appliances, motors, etc.
- Leakage detecting circuit will indicate continuity from zero ohms to 5 megohms (5,000,000 ohms).
- Will test Toasters, Irons, Broilers, Heating Pads, Clocks, Fans, Vacuum Cleaners, Refrigerators, Lamps, Fluorescents, Fans, Switches, Thermostats, etc.

Handsome round-cornered molded bakelite case, 3 1/4"x5 1/4"x2 1/4". Complete with all test leads. Also included is a 64 page book giving detailed instructions for testing all electrical appliances, automotive equipment, etc. Only

As an Automotive Tester
the Model 70 will test:

- Both 6 Volt and 12 Volt Storage Batteries
- Generators
- Starters
- Distributors
- Ignition Coils
- Regulators
- Relays
- Circuit Breakers
- Cigarette Lighters
- Stop Lights
- Condensers
- Directional Signal Systems
- All Lamps and Bulbs
- Fuses
- Heating Systems
- Horns
- Also will locate poor grounds, breaks in wiring, poor connections, etc.

15⁸⁵

SHIPPED ON APPROVAL NO MONEY WITH ORDER - NO C.O.D.

Try any of the above instruments for 10 days before you buy. If completely satisfied then send down payment and pay balance as indicated on coupon. No Interest or Finance Charges Added! If not completely satisfied return unit to us, no explanation necessary.

MOSS ELECTRONIC DISTRIBUTING CO., INC.

Dept. D-254, 3849 Tenth Ave., New York 34, N. Y.

Please send me the units checked. I agree to pay down payment within 10 days and to pay the monthly balance as shown. It is understood there will be no finance or interest charges added. It is further understood that should I fail to make payments when due, the full unpaid balance shall become immediately due and payable.

Address

City

Zone

State

All prices net, F.O.B., N.Y.C.

Model 70 . . . Total \$15.85
\$3.85 within 10 days. Balance \$4.00 monthly for 3 months.

Model 670-A. Total \$28.40
\$7.40 within 10 days. Balance \$3.50 monthly for 6 months.

Model TC-55. Total \$26.95
\$6.95 within 10 days. Balance \$5.00 monthly for 4 months.

**ORDER NOW!
FINEST
QUALITY!
DIAMOND NEEDLES \$10***

*Our skilled diamond craftsmen convert your present needle to a *genuine, unconditionally guaranteed* diamond-tipped needle! Send or bring your replaceable needle, check or money order for \$10. Specify either 33 or 78 rpm. If desired, new shaft supplied, \$2.75 additional.

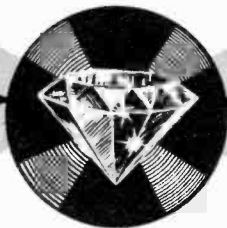

**DIAMOND
STYLUS CO.**

DEPT. L
31 WEST 47 STREET
N. Y. 36, N. Y.

SPECIAL BARGAINS

35c, but our readers may obtain a copy free by writing Audiocraft, 4402 Publishing House, Great Barrington, Massachusetts.

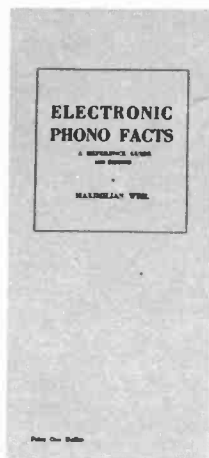

Electronic Phono Facts

A 1956 revised edition of this well-known reference guide by the famous audio pioneer, Maximilian Weil. Includes data on pickups, styli, tone arms, turntables, compensation, and record care. Regularly sells for \$1.00, but now available free from Audak Company, 500 Fifth Avenue, New York 36, N. Y.

The Classic Speaker System

In the loudspeaker chapter of this book you have seen a picture story on the finishing of a University Classic Speaker System. More detail on the construction of this unit is given in an Audiocraft reprint. Ask for *Making the University Classic* from Mr. Larry Epstein, University Loudspeakers, Inc., 80 South Kensico Avenue, White Plains, N. Y.

Schematic Diagrams

You can receive free a schematic diagram and an outline of electrical and physical specifications of any Heathkit. First get a Heathkit catalog, then order the free diagrams you want by model number. Both of these items are available from Mr. C. M. Edwards, Heath Company, Benton Harbor, Michigan.

Hi-Fi Bibliography

A listing of the best books on hi-fi by title, author, publisher, and price. Also in-

The "How-To-Do-It" Hi-Fi Monthly Magazine **audiocraft**...

**PRACTICAL
FEATURES
EVERY MONTH**

such as:

- **The Grounded Ear**, by Joseph Marshall
What's new and significant in sound reproduction
- **Tips for the Woodcrafter**, by George Bowe
- **Sound Servicing**, by Irving M. Fried
- **Tape News and Views**, by J. Gordon Holt
- **Basic Electronics**, by Roy F. Allison
- **Sound Fanciers' Guide**, by R. D. Darrell
- **Audio Aids**—New Ideas for the Hi-Fi Hobbyist
- **Audionews**—New Products in the Audio Field

PLUS...

- Pre-tested build-it-yourself designs.
- "How They Did It" picture stories.
- Articles by outstanding authors.
- Reviews of sonically unusual recordings.

**THE LATEST ISSUE
IS YOURS
FREE**

(See details in coupon
below)

audiocraft, 5322 Publishing House, Great Barrington, Mass.

Please send me, ABSOLUTELY FREE, a copy of the latest issue of **audiocraft**, and bill me for a three year subscription to start with the following issue. This is at your money-saving price of only \$9.00

I prefer 2 years at \$7.00
(24 issues)

I prefer 1 year at \$4.00
(12 issues)

NAME _____

ADDRESS _____

Add \$1 per year for subscriptions outside the U.S. and Canada.

NO RISK GUARANTEE—If my free copy does not live up to expectations, I may cancel my subscription and pay nothing.



**build your own
FORESTER
3-way
Low Distortion
SPEAKER
SYSTEM
for as little as
\$129.00**

... with 1M distortion below that of systems costing more than \$350.00. Intermodulation distortion or "blurring" of the most-listened-to middle and high frequencies is prevented by complete electrical and acoustical isolation of each speaker. This results in less than 0.5% 1M distortion to provide exceptionally clean middle tones and clear highs with no harshness. The Forester system contains 3 low distortion speakers. (A) a 12" woofer, 30-300 cps, with a 1 lb. magnet; (B) and 8" mid-range unit, 300-5000 cps with a 14.6 oz. magnet and (C) a 5" tweeter, 5000-18,000 cps with a 2.15 oz. magnet and light-weight, spiderless cone. These three speakers are controlled by a 6-element, 300:5000 cps, 12 db/octave crossover network. The entire cabinet measures 32" high, 25" wide, 14 1/2" deep.

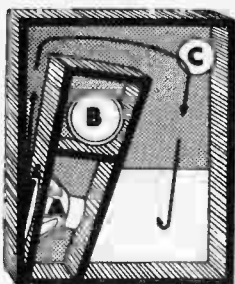

Front View

COMPLETE SYSTEMS

SF1	Spkrs., network, cabinet drawings	\$ 79.50
SF1/SFK	Spkrs., network, cabinet kit	\$129.00
SF1/SFP	Spkrs., network and assembled 3/4" unfinished plywood cabinet.....	\$154.00
SF1C	Spkrs., network, in finished bleached mahogany cabinet (illustrated).....	\$189.00

MODERNIZATION SYSTEMS

For use with your present 12" speaker, instead of the Sherwood Woofer.

SF2	Same as SF1, less 12" woofer.....	\$ 49.50
SF2/SFK	Same as SF1/SFK, less 12" woofer	\$ 99.00
SF2/SFP	Same as SF1/SFP, less 12" woofer	\$124.00

CROSSOVER NETWORKS (16 ohms)

For your own speaker system.

SFX35	300/5000 cps, 12 db/octave.....	\$ 19.50
SX2	200 cps, 12 db/octave.....	\$ 26.00
SX55	500/5000 cps, 12 db/octave.....	\$ 18.50
SX6	600 cps, 12 db/octave	\$ 16.90
SX8	800 cps, 12 db/octave	\$ 15.50
SX36	3500 cps, 12 db/octave.....	\$ 6.50

See the Forester Speaker System at your hi-fi dealer or write for free descriptive catalogue. Construction manual also available at 50c.

Other Sherwood products include: Low Distortion Amplifiers from \$99.50 and FM-AM Tuners from \$139.50



Dept. 11-F • 2802 W. Cullom Ave. • Chicago 18, Illinois

SPECIAL BARGAINS

cluded are a number of article reprints and interesting drawings on the use and care of styli. Request your packet from Mr. E. J. Marcus, The Tetrad Company, Inc., 62 St. Mary Street, Yonkers 2, N. Y.

Phono-Tape Replacement Manual

Complete data on the modernization and replacement of any phono cartridge or magnetic recording head. Also complete technical data on phono cartridges, recording heads, and styli. Ask for Manual RM-56 from Department 270, Shure Brothers, Inc., 222 Hartrey Avenue, Evanston, Illinois.

Consulting Service

Answers to all questions concerning the choice of loudspeakers, either for a complete system or to supplement existing speakers; loudspeaker enclosures and their design for use with any speakers in existence or contemplated; problems concerning the application of hi-fi loudspeakers. Write Mr. Karl Kramer, Jensen Manufacturing Co., 6601 South Laramie Ave., Chicago 38, Illinois.



Long-Playing Record

This is a 10-inch double-face LP, containing excerpts from many Capitol FDS recordings, by artists such as The Pittsburgh Symphony, Hollywood String Quartet, Billy May, and Les Baxter. Information on how to get it is available from Mr. Ted Leonard, Dictograph Products, Inc., Jamaica 35, N. Y.

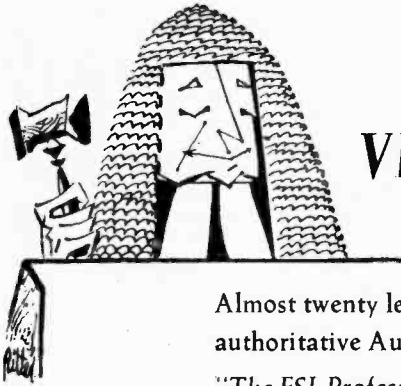

VERDICT FOR ESL

Almost twenty leading phono pickups have been tested by the authoritative Audio League. Its official verdict:*

"The ESL Professional and Concert Series cartridges are by far the finest phonograph reproducing instruments.

"These were unquestionably the smoothest, cleanest sounding cartridges tested.

"For sheer naturalness and undistorted ease, ESL has no peer."

Is your pickup obsolete? Switch to the sensational new ESL electrodynamic cartridge. Free brochure upon request.

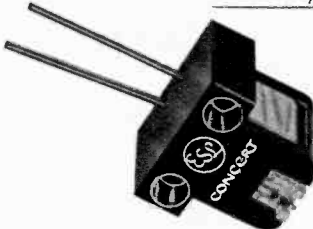

FOR LISTENING AT ITS BEST

Electro-Sonic Laboratories, Inc.

35-54 Thirty-sixth Street • Long Island City 6, N. Y.

Soloist Series from \$14.95 • Concert Series \$35.95 • Professional Series arm and cartridge \$106.50

*Authorized quotation No. 29. Please consult Vol. 1, Nos. 6-7, 10, & 12 (March-April & Nov. 1955, and April 1956) of The Audio League Report, P. O. Box 252, Mt. Vernon, N. Y., for the complete technical and subjective report.

get **MORE**
for your **HI-FI**
MONEY
with *Bell*
AMPLIFIERS
and **TAPE**
RECORDERS



Model PM 2285 — 10 Watt — \$49.95*

This new *Pacemaker* is typical of remarkable Bell value... and look at all these features!

- ★ MORE OUTPUT ★ HIGHER FIDELITY
- ★ BUILT-IN PRE-AMP ★ HUM CONTROL
- ★ 20 TO 20,000 CYCLES ★ SEPARATE TONE CONTROLS

This new Pacemaker is only one of the many fine amplifiers and tape recorders manufactured by Bell Sound Systems, all offered at moderate prices.

You can plan your High Fidelity investment for much greater value by finding out more about what Bell offers to you.

Write for free, illustrated literature and discover for yourself how to get more for your money by buying Bell.

*Priced slightly higher Denver and West.

Yes! Tell me more about Bell High Fidelity Equipment, and the name of my nearest dealer.

Name _____

Address _____

City _____ Zone _____ State _____

BELL SOUND SYSTEMS, Inc.

A Subsidiary of Thompson Products, Inc.

555 MARION ROAD COLUMBUS 7, OHIO

SPECIAL BARGAINS



Complete LP Record List

The Schwann LP Record Catalog is a complete listing of all records currently available, without the necessity of supplements or cross-indexing. All prices are listed, as well as the size, number of records in album, and title of reverse side. If your local record dealer doesn't have your free copy, send his name along with your own to Mr. W. Schwann, Publisher, 137 Newbury Street, Boston 16, Massachusetts.

Understanding Hi-Fi

A thoroughly instructive and entertaining book of hi-fi fundamentals, brought up-to-date in a third revised edition. For your copy of this 56-page book, send 25c to Mr. Larry LeKashman, David Bogen Co., Inc., P. O. Box 500, Paramus, N. J.



Recorded Tape Identification

The problem of identifying reels of recorded tape is solved by the Irish Reel Tab. Now made in two sizes, they fit snugly beneath the edges of any 5- or 7-inch reel, regardless of how much tape is on it. Made of sturdy stock, they have plenty of room

"BUILD-IT-YOURSELF" AND ENJOY

high fidelity at its finest

IN KIT FORM



① Heathkit FM TUNER KIT

Features brand new circuit and physical design. Matches WA-P2 Pre-amplifier. Modern tube line-up provides better than 10 uv. sensitivity for 20 db of quieting. Built-in power supply.

Incorporates automatic gain control—highly stabilized oscillator—illuminated tuning dial—pre-aligned IF and ratio transformers and front end tuning unit. Uses 6BQ7A Cascode RF stage, 6U8 oscillator—mixer, two 6CB6 IF amplifiers, 6AL5 ratio detector, 6C4 audio amplifier, and 6X4 rectifier. Shpg. Wt. 7 Lbs.

MODEL FM-3A **\$26.95***

② Heathkit 25-Watt HIGH FIDELITY AMPLIFIER KIT

Features a new design Peerless output transformer and KT66 output tubes. Frequency response within ± 1 db from 5 cps to 160 Kc at 1 watt. Harmonic distortion only 1% at 25 watts, 20-20,000 cps. IM distortion only 1% at 20 watts, 4, 8, or 16 ohms output. Hum and noise, 99 db below rated output. Uses 2-12AU7's, 2-KT66's and 5R4GY. Attractive physical appearance harmonizes with WA-P2 Preamplifier. Kit combinations:

W-5M AMPLIFIER KIT: Consists of main amplifier and power supply, all on one chassis. Shpg. Wt. 31 Lbs. **\$59.75** Express only.

W-5 COMBINATION AMPLIFIER KIT: Consists of W-5M amplifier kit plus Heathkit Model WA-P2 Preamplifier kit. Shpg. wt. 38 lbs. **\$81.50*** Express only.

③ Heathkit HIGH FIDELITY PREAMPLIFIER KIT

Designed specifically for use with the Williamson Type Amplifiers, the WA-P2 features 5 separate switch-selected input channels, each with its own input control—full record equalization with turnover and rolloff controls—separate bass and treble tone controls—and many other desirable features. Frequency response is within ± 1 db from 25 to 30,000 cps. Beautiful satin-gold finish. Power requirements from the Heathkit Williamson Type Amplifier. Shpg. Wt. 7 Lbs.

MODEL WA-P2 **\$21.75***

④ Heathkit HIGH FIDELITY SPEAKER SYSTEM KIT

This speaker system employs two Jensen speakers to cover the frequency range from 50 to 12,000 cps. Response is within ± 5 db through this range. Built-in crossover functions at 1600 cps. System rated at 25 watts, with nominal impedance of 16 ohms. Enclosure is a ducted-port bass reflex type. The attractive "picture frame" molding blends with any decorating scheme. You merely assemble the cabinet, wire the speakers and crossover network, and treat the furniture-grade plywood in the finish of your choice.

MODEL SS-1
Shpg. Wt. 30 Lbs.

\$399.5

⑤ Heathkit HIGH FIDELITY SPEAKER SYSTEM KIT

This Range Extending Speaker System employs a 15" woofer and a super tweeter to cover the frequencies between 35 and 600 cps, and between 4000 and 16,000 cps. When used with the Model SS-1, it extends the frequency range at both ends of the spectrum for a total coverage of ± 5 db from 35 to 16,000 cps. Provides unbelievably rich sound over the audio range.

Exposed panels are furniture grade plywood, suitable for light or dark finish of your choice. All parts are pre-cut and ready for assembly. The kit includes necessary crossover circuits and balance control. Crossover frequencies are 600, 1600, and 4,000. Power rating is 35 watts for speech and music. Nominal impedance is 16 ohms.

MODEL SS-1B
Shpg. Wt. 80 Lbs.

\$999.5

The SS-1B, alone, measures 29" high by 23" wide by 17½" deep.

Heathkits®



*Price includes 10% federal excise tax.

HEATH COMPANY

A Subsidiary of Daystrom Inc.

**BENTON HARBOR 7,
MICHIGAN**



Free CATALOG

Describes more than 65 top-quality electronic kits. Write for your free copy today!

FREE

1956
EICO[®]
CATALOG

saves you 50% on your
TEST INSTRUMENT & HI-FI COSTS!

50 EICO KITS & INSTRUMENTS to choose from!



5" PUSH-PULL
OSCILLOSCOPE

#425
KIT \$44.95
Wired \$79.95

VACUUM TUBE
VOLTMETER

#221
KIT \$25.95
Wired \$39.95



For Laboratory Precision at Lowest Cost—
buy EICO!



1000 Ohms/Volt
MULTIMETER

#536
KIT \$12.90
Wired \$14.90

TUBE TESTER #625



KIT \$34.95 Wired \$49.95

You build EICO KITS in 1 evening, but—
they last a lifetime!



NEW!
REDI-TESTER #540
KIT \$12.95
WIRED \$15.95

6V & 12V BATTERY ELIMINATOR
& CHARGER #1050



KIT \$29.95 Wired \$38.95

EICO—performance-proved by TV manufac-
turers, electronic schools and over 100,000
servicemen! OVER 1/2 MILLION in use today!

NEW! HI-FI PREAMPLIFIER
#HF-61



KIT \$24.95 Wired \$37.95
With Power Supply:
KIT \$29.95 Wired \$44.95

NEW! 20-Watt Ultra-Linear
HIGH FIDELITY AMPLIFIER
#HF 20



KIT \$49.95 Wired \$79.95

MAIL COUPON NOW. Prices 5% higher on
West Coast. Electronic Instrument Co., Inc.,
84 Withers St., Brooklyn 11, N. Y. ©56

EICO 84 Withers St., Brooklyn 11, N. Y.

Send FREE 1956 Catalog and name of
neighborhood EICO distributor. LC56

Name

Address

City Zone . . . State

Occupation

SPECIAL BARGAINS

on both sides for writing or typing. For a free supply, write stating which size you want to Mr. Nat Welch, ORRadio, Inc., T-120 Marvyn Road, Opelika, Alabama.

Free Home Trial

All Pentron tape recorders are available on a 10-day free home trial plan. See your local hi-fi dealer or write The Pentron Corporation, 777 South Tripp Ave., Chicago 24, Illinois.

Look or Listen?

A provocative article suggesting that the way to judge a loudspeaker is by listening rather than by checking frequency range or response curve statistics. Included is a suggested system for rating speakers, a field where standards are badly needed. Ask for *Shall We Look or Listen* from Mr. Karl Kramer, Jensen Manufacturing Co., 6601 South Laramie Ave., Chicago 38, Illinois.



Installation Plans

Complete construction details for a De-mountable Music Wall, consisting of simple interchangeable plywood cabinets, which house all audio, radio and TV equipment, and the record library as well. If not available free from your local lumber dealer, send 10c for Plan No. 8 to Douglas Fir Plywood Association, Tacoma, Washington.

Audio Record Subscription

A fine periodical having articles of timely interest on all phases of sound recording. Included is the annual Tape Recorder Directory, which contains performance data,

**New Craftsmen Maestro
Complete HI-FI System
Priced under \$200**

If you're looking for a top quality high fidelity system that will give you years of enjoyment, that is fine furniture, can be proudly displayed on a table or bookshelf, and is kind to your budget, here it is. The Maestro Hi-Fi system will surpass the most critical examination of the audiophile. Here are the components:

CRAFTSMEN AMPLIFIER-PREAMP WITH EQUALIZATION, LOUDNESS, AND FULL-RANGE TONE CONTROL, 10 WATTS OUTPUT. FOUR-SPEED RECORD CHANGER WITH 4-POLE MOTOR. G. E. VARIABLE RELUCTANCE CARTRIDGE. 1 MIL DIAMOND STYLUS, 3 MIL SAPPHIRE STYLUS.

All the above components housed in two beautiful cabinets available in mahogany or comb grained oak. One cabinet contains the famous Craftsmen CS-16 complete speaker system. It is well known that no single speaker can adequately reproduce every sound from one end of the audio range to the other. The CS-16 contains three speakers. There is an 8 inch woofer, an 8 inch mid-range speaker, a 3 inch tweeter. to ensure the ultimate in sound reproduction.

From a specifications standpoint the Craftsmen Maestro is the outstanding buy in high fidelity. But you must see and hear it to discover why audio experts throughout the country have hailed the Maestro as a milestone in the development of high fidelity. Visit your Craftsmen dealer today or write for new illustrated Craftsmen catalog.



RADIO **craftsmen**

div. of PRECISION RADIATION INSTRUMENTS, INC.

4223 LC WEST JEFFERSON BOULEVARD, LOS ANGELES 16, CALIFORNIA

SPECIAL BARGAINS

features and prices on all available magnetic recorders. A free subscription to *The Audio Record* is available from Audio Devices, Inc., 444 Madison Avenue, New York 22, N. Y.

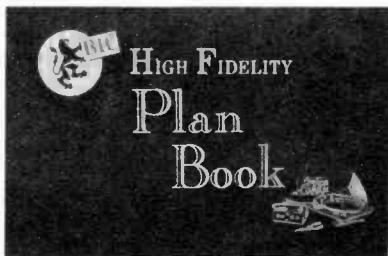

Hi-Fi Plan Book

Answers the important questions about how much to spend, suggested components, installation for best appearance, and where to buy a true hi-fi system. Ask for the *BIC High Fidelity Plan Book* from British Industries Corporation, Port Washington, N. Y.

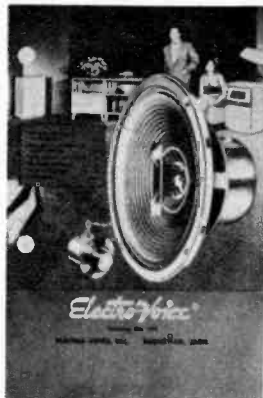

How to Choose Components

Tells how to select speaker diameter, discusses unitary versus separate speaker mountings, RETMA sensitivity ratings, crossover networks, impedance ratings, damping factor, and response curves. Ask for Bulletin No. 118 from Electro-Voice, Inc., Buchanan, Michigan.

Tape Recording Magazine

The only publication devoted exclusively

Klipschorn®

**CORNER HORN
LOUDSPEAKER
SYSTEMS**

DEDICATED to those discriminating listeners who demand REproduction of original music, the KLIPSCHORN system offers the ultimate in fidelity.

SHORTHORN®

MODERATELY sized—moderately priced, the SHORTHORN system approaches the KLIPSCHORN system in fidelity of music REproduction.

KLIPSCHORN and SHORTHORN loudspeaker systems are manufactured only by their designer, Paul W. Klipsch. Write for our latest literature.

KLIPSCH AND ASSOCIATES
HOPE, ARKANSAS

hear all
the music!



TRI-CHANNEL HI-FI System

a new dimension in high fidelity sound

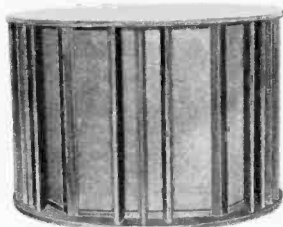

Three-way speaker system enclosure



Amplifier section

"Full-bodied bass . . . crisp mid-range . . . shimmering treble . . ." Virtually flat response from below 25 to above 25,000 cps. Distortion below recordable measurement. You must hear it to believe it! Specially designed base amplifier matched to 2 12" auditorium woofers; the mid-range amplifier being matched to its own 12" speaker and the electrostatic tweeter fed by its own amplifier. The attractive enclosure encompasses the latest advances in matched system design.

Tri-Channel Sound Matched System
\$795.00

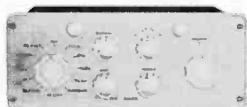

Tone Colour Unit

the Magnificent *Ferrograph*

The world's finest hi-fi tape recorder

The ultimate in high-fidelity tape recorders for home and professional use. The dual-speed, dual-track FERROGRAPH is the answer to the demand of discriminating audiophiles seeking professional tape recording results at a modest price. Meets the critical demands of B.B.C.

Frequency Response 40-15,000 cps \pm 2 db at 15 ips; wow and flutter less than 0.2%. Accommodates 8 1/2" reel, with 60-second rewind time. Speeds 3 3/4 and 7 1/2 or 7 1/2 and 15 ips, 3 heavy-duty motors; shaded pole for advance and rewind, hysteresis for tape drive.

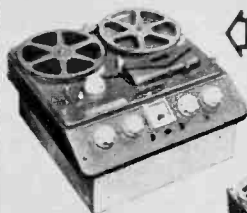

Model 66H
(custom installation)
7 1/2 and 15 ips
\$425.00

Model 3A/N
(portable with built-in speaker)
3 3/4 and 7 1/2 ips

\$379.50

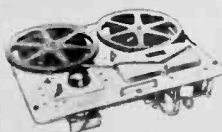
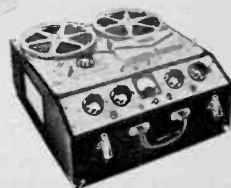

Tape Decks
3 3/4 and 7 1/2 ips
"A", 2 heads, **\$195**
"B", 3 heads, **\$225**
"C", (stereophonic) **\$250**

If You're a Connoisseur . . .
you'll want a *Connoisseur*



Turntable
\$110.00

"Dynabanced" tone arm with Mark II super-light-weight pickup w/diamond stylus **\$49.50** . . . w/sapphire stylus **\$34.50**. Mark II pickup w/diamond stylus **\$33.00** . . . w/sapphire stylus . . . **\$17.50**.

TURNTABLE

Compare the Connoisseur with any turntable and you'll marvel at its performance. Non-magnetic, 12" table; \pm 2% variation provides for all 3 speeds; hysteresis motor.

TURNTABLE: Rumble—better than 50 db down; Wow—less than 0.15% of rated speed; Dimensions—13 1/2 x 16 3/4".

PICKUP: Frequency Response—20-20,000 cps \pm 2 db at 33 1/2 rpm; Effective Mass—4 mg; Impedance—400 ohms at 1000 cps.



\$69.95

Crossover network (3000 cps)
Model DN/1
\$22.95

The **KELLY** RIBBON

UHF REPRODUCER

You can play a recording from end to end and still not hear ALL the music unless your hi-fi equipment includes a KELLY Ribbon "Tweeter". The KELLY Ribbon tweeter makes the perfect complement to any quality woofer to bring out all the subtle harmonics of live music. Duralumin foil diaphragm with matching 15-ohm transformer. Frequency Response 3000-20,000 cps, without audible resonance or back-radiation. Horn-loading—1000 cps cut off. Dim: 8 1/2" x 5 1/2" x 4 1/2".

Write today for complete literature and independent, unbiased performance test reports or inquire at leading hi-fi music centers.

ERCONA CORP. 551 Fifth Ave., Dept. LC, New York 17, N. Y.

In Canada, write Astral Electric Company Limited, 44 Danforth Road, Toronto 13.

Now you can have

BETTER MUSIC WITH YOUR PRESENT PHONOGRAPH

by installing the

SHURE "Twin Lever"
Ceramic Cartridge



You can dramatically improve the tone quality of your present phonograph with the SHURE WC-10 "Twin-Lever" cartridge. With this remarkable new Ceramic Cartridge you can enjoy the luxury of fine music reproduction at low cost.

The WC-10 has a peak-free frequency response from 40 to 13,000 cps. It replaces most 3-speed, plastic cased cartridges, crystal or ceramic, turnover or single needle . . . and is quickly installed on any tone arm with standard 1/2" mounting centers.

The unique "Twin-Lever" design, with each needle on its own shaft, provides improved, individually correct compliance for each record speed.

Needle replacement can be accomplished in seconds—without tools—with the cartridge in the pickup arm.

WC-10 with two sapphire needles—LIST PRICE \$9.50

WC-10D with diamond needle for LP and sapphire needle for 78RPM—LIST PRICE \$34.00

Available from your local SHURE distributor

SHURE BROTHERS, INC., SALES DIVISION
270 HARTREY AVENUE, EVANSTON, ILLINOIS

Please send me detailed information on the SHURE "Twin-Lever" Cartridge.

NAME

ADDRESS

CITY STATE

TLP

SPECIAL BARGAINS

to magnetic recording. Features how-to-do-it articles, how-to-build-it, plus the latest in new products and doings in the world of tape. Also has a regular review section of music on tape. For a free copy of the very excellent *Tape Recording*, write Mr. Mark Mooney, Tape Recording, Seaverna Park 10, Maryland.



Stroboscope Disc

Your sound reproduction will not be truly hi-fi unless your turntable is on speed and the music on pitch. You can readily determine whether your table is operating correctly by use of this free indicator. Accurate for all three standard speeds, under either 50 or 60 cycle illumination. Write Department 30, Rek-O-Kut Company, 38-01 Queens Blvd., Long Island City 1, N. Y.

Phono Modernization Manual

Covers both the theoretical and practical aspects of ceramic cartridge operation. Tells how they work, where they can be used, hints on using, input circuits, and mechanical aspects. Well illustrated with line drawings, characteristic curves, and schematics. Send 10c for *Phonograph Modernization Manual* to Electronic Applications Division, Sonotone Corporation, Elmsford, N. Y.

Tape Playing Time Chart

Complete and up-to-date, this gives playing time for all speeds, all reel sizes, and all types of tape, including newer Long Play and Double Play types. Write Mr. Nat Welch, ORRadio Industries, Inc., Shamrock Circle, Opelika, Alabama.

BUILD YOUR OWN FINE Jensen HI-FI SPEAKER SYSTEM

COMPLETE KITS NOW AVAILABLE—EVERYTHING YOU NEED
NO SAWING . . . NO DRILLING . . . NO WOOD FINISHING . . . NO SOLDERING

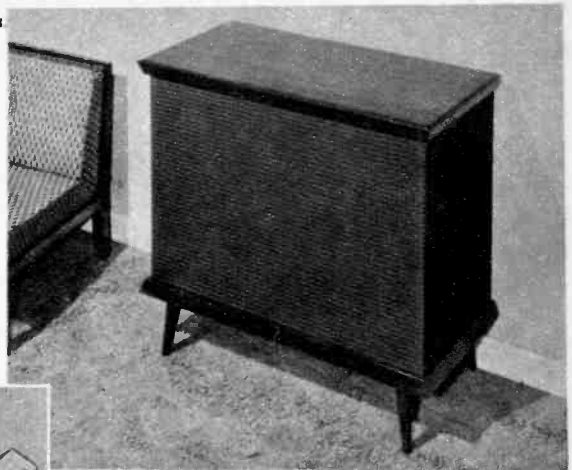
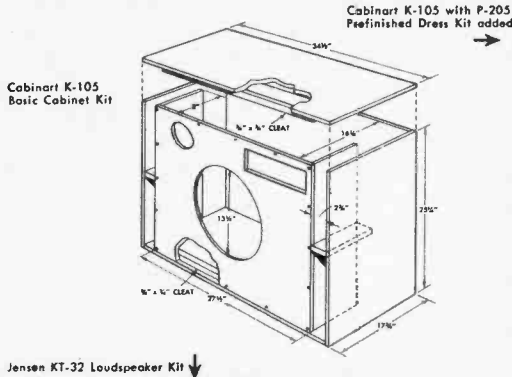

- YOU SAVE UP TO \$252.50*
- YOU DON'T HAVE TO BE A TECHNICIAN
- YOU DON'T NEED A WORKSHOP
- YOU DON'T HAVE TO BE A FURNITURE FINISHER

*Compared with factory-built Jensen Imperial reproducer

The proud owner of the Jensen 3-way hi-fi speaker system illustrated assembled the handsome low boy cabinet in a few hours in his living room with no tools except a screwdriver, pliers and a stapler. No cutting, sawing, or soldering. And the wood finishing? He just wiped off the finger prints, for the beautiful genuine selected hardwood was factory pre-finished and rubbed by professional finishers. Best of all, he saved nearly \$100 compared with cost of the equivalent factory-built speaker system.

You can have the fun and satisfaction of building your own Jensen speaker system with size and performance ranging all the way from the diminutive, economical Duette up to the big incomparable Imperial at savings which will stretch your hi-fi equipment budget. Jensen and Cabinart with their specialized skills have collaborated to make this easy and trouble-free. Everything you need is furnished.

Jensen Speaker units are matched components, carefully pretested, with the smooth, balanced, wide-range performance for which Jensen factory-made reproducers are famous. Cabinart Cabinet Kits were designed by Jensen to give the best possible acoustic performance with Jensen Loudspeaker Kits; each is carefully coordinated with the recommended Jensen Loudspeaker Kit for correct loading of the low frequency channel ("woofer"). Wood pieces are accurately cut and drilled, with all cut-outs provided. Hardware and cleats and glue are included with complete instructions for easy assembly. If you like, you can start with the Basic Cabinet Kit of your choice, add the Prefinished Dress Kit later.

Here's your way to finest hi-fi speaker performance at least cost! Ask your dealer, or write now.

System Type	"Woofer" Size	Equivalent Jensen Reproducer	Jensen Speaker Kit		Type	Cabinart Cabinet Kits			
			Model	Price		Basic Cabinet Kit	Price	Dress Kit	Price
3-Way	15"	Imperial	KT-31	\$184.50	Corner* Horn	K-101	\$89.00	P-201	\$54.00
3-Way	15"	Triplex	KT-32	169.50	Corner* Bass-Ultraflex	K-103	48.00	P-203	39.00
3-Way	15"	Triplex	KT-32	169.50	Low Boy Bass-Ultraflex	K-105	48.00	P-205	39.00
2-Way†	15"	—	KT-21	99.50	Corner* Bass-Ultraflex	K-103	48.00	P-203	39.00
2-Way†	15"	—	KT-21	99.50	Low Boy Bass-Ultraflex	K-105	48.00	P-205	39.00
2-Way†	12"	Concerto	KT-22	73.00	Corner* Bass-Ultraflex	K-107	39.00	P-207	36.00
2-Way†	12"	Concerto	KT-22	73.00	Low Boy Bass-Ultraflex	K-109	39.00	P-209	36.00
2-Way†	8"	Contemporary	KDU-10	24.75	Corner* Bass-Ultraflex	K-111	23.00	P-211	25.00
2-Way	8"	Duette Treasure Chest	KDU-10	24.75	Duette	K-113	18.00	P-213	21.00

* Gives excellent results against sidewall. Bass-Ultraflex is a Jensen trademark.
† Cabinet provides for expansion to 3-way system at any time with Jensen KTX-1 Range Extender Supertweeter Kit, price \$43.75.
‡ Available in Mahogany or Korina Blonde.

For information about Jensen Speaker Kits write:

Jensen
MANUFACTURING COMPANY
Division of The Muter Company
6601 SOUTH LARAMIE, CHICAGO 38, ILLINOIS
In Canada: Copper Wire Products Co., Ltd.

For information about Cabinart Cabinet Kits write:

CABINART
The Pioneers in High Fidelity Radio Furniture
A Division of G & H Wood Products Co., Inc.
99 North 11th Street, Brooklyn 11, N. Y.

**AMERICA'S OLDEST and
MOST AUTHORITATIVE
RECORD REVIEW MAGAZINE**

The REVIEW of RECORDED MUSIC

A monthly publication devoted to unbiased appraisals of all current classical and popular record releases.

Each Issue Contains:

THE MONTH'S BEST

REVIEWING THE CLASSICS

HI-FI AND MUSIC

A monthly article by
ED. TATNALL CANBY
one of America's leading Hi-Fi authorities

LISTENING WITH BOTH EARS

a monthly column by
ED. GRUNFELD
of WQXR "Music Magazine" Fame

CONNOISSEUR'S CORNER

TOPS IN POPS

All to be found every month in
the 32 page Review of Recorded Music

*To be fully informed of all that is new in
the world of Recorded Music, fill out the
coupon below.*

Review of Recorded Music, 119 W. 57 St., New York 19
Please enter my subscription to the Review of
Recorded Music for a six month's trial period,
for which I enclose \$1.00.

1 year \$2.00 2 years \$3.50 3 years \$5.00

NAME _____

ADDRESS _____

CITY _____ STATE _____

SPECIAL BARGAINS



Famous Designers Plans

Plans for a simply-built hi-fi storage wall, as featured in *Life* magazine. Designed by George Nelson, who also did the Herman Miller Furniture line. Included is a handsome color photo of the finished project. Ask for Bulletin SA-184, price 25c, from United States Plywood Corp., New York 36, N. Y.

Review of Recorded Music

This is a monthly publication devoted solely to unbiased appraisals of all current classical and popular records. In addition, each issue contains feature articles by writers well-known to audiophiles. The publishers offer a special six months trial subscription for \$1.00. Write Review of Recorded Music, 119 West 57th Street, New York 19, N. Y.

Technical Advice

The Technical Service Department of University Loudspeakers is ready at all times to answer consumer inquiries on loudspeakers, enclosures and systems. Hi-fi enthusiasts and technicians are invited to avail themselves of this service without obligation. Write to Mr. Larry Epstein, University Loudspeakers, Inc., 80 South Kensico Avenue, White Plains, N. Y.

Turntable or Changer?

Each side of this argument has its proponents, and you should carefully consider both before making an investment. For a forthright discussion of this question, ask for a copy of *Shall I Buy a Turntable or a Record Changer?*, from Department 30, Rek-O-Kut Company, 38-01 Queens Blvd., Long Island City 1, N. Y.

for Best Sound -  Best Protection -

famous **Walco** products!

for Complete
Record CARE!

Now — with Walco Record Care Accessories — you can give your records *complete* protection! Use STATI-CLEAN, Anti-Static Record Spray, and DISCLOTH, Anti-Static Record Cloth, to free your records of dust-attracting static. Use the DISCLEEN Clip-on Record Brush to keep dust out of grooves as records play. Get better sound, longer record wear with the BALANCED SOUND KIT. And store your records safely in DISCOVERS, Plastic Protective Sleeves.



WALCO
STATI-CLEAN
Anti-Static
Record Spray



WALCO
DISCLEEN
Clip-on
Record Brush

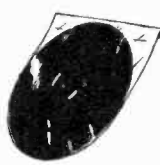

WALCO
DISCOVERS
Plastic Protective
Record Sleeves



WALCO
DISCLOTH
Anti-Static
Record Cloth



WALCO
Balanced Sound Kit
Turntable Level and
Tone-Arm Pressure Gauge

for
Safe Listening
PLEASURE!

Walco Replacement Needles for All Phonographs DIAMONDS • SAPPHIRES*

TESTED BY EXPERTS • TRUSTED BY MILLIONS

Leading phonograph manufacturers say: "...change needles frequently for best sound, least record wear!" But don't take chances with *ordinary* replacement needles. Be safe — insist on *Walco*, the needle used in more hi-fi sets than all other brands. At your record dealers!

YOUR WALCO NEEDLE GUARANTEE

Every Walco Diamond and Sapphire Needle is unconditionally guaranteed by Walco, Trade Name of ELECTROVOX CO., INC., world's largest manufacturer of Jewel Tipped needles.

At Record Dealers — everywhere!

*Synthesized

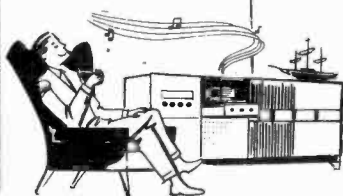

Walco

Trade Name of ELECTROVOX CO., INC.
60-L Franklin St., East Orange, N. J.

*bailed by
budget-conscious
audiophiles!*

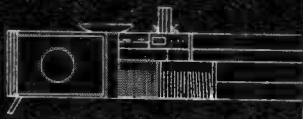

PENTRON
hi-fi

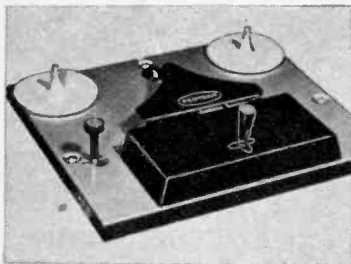

Model TM-56...\$89.95 list

Now! Custom install your own recorder. Low cost. Ready to plug into any amplifier and speaker.

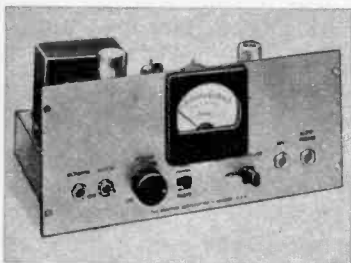

Model P-4...\$79.95 list

Tape mechanism has UniMagic 1-lever control for record-playback, fast forward and rewind with instant braking. 2 speeds—7½ and 3¾". Separate record-playback and erase heads.

Matching tape preamplifier—40-12,000 cps ± 3db, signal-noise ratio 50db. Push-pull oscillator. Professional controls. VU meter. Brushed copper and jet black finish. Carries Pentron warranty.

PENTRON

765 S. Tripp Ave.,
Chicago 34, Ill.

in Canada: Atlas Radio Ltd., Toronto

SPECIAL BARGAINS



Technical Monographs

The Technical Service Department of the Jensen Manufacturing Company have published an excellent series of technical bulletins. Of particular interest to hi-fi fans are *Loudspeaker Frequency Response Measurements*, *Frequency Range and Power Considerations in Music Reproduction*, and *Horn Type Loudspeakers*. These are priced at 25c each. The newest publication, priced at 50c, is *You Can Build Your Own Hi-Fi Speaker Systems*. Write for these to Mr. Karl Kramer, Jensen Manufacturing Company, 6601 South Laramie Ave., Chicago 38, Illinois.

Better Listening Magazine

This is a fine little monthly with a number of how-it-works, how-to-do-it and record review pieces in each issue. Free subscriptions are available through many hi-fi dealers. If yours doesn't have it, send his name as well as your own to St. Regis Publications, Inc., 7 West 44th Street, New York 36, N. Y.

Hi-Fi Consultation

Free technical advice concerning any problems of individual hi-fi systems is offered to our readers by Electro-Voice. If your system has you stumped, write Technical Service Department, Electro-Voice, Inc., Buchanan, Michigan.

The Diffaxial Speaker

Reprint of a technical paper by A. B. Cohen, describing a new concept in multi-element speakers mounted in a unitary array. The author argues that the Diffaxial

ORGANIZING THE CONTROLSthe key to high fidelity



Every control on a well designed, honestly considered high fidelity instrument has a specific useful function, related to each of the other controls.

The Prelude, Harman-Kardon's new 10 watt printed circuit amplifier illustrates this point well. With the *function selector*, choose the type of program material you plan to listen to (tuner, phono, tape or T.V.). Select the correct record equalization settings for the particular record to be played, using the separate *low frequency turnover and high frequency roll-off controls*. To minimize turntable rumble operate the *rumble filter* slide switch. With the *loudness contour selector* in the uncompensated position, turn the *loudness control* to a reasonably high level. This permits you to make the remaining adjustments while listening at your own maximum efficiency.

Adjust the *bass and treble tone controls* to

ADDITIONAL FEATURES: Printed circuit throughout. Output level: 10 watts at 3% IM. Peak Power: 15 watts. Frequency Response ± 1 db 20-20,000 cps. Rumble Filter. Tape and Record Equalization.

Write for free technical data sheets on the Prelude and matching AM-FM tuner.

harman kardon

INCORPORATED

520 Main St. Westbury, L. I., N. Y.

correct for the characteristics of your loudspeaker and for the acoustic characteristics of the room. Choose settings which, in your total system, create the proper sense of aural balance. Now reduce the loudness setting to a level, lower than the normal listening level in your room. Note that the full bodied, life-like quality you experienced at high listening level has disappeared. This is typical of human hearing since it loses sensitivity to very low and very high pitched tones as the sound level is reduced. With all other controls unchanged, switch quickly through the four positions of the loudness contour control until you find the one which most nearly duplicates the full bodied sound you enjoyed at high level.

Turn the loudness control up to the level at which you wish to listen. The controls are now properly organized and your system should perform at its very best!

Prelude, Model PC-200
(complete with cage)

\$55⁰⁰

*slightly
higher
in the
west*

NOW! THE ARM THAT SETS A NEW SOUND-STANDARD IN HI-FI



**NO TRACKING ERROR • NO SCRATCHING
• NO FUMBLING**

**ORTHO-SONIC DOES NOT MINIMIZE . . . IT ELIMINATES
TRACKING ERROR**

In Ortho-Sonic V/4 you get the only multiple precision ball bearing arm which guides the stylus radially (from edge to center in a straight line). This action duplicates the exact path of the original cutting stylus. Distortion due to tracking error is completely eliminated.

NO OTHER TONE ARM GIVES YOU THESE FEATURES

Scratchless Starting—Faultless Stopping. A slight tilt of the arm lowers your stylus on the record. A gentle contact is assured each time . . . regardless on what spot you want to start your record. You don't touch the cartridge when you stop—just tilt the arm. No scratching is possible.

Another exclusive feature of ORTHO-SONIC is the accurate cueing it affords by the permanent indexing scale, magnified at the point of reference. You can start any designated passage of your record without fumbling! This feature alone makes the ORTHO-SONIC a MUST for professionals and hi-fi enthusiasts.

**SCIENTIFIC TESTS BY LEADING LABORATORIES FIND
ORTHO-SONIC V/4 "FIRST RATE"**

"Less than 2% I.M. distortion at all Tracking forces from 1 gram up . . . No resonances could be found between 35 and 1,000 cps . . . Installation and leveling of the V/4 are unusually easy to accomplish . . . General listening quality of the arm is first rate . . . Cueing is remarkably precise . . . When the stylus is lowered it generally falls in the same groove it was playing . . . Needle talk was negligible. No acoustic resonances could be heard . . . It delivers its optimum performance at tracking forces as low as 3 grams . . ."

**MODEL #100 for all records up to and
including 12" \$35.95**

**MODEL #200 (For all records including
transcription size) \$44.50**

AT BETTER DEALERS EVERYWHERE

*If your dealer cannot supply your
needs, send your order direct to .*

ORTHO-SONIC INSTRUMENTS, Inc.

66K Mechanic Street, New Rochelle, N. Y.

SPECIAL BARGAINS

is an integrated version in one assembly of the design principles of multi-speaker systems. Rather heavy going for the amateur reader, but still worth looking into. Write Mr. Larry Epstein, University Loudspeakers, Inc., 80 South Kensico Avenue, White Plains, N. Y.

Compensator Settings

Tells what reproducer settings to use for any make of record, any speed. For a free copy of *Recommended Compensator Settings for Record Equalization*, write Brociner Electronics Laboratory, 344 East 32nd Street, New York 16, N. Y.

Temples of Tone

An excellent booklet about fine music and its reproduction. Describes the subjective aspects of music and sound, distortion, hi-fi components, hi-fi demonstrations. Write to Electro-Voice, Inc., Buchanan, Michigan.

High Fidelity Magazine

The magazine for music listeners, regarded everywhere as an authority in the field. Each issue contains numerous record reviews, reports on equipment tests, and a discography of some individual composer's works on record. Regularly 60c, a copy is available free by writing High Fidelity, 4401 Publishing House, Great Barrington, Massachusetts.

Needle Shadowgraphing

You can be sure of the condition of your stylus by having it checked periodically by shadowgraph, which provides a projected image of the tip 500 times actual size. A prompt and honest appraisal of the potential life of your stylus will be given you if you send it to Transcriber Company, 98 County Street, P. O. Drawer 478, Attleboro, Massachusetts.

Recorded High Fidelity

One of the best source books for record information is this book by Dr. Kurt List. The fund of information about recording, both artistic and technical, which he presents in this book will make it a welcome and valuable addition to your library. Revised and enlarged to 54 pages, it is now available at 25c from Westminster Recording Sales Corporation, 275 Seventh Avenue, New York 1, N. Y. •

FIRST IN HI-FI

Milton Sleeper, pioneer publisher in the hi-fi field, invites you to join the thousands of tape, record, and FM enthusiasts who say, "HI-FI MUSIC is first."

In addition to complete coverage of equipment for tape, records, and FM, HI-FI MUSIC contains more tape and record reviews in each issue than any other magazine, prepared by a board of 20 top-ranking music critics. And only in HI-FI MUSIC is each review accompanied by a rating of the composition, performance, and audio quality, an invaluable aid and time-saver for collectors.

You may enter your subscription under this no-risk guarantee: if you, too, do not say, "HI-FI MUSIC is first," your money will be refunded in full. Order your subscription now, and see for yourself.

THIRD YEAR OF
SERVICE TO
TAPE, RECORD,
AND FM RADIO
ENTHUSIASTS

MILTON B. SLEEPER, Publisher, HI-FI MUSIC MAGAZINE
209 East 37th Street, New York 16, N. Y.

In payment of a subscription under your No-Risk Guarantee, I enclose
 \$6.00 for 3 years (18 issues) \$3.00 for 1 year (6 issues)

NAME _____

ADDRESS _____

Top Quality!

THE WORLD-FAMOUS

FISHER

HIGH FIDELITY COMPONENTS



Model CA-40

THE FISHER Master Control-Amplifier

■ **Complete in every respect, Model CA-40 combines the most advanced audio control with a powerful 25-watt amplifier on one compact chassis.** Less than 1% distortion at 25 watts! Handles 50 watts peak. **Exclusive FISHER TONESCOPE**—a graphic indicator of control settings. Direct tape-head playback and microphone preamplifier. Six equalization settings. Frequency response within 0.5 db, 10 to 90,000 cycles! Hum and noise better than 90 db below full output. Cathode-follower tape recorder output. 4, 8 and 16-ohm outputs. Ten tubes. **CONTROLS:** Volume/Loudness-Balance (4-Position), Selector/Equalization, AC On-Off, Bass, Treble, Rumble Filter, Noise Filter. **SIZE:** 12¾" wide x 10¾" deep x 5" high. **WEIGHT:** 24 pounds. **\$139.50**



Model FM-40

THE FISHER Custom FM Tuner

■ **A beautifully designed FM Tuner—with all that the FISHER name implies—and only \$99.50!** The Model FM-40 represents one of our greatest values in twenty years. It is a superb combination of engineering excellence and dazzling performance at moderate cost. Stable circuitry and simplified controls make this remarkable tuner easy to use. Meter for micro-accurate center-of-channel tuning. Sensitivity—3 microvolts for 20 db of quieting. Uniform response ± 1 db, 20 to 20,000 cycles. Accommodates 72 or 300-ohm antenna systems. Three outputs: Detector/Multiplex, plus cathode-follower main output. Attractive brown-and-gold, brushed-brass front panel. 8 tubes. **SIZE:** 12¾" wide x 7¾" deep x 4" high. **WEIGHT:** 15 pounds. **\$99.50**

Blonde or Mahogany Cabinet **\$17.95**

Prices Slightly Higher In The Far West

Write Today For Complete Specifications

FISHER RADIO CORP.

21-47 44th Dr., L. I. C. 1, N. Y.

Glossary of Hi-Fi Terms

You should know these definitions
to really understand high fidelity.

- AF** — Abbreviation for audio frequency.
- AES** — Audio Engineering Society. (AES has recommended a recording characteristic used by some record manufacturers.)
- AM** — Abbreviation for amplitude modulation; the type of transmission utilized by the standard broadcast stations.
- Amplification** — Magnification (see gain).
- Amplifier** — An electronic circuit which increases the amplitude of an electric voltage or power.
- AFC** — Abbreviation for automatic frequency control; an electronic circuit used in FM tuners to correct inaccuracy in tuning a station.
- Arm (phonograph)** — A movable bracket which holds the pickup in proper position over the record (also Tone Arm).
- Attenuation** — Reduction of an electric voltage or current; the opposite of amplification.
- Audio** — The range of frequencies from approximately 30 to 15,000 c.p.s. Also an adjective used in reference to the electronic and acoustical equipment concerned with the reproduction of sound.
- Audiophile** — A person who is interested in improving musical reproduction for his own personal listening, by use of the latest audio equipment and techniques.
- Background Noise** — The total system noise, regardless of whether or not a signal is present.
- Baffle** — A barrier or partition designed to separate the sound waves generated by the front and back of a loudspeaker cone.
- Bass Reflex** — An enclosed type of speaker enclosure or baffle with a small window opening to provide for improved bass response.
- Beam Power** — A design of vacuum tube characterized by abundant power and unusually high amplification used as the output tube in power amplifiers.
- Cartridge** — Another name for the phonograph "pickup"; the device which converts the mechanical energy stored in the record grooves into electrical energy.

Chassis — The metal box, framework or other support to which the components of a tuner or amplifier or other device are attached. The term is also used to designate the entire equipment (less cabinet) when assembled.

Compensator — An electronic circuit for altering the frequency response of the amplifier system to achieve a specified result. In general this refers to such things as record equalization or loudness correction.

Constant Amplitude — The disc recording characteristic wherein the groove displacement is directly proportional to the signal amplitude.

Constant Velocity — The disc recording characteristic wherein the groove displacement is inversely proportional to the signal frequency.

Crossover Network — A filtering circuit used on multiple speaker systems which separates the high frequencies from the low frequencies and channels them respectively to the tweeter and woofer speaker units.

Crystal — Used in reference to a phonograph cartridge, it is a small slob of piezo electric material used to convert mechanical motion to an electrical voltage.

De-Emphasis — A form of equalization complementary to pre-emphasis.

Decibel —

(1) A logarithmic measure of the ocoustical level of sound intensity. 0 db is the threshold of human hearing while 130 db is the threshold of pain, i.e. the intensity level at which physical pain is felt.

(2) A logarithmic unit of measure used to express the voltage or power gain of an amplifier. With a minus sign it is also used to express the loss in attenuating circuits.

Because the ear measures differences in sound level logarithmically rather than arithmetically (if sound A is twice as loud as sound B, it will appear to the ear to be only slightly louder), and because decibel numbers can be used to represent large figures in a convenient manner (60 db equals a power ratio of 1,000,000 to 1), the decibel system is universally used by electronic engineers.

Distortion — The modification of the input signal by the discrimination against some frequencies, or by the introduction of additional frequencies not present in the original.

Equalizer — A synonym for "compensator."

Feedback — The combining of a portion of the output signal with the input signal.

(a) Degenerative (Inverse or Negative) Feedback is the type which reduces the distortion caused by vacuum tubes and improves the frequency response characteristic.

(b) Regenerative (Acoustic) Feedback is the type which causes distortion or sustained "howling" — as between the loudspeaker and cartridge.

Flutter — The frequency deviation resulting from irregular motion during recording, duplication or reproduction.

FM — Abbreviation for frequency modulation; the type of radio transmission which can provide truly high fidelity with practically no stotic or background noise.

SAVE MONEY ON EVERYTHING IN HI-FI

FREE

ALLIED'S 356-PAGE 1957 CATALOG



FEATURING THE WORLD'S LARGEST STOCKS OF HI-FI COMPONENTS AND SYSTEMS



Save on Everything in Hi-Fi

Here's your complete money-saving guide to Hi-Fi. Shows you how to select a custom Hi-Fi music system for your home at no more than the cost of an ordinary phonograph. If you prefer to assemble your own system, tells you what to look for and how to save money on each unit. Offers you the world's largest selection of complete Hi-Fi systems as well as individual amplifiers, tuners, changers, speakers, enclosures and accessories from which to make your money-saving choice. Want to build-your-own?—see the famous Hi-Fi KNIGHT-KITS. For everything in Hi-Fi —for *everything* in Electronics, get the FREE 1957 ALLIED Catalog. Write for your copy today!

America's Hi-Fi Center • Our 36th Year



ALLIED RADIO

Send for FREE Catalog

ALLIED RADIO CORP., Dept. AA-6
100 N. Western Ave., Chicago 80, Illinois

Send FREE 1957 ALLIED 356-Page Catalog

Name _____

Address _____

City _____ Zone _____ State _____

Gain — An increase in electrical energy supplied by an amplifier which produces an increase in volume.

Head — The erasing, recording or reproducing element of a tape recorder.

Hum — The extraneous portion of the output signal deriving from unwanted introduction of the power line frequency and its harmonics into the circuit.

Impedance — The opposition to an electrical current, usually measured in ohms.

Input — The terminals or connections to which wires carrying the electrical current are attached. Also refers to the electrical energy which is being fed into an amplifier, etc.

Lateral Recording — The common form of disc recording in which the groove modulation is perpendicular to the motion of the disc and parallel to its surface.

Load — The component or device which is being supplied with electrical energy from a source such as an amplifier.

LCS — Abbreviation for loudness contour selector. A circuit for altering the frequency response of an amplifier so that with various levels of loudness the characteristics of the amplifier will more closely match the requirements of the human ear.

Loudspeaker — The electro-acoustical device which converts electrical current to mechanical motion, which in turn creates sound waves.

Matching — The technique of selecting and connecting equipment so that each unit works at its peak performance capabilities.

Micro — One one-millionth (prefix).

Milli — One one-thousandth (prefix).

N.A.R.T.B. or N.A.B. — National Association of Radio & Television Broadcasters. A recording characteristic suggested by N.A.R.T.B. is used by some record manufacturers.

Noise Suppressor — An electronic circuit which reduces high frequency hiss or noise. It is utilized primarily with old records.

Ohm — The fundamental unit of measure of electrical resistance and impedance.

Output — The terminals or connections to which the load is connected. Also refers to the electrical energy being supplied from the device.

Peak — A point in the frequency range where a component delivers excessive energy, i.e., departs from a "flat" characteristic. Also used to denote the maximum instantaneous output of a device.

Pickup — The device which converts the vibrations of the stylus or needle to an electrical current which can be amplified. (Cartridge)

PM — Permanent magnet. Used as an adjective to differentiate from previous designs of speakers which required an electrical current for magnetization.

Pre-Emphasis — The introduction of additional amplification over a limited range of frequencies. FM stations introduce pre-emphasis in the treble range to override atmospheric noise.

Pressing — A disc recording produced in a record-molding press from a master or stamper.

Quieting — Denotes (in rating tuners) the degree to

Exciting News!



For Only
\$39.50

**A BELT-DRIVEN
HEAVYWEIGHT
TURNTABLE**

THE
PROFESSIONALSM
*"Junior"*SM
by COMPONENTS

The all new PROFESSIONAL Junior by Components is compact and precisely engineered with these outstanding features:

- Belt-Driven 12" Weighted Turntable of non-magnetic polished aluminum
- Rumble 60 db down, flutter and wow less than 0.25%
- Non-slip Cork Pad
- Plays all 4 speeds with accessory
- No noisy rubber idlers

Finished plywood mounting base

13½" x 13½" x 3" **\$10**

*Accessory for Extra Speed **\$2.50** each



\$99.50

The PROFESSIONAL Junior is a worthy companion to Component's distinguished PROFESSIONAL, a complete turntable unit, ready to play, with 25 pound belt-driven turntable.

"QUIET, PLEASE" — Microgroove rumble test records 8% at your dealer, or \$1.00 postpaid from Components.

Components Corporation[®]
DENVER, NEW JERSEY

which noise in the receiver is reduced below the signal.

RF — Abbreviation for radio frequency. This refers to that range beyond the limit of hearing which is suitable for transmission through the air by means of broadcasting.

Response — A contraction of "frequency response" which is the reaction of an amplifying system to a range of signal frequencies. See also "peak."

Reverberation — The persistence of sound in a room due to repeated reflections from walls, ceiling, floor, furniture and occupants.

Roll-Off — A term used in connection with recording to describe a reduction in the intensity of the high bands of frequencies to provide a specified deviation in the frequency response. It is used when playing phonograph records which have been recorded with pre-emphasis, and also in FM receivers.

Rumble — A low frequency vibration mechanically transmitted to the turntable and appearing in the reproduction as noise.

Signal — The designation given to those impulses generated by a pickup, a microphone, or received from a broadcasting station via the antenna. These signals are the electrical energy corresponding to the music or speech.

Signal-Noise Ratio —

- (1) The basis for rating sensitivity in an FM tuner. The ratio between the signal and background noise, expressed in decibels, at a stated input signal.
- (2) The ratio in an audio system between the rated output power and the noise and hum content — usually expressed in decibels.

Speaker — A short form for "loudspeaker."

Stroboscope Disc — A device for measuring the speed of a rotating object such as a phonograph turntable.

Stylus — The correct name for "needle." A rounded point of specified radius which is inserted into a pickup and rides a record groove.

Stylus Pressure — The downward force exerted on the disc by the reproducing stylus, expressed in grams or ounces.

Selectivity — The ability of a tuner to select and separate between two broadcasting stations which are close together on the dial.

Sensitivity — A measure of a tuner's ability to receive weak signals.

Triode — A type of tube used in amplifiers. It is characterized by very low distortion.

Turnover — A specified point in the lower frequencies where the recording signal is decreased in amplitude. In order to obtain proper fidelity on playback, equalization or increase of the lower frequencies is introduced in the amplifier.

Tweeter — A loudspeaker intended to reproduce the very high frequencies.

Turntable — A rotating disc upon which a phonograph record is placed.

Woofer — A loudspeaker designed to reproduce the lower range of frequencies.

Wow — A low frequency flutter.

BUILD 16 RADIO CIRCUITS AT HOME

With the New Deluxe only **\$19.95**

PROGRESSIVE RADIO "EDU-KIT" Reg. U.S. Pat. Off.

A PRACTICAL HOME RADIO COURSE

Now Includes
SOLDERING IRON AND TESTER, HIGH FIDELITY, SIGNAL TRACER, CODE OSCILLATOR, PRINTED CIRCUITRY

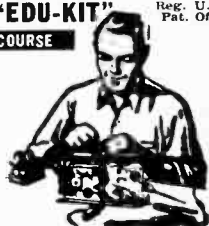

FREE TOOLS

- No Knowledge of Radio Needed
- No Other Parts, Tools Needed
- Excellent Background for TV

FREE Hi-Fi, Radio & TV Servicing Manuals on Request. (See Coupon Below).

WHAT THE "EDU-KIT" OFFERS YOU

The "Edu-Kit" offers you an outstanding PRACTICAL HOME RADIO COURSE at a rock-bottom price. You will learn radio theory, construction and servicing. You will learn how to build radios, using regular schematics; how to solder and wire in a professional manner; how to service and trouble-shoot radios. You will learn how to work with punched metal chassis as well as the new Printed Circuit chassis. You will learn the principles of RF and AF amplifiers and oscillators, detectors, rectifiers, test equipment. You will learn and practice code, using the Progressive Code Oscillator. You will build 16 Receiver, Transmitter, Code Oscillator, Signal Tracer and Signal Injector circuits, and learn how to operate them. You will receive an excellent background for TV. In brief, you will receive a basic education in Electronics and Radio worth many times the small price you pay, only \$19.95 complete.

PROGRESSIVE TEACHING METHOD

The Progressive Radio "Edu-Kit" is the foremost educational radio kit in the world, and is universally accepted as the standard in the field of electronics training. The "Edu-Kit" uses the most educational principle of "Learn by Doing." You begin by building a simple radio. Gradually, in a progressive manner, and at your own rate, you construct more advanced multi-tube radio circuits, learn more advanced theory and techniques, and do work like a professional radio technician.

THE KIT FOR EVERYONE

You do not need the slightest background in radio or science. The "Edu-Kit" is used by young and old, schools and clubs, by Armed Forces Personnel and Veterans Admin. For training and rehabilitation. The "Edu-Kit" is used in 79 countries throughout the world. Designed for universal use, the "Edu-Kit" operates on any voltage from 105 to 125 volts, AC and DC. For use in countries employing higher line voltages, a 210-250 Volt AC/DC model is available.

THE "EDU-KIT" IS COMPLETE

You will receive all parts and instructions necessary to build 16 different radio and electronics circuits, each guaranteed to operate. Our kits contain all tubes, tube sockets, variable, electrolytic and paper dielectric condensers, resistors, tie strips, coils, hardware, tubing, punched metal chassis. Instruction Manuals, etc. In addition, you receive Printed Circuit materials, including Printed Circuit chassis, special tube sockets, hardware and instructions. You also receive a useful set of tools, a professional electric soldering iron, and a self-powered, dynamic Radio and Electronics Tester. The "Edu-Kit" also includes Code instructions and the Progressive Code Oscillator. You will also receive lessons for servicing with the Progressive Signal Tracer and the Progressive Signal Injector, a High Fidelity Guide and a Quiz Book. All parts, components, etc., of the "Edu-Kit" are 100% unconditionally guaranteed, brand new, carefully selected, tested and matched. Everything is yours to keep. The complete price of this practical home radio and electronics course is only \$19.95.

TROUBLE-SHOOTING LESSONS

You will learn to troubleshoot and service radios, using the professional Signal Tracer, the unique Signal Injector, and the dynamic Radio and Electronics Tester. Our Consultation Service will help you with any technical problems.

J. Stasaltis, of 25 Poplar Pl., Waterbury, Conn., writes: "I have repaired several sets for my friends and made money. The 'Edu-Kit' paid for itself. I was ready to spend \$240 for a Course, but I found your ad and sent for your kit."

FREE EXTRAS

- Radio and Electronics Tester • Electric Soldering Iron • Set of Tools • Tester Instruction Book • Hi-Fi Book • Radio Book • FCC Amateur License Training • TV Book • Quiz Book • Membership in Radio-TV Club: Consultation Service • Printed Circuitry

— UNCONDITIONAL MONEY-BACK GUARANTEE —

ORDER FROM AD—RECEIVE FREE BONUS RESISTOR KIT WORTH \$5

- Send "Edu-Kit" Postpaid. I enclose full payment of \$19.95.
 - Send "Edu-Kit" C.O.D. I will pay \$19.95 plus postage.
 - Send me FREE additional information describing "Edu-Kit."
- Include FREE valuable Hi-Fi, Radio & TV Servicing Manuals. (Outside U.S.—No C.O.D.'s. "Edu-Kit" for 105-125 V. AC/DC \$20.95; 210-250 V. AC/DC \$23.45.)

Name _____
 Address _____

PROGRESSIVE "EDU-KITS" INC.

497 Union Ave., Room 502J, Brooklyn 11, N. Y.

What is a DIFFAXIAL?

IT IS THE LAST WORD IN WIDE-RANGE SPEAKERS

The Diffaxial is the solution to a problem that has plagued audio engineering for many years—how to produce middles and highs, and how to disperse them evenly in a wide angle—all in a single speaker.

This was accomplished so simply yet so ingeniously by means of the *Diffusicone*—a development so unique that it is patented.

The Diffaxial, incorporating the Diffusicone, is a line of high quality extended-range speakers that is capable of the most magnificent, natural production of sound. . . . It opens the gateway to a whole new world of listening enjoyment.

Here are the features which make the University Diffaxial outstanding:

1. Genuine "Diffusicone" principle with true mechanical crossover at 1,000 cps. Radial projection and aperture diffraction give *uniform* wide-angle dispersion of highs at listening points progressively off speaker axis.

2. All models contain super sensitive all-Alnico 5

Gold Dot magnet resulting in maximum conversion and superior transient response.

3. 3-way Diffaxials use only *bona fide* compression drivers for smoothest response to beyond audibility. Magnet assemblies are hermetically sealed and precision built.

4. Tweeter driver is coupled to the exclusive and patented "reciprocating flare" horn, which positively provides maximum wide-angle dispersion of highs.

5. Genuine thru-axis design. Tweeter driver unit is fitted to the "reciprocating flare" horn *through* the center of the woofer magnet assembly. This permits uncompromising design of tweeter horn flare assuring highest efficiency, lowest distortion and uniform wide-angle treble reproduction.

Listen to the University Diffaxial and bear for yourself why it has become the most desirable extended-range speaker in the Hi-Fi field.

Send for FREE folder giving the complete technical story of the Diffaxial.

UNIVERSITY LOUDSPEAKERS, Inc., White Plains, N. Y.

University 2 and 3-way Diffaxials . largest variety of extended range speakers available today.



MODEL 315

A 15" 3-way Super-Diffaxial speaker. Employs the deluxe multi-sectional "Diffusicone" element and 6½ lbs. of Alnico 5 magnet. Response to beyond audibility. Exceptional power capacity of 50 watts.* 8-16 ohms. \$132.00 User net.

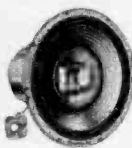

MODEL UXC-123

A 12" 3-way Diffaxial speaker. Employs the standard uni-sectional "Diffusicone" element. Response encompasses full musical reproduction range. Handles 25 watts.* 8-16 ohms. \$59.50 User net.



DIFFUSICONE-12

A 12" 2-way Diffaxial speaker. Employs deluxe multi-sectional "Diffusicone" element and extra heavy 24 oz. all-Alnico 5 magnet. Unusual 30 watt* power handling capacity. 8-16 ohms. \$33.00 User net.



MODEL 6303

A 15" 3-way Diffaxial speaker. Employs the deluxe multi-sectional "Diffusicone" element and extra heavy 2 lbs. of Alnico 5 Gold Dot magnet. Response to beyond audibility. 30 watt* power handling capacity. 8-16 ohms. \$60.10 User net.



MODEL 308

An 8" 3-way Diffaxial speaker. Employs the deluxe multi-sectional "Diffusicone" element and is the only small integrated 3-way speaker on the market. Performance is unbelievable for its size. Handles 25 watts.* 8-16 ohms. \$37.50 User net.



MODEL UXC-122

A 12" 2-way Diffaxial speaker. Standard uni-sectional "Diffusicone" element. Super-sensitive Alnico 5 magnet of shallow design for application flexibility. 25 watt* capacity, takes those heavy transients with ease. 8-16 ohms. \$29.75 User net.



MODEL 312

A 12" 3-way Super-Diffaxial speaker. Employs the deluxe multi-sectional "Diffusicone" element and extra heavy woofer Alnico 5 Gold Dot magnet. Handles 25 watts.* 8-16 ohms. \$64.50 User net.



DIFFUSICONE-15

A 15" 2-way Diffaxial speaker. Employs the deluxe multi-sectional "Diffusicone" element and heavy 24 oz. all-Alnico 5 Magnet. 30 watt* power handling capacity. 8-16 ohms. \$45.00 User net.



DIFFUSICONE-8

An 8" 2-way Diffaxial speaker. Employs deluxe multi-sectional "Diffusicone" element. Exceptional sensitivity and 25 watt* power capacity makes this an outstanding performer for its size. 8-16 ohms. \$23.50 User net.

*Integrated Program

University also offers a complete line of woofers, tweeters, networks and enclosures.

LISTEN

University sounds better



UNIVERSITY LOUDSPEAKERS, INC., 80 SOUTH KENSICO AVENUE, WHITE PLAINS, N. Y.

FREE-ANY 3

OF THESE HIGH-FIDELITY

12" COLUMBIA  RECORDS

If you join the Columbia  Record Club now—and agree to accept as few as 4 selections during the coming 12 months.

1 Ports of Call

Philadelphia Orchestra, Ormandy, conductor. 6 works—*Bolero, Espana, Escapes, Pavane, etc.*

2 The Voice

Frank Sinatra sings 12 numbers that first brought him fame... like *Fools Rush In, I Don't Know Why, Lover, Laura, Paradise, etc.*

3 King of Swing: Vol. 1

Benny Goodman and his Original Orchestra, Trio, Quartet. *Ridin' High, Peckin'*—9 more.

4 My Fair Lady

Percy Faith and his Orchestra play selections from this hit show — *I Could Have Danced All Night, etc.*

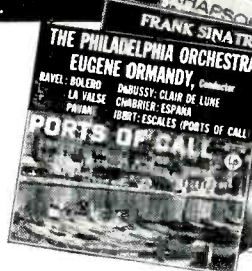

5 Mendelssohn: Violin Concerto Tchaikovsky: Violin Concerto

Francescatti, violin: New York Philharmonic, Mitropoulos, conductor.

6 I Love Paris

Michel Legrand and his Orch. play *La Vie En Rose, Paris*—12 more.

7 Jazz: Red Hot & Cool

Dave Brubeck Quartet in *Sometimes I'm Happy, Lover, Little Girl Blue, Indiana*—3 more.

8 Levant Plays Gershwin

Gershwin's three greatest orchestral works — *Concerto in F; Rhapsody in Blue; An American in Paris.*

9 Saturday Night Mood

Dance music played by 12 bands — Jimmy Dorsey, Sammy Kaye, etc.

10 Beethoven: Symphony No. 5 Mozart: Symphony No. 40

Philadelphia Orchestra, Ormandy, conductor.



11 Music of Jerome Kern

Andre Kostelanetz and his Orch. play 20 Kern favorites—*The Song Is You, You Are Love, etc.*

12 Ambassador Satch

European Concert Recordings by Louis Armstrong and All-Stars. 10 numbers in all.



YES! You may have, FREE, ANY 3 of these best-selling 12" Columbia  records. We make this offer to introduce you to the money-saving program of the Columbia  Record Club... a program that selects for you each month the greatest works in every field of music—performed by the world's finest artists and brilliantly reproduced on Columbia  records.

HOW THE CLUB OPERATES

To enjoy the benefits of this program—mail the coupon, indicating which of the four Club divisions best suits your musical taste: Classical; Jazz; Listening and Dancing; Broadway, Movies, Television and Musical Comedies.

Each month you will receive free the Club Magazine which describes the current selections in all four divisions. You may accept or reject the monthly selection for your division... or take records from the other divisions—thereby assuring you of the widest possible choice of recorded entertainment. Or you may tell us to send you NO record in any month. Your only obligation is to accept as few as 4 selections from the almost 100 to be offered during the next 12 months, and you may cancel membership any time thereafter. The records you want are mailed and billed to you for the low price of only \$3.98, plus a small mailing charge.

FREE BONUS RECORDS GIVEN REGULARLY

The 3 records sent to you now represent an "advance" of the Club's bonus system—given to you at once. After fulfilling your membership obligation by purchasing 4 records, you will receive an additional free Bonus record of your choice for every two additional Club selections you accept. Bonus records are superb 12" Columbia  records—like those shown here.

Indicate on the coupon which 3 records you want free, and the division you prefer... then mail it at once. You must be delighted with membership or you may cancel without obligation by returning the free records within 10 days.

COLUMBIA  RECORD CLUB
165 West 46th St., New York 36, N. Y.

MAIL THIS COUPON NOW!

COLUMBIA  RECORD CLUB, Dept. 493
165 West 46th St., New York 36, N. Y.

Please send me as my FREE gift the 3 records indicated here. (Select the 3 records you want from the list on this page, and circle the corresponding numbers here).

1 2 3 4 5 6 7 8 9 10 11 12

and enroll me in the following division of the Club.
(check one box only)

Classical Listening and Dancing Jazz
 Broadway, Movies, Television and Musical Comedies

Each month you will send me the Columbia  Record Club Magazine which describes the records offered in all four Club divisions. I have the privilege of accepting the monthly selection in the division checked above, or any other selection described, or none at all. My only obligation is to accept a minimum of four records in the next 12 months at the regular list price plus a small mailing charge. After accepting 4 records, I will receive a free Bonus record for every two additional records I purchase. If not delighted with membership, I may cancel within 10 days by returning all records.

Name.....
(Please Print)

Address.....

City..... Zone..... State.....

CANADA: Prices slightly higher. Address 11-13 Soho St., Toronto 26

If you wish to have this membership credited to an established Columbia Records dealer, authorized to accept subscriptions, please fill in the following information:

Dealer's Name.....

Dealer's Address..... 23

 "Columbia", ,  Marcos Reg.

Learn Radio-Television

Servicing or Communications by Practicing at Home in Spare Time

N.R.I. SENDS kits with which you practice building circuits common to Radio and TV sets. You LEARN-BY DOING to locate Radio-TV troubles. As part of N.R.I. Servicing Course, you build Vacuum Tube Voltmeter and AC-DC receiver. Use VTVM to conduct experiments, earn extra money fixing sets in spare time.

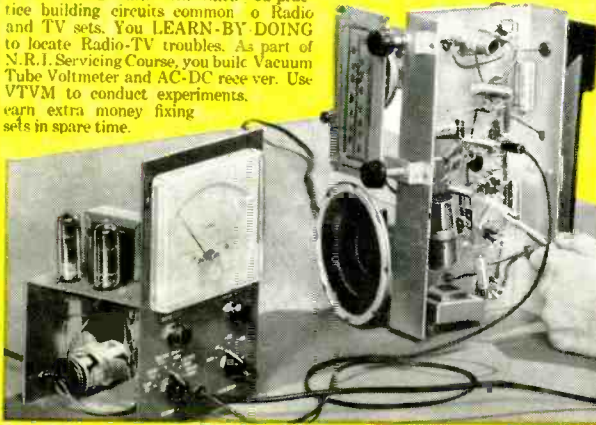

Fast Growing Field Offers You Good Pay, Success, Bright Future



J. L. SMITH
founder

Bigger than ever and still growing fast. That's why Radio-TV has special appeal to ambitious men not satisfied with their job and earnings. More than 4,000 Radio and TV stations. More than 150 million home and auto Radios, 40 million TV sets. Color TV promises added opportunities. For trained men, there are good jobs, bright futures in Radio-TV Servicing or Broadcasting.

Added Income Soon—\$10 \$15 a Week in Spare Time

See after enrolling, many NRI students start with \$15 a week in spare time fixing sets for their training and enjoy this way. Some make enough to start Radio-TV shops. NRI training gets quick results. Easy to illustrated lessons teach you sets. And you LEARN-BY-DOING with kits of equipment to "life" things you study.

RADIO-TV BROADCASTING (see above) offers important positions as Operators and Technicians. RADIO-TV SERVICING Technicians (see below) needed in every community. Their services are respected, their skill appreciated.



Training PLUS opportunity is the ideal combination for success. So plan now to get into Radio-TV. NRI can supply training quickly, without expense of going away to school. Keep your job while training. You learn at home in your spare time. NRI is the OLDEST and LARGEST home study Radio-TV school. Its methods have proved successful for more than 40 years.

Find Out What NRI Offers

NRI has trained thousands for successful careers in Radio-TV. Study fast or slow—as you like. Diploma when you graduate. Mail coupon now. Paste it on a postcard or seal in envelope. ACTUAL LESSON FREE. Also 64 page catalog that shows opportunities, shows equipment you get. Cost of NRI courses low. Easy terms. National Radio Institute, Dept. 6MB8, Washington 9, D. C.

N.R.I. TRAINED THESE MEN FOR SUCCESS



"I was repairing Radios by 10th lesson. Now I'm Engineer for WHPE." M. R. LINDEMUTH, Fort Wayne, Ind.



"Doing spare time repairs on Radio and TV. Going into full time servicing soon." CLYDE HIGGINS, Waltham, Mass.

"I had a successful Radio repair shop. Now I'm Engineer for WHPE." V. W. WORKMAN, High Point, N. C.



"There are a number of NRI graduates here. I can thank NRI for this job." JACK WAGNER, Lexington, N. C.



SEND FOR BOTH FREE

National Radio Institute

Dept. 6MB8, Washington 9, D. C.

Mail me Sample Lesson and 64-Page Catalog FREE. (No salesman will call. Please write plainly.)

Name _____ Age _____

Address _____

City _____ Zone _____ State _____

Approved Member National Home Study Council

VETERANS Approved Under G. I. Bills

