

Make Your Own

TV

REPAIRS

626

A

FAWCETT

BOOK

95¢

By ART MARGOLIS

Special:

COLOR TV REPAIRS

Tube Locations Guide

Avoiding Interference

Portable TV's

New Fringe Area Antennas

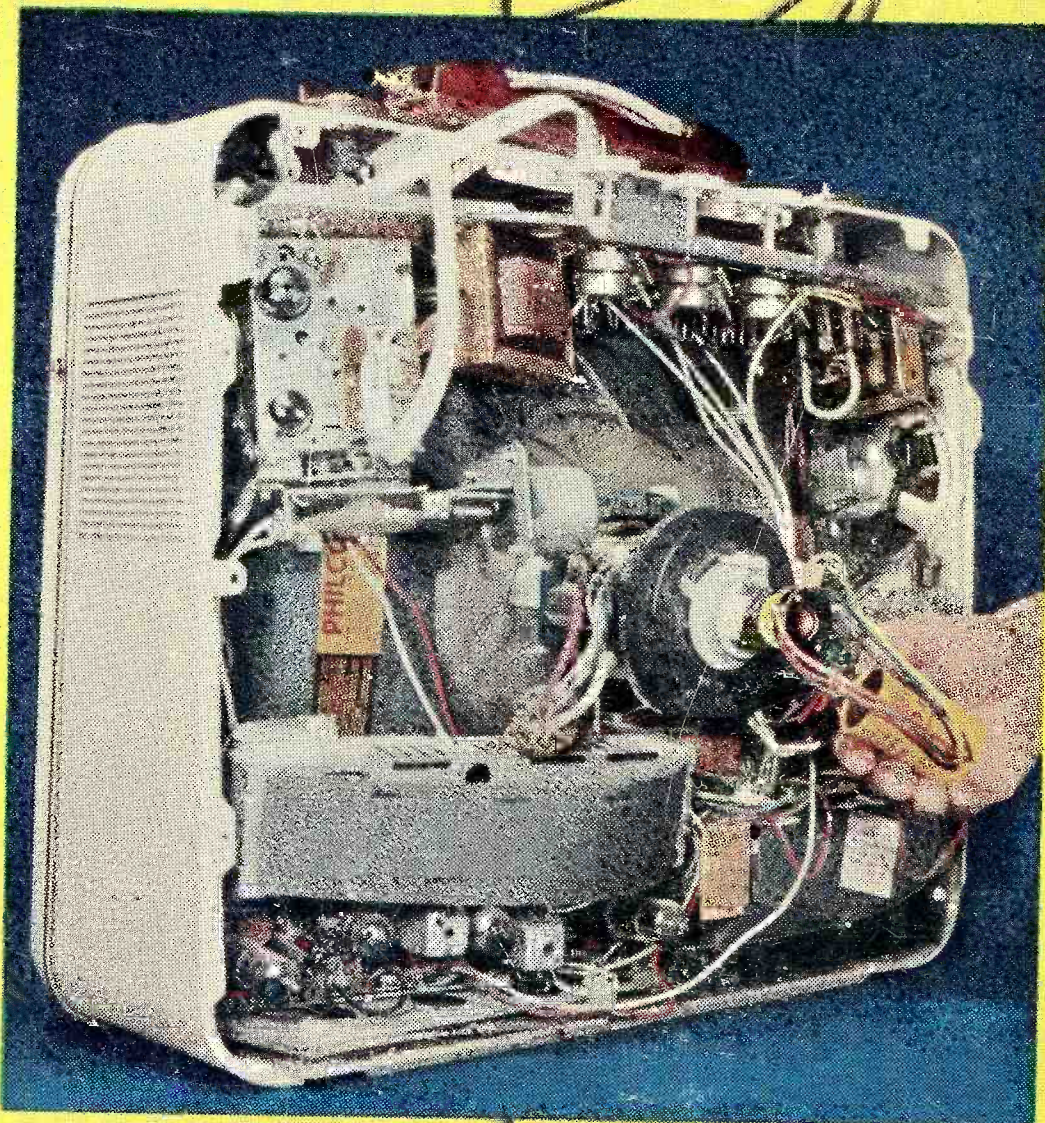
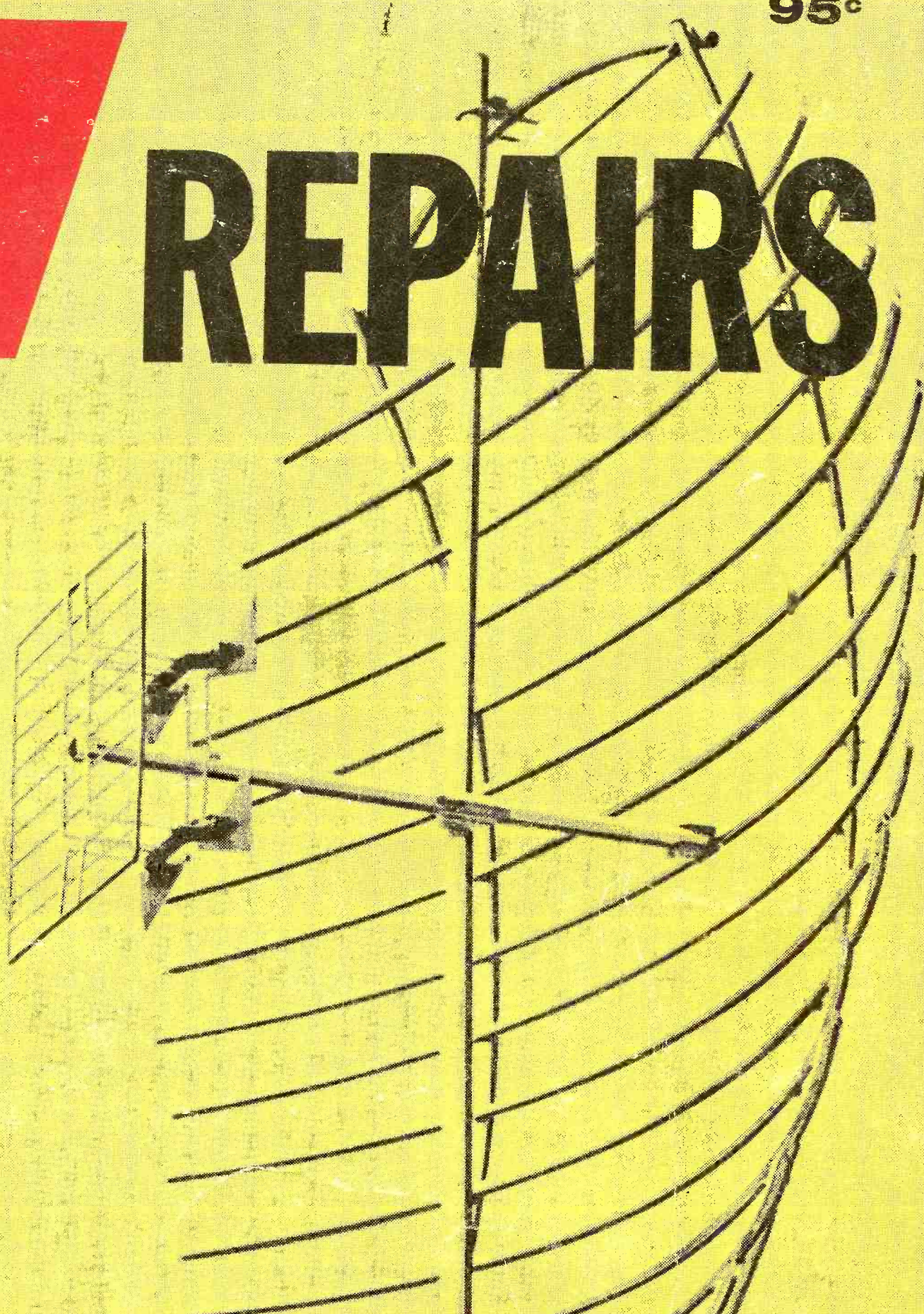

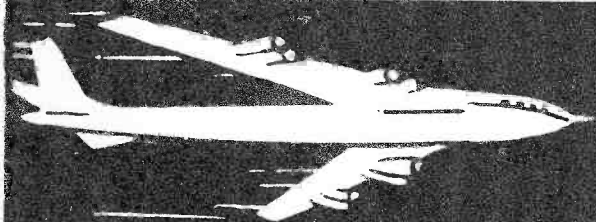

BIG MONEY

awaits

**CHRISTY-TRAINED
TV & ELECTRONICS
TECHNICIANS in the**

**4 CORNERS OF
THE WORLD !**

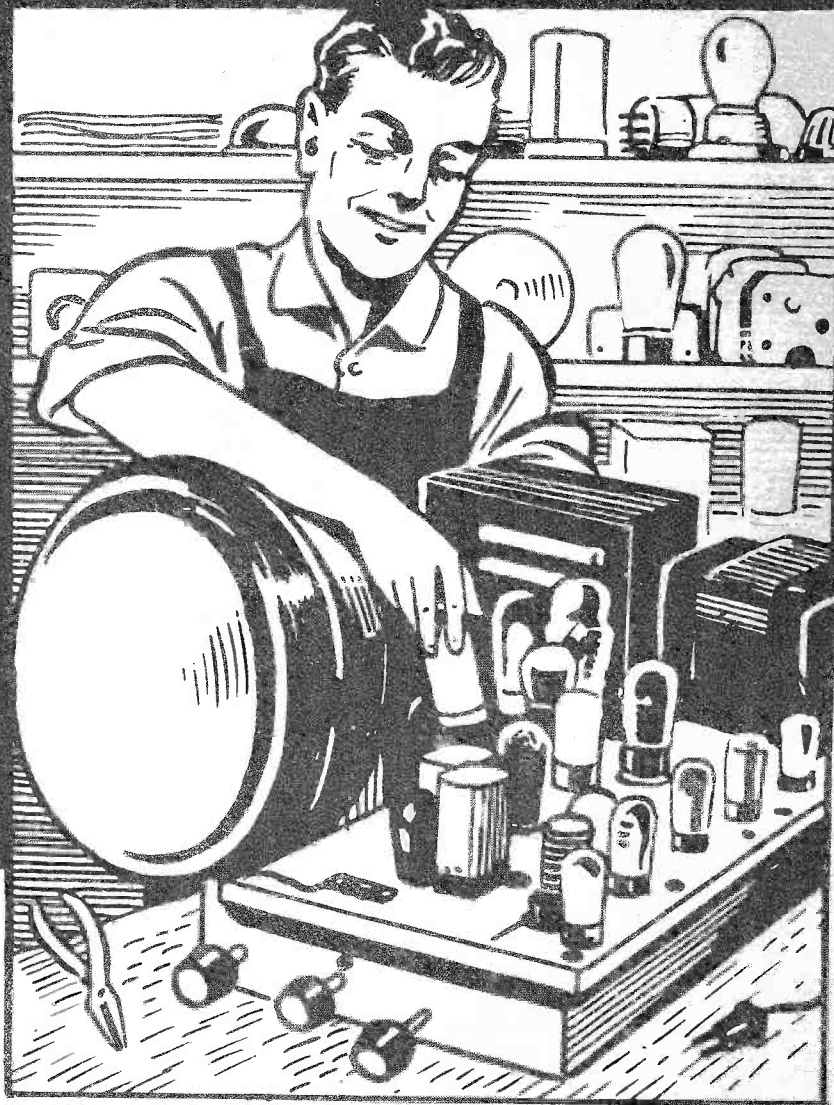

**CHRISTY OFFERS
COMPLETE TRAINING**

Big pay, interesting work, and speedy success await the man who is thoroughly trained in all branches of electronics. The Christy Master Shop-method Home Training Course enables you to obtain this knowledge without leaving home — and without leaving your job. You learn radar, sonar, television, radio, and industrial electronics. What's more, you learn them thoroughly — step by step, from the first basic principles right up to the most advanced equipment and techniques known today. This complete, comprehensive training means that more jobs will be open to you and that you will receive higher pay. Christy training is the best because it's the *only* complete course. Why be satisfied with less? . . . it's your future that's at stake!

YOU GET 19 TRAINING KITS! With your complete Christy Master Shop-method Home Training Course we send you a Multi-tester, Oscillator, Signal Tracer, Oscilloscope, Signal Generator, Electronic Timer, Regenerative Radio, 27-inch Television Set (optional) and other valuable equipment. This equipment makes your training clear, simple, and easy to understand. You work with your hands . . . you learn in the most practical, thorough way possible—by *doing*. In a few months of simple home study using the Christy system you learn what used to take years of hard work to master. Just put in a few hours of your spare time each week and before you know it you're ready for a BIG-PAY job as an Electronics Technician or for a profitable TV repair business of your own.

CHRISTY TRADES SCHOOL, INC., Dept. T-1112, 3214 W. Lawrence Ave., Chicago 60625

EARN AS YOU LEARN

You won't have to worry about payments because the Christy method enables you to begin earning money after only a few hours.

3 FREE BOOKS

give full facts. Write for them today.



MAIL COUPON TODAY!

CHRISTY TRADES SCHOOL, INC.

Dept. T-1112, 3214 W. Lawrence Ave., Chicago, Ill. 60625

Please send me, without cost or obligation, your 3 FREE BOOKS telling all about the CTS Master Shop-Method Home Training Course in radar, sonar, television, radio, and electronics, and two sample lessons.

NAME _____ AGE _____

ADDRESS _____

CITY _____ STATE _____ ZONE _____

BUILD, EXPERIMENT, EXPLORE, DISCOVER WITH NRI CUSTOM-DESIGNED TRAINING KITS



BUILD YOUR OWN PHONE/CODE TRANSMITTER

This is just one of seven training kits programmed into NRI's Complete Communications course. You get actual practice in building your own crystal-controlled, phone/code transmitter and putting it on the air. You experiment with modulation, "clamping" circuits, key filters, other aspects of commercial transmitter operation. Can be put on the air simply by attaching an antenna and complies with FCC regulations. As with all NRI training kits, you get the most modern features and parts.

Join the Thousands Who
Gained Success with NRI



"I am Frequency Coordinator for the 11th Naval District. The course was priceless." J. J. JENKINS, San Diego, Calif.



"Many thanks to NRI. I hold FCC License, am master control engineer with KXIB-TV." R. L. WOOD, Fargo, N.D.



"I am a Senior Engineering Aide. Without NRI I would still be working in a factory at a lower standard of living." D. F. CONRAD, Reseda, Calif.

Available Under NEW GI BILL

If you served since January 31, 1955, or are in service, check GI line in postage-free card.

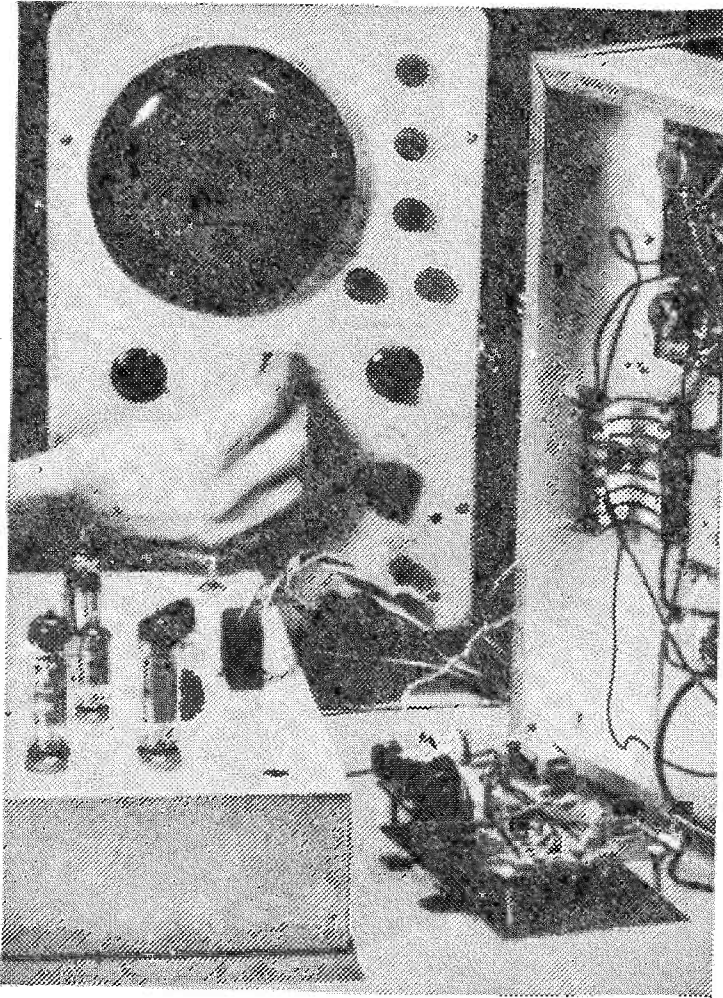

BUILD ACTUAL ANALOG COMPUTER CIRCUITS

Industry, business offices, the government and military all need trained Electronics Technicians. NRI's Industrial Electronics course prepares you. You progress through 10 carefully designed training kits, topping off your practical experience phase of training by experimenting with feedback control systems, analog computers and digital computer elements. You actually solve problems on this analog computer you build yourself. This is the *practical, fast* way to a good paying, career position.

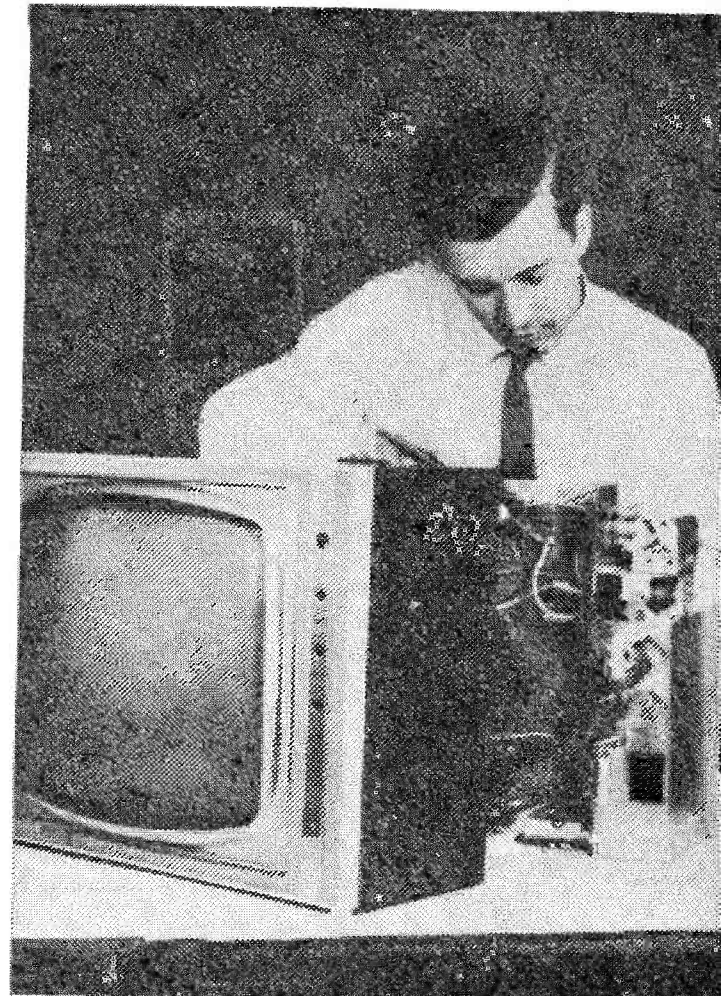

BUILD A CUSTOM-ENGINEERED TELEVISION RECEIVER

Want to earn \$3 to \$5 an hour in spare time? Want your own part-time or full-time business? In Radio-TV Servicing you learn to install, maintain, service radios, TV sets, hi-fi and stereo, other home Electronics equipment. In your training are eight training kits, including this complete, modern, slim-line TV receiver. You build it yourself, become familiar with components and circuits, learn servicing procedures . . . and earn extra money as you train. National Radio Institute, Washington, D.C.

SEE OTHER SIDE ▶

FIRST CLASS
PERMIT
NO. 20-R
Washington, D.C.

BUSINESS REPLY MAIL
NO POSTAGE STAMP NECESSARY IF MAILED IN THE UNITED STATES

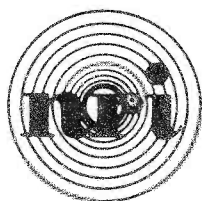

POSTAGE WILL BE PAID BY
NATIONAL RADIO INSTITUTE
3939 Wisconsin Avenue
Washington, D.C. 20016

BUILD 20 RADIO

CIRCUITS AT HOME

with the New

PROGRESSIVE RADIO "EDU-KIT"®

A Practical Home Radio Course

ONLY
\$26⁹⁵

Reg. U. S.
Pat. Off.



Training Electronics Technicians Since 1946

Now Includes

- ★ 12 RECEIVERS
- ★ 3 TRANSMITTERS
- ★ SQ. WAVE GENERATOR
- ★ SIGNAL TRACER
- ★ AMPLIFIER
- ★ SIGNAL INJECTOR
- ★ CODE OSCILLATOR

- ★ No Knowledge of Radio Necessary
- ★ No Additional Parts or Tools Needed
- ★ EXCELLENT BACKGROUND FOR TV
- ★ School Inquiries Invited
- ★ Sold in 79 Countries

**YOU DON'T HAVE TO SPEND
HUNDREDS OF DOLLARS FOR A RADIO COURSE**

The "Edu-Kit" offers you an outstanding PRACTICAL HOME RADIO COURSE at a rock-bottom price. Our Kit is designed to train Radio & Electronics Technicians, making use of the most modern methods of home training. You will learn radio theory, construction practice and servicing. THIS IS A COMPLETE RADIO COURSE IN EVERY DETAIL. You will learn how to build radios, using regular schematics; how to wire and solder in a professional manner; how to service radios. You will work with the standard type of punched metal chassis as well as the latest development of Printed Circuit chassis. You will learn the basic principles of radio. You will construct, study and work with RF and AF amplifiers and oscillators, detectors, rectifiers, test equipment. You will learn and practice code, using the Progressive Code Oscillator. You will learn and practice trouble-shooting, using the Progressive Signal Tracer, Progressive Signal Injector, Progressive Dynamic Radio & Electronics Tester, Square Wave Generator and the accompanying instructional material.

You will receive training for the Novice, Technician and General Classes of F.C.C. Radio Amateur Licenses. You will build 20 Receiver, Transmitter, Square Wave Generator, Code Oscillator, Signal Tracer and Signal Injector circuits, and learn how to operate them. You will receive an excellent background for television, Hi-Fi and Electronics.

Absolutely no previous knowledge of radio or science is required. The "Edu-Kit" is the product of many years of teaching and engineering experience. The "Edu-Kit" will provide you with a basic education in Electronics and Radio, worth many times the complete price of \$26.95. The Signal Tracer alone is worth more than the price of the entire Kit.

THE KIT FOR EVERYONE

You do not need the slightest background in radio or science. Whether you are interested in Radio & Electronics because you want an interesting hobby, a well paying business or a job with a future, you will find the "Edu-Kit" a worth-while investment. Many thousands of individuals of all

ages and backgrounds have successfully used the "Edu-Kit" in more than 79 countries of the world. The "Edu-Kit" has been carefully designed, step by step, so that you cannot make a mistake. The "Edu-Kit" allows you to teach yourself at your own rate. No instructor is necessary.

PROGRESSIVE TEACHING METHOD

The Progressive Radio "Edu-Kit" is the foremost educational radio kit in the world, and is universally accepted as the standard in the field of electronics training. The "Edu-Kit" uses the modern educational principle of "Learn by Doing." Therefore you construct, learn schematics, study theory, practice trouble-shooting—all in a closely integrated program designed to provide an easily-learned, thorough and interesting background in radio. You begin by examining the various radio parts of the "Edu-Kit." You then learn the function, theory and wiring of these parts. Then you build a simple radio. With this first set you will enjoy listening to regular broadcast stations, learn theory, practice testing and techniques. Gradually, in a progressive manner, and at your own rate, you will find yourself constructing more advanced multi-tube radio circuits, and doing work like a professional Radio Technician.

Included in the "Edu-Kit" course are 20 Receiver, Transmitter, Code Oscillator, Signal Tracer, Square Wave Generator and Signal Injector circuits. These are not unprofessional "breadboard" experiments, but genuine radio circuits, constructed by means of professional wiring and soldering on metal chassis, plus the new method of radio construction known as "Printed Circuitry." These circuits operate on your regular AC or DC house current.

THE "EDU-KIT" IS COMPLETE

You will receive all parts instruction necessary to build twenty different radio and electronics circuits, each guaranteed to operate. Our Kits contain tubes, tube sockets, variable, electrolytic, mica, ceramic and paper dielectric condensers, resistors, tie strips, coils, hardware, tubing, punched metal chassis, Instruction Manuals, hook-up wire, solder, selenium rectifiers, volume controls and switches, etc.

In addition you receive Printed Circuit materials, including Printed Circuit chassis, special tube sockets, hardware and instructions. You also receive a useful set of tools, a professional electric soldering iron, and a self-powered Dynamic Radio and Electronics Tester. The "Edu-Kit" also includes Code Instructions and the Progressive Code Oscillator, in addition to Radio Amateur License training. You will also receive lessons for servicing with the Progressive Signal Tracer and the Progressive Signal Injector, a High Fidelity Guide and a Quiz Book. You receive Membership in Radio-TV Club, Free Consultation Service, Certificate of Merit and Discount Privileges. You receive all parts, tools, instructions, etc. Everything is yours to keep.

PRINTED CIRCUITRY

At no increase in price, the "Edu-Kit" now includes Printed Circuitry. You build a Printed Circuit Signal Injector, a unique servicing instrument that can detect many Radio and TV troubles. This revolutionary new technique of radio construction is now becoming popular in commercial radio and TV sets.

A Printed Circuit is a special insulated chassis on which has been deposited a conducting material which takes the place of wiring. The various parts are merely plugged in and soldered to terminals.

Printed Circuitry is the basis of modern Automation Electronics. A knowledge of this subject is a necessity today for anyone interested in Electronics.

UNCONDITIONAL MONEY-BACK GUARANTEE

ORDER FROM AD — RECEIVE FREE BONUS
RADIO & TV PARTS JACKPOT WORTH \$15

- Send "Edu-Kit" Postpaid. I enclose full payment of \$26.95.
- Send "Edu-Kit" C.O.D. I will pay \$26.95 plus postage.
- Send me FREE additional information describing "Edu-Kit."

Name _____

Address _____

Progressive "EDU-KITS" Inc.

1186 Broadway, Dept. 511HN
Howlett, N. Y. 11557

(ATT: S. GOODMAN, M.S. in ED., PRES.)

FREE EXTRAS

• SET OF TOOLS

- SOLDERING IRON
- ELECTRONICS TESTER
- PLIERS-CUTTERS
- VALUABLE DISCOUNT CARD
- CERTIFICATE OF MERIT
- TESTER INSTRUCTION MANUAL
- HIGH FIDELITY GUIDE • QUIZZES
- TELEVISION BOOK • RADIO TROUBLE-SHOOTING BOOK
- MEMBERSHIP IN RADIO-TV CLUB • CONSULTATION SERVICE • F.C.C. AMATEUR LICENSE TRAINING
- PRINTED CIRCUITRY

SERVICING LESSONS

You will learn trouble-shooting and servicing in a progressive manner. You will practice repairs on the sets that you construct. You will learn symptoms and causes of trouble in home, portable and car radios. You will learn how to use the professional Signal Tracer, the unique Signal Injector and the dynamic Radio & Electronics Tester. While you are learning in this practical way, you will be able to do many a repair job for your friends and neighbors, and charge fees which will far exceed the price of the "Edu-Kit." Our Consultation Service will help you with any technical problems you may have.

FROM OUR MAIL BAG

J. Stataitis, of 25 Poplar Pl., Waterbury, Conn., writes: "I have repaired several sets for my friends, and made money. The "Edu-Kit" paid for itself. I was ready to spend \$240 for a course, but I found your ad and sent for your Kit."

Ben Valerio, P. O. Box 21, Magna, Utah: "The Edu-Kits are wonderful. Here I am sending you the questions and also the answers for them. I have been in Radio for the last seven years, but like to work with Radio Kits, and like to build Radio Testing Equipment. I enjoyed every minute I worked with the different kits; the Signal Tracer works fine. Also like to let you know that I feel proud of becoming a member of your Radio-TV Club."

Robert L. Shuff, 1534 Monroe Ave., Huntington, W. Va.: "Thought I would drop you a few lines to say that I received my Edu-Kit, and was really amazed that such a bargain can be had at such a low price. I have already started repairing radios and phonographs. My friends were really surprised to see me get into the swing of it so quickly. The Trouble-shooting Tester that comes with the Kit is really swell, and finds the trouble, if there is any to be found."

make your own TV REPAIRS

by Art Margolis

A FAWCETT BOOK • NUMBER 626
LARRY EISINGER • EDITOR-IN-CHIEF
GEORGE TILTON • MANAGING EDITOR
SILVIO LEMBO • ART EDITOR
HAROLD E. PRICE • ASSOC. ART EDITOR

W. H. Fawcett, Jr. President
Roger Fawcett General Manager
Gordon Fawcett Secretary-Treasurer
Roscoe K. Fawcett Circulation Director
Donald P. Hanson . . . Assistant General Manager
George H. Allen Vice President
Ralph Daigh Vice President
George H. Carl Production Director
Al Allard Art Director
Ralph Mattison Associate Art Director
Annette C. Packer Production Manager

JOSEPH PIAZZA EDITOR

STAFF ARTISTS

Mike Gaynor • John Selvaggio
Richard Rhodes • Herbert Jonas
Alex Santiago • Paul Howard

Catherine S. Carr Production Editor
Claire Herman Assistant Production Editor

Inset photo on the cover, and many other photographs in this book, contributed by Dennis Margolis.

MAKE YOUR OWN TV REPAIRS, Fawcett Book 626, is published by Fawcett Publications, Inc., Greenwich Connecticut. Editorial and Advertising Offices: 67 West 44th Street, New York, New York 10036. General Offices: Fawcett Building, Greenwich, Connecticut 06830. Printed in U.S.A. Copyright © 1966 by Fawcett Publications, Inc. MAKE YOUR OWN TV REPAIRS is registered in the U.S. Patent Office.

Printed by Fawcett-Haynes Printing Corp., Louisville, Ky.

Fawcett Publications, Inc., is a member of American Book Publishers Council, Inc.

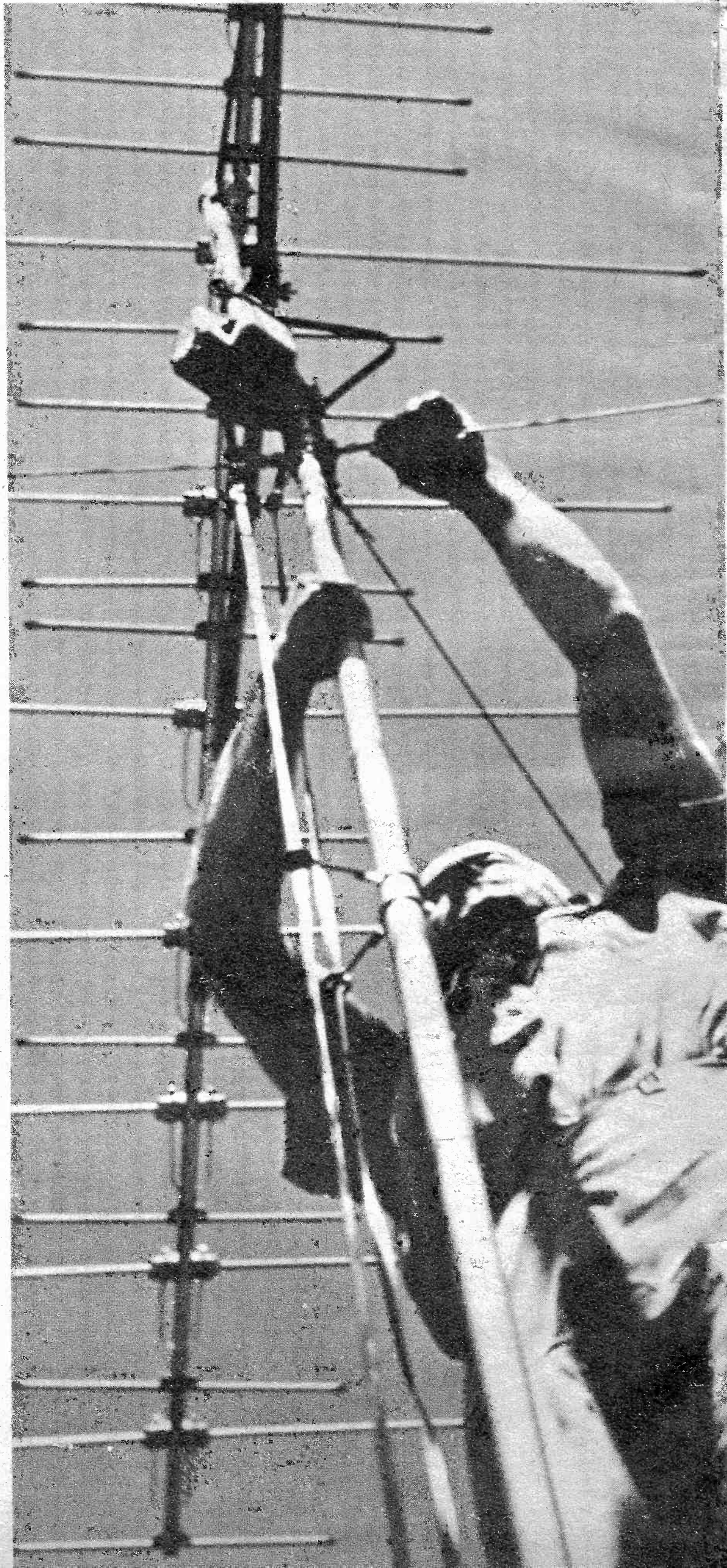

CONTENTS

TV Trouble Symptoms	6	When the Contrast Control Acts Up	54
Tricks of the Tube Location Guide	18	Fixing the Front End	62
Getting the Best Antenna	24	Getting the TV to Sound Right . .	70
Clinic for Sick Antennas	30	Latest Picture Tube Repairs	74
Don't Miss Out on UHF	34	Changing TV Picture Tubes	80
When the TV Goes Dead	38	Those Confusing Color Adjustments	90
Fixing High Voltage Troubles . .	43	Don't Be Afraid of Color Troubles	98
Stopping Rock and Roll	50	Getting Rid of TV Interference .	102
		Tips on Portable TV's	108

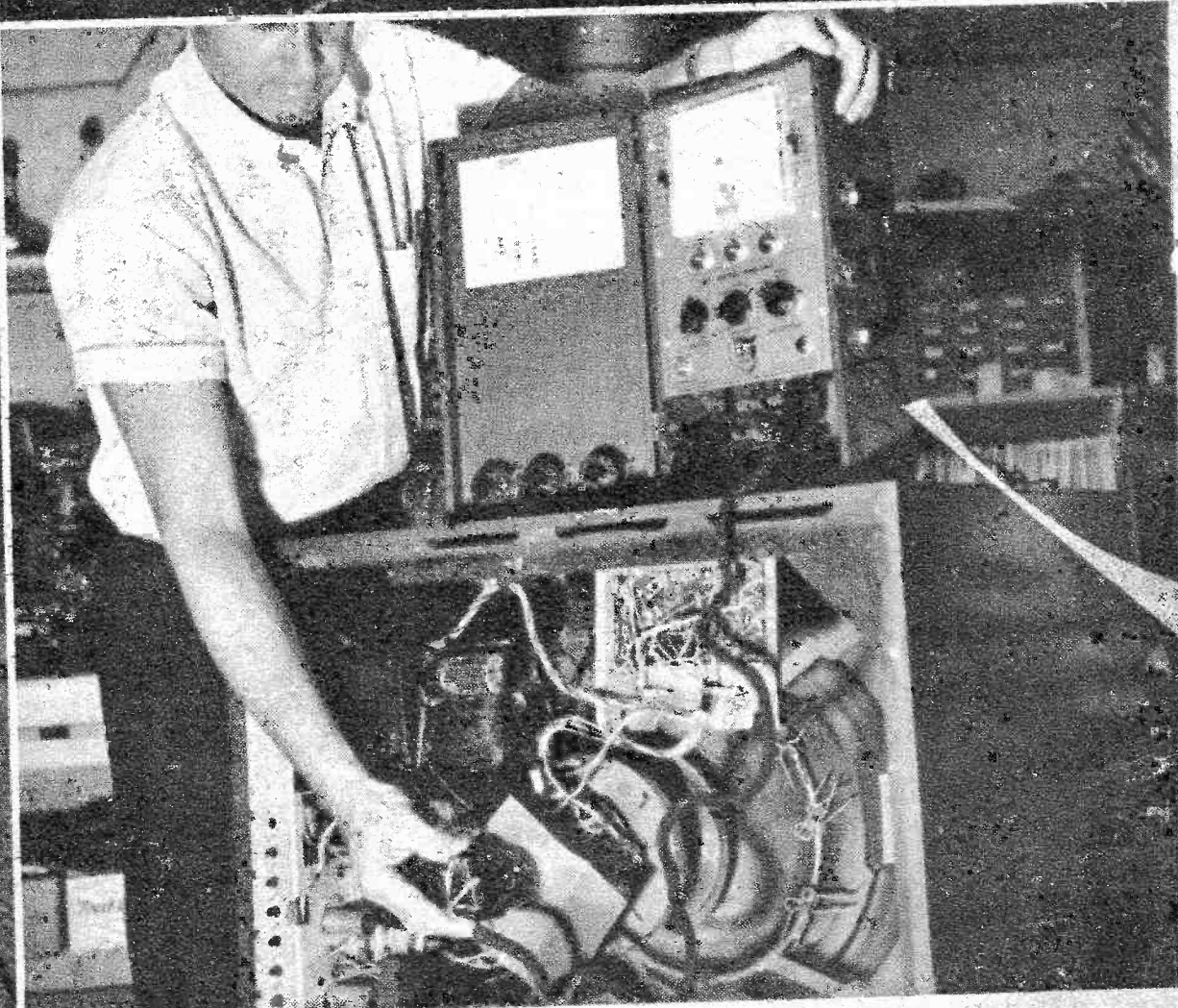
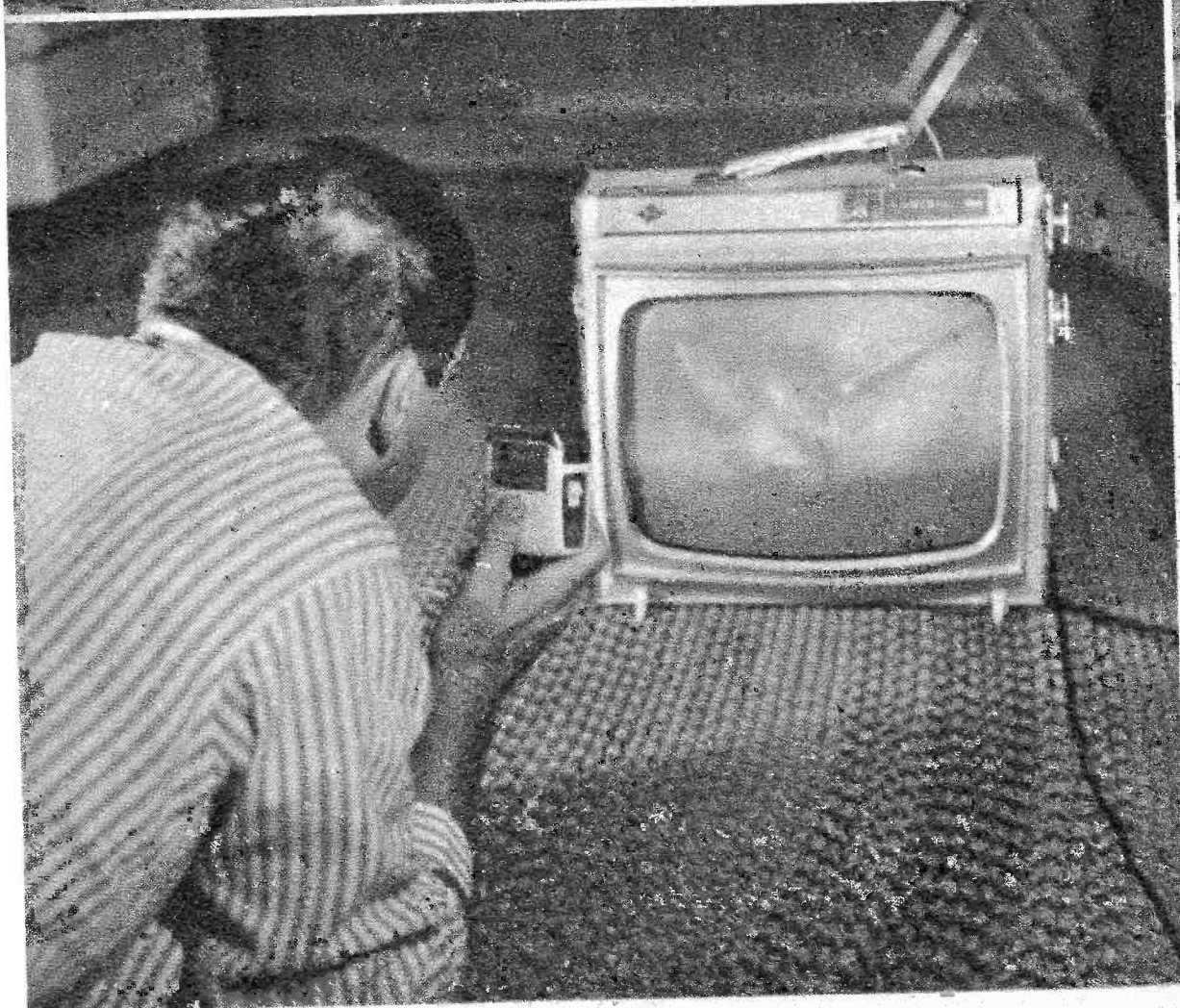
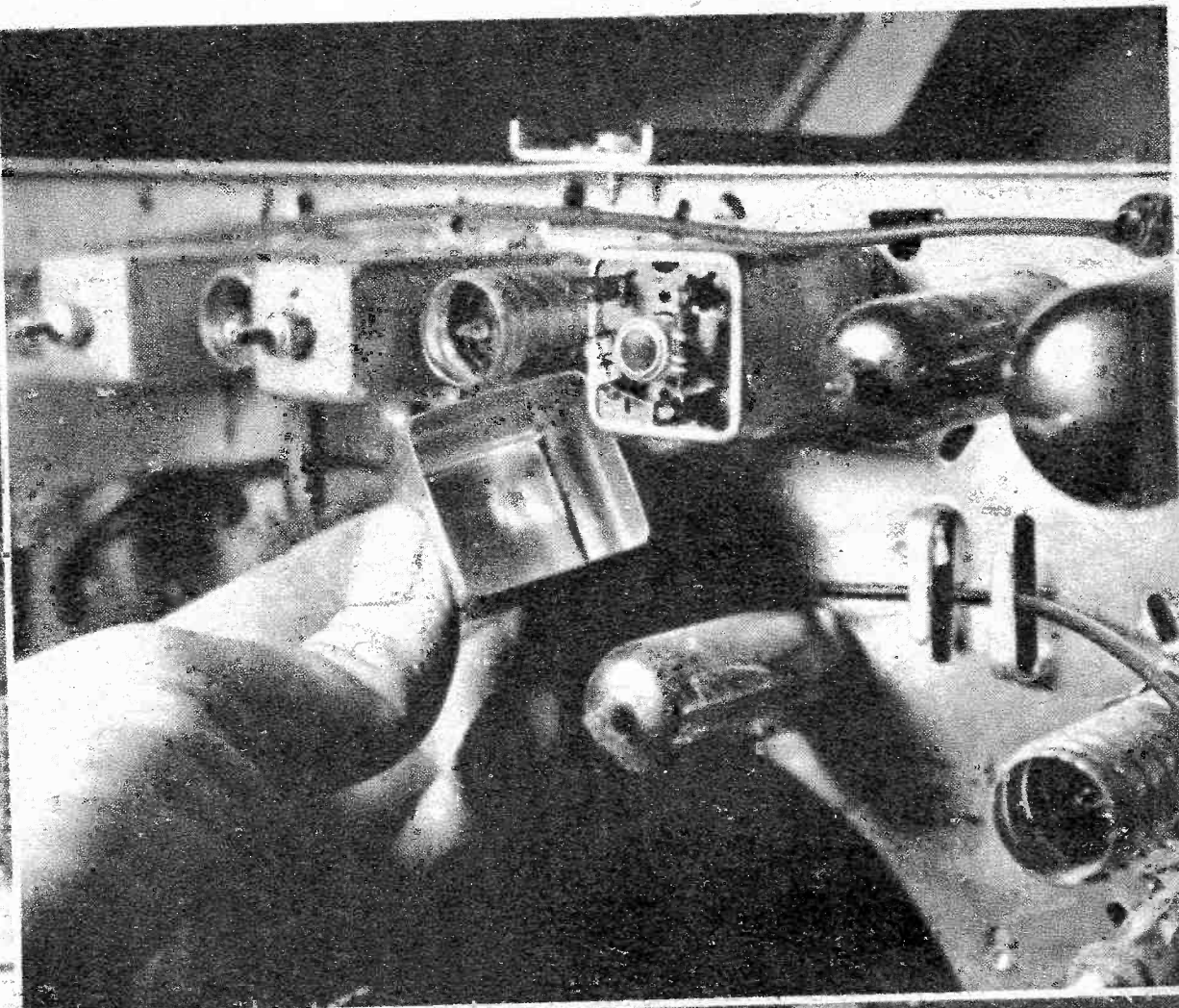
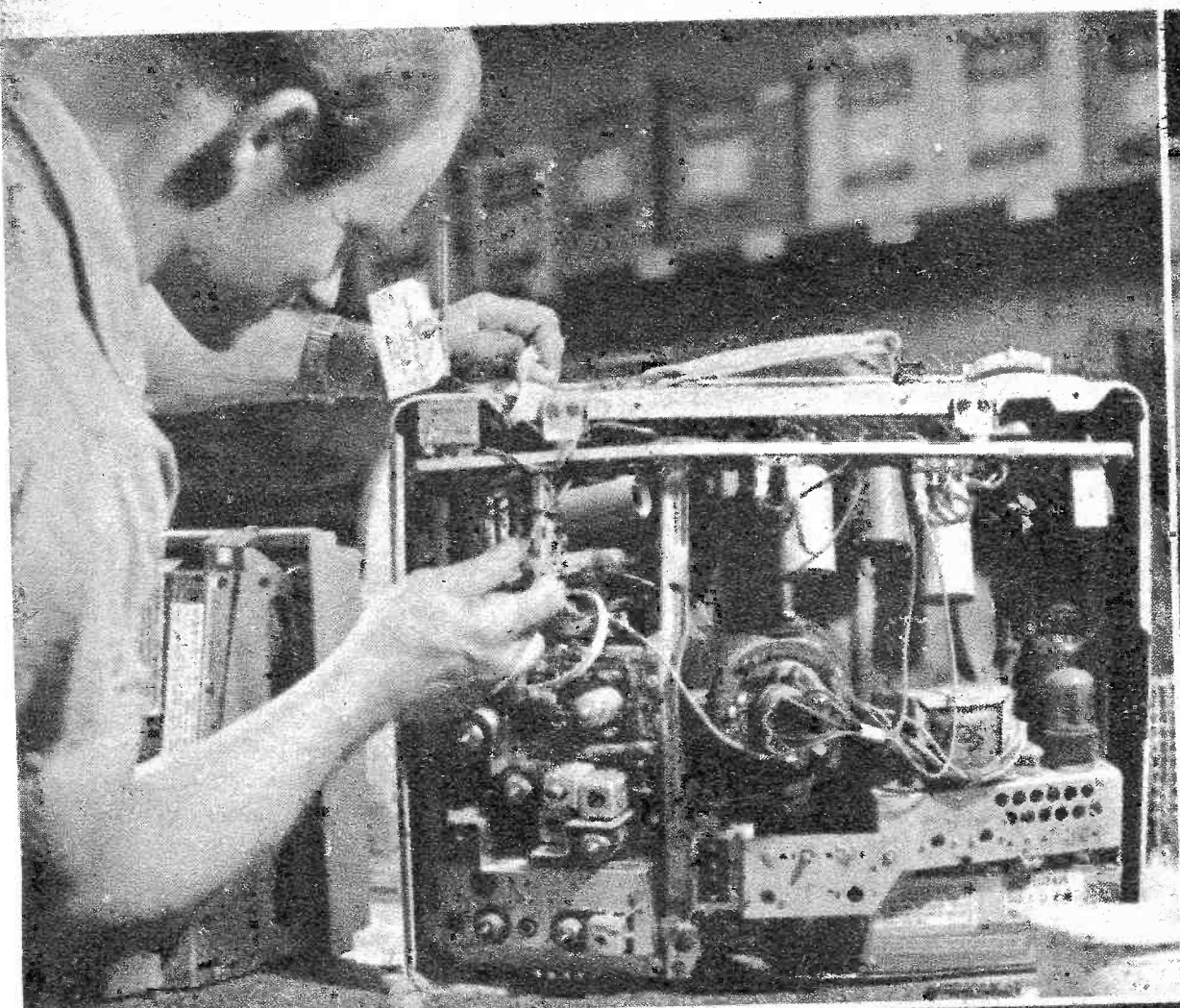

Take this big 196- page "Fix-it" book

FREE!

When you try this program—
No obligation to buy even one book
save money by making home improvements and car tune-ups
and repairs yourself, often doing them better than "high-
priced" outside help and far easier than you might think.

Yes, entirely FREE —
and packed with
plans, projects and
ideas for make-it-
yourself fun, ways to

WHY DO WE GIVE AWAY THIS
LARGE VOLUME—containing
over 100 projects, 400 how-to
pictures, 50,000 words— with-
out "strings" To demonstrate
to home owners and hobbyists
the dollars-and-cents value of our
famous "how-to" Encyclopedia.

Which project do you want
to start right away?

Want an extra room? Air condi-
tion your home? Trouble-free
your TV antenna forever? Car
tune-up, gas-saving tips? Build
bar cart? Barbecue? Attic venti-
lator? Modern arm-chair? Free
Volume I's experts guide your
hands with clear photos... in-
siders' secrets... diagrams...
checklists. Even beginners can't
go wrong, waste time or mate-
rials. Save \$2.50—\$4.96 HOUR-
LY LABOR — DO CRAFTS-
MANSHIP JOBS! Now even
amateurs can handle "skilled"
jobs. Save \$9 TV house calls.
\$4.25 carpenters' hourly rate. Big
car mechanics' bills.

How to have Vol. I
shipped FREE immediately:

Fill out and mail shipping label
below today. We'll send Vol. I
right away FREE. Do not send
it back or pay anything for it
ever. Large 7¾" x 11¼" book is
typical of all 18 volumes in
Practical Handyman's Encyclo-
pedia. 3,456 pages, 7,000 show-
how pictures, thousands of ideas
and projects: gardening, furni-
ture, plumbing, electrical, hi-fi,
electronics... boats... cabins,
cottages... photography...
built-ins, kitchens, bath... con-
crete... etc.

After examining Vol. I, you
may receive further volumes on
approval. Examine them for 7
days, then either remit only \$2.98
plus postage for each or return
and owe nothing. Buy one, two,
as many books as you like... or
whole set... or none at all. No
pressure, no "catches." We stop
sending books any time you write
us.

Send shipping label, now for
FREE VOLUME I to: Practi-
cal Handyman's Encyclopedia,
Dept. TVR10, Box 77, Cos Cob,
Conn.

ACTUAL SIZE
7¾" x 11¼"

ALL This and More in
Your FREE Book:

- ADDITIONAL BEDROOM
- BUILT-IN CLOSETS
- MODERN FURNITURE
- TV REPAIRS
- ANTENNA PROBLEMS
- HOME VENTILATION
- BURGLAR ALARMS
- ALUMINUM PROJECTS
- ATTIC EXPANSION
- HOUSE FRAMING
- GARDEN ACCESSORIES
- BOOSTING GAS MILEAGE
- WINDOW FRAMING
- SKYLIGHTS
- PLYWOOD PROJECTS
- POWER TOOLS
- AIR CONDITIONING
- HOME AND CAR
- TRANSMISSIONS
- DRIVE SHAFTS,
AND DIFFERENTIALS
- SPRAY PAINTING
- OUTDOOR FURNITURE
- WEBBING
- DORMERS
- WEATHERPROOFING
- ATTIC FANS
- BAR CART
- PATIOS
- BARBECUES
- EMERGENCY
- CAR REPAIRS
- AUTO TUNE-UPS
- STARTING PROBLEMS
- CAR COOLING SYSTEM
- ROOFING
- SHEATHING
- APPLIANCE
- REPAIRS
- GUTTERS
- & FLASHING

© PRACTICAL HANDYMAN'S ENC

SHIPPING LABEL

FROM: The Practical Handyman's Encyclopedia
Dept. TVR10, Box 77, Cos Cob, Conn.

TO:

Name _____
(please print)

Address _____

City _____ Zone _____ State _____

CONTENTS: BOOK, Volume I of The Practical Handyman's
Encyclopedia. 1¼ lbs., 196 pages, over 400 pictures,
50,000 words.

NO RISK NO OBLIGATION. WHAT YOU GET:

1. FREE 196-page, over 400-
picture, over 100-project Vol-
ume I of The Practical Hand-
yman's Encyclopedia. No
cost at any time, no "catch,"
no obligation.
2. You are entitled to receive
each new volume for 7 days
free approval. For those you
decide to keep, you pay only
\$2.98 plus shipping.
3. You never have to buy any
books at all... or you can
choose one or a few... or the
complete matched Library set,
if you wish... the choice is
yours.
4. You may instruct us to stop
shipping books simply by writ-
ing us and we'll cease ship-
ment immediately.

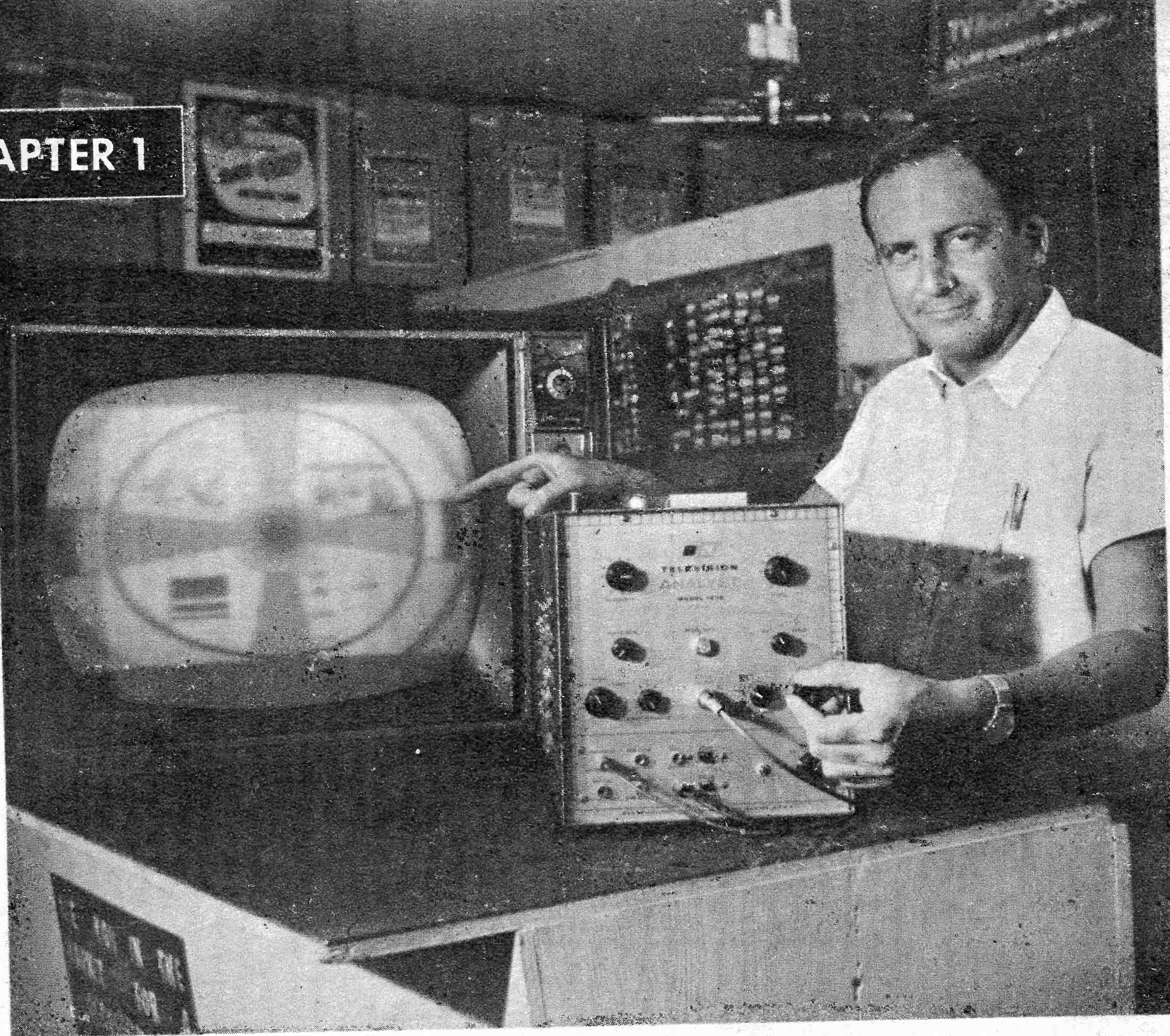

Author demonstrates a typical problem on the TV screen and use of a service instrument for diagnosis.

TV Trouble Symptoms

An approach to correct diagnosis, the most important part of TV repair

THIS BOOK will not tell you how to fix 100 percent of all TV troubles. It tells you how to repair between 80 and 90 percent—about around 80 percent on black-and-white TV's and near 90 percent on color TV's.

Sound like a large order? Not really, since these large percentages can be obtained by performing routine repairs. This means tube changing, fuse changing, adjustments, touch up alignments and easy component replacing.

To be able to perform the nonroutine repairs, that extra ten plus percent, you need a tremendous service literature library, expensive test equipment and years of bench experience. This is beyond the scope of this book. Here we are going to go

over what you as a home handyman can actually do, using your head, eyes, ears, nose, hand tools, do-it-yourself tube tester and simple ohmmeter.

The 55 TV Troubles

When your color, or black-and-white TV decides to malfunction it does so in one of 55 ways. The 55 types of troubles file out into six families. 1—Brightness trouble (variations from a black screen to an overly bright one), 2—contrast difficulties (that is no contrast, too much contrast, smeared picture, etc.), 3—synchronization problems (for instance rolling, lines, bends or jiggling), 4—color troubles (no color, wrong colors or blurred colors), 5—audio difficulties (like no sound, muffles or

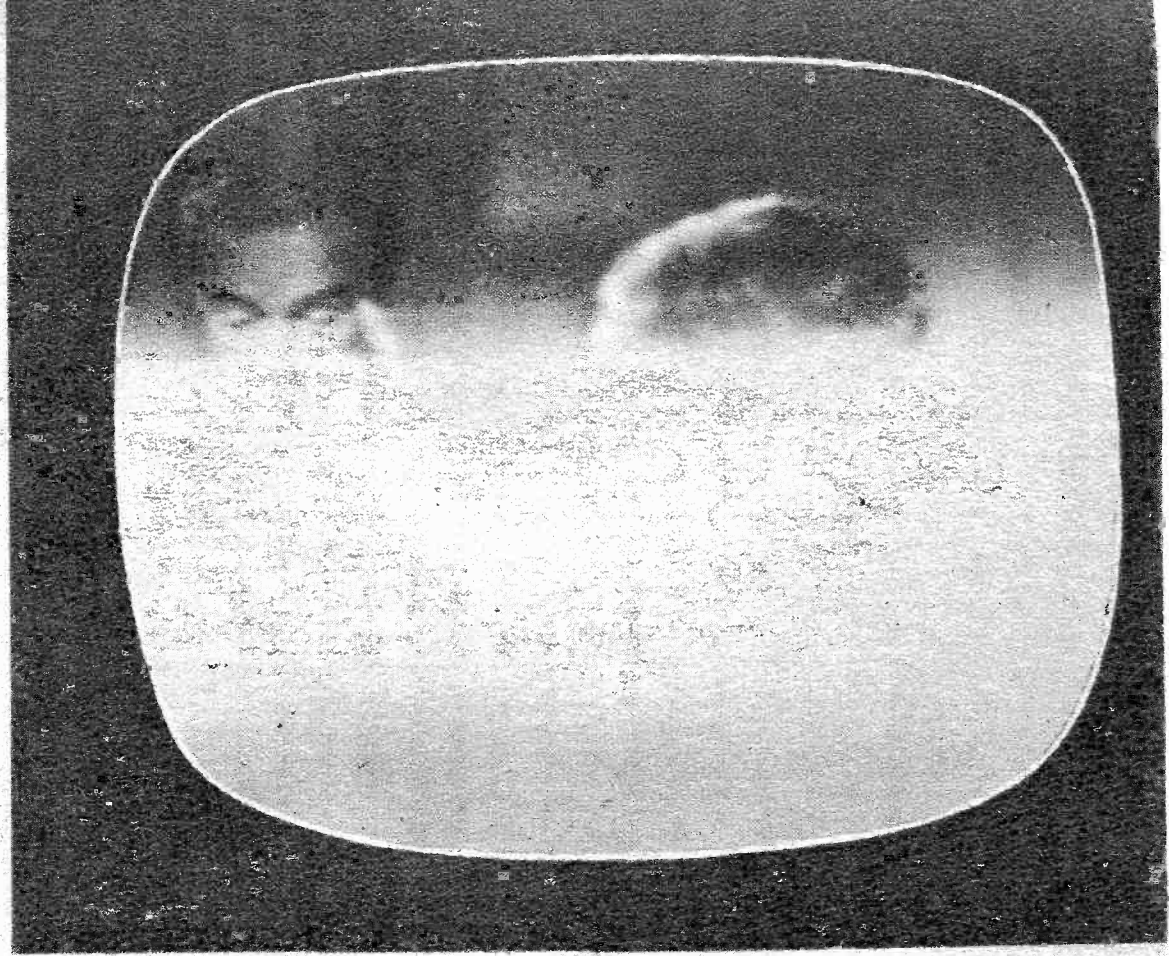

At left, 4-SIDED SHRINK is caused by low power. Test LOW VOLTAGE RECTIFIER (see Chapter 6), HORIZONTAL OUTPUT tube, DAMPER tube. Then try adjusting WIDTH, HORIZONTAL LINEARITY, HORIZONTAL DRIVE (see Chapter 7), VERTICAL LINEARITY and HEIGHT (see Chapter 8). At right, HUM BARS are caused by 60 cycle AC getting into video signal. Faulty tube is suspect. Test RF AMPLIFIER, MIXER-OSCILLATOR, IF tubes (see Chapter 10), VIDEO DETECTOR, SYNC tube and AGC (see Chapter 9).

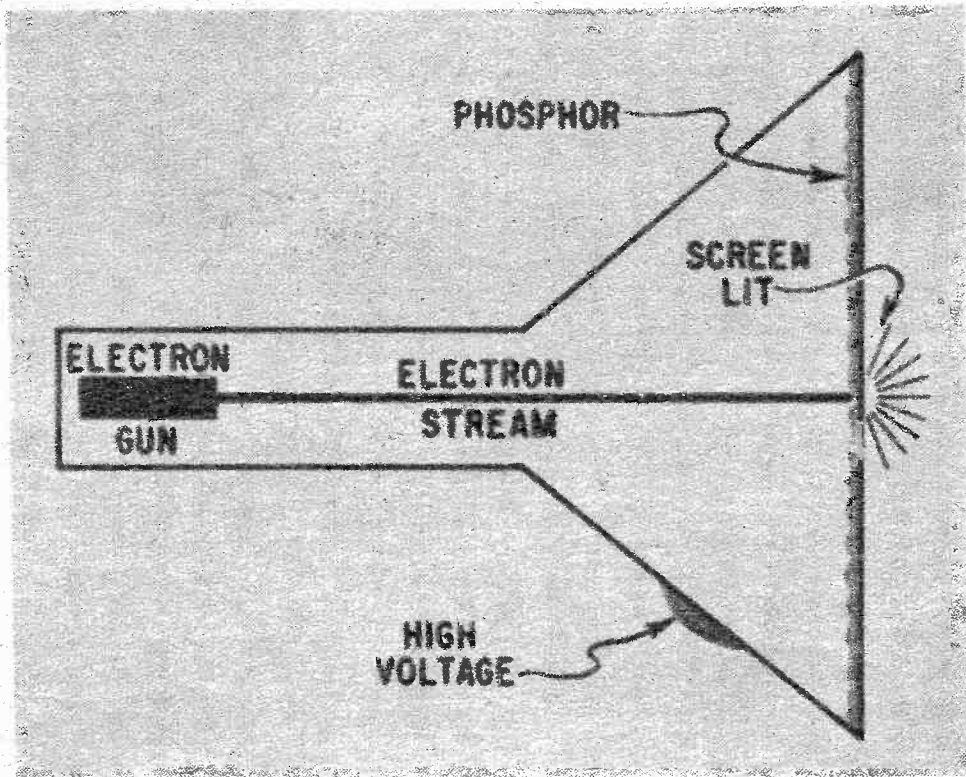

NO BRIGHTNESS—SOUND GOOD: Caused by the phosphor TV screen not being permitted to light. It happens mostly due to loss of high voltage, so test the high voltage fuse, the HORIZONTAL OUTPUT, the DAMPER, HIGH VOLTAGE RECTIFIER, HIGH VOLTAGE REGULATOR, HORIZONTAL OSCILLATOR, FOCUS RECTIFIER (see Chapter 7), and the LOW VOLTAGE RECTIFIER (see Chapter 6). On occasion the PICTURE TUBE is at fault.

LOW BRIGHTNESS, at left: This trouble comes in two variations—with or without shrinking. For the shrunk types see 4-sided and 2-sided shrink types. When it occurs without shrinking, most of the time it is the PICTURE TUBE. (See Chapter 12.) **FIXED BRIGHTNESS, at right:** Turning the brightness control has no effect. The screen can be bright or dull but the retrace lines are visible. It is either caused by the PICTURE TUBE (see Chapter 12), or the VIDEO OUTPUT (see Chapter 9).

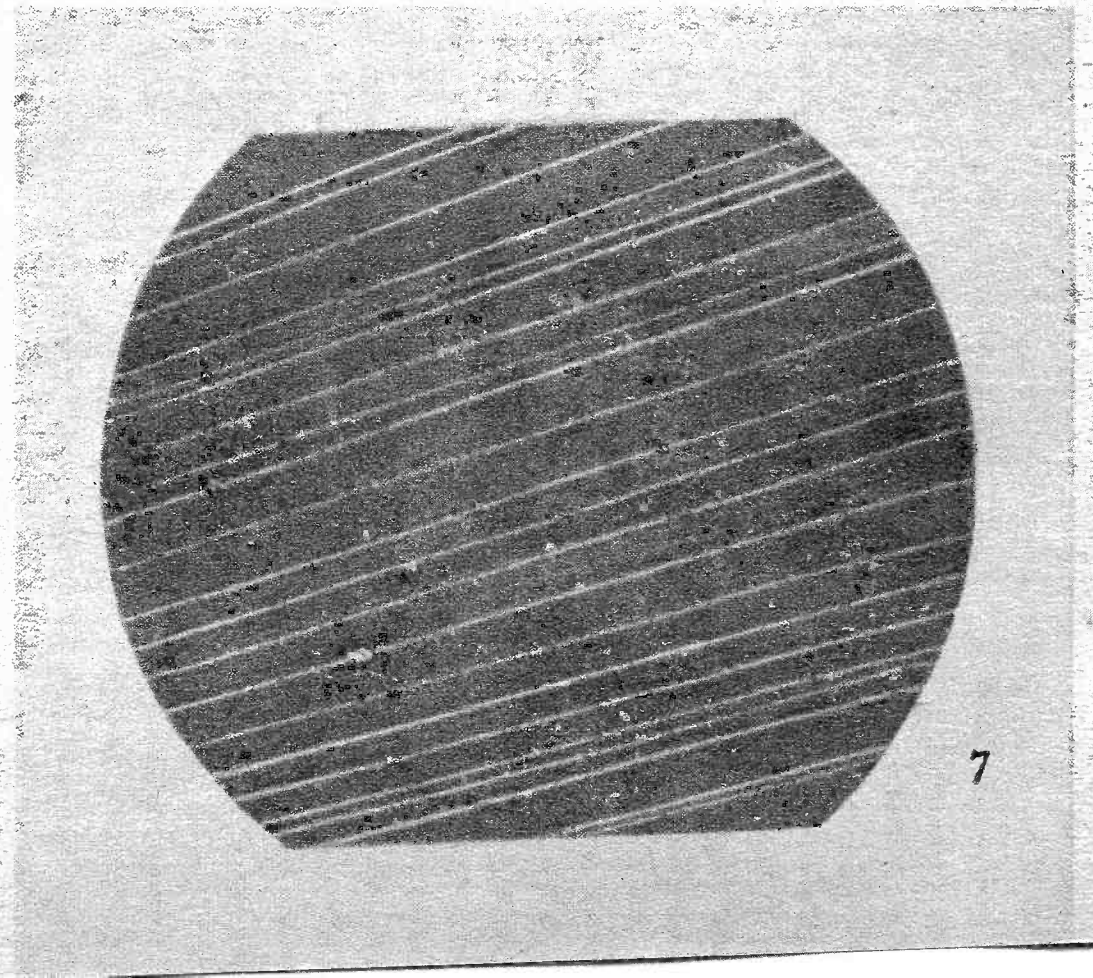

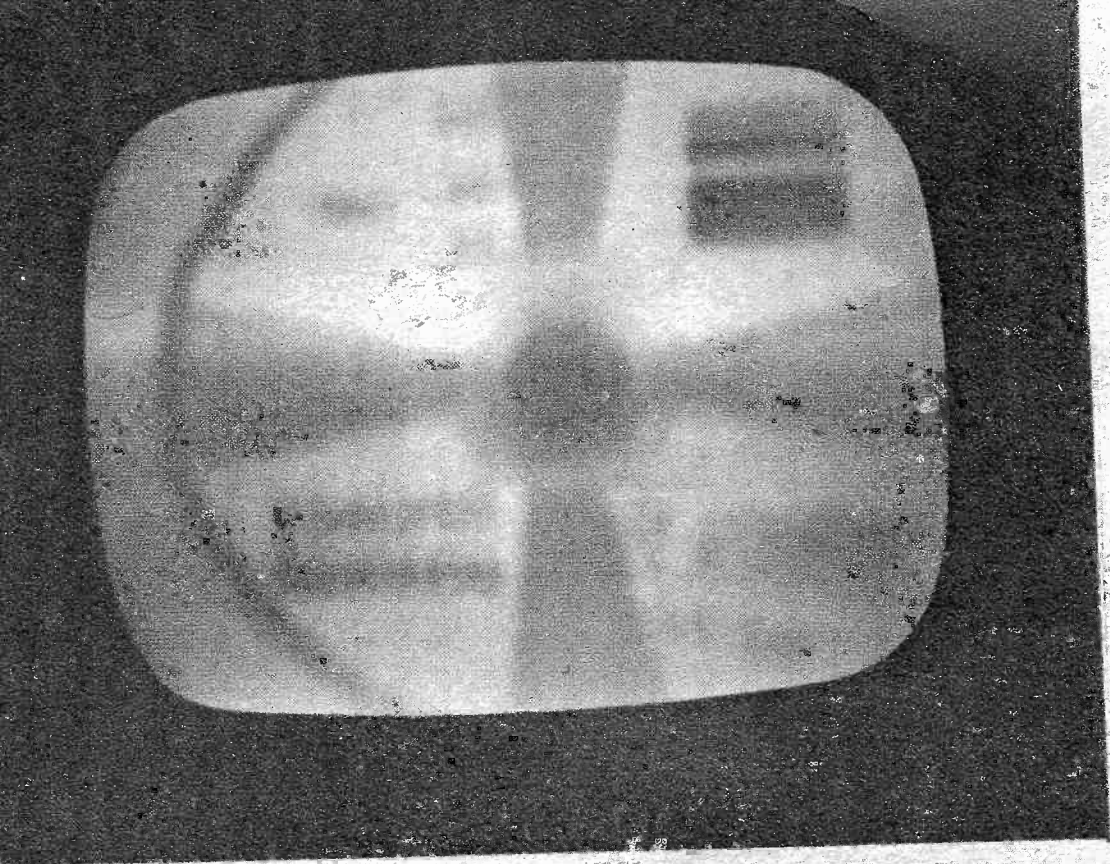

DEFOCUSED: Don't confuse this as a secondary symptom from another trouble. The pure strain is a full clear picture but blurred, caused by the lines on your TV screen becoming too thick. The **PICTURE TUBE** (see Chapter 12) is quite often at fault. Next in line, especially in color sets is the **FOCUS RECTIFIER** (see Chapter 7). Lastly, the **FOCUS** adjustments.

KEYSTONE: This trouble is usually accompanied with blooming and is 99.99 per cent of the time caused by the deflection yoke. (See Chapter 7.)

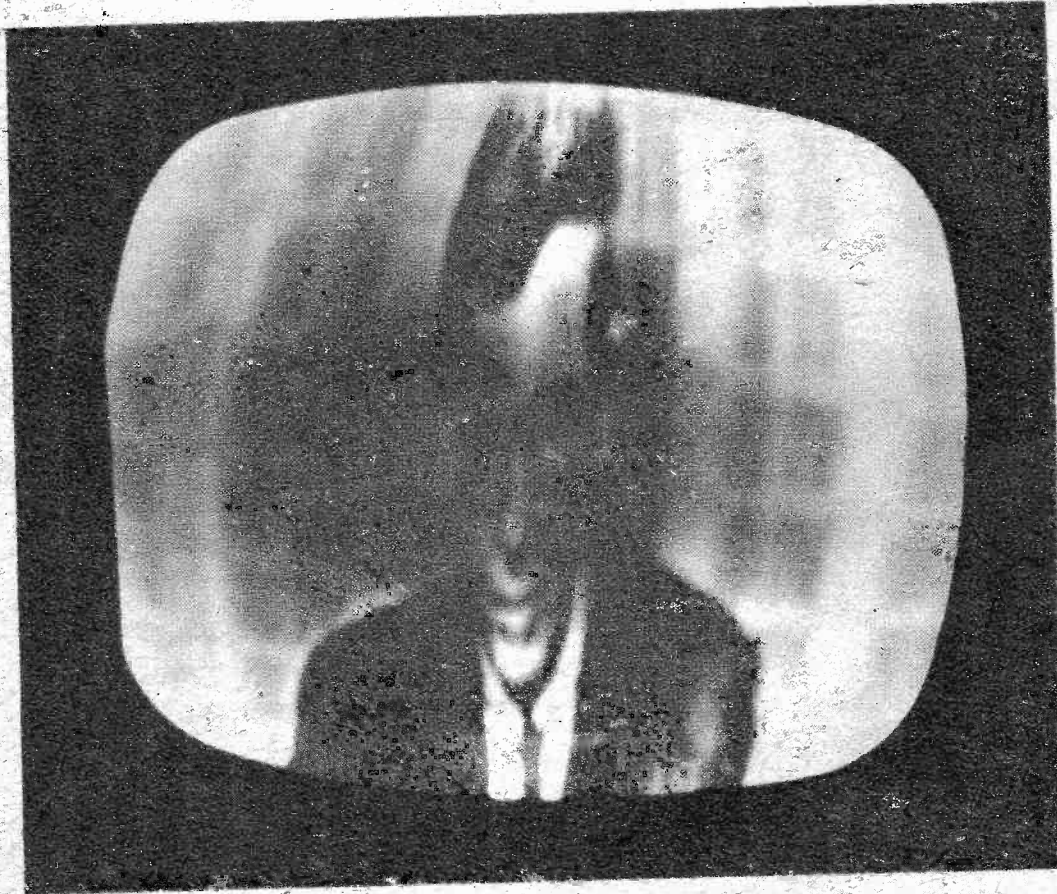

BLOOMING: Turning the brightness control makes the picture expand and contract in various degrees. It's caused by low high voltage and the number one suspect is the **HIGH VOLTAGE RECTIFIER**. Next comes the **HIGH VOLTAGE REGULATOR**, then the **HORIZONTAL OUTPUT**, the **DAMPER** (see Chapter 7), and the **LOW VOLTAGE RECTIFIER** (see Chapter 6).

TWO-SIDED SHRINK: The pure strain of this trouble is caused by the **HORIZONTAL OUTPUT** or **DAMPER**. (See Chapter 7.) Secondary accompanying symptom of blooming indicates the **LOW VOLTAGE RECTIFIER** (see Chapter 6), the **HIGH VOLTAGE REGULATOR** or **HIGH VOLTAGE RECTIFIER** (see Chapter 7). Sometimes an adjustment such as the **HORIZONTAL DRIVE**, **HORIZONTAL LINEARITY** or **WIDTH** can cure this condition.



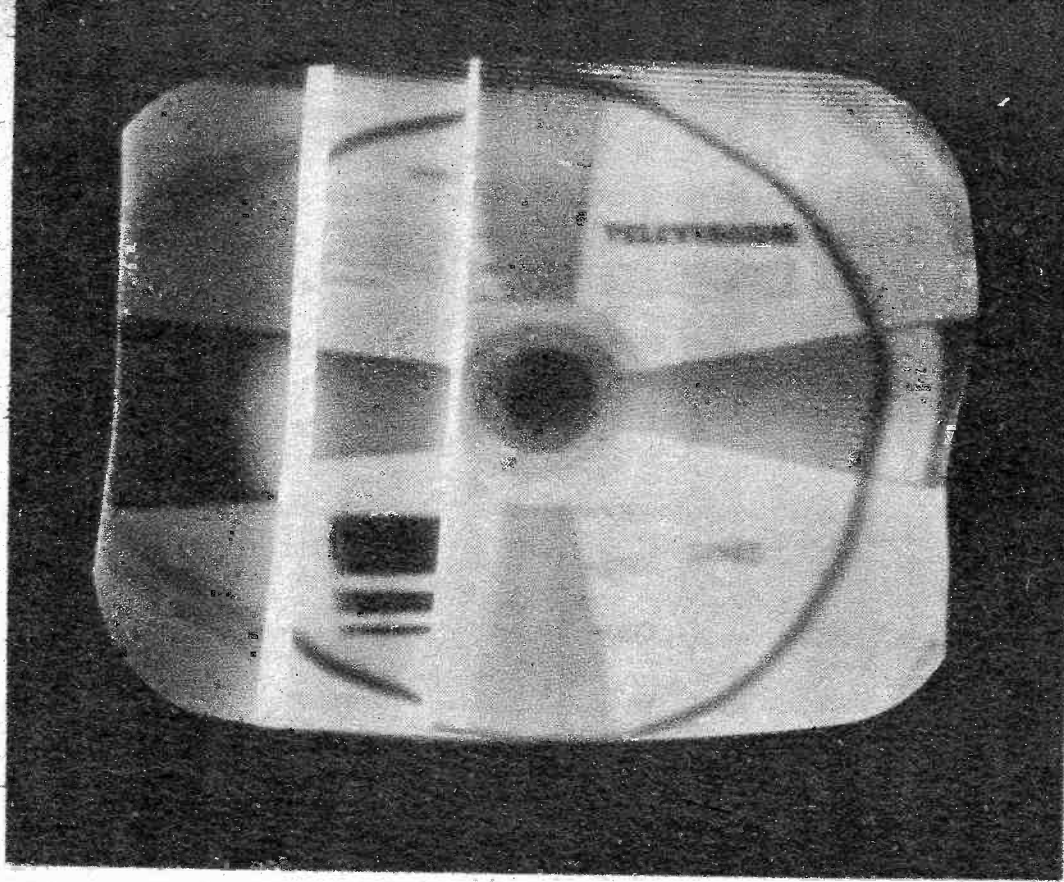

POOR HORIZONTAL LINEARITY: The main reason for this condition is a weak **DAMPER** tube. Also check **HORIZONTAL OUTPUT**, **HORIZONTAL DRIVE CONTROL**, **HORIZONTAL LINEARITY CONTROL** or **WIDTH CONTROL**. Lastly, try the **HORIZONTAL OSCILLATOR** and **HORIZONTAL PHASE DETECTOR** (see Chapter 8).



ARCING LINES ON SCREEN: Besides auto spark causing this trouble, the **HIGH VOLTAGE REGULATOR**, **LOW VOLTAGE RECTIFIER**, or shorting of the **DAMPER** tube or **HORIZONTAL OUTPUT** tube can do it. Also any arc-over in the wiring of the TV can transmit the condition onto the TV screen.

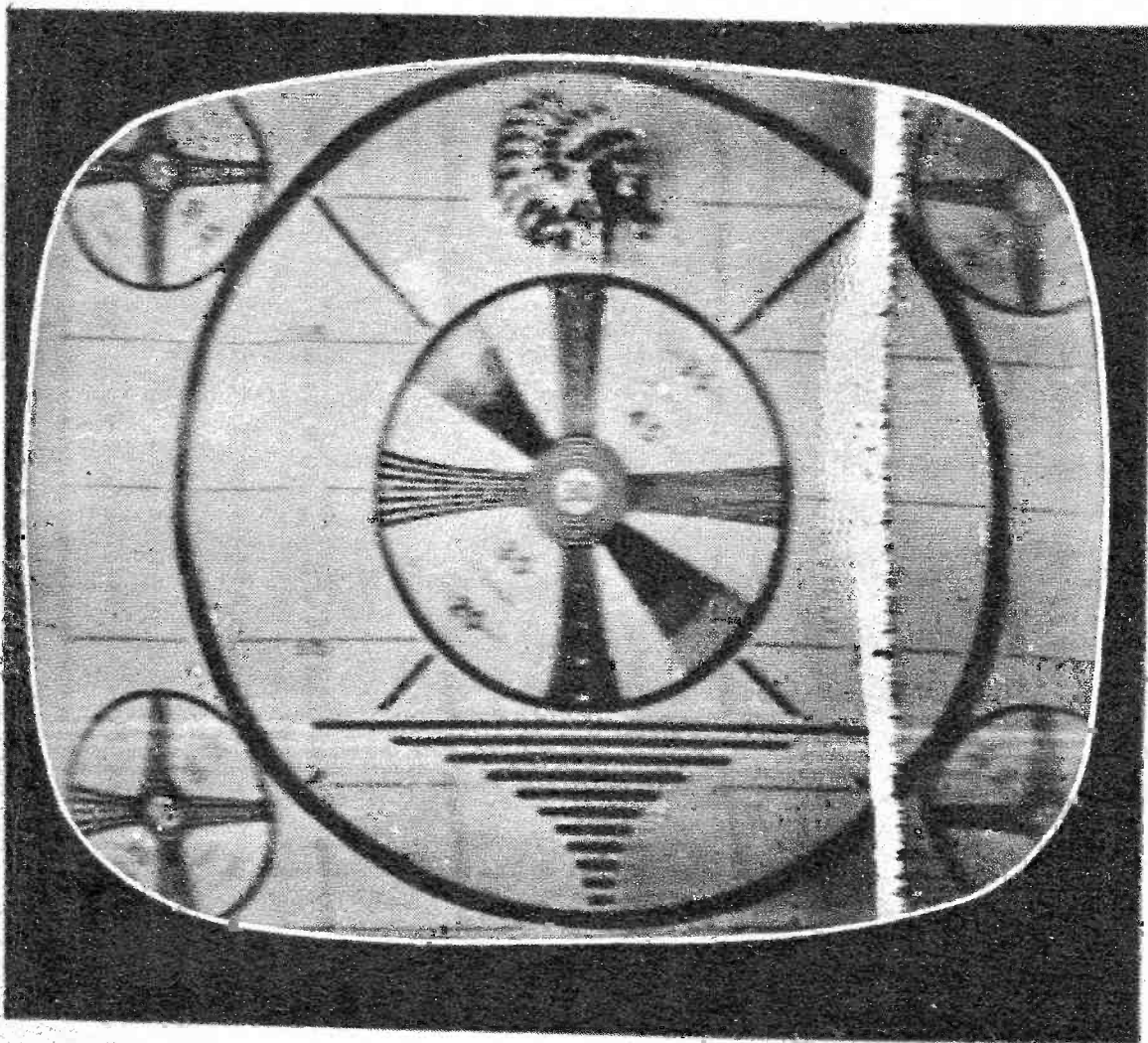

The photo at left shows two defects, **CORONA EFFECTS** and **VERTICAL BARS**. The **CORONA EFFECTS** are due to excessive humidity and moisture, or insulation breakdown; the AC high voltage spews out of its wire to a nearby ground. Drying out, reinsulating and repositioning of affected components is the cure. (See Chapter 7.) **VERTICAL BARS** are almost exclusively caused by the **HORIZONTAL OUTPUT** tube although the **DAMPER** will on rare occasions be the culprit.

buzzes), and 6—dead set (no light or sound).

The troubleshooting idea is to analyze the picture and sound and identify the trouble as belonging to a particular family. Having done so, then pinpoint the symptom as so and so, a particular member of a family.

The gallery of photos and captions on these pages will help you identify the name of the trouble. The captions also tell which tubes to test, fuse to change and adjustments to make. They will also tell you where in the book you'll find further information leading to the apprehension of the bad component or needed adjustment.

On rare occasions a TV might develop some queer looking or sounding symptoms. However a close analysis will show it up as one of the 55 classic troubles. Some symptoms might seem to bridge two or more troubles. In those cases try to follow service instructions on each of the indicated troubles one by one.

Every single trouble in the gallery is applicable to color TV. All the troubles except the family of color troubles will appear in black-and-white TV's. From a troubleshooting point of view a color TV is almost exactly like a monochrome TV, except more so.

Should you complete this book's service

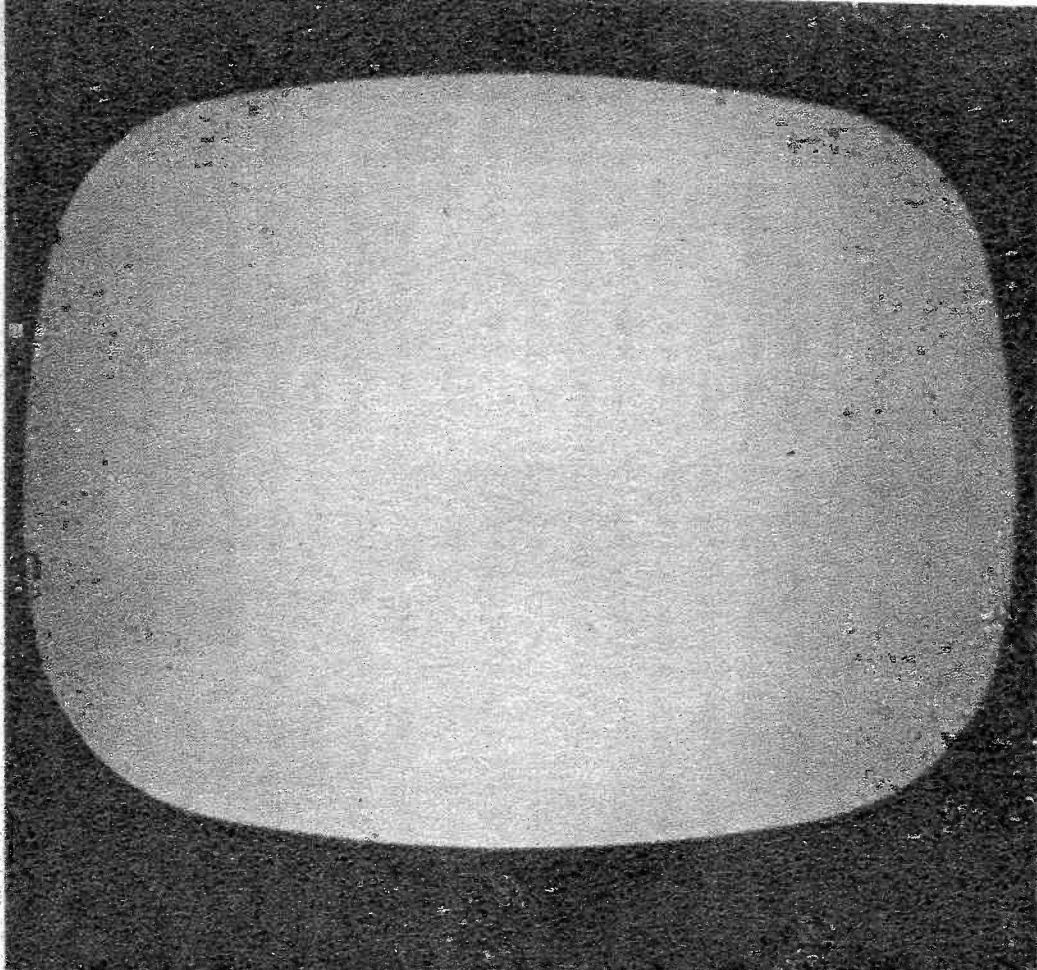

a) **RASTER—NO SOUND:** This trouble occurs in the signal path before the sound and picture are separated from one another. Test the **RF AMPLIFIER, MIXER-OSCILLATOR, IF tubes, VIDEO DETECTOR** (see Chapter 10). Finally, try the **AUDIO OUTPUT** (see Chapter 11).

b) **RASTER—SOUND OK:** The area of possible trouble is in the signal path after the sound has been taken off. Test the **VIDEO AMPLIFIERS** (see Chapter 9), the **PICTURE TUBE** (see Chapter 12), and the **AGC** (see Chapter 9).

WEAK CONTRAST: The main offender here is the **VIDEO OUTPUT tube** (see Chapter 9). Next in order test the **PICTURE TUBE** (see Chapter 12), the **VIDEO DETECTOR**, the **VIDEO IF'S**, the **AGC** (see Chapter 9), the **RF AMPLIFIER** and **MIXER-OSCILLATOR** (see Chapter 10).

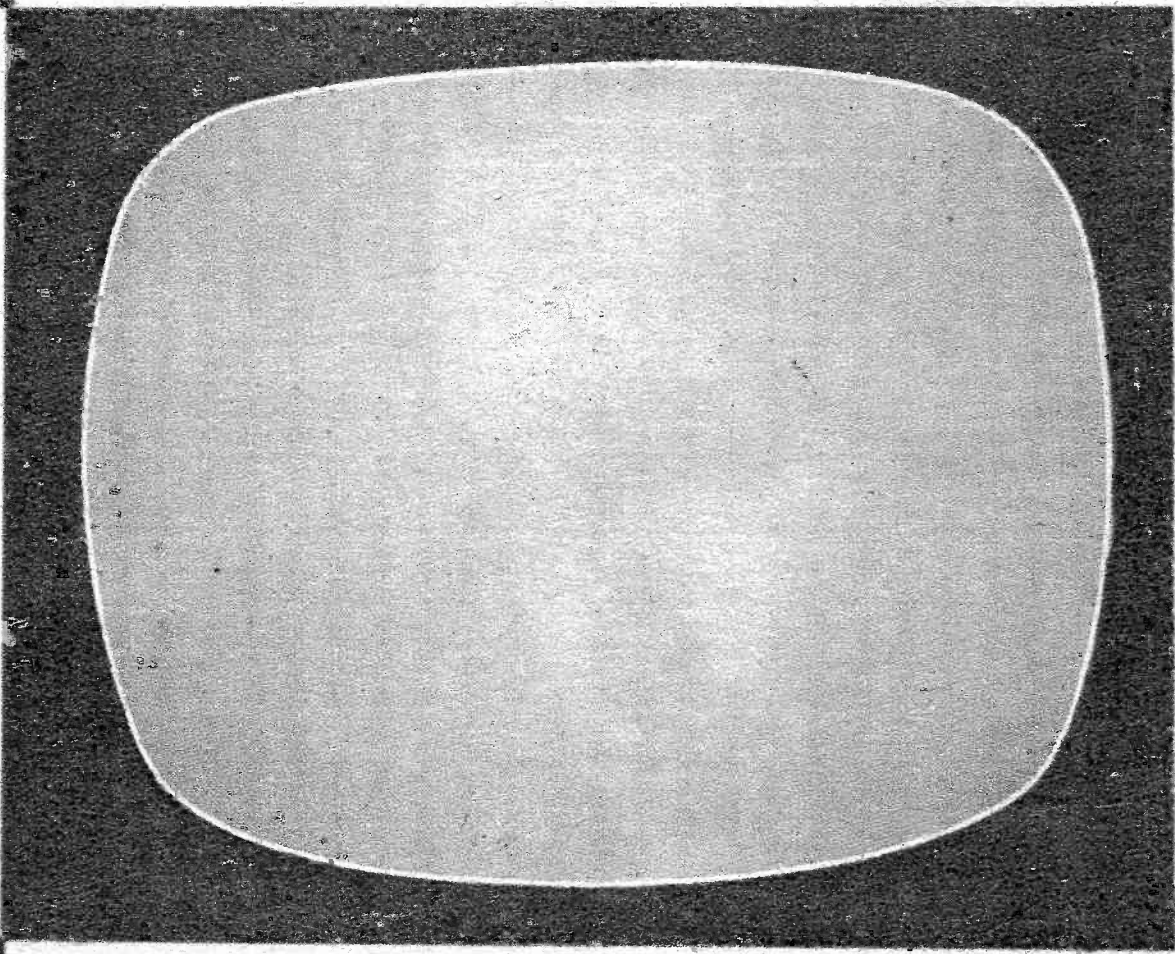

TOO MUCH CONTRAST: Usually caused by troubles in the **AGC**. Next in line, the **VIDEO IF'S** could be at fault. On rare occasions a **VIDEO DETECTOR** or the **VIDEO AMPLIFIERS** may cause the trouble.

SMEARY PICTURE: Almost invariably this trouble is caused by the **VIDEO DETECTOR** or **VIDEO AMPLIFIERS** (see Chapter 9). This trouble is easily confused with **TUNABLE GHOST** condition, so analyze carefully.

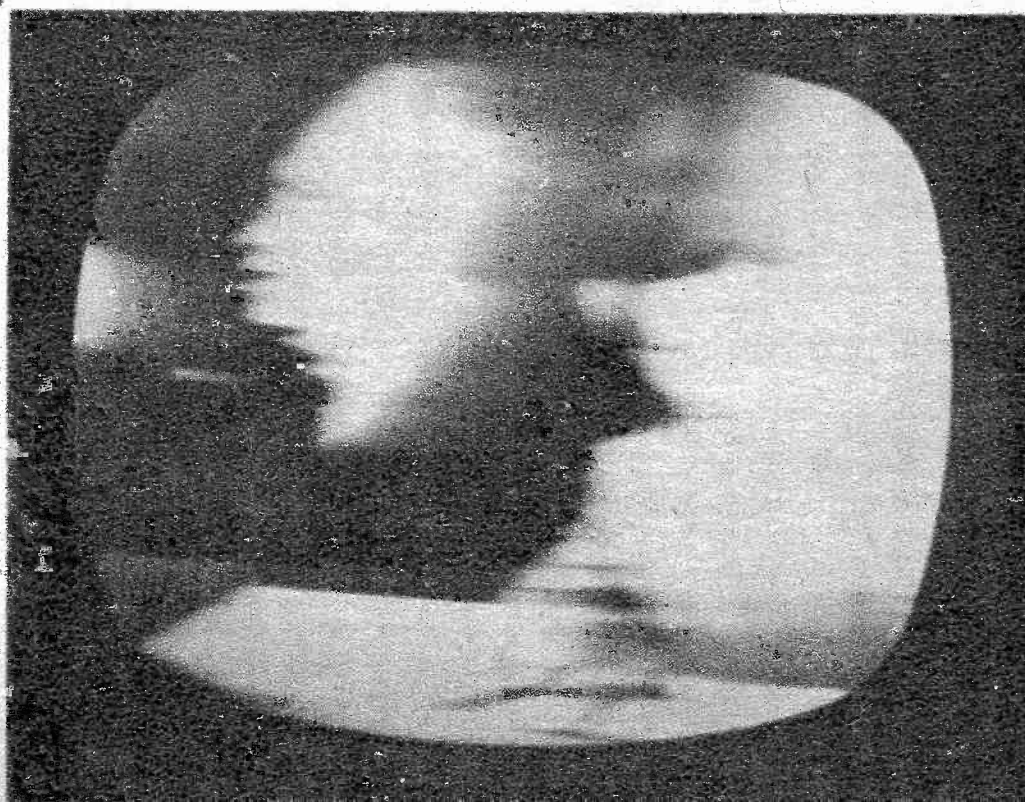

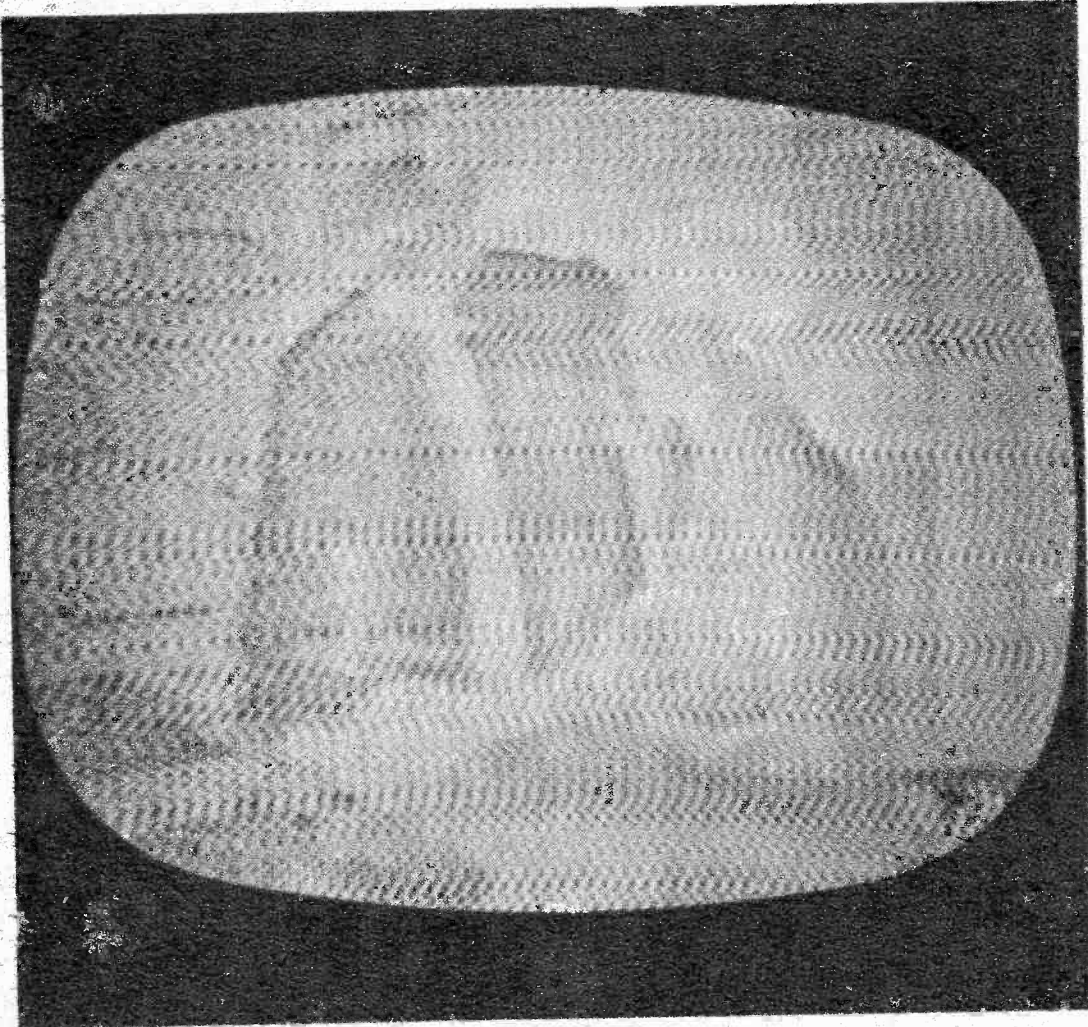

NEGATIVE PICTURE, at left: The blacks can go white and the whites go black from many sources. The commonest type is the weak **PICTURE TUBE** (see Chapter 12). Next try the **VIDEO DETECTOR** and **VIDEO AMPLIFIER** (see Chapter 9). The **AGC** is a good suspect, then try the **Video IF'S**, **RF AMPLIFIER**, **MIXER-OSCILLATOR**. Lastly, a strong outside interference can turn the picture inside out but the trouble will be accompanied by herringbone stripes. **GHOSTS**, at right, come in two strains: tunable and nontunable. When the fine tuner has no effect, check the **ANTENNA SYSTEM** (see Chapter 4). When the trouble is tunable, test the **VIDEO IF'S**, the **MIXER-OSCILLATOR**, the **RF AMPLIFIER**, the **VIDEO DETECTOR** (see Chapter 10), the **VIDEO AMPLIFIER** and the **AGC** (see Chapter 9).

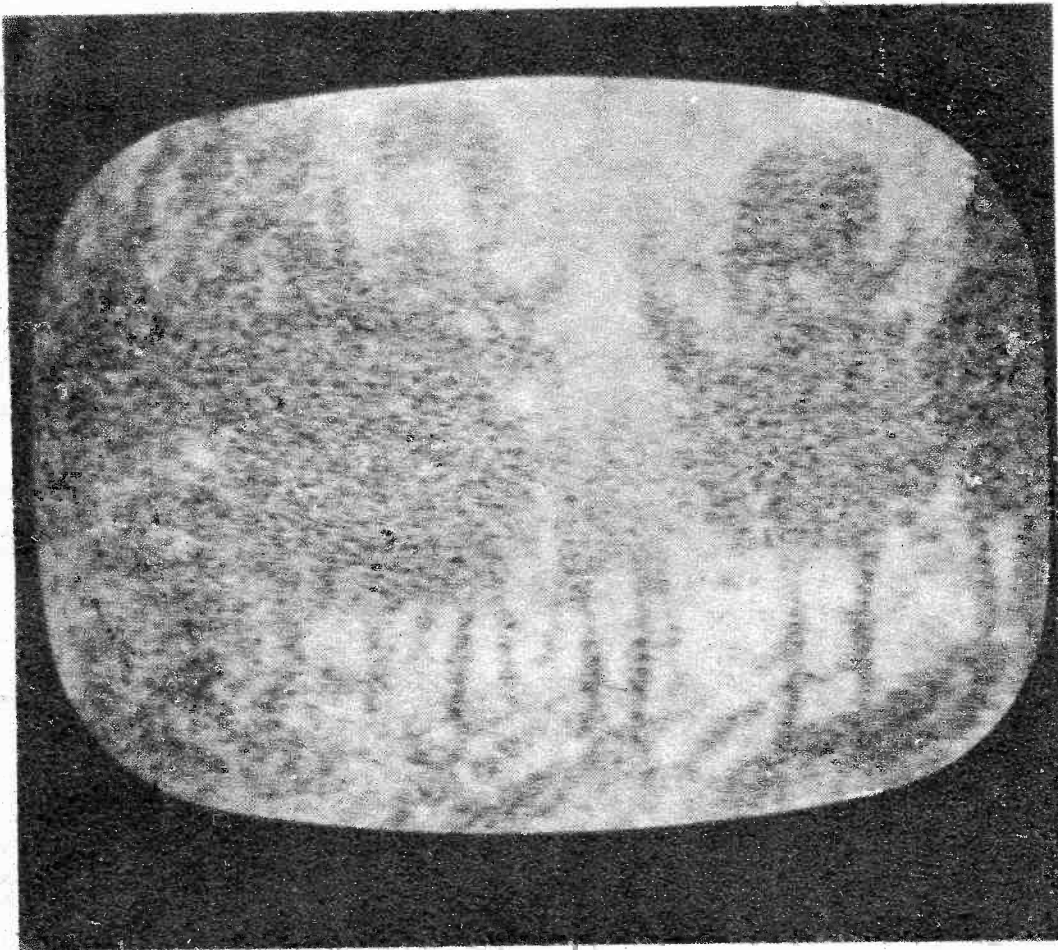

SNOW: Snow is static that you see. It's caused by weak signal. Distant stations tend to have more snow than close ones. When snow becomes a serious problem, number one suspect is the **RF AMPLIFIER**. If that doesn't solve the problem, then test the **MIXER-OSCILLATOR**, the **VIDEO IF'S** (see Chapter 10), and the **AGC** (see Chapter 9).

HORIZONTAL LINES: When the horizontal hold control won't restore the picture try the **HORIZONTAL OSCILLATOR** tube, the **HORIZONTAL PHASE DETECTOR**, the **HORIZONTAL FREQUENCY** and **PHASE** adjustments. Next, try the **SYNC** tubes (see Chapter 8).

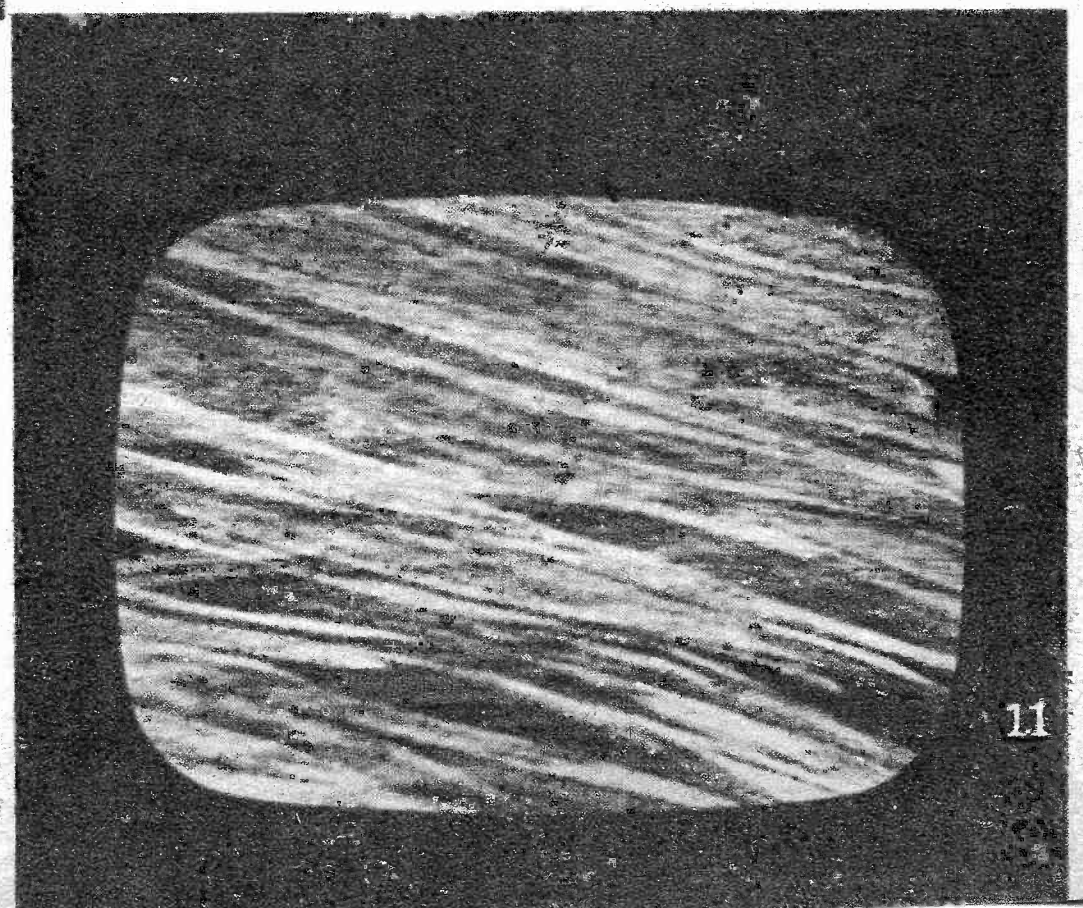

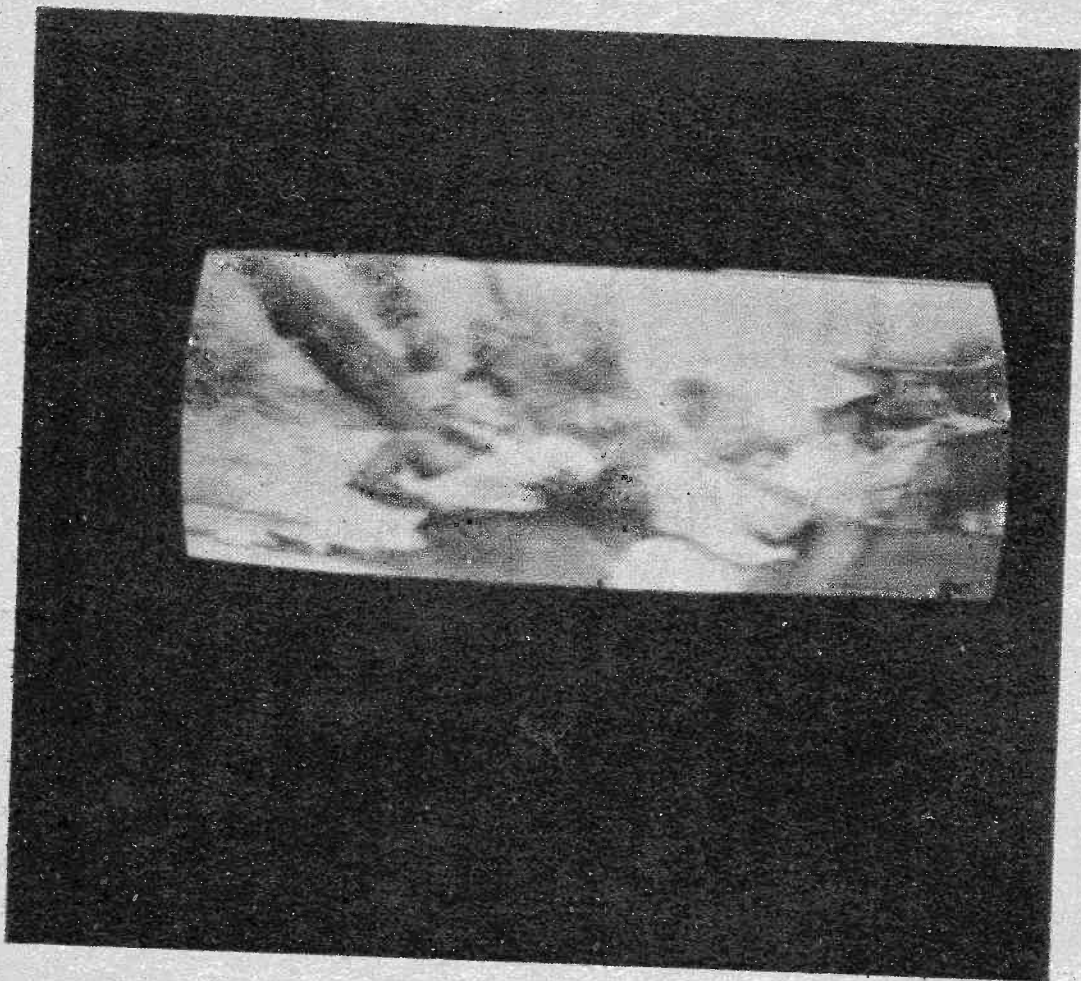

TOP AND BOTTOM SHRINK, at left: A variation of the **NO VERTICAL SWEEP** (see below, this page). Test the same tubes and try adjusting the **VERTICAL LINEARITY** and **HEIGHT** controls. **THE BENDS**, at right: the **HORIZONTAL OUTPUT** tube, the **HORIZONTAL OSCILLATOR** (see Chapter 7), the **SYNC** and **HORIZONTAL PHASE DETECTOR** (see Chapter 8), the **AGC**, the **VIDEO AMPLIFIER**, the **VIDEO IF'S** and the **VIDEO DETECTOR** (see Chapter 9).

NO VERTICAL SWEEP: When the vertical oscillator quits, this symptom is exhibited. The prime suspects are the **VERTICAL OSCILLATOR** and **VERTICAL OUTPUT** tubes (see Chapter 8).

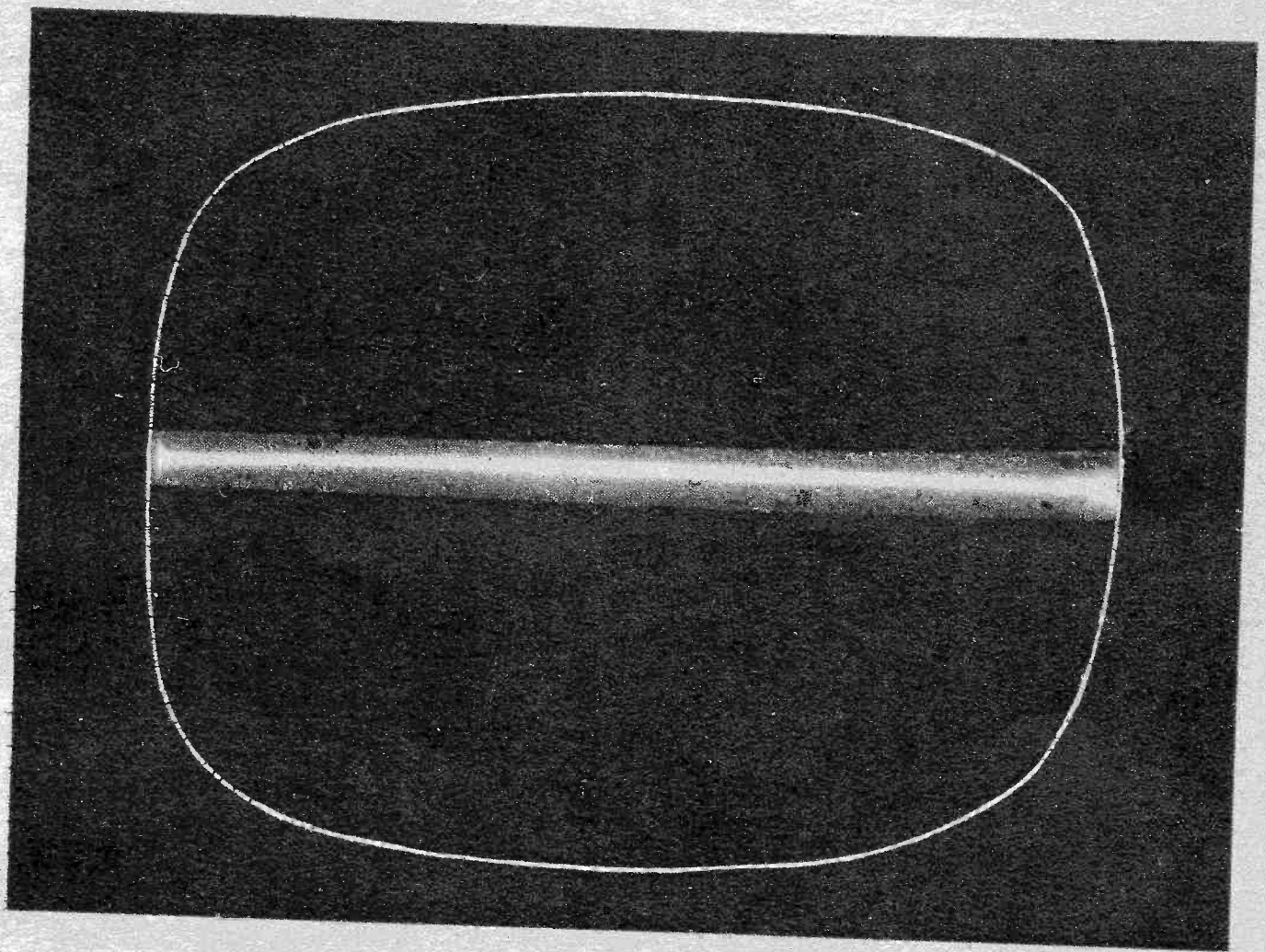

the trouble is labeled, and then as a result the defective component is pinpointed and replaced.

The 11 brightness troubles are found in variations of seven contrast symptom photographs.

The 11 Sync Troubles

The familiar motion picture film slipping is identical to the loss of vertical sync on your TV screen. Horizontal sync however has no picture film counterpart. It is an exclusive TV trouble. There are 11 separate

TV synchronization problems exemplified in the 11 symptom photos. There are many variations of these troubles, but with the proper manipulation of the vertical and horizontal hold controls you can make a correct diagnosis and then go forward to the indicated circuits. All you require is a little patience.

The 10 Color Troubles

While a separate book could be written on color-only troubles, at least 90 percent of these troubles can be quickly repaired

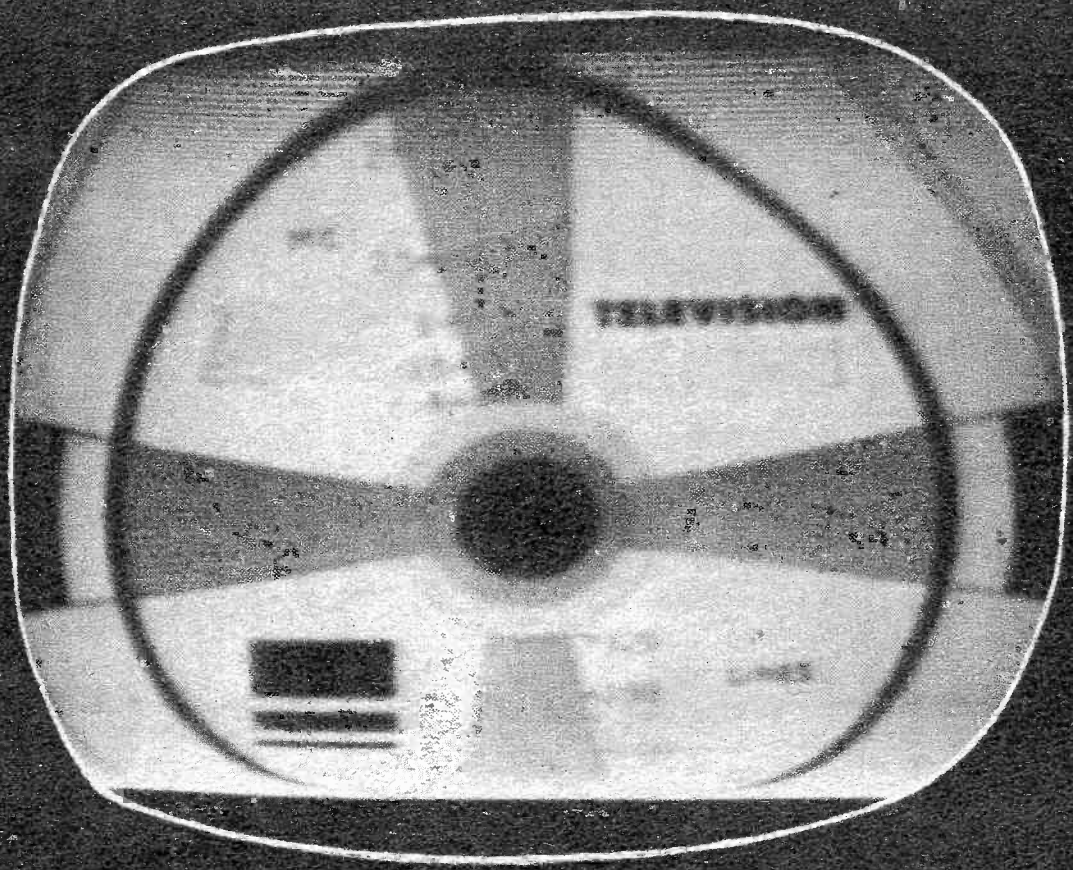

VERTICAL LINEARITY: Pointy heads and stubby legs indicate the **VERTICAL LINEARITY** and **HEIGHT** controls require adjustments. If they won't respond, try a new **VERTICAL OUTPUT** tube. Lastly, try a new **VERTICAL OSCILLATOR** (see Chapter 8), and a new **HORIZONTAL OUTPUT** tube (see Chapter 7).



VERTICAL BOTTOM FOLDOVER: Pointy heads and long legs with a whitish haze at the bottom of the screen indicates a gassy **VERTICAL OUTPUT** tube (see Chapter 8). If that doesn't help, try a new **HORIZONTAL OUTPUT** tube (see Chapter 7). Lastly, try the **VERTICAL LINEARITY** and **HEIGHT** controls.

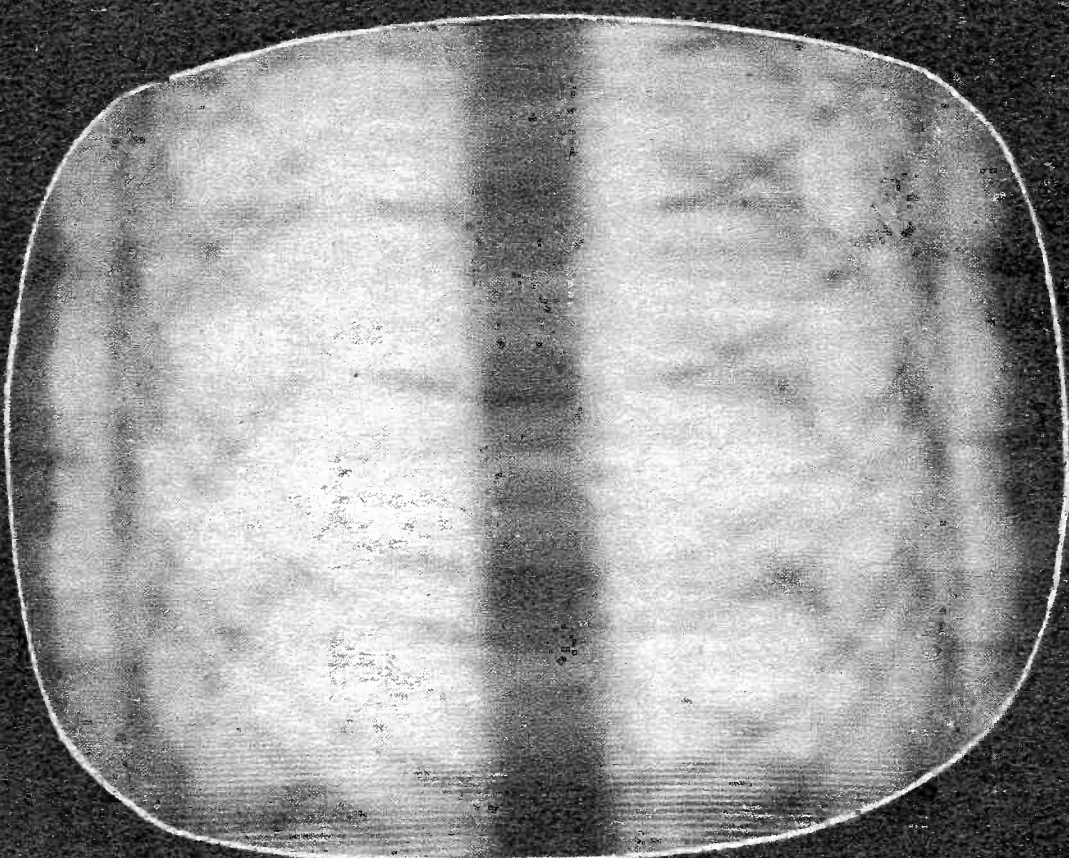

VERTICAL ROLL: When the **VERTICAL HOLD** control won't stop rolling, try the **VERTICAL OSCILLATOR** and **SYNC** tubes. Then try the **VERTICAL OUTPUT** tube (see Chapter 8).

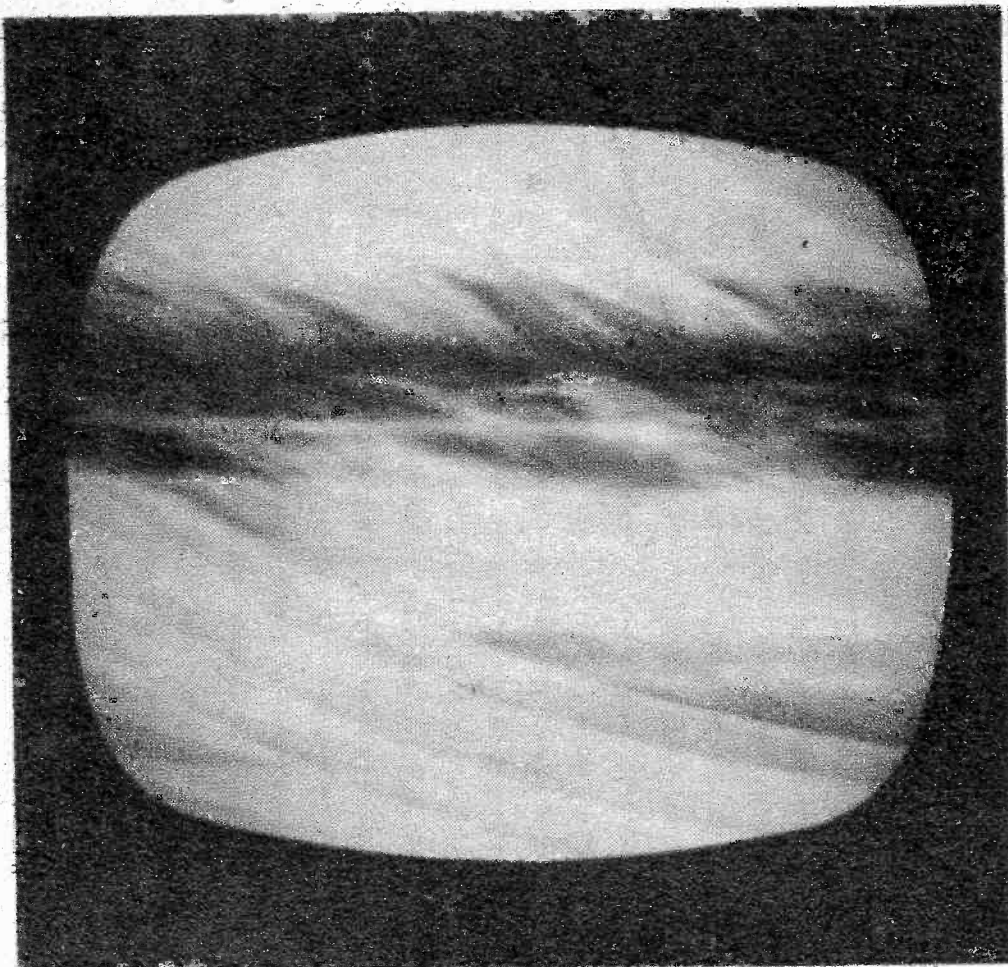

VERTICAL ROLL with HORIZONTAL LINES: This is the complete loss of lock-in power. Test all tubes that have SYNC in their name. Then test the VERTICAL OSCILLATOR and HORIZONTAL OSCILLATOR (see Chapter 8).

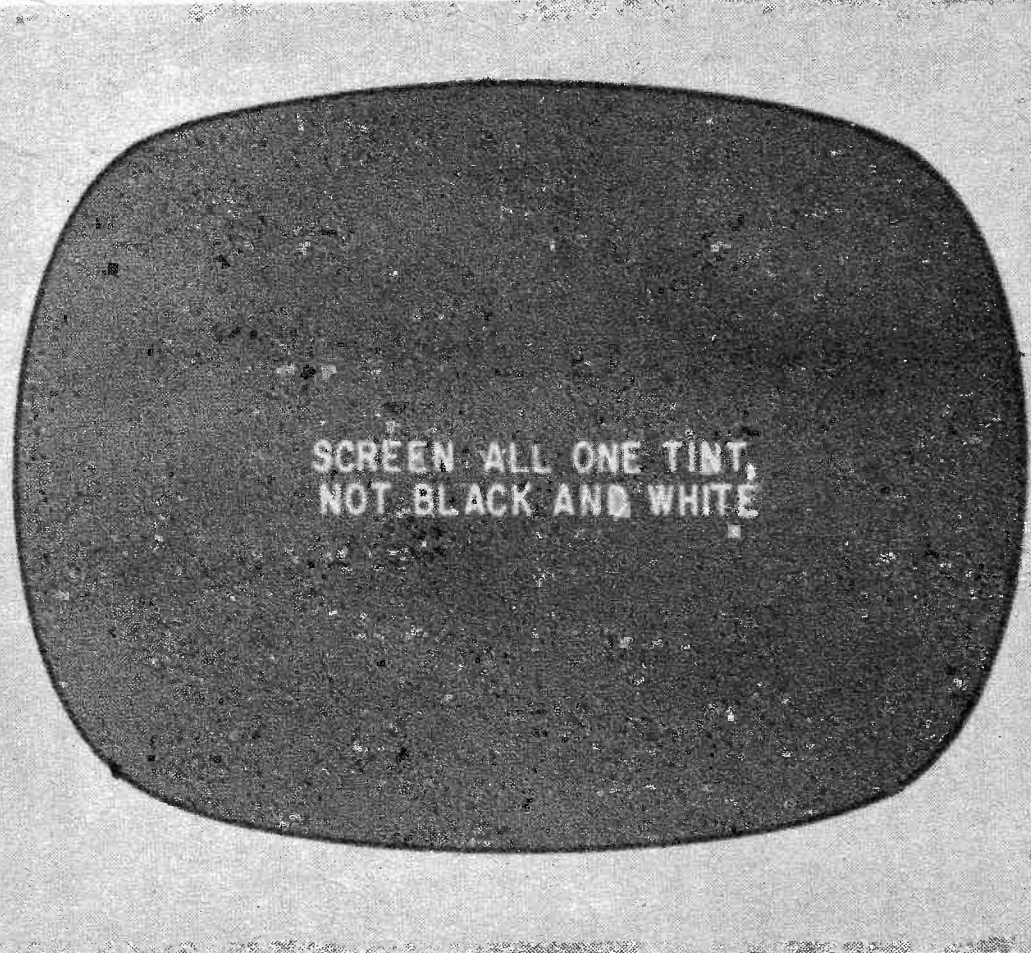

TINTED SCREEN: When the entire screen is tinted pink or green or blue, instead of black and white, your gray scale tracking is off. Follow the gray scale tracking procedure in Chapter 14.

PURITY: When the black-and-white picture has splotches of color tinting, especially in the sides or corners, the purity is off. Follow the purity adjustment procedure in Chapter 14.

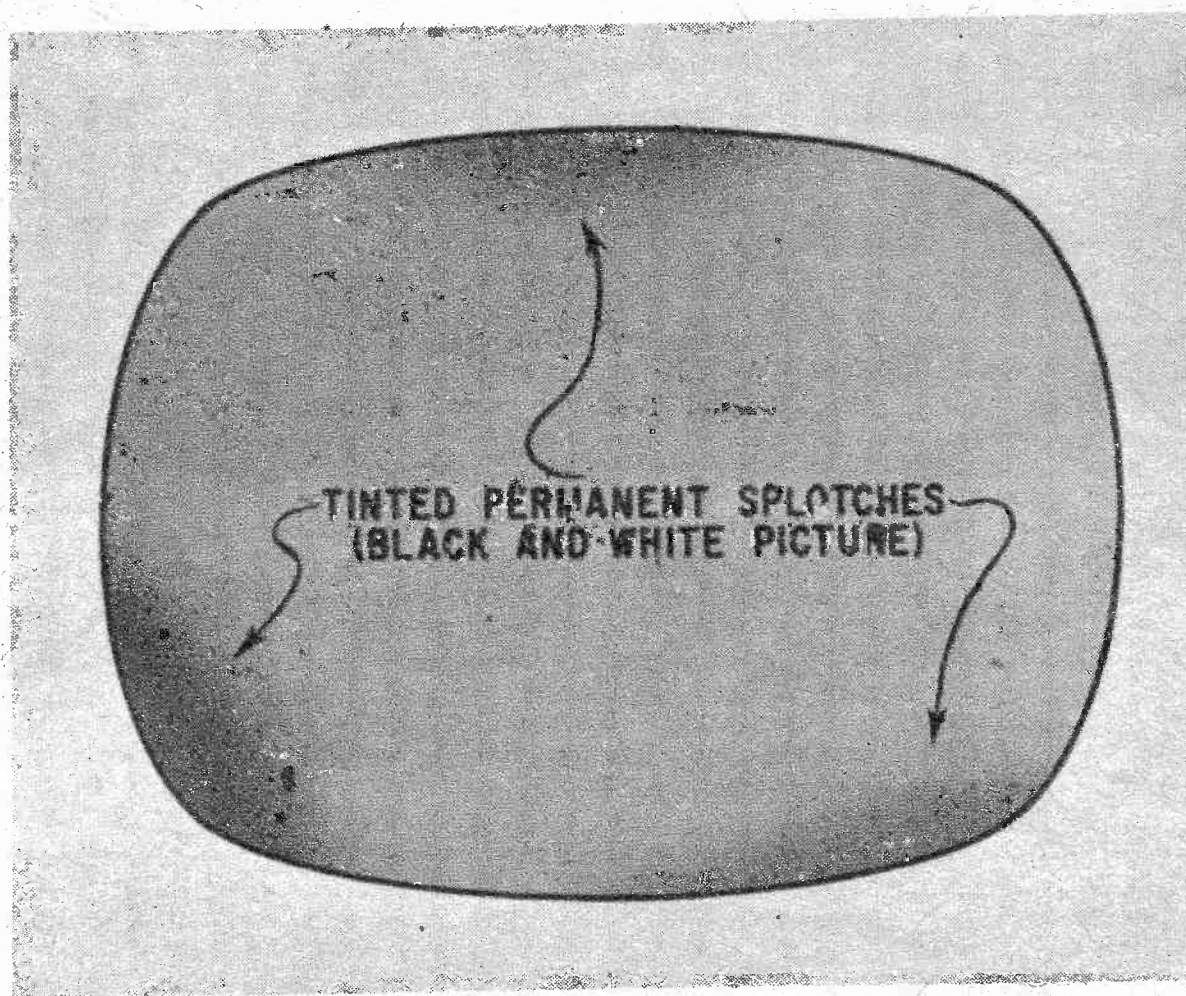

with just a briefing. The identification of the trouble is also easy as long as you're not color blind. The actual color troubles break down into two categories of seven breakdown troubles and three setup adjustment troubles. While the seven are dispatched by normal tube changing, component replacing, etc., measures, the three setup troubles can only be accomplished by careful coordinated adjusting of 23 controls. These are well known as the confusing convergence adjustments. They in

turn break down into 11 easy adjustments and 12 ticklish ones. Fortunately the 11 easy ones are needed in the great majority of repairs, while the 12 tough ones not so often.

The 5 Sound Troubles

Sound troubles can only be described verbally except when the sound gets into the picture, as shown in the photo page 17. It is important that you discern the difference between the five troubles however

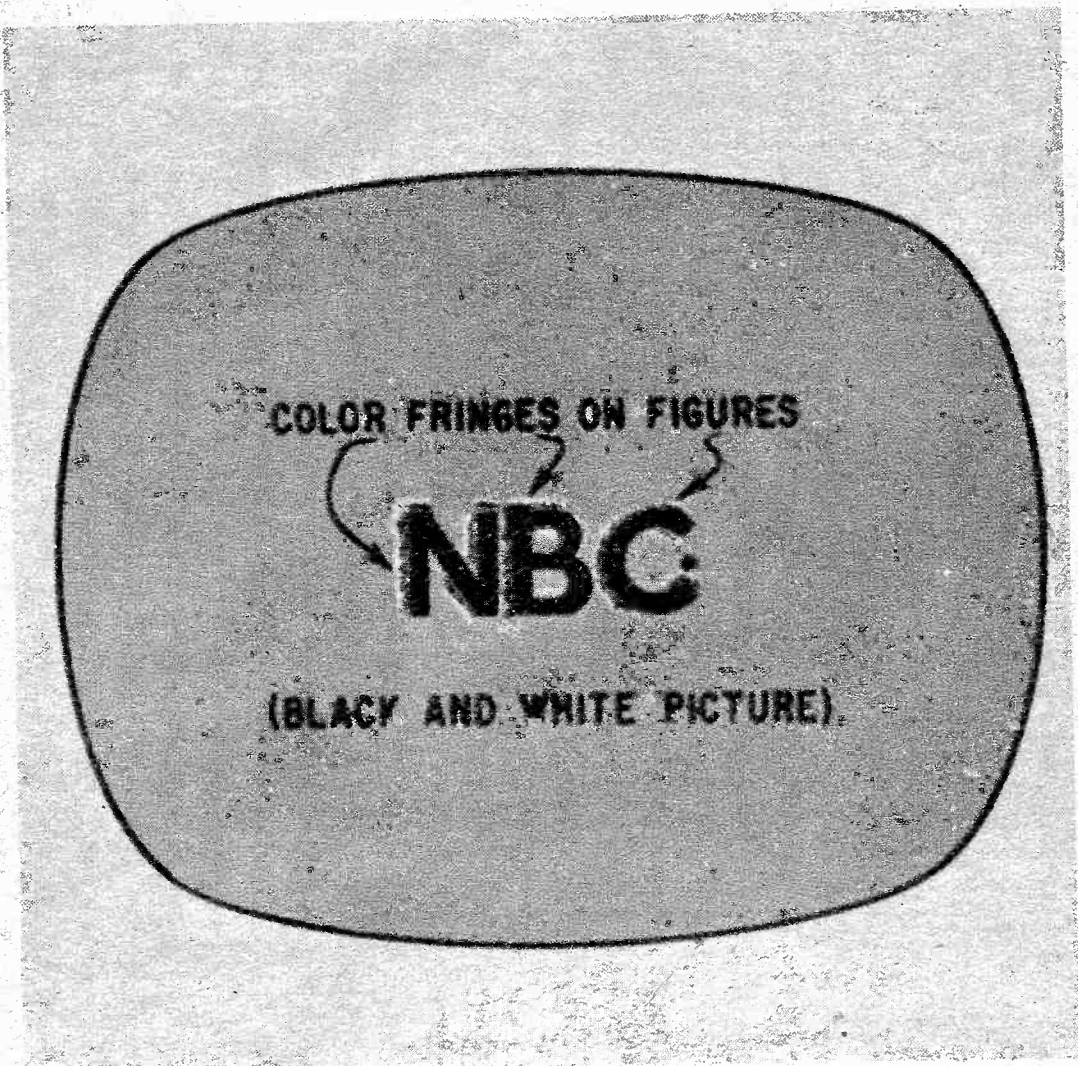

CONVERGENCE: If there is color fringing around objects, especially in supposedly black-and-white pictures, you need a convergence setup. (See Chapter 14.)

NO COLOR SYNC: The picture locks perfectly, but the color either appears as stationary horizontal bars, or shimmering rainbow waves from top to bottom of the screen. Check the **REACTANCE TUBE OSCILLATOR**, **BURST AMPLIFIER** and **3.58 MC OSCILLATOR** (see Chapter 15).

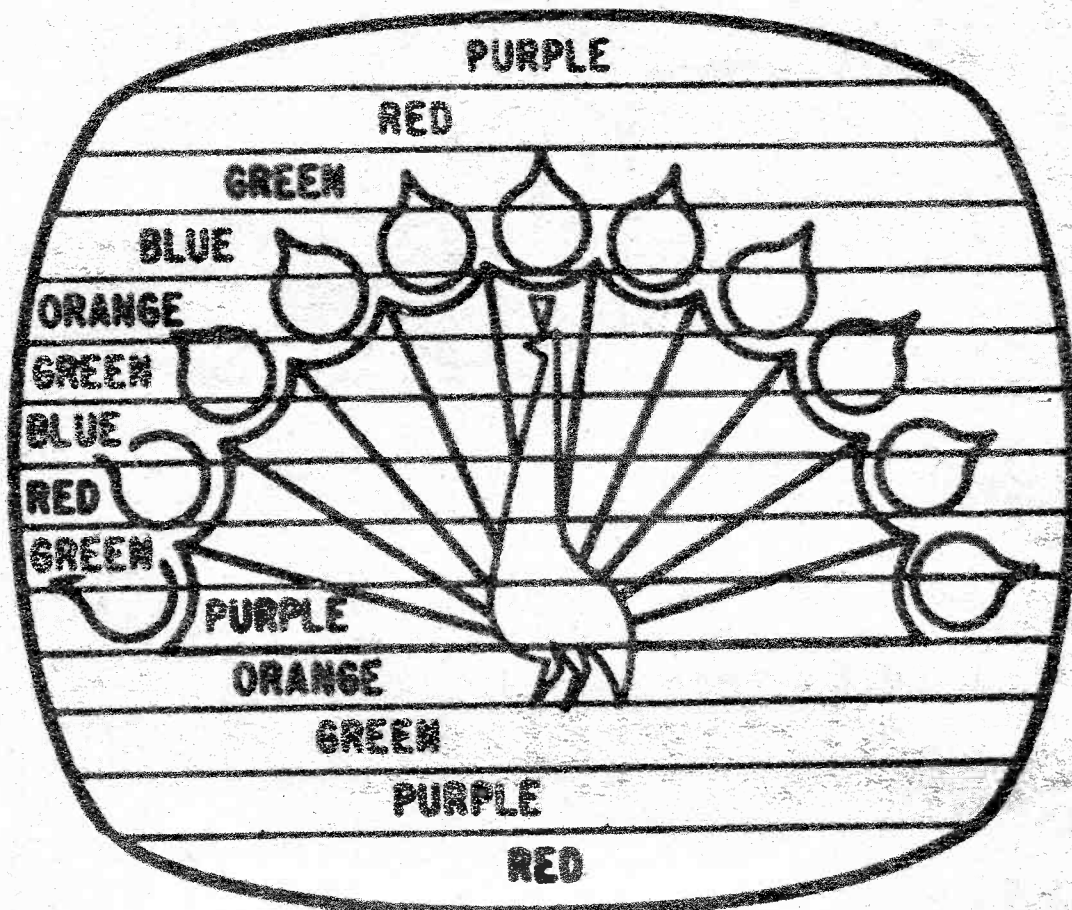

LOSS OF COLOR SYNC



SCREEN ALL ONE COLOR: When the screen goes either all red, all green or all blue and stays that way, test the **R-Y**, **G-Y** or **B-Y** modulator. When it is red, the **R-Y** tube is indicated, etc. Then try adjusting the screen controls. (See Chapter 15.)

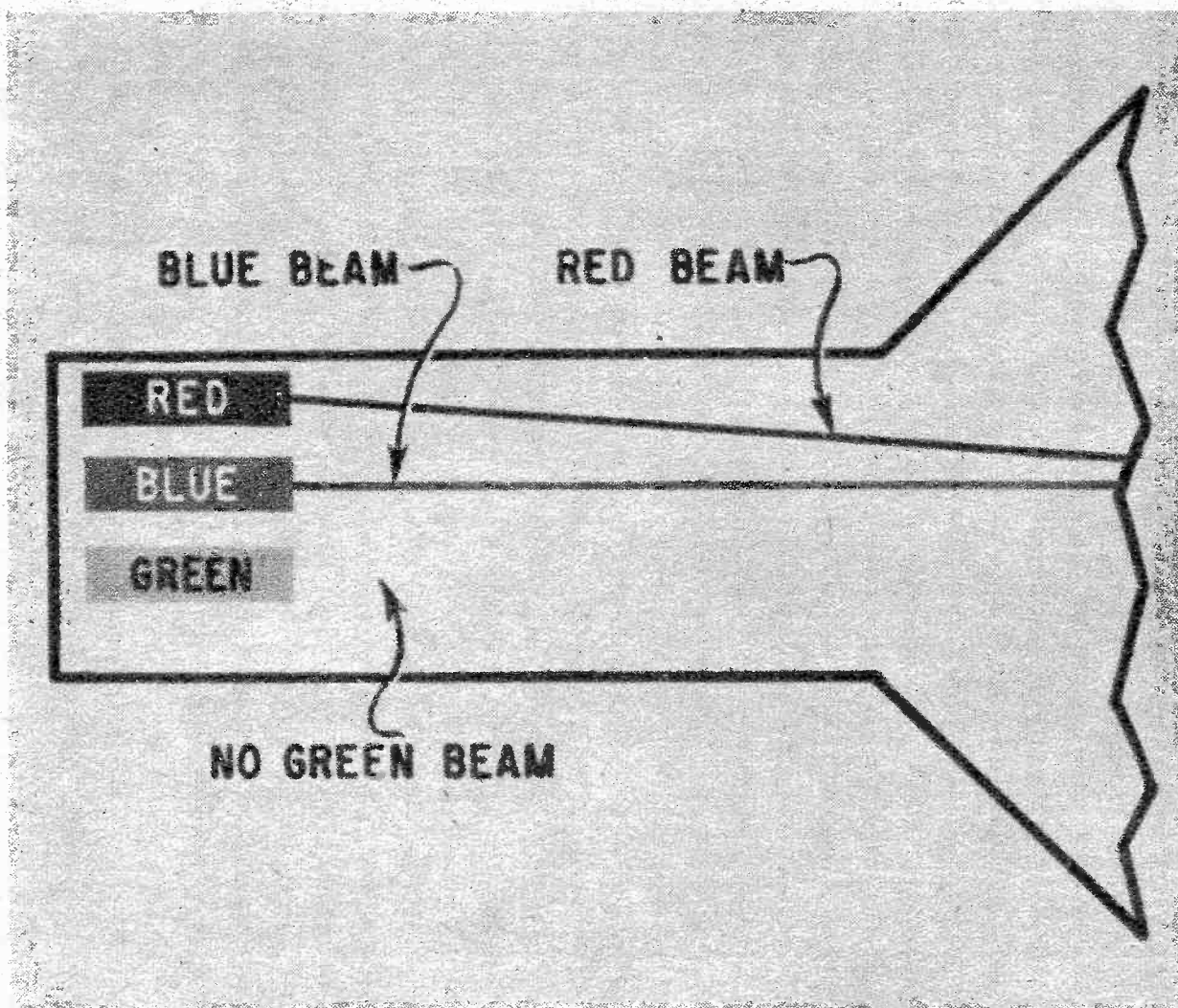

LOSS OF ONE COLOR: If you lose one color, the other two dominate. For instance, if green stops appearing, the picture becomes red, blue and purple. Unfortunately the trouble is usually the **PICTURE TUBE** (see Chapter 12). A second cause could be R-Y, G-Y or B-Y modulator. (See Chapter 15.)

SOUND BARS: The only one of the sound symptoms you can see is when the sound gets into the picture. Test the **VERTICAL OUTPUT** (see Chapter 8) and **AUDIO OUTPUT** tubes (see Chapter 11).

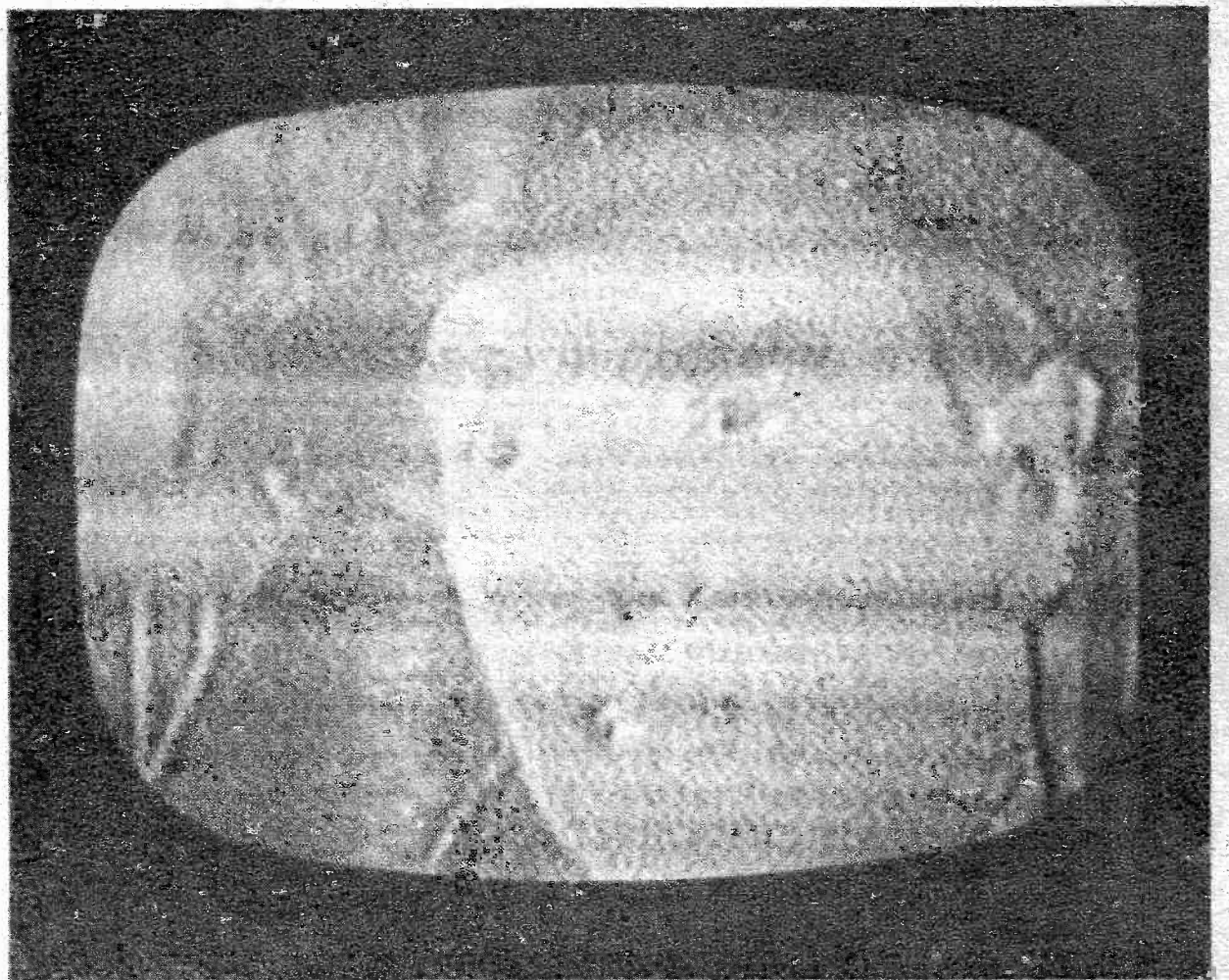

920KC Beat: When this herringbone pattern appears on the screen and can't be fine-tuned out, try new **VIDEO IF'S**, **RF AMPLIFIER**, **MIXER-OSCILLATOR** (see Chapter 10), the **ANTENNA SYSTEM** (see Chapter 4). The **3.58 MC OSCILLATOR** and **REACTANCE TUBE OSCILLATOR** (see Chapter 15), and the **AUDIO DETECTOR** (see Chapter 11).

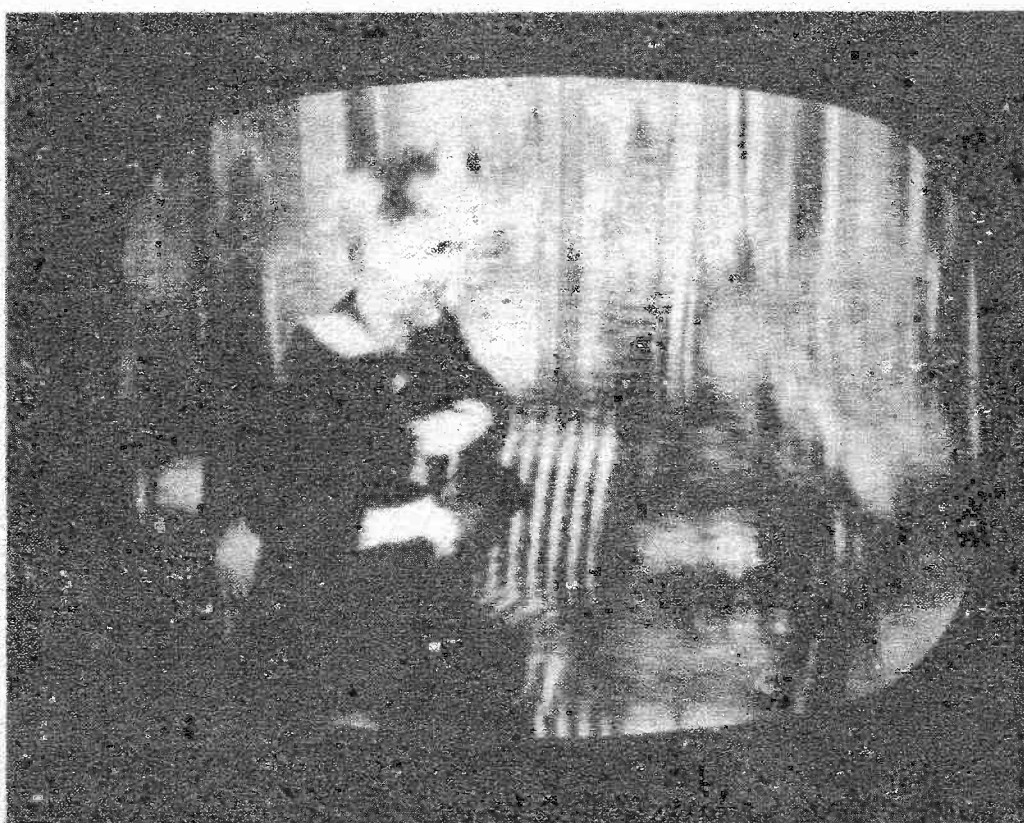

since there are a number of sound circuits each causing its own strain of trouble.

The 4 Dead Set Troubles

Even a dead set is dead in a few different ways. These troubles (see chapter 6) all come from the power supply being inoperative for some reason or another, or something in the TV causing the power supply to quit. *

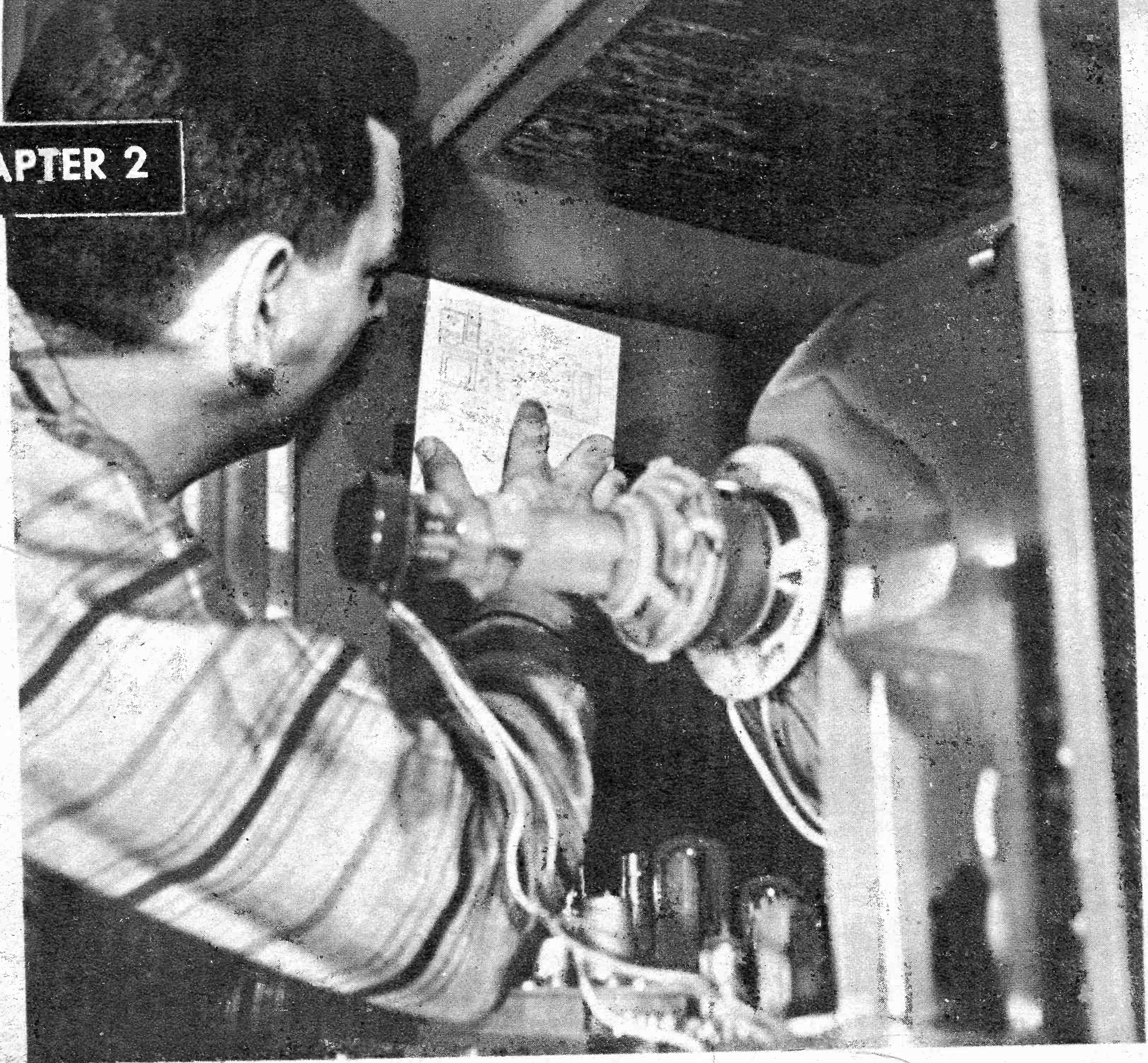

Practically every TV set, whether black-and-white or color, has a tube location guide planted in it.

Tricks of the Tube Location Guide

Here's how to add a touch of professionalism

THERE is hardly a TV ever made that doesn't have a tube location guide implanted somewhere in the cabinet or chassis. These tube location guides provide all the service information to repair at least eight out of ten TV problems.

A professional repairman, after making his diagnosis automatically takes a look at the tube location guide. Of course, the symptom has indicated to him which circuits are under suspicion, but he can't possibly know the actual number of every tube, where on the chassis the tubes are, the direction of the tube's keyway, where all the adjustments are, the fuse size and location and the heater circuit information

on many hundreds of makes and models.

The tube location guide provides all this and more at a glance. However the tube location guide can only make sense if you have an inkling of what it is showing. It actually is a block diagram of the TV. This is not a detailed map of the TV like a schematic is, it's more like a street guide showing important landmarks.

It's not necessary during quick check repairs to understand the TV component by component. It is useful though to be familiar with the route of the TV signal as it winds its way from one end of the TV to the other. Let's travel the route of a typical TV quickly.

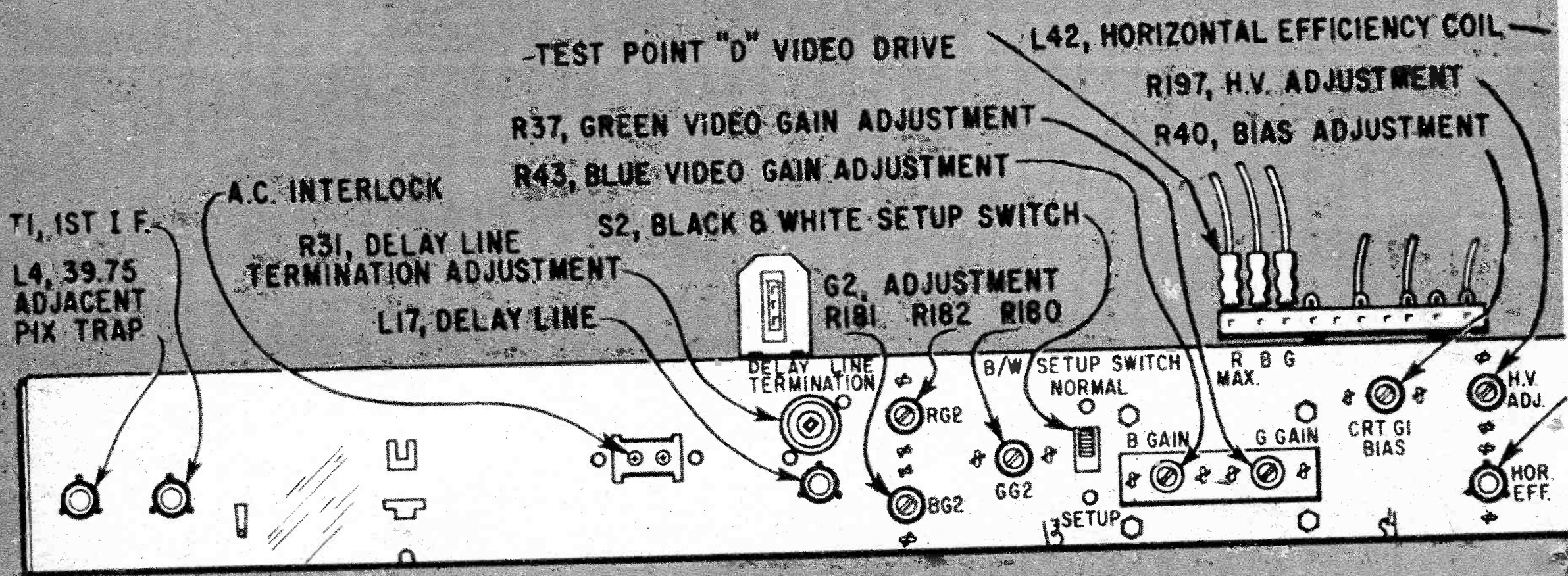

A diagram with information for adjustments is a valuable adjunct to round out a tube location guide.

Entrances

In order for the TV to work, two forms of electricity must enter it. One is the TV signal from the transmitter. The second is the 60 cycle, 117 volt house circuit.

The TV signal, a carrier wave containing the picture color, sound and lock-in signals is intercepted in the air by the antenna, funneled down the lead-in wire into the tuner. It passes through the two tuner stages the RF AMPLIFIER and MIXER-OSCILLATOR. Then it is transferred through the VIDEO IF strip into the DETECTOR. At the detector the picture is extracted and sent to the VIDEO AMPLIFIER, then on to the PICTURE TUBE; the color is taken out and sent to the BAND-PASS AMPLIFIER, and on to the PICTURE TUBE; the sound is sent to the AUDIO IF and on to the SPEAKER and the lock-in signals are sent to the SYNC SEPARATOR. From the separator the vertical lock-in and horizontal lock-in are sent on their separate ways to the vertical and horizontal oscillators. Meanwhile the 117 volt house current is coming in the line cord into the power supply. There it is divided into two segments and is sent to the LOW VOLTAGE RECTIFIER and the HEATER STRING. From the rectifier the electric power is sent to the plates of all the tubes. The heater string lights up the tubes.

Actual Guides

At its best a tube location guide will provide this information. 1—The location of every tube. 2—The number of every tube. 3—The circuit job each tube and tube

section does. 4—The keyway location of every tube. 5—The location of every hand adjustment. 6—The shape of the adjustment tool needed (screwdriver, Phillips head driver, hex head, etc.). 7—Fuse sizes and locations. 8—On series wired TV's a schematic of the heater string. 9—The model and chassis number of the TV.

At its worst a tube location guide will simply show tube locations and numbers. Fortunately, later TV's are providing more and more information. At any rate you need it during a repair.

A typical speedy repair by a home handyman follows this pattern. You turn on the TV for an evening's viewing. Instead of a picture the screen exhibits whirling, rolling lines. You try the horizontal and vertical hold controls to no avail.

A picture of the trouble is found in Chapter 1 under VERTICAL ROLL and HORIZONTAL LINES. The remedy is indicated. Test all SYNC tubes.

You look on the tube location guide. There are two tubes with sync in their names. You pull those two tubes. One tests shorted. You purchase it.

During the new tube installation you look at the tube location guide. There is a space on the suspect tube's perimeter at 3 o'clock. That is the keyway location. You install the tube being careful to place the small tube pins so the space is at 3 o'clock. In the tube slides. The picture returns in fine fettle.

More Information

While I am forced to maintain a library containing complete service information on every TV ever made, to conduct my TV

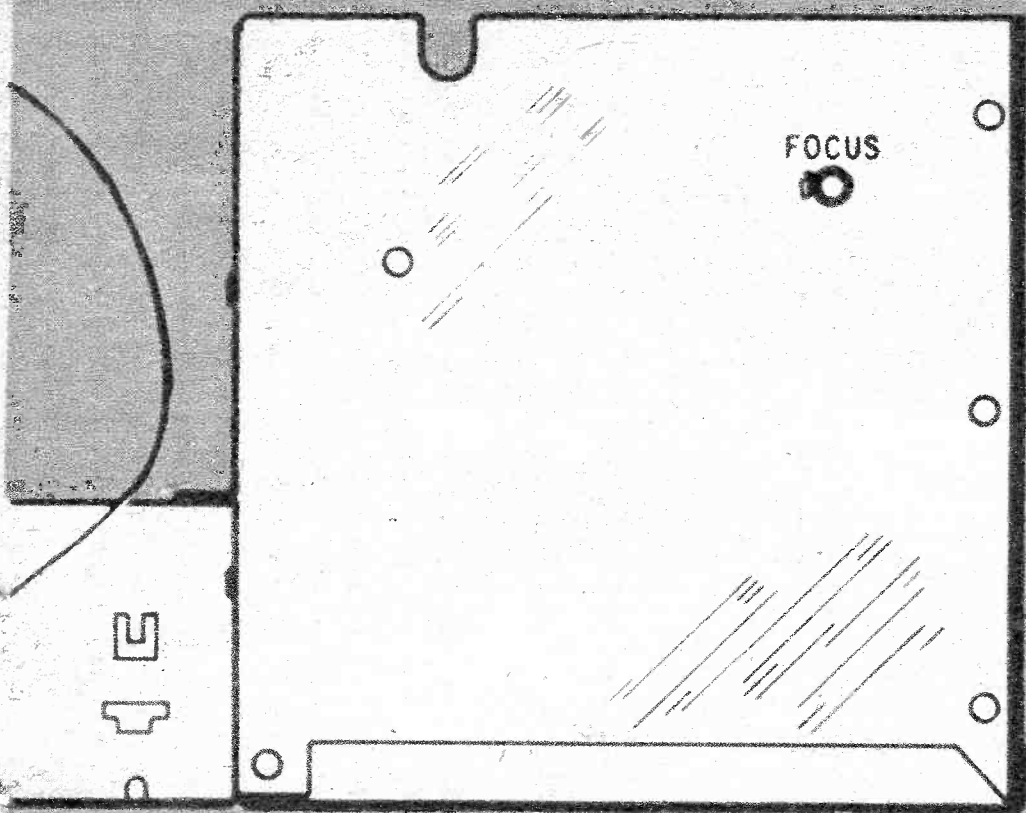

Courtesy Zenith Radio Corp.

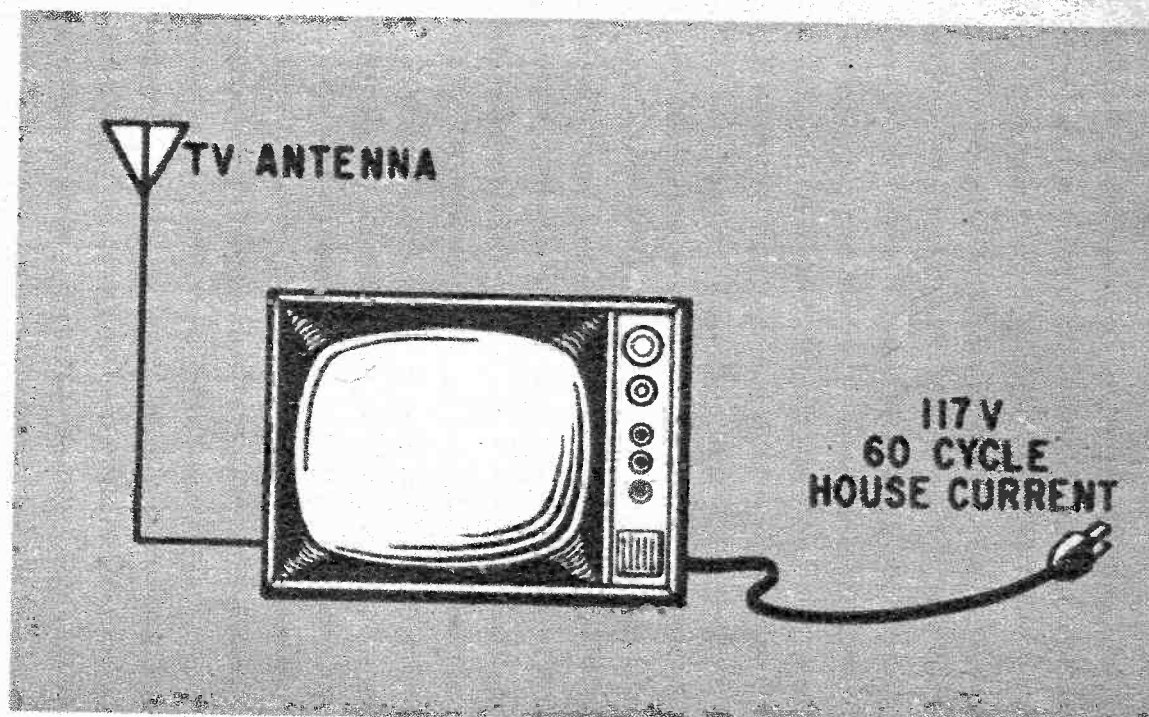

To function properly, all TV sets need a good antenna input and a good electric power input.

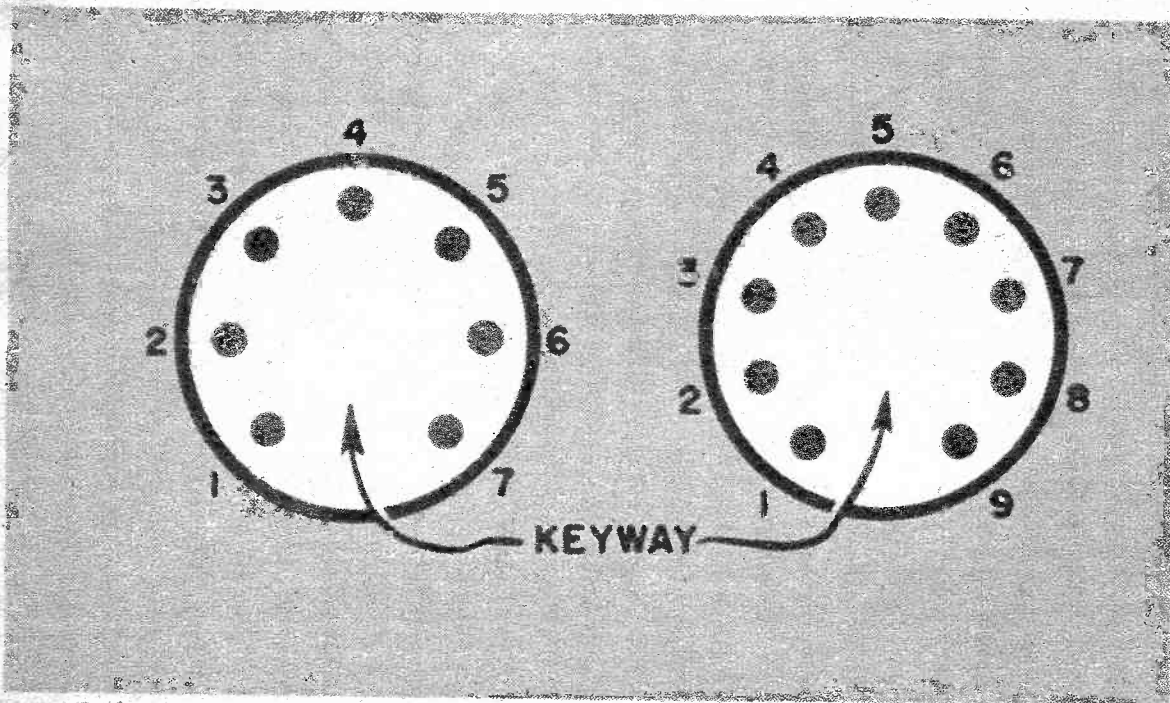

In the miniature type of tubes the keyway takes the form of a space. Count pins from the left.

In the octal type tubes the pins are equidistant and the keyway is always a plastic center.

The plastic keyway can snap off. Insert tube carefully to avoid putting pins in wrong holes.

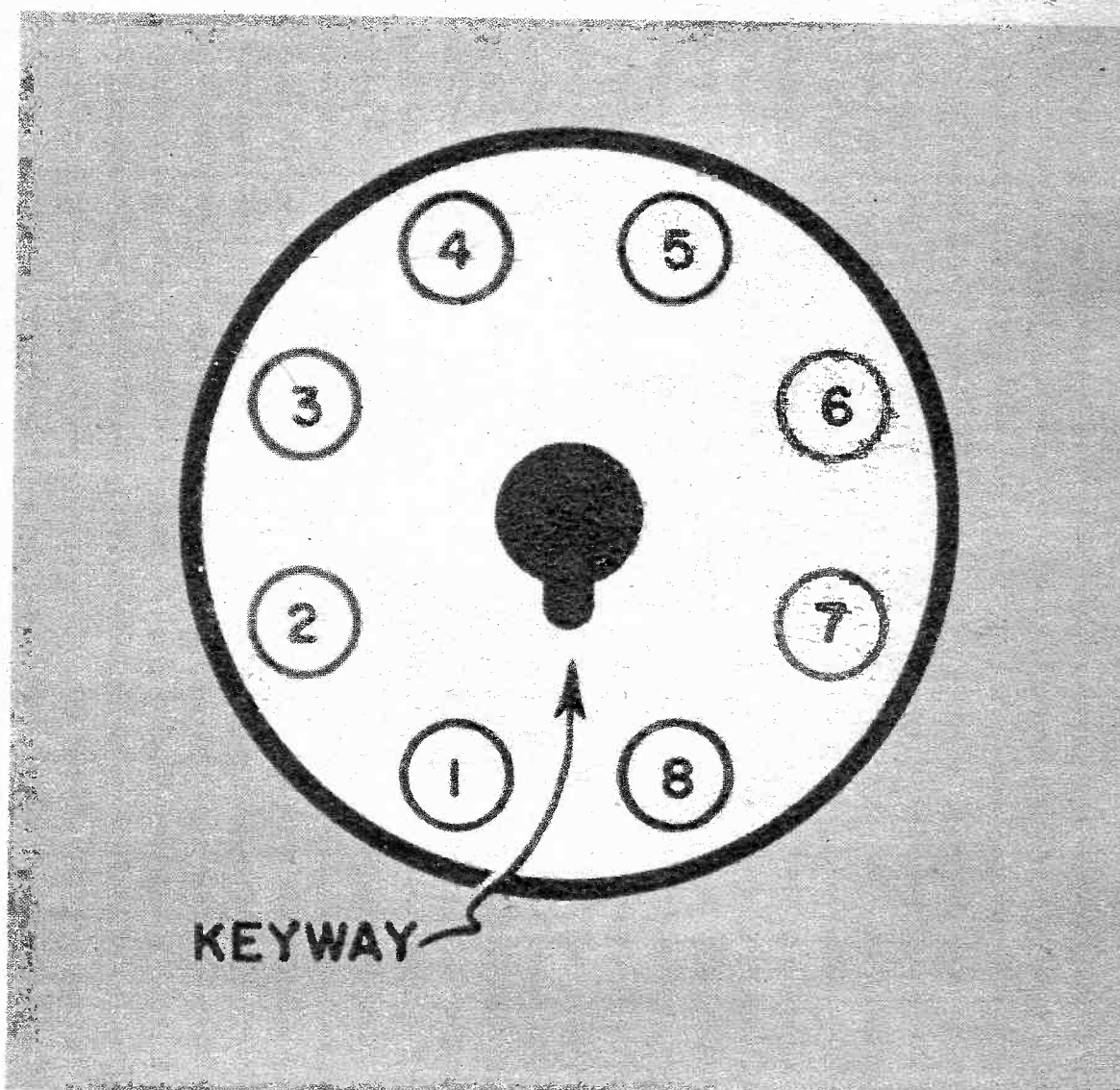

One of the pins can break off making a false keyway. Incorrect insertion can cause damage.

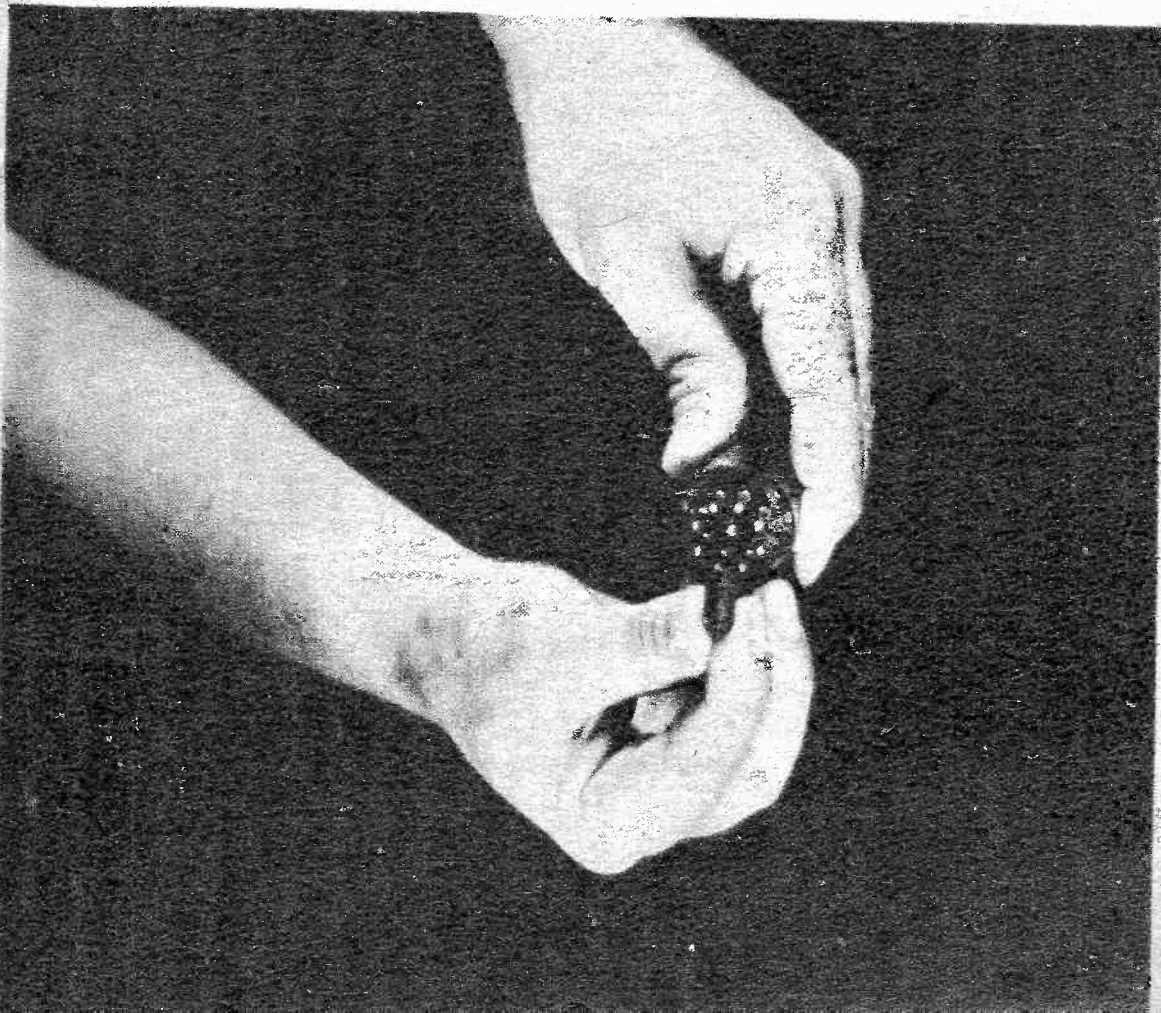

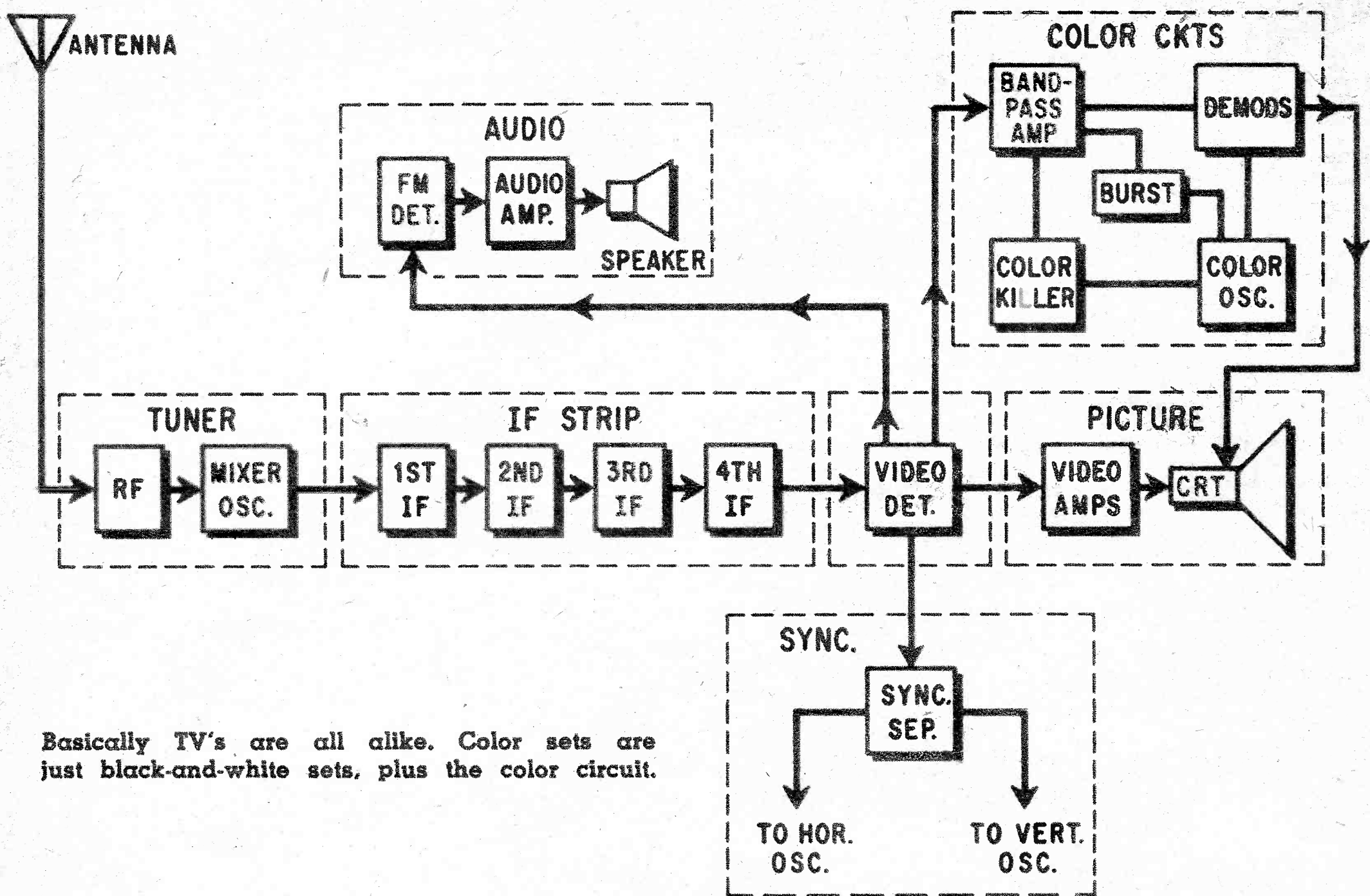

Basically TV's are all alike. Color sets are just black-and-white sets, plus the color circuit.

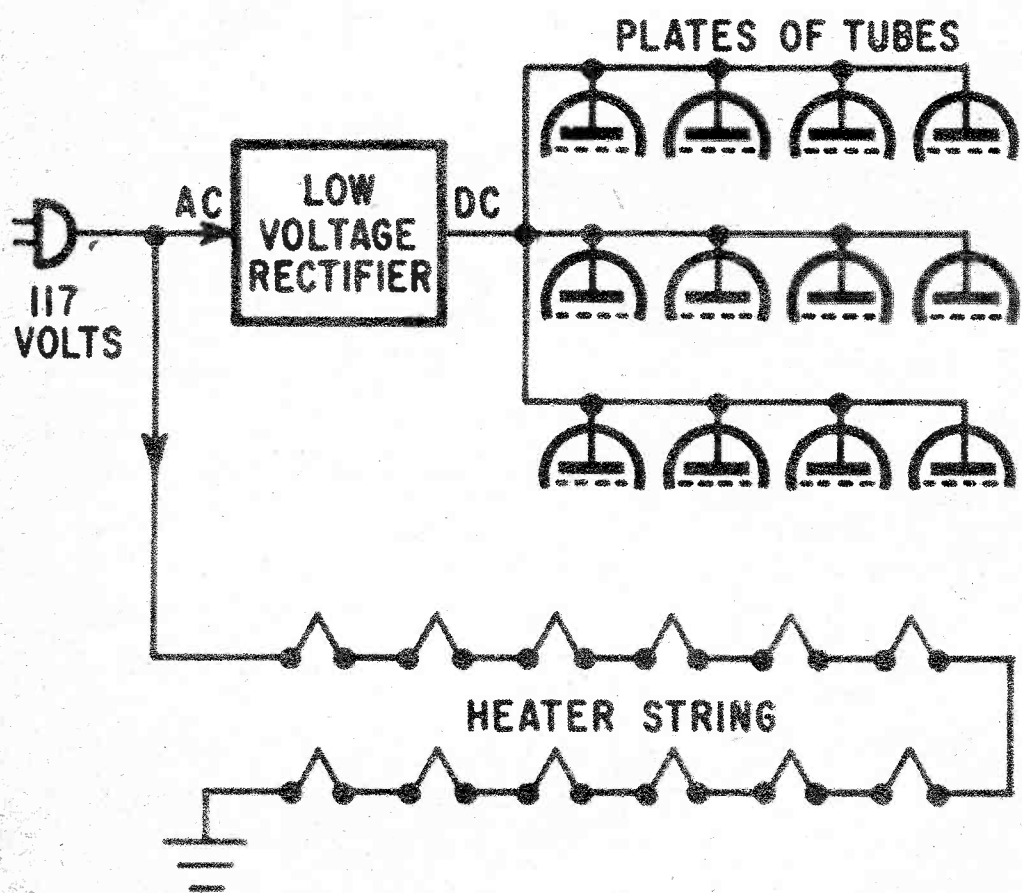

Electric power input splits in two. The first powers the plates; the other lights the tubes.

By considering the tube perimeter clockwise it is possible to judge where tube's keyway lies.

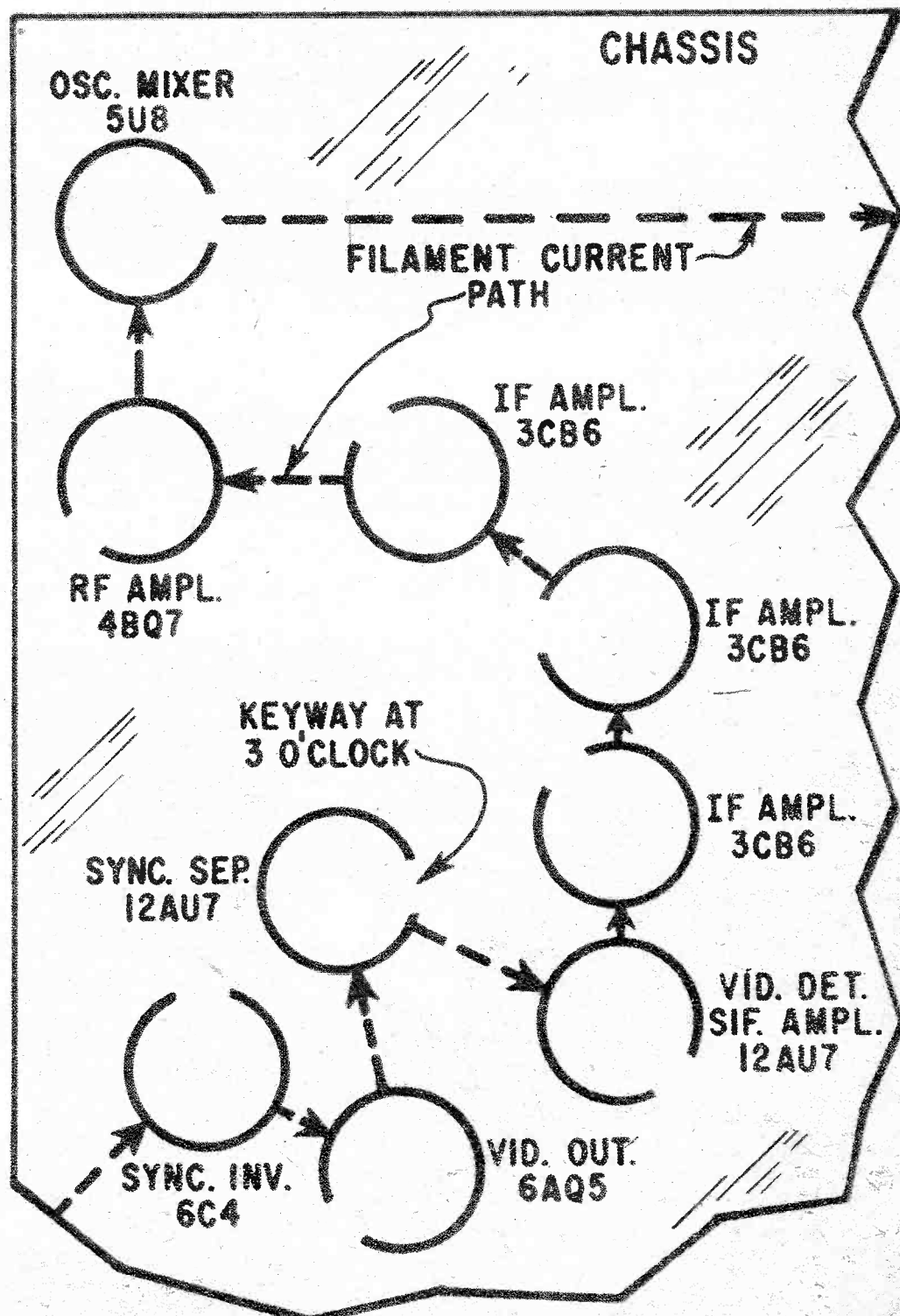



You can obtain your TV set's complete service folder and do a good job of maintenance and repair.

repair business, you only need information on your TV.

Most of the time the tube location information will suffice. However, should you want all available information, it's easy to get, and valuable to have.

Further information contained in the service folder of your TV are 1—Take apart and put together instructions step by step. 2—List of servicing tips peculiar to your TV. 3—Detailed schematic. 4—Pictures of all angles of the chassis and cabinet, labeling each part. 5—Complete parts list and suitable replacements. 6—Two tube locations are from the top and one from the bottom. 7—Detailed tuner, IF, horizontal phase, AGC, color setup and alignment instructions, step by step. Plus other things.

How can you get this information? Sometimes it's contained with the operating instructions when you buy the TV. Another approach is to write to the manufacturer of your TV giving him exact model

SERVICE HISTORY CARD

DATE	TROUBLE	PARTS
6-13-66	No Color	Bandpass Amp—6X9
7- 1-66	No Brightness (called TV Man)	Hor. Out—6JR6 H. V. Rect.—3A3
8- 4-66	No Brightness	H. V. Rect.—6BK4
9-16-66	No Color	Adjusted Color Killer

It's a good idea to keep a service history card. It will actually help you repair your television.

number. Lastly you can order it from any electronic supply house either in your area or by mail order.

There is one other bit of service information that you can provide yourself. This is a service history of your TV. Keep a card containing the date, the trouble that occurred, the remedy and your cost of repairs. This can be valuable to you. •

CHAPTER 3

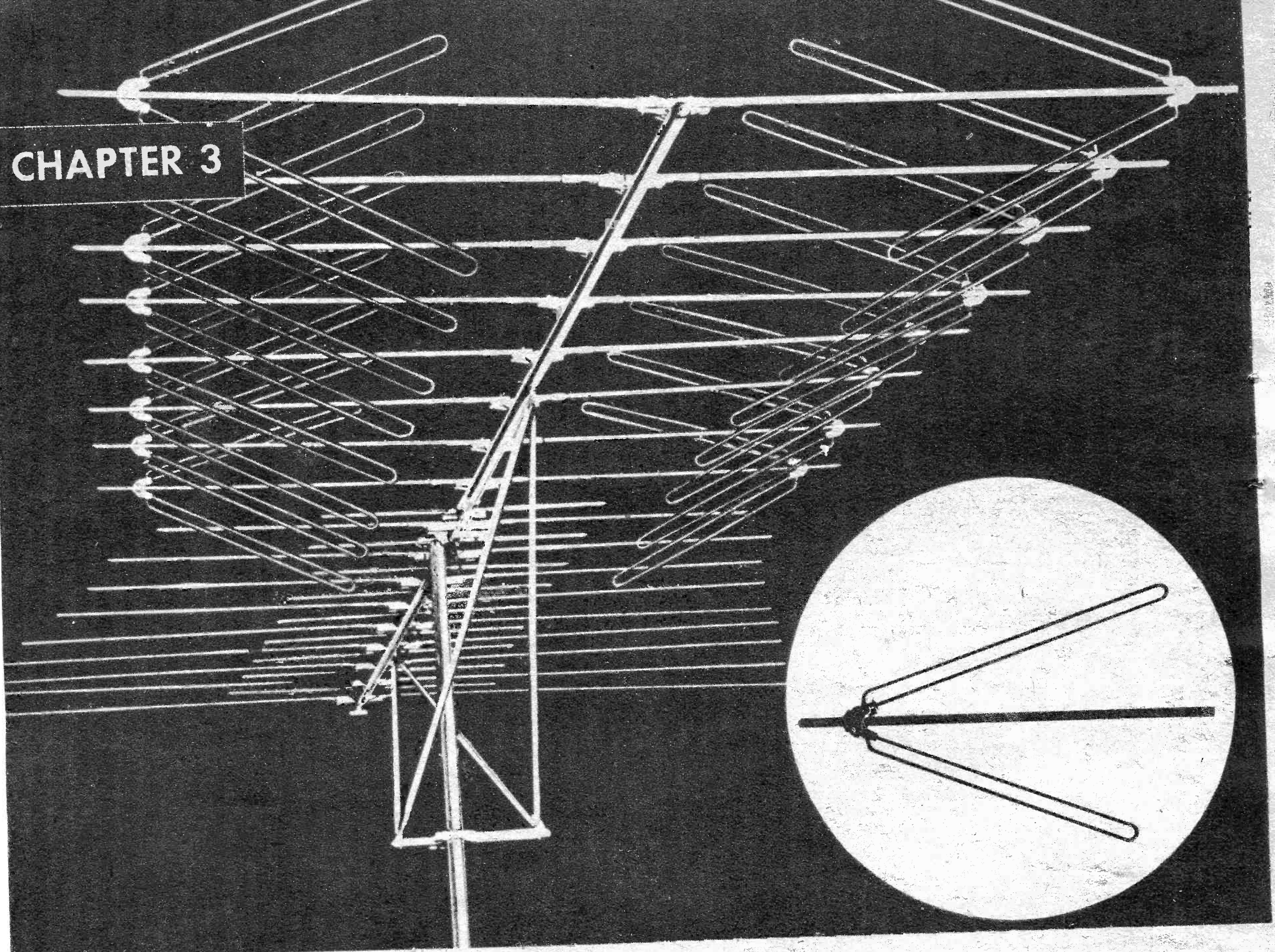

Courtesy of Channel Master

Getting the Best Antenna

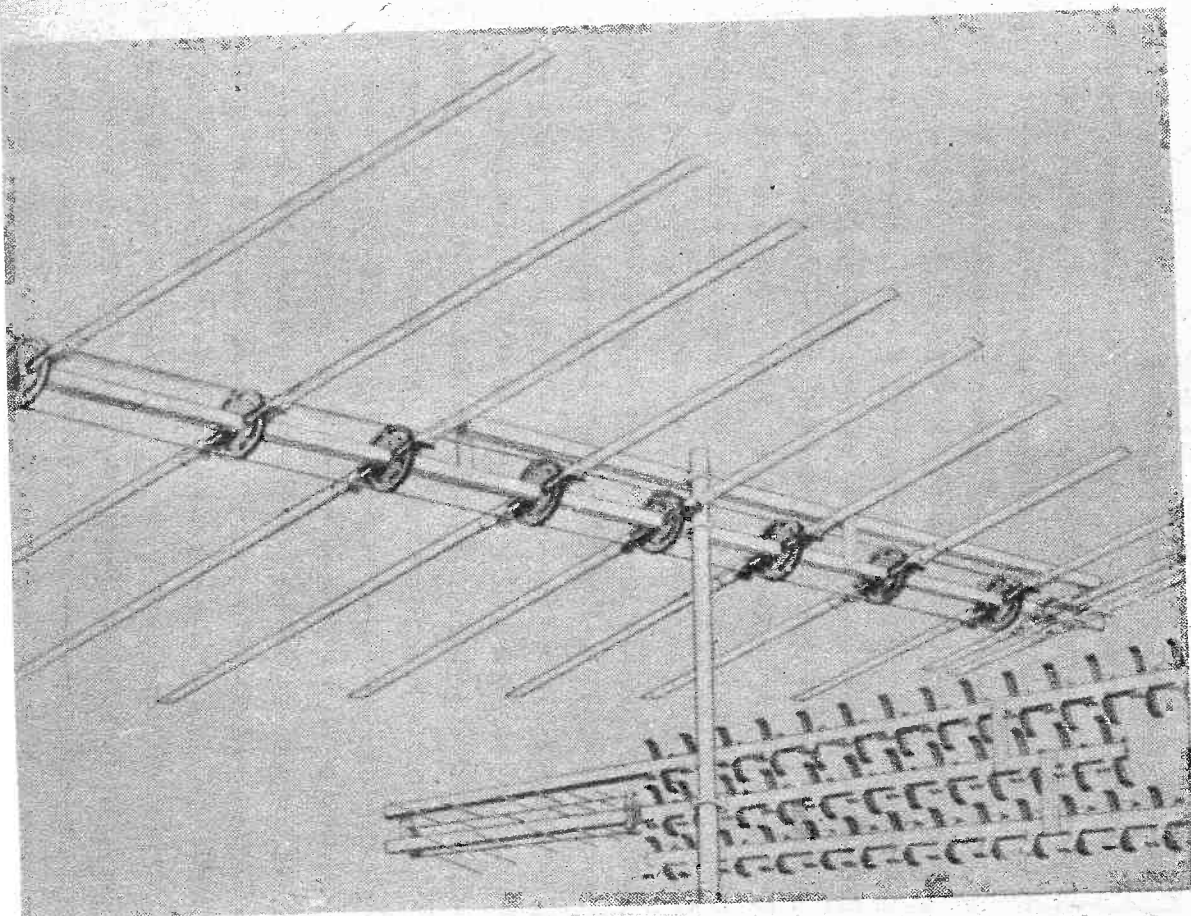

Courtesy of Jerrold Corp.

Here and at top are two super type antennas. They and those from other companies pull excellent TV.

IN THE LAST few years, with the general overall increase in TV transmitter power, and the expansion of color and UHF programming the public has been going into fancy TV antenna rigs. It's not uncommon to find TV's that can pull a channel for every number on the dial plus three or four UHF stations.

If you look on roofs you'll find high, multielement, motorized, guyed down antenna systems. Every so often you can see the antenna lumber around from direction to direction as the set owner changes channels.

What's it all about? How can you improve your channel grabbing ability? All it takes, is a little briefing on antennas, purchasing the right antenna system and getting it installed. Let's go through how you can get, or be sure you have, the best antenna.

One of the considerations of good color reception is a wider diameter for antenna elements.

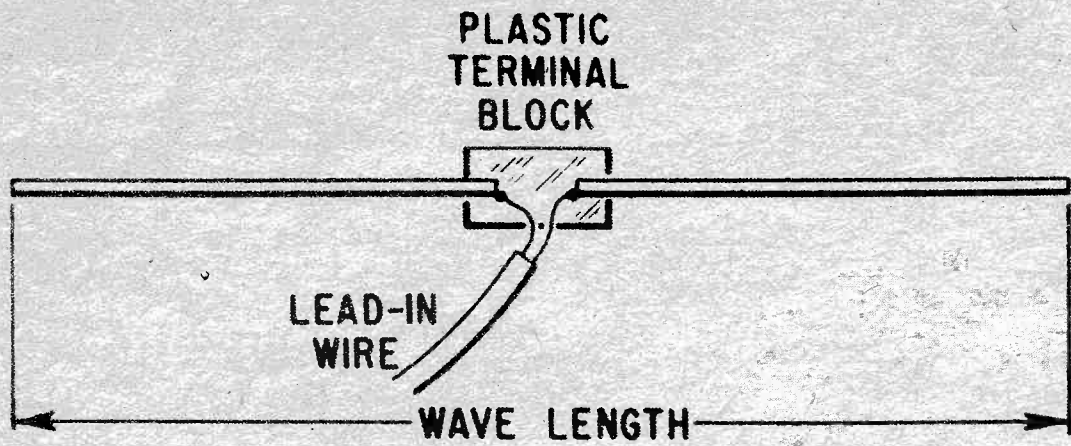

A dipole or driven element is nothing more than two equal metal sticks mounted on an insulator.

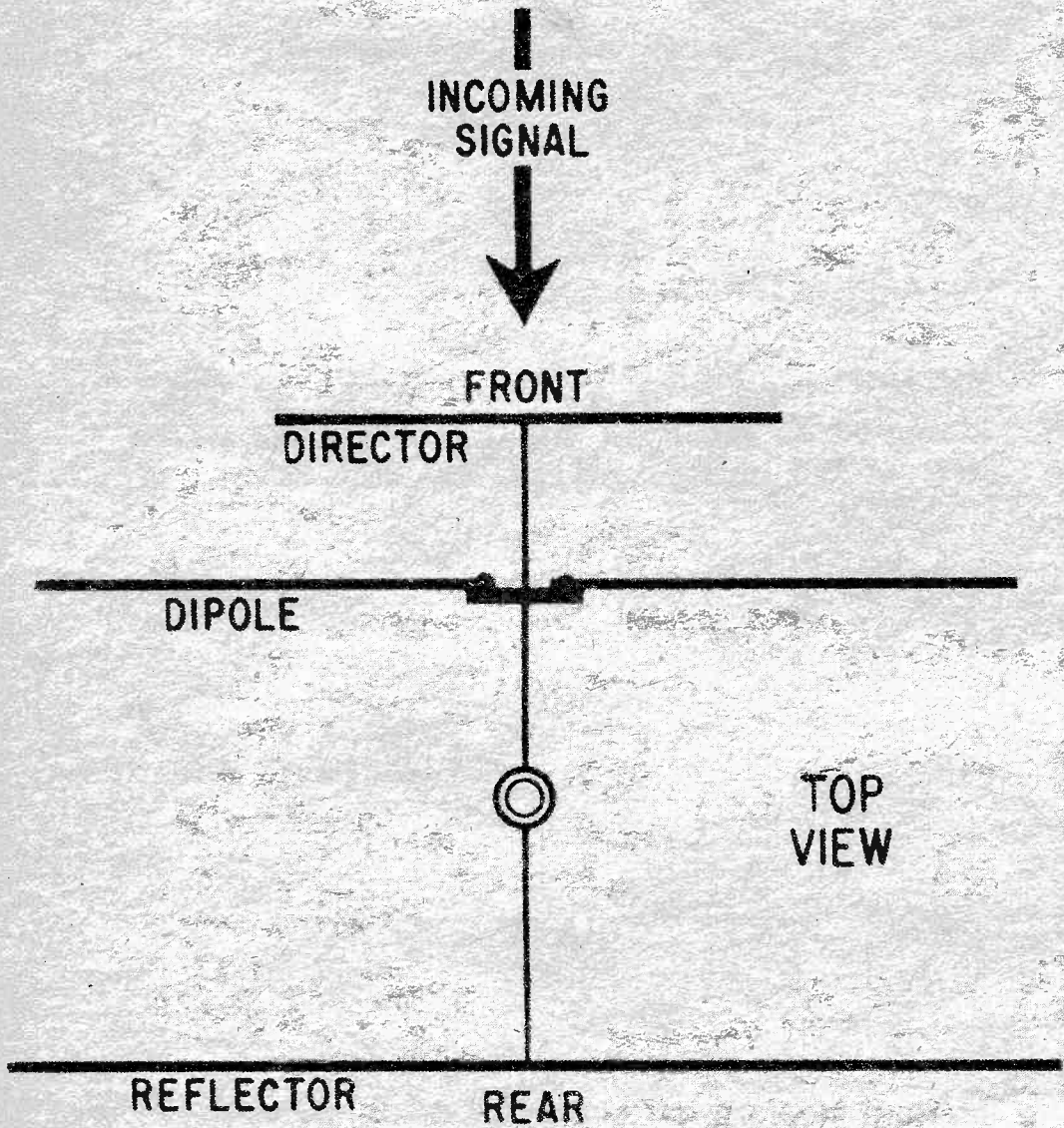

All the elements in the antenna stand broadside in a horizontal plane to the incoming TV signal.

Antenna Pieces

All the antennas on the market look somewhat the same. They are made up of specially sized dipoles, reflectors and directors. In order for your antenna to pull all channels, and respond well to color at the same time, certain requirements are demanded of the elements.

DIPOLAS: A dipole is two metal sticks that are physically held together by a plastic terminal block that insulates each arm from the other. The lead-in wire is attached to each of the elements on the ends where the metal touches the insulator. The dipole is cut at a particular half wave length and is the live or driven element of the antenna. The energy it absorbs is sent directly to the TV set.

Each station is assigned a certain wave length to transmit at. The wave length is

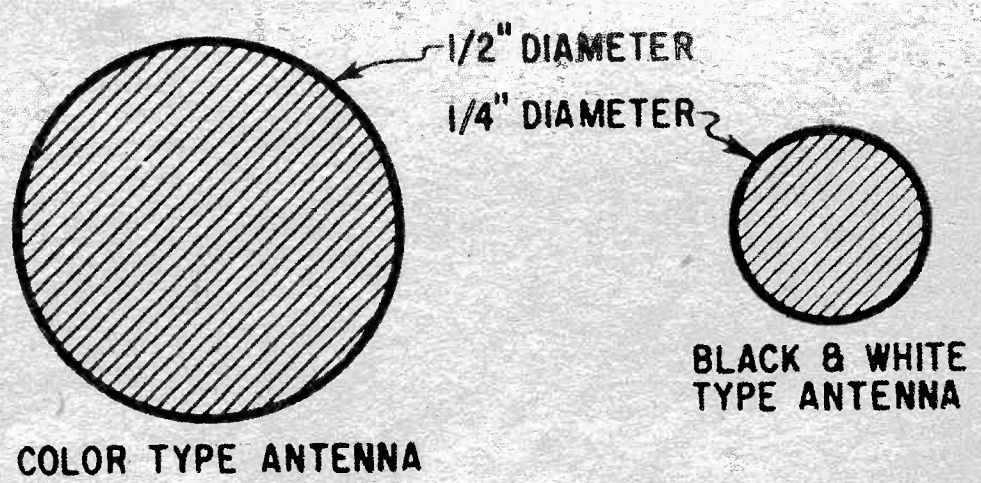

ANTENNA LENGTH CHART

CHANNELS	1/2 WAVE LENGTH INCHES	CORRECTED FOR END EFFECT
VHF LOW BAND		
2	97.2
3	88
4	80
5	70
6	65.2
VHF HIGH BAND		
7	31.2
8	30.2
9	29.2
10	28.4
11	27.6
12	26.8
13	26
UHF BAND FULL WAVE LENGTH INCHES		
Representative Group		
14	25.0
29	21.0
48	17.5
64	15.3
75	14.1
83	13.3

Antenna length chart shows actual length to cut elements. Note: UHF lengths show a full wave.

the actual length in inches of the carrier wave that flies invisibly through the air. The higher the channel the shorter the wave length. Channel 2 is 200.2 inches, channel 13 is 54 inches and the UHF channels a few inches each.

A piece of metal cut 54 inches will absorb some of channel 13's transmitted energy. It has also been found that if you cut a piece of metal 27 inches or a half wave length, it too will intercept signal from 13. Not quite as strong as the full size but enough to be practical. Since the smaller sizes are easier to handle you'll find most antennas cut for a half wave length. The cut metal is in reality a complete tuned circuit. The size tunes it.

COLOR RESPONSE: When you have only black-and-white reception to contend with, an antenna could have either a broad or narrow frequency response. A TV chan-

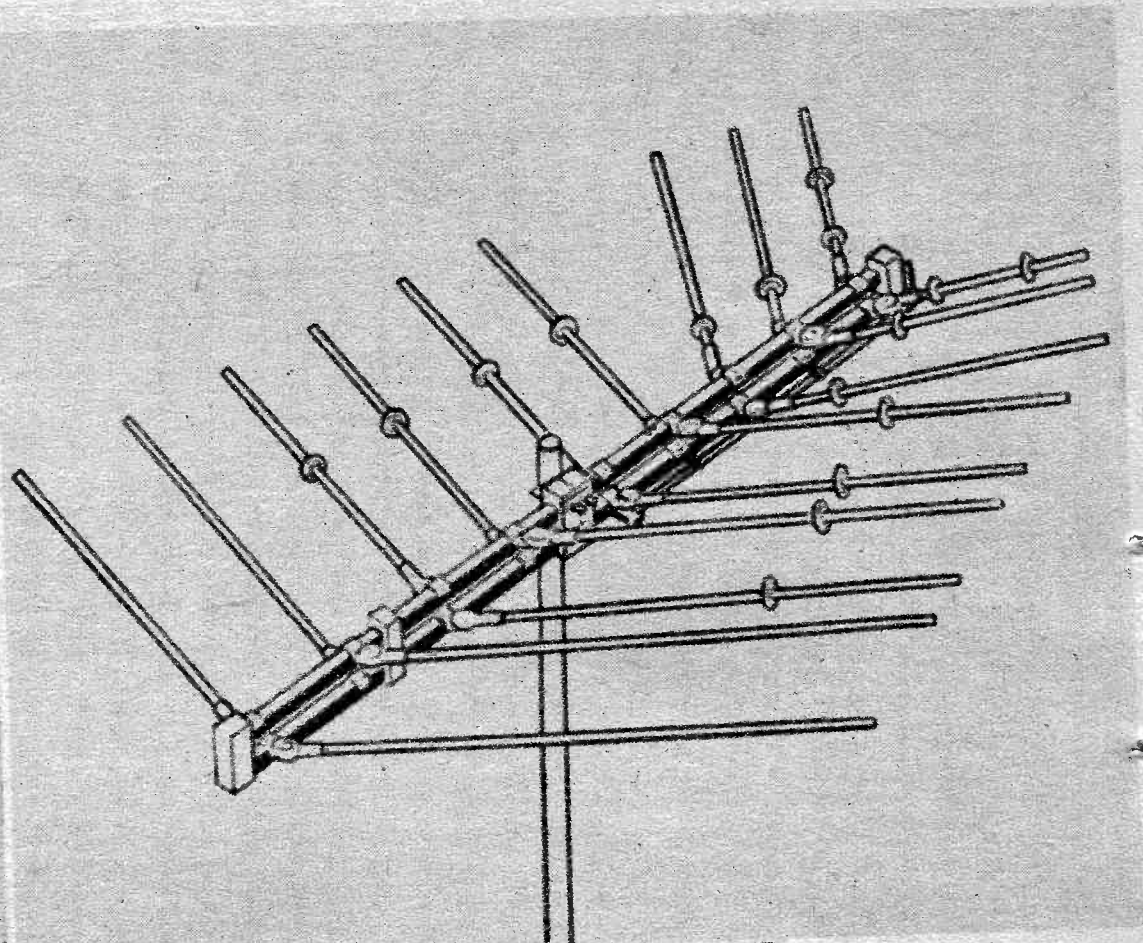
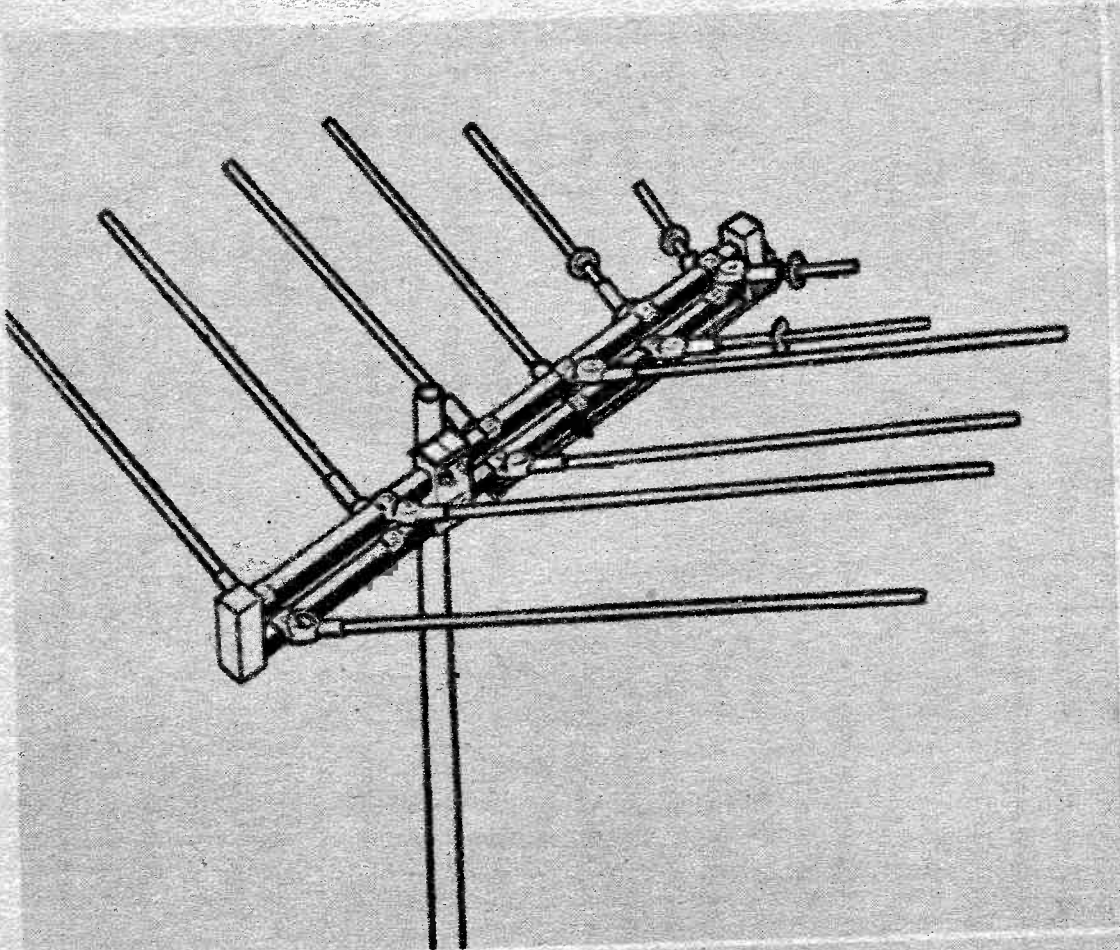

Courtesy of JFD Electronics

As this family of LPV's increase in size they increase in mileage pickup: from 60 miles, top left, to 90 miles, above, to 150 miles, at left.

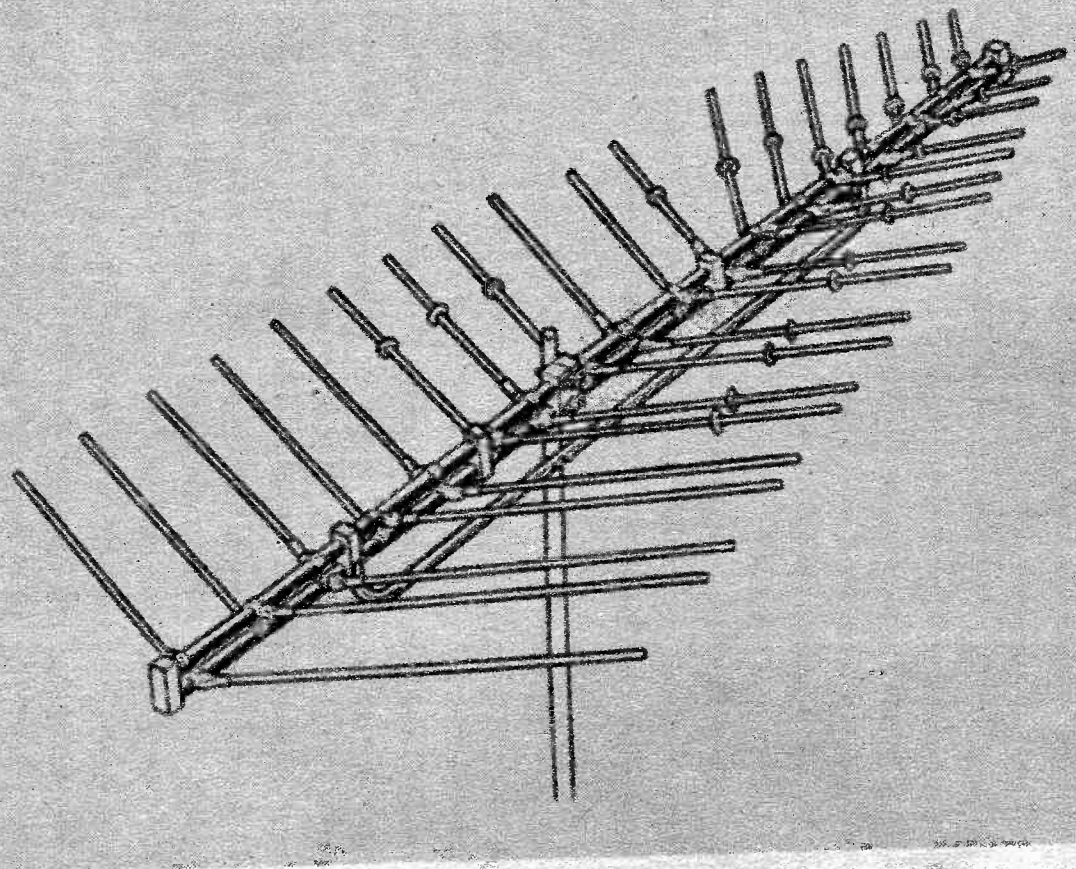

At top, opposite page, is another antenna that exemplifies high gain band pinpoint directivity.

Besides a good antenna the addition of RF stages with booster, at right, makes gain even greater.

nel is 6 megacycles wide. As long as an antenna responds to a narrow portion of the 6 megacycles it is satisfactory for black and white. However the antenna must respond broadly to all six megacycles in order for good color reception. To accomplish this an antenna stick must have a thicker diameter. Not much. An extra quarter of an inch will do, but for color it must be there.

REFLECTORS: A reflector looks like a dipole but is a parasitic rather than a live element. The lead-in wire is not attached to it and there is no insulator on it. It's cut a bit longer than the dipole. It absorbs signal strength from the air, then radiates the signal back to the dipole. It is usually placed behind the dipole and blocks off any signal that tries to come in the rear entrance.

The addition of the reflector to the dipole

increases the gain and makes the antenna more directional since signal can only come in through the front entrance and not the rear.

DIRECTORS: A director looks like a dipole but is another parasitic element. It's cut a bit shorter than the dipole and is usually placed in front of the dipole. The director as the name implies sharpens even more the directivity of the antenna by adding front gain.

All-Channel Antennas

To pull every color channel around the dial ideally, you should have twelve separate antennas each containing a wide band dipole, reflector and director.

In effect that's what these large multi-element TV antennas are, a separate antenna for each channel all hooked together.

There are many types but four of them

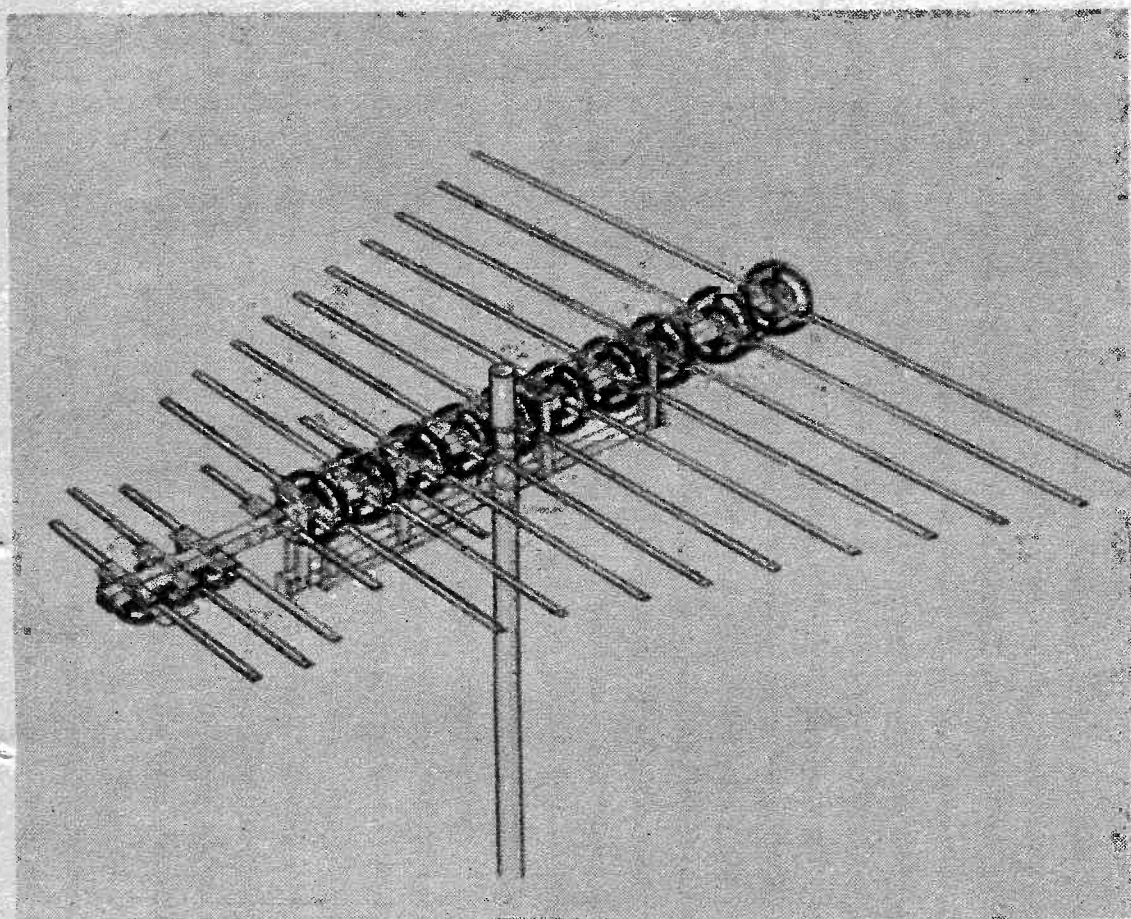

Courtesy of Jerrold Corp.

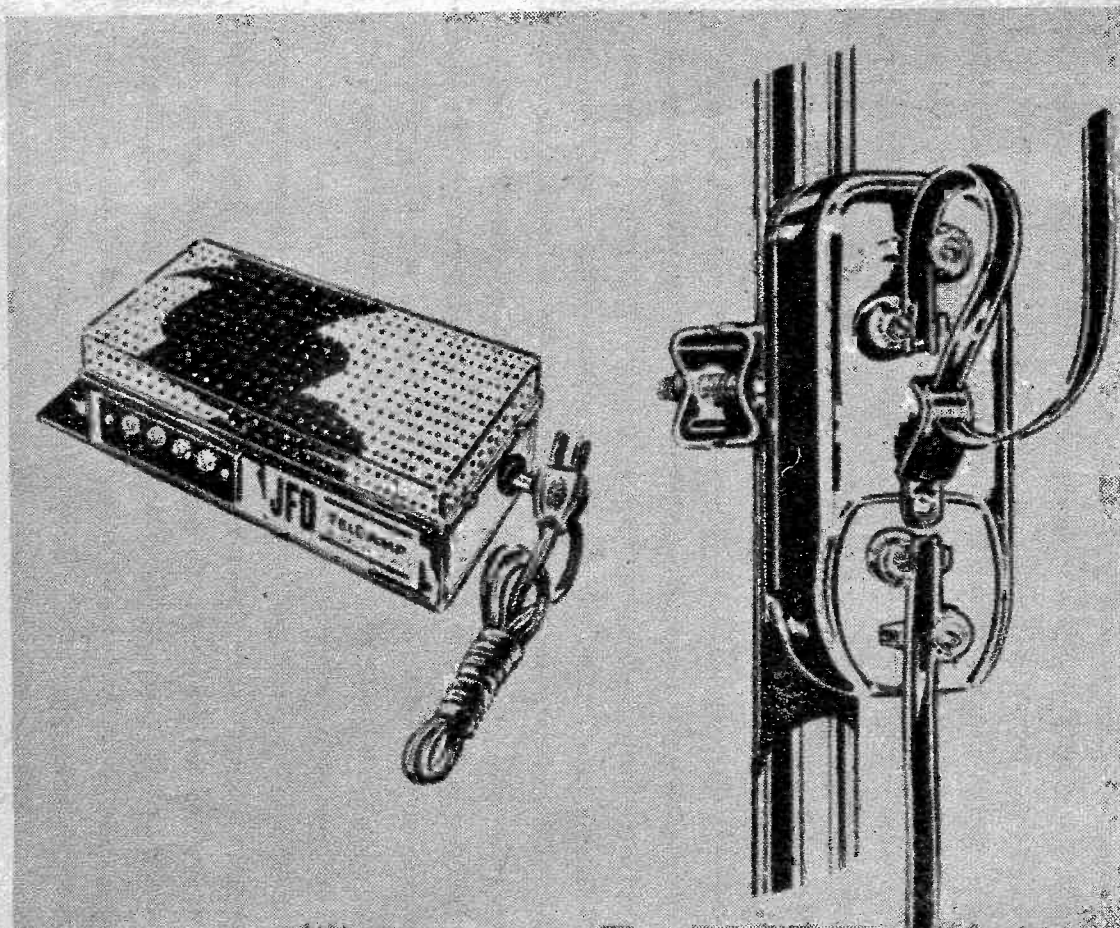

Courtesy of JFD Electronics

are popularly used. The types come in families. For instance there are 50 milers, 75 milers, 100 milers, 125 milers, etc. The larger the distance you desire to pull, the larger and more expensive the antenna rig becomes.

The JERROLD PARALOGS: This is a color designed antenna that works on the principle of providing a driven element for every channel or for every group of channels. A few directors are added here and there. All the driven elements add together and reinforce each other. This produces great gain and good directivity. One feature are those round insulators that are made extra heavy-duty and shaped so rain won't collect on them thereby giving longer trouble-free performance.

The CHANNEL MASTER CROSS-FIRES: This family of antennas uses a few less driven elements and balances the sys-

tem out with more reflectors and directors. The Channel Master engineers dubbed the operating principle as Proportional Energy Absorption. This means that every effort has been made to absorb each channel on an equal power basis. The antenna does not respond to any one channel better or worse than the others.

The WINEGARD COLORTRONS: This antenna uses only two driven elements with all of the rest being directors. Theoretically a half wave director absorbs four times as much energy as a half wave driven element. That's why they use all the directors, one for each channel or group of channels. This produces fine gain and directivity.

The Colortron also takes great pains to match the antenna to the lead-in wire. This avoidance of impedance mismatch saves signal.

The JFD LPV's: The initials indicate the Log Periodic Cellular Principle. That is it uses no parasitic elements, only driven elements, one for each channel and bent forward so the signal can be absorbed on the ends of the elements. This end-fire pickup is an old tried and true principle and adds the signal together producing great gain and directivity.

Which is the best of these antennas? From my experience they all work fine. It's like asking who is prettier, a beautiful blonde, a beautiful redhead or a beautiful brunette?

The important thing is that the antennas have fine gain, and exceptional directivity. Whether it is due to many driven elements and a few directors conventionally placed like the paralog, balanced number of directors and driven elements like the Cross-fire, many directors and few driven elements like the Colortron, or end-fire-placed driven elements like the LPV, a proven principle is being used to boost pickup and broaden pickup response many, many times over ordinary antennas.

In order for you to get best TV reception for color and be able to reach out of your signal area for additional channels, you'll need one of these powerful all channel antennas or one like them.

Extra Added Attractions

The antenna is not the only item available to increase gain. There are many types of electronic signal boosters that can be added to the antenna that will produce more gain.

SIGNAL BOOSTERS: The best place to install a signal booster is right on the antenna and run the lead-in wire from the

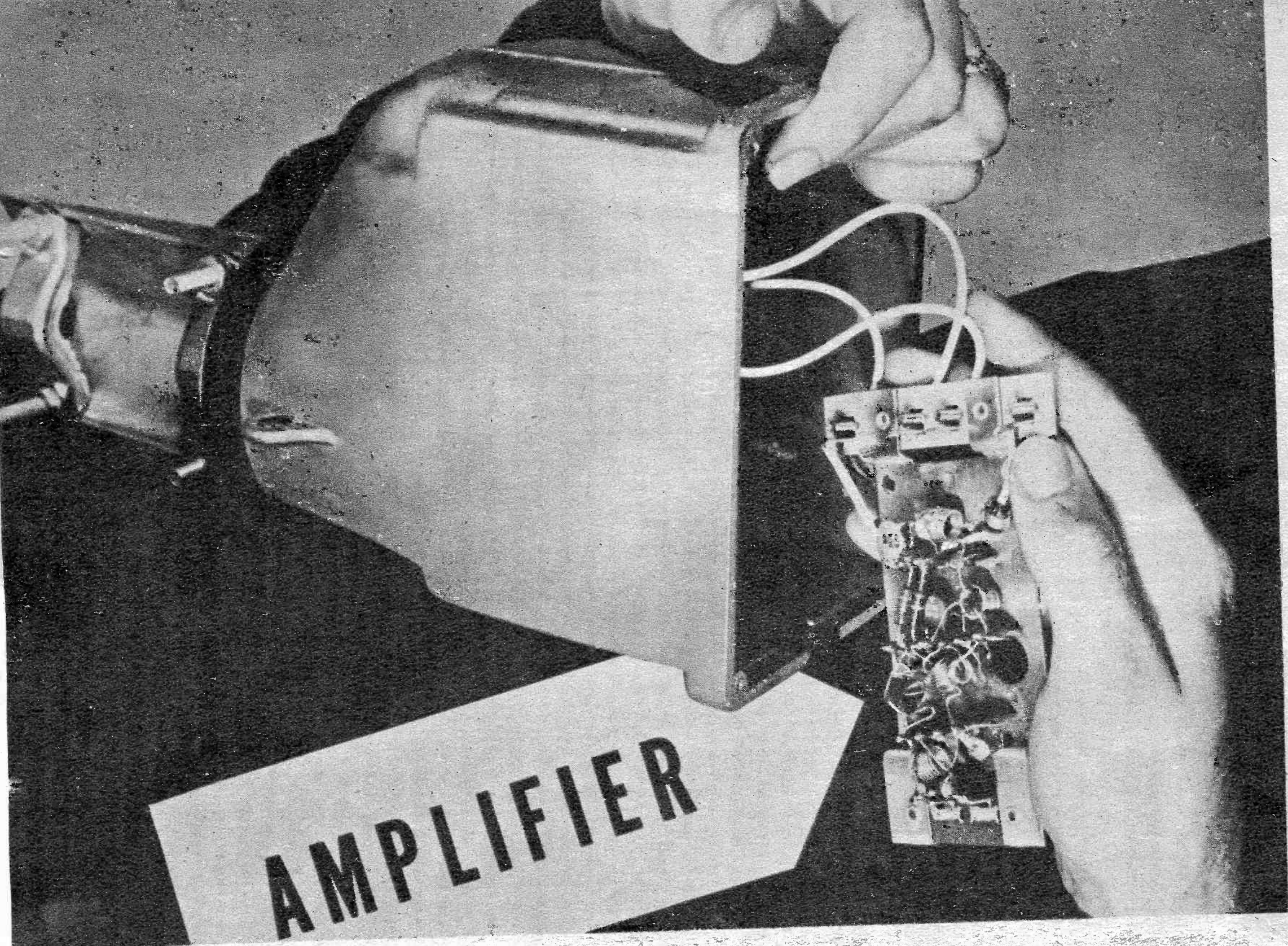

AMPLIFIER

Courtesy of Channel Master

A novel approach and good weatherproofing idea. The outdoor signal booster is inside the rotor.

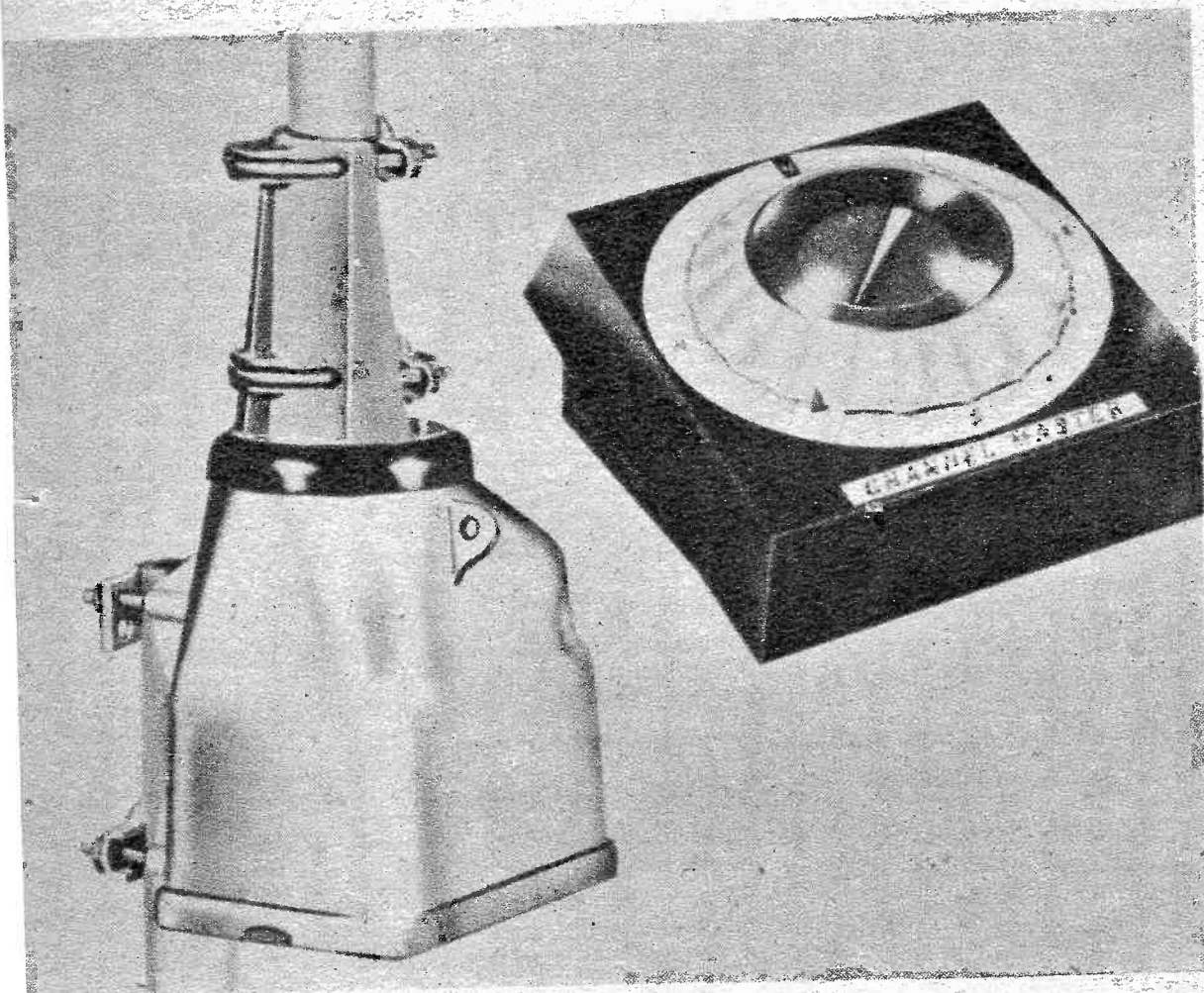

When you open a new rotor you'll find the control box packed with it. All you need is wire.

Since the advent of color, coaxial cable has been found to perform better than twin lead wire.

ACTUAL ANTENNA

WEATHERPROOF CASING

WOVEN COPPER WIRE

SOLID CORE

72 OHM TRANSMITTER

CO-AXIAL CABLE

FLAT TWIN LEAD

300 OHM TRANSMISSION LINES

POLYETHYLENE CABLE

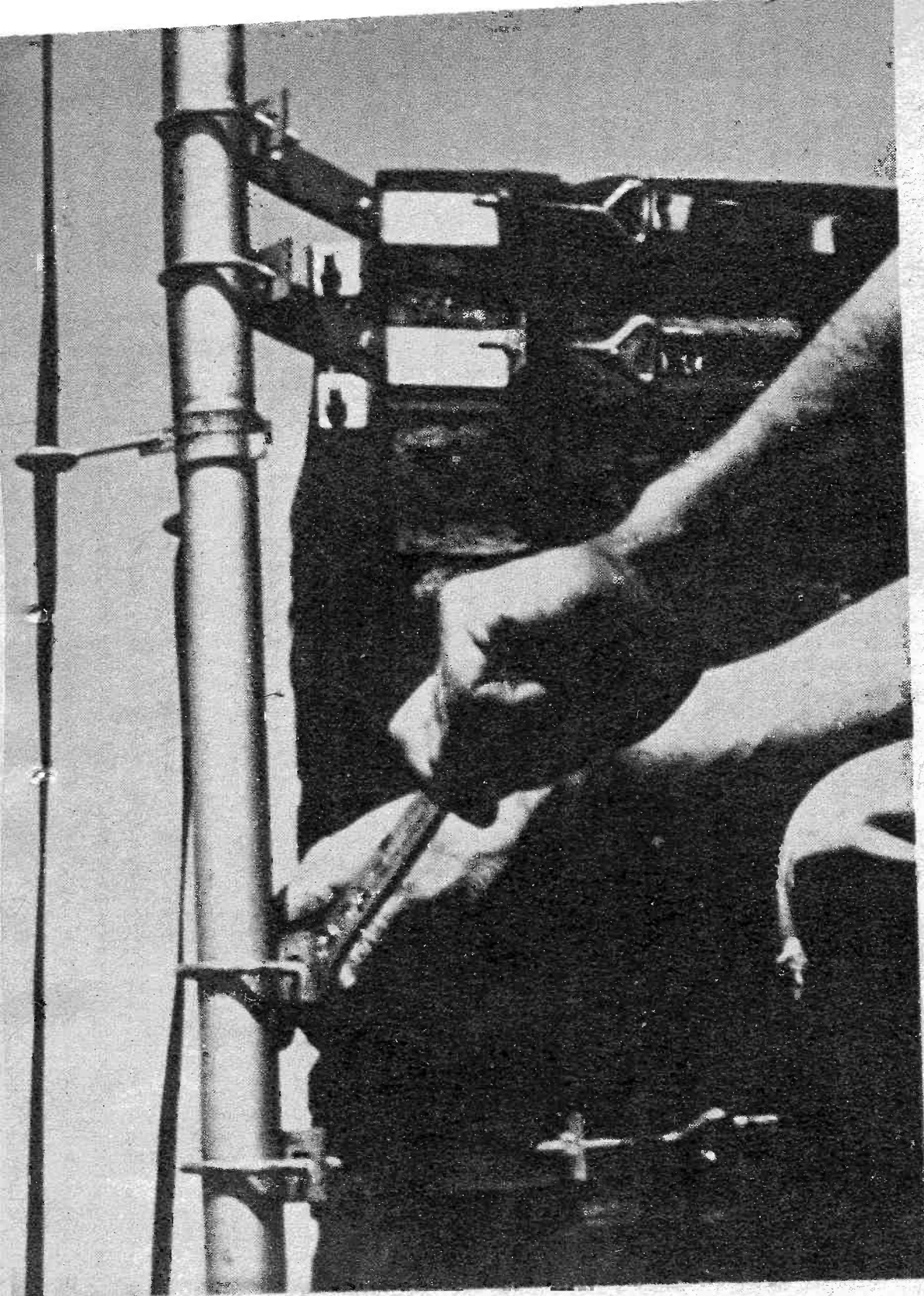

When installing a superantenna, don't skimp on the chimney straps. Instead of two, use four.

booster itself. That way the signal is pure from the antenna elements with no extraneous interference or weakening of the signal. Once the signal gets into the lead-in it is subject to all kinds of static and other weakening influences.

The best type of booster to install is one that matches your antenna. The matching characteristic of impedance is usually 300 ohms for most antennas and about 72 ohms for the rest. Find out what the impedance of your antenna is and get the correct booster. If you get the wrong one, a large percentage of gain is lost defeating the purpose of the good antenna.

Boosters come in tube or transistor models. The tube or nuvistor type is the old reliable and works well. It is stable and can pass large amounts of signal as well as small amounts. It's not quite as powerful as the transistor type but is more stable.

Transistor boosters have more gain than tube types but the ones I've seen can't handle large amounts of signal. They have the tendency to overload. Transistor types are not advised if there are local stations. They function best in a fringe area where all reception is weak.

ROTORS: The word rotor was coined from motor and rotation. That's what it does to the antenna and that's all. A popular misconception is that the motorized antenna performs some kind of signal gain job. All it does is rotate your antenna so you can aim bull's-eye at a station. If all your channels are coming from one direction you don't even need a rotor. A fixed antenna does the job.

However, to install one of the really superdirectional antennas and a signal booster, and not a rotor, is a waste. Even if your original intentions were to pull a special channel you'll find that simply rotating your antenna will pull all kinds of reception you didn't know existed out there.

There are many good antenna motors on the market. The Alliance Tenna Rotor, the JFD Rotator and the Channel Master Rotor are old favorites. They come in good, deluxe and super-deluxe models. Each step-up gives you a heavier duty motor and a fancier, easier to work control box. Basically they perform only one function though. They aim your antenna at the station. This is almost mandatory for color TV.

LEAD-IN WIRE: With the wide acceptance of color, changes in lead-in philosophy are taking place. The lead-in question has always been, twin lead or coax?

Coaxial cable has an impedance of 72 ohms. It's heavy duty and well insulated from the weather. It can be waterproofed with silicon grease at the connections. It is almost interference proof. However, it's hard to work with and expensive.

Twin lead has an impedance of 300 ohms. It's light weight and not well insulated from the weather. It cannot be waterproofed and picks up interference. However, it's easy to work with and it is inexpensive.

For black-and-white TV reception twin lead is usually satisfactory, but for color TV complications arise. That's why coaxial cable is coming back into its own for color TV antenna installations.

For a new color installation I'd advise coax. It will produce better color and the wire will last many times longer for the extra price. The only problem is the tuner input. Most TV's have 300 ohm input at the set's antenna terminals, although some of the newer color sets provide a 75 ohm terminal, too. Should there be only 300 ohm input you'll need a small matching transformer on the back of the set. It's a little extra trouble but it will be worth the effort. You'll get years of better color TV performance. •

Poor reception on your television causes blurring and flicking in the picture; may cause loss of color.

Clinic for Sick Antennas

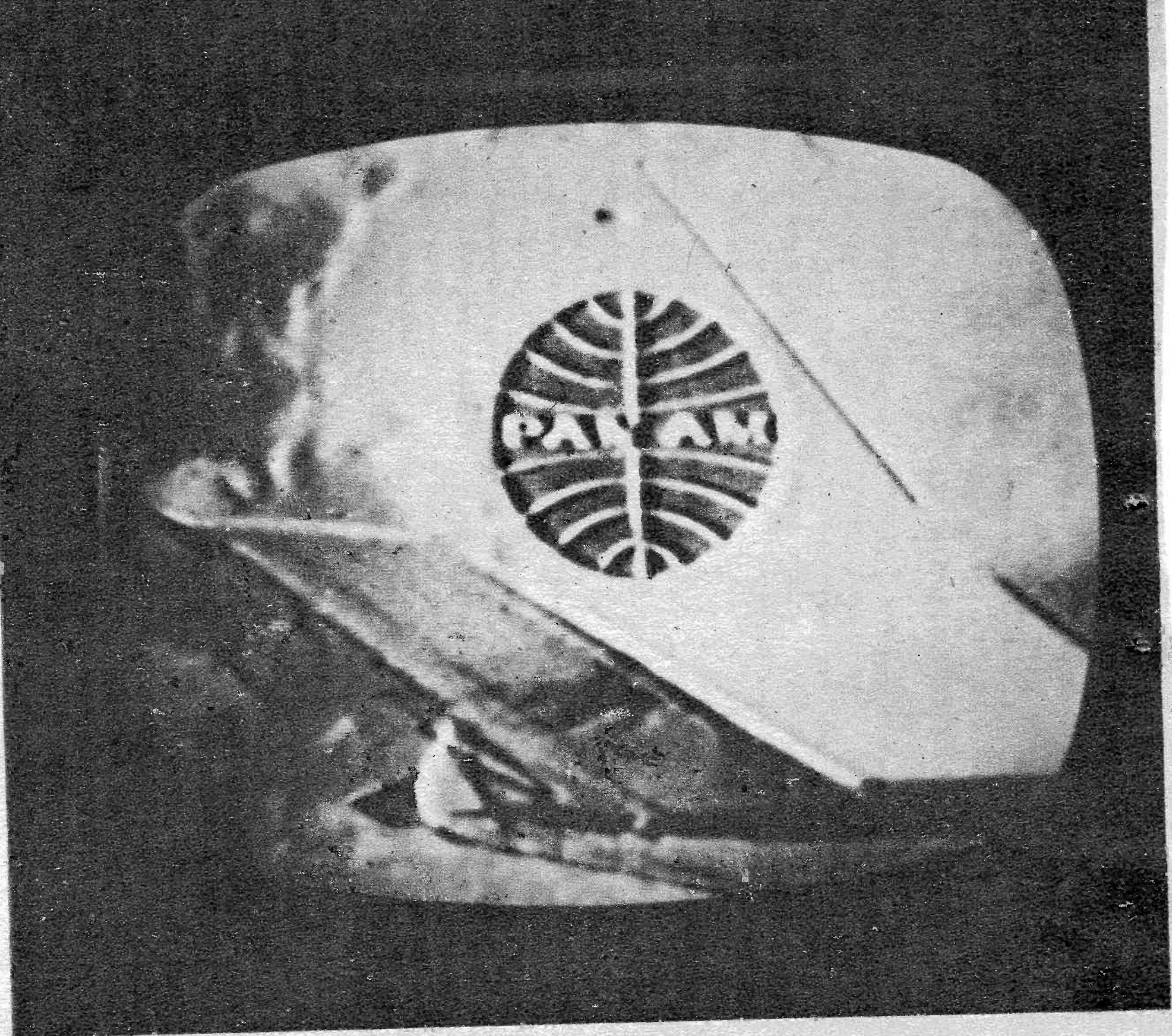

What to do to get rid of ghosts and snow, and how to restore color on the screen when the antenna is at fault

IF YOU INTEND to repair your antenna, your safety is absolutely your first consideration. Roof top work should only be performed by people who have experience with a ladder. There are two dangers on a roof and people who climb roofs should be aware of them: falling and electrical wiring. I hope I made my point. Now let's go into the ailments antennas are susceptible to.

A TV antenna can cause snow, ghosts, overloading, flashing, loss of fine detail and partial or complete loss of color. Unfortunately each one of these troubles can also be caused by a problem in the TV set too. The first troubleshooting step is the answer to the question, "Is the trouble originating in the antenna or the TV?"

You must isolate the offending system. The quick test is easy. Take a set of rabbit ears and attach it to the TV instead of the outdoor antenna. Then examine the picture again. Has the trouble disappeared? Are you now getting normal rabbit ears reception for your area? If so, the antenna is isolated as the trouble source. Or, is the trouble still just as apparent as before? If so, the TV is at fault.

Once you have decided the antenna system needs work, you begin. How does the

antenna system break down? Let's go through the various parts and see what catastrophes may befall them.

Lead-In Wire

The lead-in wire runs from two connections at the antenna, down the mast, over the roof, down the wall, through a hole in the wall to your TV set, maybe passing through a basement. The wire can become disconnected, loose, waterlogged, touched by metal, frayed or broken. The wire is supposed to be carrying the TV signal along its entire length.

In the TV signal there is the picture, sound, lock-in signals and color. A defective wire can cause loss of one or more of these passengers.

While a good blanket approach is to simply pull out the old wire and install a complete new length, you can also determine the problem with the wire and remedy it.

DISCONNECTED: When the wire disconnects from one of its terminals some of the signal is lost. If the disconnection leaves the wire a short distance from where it's supposed to be, some of the signal will bridge the gap. At any rate a disconnection can put snow in the picture, or show a good

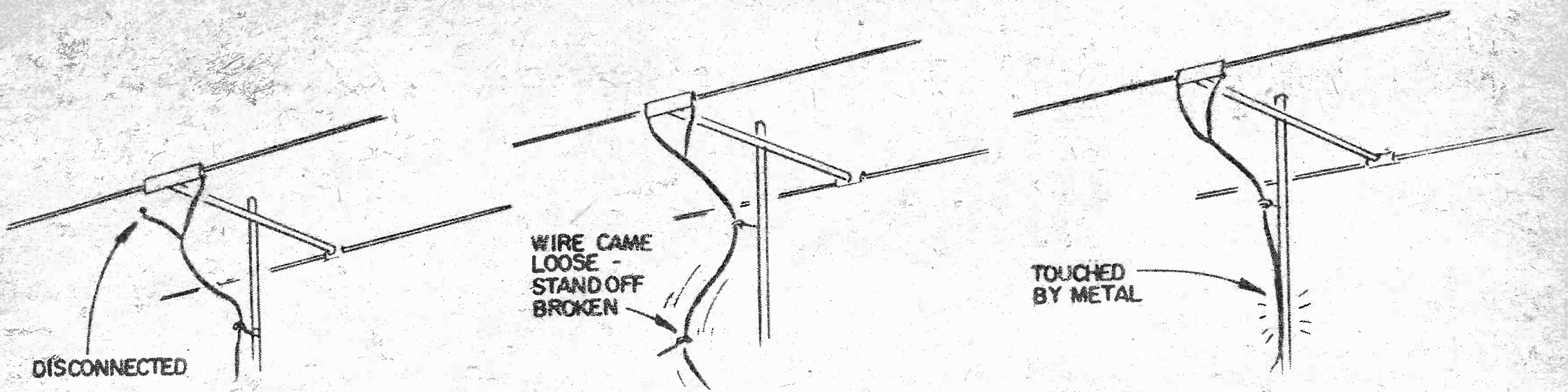

The most common maintenance reasons for poor reception is wire that becomes loose, broken or shorted.

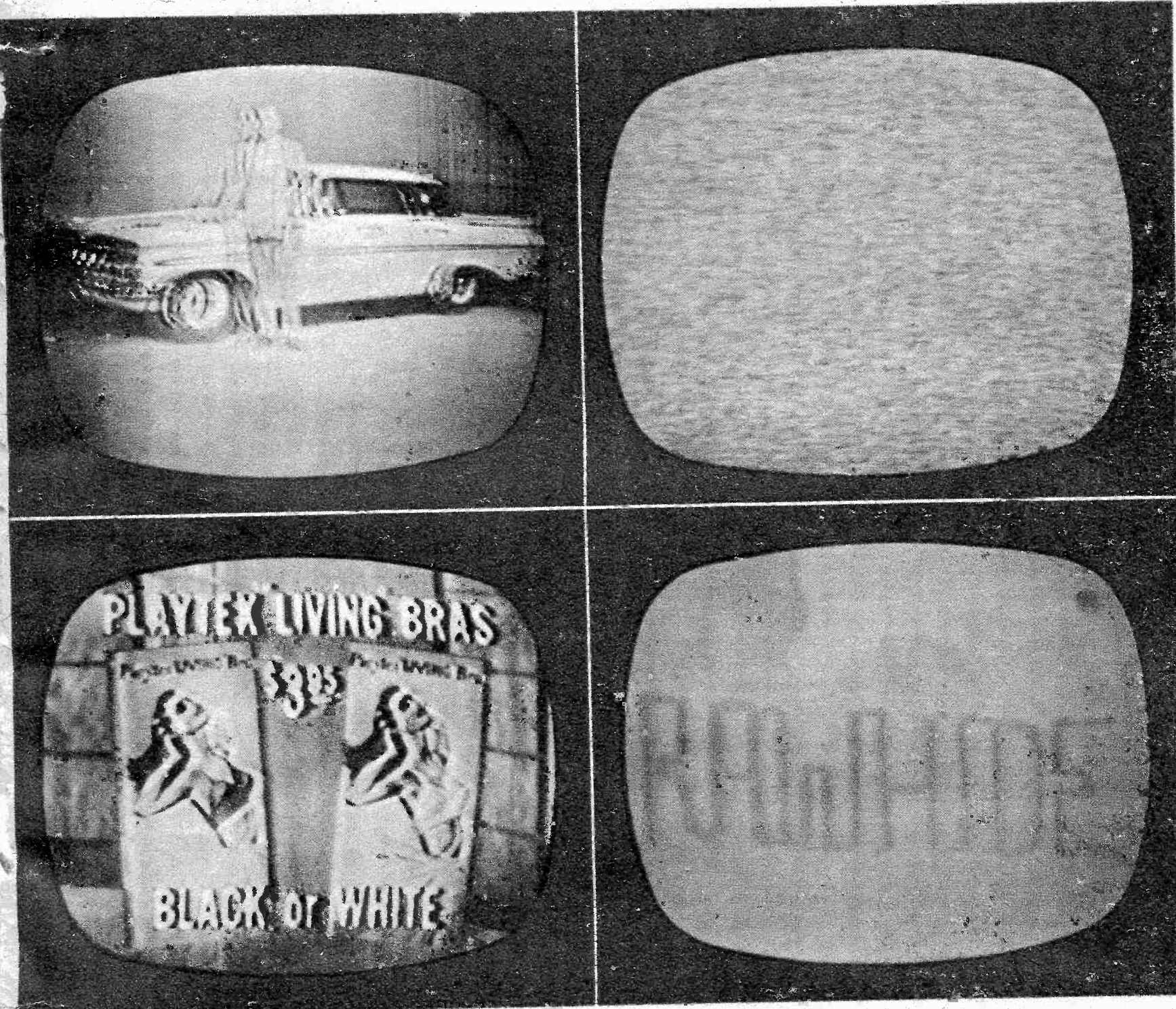

These are effects your television will show when the antenna lead-in becomes defective: ghosts, top left; snow, top right; loss of detail, bottom left; and flashing, bottom right.

picture but knock out the sound or the color, or cause the picture to roll. Disconnection is the commonest form of lead-in failure. Check the connections both top side and bottom as your first service move.

LOOSE: Throughout its entire length the lead-in should be snug. However, as the years pass the wire loosens. When this happens the wire will flap in the wind. The TV picture becomes erratic. The picture will flash, flop over or have color fading in and out. These annoyances will occur according to the degree of looseness. As a remedy snug down any loose sections of lead-in wire.

TOUCHED BY METAL: When twin

lead is installed, great care is taken to stand it off from any metal, such as rain gutters, drain pipes and even the TV mast. If you have a coaxial cable instead of twin lead you can forget about this trouble. The coax is immune to it.

However, when twin lead touches metal an impedance bump develops at that point. An impedance bump blocks off TV signal just as dirt will in a pipe. The bump also bounces the signal back up the wire. These standing waves cancel out some of the signal and also cause other signals to enter the TV at the wrong time. The trouble shows up as loss of fine detail and loss of color intensity on the screen.

If the signal booster on your TV set goes bad, it can cause one of these four picture symptoms: snow, at top left; rolling, at top right; hum bar, bottom left; and an overload, which warps pictures.

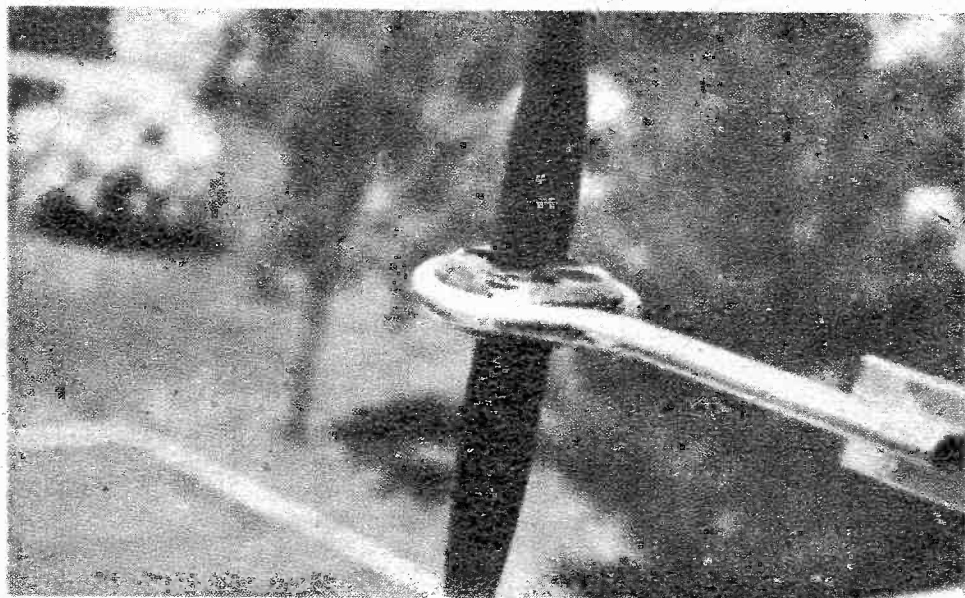
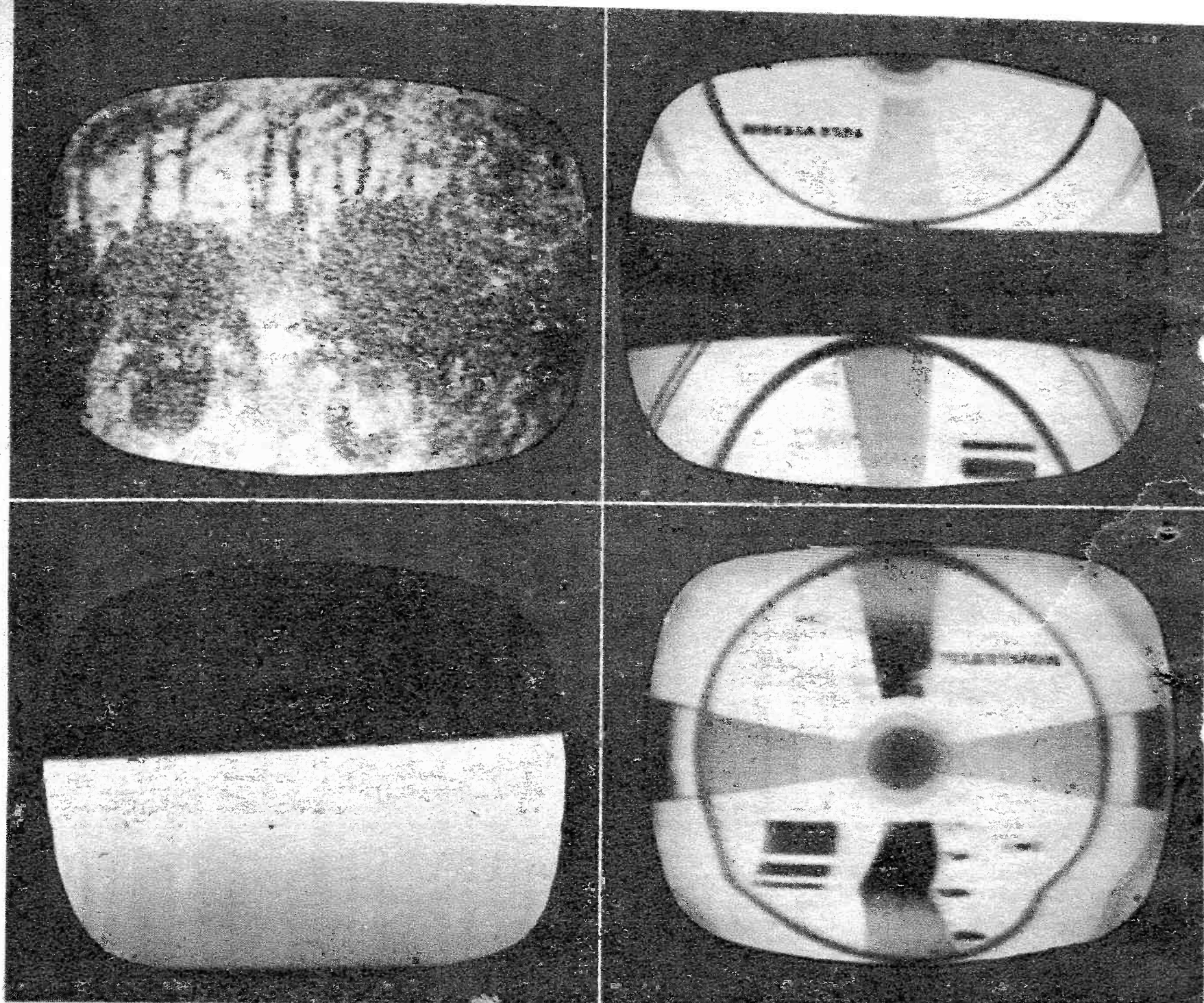

If standoff insulator breaks off it can cause much distortion. Check and replace broken insulators.

Aim your television antenna in the direction of the transmitting station for the best reception.

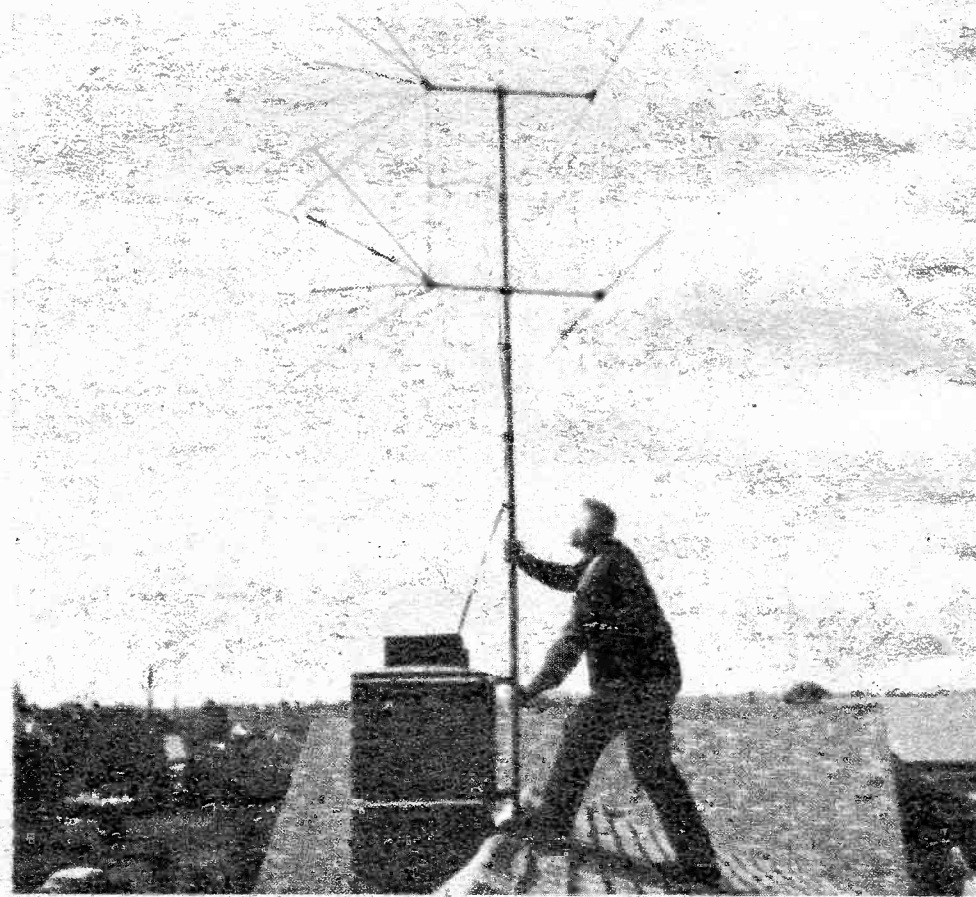

If you are using twin lead inspect the wire periodically to be sure it's not near metal. New insulators should be used to stand off any areas that do touch metal.

FRAYED OR BROKEN WIRE: This trouble usually cannot be detected visually and so becomes difficult to pin down. You can diagnose it, but finding the actual fray or break can be tricky. The trouble can produce snow, flickering, ghosts, loss of color, etc. Shaking the wire will sometimes accentuate the trouble.

When you suspect a fray or break, the best approach is to simply replace the entire length of lead-in wire. If the wire is over a year old this is the smartest move. Should the wire be fairly new or if you just want the satisfaction of finding the actual

trouble spot, here is how it can be done.

You'll need an ohmmeter. Disconnect the wire at the TV antenna terminals. Twist the two ends together to cause a short. Then working toward the antenna, pierce the insulation with the meter probes and take a reading. With the probes still attached shake the wire. As long as the meter reads short you haven't reached the break. As soon as it reads open or the needle acts erratic you have just passed the break. It lies between that reading spot and the last one. Zero in on it from there. Then you can replace the bad section of wire.

STANDOFF INSULATORS: These items break or come loose. It is usually obvious when this happens and a visual inspection of each one reveals the faulty one.

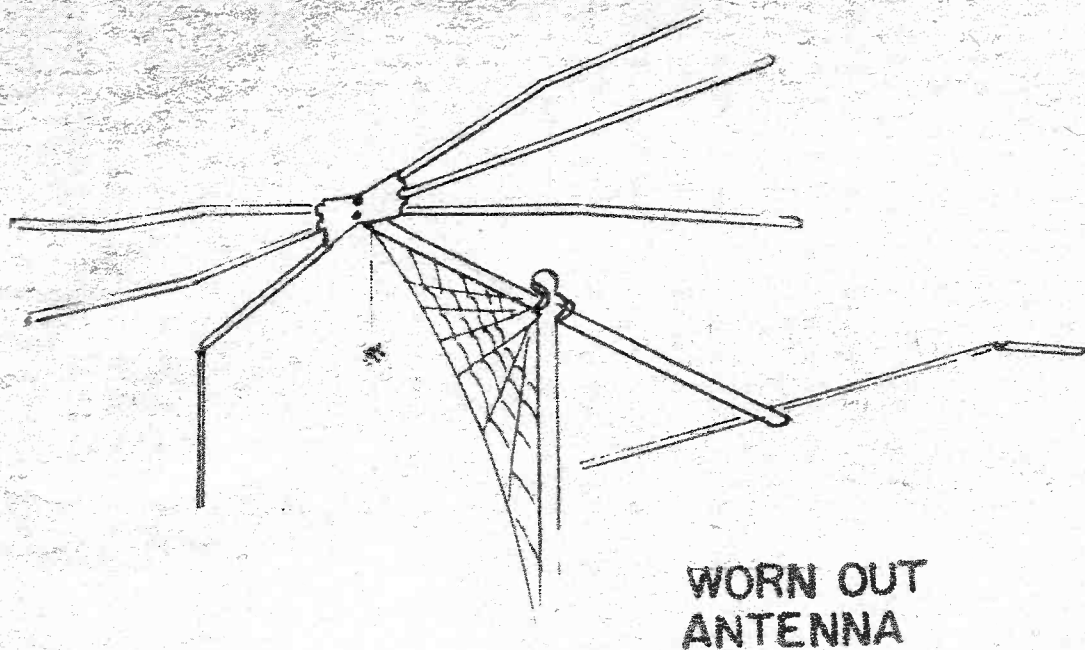

WORN OUT ANTENNA

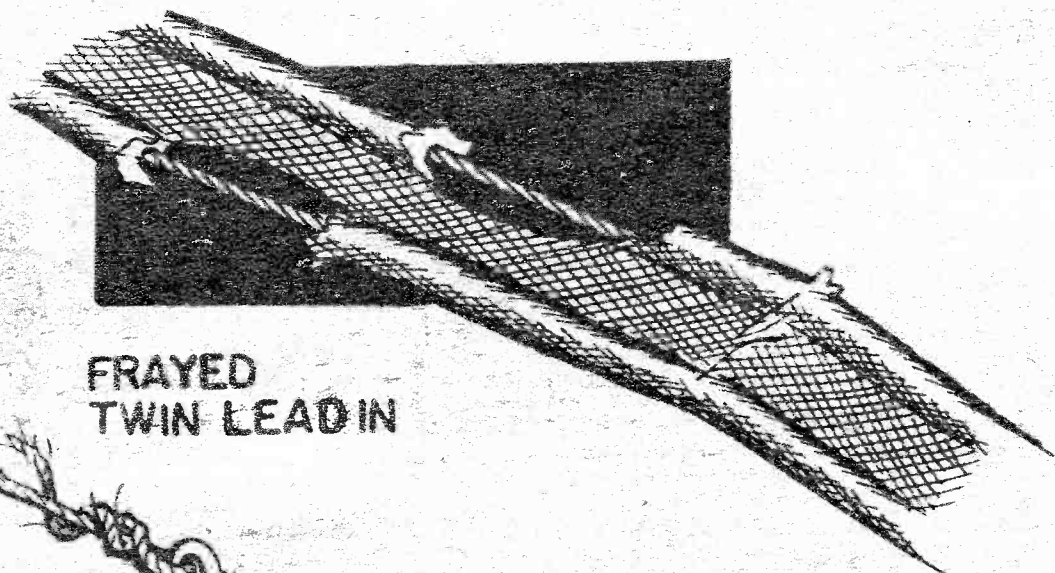

FRAYED TWIN LEAD IN

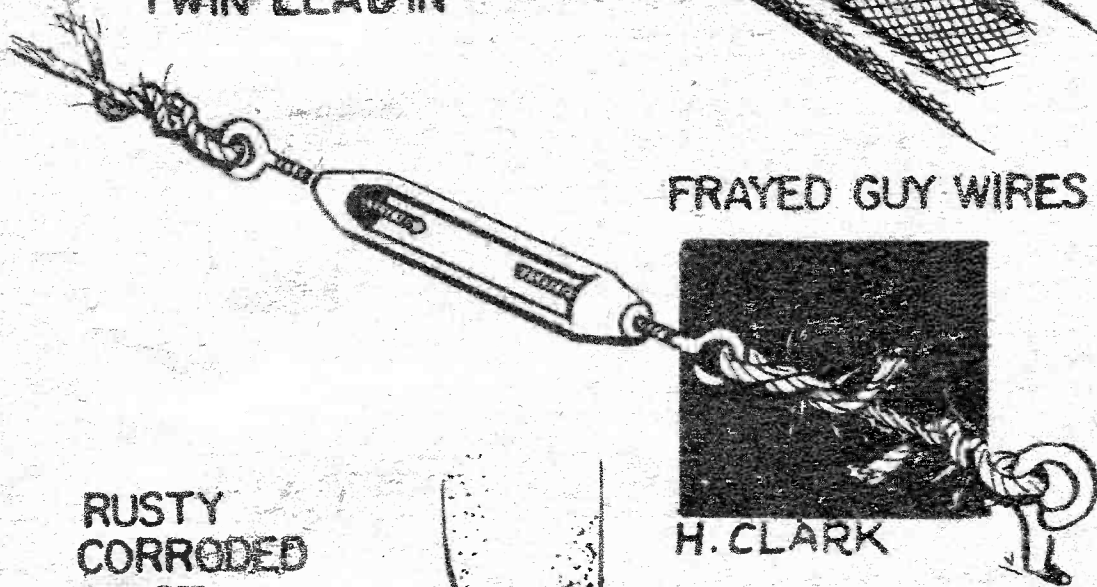

FRAYED GUY WIRES

RUSTY CORRODED MAST

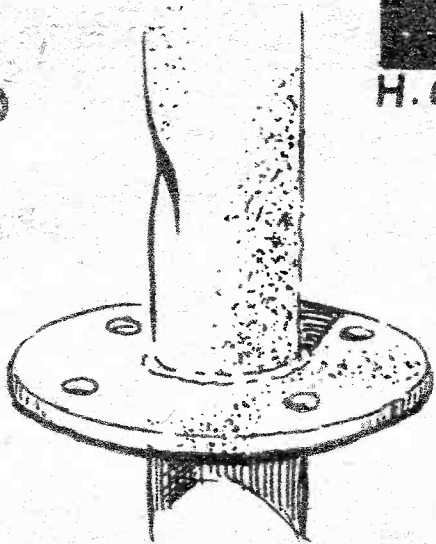

H. CLARK

To avoid trouble in TV reception make a close check and replace any worn out antenna parts.

The defective standoff can cause the lead-in to be loose, break or touch metal. Replace any standoffs that are not wearing well. They cost a few pennies each.

The Actual Antenna

The antenna head goes bad when the elements fall off, get bent, touch each other, or bolts get loose and cause the head to swing in a wrong direction. This causes all antenna type symptoms of snow, ghosts, loss of color, etc. A visual inspection will reveal most defects.

If you look skyward and see a worn out antenna, should you repair or replace? That depends on how long it's been there and whether it's an expensive job or not. If the antenna is a straight dipole, or a

conical type don't even try repairing it. Buy new heads, remove the old and install the new. An inexpensive head that's been up awhile will probably fall apart as you handle it. If you have an expensive array, the repair attempt might be worthwhile. Especially if it's a weather-treated head. These types have an anodizing on the elements that usually gives them a gold or blue color.

Bent elements need only be straightened. Broken elements need replacing. You need some 1/2-inch aluminum tubing and a hacksaw. Remove the old element and measure off a new replacement length exactly. Attach the new element.

If it's a parasitic element such as a reflector or director that needs replacing you can run screws or bolts through them at will. They are attached directly to the crossbar and mast. If a driven element needs replacing be sure you maintain the same insulation between the elements. Don't short out the spacing between the elements on the insulated element holder.

After you repair your antenna take a plastic spray can and put a coat on the antenna and the connections where the lead-in is attached.

If you have a motorized antenna you are constantly orienting your own antenna as you aim it toward one station after another. You probably would never notice direction reception changes.

However, should you own a fixed antenna new construction that places you in an electronic shadow shows up on your screen as ghosts, snow, loss of color, etc. The only cure is to turn your antenna to a new heading.

A simple type orientation is to loosen the mount, rotate the antenna a few degrees at a time and note the changes on your screen. If you find a better heading lock the antenna in at the new angle.

When a drastic change has occurred due to a new apartment building or the like, you'll have to probe the roof for a new location and height. This is quite a job and should be done by two men. One man on the roof walking around with the antenna in hand testing the different locations on the roof, different angles and various heights. When this produces poor results you will probably have to go into a more expensive type antenna.

A final word on antenna repairs. Don't try to do more than you feel you should. Antenna work requires steeplejack skills and even though you might see and know exactly what to do it might be a good idea to call an experienced man to do it, because of the heights involved.

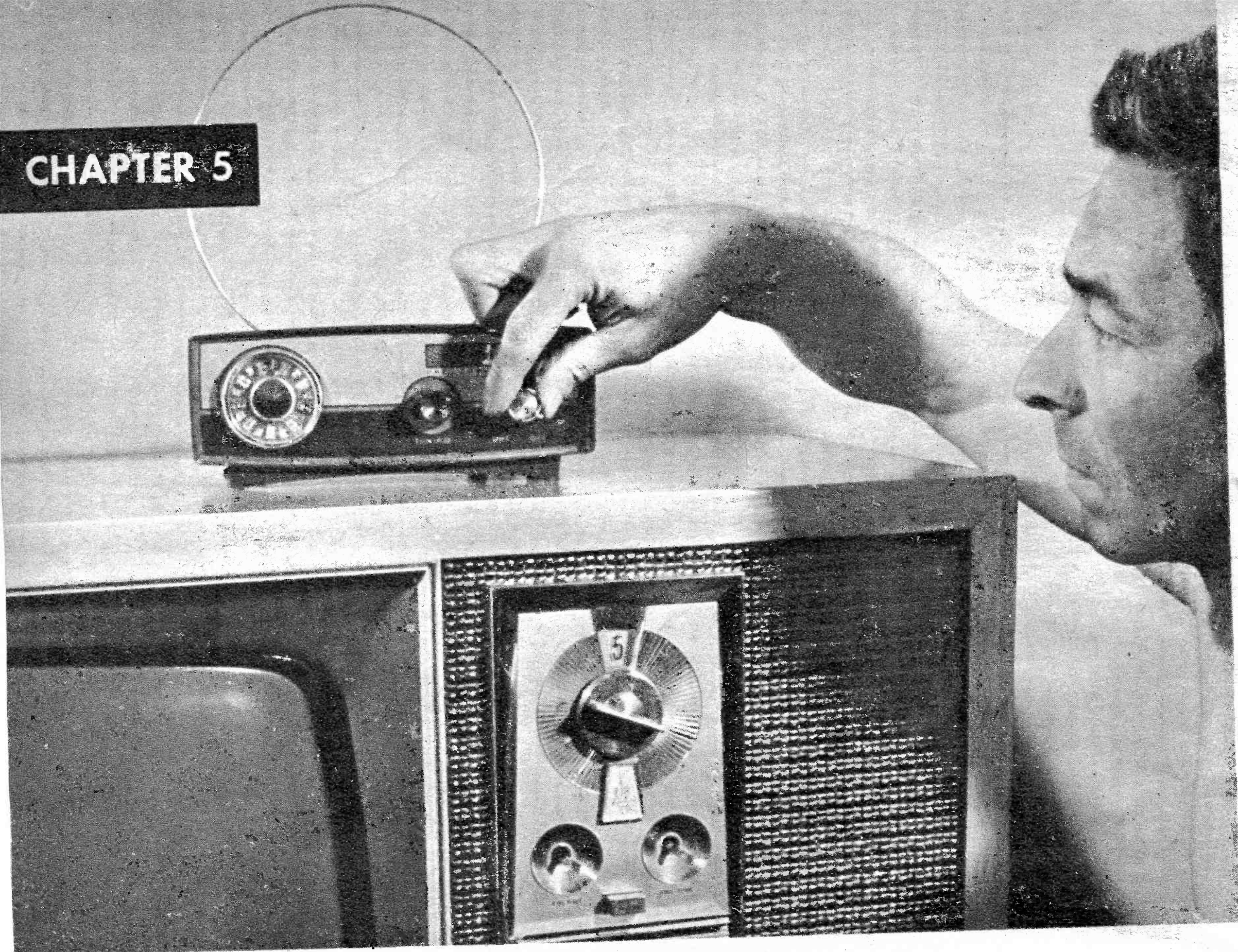

A UHF converter can be installed on any television set in regular use today, no matter how old it is.

Don't Miss Out on UHF

It's easy to add UHF channels to your old TV set

A FEW YEARS AGO the FCC decided to do something about UHF. They decided this valuable TV transmission space was being wasted. Channels 14 through 83 were practically unused. Spotted here and there in a few fringe areas were some small underfinanced stations, but that was about all. Any new pioneers who did venture into the UHF business found sparse pickings. There were hardly any sets out in TV land that could receive their offerings.

The FCC took the situation by the horns and had a law passed making it a must for manufacturers of all new TV's after April, 1964, to be able to receive the UHF band. Things started happening. A few entrepre-

neurs opened up in the metropolitan areas. They programmed sports events, adult movies and other hard to resist fare. UHF took off.

Today TV service companies purchase UHF converters and antennas by the case. People do not want to miss out on this extra programming.

How can you add UHF to your TV? It's easy. You need a UHF converter, a UHF antenna and another lead-in wire. If your TV is already UHF equipped, you don't need the converter, just the new antenna and lead-in.

One point I'd like to make. Lots of TV sets have a UHF antenna terminal strip in the rear and sometimes a hole in the front

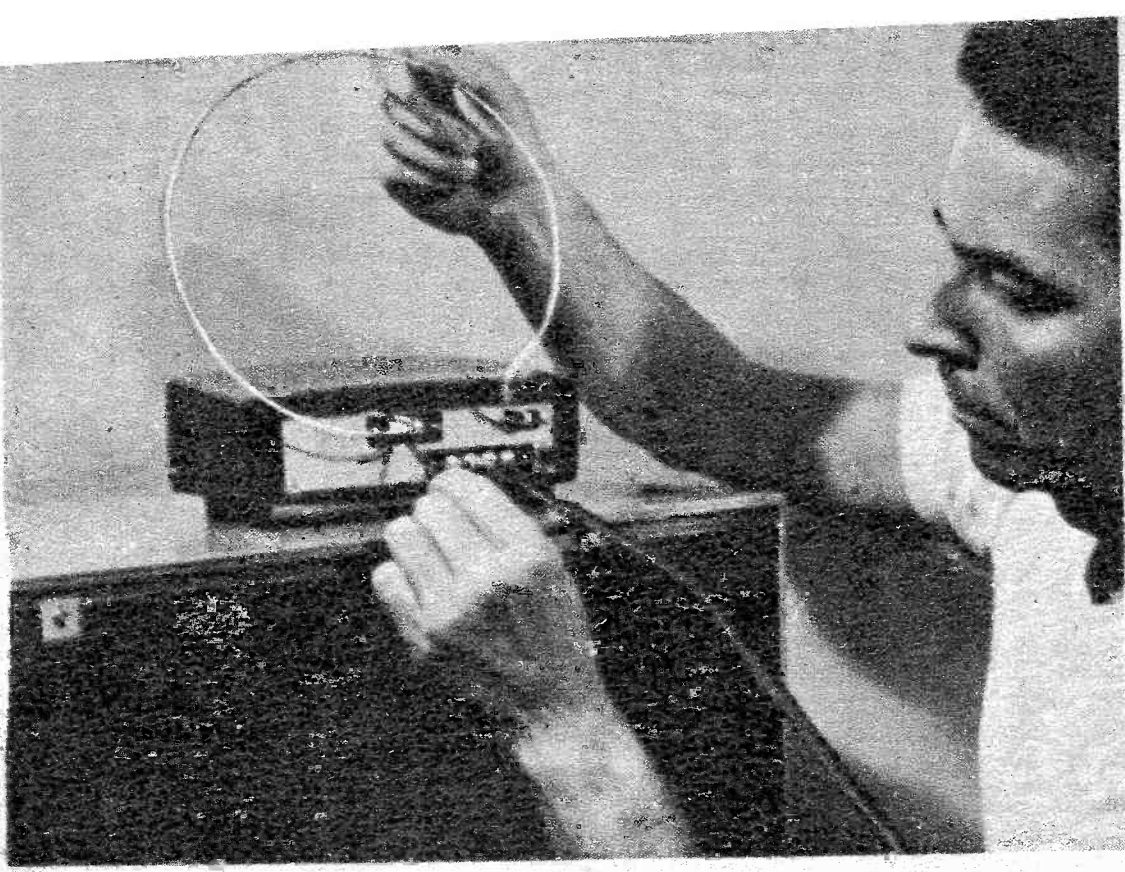

In a great number of cases, especially in city areas, a small ring UHF antenna would work well.

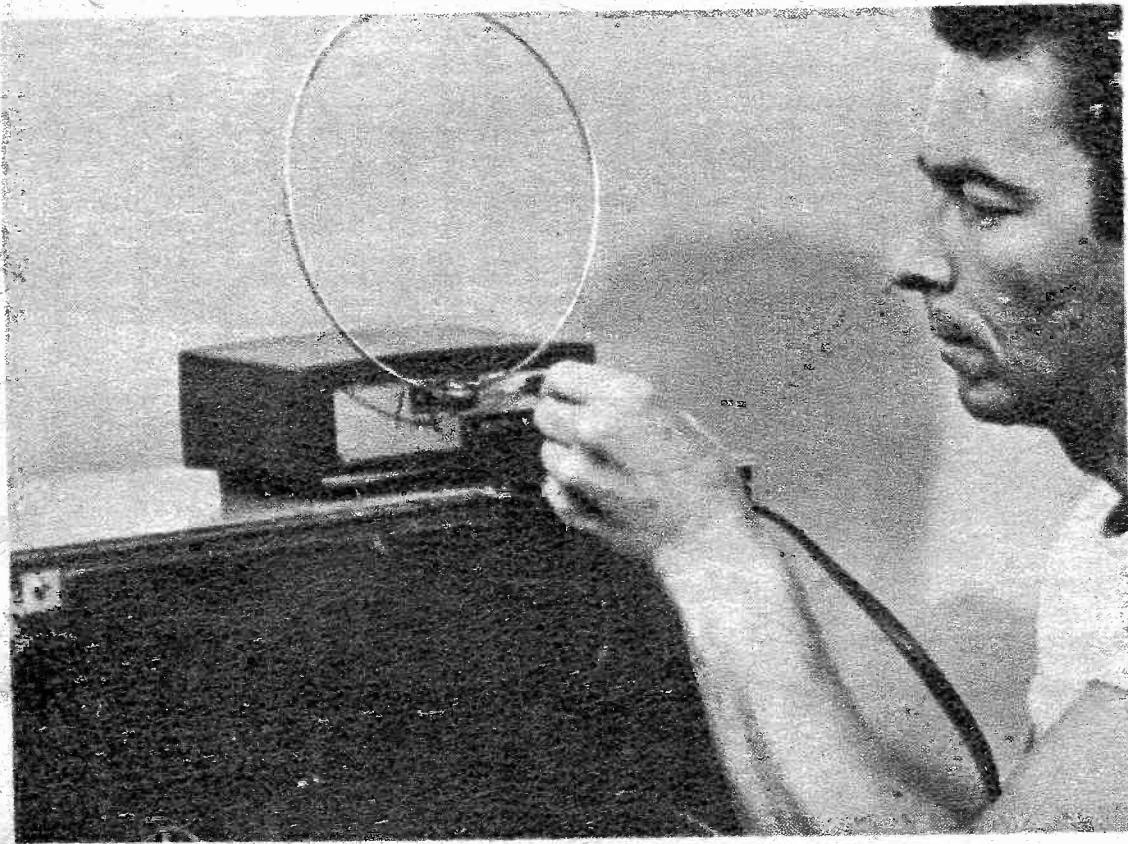

An extra feature is an AC plug found on the back of a converter. The TV line cord plugs into it.

with a cover saying UHF on it. This is not a UHF tuner. There might be a factory tuner available that will install in the hole and attach to the terminal strip. You'll have to purchase that special tuner and get it installed somehow. Then your TV will be UHF equipped.

UNIVERSAL CONVERTERS: As an alternative to the special factory tuner for your TV, there are many universal converters. From a convenience, financial and performance standpoint the universals are better than the factory jobs most of the time. They are easier to install, cost less dollar for dollar and perform better. Their only drawback is they sit outside your TV instead of inside.

They look like a little table radio as they sit on top of or alongside of your TV. The converters come in four price ranges and while they all work well, you get exactly what you pay for. They vary from about twelve to forty dollars.

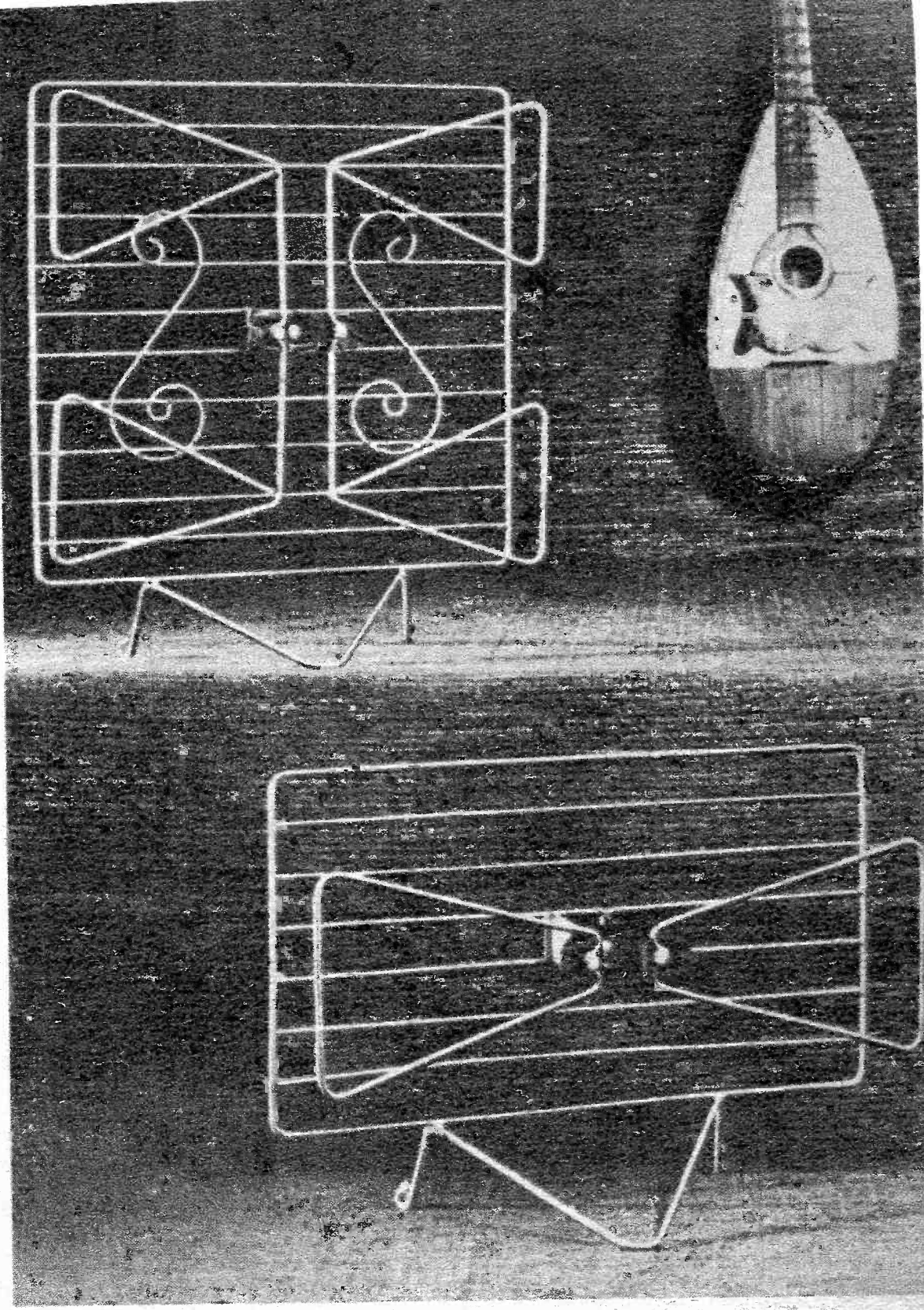

There are many forms of UHF indoor antennas. The decorative shapes, above, are half wave antennas.

In shape of a bowtie, this is actually a half wave conical antenna, made solid between the elements.

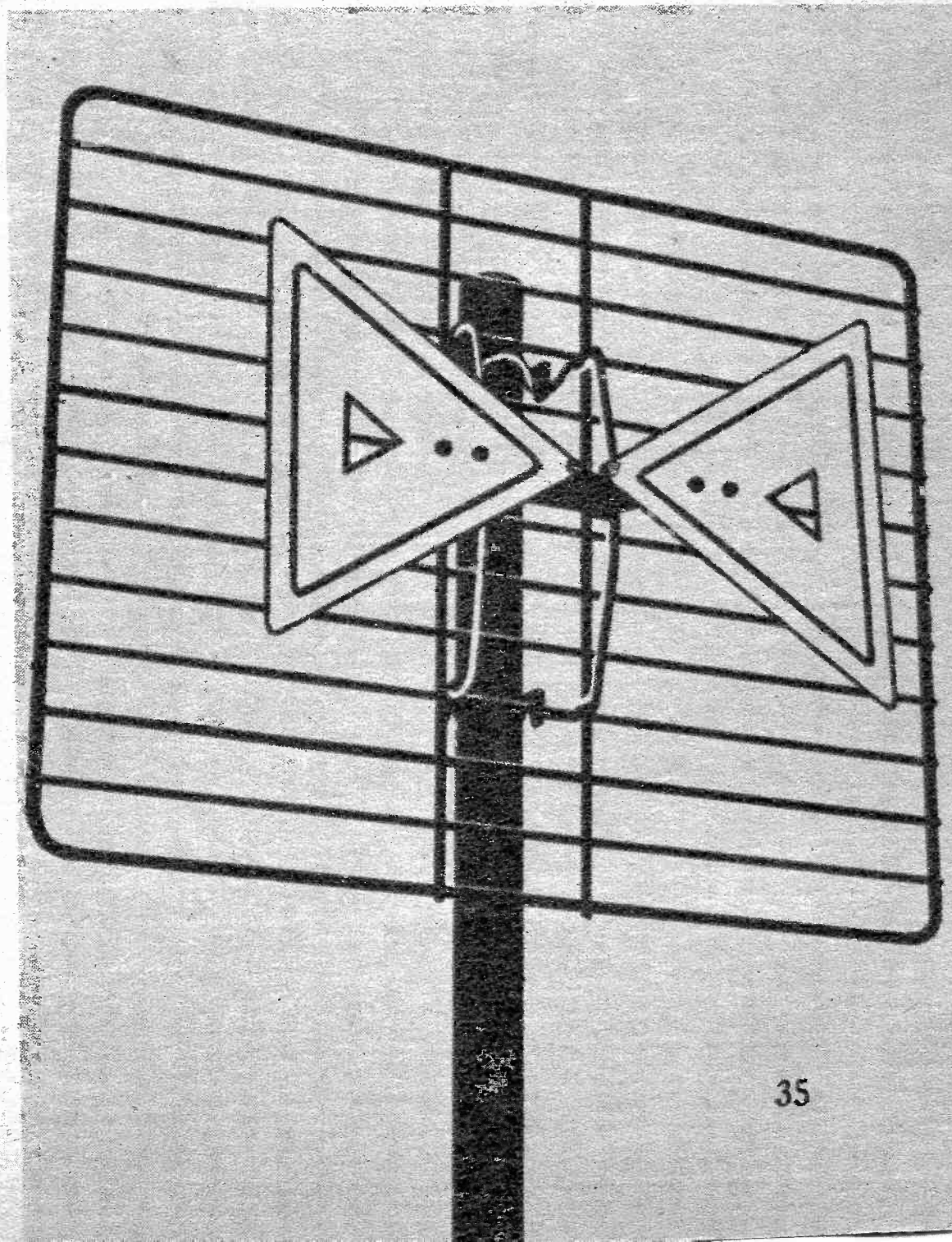

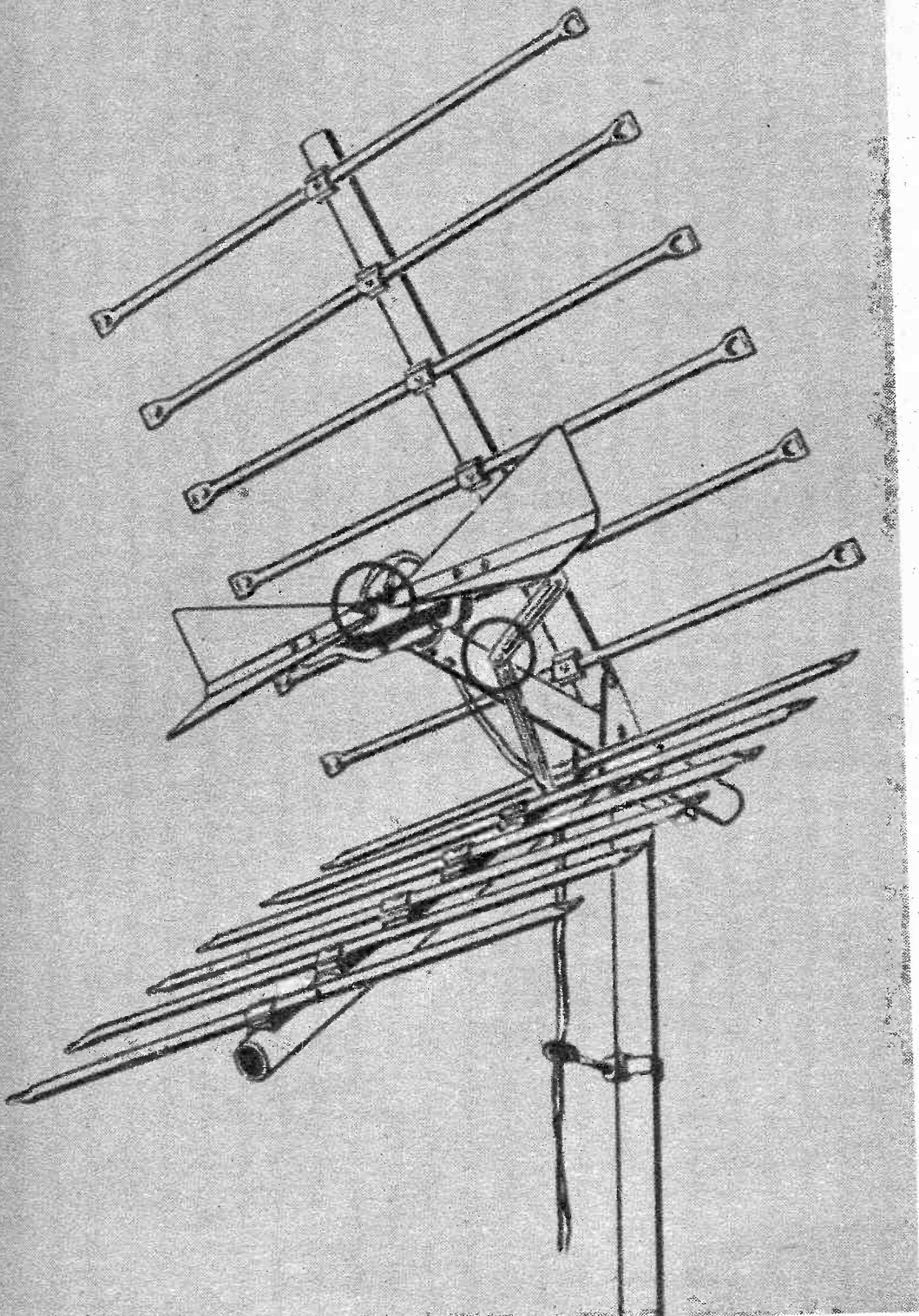

The reflectors on UHF antennas increase gain, especially the type above with a corner shape.

The best one has extra stages of amplification, a pilot bulb, a fine tuner and an AC plug in the back for the TV line cord so you do not need to use two wall plugs. Just plug in the TV to the converter, plug the converter in the wall and both instruments receive power.

The installation of a converter to your TV follows: 1—Attach your regular antenna to the terminals on the converter marked VHF ANTENNA. 2—Attach your UHF antenna to the terminals on the converter marked UHF ANTENNA. 3—Attach provided jumper wire from terminals on the converter marked TV SET. 4—Attach other end of jumper wire to the antenna terminals on your TV.

With the converter off, your TV will operate normally. With the converter on, all the UHF stations are converted to channel 5. Tune your TV for five and turn the dial on the converter for the desired stations. It's that easy.

UHF ANTENNAS: While many times your regular antenna will pull the UHF stations in fairly well, a separate UHF antenna pulls best.

The simplest antenna is an indoor type,

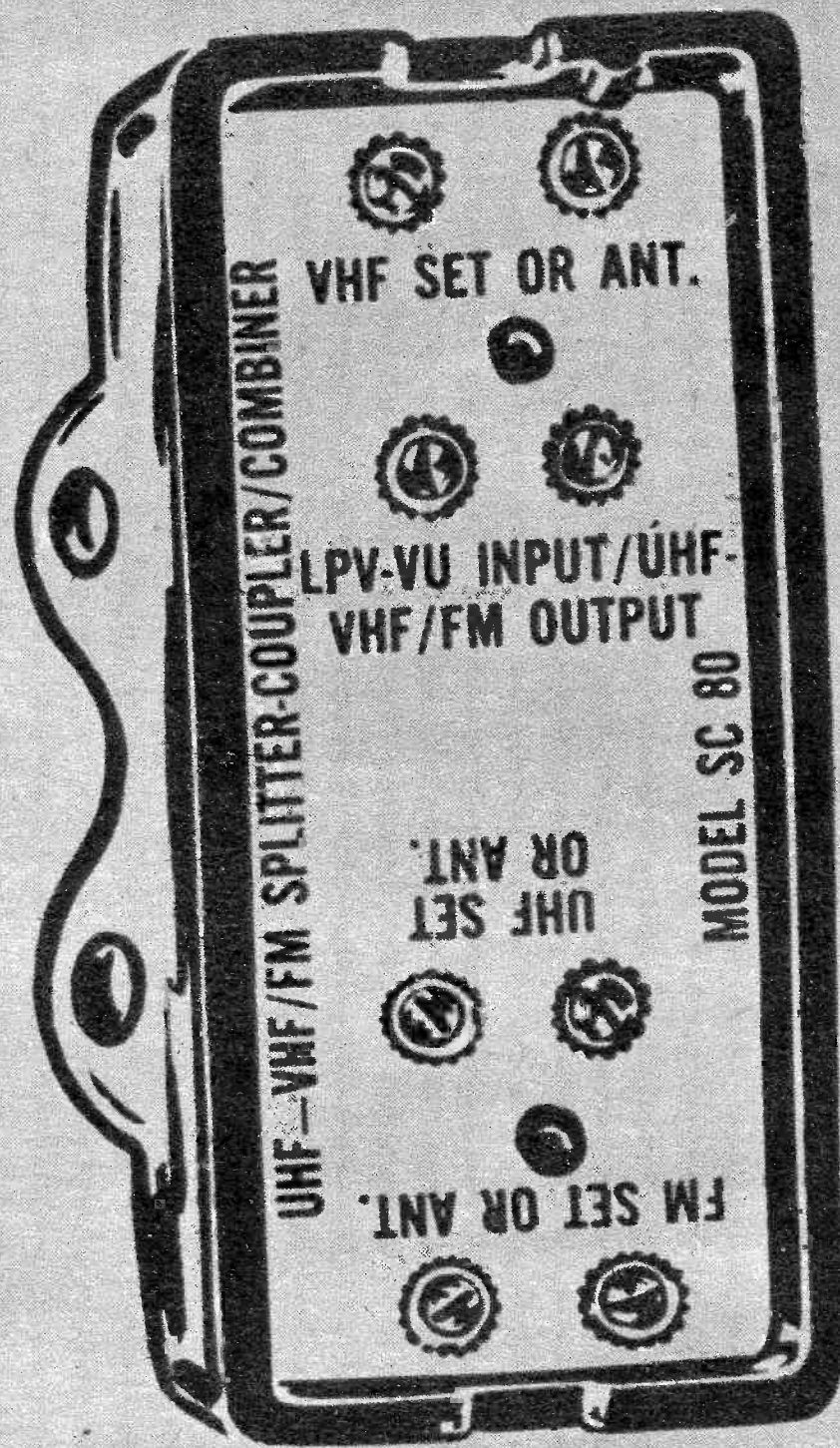

Courtesy of JFD Electronics

If your regular antenna pulls UHF satisfactorily the signal can be split in two with this gadget.

a metal ring eight inches in diameter. You can purchase one or make one from a coat hanger. It attaches directly to the UHF antenna terminal either on the TV if your tuner is built in, or on the back of the universal converter box. To orient the antenna move it up and down or rotate it.

For something more powerful than the ring, there are various indoor antennas and outdoor antennas. The outdoor antenna can be attached directly to the mast of your regular antenna. There will be no interference as long as each antenna has its separate lead-in.

SPLITTERS: If you take your regular antenna and attach it to the UHF and find it pulls satisfactorily you can dispense with a separate UHF antenna by means of a VHF-UHF splitter. This is a simple gadget that can split the signal in two.

Once you get a splitter, run the antenna into it. There is a pair of terminals for this purpose. At the other end of the splitter you'll find two other pairs of terminals. One marked UHF the other VHF. Run a lead from each and attach them to their respective terminals on the converter or TV. •

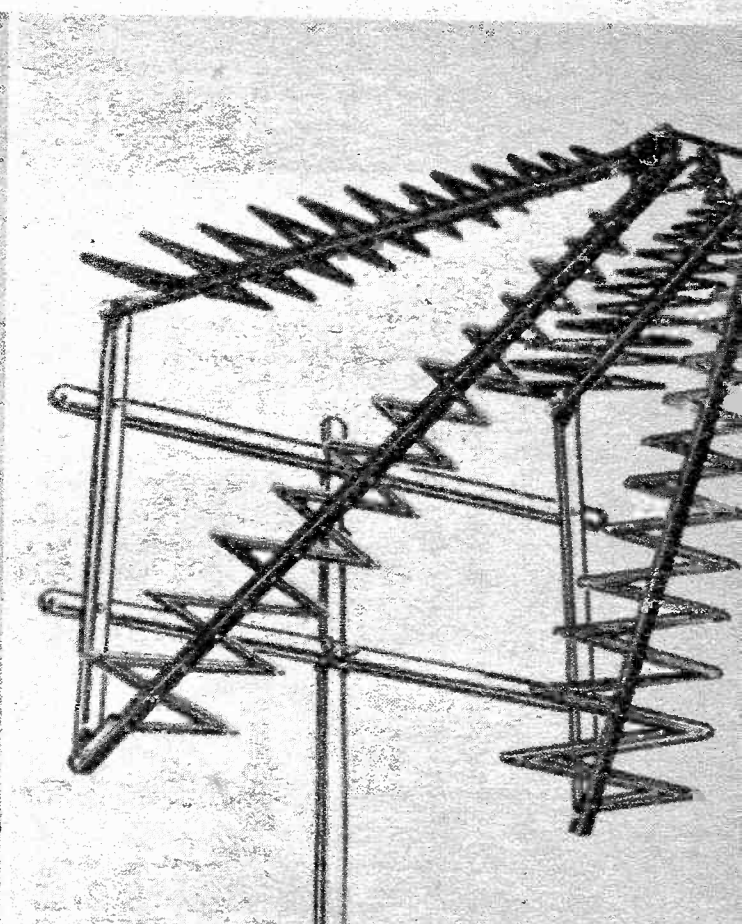
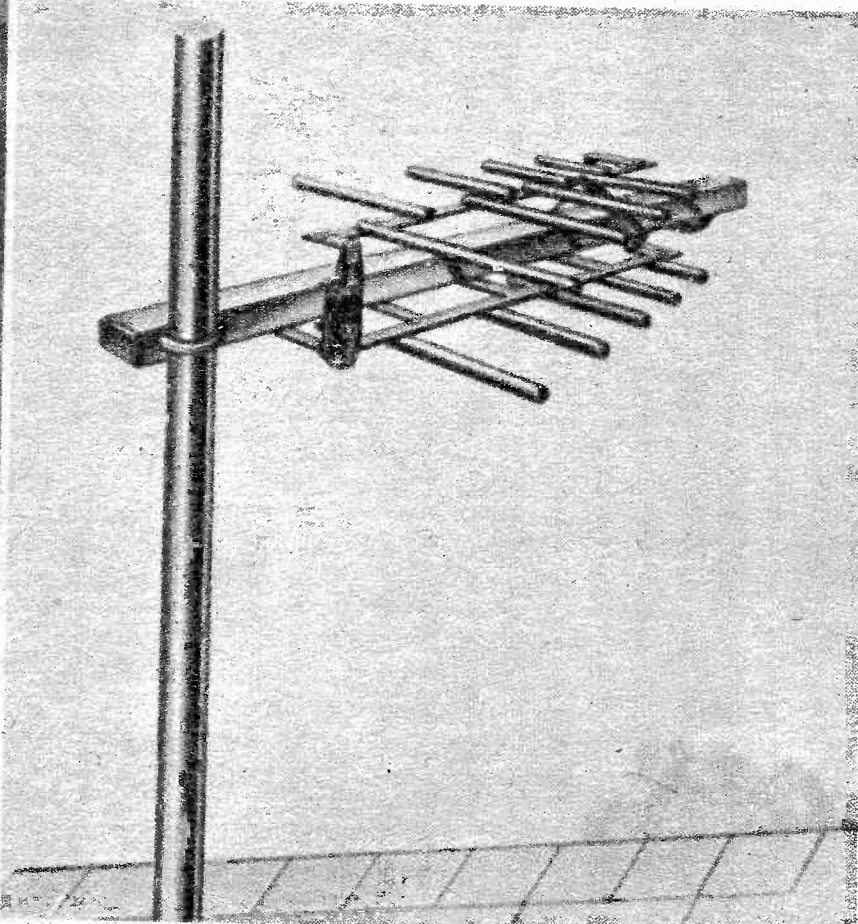
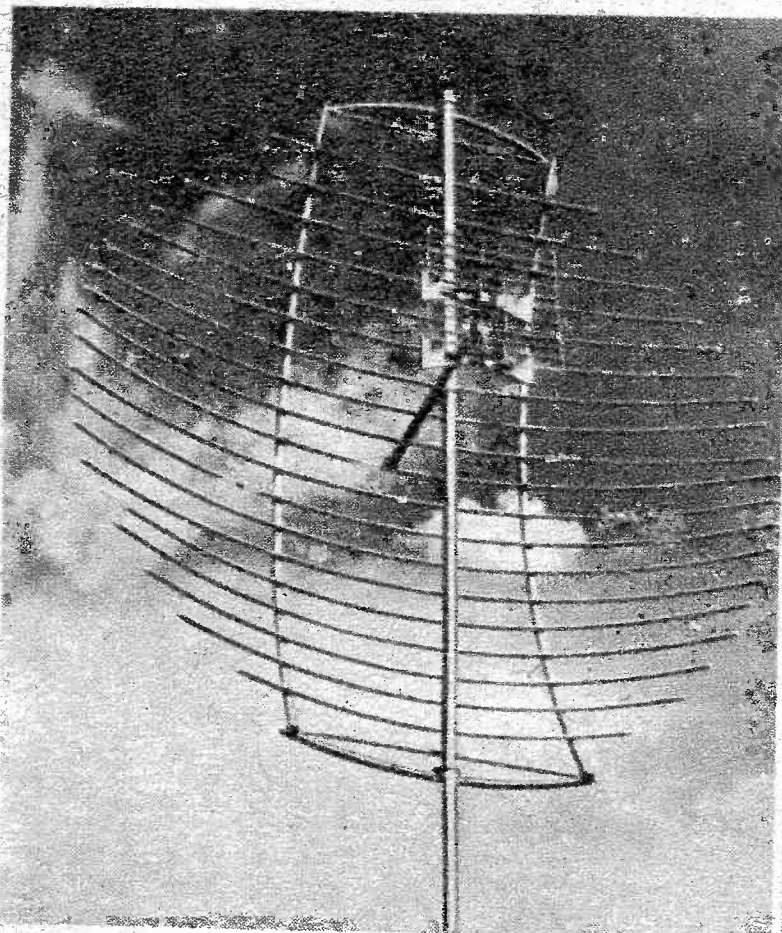

UHF antennas come in many weird shapes and sizes. The more complicated looking the better the antenna.

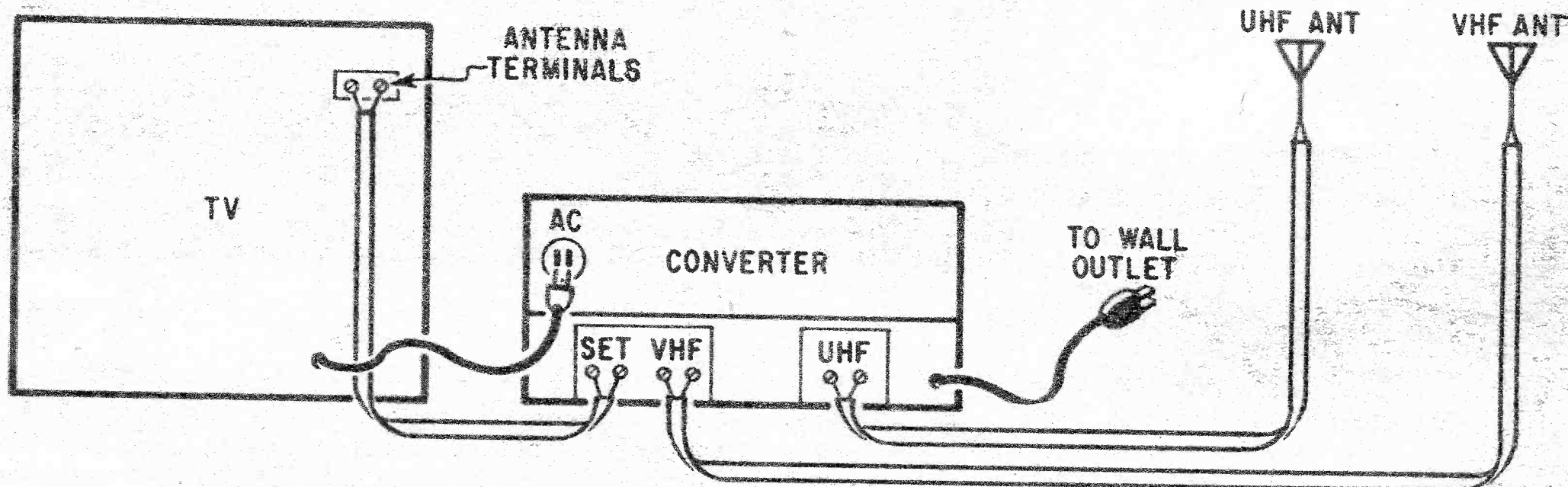

UHF CONVERTER ATTACHMENTS

The UHF converter attachments are quite simple and can be hooked up in less than five minutes.

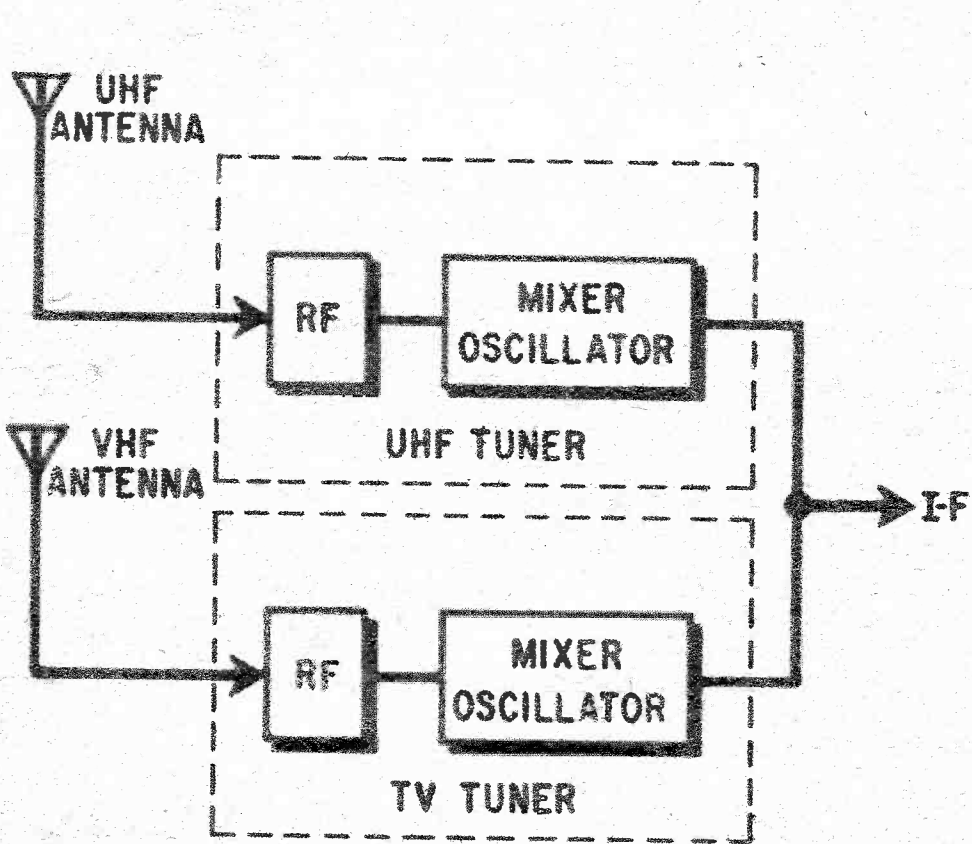

FACTORY INSTALLED UHF TUNER

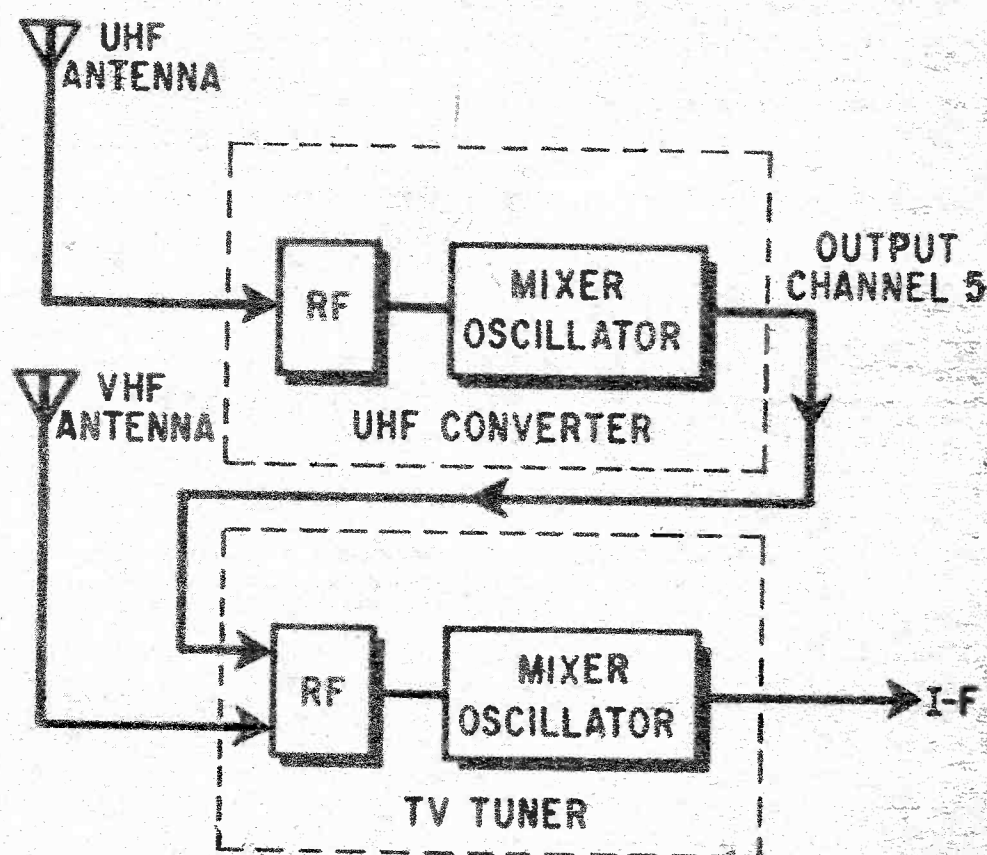

HOME INSTALLED UHF CONVERTER

Note that this is a UHF tuner, not a converter. It comes already installed in all late-model TV's.

The block diagram of a home installed converter shows that the signal must go through TV tuner.

When the TV Goes Dead

The four general ways a TV dies and how to bring it back to life

You can pull this rectifier tube out with your bare hands only when it is dead and tube is cold.

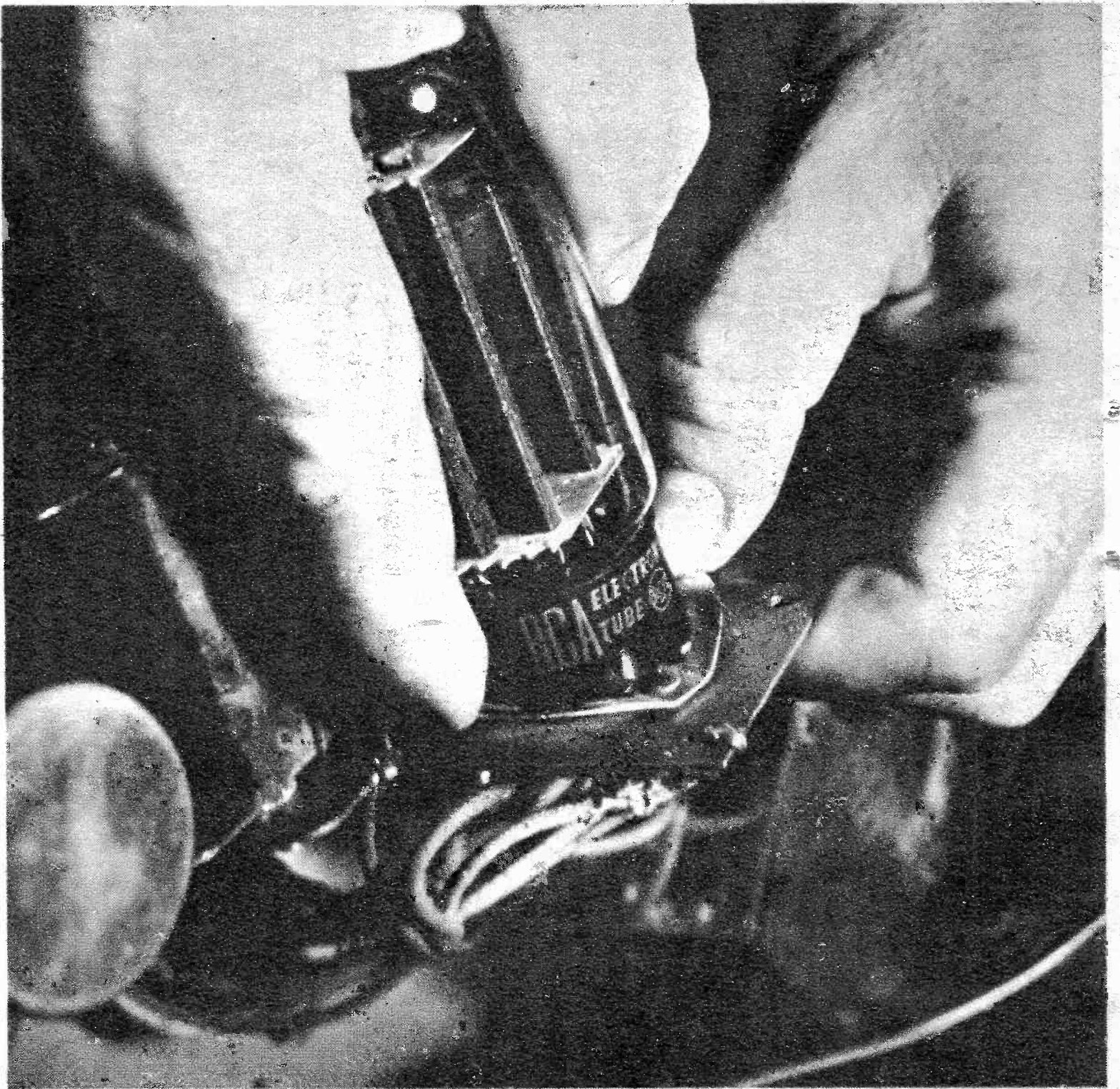

A TV SET goes dead in four ways. One, all the tubes won't light; two, the tubes are lit but there is no picture or sound; three, the TV is dead but a hum comes out of the speaker; and four, the TV keeps on blowing fuses.

To get a clearer idea of each trouble let's consider what happens when you turn on the TV. As you switch the off-on switch to "on" you let the 110-volt, 60-cycle house current into the TV's power supply.

The power supply has the job of changing the house current into other voltages that will power the TV's tubes. The tubes need heater voltage to light up the tubes and plate voltage to make the tubes perform. Once these two voltages are in place the other voltages needed are developed as a by-product from these two. Therefore should you lose either, or both, the TV dies out.

SYMPTOM #1—No heaters. When the

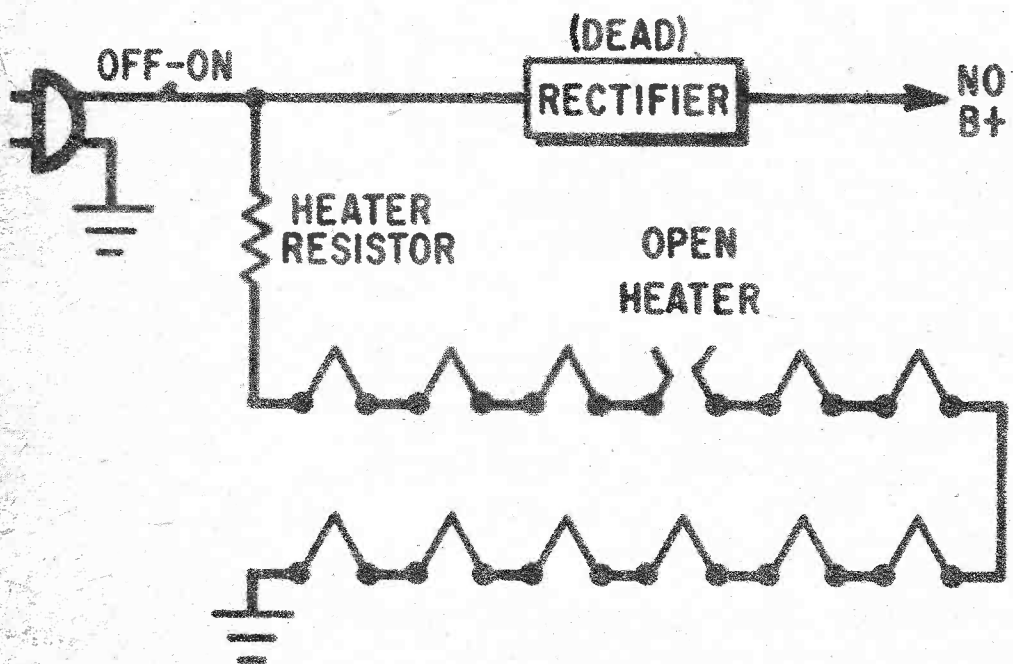

When a heater opens up in a series string the entire string goes out like Christmas tree bulbs.

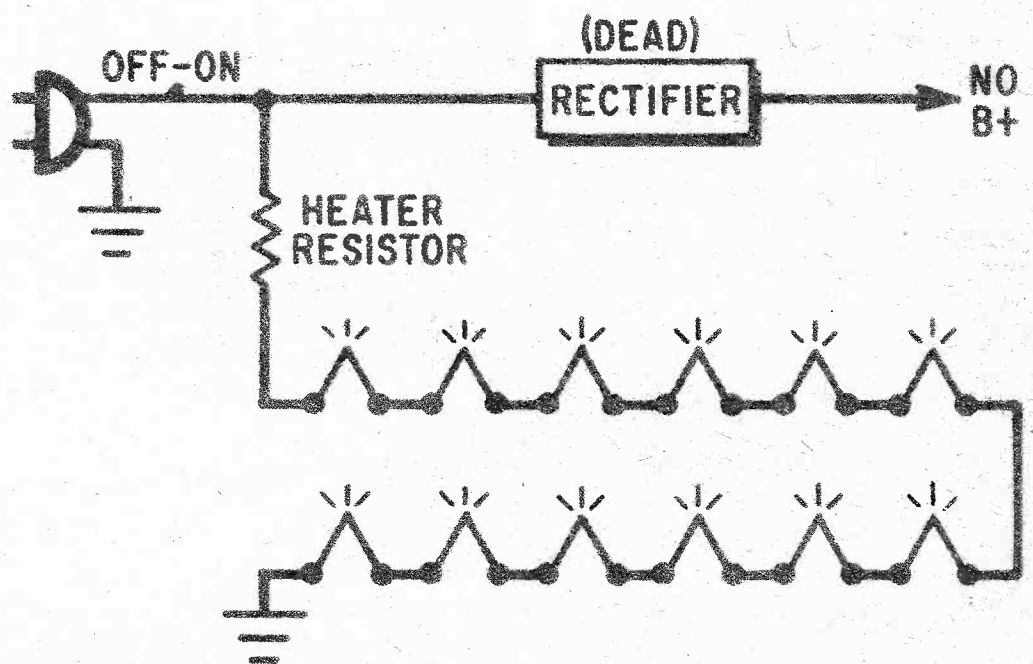

When the heaters are lit, but the B-plus power is not getting to the tubes, the TV plays dead.

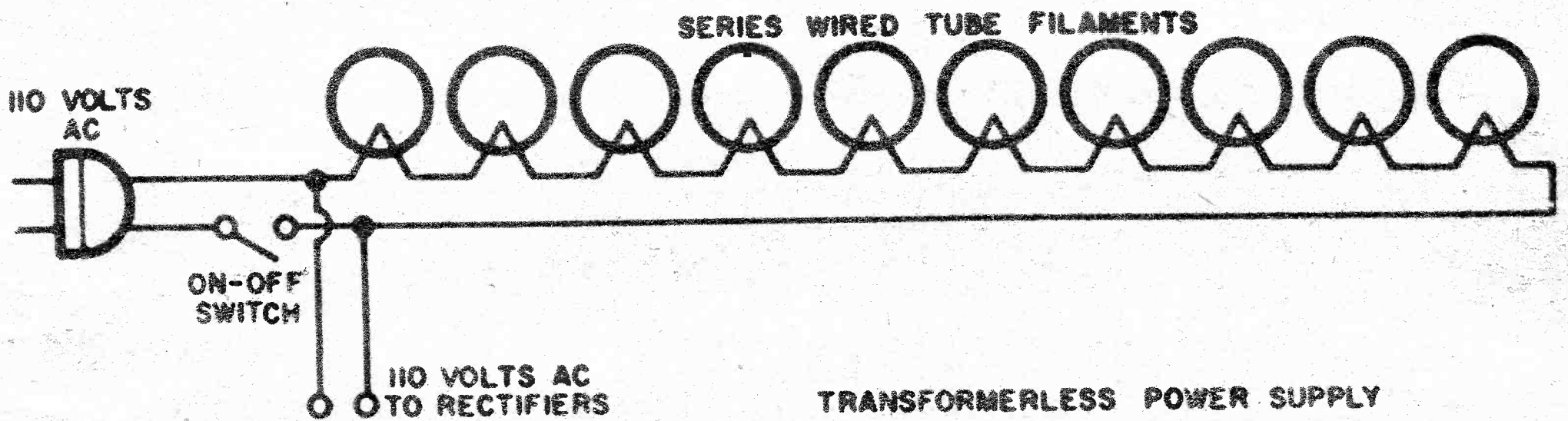
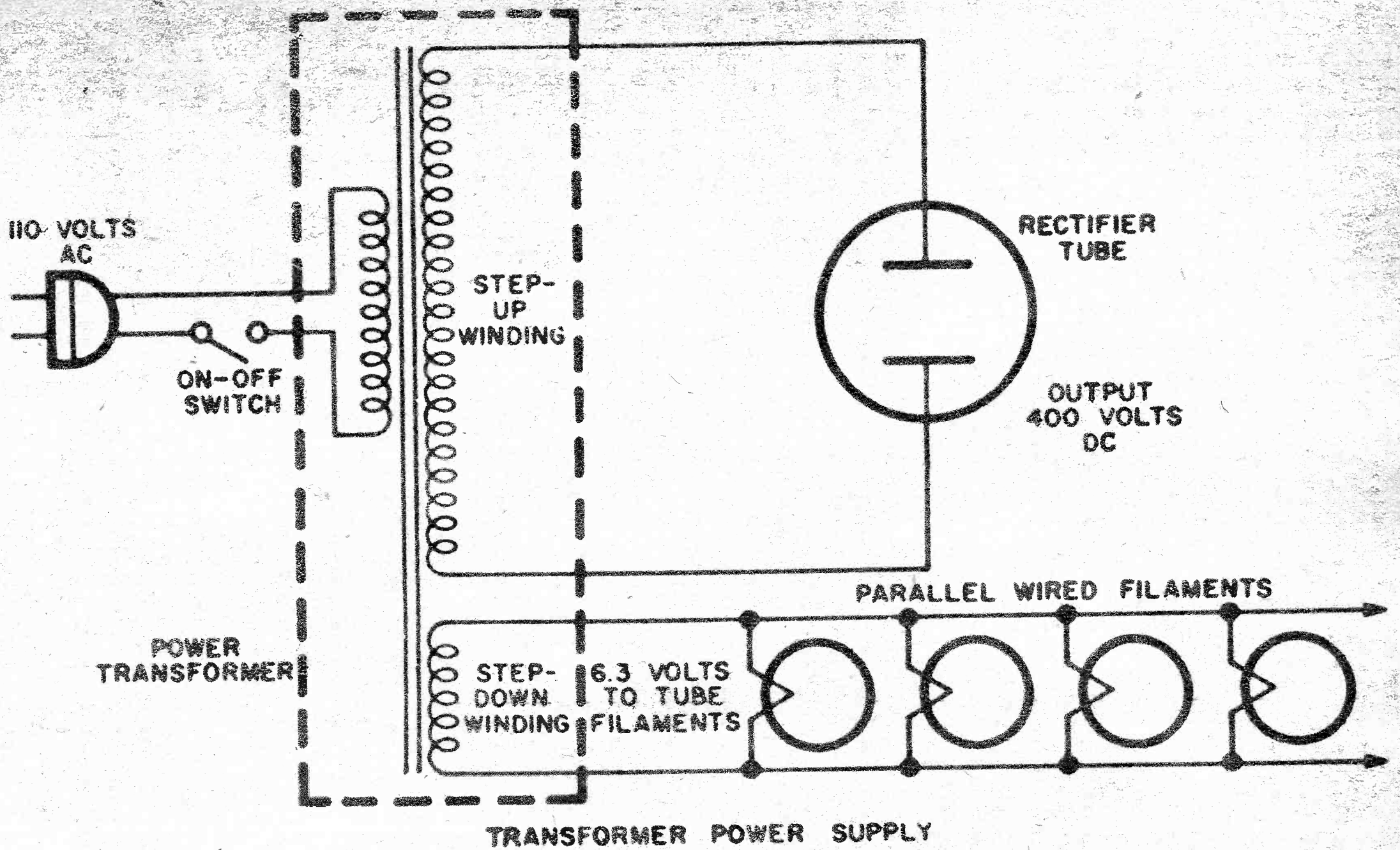

These are the two main forms of TV electric power supply. The transformer type is the more expensive.

tubes won't light the heater voltage is not working. There are two ways a heater gets current. One, from a transformer, and two, from a series heater string.

TRANSFORMER—When a set has a power transformer supplying heaters it's done by a winding in the transformer that steps down the 110 volts to 6.3 volts. The heaters are all connected in parallel across the heater windings.

If all the heaters are out, there are four immediate suspects. The heater fuse, the power line fuse or circuit breaker, the off-on switch, or a poor connection on the heater winding in the transformer.

Most of the time it is a fuse. You'll have to find it and replace it. You can test the off-on switch by taking a jumper wire and

shorting it out momentarily. If the heaters come on the off-on switch is faulty.

The poor connection and heater winding defects are rare, but happen. This you'll need skill to locate, or call a repairman.

SERIES STRING—When the TV has a series heater string the tube lighting is accomplished by wiring all the heaters together like Christmas tree bulbs. The two ends of the heater string are attached into the AC line completing the circuit.

When the string is operating normally all the heaters light, not too bright, not too dull, but with a healthy glow. The actual design puts exactly the right number of the right tubes in the string to absorb or drop the 110 volts. For example a 6BQ7 is a six-volt tube and a 12BY7 is a twelve-volt

When the rectifier tube is lit don't try to pull it out with your hands. Use a tube puller.

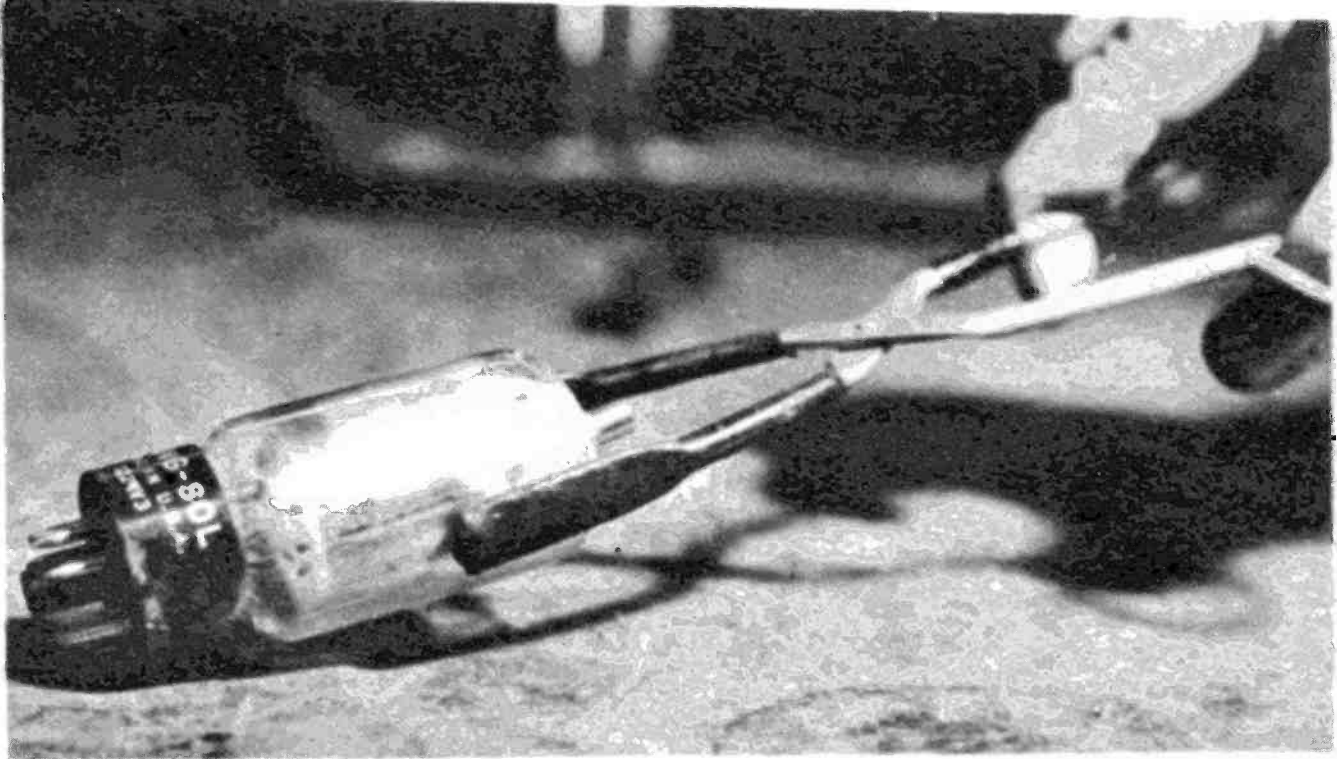

Here is just a small assortment of the many types of fuses used in common television receivers.

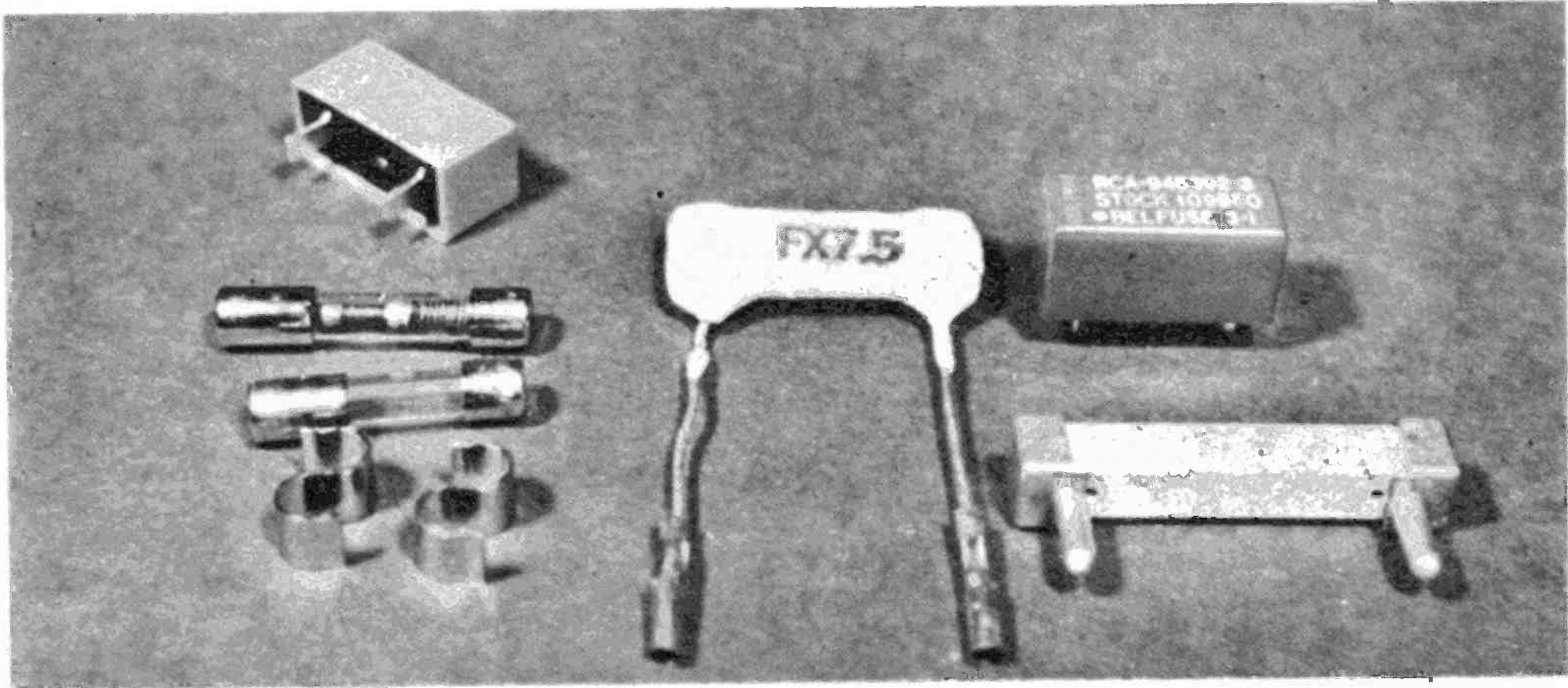

These are the main replacement parts in the transformerless TV power supply—filters and seleniums.

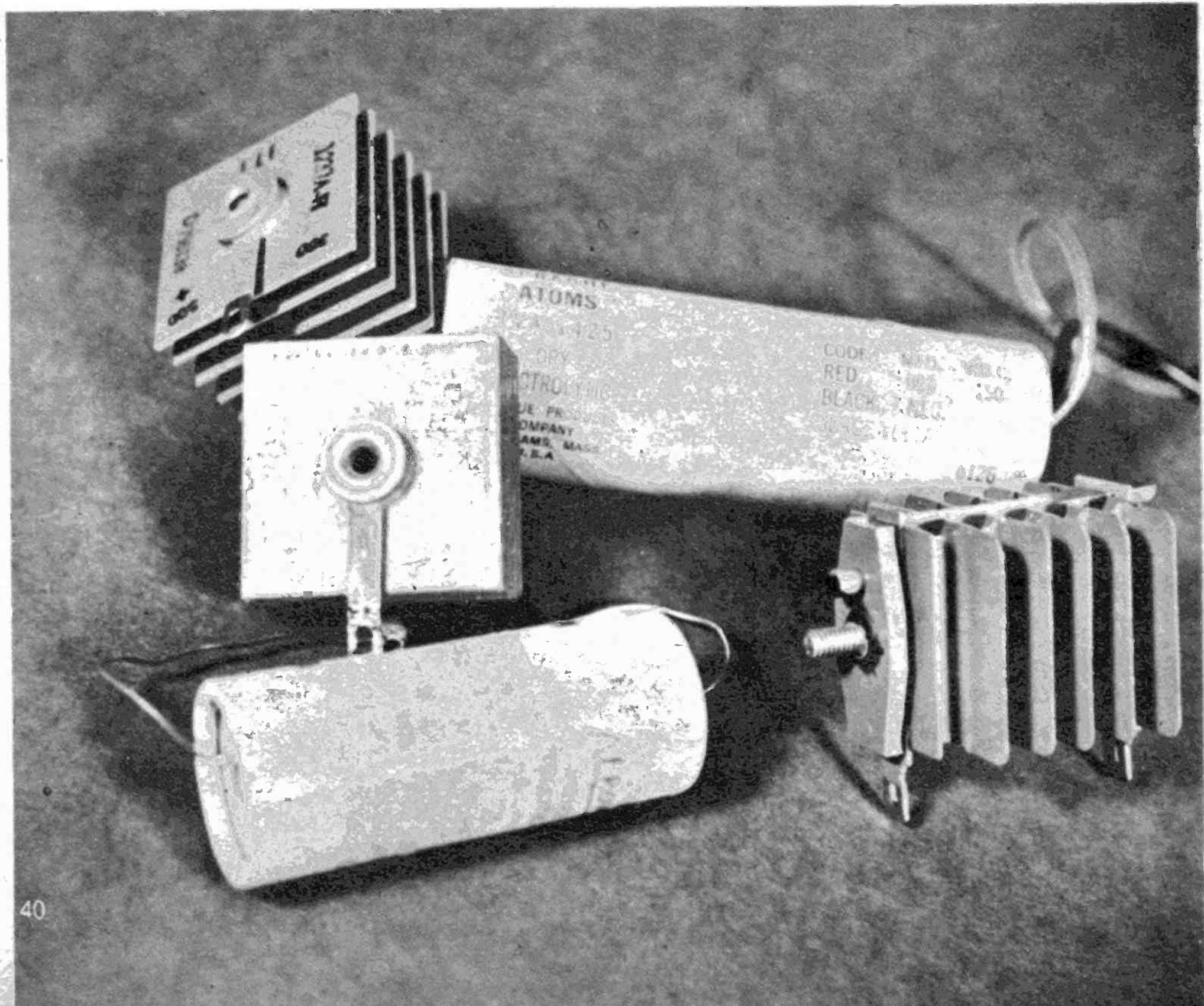

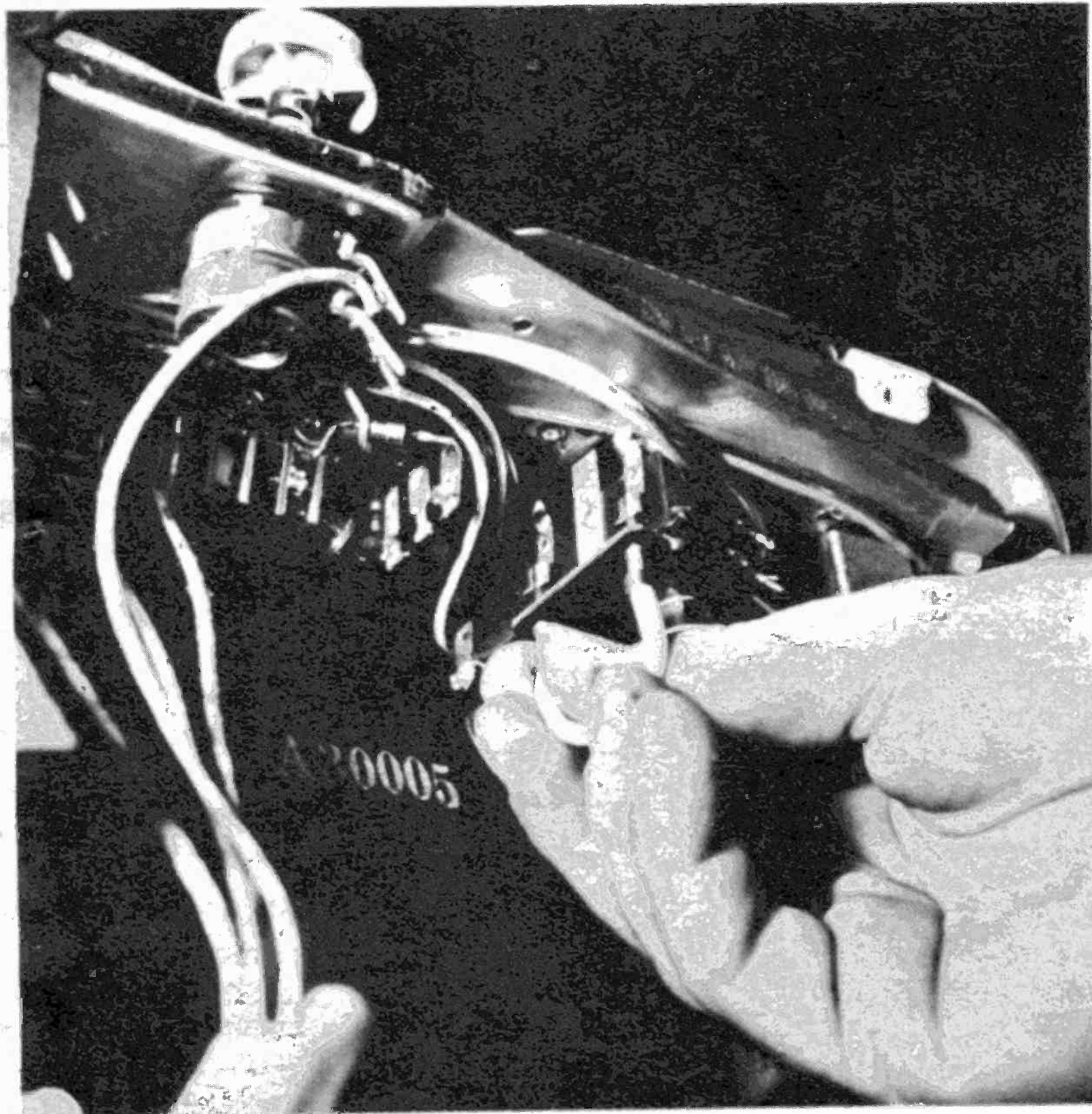

A low ohmage resistor with plug-in facilities is commonly used to fuse the B-plus power supply.

When you replace selenium rectifiers like these, be sure to get all the wires on correct spots.

tube. The right number of tubes that add up to 110 volts make a satisfactory string. A typical series string has about a dozen tubes. You'll notice some are two-volt tubes, others three-volt tubes, some five-volt tubes, etc. They add up to about eighty or ninety volts. Then a heater resistor is also placed in the string and it drops the difference between the tubes' total dropping ability and the 110 volts.

When one tube gets an open heater all the tubes go out since the circuit is opened like the Christmas tree bulb string. The first check then, when the TV is dead, is a methodical, one after another, test of the tubes. This trouble is so common a heater tester is sold in most hardware stores.

If the tubes all test good the next step is a test of the heater resistor. It can be checked with an ohmmeter, or you can quick check it by shorting it out with a jumper cord. If the tubes light up while the resistor is shorted out, the resistor is bad. Caution: don't leave the TV on for more than a few seconds! You'll notice the tubes light brighter than normally. This is because the voltage that should be passing

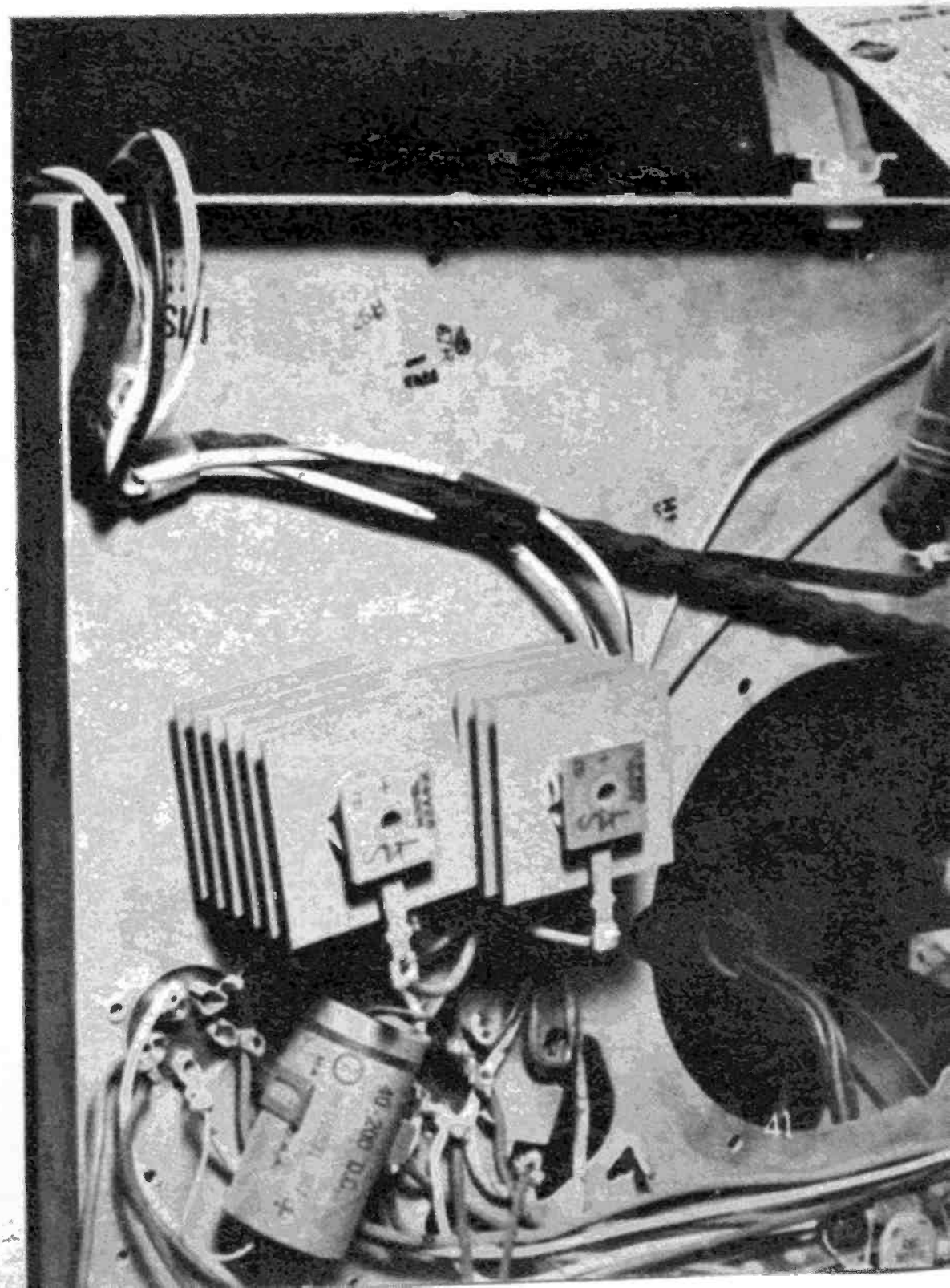

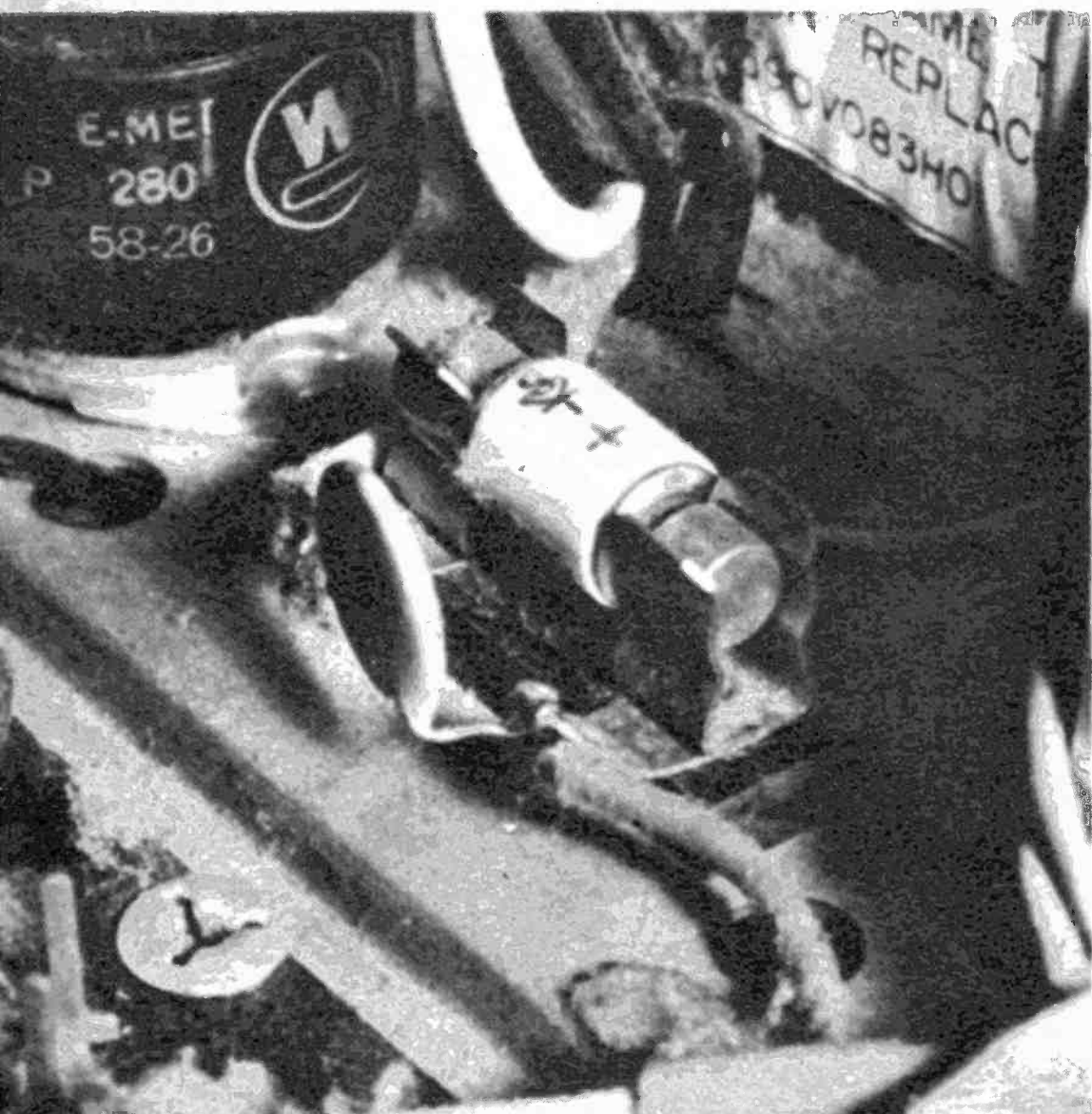

This type of silicon rectifier plugs in; simplifies replacement and eliminates wiring errors.

through the resistor is now being forced through the tubes. Prolonged extra bright running of the tubes will damage them.

Should the tubes and the dropping resistor be good, the next two suspects are the off-on switch and any line fuse or circuit breaker that might be in the TV. Test them next.

SYMPTOM # 2—Some heaters are out, some heaters are on. This is a similar trouble to “no heaters” but instead of an open tube there is a shorted tube. The bad tube is probably one that is still lit. The short in the tube is completing the heater string at the defunct tube. All the tubes in the string, after the bad tube, are getting no voltage. A tip-off of this condition is that the tubes that are lit will be overly bright. Test the lighted tubes first. If it's not one of them, test the unlit tubes.

SYMPTOM # 3—TV is dead, but heaters are lit. This symptom occurs when you lose the plate voltage, or, as it's called, B-plus voltage for the tubes.

This B-plus voltage is produced by the rectifier tube or solid state rectifier in your TV. Typical rectifier tubes are the 5U4, 3DG4, 5BC3, 5Y3, 5V4, 5V3, 5AS4, 6AX5, etc. Typical solid state rectifiers are the selenium and the silicon. As a rule the tubes are used in transformer sets and the solid state in series strings, although solid state is used in transformer types, also. In fact lots of the new color TV's use this arrangement.

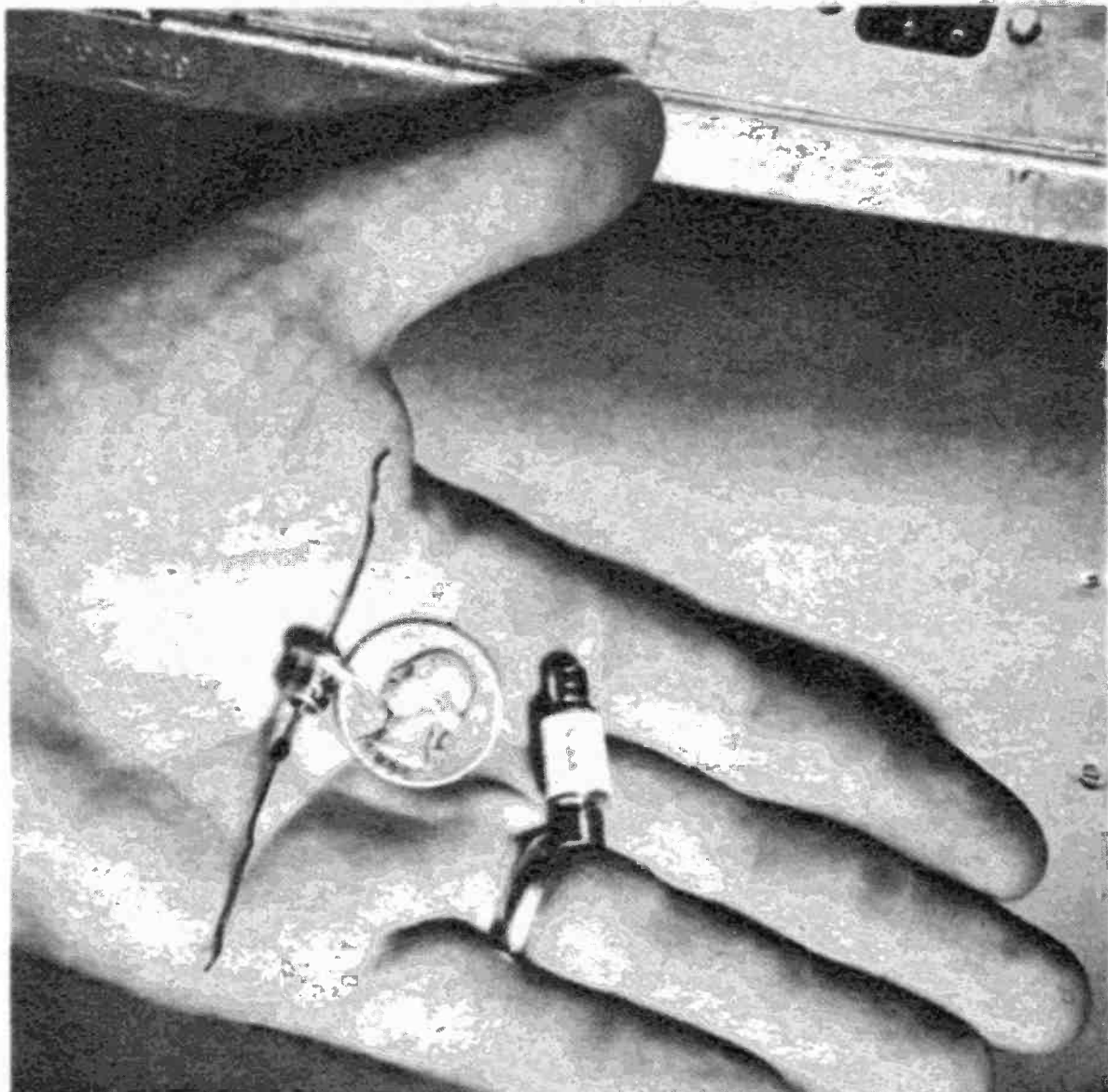

These two little types of silicon rectifiers are the exact electronic replacement for each other.

Check the suspect rectifier tube. About half the time it will be either out cold or glowing pink or purple. The other half of the time it will be lighting up normally even though it's bad. It is still the prime suspect, so test it first off. A new tube will cure the condition.

The tube is usually accompanied by a line fuse. Be sure to locate it and test it, too, with this type of trouble.

Should the rectification be solid state the line fuse is probably a fusistor or chemical fuse. Change it. If the fuse blows again, nine times out of ten one or both of the rectifiers has shorted. Replace both. Then re-replace the fuse. That should do the trick. If it doesn't halt, there is a serious short circuit in the B-plus line and needs more sophisticated troubleshooting measures.

SYMPTOM # 4—Four-sided shrink or two-sided shrink. The prime suspect in a case like this is the rectifier system. If it's a tube, it's probably weak. Should it be seleniums it's probably weak. Try new replacements.

If the set has silicon, one of them is probably open. Silicons as a rule do not get weak. They are usually good or bad with no in-between. Try replacing them. The percentages that this will cure the condition are not as good as the replacement of a tube or seleniums, but it is the first service move. The second service move is TV bench work, and you'll need help. •

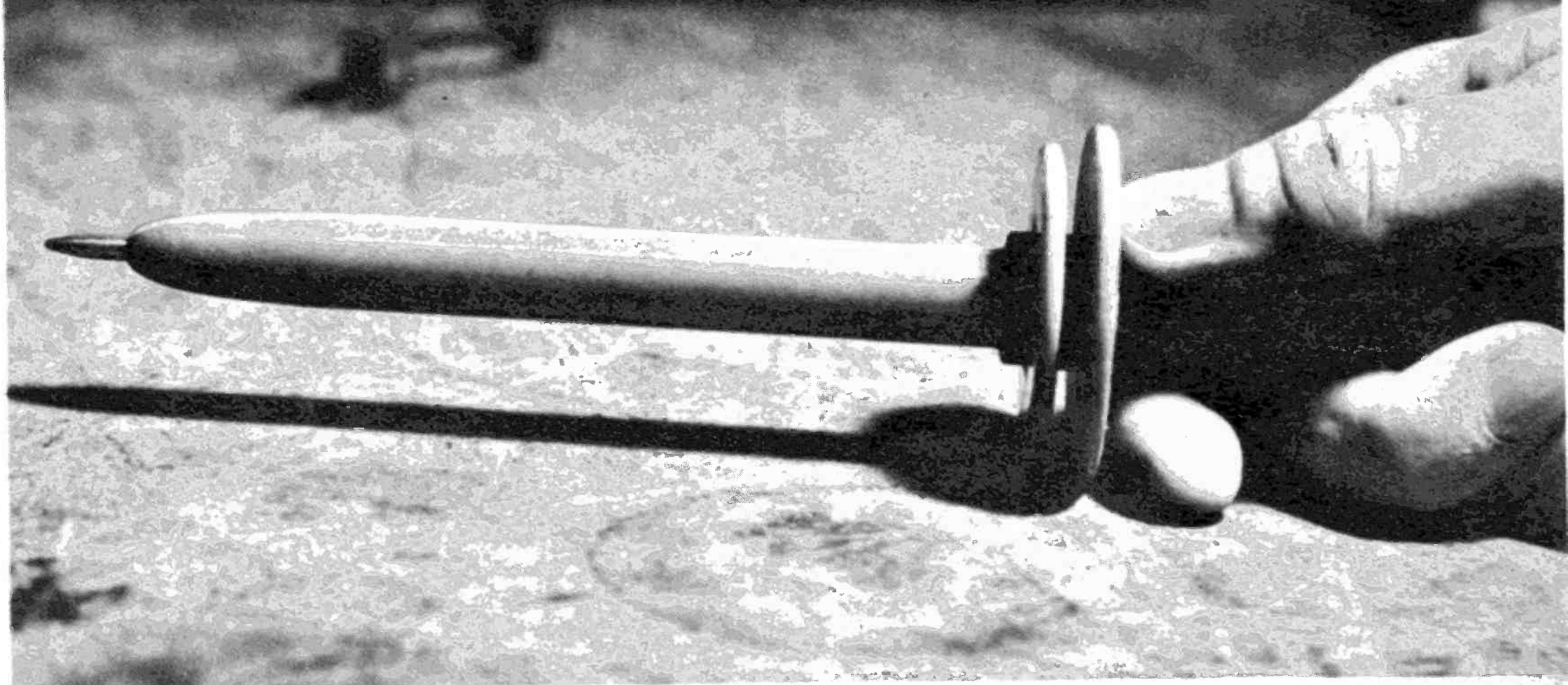

With this high voltage probe attached to a meter the high voltage in a color TV can be set exactly.

Fixing High Voltage Troubles

How to fix the main causes of the thirteen possible brightness problems

THE trouble symptom of NO BRIGHTNESS-SOUND GOOD is the commonest TV trouble. While there are other causes, most of the time the brightness quits because the high voltage quits. This is true in color and black-and-white sets.

The rest of the high voltage symptoms are caused by weak high voltage rather than dead high voltage. The high voltage is produced for the sole purpose of being applied to the well of the picture tube. Twenty-six thousand volts are produced for a color CRT (picture tube) and about eighteen thousand for a black-and-white. The high voltage is the plate voltage or B-plus of the picture tube. The high voltage power supply is like the low voltage supply except for the fact the low voltage need make only about 400 volts DC while the high voltage has to produce thousands of DC voltage potential.

The high voltage production line consists of the following circuits. These circuits and especially the tubes in the circuits are the immediate suspects during a high voltage failure.

The HORIZONTAL OSCILLATOR produces a sawtooth wave shape. The HORI-

ZONTAL OUTPUT takes the 15,750 CPS (cycles per second) waveshape and amplifies it from about 400 volts to about 3000 volts. These 3000 volts are fed into the horizontal winding of the YOKE.

The changing pulse is transferred from the yoke into the FLYBACK transformer. In the transformer the 3000 volts AC are stepped up to 18 kilovolts for black-and-white and 26 KV for color.

Between the yoke and flyback is the DAMPER. This 15,750 CPS tends to go into further unwanted oscillations. The damper dampens these oscillations. Without the damper these spurious oscillations would kill the high voltage production.

From the flyback the high AC voltage is fed into the HIGH VOLTAGE RECTIFIER. There the AC is changed to DC and sent directly to the well of the picture tube.

In color TV's a HIGH VOLTAGE REGULATOR is placed in the DC high voltage line between the rectifier and the CRT well. When there is a lot of brightness on the screen the high voltage tends to drop. The regulator keeps the twenty-six thousand volts steady at twenty-six thousand volts.

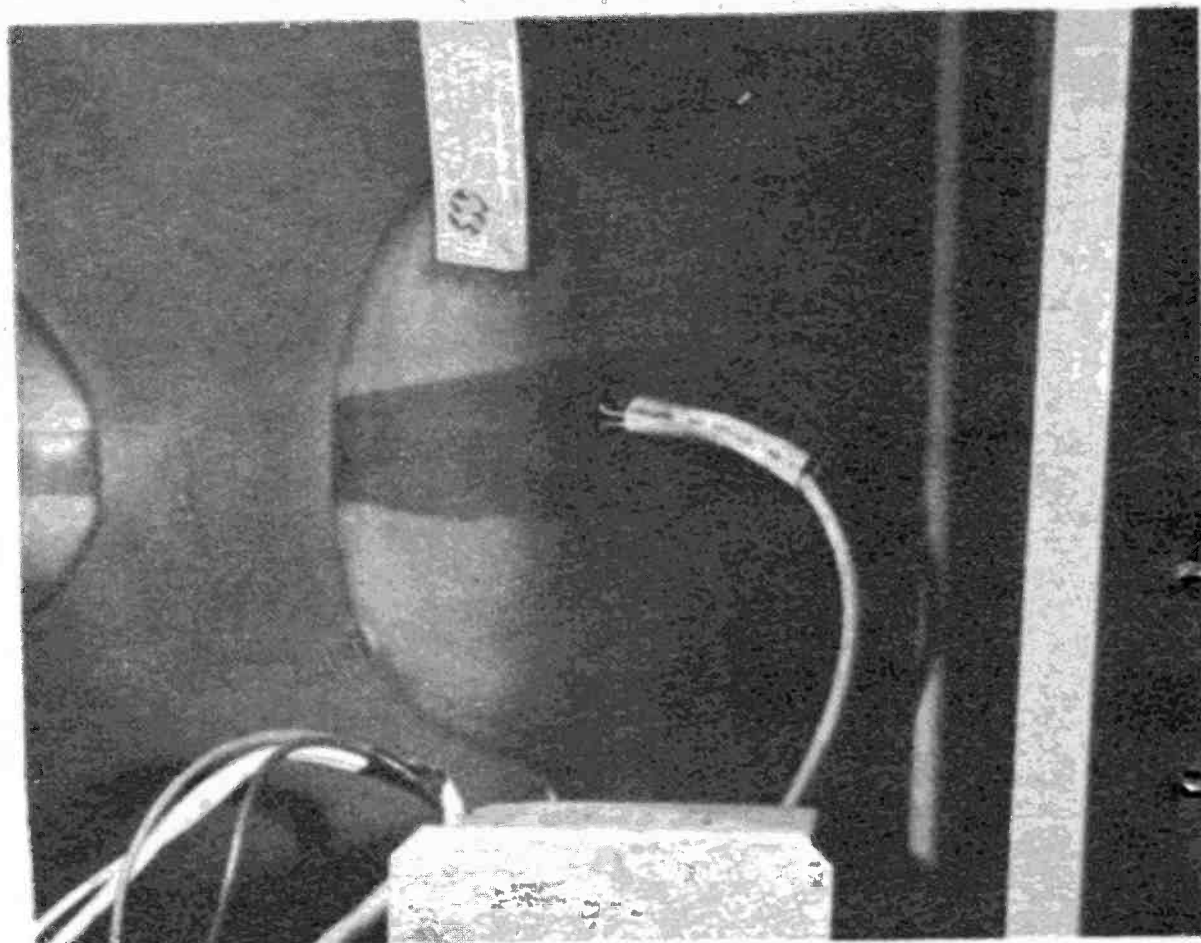
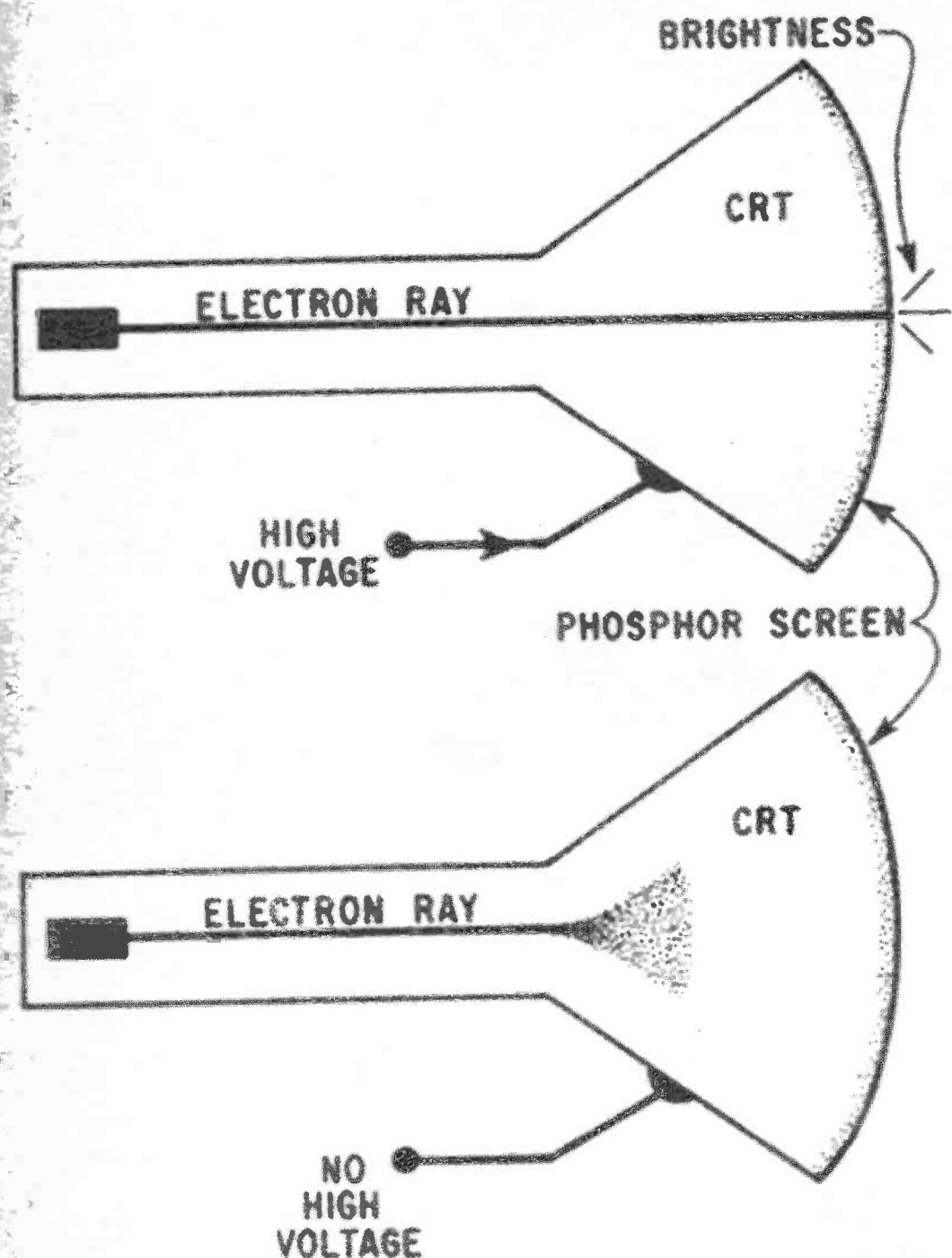

This is the well side where the high voltage enters into both color and monochrome television.

Left, when high voltage quits and cathode ray cannot get to TV screen, the picture goes black.

These seven prime suspects must be tested. You can test them one by one, using a blanket approach, to catch the bad one, or use the professional system.

NEON BULB—You'll need a neon test bulb. You can buy one in any hardware store for about fifty cents. With the TV on, place the neon near the cap of the horizontal output tube. When the high voltage is on, the RF (radio frequency) energy around the tube will light the bulb brightly. When the high voltage is weak the bulb lights dimly. When the high voltage is dead the bulb won't light.

BRIGHT—When the bulb lights bright it means the high voltage AC is good. Test the tubes that work on the DC; the **HIGH VOLTAGE RECTIFIER** and **HIGH VOLTAGE REGULATOR**.

DIM OR OUT—When the bulb lights dimly, or not at all, pull the cap off the high voltage rectifier. This disconnects the DC area. Then try the bulb test again. If it lights up now it means a part in the DC area is bad. Test the **HIGH VOLTAGE RECTIFIER** and **HIGH VOLTAGE REGULATOR**.

If the bulb still lights dimly after disconnecting DC, test the **HORIZONTAL OUTPUT**, the **DAMPER** and the **HORIZONTAL OSCILLATOR**. With the TV off, feel **FLYBACK** (it must not run hot), and

feel width coil (it can't run hot either).

When the bulb is out altogether look for a high voltage fuse or circuit breaker. There are many kinds of fuses; some look like resistors, some look like tiny square colored boxes and then there are the old familiar automobile type fuses.

If you do find a bad fuse, change the damper tube on general principles. It usually is the cause of a blown fuse. It arcs intermittently from the heater to its cathode.

The other AC area production circuits also are suspects in the attempts to restore high voltage.

The old test method of arcing the high voltage rectifier to isolate the trouble, I personally do not advise. Besides the danger of contacting the voltage potential you can burn out or weaken the flyback and horizontal output tube.

BLOOMING—The condition of blooming, that is, the picture puffs up as you advance the brightness control and shrinks as you turn the control back, is due to low high voltage. As the potential decreases the condition becomes more and more pronounced.

In black-and-white TV's whenever that condition occurred a fast replacement of the **HIGH VOLTAGE RECTIFIER** usually affected a cure. It gets a little more sticky with a color set. The rectifier is still

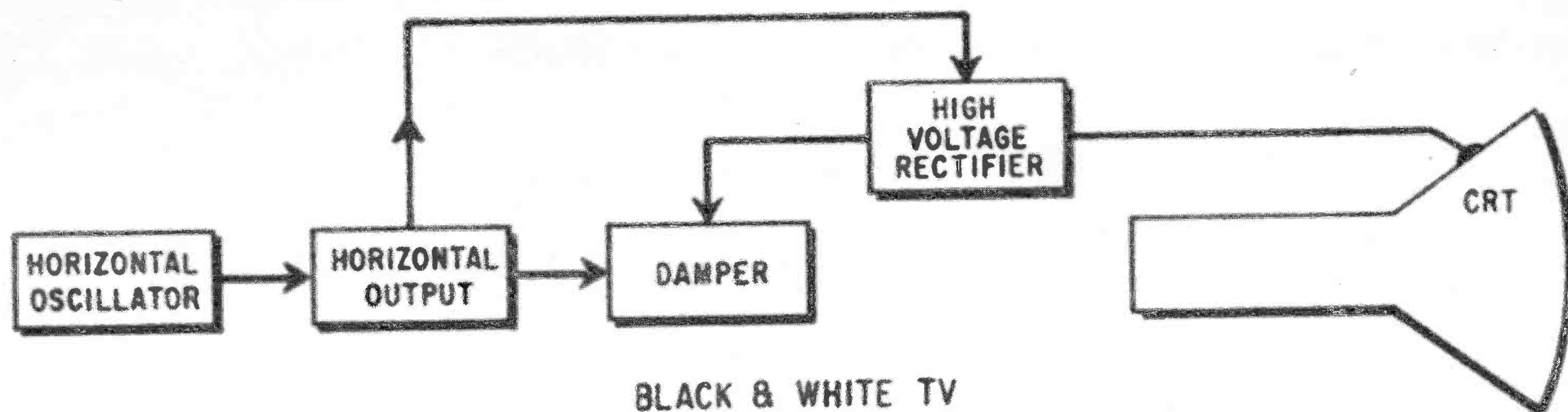

In the monochrome TV the high voltage system is simple since only eighteen thousand volts are needed.

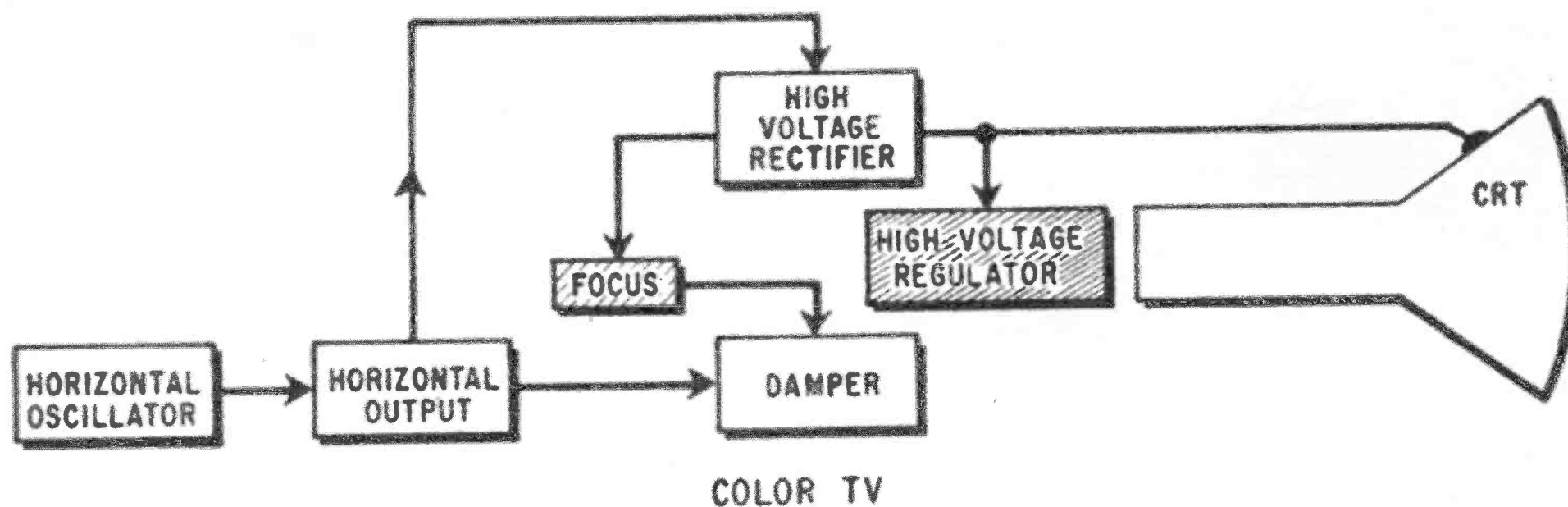

In color TV there are two extra high voltage circuits required to produce twenty-six thousand volts.

a prime suspect, but the HORIZONTAL OUTPUT tube, the DAMPER, the HIGH VOLTAGE REGULATOR, and the FOCUS RECTIFIER are also consistent troublemakers. Anything that will lower the regulated 26 kilovolts just a little bit causes the blooming. The monochrome TV could become lowered a great deal before it would display blooming.

DEFOCUSED—When you lose focus try the brightness control. If the picture blooms, too, the blooming is the real symptom with the defocusing a secondary result. If the picture doesn't bloom you have a true focus symptom. Turn the focus control in the back. On color TV's it usually sticks out of the high voltage cage. If the control has no effect, replace the FOCUS RECTIFIER. It can be a tube or a small skinny selenium rectifier. It will probably cure the trouble.

When the control does have some effect but won't quite bring the picture back into sharpness, test the focus rectifier again, first, but chances are good the HIGH VOLTAGE RECTIFIER, HIGH VOLTAGE REGULATOR or HORIZONTAL OUTPUT is at fault.

Sweeping the Raster

The light on the screen is not what it looks like. It is one pinpoint of light about

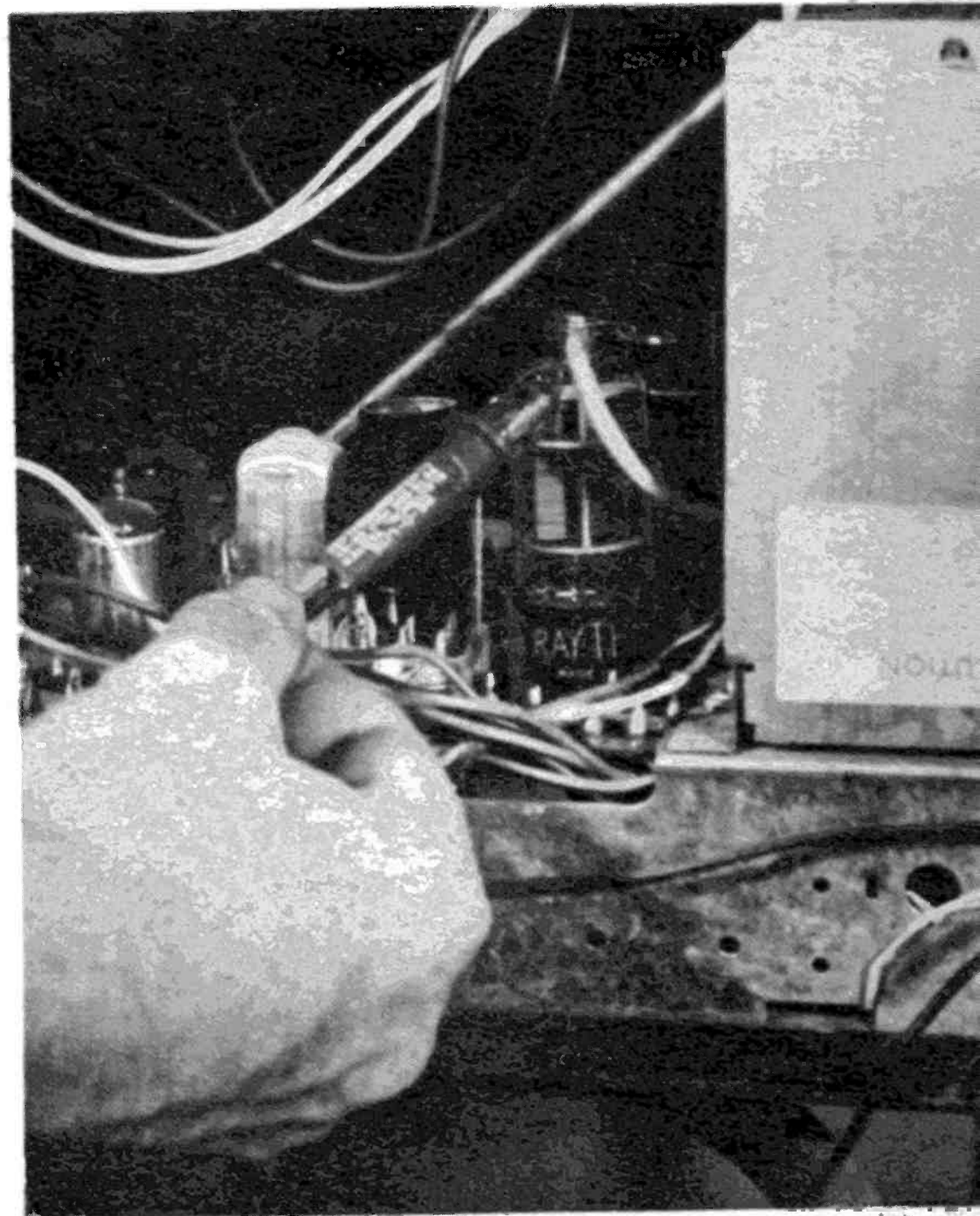

A safe and easy way to test for the presence of high voltage is to place a neon tester in here.

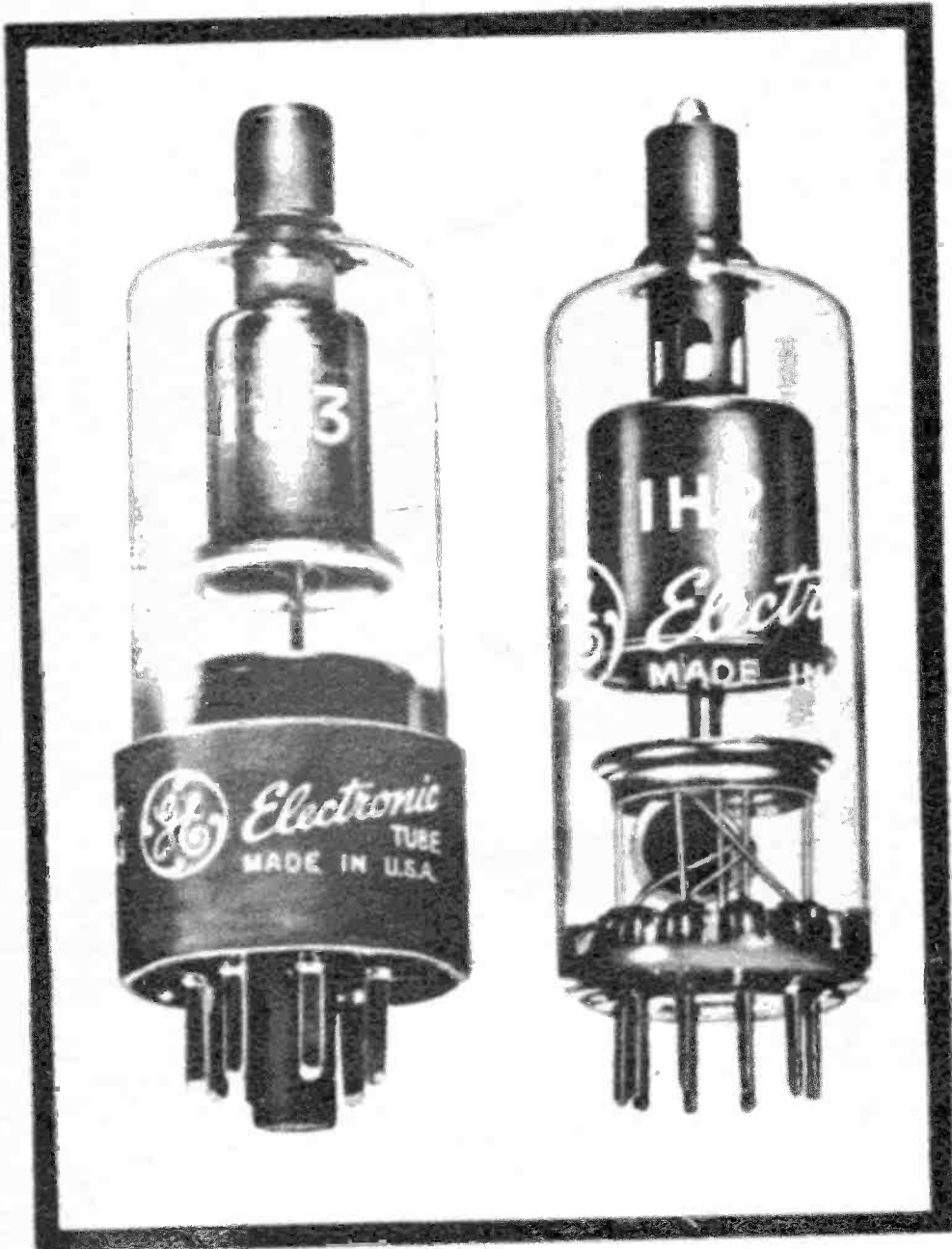

Typical high voltage rectifier tubes have heavy duty caps on tube top to pass the high voltage.

a 32nd of an inch in diameter that is swept across the screen in lines starting in the upper left hand corner and ending in the lower right. There are 525 lines in a TV picture.

On a black-and-white screen the light dot is produced from one electron gun impinging on white phosphor. On a color screen the light is produced from three electron guns impinging on three different color phosphors—one red, one green and one blue.

The monochrome phosphor is a single coat all over the TV screen. The polychrome phosphor is a set of over 330,000 trios of phosphor dots. Each trio containing one red dot, one green dot and one blue dot. The three electron guns, the red gun, the green gun and the blue gun, all fire at their respective dots. The dots are so tiny they can't be seen without a magnifying glass. Your eye sees the result, which is color addition. The three lights mix to produce either black-and-white or colored images.

In both black-and-white and color pictures the same number of lines are displayed. There are 15,750 lines drawn every second. The lines are pulled down then

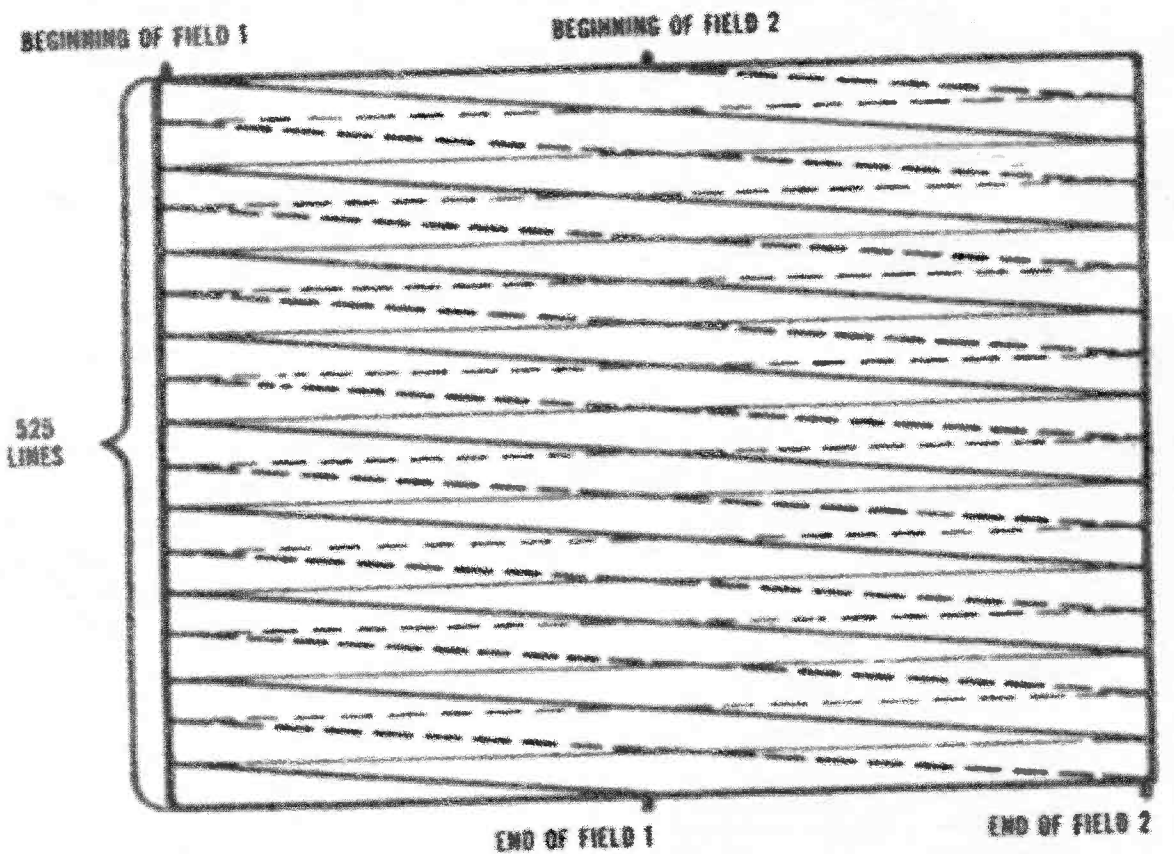
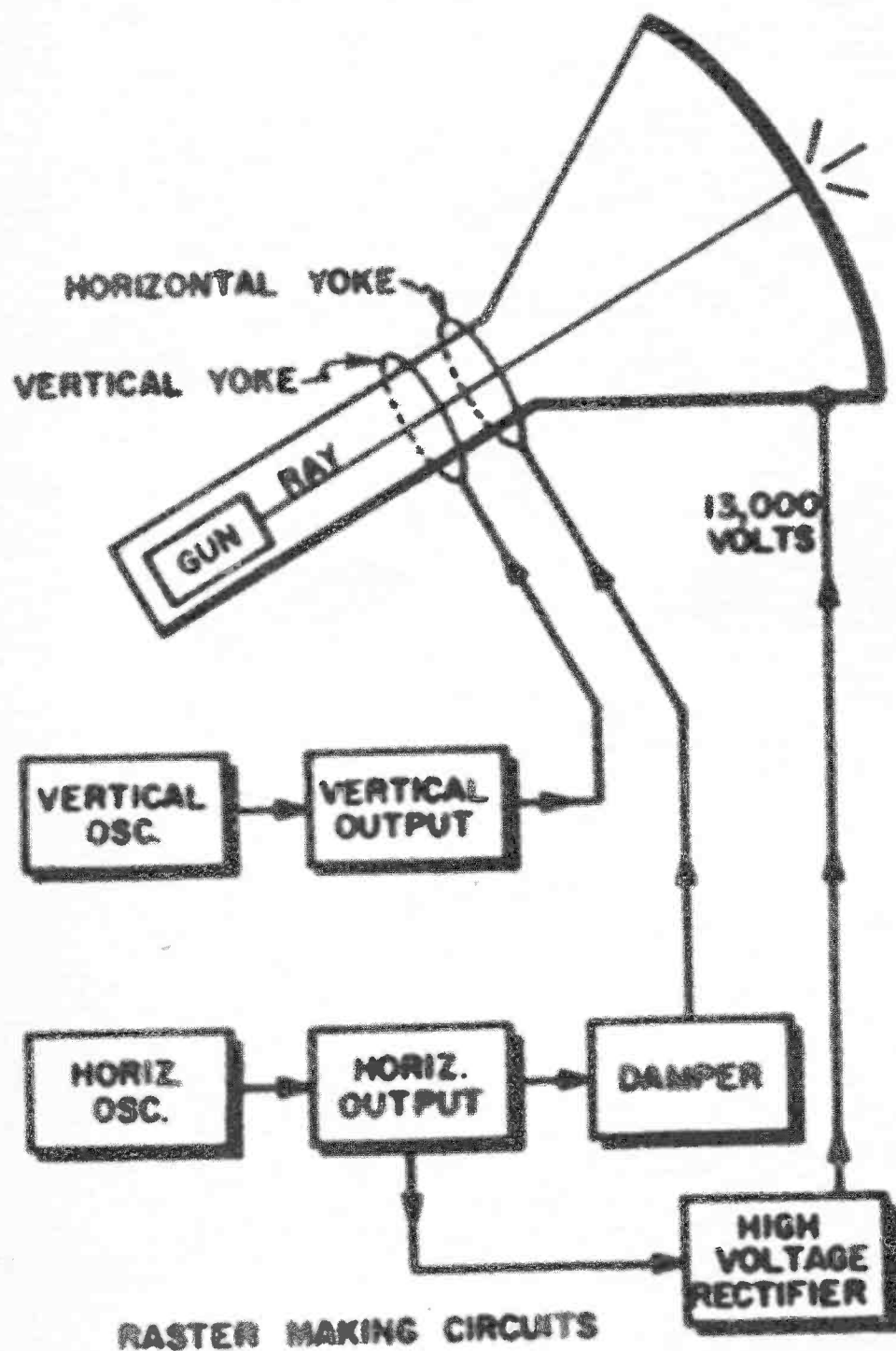

Line by line the electron ray traces two fields totalling 525 lines (one frame only) every second.

The sweep circuits cause the electron ray to sweep the TV screen from side to side and top to bottom.

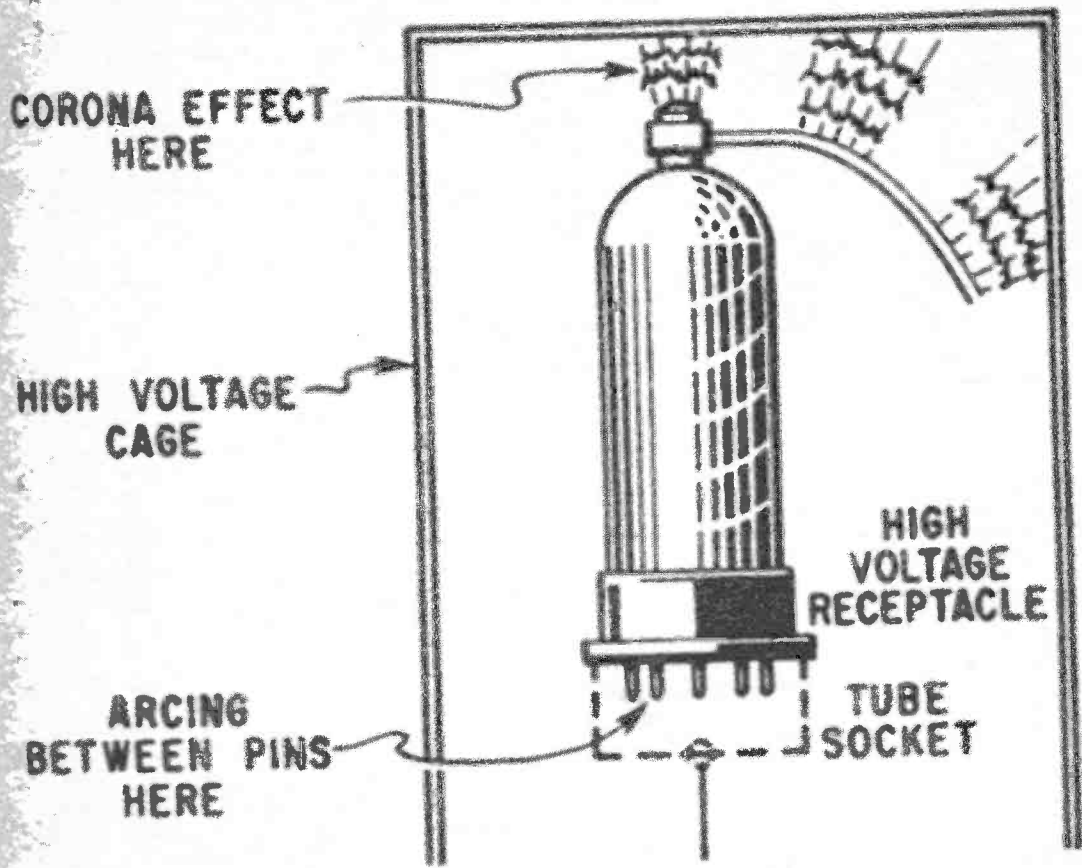

HIGH VOLTAGE LEAKAGE

A corona often occurs between HV rectifier tube cap and HV cage, and also between the tube pins.

FLYBACK or YOKE can cause this condition.

POOR HORIZONTAL LINEARITY—The damper circuit in addition to dampening spurious flyback oscillations ends up with a rectified output like a power supply. Its output is higher than the low voltage supply and is called boost B-plus. It produces about 600 volts DC. This voltage is fed to output tubes such as the horizontal, vertical and audio.

When the damper circuit weakens, especially because of a weak DAMPER tube this boost B-plus lowers and one of the results is poor horizontal sweeping of the

The corona effect can be adjusted by placing a piece of fish paper or plastic in corona's path.

CRT screen. An extreme case is a picture that exhibits a shrink from one side and an oversweep on the other. A circle on the screen looks like a flat-headed egg lying on its side.

Also, white vertical lines can appear. A slightly weak damper just pulls the picture out of shape slightly. A TV performer will have one large shoulder and one narrow one.

You can attempt the cure by replacing the DAMPER and the HORIZONTAL OUTPUT. Also by adjusting the HORIZONTAL DRIVE CONTROL, LINEARITY and WIDTH CONTROLS.

ARCING LINES—The damper circuit, because of this boost B-plus duty, has a rough voltage arrangement imposed on it. The 600 volt boost is taken off at the cathode. The heaters run around six volts. This makes the potential between the cathode and heaters close to 600 volts.

The heaters physically touch the cathode with only a ceramic sleeve between them. The insulation sleeve is subject to breakdown. When it does break the boost leaks across to the heaters. This causes the arc lines on the screen. If the arcing continues or develops into a dead short, the high voltage fuse will blow.

To cure arcing, try replacing the DAMPER tube. Also should the high voltage fuse blow out periodically, change the damper tube.

In rare cases, other tubes can cause similar troubles. Fortunately you can get a visual tipoff by looking for sparks in the tube. Look in all the tubes. Any such spark indication in any tube means the tube must be replaced.

While this is the common AC high voltage test technique, experts do not particularly advise it.

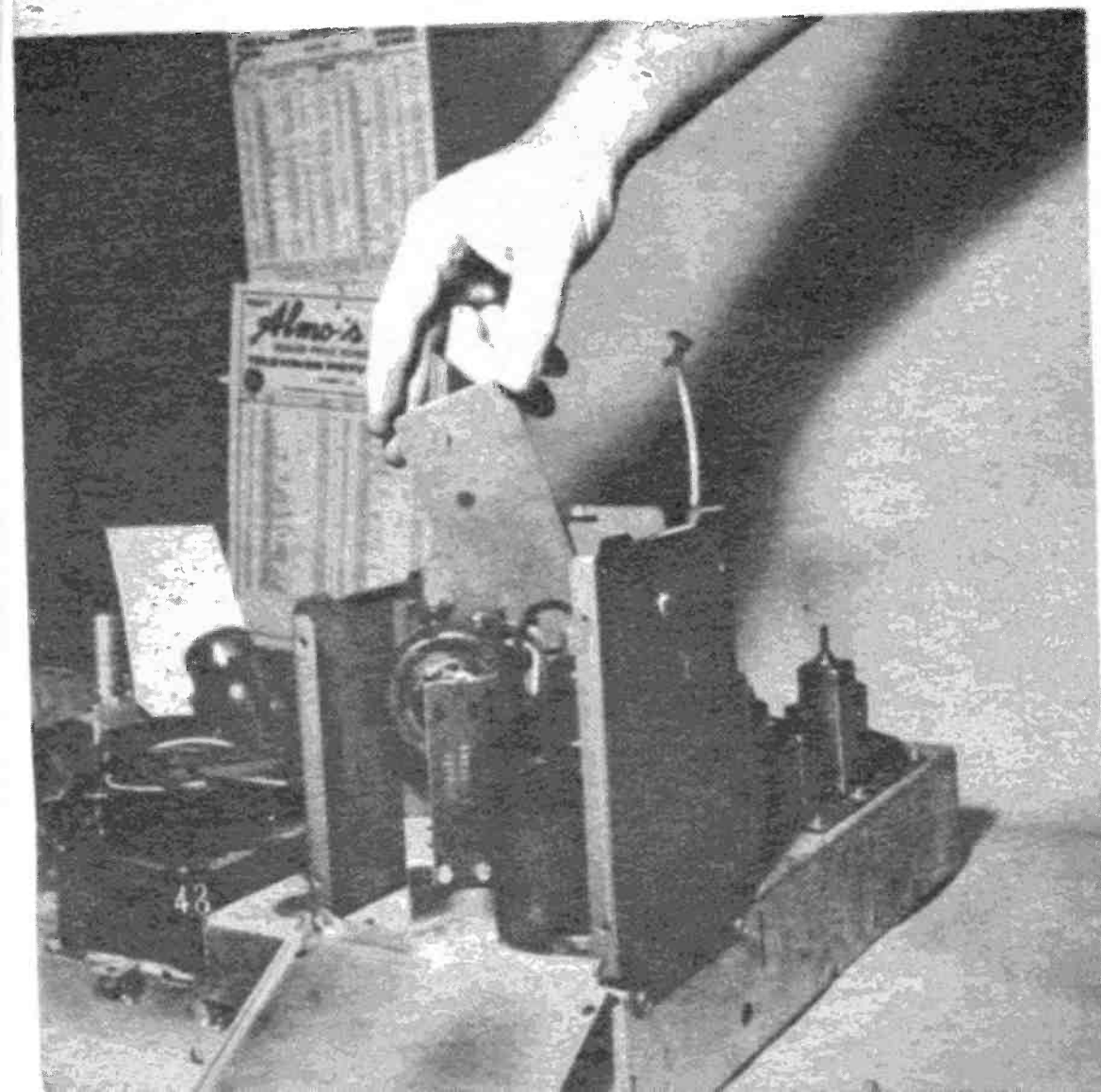

Vertical bars (Barkhausen oscillation) can be cured by wedging wood to flyback or output tube.

The only way you can make a DC test quickly is to arc the high voltage anode lead to chassis.

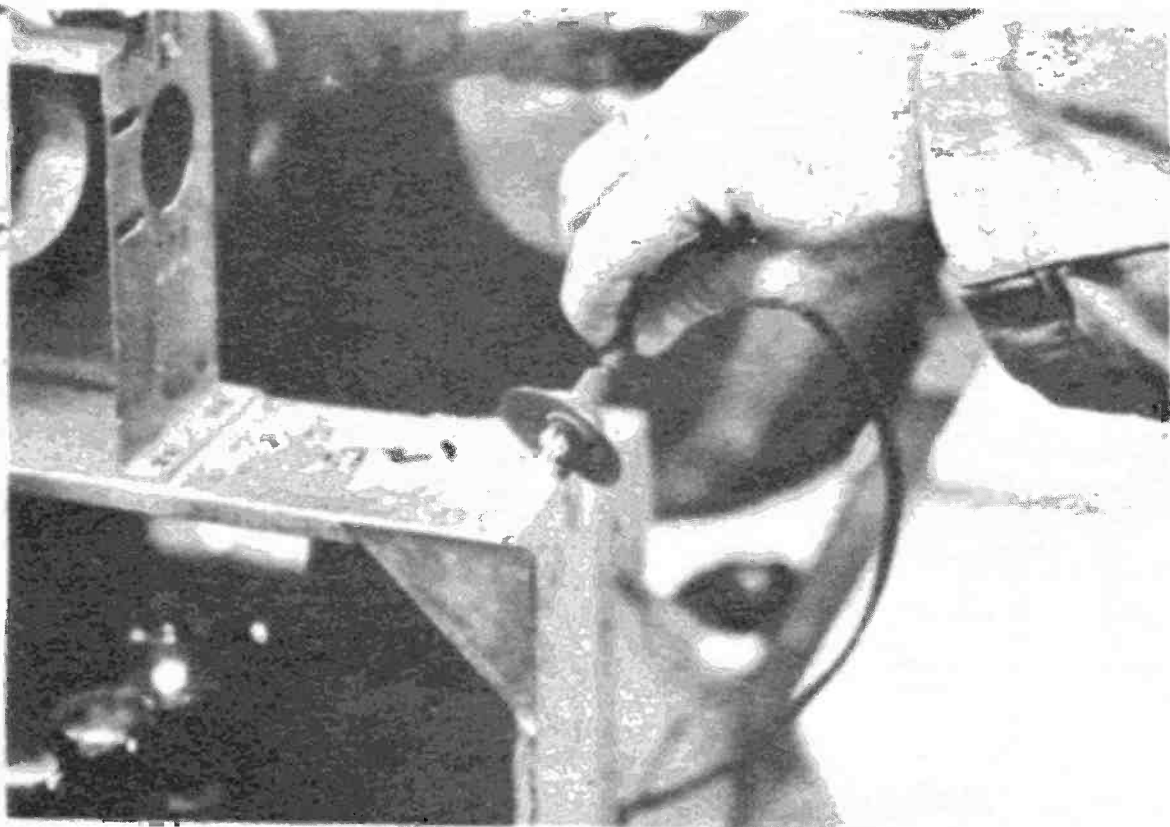

Be careful when taking the caps off HV tubes. The connections corrode and can snap off at top.

CORONA EFFECTS—This is caused by the high voltage spilling out of its circuit to the nearest ground point. When it happens you can hear the hissing, smell some ozone, and if you darken the room, see a blue trail of electricity somewhere in the high voltage or sweep circuits.

This trouble is especially prevalent in hot humid weather and will occur around the picture tube well or cap of the high voltage rectifier. The cure is usually easy. Place a piece of high voltage insulation material like plastic, or fish paper, between the emitting surface and the ground point.

If the bottom of the high voltage rectifier socket is emitting to the chassis there are plastic cups made especially to be placed there.

If the picture tube well is emitting, clean the surrounding surface thoroughly and wipe it dry. That should cure it.

Should you cure one corona discharge

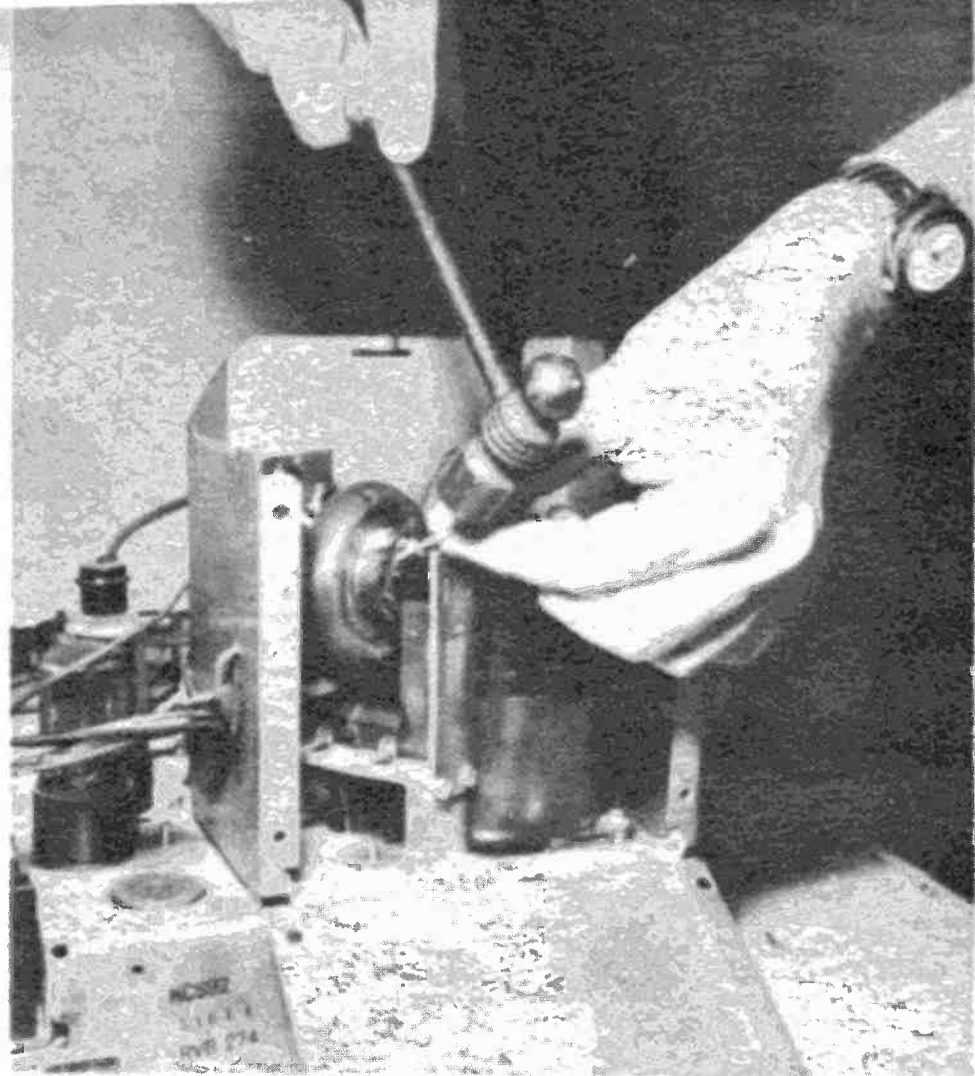

and another one starts up, there is a complication. There is a short some place else. It usually is in the anode lead from the rectifier to the picture tube well or in the rectifier heater winding in the flyback. Taping up the anode lead short usually cures the condition but the heater winding must be replaced.

VERTICAL BARS—These are called Barkhausen oscillations and are caused by radiation from the **HORIZONTAL** output tube or the **DAMPER** tube. The RF energy is being transmitted from the caps of these tubes to the tuner input lead. Besides replacing the tube, check to see if the lead from the antenna terminals to the tuner is inadvertently close to these circuits. It should be on the other side of the chassis. If it gets too close, it will pick up the interference even from good tubes. Try repositioning the lead before replacing one of the tubes. •

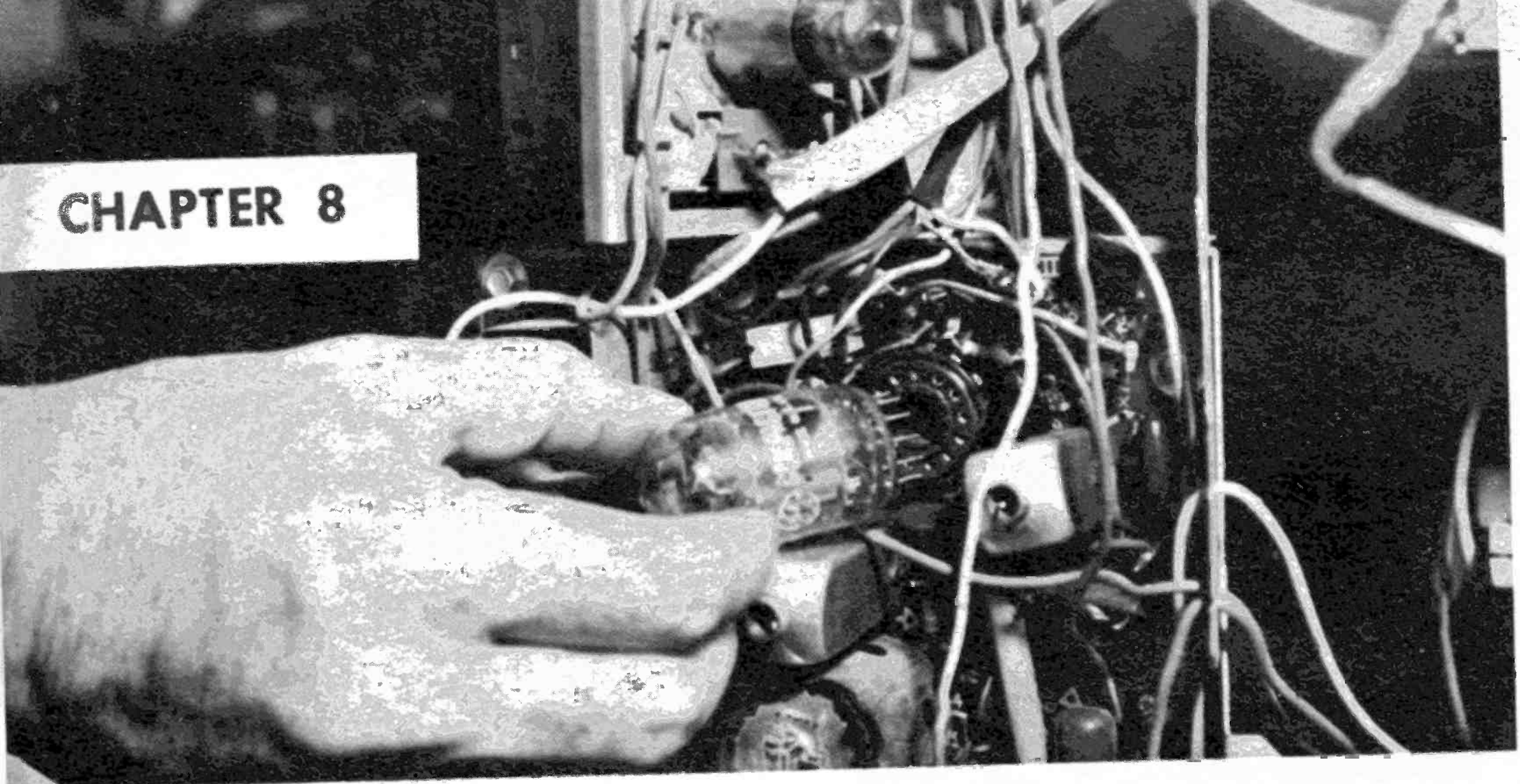

This sync tube has five sections to it. When you change the tube you replace the entire sync.

Stopping Rock and Roll

CONTAINED in the TV stations' transmission are two special lock-in signals, the horizontal sync and the vertical sync. Their main job is to flow through your TV and lock the horizontal and vertical oscillators into step with the TV picture they accompany.

If they don't do this your two oscillators run at will. As a result your picture will roll, go off into horizontal lines, or display a number of other crazy symptoms.

There is a special tap, into the path the signal takes, that pipes off the lock-in portion of the signal. There are many variations of sync circuits the lock-in signal is then fed to, but basically they all do this: First circuit is a SYNC SEPARATOR. In this tube and component area the vertical and horizontal sync signals are separated from one another. The horizontal sync comes out one exit of the separator tube, usually the cathode, and the vertical out of another exit, usually the plate.

Hooked onto the separator circuit is a companion circuit called the NOISE CANCELLER or NOISE INVERTER. It gets a tiny sampling of the sync signals too. When there is interference in the sync signal the noise canceller is activated and shuts down the sync separator for the instant the noise would have passed through the separator. If the noise had passed through, your picture would have suffered, especially a color picture. As soon as the noise clears, the canceller permits the separator to run once

again. All this takes place in a few millionths of a second.

When the horizontal sync leaves the separator it is sent onto the HORIZONTAL PHASE DETECTOR. This can be a tube, but in most newer TV's the phase detector is a three-pronged silicon diode. In the phase detector the horizontal sync pulse is shaped, given the proper voltage, and then is fed into the horizontal oscillator where it locks the 15,750 CPS into step with the line structure of the incoming picture.

When the vertical sync leaves the separator it is sent into the VERTICAL INTEGRATOR. This is a small printed circuit component that is composed of resistors and capacitors and is soldered into place between the separator and the vertical oscillator. It shapes and gives the proper voltage to the vertical sync pulse and then feeds it into the vertical oscillator.

The VERTICAL OSCILLATOR is chugging along at 60 CPS and the sync pulse locks it into step with the field frequency of the incoming picture.

This vertical oscillator produces a sawtooth waveshape and feeds it into the VERTICAL OUTPUT circuit. Both circuits are quite often in one tube. The output amplifies the signal many times and transfers it into the vertical windings of the yoke. There the magnetic influence of the vertical waveshape pulls the electron beam down, then up as the horizontal is pulling it from side to side.

The typical sync circuit takes a sampling from the video circuits into the separator and canceller.

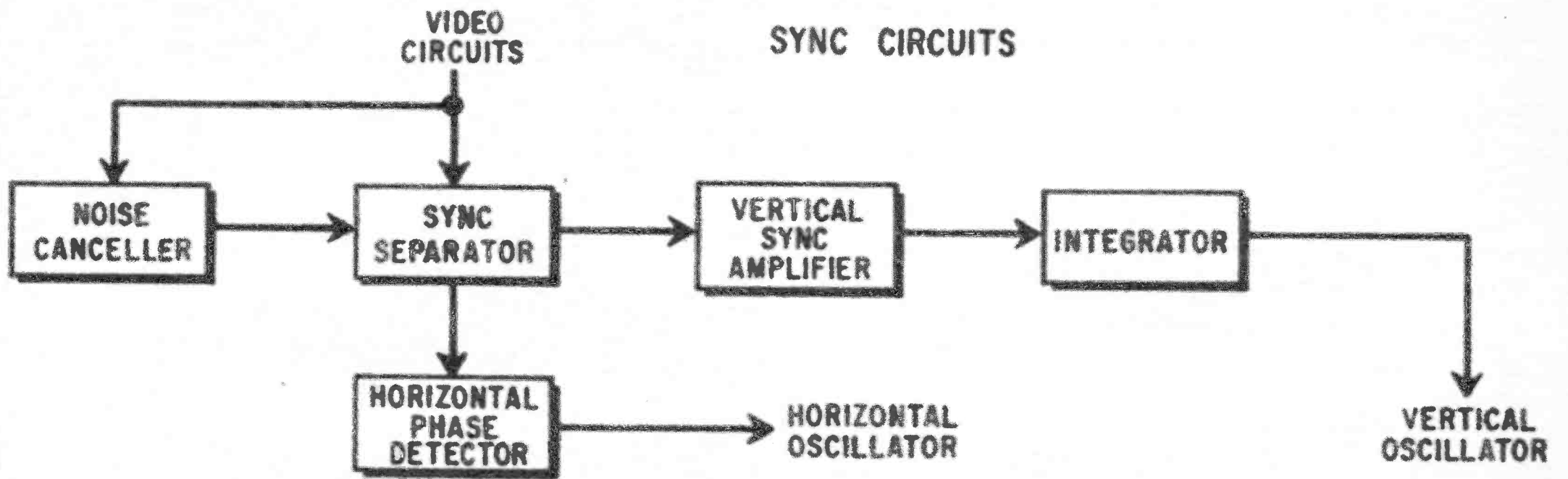

When picture begins to go in all directions, try adjusting horizontal and vertical hold controls.

A slow, vertical roll must be further diagnosed if vertical hold control does not hold picture.

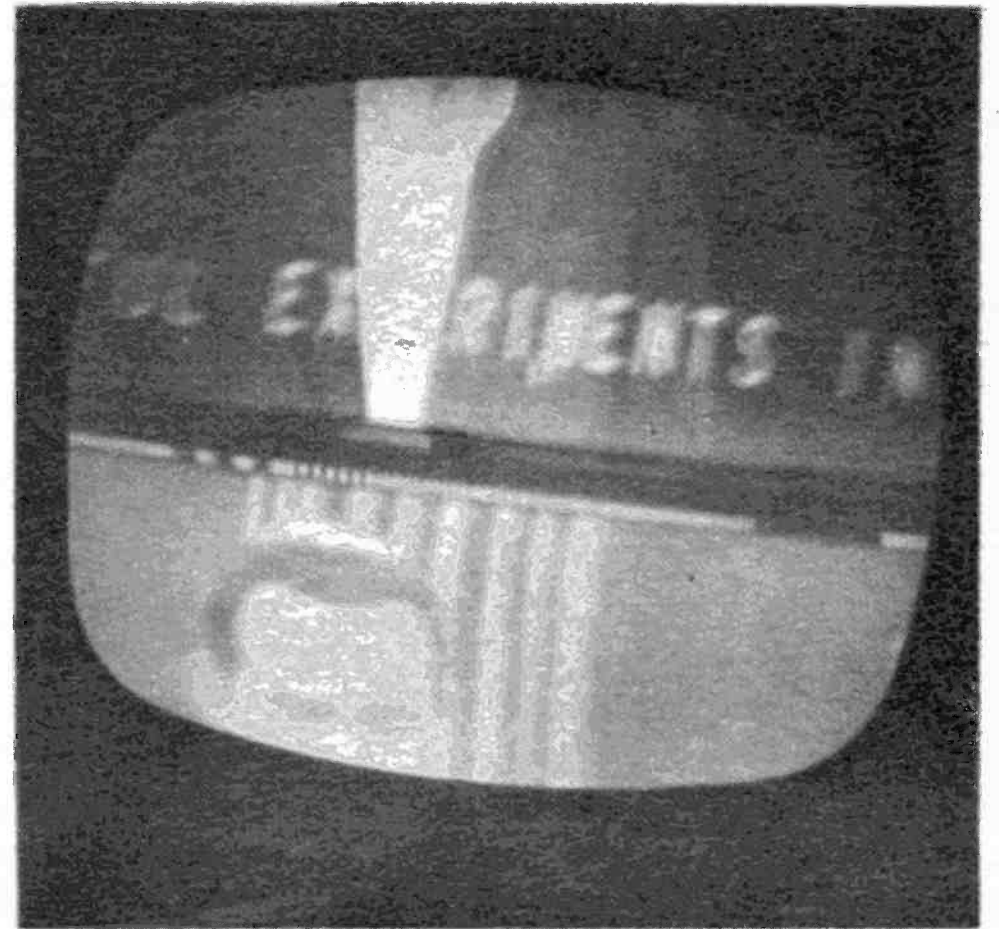
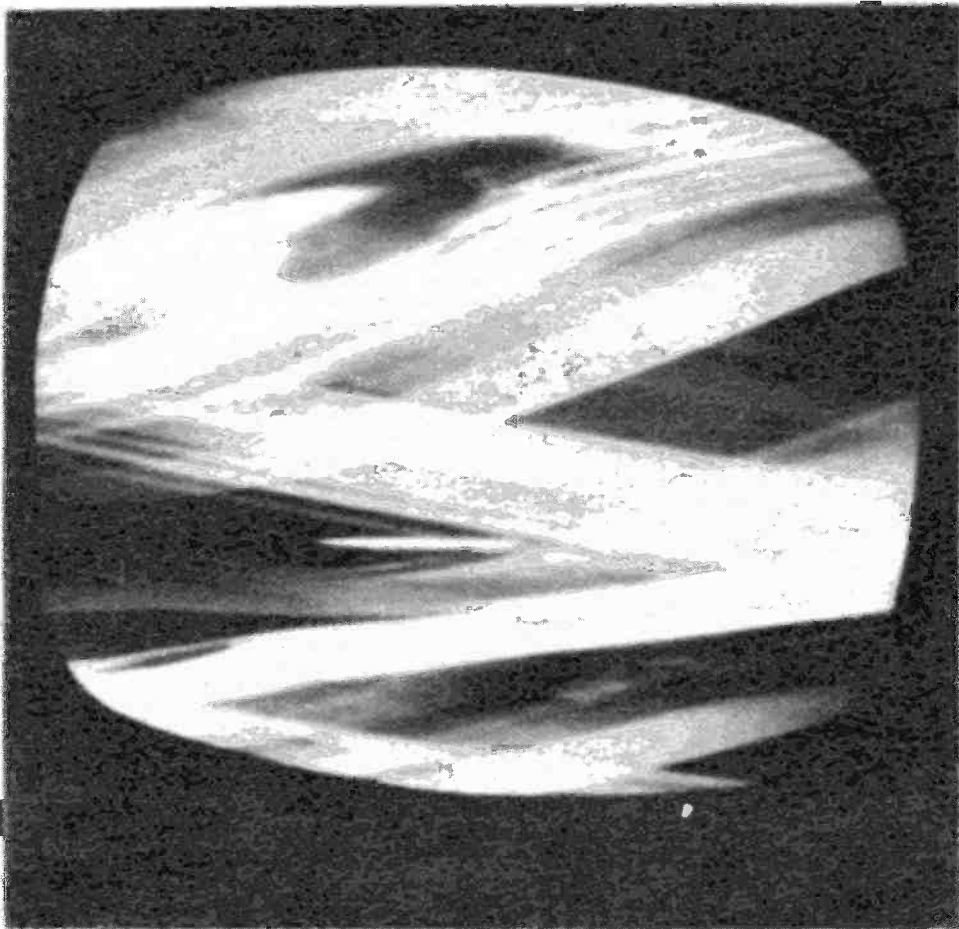

When picture on screen collapses into a white vertical line, be sure to turn down brightness.

When picture spreads out too far (vertical fold-over) the vertical output tube is prime suspect.

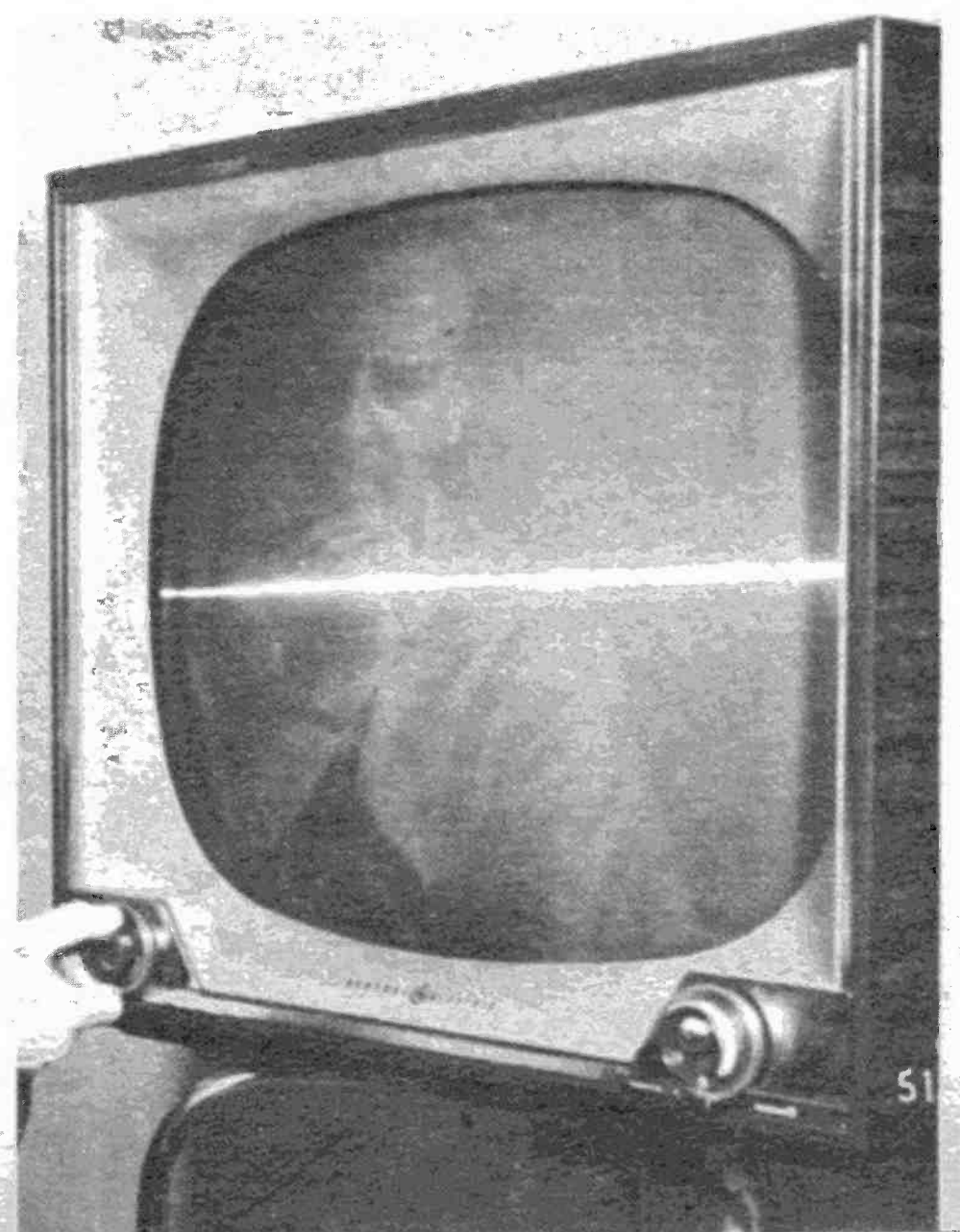
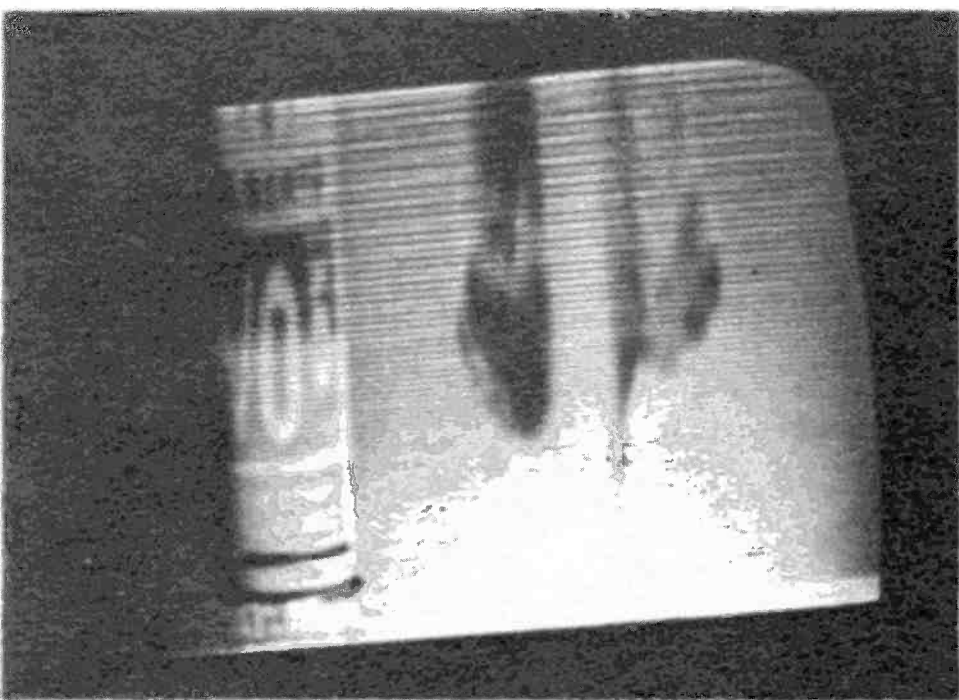

When trouble develops in these areas the familiar rock and roll symptoms are displayed on the screen. A correct reading of the symptoms tells you where the trouble is.

Your first step in reading the trouble is to try and adjust the horizontal and vertical hold controls. Check to see if either one will work. If the vertical hold stops the rolling, even though the horizontal still is acting up, the vertical circuits are cleared and the horizontal becomes the main suspect. Should the horizontal hold work, but the picture still rolls, the vertical is the prime suspect. If neither works, the sync circuits, where the two lock-in signals travel together is the first place to look.

VERTICAL ROLL—This slipping that resembles movie film slipping can be further analyzed. Adjust the vertical hold control. If the picture can be stopped, but won't lock in, test the SYNC tubes first and the VERTICAL OSCILLATOR-OUTPUT second. The oscillator is running at the right frequency but it is running free with no lock-in. When the picture rolls and can't be stopped, check the VERTICAL OSCILLATOR-OUTPUT first and the SYNC tubes second. The oscillator is not running at the right frequency.

INCORRECT VERTICAL SWEEP—This can take the form of top and bottom shrinking, top and bottom oversweep with vertical foldover, poor vertical linearity (that is pointy heads and short legs or flat heads and long legs), or no vertical sweep (that is a white horizontal line across the screen). Test the VERTICAL OSCILLATOR-OUTPUT and try adjusting the VERTICAL LINEARITY control and the VERTICAL HEIGHT control. Adjusting these controls can throw the frequency off. When

The vertical linearity control has the tendency to spread out or shrink the top of the picture.

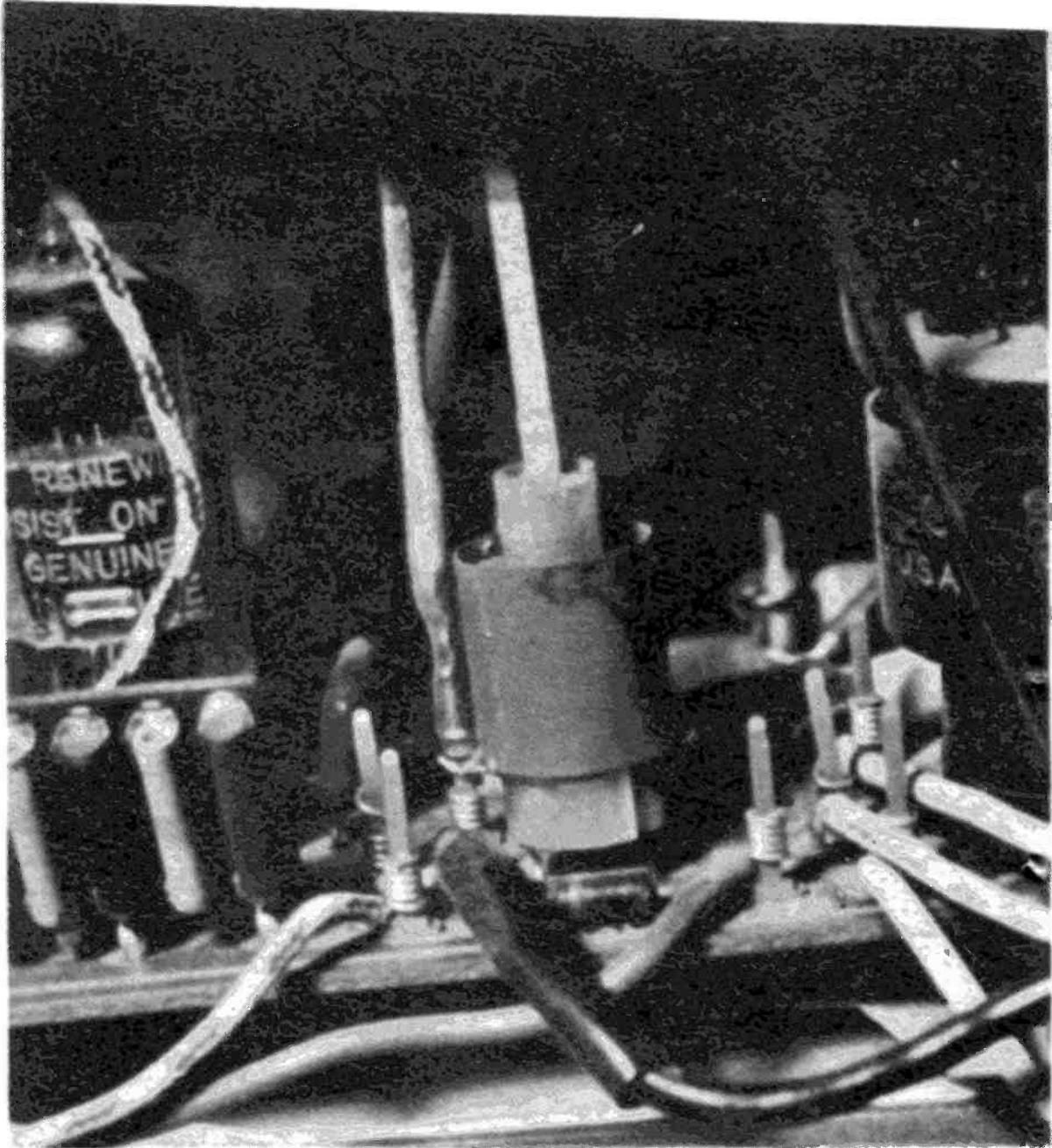

The vertical height control has the tendency to spread out or shrink the bottom of the picture.

Most common reason for horizontal phase problems is a slight misadjustment of phase coil.

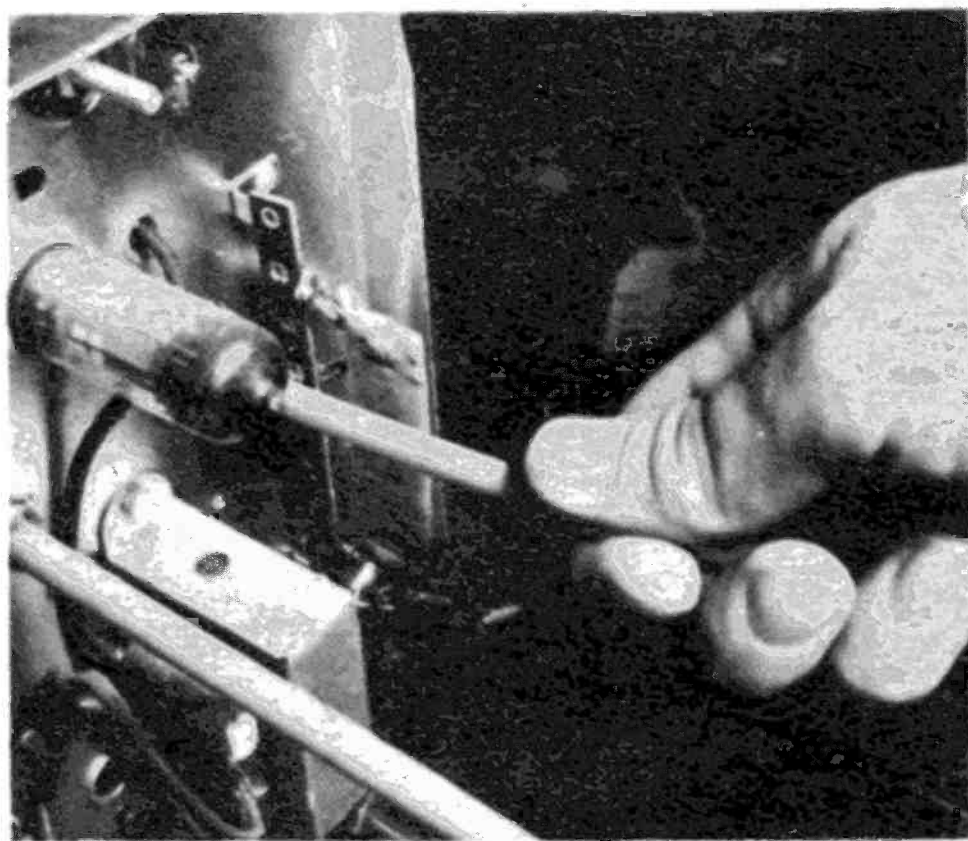

When the picture slips sideways rather than go off into horizontal lines, it's a phase problem.

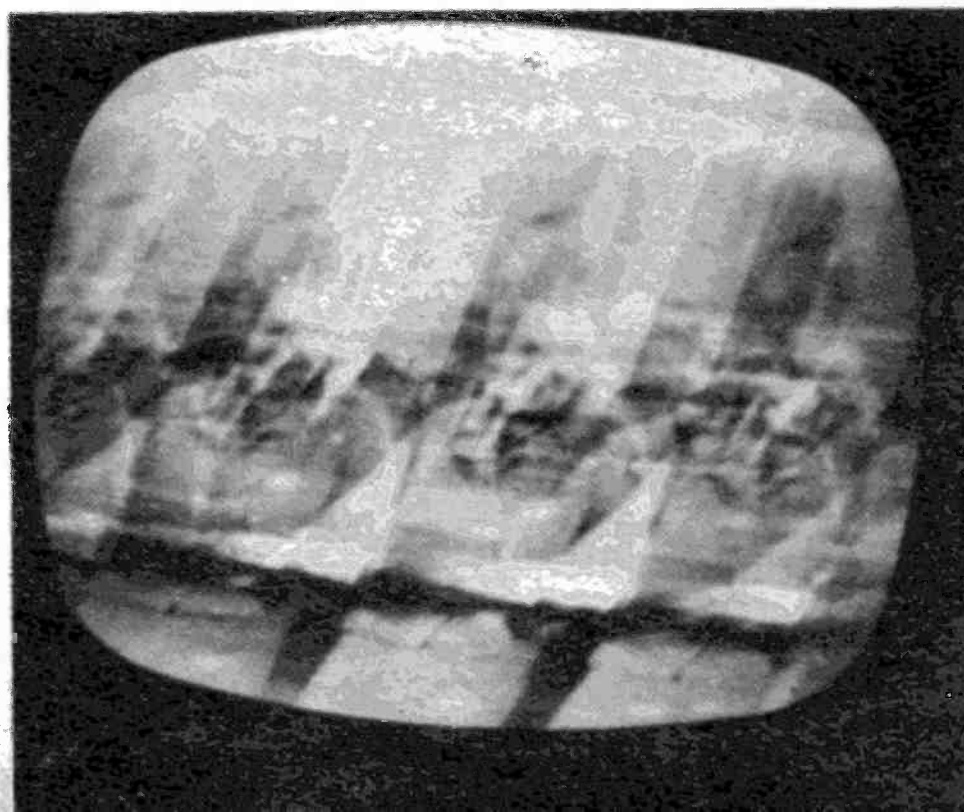

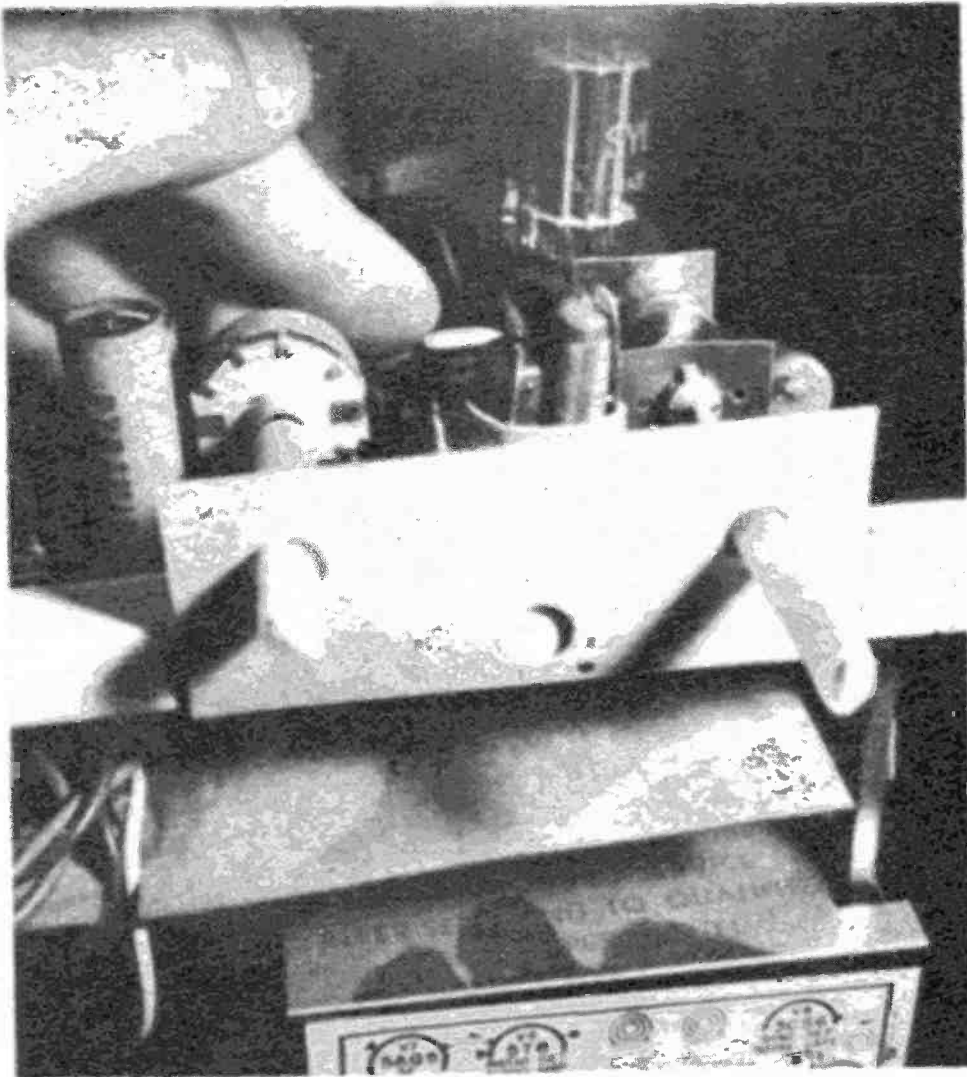

Most common component that goes bad and causes horizontal phase problems is this dual diode.

When picture is slightly out of phase, condition is called "Christmas Tree," and looks like this.

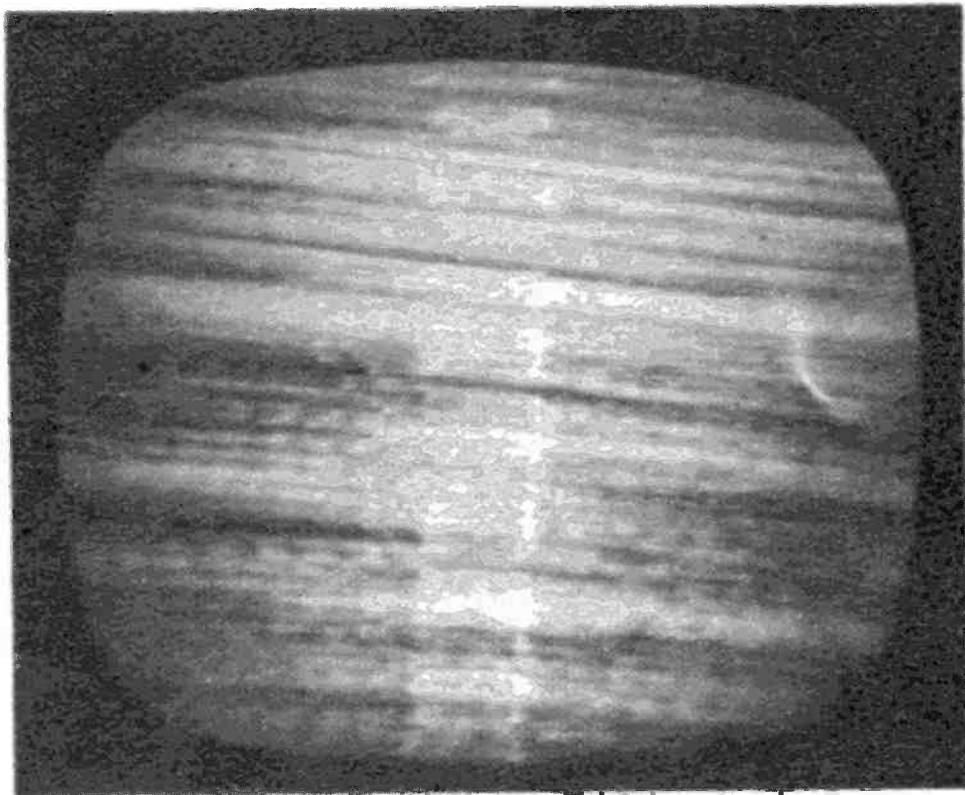

Slight bend in the picture, starting at the top, indicates a problem in one of the sync tubes.



it does, keep readjusting the VERTICAL HOLD control. As you adjust the LINEARITY and HEIGHT notice the linearity seems to affect the top of the picture and the height the bottom of the picture. Adjust accordingly.

NO HOLD CONTROL—When the horizontal slips and the vertical slides and the controls won't stop it, you have a pure sync trouble. Test the SYNC SEPARATOR, NOISE CANCELLER and any other sync tubes. Theoretically you could have a bad VERTICAL OSCILLATOR-OUTPUT and a bad HORIZONTAL PHASE DETECTOR at the same time, but it is rare.

NO HORIZONTAL SYNC—This trouble can take the form of a screenful of smooth horizontal lines, a split picture with the right on the left, the left on the right and the blanking bar down the center, or a screenful of jagged horizontal lines accompanied by a squeaking sound (Christmas tree effect).

Test the HORIZONTAL PHASE DETECTOR and HORIZONTAL OSCILLATOR. Also try adjusting with a hex head nut stick the HORIZONTAL FREQUENCY and PHASE COILS. These measures represent the great majority of cures, especially the two adjustments.

THE BENDS—This condition can vary from a slight pull at the top of the picture to a performer taking the shape of an S curve. This trouble can be caused by a heater-to-cathode short in a tube. When it's a SYNC, HORIZONTAL PHASE DETECTOR, HORIZONTAL OSCILLATOR or HORIZONTAL OUTPUT tube that's shorted, the bend will take place on an otherwise good picture. If the short is in the signal path tubes (See Chapter 9) the bend will take place as a black or white bar passing vertically through the picture and be accompanied by a hum.

While new tubes cure the trouble, most of the time other components, such as coupling capacitors, cause this trouble. In these cases the trouble is one of the hardest to pinpoint.

PIE CRUST—This is one of the classic picture-book troubles but up to recently, rarely occurred. It has been showing up in a lot of the newer portables. It's caused by loose elements that physically vibrate in a HORIZONTAL OUTPUT or DAMPER tube and a loose winding in the FLYBACK transformer. If you should encounter this trouble try replacing those tubes and try snugging the FLYBACK winding by tapping small wedges of wood between the core and the winding. •



Adjustment of the AGC control on the TV set turns the picture signal from washed out to overly black.

When the Contrast Control Acts Up

Defects that can ruin your contrast on its trip along the signal path

THE CONTRAST or picture signal is one of the passengers aboard the transmitter carrier wave. There are three other passengers, the lock-in signals (Chapter 8), the sound (Chapter 11), and the color (Chapter 15).

While there are some differences between the color TV and monochrome signal path circuits, when you are troubleshooting a contrast trouble, from the servicing viewpoint, consider all TV's alike. When you conduct sound or color troubleshooting you'll be examining a lot of the same circuits, but at that time you'll have to make the distinction between polychrome and monochrome TV's. But I repeat, for con-

trast troubles in TV, all sets are alike.

The contrast starts its journey in your TV aboard the carrier wave. The contrast enters through the antenna terminals into the tuner. First step is the RF AMPLIFIER. Here, along with the carrier and the rest of the passengers, the contrast is amplified. Next it passes through the MIXER-OSCILLATOR almost unchanged since that circuit does work on the carrier but not the passengers. From there the contrast is amplified first in the 1st IF, second in the 2nd IF and once again in the 3rd IF.

From there it goes into the VIDEO DETECTOR where it is separated from the carrier. It goes into the VIDEO AMPLI-

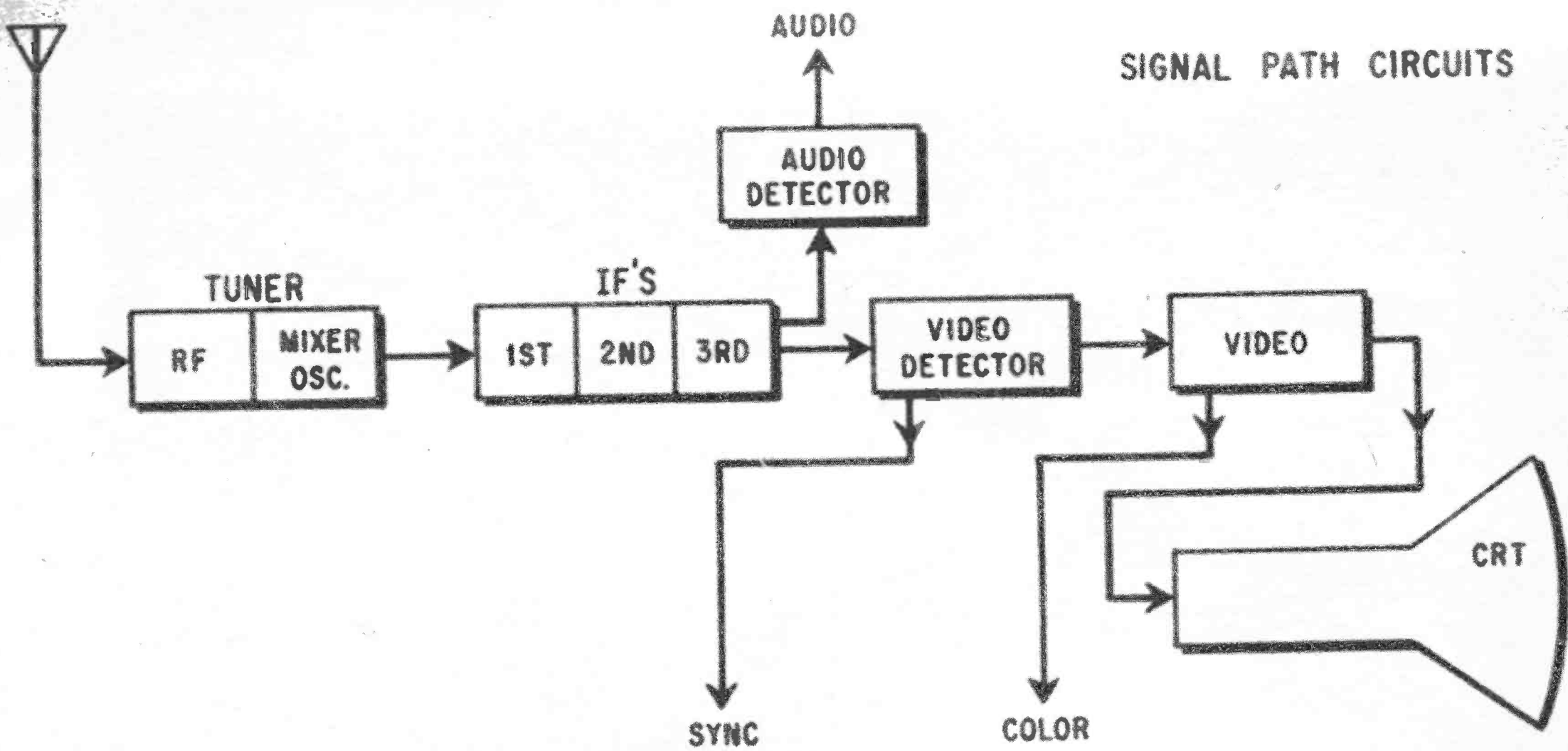

The carrier wave travels from the antenna to the detectors. There the passengers are separated.

When contrast starts acting up, the first step is to look in the tube location guide for suspects.

Then, using the location as a guide, locate the actual suspect and pull the tube out for a test.

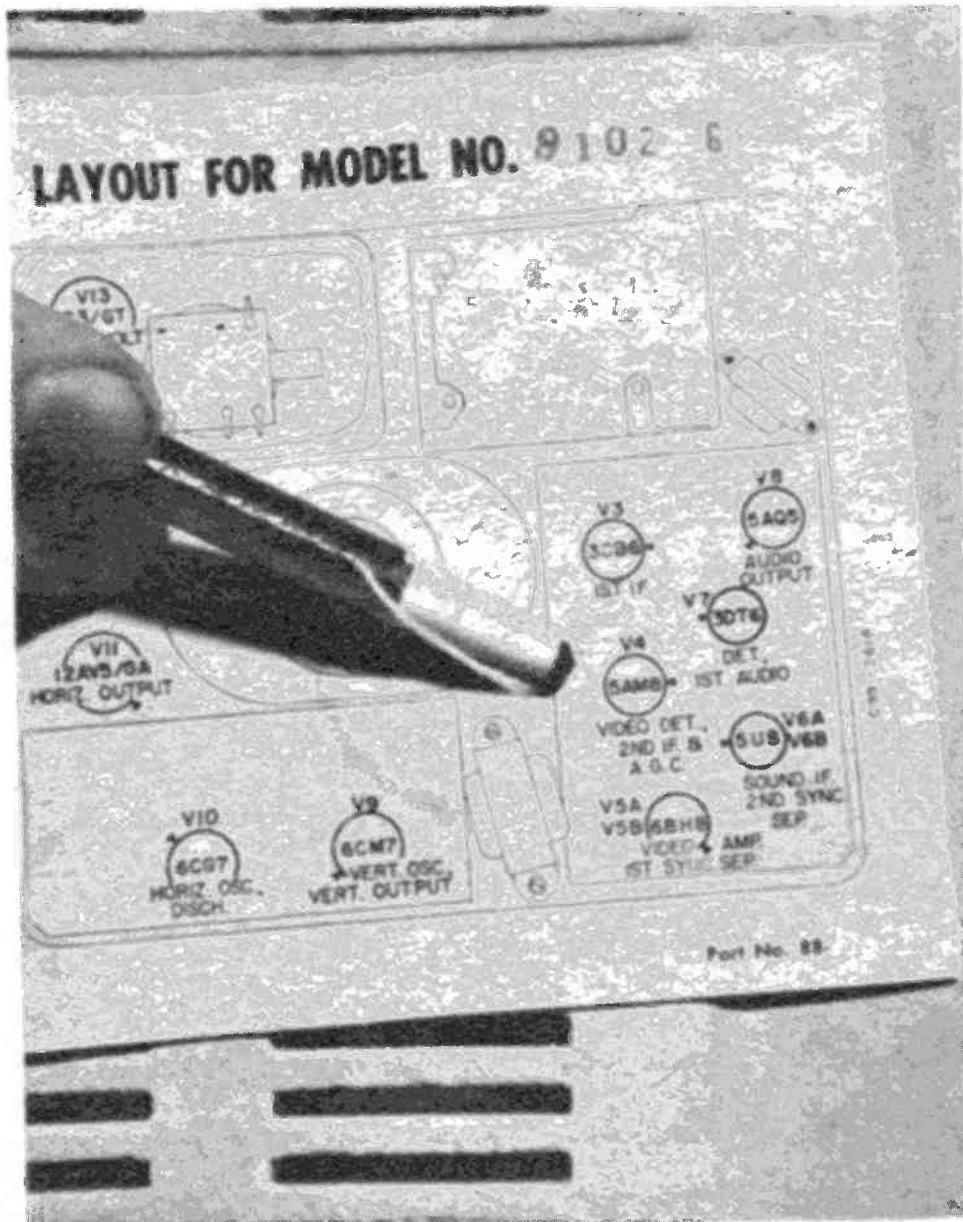

FIER and VIDEO OUTPUT and becomes amplified large enough to do work. Then the contrast signal goes to the cathode of the picture tube, in a black-and-white TV, or to the three cathodes of a color CRT. In a color set it is called the Y signal.

Actually the contrast is a voltage that is changing in amplitude that causes contrast frequency changes all the way up to four and a half million cycles per second. If you consider that audio changes in the best hi-fi are only around twenty thousand CPS, video changes are seen to have a tremendous range.

This is because the contrast represents millions of light and dark spots. On a

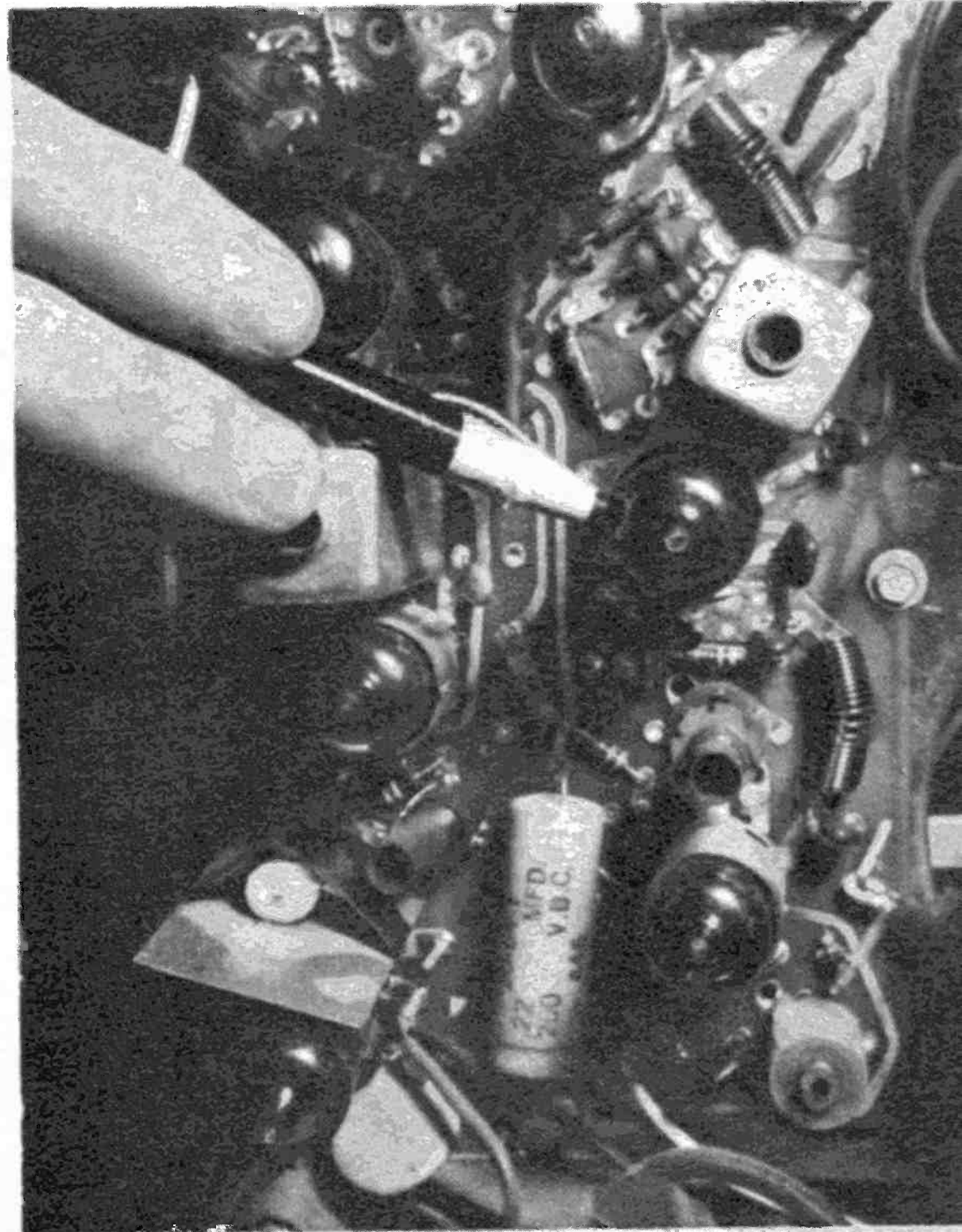

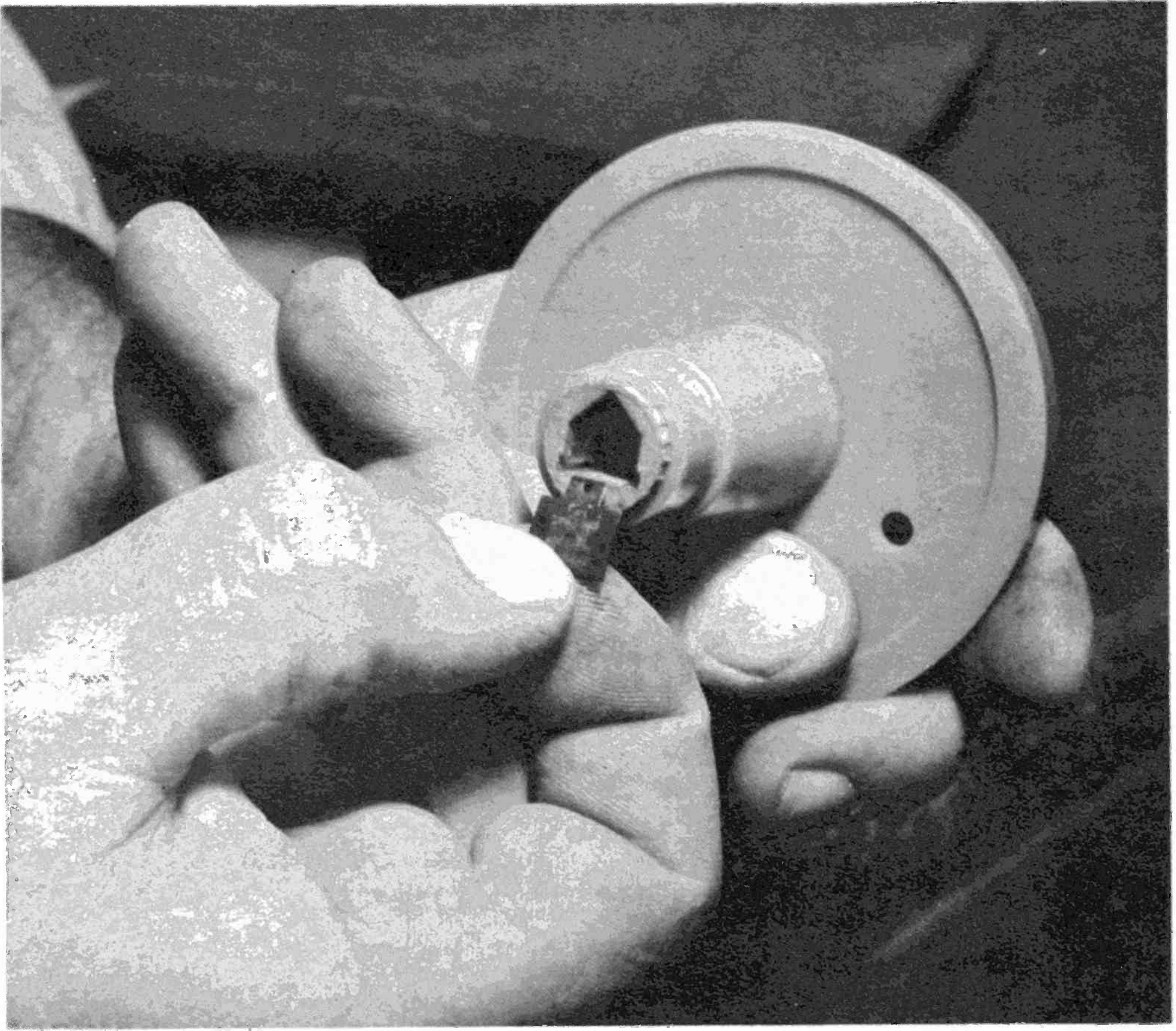

On rare occasions the contrast control won't work because the spring fell out and the knob is slipping.

Contrast troubles vary in degree from a washed out picture on your screen to an overloaded black.

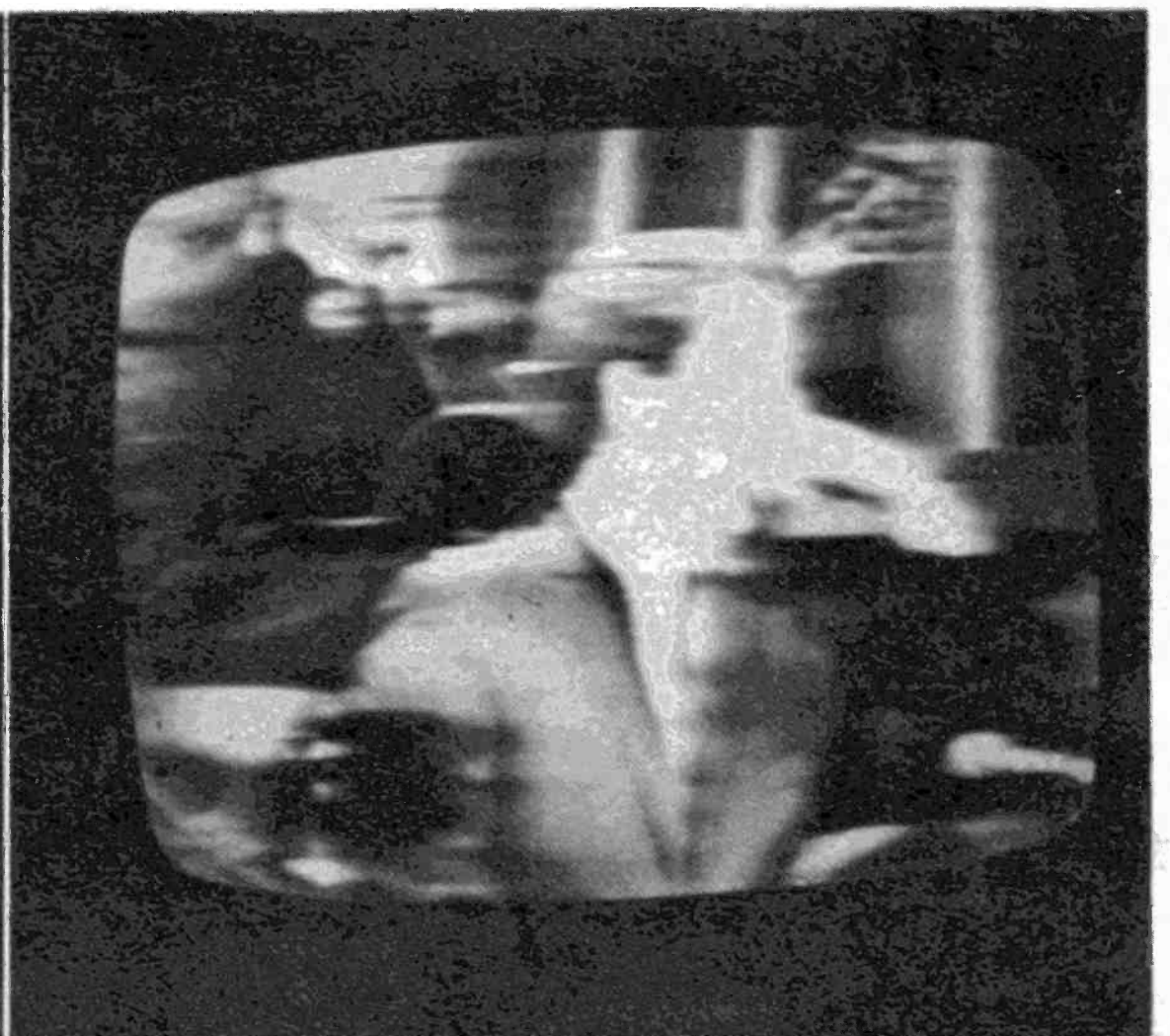
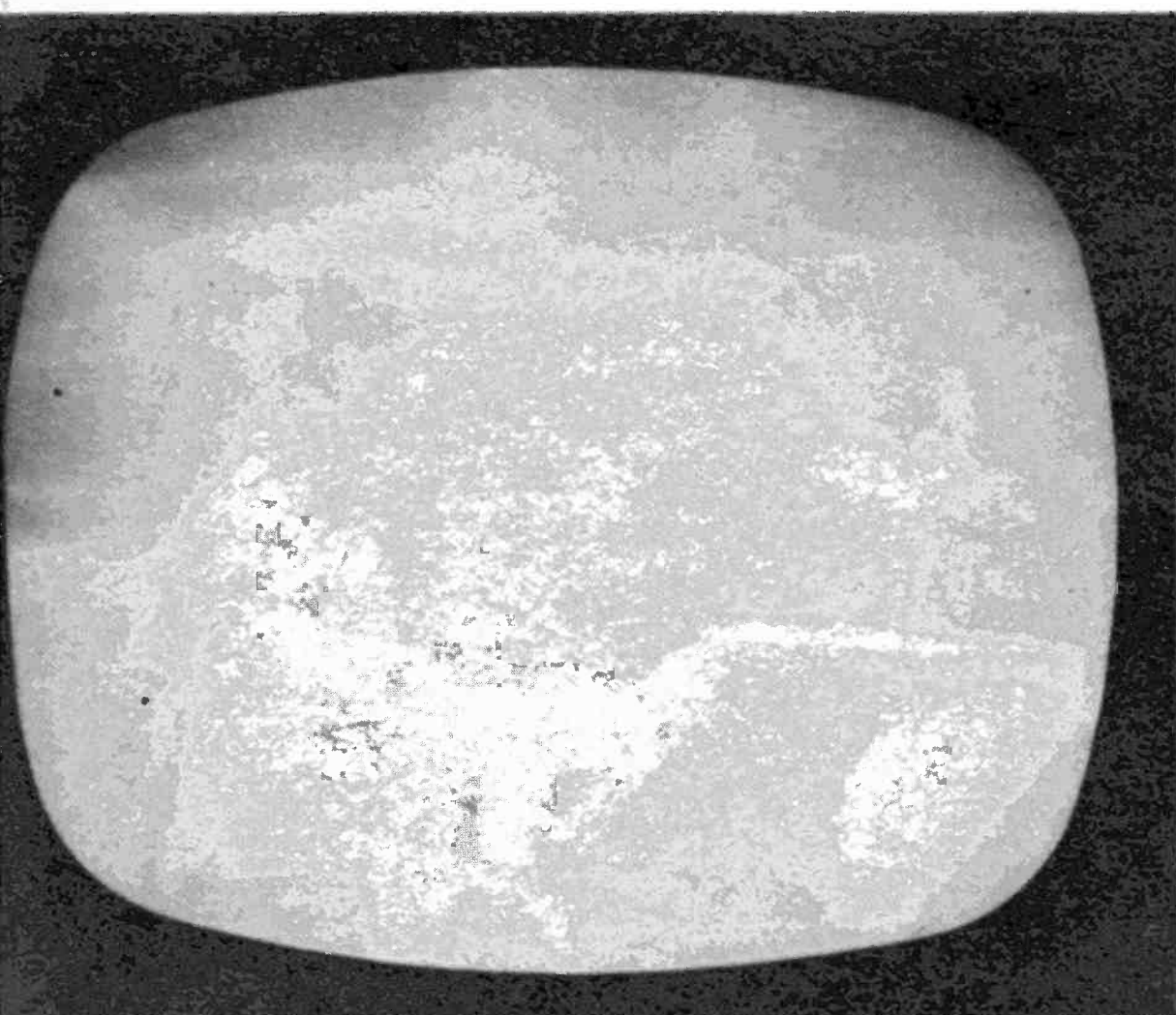

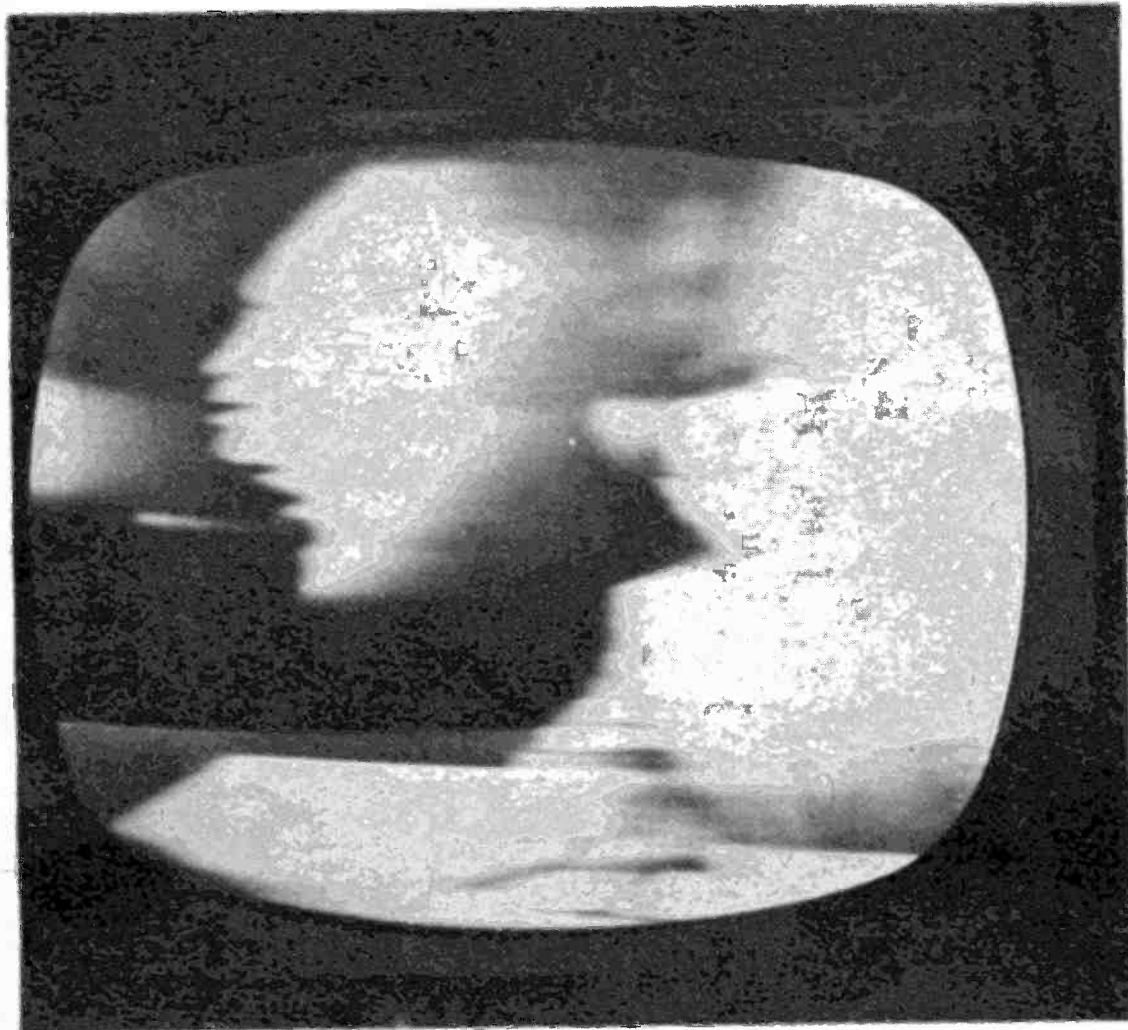
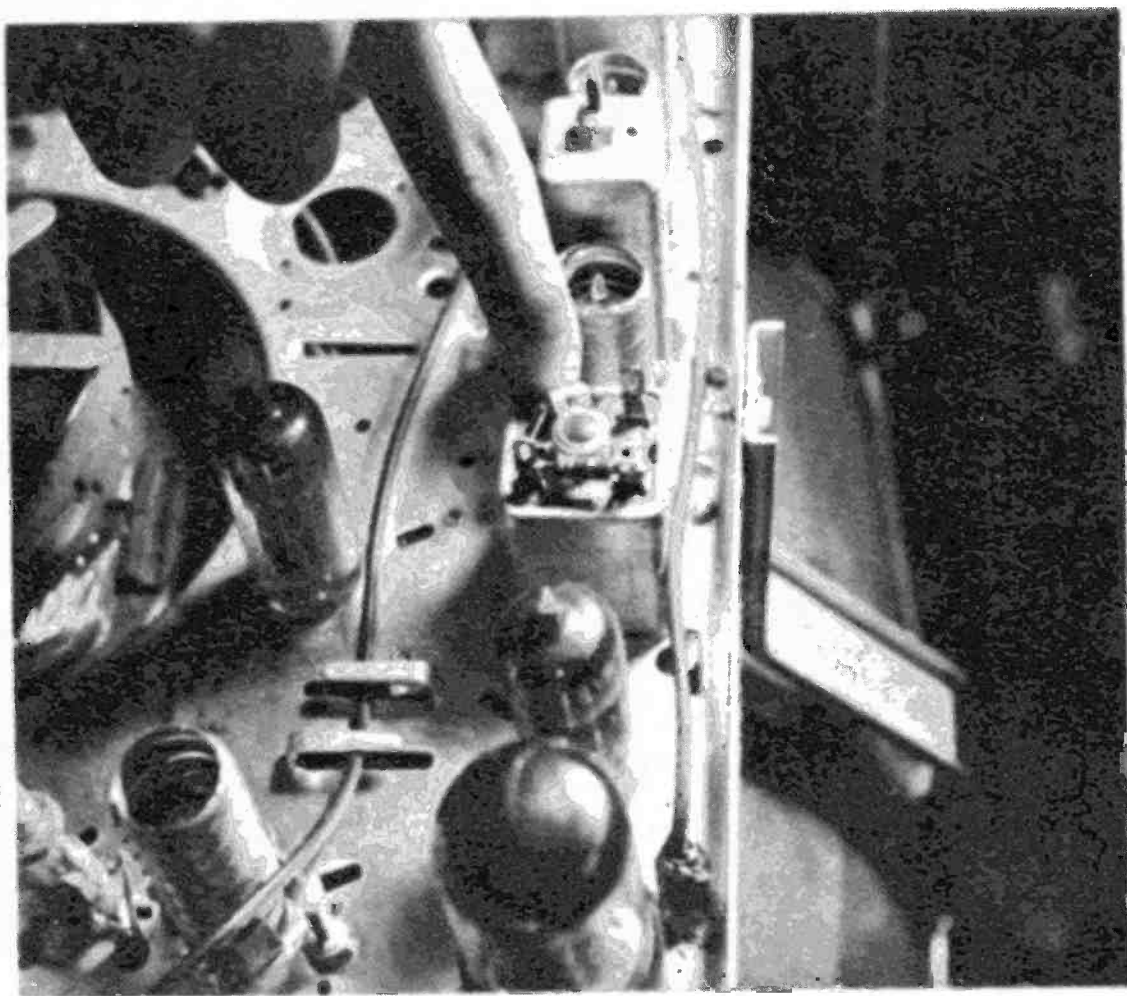

A bad peaking coil stops the video amplifier from passing the full 4.5 MC range, and causes smear.

You can locate peaking coils by looking for tiny resistors with small coils wound on their body.

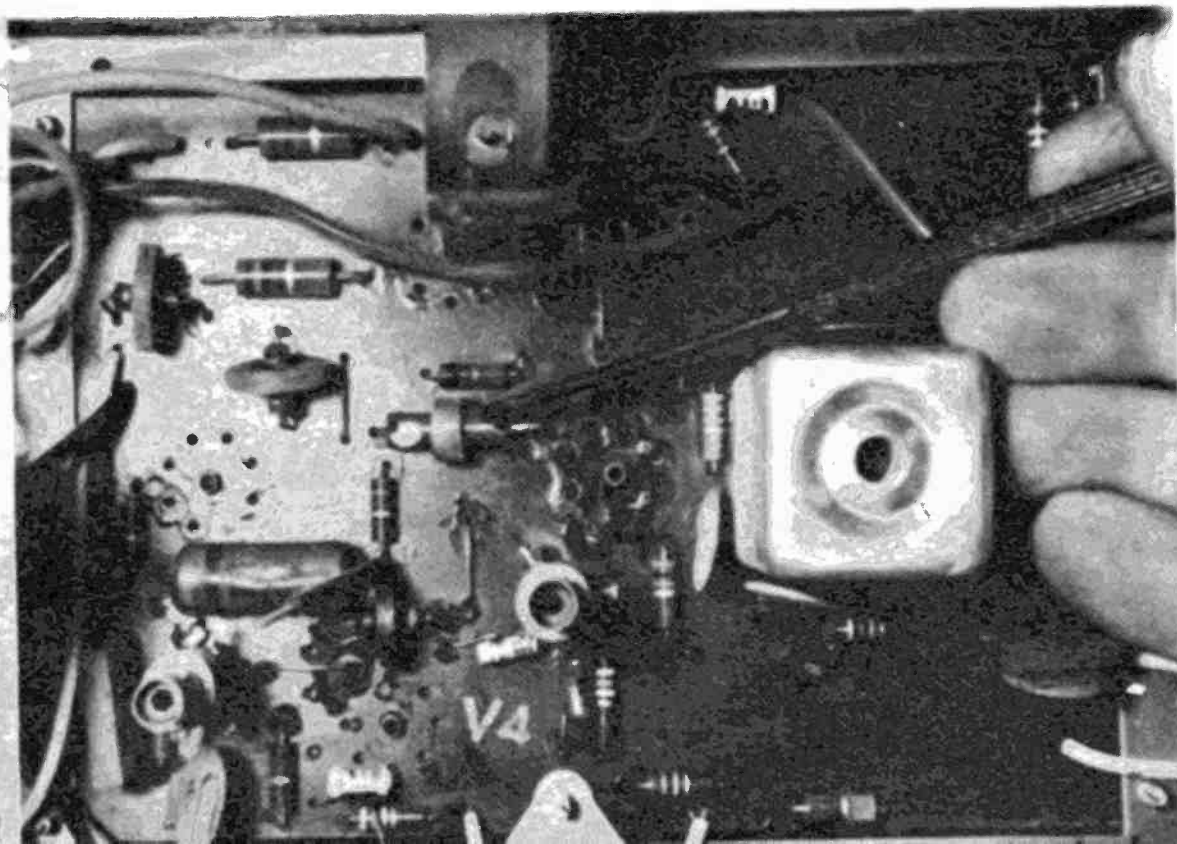

Common cause of lost video is an open germanium diode. In replacing, don't install it backward.

single line on the TV screen the picture may change from white to black to gray to black to white. The change from black to white can take place in one four-millionth of a second. In order for that change to appear on your screen with a sharp transition, that frequency must act in your TV. If it's lost you'll see a smear from black to white.

These high frequencies are the only way your TV picture can have a good gray scale from white through black with good definition and sharp contrast. Let's go through the contrast troubles and see how we can restore them.

NO CONTRAST, NO SOUND—When the light is on the screen, but there is no contrast and no sound, the trouble usually has occurred in an area before the contrast and sound are separated from one another. This would mean testing the **VIDEO DETECTOR**, the **IF's** and the **MIXER-OSCILLATOR**. As a fast try you can test the **RF AMPLIFIER**, but when it goes it usually is accompanied by a snow symptom.

Another cause that seems unusual, but is common, is the **SOUND OUTPUT** tube. In many of recent TV's the **IF's** are powered from the sound output circuit, so a fault here causes **IF** type symptoms.

Lastly, every now and then there is the occasion where two faults occur one in the sound circuits and another in the picture circuits. As a last resort look for this double trouble that causes this symptom.

NO CONTRAST—SOUND OK—This trouble, though resembling the last, is quite different. If the sound is good the trouble spot is probably after the place where the sound and picture are separated. This makes the **VIDEO AMPLIFIER**, **VIDEO OUTPUT** and **PICTURE TUBE** prime suspects. In some color TV's there are separate audio and video detectors. In these sets the **VIDEO DETECTOR** becomes a suspect.

WEAK CONTRAST—The common reasons for this condition is the **VIDEO OUTPUT** tube or **SOUND OUTPUT** tube getting weak. Otherwise this is the same as the last two troubles except it's not as severe. To really pinpoint the trouble try to analyze whether the sound is lower, too. If it is, then you have a variation of **NO CONTRAST—NO SOUND**. If the sound is good then you have a variation of **NO CONTRAST—SOUND OK**. Don't try to

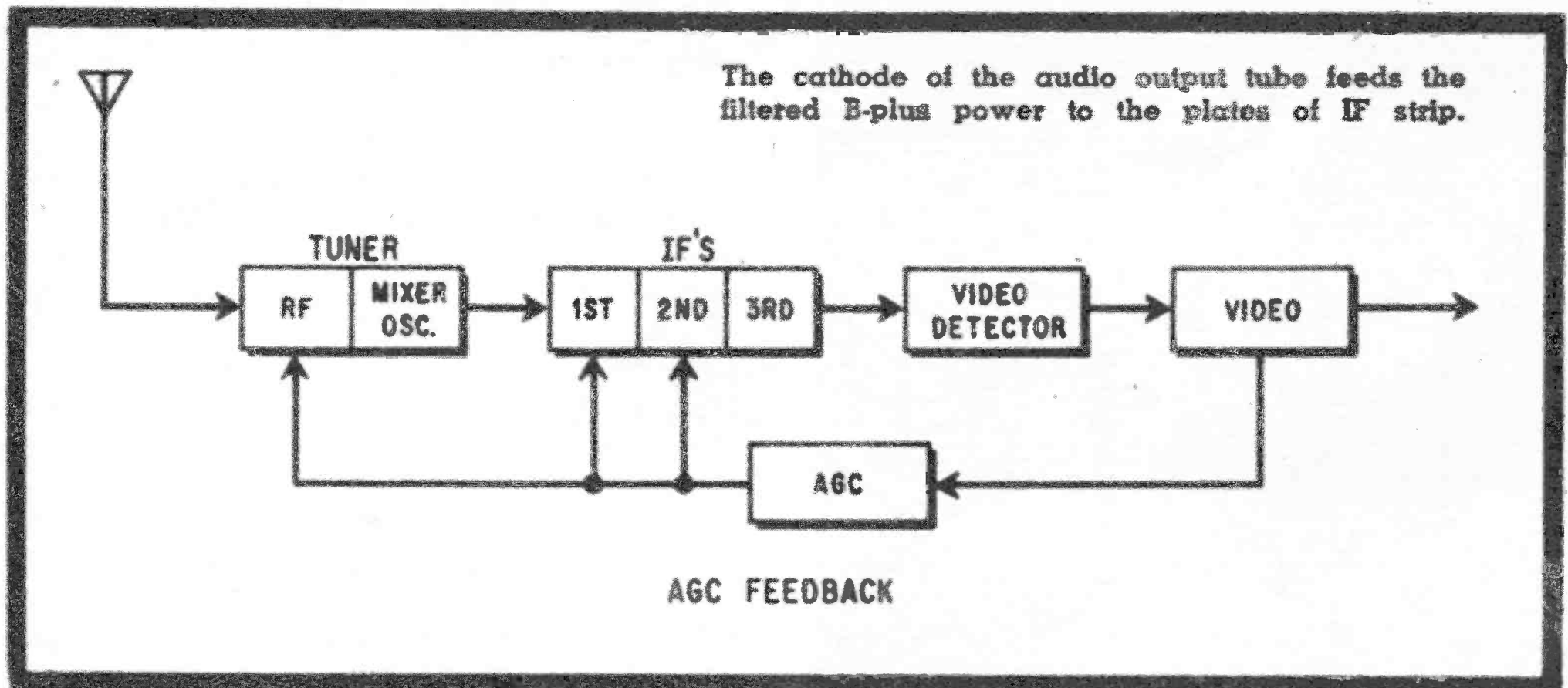

analyze the audio too carefully. If it's not apparently bad or good, test out all systems in both of the trouble types.

SMEARY and NEGATIVE PICTURES—The broad range of video frequencies have no trouble passing their 4.5 megacycles through the tuner and IF strip while they are aboard the 44 megacycle carrier. When the contrast becomes amplified, it becomes more difficult to pass the frequencies. Therefore the VIDEO DETECTOR, VIDEO AMPLIFIER and VIDEO OUTPUT circuits are made with special

video broadband devices. These are peaking coils and extra large capacitors and resistors. Also wires and components are especially positioned. Special low capacity tubes are used.

When the picture becomes smeared or negative, test these three circuits and also the picture tube.

AGC

A special part of the contrast circuitry is the AGC. It stands for Automatic Gain Control but is better defined as an auto-

Those five tubes standing in a row from front of TV are RF amp., mixer-osc., and three IF's.

It's a good idea when changing IF tubes to mark both tube and tube socket to avoid interchanging.

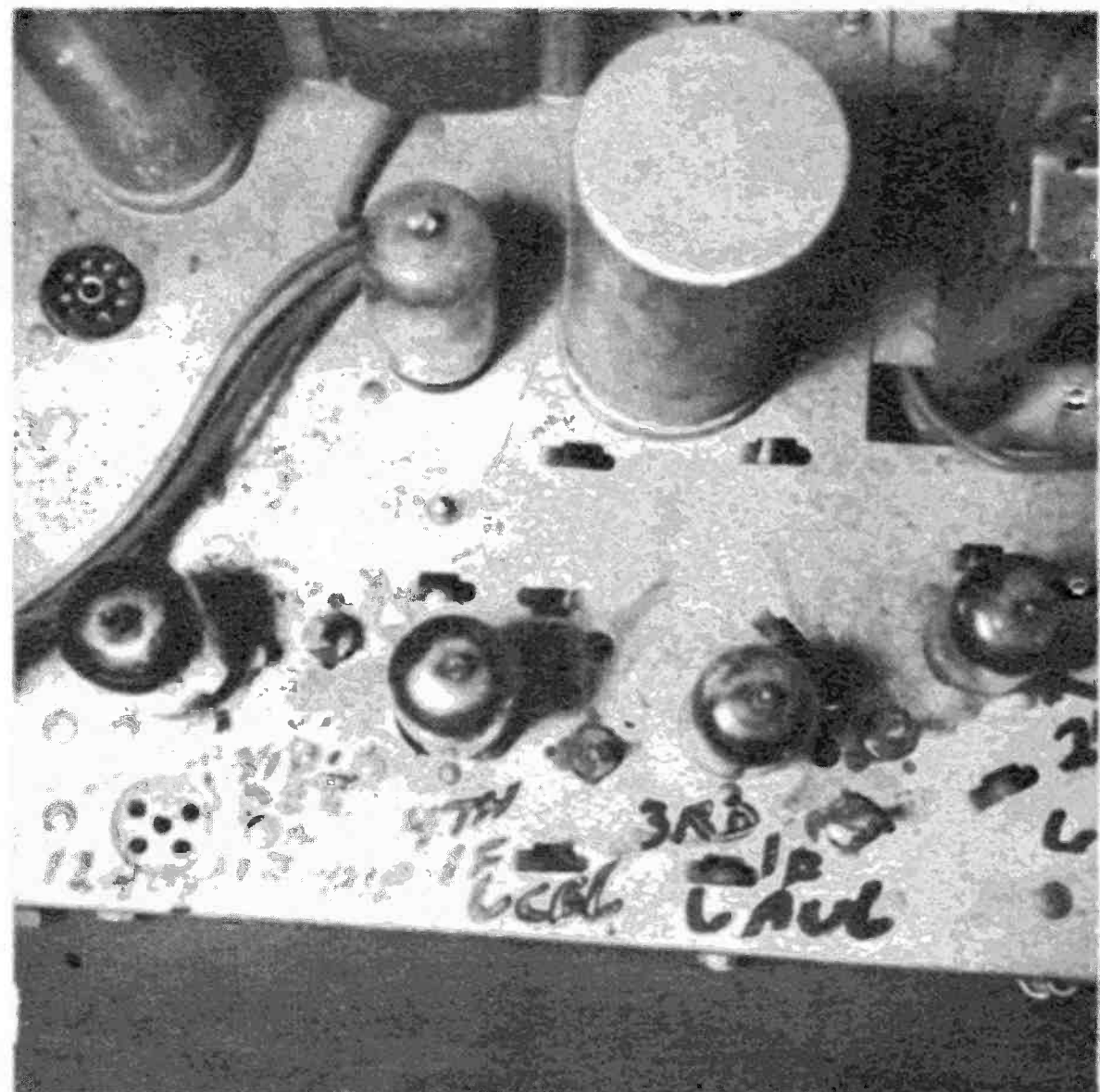

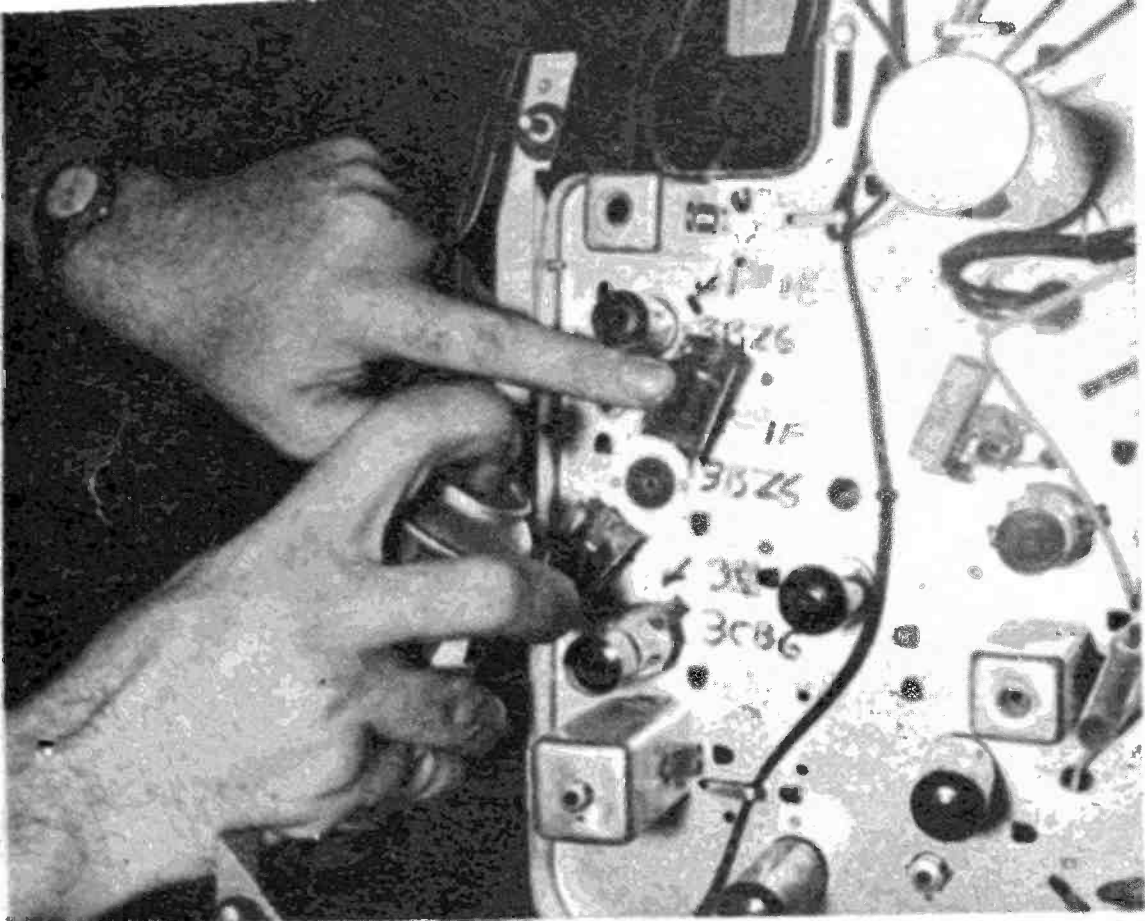

A common trouble in the IF strip is dirt in tube sockets. Spray clean and work tubes in and out.

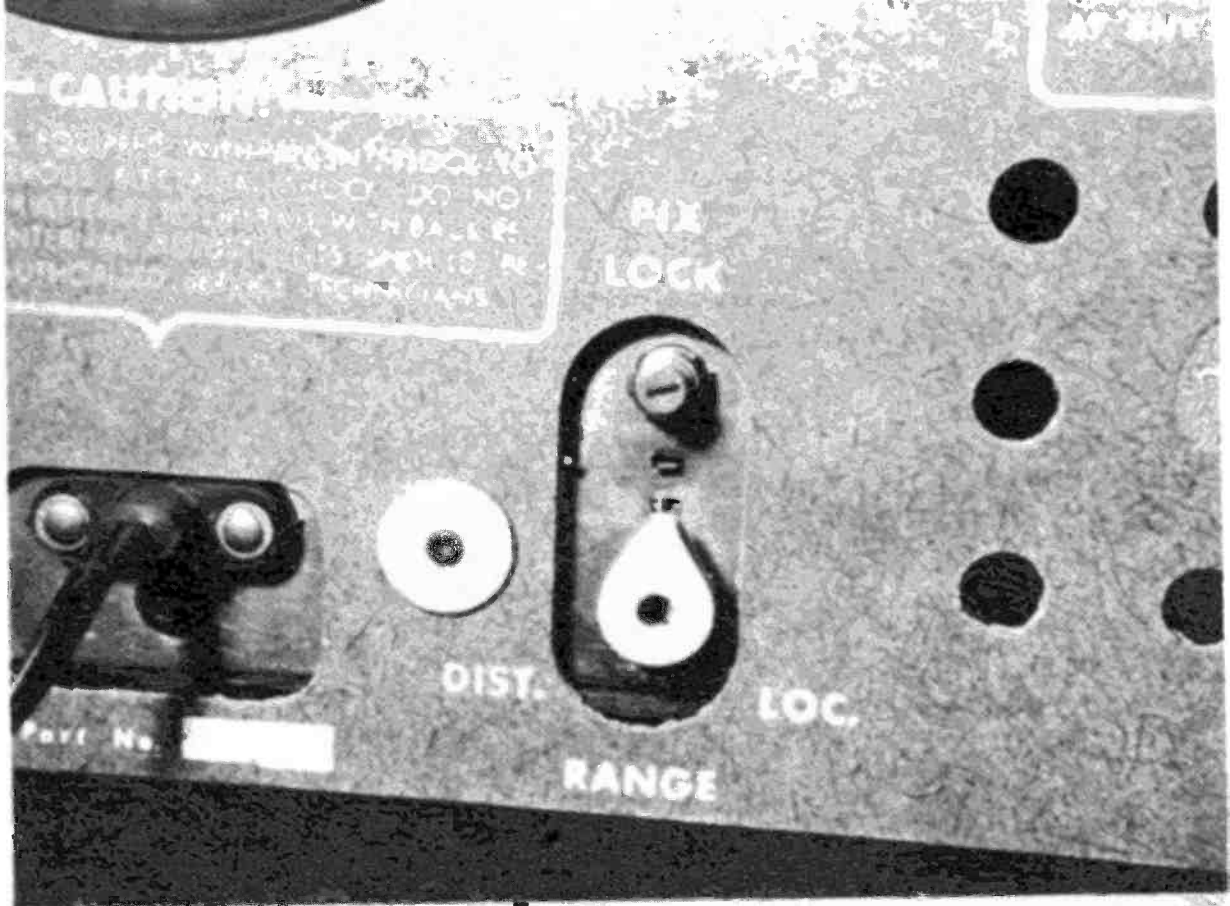

The local-distance switch is a variation of an AGC control. It turns the RF amplifier on full.

matic contrast control. It is supplementary to the regular contrast control.

It works like an instantaneous thermostat. When the picture signal tries to get too strong it turns it down a bit.

The AGC circuit takes a continuous sampling of the video signal into its input. Its output is hooked into the RF AMPLIFIER, the 1st IF and the 2nd IF. When the contrast gets too strong the AGC puts the brakes on those three tubes and cuts back the contrast. If the contrast gets too weak the AGC turns on those three tubes for

greater amplification. All this activity takes place in a few millionths of a second. When the AGC circuit fails or is worked too hard, weird symptoms result. Let's examine them.

NO STRONG CHANNELS, WEAK CHANNELS ONLY—If you find your local stations are defective in any way, but the distant stations are coming in better than they ever have, you have an AGC condition. There are no brakes on the RF amp, 1st IF and 2nd IF. They are running wide open. This is overloading the local chan-

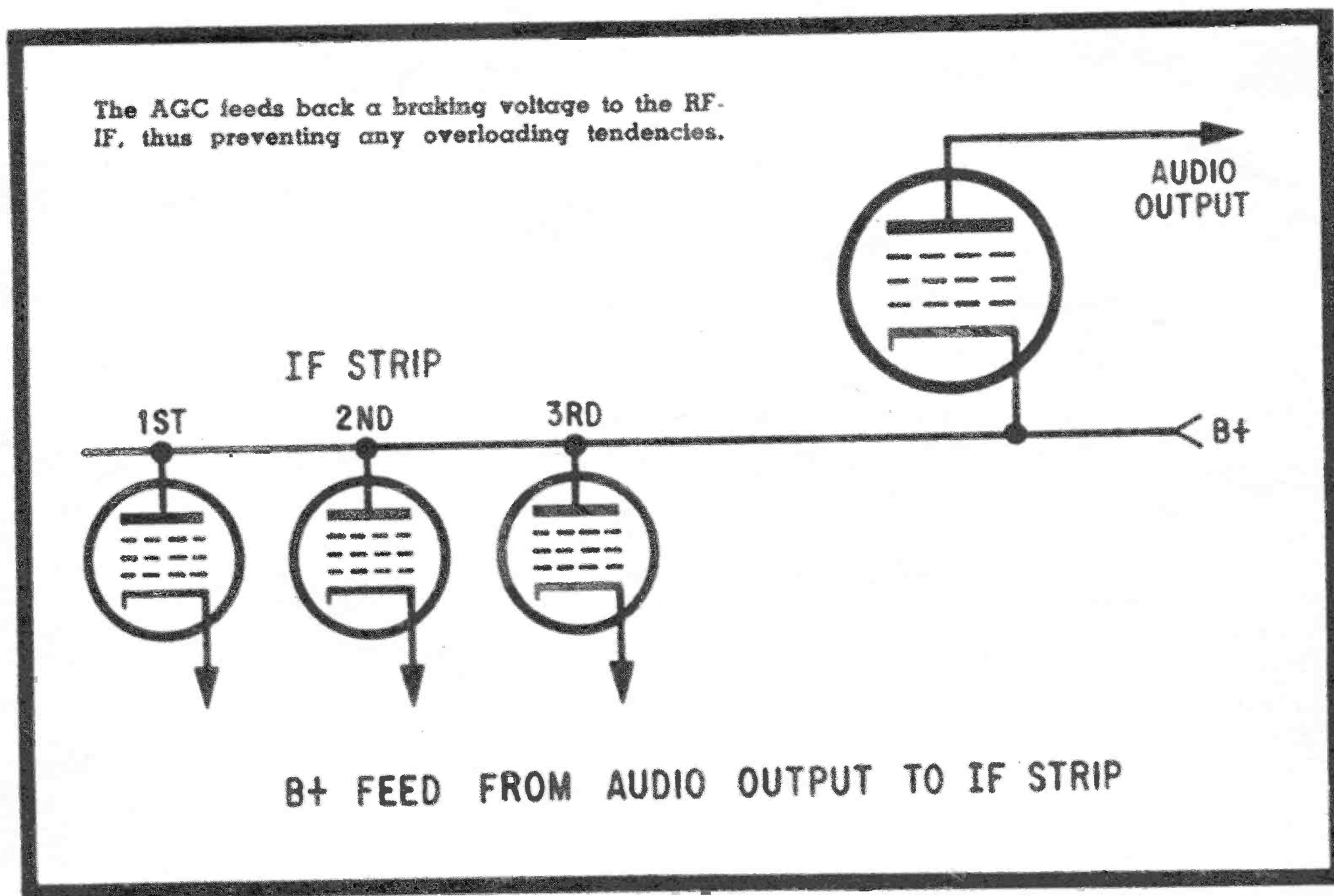

AGC

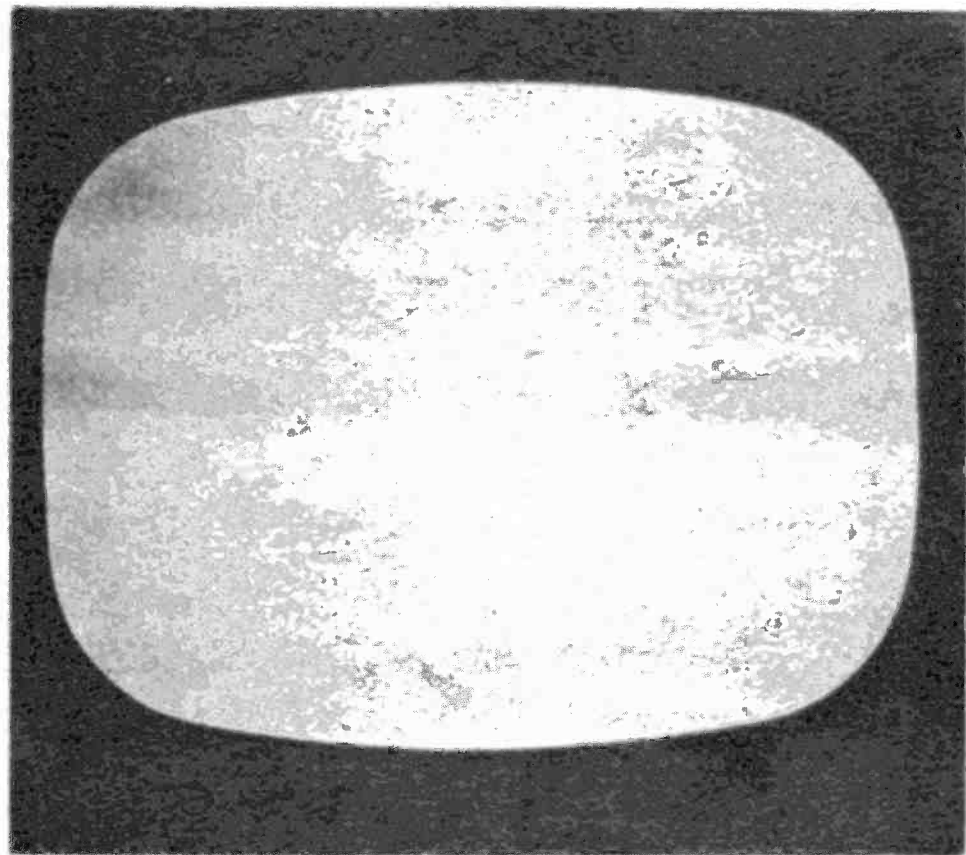

AGC symptoms can vary from a slight overload to a completely gone picture. Sound is unaffected.

Should your TV have transistors instead of tubes, like this set, leave troubles for skilled help.

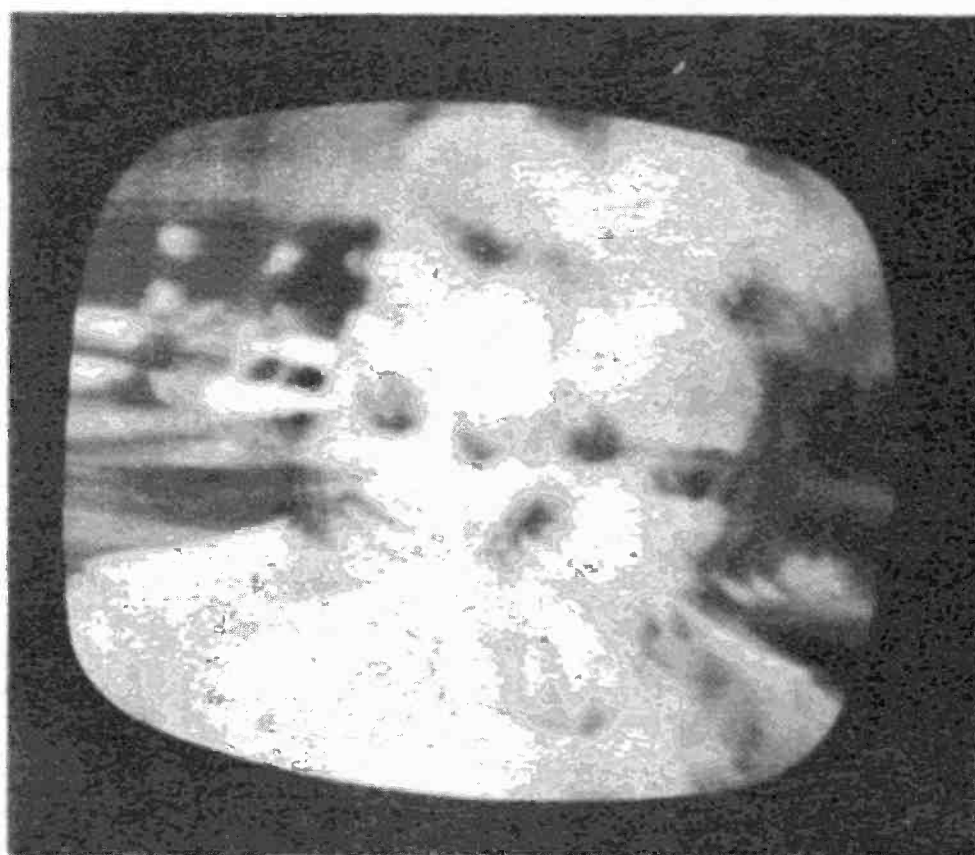

A weird but extremely common trouble occurs when one of the IF tubes makes the picture vibrate.

Test the video tubes closely for signs of gas or shorts. Slight defects cause extreme troubles.

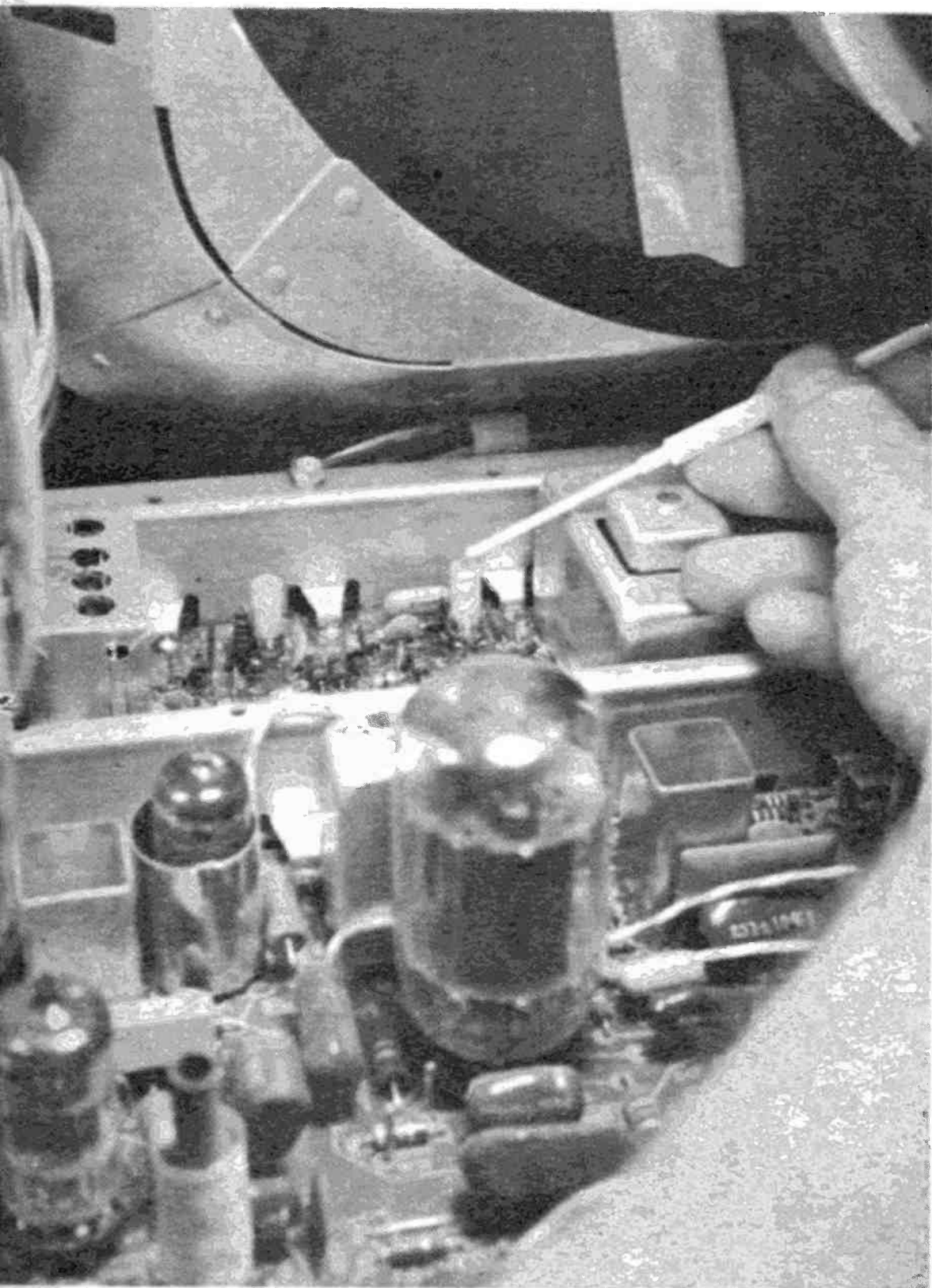

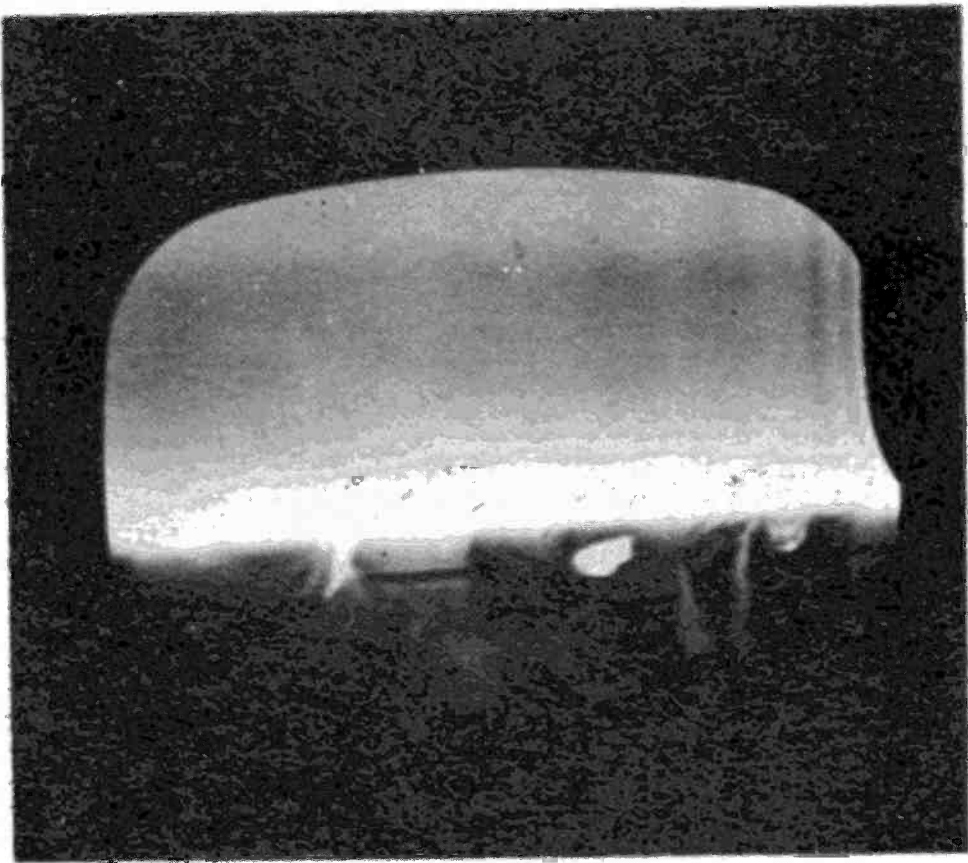

Any one of the signal path tubes will produce visible hum when it gets a heater cathode short.

A certain percentage of the time you can't make repairs. You will then need skilled benchwork.

nels so badly they are bending, going negative or blacking out altogether. Meanwhile the distant stations are getting full amplification. Try replacing the AGC tube, adjusting the AGC control, testing the IF tubes and the RF AMPLIFIER.

OSCILLATING PICTURE—The symptoms in this weird trouble proceeds in the following manner: The TV at first comes on fine. Little by little the picture becomes more and more contrasty. Then it either stays with the extreme contrast or begins to pulse and jump. Not like a sync trouble but more like a vibration. Adjustment of the contrast control and AGC control has little effect.

Fortunately the cure, most of the time, is replacement of a bad IF tube, either 1st, 2nd or 3rd. Next try a new MIXER-OSCILLATOR and RF AMPLIFIER. You can try the AGC tube last. If none of these measures help, chances are the IF strip or tuner is badly out of alignment. Only skilled help can continue from there. •

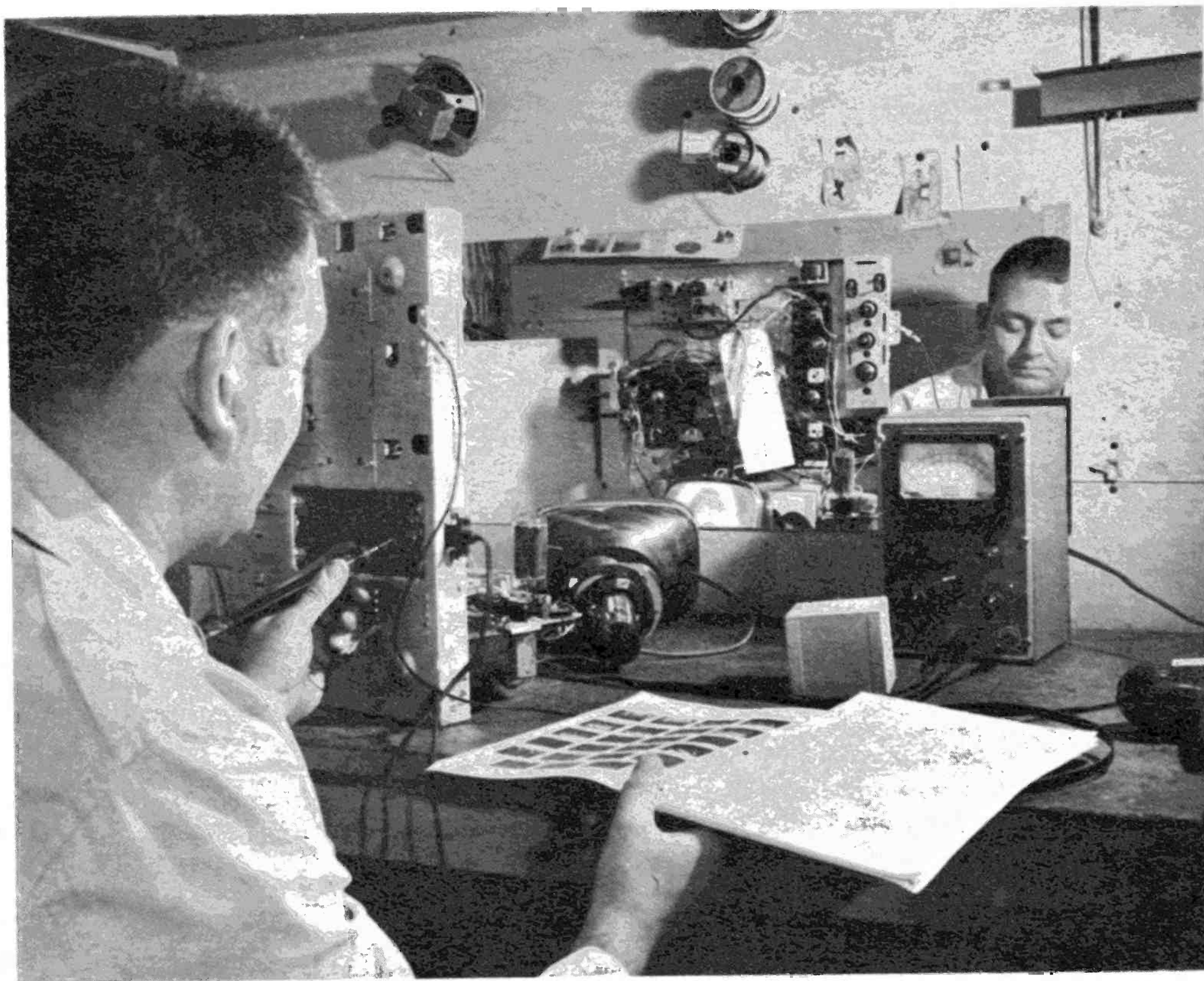

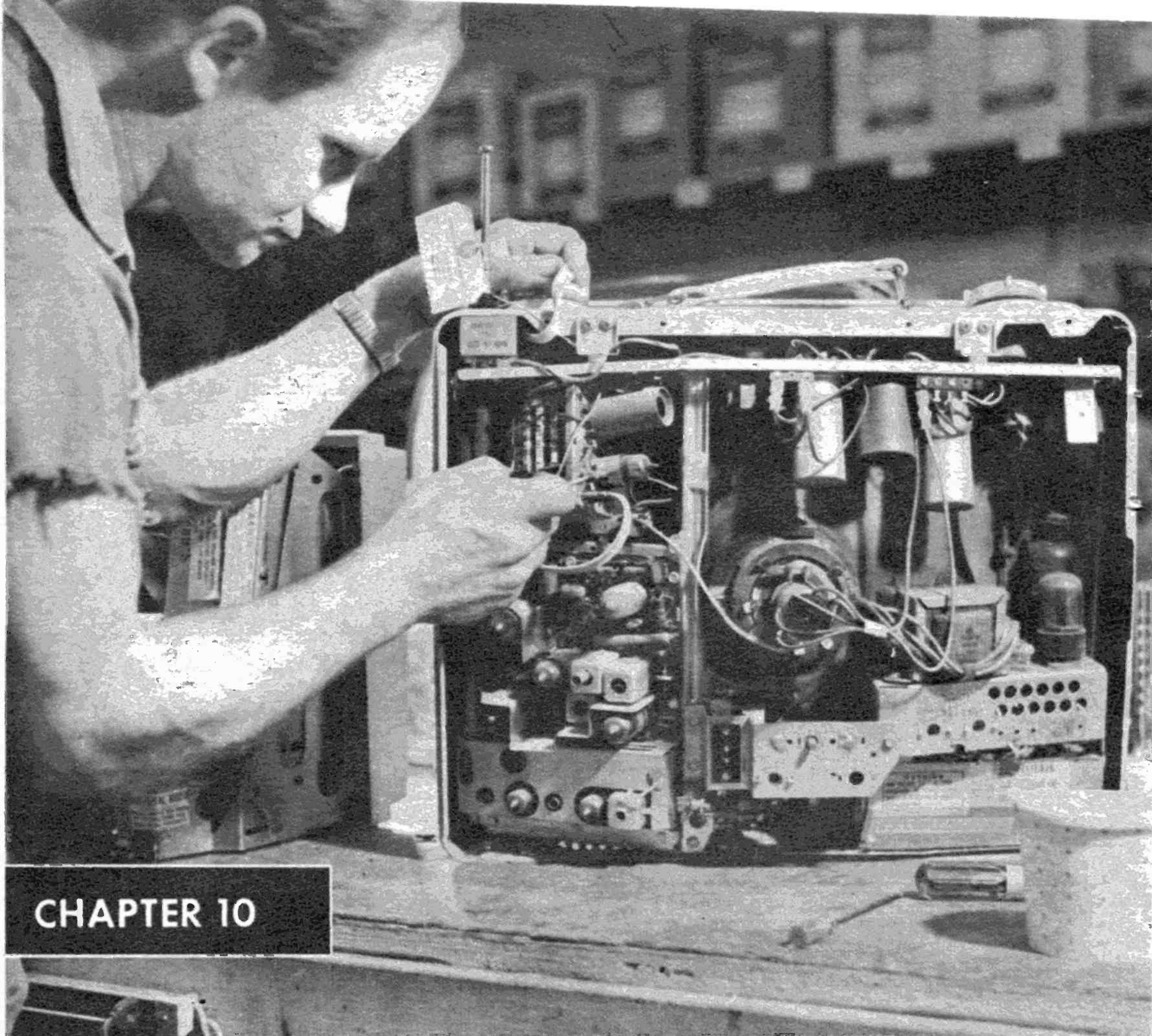

CHAPTER 10

The professional method of cleaning a tuner is to remove the cover, erase any corrosion and lubricate.

Fixing the Front End

It is the job of the tuner to amplify and further process the TV signal

THE FRONT END or tuner of your TV has the duty of picking out your desired channel out of the 82 that are available. It must do this without disturbing the picture, sound, lock-in and color signals.

There are actually two tuners, one for the VHF channels 2 through 13 and the other for the UHF channels 14 through 83. Each has its own peculiarities and ways that it breaks down.

Tuner troubles can be tricky. With two tuners to contend with, differentiating between tuner and antenna troubles and con-

sidering mechanical as well as electronic problems there is no doubt you may have your hands full. It's a good idea to take your time and make a good diagnosis before conducting troubleshooting. Also do not go too far without skilled help. Let's go through the troubleshooting procedure.

Diagnosis

There really aren't too many tuner symptoms. Besides the ones covered in Chapter 9, there is snow, ghosts, oscillations, loss of color and loss of certain chan-

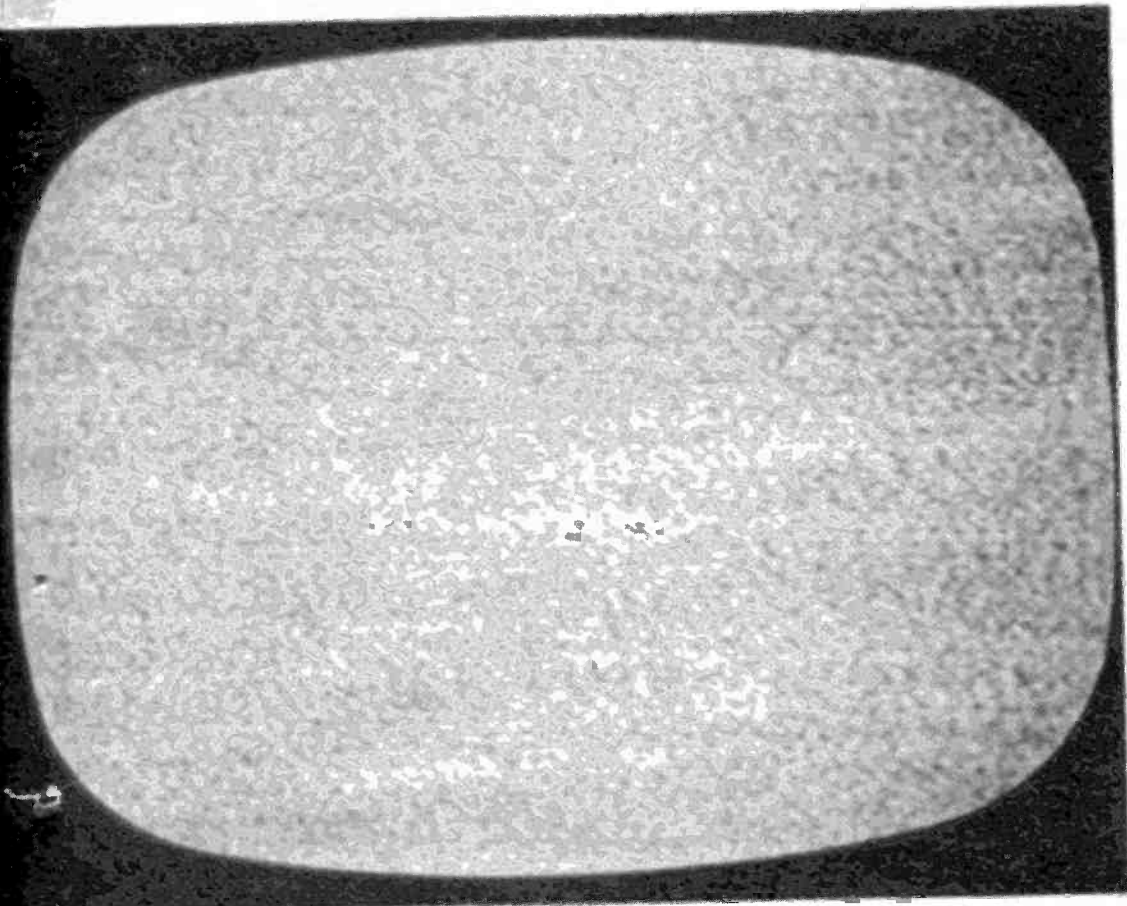

Snow is the most common tuner trouble in TV and is almost always caused by a weak RF amplifier.

Right, you can decide if antenna or tuner is causing trouble by installing a set of rabbit ears.

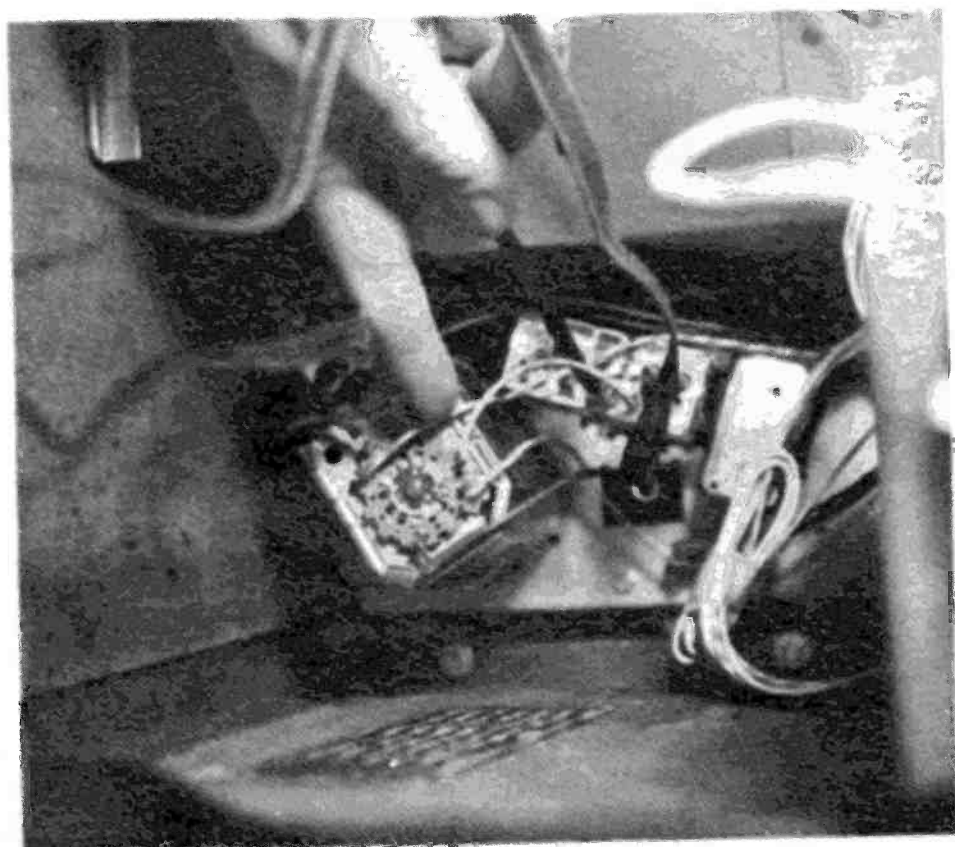
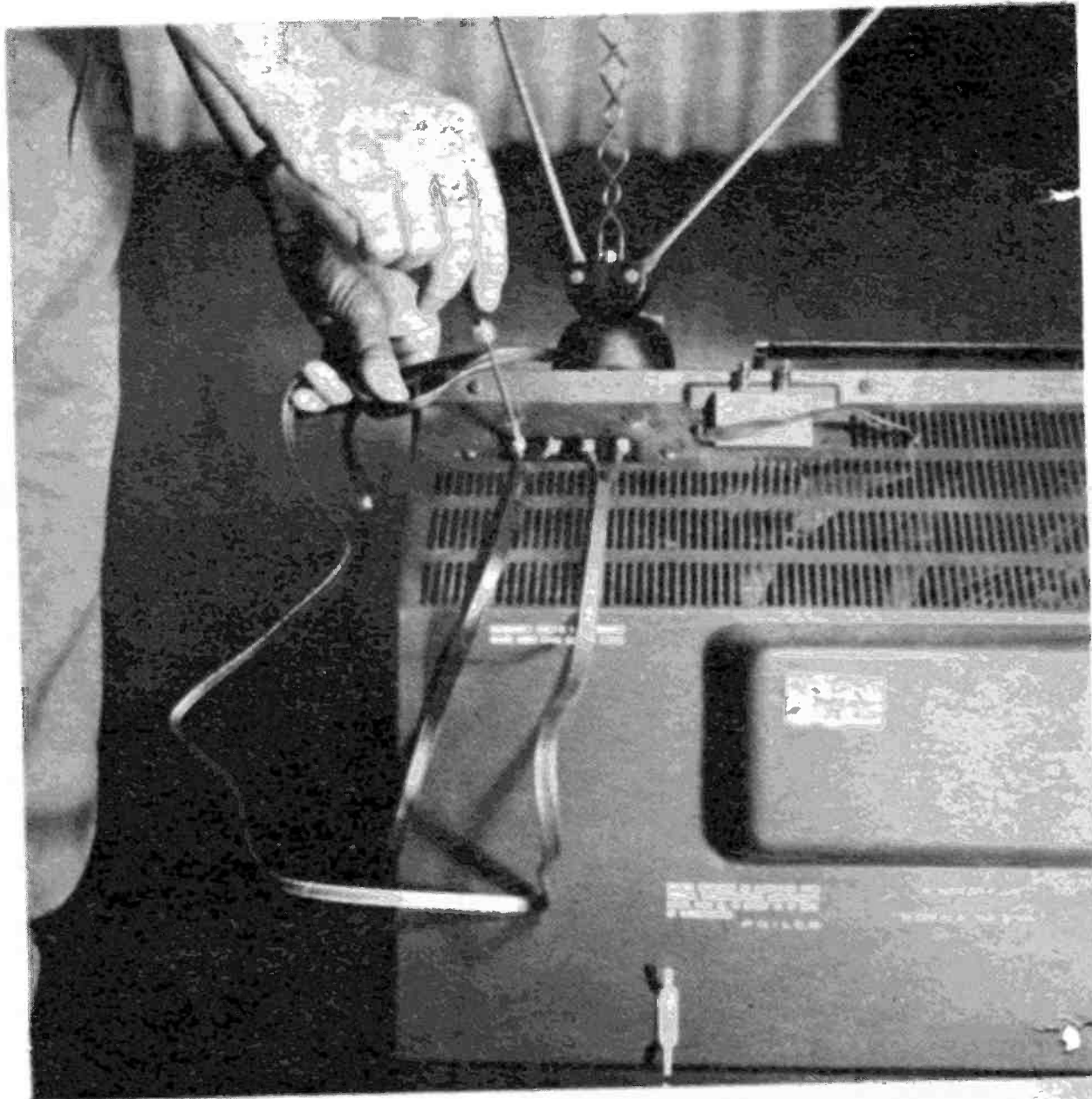

The latest color tuners are tiny in comparison to older types. Some have transistors, not tubes.

nels. These are electronic troubles. Then there are the mechanical troubles caused by a loose, or dirty tuner.

When you have a tuner suspect, the first step is to eliminate the antenna system as the trouble source. Hook up a pair of rabbit ears to the suspect tuner, either VHF or UHF and observe what happens. If the trouble clears, and normal rabbit ears reception results, the tuner is exonerated. However, if the trouble remains, the source is in the TV.

Should you live in an area where rabbit

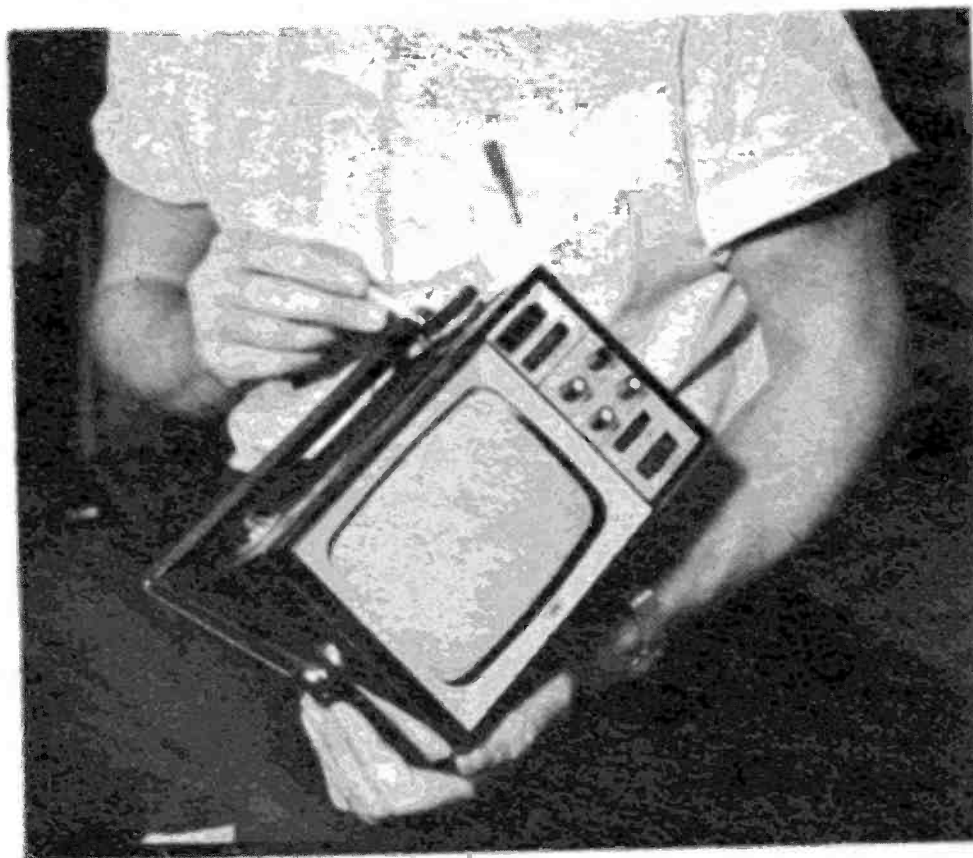

An alternative to substituting for the antenna is to substitute another TV set for the test.

ears do not work, there is another equally good isolation technique. Take another TV and hook it onto the antenna. If the second TV does the same thing, the antenna is at fault. If the second TV works well, the first TV contains the trouble.

Next step is to decide whether the trouble is electronic or mechanical. Try turning the channel selector first one way, then the other. Press the channel selector shaft easily. If the picture should return, even momentarily the trouble is probably mechanical.

Evaluate your findings. For antenna work see Chapter 4, Clinic for Sick Antennas. If it's the TV, here's what to do.

VHF SNOW—The commonest reason for a snowy picture in Channels 2 to 13 is a weak or defective RF AMPLIFIER. Its job is to amplify the carrier wave about fifty times. It is one of the tubes that breaks down most often in the TV.

Another reason for snow is a weak MIXER-OSCILLATOR. If it goes dead there will probably be no snow, just a raster since signal is cut off. A remote possibility of snow is a weak IF tube, although most of the time it just reduces contrast with no snow.

If you replace the RF amp and the snow still remains, feel the tube after it's been on awhile. It should be quite hot. If it's just warm it means the tube is not getting B-plus power and there is probably an open resistor in the RF amp's B-plus input.

As a final measure before going to skilled

help, try spraying the contacts in the tuner. If they are heavily corroded you can develop a snow condition.

UHF SNOW—In the UHF tuner there is no replaceable RF AMPLIFIER. There is a tube or transistor OSCILLATOR and a germanium diode MIXER. If either becomes defective the UHF tuner won't work, and snow appears on the screen.

GHOSTS—This is more or less a VHF phenomenon. While they might occur in UHF they are usually so covered with snow they can't be seen.

Even though you have isolated the trouble by the antenna—second TV techniques, you can recheck a ghost diagnosis by simply adjusting the fine tuner. Should a ghost be nontunable, that is remain stationary during fine tuning, chances are its origin is not in your TV. If it is tunable, it is in your TV.

A tunable ghost is a companion trouble to the OSCILLATING PICTURE in the

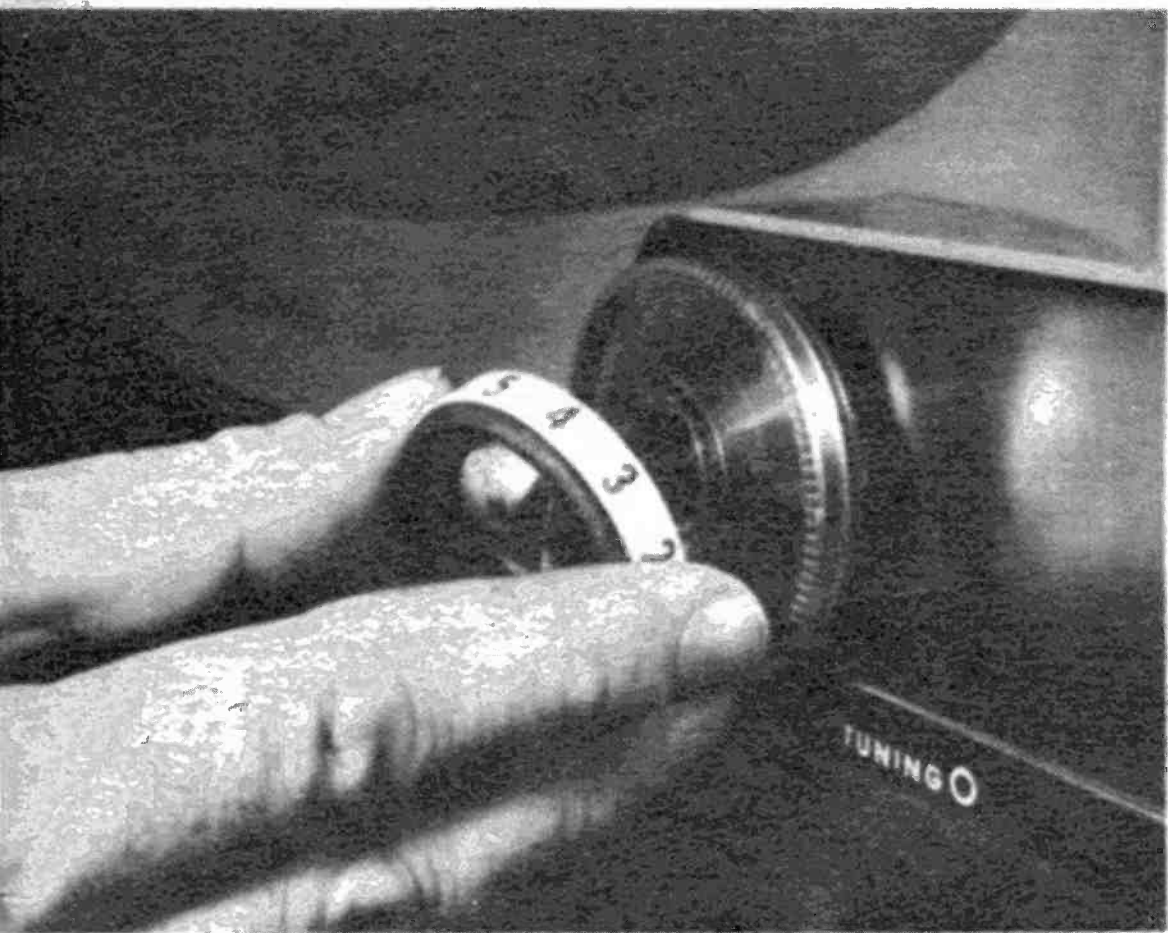

A common way a tuner tube can go is to break. When this happens the glass on tube gets milky.

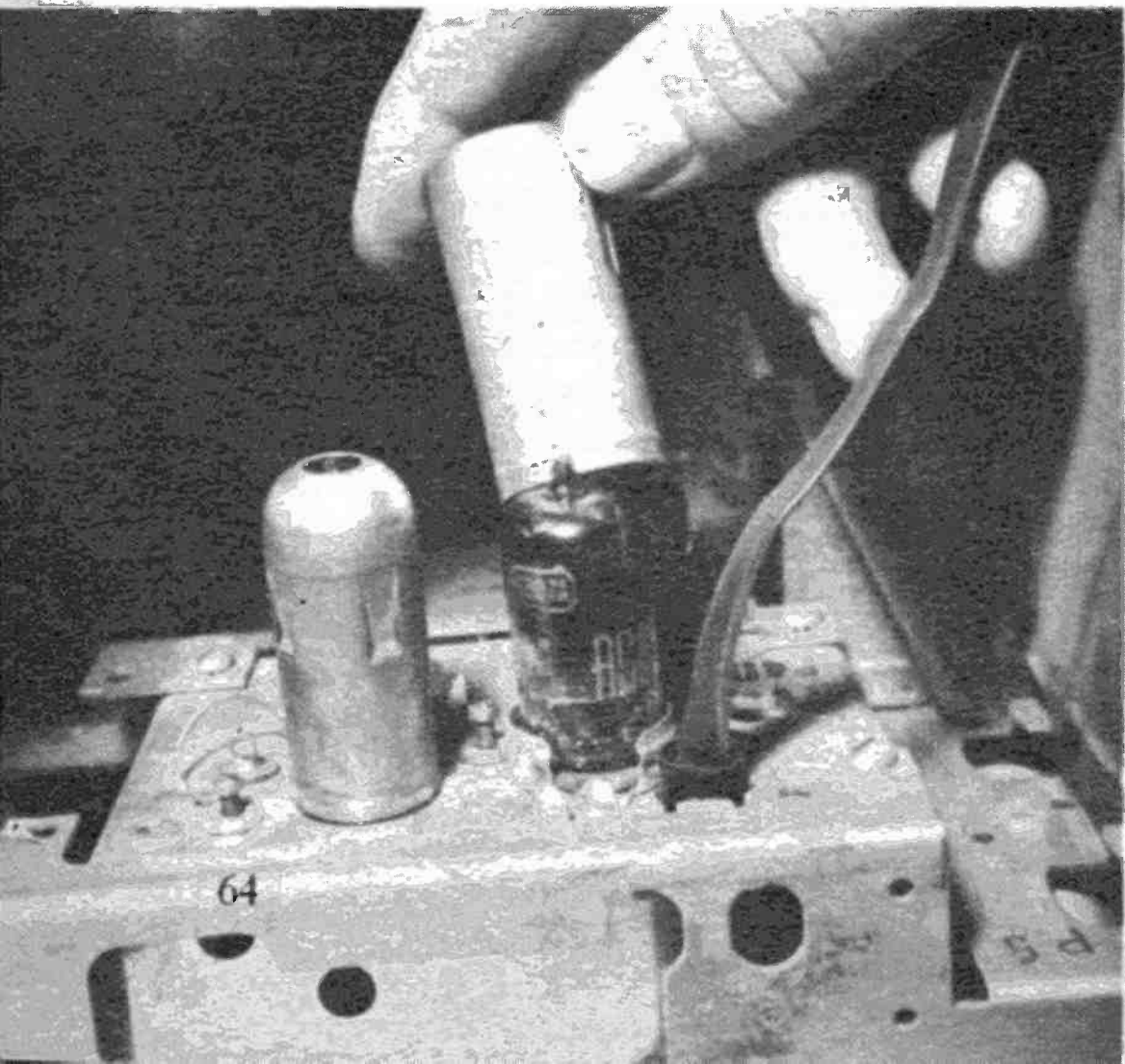

Top left, pressing tuner shaft slightly can help you decide if your tuner trouble is mechanical.

Left, tuner tubes are usually located underneath shields. Some pull off, push in or split apart.

Let I.C.S. equip you for success in radio-TV-electronics—

with professional equipment!



Brand-new "Electronic Laboratory," now being offered for the first time, can help you land in this big money-making field—FAST!

Here's an opportunity for you to turn spare time into cold cash, or begin a whole new career—in a field where the rewards have never been greater. And you *don't* need previous experience to do it!

International Correspondence Schools has just developed a new I.C.S. Electronic Laboratory you can construct in your own home. Includes series of training kits, plus the new I.C.S. VTVM—the professional quality vacuum tube voltmeter shown here. With it comes complete course instruction combining all the fundamentals with practical knowledge you can apply at once. And best of all, you build your own professional test instrument!

I.C.S. instruction gets you going with equipment you can really use!

A famous manufacturer of nationally known electronic testing equipment worked closely with I.C.S. to develop the Electronic Laboratory and the VTVM itself. Everything you get is geared to increase your skill and knowledge step by step. Until finally, you've completed a precision testing

unit you can use for practically any kind of experimentation, design or servicing work.

Here's how I.C.S. instruction works. You begin with basic study lessons. Texts are clearly worded and easy to follow. At the same time, you "act out" what you learn with simple experiments. Then, in 3 easy stages, you assemble your own precision testing unit. Throughout, your instructor gives you expert, professional help. You learn at home, in spare time, as fast as ability permits.

Coupon brings full details on your future in this fast-growing field!

Make up your mind right now to find out how I.C.S. training in Radio-TV-Electronics can pay off for *you*. See how it can help you cash in on the tremendous demand for men skilled in installation, maintenance and servicing of radios, TV sets, hi-fis, computers, automation systems and a host of other space-age devices. Clip and mail the coupon below. You'll receive 3 valuable *free* booklets—including sample lesson. They'll show how you can land in this big-money field *fast!*

Coupon brings 3 valuable FREE booklets. MAIL IT TODAY!

INTERNATIONAL CORRESPONDENCE SCHOOLS **I C S**

Dept. 2056, Scranton, Penna. 18515

(In Hawaii: P.O. Box 418, Honolulu. In Canada: I.C.S. Canadian, Ltd. In other countries: I.C.S. World, Ltd.)

Please rush me your new 64-page booklet "ElectronICS" which answers the most often-asked questions about preparing for an electronics career. Also send me "How to Succeed," and a sample I.C.S. lesson. I have indicated my field of interest below.

- | | | | | |
|---|---|---|---|---|
| <input type="checkbox"/> Electronic Fundamentals | <input type="checkbox"/> Hi-Fi/Stereo & Sound Systems | <input type="checkbox"/> Electronic Principles for Automation | <input type="checkbox"/> Industrial Electronics Engineering | <input type="checkbox"/> Industrial Electronics Telephony |
| <input type="checkbox"/> Electronic Instrumentation | <input type="checkbox"/> General Electronics | <input type="checkbox"/> Semiconductor-Transistor Circuits | <input type="checkbox"/> FCC Radiotelephone Licenses | <input type="checkbox"/> Other (please specify) _____ |
| <input type="checkbox"/> Computer Fundamentals | <input type="checkbox"/> Electronics Technician | | | |
| <input type="checkbox"/> Radio-TV Servicing | | | | |

Name _____ Age _____

Address _____

City _____ State _____ Zip Code _____

Occupation _____ Employed by _____

Working Hours _____ A.M. to _____ P.M. Convenient payment plan Training Programs for Industry

I am a member of U.S. Armed Forces. Send me facts about special low rates.



Ninety per cent of all tuner contact troubles are caused by corrosion. Spraying them would help.

Middle left: Spray by inserting nozzle into all available holes in tuner; keep rotating barrel.

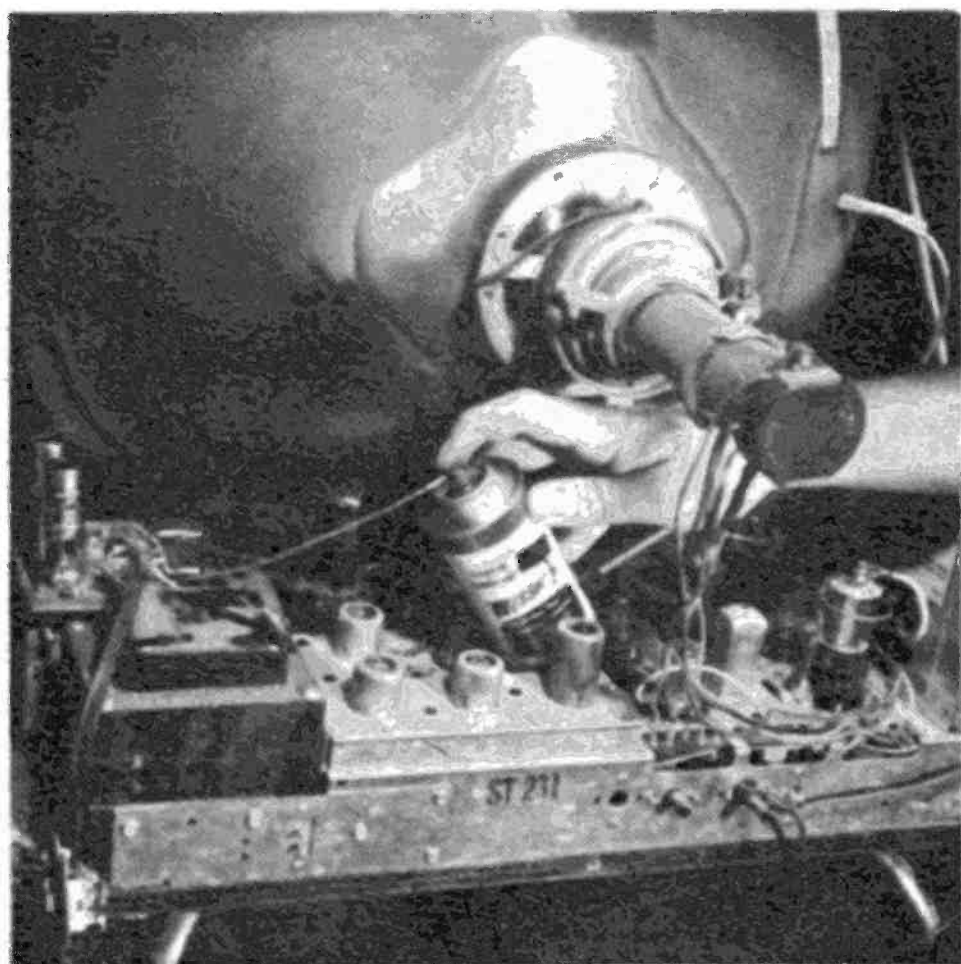

Below, if tuner trouble is not too bad, remove the tuner knobs and insert nozzle through hole.

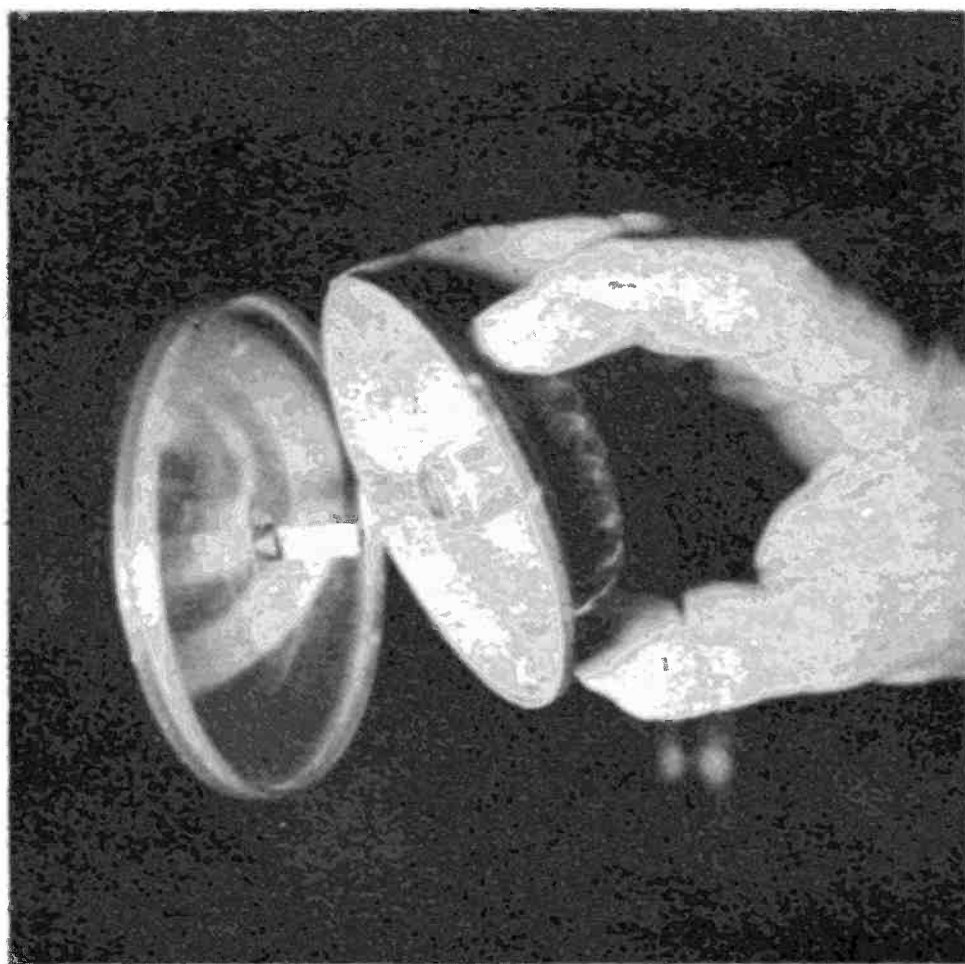

Below, when spraying won't help, you will have to clean tuner by wiping all contacts by hand.

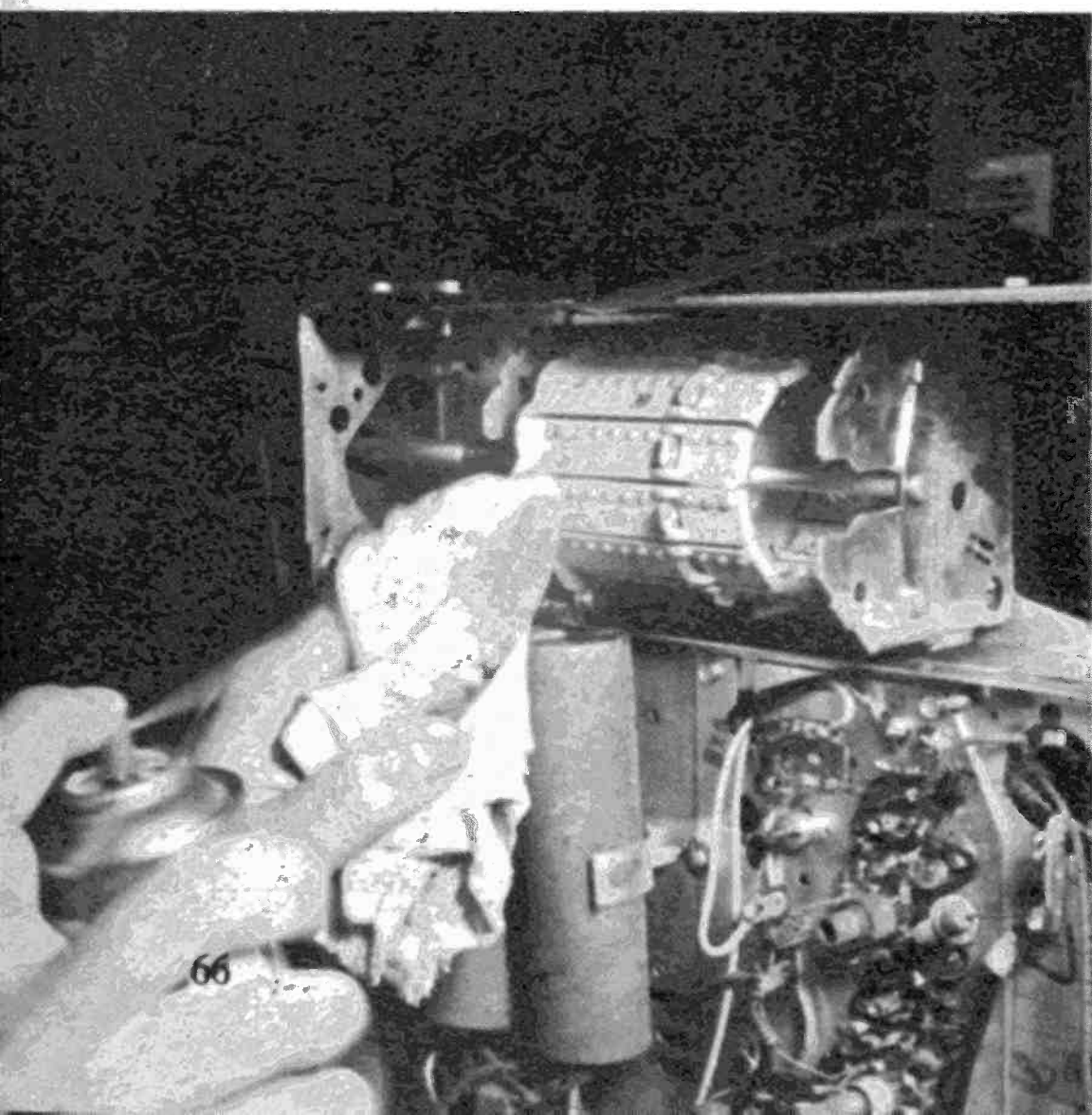

last chapter. In fact it's a mild form of the same thing. It's called ringing. Try new MIXER OSCILLATOR, RF AMPLIFIER and IF tubes. If that doesn't correct it a thorough analysis and alignment of the RF-IF stages is next in order.

OSCILLATIONS—Should your TV start off with a putt-putt sound that gradually gets faster and the screen displays black-and-white bars, your MIXER-OSCILLATOR is acting up. Try a new one.

A similar condition can occur as you tune in UHF channels. The bars on the screen will appear a little ragged, and there might be a few more of them, but the same repair measures can be employed. Try replacing the OSCILLATOR tube, and if you can, the MIXER diode.

LOSS OF COLOR—There are many variations of this trouble but they are all from the same cause. There can be a complete loss of color on all channels, a loss of color on one or a couple of channels, or a

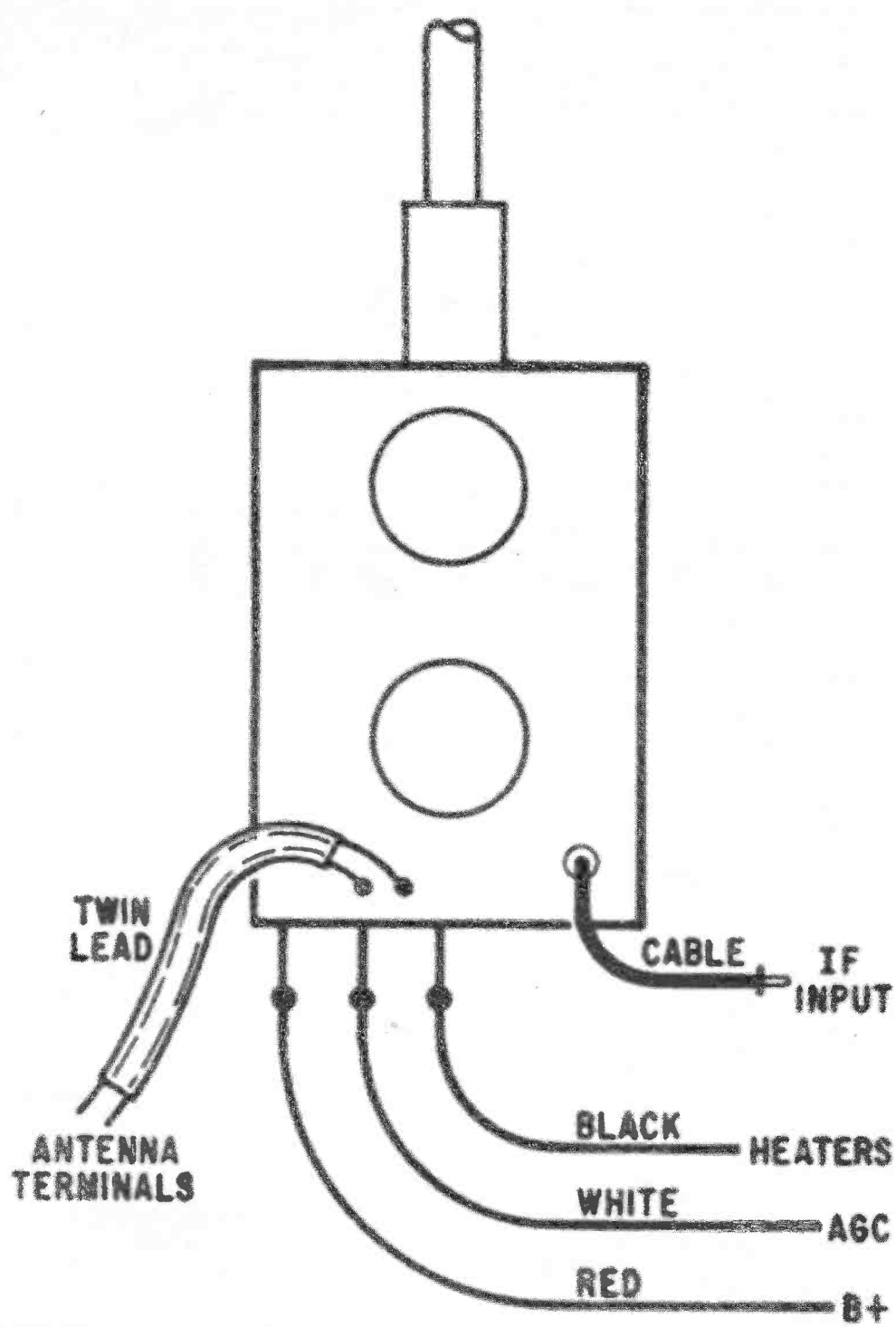

TUNER WIRING SKETCH

If you should remove your tuner from the set, be sure to make a sketch so you can replace wires.

The tuner is a separate section of the set. It connects to the main chassis by wires and bolts.

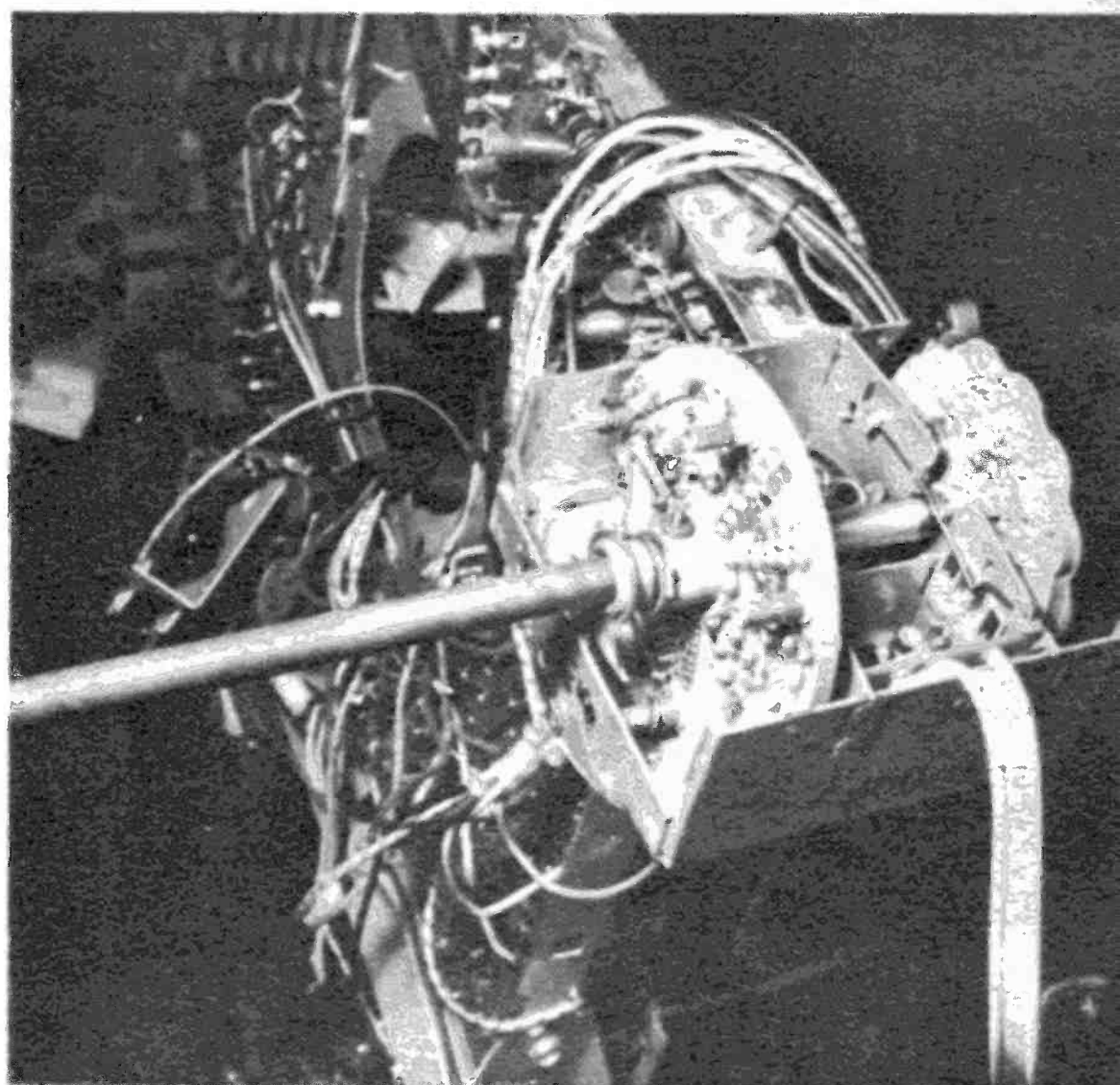
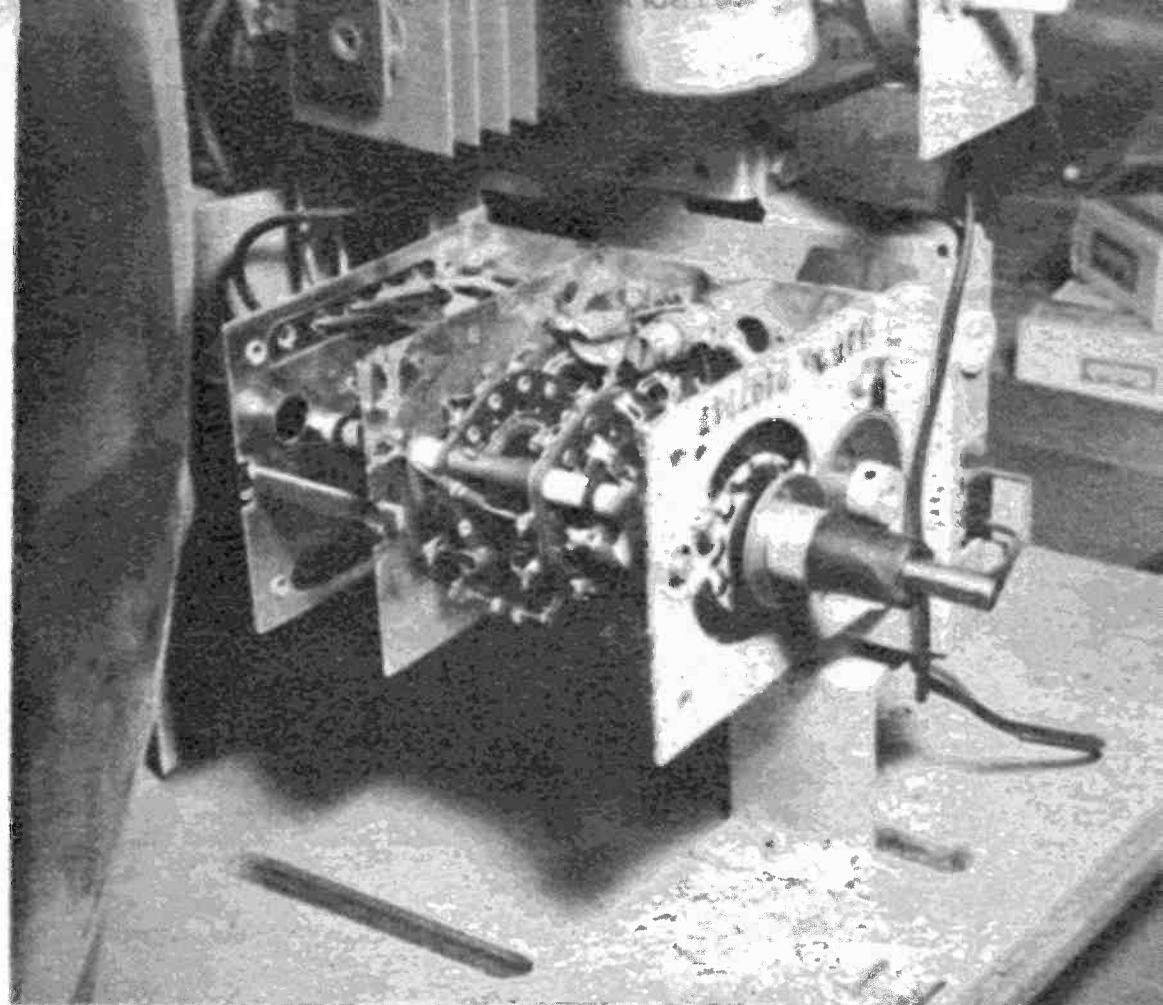

TV tuners come in all sizes, shapes and lengths. Photos above show two types with covers removed.

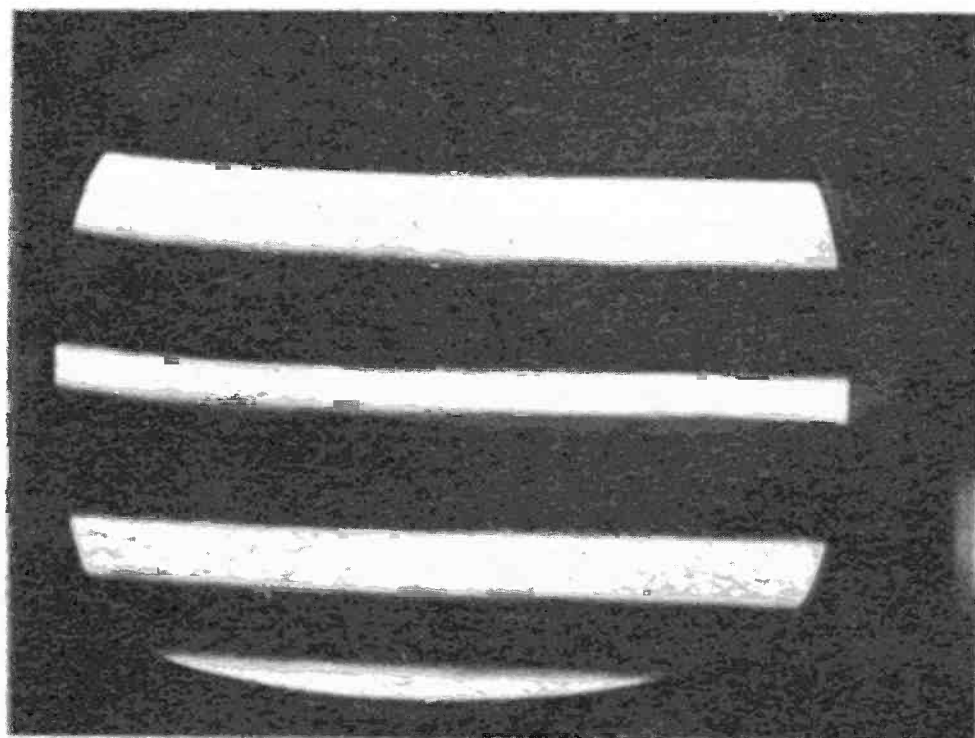
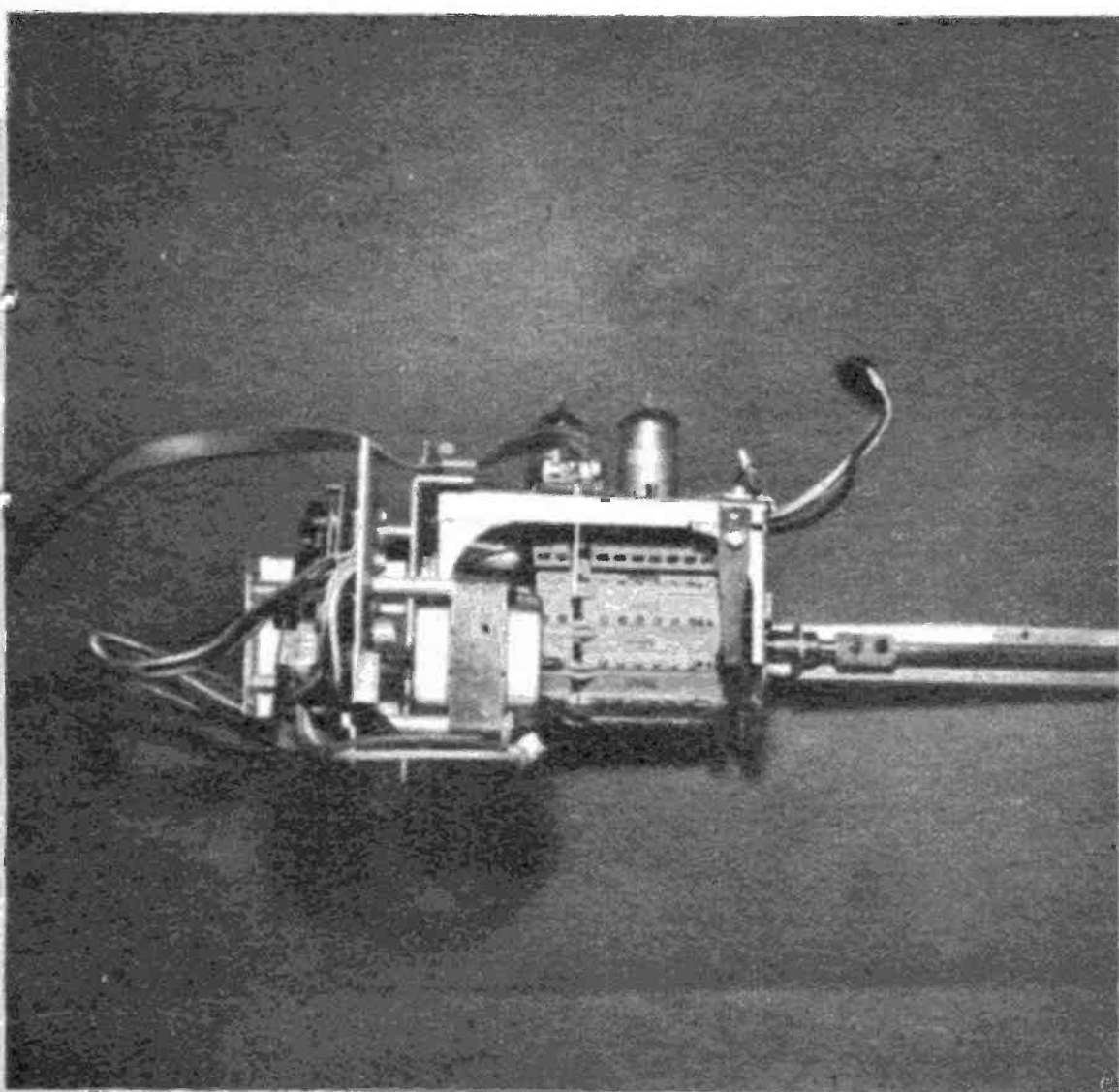

When there is a "putt-putt" noise and these bars are on the screen, check the oscillator in tuner.

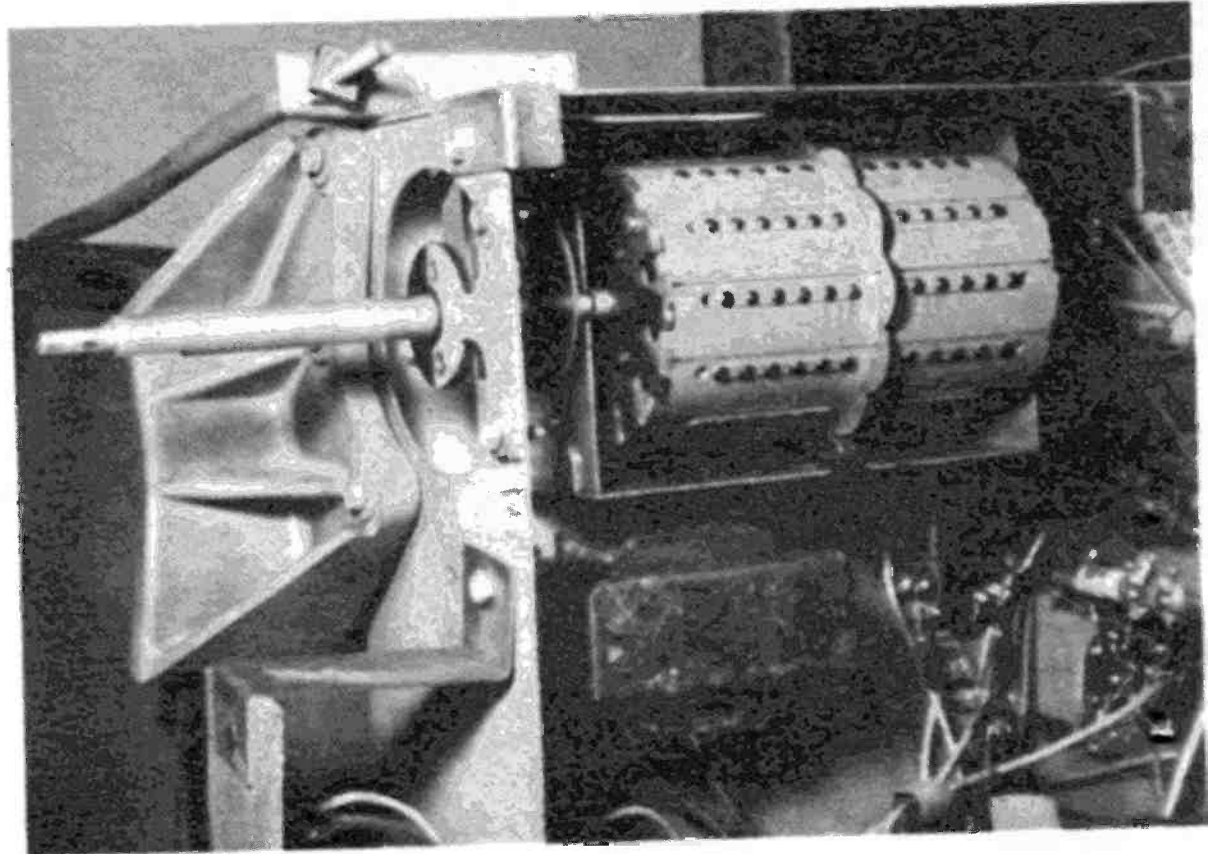
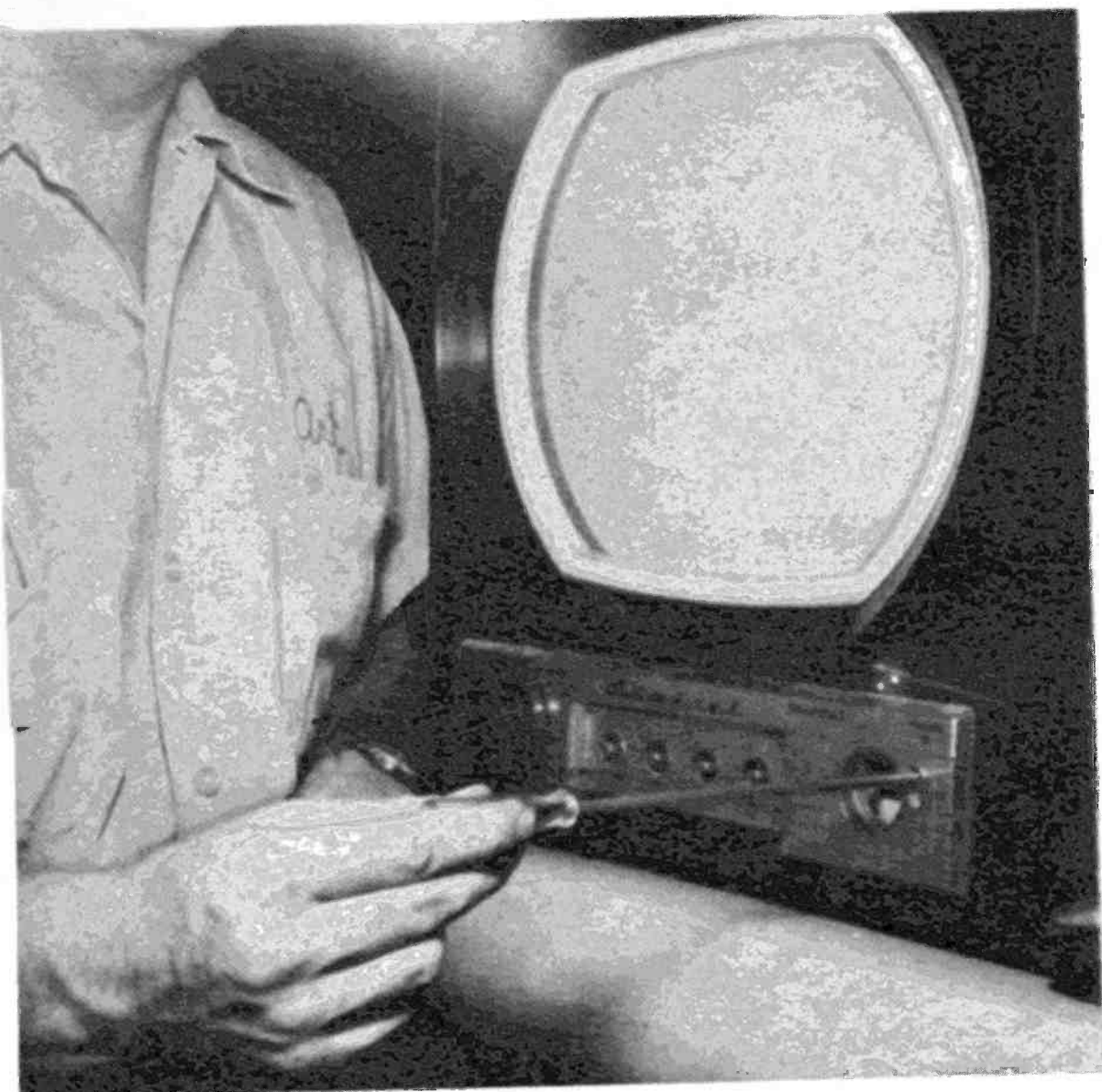

Above is a common type tuner with the channel strips exposed. Springs hold strips in place.

Old set at left lends itself to easy oscillator adjustments. The newer sets are more complex.

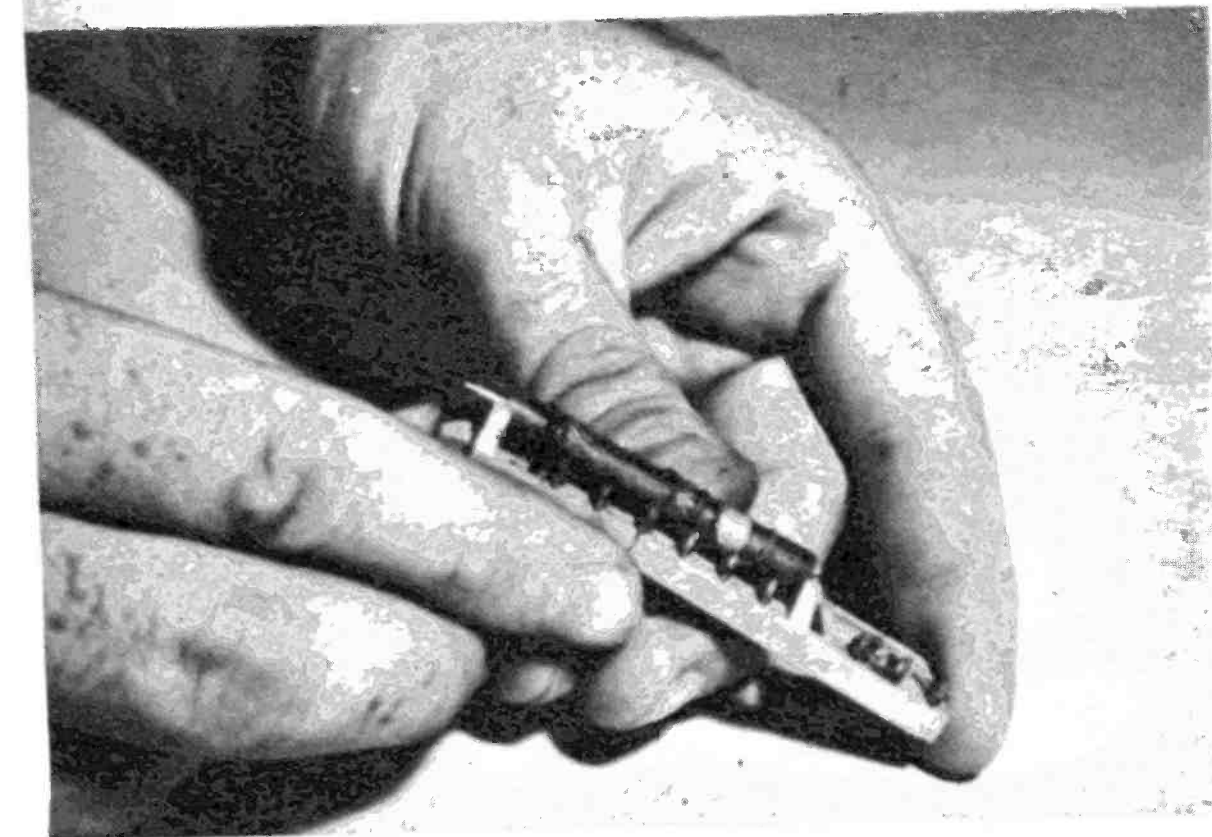

The tuner strips can be removed from the holders for closer inspection, or for special cleaning.

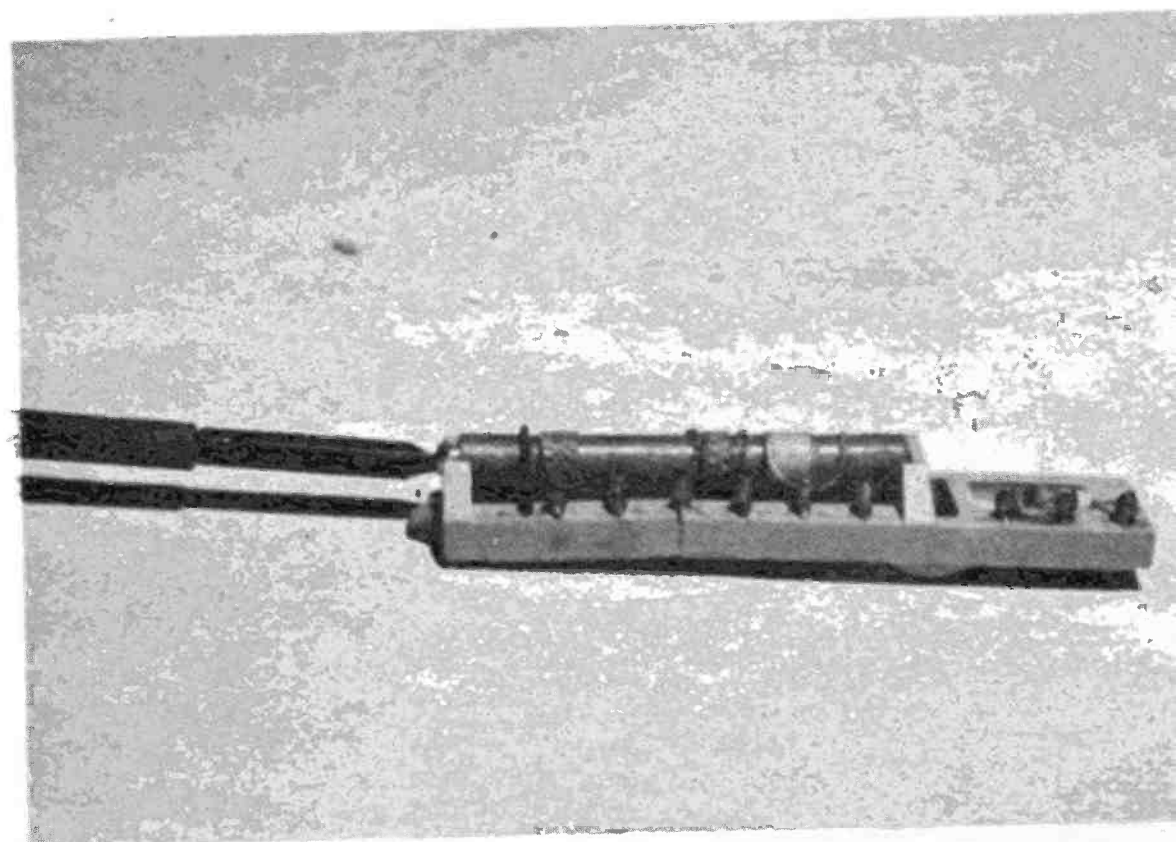

This is what happens inside the tuner when you insert a screwdriver and adjust the oscillator.

partial loss of color where all the tones are not vivid, especially red.

The tuner and IF strip in a color receiver are made to pass a broadband of each carrier. This care is not used in black-and-white TV's. Should a tube or alignment in the RF-IF not be right up to the minute, these color losses can occur. It's usually a weak RF AMPLIFIER, but try the MIXER OSCILLATOR and IF tubes, too. If this doesn't effect a cure, you'll need skilled work performed.

On UHF stations this trouble does not occur as readily. Even a snowy UHF channel will display color.

LOSS OF CERTAIN CHANNELS—As the channel numbers go up, the oscillator on duty must run at higher and higher frequencies. Sometimes a tube gets weak and can oscillate only so high. Therefore if you are getting low channels, for instance, 2 through 6, but no higher channels, like 7 through 13, try a new MIXER-OSCILLATOR. It's probably the cause.

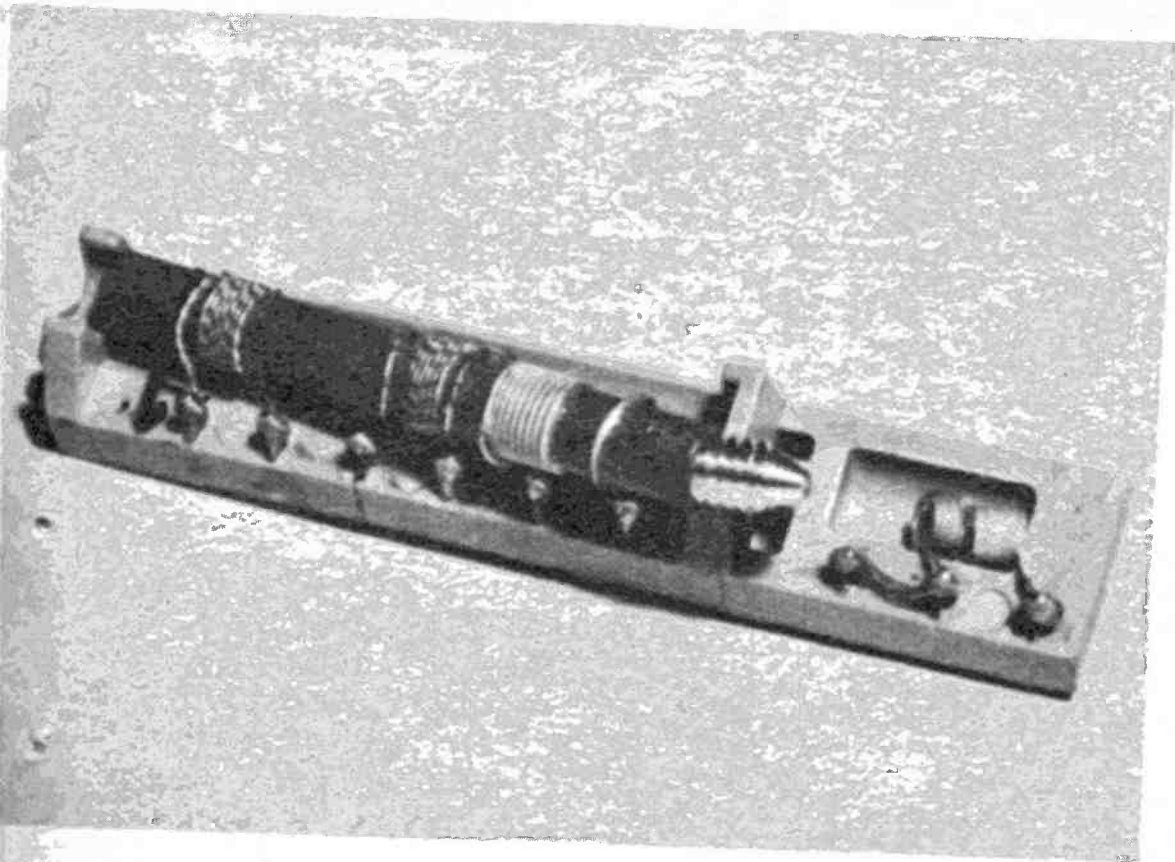

Should you turn the screw too far, the slug will fall past the stop. Retrieve at the other end.

To remove the barrel from tuner, right, take off back spring. Barrel will loosen with spring out.

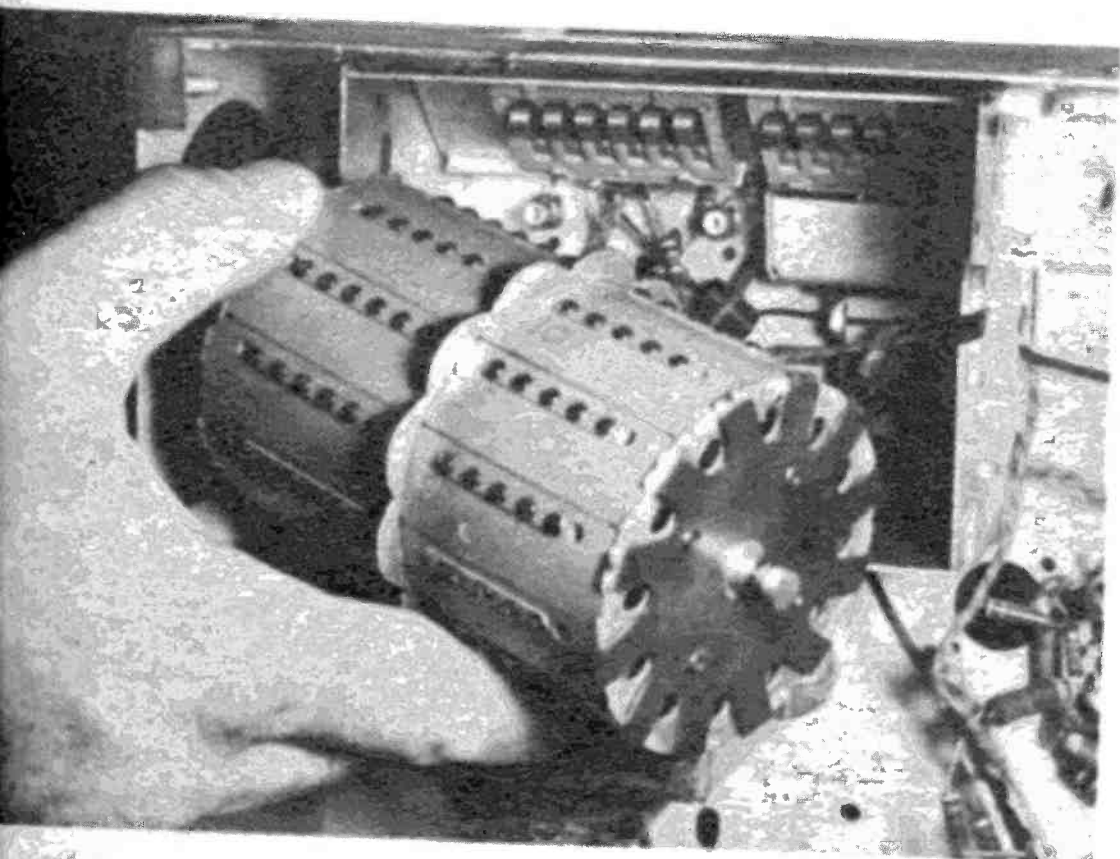
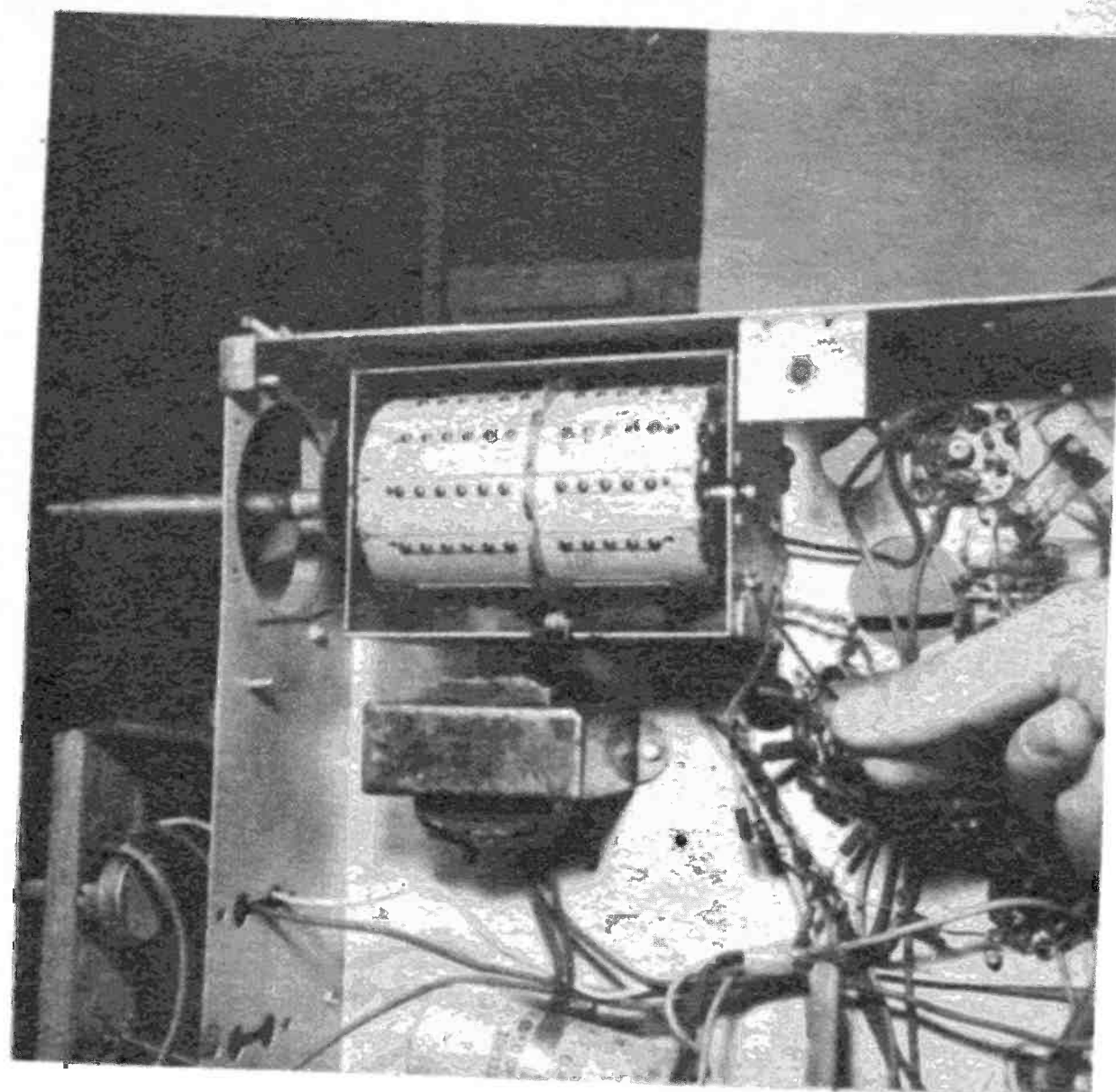

Then grasp tuner barrel and pull rear end out first. The shaft will pull through hole, next.

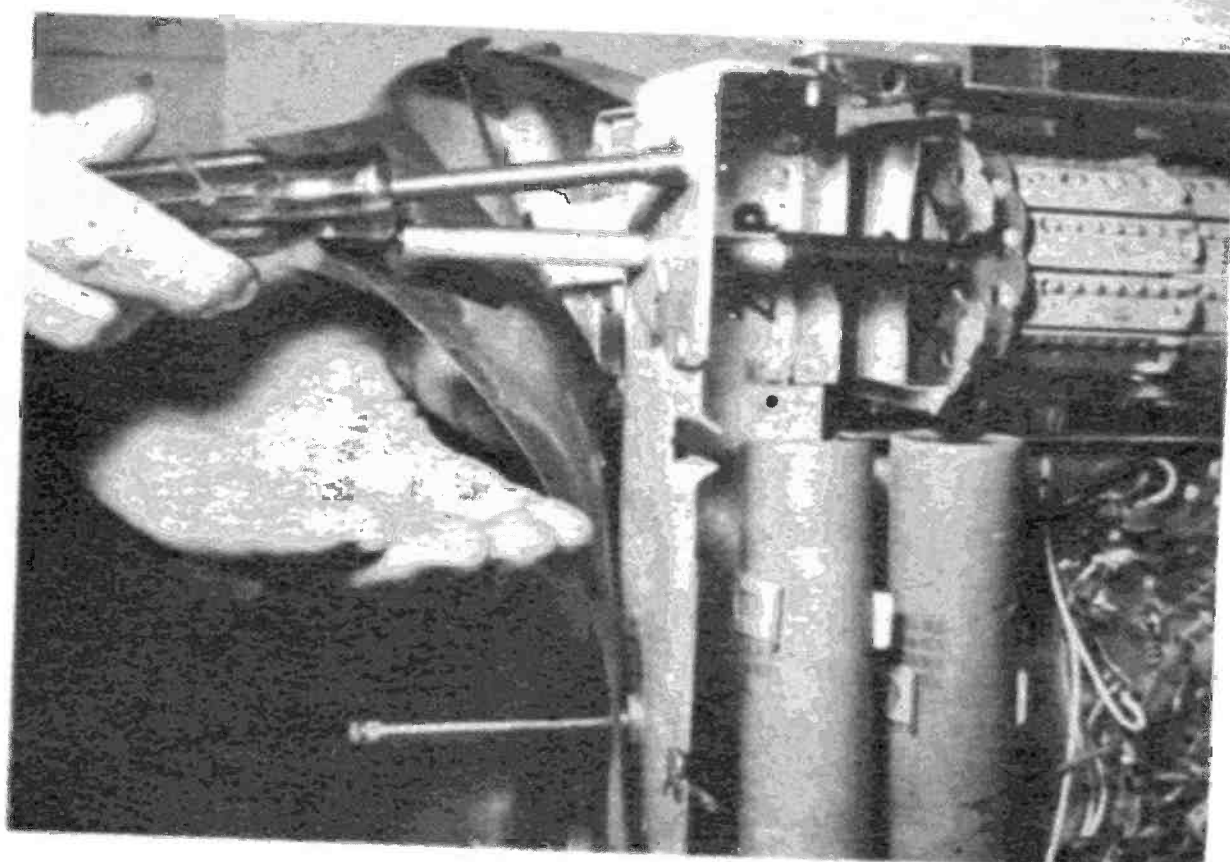

To remove the entire tuner, take off any special front brackets with appropriate hex head wrench.

If you are missing erratic channels, for instance channel 5 or channel 11, and the rest are coming in, your tuner contacts are probably not making contact on those particular channels. Try cleaning those channel strips.

In regard to all those little screws and adjustments sticking out all over the tuners, don't touch them unless you have the correct tools and factory service notes. In older TV's a do-it-yourselfer could adjust the oscillator screws in the front. Not

so today. There are a multitude of different kinds of adjustment screws and most of them have unusual arrangements. Turning a few of them could cause an expensive repair job.

There are quite a few tuner service companies around. All you have to do is remove a defective tuner from your TV and mail or drop it off to them. For a nominal fee they will repair it and mail it back. Just be sure that it is your tuner that is causing your problem. •

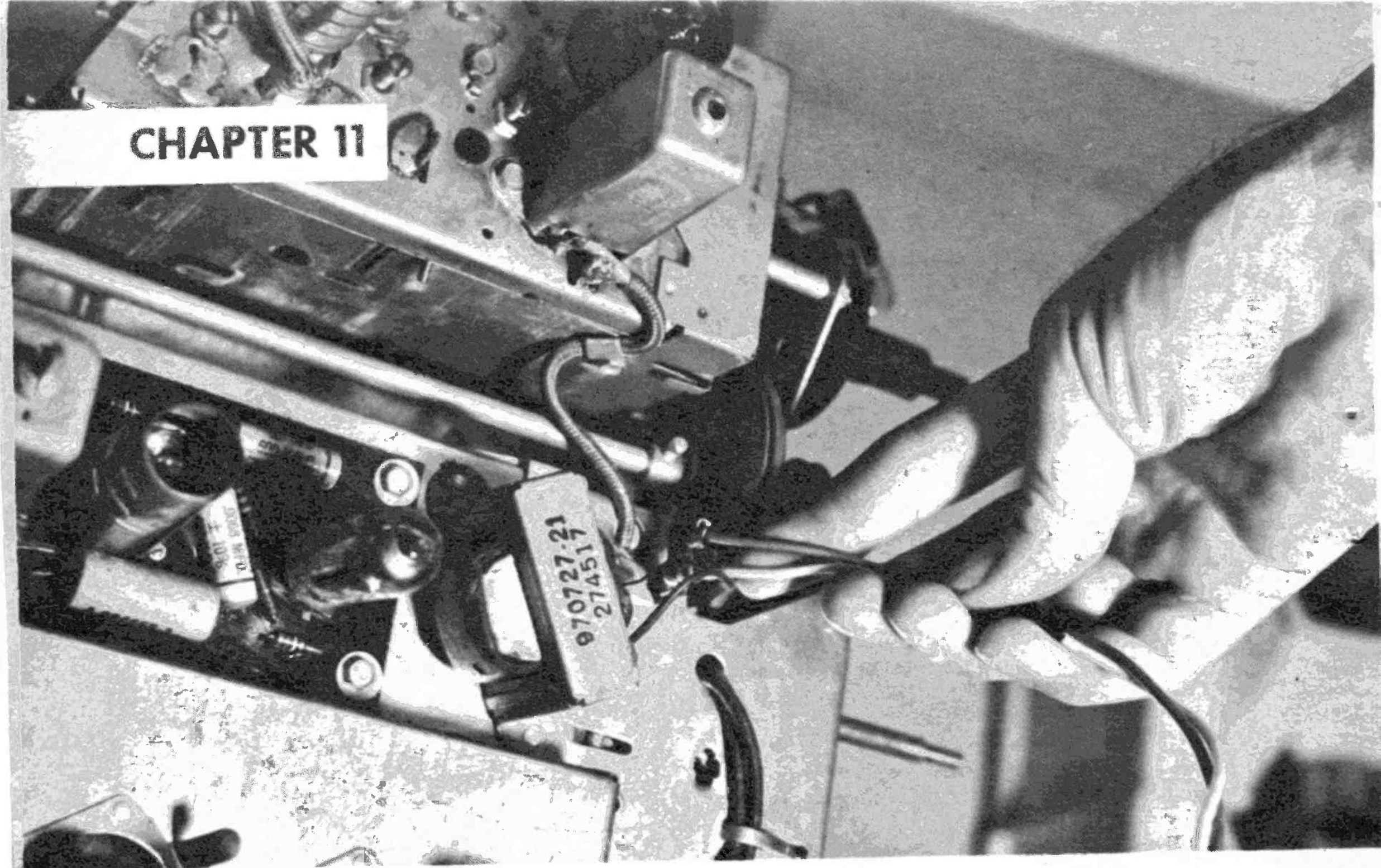

These two wires coming out of the audio output transformer of the TV carry the sound to the speaker.

Getting the TV to Sound Right

TV sound troubles are the easiest of all to diagnose and correct

SOUND TROUBLES in your TV set are probably the easiest of all to repair. There are only a few symptoms: no sound, distorted sound and sound drift. The audio section is very similar to the rear end of an FM radio. Its front end, though, is quite different. In a TV it is also the front end for the picture, lock-in and color signals. In black-and-white TV's the sound is taken off, in the video output stage, by a sound take-off transformer, commonly labeled 4.5 MC take off. In color TV's a separate audio detector is used after the IF strip. Then the audio is sent on to the audio circuits.

When trouble occurs in the RF-IF the picture, lock-in and color are affected. The audio symptoms become secondary to the primary picture problems and are mostly overlooked during troubleshooting.

When the trouble strikes in the sound-only circuits, though, the audio becomes the primary symptom and gets all the at-

ention. Let's discuss the sound-only troubles.

NO SOUND—When the audio in a radio dies out, a technician will place his finger on the center tap of the volume control. The volume control is in the center of the sound pathway as it goes through the radio. The finger touch induces a hum. If he hears the hum it means sound can go through from the volume control to the speaker. Therefore the rear half of the radio is good and the trouble is indicated to be in the front half.

Should no hum emanate from the speaker the rear half is indicated as the bad half.

In a TV this procedure is hard to do because of the layout of the TV and the fact that the circuit position is not always a hum producing spot. However, if you place your ear against the speaker and rotate the volume control you can make a similar test.

There will be one of three results. One, no trace of any sound. That means the AUDIO OUTPUT circuit is dead. Test the tube, the audio output transformer and speaker. Another common trouble is a large heavy wattage resistor that feeds B-plus voltage to this stage.

Two, there is some hard-to-hear background hum coming out of the speaker but the volume control doesn't have any effect. In this case test the AUDIO OUTPUT and AUDIO AMPLIFIER.

Three, the volume control does cause some change in the speaker output. It does not matter how low it changes the level of the background hum or tiny bit of audio. This places the source of trouble before the control. Test the AUDIO IF and AUDIO DETECTOR.

As a last resort, when this professional style doesn't produce results, be sure to revert back to a blanket approach and test all the audio circuits.

MUFFLED SOUND—When the TV performers speak in garbled tones, test all the audio circuits right off. First test is to tap the audio tubes with a pencil. If any of them ping or crackle it's probably bad and needs replacement. Be careful though that you catch the right one. The noisy tube is that way because it has loose elements and if you tap an adjoining tube the bad one might still ping.

When a tube doesn't cure the condition, examine the speaker. It might have holes or tears in it that is causing the problem. Also it could have a sticky voice coil. Substituting a good one tells the tale.

Lastly, muffled sound is caused by FM detector drift. Find the FM detector can and adjust it with a hex-head alignment stick. Just a slight turn of the top or bottom core will cure the condition. Should the touch-up alignment cure for a while, but the trouble returns, you'll probably need a new detector can.

SOUND BARS IN PICTURE—If you have a good picture but the picture quivers in time with the sound, some of the sound output is getting into the video circuit. The sound can get in there due to a defect in one of the output tubes. They are all fed from the same boost B-plus supply and when they draw too much current they affect each other.

For sound bars, try a new AUDIO OUTPUT tube, a new VERTICAL OUTPUT tube and a new HORIZONTAL OUTPUT tube. It will probably be one of them. If it's not, try the MIXER-OSCILLATOR and IF strip tubes as a last resort. •

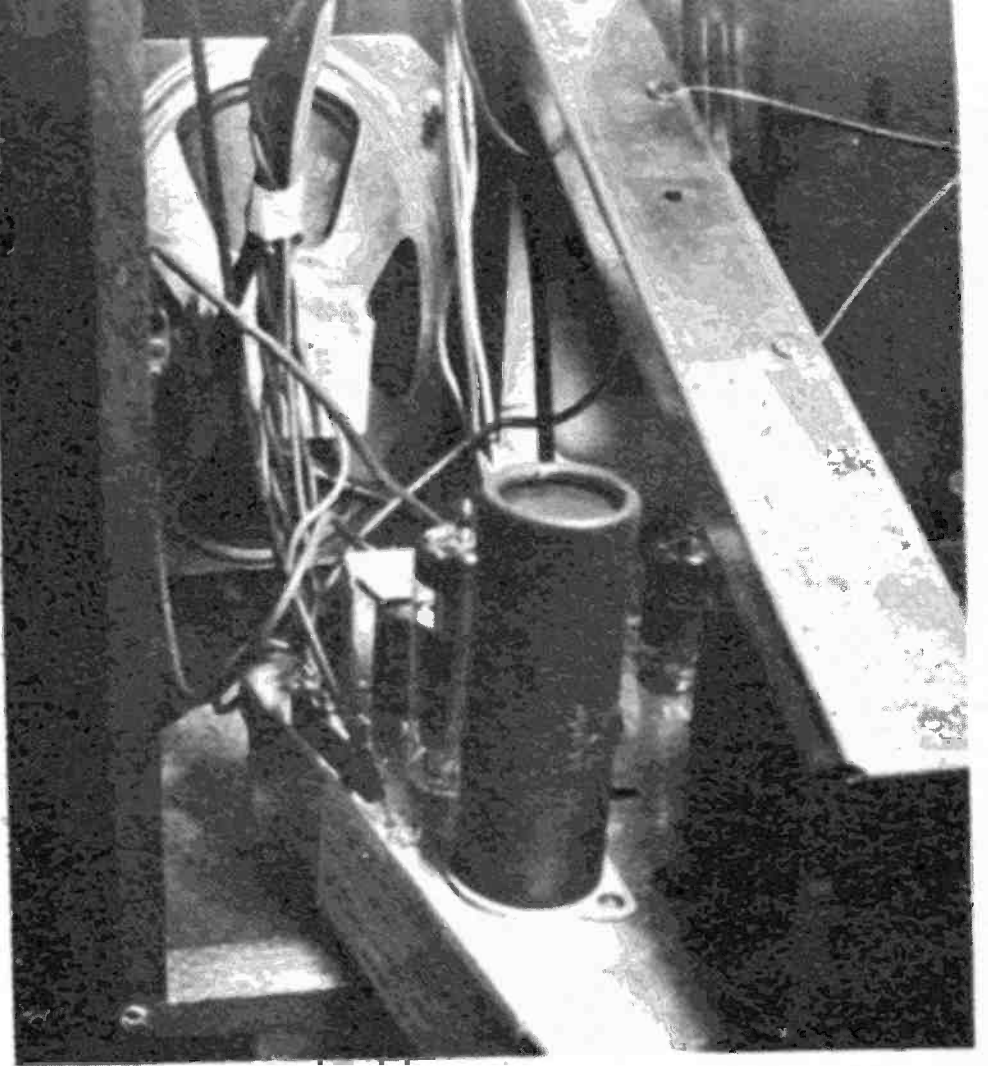

After wires leave the audio output transformer they travel to the speaker mounted in cabinet.

Common trouble-causing erratic sound is a loose connection like this capacitor on printed board.

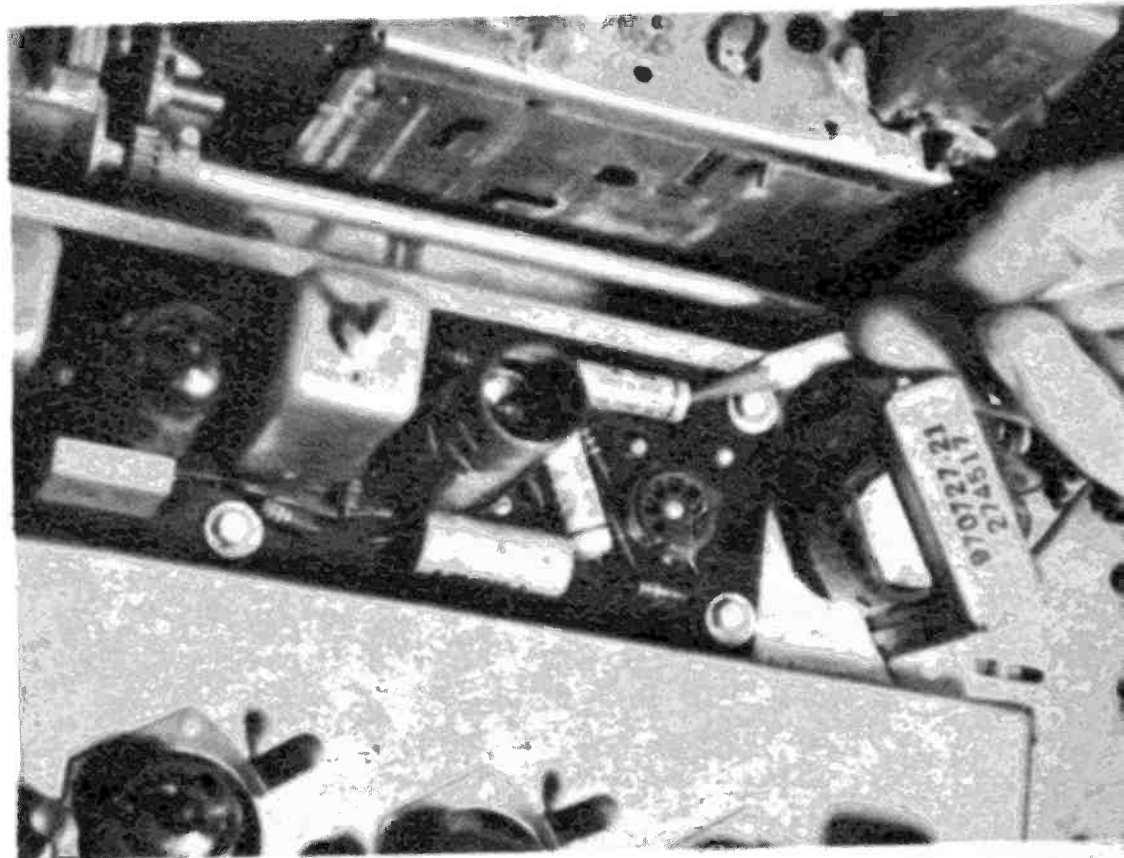

An easy way to test for a bad sound tube is to tap it gently. Bad ones will ping or crackle.

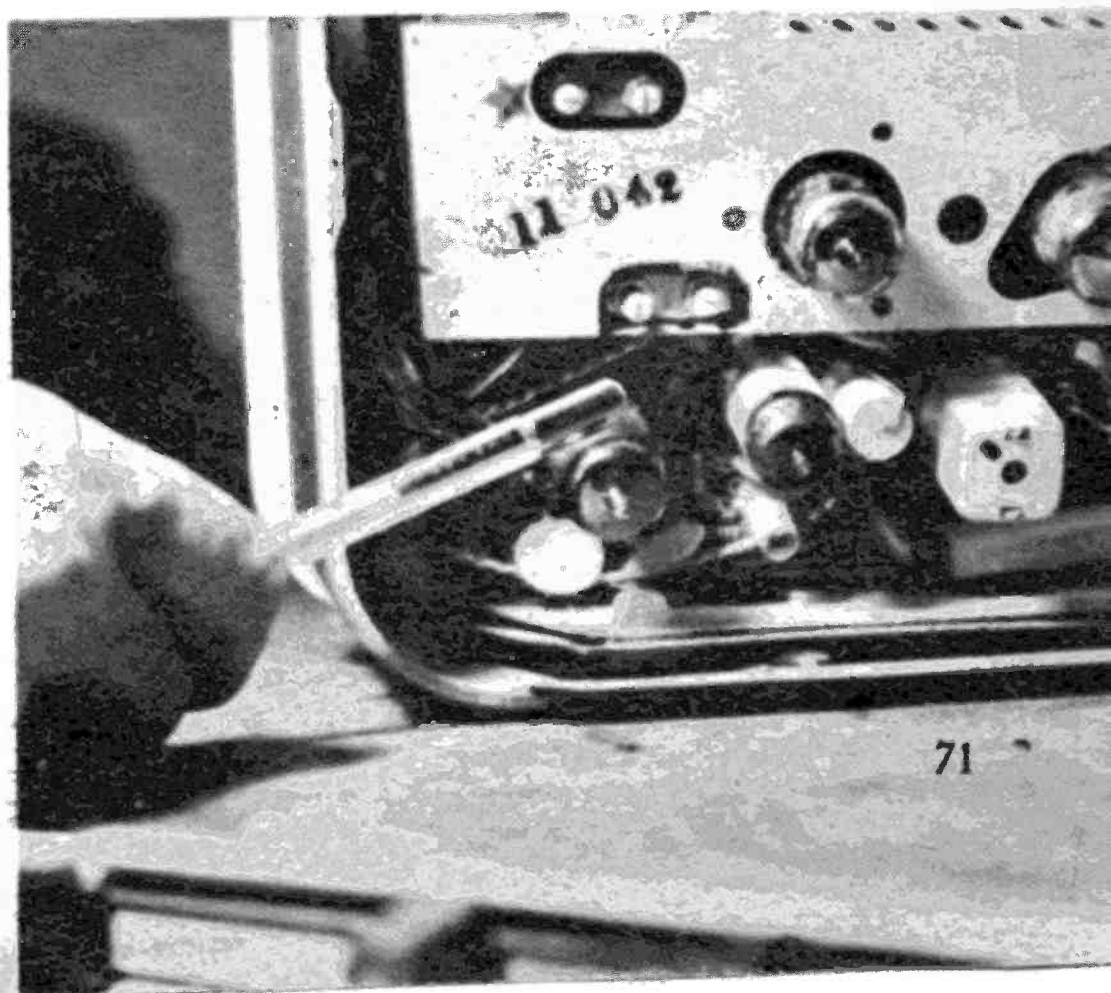

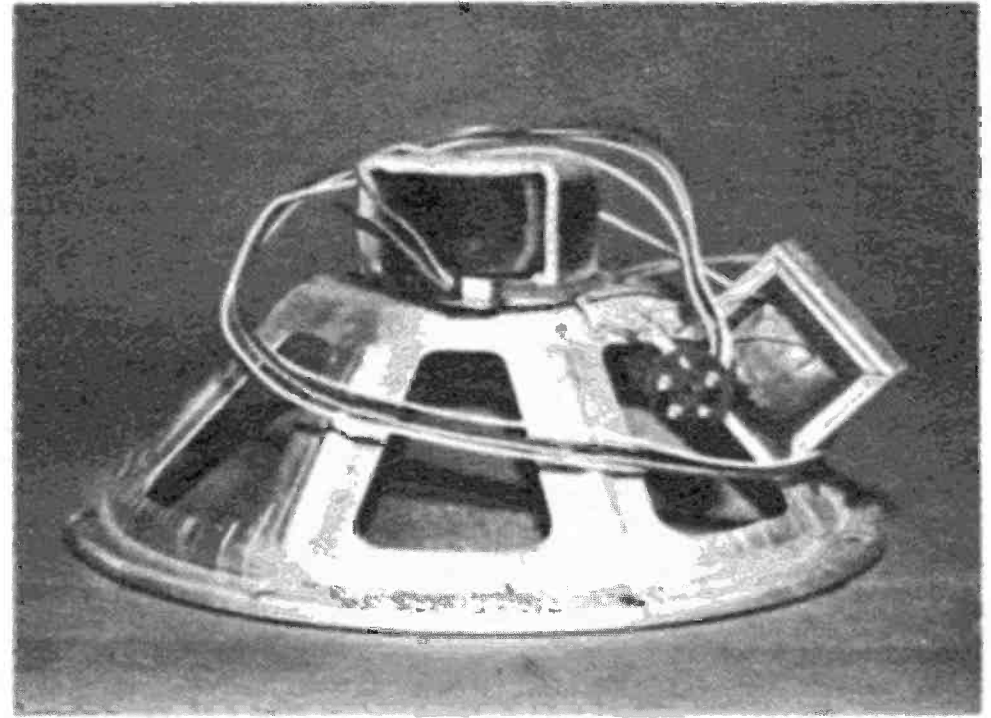
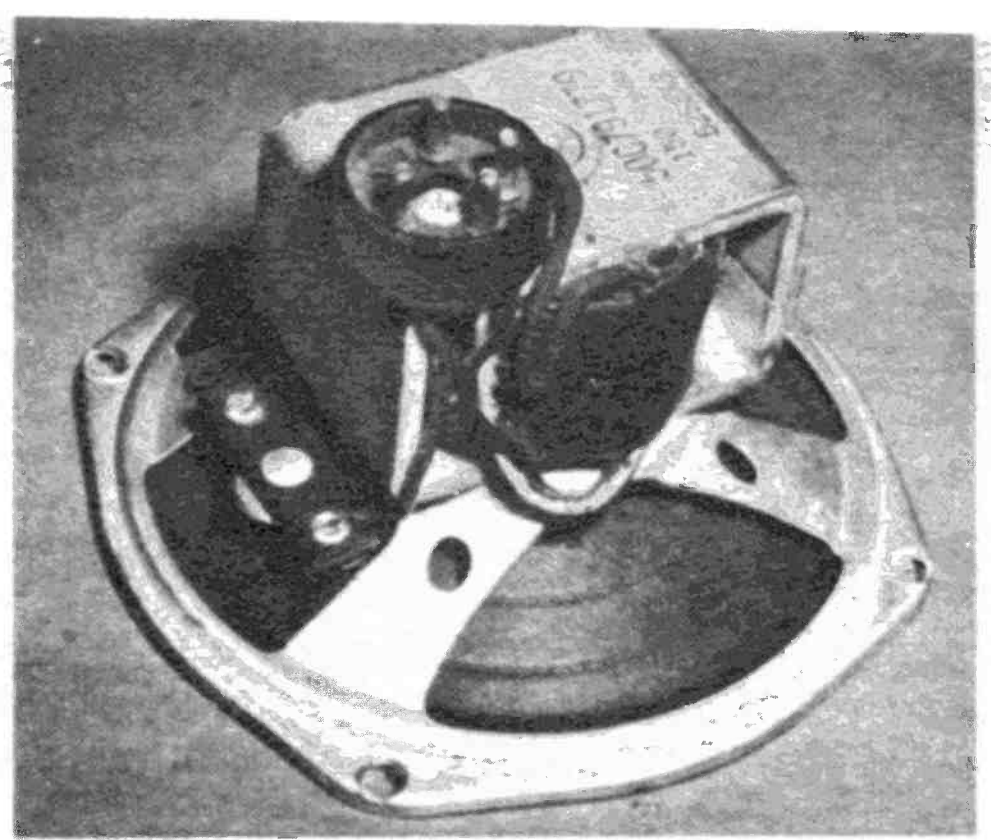
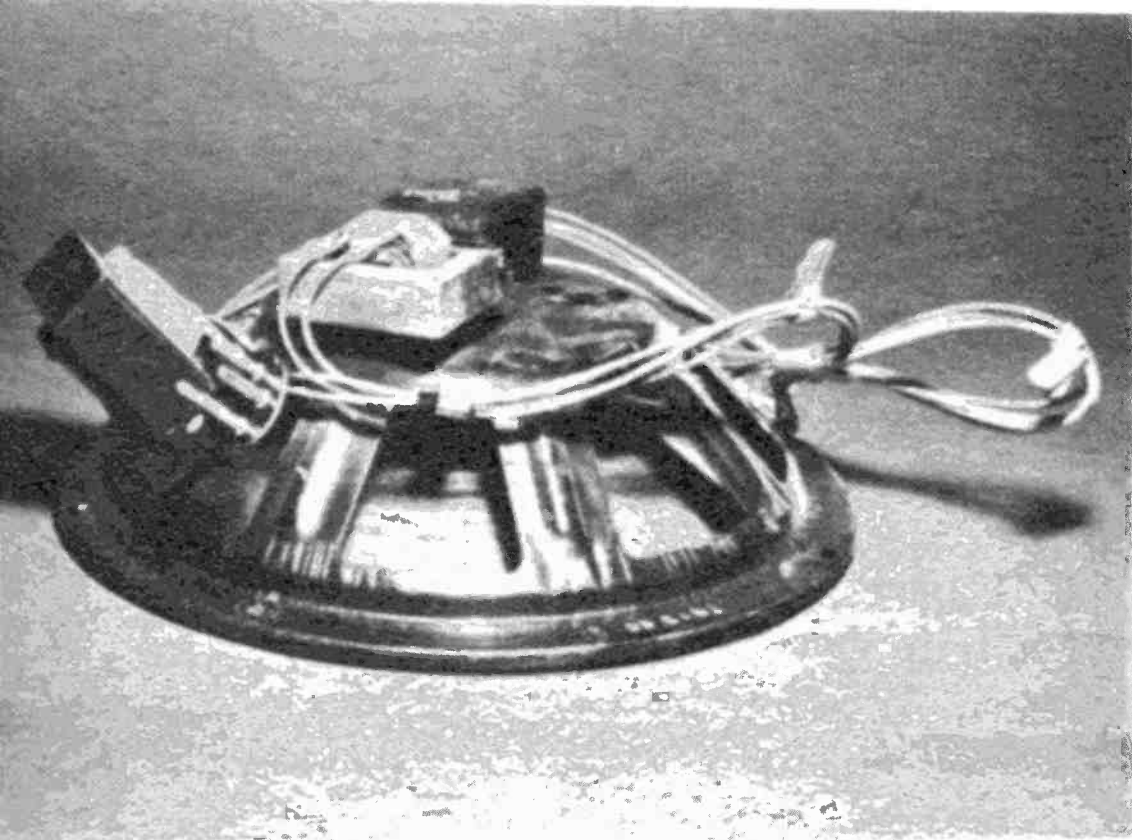

There are many sizes and types of speakers. Be sure to get the same electronic and physical replacement.

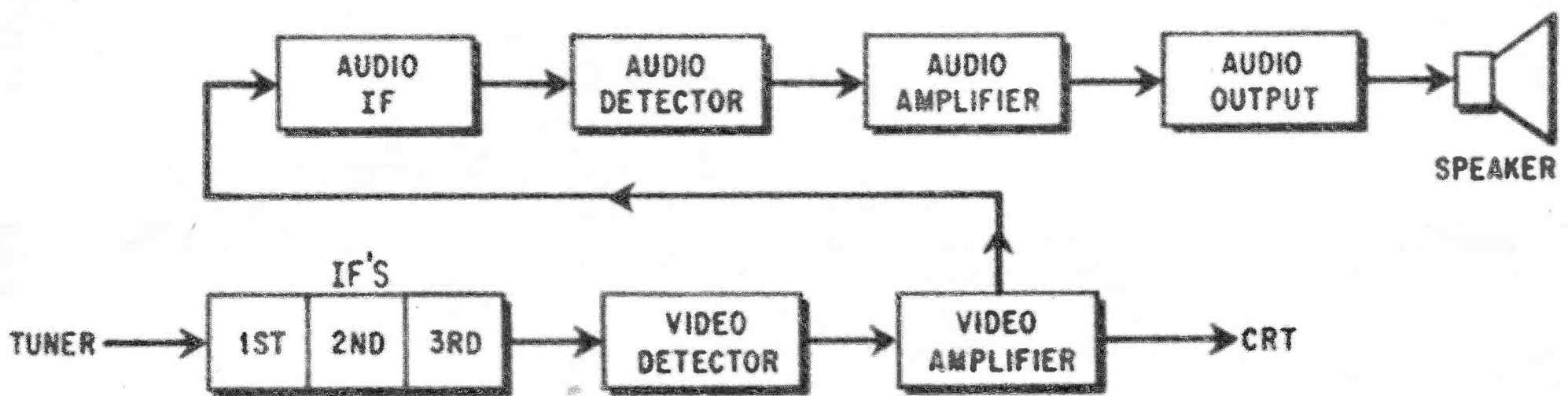

BLACK & WHITE TV AUDIO TAKEOFF

The audio section of a monochrome TV takes the sound off somewhere in video amplifier circuit.

The audio section of a color TV takes the sound off after 3rd IF to avoid picture interaction.

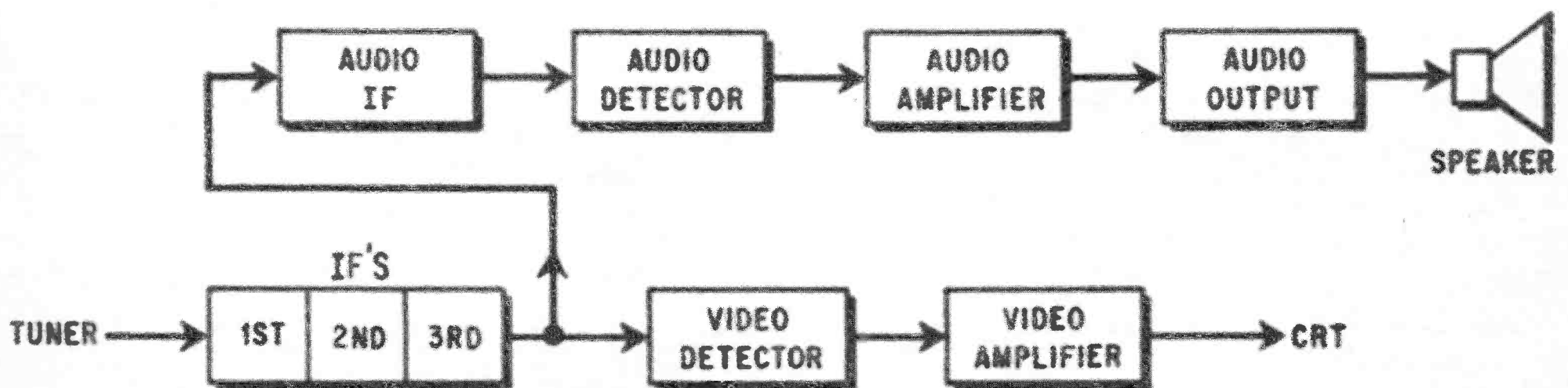

COLOR TV AUDIO TAKEOFF



The most efficient way to run a test on a color picture tube is with a cathode ray tube checker.

Latest Picture Tube Repairs

Do not change a faulty picture tube until you try these simple repairs

WHEN a picture tube goes bad for the first time, odds are in your favor that it can be repaired. This is true for both monochrome and color CRT's.

There are some ways a picture tube dies that are irreparable. However the repairable defects outnumber them considerably. The first step, of course, is making the decision a picture tube is defective.

The common symptoms on a screen are **NO LIGHT**, **DIM PICTURE**, **GASSY PICTURE** and **FIXED BRIGHTNESS**. Let's go through their repair procedures.

NO LIGHT—This trouble symptom is exactly the same as when the high voltage quits. Only, if you look at the CRT neck you'll find it's not lit.

A fast check to see if it's repairable is to grasp the cap on the CRT neck and jiggle it. Should the neck begin to light up again you'll probably be able to repair it.

Either way, pull off the cap, get a pair of pliers and squeeze the pins sticking out of the plastic socket. (If your CRT is the type that doesn't have a plastic socket you can't do this repair.) If you have a soldering iron you can heat each pin till the solder runs.

What has happened is, a layer of corrosion has built up between the wire from the electron gun and the socket pins. Crimping and reheating the solder usually puts the picture tube in working order.

Color picture tubes have an exact com-

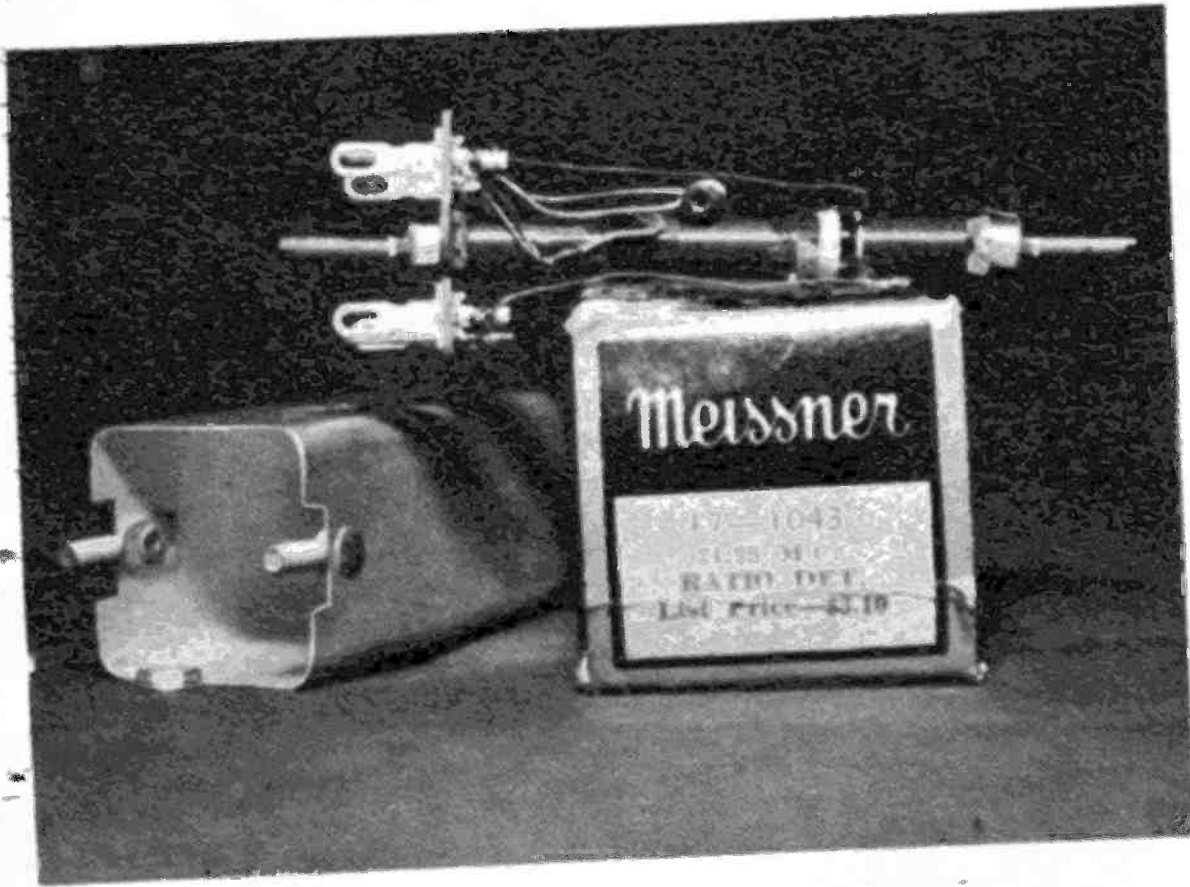

A detector can has adjustment spots on the top and the bottom. They can easily be tuned by ear.

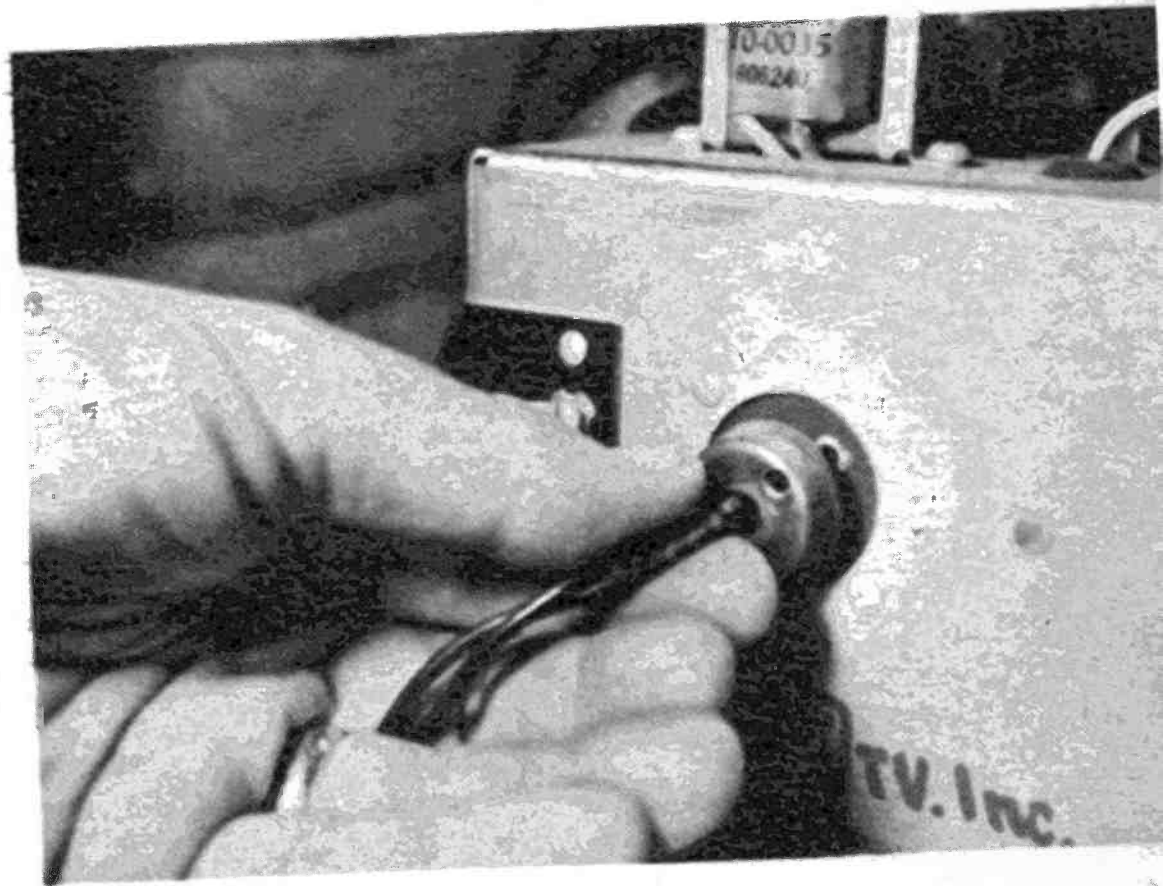

Many TV's have special plugs for speakers. It's designed to kill picture, also, when it's pulled.

This plug doesn't kill picture when pulled. Keep volume low, or output transformer may blow out.

If you touch up audio alignment, be sure to use appropriate tool like this hex head neut stick.

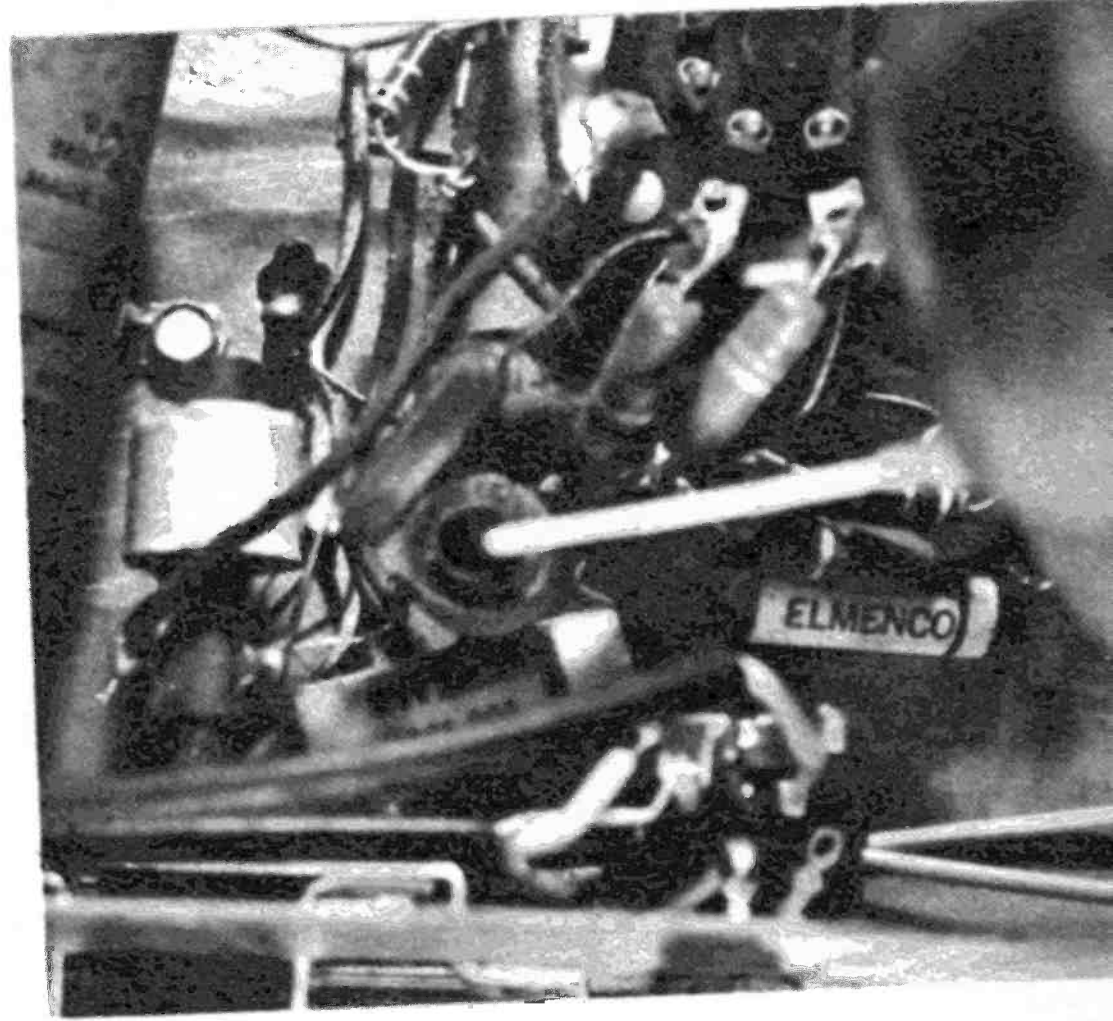
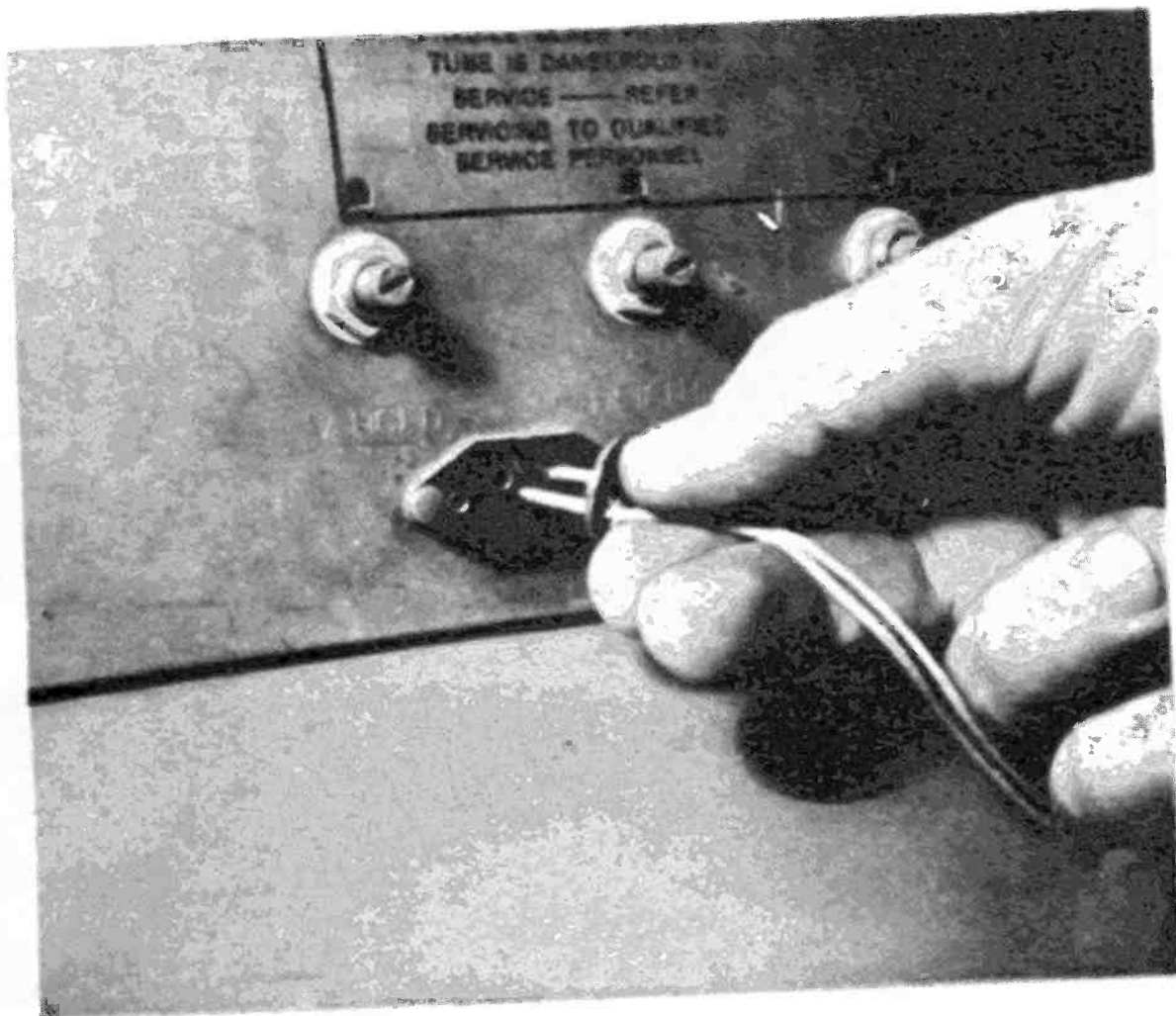

A professional way of setting audio is to hook a meter across the detector load and then align.

Some sets have a buzz control in the rear of the chassis. Adjust them by ear for clearest sound.

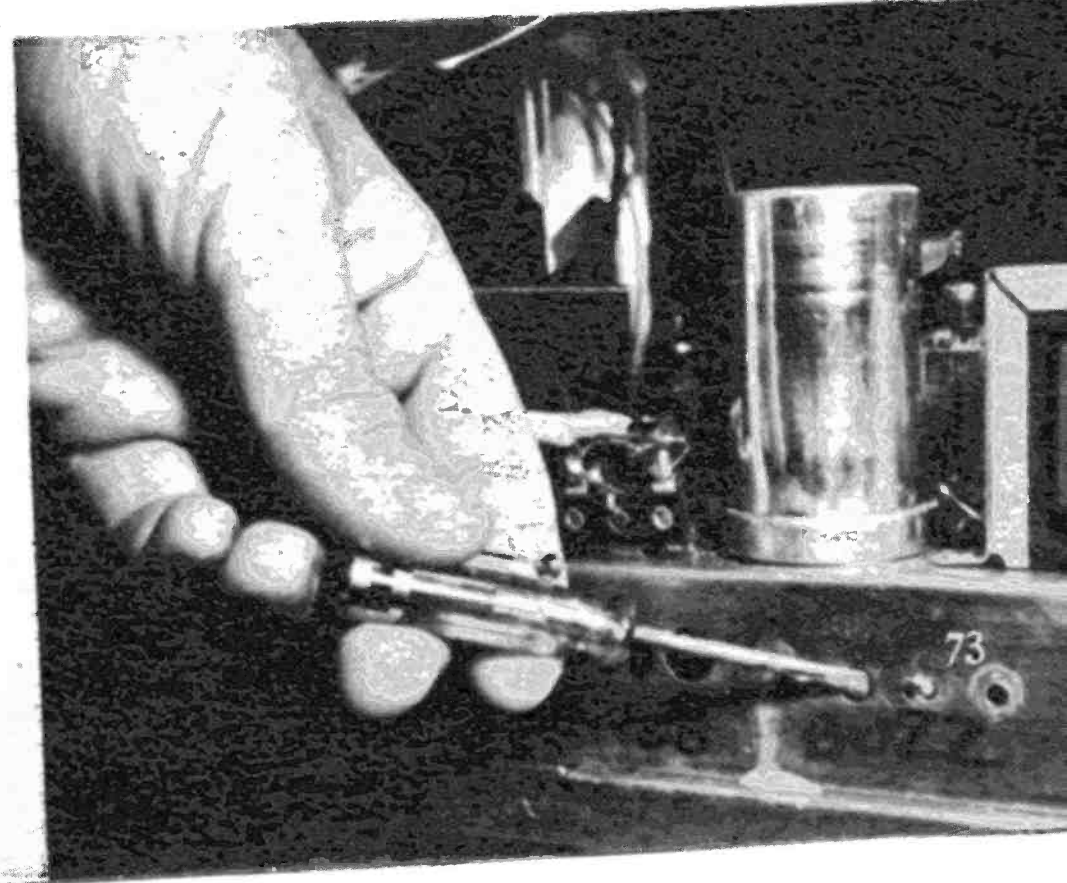
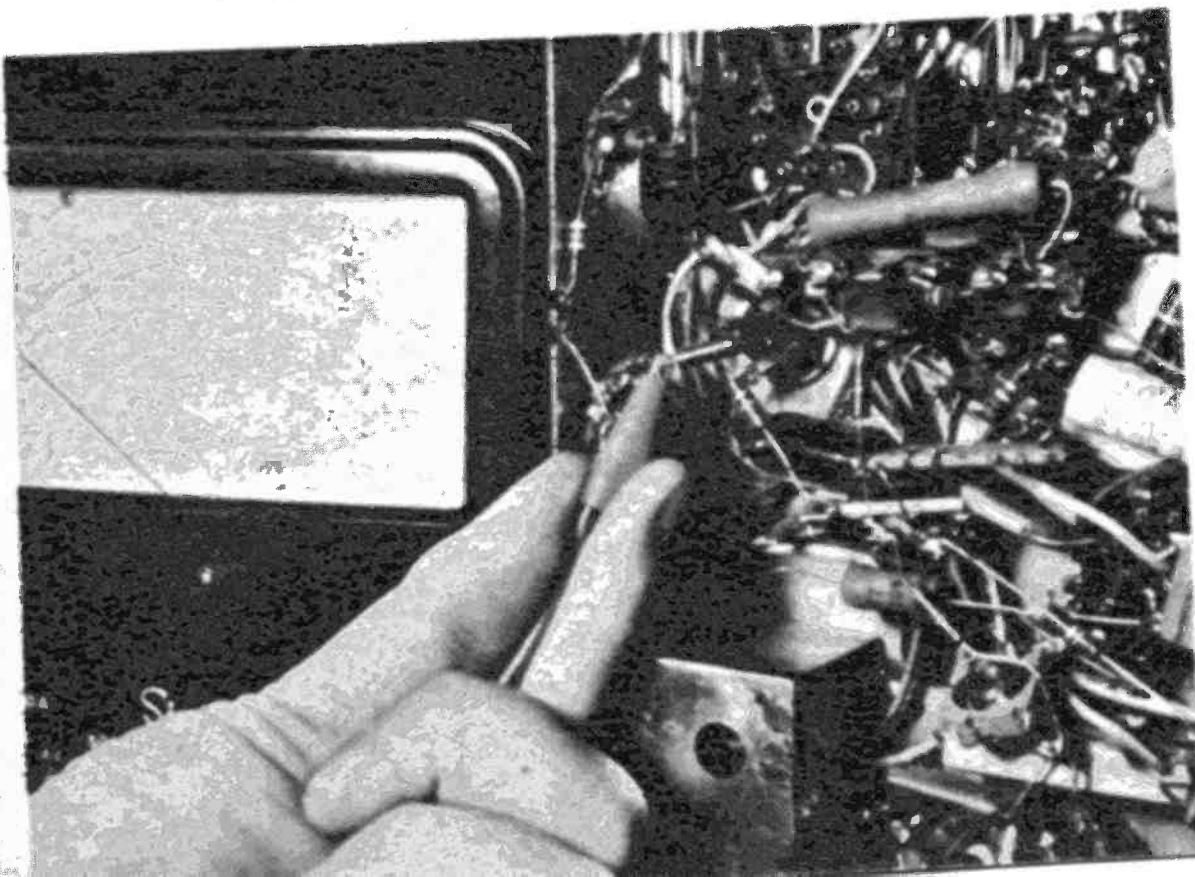

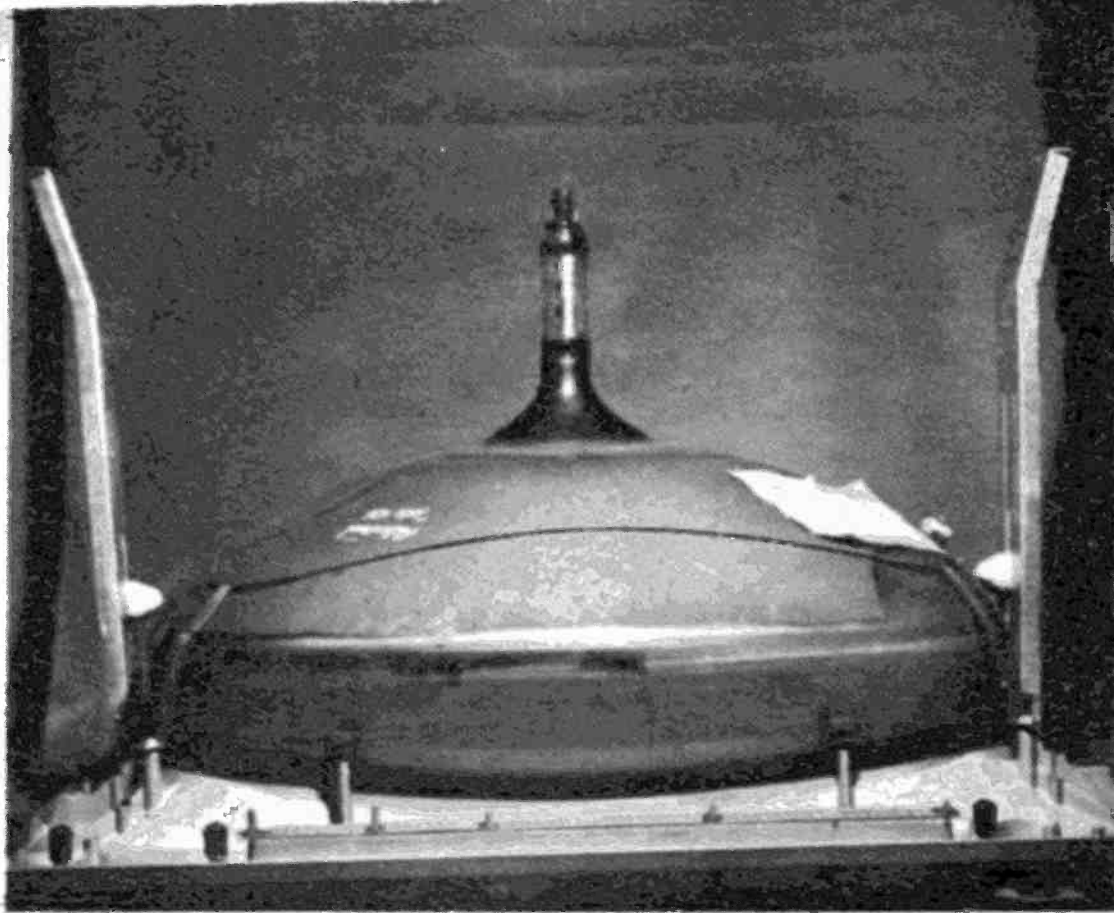

This is the latest type picture tube profile. Note short, thin neck and flattened out bell.

This is the older picture tube profile. Notice the long, fat neck and the high, elongated bell.

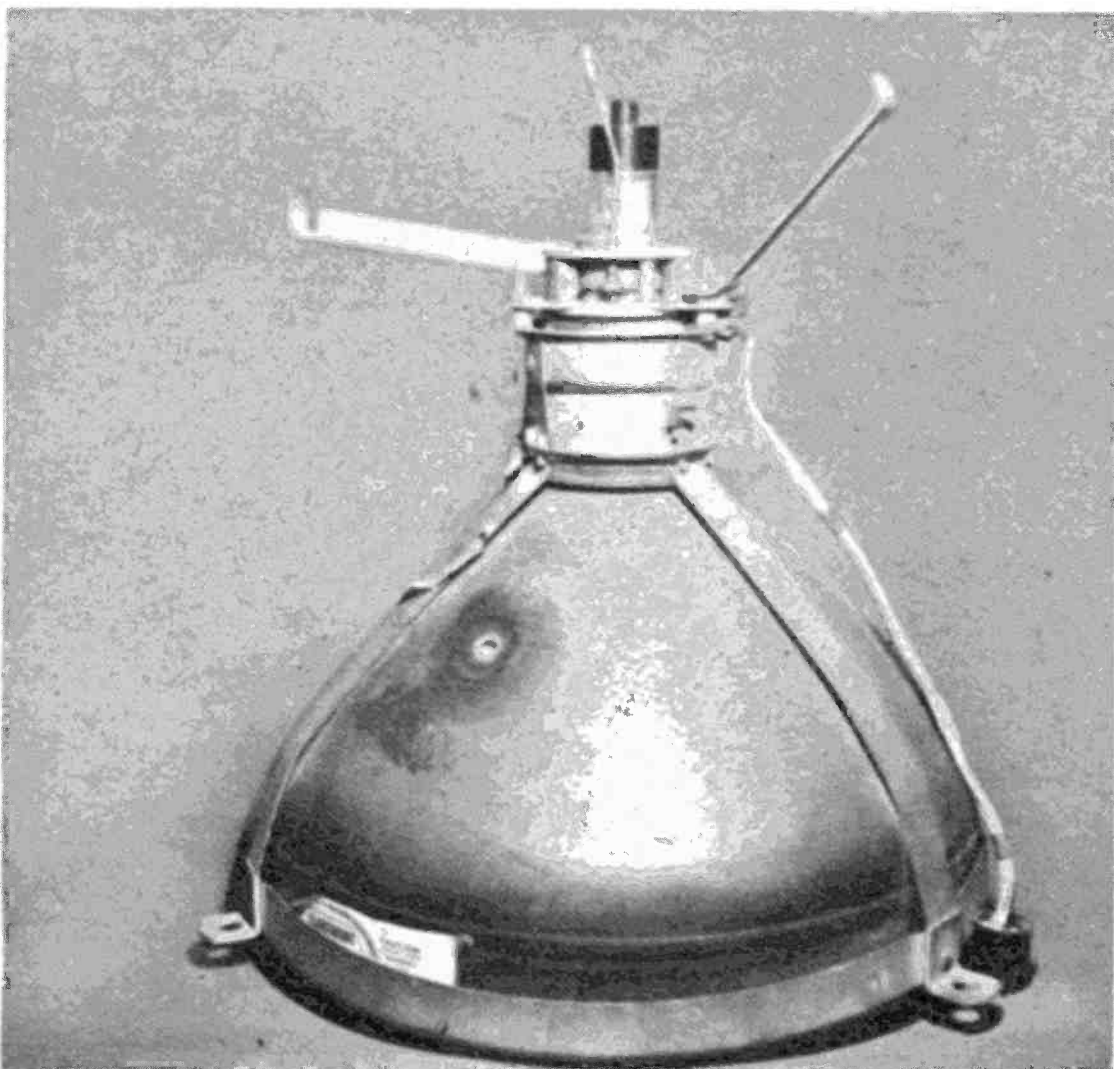

panion trouble and can be cured with the exact same procedures.

RETHREADING SOCKET—On occasion, as you pursue the above procedure, the socket will come off leaving the wires from the gun sticking out. Don't panic, you can reinstall it.

Take a solder gun and, by heating and knocking, remove all the solder from the pins in the plastic socket. Take a wire brush and carefully scrub off all the corrosion from the wires sticking out of the CRT.

Attach lengths of fine wire or strong thread to the protruding wires. Run the extensions through the proper pins in the socket and thread the socket back into place. Heat up the pins and run a little

bead of solder into the inside of the pins. Reattach the socket to the glass with some epoxy glue. This rethreading procedure works on color as well as monochrome CRT's.

DIM OR GASSY PICTURE—This trouble must occur without a secondary symptom of shrinking. When there is a shrink it's not the picture tube but the low or high voltage power supplies that are at fault.

When the symptom does appear without shrinking it's due to low emission of the one electron gun in a black-and-white CRT.

The electron gun has a cathode that has a coating of barium oxide. This coating has the ability to release electrons from the cathode. The coating can, and does, become worn out on its surface over a period of time. This is the most common reason for picture tube failure.

As the electron emission drops off, your screen gets darker and darker. As you advance the brightness control nothing much happens except the whites in the picture become annoyingly shiny.

The same thing can happen in a color CRT. However, it's usually just one gun that gets weak while the others emit satisfactorily. This removes one color from the screen. If you lose the green gun the picture becomes a mixture of blue and red. The black-and-white picture becomes shades of purple. Should you lose the red gun the picture becomes a mixture of blue and green. The black-and-white picture becomes a mixture of cyan. If you lose the blue gun the mixture of red and green shows a yellowish picture.

The repair attempt is easy. You must install a brightener on the tube. A brightener basically overheats the cathode by raising the heater voltage from 6.3 volts to 7.8 volts. The brightener will not hurt the picture tube since all heaters are rated to absorb a 100 per cent overload. You could run the heater at 12.6 volts and still not do any damage. In fact, if your picture tube loses emission a second time you can try installing a second brightener in series with the first.

The brighteners are only small step-up transformers but there are at least six kinds of black-and-white CRT's, four kinds of color CRT's and the CRT's can be wired up in parallel or series strings. That means at least ten different brighteners each in a series and parallel type. At least sixteen possible brighteners in all. Be sure you buy the right brightener for your picture tube.



CRT trouble shorts out brightness control. A fixed brightness develops with retrace lines.

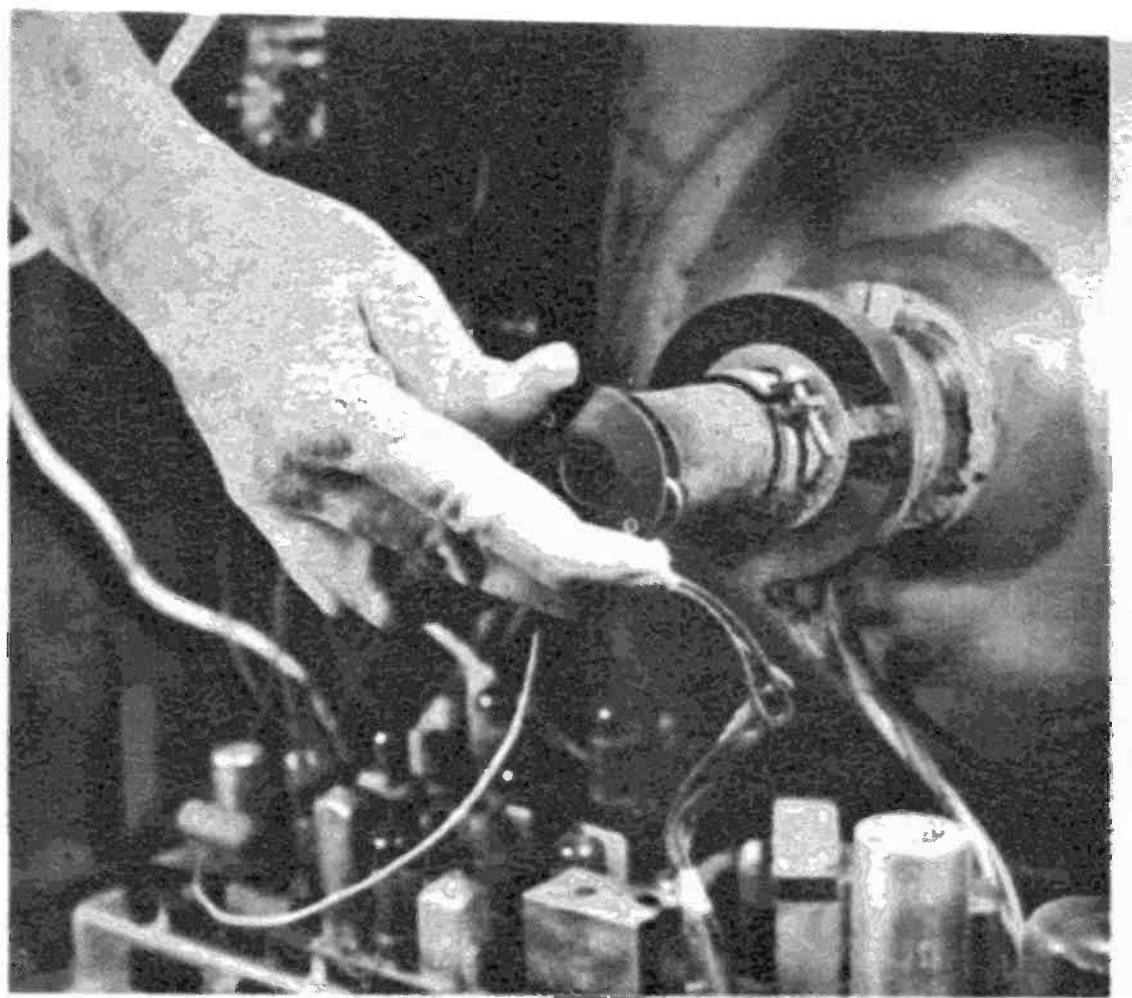

A visual check of the way the heaters are lighting will sometimes reveal valuable service clue.

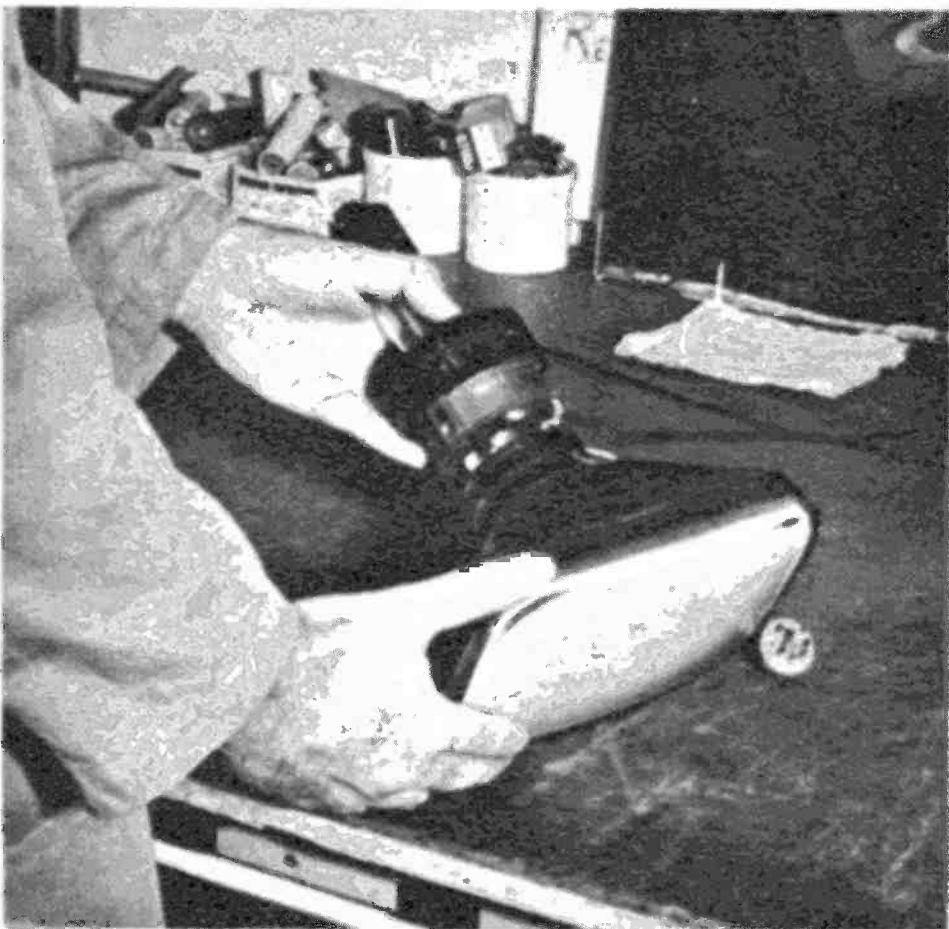

The easiest way to test for a bad picture tube is to install a test picture tube in its place.

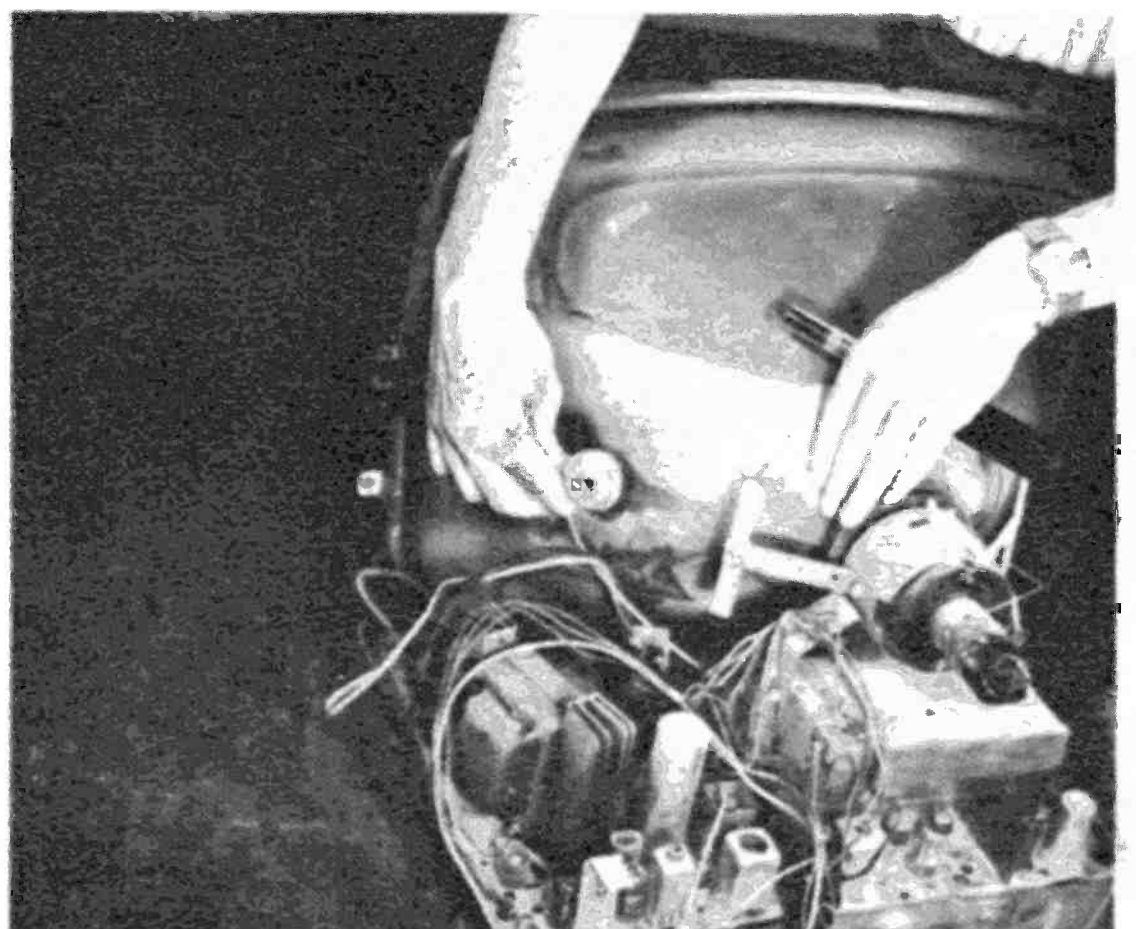

A professional tests for correct value of high voltage at CRT well during picture tube repair.

Below is closeup of high voltage well and anode cap that feeds high voltage to the picture tube.

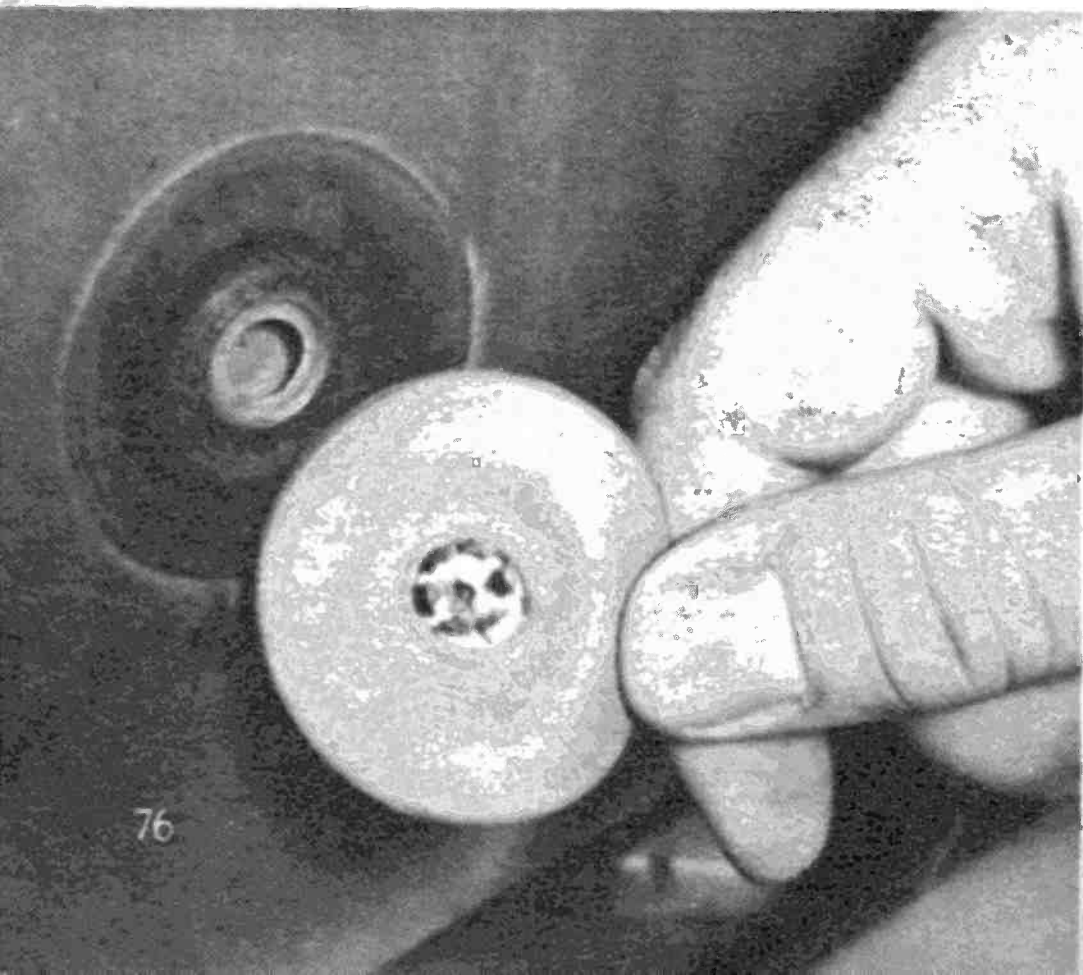

If you have your make and model, a supply store should have no trouble matching it up.

A professional uses a CRT rejuvenation machine before installing a brightener. He makes a reading of the emission first, then overheats the cathode and applies a B-plus voltage that sucks a lot of electrons out of the cathode. This has the effect of cleaning the deteriorated top layer off the barium oxide.

In a color TV, when you restore a low gun by installing a brightener, the other two guns will get brighter, too. They have to be tuned down. (See the **BLACK-AND-WHITE TRACKING** procedure in Chapter 14.)

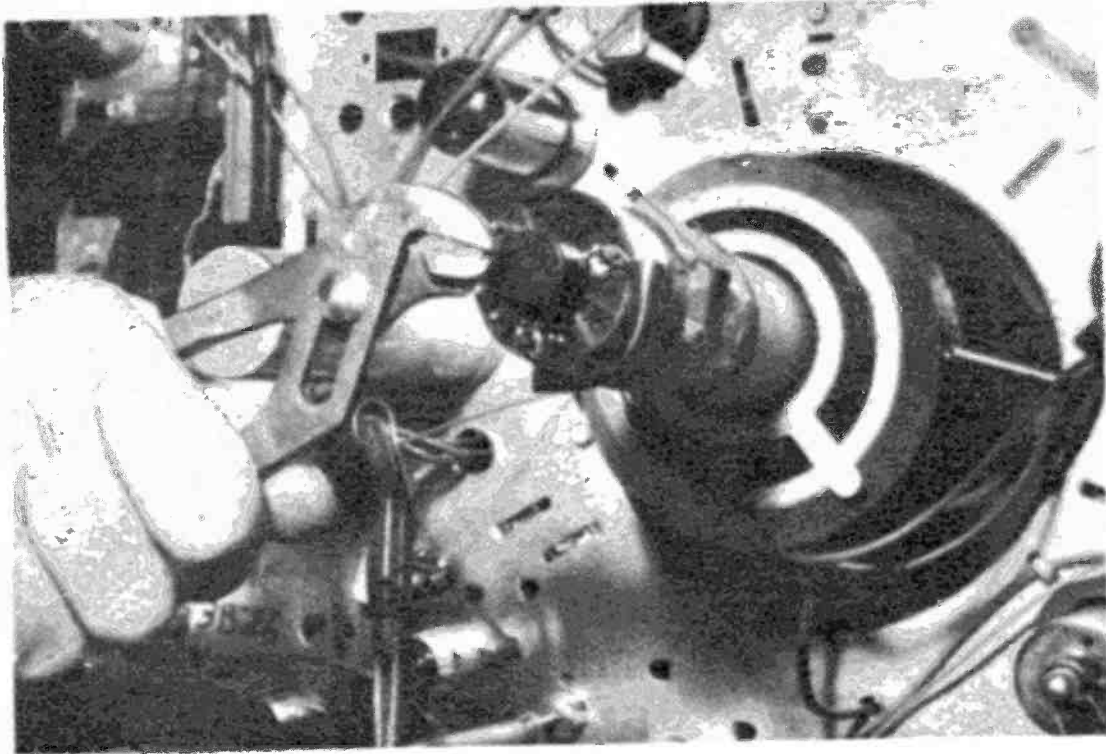

The common trouble of corrosion in heater pins can be cured by crimping the pins with pliers.

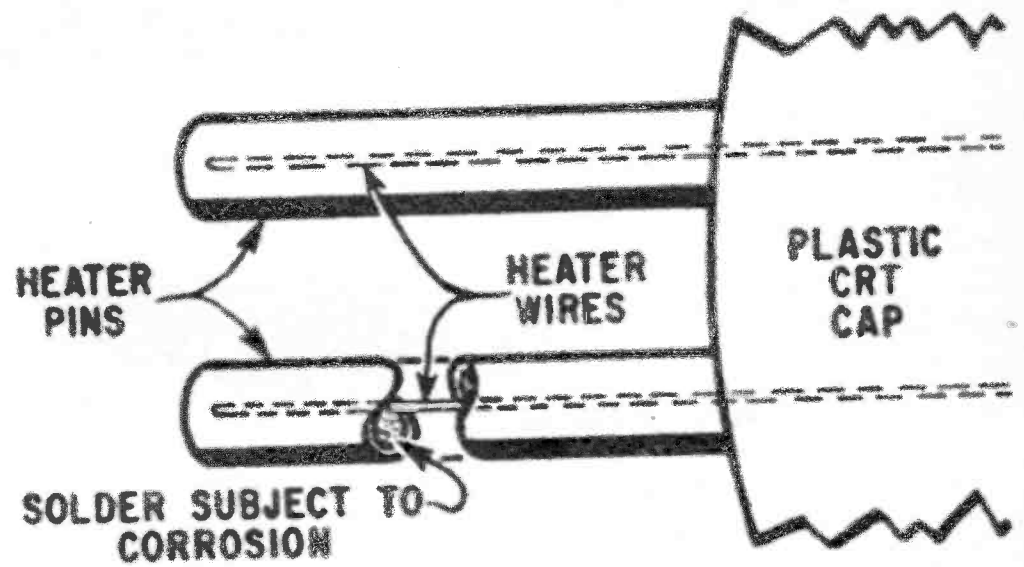

The heater pins are the most likely to develop corrosion due to the high current through them.

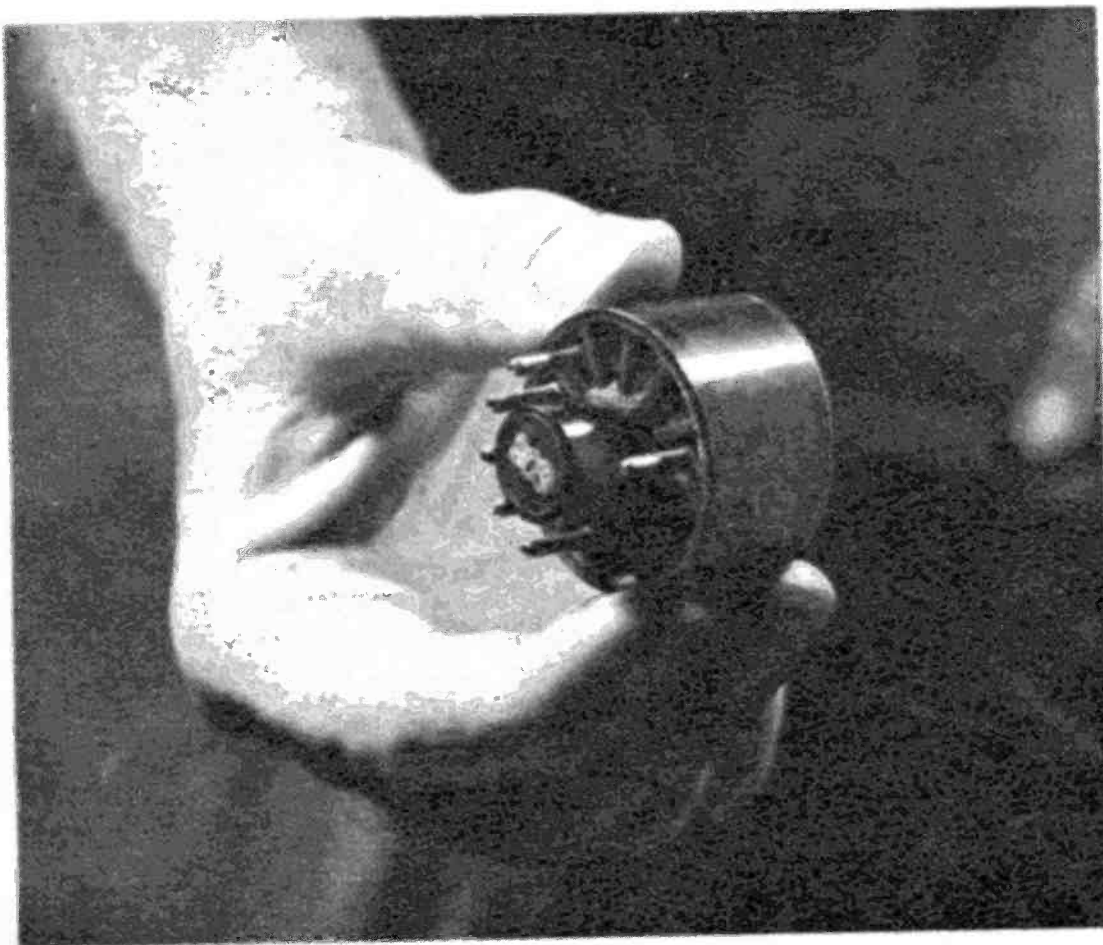

When the plastic socket comes off the neck of the tube you can rethread and solder it back on.

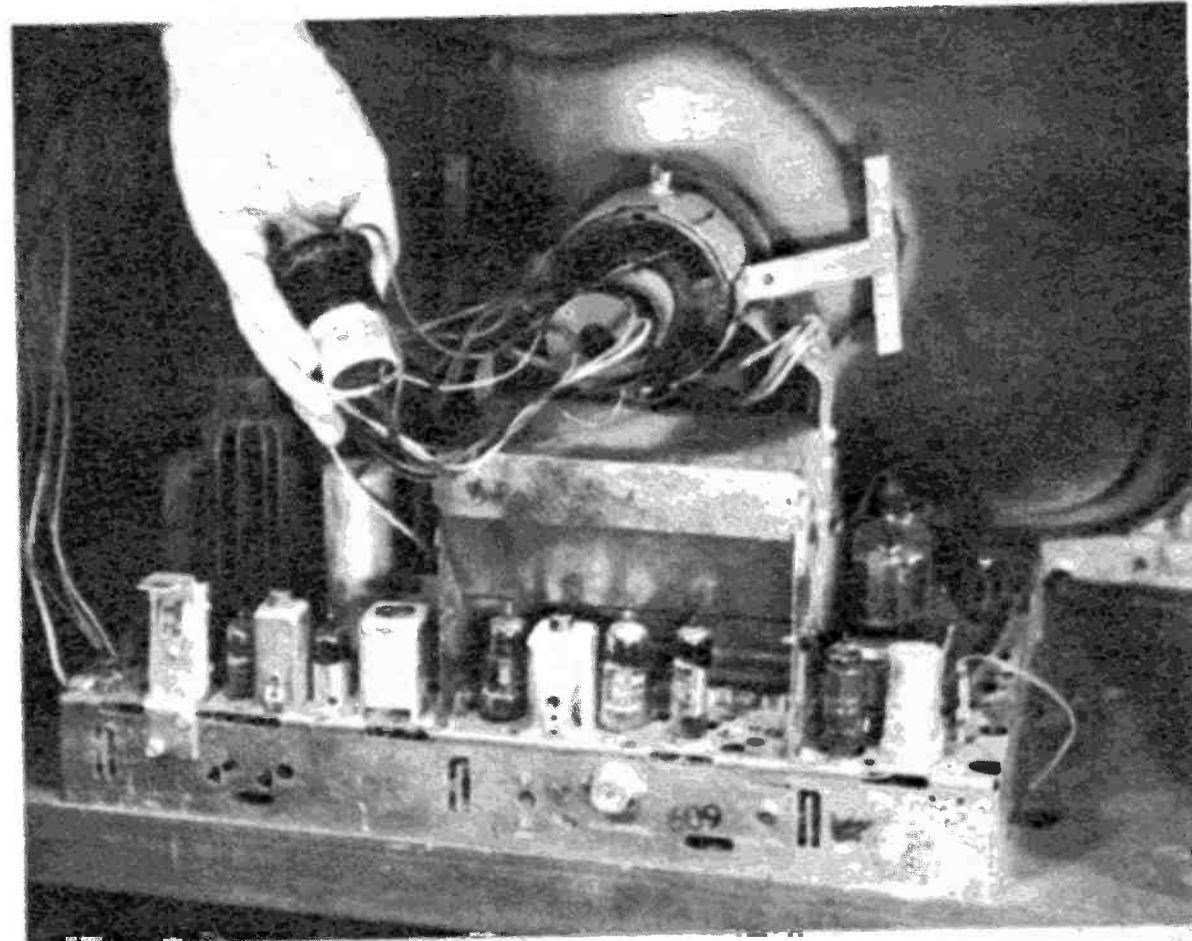

The most common CRT trouble of low brightness can be fixed quite often with a brightener.

FIXED BRIGHTNESS—When there is a dull-looking picture on the screen, usually with retrace lines showing and the brightness control has no effect, there is a short in the CRT. The various elements in the electron gun are touching. The condition looks just about the same on both monochrome and polychrome screens although the color might have prettier shades.

The short in the gun effectively shorts the brightness control right out of the circuit. Turning it produces no effect. Turning the contrast control does vary the contrast slightly.

Most of the time the short develops between the heater and the cathode. The cathode is a metal sleeve that fits over the

When a brightener has been on for a while and the CRT gets dim again, attach a second brightener.

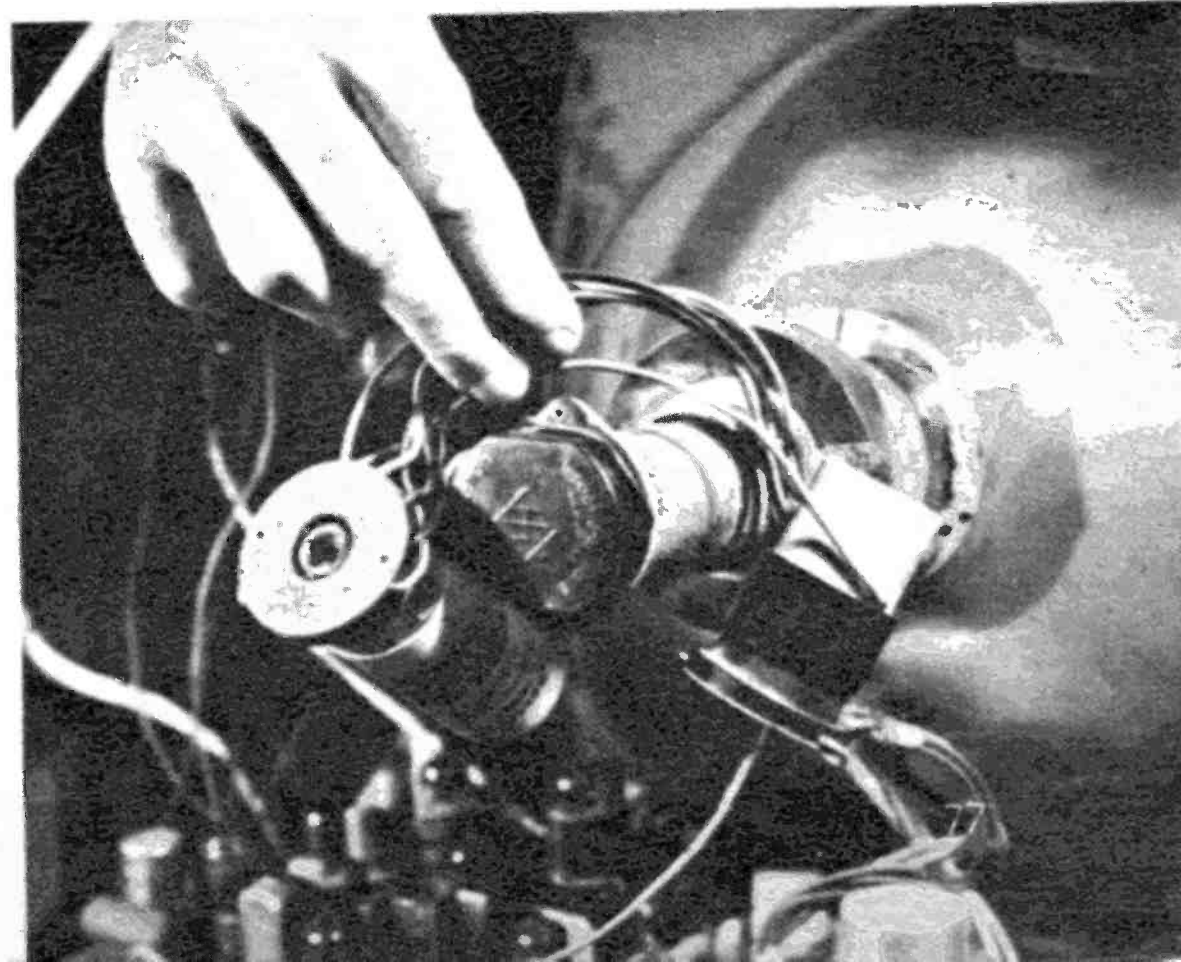



Don't overlook the obvious. A dirty CRT screen can reduce brightness. Pull chassis out and clean.



Many TV sets have built-in provisions to remove the safety glass for cleaning. Look for screws.

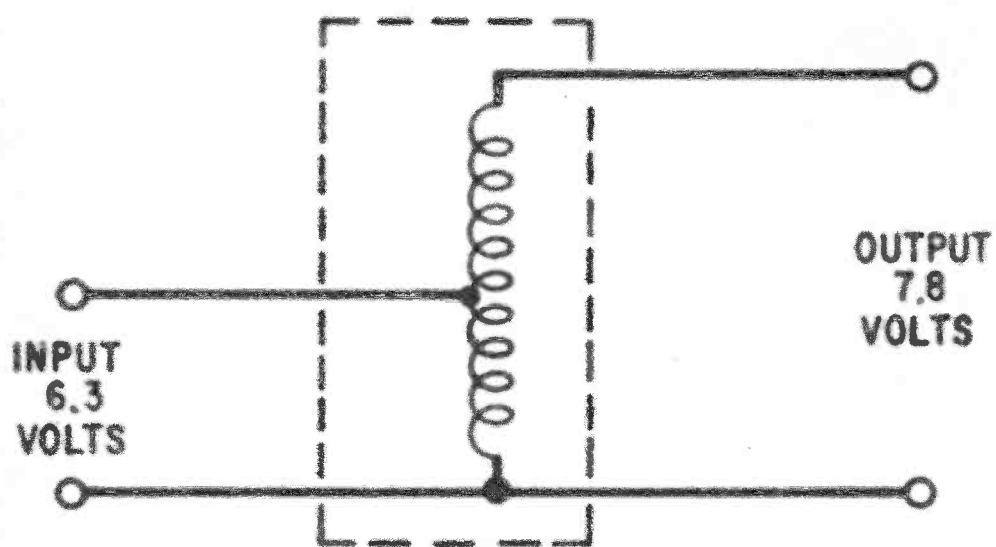

Left, brighteners can be wound in an autotransformer or isoformer way. Specify when you buy.

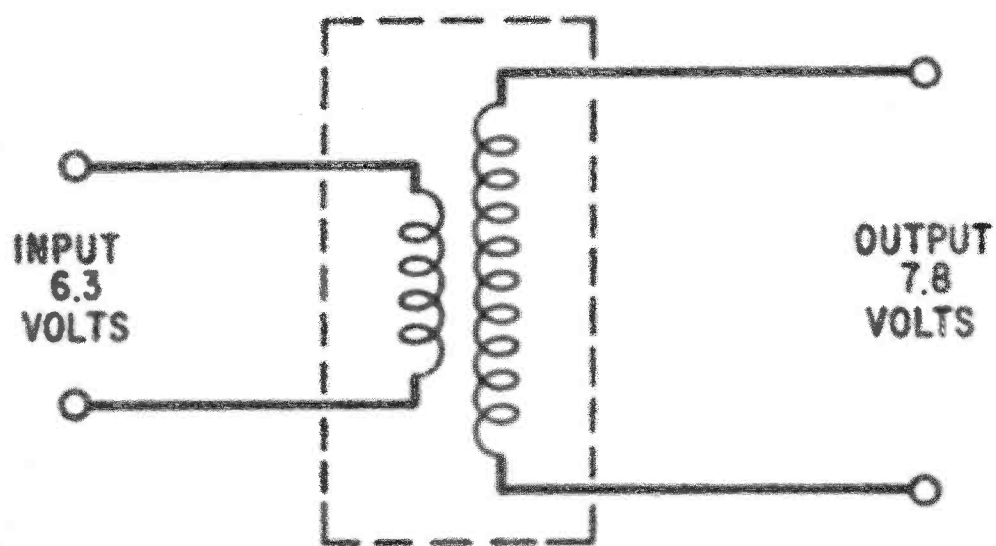

Center, left: The isoformers come in a 1:1 ratio, also in a regular step-up type as a universal.

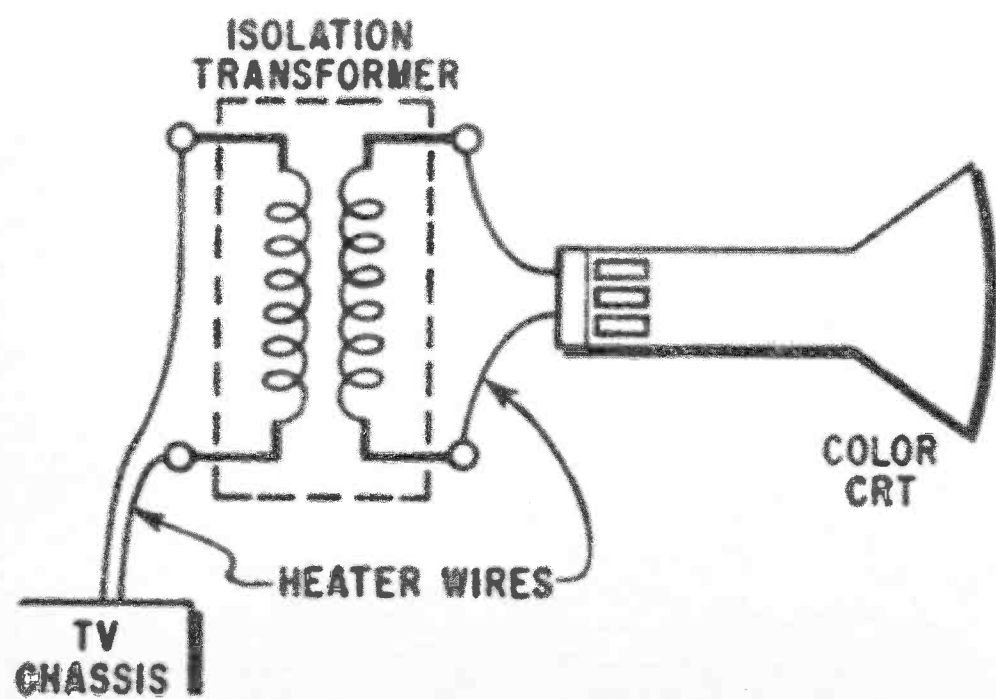

heater winding. A ceramic insulation keeps the heater from physically touching the cathode. But the ceramic deteriorates and develops cracks. This permits the two elements to short together.

The problem, when they short, is that the heater operates near chassis potential. The cathode operates around plus 300-volts DC potential. The brightness control varies the cathode potential. When the two elements short they both drop to chassis potential making the brightness control inoperative.

If you could somehow take the heater off ground potential, the cathode would stay up around 300 volts and the short wouldn't matter. You can do this with an isolation transformer.

An isolation transformer is neither step-up or step-down. It has a 1 to 1 ratio. If you install it in the CRT heater leads, the

Left, color picture-tube heaters can be isolated from the chassis by wiring in a 1:1 transformer.



Once you find the screws to loosen the safety glass, use Phillips head screwdriver to release.

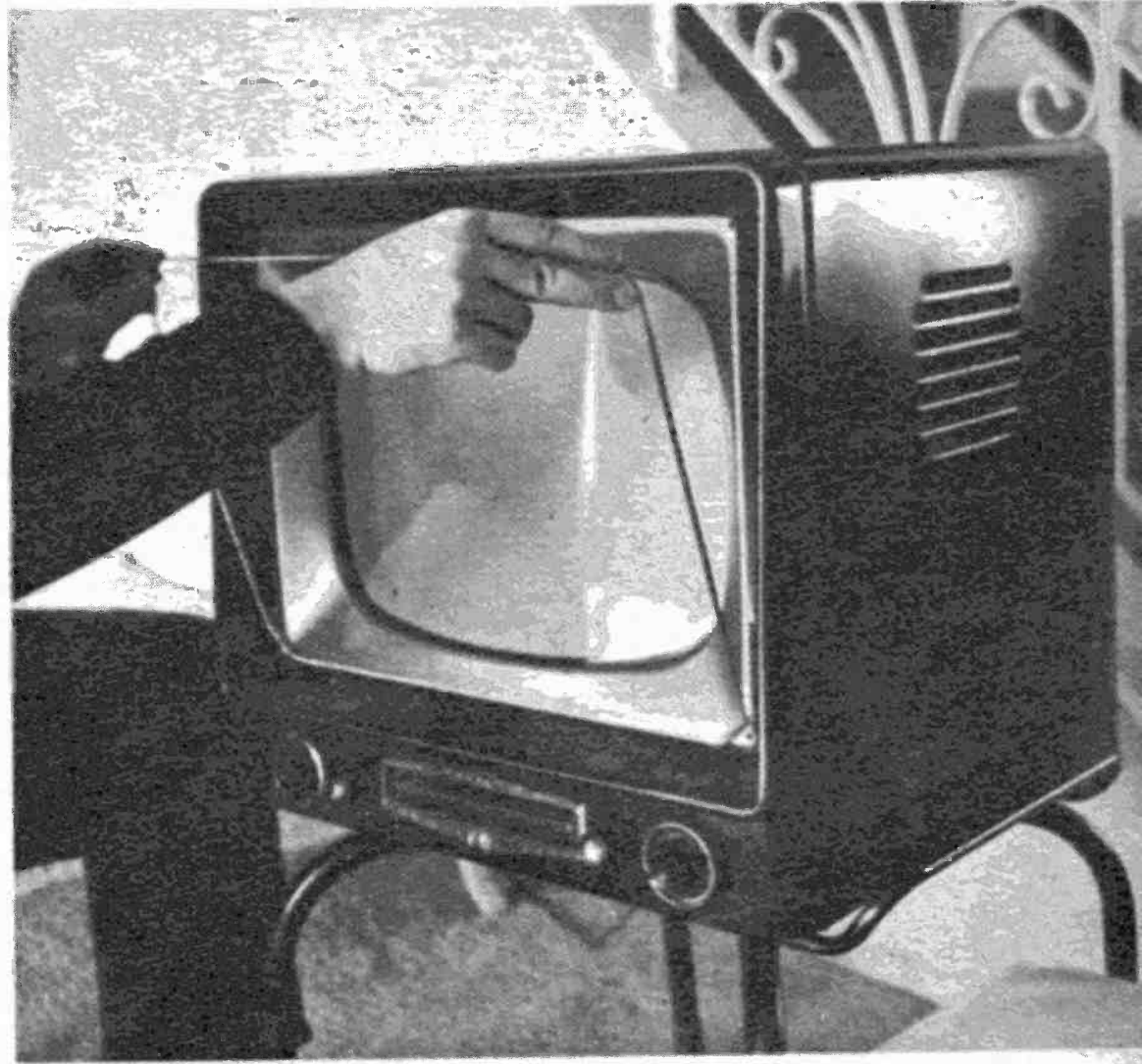

Be careful removing the glass. Often they stick and will crack if you try too hard to pry loose.

Once you get the glass loose take your time and clean CRT face, inside part of glass, and mask.

CRT heater will float. It will take the cathode potential.

Isolation transformers can be bought for black-and-white TV's. They look and install just like a brightener. In fact, you can buy a brightener that is wound in an isolation manner and performs both jobs.

As far as I know, there are no isolation transformers built especially for color CRT's, so far. You can buy one that was made for another purpose, nevertheless. Buy a 1:1 transformer with a current rating of about 2 amperes. They make them for damper tubes.

Find the heater leads of your color CRT. They are usually brown and black wires. Snip them midway between the chassis and the CRT cap. Attach the primary of the transformer to the chassis lead ends and the secondary of the transformer to the cap lead ends. Attach the transformer itself anywhere on the chassis or on the cabinet.

Installing an isotransformer is an instant repair, if it's going to function. If the same condition prevails, forget it, your entire electron gun is shorted. •



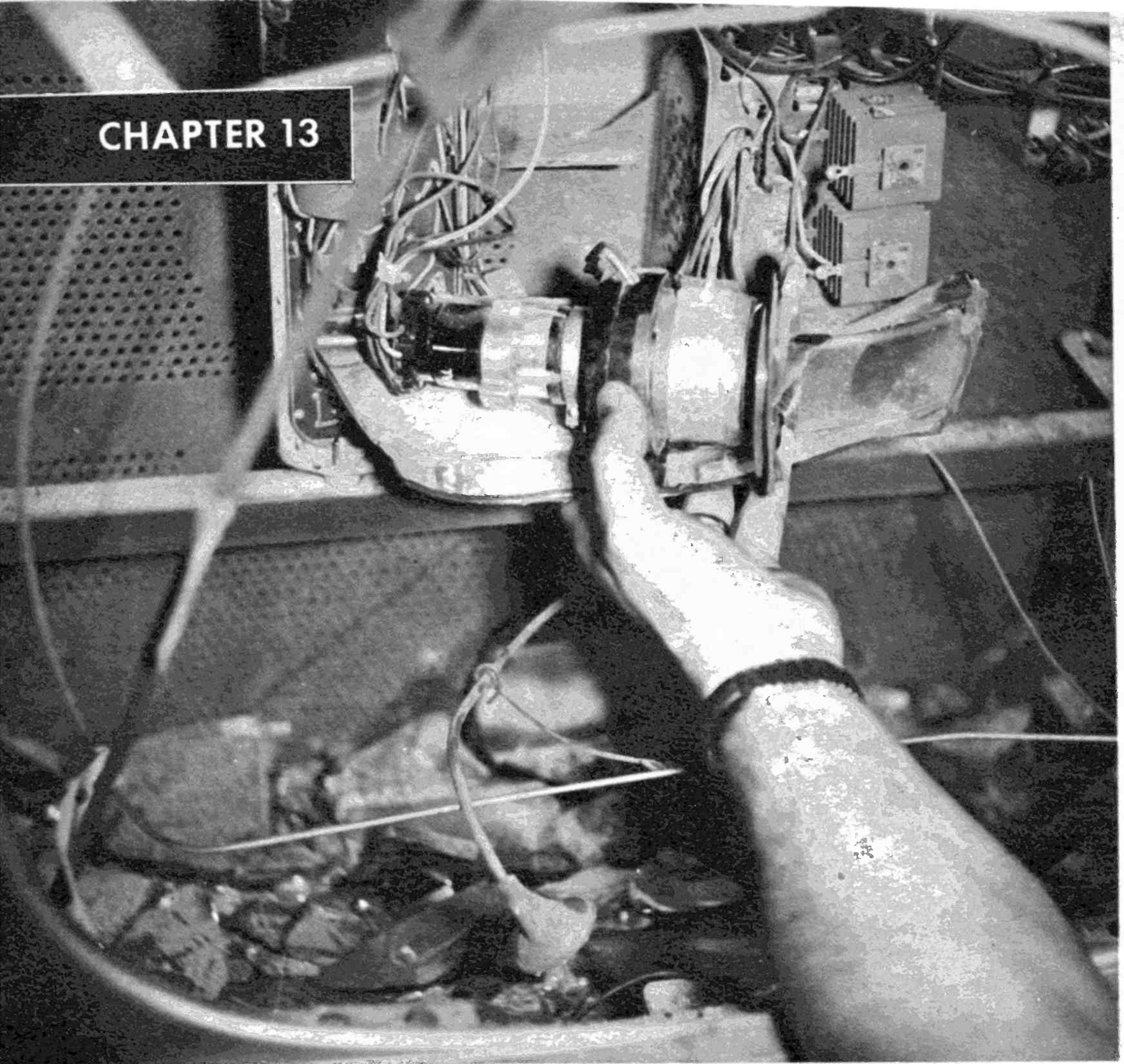

This tube obviously needs replacement. However, don't break the old tube to remove it from the set.

Replacing the Picture Tube

If repair efforts fail, tube must be replaced. Here are fine points

THE BLACK-AND-WHITE CRT— There comes a time when you can't repair the picture tube. What then?

First you need the exact number of your tube. This is obtained from the CRT neck, the CRT shell or the tube location guide. If the number is not on any of those spots take the model number of the TV and the old picture tube to the supply house. They will match it from there.

REBUILT OR NEW? There are two

main differences between a rebuilt tube and a new one. (This is not to be confused with a used picture tube.) One, the rebuilt tube uses the old glass over again while the new tube is all new, including the glass. Two, the rebuilt tube is made in a factory but is not subjected to the rigorous quality control a new one is.

On point number one, glass does not wear out easily. An inspected old glass is satisfactory in CRT use. The fact that a

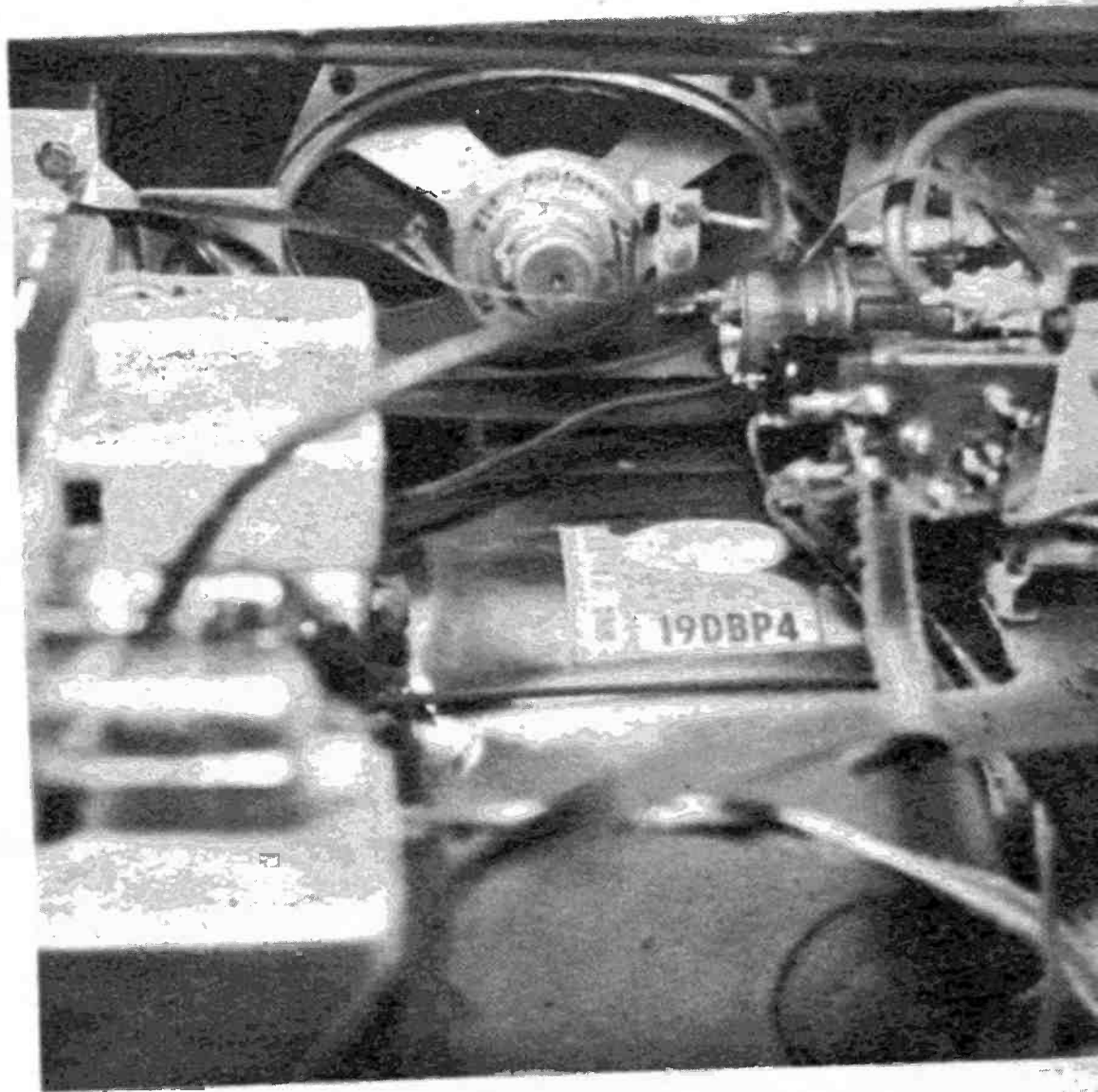

Be sure to get exact replacement. You can find the CRT number somewhere on the tube or chassis.

Top, left: Use a long coat, gloves and goggles for safety during replacement of a picture tube.

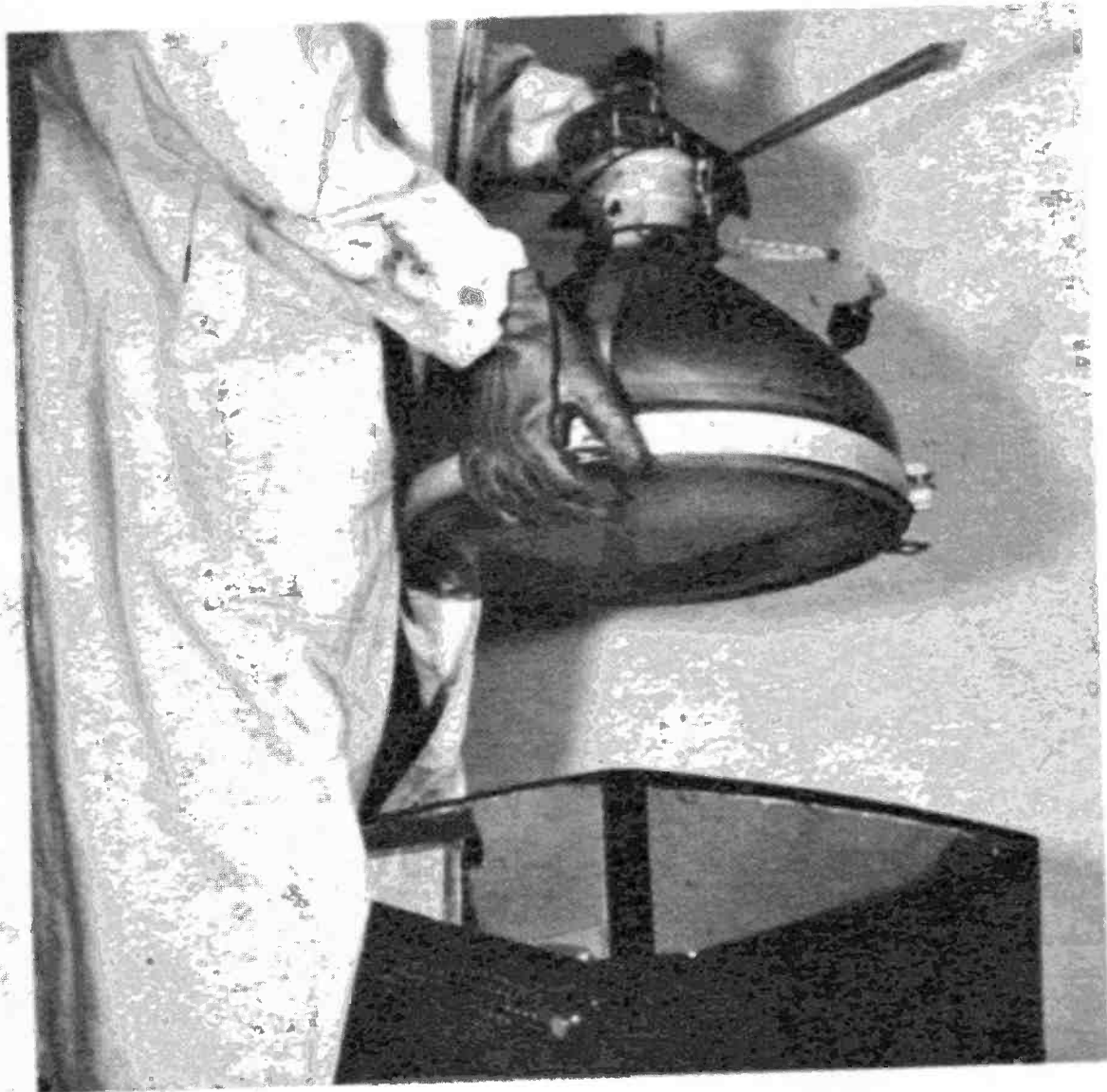

At left, when picture tube is to be removed, it's good technique to do it while set is on its face.

new glass is used does not mean the tube will work any better or last any longer. I wouldn't use a new glass instead of an old glass simply because it's new, especially since the dollar savings are so considerable. Proof that this is the popular opinion is the fact that rebuilds outsell new ones as replacements at least ten to one. In fact, rebuilders claim old glass is better since it is aged and there is less chance of damage occurring than in new glass.

On point number two, the quality control is important. I would prefer a rebuilt tube from a larger manufacturer over a smaller one unless the smaller manufacturer could prove his quality control was equally as good. You can get stuck buying way-off brand names. If you can get a rebuilt from one of the large companies, that's the one to take. There are some large companies you never heard of. Feel confident of the brand you buy.

The box must, by law, state whether the tube is new or rebuilt. If it's new, the word *new* will be prominent. If it's not, you'll find no mention except a sticker that reads something like this: "This tube is made of all new materials except the glass envelope which might be subject to reuse." That's a rebuilt, whether it's a famous brand or not.

ALUMINIZED CRT'S—The biggest bargain you can get in a new or rebuilt is

aluminizing. It's usually a little extra in cost. Here's what it is, and what it does. The CRT face, during manufacture, receives an additional coating of aluminum on top of the phosphor. The coating acts as a reflector, as in a flashlight, and almost doubles available brightness. This makes the tube last much longer. An aluminized tube, when installed in place of a plain one, will make the TV picture look better than when it was new.

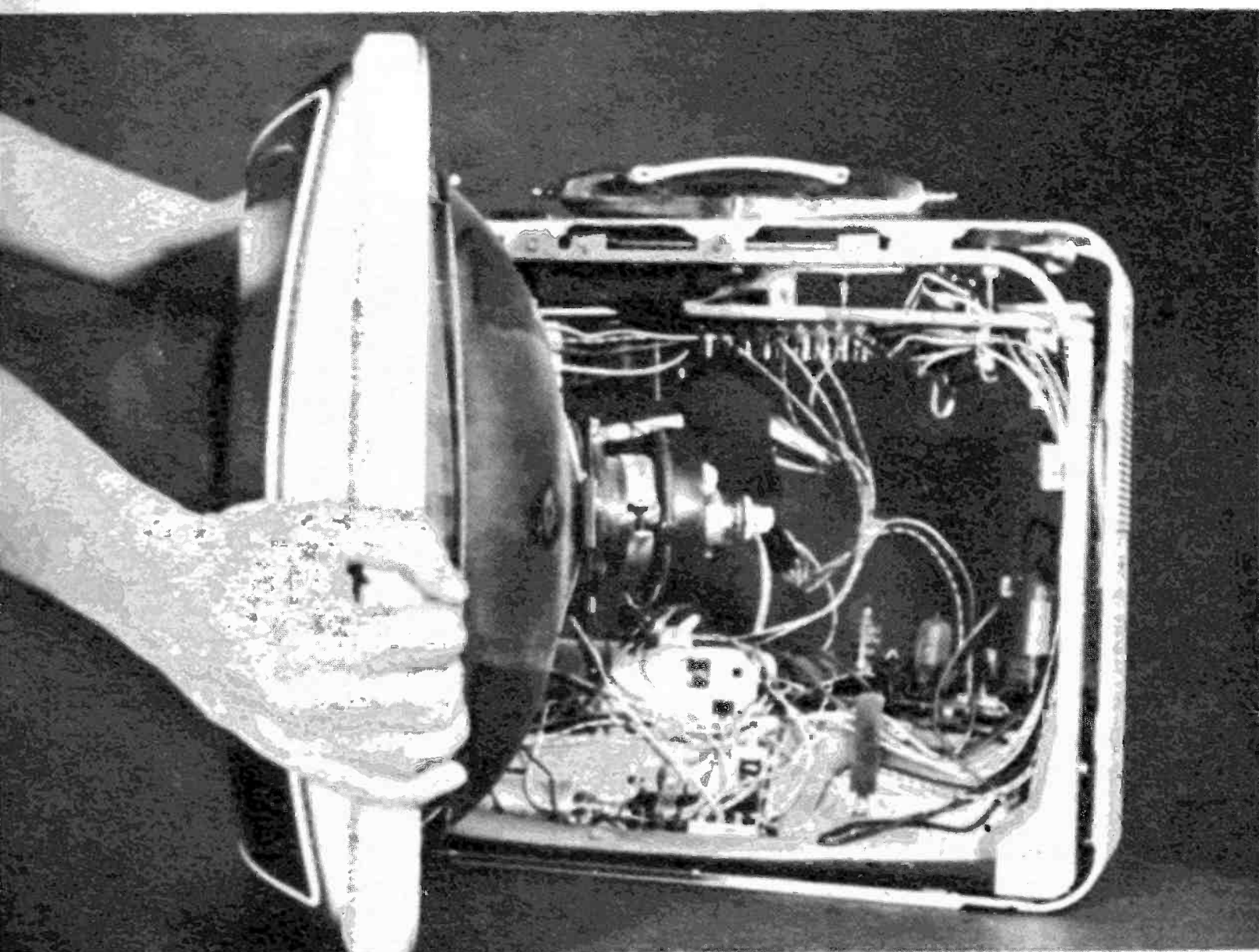
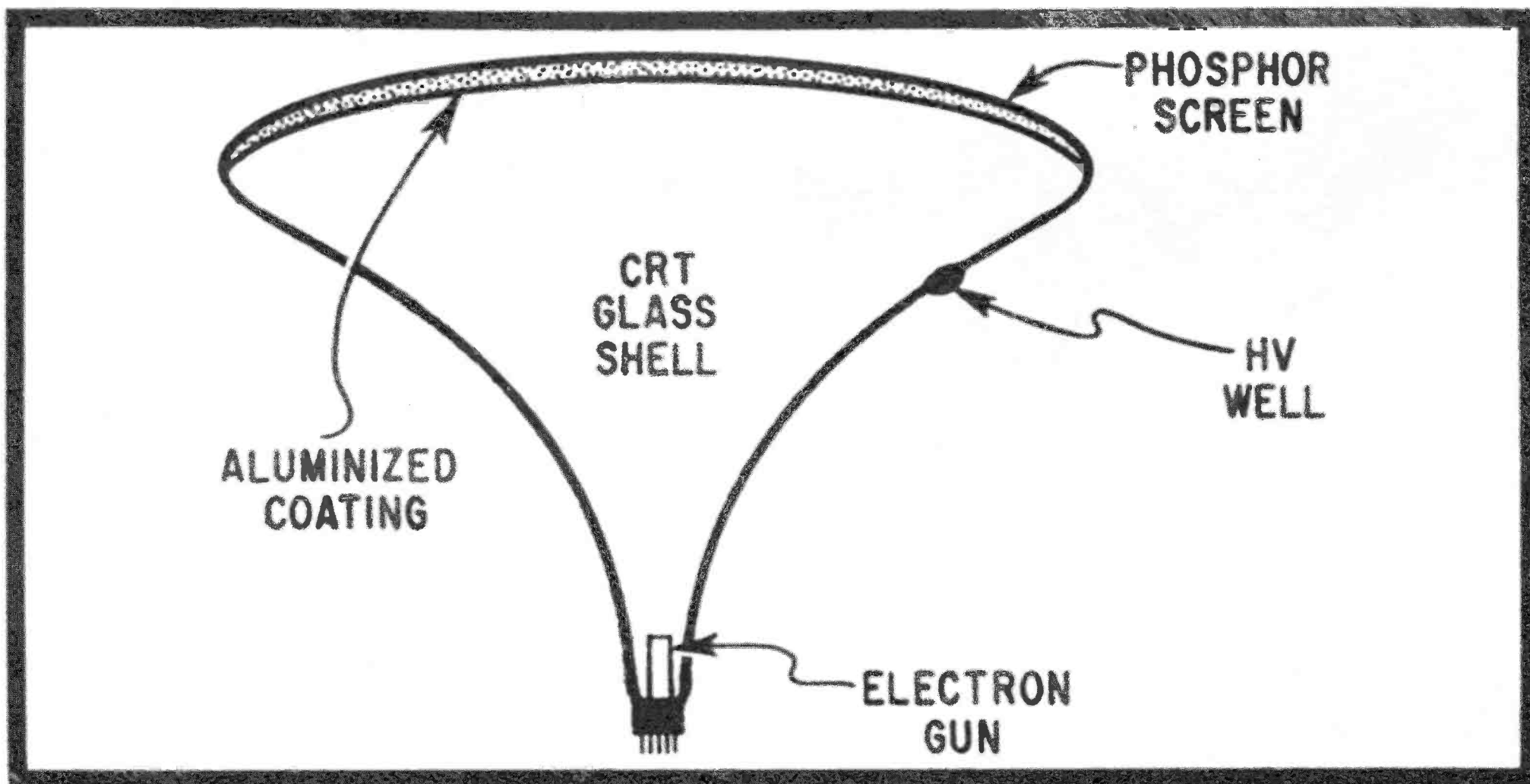

Above, an aluminized tube has the advantage of increased brightness and freedom from burn marks on the face of the glass.

A picture tube removal is really only mechanical work. Just note all the steps you make and reverse it for installation.

CRT Installation Tips

Pulling the picture tube requires removing the CRT cap, the high voltage lead and any neck encumbrances such as magnets, clips and ion traps. Then the CRT is removed by normal handyman tools and ability. (Be sure to use extreme caution in handling CRT's. In factories, gloves, goggles and long sleeves are mandatory in case of implosion.) If you run into any

snags such as rough hardware or frozen yokes on the neck, stop and call for experienced help.

Assuming your CRT removes easily, take the dud with you when you buy a new or reused tube. It's worth dollars. If you don't have an old one, the replacement will cost you extra since it's figured in the price.

Install the replacement exactly the way the old tube was mounted. Turn on the TV.

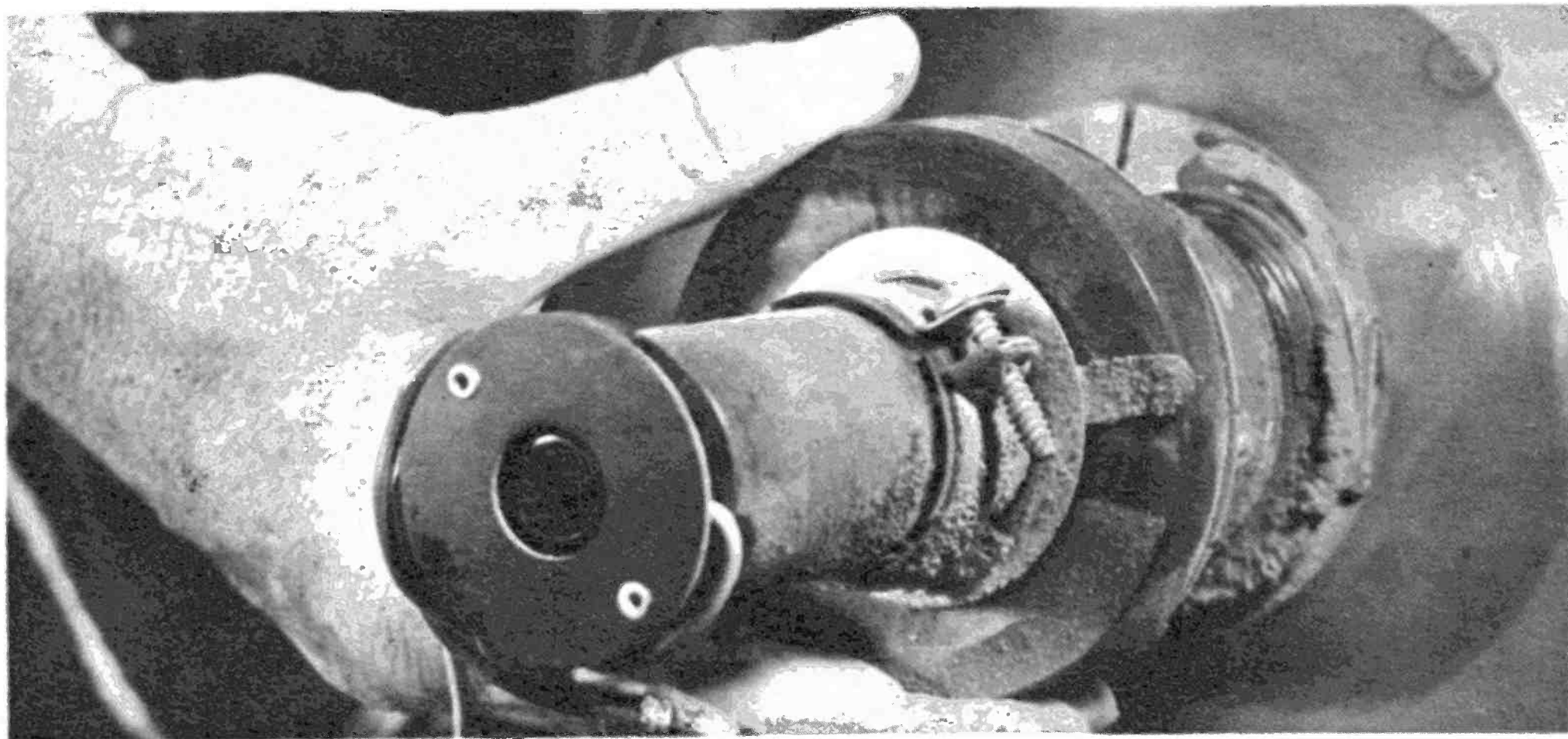

If the yoke is frozen try normal measures to pry it loose, but, refer tough ones to experienced men.

If the yoke will move a little, but won't slide, clean and grease the CRT neck before forcing it.

Don't try too hard to get the yoke off. The CRT neck is fragile and you might end up like this.

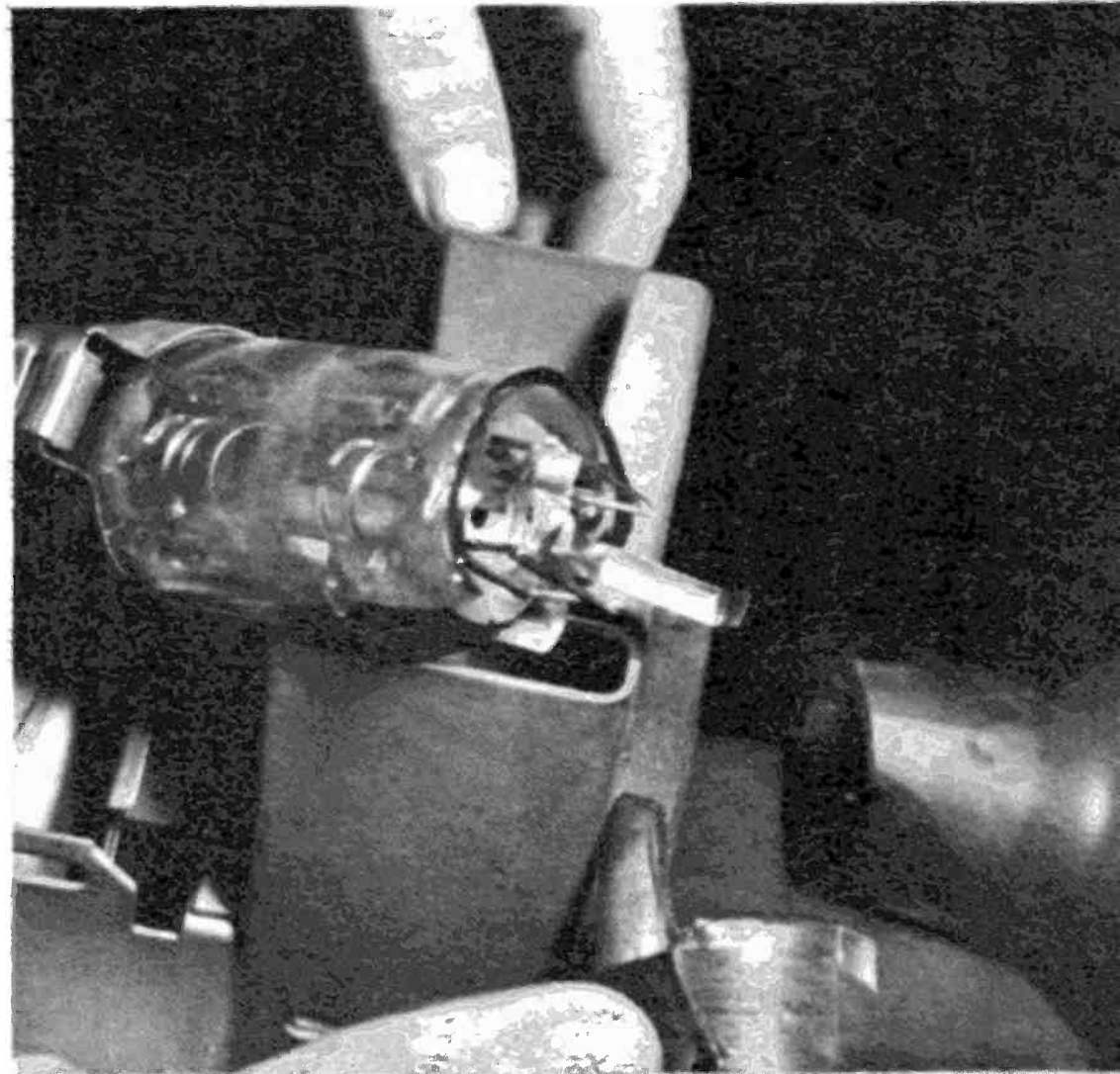
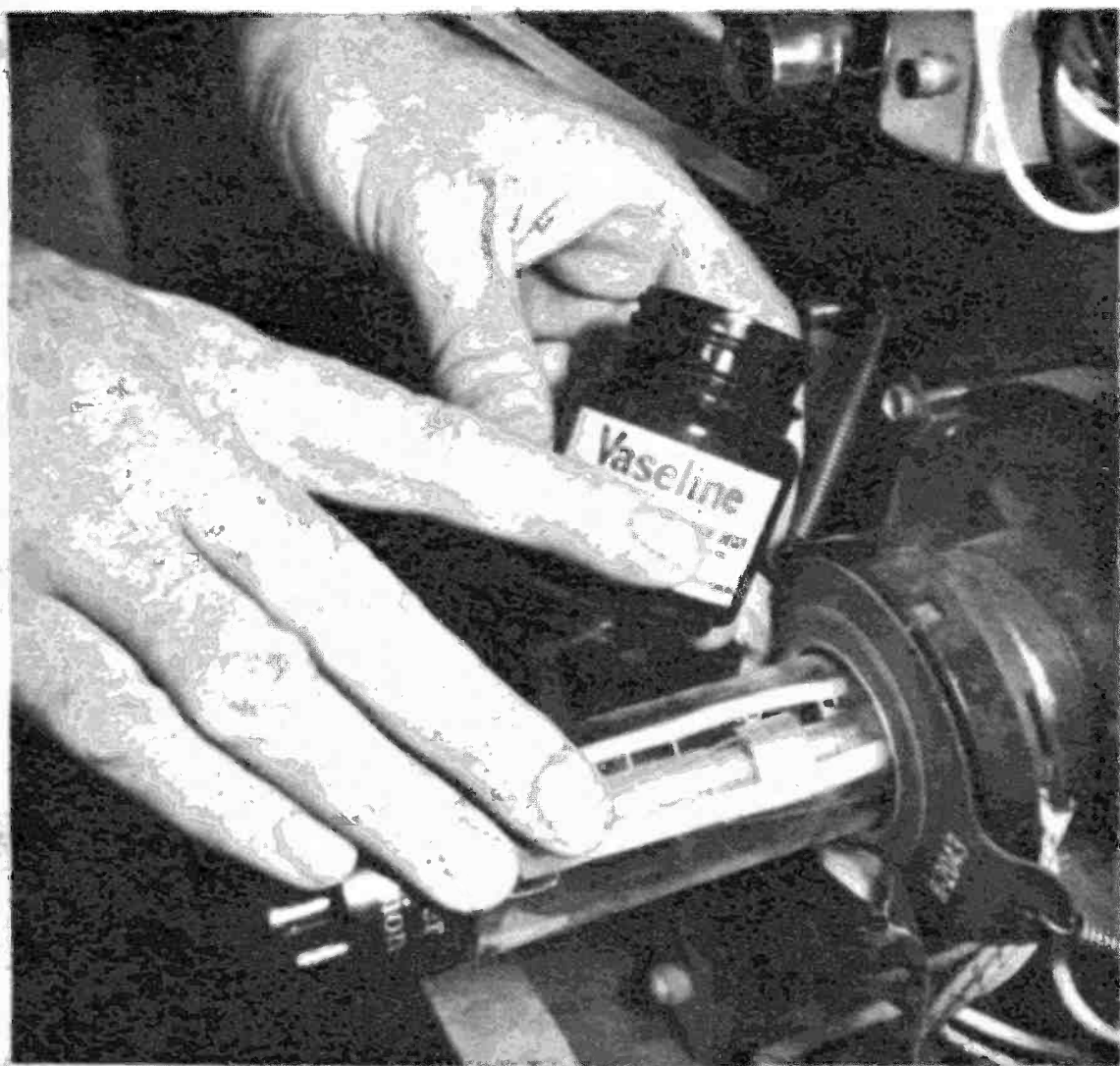

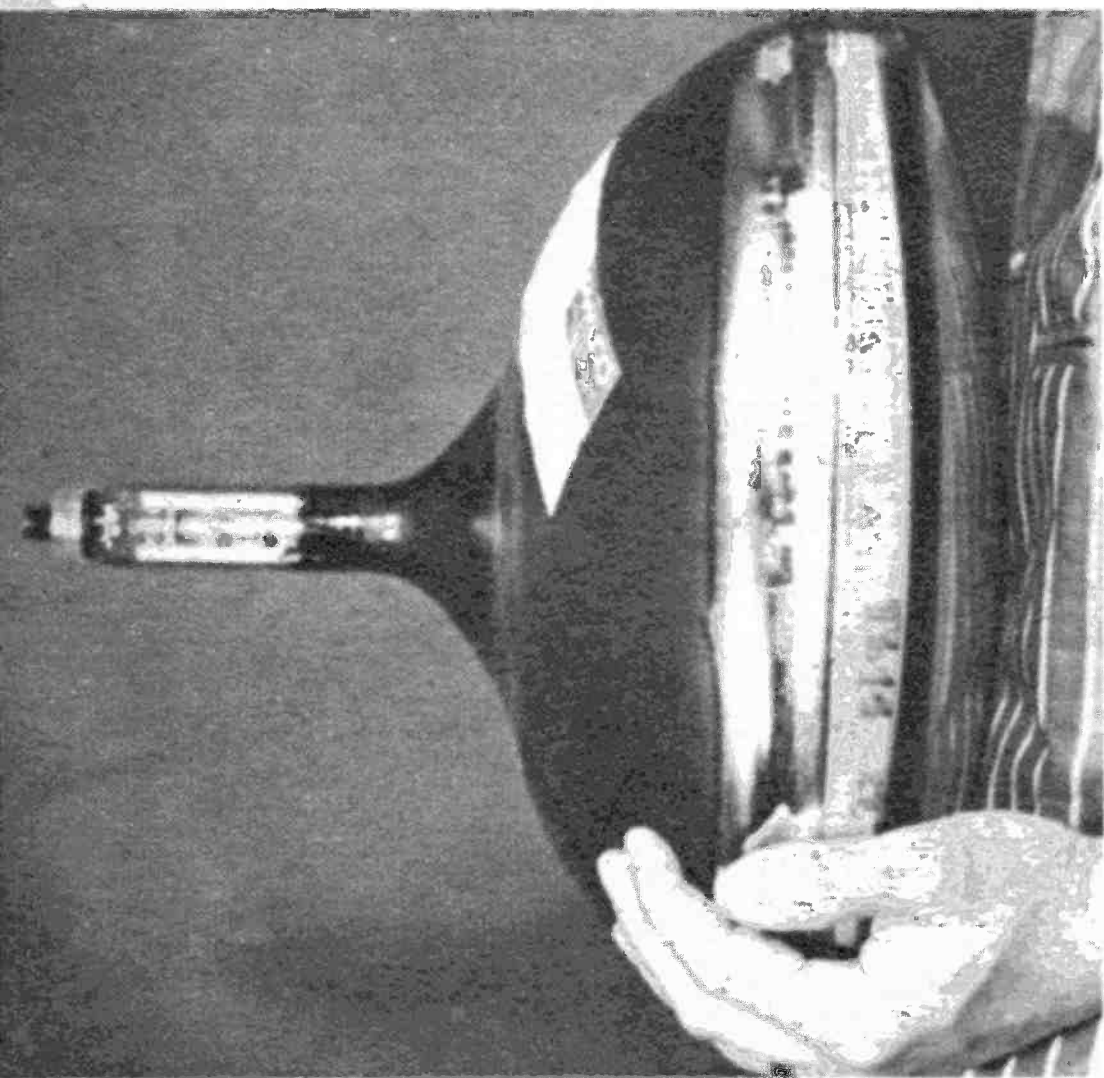

When you buy a picture tube bring the dud with you, otherwise the replacement will cost more.

You are now ready for the final tips to restore your picture.

Ion Trap Adjustment

If your CRT did not have an ion trap to start with, forget this section. If your TV did have one, but the replacement states "DO NOT USE ION TRAP," heed the advice. Some of the newer models of old tubes come this way.

Should you need the ion trap, though,

While the TV set is apart, it's a good opportunity to vacuum away all the excess surface dust.

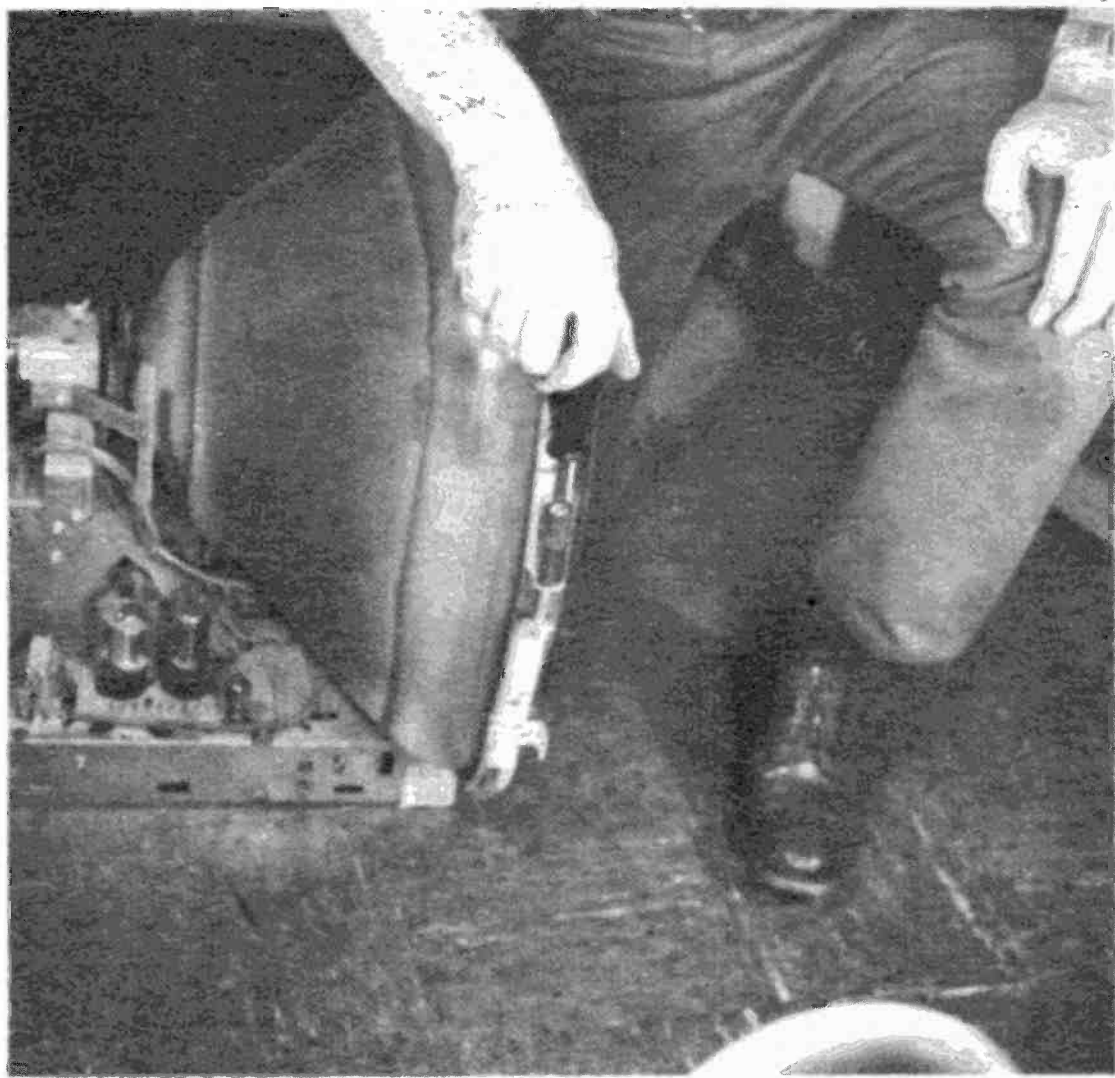

If tube comes with a metal strap, do not tighten too much. The glass must have room to expand.

here's what to do with it. Turn the brightness all the way up. Then rotate the magnet till you get maximum brilliance. Don't settle for anything else. Don't try to get rid of neck shadows or miscentering with the ion trap. Rotate the magnet and just try for best brightness.

There are two settings for the trap—one near the yoke and one near the cap of the tube. Take the one near the cap of the tube.

Make a list of all the plugs removed during the pull-apart so they can be reinstalled correctly.

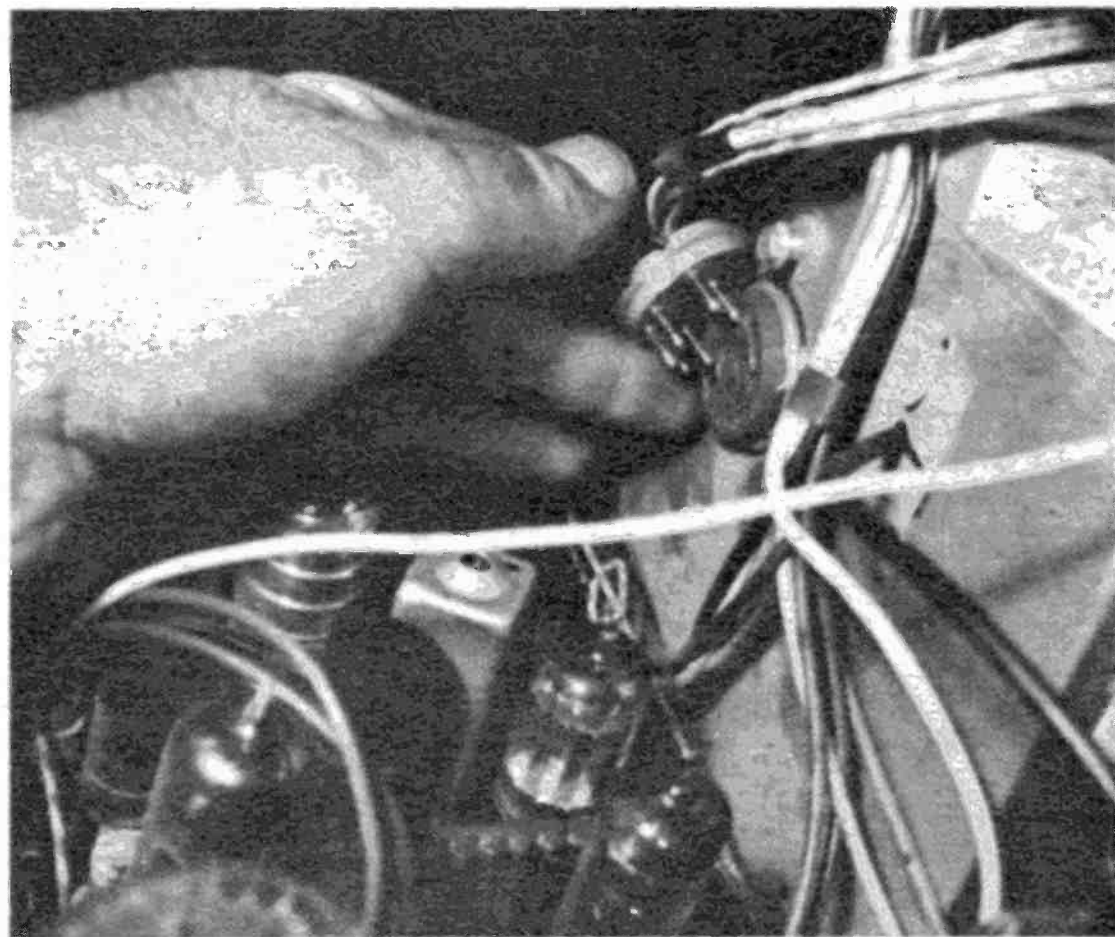
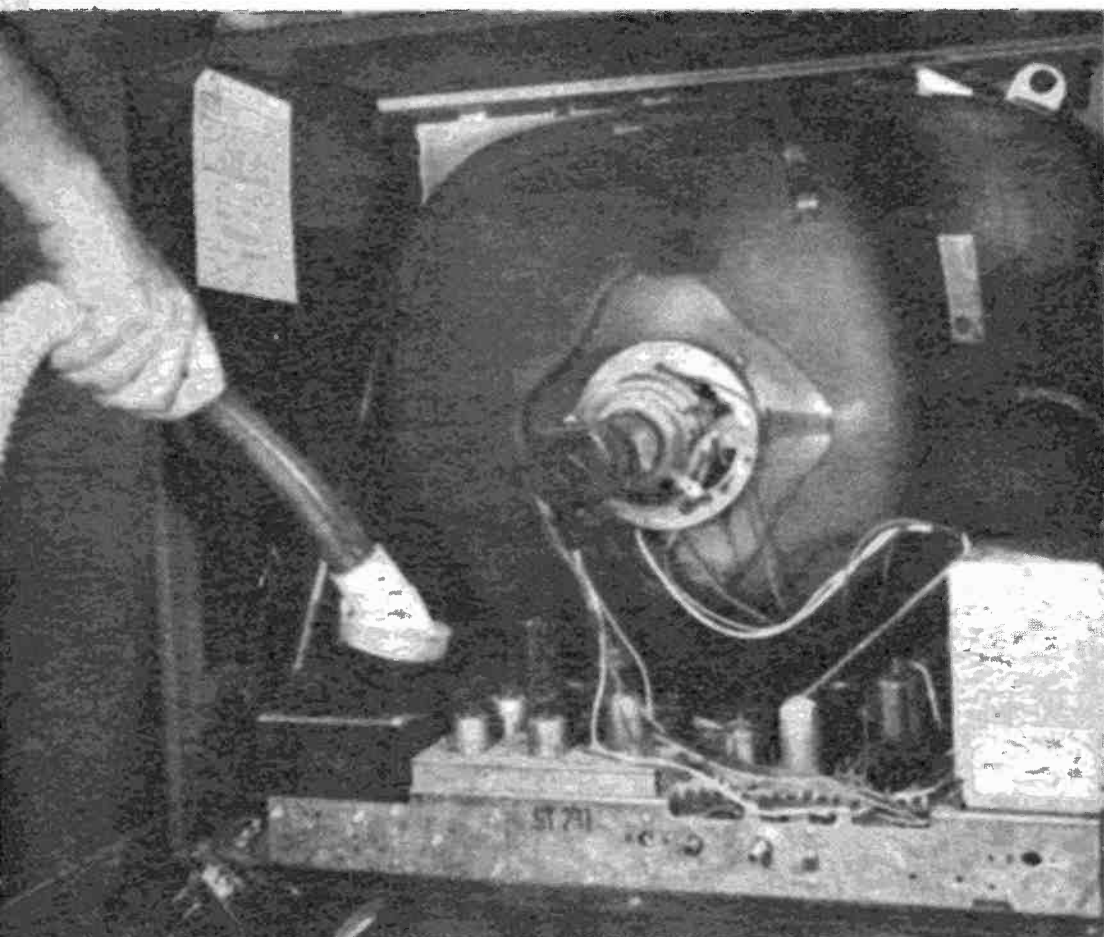

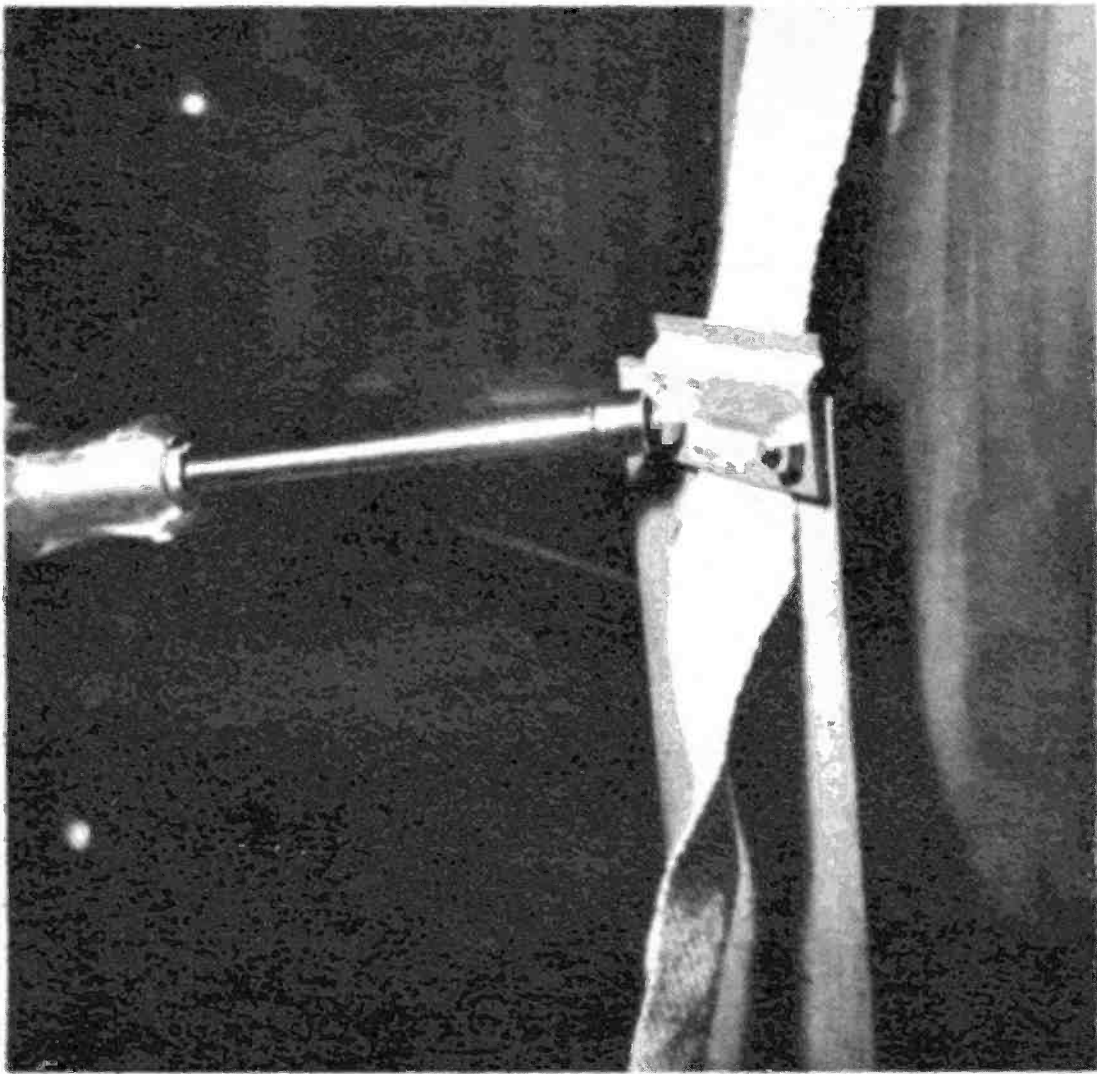

Should CRT have a cloth or plastic strap, you can tighten more because there's give in strap.

Tilted Picture

Your picture titlts when the yoke is not in position. The yoke draws the picture in any plane. To make it draw correctly, loosen the wing nut that holds it and rotate the yoke a few degrees in the direction that will correct the tilt. At the correct spot, tighten the wing nut.

SHADOWS IN CORNERS—The yoke is the culprit of this trouble, too. If the yoke windings should not be flush against the

Be sure to reinstall everything that was removed. Failure to install this strap will cause defocus.

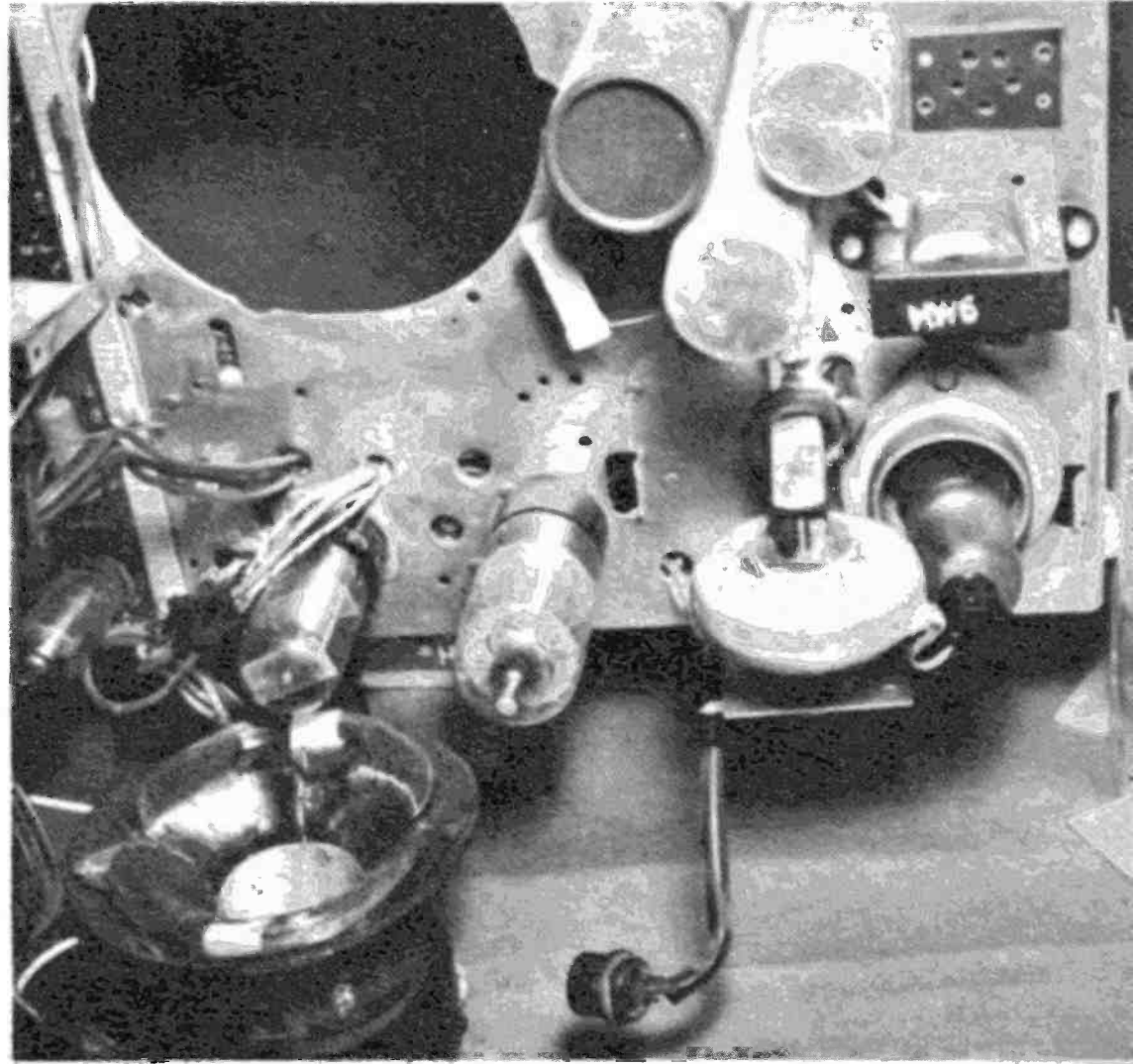

This is what your TV will look like with picture tube removed. Keep chassis in isolated place.

bell of the picture tube, as the yoke swings the cathode ray, the ray will hit the neck of the tube on its outward swing. To correct, loosen the wing nut and push yoke forward, then tighten once more.

PICTURE NOT CENTERED—Centering devices will be found on the picture neck, near the yoke or focus coil, and sometimes as a control on the chassis rear. Rock them back and forth, or up and down, till you have corrected miscentering. There

When you reinstall an ion trap, find the maximum brightness spot near the cap of the picture tube.

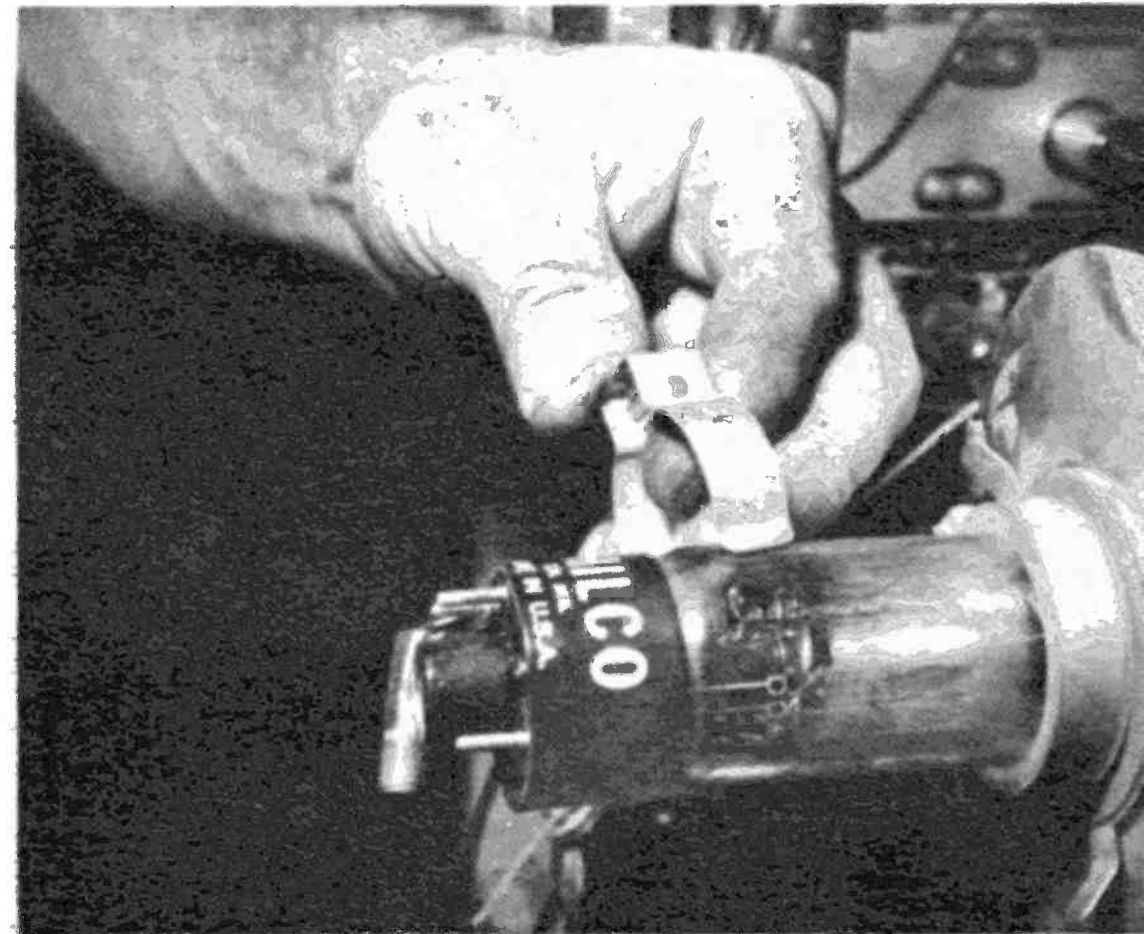
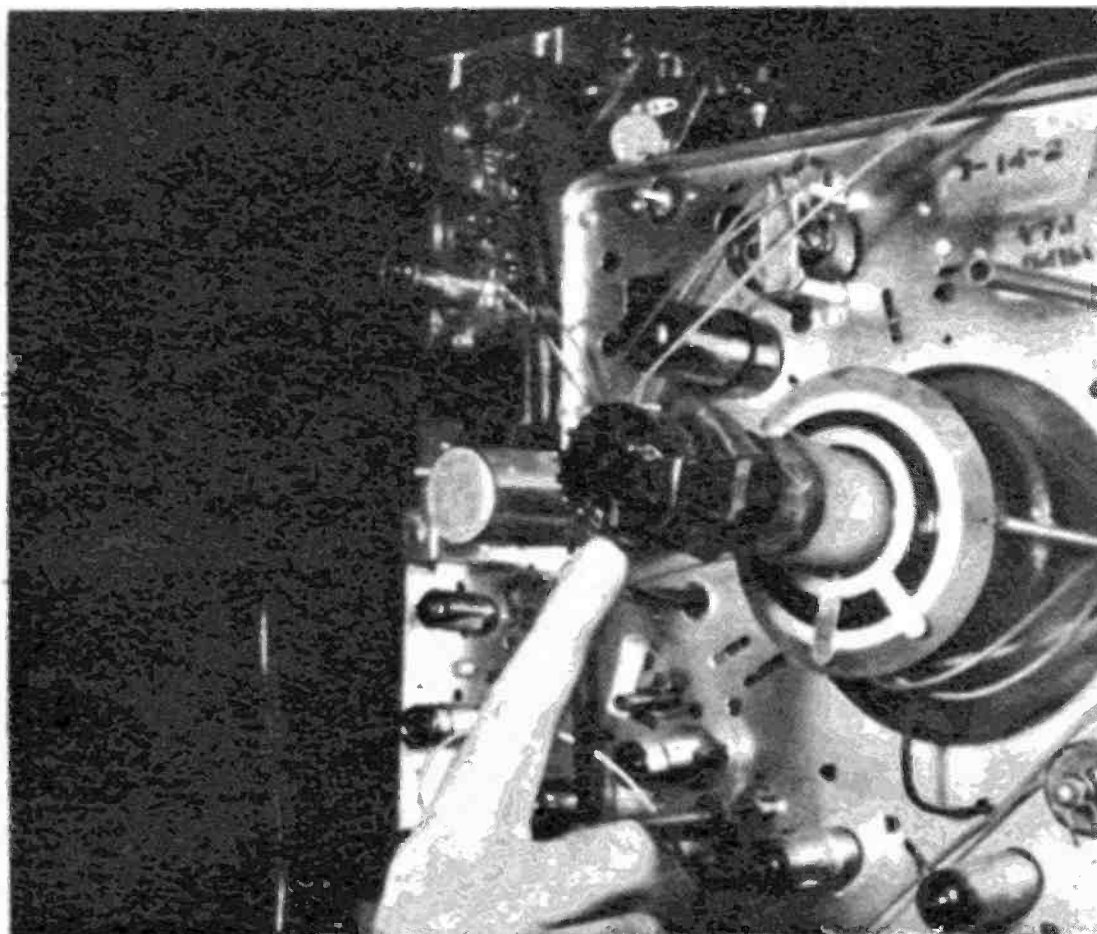

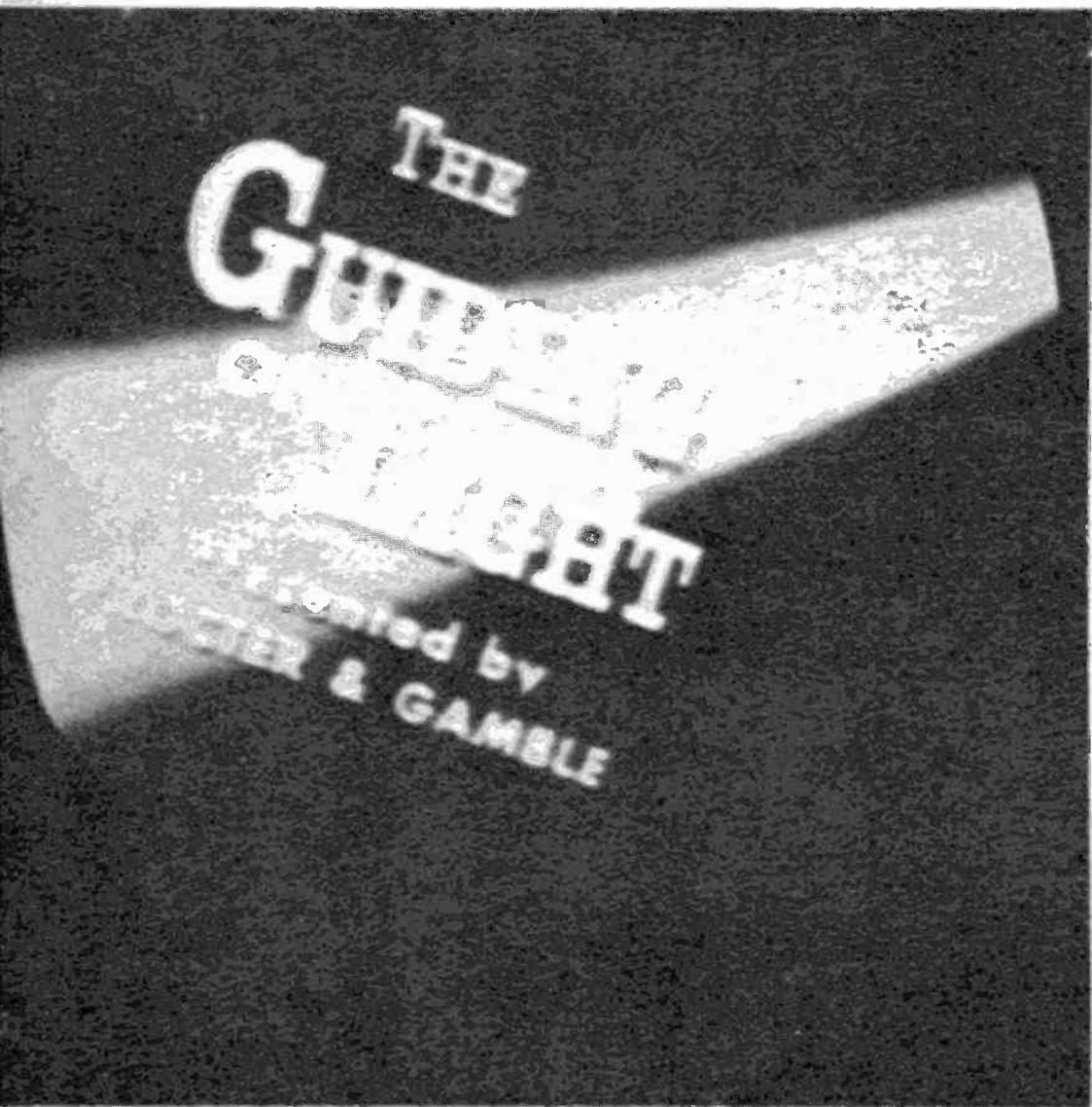

Adjust the yoke so picture is correctly tilted. This is true even if the picture is upside down.

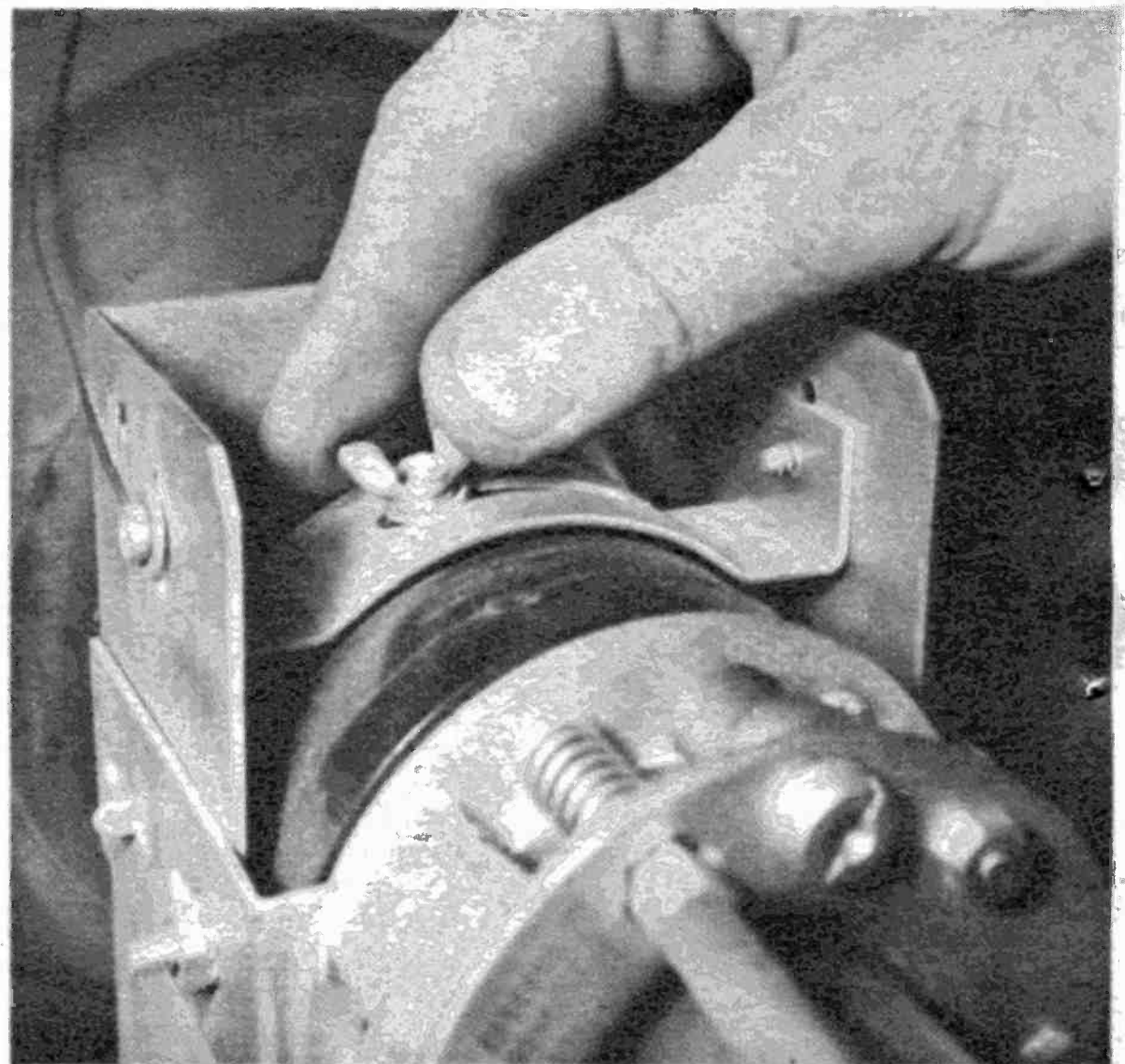

Some yokes have wing nuts on the top of center. Loosen nut and swing yoke for a tilted picture.

At bottom right, adjust the centering devices to take the shadows out of corners of the photo below. The ion trap might need some readjusting. When you rock the control up and down, picture will go sideways. When you rock the centering device sideways, the picture goes up and down.

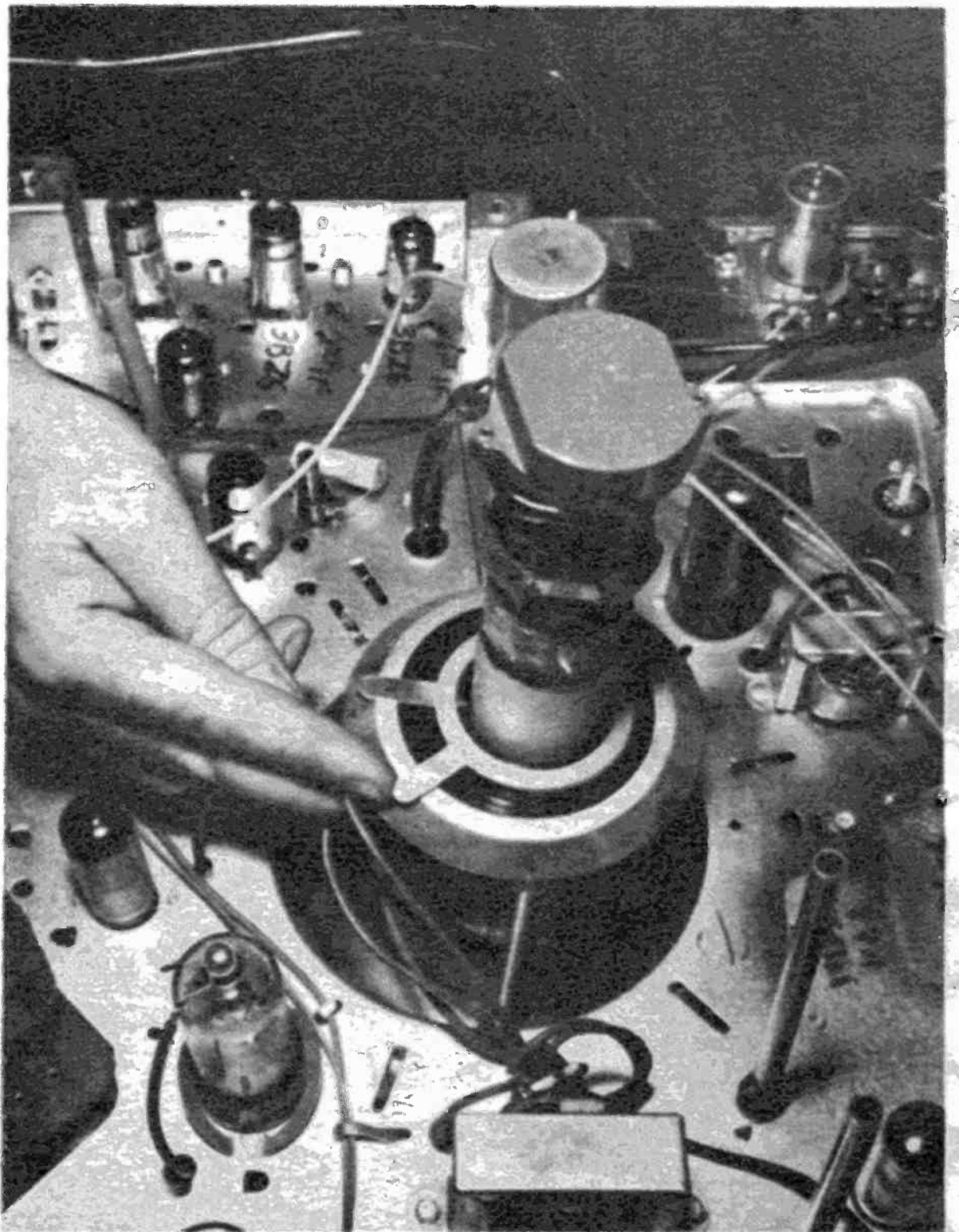



Adjust focus control till the lines of the picture stand out sharpest. That is the correct setting.

is an interesting sidelight during this adjustment that you should be aware of: when you rock the control up and down, the picture will go sideways. When you rock the centering device sideways the picture goes up and down. This is due to the fact that the magnetic field of the device affects the electron ray 90 degrees out of phase.

OUT OF FOCUS—Whatever type of focus control your TV has, you must turn

it to correct focus. The professional way to focus a picture is to adjust the control till lines of picture stand out sharpest.

Should you discover that you have lost focus completely, check to see whether your original tube had a shorting strap on the cap, attaching the focus anode, pin 6, to another tube element. You might have neglected to reinstall the shorting strap during installation. Be sure to do so and you'll restore focus.

You'll find most focus controls located near the neck of the picture tube. Turn control to make adjustment.

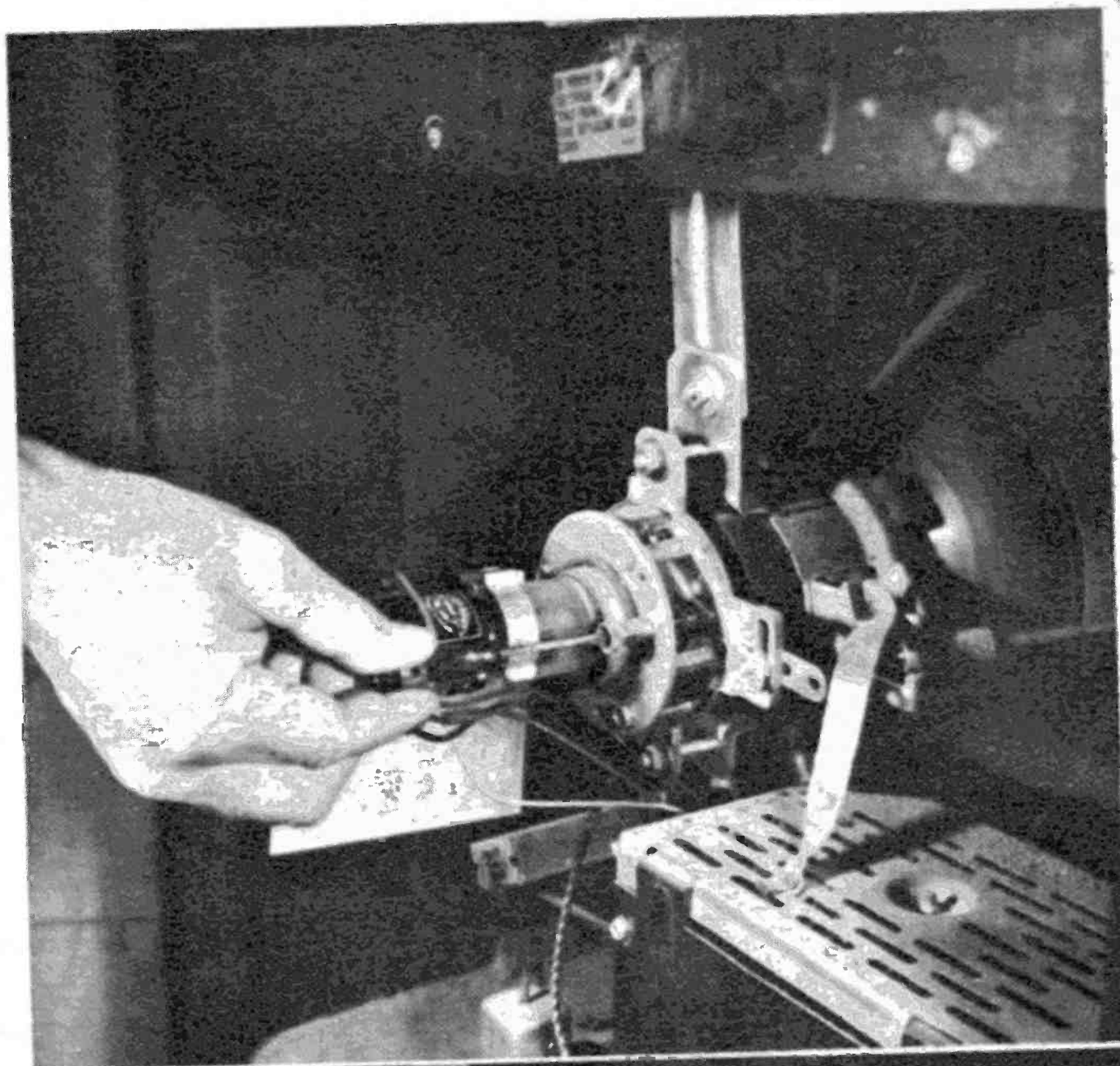

Installing a color tube is only a mechanical process, but the gadgets on the neck require settings by an electronics pro.

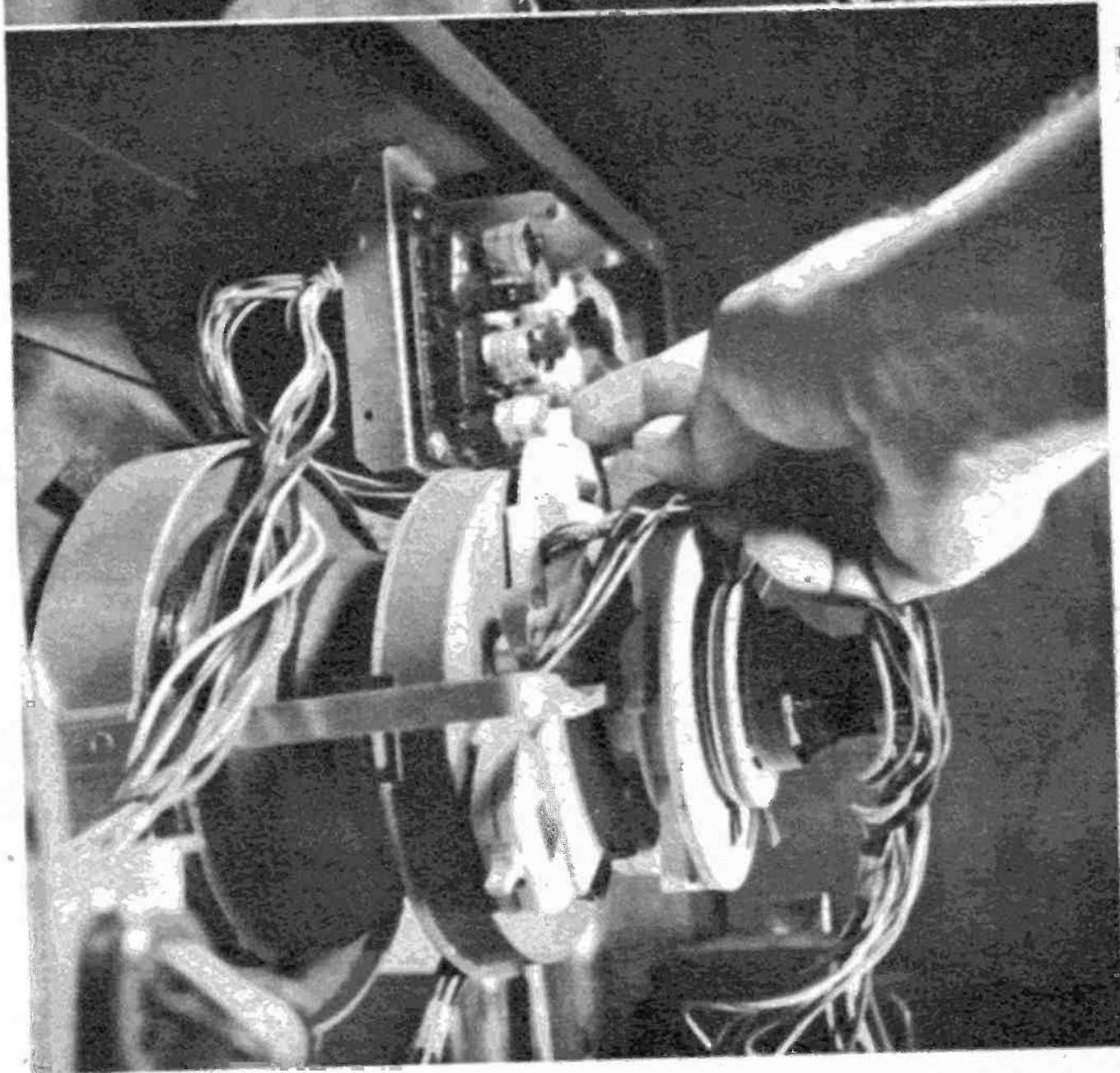

THE COLOR PICTURE TUBE—Changing the color picture tube is not an easy job. I do not advise anyone to attempt it unless he is an experienced electronic technician.

It is necessary to go through a large number of complex service procedures

anyone of which is loaded with booby traps. Only the experienced man can wend his way safely through this procedure and he will be able to smooth out the complications as they occur.

The next chapter tells how to set up a color CRT once it is installed. •

y to
utes.
ing.

ARD
OOK.

SEND CARD FOR RCA'S NEW 1966 HOME STUDY CAREER BOOK TODAY

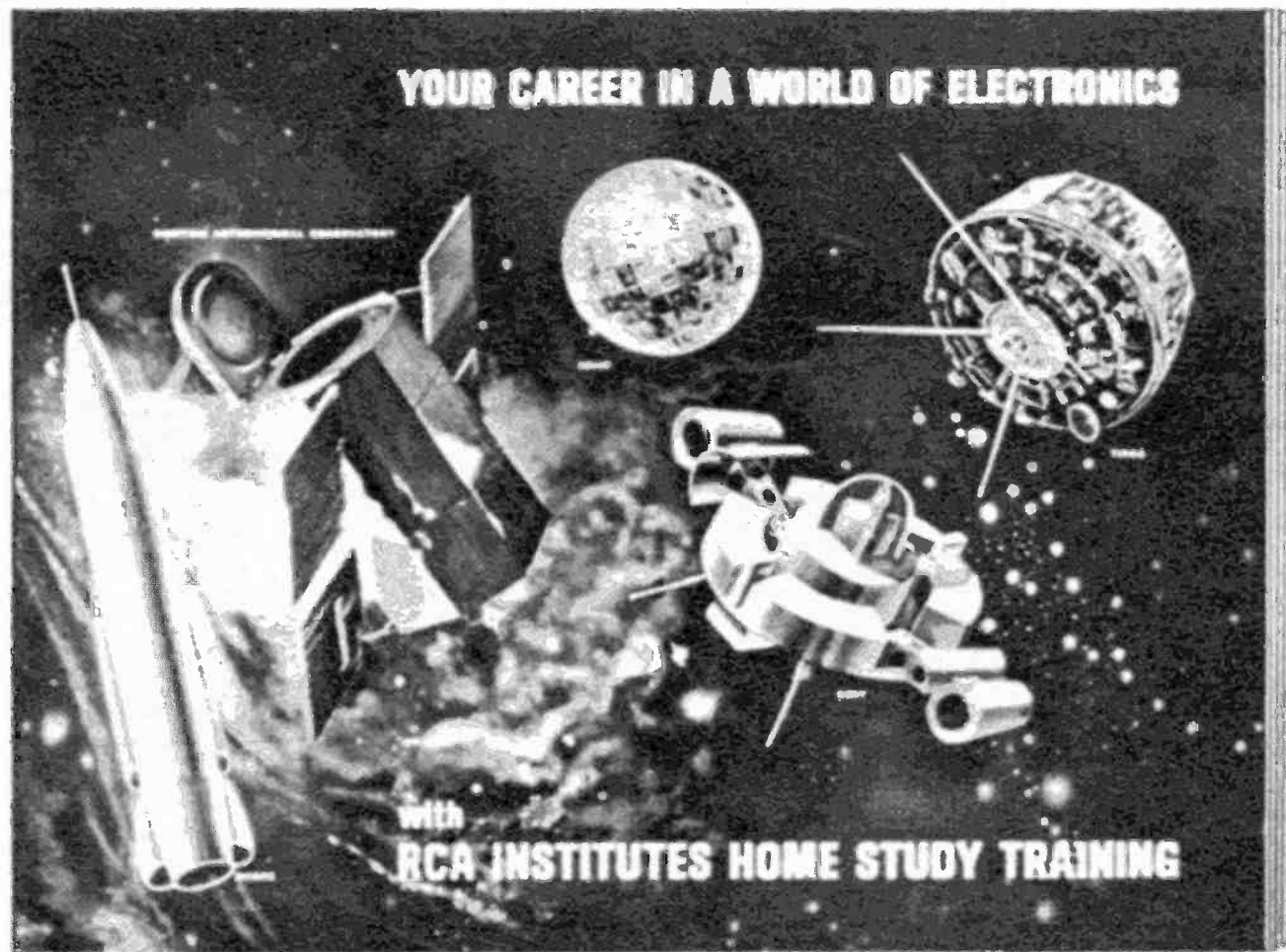

CUT THE TIME BETWEEN NOW AND SUCCESS

- Find out about RCA Institutes Career Programs.
- Learn about the amazing "Autotext" programmed instruction method—the easier way to learn.
- Get the facts about the prime quality kits you get at no extra cost.
- Read about RCA Institutes' Liberal Tuition Plan—the most economical way for you to learn electronics now.
- Discover how RCA Institutes Home Training has helped its students enter profitable electronic careers.

Lots more helpful and interesting facts too! Send postage-paid card for your FREE copy now. No obligation. No salesman will call.

RCA INSTITUTES, Inc. Dep't. RG-06
350 West 4th Street, New York, N. Y. 10014

RCA Institutes also offers
Classroom Training.
Catalog free on request.
(Courses also available in Spanish)



The Most Trusted Name in Electronics

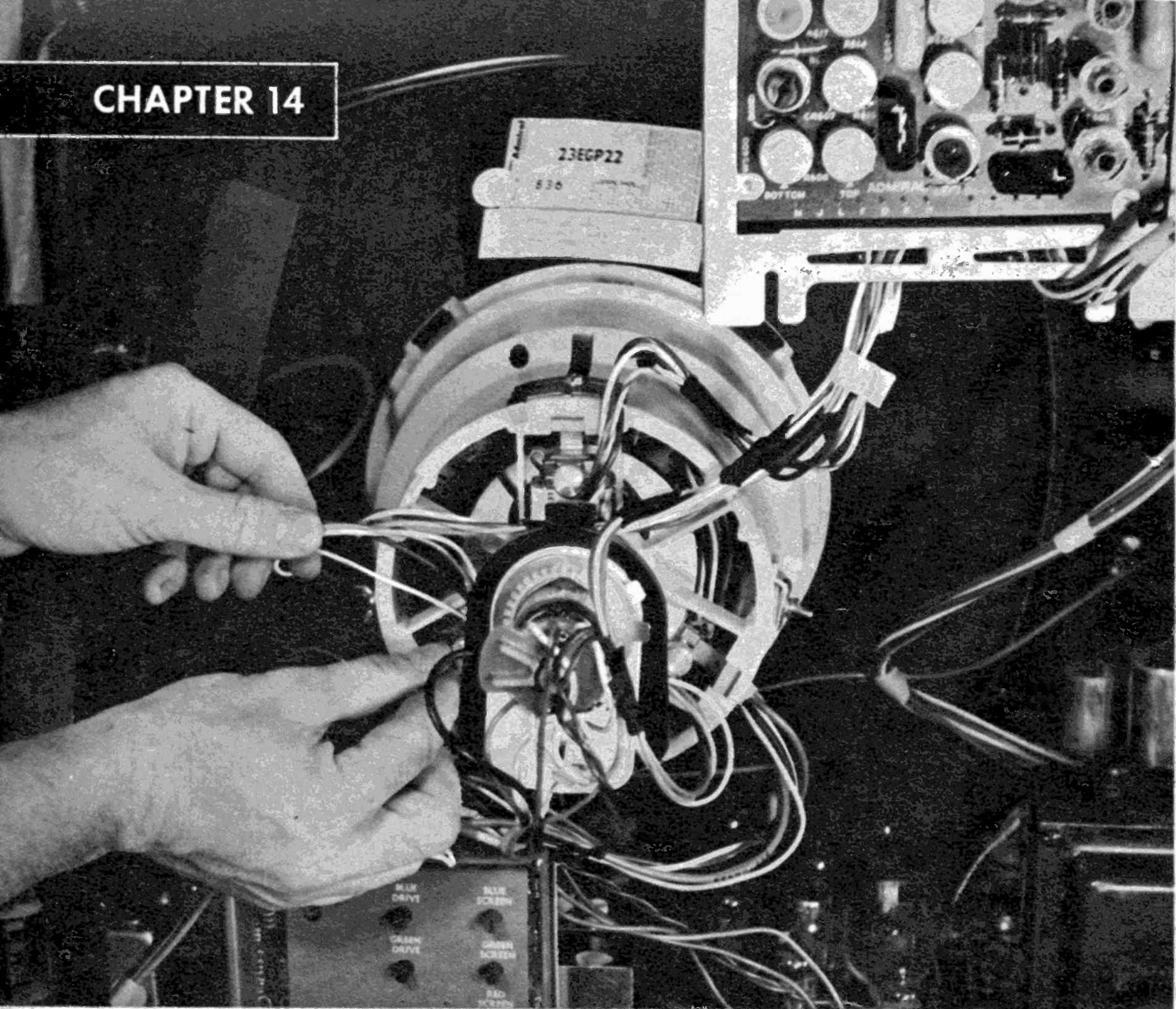

Individual adjustments on your set aren't difficult. It's just that there are 30 controls to maneuver.

Those Confusing Color Adjustments

A coverage of adjustments to make when the TV colors get mixed up

THE MAIN PROBLEM with color TV is getting the adjustments straight. There really isn't that much to each adjustment individually, but there are so many of them, thirty in all, that it can be confusing.

In a black-and-white TV there are the familiar brightness, contrast, sweep, audio, etc., adjustments. In a color TV all the black-and-white adjustments are still there, plus the color. Before trying to work on the color adjustments make sure all the black-and-white controls are set properly. If they aren't, the color controls won't react properly.

The color adjustments are the first step in attempting a color repair. They are used in performing the diagnosis and completing the repair. Don't even try to attempt color repairs unless you have some idea of

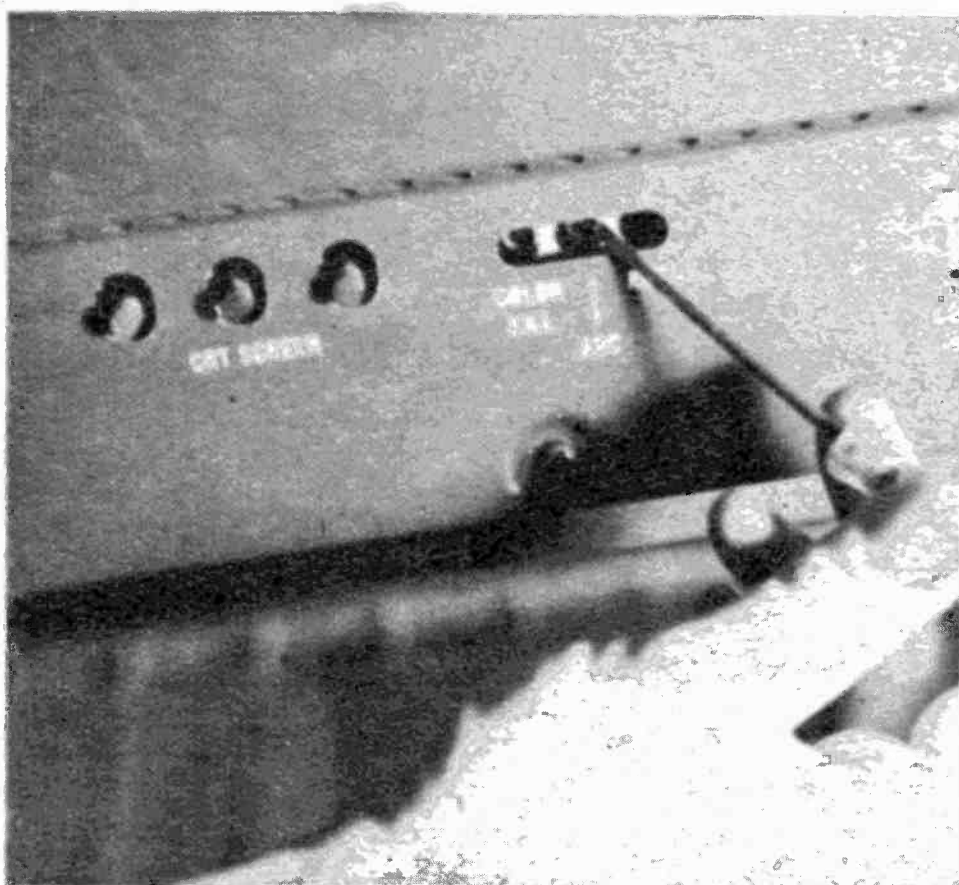

All the black-and-white adjustments are in the color TV set, plus all the color adjustments.

The hue control changes the phase of the color oscillator. In so doing it changes the color.

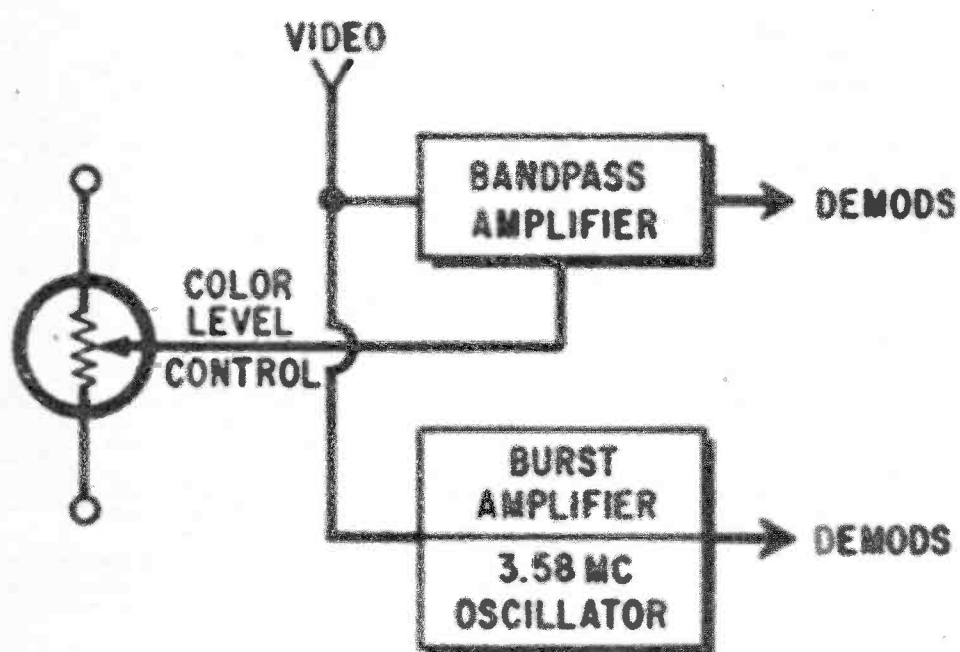

what the adjustments will do for you. Let's see what duty each control performs.

Hue Control

This is in front of the cabinet control. When you turn it the colors on the screen change. Actually you are varying the phase of the color oscillator around 3.58 megacycles. The control works properly when the flesh color of a performer changes from purple through normal to pink. Normal should be about midrange on the control.

The control works passably as long as you can get good flesh tones. When the oscillator drifts too far, and you can't get flesh tones, a touchup alignment of the 3.58 MC oscillator is indicated and/or replacement of the 3.58 MC OSCILLATOR and REACTANCE tubes.

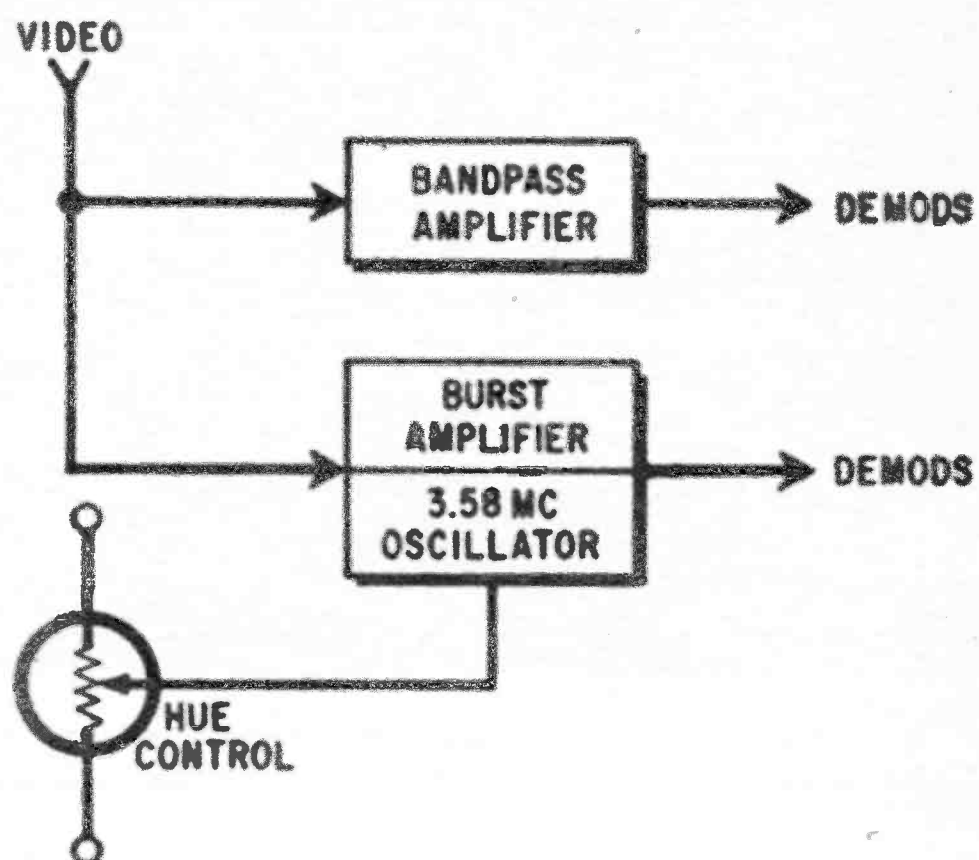

The color level control changes amplification of the bandpass circuit, thus it changes the color.

Activation of the service switch on the TV set causes picture to collapse into a horizontal line.

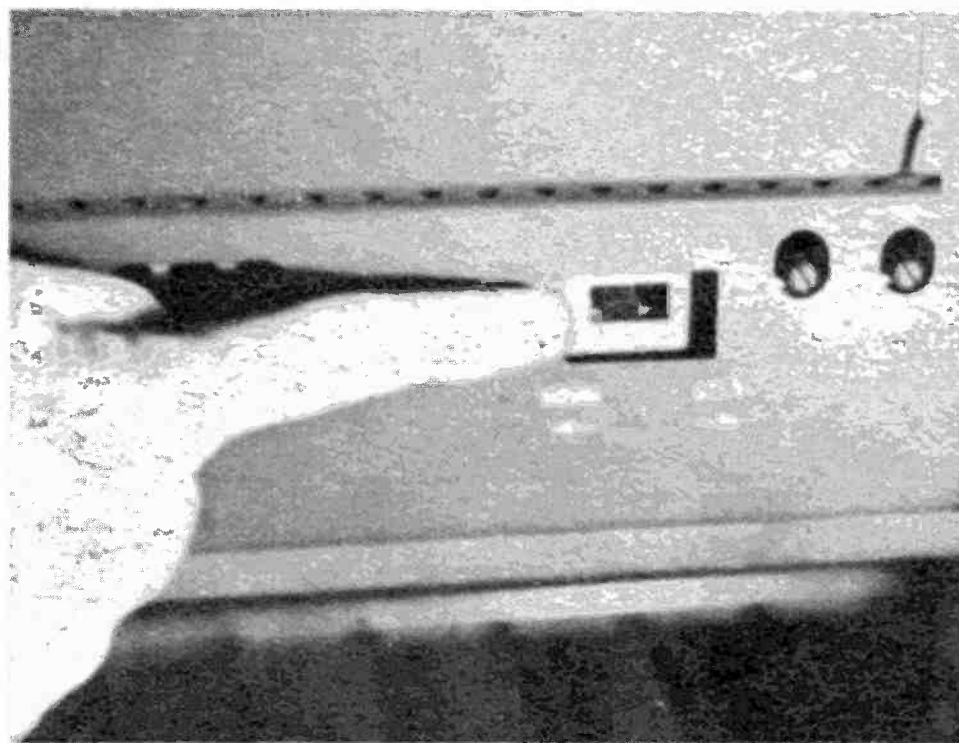

Color Level

This is another front-of-the-cabinet control. When you turn it you vary the intensity of colors. In fact, on some TV's it's called INTENSITY. It's a color contrast control. It's located in the beginning of the color circuits, near the bandpass amplifier, and varies the amount of amplification of the bandpass circuits. As you turn it the color intensity changes from no color, through normal flesh tones to a bright orange flesh tone. Normal should be about midrange on the control. The control works passably as long as you get enjoyable colors, even though you can't get the bright orange.

When you can't get enough color level you might need a stronger antenna signal or a new BANDPASS AMPLIFIER.

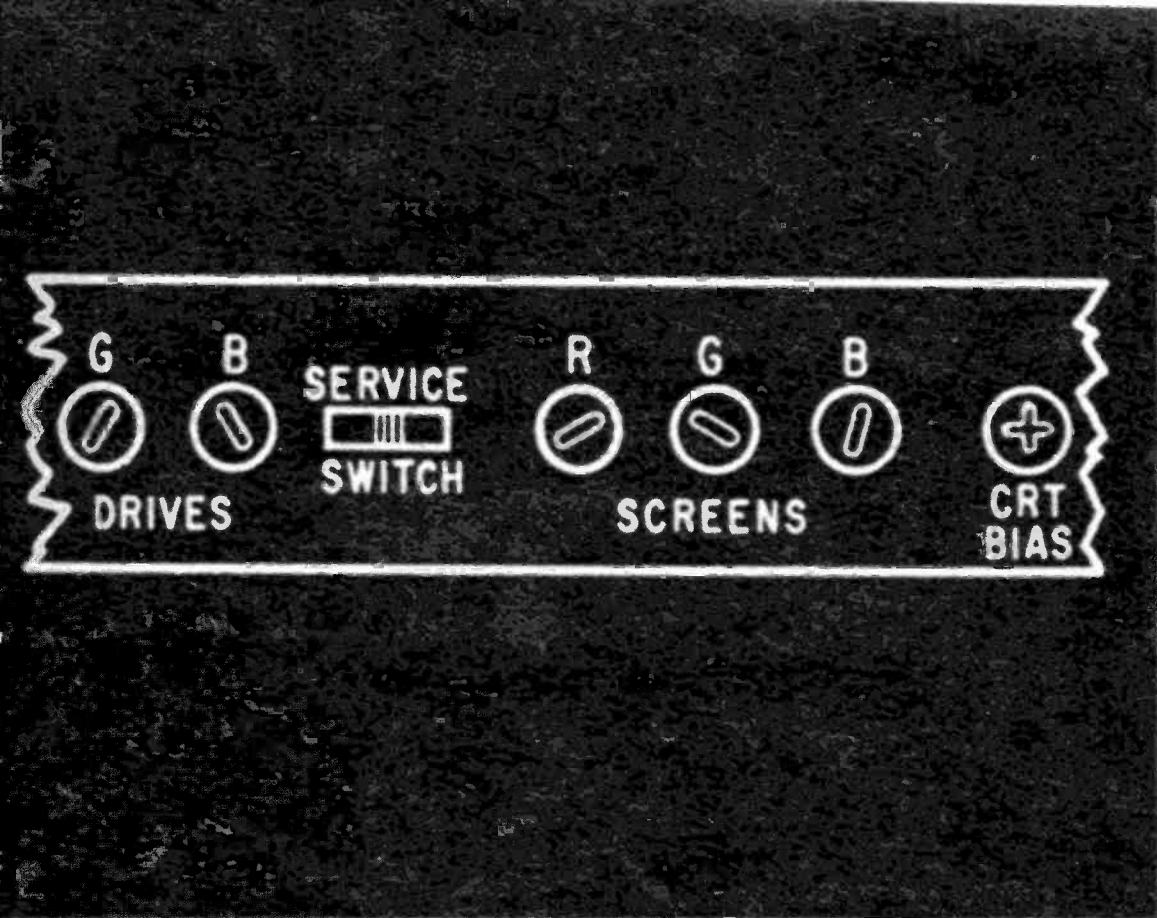

An adjustment of the CRT BIAS control causes all three electron guns to run stronger or weaker.

Slight adjustments of each control causes red, green and blue lights to vary from light to dark.

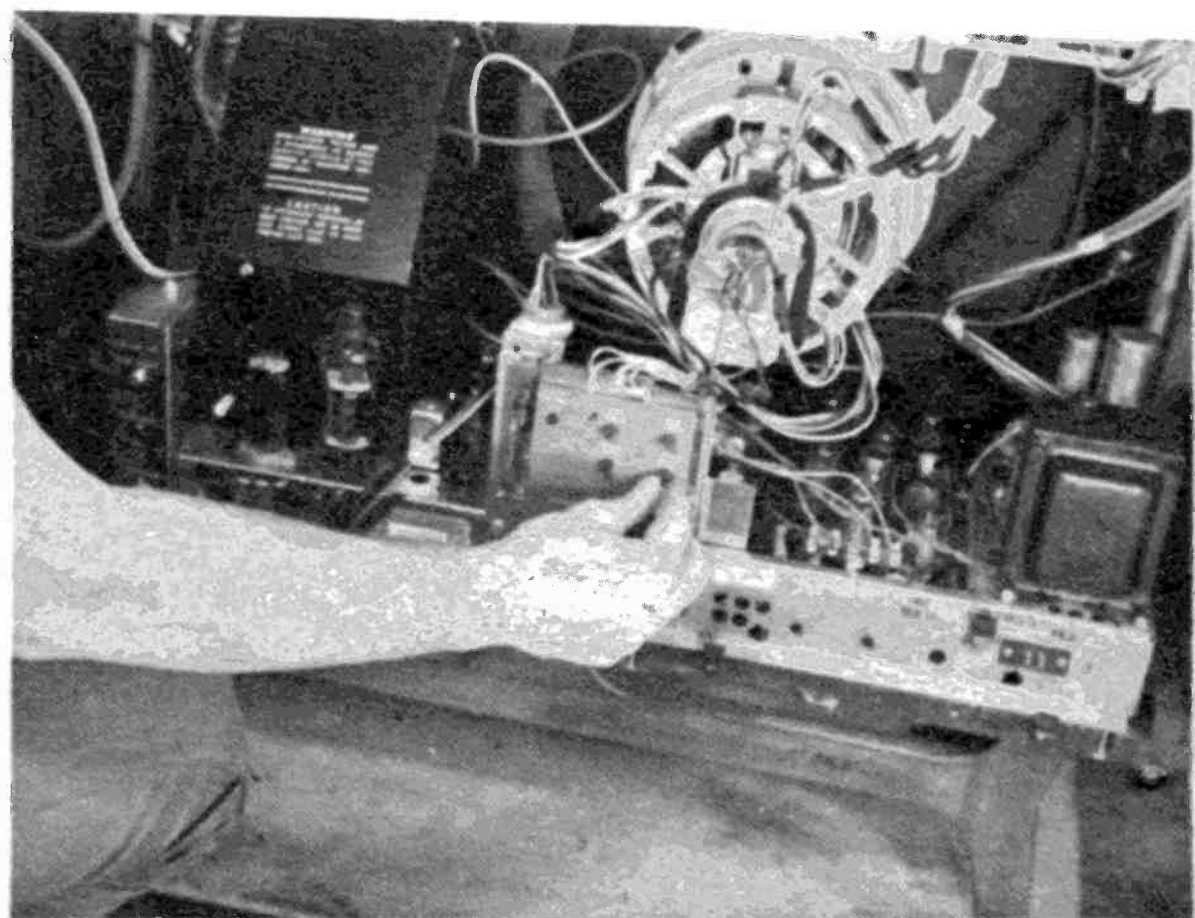

Adjusting the blue and green drive controls on the set makes picture highlights blue or green.

When there is tinting or splotches of color in a permanent spot on the screen, the purity is off.

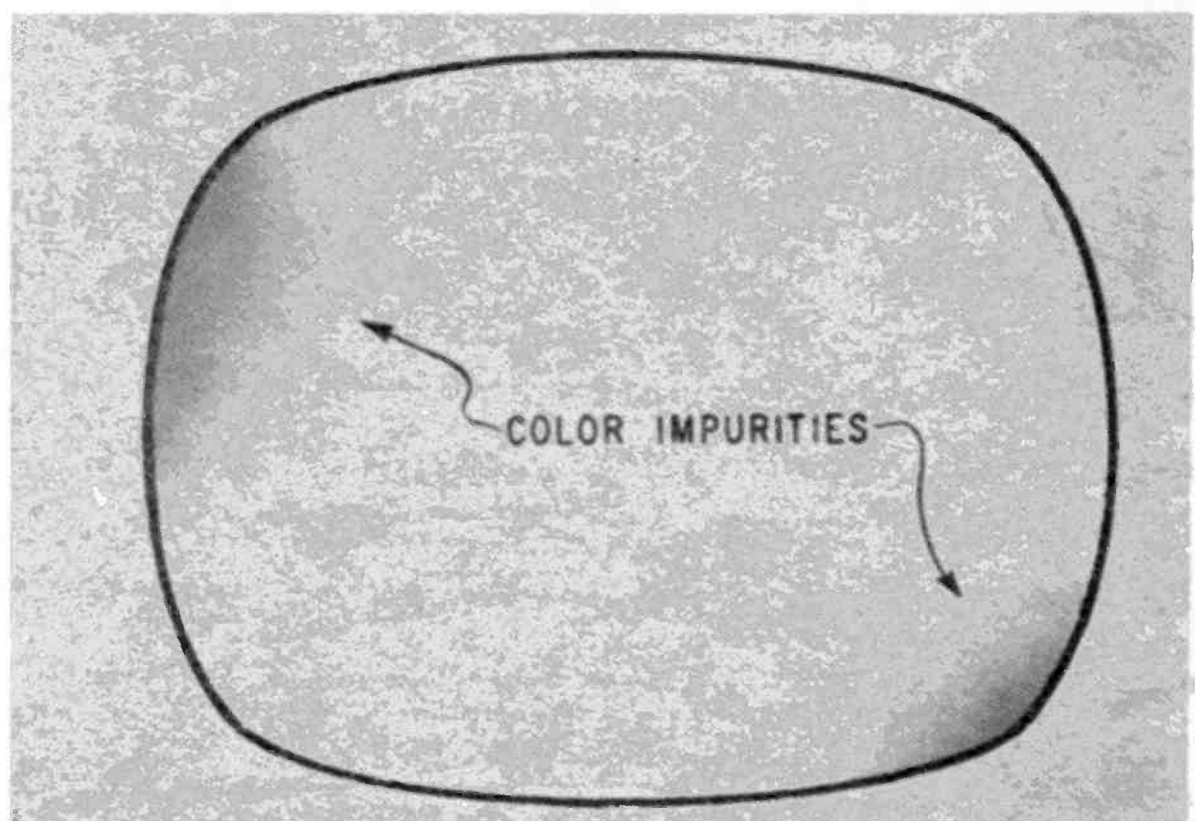
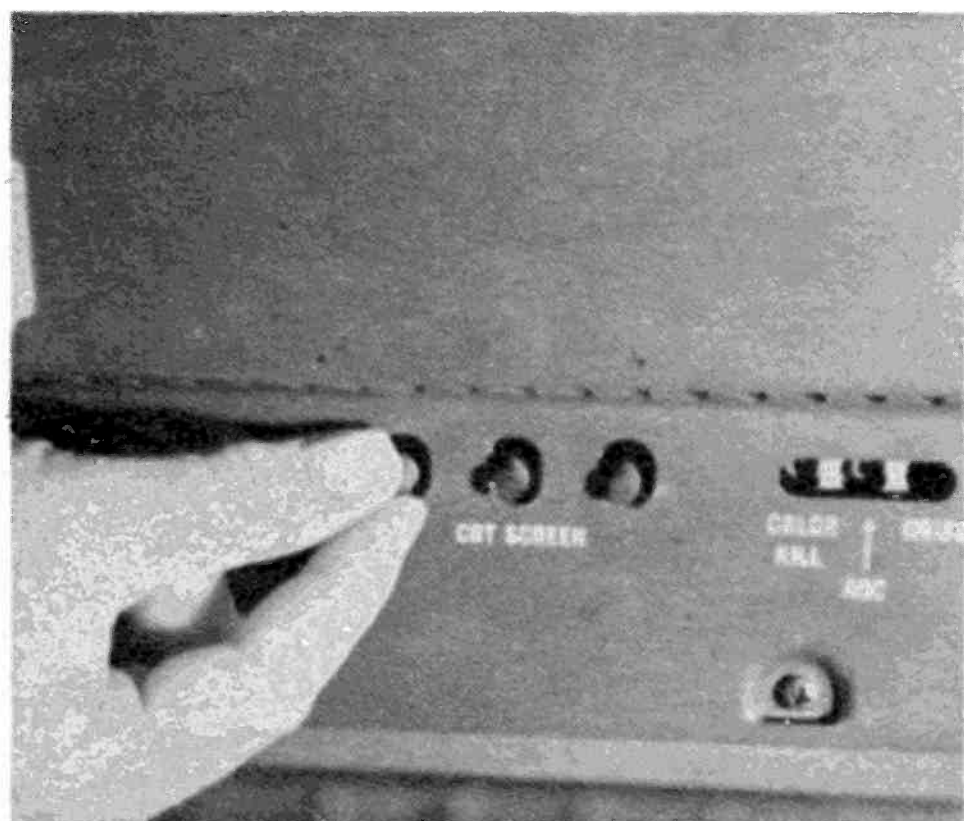

Color Fidelity

In a few color sets, notably Admiral and Motorola, a third front-of-the-cabinet control is installed. It can be called COLOR FIDELITY or TINT. (In other TV's you might find the HUE control labeled TINT. Don't confuse the different types.)

This color fidelity control has nothing to do with the colors that are transmitted. It affects the picture whether a color show is on or not. The HUE and COLOR LEVEL produce no effects unless a color show is on.

This fidelity control varies the black-and-white picture from shades of green through black and white to shades of blue. This tint control enables you to vary the tint of the picture, by color or black-and-white programming, from warm greens, to cool blues to suit your individual liking.

Color Killer

Now we go to the back of the TV or behind hidden panels in the front. The rest of these controls can and are installed all over, but they are not readily available like the HUE, LEVEL and TINT.

In the complex workings of the color TV, certain requirements need to be met. One of the most important is, during a black-and-white show no color should appear on the screen. If it does, it will show up as color interference. To eliminate this the color circuits should be shut down during monochrome programming.

The COLOR KILLER does this job. It is a circuit that turns off when there is a color show and allows the color to be processed, and turns on during a monochrome show, killing the color processing.

The killer has a control in the back of the

First step in correcting color impurities is to demagnetize the edges of the picture tube in the TV set.

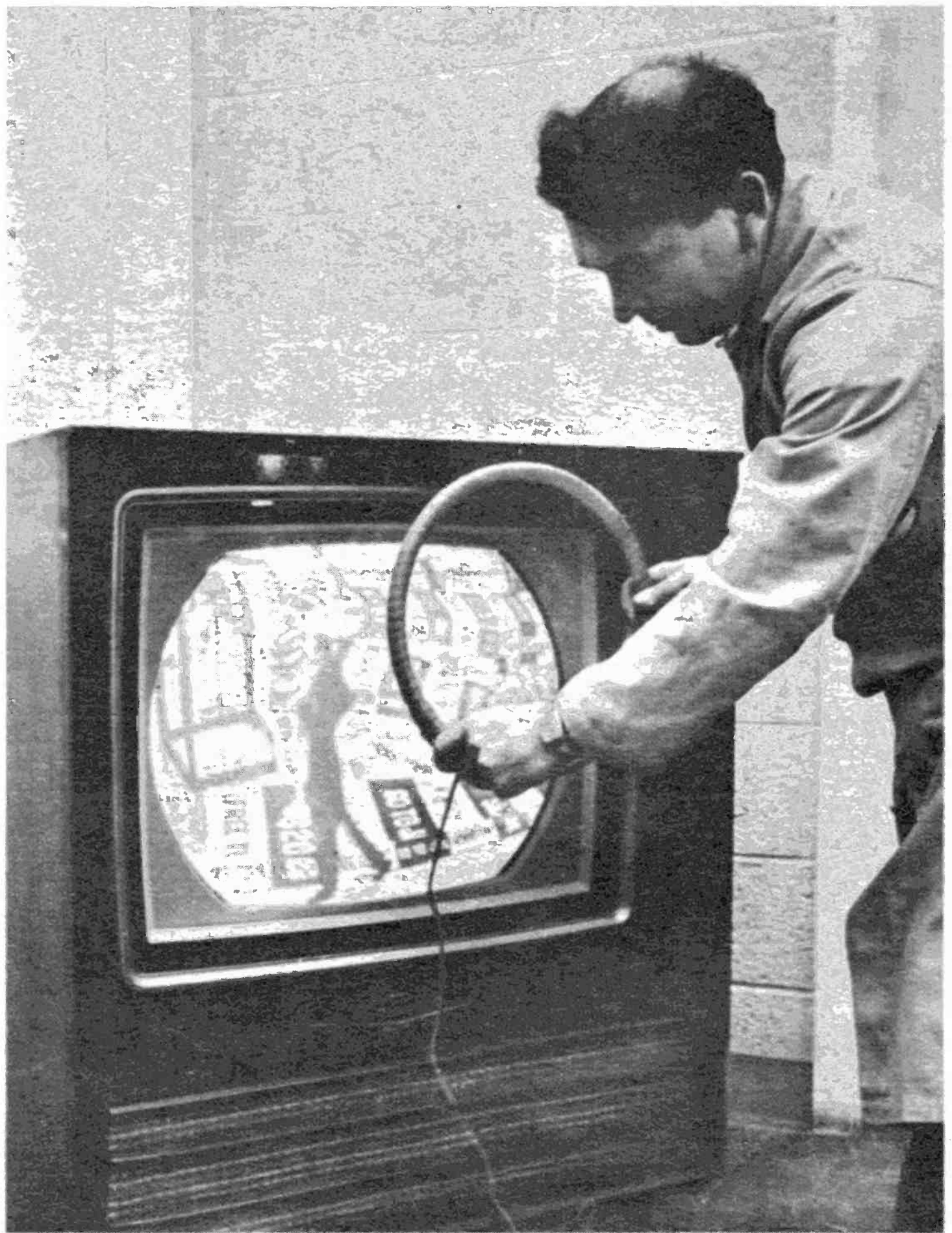

TV. You can adjust it like this: Turn on a black-and-white program. Turn the killer up till color streaks come through the picture. Then slowly turn the killer down just until the streaks disappear. That's the correct setting.

Should the killer be inoperative test the COLOR KILLER tube.

Gray Scale Adjustments

Ideally, you shouldn't be able to tell a color TV set from a monochrome TV during a black-and-white program. If there is a tint to the picture on the color set, your gray scale is off. The picture should be shades of gray from black through white, not shades of blue, green or pink.

In most color TV's there are seven controls to set up the gray scale. When they are operated with the proper sequence, and with the correct approach, a gray scale

setup is made quickly, without difficulty.

When you have a tinted picture it's because there is an improper mixture of the red, green, and blue screen lights. You'll have to read them together so they make gray tones.

Routine Adjustments

There is built-in circuitry especially for this purpose. Start off with the four controls, the SERVICE SWITCH, RED SCREEN, BLUE SCREEN and GREEN SCREEN. Most of the time these are the only controls you need activate.

With normal brightness and contrast, turn on the service switch. The picture will collapse into a white horizontal line. Next turn all three screen colors completely off. The white line should just about disappear.

Next, try each screen control by turning it up, then back down. You should be able

SETUP = SWITCH

COUNTER CLOCKWISE

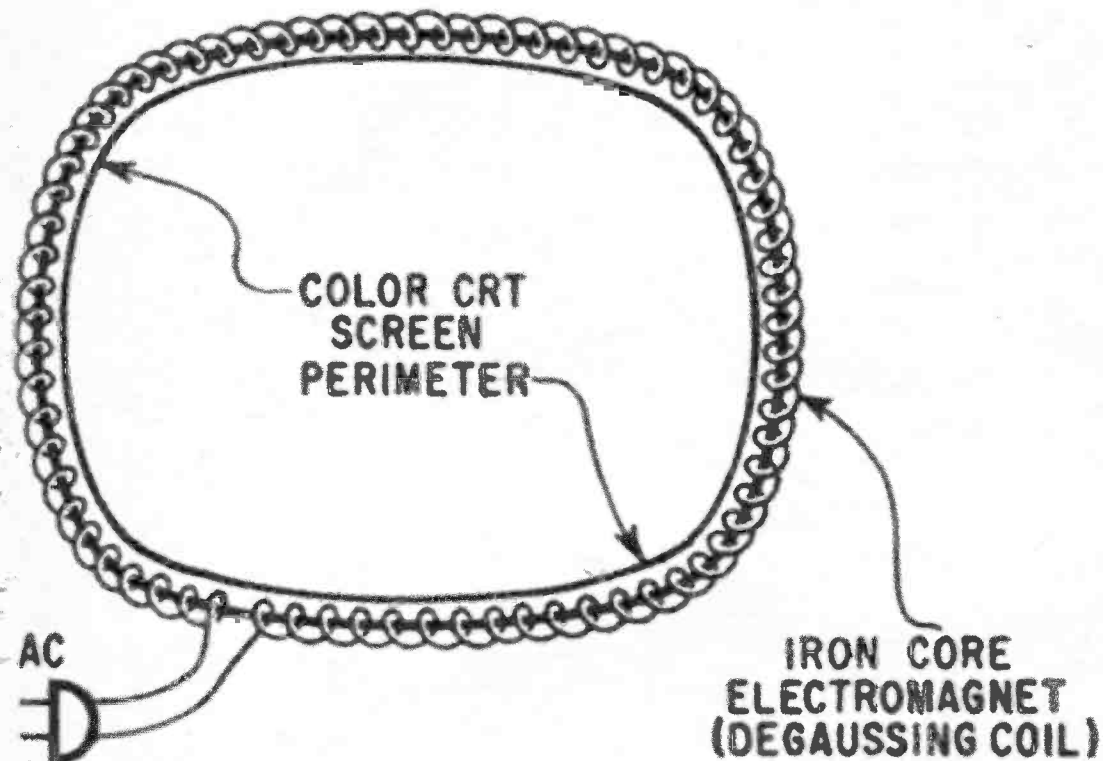

Some TV's have a degaussing coil built in around the CRT's perimeter that activates automatically.

To correct impurities near screen center, adjust the purity tabs. They look like centering device.

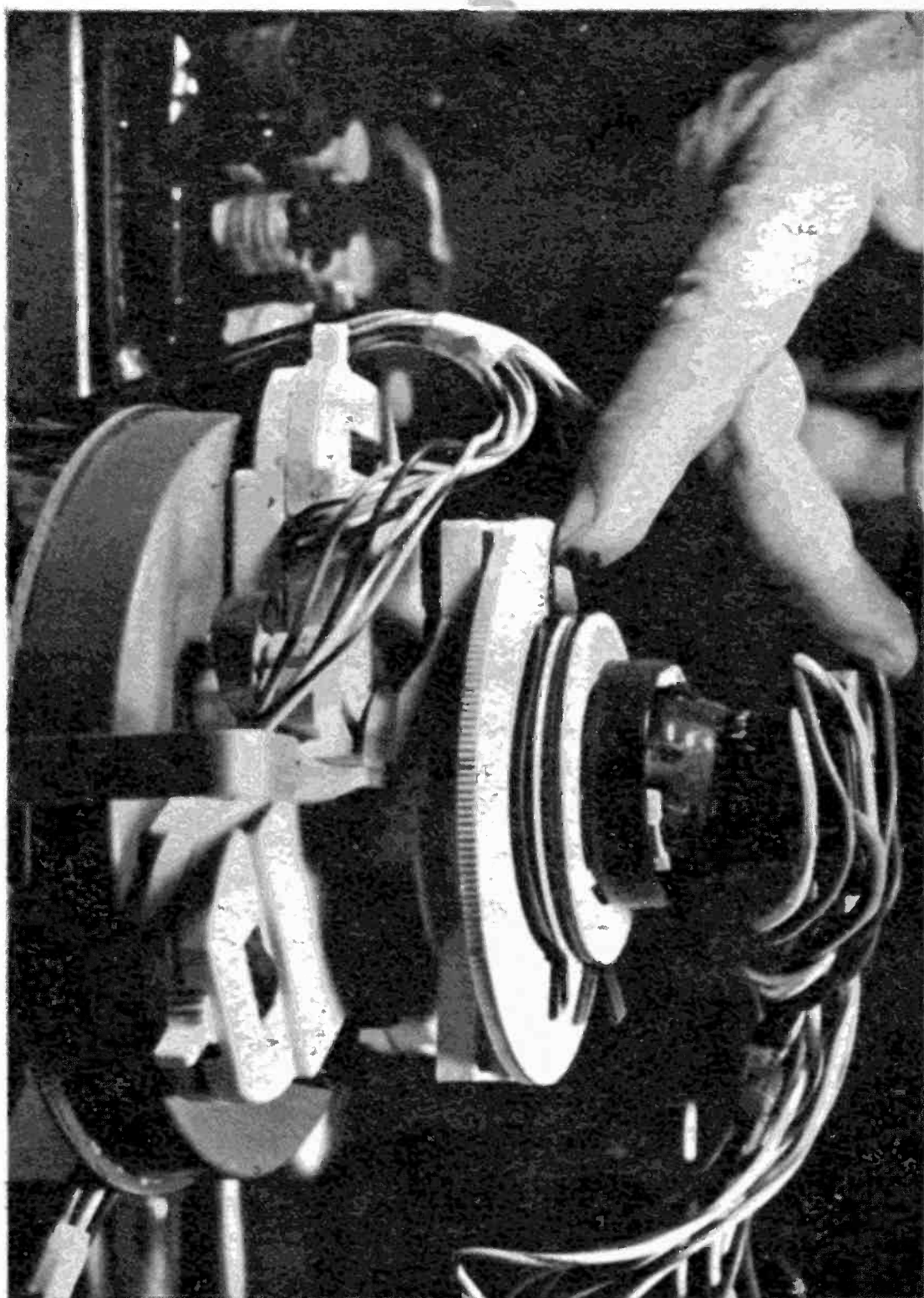

to produce a red line, a green line and a blue line.

As long as all three lines will appear all you are going to need are screen adjustments. Turn up red till you can just see it in a normally lighted room. Then turn up green till you can just see it. Where the red line touches the green the lights will mix and produce yellow.

Next turn up the blue till you can just see it. When the lines touch a white line will appear. Lastly turn off the service switch. A good black-and-white picture will appear. No more tints.

CRT BIAS—In the event you were not able to produce a red line, a green line and a blue line it means your color CRT is showing wear and it needs to be made a little brighter. Start procedure over.

Turn down all three controls. Then turn up the one screen control that's not making a line. For instance, it might be the red screen. Turn it up. Nothing is on the screen. Adjust the CRT BIAS till the red just appears. Then readjust the blue and green for your gray scale mixture.

DRIVE CONTROLS—If you find that you have performed a gray scale adjustment and there seems to be a hint of tint in the picture, try to note if the tinting is in the whites or the blacks. If it's in the whites, try adjusting the **BLUE DRIVE** to eliminate blue tinting and the **GREEN DRIVE** to eliminate green tinting. Try to turn these up as little as possible.

Purity Adjustments

Everyone has heard that the color TV set is subject to problems if it is moved. This is because the three electron beams in the picture tube are affected by the earth's magnetic field just as a magnetic compass is. The effect on the TV screen is permanent color splotches, especially around the perimeter of the tube. There are three easy ways to adjust the splotches out.

DEGAUSSING—One is by demagnetizing or degaussing the picture tube. If you take a small pocket magnet and hold it near a color-TV program you'll see the picture distort. This is what happens when a small

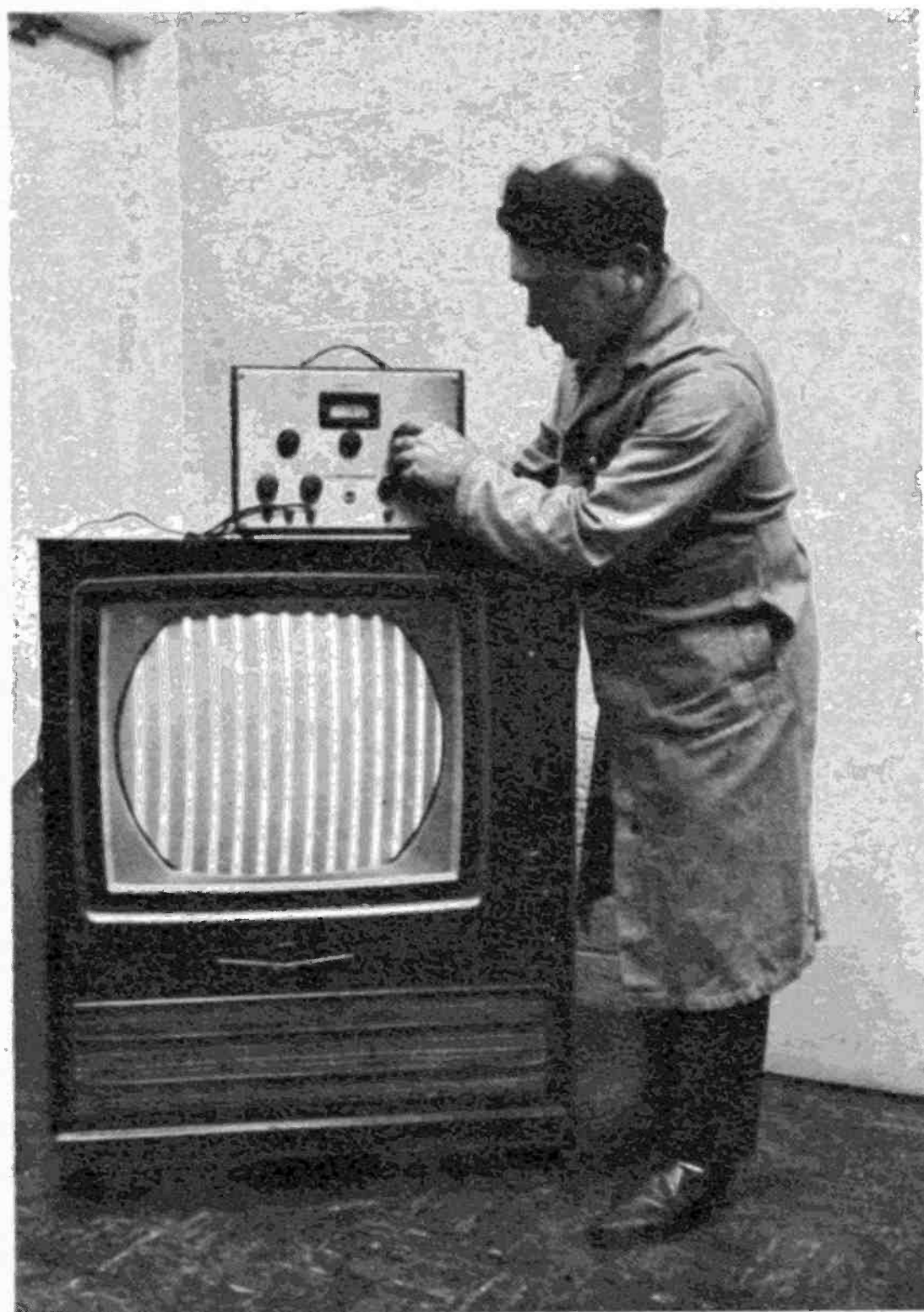

STATIC ADJUSTMENTS

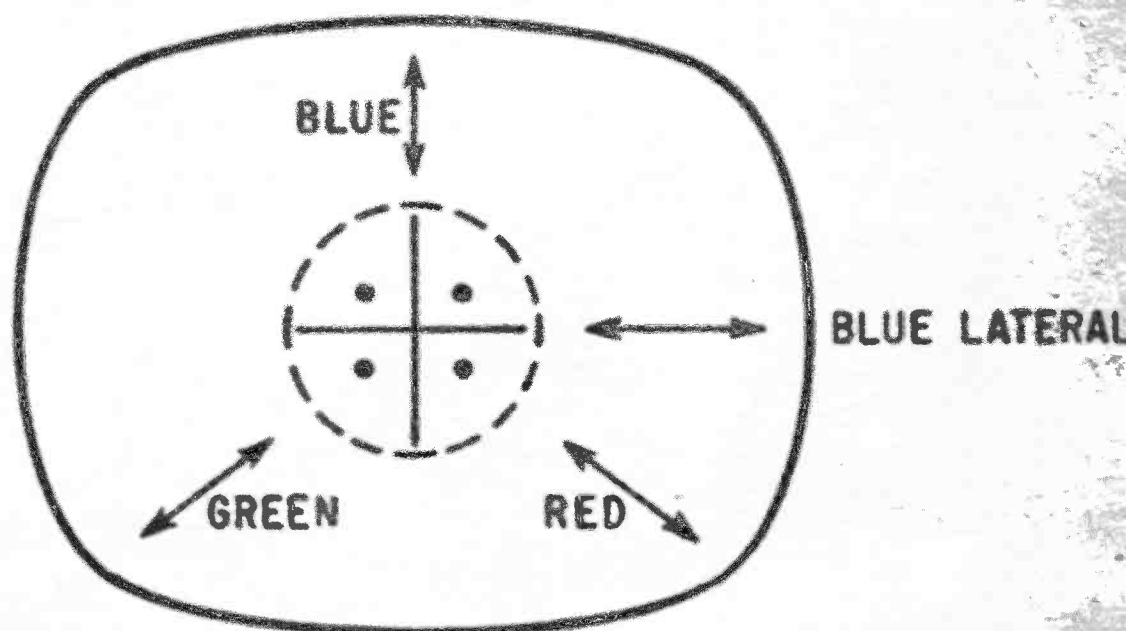

Above, static magnets move red and green diagonally and move blue up and down or side to side.

Left, you must have dots or bars on the screen in order to effect a satisfactory convergence.

magnetic field is developed somewhere on the bell of the picture tube.

If you degauss it, like a jeweler does to a watch, you'll clear up the color distortion.

Some TV's have automatic degaussing that is activated every time you turn on a cold TV. Other TV's have manual degaussing installed that you activate at will by pushing a button. Other TV's have none. For these you'll need a degaussing coil.

With the coil you simply rotate it around the perimeter of the picture tube and gradually lock off. The coil, of course, must be on when you do it, but the TV could be either on or off. It doesn't matter. Just be careful not to get the coil anywhere near the rear of the TV.

DEFLECTION YOKE—After degaussing, if some localized splotches still remain, analyze their position. Are they around the rim of the tube or nearer the screen center?

You can adjust rim and corner impurities by adjusting the position of the deflection yoke. Follow this procedure: Turn the blue and green screen control off. A red

picture remains. Adjust the red screen control for a nicely lit red picture. Then analyze the red picture. It should be uniform throughout the entire face of the tube. For imprintings around the edges, loosen the deflection yoke and move it forward and rearward till the edges are uniform.

PURITY TABS—With the red still on the picture tube, look for impurities in the center of the picture. If there are any, adjust the two purity tabs that look like centering devices. This will clear center impurities. Then go back and forth from yoke to tabs till the red field is uniform.

Once satisfied, you can double check the other two colors by turning down the red screen and turning up the blue and green screen in turn. If the red field was uniform the other two will be, too. However, if you find an impurity in the green or blue field, go back and check the red. You probably missed a spot on it.

Once your purity is good, set the picture back to the proper gray scales with the service switch, as mentioned in the **GRAY SCALE ADJUSTMENT** section.

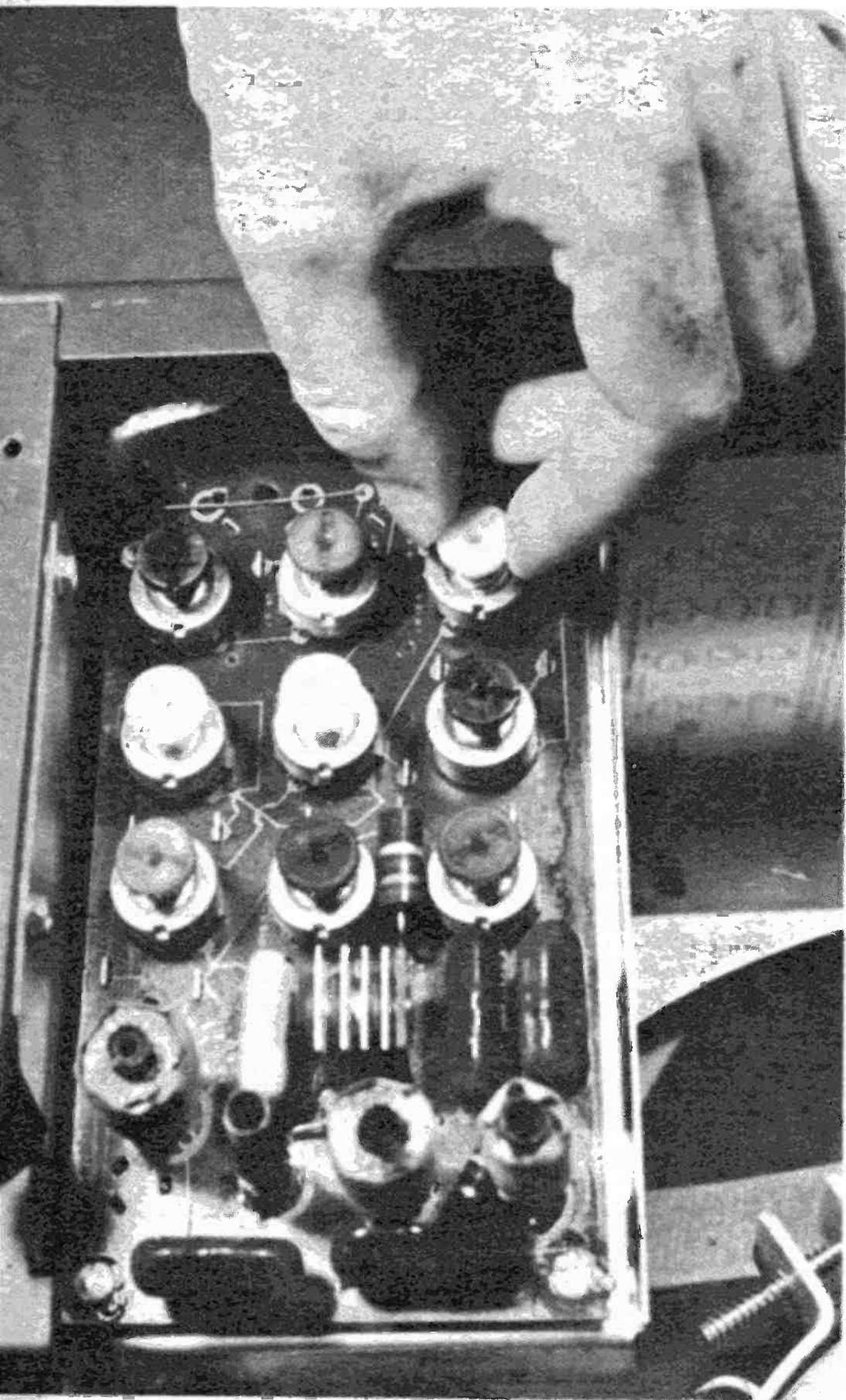

Nine of the convergence adjustments are conducted by hand. All knobs rotate 360 degrees.

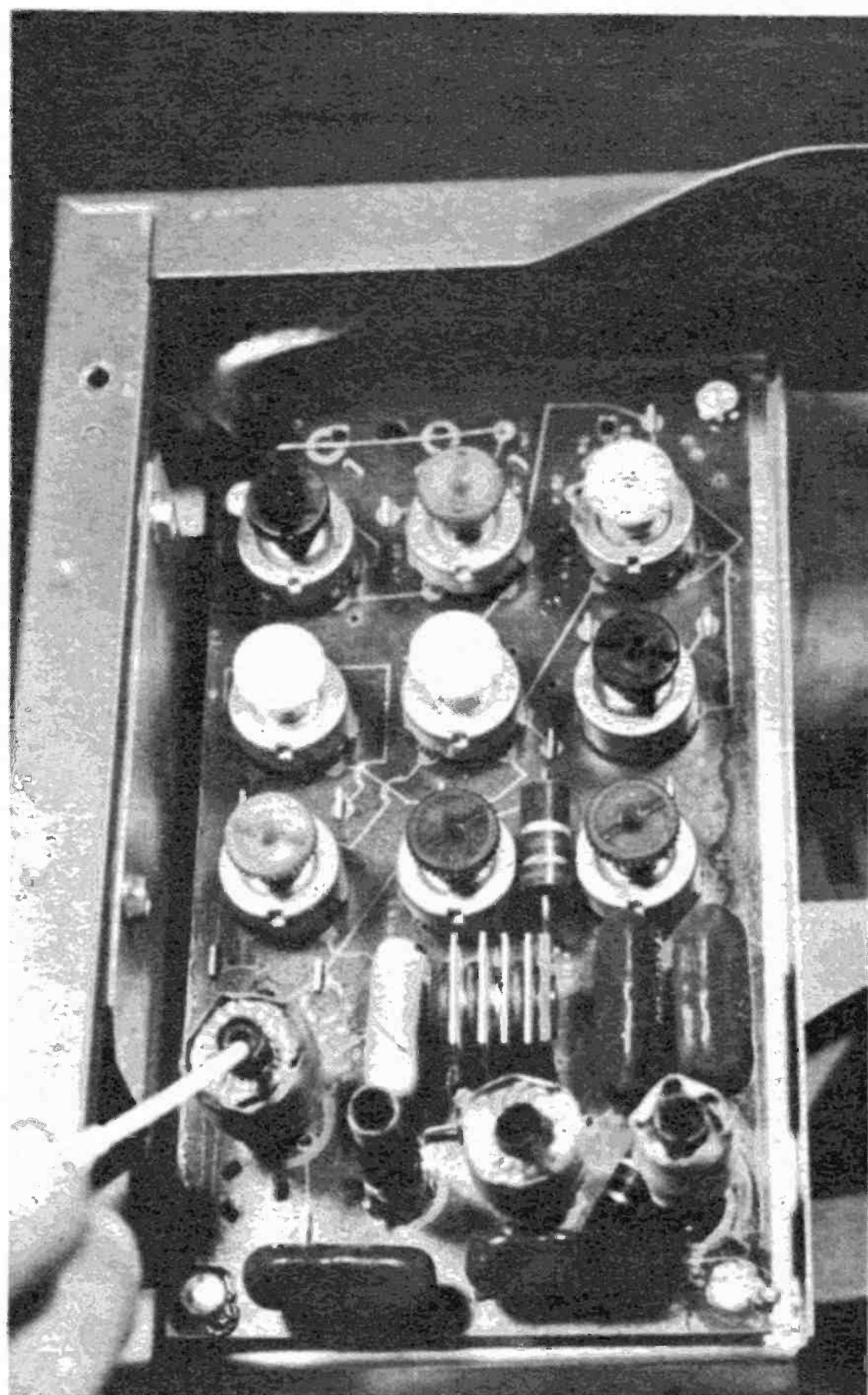

Three of the convergence adjustments need a hex-head nut stick. Be careful adjusting these.

Static Convergence

At this point we run into a complication. You can't make the **STATIC CONVERGENCE** or the **DYNAMIC CONVERGENCE** adjustments without dots and bars on the TV screen. It doesn't matter how you get the dots and bars on. Servicemen use a dot-bar generator. Some color sets have a special circuit that you can switch to that produces dots and bars on the screen. Some TV stations transmit a dot-bar pattern as their test pattern. However, in order to conduct these adjustments, the dot-bars must be there. They are what the adjustments are predicated upon.

Let's assume you can get dots and bars. They produce a still pattern that describes in detail any convergence problems. These are color fringing around performers or objects being televised. You'll see in varying degrees, red, green and blue sticking out like ghost images.

On the dot-bar pattern you can analyze whether the color fringing is at screen center, top, bottom, left side, right side, corners, in a horizontal plane or in a vertical plane, also what colors are fringing. There are controls for each one of the above mentioned areas, planes and colors.

Most of the time color fringing takes place at screen center. There are four con-

CONVERGENCE BOARD AND SCREEN

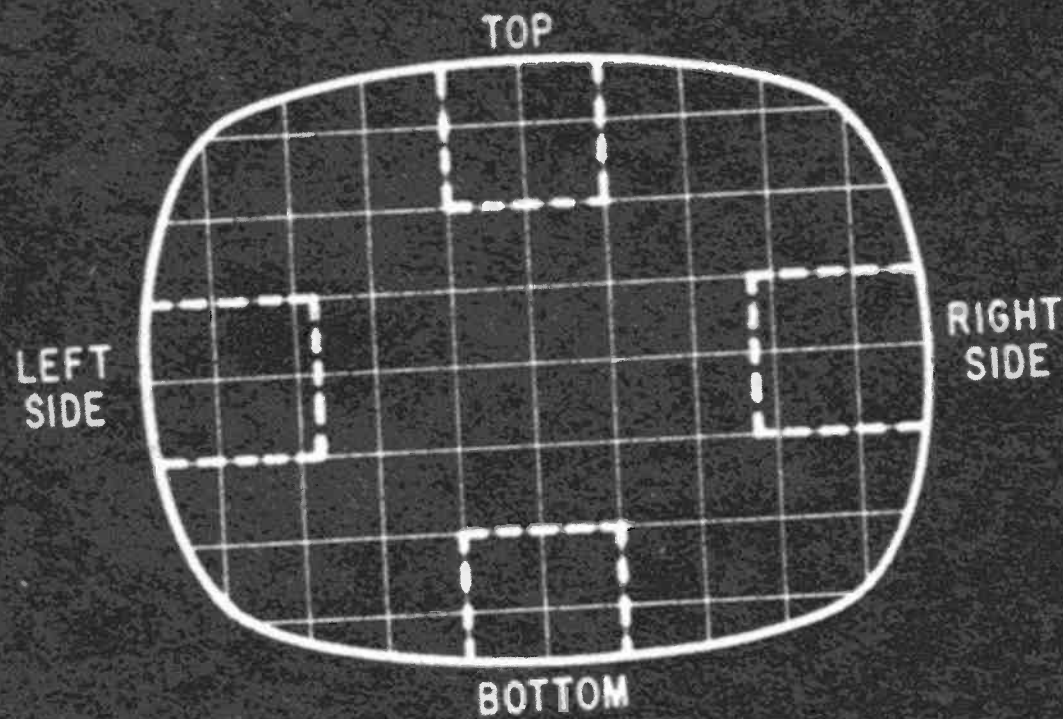

	TOP	BOTTOM	LEFT SIDE	RIGHT SIDE
RED-GREEN HORIZONTAL				
RED-GREEN VERTICAL				
BLUE HORIZONTAL				

All of the adjustments affect a specific section of the screen although there is some interaction.

trols to adjust screen center convergence. They are the RED STATIC, GREEN STATIC, BLUE STATIC and BLUE LATERAL.

The statics come in various shapes such as movable sleeves, screwdriver adjustments and knobs. In older, color TV's, they might have been on the chassis, but in newer models they almost invariably locate on the convergence yoke around the CRT neck, next to the deflection yoke. The blue lateral is also on the neck, looks like an ion trap and is the closest object to the plastic socket.

This is what they do. The red static

moves the entire red field diagonally. The green static moves the entire green field diagonally across the red field. The blue static moves the entire blue field up and down. The blue lateral moves the entire blue field from side to side.

If you watch colored dots at screen center and adjust the four controls, you can get the dots to merge and form white dots.

Dynamic Convergence

Fortunately, these last twelve dynamic convergence adjustments do not usually need anything more than a touch-up. There are so many different kinds, and there are so many possible complications, that only a skilled technician should tackle them. Try touch-ups if you have dots and bars, but if the adjustment doesn't take, the chances are good it won't take unless some other primary trouble is cured first.

The first step is to analyze the dots and bars. Note where the misconvergence exists, whether it's horizontal or vertical and what color is out.

There are four red and green horizontal adjustments. They move the red and green horizontal lines up and down at the TOP, the BOTTOM, the LEFT SIDE and the RIGHT SIDE.

There are four blue horizontal adjustments. They move the blue horizontal lines up and down at the TOP, the BOTTOM, the LEFT SIDE and the RIGHT SIDE.

By rocking all these you can get all the horizontal lines all over the screen to merge into white.

There are four red and green vertical adjustments. They move the red and green vertical lines sideways at the TOP, the BOTTOM, the LEFT SIDE and the RIGHT SIDE.

There are no blue vertical adjustments. Blue vertical is the reference you set the rest upon. If need be, you can move the blue vertical with the blue static and blue lateral adjustments.

By rocking the red and green vertical you can get the vertical lines all over the screen to merge into white.

This is not quite as simple as it sounds since you usually have to go back and re-adjust the statics, etc. However, that is the basic procedure. Should you be able to master all these controls you will have taken all the mystery and confusion of color TV out of any repair attempts you make. •

Don't Be Afraid of Color Troubles

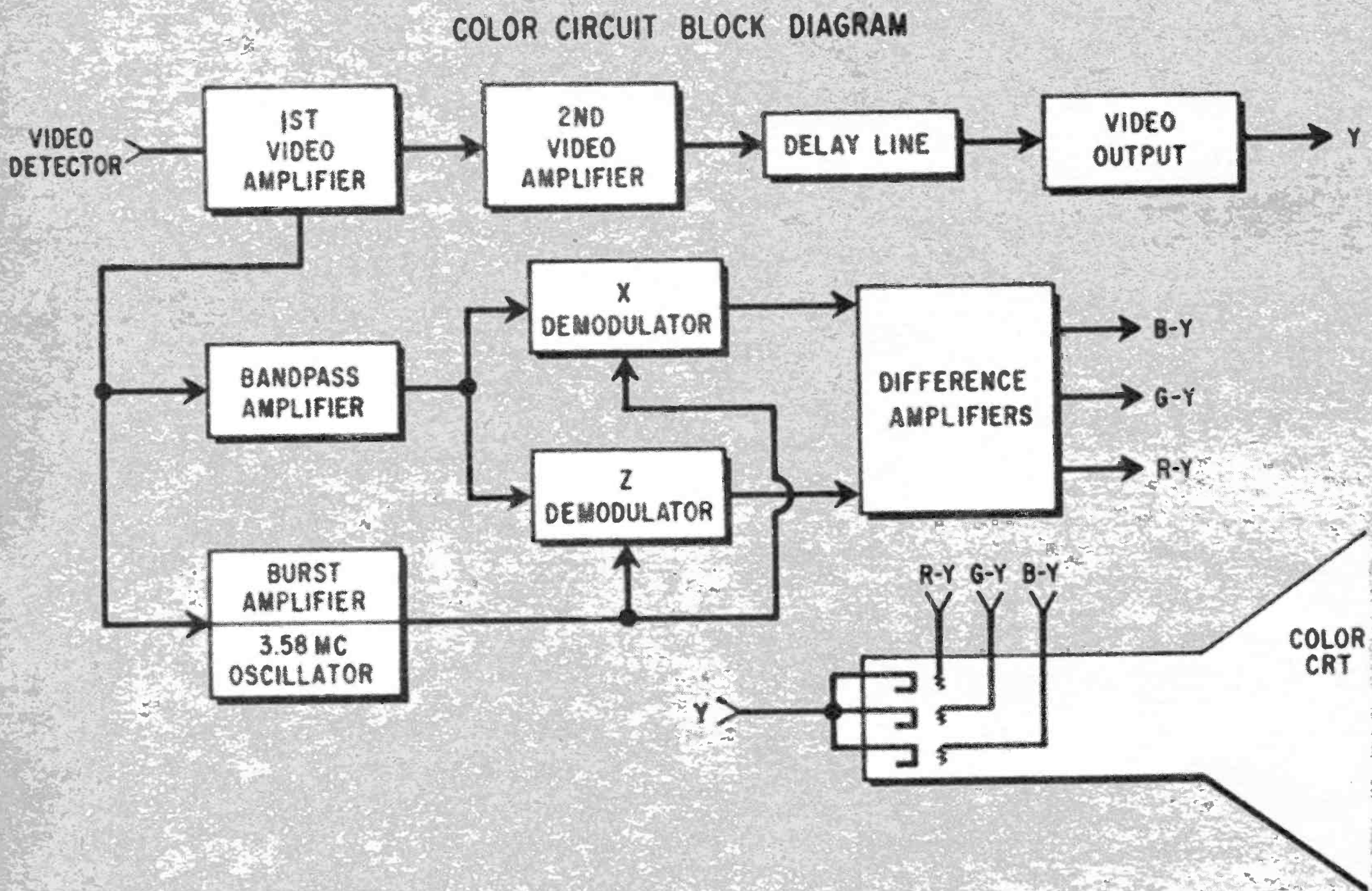

The color circuits receive the color signal and color sync. Then the color is added to the screen.

THE MAJORITY of color TV troubles have an exact counterpart in black-and-white sets. The preceding chapter dealt with the troubles that occur in setting up the black-and-white display on the color picture tube. This chapter deals with the troubles that occur in getting the color signal from the video amplifier, through the color circuits to the picture tube so it can be added onto the black-and-white display.

COLOR SIGNAL—The color signal contains two parts. One is the color sidebands that is going to be processed and then added

to the black-and-white picture. The second is the color sync or lock-in signal. It is going to lock the color oscillator into the same frequency and phase settings as the station's color oscillator.

A sampling of the complete TV signal is taken off at the 1st VIDEO AMPLIFIER. It is sent to two entrances of the color circuit area. One, the BANDPASS AMPLIFIER and the other, the BURST AMPLIFIER. In the bandpass amplifier the color sidebands are extracted from the TV signal, amplified and sent on to the DEMODULATORS. In the burst amplifier the color sync or color

burst is separated from the TV signal, the 3.58 MC oscillator is locked into the right frequency and phase, and the oscillator output is also sent to the demodulators.

In the demodulators the color sidebands and oscillator output are combined and construct the color signal. The demodulator outputs are then sent to the matrix circuits. The outputs of the matrix are B minus Y, G minus Y and R minus Y. These three outputs are applied to the three control grids of the picture tube.

Meanwhile, back at the 1st video amplifier the TV signal is amplified and sent to the 2nd video amplifier and amplified again. Then the signal, which incidentally is known as the Y signal, is sent into a DELAY LINE.

The Y signal travels through the video circuits faster than the color signal tracks through the color circuits. It is slowed in the delay line. Then the Y signal is sent into the VIDEO OUTPUT. It is amplified once again and is then applied to the three cathodes of the picture tube.

During a color program the Y from the three cathodes add in the electron guns with the B - Y, G - Y and R - Y from the three control grids. The electron gun outputs are pure Blue, Green and Red, (B minus Y plus Y equals B).

Troubles occur to the color picture when there is a circuit problem in the color circuits. Let's go through the color-only troubles.

NO COLOR—You can't tell the color is missing till a color programs appears only in monochrome on your screen. Then, ad-

TUBE LOCATION GUIDE

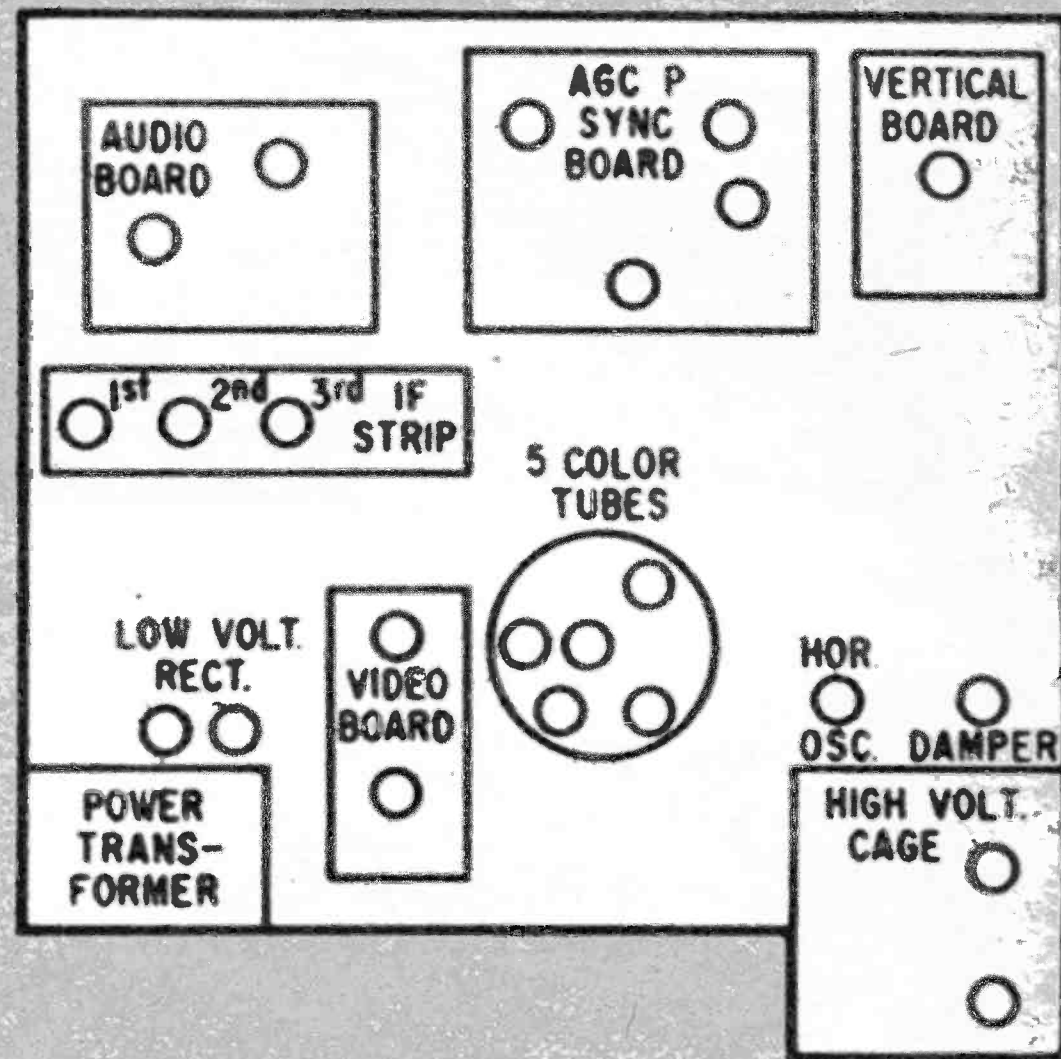

The color section of a TV set is usually in one area and needs about five tubes to do the job.

The three colors and color sync are put into a 3.58 MC subcarrier that rides on regular carrier.

COLOR TRANSMISSION

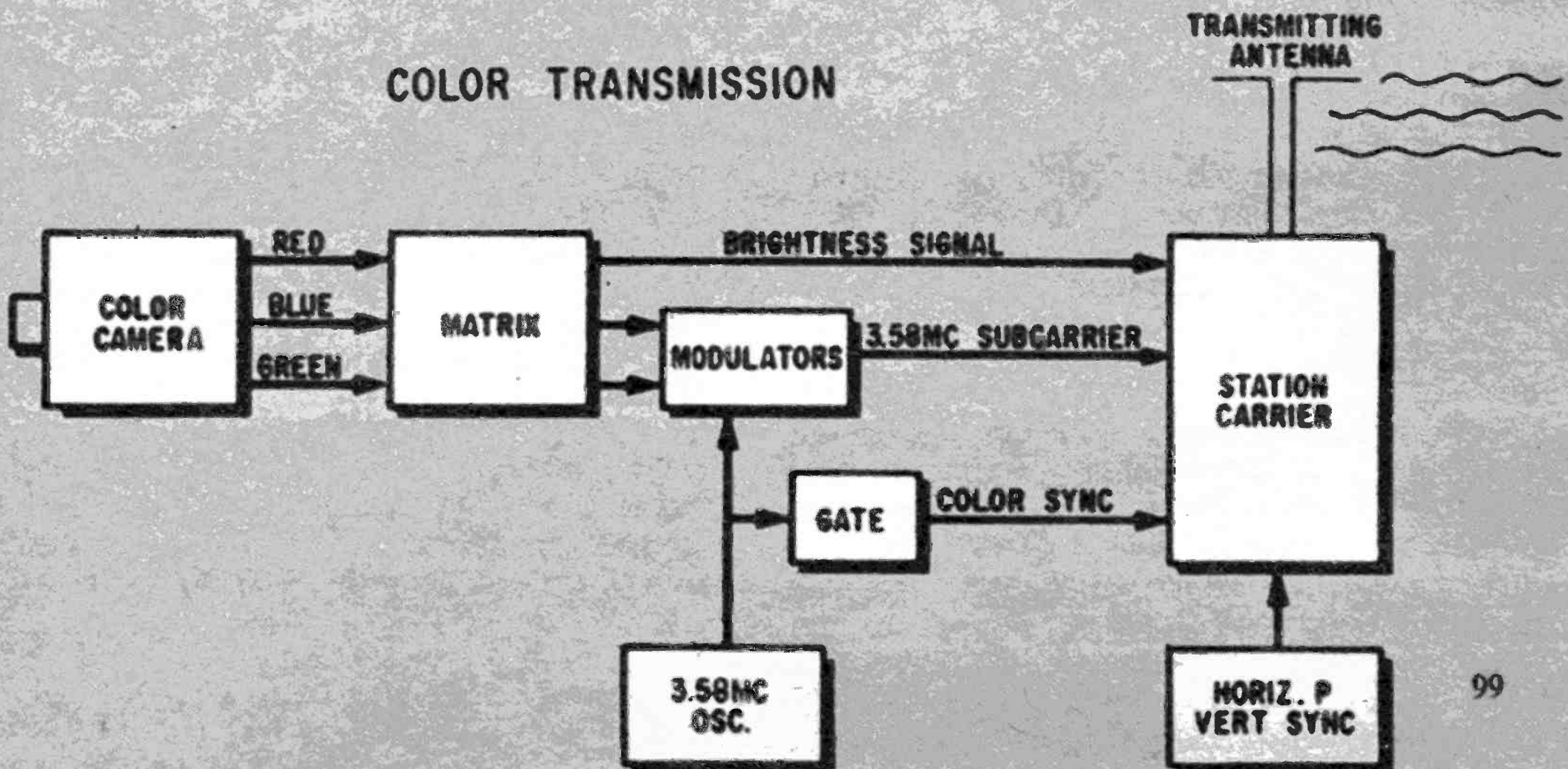

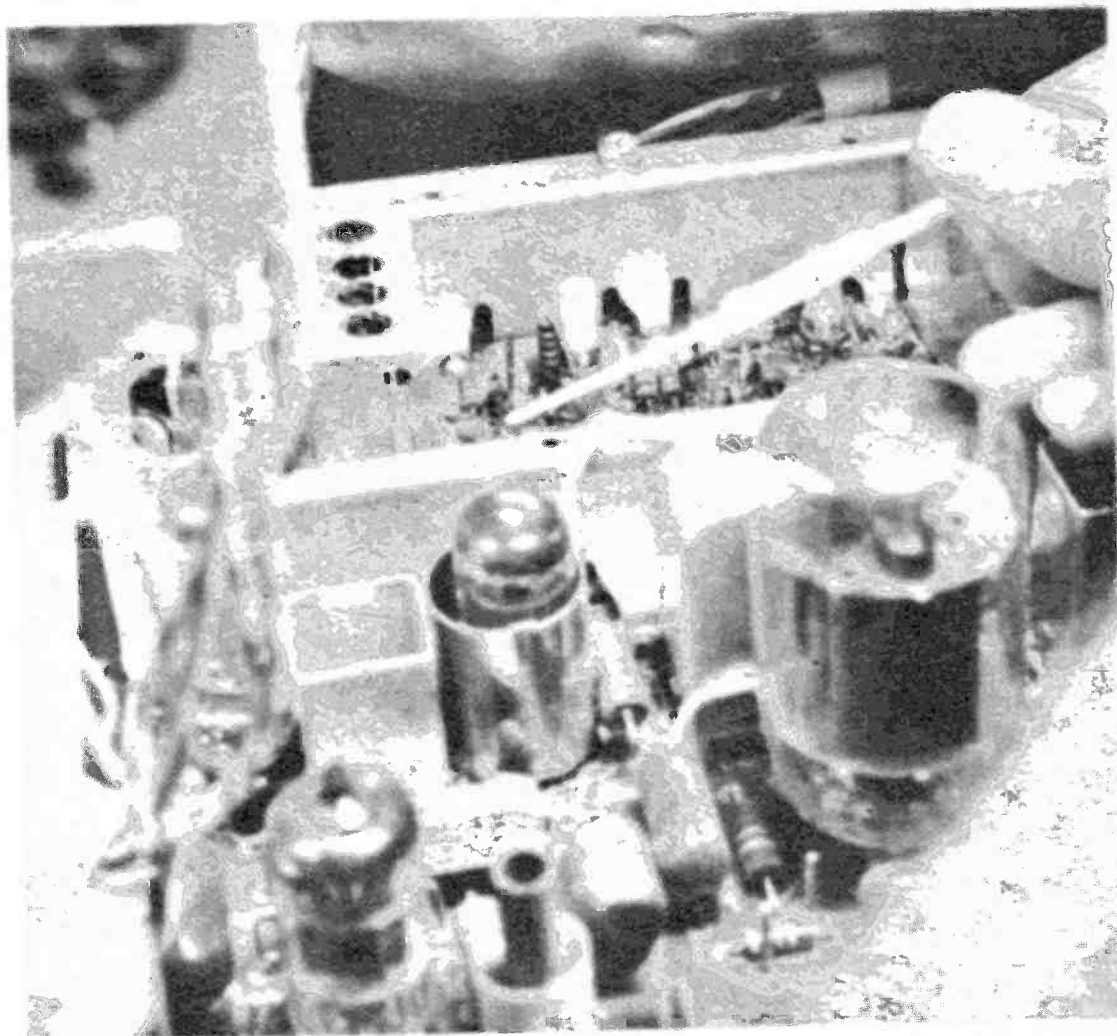
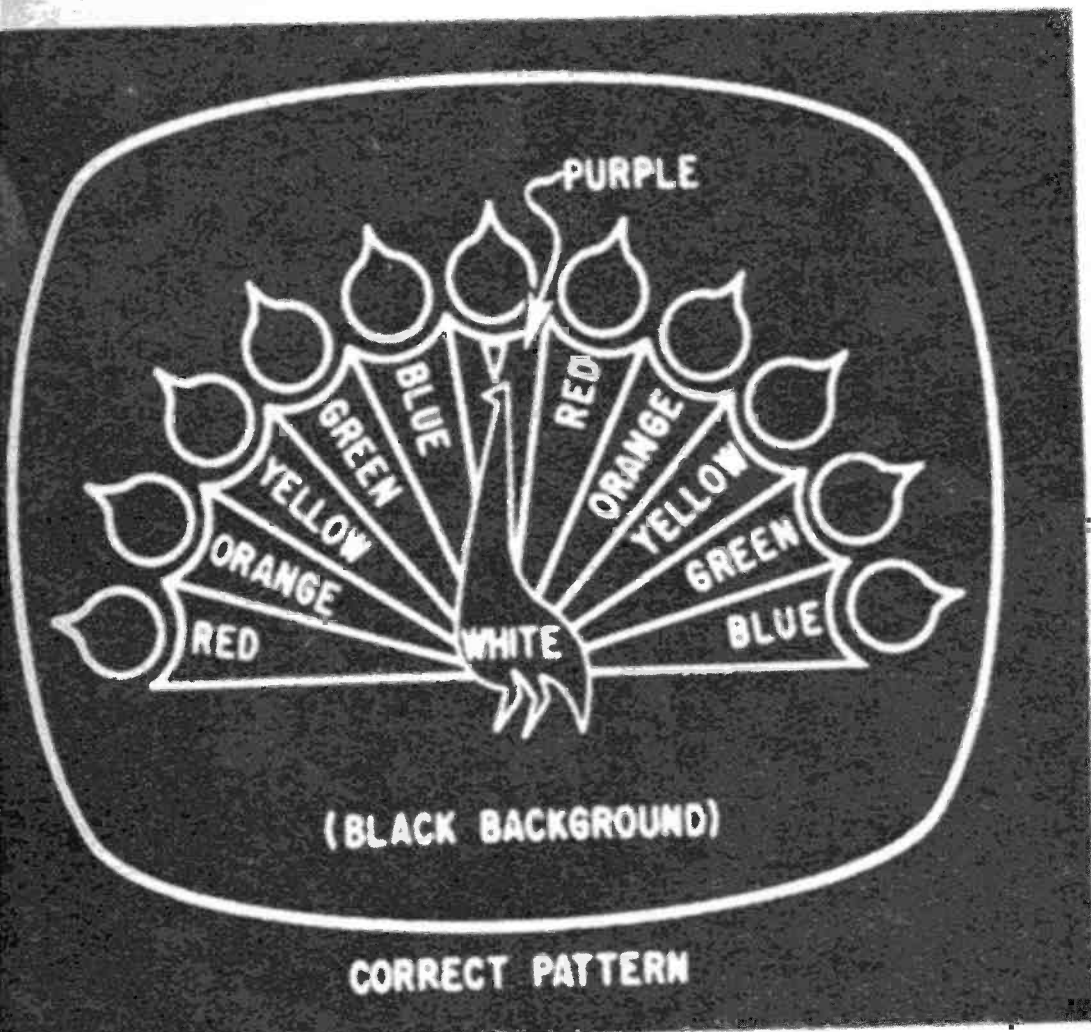

When the peacock comes on with no colors or weak colors, it indicates color tubes should be tested.

Some new color TV's have transistorized tuner and IF stages. Leave servicing for skilled hands.

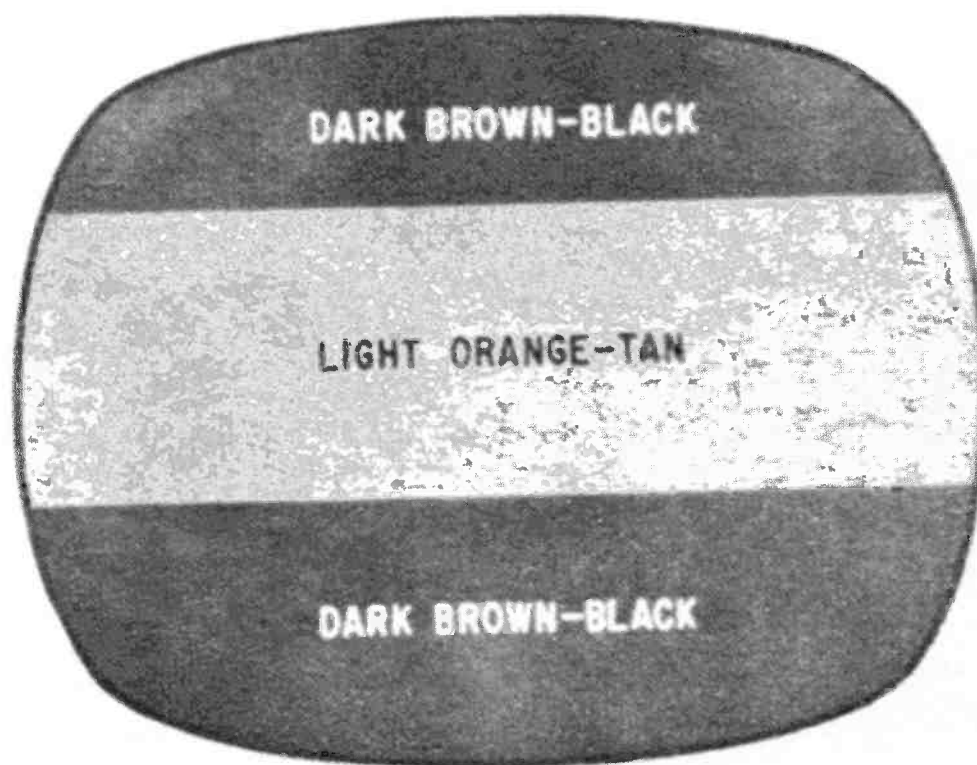
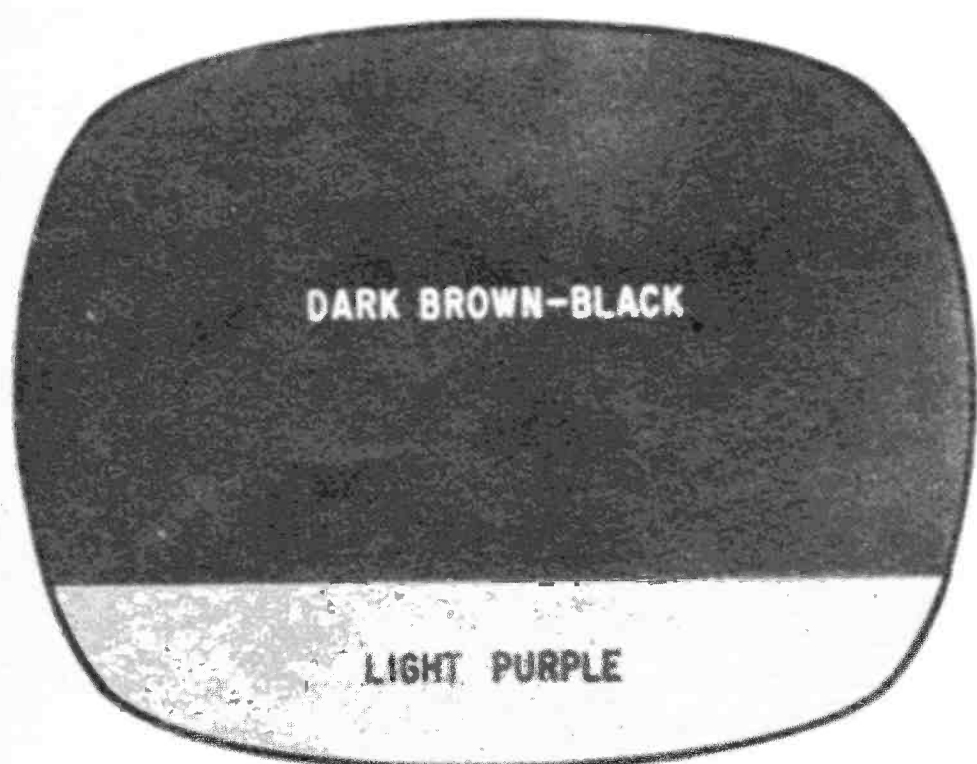

Hum bars occur from heater-to-cathode shorts in the signal path circuits. Replace the offending tube.

justing the color level control has no effect.

The prime suspect is the BANDPASS AMPLIFIER since its job is initial amplification of the color sidebands. Next in line are the 3.58 MC OSCILLATOR, BURST AMP and BURST KEYER. If the oscillation gets off frequency, the color killer gets the impression there is no color sync and shuts down the bandpass amplifier. Last suspect is the COLOR KILLER since it has the ability to turn the bandpass circuit on and off.

Should the color be missing on one or more channels, but appear on others, you have a variation of the no color symptom. In these cases a check of the antenna system is indicated. Then a testing of the RF AMPLIFIER, MIXER-OSCILLATOR and IF tubes.

WEAK COLOR—When your colors get weak the degrees of the symptom is a dull red instead of a vivid one, to a washed out picture that almost looks black-and-white except for the fact that the sky is a dull

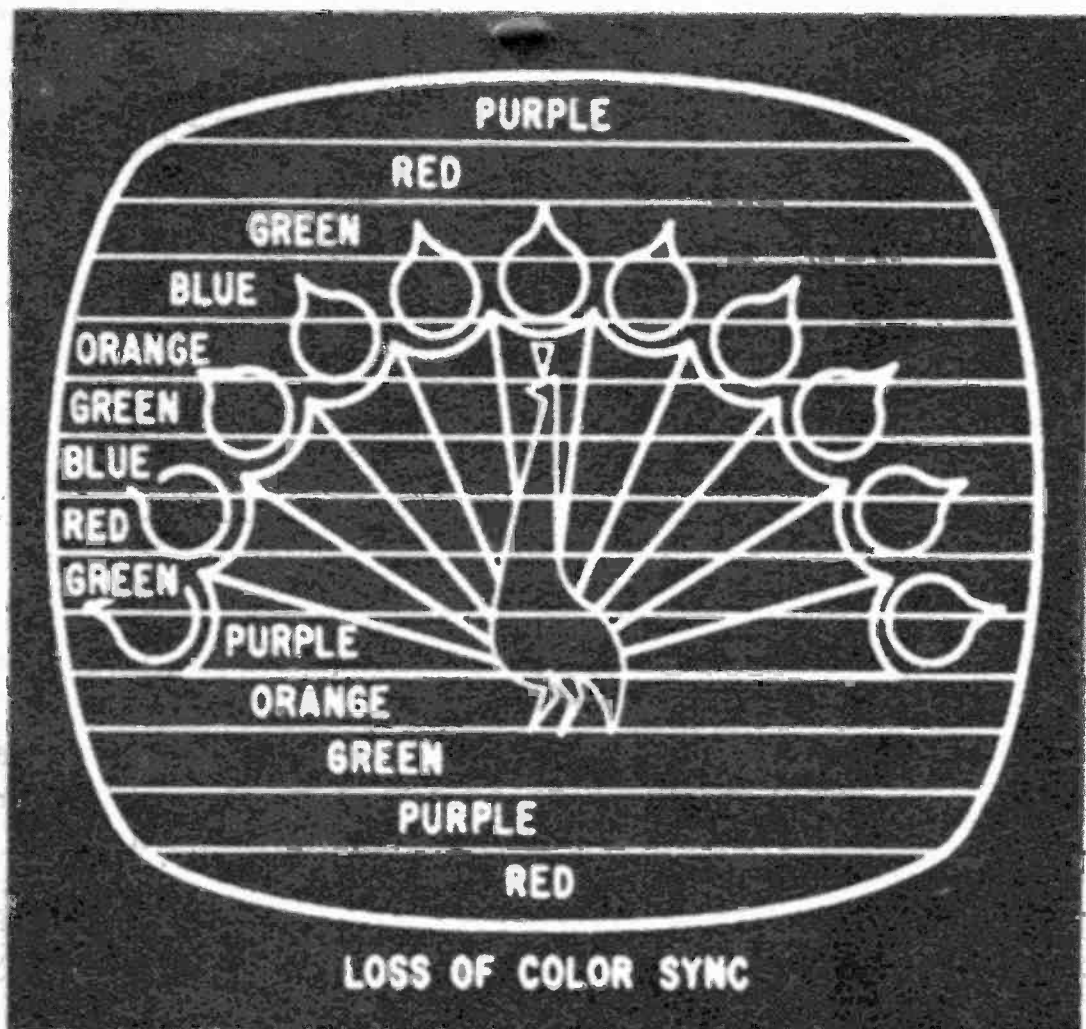

When you lose color sync the colors will lie in horizontal stripes or roll through the picture.

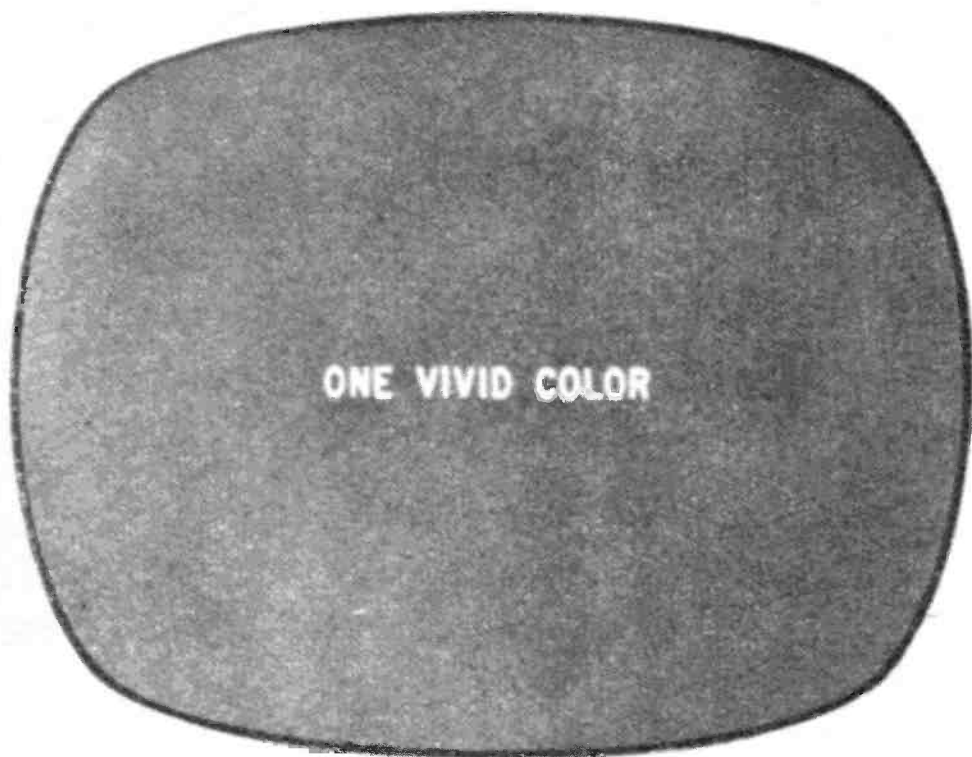

When a color difference amplifier goes bad, its respective color vividly dominates the screen.

blue and flesh tones have a slight naturalness to them.

Most of the time this trouble is caused by poor response in your antenna system. A new antenna head or new lead-in wire, or both, will probably cure the trouble.

The second most likely suspect is the RF AMPLIFIER tube, then, the IF strip tubes. Next, try the MIXER-OSCILLATOR, VIDEO amplifiers and the BANDPASS AMPLIFIER.

Before skilled help is called, a final test of the other color circuit tubes might help.

NO COLOR SYNC—When your colors go out of sync, the black-and-white picture remains firmly in place. The colors in the picture show up as horizontal stripes across the screen. They could be still, or shimmer from top to bottom.

During such a seizure test the BURST KEYS, BURST AMPLIFIER, 3.58 MC OSCILLATOR and REACTANCE tubes. One of these will probably cure. If not, test the DEMODULATORS and the G minus Y, B minus Y, and R minus Y. If that doesn't do it, the color sync is out of control and it's time to call for a professional trouble shooter.

ONE VIVID COLOR—Should your TV picture suddenly go all red, all green, all blue or all yellow, etc., that particular electron gun or guns are running wide open. For instance if it's red, the red gun is wide open. If it's yellow both the red and green guns are wide open.

Test the color-difference amplifier that the color indicates. If it's red, test the R - Y amplifier. Should it be yellow, test the R - Y, G - Y amplifier. And so on.

This trouble might look similar to the gray scale adjustment trouble discussed in the preceding chapter. There is a difference though. When one of the amplifiers goes, the screen will go vivid. When the gray scale adjustments are slightly off, the screen is just tinted slightly.

HUM BARS—Our familiar heater to cathode leakage can occur in color TV tubes, too. If there is any leakage or shorts in the RF AMPLIFIER, MIXER OSCILLATOR, IF tubes, VIDEO AMPS or OUTPUT or any of the color tubes, colored hum, that you can see, can appear on the screen. Replacing the offending tube will cure the trouble.

ONE COLOR MISSING—Should your color picture still have vivid colors, but one of the colors disappears, it's a bit tricky to analyze. When you lose green, your color and black-and-white picture changes to shades of blue, red and purple. When you lose red, your picture changes to shades of blue, green and cyan. When you lose blue, your picture changes to shades of red, green and yellow. First step is to try to restore the gray-scale adjustments (see Chapter 14). Then try the B - Y, G - Y, R - Y color difference amplifiers. Look at the neck of the picture tube to see if one of the three guns is not lit. If these two measures don't pin the trouble, you probably have a bad picture tube even though all three guns are lit. *



There isn't much you can do about interference from an electric shaver except wait until you're done.

Getting Rid of TV Interference

ONE GOOD THING you are paying for in a new color TV is extensive IF trappings. These additional tuned circuits make the color TV less interference prone which is quite a blessing. I've seen black-and-white TV's sitting next to a color TV with the monochrome pictures all but washed out while the color set wasn't affected at all.

However, when interference does appear in color, it's more annoying than on a black-and-white TV. What interferences appear where? What can be trapped out? What can't be helped? Let's start from the beginning.

There are two major kinds of TV interference. The first is RF Interference in which your TV tunes in radio frequencies (RF) just like any other channel you set it for. The second is Erratic Interference which appears on all frequencies. It is rough to get rid of.

RF Interference

This is a type that can be trapped out in varying degrees. Let's examine the different types your TV is prone to.

920 KC BEAT—This is the latest kind

and is a direct result of color TV. The sound carrier and the color subcarrier in the TV signal are set exactly 920 kilocycles apart. Whenever the sound is heard, its carrier mixes with the color. This 920 KC beat appears on the TV screen as a slight, to bad, herringbone interference in the lighter parts of the picture.

The main thing you need to cure this condition is a good color antenna. Good gain increases the signal to noise ratio and simply rejects the 920 KC beat. Also, you could orient your antenna to different directions. There might be one direction that is best for 920 KC rejection.

Other than that you'll have to judiciously adjust the fine tuner to the best spot. It's somewhere between complete loss of color and loss of picture to the sound bars. It's the nature of the beast.

Should you see little bits of the 920 KC beat in the black-and-white picture, around small objects, you have a slightly different condition. To cure this condition adjust the Color Killer control till the condition just disappears.

CO-CHANNEL INTERFERENCE: As the name implies, this is interference from



This interference is caused by color broadcast; is cured by getting a stronger signal in TV set.



Bouncing waves of a distant TV station pushing your local channel off the air cannot be helped.

Interference of the next channel on dial pushing onto desired channel can be helped with a stub.

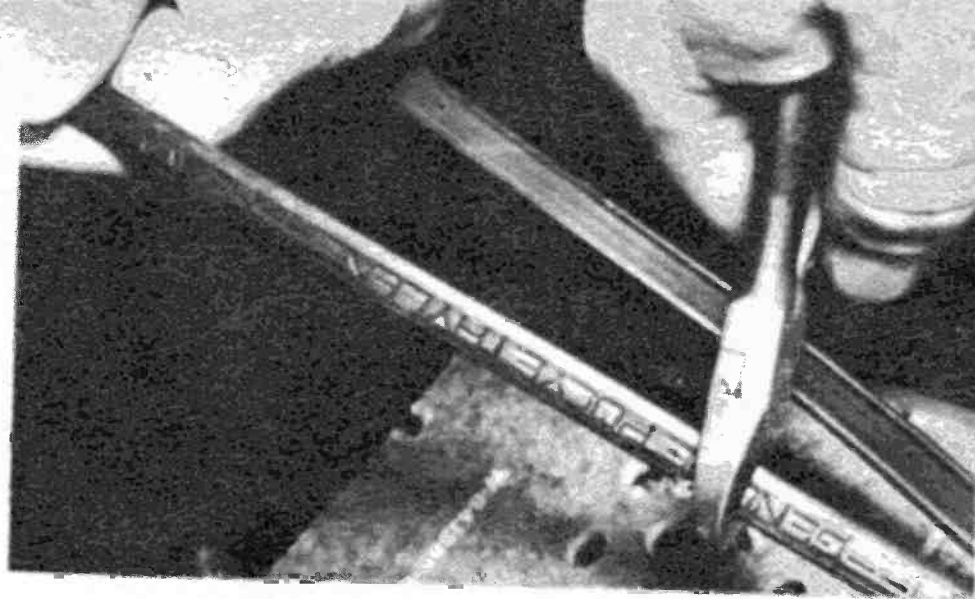

Locate the best length for a stub by watching TV picture on screen and shorting out the stub wire.

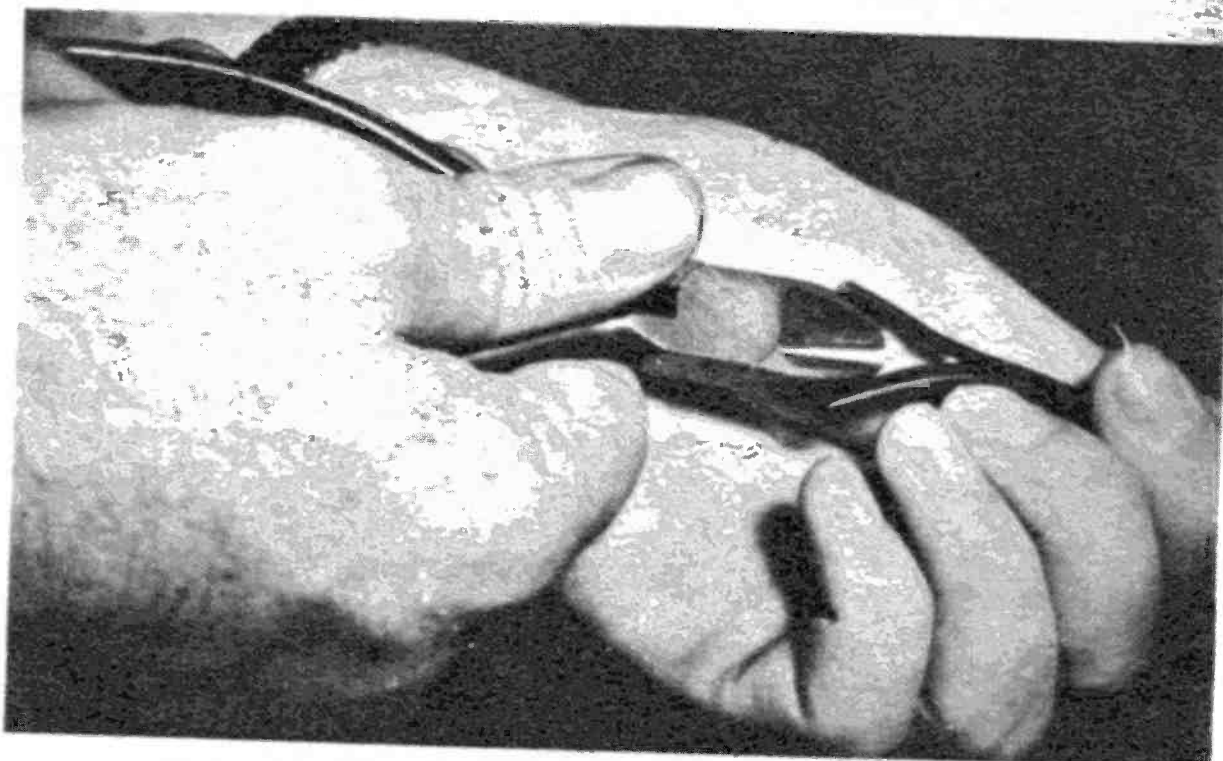

Once you have the stub length, cut wire slightly longer to accommodate the wire that will short.

a channel with the same frequency. For instance Channel 4 in Miami could possibly interfere with Channel 4 in New York, if the atmospheric conditions are correct.

The interference could be only lines or ripples in a moderate case, or, in an extreme situation your local channel can be pushed off entirely with a strange snowy picture taking its place. How is this possible?

TV carrier waves normally travel in a straight line of sight path. This gives the carrier an effective range of about 30 miles according to terrain. (Range can be increased by using principles described in the antenna section, Chapter 7.) All other transmitted energy that misses the earth travels on out to space and is dissipated. The 30-mile range was deliberate and permits many channels, with the same frequency of 2, 3, 4, etc., to function without interfering with one another. However, atmospheric conditions sometimes conspire against this well-laid plan.

There is a layer of atmosphere in the sky starting at about 50 miles, on up to about 250 miles, called the ionosphere. The layer between 50 and 80 miles is called the "E" layer. In this region, the air molecules are more sparsely spaced than at low levels,



You can purchase an RF trap that will work just like a stub and even tunes for best trap point.

yet not as sparse as at higher levels. They are just close enough together to become heavily ionized by cosmic ray bombardment, yet not close enough to collide and lose the ionization.

The E layer affects RF energy by bending the transmitted waves back toward earth. Most of the time there is not enough bending of TV waves to cause any ill effects. However, during certain atmospheric coincidences that occur a few times a year, the E layer becomes extra heavily ionized. Then it reflects a lot of the TV waves. The waves can bounce back and forth between the E layer and earth, traveling thousands of miles.

Co-channel can come from any distant station no matter how far, but the strongest type usually comes from a station about 400 miles away. It will shove your local channel off your TV screen. It's known as sporadic E skip. What can you do?

Sit down and wait till it disappears. Try to enjoy the novelty of the phenomenon. It usually doesn't last too many days.

ADJACENT CHANNEL INTERFERENCE—Not to be confused with co-channel, an adjacent channel is the one next to it, not the same one. The TV interference caused by it happens when your TV begins picking up the adjacent channel in addition to the one you have it tuned to.

The victimized channels in our area between Philadelphia and New York are 4 and 11 from New York. Channels 3 and 10 from Philadelphia keep interfering with them. The TVI appears as a writhing herringbone pattern on top of 4 and 11. On



A truck outside your door revving its motor can disturb your TV reception in this drastic way.

occasion, a weak superimposed picture appears moving quickly with the horizontal blanking bar, giving a "windshield wiper effect."

There's a good reason why Channel 3 and 10 interfere with 4 and 11 respectively. The audio portions of 3 and 10 are only 1.5 megacycles below the lowest frequencies of 4 and 11's picture information. This is closer together than the sound and picture are on any one channel taken by itself. The sound and picture on all channels are 4.5 megacycles apart.

Most TV's are not able to tune close enough to keep the sound of 3 from the picture of 4. The sound thus appears as a herringbone overlay. If the channel is strong enough, then it also wipes the windshield. Channel 10 does the same thing to 11.

There are commercial traps on the market that can be installed. One trap is tunable from Channels 2 through 6, while another is tunable from 7 through 13. They cancel out the channel you tune them to. For example, if you want to rid 4 of 3, tune the trap to 3.

RADIATION FROM YOUR SECOND TV—As people get two or more TV's per home, this type of TVI becomes more common. You'll notice it one night when one of your channels washes out to a more or less degree.

In every TV (as we covered in the tuner section, Chapter 8), there's a local oscillator. The oscillator runs at the frequency it is tuned to, plus the IF. With a 44 MC IF, the oscillator will run 44 MC above the channel you selected. In many TV's this

oscillator frequency can leak out and radiate. This can cause TVI to nearby TV receivers that become tuned to the oscillator's frequency. This happens easily.

Suppose for instance, your children are watching Channel 3. Three's carrier wave is 60 to 66 MC. This means the oscillator is running 22 MC higher or between 82 and 88 MC. Channel 6 transmits between 82 and 88 MC. If you tune your TV to Channel 6, your TV is going to pick up the kids' TVI. According to the strength of the radiation, the interference will be slight or will wash out the picture altogether.

What to do? Relocation of one or both of the TV's will cure the condition. If this remedy is to no avail, you'll have to install another RF amplifier stage to block off the radiation. These are called signal boosters and will kill spurious radiation from an offending TV.

DIATHERMY, ELECTRONIC HEATERS, ETC.—There are many different electronic instruments in common use today. In the main, they are very well shielded and cause no appreciable TVI. However, you might be unlucky enough to be in a position where this is not true. Should you be constantly annoyed with some type of RF interference, it will appear on your screen as herringbone stripes or overlays. To trap it out is going to be a tedious job of trial and error.

You're going to have to try a number of traps, installed between the antenna lead-in wire and the antenna terminals. The trap that rids you of the TVI is, of course, the one to install permanently.

For best results, rather than install it at the antenna terminals, install it as close to the tuner input as possible. The closer you get to the tuner, the less lead-in will pick up TVI after the trapping.

A convenient homemade RF trap can be made out of lead-in wire. Cut off a piece about three feet long. Attach one end right on top of the lead-in from the aerial. Then short out the stub every few inches, watching the picture full of TVI at the same time. The spot that is best, cut and short.

A word about hams: The amateur radio operator is usually blamed for all TVI from auto ignition to sporadic E skip. Mostly he is not at fault.

True he is on the air and it's possible for you to pick up his transmission. Usually though, any pickup is due to poor alignment or trapping in your TV. A high pass filter at his frequency, installed at your antenna input, will usually make up the deficiency in your TV.

If the signal still comes in, contact the

This Free sample lesson can start you on a high-pay career as **ACCOUNTANT, AUDITOR or CPA**

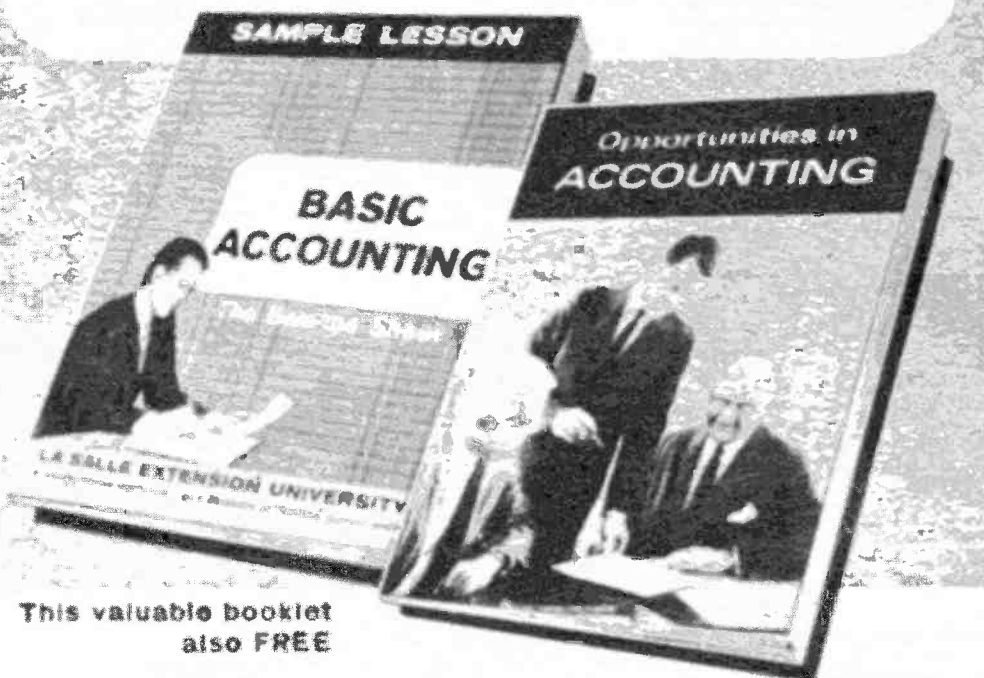

This valuable booklet
also FREE

THE demand for trained Accountants far exceeds the number available. Salaries keep going higher, promotion come faster. Why remain in a dull job with insufficient pay when you can qualify easily—in your spare time—for the big rewards offered to the Accounting-trained man?

To prove this to yourself, send for the interesting sample lesson which demonstrates the remarkable LaSalle method of home training. This lesson is yours free of cost or obligation. It will show you how you are guided step by step through actual Accounting work...how you learn by doing...how thoroughly you are prepared for every Accounting task you will be called upon to handle in the business world.

No previous experience required

LaSalle's distinguished faculty of expert Accountants and CPA instructors starts you right at the beginning...then supervises, corrects and grades your work all the way. The cost is remarkably low.

For over half a century, LaSalle has been a world leader in business education. It has provided training to more than 1,000,000 ambitious men and women. That is why a LaSalle Accounting diploma is respected by employers. Mail coupon for free lesson and "Opportunities in Accounting" booklet.

LA SALLE EXTENSION UNIVERSITY
A Correspondence Institution

417 S. Dearborn, Dept. 58-060, Chicago, Illinois 60605

Please send me your sample lesson and free illustrated booklet "Opportunities in Accounting"

Name Age

Address
City & State

County Zip No.

Occupation Working Hours.... A.M.... P.M.

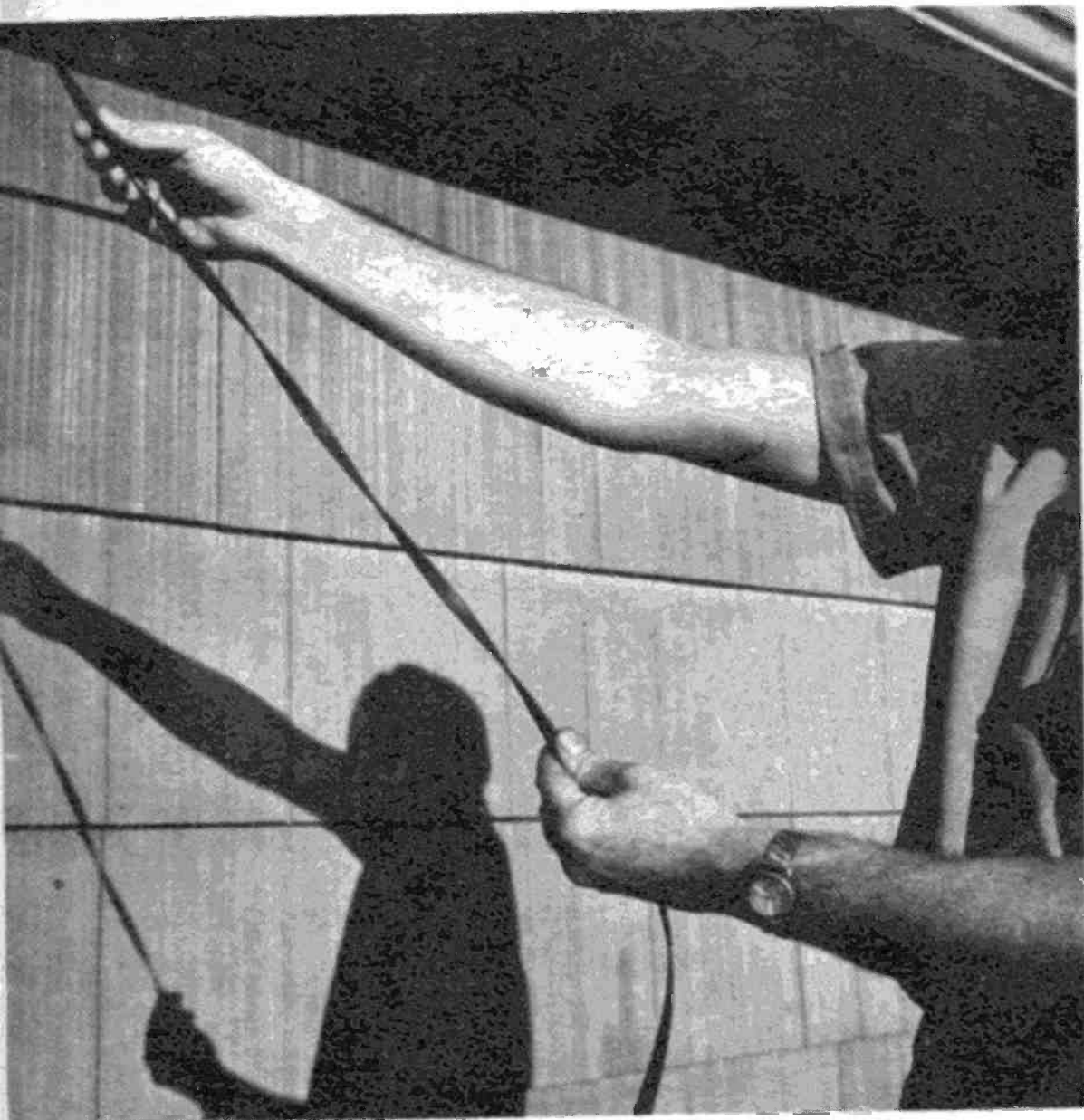

To reduce ignition type of interference, twist the antenna lead-in like this, or install coax cable.

amateur and tell him how you are receiving his signal. I've never met a ham who wouldn't be happy to help cure your TVI whether he has a hand in it or not.

Erratic Interference

This is the other major type of TVI. It includes all sparking, leaking, poor wiring, etc. It's rough to get rid of. Let's go through the major types and their cures.

LIGHT BULBS—Light bulbs are a major source of TV interference. They can cause trouble ranging from black horizontal jagged lines to three- or four-inch swaths of ripple rolling through the picture. Occasionally there will be a rippling stripe that looks like Barkhausen oscillation except that it is horizontal instead of vertical. This type of interference most often takes place around the frequency range of Channel 3.

In the interfering light bulb the filament cracks but doesn't break entirely. To the naked eye the bulb looks OK and lights as it should. Sparks fly across the crack in the bulb's filaments, however. The filaments resonate, because of the electrical energy expended, and they resonate at frequencies near Channel 3.

The resonating frequency acts like a carrier wave. The sparking modulates this carrier at 60 cycles per second. The TV picks it up just as if it were Channel 3 and ragged 60-cycle hum is seen and heard.

You repair this trouble by a process of elimination. Go from bulb to bulb while your set is acting up. Turn off each light switch or, if it's a multibulb fixture, unscrew the bulbs one by one. When the interference stops you have the culprit in your hand.

If none of the bulbs do the trick, check your attic. Repairmen have found bulbs burning in attics that people have had on, unknowingly, for years. If you still don't find it, politely check your neighbors' homes in the same way.

ELECTRIC APPLIANCES—TVI caused by electric shavers, mixers, vacuum cleaners and other appliances is very common. This type of interference is not radiated; it travels through the power line from the appliance to your TV set. While the TV power supply is designed to produce smooth DC from the 60-cycle AC line, it can't eliminate other erratic frequencies caused by appliance motors. These frequencies find their way into the circuitry of your TV receiver and produce static in the speaker as well as static lines in the picture.

The remedy is to install a filter, either at the source of the TVI or in the line of your TV receiver. AC line filters, designed to quell this sort of trouble, are available in most hardware and service shops.

DIATHERMY—This familiar type of interference is becoming less common since

This type of trap helps eliminate all kinds of interference that is coming in your antenna lead.

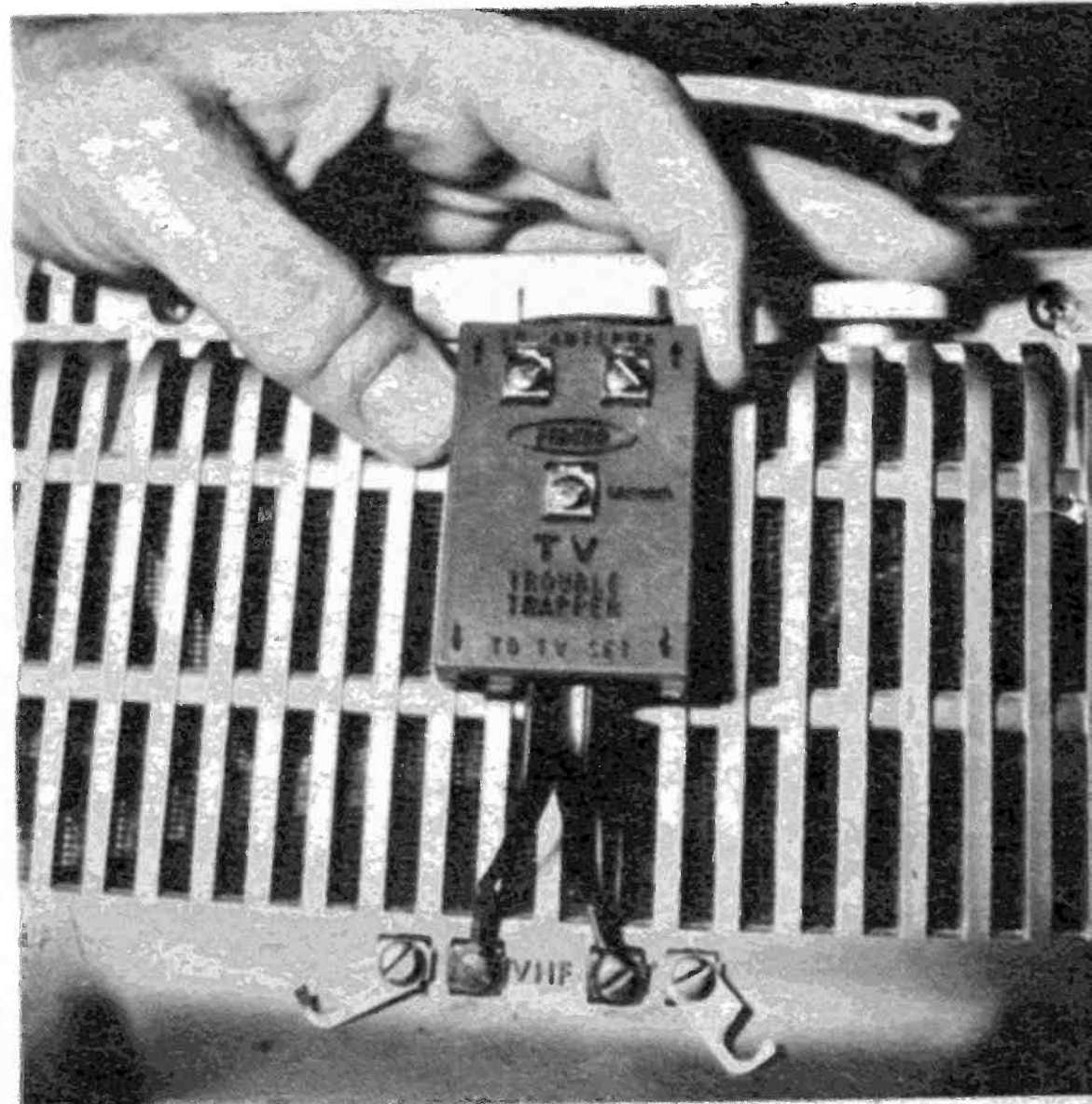

YOUR NEW COPY IS WAITING



FREE! For fun and pride in assembly, for long years of pleasure and performance, for new adventures in creative electronics mail the coupon below and get Conar's brand new catalog of quality do-it-yourself and assembled kits and equipment. Read about items from TV set kits to transistor radios . . . from VTVM's to scopes . . . from tube testers to tools. And every item in the Conar catalog is backed by a no-nonsense, no-loopholes, money-back guarantee! See for yourself why Conar, a division of National Radio Institute, is about the fastest growing entry in the quality kit and equipment business.

CONAR

MAIL THIS COUPON NOW

CONAR

JZ6C

3939 Wisconsin Ave., Washington 16, D.C.

Please send me your new catalog.

Name _____

Address _____

City _____ State _____ Z-Code _____

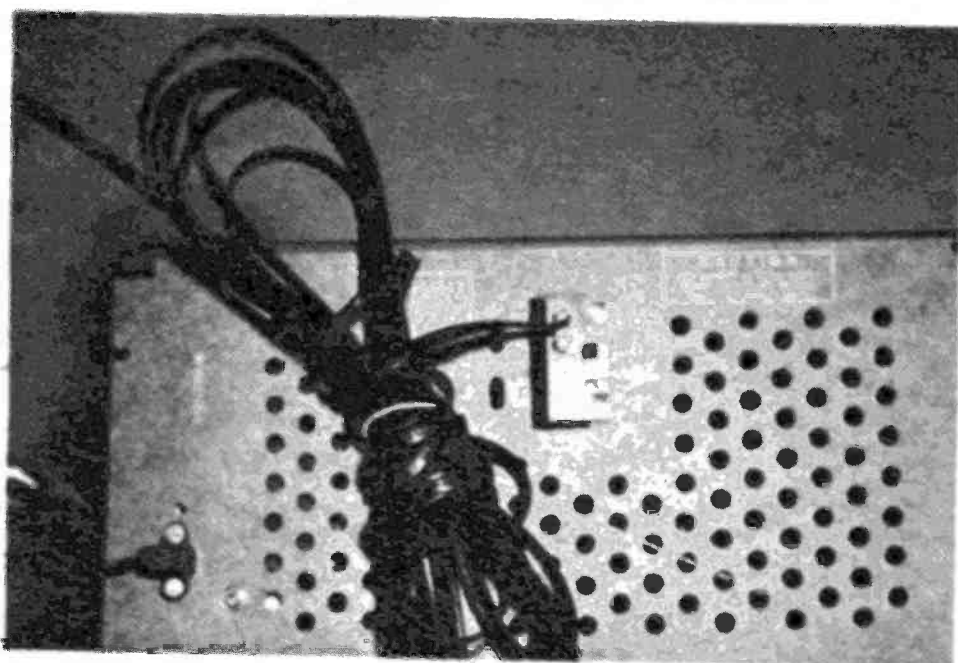

Cut off any excess lead-in wire. Don't leave a roll behind the TV. It reduces signal strength.

most diathermy machines have been rendered innocuous. There are still occasional cases, however.

In the old days, radiation from these machines put black bars into nearby TV sets. Today, for the most part, the interference is slight and looks like a horizontal herringbone stripe when it occurs.

If you know of a diathermy machine nearby, and you have reason to believe that it's causing trouble, you can cure the interference at your set if it's not too seri-

ous; simply install a high-pass filter at your antenna input.

AUTO IGNITION—The sparks produced by automobile spark plugs cause energy to be radiated by the car's ignition system. These pulses can be picked up by your TV antenna and find their way into the TV tuner where they are processed along with the TV carrier wave. Ignition noise appears on the screen as moving dots and in the sound as static. You can hear and see a driver gun or slow his motor with your TV set. If ignition noise severely affects your TV reception, there are several corrective measures you can take. One, since the energy is coming through the antenna, you can isolate the antenna from the street to cut down the interference. Check the location of your antenna. The best spot for low noise is as far away from the street as possible with the house forming a solid shield between the street and the antenna.

The antenna lead-in wire also has a tendency to pick up noise. If the antenna wire offers a flat surface to the interference it will pick up more of it. Run your lead-in wire down the side of the house away from the street and twist it a turn or two per foot. These measures will tend to cut down ignition noise. •



This 19-inch color TV portable is not small, it comes with a stand, and requires two men to carry it.

Tips on Portable TV's

The correct way to approach problems of repair on your portable TV set

ASK ANY TV dealer and you will find that 70 per cent of the number of televisions he sells are portable. Most of the rest are color. Almost everyone has a portable TV, or two. Some even portable color.

This change-over from large immobile television to easily moved TV saves you repair money. For these type of sets you no longer have to call for a TV repairman to come to your home. You can pick it up and carry it to the nearest TV shop for testing.

In fact, TV manufacturers have specified in their sales papers, a "carry-in guarantee."

The main difference between a console

TV and a portable is reduced air space. Although some economies are exercised, for the most part, all the circuitry that is in the console is in the portable. Smaller picture tubes and speakers might be used, but everything else is about the same.

The reduction in air space causes only one major problem. The mechanical approach. Taking the portable apart, putting it together, changing components and making adjustments is more difficult.

Some of the bolts and screws are set in at weird angles and require special tools like an offset hex-head wrench. The chassis can be mounted to the cabinet in a certain way that does not immediately

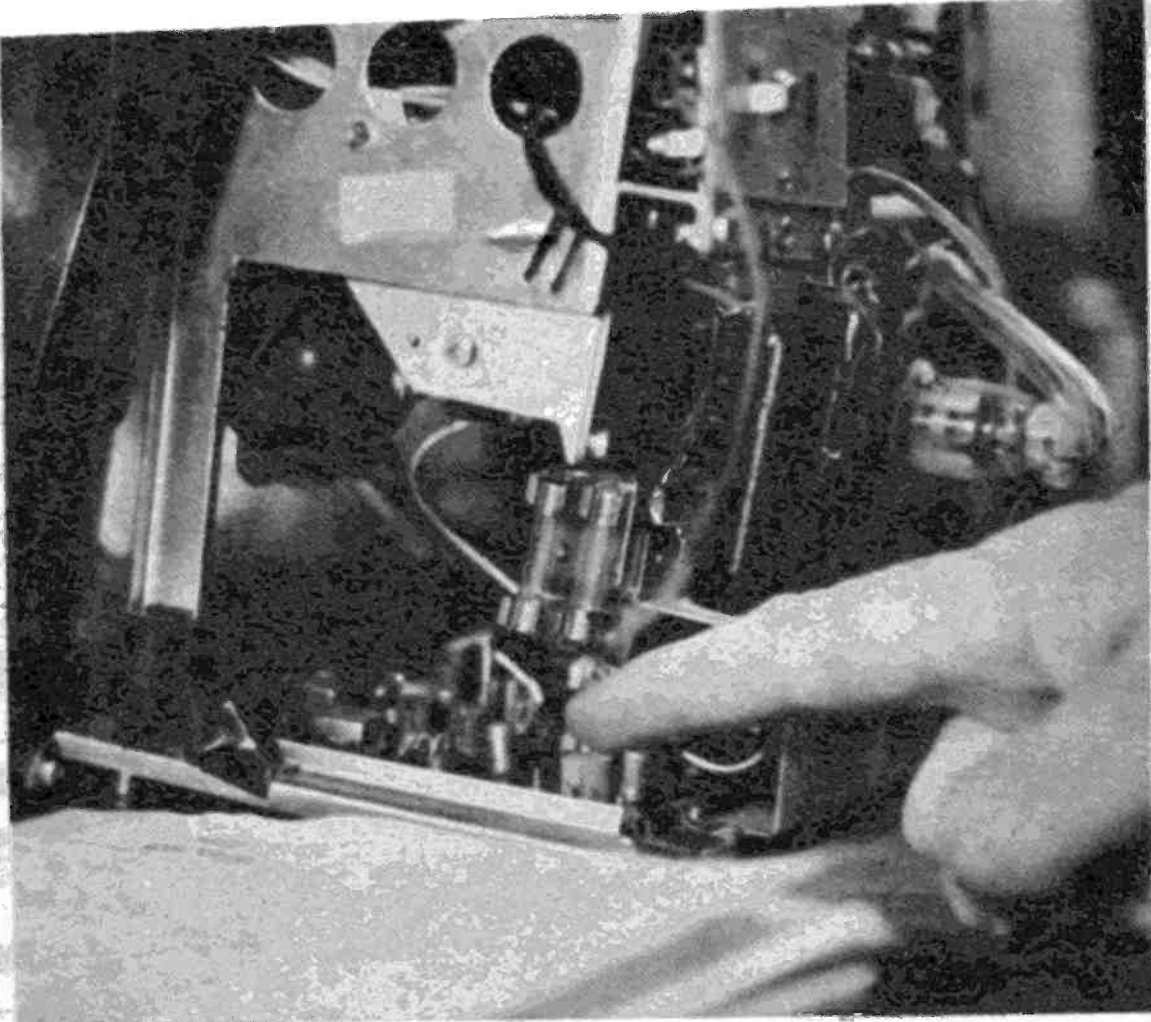

These tiny TV's are easy to carry but rough to repair; have only a high voltage and a CRT tube.

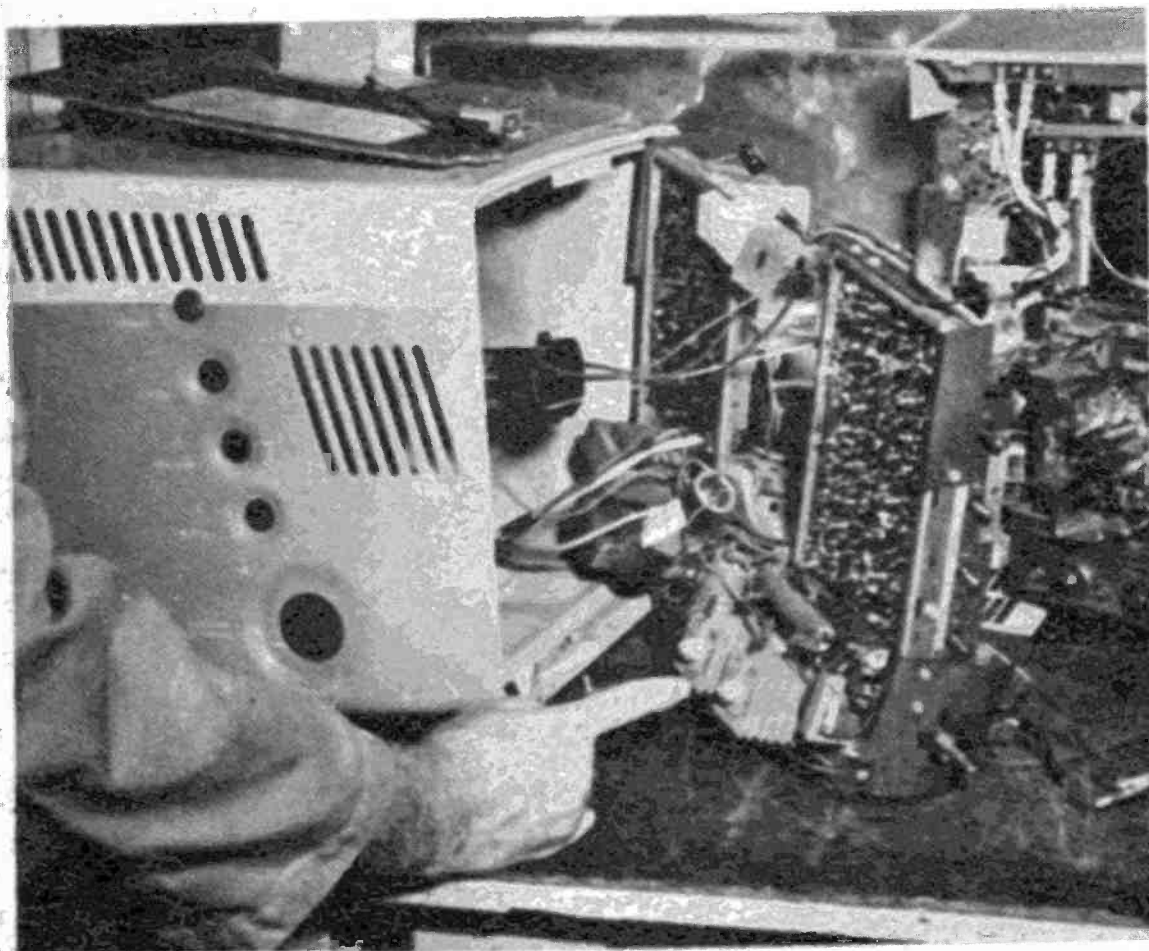

The mechanical approach of taking apart, putting together and changing the components is tougher.

There are only a few tubes in this portable, but each tube is complex and has numerous functions.

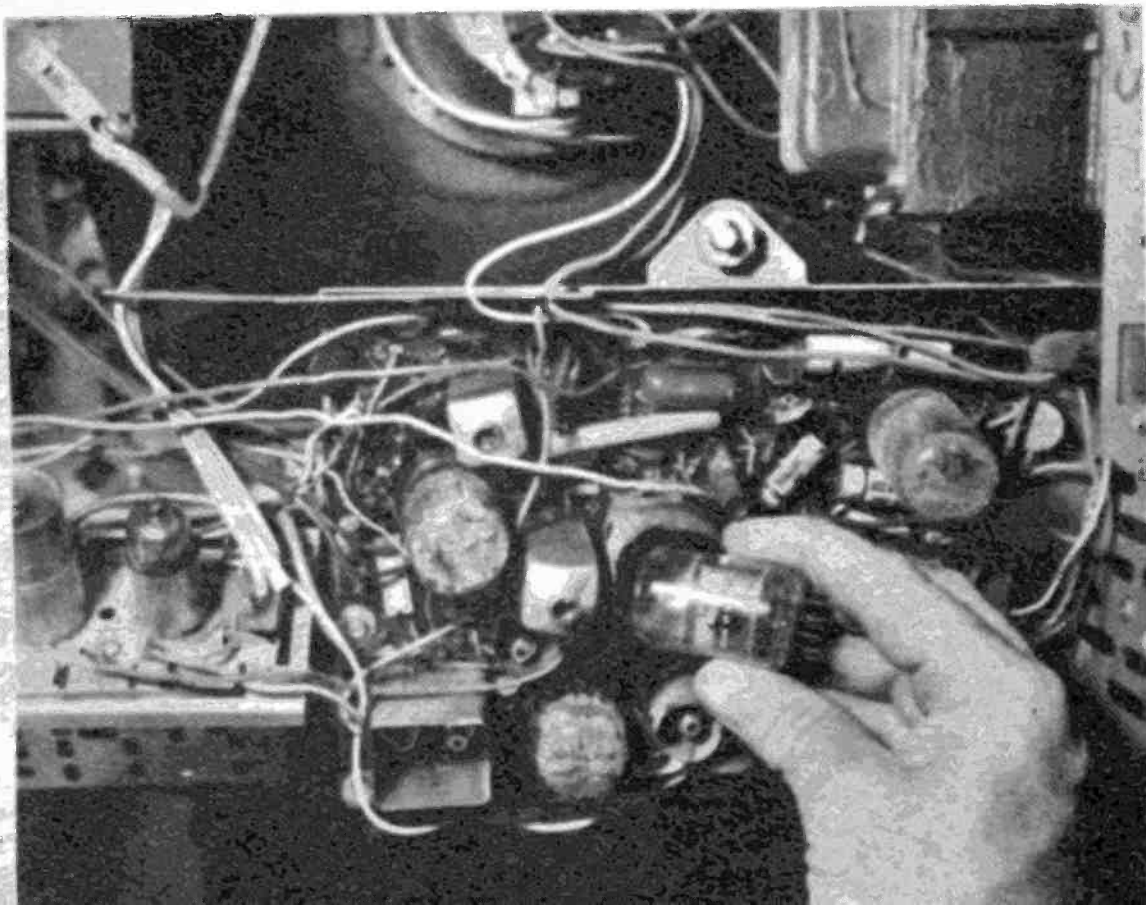

new...a dozen tools for dozens of jobs in a hip pocket set!



Really compact, this new nut driver/screwdriver set features 12 interchangeable blades and an amber plastic (UL) handle. All are contained in a slim, trim, see-thru No. 99PS-50 plastic case which easily fits hip pocket. Broad, flat base permits case to be used as a bench stand. Ideal for assembly and service work.

7 NUTDRIVERS:

3/16", 7/32", 1/4", 9/32", 5/16", 11/32", 3/8" hex openings

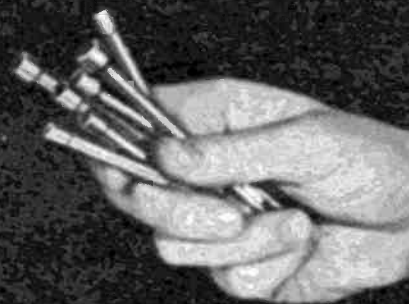

2 SLOTTED SCREWDRIVERS:

3/16" and 9/32" tips

2 PHILLIPS SCREWDRIVERS:

=1 and =2 sizes



EXTENSION BLADE:

Adds 4" reach to driving blades

HANDLE:

Shockproof, breakproof. Exclusive, positive locking device holds blades firmly for turning, permits easy removal

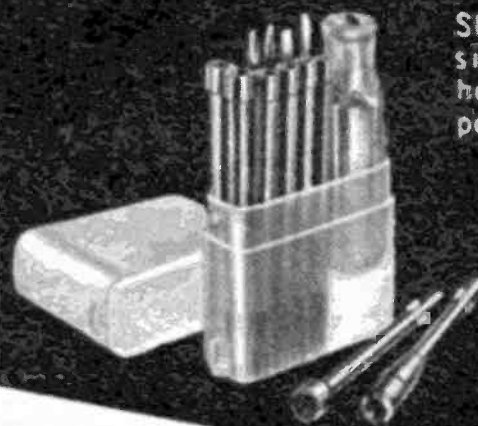

WRITE FOR CATALOG 162

XCELITE

XCELITE INC. • 78 BANK ST., ORCHARD PARK, N. Y.

Send Catalog 162 with information on 99PS-50

name _____

address _____

city _____

state & zone _____

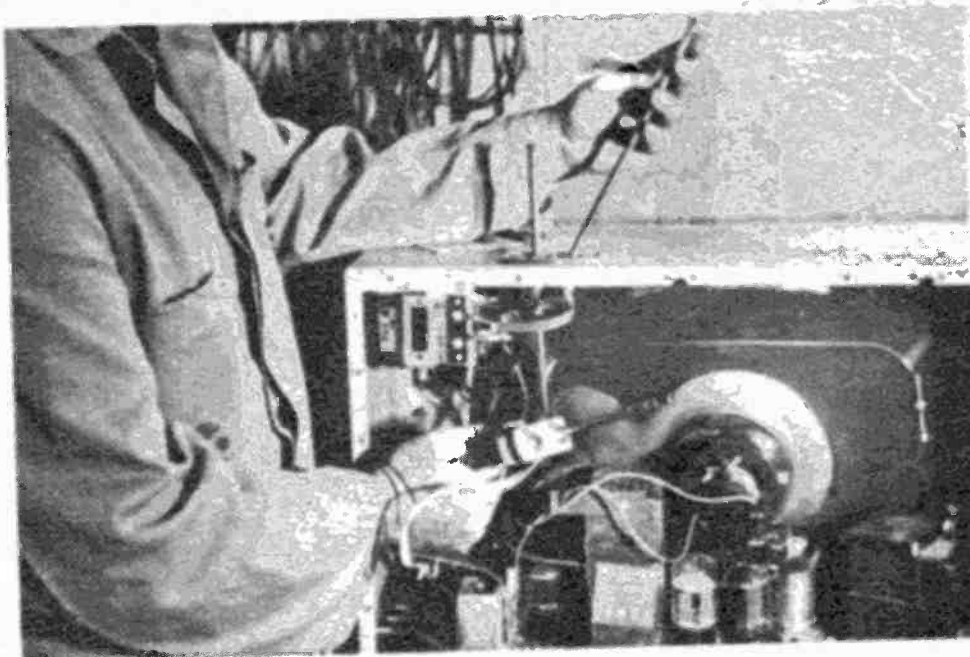
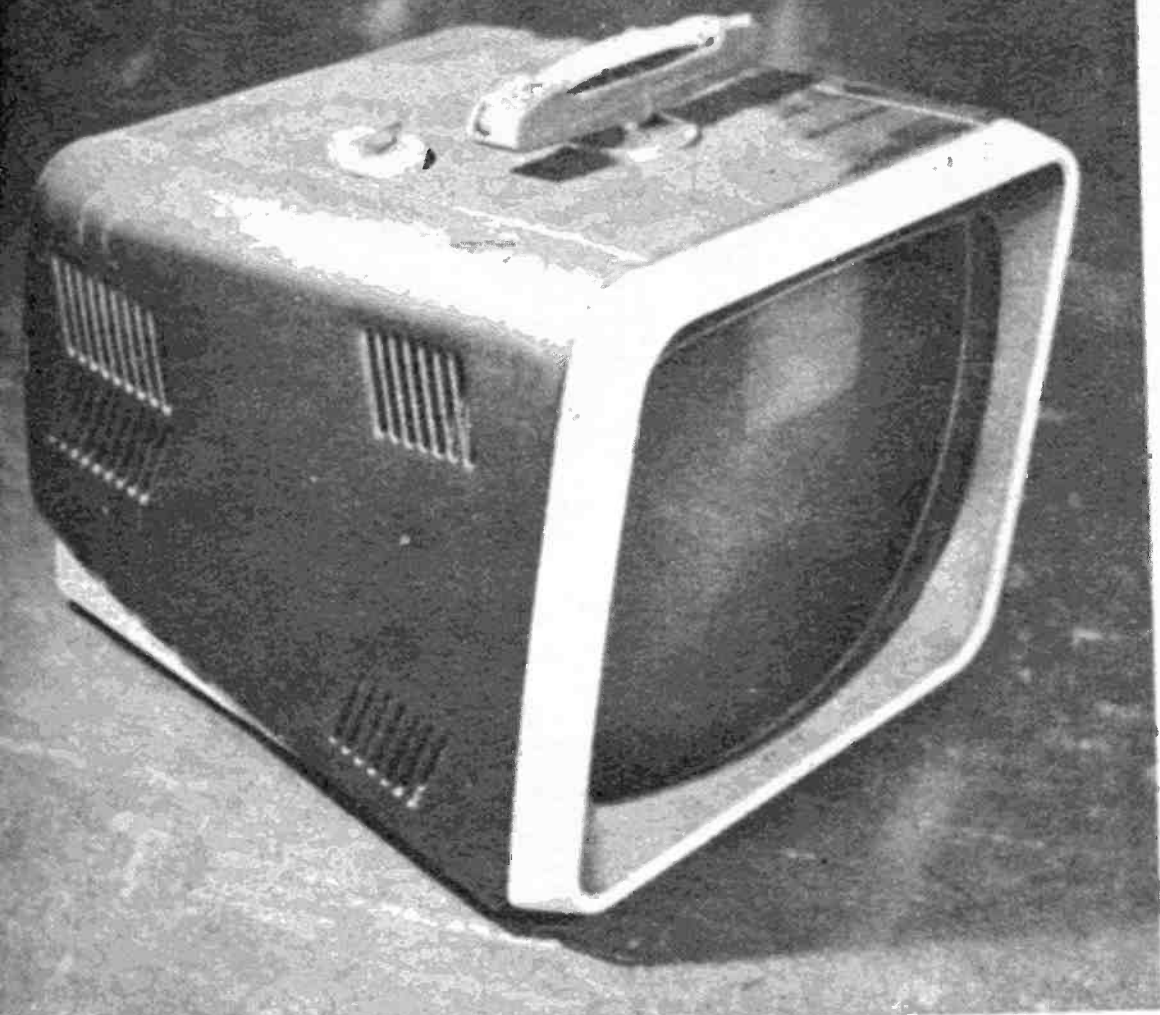

The most common portable-type breakdown is the built-in antenna. However, it is easy to replace.

Left, when portables first came out the long length of the picture tube necessitated a deep cabinet.

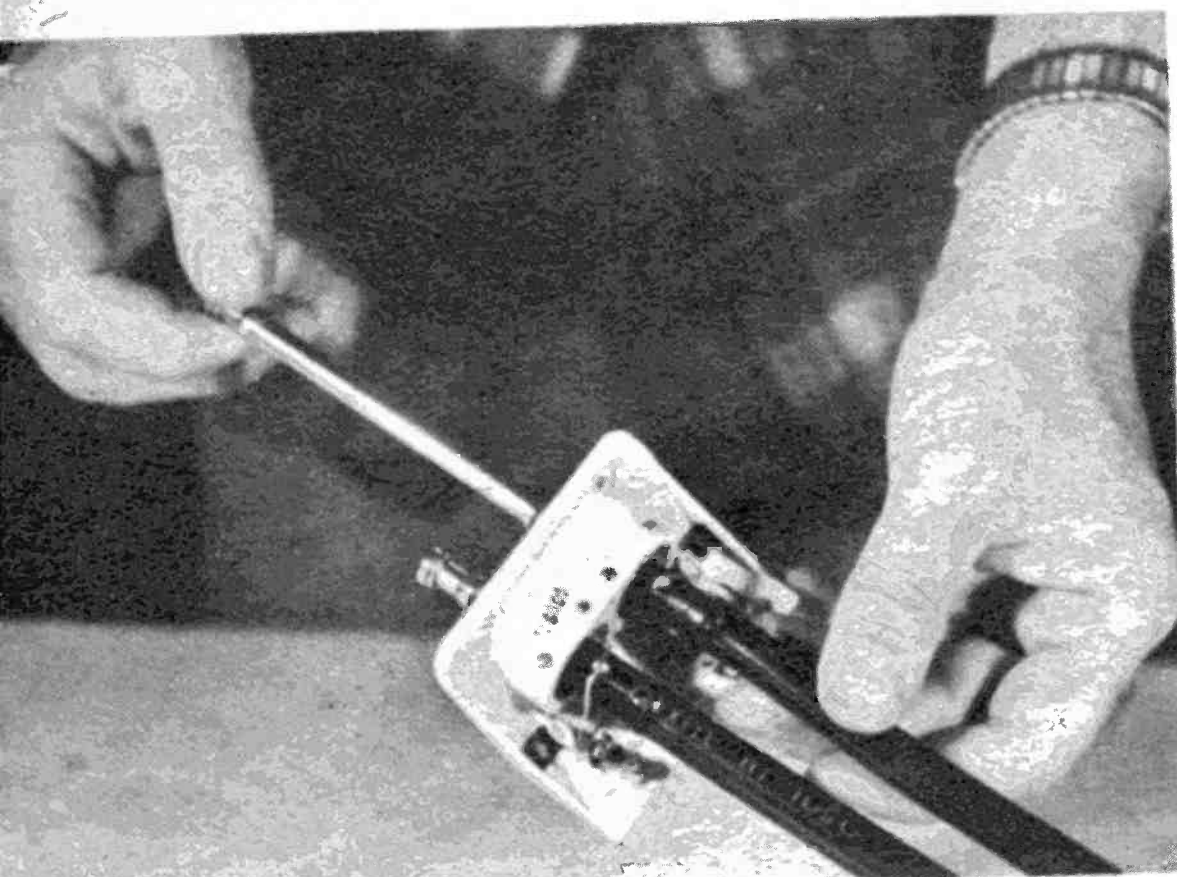

The antenna breaks easily if one tries to orient it without pulling it out fully from the socket.

The exact antenna replacements are usually readily available, but the units are quite expensive.

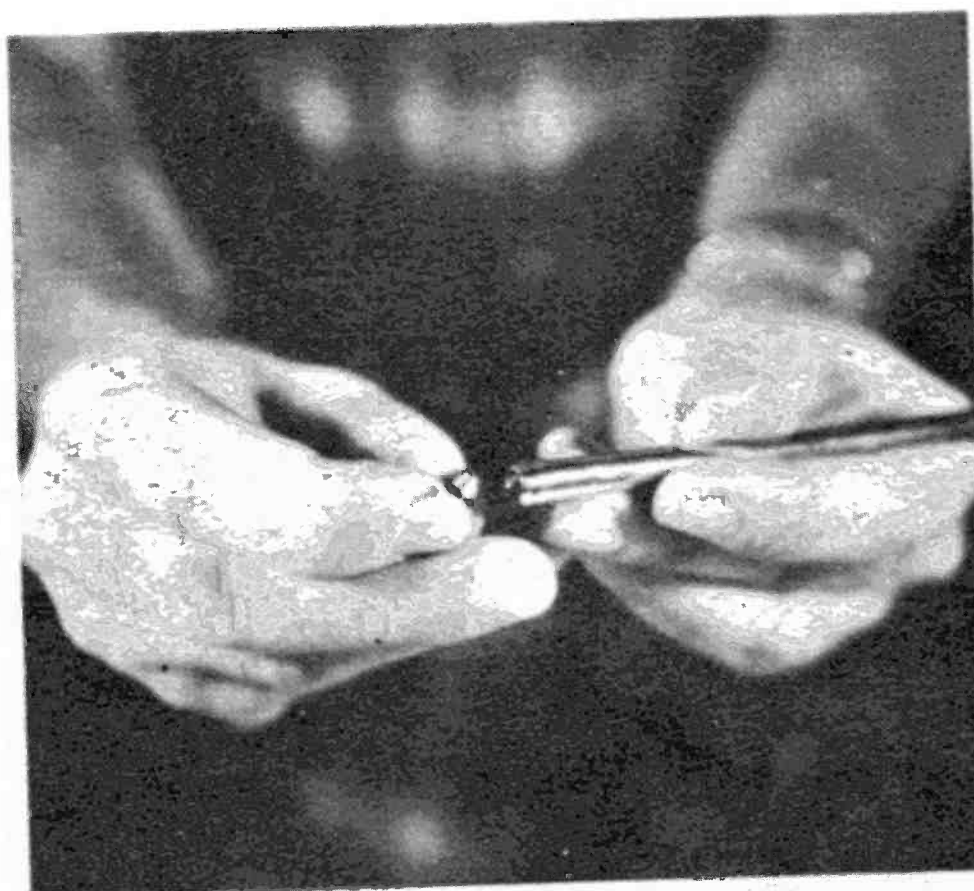

The replacement rods are universal, and package contains instruction on how to do the replacing.

hit the eye. As a result you can't get it apart neatly unless you have factory disassembly instructions.

Therefore, don't try too hard to pull them apart. Save the disassembly for the people with the correct tools and service notes, unless you happen to have these items.

Changing tubes can be just as easy or easier, since the number of tubes in a portable is at a minimum. Replacing transistors, however, is really a skilled type of job and should be left alone.

The most common casualty of a portable TV set is the built-in antenna. The main reason for their demise is: someone tries to orient the antenna without pulling the outermost shell of the telescoping unit completely out of the ball swivel. The an-



Abraham Marcus, co-author of famous best-seller
 "Elements of Radio" makes amazing offer!



TRY MY TV and RADIO REPAIR COURSE FREE FOR 1 MONTH

"If it hasn't boosted your spare-time earnings during that period, just return it and owe nothing!"

Here it is! The most amazing guarantee offered on any radio-TV course anywhere! We'll send you Abraham Marcus' course to use FREE for one full month! If in that time you haven't made more money fixing radios and TV sets, just return the books to us and pay not a penny!

Why do we make this sensational offer? First, because these books are so easy to use. They are written in the same clear, easy-to-understand language that made the author's "Elements of Radio" a 1,000,000-copy best-seller. Second, because these books get right to the point—tell you what to do in 1-2-3 fashion. For example, once you master the first few chapters of the TV book you are ready for business—ready to do service jobs in the field—jobs that account for over 80% of all service calls.

DON'T WAIT! You risk nothing when you send the coupon at right. You don't have to keep the books and pay for them unless you actually make extra money fixing radios and TV sets. Even when you decide to keep them, you pay on easy terms. Mail the coupon now.

WHAT YOU GET IN THESE 3 GIANT VOLUMES

ELEMENTS OF TELEVISION SERVICING, 2nd Edition. Analyzes and illustrates more TV defects than any other book, and provides complete step-by-step procedure for correcting each. You can actually SEE what to do by looking at the pictures. Reveals for the first time all details, theory and servicing procedures for the RCA 28-tube color television receiver, the CBS-Columbia Model 205 color set, and the Motorola 19-inch color-receiver.

RADIO PROJECTS. Build your own receivers! Gives you 10 easy-to-follow projects, including crystal detector receiver—diode detector receiver—regenerative receiver—audio-frequency amplifier—tuned-radio-frequency tuner—AC-DC superheterodyne receiver—etc.

RADIO SERVICING Theory and Practice, 3rd Edition. Here is everything you need to know about radio repair, replacement, and readjustment. Easy-to-understand, step-by-step self-training handbook shows you how to locate and remedy defects quickly. Covers TRF receivers; superheterodyne receivers; shortwave, portable, automobile receivers, etc. Explains how to use testing instruments such as meter, vacuum-tube voltmeters, tube checkers, etc., etc.



MAIL THIS COUPON

Prentice-Hall, Inc., Dept. 6864-M2
 Englewood Cliffs, New Jersey

Please send me Abraham Marcus' TV & RADIO REPAIR COURSE (3 volumes) for 10 days FREE examination. Within 10 days I will either return it and owe nothing, or send my first payment of \$6.65 plus a few cents postage. Then after I have used the course for a FULL MONTH, if I am not satisfied I may return it and you will refund my first payment. Or I will keep the course and send you two more payments of \$6.65 a month for two months.

Name _____
 Address _____
 City _____ State _____ Zip _____
 Dept. 4

While portables present all kinds of problems, to skilled TV benchmen they're just another job.

tenna immediately bends. Once bent, it is ruined.

You can purchase a replacement for the telescoping dipole. Fortunately, 90 per cent of them are all alike. A universal replacement installs quite easily.

Remove the back of the TV and take the defective unit out. If it's stuck, hacksaw it out. The replacement comes in two pieces. The dipole and a stud. Push the dipole through the ball swivel. Then insert the stud into the base of the dipole. The stud holds the dipole in the swivel. It's that easy, unless the spring-loaded plastic swivel holder breaks. Then you must replace the entire unit. Buy either the exact factory replacement or a universal that will mount on the rear of the TV. *

