

The FUN WAY to UNDERSTAND ELECTRONICS

1973 EDITION \$1.25

Electronics Theory Handbook

02616

Another SCIENCE & MECHANICS Annual

**DISCOVER IN
1 HOUR
HOW EASY
ELECTRONICS
REALLY IS!**
(see page 3)

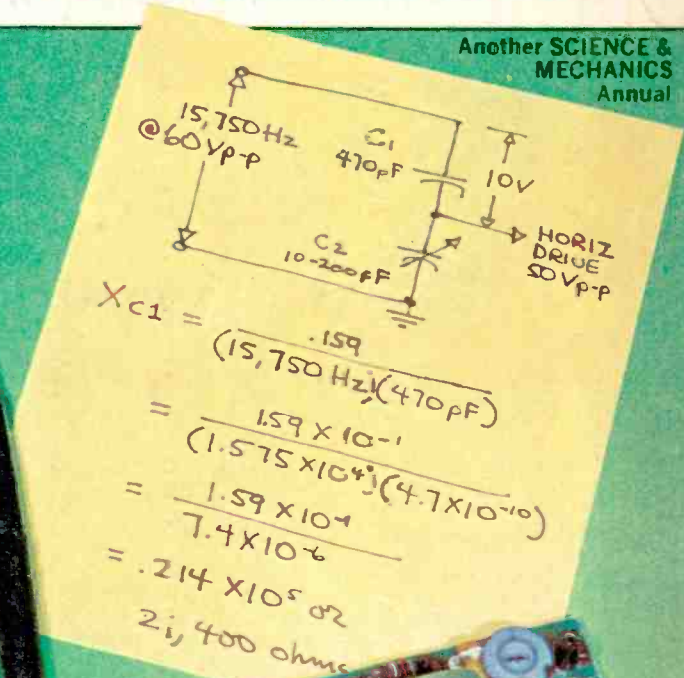

Back to Basics

- Electricity • Atom • SSB
- Magnetism • Resistance
- Inductance • Ohms Law
- Capacitance • Prefixes
- Exponents • Batteries
- Rectifiers • Filters • Fuses
- Breakers • Oscillators
- Frequency • Bridges
- Pads • Multivibrators
- Crystals • Gain • AVC
- Amps • Superhets
- Antennas • Microwaves
- CB • Communications

Plus Much More

for the ...

- ✓ Beginner ✓ Novice
- ✓ Hobbyist ✓ Experimenter
- ✓ Professional ✓ Old Timer

By the Editors of ELEMENTARY ELECTRONICS

DAVIS PUBLICATION

DON'T BUY A NEW CAR OR LIGHT TRUCK UNTIL YOU BUY A COPY OF...

AutoFacts Keeps on Scoring for Consumers!
Dan Carrigan of New Orleans La. writes—

"I have to let you know how grateful my wife and I are to your publication. We just ordered our first new vehicle and got a great deal thanks to AutoFacts! Armed with the specific cost information we did battle with local dealerships. I found that just showing the manager my AutoFacts book had an amazingly disarming effect. When all was said and done we had saved \$1010 from the quoted price of the first dealership we consulted. Keep up the good work—we appreciate you!"

signed/Dan Carrigan



SPECIAL BONUS FOR AUTOFACTS READERS!

✳ How to get a new car for only \$125 over dealer's cost.

Through the United Auto Brokers' Car/Puter organization, you can take delivery, without delay, of a brand new car for just \$125 over cost. Your purchase includes freight and pre-delivery service. You take delivery of a new car of your choice from a local dealer and you get the same new car warranty and service as if you had paid full list. The Bonus Coupon in your AUTOFACTS entitles you to a 20% discount off the Car/Puter 48-hour computerized service that helps you make the best new car deal on your own. ✳ Certain limited production or specialty models priced higher. Some foreign models not available.

"... valuable for the consumer in the market for a car. Car/Puter's AutoFacts lists the 'dealer' (wholesale) costs of new cars with all optional extras itemized and of many used cars. For comparison shopping or nitty-gritty haggling—invaluable."
 —from The New York Times
 Book Review

AutoFacts—

- ✓ makes you a smarter buyer!
- ✓ can save you up to \$1000!
- ✓ helps tailor your purchase to your pocketbook!
- ✓ tells you whether you're being offered a good deal or not!

NOW ON ALL LEADING NEWSSTANDS

If you prefer, complete and mail this coupon to Car/Puter's AUTOFACTS, Davis Publications, 229 Park Avenue South, New York, New York 10003.

- Send Actual 1973 New Car Prices edition. Payment enclosed of \$1.50 plus 25¢ for postage and handling.
- Send Spring/Summer edition of Used Car Prices. Payment enclosed of \$1.50 plus 25¢ for postage and handling.

NOTE: Write publisher for bulk rates. Add \$1.00 per issue for orders outside Continental U.S.A. and Canada.

DC-AFX

- I prefer a full year's subscription of four issues (Actual '73 New Car Prices edition; Spring/Summer '73 Used Car Prices edition; in September '73 the 1974 New Car Yearbook and Buying Guide; followed by the 1974 New Car Prices edition.)

\$6.00 for full subscription is enclosed.

name (please print)

address

city state zip code

New square-cornered Sylvania picture tube

Handsome woodgrain cabinet, at no extra cost. (Offered only by NRI)

6-position detented UHF channel selector

Modular construction with plug-in circuit boards

Automatic color control

Automatic degaussing

Automatic tint control

100% solid state chassis

Automatic fine tuning



NOW... learn color TV servicing while building this NEW 25" DIAGONAL SOLID STATE SET created by NRI for home training

NRI wanted more than a hobby kit TV . . . so we built one from the circuits up, specifically for teaching advanced electronics. You can only get this superb set from NRI . . . it's exclusive with NRI Color TV Servicing Course.

NRI was first to supply home study students with custom-designed training kits to give practical hands-on experience as you learn. Now NRI scores another first . . . with the exclusive 25" diagonal picture tube, solid chassis, color TV set designed-for-learning. You build it yourself with NRI's TV-Radio Servicing Course.

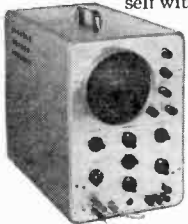

Kit for kit, dollar for dollar, you get more for your money from NRI.

The TV-Radio Servicing Course includes a wide-band service type oscilloscope and a color bar cross-hatch generator . . . along with other valuable equipment you will use to perform experiments and make repairs on your own and other sets.



You'll soon find yourself earning \$5 to \$7 an hour, in your spare time . . . even before the course is completed.

Learning at home is easy . . . the simplified NRI way. Texts are "bite-size" and fully-illustrated, leading you step by step, stage by stage, to a thorough knowledge of electronics. You can introduce defects into circuits, perform experiments, and discover the how and why of circuitry and equipment operation.

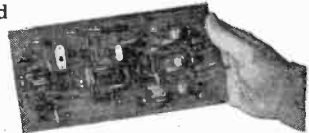

Train with the Leader—NRI.

The same training innovations which have made NRI the leader in career training at home are now available to you. Mail the insert card for a free full-color catalog which spells out the NRI "discovery" method of learning. There's no obligation. **NO SALESMAN WILL CALL.**

APPROVED UNDER NEW GI BILL. If you have served since January 31, 1955, or are in service, check GI line on reply card.



NRI TRAINING
3939 Wisconsin Avenue, N.W.,
Washington, D.C. 20016



1973 EDITION

Electronics Theory Handbook

Dedicated to America's Electronics Hobbyists

●		FEATURES 1973
13	Electricity, Magnetism and the Atom
24	Parallel Resistance Nomograph
27	Prefixes and Exponents
30	All about C-Zn Batteries
35	How to Select Batteries
41	Power Supply Basics
47	Fuses and Circuit Breakers
53	Facts on Frequency
55	Wheatstone Bridge
58	Resistive Pads
61	Multivibrators
66	All About Crystals
73	Language of Gain
77	The Superheterodyne Circuit
84	Inside AVC
88	How Squelch Works
92	Single Sideband
98	Microwaves
103	Roll Your Own Capacitor
●		DEPARTMENTS 1973
3	How Easy Electronics Really Is—An Editorial
6	Hey Look Me Over—New Products
9	Literature Library
10	Ask Hank, He Knows
11	Reader Service Page
12	Theory in Everyday Use
111	Reader Service Page

Discover How Easy ELECTRONICS REALLY IS!

An Editorial by
Julian S. Martin

□ I was at a party not too long ago and heard two fathers bragging about their sons. One claimed his son was "in electronics." In fact, he was a graduate engineer working for a large federal agency on a complex safety communications system. This raised mild interest. One or two eavesdroppers commented to the father how fortunate he was to have a bright son. The other dad mentioned in passing that his son sold men's suits, but he did have a ham rig. That was the party stopper. Immediately, the second father became the center of conversation. He told of an exotic room his son keeps in the attic, called a shack, where his son talks to people from all over the world. "For example," he asked, "do you know where the Seychelles Islands are?" No one did. His son, however, not only knew where they were, but even communicated with a ham located there each week on a regular schedule.

By now, dear reader, you may be getting the point of this little story. There is great romance, excitement, fascination and aura in hobby electronics—and you don't have to be a graduate engineer to get involved! It makes no matter whether it be ham radio, project building, shortwave listening, CB radio, fixing your own TV, or whatever interest you may have.

I suggest you give electronics a chance, and do yourself a favor at the same time. Begin reading on page 13, "Electricity, Magnetism and the Atom," now! give that section of this issue of **ELECTRONICS THEORY HANDBOOK 1973** one hour of your time. Read up to page 24. With the leftover time, go back and cover those paragraphs that troubled you, if any. Spend the full one hour on this section and you will discover how easy electronics really is!

Now that you have invested \$1.25 and one hour of your time, don't give up. Continue on! **ELECTRONICS THEORY HANDBOOK 1973** is packed with many hours of interesting reading. And if you are well along in theory, you'll find the theory increases in scope with the page number. Give yourself a break—read **ELECTRONICS THEORY HANDBOOK 1973** from cover to cover.

take your pick



LARGEST RANGE, GREATEST VARIETY

What are you driving? Slotted, Phillips, Frearson, Reed & Prince, Allen hex, clutch head, Scrulox®, Bristol Spline, or Pozidriv® screws? Xcelite makes screwdrivers for every type and size. Metrics, too.

- ⊕ from 2 1/8" miniatures to huge 2 footers.
- .040" to 1/16" tip widths.
- round or square blades.
- ⊕ tough, forged alloy steel or non-magnetic beryllium-copper.
- nickel chrome, black oxide finish, or insulation coated.
- fixed-handle or interchangeable and reversible blades.
- ⊕ straight and tee handles — regular and ratcheting types.
- available individually or in handy kits and sets.

Made in U.S.A. to highest standards.

REQUEST FREE TOOL CATALOG 171
nationwide availability through
local distributors



XCELITE®

professional screwdrivers

XCELITE, INC., 186 Bank St., Orchard Park, N. Y. 14127
Send complete tool catalog, which includes information on all Xcelite screwdrivers.

name _____

address _____

city _____ state & zip _____

In Canada contact Charles W. Pointon, Ltd.
CIRCLE NO. 5 ON PAGE 11 OR 111



- THE SHOPPING CENTER FOR ELECTRONICS
(our catalog index of Mfrs extends from ADC to XCELITE)
- HOBBYISTS . . . EXPERIMENTERS . . . SERVICE
TECHNICIANS . . . ENGINEERS •



Your Satisfaction is Our Target
Top Name Brands . . .
Low Prices

AMPLE STOCKS—including
those hard-to-find Parts

whether you want a 15¢ capacitor,
a \$50 FET-VOM, or a \$450 stereo
system—you can get it at EDI!

Send for your FREE catalog Today.

RUSH FREE CATALOG

Name _____

Address _____

City _____ State _____ Zip Code _____

ELECTRONIC DISTRIBUTORS INC.
Dept. TA-2, 4900 Elston Chicago, Ill. 60630

CIRCLE NO. 7 ON PAGE 11 OR 111

International Catalog

free!

your electronics
buying guide for
precision made
radio crystals
and electronic
equipment

International Crystal Mfg. Co., Inc.
10 North Lee, Oklahoma City, Oklahoma 73102

NAME _____ PLEASE PRINT

ADDRESS _____

CITY _____ STATE _____ ZIP _____

CIRCLE NO. 6 ON PAGE 11 OR 111

1973 EDITION

Electronics Theory Handbook

Dedicated to America's Electronic Hobbyists

- Editor-in-Chief*
JULIAN S. MARTIN, WA2CQL/KMD4313
- Technical Editor*
PETER L. DEXNIS, WA3LOQ
- Theory Editor*
STEPHEN B. GRAY
- News Editor*
JEFFREY APTER
- Workbench Editor*
HANK SCOTT
- Citizens Band Editor*
KATHI MARTIN, KA10814
- Art Director*
JIM MEDLER
- Cover Art Director*
IRVING BERNSTEIN
- Associate Art Director*
ANDY STEIGMEIER
- Art Associate*
LAWRENCE VAN PELT
- Advertising Director*
DAVID J. MILLER
- Production Director*
CARL BARTEE
- Production Manager*
GERTRUD BORCHARDT
- Assistant Production Manager*
MARILYN VARGAS
- Instruments Division Manager*
WILFRED M. BROWN
- Subscription and Marketing Director*
ROBERT V. ENLOW



- President, Chairman of the Board (1957-1972)*
B. G. DAVIS
- President and Publisher*
JOEL DAVIS
- Vice-President and General Manager*
LEONARD F. PINTO
- Vice-President and Treasurer*
VICTOR C. STABILE, KB0P681

ELECTRONICS THEORY HANDBOOK 1973 is published annually by Davis Publications, Inc. Editorial business offices: 229 Park Ave. South, New York, N.Y. 10003. Advertising offices: New York, 229 Park Avenue South, 212-OR 3-1300; Chicago, 520 N. Michigan Ave., 312-527-0330; Los Angeles: J. E. Publishers' Rep. Co., 8560 Sunset Blvd., 213-659-3810; Long Island: Len Osten, 9 Garden Street, Great Neck, N.Y., 516-487-3305; Southwestern advertising representative: Jim Wright, 818 Olive St., St. Louis, 314-CH-1-1965. Copyright 1973 by Davis Publications, Inc.

1973 EDITION

14 ways to help you earn more money

Take one of these 14 Career Guidance Booklets and "Demonstration Lessons"—free—and find out how you can now start developing the skills you need to succeed in a better-paying career.

In today's fast-moving world, you can move up to a better-paying career in less time than you may think. If you choose a career field that's right for you. And if you can get the kind of career training that today's employers are willing to pay big money for.

To help you choose the right career field, we have listed 14 opportunities in the coupon below. You are invited to discover everything you want to know about the field you like best, by simply mailing the coupon below for a free Career Guidance Booklet.

Your free booklet will describe the opportunities, income and job security you might expect in your newly chosen field. It will also explain how ICS can help you prepare for this—in your spare time...in your own home... regardless of your past experience.

In addition, you'll receive a free "Demonstration Lesson" that lets you see for yourself why you can prepare for your new career—the ICS way—in much less time than you may think.

Major corporations use ICS career training

Please bear in mind, as you fill in the coupon below, that more than 8,500,000 men and women have turned to ICS for career training, since 1890.

Some 2,000 American firms and government agencies are also using ICS training programs to upgrade and update their employees. Among these firms are such names as Ford, U.S. Steel, Chrysler, Mobil, DuPont, ITT, IBM, General Motors, 3M Company, Alcoa, Pan Am, GE, Motorola, and RCA.

ICS career training is Approved for Veterans, and is Accredited by the Accrediting Commission of the National Home Study Council. Now it's *your* turn to discover how ICS can start *you* in a rewarding new career. Just fill in the coupon below and mail today.



Take one of these Career Guidance Booklets — free!

ICS International Correspondence Schools
Scranton, Pennsylvania 18515

Please send me free booklets and a free "Demonstration Lesson" for the field I have checked below. I understand that I am under no obligation.

1. ACCOUNTING

- Business Accounting
- Bookkeeping
- CPA Training
- Income Tax Specialist

2. BUSINESS MANAGEMENT

- Business Administration
- Executive Management
- Industrial/Production Management
- Marketing/Advertising/Sales Management

3. COMPUTER PROGRAMMING

- Programming Concepts
- COBOL System 360
- Fortran IV

4. SECRETARIAL

- Medical
- Legal
- Executive

5. MOTEL/HOTEL MANAGEMENT

- Motel Management
- Club/Restaurant Management
- Resort Manager
- Hotel Executive

6. INTERIOR DECORATING & DESIGN

- Interior Decorator
- Interior Designer
- Advanced Interior Designer

7. ELECTRICIAN

- Master Electrician
- Practical Electrician

8. DRAFTING

- General Drafting
- Specialized Training (Arch., Mech., Struct., Electrical, Aircraft, Electronics)

9. AUTOMOTIVE

- Master Mechanic
- Air Conditioning Specialist
- Body Rebuilding Specialist
- Diesel/Gas Mechanic

10. ENGINEERING

- Mechanical Civil
- Chemical Industrial
- Electrical-Electronics
- Surveying & Mapping

11. AIRLINE/TRAVEL

- Reservation and Communication Specialists
- Ticket Agent
- Travel Agent

12. ELECTRONICS

- Electronics Technician
- Specialized programs in Computer Servicing, Communications/Broadcasting, CATV
- FCC Licensing

13. TV SERVICING

- Color TV Technician
- Stereo/Hi-Fi Specialist
- CATV/MATV Specialist

14. AIR CONDITIONING/HEATING

- Air Conditioning/Refrigeration Technician
- Heating Specialist

HIGH SCHOOL. (Earn a H.S. Diploma.)

Check here for special information, if age 16 or under.

Miss _____ XC672W
Mrs. _____
Mr. _____ Age _____

Address _____ Apt. _____

City _____

State _____ Zip _____

Approved for Veterans' Training. Eligible Institution under the Guaranteed Student Loan Program. Accredited Member National Home Study Council. Canadian residents use coupon address for service from ICS Canadian, Ltd. In Hawaii: 931 University Ave., Honolulu, Hawaii 96814

CIRCLE NO. 3 ON PAGE 11 OR 111

HEY, LOOK ME OVER...

Hex Head Swivel Driver

Xcelite has come up with a line of Allen hex-type screwdrivers and interchangeable blades with an unusual "ballpoint" tip design that achieves a speed and ease in engaging and turning that is unattainable with conventional drivers. The tools work at



any angle, thus being able to handle hex socket screws which cannot be reached straight-on. Because they slip into sockets more easily and faster than regular hex socket drivers, they simplify adjustments and they speed up work. Nine sizes, from .050-in. through $\frac{3}{16}$ -in., are available; fixed handle types singly or a complete set in a handy roll kit with extra pockets for associated tools, and several other combinations. Complete information, specifications, and prices are available by circling No. 40 on Reader Service Page.

Police Decoder

Introducing PD, the handy little add-on accessory that perfectly mates any police receiver to decode single inversion scrambled speech. The operation of the PD is quite simple; connect the speaker output of any police re-

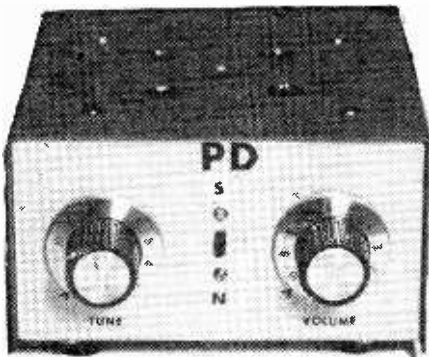

ceiver to the input of the PD. When the transmission goes scramble, switch to Decode and tune the Clarity control for best speech quality and listen to a new world of communication. Sells for only \$44.95. For more information, circle No. 41 on Reader Service Page.

Roof Topper

Big Momma III, a tough and resilient new rooftop version of Antenna Specialists Company's popular Big Momma CB antennas, is now in production. Like her namesake, the new M-412 is unconditionally guaranteed not to burn out regardless of operating conditions, and features a heavy-duty, oversized loading coil with virtually unlimited reserve power handling capability. A new professional style shock spring and heavier gauge whip contribute to Big Momma III's rugged new appearance and performance. The whip is copper and nickel plated for exceptionally cool operation. The antenna is easily removable for avoiding obstructions and car washes. Priced at \$30.99. Complete specifications may be obtained by circling No. 42 on Reader Service Page.



Phone Patch for CB/Ham

New from Radio Shack is the Realistic Phone Patch which provides an interconnection between an Amateur Radio or Citizens Band station's equipment and the telephone

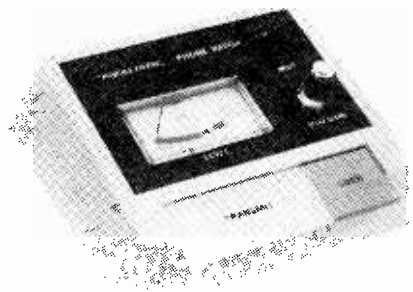

system. Now it is possible to place or receive telephone calls through a base station and relay them to a mobile unit in a car, truck or boat, or to another station which does not have access to a telephone. Phone patches have been of great use during civil emergencies, in providing communications in disaster areas, and often as a means for servicemen overseas to talk with relatives in

... New Products

the U.S. The Realistic Phone Patch is priced at \$19.95 and comes complete with 15 foot telephone leads, three foot transmitter lead and installation instructions. Realistic products are available at more than 1650 Radio Shack and Allied Radio Stores in all 50 states and Canada. Circle No. 43 on Reader Service Page for more information and catalog.

SSB CB

Dynascan has introduced a new two-way mobile radio to its Cobra line of communications products, the Cobra 132 AM/SSB mobile, with 15-watt peak envelope power. The Cobra 132 includes 69 channels (23 AM, 46 SSB);

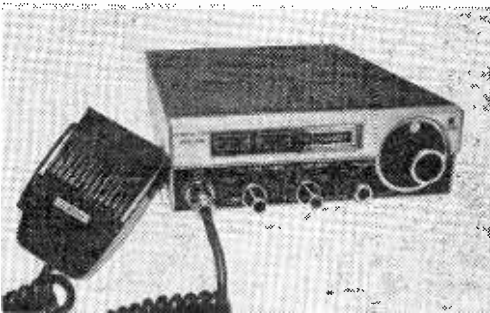

100% modulation with Cobra's exclusive "Dyna-Boost" compression circuit; better than 60 dB cross-modulation interference rejection to eliminate bleedover, howls and squeal; RF gated noise blanker that drops noise levels significantly both on AM and SSB; three filters, including one ceramic, to prevent adjacent-channel interference; and drift-free, ultrastable "Voice Lock", whose wide range, according to Dynascan, enables you to find your mobile units anywhere. The Cobra 132 design features an attractive, "professional-look" panel, with easy-access controls. Selling price of the Cobra 132 is \$219.95. For more information, circle No. 44 on Reader Service Page.

Midland Enters Ham Market

Midland Electronics Company, for over a decade a nationally recognized leader in communications equipment, has entered the amateur radio field. Midland's new amateur radio line is being marketed through franchised distributors, people who know "ham". Leading off Midland's amateur radio offerings is a 15-watt, 12-channel, 2-meter FM mobile transceiver. It transmits at 15 watts RF output or at 1 watt in the low power position, and contains a multiple FET front end receiver with high Q helical resonator filters and ceramic filters. Suggested retail price is \$249.95. Midland's 10-watt, 12-channel

FREE

LAFAYETTE 1973 CATALOG 730



Ready
Now!

The World's Largest
Consumer Electronics Catalog

Everything In Electronics for Home, Business, Industry

• Stereo/Hi-Fi Components • Musical Instruments and Amplifiers • CB & Ham Equipment • Tools and Test Equipment • Police and Fire Monitor Receivers • Public Address Systems • Photography Equipment • Semiconductors, Books, Parts • Plus Much More!

Your Complete Electronics Buying Guide

Send
Today!

Lafayette Radio Electronics
P.O. Box 10, Dept. 28063
Syosset, L.I., N.Y. 11791

Send FREE 1973 Catalog 28063

NAME _____

ADDRESS _____

CITY _____

STATE _____ ZIP _____

CIRCLE NO. 8 ON PAGE 11 OR 111

HEY, LOOK ME OVER

"220" FM unit brings a much-wanted low-cost mobile transceiver to this growing amateur band. Model 13-509 transmits at 10 watts or 1 watt RF output. Suggested retail price is \$219.95. Rounding out the the new Midland amateur radio line is a low-priced 2-watt, 6-channel 2-meter hand held transceiver. Built rugged with a die-cast metal frame, it is supplied with carrying case and crystals for .16/.76, .34/.94 and .94/.94. Power is from eight 1.5 volt internal batteries, nicad battery pack or AC adaptor (all optional). Model 13-520 has a suggested retail price of \$229.95. All of these new Midland amateur radio transceivers are described fully in a colorful new catalog. For a free copy of this catalog, circle No. 45 on Reader Service Page.

Throw Some Light

Here is a useful gadget for field or bench servicing. It's the TV Man's 900. The 900 includes a powerful and flexible spotlight

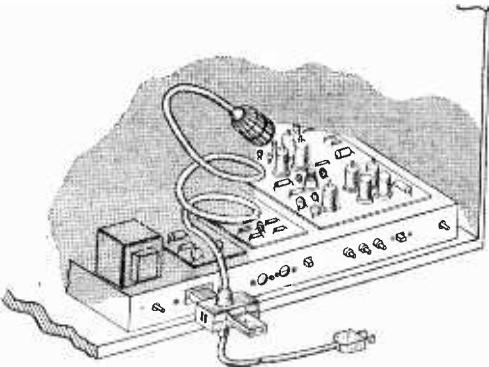

mounted on a rigid body with standard and polarized interlocks. When plugged into a TV or any other chassis, it provides AC power to the set and automatically supports itself, allowing illumination to any part of the chassis being repaired. This unit also includes a built-in AC outlet for any auxiliary feeding or extension. When not plugged into chassis, it can be conveniently used by placing it in any position or twisted, looped, hung or inserted in almost any place by the special head, neck or body. Price is only \$9.95. Order directly from Michelin International, P.O. Box 6743, Los Angeles, CA 90022.

VHF Wattmeter

A kit-form VHF wattmeter, ideal for alignment of 2-meter FM gear has been introduced by Heath Company. The HM-2102 tests transmitter output in power ranges of 1 to 25 watts and 10 to 250 watts, $\pm 10\%$ of full scale. The 50-ohm nominal impedance permits placing the unit in the transmission

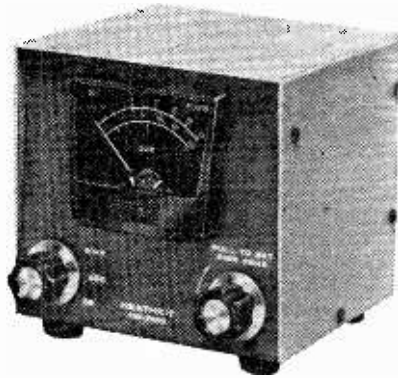

line with little or no loss. In addition, the HM-2102 has a built-in SWR bridge with less than 10-watt sensitivity for tuning 2- or 6-meter antennas for proper match. The Heath-kit HM-2102 VHF Wattmeter is priced at 29.95 mail order. Get the Heath catalog for all the facts by circling No. 1 on Reader Service Page.

Weather Radio

Lafayette Radio's new instant FM/VHF weather radio receives the 24-hour continuous United States Weather Bureau forecasts at a touch of a button. Both frequencies broadcast by the U.S. Government, 162.55 and 162.40 MHz, can be received. The radio has a volume control, a fine tuning control and a telescopic FM/VHF antenna in an attractive walnut plastic cabinet. For more information, circle No. 46 on Reader Service Page.

Combo Scanner

The new Combo from Teaberry scans two bands (VHF-4-channels, UHF-4-channels) simultaneously. The receiver is completely solid state and has two priority channels, one for each band. The priority feature enables the listener to program his receiver so he never misses a transmission of his favorite frequency. The unit can be operated in automatic or manual mode and has push button lock outs for each channel for speci-

(Concluded on page 110)

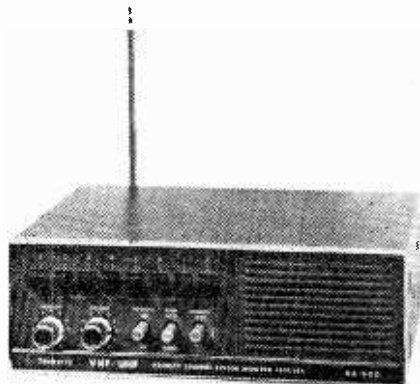



LITERATURE LIBRARY

- 101. Kit builder? Like weird products? EICO's 1973 catalog takes care of both breeds of buyers at prices you will like.
- 102. International Crystal has a free catalog for experimenters (crystals, PC boards, transistor RF mixers & amps, and other comm. products).
- 103. See brochures on Regency's 1973 lineup of CB transceivers & VHF/UHF receivers (public service/business bands—police, fire, etc.)
- 104. A pamphlet from Electra details the 6 models of the Bearcat III, a scanning monitor receiver.
- 105. Dynascan's new B&K catalog features test equipment for industrial labs, schools, and TV servicing.
- 106. Before you build from scratch, check the Fair Radio Sales latest catalog for surplus gear.
- 107. Get Antenna Specialists' cat. of latest CB and VHF/UHF innovations: base & mobile antennas, test equipment (wattmeters, etc.), accessories.
- 108. Want a deluxe CB base station? Then get the specs on Tram's super CB rigs.
- 109. Xcelite has the largest selection of screwdrivers anywhere. There's just about any size and type for every popular screwhead. They have fixed or removable handles with interchangeable blades, and come individually, in sets, or kits.
- 110. Bomar claims to have C/B crystal for every transceiver... for every channel. The catalog gives list of crystal to set interchangeability.
- 111. A Turner amplified mike helps get the most from a CB rig. This free brochure describes line of base & mobile station models.
- 112. Midland has recently published a 4-color brochure that folds out to 17" x 21", printed on both sides. Over 40 CB and scanner products are featured.
- 113. EDI (Electronic Distributors)

- has a catalog with an index of manufacturers' items literally from A to Z (ADC to Xcelite). Whether you want to spend 29 cents for a pilot-light socket or \$699.95 for a stereo AM/FM receiver, you'll find it here.
- 114. Get all the facts on Progressive Edu-Kits Home Radio Course. Build 20 radios and electronic circuits; parts, tools, and instructions included.
- 115. Olson Electronics' 188-p. fully-illustrated 1973 catalog has leading national brands, all in the electronic product categories.
- 116. Trigger Electronics has a complete catalog of equipment for those in electronics. Included are kits, parts, ham gear, CB, hi fi and recording equipment.
- 117. Get the free, new twenty-four page HUSTLER CB and Monitor antenna catalog featuring improved antennas and accessories for base station and mobile operation.
- 118. Teaberry Electronics has information on CB radios—Twin "T," Big "T," Mini "T" II, and Five by Five; also information on Scan "T" Monitor radio receiver.
- 119. Burstein-Applebee's new 1973 catalog has over 280 pages of Radio-TV/Electronics bargains. Selling for \$2, it is offered free to our readers.
- 120. For a colorful leaflet on the Golden Eagle Mark III SSB receiver and the Mark III SSB transmitter, write to Browning Laboratories.
- 121. Edmund Scientific's new catalog contains over 4000 products that embrace many sciences and fields.
- 122. Cornell Electronics' "Imperial Thrift Tag Sale" Catalog features TV and radio tubes. You can also find almost anything in electronics.
- 123. Radio Shack's 50 Anniv. cat. has 180 pages, colorfully illustrated, of complete range of hi fi, CB, SWL, ham equip. and parts (kits or wired)

- for electronics enthusiasts.
- 124. It's just off the press—Lafayette's all-new 1973 illustrated catalog packed with CB gear, hi-fi components, test equipment, tools, ham rigs, and more.
- 125. Mosley Electronics, Inc. is introducing 78 CB Mobile Antenna Systems. They are described and illustrated in a 9-page, 2-color brochure.
- 126. RCA Experimenter's Kits for hobbyists, hams, technicians and students are the answer for successful and enjoyable projects.
- 127. For "dynamic breadboards", elite 1 and 2; and for "basic breadboard," elite 3, send for *EI Instruments'* literature. Included is a catalog, "The Digital Design Line."
- 128. Avanti antennas (mobile and base for CB and VHF/UHF) are fully described and illustrated in new catalog.
- 129. A new free catalog is available from McGee Radio. It contains electronic product bargains.
- 130. Semiconductor Supermart is a new 1973 catalog listing project builders' parts, popular CB gear, and test equipment. It features semiconductors—all from *Circuit Specialists*.
- 131. Heath's new 1973 full-color catalog is a shopper's dream—chockful of gadgets and goodies everyone would want to own.
- 132. E. F. Johnson's 1973 line of CB transceivers and CB accessory equipment is featured in a new all-line brochure. Send for your free copy today.
- 133. If you want courses in assembling your own TV kits, National Schools has 10 from which to choose. There is a plan for GIs.
- 134. Free 1973 Catalog describes 100s of Howard W. Sams books for the hobbyist and technician. It includes books on projects, basic electronics and many related subjects.

ELECTRONICS THEORY HANDBOOK
Box 886
Ansonia Station
New York, N.Y. 10023

Please arrange to have this literature whose numbers I have circled at right sent to me as soon as possible. I am enclosing 25¢ to cover handling. (No stamps, please).



1973

- 101 102 103 104 105 106 107 108 109 110
- 111 112 113 114 115 116 117 118 119 120
- 121 122 123 124 125 126 127 128 129 130
- 131 132 133 134

Indicate total number of booklets requested
 Sorry, only 15 circled items maximum.

NAME _____

ADDRESS _____

CITY _____

STATE _____ ZIP _____

Not Valid After December 31, 1973



Hank Scott, our Workshop Editor, wants to share his project tips with you. Got a question or a problem with a project you're building—ask Hank! Please remember that Hank's column is limited to answering specific electronic project questions that you send to him. Sorry, he isn't offering a circuit design service. Write to:

**Hank Scott, Workshop Editor
ELECTRONICS THEORY HANDBOOK
229 Park Avenue South
New York NY 10003**

Conversion Factors

Hank, I need the conversion factors for inches, miles, gallons and pounds to centimeters, kilometers, liters and kilograms. Can you help?

—T.W., Tallahassee FL

Sure can. In fact, I'll toss in a few extra that will come in handy from time to time.

To Change	Multiply by	To Get
Inches	2.54	Centimeters
Feet	30.48	Centimeters
Miles	1.6093	Kilometers
Square Feet	.0929	Square Meters
Gallons	3.7854	Liters
Pounds	.4536	Kilograms

Wants a Book

I have just been thrust head long into the short-wave listening hobby and I was wondering if you could recommend a good book to brief me on this field.

—T.M.C., Germantown TN

I suggest you visit a local Lafayette or Radio Shack store in your neighborhood. Scan the books they have to offer and pick one. Your local library may be able to help, also. Next, begin checking *Bookmark* by *Bookworm* column in every issue of *ELEMENTARY ELECTRONICS*. There are always good SWL books listed.

Has a Stop Watch

How long does it take to scan one line across the face of a TV picture tube?

—P.M., Macon GA

53.3 microseconds—that's going from left to right during the visible trace. The retrace which is not visible takes 10.2 microseconds. Hence, a full trace takes 63.5 microseconds. Multiply this total time by 525 (total number of lines per TV picture or frame) and you'll get 1/30 second, the time it takes for one complete TV picture.

Don't Blame Anyone

How come between channel 6 and 7 there is an 86 megaHertz frequency gap? Did someone goof?

—A.M., Bronx NY

No one goofed. In between channels 6 and 7

are the bands allocated for the hams, police, airlines and airports, emergency services, business and more. Believe it or not, they planned it that way.

Much Too Big

What is a teraohm?

—B.P., San Diego CA

Tera is the prefix for an exponential value of a million-million. So, that's how many ohms are in a teraohm. But, in my book, a teraohm is an open circuit.

Can't See the Spots

When did they stop putting color dots on capacitors and stamp numbers instead?

—A.V., Phoenix, AZ

Capacitors with color dots are still being produced, however, on those units physically large to carry part values in numerals and letters, now carry the "read and know" designation as opposed to "read, interpret and know" markings. It's be kind-to-color-blind-people decade.

Wants to Know

Why are electrons negatively charged? I mean, who decided it?

—W.P., Rye NY

Let's go all the way back to the first battery. Who ever marked the terminals of that battery assigned + and - polarity by chance, with the result that to keep all things properly related from then on, electrons had to have negative charges. If we switched tomorrow, all batteries would require polarity marking changes even though they are otherwise unchanged. Let's leave it like it is—too many people have trouble learning about it as it is.

The Plague is On Us.

In the January-February 1973 issue of ELEMENTARY ELECTRONICS, R.L. complained of the static his light dimmer caused, even on battery-operated radios. You suggested buying a commercial light dimmer. That's the problem. I have a 600W G.E. dimmer control that does exactly the same thing. What can I do?

—B.B., Sedalia MO

Try reversing the lead going to the unit. Possibly, a ground connection from the dimmer
(Concluded on page 110)

READER SERVICE PAGE

Electronics Theory Handbook

ELECTRONICS THEORY HANDBOOK 1973 offers readers an easy way to get additional information about products and services advertised in this handbook. Also, if you would like more information about any new product mentioned in our new products column, it's yours for the asking. Just follow the instructions below and the literature you requested will be sent to you promptly and at no cost.

Julian S. Martin
Editor-in-Chief

The coupon below is designed for your convenience. Just circle the numbers that appear next to the advertisement or editorial mention that interests you. Then, carefully print your name and address on the coupon. Cut out the coupon and mail to ELECTRONICS THEORY HANDBOOK, Box 886, Ansonia Station, New York, NY 10023. Do it today!

Void after December 31, 1973

1973 **ELECTRONICS THEORY HANDBOOK**
Box 886, Ansonia Station, New York, N.Y. 10023

Please arrange to have literature whose numbers I have circled at right sent to me as soon as possible. I understand that this is a free service offered by the magazine.	1	2	3	4	5	6	7	8
	9	10	11	12	13	14	15	16
	17	18	19	20	21	22	23	24
	25	26	27	28	29	30	31	32
	32	34	35	36	37	38	39	40
	41	42	43	44	45	46	47	48

Name (Print Clearly) _____

Address _____

City _____ State _____ Zip _____

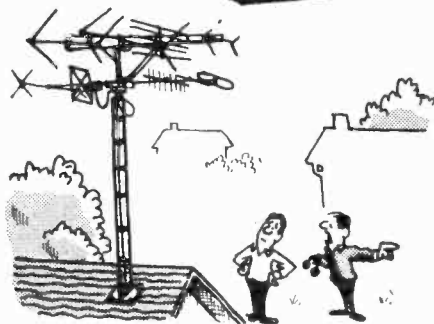

"Arnold, I know that sky hook go clear-around the world, but I can't even read your signal from across the street!"

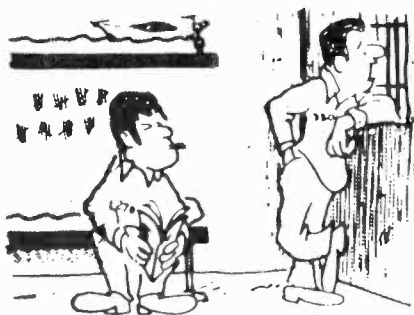

"I knew 'em all! Ohm's Law, Kirchhoff's Law . . . but I forgot the Federal Law!"

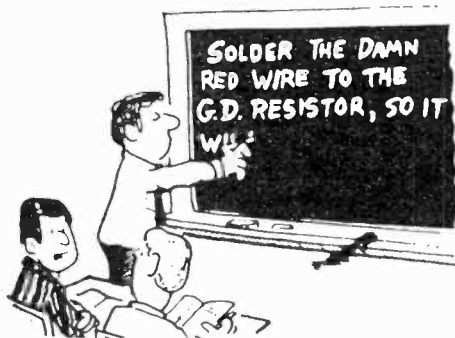

"Didn't you know? He learned his electronics in the service."

THEORY— IN EVERYDAY USE

by Jack Schmidt

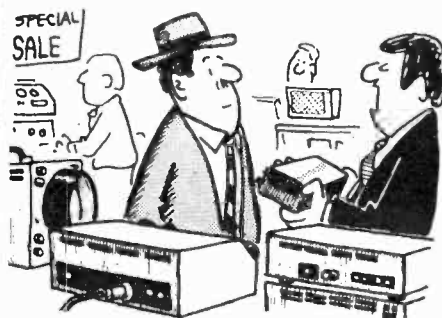

"You're right. In theory, a rig like this ought'a cost about fifty bucks, but this one is a hundred and six!"

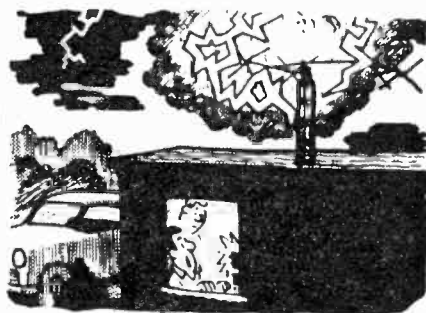

"How should I know what makes a receiver glow like that?"

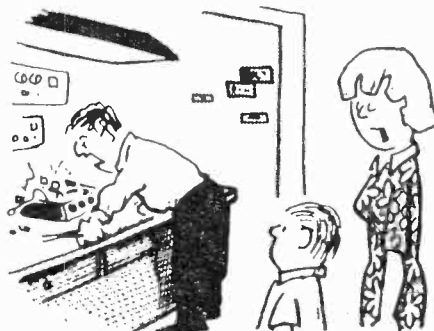

"It's always amazed me that he knows exactly the right gismo to yell at!"

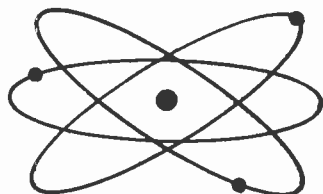

Electricity, Magnetism and the Atom

One of the most thought-provoking discoveries of modern physics is the fact that matter and energy are interchangeable. Centuries of scientific head-scratching about the nature of matter, the mystery of fire, and the once-terrifying crack of lightning have all come to focus on the smallest particle that is the building block of any given substance: the atom. An atom is necessarily matter and yet this atom of matter can undergo nuclear fission and release quantities of energy that are beyond the imagination. In the atom lies the secret of all phenomena. One theory of the universe, hypothesized by Georges Lemaitre, even regards the present universe as resulting from the radioactive disintegration of one primeval atom!

By the beginning of the 19th century, the atomic theory of matter—which actually originated in 5th century Greece when the atom was named—was firmly established. It was due primarily to the efforts of 17th century scientists who—actually working in the tradition of medieval alchemy—sought the prime con-

stituent of all matter. Mainly through the work of John Dalton, whose investigations as to how various elements combine to form chemical compounds, it came to be regarded that *an atom* was the indivisible and indestructible unit of matter.

This viable and working view of the indestructible atom served science until 1897 when the atom itself was found to be destructible! To anyone concerned with electricity or electronics, the year 1897 is a memorable one: it was the year J. J. Thomson, the English physicist, identified and experimentally revealed the existence of the first subatomic particle—the *electron*!

The First "Electronic" Experiment. We blithely speak of electricity as the flow of electrons yet, often, we are little aware of the great body of research that went into elucidating this fundamental of basic electricity. In fact, before the discovery of the electron, convention held that the flow of electric current was in the direction that a positive charge moved. This convention of *positive current*, being the flow of positive charges and opposite to the direction of electron flow, is still found to be useful in circuit analysis and is used even today.

Thomson's experiment established that a particle much lighter than the lightest atom did indeed exist. The electron, as it was named, was the first subatomic particle to be defined.

The experiment was conducted utilizing a rudimentary version of a cathode ray tube—the modern version of which is in almost every home today in the form of the television picture tube. Before Thomson's experiment, it was discovered that when electric current was passed through a gas in a discharge tube, a beam of unknown nature traveled through the tube from the negative to positive terminal (opposite to the direction conventionally held as the direction of the flow of current).

This "cathode ray" beam also traveled in a straight line and was deflected by electric or magnetic forces applied perpendicular to the beam. What Thomson did was to use these facts to determine for one of the mysterious particles comprising the beam of cathode rays the relationship of its mass, m , to its electric charge, e . By deflecting the beam with a known electric force (Fig. 1) and then measuring what magnetic force applied in the opposite direction would bring the beam back to its original undeflected position, he could determine the relationship

of e to m . He established a definite value for e/m and thereby "discovered" the electron which, as we now know, is 1,837 times smaller in mass than the lightest atom, the hydrogen atom. It also carries the smallest charge that occurs in nature; every electric charge is actually an integral multiple of the charge of the electron.

From Minus to Plus. With the discovery of the electron, it was still over a dozen years into the 20th century before a graphic conception of the atom evolved. Since the atom is electrically neutral and electrons are negatively charged, the existence of positively charged particles was a necessity, and the existence of a *proton* was postulated. Eventually the nuclear model of the atom was evolved. Each atom was conceived to resemble a solar system in miniature. The nucleus—positively charged—is surrounded by a number of electrons revolving around it; the charges balance and the atom is electrically neutral (Fig. 2). Further research in the 20th century has gone on to reveal more elementary particles than you can shake a stick at: neutrons, positrons, neutrinos, mesons, and more. The number continues to grow and yet the ultimate nature of matter remains a riddle. But, in a discussion of basic electricity, only the electron and proton need concern us.

Electrons in Orbit. An atom of matter has a number of electrons orbiting around its nucleus. A hydrogen atom, for example, has a single electron; carbon on the other hand has 6. These electrons are arranged in rings or shells around the central nucleus—each ring having a definite maximum capacity of electrons which it can retain. For example, in the copper atom shown in Fig. 3 the maximum number of electrons that can exist in the first ring (the ring nearest the nucleus) is two. The next ring can have a maximum of eight, the third ring a maximum of 18, and the fourth ring a maximum of 32. However, the outer ring or shell of electrons for any atom cannot exceed eight electrons. However, heavier atoms may have more than four rings.

The Outer Orbit. The ring of electrons furthest from the atom's nucleus is known as the *valence ring* and the electrons orbiting in this ring are known as *valence electrons*. These valence electrons, being further from the nucleus, are not held as tightly in their orbits as electrons in the inner rings and can therefore be fairly easily dislodged by an external force such as heat, light, friction,

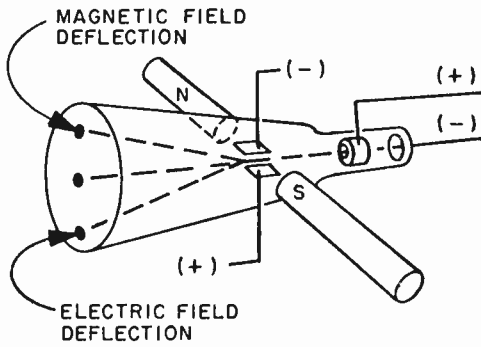

Fig. 1. Electron beam, like that in a TV picture tube (CRT), can be deflected magnetically or by an electric field. Force needed "measured" the electron.

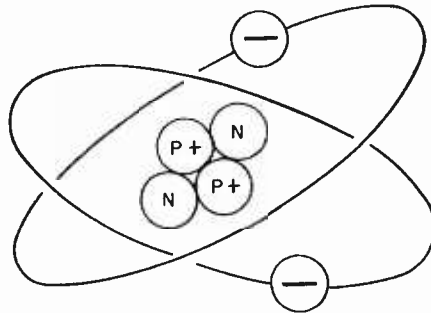

Fig. 2. Charge of each electron balances that of a proton. Other particles affect atomic mass but can be ignored in study of electronics.

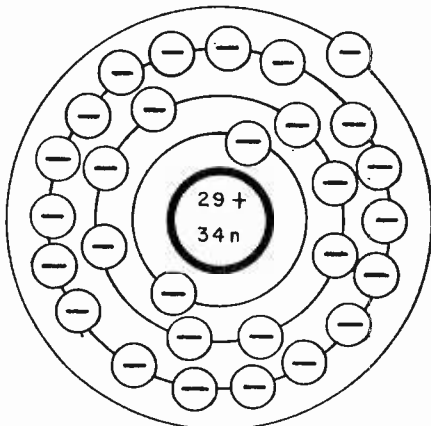

Fig. 3. The number of electrons to each ring are limited—2 in first; 8 in second; 18 for the third and a total of 32 in fourth orbital ring.

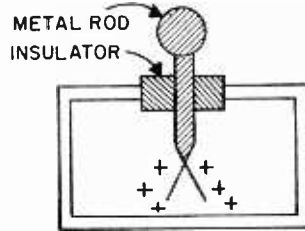

Fig. 4. Electroscope is a simple device to indicate electrical charges that are too weak to be measured with standard meters.

and electrical potential. The fewer electrons in the valence ring of an atom, the less these electrons are bound to the central nucleus. As an example, the copper atom has only one electron in its valence ring. Consequently, it can be easily removed by the application of only the slightest amount of external energy. Ordinary room temperature is sufficient to dislodge large numbers of electrons from copper atoms; these electrons circulate about as free electrons. It is because of these large numbers of free electrons that copper is such a good electrical conductor. There could be no electrical or electronics industry as we know it today if it were not for the fact that electrons can fairly easily escape, or be stripped from the valence ring of certain elements.

Electronic Charges. If an electron is

stripped from an atom, the atom will assume a positive charge because the number of positively charged protons in its nucleus now exceed the number of negatively charged orbiting electrons. If, on the other hand, the atom should gain an electron, it will become negatively charged—as the number of electrons now exceeds the protons in its nucleus. The atom with the deficiency of electrons is known as a *positive ion*, while an atom with a surplus of electrons is known as a *negative ion*.

Presence of an electrical charge on a body can be illustrated by use of an electroscope (Fig. 4). Two leaves of aluminum or gold foil hang from a metal rod inside a glass case so they're free from air disturbances. When the metal rod is touched by a charged body, the leaves acquire static electricity of

the same polarity and, since like charges repel, they stand apart. The greater the charge, the further apart the leaves spread.

Electron Flow. When an electrical conductor is placed between these two oppositely charged bodies, free electrons are attracted by the positive body—free electrons will move through the wire. This movement of free electrons will continue only until the excess of electrons is equally divided between the two bodies. Under these conditions, the charges on both bodies will be equal and the electron flow will end.

In Fig. 5 are a battery, lamp and connecting leads between the battery and lamp. In this instance, the battery serves as an electric charge pump—free electrons continually developed at its negative terminal by chemical action flow through the connecting leads and lamp back to the positive terminal of the battery by the attraction of oppositely charged bodies. The battery, connecting leads, and lamp form an electrical circuit which must be complete before the free electrons can flow from the battery's negative terminal to its positive terminal via the lamp. Thus, the battery serves as a source of potential difference or voltage by continually supplying a surplus of electrons at its negative terminal. Summing up, we can say a flow of electric current consists of the movement of electrons between two oppositely charged bodies.

We cannot progress very far into the study of electricity without first becoming familiar with the basic properties of electrical circuits. Just as we define distance in feet and inches, so do we define electrical properties in specific terms and units.

Potential. Earlier, we saw that an electric charge difference has to exist between the ends of an electrical conductor in order to cause a flow of free electrons through the conductor. This flow of electrons constitutes the electric current. The electric charge difference, or potential difference exerts a force on the flow of free electrons, forcing them through the conductor. This electric force or pressure is referred to as electromotive force, abbreviated EMF.

The greater the charge or potential difference, the greater will be the movement of free electrons (current) through the conductor as there will be more "push and pull" on the free electrons. The symbol used to designate electrical potential is the letter *E* which stands for electromotive force. The quantity of EMF is measured by a unit

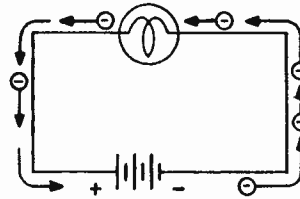

Fig. 5. Electron flow in any circuit is from negative to positive.

called the volt. Hence, the common name most often used in place of EMF is *voltage*.

Current Intensity. We have learned that an electric current consists of a flow of charge carriers (generally free electrons) between two points of different electrical potential. The rate of flow of these charges determines the intensity or strength of this current flow. Current strength is expressed in units known as *amperes*. One ampere of current flows in a circuit when 6,240,000,000,000,000,000 electrons flow out of a negative terminal, through a conductor, and back into a positive terminal in one second. The symbol for the ampere is the letter *I* which stands for intensity.

Resistance. The flow of electric current through a conductor is caused by the movement of free electrons present in the atoms of the conductor. A bit of thought then indicates that the greater the number of free electrons present in the atoms of a particular conductor, the greater will be its electrical conductivity. Gold, silver, and copper rank as excellent electrical conductors as their atoms readily release free electrons. On the other hand, the atoms of such elements as sulphur have almost no free electrons available and they are thus very poor electrical conductors. Such materials are known as electrical insulators. Between these extremes, lie elements such as carbon whose atoms have a moderate number of free electrons available and thus are moderately good electrical conductors.

Even the best electrical conductors offer some opposition to the passage of free electrons. This opposition is called resistance. You might consider electrical resistance similar to mechanical friction. As in the case of mechanical friction, electrical resistance generates heat. When current flows through a resistance, heat is generated; the greater the current flow, the greater the heat. Also, for a given current flow, the greater the resistance, the greater the heat produced.

Electrical resistance can be both beneficial and undesirable. Toasters, electric irons, etc. all make use of the heat generated by current flowing through wire coils. Resistance

is also often intentionally added to an electrical circuit to limit the flow of current. This type of resistance is generally lumped together in a single unit known as a resistor.

There are also instances where resistance is undesirable. Excessive resistance in the connecting leads of an electrical circuit can cause both heating and electrical loss. The heating, if sufficient, can cause a fire hazard, particularly in house wiring, and the circuit losses are a waste of electrical power.

Electrical resistance is expressed by a unit known as the *ohm*, indicated by the letter *R*. An electrical conductor has a resistance of one ohm when an applied EMF of one volt causes a current of one ampere to flow through it.

Resistance Factors. There are other factors beside the composition of the material that determine its resistance. For example, temperature has an effect on the resistance of a conductor. As the temperature of copper increases, for example, its resistance increases. The increase in temperature causes the electrons in the outer ring of the atom to resist release to the free electron state. This increase in resistance with an increase in temperature is known as a *positive temperature coefficient*. Not all conductors show this increase in resistance with an increase in temperature; their resistance decreases with an increase in temperature. Such materials are said to have a *negative temperature coefficient*. Certain metallic alloys have been developed which exhibit a *zero temperature coefficient*: their resistance does not change with changes in temperature.

As you might suspect, the length of a conductor has an effect upon its resistance. Doubling the length of a conductor will double its resistance. By the same token, halving the length of a conductor will cut its resistance in half. Just remember that the resistance of a conductor is *directly proportional to its length*.

The cross-sectional area of a conductor also determines its resistance. As you double the cross-section of a conductor, you halve its resistance; halving its cross-section doubles its resistance. Here again, the "why" of this is pretty easy to see: there are more current carrying electrons available in a large cross-section conductor than in a small cross-section conductor of the same length. Therefore, the resistance of a conductor is *inversely proportional to its cross-sectional area*.

Circuit Relationship. Now that we have a basic understanding of voltage, current, and resistance, let's take a look at just how they interact under circuit conditions.

Fig. 6A shows a battery, ammeter (a device to indicate current strength), and resistor connected in series. Notice that the ammeter indicates that 4 amperes are flowing in the circuit.

Fig. 6B shows the identical setup with the exception that the battery voltage has now been doubled. The ammeter now shows that twice the original current, or 8 amperes, are now flowing in the circuit. Therefore, we can see that doubling the voltage applied to the circuit will double the current flowing in the circuit.

In Fig. 6C the same circuit appears again; this time, however, the battery voltage is one-half its original value. The ammeter shows that one-half of the original current or 2 amperes, are now flowing in the circuit. This shows us that halving the voltage ap-

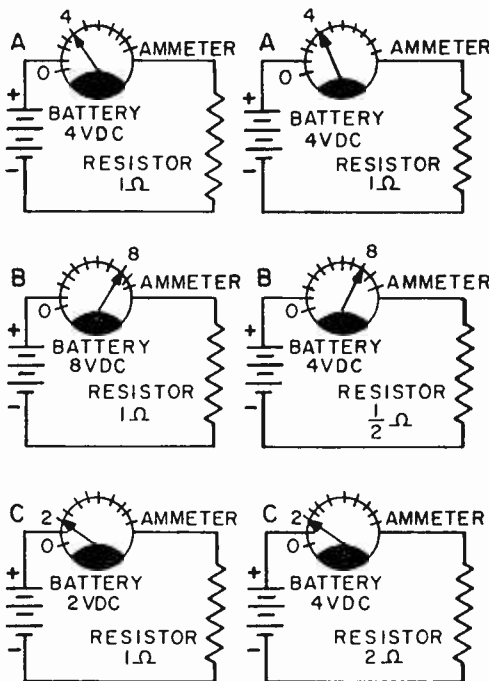

Fig. 6. In A, B, and C, the value of the resistor remains constant while the supply voltage is altered with a resulting current change.

Fig. 7. Battery voltage in A, B and C is held constant while resistor is halved and doubled in value. Resulting current changes are basis for Ohm's law.

plied to the circuit will halve the current flowing through the circuit.

All this boils down to the fact that assuming the same circuit resistance in all cases, *the current flowing in a circuit will be directly proportional to the applied voltage*—increasing as the voltage is increased, and decreasing as the applied voltage is decreased.

In Fig. 7A we again see the circuit consisting of the battery, ammeter, and resistance. Notice that the ammeter indicates that 4 amperes are flowing through the circuit.

In Fig. 7B we see that the value of resistance has been cut in half and as a result, the ammeter indicates that twice the original current, or 8 amperes, is now flowing in the circuit. This leads us to the correct assumption that for a given supply voltage, halving the circuit resistance will double the current flowing in the circuit.

Fig. 7C again shows our basic circuit, but with the resistance now doubled from its original value. The ammeter indicates that the current in the circuit is now one-half of its original value.

Summing things up: for a given supply voltage, *the current flowing in a circuit will be inversely proportional to the resistance in the circuit.*

Ohm's Law. From what you have seen so far, you are probably getting the idea that you can determine the current flowing in a circuit if you know the voltage and resistance present in the circuit, and the voltage if you know the current and resistance, or the resistance if the voltage and current are known.

All this is quite correct, and is formally stated by Ohm's Law as follows:

$$I = \frac{E}{R}$$

Where: E = voltage
I = current
R = resistance

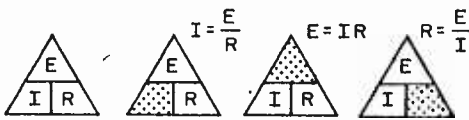

Fig. 8. Shaded portion of triangle indicates unknown quantity in the formula. Visible factors appear in their proper mathematical relation. Just fill in the known values and go on with multiplication or division.

Now, let's take a look at how this formula is used:

To find voltage:

$$E \text{ (voltage)} = I \text{ (current)} \times R \text{ (resistance)}$$

To find current . . .

$$I \text{ (current)} = \frac{E \text{ (voltage)}}{R \text{ (resistance)}}$$

To find resistance:

$$R \text{ (resistance)} = \frac{E \text{ (voltage)}}{I \text{ (current)}}$$

A handy way to remember Ohm's Law is by means of the triangle shown in Fig. 8. Simply cover the quantity (voltage, current, or resistance) that you want to determine, and read the correct relationship of the remaining two quantities. For example, if you want to know the correct current (I), put

your finger over I and read $\frac{E}{R}$. Covering

E or R will yield $I \times R$ or $\frac{E}{I}$, respectively.

Ohm's Law to Determine Voltage. Let's delve a bit more deeply into Ohm's law by applying it to a few cases where we want to determine the unknown voltage in an electrical circuit. Take a look at Fig. 9, which shows a simple series circuit consisting of a battery and resistor. The value of this resistor is given as 200 ohms, and 0.5 ampere of current is flowing through the circuit. We want to find the value of battery voltage. This is easily done by applying Ohm's law for voltage as follows:

$$E = I \times R$$

Let's go through this again, this time using a practical illustration. Fig. 10 shows a string of light bulbs, the total resistance of which is 400 ohms. You find that the bulbs draw 0.3 amperes when lighted. Let's say you would like to operate this string of bulbs

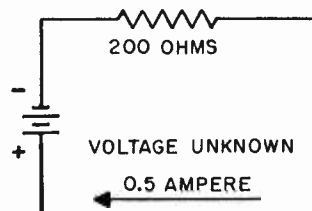

Fig. 9. Unknown quantity, voltage, found easily by applying Ohm's law.

Fig. 10. Although problem looks different the basic circuit is same as that for Fig. 9.

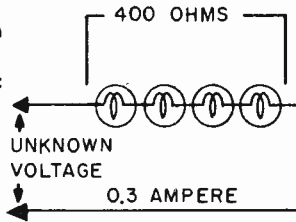

Fig. 12. Basic circuit is same as that in Fig. 11. Although three factors are given, current is unknown quantity.

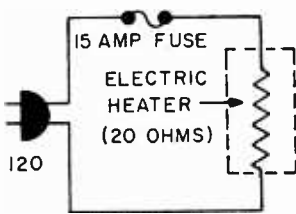

Fig. 11. Formula needed here is different since current is unknown. Just look for triangle in Fig. 8 that has I shaded.

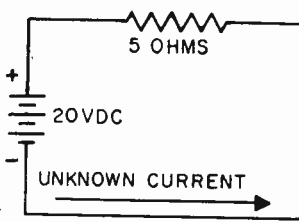
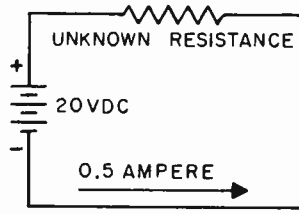

Fig. 13. Most Ohm's law problems are simple series circuits or can be reduced to simple series circuits.



from the standard 120-volt house current, but you don't know the voltage rating of the individual bulbs. By using Ohm's law for voltage, you can easily determine the voltage to light the bulbs as follows: (unknown voltage) = 0.3 (amperes) x 400 (bulb resistance) = 120 volts.

Ohm's Law to Determine Current. Now, let's take a look at a few examples of how to determine the value of unknown current in a circuit in which both the voltage and resistance are known.

Fig. 11 shows a series circuit with a battery and resistor. The battery voltage is 20 volts DC and the value of resistance is 5 ohms. How much current is flowing through the circuit?

$$\text{Ohm's law for current } I = \frac{E}{R}$$

$$I \text{ (unknown current)} = \frac{20 \text{ (battery voltage)}}{5 \text{ (resistance in ohms)}}$$

$$I = 4 \text{ amperes}$$

Again to get a bit more practical, let's take a look at Fig. 12. Here we see an electric heater element connected to the 120-volt house line. We know that this particular heater element has a resistance of 20 ohms. The house current line is fused with a 15-ampere fuse. We want to know whether the heater will draw sufficient current to blow the fuse. Here's how to find this out by use of Ohm's law for current.

$$I \text{ (unknown current)} = \frac{120 \text{ (line voltage)}}{20 \text{ (Heater resistance in ohms)}}$$

$$I = 6 \text{ amperes}$$

We find from the above use of Ohm's law for current that the heater draws 6 amperes, so it can be safely used on the line fused with the 15 ampere fuse. In fact, a 10 ampere fused line can also do the job.

Ohm's Law to Determine Resistance. Ohm's law for resistance enables us to determine the unknown value of resistance in a circuit. Fig. 13 again shows a simple series circuit with the battery voltage given as 20 volts and the current flowing through the circuit as 0.5 ampere. The unknown resistance value in this circuit is found as follows:

$$\text{Ohm's law for resistance } R = \frac{E}{I}$$

$$R \text{ (unknown resistance)} = \frac{20 \text{ (battery voltage)}}{0.5 \text{ (current in amperes)}}$$

$$R = 40 \text{ ohms}$$

Fig. 14 is a practical example of how to determine unknown resistance. Here, we want to operate a 6-volt light bulb from the 120-volt house line. What value of series dropping resistor do we need to drop the 120-volt house current down to 6 volts? The

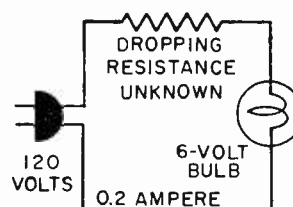

Fig. 14. This Ohm's law problem is somewhat more complex.

bulb draws 0.2 ampere.

We must first determine the voltage which must be dropped across the series dropping resistor. This is done by subtracting the line voltage (120) from the bulb's voltage (6). This gives us a value of 114 volts which we use in conjunction with Ohm's law for resistance as follows:

$$R \text{ (unknown resistance)} = \frac{114 \text{ (voltage dropped by resistor)}}{0.2 \text{ (bulb current in amperes)}}$$

$$R = 570 \text{ ohms}$$

Resistance in Series. Many practical electrical and electronic circuits use two or more resistances connected in series. The point to remember in this case is that the total resistance is the sum of the individual resistances. This is expressed by the formula:

$$R \text{ (total resistance)} = R_1 + R_2 + R_3 + \text{etc.}$$

where R_1 , R_2 , R_3 , etc. are the individual resistances. Thus, in Fig. 15 the total of the individual resistances is $R \text{ (total)} = 40 + 6 + 10 + 5 = 61 \text{ ohms}$.

Resistances may also be connected in parallel in a circuit as in Fig. 16. In this case the current flowing in the circuit will divide between the resistances, the greater current flowing through the lowest resistance. Also, the total resistance in the circuit will always be less than the smallest resistance since the total current is greater than the current in any of the individual resistors. The formula for determining the combined resistance of the two resistors is:

$$R \text{ (total)} = \frac{R_1 \times R_2}{R_1 + R_2}$$

Thus, in Fig. 16 the effective resistance of R_1 and R_2 is:

$$R \text{ (total)} = \frac{2 \times 4}{2 + 4} = \frac{8}{6} \text{ or } 1.33 \text{ ohms.}$$

In a circuit containing more than two parallel resistors as in Fig. 17 the easiest way to determine the total circuit resistance is as follows: first, assume that a 6-volt battery is connected across the resistor network. Pick a value that will make your computations simple. Then determine the

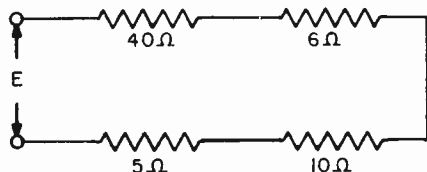

Fig. 15. Resistance in series are added. As far as voltage applied and current flow is concerned the individual resistors are only one.

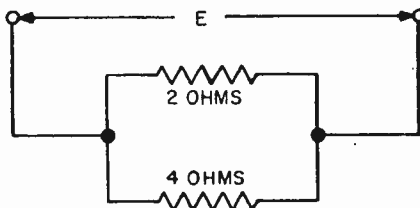

Fig. 16. Resistors in parallel are added algebraically—the result will always be a value less than that of the lowest in the circuit.

current flowing through each of the resistors using Ohm's law.

$$I = \frac{E}{R_1} = \frac{6}{2} = 3 \text{ amperes}$$

$$I = \frac{E}{R_2} = \frac{6}{3} = 2 \text{ amperes}$$

$$I = \frac{E}{R_3} = \frac{6}{6} = 1 \text{ ampere}$$

Next, add the individual currents flowing through the circuit:

$$2 \text{ amperes} + 3 \text{ amperes} + 1 \text{ ampere} \\ I = 6 \text{ amperes}$$

Inserting this 6 amperes in Ohm's law, the total circuit resistance is found to be:

$$R = \frac{6}{6} = 1 \text{ ohm}$$

The combined equation for determining the total resistance of n number of resistances would be:

$$\frac{1}{R} = \frac{1}{R_1} + \frac{1}{R_2} + \frac{1}{R_3} + \dots + \frac{1}{R_n}$$

Quite often an electronic circuit will contain a combination of series and parallel re-

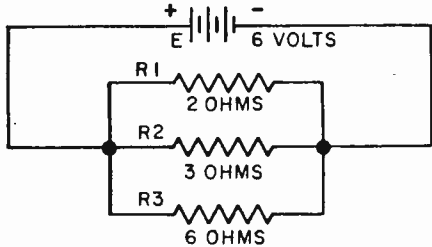

Fig. 17. Ohm's law can be used to determine the equivalent resistance of two or more resistors in parallel. Total current—then solve for ohms.

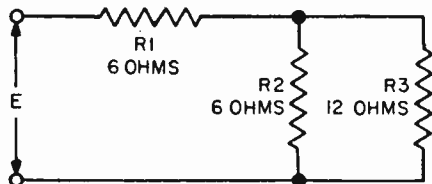

Fig. 18. Series-parallel circuit is not really difficult. Add R2 and R3 algebraically. Add effective resistance to R1 for total resistance.

sistances as in Fig. 18. To solve this type of problem, first determine the combined resistance of R2 and R3:

$$R \text{ (total)} = \frac{6 \times 12}{6 + 12} = \frac{72}{18} = 4 \text{ ohms}$$

This total value of R2 and R3 may be considered a single resistance which is in series with R1, and forms a simple series circuit. This simple series circuit is solved as follows:

$$R \text{ (total)} = 6 + 4 \text{ or a total of } 10 \text{ ohms.}$$

Power. The amount of work done by electricity is termed the *watt* and one watt is equal to one volt multiplied by one ampere. This may be expressed as: $P = E \times I$ where $E =$ voltage in volts, $I =$ the current in amperes. Also:

$$P = \frac{E^2}{R} \text{ and } P = I^2R$$

As an example, assume that a toaster draws 5 amperes at an applied voltage of 115 volts. Its wattage would then be:

$$P = 115 \times 5 \text{ or } 575 \text{ watts.}$$

Magnetism and the Electron. The atom, and a concept of its structure were a necessary preface to our discussion of basic electricity. By the same token, both are neces-

sary to understanding basic magnetism.

As we've mentioned, electrons are in continual motion about the nucleus. The orbit is, in fact, a small loop of current and has a magnetic field that's associated with a current loop. In addition, experimental and theoretical investigation seems to indicate that the electron itself has a spin. Each electron, having its own axis, is a spinning sphere of electric charge. *Electron spin*, like the quantum and wave theories of light, is not so much a literal interpretation of a phenomenon, but a useful concept that holds water when applied to the phenomenon of magnetism.

When the electron spins, the charge that is in motion produces a magnetic field. And, to briefly state the electronic explanation of magnetism, it seems that the magnetic properties of matter can be attributed to the orbital and spinning motion of the electrons comprising the atoms of the matter.

Millennia of Magnetism. Some of the basic principles and effects of magnetism have been known for centuries. The Greeks are credited as the ones who first discovered magnetism. They noted that a certain type of rock had the ability of attracting iron. Later, the Chinese noted that an elongated piece of this rock had the useful property of always pointing in a North-South direction when suspended by a string. This was the beginning of our compass.

This strange stone which intrigued people over the centuries is actually a form of iron ore known as magnetite. Not all magnetite shows magnetic properties. Another name for the magnetic variety of magnetite is lodestone—the term lodestone being derived from two separate words, lode and stone. The term lode stands for guide, hence lodestone mean "guide stone."

All magnets, whether natural or man made, possess magnetic poles, which are commonly known as the magnet's north and south poles. As is the case of the electrical charges (which we studied earlier) between unlike magnetic poles and repulsion between like poles, it has been found that this magnetic attraction and repulsion force varies inversely as the square of the distance from the magnetic poles.

The Magnetic Field. We all know how a magnet exerts a force of attraction on a piece of magnetic material such as iron or steel. Also, when the north poles of two magnets are brought close together, they will try to repel each other, while there will

be attraction between the north and south poles of two magnets. Although it is not clearly understood just what this force of magnetic attraction and repulsion is, it is convenient to visualize magnetic lines of force which extend outward from one magnetic pole to the other as illustrated in Fig. 19.

Permeability. Magnetic lines of force can pass through various materials with varying ease. Iron and steel, for example, offer little resistance to magnetic lines of force. It is because of this that these materials are so readily attracted by magnets. On the other hand, materials such as wood, aluminum and brass do not concentrate or encourage the passage of magnetic lines of force, and as a consequence are not attracted by magnets.

The amount of attraction a material offers to magnetic lines of force is known as its permeability. Iron and steel, for example, possess high permeability since they offer little resistance to magnetic lines of force. Nonmagnetic materials have low permeability. For practical purposes, we can say that reluctance is to magnetic lines of force what resistance is to an electrical current.

Electromagnetism. Any electrical conductor through which flows an electrical current will generate a magnetic field about it which is perpendicular to its axis as shown in Fig. 20. The direction of this field is dependent upon the direction of current flow, and the magnetic field strength proportional to the current strength. If this current-carrying conductor is wound into a coil, forming a solenoid, the magnetic field will be increased by each individual turn that is added. If an iron core is inserted in this current carrying coil, the generated field will be increased still further. This is because the lines of force are concentrated within the iron core which has considerably less reluctance than the surrounding air.

The magnetizing power of a multi-turn current-carrying coil through which a core is inserted is proportional to the current flowing through the coil as well as the number of turns in the coil. The current through the coil is termed *ampere turns*. As an example, if a coil consisting of 200 turns is carrying 2 amperes, its ampere turns equal:

$$\text{Ampere turns} = 200 \text{ turns} \times 2 \text{ amperes} \text{ or } 400 \text{ ampere turns}$$

Similarly a coil of 100 turns through which a current of four amperes flows also

has 400 ampere turns.

Electromagnetic Induction. We saw earlier how a current carrying conductor will generate a magnetic field which is perpendicular to the conductor's axis. Conversely, a current will be induced in a conductor when the conductor is passed through a magnetic field. The strength of this induced current is proportional to both the speed at which it passes through the field and the strength of the field. One of the basic laws pertaining to electromagnetic induction is Lenz's law which states: "The magnetic action of an induced current is of such a direction as to resist the motion by which it is produced."

Fig. 21 illustrates two coils, A and B, which are placed in close proximity to each other. Coil A is connected in series with a switch and battery so that a current may be sent through it when the switch is closed, and coil B is connected with a current-indicating DC meter. When the switch is closed, current will flow through coil A, causing a magnetic field to be built up around it. In the brief instant that the field is building up to maximum, it will "cut" the turns of coil B, inducing a current in it, as indicated by a

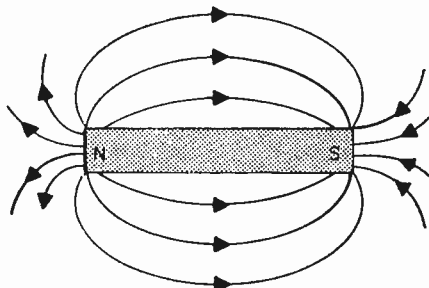

Fig. 19. Lines of force around bar magnet can be made visible by sprinkling iron filings onto white paper over magnet. Tap paper gently.

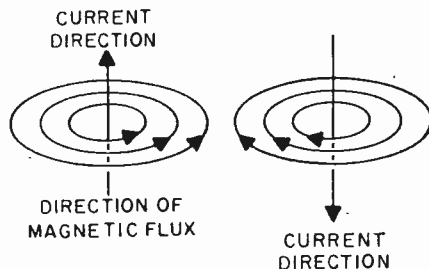

Fig. 20. Direction of flux lines is changed by direction of the current. Heavy current is needed to make flux lines visible with sprinkled filings.

momentary flick of the indicating meter. When the switch is opened, breaking the current flow through coil A, the field around coil A will collapse, and in so doing will again induce a current in coil B. This time, however, the flow of current will be in the opposite direction. The meter will now flick in an opposite direction than it did when the switch was closed. The important thing to remember is that the conductor must be in motion with respect to the magnetic field or vice versa in order to induce a current flow. You can perform this simple experiment using two coils made of bell wire wrapped around two large nails, a few dry cells in series, and a DC zero-center scale meter.

Self Induction. As mentioned a short while ago, a magnetic field is built up around a coil at the application of current through the coil. As this field is building up, its moving lines of flux will cut the turns of the coil inducing a counterelectromotive force or counter EMF which opposes the current flowing into the coil.

The amount of counter EMF generated depends upon the rate of change in amplitude of the applied current as well as the inductance of the coil. This value of inductance is dependent upon the number of turns in the coil; a coil with many turns will have greater inductance than a coil with few turns. Also, if an iron core is inserted into the coil, the inductance of the coil will increase sharply. The unit of inductance is known as the *henry*.

The Transformer. One of the most important and widely used applications of

magnetic induction is the transformer. Transformers find the major application in stepping up or down voltage and current in countless applications.

Fig. 22 shows the basic construction of a typical transformer. While two separate windings are shown here, some transformers can have as many as five or six windings.

A transformer consists of two or more separate windings, electrically insulated from each other. One winding, which is known as the primary winding, is fed from a source of alternating current.

The alternating currents flowing through the primary induce a current in the secondary winding by virtue of magnetic induction. The transformer core is constructed from a relatively high permeability material such as iron which readily conducts magnetic flux between the primary winding and secondary winding.

The alternating current flowing in the primary of the transformer produces a variation in the magnetic flux circulation in the transformer core which tends to oppose the current flowing in the primary winding by virtue of self-induction. The counter EMF is just about equal to the voltage applied to the primary winding when no load is connected to the transformer's secondary winding. This accounts for the fact that very little current flows through the primary winding when no load is connected to the secondary. The negligible current that does flow under this no-load condition is known as the transformer magnetizing current. As the current drawn from the secondary wind-

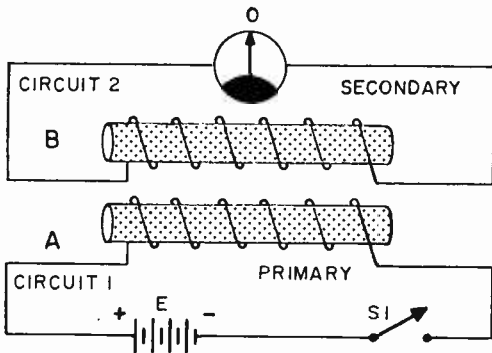

Fig. 21. Two-core transformer is inefficient since an air gap at either end does not have permeability of a ferrous metal and some flux lines do not go through core of secondary winding (B)—their effect is lost.

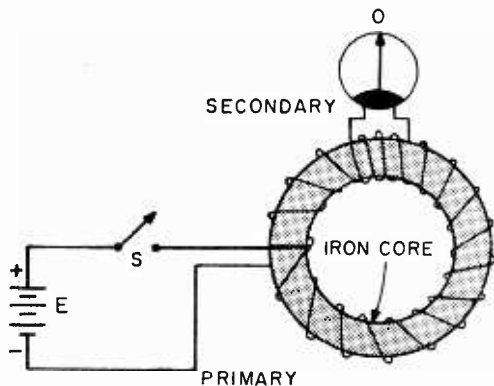

Fig. 22. Toroidal core is highly efficient but is very difficult to manufacture. Familiar C- and E-shape core has less waste and windings are slipped over the core. Efficiency is good—about 90 percent for most designs.

ing increases, the primary current will increase proportionately due to the reduction in the counter EMF developed in the primary winding of the transformer.

In any transformer the ratio of the primary to secondary voltage is equal to the ratio of the number of turns in the primary and secondary windings. This is expressed mathematically as follows:

$$\frac{E_p}{E_s} = \frac{N_p}{N_s}$$

where E_p = primary supply voltage

E_s = voltage developed across secondary

N_p = number of primary turns

N_s = number of secondary turns

The above formula assumes that there are no losses in the transformer. Actually, all transformers possess some losses which must be taken into account.

Transformer Losses. No transformer can be 100 per cent efficient due to losses in the magnetic flux coupling the primary and secondary windings, eddy current losses in the transformer core, and copper losses due to the resistance of the windings.

Loss of magnetic flux leakage occurs when *not all* the flux generated by current flowing in the primary reaches the secondary winding. The proper choice of core material and physical core design can reduce flux leakage to a negligible value.

Practical transformers have a certain amount of power loss which is due to power being absorbed in the resistance of the primary and secondary windings. This power loss, known as the copper loss, appears as

heating of the primary and secondary windings.

There are several forms of core loss—hysteresis and eddy current losses. Hysteresis losses are the result of the energy required to continually realign the magnetic domain of the core material. Eddy current loss results from circulating currents induced in the transformer core by current flowing in the primary winding. These eddy currents cause heating of the core.

Eddy current loss can be greatly reduced by forming the core from a stack of individual sheets, known as laminations, rather than from a single solid piece of steel. Since eddy current losses are proportional to the square of core thickness, it is easy to see that the individual thin laminations will have much less eddy current loss as compared with a single thick core.

Another factor which effects eddy current loss is the operating frequency for which the transformer is designed to operate. As the operating frequency is increased, the eddy current losses increase. It is for this reason that transformers designed to operate at radio frequencies often have air cores and are void of ferrous metals.

Theory and Practice. We've come a long way from our initial discussion of the atom and its importance for an understanding of electricity and magnetism. And there's still a long way to travel to understand all about the subatomic nucleus and its satellites and how they are being harnessed in an ever-expanding electronics technology. But, we move ahead by mixing theory with practice—so, put your new knowledge to work in a project or two! ■

Parallel Resistance Nomograph

□ Whether you're working at home on the final stages of a pet project or on the job servicing an electronic system, nothing is quite as frustrating as discovering that the resistance value you need isn't available. And, your usual source of supply either is closed or doesn't stock the particular value. Or maybe you want a resistance within a tolerance of 1%, and just don't feel justified in paying the extra cost.

Whatever the problem, the experienced guy doesn't lose his cool, because he knows he can come up with any resistor value he needs by connecting available resistors in series and/or parallel. This combination can

either be left in the circuit or replaced at some later time with a single resistor.

Making Resistors. Making resistors by *series-ing* several resistors to reach a desired value poses no problem as the resistances are additive; i.e., if you connect a 51-ohm resistor in series with a 68-ohm resistor the final resistance of the combination is 119 ohms.

However, when you parallel resistors, the resultant resistance is no longer so easy to calculate. If you connect a 51-ohm resistor in parallel with a 68-ohm resistor the net resistance value is about 29 ohms. About the only thing you know is that the equivalent

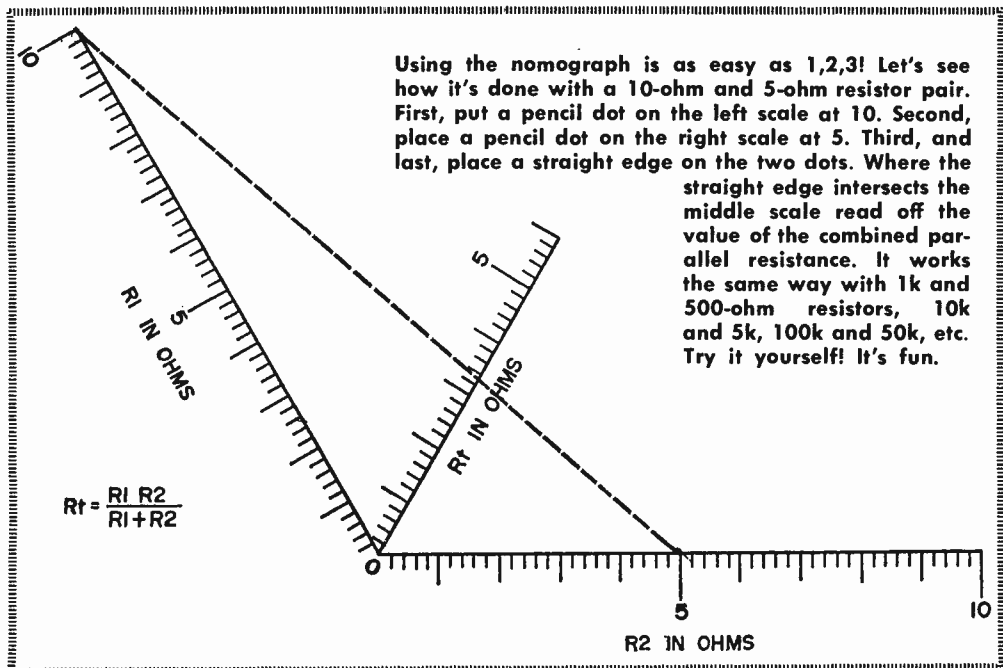

Using the nomograph is as easy as 1,2,3! Let's see how it's done with a 10-ohm and 5-ohm resistor pair. First, put a pencil dot on the left scale at 10. Second, place a pencil dot on the right scale at 5. Third, and last, place a straight edge on the two dots. Where the straight edge intersects the middle scale read off the value of the combined parallel resistance. It works the same way with 1k and 500-ohm resistors, 10k and 5k, 100k and 50k, etc. Try it yourself! It's fun.

resistance of a parallel combination will be less than the value of the smallest resistor in the combination. You can't determine the equivalent resistance of a parallel combination with simple mathematics. The formula isn't complex, but it does take time to write down and solve. The easiest, fastest modern method for determining the values of parallel resistor combinations for the serviceman is by using an equivalent resistance nomograph.

What's A Nomograph? Everyone's familiar with the old old Chinese proverb about one picture being worth a thousand words. A nomograph is simply a graphic picture of a simple approach to solving a mathematical calculation. And technicians in all fields are using nomographs in ever-increasing numbers. A nomograph can be constructed to solve almost any problem, and though the actual construction may require a master's degree in math, anyone can use the final end product to solve problems which might normally require a college degree and bushels of valuable time.

This is one of the most appealing features of most nomographs; i.e., that you don't need theoretical knowledge of the subject to use a nomograph to solve problems in that field. All that's necessary is to lay a straight edge, or draw a line, between two known values on given scales, and read the answer where the line intersects a third scale.

Making A Nomograph. The nomograph

printed in these pages is an equivalent resistance nomograph that can be cut out for use in your work. With it you can determine the resistance of any two resistors connected in parallel in much less time than you could normally write down the mathematics required to solve the problem.

The R1 and R2 scales are equal in length, and positions at an angle of 120° with respect to one another. The Rt scale is a little more than one half the length of the other two scales, and bisects the angle between them. The scale lengths and angular positioning are usually by courtesy of some slaving mathematician somewhere, but, if you have the time and patience, you can construct some nomographs by trial and error. The graduations on all scales of our nomograph are of the same length and can be assigned any value that you desire as long as the same size and values are used on all scales. For example, if one major division on the R1 scale is valued 100 ohms, then one major division on the R2 scale and one major division on the Rt scale must also be valued 100 ohms. With this in mind, let's find out how to use the equivalent resistance nomograph to solve parallel resistance problems.

Using A Nomograph. The equivalent resistance nomograph can be used in either of two ways. In one application you have two resistors connected in parallel and want to know what value single resistor will be

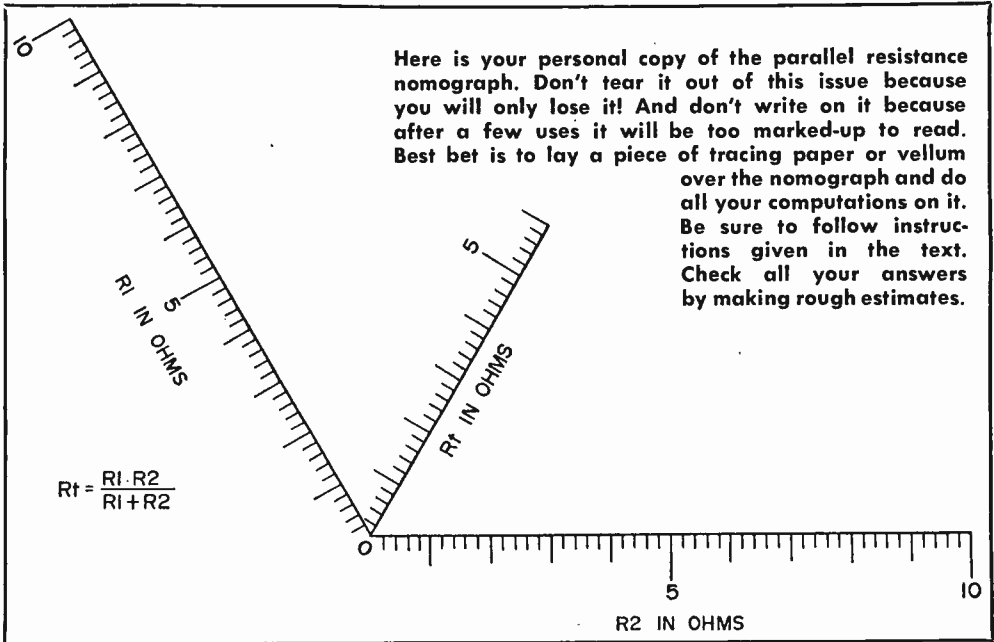

needed to replace the parallel combination. This situation often arises in breadboarding new circuits. To solve this problem you simply locate one resistance value on the R1 scale, and the other resistance value on the R2 scale. Then lay a ruler, or draw a straight-line between the points located on the R1 and R2 scales. The equivalent resistance will be where the straight edge crosses the R_t scale.

In another application you know the value of one resistor and want to know what value of resistance must be connected in parallel with it to obtain a desired value. This problem may arise because your stock of resistors is depleted, or because the required resistor is not a standard value. Non-standard values of resistance cost more, of course, and at times two resistors in parallel will enable you to get the desired resistance at a much lower cost. To arrive at the value of the resistor that you need to parallel with one of known value to reach the odd-ball resistance you want, find the mark on either the R1 or the R2 scale for the known resistance value. Next locate the resistance of the desired resistor value on the R_t scale. Then lay a straight edge between the two points, and read the value of the required parallel resistor on the remaining scale.

Typical Problems. A typical problem will serve as an example that should bring everything into sharp focus now. Let's suppose

that we have two resistors, 100,000 ohms and 47,000 ohms, connected in parallel in a project that's breadboarded and now ready for finalizing. With this parallel combination in the circuit our little jewel works fine, but the combination is bulky, unsightly, and expensive for quantity production. So obviously it's desirable to replace the bulky parallel resistor combination with a single fixed resistor.

Using the Equivalent Resistance Nomograph, locate the 100,000 ohm value on either the R1 or R2 scale (we used the R1 scale). We could have chosen any point on the scale as 100,000 ohms, but for better resolution the maximum point is the best choice. Next locate 47,000 ohms on the R2 scale, remembering that each major division is equal to 10,000 ohms because of the location of our assignment of the 100,000-ohm point on R1.

Now lay a straight edge across the nomograph so that it intersects the 100,000 and 47,000-ohm points on R1 and R2. Where the straight edge crosses the R_t scale, a line can be drawn on the nomograph, or, if you prefer, you will read the resultant resistance value, 32,000 ohms, on the R_t scale. In comparison, the correct answer, using slide rule and/or pencil and paper, of 31,950 ohms, certainly will take much longer to calculate than if you use the Equivalent Resistance Nomograph. ■

Prefixes and Exponents

□ Anyone who's dipped his little toe into electronics is certain to have run across such terms as *microFarad*, *milliHenry*, and *milliAmpere*—not to mention *megaHertz*, *megOhm*, and *kiloHertz*. The prefixes here—*micro-*, *milli-*, *mega-*, and *kilo-*—are an important part of the electronic vocabulary. It follows, then, that anyone who wants to be proficient in electronics will have to develop skill in understanding and using them.

These prefixes are used to change the value of an electronic unit of measure. For example, if you see a resistor with the familiar brown/black/green color code, you *could* call it a 1,000,000 ohm resistor. Thing is, it's usually less awkward to call it a 1-megohm resistor. Putting the prefix *meg-* or *mega-* before the Ohm inflates the value of the unit, Ohm, by 1,000,000 times.

Similarly, one kiloVolt is recognizable as 1,000 Volts, and one kiloHertz as 1,000 Hertz, and so on. These prefixes are usually so automatic with electronics aficionados that they will invariably refer to a millionaire as a guy who has one megabuck!

The Debit Side. At the other end of the scale, the *milli-* and *micro-* prefixes are useful for shrinking units. A Farad, for example, is too big a unit to use in everyday electronics. In dealing with the real-life capacitors (the kind you solder into circuits), we normally use a basic unit of *one-millionth* of a Farad—a *microFarad*. The prefix *micro-* cuts up a unit into a million tiny slices, enabling us to use one such slice as a convenient-sized unit. A micro-Ampere, similarly, is a millionth of an Ampere; a microVolt, one millionth of a Volt.

If you need larger slices, the *milli-* prefix is available, which provides a unit only one-thousandth the size of the basic unit. A milliAmpere, for example, is a thousandth of an Ampere; that is, it takes 1000 mA (milliAmperes) to equal 1 Ampere.

To handle these tiny slices of units, it's wise to spend a few minutes learning *scientific notation*, which is designed to make it easy to handle very large and very small numbers. Once you've mastered this technique, you can manipulate all the various-sized units of electronics as easily as you can add two and two!

Take, for example, the familiar *kiloHertz*,

(known until recently as the *kilocycle*). A broadcasting station operating at 840 kHz (kiloHertz) in the broadcasting band is radiating 840,000 cycles of RF energy every second. To change from 840 kHz to 840,000 Hz, you can think of the "kilo-" as being replaced by "x 1000", thus:

840	kilo	Hertz
840	x 1000	Hertz
840,000		Hertz

But you can also write "1000" as "10x10x10". And you can write "10x10x10" as "10³". (Ten to the third power, or ten cubed). As we develop these ideas further, you will see how you can simplify greatly your future work in electronics by thinking of the prefix "kilo-" as being replaceable by "x 10³", thus:

$$840 \text{ kiloHertz} = 840 \times 10^3 \text{ Hertz}$$

Similarly, a 6.8 megohm resistor, measured on an ohmmeter, will indicate 6,800,000 ohms. In this case, the prefix "meg-" can be replaced by "x 1,000,000":

6.8	meg	Ohms
6.8	x 1,000,000	Ohms
6,800,000		Ohms

But you can write "1,000,000" as "10x10x10x10x10x10" (six of 'em; count 'em), which is 10⁶. Thus, you should learn to mentally replace "meg-" with "x 10⁶", so that 6.8 megOhms becomes a 6.8 X 10⁶ Ohms. The 6 is called an *exponent*, and shows how many 10s are multiplied together.

The Minus Crowd. What about the "milli-" and "micro-" prefixes? "Milli-", we've said, is one-thousandth; in a way, it is the opposite of the "kilo-" prefix. Make a mental note, then, that milli- can be replaced with "10⁻³" (read as "ten to the *minus* three power"), which is 1/10x1/10x1/10 = 1/1000. Similarly, the "micro-" prefix can be considered as the opposite of "meg-", and replaced by 10⁻⁶.

The beauty of this approach appears when you are faced with a practical problem, such as, "if 1.2 milliAmperes flows through 3.3 megOhms, what voltage appears across the resistor?" From our knowledge of Ohm's Law, we know that E = IR; that is, to get Volts (E) we multiply current (I) times resistance (R). Without the aid of

scientific notation, the problem is to multiply 0.0012 Amperes by 3,300,000 Ohms, which is rather awkward to carry out. The same problem, however, is very easy in scientific notation, as can be seen below:

$$\begin{array}{r} 1.2 \times 10^3 \\ 3.3 \times 10^6 \\ \hline 3.96 \times 10^3 \end{array}$$

The answer is 3.96×10^3 Volts, or 3.96 kiloVolts. We obtained the answer by multiplying 1.2×3.3 to get 3.96, and adding the -3 exponent to the 6 exponent to get 3 for the exponent of the answer. The advantage of scientific notation is that the largeness and smallness of the numbers involved is indicated by numbers like 10^6 and 10^{-3} , and the largeness or smallness of the answer is found by adding the 6 and the -3.

What about a division problem? For the sake of a good illustrative example, consider the unlikely problem of finding the current when 4.8 megaVolts is applied across 2 kilOhms. The problem is written as:

$$\begin{aligned} I &= \frac{E}{R} \\ &= \frac{4.8 \text{ megaVolts}}{2 \text{ kilOhms}} = \frac{4.8 \times 10^6 \text{ Volts}}{2.0 \times 10^3 \text{ Ohms}} \\ &\quad 4.8 \div 2 = 2.4 \\ 2.4 \times 10^3 \text{ Amperes} &= 2.4 \text{ kiloAmperes} \end{aligned}$$

In division, then, finding the size of the answer becomes a *subtraction* problem, in which the exponent representing the size of the divisor ("bottom" number) is subtracted from the exponent representing the size of the dividend ("top" number).

A more practical division problem answers the question, "what current flows when 5 Volts is applied across 2.5 kilOhms?"

$$\begin{aligned} I &= \frac{E}{R} = \frac{5 \text{ Volts}}{2.5 \text{ kilOhms}} \\ &= \frac{5.0 \times 10^0}{2.5 \times 10^3} = \frac{5.0 \times 10^{(0-3)}}{2.5} \\ &= 2.0 \times 10^{-3} \text{ Amperes} \\ &= 2.0 \text{ milliAmperes} \end{aligned}$$

Note that it's perfectly legal to use 10^0 (ten to the zero power) to indicate a unit that has no prefix—in other words, one of anything.

For The Solving. Here are a few more problems:

1. The inductive reactance of a coil is given by

$$X_L = 2\pi fL.$$

What is the reactance of a coil whose inductance $L = 22$ milliHenries, when an alternating current of frequency $f = 1.5$ megaHertz is applied to it?

$$\begin{aligned} X_L &= 2 \times \pi \times (1.5 \times 10^6) \times (22 \times 10^{-3}) \\ &= 207.24 \times 10^3 \text{ Ohms} \\ &= 207.24 \text{ kilOhms} \end{aligned}$$

2. An oscillator is connected to a wavelength-measuring apparatus, and the wavelength of its oscillations determined to be 2.1 meters. What is the frequency of the oscillator?

$$\begin{aligned} F &= \frac{\text{speed of light}}{\text{wavelength}} \\ &= \frac{3.0 \times 10^8 \text{ meters per second}}{\text{wavelength}} \\ &= \frac{3.0 \times 10^8}{2.1 \times 10^0} = 1.4286 \times 10^8 \text{ Hertz} \end{aligned}$$

We wish this answer had come out with a " 10^6 ", instead of a " 10^8 ", because we can convert 10^6 Hertz directly to megaHertz. However, we can change the answer to 10^6 , by shifting the decimal point of the 1.4286. Remember this rule: To *lower* the exponent, shift the decimal point to the *right*. (Of course, the opposite rule is also true). Since we wish to lower the exponent by 2, we must shift the decimal point to the right by two places:

$$142.86 \times 10^6 \text{ Hertz} = 142.86 \text{ megaHertz}$$

3. A 3.3 microfarad capacitor is being charged from a 20-volt battery through a 6.8 kilOhm resistor. It charges to half the battery voltage in a time given by

$$T = 0.69RC$$

For the particular values given in the problem, what is the time taken to charge to half the battery voltage?

$$\begin{aligned} T &= 0.69 \times (6.8 \times 10^3) \times (3.3 \times 10^{-6}) \\ &= 15.4 \text{ milliseconds} \end{aligned}$$

Tera To Atto. Since scientific notation is so potent, you'll probably be interested in the meaning of *all* the prefixes used in the scientific community, not just the four—micro-, milli-, kilo-, and mega—that we've discussed so far. Very common in electronics is the *micro-microFarad*, which is $10^{-6} \times 10^{-6}$ Farad, or 10^{-12} Farad. This is more commonly known as the *picoFarad*. Similarly, a thousandth of a microAmpere is $10^{-3} \times 10^{-6}$ Ampere, or 10^{-9} Ampere. This is known as a nanoAmpere. At the other extreme, 1000 megaHertz is called a giga-

ELECTRONIC PREFIXES AND THEIR MEANINGS

Prefix	Pronunciation	Symbol	Exponent	Example
tera-	TEHR-uh	T	10^{12}	Frequency of infra red light is approx. 1 teraHertz
giga-	GIG-uh	G	10^9	Frequency of TV channel 82 is approx. 1 gigaHertz
mega-	MEG-uh	M	10^6	Frequency of typical shortwave broadcast station is approx. 1 megaHertz
kilo-	KILL-oh	k	10^3	Top note on a piano is approx. 4 kiloHertz
hecto-	HEK-toh	h	10^2	(not often used in electronics)
deka-	DEK-uh	da	10^1	(not often used in electronics)
deci-	DESS-ih	d	10^{-1}	A decibel is 1/10th bel
centi-	SENT-ih	c	10^{-2}	Wavelength of TV channel 82 is approx. 30 centimeters
milli-	MILL-ee	m	10^{-3}	Collector current of a typical small transistor is approx. 1 milliAmpere
micro-	MY-kroh	μ	10^{-6}	Base current of a typical small transistor is approx. 20 micro-Amperes
nano-	NAN-oh	n	10^{-9}	Time for a radio wave to travel 1 foot is approx. 1 nanosecond
pico-	PY-koh	p	10^{-12}	Collector-to-base capacity of a good high-frequency transistor is approx. 1 picoFarad
femto-	FEM-toh	f	10^{-15}	Resistance of 6 microinches of 0000 gauge wire is approx. 1 femtOhm
atto-	AT-toh	a	10^{-18}	6 electrons per second is 1 atto-Ampere

Hertz. See the table of these prefixes on page 29, together with their meanings and pronunciations.

The jargon of electronics which has grown up around these prefixes is just as important as the prefixes themselves. Here are some examples of "jargonized" prefixes as they might appear in speech:

Puff—a picoFarad (from the abbreviation, pF)

Mickey-mike—A micro-micro Farad (which is the same as a puff)

Meg—A megohm. Also, less often, a megaHertz.

Mill—A milliAmpere

Megger—a device for measuring meg-Ohms

dB (pronounced "dee-bee"—A decibel, which is one-tenth of a Bel

Mike—A microFarad. Also, to measure with a micrometer.

So, if you understand the prefixes and know their corresponding exponents, you'll have command of another set of important tools to help you do practical work in electronics. In addition, you'll be ready for the inevitable wise guy who'll ask if you can tell him the reactance of a 100-puff capacitor at 200 gigaHertz. After calculating the answer in gigaseconds, reply in femtOhms! ■

All About C-Zn Batteries

□ There are several sources of electricity available for experimenters now as opposed to very limited sources at the beginning of the electronic age. Initially, early experimenters had only static electricity, produced essentially by rubbing an insulating material such as a hard rubber or glass rod with cloth or fur, or as Ben Franklin demonstrated, by flying a kite during an electrical storm.

In this modern age of widespread power distribution nearly every home and building is wired to a power company's generating station. In addition, there are various kinds and shapes of batteries readily available that are more useful than static electricity. Main reason that static electricity is of no practical use is because modern electrical machinery, appliances, and electronic equipment require a continuous flow of current for their operation.

Since the subject of this discussion is the zinc-carbon battery, we'll confine our words to this one source of reliable electrical power. Today's very efficient dry cells evolved from the original zinc-carbon battery, called the Leclanché cell, named after its inventor, Georges Leclanché. Before the advent of electronics they were used extensively for door bells, alarms, telephones, and other applications where current is needed only intermittently.

How Batteries Are Made. There's a great deal of similarity between the original Leclanché cell and modern zinc-carbon bat-

teries. Everyone's familiar with the conventional round single cells, such as AA, C, D, and #6 sizes, which are packaged and wired together to make up higher voltage batteries. In addition, there are flat rectangular cells, that stack one on top of the other, which have been developed for higher voltage batteries. These flat cells produce a longer-lived battery since there is less wasted space, making it possible to produce a higher capacity cell in a given cubic space. Though available in many different shapes

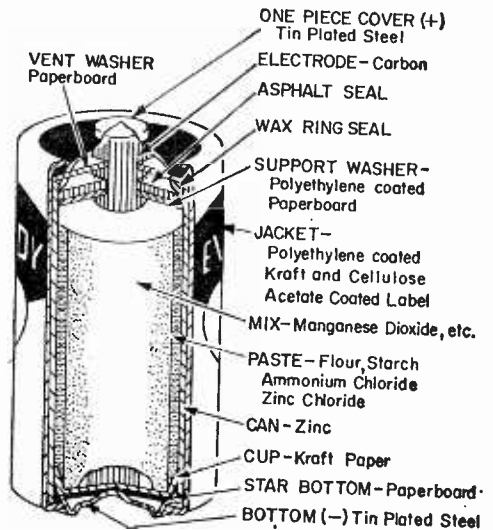

Above, cutaway view of a flashlight cell, either AA, C, or D size. This view shows various components making up cell. Study of this and reference to text helps to understand general makeup of carbon-zinc battery.

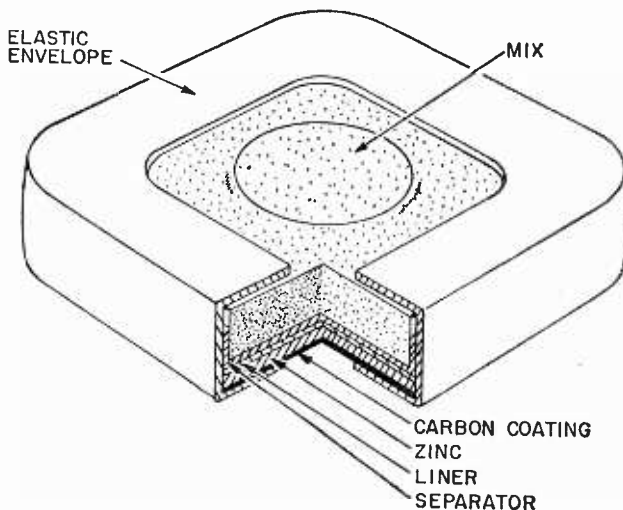

Left, cutaway view of square "mini-max" zinc-carbon cell. It develops 1.5V same as round cells; chief advantage is that for same volume of space it has greater capacity.

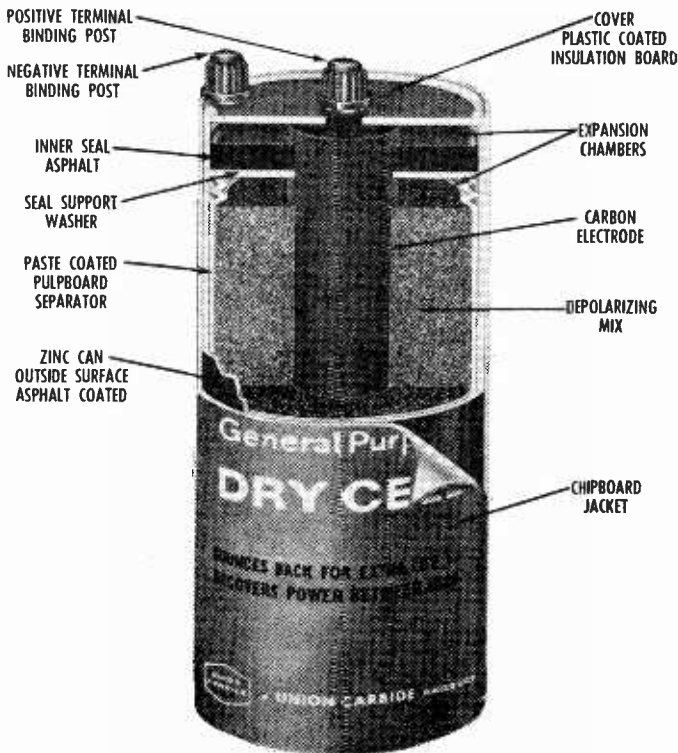

"Old Faithful" #6 dry cell shown here in cross section has been used where long life is a must. Though larger than AA, C, and D cells, its output is 1.5V

and sizes, the zinc-carbon battery, more commonly called dry-cell, is comprised basically of the same materials originally used by Leclanché.

His cell was made up of a positive carbon element, a zinc negative element formed to serve as a container, and an electrolyte. The electrolyte is a solution of sal ammoniac (ammonium chloride) that doesn't actively attack the zinc when no current is drawn from the cell, or it's being stored.

A thin separator of either porous paper, or a thin layer of wheat flour and cornstarch, lines the zinc container. The separator, which is saturated with electrolyte, separates the metal from the mix and prevents the cell from discharging itself in short order. The separator permits chemical action to take place when the cell is furnishing electrical energy to a load and prevents the chemical action when the load is disconnected and no current flows.

When current is drawn from the cell for reasonably long periods, hydrogen gas accumulates on the carbon element. This accumulation of hydrogen gas bubbles polarizes the cell, which, in turn, appreciably reduces the current it will deliver. The cell, however, doesn't revive after a rest period.

Depolarizing Agent. Continuous heavy current drain initiates the generation of hydrogen within the cell that causes it to become polarized, which soon results in low cell output. Leclanché added a chemical depolarizing agent, manganese dioxide, which is really an oxidizing agent. By definition, an oxidizing agent is a chemical that releases its oxygen readily. Since oxygen and hydrogen have a strong affinity for one another, the hydrogen that accumulates on the carbon element unites chemically with the oxygen from the manganese dioxide and forms water. In essence, the depolarizer (MnO_2) reacts with and removes the hydrogen to avoid polarization.

The term dry cell is a misnomer, since the electrolyte, though not a liquid, is a wet paste that also contains the depolarizing agent and fine particles of carbon to reduce internal cell resistance. Cell design, customized for specific applications, is based primarily on the percentage of carbon particles in the mixture. The cell won't spill, evaporate, or run over because, on commercially manufactured cells, the top is sealed. When the battery no longer produces electrical energy it isn't because the wet paste has dried up or because any one particular

chemical has been used up. Instead, it's because all of the active ingredients are chemically united to form new compounds that are not active, thus for all intents and purposes creating a worn-out cell.

A dry cell remains inactive until a load is connected, at which time electricity is produced by chemical reaction. Each zinc atom gives up two electrons to the load circuit and forms a positive zinc ion (Zn^{++}) that goes into the electrolyte. The chemical equation is:

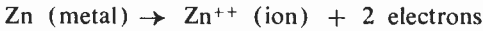

The electrons return to the cell through the positive electrode and enter into another reaction with ammonium ions (NH_4^+) and the manganese oxide (MnO_2). These electrons are absorbed in the reaction and produce manganese oxide (Mn_2O_3), ammonia (NH_3), and water (H_2O). The equation for this reaction is:

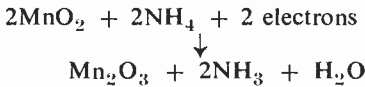

In addition, the ammonia (NH_3) combines with the zinc ion to form a complex zinc ion.

Some cells may contain zinc chloride ($ZnCl_2$) which create other reactions. Regardless of the chemicals used the electrons that make up the current flow come from the zinc metal, which is consumed in the process.

Shelf Life. Open circuit voltage of a dry cell, regardless of its size, is 1.5 Volt. As the active ingredients become depleted, the internal impedance or cell resistance increases until the cell becomes useless. The resistance of new AA, C, D, and #6 cells normally is less than $\frac{1}{2}$ ohm. Shelf deterioration results from two major factors: a) loss of moisture through evaporation because of poor seals, or b) low-level chemical reactions that occur within the cell independent of those created by current drain. Internal current leakage causes the cell to discharge itself at a slow rate. This accounts for the gradual depletion of battery output even though the cells are not connected in a circuit to supply power. This gradual depletion of battery life is commonly referred to as shelf life.

Since raising the temperature of chemical

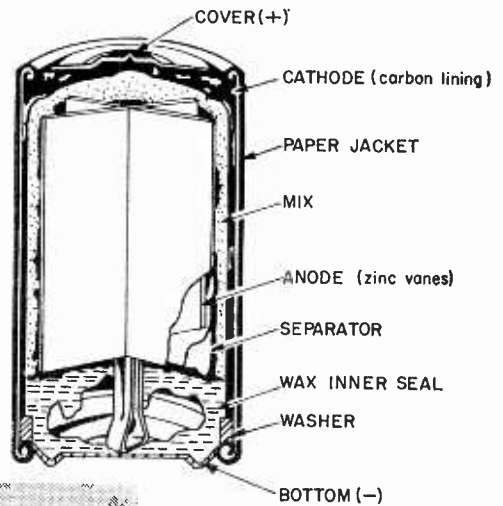

Above, cutaway view of external cathode or "inside out" type of battery. Molded carbon wall is both container and current collector. Zinc vanes are inside cell, ensuring efficient zinc consumption.

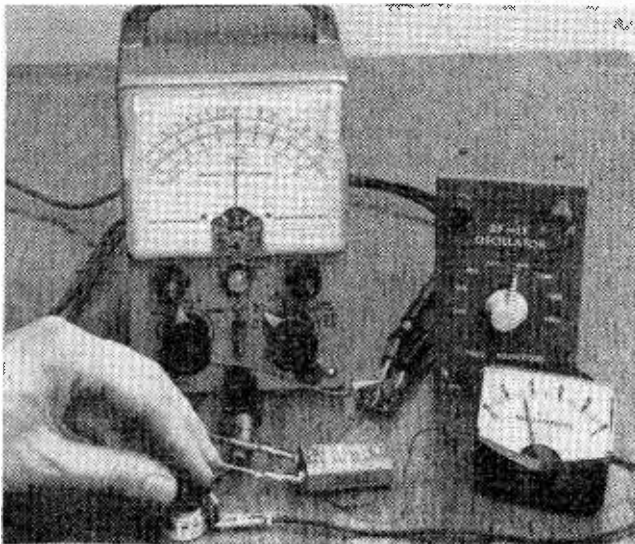

Left, checking cutoff voltage and current consumption to plot capacity of battery for most economical operation of signal generator.



'73 Heathkit® Catalog

Shown below are only a few of the more than 350 kits fully described in the 1973 Heathkit catalog. Kits for every interest, every budget...including color TV; stereo systems; electronic organs; marine equipment; a kitchen waste compactor; home intercoms and protection systems, garage door openers; table radios; portable radios and phonographs; guitar amplifiers and accessories; educational electronic workshops for youngsters and adults; tool sets; electronic test instruments; amateur and shortwave radio gear; radio-control equipment; metal locators.

Can you build a Heathkit? For 25 years people just like you have been doing it - armed with no more than a soldering iron and a few conventional hand tools.

No matter how complex the kit, the manual reduces assembly to a simple step-by-step operation. Add to that the availability of the technical correspondence department here in Benton Harbor, and service people in 36 retail stores across the country, and you see why we say "we won't let you fail." And finally, building a Heathkit is fun, pure and simple. The coupon below gets you started.

Here are just a few of the new kits in this new '73 edition



Heathkit 50-watt Stereo Receiver. \$169.95*



Heathkit VHF/FM Band-Scanning 8 channel Receiver. \$119.95*



Heathkit Cassette Deck, Dolby Circuit. \$249.95*



Heathkit 6-Digit Electronic Clock-Alarm. \$54.95*



Heathkit 25V Solid-state Color TV with detent power tuning. \$599.95*



NEW Heathkit Ultrasonic Intrusion Alarm. \$49.95*



NEW Heathkit 8-transistor AM Radio for first-time kit-builders. \$14.95*



Heathkit 2 1/2 Digit VOM. \$79.95*



NEW Heathkit 8-digit pocket Calculator. \$92.50*



NEW Heathkit 8-digit desktop Calculator. \$79.95*



NEW Heathkit Small-engine Tune-up Meter for 2- and 4-cycles, all ignitions. \$39.95*



NEW Heathkit 2-Meter Amateur Transceiver. \$179.95*

Send Today for Your Free '73 Heathkit Catalog

HEATHKIT ELECTRONIC CENTERS

ARIZ.: Phoenix, 2727 W. Indian School Rd.; CALIF.: Anaheim, 330 E. Ball Rd.; El Cerrito, 6000 Potrero Ave.; Los Angeles, 2309 S. Flower St.; Pomona, 1555 Orange Grove Ave. N.; Redwood City, 2001 Middlefield Rd.; San Diego (La Mesa), 8363 Center Dr.; Woodland Hills, 22504 Ventura Blvd.; COLO.: Denver, 5940 W. 38th Ave.; CONN.: Hartford (Avon), 395 W. Main St. (Rte. 44); FLA.: Miami (Hialeah), 4705 W. 16th Ave.; GA.: Atlanta, 5285 Roswell Rd.; ILL.: Chicago, 3462-66 W. Devon Ave.; Downers Grove, 224 Ogden Ave.; INO.: Indianapolis, 2112 E. 62nd Ave.; KANSAS: Kansas City (Mission), 5960 Lamar Ave.; MD.: Baltimore, 1713 E. Joppa Rd.; Rockville, 5542 Nicholson Lane; MASS.: Boston (Wellesley), 165 Worcester St.; MICH.: Detroit, 18645 W. Eight Mile Rd. & 18149 E. Eight Mile Rd.; MINN.: Minneapolis (Hopkins), 101 Shady Oak Rd.; MO.: St. Louis, 9296 Gravois Ave.; N.J.: Fair Lawn, 35-07 Broadway (Rte. 4); N.Y.: Buffalo (Amherst), 3476 Sheridan Dr.; New York City, 35 W. 45th St.; Jericho, L.I., 15 Jericho Turnpike; Rochester, Long Ridge Plaza; OHIO: Cincinnati (Woodlawn), 10133 Springfield Pike; Cleveland, 5444 Peart Rd.; PA.: Philadelphia, 6318 Roosevelt Blvd.; Pittsburgh, 3482 Wm. Penn Hwy.; TEXAS: Dallas, 2715 Ross Ave.; Houston, 3705 Westheimer; WASH.: Seattle, 221 Third Ave.; WIS.: Milwaukee, 5215 Fond du Lac.

HEATH Schlumberger	
HEATH COMPANY, Dept. I 16-6 Benton Harbor, Michigan 49022	
<input type="checkbox"/> Please send FREE Heathkit Catalog.	
Name _____	
Address _____	
City _____	State _____ Zip _____
*Mail order prices; F.O.B. factory. CL-470R	

CIRCLE NO. 1 ON PAGE 11 OR 111

mixtures speeds up most chemical reactions, the storage of dry cells in abnormally high ambient temperature environments will hasten wasteful zinc corrosion and other side chemical reactions within the cell to reduce its shelf life. Storage in lower than normal, but not freezing temperatures, will appreciably reduce shelf life deterioration. Temperatures above 125° will effect rapid deterioration and possible leakage. Ideal storage temperature is from 40° to 50°F. The average shelf life for dry cells not in use under ideal temperature conditions is two to three years.

Capacity. Ordinarily, dry-cell batteries are tested on circuits of constant resistance and the capacity is expressed as the time of discharge rather than in ampere hours. It's relatively easy to calculate ampere hours by determining the average value of current drain. To calculate the average drain you must first determine the average voltage by plotting voltage readings taken at regular intervals from full voltage to cutoff voltage. From this and the known fixed resistance used as a fixed load, the average current is computed, which, in turn, is multiplied by the total time of actual discharge to arrive at ampere hour capacity. Since voltage characteristics of different brands of batteries differs, the average current delivered by a particular size cell will be only an approximation of the capacity of other cells and batteries under comparable conditions.

- a) temperature—discussed previously,
- b) cutoff voltage—capacity is greater as cutoff voltage is lowered,
- c) relative time of discharge and recuperation—performance normally is better when discharge is intermittent.
- d) rate of discharge—capacity is greater as discharge current is less, down to a certain level, at which point efficiency decreases because of spontaneous reactions within the cells.

No definite statement can be made, but as an example, maximum service efficiency for continuous discharge of a #6 cell is obtained on a 60- to 100-ohm circuit, or at a current of 10 to 20 mA. For smaller cells this current will be proportionately smaller. From this it can be seen that other factors such as size, weight, convenience, and initial cost must be taken into account to determine ultimate service efficiency that can be obtained.

Selecting Batteries. From the variety of different sizes and types of batteries avail-

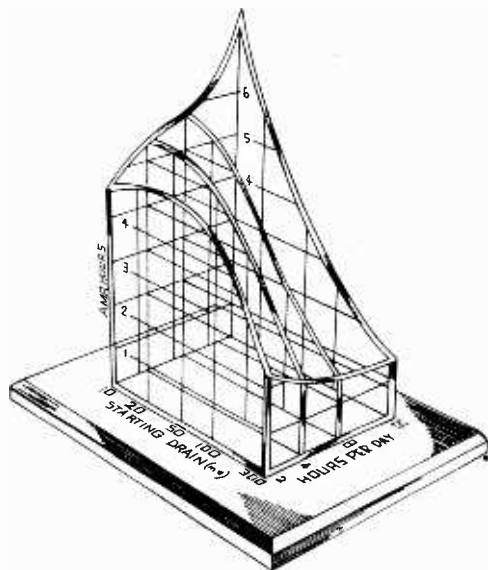

Three-dimensional graph plots service life as function of initial current drain and duty cycle of D-size carbon-zinc cell.

able one might get the impression that battery selection is a difficult task. You can reduce the problem considerably by first outlining basic operational requirements and then matching up a battery that most nearly fulfills them.

To obtain factual information of the many types of batteries available, we suggest you get a copy of a publication titled *Battery Applications Engineering Data*, published by Union Carbide, the makers of Eveready brand batteries (Burgess also publishes a similar handbook). In addition to being loaded with battery characteristics, standard test procedures, etc., it contains a most comprehensive listing of a wide variety of Eveready batteries being manufactured as well as cross-referencing to batteries of other manufacturers.

There is a certain minimum amount of information that must be tabulated before a suitable battery can be selected. You must know such things as a) nominal operating requirements of the circuit, b) its current drain, c) its operating cycle, d) its desired service life, e) temperatures in which equipment will be used, f) size and weight limitations, g) type of terminals, h) cost, etc.

If there is a limit in voltage below which the equipment will no longer function properly (called cutoff voltage) this must also be taken into account when selecting a bat-

tery. Some circuits have a high initial current drain and then operate at a more nominal drain once started—a consideration when arriving at the circuit's current drain. In arriving at the ampere-hour capacity necessary, current drain along with discharge schedule and required service life are determining factors.

Battery Charging. Dry cells generate electricity by chemical action which eats away the negative electrode. Once this has been completely destroyed, and since the structure of the cell is such that they are sealed, it's impossible to replace the negative electrode. To truly restore the charge in a dry battery you must replace this electrode. However, the operating life of the dry cell can be extended in some cases. This would be more like a rejuvenation process rather than a recharging one. As pointed out previously the chemicals added to the electrolyte deter the formation of gas around the positive electrode, which reduces the polarization and increases the life.

The longer a battery is used the more these chemicals are used up and polariza-

tion sets in, weakening the battery.

By applying a reverse polarity with current flowing in an opposite direction, electrolysis takes place in the electrolyte. This ionizes the gas atoms around the positive electrode clearing it for more efficient chemical action, which will determine how well the life of the cell can be extended. Recharging is economically feasible only when the cells are used under controlled conditions using a system of exchange of used cells for new ones.

Though dry cells are nominally considered to be primary cells, they may be restored for a limited number of times if the following conditions are used: 1) the operating voltage or discharge of the cell is not below 1 V per cell when the battery is removed from service and charged, 2) battery is placed on charge immediately after it's removed from service, 3) ampere-hours of charging should be 120% to 180% of the discharge, 4) the charging rate must be low enough that the recharge takes 12-16 hours, 5) the battery must be put into service soon after charging. ■

How to Select Batteries

□ Batteries have compelling advantages over power supplies, although they are a fairly expensive way to buy electrical power. They are safe, simple, reliable, and usually noise-free. Two dollars will keep a radio receiver or a test instrument in service for weeks to years, and a three-dollar circuit that pretends to fill two cubic inches can be operated from a comparably sized power source rather than from a transformer and rectifier system. It makes sense. Batteries are a permanent fixture in electronics.

But there are too many types! One commonly available manual runs to 550 pages of specs and engineering data, with notes on 323 different cells and batteries. Allied Radio's catalog #710 offers a mere 168 choices, probably for practical marketing reasons. Prices there range from 10¢ per cell to \$47.25, and if you have no other data there is only size, voltage, and sometimes weight to assist in your choice. It's the same problem everywhere, even in stores.

Also, there are many suggestions and legends about mercury batteries, alkaline batteries, nickel-cadmium batteries, rechargeable cells, and improved Leclanche cells, to

EVEREADY NO. AND TYPE	CAPACITY* AND COST	COST PER KWH
216 9-Volt Transistor Battery	2.1 W-H 54¢	\$260.00
276 9-Volt Large Transistor Battery	32 W-H \$1.67	\$52.00
1050 1.5-Volt D Size Cell (Least Expensive Power)	7.5 W-H 23¢	\$31.00
AC LINE POWER	—	\$.03

*W-H = Watt Hours

Fig. 1. A few rough calculations show that the least expensive battery power still costs very much more than AC line power.

name a few. And the cost of battery power is surprisingly high, as shown in Fig. 1. Let's get a general picture of all this, and then narrow down the field to a few highly appropriate candidates for all-around usage.

Cells and Batteries. When we talk about a cell or a battery, we could be talking about any of a large variety of objects. The chart of Fig. 2 will reduce the confusion.

The opening term, *box*, isn't in common use but we had to start somewhere. A box is one of those packages you get from the store when you ask for a battery. In engineering terms it may be either a *cell* or a *battery*. If it is a battery, it contains many cells, and some batteries can be dismantled into their component cells. One example is the Eveready 2606 battery, rated at +3, +6 and +9 volts, which if dismantled turns out to be six D-size cells in one package.

The standard D cell, on the other hand, is a complete electrical unit in itself. If we cut one in half as seen in some TV ads, the two halves generate the same voltage as the original cell. If you try this, clean the saw immediately after, because the battery chemicals are corrosive.

Our next step along the chart brings us to *primary* and *secondary* cells. A primary cell is a one-shot proposition, meant to be used once and discarded in favor of an unused replacement. Any rechargeable cell is a *secondary* cell, and may be used from several to several thousand discharge and recharge cycles. The boundary is rather blurred because you can recharge some primary cells with moderate success, giving them a new lease on life, and because some cells with a familiar primary-cell chemistry have been engineered to limited secondary-cell specifications. The manufacturer's literature tells you about these, and if he hasn't

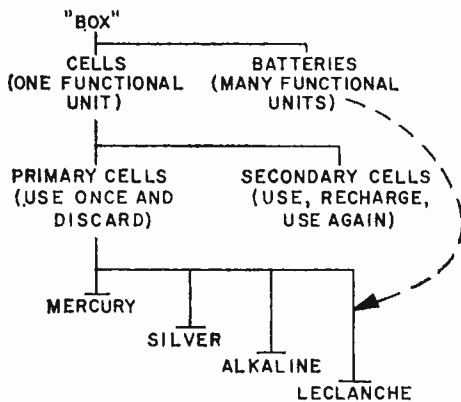

Fig. 2. Proliferating battery and cell types, along with loose usage of terms, have created a confusing situation. This chart should clear things up, and identify the area of interest for this article.

provided any it is best to avoid experiments.

Finally we come to the subject of this article: four varieties of primary cells. The most familiar types, available from catalogs, store shelves, and miscellaneous sources, are mercury cells, silver cells, alkaline cells and Leclanche cells.

Of these, two come in for an honorable mention: mercury cells and silver cells. The other two are the real workhorses, most useful for providing electrical power with maximum utility, convenience, availability, and minimum cost. These are the alkaline and Leclanche varieties. Now let's examine these, one at a time.

Mercury Cells. Mercury cells consist of a mercuric oxide anode, an amalgamated zinc cathode, and a zincated saturated potassium hydroxide electrolyte. The structure is usually a sealed steel container with an automatic vent to release internal pressures developed when the cell is providing a heavy current.

Mercury cells have a fabulous reputation for an unflinching constant voltage throughout their life, and the same terminal voltage from one cell to the next. This is wrong on both counts. Fig. 3 is a manufacturer's discharge curve for an Eveready E502E mercury cell at quite moderate current. And upon checking a number of cells at a large distributor's, a variety of terminal voltages were clustered around the accepted mean. Scratch two myths.

Also, mercury cells are very expensive, which is a sound reason to avoid them. Finally, they have no practical capacity at temperatures below freezing, as shown in Fig. 4. The low temperatures do not harm the cell, but when frozen it remains practically useless until its temperature gets back over the 40°F mark.

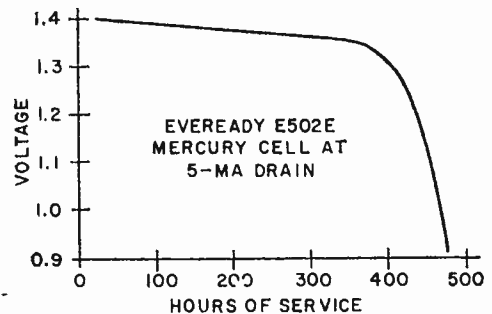

Fig. 3. Eveready's voltage/time discharge curve for their E502E mercury cell at a very moderate current. The voltage falls off with usage.

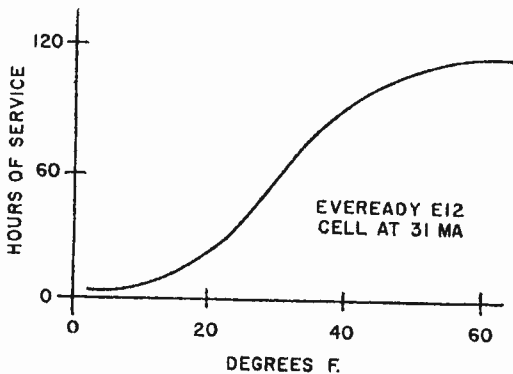

Fig. 4. Mercury cells are nearly worthless at temperatures below freezing. The rolloff is fairly sharp, but the cell will recover its capacity when it warms up again.

Silver Cells. A fairly recent market product, silver cells use silver oxide and zinc electrodes, with a potassium hydroxide electrolyte. Silver cells are used in hearing aids, electric watches, and as voltage reference sources. They are rare at present, but we will probably be seeing more of them on the market in coming months and years.

A typical silver cell has an open-circuit voltage of 1.6 volts, and this drops to 1.5 volts under normal load. Its internal resistance is very low, which is excellent from an audio or photoflash-unit viewpoint. The manufacturer reports silver cells never leak chemicals, a point toward which I maintain an extremely conservative attitude. The tiny hearing aid and watch batteries listed in Allied's 1970 catalog #290, page 295, may be silver cells. This variety deserves attention, and you may want to research it if you have a difficult application in mind.

Alkaline Cells. Alkaline cells use a zinc anode and a manganese dioxide cathode with a potassium hydroxide electrolyte. They can supply very heavy currents, and are effective at temperatures well under 32 degrees Fahrenheit.

Alkaline cells are reported to be "better than Leclanche cells" but the facts available at the consumer level are not entirely correct. They are better for *some* applications, such as photoflash, heavy-drain audio gear, tape recorders which require high currents at fast forward and reverse, and portable TV sets. Under these special conditions an alkaline cell will provide power at a lower cost than the two or three consecutive Leclanche cells it replaces. Otherwise, as in a flashlight, radio receiver, or test instrument

application, the Leclanche cells are more economical if you don't mind changing them. The cost breaker point for D-size cells is around 300-mA drain.

Leclanche Cells. These are the familiar carbon-zinc cells, by their chemical name. It is the name of the man who first built cells and batteries using their chemistry of carbon, zinc, and an ammonium chloride electrolyte. The initial versions were glass jars full of solution and hardware, but the paste or "dry" variety wins hands down for utility, convenience, and portability.

Leclanche cells are appropriate for light and moderate loads. Their below-freezing performance is poor, but better than that of mercury batteries. In the last section of this article are described various ways to use these common, inexpensive cells in place of more exotic types, making up the differences by adding simple transistor and zener-diode regulator circuits.

Avoid storing cells and batteries, if you can. They deteriorate by inner chemical activity that goes on whether they are in service or not, by a general diffusion of the chemicals, and by drying out. The deterioration process can be minimized by freezing, however, and tests indicate the life of Leclanche or alkaline cells is greatly extended if you store them in the freezer. When stored at low temperatures, cells should be protected from excessive moisture and frost deposits, and perhaps a little grease should be added to the terminals to prevent rusting.

Preferred Types. The magic behind preferred battery types is mostly common sense. One battery is less expensive than some other similar one because it is mechanically simpler or the manufacturer is making more of them. A pencil is only slightly cheaper than the far more powerful D cell because labor and sales costs far exceed the cost of materials.

The more popular cell is likely to be easier to find in the back country or in the middle of a city than is the rare one used in some elite application. If you are building new gear, it is more convenient as well as less expensive if you arrange it to use the same kind of cells or batteries you already use for other applications. If we apply these considerations, and throw in a fudge factor for convenience, what do we wind up with? See Fig. 5 on the next page.

You may have occasion to add to this short list, but for practically any ordinary application this is all you need on your shelf.

EVEREADY NO. AND CHEMISTRY	PRICE RATINGS	SIZE
215 Leclanche	54¢ 9V 0-8 ma	1 × 3/4 × 1 1/8 Long
276 Leclanche	\$1.67 9V 0-30 ma	2 1/16 × 2 × 3 1/2 High
1015 Leclanche	19¢ 1.5V 0-25 ma	} 3/4 DIA. × 1 3/32 Long AA Pencil Size
E91 Alkaline	92¢ 1.5V 0-150 ma	
1050 Leclanche	23¢ 1.5V 0-150ma	} 1 1/4 DIA. × 2 3/4 Long D Cell Size
E95 Alkaline	65¢ 1.5V 0-650ma	
731 Leclanche	\$2.30 6V 0-500ma	} 5 × 2 1/8 × 4 1/16 High Lantern Battery
732 Leclanche	\$2.30 12V 0-250ma	

Fig. 5. A small number of recommended cell and battery types. These should be available almost anywhere, and are found in consumer catalogs as well as on drugstore shelves and in other places.

Not all gear will take these sizes, you say? Then purchase something else that will, and since most designers and manufacturers are perfectly familiar with the facts described here, you probably will not have to look far for it.

Mounting Batteries. Whoever thinks battery mounting arrangements are not important, is in error. A wrongly mounted battery can come loose and batter a valuable circuit into junk. Another battery, if used beyond its capacity, may emit a corrosive jelly that reduces your neat construction job to a greasy mess.

A properly installed battery cannot batter circuits and its mounting system is easily replaced. Good design practice in bench gear construction is to place the mounting assembly at the bottom of the case, or better yet, outside on the back. Then dripping chemical slime only spoils the paint and corrodes the sheet metal. Reliance on optimistic claims of "leakproof" is risky and perhaps even justified, until the truly leakproof cell is replaced by another without that elusive virtue.

Batteries to be mounted fall generally into two classes: large batteries with their own clips or terminals, and smaller ones

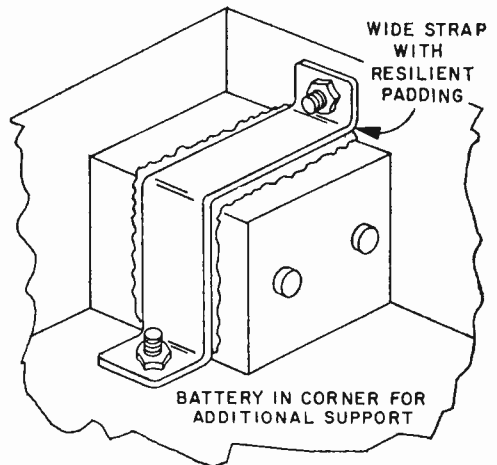

Fig. 6. An Eveready 276 nine-volt battery, solidly mounted by a strap with additional padding.

that fit into assemblies. The large batteries should be held firmly in place by metal strips with some padding to take up tension and variations in the sizes of individual batteries. See Fig. 6, which illustrates an Eveready 276 battery in an appropriate scheme for mounting inside a chassis.

Smaller cells are often mounted in commercial holders, which are very widely available nowadays. A table of some convenient plastic holders for AA cells, supplied by Allied Radio Shack, appears in Fig. 7. A visit to a nearby electronic supplier may turn up a variety of metal and plastic holders, not all equally convenient. If these holders have no mounting provisions, they may be mounted in the same style as large batteries.

If your gear is intended for portable work, the case should be designed with one compartment for the electronics, and an entirely separate one for the batteries. See Fig. 8, a simple box arrangement easily

RADIO SHACK ORDER NO.	NO. OF PENCELLS MOUNTED	PRICE
270-1432	1	\$.25
270-1433	2	.30
270-1434	3	.45
270-1435	4	.55

Fig. 7. Here are some very convenient pencil holders, available from Allied Radio Shack. They feature a very sensible standard terminal system.

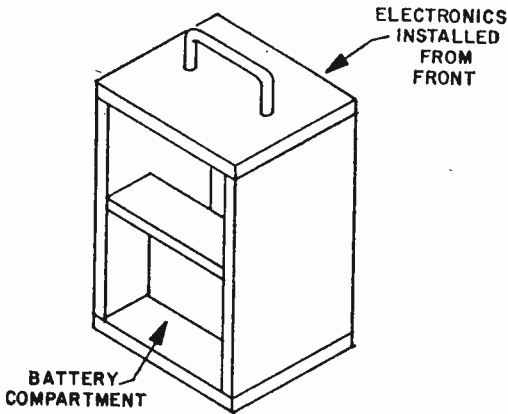

Fig. 8. Suggested battery compartment in a simple half-inch plywood box. Nailed and glued assembly is reliable in rough usage.

assembled from half-inch plywood.

The acid test for a battery-holder system is what happens if the gear is dropped on the floor. Finally, if you are shipping battery-operated gear, assume the PO will do its worst. I once asked a PO employee if there was a regulation against heaving packages more than thirty feet, and he wasn't sure. Remove the batteries before shipping, and if they *must* accompany the gear then pack them like the massive little chunks they are.

Battery Supply Circuits. For many applications there is no more to do than connect the battery and turn on the power. But this is not the general case, and if you are trying new applications or are troubled by feedback problems or short battery life, some of the following suggestions will help.

The simplest application schematic appears in Fig. 9. This hookup deserves suspicion if your circuit has a lot of signal in its supply leads (check by audio VTVM, scope, or RF probe) or shows signs of instability not caused by parts positioning. But we may be able to work an elementary improvement.

Place a capacitor across the battery or, better yet, across the stage that generates the signal observed on the supply line. 1,000 or more microfarads may be indicated for audio circuits with class-B output stages. The capacitor bypasses signal voltages developed across the battery's output resistance, and additional benefits may be gained by decoupling the supply lines to low-level or input stages.

The *apparent* battery output resistance

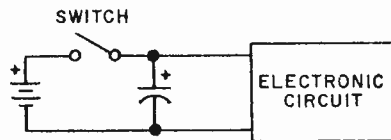

Fig. 9. The simplest battery application system. A capacitor across the battery is excellent practice, and reduces the effect of battery aging upon circuit performance.

can be reduced by adding the emitter follower regulator stage shown in Fig. 10, to isolate the supplied circuit from the battery's resistance and aging idiosyncrasies.

When you begin designing circuits you soon learn the advantages of having a bias voltage in addition to the customary supply voltage. An obvious circuit appears in Fig. 11. Power requirements are minimized, and the circuit can be designed to be relatively unresponsive to temperature changes. Now, suppose your circuit takes +6 supply and -3 volts bias (I am writing from experience) and you estimate it will run 200 hours on a set of D cells. Turns out it stops at 85 hours, which more than doubles cost of operation if we cannot do something about this. Why does it stop?

Because the supply side of the battery string delivers much more current than does the bias side. In the circuit where we play off these voltages against each other, the supply side poops out faster than the

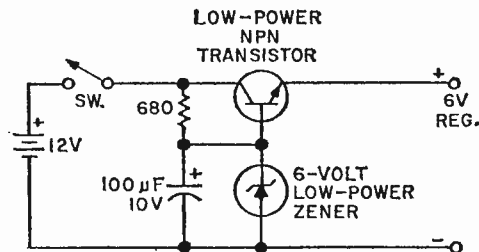

Fig. 10. The battery can be almost completely isolated by an emitter-follower regulator.

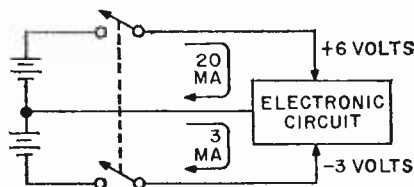

Fig. 11. The basic bipolar arrangement. Note the two circuits do not carry identical currents.

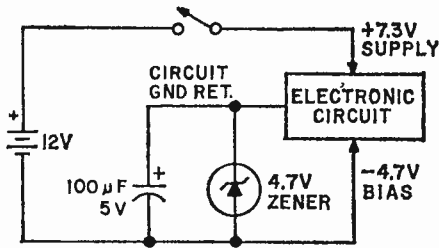

Fig. 12. Partial regulation by a zener may be the answer to some battery-supply problems.

bias side, which soon wins and turns the circuit off. One simple solution is to add a supplementary load resistor to equalize the current drain.

A solution usable in some applications appears in Fig. 12, where we see a single zener providing a fixed offset of 4.7 volts. If we take the hot end of the zener as circuit ground, then we get -4.7 volts and $+7.3$ volts, which drops as the battery ages. We haven't gained much here.

We can do it better with the circuit of Fig. 13, using two emitter followers. If the sum of our supply voltages is 12 volts, and the battery provides 18 volts when fresh, then it must run down nearly six volts before the system fails. And since all cells see the same current they wear out at equal rates, and we replace all of them on the same schedule. Note the several ways in which the circuit can see the supply voltages, since the batteries are left floating with respect to circuit ground.

When using zener regulators with battery supply circuits, we must be more conservative than with AC supplies. Here a watt is something to fight for, but with the prac-

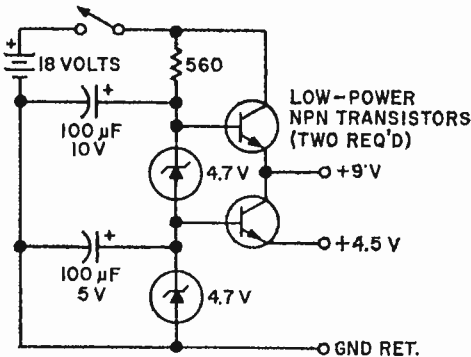

Fig. 13. Two independently stable voltages may be obtained from a single string of batteries. All the batteries see the same current drain.

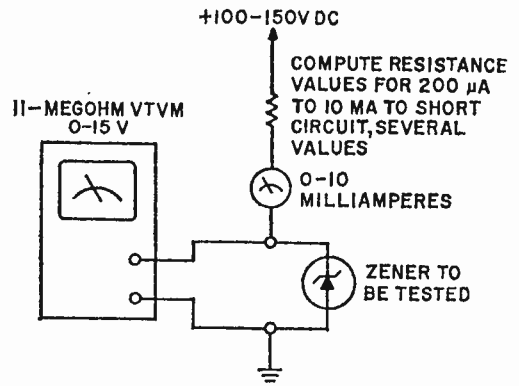

Fig. 14. This circuit checks zeners for low-current performance, and establishes their knee values.

tically free power from the AC line we may begin to feel uncomfortable with maybe thirty or a hundred watts going off as heat. For battery work, some zeners are better than others because they will regulate at lower currents. A simple circuit, shown in Fig. 14, gives us the necessary information.

At low currents the zener does not regulate, since it is not adequately energized (see Fig. 15). If we compare two apparently identical zeners we may find a crucial difference: one regulates at 500 microamps, and another having the same manufacturer's type number has a knee at 10 milliamperes. Both get by the manufacturer's checking station, since he checks them at, say, 20 milliamperes. You don't know where the

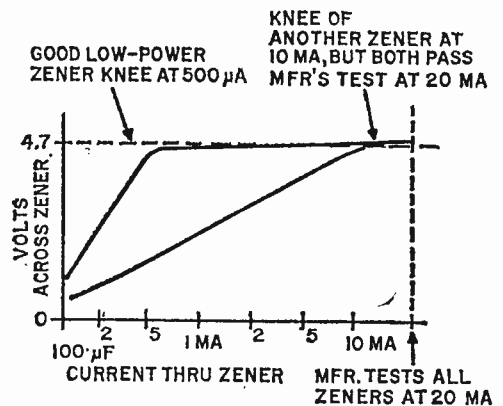

Fig. 15. Test results for some same-type zeners may diverge surprisingly, because the manufacturer is usually interested in typical rather than low-power conditions. Plotting voltage against current is not usual practice, but indicates clearly the minimum zener regulating current.

knee is until you measure it, and this simple step can save a lot of current and problems.

When choosing zener resistors, remember to select a series resistance that gives adequate zener current after the battery

is run down to the limit, *and* the circuit is drawing its rated maximum current. The capacitor across the zener catches possible zener noise and reduces the supply output resistance to signal current. ■

Power Supply Basics

□ The catalog of a leading electronics supplier contained this glowing description: A superhet shortwave receiver covering the standard broadcast band through 20 Meters. Its cabinet was luxurious walnut, its audio output push-pull into a high-quality speaker. The set boasted low current drain and the latest circuitry. The price?—a mere \$49.75.

The catalog was Allied Radio's and the date was 1932. The radio was a console meant for the living room, and it no doubt pulled in the A&P Gypsies with reasonable fidelity. Thing is, it required batteries for power.

Here's the battery complement for the handsome, but hungry, *Knight 8* vintage receiver: Three 45-volt "B" batteries for tube plates; One 2-volt "A" cell for lighting filaments; One 22.5-volt "C" battery for biasing tube grids. This mountain of Evereadys cost \$9.00, a rather steep tab even in the good old days. And they could have pooped out right in the middle of a Herbert Hoover speech.

Super Supplies. That danger is gone, thanks to power supplies. Now a receiver takes a raw electricity from the utility company and converts it to filament, plate, or bias voltages. It does the same for transistorized circuits. Or it perhaps participates in the growing trend to 3-way operation, where you use the same device at home, in a car, or carry it as a portable. The supply not only powers the equipment in the home; it also recharges the portable batteries. Cost is low because AC power is priced about 3¢ per kilowatt hour—which means you can operate a plugged-in table radio for about 100 hours on a penny.

Though power supplies operate circuits of vastly different voltage and current requirements, the basic principles are the same. In most instances a supply accepts house current—usually 117 volts AC alternating at 60 Hz (cycles)—and performs the following steps.

● **Transforming voltage.** The power com-

pany provides 117 volts for home outlets, but it's hardly the value that many electronic devices demand. The plates of receiving tubes require about 100 to 250 volts for operation, while transmitting tubes may need a "B+" several hundred volts higher. Transistors, on the other hand, usually function at least than 30 volts. So the first task of the supply is to transform voltage to the desired value. In many CB sets, for example, there's plate-voltage requirement of 250 and filament-voltage requirement of 12.6 VAC. The power transformer delivers these levels.

● **Changing AC to DC.** Furnishing correct voltage is not enough. Those voltages must often be DC—and the power company provides alternating current. So the second function of a supply is to *rectify*, or convert AC to DC. If a rectifier malfunctions in your radio you'll soon learn its function. The symptom is annoying hum in the speaker (caused by 60-Hz alternations in the audio). In a TV set, suffering rectifiers can put a thick, dark, "hum" bar across the screen.

● **Filtering.** Though rectifiers change AC to DC the product is far from suitable because it contains objectionable ripple. This will be attacked by the filter, which smooths the pulsations to pure DC.

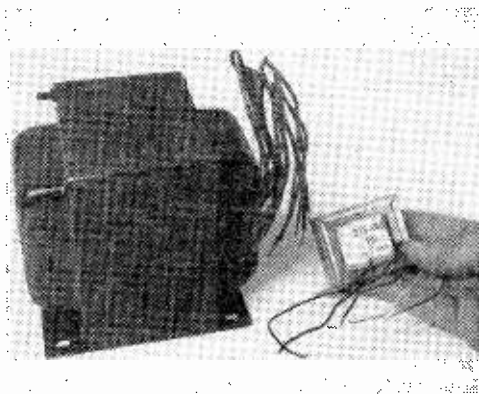

Typical power transformer sizes. Left, one for 1-kW ham rig; right, one for small receiver.

The final step of the supply depends on the designer. He can add a *bleeder*, choose a *regulator*, or insert a *divider* at the output. We'll look at these extras, but first consider how the supply's basic parts operate.

The Transformer. In Fig. 1 is a typical power transformer that's been produced by the millions with only slight variations. As we'll see, the transformer acts to create a voltage change between its primary and various secondary windings. The trick's based on the turns-ratio between the various windings. If turns in the secondary number twice those of the primary, then output voltage doubles; if turns in the secondary are a fraction of those in the primary, then a stepdown in voltage occurs.

Thus, in Fig. 1, the rectifier filament, which operates at 5 volts, has few turns compared to the primary; the high-voltage winding at 500 volts, however, has about five times as many turns as the primary. The colors shown for the windings, incidentally, are standard and observed by many transformer manufacturers.

The *centertap* connection of a winding splits the voltage in half. In our example, the high-voltage secondary is capable of 500 volts across the full winding (red to red), but only 250 volts between the centertap (red/yellow) and either end. The most important job for a centertap occurs in a *full-wave* supply, as we'll see in a moment. Note that a protective fuse and a power switch are located in one primary lead of the transformer.

Rectification. The two filament voltages from our transformer (5.0 for the rectifier and 6.3 for other tubes) will need no further processing. AC can be applied directly for filament heating (or for lighting pilot lamps on the front panel). High voltage, however, must be converted to DC before powering tube plates or transistor collectors and drains.

A circuit for changing AC and DC is a *half-wave* rectifier, shown in Fig. 2. It's based on a diode's ability to conduct current in only one direction. The rectifier cathode boils off electrons (negative) which are attracted to the plate when the plate is driven positive by incoming AC.

When the next half-cycle of the AC appears, the plate is driven negative, so electrons are repelled at this time. The net result is shown in the output; a series of positive voltage pulses appearing at the load. (The dotted line shows where the negative side occurred.)

In practical circuits the half-wave rectifier is usually reserved for light-duty power supplies. It's inefficient because it fails to make use of AC voltage half the time (during the negative pulses). Secondly, those wide spaces between pulses are difficult to filter because of low ripple frequency. In a half-wave rectifier, the pulsations occur at 60 Hz, the same frequency as the applied line voltage. But don't underrate the half-wave supply because it's been used in just about every 4- or 5-tube table radio now playing. After all, its power requirements are low

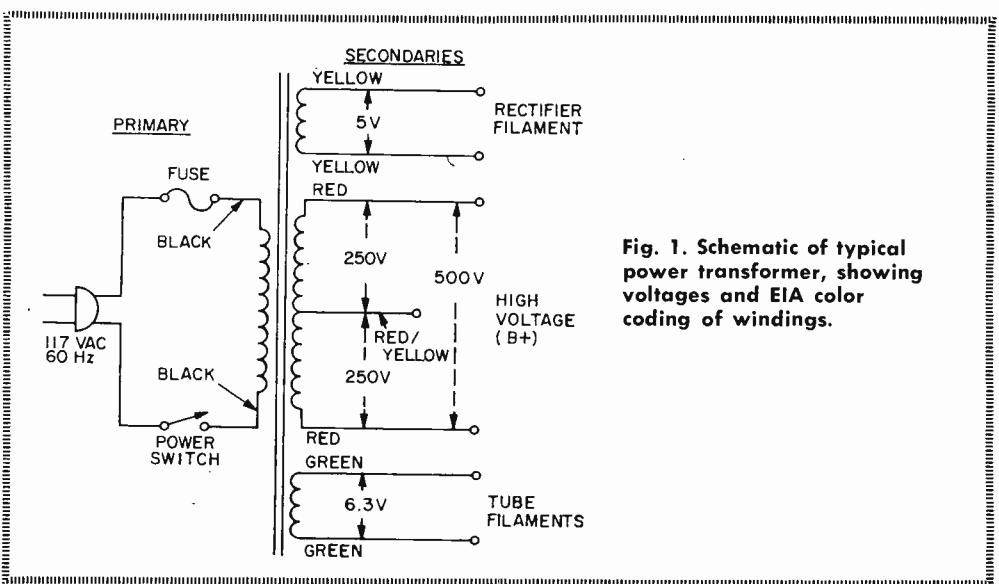

Fig. 1. Schematic of typical power transformer, showing voltages and EIA color coding of windings.

and the circuit is inexpensive to manufacture.

Full-wave Supplies. Transmitters and higher-power equipment overcome the half-wave's shortcomings with the full-wave system. It's nothing more than a pair of diodes that are driven alternately so they consume every bit of AC input voltage. The key to full-wave operation is the centertap on the transformer's secondary winding. As applied AC appears across the complete winding, it makes the top end negative (as shown in Fig. 3) and the bottom end positive.

The centertap at this time establishes the zero voltage point because it's at the common, or grounded, side of the circuit. During the time the lower diode (No. 2) has a positive plate, it does the conducting. Next, the applied AC voltage reverses and makes the top diode plate (No. 1) positive so this tube now conducts.

This load-sharing combination of two diodes and a centertapped power transformer not only improves efficiency, but doubles the ripple frequency. An input of 60 Hz emerges as 120 Hz in a full-wave arrangement because every half-cycle appears in the output. This reduces the pulsating effect (cycles are closer together) and the DC becomes easier to filter.

If you purchase a transformer, watch out for one pitfall. It may be rated, say, "250

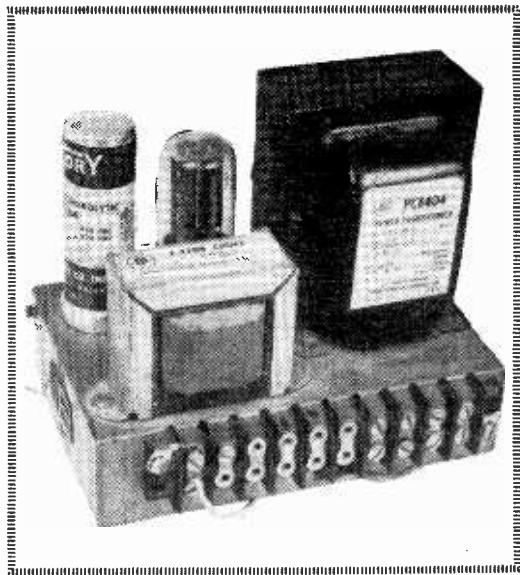

Filtering in this power-supply unit is by choke and capacitor seen at left of chassis.

volts CT" and appear to be suitable for a rig with a 250-volt plate supply. In a full-wave supply, however, the transformer voltage output would be only 125, since a centertap reduces the voltage of a winding by one-half. This can be avoided by specifying a transformer that has 250 volts *each* side of centertap or, stated another way, "500 volts CT."

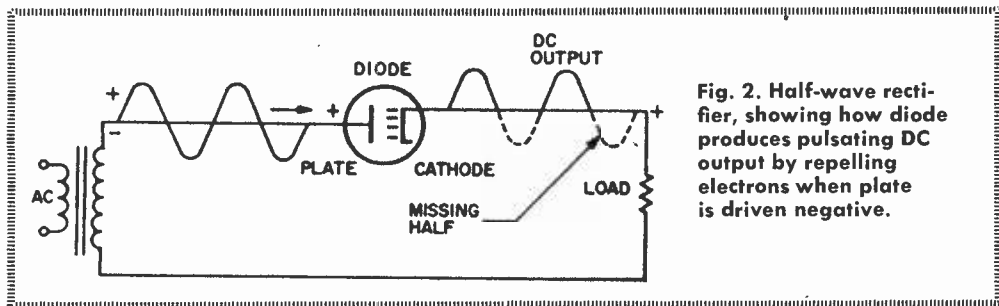

Fig. 2. Half-wave rectifier, showing how diode produces pulsating DC output by repelling electrons when plate is driven negative.

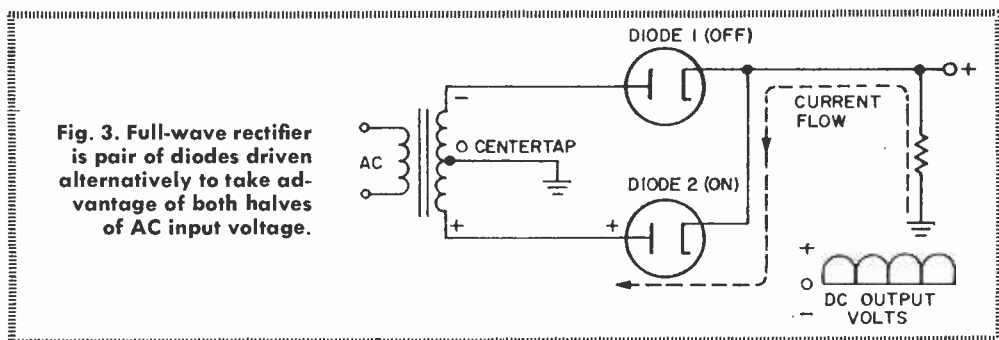
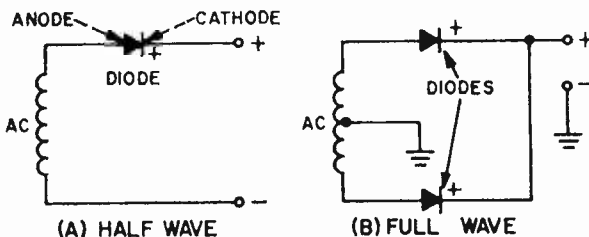

Fig. 3. Full-wave rectifier is pair of diodes driven alternately to take advantage of both halves of AC input voltage.

Fig. 4. Solid-state selenium or germanium diodes in similar half- and full-wave rectifier circuits are better than tubes since they don't need filaments or heaters for rectifying action.



Solid-State Rectifiers. Tube rectifiers are still widely found in electronic equipment, but they're destined for the Smithsonian Institute. Solid-state equivalents are superior because they don't need filaments or heaters to accomplish the same rectifying action. They're several hundred times smaller and much cooler in operation. Instead of a huge 5U4 vacuum-tube rectifier in your TV set, you're now more apt to find a pair of tiny silicon diodes.

Circuits using these semiconductors, though, are similar to those of vacuum tubes. As shown in Fig. 4, diodes can be used in equivalent half- and full-wave arrangements.

Unlike tubes, though, solid-state diodes rectify AC and DC by a semiconductor effect at the diode junction (a region between the anode and cathode). The action, in simplified fashion, occurs when "current carriers" in the material flow toward and away from the junction under the influence of applied AC. When few carriers appear at the junction, little current gets through the diode; conversely, when many carriers are in the area, they reduce the junction's opposition to current flow. Depending on the way the diode is connected in the circuit, it can recover either the positive or negative half of the AC.

Bridge Rectifiers. Another common arrangement is the full-wave bridge (Fig. 5). Though it uses four diodes, it offsets this

disadvantage by an ability to produce the same output as a regular full-wave supply without a centertapped transformer. It accomplishes the feat by operating one pair of diodes during each half cycle. And as one diode pulls current out of the load, its partner pushes current into it.

Net effect is a total voltage across the load which is about equal to the applied AC. We've shown how it occurs for diodes 1 and 2 in the diagram (Fig. 5) but a comparable action occurs in the other diodes when the AC switches polarity.

Filtering. Next major section of the supply is the filter, which smooths out the ripple. Its two major components are often a *capacitor* and *choke* which eliminate pulsations by dumping a small amount of current from the peak of each ripple into the "valleys" between them. The result, as shown in Fig. 6, is pure DC fit for a tube or transistor.

In operation, pulsating DC arrives at the filter choke, a coil of wire wound on a soft iron core. As the name implies, the choke attempts to oppose any change in current flow. The rippling part of the wave, therefore, encounters high reactance in the choke and fails to get through. This is aided by the filter capacitor which is charged by ripple voltage.

As the ripple falls (between pulses), the capacitor discharges part of its stored current into the "valley." This the combined

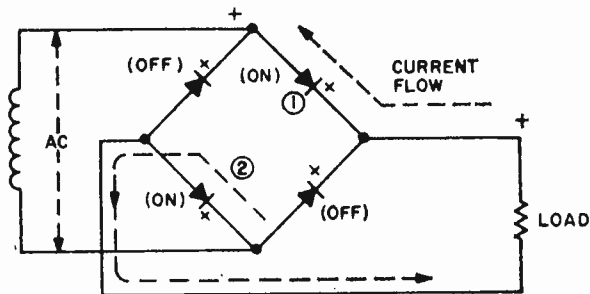

Fig. 5. Solid-state bridge rectifier provides full-wave rectification with center-tapped transformer by using four diodes.

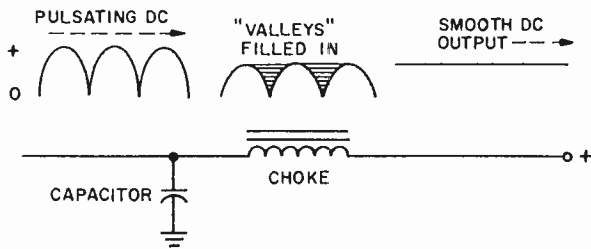
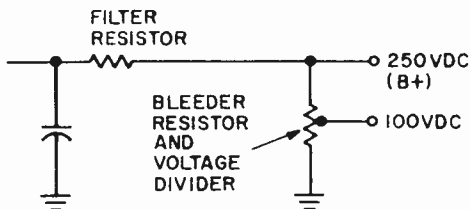

Fig. 6. Curve depicts how reactance of choke and discharge of capacitor eliminates ripple and fills in valleys for smooth DC.

Fig. 7. Choke can be replaced by filter resistor. Also shown is bleeder resistor that serves both as output regulator as well as voltage divider.



effect of choke and capacitor results in smooth DC which can have ripple as low as a few percent of the total voltage.

You won't find the choke in some power supplies because it's an expensive item. Many designers eliminate it (especially in mass-produced equipment) by using a resistor instead, as shown in Fig. 7. The resistor does the job of filtering but with one penalty; it reduces the amount of available voltage at the output. Yet, the loss can be tolerated in many circuits and filter resistors are common.

Another use for resistors in a supply is to serve as a *bleeder*, also shown in Fig. 7. In this function, it protects parts in the supply from possible damage due to sudden voltage surges when the supply is first tuned *on*. Also, a bleeder helps stabilize voltage output when the load changes (as in a keyed ham transmitter) by always drawing some small degree of load current. Bleeders, too, are found in dangerous high-voltage circuits where they bleed off the stored charge of filter capacitors that could deliver a lethal shock to a repairman (even after the equipment has been turned *off*.)

Note that a tap can be added to the bleeder to provide a second output voltage from the supply. Now the bleeder becomes a *voltage divider*. As such, it can supply the designer with multiple output voltages for operating various devices in a circuit.

Voltage Regulation. A ham who's received a "pink ticket" from the FCC for chirpy

signals, a color TV that's gone fuzzy, a shortwave receiver that won't stay on frequency—all may suffer from a problem in voltage regulation. Line-voltage fluctuations or other electrical swings can cause poor, unstable operation. So the engineers have come up with methods for "stiffening" a power supply.

If, say, line voltage changes from 105 to 130, they design the circuit to operate at 100 volts. Whatever voltage arrives over the line is reduced to 100, and the surplus is

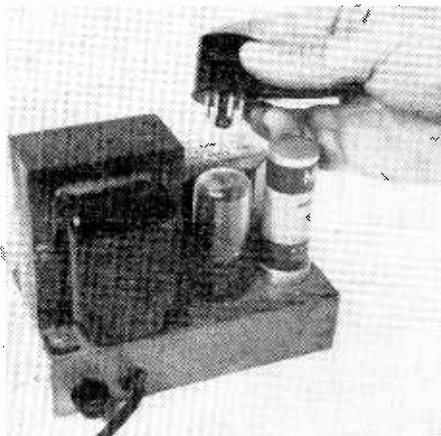

If you want to replace your vacuum-tube rectifier with solid-state one, it's easy now with plug-in replacement shown here.

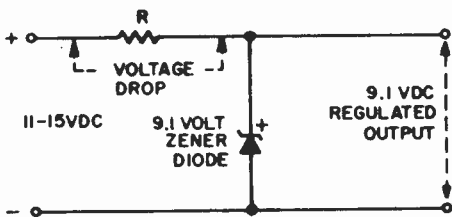

Fig. 8. For more efficient regulation than produced by bleeder resistor, Zener diode shunted across DC output will hold voltage to specified limit.

dumped (usually in the form of heat). To perform this task, the regulator establishes a reference point, then regulates around it.

A common example is the zener diode found in the power supply of many CB transceivers. Since these rigs can operate from a car's battery or generator, supply voltage can swing from 11 to 15 volts. This could happen if you're standing for a traffic light, then pull away, causing a shift between car battery and generator. If the CB set is on at this time, receiver tuning could be thrown off because of large changes in local oscillator voltage.

A zener diode can compensate for the shift, as shown in Fig. 8. At first glance it appears as an ordinary diode connected backward. Since the cathode (upper) terminal is connected to the positive side of the supply, there's a "reverse bias" condition. A zener diode, however, "breaks down" (or "avalanches") whenever its rated (zener) voltage is exceeded. In our example, the zener is a 9.1-volt unit, so the diode conducts current as the supply voltage shifts from 11 to 15 VDC.

Yet we see 9.1 volts indicated at the output. Secret of the zener's ability to hold at 9.1 is that it detours part of the supply current as the voltage increases. Since a resistor is in series with that current flow, a voltage drop (as shown) appears across the resistor. Thus, any increase in supply voltage is dissipated across the resistor and effectively subtracted from the output. This automatic and continuous action occurs for any

voltage above 9.1—the zener's nominal rating—so the output is said to be regulated.

More And Merrier. This barely brushes the subject of power supplies, since the variations are nearly endless. More than 20,000 volts for the picture tube of a color TV are derived from a special "flyback" transformer. It captures voltage from rapidly moving magnetic fields in the set's horizontal scanning section. An oscilloscope power supply contains strings of adjustable voltage dividers to move the pattern of light on the screen in any direction.

There are also high-current supplies with massive rectifiers for battery charging and super-smooth lab supplies for circuit design. But behind most of them are the simple principles which transform, rectify, filter, and regulate a voltage so it can do the job at hand. ■

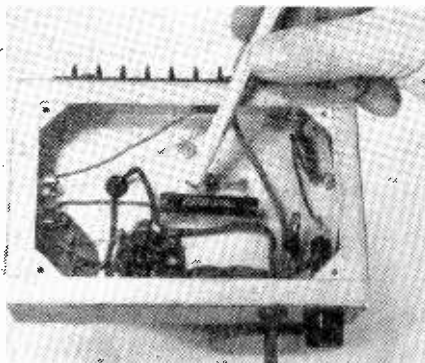

Bleeder resistor placed across rectifier/filter output acts as regulator.

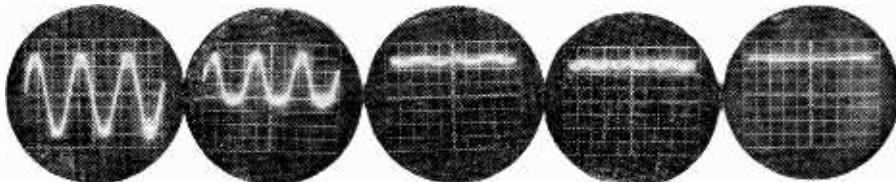

Scope photos, from left to right, shows (a) 60-Hz line voltage, (b) output from half-wave rectifier with negative portion eliminated, (c) ripple voltage from half-wave rectifier at same frequency as AC line voltage (d) frequency of ripple voltage from full-wave rectifier double that of AC line voltage (e) final DC output from power supply with no ripple voltage.

Fuses and Circuit Breakers

□ For two bits or less you can protect \$500 when you consider that an inexpensive fuse protects a costly color TV set. Would you believe ten cents worth of electric protection saves \$35,000? Fuses also keep the house from burning down. The little zinc links can *pop* in picoseconds or broil hours before blowing. Hundreds of fuses and circuit breakers safeguard electronic equipment against shortcircuit damage, momentary surges or slow overload. Pick the right one and you'll never put a penny in the fuse box, wrap cigarette foil around a glass fuse, or jump wire across cartridge clips—all dangerous dodges of those who refuse to *re-fuse*.

Thar' She Blows. Edison made the first fuse before 1900 by enclosing a thin wire in a lamp base. As an intentionally weakened part of the circuit, the wire acted as a safety valve which melted from excessive current. Trouble was, early fuses were nearly as dangerous as the condition they were designed to prevent. Fuse wire fashioned from copper, had to reach dangerous temperature before blowing. This is now cured by changing to metal alloys of lower melting point.

You can see another problem by observing how a fuse blows. See Fig. 1. The link begins to overheat in the slim center region. Overheating begins at this point since the wider ends of the link are better able to radiate heat. Soon the melted center drops away.

This supposedly ruptures the circuit, but a second effect takes over. Circuit voltage is still applied across the narrow gap in the link and it strikes an electrical arc. This burns back metal toward each end until increasing electrical resistance kills the arc. That happens during a simple overload. But everything's vastly speeded up for a dead short.

You can see in Fig. 1 that a total short circuit explodes the link. The whole center section, in fact, suddenly vaporizes. And the vapor itself becomes a good electrical conductor—so the arc keeps snapping dangerously across the gap. Is that a safety valve?

Today's fuses are not lethal weapons because of certain refinements in construction. The larger, cartridge-type fuses contain a powdery filler material that quenches the arc through cooling and condensing the

metal vapor. In smaller fuses, sturdy, insulated tubes of glass or porcelain provide necessary protection. See Fig. 2. One manufacturer states (with a Gothic turn of phrase) that today's fuse won't "belch fire."

Vengeful Volts. Most talk about fuses concerns amperage and how various types respond to current flow. Yet all fuses are rated by volts. This relates to the explosive fury of a fuse gone wrong. Although a fuse may have a well-insulated holder, certain conditions may cause voltage to soar dangerously as the fuse blows.

If it's protecting a circuit that contains a coil, for example, sudden interruption may cause an "inductive" kick to feed back to the fuse terminals. It could be sufficiently high to shatter the holder. Voltage ratings assigned to fuses, though, are quite conservative.

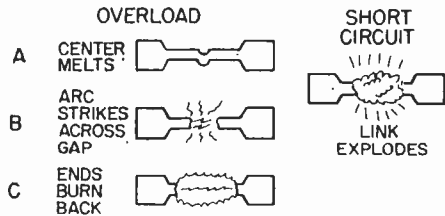

Figure 1. Major difference between overload, short circuit is amount of time it takes for fuse center link to melt apart.

When a fuse is rated at 125 volts, for example, it refers to a standard test performed by the manufacturer. He assumes that the fuse will not shatter on this voltage when subjected to a short circuit with the colossal current of *10,000 amperes!* Unless you're protecting a private power generating plant, your electronic equipment subjects the fuse to a piddling fraction of those ratings. Thus circuit voltages may usually be higher than fuse voltage rating without undue hazard.

Twin Ratings. The job of choosing a fuse would be simple if it merely meant measuring a circuit you wish to protect, then selecting a type to blow on slightly higher amperage. A hi-fi amplifier might operate with AC line current of 1.4 amps, but a 1.5-amp fuse would be a poor choice. It would cause much "nuisance" blowing. Whenever you turned on the amplifier, a sudden inrush of current (to charge big filter capacitors in the power supply, for example) might cause the

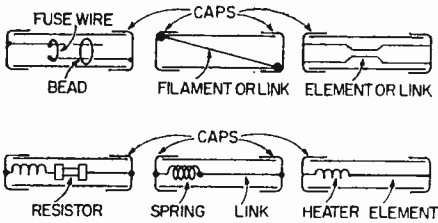

Figure 2. Construction variations between various fuse types gives each its own special set of characteristics.

fuse link to let go. And some devices, like an electric motor, draw starting currents far greater than normal running amperage.

At the other extreme, a delicate test instrument might be destroyed if the fuse didn't speedily break the circuit. These variations introduce *time* as an element that's just as important as the number of amperes. Some fuses have a built-in mechanism that decides whether to blow fast or slow, depending on circuit conditions.

But, first, what does a fuse rating actually mean? Simply saying that a fuse in a car radio is rated at $7\frac{1}{2}$ amps doesn't tell the whole story. The $7\frac{1}{2}$ amp figure means the fuse can carry that current indefinitely. Determining the current needed to melt the fuse must also reckon with overload time.

A typical automobile fuse might take fully four hours to blow when the fuse's rated current reaches 110 percent—which is amps times 1.1. This would happen as the radio drew $8\frac{1}{4}$ amps through the fuse (or 7.5×1.1). This is not a severe overload and the radio is still protected.

But if a short-circuit caused current to zoom to double the fuse rating—or 200 percent—the fuse promptly pops within 20 seconds. Higher percentages of overload would even speed up the process. Thus the radio continues to operate during minor surges. It won't blow the fuse un-

Figure 3. Note how slow-blow fuse takes considerably longer time for a current surge to open the circuit.

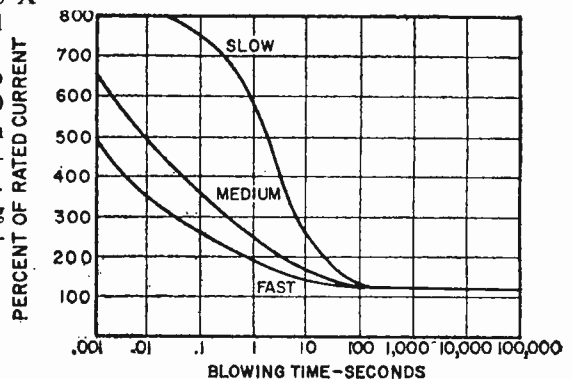
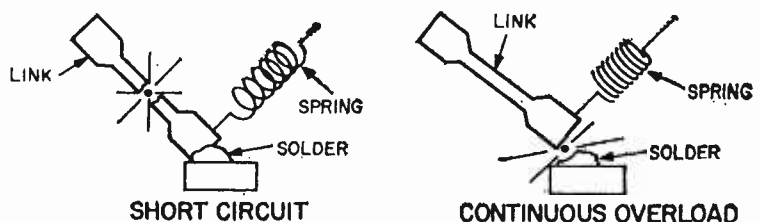

Figure 4. Dual-purpose mechanism of slo-blo fuse allows it to withstand momentary shorts, continuous overloads typically up to 400% of rated current in circuit.



less overload current threatens irreversible damage to its components.

Not all devices need this brand of protection. To cope with a wide range of equipment, fuses are manufactured in three broad categories that relate to blowing times: *Medium Lag*, *Quick-Acting* and *Time Delay*. A look at these types reveals that fuses might have the same ampere rating but behave in quite different fashion.

Medium Lag. This is the most common type you're apt to encounter. It also goes under the name "Normal Lag" or "Standard." This is the fuse for auto and other radios, amplifiers, TV sets heaters and lighting circuits. If you want an idea of how such a fuse behaves, check the curve marked "Medium" in Fig. 3. It reveals, for example, that at 200 percent of rated current (two times), the fuse typically blows in about 5 or 6 seconds. The greater the overload, the faster the action.

Common fuses in the medium category are the S.F.E. types (for automobiles) and 3AG by *Littelfuse*. There's also the AGC type made by *Bussmann*. The letters "AG", incidentally, originally meant "automotive glass".

As the "AG" number rose so did amperage rating and physical length. This was intended to foil any attempt to insert a fuse of excessive rating into a holder. So many new fuse types have appeared, however, that the system is all but abandoned. "AG" is no



Figure 5. Three different fuse styles are shown, but each has its own current rating. **Hint: NEVER substitute like-styled fuse of higher amp rating for lower-amps-rated one.**

longer a reliable index of fuse size.

Quick-Acting. This fuse category is also known as "Instrument" or "Fast-Acting." As the name implies, this kind of fuse blows faster than the medium type. It's useful for delicate instruments, meters and other devices that can't tolerate even small overload currents for any length of time. The fuse element is very fine and low mass causes it to melt at rates marked "Fast Blow" in Fig. 3. Note that at 200 percent rated current, the fuse expires in less than a second.

Slow-Blow. Also known as the "slow-acting," "time-delay" or "time-lag" fuse, this type lets a strong surge through the circuit without blowing, but protects against shorts and overloads. It is especially useful for motors, switching circuits and TV receivers. Special dual construction enables the fuse to operate in two ways.

As shown in Fig. 4, the fuse contains the regular fusible link found in other types. It is designed to blow only during extreme short-circuit conditions. The second mode of operation occurs during a continuing overload condition, far longer than a temporary surge. This causes heat to build near the spring portion. If of sufficient duration, the heat softens the low-melting solder and the spring pulls the link to break the circuit. The slow-blow fuse is often applied in circuits that can tolerate currents of about

400 percent normal for 1 to 10 seconds.

Specials. As you can see in Fig. 5, there are many variations in fuses to meet special applications. (The fuses shown in Fig. 5 were available for photography at e/e's editorial office at the time this story was prepared for publication. There are many more types and sizes.)

Some fuses signal when they've blown, others are tightly enclosed to prevent radio-frequency interference pickup (a problem in space vehicles). There are sub-miniature fuses, as well as high-reliability types with gold-plated caps that survive high G forces.

One novel type found in many TV sets is the *fusible resistor*, a combination of fuse and resistor. It's often used where solid-state rectifiers occur in the TV power supply. When the set is first turned on, a heavy inrush of current must be limited by a small-value resistor (usually less than 10 ohms) to protect the rectifiers. By making a resistance element with fuse-like qualities a single component, the fusible resistor does the job of two parts. The component is often mounted with plug-in pins for convenient replacement.

Circuit Breakers. A leading contender in the fuse field is the circuit breaker. See Fig 6. It's found on many major appliances and the newer TV sets. The attraction is obvious: you just press a red button after an

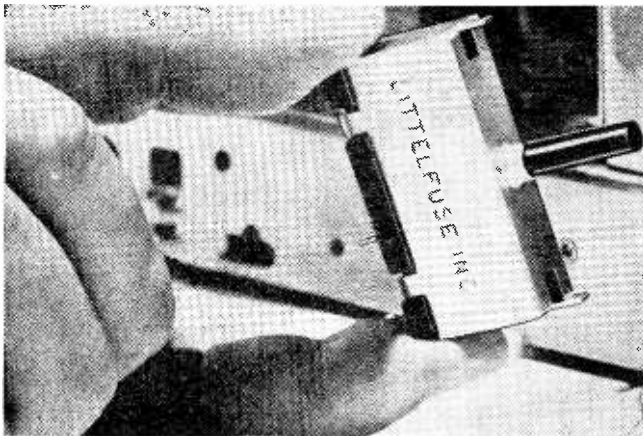

Figure 6. Forget that box of spare fuses you keep at arms distance from your tv. Circuit breaker eliminates need for replaceable fuse, can be reset as often as needed. Press cylindrically-shaped button located on top of circuit breaker after you find fault; your tv is once again protected. Circuit breakers come in many ampere ratings.

overload. No need to hunt for a fuse.

As you can see by the curve in Fig. 7, the breaker behaves like a fuse, permitting brief overload current to pass but tripping when the fault looks serious.

What happens, though, when a determined TV-viewer sees sound and picture fade just as the 5:40 comes roaring down on Millicent, tied to the track for not paying the you-know-what? Our viewer leaps behind the set, pushes the red panic button—and holds it down in an effort to restore the program. If the breaker had tripped on a severe short-circuit, not just a transient, our viewer might as well join Millicent. Yet the story has a happy ending since the breaker is viewerproof. The red button must be released before the circuit breaker closes.

The chart in Fig. 8 shows typical ratings for several *Mallory* breakers. Note in all units that breaking the current is somewhat higher than operating current, but allowable surge current is much higher than either rating. Tripping time is ten seconds or less after breaking current is reached.

The circuit breaker is also replacing certain fuses in the automotive field. It's chiefly used in high-current circuits such as headlights, convertible top motors and window motors. The car breakers, however, automatically re-set themselves when the overload no longer exists. Not only is it convenient, but a bi-metal element of the breaker won't suffer a common fault of fuses in these circuits—fatigue. Fuses tend to fail when cycled repeatedly at high (though normal) on-off currents. (Fatigue also explains mysterious fuse failure in radio and TV sets when no circuit fault exists.)

How Many Amps? The equipment designer has already done the job of figuring

the right fuse for his electronic gear. When the fuse blows—and the fault cured—the replacement fuse may merely duplicate the original. But if you home-brew equipment, you'll have to do some calculations to obtain the fuse rating. We've talked of *fuse* ratings but this is not the same as current consumed by the equipment being protected. To avoid nuisance blowing, the fuse almost always should be able to conduct more current than is drawn by the equipment.

It is considered good practice not to load a medium-blow fuse by more than 75 to 80 percent of its rating in amperes. To translate this into a practical value, you must know the number of amperes consumed by the equipment during normal operation.

Let's say it is 4 amps. This number, therefore, should be 75 percent of the fuse rating. To find the answer, divide 4 by .75. The result is 5.3 amps, the fuse rating. This is an odd value, so select the next *highest* standard fuse size, which is 6 amps.

You'll find suitable types in the catalogs to fit into clips, an extractor post or to be soldered directly into the circuit with pig-tail leads. Most common physical size for electronic gear is the glass 3AG or AGC type ($\frac{1}{4}$ "X $\frac{1}{4}$ ").

If you check commercial circuits, chances are you'll find that the fuse is operated at 50 (not 75 or 80) percent of its rating. This is another way of saying the fuse rating is double the load current. A car radio, for example, might draw 3 to 4 amperes, but the fuse is usually $7\frac{1}{2}$ or 9 amps.

You can also follow this practice, especially if your circuit is subject to temporary surges. This may seem like overfusing the circuit but the fuse should melt before anything is damaged (and it is less subject to

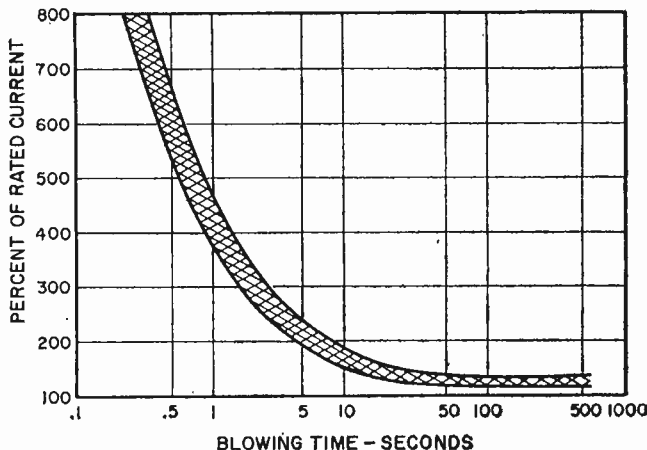
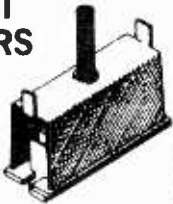

Figure 7. Curve of circuit breaker looks like medium lag fuse characteristic curve as shown in Figure 3. Current rating tolerance of circuit breaker is wider than that of normal fuse; crosshatching for this particular circuit breaker shows about 20% overall tolerance.

MALLORY RESET CIRCUIT BREAKERS

- Just Reset
- Not A Fuse—
A True
Circuit Breaker



Exact replacement circuit breakers for television and industrial applications. Button must be pressed to reset. Tripping mechanism is temperature compensating for constant protection. Normal tripping time is 10 seconds or less. All values above 3-1 amps have special heavy-duty contacts to withstand heavy surge currents. Twist tab mounting lugs. Adapter for bushing mount listed below. Shpg. wt., 4 oz.

Stock No.	Mfrs. Type	Break Curr. Amps	Oper. Curr. Amps.	Surge Curr. Amps	Net Each
33 F 14606	CBT050	0.5	0.325	2	.81
33 F 14614	CBT075	0.75	0.49	3	.81
33 F 14622	CBT100	1.0	0.65	5	.81
33 F 14630	CBT150	1.5	0.975	12	.81
33 F 14648	CBT175	1.75	1.14	12	.81
33 F 14655	CBT200	2.0	1.3	12	.81
33 F 14663	CBT225	2.25	1.46	12	.81
33 F 14671	CBT250	2.5	1.63	12	.81
33 F 14689	CBT275	2.75	1.79	12	.81
33 F 14697	CBT300	3.0	1.95	12	.81
33 F 14705	CBT310	3.1	2.1	25	.88
33 F 14713	CBT325	3.25	2.11	25	.88
33 F 14721	CBT350	3.5	2.2	25	.88
33 F 14739	CBT375	3.75	2.44	25	.88
33 F 14747	CBT400	4.0	2.6	25	.88
33 F 14754	CBT450	4.5	2.92	25	.88
33 F 14762	CBT500	5.0	3.25	25	.88
33 F 14770	CBT600	6.0	3.9	25	.88
33 F 14788	CBT700	7.0	4.14	25	.88

Type CBB adapter for bushing mount. Bushing $\frac{3}{8}$ "— $32 \times \frac{1}{4}$ " with nut.
 33 F 14796 Net .16

Figure 8. Chart taken from Lafayette's Catalog gives brief listing of circuit breakers available from Mallory. Note three different amp ratings for each.

nuisance blowing).

When equipment will certainly cause temporary overloads several times normal circuit current, then choose a time-lag or slow-blow fuse. Recall that it has a dual element to cope with this condition. It withstands brief overloads of several times normal current. With this kind of surge protection, it is common practice to select the rating of a slow-blow at a somewhat higher figure than the medium type. It should be about 80 to 90 percent. To convert this into a slow-blow fuse rating, measure the circuit's normal current and divide it by .8 or .9 for the fuse amperage.

Where to Fuse. There's some compromise in where to locate a fuse for maximum

circuit protection. Fig. 9, a typical full-wave power supply, shows why. The fuse is inserted in one leg of the incoming AC power line. Since the fuse is situated at the closest point to the power source, it provides overall protection. If a defect develops in some circuit, however, there's a chance the fuse will not blow for say, a shorted bypass capacitor that doesn't create enough excess fuse current. It could burn out a few resistors in the process. The expensive power transformer, however, gets a reasonable degree of protection with this system.

More sensitive fusing occurs in Fig. 10. With the fuse in the centertap of the transformer, it responds only to changes in the B+ current. Since this bypasses high cur-

Figure 9. Fuse in power transformer primary circuit protects entire power supply including 6.3 VAC filament source. However, it's possible that short circuit in device, while not of sufficiently high amperage to blow fuse, will damage components in power supply like filter capacitor or choke.

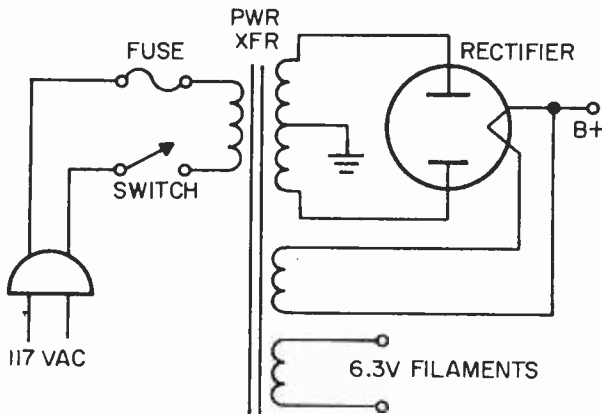
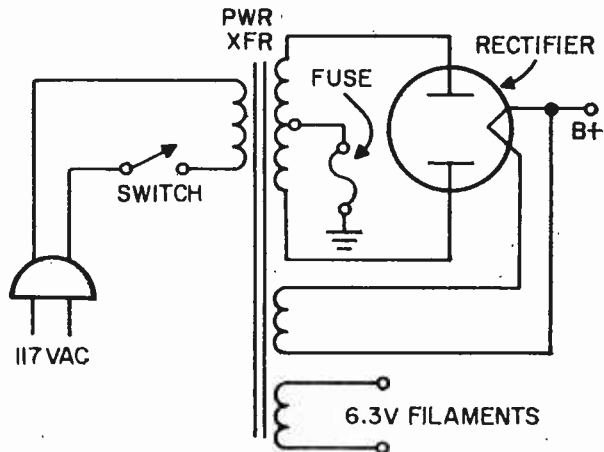

Figure 10. Secondary of power transformer is fused. Protection is for high voltage circuit only; filament supply's unfused.



rents consumed by tube filaments, the fuse can be much smaller and is responsive to partial shorts in the remaining circuits. A variation of this is in Fig. 11; a half-wave supply that might be found in an AC-DC table radio.

Only here there's a fusible resistor of the type described earlier. Since you can obtain a fusible resistor locally or from electronic part houses, why not modify your table radio today!

This leaves the problem of fusing filaments. Although a conventional fuse can be used to protect the filaments you might borrow a trick used in some circuits.

Shown in Fig. 12 is the system used in some color TV sets, one of the more thoroughly protected home-entertainment devices. There are no less than three techniques to guard against overcurrent. In one leg of the primary lead is a thermistor. Although it is not a breaker-type device, it prolongs the life of the circuit by slowing the inrush of current when the set is first turned on. It might present 120 ohms when cold, thus limiting current, but electrically disappears when hot since it sinks to just 1.5 ohms after circuit warmup.

Next site of protection is a circuit breaker in the power transformer secondary. It trips during overload anywhere along the B+ leg in the receiver. (This is equivalent to the centertap fuse shown in Fig. 10.) The filament circuit has completely separate protection. It is merely a short link of No. 26 wire that melts when a short exists along the filament supply. There's little hazard since voltage is only 6.3VAC and serious arcing won't occur.

Fusing Transistors. There have been attempts to protect transistors by fusing, but fuses generally will not react fast enough. Techniques which use additional semiconductors (such as diodes) provide a better solution. There is, though, some consideration in fusing the power supply of solid-state equipment. Since transistor circuit voltages are significantly lower than those encountered in tube circuits, the resistance of the

fuse becomes increasingly important. It may be an ohm or less, but this introduces a new element that might affect the operation of a delicate circuit. Two solutions are possible: use the largest fuse size consistent with circuit protection (since this reduces resistance) or install the fuse in the primary side of the 117 volts of Alternating Current.

Getting Clipped. How a fuse mounts is more important than is generally believed. Much trouble with nuisance blowing has been traced to defective fuse clips or holders. Poor contact between clips and fuse produces hot spots that blow the fuse prematurely. It may also introduce electrical resistance that upsets the circuit being protected.

One manufacturer suggests the following: you should hear a resounding "snap" when inserting a fuse into clips—it signals good grip strength. And you should have to pry a defective fuse from its clips. Since dirty clips are a frequent cause of trouble, shine them with contact cleaner. Just be sure to remove the AC plug from the wall outlet before touching any contact with your fingers. It helps reduce the con-fusion.

Always remember, fuses protect valuable

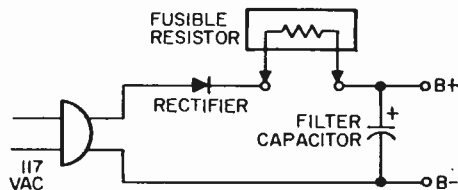
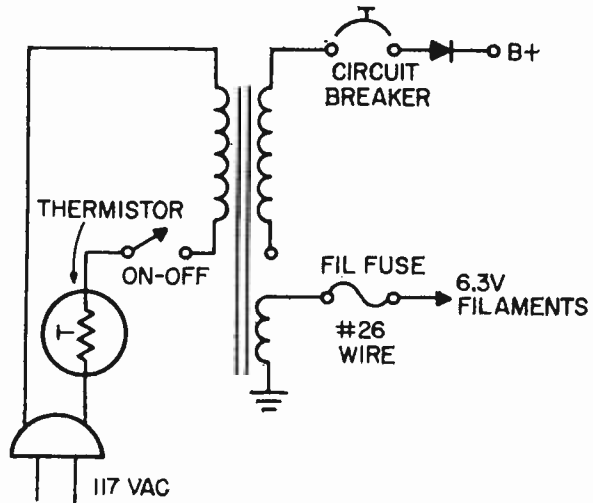

Figure 11. Fusible resistor combines surge-limiting resistor, fuse in one package shown here in AC/DC rig's power supply.

Figure 12. Three points of protection on color tv power supply are thermistor in transformer primary circuit to limit surges, circuit breaker in B+ secondary circuit, wire-type fuse for filament.

equipment from going up in smoke and eliminate dangers to human life. By overriding an existing fuse circuit with a penny, jumper, or oversized fuse, you may be putting a hole in your pocketbook—or one in the ground. ■



Facts on Frequency

□ It was 4:00 a.m. and the thermometer read 15 degrees below zero. The squad car had to deliver the package without delay! Thanks to the flashing red light and the 2 kHz note screaming from the siren, the three miles from the bus terminal to police headquarters were covered in only 2½ minutes. The chief rushed out to get the package. He likes his coffee hot.

So the siren gave out a 2 kHz note. Is that anything like, say, the 60 Hz current which lights a table lamp or, maybe, the 27.155 MHz carrier a CBER sends out from his 5-watt rig? The answer is yes—and no! No, because the siren note is actually a *disturbance of the air* which surrounds the whirling siren. The 60 Hz current which lights the lamp is actually a *disturbance of electrons* in the lamp cord. And the CB carrier is actually a *disturbance in the electromagnetic field* which surrounds the transmitting antenna. But the answer is also yes because, in spite of their apparent differences, the siren note, the 60 Hz current, and the 27.155 MHz signal all have something in common—the characteristic way each of these “disturbances” go through their vibrations.

Bouncing Air. If analyzed scientifically, each type of disturbance is seen to be a repetition of identical actions. When the siren gives out a constant howl, tiny air particles are forced to collide and spread apart—in steady rhythm. If the howl is a 2

KHz note, the colliding and spreading takes place 2000 times a second. Although the individual air particles move hardly any distance at all in their back and forth motion, the rhythmic collisions of these particles radiate from the siren in all directions, from particle to particle. This radiation is, of course, “sound” and travels through air at a speed of about 1100 feet per second.

Bouncing Electrons. Alternating current flows back and forth through a wire because electrons, in varying quantities, are made to push one another first in one direction and then the other—in steady rhythm. If this AC is 60 Hz current, such back and forth motion takes place 60 times a second. The individual electrons don’t move very far along the wire in either direction but their “bumping” travels through the wire at a speed of almost 186,000 miles per second. Naturally, this bumping action is made to change directions in step with the electrons that cause it.

Bouncing Fields. Basically, a radio signal is a disturbance in which the electric and magnetic fields surrounding a transmitting antenna are distorted, first in one direction and then the other—in steady rhythm. If this signal is a 27.155 MHz CB carrier, these fields are forced to change direction 27,155,000 times a second. This rhythmic, field-reversing action radiates from the antenna at the speed of light, 186,000 miles per second.

Feel the Vibrations. Now—it's the changing nature of these three types of disturbances that we are really interested in! Aside from what is actually and physically happening, all three seem to follow the same pattern of change while going through their vibrations. True, the 27.155 MHz signal does its vibrating much, much faster than the other two but its vibration pattern is much the same.

Instead of using a lot of words to describe how each disturbance goes through its vibrations, let's use a helpful mathematical tool—the graph. The ancient Chinese said that *a picture is worth a thousand words* and that's exactly what a graph is and its worth. More important, a graph provides us with a *lasting* picture, a permanent record, of how these vibrations change their speed and direction.

Our graph is set up in the usual manner. First there are the two reference lines, the “vertical axis” and the “horizontal axis.” In our graph, the horizontal axis is made to show the *passage of time*. How the vertical axis is used depends on which type of disturbance we are portraying. For the 2 kHz siren note, the vertical axis is made to measure *how far* each air particle moves during its back-and-forth motion. For the 60 Hz AC current, the vertical axis measures *how many* electrons are in mass movement along the wire during their forward-and-reverse motion. As for the 27.155 MHz signal, this axis tells *how much* and in what direction the electric and magnetic fields are being distorted.

So much for the preliminaries. Next comes the most important item. It doesn't matter which disturbance we are graphing—for each *instant of time* that is represented on the horizontal axis, there is a *point* above or below this axis which measures how far the vibration is displaced from its resting position. If all these individual points (and there are an unlimited number of them) are “plotted” on the graph, a continuous curve will appear. The amazing thing about this curve is that its shape looks pretty much the same for the 2 kHz note, the 60 Hz current and the CB carrier.

Study the special shape of this curve. While examining the curve (and this must be done from left to right, never from right to left!), notice that it rises abruptly, gradually tapers off, levels out for an instant, starts to fall, picks up downward speed, and falls below the horizontal axis only to re-

peat the process in upside-down fashion. The 2 kHz note will make 2000 of these waves in just one second while the 60 Hz current goes through only 60 of them. But the CB carrier will turn out 27,155,000 of these double swings during each second.

You Had Better Believe. This curve we have been discussing is something very special! It is fundamental to many different areas of science and engineering. It is the famous *sine curve*. The current leaving a simple AC generator varies according to a sine curve. So does the output of a vacuum-tube or transistor oscillator in an AM radio. Even the pendulum on a grandfather's clock swings back and forth in accordance with a sine-curve pattern.

But is must be understood and understood well! The sine curve is only a graph which shows the changing character of sound waves, alternating currents, and radio transmissions, etc. To be sure, a sine curve is a picture but it is *not* a picture of sound waves, currents and radio signals as they really look (if, in some way, we could actually see them).

Ironically (and students of electronics must not be misled because of this), there are sine-curve relationships in other fields of science where the physical occurrence actually looks like a sine curve. If a pebble is dropped into a calm pond, for example, ever-enlarging circles (ripples) will be seen leaving the splash. However, if these ripples are viewed from the side, at water level, a train of honest-to-goodness sine curves will be observed as they leave the splash area. As another example of real-life sine curves, if two persons suspend a rope between each other and one of them whips it up and down, a beautiful sine wave will run along the rope. Nevertheless, sine curves *don't* travel through electrical circuits, they *don't* travel through air as sound waves, and they *don't* radiate from transmitting antennas! Radio signals, AC currents and sounds vibrate in unison with sine curves but they *don't* look like them! However, a check of their graphs indicate they do!

Discovering Frequency. At this point, the true meaning of “frequency” should become clear. It doesn't matter if we are talking about sound waves. AC currents or radio carriers. Frequency is the number of times these various disturbances repeat their vibrations during *one second*. From a graphical standpoint, frequency is the number of times *each* complete cycle of sine curve is re-

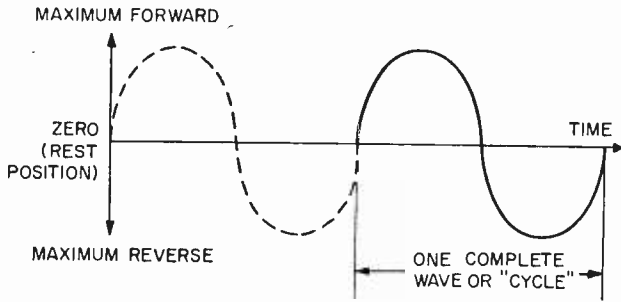

Whether you're trying to graphically picture ripples on a sylvan pond, or the unmodulated carrier of a Citizens Band RF voltage, the familiar sine wave is all you need to draw. All sine waves have peaks culminating in "maximum forward" points and "maximum negative" points, each occurring once each cycle.

peated during *one second*. Either way you look at it, frequency can be classified by its number of "cycles per second." As everyone should now know, however, this once common designation for frequency has been replaced by, simply, "Hertz" (Hz) in honor of that great German scientist of the Nineteenth Century, Heinrich Hertz.

To Sum Up. The 2000 Hz sound energy from the police-car siren, the 60 Hz AC from the wall outlet, and the 27,155,000 Hz carrier from the CB rig are three different scientific phenomena. But they have the common property of being able to be described by sine curves and, because of this, all can be measured by a common yardstick—frequency.

But hold on! Are these three so-called disturbances really so different from each other? (After all, electronics wouldn't be electronics without sound and radio signals!) They are different but not as much as you would think. With the aid

of a "transducer," one type can be *transformed* into another! Thus, a *microphone* will change 2 kHz sound waves into 2 kHz alternating current in a wire. A *loudspeaker* will change the AC back into sound waves. A *receiving antenna* will change 27.155 MHz electromagnetic energy into 27.155 MHz alternating current (AC) in a wire (the antenna feedline, that is). A *transmitting antenna* will make the opposite change.

That's it. If the interrelation between sound, electrical and electromagnetic frequencies now makes sense to you, you've learned a tremendously important bit of electronics theory. And don't forget the almighty sine curve. The sine curve can be used to explain theory in many fields of science, not just electronics. Nevertheless, keep clear in your mind just how the sine curve fits into electronics—what it is and what it isn't. Maybe you don't care whether your coffee is hot but you better stay *hot* on the *sine curve*. ■

Wheatstone Bridge

□ Back in 1843, Charles Wheatstone had a need for a convenient way to measure unknown resistances. He solved his problem by using and publicizing a circuit devised by S. H. Christie some ten years earlier. This same circuit is still widely used today, and, despite Wheatstone's earnest attempts to ascribe the invention to its proper inventor, it is best known as the Wheatstone bridge.

The circuit Mr. Christie invented in 1833 is usually shown as a diamond-shaped cluster of resistors with a battery across two of the opposite points of the diamond, and a meter or other detector across the two remaining points. See Fig. 1. With this circuit, it is possible to determine accurately the value of one of the four resistors, provided value of other three is accurately known.

To understand this bridge, first let us consider a familiar circuit, the voltage divider. As you probably know, a voltage divider is a two-resistor circuit which can convert a given voltage to a lower voltage. For example, in this circuit shown in Fig. 2 the output voltage will be two-thirds of the input voltage. And, if you don't like such low resistor values, then look at Fig. 3. This circuit will also have an output which is two-thirds of the input.

If we apply 9 volts to the input of either circuit shown in figs. 2 and 3, the output will be 6 volts. For a 90-volt input, a 60-volt output results.

Since the outputs of the two above circuits are identical, connecting a meter between the two outputs should give no read-

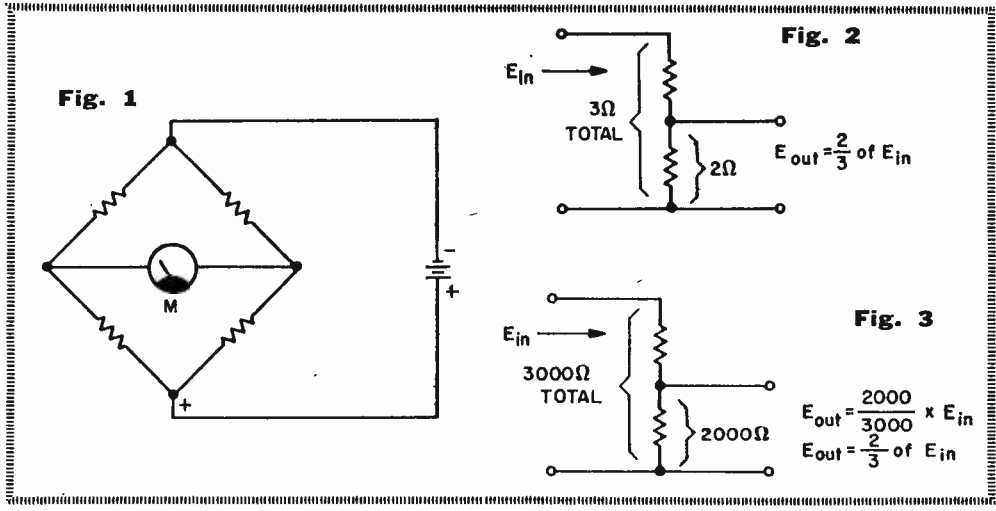

ing at all, because the two leads of the meter are connected to identical voltages. Take a look at Fig. 4. For that matter, changing the 9-volt input to 10, or 50, or 100 volts, will still give no (zero) meter reading, because each voltage divider is providing two-thirds of the same number, be it 9 volts, 10 volts, or whatever. Therefore, both meter leads are kept at the same matched voltages, regardless of the input voltage, so the meter continues to register zero.

As you have probably already deduced, by combining these two voltage dividers we have produced a Wheatstone bridge. This may be more obvious if we draw the circuit as shown in Fig. 5.

When the resistor values are such that the meter reads zero, the bridge is said to be *balanced*. The reverse is also true: if the bridge is balanced, we know that the left side of the bridge and the right side of the bridge are matched voltage dividers.

To use the bridge to determine an unknown resistance, we could arrange the circuit as shown in Fig. 6.

Since the two uppermost resistors are identical (1,000 ohms each), the bridge will be balanced only if the two lower resistors are also identical to each other. Therefore, we can connect an unknown resistor to the terminals X and X', and adjust the calibrated variable resistor until the meter reads zero. At this condition, the calibrated variable resistor is identical to the unknown, so the value on the calibration dial is the value of the unknown resistor.

Of course, if the unknown turns out to be larger than 10,000 ohms (the largest value of the calibrated variable resistor), no ad-

justment of the calibrated variable resistor will make the two lower resistors identical. Hence, the bridge cannot be balanced. How, then, can the bridge be used to determine the value of an unknown resistor greater than 10,000 ohms?

One way to measure a larger resistor with this bridge is to change one of the upper resistors from 1,000 ohms to 10,000 ohms as done in Fig. 7. Compare Fig. 7 with Fig. 6.

Since the right-hand uppermost resistor is now ten times the left-hand uppermost resistor, the bridge will be balanced only if the lower right-hand resistor (the unknown) is ten times the lower left-hand resistor (the variable one). For example, one condition of bridge balance would be as shown in Fig. 8.

On the other hand, a very *low* value of unknown resistor (for example, 69 ohms) could not be read accurately on the above bridge, because it would require that the 10,000-ohm calibrated variable resistor be set to one-tenth of 69 ohms, or 6.9 ohms. Although such a setting is physically possible, it does not result in a very accurate reading.

To measure such low-value resistors, we change the upper right-hand resistor again; this time to 10 ohms. See Fig. 9 for the balance condition.

This immediately suggests a very versatile bridge, which uses a multi-position selector switch to select a variety of values for the upper right-hand resistor. In addition to 1,000 ohms, 10,000 ohms, and 10 ohms, which were used in the above examples, we can choose 100 ohms and 100,000 ohms. Fig. 10 illustrates such a bridge.

To use this versatile bridge to measure

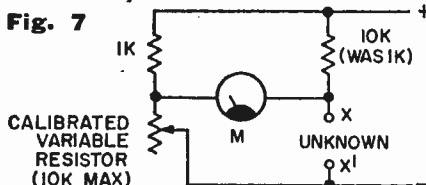
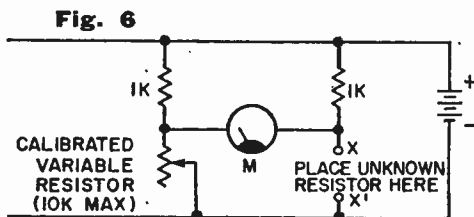
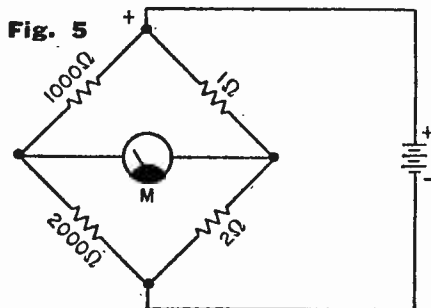
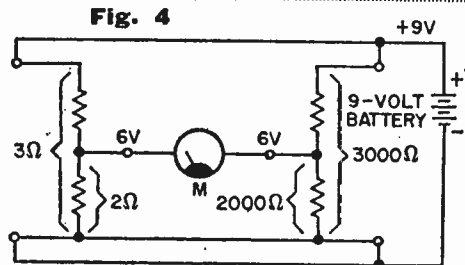

low-value resistors, select the 10-ohm resistor by placing the selector switch in the "X 0.01" position, connect the unknown resistor to the terminals X and X', and adjust the calibrated resistor until the bridge is balanced, as indicated by a reading of zero on the meter. The reading on the calibrated resistor's dial is then multiplied by 0.01 to give the value of the unknown resistor. For

example, if the reading is 3,700, the unknown is 37 ohms.

Similarly, setting the selector switch to "X 100" allows you to measure large resistors. If a certain unknown resistor results in a reading of 3,700 at balance, the unknown is 370,000 ohms.

Practical Considerations. Although this bridge can be built using ordinary 5 percent

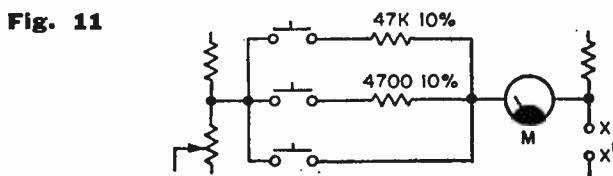
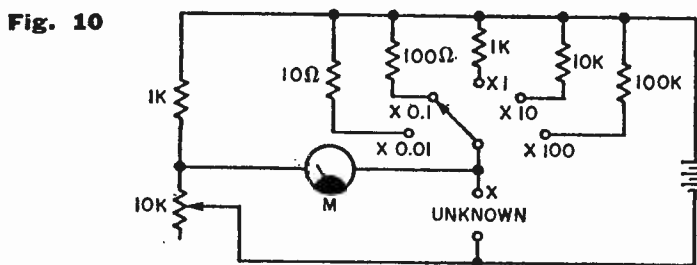
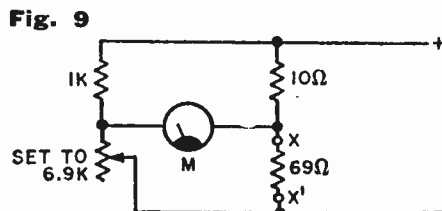
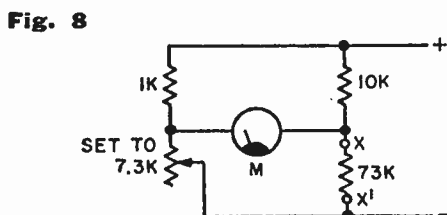

resistors, the errors in measurement will be as large as $\pm 10\%$. It's better to use 1% resistors everywhere.

The variable resistor, similarly, could be an ordinary potentiometer with a hand-calibrated dial. However, this also limits accuracy; it would be much better to use a resistance decade of the type sold by some of the leading electronic kit manufacturers. Calibrated multi-turn pots are also available.

The meter should be a zero-center microammeter (such as the 25-0-25 microamp type) for the best accuracy. However, even an ordinary 0-1 meter will suffice if you are willing to trade some accuracy to keep the cost down. Remember, however, the more sensitive the meter, the more accurately you can balance the bridge, especially on the high resistance ranges. Also, the more easily you can burn out the meter when the bridge is not balanced! To forestall this catastrophe, connect your meter to the bridge through a group of normally-open pushbuttons and resistors (10% type), as shown in Fig. 11.

Pressing the top button will give a reading on the meter if the bridge is far from balance, but the large value of resistance in series with the pushbutton will keep the

meter from being damaged by the large unbalance. Holding this button, balance the best you are able, and then press the next pushbutton, which will further increase the sensitivity of the meter and permit you to obtain a better balance. Finally, pushing the last pushbutton connects the meter directly across the bridge without any protective resistors in series, giving maximum sensitivity and accuracy.

The voltage of the battery used to power the bridge is not critical. However, the lower the voltage used, the less sensitive the bridge becomes, especially on the high-resistance ranges. On the other hand, high voltages force excessive currents through the resistors in the bridge, especially on the low-resistance ranges. These currents can damage the unknown or the calibrated variable resistor. A good compromise for the values shown is provided by a voltage of around 3 volts. At this voltage, the 10-ohm resistor should have a one-watt rating.

Well over a century separates Wheatstone and Christie from the present day, but you can bridge those years, electronically, as you find that their concise and clever circuit still does an excellent job in the integrated circuit era. ■

Resistive Pads

□ Stop to think about the various meanings the word *pad* has! A dog has several on each paw; a hippy sleeps in one; this article was first drafted on one; and it's just another name for *attenuator*. Webster tells us that when something is attenuated, it is lessened or weakened—it is reduced in strength. However, attenuation is not a pad's primary function. It just happens to be a byproduct in most cases. Primarily, a pad is used to maintain impedance matching. Yet virtually all the pads that are used in audio work started out as attenuators and owe their design principles to attenuator theory. So it's the old "Which came first, the attenuator or the pad" paradox, and to resolve it, we have to start with attenuation.

Resistance Networks. The simplest attenuator is a series resistor in a circuit. It causes a voltage drop and dissipates a certain amount of electrical energy in the form of heat. The DC resistance of an ordinary carbon or wirewound resistor is measured in ohms.

A coil of wire has a certain resistance to

the flow of direct current also. But has a different sort of resistance to alternating current, and this is called *impedance*. While impedance is also measured in ohms, it is measured at a specific frequency, since it varies with changes in the frequency of the attenuating current. When the voice coil of a loudspeaker is said to have an impedance of 8 ohms, it is measured at 1,000 cycles. At 100 cycles and at 10,000 cycles, the voice coil's impedance will be a different.

In virtually all audio amplifiers, the impedance of the speaker voice coil should "see" an equivalent impedance on the secondary of the output transformer. This equality is called an impedance match, and is very important for maximum efficiency and minimum distortion. The output transformers on high-fidelity and stereo amplifiers have several taps at different impedances for correct matching with the speaker voice coil.

Attenuators. When an attenuator is added to the circuit, naturally it is going to cause a change in circuit impedance, amount of power transfer, and general operating char-

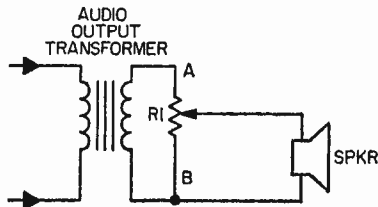

Fig. 1. Fader-type volume control for loudspeaker uses only one pot—but it's not practical in most cases.

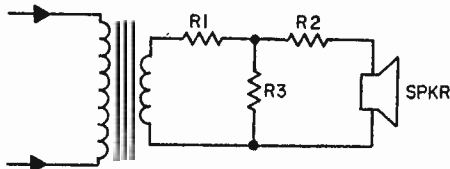

Fig. 2. A fixed T-pad gives equal impedance on both circuit ends—winding and loudspeaker see equal Z .

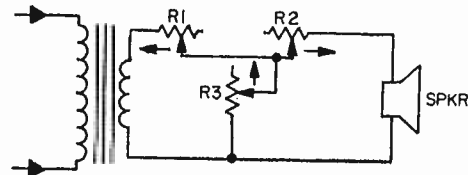

Fig. 3. A variable T-pad gives equal impedance at both sides of audio circuit and offers complete volume/power control.

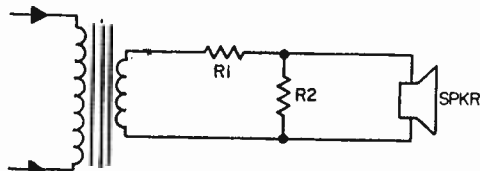

Fig. 4. The fixed L-pad has a very low energy or insertion loss. It's widely used to match two different impedances.

acteristics. A simple attenuator such as potentiometer R_1 in Fig. 1 can be used as a local volume control. It will vary the volume level of the speaker, but at the cost of causing an impedance *mismatch*. If the secondary winding of the transformer has an impedance of 8 ohms and the total resistance across R_1 is 8 ohms, then the transformer side of the circuit is perfectly matched with the wiper of R_1 located at point A . But as the wiper is moved toward point B , the effective resistance connected across the speaker voice coil decreases, causing a serious mismatch.

This is where the pad network comes in. An ideal attenuator will cause variations in speaker volume without changing the impedance (resistance in this case) across the transformer of the voice coil. A fixed attenuator called a "T-pad" is shown in Fig. 2. In this type of pad, R_1 will equal R_2 , while R_3 is some other value selected to match the impedance on both sides of the circuit.

A variable version of the T-pad is shown in Fig. 3. This type of attenuator is commonly used as a local volume control for loudspeakers in high-fidelity installations. Generally, its function is to balance a system for differences in speaker efficiency, room acoustics, and, in the case of extension speakers, act as a volume control at the speaker location. These pads are generally mounted on the speaker cabinet.

Connected a different way, the T-pad is frequently used as a "brilliance" or a "pres-

ence" control. Such pads, usually factory-wired into a loudspeaker cabinet, vary the amount of signal that is fed to the high-frequency speaker.

The three resistors in Fig. 3, R_1 , R_2 and R_3 are "ganged." They are all mounted on the same shaft so that as the knob is rotated, all three are varied by the same amount. The arrows in the drawing indicate the direction the wipers (center connections) move when the shaft of the pad is rotated clockwise to turn up the speaker volume. When the knob is turned to the full clockwise position for maximum volume, R_1 and R_2 are effectively shorted, providing a direct connection between points A and B with no loss. R_3 will offer maximum resistance, permitting very little current to flow from one side of the circuit to the other. In this position, the speaker voice coil sees only the impedance of the output transformer secondary coil—just as if there were no pad in the circuit at all.

In the opposite position, fully counterclockwise, R_1 and R_2 are at their maximum resistance and R_3 is at minimum resistance. In this position, very little current can flow through the upper leg of the pad because of the high series resistance. Any current flowing in the lower half is shorted to the upper branch through R_3 which has become zero ohms—a direct short. The resistances have been selected so that the total resistance of the pad in this position or any intermediate one, is always the same on

both sides. This way, impedance matching is maintained.

Matching Difference Impedances. A pad is a versatile device and can be used for matching two very different impedances. A frequently used configuration is the L-pad, which is simply a T-pad with one resistor removed, (See Fig. 4.) An application for this pad would be matching an output transformer with a 500-ohm secondary to a 16-ohm speaker.

Another way of looking at an L-pad is shown in Fig. 5. Viewed this way, the pad looks like nothing more than a voltage divider, and that's exactly what it is! The total resistance of R1 and R2 should equal the nominal impedance of the transformer secondary coil. The resistance of R2 alone will equal the impedance of the voice coil. In the case of matching a 500-ohm secondary with a 16-ohm speaker, R1 would equal 492 ohms and R2 would be 16 ohms.

Naturally, whenever any pad (or attenuator, if you will) is placed in a speaker circuit, there will be a certain amount of power loss—the attenuation that gives its name to these devices. Even in the case of a pad with low-value resistors, there will be some loss of energy and this is known as “insertion loss.”

Isolating with Pads. Another application for the pad is isolating of one part of a circuit from another. The need for isolation arises when a circuit has wide variations in

impedances (usually due to frequency changes) and the associated circuit must be kept at a constant impedance. A typical circuit that must frequently be isolated is the equalizing network in a high-fidelity pre-amplifier. Another instance is the output signal from a program source such as a tape recorder that is coupled to an amplifier circuit that requires constant impedance.

Effective isolation is possible with an H-pad shown in Fig. 6. The network resistance is the same at both the input and the output, providing good impedance matching. But the resistance of the network is high enough to prevent any impedance variations from being transferred from one side to the other.

The amount of actual attenuation in any pad depends on the resistance values of the total networks. There will always be a certain amount of insertion loss, even with the so-called “low-loss” types, such as the L-pad.

Signal Dividing. A commonly used pad is the two-set coupler for simultaneously operating two TV sets from the same antenna. The H-pad is usually used. Fig. 6 shows how the connections are made. The input from the antenna is across resistor R1 and the two TV sets (or one TV set and FM tuner) are connected to the two opposite sides of the “H.” Even with careful impedance matching, the insertion loss is so high that couplers of this type are practical only in strong signal areas.

Some manufacturers make “powered-

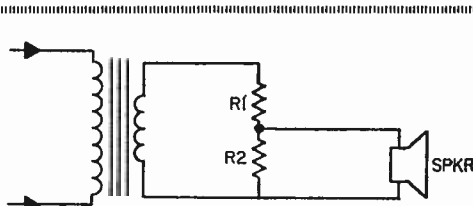

Fig. 5. Here's the L-pad again drawn to look like a voltage divider. R2 and speaker impedance are equal to that $\frac{1}{2}R2$ plus R1 should equal the transformer's secondary winding. Can you prove this statement?

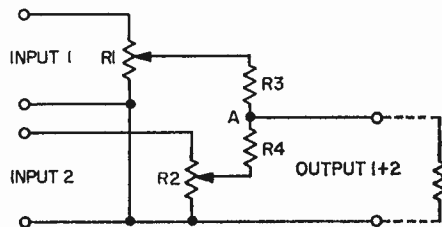
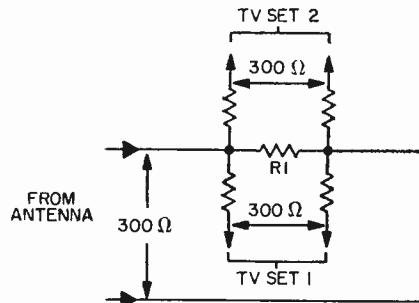

Fig. 6. They call it an H-pad because it looks like one. With the proper selection of resistors, the pad offers 3, 6, 9 or more dB loss while isolating and matching antenna from the two television sets.

Fig. 7. L-pads made from variable resistors are used to mix two (or more) audio signals prior to amplification.



couplers"—signal dividers with a tube or transistor amplifier in the circuit. They overcome the insertion loss of the resistor network, and in cases can provide enough gain to drive three or more TV sets.

Audio Mixers. A simple resistance network is often used for mixing two different signals—such as from two microphones or from a microphone and a record player—for making home tape recordings. Fig. 7 shows a circuit of this kind. Resistors R1 and R2 are, in effect, variable L-pad controls, and can vary the amount of attenuation of the input signal. R3 and R4 form the other loss of the L-pad or voltage divider. Since they are of equal resistance, the signal vol-

tage at their common point, *A*, will be a mixture of the signals from the center taps (wipers) of both R1 and R2.

While this simple mixer will do its intended job effectively, like the H-pad TV set coupler, there will be a certain amount of insertion loss. This loss will be minimal if the amplifiers used with the mixers have enough gain. Many mixers are of the powered type—that is, they have a tube or transistor at the output. This will provide enough gain to overcome the insertion loss of the attenuator. A transistor in the output has the additional advantage of constant impedance and will provide better matching over a wide frequency range. ■

Multivibrators

□ When the conversation turns from the Mets to multivibrators, you may hear all manners of strange words bandied about. Flip-flop, one-shot, astable, and bistable roll off the tongue of the all-knowing. And don't be too surprised if you hear the words free-running, single-step, and monostable—to name just a few—at your next electrified cocktail party. What do all these terms mean? Are there really so many different kinds of multivibrators? And, for that matter, of what use is a multivibrator for the experimenter?

The main job of a multivibrator is to generate square waves and pulses. Period. That's all!

A square wave is often used as a test signal for audio amplifiers to reveal frequency-response problems. In other applications, multivibrators generate short time constant pulses—only a few microseconds in duration. These mini pulses synchronize, or steady, the picture on our TV screens.

Longer pulses—those which are several seconds in duration—control the exposure time of photographic enlargers. Slow multivibrators can also drive the flashing warning lights seen by motorists as they approach roadside hazards. And, in the radio amateur's shack, faster multivibrators running at audio rates train the ham's eye and ear as he works with his code practice oscillator. Or, the same MV, as the multivibrator's also called, doubles duty as an audio signal source. The list could go on and on.

The uses of multivibrators grow daily, limited only by the ingenuity of those who

understand their working principles.

The imposing list of names in the first paragraph creates the impression that there must be almost a dozen different types of multivibrators. Fortunately, this is not so! There are only three basic types. The long list of names merely shows the existence of more than one name for the same type of multivibrator. At worst, this name-it-hodgepodge reflects minor variations of the same type of multivibrator.

The Circuit With an Alias. The three basic types of multivibrators are the *free-running* multivibrator, the *one-shot* multivibrator, and the *flip-flop*. With these three basic circuit types under your belt, you can whip up any of the jobs a multivibrator's capable of doing.

The free-running multivibrator is probably the type most familiar to the experimenter. It is very likely that the square wave generator or oscilloscope on his workbench has a free-running multivibrator buried somewhere in the instrument's circuit. The outstanding characteristic of the free-running multivibrator—and the one from which it earns its name—is that it runs freely. As long as a power supply is connected to it, the free-running MV enthusiastically pumps out a never-ending stream of square waves. This feature consistently earns the title of the Most Popular Circuit whenever John Q. Electronicsbuff needs square waves. See Fig. 1.

In contrast to the free-running MV, the one-shot multivibrator is a very reluctant beast. If fed DC from a power supply, it

does not react by joyously bubbling forth a stream of square waves like its enthusiastic free-running cousin. Instead, it sits there, grumpily doing absolutely nothing.

And, it will continue to sit there unless kicked in the right place by an externally generated pulse, called a trigger pulse.

Under this urging, it reluctantly makes one and only one pulse, and then lapses back into its former sullen condition. Until, of course, it's kicked by another trigger. It derives its name—one shot—from the fact that it gives only one pulse in response to a trigger. See Fig. 2.

Flip Out Forget-me-not. The third type of multivibrator, the flip-flop, is a forgetful fellow. It, like the one-shot, gives no output pulse unless urged by a trigger pulse. But its response to a trigger is quite different. It starts out to produce a pulse, but forgets to end it, unless told to do so by another trigger pulse. Strangely enough, this forgetfulness can be turned into a memory. The flip-flop is the heart of the registers system of large computers. See Fig. 3.

How can this be? Because, as Fig. 4 shows, the flip-flop can remember forever (or, at least, until the power is turned off) that a trigger pulse has been applied to it. Using this single basic capability, the registers of giant computers can be constructed.

Some Basic Building Blocks. Circuit diagrams for these three basic multivibrators are surprisingly similar. They're all built from the same basic building blocks. These building blocks are shown in Fig. 5.

The free-running multivibrator combines

Fig. 1

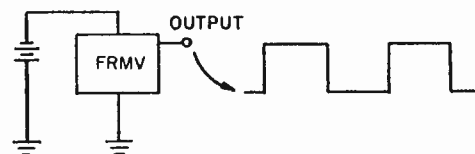
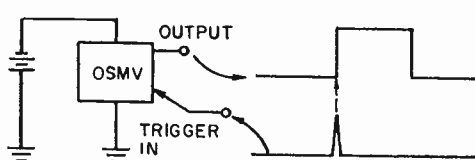

Fig. 2



these basic building blocks. The component values shown in our Fig. 6 will make a free-running multivibrator which runs at 440 Hz. Musicologists know that frequency as A above middle C on the piano.

To double that frequency, cut the values of both coupling capacitors in half; to triple it, cut them to one third the value shown, and so on. To hear the square wave, place an ordinary 2,000-ohm headset across either 1,500-ohm collector load resistor. To see the square wave, connect an oscilloscope to the point marked "output."

The one-shot multivibrator is very similar. It is built from pieces stolen from the free-running multivibrator as shown in Fig. 7 by replacing one of the coupling capacitors with a coupling resistor, and one of the "on" amplifiers with an "off" amplifier.

The values shown produce a pulse two

Fig. 3

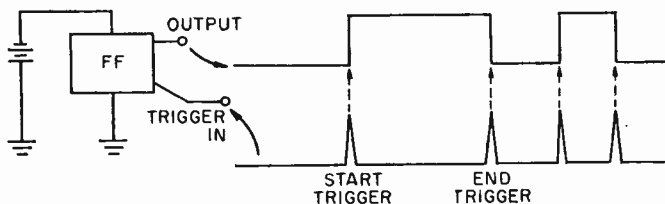

Fig. 4

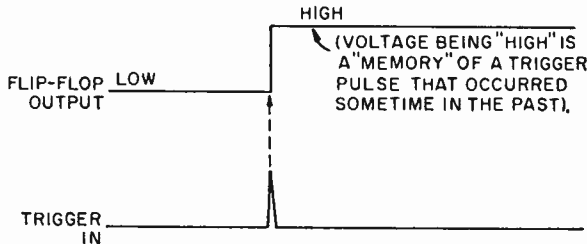
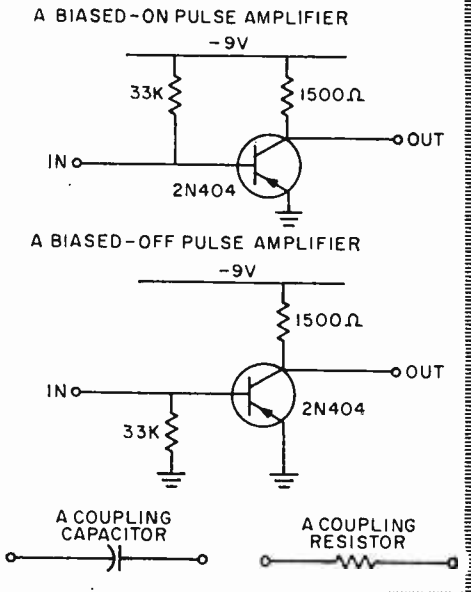

Fig. 5



seconds long. To double the pulse length, double the capacitor's value; to triple it, triple the capacitor's value, and so on. To hear the pulse, place an ordinary 2,000-ohm headset across either 1,500-ohm resistor.

Momentarily touch the point marked "trigger in" to the power supply. A click

will be heard in the headphones as the one-shot begins its solitary pulse. Two seconds later, a second click will be heard as the one-shot ends its pulse. (The actual time may be longer, because large-value capacitors sometimes actually have twice the capacity stamped on their case.)

To see the pulse, connect a voltmeter to the point marked "output." It will indicate -9 volts. Trigger the one-shot as above, by touching "trigger in" to the power supply. The voltmeter's needle will drop to zero volts, remain there for two seconds, and then pop up to 9 volts again.

To change the one-shot schematic to a flip-flop schematic, both pulse amplifiers must be of the biased-off type, and both coupling elements must be resistors. See Fig. 8. To see the action of this circuit, connect a voltmeter to output #1 or output #2—whichever of the two causes the voltmeter to register -9 volts. Leaving the voltmeter connected, short the output to ground. The voltmeter reading will drop to zero, of course, because there is a dead short right across its terminals. But, the surprising thing is that the reading will stay at zero after the short is removed.

Next, short the other output to ground. The voltmeter reading will rise to -9 volts, and stay there after the short is removed, showing that the flip-flop can remember an

Fig. 6

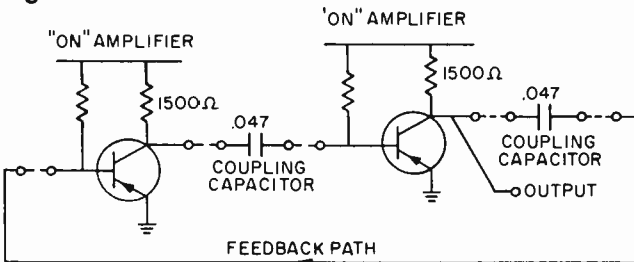
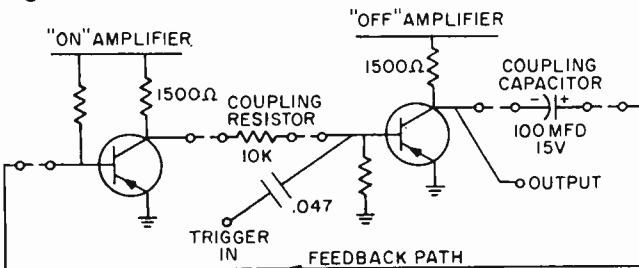
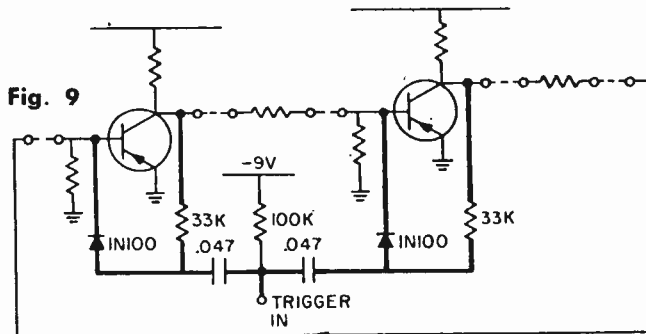
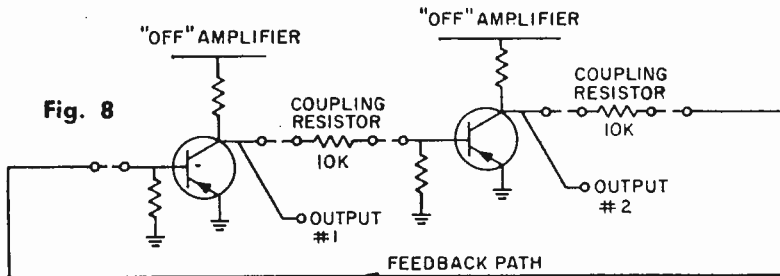

Fig. 7





occurrence (like shorting one output) even after the occurrence is ended.

Kicked by a Trigger Pulse. Of course, shorting an output to stimulate the flip-flop into action is not the same as running it from a trigger. Triggering circuitry can be added to the basic flip-flop as shown in Fig. 9. Now, leaving the voltmeter connected to one output as above, you can trigger the flip-flop by momentarily connecting the point marked "trigger in" to ground. Each time a trigger is supplied, the output that was at zero volts will jump to -9 volts. A second trigger will cause the same output to revert to zero volts.

Since it takes two triggers to make one complete output pulse from a flip-flop, feeding 500 pulses per second to the trigger input will cause only 250 pulses per second to come from the output. If these pulses are, in turn, fed to another flip-flop, its output will provide only 125 pulses per second. This ability of flip-flops to act as a frequency divider find very wide usage in applications ranging from computers to TV and electronic organs.

So much, then, for the three basic types of multivibrators. What about that long list of names we bandied about in the first paragraph? Where do they come in?

We can parcel out all those names among the three basic types. For example, the free-running multivibrator is known in formal

electron-ese as an *astable* multivibrator. The prefix "a-" tells us that it lacks a stable condition, and hence runs endlessly as long as power is supplied. The one-shot MV also answers to the name *monostable* multivibrators, its one "mono" stable state being the one in which it grumpily sits while awaiting a trigger.

And, the flip-flop is also a *bistable* multivibrator because it has two, or, "bi-" stable states, and will sit happily forever with a given output either "high" (-9 volts in the above example) or "low" (zero volts).

Other Names, Yet. Other names for the flip-flop include *toggle*, from its action in response to two successive triggers; *binary*, from its ability to rest in either of two states, and *Eccles-Jordan*, after the two men who described the circuit many years ago.

The names *one-step* and *univibrator*, as well as *single-step*, *single-cycle*, and *monovibrator*, are all much less common names for the one-shot. Similarly, the free-running multivibrator is rather infrequently referred to as an *unstable* multivibrator or an *Abraham-Bloch circuit*.

So, in spite of the abundance of names, there are only three basic types of multivibrators. Call the MV what you will, but the application of these three types reach through to almost every project the electronics hobbyist is likely to conjure up on his workbench. ■

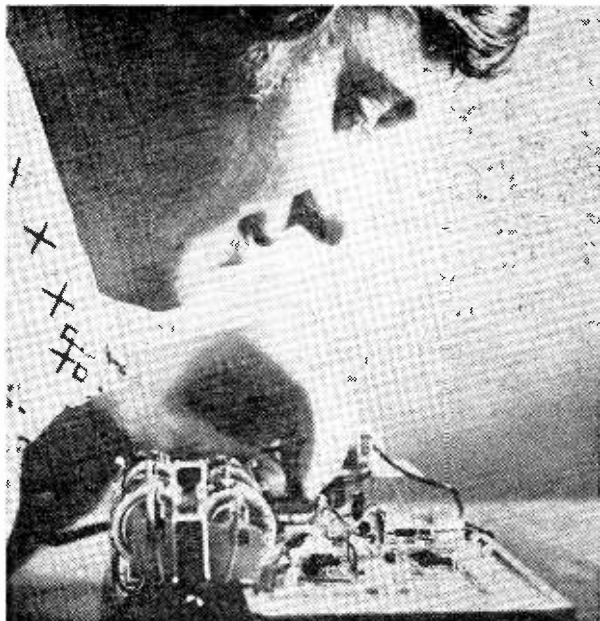

You Learn to Make Money ...with CIE's Electronics Laboratory!

Now you can learn Electronics by performing more than 200 practical, skill-producing experiments...with authentic industrial components...at home...in your spare time.

You learn by doing! This 161-piece Laboratory includes the up-to-date equipment you'll need — such things as an IC (integrated circuit), printed circuit board, FET (field effect transistor), photovoltaic cell, DC motor, microphone, multimeter, soldering iron and power supply.

You put theory into *practice* right in your own home... in your spare time...while you go right on pulling down your present pay. It's CIE's exciting space-age "Electronics Technology with Laboratory" program... a unique combination of CIE's special AUTO-PROGRAMMED® Lessons and laboratory equipment. It is the *practical* way to learn Electronics!

Prepare for a High-paying Career

You see, when you "learn by doing," you're *ready to do*...you're *armed* with the know-how to meet the challenges of a high-paying career in Electronics... prepared to go after an exciting, relevant job in a growing field such as medical technology, pollution control, radio and TV broadcasting, computers...just to name a few. Once you have some experience, you can make \$12,000 a year or more.

But that's not all! When you successfully complete your Electronics Laboratory course, you'll get a CIE Diploma. And, you'll be able to pass the Government FCC examination or *be entitled to a full refund of all tuition paid!* CIE's Money-Back Warranty is valid during the completion time allowed for your course.

Send today for CIE's 2 FREE BOOKS about opportunities in Electronics. For your convenience, we will try to have a representative call. Mail reply card or coupon to CIE...or write: Cleveland Institute of Electronics, Inc., 1776 E. 17th St., Cleveland, Ohio 44114.



You learn how to construct circuits and connect them with a soldering iron, which is part of your CIE laboratory equipment. This "hands on" experience is extremely valuable.



Testing and troubleshooting are an important part of your learning experience. Your laboratory has a precision multimeter to diagnose electronic troubles quickly and accurately.

APPROVED UNDER G.I. BILL

All CIE career courses are approved for educational benefits under the G.I. Bill. If you are a Veteran or in service now, check box for G.I. Bill information.

CIE Cleveland Institute of Electronics, Inc.

1776 East 17th Street, Cleveland, Ohio 44114
Accredited Member National Home Study Council

Please send me your 2 FREE BOOKS — The CIE school catalog, "Succeed in Electronics" and "How To Get a Commercial FCC License!"



Name _____ (Please Print)
Address _____
City _____
State _____ Zip _____ Age _____

Veterans and Servicemen:
 Check here for G.I. Bill information.

TE-01

CIRCLE NO. 4 ON PAGE 11 OR 111

All About Crystals

□ Can you imagine the chaos on the AM broadcast band if transmitters drifted as much as those inexpensive table radios? The broadcast station engineer must keep his station carrier within 20 Hertz of its assigned frequency. How does he do it? What about the CB'er unable to contact his base station with an unstable, super-regen walkie-talkie. Lost calls don't often happen to a CB'er who can keep his receiver frequency right-on the assigned channel center.

This and much more is, of course, all done with a little help from a very basic material, the Quartz crystal. It is the single component that serves to fill a basic requirement for precision frequency control. Quartz crystals not only fix the frequency of radio transmitters (from CB installations to multi-kilowatt-broadcast installations), but also establish the frequency of timing pulses in many modern computers. In addition, they can provide the exceptional selectivity required to generate and receive single-sideband signals in today's crowded radio spectrum. Yet this list merely touches upon the many uses of quartz crystals. No exhaustive list has ever been compiled.

A Real Gem. This quiet controller is a substance surrounded by paradox. While quartz composes more than a third of the Earth's crust, it was one of the three most strategic minerals during World War II. And despite its plentitude, several semi-precious gems (including agate and onyx) are composed only of quartz.

Unfortunately, quartz exercises its control in only a relative manner. When it's misused, the control can easily be lost. For this reason, if you use it in any way—either in your CB rig, your Ham station, or your SWL receiver—you should become acquainted with the way in which this quiet controller functions. Only then can you be sure of obtaining its maximum benefits.

What Is It? One of the best starting points for a study of quartz crystals is to examine quartz itself. The mineral, silicon dioxide (SiO_2), occurs in two broad groups of mineral forms: crystalline and non-crystalline. Only the large crystalline form of quartz is of use as a controller.

The crystalline group has many varieties, one of which is common sand. The variety which is used for control, however, is a large, single crystal, usually six-sided. The

leading source of this type of quartz is Brazil. However, it also is found in Arkansas. Attempts have been made to produce quartz crystals in the laboratory, but to date synthetic quartz has not proven practical for general use.

A property of crystalline quartz, the one which makes it of special use for control, is known as *piezoelectricity*. Many other crystals, both natural and synthetic, also have this property. However, none of them also have the hardness of quartz. To see why hardness and the piezoelectric property, when combined, make quartz so important, we must take a slight detour and briefly examine the idea of resonance and resonators.

Resonators and Resonance. As physicists developed the science of radio (the basis for modern electronics), they borrowed the acoustic notion of resonance and applied it to electrical circuits where it shapes electrical waves in a manner similar to an acoustic resonator. For instance, both coils and capacitors store energy and can be connected as a resonator (more often termed a resonant circuit). When AC of appropriate frequency is applied to the resonator, special things happen.

Pendulum Demonstrates. The principle involved is identical to that of a pendulum, which is itself a resonator closely similar in operation to our quartz crystals. To try it you can hang a pendulum of any arbitrary length (Fig. 1), start it swinging, then time its *period*—one complete swing or cycle. The number of such swings accomplished in exactly one second on the *natural* or *resonant* frequency of the pendulum in cycles per second (Hertz).

You can, by experiment, prove that the frequency at which the pendulum swings or oscillates is determined by the length of the pendulum. The shorter the pendulum (Fig. 2), the faster it swings (the greater the frequency). The weight of the pendulum has no effect on frequency, but has a marked effect upon the length of time the pendulum will swing after a single initial push—the heavier the pendulum, the greater the number of cycles.

A Real Swinger. Once the pendulum begins to swing, very little effort is required to keep it swinging. Only a tiny push is needed each cycle, provided that the push

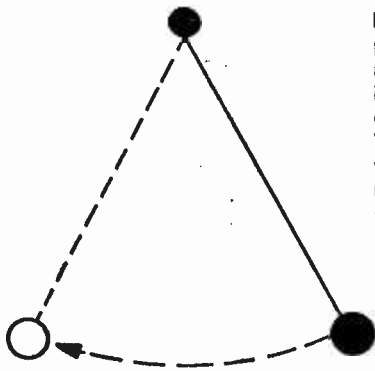

Fig. 1. A long pendulum swings at a rate determined by its length and weight at the end of the arm. To experiment at home, the arm should be made of light thread (no weight) and a small heavy mass (all the weight concentrated at one point).

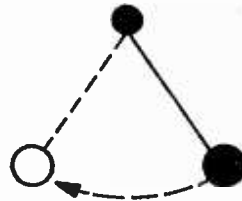
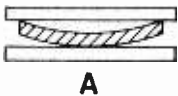
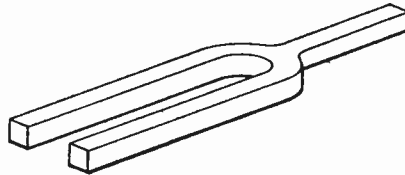
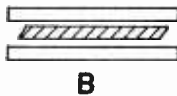

Fig 2. A short pendulum swings at a faster rate no matter what the weight is. The heavier the weight, the longer the pendulum will swing at the faster rate.

Fig. 3. The geometry of the tuning fork produces a continuous pure tone for a long time when struck gently. It is favored by piano tuners as a convenient way to carry a source of accurately-known tone or pitch.



A



B

Fig. 4. Depending on how the crystal is cut or sliced from the mother crystal, some crystals warp or bend as in A and others shear as shown in B. Each of the many cuts have special characteristics.

is always applied just as the pendulum begins to move away from the pushing point. If the push is given too soon, it will interfere with the swinging and actually cause the swing to stop sooner than it would without added energy; while if too late, added push will have virtually no effect at all. It is this principle—a tiny push at exactly the right time interval—which makes a resonator sustain sound or AC waves. You can prove it with the pendulum by first determining the resonant frequency of a pendulum, then stopping it so that it is completely still. A series of small pushes, delivered at the natural resonant frequency, (each too tiny to have more than a minute effect) will very rapidly cause the pendulum to swing to its full arc again. Pushes of the same strength at any other frequency will have little or no effect.

The pendulum is an excellent control mechanism for regulating a clock to keep time to the second, since the resonant frequency of the pendulum can readily be adjusted to be precisely one cycle per second. However, for control of audio frequencies from tens of Hertz (cycles per second) up to tens of thousands of cycles per second (kilohertz), or for radio frequencies ranging up to hundreds of millions of cycles per second

(Megahertz), the pendulum is too cumbersome a device.

The Tuning Fork. In the audio range, the equivalent of the pendulum is the tuning fork. This is an extremely elongated U-shaped piece of metal (Fig. 3), usually with a small handle at the base. When struck, it emits a single musical tone.

The operating principle is exactly the same as the pendulum. Each of the arms or tines of the fork corresponds to a pendulum arm. But here the arms are extremely short and much heavier in proportion to their size than the pendulum. (The shorter the arms of a tuning fork, the higher the resonant frequency in the audio range.) This greatly increased mass causes them to oscillate much longer when struck.

Not all tuning forks operate precisely like pendulums. The pendulum principle is based on a *flexing* of the arm upon its long dimension. While this is the most common operation, the fork may flex along any dimension.

It's even possible for a single, solid resonator such as a tuning fork to flex along several dimensions at once. A main part of the design of a good tuning fork is to insure that only a single dimension flexes or, in the language of resonators, only a

single mode is excited.

Area Too. There's no requirement that the resonator be a completely solid substance. A mass of air, suitably enclosed, forms a resonator. This is the resonator that works on a classic guitar or violin. Here, single-mode operation is distinctly *not* desired. Instead, multiple-mode operation is encouraged so that all musical tones within the range of the instrument will be reinforced equally.

Now, with the principles of resonance firmly established, we can return to the quartz crystal and its operation.

Quartz Crystal as Resonators. Like the tuning fork or, for that matter, any sufficiently hard object, the quartz crystal is capable of oscillation when struck physically or in some other way excited.

But unlike the tuning fork, or indeed any other object except for certain extremely recent synthetic materials, the quartz crystal is not only sufficiently hard to oscillate at one or more resonant frequencies, but is piezoelectric.

Piezoelectricity. The piezoelectric property means simply that the crystal generates an electric voltage when physically stressed or; on the other hand, will be physically deformed when subjected to a voltage (See Fig. 4). Other familiar objects making use of piezoelectricity include crystal and ceramic microphone elements and phonograph cartridges.

This virtually unique combination of properties (sufficient hardness for oscillation and piezoelectricity) found in quartz crystals, makes it possible to provide the initial push to the crystal by impressing a voltage across it. To provide the subsequent regular pushes, a voltage can be applied at appropriate instants.

Quality Factor. Almost any discussion of resonance and resonant circuits (or for that matter, inductance) eventually gets to a rather sticky subject labelled in the earliest days of radio, *quality factor* but now known universally as Q .

As used in radio and electronics, Q is usually defined by other means. Some of the definitions put forth at various times and places include:

- *The ratio of resistance to reactance in a coil.*

- *The ratio of capacitive reactance in a resonant circuit to the load resistance.*

- *The impedance multiplication factor, and others even more confusingly worded.*

All, however, come out in the end to be identical to the definitions cited above: The Q of a resonator is the ratio of the energy stored per cycle to the energy lost per cycle.

In a resonator, high Q is desirable. Q is a measure of this energy loss. The less energy lost, the greater the Q of the circuit.

Not so obvious (and rather difficult to prove without going into mathematics) are some of the other effects of Q . A resonant circuit is never completely selective; frequencies which are near resonance but not precisely equal to the resonant frequency pass through also!

An Interesting Fraction. The greater the Q , the narrower the band of frequencies which can affect the resonator. Specifically, the so-called half-power bandwidth (Fig. 5) of a resonator (that band in which signals are passed with half or more of the power possessed by signals at the exact resonant frequency) is expressible by the fraction Fo/Q , where Fo is the resonant frequency and Q is the circuit Q . Thus a 455 kHz resonant circuit with a Q of 100 will have a half-power bandwidth of 455/100 kHz, or 4.55 kHz. This relation is an approximation valid only for single-tuned circuits; more complex circuits are beyond this basic discussion.

The Q of Quartz Crystals. When we talk of the Q of conventional resonant circuits composed of coils and capacitors, a figure of 100 is usually taken as denoting very good performance and Q values above 300 are generally considered to be very rare.

The Q of a quartz crystal, however, is much higher. Values from 25,000 to 50,000 are not unheard of.

The extremely high Q makes the crystal a much more selective resonator than can be achieved with L-C circuitry. At 455 kHz, for example, the bandwidth will be between 10 and 20 Hertz (*cycles per second*) unless measures are taken to reduce Q . Even in practice (which almost never agrees with theory), 50-Hertz bandwidths are common with 455-kHz crystal filters.

So far as external circuitry is concerned, the crystal appears to be exactly the same as an L-C resonant circuit except for its phenomenal Q value. See Fig. 6.

At series resonance, the crystal has very low impedance. You may hear this effect referred to as a *zero* of the crystal. At parallel resonance, impedance is very high; this is sometimes called a *pole*. Fig. 7

shows a plot of *pole* and *zero* for a typical crystal. The special kind of crystal filter known as a half-lattice circuit matches the *pole* of one crystal against the *zero* of another, to produce a passband capable of splitting one sideband from a radio signal. Such filters are widely used in Ham, commercial and; to a lesser extent, in CB transmitters.

When a crystal is used to control the frequency of a radio signal or provide a source of accurate timing signals, either the

pole or the *zero* may be used. Circuits making use of the *pole* allow more simple adjustment of exact frequency, while those making use of the *zero* often feature parts economy. Later we'll examine several of each type.

From Rock to Finished Crystal. To perform its control functions properly, a quartz crystal requires extensive processing. The raw quartz crystal must be sliced into plates of proper dimension, then ground to the precise size required. Each plate must be as

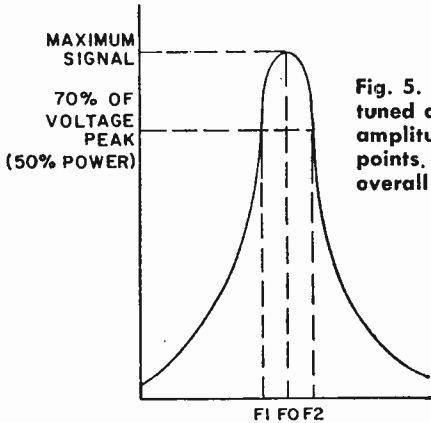

Fig. 5. Bandwidth characteristic of a typical tuned circuit shows the peak or maximum signal amplitude and the 70% voltage peak (50% power) points. This is the characteristic that determines overall selectivity.



Fig. 6. Diagram is a typical equivalent circuit for a crystal. As resistance is lowered to near zero, crystal efficiency increases. In use, the crystal holder and external circuit add some capacitance across the entire circuit.

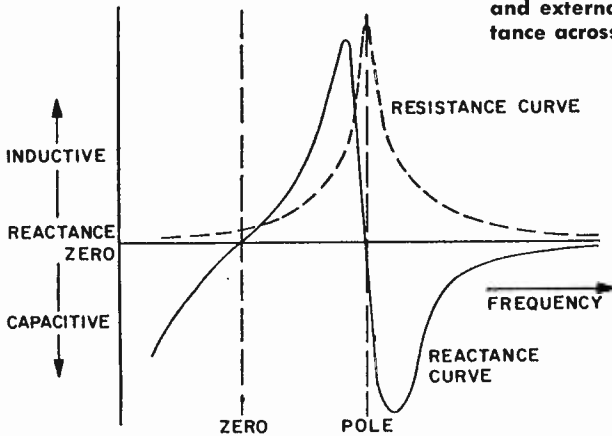

Fig. 7. Some characteristics of a quartz crystal. When slightly off resonant frequency (at the pole) a crystal exhibits inductive or capacitive reactance—just like an LC circuit.

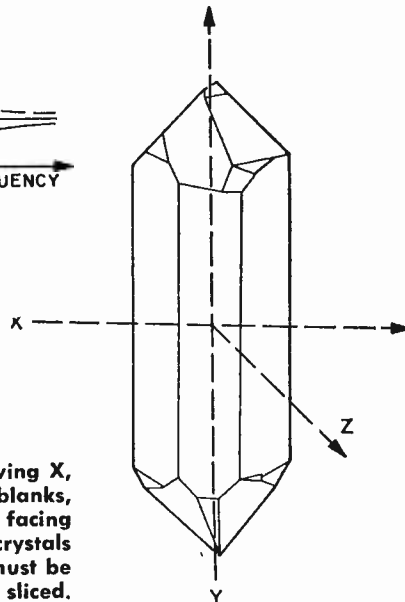

Fig. 8. A view of a mother crystal showing X, Y and Z axes. Crystal is sliced into blanks, ground to frequency, polished and plated (on facing sides) to make permanent electrodes. All crystals are not made perfect by Mother Nature and must be examined optically before being sliced.

close to precisely parallel, and as perfectly flat, as possible. The electrodes must be in proper contact with the polished plate; in many modern units, the electrodes are actually plated directly to the crystal surface, usually with gold.

The crystal plate is known as a *blank* when it is sliced from the raw crystal. The blank is cut at a precise angle with respect to the optical and electrical axes of the raw crystal, as shown in Fig. 8. Each has its own characteristics for use in specific applications. Some, notably the X- and Y-cuts, are of only historic interest. The Y-cut, one of the first types used, had a bad habit of jumping in frequency at critical temperatures. The X-cut did not jump, but still varied widely in frequency as temperature changed.

Today's crystals most frequently use the AT cut for frequencies between 500 kHz and about 6 MHz, and the BT cut for between 6 and 12 MHz. Above 12 MHz, most crystals are specially processed BT- or AT-cuts used in *overtone* modes. These cuts are important to crystal makers and not relevant to our layman's theory.

The blanks are cut only to approximate size. The plates are then polished to final size in optical "lapping" machines which preserve parallelism between critical surfaces. During the final stages of polishing, crystals are frequently tested against standard frequency sources to determine exact frequency of operation.

If electrodes are to be plated onto the crystal surfaces, frequency cannot be set precisely by grinding since the electrodes themselves load the crystal slightly and cause a slight decrease in operating frequencies. These crystals are ground just a trifle above their intended frequencies, and the thickness of the electrodes is varied by varying plating time to achieve precision.

Accuracy. The precision which can be attained in production of quartz crystals is astounding. Accuracy of ± 0.001 percent is routine, and 10-time-better accuracy is not difficult. In absolute figures, this means an error of one cycle per Megahertz. In another frame of reference, a clock with the same accuracy would require more than 11 days to gain or lose a single second.

However, such accuracy can be achieved only when certain precautions are taken. For instance, the frequency of a crystal depends upon the circuit in which it is used as well as upon its manufacture. For an

accuracy of $\pm 0.005\%$ or greater, the crystal must be ground for a single specific oscillator. If $\pm 0.001\%$ (or better) circuit accuracy is required, it must be tested in that circuit only. Thus, CB transmitters are on the narrow edge of being critical. This is why all operating manuals include a caution to use only crystals made specifically for that transmitter.

When one part-per-million accuracy is required, not only must the crystal be ground for a single specific oscillator, but most often the oscillator circuit must then be adjusted for best operation with the crystal; this round-robin adjustment must be kept up until required accuracy is achieved. Even then, crystal aging may make readjustment necessary for the first 12 to 18 months.

Frequency Variation—Causes and Cures. Possible variations in frequency stem from three major causes while cures depend entirely upon the application.

The most obvious cause of frequency variation is temperature. Like anything else, the crystal will change in size when heated and the frequency is determined by size. Certain cuts show less change with temperature than do others, but all have at least some change.

For most noncommercial applications, the heat-resistant cuts do well enough. For stringent broadcast station and critical time-signal requirements, the crystal may be enclosed in a small thermostatically-regulated oven. This assures that the steady temperature will cure one cause of frequency change.

The second well known cause for variation of frequency is external capacitance. Some capacitance is always present because the crystal electrodes form the plates of a capacitor where the crystal itself is the dielectric. Most crystals intended for amateur use are designed to accommodate an external capacitance of 32 pF, so if external capacitance is greater than this, the marked frequency may not be correct. Crystals for commercial applications are ground to capacitance specifications for the specific equipment in which they are to be used. CB crystals also are ground for specific equipment, although many transceivers employ the 32 pF standard set for Ham applications.

Trim a Frequency. When utmost precision is required, a small variable capacitor may be connected in parallel with the crystal and adjusted to change frequency slightly. The

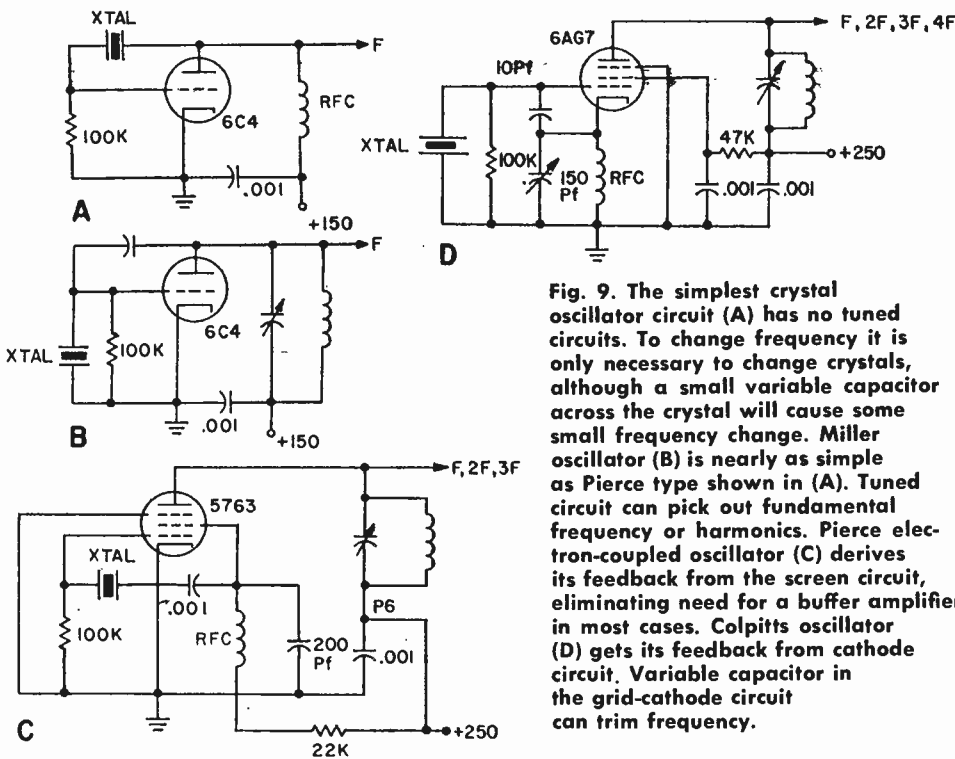

Fig. 9. The simplest crystal oscillator circuit (A) has no tuned circuits. To change frequency it is only necessary to change crystals, although a small variable capacitor across the crystal will cause some small frequency change. Miller oscillator (B) is nearly as simple as Pierce type shown in (A). Tuned circuit can pick out fundamental frequency or harmonics. Pierce electron-coupled oscillator (C) derives its feedback from the screen circuit, eliminating need for a buffer amplifier in most cases. Colpitts oscillator (D) gets its feedback from cathode circuit. Variable capacitor in the grid-cathode circuit can trim frequency.

greater the capacitance, the lower the frequency. Changes of up to 10 kHz may be accomplished by this means, although oscillation may cease when excessive changes are attempted.

Like temperature caused variations, frequency variations due to capacitance may be useful in special cases. Hams operating in the VHF regions obtain frequency modulation by varying load capacitance applied to the crystal in their transmitters.

The third cause for variation of frequency is a change in operating conditions in the associated circuit. This cause is more important with vacuum-tube circuits than with semiconductor equipment. As a rule, operating voltages for any vacuum-tube oscillator providing critical signals should be regulated to prevent change.

Again, this cause can be used to provide FM by deliberately varying voltages.

Crystal Aging. A final cause of frequency variation, small enough to be negligible in all except the most hypersensitive applications, is crystal aging. When a crystal is first processed, microscopic bits of debris remain embedded in its structure. These bits are displaced during the first 12 months

or so of use, but during that time the crystal frequency changes by a few parts per million. Extreme accuracy applications must take this change into account. For most uses, though, it may be ignored.

Using Quartz Crystals. After all the discussion of crystal theory, it's time to examine some typical circuits. While dozens of special crystal circuits have been developed for special applications, a sampling will suffice for discussion. Fig. 9 shows four typical vacuum tube crystal oscillator circuits.

The simplest of these is the Pierce circuit, Fig. 9A. While at first glance this circuit appears to employ the crystal's *zero* to feed back energy from plate to grid, the *pole* is actually used through a mathematically-complex analysis. This circuit has one unique advantage; it contains no tuned elements and, therefore, can be used at any frequency for which a crystal is available. This makes it an excellent low-cost test signal source. The major disadvantage is that excessive current may be driven through the crystal if DC plate voltage rises above 90 or so.

The Miller oscillator (Fig. 9B) is almost as simple to construct and operate as is the

Pierce and has an additional advantage of operation with overtone crystals. This is the circuit recommended by *International Crystal Mfg. Co.* for use with their overtone crystals. The capacitor shown between plate and grid is usually composed of grid-plate capacitance alone. The *pole* is used here also, energy feeds back through the grid-plate capacitance, and the *pole* selects only the parallel-resonant frequency (shorting the rest to ground).

ECO. The electron-coupled Pierce oscillator (Fig. 9C), is similar to the basic Pierce. The tuned circuit in the plate offers the possibility of emphasizing a harmonic—an RF choke may be used instead if freedom from tuning is desired and fundamental-frequency operation will suffice.

GPO. One of the most popular oscillators of all time is the Colpitts Crystal oscillator of Fig. 9D, sometimes known as the *grid-plate* oscillator. The feedback arrangement here consists of the two capacitors in the grid

circuit; feedback is adjusted by means of the 150 pF variable capacitor (the greater the capacitance, the less the feedback) until reliable oscillation is obtained. Like the other three oscillators, this circuit employs the crystal *pole* frequency.

Since all four of these oscillator circuits utilize the *pole* for frequency control, exact frequency adjustment capability may be obtained by connecting a 3-30 pF trimmer capacitor in parallel with the crystal.

Crystal oscillators may, of course, be built with transistors, too. Two typical circuits are shown in Fig. 10. Feedback mechanisms differ somewhat because of the basic differences between tubes and transistors. In general, transistorized oscillators are more stable.

As a Clock. To use a crystal as the timing element of a clock, an oscillator identical to those shown in Fig. 9 and 10 is the starting point. Crystal frequency is chosen at a low, easily-checked value such as 100 kHz. This frequency is then divided and redived by synchronized multivibrators to produce one cycle-per-second pulses. These may then be counted by computer counting circuits.

In addition to being used as oscillators and timing elements, crystals find wide application in filters. Fig. 11 shows some typical crystal-filter circuits. While all circuits shown use vacuum-tubes, transistors may be substituted without modification of the filter circuits themselves if the impedances are right.

The single-crystal filter circuit shown in Fig. 11A provides spectacularly narrow reception. When the notch control is set to precisely balance out the crystal stray capacitance, the resonance curve of the filter is almost perfectly symmetrical. When the notch control is offset to one side or the other, a notch of almost infinite rejection appears in the curve (the *pole*). The width control varies effective Q of the filter.

More popular for general usage today is the band-pass filter, shown as Figs. 11B and 11C. These filters pass a band of frequencies without excessive loss and reject all frequencies outside this band. Both circuits make use of matched crystals (X1 and X2)—the *pole* of one must match the *zero* of the other for proper results. When this condition is met, the reactances of the two crystals cancel over the passband. The passband is roughly equal to the *pole-zero* spacing.

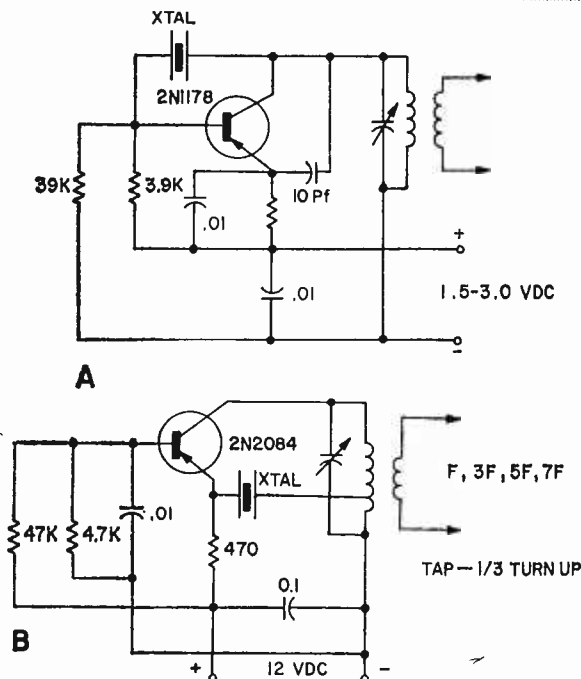

Fig. 10. Fundamental frequency transistorized oscillator (A) is quite similar to that in Fig. 9A. One difference is that tuned circuit in output replaces RFC unit. The overtone (harmonic) circuit (B) uses crystal for odd harmonic feedback. Either circuit can be used for fundamental frequency operation—just tune.

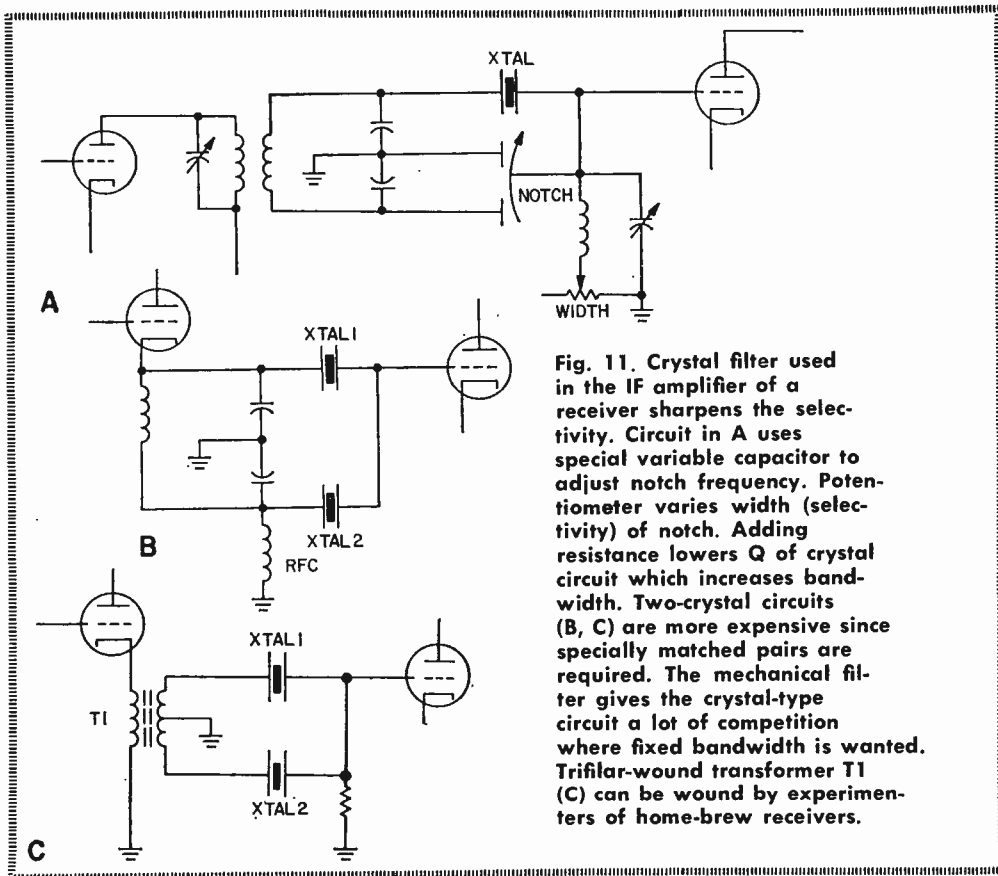

Fig. 11. Crystal filter used in the IF amplifier of a receiver sharpens the selectivity. Circuit in A uses special variable capacitor to adjust notch frequency. Potentiometer varies width (selectivity) of notch. Adding resistance lowers Q of crystal circuit which increases bandwidth. Two-crystal circuits (B, C) are more expensive since specially matched pairs are required. The mechanical filter gives the crystal-type circuit a lot of competition where fixed bandwidth is wanted. Trifilar-wound transformer T1 (C) can be wound by experimenters of home-brew receivers.

While the two circuits shown are virtually identical in operation, the transformer-coupled circuit of Fig. 11C is easiest for home construction. The only critical component is the transformer. It should be tightly coupled, with both halves of the secondary absolutely balanced. This is done by winding a trifilar layer of wire (wind three wires at the same time); the center wire becomes the primary winding and the

remaining two wires become the secondary. The left end of one secondary half connects to the right end of the other, and this junction forms the center tap. The remaining two ends connect to the crystals. If you have sufficient patience to wind on it, a toriod form is recommended. The only absolutely critical requirement of the transformer, however, is that it have no resonant frequencies. ■

Language of Gain

□ When you glide the old heap into a gas station and ask the attendant for “two bucks worth of hi-test,” he’s sure to know you want high octane gas and can part with two dollars.

But just try to ask for “two liters of Ethyl” and you just might end up with an empty gas tank and seven or eight kittens!

In this article we want to discuss gain—

the kind electronics is made of. But instead of explaining gain in textbook style (to help avoid something akin to our two liters of Ethyl misunderstanding), we think we’ve found a sort of black box dialect that’ll help you understand electronic terms associated with gain.

Mu, beta, and gm. We know that each term describes gain. Why, then, such a vari-

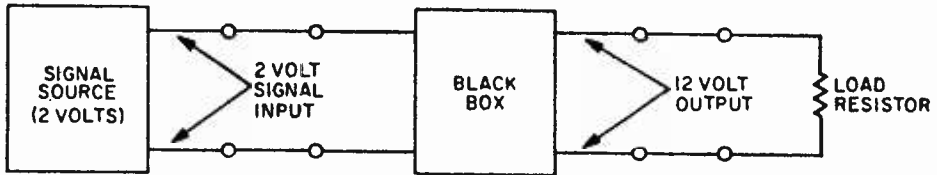

Black box (slang for an unknown circuit) test set-up for input/output voltage measurements.

ety of terms?

Can a triode have its gain described by mu, or can a FET have a beta? Exactly what do all these terms mean?

Read on . . . To answer these questions let us suppose that we concealed some type of amplifying device in a black box, and sent it to an electronics lab with a request that its gain be measured. The input and output leads are brought out and identified, but the lab is not told whether the box contains a vacuum tube, an ordinary bipolar transistor, or a FET. We also supply the lab with a 2-volt signal source for the input, and give them a load resistor to be connected across the output leads.

The lab, to enhance its reputation, decides to make four independent measurements and compare the results. The entire set-up is therefore handed to the first of four lab technicians with the only instruction, "measure the gain of this box."

The first tech takes the straightforward approach and measures input signal voltage and output signal voltage as shown.

Finding that the black box has a 2-volt input and a 12-volt output, he takes the ratio of these two voltages, and obtains the gain.

$$\text{Gain} = \frac{e(\text{out})}{e(\text{in})} = \frac{12 \text{ volts}}{2 \text{ volts}} = 6$$

Since this result is the ratio of two voltages, it is the *voltage gain*, and is usually expressed by the term mu. This tech therefore reports the black box has a mu of 6.

Joe tries. The entire set-up is then taken to a second technician, who, looking around

his lab bench, finds that he does not have at hand any convenient way to measure voltages, but has some excellent current-measuring devices all ready to use. He therefore measures the input and output *currents* as shown.

A signal current of 3 microamperes flows into the box, he discovers, causing an output signal current of 360 microamperes. Taking the ratio of these two currents, he obtains the *current gain*.

$$\text{Gain} = \frac{i(\text{out})}{i(\text{in})} = \frac{360 \text{ microamps}}{3 \text{ microamps}} = 120$$

Since current gain is usually expressed by the term beta, the tech reports to his boss that the black box has a beta of 120.

Now, remember that these two numbers, a mu (voltage gain) of 6 and a beta (current gain) of 120, are measurements made on the same amplifier, with the same signal source and the same load. The only difference between the two measurements is that voltages were measured in one case, and currents in the other.

This same set-up now is passed to a third technician, who, with a mischievous glint in his eye, proceeds to measure the output *voltage* and the input *current*. He gets yet another figure for gain.

$$\text{Gain} = \frac{e(\text{out})}{i(\text{in})} = \frac{12 \text{ volts}}{3 \text{ microamps}} = 4 \text{ megohms}$$

Fred's Folly? Hold on there! Gain, in megohms? Yes, indeed! Ohm's law states very clearly that when volts are divided by amperes, the result is in ohms. It's perfectly legitimate to express the gain of an ampli-

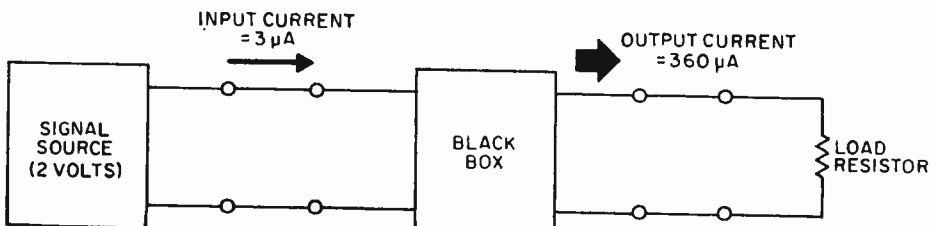

The second tech, Joe, who measures currents must describe his gain in beta.

fier in ohms, or kilohms, or megohms; whatever the ratio of its output voltage to its input current yields.

Does this mean that the amplifier can be replaced by a 4-megohm resistor? No, for the 4 megohms defined by the ratio is a special kind of resistance, called a transfer resistance, meaning that it indicates the voltage transferred to the output when a certain current is applied to the input. It is sometimes shortened to transresistance and is also called *mutual resistance* (RM).

This way of expressing gain is a bit unusual, which accounts for the mischievous glint in the third tech's eye. It is not found among the more common gain expressions given in the first paragraphs. Nonetheless, it is a perfectly valid way to describe an amplifier's gain.

Sam's System. The fourth technician, who now inherits the black box for the final measurement, has seen the stir created by his colleague's mixed measurement of current and voltage, so he decides to try for another flurry, only this time by reversing the measurements, getting readings for *output* current and *input* voltage. He obtains yet another gain measurement.

$$\text{Gain} = \frac{i(\text{out})}{e(\text{in})} = \frac{360 \text{ microamps}}{2 \text{ volts}}$$

$$\text{Gain} = 180 \text{ micromhos.}$$

This is another variation on Ohm's law. Just as volts divided by amperes gives resistance (ohms), so the inverse (amperes divided by volts) gives conductance—the inverse (reciprocal) of resistance. The unit of conductance is the mho, which is ohm spelled backwards.

The special conductance used to describe an amplifier's gain is called transfer conductance, for the same type of reason given above for transfer resistance. Similarly, shortened forms include *transconductance* and *mutual conductance*, symbolized as gm.

So the fourth and final measurement on the black box yields an answer of 180 micromhos for the gain. In summary then, four different measurements on the same amplifier gave the following differing figures for gain.

- mu (voltage gain) = 6
- beta (current gain) = 120
- rM (mutual resistance) = 4 megohms
- gm (mutual conductance) = 180 micromhos

Whatever device is in the box, it certainly can use any of the familiar gain expres-

sions—mu, beta, or gm—to characterize its gain and, moreover, can even have its gain stated by the less familiar rM.

What's relevant: In general, any device—triode, pentode, transistor, or FET—could theoretically use any of these four terms to state its ability to provide gain. But in practice, the technique chosen to measure gain depends on how relevant one method may be over another.

For example, a triode's negative-biased grid, sticking into a stream of electrons in a vacuum, draws almost no current, and even that tiny current it does draw doesn't mean much in determining the triode's output. Since the input current is so tiny, and the output current so much larger, a triode vacuum tube's beta (current gain) is extremely large, but it is difficult to measure, it would vary widely from tube to tube, and doesn't mean much anyway when it comes to practical gain calculations.

On the other hand, the voltage on the grid is very easy to measure and is very meaningful in controlling the output. So, the triode's input signal is always stated in terms of voltage.

Similarly, the pentode's grid and the FETs gate draw so little current that their betas would be astronomical but meaningless, while like the triode, their grid or gate voltages are easily measured and relate closely to the output.

Something different. The ordinary bipolar transistor, however, is a quite different animal. Instead of having a grid in a vacuum or an insulated gate, it has an input consisting of a turned-on PN junction—the base-to-emitter diode. (See e/e's Basic Course for March-April, 1972 and May-June, 1972—Understanding Semiconductors).

This diode is almost a short circuit for signals; input voltages are therefore, very hard to measure, never go above approximately 0.6 volt, and bear a very unwieldy relationship to the transistor's output. However, this turned-on diode draws an appreciable current which also happens to be the parameter that controls the transistor's output. Therefore, the quantity most conveniently measured at the bipolar transistor's input is *current*.

Check our box score on the next page.

The output circuits of these devices are the other half of the story. All of them certainly produce current, but three of them—the pentode, transistor, and FET—produce it in a most unusual way—the same way a very high voltage and a very large

DEVICE	INPUT	OUTPUT	OUT/IN	WHICH IS
Triode	Voltage	Voltage	Volts/Volts	mu
Triode	Voltage	Current	Current/Volts	gm
Pentode	Voltage	Current	Current/Volts	gm
Transistor	Current	Current	Current/Current	beta
FET	Voltage	Current	Current/Volts	gm

resistor combine to produce current in the following example.

Notice that it would make almost no difference in the 360-microampere output signal current if we dropped the 1,000-ohm load down to 10-ohms, because the total resistance (internal + load) would drop from 1,001,000-ohms to 1,000,010-ohms—an imperceptible change. An upward change of load from 1,000-ohms to, say, 10,000-ohms also has very little effect on the 360-microampere output current, because the huge resistance inside the device overwhelms the relatively small change contributed by the load. So a device that has a large internal resistance will pump out the same unvarying current, almost without regard for the value of the external load, as long as the load is much smaller than the internal resistance.

Such devices are called constant-current sources, and pentodes, transistors, and FETs behave in just this manner to provide an output signal current which is not influenced by typical load resistors. The current from these devices is, therefore, the logical parameter to be measured.

The triode, on the other hand, is not quite so single-minded about producing current as are FETs, pentodes, and transistors. Instead of some 1,000,000 or more ohms of internal impedance, triodes run from as low as 5,000-ohms equivalent resistance to approximately 50,000-ohms.

Since the triode is not a constant-current device (note that it makes quite a difference in the total resistance if the load is changed

DEVICE	INPUT PARAMETER
Triode	Voltage
Pentode	Voltage
Transistor	Current
FET	Voltage

from 1000-ohms to 10,000-ohms), we normally try to measure both current and voltage in characterizing triode gains.

The box score now reads as shown above.

This accounts for the association of beta with transistors, gm with pentodes, triodes, and FETs, and mu with triodes alone. Note that there is no device available which is best characterized as producing an output voltage in response to an input current; hence rm does not appear as a relevant item in the list.

The Unanswered Question. So, what was in the black box? Actually, no present-day device, by itself, could respond to the four tests as described above. For example, a vacuum tube would not draw in its grid circuit the 3 microamperes measured by the second and third techs, while a transistor would be destroyed if we attempted to impress 2 volts directly across its input, as measured by the first and fourth techs. Therefore, the box's contents must have included some other components. In fact, any of the above, right circuits would give the four techs the measurements they reported. However, only the transistor circuit will work with both AC and DC inputs. Coupling capacitors are used in the remain-

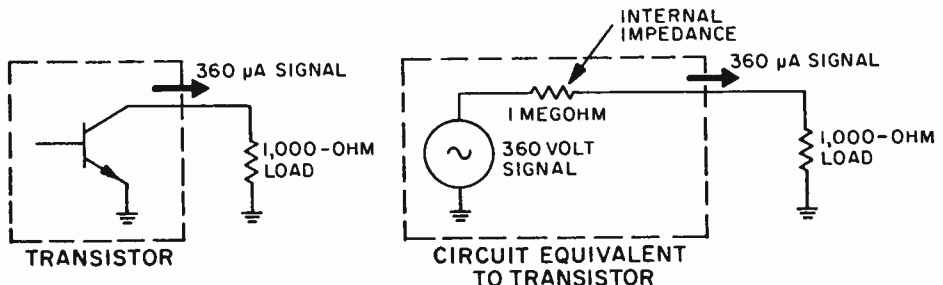

Text shows why pentodes, transistors and FET devices are called constant current sources.

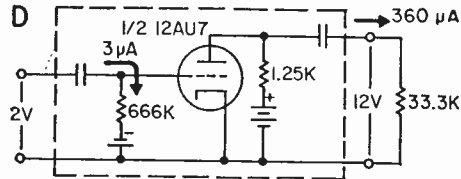
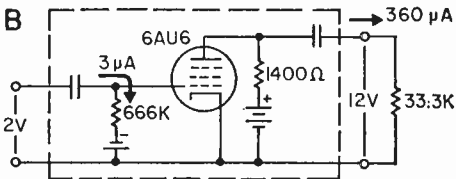
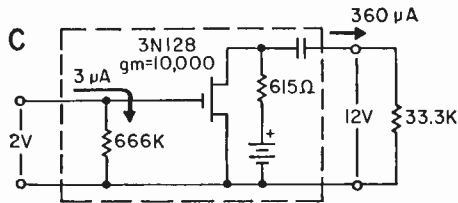
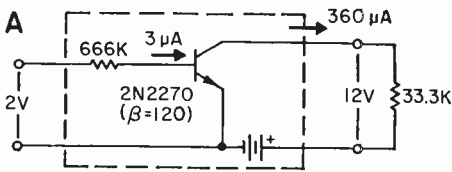

Bet those techs flipped out when they saw how all four circuits could give the same results. Note identical input and output parameters for each circuit.

ing three circuits, so only AC measurements are possible with these.

So we can conclude that μ , β , and g_m (and the unfamiliar r_m as well) all describe gain in their own way and can, in general, describe any amplifier's gain. The

individual peculiarities of tubes and transistors cause us to prefer certain terms for certain devices, and understanding what these terms are trying to tell us is very important as we learn to speak the language of gain. ■

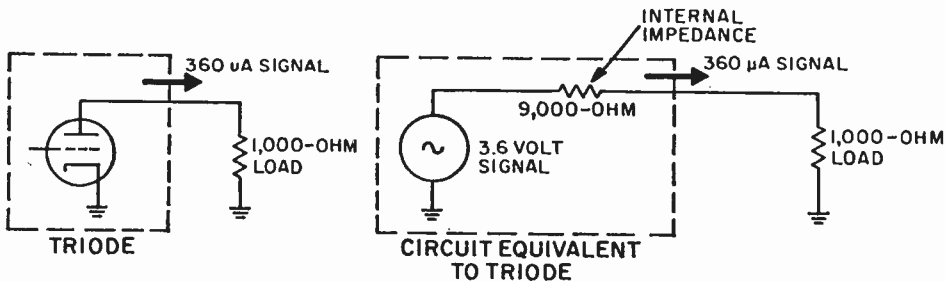

Characteristic low internal impedance makes triode gain measurable in μ .

The Superheterodyne Circuit

□ Born out of necessity during World War I, the superheterodyne receiver circuit toppled all existing conventional receiver types on electronics' popularity chart. And to this day, none of the "conventional" radios of that era were able to recapture electronics' limelight. Stranger yet, every branch of electronics is still being swept along Progress' Path by a circuit that—predictably—should have gone the way of the Flivver and Flapper. From military and industrial, to commercial and consumer—everybody who's ever seen a radio, and certainly a television set, has found himself staring face to

face with a superheterodyne receiver. Fact is, you'd be hard-pressed to find any up-to-date radio—even the integrated-circuit-and-ceramic-transformer variety—that doesn't somehow utilize the superhet circuit.

After the First World War, the "All-American Five," as it was dubbed, took its place in living room and parlor from coast-to-coast. And it continues to be built today as its inventor generally conceived of it, way back when the circuit was made to track and help locate enemy aircraft spitting fire over French skies.

Narrow Squeeze. The superheterodyne

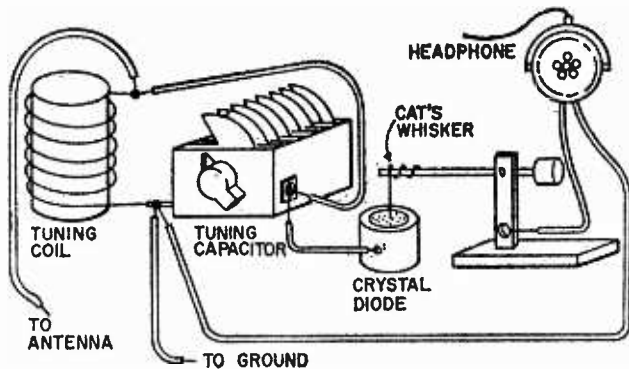

Schematic representation of crystal radio shows how cat's whisker gently contacted diode surface in order to achieve demodulation of RF signal. Earliest semiconductor diodes made were miniature crystal diode/cat's whisker affairs encased in glass package.

found itself ruling the receiver roost largely because it had a redeeming quality no other receiver of that vintage era could boast of. Called *selectivity*, this hitherto unheard of quality endowed the superhet with the ability to select the particular station a listener wanted to hear (and later see), and reject all others. Indeed, it was a revolutionary step forward in receiver design. But selectivity was hardly a quality needed back in grandfather's day. Why?

First, grandpop used to listen to signals sent by spark-gap transmitters. The primitive spark signals generated by those common-as-apple-pie transmitters were extraordinarily broad. It was like listening to the lightning crashes you can pick up as you tune across the dial of an AM radio during a thunderstorm. More important, though, there were fewer signals on the air. So, selectivity wasn't too important.

The year 1922 saw the meteoric rise of radio for entertainment and communication. As hundreds of stations took to the air, it became apparent that the primitive receiving gear capable only of broad-bandwidth reception couldn't even begin to handle the impending traffic jam beginning to build on the airwaves. And the problems of receiving but one station, without an electronic cacaphony drowning it out, takes us back even further in electronics' primeval time.

Cat's Whiskers and TRF. Digging through to the bottom of the Twentieth Century, we uncover two electronic fossils: the cat's whisker crystal receiver, and tuned radio frequency (TRF) receiver. These were popular predecessors of the superhet circuit.

The crystal set had the least selectivity of either circuit, and what it did have was obtained mostly from one measly tuning circuit. Consisting of a coil and homemade variable capacitor, these crude tuning devices

could barely pick out a desired radio signal and, hopefully, reject all RF intruders trying to elbow their way into the listener's headphone on either side of the signal. The cat's whisker consisted of a strand of fine wire for gently probing, or tickling, the crystal's natural galena surface in order to locate its most sensitive point. Though the cat's whisker detector could extract audio signals from the amplitude-modulated radio frequency signal, the galena detector couldn't help but ruin the radio's selectivity. It loaded the tuning circuit, increasing the listener's chances of picking up stations other than the desired one.

Matters improved with the TRF receiver. It aimed for, and hit, sharper reception dead center, by adding more tuned circuits. This feat wasn't practical with crystal sets, because this circuit's inherent losses ran too high to gain any benefit from any additional coils.

The invention of the triode vacuum tube gave an engineer the perfect amplifying device. Circuit losses could now be overcome with ease; the TRF took over where the cat's whisker left off, dooming the crystal set to mantelpiece and museum.

Three or four amplified radio-frequency stages were customarily added prior to the TRF's detector, all the while adding to selectivity's cause. However, all wasn't perfect in TRFville.

The amount of noise introduced by the tubes limited the number of TRF stages. So the Silver-Masked Tenor's strains could still be heard with those of the Clicquot Club Eskimos—but not by his choice, or that of the listener.

Pitching the Low Curve. The public soon learned that these newfangled TRF receivers weren't exactly the living end. The TRFs, as a rule, failed to perform satisfac-

Our schematic shows relatively advanced tuned radio frequency receiver. First TRFs had individually adjusted tuning capacitors; ganged units were still to be invented. By adjusting battery voltage twist ground, tuning circuit, radio gain's varied.

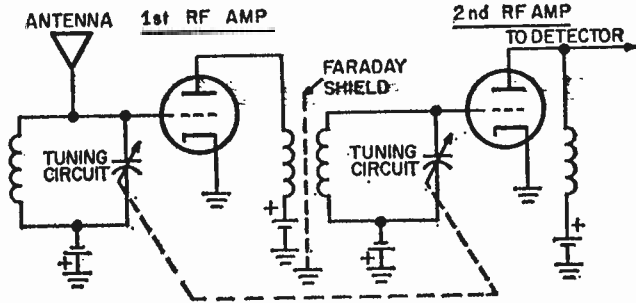

torily as frequencies inched higher into kiloHertz land. Seems that as the frequency of the signal went up, the TRF's tuned circuit efficiency for that frequency dropped almost proportionately.

To demonstrate this, look at our example. The bell-shaped curve represents response of a tuned circuit selecting some low-frequency station. The circuit delivers good selectivity, and interference on a slightly higher frequency is rejected.

But examine what happens when a similar tuned circuit is operated on a higher frequency. Although the curve's proportions remain the same, it's actually responding to a much greater span of frequencies. Now it's possible for two closely spaced stations to enter the response curve and ultimately be heard in the speaker.

Since tuned circuits grow more selective as frequency is lowered, wouldn't it be to our technical advantage to receive only low-frequency signals? This idea probably occurred to Major Edwin Armstrong, because his invention, the superheterodyne circuit, does just that.

Superselectivity. By stepping signals down to a lower frequency than they were originally, the new circuit could deliver neat-as-a-pin selectivity on almost any band. Fact is; this development helped open the high-frequency bands, and by the 1930s virtually every receiver adopted the Major's superheterodyne idea.

The word "superheterodyne," by itself is revealing. It begins with *super*, for super-sonic, referring to a new signal created within the radio. The generated signal is neither in the audio, nor higher radio-frequency range, but in between. *Hetero* means combining, the *dyne* is force. The newly-created ten-dollar term, *superheterodyne*, neatly sums up this circuit's action.

Major Blocks. You can get a good picture of the superhet in its natural habitat if you look at our block diagram. Though our schematic shows a tubed receiver, all equivalent stages tend to do the same job regardless of whether the receiver is transistor or tube. Now that you know what the superhet does and how it looks, let's take a peek at how it works.

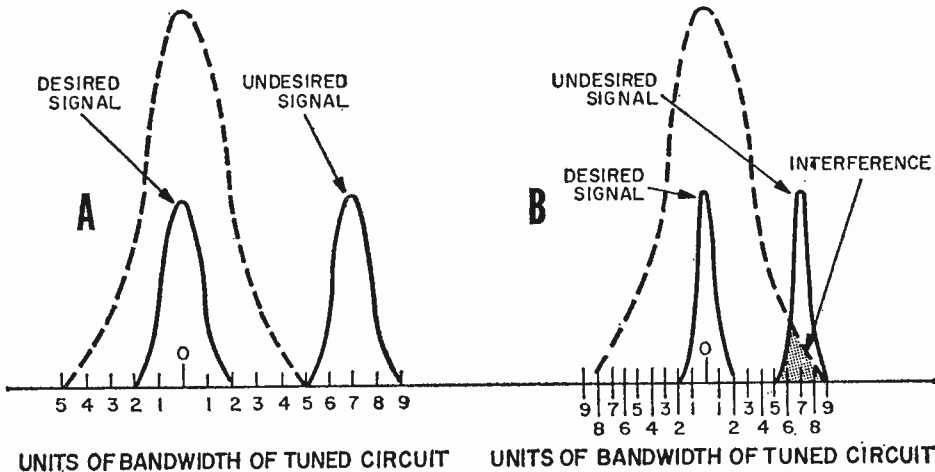

Tuned-circuit bandwidth varies proportionally with frequency. Tuned circuit A, working at low frequency, rejects unwanted signal. Tuned circuit B, working at high frequency, can't completely reject undesired signal; interference results.

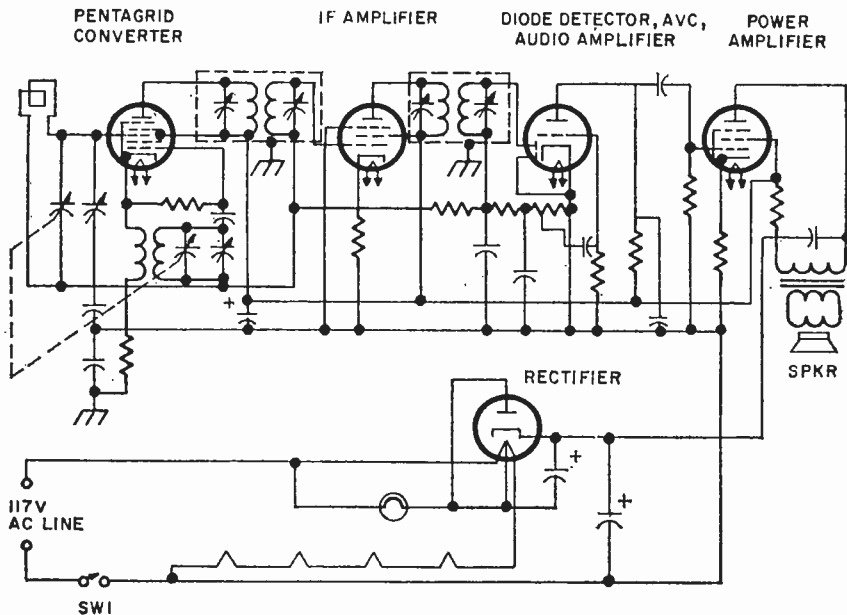

Virtually all superhets sold commercially are five tub rigs; most are also design-wise electrically and mechanically equivalent.

For sake of illustration, assume a signal of 1010 kHz in the standard BC band enters the antenna, and from there, is sent down the line to the mixer. But what, you ask, is mixed?

Our frequency mish-mash consists of the different frequencies made up of the desired station on 1010 kHz, and a second signal generated internally by the local oscillator. This oscillator perks at a frequency of 1465 kHz, for reasons which you'll understand in a moment.

True to its name, our mixer combines both signals from antenna and oscillator. And from these two frequencies, it delivers yet another frequency that is the *difference* between them—namely 455 kiloHertz. So far, our superhet circuit changed, or reduced the desired signal to a frequency having an intermediate value. Beating two frequencies together in order to produce a third signal is known by members of the Frequency Fraternity as mixing, heterodyning, or beating. And some engineers prefer to call the lowly mixer a converter; this term often appears in schematics. But whatever name you throw its way, the result is the intermediate frequency.

There's something else you should know about the intermediate, or IF, frequency. It always remains the same no matter what station you tune to. If you sweep the dial

across the broadcast band in one continuous motion, the IF frequency remains constant. How's this accomplished?

It's done by tuning the incoming signal simultaneously with the local oscillator. That's something akin to the mechanical rabbit which paces greyhounds at a race track. In the superhet a ganged tuning capacitor performs this dynamic-duo feat.

Take a close look at the tuning capacitor, and you'll see physically smaller plates assigned to the local oscillator. Since these plates are smaller than the antenna stage capacitor plates, the effect is to lower the capacity, and *raise* the frequency of the oscillator stage. That's how the oscillator stage consistently produces a signal which is 455 kHz above the incoming frequency. But, why bother, you ask?

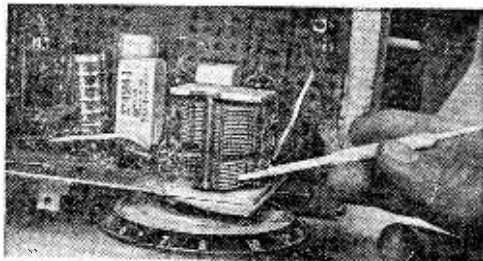

Alignment tool is pointing to oscillator section of tuning capacitor. Smaller, fewer plates mean high oscillator frequency.

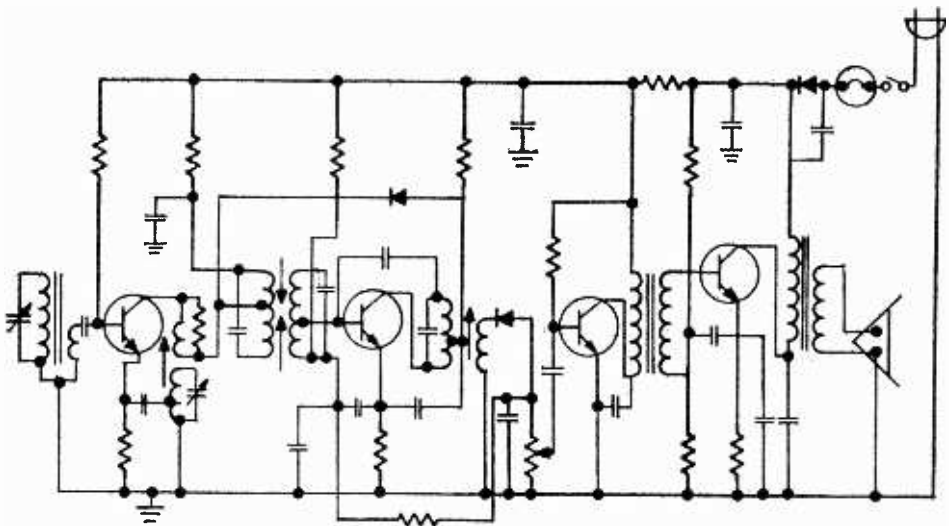

Our schematic of transistorized superheterodyne receiver is similar in function to tubed superhet found on page 80. Biggest differences between two are semiconductor diodes found in audio detector, AVC loop, power rectifier stages.

More Muscle, Too. When we convert each incoming station's frequency to the same IF, we gain yet another advantage besides better selectivity. A *fixed-tuned* amplifier always operates at higher efficiency than one which needs to muscle a multitude of frequencies. There are fewer technical bugaboos in a

one-frequency amplifier, so our tubes or transistors can operate more effectively at this lower frequency. And last but not least, circuit layout and wiring are less critical. All of this is well and fine, but how do we actually extract our Top-Forty tunes, news, and weather from our super-duper-het?

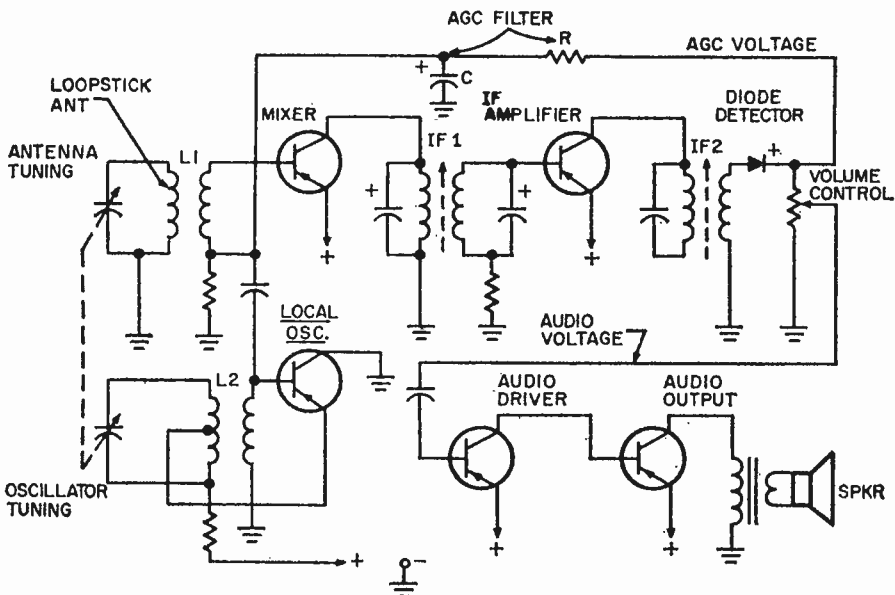

Most superhets don't have separate local oscillator, mixer function; schematic above is more typical of BCB set. Communications-type receiver needs added usefulness of separate stages—it's easier to suppress images.

Sound Sniffing. The detector stage recovers original audio voltage from the station's signal. Since we're cranking the RF voltages through a superhet circuit, the RF signal did a quick disappearing act, only to appear as an IF frequency of 455 kHz. Though the original carrier (1010 kHz) is converted downward in frequency to 455 kHz, any audio voltage variations impressed upon the carrier remain the same. So if a musical note of 1000 Hz was sounded back in the radio studio, the note still remains that value in both RF and IF circuits, despite the mixing process.

Like a ladle skimming heavy cream off the top of a jug of fresh milk, the detector rectifies either the positive-, or negative-going portion of the carrier, skimming off the audio signals from the carrier. Though audio modulation appears during both positive and negative swings of an amplitude-modulated carrier, only one half of the available signal is used. If both positive and negative portions of the RF signal were detected simultaneously, the audio signals would cancel each other at the output!

Now let's look at the stages of an ordinary solid-state superhet circuit that might be found in a common table radio or transistor portable.

Simplified Schematic. Our diagram is pretty typical of transistorized superheterodyne circuits. Of course, there may be variations on this circuit's theme, like addition of an RF amplifier ahead of the mixer to improve sensitivity. The number of IF stages also varies with receiver quality, and specialized items such as filters may appear in ham and SWL rigs.

If you can follow our basic block diagram, you'll have the key to virtually any solid-state superhet. In order to further simplify matters, many resistors and capacitors not essential to our tour through solid-state superhet country have been omitted.

Leading the pack on our superhet speedway is the antenna tuning circuit. Loopstick antenna L1 grabs the RF signal out of the ether, and also serves in partnership with the tuning capacitor in the tuning circuit. You sharpies will also notice that the antenna tuning capacitor is mechanically joined to the oscillator tuning capacitor. (This is represented schematically by a dotted line.) Remember now, we want to develop the IF frequency. This ganged antenna/oscillator capacitor ensures the necessary tracking of the local oscillator

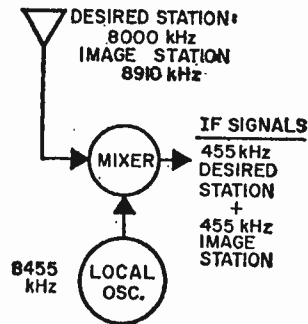

Mixer is superhet's weakest link as signal handler. Too strong input signal can develop image frequency. Too much local oscillator signal pumped into mixer has same effect.

with the radio-frequency signal.

The oscillator frequency is developed by the oscillator portion of our variable capacitor, and coil L2. In our superhet's schematic, the oscillator signal is capacitively coupled from the oscillator transistor base and sent on its way to the mixer stage. The mixer, therefore, "sees" both oscillator and incoming station frequencies. The electrons from oscillator and antenna circuit get it all together in the mixer's base, producing our intermediate frequency.

If you could look at the mixer's output, you'd see more than just the IF signal. Fact is, the mixer's load contains a jumble of frequency byproducts. As signals combine in this circuit, they add, subtract, and recombine in many ways. It's as if you had to separate the wheat from the chaff with a pair of tweezers!

Only the desired signal emerges from the mixer stage because intermediate-frequency transformer IF1 picks the proper signal to the exclusion of all the others. Now our freshly-created signal passes through a stage of IF amplification, and receiver selectivity is further whipped into shape by the second intermediate-frequency transformer IF2.

As we've already described, the detection process takes place at the diode, regaining the radio station's original audio signal. This audio voltage is fed from the volume control to both audio stages where they're further amplified and sent to the loudspeaker.

The detector diode doesn't merely extract soul sounds from the ether; it also delivers a second voltage output. Called AGC (Automatic Gain Control), this voltage controls our mixer's amplification, preventing the speaker from blasting when you suddenly

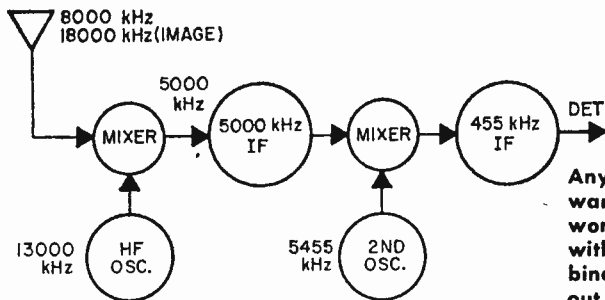

Any superhet worthy of warming an amateur shack works around image problem with dual conversion. Combination of IFs puts image out of range of either stage.

tune your radio to a strong station. In our simplified schematic, our AGC voltage is a positive-going voltage which increases proportionately with rising signal strength. But before AGC can control receiver gain, it's filtered for pure DC in a resistor and capacitor network.

Result is a DC signal which can be used to control the gain of the mixer transistor. Thus, if a strong RF signal tries to muscle its way through this stage, the mixer is subjected to a higher bias voltage on its base terminal, which tends to put the brakes on our mixer's gain.

Pitfalls, Yet. Let's not lionize the king of receivers, though, for sometimes its growl turns to a puny purr. Biggest problem, and most annoying, is a form of interference peculiar to the superhet known as an *image*. Produced by a mathematical mixup, images are all of those undesired signals finding easy routes to travel through your receiver. Take a look at our image explanation: you'll see the receiver is tuned to a desired signal of 8000 kHz.

The local oscillator generates a frequency of 8455 kHz, which places it exactly in our IF signal ball park. But note that a second station—a pop fly on 8910 kHz—also happens to be 455 kHz away from the local oscillator. For each oscillator frequency, now there are two station frequencies giving identical IF frequencies. It's up to your receiver to strike out the image station. Otherwise, the RF ball game will turn into a rout!

You might expect the receiver's antenna tuning circuit to completely reject the image signal. After all, it's supposed to be tuned generate a very high IF frequency, positioning any images developed by the mixer well

outside the tuning range of the antenna circuit. Looking at our example of a double superhet, you'll see one IF amplifier perking at 5000 kHz and another working on 455 kHz. Now if we receive an incoming signal on 8000 kHz, the local oscillator, now called a high-frequency oscillator, generates a frequency at 13,000 kHz, so the first IF signal works out to 5000 kHz. Your receiver would have to pick up a signal falling on 18,000 kHz to produce any image. Naturally, the image frequency in this instance is significantly removed from the antenna circuit, so the image is greatly attenuated.

While high IF frequencies work well against image interference, they also revive Nagging Problem Number One: the higher the frequency of a tuned circuit, the poorer its selectivity. Since this situation also applies to IF stages, a *second* conversion is required, bringing the first IF signal down to 455 kHz, where we can sharpen our receiver's selectivity curve. That's how the double-conversion receiver solves both image and selectivity hassles. Any ham or SWL rig worthy of an on/off switch is sure to have this feature. But don't think of dual conversion as a receiver cure-all.

Dual conversion is *not* usually found in entertainment receivers—radio broadcast and TV for example, because it's too sharp! High selectivity could easily slice away sidebands in an FM stereo program and kill its multiplexed channel, or rob a TV image of its fine picture detail.

But for all its faults, the basic superhet circuit we've been talking about must be doing something right. Last year over 50 million superhets were sold in the U.S. Not bad for a circuit that might have gone the way of the hip flask, eh? ■

Inside AVC

□ A world without AVC—Automatic Volume Control—would be filled with fractured audio and video. Explanation is that AVC is the steadying force in receivers of most every description—from tiny AM portables to communications receivers, TV sets, and just about everything else that breathes in a signal. Remove AVC from your table radio and it would probably break up on local stations. Take it out of your TV set and color might scramble and spill through the image—or pictures turn negative because of signal overload.

Blast it. It's been said that AVC "makes strong signals weak and weak signals strong." That simple definition goes back to AVC's original objective of reducing "speaker blasting." The phrase is perfectly descriptive because an uncontrolled receiver produces excessively loud sounds in the speaker while receiving strong signals. You could adjust the radio's volume control by hand, but imagine doing it in an automobile while driving. Your hand might never leave the volume control!

This is where AVC comes to the rescue. It senses the wavering signal, develops a control voltage in proportion to that signal, then applies it as a continuous correction. It also cures a problem that no amount of volume-control fiddling can cure. It's an overload condition where strong signals drive the receiver's early stages into highly distorted operation, resulting in mushy, unintelligible audio in the speaker.

Though a car in motion is one cause of fluctuating signals, there are others. Atmo-

spheric fading due to changes in the ionosphere has a tremendous effect on the strength of shortwave (3 to 30 MHz) stations. At higher frequencies (VHF and UHF-TV, for example), passing vehicles, changes in tree foliage, and even moisture content in the air vary the number of microvolts induced in an antenna by a distant transmitter.

In all of these cases, an AVC circuit attempts to compress or expand the signal into some mid-range or average value. As you might suspect, AVC can't recover a signal deeply submerged in atmospheric noise and make it readable. Nor can it clean the snow from a faraway TV station arriving in a remote fringe area. But it is capable of some pretty miraculous stunts, as we'll see shortly.

The AVC Idea. Almost every AVC circuit follows a similar general route. First, it taps into the receiver circuit at some point to sample a bit of the incoming signal. The sample provides information on the relative strength of the arriving station. Next, the sampled signal is processed into a form which enables it to control the radio-frequency amplification of the receiver. This becomes the AVC control voltage and it's fed back to some earlier point in the receiver.

If a powerful station is being received, it produces a high AVC voltage, which reduces the receiver's ability to amplify. Upon receipt of a weak signal, little AVC voltage develops, so the receiver runs at high amplification.

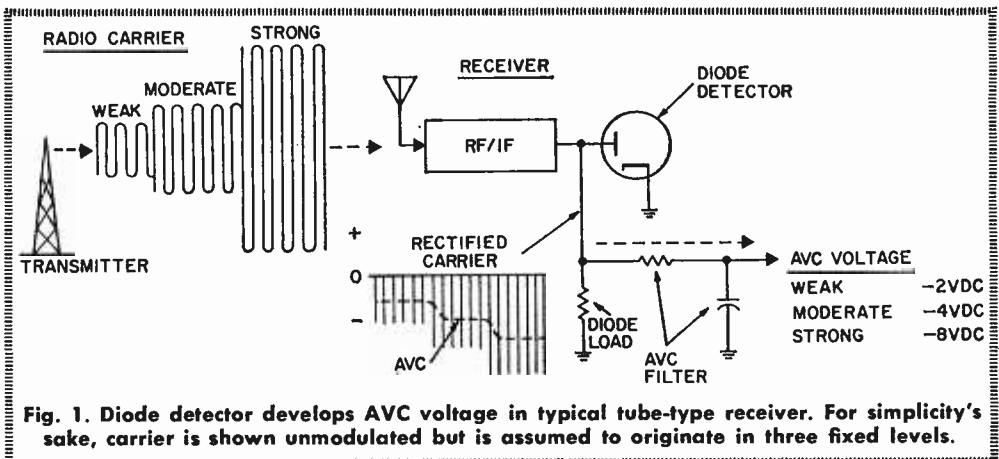

Fig. 1. Diode detector develops AVC voltage in typical tube-type receiver. For simplicity's sake, carrier is shown unmodulated but is assumed to originate in three fixed levels.

From Carrier to Control. The overall idea appears in Fig. 1. We've shown a standard broadcast station transmitting a signal whose carrier is increasing from weak to strong in three steps. Note that the carrier is assumed to be originating from the station at three fixed levels, with no audio modulation at this time. (Audio causes a complication we'll get to in a moment.)

The changing carrier signal enters the receiver antenna and proceeds through RF and IF stages until it reaches the diode detector. Since the alternating carrier can go through the diode in one direction only, it's rectified so only the negative portion appears at the resistor forming the diode load. The AVC signal, however, is still hidden within the rectified carrier, as shown by the dotted line. This means that it must be processed further before it becomes a suitable control signal—a DC voltage which varies in step with carrier strength.

This is where the problem of audio modulation (voice or music on the carrier) complicates AVC development. The trouble is that intelligence on the carrier is AM, or amplitude modulation, which is electrically similar to the changing carrier strength AVC will attempt to fight. It would hardly be suitable if AVC attacked loudness changes in the program, rather than average changes in carrier signal. Fortunately, it's possible to fashion a filter which ignores audio in the sampled carrier.

As shown in Fig. 1, there's an AVC filter comprised of a resistor and capacitor. In a

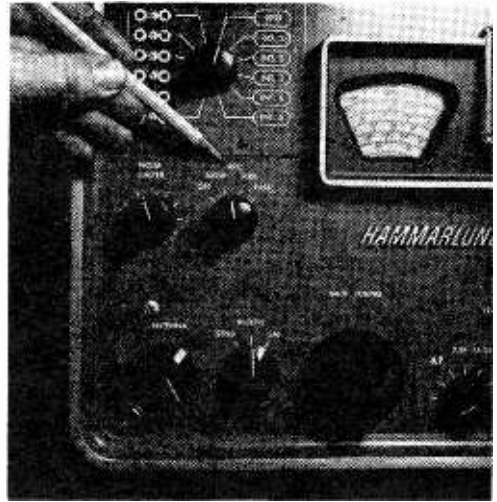

Fig. 2. Some receivers—this Hammarlund, for one—permit operator to control AVC rate.

typical tube circuit these values are a few megohms for the resistor and about $.05\mu\text{F}$ for the capacitor. They form a filter which responds at the rate of about 0.1 second (its *time constant*). This interval of time has been carefully selected to fulfill certain boundaries of AVC operation.

First, the filter must remove any audio modulation from the sampled portion of carrier. Since audio variations occur much faster than 0.1 second (the lowest audio tone is about 20 times per second), the filter smooths out any audio in the AVC circuit. Yet, the AVC filter must not respond *too* slowly. When driving in a car, for example,

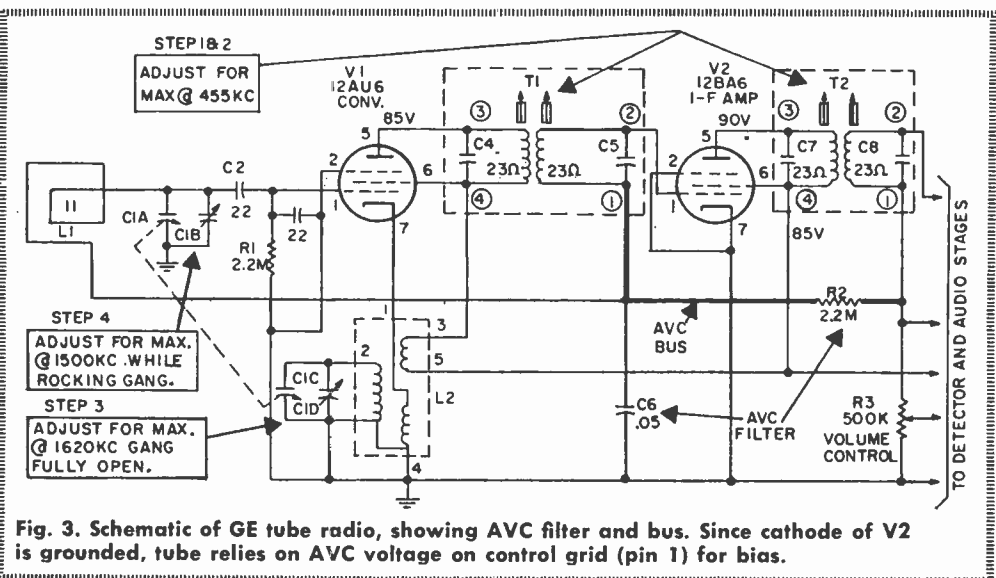

Fig. 3. Schematic of GE tube radio, showing AVC filter and bus. Since cathode of V2 is grounded, tube relies on AVC voltage on control grid (pin 1) for bias.

you might receive a fluttering signal and need fast-acting AVC to exercise quick control.

The 0.1-second filter, therefore, is designed as a compromise which attempts to fit AVC response between the two extremes. In some advanced receivers, an AVC selector switch (Fig. 2) enables the operator to choose his rate to improve the receiver's performance on certain specialized signals such as code (CW), single sideband, or other non-standard carriers.

DC Up Front. To this point the circuit has developed a control voltage that's synchronized to incoming carrier strength. As shown in Fig. 1, the carrier has produced a shift of from -2 to -8 DC volts at the output of the filter. This is approximately the AVC voltage you'd measure in typical tube-type receivers. Now it's only necessary to provide a feedback loop to carry the AVC back to an earlier stage. How this is done is illustrated in the actual schematic of a typical tube radio in Fig. 3.

The AVC signal is developed across the diode load resistor and filtered in the resistor and capacitor indicated (R2 and C6). From there, the line is usually termed the *AVC bus* and extends back to the control grid of the IF amplifier. As an incoming signal grows stronger, a correspondingly higher negative AVC voltage is created. Result is that the gain of the IF stage is reduced accordingly.

Solid AVC. Millions of tube receivers still survive, but solid-state should end that era in a few years. Transistor receivers are subject to the same signal fluctuations and similarly require AVC circuitry. In looking at transistor circuits, you may find that the term *voltage* is often supplanted by *current*.

When discussing amplification in tubes, it's almost always a matter of controlling *grid voltage*, which is generally negative in polarity. (The current flow in a receiving tube grid is infinitesimal and usually ignored.) Transistors, though, may be discussed in terms of current since the terminal voltages (unlike tubes) are very low. Because of these differences, AVC action in tube circuits is usually described as *negative grid voltage*, while the solid-state version is in terms of *base current*.

Another difference is that the polarity of a receiving tube grid is almost always negative; transistor current, in contrast, may flow in either direction, depending on whether an npn or a pnp transistor being

controlled.

Schematics for solid-state AVCs are fairly close in appearance to tube versions, as shown in the typical portable in Figs. 4 and 5. Note that a sampling of carrier signal is taken at the output of a diode detector. At this point the carrier is already rectified to DC and needs only to be smoothed in the AVC filter. Note that the polarity of AVC voltage is shown as positive (+) since the transistors being controlled are of pnp type (Fig. 5).

In pnp semiconductors, a positive-going voltage applied to the base causes lower current and a reduction in amplification (the reverse of a tube circuit). You will also find transistor AVC which runs in the negative direction. This indicates an npn transistor is being controlled since its amplification decreases with the application of negative voltage.

Fig. 5 traces the major AVC points in a commercial solid-state circuit. Note that the carrier sample isn't tapped from the regular AM detector; instead, a separate AVC diode is connected to an earlier point in the receiver (see lower right of Fig. 5.) This car receiver has an RF amplifier up front and it produces sufficient AVC voltage for the tap-off to occur at this early point. The remainder of the AVC bus resembles the tube circuit; the carrier is rectified, filtered, and applied back to the input stage. Since the RF transistor is a pnp type, an increasing carrier produces rising positive voltage and a consequent drop in transistor gain.

What's the Delay. AVC circuitry described to this point works well for table and other consumer type radios. But there's always something better. One improvement is *DAVC*, for *delayed AVC*, to overcome one disadvantage of regular AVC on weak signals. To operate at highest sensitivity, a receiver should run wide open, or at maxi-

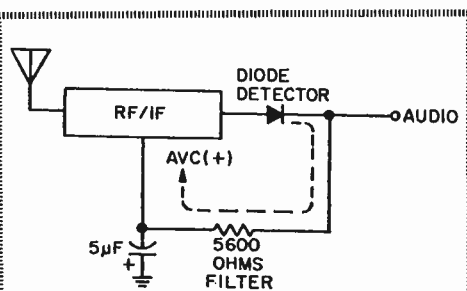

Fig. 4. As in tube sets, AVC in solid-state circuit is tapped from diode detector.

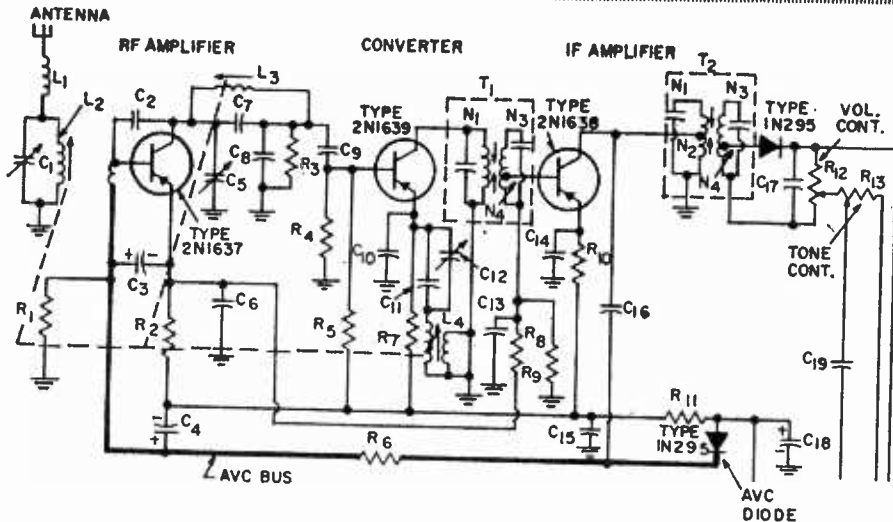

Fig. 5. Partial schematic of RCA car radio, showing separate AVC diode (lower right) and AVC bus. Since transistors here are pnp's, AVC voltage is positive rather than negative.

imum amplification. The trouble occurs when a weak signal entering the receiver commences to generate a small, but effective, AVC voltage. AVC comes on too soon and receiver sensitivity is prematurely reduced.

In the delayed AVC scheme, AVC must first overcome some fixed reference voltage before it starts to reduce amplification in the receiver's front end. For example, a conventional receiver may start to generate

AVC voltage when a carrier of about 5 microvolts is in the antenna. A high-performance ham or communications set, though, might delay AVC action until the signal attains a strength of 10 microvolts.

Another improvement in deluxe receivers is amplified AVC, meaning the control voltage is boosted before being applied back to an earlier stage. This could produce AVC voltage swings of from 0 to 35 volts, instead of a more conventional range of 0 to 7

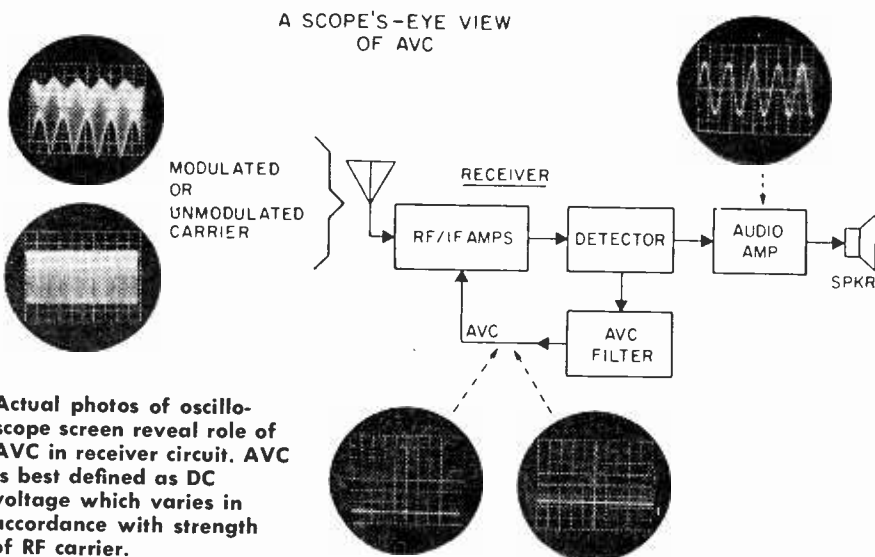
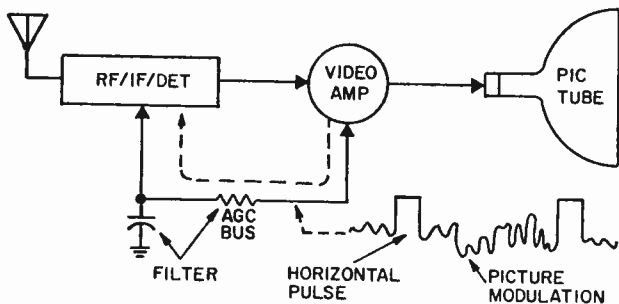

Fig. 6. In TV receiver, horizontal sync pulse must provide AGC voltage since video carrier itself isn't suitable. Note that basic idea is same as that used in AM and FM receivers.



volts. The net result is better control of the receiver under dynamic changes in signal strength.

It's AGC, Too. Though AVC began as a technique for controlling average audio level, nearly identical concepts are applied in receivers which produce pictures, navigational read-outs, or other intelligence of a non-audio nature. Since latter-day AVC may no longer control volume, its designation changes to *AGC*, for *Automatic Gain Control*. Incidentally, this term is technically more accurate even for regular radios because it's receiver radio-frequency gain, *not* audio volume that's directly regulated. A good example of AGC is in TV receivers for keeping picture contrast reasonably constant over a wide swing of signal strength. Let's examine the TV signal in some detail because the method of generating a control signal is different from that of a radio.

The video carrier which brings the TV signal to the home is not a suitable source of AGC voltage. The picture carrier changes strength with lights and darks in the scene which happens to be on the screen during a particular moment. Back in our simple radio, we could filter out audio modulation fairly easily. However, video modulation can persist over long time periods which does reflect accurate changes in signal strength due to distance, power, etc.,

rather than modulation.

That reference is the horizontal sync pulse transmitted at the beginning of each picture scanning line. Though its purpose is to lock the home set with the transmitter, it also serves as an AGC reference. As shown in Fig. 6, the pulses are captured from the set's video detector, then filtered and fed back to the receiver front end (i.e., RF, IF, and detector).

Though AVC—or AGC—originated as an equalizer of speaker volume, then went on to do the same for pictures, the circuit has other applications as well. In color sets it keeps the color signal constant by adjusting the gain of a color amplifier according to incoming color signal strength. The reference here for developing a control voltage is the color burst, a brief shot of sine-wave energy transmitted during each horizontal scanning line.

To be sure, the burst is really intended to help the receiver create an accurate color subcarrier. However, it also contains strength information which can operate the automatic color control found in most current TV sets. It's just one more example of an old idea brought up to date. In fact, the next time you see the words *control*, *feedback*, or *automatic* used to describe a circuit, chances are it borrowed an idea or two from early AVC. ■

How Squelch Works

□ You won't find a knob marked "Squelch" on your AM radio or TV set. But, just about every CB receiver now manufactured sports one of these handy controls. The reason is that squelch can silence static that's heard in a speaker when no signal is being received, making it the greatest boon to noise-pollution elimination since the inven-

tion of ear muffs. Only an incoming message trips the squelch noise mask so you're spared the static crashes, atmospherics and other electronic egg-scrambling during standby periods. Why is no squelch needed for regular radio or TV? Unlike mobile communications, the incoming signal is constant, so steady broadcast signals keep the receiver

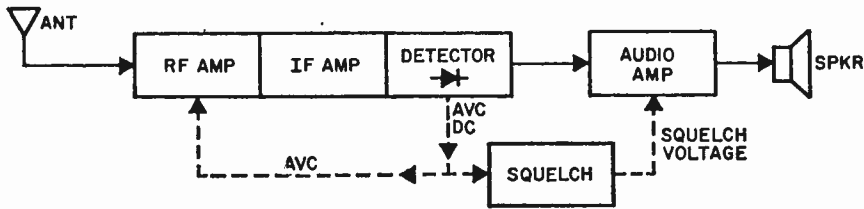

Fig. 1—Dotted lines on typical CB block diagram trace path of AVC voltage fed back to RF amp to control sensitivity and to squelch amp to open audio amp.

free of background noise.

And that's the starting point for understanding how a squelch circuit functions. The receiver can sense the presence of a signal, then automatically control the audio stages. As we'll see, squelch can also work the other way—sense the noise or static—and similarly regulate the audio. Finally, there's "tone" squelch, sometimes termed "selective call." In this specialized circuit not only is noise silenced, but also the stations on the channel you don't wish to hear.

Stealing AVC. Simple squelch circuits are little more than electronic switches tripped by the receiver's AVC (automatic volume control) voltage. The overall idea is shown in the block diagram of Fig. 1 which represents a typical CB receiver. An incoming signal from the antenna passes through various stages until it reaches the detector where it's converted to audio. In the detector, too, a portion of the carrier signal (which is AC) is converted to DC by a diode rectifier. Since the DC signal will vary in strength with the carrier, it's used to protect the receiver against overload or excessive volume changes. This is the AVC voltage and, as shown by the dotted line in Fig. 1, is fed back to earlier stages in the receiver. If an incoming signal rises in

strength, AVC is returned in a direction which reduces the RF (and sometimes the IF) amplifier gain.

If there is *no* signal in the receiver, there is no AVC voltage. Why not use AVC to directly control—or squelch—the audio along with earlier RF receiver stages? Squelch is, in fact, a brand of automatic volume control. The pitfall in using AVC directly to develop squelch action is that AVC changes too gradually, and over too-limited a range. For squelch to do its assigned job, it should create an all-or-nothing effect on audio. Thus, AVC may *start* squelch action, but additional stages are needed to impart the snap.

As seen in the block diagram of Fig. 1, this will occur in a "squelch" stage connected to AVC voltage, and also to the audio amplifier to be controlled. Let's trace how a typical squelch circuit might appear in both tube and transistor CB receivers:

Bottled squelch. A tube variety is shown in Fig. 2 and its operation boils down to this: AVC voltage is greatly boosted by an amplifier, then the magnified voltage controls the grid bias of a regular audio stage. Since AVC amplified voltage now swings over a much larger range, the audio tube switches briskly on and off. Let's trace it in some de-

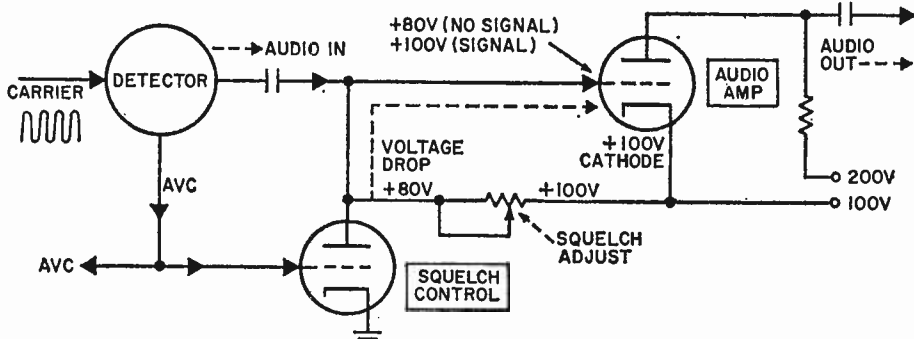

Fig. 2—In tube type CB rig change in AVC voltage (when carrier is received) lowers voltage drop across squelch control thus opening audio clamped by higher voltage.

tail in Fig. 2. First, there's the conventional audio amplifier shown connected to the detector. Since all audio signals must pass through it, the amplifier *handily* serves as a controlled stage. The other stage (near the bottom of the diagram) is the squelch control, nothing more than a *DC amplifier*. Note that the tube grid of the squelch control is operated by AVC voltage—and that the *plate* of this stage also connects upward to the grid of the audio amplifier.

Circuit action mainly occurs at the variable resistor which serves as the squelch adjust (a front-panel knob). As you can see, a voltage of 80 is at one side of the resistor, while 100 appears at the opposite end. The reason for the drop is current flowing through the squelch control tube. Assume there's no negative AVC voltage on the control tube grid; the resulting tube current flow produces the 20-volt drop shown across the variable resistor. The voltages are next applied to the audio amplifier. Note that 100 volts go to the tube cathode and 80 to the tube grid.

This set of voltages *cut off* the audio amplifier completely—no audio signals can pass. The reason is, the tube is now experiencing a relatively high *negative* grid bias. How does a negative charge develop from +80 and +100? It appears because grid voltage is always measured with relation to the cathode. Thus, if the cathode operates at +100 volts, and the grid at +80, the grid will appear to be relatively 20 volts *negative*. This is a substantial amount of grid bias and it cuts off any audio amplification through the stage. So the speaker is effectively silenced.

Now to see what happens when a signal arrives and trips open the squelch. Since an incoming carrier produces negative AVC voltage, it also cuts off current flow through the squelch tube. This kills the voltage drop across the squelch variable resistor and that 80 volts shown jumps up to 100 (the supply voltage). Since the controlled audio stage also receives 100 volts on its grid, that

high negative bias developed earlier disappears. This places both grid and cathode at 100, so the grid bias now drops to a relative value of zero-volts. The audio stage can now amplify and the receiver is unsquelched.

For the system to operate properly, you must set a squelch with care. The usual problem results when the knob is set too high and weaker stations cannot activate the squelch. As you can see in Fig. 2, a high setting could place the audio grid too far into the negative region and prevent the receiver from unsquelching except for strong signals. The technique for adjusting a squelch is to wait until no signal is being received, then rotate the knob until the background noise *just* disappears.

Transistorized, too! The solid-state version of a squelch circuit is shown in Fig. 3. The idea in this circuit is based on the forward and reverse characteristics of a silicon diode we call the squelch diode. When the diode is biased in the reverse direction, it presents an extremely high internal resistance and blocks the flow of audio between the detector and following audio stages. Consider, first, how the receiver is squelched during a no-signal period. Note that the squelch diode in Fig. 3 is receiving two voltages (besides the audio from the detector). The one from the left is control voltage tapped from the collector of an IF amplifier stage. This transistor not only operates as an IF amplifier, but also serves to drive the squelch circuit (much like the squelch control tube did earlier). When no signal is received, collector current is high in that stage, and a corresponding voltage drop occurs across resistor R1. A sample of this drop is fed back to one side of the squelch diode for biasing. Notice that a second bias voltage also reaches the diode from the squelch adjust potentiometer. The net effect of these connections is a reverse-bias condition on the diode; the control voltage makes the cathode relatively positive with respect to the anode. Now the speaker is silent since

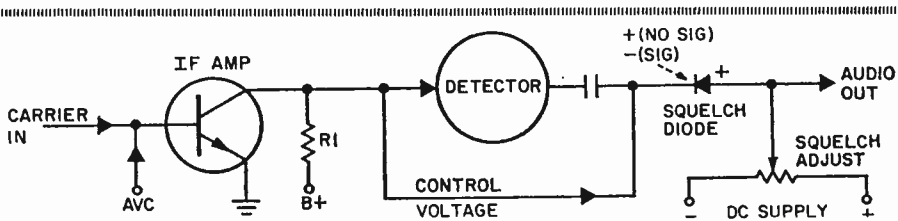

Fig. 3—Transistorized set depends on change in control voltage from IF amp when carrier is present to forward bias squelch diode reversing its clamp on audio to open it.

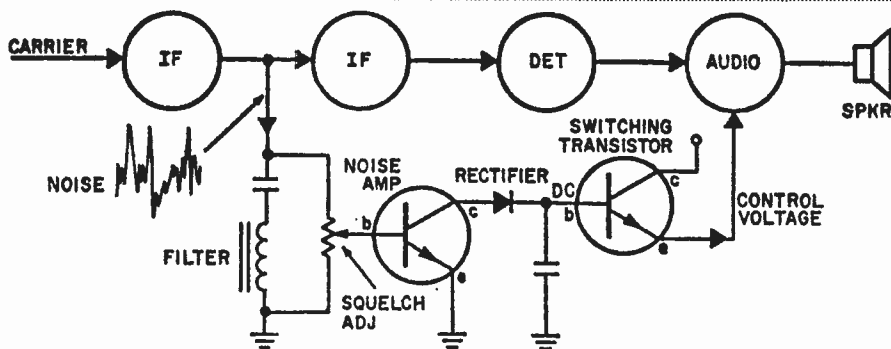

Fig. 4—Most sophisticated squelch noise operated rather than carrier derived, Filter separates white noise from other noise to develop squelch volts.

nothing can get through the audio section. But when a signal enters the receiver, the IF amplifier conducts less current (because AVC voltage is being developed) and the collector voltage drop across R1 is greatly reduced. This makes the squelch diode relatively negative on its cathode—causing a forward bias condition. The diode's resistance plummets and the receiver is opened up for audio.

These squelch circuits are common in CB equipment and they do the job. But as the clerk in the discount store says, as you examine a sale-priced item, "Let me show you something better!" In the more expensive communications gear, the squelch will act snappier and have a more sensitive threshold for awakening on weak signals.

Noise is Nice? One of the deluxe squelches is the "noise-operated" type. Circuits described earlier are *carrier-derived*, but a *noise-derived* system is more sophisticated. As shown in Fig. 4, the action begins by tapping a sampling of signal from one of the IF stages in the receiver. Assume at this time that no station is being received so the signal is only atmospheric noise or other background static. This is fed down to a filter which sharpens the response to the steady "white" noise component rather than

the clicks, clonks or other transients that might trip the squelch at the wrong time. The noise amplifier, as the name implies, boosts the noise level to a working value. Notice that the manually-adjusted squelch potentiometer is also at the input to the stage. It allows the operator to choose the operating threshold of the circuit.

Next, the amplified noise signal is rectified by a diode and smoothed to pure DC so it can exercise circuit control (as AVC did in the simpler squelches). But first, the DC is applied to a switching transistor to obtain the necessary snap-action. The switching transistor stage is little more than a conventional amplifier, but with almost no bias on its base terminal. This causes the transistor to operate wide open and saturate rapidly on an input signal. The result of the DC signal, therefore, is a rather high positive voltage at the output of the switching transistor (at the emitter). This is sent up to the audio section as the control voltage and the stage is clamped shut . . . nothing can be heard in the speaker. When an IF signal arrives due to a transmission from a CB rig, however, white noise disappears, no DC occurs and the audio stages are released for amplification.

As you can see, the noise-operated

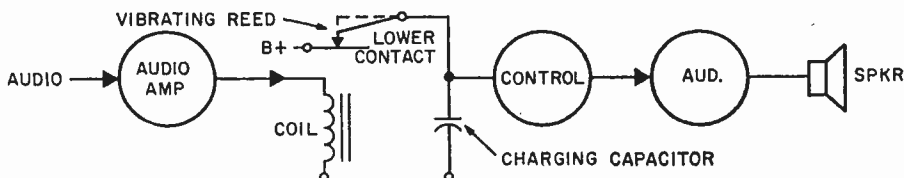

Fig. 5, Tone squelch, also called selective call, employs discrete tone signals to trigger squelch. By coding 2 or more tones, selective call is established.

sqelch has more stages than simpler versions, but its excellent control action has led to wide application in higher-priced equipment. You can set the sqelch to awaken these receivers on weak signals.

Selective Call. Sqelch circuits may silence a speaker between incoming calls but they're *non-selective*. You hear not only your own units, but anyone else who happens to speak on the same channel. Where CB is used in a business establishment this can prove distracting to office workers. They'll hear every bit of chit-chat on the channel. This may be cured by the specialized sqelch known as *selective call*. It relies on a tone-code signal sent by the calling station, and a special decoder in the receiver to activate the audio stages.

The most popular technique for achieving selectivity is shown in Fig. 5; the reed relay. The reed is a short strip of metal which resembles, and behaves like, the reed of a harmonica. Its valuable quality is that when it's set into motion (plucked), the reed vibrates very precisely on one resonant frequency, usually a few hundred hertz per second—a tone you can hear. How it operates is shown in the simplified diagram of Fig. 5. All incoming audio—noise, voice, etc.—is applied to the relay coil where turns of wire change the audio currents into corresponding magnetic fields. Poised just above the coil is the metal reed which starts

to vibrate under the pull of various magnetic fields from the coil. The total movement, however, is not sufficient to cause the reed to strike the lower contact connected to the B+ voltage. But when a station sends the correct tone, the reed commences to vibrate at its resonant frequency. Motion is so great that the reed repeatedly strikes the lower contact and sends pulses of B+ voltage down to the charging capacitor. There the pulses are stored and shaped into a steady DC control signal which *fires* (turns on) the control stage. The audio amplifier is now activated and the calling unit is heard. Only one reed is shown here, but in practical circuits it usually takes a combination of two reeds to create a code that won't cause false responses when the band is crowded with heterodynes that could simulate a single coding tone.

Similar circuits find their way into other applications. If you're watching a black-and-white movie on a color TV set, you won't be disturbed by a shower of colored confetti. Color receivers have a "color killer" which sqelches any chroma feedthrough during B & W reception. And if you tune a recent FM stereo receiver, chances are you'll hear no noise between stations as you tune thanks to another sqelch-type circuit. Sqelch is working all out for you when you hear nothing! Just be sure that your receiver is not turned off! ■

Single Sideband

□ Ask almost anyone in Citizens Radio what the maximum transmitter power is and he'll say, "Five watts." And the number of CB channels assigned by the FCC, as everyone knows, is 23. Yet, an increasing number of manufacturers are talking about transmitter power well over 5-watts and rigs that communicate on 46 channels! Is this a case for the Better Business Bureau? Not at all since there's truth in all these claims. The reason is a special method of transmitting and receiving known as SSB, or single sideband. Nearly a dozen CB manufacturers now offer rigs that fall in the sideband category.

Sideband is so efficient and powerful that military services adopted it decades ago for long-distance voice transmission. The American Radio Relay League says that hams started using it back in 1933, and to-

day it's the major mode for phone (voice) operation. Many hams, in fact, slyly ridicule regular AM as *Ancient Modulation*. Telephone companies have used sideband for point-to-point radio for years and recent FCC regulations say that everyone on the 2-3 MHz marine band must switch to sideband within a few years. Citizens Banders got into sideband about eight years ago, and recently the number of CB sideband sets has multiplied in the marketplace, with an ever-increasing variety of interesting features being offered.

If sideband's so good, why doesn't the FCC make it the rule of realm? There are good reasons that delay a complete change-over from regular AM to sideband. For one, sideband is more complex than regular AM and is priced higher. A sideband receiver must be extremely stable for good

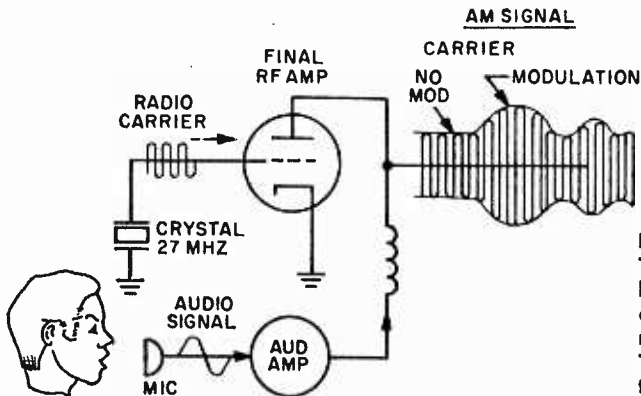

Fig. 1. This is how AM works. The carrier wave, generated by a fixed-frequency crystal oscillator, has its amplitude modulated by the audio signal. The modulated carrier is transmitted at crystal frequency.

reception. It requires extra circuitry and controls, like a speech "clarifier," since sideband is more critical to tune. Also, a sideband signal is not compatible; on a standard receiver it sounds like a dyspeptic Donald Duck. But the benefits of sideband for many operators could ultimately outweigh its shortcomings simply on an ability to double the number of channels that can be assigned a given band. There's also the sideband signal's excellent ability to penetrate interference.

Conventional AM. To grasp the mysteries of sideband, begin with regular AM. Sideband, in fact, is a form of Amplitude Modulation, but with major electronic surgery. Many students of radio have been brought up on the basic picture of AM shown in Fig. 1. It shows a radio carrier produced by an oscillating crystal, then amplified in a final radio-frequency stage of a transmitter. As the name implies, the carrier bears the voice or intelligence over long distances. (It takes carrier frequencies far higher than audio to create electromagnetic fields that leave the antenna.) Note that an audio signal from the mike (after amplification) is joined to the carrier in the final RF stage. Since audio is delivered as a varying voltage

to the tube plate, voice frequencies apparently control the amplitude, or strength, of the emerging carrier. This creates the classic AM signal—one where the carrier antenna:

Upper sideband—The audio tone and carrier *add* ($1 \text{ kHz} + 27 \text{ MHz}$) and create 27.001 MHz , the upper sideband;

Lower sideband—The tone and carrier also *subtract* ($1 \text{ kHz} - 27 \text{ MHz}$) and create 26.999 MHz , the lower sideband;

Carrier—The third product is the RF carrier, which emerges *without* a trace of modulation on 27 MHz .

Thus a CB rig's output is actually a three-part affair. The surprise, in terms of a conventional textbook picture of an AM signal, is the carrier. It actually emerges with no modulation and is as steady as the pulsates in exact step with audio.

Missing Links. But that's only part of the picture. A closer look at an AM signal would reveal that it actually consists of *three*, not one, basic components. The reason is that audio within the final stage is actually *mixing* with the carrier. Assume, for example, that audio is a tone of 1 kHz (which may also be written as $.001 \text{ MHz}$) and this intelligence is modulated onto the

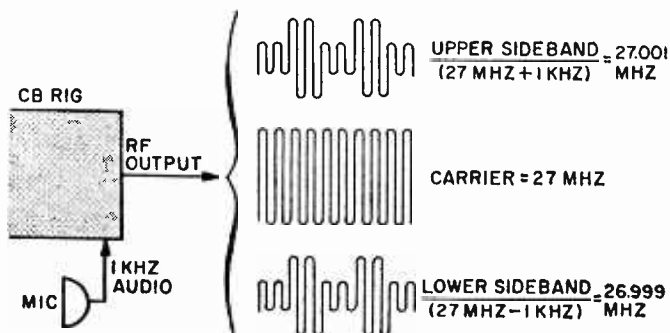

Fig. 2. When analyzed, the AM signal is found to be a combination of an unmodulated carrier plus sidebands. The sideband frequencies are equal to the carrier frequency plus and minus the audio frequency.

27-MHz CB radio carrier. As shown in Fig. 2, audio and radio mix in the final amplifier and three distinct signals go to the crystal that produced it. And once it leaves the final stage it serves no further purpose. It has already done its job in the RF amplifier—mixing with audio to create sidebands, which actually bear the modulation. Another surprise is that one sideband is also useless. Since uppers and lowers are mirror images of each other—and carry identical audio—one can be cast aside without losing a syllable. (That's why conventional AM, the sideband supporters say, transmits a lot of air pollution.)

Puckered-Out Power. To heap another indignity on old-time AM, let's see how much power it wastes. As shown in Fig. 3, if a CB transmitter is putting out 3 watts of RF power, then two watts fall to the carrier. The remaining watt then divides between the two sidebands. Thus, fully two-thirds of the transmitter RF power is lost. When the duplicate sidebands arrive at the receiver, they add their voltages so there's no power loss here. But even though both sidebands can be ultimately used in receiving, there's still a major disadvantage in transmitting upper and lower, as shown in a moment.

Suppressing the Villains. Now take the array of signals and let's repackage them in far more efficient fashion. As shown in Fig. 4, the same three RF watts have been completely jammed into the upper sideband. The carrier is now considered *suppressed*, its energy poured into the upper sideband. Similarly, the lower sideband is suppressed and its energy also shifted to the upper sideband. Now, every bit of RF wattage is serving the cause; to send maximum voice power without violating FCC power restrictions. Before seeing how this three-into-one package is created, note another important benefit in Fig. 4. The signal—now single sideband—is far narrower than the original. It's about 3 kHz wide instead of 6 or more kHz. This is behind the claim that sideband takes 23 channels and doubles them to 46. It's possible for two independent sideband stations to operate on the same assigned channel; one selects the lower sideband as the other transmits on the upper position. Since they're several kHz apart, there's no mutual interference. What's more, these stations will not produce those annoying heterodynes usually heard on a busy band. Sideband stations transmit no carriers to

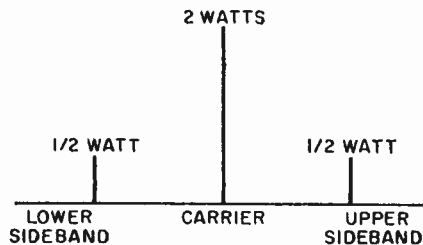

Fig. 3. The power distribution in an AM signal shows how much is wasted in the sidebands.

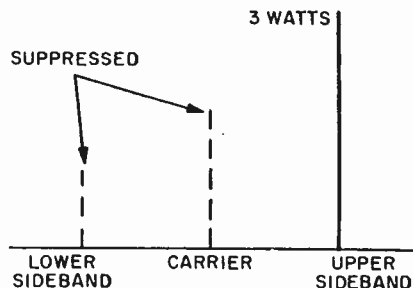

Fig. 4. One sideband receives all the power once used by suppressed carrier and other sideband.

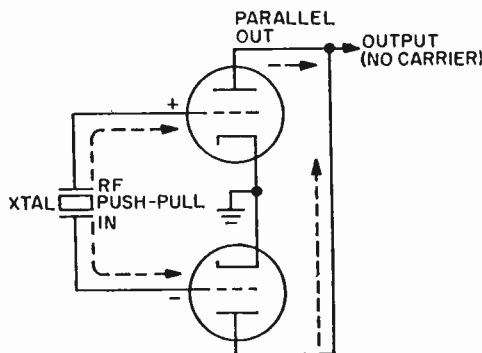

Fig. 5. This balanced modulator suppresses the RF carrier by cancellation in the load.

create this type of interference.

Because of its efficiency, it's generally stated that single sideband will have about 8 times the effectiveness of an equivalent AM signal—and occupy half the bandwidth. Before seeing how the receiver is adapted for SSB reception, consider the basic transmitter circuits that create the sideband signal.

Signal Splitting. A popular circuit for producing sideband is the "filter" method. It begins by suppressing the carrier in the *balanced modulator* stage shown in Fig. 5.

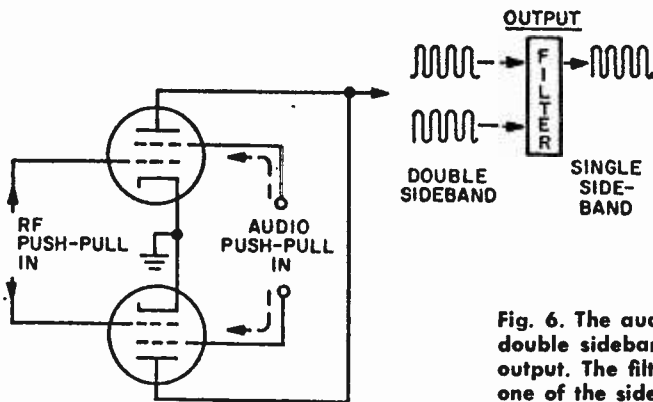

Fig. 6. The audio signal causes a double sideband to appear in the output. The filter then removes one of the sidebands.

Although there are various ways to construct the circuit, the idea is to take the carrier, which alternates between plus and minus, then rearrange it to cancel itself out. Note in Fig. 5 that a crystal is generating the RF carrier and feeding it to the grids of a pair of triode tubes. The key action is that the signal is applied in *push-pull* (one grid is driven positive while the other is driven negative), much like push-pull audio in a hi-fi amplifier. But the big difference is at the output connection. In conventional push-pull, the load is split so signals *add* in the output. In the balanced modulator, though, tubes are connected in *parallel*. The net effect is that each tube contributes a signal of opposite polarity—and the result is cancellation in the load. So push-pull in, and parallel out, phases out the carrier.

Add Audio. Now to introduce the voice intelligence. Let's modify the balanced modulator by adding a screen grid, which is a convenient point for introducing audio. Tracing the action in Fig. 6: when no audio occurs, there is no RF output because of the phasing-out process just described. But start to speak and audio is applied to the screen grids. The tubes are now unbalanced at an audio rate. Unbalance occurs as audio drives one screen more positive than the other, and unequal tube currents result. Now the RF signal sees an "unbalanced" modulator. This means the RF signal can no longer cancel itself completely in the output, so some carrier signal appears. That carrier, however, flows exactly in step with the voice, or rate of unbalance. The total effect is the appearance of the two RF sidebands—and a suppressed carrier.

Filters. There remains another major step.

We want single, not double, sideband, so one sideband is passed through an extremely sharp filter with very high attenuation on the undesired sideband. One example is the Collins unit in Fig. 7, an electromechanical device which resonates very sharply on a single frequency (the desired sideband) and rejects the unwanted signal. Fig. 8 shows the actual circuitry.

This signal processing is done at very low-level stages in the transmitter and it wins sideband's great power efficiency. By eliminating carrier and sideband early in the circuit, these unwanted components never reach later stages for amplification. Only the desired sideband is boosted in the final tube or transistor and all the wattage goes into talk power.

Receivers. A conventional receiver picks up sideband as sheer gobbledygook. The reason is that the carrier is missing. The detection process in any receiver is exactly the opposite of modulation back in the transmitter, even for conventional AM signals. Recall that the carrier originally mixed with audio to produce sidebands. The identical mixing must be repeated in the receiver to convert the sideband back to audio. Since no carrier is supplied with an SSB signal, the receiver must "reinsert" it for sideband detection. This is easily done by switching on the receiver BFO (beat-



Fig. 7. This is the type of filter used to remove the unwanted sideband from the RF output signal.

frequency oscillator), the same type used to make code signals audible. The receiver, therefore, supplies a "local" RF carrier to beat, or heterodyne, against the incoming sideband. The mixture of the two recovers the original audio frequency. It is far more efficient for the receiver to supply a carrier of a few milliwatts than to use the powerful, but wasteful, carrier sent with a regular AM signal.

One reason why sideband is more difficult to tune than a standard signal is because of that local carrier. The receiver must supply an extremely accurate frequency so sideband and local carrier mix to create the original frequency. This is never a problem in regular AM because you're always receiving the original carrier (that one that produced the sidebands) and frequency error can't occur. But the SSB receiver must be very accurately tuned. Unless you're within less than 100 Hz (cycles) of the correct frequency, speech is inverted or unintelligible. Fine control over the local frequency is done with the "clarifier" knob adjusted by the operator.

Another special quality in receiving sideband is selectivity. To fully exploit the system's ability to reject interference and noise, a receiver must narrow its response to signals of about 3 kHz in width. This is the approximate width of one sideband, and, broader response by the receiver admits unnecessary noise and adjacent-

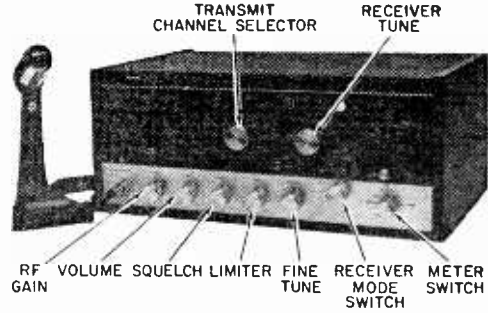

Fig. 9. Single-sideband transceiver by Tram gives choice of either sideband on any Citizens Band channel.

channel interference. Such sharp selectivity in the receiver is usually obtained by crystal or mechanical filters.

Commercial Circuits. How the Tram Company achieves sideband operation in its Titan III is shown in Fig. 9. Note that a knob (Receiver Mode Switch) on the front panel allows the operator to choose upper or lower sideband on any channel, as well as regular AM for transmitting to CBers not equipped for sideband reception. Fig. 10 is a block diagram of the same rig's transmitting arrangement for CB Channel 11. As shown, the carrier is generated at about 6 MHz, then balanced out. The crystal filter chops away either sideband, and the final transmitting frequency is obtained by mixing the sideband up to 27 MHz. The reason for all these steps is that a sideband is easier

Fig. 8. Filtering circuit uses a 4-diode balanced modulator. The RF signal is generated by one of the two crystals, one for each sideband. The RF is fed up to the center of the modulator, and phasing of the

signal cancels the RF. But when audio is applied to the modulator, the resulting imbalance allows RF to appear in the output. This RF is a double-sideband signal, minus the steady carrier. To get rid of one sideband, the composite signal passes through the filter. The resulting single-sideband signal is heterodyned in the transmitter's later stages, up to the final operating frequency of 27 MHz.

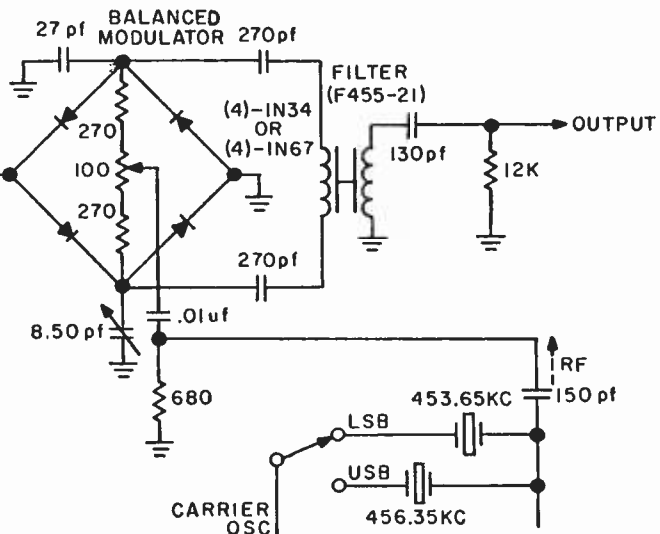

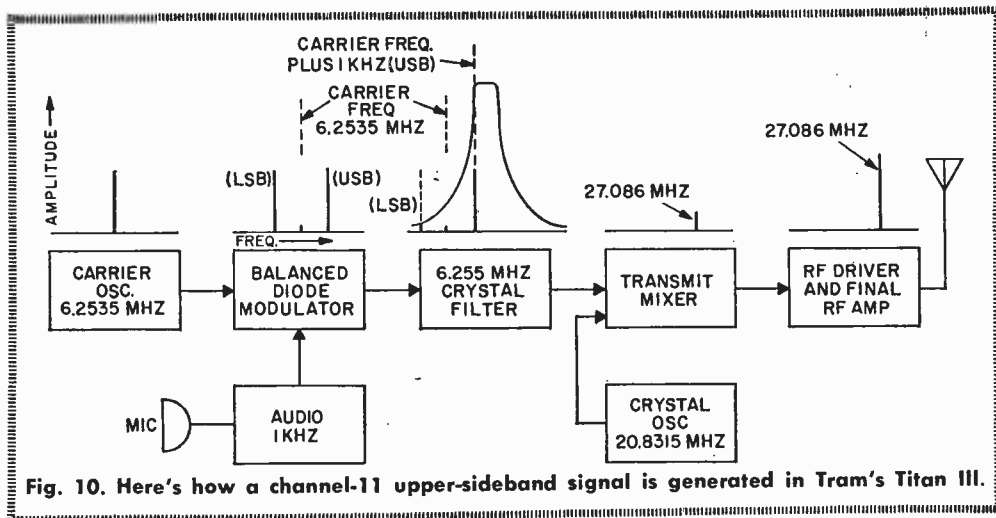

Fig. 10. Here's how a channel-11 upper-sideband signal is generated in Tram's Titan III.

to generate and filter at relatively low frequency of 6 MHz, then boosted to the final value by further mixing.

The Regency Imperial II (Fig. 11) is actually a *double* sideband set, an intermediate type of operation. The carrier is suppressed, but both sidebands are transmitted. This produces a broader signal, but one that gains some of the power once carrier strength would be. The alternate (unwanted) sideband is suppressed by about the same amount. A close look at the front panel of this rig reveals it has an "RF Gain" control, usually missing from a regular set. This is provided since the conventional circuit has an automatic gain control (AGC) to prevent the receiver front end from overloading. Since an AGC circuit operates by sensing the strength of the incoming carrier, it's not practical in sideband (which has no carrier). Thus an RF gain control is provided so the operator can manually reduce receiver gain to prevent assigned to the carrier. Double sideband sacrifices the 46-channel transmitting feature of single sideband, but the audio signal will have more talk power than a conventional AM circuit. Still, the design is "old

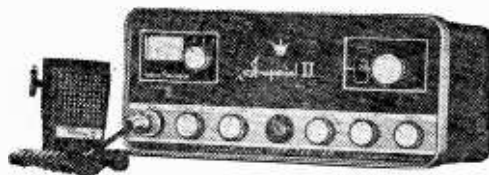

Fig. 11.—The Regency Imperial II double-sideband CB transceiver operates on 117 VAC or 12 VDC.

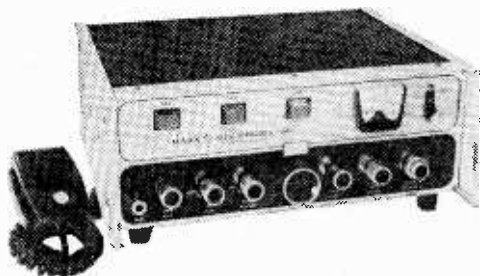

Fig. 12.—Mark Products Sidewinder-46 single-sideband CB transceiver uses a crystal lattice filter.

hat" and not as good as SSB rigs. The double sideband signal can be received on sets fitted for single sideband reception. The Regency circuit can also transmit conventional AM for compatibility.

Mark Products Sidewinder-46 is a single sideband transceiver (Fig. 12) that uses a crystal lattice filter to slice away the undesired sideband. The carrier is suppressed by more than 40 dB, which means it's about one-ten thousandths of what a conventional overload.

Another item peculiar to sideband because a carrier-less operation is the rating of the final power amplifier. In a regular CB set, output wattage is easily figured by measuring the voltage and current in the final transmitter stage, then multiplying the two figures for a rating in watts. Sideband, however, produces an RF signal that's varying at an audio rate, so the method of measurement is different. It's done by using the peak value of signal as a reference. The power rating, therefore, is always greater than the customary five watts. It's always

understood, though, that sideband measurements refer only to instants of peak power. The letters "P.E.P." (peak envelope power) qualify the rating. The Sidewinder, for example, is specified at 3.5 watts AM, but 8 watts P.E.P. sideband. This is equivalent to more than a doubling in power, though, since voice power in sideband is about eight times more potent because so little power is wasted in the carrier.

The SBE Sidebander by Linear Systems illustrated in Fig. 13 is a compact sideband rig. Note a front panel knob marked "Clarifier" to fine-tune speech. The mode selector chooses upper or lower sideband in each channel. Pick the wrong one and speech will be detected backwards and sound like gibberish. A red output lamp

on this set glows when AM is being transmitted and brightens as the operator speaks. It will flash rapidly during sideband transmission, however, because there's no carrier to keep it illuminated between words. The Mode Selector picks AM, USB or LSB.

So the next time you hear a signal on the air that sounds like the Martians have landed in Grovers Corners, N.J., attribute it to single sideband. It's taken a long time to catch on in CB, probably because CBers like to talk to other operators and sideband isn't compatible. Everyone has to have the same receiving capability. But the powerful boost of sideband, its narrower bandwidth and ability to cut through noise and interference should guarantee it a position among conventional AM sets. ■

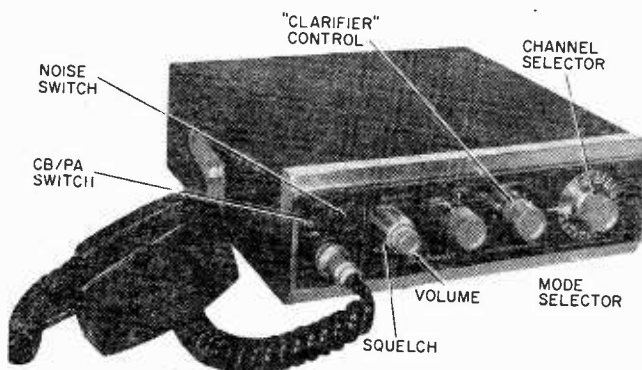

Fig. 13. SBE Sidebander by Linear Systems has a lamp that lights when AM is transmitted and which brightens as the operator speaks. The "Clarifier" control provides fine tuning for speech. The mode selector has three settings, one for AM, and the other two for the upper and lower sidebands.

Microwaves

□ In the 25-odd years since World War II, the electromagnetic spectrum has been gobbled up faster than a bushel of bananas at a monkey Bar Mitzvah. The sad truth of the matter: the demand for frequencies has been growing faster than technology has been able to supply them.

Some parts of the radio spectrum are already overcrowded; others are rapidly becoming saturated to the point of bursting. To make matters worse, new communications techniques will mean that additional services will soon be clamoring for spectrum space as well.

Highway safety systems of the future, for example, will require frequencies for computerized traffic control, automatic guidance systems, visual and audible hazard warnings, and highway sign control. Picturephones, now being developed by Bell Laboratories, will also require spectrum space for their operation. And these are but two drops of

the torrent expected to engulf the spectrum as we know it.

Expert Opinion. How will the problems created by frequency congestion be solved? Experts differ, and many solutions have been proposed. One report, recently made public, was prepared by some 200 of the nation's top telecommunications experts and took four years to complete. The 6-lb., 1200-page document, *Spectrum Engineering—The Key to Progress*, deals with the manner in which the spectrum is now being utilized, as well as the technical aspects of using it even more efficiently. The report also recommends increased research to find ways to better utilize those parts of the electromagnetic spectrum that are now largely unused. In particular, the sparsely used microwave portion of the spectrum, because of the vast amount of space available in that range, appears to be the last frontier in what is otherwise a morass of congestion.

Fig. 1. Microwave propagation. Microwaves are propagated in straight line, from transmitter to receiver, or to satellite. They are also scattered in troposphere, which explains why they can be transmitted to locations which lie well beyond horizon.

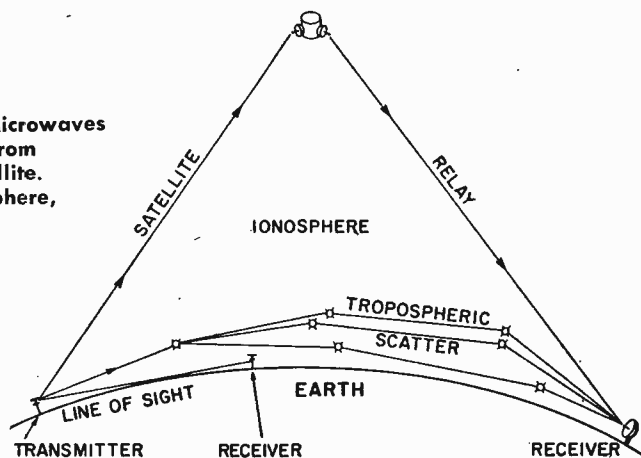

Frequency-wise, the microwave portion of the spectrum extends from 1000 MHz to the far infrared range of electromagnetic radiation, up to frequencies of 300,000 MHz! Imagine! Two hundred and ninety-nine thousand MHz of spectrum space! When we consider that the entire shortwave spectrum comprises a paltry 27 MHz, we realize what a bonanza the full use of the microwave region would be to communications.

Evidence indicates that in the years to come a great deal of research and development will be concentrated in this portion of the spectrum. If so, chances are that terms such as tropo scatter, magnetron, klystron, TWT, and waveguide will be as common as ionosphere, diode, and transmission line are to communications today.

Because microwaves truly represent the waves of the future, let's take a closer look at them so we can get a better understanding of their potential. Many telecommunications experts believe that microwaves will bring about a communications revolution before long. Here's why.

Microwaves have wavelengths that lie between those of radio waves and of ordinary light—30 centimeters to 1 millimeter. Because of this, they display characteristics that are common to both. Like radio waves, their generation stems from the use of low-frequency systems, and they can be modulated to carry intelligence, such as voice, teletype, pictures, etc.

And like light, they travel in straight lines, are blocked by most solid objects, are affected by the weather, and can be focused and beamed in an optical system.

Tropo Scatter. Fig. 1 shows how microwaves are propagated. As anyone who has

driven through a fog at night knows, the light from the headlights striking the fog is scattered and dissipated. Similarly, microwaves traveling through the Earth's lower atmosphere (the troposphere) are scattered. This scattering enables the transmission of some signals far beyond the Earth's horizon. Unlike shortwave signals, microwaves aren't affected by the ionosphere and pass completely through it. Tropospheric, or tropo, scatter is therefore the only means of transmitting over relatively long distances without the use of intermediate repeater stations.

A number of military scatter circuits are currently in operation, including one across the Pacific Ocean in island-hopping fashion, and one across the Arctic, linking our early warning radar stations. Significantly, the distance for a microwave scatter "hop" varies with the frequency. But at 1000 MHz, hops of several hundred miles are possible.

Commercial microwave scatter links are also in operation. One such link provides 72 telephone circuits between Miami and the string of islands called the Bahamas.

Unfortunately, the energy transmitted by tropo scatter is extremely small. Because of this, high-power transmitters and high-gain antennas are required for successful communications.

Repeater Circuits. A second method of propagation is via line-of-sight propagation. In such circuits, the microwaves travel in essentially straight paths direct from the transmitting antenna to the receiving antenna. In general, the transmitting and receiving antennas are spaced about 30 miles apart.

Energy entering the receiving antenna is often amplified and retransmitted to another repeater, some 30 miles further away. In

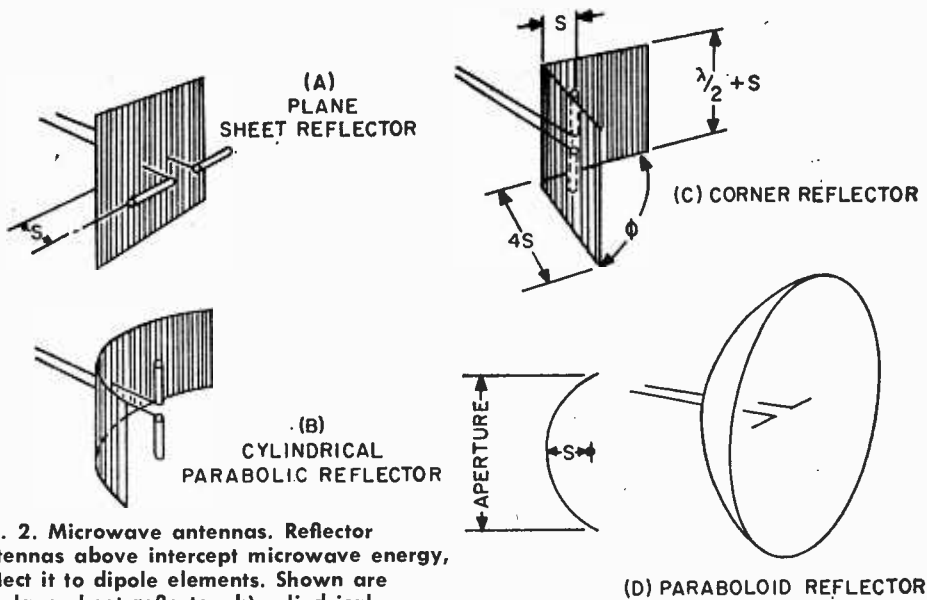

Fig. 2. Microwave antennas. Reflector antennas above intercept microwave energy, reflect it to dipole elements. Shown are a) plane sheet reflector, b) cylindrical parabolic reflector, c) corner reflector, and d) paraboloid reflector. Horn antennas at right gather energy, transmit it to antenna elements, which are not shown in drawings.

practice, the distance between transmitting and receiving antennas is slightly greater than true line-of-sight distance because some bending of the signal occurs as it passes through the lower atmosphere.

Numerous microwave networks, making extensive use of repeaters are in operation within the U.S. Many of these run from coast to coast.

Satellite Relays. In addition to tropo scatter and repeater circuits, another use of microwaves involves satellites to relay the signal to some distant point on Earth. All new-generation COMSAT communications satellites operate in the microwave portion of the spectrum, enabling the transmission of a great deal of information. Ground stations receiving this microwave energy require the use of elaborate antenna systems because the incoming signal is very weak.

Antennas. Since antenna elements are proportional to the wavelength of the radiated signal, microwave antennas lend themselves to designs that would be unwieldy at lower frequencies. A half-wave dipole operating the 6-MHz band, for example, is roughly 25 meters long. At 1000 MHz, a half-wave dipole antenna is 15 centimeters (about 6 in.) long. And at 10,000 MHz, an antenna element less than an inch long can be used.

As a result, a wide variety of exotic

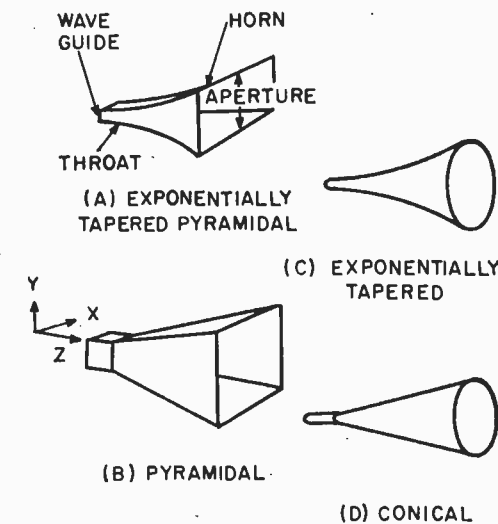

shapes and sizes of antennas have been developed; some of these are shown in Fig. 2. In general, all microwave antennas are designed to gather as much energy as possible. Reason is that some microwave signals, particularly those coming from satellites and those operating on scatter circuits, are very weak.

Because of the large number of antenna elements that can be used for transmitting or receiving microwave signals, antenna gains of the order of 30 dB and more are possible. This enables the reception of very weak signals over vast distances. The Mariner 9 spacecraft, for example, transmitted

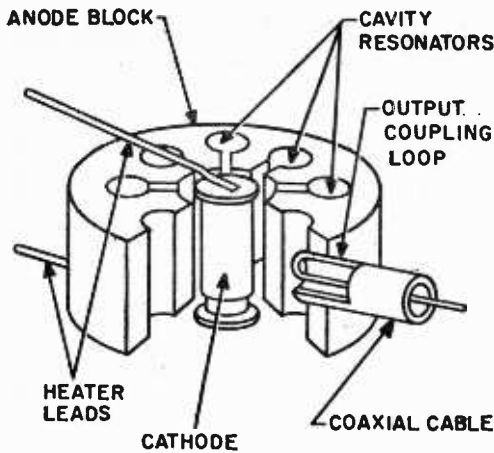

Fig. 3. Magnetron. Electrons from cathode move in circular orbits inside tube, generating microwaves in cavities. Tube is actually diode in structure, requires external magnet to provide magnetic field.

television pictures over a distance of approximately 60 million miles!

Microwave Oscillators. Special tubes have been developed to produce microwave energy because ordinary vacuum tubes don't work effectively at frequencies in the microwave range. In a vacuum tube, electrons travel between the electrodes. At microwave frequencies, the electrons oscillate so rapidly that they change directions before they've been able to pass from one electrode to another. As a result, the electrons literally get hung up within the tube.

Solving this problem introduces another:

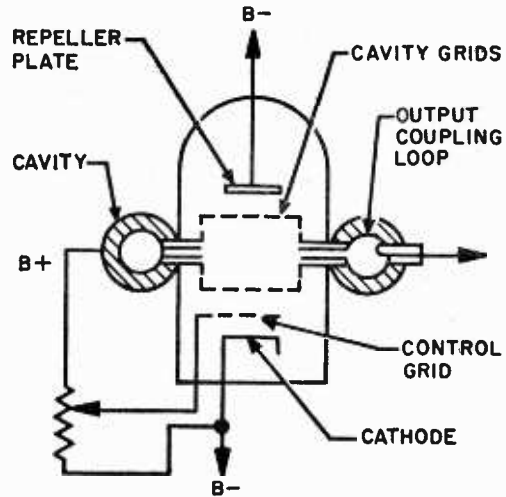

Fig. 4. Klystron. Electrons passing between electrodes are bunched at regular time intervals by changing voltages. Electron beam passes opening of cavity, produces microwave oscillation or amplification.

at microwave frequencies, capacitance between the electrodes tends to short out the elements in the tube. To cut the capacitance, the spacing between electrodes can be increased. But this makes the first problem of electrons not getting from one electrode to another even greater.

To overcome these stumbling blocks, tubes of a radically different design have been developed. Three of these, the magnetron, the klystron, and the TWT are shown in Figs. 3, 4, and 5.

The Magnetron. A resonant cavity is responsible for the magnetron's ability to pro-

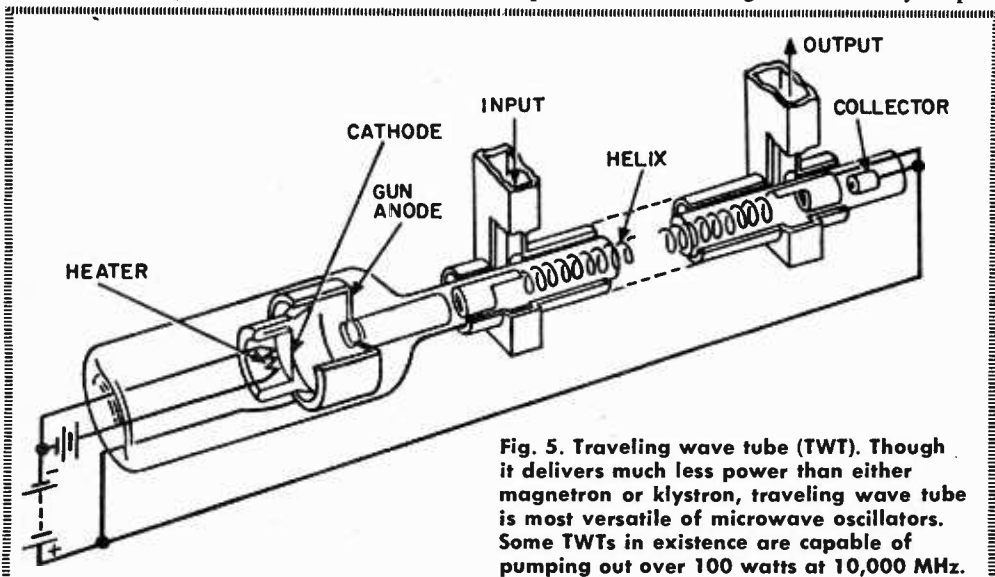

Fig. 5. Traveling wave tube (TWT). Though it delivers much less power than either magnetron or klystron, traveling wave tube is most versatile of microwave oscillators. Some TWTs in existence are capable of pumping out over 100 watts at 10,000 MHz.

duce microwave energy. Each cavity has a characteristic resonant frequency depending on the inductance of the walls of the cavity and the capacitance due to spacing between the walls. Thus, the cavity resembles a simple tank circuit that employs capacitances and inductances to form a resonant circuit at a particular frequency.

The magnetron of Fig. 3 has a series of cavities, and the entire tube is operated between the poles of a powerful electromagnet not shown here. The cathode emits electrons which travel in circular paths because of the influence of the magnetic field. The shape of the tube is such that the electrons graze the openings of the cavities, passing energy to them and setting them into oscillation.

Magnetrons can be made to deliver pulses of very high power, but they have two limitations. First, they require a heavy magnet to propel the electrons in circular orbits inside the tube. Second, the cavities are extremely small at higher frequencies, making manufacture difficult.

The Klystron. Illustrated in Fig. 4, the klystron doesn't require a magnet because electrons travel a straight line within its electrodes. Grid voltages are adjusted so that bursts of electrons flow past the cavity openings only at certain times. These bursts are synchronous with the resonant frequency of the cavity, and the electrons transfer their energy to the cavity, developing high power oscillations inside the cavity. The process has been compared with the periodic pushing of a swing to make it go higher.

Klystrons can operate at frequencies well above 100,000 MHz, but at these frequencies output power is very low.

The Traveling Wave Tube. A very convenient device for space applications is the traveling wave tube (TWT), which amplifies or generates microwave energy with very low noise and high sensitivity. Shown in Fig. 5, the tube consists of a narrow evacuated tube with a wire helix wound around it. A beam of electrons is sent along the inside of the tube while the signal to be amplified is fed into the helix.

By controlling the speed of the electron beam, the energy of the beam of electrons is passed to the signal in the helix, thus amplifying it. Similarly, by feeding pulses of energy into the helix, it will generate microwaves by amplifying the pulses.

The traveling wave tube can be tuned over a wide range of microwave frequencies

and is very sensitive. Its disadvantage is that it delivers much less power than magnetrons or klystrons.

Waveguides and Cables. At microwave frequencies ordinary wire can't be used to transmit energy because the values of inductance and capacitance in the wire combine to block any current flow. To allow for transmission of microwave energy through transmitter and receiver circuits, new components had to be developed to carry the energy. Coaxial cable and waveguides were found to carry microwave energy efficiently.

Coax, as you may know, consists of a wire surrounded by a dielectric, or non-conducting material, such as polyethylene, surrounded by a cylindrical outer conductor. Microwave energy flows through the dielectric between the inner and outer conductors.

In contrast, waveguides are usually rectangular tubes which conduct the microwave energy within their walls. The tubes can be bent into many shapes without affecting their ability to carry microwave energy.

In both coaxial cable and waveguides, dimensions are highly critical and depend on the frequency of the microwave to be transmitted. With both types of conductor, efficiency and power-handling capacity diminish with increasing frequency.

The Future. Of the 299,000 MHz available in the microwave region of the spectrum, only some 10% is now being used, and much of this is still experimental. Essentially, the problems are generating power at frequencies of 10,000 MHz and above, and of developing components that will operate at frequencies of 30 to 40 GHz and higher (1 GHz equals 1000 MHz).

A great deal of research is now going on in search of techniques and materials that will produce useful results at the mid- and upper-end of the microwave region. Experimentation involving solid-state devices is being successfully conducted in hundreds of laboratories. The general feeling is that technology will continue to expand the useful range of frequencies in this region of the spectrum.

Most of these studies are being financed by the government, and they are costly. But progress has been good—and steady. For hardly a week passes without some news of another breakthrough in this vast region of the spectrum, pushing the frontiers of usable spectrum space ever higher. ■

Roll Your Own Capacitor

□ Early electrical experimenters and radio operators made many of their components. Not because they thought it was great fun, but because that was the only way they could get many of the parts they needed to proceed with their work. Many of the early break-throughs in electricity were aided by this make-it-yourself spirit, because those early experimenters really had to understand the fundamentals of electricity in order to build electrical components completely by hand.

Nowadays only those who work in state-of-the-art electronics have to build anything by hand, and then it's usually a new type of transistor or multi-component integrated-circuit chip. The rest of us are content to use ready-made resistors, tubes, capacitors, transistors, etc., to build projects of all types, but how many *really* understand just how those basic parts work? Or even care what's going on inside of them?

This project is designed to help you learn most of what there is to know about capacitors by *rolling your own* out of common kitchen aluminum foil and waxpaper. And what's more, the finished product will actually work in circuits that you can build using the RYO.

The oldest form of capacitor is the Leyden Jar, first built by Muschenbroeck at the University of Leyden in about 1745. Leyden jars were the first electrical devices that permitted experimenters to "imprison" or store electricity for long periods of time, and they are still used by scientists when heavy electric charges are needed. Whoever invented the modern form of metal foil and dielectric capacitor covered his tracks too well to

be uncovered by reasonable research, but it appears that such components were in common usage as early as the 1890's.

What a Capacitor Is. A capacitor is an electrical device for storing quantities of electricity in much the same way that a reservoir is a container for storing water, or a steel tank is a container for storing gas. Two plates or sheets of metal that are separated by air, glass, mica, or some other *dielectric* form a capacitor.

The principles of a capacitor are illustrated in the drawing on this page. One plate of the capacitor in each diagram is grounded and the other is insulated. Initially both plates are neutral, and neither has a charge. Referring to A, if the insulated plate is given a positive charge as shown, electrons from ground are attracted up into the other plate by the positive charge. If the insulated plate is given a negative charge as shown in B, electrons are repelled from the other plate into ground.

It is because of the physical laws that opposite charges attract each other, and like charges repel each other, that a capacitor works. When, through the "capacitor action" described above, a capacitor becomes charged, then a difference of potential exists between its plates—it has stored electricity. If the two plates of the capacitor are suddenly connected together by a wire, the excess electrons on the negatively charged plate will move through the conductor to the positively charged plate until both plates are again neutral. The capacitor is then said to be discharged.

The capacitance of a capacitor, or the amount of electricity it can store, can be

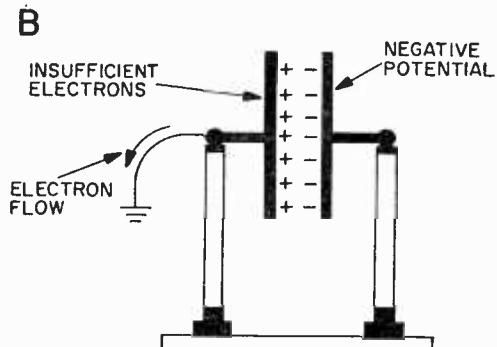
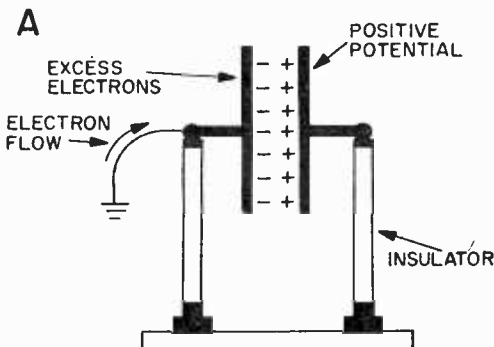

The insulated plate is given a positive charge in A and a negative charge in B. The grounded plate (left) will have the opposite charge of the insulated plate (right).

increased by several methods:

- The area of the plates can be increased.
- The plates can be positioned closer together.
- A more suitable dielectric can be placed between the plates.

If the area of the plates is increased, there is more room for more electrons or electricity. If the plates are placed closer together, or a more suitable dielectric is used, the electrostatic forces of attraction between the plates are stronger, and the positive plate will be able to attract more electrons to the other plate.

Calculating Capacitance. The general formula for calculating the capacitance of a parallel plate capacitor is

$$C = K \frac{A}{d}$$

where A is the area of one of the plates, d is the distance between the plates, C is the capacitance of the capacitor in farads, and K is a constant that depends on the medium between the plates.

As a capacitor is being charged, the plates develop a greater and greater differ-

ence of potential. The amount of charge that a given capacitor can store is limited only by the breakdown of the dielectric between the plates. When the charge exceeds the breakdown-voltage of the dielectric, a spark will jump between the plates and discharge the capacitor just as if a wire had been connected between them.

The capacitance of a capacitor is defined as the amount of charge, Q , required to raise the potential of one of the plates one volt above the other. In mathematical form the formula is

$$\text{Capacitance} = \frac{\text{Charge}}{\text{Volts}}$$

$$C = \frac{Q}{V}$$

This explains why capacitors with the same value can vary so greatly in physical size. By changing the dielectric, we can make a capacitor that will require either more or less charge to establish a difference of potential of one volt between the plates.

The major unit for measuring capacitance is the *Farad*, named in honor of Michael Faraday. One farad is defined as the

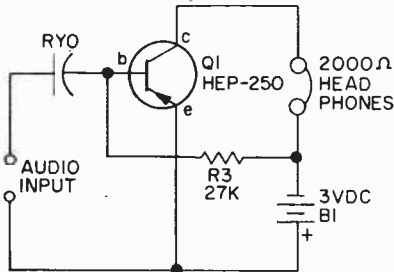

This audio amplifier (above) and code-practice oscillator (right) can be built with the RYO capacitor. In these circuits the polarity of the RYO doesn't matter, but for RF circuits the outer lead should be grounded.

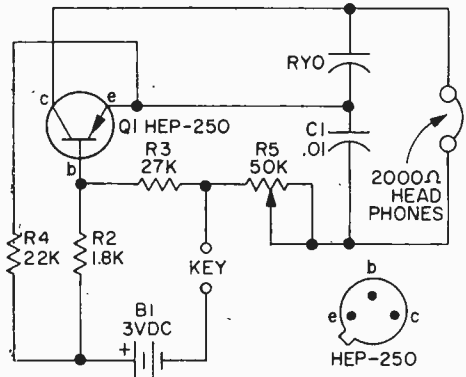

PARTS LIST FOR ROLL-YOUR-OWN CAPACITOR

- C1—.01- μ F, 200 VDC capacitor
- Q1—Germanium medium-gain pnp transistor (Motorola HEP-250 or HEP-253)
- R1—10,000,000-ohm, 1/2-watt resistor
- R2—1,800-ohm, 1/2-watt resistor
- R3—27,000-ohm, 1/2-watt resistor
- R4—22,000-ohm, 1/2-watt resistor
- R5—50,000-ohm potentiometer (any taper)
- B1—3-volt battery, 2 D cells or equiv.
- Misc.—Two pieces of #16 wire 12 inches long, kitchen-type waxpaper and aluminum foil, candlewax, 2000-ohm headset, NE-2 neon bulb.

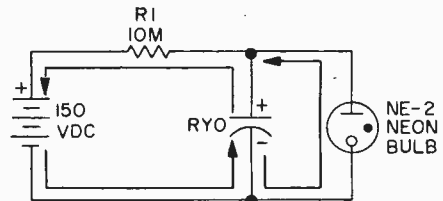

To test the roll-your own capacitor, you can use an ohmmeter, or build this relaxation oscillator around it. If you don't have a 150-volt battery, the power supply below will furnish the required voltage.

This power supply will operate the relaxation oscillator, if you don't have a 150-volt battery handy. CAUTION: This supply is not isolated from ground—if you have a line-isolation transformer, use it.

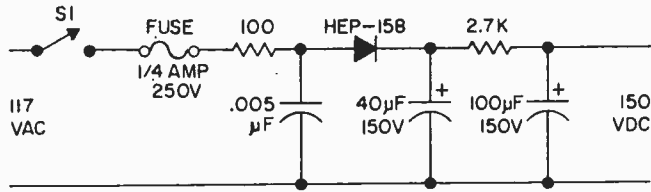

capacitance of a capacitor that will have a 1-volt difference of potential between its

plates when it has stored a charge of 1 coulomb. One coulomb is equal to the charge of 6.28×10^{18} electrons.

$$1 \text{ Farad} = \frac{1 \text{ Coulomb}}{1 \text{ Volt}}$$

Make Your Own Tubular Capacitor.

Making your own RYO capacitor out of aluminum foil and wax paper is easy, fun, inexpensive, educational, and will set you apart as one who does his own thing. Most of the required materials can be found right in your own kitchen.

The first step is to cut out two sheets of aluminum foil 3 inches wide and 12 inches long, and two sheets of waxpaper $3\frac{1}{2}$ inches wide and 13 inches long. Place one of the aluminum sheets on a flat surface such as the top of your kitchen table. Then center the second sheet of aluminum foil between the two sheets of waxpaper, and lay this combination on top of the sheet of aluminum foil that is laying on the table. Be certain that the two sheets of aluminum foil are centered in relation to the edges of the waxpaper so they can not touch.

Carefully roll the four sheets into a tight cylinder, being certain that the sheets of aluminum foil do not touch at any point. The bottom foil layer should be on the outside. Tie a string around the assembly to keep it tightly rolled together during the rest of the operation. Connecting the leads to the capacitor requires a little time and patience because the aluminum foil tends to tear if it is bent too often, but the actual process is simple. At either the same or opposite ends of the cylinder, punch a small hole in one corner of each sheet of aluminum foil, about half an inch from each edge. Connect a 12-inch wire lead to each sheet of foil using $\frac{1}{4}$ -inch long, small diameter screws with bolts and three washers, as shown in the figure. These connections should be as tight as possible to ensure a permanent contact, and to be certain that no wax can seep into the joint when the capacitor is sealed. It is important that these connections be made carefully. If you slip and jerk the

(Continued on page 110)

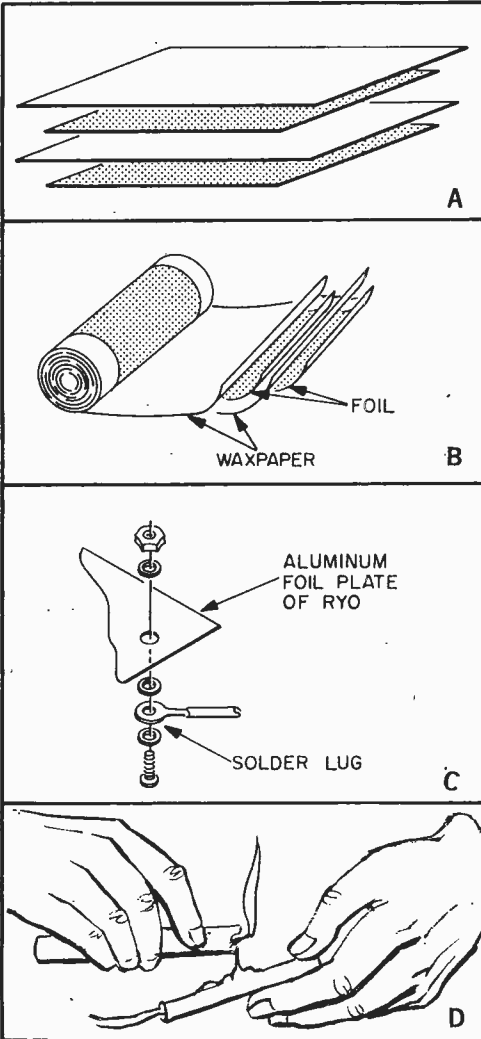

How to Roll Your Own! Stack and center the waxpaper and foil sheets (A). Roll the alternating layers into a tight cylinder (B), with a foil layer on the outside. Trim the ends. Connect wires to the foil plates of the RYO capacitor (C)—be careful not to tear the foil. Tuck in the ends. If you don't have a pan of melted wax, use a candle (D) to drip wax onto the RYO to form a protective coating.

CLASSIFIED Market Place

Classified Ads only 65¢ per word, each insertion, minimum 15 words, payable in advance. For information on Classified ads—to be published in our next THEORY OF ELECTRONICS—write R. S. Wayner, Classified Ad Mgr., 229 Park Avenue South, New York, N. Y. 10003.

ADDITIONAL INCOME

WIN ONE MILLION DOLLARS in the New Jersey State Lottery. Rush \$3.00 for complete details and instructions. Satisfaction Guaranteed. Davidson's, Box 274-SM, Belleville, Illinois 62222.

AGENTS WANTED

SELL: Personalized, Colored, Social Security Plates. Choice of Fifty-nine Emblems! Big Profits! Free Sample! DR8 Specialties, Dept. 201F, 73 Hunter Place, Pompton Lakes, New Jersey 07442.

AUTHOR'S SERVICE

PUBLISH your book! Join our successful authors: publicity advertising promotion, beautiful books. All subjects invited. Send for free manuscript report and detailed booklet. Carlton Press, SMH, 84 Fifth Avenue, New York 10011.

AUTO PARTS & ACCESSORIES

GENUINE ROLLS ROYCE appd. liquid car cleaner/wax. Standard on new RR's. Amazing results guaranteed. Free literature or \$4.99 plus 50¢ handling. Noel Roberts, Dept. R-D6, 236 East 48th, Brooklyn, N.Y. 11203.

BOOKS & PERIODICALS

WIRETAPPING — National scandal — your privacy invaded. Free brochure. Don-Q, Box 548, Seattle, Wash. 98111.

BEST Reading in Mechanical Field—Science & Mechanics! \$4.00 for year's subscription. Science & Mechanics, 229 Park Avenue So., New York, New York 10003.

BUSINESS OPPORTUNITIES

I MADE \$40,000.00 Year by Mailorder! Helped others make money. Start with \$10.00—Free Proof! Torrey, Box 318-T, Ypsilanti, Michigan 48197.

MAKE Magnetic Signs. Big profits. Details. Universal, Lenora, Kansas 67645.

100% PROFIT Bronzing Keepsakes. Free Literature, NBC, Box C-4-0, Coral Springs, Florida 33065.

LIKE Free Mail-Order Catalogs? Write to: Diane D. Anderson, 260 Crittenden Blvd., Rochester, N.Y. 14642.

HERBALISM! The home gold mine! Free lesson, Herbalism Institute-D, 1339 Remuda, Glendora, Ca. 91740.

BUSINESS OPPORTUNITIES—Con't.

FREE BOOK "2042 Unique Proven Enterprises." Beat inflation with fabulous successful "Little Knowns." Work Home! Haylings-E8, Carlsbad, Calif. 92008.

ADDRESSERS and Malters needed. Details 10¢. Lindbloom Services, 3636 Peterson, Chicago 80659.

FREE-Wholesale Catalog and Sales Plan. JAM Enterprises, 3100T Liberty Avenue, Pittsburgh, Pa. 15201.

\$1000 MONTHLY from your own home. write: Jordan, 27495 Road 176, Dept. DC4, Exeter, Calif. 93221.

MAKE Your Classified Ad Pay. Get "How To Write a Classified Ad That Pulls." Includes certificate worth \$2.00 toward classified ad in S & M. Send \$1.25 (includes postage) to R. S. Wayner, Science & Mechanics, 229 Park Ave. South, New York 10003.

WE NEED GINSENG GROWERS! \$3,000-\$30,000 annually! We Buy Your Crop. Send \$2. For seed sample and information. Glass's Ginseng Exchange, Box 336, Rochdale Station, Jamaica, N.Y. 11434.

DO-IT-YOURSELF

PROJECTION TV—Convert your portable to SEVENTY INCH TV projector for under \$15.00. Free details: Macrocoma Dept. SMC5, Washington Crossing, Pennsylvania 18977.

NEW CRAFT PRINT CATALOG—Choose from over 100 great easy-to-build plans. Send \$1.00 (completely refunded with your first order). BOAT BUILDER, (CP Div.) —229 Park Avenue South, New York, N.Y. 10003.

EDUCATION & INSTRUCTION

LIFETIME Ordination Church charters. Details 25¢. Life Science, 2207 Cardinal, Rolling Meadows, Illinois 60008.

FARMS, ACREAGE & REAL ESTATE

GOVERNMENT LANDS—Low as \$1.25 Acre! Buy, lease or homestead. Free Details! Lands Digest, Box 25561-JC, Seattle, Wa. 98125.

FISHING TACKLE, BAIT & LURES

HANDSOME fishing rod rack—\$2.98. Professional dry fly assortment 20-\$5.98. Satisfaction guaranteed. Diane H. Anderson, 260 Crittenden Blvd., Rochester, N.Y. 14642.

HEARING AIDS

HUGE SAVINGS! BUY DIRECT! Eliminate dealer markups, 20 days FREE Trial. Terms arranged. No salesman will call. LLOYD'S-79, Rockford, Illinois 61108.

HI-FI EQUIPMENT

FREE CATALOG—Electronic Kits—Amplifiers—Preamplifiers—Psychedelia Sirobes—SCA Adaptors—Color Organs—Digital Instruments—Guitar Amplifiers. FREE Subscription. SWTFC, Box SM32040, San Antonio, Texas 78284.

HOME WORKSHOP SUPPLIES

25 WEEKEND BUILD-IT PROJECTS—Practical designs for home/shop buffs who enjoy working with wood, tools, materials and techniques. Send \$1.00 for your copy (includes postage) to Davis Publications, Inc., 229 Park Avenue South, New York, N.Y. 10003.

INVENTIONS WANTED

We either sell your inventions or pay cash bonus. Write for details. Universal Inventions, 298-4 Marlon, Ohio 43302.

LOGIC

LOGIC NEWSLETTER, Design, Theory, Construction. Sample copy \$1.00. Logic Newsletter, POB 252, Waldwick, N.J. 07463.

MAGIC TRICKS, JOKER NOVELTIES & PUZZLES

CATALOG 10¢. 1,500,399 Trick's, Novelty, Jokes, Elbee, 7408-S, San Antonio, Texas 78027.

MAGNETS

TWENTY disc. or 10 small bar Magnets. \$1.00. Magnets, Box 192-DD, Randallstown Maryland 21133.

MAIL-ORDER OPPORTUNITIES

100% PROFIT. SELL SECURITY products by mail. Details. samples free. CSA, Dept. 1D, Box 12127, Dallas, Texas 75225.

OVER 100 Distinguished Gifts Mail Ordered. Satisfaction Guaranteed or Money Back. Write for Catalog "HORESH" 105-24 64 Rd., Forest Hills, New York 11375.

MONEYMAKING OPPORTUNITIES

GUARANTEED Home Income raising chinchillas. 25¢. Chinchilla, 11DC2, Port Richey, Fl. 33568.

FOR GREATER CLASSIFIED PROFITS, RESULTS AND SAVINGS

Place your ad in one of our SPECIAL COMBINATIONS: Business, Science & Mechanics, or Davis Combination. Each Combination is designed to give you the largest audience available. For further information write to R. S. Wayner, Manager, Classified Advertising, Science & Mechanics, 229 Park Avenue South, New York, N.Y. 10003.

CLASSIFIED MARKET PLACE—Cont.

MONEYMAKING OPPORTUNITIES—

MAKE BIG MONEY raising Chinchillas, Cavies, Rabbits for us. Catalog 25¢. Keeney Brothers, New Freedom, Penna. 17349.

WANT \$90,000—\$115,000? Save \$30.00 Weekly. Create Cash Reserve in 13-15 Years. 8¢ Stamp, \$1.00 for information. WHEN'S INTERNAT'L, Box 20964, DC-6, Los Angeles, Calif. 90006.

OF INTEREST TO WOMEN

\$25.00 DAILY Possible addressing-stuffing envelopes. Typewriter-longhand also clipping News Items at home. Information; Send stamped addressed envelope. Ame-7, Box 310, Le Mars, Iowa 51031.

PRACTICAL tips for home, garden and workshop are in "1001 How-To Ideas." Send \$1.00 for your copy (includes postage) to 100 HOW-TO Ideas, 229 Park Avenue South, New York, New York 10003.

OPTICAL GOODS—TELESCOPE

EYEGLASSES Wholesale—Free Catalog. A-Z Optical Company, Box 175, Dept. 28 C, Bay Station, Brooklyn, N.Y. 11235.

PERSONAL

ORIENTAL introductions! Photographs, descriptions, questionnaire, brochure details \$1.00. INTER-PACIFIC, Box 304 SC, Birmingham, Michigan 48012.

ANALYZE Handwriting, 208 Page Book tells all. Fun at parties. Send \$2.00. Thomas Jaye, 1032 Goehring, Pgh. Pa. 15212.

CONTRACEPTIVES for Men—by mail! Eleven top brands—Trojan, Sultan, Three Samples \$1. Twelve mixed samples: \$3. Plain package, Poplan, Box 2556-DCG3, Chapel Hill, North Carolina 27514.

PHOTOGRAPHY—PHOTO FINISHING & SUPPLIES

SAVE HUNDREDS OF DOLLARS!!! Make your own S & M Densitometer. Send \$3.00 for detailed drawings and instructions. A must for successful photography in your darkroom. Order direct from S & M Instruments, Dept. H-6, 229 Park Avenue South, New York, New York 10003.

PRINTING, MIMEOGRAPHING & MULTIGRAPHING

HIGH Class Business Cards—Free Samples. Catalog. Youngers, Princeton, Iowa 52768.

REMAILING SERVICE

RECEIVING — Forwarding-Remailing, monthly rates. Nortex, Drawer 430, Weatherford, Texas 76086.

SONGWRITERS

SONGS, Poems Wanted! For Publishing, recording at our expense! Talent, 17-H6, Longwood Road Quincy, Mass. 02169.

SPORTING GOODS, FISHING TACKLE, ARCHERY, ETC.

THROWING Tomahawks! Knives! Guaranteed. Free Information. BEEJAYS, BX8711DC, Canton, Oh. 44711.

THERE IS NO CHARGE FOR THE ZIP CODE — PLEASE USE IT IN YOUR CLASSIFIED AD

Roll Your Own C

Continued from page 105

connection it will most likely tear the corner off the aluminum sheet.

After each lead is connected to the aluminum plate of the capacitor, tie the wire against the body of the assembly, using string to prevent further movement. When both leads are connected, connect an ohmmeter between them to verify that the two plates of the capacitor are not shorted together. Fold the excess waxpaper at each end of the capacitor down as you would the end of a roll of coins. Then light a candle and slowly drip wax all over the outside surface and ends of the RYO. Repeat the process every 10 or 15 minutes until the wax coating is at least $\frac{1}{64}$ th of an inch thick at all points. Be very generous with wax around the capacitor leads—this will add strength to the connections. Also, a good coating of wax will protect the RYO from physical damage that might short the plates together, will hold the unit together much better than string, and will keep moisture out that could change the characteristics of the RYO. And it makes the finished product look better, especially if you can dip the final product into a pan of melted wax.

How to Test and Use the RYO. After the RYO capacitor has been sealed in wax, it

must be tested to ensure that no short-circuits have developed during the sealing process. The easiest way to do this is, of course, with an ohmmeter. But if you don't have an ohmmeter, or are the impatient type, you can test the RYO and use it at the same time by building a simple circuit. Probably the simplest circuit that can be assembled using the RYO is the relaxation oscillator shown on page 61. When voltage is applied to this type of circuit, the RYO begins to store electricity by absorbing all of the current that flows into the circuit as shown by the solid lines. The potential difference across the RYO increases until it reaches a voltage value that will ignite the gas in the neon bulb—about 85 volts. At that time the electrons stored in the RYO will quickly flow from the negatively charged plate of the capacitor, through the ionized gas of the neon bulb, to the positive terminal of the voltage source, as shown by the dotted line. This process will continue until the voltage across the RYO decreases to a value that will not sustain current flow through the neon bulb. Then the neon bulb will stop conducting current, and the capacitor will begin to charge again. The speed at which this cycle will occur depends upon the value of the RYO, the value of the series resistor, and the voltage applied to the circuit.

The RYO described here has a value of 0.0235 μ F, as measured on a quality labora-

(Continued on page 110)

YOU'RE INVITED TO ACCEPT

in the most remarkable camping/travel club ever developed!

Act Now! Enjoy savings and privileges you never before dreamed were possible. Your special group discounts will pay for your membership many times over. Here are all 21 benefits!

★**\$10,000 Travel Accident Insurance.** Membership covers you 24 hours a day (not just portal to portal) with Accidental Death and Dismemberment Insurance whether you are on a vacation trip, going to work or just crossing the street. You are covered as a passenger in a taxi, bus, train, airplane, ship, etc. to carry passengers for hire. You also get \$1,000 protection while driving or riding as a passenger in any private passenger car or recreational vehicle. ★**RV and Auto Trip Planning Tour Kit.** Tell us where you are going. We'll send you your custom-prepared tour kit complete with full-color maps, mileage charts, check lists and other information. ★**FULL YEAR OF CAMPING JOURNAL Magazine.** Your \$12 dues—\$5.95 of which is allocated for a subscription to **CAMPING JOURNAL**—cover all membership privileges for one year including a year of **CAMPING JOURNAL Magazine**. ★**\$500 RV or Auto and Home Burglary Reward.** Decals warn would-be thieves that your car or rig and your residence are protected by a \$500 reward to anyone giving information leading to the arrest and conviction of a person who has stolen your property. ★**20% Discount on Car Rentals.** Membership entitles you to a 20% cash discount on Hertz Rent A Cars, and 10% on Hertz trucks. ★**Mail Forwarding Service.** We'll forward first-class mail to any address you specify. ★**25% Discount on Books.** On any book you come across, on camping or whatever subject—simply send us the title, publisher, author, and remit the price of the book less 25% plus 50¢ per book for postage and handling. Over 100,000 titles (fiction and non-fiction) to choose from. As many as you want! ★**Membership I.D. Card, Luggage Tags and Club Decals.** Your I.D. card is imprinted with your name and membership number and has space for important medical and emergency data. Luggage tags hasten the return of lost bags. A distinct car-window emblem attests to your membership. ★**SAVE Hundreds of \$s on U.S. Make New Cars (including Station Wagons) and Vans and Pickups.** Learn how to buy a brand new car or light truck at only \$125 over dealer's cost! ★**Weather Forecasts.** Plan your trips with our professionally prepared monthly weather forecasts. ★**Group Discounts on Merchandise.** Save on camping equipment, radios, TV, luggage, sports equipment, appliances. Hundreds of items available. More becoming available as expanded arrangements are made for merchandise ranging from food for campers to motorhomes. Buy direct and save! ★**Overseas Travel Aids.** Useful, free directories. One directs you to English-speaking doctors and gives you their prescribed rates. You receive information on passports, immunizations, foreign currency, customs duties, tipping hints and more. ★**20% Member Discount on Home Movies.** Professionally produced film tours of the world's most interesting cities

and countries. Save 20% on the retail price of 8mm and 16mm . . . color, black and white, sound or silent. ★**10% Hotel/Motel Discount.** A 10% cash discount on rooms at more than 4,000 hotels and motels in 50 states, Canada and Mexico. ★**20-50% Discounts on Vitamins & Prescriptions.** Order drug and vitamin needs by mail, save 20-50% compared to regular drug store prices! Big savings for diabetics and on life-sustaining medication! Each member of your family gets a \$3 cash discount on his first prescription order! ★**Travel Club Newsletter.** Updates you on new money-saving opportunities and ideas. ★**10% Restaurant Discounts.** Your Directory to over 500 outstanding restaurants, and a 10% discount off the check. ★**Optional Special Insurance Plans.** Without obligation, your membership makes you and your family eligible for specially priced association protection NOT AVAILABLE ON AN INDIVIDUAL BASIS! For example: **Disability Income Plan.** Guarantees regular monthly income as long as you cannot work because of covered sickness or injury! Select the amount you need according to your income. **Hospital-Surgical Insurance.** Helps pay for hospital room and board, surgical and maternity benefits. Features specified miscellaneous benefits as outlined in the policy to help pay for many hospital "extras." Many other health insurance plans are available—plus life insurance. Because rates are Association rates, they are specially priced. Regardless of how many claims you have, your rate will not increase. Exception would be when all policy holders of the same form in the same state are given an increase on a class basis. You are never obligated to take out any policy with your membership. Protection underwritten by Bankers Life & Casualty Company of Chicago, Illinois and Bankers Multiple Line Insurance Company of Des Moines, Iowa. ★**Photo Finishing Savings.** A custom-quality service to members at low prices for color, black and white, and including slides and movies! ★**Camping Information Service.** Tell us where you plan to stop and we'll send you a rundown on campsites along your route with accommodations and nearby places of interest. ★**Recreational Vehicle Insurance Plan.** Through CJTCA you can purchase RV insurance, at special low group rates and especially designed for the needs of campers and travelers. If you need an immediate binder, you can arrange it by placing a TOLL-FREE call. The same TOLL-FREE privilege available for reporting any claim. Applies to all RV's: Motorhome, Snowmobile, Travel Trailer, Tent/Camper Trailer, All Terrain Vehicle, Houseboat, Sailboat, Yacht, Runabout, Motorcycle, Mini-Bike, Motor Bike, Air Cushion Vehicle, or Trail Bike. On certain policies offered, you can also get emergency expense allowance, personal effects coverage, towing coverage, supplemental vacation liability—all with nationwide claim service.

GET CHARTER MEMBERSHIP AT SPECIAL SAVINGS! MAIL APPLICATION TODAY!

A CHARTER MEMBERSHIP

in the Camping Journal
Travel Club of America

You'd expect CAMPING JOURNAL, with over 1½ million camping-enthusiast readers, to bring you a camping/travel club that gives you MORE OF EVERYTHING USEFUL AND ENJOYABLE FOR YOU AND YOUR FAMILY. And it does that—and more!—with its fabulous brand-new CAMPING JOURNAL TRAVEL CLUB OF AMERICA! Here is your open road past city skylines, beyond the fences and time-tables . . . your chance to enjoy the pleasure and fun of outdoor recreation and camping vacations all year 'round! As a member of CJTCA, you'll discover new opportunities for you and your family to DO MORE . . . SEE MORE . . . ENJOY MORE camping/travel in the U.S. and elsewhere. All at savings that would not be available to you any other way!



Membership in Camping Journal's Travel Club is regularly \$20 a year—but your participation as a Charter Member now entitles you to a special 40% SAVINGS off the regular price. Only \$12 for a full year of fabulous Club privileges for you and your family whenever you're camping or traveling.

Whether on a weekend trip or an extended camping vacation . . . you may be a tent camper, backpacker, or owner of a fully equipped recreational vehicle—YOU'RE ENTITLED TO ALL THESE 21 CJTCA MEMBER BENEFITS

SPECIAL BONUS

Get CAMPING JOURNAL magazine for as many years as you like at the **LOWEST POSSIBLE PRICES!**

Yours! 21 outstanding benefits
for ONLY \$12—regularly \$20!

Charter Membership APPLICATION

CAMPING JOURNAL TRAVEL CLUB OF AMERICA
a division of NACT Dept. THRY 73
1000 Sunset Ridge Road, Northbrook, Ill. 60062

40% SAVINGS
if you act now!

Please enroll me as a Charter Member of the Camping Journal Travel Club of America, entitling me to all membership privileges.

I understand my travel/accident insurance becomes effective on the first of the month following your approval of my Club membership. NO MEDICAL EXAMINATION IS NEEDED FOR A CLUB MEMBER TO OBTAIN THIS INSURANCE COVERAGE.

To make this Charter Membership Application valid, please sign here, complete the information, and mail your dues.

Your signature _____ Date _____
(PLEASE PRINT) Month/Day/Year

Mr./Mrs./Miss _____
Last Name First Name Initial

Address _____

City _____ State _____ Zip _____

Name of Beneficiary for
Travel/Accident Insurance _____

If different from yours, please
give address of beneficiary here _____

City _____ State _____ Zip _____

Your Birthdate _____ (Month) _____ (Day) _____ (Year) _____

My Charter Membership dues of \$12, which includes \$5.95 for a subscription to Camping Journal magazine, is enclosed. Please send approved insurance certificate, Club Membership identification and camping/travel benefits card, plus other money-saving materials to which I am entitled.

Yes, I'll take the SPECIAL BONUS! Send me CAMPING JOURNAL for the number of years shown below AT THE LOWEST POSSIBLE PRICE.

Bill me for _____ year(s) x \$3.67 . . . \$ _____
(Total)

B544

Roll Your Own C

Continued from page 107

tory capacitance bridge. With the 10-megohm series resistor shown in the schematic, the neon bulb should blink about two times a second. Increasing the voltage applied to the circuit will increase the number of flashes per second, because more current will flow in the circuit. Increasing the value of either the series resistor or the RYO will decrease the number of flashes per second. This is because less current will flow in the circuit with a larger value of resistor, and with a larger value of RYO more current will have to enter the capacitor before the ignition, or firing, voltage of the neon bulb is reached.

When you are satisfied that the RYO is

not shorted, you can proceed to use it in any circuit that requires a capacitor with a value of approximately $0.025 \mu\text{F}$. The two circuits shown are common types that will give you a chance to use the RYO and build a useful circuit. Of course, any circuit you need that requires an $0.025 \mu\text{F}$ capacitor, can be built using the RYO described above. If you need a different value of RYO, a good rule of thumb is to change the area of the plates accordingly. For example, if you need an $0.05 \mu\text{F}$ capacitor make the plate area of your next RYO twice as large, or connect two RYO's such as we have described in parallel.

The only true limitation in using RYO capacitors is your own imagination. If you have access to a capacitance bridge, and are industrious enough, there is no reason why you can't build fairly complex circuits using only RYO capacitors. ■

Hey, Look Me Over

Continued from page 8

fic programming requirements. The Combo receiver, which sells for \$159.00, can be operated base or mobile and comes complete with mounting bracket, AC and DC power cords. For more facts, circle No. 47 on Reader Service Page.

A Sensitive VOM

Dynascan has added the Model 120P VOM to its B&K line of test equipment for labs, hobbyists, and schools. A sensitivity of 20,000 ohms per volt and 2% accuracy on DC, the new 120P also offers a .25 volt

DC range and a 50 microampere DC current range. In addition, it features a resettable electronic overload protection circuit that prevents accidental destruction of instrument, shunts, multipliers, meter, pointer and sensitive rectifier. Ranges covered by the 120P are as follows: DCV: 0-1000 V in 8 ranges; DC Current: 0-10 amperes in 6 ranges; ACV: 0-1000 V RMS, with 3% accuracy and frequency response of ± 1 dB to 100 KHz through 50 VAC, to 20 KHz on 250 VAC range; AC Output Volts: 0-250 VAC in 4 ranges; Ohms: Rx1, Rx100; Rx10,000; it also reads decibels. Test leads, batteries and instruction manual are supplied at the price of \$69.95. Get all the facts, and more, by circling No. 48 on Reader Service Page. ■

Ask Hank, He Knows

Continued from page 10

case to the electrical box is needed. In fact, be sure the dimmer is in a metal wall box. Some new building codes permit plastic boxes—I'll never know why. If this doesn't help, dump the dimmer.

Wants SSB CB, Not AM CB, See?

Is it okay to go right into SSB with a Corba unit without ever being on AM? I got a FCC CB ticket.

—D.R., Hinsdale IL

Bet your life it is. In fact, you'll be doing yourself a favor and every CBER on the band. SSB opens more available channel space for the same given frequencies and helps keep the background noise down. ■

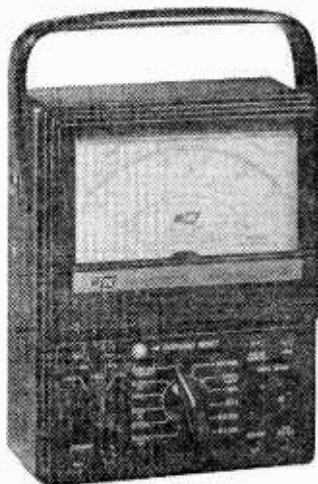

READER SERVICE PAGE

Electronics Theory Handbook

ELECTRONICS THEORY HANDBOOK 1973 offers readers an easy way to get additional information about products and services advertised in this handbook. Also, if you would like more information about any new product mentioned in our new products column, it's yours for the asking. Just follow the instructions below and the literature you requested will be sent to you promptly and at no cost.

Julian S. Martin
Editor-in-Chief

The coupon below is designed for your convenience. Just circle the numbers that appear next to the advertisement or editorial mention that interests you. Then, carefully print your name and address on the coupon. Cut out the coupon and mail to ELECTRONICS THEORY HANDBOOK, Box 886, Ansonia Station, New York, NY 10023. Do it today!

Void after December 31, 1973

1973 **ELECTRONICS THEORY HANDBOOK**
Box 886, Ansonia Station, New York, N.Y. 10023

Please arrange to have literature whose numbers I have circled at right sent to me as soon as possible. I understand that this is a free service offered by the magazine.	1	2	3	4	5	6	7	8
	9	10	11	12	13	14	15	16
	17	18	19	20	21	22	23	24
	25	26	27	28	29	30	31	32
	32	34	35	36	37	38	39	40
	41	42	43	44	45	46	47	48

Name (Print Clearly) _____

Address _____

City _____ State _____ Zip _____

IF YOU CAN USE ANY OF THESE TOOLS...

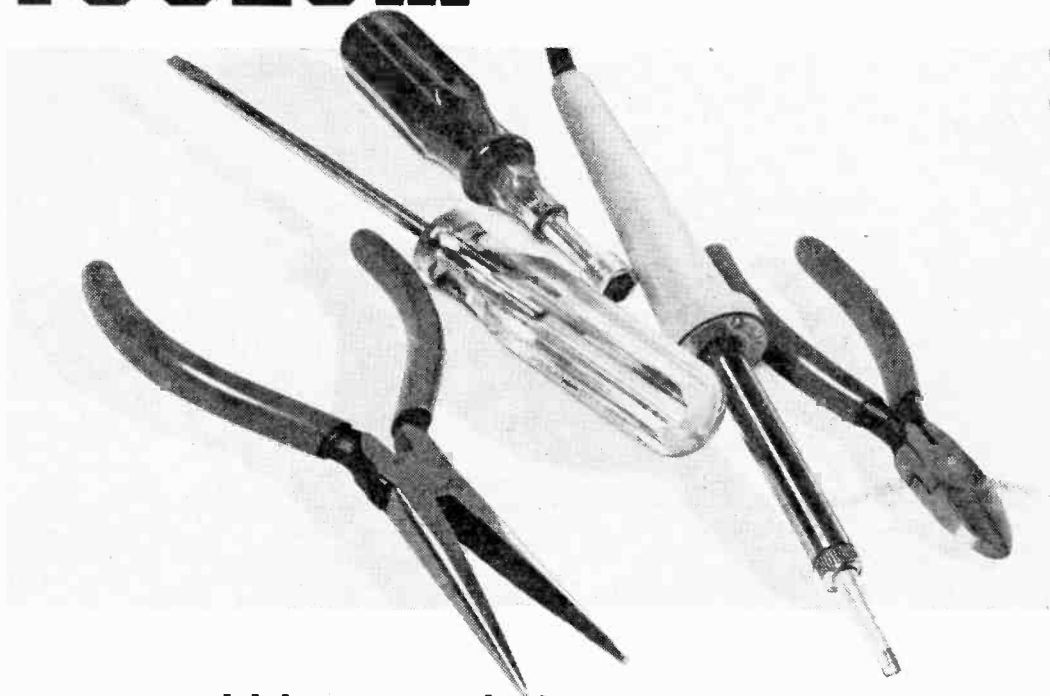

...you could build a whole new future...

and build
yourself
a Bell & Howell
solid state
color TV while
you're at it!

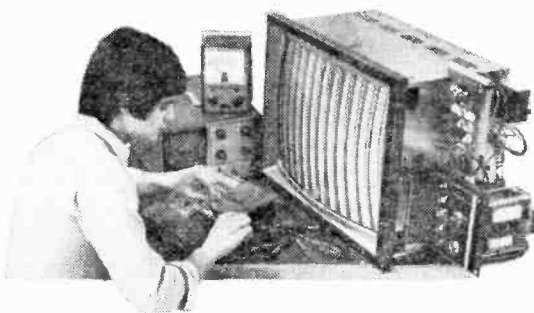

If you're already handy with a set of tools, here's a way to pick up a pretty thorough knowledge of electronics: build yourself a solid state color TV as part of a complete learn-at-home program from Bell & Howell Schools.

This important project gives you valuable "hands on" experience with solid state circuitry—the kind of *practical* experience you'll need to build a successful career. It's a vital part of your total electronics education.

Once you've completed your program, you could be ready to build a new career—or start a business of your own—in home entertainment electronics.

Fix stereo systems . . . FM-AM radios . . . phonographs . . . tape recorders

With your new skills, you can build and service stereo-hi-fi systems—including FM-AM radios . . . phonographs . . . open reel tape recorders and cassette or cartridge player/recorders. You could even build yourself a complete "home entertainment communications center"—complete with the new gadgetry of cartridge television when it comes out. The skills you build up by following this brand-new program are more than enough to service almost any type of home entertainment electronic device.

A complete at-home learning program in home entertainment electronics

Don't confuse this program with an ordinary hobby kit. It's much more than that. It's a complete at-home learning program prepared by skilled instructors at Bell & Howell Schools.

It doesn't matter if you've never had any training in electronics before. Nobody's going to start throwing "diodes" and "capacitors" at you right off. You start with the basics. You take it one step at a time. You walk before you run. And you'll be amazed at how quickly you start to feel comfortable with things that seemed complicated at the beginning.

Attend special "help sessions" if you like

In case you should run into a sticky problem or two—one that you can't handle on your own—come in and see us. We've scheduled help sessions every few Saturdays at the Bell & Howell Schools and in many other cities throughout the U.S. and Canada. Drop by. Meet an expert instructor in person. Talk over any rough spots with him—and with other students. You'll enjoy the chance to "talk shop."

Master the most up-to-date solid state circuitry

Solid state is here to stay. Not just color TV but almost every type of electronic device will eventually move farther and farther in the direction of *total* solid state circuitry. Get to know the most advanced "trouble-shooting" techniques for these sophisticated circuits. You'll find an almost irresistible demand for your skills.

Why you should know electronics

No matter where you look, the amazing

technology of electronics is becoming a bigger and bigger part of the picture. More and more automotive parts and diagnostic instruments are electronic. Many large manufacturing plants use sophisticated electronic systems—controlled by a few skilled electronics technicians. The increasing use of two-way radio . . . the huge promise of cable television . . . the astonishing growth of electronic data processing all open doors to exciting new career opportunities for the man with thorough training in electronics. In fact, the day may come when the man who does not have electronic skills will be severely handicapped in many industries.

Why you should get your training from Bell & Howell Schools

Skilled instructors at Bell & Howell Schools—carefully selected for their knowledge, experience and teaching ability—plan each program with the utmost care and attention. Each year, they spend about \$200,000.00 improving programs and materials and keeping them in step with new developments in electronics. Thousands of people have used their Bell & Howell Schools training as the foundation for new careers and businesses of their own in electronics.

You build and keep the exclusive Bell & Howell Schools Electro-Lab®—a complete laboratory-in-the-home

To make sure you get practical experience with instruments used daily by professionals, you build and keep a Design Console, an Oscilloscope and a Transistorized Meter (see details at right). These are the three instruments you'll work with constantly—both during your program and thereafter.

CONSIDER THESE ADVANTAGES:

Help Sessions We've scheduled "help sessions" every few Saturdays at the Bell & Howell Schools and in many other cities throughout the U.S. and Canada. Top instructors give you expert guidance and you meet other students, too.

Resident Study After you complete your program, you can transfer to any of the resident schools for more advanced study, if you wish.

Lifetime National Placement Assistance When you complete your course, we help you locate a position in the field of Electronics that fits your background and interests. This unique service is available at any time after you graduate.

Veterans' Benefits We are approved by the state approval agency for Veterans' Benefits. Check the box for details.

Student Financial Aid We are an eligible institution under the Federally Insured Student Loan Program. Check the box for details.

Detach postage-paid reply card and mail today for free information



25-inch picture (measured diagonally)

■ **Bell & Howell Solid State Color TV.** Ultra-rectangular tube . . . 25-inch picture measured diagonally . . . full 315 sq. inch viewing area. Solid state modular circuitry . . . 4 advanced IC's . . . 100 transistors . . . 72 diodes . . . individual plug-in circuit boards. Special UHF/VHF tuning features . . . built-in self-service components.

■ **Design Console** Use this to rapidly "breadboard" circuits without soldering. Equipped with built-in power supply . . . test light . . . speaker . . . patented plug-in modular connectors.

■ **Oscilloscope** Portable 5-inch wide-band oscilloscope offers bright, sharp screen images . . . calibrated for peak-to-peak voltage and time measurements . . . 3-way jacks for leads, plugs, wires.

■ **Transistorized Meter** Combines most desired features of vacuum-tube voltmeter and quality multimeter. Registers current, voltage and resistance measurements on a large, easily-read dial. Features sensitive, 4-inch, jewel-bearing d'Arsonval meter movement.

For Free Information, Mail Card Today!

If card has been removed, write:

An Electronics Home Study School
DeVRY INSTITUTE OF TECHNOLOGY
 ONE OF THE
BELL & HOWELL SCHOOLS
 4141 Belmont, Chicago, Illinois 60641

BUILD YOUR OWN RADIO

and Electronics Circuits

PROGRESSIVE HOME RADIO-T.V. COURSE

Now Includes

- ★ 12 RECEIVERS
- ★ 3 TRANSMITTERS
- ★ SQ. WAVE GENERATOR
- ★ SIGNAL TRACER
- ★ AMPLIFIER
- ★ SIGNAL INJECTOR
- ★ CODE OSCILLATOR

- ★ No Knowledge of Radio Necessary
- ★ No Additional Parts or Tools Needed
- ★ EXCELLENT BACKGROUND FOR TV
- ★ SCHOOL INQUIRIES INVITED
- ★ Sold In 79 Countries



Reg. U. S. Pat. Off.

Training Electronics Technicians Since 1946

FREE EXTRAS

• SET OF TOOLS

- SOLDERING IRON
- ELECTRONICS TESTER
- FLIERS-CUTTERS
- VALUABLE DISCOUNT CARD
- CERTIFICATE OF MERIT
- TESTER INSTRUCTION MANUAL
- HIGH FIDELITY GUIDE
- TELEVISION BOOK
- RADIO TROUBLE-SHOOTING BOOK
- MEMBERSHIP IN RADIO-TV CLUB
- CONSULTATION SERVICE, FCC AMATEUR LICENSE TRAINING
- PRINTED CIRCUITRY

YOU DON'T HAVE TO SPEND HUNDREDS OF DOLLARS FOR A RADIO COURSE

The "Edu-Kit" offers you an outstanding PRACTICAL HOME RADIO COURSE at a rock-bottom price. The "Edu-Kit" is designed to train Radio & Electronics Technicians, making use of the most modern methods of home training. You will learn radio theory, construction practice and servicing. THIS IS A COMPLETE RADIO COURSE IN EVERY DETAIL. You will learn how to build radios, using regular schematics; how to wire and solder in a professional manner; how to service radios. You will work with the standard type of punched metal chassis as well as the latest development of Printed Circuit chassis.

You will learn the basic principles of radio. You will construct, study and work with RF and AF amplifiers and oscillators, detectors, rectifiers, test equipment. You will learn and practice code, using the Progressive Code Oscillator. You will learn and practice trouble-shooting, using the Progressive Signal Tracer, Progressive Signal Injector, Progressive Dynamic Radio & Electronics Tester, Square Wave Generator and the accompanying instructional material.

You will receive training for the Novice, Technician and General Classes of F.C.C. Radio Amateur Licenses. You will build Receiver, Transmitter, Square Wave Generator, Code Oscillator, Signal Tracer, Signal Injector, circuits, and learn how to operate them. You will receive an excellent background for television, Hi-Fi and Electronics.

Absolutely no previous knowledge of radio or science is required. The "Edu-Kit" is the product of many years of teaching and engineering experience. The "Edu-Kit" will provide you with the finest education in Electronics and Radio, worth many times the low price you pay. The Signal Tracer alone is worth more than the price of the kit.

THE KIT FOR EVERYONE

You do not need the slightest background in radio or science. Whether you are interested in Radio & Electronics because you want an interesting hobby, a well paying business or a job with a future, you will find the "Edu-Kit" a worth-while investment. Many thousands of individuals of all

ages and backgrounds have successfully used the "Edu-Kit" in more than 79 countries of the world. The "Edu-Kit" has been carefully designed, step by step, so that you cannot make a mistake. The "Edu-Kit" allows you to teach yourself at your own rate. No instructor is necessary.

PROGRESSIVE TEACHING METHOD

The Progressive Radio "Edu-Kit" is the foremost educational radio kit in the world, and is universally accepted as the standard in the field of electronics training. The "Edu-Kit" uses the modern educational principle of "Learn by Doing." Therefore you construct, learn schematics, study theory, practice trouble shooting—all in a closely integrated program designed to provide an easily-relearned, thorough and interesting background in radio.

You begin by examining the various radio parts. Of the "Edu-Kit." You then learn the function, theory and wiring of these parts. Then you build a simple radio. With this first set you will enjoy listening to regular broadcast stations, learn theory, practice testing and trouble-shooting. Then you build a more advanced radio, learn more advanced theory and techniques. Gradually, in a progressive manner, and at your own rate, you will find yourself constructing more advanced multi-tube radio circuits, and doing work like a professional Radio Technician.

Included in the "Edu-Kit" course are Receiver, Transmitter, Code Oscillator, Signal Tracer, Square Wave Generator and Signal Injector Circuits. These are not unprofessional wiring and soldering on metal chassis, plus the new method of radio construction known as "Printed Circuitry." These circuits operate on your regular AC or DC house current.

THE "EDU-KIT" IS COMPLETE

You will receive all parts and instructions necessary to build twenty different radio and electronics circuits, each guaranteed to operate. Our Kits contain tubes, tube sockets, variable, electrolytic, mica, ceramic and paper dielectric condensers, resistors, tie strips, hardware, tubing, punched metal chassis, Instruction Manuals, hook-up wire, solder, selenium rectifiers, coils, volume controls and switches, etc.

In addition, you receive Printed Circuit materials, including Printed Circuit chassis, special tube sockets, hardware and instructions. You also receive a useful set of tools, a professional electric soldering iron, and a self-powered Dynamic Radio and Electronics Tester. The "Edu-Kit" also includes Code Instructions and the Progressive Code Oscillator, in addition to F.C.C. Radio Amateur License training. You will also receive lessons for servicing with the Progressive Signal Tracer and the Progressive Signal Injector, a High Fidelity Guide and a Quiz Book. You receive Membership in Radio-TV Club, Free Consultation Service, Certificate of Merit and Discount Privileges. You receive all parts, tools, instructions, etc. Everything is yours to keep.

Progressive "Edu-Kits" Inc., 1189 Broadway, Dept. 501GM, Hewlett, N.Y. 11557

UNCONDITIONAL MONEY-BACK GUARANTEE

Please rush my expanded "Edu-Kit" to me, as indicated below:
Check one box to indicate choice of model

- Deluxe Model \$31.95
- New Expanded Model \$34.95 (Same as Deluxe Model Plus Television Servicing Course and valuable Radio & TV Tube Checker).

Check one box to indicate manner of payment

- I enclose full payment. Ship "Edu-Kit" post paid.
- I enclose \$5 deposit. Ship "Edu-Kit" C.O.D. for balance plus postage.
- Send me FREE additional information describing "Edu-Kit."

Name

Address

City & State

PROGRESSIVE "EDU-KITS" INC.

1189 Broadway, Dept. 501GM, Hewlett, N. Y. 11557

SERVICING LESSONS

You will learn trouble-shooting and servicing in a progressive manner. You will practice on the equipment that you construct. You will learn symptoms and causes of trouble in home, portable and car radios. You will learn how to use the professional Signal Tracer, the unique Signal Injector and the dynamic Radio & Electronics Tester. While you are learning in this practical way, you will be able to do many a repair job for your friends and neighbors, and charge fees which will far exceed the price of the "Edu-Kit." Our Consultation Service will help you with any technical problems you may have.

FROM OUR MAIL BAG

J. Statitis, of 25 Poplar Pl., Waterbury, Conn., writes: "I have repaired several sets for my friends, and made money. The "Edu-Kit" paid for itself. I was ready to spend \$240 for a course, but I found your ad and sent for your Kit."

Ben Valerio, P. O. Box 21, Magna, Utah: "The Edu-Kits are wonderful. Here I am sending you the questions and also the answers for them. I have been in Radio for the last seven years, but like to work with Radio Kits, and like to build Radio Testing Equipment. I enjoyed every minute I worked with the different kits; the Signal Tracer works fine. Also like to let you know that I feel proud of becoming a member of your Radio-TV Club."

Robert L. Shuff, 1534 Monroe Ave., Huntington, W. Va.: "Thought I would drop you a few lines to say that I received my Edu-Kit, and was really amazed that such a bargain can be had at such a low price. I have already started repairing radios and phonographs. My friends were really surprised to see me get into the swing of it so quickly. The Trouble-shooting Tester that comes with the Kit is really swell, and finds any trouble, if there is any to be found."

PRINTED CIRCUITRY

At no increase in price, the "Edu-Kit" now includes Printed Circuitry. You build a Printed Circuit Signal Injector, a unique servicing instrument that can detect many Radio and TV troubles. This revolutionary new technique of radio construction is now becoming popular in commercial radio and TV sets.

A Printed Circuit is a special insulated chassis on which has been deposited a conducting material which takes the place of wiring. The various parts are merely plugged in and soldered to terminals.

Printed Circuitry is the basis of modern Automation Electronics. A knowledge of this subject is a necessity today for anyone interested in Electronics.

CIRCLE NO. 2 ON PAGE 11 OR 111