

POPULAR ELECTRONICS

# ELECTRONIC KITS

2<sup>nd</sup>  
EDITION

THE BUILDER'S  
GUIDE & DIRECTORY

\$1.00

(\$1.25 in Canada and elsewhere)



**How to Choose  
& Build Kits**

**NEW**

Stereo Units  
 Test Equipment  
 Ham Gear  
 Transistor Radios

**KITS FOR**

Hi-Fi  
 Workshop  
 Ham Shack  
 Fun & Education



World Radio History

# 2 Kits and a Cartridge play everything



With *Weathers*  
inexpensive Turntable Kit,

Electronic Speed Control Kit, and StereoRamic Cartridge you are ready for superb sound reproduction from any speed or any type disc in the World . . . truly limitless enjoyment.

THE WEATHERS LIGHT WEIGHT TURNTABLE is unbelievably quiet. It eliminates mechanical noises, is shielded against outside vibrations, and maintains constant speed at all times. THE WEATHERS ELECTRONIC SPEED CONTROL adjusts to speeds of  $16\frac{2}{3}$ ,  $33\frac{1}{3}$ , 45 and 78 and has a Vernier setting for even more accurate pitch and speed control. THE WEATHERS STEREOAMIC CARTRIDGE is completely compatible to both monophonic and stereophonic records. It outperforms any magnetic cartridge, tracks at 2 grams, and fits any tonearm.

With these Weathers components your stereo system brings you the unlimited enjoyment of any of the World's finest recordings. See your dealer or write us for literature.

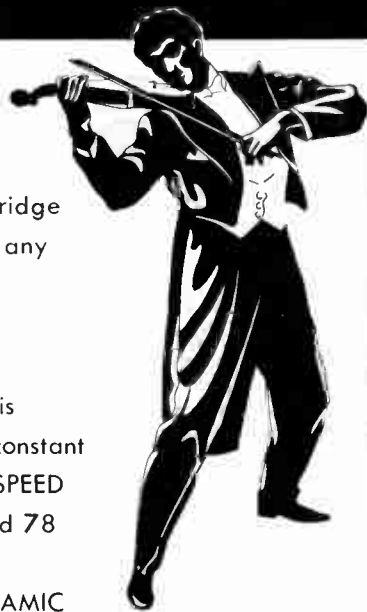

*Weathers Industries*

DIVISION OF ADVANCE INDUSTRIES, INC.

66 E. Gloucester Pike, Barrington, N. J.

Expost: Joseph Plascencia, Inc., 401 Broadway, New York, N. Y.

**WEATHERS TECHNICAL MAGIC IS SOUND**

a quarter-century of  
**PRECISION** know-how is yours  
... in

**PACO**

quality electronic equipment in **KIT FORM**

**PACO** is the only line of test instrument kits engineered and produced under the auspices of a leading test equipment and meter manufacturer—and you pay nothing extra for the convenience of buying **PACO** kits directly from your local electronic parts distributor.

- Compare **PACO** kits against any others for performance, appearance, ruggedness, ease of operation and simplicity of assembly.
- Compare **PACO's** superbly detailed, step-by-step instruction manuals and giant size wiring diagrams, against any you have ever seen.

for

electronic hobbyists and amateur radio  
radio-TV service and maintenance  
science education and technical schools  
hi-fi custom-building and service  
industrial testing and quality control



**Model G-30  
BATTERY  
ELIMINATOR  
KIT**

- 160 Kc to 240 Mc in 8 bands
- 120 Mc fundamental output

**Code: GENNY**  
Kit Net Price: 28.50  
Factory Wired: 39.95

**Model G-30PC** Same as Model G-30 but with pre-calibrated front end.  
**Code: GERRY** Kit Net Price: \$35.50



**Model M-40  
HIGH-SENSITIVITY  
V-O-M KIT**

- 20,000 ohms/volt DC
- 10,000 ohms/volt AC

**Code: METER**  
Kit Net Price: 31.50  
Factory Wired: 37.50



**Model B-10  
BATTERY  
ELIMINATOR  
KIT**

- less than 0.3% ripple output
- no external filter-adaptor required

**Code: HEAVY**  
Kit Net Price: \$41.95  
Factory Wired: 49.50



**Model C-20  
RESISTANCE-  
CAPACITY-  
RATIO BRIDGE  
KIT**

- 10 mmfd to 2000 mfd
- 1/2 ohm to 200 megs

**Code: RATIO**  
Kit Net Price: 20.95  
Factory Wired: 31.50



**Model S-50  
5 INCH  
CATHODE RAY  
OSCILLOSCOPE  
KIT**

- push-pull vertical and horizontal amplifiers

**Code: SCOPE**  
Kit Net Price: 49.50  
Factory Wired: 84.50



**Model S-55  
WIDEBAND 5"  
OSCILLOSCOPE**

- response DC to 5 Mc
- push-pull V and H amplifiers

**Code: SCALE**  
Kit Net Price: 87.50  
Factory Wired 139.50



**Model T-60  
TUBE CHECKER  
KIT**

- full free-point lever selector system
- built-in roll chart

**Code: CHECK**  
Kit Net Price: 38.75  
Factory Wired: 54.50

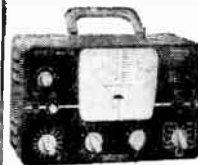

**Model T-65  
TRANSISTOR  
and Crystal Diode  
TESTER KIT**

- test lcco, gain, leakage, shorts, etc.
- tests both p-n-p and n-p-n transistors, plus tetrede types

**Code: TRAIN**  
Kit Net Price: 29.50  
Factory Wired: 59.50

**ACCESSORIES**

Complete factory-wired and tested—ready for use

- For the Model V-70 VTVM
- AV-1 RF crystal probe \$5.95
- AV-2 High-voltage probe \$5.95

- For the Models S-50 and S-55 OSCILLOSCOPES
- AS-1 Set of oscilloscope probes consisting of: low-capacity probe, demodulator probe, direct probe. \$14.95

- For the Model T-60 TUBE TESTER
- AT-1 Standard picture-tube test cable \$4.50
- AT-2 110° picture tube socket adapter \$4.50
- AT-3 Hinged cover for tube tester cabinet \$3.95

- For the Model M-40 V-O-M
- AM-1 High-voltage probe \$5.95

**PACO** kits are available and on display at leading electronic parts distributors. Ask for free descriptive bulletin.

Number 2



**Model V-70  
VACUUM TUBE  
VOLTMETER  
KIT**

- wide-range
- peak-to-peak

**Code: RANGE**  
Kit Net Price: 31.50  
Factory Wired: 47.50



**Model Z-80  
RF-AF SIGNAL  
TRACER KIT**

- high gain RF & AF amplifier
- visual and audible indicator

**Code: TRACE**  
Kit Net Price: 29.50  
Factory Wired: 42.50

All prices and specifications subject to change without notice

**PACO ELECTRONICS CO., INC.**

A DIVISION OF **PRECISION** Apparatus Company, Inc.

70-31 84th Street, Glendale 27, L. I.

Export: 458 Broadway, New York 13 Canada: Atlas Radio Corp., Toronto 19

POPULAR ELECTRONICS

# ELECTRONIC KITS

2nd Edition

*Cover photography by Bruce Pendleton*

**Oliver Read**, Publisher  
**David A. Findlay**, Editor  
**Art Flitzthum**, Art Editor  
**Fred Wetzi**er, Assistant Editor  
**Barbara R. Hearst**, Editorial Assistant  
**John A. Ronan, Jr.**, Advertising Director  
**William G. McRoy**, Advertising Manager



ZIFF-DAVIS PUBLISHING COMPANY, One Park Ave., New York 16, N. Y.  
William B. Ziff, Chairman of the Board (1946-1953);  
William Ziff, President;  
W. Bradford Briggs, Executive Vice President  
Michael Michaelson, Vice President and Circulation Director,  
Hershel B. Sarbin, Secretary;  
Howard Staughton, Jr., Treasurer;  
Albert Gruen, Art Director.

Copyright © 1959 by Ziff-Davis Publishing Company. All Rights Reserved

Electronic Kits

# The Greatest In... TEST INSTRUMENTS

... that's the opinion of leading electronic engineers, radio service people and amateur radio enthusiasts. And Precise has achieved this reputation, too, because of its efforts to bring you the best possible equipment at the lowest possible prices. You can depend on Precise for quality—based upon ingenuity, originality, and production "know-how."

## Mutual Conductance and Emission TUBE TESTER

Here is a tester that actually checks a tube for its application, not whether it is just good or bad. GM and emission are checked separately. It is the first and only device that measures 600-mil tubes on a meter. Sweeps from 0 through the normal testing range when making measurements to give an average evaluation of the tube over an extended range of operation. Selected for use by the United States Department of Standards. MODEL 111K, Kit, \$79.95; MODEL 111W, Factory-wired.....\$139.95

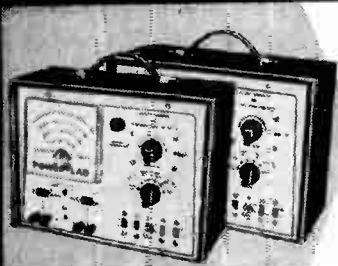

## Precise Development's POWER-LAB

A single instrument that takes the place of eleven pieces of equipment. Operates as A BATTERY ELIMINATOR, BATTERY CHARGER, HIGH CURRENT (20-AMP.) LINE VOLTAGE VARIAC, AC LINE VOLTAGE METER, AC LINE AMMETER, AC LINE WATTMETER, AC LINE ISOLATION TRANSFORMER, LOW-VOLTAGE HIGH-CURRENT AC SUPPLY, DC LINE VOLTAGE VARIABLE SUPPLY, DC HIGH CURRENT AMMETER, AGC BIAS BOX. Large, professional meter—it's fantastic—and what a value! With 100 watts of isolation: MODEL 711, kit, \$49.95; MODEL 711W, Factory-wired, \$64.95. With 300 watts of isolation: MODEL 713K, Kit, \$62.95; MODEL 713W, Factory-wired.....\$79.95

## Printed-Circuit, Voltage-Regulated, Peak-to-Peak VTVM

With Tilting Meter Movement and Magic Lead Switch. Here's another all-new Precise-engineered instrument, designed with you in mind... to make it easier and more convenient as you test. All-new features include voltage regulation, printed circuitry, etched front panel PLUS the exclusive Meter Movement Tilt that permits you to turn the meter to face eye-level, no matter where you place the instrument on the bench... AND the Magic Lead Switch that permits you to short and open leads automatically for zero or infinite adjust without removing the leads from the circuit under test! MODEL 904K, Kit, \$34.95; MODEL 904W, Factory-wired.....\$49.95

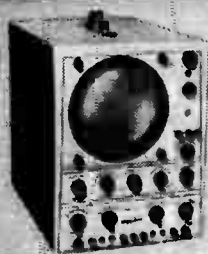

## Precise Development's COLOR TV OSCILLOSCOPE

No other oscilloscope at any price, high or low, offers so many desired features! Providing a big 7-inch tube, this fabulous instrument is designed to help you solve any color TV problem. It contains low-loss components and has an over-designed fused power supply for additional circuitry.

You'll find such special features as a Sweep Magnifier, Triggered Sweep Sync Amplifier, Differential Inputs, Gated and Saw-tooth Outputs, etc. This amazing new scope is the result of over 12,000 hours of engineering. It shows more, tells more and gives more than all other commercial scopes. MODEL 300K, Kit, \$99.95; MODEL 300W, Factory-wired.....\$199.50

# precise

DEVELOPMENT CORPORATION  
OCEANSIDE, N. Y. Cable Address: CHURCHIN

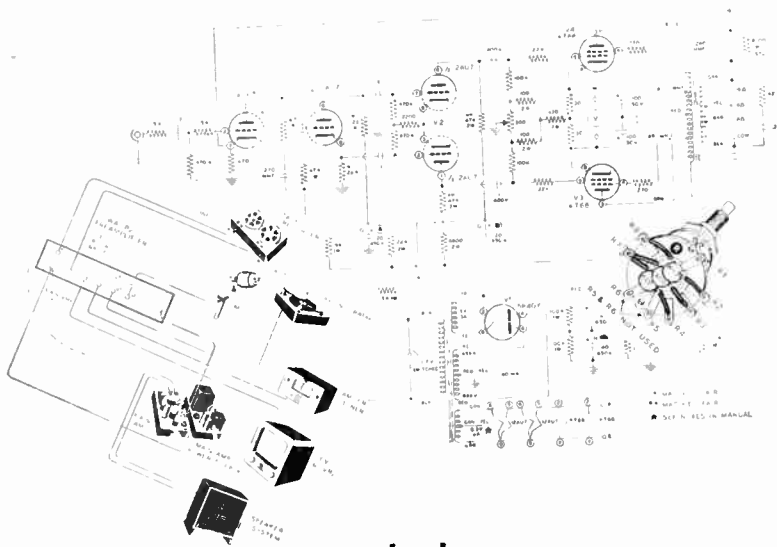

## contents

kit builder's guide.....	10
kits for your hi-fi.....	27
directory of hi-fi kits.....	61
kits for the shop.....	83
directory of shop kits.....	103
kits for the ham.....	119
directory of ham kits.....	130
kits for fun and education.....	141
Directory of Kits For Fun And Education.....	150

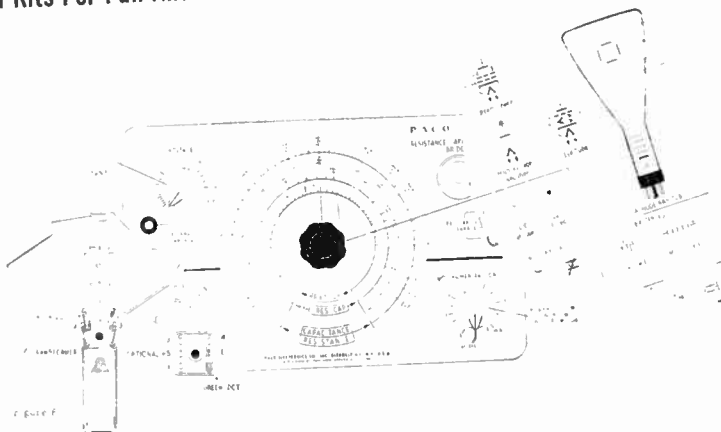

**SOMETHING NEW\* HAS BEEN ADDED TO THE DEVRy TECH TRAINING PROGRAM**

Prepare in Spare Time At Home for a

# JOB THAT PAYS REAL MONEY

## in TELEVISION-RADIO-ELECTRONICS

Many DeVry-trained men who now hold good jobs paying real money were once looking for opportunity, yet wondering if they needed advanced schooling, special experience, or higher math. They clipped a DeVry Tech coupon, mailed it in—and were pleasantly SURPRISED! Now they work in one of today's fastest-growing fields—TELEVISION-RADIO-ELECTRONICS. Many have their own profitable service shops. DeVry Tech's "Learn-by-Seeing," "Learn-by-Reading," "Learn-by-Doing" training made the difference! You, too, may train at home the DeVry Tech way with wonderful, helpful movies, clear texts and valuable home laboratory equipment—or in our well-equipped Chicago or Toronto Training Centers.

Now something NEW\* has been added to help you learn more by "doing." You can choose to build and keep your own top quality 6-speaker STEREPHONIC SOUND SYSTEM that will provide thrilling enjoyment for years to come. Plans are furnished so that you can also build your own speaker cabinets—or we can tell you where to buy them. DeVry Tech's specially designed Stereo System includes:

- Turntable with Stereo cartridge • Stereo Amplifier
- Stere Pre-Amplifier • 2 Cross-Over Networks
- Six Speakers: two 12-in., two 8-in., two 3-in.

When you build your own equipment, you learn about the working parts. You can repair, adjust, maintain. You learn by doing—the DeVry Tech way. You put basic principles into "on-the-job" practice.

**\* NEW!**

### Build Your Own 6-Speaker HIGH FIDELITY STEREPHONIC SOUND SYSTEM

... another wonderful DeVry advantage

Special SHORT COURSE in High Fidelity Sound Reproduction including Stereophonic Systems also available. Ideal for hobbyists, music lovers and those wanting to ADD to their incomes.

#### MANY OPTIONS!

NOW . . . DeVry Tech men can take their choice of any or all of the quality equipment shown above: The Stereo System . . . the Scope and Meter . . . a 21-inch TV Set (not pictured) . . . or ALL THREE. But no matter which way you do it, you get practical home training at its best . . . the kind you need to get started in the fast-moving Electronics field. Send coupon for details.

"One of North America's Foremost Electronics Training Centers"

Accredited Member of National Home Study Council



## DEVRY TECHNICAL INSTITUTE

4141 BELMONT • CHICAGO 41, ILL. • Formerly DeFOREST'S TRAINING, Inc.



VACUUM TUBE VOLT METER

5 INCH COLOR OSCILLOSCOPE

**GET 2 FREE BOOKLETS!**

Clip the coupon now for two booklets that answer many questions about your chances for success in this field. "Electronics and YOU" and the remarkable "Pocket Guide to Real Earnings" (just off the press) are yours without obligation.

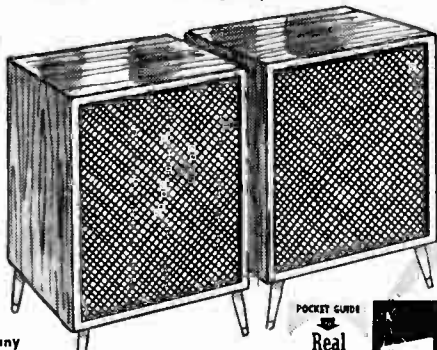

#### EMPLOYMENT SERVICE

DeVry Tech offers real, down-to-earth employment service to help you toward a good job's offer graduation — even provides help in starting your own servicing business.

POCKET GUIDE Real Earnings



#### MAIL TODAY FOR FREE FACTS

DeVry Technical Institute  
4141 Belmont Ave., Chicago 41, Ill., Dept. EK-P  
Please give me your two FREE booklets, "Pocket Guide to Real Earnings" and "Electronics and YOU," and tell me how to prepare to enter one or more branches of Electronics.

NAME \_\_\_\_\_ AGE \_\_\_\_\_

STREET \_\_\_\_\_ A.P.T. \_\_\_\_\_

CITY \_\_\_\_\_ ZONE \_\_\_\_\_ STATE \_\_\_\_\_

Check here if subject to military training

DeVry Tech's Canadian Training Center is located at

2053 626 Roselawn Avenue, Toronto 12, Ontario

## article index

Fun With Kits.....	12
Kit Component Identification Guide.....	16
Troubleshooting Without Tears.....	22
Picking Your Hi-Fi Kits.....	28
Building Your Own Monaural Amplifier.....	30
Thorens Turntable Kit.....	32
Grommes 60 Watt Power Amplifier.....	36
Knight Stereo Preamp.....	38
Four-Speed Changer Kit.....	40
Building a Stereo Preamp Control Center.....	42
Making the Precise AM-FM Tuner.....	46
Building Your Own Tape Recorder.....	48
Stereo Remote Control Center.....	50
Integrated Amplifier for Stereo.....	51
Rek-O-Kut K33 Turntable.....	53
Acrosound Ultra-Linear II Power Amplifier.....	55
Electro-Voice Aristocrat Enclosure.....	57
Quick-Built Speaker Enclosure.....	58
Directory of Hi-Fi Kits.....	61
Paco T-65 Transistor Tester.....	84
Build A Vacuum-Tube Voltmeter.....	86
Paco Audio R. F. Signal Tracer.....	89
An Easy-To-Wire Multitester Kit.....	91
Build A Wide-Band Oscilloscope.....	94
Electro Products KPS-2 Power Supply.....	96
Precise AM-FM Signal Generator.....	99
Make A King Size VTVM.....	101
Directory of Shop Kits.....	103
Kits And Amateur Radio.....	120
Build A 90-Watt CW Transmitter.....	122
Mobile Transmitter For Phone Fun.....	125
Build A Variable Frequency Oscillator.....	127
Intercom For Your Home.....	142
A Superhet For Your Table.....	143
A Radio In Your Pocket.....	144
Clock Radio.....	146
Lafayette Telephone Amplifier.....	148
Directory of Kits For Fun And Education.....	150



**New!  
YEARS AHEAD!**

# Lafayette STEREO TUNER KIT

**THE MOST  
FLEXIBLE TUNER  
EVER  
DESIGNED**

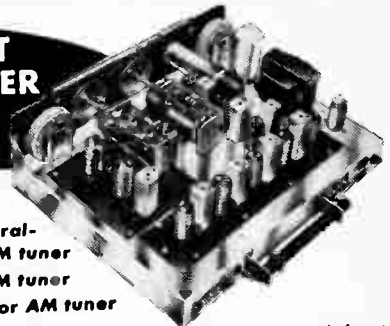
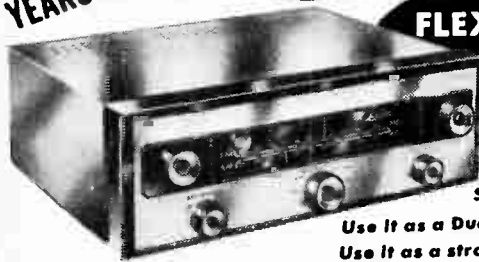

Use It as a Binaural-  
Stereophonic FM-AM tuner  
Use It as a Dual-Monaural FM-AM tuner  
Use It as a straight Monaural FM or AM tuner

- Multiflex Output for New Stereo FM
- 11 Tubes (including 4 dual-purpose) + Tuning Eye + Selenium rectifier Provide 17 Tube Performance
- 10KC Whistle Filter • Pre-aligned IF's
- Tuned Cascades FM • 12 Tuned Circuits
- Dual Cathode Follower Output
- Separately Tuned FM and AM Sections
- Armstrong Circuit with FM/AFC and AFC Defeat
- Dual Double-Tuned Transformer Coupled Limiters.

More than a year of research, planning and engineering went into the making of the Lafayette Stereo Tuner. Its unique flexibility permits the reception of binaural broadcasting (simultaneous transmission on both FM and AM), the independent operation of both the FM and AM sections at the same time, and the ordinary reception of either FM or AM. The AM and FM sections are separately tuned, each with a separate 3-gang tuning condenser, separate fly-wheel tuning and accurate volume control for proper balancing when used for binaural programs. Simplified accurate knife-edge tuning is provided by magic eye which operates independently on FM and AM. Automatic frequency control "locks in" FM signal permanently. Aside from its unique flexibility, this is, above all else, a quality high-fidelity tuner incorporating features found exclusively in the highest priced tuners.

The 5 controls of the KT-500 are FM Volume, AM Volume, FM Tuning, AM Tuning and 5-position Function Selector Switch. Tastefully styled with gold-brass escutcheon having dark maroon background plus matching maroon knobs with gold inserts. The Lafayette Stereo Tuner was designed with the builder in mind. Two separate printed circuit boards make construction and wiring simple, even for such a complex unit. Complete kit includes all parts and metal cover, a step-by-step instruction manual, schematic and pictorial diagrams. Size is 13 3/4" W x 10 3/8" D x 4 1/2" H. Shpg. wt., 22 lbs.

The new Lafayette Model KT-500 Stereo FM-AM Tuner is a companion piece to the Models KT-600 Audio Control Center Kit and KT-310 Stereo Power Amplifier Kit.

**KT-500 IN KIT FORM**  
**74.50**  
ONLY 7.45 DOWN  
7.00 MONTHLY

Net 74.50  
Net 124.50

KT-500 .....  
LT-50 Same as above, completely factory wired and tested .....

## NEW! LAFAYETTE PROFESSIONAL STEREO MASTER AUDIO CONTROL CENTER

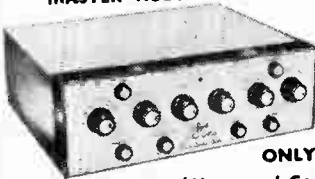

**KT-600**  
**79.50**  
IN KIT FORM

ONLY 7.95 DOWN

Solves Every Stereo/Monaural Control Problem!

- UNIQUE STEREO & MONAURAL CONTROL FEATURES
- AMAZING NEW BRIDGE CIRCUITRY FOR VARIABLE 3d CHANNEL OUTPUT & CROSS-CHANNEL FEED
- PRECISE "NULL" BALANCING SYSTEM

**A REVOLUTIONARY DEVELOPMENT IN STEREO HIGH FIDELITY.** Provides such unusual features as a Bridge Control, for variable cross-channel signal feed for elimination of "ping-pong" (exaggerated separation) effects and for 3d channel output volume control for 3-speaker stereo systems; 3d channel output also serves for mixing stereo to produce excellent monaural recordings. Also has full input mixing of monaural program sources, special "null" stereo balancing and calibrating system (better than meters), 24 equalization positions, all-concentric controls, rumble and scratch filters, loudness switch. Clutch type volume controls for balancing or as 1 Master Volume Control. Has channel reverse, electronic phasing, input level controls. Sensitivity 1.78 millivolts for 1 volt out. Dual low-impedance outputs (plate followers), 1300 ohms. Response 10-25,000 cps  $\pm$  0.5 db Less than .03% IM distortion. Uses 7 new 7025 low-noise dual triodes. Size 14" x 4 1/2" x 10 3/4". Shpg. wt., 16 lbs. Complete with printed circuit board, cage, profusely illustrated instructions, all necessary parts.

LAFAYETTE KT-600 - Stereo Preamplifier Kit Net 79.50  
Lafayette IA-600 - Stereo Preamplifier, Wired Net 134.50

## NEW! LAFAYETTE STEREO/MONAURAL 36-WATT BASIC AMPLIFIER

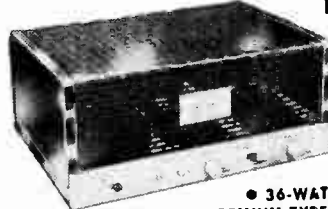

**KT-310**  
**47.50**  
IN KIT FORM  
ONLY 4.75 DOWN

- 36-WATT STEREO AMPLIFIER
- 4 PREMIUM-TYPE 7189 OUTPUT TUBES
- RESPONSE 35-30,000 CPS  $\pm$  1/2 DB • 18 WATTS PER STEREO CHANNEL OR 36 WATTS MONAURALLY
- 2 PRINTED CIRCUIT BOARDS FOR NEAT, EASY WIRING

A superbly-performing basic stereo amplifier, in easy-to-build kit form to save you lots of money and let you get into stereo now at minimum expense! Dual inputs, each provided with individual volume control. The unit may be used with a stereo preamplifier for 2 18-watt stereo channels, or at the flick of a switch, as a top-quality 36-watt monaural amplifier; or, if desired, it may be used as 2 separate monaural 18-watt amplifiers! CONTROLS include 2 input volume controls, channel reverse switch (AB-BA), monaural-stereo switch. **DUAL OUTPUT IMPEDANCES** are: 4, 8, 16 and 32 ohms (permitting paralleled monaural operation of 2 speaker systems of up to 16 ohms). **INPUT SENSITIVITY** is 0.45 volts per channel for full output. TUBES are 2-6AN8, 4-7189; GZ34 rectifier. **SIZE** is 9-3/16" d (10-9/16" with controls) x 5 1/4" h x 13 3/4" w. Supplied complete with perforated metal cage, all necessary parts and detailed instructions. Shpg. wt., 22 lbs.

KT-310 Stereo Power Amplifier Kit Net 47.50

**Lafayette Radio**

P.O. Box 511 JAMAICA 31, N.Y.  
DEPT. KBH-9

CUT OUT  
AND PASTE  
ON POST  
CARD

Send FREE LAFAYETTE Catalog 590  
Name.....  
Address.....  
City..... Zone..... State.....

165-08 Liberty Ave. JAMAICA, N. Y. AXtel 1-7000

NEW YORK BOSTON BRONX NEWARK PLAINFIELD  
100 Sixth Avenue 110 Federal St 542 E. Fordham Rd 24 Central Ave 139 W. Second St

## kit builder's guide

Fun With Kits	12
Kit Component Identification Guide	16
Troubleshooting Without Tears	22

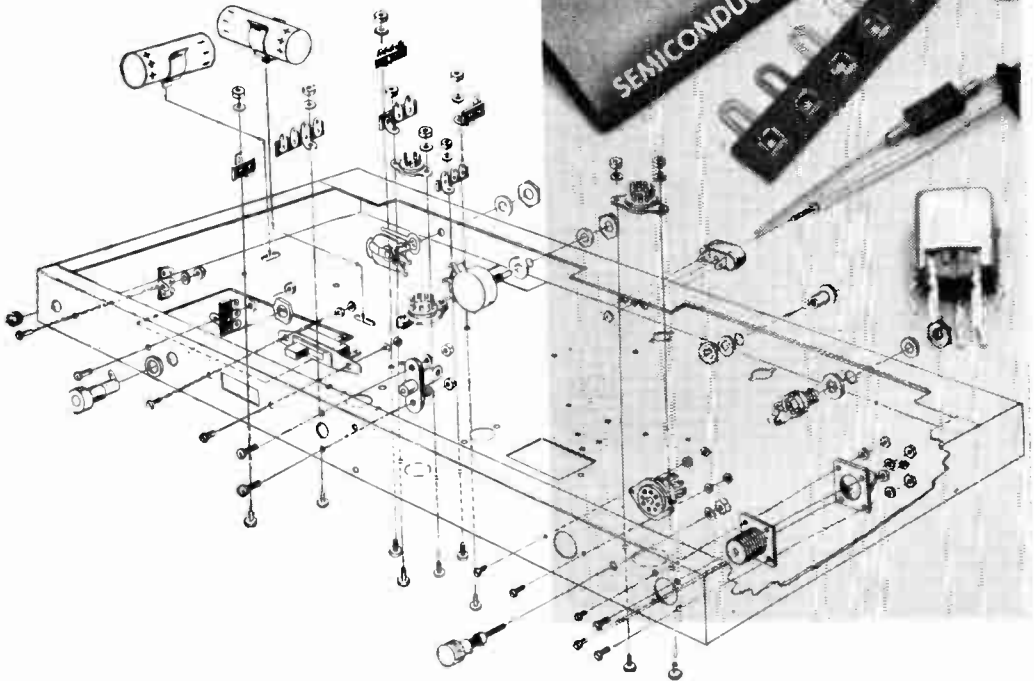

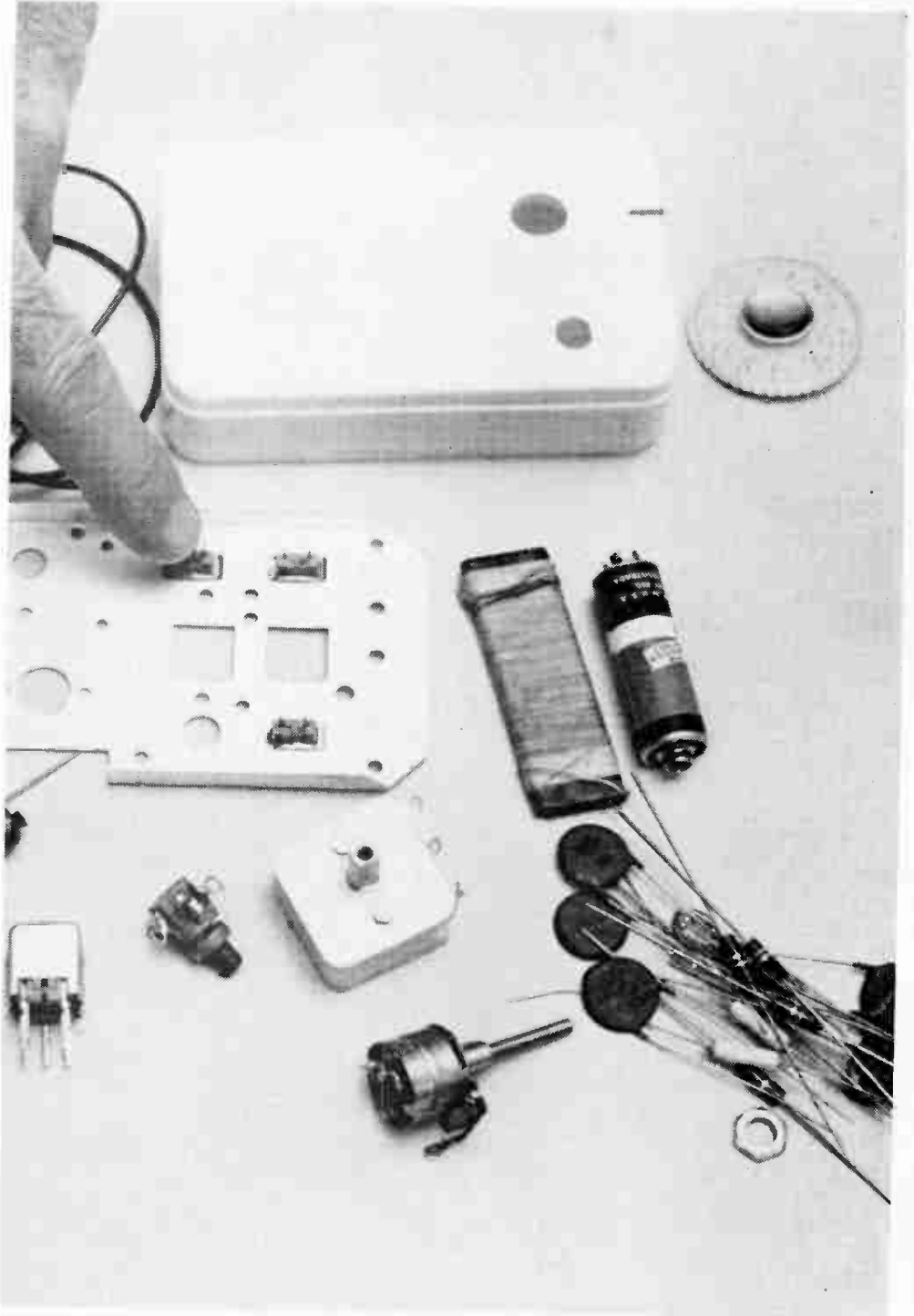



## Fun with Kits

Do-it-yourself has long been an American pastime. Gardening, home decorating, and home crafting with expensive power tools are just a few of the hobbies that have occupied many of us in our spare time. A modern one, electronics, although a highly technical subject, has become one of the most interesting do-it-yourself activities for many people, young and old.

One reason for the growing popularity of electronic kits is that very useful devices can be built with only a handful of tools. Too, only minimum space is required in the home for the assembly. Although metal chassis and mountings are used, no power drills, lathes or other metal-working machinery are needed. All metal parts are cut to size and holes drilled by the kit manufacturer. All engineering and design work has been done and all parts are of good quality.

Attesting to the quality of the finished equipment, and the job it can do, is the fact that many production lines and laboratories of companies making radio and television receivers and other electronic gear are using test instruments assembled from kits avail-

able to anyone. Although they depend on expensive laboratory equipments for high accuracy, they use units built from kits for routine checking and monitoring of electronic circuits.

Many kits form final units that are of use to anyone in the home. Radio receivers, television sets, hi-fi amplifiers and other components, safety devices for car and boat, all are available as kits, as well as the more specialized pieces of equipment used by amateur radio operators, experimenters, technicians and engineers.

Fun starts when you receive the kit and start unpacking it. Many of the components will be in boxes, others will be in paper envelopes. Sometimes parts will be wrapped in tissue paper so be sure to examine all of the packing materials before throwing them away.

At first you will take components out of the box at random just to see what they are, to admire them and to imagine with pride the appearance of the finished piece of equipment. When you come to the packing slip, or slips as the case may be, put them aside in

Electronic Kits

a safe place. After the unpacking excitement has worn off, check all of the items found against the parts list to be sure that none are missing or broken. If there is another list of parts in the instruction manual that accompanies the kit, check every item against this list also.

Some readers may not be familiar with the technical names of certain parts and may have difficulty identifying them on the parts list. Put these strange ones in a special spot on the table where you are working and continue checking off those that can be positively identified. After all of these are checked, the handful of strangers can be located in the photographs or pictorial drawings in the manual. They are usually marked by call-outs or keyed by part numbers.

It will seldom be found that parts are missing or even broken during shipping, but if either has occurred it is imperative that you get in touch with the manufacturer, the post office or the express company as soon as possible.

#### where to assemble a kit

All of us can find enough space for working on our kits. Some have cellars, attics or garages where we can get away from it all, and we are not stepping on some one else's living space. If we live in an apartment, the problem is more serious. Our gear then is subject to

the whims of other members of the family, wife and small children, when we are not around to protect it. And the small electronic parts we find so interesting and essential are attractive nuisances to others.

Fortunately, the space we need is only a table or desk top. Even a card table in a bedroom can do a very creditable job and has the added advantage that it can be cleared off each evening, folded up, and put away until we find more spare time to continue our project. Since only a very few kits are one-evening projects, there is some advantage in being able to stop our assembly and leave everything just so, to be continued from there next time.

Try to provide adequate lighting from overhead rather than from a desk lamp. The lamp takes up work space that is more valuable for the components and tools and it might tip over into your project if its cord gets tangled with your soldering iron cord. Use an extension cord for the iron if necessary to keep the cord from draping itself across the desk. Use a straight-back chair, you will be so interested in what you are doing that you won't want to lounge. Avoid cluttering up the work space with parts that won't be needed until the last steps. Pieces that form the cabinet and the tubes won't be a problem if you store them in the carton on the floor or a shelf some place.



Some valuable small parts may be overlooked.

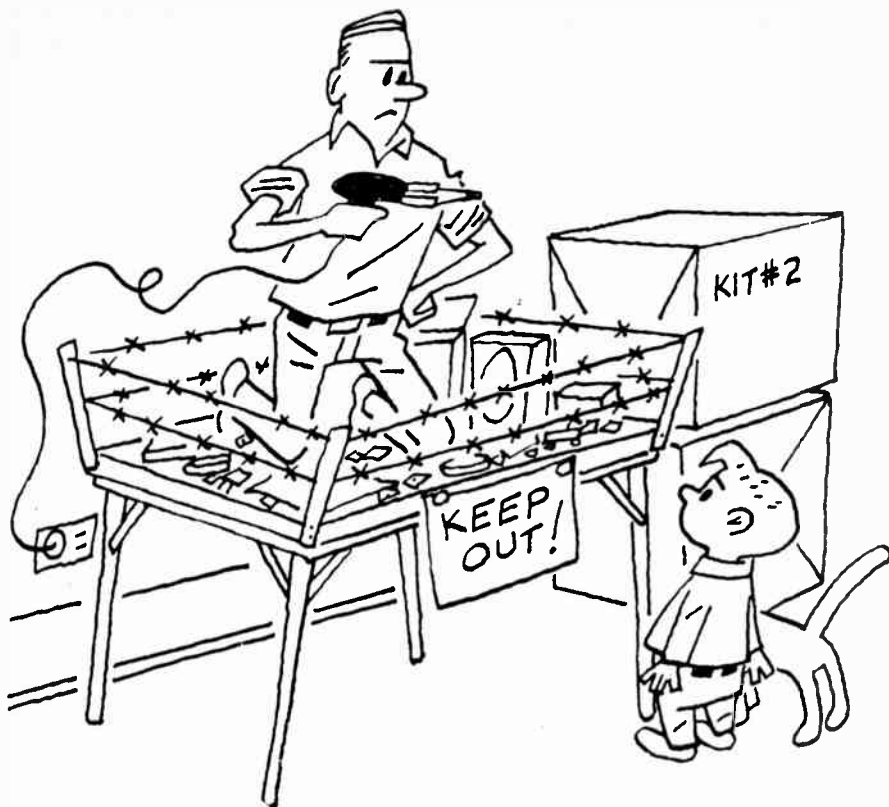

\*  
\*  
\*  
\*  
\*

If you can persuade the other members of the family not to touch anything when you're not around, you will have an ideal setup.

Most kit instruction manuals have been prepared by skilled technicians who have tested the steps by having inexperienced people assemble sample kits. The errors that they made have been noted and the instructions revised to prevent purchasers of the kit from making the same errors. The steps involved are arranged in a logical order to simplify the assembly for you.

Please be sure that you understand the step before you carry out the instruction. Use the check space along side of each step after you have completed it. This is particularly important if you have to stop your work and do some errand or are otherwise interrupted. If each step is checked as you progress, you can resume work at once, even after days of layoff.

Some kit builders mark the circuit diagram with a colored pencil when they add each part and wire to the assembly. Any that have been inadvertently omitted then show up when the last stages are reached with no colored markings. Other kit builders want

to keep the circuit diagram intact for future reference use and put a piece of tracing paper over the diagram and mark each part and wire on this.

Sometimes instruction sheets that are in addition to the manual come with a kit. These may give alternate circuits that can be followed for special purposes or may add additional instructions that the manufacturer has found helpful to you after he has sold several thousand kits. Transfer these notes into the regular manual before starting construction of your kit. Page and step numbers are provided so that you make the proper insertion. If you leave this to later, you will find that previous steps will need to be undone or changed, or worse, you won't correct previous steps and wind up with a mess that will be exceedingly difficult to trace and correct.

All instruction manuals for kits contain complete instructions for soldering. If you have never done any soldering of electronic circuits, study the instructions carefully and do some practicing with scrap pieces of wire and some junk parts. If the parts are very old the lugs will be oxidized and dirty and you will find that the solder will not flow to the lug properly and make a good joint. It will tend to "ball" and although it may seem to be mechanically sound, a slight movement of the wire will permit the gob of solder to work loose. It may not fall out of the lug and it may stick properly to the wire if it is new wire, but it is not making a good electrical connection. Remove the wire from the lug and scrape the oxidation and dirt from the lug with a small knife. Turn it and scrape it on all sides until the metal is shiny. If you

have done a thorough job, you can resolder the wire to the lug and it will form a good joint. The solder will flow evenly into the lug and securely hold the wire. Moving the wire now should not loosen it.

Some experienced kit builders measure the resistance of each resistor with an ohmmeter. This is a good idea, but unless you are adept at reading the scale correctly on each range, you might make errors, particularly on the crowded portion of the meter scale. It is necessary to remember that nearly all resistors have a tolerance of plus or minus 20 percent. Thus a resistor that is color coded 100 ohms might show as little as 80 ohms or as high as 120 ohms on an ohmmeter. Any value in between is all right to use. Where precision resistors are used by kit manufacturers, the resistors are usually marked 1%, and these will read that value on an accurate ohmmeter.

Occasionally the manufacturer may be short of a certain value of resistor and will substitute another value, such as 220,000 instead of 200,000 ohms. No problem, such substitutions have been checked and the equipment will operate just as well.

After all of the wiring is completed, make the tests recommended in the instruction manual. If some circuit doesn't check out properly, go back and retrace the steps involved. Take your time now, you may save a lot of time and trouble—and money. One wire to the wrong lug and one or more tubes might burn out or other fireworks take place when the instrument is plugged in to the power line or batteries.

Finally there comes that breathless moment. You throw the power switch on . . . YOW! It works!

To all, the finished kit furnishes pride of achievement and the fun of putting it together.

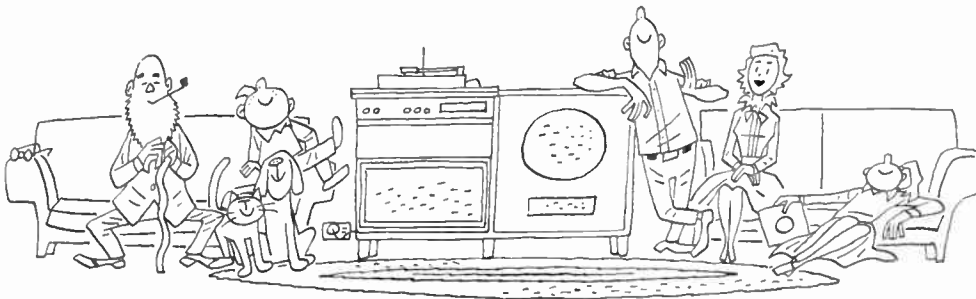

# KIT COMPONENT IDENTIFICATION GUIDE

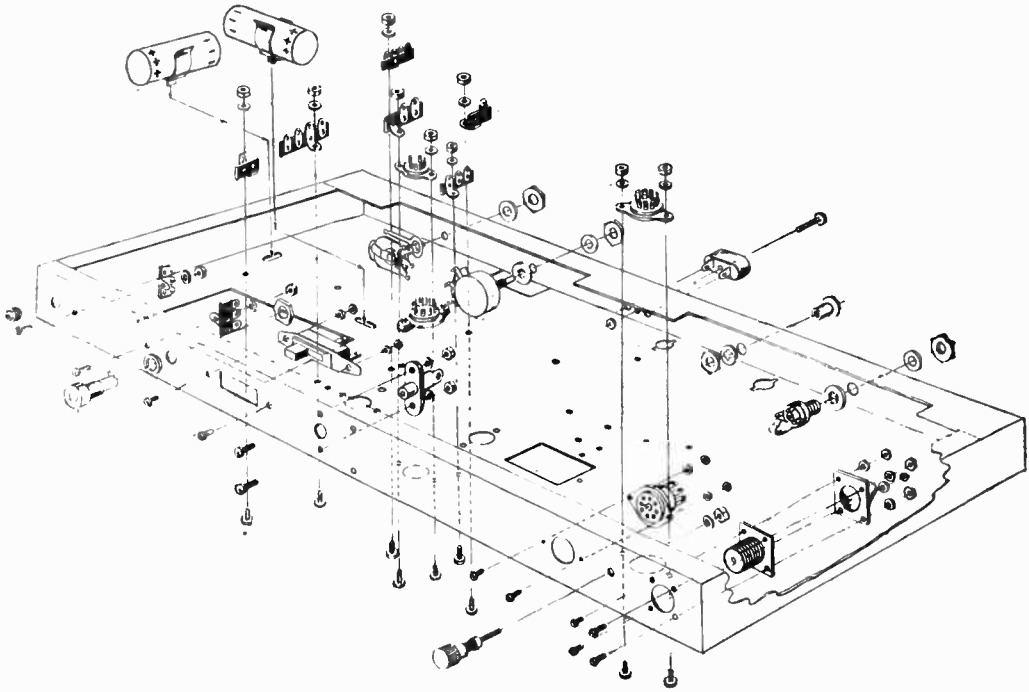

When you first open your kit, a myriad of components, wires, diagrams and instructions confront you. Taking first things first, familiarize yourself with the instructions and step-by-step procedure, checking pictorials as you go. The next thing to do is check all the parts against the parts list.

The hunt begins.

For those who don't know a resistor from a grommet, parts identification will be a long task, indeed.

It would be next to impossible to list all sizes and shapes of all conceivable components here, but on the following pages is a comprehensive general guide to most often used components.



## RESISTORS AND CAPACITORS



RESISTOR 1/2 WATT



CERAMIC DISC CAPACITOR



CERAMIC DISC CAPACITOR



MOLDED TUBULAR CAPACITOR



ELECTROLYTIC CAPACITOR



ELECTROLYTIC CAPACITOR

## TRANSFORMER AND RECTIFIER

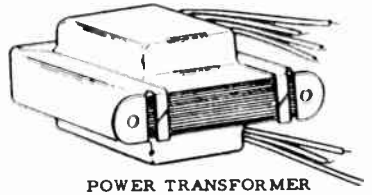

POWER TRANSFORMER



SELENIUM RECTIFIER

## SOCKET, TERMINAL POSTS AND JACKS



2-LUG TERMINAL POST



3-LUG TERMINAL POST



SINGLE PHONO JACK

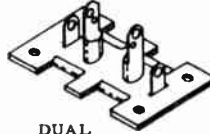

DUAL PHONO JACK

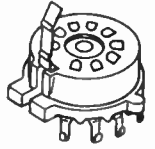

9 PIN MINIATURE TUBE SOCKET

## SWITCH AND CONTROLS

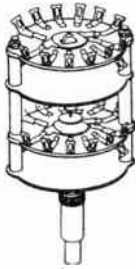

4 POLE, 5 POSITION SWITCH

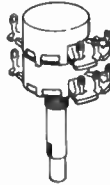

CLUTCH TYPE DUAL VOLUME CONTROL

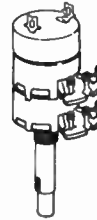

DUAL CONTROL WITH SWITCH

## tube sockets



TRANSISTOR



MOUNTING RING



SOCKET

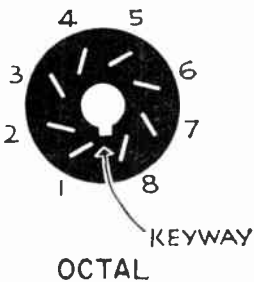

OCTAL

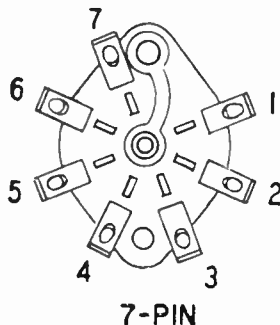

7-PIN

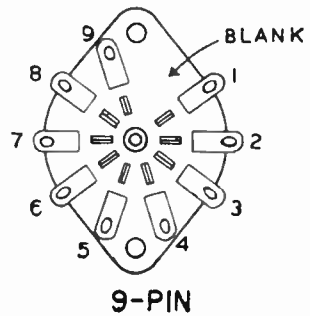

9-PIN

# Resistor-Capacitor Color Code

## COLOR BAND SYSTEM

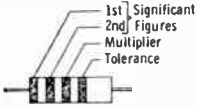

Resistors With Black Body Color Are Composition, Non-Insulated. Resistors With Colored Bodies Are Composition, Insulated. Wire-Wound Resistors Have The 1st Digit Color Band Double Width.

## RESISTOR CODES (RESISTANCE GIVEN IN OHMS)

COLOR	DIGIT	MULTIPLIER	TOLERANCE
BLACK	0	1	±20%
BROWN	1	10	±1%
RED	2	100	±2%
ORANGE	3	1000	±3%
YELLOW	4	10000	GMV*
GREEN	5	100000	±5% (RETMA Alternate)
BLUE	6	1000000	±6%
VIOLET	7	10000000	±12 1/2%
GRAY	8	.01 (RETMA Alternate)	±3%
WHITE	9	.1 (RETMA Alternate)	±10% (RETMA Alternate)
GOLD		.1 (JAN and RETMA Preferred)	±5% (JAN and RETMA Pref.)
SILVER		.01 (JAN and RETMA Preferred)	±10% (JAN and RETMA Pref.)
NO COLOR			±20%

\*GMV - guaranteed minimum value, or -0 - 100% tolerance.  
 ±3, 6, 12 1/2, and 30% are ASA 40, 20, 10, and 5 step tolerances.

## BODY-END-DOT SYSTEM

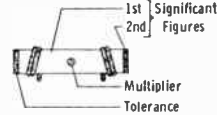

## BODY-END BAND SYSTEM

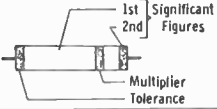

## DISC CERAMICS (5-DOT SYSTEM)

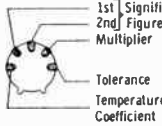

## DISC CERAMICS (3-DOT SYSTEM)

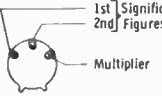

## CERAMIC CAPACITOR CODES (CAPACITY GIVEN IN MMF)

COLOR	DIGIT	MULTIPLIER	TOLERANCE		TEMPERATURE COEFFICIENT PPM/°C	EXTENDED RANGE TEMP. COEFF. SIGNIFICANT FIGURE
			10MMF or LESS	OVER 10MMF		
BLACK	0	1	±2.0MMF	±20%	0(NPO)	0.0
BROWN	1	10	±0.1MMF	±1%	-33(N033)	-1
RED	2	100		±2%	-75(N075)	1.0
ORANGE	3	1000		±2.5%	-150(N150)	1.5
YELLOW	4	10000			-220(N220)	2.2
GREEN	5		±0.5MMF	±5%	-330(N330)	3.3
BLUE	6				-470(N470)	4.7
VIOLET	7				-750(N750)	7.5
GRAY	8	.01	±0.25MMF		+30(P030)	
WHITE	9	.1	±1.0MMF	±10%	General Purpose Bypass & Coupling +100(P100) (Jan)	
SILVER						±10000
GOLD						

Ceramic capacitor voltage ratings are standard 500 volts, for some manufacturers, 1000 volts for other manufacturers, unless otherwise specified.

## HIGH CAPACITY TUBULAR CERAMICS INSULATED OR NON-INSULATED

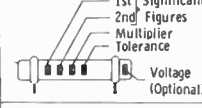

## TEMPERATURE COMPENSATING TUBULAR CERAMICS



## MOLDED-INSULATED AXIAL LEAD CERAMICS

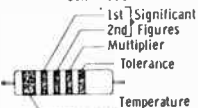

## TYPOGRAPHICALLY MARKED CERAMICS

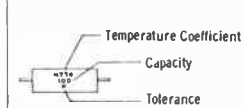

JAN LETTER	TOLERANCE	
	10MMF or LESS	OVER 10MMF
C	±0.25MMF	
D	±0.5MMF	
F	±1.0MMF	±1%
G	±2.0MMF	±2%
J		±5%
K		±10%
M		±20%

## EXTENDED RANGE T.C. TUBULAR CERAMICS

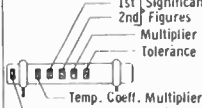

## MOLDED CERAMICS Using Standard Resistor Color-Code

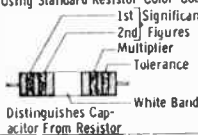

## BUTTON CERAMICS

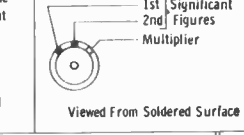

## STAND-OFF CERAMICS

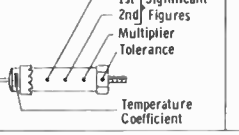

## FEED-THRU CERAMICS

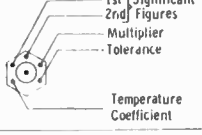

## MOLDED MICA CAPACITOR CODES (Capacity Given In MMF)

COLOR	DIGIT	MULTIPLIER	TOLERANCE	CLASS OR CHARACTERISTIC
BLACK	0	1	20%	A
BROWN	1	10	1%	B
RED	2	100	2%	C
ORANGE	3	1000	3%	D
YELLOW	4	10000		E
GREEN	5		5% (RETMA)	F (JAN)
BLUE	6			G (JAN)
VIOLET	7			H (RETMA)
GRAY	8			I (RETMA)
WHITE	9		5% (JAN)	J (RETMA)
GOLD		.1	5%	
SILVER		.01	10%	

Class or characteristic denotes specifications of design involving Q factors, temperature coefficients, and production test requirements. All axial lead mica capacitors have a voltage rating of 300, 500, or 1000 volts. \*or ±1.0 MMF whichever is greater.

## MOLDED PAPER CAPACITOR CODES (Capacity Given In MMF)

COLOR	DIGIT	MULTIPLIER	TOLERANCE
BLACK	0	1	20%
BROWN	1	10	
RED	2	100	
ORANGE	3	1000	
YELLOW	4	10000	
GREEN	5	100000	5%
BLUE	6	1000000	
VIOLET	7		
GRAY	8		10%
WHITE	9		5%
GOLD			10%
SILVER			20%
NO COLOR			

## MOLDED PAPER TUBULAR

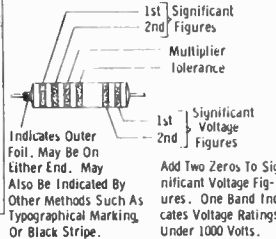

## CURRENT STANDARD JAN AND RETMA CODE

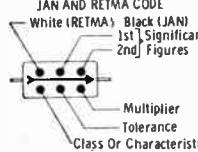

## BUTTON SILVER MICA

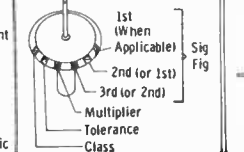

## MOLDED FLAT PAPER CAPACITORS (COMMERCIAL CODE)

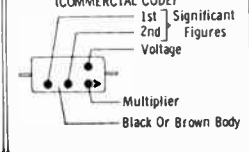

## MOLDED FLAT PAPER CAPACITORS (JAN CODE)

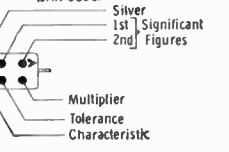

# Symbols for Electronic Circuits

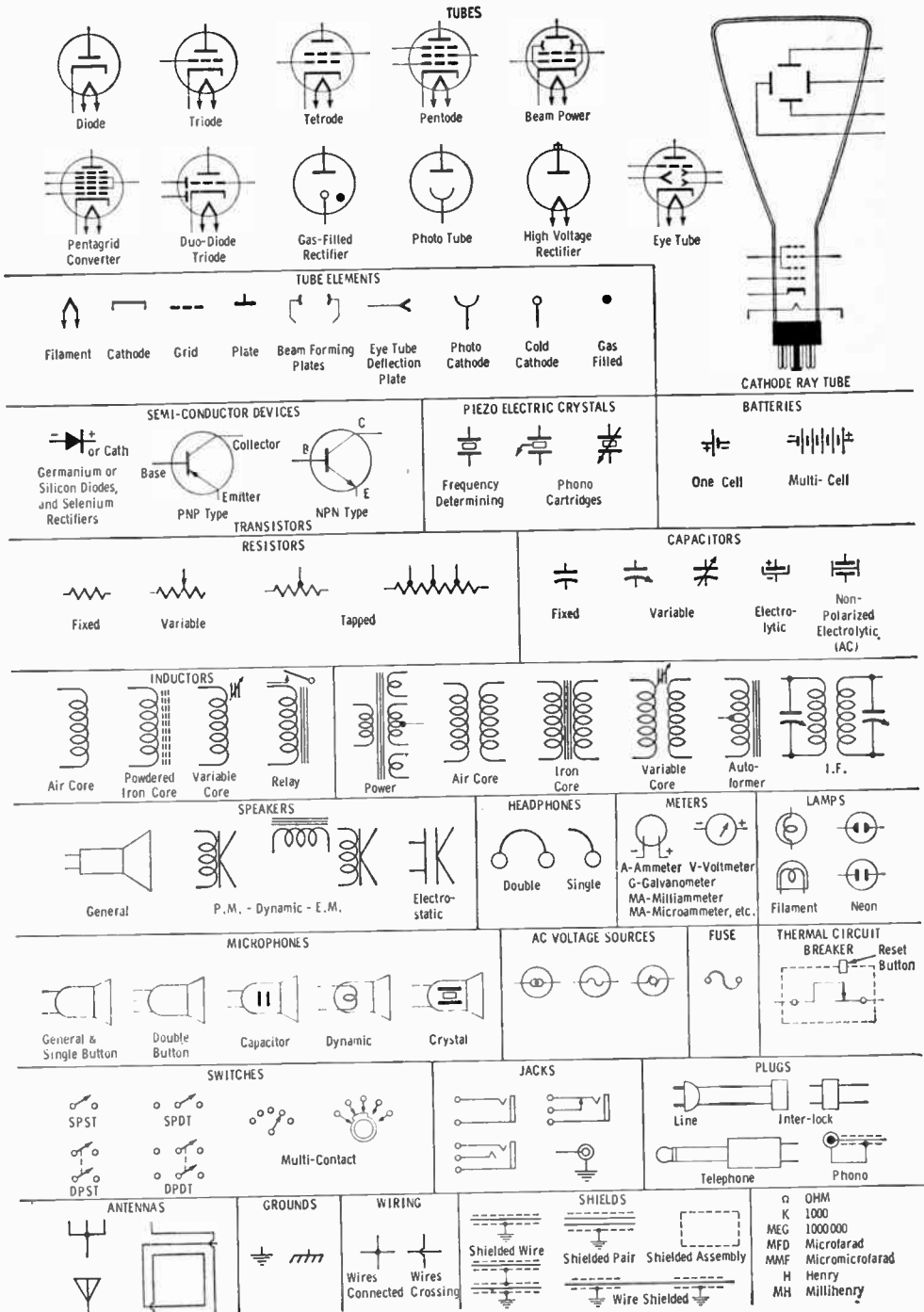

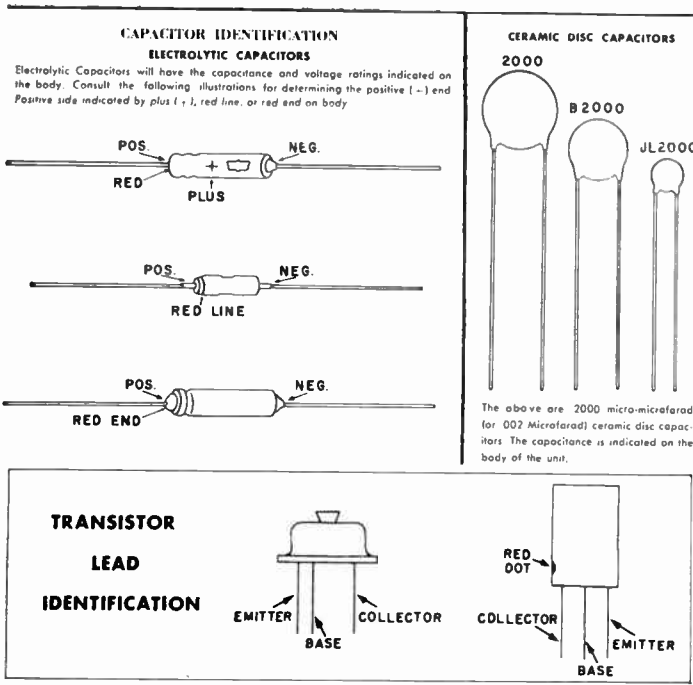

## COMMON ABBREVIATIONS

**a.c.**—alternating current  
**a.f.**—audio frequency  
**a.f.c.**—automatic frequency control  
**a.g.c.**—automatic gain control  
**AM**—amplitude modulation  
**amp.**—ampere  
**a.v.c.**—automatic volume control  
**b.f.o.**—beat frequency oscillator  
**cps**—cycles per second  
**c.t.**—center-tapped  
**c.w.**—continuous wave  
**db**—decibel  
**dbm**—decibels above one milliwatt  
**d.c.**—direct current  
**d.c.c.**—double cotton covered (wire)  
**d.p.d.t.**—double-pole, double-throw  
**d.p.s.t.**—double-pole, single-throw  
**elec.**—electrolytic  
**FM**—frequency modulation  
**freq.**—frequency  
**hi fi**—high fidelity (of sound reproduction)  
**hy.**—henry  
**i.f.**—intermediate frequency  
**K**—kilo (one thousand)  
**kc.**—kilocycle  
**M**—mega (one million)  
**ma.**—milliampere  
**mc.**—megacycle  
**meg.**—megohm  
**mike**—microphone, microfarad  
**mil**—milliampere  
**mu**—amplification factor  
**μfd.**—microfarad

**μfd.**—micromicrofarad  
**mw.**—milliwatt  
**PA**—power amplifier  
**p.a.**—public address  
**PM**—phase modulation, permanent magnet (speaker)  
**pos.**—position (of a switch)  
**pot.**—potentiometer  
**pri.**—primary  
**R-C**—resistance-coupled  
**R/C**—radio control  
**rect.**—rectifier  
**res.**—resistor  
**r.f.**—radio frequency  
**r.m.s.**—root mean square  
**sec.**—secondary  
**s.p.d.t.**—single-pole, double-throw  
**spkr.**—loudspeaker  
**s.p.s.t.**—single-pole, single-throw  
**s.w.**—short-wave  
**SWL**—short-wave listener  
**sync.**—synchronization  
**t.**—turns (of a coil)  
**trans.**—transformer  
**TV**—television  
**u.h.f.**—ultra high frequency  
**v.**—volt  
**v.f.o.**—variable frequency oscillator  
**v.h.f.**—very high frequency  
**VR**—voltage regulator  
**v.t.v.m.**—vacuum-tube voltmeter  
**vu**—volume unit  
**w.**—watt  
**xmtr.**—transmitter

## HARDWARE



4-40 x 1/4"  
STEEL  
MACHINE  
SCREW



#4 INTERNAL  
TOOTH  
LOCKWASHER



4-40 x 1/4"  
STEEL  
HEX NUT



6-32 x 1 1/4"  
STEEL  
MACHINE SCREW



6-32 x 1/4"  
STEEL MACHINE  
SCREW



#6 INTERNAL  
TOOTH  
LOCKWASHER



6-32 x 1/4"  
STEEL  
HEX NUT



1/4" x 1/4"  
BRASS SPACER



#6 x 1/4"  
HEX  
HEAD SELF  
TAPPING  
SCREW



6-32 x 3/4"  
PHILLIPS HD  
MACHINE  
SCREWS



3/8"  
LOCK  
WASHER



3/8"  
HEX  
NUT



#8 x 1/2"  
FLAT WASHER



8-32 x 1 1/4" STEEL  
MACHINE SCREW

## MISC.



STRAIN  
RELIEF  
ASSEMBLY



5/16" RUBBER  
GROMMET

PILOT LAMP  
ASSEMBLY



RUBBER  
FOOT



9 PIN TUBE  
SHIELD

## HARDWARE

Make sure that you can identify all hardware before you pick up a screwdriver. The following are rules of thumb about screws and nuts:

1. Short, flat or round head screws such as 6-32 x 1/4" are used to mount small components. Nuts will be the same hole size.
2. Longer screws are used to mount transformers, sub-chassis, etc.
3. Self-tapping screws need no nuts and are used generally for bracket to chassis assemblies. These screws are tapered.

# Choose XCELITE Hand Tools... the Professionals do!

You need the BEST TOOLS to do the BEST JOB . .

Your Radio, TV and  
Electronic Parts Distributor has them!

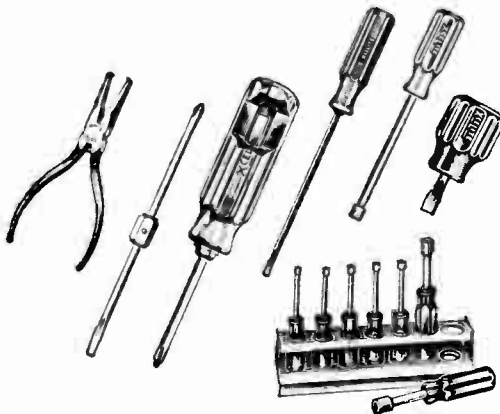

### Check the "SEIZER" ✓

Provides the necessary  
"third hand" in so many  
tricky situations!

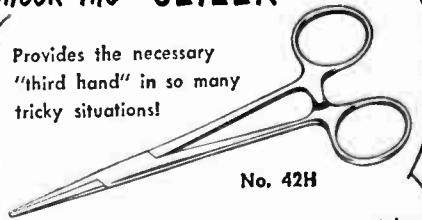

No. 42H

- Clamps on as a Heat Sink.
- Holds wires etc. while soldering.
- Holds dial cords when stringing them.
- Retrieves small items from awkward places.
- Out-reaches and out-holds needle nose pliers.

Select from the Complete Line of Quality Tools and Handy Kits . .

**XCELITE**, INCORPORATED  
ORCHARD PARK, NEW YORK  
Canada: Charles W. Pointon, Ltd., Toronto

**XCELITE**  
*Quality Hand Tools*  
PREFERRED BY THE EXPERTS

# Troubleshooting

## Without

## Tears

*. . . or, how to make it work*

What's more discouraging to an earnest kit builder than to plug in a newly completed project and discover that it is not functioning properly—if at all.

Turning hopefully to the trouble-shooting notes in his construction manual, the novice builder usually finds this section either too complex or that he is required to use some unavailable test instrument. What to do? Generally the builder will sigh, and sadly pack his smoking, humming failure for shipment back to the factory or to a repair shop.

Before you give up hope there are a few things you can do. After all if you're the one who made the mistakes—you should be able to unmake them too! With a good troubleshooting system, patience and knowledge of *where* as well as *how* to look, even the most inexperienced do-it-yourselfer should be able to locate his errors.

### **the pictorial diagram**

Since the pictorial diagram is going to be our major "reference work" the first step is to mount it in some convenient spot. Then orienting the chassis so that it is in the same position as the pictorial, choose a corner of the chassis as your first point of attack and go to work.

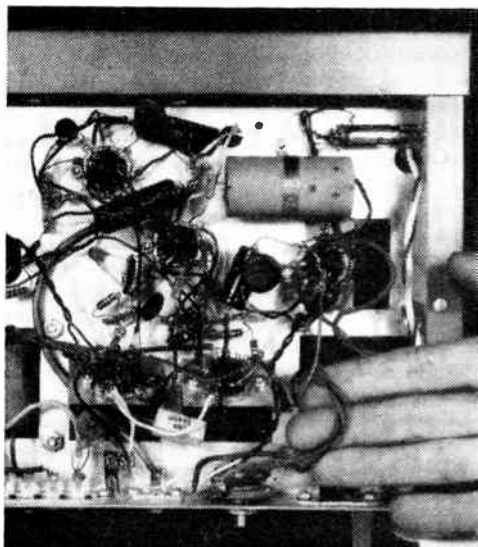

Leads should be run as short and direct as possible. Avoid loops of wire curling about chassis as these can be a source of operating difficulty when the unit is completed.

### **how to look**

Check out each section carefully and methodically. At each of the tube sockets check pin one, pin two, etc. Check each pin lug for the correct number and values of components soldered to it. As a crosscheck, make sure that each capacitor or resistor is properly connected at its other end, too. Bare hookup wire or component leads crossing each other are another evil to beware of. While checking the accuracy of your connections, take the time to have a close look at your solder joints. It seems that no matter how many trouble-shooting hints, articles and illustrations are published in the kit construction manuals, poor solder connections continue to be the prime cause of defective operation.

If the solder at the connection has a dirty gray color or a dingy flaky appearance, it is probably a "cold" solder point. Application of a hot iron will generally cause the solder already at the connection to flow into the smooth shiny surface it should have. Add more solder only if absolutely necessary. A gentle tugging of the wires with a pair of long nose pliers at questionable connections will show up any bad joints. If the wires wiggle, a touch-up soldering job is in order. When in doubt, remelt the solder on any

joint that looks suspicious. The old cliché—better to be safe than sorry—very definitely applies here. And you may have noticed at several lugs there are two or three wires soldered to one connection—these may just be your source of trouble. Check and recheck these points with the utmost care to make sure you haven't soldered only two out of three—or just three out of four.

Continue the systematic checkout as outlined, going through each section until the complete unit has been rechecked.

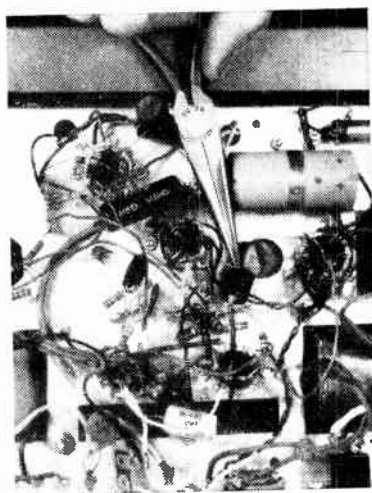

In point-to-point wiring, component leads should be neither too short nor too long. Manufacturer's specified lead lengths are generally right for the best operation of the unit.

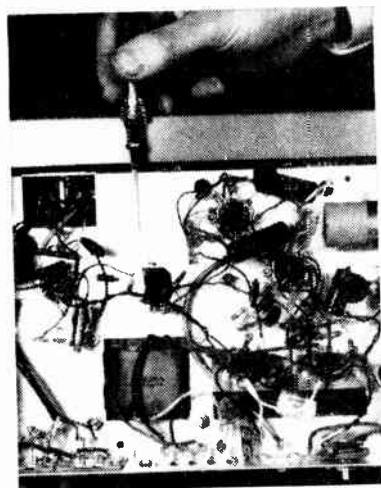

Avoid running ac. carrying leads over high-gain areas or hum pickup will result. Twist all ac. leads tightly and press close to chassis, following lead dress specifications.

#### what to look for

The above procedure will localize most random errors but here are a couple of notes on a few specific items to check. In checking out your unit the following possibilities deserve special attention.

Terminal boards or tie points are a frequent source of trouble. It is a simple matter to put in the wrong terminal strip in the wrong place, or install it backwards which could result in the grounding of a hot lead or in an ungrounded ground point.

Another common error which will show up easily if, of course, you're looking for it

is an improperly oriented tube socket. A close examination of the pictorial showing the key way of the tubes will serve as a quick check of this possibility. In a tuner kit check the orientation of the I. F. transformer lugs against the pictorial.

The exterior of the chassis is another potential haven for errors. An incorrectly mounted speaker screw terminal board (mounted inside the chassis instead of outside) could easily cause shorting of the speaker leads. In a tuner a similar mistake with the antenna terminal strip could easily short the antenna leads to ground.

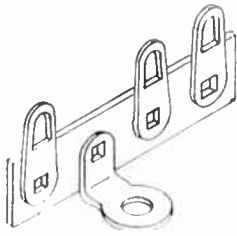

3 LUG TERMINAL STRIP

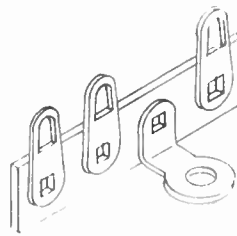

3 LUG TERMINAL STRIP

A common error is to confuse these two types of 3-lug terminal strips. Make sure that you use correct one, and that ground lug is at proper point.

### hum

A 60-cycle hum may indicate improperly oriented filament leads. Once again check your pictorial for proper placing of these leads and make sure they're close to the chassis.

By the time you've done all the above—tempers will be frayed, the kitchen table will probably be not unlike a workshop bench—but pause a moment—take another

look at the tube placement chart. A 12AU7 might conceivably have been substituted for a 12AX7. Don't scoff—the simplest errors are often the toughest to find.

Your unit by now is ready for cooking. Make sure the fuse is inserted and turn it on. What? It doesn't work? I know you wouldn't be guilty of such an error but are you sure it's plugged in?

## Plug-in Laboratory Standards

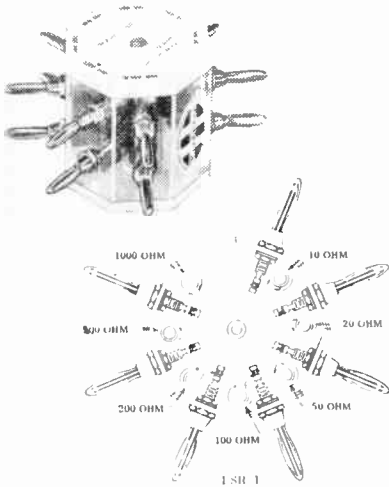

In many stages of experimental circuit tinkering, the need arises for high-tolerance resistors and capacitors. The Heath Company now offers a resistance and capacitance plug-in laboratory standard in kit form. This kit consists of four separate units, each containing seven highly accurate precision standards. Banana pin connectors with standard  $\frac{3}{4}$ " spacing are used to enable the units to fit directly into most laboratory instruments.

These units are designed for calibrating or checking calibration of test equipment such as ohmmeters, capacity meters, impedance bridges, and other measurement equipment. They can also be used for determining circuit parameters, where precision components are necessary.

UNIT	VALUES	TOLERANCE
LSR-1	10, 20, 50, 100, 200, 500 and 1000 ohm resistors	$\pm 0.5\%$
LSR-2	1000, 2000, 5000, 10,000, 20,000, 50,000 and 100,000 ohm resistors	$\pm 0.5\%$
LSC-1	100, 200, 500, 1000, 2000, 5000 and 10,000 $\mu\text{fd.}$ capacitors	$\pm 0.25\%$
LSC-2	.001, .002, .005, .01, .02*, .05* and 0.1* $\mu\text{fd.}$ capacitors	$\pm 0.25\%$ $\pm 0.5\%*$

All resistors are 1 watt and all capacitors are 350 volts, d.c., maximum.



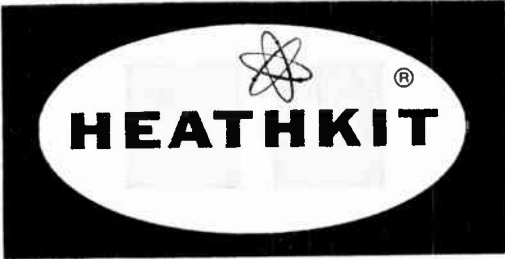

WORLD'S LARGEST  
MANUFACTURER OF  
**easy-to-build**  
**do-it-yourself**  
ELECTRONIC KITS

# "bookshelf" 12 watt amplifier kit COMBINES BEAUTY, STYLE AND QUALITY

Build this high quality amplifier in a few hours of your spare time and enjoy true high fidelity performance for years to come. Provides full range frequency response from 20 to 20,000 CPS within  $\pm 1$  db, and has less than 1% harmonic distortion at full 12 watt output over the entire range (20—20,000 CPS). Miniature tubes are used throughout the advanced circuitry, including EL84 output tubes in a push-pull tapped-screen output circuit. The special design output transformer has taps for 4, 8 and 16 ohm speakers. The model EA-2 has its own built-in preamplifier with provision for three separate inputs, mag phono, crystal phono and tuner. Features RIAA equalization, separate bass and treble tone controls, and a special hum-balance control. Complete with instructions for easy assembly.



*Only*

MODEL EA-2  
**\$28<sup>95</sup>**  
SHPG. WT. 15 LBS.

## Complete selection of Monophonic and Stereo Kits!



TUNERS



PREAMPLIFIERS



AMPLIFIERS

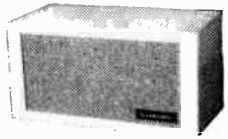

SPEAKER SYSTEMS

**Send for FREE catalog**

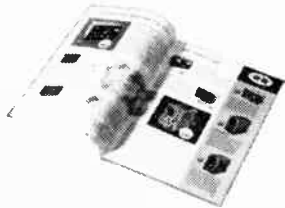

listing over  
100 high quality  
dependable  
Heathkits for you  
to choose from.

**HEATH**  
pioneer in  
"do-it-yourself"  
electronics

**COMPANY**  
BENTON HARBOR 11, MICH.  
 a subsidiary of Daystrom, Inc.

Please send your latest FREE Heathkit catalog.

name \_\_\_\_\_  
address \_\_\_\_\_  
city & state \_\_\_\_\_

ALL PRICES F.O.B. BENTON HARBOR, MICH. PRICES AND SPECIFICATIONS ARE SUBJECT TO CHANGE WITHOUT NOTICE.



For **STEREO** or **MONAURAL** . . .  
whatever your kit plans are  
build your Hi-Fi system  
around a

**Garrard**  
WORLD'S FINEST  
RECORD CHANGER

. . . and then house your components in  
"living-room quality" furniture by



with the new **MODULAR Series "100"**





**VERSATILE!**  
FROM 5 BASIC UNITS - DOZENS  
OF BEAUTIFUL COMBINATIONS!

**FINE FURNITURE!**  
Birch hardwood which accepts a  
finish to match your fine furniture.

**FINISH OR ASSEMBLE!**  
Anybody can do it. Complete instructions  
... every piece clearly lettered ...  
all materials supplied.

Fine modular hardwood furniture in kits,  
or as assembled units ready to finish

... planned to go together in dozens of interesting  
ways. Equipment cabinets are engineered by audio  
experts to protect high fidelity mechanisms. The speaker  
enclosure is acoustically right, artistically in keeping,  
and mechanically correct. Start now to build your own  
grouping with River Edge modular units. You'll have a  
custom-look job that will fill you with pride.

EQUIPMENT CABINET	SPEAKER ENCLOSURE	RECORD CABINET	PLAYER CABINET	60" BENCH
				
Model 100. Holds record player, or tape recorder, tuner, amplifier. Kit \$39.50 Assembled \$48.50	Model 110. Bass reflex for speaker up to 12"; with tweeter to 9"x12". Kit \$39.50 Assembled \$48.50	Model 120. Three separated storage sections. Kit \$24.50 Assembled \$31.50	Model 130. Holds record changer, transcription turntable with 12" arm, or tape deck. Kit \$24.50 Assembled \$31.50	Model 140. Supports the units shown. 4 wooden legs with brass ferrules. Kit \$39.50 Assembled \$48.50



For more information about the **GARRARD** and **RIVER EDGE** lines write to Dept. GD-1219

**BRITISH INDUSTRIES CORPORATION • PORT WASHINGTON, NEW YORK**

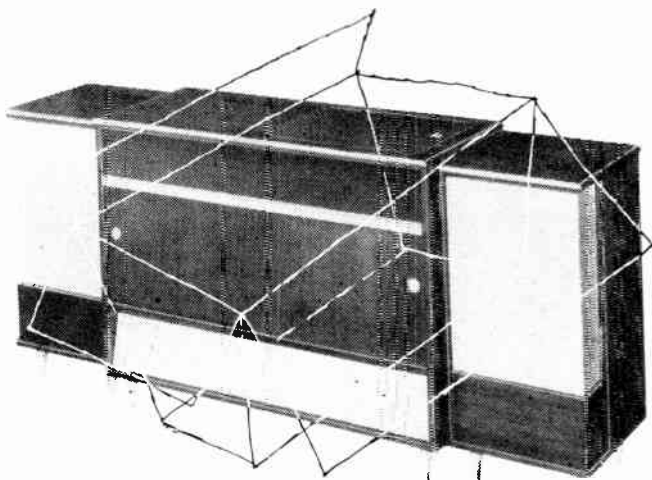

section I  
kits for the hi fi

Picking Your Hi-Fi Kits	28
Building Your Own Monaural Amplifier	30
Thorens Turntable Kit	32
Grommes 60 Watt Power Amplifier	36
Knight Stereo Preamp	38
Four-Speed Changer Kit	40
Building a Stereo Preamp Control Center	42
Making the Precise AM-FM Tuner	46
Build Your Own Tape Recorder	48
Stereo Remote Control Center	50
Integrated Amplifier For Stereo	51
Rek-O-Kut K33 Turntable	53
Acrosound Ultra-Linear II Power Amplifier	55
Electro-Voice Aristocrat Enclosure	57
Quick-Built Speaker Enclosure	58

\* directory  
of hi-fi kits page 61

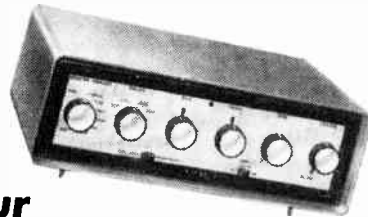
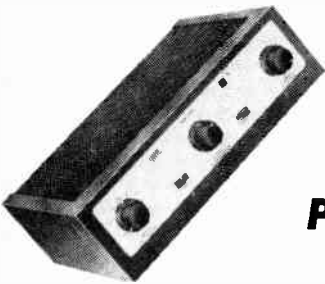
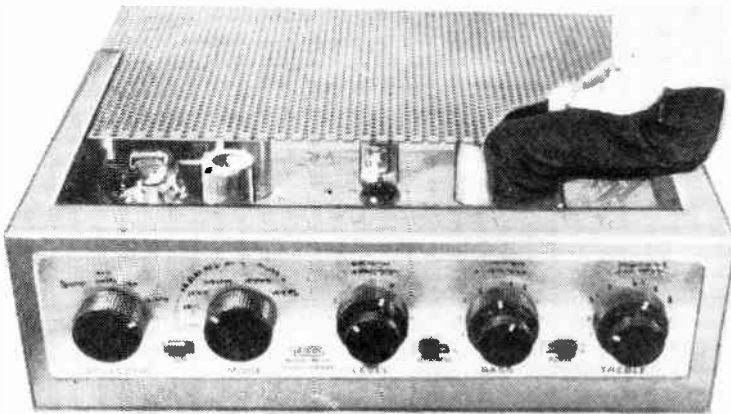
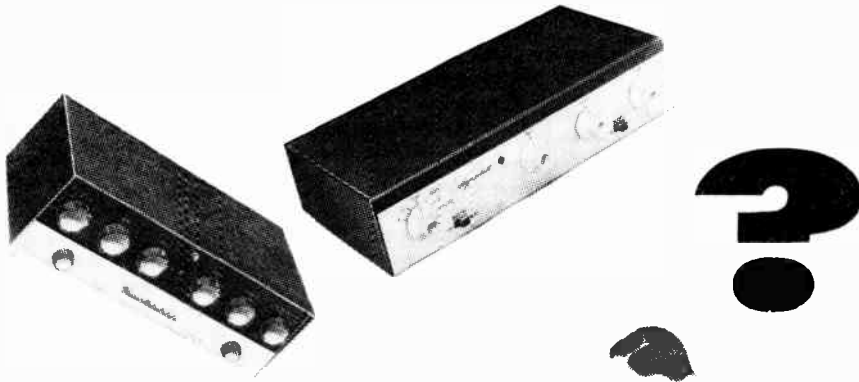

## **Picking Your Hi-Fi Kits**

*decisions, decisions and more decisions*

Are you caught in the familiar hi-fidelity dilemma—trapped between good taste in music reproduction on one hand and a low budget on the other? Here's a solution which is both economical and, at the same time, practical. Why not consider a completely kit built setup?

**rules of the game**

As you must know by now there are no hard and fast rules whenever and wherever you are talking high fidelity. Nonetheless there is one rule of thumb you can use as a guide: every component in your system should be balanced as to the relative quality of

each item. For instance the cost of a 60-watt amplifier kit which is \$80 almost precludes your using a speaker which costs \$15. There is a corollation between price and quality. The weakest link in the system governs its overall quality.

### why high power?

How much power does your amplifier need? Let's consider first the amplifier in relation to the speaker. Speakers are either inefficient or efficient. This has no relation to quality, but is merely a matter of design. For inefficient speakers, high powered amplifiers are required (in the range of 35 watts and up). An efficient speaker may use lower powered amplifiers.

Perhaps your budget is quite limited. In that case a lower powered amplifier is called for. There are units available in the 10 to 22 watt range which cost from about 20 to 40 dollars. But this omits the preamplifier. Preamps are available separately and will vary in price from 20 to 35 dollars. If you must get down to rock bottom there is the integrated amplifier. This means that the amplifier and preamplifier are built on the same chassis. Here you may find kits of low power (10-15 watts) costing \$25 to \$40. Some higher powered amplifiers are also available in integrated form at slightly greater cost.

We've briefly covered the low-cost kit amplifier and preamplifier. Now a word about higher powered amplifiers. The fiery arguments between audiophiles about high power versus low power continues without cessation. We'll avoid the firing line at this point. For those of you interested in higher power, say above 30 watts, you have a wide choice up to the 70 watt level. The cost here varies from about \$40 for 30 watts up to about \$110 for 70 watts. For stereo you can double these figures. Dual amplifiers on a single chassis are also available.

The preamplifier choice should also be a carefully considered one. Low noise level as well as good frequency response should be prime considerations in your choice. You must also decide whether the selector switch has all the functions which you will need. Look for the RIAA curve on the playback function since most records today are re-

corded with those characteristics. If you are thinking of adding a tape recorder chances are that most preamps today will have a tape position but it is advisable to check on this also. A large number of controls do not necessarily make a good preamp. The basic controls are a bass, treble and level control and either a loudness control (this varies the bass boost inversely with the volume) or a loudness switch which cuts in the loudness control at will.

### take your pick

In 33 $\frac{1}{3}$  rpm turntable kits you have a wide selection which take from a 1/2 hour to an hour for assembly. One unique turntable uses a small synchronous clock motor, an innovation in turntable drive mechanisms. More conventional hysteresis synchronous motors are available in some kits. The price of these tables is reasonable—about \$50. For those desiring a 3-speed record changer in kit form this, too, is obtainable in a unit designed for stereo.

### considering specifications

Unless you are fully familiar with the various reference points used in the specifications of hi-fi equipment it's best to consult with your hi-fidelity salesman to gain some understanding of their meaning. Some points to remember: when shopping for amplifiers or preamplifiers look for low noise level, minimum I. M. distortion and insignificant decrease in output at either end of the spectrum. Wow and flutter specifications for the turntables are straight forward and turntable kits show outstanding performance in this area.

### tuner kits

Your choice of a tuner kit should be postponed until you've finished the amplifier and preamplifier. The sensitivity specifications of the tuner is one way of determining the tuner's quality. In a large city where reception is good, you do not need as sensitive a unit as you would in a fringe area. You've also a choice of FM only, AM only, AM-FM or AM-FM stereo. Construction of the tuner requires great care in building so be careful with the length of the leads, proper placement of I. F. transformers and, as always in kit construction good, clean solder joints.



## ***Building Your Own Monaural Amplifier***

*a conventional amplifier with a transistor preamp*

A kit builder (of the after-work and weekend variety) generally wants his building instructions clear, and his construction simplified. The Arkay monaural amplifier fits this need to a "T". For ease of construction, each of the four sections (main chassis, front panel, rear panel, transistor chassis) are mounted and wired individually, and then interconnected. This system leaves little room for error since the instructions are categorized for each amplifier section.

The main chassis is fitted with end brackets on which the other sections mount, leaving plenty of "elbow room" for final wiring to the main chassis.

No matter what your power tastes are, this amplifier can satisfy them with its 30 watts, which is just about the middle of the road. In addition, it has separate bass, treble, level set, and loudness controls, with an extra control for balance (high and low frequency adjustment). You can also choose three record equalization positions—RIAA, Eur., and LP.

High-gain, one stage preamplification is achieved by using a transistor. The regular amplifier is a linear Williamson circuit with two EL-34/6CA7 push-pull power amplifiers.

Again, for those who want their job made real easy, this model is just what the doctor ordered.

**1** Main chassis was biggest wiring job. Pictorials were easy to follow and gave best lead dress positions. Wire lead length was specified, eliminating necessity of measuring point-to-point. Power transformer is at left, output transformer is connected later to rear panel terminal strips. Note the two end brackets which allow a building-block assembly, as well as serving as a stand for unit during construction.

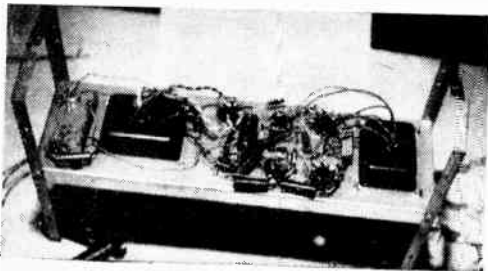

**2** Front panel is mounted and wired before assembly to bracket. Leads to main chassis have been connected to front panel, but hang free to facilitate final wiring. Function switch is at left, balance switch at right with battery of resistors across it.

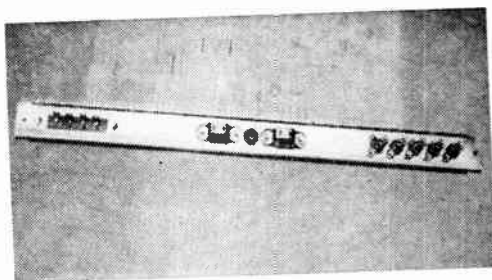
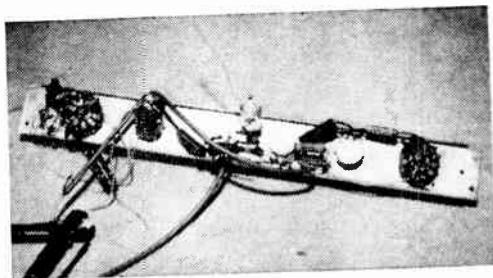

**3** Rear panel inputs for mag. phono, tuner, two auxiliaries and tape are connected to function switch with insulated shielded cable. Speaker output impedances are 4, 8, and 16 ohms.

**4** Front and rear panels mount on end brackets. Hanging leads from front panel are connected to main chassis. The large space between panel and chassis made it easy to connect these free leads and the shielded cable from rear panel to function switch.

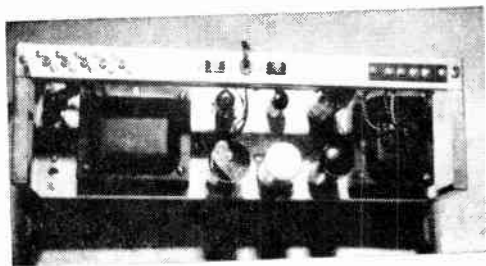
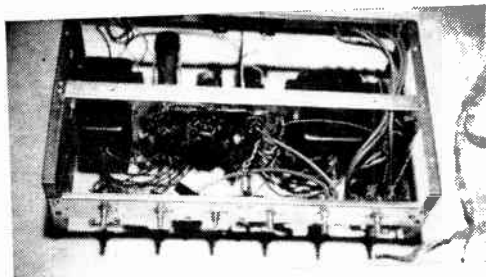

Number 2

**5** Tiny transistor preamp chassis is mounted upper right. The use of self-tapping screws for mounting to end brackets give the whole unit rigidity.

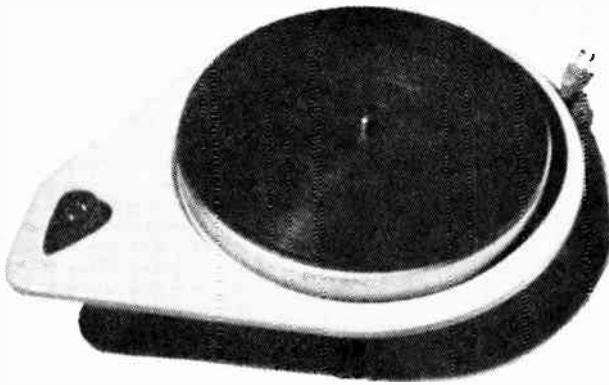

## **Thorens Turntable Kit—A One Evening Project**

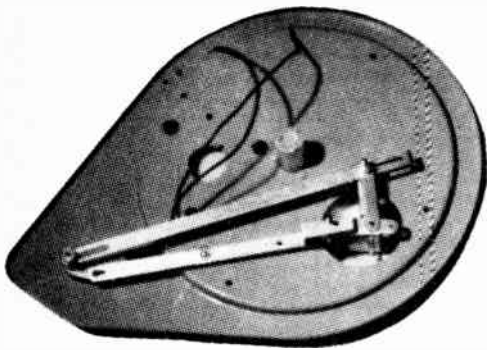

**1** Switch connecting bar on bottom is linked with start-stop knob spindle and idler wheel bracket assembly. Hole in bar fits onto toggle switch. Speed adjusting bar is looped at end (right). Adjustments are made by sliding bar from thickest part of loop to thinnest.

Close tolerance machining has always been the top Swiss skill. Not only are their watches well known, but their lathes and other machine tools have also found an appreciative market here. The Thorens turntable kit is no exception to these standards. All components such as spindles, bushings, and pulleys are machined to a bright finish and close tolerance.

In assembling the kit, there are two mechanical assemblies which must be made with care. A switch connecting bar assembly turns the motor on and off. One end of the bar is connected to the on-off switch spindle underneath the base plate, a middle hole fits over the toggle switch, and the other end of the bar is hooked up to the idler wheel bracket assembly. These must be installed correctly for proper operation. The other assembly is the speed adjusting link and idler wheel bracket. An end is fastened to the bushing holding the speed reduction wheel spindle. This whole unit is adjustable and has the effect of changing drive ratios by raising or lowering the conical wheel shaft. This wheel drives the idler wheel which in turn drives the turntable.

When inserting the speed reduction wheel on its spindle, be extra careful that the little ball-bearing does not fall out.



You save 50% with EICO KITS . . .  
easy creative fun to build . . .  
and they last a lifetime.

here's why the experts say

# YOUR BEST BUY IS **EICO**®

Stereo & Mono Hi-Fi • Test Instruments • "Ham" Gear

## Kits & Wired

EICO is a pioneer (1945) in kit equipment — leads the industry in distributor sales to trained and critical users. EICO has achieved this acceptance because

EICO engineering policy is to stress mechanical and electrical quality, soundness and functional completeness;

EICO invests the extra money and longer time it takes to focus additional engineering mind-power on prototype development to engineer-in more vital features. So that, model for model, you get more accuracy, versatility, stability, and protection against obsolescence, than in competitive units, kit or wired.

EICO prices are low because they are justly related to costs and geared for volume sales.

**GUARANTEED PERFORMANCE** — All EICO kits and factory-wired equipment are guaranteed to meet or surpass all advertised specifications when assembled and/or operated according to instructions. EICO guarantees the performance, components and instructions.

**LIFETIME SERVICE & CALIBRATION GUARANTEE** — Since EICO products are designed and built to the highest standards, you may never need service, repair or calibration. But if you ever do, EICO guarantees them—for the LIFETIME of the unit—at the nominal less-than-cost charge as stated in the instructions and Guarantee Card.

**QUALITY CONTROL**—Every step of production, from incoming parts to outgoing finished product, kit or wired, is under continuous careful inspection.



**FINEST COMPONENTS**—Nationally famous standard brand components, like GE, RCA, Sylvania, Mallory, Centralab, etc., are used in EICO products—your assurance of the very best components.



**SIMPLE, EASY INSTRUCTIONS** — Each EICO Kit contains 2 Instruction Manuals, Assembly and Operation, complete with "Beginner-Tested" step-by-step construction procedure, pictorial perspective diagrams, schematic, and application data.

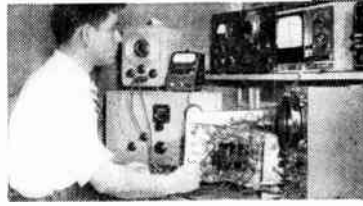

**ADVANCED ENGINEERING** — "Design it better" is the watchword of EICO's complete staff of experienced research and development electronic engineers. Even the orthodox and time-proven circuitry are constantly re-evaluated in the light of the most modern developments.

**PERFORMANCE-PROVEN** — Since 1945, over 100,000 technicians, leading schools and universities, TV and industry leaders like Emerson, Stromberg-Carlson, CBS-Columbia, Federal Telephone & Radio, have bought and recommended EICO kits and instruments. There are now over 1 million EICO products in use throughout the world. This is the world-wide renown — this is the manufacturing experience — that backs up each EICO you buy.

ELECTRONIC INSTRUMENT CO., INC., Dept. EK 33-00 NORTHERN BLVD., L. I. C. 1, N. Y.

**2** Idler wheel bracket assembly fits through large hole in base plate. Idler wheel mounts on spindle. Bottom of toggle switch is shown center left.

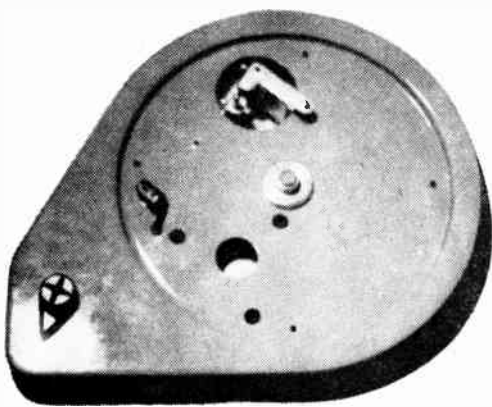

No soldering is necessary. The two motor wires, two start-stop switch wires, a.c. line, and a .01 mf capacitor all connect to a screw terminal block.

The finished unit gives smooth, trouble free operation. No hum or noise of any sort could be detected.

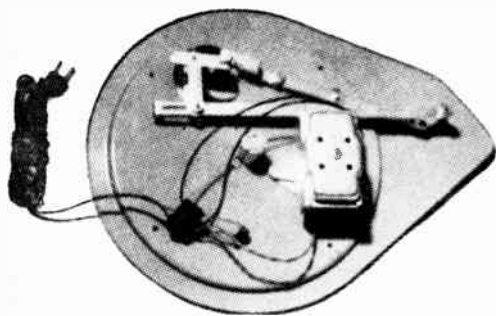

**3** Motor is mounted through grommets in base plate and secured with c-rings on other side. Bracket assembly is now completed showing adjusting link spline hole in loop. Wires are connected to terminal block.

**4** Speed reduction wheel (shiny metal,) belt-driven directly by motor pulley, drives rubber idler wheel puck. Speed is regulated by raising or lowering speed reduction wheel.

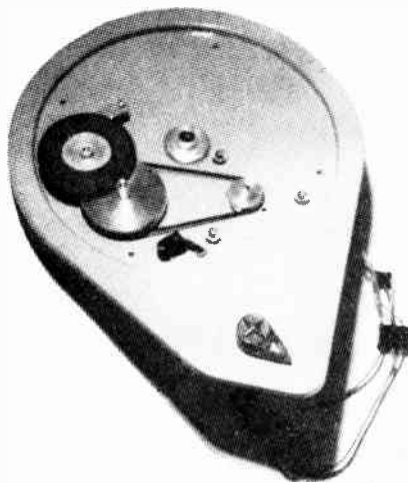

THE SMASH-HIT THAT DREW THE CROWDS at  
NEW YORK'S HIGH FIDELITY and MUSIC SHOW!

precise DEVELOPMENT'S

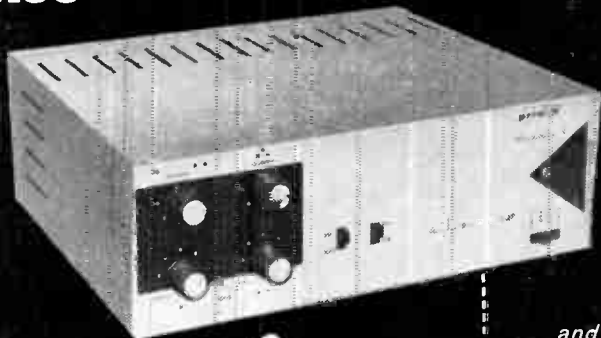

*mark v*  
"The Stereo Unit That Has Everything"

and retails  
for only  
**\$59<sup>95</sup>**

At the very moment when Stereo is sweeping the country . . . Precise puts it within the reach of every budget! Just think — all you need with the MARK V is two speakers, a turntable and a stereo cartridge . . . an easy chair and the time to listen. If you already have a Hi-Fi system, all you'll need is another speaker and the stereo cartridge

(your late model changer is probably designed to accept it). Ask your favorite High Fidelity Dealer about the MARK V . . . he probably has them in stock . . . or has detailed information available. If he does not, fill out the attached coupon and mail it today. We'll see that both you and he get the dramatic MARK V story!

**MAIL THIS COUPON TODAY!**

**Fabulous Features Packed Into a Single Stereo Unit:**

- Two individual Stereo Amplifiers — each with more than six times as much power as you'd need in a normal room
- Two Preampifiers — compensated for all three types of cartridge — magnetic, ceramic and crystal
- AC Power transformer • Channel balance control
- Phasing switch affording normal stereo, reverse channel stereo and monophonic listening
- Loudness Contour control • Muting switch • Dual tape inputs
- Inputs for two tuners so that both AM and FM tuners can be operated simultaneously in areas where such broadcasts are available.
- Factory wired (not a kit) — and complete with cage

**Precise Development Corp.**  
**Oceanside, Long Island, N. Y.**

Gentlemen —

Please send me detailed information about the MARK V Stereo unit

Name \_\_\_\_\_

Address \_\_\_\_\_

City \_\_\_\_\_ Zone \_\_\_\_\_ State \_\_\_\_\_

My Dealer would like information about the MARK V, too!

He is \_\_\_\_\_

Address \_\_\_\_\_

City \_\_\_\_\_ Zone \_\_\_\_\_ State \_\_\_\_\_

**precise** DEVELOPMENT CORP.  
HIGH FIDELITY DIVISION

OCEANSIDE, LONG ISLAND, N. Y.

# GROMMES 250K 60-Watt Power Amplifier

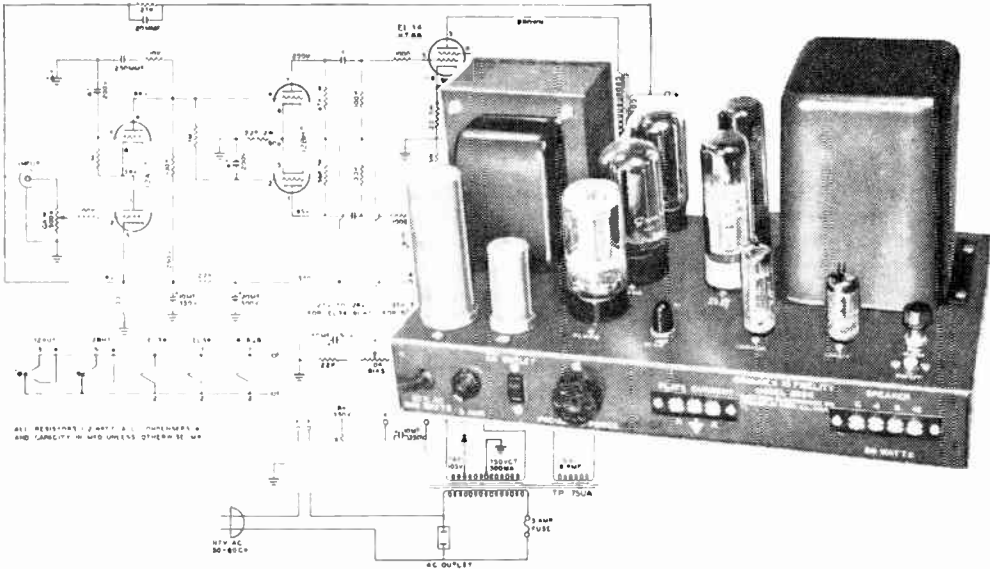

The argument of high-power audio amplifiers versus low-power circuits continues unabated. Precision Electronics, Inc. (9101 King Ave., Franklin Park, Ill.), with its new Grommes 60-watt 250K basic amplifier kit has produced a strong case for the high power side of the controversy.

## assembly instructions

Those of you who have wired other kits may be a bit surprised at the Grommes construction book. Instead of the usual step-by-step instructions, you will find large color-coded wiring pictorials.

The first of these is a well illustrated parts identification and "how to mount components" sheet. This system leaves no doubt as to where and how an unfamiliar component should be mounted.

The second diagram is devoted to mechanical assembly. Parts to be mounted from the underside of the chassis are easily identified, but the information concerning top chassis components (transformers and electrolytics) was slighted. We found it best to mount the transformers first so that they would act as "stand-offs" and keep the chassis above the workbench top, thus avoiding possible damage to the other components during mounting.

There are two punched chassis holes which match the two lead openings in the power transformer shell, but only one opening appears on the chassis pictorial. If the yellow and yellow/green leads are put through the unmarked chassis hole, they reach the correct wiring points. Since the output transformer leads were slightly off-color, care had to be taken in their identification. If you are in doubt, check the leads with a VOM.

All hookup wire and transformer leads are color-coded to the wiring diagram and pre-cut. Taking it slow and carefully, total assembly time came to about 6½ hours.

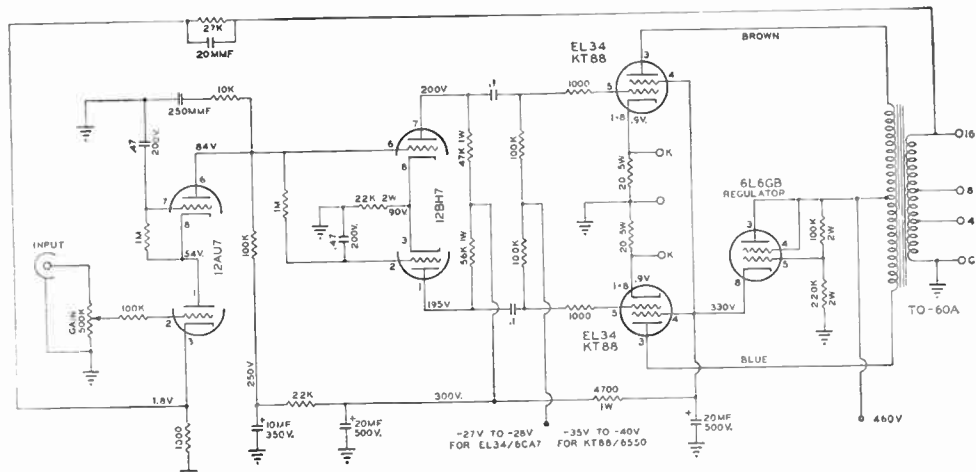

**Circuit of Grommes 60-watt power amplifier. Bias adjustment terminals are included to facilitate measuring output tube current.**

In general, the construction manual was clear and explicit. A pictorial of the complete unit, however, would have been useful for rechecking and trouble-shooting.

#### circuit design

The Grommes 250K uses a somewhat novel design. The input tube, a 12AU7, is connected in cascode and direct-coupled to a 12BH17 wired as a long-tailed-pair phase inverter. The output tubes are EL34's with fixed bias. A 6L6 tube is employed solely as a screen grid regulator and two 5U4 tubes are used in the power supply.

Features include a bias adjustment and terminals for measuring output tube current, input level control, 4-, 8-, and 16-ohm taps, and a preamp power output socket. The unit is fused and has an a.c. convenience outlet. Damping factor of the amplifier is 15. A kit, the DF-1, is available for installing variable damping if desired.

#### test results

Input sensitivity of the Grommes checked out at .97 volts for rated output. The hum and noise level was better than the specified -90 db. At a full 60-watts output, the 250K produced a clean sine wave from 20 to 20000 cycles. This performance is exceptionally good.

It is interesting that the square wave response was the only test that did not meet or better the manufacturer's specifications. The oscilloscope showed some ringing at 10 kc. Further checks indicated that 120- $\mu$ fd. shunted across the 20- $\mu$ fd. capacitor in the feedback loop would minimize the ringing. The effect of this slight instability was not audible in listening tests; the amplifier is clean sounding and performs well at all power levels.

**Underchassis view of completed amplifier. Large chassis and careful layout design simplify soldering.**

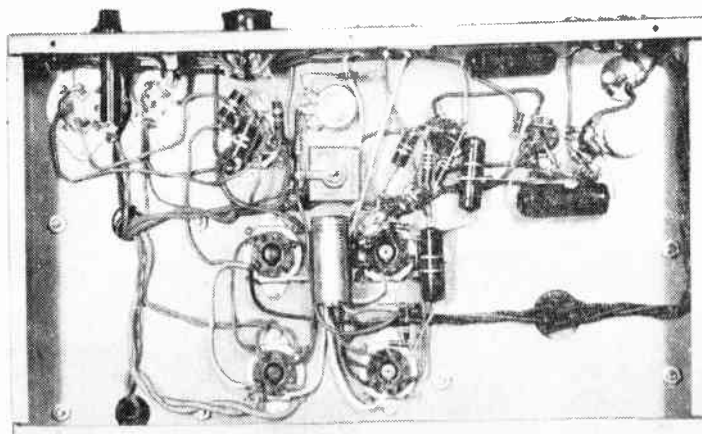

## Knight Stereo Preamplifier

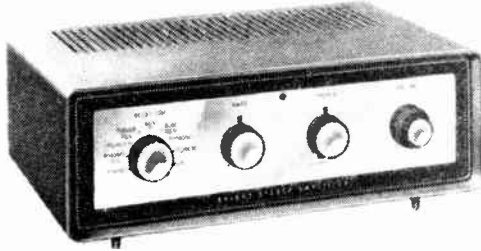

*printed circuits make it a cinch*

If this Knight kit is any indication of a trend, printed circuits will make regular wiring as obsolete as the 5¢ hamburger. There are two printed circuit boards—a large one for the tubes and associated resistors and capacitors, a smaller one for the equalization control and channel balance switches. Even the switch elements are plug-in, have printed circuits.

### **construction**

A person who has mostly built kits without printed circuits, this writer found a paradise using the prepared boards. As an example, the switch assemblies mount on their board like a tube in its socket; they have pins which simply plug into the board after all other components have been mounted. Incidentally, both pc boards are mounted upside-down in the chassis. This design makes it easy to get at the tubes from underneath the chassis.

Probably the most vivid memory of this job was the actual sizes and part numbers printed right on the board. It left practically no room for error or bad lead dress by the builder.

All the wiring (there's some of that to do, too) is made easy by means of precut-to-size, color-coded wire. All the red leads are 2" long, and all the green leads are 5", and so on.

The "rear panel" is on the bottom of the chassis so that all output leads have to plug into jacks underneath. Buss bar is inserted between the jacks and chassis for proper grounding and elimination of a possible hum source.

The preamplifier has six equalization positions, separate bass and treble controls, five pairs of stereo inputs, and four monaural inputs, making for a very flexible unit in any type of installation.

Everything about this kit was designed for speed and simplicity. It can be put together in a week of evenings (while you listen to but not watch TV). It operated well right from the start, thanks to the almost foolproof printed circuits. The attractive housing makes this preamp something to display with pride.

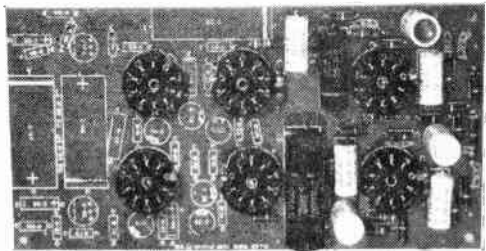

Large printed circuit board mounts upside down. Note part sizes and corresponding parts numbers on board. Large boxes at left are for placement of electrolytic capacitors. Note that polarity is also indicated.

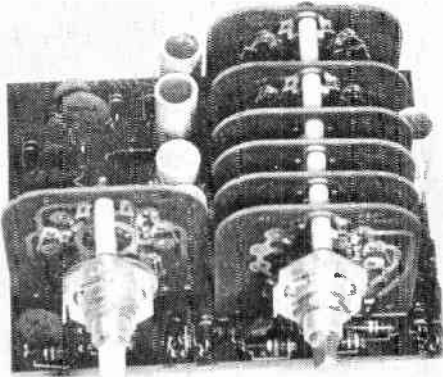

Small printed circuit board with switches plugged into it. Switch elements are also printed circuits.

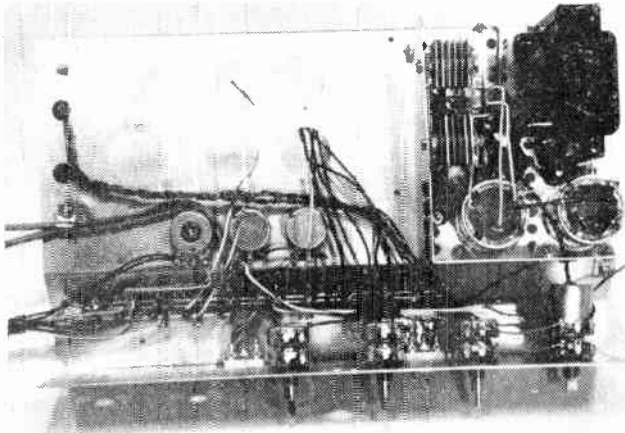

Main chassis is wired with pre-cut, color-coded leads. Power supply and filter system are at top right. Tone, level, and volume controls are at front.

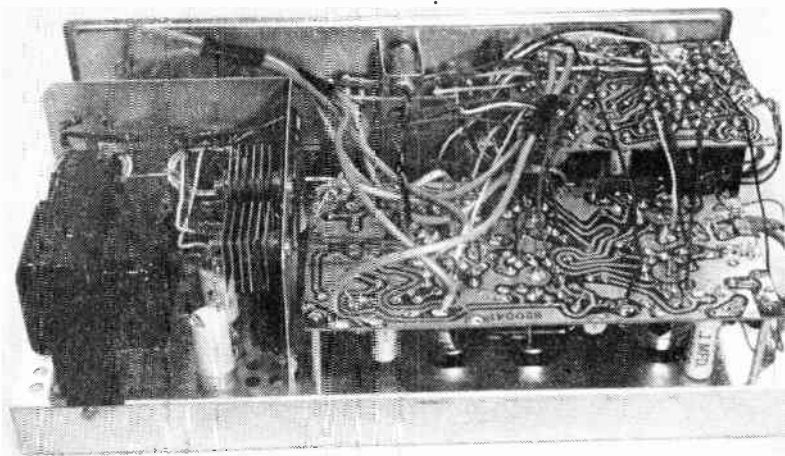

Completed preamplifier shows wiring to bottom side of both printed circuit boards. Output terminals (not shown) are underneath chassis.

Number 2

# Four Speed Changer Kit



The underside of a hi-fi record changer is a maze of cams, levers, shafts and wheels. To put such a mechanical device in kit form for the novice builder is a real challenge to the kit manufacturer. The Heath Company has met this challenge well with their RP-3 record changer kit. A first class instruction manual is the key to ease of construction.

It would, however, be impossible for any instruction manual to make construction of a record changer into a five minute job. This is particularly true of a changer such as the Heath unit, that offers such features as 4 speeds with automatic speed selection and indexing, and automatic turntable stop and sound shutoff during the change cycle.

Parts for Heath changer kit with turntable and motor at left, preassembled portion of changer at center and base assembly at right. Tone arm and hardware are in foreground.

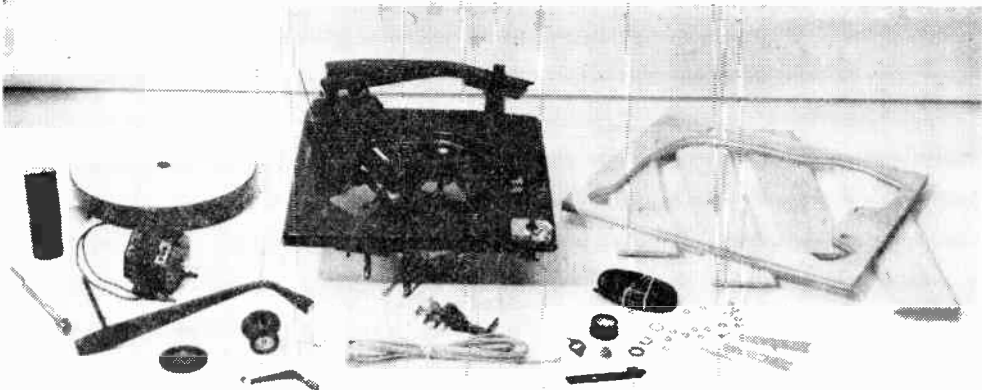



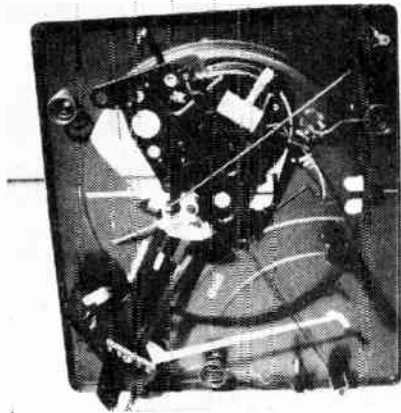

Underside of changer mechanism after assembly. Motor mounts in holes at upper left of photo. Springs at either side and bottom serve as shock mountings.

construction

A large part of the changer subassembly is preassembled by the Heath Company, but there are still a lot of parts for the builder to install. There are some recommendations that can be made that will help smooth the path. First, make use of the large size drawings provided. Hang them up where you can see them easily. Before each assembly step read all of the instructions applying to that step. Refer to the drawings to be certain that you understand what is to be done. Next, gather together all of the parts needed for the assembly and put them together as per instructions. Before moving on to the next step, check the finished assembly against the drawings.

The pickup cartridge and changer mounting base are supplied with the kit, so the unit is ready to play as soon as construction is completed.

# WHEN DISASTER STRIKES...

**LIVES AND PROPERTY SAVED BY AMATEUR OPERATORS!**

**TORNADO-EXPLOSION  
- FLOOD-HURRICANE -**

WE INTERRUPT THIS PROGRAM FOR A SPECIAL BULLETIN...

LOOKS AS IF OUR RADIO CLUB WILL BE NEEDED FOR ON-THE-SPOT COMMUNICATIONS...

**LATER**

HOW DO YOU LIKE MY VIKING "NAVIGATOR" REALLY SWELL! WITH TIMED SEQUENCE KEYING?

**BOY! IT'S REALLY SWELL! 40 WATTS INPUT-- BUILT-IN VFO-- TVI SUPPRESSED--IT'S EASY TO OPERATE AND PUTS OUT A SOLID SIGNAL!**

WELL, NOW THAT YOU'VE OPERATED BOTH THE VIKING "ADVENTURER" AND "NAVIGATOR" TRANSMITTERS AT THE CLUB STATION--WHICH DO YOU LIKE BEST?

I'D RECOMMEND EITHER UNIT. THEY'RE BOTH AVAILABLE IN EASY-TO-BUILD KITS --BOTH PRODUCE A CLEAN CW NOTE-- AND THEY'RE PRICED RIGHT, TOO!

OUR COMMUNITY WANTS TO THANK YOU AND YOUR FELLOW AMATEUR OPERATORS FOR A JOB WELL DONE..

**CIVIL DEFENSE C**

THANK YOU FOR THE PUBLIC SERVICE AWARD--BUT WE CAN'T TAKE ALL THE CREDIT. OUR VIKING TRANSMITTERS REALLY STOOD UP UNDER SEVERE CONDITIONS, PROVIDING US WITH CONTINUOUS AND RELIABLE COMMUNICATIONS!

**"ADVENTURER"** 240-126-1..Kit...\$149.50 Net  
240-181-1..Kit...\$54.95 Net

**"NAVIGATOR"** 240-126-2..Wired..\$199.50 Net

**E. F. JOHNSON COMPANY**  
3143 Second Ave., S. W., Waseca, Minnesota

• Please send me a copy of your most recent amateur catalog. (Please Print)

Name \_\_\_\_\_  
Address \_\_\_\_\_  
City \_\_\_\_\_ State \_\_\_\_\_

**MAIL TODAY FOR YOUR FREE CATALOG**

# Building a Stereo Preamp Control Center

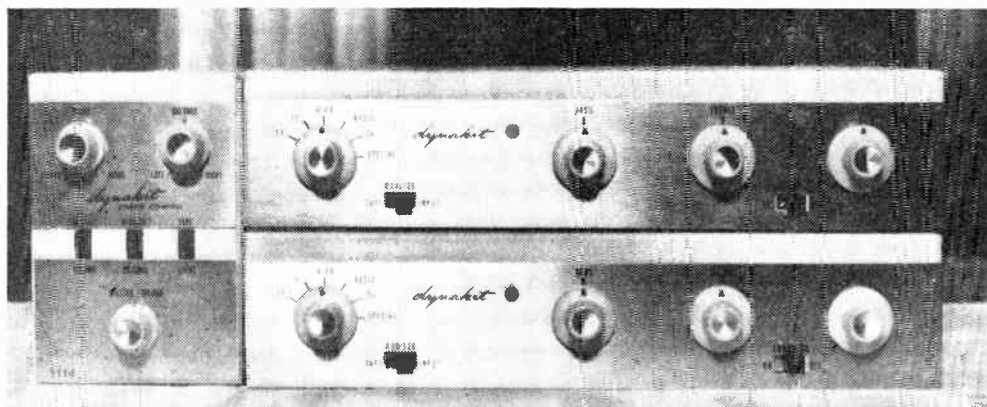

*An easy-to-build system, the Dynakit "60" combines two monaural preamps with a matching stereo control unit.*

**1**

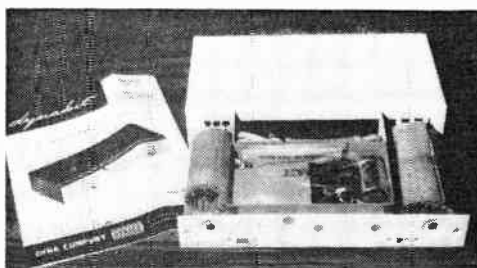

Two 12AX7 tubes control the tone and amplify. This dual function is possible because of the unusual Dynakit "60" circuitry which is described in the text.

All components are packed in a container not much larger than the finished chassis. The instruction booklets are well organized and clear, permitting easy construction by a novice.

**2**

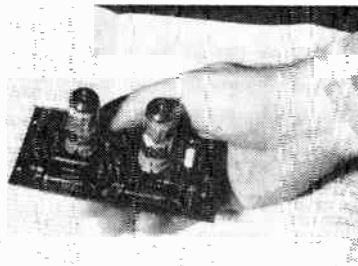

**3**

Thanks to the use of a printed circuit board, assembly of the preamplifier is not at all difficult. Although the parts all fit perfectly without any filing or manipulating, most of the assembly time is taken up in mounting components.

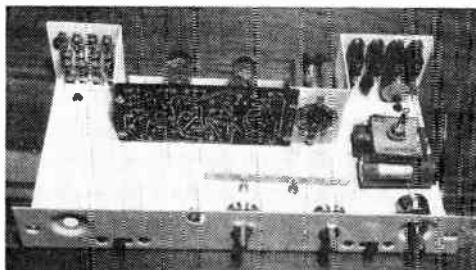

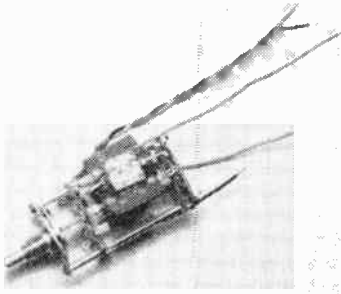

## 4

The ganged function switch selects three equalization positions: LP, 78, RIAA, as well as radio, and TV high level signal input. An added special position allows for mag. phono, microphone, and tape.

An easily constructed unit, the Dynakit "60" consists of two preamplifiers, a master stereo control center and an external power supply. There is a very novel circuit worth mentioning in each preamp.

The use of positive and negative feedback allows the unit to perform with only two tubes. Amplification and equalization for the phono, tape head, or mike, is provided by the first 12AX7 tube. The feedback loop from plate of the second tube to cathode of the first includes equalization networks. A 100K resistor joining the two cathodes provides positive feedback while increasing the gain of each tube tremendously. This gain permits complete bass boost and leaves enough additional gain to provide adequate feedback,

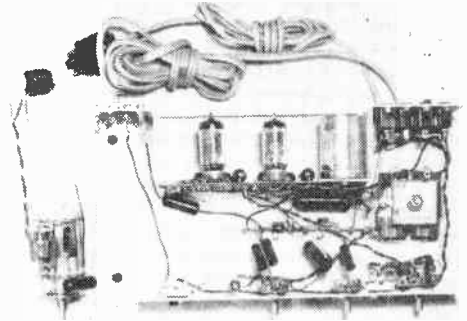

## 5

Switch is shown at left pre-wired for ease in installing in chassis. The printed circuit board has been wired to the chassis, and larger components installed.

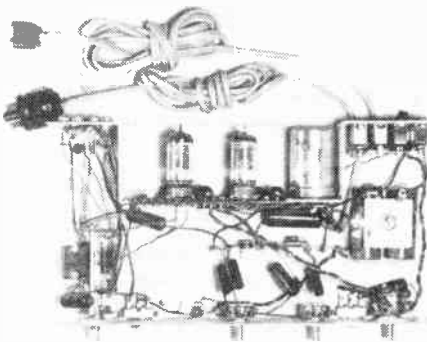

## 6

The selenium rectifier and filter circuit is shown at right. Switch is mounted left side. Lower cord (top left) goes to power amplifier or separate power supply for B+ and filament voltages of twin 12AX7's. Other cord provides power for switched accessory slugs. Electrolytic condenser can is next to tubes on the printed circuit board.

even at bass frequencies. In addition to positive and negative voltage feedback, the tube's cathode resistor, without by-pass condenser, supplies current feedback. The beauty of this arrangement is that it permits a high feedback factor resulting in extremely low distortion.

An analysis of the tone controls circuits

reveals a variation of the Baxandall "sliding-crossover" circuit.

### evaluation

Despite these rather unusual circuits, or because of them, the results are excellent. The frequency response is from 6 to 60,000 cps.  $\pm 0.5$  db., and the IM distortion is only

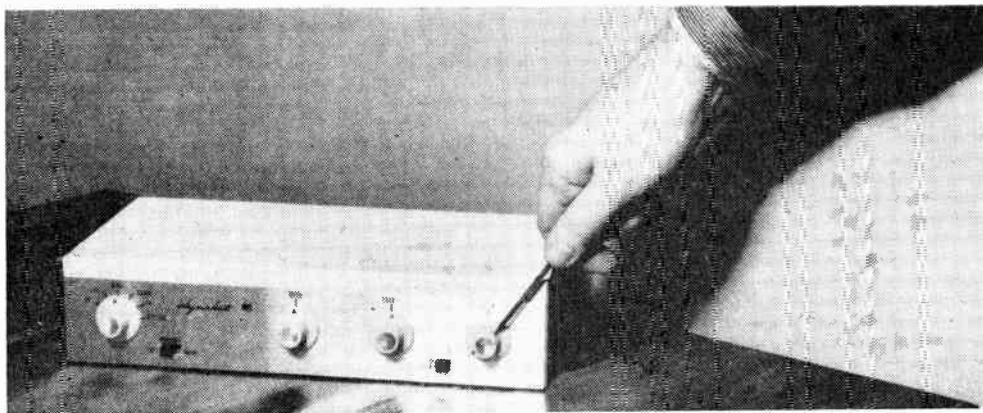

**7** Completed preamplifier has separate bass and treble controls. The volume control may be eliminated from the circuit by means of switch next to it.

**8** The stereo control unit can be built in an hour's time. This "brain" regulates the output of both preamps by controlling volume, channel balance, stereo reverse, and the amount of separation between channels (blend control).



**9**

Both preamps are stacked piggy-back and wired to the stereo control center. Line cords (left) plug into separate power supply unit.

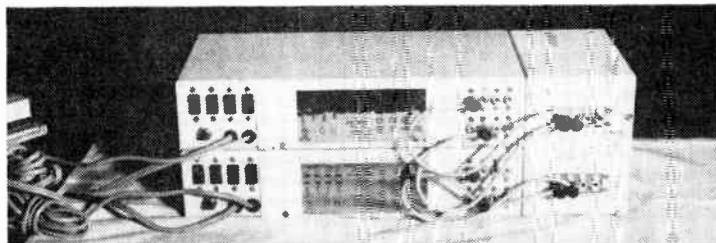

0.1% at output levels sufficient to drive any power amplifier.

Without exception each of the preamps worked exactly as expected when put into action. This was more a tribute to the clarity of the instruction booklets than to the skill of the constructor. Furthermore, the performance specifications advertised by the manufacturer were fully met in every detail of operation.

In actual use, the Dynakit stereo preamplifier control unit fulfilled all expectations. The

flexibility of the system, with inputs and outputs for every conceivable purpose, left nothing to be desired. Every kind of stereo and monaural source can be accommodated. The "blend" control is a most useful one and may just initiate a trend towards the inclusion of such a handy device.

If you are planning a stereo system and would like to have a control system of the highest quality at medium cost, the Dynakit stereo control system is heartily recommended.

# HEAR

## BASS NOTES DOWN TO 35 CPS... BUILD THE ELECTRO-VOICE ARISTOCRAT

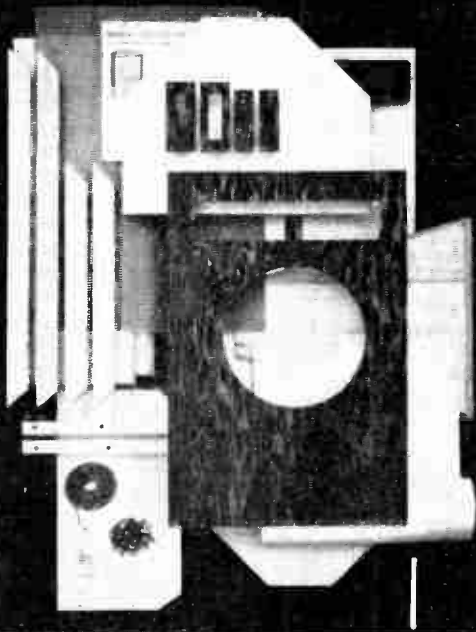

**DRAMATIC PERFORMANCE** has made the Electro-Voice Aristocrat the world's most popular enclosure for 12" loudspeakers. The Aristocrat will make an exciting difference in the performance of your loudspeaker—hear deep, extended bass response without annoying boom; sharp, well-defined low frequency transients, and all with greatly increased power handling capacity.

**ASSEMBLE THE ARISTOCRAT YOURSELF AND SAVE 50%.** When completed, the KD6 Aristocrat Kit interior construction is identical to E-V's factory-assembled Aristocrat enclosure, but with this difference: you save 50% and have an evening's fun.

**AS EASY AS ONE... TWO... THREE.** The KD6 Aristocrat Kit can be assembled in only one evening with E-V's exclusive sub-assembled parts and exploded view, step-by-step instructions. All you need is a screw driver; the rest is in the box. And E-V's accurately milled, furniture grade woods and veneers plus a choice of six finishing kits create an enclosure that will match your finest furniture.

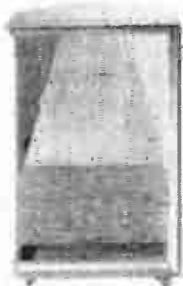

2

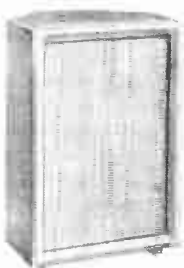

3

- Model KD6 Aristocrat Kit      Audiophile Net. \$39.00
- Model FK Finishing Kits, each      Audiophile Net. 5.00
- Factory Finished Aristocrat Enclosure, Mahogany      Audiophile Net. 72.00
- Limed Oak or Walnut      Audiophile Net. 79.00

Mail this coupon for free illustrated literature... see why more E-V Enclosure Kits have been built than all others combined.



### Electro-Voice<sup>®</sup>, INC.

BUCHANAN, MICHIGAN

**Superb New Products Through Research:**  
Microphones—Phono Cortridges—  
High Fidelity Loudspeakers and Enclosures—  
Public Address Speakers—  
Marine Instruments—Communication Equipment—  
Electronic Test Instruments and  
Material for Defense.

Electro-Voice, Inc.  
Buchanan, Michigan

Dept. GY-9

Gentlemen: Please send me free illustrated literature on E-V kits, enclosures and speakers.

NAME \_\_\_\_\_

ADDRESS \_\_\_\_\_

CITY \_\_\_\_\_ ZONE \_\_\_\_\_ STATE \_\_\_\_\_

## Making the

# Precise AM-FM Tuner

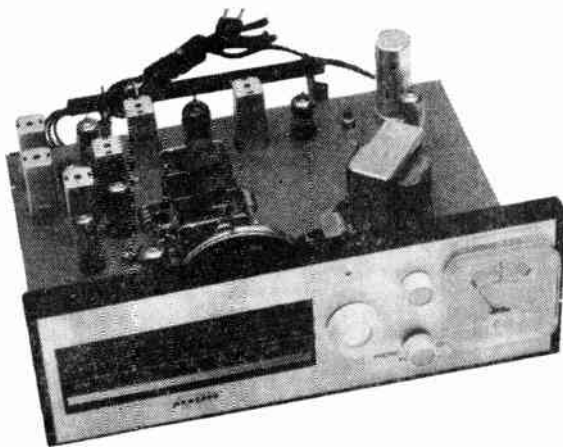

An AM-FM tuner is by necessity an exact, sensitive instrument. Because of this, the layout of a tuner kit is intricate, and will be a tough project for a novice kit-builder. Components must be mounted close together. Because of the high frequencies involved in the FM section all leads must be as short as possible, otherwise oscillation, detuning, hum, etc. will result.

The Precise model TUM AM-FM Tuner uses straightforward wiring on a horizontal chassis with a front mounted sub-chassis. Parts mounting was an easy job, and the hardware was easily identified. The only snag here was mounting the power transformer (as instructed) before its leads were inserted through two grommets on the chassis. Since the transformer sits close to the chassis, it was hard to put the leads

through the grommets and consequently took more time than should be necessary. You can avoid this difficulty by putting all leads through the grommets before installing the transformer. After mounting, all the components were soldered to the chassis to insure a good ground.

The diagrams in the instruction manual consist of photos of the mounted chassis with the wiring superimposed on it, instruction steps are placed around each photo. The wiring sequence should be carefully followed because of the complex circuit. We found that reading ahead in the instructions helped to place components in properly. Since the tube sockets have so many wires, resistors and capacitors connecting to them, the job of positioning all the leads so that none will touch became quite a problem.

## A

FM tuning coils are wound using ordinary pencil as a mandrel. Squeezing coils to size can be done before mounting.

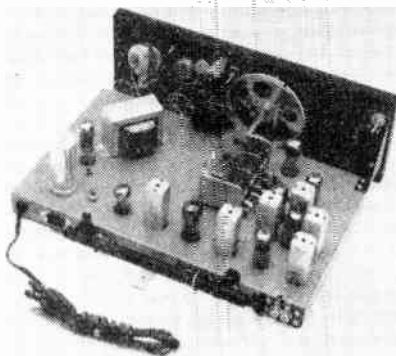

**B**

Shielded cable connects the function switch with output terminals. Tube sockets are 9 and 7-pin miniature. Components are soldered to the chassis ground.

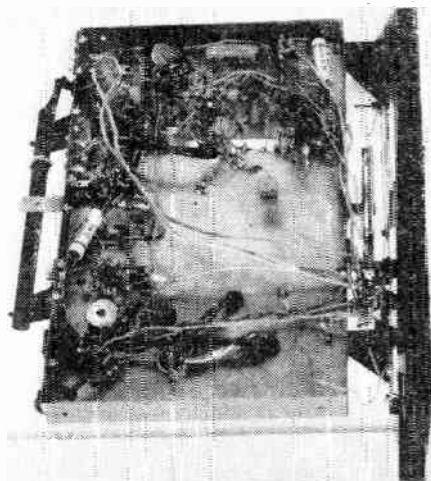

The RF coils for the FM section were wound from a length of bus bar supplied with the kit. These are tuning coils and hence should be wound exactly as the instructions specify. Any changes in dimension other than those specified can throw off the tuning of the FM band. We wound the coils on an ordinary pencil, and squeezed the turns to size after winding.

It was difficult to handle these coils for mounting and soldering due to their inflexibility. But a thin piece of string, wound around the coils and tied to convenient points on the chassis, held them firmly in place so they could be soldered correctly.

Uncovered shielded wire was supplied with the kit to connect the function switch to the output terminals and power supply. Newer Precise kits use insulation covered

shielded cable to insure against any shortening out caused by the bare shields after the bottom plate is installed.

Threading the dial cord is always a rough job. But thanks to Precise, we just had to wind the cord around the main and secondary pulleys, and then over two small pulleys which provide the track for the indicator.

Completing the tuner was only a matter of fitting the face plate on the sub-chassis front, putting on knobs, and indicator.

When the set was turned on, the FM section tuned in about half the full range, but the AM section was off the broadcast band entirely. Although Precise includes instructions for aligning, we thought it best to let a serviceman do the work since a signal generator was not available and the writer wanted perfect results.

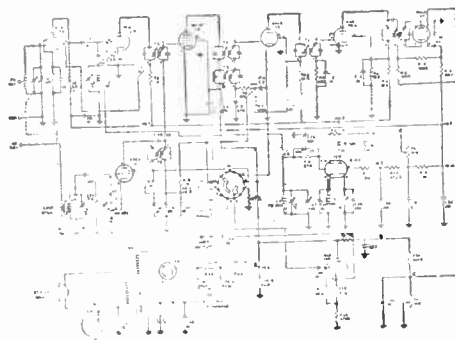

# Building Your Own Tape Recorder

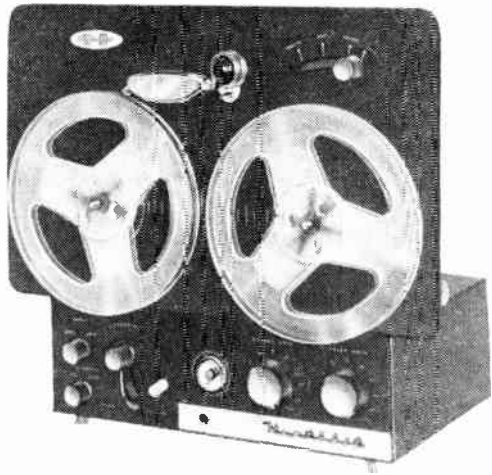

Building a tape recorder in kit form is an interesting job that can be done by anyone with some aptitude for a soldering iron and a screwdriver. The Heath tape recorder kit TR-1A comes in two separate packages. One contains the tape mechanism and the other is the tape record-playback preamplifier. For such a complex piece of equipment as a tape recorder, construction time is surprisingly small. With the aid of a good instruction book and large size drawings of the assembly and parts, building the tape unit took one evening of work. The record-playback preamplifier took another two evenings—one to mount components on the two printed circuit boards and main chassis and another evening to interconnect the boards with the chassis. Again the clear instructions were a big help in making the preamp a fast moving building job.

## tape deck

The tape deck consists of relatively few parts for the large number of functions it

performs. Some of the levers and brake assemblies are pre-installed for you by Heath. Although the interlocking of shafts and levers follows a complicated path, no difficulty was encountered either in assembly or operation of the finished unit. Aside from a screwdriver and a pair of pliers, the only tool required was an Allen wrench for tightening the drive pulley to the motor shaft. This special wrench was supplied with the kit.

## adjustments

The erase and recording head assemblies are pre-aligned and mounted on a support bracket, so there is no need for adjustment.

After the basic assembly is completed there are a few adjustments to be made on the supply and take-up reel drive. The only difficulty encountered in the whole assembly procedure came in the adjustment of the lever controlling the supply-reel rewind drive. A special nut used on this shaft has a plastic insert that locks the nut in place. But, it also makes it difficult to turn. Since

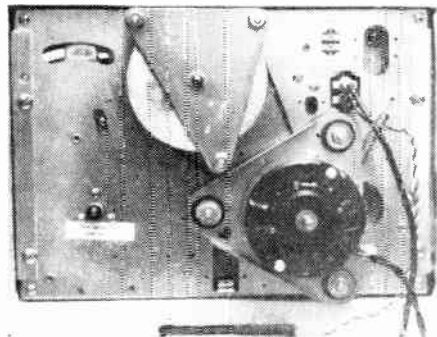
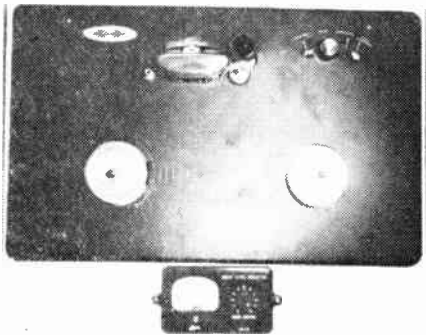

Electronic Kits



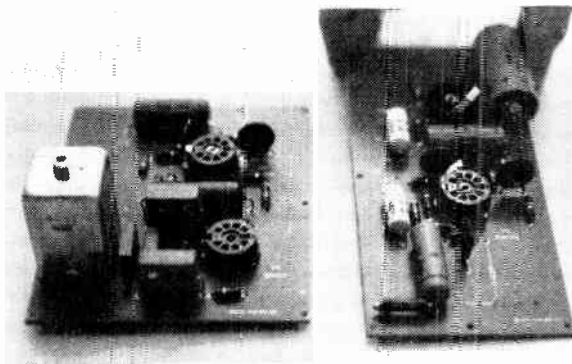

Two printed circuit boards make up almost all wiring for record and playback preamplifiers.

the nut is located close to the mounting panel, it is difficult to get a good grip with long-nose pliers. However, a little patience got the job done. If you have a small box wrench you will have no difficulty with this step.

Adjusting the brakes on the supply and take-up reels is a simple job, made even simpler by a tension measuring gauge supplied with the kit. The gauge, shown in the illustration, consists of a bent piece of wire that is hooked over the hub of the reel mount. The brakes on the reel drive are then adjusted until the wire gauge bends a specified amount when used to turn the hub. That's all there is to it!

The tape recorder electronic unit is a 4 tube assembly that provides amplification for recording and playback. An electron-eye tube is included as a recording-level indicator. Two printed circuit boards are used to mount all of the tubes and circuit components. Pictorials show placement of parts,

and in addition, the part number and connection are printed on the board. There is little chance of going wrong anywhere along the way.

After the boards are soldered and mounted on the main chassis the wiring connecting the boards to the panel switches and inputs and outputs are connected. In some portions of this wiring, a spiral shielding is used. This shielding consists of a spring-like tubing that is cut to the required length and slipped over the wires. A plastic tubing slipped over the shield insulates the whole thing.

After the assembly of both units was completed, the big test was begun—a signal from a tuner was fed into the recorder. The electron-eye indicator tube showed that the amplifier was working properly, but was there anything being recorded on the tape? Only one way to find out—play it back. Yes, everything worked fine and the playback sounded as clear and sharp as the original.

View of preamplifier with printed circuit boards installed. Switches and front panel still have to be wired. Electron-eye indicator tube mounts on bracket in center.

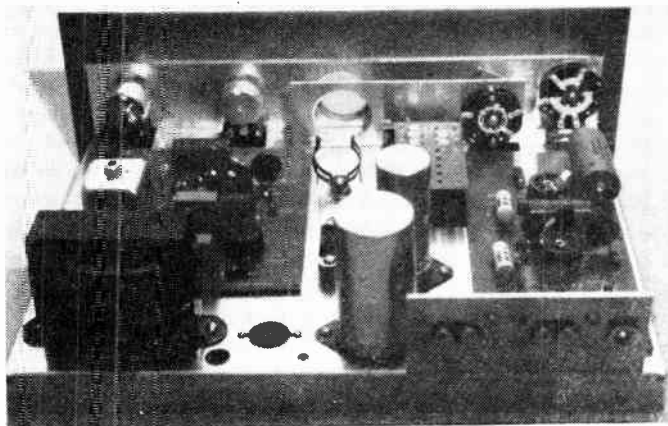

# Stereo Remote Control Center

The full enjoyment of stereo cannot be realized unless the two channels are reasonably balanced. Some stereo recordings produce a noticeable "ping-pong" effect between channels. This can become annoying after awhile, and to eliminate it, you've got to go back and forth to your set and change the balancing.

One solution to this problem is to install a remote stereo control adapter. It will enable you to maintain balance without leaving your seat. The Lafayette KT-315 Stereo Remote Control Center is easily assembled in an afternoon. In addition to channel reversing and phase reversing, it allows a third channel output to get rid of the "hole in the middle effect."

This stereo adapter can be used with any dual amplifier system, or combined amplifier-preamplifier unit.

The kit is supplied complete with all components and mounting hardware plus a well planned assembly manual. The bulk of the wiring is substantially simplified by the use of a printed circuit board on which is engraved the exact position and values of components. After the mechanical assembly is completed, the next step involves prewiring the double wafer switch. The pictorial diagrams furnished with the manual show the exact locations of wires and components.

In soldering connections to the printed board, as with all printed circuits, a small soldering gun or iron rated as 25 or 30 watts should be used. Extreme caution should be taken on this point so as not to damage the etched circuit on the printed board.

Several other precautions are suggested by the manufacturer, and it is recommended that they be followed to avoid the puff of smoke that might otherwise greet the fearless builder in lieu of music.

Briefly reviewing the KT-315 specifications, its frequency response is within 0.5 db from 5 to 50,000 cps. Normal gain is 6 db, (0.5 volt input for 1 volt output) and intermodulation is less than 0.05 percent at 2 volts equivalent sine wave output, using 60 cps and either 2, 7, or 12 kc mixed in the ratio of 4 to 1. It contributes less than 0.1 percent total harmonic distortion from 30 to 15,000 cps at 2 volts output.

Hum and noise are down 80 db, crosstalk being better than 55 db between channels. Output switch positions are, REVERSE CHANNEL/REVERSE PHASE, REVERSE CHANNEL, NORMAL, REVERSE PHASE and CALIBRATE. Input switch positions are, MICROPHONE A, MICROPHONE B, STEREO, A PLUS B and CALIBRATE. The KT-315 uses two type 7025 tubes, stands 4½" high, 6½" wide and 8" deep (excluding knobs). It operates on 105-115 volts ac, 50 to 60 cps, and consumes 12 watts. The power supply is built in.

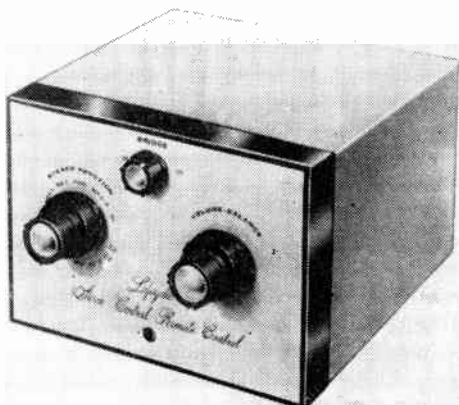

Compact remote control housing.

# Integrated Amplifier For Stereo

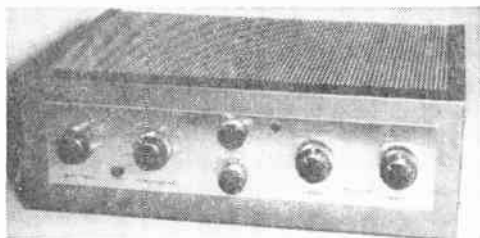

Unit has two 14 watt amplifiers, two preamps, and a power supply. There is a lot of room to spare for wiring. Controls include focus for stereo balance.

The everything-in-one-package arrangement of an integrated amplifier has made this type of unit popular with many hi-fi enthusiasts. With the "double everything" required by stereo this compact design has even greater attractiveness.

The Eico III-81 stereo amplifier is a good example of why the integrated amplifier is so popular. The designers have packed two complete 14 watt amplifiers with preamps and power supply onto one chassis. The most surprising part of the whole thing is that there is plenty of working space for the constructor. Of course, with two complete amplifiers, there is plenty of wiring to be done in that space. The Eico III-81 is by no means a one evening project. However, all of the wiring is straightforward and should cause no difficulty if the instructions are followed.

One of the factors that add to the number of wiring steps is the flexibility of this stereo amplifier. Provisions are made for operation as two 14 watt amplifiers for stereo, or as a 28 watt monaural amplifier. There are arrangements for checking either channel for proper operation and for reversing channels. Tape outputs are provided for either stereo or monaural recording and for combining the two power amplifiers for 28-watts output on channel one. The output from the channel two preamplifier can then be fed to an external power amplifier. The advantage of this latter arrangement is that you can have two high power amplifiers with all of the control functions concentrated in the III-81.

## construction

Eico has traditionally held to reliable, conventional circuit layout, with few concessions to making the assembly job more rapid. Although it may take a bit longer to put this kit together, the builder is assured of a solid, well-designed unit with no gimmicks or tricks that make the circuit difficult to trace or repair.

The instruction manual is clear and full page layout drawing make the steps easy to follow. The selector switch assembly is wired before installation making for little work in tight corners. Two preassembled printed circuit plates are used to wire all of the components in the tone control circuits. These

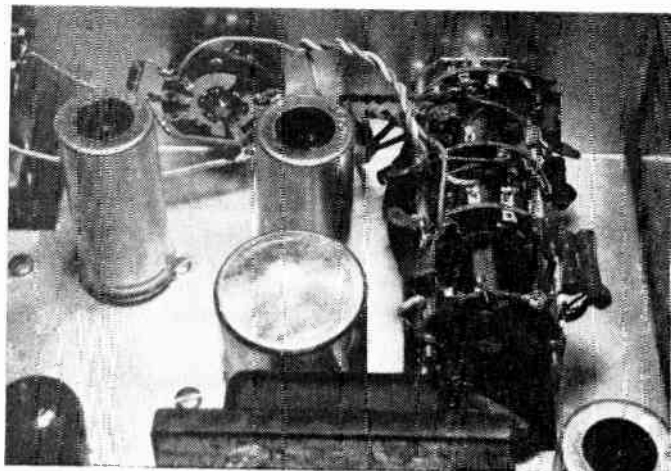

Inputs include tuner, phono, microphone, multiplex and tape. Full 28 watts monaural output, or 14 watts each stereo channel.

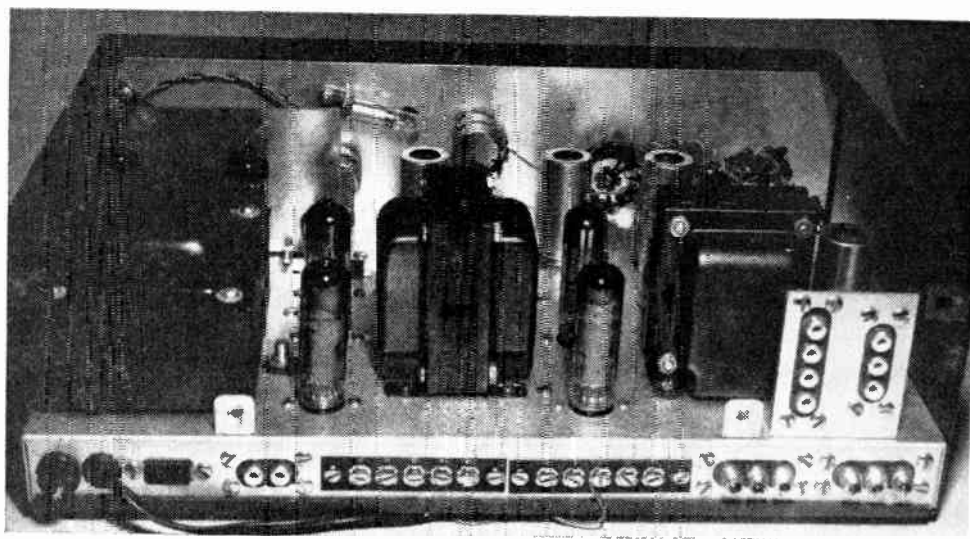

Selector switch assembly is wired before mounting. Tone control components are mounted and wired easily to two printed circuit boards.

plates make the wiring of the tone controls a one minute job. Underchassis wiring may seem complex if you look at the drawings, but actually all is straightforward point-to-point connections. A little care taken to double check each step will avoid any possibility of wrong connections.

The completed amplifier performed well on first try. The 14-watt output was more than enough to drive the high-efficiency speaker system used by the builder. The IIF-81 provides a lot of quality and flexibility for its price and will provide a lot of satisfaction for the builder.



## **The Rek-O-KUT K-33 Turntable**

*it goes together in no time at all*

A turntable is a piece of equipment that requires careful balancing and close mechanical tolerances in order for the equipment to operate properly. This might make it seem impractical for manufacturers to provide this precision apparatus in a form that could be assembled by a novice builder. Actually, it is the high degree of precision required that makes the Rek-O-Kut K-33 turntable one of the easiest assembled kits in the hi-fi stable.

If this sounds like a paradox, look at it this way—the hi-fi fan does not have equipment for balancing a heavy turntable to the precision required in a hi-fi system—the manufacturer must do it for him. An electric motor is a complex thing and requires skilled assembly—the manufacturer must do this, too. The same applies to the turntable bearings and drive gear. As a consequence, the hard part of assembling a turntable must be done by the manufacturer.

All the builder has to do is put these assemblies in the right place on the mounting plates. In the Rek-O-Kut K-33, this job consists of mounting the drive motor, turntable bearing and baseplate and installing the turntable. The whole job takes about three-quarters of an hour if you work carefully. A mounting base is also available if you need it.

### **8:00 PM**

First step in assembly of Rek-O-Kut turntable is installation of shock mounted motor plate. Three screws and a spring complete the job.

Number 2

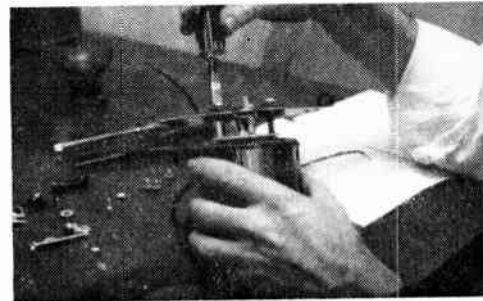

**8:10 PM**

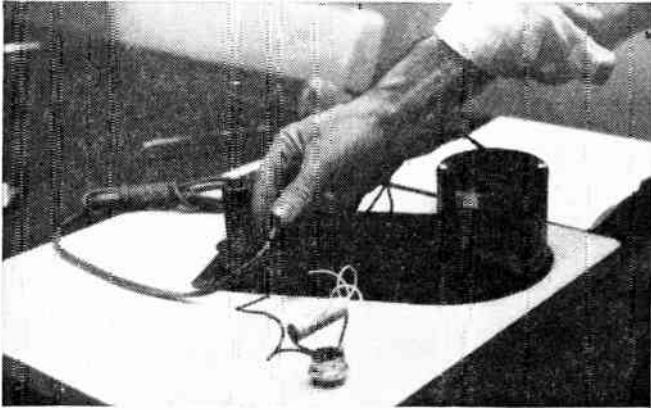

The main mounting plate is next installed on the precut base board. Motor is then installed in hole on plate and the turntable bearing (not visible behind hand).

**8:17 PM**

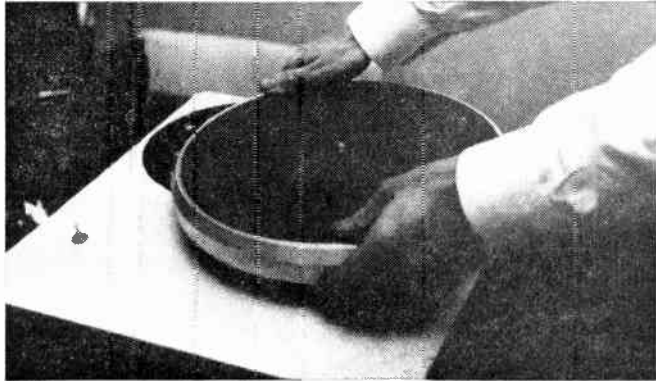

With motor and bearing tube installed wiring of on-off switch and motor is completed. Only soldering required is on the switch terminals.

**8:29 PM**

Turntable is now ready for installation. Before installing, be sure that small ball bearing has not dropped out of the bearing tube.

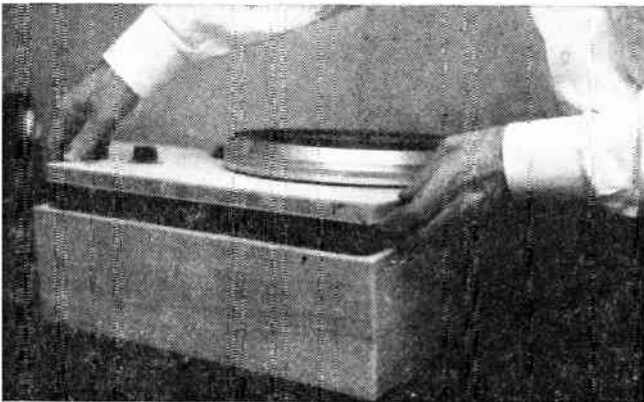

**8:36 PM**

Completed assembly is now placed in base. Note drive belt around side of turntable. All that is needed now is installation of a pickup arm and cartridge.

Electronic Kits

# ACROSOUND Ultra-Linear II Power Amplifier

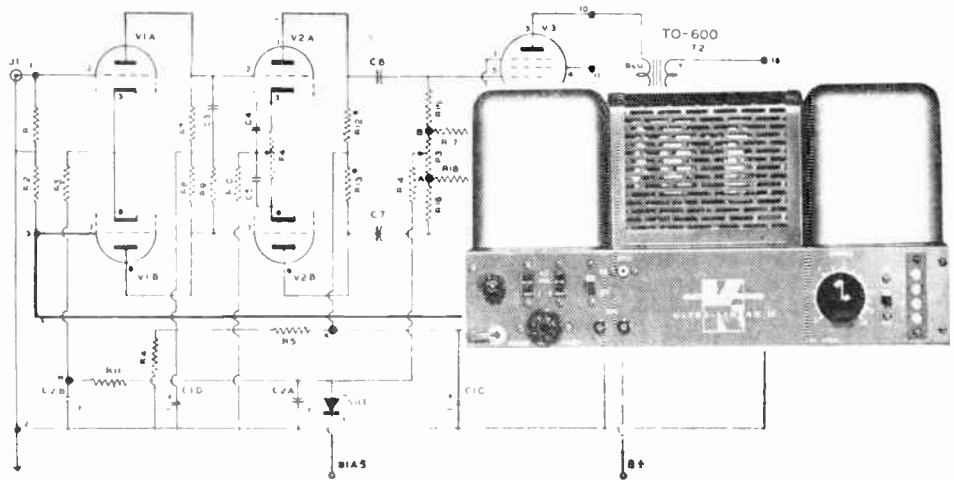

*A basic amplifier with plenty of power*

The growing popularity of low-efficiency speaker systems and multiple speaker installations has focused attention on the desirability of higher power amplifiers. One entry in the high power field is the Acrosound Ultra-Linear II, a basic 60-watt amplifier kit (Acro Products, 369 Shurs Lane, Philadelphia 28, Pa.).

Assembly of the kit is exceptionally simple as most of the components are pre-mounted and pre-wired on a printed-circuit board.

The first step includes mounting and wiring the two a.c. outlets, on-off switches and variable damping control on the front panel. The second consists of assembling the four-section chassis, mounting the transformers and printed-circuit board. Connecting the leads to the printed-circuit board and the mounting and soldering of a few remaining resistors finishes the job.

Sound simple? Well, it is. The steps are

few and the booklet and accompanying pictorial are clear and easy to follow. Wiring time, including the parts check and the bias and two balance settings, was 3½ hours.

The input is fed directly to a 12AX7 tube hooked up as a long-tailed pair phase inverter. A grid of one of the tubes of this type of phase inverter which is normally grounded (a.c. wise) is used as the feedback point for the "hybrid" winding on the output transformer. This achieves isolation between the load impedance and the feedback circuit making possible the inclusion of a variable damping control which does not affect the over-all feedback.

Output of the phase inverter is direct coupled to a 12AU7 push-pull voltage amplifier with special balancing provisions in the cathode. The 12AU7 is RC-coupled to the push-pull output stages. The output circuit comprises two EL-34's with fixed bias and

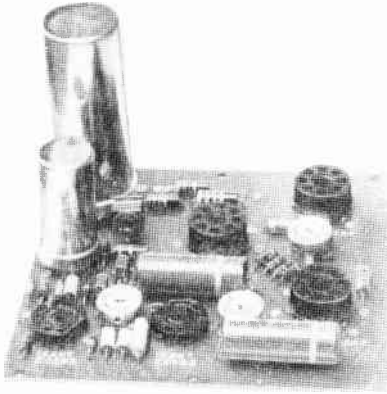

Printed-circuit board simplifies construction of the Acro Ultra-Linear II.

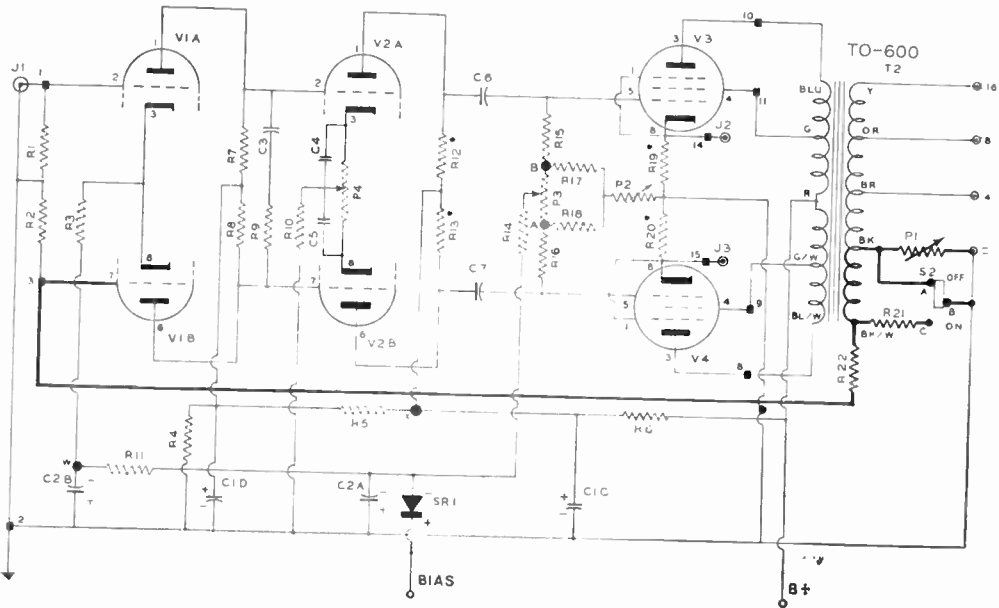
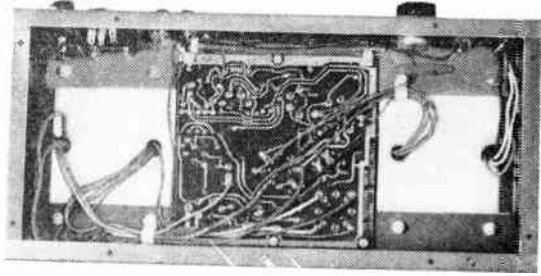

Dark lines in schematic diagram indicate unique feedback damping circuit used in Acrosound amplifier.

an Ultra-Linear output transformer.

The Acro has a preamp power socket, 4-, 8-, and 16-ohm speaker taps and a damping control variable from 0.5 to 10. The control may also be switched out for a fixed damping factor of 15.

Input sensitivity for rated output is 1.6 volts. This amplifier tested out flat from 20 to 20,000 cps within 0.5 db at 60 watts.

Hum and noise was 90 db below rated output.

Square wave response was excellent at all audio frequencies and at all power levels. Variable damping did not seem to affect response in any way except for a very slight drop in power. In the last and most important test, the amplifier sounded clean and performed beautifully at all volume levels.



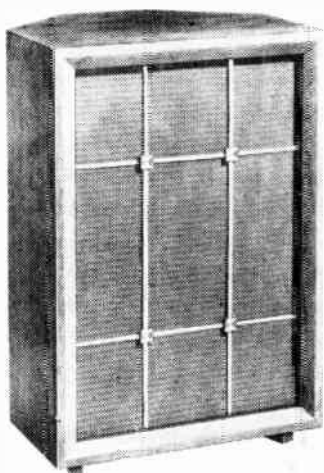

## The Electro-Voice Aristocrat Enclosure

*...all you need is a screwdriver*

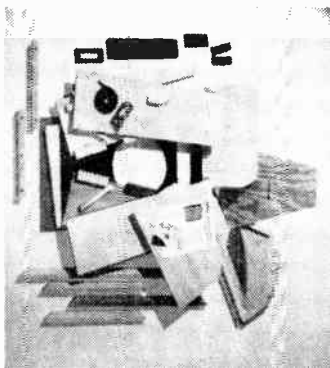

**A** Finished unit took no more than  $\frac{3}{4}$  hour working time. Front baffles and molding will have to be disassembled when mounting speakers. Aluminum grille is extra kit AK6 which is not included in Aristocrat

**B** Before assembling, try "dry-fitting" the sections together. This provides a check on any warping in the wood that might cause trouble later.

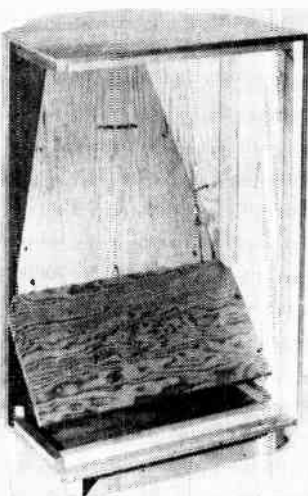
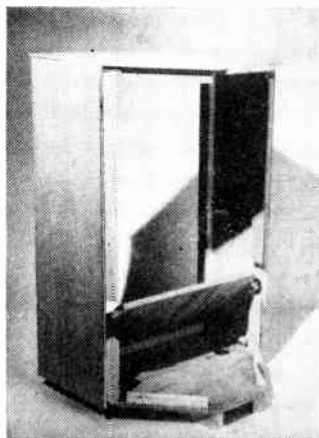

**C** Assembling the enclosure is a simple matter of gluing and screwing the pre-cut sections. Carpentry skill is not necessary. Top, bottom, and two sides too no more than 10 minutes, with half an hour for each glued joint to dry.

**D** Front baffle is used as squareness gauge for mounting side and rear panels. Insulation padding is tacked to both deflector boards, and rubber strip ping is pressed around front edge of cabinet.

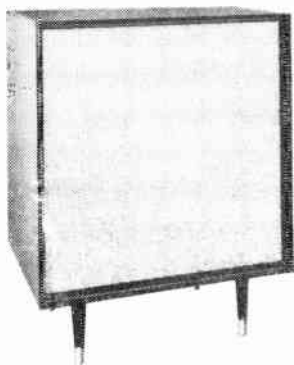

## Quick-Built Speaker Enclosure

*... no screws, no blues*

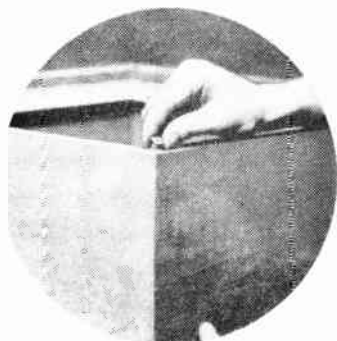

For the hi-fi'ers who assemble their rigs component by component, here is a new and economical solution to the choice between expensive custom cabinets and homemade boxes. The cabinet kits of Artizans of New England (Dept. 9A, Route 39 North, Sherman, Conn.) are noteworthy because of the new method of construction used. Ease of assembly is insured by utilizing hidden steel locking and reinforcing supports, which join the mitered corners of the cabinets without nails or screws.

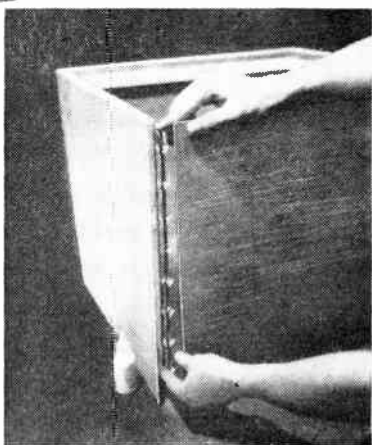

**2** After assembly of the four sides of the cabinet, the metal leg brackets are attached to the bottom. Since the four sides are equal size, choose the side with the best grain design as the top of the cabinet. The leg brackets permit either straight or tilted leg mounting to match your listening room decor.



**1** The four sides of the Model 501 cabinet are fitted together with a metal "fishbone." The joint is then pressed together. As the "fishbone" is tightened with a screwdriver, the fishbone barbs pull the adjoining surfaces together. The assembled sides are then finished with the wipe-on oil stain provided and the front edges of the cabinet are trimmed in black varnish.

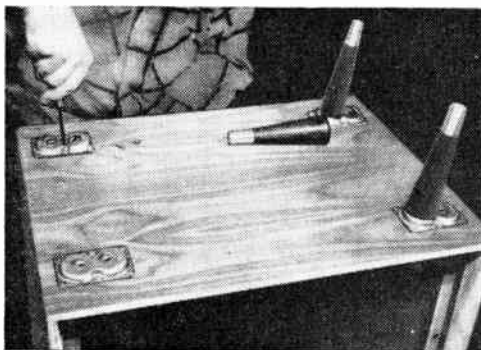

Electronic Kits

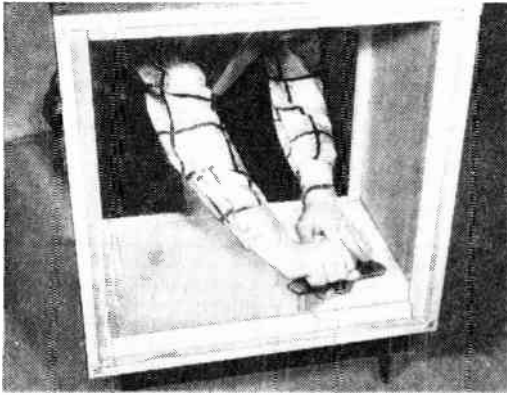

**3** Glass wool is stapled to all internal surfaces in the cabinet except the speaker mounting board. Adequate cabinet damping is insured by the liberal use of acoustic absorbent material.

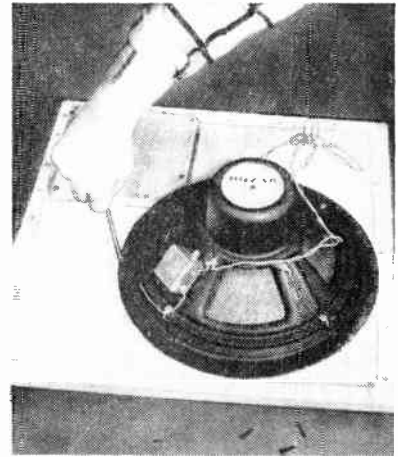
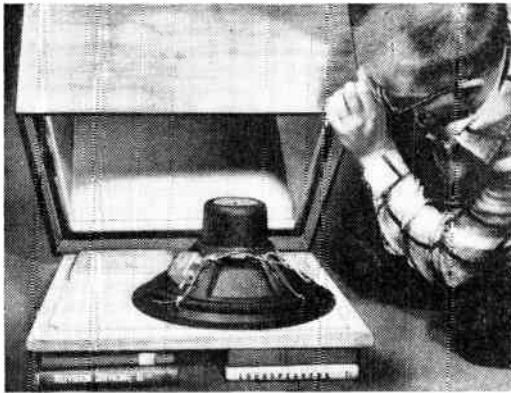

**4** A Bozak 207A loudspeaker is mounted on the front panel. The 8" hole intended for a tweeter or port is sealed with a  $\frac{3}{4}$ " plywood panel supplied with the kit, thus providing the infinite baffle required by the Bozak speaker. The grille cloth is stretched over front panel and tacked down inside.

**5** To install the front panel, prop up the speaker mounting board with books, then ease cabinet into position on board. The front panel now rests flush against the recessed cleats in the cabinet, and can be screwed into place from the rear. Install rear panel with cabinet upright. And, finally, hook the cabinet up to your hi-fi system and enjoy the fruits of your labor.

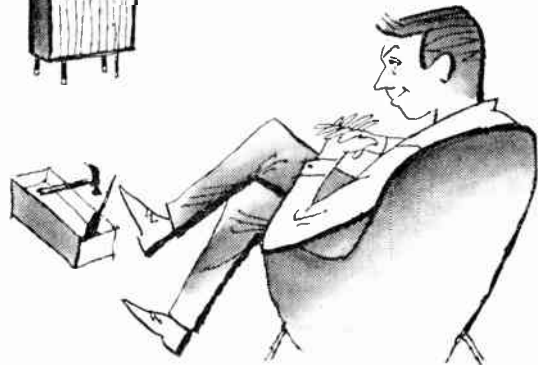

another "first"... from  
 the first name in high  
 fidelity turntables—a  
 RONDINE turntable with  
**hysteresis motor\*** at



\$

**49**

**95**  
net

**REK-O-KUT RONDINE**

**K33H  
KIT**

Rondine K-33H Specifications; powered by Rek-O-Kut hysteresis synchronous motor. Single-speed (33 $\frac{1}{3}$  rpm) with Crown-Spindle belt drive; includes built-in strobe disc and on-off switch. Assembly: 30 minutes or less with ordinary tools. Complete instructions in each kit. Price: \$49.95 net, K-33H Turntable Kit only.

For ease of installation, handsome Rek-O-Kut bases and pre-drilled motor boards are available. Bases from \$10.95; Mounting Boards from \$4.95. Rek-O-Kut Tone-arms from \$27.95. \*Hysteresis motors are essential for the professional quality required by broadcast and recording studios.

**REK-O-KUT**

HIGH FIDELITY TURNTABLES  
 TURNTABLE ARMS

Rek-O-Kut Co., Inc.  
 Dept. EK-5  
 38-19 108th St. Corona 58, N.Y.

Please send complete information on the new Rondine K33H Kit with hysteresis motor.

Name \_\_\_\_\_

Address \_\_\_\_\_

City \_\_\_\_\_ Zone \_\_\_\_\_ State \_\_\_\_\_

Export: Morhan Exporting Corp., 458 Broadway, New York 13, N. Y.  
 Canada: Atlas Radio, 50 Wingold Ave., Toronto 10, Ontario

RK-40

**Rondine — the Hysteresis Line... Engineered for the Studio... designed for the home!**

# Directory of Hi-Fi Kits

## ACRO PRODUCTS COMPANY

### Acrosound Ultra-Linear II Amplifier

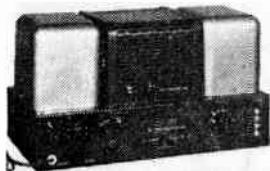

Power output 60 watts; response 18 cps to 30kc  $\pm$  1 db at 60 watts; less than 1% IM distortion at 60 watts; hum level 90 db below full output; 1.6 volts rms for 60 watts output; output impedances are 4, 8, and 16 ohms; 7" x 15 1/8" x 8" h.; tubes used are 12AU7, 12AX7, GZ34, 2-EI34 or 6CA7; variable damping from 0.5 to 10; damping control may be switched out to provide a fixed damping factor of 15; 30 lbs.; TO-600 output transformer; dark brown chassis and dust cover; estimated assembly time 1 1/2-2 hours. . . . \$79.50  
With 125 and 500 ohm output . . . . . \$89.50

### Stereo 20-20

Basic power amplifiers rated at 18 watts per channel; both may be paralleled for full 36 monophonic watts; frequency response 10-70,000 cps  $\pm$  1 db. at 1 watt; sensitivity 1.5 volts RMS for 18 watts output; 1.5% IM distortion at 18 watts equivalent sine wave power per channel; tubes are EL84, 6BQ5, ECC83, 12AX7; estimated time of assembly 2-3 hours. . . \$69.50

### Stereo 20

Exactly the same as above but only on monophonic amplifier; estimated time of assembly 1 hour. . . . . \$44.50

Number 2

### Stereo 20A

This is the identical amplifier in the Stereo 20 above minus power supply; estimated time of assembly 1 hour. . . . . \$29.50

## APPROVED ELECTRONIC INSTRUMENT CORP.

### Model A-870 Amplifier

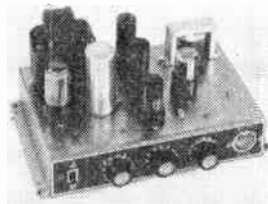

6 watts; frequency response: 40 to 12,000 cps  $\pm$  1.5 db; hum: 78 db below full output; separate bass and treble controls with 12 db maximum boost; sensitivity: 0.5 volt; output impedances: 4, 8, 16 ohms; tubes: 12J5, 12SL7, 2-12A6, 5Y3GT, 1629 (output indicator); 11" w x 5 1/2" h x 6 1/2" d . . . . . \$17.45

### Model A-880 Binaural Amplifier

Two amplifiers on one chassis; channel 1 has preamp; maximum output (each channel): 4 watts; frequency response: 40 to 12,000 cps  $\pm$  1 db; hum level 78 db below rated output; bass and treble controls supply 12 db maximum boost; function selector for monaural or binaural use; inputs: magnetic, crystal, tape, radio; maximum gain on phono inputs 35 db; output indicators; output impedances:

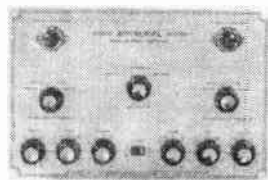

4, 8, 16 ohms; tubes: Channel 1, 2-6F5, 6V6GT, 1629; Channel 2, 2-6F5, 6V6GT, 1629 both channels; 6SC7, 5Y3GT gold finish; 13" w x 8 1/2" h; 9" d . . . . . \$39.95

### Model A-890 Amplifier



20 watts; frequency response 10 to 100,000 cps  $\pm$  0.5 db harmonic distortion (20 to 20,000 cps) 0.5%; IM distortion 1% at 12 watts; hum 78 db below rated output; output impedance: 4, 8, 16 ohms; a.c. convenience outlet; level control; tubes: 2-6SN7GT, 2-5881, 5V4G; 15" w x 7" h; 9" d . . . . . \$47.50

### Model A-800 Preamplifier

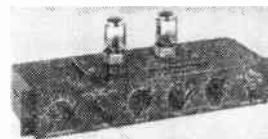

Provides 6 positions of record equalization; bass and treble controls allow 15 db boost and gain; inputs: magnetic phono, crystal phono, tuner; tubes are 2-7F7; power requirements: 60 volts a.c. or d.c. at .6 amp, 150 volts d.c. at 7 milliamps; 12" v x 4" dx 2" h . . . . . \$17.95

### Model V-5 AM Tuner

Sensitivity: 5 microvolts; tuned r.f. stage and iron core tuned i.f. transformers; frequency response: 20 to 7,500 cps  $\pm$  3 db cathode follower output; tubes 6BE6, 2-6BA6, 6AL5, 6C4; 65

# Directory of Hi-Fi Kits

selenium rectifier; gold finish; 9 3/4" w x 5" h x 5 7/8" d . . . \$29.45

## Model V-9 FM Tuner

Tuned r.f. stage; temperature compensated oscillator; sensitivity: 10 microvolts for 20 db quieting; frequency response: 20 to 20,000 cps  $\pm$  0.5 db; bandwidth: 200 kc; hum 70 db below average output; average output: 0.5 volt; cathode follower output; tubes: 6CB6, 2-6AB4, 4-6AU6, 6AL5, 6C4; 65 selenium rectifier; gold finish; 9 3/4" w x 5" h x 8" d . . . \$33.50

## Model V-12 AM-FM Tuner

Tuned r.f. stage; temperature compensated oscillator; sensitivity: FM, 5 microvolts for 20 db quieting; AM, 5 microvolts; frequency response: FM, 20 to 20,000 cps  $\pm$  0.5 db; AM, 20 to 7,500 cps  $\pm$  3 db; FM bandwidth: 200 kc; hum 70 db below average output; average output: 0.5 volts rms; cathode follower output; tubes: 2-6BA6, 6CB6, 2-6AB4, 6BE6, 4-6AU6, 6AL5, 6C4; 1N34-60 crystal diode detector; requires external power supply: 190 volts d.c. at 55 milliamps, 6.3 volts a.c. at 4 amp; gold finish; 9 3/4" w x 5" h x 8" d . . . \$38.50

## Model A-620

Power Supply (wired) . . . \$12.00

## ARGOS PRODUCTS CO.

### "Californian" Speaker Enclosures

Jensen Bass Utraflex design with "tuned tunnel;" DSE-1K "Californian": 24" w. x 29" h. x 15" d., 4.3 cubic feet—DSE-2K "Californian Jr.": 19 1/2" w. x 23 3/8" h. x 13 1/2" d., 2.5 cubic feet; 1/2" 5-ply plywood, DSE-1K accommodates 15" or 12"



woofer and tweeter or coax speaker; DSE-2K accommodates 12" or 8" woofer and tweeter or coax speaker; reducing ring and tweeter port cover supplied with mounting hardware; estimated assembly time 1-2 hours; blonde or mahogany.

DSE-1K . . . \$40.50  
DSE-2K . . . \$32.50

## ARKAY RADIO KITS

### Model AM-5 AM Tuner

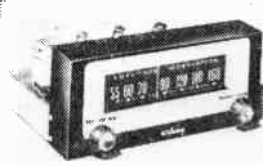

Sensitivity: 2 microvolts for 20 db signal-to-noise; frequency response 20 to 8,500 cps in wide-band position, 20 to 3,500 cps in narrow-band position; 1 volt adjustable cathode follower output; 10 kc whistle filter; tubes are 2-6BA6, 6BE6, 6AL5, 6AV6; self powered; 9 lbs.; estimated assembly time 7-12 hours . . . \$29.95

### Model FM-6A FM Tuner

Sensitivity: 4 microvolts for 20 db quieting; selectivity: 200 kc bandwidth 6 db down; 30 db minimum image rejection; hum level -65 db; temperature compensated oscillator; 3 i.f. stages; Foster-Seecley discriminator; AFC with defeat switch estimated assembly time 10-12 hours; 5 1/4" x 9 1/2" x 8" . . . \$25.75

### Model FM-8 FM Tuner

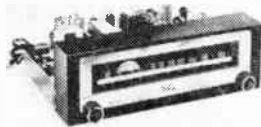

Three tuned stages; all triode front end, five double-tuned i.f. stages, dual limiters, Foster-Seecley discriminator, variable AFC; AGC; front-panel sound muting control for silent meter tuning; standby switch; low-filter switch; sensitivity 1.9 microvolts for 20 db quieting; tuning meter, frequency response 20 to 20,000 cps; outputs: cathode follower, high level, and binaural FM (multiplex); tubes 2-12AT7, 2-6BA6, 2-6AU6, 6AL5, 12AU7; edge-lighted slide rule dial; estimated assembly time 16-24 hours. . . \$39.95

### Model HFT-7 AM-FM Tuner

FM specifications identical to FM-6 tuner kit; AM sensitivity is 25 microvolts; selectivity of 8 kc bandwidth 6 db down; esti-

mated assembly time 12-20 hours; 5 1/4" x 9 1/2" x 8" . . . \$33.00

### Model ST-11 AM-FM Stereo Tuner

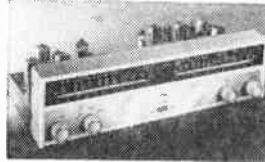

AM and FM completely separate and independent; FM specifications: sensitivity 4 microvolts for 20 db quieting, bandwidth 200 kc at 6 db down, image rejection 30 db minimum, frequency response  $\pm$  .5 db 20 to 20,000 cps, hum level -65 db, AFC, cathode follower output; AM specifications: sensitivity 2 microvolts for 20 db signal-to-noise, frequency response 20 to 8,500 cps, two bands—narrow and wide, whistle filter, cathode follower output; self powered; weight 12 lbs.; estimated assembly time 12-20 hours . . . \$19.95

### Model A-12 Amplifier

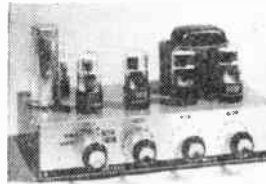

Rated at 12 watts;  $\pm$  1.5 db 20 to 20,000 cps at 2 watts; distortion less than 2% at 2 watts; five inputs; separate bass and treble controls; output impedance of 4, 8, 16 ohms; estimated assembly time 6-12 hours; 11" x 7" x 5" . . . \$22.95

### Model FL-10 Amplifier

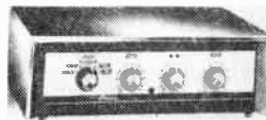

Rated at 12 watts; 40 to 40,000 cps  $\pm$  0.5 db below 10 watts; hum on phono input 55 db below full output; tone controls  $\pm$  16 db at 50 and 10,000 cps; bass, treble, and loudness controls; three-position record equalization switch; phono and two low gain inputs; output impedances of 4, 8 and 16 ohms;

tape output; estimated assembly time 6-12 hours; rose gold panel with black cabinet; 12½"x4"x8½" .....\$29.95

Model FL-30 Amplifier



Rated at 30 watts;  $\pm .5$  db 20 to 30,000 cps; IM 1.5% at 30 watts; hum 120 db below rated output; transistor preamp; three-position record equalization; controls are function, loudness, bass, treble, level, and balance; tone controls provide  $\pm 16$  db at 50 and 10,000 cps; tape output jack; two switched a.c. outlets; output impedances of 4, 8, 16 ohms; estimated assembly time 12-24 hours; rose pink panel, black cabinet; 16"x5"x9"; 26 lbs.....\$49.95

Model SA-25 Stereo Preamplifier-25 Watt Amplifier



Channel 1 drives a 25-watt amplifier, equalization for LP-RIAA-EUR magnetic phono, inputs for NARTB (tape head), tuner, and auxiliary equipment; Channel 2 is a preamp with 0.5 volt cathode follower output, has inputs and equalization identical to Channel 1, may be used to drive any amplifier to provide stereo-binaural playback; both Channels 1 and 2 are regulated by a single-ganged volume control; tone control for bass is  $\pm 16$  db at 60 cps, for treble  $\pm 16$  db at 10,000 cps; low cut filter is -6 db and -12 db, high cut filter is -6 db and -12 db; loudness control; IM distortion 1.8% at 20 watts; hum -90 db; tape -70 db; frequency response 20 to 30,000 cps,  $\pm 0.5$  db; eight tubes: 2-6L6GB, 5U4/GZ3-1, 2-12AX7/ECC83, 12AT7/ECC81, 12AU7/ECC82, 6C4; estimated assembly time 20-30 hours; 29 lbs.....\$59.95

Model SP-6 Stereo Preamplifier  
Two sets of inputs for tape deck, magnetic phono, tuner, and aux-

**BUILD THE BEST!**  
build quality money-saving  
**knight-kits**  
A PRODUCT OF ALLIED RADIO

SAVE UP TO 50%

free send for

**ALLIED'S  
KIT CATALOG**

**BUILD YOUR OWN  
IT'S EASY...IT'S FUN!**



20 Watt  
Stereo Amplifier  
for only \$44.50



4-Band  
"Span Master"  
Receiver,  
only \$24.95



Quality  
VTVM—  
top buy at  
\$25.75



Amateur  
Communications  
Receiver  
only \$104.50

Send for this value-packed catalog describing fully the complete KNIGHT-KIT line. See everything in Stereo Hi-Fi, Hobby, Test Instrument and Amateur kits. KNIGHT-KITS are lowest in cost, convenience-engineered for easiest assembly (no previous electronic experience necessary), most advanced in circuit design and styling—the only kits with money-back guaranteed specifications that assure superior results. When you build a KNIGHT-KIT you build the best. You'll be proud of your finished equipment—you'll marvel at the quality and performance—you'll like the savings!

**EASY TERMS AVAILABLE**

Send coupon for Free Catalog showing the complete KNIGHT-KIT line, showing everything in Hi-Fi, Hobby, Amateur and Test Instrument kits.

send today free

**ALLIED RADIO**  
100 N. Western Ave., Dept. 139-9-2, Chicago 80, Ill.

Send FREE KNIGHT-KIT CATALOG

Name \_\_\_\_\_

Address \_\_\_\_\_

City \_\_\_\_\_ Zone \_\_\_\_\_ State \_\_\_\_\_

## Directory of Hi-Fi Kits

iliary; single volume control knob for both channels; individual input level controls for each input channel; two 3-volt cathode follower outputs; bass control gives  $\pm 16$  db at 50 cps; treble  $\pm 16$  db at 10,000 cps; hi and low filters each have three positions, 0, -6 db, -12 db; equalizations are phono, RIAA, EUR; variable loudness control; frequency response from 10 to 30,000 cps.  $\pm .5$  db; d.c. biased filaments; left and right balance controls; estimated assembly time 12-20 hrs.; 15 lbs. \$39.95  
**SPA-55 Stereo Bi-Channel Power Amplifier**

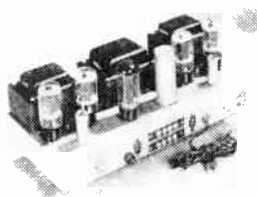

Two 30 watt amplifiers with combined output of 60 watts; includes phantom channel for resultant information from both channels; no cross-talk; tubes are four 6L6GB, two 6AN8, 5U4GB; frequency response 20-20,000 cps.; IM distortion 1.5% at 25 watts; harmonic distortion .9% at 25 watts; controls for input level, balance, bias level; 15 1/2" x 8" x 6"; estimated time of assembly 6-12 hours. . . . \$61.95

### CS-12 Stereo Preamp and Amplifier

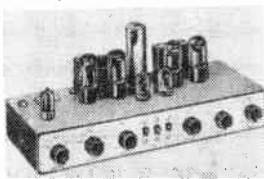

Integrated amp for both stereo and monaural; 12 watts output up to 20 watts peak; frequency response  $\pm 1$  db., 20-20,000 cps. IM distortion, 4 to 1 60-7,000 cps. 1.2%; input .3 volts for full output; controls are bass, treble, function, balance, selector; selenium rectifiers; 15" x 6 1/4" x 5 1/2"; estimated assembly time 6-12 hours. . . . \$35.95

### CS-28 Stereo Amplifier, Preamp, And Control Center

Dual 14 watt amplifiers convert to 28 watts monaural operation; full 28 watts can be combined

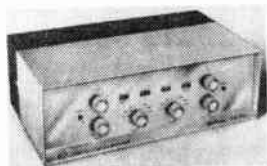

with existing amp for extended stereo operated with dual pre-amp; frequency response 20-20,000 cps.; IM distortion 4 to 1; harmonic distortion less than 1%. 30-20,000 cps.; preamp output 2 volts; tape recorder output 10 volts; estimated time of assembly 12 to 24 hours. . . . \$64.95

### AV-20 6" Audio VTVM Preamplifier

An audio VTVM of high sensitivity for measuring RMS voltages; estimated time of assembly 4-6 hours. . . . \$29.95

## AUDAX, INC., DIV. OF REK-O-KUT CO., INC.

Audax Tonearm

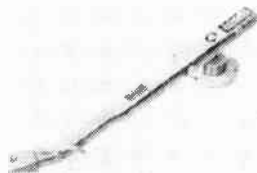

One-piece arm construction with precision vertical and lateral pivots; removable cartridge shell; for monaural or stereo cartridges; adjustable stylus pressure; estimated assembly time 15 minutes.

KT-12 (12") . . . . . \$15.50  
 KT-16 (16") . . . . . \$18.50

## BOGEN-PRESTO, A DIVISION OF THE SIEGLER CORP.

Model K-DB20DF Amplifier

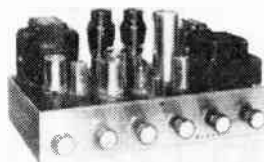

20 watts output (peak 30 watts); harmonic distortion 0.3%; frequency response 20 to 20,000 cps.  $\pm 0.7$  db; 7-position equalizer; dual tone controls; 5-position loudness control switch;

inputs are magnetic phono, radio, tape, and aux.; rumble filter switch; variable damping factor; 15" x 10" x 8" . . . . . \$69.50  
 CG-22 metal cage. . . . . \$8.25

### Model K-DB110 Amplifier

12 watts output (16 watts peak); controlled feedback circuitry; 15 to 30,000 cps.  $\pm 0.5$  db; harmonic distortion 0.65% at 12 watts; noise level -85 db; six

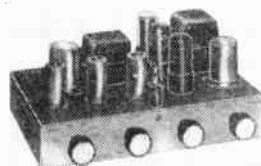

tubes including two 6V6GT output tubes; infinity damping factor; Silectron core output transformer; 3-position compensator; 4 inputs—phono, mike, radio and aux.; separate bass and treble controls; tape output jack; 11" x 7 1/4" x 5 1/2" . . . . . \$43.90  
 CAG-110 metal cage. . . . . \$5.25

## R. T. BOZAK SALES CO.

E-300 Enclosure

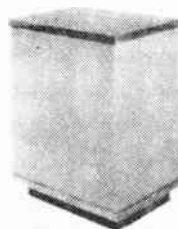

Infinite baffle design; designed primarily for use with Bozak speakers; 3/4" unfinished birch plywood; supplied with either light or dark grille cloth; estimated assembly time 7-10 hours; 24" w x 17" d x 30 1/2" h . . . . . \$12.50

## CLETRON

Matched Speaker Kit



Includes 12" woofer, 8" middle range, dual 5" tweeters and con-

Electronic Kits



trollable I.C. network; woofer has full 1" excursion at 16 cps.; efficient operation at 5 watts with peaks at 35 watts; midrange ranges to 8000 cps. with axial sensitivity of 95 db.; tweeters range to 18,500 cps.; requires mounting in enclosure .....\$98.00

### DANCO MFG. CO.

Model 14 Amplifier Printed Circuit Board

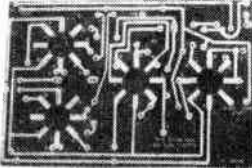

Provides nucleus for building Williamson-type hi-fi amplifier; necessary parts marked on board; tube sockets included; recommended for person with advanced kit experience....\$4.95

Model 21 Preamplifier-Equalizer Printed Circuit Board

For use with magnetic cartridges; 3-position equalization; gain control; gain: 46 db; power requirements: 150 volts d.c. at 3 ma, 6.3 or 12 volts a.c. or d.c. for filaments.....\$2.25

Model 31 Selector-Tone Control Printed Circuit Board

Provides switching for 3 inputs; Baxendall-type tone controls; 20 db boost or cut for treble and bass; power requirements: 150 volts d.c. at 3 ma, 6.3 or 12 volts a.c. or d.c. for filaments.....\$2.25

Model 41 Gain Compensator-Output Stage Printed Circuit Board

Master gain control; switched loudness compensation; cathode follower output; gain: 22 db; power requirements: 200 volts d.c. at 4 ma, 6.3 or 12 volts a.c. or d.c. for filaments.....\$2.25

### DYNA CO.

Dynakit Preamplifier



Six inputs: high and low level magnetic phono, tuner, TV, tape, plus option of tape head,

# ADSON PRESENTS... EICO KITS

There's over 1 million EICO kits in operation. The reason? . . . Each EICO product represents the finest in engineering without compromise...quality components, pre-tested instructions assure you of many years of dependable performance.

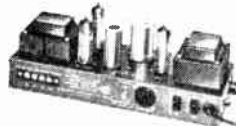

Eico Model **HF-14**  
14 Watt BASIC POWER  
AMPLIFIER

The moderate power amplifier that made the expert rave. Despite its low price it gives delivery plus . . . stability & excellent transient response. Freq. resp.  $\pm 0.5$  db 10-100 kc; 1W Hum 90 db below rated output Harmonic distortion: 8W - less than 1% from 30-10,000 c/s. Especially adaptable for up-dating to stereo. **KIT \$23.50** **WIRED \$41.50**

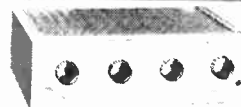

Eico Model **HF-12**  
12 Watt INTEGRATED  
AMPLIFIER

Excellent for the budget-minded audiophile. Has features included only in the most expensive "gear." Two low level, two high level inputs. Extremely low distortion. Freq. resp.  $\pm 0.5$  db 25-20,000 c/s. Highly stable Williamson-type power amplifier circuit. Truly "a honey for the money" . . . and so easy to build! **KIT \$34.95** **WIRED \$57.95 with cover**



Eico Model **HF-32**  
30 Watt INTEGRATED  
AMPLIFIER

with pre-amplifier, equalizer and control section. Gives 30 husky, clean watts of power (47 watt peak). Frequency resp: 0.5 db. 10 c/s-50 kcs. Complete equalization for all type inputs . . . scratch & rumble filters. Uses top quality 6 lb. output transformer for peerless reproduction. **KIT \$57.95** **WIRED \$89.95**

A complete Stereo Control center plus two 14 watt channels (28 watt monaural). Gives precision-control to any stereo source: tape discs or broadcast. Each channel has low level inputs for mag. phono, tape head, microphone-high level for AM, FM, FM Multiplex plus auxiliaries. Independent full-range bass & treble controls for each channel. The many features of this unit makes it the most precise, flexible and outstanding performer at any price level. **KIT \$69.95** **WIRED \$109.95**

EICO Model **HF-81**  
STEREO  
AMP-PREAMP

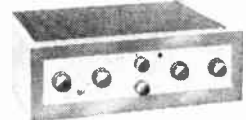

for monaural or stereo

EICO Model **HFT-90**  
FM TUNER

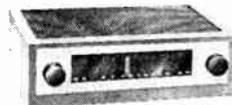

with precision  
"eye-tronic" tuning

FREE  
... FEDTRO

The first kit to include an entirely pre-wired, pre-aligned front-end (completely shielded). Exceptional sensitivity, drift-free tuning, advance circuitry & low, low hum & distortion. Cathode follower and MULTIPLEX outputs. Flexible design for all installations. Frequency resp: Uniform 20-20,000 c/s 1 db. Sensitivity: 1.5 uv for 20 db. quieting. **KIT \$39.95** **WIRED \$65.95** **Cover \$3.95**

(Reg. \$3.50 value)  
Free with any  
above kit . . .  
the all purpose  
soldering iron

**SOLDERETTE**

The handiest soldering iron on the market! Ideal for kit builders, close soldering designed for dependable, long life. Replaceable tips. Tested & guaranteed.

**ADSON**  
Radio & TV Corp.

189 Greenwich St. New York City  
SEND 25% DEPOSIT with Order Balance C.O.D.

# Directory of Hi-Fi Kits

mike or extra phono position; two outputs, low impedance (1,000 ohms), and tape output; equalization for RIAA, LP, 78 rpm records; tape A-B monitor switch; separate bass and treble controls with up to 15 db of boost or cut at 30 cps and 15 kc; loudness control with switch; IM distortion under 0.1% at 1.5 volts output; noise level less than 3 microvolts equivalent input noise on RIAA position; frequency response 6 to 60,000 cps  $\pm$  0.5 db; d.c. filaments; 2-12AX7 or ECC83, selenium rectifier; 4 a.c. outlets, 2 switched; 12"x6"x2 $\frac{3}{4}$ "; 7 lbs.; preassembled printed circuit board; estimated assembly time 4-6 hours. . . . . \$54.95

loudness, dual tape monitoring facility; estimated assembly time 1 hour. . . . . \$12.95

### Model PS-1 Power Supply

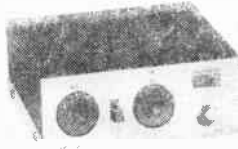

Provides power for two preamplifiers; individual heater supplies for minimum hum; estimated assembly time 1 $\frac{1}{2}$  hours. . . . . \$8.95

### Stereo 70 Amplifier

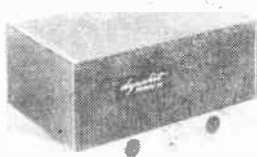

Two power amplifiers 55 watts each; full 70 watts on monoaural operation; printed circuit board; 7199 driver; push-pull EL818; frequency response  $\pm$  0.5 db, 15-40,000 cps; IM distortion less than 1% at 35 watts; sensitivity 1.3 volts rms input for 55 watts output; estimated time of assembly 4-6 hours. . . . . \$99.95

## EICO (ELECTRONIC INSTRUMENT CO., INC.)

### Model HF-12K 12-Watt Amplifier

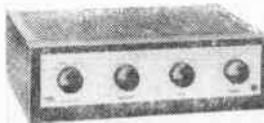

Power output 12 watts (25 watts peak); Williamson type; 25 to 20,000 cps at 12 watts,  $\pm$  0.5 db; harmonic distortion 2% at 50 cps, 1% at 10,000 cps; hum and noise on magnetic phono -60 db, tape head -55 db, tuner and aux. -75 db; input for 12 watts output; magnetic phono, 9 millivolts, tape head 6 millivolts tuner and aux. 0.5 volts; 4, 8, and 16 ohms output impedances; 2-ECC83/12AX7, FCC82/12AU7, 2-EL81, EZ81; low-noise dual-triode preamplifier with equalization for either input; d.c. biased filaments,

separate bass, treble, and volume controls; 3 $\frac{5}{8}$ "h x 12" w x 8 $\frac{1}{4}$ " d. . . . . \$34.95

### Model HF-20K 20-Watt Amplifier

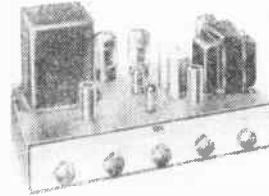

Power output 20 watts (54 watts peak, ultra-linear Williamson type; 15 to 35,000 cps,  $\pm$  0.5 db; harmonic distortion 1% (20 to 20,000 cps at 1 db under 20 watts); intermodulation distortion 1.5% at rated power; hum and noise on magnetic phono -60 db, tuner -75 db; sensitivity, magnetic phono 4 millivolts; 20 watts output, tuner, TV, tape, auxiliary 0.4 volts for 20 watts output; bass, treble, loudness, and level controls; five equalization positions; d.c.-biased filament supply; four high-level and two low-level inputs; low impedance tape output jack; potted high quality output transformer; several switched and unswitched convenience outlets; hum balance control; 4, 8 and 16 ohms output impedances; 12AX7/ECC83, 2-12AU7/ECC82, 2-6L6GB, 5U4-GB; 8 $\frac{1}{2}$ "h x 15" w x 10" d. . . . . \$49.95  
L-1 (matching cover) . . . \$1.50

### Model HF-32K 30-Watt Amplifier

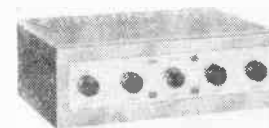

Integrated amplifier with performance specifications identical to HF-30 basic amplifier; tone controls allow 15 db boost and 15 db cut at 10,000 cps, 11 db boost and 15 db cut at 50 cps; 4 positions record equalization; tape head input is NARTB; sensitivity: phono, 5 millivolts; tape head, 2 millivolts; microphone, 1 millivolts; high level (5), 0.4 volts; hum and noise 60 db down on phono input, rumble and scratch filters oper-

### Dynakit Mark III Amplifier



Power output 60 watts continuous, 140 watts peak; less than 1% IM distortion at 60 watts; 20-20,000 cps  $\pm$  1 db at 60 watts without exceeding 1% harmonic distortion; 6 to 60,000 cps  $\pm$  0.5 db; sensitivity 1.5 volts for full output; damping factor 15; output 4, 8, and 16 ohms; estimated assembly time 2-3 hours; socket for powering preamp; 9"x9"x6 $\frac{3}{4}$ "; 27 pounds. . . . . \$79.95

### Dynakit Mark II Amplifier

Similar to Mark III but with power output of 50 watts. . . . . \$69.75

### Model DSC-1 Stereo Control



Provides master controls for stereo systems; adds dual volume control, balance control, blend control, channel reversing,

ate at 12 db/octave slope at 5,000 and 70 cps; level and loudness controls; tape recorder output; tubes are 2-ECC83/12AX7, 2-EC90/6C4, 4-EL84, 2-EZ81; convenience a.c. outlets; hum balance control; 15" w x 4 3/4" h x 10 1/2" d. . . . . \$57.95

**Model HF-52K**  
50-Watt Amplifier

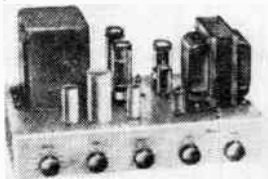

Power output 50 watts (100 watts peak); 20 to 30,000 cps  $\pm$  0.1 db at 50 watts; harmonic distortion 1% 20 to 20,000 cps within 1 db of 50 watts; intermodulation distortion 1% at 50 watts, 1/2% at 20 watts (60 and 6000 cps at 4:1); hum and noise on magnetic phono -60 db, tuner -75 db; sensitivity; magnetic phono, 8 millivolts for 50 watts output, tuner, TV,

tape, auxiliary 0.6 volts for rated output; 4, 8 and 16 ohms output impedance; 2-EL34/6CA7, 2-ECC83/12AX7, EC90/6C4, 6CG7, GZ34; preamplifier-equalizer circuit has five equalization positions; bass, treble, loudness, and level controls; d.c. biased filament supply; four high-level and two low-level inputs; low-impedance cathode follower tape output jack; high quality fully-potted output transformer; d.c. balance adjustment; bias voltage control; convenience outlets; hum balance control; 8 1/2" h x 15" w x 10" d. . . . . \$69.95  
Matching cover. . . . . \$4.50

**Model HF-61K Preamplifier**

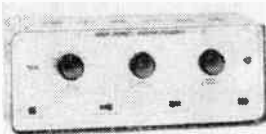

Master control preamplifier; six inputs: four high level, two low level; low-impedance to tape recorder (unaffected by tone and loudness control settings); low-

impedance cathode follower output to amplifier; input level controls; separate bass and treble controls; five equalization positions for recordings; 12 db/octave slope high and low filters; Centralab printed circuit loudness control; sensitivity for magnetic phono 10 millivolts for 2 volts output to power amplifier and 3.4 volts to tape recorder; tuner and other high level inputs require 0.6 volts for same outputs; IM distortion at 1.5 volts rms output 0.25%, at 0.5 volt output 0.05%; harmonic distortion 0.1% at 1.5 volt output at 1 kc, 0.3% 20 to 20,000 cps at 1.5 volts; hum and noise on tuner -75 db, on phono -60 db; frequency response, 8-100,000 cps  $\pm$  1 db, 12 to 50,000 cps  $\pm$  .3 db; d.c. biased filaments; 12A X7/ECC83, 2-12AU7/ECC82, 6X4; three switch controlled a.c. outlet, one unswitched a.c. outlet; brown enamel steel cabinet with brushed brass panel; 4 7/8" h x 12 5/16" w x 4 1/8" d; 8 lbs. . . . . \$29.95  
HF-61A (no power supply) . . . . . \$24.95

## NEW! SUPERKIT PORTABLE RADIO KITS NATIONALLY ACCLAIMED AS THE FINEST!

NOW you can build your own personal portable radio! Learn and have fun while you build . . . enjoy your radio in the years ahead. Both kits are complete with all parts and simple illustrated instructions. They also feature a phone jack for private listening, 2 1/2" loud speaker, unbreakable plastic cases, and pre-punched printed circuit boards.

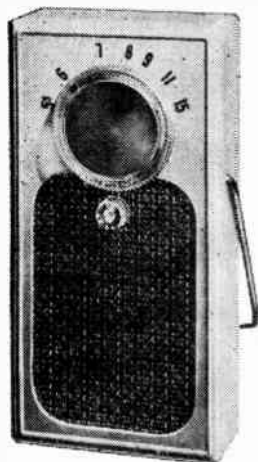

The "Sextet" uses six transistors plus a diode in a powerful Superhet circuit. It has 3 tuned I.F. stages, push-pull audio, high gain "Flat Loopstick," and full action A.V.C., a tremendous value at only \$25.95 net.

The "Partner" uses 4 transistors plus a diode in a proven low battery consumption circuit. It is very simple to build, and will give many years of enjoyment. Features the new Flat Loopstick for power and sensitivity. Complete at Only \$17.95 net.

**"SEXTET"**  
6 Transistor Portable  
MODEL TR-66 \$25.95

(Both sets shown approx. half size.)

If your dealer cannot supply you write direct.

**"PARTNER"**  
4 Transistor Portable  
MODEL TR-4-K \$17.95

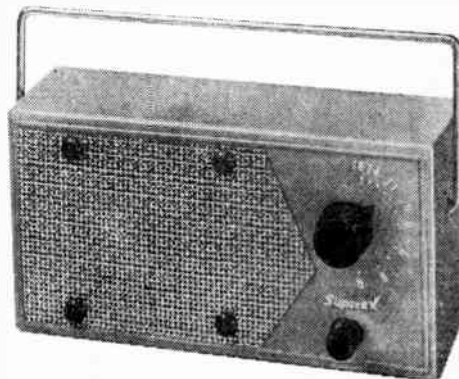

**FREE!** COMPLETE CATALOG OF SUPERKIT RADIOS

**SupereX** ELECTRONICS CORP. successor to Grayburne  
6 Radford Pl., Yonkers, N.Y.

# Directory of Hi-Fi Kits

## Model HF-65K Preamplifier



Frequency response 5 to 400,000 cps  $\pm$  0.3 db at 3 volts output; sensitivity for 2 volts output: phono, 1 millivolt; microphone, 1 millivolt; tape head, 0.5 millivolt; high level inputs, 0.17 volts; hum and noise: phono and microphone, -60 db; tape head, -75 db; high level inputs, -75 db; IM distortion (60 and 7000 cps at 4:1) 0.03% at 1 volt output, 0.17% at 5 volts output; harmonic distortion 0.1% at 3 volts output; rumble and scratch filters operate at 9 db/octave slope at 50, 100, 5,000, and 10,000 cps; bass and treble controls allow 15 db cut or boost at 50 and 10,000 cps; 4-position phono equalizer; NARTB tape equalization; inputs for magnetic phono, tape head, microphone, tuner, 1V, tape, and crystal or ceramic phono; volume-loudness control; low impedance outputs to power amplifier and tape recorder; hum balance control; switched and unswitched a.c. outlets on self-powered models; tubes are 3-12AX7/ECC83, 6X4; 3 $\frac{3}{8}$ "h x12"w x8 $\frac{1}{4}$ "d; 9 lbs. ....\$33.95  
HF-65A (less power supply)....\$29.95

## HF-86

### Stereo Dual Power Amplifier

Dual 14 watt amplifiers; Williamson circuit with two EL84 push-pull output; full 28 watts when used in parallel for monophonic; level controls at each input; circuit includes newly developed 12DW7 tube providing improved performance; frequency response 2 watts .5 db. 10-10,000 cps.; inverse feedback 20 db. ....\$43.95

## Model HF-85K

### Stereo Preamplifier

Essentially stereo version of Model HF-65K preamplifier; specifications similar to Model HF-65K; 3 low-level stereo inputs; 3 high-level stereo inputs; tone controls for each channel may be operated separately or simultaneously; stereo outputs to amplifier and tape recorder;

tubes are 5-12AX7/ECC83 and 6X4; 3 $\frac{3}{8}$ "h x12"w x8 $\frac{1}{4}$ "d. ....\$39.95

## Model HF-81K Stereo Amplifier

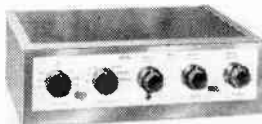

Combines two 14-watt integrated amplifiers on one chassis; 28-watt output on monaural sources (56 watts peak); frequency response 10 to 100,000 cps  $\pm$ 0.5 db at 1 watt output per channel: IM distortion 2% at 14 watts per channel; hum and noise; phono, -60 db; tape head, -51 db; microphone, -57 db; tuner and aux, -75 db; input sensitivity for full output; phono, 4 millivolts; tape head, 2 millivolts; microphone, 6 millivolts; tuner and aux, 0.5 volts (all are twin inputs); bass and treble controls allow 15 db boost or cut at 50 cps and 10,000 cps; twin speaker outputs for 4, 8, and 16 ohms; tubes are 4-ECC83/12-AX7, 2-ECC82/12AU7, 4-EL84, 2-EZ81; 15"w x4 $\frac{3}{4}$ "h x 10 $\frac{1}{2}$ "d; 24 lbs. ....\$69.95

## Model HF-50K

### 50-Watt Amplifier

Ultra-linear power amplifier; output 50 watts (100 watts peak);  $\pm$  0.5 db 6 to 60,000 cps at 1 watt;  $\pm$  0.1 db from 15 to 30,000 cps at rated output; harmonic distortion 0.5% 20 to 20,000 cps; intermodulation distortion below 1% at 50 watts, 0.5% at 45 watts; noise level -90 db; sensitivity 0.55 volts input for 50 watts output; 4, 8 and 16 ohms output impedances; tubes EF86, 6SN7GTB, 2-EL34, GZ34; damping factor is 17; 21 db inverse feedback; input level control; bias and d.c. balance adjustments; socket provided for preamp power takeoff; 7"x14"x8".....\$57.95

## Model HF-60K

### 60-Watt Amplifier

Ultra-linear power amplifier output 60 watts (130 watts peak); Acro TO-330 output transformer; 5 to 100,000 cps  $\pm$  0.5 db at 1 watt, 15 to 35,000 cps,  $\pm$  0.1 db at 60 watts; harmonic distortion 0.5% (20 to 20,000 cps at 60 watts  $\pm$  1 db; intermodulation distortion 1% at 60 watts (60 and 6,000 cps at 4:1), 0.5% at 50 watts; noise level

-90 db; sensitivity 0.55 volt input for 60 watts output; 4, 8 and 16 ohms output impedance; tubes EF86, 6SN7GTB, 2-EL34, GZ34 rectifier tube; damping factor is 16; 21 db inverse feedback; input level control; bias and d.c. balance adjustments; socket for preamp power takeoff; 7"x14"x8".....\$72.95

## Model HF-14K

### 14-Watt Amplifier

Power output 14 watts, 28 watts peak; frequency response 30 to 15,000 cps  $\pm$ 0.1 db at 14 watts, 15 to 100,000 cps  $\pm$ 0.5 db at 1 watt; harmonic distortion less than 1% at 14 watts; IM distortion 1.7% at 14 watts; hum 90 db below rated output; sensitivity for full output: 1.25 volts; output impedances are 4, 8, and 16 ohms; tubes are ECC83/12AX7, 2-EL84, EZ81; 3 $\frac{3}{4}$ "x12"x4"; 10 lbs. ..\$23.50

## Model HF-22K

### 22-Watt Amplifier

Power output 22 watts, 44 watts peak; frequency response 19 to 40,000 cps  $\pm$ 0.5 db at 22 watts; harmonic distortion below 1% within 1 db of 22 watts; IM distortion 1% at 22 watts; hum 85 db below rated output; sensitivity for full output: 0.6 volts; output impedances are 4, 8, and 16 ohms; tubes are EF86/Z729, 6SN7, 2-6L6GB, 5U4GB; 7"x14"x8".....\$38.95

## Model HF-30K

### 30-Watt Amplifier



Power output 30 watts continuous, 47 watts peak; frequency response 15 to 50,000 cps  $\pm$  0.5 db; harmonic distortion less than 1% 20 to 20,000 cps within 1 db of 30 watts; IM distortion 2% at 30 watts (60 and 7,000 cps mixed 4:1); hum: 80 db below rated output; feedback: 20 db; damping factor: 10; sensitivity: 1.24 volts for 30 watts output; octal socket for powering auxiliary equipment; output impedances: 4, 8, and 16 ohms; tubes are 6AV6, EC90/6C4, 4-EL84, 2-EZ81; power consumption: 125 watts; 5"h x12"w x 7"d; 17 pounds.....\$39.95  
Matching cover.....\$3.95

# Directory of Hi-Fi Kits

## Model HF-35K 35-Watt Amplifier

Power output 35 watts, 70 watts peak; frequency response 15 to 40,000 cps  $\pm 0.5$  db at 35 watts; harmonic distortion less than 1% within 1 db of 35 watts; IM distortion 1.5% at 35 watts; hum 90 db below rated output; sensitivity for full output: 0.43 volts; output impedances are 4, 8, and 16 ohms; tubes are EF86/Z729, 6SN7, 2-EL34/6CA7, GZ34; 7"x14"x8"; 25 lbs.

..... \$47.95

## HFT-94 AM Tuner



Includes wide bandpass to 14 kc., and narrow bandpass to 7 kc.; high-Q filter eliminates 10 kc. whistle; pre-aligned RF and IF coils; sensitivity 3uv at 30% mod. for 1 volt output; frequency response (wide) 20-9000 cps., (narrow) 20-5000 cps.; less than 1% harmonic distortion at 100% modulation; low impedance plate follower output (8000) ohms; tuning eye for exact tuning; 3 $\frac{3}{8}$ "x12"x8 $\frac{1}{4}$ "; 12 lbs.....\$39.95

## HFT-90K FM Tuner

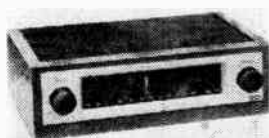

Sensitivity 1.5 microvolts for 20 db quieting; frequency response 20 to 20,000 cps  $\pm 1$  db; i.f. bandwidth 260 kc at 6 db points; detector bandwidth 400 kc; maximum drift 20 kc from cold start; hum 60 db below 1 volt; pre-wired front end; pre-aligned front end, i.f., and ratio detector; DM-70 tuning eye that travels along dial; fly-wheel tuning; AGC; 300 ohms input; outputs are cathode follower to amplifier and multiplex; tubes are ECC85/6AQ8, 3-6AU6, 6AL5, 6X4, DM70; 5 $\frac{3}{8}$ "h x12"w x8 $\frac{1}{4}$ "d; 10 pounds.....\$39.95  
Cover.....\$3.95

Model HF-S1 Speaker System  
Two-way speaker system; response 70 to 12,000 cps,  $\pm 6$

Number 2

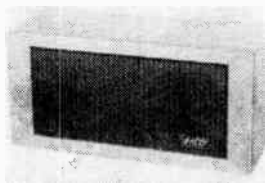

db; tuned bass reflex; Jensen 8" woofer, 6.8 oz. magnet, and matching Jensen compression-driver exponential horn tweeter with level control; crossover at 1800 cps; power handling capacity 25 watts; unfinished birch hardwood with neutral grille cloth; 23"x11"x9".....\$39.95

## ELECTRO-VOICE, INC.

### Model KD1-Patricia IV

Enables reproduction to 25 cps, down 6 db at 16 cps using Electro-Voice Model 18WK woofer; designed for use with



Electro-Voice Model 103E driver components; 57 $\frac{1}{2}$ "h x34 $\frac{1}{2}$ " w x26 $\frac{7}{8}$ "d; estimated assembly time 6-12 hours; 135 lbs.....

.....\$118.00

### Model KD2A-Georgian



Designed for use with Electro-Voice Model 105E driver components; estimated assembly time 3-9 hours; 38 $\frac{1}{2}$ "h x26 $\frac{3}{4}$ " w x22 $\frac{1}{2}$ "d; 94 lbs.....\$75.00

### Model KD4-Regency

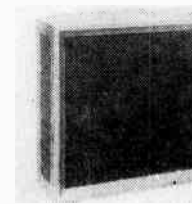

For use in corner or along wall with 15" speakers or two or three speaker systems; estimated assembly time 36 hours; 29 $\frac{3}{8}$ " h x33 $\frac{1}{2}$ "w x19"d; 70 lbs. \$73.00

### Model KD5-Empire

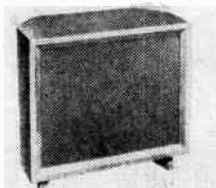

Lowboy style; uses combination of lenticular slotted porting and rear air mass loading for augmented bass response; for 15" speakers or 3-way systems; estimated assembly time 3-6 hours 29 $\frac{3}{8}$ "h x32"w x16"d; 57 lbs. ....\$51.00

### Model KD6-Aristocrat

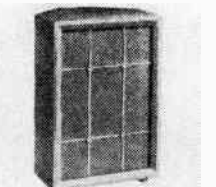

Folded horn corner enclosure for 12" speakers or 3-way systems; estimated assembly time 3-5 hours; less metal trim kit 29 $\frac{3}{8}$ "h x19"w x15 $\frac{3}{4}$ "d; 36 lbs.....\$39.00

### Model KD7-Baronet

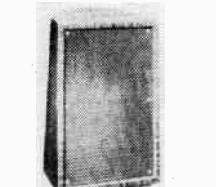

Folded horn corner enclosure for 8" speakers or 2-way systems; estimated assembly time 3-5 hours; 23"h x14"w x13"d 16 lbs.....\$26.00

## FK Finishing Kits

Consist of stain filler, sealer shellac, high gloss and satin varnishes, finishing paper, brushes and instructions. FK10 (walnut), FK20 (mahogany), FK30 (fruitwood), FK40 (cherry), KF50 (golden oak), FK60 (ebony) each.....\$5.00

# Directory of Hi-Fi Kits

## AK Metal Trim Kits

Decorative trim for KD enclosures.

AK3 (For "Patrician" and "Georgian") 4 lbs...\$12.00

AK5 (For "Regency")...\$6.00

AK6 (For "Aristocrat")...\$4.80

## ERIE RESISTOR CORP.

### Pac-Amp-I Audio Amplifier

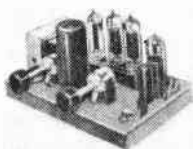

Power output 2 watts; frequency response 30 to 12,000 cps  $\pm$  2 db; output impedance 4 ohms; sensitivity 0.56 volts for full output; uses Erie plug-in components and printed circuit board; volume and tone controls; estimated assembly time 1/2-1 hour; 6 7/8" x 4 1/16" x 3 7/8"....\$12.95

## GROMMES (Precision Electronics, Inc.)

### Model LJ6K



"Little Jewel" 10 watt amplifier, 15 watts peak; frequency response  $\pm$  1 db 20 to 20,000 cps at 1 watt; distortion; 2% harmonic and 3% intermodulation at 10 watts; hum and noise 80 db below output (tuner input); treble control allows attenuation of - 18 db; bass control allows boost of + 15 db; loudness control feature; inputs are tuner, phono (2) and aux; magnetic phono channel compensated for RIAA and early LP; output impedances 4, 8, 16 ohms; sensitivity 5 millivolts on phono channel for 10 watts output; tubes 2-12AX7, 2-6V6GT, 5Y3GT; fused; a.c. outlet; for 110-120 volts 60 cycles; charcoal and brass finish; estimated assembly time 6-8 hours; size 10"x6"x6"; shpg. wt. 11 lbs....\$24.95

### Model 20 PG-8-K

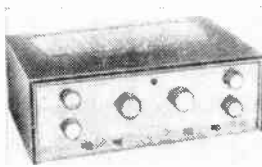

Power output 20 watts; 40 watts peak; frequency response  $\pm$  0.5 db 20 to 20,000 cps at 1 watt; distortion 1% harmonic and 2% intermodulation at 20 watts; hum and noise 75 db below rated output (tuner input); bass controls  $\pm$  20 db, treble  $\pm$  15 db; 4 positions for both turnover and rolloff; on-off loudness control; on-off rumble and scratch filters; inputs: tuner, tape (2), phono (2); aux; outputs: 4, 8, 16 ohms, tape output; sensitivity: tuner .3 volts, magnetic phono 4 millivolts for 20 watts output; tubes are 3-12AX7, 2-EL84, EZ-81, OB2; 2-a.c. outlets; fused for 110-120 volts a.c.; charcoal and brass finish estimated assembly time 8-12 hours; 13" w x 4 1/2" h x 9" d. ....\$59.50

### Model 207AK

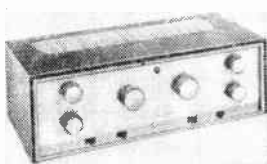

Preamp-control unit; 6 inputs: tuner, tape amp, tape head, magnetic phono, crystal phono, aux; outputs for main amplifier and tape recorder; bass control  $\pm$  20 db; treble control  $\pm$  15 db; 4 positions for both rolloff and turnover; on-off loudness control; on-off rumble and scratch filters; sensitivity: tuner .2 volts, magnetic phono channel 3 millivolts for 1 volt output; .05% harmonic and 0.1% intermodulation distortion at rated output; hum and noise -75 db on high level inputs and 60 db on phono channel below 2 volts output; frequency response  $\pm$  0.5 db 20 to 20,000 cps; circuit features feedback throughout; 5 tubes: 3-12AX7, 6X4, 12AU7; estimated assembly time 6-8 hours; charcoal and brass finish; 12 3/4" x 4" x 7".....\$44.50

### Model 250K

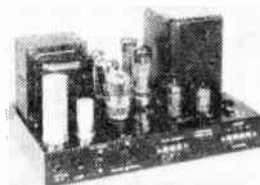

Power output 60 watts, 120 watts peak; frequency response  $\pm$  .5 db 5 to 50,000 cps; distortion: 0.5% harmonic and 1% intermodulation at 60 watts; hum and noise 90 db below rated output; sensitivity 1 volt input for full output; output impedances 4, 8, 16 ohms; tubes are 12AU7, 12BH7, 2-EL34, 6L6, 2-5U4GB; socket supplies power for preamplifier; estimated assembly time 6-8 hours; size 14"x8 1/4"x8"; shpg wt 40 lbs. ....\$79.50

### Model 101GTK FM Tuner



Sensitivity 4 microvolts for 20 db quieting; frequency response  $\pm$  0.5 db 20 to 20,000 cps; distortion 1% or less; hum and noise: 65 db below 100% modulation; tuning eye; AFC with defeat; one volt average output from cathode follower; tubes 6BQ7A, 12AT7, EM81, 6BA6, 2-6AU6, 6AL5, 12AU7, 6X4; charcoal and brass finish; printed circuit construction; estimated assembly time 6-8 hours.....\$59.50

## HEATH CO.

### Model EA-2 12 Watt Amplifier

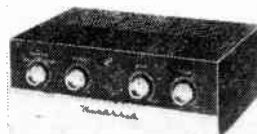

Frequency response 20 to 20,000 cps  $\pm$  1 db; harmonic distortion less than 1% at 12 watts; IM distortion less than 1.5% at 12 watts; three inputs: magnetic phono (RIAA), crystal phono, and tuner; separate bass and treble controls; hum balance control; screen-tapped output

Electronic Kits

circuit uses EL84 output tubes; output impedances: 4, 8, and 16 ohms; estimated assembly time 7-8 hours; complete with black and gold cabinet; 12 $\frac{1}{4}$ "w x 8 $\frac{3}{16}$ "dx4 $\frac{3}{8}$ "h; 15 lbs. \$28.95  
**Model A-9C Amplifier**  
 Rated output: 20 watts; built-in pre-amp; two-position record equalization; bass control: 15 db boost or cut at 30 cps; treble

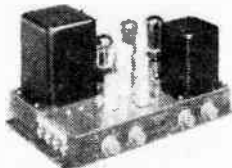

control: 15 db boost and 20 db cut at 15,000 cps; frequency response: 20 to 20,000 cps  $\pm$  1 db; harmonic distortion: 1% at 3db below 20 watts; inputs: magnetic (7 millivolt; sensitivity), mike, crystal phono, tuner; output impedances: 4, 8, 16, 500 ohms; tubes: 12AX7, 2—12AU7, 2—6L6G, 5V4G; 14"x8 $\frac{7}{8}$ "x7 $\frac{3}{8}$ " high. . . \$35.50  
**Model WA-P2 Preamplifier**



Frequency response 15 to 35,000 cps  $\pm$  1.5 db; 4-position turnover control; 4-position rolloff control; bass control; 18 db boost and 12 db cut at 50 cps; treble control: 15 db boost and 20 db cut at 15,000 cps; harmonic distortion: 0.24% at 2.5 volts out (phono input, 1,000 cps.); IM distortion (60 and 7,000 cps, 4:1) 0.55% at 2.5 volts out on low level input; hum and noise: 72 db below 2.5 volts on high level input, 62 db on phono input; inputs: phono (2.5 millivolts sensitivity for 1 volt output), mike, tuner; cathode follower main output, tape output before volume and tone controls; individual input level controls; tubes: 2—12AX7, 12-AU7; estimated assembly time 12-16 hours; 12 $\frac{1}{16}$ "l x 3 $\frac{3}{8}$ "h x 5 $\frac{7}{8}$ "d; gold finish. . . . \$19.75

**Models SP-1 and SP-2**

**Monaural-Stereo Preamplifier**  
 Basic monaural preamplifier unit, Model SP-1, may be converted to stereo preamplifier unit, Model SP-2, by addition of conversion unit, Model C-SP-1, without rewiring Model SP-1; Model SP-1 features 6 inputs;

**DEMAND QUALITY  
 USE INTERNATIONAL  
 HAM KITS!**



**STP-50  
 6 METER  
 TRANSMITTER**  
 Kit, less tubes & crystal \$21.50.  
 Kit, with tubes less crystal \$26.50.  
 Wired, with tubes but less crystal \$32.50.  
 Crystal, FA-5, 12 MC \$4.00.

Shipping Weight 5 lbs.

**STP-10 10 WATT  
 MODULATOR**

Designed specially for International's STP-50 transmitter.  
 Kit, less tubes \$22.75. Kit, with tubes \$25.25. Wired and tested, with tubes \$30.50.  
 Shipping weight 3 lbs.



**FCV-2  
 CONVERTER**

Model 50, 6 Meters—Model 144, 2 Meters, Kit with crystal less tubes \$12.95. Wired with crystal and tubes \$17.95.  
 Shipping Weight 2 lbs.

**STP-PW-1  
 POWER SUPPLY**

300 VDC @ 100 ma.  
 For use with STP-10 or STP-50.  
 Kit with tube \$16.50.  
 Wired and tested, with tube \$21.75.  
 Shipping Weight 5 lbs.

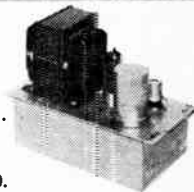

**HOW TO ORDER:**  
 Order direct from International Crystal, address below. Terms F.O.B. Oklahoma City. Other shipments C.O.D. On C.O.D. orders of \$25.00 or more, 1/3 down payment with order is required.

**SEND FOR  
 YOUR  
 FREE  
 CATALOG  
 TODAY!**



**18 N. LEE  
 OKLAHOMA CITY, OKLA.**

## Directory of Hi-Fi Kits

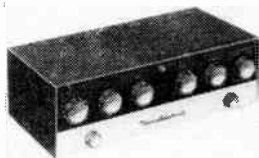

tape head, microphone, magnetic phono, and 3 high level; magnetic phono and high level inputs have level controls; sensitivity magnetic phono input: 2.5 millivolts; NARTB tape head equalization; 3 positions phono equalization; separate level and loudness controls; two-position scratch filter; a.c. convenience outlets: 1 unswitched, 3 switched, plus 1 on separate switch; cathode follower outputs to amplifier and tape recorder; Model C-SP-1 plugs into Model SP-1 and provides duplicate functions except that scratch filter is replaced by function selector switch—provides two-channel mixing, single or dual channel monaural, and stereo; remote balance control allows balancing stereo channels; printed circuit construction; black leather textured vinyl covered steel cover with gold design.

Model SP-1 .....\$37.95  
 Model SP-2 .....\$56.95  
 Model C-SP-1 .....\$21.95

### Model UA-1 12 Watt Amplifier

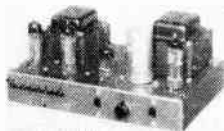

Less than 2% harmonic distortion from 20 to 20,000 cps at 12 watts; output impedances 4, 8, and 16 ohms; 16 ohm tap features switch-controlled damping for unity damping or maximum damping; input level control; octal socket for powering auxiliary equipment; output circuit features 6BQ5/EL84 output tubes working in push-pull operation; estimated assembly time 6-7 hours; 13 lbs. ...\$21.95

### Model W-3AM Amplifier

Rated output: 20 watts, 36 watts peak; dual chassis Williamson type circuit; frequency response: 20 to 80 kc.  $\pm 1.5$  db at 1 watt; harmonic distortion: less than 1.3% at 20 watts; sensitivity: 1 volt for 22 watt

output; hum and noise 88 db below rated output; output impedances: 4, 8, 16 ohms; damping factor: 14; tubes: 2-6SN7-GT, 2-5881, 5V4G; Acrosound TO-300 output transformer; estimated assembly time 8-10 hours; each chassis 7" h x 5 1/2" w x 11" l. ....\$49.75

### Model W4-AM Amplifier

Rated output: 20 watts, 36 watts peak; Williamson-type circuit; frequency response: 10 to 100,000 cps  $\pm 1$  db; harmonic distortion: less than 1.5% at 20 watts; IM distortion: less than 2.7% at 20 watts; sensitivity: 2 volts for full output; hum and noise: 95.2 db below rated output; output impedances: 4, 8, 16 ohms; damping factor: 28.5; tubes: 2-6SN7, 2-5881, 5U4G; estimated assembly time 8-10 hours; 15 1/4" x 8 7/8" x 7" high. ....\$39.75

### Model W-5M Amplifier

Rated output: 25 watts, 47 watts peak; frequency response: 5 to 160,000 cps  $\pm 1$  db at 1 watt; harmonic distortion: less than 1% at 25 watts; IM distortion: less than 1% at 20 watts; sensitivity: 2.2 volts for 25 watt output; hum and noise 99 db below rated output; output impedances: 4, 8, 16 ohms; damping factor: 40; tubes: 2-12AU7, 2-KT66, 5R4GY; Peerless output transformer; "tweeter saver" prevents damage from high frequency oscillation; "Bass-Bal" circuit requires only voltmeter for output tube balance; estimated assembly time 10-12 hours; black cage, gold finish chassis. \$59.75

### W-7M 55 Watt Amplifier



Power output 55 watts from 20 to 20,000 cps with less than 2% total harmonic distortion; output connections permit switching from "unity" to "maximum" damping for 4, 8, and 16 ohm speakers; each output has separate current feedback circuit; current feedback shorted out when not in use; output

tube balance control; EL34 output tubes; screen-tapped Chicago output transformer; special 70 volt output; silicon diode power supply; current controlled until tubes have warmed up; black and gold case; estimated assembly time 8-10 hours; 6" h x 8 1/2" d x 15" w; 28 pounds. ....\$54.95

### Model W-6M Amplifier

Rated output: 70 watts; frequency response: 6 to 70,000 cps  $\pm 0.5$  db at 0.5 watt; harmonic distortion: less than 2% at 70 watts; IM distortion: less than 1% at 70 watts; hum and noise: 88 db below rated output; sensitivity: 1.1 volt for full output; output impedances: 4, 8, 16 ohms; 70.7 volt line out-

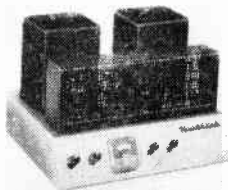

put; damping factor variable from 0.5 to 10 by calibrated control; output balance and bias adjustments with meter and meter switch; Peerless output transformer; tubes: 12AU7, 12-AX7, 12BH7, 2-6550; 4 silicon diode rectifiers; estimated assembly time 8-10 hours; 11 7/8" d x 9 1/16" h x 14 1/4" w; gold finish chassis with black cage. \$109.95

### Model XO-1

#### Electronic Crossover

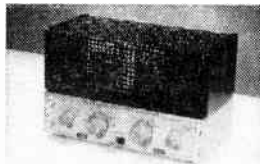

Separate audio signal from pre-amplifier into high and low frequencies and then provides outputs to allow their being fed to two power amplifiers; virtually eliminates IM distortion and speaker matching problems; crossover frequencies for each channel at 100 cps, 200 cps, 400 cps, 700 cps, 1200 cps, 2000 cps, and 3500 cps; estimated assembly time 6-10 hours; 6 pounds. ....\$18.95



# Directory of Hi-Fi Kits

## Model BC-1A AM Tuner



Detector circuit employs two germanium diodes connected in voltage doubler circuit for increased audio and AVC voltage; sensitivity better than 3 microvolts for 1 volt output; frequency response: 20 to 9,000 cps  $\pm 1$  db; 5 db pre-emphasis at 10 kc; 400 cps distortion: 0.8% at 30% modulation, 1% at 70% modulation; signal-to-noise ratio better than 12 db at rated sensitivity; output voltage: 1 volt average; two outputs: one medium impedance, one cathode follower; 10 kc whistle filter; pre-aligned r.f. and i.f. coils; tubes: 2-6BA6, 6BE6, 12AU7, 6X4; two germanium diodes; estimated assembly time 7-9 hours; cabinet included; 12 $\frac{9}{16}$ " l x 3 $\frac{3}{8}$ " h x 5 $\frac{7}{8}$ " d. ....\$26.95

## Model FM-3A FM Tuner

Ratio detector circuit with temperature compensated oscillator; cascode r.f. amplifier; AGC; pre-aligned i.f. and ratio transformers; sensitivity: better than 10 microvolts for 20 db quieting; frequency response: 20 to 20,000 cps  $\pm 3$  db; output voltage: 1.5 volts for 30% modulation; cathode follower and detector outputs; tubes: 6BQ7A, 6U8, 6AL5, 2-6CB6, 6C4, 6X4; estimated assembly time 7-9 hours; 12 $\frac{9}{16}$ " l x 3 $\frac{3}{8}$ " h x 5 $\frac{7}{8}$ " d; gold finish cabinet. ....\$26.95

## Model PT-1 AM-FM Stereo Tuner

AM and FM sections may be used separately or simultaneously for AM-FM stereo reception; sensitivity: FM, 1 microvolt, AM, 2 microvolts; FM has AFC; pre-wired, pre-aligned 3-tube FM front end; pre-aligned i.f.; broad-band FM i.f. and FM discriminator; "narrow" and "broad" AM bandwidth; delayed AVC; 10 kc AM whistle filter; tuning meter operates on AM and FM even in stereo operation; cathode follower outputs with individual level controls; built-in AM antenna; provision for external AM and FM antennas; tubes are 5-6AU6, 2-12AU7, 6AL5, 4-6BA6, 6BE6, 6BS8, 6AB4, 12-AT7; silicon diode rectifiers; printed circuit. ....\$89.95

## PT-1 Stereo AM-FM Tuner Kit



Three circuit boards; pre-wired and pre-aligned cascode front end; AFC with tuning meter; separately tuned AM-FM circuits; 16 tubes; cathode follower output; silicon diode rectifier; pre-aligned IF transformers and coils; multiplex jack for addition of converter to receive stereo FM; estimated assembly time—15 hours .....\$89.95

## Model CE-1T

### Chairside Equipment Cabinet



Houses Heathkit preamplifier, basic amplifier, two tuners, and record changer; tilt-out shelf installed on either right or left side; all parts pre-cut and pre-drilled; 18" w x 24" h x 35 $\frac{1}{2}$ " d; changer compartment: 17 $\frac{3}{4}$ " l x 16" w x 9 $\frac{3}{8}$ " d; contemporary style in either mahogany or birch, traditional style in mahogany; estimated assembly time 10-11 hours; 46 pounds. ....\$43.95

## Stereo Equipment Cabinet

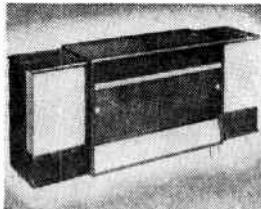

Accommodates tuner, preamplifier, amplifier, record changer, record storage, and speakers; equipped with panels pre-cut for Heathkit components and blank panels for use with any components;  $\frac{3}{4}$ " solid core mahogany or birch plywood construction; sliding top panel for access to tape deck and control unit; sliding doors for front ac-

cess to changer and record storage compartment; all parts pre-cut and pre-drilled; tape deck and preamplifier area 20 $\frac{3}{4}$ " l x 17 $\frac{3}{4}$ " w x 10" d; record changer area 21" w x 16" d x 9 $\frac{5}{8}$ " h; record storage area 22 $\frac{3}{8}$ " w x 14 $\frac{1}{2}$ " h x 12 $\frac{1}{2}$ " d; speaker wing area (inside) 14" w x 29 $\frac{1}{2}$ " h x 15 $\frac{3}{4}$ " d tuner area 20 $\frac{1}{2}$ " w x 5 $\frac{1}{4}$ " h x 14" d; amplifier (2 areas) 15 $\frac{1}{4}$ " w x 10 $\frac{3}{4}$ " h x 13 $\frac{1}{4}$ " d; overall measurements (with wings) 82" w x 37" h x 20" d; center unit alone 47" w x 37" h x 20" d.

Model SE-1B (center unit kit in birch) .....\$149.9  
Model SE-1M (center unit kit in mahogany) .....\$149.9  
Model SC-1BR (right speaker wing in birch) .....\$39.9  
Model SC-1BL (left speaker wing in birch) .....\$39.9  
Model SC-1MR (right speaker wing in mahogany) ...\$39.9  
Model SC-1ML (left speaker wing in mahogany) ...\$39.9

## Model TR-1A Tape Deck



Monaural record and playback frequency response 50 to 10,000 cps  $\pm 2$  db at 7 $\frac{1}{2}$  ips, 50 to 5,000 cps  $\pm 2$  db at 3 $\frac{3}{4}$  ips flutter and wow less than 0.35%; may be mounted vertically or horizontally; sold in combination with Model TE-1 only; signal-to-noise ratio 45 db below normal recording level with less than 2% total harmonic distortion; includes microphone and blank reel of tape tape deck and preamp 15 $\frac{1}{2}$ " v x 13 $\frac{1}{2}$ " h x 8" d. ....\$99.9

## Model TE-1 Tape Preamplifier

Provides recording and playback facilities when used with tape deck; two inputs; separate record and playback gain controls; "magic eye" recording level indicator; cathode follower output; hum control; 4" h x 12 $\frac{1}{2}$ " w x 8" d. ....\$39.9

## Model SS-2 Speaker System

Ducted-port bass reflex bookshelf style enclosure; frequency response: 50 to 12,000 cps  $\pm$  db; power rating: 25 watts of program material; impedance:

# Directory of Hi-Fi Kits

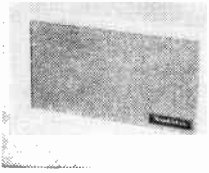

16 ohms; 8" Jensen low frequency speaker; Jensen high frequency horn loaded compression driver; built-in high pass filter and L-pad; 1/2" plywood construction; estimated assembly time 4-5 hours; 11 1/2" h x 23" w x 1 3/4" d. .... \$39.95

## Model SS-1B Range Extending Speaker System



Designed for use in conjunction with Model SS-2 speaker system for extension of low and high frequency response; frequency response in combination with Model SS-2: 35 to 16,000 cps  $\pm 5$  db; power rating: 35 watts of program material; 15" Jensen woofer; compression type horn-loaded super-tweeter; ducted-port bass reflex cabinet; two constant resistance divider networks with 12 db/octave attenuation (600 and 4,000 cps crossovers); provision for use of electronic crossover; 3/4" plywood construction; estimated assembly time 11-12 hours; 29" h x 23" w x 1 7/2" d. .... \$99.95

## Model HH-1 "Legato" Speaker System

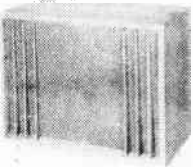

Modified infinite baffle enclosure; frequency response: 25 to 20,000 cps; power rating: 50 watts of program material; impedance: 16 ohms; 3-way, 3-speaker system; two Altec 15" low frequency drivers, one Al-

tec high frequency driver with special horn; speaker magnet weights: low frequency drivers, 2.4 lbs. each; high frequency driver, 1.2 lbs.; "M" derived parallel filter type dividing network with 500-cps crossover; 3/4" plywood; in blond or mahogany; estimated assembly time 17-20 hours; 41" w x 22 3/4" d x 3 4" h. .... \$299.95

## HOLT STEREO

### Stereo Converter

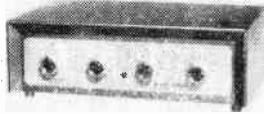

Adds binaural compensation to monaural source for stereo effect; connects between amplifier output and second speaker; includes 10-watt push-pull output amplifier; frequency response 30 to 20,000 cps  $\pm 2$  db; IM distortion less than 2% at 10 watts; switched input for use on two-channel stereo; output impedances are 4, 8, and 16 ohms; tubes are 2-12AX7, 2-6V6, 12AU7, 5Y3; sold direct only .... \$45.00  
Stereo Phase-Shift Network only .... \$12.00

## KARLSON ASSOCIATES, INC.

### Model 15 Speaker Enclosure

Employs front and back speaker loading with only one radiation aperture; accommodates 15" wide-range or coaxial speaker; size: 34 1/2" x 22 1/2" x 18" .. \$57.00

### Model 12 Speaker Enclosure

Employs front and back speaker loading with only one radiation aperture; accommodates 12" wide-range or coaxial speaker; size: 24 3/4" x 16 3/4" x 12 3/4" .. \$42.00

### Model 8 Speaker Enclosure

Accepts 8" speakers, size: 17 1/4" x 11 3/4" x 9 3/4" .... \$18.60

## KNIGHT-KIT (ALLIED RADIO CORP.)

### FM Tuner



Sensitivity 4 microvolts for 20 db quieting; i.f. bandwidth of

200 kc at 50% on curve; image rejection 40 db with a 10 microvolt signal; audio frequency response 20 cps to 20 kc  $\pm 1/2$  db; hum level 45 db below 1 volt; cathode follower output; separate AFC, cascode r.f. amplifier; flywheel tuning; printed circuit wiring board; prealigned i.f. transformers; estimated assembly time 6-8 hours; tubes are 6BQ7A, 6BA7, 12AT7/ECC81 2-6AU6, 12AU7/ECC82, 6AL5, 6X4; 13" x 8" x 4" ..... \$38.95

### Hi-Fi FM-AM Tuner



Printed circuit with tuned RF stage on FM. 2.5 microvolt sensitivity for 20 db quieting; two cathode follower outputs for multiplex; flywheel tuning and AFC; AFC defeat; slide rule scale with neon glow pointer; frequency response 20 to 20,000 cps  $\pm 0.5$  db; distortion less than 0.6%; hum and noise —60 db; AM sensitivity 3 microvolts for 10 db signal to noise ratio; with pre-aligned r.f. and i.f. sections; estimated assembly time 7-9 hours; 8" x 4 1/4" x 13 1/4"; 12 lbs. .... \$49.95

### 18-Watt Amplifier

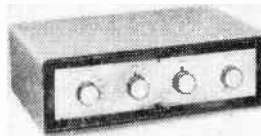

For use with monophonic or stereo systems; frequency response 20 to 20,000 cps  $\pm 1$  db at 18 watts; distortion 0.5% at 18 watts; hum and noise better than 60 db below 18 watts; sensitivity on low level inputs: 5 millivolts; bass and treble controls; 7 position record equalization; inputs: magnetic phono, ceramic phono, tape head, tape, aux., tuner; output impedances, 4, 8, 16 ohms; tubes are 3-ECC83/12AX7, 2-6Y7, 6Z81; printed circuit construction; estimated assembly time 6-10 hours; 4 1/4" x 13 1/2" x 8"; 15 pounds. .... \$39.95

### 30-Watt Amplifier

Frequency response 15 to 100,000 cps  $\pm 0.5$  db at 30 watts

# Directory of Hi-Fi Kits

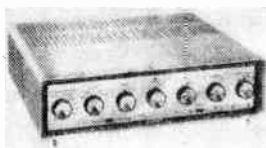

output; harmonic distortion less than 0.55% at mid-frequencies, below 1% from 20 to 40,000 cps at 30 watts; IM distortion 0.74% at 20 watts; hum and noise 75 db below 30 watts on high level inputs, 60 db down on low level inputs; bass and treble controls allow 15 db boost or cut at 20 cps and 20,000 cps; separate high and low frequency record equalizers allow 16 record equalization settings; loudness control; rumble filter; 3-way speaker selector switch; d.c. on preamp filaments; output impedances are 8 and 16 ohms; inputs: tape head, tape, magnetic phono, ceramic phono, microphone, tuner, aux.; tubes are 12AY7, 4-ECC82/12AU7, 2-5881, GZ34; balance adjustment for output tubes; printed circuit construction; estimated assembly time 11-14 hours; 4 1/2"x15 1/2"x15"; 32 pounds...\$76.95

**Preamplifier**

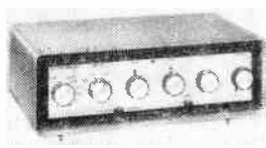

Features eight high level and low level inputs, including equalized input for tape heads; cathode follower output; separate turnover and rolloff controls; loudness control; separate bass and treble controls. 15 db of bass boost or cut at 20 cps; 15 db of treble boost or cut at 20 kc; rumble filter; frequency response flat from 20 cps to 40 kc at 1 volt output; harmonic distortion less than .15% in mid-band frequencies at 1-volt output; hum and noise are 60 db below 3 volts on high gain inputs; 80 db below 3 volts on low gain inputs; self-powered; d.c. filaments; tubes are 1-12AY7 and 2-ECC82/12AU7; two a.c. power outlets; printed circuitry throughout; estimated assembly time 7-10 hours; 13"x4 1/4"x8"; 12 1/2 lbs....\$39.95

Number 2

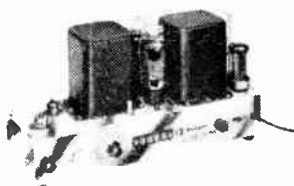

**25-Watt Basic Amplifier**

25-watt basic amplifier has Williamson-type circuit; printed circuit board construction; frequency response 9 to 70,000 cps  $\pm 1/2$  db at 12 1/2 watts; harmonic distortion 0.11% at 25 watts; intermodulation distortion 0.17% at 25 watts; has separate control for balancing output tubes; damping control to prevent low-frequency distortion; 4, 8, and 16 ohm output; estimated assembly time 7-9 hours; tubes used are EF86, 12AX7, 2-EL37, and GZ34 rectifier; 4 3/4"x14 1/2"x7 1/8"; 25 lbs....\$44.50 Metal cover for above; gold finish; 3 lbs....\$4.75

**Stereo Control**



Centralized control for stereo systems using amplifiers rated up to 20 watts; connects between speaker terminals and amplifier outputs; no rewiring of amplifiers necessary; allows speaker volume balancing and serves as master gain control; provides channel reversal; phase reversal switch assures optimum stereo performance; controls for volume, balance, selector (stereo, B-channel, B-monophonic, channel reverse, A-channel, A-monophonic); phase reversal; negligible line insertion loss; estimated assembly time 1-2 hours; 4 1/2"x7 3/4"x4"; 3 1/2 lbs...\$9.95

**20-Watt Stereo Amplifier**



20-watt monophonic amplifier or a dual 10-watts-per-channel complete stereo amplifier; separate

concentric clutch-type level controls adjust volume on each channel individually or simultaneously; frequency response 20-20,000 cps  $\pm 1.5$  db; harmonic distortion less than 1.5% at 10 watts output; hum and noise 85 db below 10 watts; 13 db negative feedback; crosstalk between channels —45 db for all stereo inputs; selector switch for stereo phono, phono reverse, tuner, tuner reverse, aux. aux reverse and monophonic phono, tuner, and aux; treble control provides 5 db boost or 7 db cut at 10 kc; bass control provides 10 db boost or cut at 35 cps; d.c. on preamp tube filaments; output impedances 4, 8, and 16 ohms on each channel; point-to-point wiring; estimated assembly time 8-10 hours; 5"x13 1/4"x9"; 27 lbs....\$44.50

**Stereo Preamplifier**

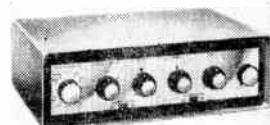

Stereo control center with printed circuit construction plus printed circuit switches; concentric clutch-type level, bass, and treble controls; frequency response 7-120,000 cps through tuner input; harmonic distortion less than 0.15% at 1 volt output; hum level 60 db below 1 volt at high gain inputs, 80 db below 1 volt at low gain inputs; stereo inputs include tape head, magnetic phono, ceramic phono, tuner, and aux; monophonic inputs include G.E., Pickering, or ceramic phono, and microphone; equalization for RIAA, EUR, 250 cps, FFRR, AES, and NAB; channel selector for stereo, stereo reverse, channel-A, channel-B, A-monophonic, and B-monophonic; L-C scratch filter; R-C rumble filter; bass and treble controls provide 15 db of bass and treble boost and cut at 20 cps and 20,000 cps; crosstalk between channels —45 db or better on all inputs; 2-12AY7, 4-ECC82/12AU7; cathode follower outputs; tape outputs; estimated assembly time 11-13 hours; 4 1/4"x13"x3"; 17 1/2 lbs. ....\$62.50

**12-Watt Amplifier Kit**

Frequency response 30 to 15,000 cps  $\pm 1/2$  db; 15 db inverse feedback circuit for low distortion

(For additional information use coupon on page 160)

# Directory of Hi-Fi Kits

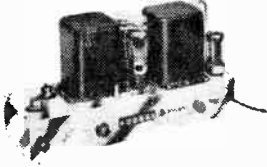

tion; harmonic distortion less than 1% at full power; has pre-amp stage equalized for magnetic cartridges; hum and noise level better than 45 db down thru phono input and 65 db thru tuner input; output impedances 4, 8, and 16 ohms; estimated assembly time 4-6 hours; 5"x9<sup>3</sup>/<sub>4</sub>"x7" (in cage); 7<sup>1</sup>/<sub>2</sub> lbs.....\$19.95  
Metal cover for above; French-gray; perforated; 3 lbs...\$3.95

**Basic 60-Watt  
Deluxe Stereo Amplifier**



30-watts-per-channel stereo, 60-watts monophonic, basic amplifier; frequency response  $\pm 1/2$  db, 15-31,000 cps at 30-watts (stereo);  $\pm 1/2$  db, 17-31,000 cps at 60-watts (monophonic); harmonic distortion at full rated output with 1 kc reference signal 0.15% (stereo), 0.08% (monophonic); hum and noise 90 db below 30-watts (stereo), 95 db below 60-watts (stereo); crosstalk between channels —70 db; output impedances 4, 8, and 16 ohms for stereo and monophonic; tubes are 2—EF86/Z729/6267 voltage amplifiers. 2—ECC83/12AX7/7025 driver-inverters, 4—EL37 power outputs, 2—GZ34/5AR4 rectifiers; separate level control for each channel; printed circuitry; chrome plated chassis; estimated assembly time 12-14 hours; 9"x14"x8<sup>1</sup>/<sub>4</sub>"; 36 lbs.....\$84.50  
Amplifier Cover; 4 lbs...\$6.50

**KN-1400K Deluxe Hi-Fi  
Components Cabinet**

Components cabinet styled to match KN-1215K speaker enclosure; permits housing of all components of a system; compartments for record changer on a base, tuner, amplifier, and record storage; pre-finished mahog-

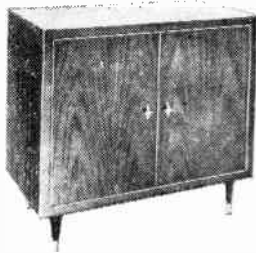

any, limed oak, or walnut; tongue-and-groove joints, tapered legs with brass ferrules, easy-grip brass door handles, vented rear panel; compartment sizes: 6"x32<sup>1</sup>/<sub>2</sub>"x14<sup>3</sup>/<sub>8</sub>"; 13"x18<sup>1</sup>/<sub>4</sub>"x14<sup>3</sup>/<sub>8</sub>"; and 13"x13<sup>5</sup>/<sub>8</sub>"; overall cabinet size, 27"x33<sup>1</sup>/<sub>2</sub>"x16"; estimated assembly time 1/2-1 hour; 65 lbs.....\$54.50

**KN-1215K Dual Ducted-Port  
Hi-Fi Speaker Enclosure**

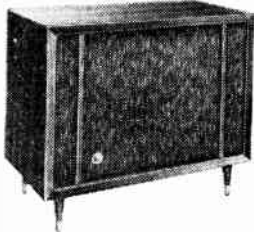

Dual ducted-port design provides low distortion bass response; accommodates any 12 or 15 inch speaker and includes adapter board for tweeter components; rigid construction—extra dense, vibration-resistant 3/4" panels; choice of mahogany, limed oak, or walnut hand-rubbed veneer; boucle-weave grille cloth and tapered legs with brass ferrules; estimated assembly time 1/2-1 hour; 27"x32"x16"; 75 lbs.....\$54.50  
KN-1215K with KN-800, 12" 3-way speaker; 87 lbs....\$88.45  
KN-1215K with KN-810, 12" 3-way speaker; 90 lbs...\$98.45

**2-Way Speaker System**

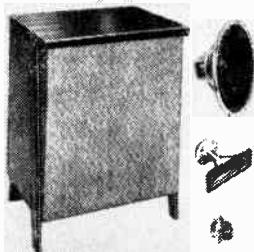

Ducted-port speaker system requires assembly of 7 pieces; pre-finished in mahogany, blonde, or walnut; delivers balanced sound from 45 to 14,000 cps; includes 12" woofer, tweeter, and L-pad tweeter control; impedance of system, 16 ohms; grille cloth is pre-fitted on front panel; comes complete with acoustic material, glue and all necessary hardware; estimated assembly time 1-2 hours; 26"x29"x14"; 33 lbs....\$49.95

**KN-1260K Ducted-Port  
Speaker Enclosure**

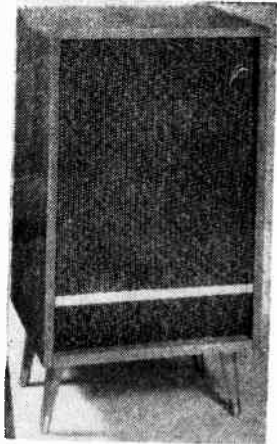

Pre-finished enclosure kit for 12" speakers; ducted-port design for performance equal to bass reflex enclosures of greater size; tight tongue-and-groove joints; non-resonant panels; hand rubbed, satin-lacquered furniture veneers; contemporary styling with choice of mahogany, limed oak or walnut finish; estimated assembly time 1/2-1 hour; 32"x17<sup>1</sup>/<sub>2</sub>"x15"; 35 lbs.....\$36.50  
KN-1260K with KN-800 12" 3-way speaker; 52 lbs....\$73.45  
KN-1260K with KN-812 12" 3-way speaker; 74 lbs....\$98.00

## LAFAYETTE RADIO

**Model KT-500 Stereo Tuner**

AM-FM tuner kit with independent AM and FM sections for stereo use; Armstrong FM



# Directory of Hi-Fi Kits

circuit; sensitivity: FM, 2 microvolts for 30 db quieting; AM, 5 microvolt terminal sensitivity; AFC with defeat provision; tuning eye; frequency response: FM, 20 to 20,000 cps  $\pm$  0.5 db; AM, 20 to 5,000 cps  $\pm$  3 db; harmonic distortion under 1% on FM, under 1% on AM for up to 80% modulation; hum 60 db below 100% modulation; bandwidth: FM, 200 kc, 6 db down; AM, 8 kc, 6 db down; IF rejection: FM, 70 db; AM, 50 db; image rejection: FM, 40 db; AM, 30 db; FM drift:  $\pm$  5 kc max; AM whistle filter; two cathode follower outputs; output level; FM, 2.5 volts for 100% modulation; AM, 1 volt average; tubes: 4-6BA6, 2-6AU6, 1-6KB7A, 1-ECC85, 1-6AL5, 1-6BE6, 1-12AU7, 1-6U5; selenium rectifier; estimated assembly time 16-24 hours; 13 $\frac{3}{4}$ "w x 10 $\frac{3}{8}$ "d x 4 $\frac{1}{2}$ "h. . . . . \$74.50

## Model KT-300 Preamplifier

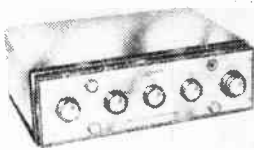

Preamp-control unit, uniformly flat frequency response over the entire audible range; less than .09% IM and .07% harmonic distortion at 1 volt output; 7 position function selector: radio, aux, tape and four phono turn-over positions; 6 position roll-off control; bass control gives 16 db boost and 18 db cut at 30 cycles, treble gives 11 db boost and 18 db cut at 10,000 cps; separate volume and loudness controls; tape monitor switch; rumble filter switch; inputs are radio, tape, aux, magnetic phono, crystal phono, tape head and separate high level input for second channel of binaural system; two cathode follower outputs, one for second channel of binaural system, operating from second high level input; sensitivity 2 millivolts for 1 volt output on magnetic phono, .2 volt for 1 volt output on high level inputs; hum and noise 80 db below 3 volts at full gain on high level inputs, better than 60 db below effective program level at full gain with 10 millivolts in-

put on phono or tape; 3-ECC83 and 2 selenium rectifiers; d.c. supply on all filaments; printed circuit construction; estimated assembly time 12-18 hours; three a.c. outlets; 12 $\frac{3}{4}$ "w x 3 $\frac{3}{4}$ "h x 9 $\frac{1}{8}$ "d. . . . . \$39.50

## Model KT-400 Amplifier

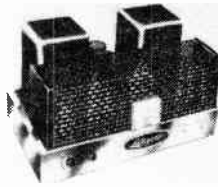

Seventy-watt power amplifier; frequency response at 1 watt 10 to 100,000 cps  $\pm$  1 db; harmonic distortion less than 2% to 20,000 cps within 1 db at 70 watts, less than 1% at 60 watts; IM distortion below 1 $\frac{1}{2}$ % at 70 watts, below 1% at 60 watts; damping factor variable .5 to 12; sensitivity 2 volts for 70 watts output; bias and balance adjust controls with meter switch; tubes are 2-KT88, 6AN8, GZ34, plus selenium rectifier; socket for powering preamp; 2 a.c. outlets; outputs 4, 8, and 16 ohms; Chicago transformers; estimated assembly time 8-12 hours; 14 $\frac{1}{2}$ "w x 7 $\frac{3}{8}$ "h x 10"d; 40 lbs. . . . \$69.50

## Model KT-600 Stereo Preamplifier

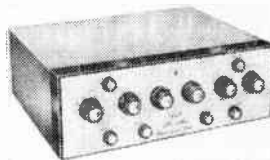

For all stereo or monaural program sources; frequency response 10 to 25,000 cps  $\pm$  0.5 db; distortion: IM less than 0.03% at 2.5 volts output, harmonic less than 0.1% at 5 volts output; hum and noise 88 db below 2.5 volts on high level channels, 62 db below 2.5 volts on low level channels; individual tone controls for each channel provide 15 db boost or cut at 30 cps and 13 db boost and 18 db cut at 10,000 cps; sensitivity: phono, 4.4 millivolts for 2.5 volts output; high level inputs, 0.22 volt for 2.5 volts out-

put; presence control; rumble and scratch filters; 24 positions of phono equalization; 2-position tape equalization; balance control; phase reverse, channel reverse; "third channel" output for use with third amplifier-speaker or for blending stereo channels; output impedance 1300 ohms; a.c. outlets: 3 switched, 1 unswitched; tubes are 7-7025 plus 2 selenium rectifiers; 14"x4 $\frac{1}{2}$ "x10 $\frac{3}{8}$ ". . . \$79.50

## Model KT-310 Stereo Basic Amplifier



Dual 18-watt amplifiers on one chassis; may be used for stereo or monaurally (36 watts output); frequency response 35 to 30,000 cps  $\pm$  0.5 db; harmonic and IM distortion less than 1%; input sensitivity per channel; 0.45 volts for full output; tubes are 2-6AN8, 4-7189, GZ34; 9 $\frac{1}{16}$ "x5 $\frac{1}{4}$ "x13 $\frac{1}{4}$ ". . . . \$47.50

## Model KT-126 Stereo Amplifier

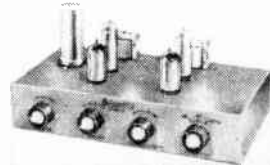

Two-channel amplifier; output 2 watts per channel or 4 watts monaural; ganged tone control separate volume controls; sensitivity 40 millivolts; transformer-operated; 9 $\frac{1}{2}$ "x5"x4 $\frac{1}{2}$ ". . . . . \$18.95

## KT-315 Stereo Remote Control Center

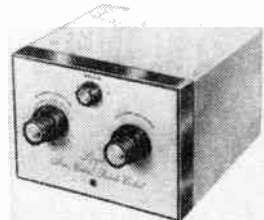

Provides control for either two monophonic systems or stereo can operate separate amp pre-

# Directory of Hi-Fi Kits

amps or combined preamps and amps; low output impedance permitting remote operation; cross-feed control for varying amount of audio each channel; eliminates hole in the middle effect; frequency response 5-50,000 cps.; 6 db. input to output gain; crosstalk better than 55 db. separation between channels; output positions: reverse channel/reverse phase, reverse channel, normal, calibrate; two 7025 triodes; 4 1/2"x6 1/2"x8"; estimated time of assembly 6-8 hours...\$27.50

## Model KT-92 5-Watt AC-DC Amplifier

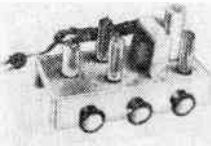

Power output 5 watts push-pull; may be operated on a.c. or d.c.; bass, treble, and volume controls; may be used with crystal or ceramic cartridges; tubes are: 12AX7, 2-35C5, 35W4; estimated assembly time 4-7 hours...\$10.95

## Model KT-117 Transistor Amplifier

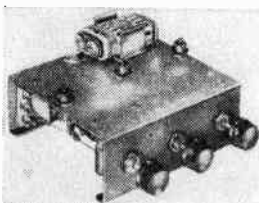

Uses 3 GE 2N190 transistors; frequency response 20 to 20,000 cps; maximum gain 40 db; zero hum level; noise 48 db below 10 millivolts input for high impedance cartridges, 52 db below 2 millivolts for low impedance cartridges; three phono inputs and one microphone input; output 0.5 to 1 volt; bass, treble, and volume controls; may be used up to 175 feet from amplifier; 4 1/8"x3 3/4"x1 1/2"....\$18.45

## Model KT-104 5-Transistor Audio Amplifier

Frequency response 30 to 10,000 cps; power output 3/4 watt; push-pull Class B operation;

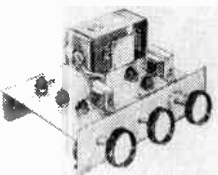

bass and treble controls; three inputs, including preamplifier input; output impedance 3.2 ohms; estimated assembly time 7-10 hours; 5 1/8"x4"x1".....\$19.95  
Model KT-105 (output impedance 8 ohms).....\$19.95

## J. W. MILLER CO.

### Model 565 AM Tuner

Negative mutual coupled AM bandpass tuner; broad tuning with no sideband cutting; germanium diode crystal detector; no tubes or power supply, no hum or tube microphonics; output voltage ranges from .07 to .7 volt on stations within 25 miles radius; gain control; vernier dial; in ebony black or ivory bakelite cabinet; 4"x7"x3 1/2".....\$14.70

## PHILMORE MFG CO., INC.

### Model PAK-1 Preamplifier

Conforms with RIAA curve; for all variable reluctance cartridges; transistorized; no hum or microphonics; frequency response from 20 to 20,000 cps; printed circuit construction; estimated assembly time 1/2-1 hour; in plastic cabinet 4 1/2"x3 1/2"x1 1/2".....\$9.75

## PRECISE DEVELOPMENT CORP.

### Model UPA-1 "Ultra" Preamp



Preamp-equalizer; 4 inputs; magnetic phono, mike, FM, miscellaneous; 1 cathode follower output; separate bass, treble, and volume controls; compensation: AES, 78, LP, RIAA; estimated assembly time 3-4 hours; 12"x4"x4"; weight 6 lbs.

Model UPA-1PK (Self-powered) .....\$25.95  
Model UPA-1NK (Not self-powered) ....\$19.95

### Model AMK Amplifier



Power output 40 watts; bass and treble controls provide 18 db boost or cut; volume and loudness controls; rumble filter; phono sensitivity 5 millivolts; muting switch; 24 positions of record equalization; output meter reads power output or output to tape recorder; cathode follower tape output; hum -80 db on radio, -60 db on phono; selectors for output impedance and speakers; d.c. on input tubes; 10 tubes; printed circuits; estimated assembly time 7-8 hours; 13"x4 1/4"x12".....\$69.95

Frequency response 30 to 10,000 cps; power output 3/4 watt; push-pull Class B operation; bass and treble controls; three inputs, including preamplifier input; output impedance 3.2 ohms; estimated assembly time 7-10 hours; 5 1/8"x4"x1".....\$19.95

Model KT-105 (output impedance 8 ohms).....\$19.95

### Model TUMK AM-FM Tuner



Features dual limiters, Foster-Seeley discriminator, variable AFC, output meter, and cathode follower output; estimated assembly time 7-8 hours; 13"x4 1/4"x9 3/4".....\$49.95

### Model TUK AM-FM Tuner

Similar to Model TUMK but without meter .....\$44.95

## PRINTED ELECTRONIC RESEARCH, INC.

### "Peri-50" Amplifier

Power output: 50 watts, 100 watts peak; frequency response: ±0.1 db 20 to 30,000 cps at any level from 1 milliwatt to 50 watts; harmonic distortion does not exceed 1% 20 to 25,000 cps

(For additional information use coupon on page 160)

Electronic Kits

# Directory of Hi-Fi Kits



within 1 db of 50 watts; inter-modulation distortion less than 1% at 50 watts; sensitivity 0.75 volts rms for 50 watts; 1 volt rms for 100 watts; output impedances 8 and 16 ohms (4 ohms available on special order); damping factor: 25; 20 db feedback; fixed bias on output tubes; all wiring except transformer leads contained in deep-etched copper printed-circuit laminated to under side of base plate, components leads plug into holes on top side of board and point-soldered to bottom; estimated assembly time 2 hours; tubes are 2-EL34, 6AN8, 5U4.....\$69.75

### "Peri-60" Amplifier

Similar to "Peri-50" except for power output of 60 watts, 120 watts peak; all specifications identical except that measurements are made at 60 watts....\$79.95

### Model PPC-210-B Preamplifier

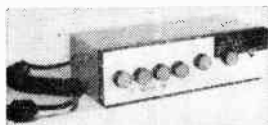

Frequency response 10 to 50,000 cps  $\pm 1$  db at 1 volt output; harmonic distortion less than 0.15% at 1 volt output; IM distortion 0.02%; hum and noise 60 db below 3 volts on high gain inputs, 82 db below 3 volts on low gain inputs; sensitivity for 1 volt output: tape head and phono, 2 millivolts; tape and tuner, 0.125 volts; ceramic phono, 0.150 volts; microphone, 24 millivolts; aux, 0.4 volts; separate bass and treble equalization allows 16 equalization positions; tone controls allow 15 db boost or cut at 20 cps and 20,000 cps; d.c. on filaments; loudness control; rumble filter; 4 switched a.c. outlets; tubes are 12AX7, 2-12AU7, plus two selenium rectifiers; 12"x5½"x3½", separate

Number 2

power supply 4"x6"x7½"; estimated assembly time 3 hours...\$49.75

### Model PPC-226-JT BBO Meter



For use with hi-fi basic amplifiers; provides bias indication scale for EL34/6CA7, KT88, and 6550; indicates output tube balance and power output; estimated assembly time ½ hour.....\$15.75

### Peri FM Tuner

Kit is pre-wired; tuning range 88-108 mc.; Foster-Seeley discriminator; selectivity 200 kc. bandwidth 6 db. down; less than 1% distortion at full output;  $\pm 8$  kc. maximum drift; grounded twin shielded oscillator and mixer, selenium rectifier; estimated assembly time 15-30 minutes.....\$58.75

### Peri Master Balance Control

Complete volume and channel output control; meter regulation estimated time of assembly 10-15 minutes.....\$16.95

## QUALITY ELECTRONICS, INC.

### Model 1000 AM-FM Tuner



Armstrong FM circuit with Foster-Seeley discriminator; sensitivity: FM, 5 microvolts for 30 db quieting; AM, 25 microvolts; AFC with defeat provision; frequency response: FM, 20 to 20,000 cps  $\pm 0.5$  db; AM, 20 to 5,000 cps  $\pm 3$  db; distortion: less than 1% on FM; band-width: FM, 200 kc; AM, 8 kc; hum level; -60 db; output voltage: FM, 2 volts for 100% modulation; AM, 1 volt; tubes: 2-12AT7, 6BE6, 6BA6, 2-6AU6, 6AL5; one selenium rectifier; estimated assembly time 8-12 hours; 10¾"w x 4"h x 8"d.....\$31.85

### Model 1200 AM Tuner

Specifications similar to AM section of Model 1000 AM-FM



tuner; estimated assembly time 5-8 hours.....\$19.95

### Model 1100 FM Tuner



Specifications similar to FM section of Model 1000 AM-FM tuner; estimated assembly time 5-8 hours.....\$25.50

### Model 2000 Amplifier

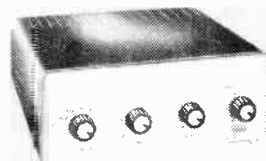

Rated output: 12 watts; built-in preamp; 3-position record equalization; separate bass and treble controls with 16 db of boost or cut at 50 and 10,000 cps; frequency response: 20 to 20,000 cps  $\pm 0.5$  db, 40 to 15,000 cps  $\pm 0.5$  db at 12 watts; hum 60 db below 12 watts on high level input, 50 db on phono input inputs: magnetic (6 millivolt sensitivity), crystal phono, tape tuner; output impedances: 4, 8, 16 ohms; one a.c. convenience outlet; tubes: 12AX7, 12AT7 12AU7, 2-6V6, 5Y3; estimated assembly time 8-12 hours 12½"w x 3½"h x 7¾"d. \$28.50

### STA-36

### Stereo Amplifier and Preamp



Complete 2 channel preamp with 2 separate 18 watt amplifiers dual ganged bass, treble and loudness control; stereo balance control; rumble filter, equalization switch; frequency response:

(For additional information use coupon on page 160)

# Directory of Hi-Fi Kits

$\pm 1/2$  db. 20-20,000 cps.; less than 1% harmonic distortion; two EL84 self-biased push-pull output.....\$49.95

**2200 12 Watt Amp, Preamp**

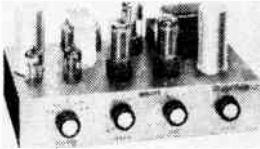

Williamson integrated amp.; beam power push-pull circuit; inputs are mag phono or tape, xtal phono, tuner, mike, aux.; separate bass and treble controls; frequency response 1 db. 20-20,000 cps.; inverse feedback; suitable for use with electric guitar, P.A. system. \$22.75

## STA-24 Stereo 24 Watt

**Complete 2 Amps, 2 Preamps**  
Complete stereo control center; accommodates tapes, records, all broadcasts including multiplex; Williamson type amplifiers; frequency response  $\pm 1$  db. 20-20,000 cps.; distortion 1% at rated output; tuner/crystal phono 80 db. below 12 watts; mac. phono/tape 60 db. below 12 watts. ....\$39.95  
Case .....\$ 5.95

**Two Band Broadcast and Shortwave AC-DC Radio**  
Shortwave 5.8-18 mc.; 5 tube superhet circuit; loop antenna for broadcast, external antenna for shortwave; 455 kc. 1F; estimated time of assembly 8-10 hours. ....\$19.75

## REGENCY

**Model HFT-1K**  
Preamplifier-Equalizer



Transistorized preamp; RIAA record equalization; bass control; 15 db boost or cut at 20 cps; treble control; 8 db boost and 20 db cut at 20,000 cps; frequency response 20 to 20,000 cps  $\pm 0.5$  db; IM distortion less than 0.5% at normal output, less than 1% at 2 volt output; hum: inaudible; noise 70 db below 1 volt output; inputs: magnetic (11 millivolts sensitivity), mike (0.2 millivolts sensitivity), two high level; low impedance output; printed

circuit wiring; battery operation; three type pnp transistors; estimated assembly time 2-3 hours; gold and black finish;  $7\frac{1}{2}$ " w x  $2\frac{1}{2}$ " h x  $3\frac{7}{8}$ " d; less batteries .....\$34.95

## REK-O-KUT COMPANY

**Model K-33 Turntable**

Single-speed ( $33\frac{1}{3}$ ) belt-driven turntable; noise level 47 db be-

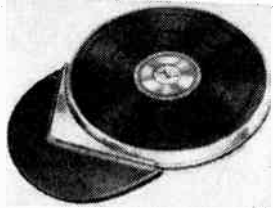

low average recording level; 4-pole induction motor; cast aluminum turntable with strobe disc; estimated assembly time  $1/2$  hour; chassis  $15\frac{7}{8}$ " x  $15$ ".  
.....\$39.95

## K-33-H Hysteresis Turntable Kit

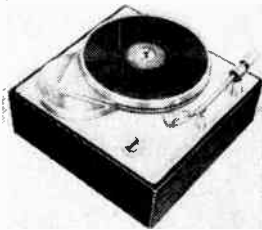

Single speed ( $33\frac{1}{3}$  rpm) crown-spindle belt-drive; high efficiency hysteresis synchronous motor; noise level -52 db.; wow  $\pm 2\%$ ; small external stray field minimizes effect on pick-ups which may be near the motor; price does not include arm, base, or motor board; estimated time of assembly  $1/2$  hour. ....\$49.95

## RIVER EDGE SALES CORP.

**Model 100 Equipment Cabinet and Model 110 Enclosure**

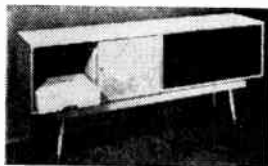

Model 100 accommodates record changer and tuner with amplifier; Model 110 accommodates 12" speaker or 2-way system

with 12" woofer and any tweeter up to  $6$ " x  $12$ " round or rectangular;  $3/4$ " birch hardwood; plywood pre-cut to size; equipment panels are removable; both cabinets  $36$ " w x  $16$ " d x  $16$ " h.  
Model 100.....\$39.50  
Model 110.....\$39.50

**Models 120, 130, 140, and 150**

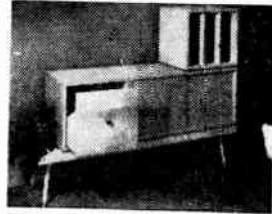

Model 120 record storage cabinet;  $18$ " w x  $16$ " d x  $16$ " h. ....\$24.50

Model 130 player cabinet;  $18$ " w x  $16$ " d x  $16$ " h. ....\$24.50

Model 140 60" bench with wooden legs and brass ferrules;  $16$ " w x  $16$ " d x  $14$ " h. ....\$39.50

Model 150 set of 4 black wrought iron or wooden legs;  $16$ " high .....\$6.30

## Model 900 Enclosure

Horn loaded corner enclosure kit; corner speaker enclosure; accommodates 12" or 15" woofer and any size tweeter up to  $7$ " x  $12$ ", rectangular or round,

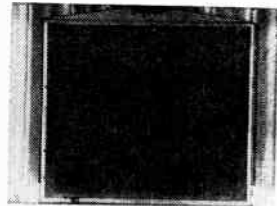

all necessary adaptors included; all plywood and lumber supplied pre-cut to size; full acoustical insulation supplied; all equipment panels are removable:  $36$ " w x  $18\frac{3}{4}$ " d x  $32$ " h. ....\$18.00

## Models 920 Equipment Cabinet and 915 Speaker Cabinet

Model 915 is a bass reflex enclosure for 15" speakers—Model 912 available at same price for 12" speakers; Model 920 cabinet holds changer, tuner, and amplifier; kits contain plywood and lumber, cut and machined to exact size; acoustical insulation, glue, wood filler, sandpa-

Electronic Kits



# Directory of Hi-Fi Kits

per, and full instructions for assembly and finishing; all equipment panels are removable; both cabinets 23" w x 16" d x 33 1/2" h.

Model 920 (Equipment cabinet kit) .....\$26.70  
Model 915 (Bass reflex enclosure kit).....\$18.00

## TECH-MASTER CORP.

### Model 19K Preamp-Amplifier

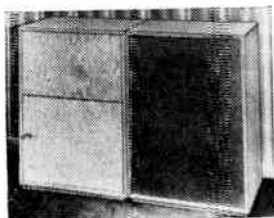

Power output 60 watts from 20 to 20,000 cps; frequency response flat 10 to 50,000 cps; IM distortion below 1% at 60 watts and below .25% at normal listening levels; hum level 65 db below rated output through magnetic input; five-position equalizers; inputs for crystal cartridge, magnetic, tuner, TV, and tape; feedback type tone controls; tape output; 4, 8, and 16 ohms; "ultra linear" output transformer; tubes are 12AX7, 12AU7, 6AN8, 2—6550 output, 5U4GB, and selenium rectifier for bias; black and gold panel; 14 1/2" w x 10" d x 5 1/4" h 28 lbs.

Model 19K Kit.....\$79.95  
Cabinet 19C.....\$7.50

### Model 21K Preamp-Amplifier

Circuitry, components, and performance similar to Model 19K up to rated power of 25 watts; equalizer has RIAA position with calibrating feature on treble control for compensation of AES, NAB, LP, and 78; tubes similar to 19K except for power output tubes, which are 6L6's; 14 1/4" w x 9" d x 5 1/4" h; weight 21 lbs.

Model 21K Kit.....\$59.95  
Cabinet 21C.....\$7.50

### TM-15A Amplifier

Utilizes Williamson circuitry; 20 watts undistorted output; 10 to 70,000 cps ± db at 15 watts; 8 to 100,000 ±1 db at 5 watts; IM and harmonic distortion .25% at 10 watts, .5% at 15 watts; hum level 70 db be-

low rated output; 20 db feedback; 1.1 volt for full output; 4, 8, and 16 ohms; tubes are 2—6SN7, 2—5881, 5V4; 9" x 12" x 6 1/2"; 27 pounds...\$49.95

### Model 24K Preamplifier

Battery-operated transistorized preamplifier-control unit; separate bass and treble controls; inputs: 1 low level, 3 high level; less battery; 3" h x 9" w x 5 1/2" d. ....\$24.50

### Model 41K Stereo Preamplifier

Similar to Model 24K but with dual-channel circuitry; balance and master volume controls; separate bass and treble controls for each channel; less battery; 3" h x 9" w x 5 1/2" d. ..\$49.50

## TRANSVISION, INC.

### Model A101 Amplifier



Power output 24 watts; frequency response 20 to 20,000 cps ± .5 db; distortion less than .3%; record compensator; bass and treble controls; 6 inputs; tubes are 2—12AU7, 6SL7, 5U4, 2—6L6; estimated assembly time 10—15 hours; 13" w x 8" h x 6" d. ....\$39.00

## UNIVERSITY LOUDSPEAKERS, INC.

### KEN-12 Enclosure Kit

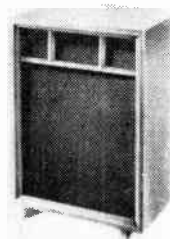

Horn loaded "cornerless corner" design; for use with any 12" speaker; has provision for adding separate tweeter and mid-range speaker; estimated assembly time 5 to 7 hours; 29 1/2" h x 21 1/2" w x 15 1/2" d. ..\$44.75

### KEN-15 Enclosure Kit

Similar to KEN-12 but for 15" speakers; 18 1/2" d x 29" w x 35 1/4" h .....\$59.50

### CUL-10

Ultra linear speaker kit; 12" woofer response 18-2500 cps.; high compliance tweeter, and crossover network. ....\$98.75

### CUL-11

Kit includes 15" woofer with 15 cps. cone resonance, responds to 800 cps, 4-20 ohms; 8" midrange frequency response 70-13,000 cps. ....\$164.50

## WATSON INDUSTRIES, INC.

### Crossover Networks

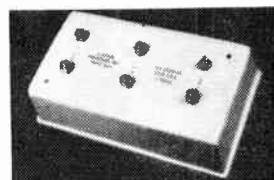

Inductance-capacitance crossover networks with crossovers at 2500 cps 8 ohms (Model FDS-1/K or 5000 cps 16 ohms (Model FDS-2/K) quarter-section constant-resistance type; 6 db/octave slope; air-core inductors; paper dielectric capacitors; plastic case; available from manufacturer only.

FDS-1K .....\$5.95  
FDS-2K .....\$5.50

## WEATHERS INDUSTRIES

### KL-1 Turntable Kit

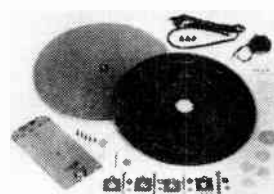

New light-weight turntable with 12-pole synchronous motor; speed is 33 1/3 rpm; provision for spring-mounting mounting board; estimated assembly time 12-20 minutes; includes turntable mat; can be assembled on motorboard 14 1/8" x 15 1/8" with overall height of 2 1/2" ..\$34.50

### SC-1 Electronic Speed Control

Four speed control including a vernier for fine adjustment; used with KL-1 Turntable kit. \$74.50



# LET RCA TRAIN YOU IN ELECTRONICS

*RCA Institutes celebrates Fifty Years of Electronic Training by introducing its newest Home Study Course . . .*

## *ELECTRONICS FOR AUTOMATION*

. . . Now you have *four* comprehensive courses for your electronic training . . . from basic electronic theory to the more advanced principles of color TV and Automation.

**Electronic Fundamentals**

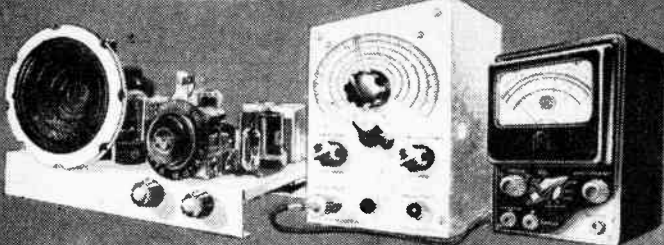

**Electronics for Automation**

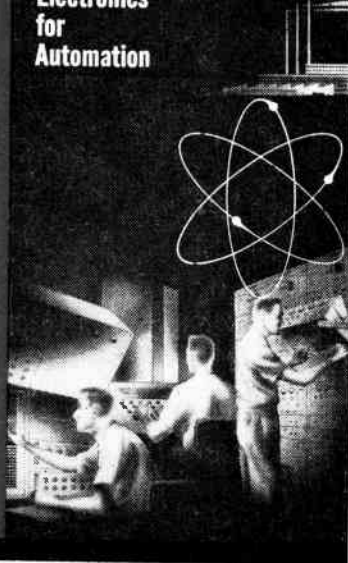

**Television Servicing**

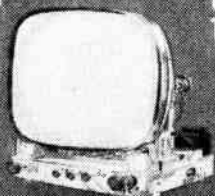

**Color Television**

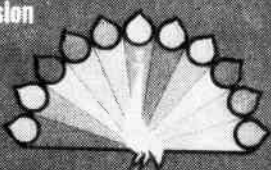

Send for our 64 page Home Study Catalog

**FREE!**

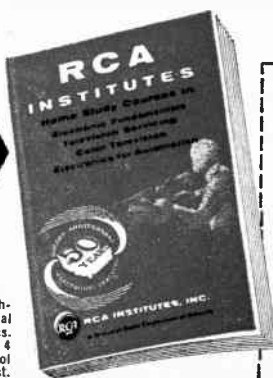

Practical work with the very first lesson. Pay-as-you-learn. You need pay for only one study group at a time.

**RCA INSTITUTES, Inc.** Home Study School, Dept. KE-49

A Service of Radio Corporation of America  
350 West Fourth Street, New York 14, N. Y.

Without obligation, send me the FREE catalog of Home Study Courses. No salesman will call.

Name .....

Please print

Address .....

City..... Zone..... State.....

Korean Vets! Enter Discharge Date.....

**CANADIANS** — Take advantage of these same RCA courses at no additional cost. No postage, no customs, no delay. Send coupon to: RCA Victor Company, Ltd., 5001 Cote de Liesse Rd., Montreal 9, Quebec  
To save time, paste coupon on postcard.

Electronic Kits

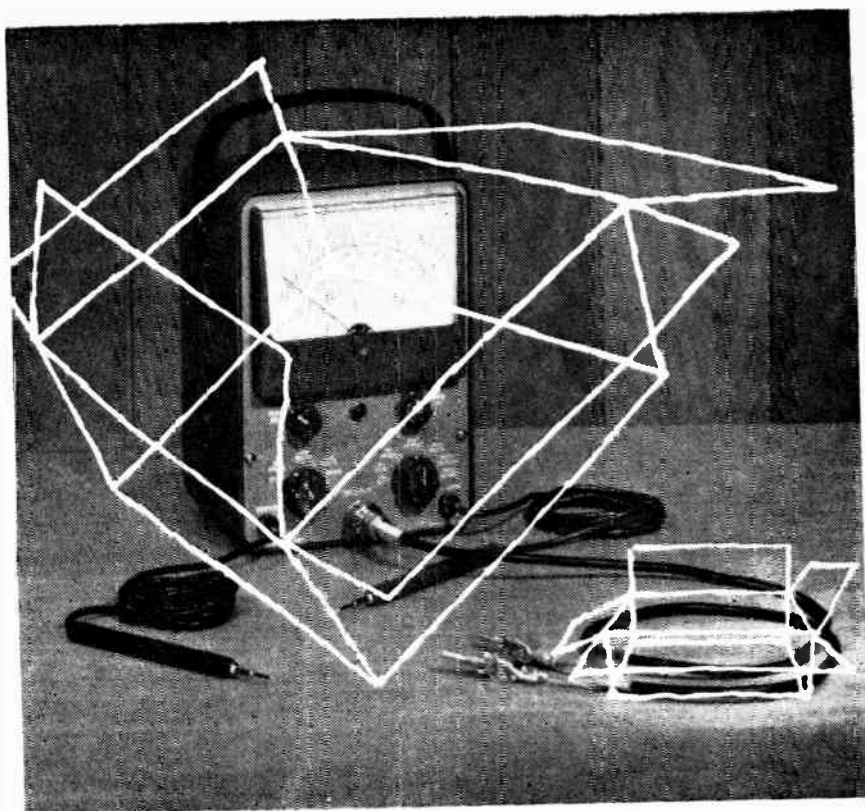

section II  
kits for the shop

Paco T-65 Transistor Tester	84
Build a Vacuum-Tube Voltmeter	86
Paco Audio R.F. Signal Tracer	89
An easy to wire Multitester kit	91
Build a Wide-Band Oscilloscope	94
Electro Products KPS-2 power supply	96
Precise AM-FM Signal Generator	99
Make a king size VTVM	101

 directory  
of shop kits page 103



Steps in assembly of the T-65 transistor tester, (1) prewiring of switch, (2) mounting components on front panel, (3) interconnecting switches and (4) completion of power supply subassembly wiring. Wiring color code is given on diagrams as required.

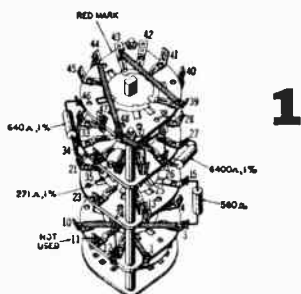

**1**

**2**

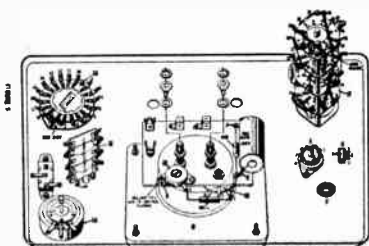

**3**

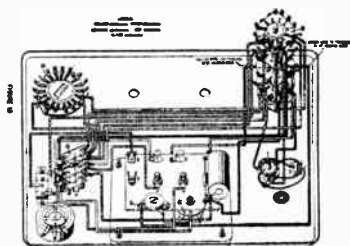

**4**

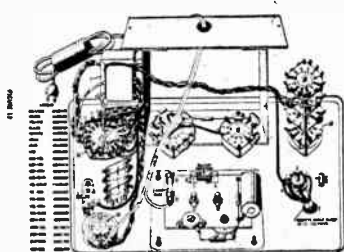

match the drawings in the manual. Re-check your work before mounting the switches.

Your particular kit may include switches that are slightly different mechanically from those in the diagrams. They may have crimped metal tabs holding the contact wafers to the assembly or nuts and bolts as in the manual illustration. In either case they are directly interchangeable and will present no problem.

It is a good idea to check all soldered connections. Remember that unless a joint is well soldered it may add resistance to the wiring that will upset some critical test circuit.

It might be found that the 4-pin-in-line transistor socket won't quite fit into its cutout hole in the panel. In such a case, don't try to force the socket but use a small file to enlarge the hole.

After you have completed all construction steps in the manual, there will be three extra resistors. Their values are 33, 390 and 4700 ohms. Clipped to the test leads, these resistors provide a means for checking out the finished instrument as described in the instruction manual.

#### wide voltage range

Some transistor testers are battery-operated but a wide range of voltages is needed for testing many of the newer transistors. The Model T-65 provides 17 different voltages, allowing front-panel selection of collector voltages from 0.5 to 100 volts, d.c. These voltages are also used for diode back-resistance tests. Diode forward tests are made in current ranges from 5 ma. to 500 ma. at any of the 17 voltages from 0.75 to 75 volts.

All transistor test readings are made on a large plastic-cased D'Arsonval-type meter. This meter is also used to adjust the input line voltage. A similar line voltage control is used in tube testers to compensate for power line voltage variation.

Transistor and diode test data sheets accompany the kit. They give an outline drawing of each transistor type and the proper settings of each switch on the tester panel. Complete data is given for testing 411 transistor types and 123 diode types.

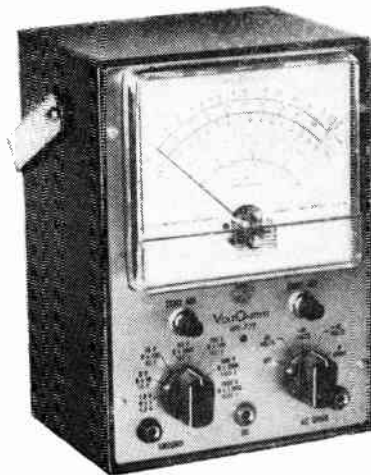

## Build a Vacuum-Tube Voltmeter

*printed-circuit board  
makes the RCA Volt-  
Ohmyst easy to assemble*

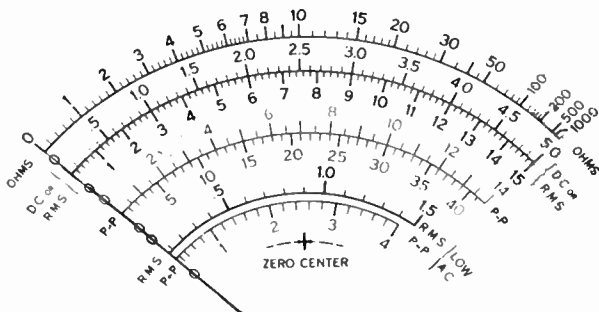

**Large, clear dial face permits quick, accurate readings to be made.**

The first piece of quality electric test equipment you should have for your test bench is a vacuum-tube voltmeter. A VTVM found in service shops and industrial plants throughout the country, the RCA "VoltOhmyst," Type WV-77EK, is now being offered in kit form by the Radio Corporation of America.

### what it can do

The VoltOhmyst WV-77EK measures a.c. (r.m.s.) and d.c. voltages up to 1500 volts, peak-to-peak voltages to 4000 volts, and resistance up to 1000 megohms. There is a high input impedance on all d.c.- and a.c.-voltage ranges, allowing the use of this VTVM in circuits where VOM's with a lower input impedance would result in loading of the circuit under test—and a resultant

error in voltage reading on the meter.

The VoltOhmyst utilizes a push-pull balanced d.c. bridge with the meter in the plate circuit, which affords excellent linearity of response, good stability, and very high input impedance. Additional features include: provision for zero-center indication, useful in discriminator and bias measurements; separate scales for low a.c.-voltage measurements to assure accurate readings; a circuit design which allows measurement of a.c. in the presence of d.c. and vice versa; a separate d.c. probe with a 1-megohm resistor which minimizes capacitance-loading effects; and electronic protection against meter burn-out. Also, the resistors in the ohmmeter ranges are protected by a separate fuse.

### putting it together

The WV-77EK utilizes a printed-circuit board to facilitate assembly. This board provides a rugged, pre-wired mounting for the components and, if the parts are properly

**GET MORE  
ENJOYMENT OUT  
OF YOUR HI-FI  
FOR ONLY  
\$1.00!**



photo courtesy ELECTRO VOICE, INC.

*that's the cost of the new 1959 edition of the*

# HI-FI GUIDE & YEARBOOK

**ON SALE NOW AT NEWSSTANDS OR ORDER BY MAIL BELOW**

The authoritative Ziff-Davis Annual, HI-FI GUIDE & Yearbook, covers every facet of high fidelity enjoyment—shows you how to get more listening pleasure from your hi-fi set! Besides telling you how to use your equipment for the best possible reproduction, the 1959 HI-FI GUIDE & Yearbook presents a round-up of the trends in the hi-fi field . . . tells you how to save on repairs . . . guides you in the selection of records . . . gives you tips on tapes.

You'll find this Annual a wonderfully practical source of information on improving the sound output of your system. Articles are presented in easy-to-understand, non-technical language. It's like getting two books for the price of one:

**GUIDE:** Section 1: IMPROVING YOUR HI-FI  
Section 2: INSTALLING YOUR HI-FI SYSTEM  
Section 3: TAPE RECORDING

**YEARBOOK:** Trends in Hi Fi  
Critics' Choice of Recordings  
The Ultimate in FM Stations  
Latest Report on Stereo

**PICK UP YOUR COPY OF THE 1959 HI FI GUIDE AND  
YEARBOOK TODAY AT YOUR NEWSSTAND OR RADIO PARTS STORE—  
OR ORDER BY MAIL USING HANDY COUPON. ONLY \$1.00**

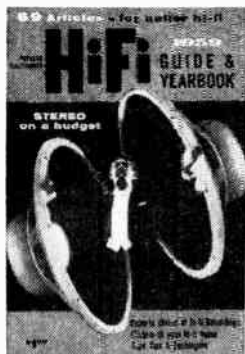

Ziff-Davis Publishing Company  
Department K2 9  
434 South Wabash Avenue  
Chicago 5, Illinois

Please send me a copy of the 1959 HI-FI GUIDE AND YEARBOOK. I enclose \$1.00, the cost of the YEARBOOK, plus 10¢ to cover mailing and handling charges (Canada and Foreign, \$1.25 plus 10¢ postage).

NAME .....

ADDRESS .....

CITY..... ZONE..... STATE.....

inserted and soldered, makes for a neat and trouble-free assembly.

The symbol number of the part to be mounted is printed on one side of the board, and the copper wiring is etched on the other side. When the assembly instructions call for mounting a part, make sure the leads of the component form a right angle to the body of the part. The leads, when properly bent, form the two long portions of a "U" shaped unit, the bottom of the "U" match-

construction steps. The builder who assembled the Volt-Ohmyst makes the following recommendations.

- Insert *R14* as the first substep in Step 2. This section of the printed circuit is crowded. Installing *R14* first will permit you to mount the adjoining components with ease.
- After mounting the two snap-in sockets on the printed-circuit board as instructed in Step 2, be sure to solder each connection point as instructed. Do not be fooled into

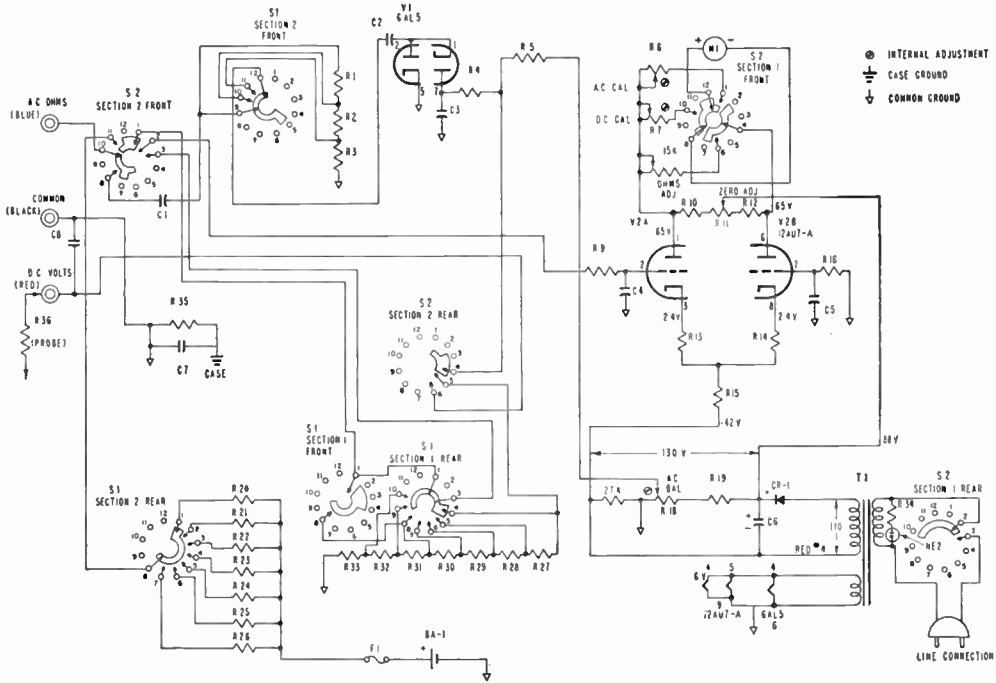

The Volt-Ohmyst uses a time-proven RCA circuit for optimum results.

ing the dimension between the two holes. Some parts, such as the disc capacitors, tube sockets and the selenium rectifier, do not require bending.

Place the leads in the holes provided and pull the part snug to the board, so that the leads protrude on the etched side of the board. Spread the leads slightly to prevent the part from falling out. After soldering the leads to the copper foil, cut them to 1/8" from the board.

### recommendations

The instructions for assembling and wiring the Volt-Ohmyst have been carefully thought out and presented in seven major

thinking that these connection points make a good electrical connection.

- When connecting *R10* to the printed-circuit board in Step 4, do not cut the leads. Otherwise, wire must be added to reach a connection point later on.
- In Step 4, the instructions call for tinning the negative and positive terminals of the dry cell. When doing this, be careful not to apply too much heat with the soldering iron, as heat can damage the cell.

The instructions state exactly how to calibrate the Volt-Ohmyst. After calibration, our model was checked against laboratory standards. All scales except the a.c. ranges were found to be accurate to within 3%.





## ***Build a Signal Tracer***

As originally conceived and used back in the pre-TV era, the signal tracer was a popular and handy gadget for quickly localizing less obvious defects in a broadcast radio. It offered the advantage of providing direct indication of the absence or presence of signal anywhere in the a.f., i.f., or r.f. portions of the receiver—and indication of the condition of that signal—with a single instrument. While similar tests could be made in other ways, more elaborate instrumentation was required to obtain less direct evidence.

As electronic servicing began to encompass TV, FM, and hi-fi gear, this reliable type of tester lost some of its status. The impression seems to have developed that its usefulness for such sophisticated equipment was limited. However, if you give PACO's Model Z-80 a try, you will be surprised at what you can do with it on all types of audio equipment, FM tuners, and TV receivers. It will not only perform the conventional

signal-tracing function in hi-fi systems, in FM receivers, and in TV sets, it will also noise-test specific components, help localize short circuits and partial shorts with an interesting wattmeter circuit, check speakers and output transformers, facilitate power-supply and filament circuit checks, and help in other jobs.

A kindly feeling toward the Z-80 begins to develop before it is so much as used once. In fact, you will begin to like the tester before it is assembled. The reason for this is the superior manual that accompanies it, which insures a problem-free assembly of an instrument already carefully designed to go together with practically no complications.

Our wiring and instruction manual had a slip of paper with some notes to be added for some of the steps. The only special attention these require is that of penciling in a few words next to some of the steps in the body of the manual, just to avoid oversight once you get involved with actual assembly.

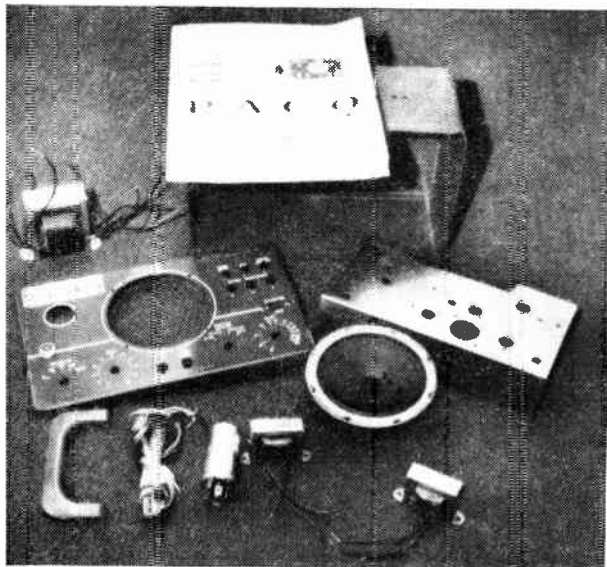

Major chassis and cabinet parts before assembly. Be sure to sort out smaller parts before starting to work.

Completely wired signal tracer chassis with eye tube installed. Chassis size provides plenty of working space.

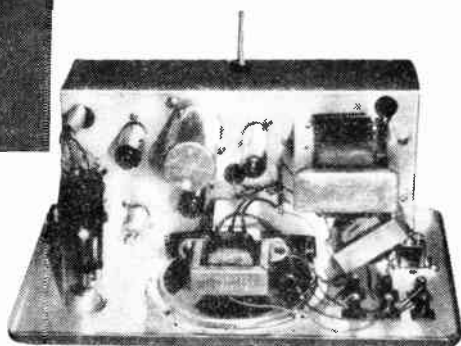

One of these notes had to do with a letter "O" marked on the speaker frame for proper physical orientation of the speaker during mounting. If the mark is missing on your speaker, as it was on ours, forget it. The speaker will go together properly anyhow.

You can almost put the Z-80 together like an automaton, without giving much thought to what you are doing. This is made possible by a carefully worked out step-by-step procedure, supported with superior illustrations, with most of the latter duplicated on a separate fold-out sheet to avoid unnecessary back-and-forth page turning. However, there are two points where a little extra attention will pay off. The first of these occurs at the very beginning of the mechanical assembly. The Timmerman fasteners, used to fix the red and black pin jacks to the panel, may not go on as easily as you'd like. If so, try flexing them a little with a pair of pliers to make them slightly more con-

cave. We also recommend performing step 7 immediately after step 1, and then reverting to the printed procedure for remaining steps. Otherwise you will find that, by the time you get to installing the black pin jack at location B in step 7, your working space has been blocked off by preceding assembly.

With the unit completed, putting it to work is quite easy: the "Applications" section of the manual is as clear and complete as the wiring and assembly procedure. Calibrated controls, in conjunction with a built-in eye tube as indicator, make actual stage-gain measurements possible. Since the r.f. probe will readily detect signals in the TV transmission range (we tested it out up to 110 mc.), its use in TV and FM receivers is entirely feasible. For TV tracing, you can listen for the conspicuous sync buzz that is mixed with the television signal and remains relatively constant without regard to other signal-content changes.

## An Easy To Wire Multitester Kit

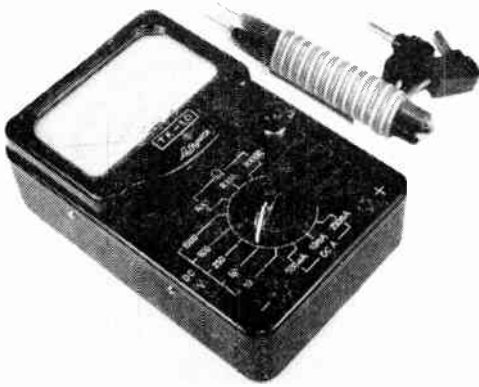

**A** The Lafayette multi-tester takes very little time to build and is a handy instrument to have.

**B** The TK-10 is mostly a wiring job. The components are installed for you.



Hams, gadgeteers, student technicians, and apprentice servicemen often have divergent interests. But they all share one thing in common. Next to their soldering iron and small hand tools, the most important item in their home workshop or laboratory is or should be a good quality general purpose multitester.

With such an instrument available, the student or apprentice can demonstrate many of the basic electrical laws he studies. The ham can gain practical experience which will stand him in good stead when he tries for a higher grade license. The gadgeteer can "troubleshoot" his construction projects. And, of course, a multitester is essential to electronic maintenance and servicing.

Unfortunately, if you must watch your pennies . . . like most beginners . . . you may find that good quality instruments tend to be a bit expensive. As a result, you might put off the purchase of a badly needed piece of gear.

One solution, of course, is the purchase of a kit-type instrument. Experience you can obtain when assembling the kit can be invaluable as you advance in your career or hobby. However, multitesters, with complex switching networks and a maze of multipliers, shunts, and calibrating resistors can be hard to wire.

If you're a beginner, then, you might hesitate to obtain a multitester kit until you've acquired more skill in wiring . . . even though the purchase of a kit may represent the only way you can afford a badly needed instrument.

Lafayette Radio has recently introduced a new type of multitester kit which is so easy to wire that even a beginner should have no difficulty in doing a truly "professional" job of assembly. In the Model TK-10 "semi-kit," all major components, including the meter, battery holder, ohmmeter control, A.C. rectifier, test-lead jacks, and selector switch, are pre-mounted. Most of the smaller components . . . multiplier resistors and shunts . . . are also pre-mounted. The only "loose" parts furnished with the kit

are two resistors, plus small hanks of hook-up wire and insulated spaghetti tubing.

### specifications

The TK-10 has a 40 microampere 3" D'Arsonval meter movement, giving an overall sensitivity of 20,000 ohms per volt on D.C. and 10,000 ohms per volt on A.C. It has sixteen switch positions and a total of twenty calibrated ranges: D.C. volts, 0-10-50-250-500-1000; A.C. volts, 0-10-50-250-500-1000; D.C. current, 0-500 microamperes, 0-10-250 milliamperes; Ohms, 0-10K-100K-1 Megohm; Decibels, -20 to -36 in two ranges; Capacitance, 250 MMF. to 0.02 MF.; Inductance, 0-5000 Henries. As furnished by the manufacturer, the kit includes an ohmmeter battery (a single 1.5 volt penlight cell) and a set of test leads.

### assembly and wiring

Since all major parts are premounted, the TK-10's assembly is basically a "wiring" job. For this, you'll need a good soldering iron (or gun), long nose pliers, diagonal cutters, and a supply of rosin core solder. A small screwdriver will be needed when the instru-

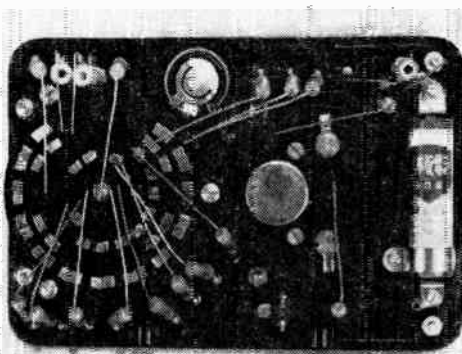

**C** Basic unit showing resistors, battery and switch before wiring.

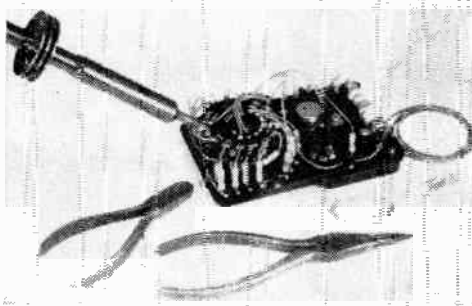

**D** A clean, hot, well-tinned soldering iron should be used along with other standard tools shown.

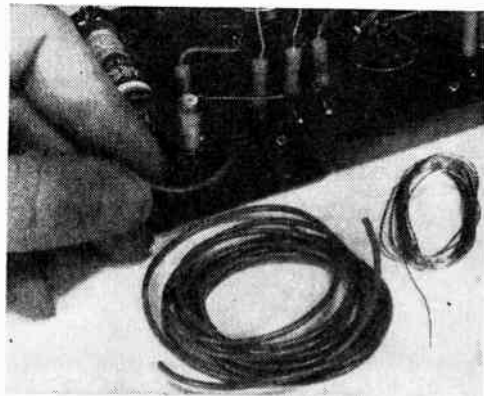

**E** Wiring is done with bare, tinned hook-up wire and insulated sleeving.

ment is mounted in its case, but is not required for assembly.

Use a hot, clean, well-tinned soldering iron, completing each soldered joint as quickly as possible. Most of the circuit connections are made using "lap" joints rather than the more familiar "closed hook" connection; therefore, use enough solder to insure a secure joint, but not so much that the solder spreads and causes shorts.

Multiplier resistors and shunts are wired in place with their own leads, insulated with slipped-on spaghetti tubing. Each connection should be short and direct, but don't apply excessive tension to the leads.

An interesting technique is used for point-to-point circuit wiring. Instead of familiar insulated hook-up wire, circuit wiring is completed with tinned bus bar, insulated with spaghetti tubing.

The builder had some doubts about this technique when he started assembly of his TK-10 kit. As the work progressed, however, he found that this approach is actually much faster than the conventional practice of using insulated wire.

When insulated wire is used, the builder must first measure the length of wire needed between the two terminals to be connected, allowing a little extra for the soldered connections. The wire is then cut to length, insulation is stripped at both ends, and the prepared wire installed.

When bus bar is used, there is no need to pre-measure its length, to pre-cut to length, nor to strip insulation. One end of the hank of wire is soldered to one connection point, the wire unrolled and run to the second terminal, where the free end is cut. A piece of spaghetti tubing slightly shorter than the resulting wire is cut and slipped over the free end . . . after which the wire is soldered to the second terminal.

This technique results in a clean, neat, professional appearing job . . . and eliminates the waste resulting from misgauging wire lengths. It easily could be adapted to the assembly of other types of projects . . . amplifiers, receivers, and other instruments.

Check your work as the wiring progresses, making sure you have made no errors, that each soldered joint is secure, and that there are no accidental shorts.

Working at a normal pace, even a "slow" worker should have no difficulty completing the assembly of a TK-10 kit in a single evening.

#### operation and test

With the wiring completed and double-checked for accuracy, the ohmmeter battery may be installed (watch polarity!) and the instrument given a preliminary check before installation in its case.

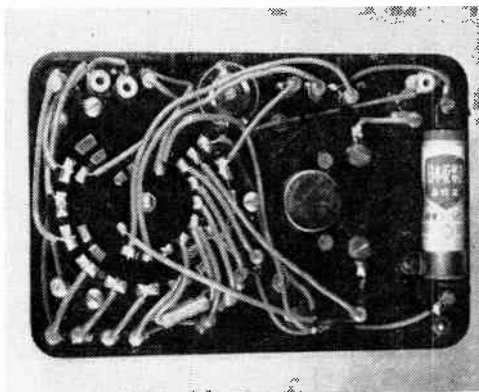

**F** The completed unit with 40 ua meter movement being used to check pocket-sized transistor receiver.

Rotate the selector switch to one of the three ohmmeter ranges. Install the test leads in their jacks and short the free ends together. If there are no wiring errors, you should be able to obtain a full-scale meter reading by adjusting the ohmmeter rheostat. If you obtain an up-scale . . . but not a full-scale (or "0" ohms) reading, it generally indicates that the battery is weak. Install a replacement cell.

The finished TK-10 multitester, although assembled from a kit, is a good quality standard instrument and, therefore, is used like any other multitester. Leads are inserted into the jacks, the selector switch rotated to the proper range, and the free ends of the test leads applied across the two terminals where a voltage (or resistance) is to be measured. Observe polarity when making D.C. measurements. If in doubt about the proper meter range to use, switch to a higher (or to the highest available) range before using the instrument . . . you can always switch to a lower range to obtain a more accurate reading, but the application of excessive voltage (or current) can damage the meter.

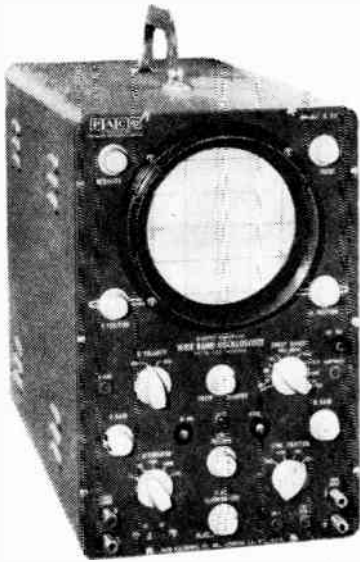

## Building a Wide-Band Oscilloscope

Oscilloscopes were as rare as television sets in the days before World War II. Considered a highly specialized instrument, the scope was seldom seen outside the electronics laboratory and never on the service technician's test bench.

The post-war TV boom changed all that. The oscilloscope quickly became as indispensable as the VTVM, and was granted a

favoured spot on the test bench.

A fine example of the best in modern-day oscilloscope kits is the Paco wide-band d.c. oscilloscope model S-55. The circuitry and features would astonish a technician who knew only the early scopes. The frequency response, for example, is flat from zero cycles (d.c.) to 4.5 megs and only 5 db down at 5 megs. The a.c. sensitivity is 25 millivolts (rms) per inch. The other special features, too numerous to list completely, include automatic synchronization, built-in calibration voltage, illuminated screen graticule and front panel mounted d.c. balance and astigmatism controls.

Although the designers have obviously expended every effort to simplify and clarify the step-by-step construction procedures in the manual, this kit is not a job for a beginner. The two printed-circuit boards are extremely helpful in minimizing the chance of error, but in the twenty-odd hours of construction time required, there are just too many chances for the beginner to "goof."

After the major wiring steps are completed, the final mechanical assembly consists of mounting the above and below-chassis shields. At this point the reason for some of the odd-seeming lead dress instructions becomes clear. Since the leads are meant to run through cutouts in the shielding plates, and if the dress instructions are not followed exactly, you may find yourself with the necessity of rewiring several areas below the chassis in order to have the leads fall in the notches.

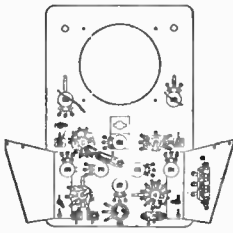

FIGURE 1

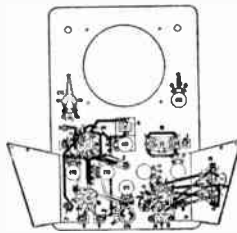
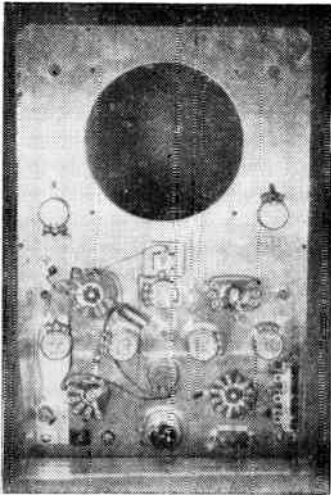

FIGURE 2

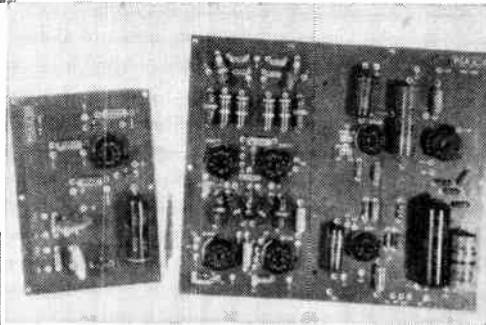

FIGURE 3

**Placement of pots, jacks and side flanges which hold the input compensation trimmers. View (right) is of printed circuit boards after installation and before wiring to remainder of circuit.**



The first two steps (after the check of parts list, etc.) involve mounting the various pots, switches and input jacks on the front panel. The switches are then interwired, and several 5% resistors are connected to the vertical attenuator switch. Note that in all areas of the kit where 5% color-coded units are specified, carbon-deposited types with their values marked directly on them were supplied.



There's a page labeled "Notes on Printed Wiring Boards" introducing the section of the manual detailing the wiring of the P-C board. Read it carefully; it's chock full of information.

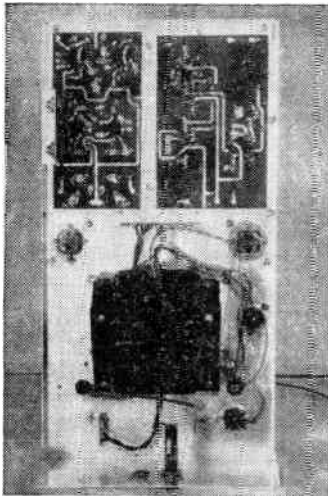

Everything went fine in the wiring of the boards until it became necessary to solder the leads which approached the board from the foil side. Inserting the stripped end of the wire into the hole in the board provides no available point to which the solder can adhere and results only in charred insulation. The builder found it far more convenient to form a slight "L" bend of the stripped end of the wire and to solder onto the area of the punched hole connection, rather than into it. The lack of mechanical stress at these connections makes this procedure feasible.

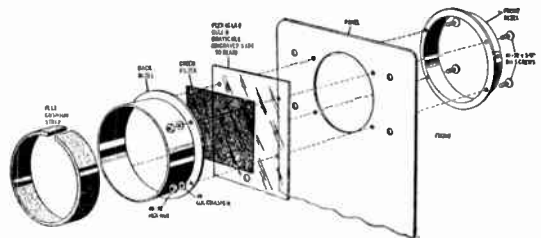
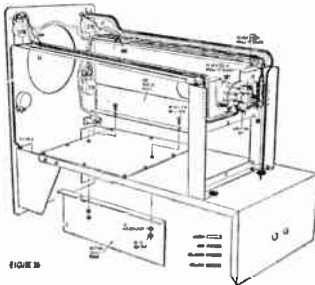

Final mechanical assembly of chassis, sub-chassis, and bracket. Diagram right is illuminated graticule assembly.

# **ELECTRO PRODUCTS KPS-2 Power Supply**

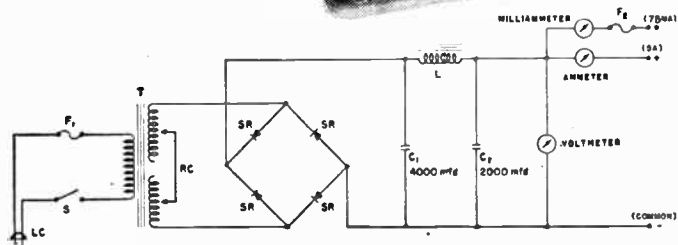
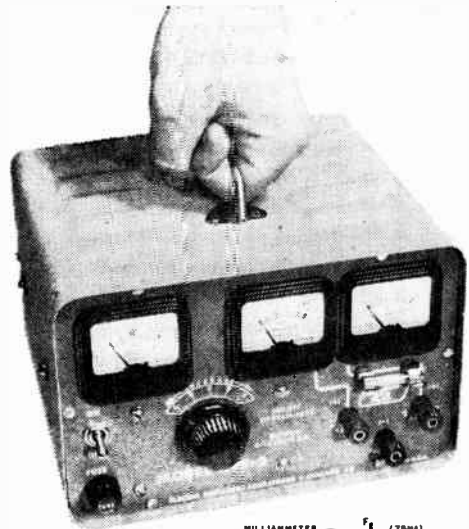

Often the home experimenter finds he can easily fix just about any radio he can get onto his test bench—except the one from his own car. The problem is how to get the 6 or 12 volts needed for operation of the receiver once it is removed from the car. Using the car's battery on the bench is a solution, but a messy one.

The KPS-2 d.c. power supply kit was designed by Electro Products Laboratories (4501 N. Ravenswood Ave., Chicago, Ill.) to solve such problems. Any 6 or 12-volt car radio can be powered by this rugged kit. As an extra bonus, 0-20 volt, 75-ma. metered output is provided for those who need well-filtered low-voltage d.c. for transistor circuit experimentation. Wiring time runs about three hours.

### **features**

The KPS-2's two controls are an on-off switch and a voltage control knob. As the knob is turned clockwise, a d.c. voltmeter indicates the d.c. voltage being supplied to the load.

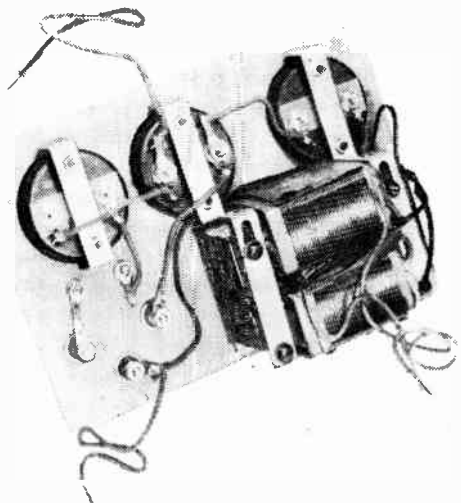

**Meters and transformer are mounted on back of front panel. Simplicity of the circuit makes for fast assembly with little chance for wiring errors.**



Two current meters are included. A 0-10 amp meter reads the up-to-10-amp main output current, and a second meter reads the up-to-75-ma. transistor test current through a separately fused circuit.

It is necessary to rotate the voltage control knob several times throughout its entire range before plugging in the KPS-2 power supply. This will insure good contact between the voltage control wiper and the enameled copper wire on the step-down transformer.

The output of the variable step-down transformer is rectified by a full-wave bridge selenium rectifier and filtered by a pi-filter network comprising a choke and a 4000-2000  $\mu$ fd. dual electrolytic capacitor.

#### operation

The KPS-2 power supply can be operated continuously supplying up to 16 volts with a 5-amp current load. Overload currents up to 10 amperes may be drawn for short periods.

Under actual test conditions the KPS-2 was used to charge a 12-volt battery at 5 amperes for 24 hours. During this time, it supplied a charge of 120 amp-hours to the rundown battery without any sign of strain.

A factory-wired model of this d.c. power supply, having the same features as the kit, is also available.

**Power supply cabinet** mounts four dry rectifiers on its sides. The sides are used as a heat sink to dissipate heat. Mounted on the base of the cabinet are the d.c. choke and the two-section electrolytic capacitor.

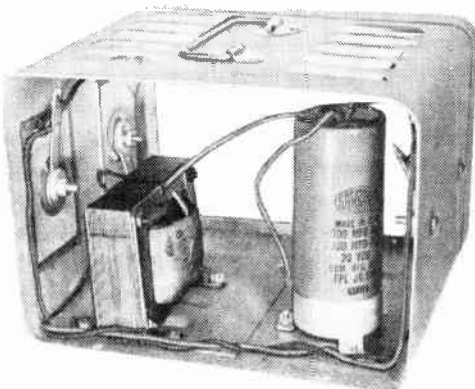

Number 2

## FREE CAREER BOOKLET



To guide you to a successful future in

## ELECTRONICS RADIO-TV COMPUTERS ELECTRICAL ENGINEERING

This interesting pictorial booklet tells you how you can prepare for a dynamic career as an Electrical Engineer or Engineering Technician in many exciting, growing fields:

**MISSILES • AVIONICS • AUTOMATION  
SALES • DEVELOPMENT  
ELECTRICAL POWER • ROCKETRY  
RADAR • RESEARCH**

Get all the facts about job opportunities, length of study, courses offered, degrees you can earn, scholarships, part-time work — as well as pictures of the Milwaukee School of Engineering's educational and recreational facilities. No obligation — it's yours free.

### MILWAUKEE SCHOOL OF ENGINEERING

#### MAIL COUPON TODAY!

**Milwaukee School of Engineering**  
Dept. EK-59, 1025 N. Milwaukee St., Milwaukee, Wis.  
Please send FREE "Your Career" booklet  
I'm interested in

Electronics  Radio-TV  Computers  
 Electrical Engineering  Mechanical Engineering

Name \_\_\_\_\_ Age \_\_\_\_\_

PLEASE PRINT

Address \_\_\_\_\_

City \_\_\_\_\_ Zone \_\_\_\_\_ State \_\_\_\_\_

I'm eligible for veterans education benefits.  
Discharge date \_\_\_\_\_

MS-117

# Here's how you can receive the next 6 months of **POPULAR ELECTRONICS** Free... as part of a special introductory offer

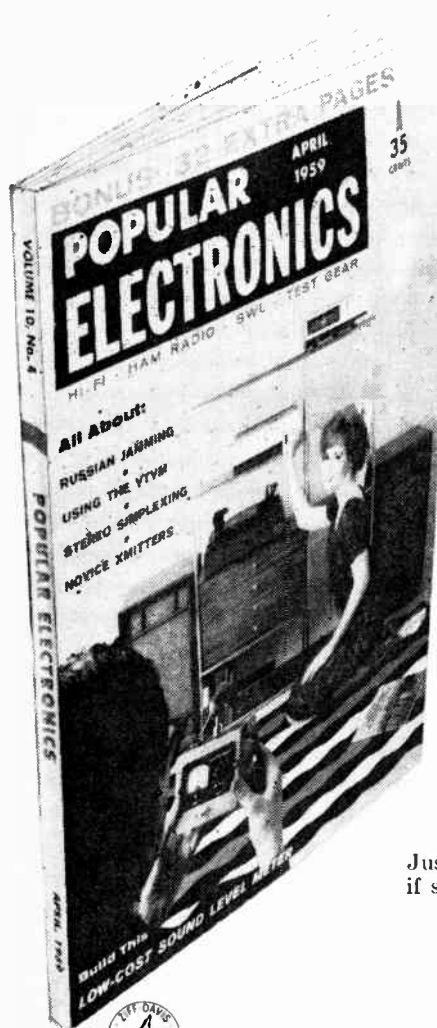

The regular subscription rate for 1 year (12 issues) of *Popular Electronics* costs \$4. However, if you mail the card alongside this page, you'll receive 18 project-packed issues for *less* than the regular price of 12—actually giving you 6 EXTRA ISSUES AT NO EXTRA COST!

If you like to take a set of diagrams and photos, a paragraph or two of clear directions, some simple tools, and build a practical, exciting electronics project—*then this offer is for you.*

During the next year and a half, *Popular Electronics* will bring you more than 270 projects—each one in complete detail, with exclusive “pictorial diagrams” that guide each step, complete parts lists, and clear instructions. Experts who have designed and built these projects will show you how to construct or assemble such valuable devices as hi-fi components and enclosures, money-saving test equipment, tape recorder gear, electronic games and computers, photo aids, radio apparatus, short wave receivers and antenna systems, solar powered and transistorized equipment—and much more.

*Popular Electronics* also reviews every major electronic kit released, gives full specifications, and the experts' opinions.

**SPECIAL NOTE!** *Popular Electronics* is now bigger and better than ever... 32 pages bigger, and printed on high quality glossy paper... easier to read, and packed with more feature articles, and much more valuable information on projects and kits.

Just fill in the card alongside this page and mail it today. Or, if someone has already used the card, write to:

POPULAR ELECTRONICS, Dept. EK2,  
434 S. Wabash Ave., Chicago 5, Ill.



ZIFF-DAVIS PUBLISHING COMPANY • One Park Avenue • New York 16, N. Y.

# Build a RF-AF Signal Generator

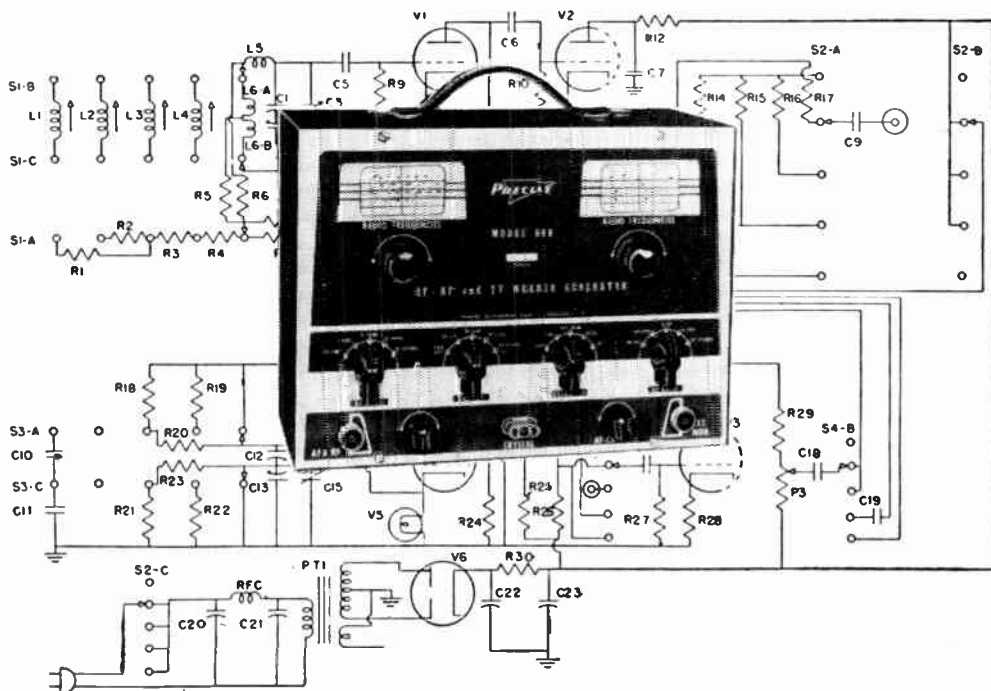

*. . . for two-in-one versatility*

Sometimes one plus one equals more than two. For example, suppose you have a conventional r.f. generator. Then suppose you replace the usual fixed audio oscillator in the r.f. generator with a full-range variable audio generator, usually a separate instrument. You will have a combination whose versatility goes beyond the two separate instruments.

Alert to the potential of such a combination, Precise Development Corp., Oceanside, N. Y., has wedded these two generators in its RF-AF-TV Marker Generator, Model 630.

The 630 kit is available in two forms. You can do all the work yourself or, for a slightly higher price, have the entire r.f. subchassis pre-wired, tested, and calibrated. We strongly recommend the latter choice.

First, individual, small differences in wir-

ing and soldering any wide-range r.f. oscillator can accumulate into problems of accuracy and calibration. Secondly, mechanical assembly of the r.f. and a.f. tuning units is on the tricky side. With the former pre-built, you save time on the assembly of the a.f. section by using the r.f. section as a model.

## construction hints

Construction manuals of most kit manufacturers tend to follow a similar plan. The somewhat different pattern used in the Precise manual, which has merits of its own, may at first puzzle kit builders used to other styles of presentation. Some precautions will guard against pitfalls. As for actual errors, there were none. The unit worked immediately after completion.

## calibration

The alternate calibration procedures for r.f. suggested in the manual, depending on what facilities you may or may not have, are quite satisfactory. However, remember that the purpose of this check is to record frequency variations. Laboratory accuracy is only possible with laboratory generators, the cheapest of which costs far more than many service dealers or hobbyists can spend. Draw up a calibration chart showing actual frequency versus dial indication. This way you can tune the generator with the accuracy your work requires.

As to the audio generator, an inexpensive pitch pipe proved an excellent calibrator. Even one with a single, identified tone, usu-

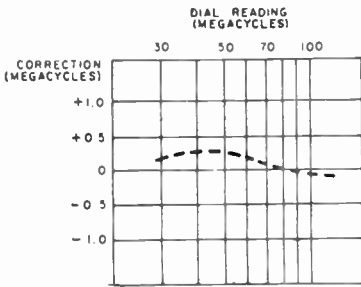

Standard tuning fork can be used for easy calibration. Zero-beat point is established when both tones blend without any low-frequency beat tone.

ally "standard A (440 cycles)," is adequate—and you don't have to be a musician to use it. Feed a.f. signals into an amplifier and speaker. Rock the tuning dial back and forth in the vicinity of 440 cycles while blowing the pipe. The "zero-beat" point is where the two tones blend into one without a low-frequency beat note.

The same check can be made with generator harmonics and subharmonics of 440 cycles. Thus, you can calibrate the generator upward to 880 cycles, 1320, 1760, etc., or downward to such submultiples of 440 as 220 cycles, 146.67, 110, 88, etc. You will probably find the a.f. section quite accurate with out adjustments.

## applications

Coming back to the versatility we mentioned earlier, the 630 can be used—like any

r.f. generator—for aligning the r.f. and i.f. portions of any type of receiver, or for troubleshooting by signal injection.

In addition to such expected functions, it can be used for bandpass checks on AM receivers, e.g., when it may be desired to stagger-tune the i.f. system for improved fidelity. Feeding modulated r.f. into the receiver, you can run the audio generator through its range and note the frequencies at which audio level begins to drop off. You can check again after i.f. readjustment.

When the 630 is used as a bar generator in checking the linearity of a TV picture, a modulated r.f. signal is fed into the antenna input of the TV set, with the r.f. dial adjusted to the same frequency as the video channel to which the set is tuned. The audio generator is then tuned to produce a convenient number of visible horizontal or vertical bars. Adjusting the TV receiver controls for bars of equal thickness and spacing produces good picture linearity.

Through the external-modulation input, you can amplify and modulate voice or other audio signals on the r.f. output. Thus, an inexpensive high-output microphone converts the instrument into a transmitter. Since such transmission on clear frequencies in the AM broadcast band is permissible over short, local distances, you now have a convenient "wireless baby sitter" when you visit nearby neighbors. Just put the 630 with the mike in the nursery, and tune your neighbors radio to the frequency you have chosen.

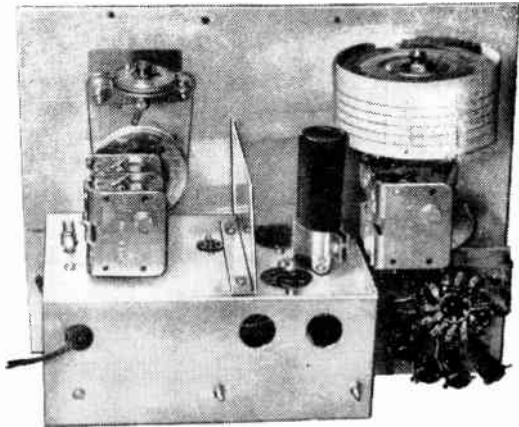

The r. f. sub-chassis can be obtained pre-wired and tested, and then used as a model for the a. f. section, saving the builder time.

# Make A King-SIZE VTVM

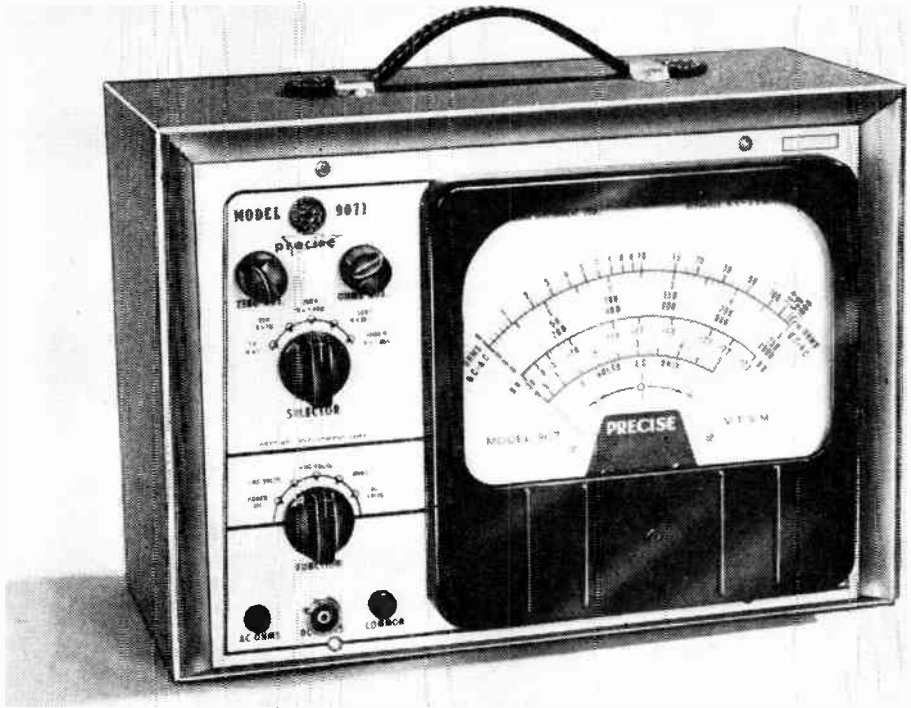

There is possibly no instrument more useful to the ham, experimenter, or service technician than the vacuum tube voltmeter. Commonly known as the VTVM, the tube-driven meter has a number of advantages over the less expensive volt-ohm milliammeters. The most important of these advantages is the high sensitivity which allows the VTVM to produce meaningful readings in circuits which a vom would practically short out.

The VTVM seems to be a natural for the kit manufacturers, as almost every one of them has one or more vtvm's in his line. One of the currently available VTVMs with some interesting features is the Precise Model 9071. This kit features a 7½" meter movement and a voltage-regulated power supply that insures drift-free, stable readings. The Precise presents an attractive external appearance, the large easy-to-read meter move-

ment taking up about three quarters of the front panel. The usual provisions for a.c. and + and - d.c. volts, ohms, are incorporated in the same function switch that turns the instrument on and off. The five position selector switch provides ranges from 5 to 1,000 volts a.c. and d.c. and ohmmeter readings up to R x 1 meg. The R x 1 meg. scale will literally read up a billion ohms with good accuracy.

The Precise construction manual is, unfortunately, not quite up to the standards set by the physical and electronic design of the instrument. There are no errors in the construction manual, but the wiring of the function switch is somewhat difficult to follow because of the small photographs. The builder of the Precise kit would certainly benefit by an enlarged drawing of the switches interconnections.!

Rear of front panel of 7-inch vacuum-tube voltmeter ready for wiring. Selector switches are at lower center with balancing potentiometers above and at right.

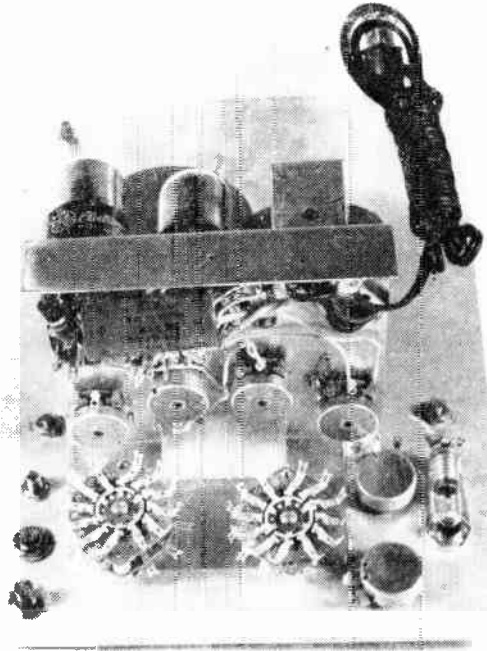

The Precise 9071 VTVM uses what is by now the standard bridge circuit. The meter movement and calibration controls are connected from cathode to cathode of a 6SN7 bridge tube. One triode of the dual-triode 6SN7 operates with a grounded grid and is the "reference" triode of the bridge. The other triode of the 6SN7 has the input voltage fed to its grid after voltage division by the range switch.

On the a.c. function, the input voltage is fed into a 6AL5 tube hooked up as a balanced

rectifier with provision for bucking out contact potential voltage. A. C. input impedance is approximately 3.5 megohms and the D. C. input impedance is a higher-than-normal 25 megohms.

The Precise model 9071 VTVM is a handsome, useful instrument that should maintain its calibration accuracy over long periods. The 7½ inch meter movement is well damped with large, easy-to-read scales and is suitable for a prominent role in anyone's electronic test and service work.

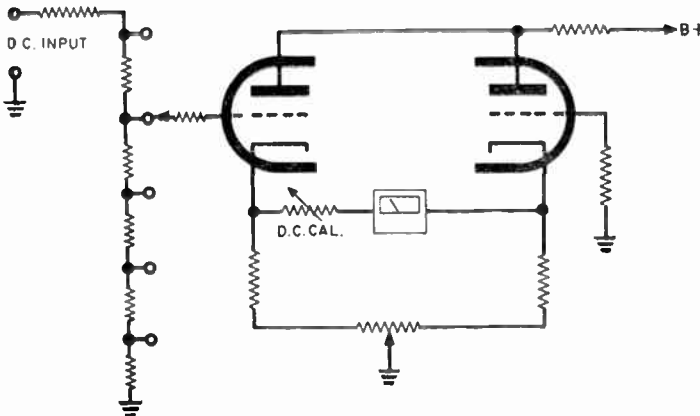

Basic bridge circuit for vacuum-tube voltmeter of the type used in the Precise VTVM.

# Directory of Shop Kits

## ARKAY

### AV-20

**6" Audio VTVM Preamplifier**  
An audio VTVM of high sensitivity for measuring RMS voltages; estimated time of assembly 4-6 hours. . . . . \$29.95

### AW-30 6" Audio Wattmeter

Measures audio power output from 0.500 watts in 6 ranges. For lab and general use; estimated time of assembly 4-6 hours. . . . . \$29.95

### CAP-40 6" Direct Reading Capacity Meter

1% precision calibration capacitors and 6" 200  $\mu$ a meter movement; 0-1 mfd in 6 ranges; estimated time of assembly 4-6 hours. . . . . \$29.95

### MT-50

**6" 20,000 Ohms Per Volt Meter**  
Portable multi-tester of high accuracy; sensitivity 20,000 ohms per volt d.c.; 5,000 ohms per volt a.c.; estimated time of assembly 4-6 hours. . . . . \$29.50

## EICO (ELECTRONIC INSTRUMENT CO., INC.)

### Model 232K Peak-To-Peak VTVM



Peak-to-peak volts 0-4, 14, 42, 140, 420, 1400, 4200; d.c. and rms volts 0-1.5, 5, 15, 50, 150, 500, 1500 (to 30,000 volts with HVP probe and to 250 mc with PRF probe); ohms 0.2 ohms to 1000 megohms;  $4\frac{1}{2}$ " meter; zero center; 1% multipliers; balanced bridge circuit; high im-

Number 2

pedance input; complete with Uni-Probe which selects d.c. or a.c.-ohms;  $8\frac{1}{2}$ "x5"x5" . . . \$29.95

### Model 249K VTVM



Similar to Model 232 but has  $7\frac{1}{2}$ " meter. . . . . \$39.95

### Model 214K VTVM



Similar to Model 221 but has  $7\frac{1}{2}$ " meter. . . . . \$34.95

### Model 536K

1,000 Ohms/Volt Multimeter



Ranges a.c. and d.c. volts: 0-1, 5, 10, 50, 100, 500, 5000; a.c. and d.c. current: 0-1, 10 ma, 0.1, 1 amp; ohms: 0-5000, 100K, 1 megohm; db from -20 to +69 in 6 ranges; 3" 400-

microamp meter;  $6\frac{1}{2}$ " x  $3\frac{3}{4}$ " x  $2\frac{3}{4}$ " . . . . . \$12.90

### Model 526K

1,000 Ohms/Volt Multimeter  
Identical to Model 536 but has 1% precision resistors. . . \$13.90

### Model 540K Redi-Tester

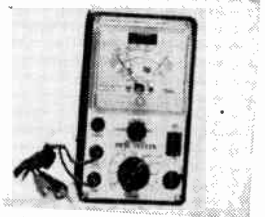

Provides functions of a.c./d.c. voltmeter, ammeter, ohmmeter, wattmeter, and leakage checker; may be used for electrical, electronic, home, and auto repairs;  $3\frac{3}{4}$ "x $6\frac{1}{2}$ "x $3\frac{1}{2}$ " . . . . . \$12.95

### Model 565K

20,000 Ohms/Volt Multimeter



D.c. sensitivity 20,000 ohms/volt; a.c. sensitivity 1000 ohms/volt; ranges a.c. and d.c. volts: 0-2.5, 10, 50, 250, 1000, 5000; d.c. current: 0-100 microamps, 10, 100, 500 ma, 10 amps; ohms: 0-2000, 200K, 20 megohms; db from -12 to 55 in 5 ranges;  $4\frac{1}{2}$ " 50-microamp meter;  $6\frac{3}{4}$ "x $5\frac{1}{4}$ "x3" . . . . . \$24.95

### Model 555K

20,000 Ohms/Volt Multimeter  
Identical to Model 565 but has 1% precision resistors. . . \$29.95

(For additional information use coupon on page 160)

# Directory of Shop Kits

**Model 566K**  
**1,000 Ohms/Volt Multimeter**  
 Voltage ranges on a.c. and d.c.:  
 0-1.5, 10, 50, 100, 500, 5000;  
 current ranges on a.c. and d.c.:  
 0-1, 10 ma, 0.1, 1 amp; ohms



range: 0-5000, 100K, 1 meg;  
 db ranges cover -20 to +69  
 in 6 ranges; 4 1/2" 400-microamp  
 meter; 6 3/4" x 5 1/4" x 3"....\$14.90

**Model 556K**  
**1,000 Ohms/Volt Multimeter**  
 Identical to Model 566, but has  
 1% precision resistors...\$16.90

**Model 425K 5" Oscilloscope**

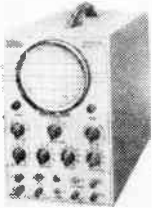

Push-pull vertical and horizontal  
 amplifiers; vertical and horizontal  
 sensitivity 0.05-1 rms volts/  
 inch; vertical and horizontal fre-  
 quency response 5 cps to 500 kc,  
 useful to 2.5 mc; sweep 15 cps  
 to 75 kc; provision for internal  
 or external sync; 15" x 8 7/8" x  
 17 3/4".....\$44.95

**Model 460K**  
**D.C. Wide Band 5" Oscilloscope**



Flat frequency response from  
 d.c. to 4.5 mc, -10 db at 10  
 mc; employs d.c. amplifiers;  
 vertical sensitivity 25 mv/inch;  
 sweep frequencies 10 cps to 100  
 kc; automatic sync limiter and  
 amplifier; front panel controls:  
 internal modulation, saw-tooth  
 output, 60 cps, external sych,  
 external capacitor jacks; 60 cps

variable phase sine sweep; pre-  
 set TV vertical and horizontal  
 sweep positions; edge-lit plexi-  
 glass screen with variable illu-  
 mination; 4 frequency compen-  
 sated attenuator positions up to  
 1000:1 on either direct or capac-  
 itive coupled input; 13" x 8 1/2" x  
 16".....\$79.95

**Model 470K 7" Oscilloscope**



Push-pull circuitry; vertical fre-  
 quency response 10 cps to 1 mc  
 $\pm 2$  db; vertical sensitivity .01  
 rms volts/inch; horizontal fre-  
 quency response 10 cps to 200  
 kc, -4 db at 500 kc; horizontal  
 sensitivity 0.3 rms volts/inch;  
 sweeps from 15 cps to 100 kc;  
 3-step frequency compensated  
 attenuator; cathode follower in-  
 puts and push-pull outputs in  
 both amplifiers; return trace  
 blanking; variable phasing of  
 60 cps sine sweep; internal vol-  
 tage calibrator; direct connection  
 to CRT plates; internal modula-  
 tion input; sawtooth from sweep  
 oscillator and 60 cps outputs;  
 15" x 10" x 15".....\$79.95

**Model 488K Electronic Switch**

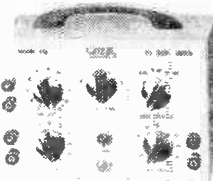

Allows simultaneous observation  
 of two patterns on one scope;  
 continuously variable switching  
 from less than 10 cps to over  
 2000 cps; may be used as square  
 wave generator over same  
 range; frequency response d.c.  
 to 30,000 cps  $-2$  db, useful to  
 300,000 cps; maximum gain:  
 10; input impedance 100,000  
 ohms; output impedance 50,000  
 ohms; 6" x 8" x 6".....\$23.95

**Model 495K**  
**Oscilloscope Voltage Calibrator**  
 Allows peak-to-peak measure-  
 ments of a.c. voltages on an os-



cilloscope; variable output on  
 all ranges with full-scale read-  
 ings of 0.1, 1, 10, and 100 volts  
 peak-to-peak; accuracy  $\pm 5\%$ ;  
 power supply has voltage regu-  
 lator tube; 5" x 7 7/8" x 4".....  
 \$12.95

**Model 377K Sine and  
 Square Wave Generator**



Wien bridge tuning circuit; fre-  
 quency range: sine wave 20 to  
 200,000 cps; square wave 60 to  
 50,000 cps; frequency response  
 60 to 150,000 cps  $\pm 1.5$  db; dis-  
 tortion less than 1%; hum less  
 than 0.4%; accuracy  $\pm 3\%$ ;  
 output 10 volts across 1000  
 ohms rated load (100 milli-  
 watts); 1% resistors; 7 1/8" x  
 11 1/8" x 7 7/8".....\$31.95

**Model 324K**  
**RF Signal Generator**

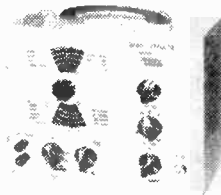

Fundamental frequency bands:  
 150-400 kc, 400-1200 kc, 1.2-  
 3.5 mc, 3.5-11 mc, 11-37 mc,  
 37-145 mc; harmonic band:  
 111-435 mc; frequency accuracy  
 $\pm 1.5\%$ ; Colpitts r.f. oscillator  
 directly modulated by cathode  
 follower; 400 cps sine wave may  
 be modulated 0-50%; variable  
 gain external modulation ampli-  
 fier; turret-mounted, slug-tuned  
 coils; fine and coarse r.f. atten-  
 uators; output impedance 50  
 ohms; r.f. output 100,000 mi-



## Directory of Shop Kits

crovolts, a.f. output to 10 volts; etched tuning dials; plexiglass windows; edgelit hairlines; 8" h x 10" w x 4 3/4" d; 10 lbs... \$26.95

### Model 315K RF Signal Generator

Frequency range: 75 kc-150 mc in 7 ranges; output over 100,000 microvolts; VR tube power supply; 400 cps modulation; provision for external modula-

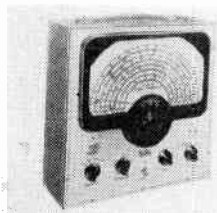

tion; 1% accuracy; 13"x12"x7".  
.....\$39.95

**Model 710K Grid Dip Meter**  
Frequency range 300 kc to 250 mc in 7 ranges; 500-microamp meter; supplied with set of

plug-in coils; transformer-operated power supply; 2 1/4" h x 2 3/8" w x 6 7/8" l. ....\$29.95

### Model 360K TV/FM Sweep Generator

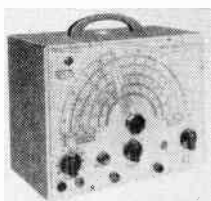

Covers 500 kc-228 mc on fundamentals; continuous sweep width 0-30 mc; crystal marker oscillator; variable phasing of 60 cps

output; provision for injection of external marker; 8"x10"x 6 3/4"; less crystals.....\$34.95  
Crystals (5 mc or 4.5 mc) each  
.....\$3.95

**Model 368K TV-FM  
Sweep Generator and Marker**  
Features electronic sweep circuit; 5 fundamental sweep ranges: 3-216 mc; 3 fundamental plus 1 harmonic marker ranges; 2-225 mc; external marker may be mixed with crystal and variable markers for up to 3 marker pips on 1 trace; continuously variable separate

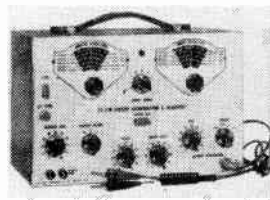

marker size control; 4-step decade coarse and fine attenuators for both sweep and marker out-



**Olson's Old Fashioned Bargain Prices**  
**KITS**

# 8 Wholesale Catalogs

## Save up to... 1/2

# \$1

- HI-FI
- TV
- RADIO
- TOOLS



### • ATTENTION, KIT BUILDERS

Our \$1,000,000.00 inventory includes the finest in kits for the "Do It Yourself" man or the professional - all at Bargain Prices. Save money on Hi-Fi and Electronic Kits as well as on TV Antennas, Test Equipment, Intercoms, Tools, Speakers, Microphones, Wire, Solder, Tubes, PA Systems, Appliances, Turntables, Enclosures, and thousands of other items - made by manufacturers such as GE, RCA, Magnavox, University, Eico, Fanon, Ram, Jensen, Garrard, Collaro and many others. Easy to follow instructions are included with each kit. We also offer a complete line of tools for their easy assembly. Send \$1.00 with coupon at right for your 8 Wholesale Catalogs full of these amazing bargains. Money back if not 100% satisfied.

### MAIL TO — OLSON RADIO WAREHOUSE

L-260 S. FORGE ST. AKRON 8, OHIO

Enclosed find \$1.00 for 8 Olson Wholesale Catalogs - to be sent to me one every 6 weeks. If I buy from any one of the 8 catalogs, my \$1.00 will be deducted from my first order and I will still get the remainder of the catalogs FREE! I must be 100% satisfied or I can return the first catalog and get my \$1.00 back.

NAME \_\_\_\_\_

ADDRESS \_\_\_\_\_

CITY \_\_\_\_\_ ZONE \_\_\_\_\_ STATE \_\_\_\_\_

## OLSON RADIO WAREHOUSE

L-260 S. FORGE ST.  
AKRON 8, OHIO

# Directory of Shop Kits

put together; 2-way blanking; narrow range phasing control; sweep width 0-3 mc lowest maximum deviation to 0-30 mc highest maximum deviation; includes output cable, scope horizontal cable, and compensated scope vertical cable; 8 $\frac{3}{4}$ "x13 $\frac{1}{2}$ "x7 $\frac{1}{4}$ ".....\$69.95

## Model 352K Bar Generator

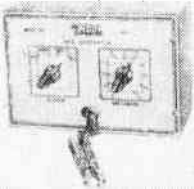

Operates on channels 2-6; 16 vertical bars to check horizontal linearity; 12 horizontal bars to check vertical linearity; shows picture size, linearity, and vertical and horizontal sync circuit stability; output 100,000 microvolts; 7 $\frac{1}{2}$ "x5"x4 $\frac{1}{2}$ "; independent of station signal.....\$14.95

## Model 666K Dynamic Conductance Tube and Transistor Tester

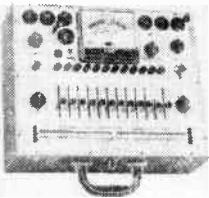

Tests all transistors and tubes including series string tubes; composite indication of mutual conductance, plate conductance, and peak emission; multi-circuit lever switch; variable grid voltage; 200-microamp meter; interelement leakage may be read in ohms; ten 6-position switches; 1% meter shunts; wire-wound vernier potentiometer; meter reading may be translated into plate and screen currents from control settings; gear-driven rollchart; 12"x15"x4 $\frac{1}{2}$ ".....\$69.95

## Model 625K Tube Tester

Emission-type tester tests all conventional tubes and CRT with special adapter; 10 lever-type element switches; 4 $\frac{1}{2}$ " meter; 3-color scale; illuminated "speedroll" roll-chart; overload bulb; line-adjust control; blank

socket for future tube types; pilot light test socket; tests filament series string tubes.

Model 625 (counter model).....\$34.95  
Model 625-CK (case model).....\$44.95  
CRA CRT adapter.....\$4.50  
CRA-110 CRT adapter (for 110° deflection tubes)....\$3.95

## Model 630K CRT Checker

Tests all types and sizes of TV picture tubes or scope CR tubes without removing from set; bridge measurement of peak beam current using neon lamp as balance indicator; balancing control calibrated in terms of tube condition; indicates open and shorted elements; 9 $\frac{1}{2}$ "x6 $\frac{1}{2}$ "x3".....\$13.95

## Model 584K Battery Tester



Provides dynamic test of radio, hearing aid, and electronic equipment batteries; voltage test positions: 1.5, 4.5, 6, 7.5, 9, 22.5, 45, 67.5, 75, 90, and spare position; 6 $\frac{1}{4}$ "x3 $\frac{3}{4}$ "x2".....\$9.95

## Model 944K Flyback Transformer and Yoke Tester



Checks flybacks and yokes for opens and shorted turns; employs grid-dip principle; separate calibration for air and iron core flybacks; may be used for general continuity testing; 4 $\frac{1}{2}$ " 50-microamp meter; 7"x5"x4".....\$23.95

## Model 147 Multi-Signal Tracer

Separate high gain r.f. and low gain a.f. inputs; speaker and magic eye monitor both channels for estimation of signal strength and gain-per-stage; noise locator

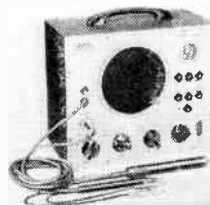

circuit; calibrated wattmeter; includes r.f. demodulator and audio probes; 8"x10"x4 $\frac{3}{4}$ ".....\$24.95

## Model 145 Multi-Signal Tracer

Audibly traces all i.f., r.f., video, and audio from antenna to speaker or CRT without switching; germanium crystal diode probe has response to over 200 mc; 8"x10"x4 $\frac{3}{4}$ ".....\$19.95

## Model 320 RF Signal Generator

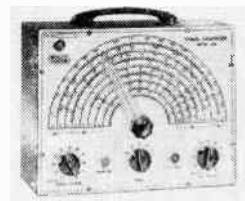

Hartley r.f. oscillator; 150 kc to 34 mc, with calibrated harmonics to 102 mc; Colpitts 400-cps oscillator may be used as audio output or to modulate r.f.; 8"x10"x4 $\frac{3}{4}$ ".....\$19.95

## Model 322 RF Signal Generator

Similar to Model 320 with individual calibration of each of its 5 bands.....\$23.95

## Model 221 VTVM

Range a.c./d.c. volts: 0-5, 10, 100, 500, 1000 (to 30,000 volts with HVP probe, to 250 mc with PRF probe, and peak-to-peak with PTP probe); ohms to 1000 megohms; db -20 to +55; input resistance 25 megohms; 1% precision resistors;



4 $\frac{1}{2}$ " meter; zero center; 9 $\frac{7}{16}$ "x6"x5".....\$25.95

**Model 1140K RC Network Box**  
Provides functions of Models 1100 and 1120 in one instrument; switching permits selection of any resistance or capacitance alone or in any combination in series or parallel; open circuit and short circuit positions; top-jack binding posts. . . . . \$13.95

**Model 1120K RETMA Capacitance Substitution Box**  
Allows substitution of capacitance values from 0.0001 to 0.22 mfd in operating circuit; minimum accuracy  $\pm 10\%$ ; silver mica and molded plastic capacitors rated at 600 volts; 5-way jack-type binding posts;  $3\frac{3}{4}'' \times 6\frac{1}{2}'' \times 3\frac{1}{2}''$  . . . . . \$5.95

**Model 1180K Decade Condenser Box**  
Provides 100 mmfd to 0.111 mfd in steps of 100 mmfd; voltage rating 350 volts d.c. continuous, 500 volts d.c. intermittent; positive detent ceramic wafer switches with silver-plated contacts; accuracy  $\pm 1\%$ ;  $9'' \times 3\frac{1}{2}'' \times 3\frac{1}{2}''$  . . . . . \$14.95

**Model 1100K RETMA Resistance Substitution Box**  
Allows substitution of resistance values from 15 ohms to 10 megohms in decade multiples of 15, 22, 33, 47, 68, 100 ohms; 1-watt  $\pm 10\%$  resistors;  $3\frac{3}{4}'' \times 6\frac{1}{2}'' \times 3\frac{1}{2}''$  . . . . . \$5.95

**Model 1171K Decade Resistance Box**  
Provides 0-99,999 ohms in 1-ohm steps with 5 decades and  $\frac{1}{2}\%$  precision; 1-watt resistors;  $12'' \times 3\frac{1}{2}'' \times 3''$  . . . . . \$19.95

**Model 950BK R.C. Bridge and R.C.-L Comparator**  
Bridge-type circuit; reads 0.5 ohms-500 megohms resistance (4 ranges); 10mmfd-5000mfd capacitance (4 ranges), and

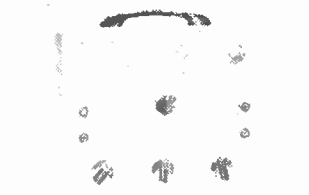

power factor; comparator range for R, C, and L comparison measurement against external standard; capacitors tested at rated working voltage with internal

# ADSON PRESENTS

## AWARD WINNING arkay STEREO KITS or PRE-WIRED



Why wait? You can afford the finest in hi-fi STEREO with ARKAY quality equipment—now! Get advanced engineering, outstanding performance, styling and value, plus extra pride and savings when you build-it-yourself.

**Arkay CS-12 12 Watt Stereo Pre-Amp and Amp**  
Easy-to-build Kit **\$36.95**

Enjoy the latest in High Fidelity listening—Stereophonic reproduction through the new ARKAY low-cost Stereo Pre-amp and amp, Model CS-12. 12 watt Stereophonic and Monaural integrated power amplifier and pre-amp of advanced design. Selects and controls all Stereo or Monaural program material. Operates from any ceramic or crystal cartridge, high output tape decks, tuners and other auxiliary equipment. All inputs are of the dual variety for the rendering of full Stereo reproduction.

**ARKAY SPA-55 STEREO AMP**  
Two 27½ watt distortion-free hi-fi amplifiers for stereo. Or use as 55 watt monaural amplifier.  
Easy-to-build Kit **\$64.95**  
Wired and tested **\$79.95**

**ARKAY SP-6 STEREO CONTROL CENTER**  
Versatile stereo pre-amp with dual inputs and outputs. Hi-lo filters, reverse position, balance control. Less cover.  
Easy-to-build Kit **\$39.95**  
Wired and tested **\$62.95**

**ARKAY ST-11 AM-FM STEREO TUNER**  
Here, for the first time, is an AM-FM STEREO Tuner within the reach of every audiophile. Unmatched by units costing twice the price, the ST-11 is two distinct receivers in one featuring 4  $\mu$ V. for 20 db quieting. Variable AFC. Single front panel switch controls AM, FM or STEREO selection.  
Wired and tested **\$74.50** Easy-to-build Kit **\$49.95**

**NEW! ARKAY VT-10 6-INCH MULTI-PURPOSE VACUUM TUBE VOLTMETER**  
Advanced design and precision features make the Arkay VT-10 a truly sensational buy, unmatched at this price. You get exclusive larger 6-INCH 400 ua meter movement, within 2% accuracy, and edge-lighted for easier reading. 1% precision multiplier resistors are used throughout the range switch. There are 7 AC (RMS) and DC ranges. 7 AC (peak-to-peak) ranges. Resistance, db and other essential ranges. Durable plastic case.  
Wired and tested **\$47.95** Easy-to-build Kit **\$25.95**

**FREE ... FEDTRO SOLDERETTE** (Reg. \$3.50 value - Free with any above kit... the all purpose soldering iron. The handiest soldering iron on the market! Idea for kit builders, close soldering designed for dependable, long life. Replaceable tips. Tested & guaranteed)

**ADSON Radio & TV Corp.**  
189 Greenwich St. New York City  
SEND 25¢. DEPOSIT with Order Balance C.O.O.

# Directory of Shop Kits

0-500 d.c. source; "magic eye" capacitor leakage indicator; 8" x 10" x 4 3/4" ..... \$19.95

**Model 1050K Battery Eliminator**  
Provides power for charging 6-volt and 12-volt batteries and

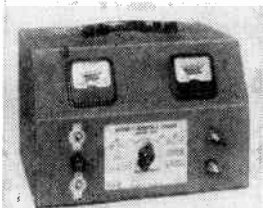

servicing battery-operated equipment; d.c. ranges: 0-8 volts (10 amps continuous, 20 amps intermittent), 0-16 volts (6 amps continuous, 12 amps intermittent); continuous voltage variation with variac-type transformer; separate voltmeter and ammeter; heavy duty selenium rectifiers; fused primary, automatic reset circuit-breaker opens secondary circuit on overload; 8 3/4" x 10 1/2" x 7 3/4"; 15 lbs. ... \$29.95

**Model 1055K Accessory Filter**  
L-C filter provides additional filtering of output of Model 1050 when being used for powering transistor or "hybrid" equipment; maximum current rating 10 amps ..... \$11.95

**Model 1060K Battery Eliminator**  
Combines functions of Model 1050 and Model 1055 in single unit; 8 3/4" x 10 1/2" x 7 3/4" ..... \$38.95

**Model 803 Geiger Counter**  
All-electronic geiger counter indicates by neon flashing and headphone clicks; less 2-67 1/2-volt batteries and 2-1 1/2-volt batteries; 7" x 4 1/2" x 2 1/4" ..... \$19.95

**1020 Transistorized Power and Bias Supply**



Low ripple d.c. power and bias supply provides variable output voltage monitored by dual range voltmeter (0-6, 0.30 volts d.c.); two 2N256 transistors in the transformer operated circuit; max. load current from 150 ma. at 0-12 volts, and 300 ma. at 24-30 volts; useful in servicing, development, aligning, filament supply, or bias supply; ripple (120 cps.) 1/200% at full load ..... \$19.95

**612 Battery Powered Filament Continuity Tester**

Enables fast checking of filaments; sockets for 9-pin, octal, loctal, and 7-pin; 7-pin and 9-pin straighteners provided; picture tube adapter for 14-pin, 12-pin, 8-pin (110°); cartridge fuse checking; 6 1/2" x 3 1/4" x 2" ..... \$3.95

## ELECTRONICS MEASUREMENTS CORP.

**Model 102**  
Volt-Ohm-Milliammeter



Ranges: a.c. volts, 0-12-120-600-1200-3000; d.c. volts, 0-6-60-300-600-3000; a.c. current, 0-30-150-600 ma; d.c. current, 0-6-30-120 ma-1.2 amps; ohms, 0-1000 ohms, 0-1 megohm; 3 1/2" 2% accurate meter; estimated assembly time 1-2 hours ..... \$12.50

**Model 103**  
Volt-Ohm-Milliammeter

Similar to Model 102 with addition of db range from -4 to +64; 4 1/2" meter; estimated assembly time 1-2 hours .. \$14.90

**Model 104**  
Volt-Ohm-Milliammeter

Ranges: a.c. and d.c. volts, 0-60-300-600-3000; d.c. sensitivity, 20,000 ohms/volt; d.c. current, 0-6-60-600 ma; a.c. current 0-30-300 ma-3 amps; ohms, 0-20K-200K-20 megohms; db, -4 to +67; 4 1/2" 50-microamp meter, estimated assembly time 1 1/2-2 1/2 hours ..... \$19.25

**Model 106 VTVM**

Ranges: a.c. and d.c. volts, 0-

1.5-10-100-300-1000 volts; a.c. frequency response flat from 25 to 100,000 cps; d.c. voltage range may be extended to 30,000 volts with accessory probe; d.c. input resistance 16.5 megohms; ohms, 0-1000-10K-100K-10 Meg-1000 Meg; db -24 to +55 in 5 ranges; estimated assembly time 3-4 hours .. \$23.90

**Model 108 Handi-Tester**

Ranges: d.c. and a.c. volts, 0-15, 0-150, 0-300; a.c. and d.c. amps, 0-15; a.c. and d.c. watts, 0-1500; ohms, 0-2000; neon leakage test, 0-5 megohms; 3 1/2" 800-microamp meter; 6 1/4" x 3 3/4" x 2 1/2"; 1 1/4 lbs.; estimated assembly time 1 1/2-2 hours ..... \$12.95

**Model 205P Tube Checker**

Provides emission check on all standard tubes; tests all cold cathode, magic eye, voltage regulator, and ballast tubes; checks for shorts and leakage;



4-position lever-type switches; line voltage control; 4 1/2" meter; estimated assembly time 3 1/2-5 hours ..... \$34.50

**Model 209**

**Tube Tester and Rejuvenator**

Miniaturized emission-type tube tester; tests all standard tubes; complete switching flexibility; line voltage control; 3 1/2" meter; estimated assembly time 3-4 hours ..... \$25.90

**Model 210 Transistor Checker**

Checks all types of transistors and diodes; checks gain in 3 stages; measures leakage on "poor-good" scale; estimated assembly time 3/4-1 hour .. \$7.95

**Model 301P Speedi Tube Tester**

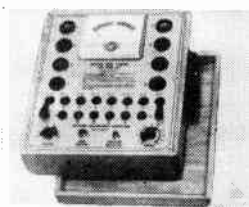

Checks all standard tubes for quality, shorts, and leakage; only two necessary adjustments;

# Directory of Shop Kits

4 1/2" meter; estimated assembly time 3 1/2-5 hours ..\$33.20

**Model 302 Speedi Tube Checker**  
Similar to Model 301P, but with 7 1/2" meter; estimated assembly time 3 1/2-5 hours \$49.90  
**Model 800 White Dot-Cross Hatch Bar Generator**

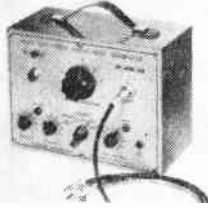

Produces variable number of vertical or horizontal bars, variable cross hatch pattern, variable number of dots; connects directly to antenna terminals of TV receiver; estimated assembly time 3 1/2-5 hours ..\$22.50

**Model 900 Resistance-Capacity Substitution Box**

Allows the substitution of 36 values of resistance from 150 ohms to 10 megohms (one-watt resistors, ±10% accuracy); 18 values of capacitance from .0001 to .22 mfd; estimated assembly time 1 1/2-2 hours \$10.25

**Model 905 Battery Eliminator**

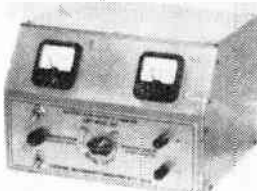

Continuously variable voltage output from 6 to 12 volts; provides 6 volts at up to 10 amps or 12 volts at up to 6 amps in continuous operation; provides 6 volts at up to 20 amps or 12 volts at up to 12 amps; separate voltmeter and ammeter; automatic overload relay resetting; heavy duty rectifier; may be used as battery charger; estimated assembly time 2-3 hours ..\$28.90

**Model 906 Vibrator Checker**

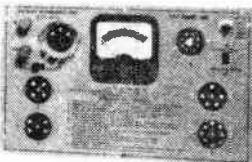

Checks all 6 and 12-volt inter-rupter and self-rectifier vibrators for proper starting point and quality on "good-bad" scale; may be used with any battery eliminator; estimated assembly time 3-5 hours. \$17.05

## HEATH CO.

**Model M-1 Handitester**



Measures a.c. or d.c. voltage at 0-10, 30, 300, 1000 and 5000 volts; direct current ranges are 0-10 ma and 0-100 ma; ohm-meter ranges are 0-3000 and 0-300,000; estimated assembly time 6-10 hours ..\$17.95

**Model MM-1**

20,000 Ohms/Volt VOM



Employs 4 1/2" meter; features 1% precision multiplier resistors; requires no external power; sensitivity 20,000 ohms-per-volt d.c. and 5000 ohms-per-volt a.c.; ranges are 0-1.5, 5, 50, 150, 500, 1500 and 5000 volts a.c. and d.c.; direct current in ranges of 0-150 u.a., 15 ma, 150 ma, 500 ma and 15 a; resistance multipliers are X1, X100 and X10,000; -10 db to +65 db; estimated assembly time 10-15 hours. ..\$29.95

**Model V7-A**

Etched-Circuit VTVM



Employs 4 1/2" panel meter, precision 1% resistors, etched metal circuit board; a.c. (rms) and d.c. voltages in ranges of 0-1.5,

5, 15, 50, 150, 500 and 1500; peak-to-peak a.c. voltage in ranges of 0-4, 1-1, 40, 1-40, 400, 1-400 and 1000; resistance measured from 0.1 ohm to 1000 megohms; estimated assembly time 5-9 hours. ....\$25.95

**Model AO-1 Audio Oscillator**

Provides sine or square wave output from 20 to 20,000 cps; distortion less than 0.6% from 100 cps through audible range; low impedance output provides up to 10 volts no-load; thermistor regulation. ....\$24.50

**Model AG-8 Audio Generator**

Provides sine wave output from 20 cps to 1 mc; distortion less than 0.4% from 100 cps through audible range; provides up to 10 volts output under no-load conditions; transformer-operated power supply. ....\$29.50

**Model AG-9A**

Audio Signal Generator

Incorporates step-type and continuously variable output

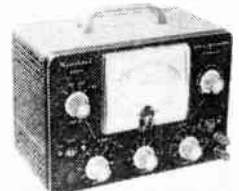

attenuator; 4 1/2" panel meter calibrated in volts and db; attenuator system operates in 10 db steps, in ranges of 0-.003, .01, .03, .1, .3, 1, 3 and 10 volts rms; "load" switch permits use of built-in 600-ohm load, or external load of different impedance; output and frequency indicators accurate to within ±5%; distortion less than .1 of 1% between 20 and 20,000 cps; total range 10 cps to 100 kc; estimated assembly time 8-15 hours ..\$34.50

**Model SQ-1 Square Wave Generator**

Provides square wave output from 10 cps to 100 kc; low impedance cathode follower output variable from 0 to 20 volts; provision for injecting sync signal. ....\$29.50

**Model AG-10**

Sine-Square Generator

Frequency response 20 cps to 1 mc on sine and square waves ±1.5 db with less than 0.25% sine wave distortion 20 to 20-

# Directory of Shop Kits

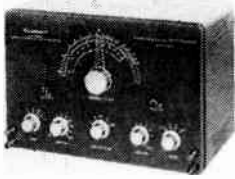

000 cps; sine wave output impedance 600 ohms, square wave output impedance 50 ohms (except on 10-volt ranges); square wave rise time less than 0.15 microseconds; 5-position band-switch; continuously variable tuning; shielded oscillator circuit; separate step and variable output attenuators in ranges of 10, 1, and .1 volts for both sine and square wave, with extra range of .01 volt on sine wave; silicon diodes in power supply; estimated assembly time 15-20 hours. ....\$49.95

## Model AV-3 Audio VTVM

Employs cascade amplifier with cathode-follower isolation between input and amplifier and between output stage and preceding stages; frequency response essentially flat from 10 cps to 200 kc; input impedance 1 megohm at 1000 cps; a.c.



(rms) voltage ranges are 0-.01, .03, .1, .3, 1, 3, 10, 30, 100 and 300 volts; db ranges cover -52 db to +52 db; 4½" 200-microampere meter; 1% precision resistors; estimated assembly time 5-9 hours. ....\$29.95

## Model AW-1 Audio Wattmeter

Load resistors are built in for 4, 8, 16 or 600 ohms impedance; five power ranges cover 0-5 mw, 50 mw, 500 mw, 5 w, and 50 w full scale; five switch-selected db ranges cover -10db to +30 db; all indications read directly on 4½" 200-microampere meter; frequency response ±1 db from 10 cps to 250 kc; precision type multiplier resistors; crystal diode bridge; estimated assembly time 4-8 hours. ....\$29.50

## Model HD-1 Harmonic Distortion Meter



Used with audio signal generator; measures harmonic distortion at all frequencies between 20 and 20,000 cps; distortion read on panel meter in ranges of 0-1, 3, 10, 30 and 100% full scale; voltage ranges of 0-1, 3, 10 and 30 volts are provided for initial reference settings; signal-to-noise ratio measurements are permitted through use of separate meter scale calibrated in db; estimated assembly time 8-12 hours. ....\$49.50

## Model AA-1 Audio Analyzer

Combines the functions of an AC VTVM, audio wattmeter, and intermodulation analyzer; input and output terminals are combined; high and low frequency oscillators are built in; VTVM ranges are 0-.01, .03, .1, .3, 1, 3, 10, 30, 100 and 300 volts (rms); wattmeter ranges are .15 mw, 1.5 mw, 15 mw, 150 mw, 1.5 w, 15 w and 150 w; IM scales are 1%, 3%, 10%, 30% and 100%; provides internal load resistors of 4, 8, 16 or 600 ohms; estimated assembly time 8-15 hours. ....\$49.95

## Model SG-8 RF Signal Generator

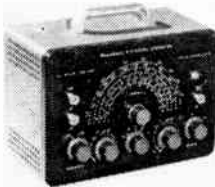

Produces r.f. signals from 160 kc to 110 mc on fundamentals in five bands; covers 110 mc to 220 mc on calibrated harmonics; low impedance r.f. output in excess of 100,000 microvolts, is controllable with a step-type and continuously variable attenuator; selection of unmodulated RF, modulated RF, or audio at 400 cps; estimated assembly time 6-8 hours. ....\$19.50

## Model LG-1 RF Generator

Features voltage-regulated B+, double shielding of oscillator circuits, copper-plated chassis, variable modulation level, metered output; generates r.f. signals from 100 kc to 30 mc on fundamentals in five bands; meter reads r.f. output in microvolts or modulation level in percentage; r.f. output available up to 100,000 microvolts, controlled by a fixed-step and variable attenuator; provision for external modulation; estimated assembly time 10-20 hours. ....\$48.95

## Model TS-4A TV Alignment Generator



Covers 3.6 mc to 220 mc in four bands; sweep deviation controllable from 0 to 42 mc; all-electronic sweep circuit; crystal marker and variable marker oscillators built in; crystal (included with kit) provides output at 4.5 mc and multiples thereof; variable marker provides output from 19 to 60 mc on fundamentals and from 57 to 180 mc on harmonics; two-way blanking; phasing control; three output cables; estimated assembly time 15-20 hours. ....\$49.50

## Model CD-1 Color Bar and Dot Generator

Combines color bar generator and white dot generator in one portable unit; crystal-controlled accuracy and stability (no external sync lead required); produces white-dots, cross hatch, horizontal and vertical bars, 10 vertical color bars, and a new shading bar pattern for screen and background adjustments; variable r.f. output on any channel from 2 to 6; positive or negative video output, variable from 0 to 10 volts peak-to-peak; crystal controlled sound carrier with off-on switch; voltage regulated power supply using silicon rectifiers; estimated assembly time 20-25 hours. ....\$59.95

**Model OM-3 "General Purpose"  
5" Oscilloscope**

Vertical frequency response  $\pm 3$  db from 4 cps to over 1.2 mc; five-inch crt, and sweep generator operation from 20 cps to over 150 kc; calibrated grid screen allows precise signal observation; external or internal sweep and sync; 1-volt peak-to-peak calibrating reference; 3-position step-attenuated input; adjustable spot shape control; push-pull horizontal and vertical amplifiers; etched-metal circuits. . . . . \$39.95

**Model O-12  
"Extra Duty" 5" Oscilloscope**



Features push-pull horizontal and vertical output amplifiers, a 5UP1CRT, built-in peak-to-peak calibration source, compensated 3-position step-type input attenuator, retrace blanking, phasing control, and provision for Z-axis modulation; vertical amplifier frequency response within  $+1.5$  and  $-5$  db from 3 cps to 5 mc; response at 3.58 mc down 2.2 db; sensitivity 0.025 volts rms/inch at 1 kc; sweep generator covers 10 cps to 500 kc in five steps; etched-metal circuit boards; estimated assembly time 8-15 hours. . . . . \$65.95

**Model OP-1 Oscilloscope**

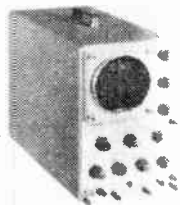

Features d.c. coupled amplifiers and CR tube unblanking; triggered sweep operates on either internal or external signals and may be a.c. or d.c. coupled; vertical frequency response  $\pm 3$  db from d.c. to 4.5 mc; rise time less than .1 microsecond; input impedance 3.6 megohm shunted by 28 mmf; sensitivity: d.c. coupled, .1 volt peak-to-peak for 1 cm deflection. a.c. coupled, .01 volt peak-to-peak

**MORE THAN 600,000 ELECTRONIC HOBBYISTS,**

**EXPERIMENTERS, STUDENTS AND HI-FI FANS**

**WATCH FOR ADS LIKE THESE EACH MONTH!**

BEST offer ever \$125 buys my 8250 Zenith All-Transistor Time-Recorder Portable. Never used. Nathan, Suite 2018, 97 Wall Street, New York 5.

"TRANSISTORS For Beginners." At last a treatment of transistors you can easily understand. Clearly describes in simple language transistor action, amplification, biasing NPN and PNP transistors, etc. Completely diagrammed. A must for beginners. \$1.00. P. Polton, 3702 E. Oakwood, South Milwaukee, Wisconsin.

FOR Sale Custom-built 70 watt Heathkit amplifier. (W. Me.) guaranteed to exceed published specifications. \$175. Heathkit preamp (WA-72) Custom kit. \$25. Parcel Post, Box 383, Michigan City, Indiana.

These classified ads are typical of the hundreds that appear each month in the pages of POPULAR ELECTRONICS, HI FI REVIEW, and ELECTRONICS WORLD (formerly RADIO & TV NEWS). They bring top-notch results! As the above advertisers can attest, there's no better spot for a classified ad in the field of electronics!

If you have used equipment or information or services to sell, you too will find the classified columns of Ziff-Davis electronics magazines to be perfect market places. Your ad will get results quickly and profitably.

*for complete details, drop a postcard to:*

**MARTIN LINCOLN  
BOX EK-2  
Ziff-Davis Publishing Company  
One Park Avenue  
New York 16, New York**

# Directory of Shop Kits

for 1 cm deflection (using built-in preamp); horizontal frequency response  $\pm 3$  db from d.c. to 900 kc; sensitivity 0.2 volts peak-to-peak for 1 cm deflection; CR tube is flat face 5ADP2; edge-lighted grid screen; voltage regulated power supply; prewired terminal board construction; estimated assembly time 40-60 hours.

..... \$179.95

## Model S-3 Electronic Switch

Allows simultaneous oscilloscope observation of two signals by producing both signals, alternately, at its output; four switching rates; provides gain for input signals; frequency response  $\pm 1$  db, 0 to 100 kc; sync output provided to control and stabilize scope sweep.

..... \$21.95

## Model VC-3 Voltage Calibrator

Produces square wave signals of known amplitude; precision 1% attenuator resistors; multivibrator circuit; output frequency approximately 1000 cps; fixed outputs selected by panel switches are; .03, 0.1, 0.3, 1.0, 3.0, 10, 30 and 100 volts peak-to-peak; allows measurement of unknown signal amplitude by comparing it to the known output of the VC-3 on oscilloscope; estimated assembly time 4-6 hours. .... \$12.50

## TC-3 Tube Checker Kit

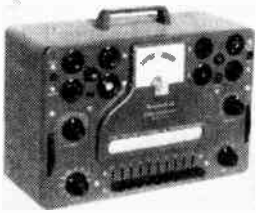

Specially designed roll chart assembly; blank socket for future tube types; will check all tubes encountered in everyday TV and radio service; sockets provided are: 4-pin, 5-pin, 6-pin, 7-pin large or miniature, 7-pin sub-miniature, octal, loctal, and 9-pin miniature; multiple filament voltages, adjustable cathode current, variable meter sensitivity; individual element switching; estimated time of assembly 10-15 hours ..... \$39.95

## Model CC-1

### Picture Tube Checker

Checks cathode emission, beam current, shorted elements, and

leakage between elements in electromagnetic picture tube types; self-contained power supply;  $4\frac{1}{2}$ " meter; CRT condition indicated on "good-bad" scale; relative condition of tubes fluorescent coating is shown in "shadowgraph" test; permanent test cable with CRT socket and anode connector; estimated assembly time 6-10 hours.

..... \$24.95

## Model IB-2A Impedance Bridge

Employs Wheatstone bridge, capacity comparison bridge, Maxwell bridge, and Hay bridge; measures resistance from 0.1 ohm to 10 megohms, capacitance from 100 mmf to 100 mfd, inductance from 0.1 mh to 100 h, dissipation factor (D) from 0.002 to 1, and storage factor (Q) from 0.1 to 1000; 100-0-100 microamp meter; decade resistors are 1% tolerance; built-in power supply, 1000-cycle generator, and vacuum-tube detector; two-section CRL dial; estimated assembly time 10-20 hours. .... \$59.50

## Model QM-1 "Q" Meter

Permits measurement of inductance from 1 microhenry to 10 millihenry, "Q" on a scale calibrated up to 250 full scale, with



multipliers of 1 or 2, and capacitance from 40 mmf to 450 mmf  $\pm 3$  mmf; built-in oscillator permits testing components from 150 kc to 18 mc;  $4\frac{1}{2}$ " panel meter; checks peaking coils, chokes, etc.; may be used to determine values of unknown condensers, compile data for coil winding purposes, or measure r.f. resistance; checks distributed capacity and Q of coils; test coil furnished; estimated assembly time 6-10 hours.

..... \$44.50

## Model CM-1 Direct-Reading

### Capacity Meter

Capacitor value read directly on  $4\frac{1}{2}$ " panel meter calibrated in mmf and mfd; ranges are 0 to 100 mmf, 1,000 mmf, .01 mfd, .1 mfd full scale. .... \$29.50

## Model CT-1

### "In-Circuit" Capaci-Tester

Allows checking most capacitors for "open" or "short" in the circuit; detects open capacitors from about 50 mmf up, if capacitor is not shunted by excessively low resistance value; will detect shorted capacitors up to 20 mfd (not shunted by less than 10 ohms); (does not detect leakage); employs 60 cycles and 19 megacycle test frequencies; electron beam "eye" tube used as indicator; test leads included. .... \$7.95

## Model C-3 Condenser Checker

Uses electron beam "eye" tube as an indicator to measure capacity in ranges of .00001 to .005 mfd, .5 mfd, 50 mfd and 1000 mfd; measures resistance from 100 ohms to 5 megohms in two ranges; selection of five polarizing voltages; estimated assembly time 6-10 hours. .. \$19.50

## Model CS-1

### Condenser Substitution Box

Contains 18 capacitors in RET-MA standard values from 0.0001 mfd to 0.22 mfd. \$5.50

## Model RS-1

### Resistance Substitution Box

Contains 36 10% 1-watt resistors from 15 ohms to 10 megohms. .... \$5.50

## Model DC-1

### Capacitance Decade Box

Employs 1% silvered mica capacitors. .... \$16.50

## Model DR-1

### Resistance Decade Box

Employs 20 1% resistors. \$19.50

## Model IT-1

### Isolation Transformer

Provides complete isolation from power line; output voltage variable from 90 volts to 130 volts; rated for 100 volt-amperes continuously or 200 volt-amperes intermittently; panel meter monitors output voltage; estimated assembly time 4-6 hours. .... \$16.50

## Model T-4

### Visual-Aural Signal Tracer

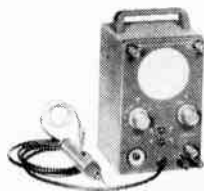

Features high-gain channel with demodulator probe, and low-

(For additional information use coupon on page 160)

Electronic Kits



# Directory of Shop Kits

gain channel with audio probe; traces signals in all sections of radio receivers and in many sections of FM and TV receivers; built-in speaker and electron beam eye tube indicate relative gain, etc.; built-in noise locator circuit; provision for patching speaker and/or output transformer to external set; estimated assembly time 10-15 hours. ....\$19.95

### Vibrator Power Supply

Two models: Model VP-1-6 is for 6-volt batteries. Model VP-1-12 is for 12-volt batteries; each unit provides 260 volts d.c. at up to 60 milliamps; multiple units may be connected in parallel for increased current capacity; estimated assembly time 2-3 hours. ....\$7.95

### Model BE-5 Battery Eliminator

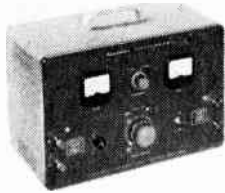

Can be used to power all transistor-type circuits requiring 0 to 12 volts d.c. and "hybrid" automobile radios using transistors and vacuum tubes; d.c. output contains less than .3% a.c. ripple; separate output terminals for low-ripple or normal filtering; supplies up to 15 amps on 6-volt range or up to 7 amps on 12-volt range; output variable from 0 to 8 or 0 to 16 volts; two meters monitor output voltage and current; may be used as battery charger; estimated assembly time 6-8 hours. ....\$59.95

### Model BT-1 Battery Tester

Tests all kinds of dry cell batteries within range of 0-15 volts and 0-180 volts; slide switch provides for either 10 ma or 100 ma load; "loads" battery under test. ....\$8.50

### Model CI-1

#### Battery Charge Indicator

Checks as few as one, or as many as eight storage batteries, by turning switch and watching meter; 2 7/8" w x 5 11/16" h x 2" d; operates on either 6 or 12 volt systems using lead-acid batteries, regardless of size; estimated assembly time 1/2-1 hour. ...\$16.95

### PS-4 Variable Voltage Regulated Power Supply

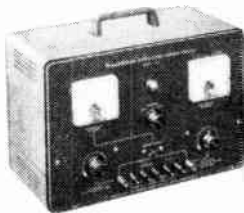

B+ voltage from 0-400 volts dc, up to 100 ma. (125 ma. max.); bias voltage from 0-100 volts dc. at 1 ma; filament 6.3 volts at 4 amps available; voltage and current output monitored by separate meters; separate switched filament and high-voltage transformers; silicon diode power supply; parallel 6L6 series regulators; estimated time of assembly 8-12 hours; 16 lbs. ..\$54.95

## HICKOCK ELECTRICAL INSTRUMENT COMPANY

### 225-K Volt-Ohmmeter

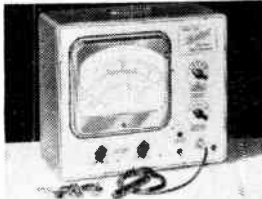

High input impedance resulting in negligible loading; d.c. volts from 0-1200; input resistance 10.5 meg.; a.c. volts from 0-1200 RMS, peak-to-peak 0-3200; center ohms 10; readability from .02 ohms to 1000 meg.; tubes are 12AU7 balanced br.dge. 6AL5 rectifier; dual-probe included; 13 1/4" x 16 1/4" x 4"; sensitivity 350  $\mu$ a.; estimated time of assembly 4-8 hours. ....\$59.50

### VT-10 6" Multi-Purpose VTVM

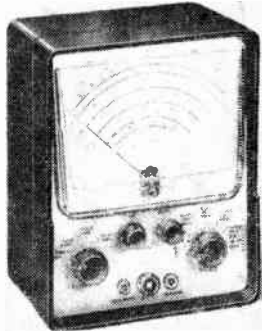

Edge lit 400  $\mu$ a meter movement; 2% accuracy; 7 a.c. and d.c. ranges, 0-1500 volts; 7 a.c. peak-to-peak ranges 0-2000 volts; resistance 0-1000 meg, 12AU7 for d.c. ranges; 6AL5 for a.c.; selenium rectifier; estimated time of assembly 4-6 hours .....\$25.95

## KNIGHT-KIT (ALLIED RADIO CORP.)

### 1000 Ohms/Volt VOM



38 range VOM with 1% precision resistors; ranges; a.c., d.c., and output volts, 0-1-5-10-50-100-500-5000; resistance 0-1000-100,000 ohms and 0-1 megohm; current (a.c. and d.c.) 0-1-10-100 ma and 0-1 amp; decibel: -20 to +69; 1% precision resistors; 4 1/2" 400-microamp meter; estimated assembly time 2 1/2-3 1/2 hours; 6 3/4" x 5 1/4" x 3 3/4" 2 1/2 lbs. ....\$16.95

### 20,000 Ohms/Volt VOM

Ranges a.c., d.c., and output volts: 0-2-5-10-50-250-1000-5000; resistance 0-2000-200,000 ohms and 0-20 megohms; d.c. ma 0-1-10-100; d.c. amps 0-1-10; decibels -30 to +63; 1% precision resistors; 4 1/2" 50 microamp meter; estimated assembly time 2 1/2-3 1/2 hours 6 3/4" x 5 1/4" x 3 3/4"; 5 lbs. \$29.50

### Printed-Circuit VTVM

Input resistance 11 megohms d.c. and a.c. rms volts 0-1.5-5-15-50-150-500-1500; a.c. peak-to-peak volts 0-4-14-40-140-100-1400-1000; resistance 0-1000-10K-100K ohms, 1-10-100-1000 megohms; decibels -10 to +5 frequency response 30 cps to mc; 1% precision resistors; balanced-bridge push-pull circuit polarity reversing switch; 4 1/2" 200-microamp meter; printed circuit construction; estimated assembly time 4-5 hours; 7 3/4" x 5 1/4" x 4 3/4"; 6 lbs. ....\$25.75

High-Voltage Probe Kit (extends d.c. voltage range to 50,000 volts) 1 1/2 lbs. ....\$4.75

High-Frequency Probe Kit (extends a.c. range to 250 mc) .....\$3.45

# Directory of Shop Kits

**Model "600"**  
Portable Tube Checker

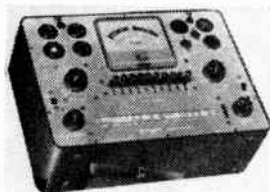

Cathode emission-type checker;  $4\frac{1}{2}$ " meter reads "Good-?-Replace"; checks shorts, open elements, cathode-to-filament leakage, and heater continuity; provision for testing series-string TV tubes; line voltage indicator with line adjust control; provides 16 filament voltages from 0.63 to 117 volts; blank panel socket accommodates future tube types; pre-assembled 10-lever function switch; illuminated roll chart lists 600 tube types; estimated assembly time  $7\frac{1}{2}$ -9 hours;  $6\frac{1}{2}$ "x $14\frac{1}{2}$ "x $10\frac{1}{2}$ "; 15 lbs.....\$34.75  
Counter Model ( $5$ "x $14$ "x $10$ " ) .....\$29.75  
TV Picture Tube Adapter (permits testing TV tubes without removing from chassis) .\$.425

## Transistor and Diode Checker

Checks leakage-to-gain ratio and noise level of transistors, forward and reverse current conduction of germanium and silicon diodes and selenium rectifiers; estimated assembly time 1-2 hours;  $5$ "x $3$ "x $2$ ";  $2\frac{1}{2}$  lbs. ....\$8.50

## Capacitor Checker



Makes in-circuit checks of capacitors from 20 mmf to 2000 nfd for shorts and opens (not leakage); "Magic Eye" indicator; estimated assembly time  $2\frac{1}{2}$ -3 hours;  $7\frac{3}{4}$ "x $5\frac{1}{4}$ "x $5$ "; 5 lbs. ....\$12.50

## Resistor-Capacitor Tester

Measures resistance and capacitance by balanced bridge method; "magic eye" indicator shows values, opens, shorts, intermittents, and power factor; test voltages: 50, 150, 250, 350, 450 volts; capacity ranges 10 mmf

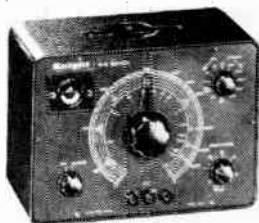

to .005 mfd, .001 to 0.5 mfd, 1 to 50 mfd, 20 to 1000 mfd; resistance ranges 100 to 50,000 ohms and 10,000 to 5 meg-ohms; accuracy  $\pm 10\%$ ; power factor range 0-50%; estimated assembly time 4-5 hours;  $7$ "x $10$ "x $5$ "; 10 lbs. ....\$19.50

## Audio Generator



Uses 6CB6 bridge-T R-C oscillator; frequency range 20 cps to 1 mc in 5 ranges; output voltage 10 volts  $\pm 1$  db to 1 mc; output impedance 600 ohms; distortion less than .25% from 100 cps through audible range into high impedance, less than .5% driving 600-ohm load at maximum output; tubes are 6CB6, 2-6CL6, 5Y3; estimated assembly time 7-8 hours;  $8\frac{1}{2}$ "x $11$ "x $7\frac{1}{2}$ "; 16 lbs.....\$32.95

## RF Signal Generator

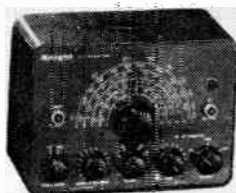

Fundamental frequency output for alignment of RF and IF stages; from 160 kc to 112 mc, useful harmonic output to 224 mc; built-in 400-cps audio oscillator may be used separately to troubleshoot audio or to modulate r.f. output; jack for external modulation; Colpitts circuit; maximum audio output 10 volts, r.f. output over 0.1 volt on all ranges; step and continuous attenuator controls; estimated assembly time  $2\frac{1}{2}$ - $3\frac{1}{2}$  hours;  $7$ "x $10$ "x $5$ "; 11 lbs. ....\$19.75

TV-FM Linear Sweep Generator

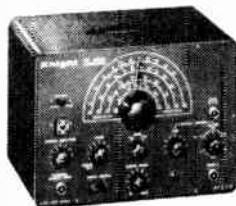

Frequency range 300 kc to 250 mc on fundamental frequencies for alignment; sweep width variable from 0 to 13 mc; built-in crystal marker and input for external marker; up to 0.15 volts output; sweep circuit output within 1 db over swept range; electronic retrace blanking; estimated assembly time 8-10 hours;  $8\frac{1}{2}$ "x $12$ "x $7\frac{1}{2}$ "; 16 lbs.; less crystal.....\$44.95  
4.5 mc crystal .....\$ 4.80  
5.0 mc crystal .....\$ 3.95  
10.7 mc crystal .....\$ 3.95

## High-Gain Signal Tracer

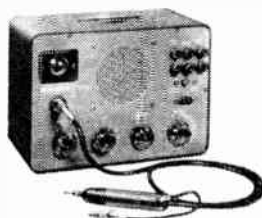

Has magic eye indicator and 4" speaker for visual and audible signal tracing; gain 91,000; input capacitance 6 mmf; 2-position r.f.-a.f. probe; wattmeter calibrated from 25 to 1000 watts; allows gain-per-stage measurements; provides 280 volts d.c. for external tests; tubes are 6AU6, 6AV6, 6V6GT, 6E5, 6X4; estimated assembly time 5-6 hours;  $7$ "x $10$ "x $5$ "; 12 lbs. ....\$26.50

## 5" General Purpose Oscilloscope



Vertical response 3 cps to 1.5 mc  $\pm 3$  db; to 2.5 mc  $\pm 6$  db; vertical sensitivity .025 rms v/inch; sweep 15-150,000 cps in

(For additional information use coupon on page 160)

Electronic Kits

# Directory of Shop Kits

4 ranges; horizontal sensitivity .07 rms v/inch; horizontal amplifier down 3 db at 200 kc; vertical input impedance 3.3 megohms shunted by 45 mmf; calibrating voltage 1 volt peak-to-peak, voltage-regulated square wave (applied by spring return slide switch); retrace blanking; internal, external, positive, and negative synch; printed circuit construction; estimated assembly time 10-12 hours;  $9\frac{1}{2}'' \times 13\frac{3}{4}'' \times 17\frac{3}{4}''$ ; 40 lbs. .... \$42.00

## 5" Wide-Band Oscilloscope

Vertical response 5 cps to 5 mc  $\pm 3$  db; vertical sensitivity 0.025 rms v/inch; input impedance 2.9 megohms and 20 mmf; horizontal response down 3 db at 600 kc, 4 db at 1 mc; horizontal sensitivity 0.6 rms v/inch; sweep range 15 cps to 600 kc; cathode-follower inputs; push-pull vertical and horizontal amplifiers; estimated assembly time 10-13 hours; printed circuit construction;  $14\frac{1}{2}'' \times 9\frac{1}{2}'' \times 16''$ ; 40 lbs. .... \$65.75

## Voltage Calibrator



Allows the use of any scope as a peak-to-peak a.c. voltmeter; selects voltages from .01 to 100 volts in 4 ranges; accuracy  $\pm 6\%$ ; voltage regulator tube; shunt capacitance 15 mmf; VOM or VTVM required for initial calibration; estimated assembly time 2-3 hours;  $7\frac{3}{4}'' \times 5\frac{1}{4}'' \times 4\frac{3}{16}''$ ; 5 lbs. .... \$12.75

## Resistance Substitution Box

Resistance ranges 15-10K ohms and 15K to 10 megohms; accuracy  $\pm 10\%$ ; 18-position rotary switch selects desired value of resistance; estimated assembly time 1-2 hours;  $5'' \times 3'' \times 2''$ ; 2 lbs. .... \$5.95

## Capacitance Substitution Box

Substitutes 18 values of capacitance from .0001 mfd to .22 mfd; accuracy  $\pm 20\%$ ; all

values rated at 600 volts, except .15 and .22 mfd which are 400 volts; estimated assembly time 1-2 hours;  $5'' \times 3'' \times 2''$ ; 2 lbs. .... \$5.95

## Flyback Checker



Checks horizontal output transformers, deflection yokes, linearity and width coils; indicates shorted turns for any coil with a "Q" greater than 1 and inductance between .003 and 2 henries; checks continuity of circuits with resistances between 0 and 500,000 ohms;  $4\frac{1}{2}''$  meter with 400-microamp movement; isolation transformer power supply; leather handle; estimated assembly time  $2\frac{1}{2}$ -3 hours;  $7\frac{3}{4}'' \times 5\frac{3}{8}'' \times 5''$ ; 6 lbs. .... \$19.50

## 6V-12V Battery Eliminator

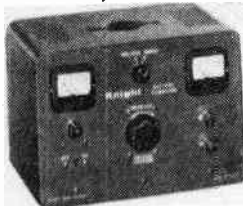

Provides d.c. output at 0-8 or 0-15 volts; continuous current rating 15 amps at 6 volts, 10 amps at 12 volts; intermittent current rating 17.5 amps at 6 volts, 12.5 amps at 12 volts; meter ranges 0-15 volts; 0-20 amps; suitable for transistor and radio servicing; estimated assembly time  $3\frac{1}{2}$ -5 hours;  $9'' \times 12\frac{1}{8}'' \times 7\frac{3}{8}''$ ; 18 lbs. .... \$32.95

## LAFAYETTE RADIO

### TK-10 Semi-kit Multitester

20,000 Ohms Per Volt  
Difficult parts already mounted; sensitivity 20,000 ohms/volt d.c.; 10,000 ohms per volt a.c.; d.c.-a.c. volts: 0-10-50-250-500-1000; d.c. current 0-.5-10-250 ma; resistance 0-10K-100K-1 meg.; capacitance 250 mmf-.02 mf.; inductance 0-5000 henries; db.-20 to +22, +20 to +36; estimated time of assembly 3-5 hours. .... \$11.95

## Model KT-86A Transistor-Diode Checker



Checks P-N-P and N-P-N transistors for leakage, gain, and shorts; indicates diode and selenium rectifier quality by checking forward and reverse current characteristics; estimated assembly time 3-5 hours;  $6\frac{1}{4}'' \times 3\frac{3}{4}'' \times 2''$ . .... \$7.95

## PACO ELECTRONICS CO., INC.

### Model M-40 VOM

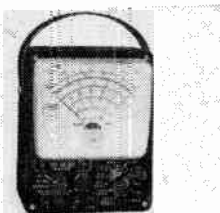

Sensitivity: d.c., 20,000 ohms/volt, a.c., 10,000 ohms/volt; d.c. voltage ranges: 1.5-6-30-150-600-1500-6000; (to 30,000 volts with high-voltage probe) a.c. voltage ranges: 3-12-60-300-1200-3000-12,000; ohm ranges: 0-2000, 0-200K, 0-20 megohms; d.c. current ranges 0-60 microamps, 0-1.5-15-150 milliamps, 0-1.5-15 amps;  $4\frac{3}{8}''$  50-microamp meter, 2% ac accuracy; 1% precision resistors phenolic case; estimated assembly time 4-5 hours;  $5\frac{1}{4}'' \times 6\frac{7}{8}'' \times 2\frac{3}{8}''$ . .... \$31.50

### Model V-70 VTVM

D.c. and a.c. volts ranges: 0-1.5, 15, 50, 150, 500, 1500; input resistance 11 megohms (megohm in probe); sensitivity  $7\frac{1}{4}$  megohms/volt on 1.5 volt scale; d.c. accuracy  $\pm 3\%$  full scale, a.c. accuracy  $\pm 5\%$  full scale; a.c. peak-to-peak ranges 0-4, 14, 140, 400, 1400, 4000 volts; a.c. frequency responses (5 volt range) 40 cps to 4 m  $\pm 1$  db (600 ohms source); d from -6 to +66 in 6 ranges ohms ranges: 0-1000, 10,000, 100,000, 1 meg, 10 meg, 100 meg, 1000 meg;  $4\frac{1}{2}''$  400 microamp meter; 1% precision multipliers .... \$31.50

# Directory of Shop Kits

## S-55 Wide Band Oscilloscope

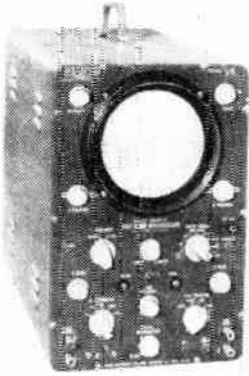

Push-pull vertical amplifier: 5 cps. to 1.2 mc. within 3 db.; within 6 db. to 2 mc.; 90 mv. RMS per inch at 1000 cps.; cathode follower vert. input; input impedance 1.5 meg. with 25mmf.; vertical input step attenuator; push-pull horizontal amplifier; frequency response flat within 3 db. to 45,000 cps.; cathode follower sensitivity 250 mv. RMS per inch at 1000 cps.; peak to peak voltage calibrator; internal linear saw tooth sweep; wide angle phasing control; multiple sync. selector; estimated time of assembly 25-30 hours .....\$87.50

## Model T-60 Tube Checker

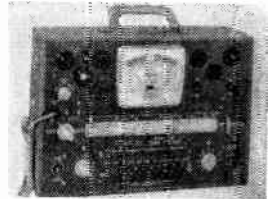

Tests all modern tube types, including series string type; tests for filament continuity, emission, open and shorted elements, and hot cathode leakage; tests gas tubes and pilot lights; meter has  $\pm 2\%$  accuracy; provides 17 filament voltages from .75 to 110 volts; gear-operated roller-chart; variable line voltage adjusts; lever element selector-distribution system;  $10\frac{1}{2}'' \times 15\frac{1}{4}'' \times 4\frac{3}{4}''$ ; estimated assembly time 6-8 hours ..\$38.75 Matching removable cover \$3.95

## Model T-65 Transistor and Crystal Diode Tester

Provides tests for gain, leakage, shorts, etc., on p-n-p, n-p-n, and tetrode transistors; collec-

tor current indicated directly on  $5\frac{1}{2}''$  100-microamp meter; collector potentials from 0.5 to 100 volts d.c. in 17 steps; clip-lead system provides for future-type semiconductors; estimated assembly time 8-10 hours; 20,000 ohms/volt multimeter required for initial adjustment;  $7'' \times 11\frac{1}{2}'' \times 5''$  .....\$39.95

## Model G-30 RF Generator

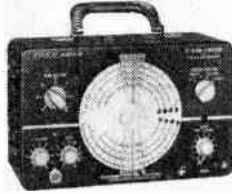

Frequency range 160 kc to 120 mc on fundamentals, to 240 mc on harmonics in eight bands; special provisions for split-sound i.f., 40 mc TV i.f., FM i.f., broadcast band; r.f. output over 100,000 microvolts; 400 cps audio output of up to 15 volts may be used directly or to modulate r.f. output; modulation continuous variable; estimated assembly time 5-7 hours;  $7'' \times 11\frac{1}{2}'' \times 5''$  ...\$28.50

## Model G-30PC

Similar to Model G-30 but with pre-calibrated front-end; estimated assembly time 3-4 hours .....\$35.50

## Model S-50 5" Oscilloscope

Horizontal and vertical amplifiers are push-pull type; vertical response 5 cps to 1.2 mc  $\pm 1.5$  db, to 2 mc  $\pm 6$  db; vertical sensitivity 90 millivolts rms/inch at 1000 cps; cathode follower input with input impedance of 1.5 megohms in parallel with 25 mmfd; compensated vertical 3-step attenuator; horizontal response to 450 kc  $\pm 1.5$  db, to 700 kc  $\pm 6$  db; horizontal input sensitivity 250 millivolts rms/inch at 1000 cps; cathode follower input with input impedance of 10 megohms in parallel with 25 mmfd; built-in peak-to-peak voltage calibrator; sawtooth sweep from 20 cps to 150 kc in 4 ranges; wide angle horizontal phasing control; provision for external horizontal sync and sweep;  $13\frac{3}{8}'' \times 8\frac{3}{4}'' \times 17\frac{1}{4}''$ ; printed circuit construction; estimated assembly time 10-12 hours \$49.50

## Model Z-80 Signal Tracer

Enables direct tracing of all r.f. and a.f. signals with visual

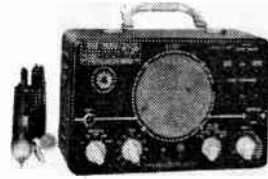

and audible signal indicators plus output for use with oscilloscope; permits gain-per-stage, power drain, and noise test measurements; may be used as PA or paging amplifier; 2-way a.f.-r.f. probe; fine and coarse attenuators; estimated assembly time 7-9 hours;  $11\frac{1}{2}'' \times 7'' \times 5''$  .....\$29.50

## Model C-20 Resistance-Capacity Ratio Bridge

Measures virtually any unknown resistance or capacitance; enables determination of reactance to resistance ratio between any two capacitors, inductors, or resistors between 105 to 1 and 20 to 1; can be used to determine turns ratio of transformer windings between .05 to 1 and 20 to 1; capacitance 10 mmfd to 2000 mfd in 4 ranges; resistance .5 ohm to 200 megohms in 4 ranges; capacitor test voltage variable between 0 and 500 volts d.c.; capacitor leakage test; power factor 0 to 60% (from .1 mfd to 2000 mfd;  $7'' \times 11\frac{1}{2}'' \times 6\frac{3}{8}''$ ; estimated assembly time 6-8 hours .....\$20.95

## Model B-10 Battery Eliminator and Charger



Continuously variable output voltage from 0 to 16 volts d.c.; current capacity on 6-volt range: 10 amps continuous, 20 amps intermittent; current capacity on 12-volt range: 6 amps continuous, 12 amps intermittent; special low ripple output provides up to 5 amps current at 0.3% maximum ripple; may be used as battery charger;  $7'' \times 11\frac{1}{2}'' \times 6\frac{3}{8}''$ ; estimated assembly time 3-4 hours .....\$41.95

Electronic Kits

# Directory of Shop Kits

## PRECISE DEVELOPMENT CO.

### Model 111K Tube Tester



Allows separate checks of emission and mutual transconductance of all modern tubes, including 600-mil series string tubes; 10 rotary switches including one for future tube types; single rotary switch for making tests for shorts; tube bias indicated directly on meter; provision for checking CRT's with adapter; 14"x16"x6"; 24 lbs., estimated assembly time 15-20 hours .....\$79.95

### Model 116K Tube Tester

Tests for emission, mutual transconductance, shorts, gas, etc.; may be used for checking transistors and CRT's; allows checking up to 5 tubes of the same type at once; may be modified to test filament current, etc.; estimated assembly time 12-15 hours .....\$69.95

### Model 904K VTVM



Features 4 1/2" meter that may be tilted in any direction and "lead magician switch" which allows all functions without changing leads; d.c. input impedance 11 megohms; ranges: a.c., -d.c., and +d.c. volts, 1.5, 5, 15, 50, 150, 500, 1500; a.c. volts peak-to-peak, 4, 14, 40, 140, 400, 1400, 4000; resistance, 0.2 ohms to 1 billion ohms; voltage ranges may be extended to 30,000 volts and to 250 mc with accessory probes; zero alignment scale; complete with test probes and battery; estimated assembly time 3-4 hours; etched circuit board construction; 9 1/2"x6"x5" .....\$34.95

### Model 909K VTVM

Ranges: +d.c. -d.c., and a.c.,

Number 2

0 - 5 - 25 - 250 - 500 - 1000 volts; ohms, 0.2 ohms-1000 megohms; db, -20 to +55 db; voltage ranges may be extended to 250 mc and 30,000 volts with accessory probes; input impedance 25 megohms on d.c.; 4 1/2" meter; 1% precision resistors; zero alignment scale for FM and TV discriminators; complete with leads and battery; estimated assembly time 4-5 hours; 9 1/2"x6"x5"; 10 lbs. ....\$25.98

### Model 9071K VTVM

Ranges: +d.c., -d.c., and a.c., 0 - 5 - 25 - 250 - 500-1000 volts; ohms, 0.2 ohms-1000 megohms; db, -20 to +55 db; voltage ranges may be extended to 250 mc and 30,000 volts with accessory probes; d.c. input impedance 25 megohms; 7 1/2" meter; 1% ceramic precision resistors; voltage regulated power supply; zero alignment scale for FM and TV discriminators; complete with leads and battery; estimated assembly time 4-5 hours; 12"x8 1/2"x5"; 11 lbs. ....\$35.95

### Model 635K AF Generator

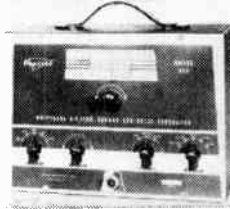

Sine wave, square wave, and pulse generator; sine wave frequency range 20 to 200,000 cps; square wave and pulse range to 50,000 cps; wein type bridge sine wave generator; variable impedance output; 1% precision resistors; uses 5 tubes and 6S6 variable resistance bulb; estimated assembly time 4-5 hours. ....\$33.50

### Model 610K RF Generator

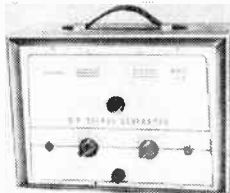

Frequency range 300 kc to 110 mc on fundamentals, to 330 mc on harmonics; variable external or internal 60 cps or 400 cps cathode follower output; esti-

mated assembly time 3-4 hours; 8 1/2"x12"x5 1/2"; 10 lbs. \$23.95  
Model 610KA (with pre-assembled r.f. head) ....\$28.95

### Model 630K

#### RF-AF-TV Marker-Bar Generator

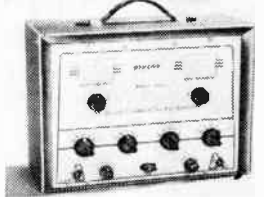

Frequency range on r.f.: 300 kc to 110 mc on fundamentals, to 330 mc on harmonics; frequency range on a.f.: 20 to 20,000 cps; variable internal or external modulation; crystal marker; bar generator; Wien bridge a.f. oscillator; Colpitts r.f. oscillator; cathode follower output; estimated assembly time 4-5 hours; 8 1/2"x12"x5 1/2"; 10 lbs. ....\$33.95

Model 630 KA (with pre-assembled r.f. head).....\$38.95

### Model 315K 5" Oscilloscope



Vertical amplifier frequency response to 500 kc  $\pm 6$  db; sensitivity 250 millivolts/inch pushpull outputs; horizontal amplifier specifications similar to vertical amplifier specifications; cathode follower inputs internal and external synch sweep frequencies from 10 cps to 100 kc; 6.3 volt sine wave calibration; focus, intensity, and astigmatism controls; frequency compensated attenuators; estimated assembly time 8-10 hours .....\$49.95

### Model 3151K 5" Oscilloscope

Specifications similar to Model 315K with following features vertical amplifier frequency response flat to 5 mc and  $\pm 8$  db to 9 mc; vertical sensitivity 10 millivolts/cm; horizontal sensitivity 40 millivolts/cm; estimated assembly time 9-12 hours 1 3/4"x8 3/4"x18 1/2". ....\$59.95

# Directory of Shop Kits

## Model 300K 7" Oscilloscope



Vertical and horizontal amplifiers have frequency compensated stepping attenuators and pushpull circuitry throughout; vertical amplifier frequency response from d.c. to 5 mc  $\pm 1.5$  db; sensitivity 10 millivolts in pushpull,  $\pm 6$  db; sweep rate from 1 cps to 80 kc in 5 ranges; bridge-type positioning on vertical and horizontal; internal retrace blanking; magnifier positioner allows any part of waveform to be examined in detail; synch positions: external, internal-positive, internal-negative, internal-60 cycle, internal-120 cycle; internal square wave calibrator; switch controlled edge-lit scale; front panel outputs: plus gate, sawtooth, 60 cycle phasing, 60 cycle unphased; calibration; astigmatism, focus, and intensity controls; direct connection to deflection plates from rear of cabinet; Z modulation through internal modulation amplifier; estimated assembly time 10-15 hours; 11"x14"x17". . . . . \$99.50

## Model 308K 8 1/2" Oscilloscope

Specifications similar to Model 300K with the following features: separate 3rd anode intensifier ring plus separate high voltage supply; low, high, and normal sync. frequency selector; 8 1/2" tube; voltage regulated power supply; girder reinforced chassis construction; 11"x14"x19". . . . . \$129.50

## Model 478K

### Capacitance Decade Box

Provides values of capacitance from 100 mmfd to 1.11 mfd in steps of 100 mmfd; accuracy within 1%; silver mica or molded oil impregnated capacitors. . . . . \$18.95

## Model 468K

### Resistance Decade Box

Provides values of resistance from 10 ohms to 1.11 megohm in 5 decades. . . . . \$18.95

## Model 760K Power Supply

Voltage regulated power supply; provides regulated d.c. voltages from 140 to 450 volts; regulation within 1% at specified current durations; ripple .01% at specified currents; maximum current 11 ma; variable unregulated positive or negative d.c. voltage to 1000 volt; unregulated 6.3 volt, 4 amp a.c. output; 375 volt, 50 ma unregulated a.c. output; 4 1/2" meter; 1% shunt and multiplier resistors; estimated assembly time 4-5 hours; 11 lbs. . . . . \$39.95

## Models 711K and 713K Power-Lab



Provides functions of battery eliminator, battery charger, line voltage variac, a.c. line voltage meter, a.c. line ammeter, a.c. line wattmeter, a.c. line isolation transformer, d.c. line voltage variable supply, etc.; ranges: d.c. volts, 0-30 at 20 amps maximum, 10 amps continuous, 110-180 at 1 amp maximum, .075 amps continuous; a.c. volts, 0-24 at 20 amps continuous, 90-140 at 20 amps maximum, 10 amps continuous (no isolation), 90-140 at 3 amps (Model 713) with isolation, 90-140 at 1 amp (Model 711) with isolation; estimated assembly time 4-5 hours.

Model 711K . . . . . \$49.95

Model 713K . . . . . \$62.95

## Model T1 Transistor Circuit Kit

Provides parts for experiments with transistor circuits, including one-stage audio amplifier, two-stage RC coupled audio amplifier, two-stage transformer coupled amplifier, multi-vibrators, audio oscillator, r.f. oscillator, signal tracer, tuned signal tracer, etc.; less microphone, loudspeaker or headphone, and batteries . . . . . \$14.95

## PRECISION ELECTRONICS, INC.

### Model 202K Signal Tracer

Allows stage-by-stage checks from antenna to speaker or picture tube; locates intermittents,



opens, hum, noise, and distortion, visual and aural tracing with indicator eye and built-in 5" speaker; built in wattmeter, 25 to 300 watts. . . . . \$26.00

## Model 1000K VTVM

Voltages ranges a.c. and d.c.: 0-1.5-5-15-50-150-500-1500; a.c. peak-to-peak ranges 0-4-14-40-140-400-1400-4000; d.c. input impedance 11 megohms; accuracy d.c.  $\pm 3\%$ , a.c.  $\pm 5\%$ ; ohms ranges .1 ohm to 1000 megohm. . . . . \$29.95

## RADIO CORPORATION OF AMERICA

### WV-77E(K) VoltOhmyst



Separate scales for 1.5 volts rms and 4 volts peak-to-peak; dc. from 0.02-1500 volts in 7 overlapping ranges; ac. from 0.1-1500 volts rms. 0.02-4000 volts peak to peak; resistance from 0.02 ohms-100 meg zero center indication for discriminator alignment; accuracy  $\pm 3\%$  full scale dc.,  $\pm 5\%$  full scale ac.; . . . . . \$49.95

## TRANSVISION, INC.

### Model TR-1 VTVM-VOM



Transistorized combination VTVM and VOM; measures a.c. and d.c. voltages, ohms, db, d.c. current; 50-microamp meter; 1% resistors. . . . . \$39.95

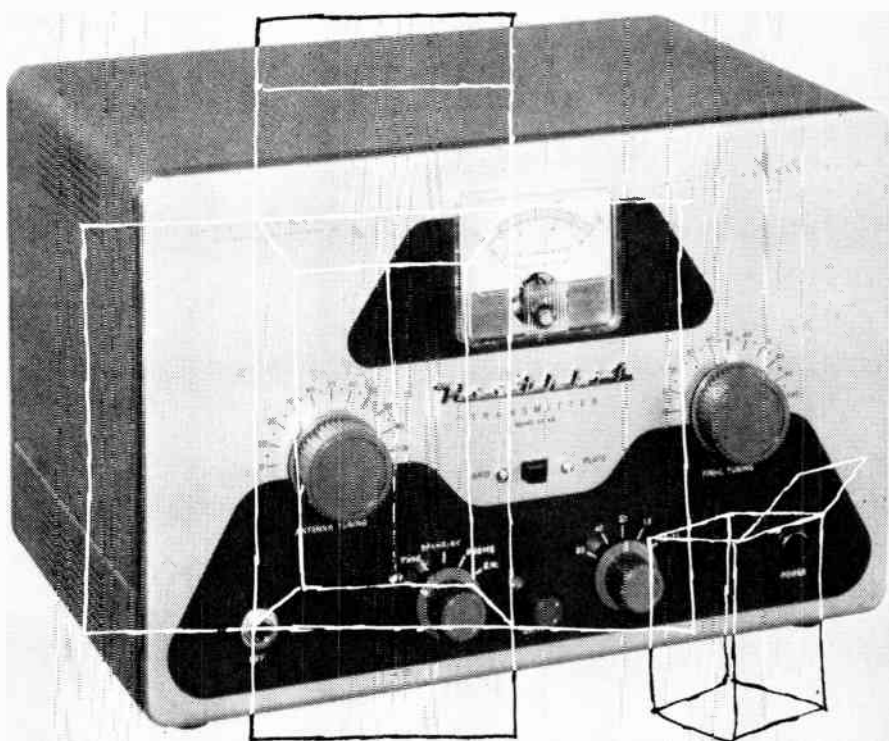

section III  
kits for the ham

Kits And Amateur Radio	120
Build a 90 Watt CW Transmitter	122
Mobile Transmitter For Phone Fun	125
Build a Variable Frequency Oscillator	127

\* directory  
of ham kits page 130

# Kits And Amateur Radio

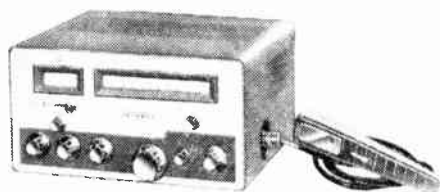
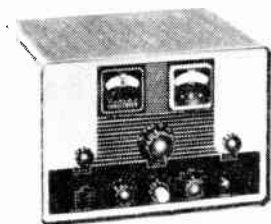
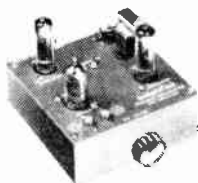

Do-it-yourself amateur radio kits offer many advantages over “home brew” and commercially built equipment. Most important are the obvious benefits of “more watts per dollar” and pride of achievement.

The average amateur may find that home brew equipment costs much more in the long run, and that when he decides to make a change, his equipment has practically no value as to trade-in. With kits, he has a chance to learn and use the most modern design and construction techniques. He is assured that the end product will perform well if he follows instructions.

However, it is possible to miss all the above benefits. For example, the amateur who “starts small” and keeps stepping up without some sort of planning can, in the long run, spend more time and money than necessary. Likewise, the kit builder who blindly follows step after step of the instructions without really noticing what he is doing, loses half the value of kit building.

There are roughly three classes of amateur radio communications receivers currently available in kit form. The least expensive uses one or two tubes in a regenerative circuit and covers primarily the lower frequency amateur bands. These kits, for the price and size, are capable of amazing performance when conditions are right, and when ample time for critical tuning is available.

They will suffice to acquaint the newcomer with the radio spectrum. They will pick up code signals and thus help the aspiring ham learn the code. By listening to other amateurs on the lower frequency bands, he can familiarize himself with ham jargon, and when his ticket finally arrives, he will be quickly accepted as one of the boys.

This type of receiver, however, loses its usefulness when the ticket finally arrives. The set lacks sensitivity and more important, it lacks selectivity. It is virtually worthless for anything but the most basic two-way communications, for example, local stations working under ideal conditions.

The middle class of receiver in kit form is the “all-band” superhet. This class has many subdivisions, starting with the simple 5-tube circuit that sells for less than \$30,



and ending with sets costing \$100 or more.

As might be expected, performance is proportional to price. In most cases, when used with a good antenna, and when conditions are favorable, signals will be heard on all bands from points all around the world.

The more expensive varieties in this class have extra features which can make them substantially more useful than their less expensive competitors. For example, a tuned radio frequency stage can greatly increase sensitivity on the higher frequency bands and a Q multiplier can provide significantly improved sensitivity. In addition, crystal calibrators and signal strength meters can add to operating convenience and efficiency. These features can be added to the smaller receivers, but seldom as effectively as those designed into the package as an integrated working unit. Calibrated bandspread is an extremely useful feature, although few are too accurate in the middle class of receivers.

The third class of receiver carries a price tag of several hundred dollars, but with commensurate results. In this type of design, selectivity, sensitivity and stability comparable with the finest communications equipment available can be achieved.

Depending on many factors, including financial situation, the beginner can plan to pass through all three stages, or he can start with class one and skip class two, or vice versa. It is doubtful that much benefit can be derived from building a receiver which is inadequate for his needs. Fortunately, advice on such matters is extremely easy to come by in most ham circles. In general, the performance will be proportional to cost and construction time.

The transmitter picture differs somewhat. The required expenditure for a transmitter depends more on the user's operating habits. The low-power (75 watts or less) crystal-controlled transmitter selling for less than \$50 is ideal for the novice. But many a veteran amateur enjoys a challenge, and thus satisfies himself with just such equipment.

The variable frequency oscillator, which can be added to any crystal-controlled transmitter (if the operator holds a General class license or better), increases the transmitter's capability many times. Typical vfo's cost from about \$20 to \$50. With a low power

transmitter and a stable vfo, the cw amateur is ready for many hours of enjoyable operating.

Bandswitching is another important factor to be considered. Most kits follow the precedent set by commercial manufacturers in providing switching from 80 meters to 10 meters, some including 160 and 6 meters as added features. An amateur's operating habits are likely to change frequency, consequently bandswitching is important. In all cases, freedom from television interference is a consideration, and most kits have provisions for minimizing troublesome harmonic radiation. The phone enthusiast can obtain only limited success with low power on the lower frequency bands. When conditions are good, the 50-watt phone transmitter can perform like a kilowatt, especially when coupled to a good antenna. Many contradictory comments will be heard regarding the relative merits of various modulation techniques, that is, screen modulation vs plate modulation, etc., but these differences go hand in hand with low power—when conditions are right, the difference is slight.

Finally, there are the more expensive and more versatile kits, some of which provide the beginning amateur with equipment that will last him a lifetime. Some of the more desirable features are accurate calibration and stable variable frequency oscillators, complete and effective tvf suppression, high-level plate modulation with speech tailoring for efficient phone operation, special keying circuits, and provisions for adding additional features such as single-band adaptors.

Again reviewing, it will be noticed that the transmitter receiver combination can be obtained for \$100 to serve the novice and the not-too-demanding veteran. By adding such features as vfo, Q multiplier, crystal calibrator, antenna tuner, standing wave ratio bridge, modulator (when omitted from initial set-up), power amplifiers and various other outboard improvements, each available in kit form from \$10 to several hundred, performance can be improved. All of these added features, and more, are available in transmitter-receiver combinations costing \$500—if they can be afforded as part of the initial investment.

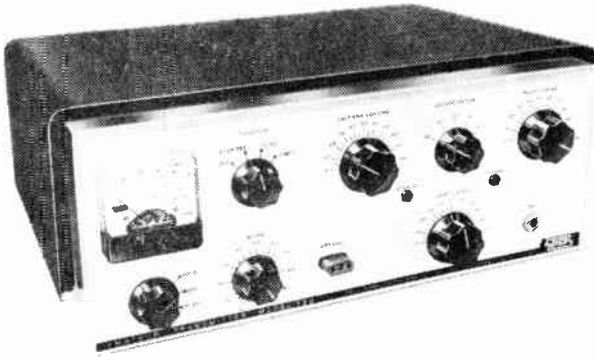

## **Build a 90 Watt CW Transmitter**

*Eico Model 720 is ideal for veteran or novice*

The first purchase a ham radio operator will make is the transmitter. This he considers as his reward for the hours of study and code practice required to pass the FCC amateur license test. One of the top quality transmitter kits on the market is the new Eico amateur transmitter Model 720. It is the type of reward all hams should award themselves.

The Model 720 is a very "clean" 90-watt cw, band-switching amateur transmitter covering 80 through 10 meters. Some important design features are: one-knob band-switching; one-knob power, tune and operate switch, final amplifier grid drive control without detuning oscillator; oscillator keying for break-in operation; matching antennas from 50 to 1,000 ohms. The completely sealed cabinet and careful by-passing and choking of all inputs and outputs, effectively suppresses TVI.

### **circuit**

A high transconductance 6CL6 pentode is employed as an electron-coupled Colpitts

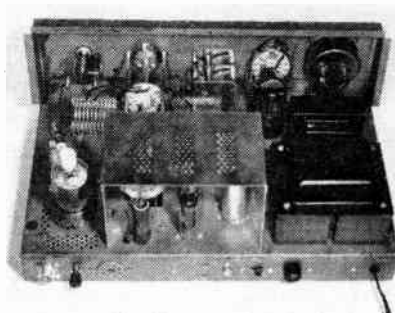
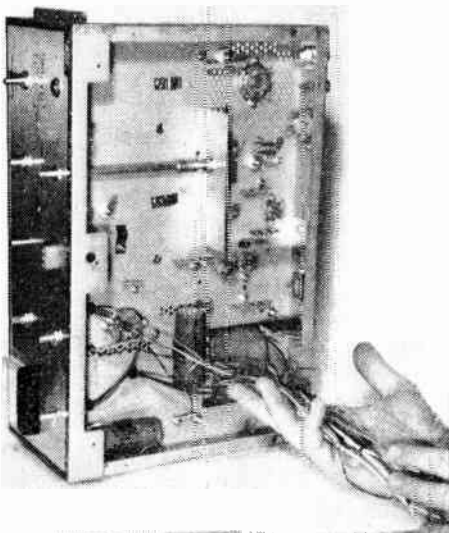

**Before** turning chassis upside-down for wiring, the builder found it a good idea to install the top shield (at right) first, so that tubes, bandswitch, etc., would not be damaged when assembling. Top shield may be removed later for top-chassis wiring. Make sure, when wiring, that all steps are followed exactly as instructed rather than directly from the pictorials. This will insure against leaving out any wires to cause you trouble later.

crystal oscillator. This circuit is noted for its high harmonic output and low crystal heating. Since the oscillatory part of the circuit is isolated from the load side by the screen grid, frequency shift due to plate loading is minimized.

The plate tank circuit consists of a broadly tuned slug coil. It resonates at 40 meters for all bands of operation. The coil acts as an RF choke for 80 meter operation. The 80 meter crystals are used for 80 and 40 meters, and 40 meter crystals are used for 20, 15, and 10 meters. An external VFO jack is provided which is connected to the grid of the 6CL6 and is selected by a slide switch.

A 6AQ5 tube is used as a class-A buffer on 80 and 40 meters and a class-C multiplier on all other bands. Second, third and fourth harmonics are obtained for operation on the 20, 15, and 10 meter bands. A pi-network is employed in the plate circuit to provide a stable load for the final amplifier. The screen voltages of the 6AQ5 is variable by a wire-wound potentiometer to provide drive control of the final stage. By this means, efficient and stable operation of the

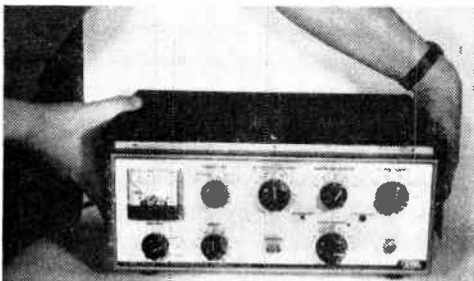

**Transmitter** is complete except for adjusting plate load coil L1 in oscillator circuit. This is the only adjustment needed until a crystal or VFO is chosen.

buffer and final is obtained.

A 6146 high perveance power pentode is used as a straight-through Class-C power amplifier. The grid circuit is driven by the pi-network of the buffer stage. This type of coupling helps to prevent parasitics and self-oscillation in the final and also attenuates any high order harmonics that may be present in the grid circuit. The 68 mmf capaci-

tor connected between grid and cathode provides stability for the 6146.

A variable pitch, band-switching, pi-network tank circuit is used to match the final amplifier to various loads between 50 and 1,000 ohms approximately. This type of circuit is highly efficient and provides additional harmonic attenuation. A variable 900 mmf capacitor is connected across the output of the pi-network for controlling the degree of loading of the antenna or other load. This tank tunes the 80, 40, 20, 15 and 10 meter bands only.

A 6AQ5 clamper tube is employed to prevent excessive plate current flow if grid drive of the final should fail. It operates by dropping the 6146 screen grid voltage to a low value in the event of such failure. This tube also is part of the key circuit and acts as a type of oscillator screen grid regulator when the transmitter is keyed. The transmitter is basically keyed in the oscillator and final cathode circuits, which results in a clean crisp note.

#### putting it together

Eico prepared an excellent manual for directing the kit builder. The instructions are very clear and correct. Eleven two-color page-size pictorials illustrate the 13-page step-by-step assembly and wiring procedure. Do not be tempted to disregard the instructions and follow the pictorials only. You may leave out one wire which will only cause you hours of trouble shooting later.

Here are a few hints that will make the assembly and wiring of the Eico transmitter a bit easier.

- Before starting the instructions given on page 13C, install the top shield as directed in step 19 on page 23C. This will permit you to turn the chassis upside down, avoiding possible damage to the band switch on top of the chassis. Remove the top shield whenever it interferes with chassis-top wiring.
- A 100-watt soldering iron is suitable for most soldered connections. However, there are a few connections which will be difficult to make with a 100-watt iron. A good quality pencil soldering iron or soldering gun can reach these connections without causing heat damage to nearby parts and wires.
- Use only the wiring paths shown in the

pictorials. Don't take any apparent shorter routes to save wire. If the wire is too long, cut off the excess. Leads which are too long or too short may cause trouble due to capacitive coupling.

- After the wiring is completed, perform the tests advised in the final steps. Then, make a resistance check at all tube pin connections. Eico supplies a complete voltage-resistance chart for this purpose. The resistance check may locate wiring mistakes.

### adjustment

Except for the front panel controls, only one adjustment is required and this is made on the chassis bottom. Coil L1, a broad band plate load for the oscillator circuit, is adjusted with the power on. Be sure to use a plastic alignment tool. If an iron hex wrench is used, a false setting will be obtained. Also, the iron will heat up and may burn your fingers. After this adjustment is made, all others on the front panel are

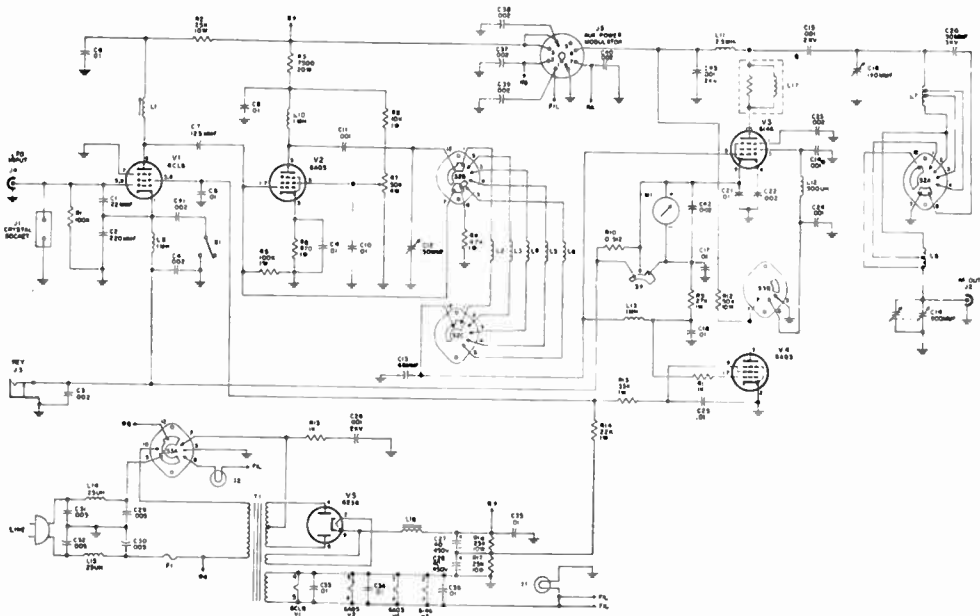

made after a crystal or VFO frequency is selected. The frequency ranges are:

BAND	CRYSTAL OR VFO (KC)
80	3500-4000
40	7000-7300
20	7000-7175
15	7000-7150
11	6740-6807
10	7000-7425

For CW operation, 80 meter crystal can be used for the 40, 20, and 15 meter bands for improved keying characteristics providing that the GRID TUNING control is set within the ranges given above. This will eliminate the possibility of tuning to the wrong harmonic.

There can only be one good final check

of an amateur transmitter and that is—getting on the air, and receiving a QRK5 report from on a distant DX. Coupled to a rotary beam antenna, DX'ing all the continents is no longer a chore but a weekend warmup.

#### SPECIFICATIONS:

**Power Input:** 90 watts cw (novice limit calibration on meter); 65 watts AM-phone with EXT plate modulation.

**Output Load Impedance:** 50-100 ohms.

**Operation:** XTAL, EXT, VFO.

**Tubes:** 1-6146 final amplifier; 1-6CL6 oscillator, 1-6AQ5 clamer; 1-6AQ5 buffer-multiplier, 1-6Z34 rectifier.

**Power Requirements:** 117 volts, 60 cycles AC, 175 watts.

**Cabinet Size:** 15" wide x 6" high x 9" deep.

**Weight:** 27 lbs.

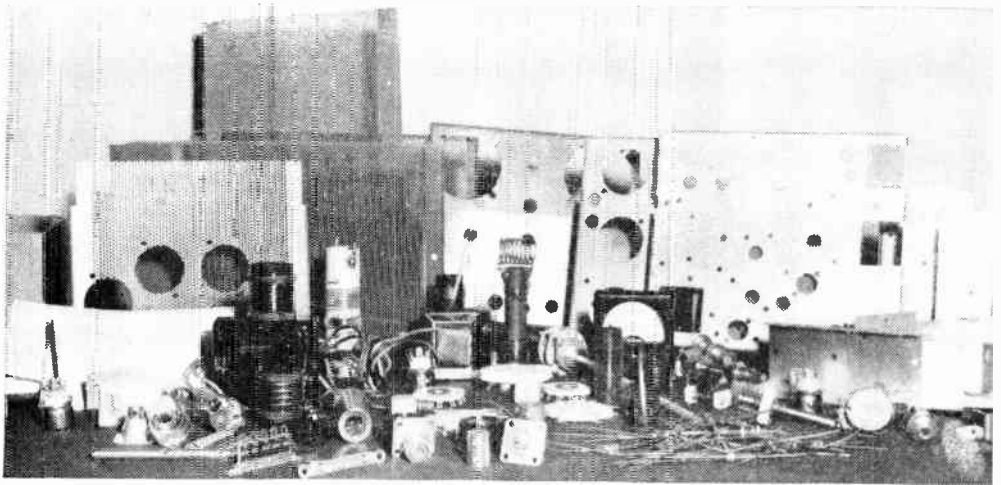

## **Mobile Transmitter for Phone Fun**

Rigs in cars get a lot of jolting and vibration that can loosen mounting bolts, snap wire leads, change tuning adjustments, and make cold-soldered joints no joint at all. Amateurs that operate mobile find this out, sometimes to their sorrow, in the first month of operation.

Good construction and wiring are necessary and these are best done by experienced workers at the factories. That's one reason why most manufacturers haven't made mobile radio equipment available in kit form, it's too easy for the home-builder to do a careless job.

One tried and true kit in this area is the Viking Mobile Transmitter put out by E. F. Johnson Company of Waseca, Minn. Using an 807 in the final, modulated by two 807s, it packs a hefty wallop in extremely small space. Since it is so compact, it is necessary that the steps in assembling the kit be followed in the order they are given in the 50 pages of assembly instructions that accompany the kit. This is in addition to the 25 pages plus illustrations provided in a separate tune-up and operating manual.

It is a good idea to study each step first, then carry out the operation. If the reason for an operation is not obvious at the time it is called for, don't worry about it, the reason will show up later. All of the steps have been very carefully planned to fit the parts and wiring into the compact final unit required.

The crystal oscillator is a 6B16 tube. The

crystal switch selects any of four crystals on the crystal socket or connects the 6B16 input circuit to the vfo receptacle at the rear of the transmitter. With crystal operation, the 6B16 screen grid and cathode become a Pierce oscillator. The plate is electron coupled to the other elements which makes it a good frequency doubler. The oscillator tank is tuned to the 75-meter range when the band-switch is on 75 meters, to the 40-meter range when the bandswitch is on 40 or 20 and to the 20-meter range when the bandswitch is on 10.

The 6AQ5 buffer serves as a straight-through amplifier on 75 and 40-meter operation and as a frequency doubler on 20, 15, and 10 meters. The 6AQ5 screen potential is varied by the drive control to provide an adjustment for the final grid current. Some fixed voltage is applied to the grid of the 6AQ5 grid to limit the buffer no-signal current.

The grid circuit bias for the 807 final is provided by the grid current drop across a 10,000-ohm grid resistor and a negative voltage of 25 to 35 volts from the bias oscillator supply. It was noted that the grid current specified for the Viking Mobile operation and the bias voltage are less than those shown in the tube handbooks under typical operating conditions. The values used were found to be best values for maximum efficiency and good output over the whole voltage range of the Viking Mobile.

The final tank consists of a coil for the 75

id 40 meter bands, a coil for the 20 meter  
 id, a coil for the 15, and 10 meter bands  
 id a tuning capacitor, which is ganged to  
 e buffer and oscillator capacitors. The 75-  
 eter band is padded by fixed capacitors to  
 ing the loaded 75-meter tank  $Q$  to within a  
 od operating range. The final plate has a  
 ries d.c. high voltage feed so that the coils  
 id final capacitor rotor have modulated d.c.  
 oltage on them when the transmitter is op-  
 ating with the "tune-rec-send" switch in  
 e "send" position. The screen of the final  
 07 is fed from the modulation transformer  
 onduary through a series dropping resistor.  
 For output coupling, each tank coil has a  
 ncentric coupling coil with a relatively high  
 upling coefficient in the maximum coup-  
 ng position. The coupling coils are moved  
 and out of the tank coil by a coupling con-  
 ol. The coupling coils are switched to the  
 utput cable and antenna jack. Capacitance  
 mpensation is provided in each coupling

tively high gain for a crystal or a high level  
 dynamic microphone. The gain of the speech  
 amplifier is sufficient in either case for close  
 talking into most good quality microphones.  
 The biasing current for the carbon micro-  
 phone is the cathode current of the speech  
 amplifier stage.

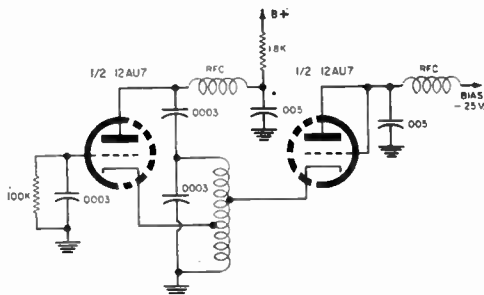

Bias supply uses 12AU7 for two operations. Half the tube is being used as an r.f. oscillator, the other half for oscillator output voltage rectification.

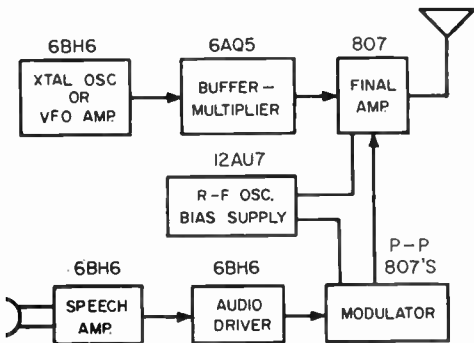

Assembly steps must be followed exactly because of the number of steps involved in the 50 page manual, and the close working areas in the compact transmitter.

circuit to cancel the coupling coil reactance and provide some reactance correction for a 50-ohm feedline approximately 15 feet long.

### audio section

The modulator consists of a pair of 807's operating in class AB1 push-pull driven by a transformer-coupled 6B116 driver and a 6B116 resistance-capacitance coupled speech amplifier. The audio control is a potentiometer which adjusts the audio input to the driver stage. The input speech amplifier may be wired to have a very low gain for carbon microphone use or may be wired to have a rela-

An interesting circuit is that of the bias supply. It consists of one section of a 12AU7 tube operating as an rf oscillator and the other section which operates as a rectifier of the oscillator output voltage. The r.f. frequency is in the neighborhood of 4.5 mc. All leads are carefully bypassed and filtered to prevent any of the r.f. voltage from reaching the exciter stage of the transmitter. The oscillator can be picked up by a receiver in the vicinity of the transmitter but the signal is quite weak (several thousand times smaller than any signal voltages on the exciter stages of the transmitter). The bias supply provides approximately 25 volts of bias to the modulator and final stage grids. The value of the fixed bias voltage depends on the low voltage B+ source.

The Viking Mobile can be operated from one power supply having an output as low as 300 volts, or as high as 600 volts at 200 ma. The r.f. exciter and the speech amplifier stages would then be fed through a dropping resistor. The power supply of the automobile receiver can be used to feed these stages if it can provide about 250 volts.

# Build a Variable Frequency Oscillator

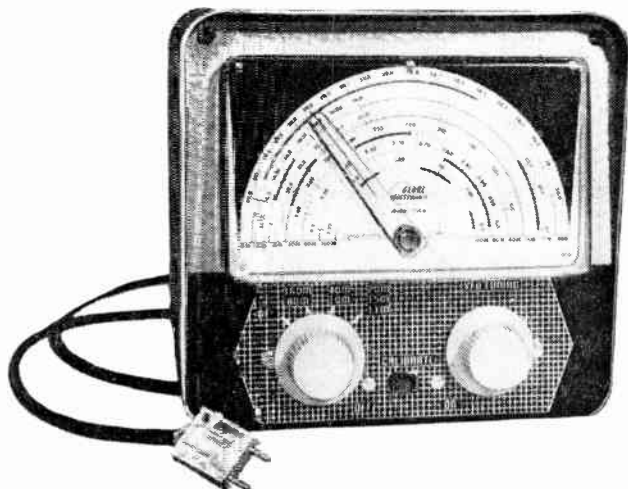

The first unit to be purchased by most hams who graduate from, Novice to General Class, is the variable frequency oscillator. A VFO unstraps the ham from the fixed frequencies of crystal-controlled transmitters and permits transmission over the entire ham band. Compact, light in weight, and easy to use, it is a ham shack must.

One of the basic problems with VFO's is lack of long-term stability. Part value change due to heat broadens the frequency space occupied by the transmitted signal. It is unpleasant to hear, hard to copy, and illegal. The Model VFO 755A kit offered by Globe Electronics, Inc., Council Bluffs, Iowa, has been designed to avoid or eliminate all of these troubles and others, like TVI. Careful selection and placement of heat-stable components has made the VFO 755A a reliable kit to build and use.

## how it operates

The oscillator stage, utilizing a 6AU6 tube, is basically a series-tuned Clapp oscillator with additional padding capacitors. This modification of the Clapp circuit provides better frequency stability and constant output without tube loading.

Frequency stability of the oscillator is maintained by voltage regulation and temperature-compensating capacitors at critical points in the circuit. The fundamental oscillator output frequency is in the 160- and 40-meter bands. Other ham bands, 80, 20, 15 and 10 meters, are available through frequency multiplication.

Cathode keying of the oscillator is employed because it is the easiest and most dependable type. The resulting transmitted signal is clean and crisp. A broadband load choke in the output circuit of the oscillator circuit supplies r.f. drive to the buffer amplifier stage through a small coupling capacitor.

The buffer stage employs a type 6CB6 tube operating as a class A r.f. amplifier. The plate circuit of this stage is band-switched to broadband r.f. coils which supply r.f. output in the 160- and 40-meter bands through an output coupling capacitor to the crystal jack.

Of conventional transformer-selenium rectifier design, the power supply furnishes all high voltage without unnecessary heat. Screen voltage to the oscillator stage is held

**Chassis in three stages of construction.** Underchassis view is shown (left) after mechanical assembly. The variable coil and trimmer capacitor are preset to the mid-range position on wired unit (center). Below, completed unit is being housed in its perforated steel case.

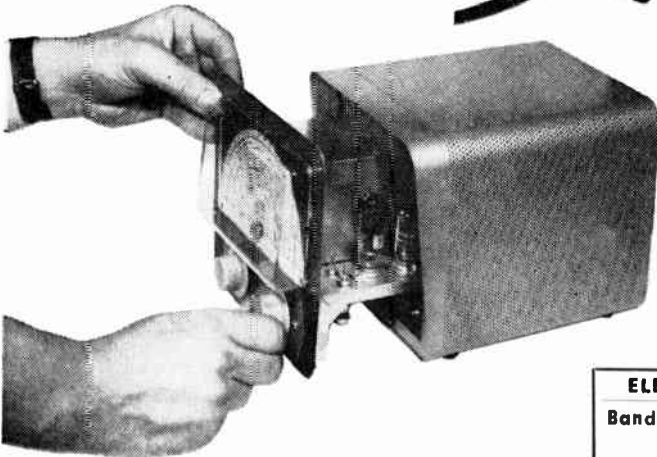
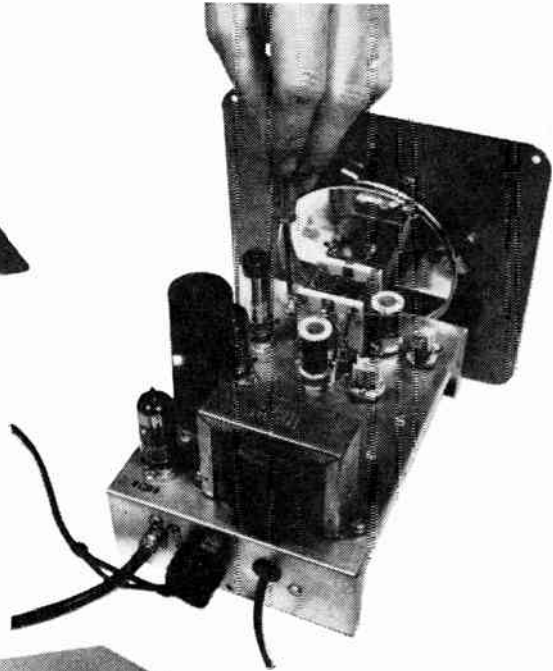

**ELECTRICAL SPECIFICATIONS**

<b>Band Coverage (mc.):</b>	1.75 — 2.0
	3.5 — 4.0
	7.0 — 7.45
	14.0 — 14.3
	21.0 — 21.45
	27.0 — 27.2
	28.0 — 29.8

**Output:** Coaxial cable

**Power Requirements:** 115 volts, 50/60 cycles, 10 watts



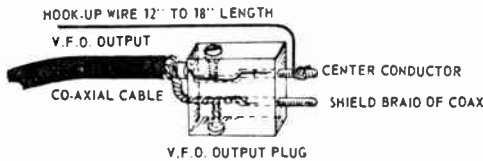
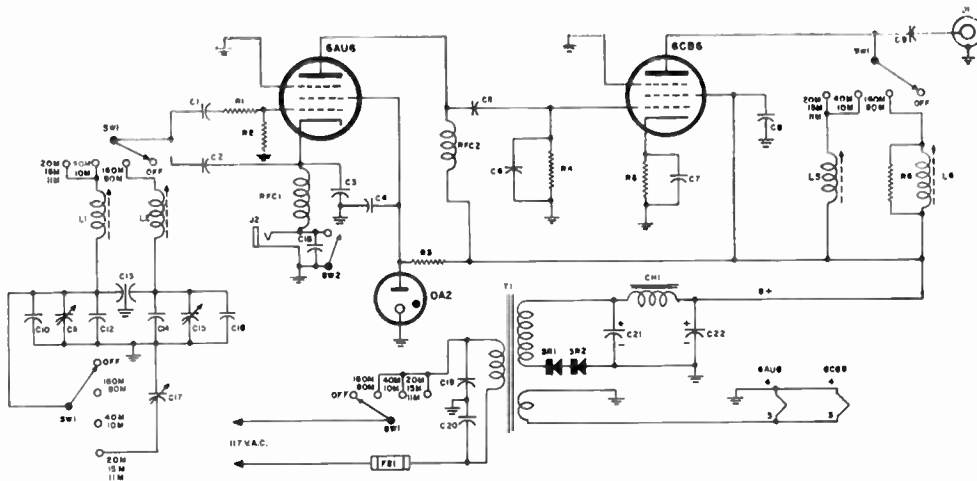

To increase the VFO output signal for frequency checking, add a 12" to 18" wire to the center conductor of the VFO output cable. The plug can be inserted into the crystal jack or the transmitter.

constant by a voltage regulator tube. In addition, the B+ output is stable because the buffer stage operates continuously and oscillator current drain is very low. As a result, keying characteristics are clean, and over-all stability is greatly improved.

### building the kit

Globe Electronics has obviously taken great pains to prepare a top-notch instruction manual. Construction is divided into two parts; mechanical assembly and wiring. Each section is clearly written and easy to follow. An itemized correction sheet is included with the original instruction manual; just pen the suggested corrections into the manual and you'll have no trouble.

Due to the critical nature of wire location, you should follow the instructions and illustrations to the letter. Keep leads short and use a good clean iron.

### calibration

The best technique for VFO calibration is to zero-beat the output signal against the harmonics of a 100,000-cycle crystal oscillator. Use a short-wave receiver to detect the zero-beat signal.

Complete calibration instructions are given in the manual. As a final check, zero-beat the output signal against your transmitter which uses a Novice crystal. Make several spot-checks before placing the VFO in operation. The FCC will thank you by not sending violation notices.

We connected the completed VFO to the crystal jack on a 90-watt transmitter and put it on the air. After a minute of CQ'ing on 3510 kc., a 600-mile DX with a QRK5 report was received.

# Directory of Ham Kits

## EBY SALES CO.

### Model PCK 100 Novice Transmitter

Covers two bands, 40 and 80 meters; uses 6C4 in Pierce-type oscillator and 5763 tuned amplifier; requires no meters for tuning; works into simple antenna system; may be used as exciter for higher powered transmitter; requires 300 volts d.c. at 80 milliamps and 6.3 volts a.c. or d.c.; estimated assembly time 1-2 hours; less tubes and power supply ..\$9.95

**Model PS-100 Power Supply**  
Provides power for Model PCK-100; estimated assembly time 1-2 hours .....\$11.95

### EICO (Electronic Instrument Co., Inc.)

#### Model 730K Modulator



Class B universal modulator; delivers 50 watts undistorted audio; may be used to modulate transmitters having r.f. inputs up to 100 watts; output transformer matches 500-10,000 ohms; low level speech clipping and filtering; inputs for crystal or dynamic microphones and phone patch, etc.; 7 tubes; 6" h x 14" w x 8" d; 21 lbs.

.....\$49.95  
Model E-5 cover .....\$4.50

#### Model 720K CW Transmitter

Provides 90 watts CW, 65 watts external plate modulation; covers 80 through 10 meters; matches load impedances from 50 to 1000 ohms; operated by

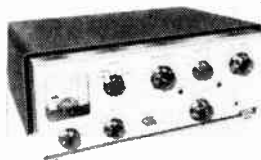

crystal or external VFO; may be used as basic exciter unit; TVI shielded; tubes are 6146, 6CL6, 2-6AQ5, GZ34; 15" w x 5" x 9" .....\$79.95

## ELECTRONIC KITS SUPPLY CO.

### Model CO-1 Code Practice Oscillator

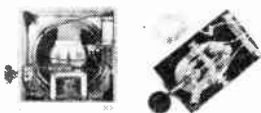

Transistorized code practice oscillator; provides volume adequate for small rooms; estimated assembly time 2-3 hours; includes battery and key....\$6.95

## HEATH COMPANY

### Model RX-1 "Mohawk" Receiver



Covers amateur bands from 160 through 10 meters with extra band calibrated to cover 6 and 2 meters using a converter; crystal controlled oscillators for upper and lower sideband selection; prewired and prealigned front end coil assembly; five selectivity positions from 5 kc

to 500 cps; double conversion i.f.'s; built-in 100 kc crystal calibrator; provides 10 db signal-to-noise ratio at less than 1 microvolt input; front panel features S-meter, separate r.f. i.f., and a.f. gain controls, T-notch tuning, T-notch depth, ANL, AVC, BFO, band-switch tuning, antenna trimmer, calibrate set, calibrate ON, CW-SSB-AM, receive-standby, upper-lower sideband, selectivity, phone jack and illuminated gear driven, vernier slide rule tuning dial; 15 tubes; estimated assembly time 30-40 hours.

.....\$274.95

### Model TX-1 "Apache" Transmitter



Covers amateur band from 80 to 10 meters; 150-watt phone input; 180-watt CW input; may be used for single-sideband transmission with adapter; stable VFO with slide rule dial; adjustable low-level speech clipping; modulator stage uses two 6CA7/EL34's in push-pull class AB operation; time sequence keying; shielded for TVI and stability; output coupling matches antenna impedances from 50 to 72 ohms; 19 tubes; estimated assembly time 50-70 hours. Includes cooling fan.

.....\$234.95

### Model SB-10 Single Sideband Adapter

For plug-in use with Model TX-1; may be used with Model

(For additional information use coupon on page 160)

Electronic Kits

DX-100-B with circuit modifications; operates on 80, 40, 20, 15, and 10 meters; built-in electronic voice control; 3-position sideband selector; power output approximately 10 watts PEP; not self-powered; 10"x6 $\frac{3}{4}$ "x13". . . . . \$89.95

**Model DX-20 CW Transmitter**

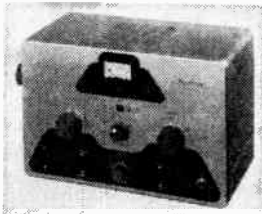

Uses single 6DQ6A tube in final amplifier stage for plate power input of 50 watts; single-knob band switching covers 80, 40, 20, 15 and 10 meters; pi-network output circuit matches various antenna impedances between 50 and 1000 ohms; access for crystal changing provided; estimated assembly time 15-20 hours. . . . . \$35.95

**Model DX-40  
Phone and CW Transmitter**



Provides phone and CW facilities for operation on 80, 40, 20, 15 and 10 meters; 6146 tube in final amplifier stage to provide 75-watt plate power input on CW, or control carrier modulation peaks up to 60 watts for phone operation; modulator and power supplies built in; single knob bandswitching; shielding to minimize TVI; 4-position switch provides convenient selection of three different crystals or a jack for external VFO; crystals reached through rear of cabinet; estimated assembly time 20-30 hours. . . . . \$64.95

**Model DX-100B  
Phone and CW Transmitter**

Features built-in VFO, modulator and power supplies; shielding to minimize TVI; pi network output coupling to match impedances from approximately 50 to 600 ohms; r.f. output in excess of 100 watts on phone and 120 watts on CW, on all ham bands from 10 to 160

on sale at newsstands . . .

or order by mail today!

Popular Photography's New

# 1959 COLOR ANNUAL



Here's one of the outstanding photographic achievements of the year! Compiled by the editors of Popular Photography, the 1959 COLOR ANNUAL is a real gem—over 172 pages, including the year's best color shots and such features as:

- A symposium of experts on WHAT MAKES A GOOD COLOR PICTURE?
- Ten-page portfolios by two masters: Emil Schulthess and Hy Peskin
- How a pro like Ralph Morse solves problem pictures
- A look at color photography by the inventors of Kodachrome
- A forty-page International Portfolio
- Technical review of the year
- Notes on all pictures—why they were chosen, how they were made

The 1959 COLOR ANNUAL is on sale at newsstands or order by mail below:

Ziff-Davis Publishing Company K2/9  
434 South Wabash Avenue  
Chicago 5, Illinois

Please send me \_\_\_\_\_ copies of Popular Photography's 1959 COLOR ANNUAL. I enclose \$1.25 per copy, plus 10¢ to cover cost of handling and mailing.

NAME \_\_\_\_\_  
ADDRESS \_\_\_\_\_  
CITY \_\_\_\_\_ STATE \_\_\_\_\_

# Directory of Ham Kits

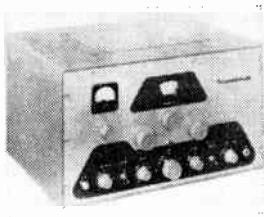

meters; single-knob band switching; illuminated VFO dial and meter face; r.f. output stage uses a pair of 6146 tubes in parallel, modulated by a pair of 1625's; "potted" transformers; silver-plated or solid coin silver switch terminals; aluminum heat-dissipating caps on the final tubes; copper plated chassis; estimated assembly time 40-50 hours. ....\$189.50

## Model AR-3 All-Band Communications-Type Receiver

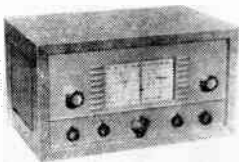

Covers 550 kc to 30 mc in four bands; transformer type power supply; illuminated dial scale; electrical band spread; antenna trimmer; headphone jack; automatic gain control; beat frequency oscillator; ham bands marked on dial scale; accessory sockets for using Model QF-1 and for powering auxiliary equipment; estimated assembly time 12-15 hours. ....\$29.95  
Fabric covered cabinet with aluminum panel.....\$4.95

## Model VF-1 Variable Frequency Oscillator

Covers 160-80-40-20-15-11 and 10 meters with three basic oscillator frequencies; better than 10 volt average r.f. output on fundamentals; voltage regulation; illuminated dial; requires power source of only 250 volts d.c. at 15 to 20 milliamperes and 6.3 volts a.c. at 0.45 amperes; copper-plated chassis; ceramic coil forms; estimated assembly time 5-8 hours. \$19.50

## Model GD-1B Grid Dip Meter

Features continuous frequency

coverage from 2 mc to 250 mc with set of prewound coils and 500-microamp panel meter; sensitivity control for meter; phone jack for listening to "zero-beat"; also doubles as absorption-type wave meter....\$21.95  
Low Frequency Coil Kit (two extra plug-in coils to extend frequency coverage to 350 kc). ....\$3.00

## Model VX-1 Electronic Voice Control

Enables switching from receiver to transmitter by talking into microphone; sensitivity and variable time delay controls; built-in power supply; estimated assembly time 6-10 hours. \$23.95

## Model QF-1 "Q" Multiplier

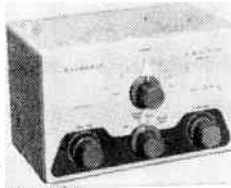

Adds additional selectivity to any AM receiver with i.f. frequency between 450 and 460 kc and is not a.c.-d.c. type; front panel tuning knob; effective Q of 4000; requires 6.3 volts a.c. at 300 ma (or 12 volts a.c. at 150 ma) and 150 to 250 volts d.c. at 2 ma; uses 12AX7 tube and high-Q shielded coils; includes cable and plugs; estimated assembly time 3-5 hours. ....\$9.95

## Model AM-1 Antenna Impedance Meter



Frequency range 0-150 mc; impedance range 0-600 ohms; null indicator 100-microamp meter; estimated assembly time 1-2 hours; 2 1/2"x3"x7". ....\$14.50

## Model PM-1 RF Power Meter

Indicates r.f. output radiation from any transmitter antenna; operates with any transmitter having output frequencies between 100 kc and 250 mc; sensitivity 0.3 volts rms full scale with control allowing for further adjustment of sensitivity; requires no batteries or power and needs no direct connection to antenna; 200-microamp meter mounted on chrome-plated brass panel; estimated assembly time 1/2-1 hour; 3 3/4"xw x6 1/4"x1 x2"d. ....\$14.95

## Model AM-2 Reflected Power Meter

Handles peak power of over 1 kilowatt and may be left in the antenna system feed line at all times; band coverage 160 meters through 6 meters; input and output impedances for 50 or 75 ohm lines; no external power required; meter indicates percentage forward and reflected power, and standing wave ratio from 1:1 to 6:1; may be used for matching impedances between exciters or r.f. sources and grounded grid amplifiers; estimated assembly time 2-3 hours; 7 3/8"x4 1/8"x4 5/8". \$15.95

## Model B-1 Balun Coil

Matches unbalanced coax lines to balanced lines of either 75 or 300 ohms impedance; enables transmitters with unbalanced output to operate into balanced transmission line; can be used over the frequency range of 80 through 10 meters, and will handle power inputs up to 250 watts; 9" square by 5" deep; may be located any distance from transmitter or antenna; enclosed for outdoor installation; estimated assembly time 1-2 hours. ....\$8.95

## PM-2 Power Meter Kit

Picks up energy from mobile antenna and indicates when transmitter is tuned for maximum output; variable sensitivity control; magnet on swivel mount for securing to dash board of

Electronic Kits

(For additional information use coupon on page 160)

# Directory of Ham Kits



car; has built-in antenna; 200  $\mu$ a meter . . . 2 pounds; estimated assembly time—2 hours. . . . . \$12.95

## MP-1 Mobile Power Supply Kit

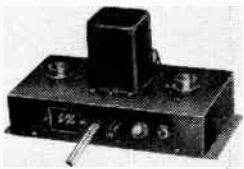

Heavy duty transistor power supply; two 2N442 transistors; 400 cps. switching circuit supplies 120 watts dc.; intermittent operation up to 150 watts dc.; includes 12' heavy battery cable; tap-in studs; uses 12-14 volt battery; relay allows push-to-talk mobile operation; 9 $\frac{1}{8}$ "x 4 $\frac{3}{4}$ "x2" . . . 7 pounds; estimated assembly time—6 hours. . . . . \$44.95

## MT-1 "Cheyenne" Mobile Ham Transmitter Kit



High power mobile operation with minimum battery drain; up to 90 watts input on modulation peaks with carrier control modulation; covers 80, 40, 20, 15, 10 meter bands; VFO, modulator, 4 RF stages, 61-46 final amplifier; pi network (coaxial) output coupling; requires 500-600 volts dc. at 150 ma and 300 volts dc. at 100 ma; mounting holes on top, bottom, and sides for mounting receiver MR-1; ceramic microphone insures effective modulation response; push-to-talk switch; 19 lbs. . . . . estimated assembly time—32 hours . . . . . \$99.95

## MR-1 "Comanche" Mobile Ham Receiver Kit

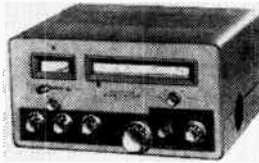

Eight tube superhet ham receiver for AM, CW, SSB, on the 80, 40, 20, 15, 10 meter amateur bands; 3 mc. crystal IF filter permits usage of a single conversion without image interference; circuit includes RF stage, converter, 2 IF stages, 2 detectors, limiter, 2 audio stages and voltage regulator; sensitivity 1 mv all bands; signal to noise ratio better than 10 db. at 1 mv; provides 2 full watts undistorted audio output; wired for either 6 or 12 volts; . . . 19 lbs.; estimated assembly time—32 hours. . . . . \$119.95

## INTERNATIONAL CRYSTAL MFG. CO.

### Model IFA-10 I.F. Amplifier

Frequency range 600 kc through 30 mc; plate power 250 volts at 4-6 ma; heater power 6 volts at 450 ma; 6AH6 tube; printed circuit construction; estimated assembly time 1/2-1 1/2 hours; 2 $\frac{7}{8}$ "x2 $\frac{3}{16}$ "x3 $\frac{1}{2}$ " . . . . . \$5.75

### Model VFA-1

#### Cascode Preampifier

Frequency range 50-54 mc or 144-148 mc (specify); plate power 250 volts at 10-15 ma; heater power 6.3 volts at 400 ma; 6BQ7A tube; printed circuit construction; estimated assembly time 1/2-1 1/2 hours; 2 $\frac{7}{8}$ "x2 $\frac{3}{16}$ "x3 $\frac{1}{2}$ " . . . . . \$4.75

### Model T-12 Transmitter

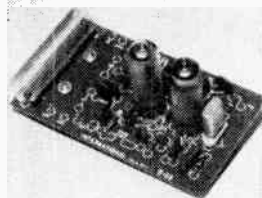

Frequency range 3500-4000 and 7000-7300; power input to final 12 watts; power output 7 watts; output impedance matches 50-500 ohms; plate requirements 350 volts d.c. at 50 ma; filament

requirements 6.3 volts a.c. at 1.35 amp; tubes are 12BH7 and 5763; printed circuit construction; estimated assembly time 1/2-1 1/2 hours; 3 $\frac{1}{2}$ "x6"x3 $\frac{1}{4}$ " . . . . . \$8.95

### Model FO-6 Transmitter

Midget 6-meter transmitter; crystal oscillator range 48 to 54 mc; Type FA-5 crystal required; plate power requirements 250 volts at 20 ma; filament power requirements 6.3 volts at 450 ma; printed circuit construction; estimated assembly time 1/2-1 1/2 hours; 2"x2 $\frac{3}{4}$ "x2 $\frac{3}{4}$ " . . . . . \$5.95

### STP-50 6 Meter Transmitter

Easily aligned crystal transmitter; tubes are oscillator-buffer 12BY7, final 2E26; uses 12 or 8 mc. fundamental crystal; 30 watts max. input. . . . . \$30.50

### STP-10 10 Watt Modulator

For use with STP-50 transmitter; gain control provided; 6AN8 amplifier and driver, 1635 modulator; output impedance 5000 ohms; maximum output 10 watts; crystal microphone input; 7 $\frac{1}{4}$ "x5"x4". . . . . \$25.25

Microphone . . . . . \$ 3.95

### FO-200 Transmitter

Battery operated 27 mc. transmitter; uses a 1L4 oscillator and 3A4 final amplifier; pi-network coupling; .005% tolerance to meet FCC requirements. \$34.95

### Model FCV-1 6-Meter Converter

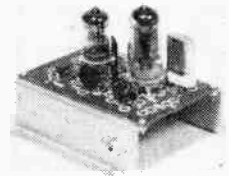

Frequency range 50-54 mc; sensitivity 1 microvolt; output i.f. 600 kc to 1500 kc, 7 mc to 11 mc; plate power required 150 to 250 volts d.c. at 15-20 ma; heater power required 6.3 volts at 625 ma; tubes are 6AK5 and 6J6; printed circuit construction; estimated assembly time 1/2-1 1/2 hours. . . . . \$10.95

### Models 50 and 144 FCV-2 Converter

Frequency range Model 50, 50-54 mc. Model 144, 144-148 mc; sensitivity 0.5 microvolt; output i.f. 600 kc to 4600 kc, 7 mc to

# Directory of Ham Kits

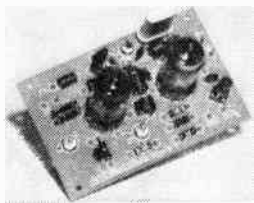

11 mc. special up to 30 mc; crystal frequency Model 50, 49.4 or 43 mc. Model 144, 47.8 or 45.6 mc; plate power 250 volts d.c. at 26-30 ma; heater power 6.3 volts at 850 ma; tubes are 6BQ7A and 6U8; printed circuit construction; estimated assembly time 1/2-1 1/2 hours; 3"x4 1/2"x2 7/8".....\$12.95

### Model FO-1 Printed Circuit Oscillator

Frequency range 200 kc to 15,000 kc; r.f. output 3-10 volts into 1200 ohms; maximum drift  $\pm .002\%$ ; required voltages are 210 volts at 5 ma and 6.3 volts at 150 ma; 6BH6 tube; estimated assembly time 1/2-1 hour. ....\$3.95

**Model FO-1L 100 KC Oscillator**  
Printed circuit oscillator for band edge calibrator and frequency standard use; requires 6.3 volts a.c. at 150 ma and 150 volts d.c. at 8 ma; estimated assembly time 1/2-1 hour.....\$12.95

### Model FO-1B Printed Circuit Oscillator

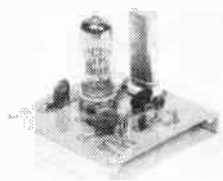

Frequency range 15-60 mc; r.f. output 2-7 volts into 18,000 ohms; maximum drift  $\pm .002\%$ ; required voltages are 150 volts at 8 ma and 6.3 volts at 175 ma; 6AK5 tube; estimated assembly time 1/2-1 hour. ....\$3.95

### Model FMV-1 Multivibrator

Designed to be used in conjunction with the FO-1L 100 kc oscillator to form a complete secondary frequency standard; frequency measurements to 30 mc can be made; requires 12AT7 tube, 6.3 volts a.c. at

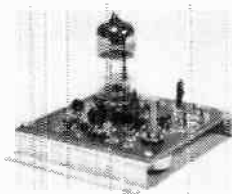

300 ma and 150 volts d.c. at 15 ma; printed circuit construction; estimated assembly time 1/2-1 hour.....\$5.95

### E. F. JOHNSON CO.

#### Viking Adventurer Transmitter

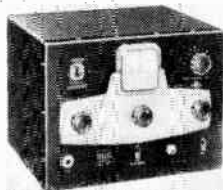

Power input 50 watts; covers 80, 40, 20, 15, and 10 meter bands; TVI suppression; matches antenna impedances from 50 to 600 ohms; 7 3/8"x10 3/8"x8 1/8"; estimated assembly time 6-10 hours; less crystals and key. ....\$54.95

#### Viking Mobile Transmitter

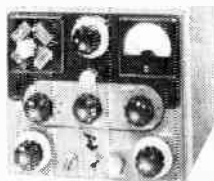

Covers 75, 40, 20, 15, and 11-10 meter bands; mounts under dashboard; 60 watts; 52-ohm output; crystal or external VFO controlled; r.f. fixed bias supply; push-to-talk operation; requires 300-600 volts d.c. at 200 ma; 6 1/8"x7 1/8"x10 5/16"; estimated assembly time 35-60 hours; less tubes, crystals, microphone, and power supply. ....\$107.00

#### Viking Miniature Mobile VFO

Complete with cables and connectors; 4"x4 1/2"x5"; estimated assembly time 8-20 hours; less tubes. ....\$33.95

#### Viking 6N2 Transmitter

Covers 6 and 2 meters; 150 watts CW, 100 watts AM phone; cathode keying; built-in crystal control, may be used



with external VFO; requires power supply-modulator providing at least 6.3 volts a.c. at 3.5 amps, 300 volts d.c. at 70 ma, 300 to 750 volts d.c. at 200 ma, and 30 or more watts of audio; estimated assembly time 15-25 hours; 13 1/8"x8 3/8"x8 1/2"; less crystals, key, and microphone. ....\$129.50

#### Viking "Navigator" Transmitter



Bandswitching coverage of 160, 80, 40, 20, 15, 11, and 10 meter bands; 40 watts CW input; built-in VFO; TVI suppression; matches antenna impedances from 50 to 600 ohms; may be crystal controlled; meter reads final grid and plate currents; 7 tubes; estimated assembly time 20-30 hours; 13 1/4"x9 1/8"x10 1/16". ....\$149.50

#### Viking Ranger Transmitter/Exciter

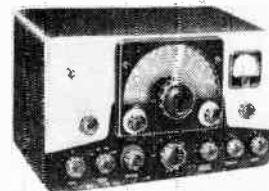

Covers amateur bands from 160 to 10 meters; 75 watts CW or 65 watts phone input; crystal control or built-in VFO operated; 100% AM modulation; matches antennas from 50 to 500 ohms impedance; TVI shielding; will drive any popular kilowatt level tubes when used as exciter; provides power for auxiliary equipment; estimated assembly time 30-40 hours; 15"x11 1/16"x9"; less tubes, crystals, key, and microphone. ....\$229.50

Viking Valiant Transmitter



Covers amateur bands from 160 to 10 meters; 275 watts SSB and CW, 200 watts AM; crystal control or built-in VFO operated; matches antenna impedances from 50 to 600 ohms; TVI shielded; push-to-talk audio; may be used as an exciter; estimated assembly time 30-40 hours; 11 $\frac{5}{8}$ "x21 $\frac{1}{8}$ "x17 $\frac{3}{8}$ "; less crystals, key, and microphone. ....\$349.50

Viking "Courier" Transmitter

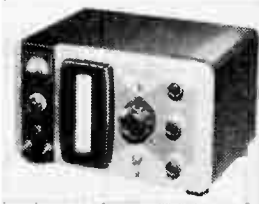

Continuous coverage from 3.5 mc through 30 mc; power input: 500 watts CW, Class C, 200 watts AM linear Class B, 500 watts P.E.P. linear Class B; drive requirements 5 to 35 watts; meter indicates amplifier grid and plate current; output matches 40 to 600 ohms; TVI suppression; built-in power supply and ventilation fan; tubes are 2-811A, 2-866A; estimated assembly time 15-20 hours; 15 $\frac{1}{2}$ "x9 $\frac{5}{8}$ "x14". ....\$244.50

Viking "Thunderbolt" Transmitter



Continuous coverage from 3.5 mc through 35 mc; power input: 1000 watts CW Class C, 750 watts AM linear, 2000 watts P.E.P. linear Class AB2; drive requirements 10-20 watts; two separate meters; output matches 40 to 600 ohms; TVI suppression; built-in power supply and ventilation fans; 10



on your **Hi-Fi** Kit Parade

ACROSOUND • ARKAY • AUDAX • DYNAKIT • WEATHERS • EIGO • KARLSON  
REK-O-KUT • UNIVERSITY

Beat the band . . . when you buy the best . . . at unbeatable prices! Write for your copy of our unusual audio catalog A-10, today!

KEY ELECTRONICS CO.  
120 LIBERTY ST. N. Y. 6, N. Y.

**DYNAKITS**

the finest high fidelity equipment  
in dollar-saving kit form

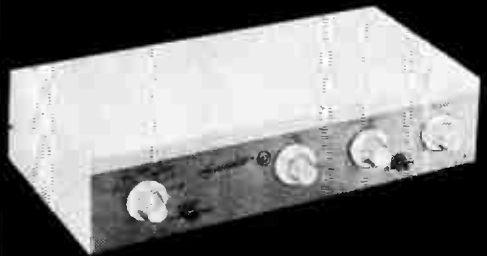

Unequaled simplicity of construction makes it practical for anybody to build Dynakits. The use of premium quality components and advanced engineering techniques provide superior quality of performance and resultant listening pleasure.

**IT'S FUN TO BUILD THE BEST.**

See them at your Hi Fi dealer or write for complete literature.

DYNACO, INC., 617 N. 41st St., Phila. 4, Pa.

# Directory of Ham Kits

tubes; estimated assembly time 15-25 hours; 21"x11 $\frac{3}{8}$ "x16 $\frac{7}{16}$ ".  
.....\$450.00

## Viking "Five Hundred"

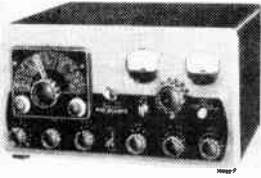

Frequency range: 80, 40, 20, 11, and 10 meters; power input 600 watts CW, 500 watts AM and SSB; operated by built-in VFO or crystal; timed sequence keying; r.f. unit 11 $\frac{3}{8}$ "x21 $\frac{1}{8}$ "x17 $\frac{3}{8}$ ", power supply-modulator unit 10 $\frac{7}{8}$ "x20 $\frac{3}{8}$ "x15 $\frac{3}{4}$ "; estimated assembly time 60-80 hours; less crystal, key, and microphone. ....\$749.50

## Viking 2-meter VFO

Provides output frequencies from 7.995 mc to 8.235 mc; requires 250-300 volts d.c. at 6 ma and 6.3 volts at .3 amp; estimated assembly time 8-20 hours. ....\$29.50

## Viking 6- and 2-meter VFO

Variable frequency oscillator for use on 6 and 2 meters; r.f. output from 7.995 mc to 9.010 mc; uses 6BH6 oscillator and OA2 voltage regulator; requires 250-300 volts d.c. at 10 ma and 6.3 volts a.c. at 0.3 amps; estimated assembly time 8-20 hours; 4"x4 $\frac{1}{2}$ "x5". ....\$34.95

## Challenger Transmitter

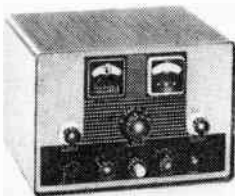

Compact cw transmitter; band-switching between 80 and 6 meters; 6DQ6A buffer drives two bridge neutralized 6DQ6A amplifiers; high-Q, wide-range, pi network coupling from 40 to 600 ohms; 3 RF stages; provision for crystal or external VFO control; 12AX7 dual triode speech amplifier; 6AQ5 clamp modulator provides modulation levels up to 100% with clear audio response; 13 $\frac{1}{4}$ "x10 $\frac{1}{16}$ "x9 $\frac{1}{8}$ "; estimated time of assembly 8-10 hours...\$114.75

## 6N2 VFO

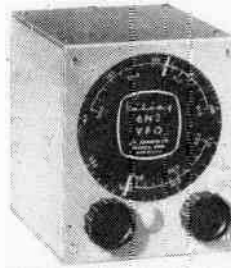

Provides stable frequency control between 6 and 2 meters; 6BH6 series tuned oscillator, OA2 voltage regulator; ceramic insulated air dielectric trimmers; output range 7.995 to 9.010 mc. calibrated 144-148 mc., 50-51.5 mc., 51.5-53 mc., and 53-54 mc.; 10 to 1 vernier tuning .....\$34.95

## 6N2 Converter

Provides instant bandswitching from normal operation to 6 or 2 meters; 6ES8 dual triode RF amplifier with "frame grid" construction in a cascode circuit; semi-remote cut-off characteristics produces minimum cross modulation and overload; double tuned, overcoupled, interstage circuits on both bands provide maximum image and IF rejection; includes RF gain control, 6U8 crystal oscillator multiplier, 6U8 mixer; estimated time of assembly 6-8 hours. ....\$59.95

## KNIGHT-KIT (ALLIED RADIO CORP.)

### Knight-Kit RF Z-Bridge



Measures standing wave ratio from 1 mc to 150 mc; measures impedance on frequencies to 100 mc; for 20 to 400 ohm lines; low-loss coaxial input and output connectors; meter inputs for metering input and bridge voltages; dial gives direct impedance reading; estimated assembly time 1-2 hours; 2 $\frac{1}{2}$ "x3 $\frac{1}{2}$ "x4"; 1 $\frac{1}{2}$  lbs. ...\$5.85

## Knight-Kit Deluxe Amateur Communications Receiver

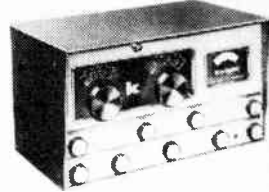

Printed circuits; covers 540 kc to 30 mc in 4 ranges; sensitivity 1.5 microvolts for 10 db signal-to-noise ratio on bands thru 10 meters; selectivity variable from 300 cps to 4.5 kc at 6 db down; calibrated electrical bandspread on the 80-10 meter amateur bands; B+ to HFO is voltage regulated; built-in Q-multiplier; delayed AVC; provision for crystal calibrator; exalted BFO injection; controls are main tuning, bandspread tuning, band selector, Q-multiplier selectivity; Q-multiplier tune, null-off-peak, BFO pitch, r.f. gain, a.f. gain, BFO-MVC-AVC-ANL, off-stby-recv-cal, antenna trimmer; tubes are 6BZ6, 6BH8, 2-6AZ8, 6BC7, 6AW8, 12AX7, 6X4, and OB2; printed circuit construction; estimated assembly time 18-22 hours; 10" x 16" x 10 $\frac{3}{4}$ "; 30 lbs; less phones, loudspeaker, and S-meter. ....\$104.50  
S-Meter Kit.....\$10.75  
Loud Speaker Kit.....\$7.50

## Knight-Kit 50-Watt CW Transmitter

Bandswitching transmitter with 6AG7 Pierce crystal oscillator serves as a buffer-multiplier when used with a VFO; 50 watts input to an 807 final; covers 80 through 10 meters; shielded for TVI suppression; pi-type antenna output permits operation with any type of antenna; matches antenna impedances from 50 to 2000 ohms; cathode keying of oscillator and final; metering of final plate and grid current; provision for external modulator; plug for powering other accessories; controls are oscillator tuning, antenna loading, grid-plate meter switch, on-off; estimated assembly time 8-10 hours; 8 $\frac{1}{2}$ " x 10 $\frac{1}{2}$ " x 8 $\frac{1}{4}$ "; 18 lbs; less crystal and key.....\$38.95

## Knight-Kit VFO

Controls transmitter's frequency; calibrated for 80, 40, 20, 15,



# Directory of Ham Kits

and 10 meters; output on 80 and 40 meters; 40-volt output on 80 meters and 20-volt output on 40 meters; voltage regulated power supply; TVI suppression; tubes are 6BL6, 6AK6, 6X4, OA2; estimated assembly time 5-8 hours; 6" x 6" x 8 $\frac{3}{4}$ "; 11 lbs. ....\$29.50

## Knight-Kit 100 kc Crystal Calibrator

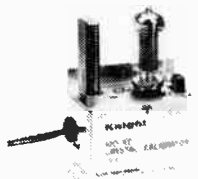

Provides marker every 100 kc up to 32 mc; mounting flanges for in-cabinet mounting; requires 6.3 volts at 0.15 amp and 150-300 volts d.c. at 3-6 ma; trimmer for zero-beating with WWV; estimated assembly time 1 $\frac{1}{2}$ -2 $\frac{1}{2}$  hours; 1 $\frac{1}{2}$ " x 1 $\frac{1}{2}$ " x 3"; 1 lb. ....\$10.95

## Knight-Kit Transistor Code Practice Oscillator

Provides 500 cps tone; low current consumption; output jacks for standard headphone tips; screw type terminals for key; estimated assembly time 1-2 hours; 2 $\frac{3}{8}$ " x 3 $\frac{3}{4}$ " x 1 $\frac{1}{2}$ "; 1 lb. ....\$3.95

## LAFAYETTE RADIO

### Model KT-118 Code Practice Oscillator

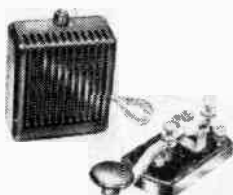

Transistorized audio amplifier; variable pitch audio tone; high-efficiency speaker; less key; 3 $\frac{1}{16}$ " x 2 $\frac{3}{4}$ " x 1 $\frac{3}{8}$ "; estimated assembly time 3-4 hours....\$6.95  
MS-319 Key.....\$1.79

### Model KT-72 Transistor Code Practice Oscillator

Transistorized feedback oscillator circuit; complete with batteries; estimated assembly time

Number 2

2-3 hours; requires headset....  
.....\$2.99

## OLSON RADIO WARE- HOUSE, INC.

### Model KB-53 Transistor Code Oscillator

Operates from standard penlight cell; plastic case; less key and phone; estimated assembly time  $\frac{1}{2}$  hour; 3 $\frac{3}{8}$ " x 2 $\frac{7}{8}$ " x 1 $\frac{3}{16}$ ".  
.....\$3.95

### Model KB-57 Dry Cell Rejuvenator

Extends useful life of dry cell batteries; estimated assembly time  $\frac{1}{2}$  hour.....\$2.98

## PHILMORE MFG CO., INC.

### Model NT-200 Novice Transmitter

Power input 25 watts; covers 15, 40, 80 meters; untuned Pierce-type crystal oscillator; tuned output amplifier; less crystals; estimated assembly time 3-6 hours.....\$29.40

### Model CO-206 Code Practice Oscillator

Uses 12AX7 as oscillator-rectifier; less tube, phone, and key; estimated assembly time 2-3 hours; 4" x 4" x 2".....\$8.50

## SPRINGFIELD ENTERPRISES

### Walkie-Talkie Radiophone

Usable at ranges up to 5 miles (depending on natural obstructions); powered by standard radio and flashlight batteries; electronic chassis wired and tested; includes aluminum case, antenna, telephone handset, impedance matching transformers, and quartz transmitting crystal; complete unit weighs less than 5 $\frac{1}{2}$  lbs; estimated assembly time 1-2 hours.

Model TC-144 (variable frequency transceiver circuit; tunes from 144 to 148 mc) ..\$26.92

Model TR-144 (similar to above but with independently tuned receiver and transmitter circuits) .....\$30.92

Model TRX-50 (crystal controlled transmitter and variable frequency receiver; tunes from 50 to 54 mc) .....\$39.90

Model TRX-50-A (similar to above but with transistorized audio booster stage) ....\$41.90

### TRX-28-A Walkie-Talkie Radiophone



Wired and tested; operates on general class amateur bands; tunable from 28 to 30 mc. AVC, transistorized audio amplifier.....\$41.90

### TRX-27-A Walkie-Talkie Radiophone

Chassis is factory wired and meets FCC requirements for citizens' band class "D" 27 mc; requires simple mechanical assembly and soldering; crystal controlled transmitter; 1 watt input to RF stage. ....\$41.90

## VANGUARD ELECTRONICS LABS

### VHF Radio Receiver

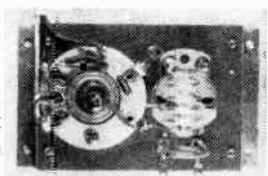

One tube super-regenerative receiver; tunable from 60-200 mc. both AM and FM; output to carphones or audio amp...\$6.99

## WORLD RADIO LABORATORIES

### Model DSB-100 Sidebander

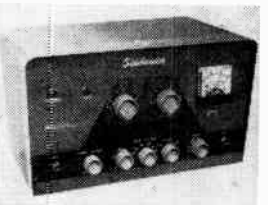

Bandswitching suppressed carrier sideband rig for 80-10 meters with continuous band coverage, 3-9 mc and 12-30 mc; minimum of 35 db carrier sup-

# Directory of Ham Kits

pression on all bands; three-stage r.f. section; internal tone generator; output matches antenna impedances from 52 to 600 ohms; speech clipping and filtering; provisions for powering auxiliary equipment and antenna relay control; estimated assembly time 28-35 hours; 8"x14"x9".....\$119.50

## Model VHF-62 Hi-Bander

Bandswitching transmitter for 6 and 2 meters; power input on 6 meters 70 watts CW. 60 watts AM; power input on 2 meters 60 watts CW, 50 watts AM; four-stage r.f.; fixed bias operation; regulated screen supply; 52 to 72-ohm coaxial output; variable antenna loading control; suitable for use as mobile transmitter; may be used to power auxiliary equipment; 6 tubes; estimated assembly time 25-30 hours; 8"x9"x14".....\$129.95

## Globe 6 Meter Converter

Crystal converter with cascode RF stage, band pass coupling; tubes are 6U8, 6BQ7; printed circuit board; 3"x5 1/2"x4 1/2".....\$21.95

## Model 90A Globe Chief

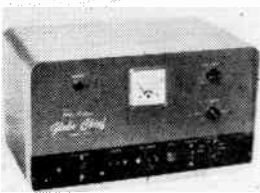

Covers from 160 to 10 meters; 90 watts full input all bands, 75 watts for novice use; matches antenna impedances from 52 to 1000 ohms; modified grid-block keying; provisions for use with external VFO, speech modulator, antenna change-over relay; 2-807 tubes in final plus 6AG7 and 5U4GB; estimated assembly time 15-20 hours; 8"x8"x14 1/2"; 27 lbs. ....\$59.95

## Model 680A Globe Scout

Covers from 6 to 80 meters; 65 watts CW, 50 watts phone; crystal or VFO operation; output matches antenna impedances from 52 to 1000 ohms; TVI-shielded; 6146 final; 5 tubes; estimated assembly time 20-25



hours; 8"x14"x8"; 27 lbs. ....\$99.95

## Model LA-1

Globe Linear Amplifier



Capable of 200 watts input operated AM Class B linear. 300 watts d.c. input, or 420 P-E-P input. Class B linear SSB or DSB; requires 7 to 15 watts r.f. driving power; 200 watts Class C for CW with 18 watts r.f. driving power; covers bands from 80 to 10 meters; matches output loads 30 to 150 ohms; meter indicates final plate currents and approximate r.f. output voltage; estimated assembly time 15-20 hours; 8"x8"x14".....\$99.50

## Model AT-4 Globe Matcher Sr.



Combined VSWR and antenna tuner; handles up to 600 watts r.f. input power; covers from 10 through 80 meters; maximum harmonic attenuation; coaxial input and two-wire balanced output; built-in VSWR bridge indicates reflected voltage SWR; estimated assembly time 5-8 hours; 8"x8"x14".....\$69.50

## Model AT-3 Globe Matcher Jr.

Aids in matching transmitter

output to antenna; operates with transmitters having power input of 100 watts or less; reduces second harmonic distortion when

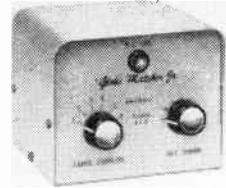

properly tuned; estimated assembly time 1-2 hours; 5"x4"x4".....\$11.95

## Model 6-2 VFO

Designed for driving Hi-Bander and similar transmitters on 6 and 2 meters; temperature compensated; voltage regulated power supply; approximately 50 volts r.f. output; plugs directly into crystal socket of transmitter; estimated assembly time 10-17 hours.....\$49.95

## Model 755A VFO

Calibrated on 160, 80, 40, 20, 15, 11, and 10 meters; output on 160 and 40 meters; series tuned Clapp oscillator circuit; temperature compensated; 50 r.f. volts output; plugs into crystal socket of transmitter; estimated assembly time 8-15 hours; 7 1/16"x6 7/16"x7 7/8".....\$49.95

## Model PB-1 Power Booster

Allows straight-through operation on 6 meters; 50% more power output while attenuating harmonic and further suppressing TVI; estimated assembly time 3-5 hours.....\$14.95

## Model FCL-1 Speech Booster

Improves intelligibility of speech in radio communications; frequency response 300 to 2500 cps; higher and lower frequencies clipped filtered; suppresses harmonics; requires operating voltages; plugs directly into Globe Scout and Globe Hi-Bander; connects between microphone and transmitter microphone input; estimated assembly time 3-5 hours.....\$15.95

## Model UM-1

Universal Modulator

Supplies 10 to 45 watts audio

output to modulate r.f. inputs 8 to 100 watts; may also be used as driver or as PA amplifier; output matching impedances from 500 to 20,000 ohms; provisions for carbon or crystal micro-

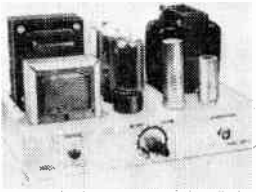

phone, addition of modulator cathode current meter, remote control; uses 6U8, 5U4, 2-6L6; estimated assembly time 7-10 hours; 6"x7"x11"; less tubes. . . . . \$32.50

**Model CPO-3 Code Oscillator**  
Transistorized code practice oscillator; screw terminal input; phone jack output; printed circuit construction; complete with batteries; estimated assembly time 2-4 hours; 1 5/8"x2 1/8"x4". . . . . \$4.95

**Model SM-90 Screen Modulator**  
May be used with any transmitter having 807 or 6L6 final tubes; plugs directly into WRL Globe Chief; printed circuit construction; not self-powered; estimated assembly time 3-5 hours; tubes are 12AX7 and 12AU7; 5 1/4"x2 7/8"x2 1/8". . . . . \$11.95

**Crystal-Controlled 6-Meter Converter**  
Converts 10-14 mc receivers to receive 50-54 mc; may be used to 49.5 mc; connects between antenna and receiver antenna terminals; requires 6.3 volts at 0.85 ma, 150 to 250 volts at 12 to 20 ma; estimated assembly time 5-8 hours. . . . . \$19.95

**Model VOX-10**  
Designed for voice-operated control of Sidebander and similar transmitters; estimated assembly time 3 1/2-5 hours. . . . . \$19.95

**W8QMT ELECTRONICS MFG.**

**Model EM-25 CW Transmitter**  
CW transmitter; 25 watts input; crystal or VFO controlled; 80, 40, and 20 meter bands; estimated assembly time 4-8 hours; gold and black chassis . . . . . \$22.50

**This is a "Fuzzy Feeler"**



Don't let "fuzzy feelers" of ordinary grille fabric ruin your hi-fi sound. Hear all the sound you paid for with . . .

**Mellotone**

THE HIGH FIDELITY GRILLE FABRIC

At better high fidelity and stereo dealers.

**PURCHASING A HI-FI SYSTEM?**

Send Us  
Your List of  
Components  
For A  
Package  
Quotation

**WE WON'T BE UNDERSOLD**

All merchandise is brand new, factory fresh and guaranteed.

**AIREX RADIO**

CORPORATION

64-EK Cortlandt St., N. Y. 7 CO 7-2137

**PARTIAL LIST OF BRANDS**

- Altec Lansing
- Electrovoice
- Jensen • Hartley
- University
- Acoustic Research
- Janszen
- Wharfedale
- Karlon
- Viking
- Concertone
- Bell • G.E.
- Weathers
- Harman—Kardon
- Eico • Pilot
- Sherwood
- Acrosound
- Fisher
- Bogen • Leak
- Dynakit
- H. H. Scott
- Pentron
- Ampro • VM
- Revere • Challenger
- Wollensack
- Garrard
- Miracord
- Glaser-Stears
- Components
- Rek-O-Kut
- Norelco
- Fairchild
- Pickering • Gray
- Audio Tape
- Full Line Cabinets

# BUILD 125 COMPUTERS AT HOME WITH GENIAC®

ONLY  
\$19<sup>95</sup>

With the 1959 model GENIAC®, the original electric brain construction kit including seven books and pamphlets, over 400 parts and component rack, and parts tray, and all materials for experimental computer lab plus DESIGN-O-Mat®.

## A COMPLETE COURSE IN COMPUTER FUNDAMENTALS

The GENIAC Kit by itself is the equivalent of a complete course in computer fundamentals, in use by thousands of colleges, schools and industrial training labs and private individuals. Includes everything necessary for building an astonishing variety of computers that reason, calculate, solve codes and puzzles, forecast the weather, compose music, etc. Included in every set are seven books described below, which introduce you step-by-step to the wonder and variety of computer fundamentals and the special problems involved in designing and building your own experimental computers—the way so many of our customers have.

## ANYONE CAN BUILD IT!

You can build any one of these 125 exciting electric brain machines in just a few hours by following the clear cut step by step directions given in these thrilling books. No soldering required . . . no wiring beyond your skill. But GENIAC is a genuine electric brain machine—not a toy. The only logic and reasoning machine kit in the world that not only adds and subtracts but presents the basic ideas of cybernetics, boolean algebra, symbolic logic automation, etc. So simple to construct that a twelve year old can build what will fascinate a PhD. In use by thousands of schools, colleges, etc., and with the special low circuitry you can build machines that compose music, forecast the weather, which have just recently been added.

## TEXT PREPARED BY MIT SPECIALIST

Dr. Claude Shannon, known to the readers of Popular Electronics for his invention of the electronic mouse, that runs a maze, learning as it goes, formerly a research mathematician for Bell Telephone Laboratories is now a research associate at MIT. His books include publications on Communication theory and the recent volume "Automat Studies" on the theory of robot construction. He has prepared a paper entitled "A Symbolic Analysis of Relay and Switching Circuits" which is available to purchasers of the GENIAC. Covering the basic theory necessary for advanced circuit design it vastly extends the range of our kit.

The complete re-designing of the 1958 kit and the manual as well as the special book DESIGN-O-MAT® was created by Oliver Garfield, author of "Minds and Machines," editor of the "Gifted Child Magazine" and the "Review of Technical Publications."

## KIT IS COMPLETE

**Oliver Garfield Co., Inc.** Dept. EK-59  
108 East 16th St., N. Y. 3, N. Y.

Please send me at once the GENIAC Electric Brain Construction Kit, 1959 model. I understand that it is guaranteed by you and may be returned in seven days for a full refund if I am not satisfied.

I have enclosed \$19.95 (plus 80c shipping in U. S., \$1.50 west of Miss., \$2.00 foreign), 3% New York City Sales Tax for N. Y. City residents.

Send GENIAC C.O.D. I will pay postman the extra C.O.D. charge.

Name .....

Address .....

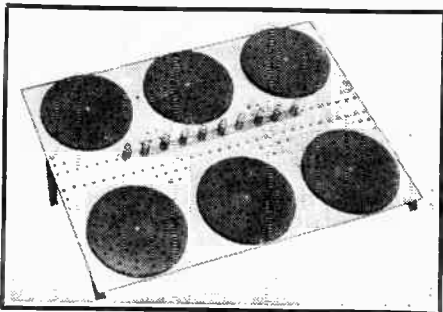

OVER 20,000  
SOLD

We are proud to announce that over 20,000 GENIACS are in use by satisfied customers—schools, colleges, industrial firms and private individuals—a tribute to the skill and design work which makes it America's leading scientific kit. People like yourself with a desire to inform themselves about the computer field know that GENIAC is the only method for learning that includes both materials and texts and is devoted exclusive to the problems faced in computer study.

You are safe in joining this group because you are fully protected by our guarantee, and have a complete question and answer service available at no cost beyond that of the kit itself. You share in the experience of 20,000 kit users which contributes to the success of the 1959 GENIAC—with DESIGN-O-Mat® the exclusive product of Oliver Garfield Co., Inc., a Geniac is truly the most complete and unique kit of its kind in the world.

## COMMENTS BY CUSTOMERS

We know the best recommendation for GENIAC is what is has done for the people who bought it. The comments from our customers we like best are the ones that come in daily attached to new circuits that have been created by the owners of GENIACS. Recently one man wrote: "GENIAC has opened a new world of thinking to me." Another who designed the "Machine that Forecasts the Weather" commented:

"Several months ago I purchased your GENIAC Kit and found it an excellent piece of equipment. I learned a lot about computers from the enclosed books and pamphlets and I am now designing a small relay computer which will include arithmetical and logical units . . . another of my pet projects in cybernetics is a weather forecaster. I find that your GENIAC Kit may be used in their construction. I enclose the circuits and their explanation." Eugene Darling, Malden.

The 1959 GENIAC comes complete with seven books and manuals and over 400 components.

- 1) A sixty-four page book "Simple Electric Brains and How to Make Them."
- 2) **Beginners Manual**—which outlines for people with no previous experience how to create electric circuits.
- 3) "A Symbolic Analysis of Relay and Switching Circuits" By Dr. Claude Shannon provides the basis for new and exciting experimental work by the kit owner who has finished book No. 1.
- 4) **DESIGN-O-MAT®** introduces the user to over 50 new circuits that he can build with GENIAC and outlines the practical principle of circuit design.
- 5) **GENIAC STUDY GUIDE** equivalent to a complete course in computer fundamentals, this guides the user to more advanced literature.
- 6) **A Machine to Compose Music** shows in an actual circuit what other GENIAC owners have been able to do on their own in designing new devices.
- 7) **A Machine to Forecast the Weather**—again a new adventure in scientific thinking created by one of our users who was trained on his GENIAC Kit.

Plus all the components necessary for the building of over 125 machines and as many others as you can design yourself.

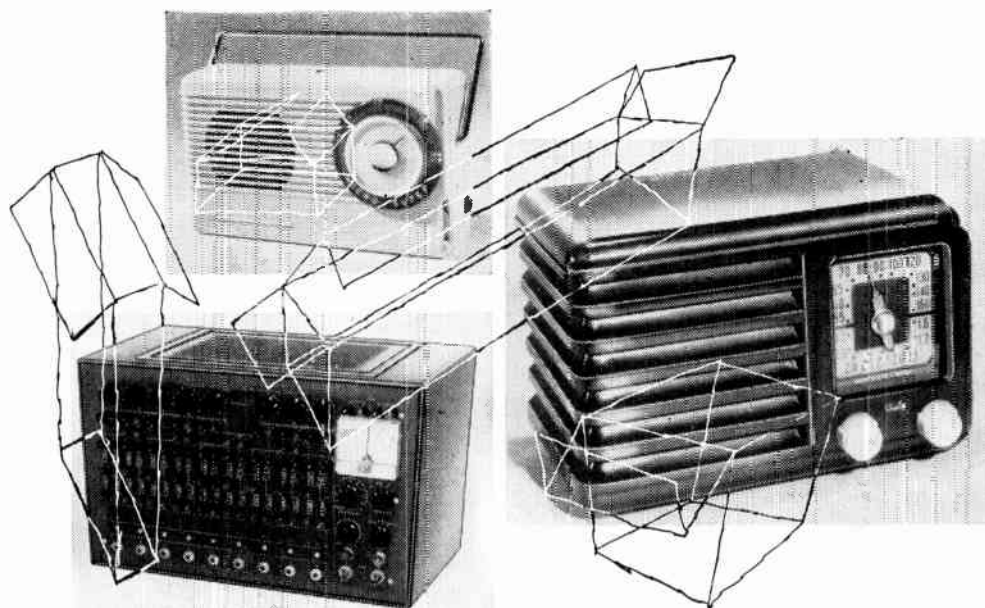

section **IV**  
**kits for fun and education**

<b>Intercom For Your Home</b>	142
<b>A Superhet For Your Table</b>	143
<b>A Radio In Your Pocket</b>	144
<b>Clock Radio</b>	146
<b>Lafayette Telephone Amplifier</b>	148

\* directory  
of kits

for fun and education page 150

# Intercom For Your Home

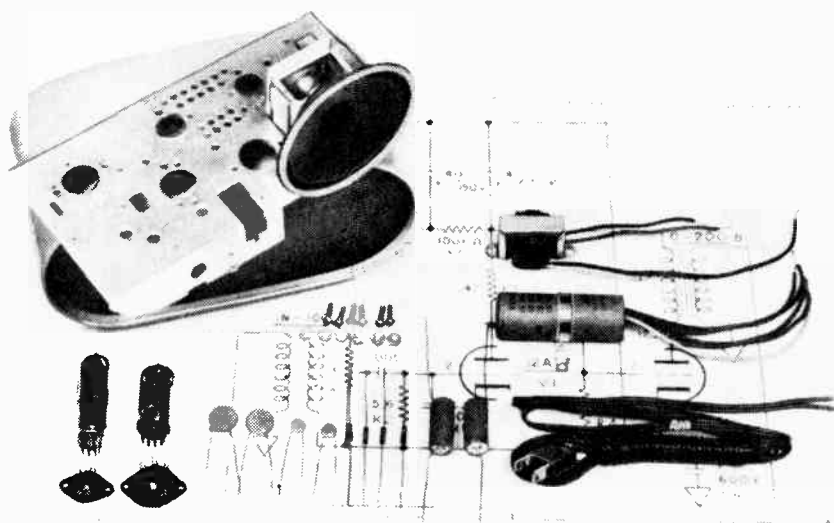

Every housewife wants an intercom for her home. Instead of shouting from room-to-room or floor-to-floor, she can flip a switch and talk in a normal voice. Her voice is amplified by the pickup unit and transmitted by wire or radio waves to another part of the house. Also, if need be, the mother-housewife can use her intercom to keep tabs on Junior. She simply leaves an intercom unit in the playroom and goes about her business. Every sound Junior makes is heard. If Junior gets **TOO QUIET** or **TOO NOISY**, Mom knows something is up. She can then either talk to Junior over the intercom or go upstairs.

Masco (Mark Simpson Mfg. Co., Inc.) offers a two station intercom system kit and a wireless watcher kit to handle these situations. Each has its own merits. The intercom kit consists of a master unit and a remote unit. The units are interconnected by a three conductor cable supplied with the kit. This setup permits two way communications be-

tween stations up to 500 feet away. Any two rooms in a home can be interconnected or a direct line can connect two neighbors. The wireless unit provides only one way communications but requires no wires running through the house. All you have to do is turn on the unit in one room and listen in on any radio in the house. The tuning range of the wireless is 1300 to 1650 kilocycles. Any number of broadcast receivers within 300 feet can be tuned to listen in.

Construction is utter simplicity for both kits. The chassis has almost all parts pre-mounted and all wires are cut to size and color coded. Just mount the remaining parts and start wiring. The circuits used have been tested in millions of phono amplifiers and radios for many years. So, follow the simple directions given in the Masco instruction manual and the kits will work the first time tried. Construction of each station should take no more than one evening.



## A Superhet For Your Table

There's a popular belief among kit builders that anyone can attempt to build an amplifier, but putting together a receiver is strictly for experts with hordes of test equipment.

The Qual AC-DC Radio Kit #250 (Quality Electronics, Inc., 319 Church Street, New York 13, N. Y.) is proof that receivers can be as easy to construct as amplifiers – and will work as well upon completion.

### assembly instructions

Instruction is unusually clear, since the writer of the instruction book takes no knowledge for granted. Everything is explained down to the last detail, from how to solder to distinguishing between #4/40 and #6/32 screws. Chassis room is adequate and well planned.

A source of annoyance came from the fact that the kit doesn't provide wire. If you happen to be the type that has the material on hand, fine. If not, it's another trip to the store.

Of special interest to novices is the introduction in the manual. It amounts to a brief but extremely useful course in how a radio works. This is the type of thing more kit manufacturers would do well to include in their instructions.

### test results

The unit worked upon completion, with one exception—one tube needed replacing. The two I.F. stages were prealigned so no adjustment was necessary. The receiver pulled in stations loud and clear with a minimum of whistling, hum, static noises. The amplification is adequate and the 4" PM speaker offers reasonably good sound. This is a fine little AM Receiver for the price.

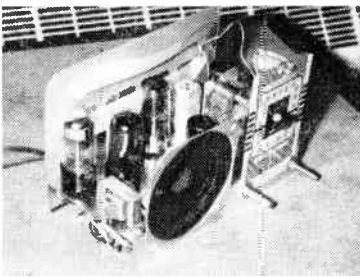

Qual-kit AM receiver has two pre-aligned IF stages. Clear instructions enabled builder to construct kit easily.

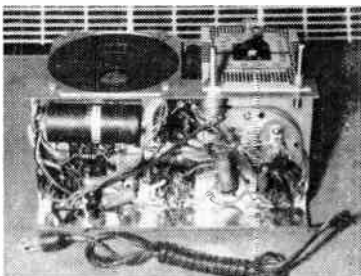

Wiring and soldering should be done with care, observing lead lengths as specified and proper lead dress around the tube sockets.



## **A Radio In Your Pocket**

### **...The Superhet "Sextet"**

As an experiment, the Superex "Sextet" 6 transistor radio was turned over to our editorial assistant as construction project. It was an experiment for a number of reasons. First, she didn't know a capacitor from a printed circuit board. Second she had never handled a soldering iron. And third, the manufacturer labels the kit "for the experienced builder".

The results of the experiment showed that she didn't have to know a capacitor from a circuit board. Second, soldering came easy after a few tries. And third, the manufacturer might scare away a lot of beginners that would enjoy building this kit. We found that experience was not necessary since the kit is planned out so well that it is almost impossible to make an error in assembly. The only difficulty encountered was a number of bad joints due to improper soldering techniques. Be sure to get a good flow of solder over each terminal, but don't apply too much heat as this can damage the printed circuit board.

The secret of the simplicity of assembly is in the printed circuit board. The layout is arranged so that transistor sockets, transformers and other parts can be inserted in only one way. Every hole is marked to show the part that connects to it. Exact size drawings show where each part should go. This type of arrangement make it possible to assemble most of the kit without reading the detailed instructions. This isn't a good practice, since the instructions give you progressive check points where you can make certain that everything has been done right, up to that point.

The instruction manual is clear and concise, and after the cold soldered joints were resoldered the finished unit performed as neatly as it went together.



# BUILD 16 RADIO

**CIRCUITS AT HOME**  
with the New Deluxe  
**PROGRESSIVE RADIO "EDU-KIT"®**

ONLY  
**\$22.95**



**A Practical Home Radio Course**

**Now Includes**

- ★ 12 RECEIVERS
- ★ TRANSMITTER
- ★ SIGNAL TRACER
- ★ SIGNAL INJECTOR
- ★ CODE OSCILLATOR

- ★ No Knowledge of Radio Necessary
- ★ No Additional Parts or Tools Needed
- ★ EXCELLENT BACKGROUND FOR TV
- ★ School Inquiries Invited
- ★ Sold in 79 Countries

**YOU DON'T HAVE TO SPEND  
HUNDREDS OF DOLLARS FOR A RADIO COURSE**

The "Edu-Kit" offers you an outstanding PRACTICAL HOME RADIO COURSE at a rock-bottom price. Our Kit is designed to train Radio & Electronics Technicians, making use of the most modern methods of home training. You will learn radio theory, construction practice and servicing. THIS IS A COMPLETE RADIO COURSE, IN EVERY DETAIL. You will learn how to build radios, using regular schematics; how to wire and solder in a professional manner; how to service radios. You will work with the standard type of punched metal chassis as well as the latest development of Printed Circuit chassis. You will learn the basic principles of radio. You will construct, study and work with RF and AF amplifiers and oscillators, detectors, rectifiers, test equipment. You will learn and practice code, using the Progressive Code Oscillator. You will learn and practice trouble-shooting, using the Progressive Signal Tracer, Progressive Signal Injector, Progressive Dynamic Radio & Electronics Tester and the accompanying instructional material. You will receive training for the Novice, Technician and General Classes of F.C.C. Radio Amateur Licenses. You will build 16 Receiver, Transmitter, Code Oscillator, Signal Tracer and Signal Injector circuits, and learn how to operate them. You will receive an excellent background for television, Hi-Fi and Electronics.

Absolutely no previous knowledge of radio or science is required. The "Edu-Kit" is the product of many years of teaching and engineering experience. The "Edu-Kit" will provide you with a basic education in Electronics and Radio, worth many times the complete price of \$22.95. The Signal Tracer alone is worth more than the price of the entire Kit.

## THE KIT FOR EVERYONE

You do not need the slightest background in radio or science. Whether you are interested in Radio & Electronics because you want an interesting hobby, a well paying business or a job with a future, you will find the "Edu-Kit" a worth-while investment. Many thousands of individuals of all

ages and backgrounds have successfully used the "Edu-Kit" in more than 79 countries of the world. The "Edu-Kit" has been carefully designed, step by step, so that you cannot make a mistake. The "Edu-Kit" allows you to teach yourself at your own rate. No instructor is necessary.

## PROGRESSIVE TEACHING METHOD

The Progressive Radio "Edu-Kit" is the foremost educational radio kit in the world, and is universally accepted as the standard in the field of electronics training. The "Edu-Kit" uses the modern educational principle of "Learn by Doing." Therefore you construct, learn schematics, study theory, practice trouble-shooting—all in a closely integrated program designed to provide an easily-learned, thorough and interesting background in radio. You begin by determining the various radio parts of the "Edu-Kit." You then learn the function, theory and wiring of these parts. Then you build a simple radio. With this first and trouble-shooting. Then you build a more advanced radio, learn more advanced theory and techniques. Gradually, in a progressive manner, and at your own rate, you will find yourself constructing more advanced multi-tube radio circuits, and doing work like a professional Radio Technician.

The "Edu-Kit" course are sixteen Receiver, Transmitter, Code Oscillator, Signal Tracer, and Signal Injector circuits. These are not unprofessional "breadboard" experiments, but genuine radio circuits, constructed by means of professional wiring and soldering on metal chassis, plus the new method of radio construction known as "Printed Circuitry." These circuits operate on your regular AC or DC house current.

## THE "EDU-KIT" IS COMPLETE

You will receive all parts and instructions necessary to build 16 different radio and electronics circuits, each guaranteed to operate. Our Kits contain tubes, tube sockets, variable, electrolytic, mica, ceramic and paper dielectric condensers, resistors, test strips, coils, hardware, tubing, punched metal chassis, Instruction Manuals, hook-up wire, solder, etc. In addition, you receive Printed Circuit materials, including Printed Circuit chassis, special tube sockets, hardware and instructions. You also receive a useful set of tools, a professional electric soldering iron, and a self-powered Dynamic Radio and Electronics Tester. The "Edu-Kit" also includes Code Instructions and the Progressive Code Oscillator. You will also receive lessons for servicing with the Progressive Signal Tracer and the Progressive Signal Injector, a High Fidelity Guide and a Quiz Book. You receive Membership in Radio-TV Club, Free Consultation Service, Certificate of Merit and Discount Privileges. You receive all parts, tools, instructions, etc. Everything is yours to keep.

## PRINTED CIRCUITRY

At no increase in price, the "Edu-Kit" now includes Printed Circuitry. You build a Printed Circuit Signal Injector, a unique servicing instrument that can detect many Radio and TV troubles. This revolutionary new technique of radio construction is now becoming popular in commercial radio and TV sets. A Printed Circuit is a special insulated chassis on which has been deposited a conducting material which takes the place of wiring. The various parts are merely plugged in and soldered to terminals.

Printed Circuitry is the basis of modern Automation Electronics. A knowledge of this subject is a necessity today for anyone interested in Electronics.

## FREE EXTRAS

- SET OF TOOLS**
- SOLDERING IRON
  - ELECTRONICS TESTER
  - PLIERS-CUTTERS
  - ALIGNMENT TOOL
  - WRENCH SET
  - VALUABLE DISCOUNT CARD
  - CERTIFICATE OF MERIT
  - TESTER INSTRUCT. & MANUAL
  - HIGH FIDELITY GUIDE & QUIZZES
  - TELEVISION BOOK & RADIO TROUBLE-SHOOTING BOOK
  - MEMBERSHIP IN RADIO-TV CLUB: CONSULTATION SERVICE, FCC AMATEUR LICENSE TRAINING
  - PRINTED CIRCUITRY

## SERVICING LESSONS

You will learn trouble-shooting and servicing in a progressive manner. You will practice repairs on the sets that you construct. You will learn symptoms and causes of trouble in home, portable and car radios. You will learn how to use the professional Signal Tracer, the unique Signal Injector and the dynamic Radio & Electronics Tester. While you are learning in this practical way, you will be able to do many a repair job for your friends and neighbors, and charge fees which will far exceed the price of the "Edu-Kit." Our Consultation Service will help you with any technical problems you may have.

J. Stathis, of 25 Poplar Pl., Waterbury, Conn., writes: "I have repaired several sets for my friends, and made money. The "Edu-Kit" paid for itself, I was ready to spend \$240 for a Course, but I found your ad and sent for your Kit."

## FROM OUR MAIL BAG

Ben Valerio, Box 21, Mayna, Utah: The "Edu-Kits are wonderful here I am sending you the questions and also the answers for them. I have been in Radio for the last seven years, but like to work with Radio Kits, and like to build Radio Testing Equipment. I enjoyed every minute I worked with the different kits; the Signal Tracer works fine. Also like to let you know that I feel proud of becoming a member of your Radio-TV Club."

Robert L. Shuff, 1531 Monroe Ave., Huntington, W. Va.: "Thought I would drop you a few lines to say that I received my Edu-Kit, and was realy amazed that such a bargain can be had at such a low price. I have a ready started repairing radios and phonographs. My friends were really surprised to see me get into the swifly. The Troubleshooting Tester that comes with the Kit is really swell, and finds the trouble, if there is any to be found."

## UNCONDITIONAL MONEY-BACK GUARANTEE

**ORDER DIRECT FROM AD—RECEIVE FREE BONUS  
RESISTOR AND CONDENSER KITS WORTH \$7**

- Send "Edu-Kit" postpaid.  enclose full payment of \$22.95.
- Send "Edu-Kit" C.O.D. I will pay \$22.95 plus postage.
- Rush me FREE descriptive literature concerning "Edu-Kit."

Name .....  
Address .....

**PROGRESSIVE "EDU-KITS" INC.**  
1186 Broadway, Dept. 502AH, Hewlett, N. Y.

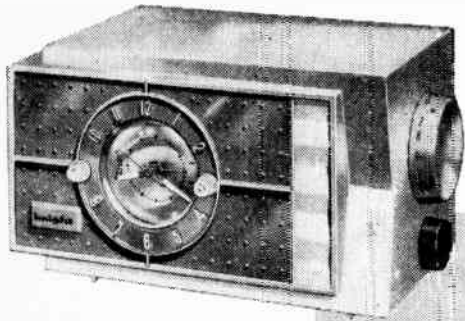

## Clock Radio

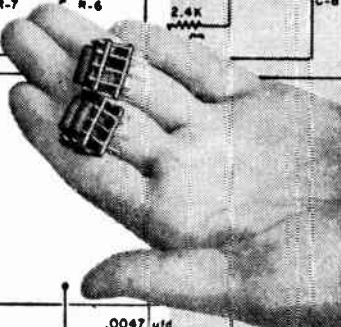
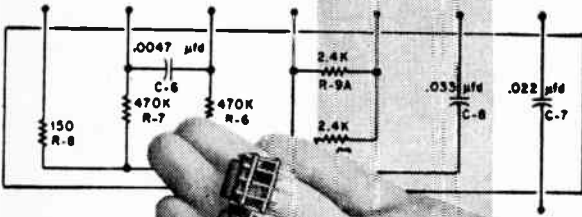

...Knight-Kit "Ranger"

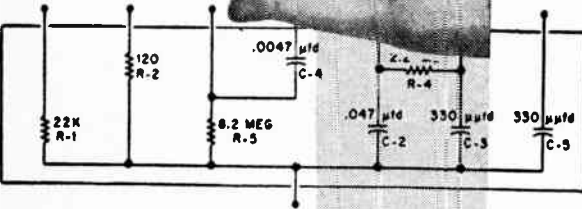

One of the finer quality clock-radio kits available, the Knight-Kit "Ranger" has an efficient superhet circuit which provides excellent reception

of the entire broadcast band. In addition, the Telechron clock has a versatile sleep-switch timer plus an automatic wakeup alarm switch.

Besides providing listening pleasure and the correct time, here is what this clock radio can be set up to do for you:

- Shut off the radio automatically, after any interval up to one hour, so you can drift off to dreamland with music.
- Turn on the radio in the cold light of dawn to provide wake-up music.
- For heavy sleepers, sound an alarm 10 minutes after wake-up music comes on.
- Turn on your electric coffee-maker at the same time you wake up to music.

### printed-circuit boards

Assembly is simplified by the use of a printed-circuit board. There's no chance for error here, since the component identification markings are stenciled directly on the board. Two special ceramic modules which incorporate all the resistors and capacitors used by the receiver are soldered on the board.

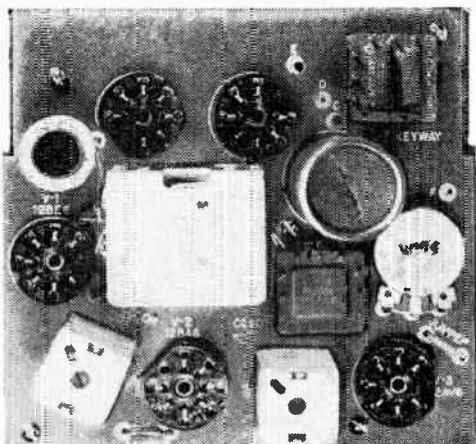

All parts of the "Ranger" except the Telechron clock and speaker are mounted and soldered on the printed-circuit board. Square cardboard sleeves are slipped over the i.f. transformers to reduce shock hazards.

The Telechron clock and a.c. power circuits are wired as a unit. Then the clock power circuit and PM speaker are connected to the printed-circuit board and the board is mounted in the plastic cabinet.

#### testing

Alignment of the "Ranger" is no problem. When the set was first turned on, it worked without alignment—all local stations came in clean and clear. But as a check of the Knight-Kit instructions, the set was purposely misaligned. Using the plastic alignment tool supplied with the kit, the clock radio was successfully retuned in a matter of minutes.

#### comment

The expertly designed module components and printed-circuit board reduced assembly time to two hours. No special tools were used—only pliers, cutters, screwdriver and soldering iron. The clearly written, step-by-step instructions and giant-size diagrams helped in assembling the professional-looking clock radio. Anyone can build this kit—try it, it's fun.

Number 2

## Grammes Little Genie HIGH FIDELITY KITS

• LAYER BUILT • COLOR GUIDE

"So simple . . . it's like magic"

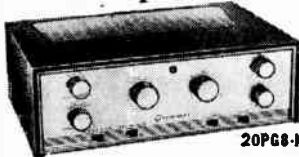

20PG8-K

Before you build another kit, see this new method of kit assembly. Each kit complete with all parts and instructions.

20PG8-K 20 Watt Amplifier with built-in preamplifier and all controls. Net 59.50

LJ-6K 10 Watt Amplifier (Little Jewel). Has built-in preamplifier and record compensator on phono channel. Net 24.95

207A-K Hi-Fi Preamplifier (Self-Powered). Feedback circuit with 10 controls. Net 44.50

250-K 60 Watt Basic Hi-Fi Amplifier. For use with a preamplifier (such as 207A-K). Net 79.50

Grammes—Div. of Precision Electronics, Inc.  
Dept. K-59, 9101 King St., Franklin Park, Ill.

Name of Dealer \_\_\_\_\_

Send complete Kit details.

Kit

Check or M.O. enclosed

C.O.D. \$5 enclosed

Name \_\_\_\_\_

Address \_\_\_\_\_

City \_\_\_\_\_

Zone \_\_\_\_\_

State \_\_\_\_\_

# FREE

## GIANT NEW 1959 B-A CATALOG

A COMPLETE BUYING GUIDE FOR EVERYTHING IN  
**RADIO TV ELECTRONICS**

**180 KING-SIZED PAGES**

EVERYTHING IN RADIO TV AND ELECTRONICS

100'S OF NEW ITEMS LISTED HERE FOR 1st TIME

21 PAGES OF BARGAINS NOT IN ANY OTHER CATALOG

**BURSTEIN-APPLEBEE CO.**  
Dept. EEK, 1012 McGee St., Kansas City 6, Mo.

Send Free 1959 B-A Catalog No. 591.

SEND FOR IT TODAY

Name \_\_\_\_\_

Address \_\_\_\_\_

City \_\_\_\_\_ State \_\_\_\_\_

*the whole family can  
listen in with a . . .*

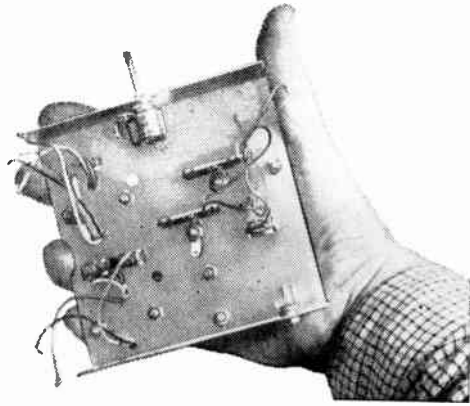

## Lafayette Telephone Amplifier

**Note size of chassis in photo at upper right. Completed amplifier (below, right) can be installed at a much greater distance from the telephone than shown here.**

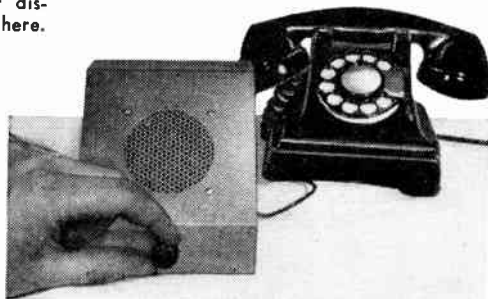

Many electronic items currently being transistorized do not, in terms of their function, really warrant the redesign required. Some products, such as the Lafayette kit described below, benefit from use of transistors. Minimum hum pickup, instant warmup, and compact dimensions are achieved.

The KT-131 is a four-transistor amplifier fed by an inductive telephone pickup and operating a 4" speaker. The unit will permit the whole family to enjoy long-distance phone conversations with relatives and friends. It's invaluable for group listening on business calls and conferences. Other uses may suggest themselves to you after you have built the amplifier.

### putting it together

The components come neatly packaged in polyethylene bags and plastic boxes. Construction directions follow the step-by-step method.

The pictorial diagrams are so clear, and there are so few components to work with, that your reviewer abandoned the step-by-step procedure about halfway through. If Lafayette had marked the component values on the pictorial, the wiring time would have been less than 2½ hours.

All subminiature components require a small-tip iron for soldering; the transistor socket lugs, in particular, require special care to prevent shorts from developing.

The speaker is mounted separately in the sloping-front cabinet and wired to the amplifier in the last steps of the manual. Required for operation, but not supplied with the kit, are an inductive telephone pickup coil and a small 9-volt battery.

### circuit features

Despite the use of four transistors, the telephone amplifier has surprisingly few components to be soldered into place. Transformer coupling between the driver stages accounts both for the small number of parts and the very high gain of the amplifier.

All four of the transistors are CK722 or 2N107 types in a standard base-fed circuit. A class "B" push-pull output stage drives the speaker.

The telephone amplifier operated from the moment it was turned on. The Lafayette telephone pickup coil, when used with a high-gain tube amplifier, tends to be particularly responsive to hum and noise unless a great deal of care is taken to avoid ground loops and spurious inductive pickup. The transistor amplifier, however, is not particularly sensitive to a.c. hum pickup.

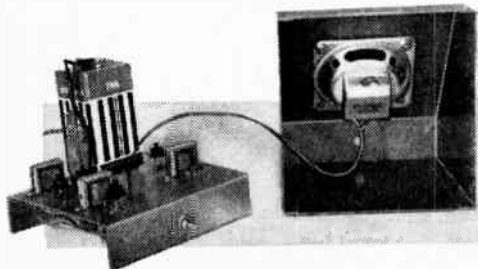

Amplifier chassis before installation in cabinet.

on sale at newsstands . . .

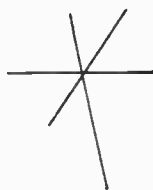

or  
order  
by  
mail today!

## POPULAR PHOTOGRAPHY'S New Guide To 35-MM Photography!

Here for the first time is a complete guide to 35-MM, prepared by the editors of POPULAR PHOTOGRAPHY, the world's largest selling photo magazine. If you now own a 35-MM camera or plan to buy one soon, this Annual will be invaluable to you. In it, you'll find everything you want to know about 35-MM photography in six big sections covering:

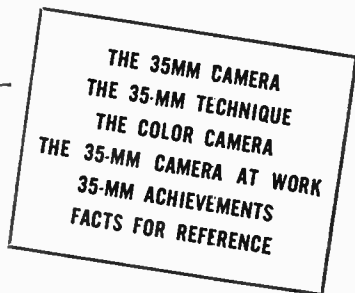

**PLUS: BOB SCHWALBERG ON 35-MM:** a 40-page complete guide to miniature photography by the leading writer and technician in the field.

**POPULAR PHOTOGRAPHY'S 35-MM ANNUAL** is on sale at newsstands or order by mail below:

Ziff-Davis Publishing Company  
434 South Wabash Avenue  
Chicago 5, Illinois

K 2

Please send me ..... copies of Popular Photography's 35-MM ANNUAL. I enclose \$1.00 per copy, plus 10¢ to cover cost of mailing and handling. (Canada and foreign \$1.25 per copy, plus 10¢)

NAME .....

ADDRESS .....

CITY..... STATE.....

# Kits for Fun and Education

## ACE RADIO CONTROL

### Commander Transmitter



Remote control CW transmitter operating on 27.255 mc; uses 3A4 in triode-connected oscillator; input over 2½ watts; complete with tube and 27.255 mc crystal; multimeter required for initial adjustment; less batteries and simple antenna; 3"x5½"x8"; estimated assembly time 1-1½ hours .....\$9.95

### Commander Receiver

Uses 3S4 tube; two tuning adjustments; complete with relay and tube; multimeter required for initial adjustment; less batteries; estimated assembly time 1-1½ hours .....\$7.95

### Marcytone Transmitter

May be used as single-channel audio transmitter for virtually any nonselective audio receiver; provides variable audio from 1500 to 7,000 cps or from 200 to 3,000 cps with slight circuit modification; may be converted to multi-channel operation; uses 2—3A5 tubes; estimated assembly time 4 hours; multimeter required for initial adjustment; 3"x5½"x8" ..\$18.95

### Marcytone Receiver

Single-channel receiver; may be converted to multi-channel re-

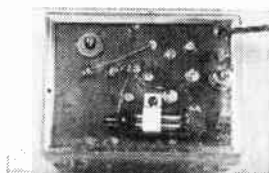

ceiver; uses 6007 detector and 2 Philco T0037 transistors; current rise in relay stage is from 100 microamps to over 4.5 milliamps; estimated assembly time 4 hours .....\$17.95

### WAG TTPW Transmitter

Designed for use with WAG TTPW receiver; uses two tones and pulse width systems; provides for dual proportional control of both rudder and elevator; may be used as CW or single audio transmitter; push-button motor control; includes 8 tubes, 13 mc crystal, 112" telescoping antenna; less batteries; estimated assembly time 12 hours; not recommended for beginners or those with limited R/C experience; multimeter required for initial adjustment; 8"x10"x10" .....\$74.95

### WAG TTPW Receiver

Designed for use with WAG TTPW transmitter; 6007 super-regenerative detector; 1AH4 amplifier; provides proportional rudder and elevator control through actuators; fail safe when worked with escapement or servo; estimated assembly time 8 hours; not recommended for beginners or those with limited R/C experience; VTVM required for initial adjustment .....\$39.95

## AMERICAN BASIC SCIENCE CLUB, INC.

### Home Science Laboratory Series

Provides materials to perform experiments in basic electricity, principles of light, photography, etc.; Kit # 1 covers magnetism, static electricity, d.c. electricity, and a.c. electricity; Kit # 2 covers heat and electricity, resistance, vacuum tube rectifiers and capacitors; Kit # 3 covers vacuum tube amplifiers, oscillation, and sound; Kit # 4 covers microphones, radio receivers, radio transmitters, and signal tracing; Kit # 5 covers the nature of light and optical lenses and equipment; Kit # 6 covers experiments in light using mirrors and prisms, microscopes, spectroscopes, ultraviolet light, etc.; Kit # 7 covers photography, including experiments with enlarger, electronic timer, printing, photo micrography, assembling 35-mm slide projector, and experiments with photoelectric devices; Kit # 8 covers experiments with weather station instruments and experiments with atomic energy; available only in complete set of 8 kits.....\$29.60

## ARKAY RADIO KITS

### Model TR-5 Pocket Transistor Receiver

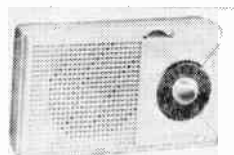

(For additional information use coupon on page 160)

Electronic Kits

# Kits for Fun and Education

Five-transistor superhet printed circuit; plays through built-in speaker or through earphone; built-in antenna; battery life approximately 150 hours intermittent service; estimated assembly time 7-10 hours.....\$29.95

## ATOMIC LABORATORIES, INC.

Atomotron



Allows experiments with static electricity; makes artificial lightning, etc.; produces 75,000 volts on 2" diameter sphere; safe for children; 6" high; estimated assembly time ¾-1½ hours .....\$14.95

## BERKELEY ENTERPRISES, INC.

### "Brainiac"

Allows the construction of over 100 small electric brain machines such as logic machines, game machines, computers, puzzle-solving machines, quiz machines, signaling machines, and cryptographic machines; over 450 parts; no soldering necessary .....\$17.95

## EDUCATIONAL ELECTRONICS CO.

### Model 115 Crystal Radio

Features factory-wound coil, mounting base, and crystal; includes earphone; estimated assembly time ½ hour....\$3.00

### Model 105

Germanium Diode Radio  
Pre-wound coil; includes mounting board, all necessary hardware; and headphone; estimated assembly time ½ hour....\$4.95

### Model 140-8 Transistor Radio

Pre-soldered assembly; one-transistor circuit; includes earphone; estimated assembly time ½ hour.....\$7.95

### Model 110 2-in-1 Radio

Allows broadcasting through any AM radio or phono; pre-wired and pre-soldered; uses



3A5 tube; battery-operated; estimated assembly time 1-2 hours.....\$9.95

### Model 130 4-in-1 Transistor Radio

Allows the construction of the following projects: radio receiver, germanium diode receiver; code practice blinker; Morse code practice key; no soldering necessary; includes earphone; estimated assembly time 1-2 hours.....\$9.95

### Model 204 Portable Radio

Features 3A5 tube, built-in antenna, plastic case, and headphone; battery-operated; estimated assembly time 1-3 hours.....\$12.95

### Model 180 Transistor Portable



Features 2 transistors, germanium diode, and miniature speaker; battery-operated; estimated assembly time 2-3 hours.....\$19.95

### Model 212 Short Wave Converter

May be used with any AM receiver to pick up short wave broadcasts; estimated assembly time 3 hours.....\$14.95

### Model 102 7-in-1 Lab Kit



Allows the construction of the following educational projects: one-tube radio, code practice key, signal tracer, wireless home broadcaster, code blinker, sine wave generator, wireless code practice key; estimated assembly time 3-4 hours.....\$15.95

### Model 208

#### 10-in-1 Transistor Lab Kit

Allows the construction of the following educational projects: germanium diode radio, transistor receiver, transistor receiver with one-stage amplification, wireless code practice key, code practice oscillator, code blinker light, wireless home broadcaster, sine wave clipper, audio preamplifier, transistor sun battery receiver; includes sun battery, transistor, headphone, etc.; estimated assembly time 1-2 hours.....\$12.95

### Sky Chief Loudspeaker Radio Kit



Easily assembled kit; no soldering, all parts fit into clips; PM speaker, 2 tubes; finished wood cabinet; estimated time of assembly 1-3 hours.....\$16.95

## ELECTRONIC BRAIN ENTERPRISES, INC.

### "Allsolver"



Solves algebra, simultaneous equations, trigonometry and special problems; finds the sin, cos, tan of angles, set the powers, roots, and logs of numbers; answers read on calibrated dial; battery-operated; estimated assembly time 5-6 hours...\$56.50

### Model TR-1 Transistor Digital Experimental Kit

Provides parts and instructions for basic digital computer circuits; covers units such as flip-flops, multivibrators, etc.; may be expanded to enable large number-handling; knowledge of algebra required; transistor operated; battery included; estimated assembly time 20-30 hours.....\$72.50

### Model 9C Experimental Analog Computer

Provides electronic parts and instructions to build an experimental computer containing 4

# Kits for Fun and Education



operation amplifiers, 2 regulated power supplies, quarter-square multipliers, meter, etc.; solves all types of algebra problems and differential equations; thorough knowledge of algebra essential; estimated assembly time 25-30 hours.....\$138.50

### Model TR-2 Advanced Digital Experimental Kit

Similar to Model TR-1, but includes more parts making possible more experiments and more complicated problems in switching and problem solving; estimated assembly time 30-40 hours.....\$138.50

### Model 10E Analog Computer

Complete analog computer; may be used to add, subtract, multiply, divide, integrate, differentiate, average, take absolute values, etc.; dual regulated power supply; 10 operational amplifiers; ten-turn potentiometer; drift less than 10 mv per day; open loop gain: 25,000; may be used not only in solving linear and non-linear problems such as algebra, calculus, and differential equations, but also as an electronics aid and experimental tool; estimated assembly time 60 hours.....\$485.00

## ELECTRONIC ORGAN ARTS, INC.

### Artisan "Theater" Organ



Plate keying; 2 manuals; 61 keys per manual; 32 pedals; 2 volume control pedals; 40 stops; 166 oscillators; 22 preamplifiers; 2 vibratos; 3 output channels; average output: .5 volts; tuning forks required for initial adjustment; estimated assembly time 300-400 hours...\$2195.00

### Artisan "Showman" Organ

Plate keying; 2 manuals; 61 keys per manual; 25 pedals; 1 volume control pedal; 25 stops; 98 oscillators; 14 preamplifiers; 1 vibrato; 2 output channels; average output voltage: .5 volts; tuning forks required for initial adjustment; estimated assembly time 200-300 hours...\$1495.00

## ELECTRONIC KITS SUPPLY CO.

### Model PO-1 Phono Oscillator

Allows the output of a crystal phono cartridge to be picked up on any AM radio with no interconnecting wires; operates from 1200 to 1700 kc; uses 50C5 and 35W4 tubes; estimated assembly time 3-6 hours; metal punch and drill required.....\$4.95

### Model 4SRP Record Player

4-speed motor and turntable; tonearm has turnover crystal cartridge; 13 1/2"x16 3/8" plywood panel; estimated assembly time 4-5 hours; wood drills required.....\$11.95

### Model DT-1 Radio

Diode-transistor circuit; estimated assembly time 4-6 hours; requires external antenna and headphone.....\$4.95

### 3RT1 Private Superhet Transistor Receiver

Three transistors and germanium diode; printed circuit construction using subminiature components; private earphone; estimated assembly time 3-6 hours.....\$15.95

### 5R1 5 Tube AC-DC Receiver

Superhet circuit; built-in antenna; tubes are 12BE6, 12BA6, 12AV6, 50C5, 35W4 rectifier; estimated assembly time 6-12 hours.....\$13.95

### 6RT2

### Portable Transistor Radio Kit

Battery powered, printed circuit superhet receiver; all sub-miniature components; 5 transistors, one diode; 3 1/8"x6 1/8"x1 1/8"; estimated assembly time 6-12 hours w/out battery...\$27.95

## ELECTRONIC (SCIENCE ELECTRONICS, INC.)

### Model T-125 Transistor Set

Allows the construction of the following educational transistor circuits: code practice set, crystal radio set, transistor radio set, crystal and transistor radio set; plug-in construction; no



soldering necessary; operates from flashlight battery...\$10.95

### Model T-150 Transistor Set

Allows the construction of the following educational transistor circuits: voice transmitter, code transmitter, code blinker practice set, and six progressive radio circuits; plug-in construction; no tools or soldering necessary; operates from flashlight battery.....\$14.95

### Model T-175 Two-Transistor Receiver and Broadcast Set

Allows the construction of the following educational two-transistor circuits: code practice set, musical tone producer, code transmitter, 5 progressive radio receivers, 2 voice transmitters; plug-in construction; no tools or soldering necessary; operates from flashlight battery...\$16.95

### Model T-200 15-Circuit Tube Set

Allows the construction of the following educational vacuum tube circuits: shortwave radio, code transmitter, voice transmitter, 2 crystal radios, 6 crystal and tube radios, 2 pentode super radios, code practice oscillator; plug-in construction; no tools or soldering necessary; operates from 1-1 1/2-volt and 1-45-volt batteries (not included).....\$19.95

### Model T-200B (with batteries)

.....\$22.95

### Model 2RF Radio Circuit Kit

Basic training and demonstration unit; allows the construction of 14 radio circuits; 3 tubes; 14 templates; operates with headphones (included); 110 volts a.c. required; in wooden carrying case 5 1/2"x12" x 18".....\$49.50

### Model AC-100 Amplifier Set

Basis training and demonstration unit; serves as introduction to amplifier circuitry; allows the construction of 3-tube amplifier; 110 volts a.c. required; in wooden carrying case 5 1/2"x12"x18".....\$49.50

### Model BE-3 Basic Electricity Set

Provides facilities to build 27 circuits covering basic princi-



# Kits for Fun and Education

ples of electricity and electronics; designed for use with RETMA manuals; in carrying case 5½" x 12" x 18" . . . \$79.50

**Model BE-4 Basic Electronics Set**  
Designed for use with RETMA electronics course; consists of 23 experiments with electronic circuitry; in carrying case 5½" x 12" x 18" . . . \$145.00

**Model BE-5 Basic Electricity/Electronics Set**  
Designed to cover all experiments in BE-3 and BE-4 as well as 8 experiments in RETMA "Basis Radio" course; in carrying case 5½" x 12" x 18" . . . \$190.00

**Model E-10 Development Engineering Set**  
Designed to provide sufficient electronic components to allow the construction of any electronic circuit within the limitations of the system; in portable wooden cabinet with separate drawers for each group of component values . . . \$395.00

## OLIVER GARFIELD CO., INC.

**Model K-1 "Geniac" Electric Brain**

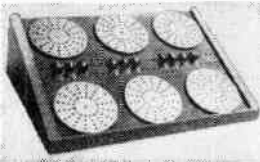

Allows the construction of up to 125 electric brain machines; adds, subtracts, multiplies, divides; plays tic-tac-toe, nim, etc.; composes music; includes four instruction booklets. . . . \$19.95

## GROMMES (PRECISION ELECTRONICS, INC.)

**Model PE-10K PA Amplifier**



Power output 10 watts; frequency response 70 to 10,000 Number 2

cps ± 2 db; controls: microphone, phono, tone, power; hum and noise 60 db below rated output; gain: microphone 105 db, phono 65 db; output impedances 4, 8, 16, and 500 ohms (70 volt line at 10 watts); tubes are 12AX7, 6L6, 6X5GT; estimated assembly time 4-6 hours. . . . \$21.50

**Model PE-30K PA Amplifier**  
Power output 30 watts; frequency response 30 to 15,000 cps ± 2 db; controls: microphone 1, microphone 2, phono, bass, treble, power; hum and noise 70 db below rated output; gain: microphone 125 db, phono 80 db; output impedance 4, 8, 16, and 250 ohms (70 volt line at 20 watts); tubes are 3-12AX7, 2-6L6GB, 5Y3GT; estimated assembly time 6-8 hours. . . . \$39.00

## GYRO ELECTRONICS CO.

**Model EZ900 D.C. Power Converter**

For use with miniature receivers or other electronic equipment; input: 3-6 volts d.c. (Penlite Batteries); output: 30-67½ volts to 7 ma; estimated assembly time 1½-¾ hours; overall size: 1¼" x 1½" x ¾"; less transistors . . . \$5.95

**Model EZ1000 Power Converter**  
Portable transmitter d.c. power converter; for use with portable transmitters or other electronic equipment; input: 4-6 volts d.c.; output: 135v up to 30 ma; estimated assembly time 1½-2¼ hours; overall size: 2" x 3½" x 1¼" . . . \$16.95

**Model EZ-PE Walkie-Talkie**



144 megacycles for radio amateur band; estimated assembly time 2¾-4½ hours. . . . \$7.65  
Complete kit which includes microphone, earphone, cabinet and accessories. . . . \$17.35

**Model EZ233**

**Vibrator Power Supply**  
Input: 2 volts; output: 180v at 40 ma; for use with portable transmitters or other electronic equipment; estimated assembly time 1½-4½ hours. . . . \$6.95

**Model EZ225 Battery Charger**

Will charge any storage battery

from 1½ to 6 volts; charging rate at 2 volts equals 2 amps approx.; charging rate at 6 volts equals 400 ma approx.; charging rate automatically tapers off as battery becomes charged; estimated assembly time 1-2½ hours . . . \$4.95

**Model EZ824**

**Radio Control Receiver**  
27¼ mc; responds to carrier signal; uses simple circuit consisting of one thyatron and one transistor; very low battery drain; estimated assembly time 3-4½ hours; overall size: 1¼" x 2¼" x 1¾" . . . \$13.20

**Model EZ-A1**

**Radio Control Transmitter**  
27.255 mc; for use in control of models; no FCC examination required; estimated assembly time 2¼-4 hours. . . . \$11.95

## HEATH CO.

**Model DF-1 Direction Finder**

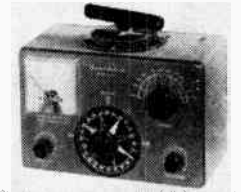

Self-contained, self-powered, 6-transistor super heterodyne broadcast radio receiver incorporating a directional loop antenna, indicating meter, and integral speaker; designed to serve as an aid to navigation when out of sight of landmarks; powered by a 9-volt battery (spare battery included); frequency range covers the broadcast band from 540 to 1600 kc and will double as portable radio; directional high-Q ferrite antenna rotated from front panel to obtain a fix on a station and a 1 ma meter serves as null and tuning indicator; controls: tuning, volume and power (on-off), sensitivity, heading indicator (compass rose) and bearing indicator (antenna index); 7½" w x 5⅞" h x 5⅜" d; slip-in-place mounting brackets; estimated assembly time 8-12 hours. . . . \$54.95

**Model DF-2 Direction Finder**

Two-band transistorized portable radio-direction finder; six-transistor circuit; receives aeronautical and marine beacons as

(For additional information use coupon on page 160)

# Kits for Fun and Education

well as standard broadcast band; ranges are 200-100 kc and 5-10-1620 kc; takes directional "fixes" on broadcast stations and aircraft or marine beacons; controls; sensitivity, bearing, volume, tuning, bandswitch; dial light may be operated with special switch; powered by 6 flashlight batteries; battery life 1 year under normal operation; corrosion, moisture, and fungus proof; estimated assembly time 10-15 hours; 9½" w x 8" h x 5" d. . . . . \$69.95

**Model MC-1 Marine Converter**  
Charges 6 or 12-volt batteries from "shore" current; provides up to 20 amps continuously for 6-volt batteries or up to 10 amps continuously for 12-volt batteries; 25-amp meter; fused primary; convection cooling; silicon rectifier; mounting brackets supplied; estimated assembly time 3-4 hours. . . . . \$39.95

**Fuel Vapor Detector**  
Indicates the presence of fumes on a three-color "safe-dangerous" meter scale; pilot light on the front panel shows when detector is operating; can be left on continuously or used intermittently; panel control enables initial calibration; hermetically-sealed meter with chrome bezel and a chrome-plated brass panel; Models FD-1-6 (6 volts d.c.) and FD-1-12 (12 volts d.c.); operates from boat batteries; spare detector unit. . . . \$35.95

**EC-1 Educational Electronic Analog Computer**

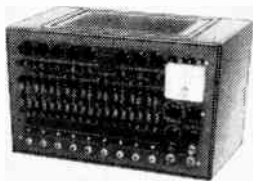

For use in engineering, physics, schools, and colleges; includes 9 d.c. amplifiers, 3 initial condition power supplies, five coefficient potentiometers, 4 sets of relay contacts, electronically operated power supply for automatic operation; precision resistors, Mylar capacitors, silicon diodes; results are read directly on the meter, or externally with an oscilloscope, etc.; manual provided for basic computer information as well as setting up and solving typical problems; . . . 43 lbs.; estimated assembly time—40 hours. . . . . \$199.95

## Model RI-1

### Rudder Position Indicator

Enables operator to see position of rudder at all times; calibrated 60 degrees to port and starboard from dead ahead; operates on 6 or 12-volt battery systems; includes 20 feet of cable and all necessary mechanical linkage; estimated assembly time 2-3 hours. . . . . \$14.95

## Model ET-1 Enlarger Timer

Used in timing enlarger operations; timer dial covers 0 to 1 minute, calibrated in 5-second gradations; continuously variable timing control; enlarger plugged into receptacle on front panel; "safe light" can also be plugged in so that it is automatically turned "on" when the enlarger is turned "off"; handles up to 350 watts with built-in relay; all-electronic timing cycle; does not have to be reset after each cycle (flip lever switch to print to repeat time cycle); control provided for initial calibration; plastic case. . . . . \$11.50

## Model IA-1

### Electronic Ignition Analyzer

Traces dynamic action of voltage in an ignition system on a cathode-ray tube screen; wave form can be analyzed and used as a "sign-post" to ignition system performance; will detect inequality of spark intensity, a poor spark plug, defective plug wiring, breaker-point bounce, an open condenser, and allow setting of dwell-time percentage for the points; checks dynamic performance with engine in operation (400 to 5000 rpm); shows complete engine cycle or only one complete cylinder; can be used on automobiles, boats, aircraft engine, etc. . . . \$59.95

## Model RC-1

### Professional Radiation Counter

Provides high sensitivity with ranges from 0-100, 600, 6000 and 60,000 counts-per-minute, and 0-.02, .1, 1 and 10 miliroentgens-per-hour; employs 900-volt bismuth tube in beta/gamma sensitive probe; probe and 8-foot expandable cable included; radiation sample for calibration; selectable time constant; meter calibrated in CPM or mR/hour in addition to "beep" or "click" from panel-mounted speaker; prebuilt "packaged"

high voltage power supply with reserve capacity above 900 volt level at which it is regulated; changing regulator tube type allows use of scintillation probe if desired; employs five tubes (plus a transistor); includes batteries. . . . . \$79.95

## Model CR-1 Crystal Radio

Uses sealed germanium diodes and "high-Q" coils; two tuned circuits, each with a variable tuning capacitor; covers broadcast band from 540 to 1600 kc; requires no external power; includes headphones; estimated assembly time ½ hour. . . \$7.95

## Model BR-2

### Broadcast Band Radio

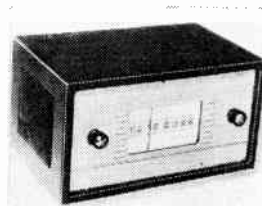

Covers standard broadcast band from 550 to 1600 kc; 5½" PM speaker; high-gain i.f. transformers; miniature tubes; rod-type built-in antenna; power supply transformer operated; estimated assembly time 6-7 hours; less cabinet. . . . \$18.95

## Model XR-1

### Transistor Portable Radio



Six Texas Instrument transistors; 4" by 6" PM speaker; power supply uses six standard size "D" flashlight cells; battery life between 500 and 1000 hours; unbreakable molded plastic cabinet; transformers prealigned; built-in rod-type antenna; 9" l x 8" h x 3¾" d; estimated assembly time 5 hours; less batteries.

Model XR-1P (as shown) . . . . . \$29.95  
Model XR-1L (with leather case) . . . . . \$34.95

## KNIGHT-KIT (ALLIED RADIO CORP.)

**Knight-Kit Crystal Set**  
Allows receptions of local AM stations; employs fixed-type germanium crystal diode detector; estimated assembly time 1-2 hours; less headphones and antenna kit; 1 lb. ....\$2.35  
Headphones  
(1000 ohms) .....\$1.08  
Antenna Kit, 1½ lbs. ....\$1.03

### Knight-Kit "Trans-Midge" 1-Transistor Radio

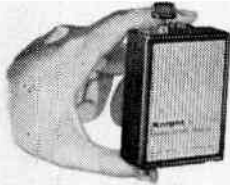

Pocket-size transistor AM radio; battery lasts for months of operation; requires external antenna and headphones; plastic case; estimated assembly time 1-1½ hours; 3⅝" x 2⅝" x 1⅜"; 8 oz. ....\$2.45  
Headphones  
(4000 ohms) .....\$2.15  
Antenna Kit .....\$1.03

### Knight-Kit Printed Circuit Transistor Radio

Covers AM band; includes high sensitivity coil and ball bearing tuning capacitor; estimated assembly time ½ to 1 hour; less headphones and antenna; 3⅛" x 3⅞" x 3"; 1 lb. ....\$3.95

### Knight-Kit "Ocean Hopper" Receiver

Regenerative receiver for long and short wavebands; covers from 155 kc to 35 mc, using coils listed below; controls are tuning, bandspread, antenna trimmer, and off-on/regeneration; tubes are 12AT6, 50C5, and 35W4; broadcast band coil and cabinet supplied with kit; 6" x 9½" x 5"; 7 lbs. ....\$15.95  
Plug-in Coils  
155-470 kc. ....\$0.79  
1.65-4.1 mc .....\$0.65  
2.9-7.3 mc .....\$0.65  
7-17.5 mc .....\$0.65  
15.5-35 mc .....\$0.65  
2000 ohm headset .....\$2.00

### Knight-Kit 5-Transistor Superhet Radio

Battery-operated portable unit; 3½" speaker; ferrite loopstick antenna; phone jack output for use with earphone; 200 hours playing time from single 9-volt battery; two controls: off-on-



## NEW Low Cost Do-it Yourself, Electronic Intercom "Kits"

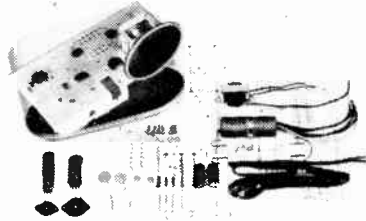

### Easy-to read Construction Manual

Baby Tender Kit (One Station "no wire type") .....\$11.75  
Quick Talk Kit (Two Station Wired Type) .....\$13.95  
Extra Remote Station KQL makes Quick Talk a three station system .....\$ 4.75  
Big Talk Kit (Two Station Wired Type) .....\$18.25  
Big Talk Kit (Extra remote station KBW makes Big Talk a three station system) .....\$ 7.75  
Wireless Watcher Kit (Two Station "no wire type") .....\$31.95  
Extra Remote Station model KWW can be added to wireless watcher.  
Thrifty Talk Kit (6 station wired type for master to remote or master to master installation) .....\$18.75  
Remote Station Kit KTW for use with Thrifty Talk Master when used in master to remote installation.

WRITE FOR FREE CATALOG Number 2500

**MARK SIMPSON MANUFACTURING CO. INC.**  
32-28 49th STREET, LONG ISLAND CITY 3, N. Y.

## NOW . . . All-Transistor R/C Kits by Ace!

The TR 4.5 all-transistor 27¼ mc. receiver includes: reliable operation over a wide temperature range; high current range; long battery life. Requires only 4½ volts of battery—idles at 2 mils, rises to 35-40 mils upon receipt of modulated signal of 400 cycles at 100%. Coils are completely wound. Special ferrite core RFC insures small size; has Allen-Bradley resistors, Goodall capacitors.

Case is aluminated—size: 2" x 2⅞" x 3¼". Weight is approximately 2 oz. Also includes 3 special transformers, special Gem relay, 4 transistors, including a specially selected and tested AO1 for operation at 27¼ mc. Temperature checked from 130° to 20°, and is reliable throughout this range.

Kit Complete—less batteries .....\$22.95

**NEW KITS AND R/C COMPONENTS CONSTANTLY BEING ADDED TO THE ACE LINE. WRITE FOR ILLUSTRATED FREE CATALOG 59A.**

**ACE R/C WEST**  
Box 18, Carmichael, Calif.

**ACE R/C EAST**  
3029 W. Cary St., Richmond, Va.

*Ace Radio Control*

BOX 361

HIGGINSVILLE, MO.

# Kits for Fun and Education

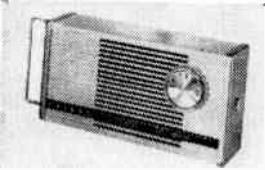

volume and tuning; ivory, black and gold styling; printed circuit construction; estimated assembly time 5-8 hours;  $3\frac{3}{4}'' \times 7\frac{1}{2}'' \times 3\frac{3}{4}''$ ; 2 lbs. less battery and earphones ..... \$25.95  
 9 volt battery ..... \$1.43  
 Earphones ..... \$1.97

**Knight-Kit  
 Space Spanner Receiver**  
 Regenerative receiver; standard AM band and shortwave from .5 to 17 mc; 4" speaker; controls: handspread, main tuning, antenna trimmer, bandswitch, regeneration, volume; output or use with headphones; includes cabinet; estimated assembly time 4-6 hours;  $7'' \times 10\frac{1}{2}'' \times 7\frac{1}{2}''$  lbs. .... \$18.95

**Knight-Kit Two-Transistor  
 Pocket Radio**  
 Requires no external antenna to pick up local stations; single battery provides power for months of operation; two con-



ols: off-on-volume and tuning; printed circuit construction; tan carrying case; estimated assembly time 3-4 1/2 hours; includes battery and earphone with 3-ft. cord;  $4'' \text{h} \times \frac{1}{4}'' \text{w} \times 1\frac{3}{4}'' \text{d.}$  ..... \$11.50

**Knight-Kit 10 Circuit Transistor  
 Lab Kit**  
 Allows construction of ten educational projects; plug-in leads; stage AM radio, photoelectric relay, wireless broadcast; code practice oscillator, electronic switch, 2-stage audio amplifier, capacity-operated relay, electronic timer, voice-operated relay, electronic flasher; no soldering after basic construction completed; includes battery, headphones, and all necessary parts; 3 lbs. .... \$15.75

**Knight-Kit Intercom**  
 Two-station ac-dc intercom system which may be used in pri-

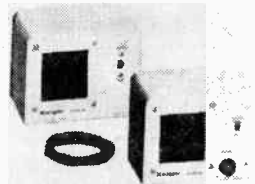

ivate or non-private operation; master can listen in on remote, master has "press-to-talk" switch, remote has "talk-listen" switch; master can call remote regardless of switch position on remote; master can handle up to 3 remote units in parallel; 2-stage amplifier and 4" speakers; finished in antique white; estimated assembly time 3-5 hours; each unit  $4\frac{3}{4}'' \times 6\frac{1}{2}'' \times 4\frac{3}{8}''$ ; complete with 50-ft. cable ..... \$14.95  
 Extra remote unit kit. .... \$3.95  
 Extra cable, per foot. .... \$0.03

**Knight-Kit Photoelectric  
 Relay System**  
 Relay kit for use as burglar alarm, door opener, etc.; employs cadmium-selenide photocell in thyatron circuit permitting operation up to 250 ft. from light source; relay may be adjusted to maintain position after light source is interrupted or to operate each time beam is broken; supplies 6.3 volts a.c. at 0.6 amps for alarm, counter, etc.; estimated assembly time 2 1/2-4 hours;  $5'' \times 3'' \times 5''$ ; 3 1/2 lbs. .... \$13.50  
 Light Source Kit provides light beam for relay unit; deep red filter ( $6'' \times 6'' \times 4''$ ); 3 1/2 lbs.) \$6.75

**Knight-Kit Electronic Photoflash**  
 Xenon-filled reflector-bulb assembly; self-contained trigger transformer; pre-assembled reflector-bulb socket; universal mounting bracket; flash speed is 1/700th second; output 50 watt-seconds; daylight spectral quality permits daylight-type color film indoors; ideal for use with "X" or "O" shutters only; requires sync cable and either battery or a.c. power supply; estimated assembly time 2-4 hours; 4 lbs. .... \$29.50  
 AC Power Supply Kit. . . \$ 3.95  
 Battery (Burgess U-200) \$ 7.70

## LAFAYETTE RADIO

**Model KT-97 1-Transistor  
 Pocket Radio**  
 Tapped variable Ferri-Loop; 365 mmfd tuning capacitor; crystal diode detector; external

antenna recommended; uses penlight battery;  $3\frac{3}{8}'' \times 2\frac{3}{8}'' \times 1''$ ; estimated assembly time 2-3 hours; less earphone. .... \$3.95

**Model KT-98 2-Transistor  
 Pocket Radio**  
 Similar to Model KT-97 but has 2-transistor circuit; less earphone; estimated assembly time 3-4 hours. .... \$5.45

**Model KT-116 3-Transistor  
 Superhet Receiver**

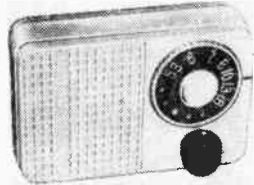

Uses 2 r.f. transistors, an audio transistor, and a crystal diode; requires no external antenna or ground; plastic case; plays through earphone; estimated assembly time 7-10 hours;  $4\frac{1}{8}'' \times 2\frac{7}{8}'' \times 1\frac{1}{16}''$ ; less earphone) .... \$14.95

**Model KT-19 AC-DC Radio Set**

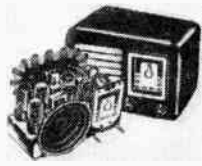

Covers broadcast band from 550 to 1600 kc; 5 tubes; brown plastic cabinet with built-in antenna; estimated assembly time 7-11 hours. .... \$17.10

**Model KT-132 "Sunflex" Receiver**

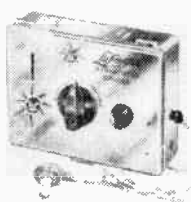

Uses 2 transistors and crystal diode; no antenna required for receiving most local stations; operates on 2 penlight batteries or with silicon solar battery;  $4\frac{3}{4}'' \times 3\frac{3}{8}'' \times 1\frac{1}{8}''$ ; estimated assembly time 5-8 hours; com-

(For additional information use coupon on page 160)

Electronic Kits

# Kits for Fun and Education

plete with plastic case and batteries; less earphone and solar battery.....\$11.95  
 MS-260 Earphone.....\$3.95  
 MS-420 Silicon Solar Battery.....\$7.75

**Model KT-36A 10-in-1 Lab Kit**  
 Allows the construction of the following educational projects: radio receiver, phono-microphone amplifier, phono oscillator, broadcast station, code practice oscillator, signal tracer, capacity operated relay, electronic timer, electronic switch, photocell relay; low voltages used throughout; includes three tubes and microphone; less headphone, photoelectric cell and socket.....\$12.95  
 Photocell 868.....\$2.85  
 Photocell socket.....\$.08  
 1000-ohm headphone.....\$1.18

**KT-134 15-in-1 Transistor Experimenter's Kit**  
 Allows the construction of the following educational transistor circuits: electronic timer, burglar alarm, 2-stage audio amplifier, photo-electric relay, code practice oscillator, audio preamplifier, electronic flasher, TV commercial killer, rain alarm, signal injector, intercom, 2-stage broadcast receiver, wireless broadcaster, wireless code transmitter, regenerative radio receiver; no soldering after basic assembly is completed; complete with headphones, battery, etc.....\$14.95

**KT-127  
 Citizen Band Transmitter Kit**

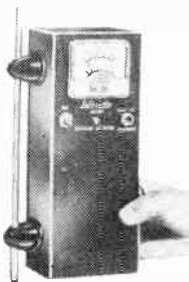

Crystal controlled transmitter; frequency 27.255 mc.; line of sight range one mile; wide non-critical tuning; 354 power pentode; 60" telescopic antenna; two B batteries 67½ volts and one A battery 1½ volts; estimated time of assembly 3-5 hours.....\$15.95

**Model KT-57 Broadcast Receiver**

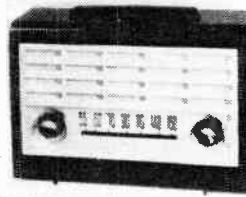

Operates on a.c., d.c., or batteries; covers broadcast band from 550 to 1600 kc; uses miniature low-drain tubes; built-in antenna; tubes are: 1R5, 1U4, 1U5, 3V4, plus selenium rectifier; polystyrene cabinet; 10"x4½"x7"; less batteries; estimated assembly time 8-12 hours.....\$20.00

**Model KT-58 Broadcast-Short Wave Receiver**

Operates on a.c., d.c., or batteries; covers broadcast band and 6-18 mc short wave bands; tubes are: 1U4, 1U5, 1R5, 3V4, plus selenium rectifier; leatherette cabinet; less batteries; estimated assembly time 10-15 hours.....\$26.75

**Model KT-119A Transistor Superhet Receiver**

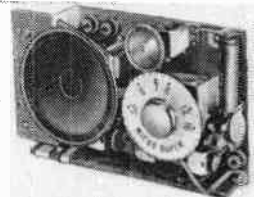

Uses 3 r.f. transistors, 3 audio transistors, and crystal diode; Class B push-pull audio output; 2¾" speaker; earphone jack; 6"x3½"x1½"; estimated assembly time 18-24 hours; less case and battery.....\$27.50  
 9-volt battery.....\$1.30  
 Leather case.....\$2.95  
**Model KT-135 "Explor-air" Radio**

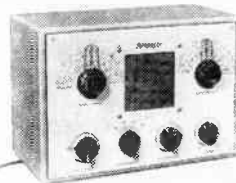

Four-band, 3-tube, regenerative short wave receiver; 4" speaker; accommodates phones; operates

from 1.7 to 30 mc; a.c.-d.c.; 10" x 7" x 5".....\$18.50  
 ML-150 Cabinet.....\$2.75

**Model KT-133  
 Photo-Electronic Relay**

May be used as burglar alarm, door-opener, etc.; cadmium sulphide photocell; relay contacts rated at 5 amps; instantaneous or sustained switch operation; estimated assembly time 5-8 hours; 3"x4"x5".....\$12.95

**Model KT-131 Telephone Pickup**

Enables group listening of telephone calls; uses induction pickup; 4 transistors with Class B push-pull output; 4½"x4¼"x4¼" less pickup and battery; estimated assembly time 3-5 hours.....\$17.95  
 Battery.....\$1.30  
 MS-16 Pickup Coil.....\$1.95

**MARS  
 MANUFACTURING CO.**  
 Silver Circuit Crystal Radio



Covers from 550 to 1750 kc; high-Q slug-tuned coil; will pick up local radio station, police calls, and some amateurs; printed circuit board allows screw-together construction; vernier slide rule dial; preassembled dial cord; estimated assembly time ¼-¾ hour; includes earphones.....\$4.49

**Silver Circuit  
 Satellite Worldwide Radio**

Covers from 7 to 25 mc, including amateur, foreign, and space satellite frequencies; self-queching circuit; vernier slide rule tuning; preassembled dial cord; printed circuit board allows screw-together construction; estimated assembly time 1-2½ hours; includes tube, earphone, and antenna; less 1½-volt C battery and 45-volt B battery.....\$8.95

**OLSON RADIO WAREHOUSE, INC.**

**KB-72 6 Transistor Receiver Kit**  
 Superhet circuit with push-pull output; high Q loopstick anten-

# Kits for Fun and Education

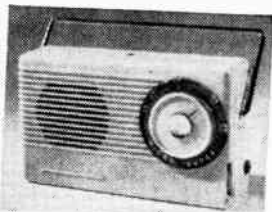

**Model 7001B**  
Two-tube a.c.-d.c. radio; tubes are: 35Z5GT and 12SJ7; estimated assembly time 2-3 hours. . . . . \$12.50

includes carrying case and earphone; estimated assembly time 3-4 hours, 8"x5 1/2"x2 1/2"; 2 1/2 lbs. . . . . \$40.00

**Model TR-22**  
Two-transistor portable radio; built-in antenna; 4" speaker; powered by 9-volt "A" battery;

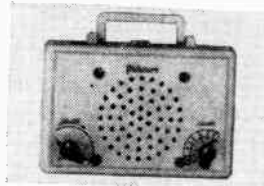

estimated assembly time 2-3 hours. . . . . \$20.45

**Model 7001C**  
Three-tube a.c.-d.c. radio and short wave receiver; 4" speaker; estimated assembly time 3-4 hours. . . . . \$20.00

**Model 201**



Five-tube a.c.-d.c. radio; superhet circuit; built-in antenna; estimated assembly time 4-6 hours; multimeter and signal generator required for initial adjustment; walnut bakelite cabinet; 9"x5 1/2"x5 1/4".

Model 201 . . . . . \$34.00  
Model 202 (covers AM and shortwave) . . . . . \$39.00

**Model TR-44 "Hit Parader"**



Four-transistor portable radio; superhet circuit; built-in antenna; 4" speaker; powered by 9-volt battery; prealigned i.f. transformers and oscillator coil;

## PROGRESSIVE "EDU-KITS" INC.

"Edu-kit"

Enables stage-by-stage construction and study of radio circuits, including r.f. amplifiers, oscillators, i.f. amplifiers, detectors, and a.f. amplifiers; also constructed are transmitter, signal tracer, signal injector, and code practice oscillator; includes set of tools with soldering iron and electronics tester. . . . . \$22.95

## QUALITY ELECTRONICS, INC.

250 5 Tube Superhet Radio, AC-DC

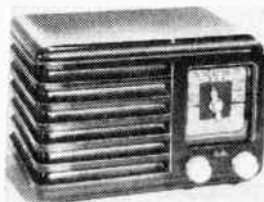

Excellent pick up in weak signal area; AVC for super-sensitivity and selectivity; tubes are 12SA7, 12SQ7, 12SK7; and 50L6 beam power amplifier; 1.8 watts maximum output. . . \$16.45

## RADIO MERCHANDISE SALES, INC.

Model FX-4 FM Antenna

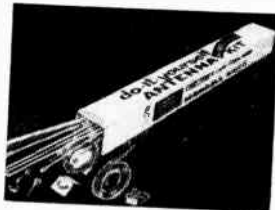

All-directional FM antenna; snap-lock construction; complete with 5 ft. antenna mast, standoffs, wallmount, 50 ft. 300-ohm lead-in wire. . . \$10.75

Model BK-100 All-Channel Yagi Antenna

All-channel yagi antenna for Electronic Kits

na; matched set of three IF transformers; tunes standard broadcast band; private listening with built-in earphone jack; estimated time of assembly 2-3 hours. . . . . \$11.88

## PHILMORE MFG. CO., INC.

Model 7000K "Little Wonder"



Crystal radio receiver; estimated assembly time 1/2 hour; less earphone and antenna. . . . . \$2.00

Model 400 "Sky Rover"

Crystal radio receiver; estimated assembly time 1/2 hour; includes earphone. . . . . \$4.15

Model 7001A

Crystal radio receiver; estimated assembly time 1/2 hour; includes earphone. . . . . \$4.90

Model VC1000

Germanium diode radio receiver; estimated assembly time 1/2 hour; includes earphone. . . \$5.00

Model 700 "Globe Ranger"

Germanium diode radio receiver; estimated assembly time 1/2 hour; includes earphone. . . \$7.25

Model TR-9

Transistor and germanium diode radio receiver; estimated assembly time 1 hour; includes earphone and antenna. . . . . \$9.75

Model TR-101

Transistor and germanium diode radio receiver; estimated assembly time 1 hour; includes earphone. . . . . \$9.75

Model 7501 Portable Radio

Battery-operated one-tube radio; uses 3V4 power amplifier tube; requires no soldering; estimated assembly time 1-2 hours. . . \$12.50

# Kits for Fun and Education

metropolitan and semi-fringe operation; snap-lock construction; complete with all parts and 50 ft. 300-ohm lead-in wire .....\$22.20

## Model BK-200

Stacked version of Model BK-100; for fringe area operation .....\$53.50

## Model MK-52 Conical Antenna

High-gain, broadband performance; complete with all parts and 50 ft. 300-ohm lead-in wire .....\$12.95

## Model MK-53S

Stacked version of Model MK-52; for fringe areas ...\$20.70

## Model MK-54 Conical Antenna

High-gain, all-channel performance; 4 elements front plus 2 high frequency stubs, 4 rear elements; snap-lock construction .....\$13.90

## Model MK-54S

Stacked version of Model MK-54; for fringe areas ...\$22.35

## SCHOBER ORGAN CORP.

Electronic Organ, Concert Model



Concert organ; plays through hi-fi system; conforms to specifications of American Guild of Organists; two 61-key manuals; 32-note radiating, concave pedal clavier; 19 stops; 6 couplers; tone colors and registration facilities conform to standard pipe-organ; controls: vibrato (3 types), brilliance, pedal balance, manual balance; electronic parts and cabinet available separately; printed circuit electronic construction; available in 24 separate kits averaging about \$50.00 each; estimated assembly time 75-200 hours; console 55" w x 29" d x 43 1/2" h; console supplied built and finished in walnut, custom finishes, or unfinished. Total price including cabinet approximately \$1200.00

Electronic Organ, Console Model

Smaller organ; plays through Number 2

hi-fi system; two 61-key manuals with standard pipe-organ overhanging keys; 22 stops with pipe-organ-type stop tablets; 13 toe pedals with 16-foot tones; tone colors and registration same as for pipe-organ; electronic parts and cabinet available separately; printed circuit electronic construction; available in 21 separate kits averaging about \$40.00 each; estimated assembly time 50-150 hours. Total price including cabinet approximately \$800.00

## SCIENCE ELECTRONICS, INC.

### Basic Electrical Circuit Kit

Ideal for developing principles in series, parallel, and series-parallel circuits; provides experiences in measurements, practical circuit interpretations, demonstrates Ohm's Law, Kirchhoff's Law and power equations; uses standard lamp bulbs as circuit loads; examination sheet, two-color instruction and experimental manual included; parts include: plug-in panel base, 4 lamp sockets, 1 DPDT switch, 2 SPDT switches, 2 3-way switches, 0-150 AC volt meter, 0-3 AC ammeter, fused line cord; jiffy connectors, instruction manual. ....\$29.95

### Radio Demonstration and Training Unit

For junior-high or high-school science and industrial arts courses; demonstration and training kit, covering 14 basic single and multiple-tube radio circuits; operates on headphones, powered by 110 AC current with step-down transformer; three tubes, 14 templates; 5 1/2 x 12 x 18" .....\$59.50

### Basic Electricity and

### Electronics Training Set

Designed to cover all 50 experiments in BE-3, BE-4 as well as 8 experiments in EIA Manual, "Basic Radio," dealing with super-heterodyne receivers; complete laboratory course of 58 projects covering basic principles of electricity, electronics and radio for use in high-school electronics, vocational schools, and industrial training courses; 5 1/2 x 12 x 18" .....\$195  
With tubes .....\$210

### Basic Electronics Training Set

Designed for use with the EIA Laboratory course in electronics; 23 experiments in vacuum tubes

and vacuum tube applications, including rectifiers, amplifiers, detectors, oscillators and phase inverters; for use in high school electronics, vocational schools or industrial training courses; designed to emphasize understanding of basic principles; 5 1/2 x 12 x 18" .....\$165.00  
With tubes .....\$180.00

### Basic Transistor Circuits Kit

A demonstrational and training unit covering basic transistor circuits complete with manual, *Exploring Electronics*, containing theory and 14 experiments; circuits progress from simplest crystal radio to regenerative voice transmitter; parts include two transistors, earphone, tuning coil, capacitors, resistors; no soldering required with JIFFY clips. ....\$27.95

### Research and Development

### Engineering Kit

Many electronic circuits can be developed using the 830 components supplied; no soldering required. ....\$395

## SUPEREX ELECTRONICS CORP.

Model LCRK Crystal Radio

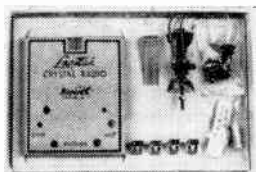

Picks up local stations; slide rule dial; assembled with screwdriver in 2-3 hours; requires earphones; operates without batteries or house current...\$2.65

### Model MWK Diode Radio

Features loopstick tuner; picks up local stations; assembled with screwdriver in 1-2 hours; includes earphone.....\$3.49

### Model TRK I-Tube Radio

Features loopstick tuner and 1-tube battery-operated circuit; picks up local stations; slide rule dial; assembled with screwdriver in 2-3 hours; requires headphones .....\$3.55

### Model GDK Germanium Diode Radio

Picks up local stations; includes germanium diode, earphone, and antenna kit; assembled with screwdriver in 2-2 1/2 hours....\$3.95

(For additional information use coupon on page 160)

**ELECTRONIC KITS, BOX 752  
CHURCH STREET STATION  
NEW YORK 8, NEW YORK**

Please have the manufacturers, whose code numbers I have circled, send me additional information about their products listed in the directory sections.

- 1 2 3 4 5 6 7 8 9 10 11 12 13 14 15 16 17 18  
19 20 21 22 23 24 25 26 27 28 29 30 31 32 33 34 35 36  
37 38 39 40 41 42 43 44 45 46 47 48 49 50 51 52 53 54  
55 56 57 58 59 60 61 62 63 64 65 66 67

Please indicate total number of circled numbers

---

Name (Please Print).....  
Address .....  
City.....Zone..... State.....

- |   |  |  |
|---|--|--|
| <p>1. <b>Aco Radio Control</b><br/>Box #301<br/>Higginsville, Mo.</p> <p>2. <b>Acro Products Company</b><br/>369 Shurs Lane<br/>Philadelphia 28, Pa.</p> <p>3. <b>Allied Radio (Knight-Kit)</b><br/>100 North Western Avenue<br/>Chicago 80, Illinois</p> <p>4. <b>American Basic Science Club, Inc.</b><br/>Box #524<br/>San Antonio, Texas</p> <p>5. <b>Approved Electronic Instrument Corp.</b><br/>51 Vesey Street<br/>New York 7, New York</p> <p>6. <b>Argos Products Company</b><br/>310 Main Street<br/>Genoa, Illinois</p> <p>7. <b>Arkay</b><br/>120 Cedar Street<br/>New York, New York</p> <p>8. <b>Artizans of New England</b><br/>Route #39<br/>Sherman, Connecticut</p> <p>9. <b>Atomic Laboratories</b><br/>3086 Claremont<br/>Berkeley, California</p> <p>10. <b>Audax</b><br/>Div. of Rek-O-Kut Co., Inc.<br/>38-19 108th Street,<br/>Corona 68, New York</p> <p>11. <b>Berkeley Enterprises, Inc.</b><br/>815 Washington Street<br/>Newtonville, Massachusetts</p> <p>12. <b>David Bogen Co., Inc.</b><br/>P. O. Box #500<br/>Paramus, N. J.</p> <p>13. <b>Bozak Sales Company</b><br/>P. O. Box #966<br/>Darien, Connecticut</p> <p>14. <b>Cletron, Inc.</b><br/>1974 East 61 Street<br/>Cleveland 3, Ohio</p> <p>15. <b>Danco Manufacturing Co.</b><br/>P. O. Box #533<br/>Van Nuys, California</p> <p>16. <b>Doss Electronic Research, Inc.</b><br/>820 Baltimore<br/>Kansas City 5, Missouri</p> <p>17. <b>Dyna Company</b><br/>617 North 41st Street<br/>Philadelphia, Pennsylvania</p> <p>18. <b>Eby</b><br/>280 Lafayette Street<br/>New York 12, New York</p> <p>19. <b>Educational Electronics Co</b><br/>1227-31 Coyola Avenue<br/>Chicago 26, Illinois</p> <p>20. <b>Eico</b><br/>33-00 Northern Boulevard<br/>Long Island City, New York</p> <p>21. <b>Electronic Brain Enterprises, Inc.</b><br/>1015 Atkin Avenue<br/>Salt Lake City 6, Utah</p> <p>22. <b>Electronic Kit Supply</b><br/>1721 Glendale Avenue<br/>Los Angeles 26, California</p> | <p>23. <b>Electronic Measurements Corp.</b><br/>625 Broadway<br/>New York, New York</p> <p>24. <b>Electronic Organ Arts, Inc.</b><br/>4878 Eagle Rock Blvd.<br/>Los Angeles 41, California</p> <p>25. <b>Electro-Voice, Inc.</b><br/>Cecil &amp; Carroll Streets<br/>Buchanan, Michigan</p> <p>26. <b>Erie Electronics</b><br/>644 West 12th Street<br/>Erie, Pennsylvania</p> <p>27. <b>Oliver Garfield Co.</b><br/>208 East 16th Street<br/>New York 16, New York</p> <p>28. <b>Grommes Div. Precision Electronics</b><br/>9101 King St.<br/>Franklin Park, Illinois</p> <p>29. <b>Gyro Electronics</b><br/>325 Canal Street<br/>New York, New York</p> <p>30. <b>Heath Company</b><br/>Benton Harbor 15, Michigan</p> <p>31. <b>Hickok Electrical Instrument Co.</b><br/>10500 DuPont Avenue<br/>Cleveland, Ohio</p> <p>32. <b>Holt Stereo</b><br/>4712 West Magnolia Blvd.<br/>Burbank, California</p> <p>33. <b>Int'l Crystal Mfg.</b><br/>18 North Lee St.<br/>Oklahoma City, Okla.</p> <p>34. <b>Int'l Rectifier Corp.</b><br/>1521 East Grand Avenue<br/>El Segundo, California</p> <p>35. <b>E. F. Johnson Co.</b><br/>2805 Second Avenue, SW<br/>Waseca, Minnesota</p> <p>36. <b>Karlson Associates, Inc.</b><br/>433 Hempstead Avenue<br/>W. Hempstead, L. I., N. Y.</p> <p>37. <b>LW Electronic Laboratories</b><br/>Route #2<br/>Jackson, Michigan</p> <p>38. <b>Lafayette Radio</b><br/>165-08 Liberty Ave.<br/>Jamaica, New York</p> <p>39. <b>Masco</b><br/>32-28 49th Street<br/>Long Island City 3, N. Y.</p> <p>40. <b>J. W. Miller</b><br/>5917 S. Main St.<br/>Jamaica, New York</p> <p>41. <b>Olson Radio Warehouse, Inc.</b><br/>T-38 Forge St.<br/>Akron 8, Ohio</p> <p>42. <b>Paco Electronics Co., Inc.</b><br/>70-31 84th Street<br/>Glendale 27, L. I., N. Y.</p> <p>43. <b>Petersen Radio Co.</b><br/>2800 W. Broadway<br/>Council Bluffs, Iowa</p> <p>44. <b>Philmore Mfg. Co.</b><br/>130-01 Jamaica Avenue<br/>Richmond Hill 18, New York</p> <p>45. <b>Precise Development Corp.</b><br/>2 Neil Court<br/>Oceanside, New York</p> | <p>46. <b>Precision Electronics, Inc.</b><br/>9101 King Street<br/>Franklin Park, Illinois</p> <p>47. <b>Printed Electronic Research, Inc.</b><br/>4212 Lankershim Blvd.<br/>North Hollywood, California</p> <p>48. <b>Progressive "EDU-KITS" Inc.</b><br/>497 Union Avenue<br/>Brooklyn 11, New York</p> <p>49. <b>Quality Electronics</b><br/>319 Church Street<br/>New York 13, N. Y.</p> <p>50. <b>Radio Mds. Sales, Inc.</b><br/>2016 Bronx Dale Ave.<br/>New York 62, New York</p> <p>51. <b>Regency, Div. of I.D.E.A., Inc.</b><br/>Indianapolis 26, Indiana</p> <p>52. <b>Rek-O-Kut Inc.</b><br/>38-19 108th St.<br/>Corona 68, N. Y.</p> <p>53. <b>River Edge Sales</b><br/>80 Shore Rd.<br/>Port Washington, N. Y.</p> <p>54. <b>Schober Organ Corp.</b><br/>2248-A Broadway<br/>New York 24, New York</p> <p>55. <b>Science Electronics, Inc.</b><br/>195 Massachusetts Avenue<br/>Cambridge 39, Mass.</p> <p>56. <b>Springfield Enterprises</b><br/>P. O. Box 54<br/>Springfield Gardens 13, N. Y.</p> <p>57. <b>Superex Electronics Corp.</b><br/>4-6 Radford Place<br/>Yonkers, New York</p> <p>58. <b>Tech-Master Corp.</b><br/>75 Front St.<br/>Brooklyn 1, N. Y.</p> <p>59. <b>Transvision, Inc.</b><br/>460 N. Avenue<br/>New Rochelle, N. Y.</p> <p>60. <b>Universal Scientific Co., Inc.</b><br/>1102 Shelby Street<br/>Vincennes, Indiana</p> <p>61. <b>University Loudspeakers, Inc.</b><br/>80 S. Kensico Avenue<br/>White Plains, N. Y.</p> <p>62. <b>WBQMT</b><br/>Box #5<br/>Garritsville, Ohio</p> <p>63. <b>Watson Industries</b><br/>110 Mildred Avenue<br/>Venice, California</p> <p>64. <b>Weathers Industries</b><br/>Barrington, New Jersey</p> <p>65. <b>Wellcor, Inc.</b><br/>1214 North Wells<br/>Chicago, Illinois</p> <p>66. <b>World Radio Labs.</b><br/>3415 W. Broadway<br/>Council Bluffs, Iowa</p> <p>67. <b>Worner Electronics</b><br/>Box #10A<br/>Rankin, Illinois</p> |
|---|--|--|



# USE THIS COUPON TO GET ALL THE INFORMATION

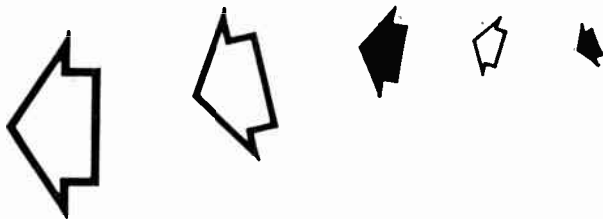

## YOU NEED ON ELECTRONIC KITS

### Kits for Fun and Education

#### Model TTKE Transistor Radio



Features transistor and germanium diode; includes plastic case, earphone, and batteries; assembled with screwdriver in 2-3 hours. . . . . \$6.49

#### Model MTKE Transistor Radio

Features 2 transistors, a germanium diode, pre-punched printed circuit board, and loopstick tuner; includes plastic case, batteries, and earphone; estimated assembly time 2-4 hours. . \$7.98

#### Model TR4-K 4-Transistor Radio

Features 4 transistors, diode, and pre-punched printed circuit board; includes loopstick tuner, simulated cowhide case, speaker, and earphone; battery-operated;

estimated assembly time 3-8 hours; 3 1/2" x 5 7/8" x 1 3/4". \$17.95  
**Vest Pocket Transistor Radio**

No antenna or ground needed; 3 transistors and germanium diode; printed circuit board; flat loopstick; includes earphone; estimated time of assembly 4 hours. . . . . \$11.95

#### TR-66 Sextet 6 Transistor

##### Portable Radio

Superhet AM radio with 6 transistors, one diode; 3 tuned IF stages; prepunched printed circuit board; includes AVC; jack for private listening; push-pull output; estimated time of assembly 8 hours. . . . . \$25.95

### TECH-MASTER CORP.

#### Model 5516W TV Set

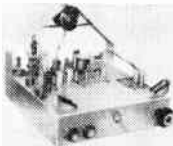

Suitable for use with 17" or 21" picture tubes; 12-channel turret

tuner; 600-milliamp tubes; 3 i.f. stages; AFC; preadjusted coils; estimated assembly time 8-12 hours; 17" x 17" x 9"; less picture tube. . . . . \$99.50

#### Model 3B5K Radio

A.c.-d.c. circuit; built-in antenna; AVC; 5 tubes; bakelite cabinet; 10" x 5 1/2" x 5 1/2"; estimated assembly time 2-4 hours. . . . . \$19.95

### TRANSVISION, INC.

#### Model EP-1 Electronic Photoflash



Flash duration 1/1000 second; 50-watt-second output; test flash button; operates on a.c. or batteries; weighs less than 3 pounds; includes flash head, power pack (batteries not included), leatherette carrying case, mounting bracket, and a.c.

## METAL LOCATOR ENTHUSIASTS

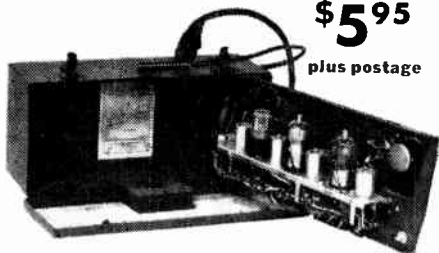

**\$5.95**  
plus postage

This is for you . . . BC-1141-C amplifier, the electronic heart of the famous SCR-625 mine detector. This unit is brand new with 2-1N5 and 1-1G6 vacuum tubes, in steel carrying case with handle; net weight with batteries is only 10 pounds. It operates from internal batteries (not included) and is complete with schematic diagram of the whole SCR-625 detector set. Case measures 14" x 6" x 5" including hinged cover. Operating panel hinges out for easy access to interior shock mounted chassis. This is a 1000 cycle fixed frequency amplifier, brand spanking new, and a once-in-a-lifetime bargain at \$5.95. Simple, easily followed drawings and description for building a sensitive budget-priced detector furnished free with each amplifier. Set of three spare vacuum tubes just \$1.00. Shipping weight of amplifier is 12 pounds . . . available.

WRITE FOR FREE GOVERNMENT SURPLUS BARGAIN BULLETIN

**JOE PALMER**

P. O. Box 6188CC  
SACRAMENTO, CALIF.

*Start with the Best—  
To Hear the Best—*

## TACO FM ANTENNAS

The FM antenna is the most important link between your tuner and the station. Poor signal capture cannot be made up within the tuner and amplifier. So start with the best to hear the best—install a Taco FM antenna. There's a model for every installation requirement, and all are available in easy-to-install kits with all necessary transmission wire and hardware. All models available in gold anodized finish.



**FREE!** The FM antenna story—send for your free copy. The complete details on the whys and wherefores of FM antennas . . .

**TECHNICAL APPLIANCE CORPORATION**  
SHERBURNE, N. Y.

**TACO ANTENNAS ARE AVAILABLE IN KIT FORM**

line cord; estimated assembly time 3-4 hours.....\$29.95

**Model E-I TV Set**

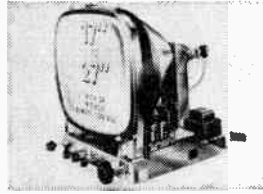

Consists of 12 different kits allowing construction of TV set with up to 27" picture tube; VHF and UHF models; kits average about \$18.00 each; total price about \$130.00.

**UNIVERSAL SCIENTIFIC COMPANY, INC.**

**Electronic Tubes, Circuits and Devices Kit**  
Key experiments in electronics from a loose leaf instruction manual dealing with tube principles, circuitry, RF generators, computers, VHF techniques, radar and tv. ....\$123.50

**Basic Electronics Equipment**  
Covers the subject and application of electronics equipment; kit includes capacitors, coils, transformers, rectifiers and filters, resistors, oscillators, and manual of instruction. ...\$128

**Basic Electricity Kit**  
Complete laboratory for the beginner; includes magnetism, electro-magnetism, circuitry, switches, fuses, transformers, AC and DC motors and many others. ....\$69.50

**WORNER ELECTRONIC DEVICES**

**Model 69 Electric Eye**

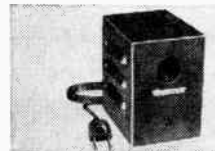

Provides photocell-amplifier unit which operates with incandescent light source or flashlight; may be used to open and close circuits and for automatic operation of various electrical appliances; relay contacts rated at 2 amps inductive. 5 amps non-inductive; 2 1/2" x 3 1/2" x 4" \$19.50

**Model 39 Exciter Lamp**  
Projects light beam to be used for triggering Model 69; operates up to 15 feet from Model 69; 2 1/4" x 4" x 4 1/2" ....\$12.60

**INDEX OF  
ADVERTISERS**

ADVERTISER	PAGE NO.
Ace Radio Control .....	155
Adson Radio & TV Corp. ....	65, 107
Airex Radio Corporation .....	139
Allied Radio .....	63
British Industries Corporation .....	26
Burstein-Applebee Co. ....	147
DeVry Technical Institute .....	7
Dynaco, Inc. ....	135
EICO .....	33
Electro-Voice, Inc. ....	45
Garfield Co., Inc., Oliver .....	140
Garrard Sales Corp. ....	26
Grommes—Div. of Precision Electronics, Inc. ....	147
Heath Company .....	25
HiFi Guide & Yearbook .....	87
International Crystal Mfg. Co., Inc. ....	71
Johnson Company, E. F. ....	41
Key Electronics Co. ....	135
Lafayette Radio .....	9
Milwaukee School of Engineering .....	97
Mellotone .....	139
National Radio Institute .....	FOURTH COVER
Olson Radio Warehouse .....	105
Pacc Electronics Co., Inc. ....	3
Palmer, Joe .....	161
Popular Electronics Subscriptions .....	98
Popular Photography Color Annual .....	131
Popular Photography 35mm Annual .....	149
Precise Development Corporation .....	5, 35
Progressive "Edu-Kits", Inc. ....	145
RCA Institutes, Inc. ....	82
Rek-O-Kut Co., Inc. ....	60
Simpson Manufacturing Co., Inc., Mark .....	155
Suprex Electronics Corp. ....	67
Technical Appliance Corporation .....	162
Thorens Swiss Made Products .....	THIRD COVER
Weathers Industries .....	SECOND COVER
Xcelite Incorporated .....	21
Ziff-Davis Electronics Division Classified .....	111

new

THORENS KIT

“TD”



*easily assembled...  
no special tools...  
no experience needed*

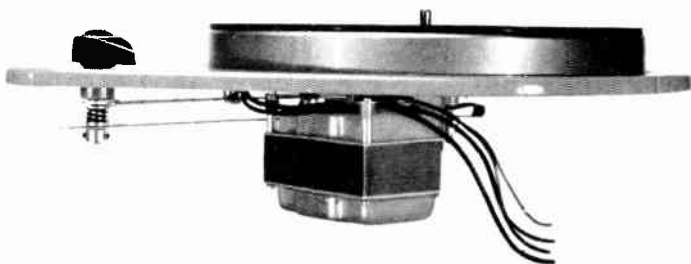

Now for the first time you can get a Thorens TD transcription turntable in kit form—at big savings to you.

It's the new TDK-101 featuring the same precision Swiss craftsmanship that made the now-famous TD-124 an immediate success on the American market. Just examine the mirror-finished machining on this kit turntable (or for that matter on any of the Thorens "TD" units) and compare with that of any other make of turntable. You'll see the reason for the TDK's extremely low rumble, wow and flutter. See the TDK-101, newest member of the TD family of fine turntables, at your Thorens hi-fi dealer's.

**Features:**

Same compliant belt-plus-idler drive as on more expensive TD units; provides complete motor isolation. Single, retained, ball-thrust bearing, plus mirror-finished main bearing, for absolute minimum of rumble, both vertical and horizontal—so necessary for stereo. Single-speed 33 1/3. Adjustable speed (±3%, a total of about one musical semitone). Built-in strobe allows setting to exact speed. Automatic disengagement of idler when unit is switched off. Drive mechanism completely enclosed—no "string" belts or external belt shields. Accessory wooden base is available in walnut, blond, or mahogany; \$9.00 net.

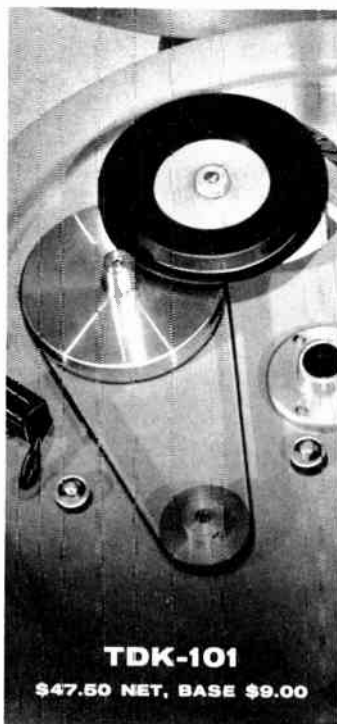

**TDK-101**

**\$47.50 NET, BASE \$9.00**

*And these precision "TD" units  
... completely assembled*

**TD-124.** Absolute tops for stereo or mono records... quietest, smoothest, most exact. 11 1/2 lb. table; clutch for fast, noise-free starts with needle in groove. 4 speeds, all adjustable (±3%) for perfect pitch; built-in illuminated strobe; built-in level. All assembled TD turntables are 100% tested electronically and aurally for wow, rumble and flutter before shipment. **\$99.75 net. Base \$9.00.**



**TD-184.** This 4-speed high-quality turntable with integral arm has same precision-machined adjustable speed drive as Thorens TD-124. Semi-automatic operation—one dialing motion selects 7", 10", 12" record size. Arm literally floats down to record on air. Absolutely no connection between arm and table. **\$75.00 net. Base \$6.00.**



**TD-134.** 4-speed turntable with integral arm for manual operation. Same high-performance tone arm as used on TD-184 equals tracking performance of arms costing as much as half the price of this entire unit. Same adjustable speed drive mechanism as on more expensive units. **\$60.00 net. Base \$6.00.**



**SWISS MADE PRODUCTS**  
MUSIC BOXES • HI-FI COMPONENTS  
SPRING-POWERED SHAVERS • LIGHTERS  
NEW HYDE PARK, NEW YORK



**THORENS**

Write Dept. K-4 for catalog on complete Thorens hi-fi line.

# Learn Radio-Television

## Servicing or Communications by Practicing at Home in Spare Time

N. R. I. SENDS kits with which you practice building circuits common to Radio and TV sets. You LEARN-BY-DOING to locate Radio-TV troubles. As part of N. R. I. Servicing Course, you build Vacuum Tube Voltmeter and AC-DC receiver. Use VTVM to conduct experiments, earn extra money fixing sets in spare time.

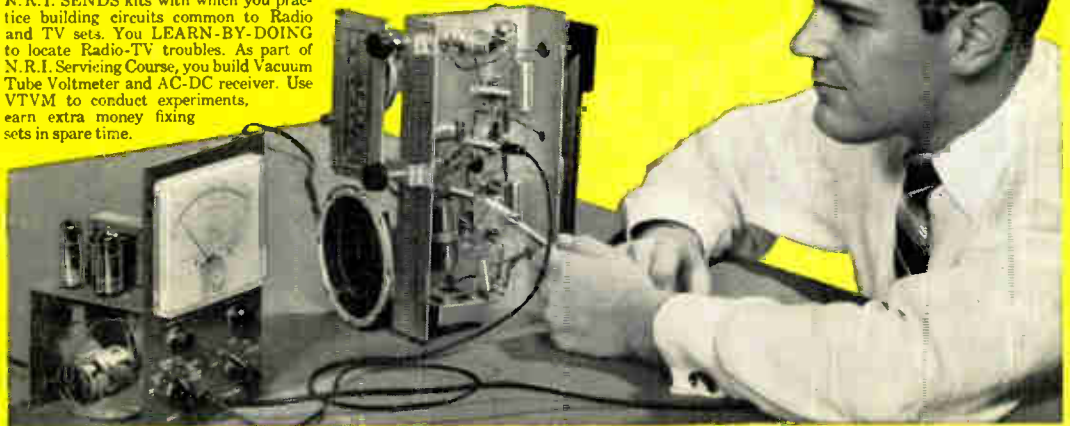

RADIO-TV BROADCASTING (see above) offers important positions as Operators and Technicians. RADIO-TV SERVICING Technicians (see below) needed in every community. Their services are respected, their skill appreciated.



## Fast Growing Field Offers You Good Pay, Success, Bright Future



J. E. SMITH  
founder

Bigger than ever and still growing fast. That's why Radio-TV has special appeal to ambitious men not satisfied with their job and earnings. More than 4,000 Radio and TV stations. More than 150 million home and auto Radios, 40 million TV sets. Color TV promises added opportunities. For the trained man, there are good jobs, bright futures in Radio-TV Servicing or Broadcasting. Training PLUS opportunity is the ideal combination for success. So plan now to get into Radio-TV. The technical man is looked up to. He does important work, gets good pay for it. Radio-Television offers that kind of work. NRI can supply training quickly, without expense of going away to school. Keep your job while training. You learn at home in your spare time. NRI is the OLDEST and LARGEST home study Radio-TV school. Its methods have proved successful for more than 40 years.

### Added Income Soon - \$10, \$15 a Week in Spare Time

Soon after enrolling, many NRI students start to earn \$10, \$15 a week in spare time fixing sets. Some pay for their training and enjoy extra luxuries this way. Some make enough to start their own Radio-TV shops. NRI training is *practical*—gets quick results. Easy to understand, well illustrated lessons teach you basic principles. And you LEARN-BY-DOING by practicing with kits of equipment which "bring to life" things you study.

### Find Out What NRI Offers

NRI has trained thousands for successful careers in Radio-TV. Study fast or slow—as you like. Diploma when you graduate. Mail coupon now. Paste it on a postcard or mail in envelope. ACTUAL LESSON FREE. Also 64 page catalog that shows opportunities, shows equipment you get. Cost of NRI courses low. Easy terms. NATIONAL RADIO INSTITUTE, Dept. 9EX7, Washington 16, D. C.

### N. R. I. TRAINED THESE MEN FOR SUCCESS



"I was repairing Radios by 10th lesson. Now have good TV job." M. R. LINDEMUTH, Fort Wayne, Ind.



"Doing spare time repairs on Radio and TV. Soon servicing full time." CLYDE HIGGINS, Waltham, Mass.



"I had a successful Radio repair shop. Now I'm Engineer for WHPE." V. W. WORKMAN, High Point, N. C.



"There are a number of NRI graduates here. I can thank NRI for this job." JACK WAGENER, Lexington, N. C.

### VETERANS Approved Under G. I. Bills

## SEND FOR BOTH FREE

### National Radio Institute

Dept. 9EX7, Washington 16, D. C.  
Mail me Sample Lesson and 64-Page Catalog FREE. (No salesman will call. Please write plainly.)

Name \_\_\_\_\_ Age \_\_\_\_\_

Address \_\_\_\_\_

City \_\_\_\_\_ Zone \_\_\_\_\_ State \_\_\_\_\_

Accredited Member National Home Study Council

