

# ELECTRONICS HOBBYIST

1980 EDITION \$1.95

by the EDITORS of ELEMENTARY ELECTRONICS

## BUILD FUN PROJECTS YOU CAN'T BUY

- ✓ Las Vegas LED
- ✓ New Shell Game
- ✓ Scope Magician
- ✓ Disco King
- ✓ Simple Syn
- ✓ TV Light Pen
- ✓ Game Stopper
- ✓ Super Sound Synthesizer
- ✓ Electronic Slot Machine



Super Bass

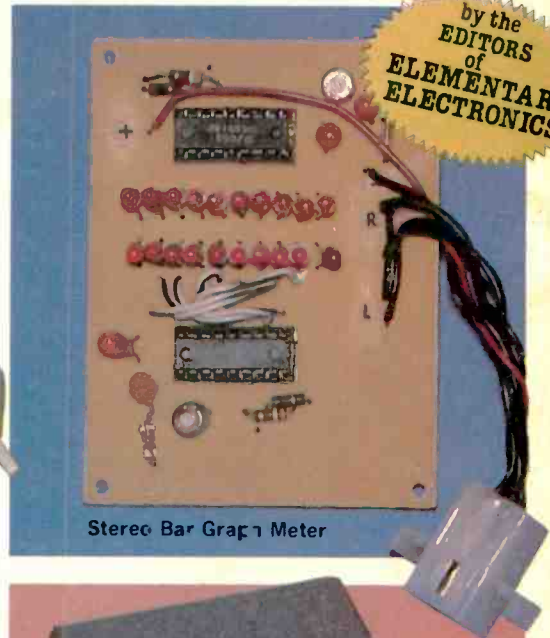

Stereo Bar Graph Meter



Tape Tester



Scope Calibrator

## BCD Clock

-tells time like a computer

## Roaring Twenties Receiver

-old-time listening in



BCD Clock



Big Boost



# The Personal Computer Line by OHIO SCIENTIFIC



## Personal Computers

**C1P: \$349** A dramatic breakthrough in price and performance. Features OSI's ultra-fast BASIC-in-ROM, full graphics display capability, and large library of software on cassette and disk, including entertainment programs, personal finance, small business, and home applications. It's a complete programmable computer system ready to go. Just plug-in a video monitor or TV through an RF converter, and be up and running. 15K total memory including 8K BASIC and 4K RAM—expandable to 8K.

**C1P MF: \$995** First floppy disk based computer for under \$1000! Same great features as the C1P plus more memory and instant program and data retrieval. Can be expanded to 32K static RAM and a second mini-floppy. It also supports a printer, modem, real time clock, and AC remote interface, as well as OS-65D V3.0 development disk operating system.

## Professional Portables

**C4P: \$698** The professional portable that has over three times the display capability of C1Ps. Features 32 x 64 character display in up to 16 colors, graphics, audio output, a DAC for voice and music generation, key pad and joystick interfaces, AC remote control interface and much more. Utilizes a 4-slot BUS (2 used in base machine), 8K BASIC-in-ROM, 8K of static RAM and audio cassette interface. Can be directly expanded to 32K static RAM and two mini-floppy disks.

**C4P MF: \$1695** The ultimate portable computer has all the features of the C4P plus real time clock, home security system interface, modem interface, printer interface, 16 parallel lines and an accessory BUS. The standard machine operates at twice the speed of currently available personal computers (with GT option it runs even faster!). The C4P MF starts with 24K RAM and a single mini-floppy and can be directly expanded to 48K and two mini-floppies. Available software includes games, personal, business, educational and home control applications programs as well as a real time operating system, word processor and a data base management system.



Computers come with keyboards and floppies where specified. Other equipment shown is optional.

## Home/Small Business Systems

**C8P: \$895** Same great features as the C4P in a tremendously expandable "main-frame package." Features over three times the expansion capability of the C4P for advanced home and demanding business applications. Can be expanded to 48K RAM, dual 8" floppies, hard (Winchester) disks and multiple I/O devices such as Voice I/O and a universal telephone interface.

**C8P DF: From \$2597** The ultimate Home/Very Small Business Computer at a personal computer price. Features 32K RAM (expandable to 48K) and dual 8" floppy disks (stores eight times as much information as a mini-floppy). Has all personal computer capabilities including 32 x 64 display, color graphics, sound, DAC, joystick interfaces, home features including real time clock, AC remote interface, home security and fire detection interface and can be expanded to include voice I/O and a universal telephone system for answering and initiating calls! Its large memory capability and 8" floppies allow it to run most Ohio Scientific business system software including a complete accounting system, word processor and information management system.

For literature and the name of your local dealer, CALL 1-800-321-6850 TOLL FREE.



CIRCLE 9 ON READER SERVICE COUPON

**OHIO SCIENTIFIC**  
1333 SOUTH CHILLICOTHE ROAD  
AURORA, OH 44202 • (216) 831-5600



All-in-One Computer



Computer Peripherals



Amateur Antenna Tuner



Oscilloscopes



Giant screen projection TV



Dual Wattmeter



Hand-held Digital Multimeter



Groundtrack® Metal Locator



Digital Electronic Scale



Car Thermometer



One-button Phone Dialer



Pro-Series Audio Components



Speedometer/Tachometer



4-band Shortwave Radio

# FREE HEATHKIT® CATALOG



**400 electronic kits:** test instruments, computers, amateur radio gear, electronic educational programs, color televisions, stereo components, R/C gear, home products, energy conservation devices, marine and aviation gear, and more — things you've always wanted and needed, now at low kit prices from Heath.

**Discover the fun of kit building —** it's a great way to relax in your spare time and share a rewarding

pastime with your whole family. The useful items you build will reflect the pride of your craftsmanship, too. The famous Heathkit illustrated manuals make it easy for anyone to build reliable, professional-quality kits.

### SEND FOR YOURS NOW!

The 104-page catalog is Free! If coupon is missing write: Heath Company, Dept. 026-632, Benton Harbor, MI 49022



Rechargeable Camp Light



Educational Programs



Chart Recording Depth Sounder



R/C Gear



Computerized Weather Station

## Heathkit

Heath Company, Dept. 026-632, Benton Harbor, MI 49022

Send my free Heathkit Catalog now. I am not currently receiving your catalog.

Name \_\_\_\_\_

Address \_\_\_\_\_

City \_\_\_\_\_ State \_\_\_\_\_

CL-727 \_\_\_\_\_ Zip \_\_\_\_\_

**FREE CATALOG**

Heathkit products are displayed, sold and serviced at Heathkit Electronic Centers® nationwide. Consult your telephone directory white pages for location. \*Units of Veritechnology Electronics Corporation. Some retail prices may be slightly higher.

CIRCLE 1 ON READER SERVICE COUPON

# ELECTRONICS HOBBYIST

CONTENTS

1980 EDITION

## HOUSEHOLD CONSTRUCTION FEATURES

- 12 Simplex-a-Thing
- 13 BCD Clock
- 22 Electrolok
- 66 Fridgalarm
- 73 L'il Wailer
- 84 Kitchen Kontroller
- 93 Cyclops

Build these projects and have the most wired-up house on your block. They'll keep the old place humming.

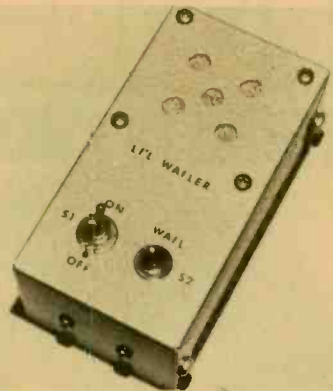

## FUN AND GAMES PROJECTS FOR ALL

- 8 Imagician
- 45 Electronic Slot Machine
- 47 Las Vegas LED
- 57 Lissy the TV Light Pen
- 64 Stoppit
- 67 New Shell Game

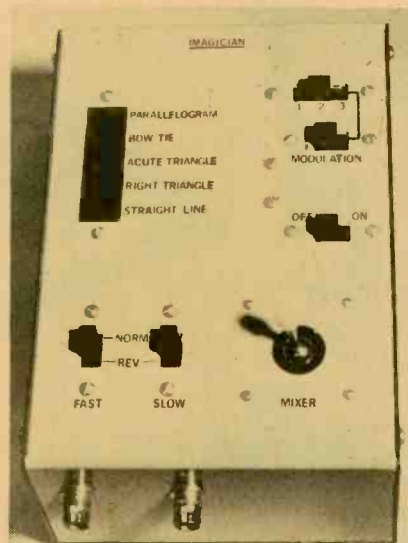

You'll never be bored when you build these simple, high-technology projects. They're fun for the whole family, and easy to get going.



## BUILD MUSIC MASTERS

- 20 Super Sound Synthesizer
- 51 Simple Syn
- 61 Disco King
- 71 Big Boost
- 78 Super Bass
- 79 Tape Tester
- 89 Stereo Bar Graph Meter

Be your own orchestra conductor, or lead a jazz or disco band with these construction projects you'll never see on a store shelf.

## RADIO RECEIVERS AND ACCESSORIES

- 41 Roaring Twenties Receiver
- 44 Low Cost CW Filter
- 82 Shortwave Supercharger

Flappers and Stutz Bearcats will dance on your table when you put the final touches on our slick "Roaring Twenties Receiver." There are more radio accessories, too.



## REGULAR DEPARTMENTS

- 3 New Products
- 99 Literature Library
- 102 Ask Hank, He Knows

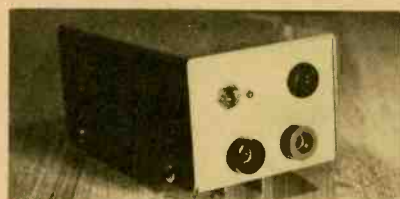

So you're a hobbyist? Well, these construction projects will put you in the professional class—in the darkroom, in the lab, and at the workbench.

## HANDY HOBBY PROJECTS

- 25 Darkroom Color Analyzer
- 31 Mini Reg
- 38 Beer Can Signal Tracer
- 39 Smart Power Supply
- 72 Diode Digest
- 75 Digital Voltmeter
- 86 Bargain TTY Interface
- 87 VOM Scope Calibrator
- 92 RF From Your Calculator



# New Products

## Hand-Held 3½ DMM

With a choice of either LCD or LED displays, two new VIZ 3½ digital multimeters provide an accuracy of 0.1% (DCV) with an input impedance of 10 megohms. The LCD model, WD-759, offers the advantage of a visual indication of function (DC or AC voltage, ohms or amperes) in the display window, as well as the measurement value. The suggested price is only \$159. Measurement ranges are from 100-microvolts to 1000-VDC and up to 600-VAC; from 0.1-ohm to 20-megohms and from 0.1-microamp to 1-amp, DC and AC. The units also provide for measurement of either high or low power ohms in all ranges, switch selectable. For easy service in the field, there is a 1-amp fuse, plus spare, located in the rear battery compartment. An optional AC adaptor is available for bench operation. A carrying case is available that permits use of the instrument while in the case. Another optional accessory is a high-voltage probe (50-KV DC). The LED model, WD-758, is

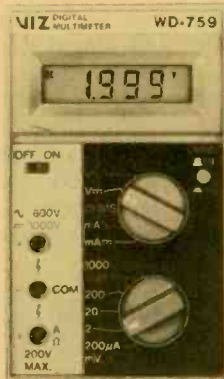

CIRCLE 35  
ON READER  
SERVICE  
COUPON

identical in electrical performance except that it doesn't provide function indication in the display. Price for this model is only \$149. For additional details, contact any VIZ distributor or write to VIZ Mfg. Co., 335 E. Price St., Philadelphia, PA 19144.

## Custom Mount

The new Model K-4A-DD Firestik Super Stud Disco-Disc Mount uses a chrome-plated steel disc for strength and beauty. It comes complete with SO-239 base, heavy-duty mounting stud and 3/8-

24 solid brass threaded shank. The K-4A-DD accepts PL-259 terminated cables: A low-profile deck mount (less than 1/4-in. from deck to stud) must be used with spring. The unit is designed to hold

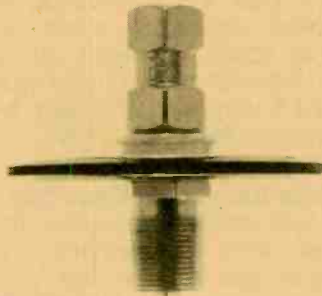

CIRCLE 40 ON READER SERVICE COUPON

heavy duty Firestiks or similar antennas up to 4 ft. in length. Excellent for use with CB, VHF or amateur antennas for installation on trucks, boats, automobiles, RV's, etc. Sells for \$5.95. For more information, write to Firestik Antenna Corporation, 2614 East Adams, Phoenix, AZ 85034.

## Electronic Keyer

The new MFJ-408 Deluxe Electronic Keyer II has a readout meter and a socket for Curtis accessories. The MFJ-408 lets you read your sending speed to 50 WPM, and the accessory socket allows you to use the following Curtis accessories: external memory, random code generator, or keyboard. (These are accessory PC boards or boxes.) The MFJ-408 is based on the proven Curtis 8044IC keyer chip, and sends iambic, automatic, semi-automatic, or manual CW. Dot-dash memory provides self-completing dots and dashes with jam proof spacing.

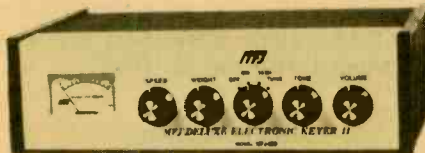

CIRCLE 41 ON READER SERVICE COUPON

The MFJ-408 provides solid state keying for grid block, cathode or solid state transmitters (-300-V, 10-ma. max, +300-V 100-ma. max). The MFJ-408 is completely portable.

## THE STAFF

Associate Publisher & Editor-in-Chief  
**Julian S. Martin, KA2GUN**

Managing Editor  
**Alan H. Rose, K2RHK**

Associate Editor  
**Lee Lensky, KA2DKT**

Associate Editor  
**Paul Margolis**

Communications Editor  
**Don Jensen, WDX9EZ**

Citizens Band Editor  
**Kathi Martin, KGK3916**

Editorial Assistant  
**Cynthia McClean, KBKF3780**

Workbench Editor  
**Hank Scott**

Art Director  
**Ralph Rubino**

Associate Art Director  
**David Pindar**

Assistant Art Director  
**Michael Vessio**

Cover Art Director  
**Irving Bernstein**

Art Editor  
**Delia Nobbs**

Art Assistant  
**Susan Mahler**

Advertising Director  
**Ralph Vega**

Production Director  
**Carl Bartee**

Production Manager  
**Carole Dixon**

Production Assistant  
**Annette Simon**

Newsstand Circulation Director  
**Don Gabree**

Classified Advertising Director  
**Rose Wayner**

Subscription Circulation Director  
**Robert V. Enlow**

Subscription Circulation Manager  
**Eugene S. Slawson**

Marketing Director  
**James C. Weakley**

President and Publisher  
**Joel Davis**

Vice President and General Manager  
**Leonard F. Pinto**

Vice President and Treasurer  
**Victor C. Stabile, KBP0681**

ELECTRONICS HOBBYIST is published annually by Davis Publications, Inc. Editorial and business offices: 380 Lexington Avenue, New York, N.Y. 10017. Advertising offices: East Coast, 380 Lexington Ave., New York, N.Y. 10017, 212-557-9100; Midwest, 360 N. Michigan Ave., Chicago, IL 60601, 312-346-0712; West Coast, J. E. Publishers' Rep. Co., 8732 Sunset Blvd., Los Angeles, CA 90069, 213-659-3810.

EDITORIAL CONTRIBUTIONS must be accompanied by return postage and will be handled with reasonable care; however, publisher assumes no responsibility for return or safety of manuscripts, artwork, or photographs. All contributions should be addressed to the Editor-in-Chief, ELECTRONICS HOBBYIST, 380 Lexington Avenue, New York, N.Y. 10017. Copyright 1980 by Davis Publications, Inc.

# Panasonic Portable Light Scope

When you depend on  
an eye for detail



\*Suggested  
retail price  
\$24.95

The powerful Panasonic Light Scope FF-393E lets you make brilliant observations . . . every time, anywhere. It's the ideal tool for students, engineers, collectors, jewelers, chemists, hobbyists, printers, textile inspectors . . . and other sticklers for detail. For the professional perfectionist, it's hand-held technology at a pocket sized price.\* It features:

- 30-power magnification
- blue light filter
- thumbwheel lens focus
- battery operation (operates on 2 "AA" size batteries, not included)
- compact — 5½" total length
- automatic shut off when folded
- carrying pouch

For more information about Panasonic portable light scopes, fill out and mail us this coupon.

Panasonic Company,  
Battery Dept.  
P.O. Box 1500  
Secaucus, NJ 07094

I would like more information  
about Panasonic light scopes.

Name \_\_\_\_\_

Firm \_\_\_\_\_

Address \_\_\_\_\_

City/State/Zip \_\_\_\_\_

Phone \_\_\_\_\_

CIRCLE 11 ON READER SERVICE COUPON

# New Products

ble; it operates up to 1 year on 4 C-cell batteries. It has a 2.5 mm phone jack for external power (6 to 9-VDC) or order the optional AC adapter for \$7.95. The MFJ-408 Deluxe Keyer II is available from MFJ Enterprises, Inc. for \$79.95 plus \$3.00 shipping and handling, accessory cable with plug is \$3.00. To order call toll free 1-800-647-1800 or mail order to MFJ Enterprises, P.O. Box 494, Mississippi State, MS 39762.

## Wide-Bandwidth Equalizer

A new graphic equalizer from Sansui, with a suggested retail price of just \$230, boasts a flat frequency response of 0-100,000-Hz  $\pm 0$ ,  $-1$ -dB to ensure that any alteration in frequency balance is limited to changes deliberately made by the listener. The new Sansui SE-5 provides equalization in eight frequency bands, centered on 80, 160, 315, 630-Hz, and 1.25,



CIRCLE 39 ON READER SERVICE COUPON

2.5, 5 and 10-kHz, for precise control of the reproduced sound to compensate for room acoustics, limitations of other components, characteristics of the music being listened to or personal taste. The SE-5 can be switched to apply equalization to a recording as it is made. This is useful when dubbing from old, noisy recordings, compensating for vocal or instrumental limitations or in preparing specially equalized tapes for use in cars, planes or boats with high ambient noise. For further information, write to Sansui Electronics Corporation, 1250 Valley Brook Avenue, Lyndhurst NJ 07071.

## Disco Delight

Numark's Studio Amplifier, Mixer, Equalizer MA4000 combines all the essential features in one package for any disco application, portable or permanent. The amplifier section features 50 watts RMS per channel at less than 0.1% THD, from 20 Hz to 20,000 Hz,

along with 12 level LED display for accurate monitoring. The unit also features a five-band equalizer with a range of  $\pm 12$  dB. The mixing section provides for two

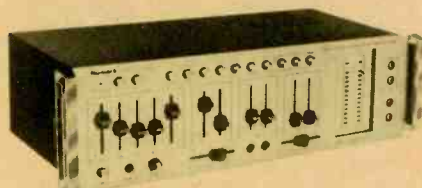

CIRCLE 38 ON READER SERVICE COUPON

phono, two line and two mike inputs. Other features include fader and cue control, phone level adjustment and talk-over switch. The unit features a bridging circuit that allows any power amplifier to be tied into the MA4000 for unlimited versatility. Suggested retail price is \$580.00. Music lovers can get all the facts from Numark Electronics Corp., 503 Raritan Center, Edison, NJ 08817.

## Direct-Drive Turntable

The Realistic LAB-500 turntable from Radio Shack is fully automatic and has an electronic quartz-locked circuit designed for absolute speed precision at 33½ or 45-RPM. Using a quartz crystal frequency standard and PLL electronic circuitry, motor speed is constantly monitored and corrected for variations in line voltage. Just 1.5 seconds after start-up, the speed is kept accurate to with-



CIRCLE 32 ON READER SERVICE COUPON

in 0.0005%. The result: wow and flutter is less than 0.04% WRMS. The LAB-500 has a 3.1-lb. aluminum alloy die-cast platter which rests directly atop a 12-pole brush-

less DC servomotor. To complement its drive system, there's a statically balanced S-shaped tone-arm with an integrated head-shell/cartridge for extremely low mass. The cartridge provides a linear frequency response from 20-20,000 Hz at tracking forces of under one gram. LAB-500 functions include electronically-controlled oil-damped cue/pause, start/stop, record size and speed selectors, and a single-play/repeat knob for automatic replay or shutoff at disc's end. Priced at \$259.95, the Realistic LAB-500 turntable is sold exclusively by Radio Shack stores and dealers nationwide and in Canada.

### Upgrade 6800 MPU to 6809

Percom Data Company is now offering a 6809 adapter for Southwest Technical Products' MP-A2 processor card. Although designed for the SWTP card, the Adapter may in fact be used to upgrade

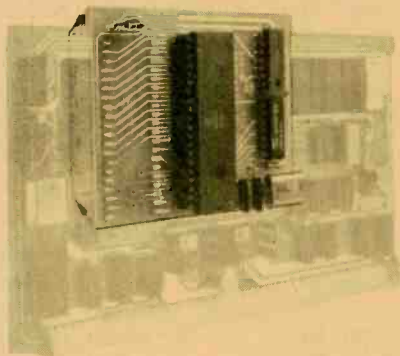

CIRCLE 36 ON READER SERVICE COUPON

most other 6800 or 6802 MPUs to 6809 operation. The 6809 micro-processor chip offers several advantages over the 6800 chip, including more registers, expanded memory and register addressing capability, and a command/instruction set that includes the 6800 commands as a subset and faster throughout. The kit, which sells for \$69.96, is an inexpensive way for owners of 6800 or 6802 computers to upgrade to 6809 operation without changing any permanent wiring on the processor board, mother board or elsewhere. The original system may be restored by simply removing the Adapter, which plugs into the 6800 socket, and a wire-jumpered DIP header, which plugs into the clock generator IC socket, and reinserting the original components. The Adapter, which is supplied

assembled and tested, includes the 6809 IC, a crystal, other essential parts and user instructions. The wire-jumpered DIP header is also included. An operating system—a version of PSYMON, Percom's operating system for the company's 6809 single board computer—is also available for users of the upgrade adapter. Orders may be placed by dialing 1-800-527-1592 (outside of Texas) or 214/272-3421 (within Texas), and may be paid by check or money order, COD or charged to a Visa or Master Charge accounts. When you call, tell Percom that ELEMENTARY ELECTRONICS sent you.

### Get Ticket at Home

A self-instruction program for passing the FCC Technician and General Class Amateur Radio License exams has been introduced by the Heath Company. The program, divided into 15 units, covers the material FCC exams are based on. Unit exams check the student's progress while giving practice at exam taking. Also included are cassette practice tapes to prepare the individual to send and receive Morse code up to 15 words per minute, two words per minute above the FCC General Class requirement. The program also includes a code practice workbook, a world map, a booklet on solving radio and TV interference problems, a log book, a copy of FCC



CIRCLE 1 ON READER SERVICE COUPON

amateur radio rules and regulations, FCC Form 610 required to apply for the exam and a schedule of exam dates and locations.

# FOR THE EXPERIMENTER

INTERNATIONAL CRYSTALS and KITS

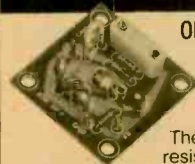

OF-1 OSCILLATOR

**\$4.93**  
ea.

The OF-1 oscillator is a resistor/capacitor circuit providing oscillation over a range of frequencies by inserting the desired crystal, 2 to 22 MHz, OF-1 LO, Cat. No. 035108. 18 to 60 MHz, OF-1 HI, Cat. No. 035109. Specify when ordering.

**MX-1 Transistor RF Mixer**  
3 to 20 MHz, Cat. No. 035105  
20 to 170 MHz, Cat. No. 035106 ..... **\$6.38 ea.**

**SAX-1 Transistor RF Amp**  
3 to 20 MHz, Cat. No. 035102  
20 to 170 MHz, Cat. No. 035103 ..... **\$6.38 ea.**

**BAX-1 Broadband Amp**  
20 Hz to 150 MHz, Cat. No. 035107 ..... **\$6.67 ea.**

.02% Calibration Tolerance  
**EXPERIMENTER CRYSTALS**  
(HC 6/U Holder)

**\$5.74**  
ea.

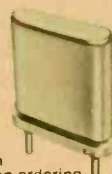

| Cat. No. | Specifications  |
|----------|---|
| 031300   | 3 to 20 MHz—For use in OF-1L OSC Specify when ordering  |
| 031310   | 20 to 60 MHz—For use in OF-1H OSC Specify when ordering |

Enclose payment with order (no C.O.D.). Shipping and postage (inside U.S., Canada and Mexico only) will be prepaid by International. Prices quoted for U.S., Canada and Mexico orders only. Orders for shipment to other countries will be quoted on request. Price subject to change. Address orders to: M.S. Dept., P.O. Box 32497, Oklahoma City, Oklahoma 73132

WRITE FOR BROCHURE



International Crystal Mfg. Co., Inc.  
10North Lee, Oklahoma City, Oklahoma 73102

CIRCLE 8 ON READER SERVICE COUPON

## WRITE NOW FOR **McGEE'S** **BIG SPEAKER CATALOG**

**1001 BARGAINS IN**

**SPEAKERS — PARTS — TUBES — HIGH FIDELITY COMPONENTS — RECORD CHANGERS**  
Tape Recorders—Kits—Everything in Electronics  
1901 McGee Street, Kansas City, Missouri 64108



**Take stock in America.**

# New Products

Mail order priced at \$49.95, the program carries a money-back guarantee should the purchaser fail the Technician or General Class FCC exam. Get the details direct from Heath Company, Dept. 570-220, Benton Harbor, MI 49022.

## Home Burglar Alarm

With over 3 million home burglaries reported last year (authorities estimated twice as many went unreported), the 54 Heathkit Electronic Centers in 28 states are about to introduce a remarkably effective device that does what most custom-installed burglar alarms do. It's the MIDEX-55, a compact, professional-grade home burglar alarm system that uses sophisticated motion sensing electronics to detect, then startle and drive off intruders. The MIDEX-55 is capable of emitting up to 120 decibels of sound. It can be installed in just three minutes, activated with the push of a button and, best of all, it sells for un-

der \$250 complete. Designed for use in the home, apartment, weekend retreat or small office, the MIDEX-55 system consists of just two components: a combination transceiver control unit (\$199.95) and a companion blast-horn speaker (\$39.95). Operating off normal house current, the MIDEX-55 can be set up by connecting the speaker wires to the back panel of the control unit using only a screwdriver. To ensure performance reliability, Solfan Systems, Inc. tests each component part of the MIDEX-55 control unit at extreme tolerances and then individually bench tests each assembled system under full power for seven days. This pre-shipment testing is designed to simulate three full months of continuous use, and is further backed by an

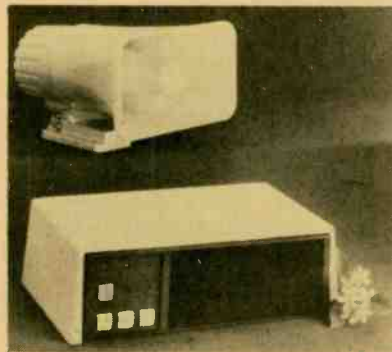

CIRCLE 37 ON READER SERVICE COUPON

unconditional one-year warranty for all parts and labor. Solfan Systems also maintains a "consumer hot line" toll-free telephone number: (800) 227-8065. Or, write to Solfan Systems, Inc., Midex Consumer Division, 665 Clyde Avenue, Mountain View, CA 94043. In either case, tell Solfan, "ELEMENTARY ELECTRONICS sent you."

## Prototype Boards

O.K. Machine and Tool Corp. has introduced a new series of Circuit Mount boards for electronics projects and prototypes. All boards feature solderless insertion type sockets on 0.1 inch centers. Each row has 5 common points. Larger boards also feature 40-point bus lines, and a separate bus strip module is also available. All boards can accept standard component leads, including DIP's,

while interconnections are easily made using standard 22 AWG solid wire. Prices are: \$25.95 for the 1020 point CM-100, and \$16.45 for the 630 point CM-200. Delivery

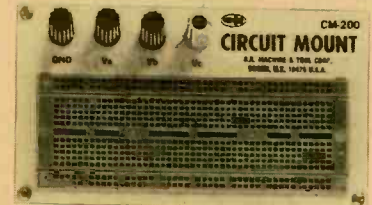
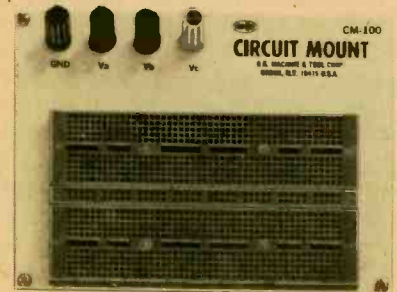

CIRCLE 33 ON READER SERVICE COUPON

is from stock at local electronics retailers or directly from O.K. Machine and Tool Corp., 3455 Conner Street, Bronx, NY 10475. To get all the facts on these boards and other prototype boards, write directly to O.K. Machine and Tool Corp.

## Four More for Good Audio

Four new high fidelity Home Speaker Systems from Audiotech of GC Electronics feature a unique total motor system which results in higher than normal efficiency for acoustic suspension speakers. Now available is the 8-in., two-way system (Cat. No. 94-1200) with a suggested retail price of \$59.95 each. An 8-in. woofer and



CIRCLE 34 ON READER SERVICE COUPON

a phenolic-ring tweeter get the most out of this compact cabinet. Power handling capacity is 35 watts RMS with a frequency response of 45 to 20 kHz. A 10-in. woofer and brilliant wide-dispersion phenolic-ring tweeter highlight the Audiotech 10-inch, Two-Way System (Cat. No. 94-1300),

# AMAZING DEVICES

## ((( PHASERS )))

**PPF-1 PHASER PAIN FIELD** — This device recently developed and patented in our labs is being evaluated by law enforcement agencies for riot and crowd control. It is now available but soon will come under the jurisdiction of weapons and internal machine control making it unavailable to the public. The device is hand-held and looks like a BUCK ROGERS ray gun. It is hazardous if not used with discretion.

**PPF-1 PLANS \$15.00**

**IPG-1 INVISIBLE PAIN FIELD GENERATOR** — This amazing, simple hand-held device is about the size of a pack of cigarettes and generates a directional field of moderate to intensive pain in the lower part of the head up to a range of 50'. Device is simple and economical to make.

**IPG-1 PLANS \$6.00 IPG-1K ALL PARTS \$39.50 IPG-10 ASSEMBLED & TESTED FOR ANIMAL CONTROL \$49.50**

## LASERS

**RUBY LASER RAY PISTOL** — Produces highly intense red beam, capable of burning. A hazardous device. **PLANS, PARTS, SOURCES \$15.00**

**HIGH POWERED CARBON DIOXIDE BURNING AND CUTTING.** Complete plans and all parts sources **\$15.00**

**SOLID STATE IR 12 WATTS** with built in power supply plans **\$8.00** Complete kit with collimator **\$74.00**

**POCKET LASER** pulsed, visible red, plans **\$7.00** Complete kit **\$59.50** Also complete plans and parts sources for RUBY, YAG, NEDDYNIUM, HeNe ARGON, DYE, NITROGEN and many more lasers.

## SECURITY

**SNP-2 SNOOPER PHONE** — Dial home or office phone while on vacation activating sensitive mike without phone ringing. Excellent property protection and intrusion device.

**SNP2 PLANS \$7.00**

**SNP2K ALL PARTS \$49.50**

**SNP20 ASSEMBLED AND TESTED \$89.50**

**LONG RANGE XMTR PLANS \$6.00**

**SEE-IN-THE-DARK PLANS \$8.00**

**DIRECTIONAL SHOTGUN MIKE PLANS \$7.00**

**SUPER SENSITIVE PARABOLIC MIKE PLANS \$7.00**

**SOUND & TELEPHONE OPERATED TAPE RECORDER \$6.00**

**CATALOG ON PLANS, KITS & FINISHED UNITS \$1.00**

Send check or money order to

**SCIENTIFIC SYSTEMS, Dept. A10, Box 276**

**AMHERST, N. H. 03031**

CIRCLE 12 ON READER SERVICE COUPON



which carries a suggested retail price of \$69.96 each. The system handles 35 watts RMS power with a frequency response of 40 to 20 kHz. Enjoy lifelike reproduction of sound with the new 10-inch, Three-Way System (Cat. No. 94-1350). A deep-throw 10-in. woofer, 4½-in. hardback mid-range and phenolic-ring tweeter create an unbeatable combination of power plus performance. Power handling capacity is 40 watts RMS with a frequency response of 40 to 20 kHz, and it sells for \$89.95 each. Engineered for the hard-to-please audiophile is the 12-inch, Three-Way System (Cat. No. 94-1400) with a \$99.95 price tag. Natural sound emanates from an acoustic suspension system with a 12-in. woofer, 4½-in. hardback midrange and wide-dispersion phenolic-ring tweeter. The system handles 45 watts RMS with a frequency response of 35 to 20 kHz. Audiotex speakers are manufactured from start to finish in GC's own 50,000 sq. ft. speaker plant. Audiotex makes them, tests them and backs them! Get all the facts from Audiotex Division, GC Electronics, 400 South Wyman Street, Rockford, IL 61101.

### Pocket Shortwave Receiver

Measuring only 1¾ x 2⅞ x 1, the Model EP-8 may be the smallest AM/SW 2-band receiver. In addition to the standard "broadcast"

CIRCLE 42  
ON READER SERVICE  
COUPON



band (AM), the Model EP-8 receives shortwave frequencies from 3.9 to 12 MHz. Audio output is via the supplied earphone only and the receiver is powered by two hearing-aid type batteries (included). The EP-8 has built-in Ferrite Rod antennas for both bands. Shortwave reception is satisfactory for powerful stations such as the BBC, Radio Canada International, Radio Nederland, Deutsche Welle and others. Priced at \$24.95 the Model EP-8 is available from Radios International, P.O. Box 6053, Richardson, TX 75080.

### Graphics Upgrades PET

The Micro Technology K-1008A-P Visible Memory is a graphic display board that upgrades the Commodore PET computer system to permit high resolution graphics, such as math plots, 3-D line drawings in perspective, and arbitrary character sets. During image update there is no



CIRCLE 44 ON READER SERVICE COUPON

snow or visible interference. When not used for graphics, the board serves as an 8K byte expansion memory, doubling the 8K PET capacity. K-1008-3C graphic software is also offered. The K-1008A-P puts up a high resolution matrix of 64,000 dots (320 wide x 200 high), and allows control of the on/off state of each dot individually and independently. The board interfaces to the PET with the K-1007A-1 bus adaptor with easily detached ribbon cable interconnects. Without the bus adaptor, the K-1008A-P can be used with AIM-65, KIM-1 and SYM-1 computers. The K-1005A-P expansion card file is optional. The Micro Technology K-1008A-P Visible Memory is priced at \$243.00 the K-1007A-1 bus adaptor at \$99.00, the K-1005A-P card file at \$80.00 and the K-1008-3C software at \$20.00. Literature is available on request. For more information, write to Micro Technology Unlimited, 841 Galaxy Way, P.O. Box 4596, Manchester, NH 03108.

### Quick Disconnect Adapters

Two new Quick Disconnect Adapters, for fast, easy antenna whip removal to protect against theft and damage during car washing or garaging, are now available from Antenna Incorporated. The adapters are unique because of their ease of operation and durability. The model 18016 is designed for mounting any long quarter wave ⅜ inch-24 threaded whip. The adapter can be used between ball and spring or spring and whip. It may be used on any bumper mount spring and whip, or

(Continued on page 98)

Q. Which magazine has the widest scope of equipment test reports?

A. hi-fi stereo BUYERS' GUIDE

Read it regularly for the most in consumer audio information and advice.

A low 6 to 8 weeks for delivery of first copy.

### Hi-Fi/Stereo BUYERS' GUIDE

gives you the absolute tops in number of equipment test reports per issue.



If you're a "best-buy" buyer, don't miss a single issue!

Mail this coupon to:  
Hi-Fi/Stereo  
BUYERS' GUIDE  
Box 1855 GPO  
New York, NY 10001

SAVE \$2.00 off regular subscription rate.  
\$2.15 off newsstand rate.

Enclosed is \$5.95 for 6 issues of HFSBG (outside U.S.A., possessions send \$7.00)

Name \_\_\_\_\_  
Address \_\_\_\_\_  
City \_\_\_\_\_  
State \_\_\_\_\_ Zip \_\_\_\_\_

### CREDIT CARD OWNERS

You may use Master Charge or Visa card.

12 issues for \$11.50

Canada, other countries  12 issues \$13.50.

Credit Card #

\_\_\_\_\_

EXPIRATION DATE \_\_\_\_\_

SIGNATURE \_\_\_\_\_

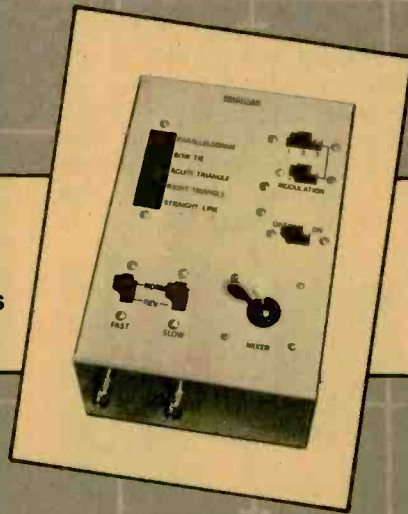

With a little help, your scope becomes an electronic canvas

# IMAGICIAN

**H**OW WOULD YOU LIKE TO be able to generate beautiful geometric line drawings electronically? And what if these figures could be made to look 3-dimensional, with forms that expand, rotate, and flow under the command of a joystick? Sounds expensive and complicated, doesn't it? If you've seen some of the graphics produced by hobby-type digital computers, you're probably skeptical and rightfully so. Small digital computers generate simplistic graphics with a chunky appearance. Generating smooth lines and complex figures with a digital computer requires much more memory than most computer hobbyists can afford.

But if a few ideas are borrowed from the *analog* computer, a device

rarely mentioned anymore, it's possible to generate dazzling graphics with simple, inexpensive circuitry. That's the principle of the Imagician, a simple, two-IC project that transforms your oscilloscope's screen into a window on a magic land of animated geometric figures.

**The Lissajous Figure.** Before delving into the workings of the Imagician's circuit, let's talk about Lissajous figures. If you own a scope, no doubt you are familiar with them. A Lissajous figure is a closed curve that results when two harmonically related signals are applied to a scope—one signal to the vertical input, the other to the horizontal input. The most familiar figure occurs when a sine wave is applied to one input, and a phase-shifted sine of

the same magnitude and frequency is fed to the other input. On the scope's screen there appears either an elliptical or circular trace, depending upon the phase relationship between the two signals. With non-sinusoidal waveforms driving the X and Y inputs, other geometrical displays can be created.

Let's examine the various waveforms synthesized within the Imagician (Figure 2). From just these six signals, thousands of fascinating displays can be produced. Waveforms *a*, *b* and *c* all oscillate at 60 Hz; signal *a* is a triangle wave, *b* is a symmetrically clipped triangle, and *c* is trapezoidal. Signal *d* is another triangular waveform, but with a frequency of 120 Hz. For reasons that will be apparent later, let's call figures *a* thru *d* "slow" figures.

It stands to reason that there must be some fast signals, too. Waveforms *e* and *f* are the fast ones, with a frequency equal to 3840 Hz (64 times faster than 60 Hz). Signal *e* might be called a "soft-shouldered square wave," while *f* just begs to be called a "shark-fin wave."

What are the simplest Lissajous figures that can be generated by selected pairs of the above six waveforms? Figure 3 shows these fundamental figures along with the X and Y components necessary for their generation. It is assumed that the X and Y components are of equal magnitude; if such is not the case, the shapes will be distorted to new forms. Note that these fundamental Lissajous figures are segregated into slow and fast classes. The slow figures have slow waveforms (*a* through *d*) as components, while the fast figure has fast components (*e* and *f*). The slow figures include familiar geometric shapes: a straight line, a right triangle, a parallelogram, an acute triangle and the perhaps not-so-

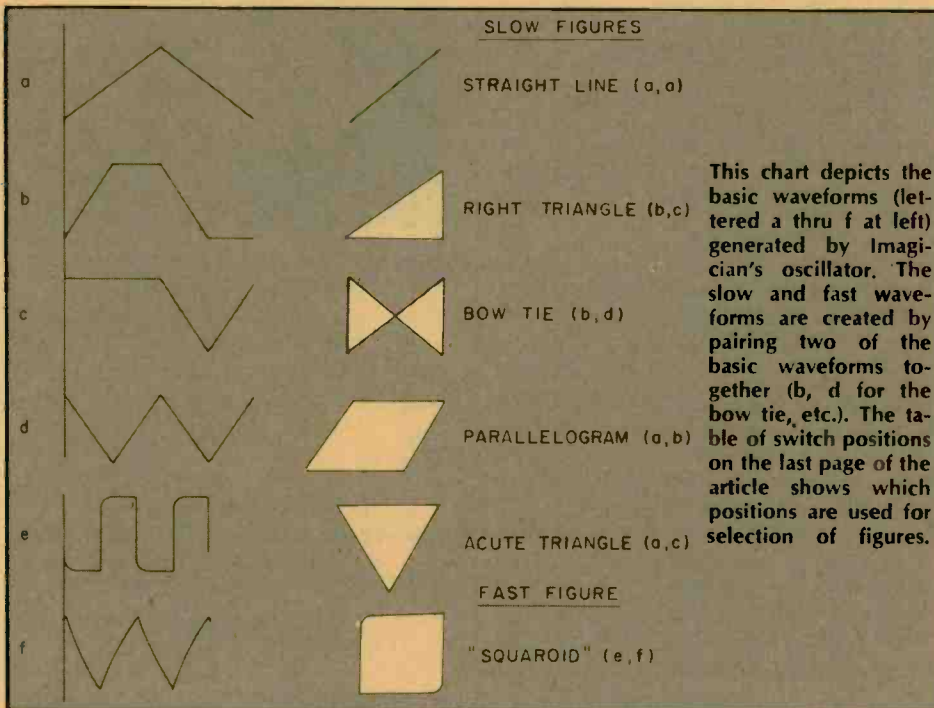

familiar bow tie. Were it not for a slight slope to the sides and a pair of rounded corners, the fast figure would almost appear to be a square. In recognition of the similarity, let's call the fast figure a "suaroid."

New complex Lissajous figures, some of which will appear to be 3-dimensional, can be synthesized by adding together one of the slow figures and the suaroid. This is accomplished by summing the X- and Y-component waveforms of the two figures independently. Furthermore, it's not necessary to mix signals in a one-to-one ratio. Different mixing ratios yield new and fascinating displays in a manner that's often hard to predict. As a final touch, the components of the fast figure (suaroid) can be amplitude-modulated. The type of modulation used here was specifically chosen to enhance the illusion of perspective in those displays that appear 3-dimensional.

**The Circuit.** Let's consider the Imagician's circuit in detail. Two batteries, B1 and B2, provide +9V and -9V supply potentials for the circuit when power switch S1 is closed. Diodes D1 and D2 protect the ICs from incorrect battery installation and also drop the supply potential slightly, which is desirable here. Capacitors C1 through C4 provide supply bypassing.

Q1, a programmable unijunction transistor (PUT), works together with R1, R2, R3 and C5 to form an oscillator that feeds pulses to the clock input (pin 1) of U1, a 4024B seven-stage binary frequency divider. U1 divides the input frequency by 2, seven times in succession to yield seven harmonically related square-wave outputs. We need harmonics in order to generate Lissajous patterns, but square waveforms do not yield interesting displays. Consequently, the greater portion of the Imagician's circuitry is devoted to the shaping of square waveforms into other more useful signals.

At pin 3 of U1, we find the lowest-frequency square wave (60 Hz), while pin 4 supplies the second harmonic (120 Hz). R15 and C6 integrate the

60 Hz signal to a triangular waveform (a). Diodes D3 and D4 together with integrating network R16/C7 produce the symmetrically-clipped 60 Hz triangle (b). Driven by both the 60 and 120 Hz signals, the D5/D6/R17/R18/C8 network yields a 60 Hz trapezoid (c). Finally, the last slow waveform, triangle wave d, is generated when R19 and C9 integrate the 120 Hz square-wave signal.

Fast waveforms e and f are formed with the aid of shaping networks R22/C10 and R23/C11, respectively. When

modulated 3840 Hz square-wave current will be fed to each R/C shaping network. Consequently, signals e and f will be of constant amplitude.

The rest of the circuitry serves only to combine signals a through f in various ways. Switch S3 selects pairs of X and Y components for the 5 slow Lissajous figures. These signal pairs are routed to the vertical (R24a) and horizontal (R24b) mixers via reversing switch S4. (When a Lissajous figure's X and Y components are interchanged, it flips to a new orientation on the

This underside view of the chassis shows the positions of the panel switches and joystick control. As usual, this should only serve as an example of how you can go about building your own model. There are no critical component placements in Imagician.

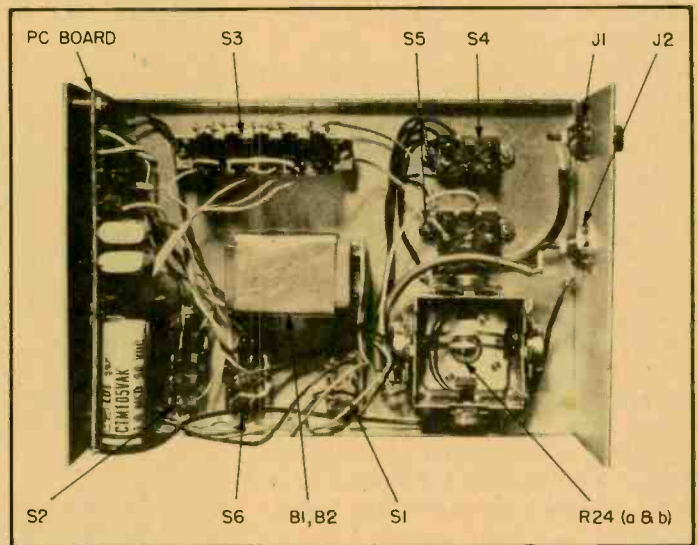

S6 is flipped to the left, as indicated in the schematic, amplitude-modulated currents at 3840 Hz are fed to the shaping networks just discussed. As a result, waveforms e and f are also amplitude-modulated. The manner in which modulation is obtained here requires further explanation: U2, a 4070B quad EXCLUSIVE-OR gate, taps harmonically related signals from frequency divider U1. The gates within U2 are connected so as to yield a sort of digital multiplier when the various outputs are summed together (by R5/R9 and R10/R14). Switch S2 controls the shape of the modulation envelope, with three choices available. If S6 should now be flipped to the right, an un-

screen.) Switch S5 performs the same function as S4, but it operates on the components of the fast figure instead. Addition of the X components of the slow and fast figures occurs in the horizontal mixer; the vertical mixer sums their Y components. R24a and R24b are part of a joystick assembly; north-south movement of the stick controls R24a, while east-west motion affects R24b. Thus, a single control manipulates two pots independently of one another. If desired for reasons of economy, however, two separate potentiometers could be used for R24a and R24b. Jacks J1 and J2 send the mixer output signals to the appropriate high-impedance (1 Megohm) scope inputs.

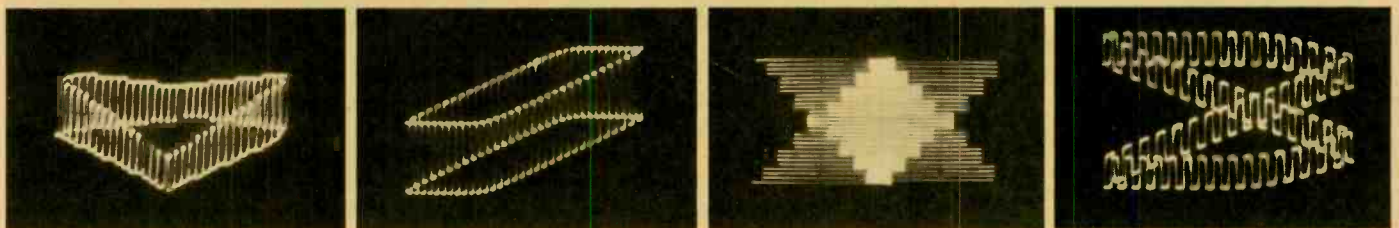

Here are a few examples of the designs which can be produced by mixing of the basic waveforms. What we can't show are the moving figures and the shifts which are possible. From left to right are: acute triangles, parallelograms, inverted acute triangles, and a double bow tie formed in a dot pattern instead of solid lines. With experimentation, you can come up with many more.

# IMAGICIAN

**Construction.** Printed-circuit construction of the Imagician is recommended, and complete details of the board can be found in Figures 4 and 5. For the sake of shielding, an aluminum cabinet should be used to house the circuit. Furthermore, the chassis should be connected to system ground at some point. Connections between the Imagician and your oscilloscope should be effected by means of relatively short, (18-inches or less) shielded cables.

As usual, solder joints should be made with a small, 25-watt iron and resin-core solder. Sockets are required for the two CMOS ICs, which should be installed only after all soldering is finished. Be certain that U1 and U2 both have the "B" suffix—devices with an "A" suffix will not work in this circuit.

Capacitor C5 must be a polystyrene (or mica) unit to ensure that your oscillator's frequency is close to that of the prototype. Be careful with those devices requiring proper orientation—electrolytic capacitors C1 and C2, Q1, the ICs, and the diodes. Although S3 is shown schematically as a rotary switch,

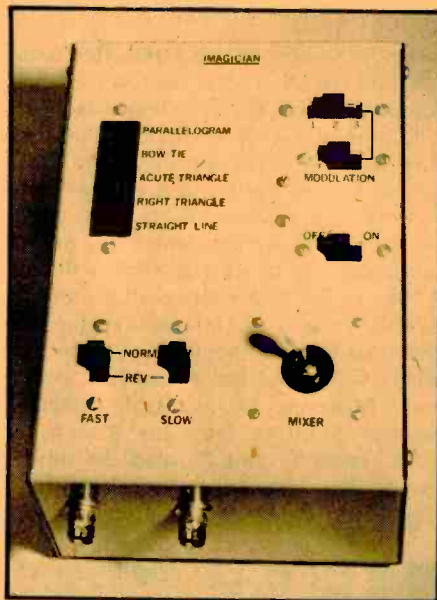

This front panel closeup shows the relative positions of all the controls, and the dry transfer lettering we utilized to achieve a more professional appearance for the prototype. We positioned the input and output coaxial jacks at the bottom front rather than at the top, so as to minimize the effects of body capacitance when one's hand is brought into proximity of the input and output cables. This feature also allows much more freedom of access to the controls as opposed to top mounting of the jacks.

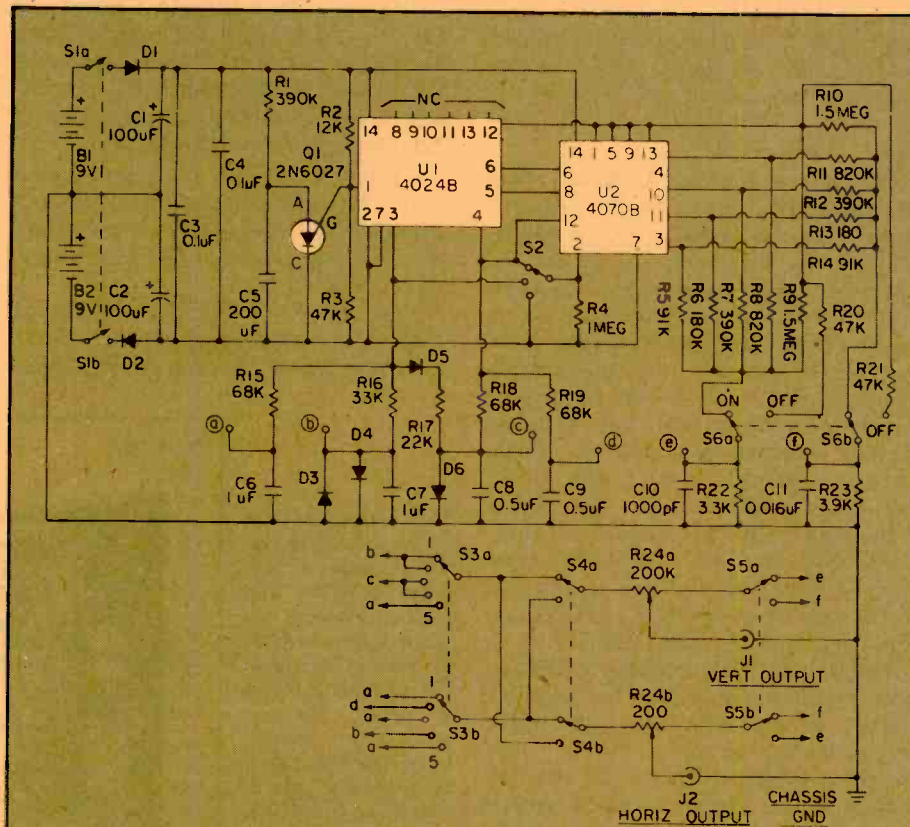

## PARTS LIST FOR IMAGICIAN

- B1, B2—9-volt transistor battery
- C1, C2—100- $\mu$ F, 16-VDC electrolytic capacitor
- C3, C4—0.1- $\mu$ F ceramic disc capacitor, 100-VDC
- C5—200-pf polystyrene capacitor 100-VDC
- C6, C7—1.0- $\mu$ F mylar capacitor, non-polarized
- C8, C9—0.5- $\mu$ F mylar capacitor 100-VDC
- C10—1000-pf polystyrene capacitor 100-VDC
- C11—0.016- $\mu$ F mylar capacitor 100-VDC
- D1 thru D6—1N914 diode
- J1, J2—BNC jack
- Q1—programmable unijunction transistor—2N6027, 2N6028 or HEP S9001. (Note: 2N6028 Available from SOLID STATE SALES, BOX 74A, Somerville, MA 02143.)
- R1, R7, R12—390 K,  $\frac{1}{2}$ -watt resistor, 5%
- R2—12 K,  $\frac{1}{2}$ -watt resistor, 5%
- R3, R20, R21—47 K,  $\frac{1}{2}$ -watt resistor, 5%
- R4—1 Megohm,  $\frac{1}{2}$ -watt resistor, 5%
- R5, R14—91 K,  $\frac{1}{2}$ -watt resistor, 5%
- R6, R13—180 K,  $\frac{1}{2}$ -watt resistor, 5%
- R8, R11—820 K,  $\frac{1}{2}$ -watt resistor, 5%
- R9, R10—1.5 Megohm,  $\frac{1}{2}$ -watt resistor, 5%
- R15, R18, R19—68 K,  $\frac{1}{2}$ -watt resistor, 5%
- R16—33 K,  $\frac{1}{2}$ -watt resistor, 5%
- R17—22 K,  $\frac{1}{2}$ -watt resistor, 5%
- R22—3300-ohm,  $\frac{1}{2}$ -watt resistor, 5%
- R23—3900-ohm,  $\frac{1}{2}$ -watt resistor, 5%
- R24a, b—two, linear-taper 200K-ohm pots mounted in a joystick assembly (Herbach & Rademan #TM21K167; address is 401 E. Erie Ave., Philadelphia, PA 19134)
- S1—DPST slide switch
- S2—SP3T rotary or slide switch
- S3—DP5T rotary or pushbutton switch
- S4, S5, S6—DPDT slide switch
- U1—4024B binary ripple counter
- U2—4070B quad EXCLUSIVE-OR gate
- Misc: aluminum cabinet, IC sockets.

Note: An etched and drilled printed circuit board for the Imagician is available from LECTROGRAPHIX P.O. Box 537, Auburn, NY 13021, for \$5.90 postpaid to U.S. and Canadian residents. Foreign and overseas orders should include an additional \$1.50 for postage and handling, and should remit the cost in the form of a money order or other drafts payable in U.S. currency. Allow 2 to 3 weeks for delivery. NY residents add 7% sales tax.

It's obvious from the photos that a push-button unit was used in the prototype. You can use whatever is most convenient.

Current consumption is on the order of 1-milliamper, so batteries will last a long time. Be sure that both batteries are fresh—if they are not, lop-sided displays will result.

When wiring the joystick, you'll find that it comes equipped with four pots.

Use any two pots on adjacent sides of the square support assembly. The potentiometers on opposite sides are ganged together and cannot be adjusted independently.

**Checkout and Operation.** After construction is complete, the circuit should be given a thorough workout to make sure that everything is in order. Begin by turning on your scope and allowing 15 minutes warm-up time. If the grati-

cule on your scope is removable, as on the older Heath and B&K models, it might be a good idea to take it off; the gridwork of lines serves no useful purpose in this application, but it may distract attention from the display. If the graticule cannot be removed, just turn the **GRATICULE ILLUMINATION** control completely off.

Both the X and Y inputs should have an impedance of about 1-Megohm. This almost universally is the case, but check your scope's specifications to be sure—especially if a very old model is being used. With the horizontal and vertical inputs grounded, center the dot on your screen. Signals from both channels of the Imagician have peak-to-peak amplitudes of 1.2-volts; set your vertical and horizontal gain controls so that a 1.2-volt signal would roughly span the screen.

On the Imagician, turn **MODULATION** switch S6 to **OFF**, and set **SLOW-FIGURE SELECTOR** S3 to its **PARALLELOGRAM** position. Connect the outputs of the Imagician to the appropriate scope inputs with short shielded cables. After turning on the power with S1, you should see an image of some sort on your screen. The display will probably be faint, so rotate your scope's **INTENSITY** control to maximum. (However, when centering the dot as described above, you should use only *minimal* intensity to avoid burning the scope's screen.) Now, re-adjust the scope's vertical and horizontal gain controls so that the image just fills the screen. Finally, adjust the **ASTIGMATISM** and **FOCUS** controls, if your scope has them, for an image that is sharp and clear at all points on the screen.

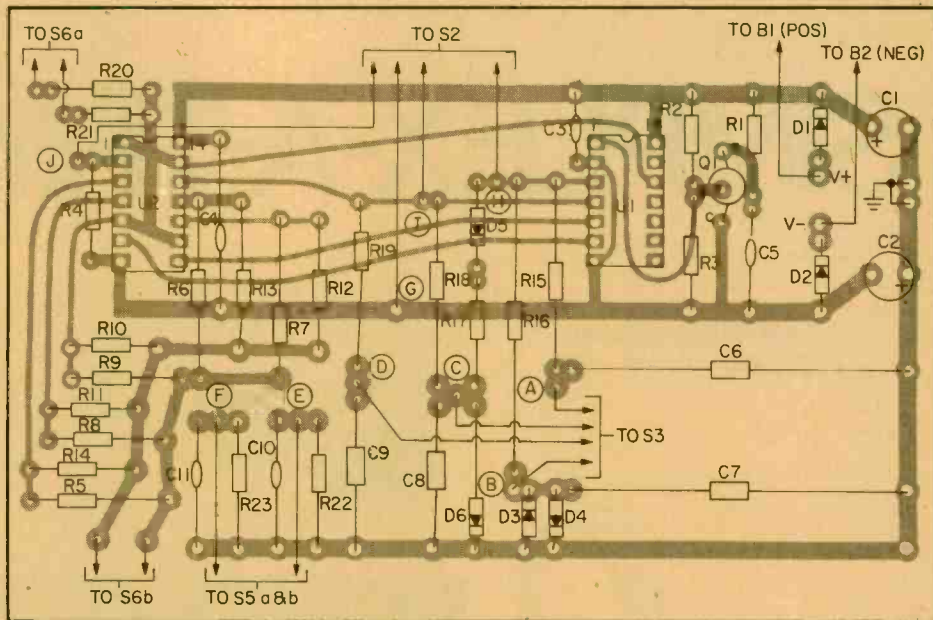

This is the component location guide used with the printed circuit board. Just about all of the components used in Imagician, with the exception of the switches, jacks and R24, are mounted directly on the board. Use IC sockets and be sure to orient them properly. Take special note of the takeoff points that lead away to the switches.

- S1—Power  
 S2—Modulation Selector  
 S3—Slow-Figure Selector:  
 1 = parallelogram  
 2 = bow tie  
 3 = acute triangle  
 4 = right triangle  
 5 = straight line

- S4—Slow-Figure Reversing Switch  
 S5—Fast-Figure Reversing Switch  
 S6—Modulation ON/OFF  
 R24a, b—Mixer

This table shows which switches perform what functions and, for S3, what figures are generated in each switch position.

Bend your Imagician's joystick until you reach the position where a simple parallelogram fills the screen. Next, flip S3 to its four other positions so that the rest of the slow figures may be observed. After viewing them all, return to the parallelogram. Use the joystick now to create new images. Note that this is a "high-powered" control—a seemingly slight adjustment can lend a whole new character to the display. With practice, you'll learn to make images dance and change form at will through skillful manipulation of the stick.

Still using the parallelogram, adjust the joystick until the resultant display has a 3-dimensional character. Turn on the modulation via S6, and check out the various effects produced by **MODULATION SELECTOR** S2. Manipulate the joystick, too, in order to get different views.

**Conclusion.** By now, you should be somewhat familiar with the controls on the Imagician. You can proceed to create 3-D patterns based on the remaining four slow figures. Also, check out the effects of the reversing switches, S4 and S5; the effects of S5 are subtle and depend upon the setting of the joystick, so watch closely. If you wish, it's possible to capture some of your prize creations on film with the aid of a Polaroid scope camera, which you might be able to borrow from a school science department. With a little imagination in the photodeveloping process, you may become the first electronic Picasso!

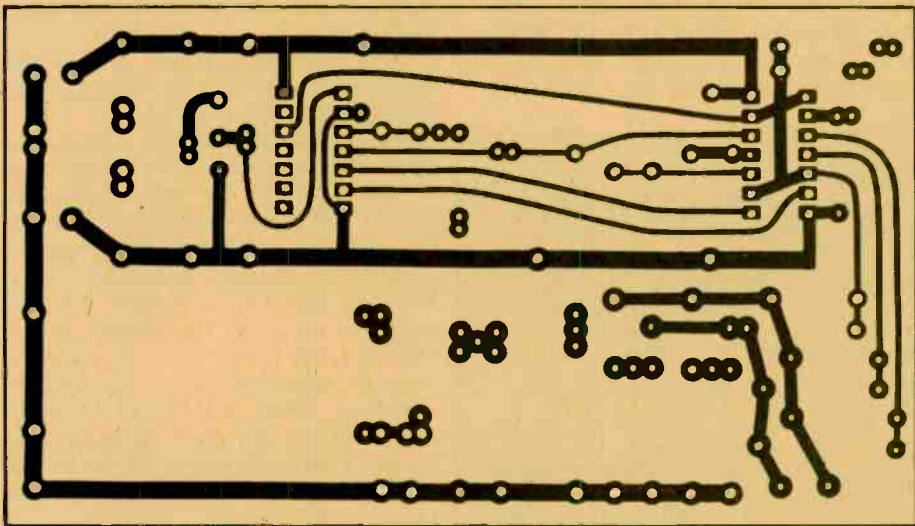

This is the etching guide for the PC board, shown in exact scale. If a project of this magnitude is beyond your abilities, you can obtain a ready-made circuit board from **LECTROGRAPHIX**. Their address and ordering information is shown beneath the parts list.

# SIMPLEX-A-THING



Stop missing those important phone calls

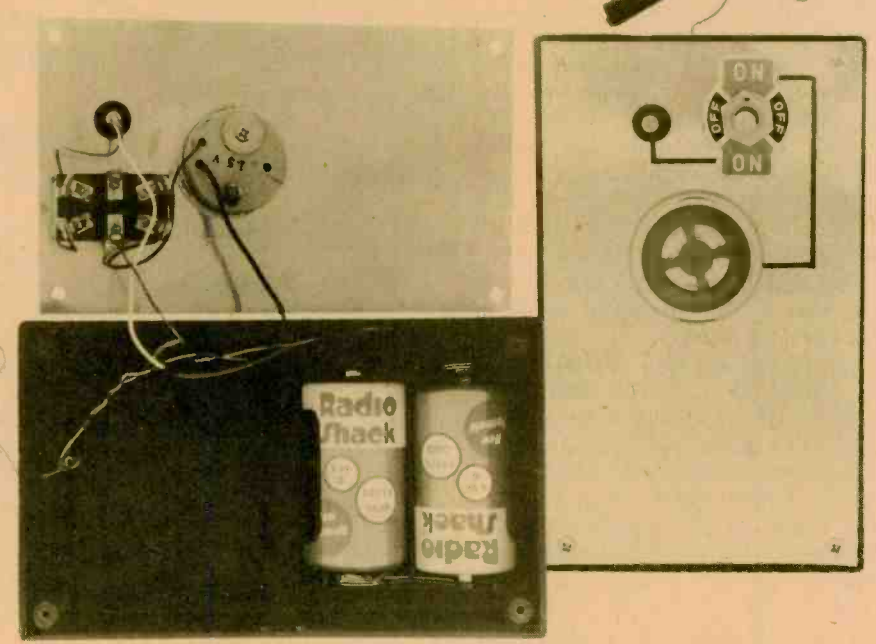

**Y**OU WON'T MISS any more phone calls when out of hearing range of your telephone, if you add this simple remote signalling unit which alerts you to incoming calls by means of either a buzzer or blinker light. The unit is self powered for easy placement in any room in your home, or even outdoors where there are no AC outlets.

Now that you are permitted to own your own phone, you don't have to worry about the legality of add-on convenience devices, so long as you don't

upset the phone company's circuits. This unit won't bother Ma Bell one bit because it is *not* electrically hard-wired to the telephone lines, and therefore cannot possibly cause voltage drops that could be detected at the phone company switching station. This gadget simply senses the normal ringing of the telephone by means of a magnetic reed switch placed near the telephone ringer armature. When the phone rings, the armature generates a strong electro-magnetic field, which trips the reed switch.

The switch is triggered even if you turn the regular telephone bell off to provide completely silent signalling by means of a blinker light.

**Construction.** Solder a 14-inch-long insulated wire to each end of the reed switch and terminate these leads with a phone jack. Insulate the switch body before installation in the telephone, by means of a plastic sleeve or with electrical tape.

Open the telephone and remove the bell-clapper arm back to where it joins the armature-coil assembly.

Have someone call you on another dialer mechanism by gently lifting it off its mount. Find the ringer armature located just behind the dialer. You can recognize the armatur by following the telephone so that the regular bell rings. With the reed switch plugged into the signalling unit, and the selector switch thrown to the buzzer position, gradually move the reed switch close to the ringer armature. When the buzzer beeps in time with the telephone bell, the reed switch is correctly placed. If the buzzer sounds continuously, even when the phone stops ringing, back the reed switch off a little. In the telephone shown here, mounting was achieved easily by simply faping the reed switch to a large capacitor.

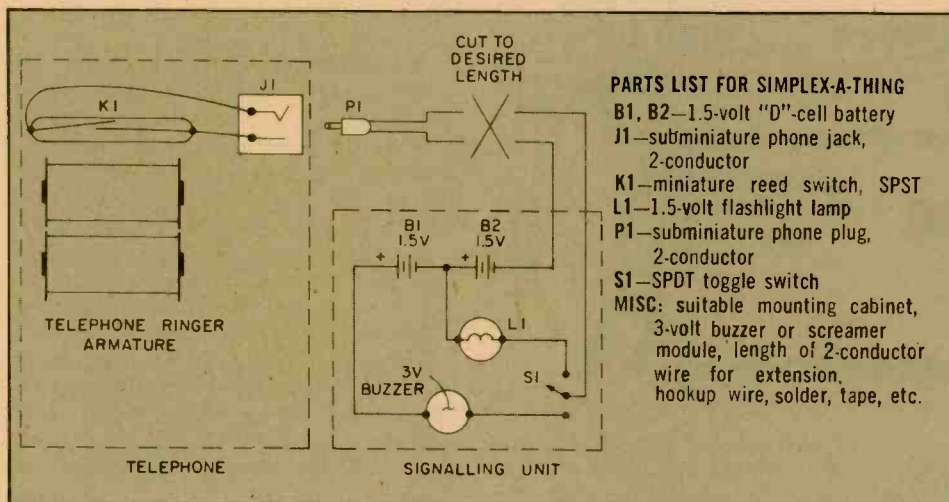

# 24-Hour BCD Clock

Learn to count like  
a computer with  
this binary clock



**O**VER THE CENTURIES inventors have made ingenious devices to keep track of time, and displays of all sorts have been used. From interpreting the sun's shadows falling on the marked circle of the ancient sundial to the simplicity of the modern digital displays, man has developed myriad ways to represent the passage of hours, minutes and seconds. In the last few years many innovative clocks have appeared. The "Ball Clock," for example, uses an electric motor to place steel balls in counterbalanced tracks, one per minute. The balls circulate in response to the

laws of gravity and the physics of levers to "read" time by totalling the number of balls in each track. Another unique clock uses three concentric circular groups of LED's (light-emitting diodes); as each LED lights it represents the tip of the hour, minute or second hand of a conventional clock face.

**Clock With a Code.** Which brings us to the BCD Digital Clock. Here the display reads out hours, minutes and seconds in a code familiar to virtually anyone involved with computer technology—BCD or Binary-Coded Decimal. The clock is extremely easy to

build if a printed circuit board is used, taking less than an hour to assemble.

The BCD Digital Clock reads in a 24-hour format on either 50 or 60 Hz. Built around an MM5311 or MM5309 integrated circuit clock chips, which have BCD outputs, you don't have to add much more than indicator LED's, driver transistors and resistors. The "on-board" rectifier/filter assembly allows use on low-voltage AC. For simplicity in packaging an external wall-plug transformer is used for AC power.

You can also use this clock as an elapsed timer by using the MM5309 clock chip in place of the MM5311; they are interchangeable with only one pin function difference, as explained later. A complete kit of parts is available for under \$20, with an optional fitted stained wooden case and drilled faceplate for under \$5.

**Why BCD?** Admittedly, BCD readout is used here for novelty purposes. It makes a great conversation piece, especially among the scientific community. However, from a practical standpoint, if you're not already familiar with BCD you'll quickly learn to read it and will soon be explaining it to others—so the BCD clock has educational value.

While machines and electronic circuits readily handle "binary" numbers—0's and 1's in a powers-of-2 format—people are used to working with decimal numbers. So, whenever people and digital circuits confront each other, the data will usually be presented in a decimal format. The digital circuits in these cases use binary codes to convert

All of the 24-Hour BCD Clock's parts fit neatly on a PC board. Righthand set of LEDs is for seconds, the center group for minutes and the lefthand group is for hours.

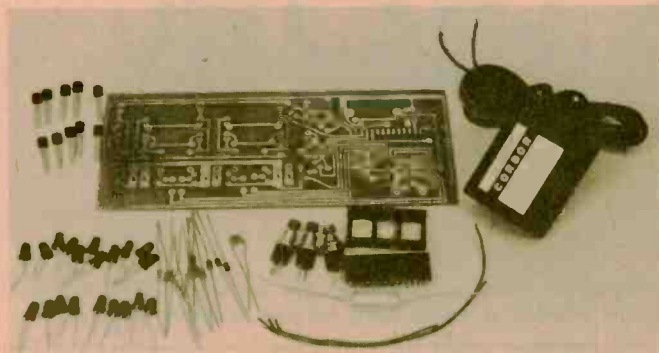
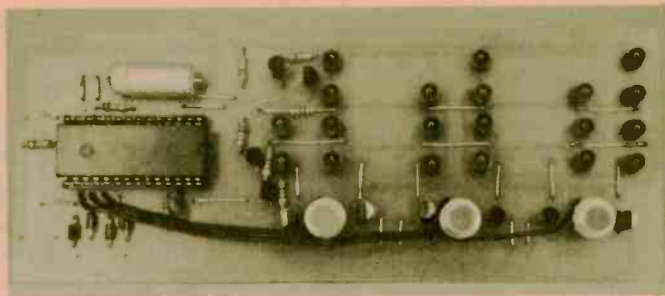

A complete kit of parts is available from West Side Electronics. Be sure to decide which integrated circuit you are going to use before you order the IC.

# BCD Clock

binary numbers to decimal numbers. Of various binary codes that have been developed, the Binary-Coded-Decimal, or BCD, format is the most common.

**Reading BCD.** A BCD code contains from one to four "bits" (binary digits) for each decimal digit. A bit can be either a 0 or a 1. The so-called "8421 Code" is the BCD code most frequently used, and is relatively simple to understand with a little explanation.

The BCD Code chart shows the 8421 Code for decimal digits. Note that each column of the 8421 code, reading from right to left, increases by a power of 2, starting at  $2^0$  (which is equal to 1). This is the basis of the binary code. By simply using the decimal equivalent of each bit and adding them together you obtain the BCD value.

A simple example is binary 0101. Since there is a "1" in the "1" ( $2^0$ ) column, and a "1" in the "4" ( $2^2$ ) column, we add 1 and 4 to get decimal 5. Therefore, as stated before, any decimal digit from 0 to 9 can be represented by four binary digits.

**What Time Is It?** Now look at the BCD clock display diagram, which is a representation of the "face" of the BCD Digital Clock. The LED's are placed in six vertical columns and four horizontal rows, with each column representing hours, minutes or seconds, as indicated. The LED's in the lowest row represent a decimal 1, the next highest row in each column represents a deci-

| 8421 BCD CODE CHART |                  |                  |                                |         |
|---------------------|------------------|------------------|--------------------------------|---------|
| ( $2^3$ )<br>"8"    | ( $2^2$ )<br>"4" | ( $2^1$ )<br>"2" | ( $2^0$ ) ← POWERS OF 2<br>"1" | DECIMAL |
| ○                   | ○                | ○                | ○                              | = 0     |
| ○                   | ○                | ○                | ●                              | = 1     |
| ○                   | ○                | ●                | ○                              | = 2     |
| ○                   | ○                | ●                | ●                              | = 3     |
| ○                   | ●                | ○                | ○                              | = 4     |
| ○                   | ●                | ○                | ●                              | = 5     |
| ○                   | ●                | ●                | ○                              | = 6     |
| ○                   | ●                | ●                | ●                              | = 7     |
| ●                   | ○                | ○                | ○                              | = 8     |
| ●                   | ○                | ○                | ●                              | = 9     |

The BCD numbering system is very logical once you understand the binary sequence.

mal 2, the next a 4 and the uppermost an 8. Some columns have only 2 or 3 LED's since they need not count higher than 2 or 5.

Once again, an example makes things clear. A lighted LED is "On," and represents the decimal number of its row, a 1, 2, 4 or 8. "Off" LED's represent a zero. Reading from left to right this time, the first column, tens of hours, is a 1. In the second column, unit hours, the 4 and 1 LED's are lighted, so the decimal digit is a 5. Taking the first two columns together, we have 15 hours (that's 3 PM in 24-hour format time). Column 3, tens of minutes, has

LED's 2 and 1 lighted, giving a decimal 3, while the unit-minutes column has a 4 and 2 lighted for a decimal 6. Therefore, the minutes read 36. Similarly, the last two columns read 29 seconds. Now, that's not really so hard, is it? With a little practice, it's easy—and your non-technical friends will think you're a genius!

**The Circuit.** The integrated circuit, U1, is a clock chip with multiplexed BCD and 7-segment outputs. Only the BCD outputs are used in this clock. Twenty LED's are arranged in a matrix of six vertical columns and four horizontal rows. The column-driver PNP transistors, Q1-Q6, are biased on when the corresponding digit outputs of IC1 (pins 20-25) are low. Similarly, each row-driver PNP transistor, Q7-Q10, is biased on when the BCD output connected to its base goes low. Since each LED is in series with only one, row-driver and one column-driver, it only lights when both drivers are conducting. For example, LED6 lights only when Q8 and Q3 are biased on by low signal levels at pins 3 and 25 respectively.

"Multiplexed" means that each of the outputs are sequentially enabled by the IC circuitry at a speed controlled by R1 and C2—about 1,000 times a second. The IC time-keeping circuitry determines whether a high or low voltage appears at each BCD output as it enables (with a low) each digit output, S1 through H10 (in that order). In other words, as each time digit (column) output is enabled, only the BCD outputs (rows) are enabled (LO) that will indicate the proper decimal number for that digit. Using multiplexing,

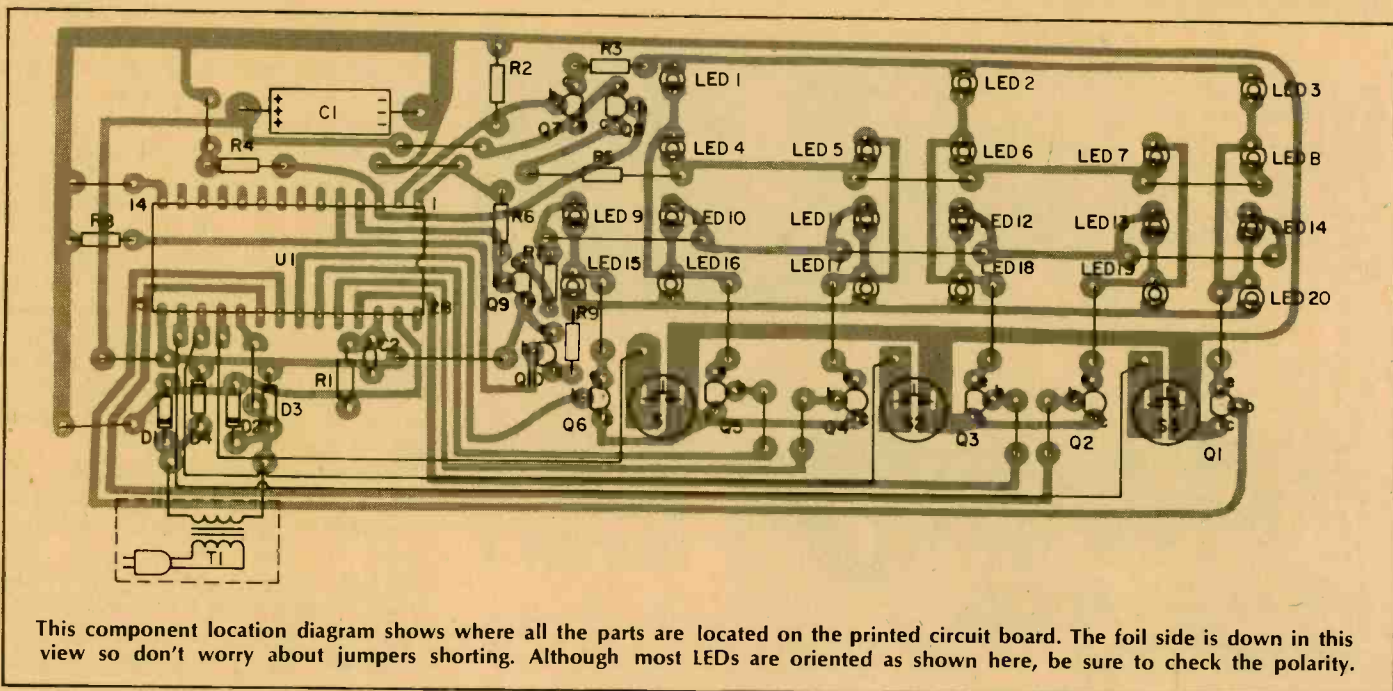

This component location diagram shows where all the parts are located on the printed circuit board. The foil side is down in this view so don't worry about jumpers shorting. Although most LEDs are oriented as shown here, be sure to check the polarity.



only 10 signal lines (6 columns, 4 rows) are needed to control 20 LED's. Otherwise, 20 signal wires would be needed. (Multiplexing shows, an even greater advantage, for example, when using 7-segment digital displays, where 6 digits would require 42 signal lines (7 x 6) if non-multiplexed, but only 13 lines (7 plus 6) if multiplexed.)

Resistors R2, R4, R6 and R8 hold the bases of the BCD output transistors high, so they are positively biased off until intentionally pulled low by a signal. Resistors R3, R5, R7 and R9 hold LED current flows to safe limits. Transformer T1 provides AC power, which is converted to pulsating DC by full-wave bridge rectifiers D1-D4, and then filtered (smoothed) by electrolytic capacitor C1. The 50 or 60 Hz input frequency is also fed to pin 19 of IC1 to control timekeeping. Switches are used to set the time, or, if an MM5309 chip is used, to reset the time to zero.

Pin 14 is grounded for a 60 Hz input, or left unconnected for 50 Hz, which is used in many countries outside of the USA.

**Construction.** Although there are a lot of jumpers and solder connections,

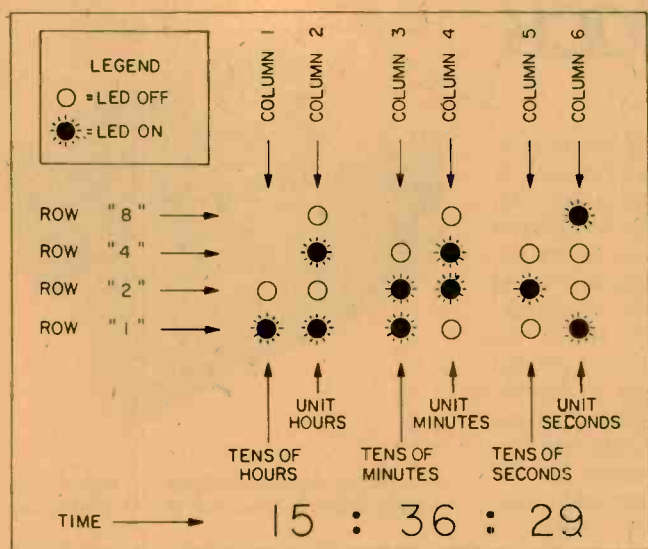

The clock numbers run from the bottom to the top, with the bottom row of LEDs representing (bit on or off respectively) 1 or 0, the second row 2 or 0, the third 4 or 0, and the fourth row 8 or 0. If there is a lit LED in the "1" and "4" rows then the decimal equivalent of that number would be 5(1+4). The unit seconds in this diagram is 9(1+8).

this is a simple project if assembled on the PC board available from the source shown in the parts list. You can, of course, build it on a perforated board with point-to-point wiring, but it's tedious and errors in wiring could be disastrous! Since all the parts are on one PC board, except for the transformer, assembly does not involve mating

boards or complex intercabling. Use the PC board layout included in this article, foil side up, if you wish to make your own board. Locate all the parts according to the diagrams. Start by putting in the bare wire jumpers as indicated—there are 23 jumpers shown. If you will be using the clock overseas, on 50 Hz, delete the jumper at pin 14.

### PARTS LIST FOR 24-HOUR BCD CLOCK

C1—220- $\mu$ F, 25-volt electrolytic capacitor  
 C2—0.01- $\mu$ F, 50-volt disk capacitor  
 D1, D2, D3, D4—1N4001 (1-amp, 50 PIV) diode  
 LED 1 through LED 20—red Light Emitting Diode  
 Q1 through Q10—2N3906 PNP switching transistor (or equivalent)  
 R1—100K, 1/4-watt resistor  
 R2, R4, R6, R8—10K, 1/4-watt resistor  
 R3, R5, R7, R9—100-ohm, 1/4-watt resistor  
 S1, S2, S3—SPST pushbutton switch  
 T1—12-VAC wall-plug transformer (100 mA minimum)  
 U1—MM5311 or MM5309 integrated circuit clock (see text)  
 Misc.—Wire, perforated or PC board, cabinet, faceplate, 28-pin integrated circuit socket, solder and hardware.

### Ordering Information

The following 24-hour BCD clock construction kits are available from:  
 West Side Electronics, Dept. EE  
 P.O. Box 636  
 Chatsworth, CA 91311

**BCD-CK\*** A complete kit of all parts above, including an etched and drilled PC board, case and drilled faceplate—\$22.95  
**BCD-PK\*** A partial kit of all the parts above, except the case and faceplate—\$19.95  
**BCD-PC** Etched and drilled PC board only—\$5.95

\* = MM5309 ONLY

**BCD-C** Case and drilled faceplate only—\$4.95  
 Add \$1 per order for shipping and handling.

Calif. residents add 6% sales tax to kit cost.  
 \* MM5311 will be supplied unless MM5309 is requested.

# BCD Clock

Next insert and solder the resistors in the positions indicated, and then C2. Now install and solder diodes D1–D4, being very careful that the black-band end is oriented as shown. Insert the leads of capacitor C1 into the board and solder only after being certain the polarity is as shown. It should be mounted right against the top of the PC board. Next insert and solder the PNP transistors. All the transistors are the same, but two of them, Q9 and Q7, face in the opposite direction of the others. It is extremely important that you orient each transistor properly—looking at the flat side of the transistor, the leads are emitter, base, collector reading from left to right. The IC socket is soldered in next.

Before assembling each LED to the PC board, be sure you have the polarity correct. This depends on the specific LED's you use. You can test them with two flashlight batteries together with a 100-ohm resistor all in series with the LED lights, the anode is connected to the positive side of the batteries. Actually, most LED's have a notch or flat at the base of the cathode; however, if you're not sure, make the test above. If the LED's are installed "backwards" in this circuit, the relatively high inverse voltage could blow them all out! Doublecheck everything!!

All that needs to be added now are the switches and transformer. The switch terminals are inserted into the PC board from the component side and soldered to the PC board pads. Insulated jumper wires run from the IC to



The circuit board switches fit into three mating holes in the red plastic faceplate.

each switch. Solder the leads from the wall-plug transformer to PC board locations C and D—no polarity required. Now carefully insert IC1 in the socket, being sure all pins are seated and that pin 1 of the IC is properly oriented. Avoid excessive handling of the IC.

**Testing And Operation.** Now it's time for the well-known "smoke test." Plug it in and see what happens! If your clock is operating normally, all or most of the LED's will stay dark, except the far right column which will start "counting" by the second. Now press S1—the LED's in the two center columns will count furiously, finally lighting column 2 and then column 1. Actually, you are fast-forwarding the time display at the rate of one hour each second. Switch S2 advances the minutes (columns 3 and 4) at the rate of one minute per second while the last two columns (seconds) race madly. Switch 3 will stop the counting entirely if you use the MM5311, or will reset the dis-

play to all zeroes if you are using the MM5309 for an elapsed timer. Check to see that all LED's light, and in proper sequence. Connecting IC Pin 28 to ground (the negative side of C1) should light all the LEDs at once.

If a particular LED does not light at all, it may have been installed with the anode and cathode reversed—and if that's the case, it has probably blown out. Replace it, properly oriented. If none of the LED's light, check the voltage at IC pins 15 and 1. This should read around 12 volts, with pin 15 positive. If not, make sure the rectifiers, D1–D4, are not reversed. Also, check the polarity of C1, and be sure U1 has not been inserted into the socket with pin 1 on the wrong end! The transistors could also be installed backwards; reversing the emitter and collector leads is easy to do, but the circuit won't work properly if at all.

If only some LED's don't work, or there is generally erratic behavior, check your solder joints. If all else fails, carefully replace the clock IC; actually, this is the least likely cause of problems unless you've treated it carelessly in handling or installation.

Set the time by advancing the hours with S1 and the minutes and seconds with S2 until the BCD code reads slightly ahead of the real time. Now hold down S3 (if you're using the MM5311) to stop the count until the real time catches up with the displayed time, and then release S3. Remember, however, that if you use the MM5309 instead of the MM5311 then S3 will reset the entire display to zero.

Since the seconds count regularly from 0 to 59 you'll get plenty of practice reading BCD by just watching the seconds counting. ■

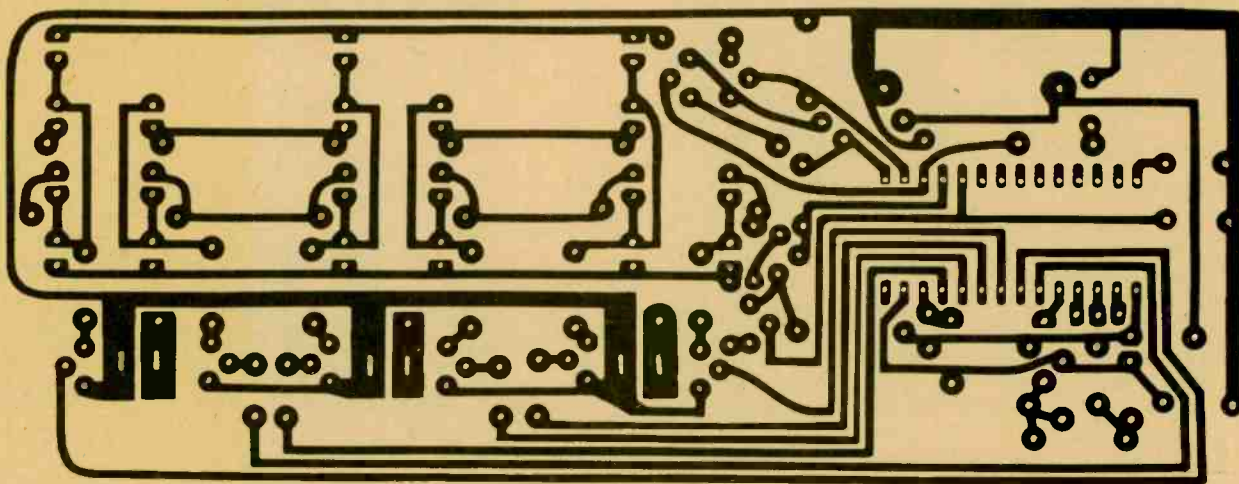

By using this full-sized printed circuit board template you can make your own BCD clock printed circuit board. Any one of the popular photo-etching techniques should work well for this board. Be careful to check the finished board for accuracy and solder bridges.

# New from NRI! 25" color TV that DIAGONAL tunes by computer, programs an entire evening's entertainment.

## Just part of NRI's training in servicing TV, stereo systems, video tape and disc players, car and portable radios.

Only NRI home training prepares you so thoroughly for the next great leap forward in TV and audio... digital systems. Already, top-of-the-line TV's feature digital tuning, computer programming is appearing, and new digital audio recording equipment is about to go on the market.

NRI is the only home study school to give you the actual "hands-on" training you need to handle servicing problems on tomorrow's electronic equipment. Because only NRI includes this designed-for-learning, 25" diagonal color TV with electronic tuning, built-in digital clock, and computer programmer as part of your training. With this advanced feature, you can pre-program an entire evening's entertainment... even key lock it in to control children's viewing.

### Exclusive Designed-for-learning Concept

The color TV you build as part of NRI's Master Course looks, operates, and performs like the very finest commercial sets. But behind that pretty picture is a unique designed-for-learning chassis. As you assemble it, you perform meaningful experiments. You even introduce defects, troubleshoot and correct them as you would in actual practice. And you end up with a magnificent, big-picture TV with advanced features.

### Also Build Stereo, Test Instruments

That's just a start. You demonstrate basic principles on the unique NRI Discovery Lab<sup>®</sup>, then apply them as you assemble a fine AM/FM stereo, complete with speakers. You also learn as you build your own test instruments, including a 5" triggered sweep oscilloscope, CMOS digital frequency counter, color bar generator, and transistorized volt-ohm meter. Use them for learning, use them later for professional servicing of TV, audio, and video systems.

### Complete, Effective Training Includes Video Systems

You need no previous experience of any kind. Starting with the basics, exclusive "bite-size" lessons cover subjects thoroughly, clearly, and concisely. "Hands-on" experiments reinforce theory for better comprehension and retention. And your personal NRI instructor is always available for advice and help. You'll be prepared to work with stereo systems, car radios, record and tape players, transistor



radios, short-wave receivers, PA systems, musical instrument amplifiers, electronic TV games, even video tape recorders and tape or disc video playback.

### Send for Free Detailed Catalog... No Salesman Will Call

Mail the postage-paid card today for our free 100-page catalog with color photos of all kits and equipment, complete lesson plans, convenient time payment plans, and information on other electronics courses. You'll also find out about NRI's new Computer Technology Course that includes your personal microcomputer. Or Complete Communications with 2-meter transceiver. If card has been removed, write to:



**NRI Schools**  
McGraw-Hill Continuing  
Education Center  
3939 Wisconsin Ave.  
Washington, D.C. 20016

# Super Sound Effects Synthesizer

Bring way out sound effects right into your home

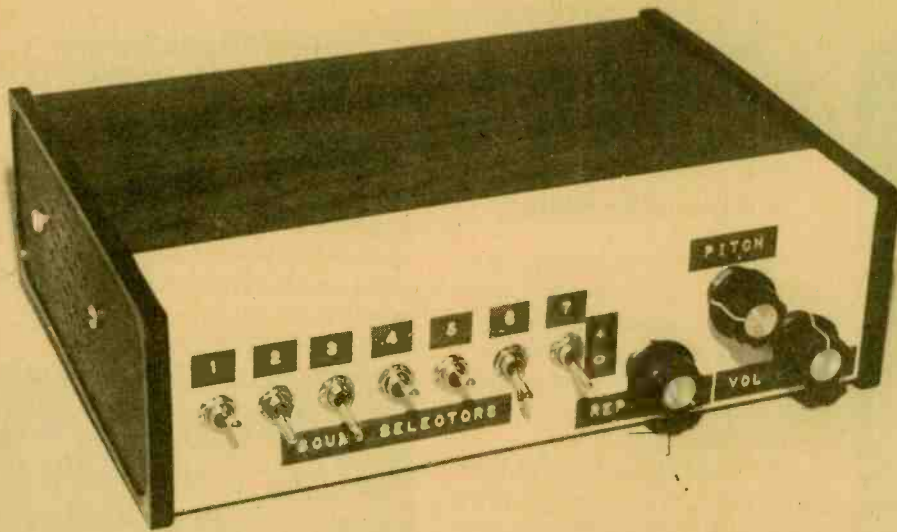

The table at right shows some of the more popular effects made possible by our synthesizer. More combinations can be had by experimenting at random with the switch positions. If you feed the synthesizer through your stereo system, the tone controls can also be used to vary the sound effects.

TABLE OF SWITCH POSITIONS

|  | 1 | 2 | 3 | 4 | 5 | 6 | 7 | Sound Effect            |
|--|---|---|---|---|---|---|---|-------------------------|
|  | + | + | + | + | + | 0 | 0 | Siren                   |
|  | 0 | 0 | 0 | 0 | + | + | 0 | Locomotive              |
|  | + | + | + | 0 | + | + | 0 | Tweeting bird           |
|  | 0 | + | 0 | 0 | 0 | + | 0 | Phaser gun              |
|  | 0 | + | + | 0 | + | + | 0 | Phaser gun              |
|  | 0 | 0 | + | 0 | 0 | + | 0 | White noise (sea sound) |
|  | + | + | 0 | + | 0 | + | + | Different siren         |
|  | 0 | 0 | 0 | 0 | 0 | + | 0 | Steady organ sound      |
|  | + | + | 0 | + | 0 | + | 0 | Ticking clock           |
|  | 0 | 0 | 0 | + | 0 | + | + | Alternating tones       |
|  | 0 | 0 | + | 0 | + | + | 0 | Interrupted tone        |

IF YOUR IDEA OF FUN is a locomotive in your bedroom, or a siren announcing breakfast, then we have the right kind of project for you! This simple-to-build sound effect generator will produce a variety of sounds resembling a ticking clock, a locomotive puffing away, a police siren, a ray gun straight out of a science fiction movie or a tweeting bird. The sound generator can be used to add a "living" sound to electronic games, or it can be a part of a futuristic bell chime.

**How It Works.** The guts of the sound generator—a newly developed integrated circuit—consist of thousands of transistors. The main building blocks of this IC are a noise generator, an audio pitch generator and a Super Low Frequency (SLF) generator. The SLF generator controls the changing pitch and the repetition rate of the audio generator by, for example, producing a slowly rising and falling pitch of a siren. The SLF generator can also turn the other two generators on and off at a slow rate. A puffing locomotive sound will result when the SLF generator controls the noise generator.

Several pins on the integrated circuit control the mixing mode of the three generators. Seven of these control pins are brought out to switches S1 through S7. The frequency of the SLF generator and of the audio pitch generator is controlled by the potentiometers R10 and R8, respectively. Transistors Q1 and Q2 drive a small speaker while potentiometer R6 adjusts the volume. Switch

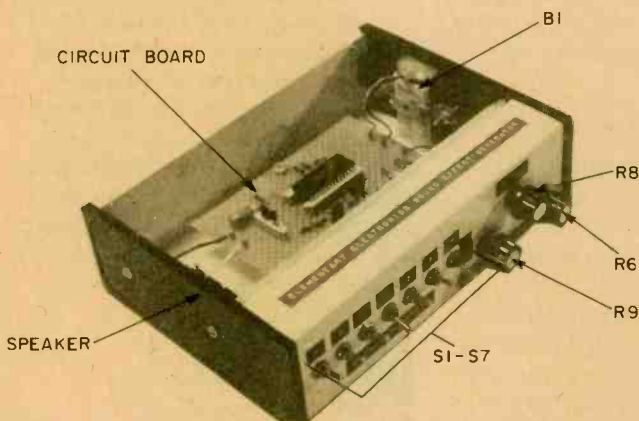

The arrangement of parts on the perfboard is not at all critical. Wire the switches and potentiometers to the circuit board before mounting them to the front of the cabinet. You may wish to purchase a larger cabinet to accommodate a larger speaker. This will definitely add depth to the sound quality of the Super Sound Synthesizer.

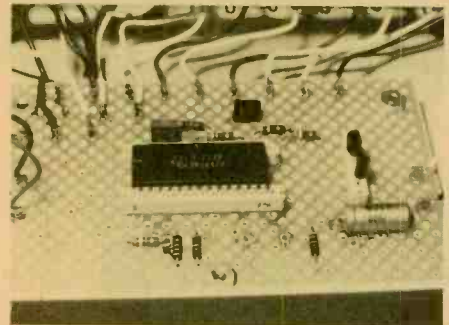

Make sure to follow the proper pin orientation for the IC. See the text for details.

S8 ganged with the volume control turns the unit on and off.

**Construction.** The sound generator operates at audio frequencies, therefore no special wiring precautions are necessary. We assembled our prototype on regular breadboard stock with point-to-point wiring techniques, and encountered no difficulties. Caution is advised when handling the IC. It is highly sensitive to static electricity discharges passed from the body, and can be destroyed before you are aware that you've done the damage. During construction, do not remove the IC from its packing until you are ready to install it in its socket, which should be fully connected to the rest of the circuit.

Take care that you have followed the correct pin orientation in wiring the socket. The pin connections are supplied with the IC, and pin number one is marked on the IC's body. Make a small mark on the IC socket to indicate pin one, and wire the pins in consecutive order to avoid confusion and possible errors.

After assembly, you may find that the small, built-in speaker does not provide sufficient sound for the purposes which you intend the synthesizer's use. To provide for direct input to your home stereo system, or to a tape deck, simply wire a 22-ohm, 1/2-watt resistor across the leads running to the built-in speaker (you must disconnect the speaker for this purpose), and run the synthesizer directly into your system.

Of course, these are only some of the many combinations and effects available. With a little experimentation, many more are available. If you are using a guitar amplifier with the synthesizer, the reverb, vibrato, and accessory controls, such as "fuzz" can also enhance the effects which are generated. Even the tone controls on your stereo can cause dramatic changes in the synthesizer's effects.

One note of caution: Your stereo speakers may not be able to handle sustained high-level output when being driven by the synthesizer. Watch your levels!

**Operation.** You can control the sound coming out of the sound generator by setting switches S1 through S7 and by adjusting the pitch and the repetition rate with potentiometers R8 and R10.

Shown are some representative switch positions and the corresponding sounds. A "+" in the Table means that the switch is connected to Vreg, a "0" means that it's connected to ground. ■

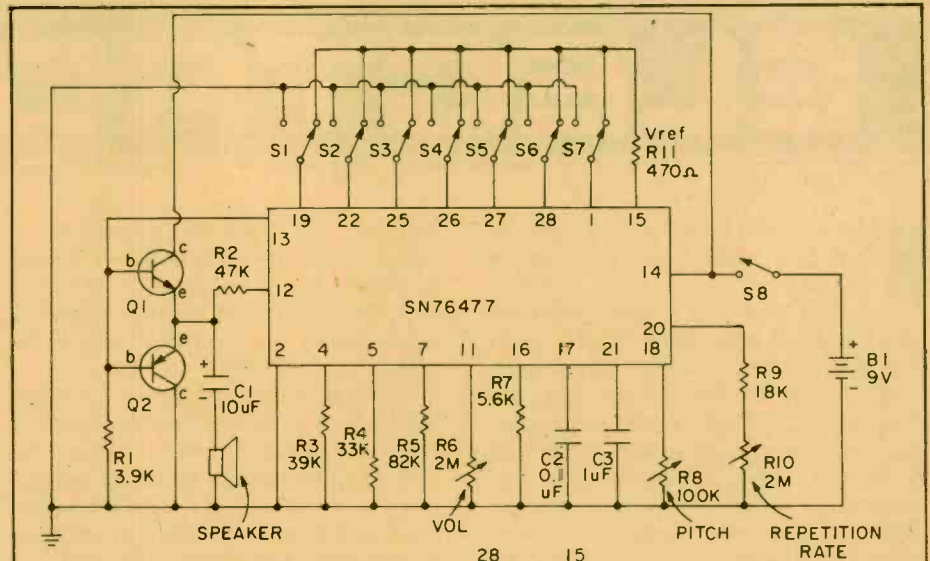

**PARTS LIST FOR SOUND SYNTHESIZER**

- B1—9-volt transistor radio battery
- C1—10- $\mu$ F, 35-volt electrolytic capacitor
- C2—0.1- $\mu$ F, 35-volt mylar capacitor
- C3—1- $\mu$ F, 35-volt electrolytic capacitor
- IC1—SN76477 (Radio Shack #276-1765)
- Q1—general purpose NPN transistor
- Q2—general purpose PNP transistor
- R1—3,900-ohm, 1/2-watt resistor
- R2—47,000-ohm, 1/2-watt resistor
- R3—39,000-ohm, 1/2-watt resistor
- R4—33,000-ohm, 1/2-watt resistor
- R5—82,000-ohm, 1/2-watt resistor
- R6—2,000,000-ohm audio taper potentiometer with SPST switch attached (S8)
- R7—5,600-ohm, 1/2-watt resistor
- R8—100,000-ohm linear taper potentiometer
- R9—18,000-ohm, 1/2-watt resistor
- R10—2,000,000-ohm linear taper potentiometer
- R11—470,000-ohm, 1/2-watt resistor
- S1 through S7—SPDT toggle switches
- S8—SPST switch, part of R6
- SPKR—8-ohm miniature PM speaker
- Misc.—cabinet, 28-pin IC socket, battery holder and clip, knobs, hookup wire, etc.

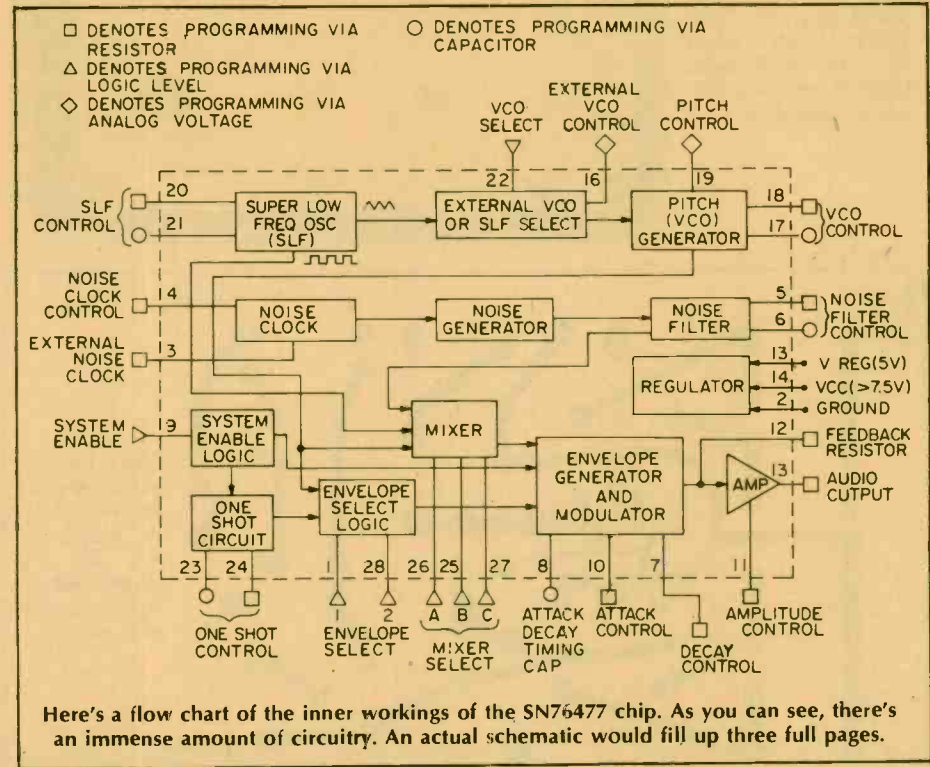
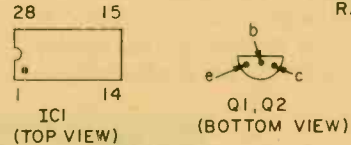

Here's a flow chart of the inner workings of the SN76477 chip. As you can see, there's an immense amount of circuitry. An actual schematic would fill up three full pages.

# ELECTROLOK

**H**AVE YOU EVER stopped to consider just how many locks there are in the average house? Take a census in your own home; the number will probably surprise you. Most of the locks you find—in fact, probably all of them—will be mechanical. While such devices are fine for the majority of household applications, sometimes what you really need is an *electronic* lock. For example, suppose you have a favorite piece of electronic equipment; something that's expensive and delicate. To make sure that no one else can meddle with it—whether it be a photographic

enlarger, an amateur transceiver, a stereo system or a computer—you need to prevent the power from being turned on. Although you might lock things up mechanically, an electronic lock is the easier, more effective solution.

**Features.** Presented here is a simple, inexpensive, electronic combination lock that's really tough to crack. To open the lock and turn on the protected apparatus, you must enter a 5-digit numerical code by means of pushbutton switches. If you enter the wrong code, the system will disable itself for about 15 seconds, during which time the lock cannot

be opened even if the correct combination is entered. Furthermore, the code must be entered quickly; if someone dawdles more than a second or so between entries, the lock won't open, even with the right code. All these features add up to a system that is both convenient (no key) and difficult to beat.

**Circuit Function.** Let's see how the lock works by taking a look at the schematic diagram. A half-wave-rectifier system consisting of T1, D1, and C1, supplies power to the lock. Resistor R1 and zener diode D2 do not regulate the supply voltage. Instead, they just clip any voltage spikes generated on the power line, thus protecting U1. You'll note that there is no power switch on the primary (117 VAC) side of T1. That's because standby power consumption is so minute, that a power switch was deemed unnecessary. (However, you might wish to include one. In that case, the primary power switch would have to be turned on before the 5-digit combination could be entered.)

Capacitor C3 is charged up by supply current flowing through resistor R2. Let's assume that enough time has elapsed after the application of AC power for C3 to have become fully charged. In that case, a logic "1" input is seen by pins 2, 5, 9 and 12 of the four AND gates comprising U1. The result is that each AND gate behaves as a very-high-gain amplifier. Specifically, if the voltage presented to the one remaining input of any gate exceeds half the supply voltage (approximately), the gate's output will be high (at supply potential). With inputs of less than half the supply potential, the output remains low (grounded).

In this lock circuit, the four AND gates are arranged to form a sort of "bucket brigade"—only it's not water that's being transferred, it's an electrical charge instead. When S1 is pressed momentarily, capacitor C4 charges rapidly to supply potential through R5. Once S1 is released, C4 begins to discharge through R6, taking a second or so to discharge half way. Since AND gate A's input (pin 1) reads the voltage on C4 through R5, we know that the gate's output (pin 3) is going to be high for about a second, which is

Electrolok may be assembled in any convenient cabinet, or combined with an easily available surplus telephone-type touch-pad to give a real finished look. Make sure that the touch-pad you get has discrete-wired switches. Other types (matrix) might not be compatible with Electrolok's wiring arrangement.

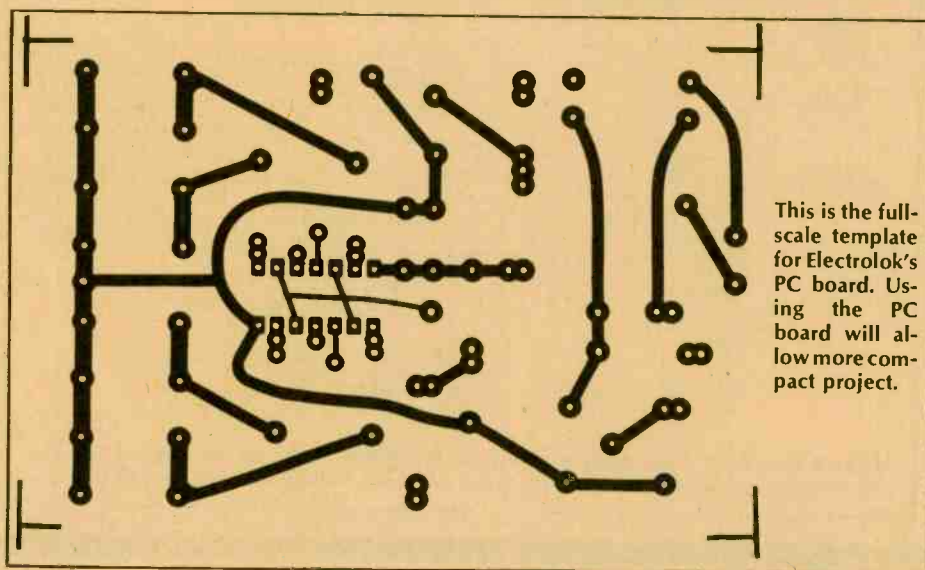
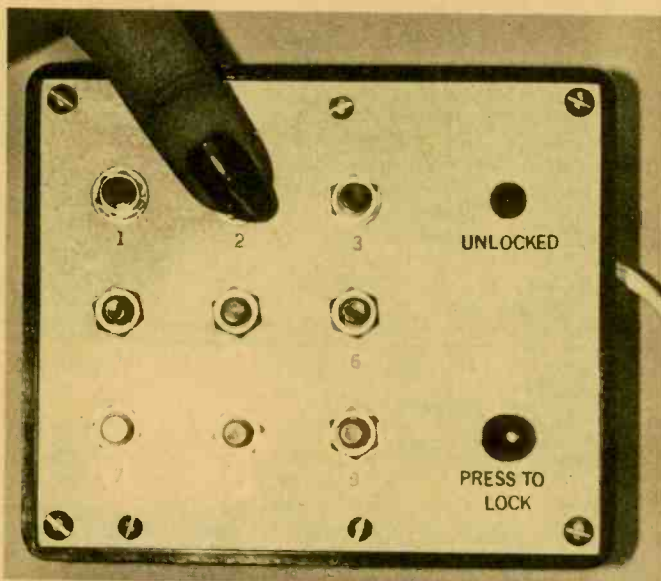

This is the full-scale template for Electrolok's PC board. Using the PC board will allow more compact project.

## This electronic combination lock keeps your equipment safe

correct one, entered while C3 is insufficiently charged, will have no effect. Once a would-be lock picker touches a dummy switch, it is very probable that he will press another dummy before C3 has been sufficiently recharged. This means that the bucket brigade remains inoperative for 15 seconds more. Consequently, the chances of cracking the code by punching in numbers at random are exceedingly slim.

Numbers may be assigned to S1 through S9 at will. Therefore, should someone break the code (an unlikely but still possible occurrence), you can easily change the combination by re-wiring some of the switches.

Although the pushbuttons used in the prototype were small discrete units, you might wish to employ a calculator-type keyboard instead. If you do, make sure that the board you choose has individually accessible switch contacts. Some keyboards have switches wired in a matrix arrangement, which would be useless here.

Select a relay that can handle the maximum expected current drawn by the equipment you intend to control. The device used in the prototype is rated for an RMS current of one amp @ 117 VAC. For heavier loads, use the Circuit Specialists #D1-966, which can

the time it takes C4 to discharge half way. Therefore, if we press S2 before the one-second interval has elapsed, it is possible to charge capacitor C5 to supply potential. (If we dawdle more than a second, however, gate A's output will have dropped to ground potential, and no charging of C5 will be possible.)

Assuming that C5 has been charged, it is obvious that gate B's output (pin 4) will remain high for the second or so that it takes R8 to discharge C5 half way. Therefore, we can now charge C6 by pressing S3 before another second goes by. Applying the same reasoning, it should then be possible to charge C7 if S4 is pressed quickly enough. Finally, pressing S5 within a second of S4 will send a current from U1-D's output (pin 11) through R13 into the gate terminal of the SCR (Q1). This causes Q1 to latch in a conducting state, thereby allowing current to flow through relay K1 and light-emitting diode LED1. Once actuated, the relay's contacts close and supply power to whatever device you wish to control. The lighting of LED1 alerts you to the fact that the circuit is unlocked.

To lock the circuit once more, it's necessary to momentarily interrupt the flow of anode current through the SCR. This can be done by pressing S10. Once the anode current has been interrupted, Q1 will not conduct until the proper code has once again been entered.

From the schematic, you can see that besides the five pushbuttons required

to open the lock, there are four extra dummy switches; S6 through S9. These serve the purpose of foiling any attempt to pick the lock. Whenever one of the four dummy switches is pressed, C3 gets discharged quickly through R4. While C3 is recharging through R2 to a potential greater than half the supply voltage—an interval of 15 to 20 seconds on the average—the bucket brigade remains disabled and all AND-gate outputs are locked at ground potential. Therefore, any code, even the

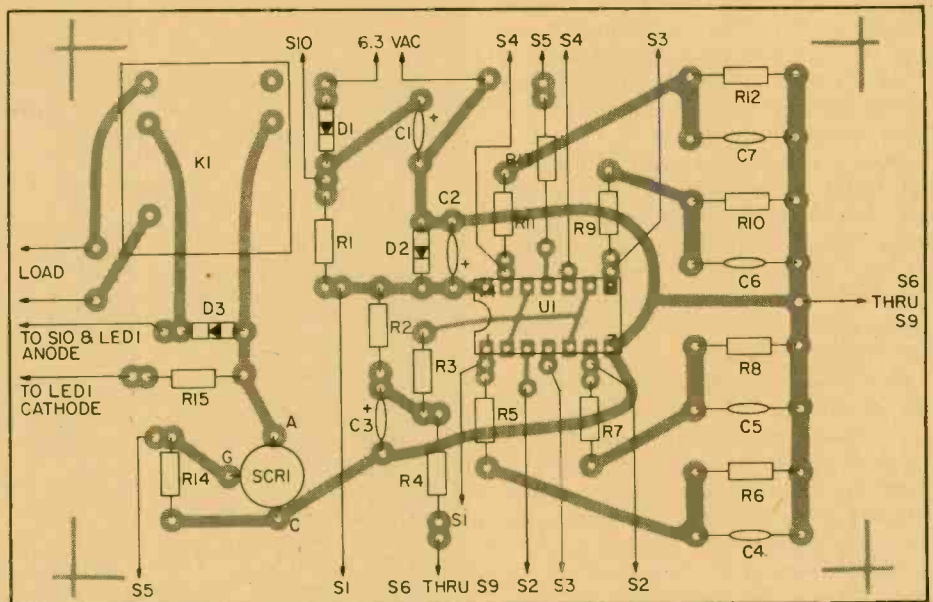

Here's a top view of the PC board showing the component locations. All parts except F1, switches, LED 1, and power transformer mount here. We recommend use of an IC socket.

# ELECTROLOK

handle three times as much current. When using the latter relay, however, be sure to modify the circuit board, which was designed specifically to accommodate the pin arrangement of the prototype's Radio Shack device.

**Construction.** Construction of the lock should be simple; either perfboard or a printed circuit will do. For those who choose PC construction, suitable templates are featured elsewhere in this article.

Use a low-heat (25-watt or less) iron and resin-core solder for all the electrical connections. It is recommended that you *not* solder U1 directly into the circuit. Instead, use an IC socket, and install the integrated circuit into the socket only after all soldering and construction are completed. This will minimize the chances of accidentally damaging your IC.

Be certain to observe proper polarities with all the diodes, Q1, U1, and all the capacitors.

Almost any small cabinet can be used to house the lock circuit. In the prototype, a 2 by 5 by 4-inch plastic cabinet was used, but if you lack experience in small-scale construction, you may be more comfortable with a larger box.

**Operation.** When construction is complete, you're ready to check out your work. In these initial stages of testing, do *not* connect any load to relay K1. Plug the circuit into the AC line, and wait one minute. This is more than enough time for C3 to charge up completely. Now, quickly punch in the correct combination (according to the way you've wired up the pushbuttons). After the entry of the last digit, LED1 should light up, and K1 should emit a faint "click" as it pulls in.

Once you have successfully unlocked the device, press switch S10. The circuit should return to its locked state, and LED1 should cease to glow. Next, hit one of the dummy switches, followed by the correct combination. Your circuit should be unaffected by the code and remain locked.

**Final Touches.** When proper operation of the lock has been verified, you can proceed to wire K1's contacts into the load circuit. In addition to the applications already suggested, you might consider using the lock to control an electronic garage-door opener or burglar-alarm system. In fact, there are so many ways to use the circuit, that you may wish to build several units—each with a different combination. ■

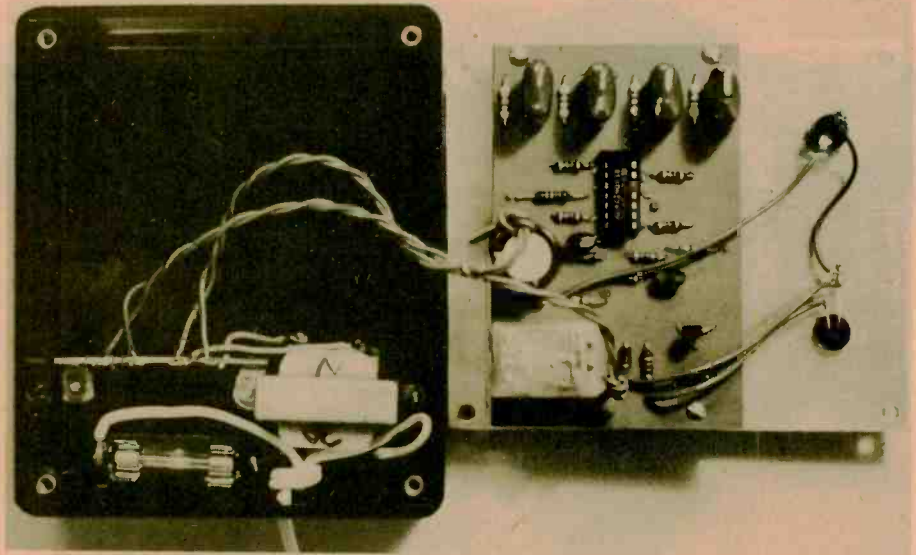

The prototype Electrolok with the cover removed, shows the placement of the PC board and off-board components. No power switch is used, as idle current is very low in the operating mode. You can add an SPST switch in series with a transformer primary lead.

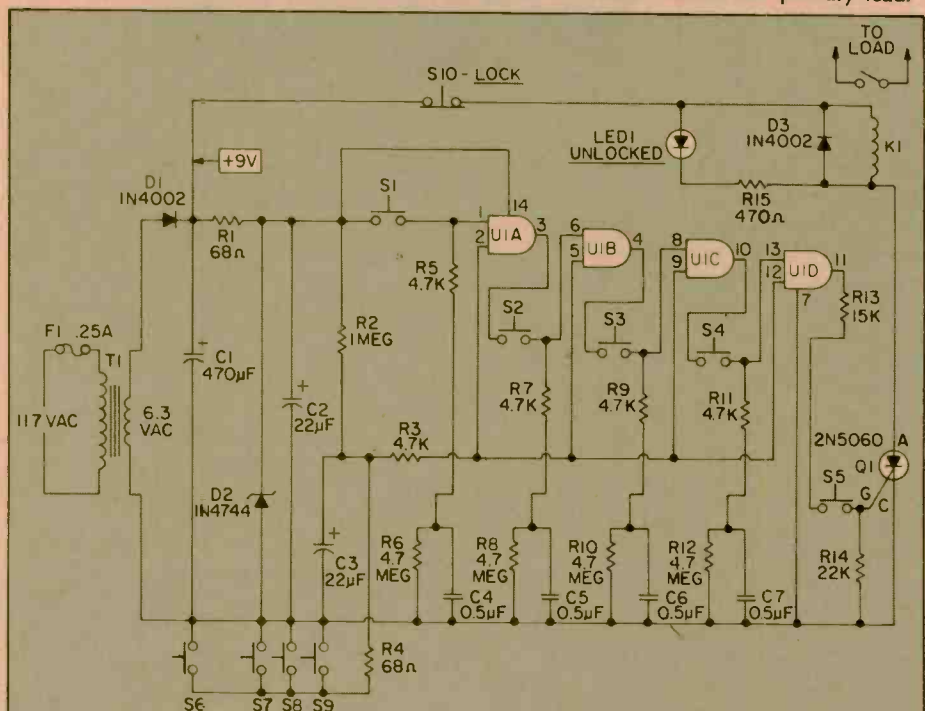

## PARTS LIST FOR ELECTROLOK

- |  |   |
|--|---|
| C1—470- $\mu$ F electrolytic capacitor, 35-VDC   | R6, R8, R10, R12—4.7-megohm, $\frac{1}{2}$ -watt resistor, 10%                |
| C2, C3—22- $\mu$ F tantalum capacitor, 25-VDC  | R13—15,000-ohm, $\frac{1}{2}$ -watt resistor, 10%                             |
| C4 to C7—0.5- $\mu$ F mylar capacitor, 25-VDC  | R14—22,000-ohm, $\frac{1}{2}$ -watt resistor, 10%                             |
| D1, D3—1N4002 diode  | R15—470-ohm, $\frac{1}{2}$ -watt resistor, 10%                                |
| D2—1N4744 zener diode  | SCR1—2N5060 silicon-controlled rectifier                                      |
| F1—0.25-amp fuse (3AG type)  | S1 to S9—SPST normally open pushbutton switch                                 |
| K1—relay with 6-VDC, 500-ohm coil (Radio Shack #275-004 or Circuit Specialists #D1-966—see text) | S10—SPST normally closed pushbutton switch                                    |
| LED1—small LED rated 20-mA @ 1.75-VDC  | T1—power transformer; primary rated 117-VAC, secondary rated 6.3-VAC @ 100-mA |
| R1, R4—68-ohm, $\frac{1}{2}$ -watt resistor, 10%   | U1—Motorola MC14081B quad AND gate  |
| R2—1-megohm, $\frac{1}{2}$ -watt resistor, 10%   | MISC.—suitable enclosure, line cord, IC socket, hookup wire, solder, etc.     |
| R3, R5, R7, R9, R11—4,700-ohm, $\frac{1}{2}$ -watt resistor, 10%                                 |   |

(Note: U1 is available from Circuit Specialists, Box 3047, Scottsdale, AZ 85257.)



# Darkroom Color Analyzer

by Herb Friedman



It's easy to make quality, bright color prints at home with modern color chemistry and this electronic color analyzer!

ONE OF THE SHUTTERBUG'S most satisfying accomplishments is producing his own color prints. For years the time spent on and the cost of making color prints were discouraging, but with modern color chemistry, such as the Beseler system, you can turn out quality color prints *in less time than for*

*black and white* (about 3 minutes), and the prints will be far superior to anything you're likely to get from a color lab.

One thing that takes the drudgery out of color work—besides the chemistry—is a color analyzer, a device that gives you the correct filter pack and

exposure time at the very first crack. Most often, the very first print made with the analyzer will be *good*. At most, it will take perhaps 0.10 or 0.20 change of filtration for a *superb* print. This is a lot less expensive and time-consuming than making test print after test print. In fact, it's really the color analyzer that puts the fun into making your own color prints!

**Color Analyzers Are Not Cheap.** A decent one costs well over \$100, and a good one runs well over \$200. But if you've got even a half-filled junk box you can make your own color analyzer for just the junk parts and perhaps \$10 to \$15 worth of new components.

A color analyzer is basically a miniature computer. You make a "perfect" print the hard way—by trial and error—and then calibrate the analyzer to your filter pack and exposure time. As long as you use the same box of paper and similar negatives, all you need to do to make a good color print is focus the negative, adjust the filter pack and exposure so the analyzer reads "zero," and hit the enlarger's timer switch. Even if you switch to a completely different type of negative, the analyzer will put you well inside the ballpark, so your second print is a winner. (And even if

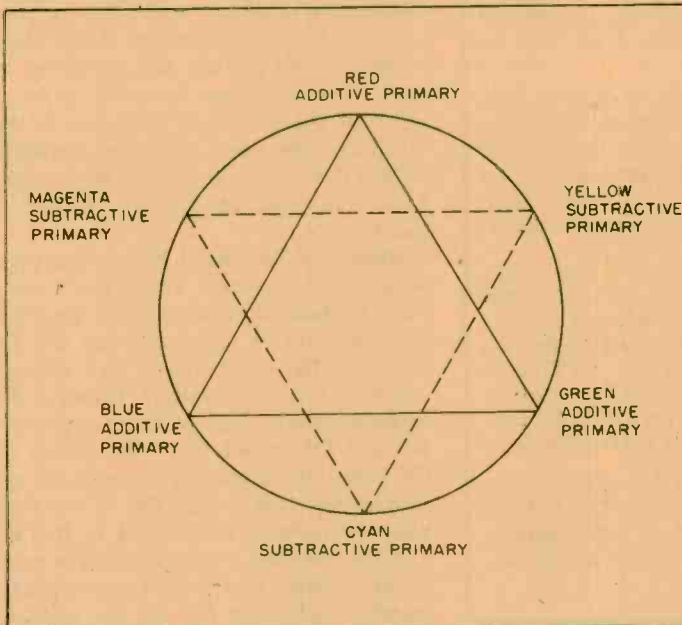

Any one of the primary colors on this circle is composed of its immediately adjacent colors in equal amounts. Each primary color is also complementary to the color directly across the center of the circle. Complementary colors added together form neutral densities. It is the balancing of additive primary colors of photographic light sources and subtractive-type color filters that provides control in color print photography.

# COLOR ANALYZER

the filtration is off, the exposure will probably be right on the nose.)

**Construction.** The color analyzer shown was specifically designed for the readers of this magazine—essentially an electronics hobbyist with an interest in photography. All components are readily available in local parts stores or as junk box parts. Several protection devices have been designed into the circuit so accidental shorts won't produce

a catastrophe. The printed circuit board template has foils for both incandescent and neon meter lamps, as well as extra terminals so you can use either a socket and plug or hard wiring for the color comparator and exposure sensor. In short, you can make a lot of changes to suit your individual needs.

The template for IC1 uses a half-minidip, Signetics V-type package lead arrangement. However, you can also use an IC with a round (TO-5) configuration. If anything is wrong with the IC you can get the TO-5 out easily. The

half-minidip removal might result in destruction of the PC board. We'll explain how to install the TO-5 IC on the PC board later.

You can either buy or make the printed circuit board (see parts list). Either way, the first step is to prepare the printed circuit board. If you do it yourself, make it any way you like, using free-hand or template resist. Nothing is critical, but be certain there are no copper shorts between the terminals for IC1. Use a #56 bit for all holes. Then use a larger bit for transformer T1's mounting screws (#4 or #6 screws), a 1/4-in. bit for resistor R6, and a #30 to 40 bit for the linecord connections (any bit that will allow the linecord wires to pass through the board).

Assemble the power supply and check it out before any other components are installed. Install transformer T1 first. Any 24-volt or 25.2-volt center-tapped transformer that will fit on the board will be fine. Get something small, like 100 milliamperes. A Wescom 81PK-100 is a perfect fit.

Bridge rectifier BR1 is the low cost "surplus" found in many distributors. This type has the positive and negative outputs at opposite ends of a diamond. The AC connections are the remaining opposite ends. Note that BR1 is installed in such a manner that its negative output is farthest from transformer T1 while the positive output is nearest to T1. Make certain your bridge rectifier has the same lead configuration; if it is different, modify the printed circuit template to conform to the rectifier you're using. Get it right the first time.

Finally, install C1 and C2, R7 and R8, and zener diodes D1 and D2. Take care that the capacitors and zener diodes are installed with the polarity correct. If the capacitors have their negative leads marked with an arrow or line, these markings face the *opposite edges* of the PC board (negative to the outside). The zener diodes are installed so that their cathodes (the banded ends) face each other towards the center of the board.

**Initial PC Checkout.** When the power supply is completed, temporarily connect a linecord. Connect the negative lead of a meter rated 10 volts DC or higher to the foil between T1's mounting screws (that's ground). Connect the meter's positive lead to the junction of R7 and D1, which is in the center of the board; the meter should indicate approximately +6.2 volts DC. Then connect the positive meter lead to the R8 and D2 junction, which is near the edge of the board. You should get approximately -6.2 volts DC. If the voltages

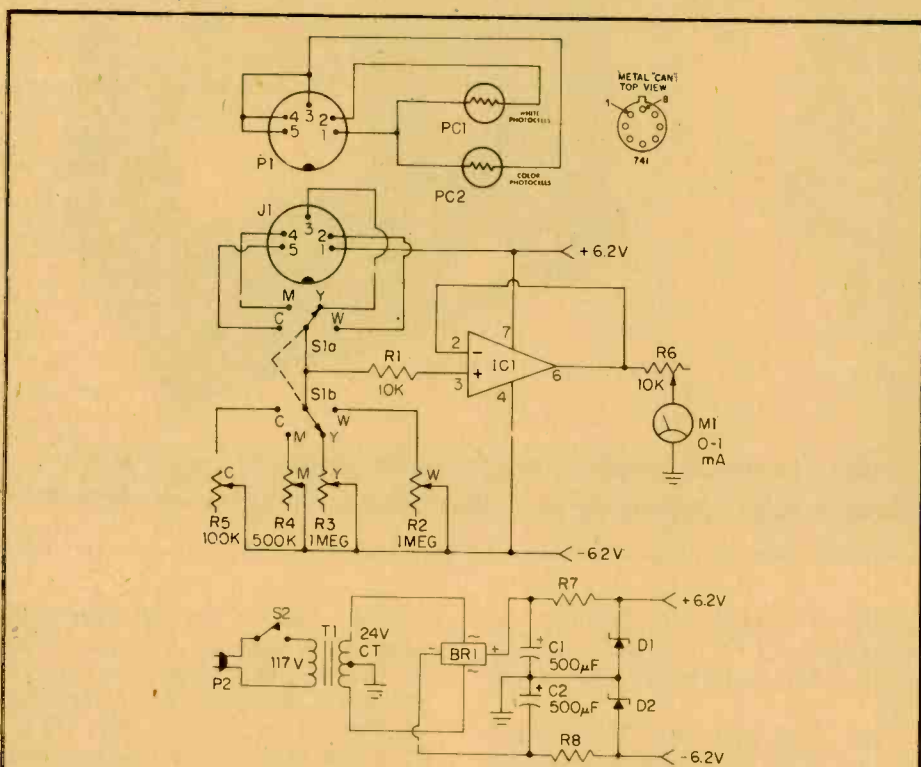

## PARTS LIST FOR COLOR ANALYZER

- BR1—50-PIV, 0.5-amp or higher silicon bridge rectifier  
 C1, C2—500-µF, 10-VDC or better electrolytic capacitor  
 D1, D2—6.2-volt, 1-watt zener diode  
 IC1—type 741C operational amplifier, see text  
 J1—5-pin socket, DIN-type (optional, see text)  
 M1—0 to 1-mA DC meter, see text  
 P1—5-pin plug, DIN-type (optional, see text)  
 PC1, PC2—Clairax CL5M5L photocell, **do not substitute**  
 R1—10,000-ohm, 1/2-watt resistor  
 R2, R3—1-megohm potentiometer, see text  
 R4—500,000-ohm potentiometer, see text  
 R5—100,000-ohm potentiometer, see text  
 R6—10,000-ohm trimmer potentiometer (Mallory MTC-14L4 for exact fit on PC board)  
 R7, R8—820-ohm, 1/2-watt resistor  
 R9—100,000-ohm, 1/2-watt resistor  
 S1—2-pole, 4-position rotary switch (Allied Electronics 747-2003; adjust stops for 4 positions)  
 S2—spst switch  
 T1—117-volt primary, 24 to 26.6-volt secondary transformer, see text for point-to-point wiring

(Note: you can also use two less expensive 12-volt transformers with secondary windings connected in series-aiding, if you have the space.)

The printed circuit board for the Color Analyzer is available direct from Electronics Hobby Shop, Box 192, Brooklyn, NY 11235 for only \$5.60. US orders add \$2.00 for postage and handling; Canadian orders add \$3.50. No foreign orders, please. Postal money orders will speed delivery; otherwise allow 6-8 weeks for delivery.

If you cannot obtain the Clairax Type CL5M5L photocell locally, write to Electronics Hobby Shop at the above address, enclosing \$5.00 for each photocell. U.S. orders add \$2.00 for postage and handling. Canadian order add \$3.50. No foreign orders, please. New York State residents add sales tax. Postal money orders speed delivery; otherwise allow 6-8 weeks for delivery.

Misc.—cabinet, pilot lamp for meter, 2-in. or 3-in. size Kodak Wratten filters #70, #98, and #99 (available from photo supply dealers), calibrated knobs, wire, solder, hardware, etc.

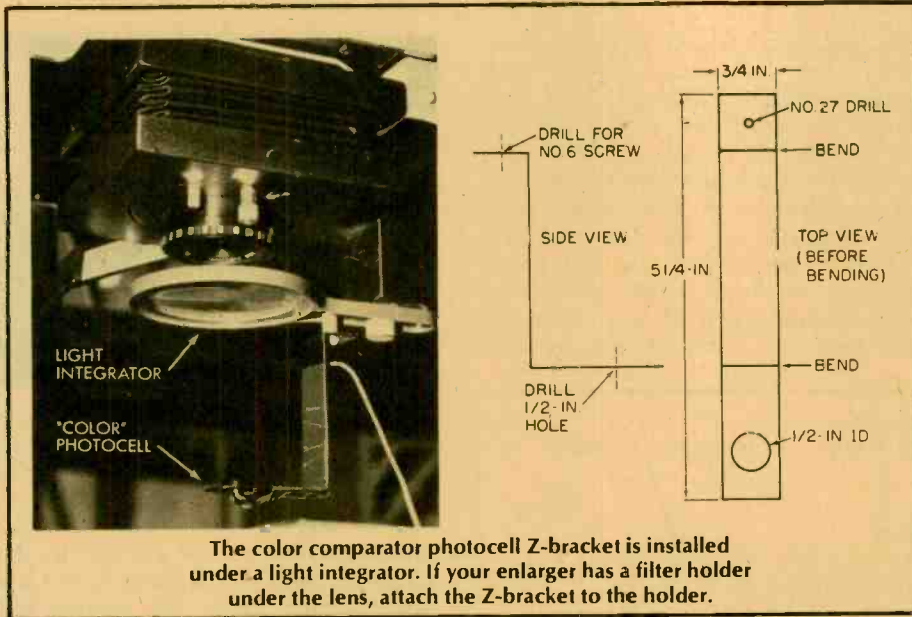

The color comparator photocell Z-bracket is installed under a light integrator. If your enlarger has a filter holder under the lens, attach the Z-bracket to the holder.

are far apart in value, or if the polarity is wrong, make certain you find the mistake *before* installing IC1.

Disconnect the linecord and complete the PC assembly. If you use a 24 or 28-volt pilot lamp to illuminate the meter you connect to the holes adjacent to T1's secondary (24-V) leads. If you plan to use a neon illuminator, install a 100,000-ohm resistor (R9) on the PC board and connect the lamp to the holes marked "neon." The lamp must have as little illumination as possible. Incandescent 24 or 28-volt lamps must be the miniature or "grain of wheat" type rated approximately 30 to 60 mA; the lamps come with attached leads. Do not use pilot lamps of the 100 to 500 mA variety. The excessive light will confuse the analyzer.

To install IC1 when it is the metal can TO5 type, fan out the #1 to 4 leads and #5 to 8 leads so they form two straight lines. Note that the lead opposite the tab on a TO5 package is #8. Insert the leads into the board leaving about 1/4 inch between the IC and the board. The IC is correctly installed if the tab faces *away* from the transformer

towards the nearest edge of the PC board. Solder IC1 and cut off the excess lead length.

The edge of the PC board nearest IC1 has four sets of paired foil terminals. These are provided as mounting terminals if you connect the photocell comparator and sensor without the use of a plug and jack. However, we strongly suggest the use of the specified DIN-type connectors as they allow for easy repairs if the connecting wires break. (The connectors aren't *that* costly).

Potentiometers R2 through R5 can be linear or audio taper, though audio taper gives a slightly smoother adjustment; use whatever you have in stock.

The analyzer shown is built in a Bud 7-inch AC-1613 Universal Sloping Cabinet. This is the least critical item and you can substitute whatever cabinet you prefer. Just be certain the cabinet will accommodate the type of meter you use.

Meter M1 should be 0-1 mA with a zero-center scale. But these are expensive, so you can substitute any standard 1-mA meter you want. You will simply calibrate the instrument for zero-center.

If you use a neon pilot lamp mount it directly above the meter and shield the forward brilliance with a piece of black tape; the lamp should radiate straight down onto the meter scale. If you use the meter in the parts list, remove the front cover by pulling it forward. Then remove the meter scale. As shown in the photographs, place a black dot approximately 3/16-inch wide at the center of the scale. If you want, you can also modify the meter for the incandescent lamp. Drill a 1/4-inch hole in the lower right of the meter *from the rear*. Position the meter in the cabinet and mark the location of the meter hole on the panel. Remove the meter and drill a 3/8-inch hole in the panel. When the meter is installed you can pass a "grain of wheat" lamp through the panel into the meter. Reassemble the meter and complete assembly.

**The Comparator.** The photocells used for the comparator and exposure sensor, P1 and P2, must be Clairex type CL5M5L. Make no substitutions. From a piece of scrap aluminum 3/4 to 1 inch wide, fashion a Z-bracket to the dimensions shown. Drill a 1/2-inch hole close to the end of the longer Z-leg. Fasten the other end of the Z-leg to your enlarger's under-lens filter holder. If your enlarger does not have a filter

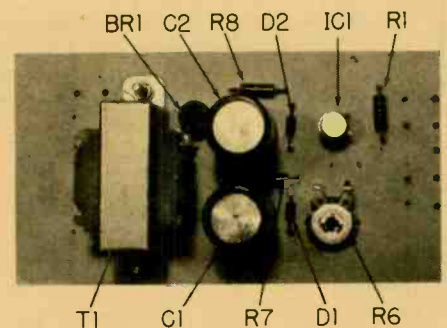

This is the parts location when our PC board is used. To get a free template of the PC board, send a Self-Addressed, Stamped Envelope to: Davis Publications, Dept. T, 229 Park Ave. South, New York, NY 10003.

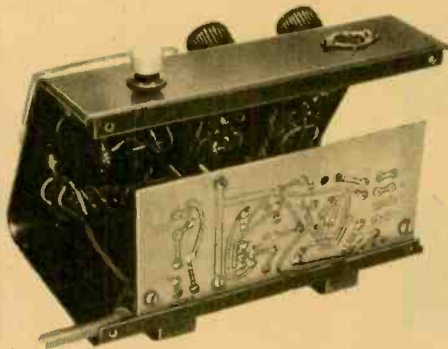

Rear view of author's color analyzer shows vertical mounting of the circuit board.

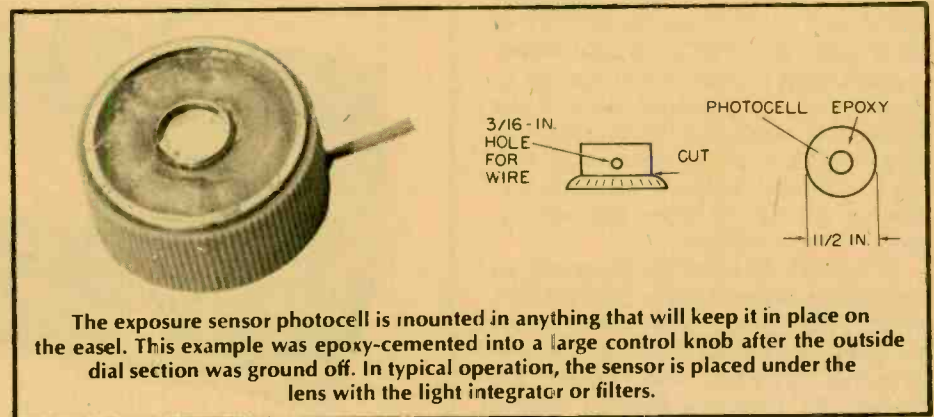

The exposure sensor photocell is mounted in anything that will keep it in place on the easel. This example was epoxy-cemented into a large control knob after the outside dial section was ground off. In typical operation, the sensor is placed under the lens with the light integrator or filters.

# COLOR ANALYZER

holder, or if it has a permanent swing-away red filter under the lens, mount a Paterson swing-away light integrator (available from local photo shops) under the lens. Fasten the short leg of the Z-bracket to the integrator—which has pre-drilled holes—so that the 1/2-inch hole is on the optical center of the lens. Then cement photocell P2

the switch and the control "C" for cyan. (We suggest you paint the cyan knob insert a blue-green. Also paint the other knobs the appropriate color.) Advance S1 one position clockwise, find the correct knob and label both "M" for magenta. Advance the switch another position clockwise, find the knob and label both "Y" for yellow. The last switch position and knob is labeled "W" for white (white light exposure). Make certain the C, M, and Y controls are read-



Close-up of meter face showing a small scale-illumination lamp in lower right corner. This lamp should not be operated at full voltage to avoid fogging the film.

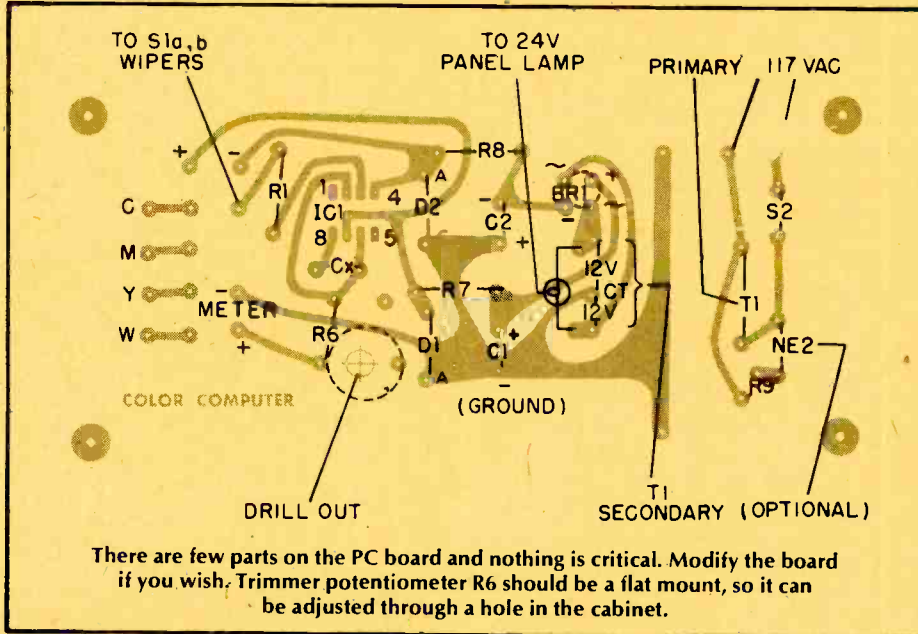

dark or very low light). This is normal and there will be no damage to the circuit or the meter. (Note: If you use a zero-center meter the pointer will barely pin on both sides.)

Install the Z-bracket under the lens. If your enlarger uses a filter holder under the lens insert a diffusion screen or glass, or a Beseler Light Integrator or similar ground glass in the filter holder. You are now ready to make color prints.

The first thing you need to make fine quality color prints is a high speed chemistry, such as the two-step Beseler system which can produce a finished print in two minutes. The second item you need is the electronic color analyzer for which we've already given you the plans.

**Color Variables.** Color materials such as the negative, printing paper, enlarger lamp, and even color correction filters vary in their sensitivity to light colors from batch to batch, roll to roll, and time to time. Even the enlarger's optical system can have a color cast. For this reason it is generally impossible to place a negative in your enlarger, expose the paper, and develop a good-let alone decent—color print.

in the hole and attach the connecting wires; these can be extra-thin zip cord such as used for short-length speaker connections. (This whole bit reads a lot more complicated than it is. Use the photographs as a guide.)

Photocell P1, which measures the exposure light, can be mounted in anything heavy enough to hold it in place on the easel. The photographs show the photocell epoxy-cemented in an oversize control knob.

When the complete analyzer is assembled, attach oversize calibrated knobs such as the Calectro E2-715 to R2 through R5. The knob calibrations are important so they should run out to the very edge of the knob skirt. If the calibrations don't run to the edge you won't be able to preset the controls with any reasonable degree of accuracy. Place a fine line or other indicator directly above each knob.

**Checkout.** Connect the photocells to the control unit and apply power. Don't worry if the meter pins at either end of the scale. Set switch S1 to the extreme clockwise position and adjust R2 through R5 until you find the control that changes the meter reading. Mark

ing P2, the color comparator mounted under the enlarger lens.

Set S1 to any position, set all other controls to their mid-position, and turn on bright room lights. If the meter pins out or approaches full scale deflection, adjust trimmer control R6 so the meter pointer just pins (don't be afraid to pin the meter). Depending on the amount of light the meter pointer will pin right (for bright light) and left (for



To avoid upsetting a control setting while groping for the on-off switch in the dark-room, mount switch S2 as far as possible from the controls.



Provides a wealth of worthwhile info for photographers interested in the color print techniques available from Kodak or your photo dealer. Their publication No. E-66.

One way we can correct for these variables is through an *additive* exposure, exposing the paper through blue, green, and red filters for differing lengths of time. Since blue, green, and red create all the colors in additive printing, any correction can be obtained by controlling the precise timing of each exposure. The additive system is a pain in the neck for the hobbyist, for the slightest desired change in the color rendition or saturation (exposure) can involve changes in the exposure through all three filters.

A printing system that's easier to use and more favored by hobbyists is the *subtractive* exposure. A single filter pack made up of two of the filters known as YELLOW, MAGENTA, and CYAN makes all the color corrections at the same time. This filter pack is placed between the enlarger lamp and the negative; virtually all modern enlargers have a drawer in the lamphouse to accommodate a filter pack. A single exposure through the filter pack is all that's required to make a color print. Some of the more expensive enlargers have what is termed a "dichroic head" with variable filters as part of the light system; the exact value of filtration is simply dialed by the user. Again, all the color correction is provided at one time by the dichroic head so only a single exposure is needed.

**More Info.** A full and complete treatment of both types of color printing is contained in the Kodak publication *Printing Color Negatives*; this book is a required reference for anyone who wants to make quality color prints. The book also gives the most convenient operating procedures for electronic color analyzers.

The subtractive printing procedure is particularly well adapted for use with a color analyzer, is the easiest method for the amateur, and is exceptionally fast-handling, so the illustrations to follow will refer to the subtractive system.

An electronic color analyzer basically consists of a photocell (vacuum tube photomultiplier or photoresistor) positioned under the lens, blue, green, and red filters mechanically positioned over the photocell (or positioned over the cell by hand) and a meter that indicates the amount of light falling on the cell. The meter is connected to the photocell through independent potentiometers as shown in the figure. Color analyzer readings will be accurate for most negatives and lighting situations as long as the same box of printing paper is used. The system needs to be recalibrated only when the printing paper is changed (so purchase boxes of at least 100 sheets to avoid extra work).

The first step is to make a really fine print from a decent negative. You can do it the hard way, one print at a time, or use a Beseler Subtractive Calculator which puts you inside the ball park on the first try. When you have made a print with satisfactory flesh tones and color saturation don't disturb the enlarger or timer controls.

**To Continue.** . . . Place the color analyzer's probe on the easel or swing it under the lens (if it is mounted on the enlarger). Install a light integrator—which is nothing more than a piece of ground glass or its equal—under the lens, between the lens and the analyzer's probe. The light integrator scrambles the picture into a diffused "white light" which contains all the color elements of your negatives and the filter pack. Place a blue filter (Kodak Wratten No. 98) on top of the light integrator. (Note that most hobbyist analyzers have a selector switch that also mechanically positions the correct filter over the photocell.) Turn on the enlarger and adjust the analyzer's *yellow* control for a convenient reference meter reading. (Usually, center-scale or "null" is used as the reference reading, but any meter reading can be used as a null.)

Remove the blue filter, install a green

filter (Kodak Wratten No. 99), switch the analyzer to *MAGENTA* and adjust the *magenta* control for a null meter reading. Remove the green filter, install a red filter (Kodak Wratten No. 70), switch the analyzer to *CYAN* and adjust the *cyan* control for a null meter reading (the color controls yellow, magenta, and cyan refer to the color of the subtractive filters in the filter pack). Finally, remove all filters from under the lens, switch the analyzer to *WHITE* and adjust the *white* control (exposure control) for a null meter reading.

(The color analyzer in this project uses a separate photocell for the exposure. If you look at the easel you'll

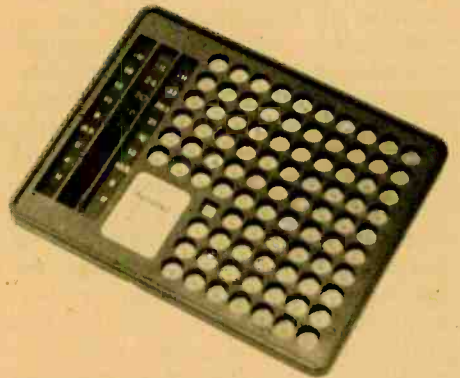

Modern color print chemistry techniques from Beseler include this subtractive color calculator to aid filter selection.

see a shadow cast by the Z-bracket holding the color comparator cell. Position the exposure cell on the easel so it is just off the edge of the shadow. If you prefer, you can place several thicknesses of opaque paper over the color comparator cell and use it for the white measurement, though we suggest you use the separate cell.)

When all the controls are adjusted you have programmed the color characteristics and exposure of your "reference" print into the analyzer, and you should note the control settings and exposure time for future use.

**Down to Business.** Now assume you want to make a print from another negative. Put the new negative in the enlarger. Then set the degree of enlargement and focus, leaving the lens wide open. Place the analyzer's probe under the lens, install the light integrator and set the analyzer's switch to *CYAN*. Install the red filter on top of the light integrator and adjust the lens aperture until the meter indicates null. Switch the analyzer to *MAGENTA*, install the green-reading filter and note the meter reading. If it is not at null, add or remove magenta filters (from the filter pack) until the meter shows a null. Then switch the analyzer to *YELLOW*, install the blue-reading filter and

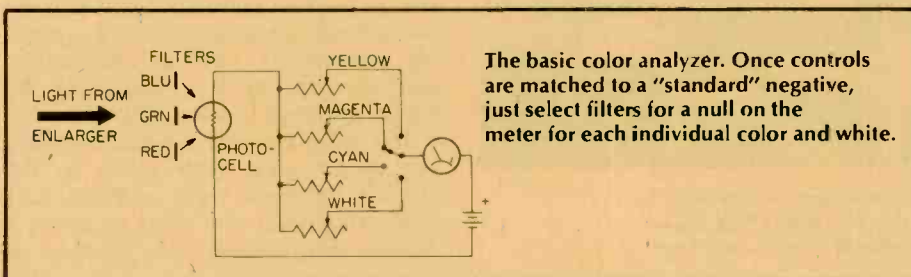

## COLOR ANALYZER

modify the yellow filtration in the filter pack until the meter shows a null. Finally, set the analyzer to WHITE, remove all reading filters and adjust the lens aperture for a null indication.

Through the color analyzer you have now established a new filter pack and exposure for the new negative. If the new negative uses similar lighting to the reference negative the print should be perfect. If the lighting was considerably different the print will be good—acceptable to most people, but requiring just a slight filter pack modification for a great print.

**Swinging Filters.** In the previous example the filter pack would wind up with magenta and yellow filters—which is what is generally needed. Some Kodak color negatives, however, might require cyan filters plus magenta or yellow (but never all three). This information will have been programmed into the color analyzer, so you will have no difficulty if you make a slight modification in procedure. The first meter reading, the one where you adjust the lens's aperture, should be made for the filter you are *not* using in the filter pack. For example, if your basic filter pack has cyan and magenta, switch the analyzer to YELLOW, place the blue-reading filter in position on the light integrator, and close down the lens for a null indication. Then proceed with the other readings. If your reference negative did not require cyan in the filter pack, if it had yellow, magenta, or both, and you find a new negative just can't be pulled in for null meter readings with yellow and magenta filters, it indicates the new negative requires cyan filtration, so start with the assumption that yellow is not

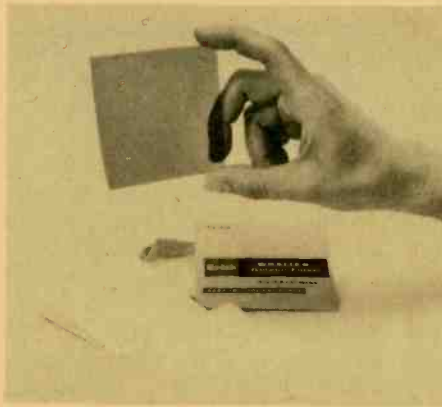

Kodak color printing filters. Typical filter designation CP20Y means color filter with a .20 density; the color is yellow.

required. If you still can't null the meter, it means magenta should *not* be in the filter pack.

As we mentioned, a more thorough discussion and procedure for using a color analyzer is found in Kodak's *Printing Color Negatives*.

Most, but not all, commercial color analyzers use photomultiplier tubes which have no light memory, nor are they confused by infrared from the enlarger lamp. These units are, as you would expect, relatively expensive. Low cost models use photoresistors.

**More Data.** Photoresistors are infrared-sensitive and they have a light memory, both of which can confuse the meter. The infrared is easily handled by installing a heat or infrared filter glass in your enlarger (it should be there to protect the negative anyway). The light memory is handled by using a consistent measurement procedure. The best way is to turn the enlarger off, install the reading filter and the light integrator, turn off the bright room lights, count to five, and then turn the enlarger *on*.

Take the meter reading, or adjust the appropriate color control, slide the new reading filter in place before withdrawing the old one, switch the analyzer, and make the new meter reading. Repeat this for the third reading filter. You'll note that this procedure keeps bright white light from falling on the photocell between meter readings. If you want to change filters under room lights, make certain there are about five seconds of darkness between turning the room lights out and turning the enlarger on.

The whole bit might sound somewhat complicated, but after you've run through the procedure once or twice to get the hang of things it shouldn't take you more than a minute or so for a full color analysis of a new negative.

The Kodak Wratten filters needed are available from professional camera shops. For the construction project, color analyzer 2-in. or 3-in. Kodak Wratten filters Nos. 98 (blue), 99 (green), and 70 (red) are recommended. If you have difficulty obtaining these specific filters you can make the following substitutions, through the analyzer's precision will be slightly reduced: 47B (blue), 61 (green), and 92 (red).

**The Pro Shop.** We could not close without some words on commercially processed color prints such as you might order from a drugstore or camera shop. Commercial color labs have as high (if not higher) a remake rate than the amateur if *quality* color prints are desired. As a general rule, it takes two tries to get a decent color print, so the hobbyist with a color analyzer is way ahead of the game because he can turn out, at worst, two *good* prints for each three first tries. The average is even higher than this as the hobbyist gets skilled in the use of a color analyzer.

Commercial labs come close to a hobbyist's results only when they are equipped with a video analyzer such as the Kodak Video Color Negative Analyzer Model 1-K; and Kodak only claims a 75%+ first try acceptance rate for their analyzer. The video analyzer is a 5-in. x 5-in. TV display. The operator views the color negative as a positive color TV image, and adjusts the TV's controls for proper color balance and brightness (saturation). The control settings are translated to the printing equipment's filter adjustments so that the final print is similar to the image displayed on the TV.

The video analyzer is a fast and easy way to get good color prints on the first try, but since video analyzers cost in the thousands, the color analyzer is the best thing going for the hobbyist. ■



Professional equipment used by color labs includes this Kodak Video Color Negative Analyzer. It uses a 5-in. color TV screen to assist an operator in selecting the correct filter.

# MINI-REG

## the regulated IC Power Supply



Keep your projects cool,  
calm and under control with this peppy power supply

**H**ERE'S A LOW-COST precision regulated DC power supply which is sure to be a welcome addition to any workbench—provided some family member doesn't appropriate the power supply for use as a universal AC adaptor! Compactly assembled in an eye-catching low profile, the Mini-Reg is continuously adjustable from 3.4 volts to 15 volts DC and delivers up to 500 milliamperes, enough for just about any job. Using the HEP C6049R precision monolithic IC regulator, the Mini-Reg effects 0.01% regulation with line voltage variations, 0.05% regulation for load variations, and its output impedance is a mere 35 milliohms. Short-circuit proofed, the Mini-Reg also features adjustable current limiting which greatly reduces the chances of damaging valuable components in the

circuits you are working on. You can also use the Mini-Reg as a constant-current source and recharge nicad batteries.

**Circuit Operation.** The HEP C6049R is actually a DC regulator within a regulator which accounts for its high performance. As shown in the block diagram, a very stable reference voltage ( $V_r$ ) is applied to the non-inverting or voltage follower input of an op-amp which serves as the first regulator and DC level shift amplifier. The output voltage of this stage can be varied from 3.4 volts to 15 volts by varying pot R11. This voltage is applied to the non-inverting input of the second op-amp which is capable of supplying up to 5000 milliamperes current to the load. This stage has unity voltage gain wherein V-out follows the input voltage to this stage. This double regulator arrangement fully isolates the DC level shift amplifier and results in very close regulation. Capacitor C4 provides frequency compensation and precludes possible circuit oscillation.

External components consisting of transistor Q1 and selectable resistor  $R_{sc}$  provide constant-current limiting should the supply be short-circuited. When the load current passing through  $R_{sc}$  becomes sufficiently high, the base of Q1 becomes forward biased causing Q1 to

conduct. When Q1 conducts, the voltage regulator delivers an essentially constant current to the load at a level depending on the value of  $R_{sc}$ . In the schematic diagram, resistor R3 places a minimum load on the regulator. Switch S3 selects the desired current limit. Jacks J1 and J2 permit insertion of a milliammeter to read load current but without impairing regulation. Diode D2 provides meter protection and diode D1 provides reverse voltage protection.

**Construction.** Assemble the Mini-Reg in an aluminum case or in a plastic case with aluminum cover plate. Select a case which will accommodate the particular meter and transformer you plan to use. Plan the layout allowing room for the PC board assembly when the cover plate is secured.

Begin by laying out and drilling mounting holes for IC1 in the heatsink. Drill a 7/16-inch-diameter hole in the heatsink to pass the lead wires of IC1. File off drill burrs and ridges so that IC1 mates perfectly on the heatsink. Drill matching holes in the cover plate. For ventilation, drill a number of holes in the cover plate and on the bottom of the case.

Make the PC board using the circuit pattern shown, taking care to locate

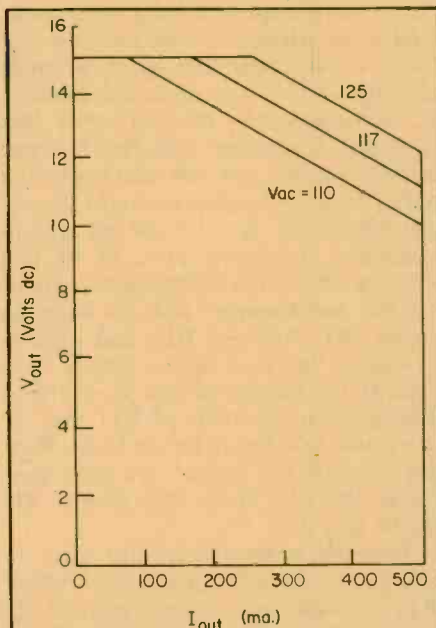

This chart shows the operating range of the Mini-Reg at various line voltages. The full 15 VDC is only available at lower currents, but few IC projects ever require that much voltage or current supply.

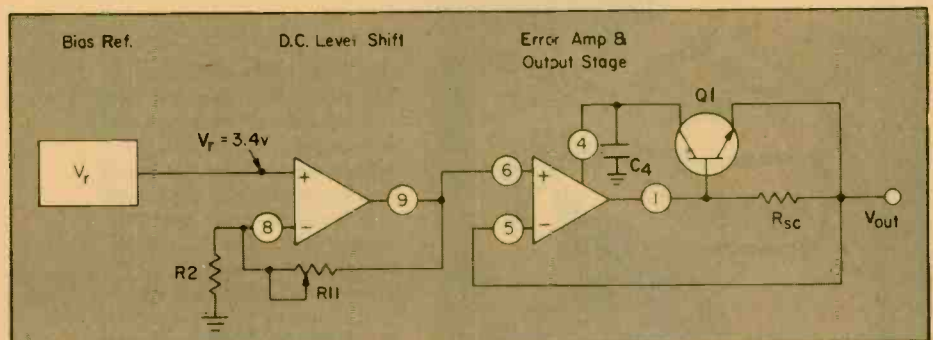

This is a simplified block diagram of the C6049R regulator chip—the heart of the Mini-Reg power supply. Thanks to such ICs construction projects are easy to build.

# MINI-REG

pads for IC1 just right. Push IC1 into the drilled board and mark and drill the mounting holes. For easier mating, countersink the lead holes for IC1 on the insulation side of the board by twirling a small drill bit.

Install and solder the jumper on the insulation side of the board and install and solder T42-1 micro-clips (Vector) on the copper side at all resistor and board take-off terminals. Clip a small heatsink (Radio Shack 276-001) on the leads of Q1 when soldering. Install remaining circuit board components excepting trim resistor R5. Using 6-32 machine screws, bolt IC1 and the heatsink to the cover plate. Place a lock washer and two 6-32 nuts on each mounting bolt. *Omit the mica washer between IC1 and the heatsink and apply a bit of silicone heatsink grease between IC1 and the heatsink.* Coil a ¼-by 1½-inch strip of fishpaper insulation and slip it down into the hole in the cover plate around the IC lead wires. Push the PC board assembly down on the mounting screws and mate with the protruding IC leads and secure. If you can't install the assembly, look for bent pins or reversed installation of IC1.

Install switches S1 and S2 along with jacks J1 and J2 on the left side of the case. Install diode D2 and capacitor C7 on switches S2. Secure two solder lugs on each binding post and install diode D1 and capacitor C6 on the binding posts. Pass the AC line cord through the left side of the case and knot the cord for strain relief. Install resistors R6 thru R10 on switch S1. Depending on the base-emitter characteristics of Q1, the specified values of current limit resistors R6 through R10 may differ somewhat in your power supply. This is why trim resistor R5 was included to properly trim the 500 mA current

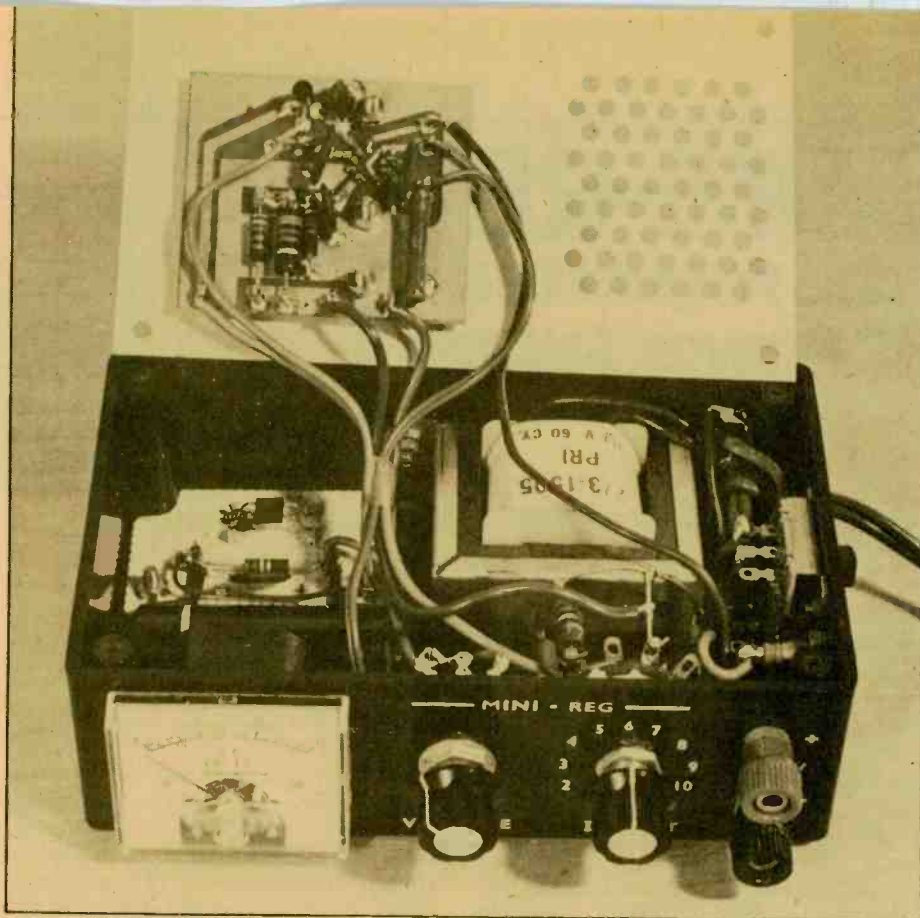

Internal view of the Mini-Reg. The circuit board is positioned so that it doesn't come in contact with the meter and transformer. The case is perforated for ventilation. You can see the tiny, square HEP 176 rectifier on the small circuit board in the bottom of the case.

limit. For this reason, you may defer installation of resistors R6 thru R9 but *do* install resistor R10.

Place RECT-1, R1, C5, and C8 on a small piece of perfboard and situate this sub-assembly behind the meter. Connect meter M1 directly to binding posts BP1 and BP2. Use #20 stranded wire for connections to the PC board. Connect a wire from board pin G to BP2. Run a wire from board pin E to the rotor lug of S3. Connect a wire from board pin D to resistors on S3. Run a wire from board pin F directly to BP1. Run a pair of wires from pot R11 to board pins B and C. Connect a wire from *V-in minus* directly to BP2. Do not make the connection from *V-in*

*plus* to board pin A at this time. You may omit the double-fused plug and provide but one fuse in the primary side of transformer T1. Carefully check all wiring and solder connections.

**Checking It Out.** We intentionally deferred installation of several components and some wiring, so that you can perform a few simple tests which preclude damage to circuit components. Connect a voltmeter across R1 and verify that *V-in plus* is nineteen volts DC. Connect a milliammeter and 100-ohm resistor in series from *V-in plus* to board pin A. Set S3 to pick up R10 and set R11 to minimum resistance. Turn S1 on and observe about five milliamperes current on the milliammeter and 3.4 volts on meter M1. Advance R11 and observe a voltage increase up to fifteen volts DC. If the output voltage is less than fifteen volts, the value of R11 may be too small or R2 may be too large. Having verified the above, you may now install the wire from *V-in plus* to PC board pin A.

Plug the milliammeter into jacks J1 and J2 and open S2 (Meter In). Adjust R11 for ten volts output and set S3 to ten milliamperes current limit. Then, connect a 500-ohm ½-watt resistor across the output terminals. If current limiting action is taking place, the milliammeter should indicate roughly ten milliamperes and the output voltage

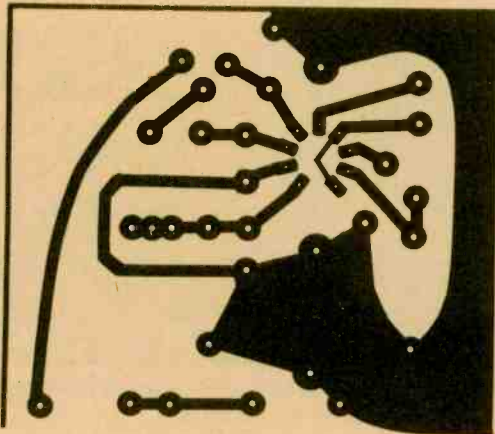

This is an exact-scale printed circuit board pattern showing the foil side of the board. This side contrary to normal, is, where the components are to be mounted. Only the jumper and the IC chip are mounted on the other side. Be careful to keep the foil-side component bodies off the metal surface to avoid shorts. Be especially careful with resistors R4 and R5 and capacitor C3.



should drop to about five volts. If much higher values are observed, current limiting is not taking place. Look for a defective or improperly installed Q1. If your current limit is, say, seven milliamperes, you can bring it up to ten by using a smaller value for R10 or by connecting a suitably larger value resistor across R10.

Only after you have verified current limiting action at low current, set S3 to pick up R4 (500 ma setting) and set the VOM accordingly. You will need either a 50-ohm 10-watt rheostat or adjustable power resistor to gradually load the supply. Or, you can use a number of small-valued power resistors. Set the rheostat to maximum resistance and connect it across the output terminals. Gradually reduce load resistance while observing output voltage and current. Current limiting should occur at below 500 ma. To increase the limit to 500 milliamperes, select and install a suitable resistor for R5. Proceed similarly to size or trim resistors R6 thru R10. You can easily include other current limits in the spare positions on S3 to match the charging currents of your nicad batteries. Do not exceed 500 milliamperes or IC1 will be damaged.

**Application.** The operating range of

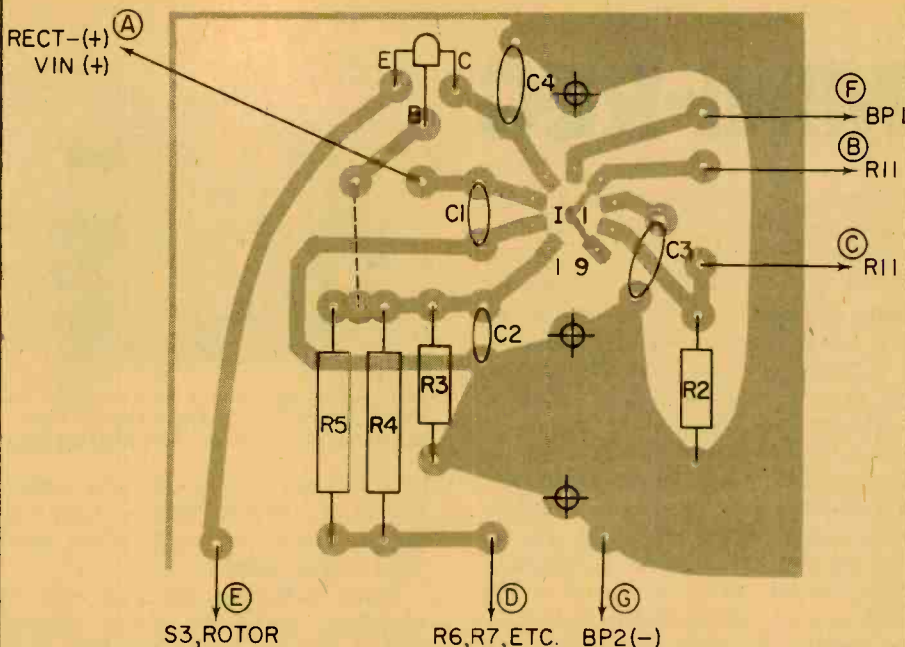

The parts should be placed according to this diagram. Note the location of the three drill holes for securing the IC and the board to the chassis. Locate the IC mounting holes very carefully so that everything mates snugly. This will help keep the chip cool.

the Mini-Reg for several line voltages is shown. The supply "drop-out" shown in the upper right hand corner of this chart is due to an insufficient difference between V-in plus and V-out which in turn depends on transformer T1 volt-

age. When you are not using a meter at jacks J1 and J2, close S2.

The adjustable current limiting feature of the Mini-Reg greatly reduces the chances of damaging circuit components of the circuit powered by the supply.

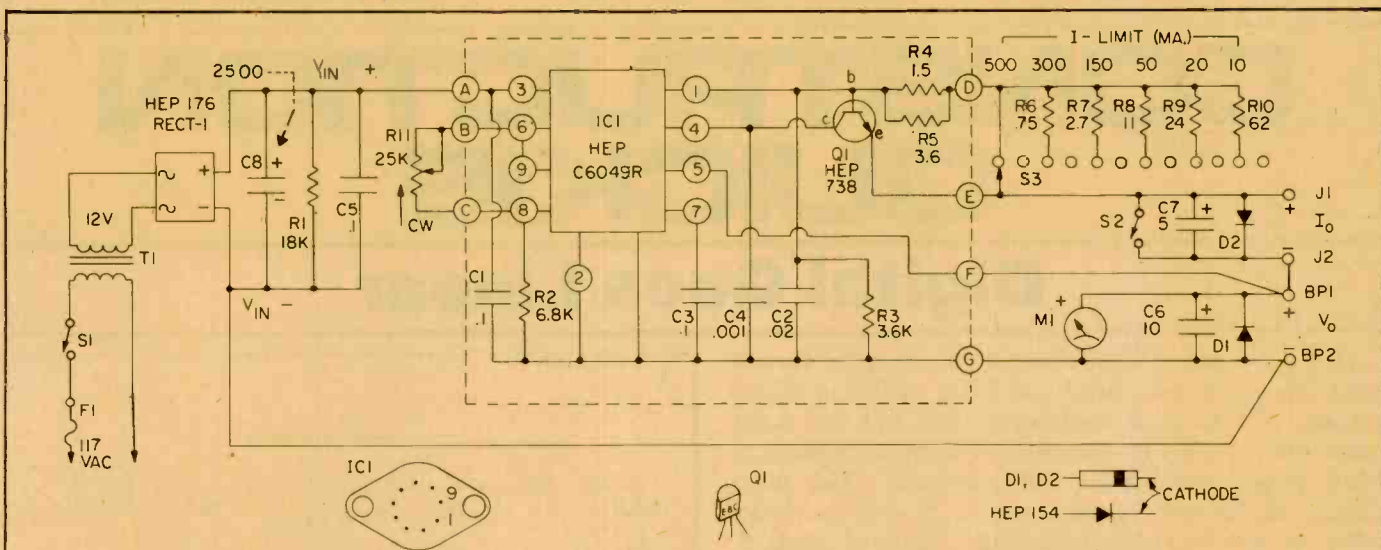

**PARTS LIST FOR MINI-REG**

- |  |   |  |
|--|---|--|
| <p>BP1, BP2—binding posts, red, black<br/> C1, C3, C5—0.1-µF 25-VDC capacitor, ceramic<br/> C2—0.02-µF 25-VDC capacitor, ceramic<br/> C4—0.001-µF 25-VDC capacitor, ceramic<br/> C6—10-µF 25-VDC electrolytic capacitor<br/> C7—5-µF 25-VDC electrolytic capacitor<br/> C8—2500-µF 25-VDC electrolytic capacitor<br/> D1, D2—1-Amp 50 PIV silicon rectifier diode, HEP 154<br/> F1—½-Amp fuse<br/> IC1—HEP C6049R voltage regulator<br/> J1, J2—insulated phone tip jacks, red, black<br/> M1—0-15 VDC miniature DC voltmeter<br/> Q1—HEP 738 transistor</p> | <p>R1—18,000-ohm, ½-watt resistor<br/> R2—6800-ohm, ½-watt resistor<br/> R3—3600-ohm, ½-watt resistor<br/> R4—1.5-ohm, 2-watt wire-wound resistor, IRC type BWH<br/> R5—3.6-ohm, ½-watt resistor<br/> R6—0.75-ohm, 2-watt wire-wound resistor, IRC type BWH<br/> R7—2.7-ohm, 2-watt wire-wound resistor, IRC type BWH<br/> R8—11-ohm, 1-watt resistor<br/> R9—24-ohm, 1-watt resistor<br/> R10—62-ohm, 1-watt resistor<br/> R11—25,000-ohm linear taper potentiometer</p> | <p>RECT-1—HEP 176 1-amp, 200-PIV bridge rectifier.<br/> S1, S2—SPST slide switch<br/> S3—1-pole, 12-position switch, non-shorting (Mallory 32112J) or equiv.)<br/> T1—12-volt, 1.2-ampere filament transformer<br/> Misc.—Plastic case with aluminum top, 6¼ x 3¼ x 2 inches; heat sink, 3 x 3½ inches, (Allied Electronics 957-2840 or equiv.); T42-1 micro-clips (Vector); AC line cord; fused cord plug or fuseholder; perforated board; copper clad board; rubber feet (4); hardware, etc.</p> |
|--|---|--|

# MINI-REG

Suppose you are experimenting with a transistorized circuit drawing five milliamperes at five volts. You would then set S2 to ten milliamperes. At these settings, the maximum power the supply can deliver is but a mere fifty milliwatts.

If you plug a transistor in backwards, the most it can draw is fifty milliwatts, probably much less; hence, the device will survive the error. However, certain semiconductors can be damaged with but microwatts of power. Nevertheless, you are far better off using current limiting supplies. If your experimental circuit draws 400 milliamperes at five volts, set S3 to 500 milliamperes limiting the power to 2.5 watts. This power level is more than enough to zap many devices if you make an error. If you have another five volt supply, split the circuit supply lines and protect those devices you cannot spare with the Mini-Reg.

Almost any circuit operating off three volts can safely operate at 3.4 volts. The output voltage can be further reduced by connecting a low-voltage zener diode in series with the plus lead to the

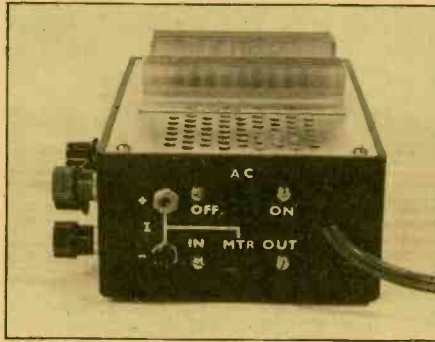

The AC line switch, current jacks and current meter switch are on the end of the case.

load and monitoring the load voltage with a voltmeter. In this case, load voltage regulation now depends on zener diode characteristics.

When recharging batteries with the Mini-Reg, connect a silicon rectifier diode in series with the plus lead going to the battery. This eliminates "back-leak" when the supply is turned off with battery yet connected. Observe battery polarity when making connections. Circuits using op-amps usually require a dual or split supply. To provide a dual six-volt supply, set the output voltage to fifteen volts, set S3 to 100 milliamperes, and connect two six-volt zener diodes in series across the output terminals. Then, connect a 100

uF 25V electrolytic capacitor across each zener diode.

The Mini-Reg handily checks and sorts zener diodes of fifteen volts or less. Set R11 for fifteen volts output and set S3 to ten milliamperes. Connect the diode across the output terminals with plus lead wire to BP1. Observe zener diode voltage on M1. Advance S3 to high currents but do not exceed rated current of the diode. The better the quality of the diode, the less increase in voltage observed on M1.

When you operate radio or audio equipment from the Mini-Reg, set S3 to a current level which supplies peak currents on audio peaks. Otherwise, you will notice audio distortion on audio peaks. With some radio and audio equipment, operations off an AC adaptor or the Mini-Reg may introduce an AC hum. Reversing the AC plug usually remedies the problem. If not, connect a ground wire to either the plus or minus terminal of the Mini-Reg, whichever proves most effective. In addition to its use as a universal AC adaptor, the Mini-Reg serves as an excellent power supply when servicing battery operated transistorized equipment. You'll wonder how you ever solved your power supply problems before you discovered Mini-Reg!

# CONSTRUCTION QUICKIE

## Digital Goes Linear

Digitally-oriented ICs are best at their intended On-Off tasks, but can be persuaded into linear operation if care is taken. CMOS lends itself better than TTL for linear operation, but good by-passing and layout is essential to avoid pickup and exotic self-oscillations. The 4009 CMOS hex-inverter sections can be biased as shown below. A typical single stage yields a gain of about 5. The triple combination can give a gain of 100 with care. These circuits could be useful where a high-impedance input circuit does not quite have sufficient amplitude to operate the digital gate.

### PARTS LIST FOR DIGITAL GOES LINEAR

- C1, C2—0.1-uF ceramic capacitor, 15 VDC
- IC1—4009 hex buffer
- R1, R2, R3—1,000,000-ohm, 1/2-watt resistor
- R4—500,000-ohm linear-taper potentiometer
- R5—5,000,000 to 10,000,000-ohm, 1/2-watt resistor

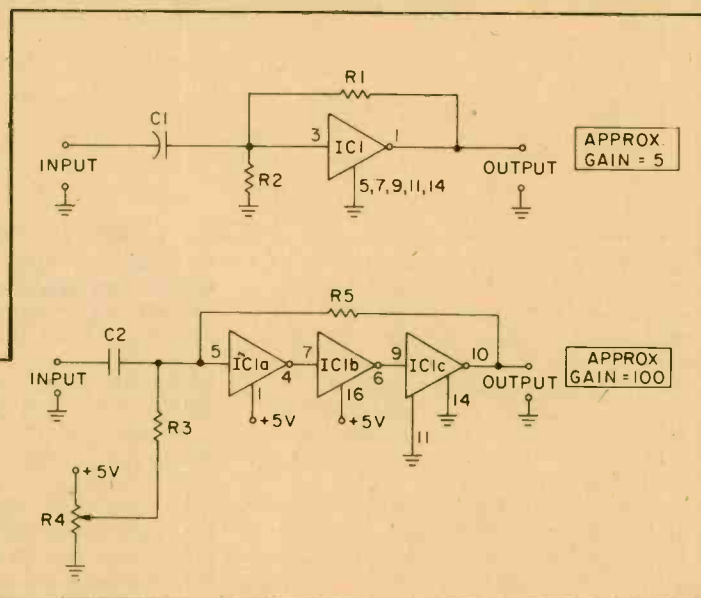

# The chances are excellent that... You have a talent other people are willing to pay for!

You're "handy" around your house, have the ability to fix things, and "make them work right"... that's why there may be a rewarding career for you in Electronics.

## A career in Electronics?

Absolutely. Because you're interested in *things*. How they work. Why they work. How to take them apart and put them back together. Plus . . . you've got a head for detail work.

## Your chances are excellent

With the right kind of *specialized* technical training, you can have a challenging, financially rewarding future waiting for you in Electronics. Think of the career opportunities . . . computers, aerospace, 2-way radio communications, radio/TV broadcasting, medical electronics, to name just a few.

And, surprisingly, you don't need a college degree!

All you need to do to qualify for one of these exciting career fields is to build upon the technical aptitude you already have . . . just put your hands and your head to work with a CIE Electronics career course.

## You learn by doing

The CIE method of instruction is the refinement of over 40 years of Electronics, independent home-study experience. It works. And you don't need *any* prior electronics experience. A CIE *career* course can take you from ground zero right up to training in Lasers, Microminiaturization, Radar, Analog Computers, and various applications in Communications.

In some CIE courses, you'll perform "hands-on" experiments and tests with your own CIE Personal Training Laboratory. And, if TV technology and digital Electronics are your main interest, you can select from several courses that involve working with and



troubleshooting a TV. (And the TV is yours to keep, too!) This combination of "head and hands" learning *locks in* your understanding of the crucial principles you'll use on the job in your new career. But, don't kid yourself . . .

Electronics is not an "easy" science and CIE courses are not "snaps." Subject matter is technical, thorough, and challenging. It has to be. We're training you for a *career*. So the presentation of ideas is logical, written in easy-to-understand language . . . you progress step by step, at your own pace.

## CIE Education by mail

There is no need to "go back to the classroom" with CIE. Because you learn at *home* or wherever else is convenient. You keep your present job and income. No cross-town commutes. *You* decide when and where *you* study best.

Your eventual success . . . at CIE and in your electronics career . . . will be determined by your own motivation and self-discipline. *You can* do it. And CIE can show you how.



Patterns shown on TV and oscilloscope screens are simulated.

## Put your talent to full use

We believe that you may be a "natural" for Electronics, and we'd like to tell you more about potential career fields and our school. We'll be glad to send you our complete package of FREE career information if you'll send in the card or write mentioning the name and date of this magazine. For your convenience, we'll try to have a school representative contact you to review vari-

ous educational programs and assist in course selection. As soon as we receive your request, we'll mail you our school catalog, complete G.I. Bill details, and special information on government FCC License preparation. There's no obligation.

Let's discuss your new career in Electronics. NOW! Send for your FREE school catalog and career information TODAY.

**CIE** Cleveland Institute of Electronics, Inc.  
1776 East 17th Street, Cleveland, Ohio 44114

Accredited Member National Home Study Council

# THE SIMPLE SIGNAL TRACER



**R**emember that AM pocket radio your cousin gave you last year? How about the one the bank gave you last week when you opened up a new account? Most electronic experimenters end up with one such useless radio at some time, and that spare radio can be converted into a piece of test equipment that will be an invaluable aid to your workbench; a signal tracer.

In AF and RF circuits, even after you have taken voltage measurements and begun to suspect certain components, it really helps to be able to *hear* what's there. The signal tracer can be used to probe the area in such cases and can also be used as a simple amp/speaker system.

This project will outperform the inexpensive tracers on the market, which cost about \$15. If you already have a spare AM radio, you can complete this project for 3 to 4 dollars. If you don't have a spare radio already, some sharp shopping should nab you one for about two or three dollars. Either way, you'll enjoy a considerable savings over the store-bought tracer, as well as better performance.

**How It's Done.** Every radio has two sections in it: An RF (Radio Frequency) section and an AF (Audio Frequency) section. The RF section yanks the radio signals from the air and demodulates them to recover the audio signals that are being broadcast. The AF section then amplifies these weak audio signals to a volume that we can hear.

What we'll do then, is to tap in just before the volume control (The volume control works by sending a varying signal to the AF section that has been produced by the RF section. The variation is the volume control setting.) So the volume control will control the loudness of the input signal that you put in when you're tracing.

Referring to the schematic, in the AF mode of operation, the signal input goes through C1, which blocks any DC coming from the circuit under test, but couples the signal to the radio's ampli-

fier input. For tracing RF signals, D1 and C2 couple and demodulate the RF signal that is being traced.

**Construction.** Remove the back cover of your radio, and locate the volume control potentiometer. Remove the small screw that is holding the volume control dial to the potentiometer's shaft, and remove the dial so that you can clearly see the three "lugs" (or pins) on the volume control potentiometer.

Now, it's necessary to find the lug that carries in the signal from the RF section of the radio. You can eliminate the center lug. Next, take an ohmmeter and clip its ground lead to the negative battery wire. Take the positive ohmmeter lead and touch it alternately to the two remaining lugs of the volume control potentiometer. The lug that, when touched reads no resistance (0-ohms), can be eliminated, as the remaining lug (the third one) is the one you'll need to operate on for the modification.

Now, take a sharp knife or cutting tool, and cut the foil on the PC board that runs to this lug on the potentiom-

With the chassis removed from the case, the connections to the radio's printed circuit board are visible. The input wire running from S1 to the volume control's input lug, as well as the ground wire from jack J1, are the only two hard-wired connections necessary.

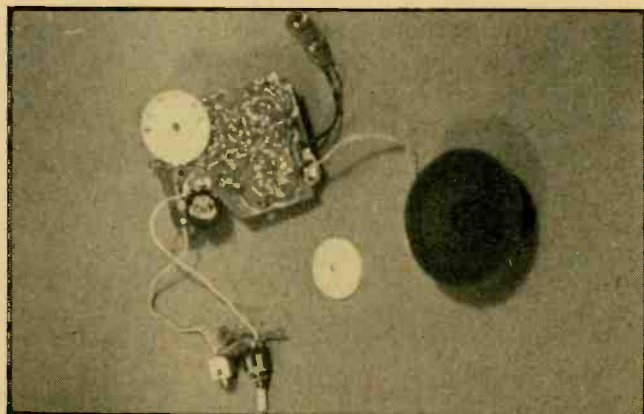

## A pocket radio dies so that others may live

eter so that there is no longer any connection there. This cuts off the signal from the radio's RF section so that it won't be heard. Now, solder a three-to-four-inch piece of insulated wire to the disconnected lug. Solder a similar length of wire to the point on the PC board where the battery's negative lead is attached.

Connect the wire from the lug of the potentiometer to the center lug of switch S1. Follow the schematic, and wire capacitor C1 to one side of switch S1, and to the tip connector on jack J1. In a similar manner, connect diode D1 and capacitor C2 to the other side of switch S1, and to the tip connection point on jack J1. Observe the polarity of D1, and use a heat sink when soldering it. Next, connect the sleeve connector of J1 to the wire from the negative side of the battery that you installed earlier. Finally, drill two mounting holes in the radio's case to accommodate J1 and S1. Be sure to mount them where there is no possibility of their connecting lugs coming in contact with the PC board. This is usually best done near the battery.

Finally, solder different colored wires (red for the center connector, black for the sleeve connector) to P1, and attach an alligator clip to the black lead, and a probe tip to the red wire. A paperclip wrapped with electrical tape will make a functional probe tip.

*(Continued on page 96)*

**W**hen working with various electronic projects, it's easy to get carried away with too many current-eating components, which can overload a power supply. Our Smart Power Supply solves this problem with its built-in LED ammeter, which always tells you what the current draw is.

The supply delivers a regulated 5 and 8-volt output at up to 1-amp, and you'll never be in the dark as to how much current is being drawn. 4 LEDs display the amount of current being utilized by the load. Each LED lights respectively to show the level of current being drawn. For example, if  $\frac{3}{4}$  of an amp (.75) is being used, the first three LEDs (".25", ".50", and ".75") will all glow to show that a current of at least  $\frac{3}{4}$  of an amp is flowing. Best of all, the current measuring resistance is an unprecedented 0.1-ohm! What's more, the cost for the ammeter portion of the circuit is only about \$5. That's way less than you'd pay for a good mechanical meter.

The 5-volt output is ideal for all of your TTL IC projects, while the 8-volt output may be selected for CMOS circuits, and other, higher-power requirements. The total cost for the whole supply, including the bargraph ammeter, is about \$15-20, depending on your buying habits, and choice of parts suppliers.

**How it Works.** IC4 is supplied by an accurate reference voltage of 5-volts by IC3. IC4 is a quad op amp used in a quad comparator configuration.

The 4 op amps (comparators) in IC4 are each fed a separate reference voltage by the divider network made up of R1-R4 and R5-R8. These comparators in IC 4 are very sensitive, and they can detect extremely small voltage differences and compare them.

Let's take the first op amp comparator as an example. Its inputs are pins 2 and 3, and its output is pin 1. The reference voltage appearing at pin 3 is compared to the voltage coming into the first comparator at pin 2. When  $\frac{1}{4}$  of an amp or more is flowing thru R10, .025-volts or more (0.1-ohms times 0.25A = .025V) appears across R10, which is enough voltage to equal pin 3's reference voltage, thus turning on the first op amp. The output of this op amp is at pin 1, so LED1 turns on to signify that at least  $\frac{1}{4}$  of an amp is being drawn. In a like manner, the other LEDs turn on or off with the changing current. The rest of the circuitry makes up a basic voltage-regulated power supply.

**Construction.** All of the circuitry, except ICs 1 and 2, can be mounted on a small piece of perfboard. These two ICs must be mounted to the cabinet. In operation, IC1 and IC2 will get hot

when the supply is run at higher currents, and they may shut down if the heat is not carried away. The back of the cabinet is the best place to mount ICs 1 and 2, for it allows a large heat dissipating area, while keeping the rest of the cabinet cool to the touch. When mounting ICs 1 and 2, smear heatsink grease between the IC cases and the cabinet, then bolt the ICs down tightly. Connect three long wires to IC1 and 2. These will be connected to the main circuit board later.

If the transformer that you wish to use has a center tap, cut it off or tuck it away. You won't need it. Bolt T1 down to the cabinet. Use heavy gauge (#16) wire for all line voltage connections, and carefully wrap all AC line connections with electrical tape. Use a



As you can see, our proto type was assembled on bread-board, with plenty of room for the components. The parts layout isn't critical.

# The Smart Power Supply

Keeps tabs automatically on current and voltage levels

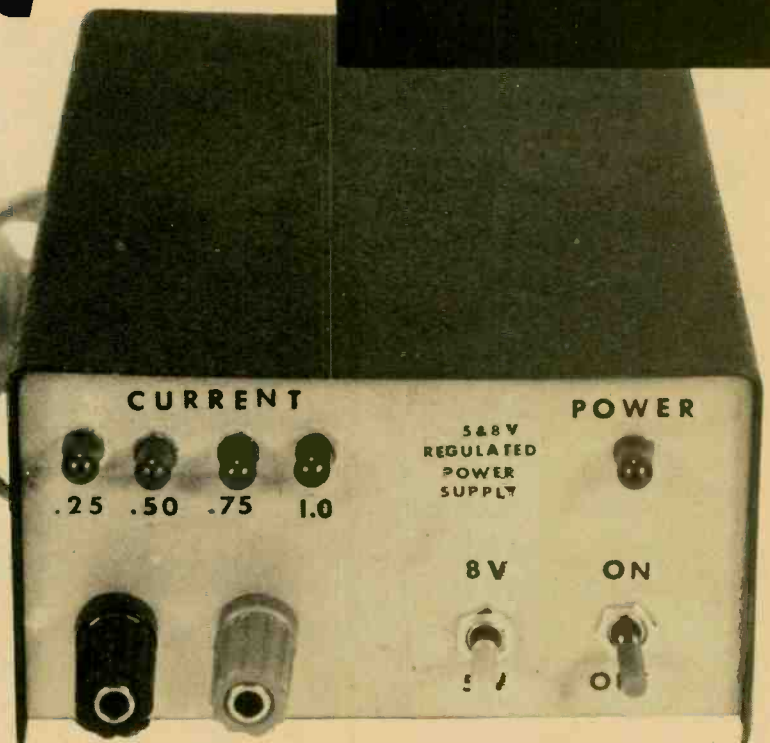

# Smart Power

grommet around the line cord exit hole in the chassis to protect the cord from the heat that will be there due to ICs 1 and 2. Tie a knot in the line cord just inside the cabinet hole to prevent it from being pulled out.

IC3, unlike ICs 1 and 2, can be mounted on the perf-board because it will not get hot in operation. You should use a 14-pin socket for IC4. In-

stall IC4 only after all of your wiring to the socket is complete.

Be careful not to make any solder "bridges" between socket pins, as they are close together. When you install IC 4 in its socket, make sure that you observe the correct orientation with regard to pin 1.

After you've installed the circuit board, attach the wires from ICs 1 and 2 to their proper places on the board. Connect the wires to the display LEDs last, and make sure that you observe polarity on each LED. Be careful not

to let the LED leads short against the metal cabinet.

**Operation.** Carefully inspect your wiring on the circuit board, especially the wiring to IC4's pins. This is a very important step, as one misplaced wire here can produce some real odd-ball systems. If everything appears to be in order, turn the unit on. The "power" LED (LED5) should glow.

Connect a voltmeter to the output jacks. Depending on what position switch S2 is in, the voltmeter will read 5 or 8 volts. Throwing S2 to its other position should cause the voltmeter to read the other of the two voltages that the supply delivers.

To test the ammeter section, connect a circuit to the output jacks. With the supply set for 5-volts, a TTL IC circuit would be good for this test.

If the circuit that you hooked up draws more than 1/4 amp, then one or more of the display LEDs will go on to show you how much current is being drawn.

**Conclusion.** You shouldn't worry about overloading the power supply, as fuse F1 will limit current draw to a peak of about 1.3-amps momentarily, before acting, and we deliberately overloaded several times in a row, with no damage occurring to the circuitry.

You might wish to attach a solderless breadboard to the top of the cabinet, to act as a permanently-powered breadboard for your experiments, or to construct an output voltage switcher for powering several projects alternately: ■

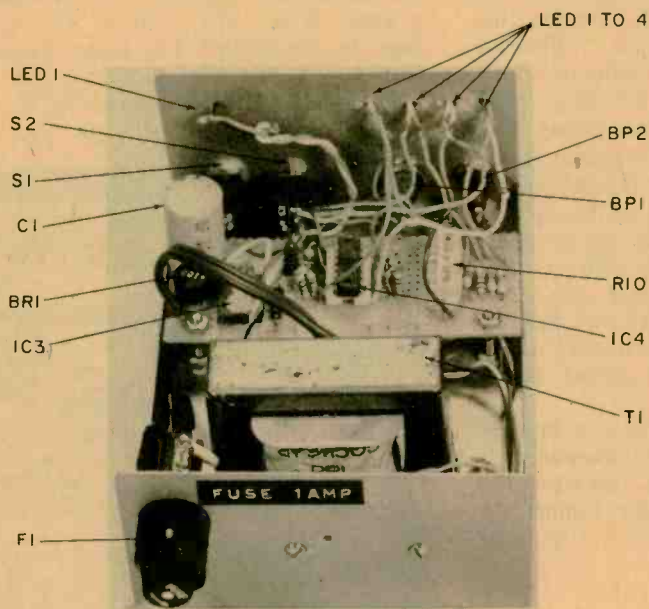

Again, parts layout is not critical in this power supply, but feel free to use our idea of where things should go. It's always a good general design idea to keep the power transformer as far away from the rest of the circuitry as cabinet size or practicality permits. Suspend the board above chassis.

## PARTS LIST FOR THE SMART POWER SUPPLY

- BP1, BP2—5-way insulated binding post
- BR1—bridge rectifier rated @ 50 PIV 2-Amperes
- C1—1,000- $\mu$ F, 24-VDC electrolytic capacitor
- F1—3AG 1-Amp fuse
- IC1, IC3—7805 linear voltage regulator
- IC2—7808 linear voltage regulator
- IC4—LM324N quad op amp
- LED1 through LED5—large, red LED rated @ 20 mA.
- R1—2,000,000-ohm, 1/4-watt resistor
- R2—1,000,000-ohm, 1/4-watt resistor
- R3—660,000-ohm, 1/4-watt resistor
- R4—500,000-ohm, 1/4-watt resistor
- R5, R6, R7, R8—10,000-ohm 1/4-watt resistor
- R9—180-ohm, 1/4-watt resistor
- R10—0.1-ohm, 5-watt resistor (Radio Shack #271-128)
- R11, R12, R13, R14—100-ohm, 1/4-watt resistor
- S1—SPST switch
- S2—SPDT switch
- T1—transformer with primary rated @ 120-VAC/secondary @ 12.6-VAC, 2-Amperes

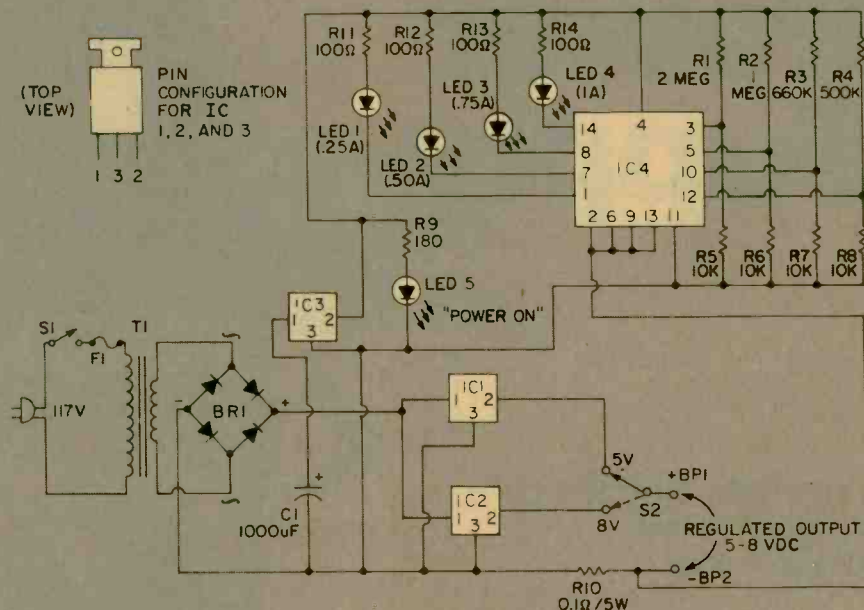

# ROARING TWENTIES RECEIVER

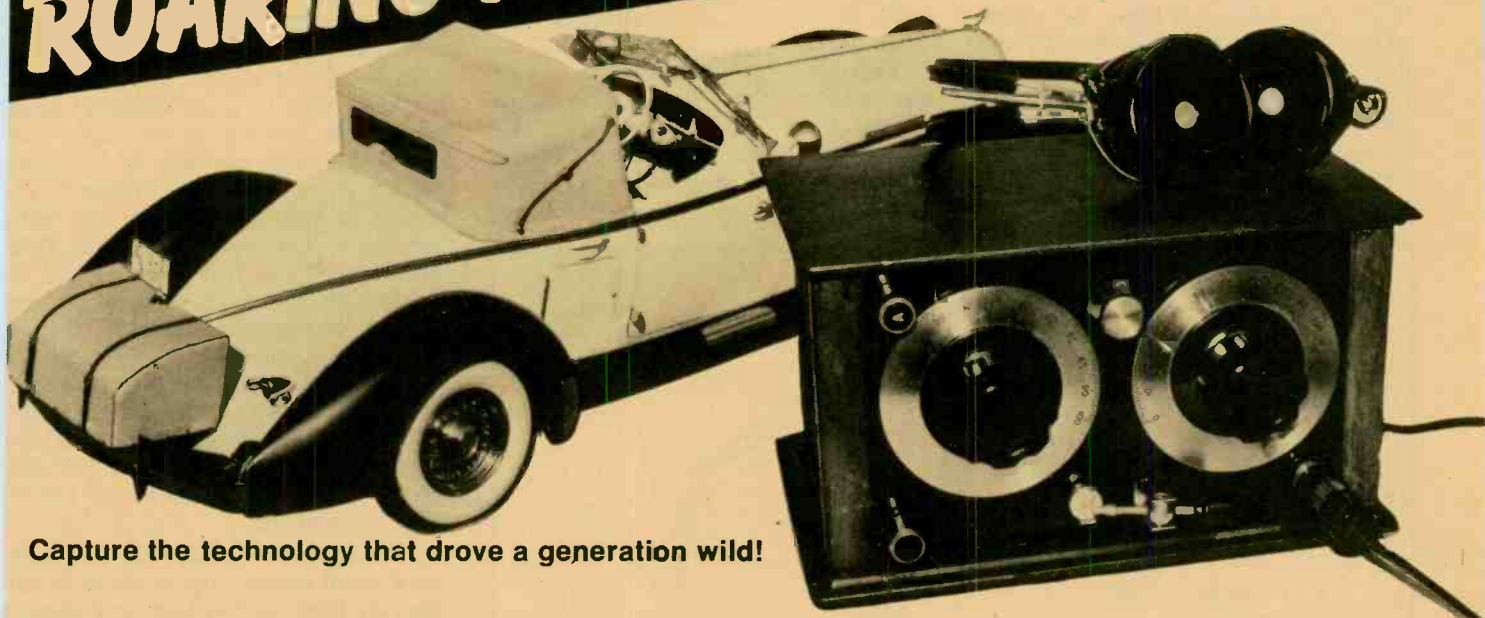

Capture the technology that drove a generation wild!

**D**URING THE ROARING 20's, the crystal set graduated from the experimenter's oatmeal box-breadboard, to wood-cabinet construction, as the quality of radio station broadcasting improved enough to interest the entire family. The crystal receiver was moved to the living room from the basement laboratory, and therefore had to appear attractive, as well as operate properly. The style of radio cabinet construction resembled the popular style of furniture of that era—heavy, ornate wood with a walnut veneer finish.

You can build a crystal set receiver similar to the ones in use during the twenties, a wood cabinet model with a

lift-up lid as shown in the photos. All of the circuit components are mounted in the back of the front panel like the old-time receivers.

**The Receiver Circuit.** The crystal set uses two hi-Q spiderweb coils with variable coupling in a two-circuit tuner for maximum selectivity and sensitivity. Antenna signals at J1 are series-tuned by C1/L1 for maximum RE gain. L1 acts as the primary winding of a tuned RF transformer, with L2/C2 as the tuned secondary. Coupling is variable for best selectivity. D1 detects the signals, and the audio is fed to the headphones at J3.

**Cabinet Construction.** As you can

see in the photos, the design of the crystal set cabinet is similar to the old radios of the 20's. The top and bottom wood sections extend outward from the cabinet sides and have rounded edges. The top section is used as the cabinet lid, and is held on to the back of the box with two metal hinges. A section of black plastic is used for the front panel in place of the bakelite used by the early constructors. If black plastic is not available, you can substitute black-painted hardboard.

Begin construction of the cabinet by cutting the wood sections to the sizes indicated in the construction drawing. Then fasten the sections together with small finishing nails and glue. The front panel should not be fastened, but should be able to move free in or out of the cabinet. Position the corner moldings, before glueing them. Notch the top of the rear panel to allow clearance for the metal hinges.

After construction of the cabinet is completed, check for any rough edges and sand the wood surface. Then stain or paint the cabinet. Our model has a walnut stain with a clear plastic finish.

**Spiderweb Coil Construction.** As shown in the drawing of the spiderweb coil form, there are seventeen "vanes,"  $\frac{7}{8}$ -inch long, and each approximately  $\frac{1}{4}$ -inch wide, positioned around the perimeter of a  $3\frac{5}{8}$ -inch disc. The coil form is made from the type of sheet

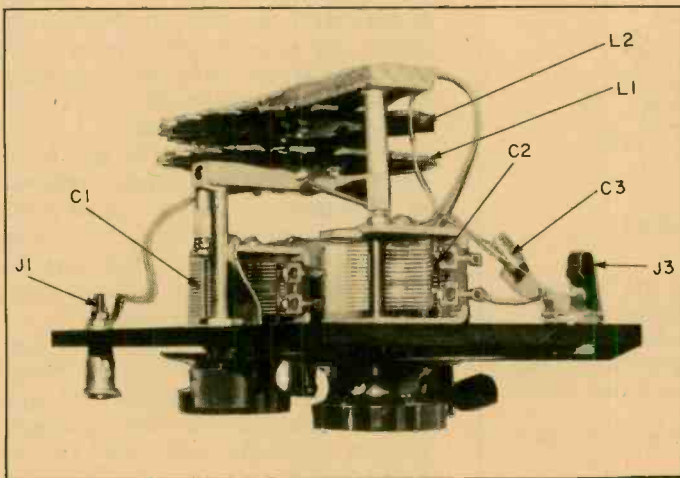

Follow the exploded parts diagram on the next page for assembly of the mounts for L1 and L2. The picture at left gives a top view of the assembly, while the drawing gives a side view. If your variable capacitor doesn't have a tapped hole for the spacer screw, drill an  $\frac{1}{8}$ -inch hole in its side, and use self-tapping screw.

# TWENTIES RECEIVER

plastic used for printed circuits (but without the copper coating) and is approximately 1/16-inch thick.

The easiest way to start construction of the coil forms, is to trace the outline of the spiderweb coil form drawing and then temporarily paste the tracing onto the plastic sheet. Fasten the plastic sheet firmly in a vise, and then cut out the vanes with a hacksaw. Remove the tracing paper from the plastic, and round off any rough edges with a file.

Carefully drill two small holes at the center of the coil form, and mount two solder lugs. Wind as much #28 enameled magnet wire around the coil forms as possible (winding over one vane, then under the next, etc.) and solder the wire ends to the solder lugs. It is not necessary to count the turns of wire, as the coils can be pruned later after testing in the receiver.

**Receiver Circuit Construction.** All of the receiver components are mounted on the black plastic front panel. The layout of the parts is shown in the photos. Start construction by taping a section of graph paper to the panel and

locating the mounting holes for the components. Install the two tuning capacitors (C1 and C2) on the panel after making allowances for the diameter of the tuning knobs.

Next, drill a hole for the shaft bushing of the L1 variable coupling rod (L). The one on our model came from a discarded volume control, with a three-inch flat (on one side) shaft. Bend a section (K) of sheet aluminum (after drilling a hole to fit the bushing) to fit against the flat side of the shaft, and install the metal tensioner and bushing on the panel. The metal section is required to keep the coupling rod from rotating as it is pushed in and out. Drill a hole to fit the shaft near one end of a block of wood (Section M in the cabinet construction drawing detail) and install a set screw to hold the shaft in place. Install the block of wood with two screws and nuts on to the spiderweb coil L1 and insert the rod end into the panel bushing. Make sure that the coil can be pushed freely in and out to vary the coupling.

Install the other spiderweb coil (L2) on a wood section that is mounted on the rear panel with spacers and screws. The mounting of the wood section will depend on the size and shape of the variable capacitors in your model. The two spiderweb coils should be positioned so that they are approximately 1/4-inch apart when the coupling rod is pushed all the way in. The wood section on our model was supported by two screws set in 1 1/2-inch metal spacers mounted on tapped holes in the rear of the two tuning capacitors. If the two capacitors in your model can not be used in this way, increase the length of the wood section and mount the wood section in the back panel.

Install the remaining parts onto the front panel as shown in the photos. If necessary, file down the head of the crystal cup screw to allow proper seating of the components as shown in the schematic. Use flexible stranded wire for the leads to L1, and position them so that there will be no interference with the tuning capacitors as L1 is moved in or out. Install solder lugs as required on all of the components, and use bare solid wire for the connections (for an antique wiring look; make square corners).

Next, install the knobs on the controls. Old-style knobs can be found at flea markets and hamfests. If none can be found, do what the old experimenters did—make your own. The big tuning knobs can be made with painted

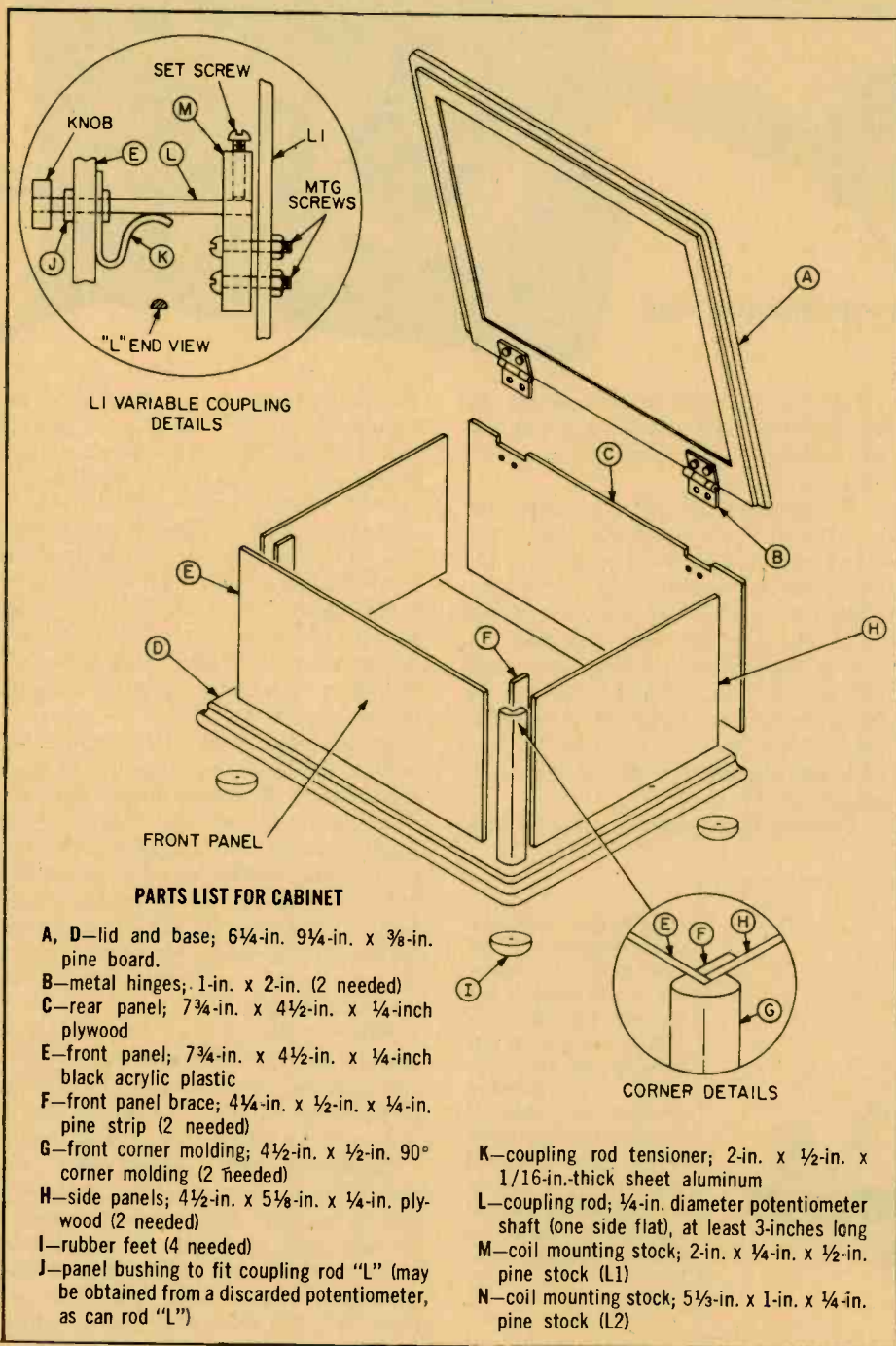



cardboard discs cemented onto the back of small plastic knobs. Fahnestock clips can be used in place of the terminals (J1, J2) on our model, and also in place of J3 for the headphone connections. Install the front panel on the cabinet and make sure that the spiderweb coils do not touch the top lid or bottom of the cabinet.

**Operation.** A good outside antenna and a good ground connection are required for best results with a crystal set receiver. There is no amplification as in vacuum tube or transistor radios, therefore the stronger the reception of the radio waves, the louder the signals will be. If you are located near a high-powered radio transmitter, an inside antenna will work. For more distant stations, an outside antenna, 25-feet or longer will be necessary. The mail order radio parts houses will be the best source for antenna kits. The ground connection can be made to a cold water pipe, or to a metal rod driven into the ground.

For ease of adjustment in the initial test of the receiver, connect a Germanium diode (1N34A or equiv.) in place of the crystal detector, D1. Plug a set of 2000-ohm earphones into J3 (low impedance stereo-type earphones will *not* work), and connect the antenna to J1 and the ground to J2.

Tune C1 and C3 for a received station, and then adjust the L1 coupling for best selectivity. Retune C1 and C3 for best signal strength, and then readjust the L1 coupling. All of the controls interact, so it will require several tuning adjustments for optimum received signal audio volume. After a

station is tuned in, remove the Germanium diode without disturbing the tuning settings and then try your luck in finding a sensitive spot on the crystal with the catwhisker (like the old radio

pioneers did). Compare the received volume with that of the germanium diode—you may be surprised at the reception you get. Now, if only we could find an antique radio station . . . ■

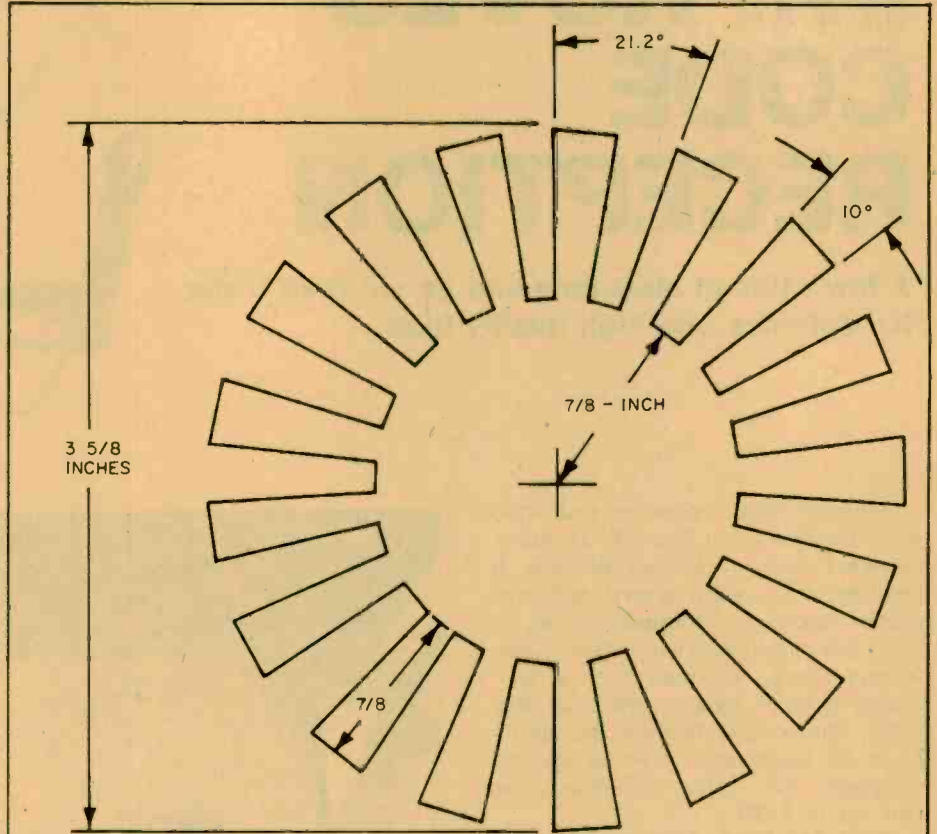

This is a full-scale template for cutting the coil forms. Cut it off the page carefully, and temporarily fasten it to the plastic coil form stock, and make your cuts. Repeat this process again for the second coil form as well. After both forms are cut, compare them to make sure that there are no differences between the two—they should be made (and wound) as identically as possible to assure you of a proper match and optimum performance. Use number 28 enameled wire for the coil windings, and leave room at the beginning and end of the coils for connections to the solder lugs which you'll use later.

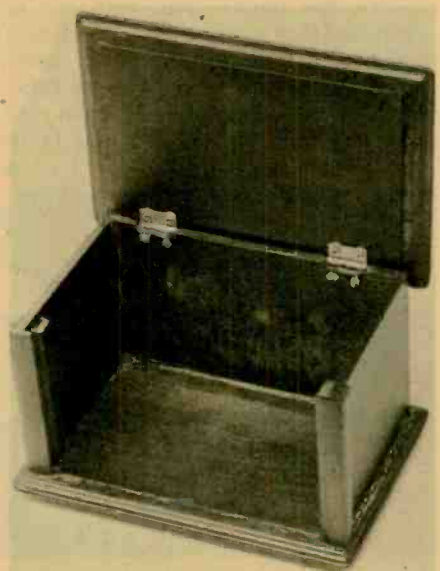

Here's the same view of the cabinet as in the drawing on the previous page. Be sure that the front panel slides in smoothly.

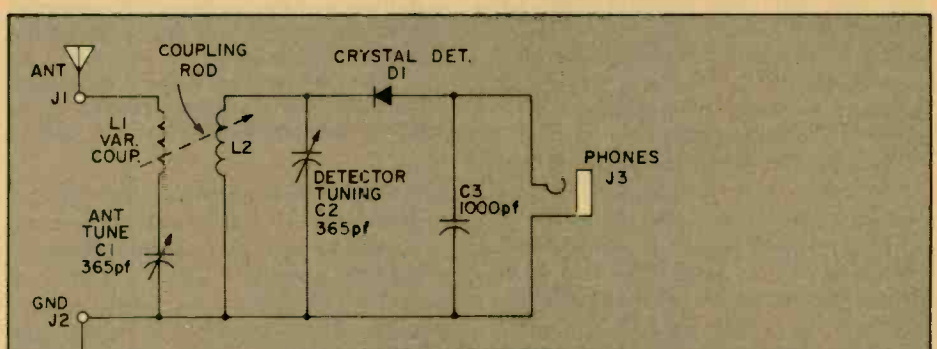

**PARTS LIST FOR RADIO**

- C1, C2—365-pf variable capacitor (Calectro #A1-227 or equiv.)
- C3—1,000-pf mica capacitor, 25-VDC or better
- D1—crystal detector/catwhisker assembly (available from Modern Radio Labs, Box 1477, Garden Grove, CA 92642)
- J1, J2—spring binding posts or Fahnestock clips
- J3—2-conductor phone jack
- L1, L2—antenna coils (see text)
- Misc.—2,000-ohm headphones, 200-feet of #28 enameled magnet wire, 1½-inch aluminum spacers (2), 1/16-in.-thick sheet plastic for coil forms, 1N34A diode for initial testing, knobs, solder, hookup wire, stain, varnish, etc.

# LOW-COST FILTER IMPROVES CODE RECEPTION

A few snips of aluminum and an old reed make headphones into high quality filter.

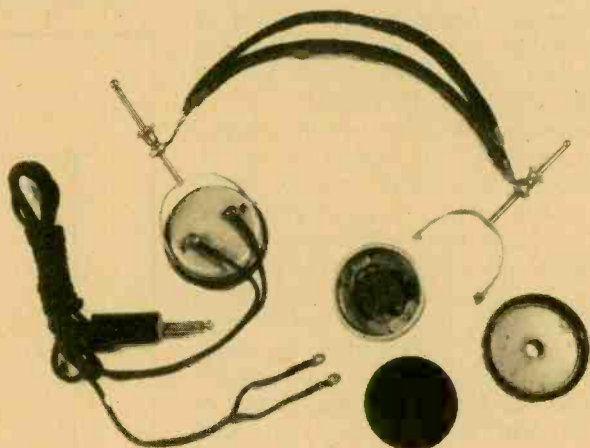

Amateur radio operators and short wave listeners often find CW (continuous-wave code) reception difficult, if not impossible, when several radiotelegraph stations are transmitting on, or near, the same frequency. Such interference can be eliminated, or at least greatly reduced, by a narrow band electronic filter circuit that can be installed in the radio receiver or transceiver. However, this extra equipment can cost up to \$150.

**What You Need.** A mechanical filter that will do the job can be built for \$15, or less. In fact, should you already own a pair of earphones—the old-fashioned kind with metal diaphragms—and have access to a music store that will sell a used steel reed removed from an accordion (the writer was given his at no cost by such a store) you can build this effective filter for practically nothing.

A low-frequency reed should be used. A 440-Hertz (A) reed will work well. In fact, anything from about 300 to 1000 Hertz will be ok.

Should you have access to a steel (not brass) reed from an old harmonica, that could be used, too.

The removed reed is installed in one earphone of the headset so that it vibrates only when an incoming CW signal sets up a beat note at the reed's resonant frequency. All other interfering signals will automatically be eliminated since they will be of a different beat frequency, and the reed will not respond (audibly) to them.

**To Get More Volume.** Should you wish to have both earphones of the headset operate in this manner, the *matching* reed of the same length (they come in pairs in the instrument) must

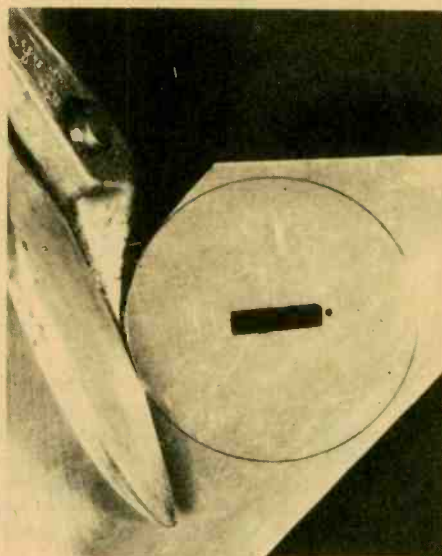

A thin piece of aluminum is cut to same size disc as the original iron diaphragm of the 'phones. Rectangular center opening is for the iron frequency-resonant instrument reed. Small hole at right of rectangle is for rivet (or nut and bolt) to secure reed.

be installed in the second earphone.

Here's how it's done: Use a pair of tin snips to cut from a thin sheet of aluminum (about 1/32-inch thick) a disc that will replace the earphone diaphragm. At the center of the aluminum diaphragm make an elongated hole that will permit the reed to vibrate freely (see picture) when it is riveted fast at one end of the opening.

In installing the reed it is important that the little strip of steel extend into its opening for the *same* vibrating distance that it did when it was in the musical instrument.

The operation is simple. The alu-

minum diaphragm, being non-ferrous metal, will not be influenced by the magnets in the earphone. Only the reed will vibrate, instead. In use, only the desired CW signal will be heard loudly as the receiver or transceiver is tuned. The resulting silence can be uncanny!

#### PARTS LIST FOR CW FILTER

Communications-type headphones, 1000-ohms or more. (Not stereo headphones, which are all wrong for this project).

Steel reed(s) from accordion or harmonica. One (or two) small rivets of the same size as were used to hold the reed in place in the instrument.

**Use These Tools.** You'll need a pair of tin snips or metal cutting shears. An electric (or hand) drill, with bits the right size for drilling out the rivet(s) which secure the reed(s) in the instrument will be needed, and you'll find a small square-edge (or triangular) file good for dressing the opening in the aluminum disc. ■

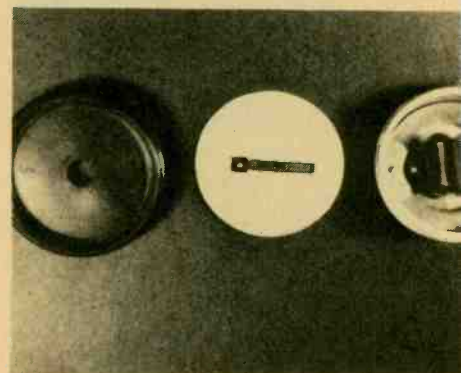

Original hard rubber cap (left), original magnet and coil assembly (right) and new aluminum diaphragm (center) with steel reed in place.

# THE ELECTRONIC SLOT MACHINE

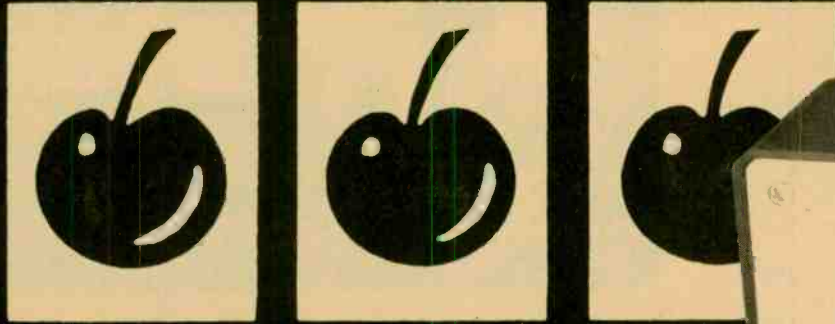

You'll need a computer and lots of luck to beat our one-armed bandit

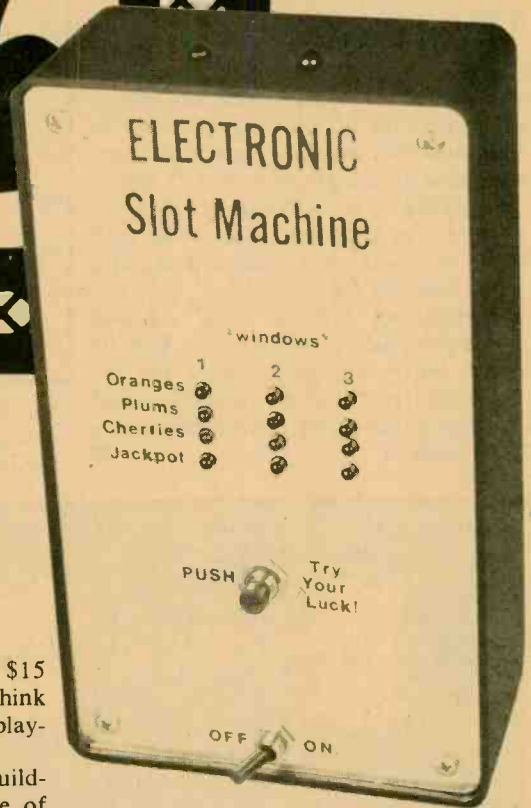

**T**HE SLOT MACHINE, or "one-armed bandit," is one of the all-time favorite gambling devices. The game can be very captivating and fun. Unfortunately, you can drop a lot of money playing on a real one, not to mention the fact that you have to go to either Las Vegas or Atlantic City to play one. You don't have to lose your shirt to have fun playing our Electronic Slot Machine.

The unit performs virtually like the real thing. Three rows of LEDs simulate the 3 windows of a real slot machine. When you push the button(S2), each of the 3 rows flash the LEDs in a cascading manner that simulates a rolling wheel. After a couple of seconds, the first row "window" will stop rolling and only one "fruit" will remain lit. In the same manner, "window" 2 will stop rolling and only one "fruit" will remain lit. Another second later, row 3 will stop.

Should you happen to have three LED "fruits" lit horizontally in a row, you're a winner! If you're lucky enough to land 3 LEDs in the "jackpot" row, then you've won a 4-to-1 payoff! Hint: It's harder than you think, because naturally, the odds are with the house. However, that's what makes this game so fascinating and worthwhile to build.

The total project cost is about \$15 or \$20. If that seems a bit much, think how fast you'd lose that money playing on a real "one-armed bandit!"

**Construction.** Before you start building, you should decide on the size of the enclosure that you wish to use. This is largely determined by the battery pack, as 4 "C" batteries are used, and they take up a bit of room. You don't necessarily have to mount the batteries in the project box itself, but it's nice to have one self-contained unit. The prototype is housed in a cabinet with dimensions of 3¾-inches wide, by 6¼-inches high, by 2-inches deep.

Use the low-power Schottky ICs as recommended in the parts list. Don't worry, these Schottky ICs are as easy to get as standard TTL types.

The project can be built on a piece of perfboard as shown in the photograph. P.C. board construction is rather impractical, because of the amount of connections between the ICs.

Notice that IC sockets are used on all ICs. This makes for easy replacement and really makes wiring up the project a lot easier. Using wirewrap IC sockets and a wirewrapping technique, you can wire up the sockets in no time. Point-to-point wiring with

solder is also satisfactory, but more time-consuming.

IC sockets, cut in half, were used for mounting the LEDs to the circuit board. While this is not necessary, it *does* make the LEDs easier to mount, especially if you want to have a faceplate that fits flush over the LEDs, as shown in the photo of the prototype. Switches S1 and S2 can be mounted right on the board to eliminate unnecessary stray wires in the cabinet.

Install the ICs in the sockets only after all of your wiring is completed. Make sure that the pin orientation is correct. Observe polarity on the tantalum capacitors. Even though they're less than 1-μF, they are polarized units, and care should be taken with them. When mounting the LEDs, make sure that you get their polarity (anode and cathode) correct as well.

Double check all of your wiring carefully. Everything look OK? Then let's try it out!

**Testing and Operation.** Connect the

# SLOT MACHINE

batteries, and turn the unit on by throwing switch S1. All 3 rows of LEDs should "roll" sequentially. If they don't, push switch S2. If the LEDs still don't roll, then turn the unit off and check for a wiring error. If the unit is performing correctly, all 3 rows of LEDs will "roll," and then they will stop in order, 1-2-3.

**Troubleshooting.** If you're sure your wiring is right, but one of the rows still won't flash correctly check the corresponding chip of the non-working row with one of a working row. (U1 controls row 1, U2 controls row 2, etc.). This switching around can reveal if the trouble is in your wiring or in the chip itself. If the display flashes erratically, fresh batteries are required.

**Conclusion.** Whether you use our Electronic Slot Machine for fun or profit, we're sure you'll agree that for the value returned, the relatively small amount of time and money invested is well worth it. ■

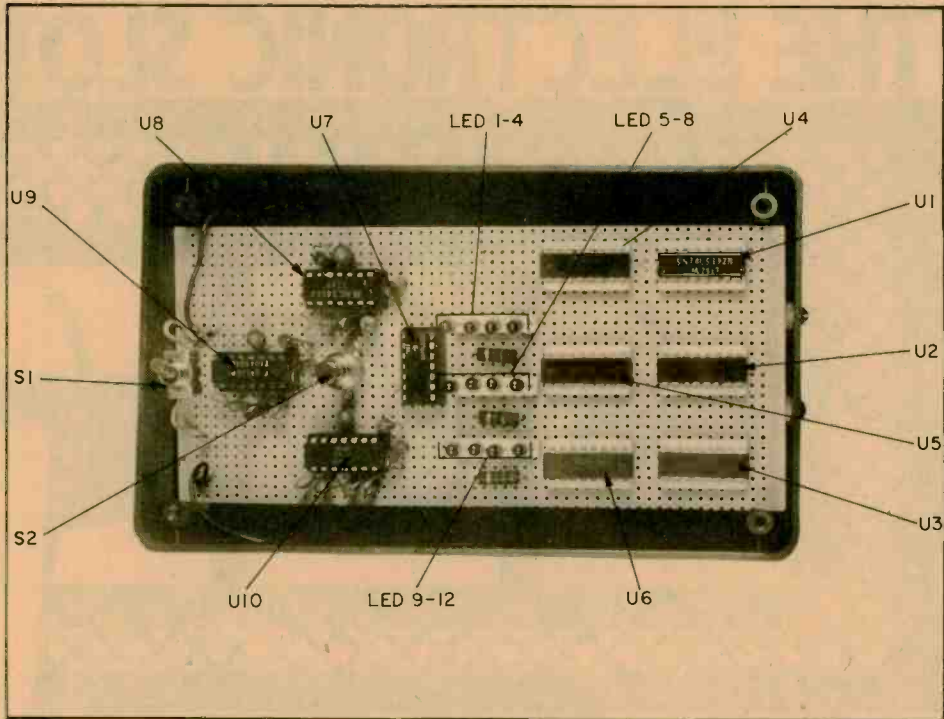

We cut some surplus DIP sockets in half to hold the rows of LEDs. If you don't care to ruin your sockets, wire the LEDs directly to the perfboard, using tie points to raise the LEDs up off the surface of the board so that they can protrude through the faceplate.

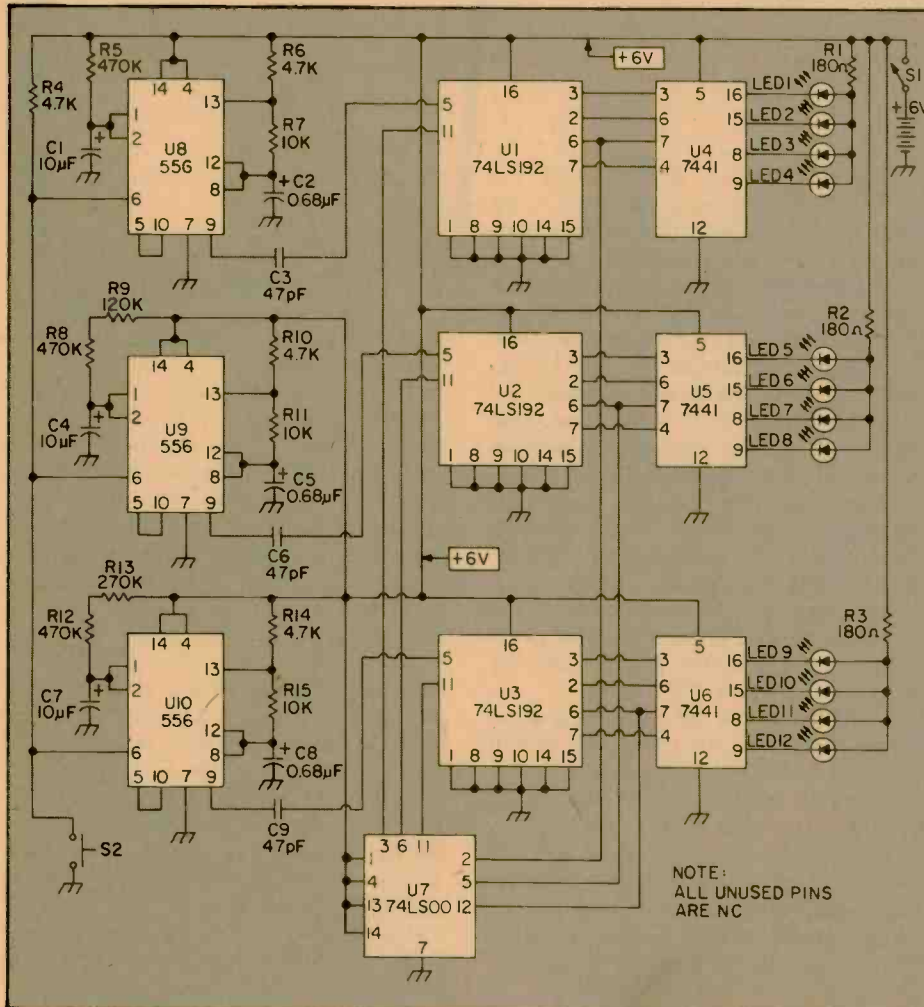

## PARTS LIST FOR ELECTRONIC SLOT MACHINE

- C1, C4, C7—10- $\mu$ F tantalum capacitor, 16-VDC
- C2, C5, C8—0.68- $\mu$ F tantalum capacitor, 16-VDC
- C3, C6, C9—47-pF ceramic disc capacitor, 100-VDC
- LED 1 to 12—LED rated 20mA @ 1.75-VDC
- R1, R2, R3—180-ohm, 1/4-watt resistor, 5%
- R4, R6, R10, R14—4,700-ohm, 1/4-watt resistor, 5%
- R5, R8, R12—470,000-ohm, 1/4-watt resistor, 5%
- R7, R11, R15—10,000-ohm, 1/4-watt resistor, 5%
- R9—120,000-ohm, 1/4-watt resistor, 5%
- R13—270,000-ohm, 1/4-watt resistor, 5%
- S1—miniature SPST toggle switch
- S2—miniature SPST momentary-contact push-button switch
- U1, U2, U3—74LS192 decade counter
- U4, U5, U6—7441 decimal decoder/LED driver
- U7—74LS00 2-input, quad NAND gate
- U8, U9, U10—556 timer
- Misc.—4, "C" batteries, perfboard, cabinet, IC sockets, solder, hookup wire, battery holder, etc.

NOTE:  
ALL UNUSED PINS  
ARE NC

A drilled and labeled printed circuit board for this project is available for \$5.50, postage included, from Niccum Electronics, Box 271B, Stroud, OK 74079. Please allow 3-4 weeks for delivery.

# Las Vegas LED

Always win on the red with electronic roulette

by Walter Sikonwiz



**P**EOPLE HAVE ALWAYS BEEN fascinated by games of chance, as diversions and obsessions. Invert-rate gambler or not, chances are you'll really like *Las Vegas LED*, our version of that old favorite, Roulette. Here's more good news—you won't have to drop a bundle of cash in on the fun.

*Las Vegas LED's* spinning wheel of fate is a revolving dot of light, provided by a ring of ten LEDs. A glance at the photographs will show you that play is governed by three controls: *Accelerate*, *brake*, and *decay*. You start by pressing the *accelerate* button, which causes a red dot of light to revolve at an ever-increasing rate until a terminal velocity is reached. If you release *accelerate*, the spinning light will gradually coast to a standstill. The rate of deceleration is determined by the *decay* control. Pressing *brake* while the light is coasting causes a more rapid, but not instantaneous, halt to the spinning.

At least two games are possible, with this control format. Using a little imagination, you can probably devise more. The first possibility is similar to standard Roulette. A player presses *accelerate*, then releases it, and hopes that the number he has predicted beforehand will be the one at which the light ultimately comes to rest. Alternatively, the player starts the light into motion; then, upon the release of *accelerate*, he tries to stop the light on a number designated by his opponent, using only one pulse of the *brake* switch for this purpose. This second variation is quite a frustrating game; particularly so if various decay times are used. Decay times from about 1.5 to 15 seconds can be selected via the *decay* potentiometer.

**How It Works.** Before discussing construction, let's delve into the theory

behind our Roulette game. We start with a very simple voltage-controlled oscillator. We then devise some means for converting the oscillation of our VCO into the apparent revolution of a spot of light (this might seem hard, but we'll see how simple it is later); the velocity of the light will be directly proportional to the VCO's frequency. The VCO's frequency, however, is proportional to the control voltage applied to it. We can produce acceleration of the revolving light if we cause the VCO's control voltage to gradually rise while the *accelerate* button is depressed. Conversely, deceleration of the light is synonymous with a gradual reduction in control voltage. How do we produce a control voltage that behaves in such a manner? We can charge and discharge a capacitor through resistors, and use the voltage across the capacitor as our control voltage.

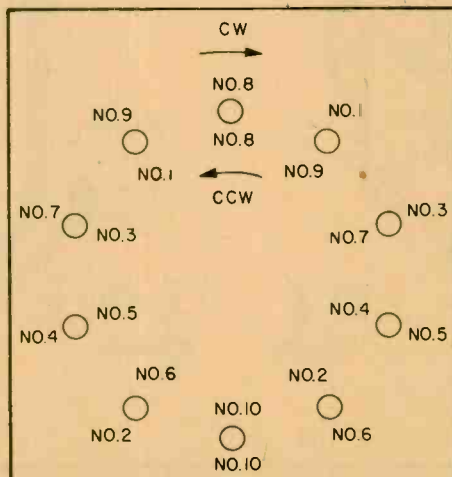

Mount the LEDs in one of the two orders shown here, which one depending on whether you wish your wheel to "rotate" clockwise (cw) or counter-clockwise (ccw).

Take a look at the schematic diagram. The voltage across capacitor C3 is our control voltage, and you can see how pressing S2, the *accelerate* button, charges the capacitor through R13. Once S2 is released, charge accumulated on C3 drains away through R13, R11, and *decay* control R12. Setting R12 to its maximum resistance produces the slowest rate of capacitor discharge; hence, as we'll see later, the revolving light will take a maximum amount of time to come to rest.

*Brake* switch S3 also discharges C3, this time through R14. Since the resistance of R14 is set to a relatively small value, the rate of discharge is quite rapid, and produces a quick cut in the speed of the light. It is the voltage on C3 that is to be our control voltage. Transistor Q11, functioning here as an emitter follower, reads C3's voltage; and because the emitter follower configuration is used, Q11 will not significantly contribute to the discharge of capacitor C3. At Q11's emitter we now have a voltage proportional to that on C3, which is used to drive our VCO.

Unijunction transistor Q13, along with R16, R17, R18, R19, and C4, comprise a relaxation oscillator, the frequency of which is proportional to the input voltage present on the left-hand end of R16. We don't have the nice, linear, voltage-to-frequency conversion of fancier VCOs, but what we have serves our purpose well enough. The output signal of our VCO appears across R19, and is a series of short-duration spikes with an amplitude of a volt or two. Such a signal won't be acceptable to the circuitry that follows, so we first feed it to transistor Q12, set up so that only a small input signal saturates it fully. The resultant output signal, available at Q12's collector, is a well-defined series of negative-going pulses, approximately 9 volts in amplitude.

Now we convert the variable-frequency pulses from Q12 into the ap-

# Las Vegas LED

parent revolution of a dot of light by using an integrated circuit known as a decade counter. One essential characteristic of such an IC is that it has ten outputs, and at any given instant of time, nine of these outputs will be at a low potential, while the tenth will be high. The second important feature of the decade counter is that whenever its input, (pin #14 in this case), senses a specific change in potential (high-to-low in this case), the lone high signal advances serially along the outputs. Specifically, successive input pulses to IC1 will cause the high signal to advance from output #1 all the way to output #10, and then back to output #1 again. You might logically assume output #1 to be available at pin #1, and so on; however, this is not the case. We won't discuss the actual location of the individual outputs, because this information is available on the data sheet that accompanies this IC.

From the schematic, we see how Q12's output feeds IC1's input, pin 14. The outputs of IC1 (pins 1 through 7, plus pins 9, 10, and 11) connect to ten LEDs through buffer transistors Q1 through Q10. These buffers are emitter followers; they're necessary because the IC alone cannot supply sufficient cur-

rent to illuminate an LED. Whenever a particular output is high, its associated driver transistor will supply current to a LED, and light it.

We arrange these LED's in a circle so that as we progress in a clockwise direction, starting at the LED associated with output #1, we encounter, in proper consecutive order, those LEDs associated with output #2 through output #10. When we feed an input signal to our IC, we see the LEDs fire sequentially so that a spot of light appears to be revolving in a counter-clockwise direction. One full revolution of the light requires ten input pulses, and the rate of revolution is in direct proportion to the input frequency.

Let's review what we have: 1) the frequency of our VCO is controlled by the gradual charge and discharge of a capacitor; 2) the variable-frequency signal from the VCO feeds a decade counter, which drives ten LEDs; and 3) proper LED arrangement results in the apparent revolution of a single dot of light, with a velocity proportional to the frequency of the VCO. That's all there is to it.

**Wiring.** Since nothing about the circuit is critical, you may build it any way you wish. Perfboard construction is good. Alternatively, you might want to copy the PC layouts provided; the choice is up to you. A good place to begin construction is by drilling your-

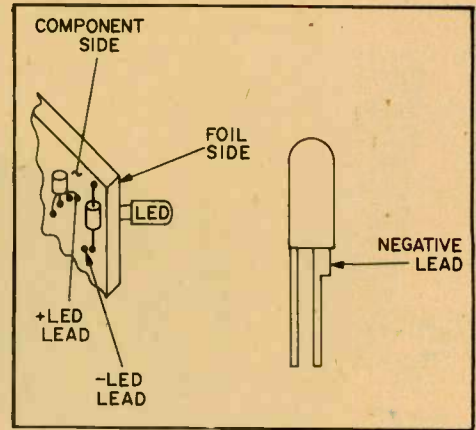

LEDs are to be wired to the foil side, with their leads left long enough that their heads poke through the front cabinet (see text). Observe polarity; the negative leads of the LEDs are notched, as shown, and should be connected as both the pictorials and the schematic indicate.

cabinet to accept the ten LEDs. With a compass, lay out a small circle on a sheet of paper. If you intend copying the PC layout provided, the circle's radius should be exactly .9 inch. With a protractor centered at the circle's center, divide the circle into arcs at 36-degree intervals. Trim away any excess paper, leaving just the circle and a small border around it. Position the circle conveniently on your cabinet, and tape it down. With a fine, sharp awl make

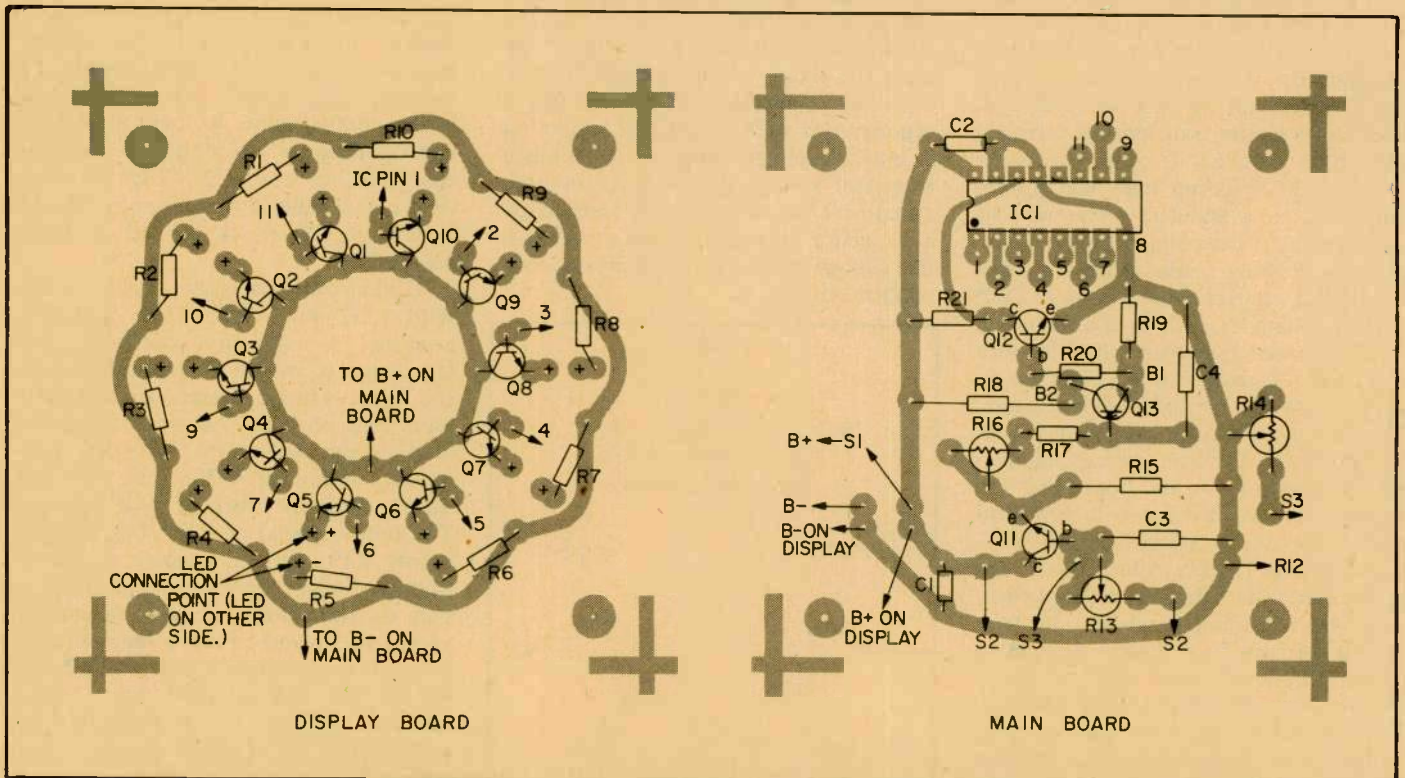

The component sides of the main and display boards are shown in this pictorial view. Make certain that the main board's IC pins are all interconnected properly to the solder-points on the display board, as labeled. Connect, for example, IC pin 1 to Q10. Don't forget about R11 which is not shown and is wired point-to-point between R12 and S2.

slight indentations in the cabinet at the points where the circle is subdivided into arcs. Remove the circle, and at each indentation drill holes through which the LEDs can protrude.

The drawing given shows the order of mounting of LEDs for both clockwise and counterclockwise revolution. The PC layout supplied for the display board provides counterclockwise revolution of the light.

The majority of the components mount on two circuit boards—either the main board or the display board. Even if you decide not to use a PC board, the PC layout provided for the display board may be helpful to you. Note that the arrangement is particularly simple, even though a good many parts are involved, because a radially

symmetric pattern is employed instead of the usual rectilinear layout.

When installing components on the display board, follow the dimensional details in the accompanying drawings. Note that Q1 through Q10, and R1 through R10 mount on the component side of the board. LED1 through LED10 mount on the opposite foil side, with leads of such a length that the tops of the LEDs extend beyond the spacers and through the cabinet's panel. The semiconductors that mount on the display board are not especially fragile, but as is the case with all solid-state devices, excess heat can be damaging. Solder all connections quickly, using a 25-watt iron and fine, rosin-core solder. Twelve wires will run between the display board and the main board; ground,

+, and the ten counter output leads.

The main board contains the rest of the components. Note that if the PC patterns supplied are copied, the main board may be stacked right behind the display board. This makes for a very dense packing arrangement, but if you have ample space, the boards may be mounted in any manner you like. R11 does not appear on either circuit board; instead, it is wired point-to-point between R12 and S2. Be sure to use a 16-pin socket for IC1. This IC is a CMOS unit, and should be inserted into its socket only after all soldering is finished. If, in checking out your unit, you should find an error that requires re-wiring, remove IC1 before applying a soldering iron to the board.

In assembling the circuit, pay atten-

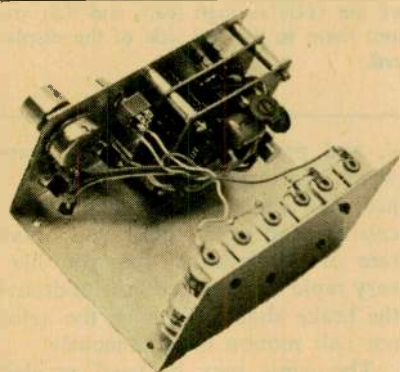

Inside view of Vegas LED showing stacking of PC boards.



Completed Vegas shown fully assembled, and installed in case.

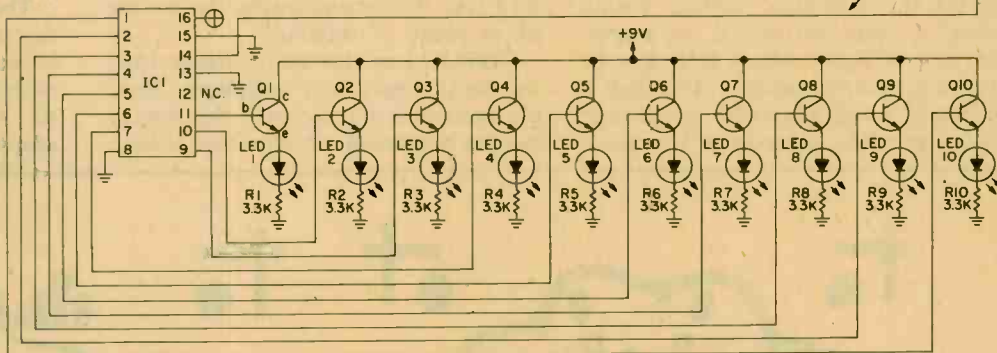
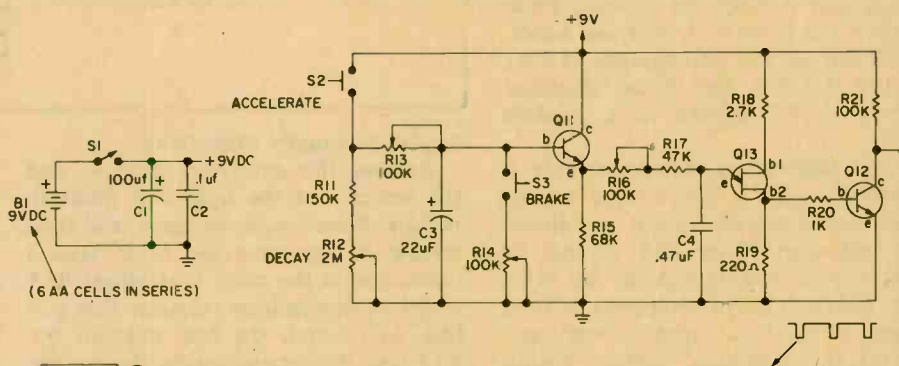

#### PARTS LIST FOR LAS VEGAS LED

- B1—Six AA (penlight cells) 1.5 VDC
- C1—100- $\mu$ F, 16-VDC capacitor
- C2—.1- $\mu$ F capacitor
- C3—22- $\mu$ F, 16-VDC tantalum capacitor
- C4—.47- $\mu$ F, capacitor
- IC1—Decade Counter/Divider CD4017
- LED1-LED10—Light Emitting Diodes
- Q1-Q12—2N3904 transistors
- Q13—Unijunction transistor
- R1-R10—3300-ohm resistor
- R11—150,000-ohm resistor
- R12—2-Megohm potentiometer

- R13, R14, R16—100,000-ohm trimmer
- R15—68,000-ohm resistor
- R17—47,000-ohm resistor
- R18—2700-ohm resistor
- R19—220-ohm resistor
- R20—1000-ohm resistor
- R21—100,000-ohm resistor
- S1—SPST toggle switch
- S2, S3—SPST pushbutton switches, normally open
- Misc.—Battery clips, IC socket, aluminum spacers, wire, solder, hardware, etc.

You might not be able to afford a trip to Vegas; but Las Vegas LED will bring the glittering, gambling glamor of that city right into your own home town. When you assemble the circuit, just pay strict attention to the orientation of C3 and C1. It also pays to doublecheck the positions of all ICs and transistors; you'd be surprised how often a simple positioning error can lead to hours of fruitless trouble-shooting. The boards may be mounted in any way you like within the cabinet, but remember to leave room for the batteries to fit into later on. Finally, make absolutely sure you have positioned the LEDs properly depending on whether you want clockwise or counter-clockwise rotation of your "wheel." Follow the diagram on the first page very exactly. Once it's all together just get your bet down and start Las Vegas LED spinning around.

# Las Vegas LED

tion to the orientation of C3 and C1. Likewise, make sure the transistors and IC are correctly positioned. The LEDs must also be properly oriented. The leads of all these devices are identified on the packages in which they are sold. Because of the circuit's low power consumption, six 1.5-volt penlite cells in series will power it for a long, long time. A single 9-volt transistor battery could also be used.

Because this is not a finicky circuit, the operating controls and circuit boards can be mounted in any convenient way inside your cabinet, but be certain to allow sufficient room to accommodate the batteries. When you've completed cutting and drilling the cabinet, finish off the front panel with press-on decals. As shown in the photographs, LED1 through LED10 should be identified with numerals applied in a random order.

**Final Calibration.** After assembly is complete, only a few simple adjustments are necessary to put the circuit into operation. Turn R12 so that its resistance is at a minimum. Set R13, R14, and R16 to the midpoints of their ranges of rotation. Apply power, and depress the *accelerate* button. Within several seconds you should see a spinning dot of light. Adjust R16 for the desired maximum velocity. Too high a maximum speed blurs the image and spoils the effect, whereas a slow-poke

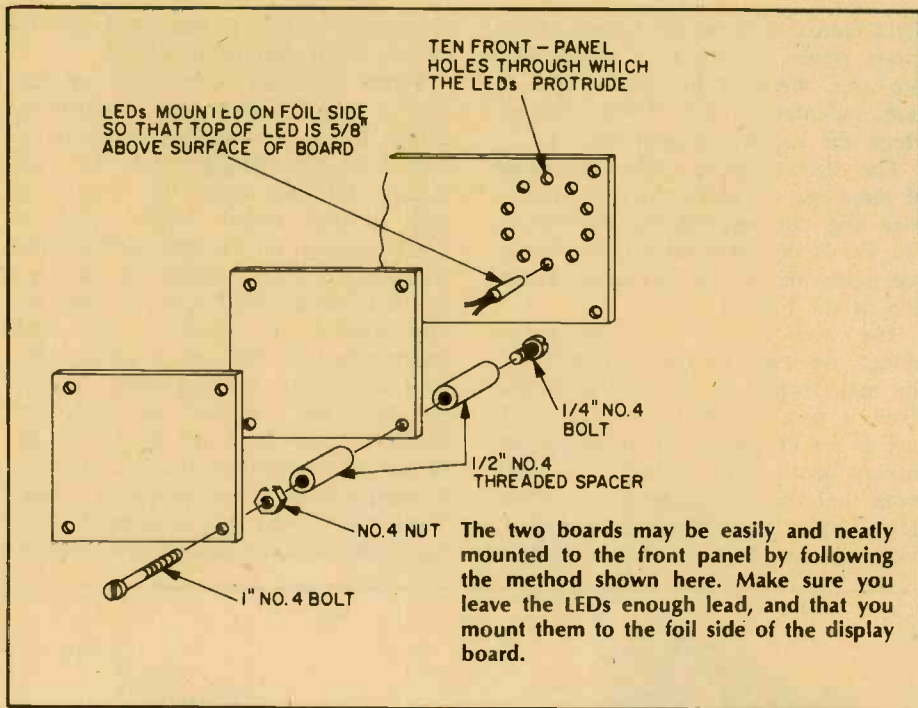

display is equally undesirable.

Release the *accelerate* button, and the velocity of the light will diminish rapidly. Press *accelerate* again, and then release it, repeating the cycle several times, and at the same time adjust R13 to get an acceleration response that you like. In general, the best position for R13 will be somewhere in the middle of its range of rotation.

Turn R12 so that its resistance (and the decay time) is a maximum. Press the *accelerate* button until the display reaches maximum velocity, then release

it, and press *brake*. Note the rate at which the display is slowed down. Adjust R14 while alternately pressing *accelerate* and *brake* until you obtain a rate of deceleration that you like. A very rapid braking action is undesirable; the brake should diminish the velocity, not halt motion instantaneously.

The game may be used as already described in the opening paragraphs. However, just as dice can be found as constituent parts of many other games, so too can Las Vegas LED be adapted to games of your design. ■

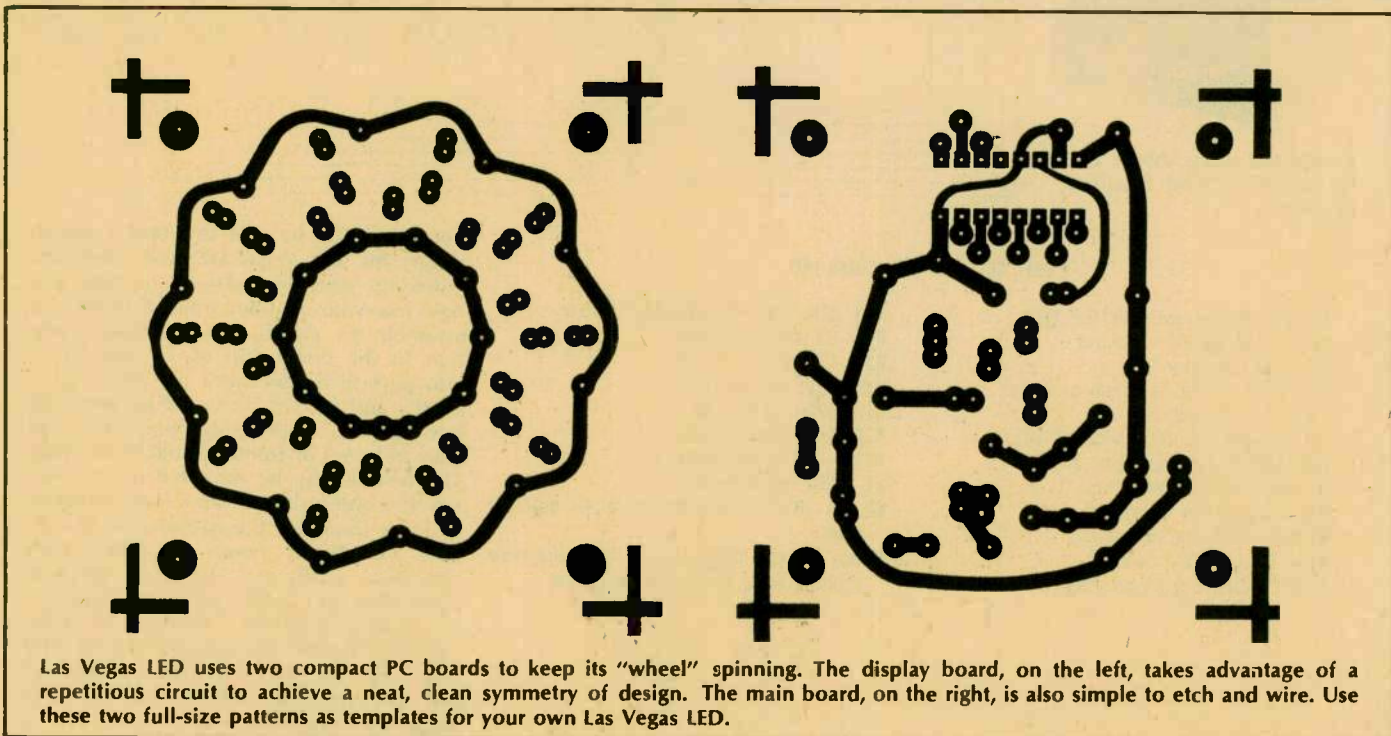

Las Vegas LED uses two compact PC boards to keep its "wheel" spinning. The display board, on the left, takes advantage of a repetitious circuit to achieve a neat, clean symmetry of design. The main board, on the right, is also simple to etch and wire. Use these two full-size patterns as templates for your own Las Vegas LED.



# SIMPLE-SYN, THE MUSIC MACHINE

This simple project, using an integrated circuit does more, better than many professional devices a generation ago.

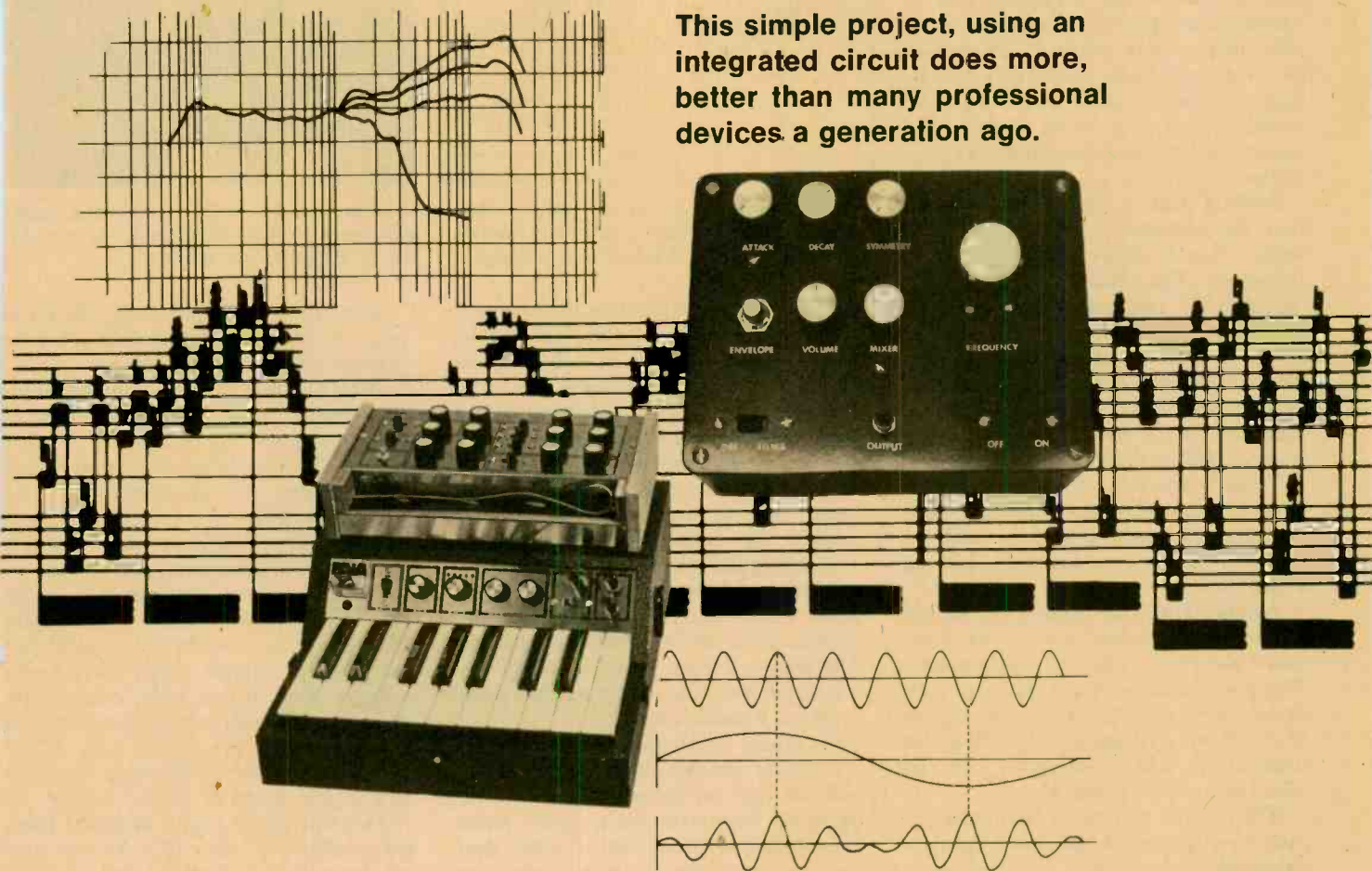

IT WAS INEVITABLE that modern man would use electronics to imitate the sounds of earlier musical instruments. Just as the pipe organ has been used for centuries to produce sounds similar to trumpets, flutes, and strings, for the past thirty years electric pianos and organs have been used to mimic the pianoforte and the pipe organ. Only today, with the advent of microelectronics—integrated circuits and other improvements on the vacuum tube and discrete transistors—we are seeing an explosion in the design and manufacture of electronic musical instruments.

*In the Beginning.* We've had electronic instruments as far back as the 1930's, though they were far simpler than even today's toys. In France the Martinot and the Oniophone used piano-like keyboards to control electronic oscillators which produced sustained tones. They were the forerunners of the keyboards which most rock-pop groups use today to produce those massive 120-dB sound crushers at festivals and concerts—to say nothing of thundering

dance halls and discotheques.

*Early Instruments.* The best-known electronic instrument before today's was the Theremin. It consisted of two radio-frequency oscillators. One had a fixed frequency, and the frequency of the other was controlled by the player moving one hand nearer to, or farther from a sensing plate. The difference between the frequencies of the fixed and the variable oscillator produced a tone capable of being shifted throughout the audio range. The volume was controlled by slight movements of the player's other hand. Because nothing was actually touched to produce the frequency and volume changes, the Theremin made a weird, gliding tone which could, in the hands of a skilled performer, be extremely effective. However, it could produce only one tone at a time, and the world of music had to await the development of much more sophisticated circuitry before true electronic musical instruments were developed.

*Electronic Music Today.* The modern

electronic synthesizer came into being with the construction of a vacuum-tube monster with thousands of tubes and other components. Called the Mark I RCA Synthesizer, and built at Princeton, New Jersey, it was dismantled after several years of experimentation to supply parts for the Mark II. This machine is still in use, and though smaller than the Mark I, it measures about 17 feet square and 7 feet high. It is still in use in the Columbia-Princeton Music Center, in New York City.

In the early 1960s Robert Moog (pronounced like "vogue") began developing and producing a line of electronic music synthesizers which revolutionized music. Within the next few years several other firms began producing synthesizer equipment, and in the last several years the microminiaturization made possible by the development of integrated circuits has made possible synthesizers controlled by keyboards—so now real performance instruments exist.

*The Nature of Music.* Before describing the construction of our simple syn-

# SIMPLE-SYN

thesizer, Simple-Syn, we should first examine the composition of its end product—the music itself. Musical instruments all produce sounds, which can be defined in terms of their *frequency* (also called *pitch*), *dynamics* (often described, inaccurately, as *loudness*), and *timbre*.

**Timbre.** This is the quality of sound that differentiates a trumpet from a violin when both are playing the same frequency. The timbre is the result of “secondary” frequencies (harmonics—also called “overtones”) being present in the sound of the respective instruments. If there are many harmonics present, the sound is called bright. If there are only a few present, the sound is called dull or mellow.

These harmonics are *above* the basic pitch being played. The timbre of each instrument is different because each instrument has its own particular pattern of harmonics.

Assume both the violin and clarinet are playing the same pitch, A440. Then A440 would be called the fundamental. The first overtone has a pitch of 880 cycles per second ( $2 \times 440$ ); the second overtone has a frequency of 1320 cycles a second ( $3 \times 440$ ); the third overtone has 1760 cps ( $4 \times 440$ ) and so on.

The clarinet and violin have different overtones. The violin produces the fundamental and all the *odd* and *even* numbered overtones. The clarinet on the other hand produces the fundamental and the odd numbered overtones. The overtones are not as loud as the basic frequency and are therefore not recognized as the fundamental. The loudness of the higher numbered overtones decreases rapidly.

In other words, every instrument has its own set of overtones that make up

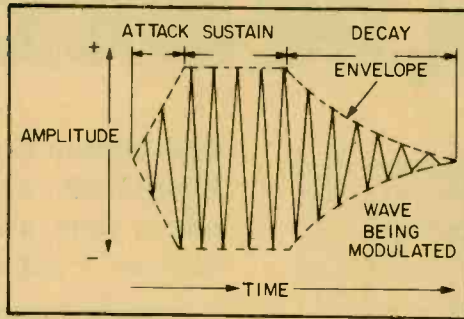

Typical musical note shows approximate areas of attack, sustain, and decay. Any or all of these may be much shorter or longer.

its timbre. The two factors that account for the difference in timbre are: which overtones are present; and the relative strength of those overtones.

There are four basic combinations of fundamental and overtones that are important in electronic music. These specific combinations are named: sine, triangle, square, and sawtooth. A sine wave is like a flute in quality.

A triangular wave consists of a fundamental and the odd numbered overtones. The overtones that produce the triangle wave are very weak in strength. The quality of the sound produced by a triangle waveform at an audible pitch is like a wooden recorder.

A square wave, like the triangular waveform, consists of the fundamental and the odd numbered overtones. The overtones that make up a square wave are more numerous and louder than the same overtones in the triangle. The square wave has a “hollow” sound to it, like a clarinet.

Lastly, the sawtooth waveform consists of the fundamental frequency and the even and odd numbered overtones. The sawtooth sound quality is very “bright” like a string or brass instrument.

**Dynamics (loudness).** Dynamics is the third property of sound. It has two important aspects. It includes *overall loudness*, which can vary from the rustle of leaves to the blast of a rocket. It also includes the changing ratios of sound as time passes.

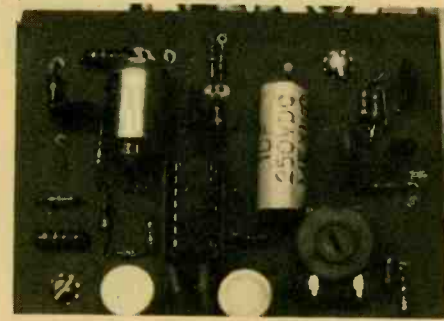

Closeup view of printed circuit board shows placement of the components. Be sure to use an IC socket for the IC.

For most musical sounds the loudness versus time characteristic may be broken into three parts:

1. Attack time—the time period from silence to when the sound reaches its maximum loudness.
2. Sustain time—the period during which the sound is maintained at some loudness level.
3. Decay time—the period during which the sound fades away to silence.

The voice is an example of a sound that has flexible loudness. A sound from a voice can begin very quietly and increase in volume, then hold some volume level for a time, and finally decrease the loudness of sound until it is silent.

A graph of the variations in loudness in a typical sound is shown.

Two sine waves drawn in dotted lines are labeled “A” and “B.” As you can see from the drawing, waveform “B” goes through two cycles in the time that it takes waveform “A” to complete a single cycle. Waveform “B” is therefore twice the frequency of “A” and is said to be the *first* harmonic of the *fundamental* frequency “A.” If we draw another wave three times the frequency of “A” it will be the *second* harmonic, four times will be the *third* harmonic, and so on.

If at every point in time we sum together the amplitudes of waveform A and B the result is the waveform shown by the solid line. Note that while the new wave is shaped differently than

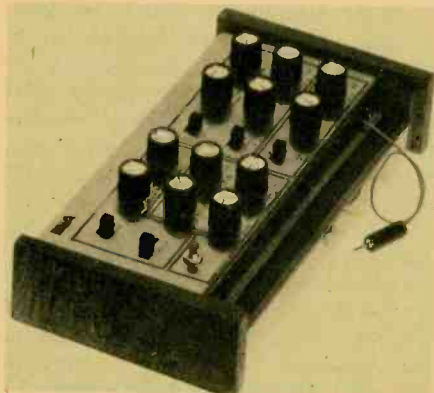

Small electronic musical instruments may be built from kits like this one from PAIA Electronics (address at end of article)

Musical tones may be generated by oscillators making simple sine waves, or any of several other shapes. The most common of these are shown. Note that the frequency of each note is the same, but the timbre (sound quality) will be different, depending on the wave-shape.

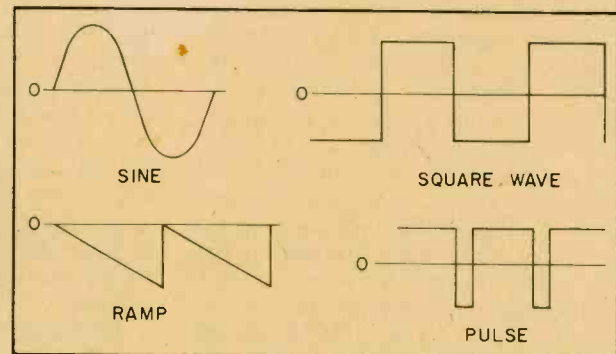

either A or B it has the same frequency (and consequently pitch) as the fundamental frequency A. If third, fourth, fifth and higher order harmonics were added into this wave the result would continue to change shape but the frequency would remain the same.

It is not necessary that every harmonic of a fundamental frequency be included in a wave and indeed the most musically interesting sounds have certain harmonics deleted. The square wave is a good example. It is difficult to imagine that the sharp-edged wave illustrated could be built up from smoothly changing sine waves, but it can, as shown in the progression of diagrams (a) through (e). In (b) the fundamental frequency is added to its third harmonic, producing the waveform shown by the solid line. In (d) the fifth harmonic has been added to the result of (b) to produce the new solid waveform and in (e) the seventh harmonic has been added to all the rest. You can see that the trend as higher order harmonics are added is to steepen the sides of the square and flatten and reduce the ripple in the top. When enough harmonics have been added the result will be a square wave. Notice in particular that not all harmonics are added together for a square wave, only the *odd* harmonics (3rd, 5th, 7th, etc.) are included.

**Making Waves.** It is much easier to generate a complex ramp or square wave than a sine wave. Since synthesizers operate with harmonic-rich waveforms as their primary signal source there is no need to start out with a sine wave at all. The VCO's supplied with most synthesizers provide a variety of waveforms each of which provides different harmonic structures. Common practice is to use a relaxation oscillator to generate a voltage ramp which is then converted to triangle and pulse waves using simple shaping circuits. In some cases the triangle will also be shaped into a sine wave. These

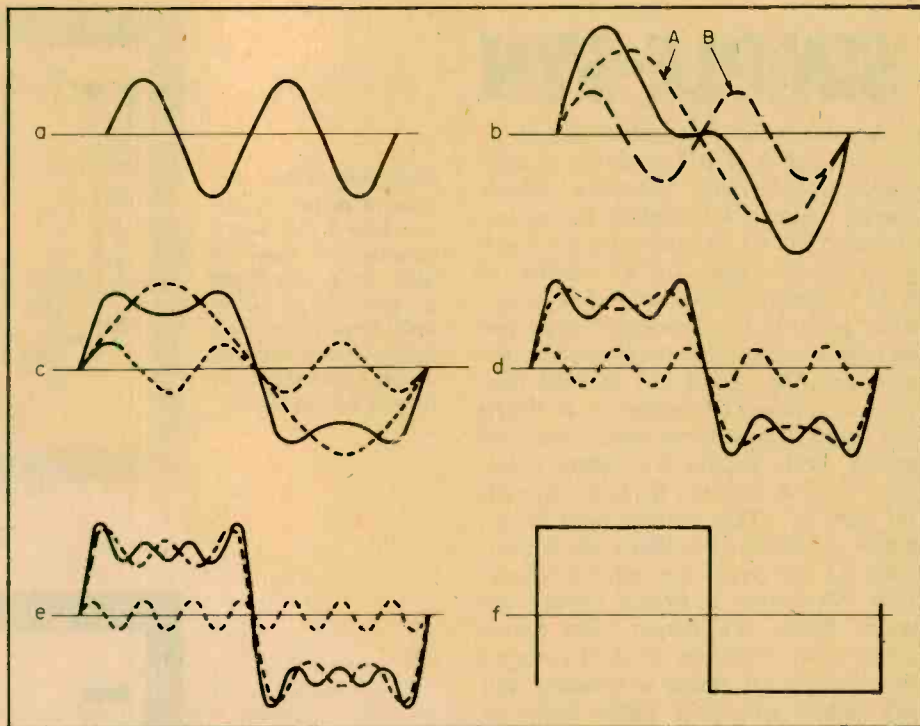

Waveforms show how harmonics of sine wave, added sufficiently, can form square wave. At (b) the fundamental (A) and its first harmonic (B) add to produce shape (b). At (d) and (e) additional harmonics begin to approximate square wave. An infinite number of harmonics would make a perfect square wave, as in (f).

waveforms and their harmonic contents are listed in the Table.

**Building Blocks.** Modern synthesizers are made up of one or more each of several different kinds of building blocks, just the way all component hi-fi systems include similar blocks (pre-amplifier, controls, power amplifier). These building blocks are mostly *oscillators, filters, envelope generators, mixers, and amplifiers*. Each circuit is itself fairly simple. When a number of them are connected together they can comprise a performer's synthesizer. To demonstrate the basic principles of the most important of these building blocks we are presenting Simple-Syn—a one-tone synthesizer which incorporates most of the principles needed for practical music synthesizers.

The simple synthesizer in this project shows how basic oscillators (tone generators) work, and how the frequencies they produce are modified to produce a wide variety of sounds.

Simple-Syn is capable of simulating many naturally-occurring sounds, as well as some unnatural ones. It will be useful as a demonstrator of the characteristics of sound, as well as a sound-effects machine for tape recordists. The output of Simple-Syn is sufficient to drive the *Aux* input of an amplifier or the *Line* input of a tape recorder. It may also be adapted to other uses, as will be discussed later.

Shown here is a diagram of a burst

of sound. The time interval during which the sound's volume builds from zero to some reference level is called the *Attack* time, while the interval during which the sound remains at the reference level is called the *Sustain* time. Finally, the period during which the sound level decays exponentially back to zero is the *Decay* time.

As you can see, what we have here is an amplitude-modulated sine wave. Now suppose that this sine wave is replaced by some other periodic waveform of the same frequency but with a different waveshape. For instance, consider the ramp, square, and pulse waveforms shown. If you think that they will sound different from the sine wave, you're right. Although these waveforms all have the same frequency as the sine wave, they are aurally perceived as having different timbre.

An important characteristic of natural sound generators is that they filter the waveshapes of the sounds they generate. For example, the body of a violin and the horn of a trumpet are natural resonators which reinforce some frequencies, and attenuate others. The overall shape of a waveform is correlated with the relative amplitudes of its harmonics. So, if a harmonic-rich waveform is filtered, we will alter its shape, since some of its harmonics will be attenuated more than others. Thus, *filtering* produces changes in *timbre*.

**How the Circuit Works.** Now let's turn

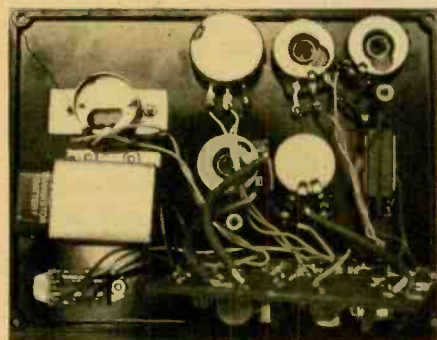

Underside view of front panel shows printed circuit board in place, ready to be dropped into its case.

# SIMPLE-SYN

to the schematic of the synthesizer. Sections A and B of IC1 comprise a voltage-controlled ramp generator, whose control voltage is supplied by potentiometer R1. C1 bypasses contact noise generated by rotation of R1. Section A is an integrator, which when fed a constant positive input voltage, produces an output voltage that decreases linearly with time. Section B is a Schmitt trigger which senses the output of A. When A's output drops below some lower reference level, Section B's output drops low, causing current to flow through D1 and R5. This current flow is opposite to (and greater than) the current from R1 that passes through R3. Therefore, A's output is forced rapidly upward. When A's output rises above some upper reference level, B's output swings high, D1 ceases to conduct, and A's output can once again begin to linearly drop. Thus, the whole process repeats itself.

The ramp waveform is fed through C3 to section C, which acts as a comparator. By adjusting the *Symmetry* control, R11, we can shift the reference level at which the comparator switches, and thus the ratio of "high" time to "low" time of the rectangular wave at C's output. This rectangular wave is clipped by D2 and D3. The ramp and rectangular waves are mixed in R13 and fed to volume control R15. Closing S1 connects C4 across R15, thus forming a low-pass filter. C5 couples the signal from R15 to the voltage divider formed by R16 and Q1, an N-channel JFET whose resistance decreases



as its gate bias decreases. Gate voltage for Q1 is developed across C8, which we can consider initially discharged with S2 in the position shown. Therefore, Q1's resistance is minimal and the audio signal at its drain is also minimal. Flipping S2 upwards causes C8 to gradually charge through R19, R20, and R21; consequently, Q1's resistance increases and so does the volume. Flipping S2 down again causes C8 to slowly discharge through R22 and R23, and the volume drops once again. Finally, the audio signal from Q1's drain is coupled by C6 to the buffer amplifier formed by section D of IC1.

Placement of the components on printed circuit board. Perf board construction may be used since placement is non-critical. Controls, however, should be positioned approximately as indicated, for manual convenience.

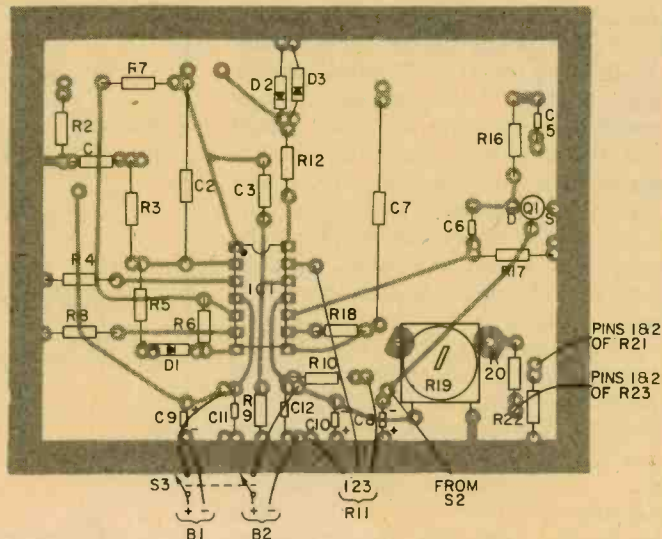

Printed circuit board layout for Simple-Syn is easy to make even if you haven't made one before. Radio Shack has inexpensive kits for boards.

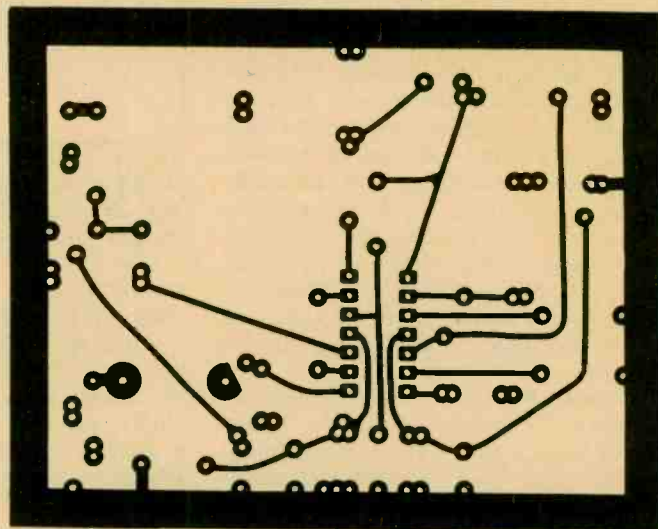

es as its gate bias decreases.

Gate voltage for Q1 is developed across C8, which we can consider initially discharged with S2 in the position shown. Therefore, Q1's resistance is minimal and the audio signal at its drain is also minimal. Flipping S2 upwards causes C8 to gradually charge through R19, R20, and R21; consequently, Q1's resistance increases and so does the volume. Flipping S2 down again causes C8 to slowly discharge through R22 and R23, and the volume drops once again. Finally, the audio signal from Q1's drain is coupled by C6 to the buffer amplifier formed by section D of IC1.

**Building Simple-Syn.** Construction of the synthesizer is not critical. The best method would be to copy the printed circuit layout shown. The board is simple enough to be copied using one of the kits available at Radio Shack and elsewhere. My Simple-Syn was built in a plastic box but a metal case is recom-

mended in order to eliminate hum-pick-up problems. The control layout shown in the photograph should be used. The completed printed circuit board will mount behind the control pots, with its foil side facing them, using 1/4-inch spacers.

After you have fabricated the board, install the IC socket. The other components may be installed in any order, but solder Q1 last. Be sure to observe proper orientation of Q1, D1, D2, D3, C8, C9, and C10. Trimmer R19 used in my prototype was mounted horizontally. The two large upper pads connect to its wiper. If you use a vertical-mounting trimmer instead you will have to change the position of the pads to accommodate it. Finally, install IC1 in its socket and set the board aside temporarily.

Try to copy the construction of Simple-Syn's prototype cabinet as closely as possible. *Frequency control* R1 mounts in the upper-right-hand quad-

rant and is actuated by the largest knob. Directly below that pot is an aluminum bracket holding B1 and B2. Right below the bracket is Power switch S3.

The first row of controls on the left-hand side of the front cover contains R21, R23, and R11 (from left to right). The second row contains S2, R15, and R13. Below the second row are Filter

switch S1 and Output jack J1. With this arrangement, the interconnecting wiring is shortest, and all components mount on the cover, which is convenient when batteries have to be changed. Incidentally, the battery drain is less than 2 ma., so the batteries will last a long time.

After you've located and drilled all

holes in the front panel, including those for the spacers that mount the printed circuit, solder short lengths of #22 stranded wire to the appropriate lugs of the controls, then mount them. Six-inch lengths of wire will suffice. This is easier than mounting the controls and then trying to solder to the leads in close quarters. Note that R14 is not on the

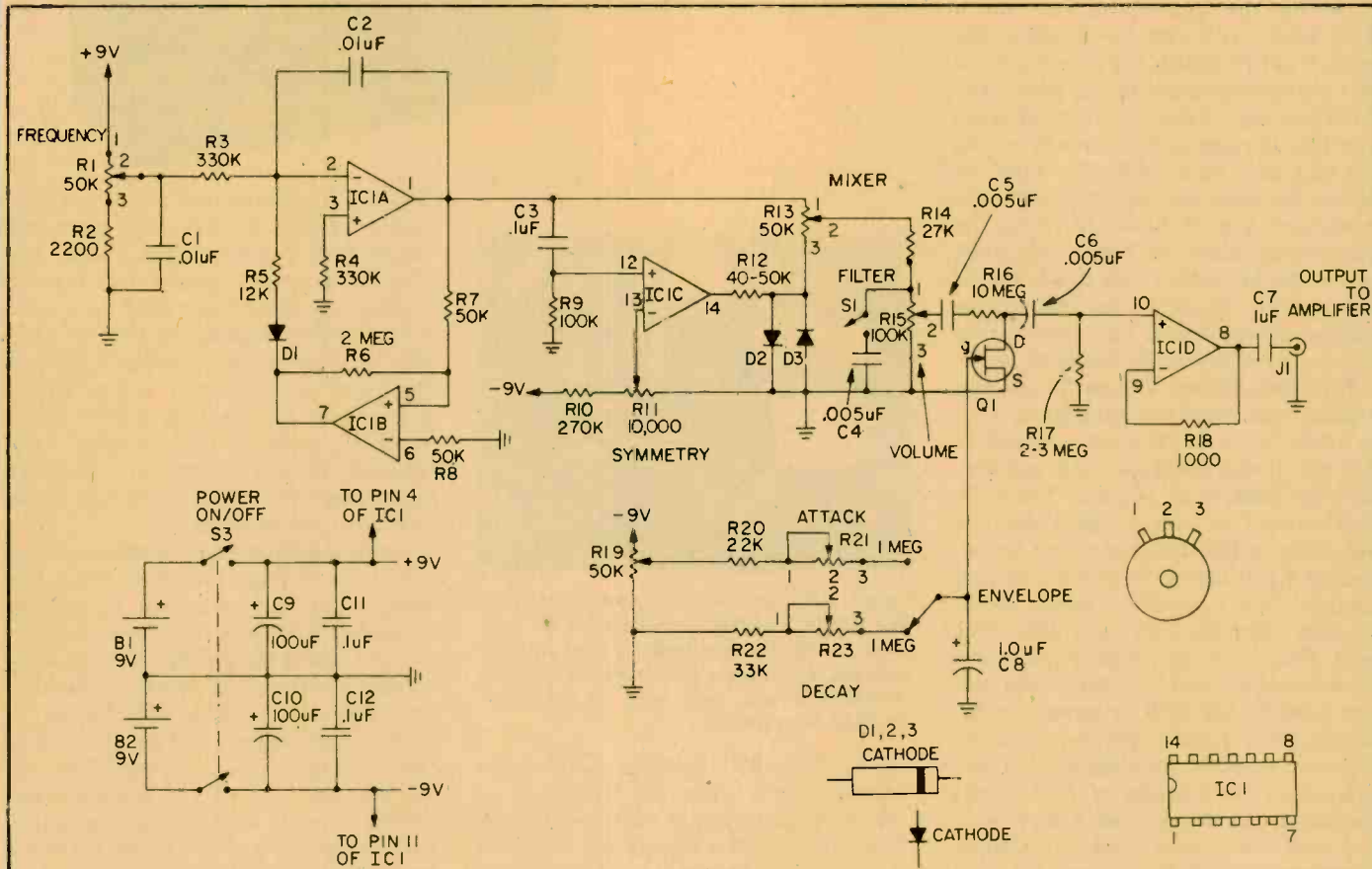

#### PARTS LIST FOR SIMPLE-SYN TONE SYNTHESIZER

- C1—.01-µF capacitor
- C2—.01-µF mylar capacitor
- C3, 11, 12—.1-µF capacitor
- C4, 5, 6—.005-µF capacitor
- C7—1.0-µF, 250-VDC capacitor
- C8—1.0-µF tantalum capacitor
- C9, 10—100-µF, 16 VDC electrolytic capacitor
- D1, 2, 3—1N914 silicon diode
- IC1—LM324 quad operational amplifier IC
- Q1—2N3819 JFET (N-Junction field-effect transistor)
- R1—50,000-ohm, audio taper potentiometer (Allied Electronics 854-7333 or equiv. See end of Parts List for Allied's address)
- R2—2200-ohm, ½-watt resistor
- R3, 4—330,000-ohm, ½-watt resistor
- R5—12,000-ohm, ½-watt resistor
- R6—1.8 to 2.2-megohm, ½-watt resistor
- R7, 8—47,000 to 51,000-ohm, ½-watt resistor
- R9—100,000-ohm, ½-watt resistor
- R10—270,000-ohm, ½-watt resistor

- R11—10,000-ohm, linear taper potentiometer
- R12—39,000 to 47,000-ohm, ½-watt resistor
- R13—50,000-ohm, linear taper potentiometer
- R14—27,000-ohm, ½-watt resistor
- R15—100,000-ohm, audio taper potentiometer
- R16—10-megohm, ½-watt resistor
- R17—2.2 to 3.3-megohm, ½-watt resistor
- R18—1000-ohm, ½-watt resistor
- R19—50,000-ohm, linear taper potentiometer
- R20—22,000-ohm, ½-watt resistor
- R21, 23—1-megohm, linear taper potentiometer
- R22—33,000-ohm, ½-watt resistor
- S1—SPST slide switch
- S2—SPDT pushbutton switch
- S3—DPDT slide switch
- Misc.—knobs, cabinet (preferably metal); 9-VDC transistor radio batteries (2); battery clips; socket for IC1, wire, solder, etc.

Allied Electronics' address is 401 East 6th St., Ft. Worth, TX 76102.

Workbenches are alive with the sound of music—wherever Simple Syn is being built! When the first caveman whistled the first tune, who would have thought that just five million short years later such sweet music would be floating from an electronics filled box? Well, Cro-mag-non Man didn't have the editors of e/e backing him up. Today, you'll find that building a state-of-the-art music machine can be as simple as Do-Re-Mi following our PC board foil and component side layouts. You'll find dozens of uses for the Simple-Syn, especially if you make tape recordings and are in need of special effects. Besides music, Simple-Syn can be used to imitate foghorns, sirens, whistles and can make eerie, creepy, wailing noises like from the soundtrack of a Grade B science-fiction movie of the Fifties. But, more to the point, Simple-Syn can be calibrated to produce some really outrageous music. Just calibrate the frequency control and the Simple-Syn can span more than three full octaves, a wider range than many popular singers of today command.

# SIMPLE-SYN

circuit board—it mounts point-to-point between lug #2 of R14 and lug #1 of R15. Likewise, C4 is off the board, wired between S1 and R15 as the schematic indicates.

Position the front panel face down on a table, and next to it place the printed circuit board, foil side up. Connect the control leads to the pads indicated on the board by inserting each lead into the appropriate hole from the foil side and then soldering. Trim off the excess wire that protrudes from the component side of the board. When the connections have all been completed, mount the board foil side down behind the controls. All the wiring will now be underneath the board, and your project will not be cluttered by dangling wires.

**Final Adjustment.** When Simple-Syn is completed, only one adjustment must be made. Turn on the power and adjust R21 for minimum attack time, and then R15 for maximum volume. Press S2. Now turn R19 fully to the right, and then fully to the left. Leave it at whichever end provides a loud tone in your speaker (the opposite extreme should produce silence). Now turn R19 back until there is a just barely-noticeable diminishing of sound intensity. The correct position for R19 is anywhere between R19's present position and the position it was in previously. You will notice that the position of R19 affects the attack and decay times somewhat if you play with those controls. Choose a position for R19 (within the two bounds previously indicated) that produces the most pleasing attack and decay behavior.

**Using Simple-Syn.** If you make tape recordings, Simple-Syn can be used to imitate foghorns, train whistles, sirens, musical instruments, insect buzzes and hums, as well as surreal science-fiction-movie sounds. In conjunction with a small amp and loudspeaker it can provide realistic horn and whistle effects for a model railroad. You might use it to replace your humdrum doorbell with some really wild sounds. Finally, Simple-Syn can be used as a musical instrument. All that is necessary is that you calibrate the frequency control, perhaps using a pointer affixed to the frequency knob and a scale with the positions of the various notes marked on it. Simple-Syn spans more than three octaves, so the larger scale you use, the easier it will be to calibrate. Calibration is easiest with a frequency counter, but you can also tune it by ear, using a piano as reference. In addition, you can

Completed prototype shows layout of controls. If your cabinet is larger you should still stick to this physical layout, to keep internal leads as short as author did.

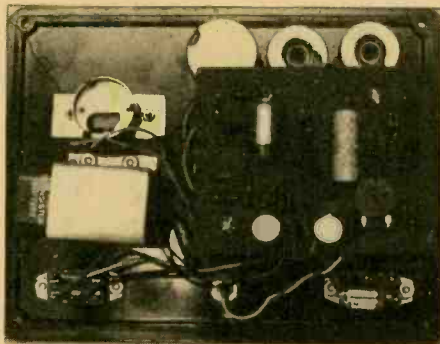

Here's what the author's prototype looks like inside. Everything mounts on the top panel, so the cabinet body is used just for support. If you use a metal cabinet (recommended) it will also serve to minimize possible hum pickup.

replace the 9V. batteries with 8.6V. mercury cells, since the frequency of the ramp generator is voltage-sensitive. Your calibration with mercury cells will stay accurate because, unlike zinc-carbon cells whose voltage decreases with age, a mercury cell's voltage remains quite constant throughout its useful life.

**Final Remarks.** A few final remarks about operation of the synthesizer might be helpful. First, the *Symmetry* control will have its maximum effect when the *Mixer* is rotated to yield a pure rectangular wave; its effect will be inaudible when *Mixer* is rotated to pure ramp. The effect of *Symmetry* and *Mixer* controls, which vary the harmonic structure of the output, will be most evident at low frequencies. This is because the important harmonics (all those up to about the thirtieth) of the higher frequency tones fall above 15 kHz. Beyond 15 kHz the human ear has a rapidly diminishing sensitivity. Thus, a high frequency ramp won't sound tremendously different from a high frequency rectangle because the human ear does not respond to all the important harmonics.

The effect of the *Filter* control will be to attenuate the higher harmon-

ics of a waveform, and produce a more mellow sound. In most natural sounds decay time is longer than attack time. Try using a long attack time together with a very short decay time for a really strange effect. Finally, if you are feeding the synthesizer's output into your hi-fi system, be careful not to sustain a loud tone for too long a time. Home speaker systems can handle large amounts of power only on a transient basis; sustained operation at high power can burn out voice coils.

**Learning More About Synthesizers.** If you'd like to learn lots more about how today's practical electronic musical instruments work you can get an excellent booklet called the *Synthesizer Primer* by writing to Electronic Music Laboratories, Box H, Vernon, CT 06066. If you're interested in knowing more about their extensive line of Synthesizers, say so, and they'll send you literature and prices, as well as a fascinating 7-inch phonograph disc of five short selections performed on EML synthesizers.

Another good source of information on the subject is PAIA Electronics, Inc., Box 14359, Oklahoma City, OK 73114, the makers of a wide variety of kits for synthesizers and allied instruments. They have several very interesting low-cost modules for producing all sorts of sounds, including wind, surf, chimes, in addition to musical and other sounds. The PAIA "Gnome" micro-synthesizer produces many sounds, such as winds and flutes. Gnome kit costs \$48.95. For more information circle number 71 on the Reader Service coupon.

If you're into really heavy performing instruments you can look over the state-of-the-art models being sold by ARP Instruments, 45 Hartwell Ave., Lexington, MA 02173. ARP will send you a record demonstrating the sounds of the ARP Omni, which they call the world's first symphonic electronic keyboard, for \$1.00. Moog and Buchla synthesizers are also still being produced, and are available in many music stores.

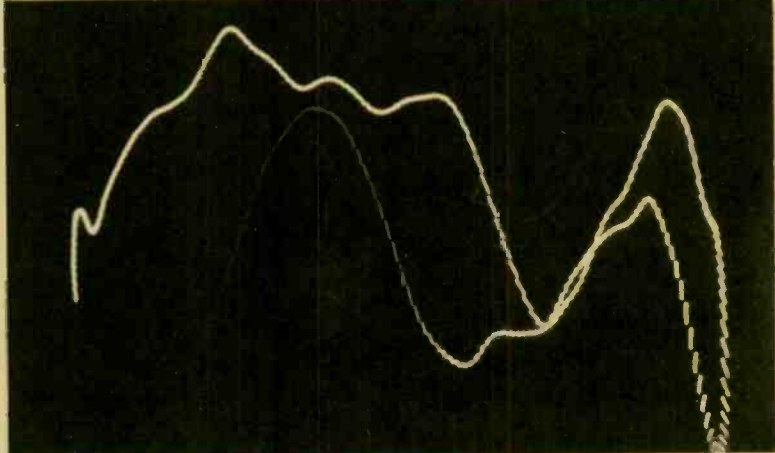
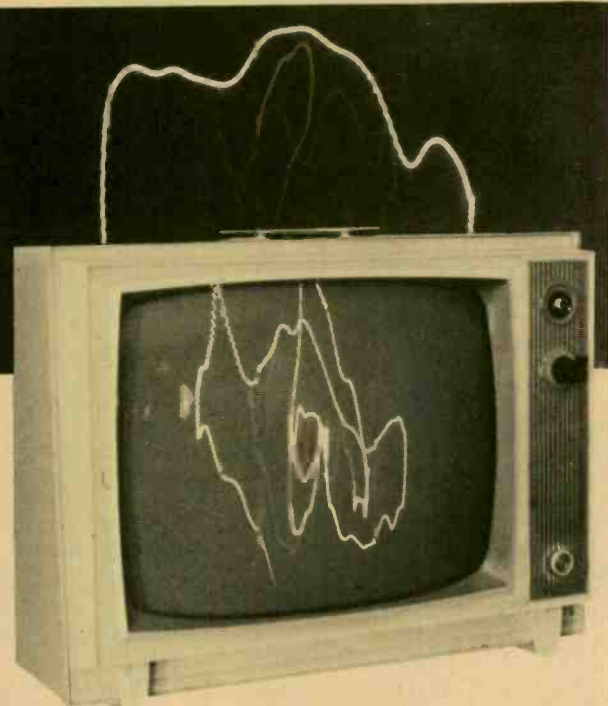
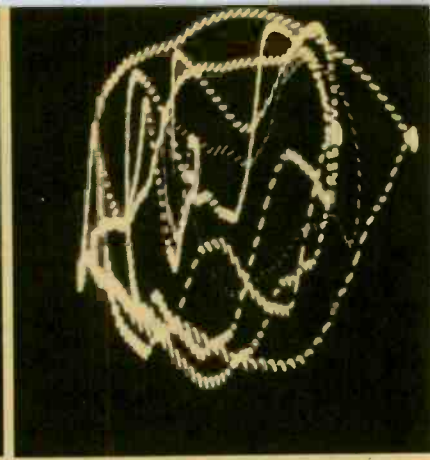
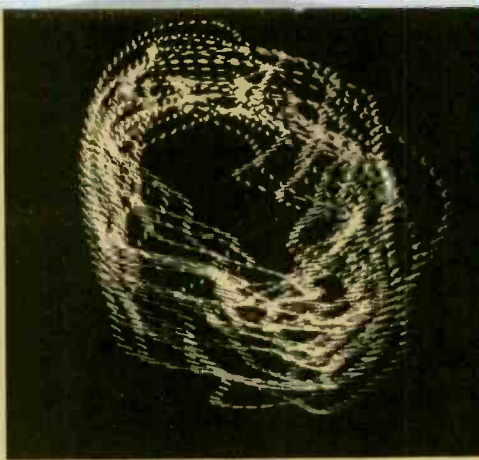
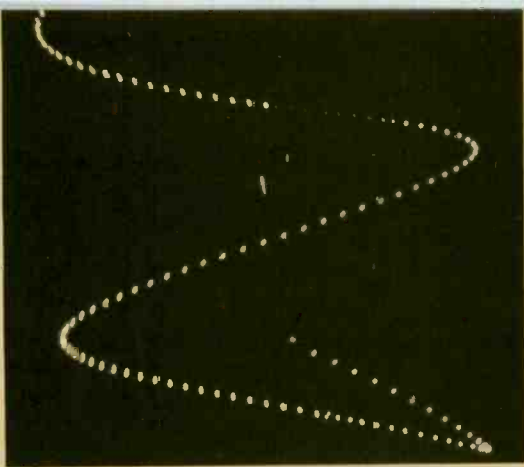

## LISSY, THE TV LIGHT PEN

Lissajous patterns on your old TV add excitement to stereo.

□ Are you an avid stereo enthusiast looking for a new way to experience your favorite music? Have you tried conventional "color organs" and found them fun for a few minutes, but dull as dishwasher thereafter? Have you perhaps seen an oscilloscope hooked up with a microphone on its input and watched in fascination as the sound waves dance on the screen in perfect synchronism with your voice?

If you'd like something new to stretch your visual sense and expand the aural connection with your eyes, look no further. *Lissy*, the adapter which turns any beat-up old TV set into an oscilloscope for stereo sound, displays myriad sound patterns on the receiver screen. Its *Lissajous* patterns respond to both right and left-hand stereo signals—although it can also work with just one channel—providing an infinitely-variable light/sound display for your friend's pleasure and amazement.

**What's a Lissajous?** Let's go back to basics for just a minute, and review what a Lissajous figure is. Those of you who are familiar with the theory and

practice of oscilloscope use, and know it well, will recall that Lissajous figures are 'scope displays of two signal inputs to the display screen—not just the usual vertical input signal which we use when we want to measure the amplitude of a voltage or watch how its amplitude changes with respect to time (the most common use of the oscilloscope).

With signals going to both the vertical and the horizontal inputs of an oscilloscope we can measure the relationship with respect to time (it's called *phase*) between the two signals.

For example, if a known signal is applied to the horizontal input and an unknown signal is applied to the vertical input, the resulting Lissajous pattern shows the phase relationship of the two signals.

Lissajous patterns can also be used to measure frequency. A known frequency is applied to the horizontal amplifier and an unknown frequency is applied to the vertical. By counting the number of tangency points at the top and at one side, a ratio of unknown-to-

known frequency can be obtained. By multiplying the ratio times the known frequency, you can determine the frequency of the unknown.

**A Simple Pattern.** The drawing shows a Lissajous pattern for two sine waves. Numbers have been assigned to corresponding voltage points on the two signals. Extensions of these points are brought to the screen. The intersection of corresponding numbered lines is the position of the electron beam at that instant of time. In this case the two sine waves are in phase.

In the figure below, voltage/time relationships are different; corresponding voltage points are 45° apart. Therefore the waveforms are 45° out of phase.

**Lissy's Pictures.** A continually shifting Lissajous pattern results when the phase relationship between the two input signals is constantly changing. The more complex the pattern (resulting from a frequency ratio having large numbers, such as 17/13) the harder it is to interpret. But since we're not trying to analyze Lissy's pictures, we can just lean back and enjoy. (Please turn page)

# LISSY TV LIGHT

**How Lissy Does It.** By connecting the parts of an old TV set so that the output from one channel of a stereo set (for example, the left) drives the electron beam of TV tube vertically, and the output of the stereo set's right channel drives the beam horizontally, we can use the TV set to display Lissajous figures created by the signals from the two stereo channels. What we do is make the old TV set/stereo amplifier combination into an uncalibrated oscilloscope. Then we feed it the two signals without worrying what they mean.

**Putting It Together.** Begin with an old television set. You can use one in which the tuner, IF, and sound sections do not work since they will not be used. You'll also need an extra deflection yoke from another old set. Most of the older tube-type black and white sets have yokes the same size. As long as the extra yoke will fit over the neck of the set's picture tube it can be used. A junked TV is the best place to look. You must also have a stereo set with amplifiers capable of producing 12-15 watts of output power per channel. Even better is a spare (second) stereo set. This will insure better results and will also allow you to adjust the tone, volume and balance controls to the TV set without upsetting your listening pleasure, by changing the volume setting while you listen.

Begin by removing the back from the old TV set. Disconnect the socket from the rear of the picture tube. Loosen the clamps holding the deflection yoke and slide it off the neck of the tube. Do not disconnect any of the wires from the

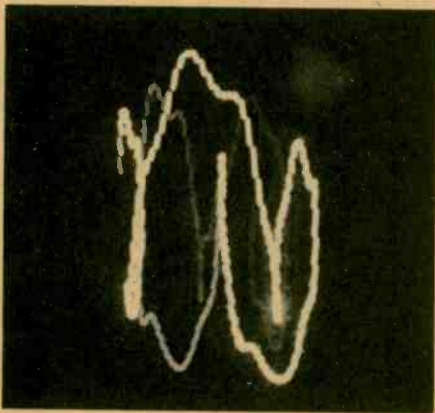

These patterns appear from moment to moment on the TV screen when it's being driven by signals from music. To see what they really look like you'd have to have motion pictures.

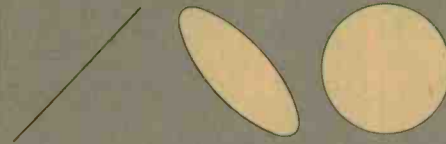

Simple Lissajous figures like these result from putting the same (or almost same) signal voltages on horizontal input and vertical input of oscilloscope (or TV picture tube).

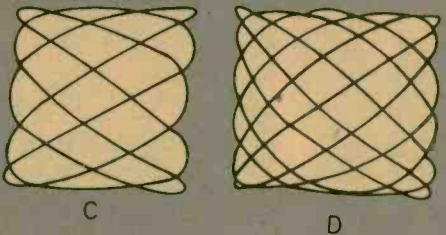
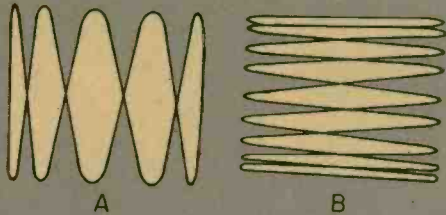

These more-complex Lissajous patterns are created by feeding a simple sine wave to the horizontal input of a scope and sine waves of exactly five times as high a frequency (A), one-ninth the frequency (B), 3/5 frequency (C), and 5/6 frequency (D).

The added deflection yoke from second TV set is connected as shown above to the two stereo channels of an amplifier or receiver. Using a separate amp (from the one you listen to) is recommended, but not essential.

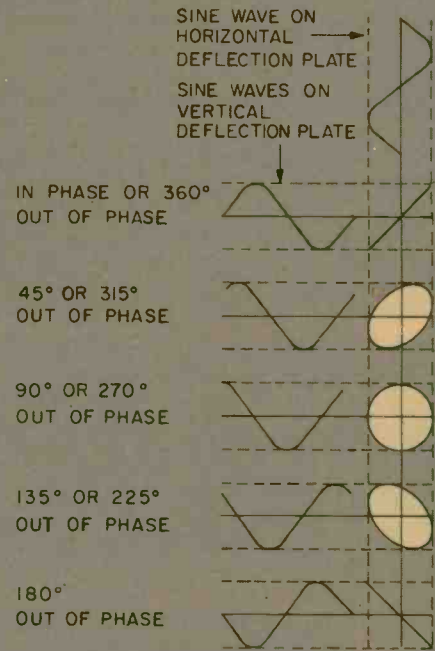

If your two stereo channels put out exactly the same signals (or you put a mono signal into both) you should get a straight (diagonal) line on the screen. If not, adjust gain of one channel. Other Lissajous patterns like these will result from out-of-phase signals. Music waveforms are extremely complex compared to the signals used to derive simple patterns shown here.

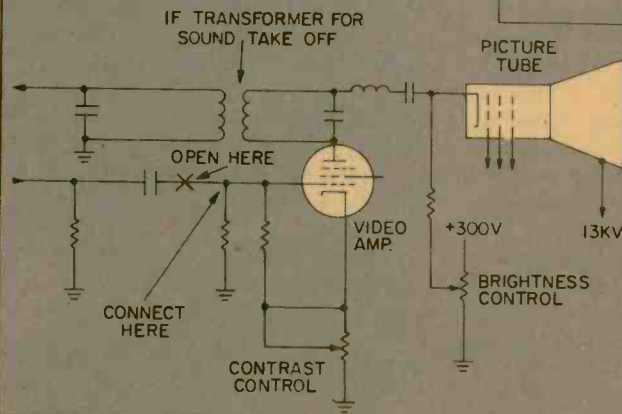
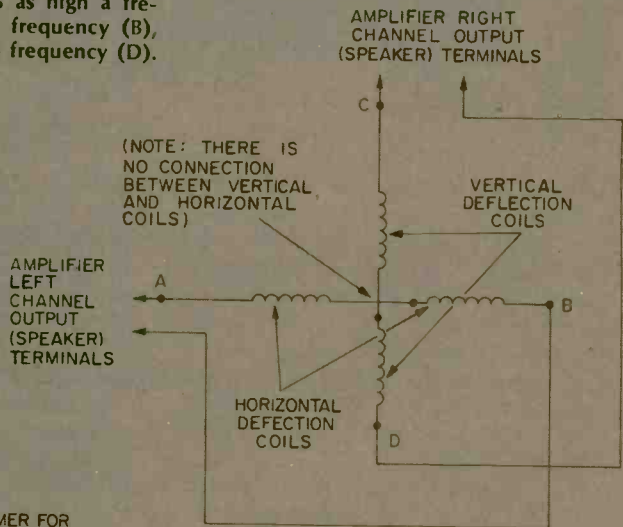

This schematic shows a typical video amplifier tube for TV sets six to 15 years old. Disconnect the video input signal on the grid side of the grid-coupling capacitor and connect your Lissy oscillator at the same point to make Lissy do extra tricks.





Here's how the back of author's set looks with the new picture tube yoke (deflection coils) on neck of picture tube. Original deflection yoke is removed from tube but kept hooked up because it's also used in the circuit which generates high voltage for picture tube. It's tied out of way at upper right, atop high voltage cage.



Closeup of picture tube neck shows large circular positioning magnet which some sets have behind yoke. Be sure to replace any magnets your set had into their original position after you replace the yoke.

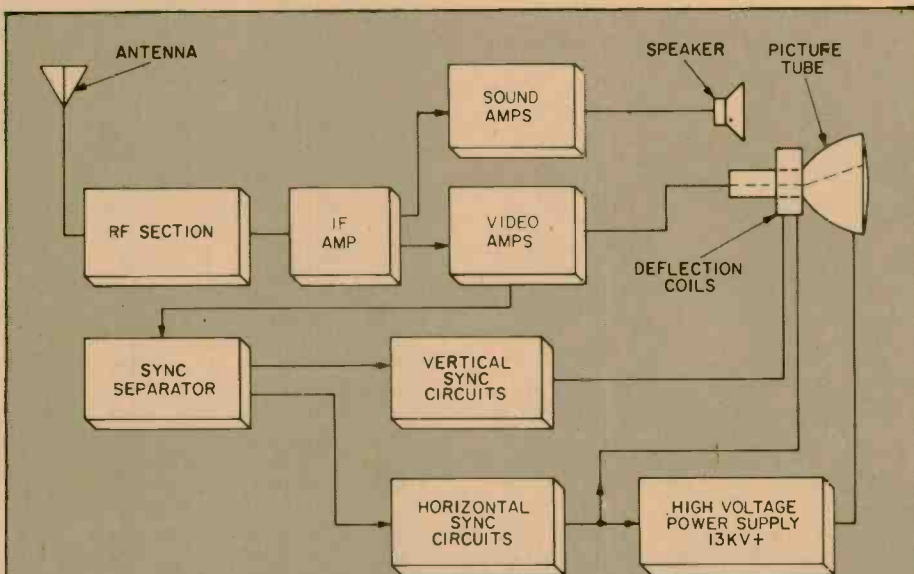

Simplified block diagram of TV set shows how vertical and horizontal sweep currents are derived from the synchronizing signals sent from the transmitter. Vertical and horizontal sweeps feed vertical and horizontal deflection coils.

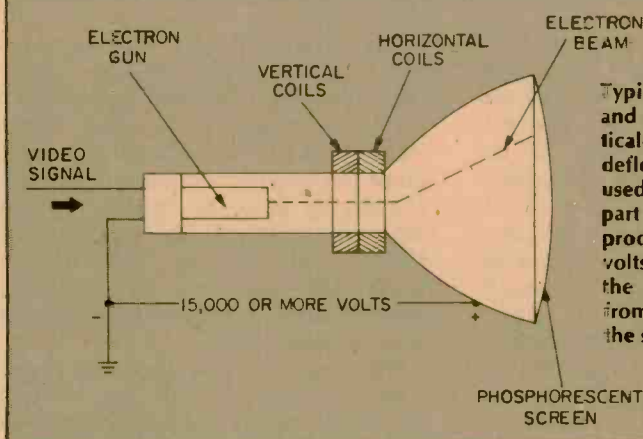

Typical TV picture tube and its horizontal and vertical-deflecting coils. Old deflection yoke is still used in Lissy because it's part of the circuit which produces thousands of volts required to attract the stream of electrons from the electron gun to the screen.

yoke since it is part of the circuit for putting the beam on the screen. Secure the old yoke to the chassis of the TV somewhere out of the way, taking care in seeing that it does not short circuit.

**Preparing the Deflection Yoke.** There are two coils in the deflection yoke of a TV set. One is called the horizontal and one the vertical.

Each of these two coils is divided into two sections, and we must eliminate any extra parts such as a small resistor or capacitor which are often connected to one or both of the yokes. They are usually connected to the midpoint of the horizontal coil or vertical coil. Simply remove any resistor or capacitor connected to any parts of the yoke, and if this separates the two sectional parts of either the horizontal or vertical coil, put a jumper between the two sections. Check with a voltmeter to be sure which terminals are connected (through the two coils) together. Mark them in some way so that you'll know which two leads of each coil are connected together (through each coil). Solder 2 three-foot lengths of speaker wire to the terminals of the vertical and horizontal coils.

**Putting It Together.** Take the yoke and slide it on to the neck of the picture tube securing it with a clamp. Return the socket to the back of the tube along with any magnets that may have been removed. Put the magnets back exactly where they were. (Adjust to center beam, later.) Route the speaker wire out the back of the TV set as you put the cover back on. Run wires from the speaker outputs on your stereo to the TV set and connect the two sets of wires together using a terminal strip.

You are now ready to test out Lissy. Leave your stereo off and turn on the TV set. After warmup a small dot should be visible in the middle of the screen. Adjust the magnets, if any, to

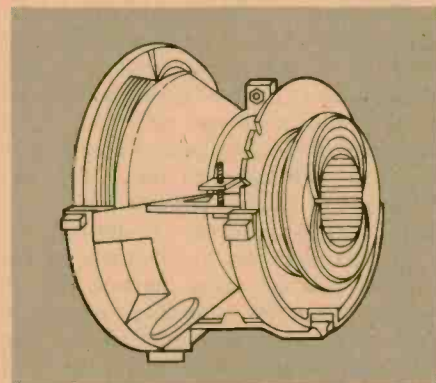

Most old TV sets have deflection yokes which look like this. Large end (left here) goes snug up against the flare of the picture tube. May require loosening of screw which secures clamp around coils.

# LISSY TV LIGHT

center the beam. If necessary turn the brightness control up or down. Now turn on the stereo set and turn up the volume slowly until you start to notice the dot moving. By adjusting the balance control you should be able to make the dot move about an equal amount horizontally and vertically. It may be necessary to disconnect the speakers in order to move the beam enough. Adjust the brightness for a pleasing light level without burning the screen phosphor. Low bass notes will show up as rotating circles. Each tone has its own pattern which intensifies with the volume.

Now that you are finished sit back and enjoy the added dimension of the music TV in a dark room. It will provide you with many hours of listening and viewing pleasure.

**More Fun With Lissy.** Once your Lissy is working you may want to add an extra circuit which will strobe the moving pattern on and off, making a more unusual and interesting light display. By connecting the output of an oscillator to the grid of the TV set's video amplifier tube you can turn on and off the electron beam in the picture tube. This will produce dots and dashes as the beam is moved around on the screen. The effect is quite pleasing. A stop-action type of display (called "strobe") is only one interesting improvement you'll see.

The added circuit is a simple two-transistor oscillator. The switches and potentiometers allow you to select different dot line lengths and frequencies. By connecting the output of the oscillator to the grid of the video amplifier you force the tube alternately into conduction and cutoff.

The oscillator and power supply are not critical and can be constructed any way that is convenient, as long as safe construction practices are used. The circuit in the prototype was built on a terminal strip using point-to-point wiring and then mounted inside the TV. Almost any general purpose PNP transistors can be used for Q1 and Q2.

If you can't get a schematic of the TV set you are using the best way to locate the video amplifier tube is to look at the tube placement chart (usually on the side or back of the TV) and find the tube which is labeled *Video Amp*. If the video amp tube also contains other elements in the glass envelope you will have to trace down that part of the tube which has its plate connected to the sound trap transformer

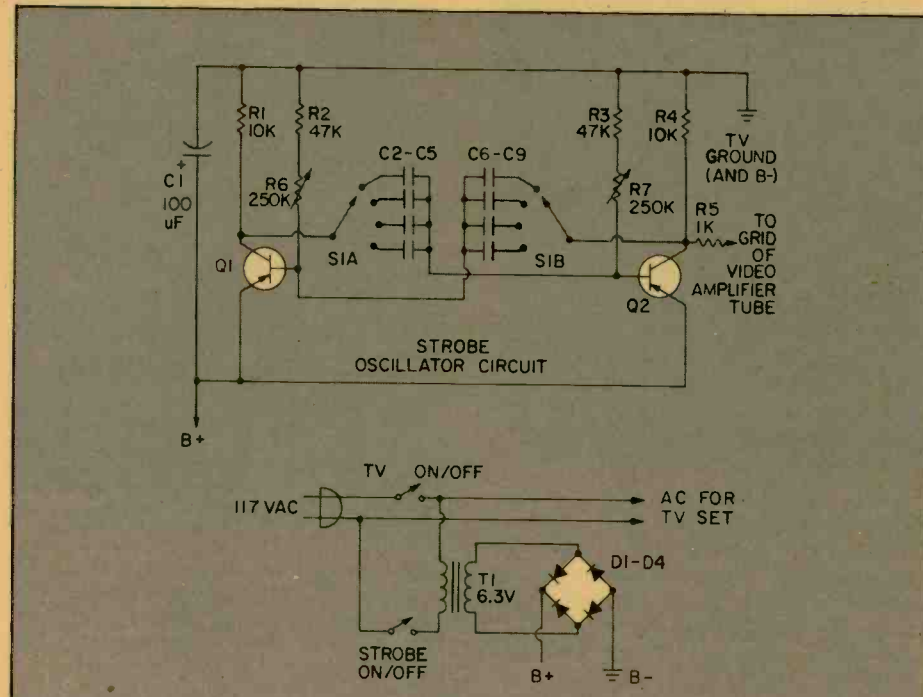

## PART LIST FOR LISSY—THE TV LIGHT ORGAN

TV receiver—which has light (raster) on the picture tube. It need not have a working tuner or IF section, nor sound.  
Picture tube deflection yoke—in working condition. (Most are—this is a part that rarely

fails in TV sets.)  
Speaker wire—8-10 ft.  
Stereo amplifier or receiver—preferably 12-15 watts or more per channel.  
Misc.—Solder, wire, switches, etc.

## PARTS LIST FOR STROBE CIRCUIT FOR LISSY

C1—100- $\mu$ F, 16-VDC electrolytic capacitor  
C2, 6—.002 or .22- $\mu$ F capacitor  
C3, 7—.01- $\mu$ F capacitor  
C4, 8—.1- $\mu$ F capacitor  
C5, 9—.1- $\mu$ F capacitor  
D1, 2, 3, 4—rectifier diodes, 30 PIV or better, any amperage  
R1, 4—10,000-ohm, 1/4-watt resistor  
R2, 3—47,000- $\mu$ F, 1/4-watt resistor

R5—1000-ohm, 1/4-watt resistor  
R6, 7—250,000-ohm potentiometer (or 500,000 if 250,000 not available)  
S1—Single-pole, 4-position (or more) rotary switch  
Q1, 2—General-purpose PNP silicon transistors, HEP-242 or similar  
T1—Power transformer, 117 VAC primary, 6.3 VAC secondary, any amperage

You can call Lissy's designs Lissajous patterns, but your friends will call them "out-of-sight"! The twisting, convoluted, ever-changing, swirling designs are truly a visually exciting wonder which can't fail to draw the viewer's eye into almost hypnotic attention. You can convert almost any old television from a boob tube to a groove tube with just a little effort, and at almost no cost at all. Just an evening's work, and your place will be jumping like never before.

(usually a metal can type) and its cathode connected to the contrast control. This may vary slightly in your set.

Once you have found the video amplifier cut one of the leads of the capacitor going to the grid and replace it by connecting the oscillator output to the tube in its place, (see the schematic). Connect the negative lead on the oscillator's power supply to the TV common ground.

**Fire Her Up.** Now you are ready to test the circuit. Look it over for any wiring errors. Set the potentiometers to maximum resistance and set the rotary switches at the .01  $\mu$ F capacitors. Turn

on the TV set and allow it to warm up. Get a music display on the screen. Turn down the brightness control until you can no longer see the raster (white lines). Turn on the strobe oscillator and adjust the brightness control as needed. The display should be chopped up into little line segments. By adjusting the controls you can get different line lengths and frequencies—anything from star-like dots to a pulsating array of stopped action traces.

Now you can lean back and enjoy your Lissy—the TV light organ which will amuse and amaze your friends for many evenings ahead.



# DISCO KING



Drum up a storm  
with this  
percussive project!

**D**ISCO MUSIC ENJOYS a phenomenal popularity, as evidenced by many of today's most popular records and movies. This popularity is due, in part, to the uniquely identifiable Disco percussion pattern which is basically identical in all songs. *Disco King* is a low cost rhythm unit which produces the standard Disco pattern plus three variations (selected by moving the "Pattern Select" jumper wire). The King also doubles as a base drum synthesizer which is triggered by means of a standard footswitch.

*Disco King* is simple to construct, uses readily available CMOS and analog active devices and is powered by two 9 volt batteries. Construction cost for the basic unit should be less than \$20.00 (see parts list for kit availability).

**How It Drums.** As indicated in the schematic diagram, CMOS NAND gates IC1A and IC1B form a gated oscillator which serves as the clock for the unit. The clock output frequency (set with *Tempo* control R2) is divided by two in D Flip Flop IC2B and again by two in D Flip Flop IC2A. Either the clock output, the Q output of IC2A or B or the Q output of IC2A can be used as the cymbal trigger signal.

Transistor Q1 generates a continuous white noise signal which is A.C.-coupled through C9, amplified in IC3A and provided to IC4, a transconductance Operational Amplifier. The trig-

ger signal selected is A.C. coupled through (and differentiated by) C7 and used to Amplitude Modulate the white noise signal in IC4. In this way, a repeating pattern of cymbal sounds is generated. Initially, R20 is adjusted to set the decay portion of the differentiated trigger pulses to create the characteristic amplitude envelope of a high hat cymbal. A portion of the IC4 output signal is tapped off *Cymbal Level* control R16 and provided to IC3B, where it is further amplified and summed with the synthesized base drum.

The Q output of IC2A is differentiated by C4 and R5 to produce a narrow trigger pulse. D1 eliminates the negative portion of the differentiated pulse. The Q output signal is also inverted in IC1C which drives LED 1 to indicate the start of the pattern (in musical terms, the start of the *bar*). In lieu of the Q output, a switch may be connected to J1. When depressed, the switch will manually generate a trigger pulse. In this manual mode, C3 and R4 eliminate switch bounce which would cause undesirable multiple trig-

The beat goes on . . . and on . . . and on . . . when you build our *Disco King*. It's really simple to put together, as it uses readily available CMOS and analog integrated circuit devices. The full-size printed circuit template is shown here, and it is easily duplicated by using one of the popular kits on the market today. For all of you would-be DJs, the *Disco King* is an excellent device for running mixes!

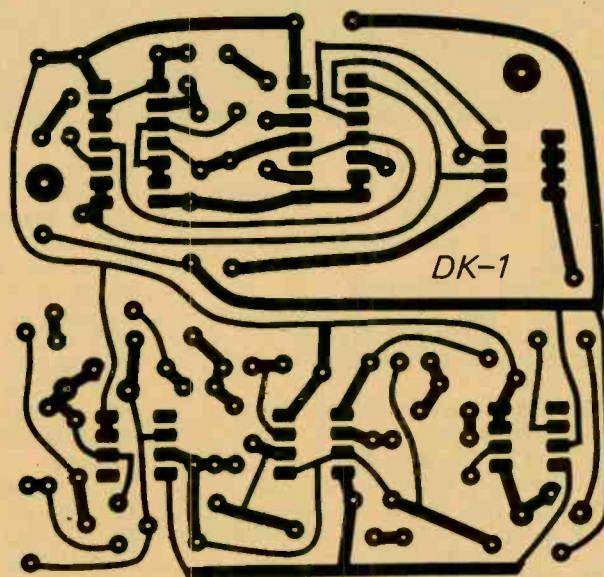

# DISCO

gering. In either the manual or automatic mode, the resultant pulse triggers the base drum generator.

C5, C6, C8, R11, R13 and R14 form a Twin-T notch filter tuned to the base drum frequency and make up one of two feedback loops for Op Amp IC5. If this were the only feedback loop, IC5 would simply oscillate at the notch frequency. Feedback loop R7, however, provides sufficient negative feedback to suppress continuous oscillation. The positive going trigger pulse momentarily overcomes the feedback through R7 and generates a damped sine wave output. The setting of R7 determines the amount of feedback and how long the oscillation lasts.

With S2 open, operation is as described above. Closing S2 (*stop*) grounds the input to pin 1 of IC1A, stopping the clock and resetting both Flip Flops with the high output of inverter IC1D. When S2 is released, the clock restarts and the sequence restarts at the beginning of the bar with the base drum sound. Power ( $\pm 9$  volts) is supplied by two 9 volt batteries.

**Construction.** Although not absolutely necessary, a PC Board is recommended as the means of construction. A PC pattern and components placement guide are provided. Observe standard precautions when handling and soldering CMOS ICs 1 and 2. Sockets may be used if desired. The CA3080 IC in the TO-5 can is available in two different lead configurations. The "S" configuration has the

leads preformed in an 8 pin DIP (Dual Inline Package) pattern, where the "plain" configuration does not. If necessary, form the leads in an 8 pin DIP pattern prior to insertion. After all components are installed, perform final wiring.

Any suitable case may be used to house the project (although a case is not actually necessary). The case may be marked as shown in the photo using transfer lettering or other similar marking methods. A suitable holder for the two 9 volt batteries can be formed from a 1" by 3" strip of aluminum. Drill a 3/16" hole in the center of the strip and form it into a stubby "U" shape, the two shorter sides being 3/8" each. Drill a 3/16" hole in the bottom of the case and pass a #6-32 x 1" machine screw through the hole, between the two batteries and on through the

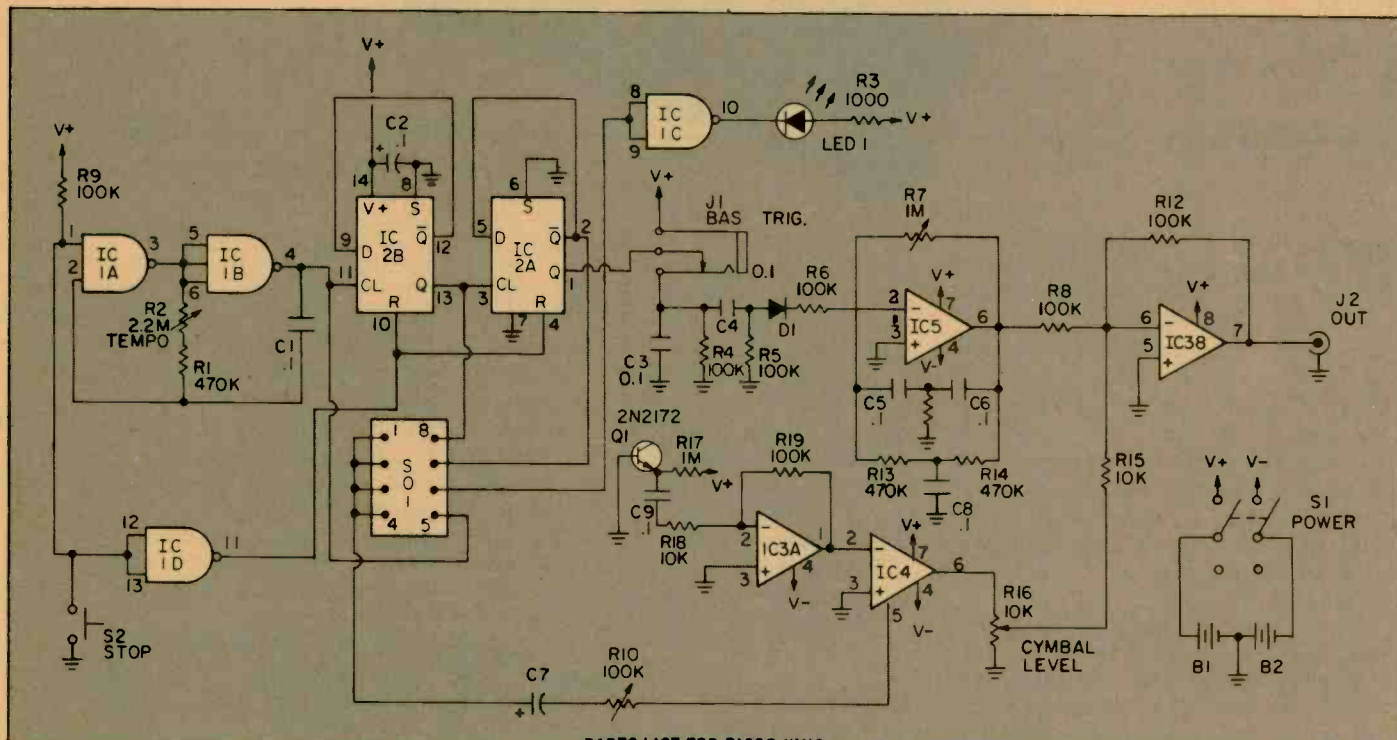

## PARTS LIST FOR DISCO KING

- B1, B2—9-volt battery
- C1, C3, C4, C5, C6, C8, C9—1- $\mu$ F capacitor, disk ceramic, 25VDC
- C2, C7—1.0- $\mu$ F electrolytic capacitor (radial leads), 10VDC
- D1—1N4148 or 1N914 diode
- IC1—4011 Quad 2-input CMOS NAND Gate
- IC2—4013 Dual CMOS D Flip Flop
- IC3—Dual 8-pin Op Amp (5558, LM1458 or similar)
- IC4—Transconductance Op Amp (CA3080 or CA3080S or similar)
- IC5—741 Op Amp (8-pin DIP)
- J1—Phono jack, closed circuit, 1/4-inch
- J2—Phono jack, open circuit, 1/4-inch
- LED 1—Light Emitting Diode, type NSL5053, TIL32 or similar
- Q1—2N2172 transistor

- R1, R13, R14—470,000-ohm resistor, 1/4-watt
- R2—2.2 Megohm linear taper potentiometer, 1/2-watt
- R3—470-ohm resistor, 1/4-watt
- R4, R5, R6, R8, R9, R12, R19—100,000-ohm resistor, 1/4-watt
- R7—1 Megohm trim potentiometer, 1/4-watt
- R10—100,000-ohm trim potentiometer, 1/4-watt
- R11—4700-ohm resistor, 1/4-watt
- R15, R18—10,000-ohm resistor, 1/4-watt
- R16—10,000-ohm linear taper potentiometer, 1/2-watt
- R17—1 Megohm resistor, 1/4-watt
- S0—8-pin DIP socket
- S1—DPST slide switch
- S2—Momentary pushbutton switch, N/O (normally open)

Misc.—Suitable enclosure, aluminum strip, knobs, wire, solder, hardware, etc.

Note: The following are available from BNB Kits, RD #1, Box 241H, Tennent Road, Englishtown, N.J. 07726; Parts Kit (DK-1) consisting of all electronic parts, controls, switches, jacks, wire and etched and drilled P.C. Board at \$18.95. Etched and drilled P.C. Board alone (DK-1PC) at \$5.95. Prices include handling and U.S. Postage. Canadian residents please add \$1. U.S. Funds only. Please allow 3 to 6 weeks for delivery.

Note: Blank case as shown in photo available from Continental Specialties Corporation, 44 Kendall Street, P.O. Box 1942, New Haven, CT 06509 (DMC-2). Write for current price.

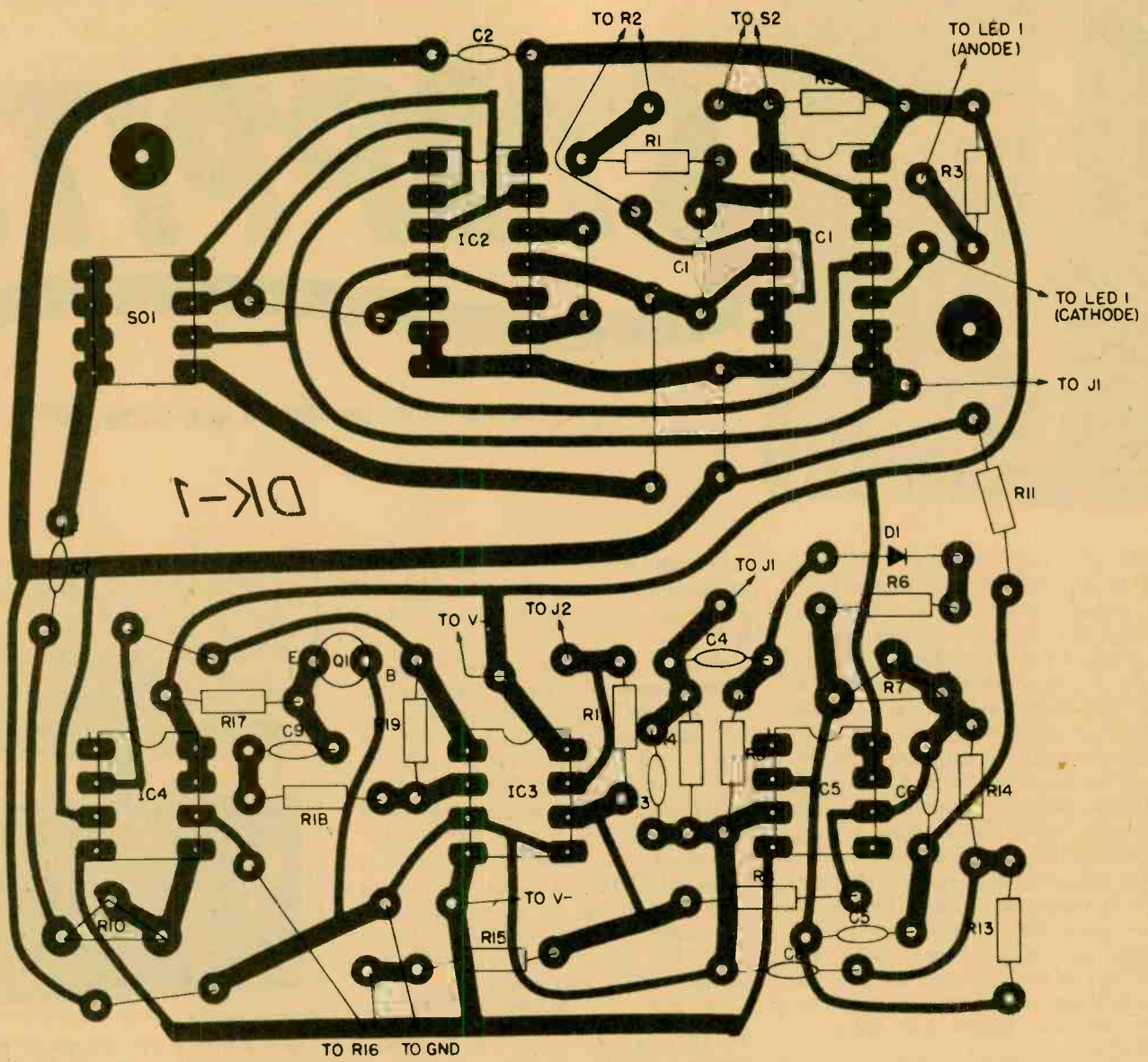

The overlay, shown above, provides you with the placement of all on-board components, as well as the wiring connections for the switches and jacks. Take care to observe correct polarity for diode D1. This view of the board is foil side down, with the parts on top.

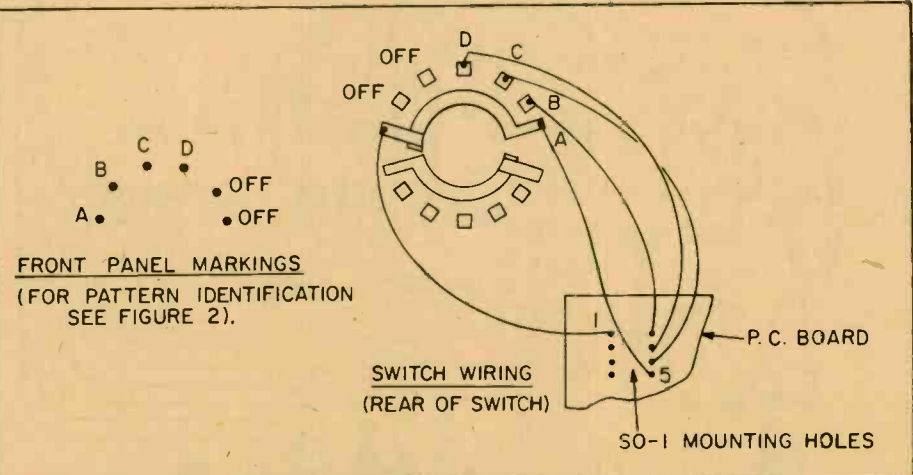

Here's an easy modification to our Disco King! Our own unit uses jumper wires in the SO-1 socket to change the beat but if you'd like a rotary switch could be installed.

hole in the holder. Secure the holder with a #6-32 nut.

**Initial Adjustment and Checkout.** Set Trim Potentiometers R7 and R10 and controls R2 (*Tempo*) and R16 (*Cymbal Level*) to mid position. Connect the output of the unit to a music amplifier or hi-fi. When power is applied, you will hear a repeating base drum sound. Adjust R7 for a non-boomy, short duration "thud" sound. Form a jumper from a short length of #20 or #22 solid wire and insert it into pins 4 and 5 of socket SO-1. Set R2 for medium speed and adjust R10 for a short duration cymbal sound. This completes the adjustments required. To insure the unit is performing properly, check the following. Note  
(Continued on page 97)

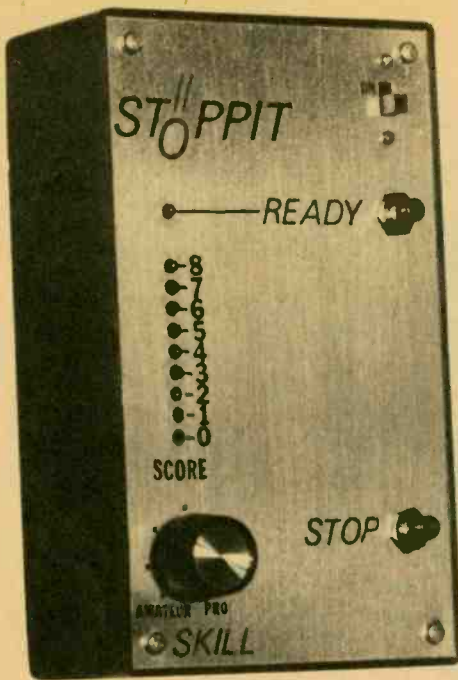

# STOPPIT!

Are your reflexes faster than a speeding LED?

**H**OW FAST CAN YOU REACT? One way to find out is by playing our LED game, named *Stoppit*. Start by pressing and holding the *ready* button. The ready LED will light and remain on for an unspecified time. Then the light will begin "falling" at a speed determined by the *skill* control (the illuminated light will extinguish and the one below it will go on, and so forth). If the zero position is reached, this light will remain on until the game is reset by pressing the *ready* button.

The object of the game is to stop the action as quickly as possible (thus earning a high score) by momentarily depressing the *stop* button. Since the *ready* button must be held down until the action starts, you must be quick to reach the *stop* button and obtain a high score.

Stoppit uses readily available CMOS devices, is powered by a single 9 volt battery and can be built for between \$15 and \$20.

**How It Works.** The "heart" of Stoppit is a 4017 CMOS Decade Counter with decoded outputs. It contains 10 output pins that are sequentially energized (count from 1 to 10) with each input clock pulse. Only one output at a time is high. A high input to reset pin 15 will set the count to 1. A high input to enable pin 13 will stop the counting.

As seen in the schematic diagram, the decade counter's (IC2) outputs drive 10 inverting buffers. When any one of the counter outputs goes high, the corresponding buffer output goes low and sinks sufficient current to allow the associated LED to light. R7 limits the current drawn by the LED. The last output (pin 11) is also connected to the *enable* pin. This output

is low until the last count, allowing IC2 to sequence. At the last count, pin 11 goes high, energizing L1 and disabling IC2.

Another way of stopping the count is by stopping the input clock signals. IC1, a Quad 2-input NAND gate serves two purposes. It is used to form a gated clock oscillator (IC1C and D) and an R/S (Reset/Set) Flip Flop (IC1A and B). When S1 is closed, a negative pulse is transmitted through C2 which resets the R/S Flip Flop through D2. This causes the "Q" output (Pin 4 of IC1B) to go low and the "Q" output (Pin 3 of IC1A) to go high. The negative pulse is also inverted in IC3F and resets IC2. At the same time, C1 begins to discharge

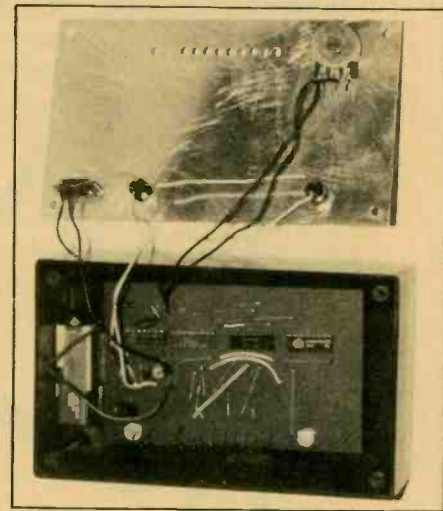

The LEDs are mounted carefully on the PC board so that they just fit through the holes in the front panel. You may have to fiddle around with the spacing between the PC board and project box. The diagram below shows how the various components fit on the PC board.

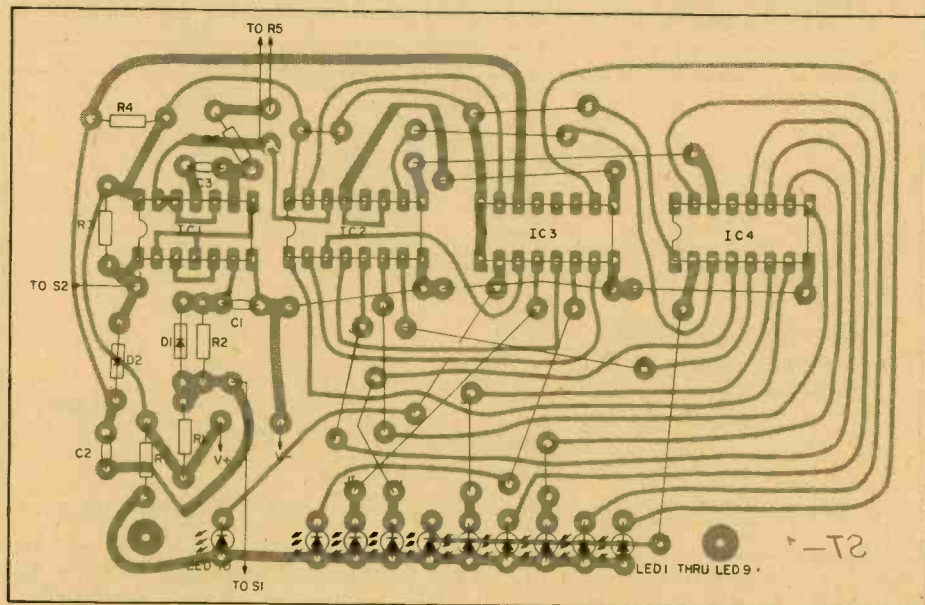

through R2 and S1 to ground. When the voltage across C1 decays to the CMOS low level ( $\frac{1}{2}V^+$ ), the R/S Flip Flop is set, forcing the "Q" output high and the "Q" output low. The high "Q" output enables the clock oscillator and allows IC2 to begin counting at a rate determined by R5 (Skill), R6 and C3. R6 limits the upper frequency of the clock oscillator. Closing S2 (Stop) resets the R/S Flip Flop, disabling the clock and stopping the count. Since the set pin of the Flip Flop must be high before it can be reset, S1 must be released to allow C1 to recharge through R1 and D1 before S2 has any affect. Since R1 is relatively small, C1 recharges "instantaneously." Thus, in operation, S1 is depressed until the counting begins. S1 is then released and S2 is quickly closed to stop the count. Power is supplied by a 9 volt battery.

**Construction.** Stoppit can most easily be assembled using our PC Board layout and components placement. In this way, all components except for the switches and *skill* control are mounted directly on the board. Note that there are 18 jumpers, 3 of which are insulated. Standard handling precautions should be observed for the CMOS devices and I.C. sockets may be used. To be compatible with the PC Board layout,  $\frac{1}{8}$ " diameter LEDs should be used. The leads should be long enough so that, when mounted, the top of the LED is at least  $\frac{3}{4}$ " above the PC Board. Mount the LEDs so that they form a straight line and are of uniform height. The finished unit can be mounted in any convenient case. A simple battery holder can be made from a  $\frac{3}{4}$ " x  $1\frac{3}{4}$ " piece of aluminum stock by forming it into a "Z," the vertical portion of the "Z" being the dimension of the wider side of the battery. A hole can then be drilled in the lower horizontal portion of the "Z" so that it can be anchored to the bottom of the case with a machine screw and nut.

**Playing The Game.** When the unit is first turned on, the lights will sequence and stop on the *zero* position. Place the *skill* control near the *amateur* position. Depress and hold the *ready* button. After a few seconds, the *ready* LED will extinguish and the numbered LEDs begin to sequence. As soon as this happens, release the *ready* button and momentarily depress the *stop* button. Repeat this process five times, noting your score each time. Your total score is then the sum of the five individual scores. As your proficiency increases (as noted by an increased total score), advance the *skill* control. You may wish to challenge your family or friends in a test of quick reactions. ■

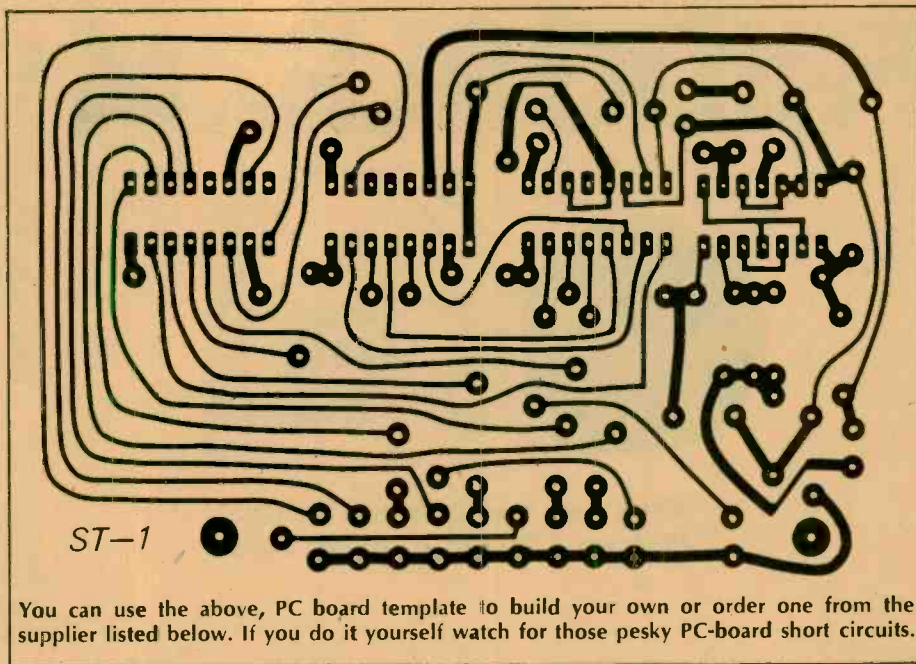

You can use the above, PC board template to build your own or order one from the supplier listed below. If you do it yourself watch for those pesky PC-board short circuits.

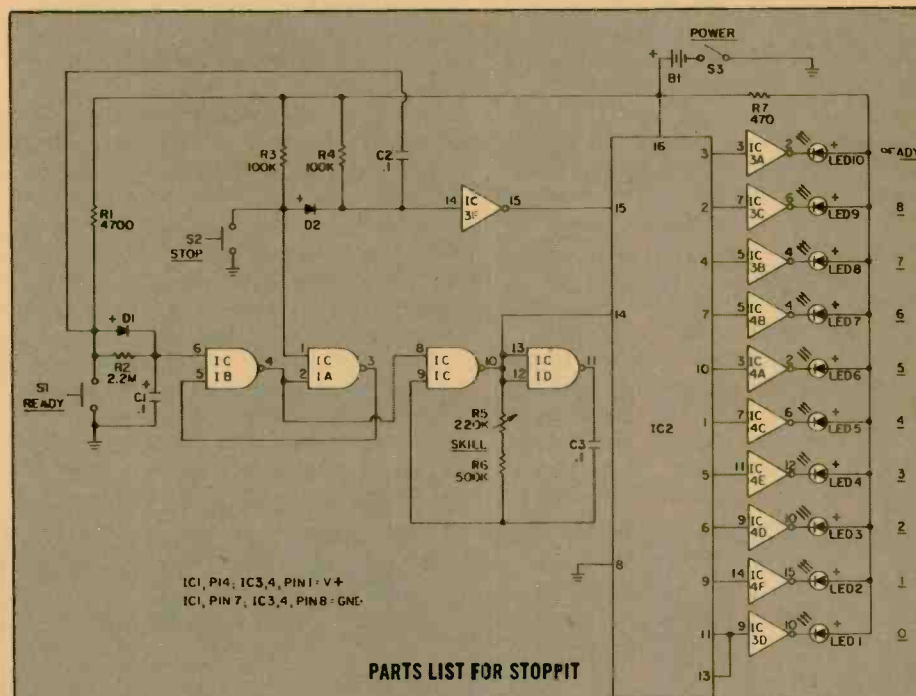

- C1—1-uf, 10 volt electrolytic capacitor
- C2, C3—0.1-uf, 25 volt disk capacitor
- D1, D2—1N4148 or 1N914 diode
- 4011 Quad 2-Input NAND Gate (CMOS)
- 4017 Decade Counter with Decoded Outputs (CMOS)
- 4049 Hex Inverting Buffer (CMOS)
- LED 1—LED 10— $\frac{1}{8}$ " dia. LED (Such as Continental Specialties Corp. LD-12)
- R1—4700-ohm,  $\frac{1}{4}$  watt resistor
- R2—2.2 Megohm,  $\frac{1}{4}$  watt resistor
- R3, R4—100,000-ohm,  $\frac{1}{4}$  watt resistor
- R5—220,000-ohm,  $\frac{1}{4}$  watt resistor
- R7—470 ohm,  $\frac{1}{4}$  watt resistor
- R6—470,000 or 500,000-ohm,  $\frac{1}{2}$  watt potentiometer (Audio Taper)
- S1, S2—Pushbutton Switch, normally open

- S3—SPST slide switch
- Misc—9 volt battery and battery clip; suitable case (such as Radio Shack 270-627); one knob; two #5-32 x  $1\frac{1}{4}$ " machine screws and nuts; one #6-32 x  $\frac{1}{2}$ " machine screw and nut, wire, etc.

Note—The following are available from BN& Kits, R.D. #1, Box 241 H, Tennent Road, Englishtown, N.J. 07726: Kit containing all parts and P.C. board (less case and mounting hardware) (STOPPIT) at \$17.50; P.C. Board only (STOPPIT-PC) at \$6.00. Prices include postage and handling. Canadian residents please add \$1.00. U.S. Funds only. N.J. residents add 5% sales tax. Please allow 3 to 6 weeks for delivery

# FRIDGALARM

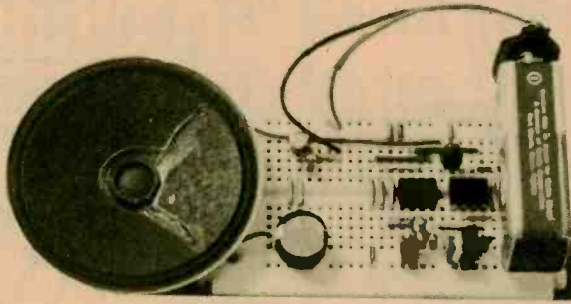

Keep your waistline and electric bill down with this door-ajar alarm.



EVERY CREATURE IN THE WORLD has its natural enemies and the refrigerator is no different. Perhaps the most dangerous of the ice box invaders are dieters and children. Either is likely to lodge in front of the door and stare longingly inside, feverishly calculating which item would be least likely missed. Inevitably, as the hours of openness pass, a layer of permafrost grows inside that requires a chisel and a contingent of National Guardsmen to remove, and the electric bill rises ever the higher heavenward.

In our households, frugality is the mother of invention, so we followed our pursestrings to the workbench, grabbed a handful of parts, and created the Refrigerator Alarm. Now, should one of the pantry predators decide to

camp out in a lean-to made from the ice-box door for longer than our preset interval, the alarm lets out a piercing squeal until all the cold is again locked safely within.

**The Circuit.** Our circuit is based on a pair of versatile 555 timer chips and a photoresistor, and offers not only a useful project, but also a quick and fun lesson on how each part works. One of the 555s is used to time the period before the alarm goes off (the filching interval). The other generates a tone that serves as the alarm proper.

Let's start at the beginning and see exactly what makes the alarm work. The photoresistor is used to detect the lamp that lights inside the refrigerator to let you see how good the pickings are. The circuit is sensitive enough,

though, to trigger even if the bulb has burned out. Once the door is closed, the inside of the average refrigerator is dark, really dark, and opening it changes the light level enough that it can easily be electronically detected.

The photoresistor R6 is a light-sensitive resistor. The more light it sees, the less it wants to conduct electricity and the higher its resistance becomes. In total darkness, its resistance is low enough that it effectively shorts the base of transistor Q1 to ground so that Q1 will not conduct. (Q1 is actually operating as an inverting amplifier.)

Resistor R1 limits the current through R6 and is effectively the only current-consuming element in the circuit when no light is present. The light sensitivity of the alarm can be adjusted to some degree by varying the value of R1.

When the light goes on, the resistance of R6 increases, and there is a corresponding voltage drop across it. When this voltage becomes great enough, Q1 begins to conduct and supplies current to the circuitry.

U1 is the timer, determining how much time must pass after the light goes on and Q1 turns on, before the alarm is triggered. U1 is set up for astable operation to conserve battery life once the alarm sounds. In other words, it functions as a long-period oscillator, turning the sound on and off.

The initial timing period is determined by the time it takes to charge C1 two-thirds of the way up through R2 and R3. (The regular on and off periods of the alarm are one-half this value, because the 555 only discharges C1 to one-third of its capacity, hence C1 oscillates in charge between 1/3 and

(Continued on page 97)

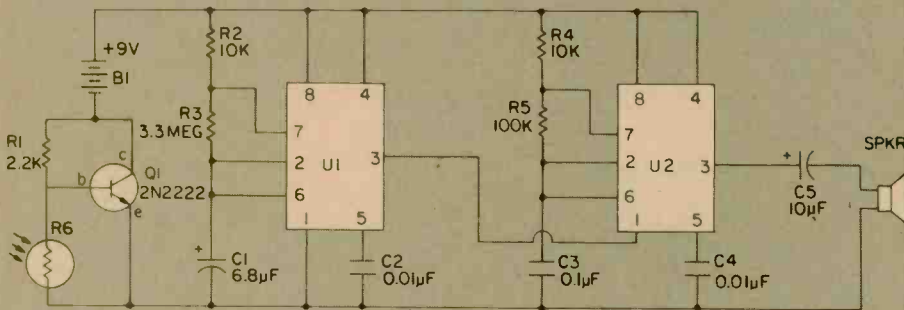

## PARTS LIST FOR FRIDGALARM

- |  |   |
|--|---|
| B1—9-volt transistor radio battery                   | R5—100,000-ohm, 1/4-watt resistor, 10%  |
| C1—6.8- $\mu$ F tantalum capacitor, 25-VDC           | R6—photoresistor (CdS type) 5-Megohm to 100-ohm resistance range—Radio Shack #276-116 |
| C2, C4—0.01- $\mu$ F ceramic disc capacitor, 100-VDC | SPKR—8-ohm PM miniature speaker   |
| C5—10- $\mu$ F electrolytic capacitor, 15-VDC        | U1, U2—555 timer  |
| Q1—2N2222 general purpose NPN transistor             | MISC—battery clip, breadboard, etc.   |
| R1—2,200-ohm, 1/4-watt resistor, 10%                 |   |
| R2, R4—10,000-ohm, 1/4-watt resistor, 10%            |   |



# the new Shell Game

Step right up and build this semiconductor con game

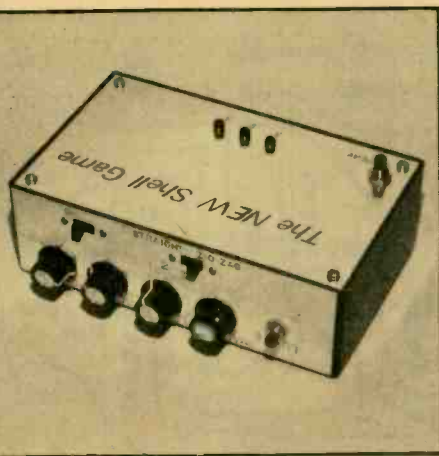

**YOU WILL HAVE** to be alert to win at *The New Shell Game*. In this electronic version of the famous carnival shell game, the electronic "pea" is manipulated in full view, rather than hidden under one of three walnut shells. As the game starts, the three light emitting diodes (LEDs) are dark. The operator presses the *start* button, a single LED lights and then moves back and forth in a straight or zig-zag pattern. After a time, the light goes out. The player's job is to follow the light's movement in an effort to determine which one was on last.

How fast the light moves, the total time of the manipulation, which light is on last, and for how long, are all con-

trolled by the operator. The operator also selects either the straight or zig-zag sequencing pattern. The controls allow a full range of settings, from one that is fully obvious, to one that is totally misleading.

The skill of the player is pitted against that of the operator in this project that uses readily available CMOS devices, is powered by a single 9 volt battery, and can be built for about \$20.00.

**How it Works.** As shown in the schematic diagram, flip-flops IC1 and IC2 form a four stage shift register. When *start* switch S3 is depressed, a logic "1" is loaded into IC1a through the *set* input, while all other stages are set

to zero. As the shift register is clocked, the "1" bit continually circulates like a standard ring counter. Outputs 2 (IC1b), and 4 (IC2b) are combined in the discrete OR gate made up of D1, D2, and R3. The 1, 2 (or 4) and 3 outputs drive LEDs 1, 2, and 3 respectively.

NAND gate IC3 and associated components form a one-shot (monostable) multivibrator. When S3 is depressed, C3 discharges rapidly through D4, and drives the IC3c gate output high. When S3 is released, C3 charges through R5 and R6 with a time constant proportional to  $[C3 \times (R5+R6)]$ . When the voltage across C3 reaches 4.5V (the CMOS logic level), the output of IC3c

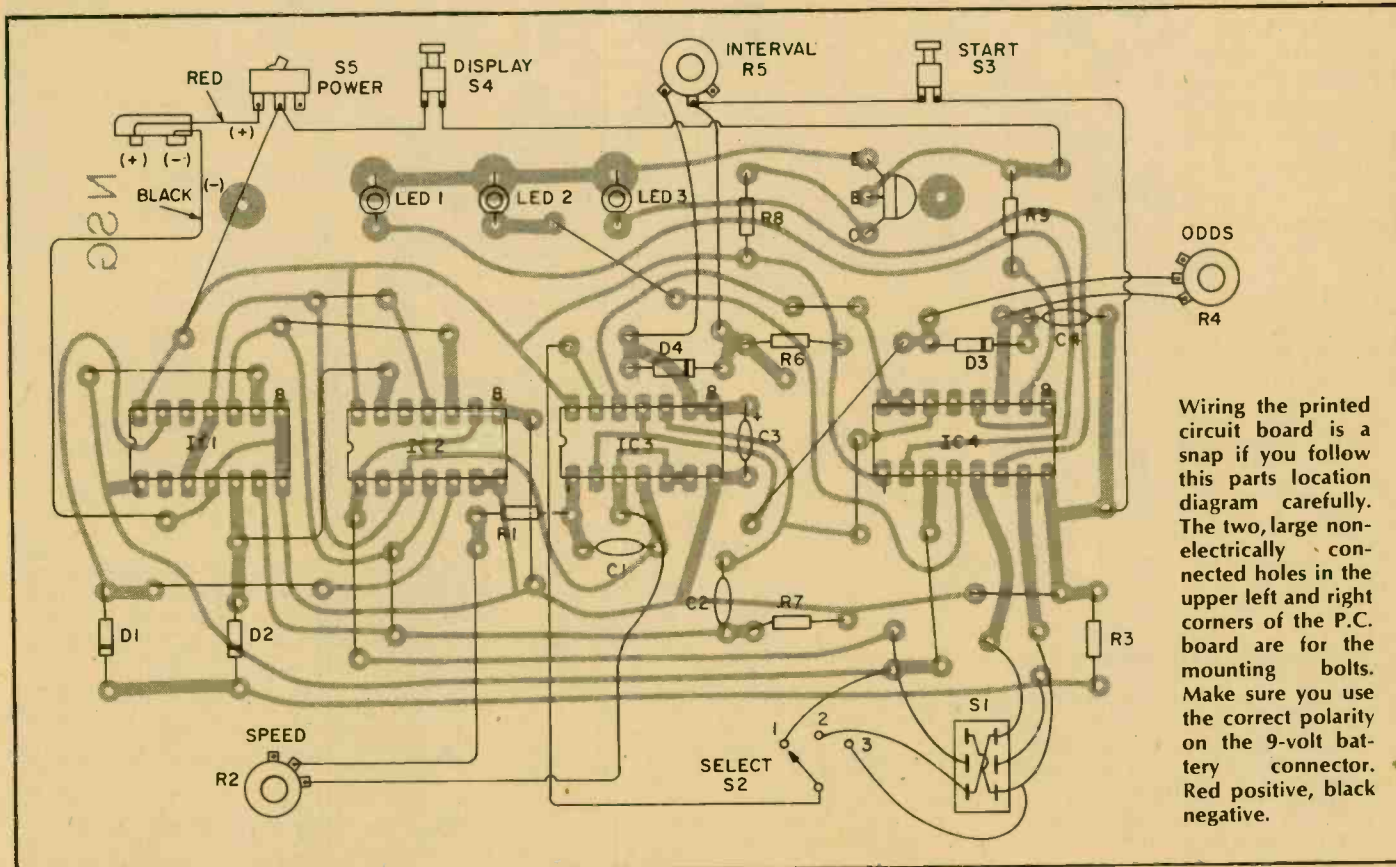

Wiring the printed circuit board is a snap if you follow this parts location diagram carefully. The two, large non-electrically connected holes in the upper left and right corners of the P.C. board are for the mounting bolts. Make sure you use the correct polarity on the 9-volt battery connector. Red positive, black negative.

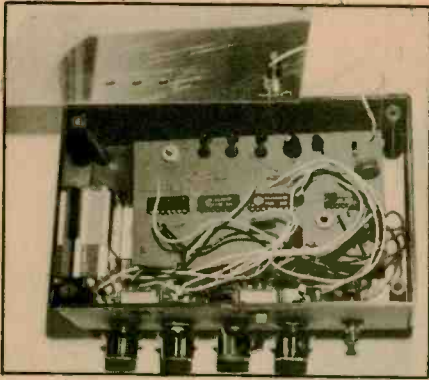

The three LEDs must be carefully soldered to the PC board so that they will just fit through the holes in the project faceplate.

To the right is the full-sized printed circuit board template for New Shell Game.

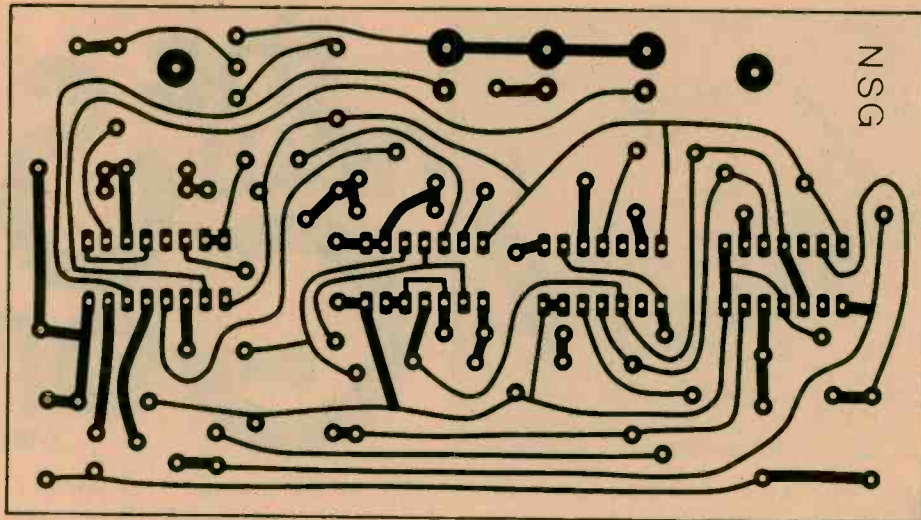

returns to the low level. The positive portion of the IC3c output is differentiated by the C2, R7 combination which provides a *set* pulse to IC1a and a *reset* pulse to the other flip-flops. The output of IC3c is also inverted in IC4f and provided to IC3d. The other input to IC3d is one of the three shift register

outputs routed through *select* switch S2. Thus, when S3 is depressed, the output of IC3d goes high, enabling the clock. The clock is simply an oscillator (made up of IC3a and B, R1, R2, and C1) which is controlled by the output of IC3d. Aside from turning on the clock, the output of IC3d also charges

C4 through D3. When the voltage IC4d goes high, and turns on driver across C4 reaches 4.5V, the output of transistor Q1. This furnishes power to the LEDs, allowing them to light when driven by either IC4a, IC4b or IC4c.

At the end of the one-shot interval, (Continued on page 96)

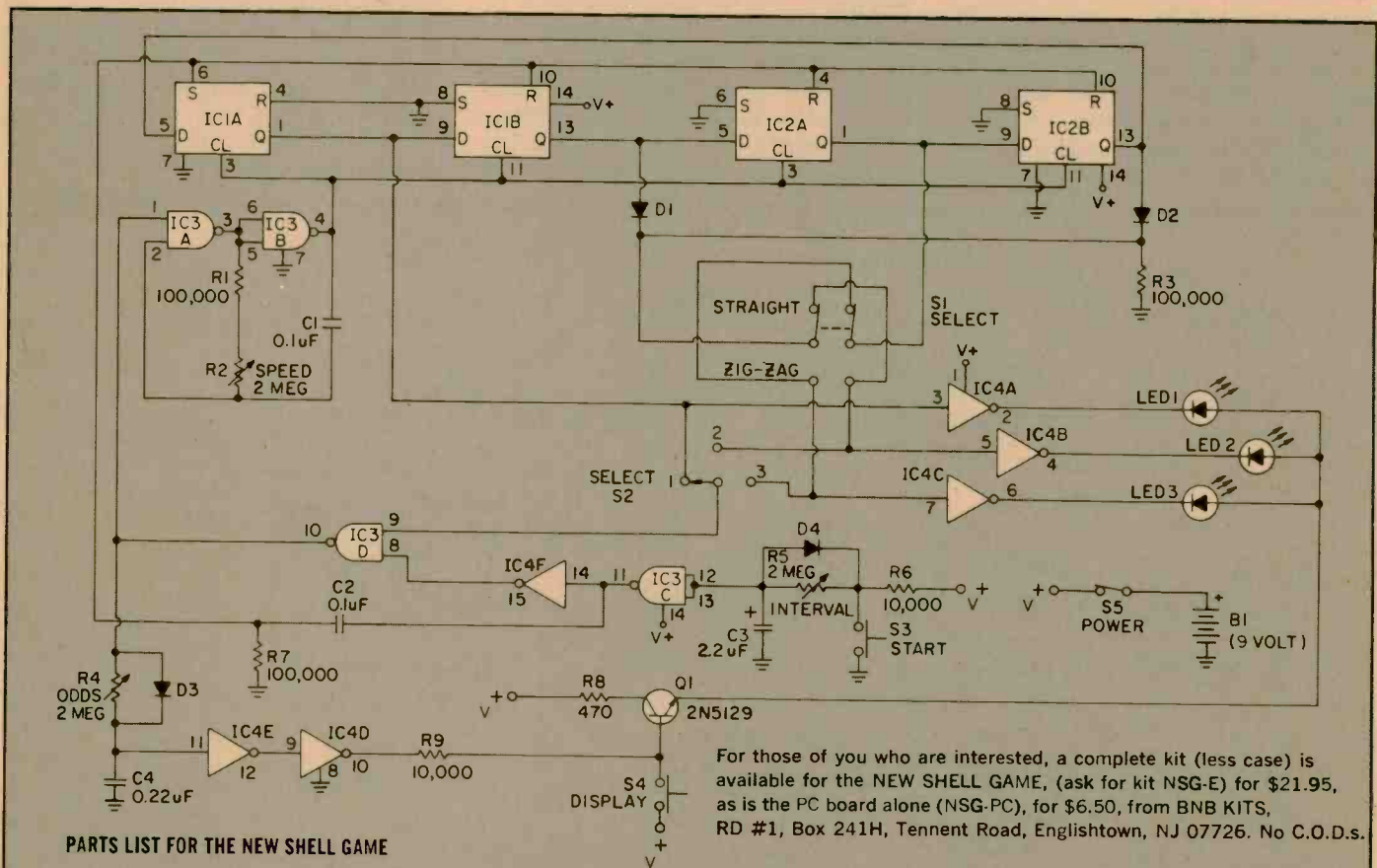

**PARTS LIST FOR THE NEW SHELL GAME**

- C1, C2—0.1- $\mu$ F ceramic disc capacitor, 10 VDC
- C3—2.2- $\mu$ F electrolytic capacitor, 10 VDC
- C4—0.22- $\mu$ F ceramic capacitor, 10 VDC
- D1, D2, D3, D4—1N4148 or 1N914 diode
- IC1, IC2—4013 dual flip-flop
- IC3—4011 quad NAND gate
- IC4—4049 hex inverter w/ buffer

- LED1, LED2, LED3—small, red LED
- Q1—2N5129 transistor
- R1, R3, R7—100,000-ohm, 1/4-watt resistor
- R2, R4, R5—2,000,000-ohm, linear-taper potentiometer
- R6, R9—10,000-ohm, 1/4-watt resistor
- R8—470-ohm, 1/4-watt resistor

- S1—DPDT slide switch
- S2—1-pole, 3-position rotary switch
- S3, S4—SPST momentary-contact pushbutton switch
- S5—SPST slide switch
- Misc.—battery clip, mounting case, hookup wire, knobs, etc.

For those of you who are interested, a complete kit (less case) is available for the NEW SHELL GAME, (ask for kit NSG-E) for \$21.95, as is the PC board alone (NSG-PC), for \$6.50, from BNB KITS, RD #1, Box 241H, Tennent Road, Englishtown, NJ 07726. No C.O.D.s.

# BIG BOOST

This inline preamp puts more punch in your mike



WHEN THE VOCALIST can't make it over the bass player, or the lead guitar gets buried behind the rhythm section, or the audience can't tell the keyboard player is really tickling the ivories, that's the time you need a big boost in preamplification between the performers and the amplifiers. And that's just what you'll get from Big Boost, a self-contained mike/guitar/keyboard preamp you can plug directly into the amp, or into the mike or instrument itself.

**Big Features.** Though the Big Boost is a simple one-transistor project, it has several features specifically intended for rock or dance band use, or just for straight vocal amplification. First off, the Big Boost contains its own battery power supply, a standard 9-volt transistor radio battery operating at only 1 mA drain. Next, it is virtually overload immune; whether driven by a mike or the signal from an electric guitar pick-up (about 0.1-volt) the output signal is

not driven into clipping. As for gain, it's a whopping 25 dB, almost "ruler flat" from 100 Hz to about 20kHz. If you need extra bass for a keyboard, simply change C1 to 0.1- $\mu$ f. Finally, the whole device is assembled in a palm-sized metal cabinet, and using a Switchcraft phone plug-to-phone plug adaptor, you can plug the Big Boost directly into an amplifier input. Or, because it's also unusually light, you can plug the preamp into the guitar or keyboard so the volume control is directly at the instrument.

**Assembly.** The unit shown in the photographs was assembled inside of a 2 $\frac{3}{4}$  by 2 $\frac{1}{8}$  by 1 $\frac{5}{8}$ -inch Mini-Box. Admittedly, it's a tight fit, but it can be done if input and output phone jacks J1 and J2 are installed  $\frac{1}{8}$ -inch off-center on each end (make certain they are offset to the same side). This should leave just enough clearance for battery B1 on one side. Rotate J1 and J2, and bend their lugs if necessary, until you are certain the battery will fit with the Mini-Box's cover in place.

Potentiometer R5 is the volume control, and the miniature type specified in the parts list must be used if you want to get everything in a miniature cabinet. You must be certain R5 will not interfere with insertion of plugs into J1 and J2. It might appear that there's lots of room, but there really isn't. To avoid problems, it's best to insert a dummy plug into both J1 and J2 while marking R5's mounting spot.

R1 is supplied with a DPDT switch, S1a and S1b. Take note that some types have only two wire lugs for each switch

section, the third connection being a rivet through which the builder sticks the component lead before soldering. Don't think something is wrong with the potentiometer because each switch section has only two lugs. Remember, the third connection for each switch is a solder-rivet.

No terminal strip is needed for assembly. All components are self-supported by simply twisting them together and soldering. If you keep the connecting leads as short as possible, the assembly will be sufficiently rigid to take the most rugged handling without shorts or "sound dropouts." It will all squeeze in nicely if the resistors used are  $\frac{1}{4}$ -watt units, and the capacitors are the miniature mylar printed circuit type (both leads from the same end) available from Radio Shack.

As with the mounting of R5, double-check that inserting a plug into J1 or J2 does not touch any wire or compon-

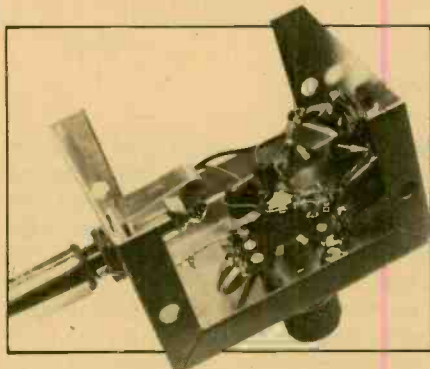

Use the jacks and volume control leads to wire up your amp point-to-point. Parts layout is not critical with this project.

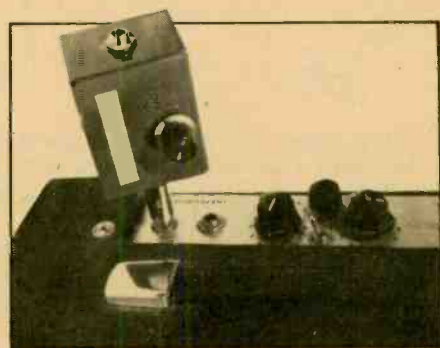

Use of the double male phone plug allows placement of the preamp at the amp's control head or right at mike stand.

# BIG BOOST

ent. Again, your best bet is to wire the project with dummy plugs installed.

**Checkout.** Install a battery, rotate R5's shaft until you hear the power switch click, and then check the voltage from Q1's collector to the cabinet. It should be about half the battery voltage (4 to 5-volts). If it's excessively high, around 8-9 volts, or excessively low, 1-2 volts, you have either made a wiring error or substituted an improper transistor for the specified Q1.

Connect a mike or an electric instrument's output to the Big Boost input and connect the preamp's output to your main amplifier's input. Advance R5 as you speak into the mike or play the instrument. The volume should increase as R5 is advanced. If it doesn't, you have wired S1a/S1b incorrectly. Note that when R5 is fully counterclockwise (off) the battery is disconnected and J1 is connected through S1a directly to J2. When R5 is advanced, closing S1, the battery is connected and S1a connects the preamp's output via R5's wiper to J2.

**Plug to Plug.** While you can use patch cords to connect the Big Boost to your equipment, it's usually a lot more convenient and less of a hazard if the Big Boost is right at the amplifier input. Professional musicians do this by us-

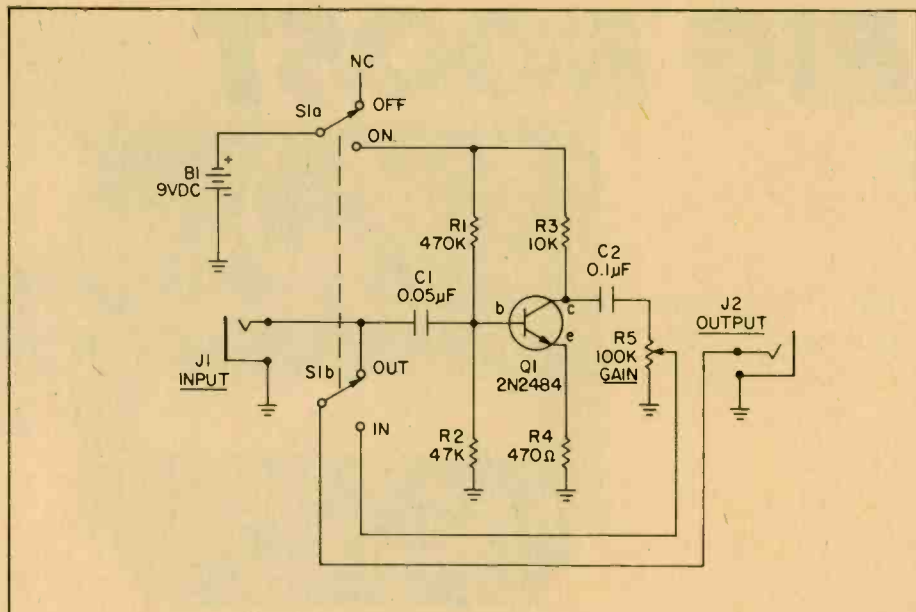

PARTS LIST FOR BIG BOOST

- |   |  |
|---|--|
| B1—9-volt transistor battery                  | R3—10,000-ohm, ¼-watt resistor, 10%  |
| C1—0.05-μF, 15 VDC mylar capacitor (see text) | R4—470-ohm, ¼-watt resistor, 10%   |
| C2—0.1-μF, 15 VDC mylar capacitor             | R5—100,000-ohm audio taper potentiometer with built-in DPDT switch (Radio Shack part #271-216 or equiv.) |
| J1, J2—¼-inch standard phone jack             | S1—DPDT switch (part of R5)  |
| Q1—PN2484 NPN transistor                      | Misc.—cabinet, wire, battery clip, knob, phone plug (female-to-male) adaptor, etc.                       |
| R1—470,000-ohm, ¼-watt resistor, 10%          |  |
| R2—47,000-ohm, ¼-watt resistor, 10%           |  |

ing a special *phone plug-to-phone plug* adaptor sold at music instrument shops. You can use the adaptor for either the input or output. If desired, you can

plug the Big Boost directly into an electric guitar or keyboard output jack, and then use a regular patch cord to the amplifier's input. ■

# DIODE DIGEST

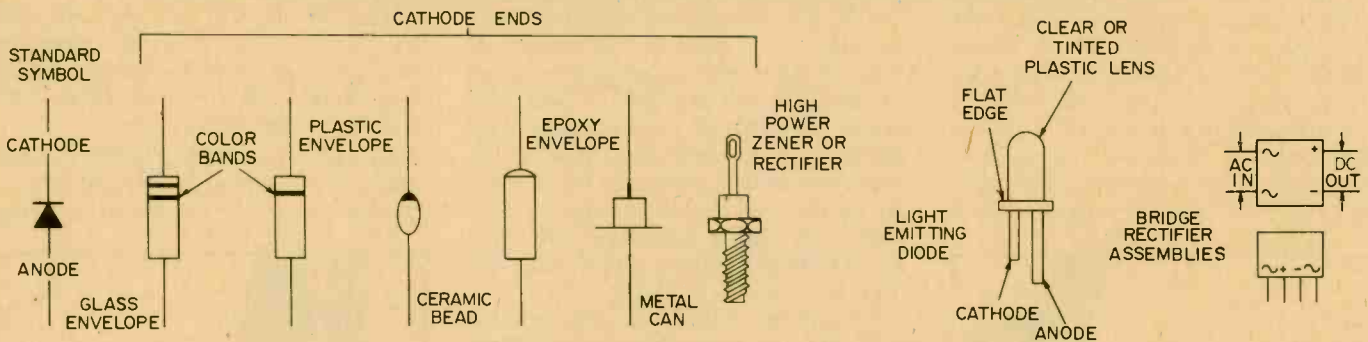

IT MAY SOUND SILLY, but it seems that a lot of people still don't know which end of a diode is up. A letter we received recently from O.M.S. of Guilford, Connecticut illustrates this point. He writes:

*"I have been trying for the last three months to purchase a power supply that I can use to power a walky-talky from house current. I've finally given up and decided to build my own. I have a transformer that converts 110 VAC to 12.6 VAC, some large filter capacitors salvaged from an old television, and some 'bargain bag' diodes I purchased from a discount store. The diodes are black, unmarked, and have one rounded end. Can I use them,*

*or will I have to shell out for ones with known values?"*

Of course, we couldn't be sure of just exactly what he had in hand, but from the description, and basing our guess on the chart, we were pretty sure that these were epoxy-encapsulated rectifiers, with probably about a 100 to 200-PIV rating. These would fill his needs if our guess was right. Although we haven't heard any more from that gentleman, we assume he didn't blow himself up. By tearing out the chart and pasting it up inside the cover of your spare parts box, you can have a handy reference guide for identifying the leads and types of whatever diodes happen to find their way into your hands. ■

BUILD THE LIL

# WAILER

Slip this small package into your pocket, walk down the street with one of your friends, and push the button; he or she will go crazy trying to figure out where the sound is coming from. You can "raid" your local poker group, or let it sound off at a party. We don't recommend using it within earshot of your local gendarme (unless you want to attract his attention) however.

Our 'Lil Wailer sounds like a police siren, and can be adjusted from a barely discernible cry to a scream that will attract attention for at least 100-feet around. It is rugged and small, and can be built in an evening or two with readily available parts.

**How it Works.** A combination of old and new technology is used in the design of the wailer. The heart of the circuit is the venerable unijunction (UJT) transistor. With power switch S1 on, and with trigger S2 depressed, capacitor C2 charges through Q1 until the level at the emitter of the UJT (Q2) causes it to fire. It discharges through R5 to create the basic siren tone. The voltage applied to the UJT charging circuit is varied to produce the ascending and descending pitch required. As S2 is held, capacitor C1 charges through R1, with the emitter voltage at Q1 "following." Thus, the UJT fires at a faster and faster rate, peaking when C1 is essentially fully charged. When S2 is released, C1 discharges through Q1, causing the voltage to the UJT charging circuit (R2, R3 and C2) to decrease, with the firing rate dropping slowly to zero. R3 provides an adjustment to select the most "authentic" tone.

The sawtooth-like waveform at the emitter of Q2 is then coupled through R6 and R7 to IC1, the LM386 audio amplifier. IC1, a 10-transistor linear amplifier, amplifies the waveform to a level sufficient to drive the tiny 8-ohm speaker through C3. The level at Q2's emitter is fairly high, so R6 and R7

divide it to prevent overdriving the amplifier, with R7 serving additionally as the volume control. The high value of R6 prevents loading down the UJT emitter circuit, ensuring proper operation of the device.

R4 and R5 are values typically associated with the unijunction transistor's characteristics. R4, in particular, was chosen to provide the best temperature stability of the circuit, a dubious requirement in this application. If a 2N2646 were to be used, R4 would be 2K. Due to another characteristic of the UJT, its *Intrinsic Stand-off Ratio*, use of the 2N2646 may increase the frequency of the tone, as compared to the 2N1671. It may be necessary to increase the value of R2 to 2.7K, or higher, in order to compensate.

The 2N2102 and the 2N1671B, were used in the author's wailer simply because of their availability from the "junk" box. A 2N2646 may be used, with the value of R4 adjusted as described above. Similarly, a 2N3646 or almost any inexpensive NPN silicon transistor will work, although if the device's gain is too high, the descending wail will be prolonged. The builder may wish to try neighboring values around C2, if the peak pitch, within the ad-

justment range of R3, is not completely suitable to his ears. In like manner, variations in C1 will cause a variation in the tone's rate of ascent and descent; a larger value for C1 slowing both processes.

**Construction.** Lay-out is not critical, except for the space allotted by the specified box. Perf-board was used because of the circuit's simplicity. The material used in the unit shown required additional holes drilled to mount the IC. Board material with 0.100-inch spacing would avoid that inconvenience. An IC socket may be helpful in protecting the amplifier during soldering, but since one wasn't handy, the chip was pushed flat against the board, bending over the unused leads to hold it in place.

The perf-board mounting brackets were bent from thin sheet stock and bolted to the enclosure so as to seat the board firmly against the speaker magnet. This keeps the heaviest part, the battery, from bending the board. Foam tape, strategically placed at the end of the battery and also on the cover, secures it nicely, making a rattle-free unit. Care should be taken to ensure that no contact is made between the switch terminals and circuitry on



# WAILER

the bottom of the board when the board is in place.

Although glue would likely be adequate to secure the speaker, four mounting brackets (see detail) were made from spade-tongue terminals. A piece of grill cloth was cemented inside the box to cover the five, 1/4-inch holes drilled to pass the sound.

**Checkout.** Before connecting the battery, carefully check all wiring, especially to the LM386. Then, connect the battery and flip S1 to "on." A soft click should be heard from the speaker as IC1 gets power. Set the pitch and volume controls at mid-point and hold S2 down. After a short delay, the siren should wail up, and volume can then be set at the desired level. Adjust the pitch control next for the desired "high-point" of the wail. Release S2 and the unit should wail down and stop—just like a police siren. Check for suitable wail-up and wail-down times by depressing and releasing S2.

After satisfactory operation is obtained, place the cover on the box, adjusting the foam tape as necessary to ensure a solid, rattle-free unit. Then, have fun with it, and just *try* to keep the kids' hands off of it!

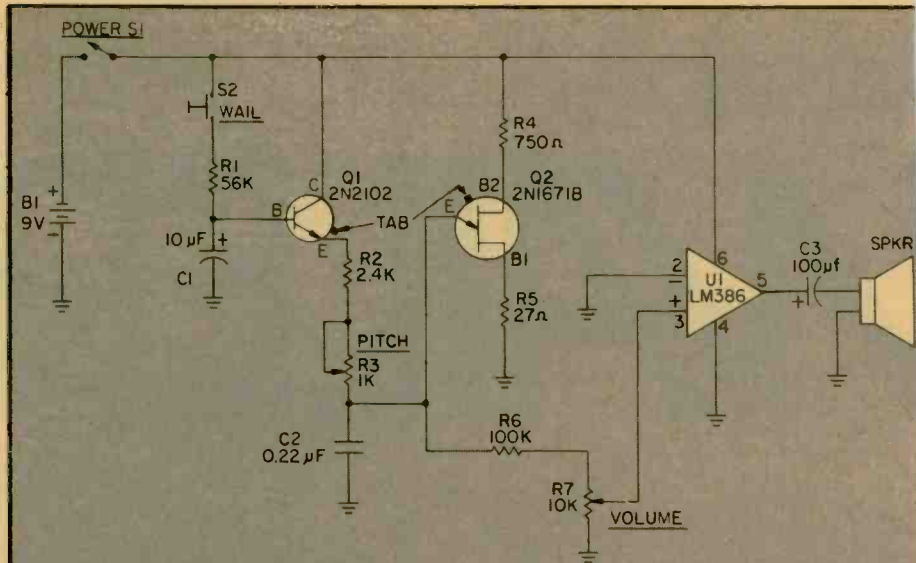

## PARTS LIST FOR 'LIL WAILER

- B1—9-volt transistor radio battery
- C1—10- $\mu$ F, 25-VDC electrolytic capacitor
- C2—0.22- $\mu$ F, 15-VDC mylar capacitor
- C3—100- $\mu$ F, 25-VDC electrolytic capacitor
- Q1—2N2102 NPN transistor (or equivalent, see text)
- Q2—2N1671 (or 2N1671A, or 2N1671B) uni-junction transistor
- R1—56,000-ohm, 1/4-watt resistor
- R2—2,400-ohm, 1/4-watt resistor
- R3—1,000-ohm, PC-type trimmer potentiometer
- R4—750-ohm, 1/4-watt resistor
- R5—27-ohm, 1/4-watt resistor

- R6—100,000-ohm, 1/4-watt resistor
- R7—10,000-ohm, PC-type trimmer potentiometer
- S1—SPST miniature toggle switch
- S2—SPST miniature pushbutton switch normally open
- SPKR—8-ohm, 2-inch miniature speaker
- U1—LM386 audio amplifier

MISC.—cabinet: 4-inches long, 2 1/8-inches wide, 1 5/8-inches deep (Bud # CU2102A), battery clip, perfboard, hardware, hookup wire, spade lugs (4), grille cloth, 8-pin DIP socket (optional), etc.

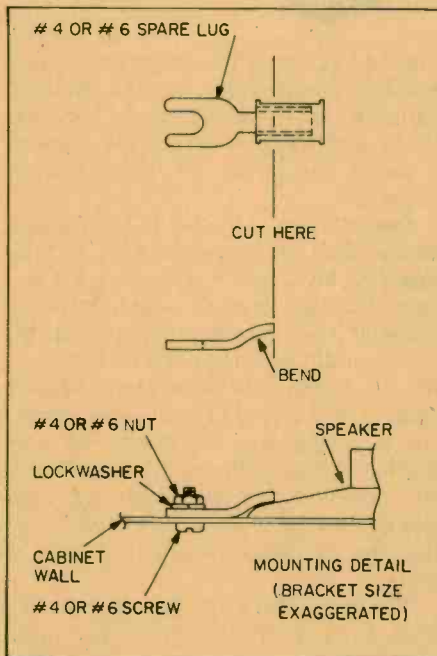

Here's a novel way to mount subminiature speakers that don't have tabs for mounting screws. A few spade lugs bent to the proper angle will solve the problem. You might use this same method (on a larger scale, of course) to flush-mount speakers in your car, where space doesn't allow for running screws through the mounting tabs in the speaker frame, as on door mounts.

At right is a photo, and below is a placement diagram, showing how the project goes together on perfboard. Both the photo and the diagram are just about to scale, so you can get an idea of how compact the Wailer will be when completed. With a little ingenuity it can possibly be made even smaller for pocket use.

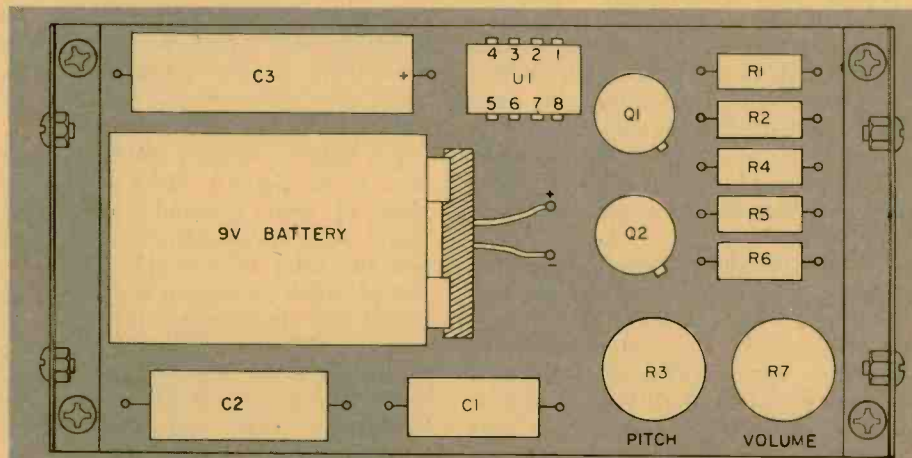
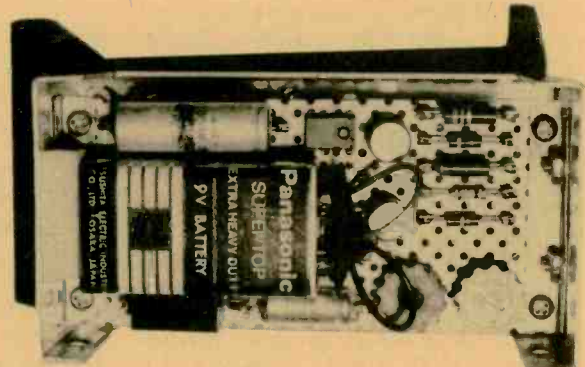

# Dashboard Digital Voltmeter

Keep an electronic eye on the voltage level of your vehicle's electrical system

**Y**OU'RE MAKING TIME down the interstate at three in the morning, and all of a sudden you become aware that the lights on the dash seem kind of dim, and that the headlights don't seem to be reaching out as far ahead to warn you of darkened semis parked on the shoulder. Are your eyes just playing tricks on you, or is there something the matter with your car's electrical system? A quick glance down at the three glowing LED numerals on the dash gives you the instant answer. Either you pull into a rest area and grab a few hours of shuteye, or you pull into a service area and have the battery, alternator and voltage regulator given a good scrutinizing by the mechanic.

In either case, your car's digital voltmeter has given you the information sought about the state of the electrical system, and maybe saved you either a headache, a smashup, or a king-sized repair and towing bill. Maybe all three.

Recent advances in the design and availability of industrial integrated circuits have opened up many doors to the electronics hobbyists. Analog-to-digital devices have become more complex internally, thus making the portions of the circuitry which have to be assembled by the hobbyist that much more simple. The Dashboard Digital Voltmeter takes advantage of these advances, utilizing three ICs and a small handful of discrete components to give you an instrument capable of better than  $\pm 1\%$  accuracy in reading the voltage level delivered by your car's (or boat's) electrical system.

**Two New ICs.** The system is built about three ICs: the LM340T-5 (a 5-volt regulator now available for several years); a CA3162E; a CA3161E; and a support combination of diodes, resis-

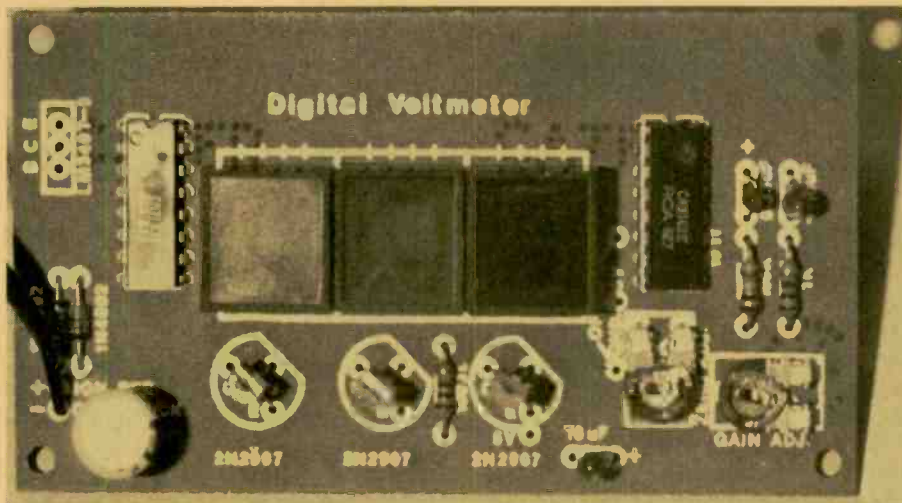

tors, and capacitors. It is the CA3161E and CA3162E that now open the door to new horizons in possible applications not only because of their unique capabilities, but also because they reduce substantially the numbers and types of formerly required support components. The heart of this system is the CA3162E, a dual-slope, dual-speed, A/D converter industrial chip. Its almost equally important companion, the CA3161E, is a BCD, 7-segment, decoder/driver chip. It is also unique in that it has a current-limiting feature. This eliminates the necessity of resistors in series with the 7-segment displays that were required in earlier designs.

The above feature not only reduces circuit board space requirements, but reduces the probability of component failure. Power required to operate this voltmeter is minimal (160 mA or less), a result of the multiplexing feature of the CA3162E. With that as a background, let's consider some of the more important operations of this simple, but very accurate digital instrument.

**Circuit Function.** Analog voltage from 000 mV to 999 mV can be applied between pins 11 (+) and 10 (-) of the CA3162E (U2). That IC converts the

voltage into a Binary Coded Decimal (BCD) equivalent. The BCD leaves pins 2, 1, 15, and 16 (the group represents the 1's, 2's, 4's, and 8's) and enters pins 7, 1, 2, and 6 respectively of the CA3161E (U3). The latter IC takes the BCD code, converts the output, then uses it (in conjunction with the 7-segment display) to generate (form) the number that correlates to the BCD input of the CA3161E. The multiplexing driver pins 5, 3, and 4 (5 being the least significant and 4 the most significant) turn on that display by means of the PNP switching transistors. Concurrently, the CA3162E is providing the BCD information to the CA3161E driver/decoder.

As indicated earlier, the system includes a combination of diodes and capacitors. These are required to control or minimize the voltage spikes (positive and negative) that result from turning inductive devices on and off; e.g. windshield wiper, air conditioner, and electric windows, etc.

The maximum input differential between pins 11 and 10 of CA3162E is 999 mV. A resistor network (R1, R2) is used to attenuate the applied 13.8-volts to 138 mV. An Ohm's Law cal-

This view of the assembled PC board shows the voltage regulator, (U1) mounted on the underside of the PC board. This was done in order to accommodate a flush-mount installation in a smaller car. Let your space needs dictate placement of this component.

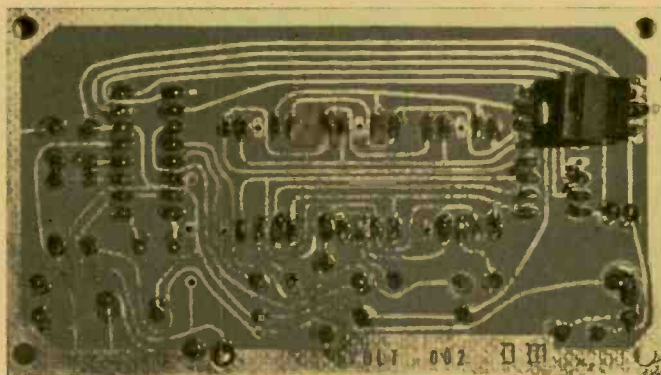

# Digital Voltmeter

calculation would give a result of 136.6 mV. The gain-adjust potentiometer compensates for the slight drop. The FND 507s display this as 13.8-volts.

Note the point marked OPTION on the schematic. With Pin 6 of the CA-3162E grounded or disconnected, there are four conversions or comparisons made each second. Tying pin 6 to the 5-volt line will result in 96 conversions or comparisons per second. The 96/second rate moves with excessive rapidity, is not appealing to the eye, and usually results in the least significant digit appearing to be blurred. Of the two rates, the 4/second conversion (4 Hz) is by far the more pleasing to the eye, is easier for the eye to focus on quickly, and is the recommended rate. These rates could vary slightly because of capacitor difference and manufacturer variance from stated values.

**Assembling the Voltmeter.** The unit may be assembled quickly and relatively easily using a predrilled and etched circuit board. If a Digital World circuit board is being used, the four corner

holes will have been drilled. If a blank board is being used, drill the corner holes *before* starting to "stuff" the board. It is easy at this point to scribe the plexiglass panel and mark the corner holes on it for later drilling and perfect alignment. Additionally, examine the recess or place where the completed unit will be mounted. Determine how it will be secured (bolted, clamped, or glued), doing any additional drilling that may be required.

Get the workbench ready for soldering. Use a low wattage, electrically-isolated, fine-tipped soldering tool and fine solder. A blunt-nosed tool could damage or destroy the ICs and create foil bridges between pins. This is both expensive and frustrating. If you have had limited experience in soldering in small areas, it may be wise to practice on something else before you start.

Now, locate all resistors and potentiometers on the circuit board placement diagram and install them in their respective holes. Next, do the same for all capacitors, observing polarity. Install the CA3161E and CA3162E. **Caution!** When inserting the ICs, be careful *not* to fold the pins under or bend them in any way.

IC orientation is critical. Be sure

these chips (CA3162E and CA3161E) are aligned as shown on the diagram. Note the notch mark on the chips and the corresponding notch mark on the schematic, or the "1" on pin 1 on top of the plastic case. All manufacturers use one or both of these base reference directional indicators.

If you have doubts about your soldering ability or the type of solder tool you have (grounded or not grounded), place two 16-pin sockets in the chip holes. The ICs may then be placed (not soldered) in the sockets. Next, insert the three LEDs, noting the notch marks on the LEDs and the notch marks indicated on the diagram. For the final action on this side of the board, insert both diodes in their respective holes (observing cathode markings).

Reverse the circuit board and install the LM340T-5 regulator. **Caution!** This must be correctly placed or it will destroy your unit when power is applied. The *metal side* of the regulator must be facing the FND 507 pins. Recheck it to make sure.

Now, turn the board over again. Use a red wire for the ignition line and a black wire for the chassis ground. Determine the lengths required (usually three-feet is sufficient). Solder the red wire to the point marked IGNITION on the diagram and the black wire to the GROUND.

**Calibration Procedure.** Correct calibration determines the accuracy of your voltmeter. Follow these steps carefully and sequentially. Apply a *known* voltage source (above 10 and below 16-volts) to the IGNITION point. We recommend a 13.8-volt source. Next, for zero adjustment, ground pins 11 and 10 to the circuit board ground momentarily. Using a small screwdriver, slowly rotate the wiper arm on R3 until there is a reading of 000. Remove the ground from pins 10 and 11. Set the *gain control* (R4) by rotating the wiper arm until the displays are displaying the same voltage as is being applied.

**Installation.** One final action is necessary before your unit is ready to be mounted in the dash location of your choice. Secure the black wire to the metal chassis ground and the red wire to any accessory line that is active only when the motor is running. Secure and mount the voltmeter in the location of your choice.

A colored plexiglass facing (cover) is required and we recommend red for most display contrast. A location which is not usually exposed to the sunlight will make the displays easier to read during the brighter periods of the day. If the unit is going into an existing recess, the present glass cover may be

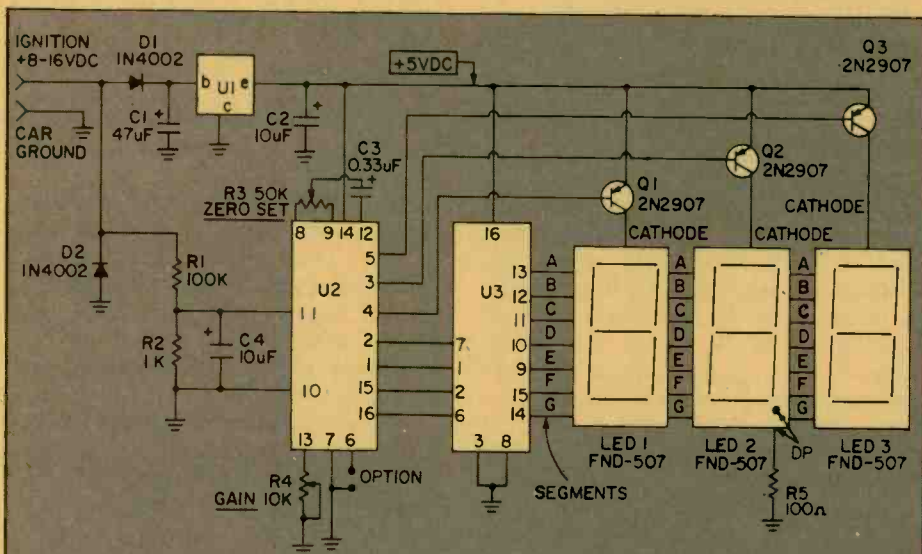

## PARTS LIST FOR DIGITAL VOLTMETER

- |  |  |
|--|--|
| C1—47- $\mu$ F electrolytic capacitor, 25 VDC              | R3—50,000-ohm PC trimmer potentiometer   |
| C2, C4—10- $\mu$ F tantalum electrolytic capacitor, 16 VDC | R4—10,000-ohm PC trimmer potentiometer   |
| C3—0.33- $\mu$ F tantalum capacitor, 35 VDC                | R5—100-ohm, 1/4-watt resistor, 5%  |
| D1, D2—1N4002 diode  | U1—LM340T-5 5-volt voltage regulator   |
| F1—1-amp fuse  | U2—CA3162E Analog-to-Digital converter   |
| LED1, 2, 3—FND-507 7-segment LED display                   | U3—CA3161E BCD display driver  |
| Q1, 2, 3—2N2907 PNP transistor                             | Misc.—solder, hookup wire, red plexiglass (for display filter), IC sockets, transistor sockets, suitable enclosure, etc. |
| R1—100,000-ohm, 1/4-watt resistor, 5%                      |  |
| R2—1,000-ohm, 1/4-watt resistor, 5%                        |  |

Note: An etched and drilled circuit board for the Digital Voltmeter is available for \$6.50 (postpaid in U.S. and Canada), and a complete parts kit, including PC board but not including plexiglass, is available for \$27.50 from: Digital World, P.O. Box 5508, Augusta, GA 30906. Please allow 4 to 6 weeks for delivery. No C.O.D.s or foreign orders, please.



used as a template for the plexiglass cover dimensions. One-eighth or 3/16-inch thickness plexiglass works well and is relatively easy to cut using a roofer's shingle cutter knife. Place two clamps on a straight line along the template edge, then cut one side at a time. Scribe it deeply with a dozen or more strokes, then break off the excess with a pliers. When drilling screw holes, use a small starter bit first, then the larger bit. This should prevent the larger bit from wandering across the plexiglass.

The plexiglass must be "spaced" away from the board by approximately 3/8-inch, using either spacers or the bolt/nut method. The latter method is to insert a bolt through the plexiglass corner hole and put a nut on the reverse side. Put a second nut on the bolt, allowing a 1/2-inch inside space between the two nuts. Do this on all corners. Next, insert the bolts into the board corner holes and put on the final nuts. We recommend securing all four corners, rather than just two.

**Troubleshooting.** If the unit does not light up for the calibration procedure, first check that the wiper of R3 is centered. If it still does not light up, recheck your work. Carefully inspect for possible solder bridges and loose connections. If a solder bridge is discovered, remove it carefully. It is easy to destroy a chip during the removal process. If it still fails to light up, start a systematic test check to isolate possible faulty component(s).

If the unit does not function after installation, recheck for a good electrical connection on the line that supplies power from the car. Did you break or loosen the solder connections of the source wires during installation? If so, this will require removal and resoldering, plus a bit more care during installation the second time.

**One Final Note.** Some ICs, and quite possibly the ones used in this project, generate high frequency harmonics which might find their way into your car's radio. Try holding your LED readout pocket calculator next to the radio antenna with the radio tuned to a blank spot on the AM dial to see what we mean. If you experience any interference from the voltmeter circuit, try rerouting the antenna coax away from the voltmeter itself. A metal case around the voltmeter's PC board will also aid in the reduction of RFI. We suggest that you avoid using the radio's power lead as the voltage source for your voltmeter. The power lead to the horn (or horn relay) or the hot lead of the windshield wiper switch (find it at the fuse box) is probably the best place to attach the voltmeter. ■

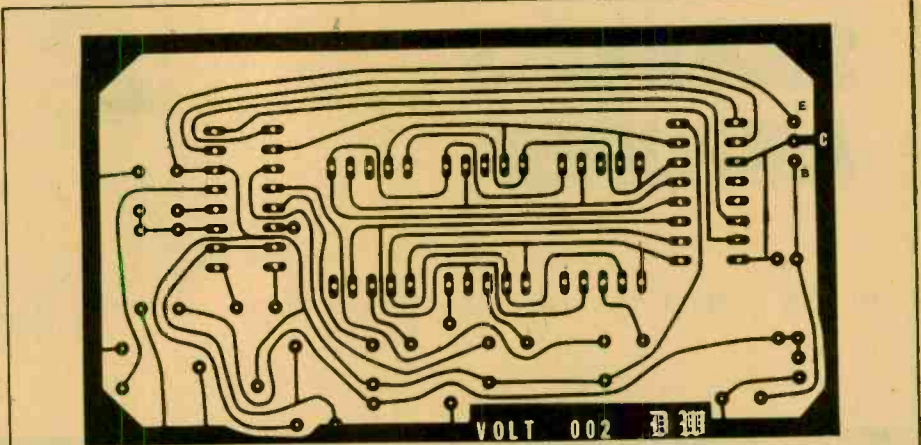

This full-scale etching guide for the voltmeter's PC board is one of the trickiest we've offered. Unless you know your stuff, we suggest you use a Digital World board.

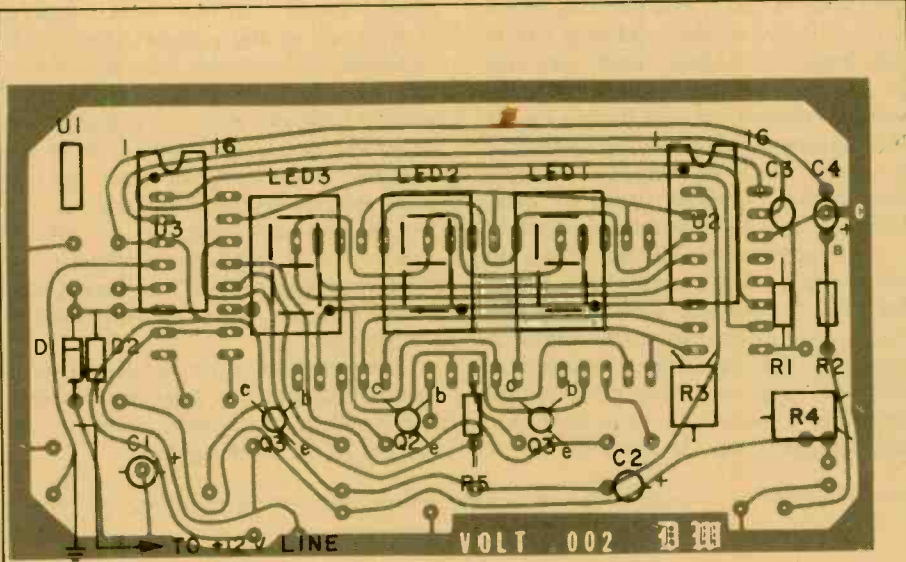

The component placement diagram for the PC board shows all IC and capacitor polarities. Take special care to observe them during assembly phases of project.



Even the best voltmeter in the world won't help you keep your car running if you don't take care of your battery. Check water level often and add only pure, distilled water.

# SUPERBASS AMPLIFIER

For the hard-hitting superbass sound of today



**S**uperbass is today's sound . . . whether it's the driving, gut-vibrating pulsations of disco, or the solid bass line of soft, hard, or laid-back rock. One way to get the modern superbass sound without running out and buying an all-new expensive piece of equipment is to use a Superbass amplifier between your guitar, electronic organ or what-have-you, and the instrument amplifier.

A Superbass strips the highs from the instrument's output signal and amplifies low frequencies, feeding on "all-bass" sound to the instrument amplifier. Naturally, the bigger the speakers used with the amp, the more powerful the bass: use 15-inchers with a Superbass and you can rattle the windows.

The Superbass is powered by an ordinary 9-volt transistor radio battery. It is keyed in and out—switching from superbass to standard instrument output—by a foot operated switch. A level control allows you to equalize the superbass sound level with that of the musical instrument, so your volume level remains relatively constant as you key the superbass sound in and out. Of course, if you want the superbass to be louder or softer than the unequalized sound, you can adjust the level control accordingly.

The superbass connects between your instrument and its amplifier through two standard phone jacks—you can use your regular "patch cords".

**Construction.** Since you're going to stomp down on a footswitch to key the superbass in and out, the project should be assembled in a sturdy metal cabinet. We suggest one of the flat "instrument-type" cabinets which are available from time to time. The project fits nicely into a 1¼-inch x 3-inch x 5½-inch cabinet such as the one shown in the photographs. The "instrument" cabinets are not always available; as a substitute we suggest an aluminum "handy" or "Minibox." Do not use a plastic cabinet with a metal cover because it will probably fall apart after a few stomps.

**Plug-in Circuitry.** The amplifier itself can be assembled on a small printed circuit board, or on a perf-board using point-to-point wiring. Perhaps the easiest construction is the one used for the model shown: it uses a combination of printed circuit and perf-board. The board is an "Op-Amp IC Experimental Breadboard," available from Radio Shack stores. It has factory-etched copper strips, ground loops and buses that are pre-drilled in a perf-board pattern. You simply plug the parts into the board so the leads stick out on the foil side and solder. When finished, you have a printed circuit without the bother of making the PC board itself. (Use a 1½-inch x 1¾-inch piece for this project.)

While the overall layout isn't critical, try to follow the layout shown because it keeps cables and the level control away from the footswitch. To conserve space, level control R2 can be any type of miniature audio taper potentiometer.

The battery is held in place by a small L-bracket. To prevent the battery from sliding around, two small strips of cork or rubber are cemented to the bracket. The bracket should be positioned so the battery must be lightly forced into position—in this way the

(Continued on page 101)

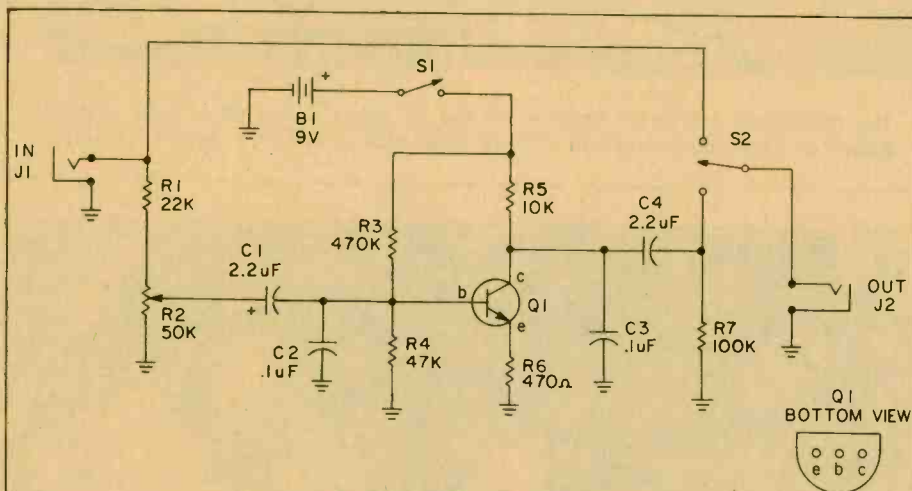

## PARTS LIST FOR SUPERBASS

- B1—9-volt battery, Burgess 2U6 or equivalent
- C1, C4—2.2-4.7- $\mu$ F, 10-VDC electrolytic capacitor (see text)
- C2, C3—0.1- $\mu$ F Mylar capacitor, rated 10-VDC or higher
- J1, J2—3-conductor, ¼-inch phone jack
- Q1—NPN transistor (Radio Shack RS-2010, or equiv.)
- All resistors 1/10 or 1/4-watt, 10%
- R1—22,000-ohm resistor
- R2—100,000-ohm audio taper potentiometer

- (see text)
- R3—470,000-ohm resistor
- R4—47,000-ohm resistor
- R5—10,000-ohm resistor
- R6—470-ohm resistor
- R7—100,000-ohm resistor
- S1—SPST switch (see text)
- S2—SPDT push On-push Off switch

Misc.—9-volt battery clip, aluminum cabinet, screws and other hardware.

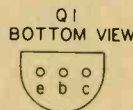

**V**IRTUALLY NO TWO BRANDS of recording tape, particularly the cassette tapes, deliver similar results at slow speeds. Even within the same price range, tape A might sound best on machine X, while tape B is the right one for machine Y. Fact is, because there is so much variation between tapes, many of the better cassette decks provide some means to optimize the bias for optimum frequency response from the tape playback.

The trouble is, not all machines have user-adjustable bias, and some models with the adjustment have no test system. The user must try for an adjustment that sounds right to the ear, a somewhat dubious method. Basically, most of us simply try a wide assortment of brands and types hoping to find the one that works best on our recorder.

With our easy-to-build Tape Tester, however, you can check out tapes in seconds to find the one that gives the best response in your sound system. And the same thing goes if your deck has a bias adjustment; again, it takes just a few seconds to find the optimum adjustment for peak performance.

**Easy to use.** The tape tester provides two switch-selected test tones of approximately 1000 and 12,000 Hz at 0 dB reference output level—for adjustment of the recording level—and at approximately -20 dB, the standard cassette test level. (Of course, it can be used for reel-to-reel machines, though their test level is generally -10 dB.)

To determine whether you are using the best tape for your machine, or to make a bias adjustment, you simply record the -20 dB 1000 Hz signal for a



# Tape Tester

A scientific method for determining the proper tape for your recorder

few seconds, followed by 12,000 Hz. On playback, the 12,000 Hz tone should be within 3 dB of the 1000 Hz reference for "average" performance, and within 1 dB for optimum sound reproduction. If you're using metal tape and want to see how well the tape, or the machine itself, handles high-frequency high-level saturation, simply use the 0 dB output before running the standard -20 dB level test.

As an example, assume you've checked a tape and the 12,000 Hz playback is 7

dB below the 1000 Hz playback. Obviously, this isn't hi-fi, so try a tape with "hotter" highs. Alternately, if the 12,000 Hz output was 6 dB above 0 dB, you need a tape with less high frequency output—generally a less expensive tape. If your machine has a bias adjustment but no test system, simply adjust the bias until the 12,000 Hz playback level reads within 1 dB of the 1000 Hz playback level on your deck's VU record/playback meters.

**Construction.** The Tape Tester shown

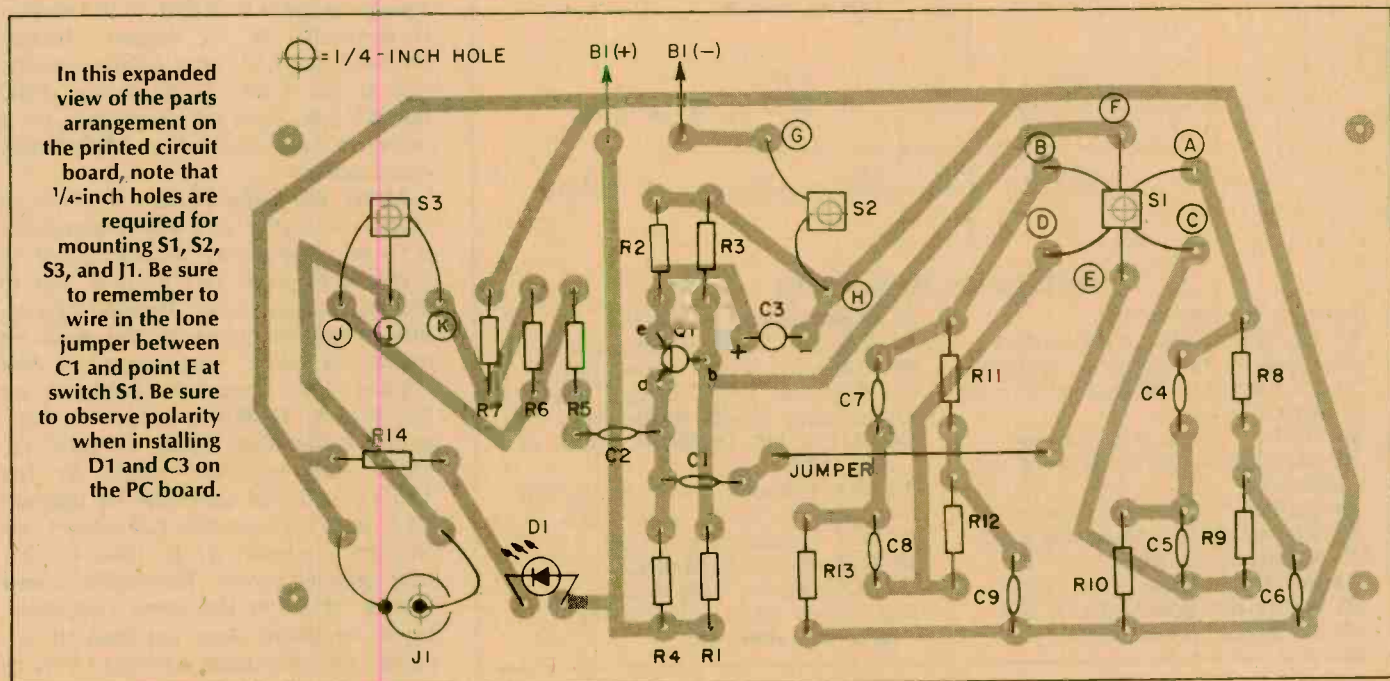

# Tape Tester

in the photographs is assembled in a plastic cabinet sized approximately 2½ by 1½ by 5-inches, usually available from Radio Shack or Callectro. Some cabinets have square corners, some are round; it doesn't make any difference unless you contemplate problems in rounding the corners of a printed circuit board.

The cabinet cover (which replaces the supplied metal cover) is the printed circuit board itself. This arrangement eliminates the hassle of trying to mount the PC board inside the cabinet.

Before etching the printed circuit, make certain the board is cut to the exact size of the metal cover supplied with your particular cabinet. Not only

is there the problem of round or square corners, but the overall dimensions and the location of the mounting holes vary from cabinet to cabinet. The holes for the switches and jack are ¼-inch diameter, and all other component holes are made with a #58, #59, or #60 drill.

All oscillator values have been selected so the project will work with low-cost, normal tolerance components. There is no need to go through the extra expense of purchasing precision resistors and capacitors. However, take extra care that you do not change any specified value. For example, do not change R1 to 270K, or R13 to 1200-ohms.

If you cannot obtain the specified values, make them. For example, the 0.003-μF capacitor used for C9 can be a 0.002-μF and a 0.001-μF connected in parallel by simply twisting their leads together. Similarly, C7 and C8 can be

a 0.001-μF in parallel with a 0.0005-μF (500 pF). The 0.022-μF capacitor is a standard value available just about anywhere. Similarly, all resistor values are "standard" in the sense that they are generally available types.

Since the switches are installed from the foil side of the board, take care that the connecting wires don't extend up through the board where they can act as a hazard to fingers working the switches. The photograph shows how to handle the switches and jack installations. Note that there is a small loop in the wire from the switch contact to the board. First, solder the wire to the switch contact (or jack). Before soldering to the board, trim the wire flush with the top (non foil side) of the PC board. Next, using long nose pliers or tweezers, back the wire very slightly towards the switch so the end is just below the top of the PC board—but still within the hole—then solder the wire to the foil. If done correctly, there will be no sharp edges sticking up through the PC board.

Check the LED polarity before you install it on the PC board, because some of the instructions supplied with "hobby grade" LEDs are incorrect. Temporarily tack-solder a 1000-ohm resistor to either LED wire. Clip one LED wire to either battery terminal. Touch the free end of the resistor to the other battery terminal. If the LED doesn't light, reverse the wires to the battery. When the LED lights, the LED wire attached to the resistor is the same polarity as the battery terminal to which the resistor connects. (If the resistor connects to the positive battery terminal, the LED wire on the opposite end of the resistor is the ANODE.) If the LED doesn't light with either polarity, it is defective (not unusual in LED hobby assortments.)

**Using the Tape Tester.** The output of the calibrator at 0 dB is nominally 0.5-volts, and should be connected to a recorder's LINE/AUX input, not to the microphone input. Because of normal component tolerance, the oscillator might not "start" when power is first applied if the frequency switch is set for 12kHz. If this occurs with your model, rather than trying to "trim" resistor and capacitor values in the Twin-T feedband networks—R8 through R13 and C4 through C9—simply set frequency selector S1 to 1000 Hz before applying power. The oscillator will always "start" at the lower frequency. If the oscillator does not start at all, either you have made, a wiring error, or

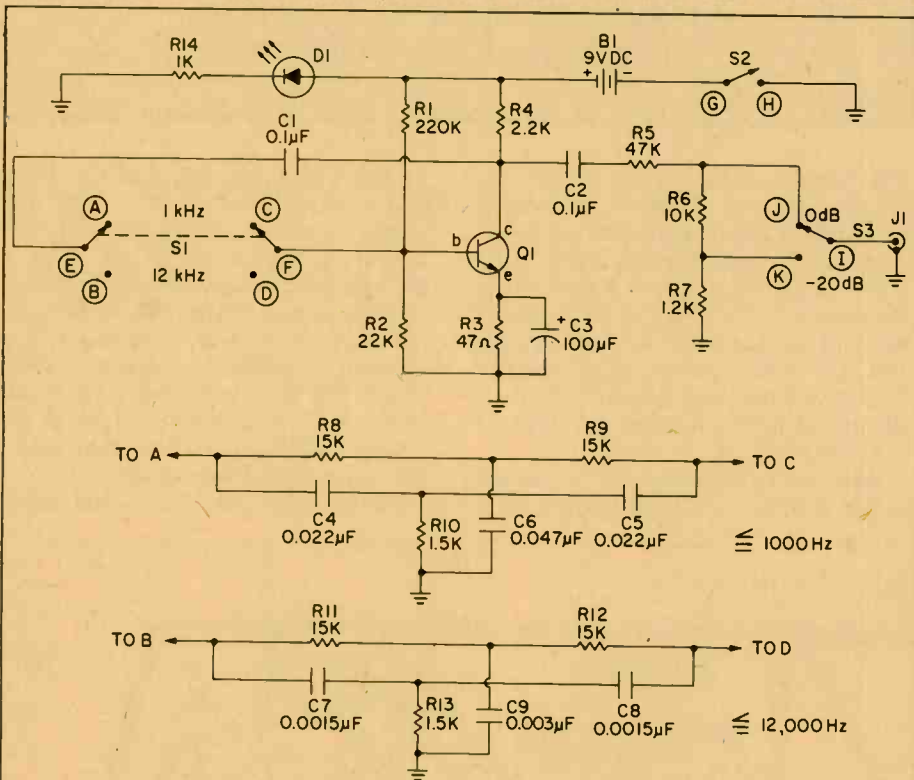

## PARTS LIST FOR THE TAPE TESTER

- |   |  |
|---|--|
| B1—9-volt transistor battery                        | R3—47-ohm, ¼-watt resistor, 10%                                    |
| C1, C2—0.1-μF, 10 VDC mylar capacitor               | R4—2,200-ohm, ¼-watt resistor, 10%                                 |
| C3—100-μF, 25 VDC electrolytic capacitor            | R5—47,000-ohm, ¼-watt resistor, 10%                                |
| C4, C5—0.022-μF, 10 VDC ceramic or mylar capacitor  | R6—10,000-ohm, ¼-watt resistor, 10%                                |
| C6—0.047-μF, 10 VDC mylar capacitor                 | R7—1,200-ohm, ¼-watt resistor, 10%                                 |
| C7, C8—0.0015-μF, 10 VDC ceramic or mylar capacitor | R8, R9, R11, R12—15,000-ohm, ¼-watt resistor, 10%                  |
| C9—0.003-μF, 10 VDC mylar capacitor                 | R10, R13—1,500-ohm, ¼-watt resistor, 10%                           |
| D1—any type of LED (light-emitting diode)           | R14—1,000-ohm, ¼-watt resistor, 10%                                |
| J1—RCA-type phono jack                              | S1—DPDT miniature toggle switch                                    |
| Q1—PN2484 NPN transistor (or equiv.)                | S2—SPST miniature toggle switch                                    |
| R1—220,000-ohm ¼-watt resistor, 10%                 | S3—SPDT miniature toggle switch                                    |
| R2—22,000-ohm, ¼-watt resistor, 10%                 | Misc.—battery clip, cabinet, PC board material, wire, solder, etc. |

the capacitors in each Twin-T network are not approximately equal to the specified values. Generally, the C4/C5 and C7/C8 combinations don't have to be the precise specified value, but each capacitor in a pair must be close in value to the other.

Set S3 for 0 dB output, S1 for 1000 Hz, and turn power switch S2 on. Adjust the record level for a 0 dB record level, or whatever is the maximum meter-indicated level for your recorder. Set switch S3 for a -20 dB output; you will see the recorder's meter drop 18 to 20 dB. (The exact amount depends on the components used in your project. It doesn't matter what the drop is, as long as it's near 20 dB.)

Start the recorder in the record mode and record a few seconds of 1000 Hz, followed by a few seconds of 12,000 Hz. On playback, the output of the two frequencies should be within 3 dB. Adjust the recorder's bias, or select a tape type that delivers this performance. Because of the 20 dB input attenuation, you will probably need an external level indicator because the usual -20 dB indication on a recorder's meter is not all that easy to "read" for precise value on playback. Use any external indicator, such as the meters on another recorder (feed the output of the recorder being tested to the input of a second recorder), the meters of a power amplifier, or an AC/audio meter. You can even use an oscilloscope if you have one.

To check for metal tape saturation at maximum recording level, set S3 for 0 dB and record at 0 dB record level, or whatever value is maximum for your recorder.

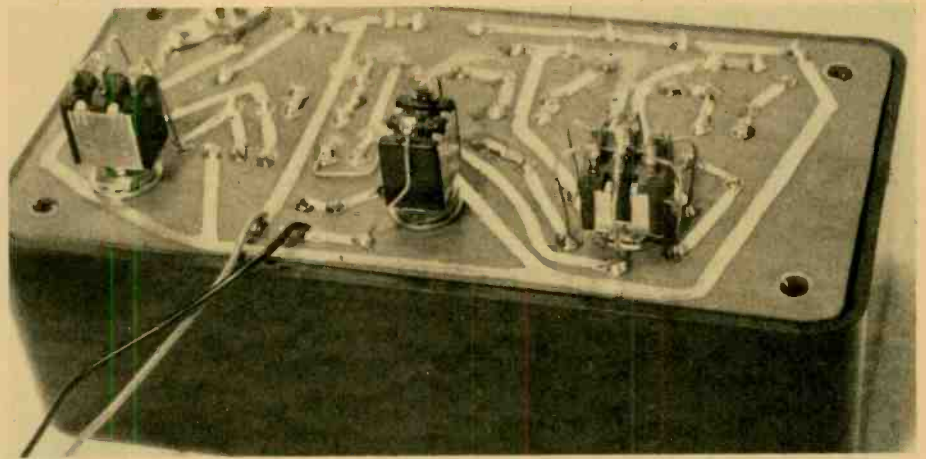

Here's the underside of the completed board with all three switches and J1 installed. The two wires leading away run to the 9-volt transistor battery which will fit in the cabinet.

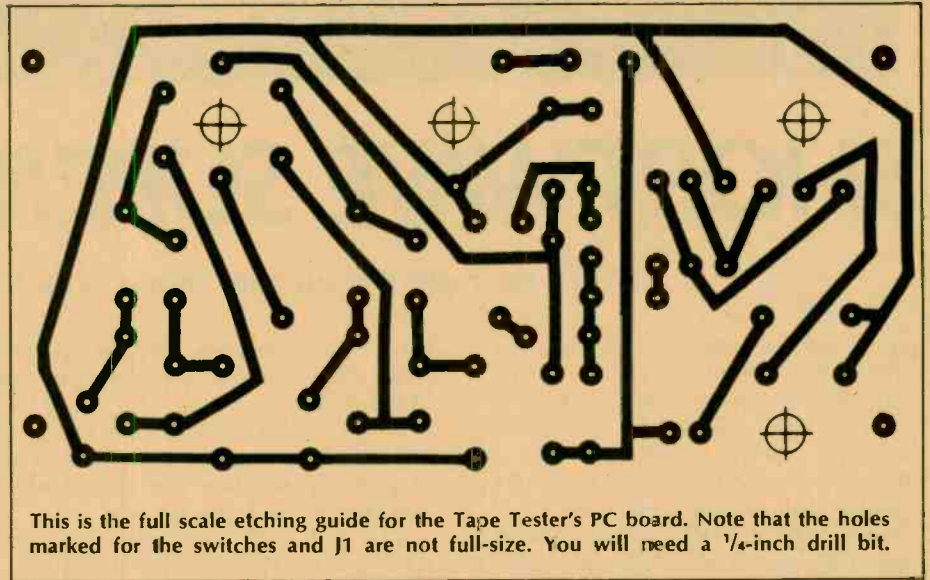

This is the full scale etching guide for the Tape Tester's PC board. Note that the holes marked for the switches and J1 are not full-size. You will need a 1/4-inch drill bit.



There are so many types of tapes on the market today, that a device such as our Tape Tester is a virtual necessity for determining the correct type of tape to use with your machine. For instance, although both of the tapes at bottom have the same bias, AD type at left may exhibit different high-end characteristics than D type at right. Only the Tape Tester can tell you for sure which one will be right for your machine and your ears' tastes.

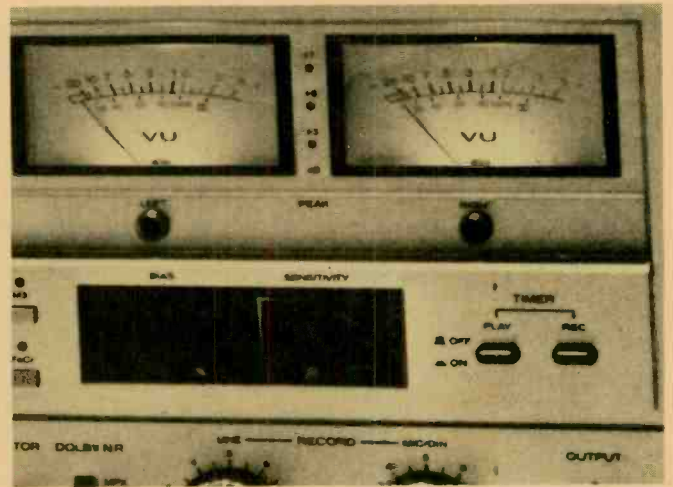

You'll have to depend upon the accuracy of your tape deck's meters for working with Tape Tester. If your meters aren't sensitive enough to record the 20 dB drop in calibration levels, feed monitor output of your deck into a good deck and use its meters to complete the calibration procedure. You can do this because you only have to see a "relative" drop on the record level, and not necessarily a "calibrated" drop, in order to use the device.

**S**OME BIG CHANGES are on the way for the SWL, especially in the upper shortwave bands from the 25-meter band on up to 30 MHz and beyond. The Sun is now entering one of its periods of increased sunspot activity after a 20-year period of relative calm. This will make short range communications unreliable and long range DX an everyday affair. Signals from stations just down the road will be, literally, lost in outer space, and wishy washy signals from outer nowhere will come booming



# SHORTWAVE SUPERCHARGER

Turn your old SW clunker into a high-band hot-rod.

into your listening post like they were right next door.

Under these conditions many old and some not-so-old shortwave receivers will need a bit of help when they try to work the high bands. Their circuits tend to get a little frazzled. As a matter of fact, almost any SWL would appreciate a bit of a signal boost now and then. It might just

make the difference between a very good DX catch and a record breaking DX discovery.

If you decide you want a DX boost or you need to increase the versatility of your old set then you should build this Shortwave Supercharger.

This unit will boost selectively the RF signal by 20-30 dB and it will compensate for many deficiencies of your set.

It will not only improve the gain of the shortwave receiver but will also improve its selectivity and the image frequency rejection. Simple, single conversion superhet SW sets have the annoying tendency of receiving spurious signals separated by twice the IF frequency from the desired signal. For example if you tune to 20 MHz you may also receive  $20 + (2 \times 0.455) = 20.910$  MHz (image frequency) signal which will interfere with the 20 MHz signal. In addition you will be able to pull in many SW stations you didn't even know existed. With 10- to 15-feet of wire behind your sofa as an antenna you may receive stations as distant as Australia or mainland China.

**How does it work.** The circuit is based on an inexpensive integrated circuit manufactured by Motorola and its HEP subsidiary. Its innards consist of three transistors, a diode and four resistors which together form an excellent automatic gain controlled (AGC) radio frequency amplifier. To build the circuit with separate discrete components would cost a bundle and the result would not be as good. The incoming RF signal is coupled with a few turns of wire to the coil L1. The tuned parallel-resonant circuit consisting of L1 and C1 selects the wanted signal by rejecting adjacent frequencies and feeds the sig-

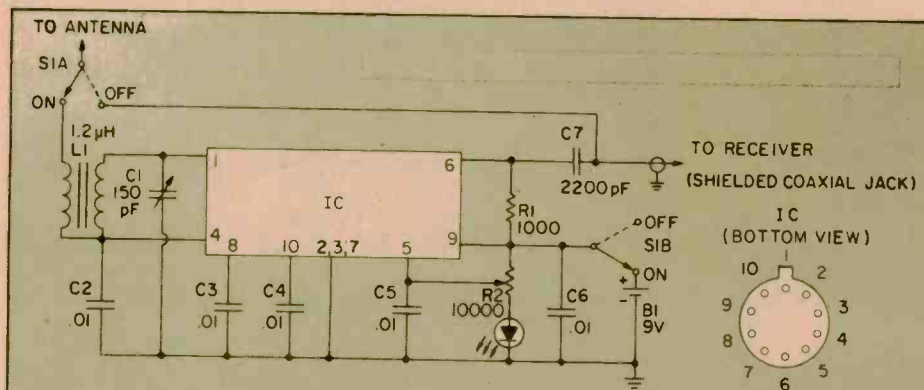

PARTS LIST FOR SHORTWAVE SUPERCHARGER

- B1—9V transistor radio battery
- C1—150-pF variable capacitor
- C2, C3, C4, C5, C6—0.01 uF capacitor
- C7—2200-pF capacitor
- R1—1000-ohm ¼-watt resistor
- R2—10,000-ohm variable resistor
- IC—Motorola MC1550, HEP 590 or HEP C6091

- LED—Red LED indicator
- L1—Miller 4502, 1.1-1.5-microhenry coil (for winding your own, see text), for antenna connection use 3 turns of wire wound tightly around the coil.
- S1—DPDT switch
- Misc.—case, knobs, jacks for shielded cable

nal to pin 1 of the integrated circuit. The amplified signal leaves the IC on pin 6. The AGC input on pin 5 is used to control the gain of the amplifier when you turn potentiometer R2. The light emitting diode indicates that the circuit is on and that the battery is still alive. The DPDT switch S1 selects between straight-through connection, booster off and booster on.

**Construction.** This is a radio frequency project which requires a neat soldering job and short connections. However, if you do a half-decent job the supercharger should fulfill your expectations. The author used point-to-point wiring on a perf board. If you have some experience with PC boards you might use the layout shown here. The Super-

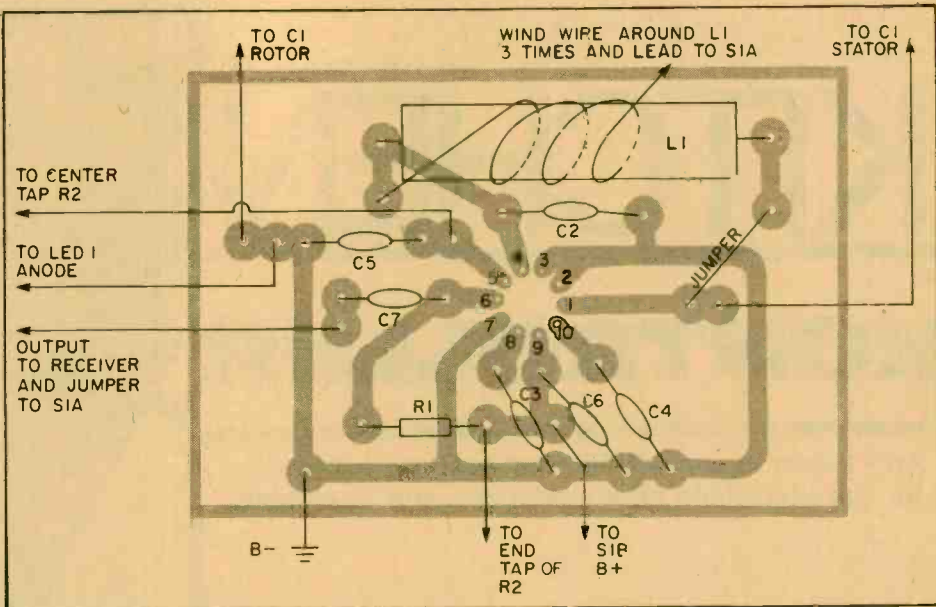
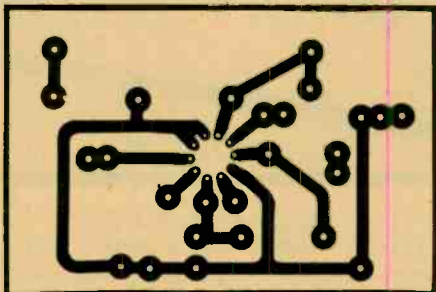

This part's location overlay is twice the actual size in order to make the positioning clearer. If you use a loop different than specified in the parts list you may want to modify the appropriate spacing on the printed circuit board. Don't forget to wrap the L1-to-antenna wire around the loop stick three times. You might install an integrated circuit socket on the printed circuit board to simplify installation and repair.

Use this full-size circuit-board template to build your Shortwave Supercharger. You can find etching materials at a radio shop.

charger with the indicated component values will cover approximately 10-30 MHz. Using different values for L1 or C1 will change this range, though the ratio of minimum to maximum frequency will remain 1:3. Doubling the capacitor or inductance value lowers the frequency by 1.41 and lowering either value increases the frequency by the same factor. If you want to substitute some parts, or wind your own coil or use a different capacitor, the circuit is quite flexible in this respect. For example you may want to replace the 150 pF capacitor C1 used by the author since this is often difficult to find. Use instead the oscillator half of the stand-

ard AM tuning capacitor from any pocket transistor radio. Instead of the coil mentioned in the parts list you might try to wind 15-20 turns of insulated copper wire on a pencil.

Mount the Shortwave Supercharger inside a metal case which you can find in most electronic supply stores. Use shielded cable between the supercharger and your receiver otherwise the connecting wire will behave like an antenna and some of the features of your supercharger will be lost. The final job is to make a dial. You can calibrate it with your shortwave receiver by tuning C1 to optimum reception.

If you find that the circuit "whistles" at certain frequencies (this may easily happen if you do not use a PC board or your connections are too long), the simplest cure is to thread a few small ferrite cores through pins 1 and 4 of the

IC. Such cores can be purchased from many electronic surplus dealers.

**Operation.** Tune your receiver to the desired frequency and then tune C1 till you can hear maximum signal or noise, if no station is present. Returning your receiver with the fine tuning knob should require no readjustment of the supercharger. You can use R2 as your volume control or leave it in some intermediate position and use the volume control of the receiver. For strong signals you may want to turn R2 back to prevent overloading the receiver with the corresponding increase in the background noise.

Once you get it working, start digging deeper into the higher shortwave frequencies. There is a lot going on out there and with the increased sunspot activity and a Shortwave Supercharger you can't go wrong. ■

The author's prototype, shown here, used perf-board and point-to-point construction. You may build your Shortwave Supercharger using this technique or by making a printed circuit board and soldering on all the parts. The author added a small LED power indicator to prevent dead batteries if left on.

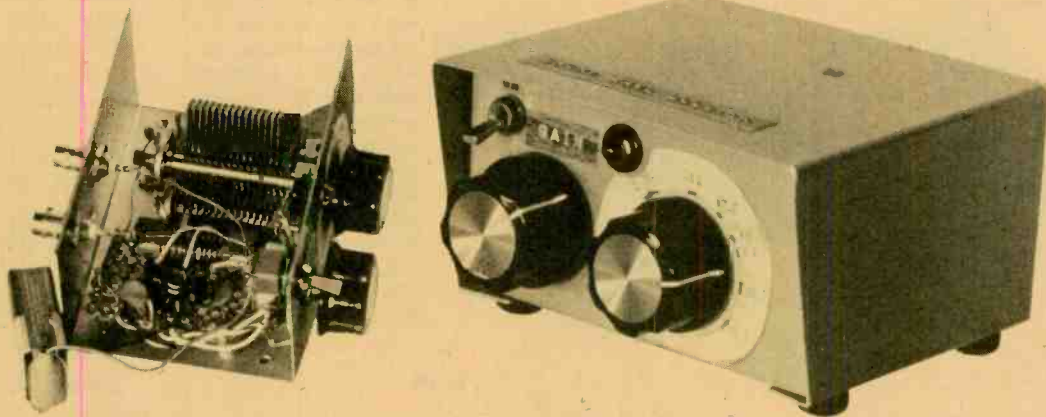

# KITCHEN KONTROLLER



Add a new dimension to your culinary artistry—  
let our electronic chef command your appliances

Here is an inexpensive project—the cost of parts is under \$10—which will make many of your kitchen appliances perform better than they were originally designed to. It is a motor speed control combined with an optional automatic on-off-on-off cycling pulser/interruptor. The pulsing feature is particularly important for kitchen blenders, mixers and food processors. The short pause, during which the appliance stops, allows you to see the progress of the food preparation. You can then stop before your food processor grinds and mashes everything to bits. Modern kitchen appliances frequently operate at such high speeds, that a few seconds difference in running time can transform an exquisite meal into meat loaf. Many appliances

such as blenders also mix the food better when operating with an on-off cycle, which prevents the food from sticking to one side of the bowl. It should be noted that the duration of both the “on” cycle and the “off” cycle in the Kitchen Helper can be adjusted separately. The continuously variable speed/dimmer control used in conjunction with the pulser adds another desirable feature to many of your appliances. The pulsing/interrupting feature can also be bypassed by flipping a switch, and the Kitchen Helper becomes a regular variable-speed or light dimmer control for your power tools, Christmas lights, Halloween pumpkins, etc. In fact, you may have trouble deciding between the kitchen and the work bench, as to where it should be kept.

Don't fret too much, build a pair!

**How It Works.** The schematic diagram consists of two distinct sections: The low-voltage on-off pulser with a heart made out of our old friend—the 555 timer (IC1), and the high-voltage section, consisting of a 600-watt/110-volt Triac speed control. A small lamp (L1) and a photocell (PC) tied together, act as a light coupler by separating the high and low voltage sections. When the timing circuit puts a voltage across the lamp (L1), it lights up, the resistance of the photocell decreases, and the Triac conducts. Potentiometers R5 and R6 control independently the “on” and “off” cycles of the timer, with time on—1.1xC4xR5, and time off—1.1xC6xR6. With the values chosen for resistors and capacitors, the “on” and “off” cycles can be set between 0 and 5 seconds. Switch S1, when closed, bypasses the timing section of the circuit. Power for the low-voltage section is provided by transformer T1 with the associated rectifier bridge (Z1) and capacitor C3.

The high-voltage section of the circuit is a standard Triac motor speed/dimmer control for lights and appliances up to 600-watts. Capacitors C1 and C2, resistors R1, R2, R3 and the photocell resistance, set the firing point of the Triac, and vary its duty cycle for conduction. Potentiometer R1 is used as the speed/dimmer control, and neon light NE provides the hysteresis required by the speed control circuit for smooth operation.

**Construction.** The circuit can be built easily on a 2½ by 3½-inch perf-

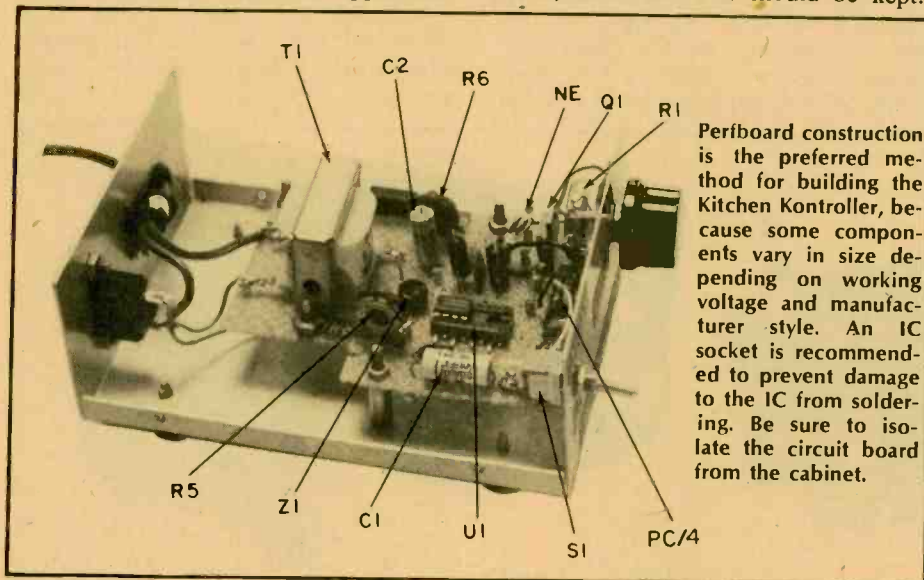

Perfboard construction is the preferred method for building the Kitchen Kontroller, because some components vary in size depending on working voltage and manufacturer style. An IC socket is recommended to prevent damage to the IC from soldering. Be sure to isolate the circuit board from the cabinet.



If you decide to put together more than one Kitchen Controller, it might be a wise idea to investigate the bulk prices for components offered in the HOBBY MART section at the back of the magazine. The dimmer feature, coupled with the slow pulse timer can be a real bulb-saver with photo-flood lamps, and other high-wattage / high-priced lamps. Be sure not to exceed the load rating of your Triac in use.

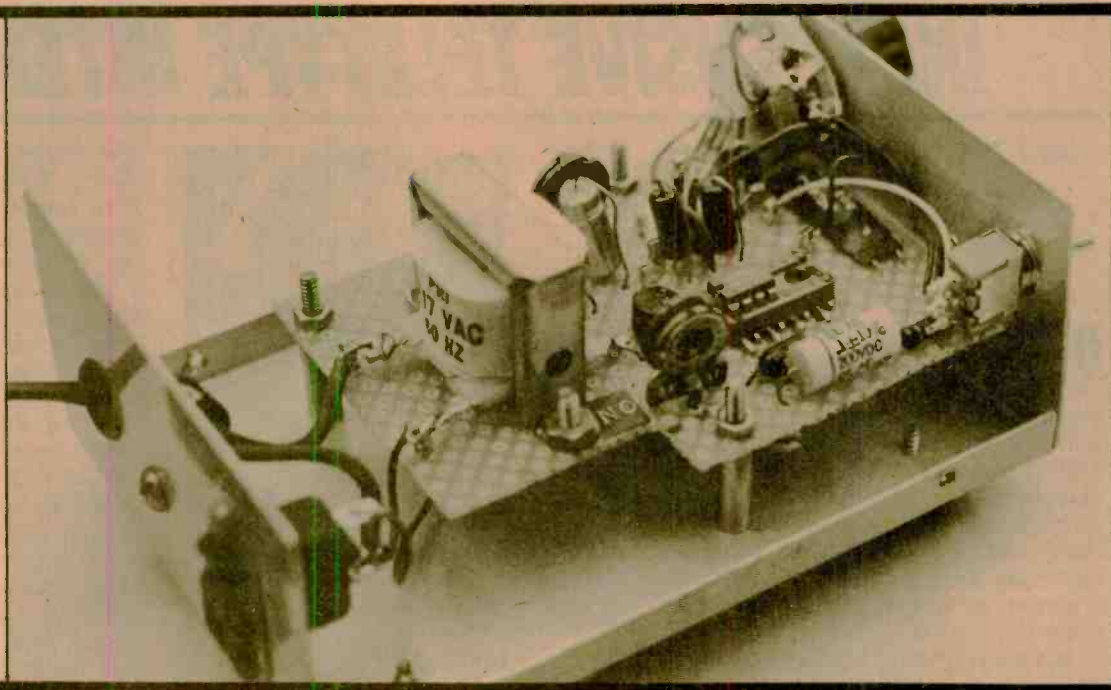

board, using point-to-point wiring. No special wiring precautions are necessary, except for the section of the circuit which carries AC voltage. It should be well-insulated, and kept away from the rest of the circuit and the cabinet. We strongly recommend using a 3-prong cable and jack, with the ground wire connected to the cabinet. The light coupler consists of the photocell and the lamp tied together with black electrical tape. Make sure that the active side of the photocell faces the lamp, and that the photocell pins do not touch the lamp wires.

The "on" and "off" controls, R5 and R6, can be mounted externally on the case, or internally on the perfboard. Mounting them inside makes for neater appearance, but changing the timing becomes a chore. We found that 3-seconds "on" and 2-seconds "off" were optimum for most applications.

**Operation.** Operation of the Kitchen Helper is very simple. Plug it into an AC outlet, and plug your appliance into jack J1 on the case of the Kitchen Helper. You can vary the speed or brightness—if you use it as a dimmer—with R1. If you don't need the pulsing feature flip switch S1. That's all there is to it! Bon appetit!

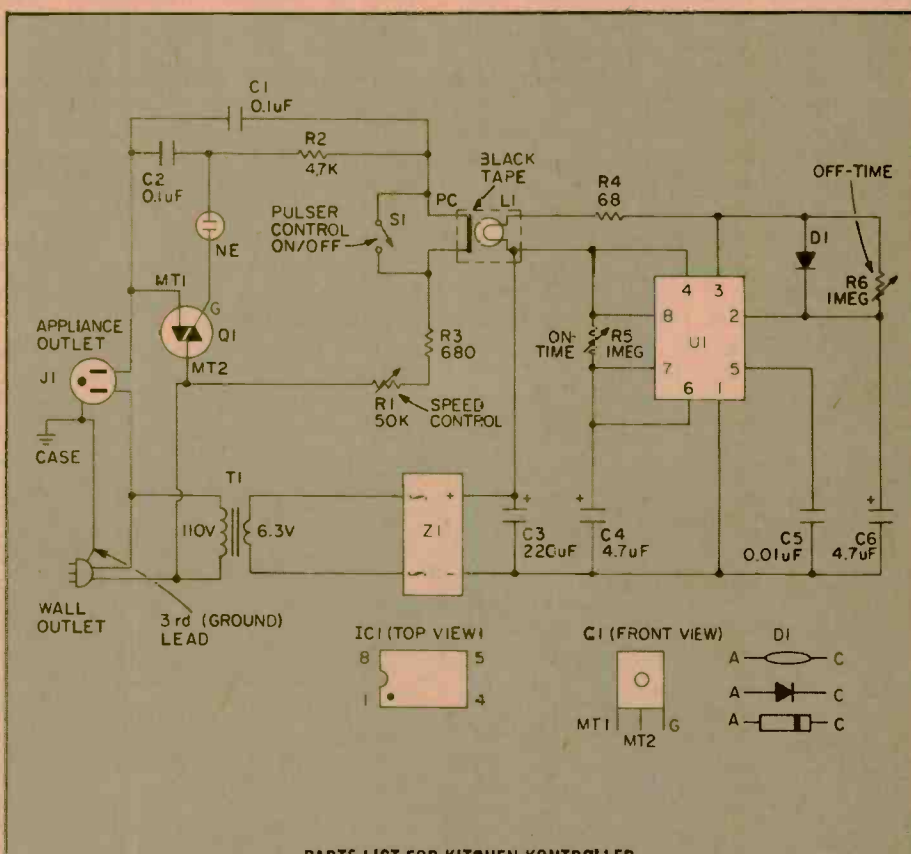

**PARTS LIST FOR KITCHEN CONTROLLER**

- C1, C2—0.1-µF, 200-VDC tubular capacitor
- C3—220-µF, 25-VDC electrolytic capacitor
- C4, C6—4.7-µF, 35-VDC electrolytic capacitor
- C5—0.01-µF, 35-VDC mylar capacitor
- D1—1N4000 diode
- J1—3-prong AC appliance receptacle
- L1—6-volt pilot lamp, low current-type
- NE—NE-2 neon lamp
- PC—CdS photocell (Radio Shack #276-116 or

- equiv.)
- Q1—Triac rated @ 200-volts @ 6-Amperes (GE-X12 or equiv.)
- R1—50,000-ohm, linear taper potentiometer
- R2—4,700-ohm, ½-watt resistor
- R3—680-ohm, ½-watt resistor
- R4—68-ohm ½-watt resistor
- R5, R6—1,000,000-ohm, linear taper potentiometer

- S1—SPST switch
- T1—transformer with primary rated @ 110-VAC/secondary @ 6.3-VAC @ 300 mA.
- U1—555 timer
- Z1—full-wave bridge rectifier; 200 PIV @ 4-Amperes
- MISC.—cabinet, perfboard, hookup wire, solder, knob, AC plug and line cord combo., etc.

# INEXPENSIVE TELETYPE INTERFACE

Add TTY capability to your RS232 I/O port and print for peanuts

**O**UT IN THE REAL WORLD, away from the marketing pundits, are not to be found thousands of personal computer hobbyists waving thousand-dollar bills and screaming for line printers and DECwriters to interface with the RS232 output of their computers. The fact is, after paying for the basic computer, there aren't too many hobbyists who could afford to even think of purchasing a printer, in the near future, for something like \$1000.

But the real world has thousands and thousands of model 33 teletypewriters and printers lying idle in schools, surplus dealer basements, and even in some computer hobbyists' homes. They make superb printers, whose copy is generally more readable than what you can get from most matrix (dot) printers. Out in the real world, you can pick up a surplus model 33 RO (printer only, no keyboard) for \$150 to \$300, or even less, assuming you can find some being scrapped by a school that converted from TTYs to DECwriters.

The problem is, how does one easily connect an RS232C computer output to a TTY, which requires a 20 mA current loop for computer feed? The answer is an RS232C to TTY converter, which



can be assembled for less than \$1 to under \$10, depending on whether you have a filament transformer lying around, or how fancy you want the cabinet.

The converter takes the DC voltage output of an RS232C I/O port, and converts the computer signals to a 20 mA current loop. It is strictly a printing converter, hence its simplicity. (It does not need to handle the negative to positive 232C excursion, rather, it need only sense the negative "marking" voltage interruptions to convert to the TTY 20 mA current loop.)

Your only problem is to have the RS232 output at the 110 baud rate required by the TTY. If your computer's RS232 output is "locked" at 300 baud

and higher, this converter won't work with a TTY. Most RS232 I/Os however, can be hardware or software programmed for 110 baud, as is true of the Heathkit and Radio Shack R23 I/Os, among others. You will also have to program the RS232 output for two stop-bits, though TTYs can work with one stop-bit if the printing speed isn't maximum.

**Using the Converter.** Referring to the schematic, the output from the RS232 I/O connects to the converter input. Make certain that the I/O signal ground (or common) and the protective ground (if present) connect to the input ground. The TTY printer connects in series with Q2's collector—neither lead is grounded. Make certain that the positive (+) TTY printer connection connects to R3. The TTY's negative (-) connection does not mean ground; it isn't grounded to anything in the TTY; the (-) connection goes to Q2's collector. Set your computer's RS232 I/O for 110 baud, two stop-bits, and turn the TTY on to the LINE setting (not LOCAL). That's it. You'll get a TTY printout.

**How It Works.** Transistor Q2 is normally conducting (on), which is caused by bias applied through R2 to Q2's base. This allows current to flow through the TTY printer, holding it in the "marking" state. (If the TTY "runs wild," there is no current through Q2; either you have made a wiring error failed to apply the power, or the RS232 I/O is not yet initialized—turned on.) Since the marking output from the RS232 I/O is negative, Q1 is held "open," and acts as a cut-off. When the RS232 I/O transmits characters, the "spacing" is sent as positive voltage bits, representing the characters. Each

(Continued on page 98)

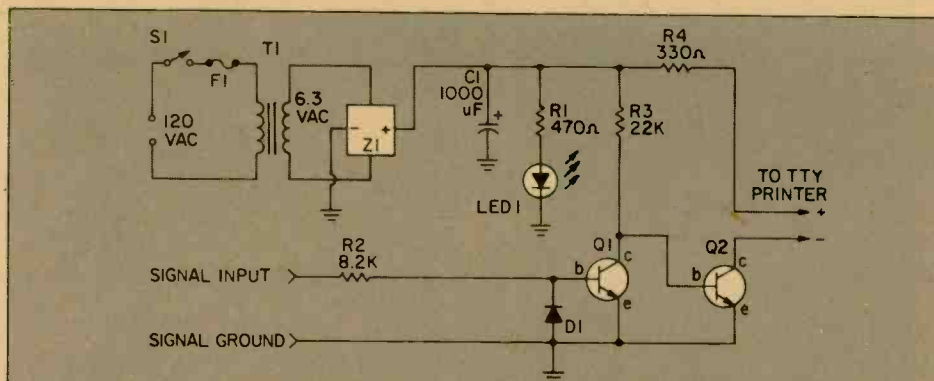

## PARTS LIST FOR TTY INTERFACE

C1—1,000-uF electrolytic capacitor, 25-VDC  
 D1—silicon diode rated 25 PIV @ 1-amp  
 F1—¼-amp slow-blow fuse  
 LED1—small LED rated 1.75-VDC @ 20-ma  
 Q1, Q2—NPN switching transistor, MPS-3704 or equiv.  
 R1—470-ohm, ¼ or ½-watt resistor  
 R2—8,200-ohm, ¼ or ½-watt resistor  
 R3—22,000-ohm, ¼ or ½-watt resistor

R4—330-ohm, ¼ or ½-watt resistor  
 S1—SPST toggle switch  
 T1—transformer with primary rated 120-VAC @ 1A/secondary 6.3-VAC @ 300-ma  
 Z1—full wave rectifier bridge rated 50 PIV @ 1-amp

MISC.—cabinet, Molex connectors, perfboard, fuse holder, solder, hookup wire, etc.

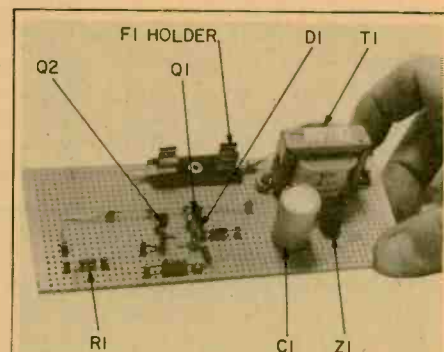

Breadboard offers the easiest method of construction for the TTY Interface.

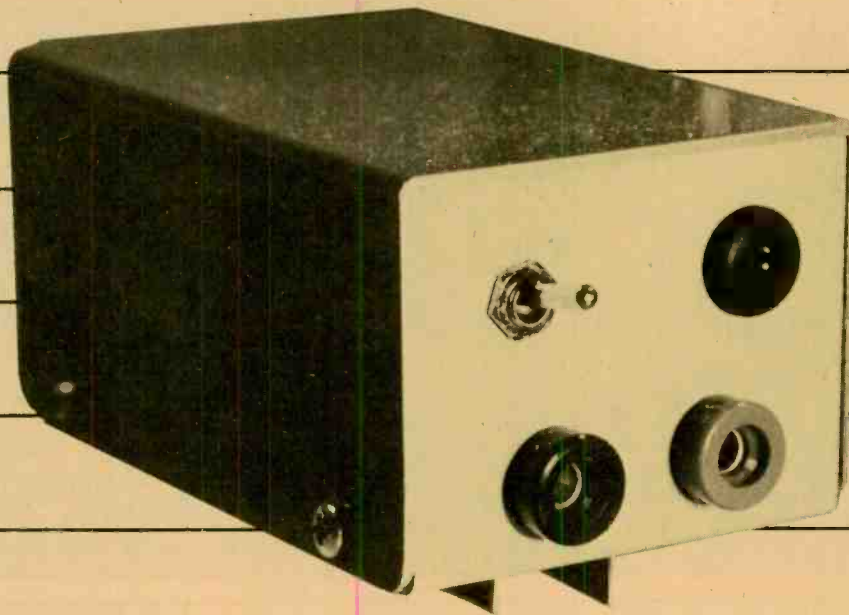

# BUILD A SIMPLE VOLTMETER AND SCOPE CALIBRATOR

Make your test instruments  
precision measuring devices

**P**RECISION VOLTAGE MEASUREMENTS require a calibrated source against which to compare the readings of the voltmeter or oscilloscope. In really high-class measurements, where absolute accuracy is needed, laboratories will use something like a Weston cell and a precision potentiometer. But to the hobbyist, such instruments are both too costly and, in most cases, more accurate than is necessary. In the past, the hobbyist had to be content with zener diode calibrators. Unfortunately, these diodes are not the best and tend to drift. But today, a new breed of regulator is available. Several manufacturers are now offering regulator/reference source ICs using *band gap* zener diodes, and internal amplifiers. These ICs give the hobbyist a low-cost method for building a reference voltage source.

**Calculate Your Needs.** The circuit in Fig. 1 is sufficient to operate as a hobbyist-grade voltage calibrator. Only a power supply (in this case a battery), a resistor, the regulator IC, and a means for turning it on and off are required.

The value of the series resistor depends upon the reference current selected and the power supply voltage. The reference current may be set at any point in the range of 2 to 120 milliamperes, provided that the overall power dissipation is kept to less than 300 milliwatts. In practice, however, one is advised to select a value in the 2 to

5 mA range. In the example of Fig. 1 we have selected 8.75 mA for a very special, high level, technical reason—we had a 4.2-volt battery and a 200-ohm resistor in the junkbox at the time.

The series resistor's value is computed as:

$$Rl = \frac{Eb - Eo}{Ir}$$

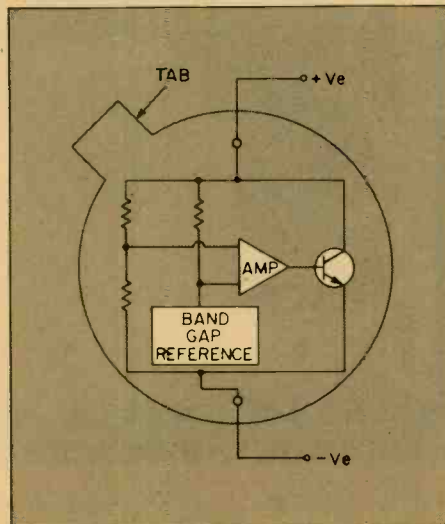

Here is an internal schematic of the band gap zener diode, which serves as the heart of the calibrator. Use the tab on the case as the reference point for making circuit connections. No heatsink is required here.

Where:

$E_b$  is the battery voltage

$E_o$  is the output voltage (1.26 or 2.45 volts)

$I_r$  is the reference current

$R_l$  is the resistance in series with the IC

Example:

In the circuit of Fig. 1, we used a 4.2-volt mercury battery, and selected a reference current of 8.75 mA. Find the value of the resistor needed for  $R_l$ . A ZN458 (2.45 volts) is used.

$$Rl = \frac{(4.2 - 2.45) \text{ volts}}{(0.00875) \text{ Amp}}$$

$$Rl = \frac{(1.75)}{(0.00875)} = 200\text{-ohms}$$

The resistor used should be a low temperature coefficient type. We used a wirewound precision resistor for  $R_l$ , and selected it because it was in the junkbox. Contrary to the example above, we actually selected the reference current based on the resistors on hand. An ordinary carbon composition resistor could be used, but the results are not guaranteed.

**Construction.** The construction of the calibrator is shown in Fig. 3. The largest part in the project is the battery, so a small LMB aluminum box was selected to house the calibrator. The electronic circuitry was built using the banana jacks as tie points; no wire

# SCOPE CALIBRATOR

board is needed. The battery holder is ordinarily used with size "C" batteries, but the Mallory TR233 (4.2-volt mercury cell) fits nicely. The battery holder was fastened to bottom of the box using a small 4-40 machine screw. Small rubber feet can then be glued to the box to offset the "bump" created by the screw head. If you want to avoid this, however, it should be easy to superglue the battery holder flush to the aluminum.

The ZN458 has a 100 parts per million (PPM) drift specification, the ZN458A is a 50 ppm device, while the ZN458B is a 30 PPM device. The voltage output is nominally 2.45-volts DC. (measured at 2 mA reference current), but may have an absolute value between 2.42 to 2.49-volts. With no additional circuitry, then, these devices will produce an accuracy of  $\pm 40$  millivolts, or better. This voltage cannot easily be adjusted without external circuitry, but you can use any of the standard IC operational amplifier voltage regulator circuits to set the output voltage to a standard level. Fig. 2 shows a circuit that is usable for this purpose. The ZN458 is used to set the voltage at the noninverting input of the op amp. The output voltage can then be trimmed to the desired value by potentiometer R3. This circuit is an ordinary op amp noninverting follower, so the desired output voltage can be derived in the following equation:

$$E_o = E_b \left( \frac{R_3 + R_2}{R_1} + 1 \right)$$

The table shows values for R2/R3 needed for output voltages of 5 and 10-volts. Note that the resistors used in this circuit must be low temperature coefficient precision (1%) resistors, or drift will result. It is even more important in this circuit, than in the circuit of Fig. 1. The trimmer potentiometer should be a ten-turn, precision type, so that very tight control over the adjustment of the output voltage is possible.

There is, however, a hitch in this variable output circuit. It is not inherently "calibrated" as is the case of Fig. 1. Although this circuit is capable of better accuracy, initially, it must be adjusted. You will have to find a very accurate voltmeter, or precision reference potentiometer to make the initial adjustment. After this adjustment, however, it should remain in calibration for a long time. ■

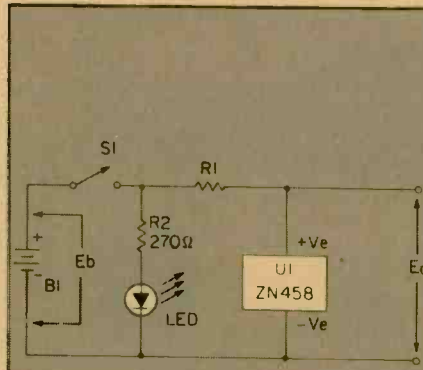

Fig. 1. This is a basic schematic used to demonstrate the calculations necessary to determine the value of the associated components used in the regulator circuit. Refer to the text for a full explanation.

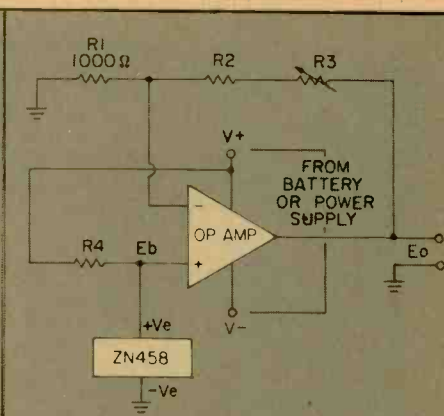

Fig. 2. This schematic depicts a variable regulated power supply, with the source being either a battery or a line-powered DC source. Refer to the table below and text, to determine your own parts needs.

TABLE 1—ZENER SELECTION

| Type   | Voltage | Drift   |
|--------|---------|---------|
| ZN423  | 1.26    | —       |
| ZN458  | 2.45    | 100 ppm |
| ZN458A | 2.45    | 50 ppm  |
| ZN458B | 2.45    | 30 ppm  |

TABLE 2—R2/R3 SELECTION

| Output Voltage | R2        | R3       |
|----------------|-----------|----------|
| 5              | 1000-ohms | 100-ohms |
| 10             | 2600-ohms | 500-ohms |

The four most popular low-voltage band gap zener diodes are listed above, with their respective drift figures. Obviously, the smaller the drift figure (in terms of parts per million) the more accurate the calibrator circuit will be. Use the highest tolerance parts available, in order to enhance the accuracy of the circuit. Refer to the text for an explanation of the significance of the values given for R2 and R3 in Table 2 above.



Fig. 3. The compact construction of the calibrator is seen here. We wired all components to the terminals of the banana jacks first, and then bolted in the battery holder to the bottom of the chassis to allow working room for assembly. You may choose to utilize either perfboard or even a printed circuit board for your model. This will allow you to mount it directly inside the cabinet of whatever test instrument you wish to calibrate. With this method you can always have a reliable source of instrument calibration with you, no matter where you might happen to be doing your repair or field operations.

# STEREO BAR

# GRAPH METER

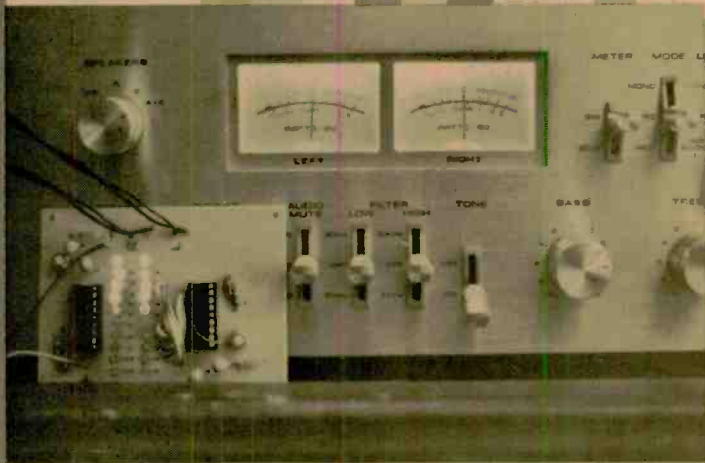

Keep your watts RMS in balance with this simple project

IS YOUR STEREO SYSTEM delivering its full rated power into your speakers? Are you driving the amplifiers beyond their power rating, resulting in excessive distortion and possible damage to the amplifier or speakers? Is your balance control set for proper output from each side of your stereo sys-

tem? There is no need to guess at the answers to these questions if you build and use this stereo power meter.

**Bar Graph Chip.** National Semiconductor Corporation has developed a new integrated circuit which will drive up to ten LEDs in response to an analog voltage, and such a chip can be used to provide a visual indication of the instantaneous power being developed by an audio amplifier. By using two of these chips, you will be able to continuously monitor the audio output power of both sides of your stereo system. This will permit you to properly set the balance control for equalized outputs, and will alert you if there is a degradation of audio power due to a malfunction of the amplifier. It will also provide indication if you have set your volume control too high, resulting in excessive power being delivered to the speakers on audio peaks. The use of this instrument will provide positive indication of the status of your stereo amplifier, and is far superior to the human ear for power measurement.

Most of the circuitry for this dual power meter is contained in the integrated circuits, resulting in an easy-to-build circuit with a minimum of external parts. It is not necessary to build the entire dual circuit if you are strictly interested in an audio power meter. By deleting about half the components you can have a simple, easy to use audio power meter which can be battery operated for complete portability and ease of use. Power measurement is attained by direct connection to the speaker terminals of the amplifier.

**About the Circuit.** The Stereo Power and Balance Meter consists of two identical circuits, each containing an LM3914 Dot/Bar display driver chip. Each integrated circuit consists of a precision ten step voltage divider, a voltage reference, and a set of ten voltage comparators with current limited outputs which are used to drive separate LEDs.

The ten step voltage divider network is connected between the built-in reference voltage source and ground. Each step of the divider provides a different sensing voltage for the positive input terminal of the comparators. The negative input of all comparators is driven by the signal input voltage applied to pin 5 of the chip, after being buffered by a resistor-diode network and amplifier. The output of each comparator feeds one LED of the display. It can be seen that this arrangement will result in any number of LED, from zero to ten, being illuminated depending upon the level of voltage fed to the input, pin 5.

Since it is desired to drive the LM3914 with only DC voltages at pin 5, a rectifying diode and storage capacitor has been provided to convert the audio voltage to DC. A potentiometer has been included so that the circuit can be calibrated to the proper power level for any audio system. The LM3914 will respond to audio voltages as low as 2.5 volts RMS, and is sensitive enough for the smallest of stereo systems. There is no limit to the maximum power range of the instrument, since the voltage divider action of the calibrating potentiometers will reduce the input driving

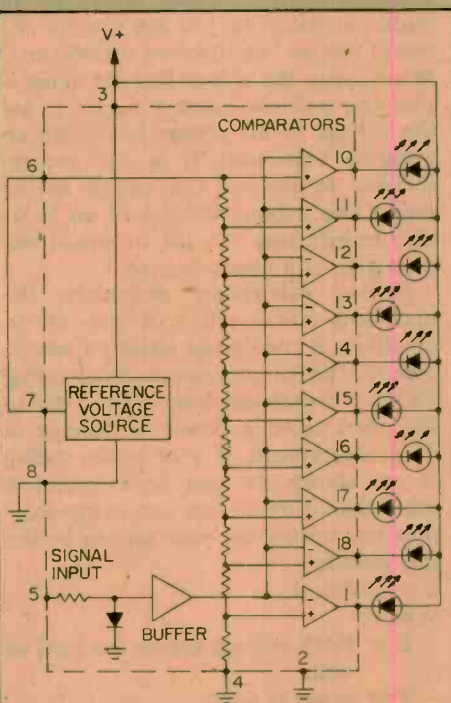

This is essentially a flow diagram of the LM 3914, with the LED output indicators in position (for reference). See the text for a more detailed explanation of the workings of the chip and the circuit as a whole.

# STEREO METER

voltage to the necessary value for the desired full scale range of the unit. A calibrating procedure is provided at the end of this article.

Power to drive the instrument is provided by a set of three NiCad cells connected in series which will deliver about 4 volts. The use of such cells allows the instrument to be completely portable. In addition, the excellent voltage regulation-characteristic of NiCad cells preserves the calibrated accuracy of the

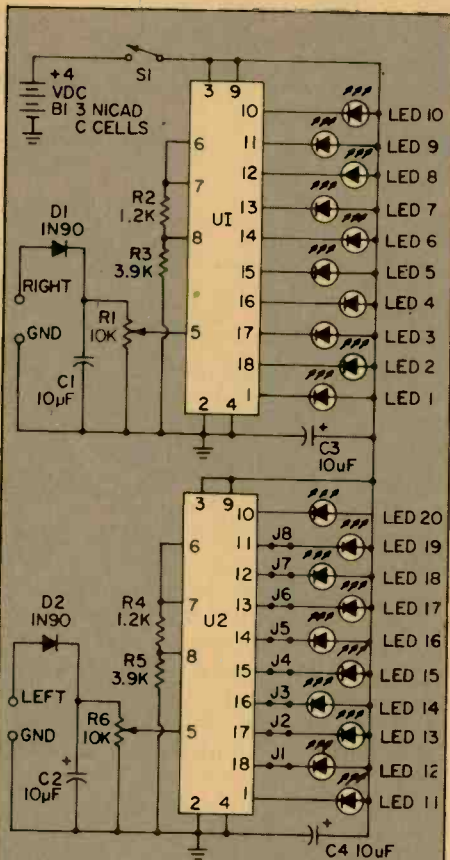

## STEREO POWER AND BALANCE METER PARTS LIST

- B1—Three, size C NiCad cells connected in series
- C1, C2, C3, C4—10 µF, 35-volt tantalum capacitor
- D1, D2—1N34/1N90 germanium diode
- LED1 through LED20—10 milliamper light emitting diode
- R1, R6—10K potentiometer
- R2, R4—1200-ohm, ¼ watt 10% resistor
- R3, R5—3900-ohm, ¼ watt 10% resistor
- S1—SPST switch
- U1, U2—LM3914 (Radio Shack 276-1707)
- Misc.—wire for jumpers and connections, printed circuit board, solder, mounting box, solder and hardware.

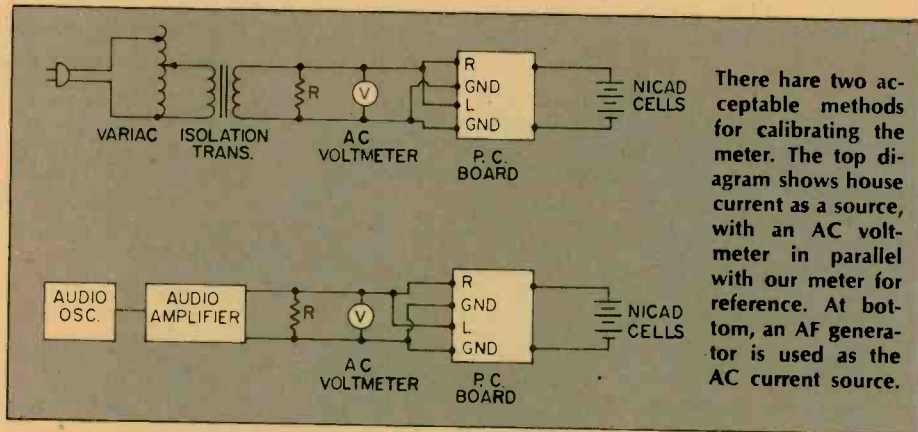

There are two acceptable methods for calibrating the meter. The top diagram shows house current as a source, with an AC voltmeter in parallel with our meter for reference. At bottom, an AF generator is used as the AC current source.

instrument. Any stable, 5 VDC power supply could be used with this unit. Just substitute it for the battery.

**Construction.** The entire circuit, with the exception of the power supply, is contained on a single sided printed circuit board measuring 2½ by 3½ inches. The set of 20 LEDs can be soldered directly to the board, taking advantage of the full lead length of each LED. This will permit the indicators to sit about ½ inch above the board so that the entire assembly can be mounted just behind the front panel of whatever enclosure you are going to use. You can cut two narrow openings in the enclosure, measuring about 1¼ by 3/16 inches, to accommodate the LEDs. Drill mounting holes in each corner of the printed circuit board and use ½-inch spacers to position the board away from the front panel. This type of construction avoids the problem of mounting twenty LEDs to the front panel, and makes the entire circuit easily removeable for service.

The LM3914 chips are supplied in 18-pin DIP plastic cases. It is strongly recommended that you use IC sockets instead of soldering the chips directly to the printed circuit board. It is almost impossible to remove a multipin IC that has been soldered to a printed circuit board without destroying the IC or printed circuit. Note that the orientation of the two integrated circuits are opposite to each other. Be sure to follow the proper layout as shown in the diagrams. Pin 1 of the IC is indicated by a small dot at one corner of the chip.

When mounting the LED's, capacitors, and diodes be sure to position these parts as shown. The circuit will not work if any of these polarized components are inadvertently placed in the board in the wrong direction. Double check before soldering them.

After you have mounted all components, you will note 16 unused holes in the board. To complete the circuit solder 8 jumper wires between U2 and one set of LEDs. Follow the schematic

diagram and parts' location diagram for the correct location of the jumper wires

External connections to the printed circuit board are accomplished by means of six wires. It is best to use different colors to avoid misconnections. Note that separate ground wires are used for each speaker connection, as well as the power supply negative lead. This is done to avoid ground loop problems which could cause unstable operation of the circuit. Follow the hookup as shown in the schematic diagram and you will have no trouble.

**Checkout and Calibration.** In order to calibrate the circuit you will need a source of AC power which can deliver up to 30 volts RMS into a low impedance load. For this purpose you can use your stereo amplifier driven by an audio oscillator, or you can use the AC power line and an isolation transformer. When using the power line for calibration you will also need a Variac to set the voltage to the proper level with an accurate voltmeter. It is not recommended to connect the circuit to the power line without the use of an isolation transformer. To do so would expose you to a shock hazard.

Before calibration determine the maximum power rating of your stereo amplifier, if you do not already know it. This will be the continuous power rating (RMS) of each amplifier. Then refer to the chart relating power to voltage in an 8 ohm system. If your power rating is not shown, or you have a system other than 8 ohms, you can easily compute the voltage for your system by the relationship

$$E = \sqrt{P \times R}$$

Where:

E = RMS voltage across the load in volts

P = Power in watts

R = Speaker impedance in ohms

The diagrams here illustrate the proper connections to calibrate the unit using either the power line or audio amplifier as the source of power. Note that you will need a load resistor to simu-

late the speakers of your system, and an AC voltmeter to measure the voltage. The value of the resistor is not critical; you can use any value from 8 to about 50 ohms. What is important is to use a load resistor that has a sufficient power rating to handle the full power at which you will be calibrating the instrument. When using the audio amplifier as the source of power, the operating frequency can be anything in the low range. 100 Hz is recommended.

Adjust the Variac or audio amplifier so that the AC voltmeter reads the correct RMS voltage as indicated in the calibration chart (or your own calculation). Apply power to the printed circuit circuit, using either the NiCad cells or AC power source. Note that as you vary R1 and R6 you will be able to illuminate some or all of the LEDs. The proper adjustment of both potentiometers will be the point at which the tenth LED of each set just becomes illuminated. You can check operation of the circuit by varying the level of the audio voltage fed to the printed circuit board. With zero volts drive, all LEDs will be extinguished. As you raise the voltage a pair of LEDs will light until you reach the full output power level at which time all 20 LED's will be illuminated. This completes calibration of the instrument.

**Using the Meter.** Connect the meter to your stereo system at the speaker terminals on the rear of the amplifier chassis. Be sure to use 4 wires for the connections and observe correct polarity of the leads as shown in the schematic diagram. Turn on your system and adjust the volume control for any desired volume level. If only 1 or 2 LEDs are illuminated it means that your power output at this listening level is very low. Increase the volume to illuminate more LEDs. Now you will be able to adjust the balance control of your system so that both sides of the system are delivering about the same output power. To test the maximum capability of your system, increase the volume level until the tenth LED of each set becomes illuminated on sound peaks. If the audio quality emanating from the speakers is still good, then your stereo amplifier is delivering the full power that was designed into it.

If it is desired to calibrate the power level of each LED, bear in mind that the circuit has a linear response to voltage, not to power. Thus, if only nine LEDs of each set are illuminated then the amplifier is delivering 90% of its rated voltage. This is equivalent to 81% of its rated power. The same square-law relationship holds for any number of illuminated LEDs. ■

This closeup of the meter shows the position of the jumpers and the LEDs. Small size allows you to build it into the cabinets of existing amps.

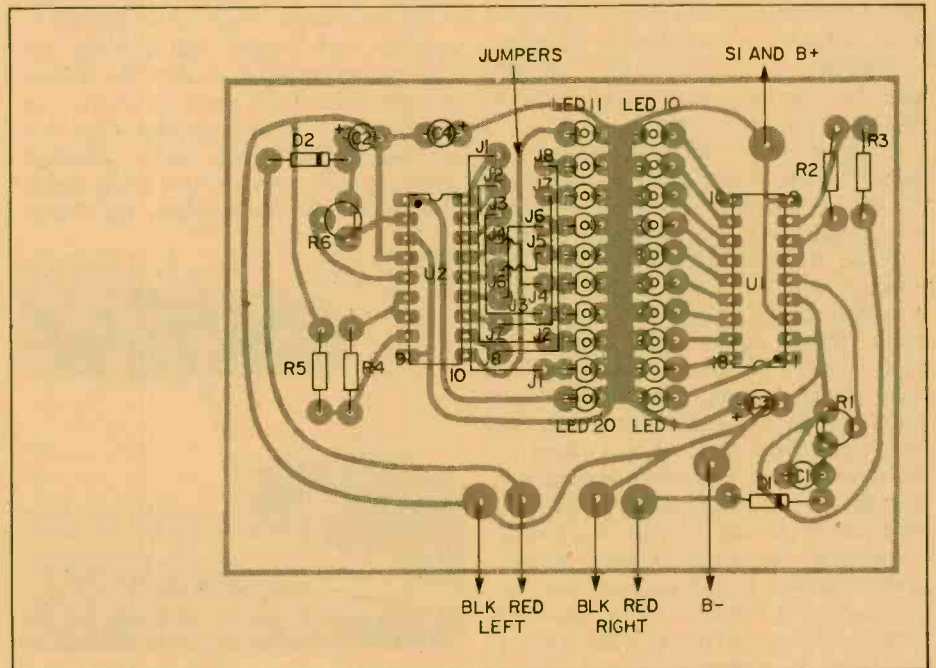
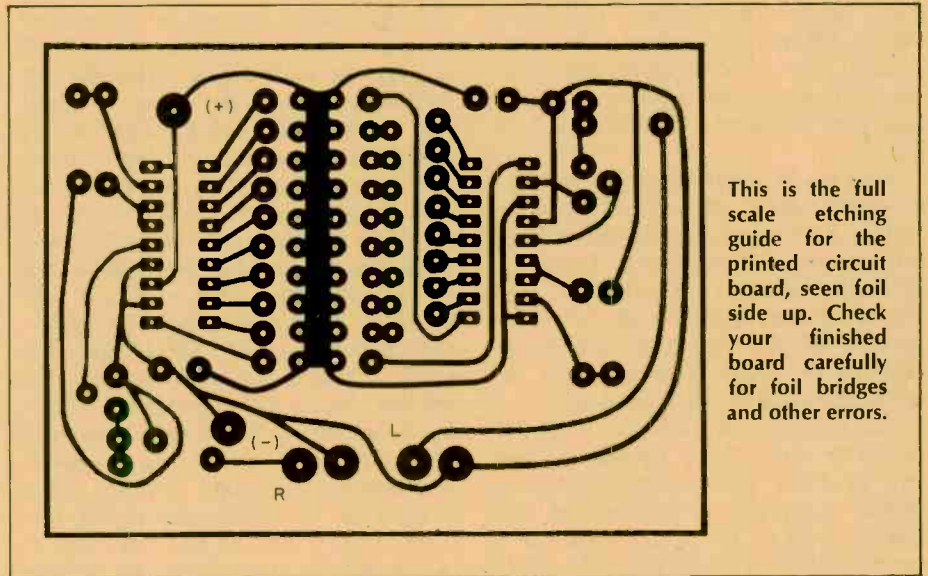
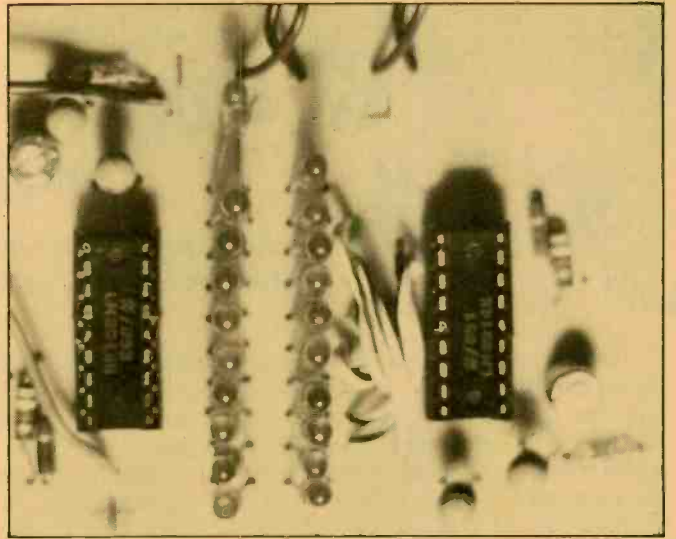



# RF from your Calculator

Your pocket calculator can save you sums, when you use it as an RF signal generator.



□ The virtues of portable electronic calculators are by now so well-known and their prices have dropped so low that the units are found almost everywhere. Many presently-available machines—especially those employing LED displays—can be used as quick troubleshooting aids in addition to performing their usual day-to-day calculating chores. Whenever you need a fast, convenient, and portable amplitude-modulated RF source for equipment check-out, your calculator can often fill the bill.

Here's why. Just about all battery-powered calculators emit strong, wide-band RF signals which extend well up into the tens of megahertz. These signals are generated primarily as side-effects by the operation of two components of the calculator: the power supply's DC-to-DC converter and the multiplexed LED digital readout.

Not every calculator has a DC-to-DC converter. But those operating from two or three penlight or nicad cells usually do, using it to step the battery voltage up to a higher level more suitable for operating the MOS ICs which do the arithmetic. The converter produces a harmonic-rich square-wave output at a fundamental frequency typically between 20 kHz and 100 kHz—but the harmonics extend well up into the megahertz region.

Even if your calculator is one of those without a DC-to-DC converter, it's still almost certain to use a multiplex system to drive the output digital display. Multiplexing means that each selected segment of the digital readout is rapidly turned on and off many times each second rather than staying on continuously. When this switching is done rapidly enough, the readout appears to stay on all the time because of the relatively slow response time of the human eye. Readout devices are multiplexed for two reasons. First, multiplexing drastically reduces the power required to operate the readout at any given *apparent* brightness level because the readout is actually on and drawing current for only a small percentage of the time. As a consequence, batteries last much longer. Secondly, multiplexing permits a great reduction in the

total number of IC's needed to actuate the calculator's readout display with an attending cost reduction at the time of purchase.

With a standard calculator's seven-segment LED readout and anywhere from 8 to 12 display digits, the multiplexing frequency is typically around 100 kHz. When currents of 20 mA or so are abruptly switched on and off through the LED display segments, significant amounts of RF energy at multiples of the multiplexing frequency are generated. These harmonics may extend well into the tens of megahertz. In fact, this harmonic radiation is one of the main reasons there are so few AM clock radios with LED time displays on the market today. The standard AM broadcast band is almost totally obliterated if the receiver's RF sections are within a foot or so of the multiplexed readout display unless extensive shielding is employed. Fortunately, there are two more practical and less expensive solutions than shielding. The first is the addition of resistance-capacitance networks to slow the rise and fall times of the multiplex waveform—and consequently filter out most of the higher-order harmonics. The second method is to drive each display digit directly and not use multiplexing at all. This second technique is much more practical in a clock radio than in a calculator for two reasons. First, clock radio displays normally have considerably fewer digits than most calculators; hence, the circuit

problem isn't nearly so complex. And secondly, with a clock operated from the AC power line, the problem of rapidly discharging the batteries unless the output is multiplexed is eliminated. National Semiconductor Corporation has recently introduced a clock chip with direct drive of all readout segments to eliminate RF interference. It was designed with clock radio applications in mind.

But now back to your calculator, which almost certainly is multiplexed and unfiltered and produces a rich harmonic output. Turn it on and slowly bring it near a standard AM radio which is tuned either to a weak station or between stations. You should hear a mixture of buzzes and tones as the calculator is brought within several inches of the radio or its antenna. These tones probably will shift in frequency if you key different numbers into the display.

Now that you've verified that your calculator is a portable, wideband, RF source, what can you use it for? Well, a number of applications are obvious. Anytime you need a quick check to see if the RF and IF stages of an AM receiver are working, your calculator can provide a test signal. Probably its handiest use, though, is in continuity testing antennas and connecting cables. Auto antennas and their accompanying cables and connectors are easily tested for opens and shorts by bringing the calculator near the antenna while monitoring the radio output. Perhaps the ultimate example of this technique you can perform in your automobile. Place a calculator near the windshield antenna of a late model General Motors car. In cases of poor or non-existent reception, one or both of the two thin antenna wires imbedded inside the glass may be broken. By carefully tracing the path of each individual wire, a break or faulty connection can be located when the radio's output changes abruptly.

And one final thought. Those of you with LED digital watches might experiment with them. The power is much lower, and the metal watch case provides a lot of shielding, but there just might be enough RF coming from the display to be useful.



One of the many uses for your calculator other than calculating. Here it is being used to check a windshield antenna.



# CYCLOPS

Sleep for 1001 peaceful nights  
with this electronic genie standing faithful guard

**B**UILD CYCLOPS. With his space age magic eye he will stand guard over your house or property and sound a musical alarm if an intrusion should occur. He does this without the use of any special light source by monitoring the ambient light intensity falling on his eye. Cyclops performs his guard duty with a very meager appetite for power, consuming only 1/2 watt while he is on duty. If an intrusion should occur, Cyclops responds by sounding an attention getting alarm, and automatically resets himself after a specified time delay selected by you.

You can also take advantage of Cyclops' unflinching eye by using him as an automatic doorbell. When someone approaches the door of your house and casts a shadow, the resulting change in light intensity falling upon Cyclops will cause him to sound a short and pleasant series of musical notes. You can extend his detection range by placing him in your driveway or garage to announce the arrival of an automobile at night, when he sees the headlights of a car.

**Versatility.** Cyclops is quite versatile and can be used for purposes other than an intrusion alarm or automatic doorbell. For example, you can construct an electronic rifle range by placing Cyclops' eye at the center of a bull's eye and shooting with a beam of light from a home-made ray gun. Each time the bull's eye is hit, a series of musical tones will sound. An electronic ray gun or rifle can be constructed by modifying a small flashlight which emits a narrow beam so that the light rays are concentrated. In order to produce a "shot," the circuit shown can be used. This will drive the light bulb from a charged capacitor and result in a pulse of light. Use a spring loaded SPDT switch.

Cyclops' built-in musical ability can be used as the basis for a "Close Encounters" sound generator accompa-

nied by a flashing light, or you can even place Cyclops in your car and have an unique musical horn. This and all the other features of Cyclops can be performed by a single electronic assembly which can be constructed at low cost. Simple modifications of the circuit will permit you to use Cyclops for whatever purpose you desire.

**About the Circuit.** The eye and heart of Cyclops is a specialized integrated circuit which is the result of a marriage between a photodiode and a digital and linear circuit on a single chip. Such a device is called an Optolinear and is available to you from the source specified in the parts list for Cyclops. This is the 14-pin IC chip shown in the photograph of the Cyclops PC board.

The Optolinear IC chip is the eye of Cyclops. This nifty little package detects small changes in the ambient lighting conditions and triggers the alarm. You can use this handy device as a burglar alarm or as a household remote controller.

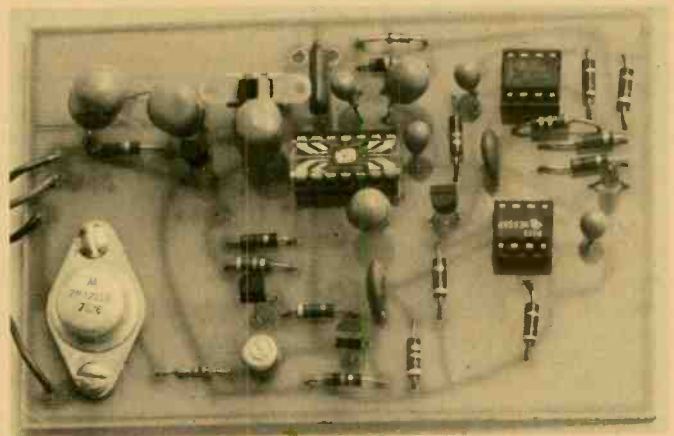

IC1 is an integrated circuit motion detector which monitors the ambient light intensity falling on the built-in photodiode. When a change in light intensity occurs, a circuit is triggered which produces a series of pulses of varying frequency in the audio range. A digital counter within the chip permits a specified number of pulses to be generated, and then resets the circuit back to a standby mode to await the next change in light intensity falling upon the photodiode. The series of

audio pulses produced, when amplified and fed to a loudspeaker, is a simulation of the familiar whooping sound which is characteristic of some alarms. C4 determines the rate at which the circuit changes from one tone to the next, and can be changed to suit individual tastes. IC1 has an additional digital circuit which produces a second set of random musical tones which might be described as "Close Encounters" music. When the chip is in this mode of operation, it is also capable of flashing a 6 volt light bulb in time with the music.

Control of the operation of IC1 is accomplished by feeding a positive voltage to either or both control input terminals, pins 11 and 14. When ter-

minals C and D of the printed circuit are connected together and terminals A and B are open, the circuit is set to perform as an intrusion alarm. Opening the circuit between terminals C and D, and A and B, programs the circuit for "Close Encounters" music. Automatic control of terminals A and B of the circuit is provided by IC2 and IC3, and manual control of terminals C and D is provided by a single pole slide switch mounted directly on the printed circuit board.

# CYCLOPS

Power to drive a loudspeaker is provided by Q2 and Q5 which amplify the low voltage output pulses of IC1 and deliver peak currents of up to 1 ampere into the speaker. When IC1 is in standby mode, the voltage at the output terminal, pin 1, is about 4 volts. This cuts off both Q2 and Q5 so that current in the loudspeaker is zero. When IC1 is activated, Q2 conducts current and provides base drive to Q5 through R3 which acts as a volume control. When the circuit is set for maximum volume, Q5 acts as a switching transistor, driving the loudspeaker with pulses of about 12 volts. The circuit will drive loudspeakers of any impedance. Greatest volume will be obtained with a 3.2 ohm speaker, since this will draw the highest load current from Q5. Peak power delivered to a 3.2 ohm speaker can be as high as 40 watts when the volume control is set to maximum. Average power will be much less than this since the circuit delivers pulses with a duty cycle of less than 50%.

**Construction.** Cyclops can be constructed on a single sided printed circuit board measuring 2 7/8 by 4 1/4 inches. This includes all the necessary circuitry with the exception of the 12 volt power source. If an AC operated power supply is desired, it can be added to the circuit at the option of the builder. A typical power supply circuit is shown

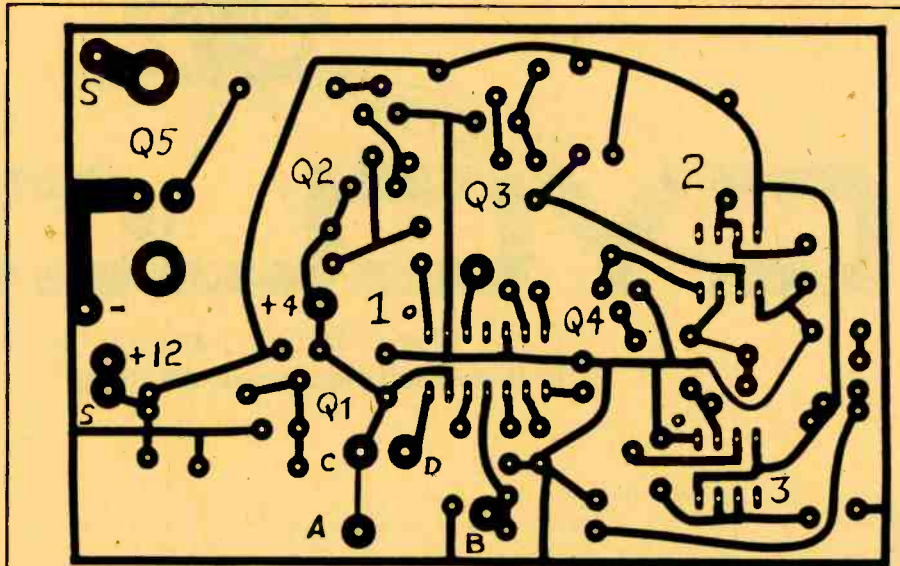

Use this full-sized printed circuit board template to make your own Cyclops. You might try out one of the new PC kits from Vector that lifts the pattern from a magazine page.

with the schematic on the next page.

The printed circuit layout in this article is shown full size as seen from the copper side of the printed circuit board. The component layout is also shown. If possible, make photocopies of the printed circuit, component layout, and schematic diagram and work from these copies. This will avoid wear and tear on the originals which you will want to keep in good condition for future reference.

After etching the printed circuit, go over it with a magnifying glass to pick up any shorts or opens which may ex-

ist. This will help avoid problems when the circuit is first placed in operation. For a slight additional cost, it is strongly recommended that sockets be used for the integrated circuits. Their value in a printed circuit assembly cannot be overemphasized. The use of sockets give you the ability to troubleshoot the circuit, should a problem exist, in much less time than if the IC's were soldered in place. It is extremely difficult to remove a multi-pin IC which has been soldered into a printed circuit without destroying the IC or printed circuit. Do not mount the integrated

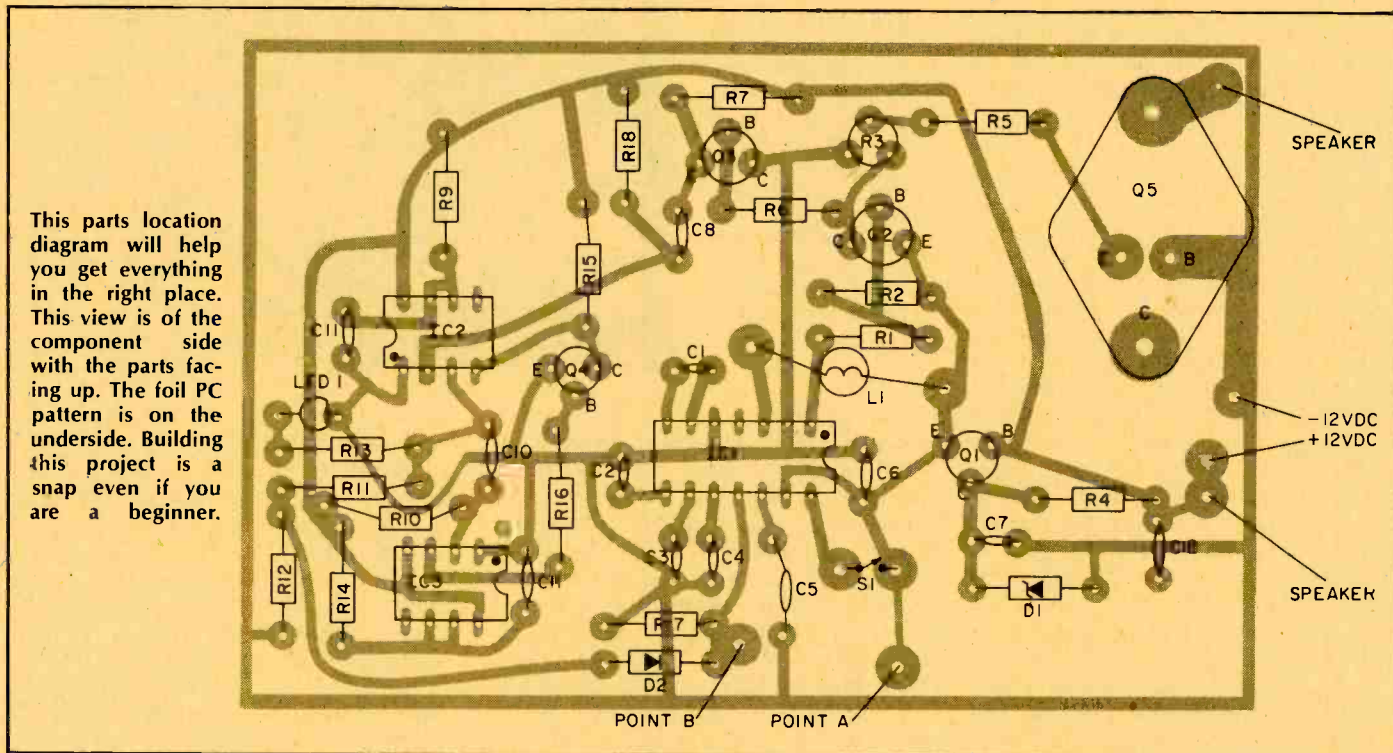

This parts location diagram will help you get everything in the right place. This view is of the component side with the parts facing up. The foil PC pattern is on the underside. Building this project is a snap even if you are a beginner.

circuits until instructed to do so in the checkout procedure.

The component layout shows control switch S1 and volume control R3 mounted directly to the printed circuit board. You may want to mount the printed circuit board in a small cabinet with these components accessible from the outside. If you are going to use the lamp with the circuit, be sure to place it so that its light will not fall upon IC1. Should this happen, the additional feedback signal from the lamp may cause a circuit malfunction, although no damage will occur.

You will note that the power output transistor, Q5, is mounted to the printed circuit board with no heat sink. None is required since this transistor operates as a switch at high current levels, and therefore dissipates very

little heat. Mount Q5 to the printed circuit board with two 4-40 screws and nuts. Make them tight but not overtight.

**Checkout Procedure.** The printed circuit assembly should be checked with power applied before installing any of the integrated circuits in place. This will avoid damaged components in the event of possible short circuits or miswiring. Apply 12 VDC power to the circuit using a battery or AC operated power supply, observing correct polarity. Measure the voltage at pin 13 of IC1 using the negative side of the DC power supply as the meter reference. This should be between +3.5 and +4.5 volts DC. If the voltage is not within this range, check zener diode D1 for a voltage drop of 4.2 to 5.2 volts. Check also that D1 is mounted

(Continued on page 98)



If Cyclops really appeals to you as a useful gadget, but you don't have the time or experience to put it together, then you might consider ordering Delta Electronics' Motion Detector. It uses the same IC as Cyclops. It sells for \$24.50 in kit form or \$69.50 fully assembled with NiCad batteries and charger. Delta's address is in the parts list of this article.

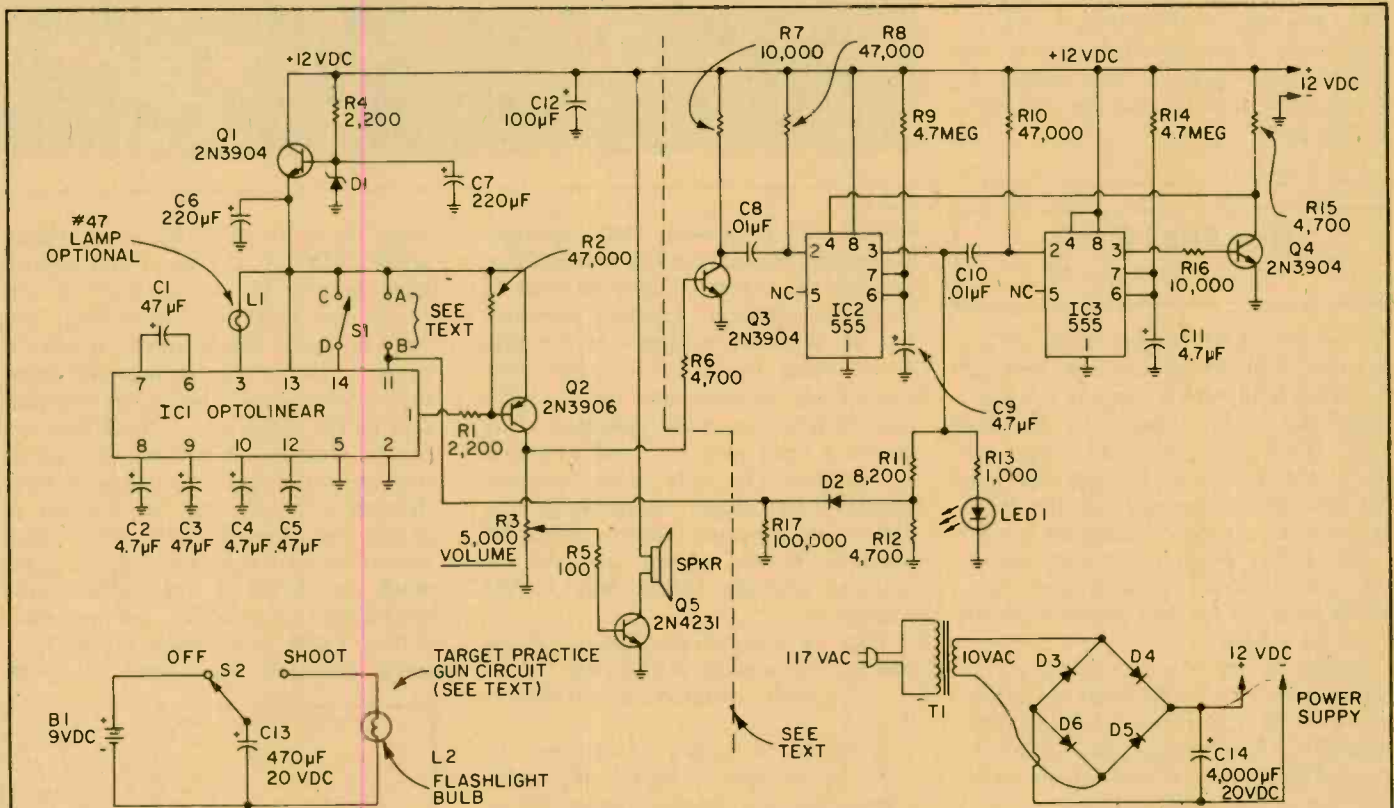

**PARTS LIST FOR CYCLOPS**

- B1—9-volt battery
- C1, C3—47- $\mu$ F electrolytic capacitor, 10 VDC
- C2, C4—4.7- $\mu$ F electrolytic capacitor, 10 VDC
- C5—0.47- $\mu$ F ceramic disc capacitor, 10 VDC
- C6, C7—220- $\mu$ F electrolytic capacitor, 20 VDC
- C8, C10—0.01- $\mu$ F ceramic capacitor, 10 VDC
- C9, C11—4.7- $\mu$ F electrolytic capacitor, 20 VDC
- C12—100- $\mu$ F electrolytic capacitor, 20 VDC
- C13—470- $\mu$ F electrolytic capacitor, 20 VDC
- C14—4,000- $\mu$ F electrolytic capacitor, 20 VDC
- D1—1N5230 4.7 volt zener diode
- D2—1N4148 silicon diode
- D3, D4, D5, D6—1N2069 silicon diode
- IC1—Optolinear IC (see text for explanation)
- IC2—555 timer
- IC3—555 timer

- L1—#47 lamp
- L2—flashlight bulb
- LED1—light emitting diode
- Q1, Q3, Q4—2N3904 NPN silicon transistor
- Q2—2N3906 PNP silicon transistor
- Q5—2N4231 NPN silicon transistor
- R1, R4—2,200-ohm, 1/4-watt resistor
- R2, R8, R10—47,000-ohm, 1/4-watt resistor
- R3—5,000-ohm trimmer potentiometer (PC board mounting type)
- R5—100-ohm, 1/4-watt resistor
- R6, R12, R15—4,700-ohm, 1/4-watt resistor
- R7, R16—10,000-ohm, 1/4-watt resistor
- R9, R14—4,700,00-ohm, 1/4-watt resistor
- R11—8,200-ohm, 1/4-watt resistor
- R13—1,000-ohm, 1/4-watt resistor

- R17—100,000-ohm, 1/4-watt resistor
- SPKR—3.2-ohm PM type speaker
- S1—SPST miniature slide switch
- S2—SPDT momentary-on switch
- T1—10-volt, 1.2 amp transformer
- Misc.—large plastic cabinet (8 in. by 4 in. by 4 in.) screws, spacers, wire, AC plug and zip cord, etc.

Note: IC1 is available from:  
 Delta Electronics  
 7 Oakland St.  
 P.O. Box 2  
 Amesbury, Mass. 01913  
 Catalog #1072W  
 Price: \$8.95

## Signal Tracer

(Continued from page 51)

**Use.** Turn on the tracer, as you would regularly turn on the radio, and set the volume up half-way. Now insert the plug with the input leads into jack J1. Connect a signal source to the tracer's input leads and listen for it.

With its RF circuitry, you can listen to modulated RF signals when switch S1 is in the RF position. The normal procedure is to connect the tracer's ground (-) input lead to the ground of the unit under test, and connect the positive tracer lead in a radio frequency circuit somewhere before the "detector."

Books on troubleshooting can give you many tips on how to best utilize a signal tracer and with only a little practice, you can start beating down the high cost of professional service, and maybe even make a little money by fixing your friends' and family's electronic gear!

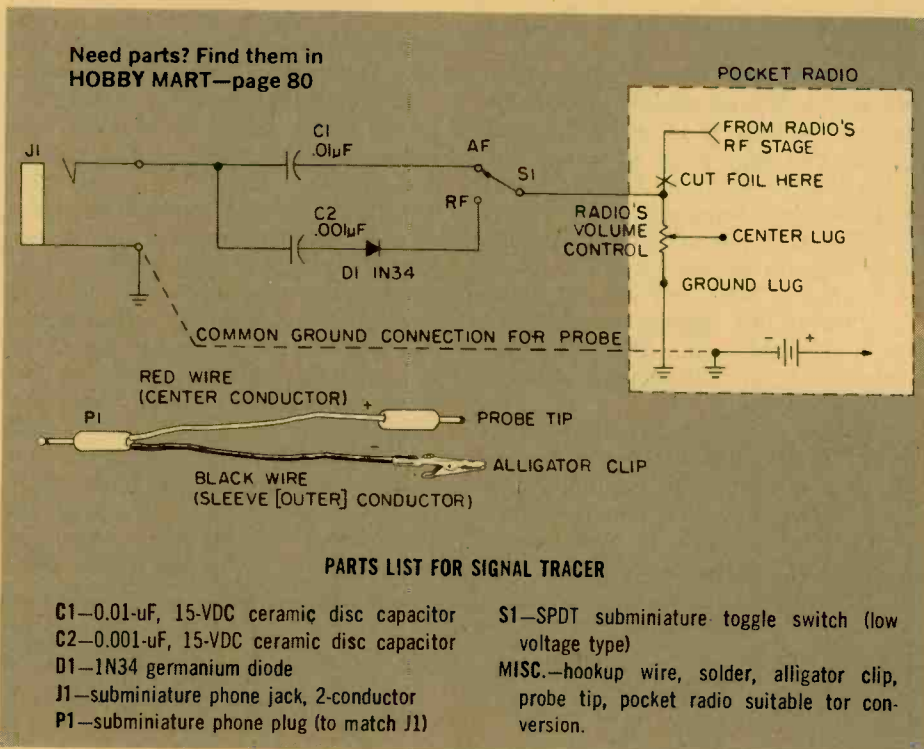

## New Shell Game

(Continued from page 67)

the output of IC4f goes high. IC3d, however, will not go low and turn off the clock until *both* its inputs are high. When the output selected by S2 goes high, IC3d goes low and stops the clock. C4 discharges through R4 into the near ground potential of the IC3d output with a time constant set by the value of R4. When the voltage across C4 decays to 4.5V, IC4d goes low, which turns off Q1 and removes power from the LEDs.

Switch S1 reverses the stage 2 and 3 connections to provide either a straight (1-2-3-2) or zig-zag (1-3-2-3) lighting sequence. Depressing S4 forward-biases Q1, allowing display of the static contents of the shift register.

With values as specified, the *interval* time can be as long as 3 seconds, the last LED on-time of up to 0.3 seconds, and the clock speed can be varied from 1 Hz to about 40 Hz. Power, which is applied through switch S5, is supplied by a single 9 volt battery.

**Construction.** While any standard means of construction, such as perf-board or wire wrap, may be used, a PC board is recommended. Solder all components onto the PC board, using as little heat as is required to make a good solder joint. Observe the indicated polarity for all diodes, C3, and the ICs. Be careful when handling the

CMOS ICs to prevent static damage. IC sockets may be used if desired. You can use the excess component leads to form the fourteen jumpers identified by "J" in the component layout diagram. After the PC board has been completed, interconnect the controls and switches to it as indicated. Any standard case may be used to house the project. The only restrictions are that the LEDs should be visible to both player and operator, display switch S4 accessible to the player, and all remaining controls visible only to the operator.

**Use.** A general description of the operation procedure is as follows:

1. Set *select* switch S2 to position 1, 2 or 3.
2. Set S1 to *zig-zag* or *straight*.
3. Adjust *speed* control R2, *odds* control R4, and *interval* control R5 as desired.
4. Press *start* switch S3. As soon as S3 is depressed, the LEDs will sequence, starting with LED1, in the pattern and at the speed selected. The sequence will continue for the interval chosen, whereupon the LED selected will remain on for the time chosen by the setting of the *odds* control.

Initially, the operator should set a slow speed, medium interval and high odds. As the player becomes more confident, the control settings should be changed in an effort to fool the player. The controls can be set so that the last LED to illuminate does not appear to

come on at all. With the *odds* control set to minimum, the *speed* and *interval* controls can be set so that on-time of the last LED will be so short that (in a normally lighted room) it will not be seen. The proper settings will cause the interval to end during the low portion of the clock signal. Since this can not be determined without monitoring the internal signals, the operator must develop a "feel" for the controls to obtain the desired effect. This effect should be used sparingly lest the player catch on. Although the game should not be used for gambling, non-monetary betting (with poker chips or the like) makes the game more entertaining. ■

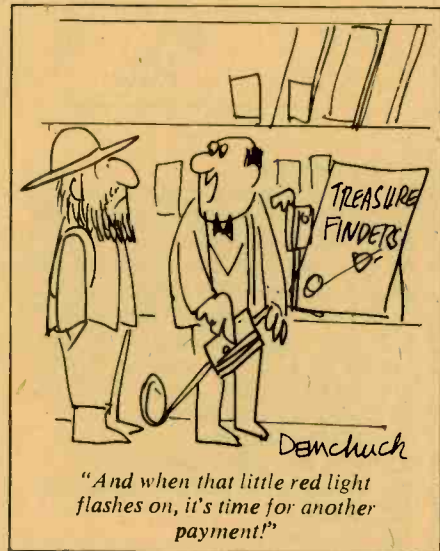

## Disco King

(Continued from page 63)

R2 varies the Tempo from extremely slow to very rapid and that LED 1 lights each time the base drum is heard. Depress and hold S1 and note that the sounds stop. Release S1 and note that the sounds restart with the base drum. If you plan to use the manual base drum triggering facility, you may construct a simple footswitch. Connect the footswitch to J1 (*Base Drum Trigger*) and note that the base drum sound is heard each time the footswitch is pressed.

**Drum Up a Storm.** Once adjustment and checkout have been completed as indicated above, operation of the unit should be clear. The most common Disco percussion pattern is obtained with the jumper connecting SO-1 pins that R16 can adjust the cymbal volume from full off to maximum. Note that 4 and 5 (note that SO-1 pins 1 through 4 are wired together). The other three pattern variations are obtained by connecting pins 1 & 8, 2 & 7 or 3 & 6. Removing the jumper disables the cymbal generator. To use the unit as an electronic base drum you can either set R16 to minimum or remove the jumper from SO-1. Always turn the unit off when not in use.

You may wish to substitute a push on-push off switch for the momentary switch S1. This will allow sustained off periods without having to keep S1 depressed. You may also wish to substitute a rotary switch for the socket

Many of our Disco King's parts mount off the PC board. Follow this connection diagram and you won't find yourself all confused.

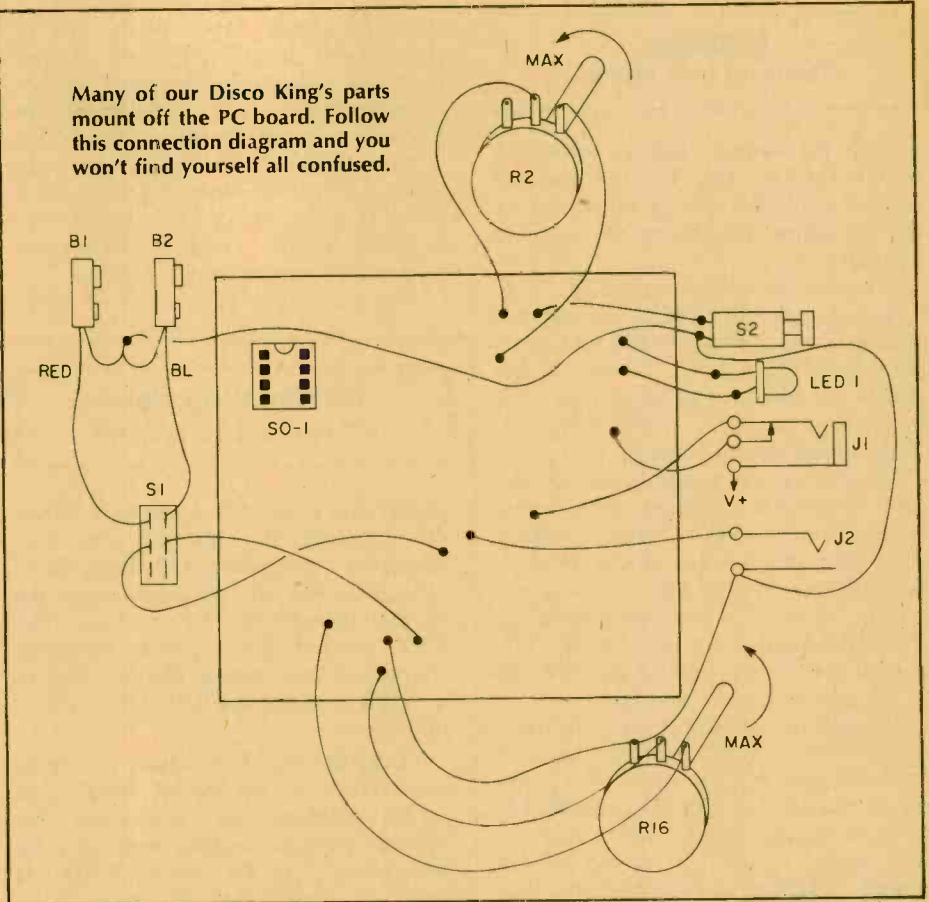

and jumper method of pattern selecting. A wiring diagram for this substitution is shown.

You'll find that Disco King is quite a conversation piece. All your friends will ask how you fit Ringo Starr into such a small box! ■

## Fridgalarm

(Continued from page 56)

$\frac{2}{3}$ , its most linear region.) As C1 reaches a charge of two-thirds of its capacity, the output of U1 (at pin 3) goes low, near ground, and thereby completes the voltage supply to U2 which also operates as an astable oscillator but with a much shorter period. As U2's output swings between high and low, it creates the sound that is coupled through C5.

**Operation.** With the values shown, the alarm will trigger about thirty seconds after the refrigerator door is opened, and sound for about fifteen seconds, then cycle on and off every fifteen seconds until the door is closed. Should you prefer the alarm to sound continuously until the door closes, remove the connection between pin 2 on U1 and the rest of the circuitry. This prevents

the timer from resetting until supply voltage is removed by closing the door.

Should the tone we've chosen not be noxious enough for you, you can change its pitch by varying R5 (which changes the frequency of U2's oscillations), to a higher value producing a *lower* frequency, or by changing C3 to a lower value, producing a *higher* frequency. Similarly, the timing period before the alarm sounds can be varied by changing either C1 or R3.

**Construction.** We built our project on a Continental Specialties Corporation Experimenter 350 solderless breadboard, which enabled us to jockey the parts around.

**Conclusion.** Since both our electric bills and the weights of our wives are down, and we must no longer regularly treat the kids for frostbite, we feel secure in calling the Refrigerator Alarm a chilling success. ■

## elementary Electronics

\$1.25 At Your Newsstand

### Super New Projects

Build a darkroom print perfecter, a digital voltmeter for auto, a unique audio frequency generator, a home-brew TTY interface.

### All about . . .

Receiving satellite TV at home, keeping time in the ham shack, space-age light bulbs, scanner antennas.

### Dynamite Departments

On antique radio, up-to-date computer developments, new products from everywhere, CB radio today, shortwave radio, electronics books.

ON SALE FEB. 21, 1980

## Cyclops

(Continued from page 95)

so that the cathode side is connected to the base of Q1. Do not proceed further until the voltage at pin 13 of IC1 is within the range of +3.5 to 4.5 volts.

Measure the voltage at pins 2, 5, 6, 7, 8, 9, 10, and 12 of IC1. This voltage should be zero. Measure the voltage at pin 8 of IC2 and IC3. This voltage should be about +12 volts. Measure the voltage at pin 1 of IC2 and IC3. This voltage should be zero.

Disconnect the power from the circuit. Very carefully insert the integrated circuits in their sockets, paying strict attention to the proper orientation for pin 1 as shown in the component layout. Pin 1 of the Optolinear IC is indicated by a red dot or "U"-shaped indentation molded into the top of the plastic case at one end.

Be sure the speaker is properly connected to the circuit between the +12 volt bus and the collector of Q5. Set S1 to the ON or closed position. Adjust the volume control about halfway and apply 12-volts of power to the circuit, observing correct polarity. You should hear the whooping sound generated by the circuit, and the LED should light. The LED should remain lit for about 30 seconds, and when it goes out, the sound should continue for a few seconds more. Once the sound stops, you can wave your hand over IC1 and cause the sound to start again. This time the circuit will reset itself after a few seconds, since IC2 is being inhibited by the timed cycle of IC3. After another 30 seconds has passed, the cycle can be repeated.

To generate the "Close Encounters" music sound, throw S1 to the OFF or open position. When you apply power to the circuit, Cyclops will generate the whooping sound for 30 seconds, and then will switch to the "Close Encounters" music for another 30 seconds as IC2 and IC3 switch on and off. This sequence will repeat indefinitely. If you wish to generate only the "Close Encounters" sound, remove IC2.

**Applications.** Cyclops can be used in many applications depending upon the connections between terminals A, B, C, and D of the circuit and whether or not the timing circuitry of IC2 and IC3 is included in the assembly.

For a short timing interval, such as would be needed for an automatic doorbell or light operated rifle range, the circuit shown on the right of the dotted line of the schematic can be de-

leted. S1 should be set to the ON or closed position and terminals A and B of the printed circuit board should be connected together. For these applications, as well as using Cyclops for a musical automobile horn, you may want to slow the whooping rate for a more pleasant sound. This can be easily accomplished by changing the value of C4 to 10 microfarads or more.

The circuit can be used as an intru-

sion alarm with a long timing interval by building the complete circuit as shown in the schematic. Set S1 to the ON or closed position and short terminals A and B.

A combination whooping sound and "Close Encounters" music can be produced by building the entire circuit and setting S1 to the OFF or open position. Delete the timing circuit for continuous "Close Encounters" music. ■

## Teletype Interface

(Continued from page 86)

positive bit causes Q1 to conduct. When Q1 conducts, its collector goes low, effectively "grounding" Q2's base, thereby turning Q2 off and interrupting the current through the TTY printer. The TTY current interruptions represent characters and control modes, causing the TTY to print the RS232 I/O transmission.

**Construction.** Just about anything goes. There are no special shielding or layout problems, and just about any general purpose replacement can be used for Q1, Q2, D1, and Z1. LED 1 is simply a "power on" indicator. Resistors can be 1/4 or 1/2-watt rating. Do

not use 1/10-watt resistors.

The unit shown is built on a section of micro-perforated wiring board, using flea clips for some tie points. Other wiring is by direct connection on the underside of the board. The cabinet is a plastic "experimenter's box" approximately 2.5 by 3 by 5.25-inches. The input and output connectors are the Molex type, sold at Radio Shack and other parts stores.

Z1 is a 50 PIV silicon rectifier bridge; you can substitute a bridge made up of four individual diodes if desired. Diode D1 can be any silicon type rated 25 PIV or higher.

The perf-board assembly can be secured inside the cabinet with a few dabs of RTV silicon rubber adhesive, or even silicon rubber bathtub calk. Allow 24 hours for the adhesive to dry. ■

## New Products

(Continued from page 7)

for a 48-inch fiberglass antenna on a truck mirror mount. The Model 18017 can be installed on any standard base loaded antenna, above or below the spring. It can also be

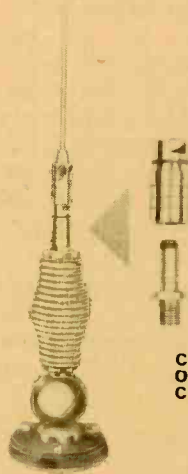

CIRCLE 43  
ON READER SERVICE  
COUPON

used with any 1/4 inch-20 thread antenna whip or spring, with placement between the spring and coil

or between the spring and whip adapter. For further information on these Quick Disconnect Adapters, or their other two-way radio communications products, contact Antenna Incorporated, 26301 Richmond Road, Cleveland, OH 44146. ■

"To Mr. Charles M. Walker,  
Wodwil, Iowa... Dear  
Mr. Walker: Yes, you may leave  
the room..."

# LITERATURE LIBRARY

399. "Firestik" Antenna Company has introduced a new and informative product catalog on top-loaded, helically wire-wound antennas and mounts.

398. Hamtronics, Inc. has announced a new 1980 catalog featuring many types of kits for the radio amateur. Products include a 435 MHz Transmitting Converter and a weather tone alert receiver module.

397. Instant Software, Inc. is offering a special holiday catalog for all kinds of year 'round software package gift-giving, as well as their regular microcomputer catalog.

396. Creative Computing's first software catalog of various education and recreation simulation programs as well as sophisticated technical application packages is available now.

395. OK Machine and Tool Corporation features the new PRB-1 Digital Logic Probe on the cover of its latest catalog of wire wrapping and other electronic assembly tools.

394. KEF Electronics Ltd. is offering two speaker systems in kit form at a significant cost-savings. The Model 104aB and the Cantata can be easily assembled and may be auditioned before purchasing.

389. You can't buy a bargain unless you know about it! Fair Radio Sales' latest electronics surplus catalog is packed with government and commercial buys.

388. SWLs need Gilfer's Shortwave Mail Order Catalog for economy one-stop armchair shopping. From top-notch rigs to reporting pads, Gilfer supplies all your hobby needs.

327. Avanti's new brochure compares the quality difference between an Avanti Racer 27 base loaded mobile antenna and a typical imported base loaded antenna.

362. A new catalog crunched full of military, commercial and industrial surplus electronics for every hobbyist is offered by B&F Industries. 44 pages of bargains you've got to see!

384. B&K-Precision has issued BK-10, a condensed catalog describing their oscilloscopes, semi-conductor testers as well as test instruments for CB, radio and TV repair.

310. Compumart Corp., formerly NCE, has been selling computers by mail since '71, and is offering a 10-day return policy on many items featured in their latest catalog.

322. Radio Shack's latest full color catalog, "The Expanding World of TRS-80," is out now, packed with up to the date information on this microcomputer. Specifications for the new Model II as well as the Model I are included.

386. If you're looking for books on computers, calculators, and games, then get BITS, Inc catalog. It includes novel items.

335. The latest edition of the TAB BOOKS catalog describes over 450 books on CB, electronics, broadcasting, do-it-yourself, hobby, radio, TV, hi-fi, and CB and TV servicing.

338. "Break Break," a booklet which came into existence at the request of hundreds of CBers, contains real life stories of incidents taking place on America's highways and byways. Compiled by the Shakespeare Company, it is available on a first come, first serve basis.

345. For CBers from Hy-Gain Electronics Corp. there is a 50-page, 4-color catalog (base, mobile and marine transceivers, antennas, and accessories).

393. A brand new 60-page catalog listing Simpson Electric Company's complete line of stock analog and digital panel meters, meter relays, controllers and test instruments has just come out.

385. Amateur Radio buffs and beginners will want the latest Ham Radio Communications Bookstore catalog. It's packed with items for the Ham.

373. 48-page "Electronic Things and Ideas Book" from ETCO has the gadgets and goodies not found in stores and elsewhere.

382. Buys by the dozens in Long's Electronics super "Ham Radio Buyer's Guide." Good reading if you're in the market for a complete station or spare fuses.

383. If you're a radio communicator, either ham, SWL, scanner buff or CBER, you'll want a copy of Harrison Radio's "Communications Catalog 1979." Just what the shack book shelf needs.

380. If your projects call for transistors and FETS, linear and digital ICs, or special solid-state parts, then look into Adva Electronics' mini-catalog for rock bottom prices.

301. Get into the swing of microcomputer and microprocessor technology with CREI's new Program 680. New 56 page catalog describes all programs of electronics advancement.

302. Giant savings are what Burstein Applebee has in store in their latest mail order catalog. Everything from CB test equipment to name brand audio wares are advertised.

305. A new 4-page directional beam CB antenna brochure is available from Shakespeare. Gives complete specs and polarization radiation patterns for their new fiberglass directional antennas.

371. Your computer system needn't cost a fortune. Southwest Technical Products offers their 6800 computer complete at \$395 with features that cost you extra with many other systems.

306. Antenna Specialists has a new 32-page CB and monitor antenna catalog, a new amateur antenna catalog, and a complete accessory catalog.

307. Atlas calls their 210X and 215X the perfect amateur mobile rigs. Their 6-page, full-color detailed spec sheet tells all. Yours for the asking.

330. There are nearly 400 electronics kits in Heath's new catalog. Virtually every do-it-yourself interest is included—TV, radios, stereo and 4-channel, hi-fi, hobby computers, etc.

392. The opening of the new Software of the Month Club has been announced by Creative Discount Software, which is giving out membership enrollment applications now. The Club plans to have separate branches for users of the Apple II, TRS-80, Ohio Scientific, Exity, Pet and CP/M based systems.

390. Whitehouse & Co., your "hard to find parts specialist," offers over a dozen parts and kits in their latest catalogue, featuring an entire section on gunnplexers for Amateur Radio buffs.

313. Get all the facts on Progressive Edu-Kits Home Radio Course. Build 20 radios and electronic circuits; parts, tools, and instructions included.

320. Edmund Scientific's catalog contains over 4500 products that embrace many sciences and fields.

328. If you are into audio, ham radio, project building, telephones, CB or any electronics hobby you'll want McGee's latest catalog of parts and gadgets.

333. Get the new free catalog from Howard W. Sams. It describes 100's of books for hobbyists and technicians—books on projects, basic electronics and related subjects.

354. A government FCC License can help you qualify for a career in electronics. Send for information from Cleveland Institute of Electronics.

355. New for CBers from Anixter-Mark is a colorful 4-page brochure detailing their line of base station and mobile antennas, including 6 models of the famous Mark Heliwhip.

391. A new software products catalog for the Apple II Computer has just been issued by Charles Mann & Associates. The booklet contains business accounting, accounts receivable, inventory, BASIC teaching and other special purpose business applications.

359. Electronics Book Club has literature on how to get up to 3 electronics books (retailing at \$58.70) for only 99 cents each . . . plus a sample Club News package.

311. Midland Communications' line of base, mobile and hand-held CB equipment, marine transceivers, scanning monitors, plus a sampling of accessories are covered in a colorful 18-page brochure.

## ELECTRONICS HOBBYIST Box 1849, G.P.O. New York, NY 10001

1980 EDITION  
Void After July 6, 1980

Please arrange to have the literature whose numbers I have circled below sent to me as soon as possible. I am enclosing 50¢ for each group of 10 to cover handling. (No stamps, please.) Allow 4-6 weeks for delivery.

|     |     |     |     |     |     |     |     |     |     |     |     |
|-----|-----|-----|-----|-----|-----|-----|-----|-----|-----|-----|-----|
| 301 | 302 | 305 | 306 | 307 | 310 | 311 | 313 | 320 | 322 | 327 | 328 |
| 330 | 333 | 335 | 338 | 345 | 354 | 355 | 359 | 362 | 371 | 373 | 380 |
| 382 | 383 | 384 | 385 | 386 | 388 | 389 | 390 | 391 | 392 | 393 | 394 |
| 395 | 396 | 397 | 398 | 399 |     |     |     |     |     |     |     |

300  Enter my subscription to ELEMENTARY ELECTRONICS for 6 issues at \$3.98. Check enclosed. Canada and all other countries \$5.00. HOC247

NAME (print clearly)

ADDRESS

CITY

STATE

ZIP

# Classified MARKET PLACE

**ELECTRONICS HOBBYIST — PUBLISHED ANNUALLY.** The rate per word for Classified Ads is \$1.00 each insertion, minimum ad \$15.00 payable in advance. Capitalized words 40¢ per word additional. To be included in next issue, write to R. S. Wayner, DAVIS PUBLICATIONS, INC., 380 Lex. Ave. N.Y. NY 10017

### ADDITIONAL INCOME

**LUCRATIVE SPARETIME TRAVEL AGENT CAREERS**, detailed guidebook explains, send \$3.95 (refundable) SAV Travel, Box 571-A6, Hicksville, NY 11802.

**BECOME COMMISSION MAILER.** How? Write: Grahams, DPBX 99371, Tacoma, WA 98499.

### AGENTS WANTED

**OWN DATING SERVICE.** Send SASE: Selected, Box 157, Holland, Ohio 43528.

### AUTHORS SERVICE

**PUBLISH YOUR BOOK!** Join our successful authors. Publicity, advertising, beautiful books. All subjects invited. Send for fact-filled booklet and free manuscript report. Carlton Press, Dept. SMD, 84 Fifth Avenue, New York 10011.

### AUTOMOBILES & MIDGET CARS

**NEW AUTOMOBILE YEARLY? HOW?** Details: Supercar, Box 28101-B3, St. Louis, MO 63119.

### BLUEPRINTS, PATTERNS & PLANS

**SOLAR COLLECTORS:** Economical to build, sell. Plans \$5. Moore Solar, Taft Street, Ayer, MA 01432.

**NEW CRAFT PRINT CATALOG—**Choose from over 100 great easy-to-build plans. Send \$1.50 (completely refunded with your first order). **BOAT BUILDER**, (CP Div.)—380 Lexington Ave., New York, NY 10017.

### BOOKS & PERIODICALS

**ELECTRONIC SURVEILLANCE, LOCK TECHNOLOGY**, other unusual books & manuals. Free brochures. Write: MENTOR, Dept. DP, 135-53 No. Blvd., Flushing, NY 11354.

"1980 Bulk Mailers Directory" \$5.00. Feix, POB 524-C3, Bronx, NY 10466.

**SPECIAL OFFER—**Save \$3.00 on a 1-year subscription to **ELEMENTARY ELECTRONICS**. Now only \$3.98. Send check: **ELEMENTARY ELECTRONICS**, 380 Lexington Ave., New York, NY 10017.

### BUSINESS OPPORTUNITIES

**1000% PROFIT** Bronzing Baby Shoes. Free Literature. NBC, Box 1904-DC, Sebring, FL 33870.

**STAY HOME! EARN BIG MONEY** addressing envelopes. Genuine offer 10¢. Lindco, 3636-DA, Peterson, Chicago 60659.

**MAILORDER opportunity!** Start profitable home business without experience or capital. Write for free book and details. No obligation. Gil Turk, Dept. 528, Montvale, NJ 07645.

**#480 Weekly Possible.** Amazing New Mailing Program. Details Rasmussen DP40, 1747N, 450E, Ogden, Utah 84404.

**\$534.00 WEEKLY** working three hours daily at home. \$356.00 weekly working two hours daily. \$178.00 weekly working one hour. Start immediately. Paid daily (advance) — \$106.80, \$71.20 or \$35.60. **WRITTEN EARNINGS GUARANTEE.** FREE Bulletin/Application. FAS, Postal Unit 13703-G, San Antonio, Texas 78213.

**MAKE \$1.00 Each** Addressing Envelopes. We pay postage. No Limit. Beginners Kit \$2.00. Colossi, Box 318-D, Brooklyn, NY 11204.

**\$2000.00 Monthly** mailing commission circulars. Experience unnecessary. Free details. American, 1108 Colonial, Inkster, Michigan 48141.

**\$480.00 WEEKLY!** "Guaranteed Home Mailing Program." Freedom, Box 30224-DP, Denver, CO 80230.

**\$58.90 DAILY PAY.** \$353.88 **WEEKLY HOMEWORK.** IMMEDIATE INCOME. **EARNINGS GUARANTEE CERTIFICATE.** FREE REPORT/APPLICATION. AAHIP, UNIT 29309-H, MEDCENSTA, TX 78229.

**AMAZING "Profit Plan."** Income Unlimited! Write: Phelps, 19016 Lanbury, DP-1, Cleveland, OH 44122.

### BUSINESS OPPORTUNITIES—Cont'd

**FREE INFLATION-BEATER BOOK** "2042 Unique, Proven Enterprises." Fabulous "Little Knowns." Work home! HAYLINGS-E14, Carlsbad, CA 92008.

**CABLE FM BROADCAST STATION.** Investment/experience unnecessary. Home operation possible. Excellent income reported! Free details. CAFM, Box 130-GH, Paradise, CA 95969.

**\$350 Weekly** Mailing Letters. Free Details. Bronxville House, Box 311-D, Bronxville, NY 10708.

**YOUR own Business** Without Capital. Details \$3.95. GAE, Inc. P.O. Box 384, Nashville, Indiana 47448.

**\$750.00 WEEKLY** stuffing envelopes. Guaranteed! Details: Enclose stamped envelope, 25¢. Ashco, Box 4394-I04, Corpus Christi, 78408.

**\$100,000 YEARLY!** Startling new mail order discovery! Executive type business—helping others. Offer limited. Free secrets! Treasure-R3D, Colorado 90465.

**\$500 CASH** advance available. Stuff 1000 envelopes. Free details. Dept. H, Box 1489, Spring, Texas 77373.

**CIRCULAR MAILERS** needed. Work from home. Earn hundreds \$\$\$ weekly. No experience needed. Department 51-04 box 1060, Orangepark, FL 32073.

**\$1200.00 MONTHLY** CORRECTING STUDENTS' LESSONS at home!! Start immediately. Send self-addressed stamped envelope. Alpha, Box 131-YCBV, Van Nuys, CA 91401.

**\$500.00 WEEKLY MAILING CIRCULARS!** New Guaranteed Program! Free Proof: Sunrise, Box 415-D, Lewiston, NY 14092.

### BUY IT WHOLESALE

**HIGH Profit** Cap Gun Key Chains, \$4.80 Dz. Jewelry, \$6.00 Dz. Free General Merchandise Catalog. RJR, Dept. 407, 18 Church St., Mt. View, CA 94041.

### CB RADIO

**BOOST POWER! ADD CHANNELS!** 100 watt solid-state booster, high gain beam antenna, 200% modulation booster. Plans \$4.00 each, \$10/all. **FREE CATALOG—**kits, plans, do-it-yourself repairs/modifications. PANAXIS, Box 130-GH4, Paradise, CA 95969.

### DO IT YOURSELF

**SAVE \$\$\$! MAKE OWN GAS** 15¢/gallon; HOME, CAR, BUILD SOLAR FURNACE for POWER; (under \$15.00). SEND \$3.00 (REFUNDABLE). TIMAZEE'S, Box 228-B, Drexel Hill, PA 19026.

### EDUCATION & INSTRUCTION

**BECOME ENGINEER, DJ.** Start your own radio station, receive FCC license, equipment, records. Free details. "Broadcasting," Box 130-GH4, Paradise, CA 95969.

**UNIVERSITY DEGREES BY MAIL!** Bachelors, Masters, Ph.D.s. Free revealing details. Counseling, Box 389-EH-4, Tustin, CA 92680.

### EMPLOYMENT INFORMATION

**FEDERAL JOBS AVAILABLE NOW.** The Federal Jobletter lists Federal job vacancies nationwide. All occupations, grade-levels. \$5. for two monthly issues. Washington Research, P.O. Box 32096, Washington, DC 20007.

**JOURNEYMAN CREDENTIALS GRANTED!** LEGITIMATE. Write: National Craftsman Union, 210 Fifth Avenue, Suite 1102, New York, NY 10010.

### FOR THE HOME

**SMOKE DETECTOR.** We challenge you to find better smoke detector. Free information. JM Scott, 727 Redway, Houston, TX 77062.

### GIFTS THAT PLEASE

**FREE GIFT catalog!** UNIQUE gifts from around the world. Gifts, Box 11588-EH, Spokane, WA 99211.

### GOVERNMENT SURPLUS

**SURPLUS JEEPS—\$19.30! — CARS—\$13.50! — 650 ITEMS! — GOVERNMENT SURPLUS — MOST COMPREHENSIVE DIRECTORY AVAILABLE TELLS HOW, WHERE TO BUY — YOUR AREA—\$2 — MONEYBACK GUARANTEE — "GOVERNMENT INFORMATION SERVICES," DEPARTMENT E-4, BOX 99249, SAN FRANCISCO, CALIFORNIA 94109.**

**JEEPS!! \$18.88!! . . . 675,000 Items!** Buy In Your Area! How! Where! "Money Back GUARANTEED 1980 Government SURPLUS Directory"—Including: "Buy G-LANDS," "G-Oil/G-Gas LOTTERIES," \$2.00. GSURPLUS, Box 2009-H, Syracuse NY 13220.

### HYPNOTISM

**FREE Fascinating Hypnosis Information!** Startling! DLMH, Box 487, Anaheim, CA 92805.

### INVENTIONS WANTED

**INVENTIONS, patents, wanted** cash, royalty. Auto, electro-mechanical, mechanical devices, Housewares, etc. We develop, finance, manufacture and market from an idea to perfected product. Free evaluation and brochure. Request Kit DP, Pixonix Corporation, 22 Walter Street, Pearl River, NY 10965.

### LOANS BY MAIL

**BORROW \$25,000 "OVERNIGHT"** Any purpose. Keep indefinitely! Free Report! Success Research, Box 29263-SP, Indianapolis, IN 46229.

**ELIMINATE DEBTS!** Borrow \$50,000 "overnight"! Any purpose. Free details! Treasure-118HF3, CO 80465.

**BORROW \$1,000—\$50,000** secretly—"overnight." Any one! Credit unimportant. Repay anytime. Incredibly low interest. No interviews, collateral, cosigners. Unique "Financier's Plan." Full information, \$2 (refundable). Spectrum, 79 Wall St.-16, New York 10005.

**GET cash grants—**from Government. (Never repay.) Also, cash loans available. All ages eligible. Complete information, \$2 (refundable) Surplus Funds-DG, 1629 K. St. NW, #502, Washington, DC 20006.

**QUICK \$CASHs** Signature loans! Advise amount & purpose. National, 507-DG Fifth Ave., NY 10017.

### MEMORY IMPROVEMENT

**INSTANT MEMORY . . . NEW WAY TO REMEMBER.** No memorization. Release your PHOTOGRAPHIC memory. Stop forgetting! FREE information. Institute of Advanced Thinking, 845DP Via-Lapaz, Pacific Palisades, CA 90272.

### MISCELLANEOUS

**SAVE TO 90% WEEKLY** on groceries!! Guaranteed!! Information: Rush self addressed stamped envelope plus 25¢! Martens Ent., 1046 Greenwood Ct., Rm7DPG, Oshkosh, WI 54901.

**FABULOUS Gems** for Jewelry, Collecting. Gemcutter to You! Save! Taylor's, 113-A Martin, Indian Harbor Beach, FL 32937.

**MEET sincere, beautiful people—like YOU.** Very low fees. Call DATESLINE toll-free: 800-451-3245.

### MONEYMAKING OPPORTUNITIES

**MAKE YOUR CLASSIFIED AD PAY.** Get "How to Write a Classified Ad That Pays!" Includes certificate worth \$2.00 towards a classified ad in this publication. Send \$1.50 (plus 25¢ for postage) to R. S. Wayner, Davis Publications, Inc., Dept. CL, 380 Lexington Ave., New York, NY 10017.

MORE

## For Greater Classified Savings... Results... and Profits...

Place your ad in one of our **SPECIAL COMBINATIONS:** Combo #1, or Combo #2, or Combo #3. Each combination is designed to give your ad the largest audience available. For further information write to R. S. Wayner, Classified Advertising Director, Davis Publications, Inc., 30 Lexington Ave., New York, N.Y. 10017.



# Classified Continued

## MONEYMAKING OPPORTUNITIES—Cont'd

**STUFF-MAIL ENVELOPES!** \$250.00 Profit per thousand possible! Offer-details Rush stamped addressed envelope: Worldwide-A 460, X15946, Fort Lauderdale, FL 33318.

**EASY HOMEWORK PLAN.** Stuff circulars. Big \$\$\$ Write: A&I, 5343-A Diamond Hts., San Francisco, CA 94131.

**\$300 WEEKLY SPARE TIME—Mailing Salesletters.** Details: Delta, Dept.-D, Box 2902-CRS, Rock Hill, SC 29730.

**\$2,000.00 monthly possible stuffing envelopes!** Details, send stamped self-addressed envelope. Craft, Box 3419DA, Mission Viejo, CA 92690.

**\$800.00 WEEKLY POSSIBLE!** Earn immediately mailing our 1,500 circulars free. Rush stamped envelope: GOLDEN, P.O. Box 2684A, Wichita, KS 67201.

**10% on your money.** Information 25¢. Moore Investments, Taft Street, Ayer, MA 01432.

**RECEIVE \$2 for virtually every circular mailed.** You keep all the money. Details: White Marketing Co., 11 Middle Neck Road, Great Neck, NY 11021.

**\$900/THOUSAND stuffing ENVELOPES.** Send 25¢ for details to: H.S.W., P.O. Box 21152, San Antonio, TX 78221.

**BIG MONEY with EXOTIC TROPICAL SEEDS.** Forty beautiful varieties. ETS, 825 East Belmont, Fresno, CA 93701.

**\$1,700 Weekly Possible!** Details: Stamp. Day, Box 89-TC, Licking, MO 65542.

**MAKE A FORTUNE!** Sensational new mail order plan! Spare time in your home. Treasure-3S, CO 80465.

**MAKE \$60,000 in six weeks!** Practically guaranteed! Stamp appreciated! V-J Publishing, 323-M Franklin, Chicago 60606.

**CASH ADVANCE \$500/Thousand envelopes stuffed available.** No limit! Information: Rexson 51-03, Box 1060, Orangepark, FL 32073.

**MAKE money at home.** 7 profitable programs, 50¢. Sase. Allakian, P.O. Box 1713, Albany, GA 31702.

## OLD JEWELRY WANTED

**CASH paid immediately for old rings, watches, Class Rings, gold capped teeth, coins, silver, gold.** FISHER ENTERPRISES, Meldon, Dept. 294, New Lenox, IL 60451.

## PERSONAL

**LONELY Prisoners Directory (over 300).** \$9.95. Chanan, 40-DV, Box 17693, Lockhart, FL 32860.

**UNIVERSITY DEGREES BY MAIL!** Bachelors, Masters, Ph.D.s . . . Free revealing details. Counseling, Box 389-DP4, Tustin, CA 92680.

**DON'T FORGET Important DATES!** We'll mail reminders. Write: Box 2170, Des Plaines, IL 60018.

## PHOTOGRAPHY—PHOTO FINISHING

**SAVE HUNDREDS OF DOLLARS!!!!** Make your own S & M Densitometer. Send \$3.00 for detailed drawings and instructions. Order direct: S & M Instruments, Dept. EH-4, 380 Lexington Ave., New York, NY 10017.

## PROFITABLE OCCUPATIONS

**AMAZING!** \$265,000 yearly with classified ads. Free proof, sase, Moneycraft, 2316 Dale St., Ceres, CA 95507.

## RADIO & TELEVISION

**"DISTANCE One Tube"** Handbook—50¢. 15 Distance One Tube plans—25¢. Kit catalog—50¢. Laboratories, 1477-EH, Garden Grove, CA 92642.

**CB TUNEUP/MODIFICATION REPORTS.** \$6 each, specify model. Free catalog: plans, kits, books. CB City, Box 1030EH, Woodland Hills, CA 91365.

**TV TUBES 36¢ each.** Send for Free 48 page color catalog. Cornell, 4217-W University, San Diego, CA 92105.

## RECORDS, TAPES & SOUND EQUIPMENT

**FREE Promotional albums, concert tickets, stereos, etc.** Information: Barry Publications, 477 82nd Street, Brooklyn, NY 11209.

## SCIENCE & CHEMISTRY

**FIREWORKS!** Make your own fireworks and spectacular novelties. Textbook: \$5.00. Tropic, Box 95M2, Palm Bay, FL 32905.

## SPECIAL SERVICES

**YOUR OWN printed envelopes.** Choice of lettering styles. AGC, Box 4286, Burbank, CA 91503.

## START YOUR OWN BUSINESS

**SAVE 50% on income taxes.** Start your own UNIVERSAL LIFE CHURCH, BOX 41, BLOOMINGTON, ILLINOIS 61701.

**EXECUTIVE mailorder!** "\$3,000.00 Weekly!!!!" Revealing Booklet. Cashbox 457-10, Alliquippa, PA 15001.

## Superbass

(Continued from page 76)

cork or rubber will retain the battery. You can use small cork "feet" such as sold in hardware stores for use on the bottom of bric-a-brac to prevent scratching of furniture. The cost is usually well under fifty cents and you

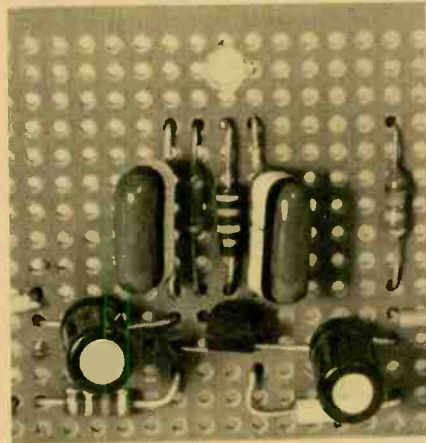

Bread board amplifier component mounting eliminates the need for etching your own PC board.

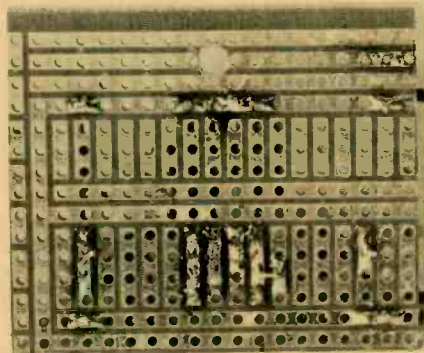

Mounting the printed circuit amplifier is quite simple. Just push the leads through the board and solder.

can cut the "feet" to the needed size.

Take extra care to get S2's wiring right the first time. Note that S2 is SPDT, switching only the output connection. The input is permanently connected to the amplifier and switch S2.

Nothing about the entire project is really critical other than the values of C2 and C3. Resistors need be no better than 10% tolerance—why spend money for better tolerance when the project won't work any better?—and electrolytic capacitors C1 and C4 can be any value from 2.2-uF to 4.7-uF. Use whatever you can get at lowest cost. The same "lowest cost" rule applies to C2 and C3; they don't have to be precision tolerance as long as their rated value is 0.1-uF.

**Using Superbass.** Connect your electric guitar or other electronic instrument to input jack J1; connect output jack J2 to your instrument amplifier's normally-used input. With power switch S1 off, key S2 so the instrument feeds directly to the instrument amplifier. With R2 set full counter-clockwise (Off), turn power switch S1 on, key S2 once, and advance R2 for the desired superbass sound level. To cut back to natural sound just stomp down on S2 and key the superbass out.

Don't worry about leaving power switch S1 on for the several hours of a gig. The circuit pulls less than 1-mA from the battery, so the battery will last many, many months.

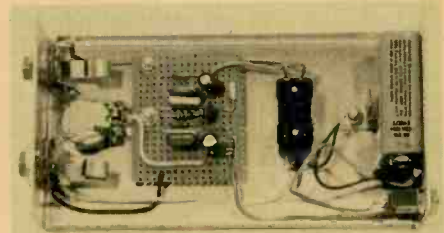

Inside the completed Superbass. Secure the amplifier board well to withstand the stress and pressure.

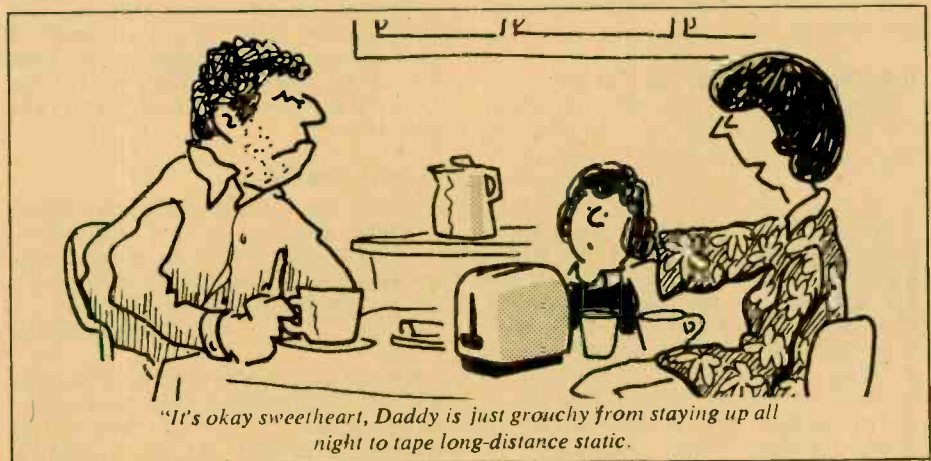

"It's okay sweetheart, Daddy is just grouchy from staying up all night to tape long-distance static."



## ASK HANK, HE KNOWS!

Got a question or a problem with a project—ask Hank! Please remember that Hank's column is limited to answering specific electronic project questions that you send to him. Personal replies cannot be made. Sorry, he isn't offering a circuit design service. Write to:

**Hank Scott, Workshop Editor  
ELECTRONICS HOBBYIST  
380 Lexington Avenue  
New York, NY 10017**

### Sound Advice

*I've been getting a lot of bull at audio dealers, Hank. Tell me, what is acoustic suspension and bass reflex?*

—J.A., Ventura, CA

In a speaker, acoustic suspension design means that air is trapped within the enclosure and is used as a spring to support the woofer cone. "Log-throw" drivers (with extremely flexible suspensions) are able to move large amounts of air necessary for good bass sound. Bass reflex design uses the speaker back wave (in the enclosure) to reinforce the front wave. This design is quite efficient because cone movement is small and thus needs only a small amount of power to produce a given volume of sound.

### No Bleep Brings Ticket

*I took the radar detector out of my old car where it worked fine, and installed it in my new wheels. Now, I can drive right into a radar trap without a warning. This happens about 50 percent of the time. What's wrong?*

—D.U., South Bend, IN

Late model GM cars are using cigarette lighter receptacles that may not provide a good ground as far as radio frequency signals are concerned. Plastic dashboard assemblies have generated some strange ground/power connections from Detroit. Inadequate grounding will cause most radar detectors to fake trigger, or not trigger at all. Don't use the cigarette lighter socket for power—wire directly to the fuse block. Also, the cigarette lighter socket will give better RF connection if the plug is turned in the socket to scrape away the dust and corrosion. Better still, keep it under 55 and save fuzz trouble and gasoline dollars.

### Industry First, Hobbyists Maybe!

*I can't seem to buy LASCR. It's a 200 PIV, light-activated, silicon controlled rectifier. What's the problem in supply?*

—D.C., Columbia, SC

Many hobby-oriented parts are supplied from manufacturers who primarily manufacture large quantities for industry and sell overruns to the parts distribution wholesalers. The overrun end of the business is usually very small, and making parts for distribution is not economical by itself. When the industry need for a part disappears, then so does the hobby supply market. That's happened to

LASCR's before they came back. Maybe it will happen again.

### This Year or Next!

*I won't mention product names. I wanted to buy a device for my hobby but a friend of mine says, "No." He tells me that there are a lot of bugs in new electronics products and I should wait for next year's model. What is your policy?*

—L.N., No. Little Rock, AR

I knew someone who waited till they got all the bugs out of penicillin. Poor fellow!

### Metal Tape

*Hank, what's all this I hear about metal tape, and can I use it on my cassette deck that plays only "normal" and CrO2 tape?*

—S.W., Spokane, WA

Any deck that has CrO2 equalization can be used to play pre-recorded metal tapes. However, to properly record on metal tapes, a deck with a metal tape bias position is needed. In this position, the recorder will use a special bias level and much stronger erase current. Metal tape has the best ever dynamic range, a very low distortion level and a high output level.

### Need Good Eyes

*I hope you can give me a hand because every project I try to build has an odd-ball part that is hard to find. Your project, Washer Watcher, (May/June 1979) indicates two IC's from National Semiconductor as LM1830. Please let me know where I can find these parts.*

—C.R., Tofield, Alberta

One of our advertisers sells the LM-1830. I admit I had to use a magnifying glass to read the IC listing, but the price made it all worthwhile. Write to Digi-Key Corp., P.O. Box 677, Thief River Falls, MN 56701.

### Speaker Matching

*My TV has a 4-ohm loudspeaker. I have an 8-ohm speaker and want to connect it to the TV. How can it be done? 4-ohm speakers cost too much and I have lots of spare 8-ohm speakers.*

—C.R., Tofield, Alberta

Speaker impedances add up like resistors. Use the applicable formula for either series or parallel circuits. Two 8-ohm speakers in parallel add up to 4 ohms.

That's your best solution. Caution: AC/DC may have one side of the chassis to the hot side of the line. Use extreme caution. Better still, use an audio isolation transformer. More: speaker efficiencies differ even though they may have equal impedances. Thus, two 8-ohm speakers may share power with 80 percent in one and 20 percent in the other. Try to match speakers.

### Do It At Home

*My problem is that each time I want to use the computer terminal at my college it is always being used. I am one of 500 students trying to learn WANG BASIC with only one terminal to serve everybody. How much would it cost me to build and buy something that would be at my disposal at home? My objective is to learn how to program a computer using BASIC. Would those home type \$500 computers work?*

—K.R., Salt Lake City, UT

You could learn more about BASIC at home with a \$500 microcomputer in one month, or a week, than you could all semester in class. It's a good buy, and should you find no reason to keep your computer after the term, you'll have no problem selling it!

### CBI

*Why does CB interfere with TV?*

—Z. B., Gallup, NM

Assume a nice rounded transmission frequency of 27 MHz in the CB band. Should the RF output stage put out too much hash due to defect or poor alignment, then a large number of harmonic frequencies will be generated. Thus, harmonic frequencies of 54, 81, 108, 135, 162, 189 MHz, etc., will be generated. Naturally, the lower harmonics will have the most power, with power diminishing as frequency is increased. TV Channel 2 is 54-60 MHz and the second harmonic of 27 MHz (54 MHz) falls into this band. The third harmonic (81 MHz) falls into TV Channel 5 (76-82 MHz). The next TV Channel that a CB harmonic can possibly fall into is Channel 9 (186-192 MHz) and as can be expected, the 7th harmonic of 27 MHz is so weak, it cannot be detected in most cases. So look to TV Channels 2 and 5 for CB interference, if any.

### Clocked Slower

*I learned in my Physics class that the speed of light is not exactly 300,000,000 meters-per-second. Therefore, all those antenna equations I ever saw are wrong. How come?*

—G. F., Bixby, OK

The speed of light is about 299,820,000 meters-per-second or about 0.06% below the "working" value. For radio design purposes, the working value for the speed of light is O.K. In fact, we are concerned about the speed of electro-magnetic waves down a conducting antenna which slows the radio waves about 3-10%, depending

on the material used in the antenna. I suggest you stick to the antenna equations for the time being.

#### Erubbing RF Noise Away

*My auto mechanic says that the Delco-Remy High Energy Ignition (HEI) systems used on GM V8 engines cause less RF noise than those ignition systems used by Ford, Chrysler, and MC. Also, he says it is easier to clean up the RF that is there. Is he correct?*

—A. M., Cleveland, TN

He knows what he is talking about. The GM HEI system has a "points," pulse amplifier, ignition coil and distributor combined in one single unit. Since there is no common cabling with the car's other wires, this system is easily RF sanitized using a single in-line filter at the ignition unit in series with the lead to the ignition key. What GM has done makes sense.

#### Keyboard

*Where can I get a keyboard without the encoder? I would like one with the switches only.*

—M. B., Blanco, TX

Where have you been burying your head? Just about every computer outlet and mail order parts house is offering one. Look in the Hobby Mart mail order section of any ELEMENTARY ELECTRONICS.

#### Send a Hand

Here are requests from some of our readers who need your help. If you can, please do so, and let old Hank know.

Δ Grunow AM/SW Receiver, Chassis No. 5H; need cabinet knob and dial assembly; Henry M. Cantor, 21 Friendly Ct., Babylon, NY 11702.

Δ Accurate Tube Tester Model 257 manual; need pages 31-34; David J. Hamm, 50C Hatchee Rd., Elgin A.F.B., FL 32542.

Δ Philco AM/FM/SW Receiver, Model 42-400; needs schematic diagram and service data; William C. Perry, 1228 Bass Dr., Enid, OK 73701.

Δ Jackson 648-1T Tube Tester; need info for roll chart after 1970; Daniel Brown, 922-15th St., Portsmouth, OH 45662.

Δ Narco VAT4 Superhomer MK-IV Aircraft Radio; operator's manual and service information; J. M. Wood, 14305 Interurban Avenue South, Tukwila, WA 98168.

Δ Superior Instrument, Model 82A Rapid Tube Tester; need tube chart; Lyle Mahlberg, 11605 W. Highway 23, Duluth, MN 55808.

Δ Minerva 2-Band Tropic Master in steel cabinet; needs schematic diagram and service data; Tom Mooningham, 5807 MEMQ, Camp Lejeune, NC.

Δ RCA Victor Snap Load Blank Cartridges, Type 264 C-1 for RCA Victor Tape Deck, Model YGB-11-T; William H. Johnson, R.D. #2, Box 3-A, Boxer Drive, Dushore, PA 18614.

Δ RCA Junior Voltohmyst; needs schematic diagram and owner's manual; Chas. Stouth, 261 Prince Frederick St., King of Prussia, PA 19406.

Δ Voice of Music Model 720; need replacement power transformer; Thurman Lamm, Rt. 2, Box 317, Baily, NC 27807.

Δ Hy-Gain 623A Utopia C transceiver; owner's manual needed; Phillip D. Cassell, Box 31, Rt. 3, Inez, KY 41224.

Δ Dyna kit Stereo 70; needs general service data and schematic diagram; Bill Hartmann, LaSalle School, 391 Western Ave., Albany, NY 12203.

Δ Surplus all-band amateur receiver and transmitter; urgently needed by a retired, semi-disabled senior citizen—if you can part with it, call (602) 272-4973; WB7-WDI, 4122 W. Flower St., Phoenix, AZ.

Δ Hallicrafters S72 receiver; needs manual and schematic diagram; Joe Crocker, 709 Vine St., Festus, MO 63028. ■



## BW-2630 Battery Tool

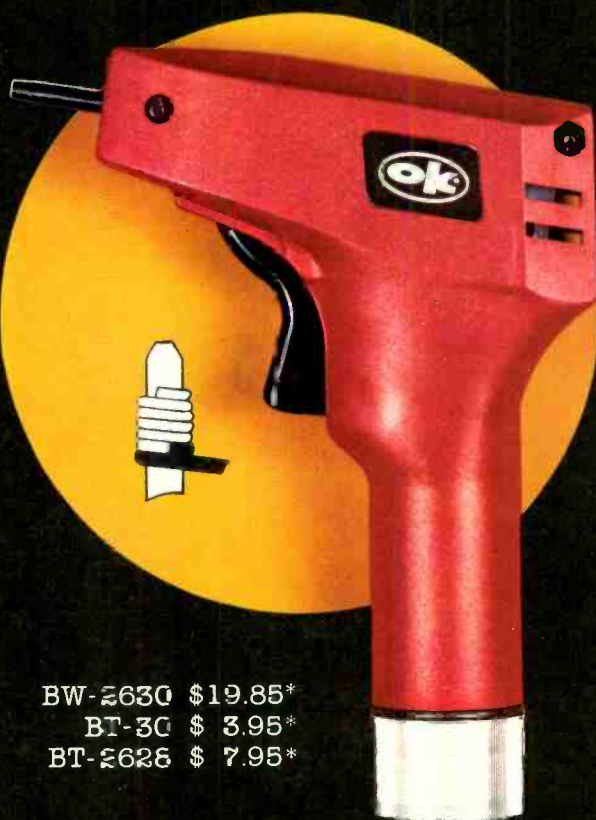

BW-2630 \$19.85\*  
BT-30 \$ 3.95\*  
BT-2628 \$ 7.95\*

### BW-2630 BATTERY TOOL

The new BW-2630 is a revolutionary battery powered wire-wrapping tool. The tool operates on 2 standard "C" size NiCad batteries (not included) and accepts either of two specially designed bits. Bit model BT-30 is for wrapping 30 AWG wire onto .025" square pins; BT-2628 wraps #6-28 AWG wire. Both produce the preferred "modified" wrap.

Designed for the serious amateur, BW-2630 even includes both positive indexing and anti-overwrapping mechanisms — features usually found only in industrial tools costing five times as much. Pistol grip design and rugged ABS construction assure performance and durability. In stock at local electronic retailers or directly from

#### OK Machine & Tool Corporation

3455 Conner St., Bronx, N.Y. 10475 U.S.A.  
Tel. (212) 994-6600 Telex 125091

\* Minimum billings \$25.00, add shipping charge \$2.00  
New York State residents add applicable tax

# BUILD 20 RADIO AND ELECTRONICS CIRCUITS

Reg. U. S. Pat. Off.



Training Electronics Technicians Since 1946

## PROGRESSIVE HOME RADIO-T.V. COURSE

### Now Includes

- ★ 12 RECEIVERS
- ★ 3 TRANSMITTERS
- ★ SQ. WAVE GENERATOR
- ★ SIGNAL TRACER
- ★ AMPLIFIER
- ★ SIGNAL INJECTOR
- ★ CODE OSCILLATOR
- ★ No Knowledge of Radio Necessary
- ★ No Additional Parts or Tools Needed
- ★ Solid State Circuits
- ★ Vacuum Tube Circuits

### YOU DON'T HAVE TO SPEND HUNDREDS OF DOLLARS FOR A RADIO COURSE

The "Edu-Kit" offers you an outstanding PRACTICAL HOME RADIO COURSE at a rock-bottom price. Our Kit is designed to train Radio & Electronics Technicians, making use of the most modern methods of home training. You will learn radio theory, construction practice and servicing. THIS IS A COMPLETE RADIO COURSE IN EVERY DETAIL. You will learn how to build radios, using regular schematics; how to wire and solder in a professional manner; how to service radios; you will work with the standard type of punched metal chassis as well as the latest development of Printed Circuit chassis.

You will learn the basic principles of radio. You will construct, study and work with RF and AF amplifiers and oscillators, detectors, rectifiers, test equipment. You will learn and practice code, using the Progressive Code Oscillator. You will learn and practice trouble-shooting, using the Progressive Signal Tracer, Progressive Signal Injector, Progressive Dynamic Radio & Electronics Tester, Square Wave Generator and the accompanying instructional material.

You will receive training for the Novice, Technician and General Classes of F.C.C. Radio Amateur Licenses. You will build Receiver, Transmitter, Square Wave Generator, Code Oscillator, Signal Tracer and Signal Injector circuits, and learn how to operate them. You will receive an excellent background for television, Hi-Fi and Electronics.

Absolutely no previous knowledge of radio or science is required. The "Edu-Kit" is the product of many years of teaching and engineering experience. The "Edu-Kit" will provide you with a basic education in Electronics and Radio, worth many times the low price you pay. The Signal Tracer alone is worth more than the price of the kit.

### THE KIT FOR EVERYONE

You do not need the slightest background in radio or science. Whether you are interested in Radio & Electronics because you want an interesting hobby, a well paying business or a job with a future, you will find the "Edu-Kit" a worth-while investment. Many thousands of individuals of all

ages and backgrounds have successfully used the "Edu-Kit" in more than 79 countries of the world. The "Edu-Kit" has been carefully designed, step by step, so that you cannot make a mistake. The "Edu-Kit" allows you to teach yourself at your own rate. No instructor is necessary.

### PROGRESSIVE TEACHING METHOD

The Progressive Radio "Edu-Kit" is the foremost educational radio kit in the world, and is universally accepted as the standard in the field of electronics training. The "Edu-Kit" uses the modern educational principle of "Learn by Doing." Therefore you construct, learn schematics, study theory, practice trouble shooting—all in a closely integrated program designed to provide an easily-learned, thorough and interesting background in radio.

You begin by examining the various radio parts of the "Edu-Kit." You then learn the function, theory and wiring of these parts. Then you build a simple radio. With this first set you will enjoy listening to regular broadcast stations, learn theory, practice testing and trouble-shooting. Then you build a more advanced radio, learn more advanced theory and techniques. Gradually, in a progressive manner, and at your own rate, you will find yourself constructing more advanced multi-tube radio circuits, and doing work like a professional Radio Technician.

Included in the "Edu-Kit" course are Receiver, Transmitter, Code Oscillator, Signal Tracer, Square Wave Generator and Signal Injector Circuits. These are not unprofessional "breadboard" experiments, but genuine radio circuits, constructed by means of professional wiring and soldering on metal chassis, plus the new method of radio construction known as "Printed Circuitry." These circuits operate on your regular AC or DC house current.

### THE "EDU-KIT" IS COMPLETE

You will receive all parts and instructions necessary to build twenty different radio and electronics circuits, each guaranteed to operate. Our Kits contain tubes, tube sockets, variable, electrolytic, mica, ceramic and paper dielectric condensers, resistors, tie strips, hardware, tubing, punched metal chassis, Instruction Manuals, hook-up wire, solder, selenium rectifiers, coils, volume controls, switches, solid state devices, etc.

In addition, you receive Printed Circuit materials, including Printed Circuit chassis, special tube sockets, hardware and instructions. You also receive a useful set of tools, a professional electric soldering iron, and a self-powered Dynamic Radio and Electronics Tester. The "Edu-Kit" also includes Code Instructions and the Progressive Code Oscillator, in addition to F.C.C. Radio Amateur License training. You will also receive lessons for servicing with the Progressive Signal Tracer and the Progressive Signal Injector, a High Fidelity Guide and a Quiz Book. You receive Membership in Radio-TV Club, Free Consultation Service, Certificate of Merit and Discount Privileges. You receive all parts, tools, instructions, etc. Everything is yours to keep.

### FREE EXTRAS

- SET OF TOOLS
- SOLDERING IRON
- ELECTRONICS TESTER
- PLIERS-CUTTERS
- VALUABLE DISCOUNT CARD
- CERTIFICATE OF MERIT
- TESTER INSTRUCTION MANUAL
- HIGH FIDELITY GUIDE - QUIZZES
- TELEVISION BOOK - RADIO TROUBLE-SHOOTING BOOK
- MEMBERSHIP IN RADIO-TV CLUB: CONSULTATION SERVICE - FCC AMATEUR LICENSE TRAINING
- PRINTED CIRCUITRY

### SERVICING LESSONS

You will learn trouble-shooting and servicing in a progressive manner. You will practice repairs on the sets that you construct. You will learn symptoms and causes of trouble in home, portable and car radios. You will learn how to use the professional Signal Tracer, the unique Signal Injector and the Dynamic Radio & Electronics Tester. While you are learning in this practical way, you will be able to do many a repair job for your friends and neighbors, and charge fees which will far exceed the price of the "Edu-Kit." Our Consultation Service will help you with any technical problems you may have.

### FROM OUR MAIL BAG

Ben Valerio, P. O. Box 21, Magna, Utah: "The Edu-Kits are wonderful. Here I am sending you the questions and also the answers for them. I have been in Radio for the last seven years, but like to work with Radio Kits, and like to build Radio Testing Equipment. I enjoyed every minute I worked with the different kits; the Signal Tracer works fine. Also like to let you know that I feel proud of becoming a member of your Radio-TV Club."

Robert L. Shuff, 1534 Monroe Ave., Huntington, W. Va.: "Thought I would drop you a few lines to say that I received my Edu-Kit, and was really amazed that such a bargain can be had at such a low price. I have already started repairing radios and phonographs. My friends were really surprised to see me get into the swing of it so quickly. The Trouble-shooting Tester that comes with the Kit is really swell, and finds the trouble, if there is any to be found."

### SOLID STATE

Today an electronics technician or hobbyist requires a knowledge of solid state, as well as vacuum tube circuitry. The "Edu-Kit" course teaches both. You will build vacuum tube, 100% solid state and combination ("hybrid") circuits.

### PRINTED CIRCUITRY

At no increase in price, the "Edu-Kit" now includes Printed Circuitry. You build a Printed Circuit Signal Injector, a unique servicing instrument that can detect many Radio and TV troubles. This revolutionary new technique of radio construction is now becoming popular in commercial radio and TV sets.

A Printed Circuit is a special insulated chassis on which has been deposited a conducting material which takes the place of wiring. The various parts are merely plugged in and soldered to terminals.

Printed Circuitry is the basis of modern Automation Electronics. A knowledge of this subject is a necessity today for anyone interested in Electronics.

Progressive "Edu-Kits" Inc., 1189 Broadway, Dept. 526-EN Hewlett, N.Y. 11557

Please rush me free literature describing the Progressive Radio-TV Course with Edu-Kits. No Salesman will call.

NAME .....

ADDRESS .....

CITY & STATE ..... ZIP .....

### PROGRESSIVE "EDU-KITS" INC.

1189 Broadway, Dept. 526-EN Hewlett, N.Y. 11557