

ELECTRONICS HOBBYIST

PROJECTS THAT EVERYONE CAN BUILD

ENTERTAINMENT & FUN

Super SCA Adaptor
Television Audio Amplifier

PRIVACY & PROTECTION

Telephone Speech Scrambler
Car Alarm for Tape Player

TEST EQUIPMENT

IC Signal Tracer
Pocket Signal Beeper

AMATEUR SCIENTIST

Laser Kit Construction
Roto-Stat Crank Generator

RADIO COMMUNICATIONS

Broadcast Band Booster
Utility Band Converter

and much, much more!

**GOOF-PROOF
CIRCUITS
-PRETESTED-**



DON'T BUY A NEW CAR!

UNTIL YOU BUY A COPY OF...



"I used AutoFacts and I estimate I saved over \$450 on a new car."

D. L. Gabree
Somerville, New Jersey

AutoFacts, a new consumer car pricing guide, gives you the knowledge that can save you up to \$1,000 on a new car!

In AutoFacts you find a complete listing of dealer's cost on all U.S. make cars and options.

Quickly and easily you compare prices of makes and models and price out the car for *your* pocketbook.!

KNOW WHETHER YOU'RE BEING OFFERED A GOOD DEAL OR NOT!

AUTOFACTS MAKES YOU A SMARTER CAR BUYER!



SPECIAL BONUS FOR AUTOFACTS READERS!

*How to get a new car for only \$125 over dealer's cost.

Through the United Auto Brokers' Car/Puter organization, you can take delivery, without delay, of a brand new car for just \$125 over cost. Your purchase includes freight and pre-delivery service. You take delivery of a new car of your choice from a local dealer and you get the same new car warranty and service as if you had paid full list. The Bonus Coupon in your AUTO-FACTS entitles you to a 20% discount off the Car/Puter 48-hour computerized service that helps you make the best new car deal on your own. * Certain limited production or specialty models priced higher. Some foreign models not available.

NOW ON ALL LEADING NEWSSTANDS—

If you prefer, complete and mail this coupon to Car/Puter's AUTOFACTS, Davis Publications, 229 Park Avenue South, New York, New York 10003.

- Send Actual 1973 New Car Prices edition. Payment enclosed of \$1.50 plus 25¢ for postage and handling.
- Send Spring/Summer edition of Used Car Prices. Payment enclosed of \$1.50 plus 25¢ for postage and handling.

NOTE: Write publisher for bulk rates. Add \$1.00 per issue for orders outside Continental U.S.A. and Canada.

- I prefer a full year's subscription of four issues (Actual '73 New Car Prices edition; Spring/Summer '73 Used Car Prices edition; Summer '73 edition of Estimated New Car Prices; Fall/Winter '73 Used Car Prices edition.) \$6.00 for full subscription is enclosed.

name _____ (please print)

address _____

city _____ state _____ zip code _____

BW-AFX

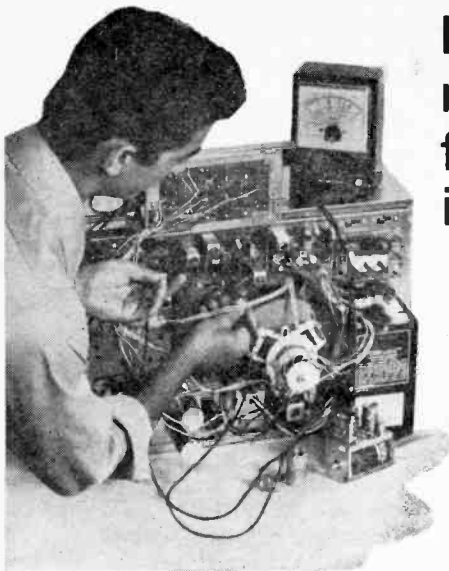

RCA Institutes Home Training may be your best investment for a rewarding career in electronics:

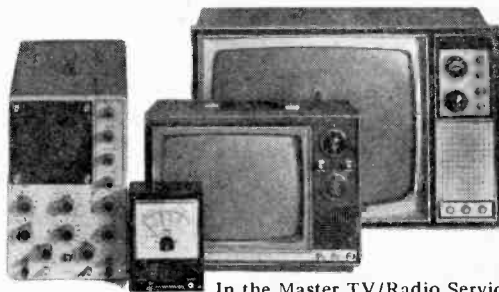

In the Master TV/Radio Servicing Program, you build and keep the all solid-state black and white TV set, the color TV set, the oscilloscope and multimeter shown above.

1 LEADER IN ELECTRONICS TRAINING

For over half a century, RCA Institutes, Inc. has been a leader in resident school technical training in electronics, and for many years, it has offered home study training in electronics.

2 RCA AUTOTEXT TEACHES ELECTRONICS RAPIDLY, EASILY

Beginner or refresher—"AUTOTEXT," RCA Institutes' own Home Training method helps you learn electronics rapidly, easily.

3 WIDE CHOICE OF CAREER PROGRAMS

Select from a wide choice of career programs, each of which starts with the amazing "AUTOTEXT" method of programmed instruction. Check over the attached card.

4 CASSETTE SYSTEM

An exciting concept — It's almost like having an instructor right in your home.

5 PERSONAL SUPERVISION THROUGHOUT

All during your program of home study, your exams are reviewed and commented upon and questions answered by RCA Institutes instructors personally involved in your efforts and ready to help you over any "rough spots" that may develop.

6 HANDS-ON TRAINING

To give practical application to your studies, a variety of valuable kits is included in many programs. In RCA's Master TV/Radio Servicing Program, you actually build and keep an all solid-state black and white TV set, and a color TV set. You also construct an oscillo-

scope and multimeter which are yours to keep and use on the job.

7 FCC LICENSE TRAINING — MONEY-BACK AGREEMENT

RCA Institutes' money-back agreement assures you your money back if you take and fail to pass the FCC exams within 6 months after completing the course.

8 CONVENIENT PAYMENT PLANS

You get a selection of tuition plans. And, we are an "Eligible Institution" under the Federally Insured Student Loan Program.

9 RCA INSTITUTES IS FULLY ACCREDITED

Accredited member National Home Study Council. Licensed by N.Y. State — courses of study and instructional facilities approved by the State Education Department.

Approved by N.Y. State Education Dept. for the training of Veterans.

RCA Institutes, Inc.

Home Study Dept. 231-301-0
320 West 31st Street
New York, N.Y. 10001

Name _____

Address _____

City _____

State _____ Zip _____

Check here if interested in Classroom Training

ELECTRONICS HOBBYIST

CONTENTS

PROJECTS

- | | | |
|------------------------------|-----|--|
| GADGET-MAN's AUTO IMPROVERS | 41 | SPRING/SUMMER 1973 |
| SPECTACULAR SCIENCE PROJECTS | 23 | Auto Alarm for Your Car Tape Player |
| OUR 9 IN 1 SURE BET | 51 | Automatic Headlighter |
| | | Light Amplification by Simulated Emission of Radiation |
| | | Roto-Stat |
| | | 9 Great IC Projects |
| | | 1. Remote Gain Control |
| | | 2. Professional Remote Amplifier |
| | | 3. Protect-a-Volt |
| | | 4. Super 15 Amplifier |
| | | 5. Comm-press Log Amplifier |
| | | 6. Great Equalizer |
| | | 7. Stereo Mike Preamplifier |
| | | 8. Gain Master Mike Preamplifier |
| | | 9. Micro-Mini Amplifier |
| MAIL ORDER PARTS PROJECTS | 27 | Scramble Phone |
| | 31 | Super SCA Adaptor |
| | 43 | Super Booster |
| | 59 | Piggyback Amp |
| FOR HOME IMPROVEMENTS | 58 | Keep a Light Flashing in the Window |
| | 81 | Visulert |
| | 90 | Pop-Up TV |
| | 97 | Hobbyist's Night Light |
| | 99 | Simcon Fet Converter |
| SOUND-MAKER'S DELIGHTS | 48 | The Beeper |
| | 58 | Grove Booster |
| | 63 | Basket of Sound |
| | 75 | Build TV Amp |
| | 110 | Vibra-Tone |
| FOR THE WORKBENCH | 83 | Cal Trace |
| | 86 | Current Swinger |
| | 91 | Gen-Trace |
| | 107 | Sound Pollution Tipster |
| | 113 | A Regulated 9 |

THE GOOD STUFF EVERY MAGAZINE SHOULD HAVE



PHOTO BY HEICKLEN

- | | |
|-----|---------------------|
| 5 | New Products |
| 14 | Ask Hank, He Knows |
| 15 | Literature Library |
| 17 | Reader Service Page |
| 22 | Mobile Meanderings |
| 117 | Reader Service Page |
| 121 | Classified Ads |

"Serutan" Crystal Rig

That old favorite, the crystal radio, becomes more than just a weak voice buried in the headphone when it's amplified with a "junk box" amplifier.

Transistor Q1 can be just about any general purpose pnp germanium type such as the 2N107, 2N109, etc. The SK3003 specified gives a little extra gain.

L1 is any ferrite antenna coil for the broadcast band, while E1 must be a magnetic headset for maximum output level. To align the receiver, set C1's dial to the known frequency of a strong local station and ad-

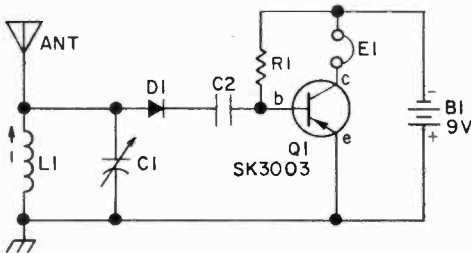

just L1's slug until you hear the station in the phones.

For reception of weaker signals the receiver should be connected to an earth ground such as the cold water pipe. The longer the antenna, the better the reception. Try 20 feet or more.

To feed the radio's output into an amplifier and speaker, replace the headphone with a 1000-ohm 1/2-watt resistor. Connect a .1 mfd, 25VDC capacitor from Q1's collector to the amplifier input. Then be sure to connect crystal radio's antenna ground to the amplifier ground.

PARTS LIST FOR "SERUTAN" CRYSTAL RIG

- B1—9-V battery
- C1—365-pF tuning capacitor
- C2—0.2- μ F, 10-VDC capacitor
- D1—1N60 diode
- E1—1000-3000-ohm impedance magnetic earphone
- L1—Ferrite antenna coil (Loopstick)
- Q1—SK3003 (RCA); HEP-250 (Motorola)
- R1—100,000-ohm, 1/2-watt resistor

now midget driver sets



for
double
duty

on dozens of popular screws & nuts



Three new assortments have joined Xcelite's family of "Compact Convertibles." Each an Xcelite "original." Nowhere will you find such a variety of sizes and types in a midget set, for driving slotted, Phillips, Allen, Scrulox®, hex, and clutch head screws. And hex nuts.

All of professional quality, precision made of finest materials. All doing "double duty" with torque amplifier handle that slips over color-coded midget tools for longer reach, greater driving power. Each easily identifiable on the bench or in the service kit thru Xcelite's exclusive, optically clear, plastic "show case" that closes securely with positive snap-lock.

nationwide availability through local distributors

NEW!

PS130 3 slot tip, 2 Phillips screwdrivers, 5 nutdrivers

PS140 4 slot tip, 3 Phillips screwdrivers, 3 nutdrivers

PS6 3 slot tip, 3 Phillips screwdrivers

PLUS PS88, PS120, PS7, PS89, PS44 and PS-TR-1 with varying selections of screwdrivers and nutdrivers

REQUEST FREE CATALOG.



XCELITE

XCELITE, INC. • 128 BANK ST., ORCHARD PARK, N.Y. 14127
Send General Catalog No. 171 with information on Midget Driver Sets.

name _____

address _____

city _____

state & zone _____

In Canada contact Charles W. Pointon, Ltd.
CIRCLE NO. 10 ON PAGE 17 OR 117

EXPERIMENTER

International EX Crystal and EX Kits



OX OSCILLATOR
\$2.95

OX OSCILLATOR Crystal controlled transistor type. Lo Kit 3,000 to 19,999 KHz Hi Kit 20,000 to 60,000 KHz (Specify) **\$2.95**

MX-1 TRANSISTOR RF MIXER A single tuned circuit intended for signal conversion in the 3 to 170 MHz range. Lo kit 3-20 MHz. Hi kit 20-170 MHz. **\$3.50**

SAX-1 TRANSISTOR RF AMP. Amplifier to drive MX-1 mixer. Lo kit 3-20 MHz. Hi Kit 20-170 MHz. **\$3.50**

PAX-1 TRANSISTOR RF POWER AMP. A Single tuned output amplifier to follow the OX oscillator. 3,000 to 30,000 KHz **\$3.75**

CIRCLE NO. 7 ON PAGE 17 OR 117



EX CRYSTAL
\$3.95

EX CRYSTAL Available from 3,000 KHz to 60,000 KHz. Supplied only in HC 6/U holder. Calib. is $\pm 0.2\%$ when operated in International OX circuit or its equivalent. (Specify frequency) **\$3.95**

BAX-1 BROADBAND AMP. May be used as a tuned or untuned amplifier in RF and audio applications 20 Hz to 150 MHz. **\$3.75**



CRYSTAL MFG. CO., INC.
10 NO. LEE • OKLA. CITY, OKLA. 73102

Write for FREE Catalog

SPRING/SUMMER 1973 EDITION

ELECTRONICS HOBBYIST

Dedicated to America's Electronics Hobbyists

Editor-in-Chief

JULIAN S. MARTIN, WAZCQL/KMD4313

Technical Editor

PETER L. DEXNIS, WA3LOQ

Project Editor

STEPHEN B. GRAY

Service Editor

BARBARA E. WILLIAMS

Workbench Editor

HANK SCOTT

Citizens Band Editor

KATHI MARTIN, KA1Ø614

Art Director

JIM MEDLER

Cover Art Director

IRVING BERNSTEIN

Associate Art Director

ANDY STEIGMEIER

Advertising Director

DAVID J. MILLER

Production Director

CARL BARTEE

Production Manager

GERTRUD BORCHARDT

Assistant Production Manager

MARILYN VARGAS

Instruments Division Manager

WILFRED M. BROWN

Subscription and Marketing Director

ROBERT V. ENLOW

Chairman of the Board (1969-1972)

B. G. DAVIS

President and Publisher

JOEL DAVIS

Vice-President and General Manager

LEONARD F. PINTO

Vice-President and Treasurer

VICTOR C. STABILE, KBPØ681

AT LAST! PROFESSIONAL HOME PROTECTION EVERYONE CAN INSTALL AND AFFORD.

Model FC-100
\$69.95
WIRED



- Start your custom Burglar/Hold-up/Fire Alarm System with the FC-100. Add on Sensors, Alarms and Accessories to suit your own needs.
- "Do-it-Yourself" Installers Handbook included. No technical knowledge needed — No soldering.
- 100% Professional in Design, Reliability, Performance.



'Fail Safe'-SYSTEM BY EICO

A New Concept in "Do-it-Yourself" Home Protection

FREE 32 PAGE EICO CATALOG

For latest catalog on EICO Test Instruments, Stereo, EICOCRAFT Projects, Environmental Lighting, Burglar/Fire Alarm Systems, and name of nearest EICO Distributor, check Reader Service Card or send 25¢ for First Class mail service.

EICO, 283 Malta Street, Brooklyn, N.Y. 11207



CIRCLE NO. 5 ON PAGE 17 OR 117



ELECTRONICS HOBBYIST is published Semi-Annually by Davis Publications, Inc. Editorial business offices: 229 Park Ave. South, New York, N.Y. 10003. Advertising offices: New York, 229 Park Avenue South, 212-OR 3-1300; Chicago, 520 N. Michigan Ave., 312-527-0330; Los Angeles: J. E. Publishers' Rep. Co., 8560 Sunset Blvd., 213-659-3810; Long Island: Len Osten, 9 Garden Street, Great Neck, N.Y., 516-487-3305; Southwestern advertising representative: Jim Wright, 818 Olive St., St. Louis, 314-CH-1-1965. Second-class postage paid at N.Y., N.Y. and at additional mailing office. Copyright 1973 by Davis Publications Publishing Co.

NEW PRODUCTS

A Real Path Beater

A new breadboarding technique has been developed, called the new Mini-Mount breadboarding system which consists of a variety of miniature etched patterns, each designed to mount an active or passive electronic component. The breadboard circuit is assembled by arranging the MiniMounts on any flat surface. No holes need to be drilled; pressure-sensitive adhesive holds the elements firmly in place, yet allows them to be moved or replaced as the circuit develops. Normal

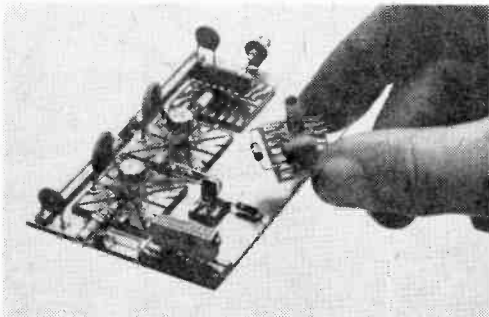

practice is to build the circuit on a copper-clad board that will serve as a ground plane. Analog, digital and RF circuits, from DC to the GHz region, can be effectively breadboarded. Path lengths are held to a minimum. Mini-Mounts are available in a number of different configurations to fit such components as 14-pin and 16-pin DIP IC packages, 6 to 12-pin round-can components, miniature potentiometers, transistors, capacitors and resistors. The Mini-Mounts are packaged as kits, with a selection of various types as used in general breadboarding work, or in bulk for cases when a particular type is used in volume. Complete information on the Mini-Mounts and their application to breadboarding problems may be obtained by circling No. 45 on Reader Service page.

For Four Ears

Quality four-channel private listening is yours for only \$39.95 if you pick the Koss K-6LCQ Quadrafones. The K-6LCQ incorporates the new Koss-designed pressure-type dynamic driver elements for fine sound reproduction. The new driver is both lighter and smaller than previous elements utilized in four-channel headphones, and special manufacturing techniques provide for a new high degree of reliability and consistency. Model K-6LCQ is designed with slide volume-and-balance controls and foam earcup cushions. It also fea-

FREE

LAFAYETTE 1973 CATALOG 730



Ready
Now!

The World's Largest Consumer Electronics Catalog

Everything In Electronics for Home, Business, Industry

- Stereo/Hi-Fi Components • Musical Instruments and Amplifiers • CB & Ham Equipment • Tools and Test Equipment • Police and Fire Monitor Receivers • Public Address Systems • Photography Equipment • Semiconductors, Books, Parts • Plus Much More!

Your Complete Electronics Buying Guide

**Send
Today!**

Lafayette Radio Electronics
P.O. Box 10, Dept. 47013
Syosset, L.I., N.Y. 11791

Send FREE 1973 Catalog 47013

NAME _____

ADDRESS _____

CITY _____

STATE _____ ZIP _____

CIRCLE NO. 2 ON PAGE 17 OR 117

NEW PRODUCTS

TO: Science & Mechanics' readers from the Editor of HI-FI STEREO BUYERS' GUIDE

"When you play your recordings you want the best hi-fi components you can get. HI-FI STEREO BUYERS' GUIDE tells you what they are, and whose equipment to buy. In addition to useful, authoritative articles on hi-fi componentry, every issue includes a new products Show Case, unbiased Tested in the Lab reports on quality hi-fi components, and Record and Tape Reviews on the Classics and Pops."

Let HI-FI STEREO BUYERS' GUIDE into your music life right now. Published four times a year, every issue is jammed full of information to aid you in a fuller enjoyment of your records and tapes.



Make certain you get each exciting issue by taking advantage TODAY of a special MONEY-SAVING introductory offer. Instead of receiving four

issues; a full year subscription at the regular \$5.00 rate, you receive an extra issue, an immediate saving to you of \$1.25. Just mail the coupon below, with your payment, to HI-FI STEREO BUYERS' GUIDE, 229 Park Avenue South, New York, New York 10003.

PAY CASH & SAVE UP TO \$2.50

HI-FI STEREO BUYERS' GUIDE,
229 Park Avenue South,
New York, New York 10003

Special Introductory offer for Science & Mechanics' Readers.

Okay! Enter my subscription to HI-FI STEREO BUYERS' GUIDE at the money-saving cash payment rate below:

One year (4 issues) PLUS ONE BONUS ISSUE. I enclose payment of \$5.00 and save \$1.25 off the newsstand and regular subscription rate.

DOUBLE MY SAVINGS! I prefer a two year subscription (8 issues) PLUS TWO BONUS ISSUES, a total of 10 issues. I enclose \$10.00 and save \$2.50 off the regular rates. B402

Enclosed is \$_____.

Name _____ (please print)

Address _____

City _____ State _____ Zip Code _____



tures a self-adjusting headband and a 10-foot long coil cord with two three-circuit plugs. For more information on this unit as well as other Koss Quadrafones and Stereofones, circle No. 57 on Reader Service page.

Beta Tracer



A new easy-to-use transistor curve generator, known as the CEI Model TCG 1, is ideal for schools, engineering labs, service shops, experimenters and hobbyists. Transistors and other semiconductor devices can be tested in or out of circuit. The transistor curve generator is used with any oscilloscope, and displays the dynamic characteristics of both npn and pnp transistors, FET's, MOSFET's and dual-gate MOSFET's, diodes, zener diodes, tunnel diodes, and other devices. The instrument incorporates all the circuits required to generate the base steps and collector sweeps. The collector sweep generator provides a ± 10 -volt sawtooth, operating at a frequency of 550 Hz, for a flicker-free display. A fully regulated power supply, utilizing a ± 15 -volt I.C. regulator, and a solid-state LED panel indicator light, are also found in the advanced solid-state design. Operation is simple and straightforward due to the minimum number of front panel controls. The Model TCG-1 is available in easy-to-build kit form, complete with all parts, high quality glass-epoxy printed circuit board, wire solder, and step-by-step assembly instructions. Kit price is only \$79.95 complete. Factory wired and tested units are only \$99.95 complete. A free data sheet, complete with

GADGETS & GEAR FOR BUILDERS

technical specifications, schematic diagram, and circuit description, is available by circling No. 46 on Reader Service page.

Weather or Not

A professional-type weather station is easily created with a kit giving amateur meteorologists or weather buffs the know-how, and means, to check predictions against official forecasts. Assembled, the complete weather station occupies only a small area. A weather station makes an ideal family hobby and can interest youngsters in a science project or meteorological career. The quality

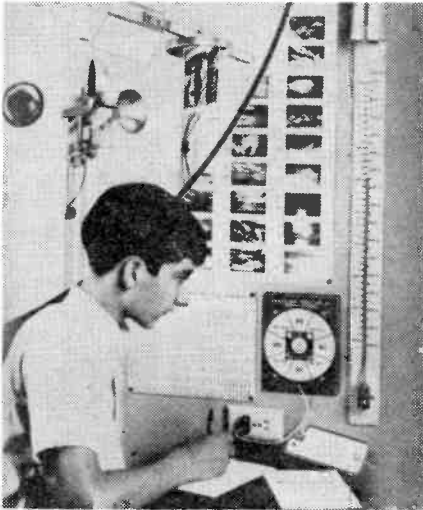

materials that comprise the kit are designed for years of service. Available by mail from Edmund Scientific Co., 380 Edscorp Bldg., Barrington, NJ 08007, the kit (Stock No. 71,022) costs \$15.95 and includes a cloud chart and a forecasting manual. For complete catalog, circle No. 48 on Reader Service page.

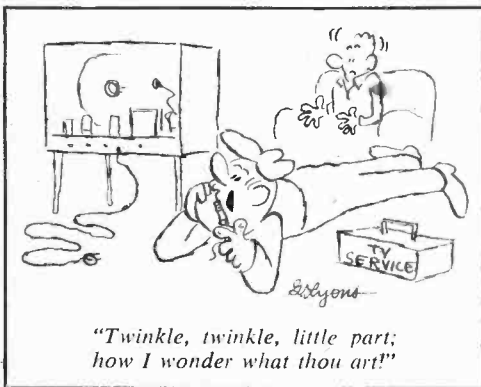

SPRING-SUMMER, 1973

THOUSANDS OF BARGAINS TOP VALUES IN ELECTRONIC PARTS

Transistors, Modules, C. B., Speaker, Stereo, Hi-Fi, Photo Cells and Thousands of Other Electronic Parts.
Send for FREE Catalogue

ELECTRONIC DISTRIBUTORS INC.

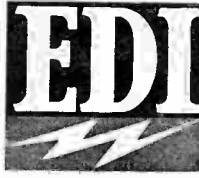

EDI

Dept. TA-2, 4900 Elston
Chicago, Ill. 60630
 RUSH CATALOGUE

Name
Address
City
State Zip Code

CIRCLE NO. 6 ON PAGE 17 OR 117

PARTS! CORNELL TUBES!
FREE Send For FREE
CORNELL'S
New Color
Catalog
48 Pgs. New Items

33¢ per tube
IN LOTS OF 100

36¢ per tube
ORDER FREE
IF NOT SHIPPED
IN 24 HOURS

4219 E UNIVERSITY AVE. SAN DIEGO, CALIF. 92105

CIRCLE NO. 4 ON PAGE 17 OR 117

WRITE
NOW FOR

McGEE'S BIG SPEAKER CATALOG

1001 BARGAINS IN

SPEAKERS—PARTS—TUBES—HIGH FIDELITY
COMPONENTS—RECORD CHANGERS—
Tape Recorders—Kits—Everything in Electronics
1901 McGee Street, Kansas City, Missouri 64108

CIRCLE NO. 8 ON PAGE 17 OR 117

MAIL EARLY IN THE DAY!

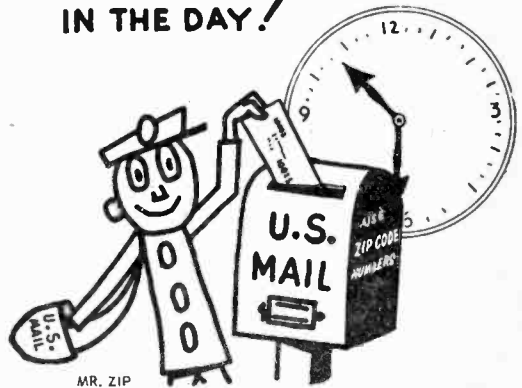

MR. ZIP

ZIP CODE NUMBERS

BELONG

IN ALL ADDRESSES



YOUR POSTMASTER

NEW PRODUCTS

GADGETS & GEAR FOR BUILDERS

Gazebo!

Remember the Gazebo? It's back in style—and in an entirely modern new version appropriate to the Seventies. Designed and engineered by Wheeling Corrugating Company, the Gazebo represents a sharp departure from the conventional steel utility building which is primarily intended to help the homeowner solve a storage problem. An eight-sided structure with a conical roof, the Gazebo offers functional versatility ranging far beyond the average yard building. The Ga-



zebo's attractive styling offers the homeowner a structure that may be used as an outdoor family room or dining pavillion. Better still, here's the shack you've been looking for—that room away from the house where you can set up your CB communications center year-'round. For complete details and interesting booklet, circle No. 41 on Reader Service Page.

Best Price Yet

Now you can enjoy the effect of four-channel sound from your present car stereo tape player or stereo FM radio with the new Realistic Auto Quatravox 4-Channel Synthesizer from Radio Shack. A 4-channel effect is created with the Quatravox by placing the rear speakers out of phase with the front. This eliminates sound common to both stereo channels, leaving only ambient sound from the rear. The Realistic Auto Quatravox 4-Channel Synthesizer is priced at \$9.95. Includes mounting hardware, 18-ft. speaker cables and instructions. Realistic products are available at more than 1500 Radio Shack and Allied stores in all 50 states and Canada,



and through Radio Shack Authorized Sales Centers, nationwide. For more information, circle No. 40 on Reader Service page.

Clean Air Respirator

For hobbyists, gardeners and do-it-yourselfers, here's a new, low-cost Health Respirator face mask from Davol available at most

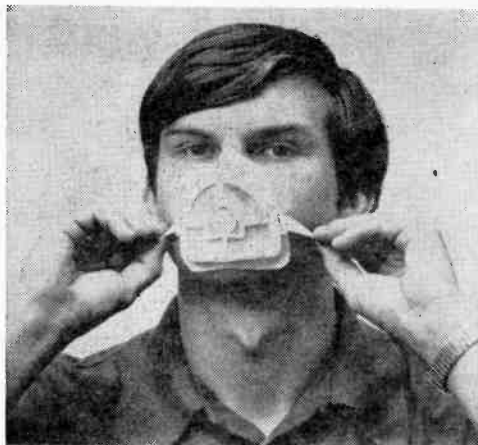

pharmacies. Made from lightweight vinyl, the three-piece face mask protects against all pollens, non-toxic dust, paint sprays, and other environmental irritants. Filter can be removed, washed, and reused. Ideal for all kinds of farm work, gardening, home decorating, paint spraying, woodworking, and wherever airborne respiratory nuisances may exist. Costs only \$2.49 each. Why not pick up a few?

Intercom Kit

Heath Company has come up with their GD-140 Intercom System for budget-priced reliable 2-way communication. Pegged at \$29.95 mail order, the easily-assembled kit-system

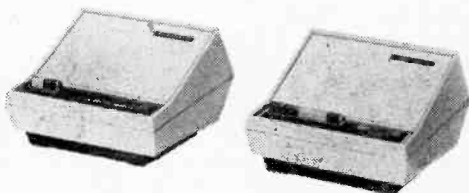

So Watt?*

How big you succeed in electronics today—bigger pay...better job... personal enjoyment—depends on how far you take the basics!

*Your reading this page now gives you the head start you need. And we'll match it with a Special Introductory Offer to keep you ahead

It always has been a matter of *knowing the basics*. Of the thousands of opportunities that are open to you in the electronics field today, you can be sure that all depend on *your understanding of basic electronics theory*. New electronic advances are triggered by yesterday's basics... just as tomorrow's amazing breakthroughs will spring from today's fundamentals.

Your taking advantage of the offer shown in the coupon below puts you in a better position to get the rewards electronics gives you today—and will offer you in the years ahead!

For Beginner or Expert—Elementary Electronics is valuable!

It shows a novice where to begin—an expert where to improve. Each issue features a *Basic Course* in an important area of electronics. Written by experts in an easy-to-follow style, with clear illustrations and diagrams, you get a practical understanding of special circuits... semi-conductors... power supplies... transformers... transistors... pulse circuitry, much more. You'll see general rules of electronics, develop trouble-shooting techniques, know how to calculate changing effects.

You may be earning an income now in electronics and hope to increase it soon. Or you may be an electronics hobbyist looking for new ideas to use at home and for recreation. Either way, for pleasure or profit, you shouldn't be without Elementary Electronics.

HI-FI • CB Radio • Shortwave • New Products • Projects in every issue! You'll find a lot more in Elementary Electronics—a fantastic variety of new

and exciting electronic information. More on today's CB activities and Shortwave Listening... expanded coverage on Product Testing from batteries and cells to stereo... new Build-It Projects for home and shop... portable music centers, weekend experiments, new products, bonus construction projects, electronic gadgets for fun and profit.

Try it. Try Elementary Electronics under the no-risk subscription offer shown in the coupon. Just fill in and mail the coupon to Elementary Electronics, 229 Park Avenue South, New York, N.Y. 10003. Send your subscription in TODAY.



**MAIL COUPON TODAY AND SAVE!
SPECIAL INTRODUCTORY OFFER
TO NEW READERS**

1 year (6 issues) only \$2.47

- Enter my trial subscription for 1 year. (I save \$2.03 off the newsstand price.)
- I prefer 1½ years (9 issues) for \$3.67. (On the newsstand \$6.75).
- Bill me Payment enclosed

Name _____ (please print)
Address _____
City _____ State _____ Zip _____

ELEMENTARY ELECTRONICS
229 Park Avenue South
New York, N.Y. 10003 **B672**

NEW PRODUCTS

includes a Master Station and one remote station. An extra remote station can be added. The Master station includes controls for Station 1, Station 2, Talk, Dictate and Volume . . . and the Master can call either or both remote stations. The Remote Stations feature Talk and Dictate controls and either Remote can initiate *private* calls to the Master. Both Master and Remote Stations feature 3-in. x 5-in. combination microphone-speakers for crisp, clear sound reproduction. Low-profile, mist-green cabinets have plastic feet for desk, shelf or tabletop use at home or at the office. And pre-drilled mounting holes in the top and bottom of the cabinet allow for wall mounting. For further information, circle No. 1 on Reader Service page.

For Wheels

Now being offered as an option by several auto manufacturers, capacitive discharge ignition systems are said to improve engine performance and economy, and provide more complete fuel combustion, thus reducing air pollution. Radio Shack has introduced the Archerkit Deluxe Capacitive Discharge System which is said to develop 50% more



spark energy for more complete combustion, and increase spark magnitude to 3-5 times normal for faster acceleration and quicker starts even in sub-zero weather. This performance will reduce the need for tune-ups by increasing point and plug life from 3-10 times, and provide 10-20% better gas mileage. The Archerkit System may be assembled in a single evening, and installs in a few minutes. No rewiring of the vehicle's original ignition system is needed, and an In-Out switch permits instant performance comparisons. The unit may be used with any 4, 6, or 8-cylinder engine having a 12 VDC negative ground electrical system. It has a

weather sealed case, 3x5x3½-in. The Archerkit Deluxe Capacitive Discharge Ignition System is priced at \$39.95. Archerkit products are available from more than 1500 Radio Shack and Allied Radio Stores, and through Radio Shack Authorized Sales Centers, nationwide. Want more information? Circle No. 52 on Reader Service page. ■

Transceiver Tool Set



The next time you want to pry into the gizzards of your transceiver, try with Vaco's new tool set combination. The set consists of a 5-piece all magnetic screwdriver with four interchangeable tips including ⅜ in. and ½-in. regular slot and #1 and #2 Phillips cross slot. The magnetism is transmitted from the shank to the tip to the screw providing a screw holding driver. The other part of the combination consists of a 7-piece hex drive socket set including ¼, ⅜, ⅝, ⅞, and 1½-in. sockets for turning all hex head nuts and bolts. A ¼-in. hex key wrench is included for driving sockets in recessed or hard-to-reach places. Wrench is also useful for driving ¼-in. recessed hex head screws and bolts. The combination offering, worth a \$7.00 value when sold separately, lists for only \$5.95 and carries a stock number of 70191. For further information, circle No. 55 on Reader Service Page.

Wrench is also useful for driving ¼-in. recessed hex head screws and bolts. The combination offering, worth a \$7.00 value when sold separately, lists for only \$5.95 and carries a stock number of 70191. For further information, circle No. 55 on Reader Service Page.

About Time!

A totally new concept in scanning monitors has been introduced in Teaberry's new Super Scan monitor. This emergency band monitor utilizes digital synthesis to create a programmable FM receiver capable of selecting any eight channels of the user's choice on the Public Service Band; HF 30-50 MHz, VHF 150-170 MHz or UHF 450-470 MHz. No

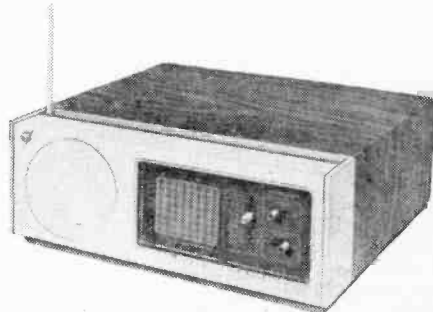

Gadgets & Gear for Builders

purchase of crystals by the customer is necessary to listen to his choice of frequencies, as is now required with all scanning monitors on the market. A program card supplied with Super Scan enables the user to have instant reception of frequencies of his choice at the time of purchase, regardless of his listening location. Furthermore, only one antenna, supplied with Super Scan, is necessary for both UHF and VHF reception. Coupled with better than .5 microvolt sensitivity is a new fixed squelch circuit, assuring top performance in all listening areas. Price is unannounced. For more information circle No. 54 on Reader Service Page.

Clean Up

The Magnetic Soap Holder is a newly developed idea for the bathroom. Attaches easily to any surface. With it the soap is simply "hung up to dry." The principle is simple. A special "tack" is inserted into the bar of soap and touched to a magnet in the holder. This holds the soap firmly in place. Satisfaction guaranteed. \$1.25 postpaid. Send orders to Stokes Enterprises, P.O. Box 373, 210 Wilderness Rd., Bristol, VA 24201.

In Sight

Sight-Light puts a bright beam of light directly along your line of sight. Permits bright illumination of hard-to-see into areas that otherwise couldn't be lighted and looked into simultaneously. Great for lighting tuners, gun barrels, pipes, sockets, auto parts, ears, nose, throat, etc. The double-duty Sight-Light also serves as a flashlight. Uses two "D" batteries. Made of heavy duty polystyrene with recessed viewing lens and eyepiece. Weight-10oz. Measures 12x4x6-in. Only \$4.95 each, postage paid. Each unit comes with a snap-in front magnifier giving a 5X magnification. Literally hundreds of uses around the house and on the job. Write to Master Man, Dept. 192A, 1544 Red Cedar Rd., St. Paul, MN 55121.

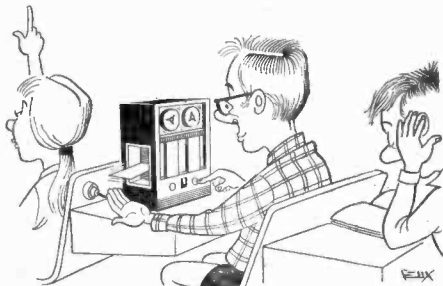

EARN HUNDREDS OF DOLLARS MORE!!

with the S & M Model A-3 Super-sensitive DARKROOM METER

Use your A-3 Meter with dial lights to become a darkroom PRO. It is easy to use at the enlarger with the 5/8 in. high EASEL probe to determine accurate exposures for B & W or color photography.

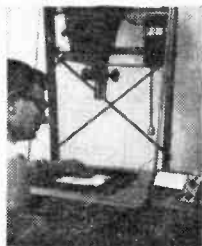

Darkroom guesswork disappears when the A-3 is there

Use your A-3 to improve your darkroom skills; to eliminate waste of prints, chemicals and time; to increase productivity and earnings by HUNDREDS OF DOLLARS.

Use your A-3 with the STANDARD probe as a STUDIO LIGHT METER. Features? Four sensitivity ranges; EV-EVS-LV settings; ASA settings from 3 to 25,000; f/stops from 0.7 to 90; exposure times from 1/15,000 sec. to 8 hours.

Use your A-3 as a densitometer to find the "base-plus-fog" density, high-light density, shadow density and density scale of your negatives. Then select the CORRECT paper for your printing. WE EXPLAIN HOW! Other applications? Ground-glass, slide duplication, photomicrography and MORE!

This battery-powered Meter uses plug-in probes. It is supplied here with the probe of your choice, 4 inch diameter exposure computer, carrying case and manual. This is your opportunity to use one free for 10 days without obligation. Mail the coupon today.

SCIENCE & MECHANICS
Instruments Division, Dept. 352
229 Park Avenue South
New York, N.Y. 10003

Send the S & M Darkroom Meter with probe indicated, computer, case and manual. Complete instructions supplied to make your own densitometer. If not satisfied, I may return the Meter within 10 days for a complete refund. (Add 10% for Canadian and Foreign orders; N.Y.C. residents add 7% for sales tax.)

- Darkroom Model A-3 @ \$75.00 with
 Standard probe; Easel probe;
 Mini-probe.

- 5/8 in. diameter Standard probe @ \$7.50
 5/8 in. high Easel probe @ \$7.50
 3/8 in. diameter Mini-probe @ \$7.50

- Check or money order enclosed, ship ppd.
 Company Purchase Order attached.

NAME _____

ADDRESS _____

CITY _____

STATE _____ ZIP _____

Dealer Inquiries Invited!

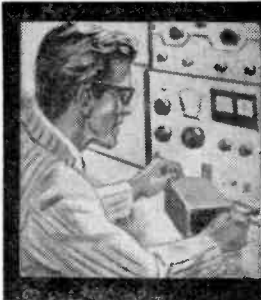

**ASK HANK,
HE KNOWS!**

Hank Scott, our Workshop Editor, wants to share his project tips with you. Got a question or a problem with a project you're building—ask Hank! Please remember that Hank's column is limited to answering specific electronic project questions that you send to him. Sorry, he isn't offering a circuit design service. Write to:

**Hank Scott, Workshop Editor
ELECTRONICS HOBBYIST
229 Park Avenue South
New York NY 10003**

Is He Kidding Me?

My big brother tells me he used a slide wire bridge in first-year college Physics. I find no reference to it in any of my radio books. He pulled a stunt like this when he told me about girls. Is he putting me on?

—L.P., Detroit, MI

You have a big brother to tell you things. I'm still learning about "soft boys". The slide wire bridge is found in every (just about) college Physics lab for freshman courses throughout the country. It is a variation of the Wheatstone bridge. See diagram. The wire has a fairly high

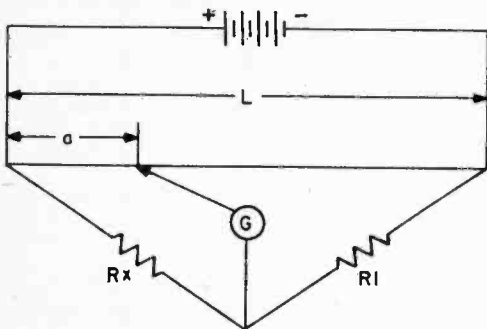

resistance. By moving the knife edge along its length, you can measure the unknown resistance by applying a simple formula:

$$R_x = \frac{a}{L-a} \times R_1.$$

L is the length of the wire and it is usually exactly one meter long, physically placed alongside a meter stick calibrated in 100 centimeters. The contact to the wire is a dull knife edge which also serves as the length indicator on the meter stick when reading value *a*. Why not build one—it's easy!

Economics of Hobbying

Why are 400, 600, and 1000 VDC capacitors often recommended for 9 VDC projects?

—R.K., Chicago, IL

Dollars, my boy, dollars! In many cases (if not all) high-voltage disc capacitors are cheaper than low-voltage units. Now, if you need a .001 disc capacitor rated at 9 Volts DC and size is not important, substitute a 200 or 400 V unit—

it's cheaper and works just as well. The voltage rating of a disc capacitor does not effect the operation of a circuit provided its voltage rating is not exceeded. Naturally, low-voltage disc capacitors are physically smaller and are used in pocket portables where space is very important.

Doesn't Read Ads

I've been reading your column for so long, I feel as if I'm writing to an old chum. In fact, it was your column, above most other Electronics Hobbyist features, that led me to buy a subscription to what I consider to be one of the most valuable publications in the hobby magazine field. My problem is a heavy garage door on a two-car garage. The door works manually and seems determined to give me a double hernia. Locally I've seen a door-opening arrangement which is nothing more than a switch-and-servomotor scheme with pulleys and all that nautical krapp. If I bought and installed such a gizmo, I'd still have to climb out of the car, unlock the door, and that would not solve my problem much. What should I do?

—G.B., Ottawa, Ont.

Thanks for the nice comment, however, read the rest of this magazine and you'll find some ads that will save you some grief. Heathkit makes a fine garage door opener that's automatic and radio controlled. It's child proof—the door is lowered slowly and if anything gets in the way, it automatically goes up. Circle No. 1 on the Reader Service Page in this issue and get their free catalog.

Wrong Again

In one of your columns you told your readers that they had to go to the Smithsonian if they wanted a CK-722 transistor. Well, you blew it! Radio Shack peddles the transistor for only \$1.19 for a set of five. Get with it, Hank!

—R.A.B., Elmhurst, IL

Okay, okay, I blew it. Thanks for your help. In case you want to order by mail, ask for part No. 276-572. How did Radio Shack ever get stuck with so many CK722's?

Can't BCB DX

Both my electric heating pads cause bad static in my AM portable, battery-operated radio when one of them is plugged in near the radio and turned on. The static is in the form of a



LITERATURE LIBRARY

101. Kit builder? Like weird products? EICO's 1973 catalog takes care of both breeds of buyers at prices you will like.

102. International Crystal has a free catalog for experimenters (crystals, PC boards, transistor RF mixers & amps, and other comm. products).

103. See brochures on Regency's 1973 lineup of CB transceivers & VHF/UHF receivers (public service/business bands—police, fire, etc.)

104. A pamphlet from Electra details the 6 models of the Bearcat III, a scanning monitor receiver.

105. Dynascan's new B&K catalog features test equipment for industrial labs, schools, and TV servicing.

106. Before you build from scratch, check the Fair Radio Sales latest catalog for surplus gear.

107. Get Antenna Specialists' cat. of latest CB and VHF/UHF innovations: base & mobile antennas, test equipment (wattmeters, etc.), accessories.

108. Want a deluxe CB base station? Then get the specs on Tram's super CB rigs.

109. Compact is the word for Xcelite's 9 sets of midget screwdrivers and nut-drivers with "piggyback" handle to increase length and torque. A "show case" serves as bench stand. Cat. 171.

110. Bomar claims to have CB crystal for every transceiver... for every channel. The catalog gives list of crystal to set interchangeability.

111. A Turner amplified mike helps get the most from a CB rig. This free brochure describes line of base & mobile station models.

112. Midland has recently published a 4-color brochure that folds out to 17" x 21", printed on both sides. Over 40 CB and scanner products are featured.

113. For everything in electronics—get the 1973 catalog from EDI (Electronic Distributors, Inc.). 152 pages of leading brands at bargain prices.

114. Get all the facts on Progressive Edu-Kits Home Radio Course. Build 20 radios and electronic circuits; parts, tools, and instructions included.

115. Olson Electronics' 188-p. fully-illustrated 1973 catalog has leading national brands, all in the electronic product categories.

116. Trigger Electronics has a complete catalog of equipment for those in electronics. Included are kits, parts, ham gear, CB, hi fi and recording equipment.

117. Get the free, new twenty-four page HUSTLER CB and Monitor antenna catalog featuring improved antennas and accessories for base station and mobile operation.

118. Teaberry Electronics has information on CB radios—Twin "T," Big "T," Mini "T" II, and Five by Five; also information on Scan "T" Monitor radio receiver.

119. Burstein-Applebee's new 1973 catalog has over 280 pages of Radio-TV/Electronics bargains. Selling for \$2, it is offered free to our readers.

120. For a colorful leaflet on the Golden Eagle Mark III SSB receiver and the Mark III SSB transmitter, write to Browning Laboratories.

121. Edmund Scientific's new catalog contains over 4000 products that embrace many sciences and fields.

122. Cornell Electronics' "Imperial Thrift Tag Sale" Catalog features TV and radio tubes. You can also find almost anything in electronics.

123. Radio Shack's 50 Anniv. cat. has 180 pages, colorfully illustrated, of complete range of hi fi, CB, SWL, ham equip. and parts (kits or wired) for electronics enthusiasts.

124. It's just off the press—Lafayette's all-new 1973 illustrated catalog packed with CB gear, hi-fi components, test equipment, tools, ham rigs, and more.

125. Mosley Electronics, Inc. is introducing 78 CB Mobile Antenna Systems. They are described and illustrated in a 9-page, 2-color brochure.

126. RCA Experimenter's Kits for hobbyists, hams, technicians and students are the answer for successful and enjoyable projects.

127. You can become an electrical engineer only if you take the first step. Let ICS send you their free illustrated catalog describing 17 special programs.

128. Avanti antennas (mobile and base for CB and VHF/UHF) are fully described and illustrated in new catalog.

129. A new free catalog is available from McGee Radio. It contains electronic product bargains.

130. Semiconductor Supermart is a new 1973 catalog listing project builders' parts, popular CB gear, and test equipment. It features semiconductors—all from Circuit Specialists.

131. Heath's new 1973 full-color catalog is a shopper's dream—chockful of gadgets and goodies everyone would want to own.

132. E. F. Johnson's 1973 line of CB transceivers and CB accessory equipment is featured in a new all-line brochure. Send for your free copy today.

133. If you want courses in assembling your own TV kits, National Schools has 10 from which to choose. There is a plan for GIs.

134. Free 1973 Catalog describes 100s of Howard W. Sams books for the hobbyist and technician. It includes books on projects, basic electronics and many related subjects.

ELECTRONICS HOBBYIST

Box 886
Ansonia Station
New York, N.Y. 10023

Please arrange to have this literature whose numbers I have circled at right sent to me as soon as possible. I am enclosing 25¢ to cover handling. (No stamps, please).

S/S-73



101 102 103 104 105 106 107 108 109 110
111 112 113 114 115 116 117 118 119 120
121 122 123 124 125 126 127 128 129 130
131 132 133 134

Indicate total number of booklets requested
Sorry, only 12 circled items maximum.

NAME _____

ADDRESS _____

CITY _____

STATE _____ ZIP _____

Not Valid After July 31, 1973

Ask Hank, He Knows

loud buzz every few seconds, lasting a second or so and drowning out the radio, regardless of the station. What should I do?

—H.D.K., Redlands, CA

The periodic buzz you hear is the hash from the 60 cycle (the heck with Hertz) line that is switched in by the pads' thermostats. I don't think line filters will help much. Why don't you switch to a hot water bottle or Jack Daniels?

Just Prying

I'm an electronics hobbyist who plans to make electronics my career. In reading your column "Ask Hank, He Knows" I find great humor, and good info tips. That's what the tech mags need, more good column writers like you. By the way, are you a ham or CBER?

—W.C., Moscow, Idaho

I'm both—ham and CBER—but get very little time on the air. I do my thing with construction projects provided I can get the parts. Thanks for the kind remark.

He'll Grow Anything!

I may be new in electronics, but like the hill-billy bride on her wedding night said, "Ma, I would rather do it myself!", I would like to know if there is a book or was there ever an article that could tell me how to grow my own npn Germanium crystals?

—D.S., Las Vegas NV

Many years ago we ran an article on how to grow a crystal. However, this crystal had a water structure and was useful only for Science Fair projects. Next, we ran an article on how to make your own cat-whisker crystal. This was great except it was too expensive, difficult to do and readers by the hundreds wrote telling us to use a store-bought diode. As for growing your own germanium crystal for transistor construction, you tell me how to draw gold wire one mil thick and I'll tell you the rest.

Glad you Asked

I have an iron core, 24-in. long, 1-in. x 2-in., weight of about 16 lbs. This core has 50 turns around it. Now, what I want to know is if I used 36 volts, how many amps would you have to use to get 1900 Gauss?

—M.S.G., Borrego Springs, CA

To properly answer this question, I would have to know the thickness of the iron laminations, the ferrus content of the iron and impurities, the time of day and what you had for breakfast. In other words, you have supplied insufficient information. Now, I have a 1970 4-door Buick with electronic solid-state ignition that bucks on mornings after a rain. Question—what was the relative humidity?

A Common Problem

I'm a beginner at DXing and I have a problem. My SW set measures in MHz, not kHz. When I see the location of a station, such as Radio Sierra Leone which broadcasts at 3,995 kHz, how do I find it on my set?

—L.M., Alapaha, GA

To convert megahertz to kilohertz (don't that sound like hell) simply multiply by 1000. So, 3.99 MHz equals 3,990 kHz. Simple? You'll get the swing of it. I did!

Lotta Noise

Recently I built a 600 Watt lamp dimmer using the circuit enclosed. Then I discovered it produced static on radios even if they were run on batteries. Is there something I can do or add to the circuit to decrease or eliminate the static?

—R.L., Monterey CA

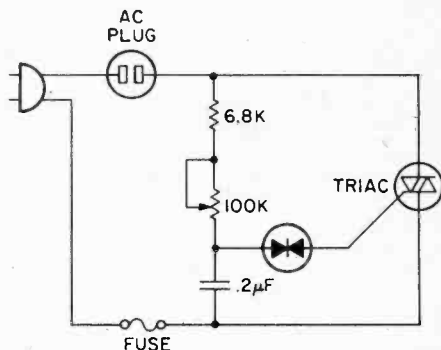

Your best bet is to operate the dimmer under water, salt water is best. Seriously, you need a heck of a lot of filtering. Assemble the unit in a steel box, and ground it to the outlet box. Next, filter the outputs and inputs with line filters. Automotive alternator feed-thru capacitors may do. But, considering the trouble, and the expense, it may be cheaper to buy a commercial unit.

Good Buy

I recently purchased a Hallicrafter S-120 receiver and am desperately in need of a manual for it. Could you advise me where to find one? Also, I would be interested in your opinion of my purchase. Is the S-120 adequate for SWLing and ultimately for use in a ham shack or should I start saving for a new one. Thank you very much.

—J.W., Sheppard AFB TX

The S-120 is good SWL communications receiver for the novice and serious listener. After you've logged all you can hear on the S-120, both you and the receiver will need an overhaul.

The Clean Up

The head in my 8-track cartridge player needs cleaning, but I have been told that cartridge

(Continued on page 115)

ELECTRONICS HOBBYIST

READER SERVICE PAGE

• The Editor of ELECTRONICS HOBBYIST offers readers an easy way to get additional information about products and services advertised in this issue. Also, if you would like more information about any new product mentioned in our new products column, it's yours for the asking. Just follow the instructions below and the material you requested will be sent to you promptly and at no cost.

• The coupon below is designed for your convenience. Just circle the numbers that appear next to the advertisement or editorial mention that interests you. Then, carefully print your name and address on the coupon. Cut out the coupon and mail to ELECTRONICS HOBBYIST, Box 886, Ansonia Station, New York, N.Y. 10023. Do it today!

Void after July 31, 1973

S/S 1972

ELECTRONICS HOBBYIST

Box 886, Ansonia Station, New York, N.Y. 10023

Please arrange to have literature whose numbers I have circled at right sent to me as soon as possible. Understand that this is a free service offered by the magazine.	1	2	3	4	5	6	7	8	9	10
	11	12	13	14	15	16	17	18	19	20
	21	22	23	24	25	26	27	28	29	30
	31	32	33	34	35	36	37	38	39	40
	41	42	43	44	45	46	47	48	49	50
	51	52	53	54	55	56	57	58	59	60

Name (Print Clearly) _____

Address _____

City _____ State _____ Zip Code _____

learn by doing!

Perform more than 200 exciting experiments with CIE's fascinating **ELECTRONICS LABORATORY PROGRAM!**

Put theory... into practice



You get your own 161-piece electronics laboratory... with authentic electronic components used by industry!

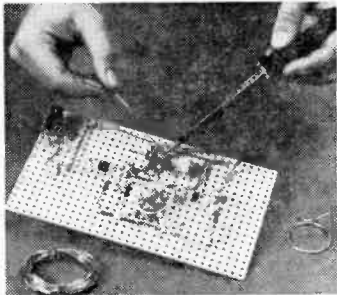

You learn how to construct circuits and connect them with a soldering iron, which is part of your CIE laboratory equipment. This "hands on" experience is extremely valuable in applying what you learn.

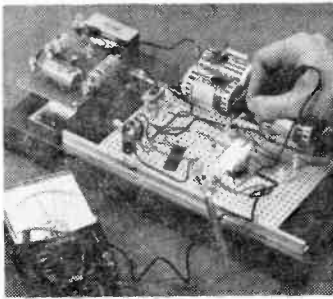

Testing and troubleshooting are an important part of your learning experience. Included in your laboratory is a precision "multimeter" to diagnose electrical and electronic troubles quickly and accurately.

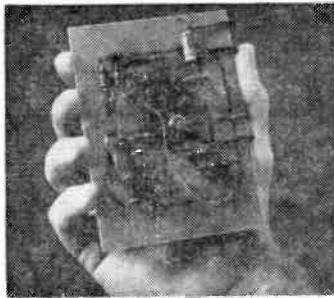

Modern space-age components like this IC (integrated circuit) are professional quality and can be used again and again in many of your projects. Lesson by lesson, piece by piece your knowledge grows!

Prepare now for a high income career in Electronics...the Science of the Seventies.

Electronic miracles are changing today's world with breathtaking speed.

And with this growth in electronics technology has come a brand new need... a demand for thousands of electronics technicians, trained in theory and practice to build the products, operate them and service them during the Seventies.

Don't just wait for something to "happen" in your present job. Get ready now for a career you'll really enjoy with a good income and plenty of opportunity for advancement.

Experience with experiments is your best teacher

"Hands on" experience helps to reinforce basic theory. When you learn by doing, you discover the "how" as well as the "why." You'll find out for yourself the right way as well as the wrong way to use electronic components. How to construct your own circuits, to discover trouble spots and learn how to fix them. And with CIE's special Auto-Programmed® Lessons, you learn faster and easier than you'd believe possible.

CIE's fascinating course, Electronics Technology with Laboratory, teaches you Electronics by making it work before your eyes. And you do it yourself, with your own hands.

Importance of FCC License and our Money-Back Warranty

Many important jobs require an FCC License and you must pass a Government licensing exam to get one.

But, a recent survey of 787 CIE graduates reveals that better than 9 out of 10 CIE grads passed the FCC License exam.

That's why we can offer this famous Money-Back Warranty: when

you complete our Laboratory Course, which provides FCC License preparation, you'll be able to pass your FCC exam or be entitled to a full refund of all tuition paid. This warranty is valid during the completion time allowed for your course.

You get your FCC License — or your money back!

You'll have high paying job opportunities

Electronics is still young and growing. In nearly every one of the new exciting fields of the Seventies you find electronics skills and knowledge are in demand. Computers and data processing. Air traffic control. Medical technology. Pollution control. Broadcasting and communications. With a CIE Diploma and an FCC License you can choose the career field you want... work for a big corporation, a small company or even go into business for yourself.

Here's how two outstanding CIE students carved out new careers: After his CIE training, Edward J. Dulaney, President of D & A Manu-

facturing, Inc., Scottsbluff, Nebraska, moved from TV repairman to lab technician to radio station chief engineer to manufacturer of electronic equipment with annual sales of more than \$500,000. Ed Dulaney says, "While studying with CIE, I learned the electronics theories that made my present business possible."

Marvin Hutchens, Woodbridge, Virginia, says: "I was surprised at the relevancy of the CIE course to actual working conditions. I'm now servicing two-way radio systems in the Greater Washington area. My earnings have increased \$3,000. I bought a new home for my family and I feel more financially secure than ever before."

Send now for 2 FREE BOOKS

Mail the reply card or coupon for our school catalog *plus* a special book on how to get your FCC License. For your convenience, we will try to have a representative call. If coupon is missing, write: Cleveland Institute of Electronics, Inc., 1776 E. 17th St., Cleveland, Ohio 44114. Do it now!



Approved
under
G.I. Bill

All CIE career courses are approved for educational benefits under the G.I. Bill. If you are a Veteran or in service now, check box for G.I. Bill information.

CIE Cleveland Institute of Electronics, Inc.
1776 East 17th Street, Cleveland, Ohio 44114
Accredited Member National Home Study Council

Please send me your two FREE books:
1. Your illustrated school catalog, "Succeed in Electronics."
2. Your book, "How to Get a Commercial FCC License."

I am especially interested in: Electronics Technology with Laboratory
 Electronics Technology Industrial Electronics
 Electronic Communications First Class FCC License
 Broadcast Engineering Electronics Engineering

Name _____ Age _____
(PLEASE PRINT)

Address _____

City _____ State _____ Zip _____

Veterans and Servicemen: Check here for G.I. Bill information.

EB-10

CIRCLE NO. 3 ON PAGE 17 OR 117

Mobile Meandering

by Jack Schmidt

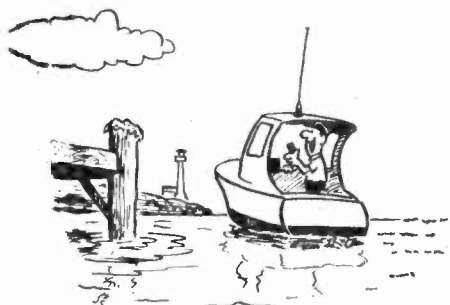

"CQ America, CQ America—this is WA2CQL at sea!"



"Mayday... Mayday..."



"REACT 7, this is REACT 9... this is not a drill!"



"Quit complaining, Gladys, it's no heavier than the baby was..."



"It's your mother!!!"



"I backed out before the garage door was the whole way up."

LIGHT AMPLIFICATION

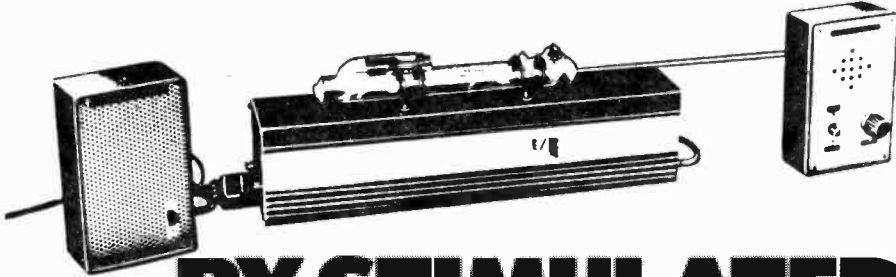

BY STIMULATED EMISSION OF RADIATION

A Helium-Neon laser for the experimenter

by Jorma Hyypia

LASER, the "pencil light" that surveys land, hem-stitches the human retina, offers true 3-D photography and many other space-age wonder achievements, is no longer a curiosity of the laboratory or an expensive industrial tool! The laser can be your experimenting tool at home at reasonable costs. You can investigate basic scientific principles—polarization, refraction, critical angle, diffraction, interference, Lloyd's mirror, Michaelson interferometer, holography, doppler effect, and many more interesting light phenomena with your own laser. Even talk on a laser beam! A simple laser system can transmit voice or data communications over a distance of several hundred feet, and the line-of-sight range can be extended to several miles by the addition of beam collimating optics. Aside from the privacy that such a system provides, there are other advantages over conventional communications methods. For one, you don't need an FCC license as you do with a CB rig. Nor do you have to pay the telephone company extra revenue for the added service. Once the laser equipment is installed, operating cost is virtually nil because the electrical power consumption of a laser communications system is very modest.

And even if you don't have a crying need for a confidential hot-line, experimenting with laser communication can be a lot of fun—especially since you would be working in an area that is on the verge of a major communications revolution. As you probably already know, laser linkages may eventually solve the problem of increasing congestion

LASER KIT

on some conventional long-distance telephone cables. Already, laser links are used over rough mountain areas to eliminate conventional wires. Other examples of laser communications applications that have arrived, or bide to do so in the near future, include ship-to-shore communications (vital when radio silence must be maintained, or when electrical disturbances garble radio-telephone communications), battlefield communications, law enforcement applications, and the rapid transmission of data between computers.

Kits Save Money. Consider building your own laser system from a kit. The laser communicator used by the author was built from a prototype kit supplied by Metrologic Instruments, Inc. of Bellmawr, New Jersey. While building and testing this system, the folks at Metro came out with a re-designed model offering notable improvements including a streamlined PC circuit, a better instruction manual, and provision for easier installation of the laser tube inside the metal housing containing the electronic circuitry. If you want to put the laser tube outside the housing so that you can watch the fascinating lasing action, make a protective shield from 1/4-in. Plexiglas. It not only protects the expensive tube from physical damage, but also protects you from dangerous shocks.

Although the equipment you might now buy from Metrologic is not identical with the prototype equipment shown here, the differences are minor, so you can safely use

this article to decide whether construction of a laser communicator is for you. Metrologic's re-designed communicator kit (model 60-250) includes: an MT 205 laser tube, 60-143 power supply, 60-164 communicator housing, a modulator kit, microphone, silicon photosensor, and a receiver. This kit is priced at \$143 and is expressly designed for voice communications. The MT-205 laser tube has a bandwidth of 60 Hz to 125 kHz. If you already own a helium-neon laser, it may be suitable for use with Metro's 60-203 laser communicator conversion kit (laser beam modulator) which is tagged at a still lower \$75. But before ordering the conversion kit, check with Metrologic to make sure that it is compatible with the laser system you have.

A new completely assembled system for both voice and data transmission is available from Metrologic. It consists of the ML-369 laser priced at \$180 and the model 60-247 receiver priced at \$50. The latter includes a microphone to complete the system. Bandwidth of the ML-369 laser is 300 Hz to 500 kHz. This system is not available in kit form.

This or any other laser construction project is not recommended for those who have trouble putting batteries into a flashlight. The voltages in any laser power pack are lethal—1700 Volts and up, depending on the unit design. But if you have experience fiddling with TV or other high-voltage equipment, the laser poses no unusual construction problems or hazards.

The low power laser beam cannot burn holes into anything, even if you try to intensify it with a lens. But there is potential danger to eyesight if the beam is allowed to enter the eye unattenuated or undiffused.

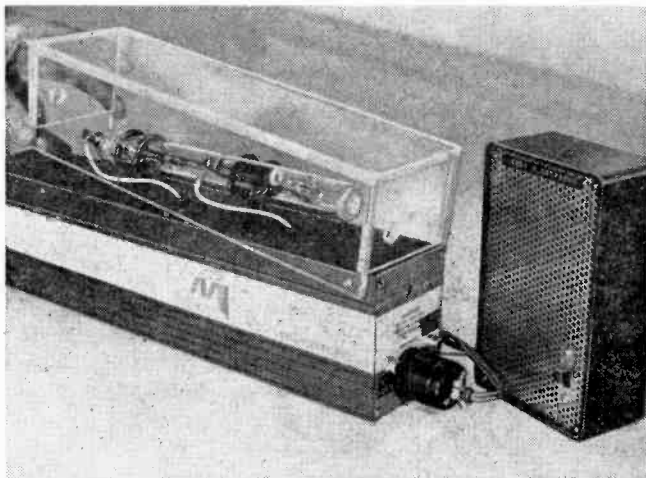

Laser tube can be mounted on top of equipment case. Lets you watch fascinating lasing action. Build a Plexiglas cover as shown for safety. Black case houses Author's microphone—a small speaker.

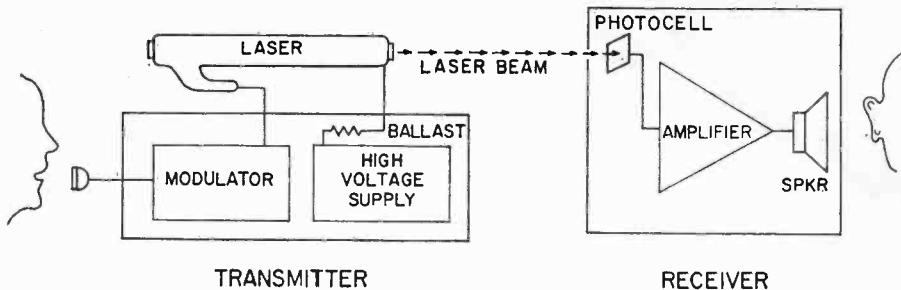

One way laser system for voice communications. Lasers shown in this article are in no way hazardous to the user as long as they are used with common sense. They are approximately as hazardous as sunlight or light of an arc-lamp projector. Take care.

So don't let anyone look directly into the beam, or into a beam reflected from a shiny surface. Viewing the beam from the side is perfectly safe. Just bear in mind that the laser communicator is definitely not a children's plaything.

Pick the Right Laser. Some laser tube designs are more suitable than other designs for communications applications. The type of information you wish to transmit—voice or computer data, for example—should be considered when making a selection.

The helium-neon laser tube shown in the prototype unit we built (Metrologic's Model MT217) offers a modulation capability for such applications as voice or data transmission. When operated with the recommended 1700-volt power supply, it provides 0.3 milliwatts of optical power at a wavelength of 6328 Angstroms (wavelength of red light).

Metro's new communications system (Model ML-369 and model 60-247) utilizes a laser having 15 percent modulation at maximum output (1.5 milliwatts). The input signal level is 200 mV peak-to-peak nominal, and .5V peak-to-peak maximum. If you need 100 percent modulation capability, as

for data transmission rather than for voice, inquire about the company's Model ML-382 100 percent modulated laser.

The light output from the laser tube is intensity modulated by modulating the electrical current that activates the tube. For voice modulation, the MT217 tube is biased at about 3.75 mA DC. The input is AC coupled so that a DC signal applied at the input will not affect the tube bias; however, an AC voltage at a frequency in the 60 Hz to 125 KHz range will make the current change and thereby affect the intensity of the light beam. The tube is driven with a current ranging from 2 mA to 5.5 mA. Above 5.5 mA cathode burnout would be accelerated; below 2 mA the tube becomes unstable.

How It Works. In this one-way communication system a speaker-microphone (or a crystal mike) drives a preamplifier-amplifier integrated circuit. The IC drives a low-voltage current-modulating amplifier (a 2N5220) which in turn drives a high voltage current modulating transistor; it is this transistor that modulates the current flowing through the laser tube. The modulator printed circuit board includes a rectifier-

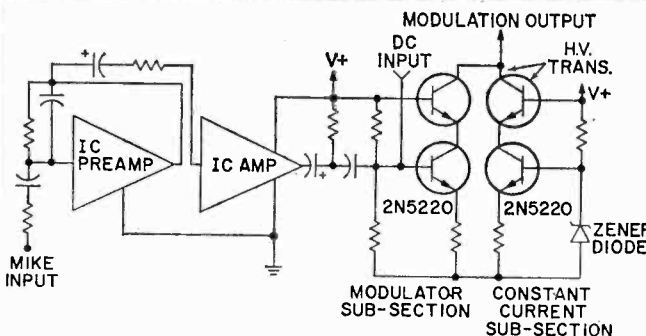

Solid-state laser modulator. Transistors at right maintain constant current through laser tube to maintain lasing action during periods of no modulation. Remaining transistors vary current in proportion to mike input signal to change intensity of beam.

LASER KIT

filter circuit to provide low voltage for the modulator circuit and a constant-current sub-section which maintains a minimum current in the laser tube by use of a separate high-voltage transistor.

The Model 60-247 receiver unit costs an even fifty dollars and contains a photocell which senses the intensity-modulated laser light and demodulates it to a current that is directly proportional to the modulated laser light level. The resulting current signal is amplified and fed to a speaker.

Inputs Can Vary. When the full amplifier section of our prototype modulator system is used, the input can be as low as 2 millivolts AC, in which case the bandwidth is limited to between 150 Hz and 10 KHz. Note the *DC Input* point at the base of the modulator's 2N5220 transistor. If the amplifier section is by-passed by injecting a

± 3 Volt input signal at this point, the bandwidth can be extended from DC to over 125 KHz, with 100 percent modulation.

The light sensor is a large area photocell which permits easy alignment and maximum light-gathering capability. The cell's upper frequency response is limited to about 25 kHz (2 dB down). However, frequencies approaching 1 MHz can be sensed by substituting a higher frequency sensor such as a photo transistor or small area photo diode.

The speaker-microphone shown is equipped with a volume control and a push-to-talk slide switch. An 8-prong (only four contacts are used in the one-way system) plugs into a receptacle at one end of the laser tube housing. The housing also has two extra jacks. One provides a connection with the *DC Input* already mentioned; the other provides an input point for such signal sources as a tape recorder, signal generator, or a crystal microphone which could be used in lieu of the speaker-mike for improved speech quality.

Performance. Divergence of the MT217 laser beam is 0.8 mRad and the beam diameter spreads from 1 mm near the tube field to 8 mm at a distance of 30 feet. Transmission up to 100 feet is feasible without use of accessory equipment.

The laser used in the new (ML-369) communicator system has a beam divergence of 1.0 mRad, but since the power output is higher (0.7 mW compared to 0.3 mW for the equipment shown), you should have no trouble communicating over distances well over 100 feet without optical collimating. The manufacturer says that an 8X collimator will boost the working distance up to 1,500 feet, and that a 20X collimator will permit communication up to a distance of 2,500 feet. If you pass the beam through a 4½ inch Palomar type reflecting telescope, the range can be increased to several miles!

If there is a physical obstruction such as a tree or building between the transmitter and receiver, small mirrors can be used to bend the beam around obstructions. Where the beam might be obstructed by passing people or animals, mirrors can be used to elevate the beam to a height that would prevent such interference, and safeguard the eyes of people who do not know the beam is there.

Certain atmospheric conditions (snow, sleet, rain and heavy fog) hamper laser
(Continued on page 120)

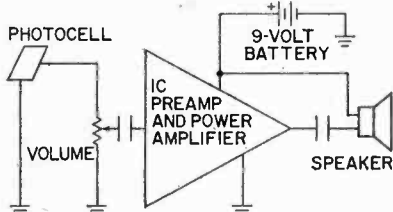

This prototype laser receiver used a 9 volt battery. Current model plugs into 117 VAC outlet, is completely assembled.

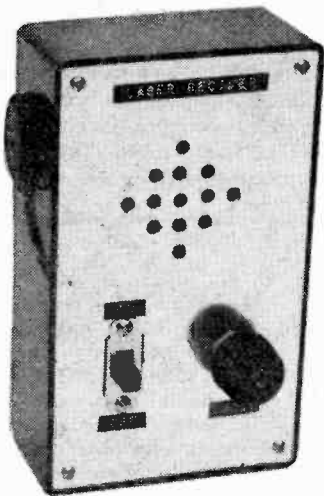

For more information about Metrologic's lasers circle No. 58 on Page 17 or 117.

build e/e's...

SCRAMBLE PHONE

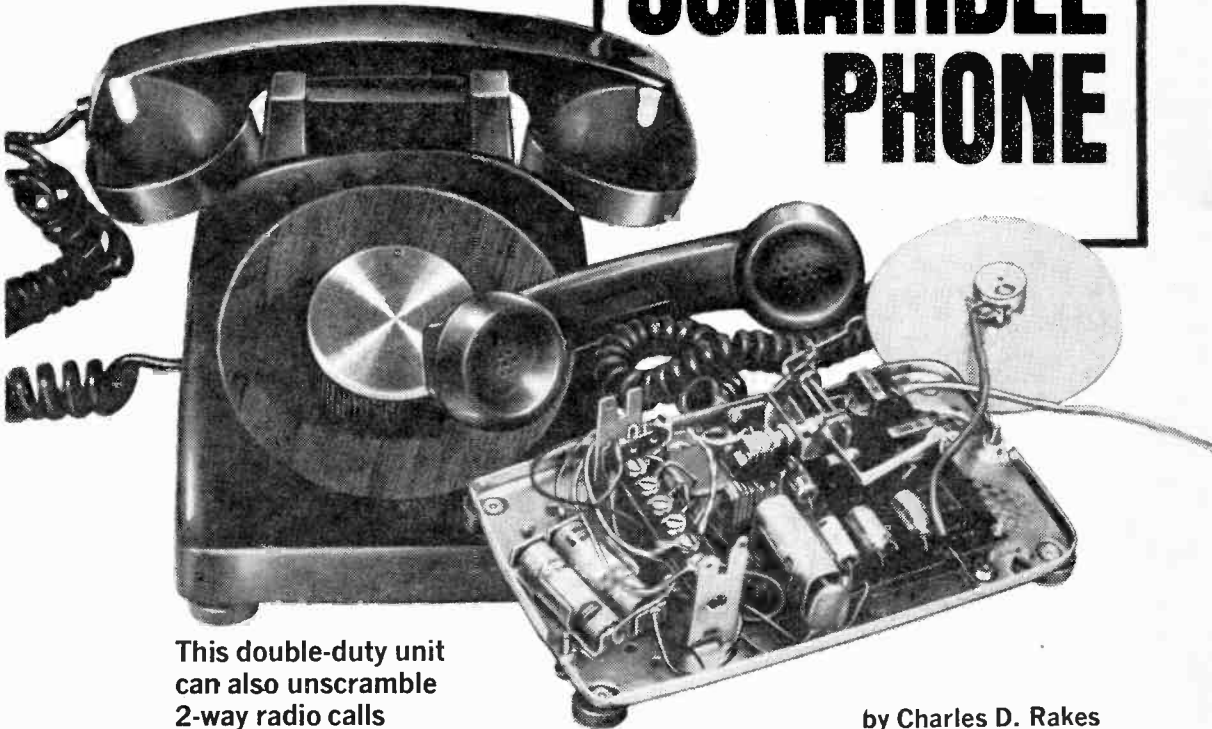

**This double-duty unit
can also unscramble
2-way radio calls**

by Charles D. Rakes

Demand ultimate privacy in your telephone conversations? If so, a secure phone link can be yours with these three easy and exciting steps. 1. Place your call with Ma Bell's instrument. 2. When your party answers, switch to your special scrambler phones. 3. A soft buzz in the ear piece says your security phone link is operational. Your line is secure. Conduct your call in complete privacy no matter how many ears are party-line-listening!

All it takes is a pair of **ELECTRONICS HOBBYIST** Scramble Phones. And with this double duty unit, you can try your hand at decoding scrambled conversations that are sometimes heard on radio receivers covering the VHF high band (148-176 MHz). The basic scrambler circuit (available in kit form, see parts list) can be simply modified for radio by removing two fixed resistors and replacing them with a dual-potentiometer.

Wait a minute! Before your soldering iron overheats, let me say that this scrambler will decode information that is encoded in the *single inversion* mode only. The highly sophisticated scramblers that are sometimes

used today can not be decoded with this decoder, but in many areas the single inversion system is still in use and may be decoded with our unit.

How It Works. IC-1 and the associated circuitry form a stable audio tone generator which feeds a buffer amplifier, Q1 and Q2. The tone output is taken from the emitters of the transistor pair to supply a carrier voltage for a balanced modulator made up of four diodes—D1 through D4—and T1 and T2. If the two transformers and the four diodes are perfectly matched (which is almost impossible to achieve and not necessary in any case) no carrier will appear at the input or output of T1 or T2. In a practical circuit, a small amount of unbalance will occur and produce a low-level carrier tone at the input and output of the balanced modulator. This tells you your scramble phone is working.

A telephone carbon mike and ear piece are connected to the low impedance winding of T1, with a three volt battery supplying the necessary mike current. When the mike is spoken into, the carrier voltage is allowed to pass, in part, through transform-

SCRAMBLE PHONE

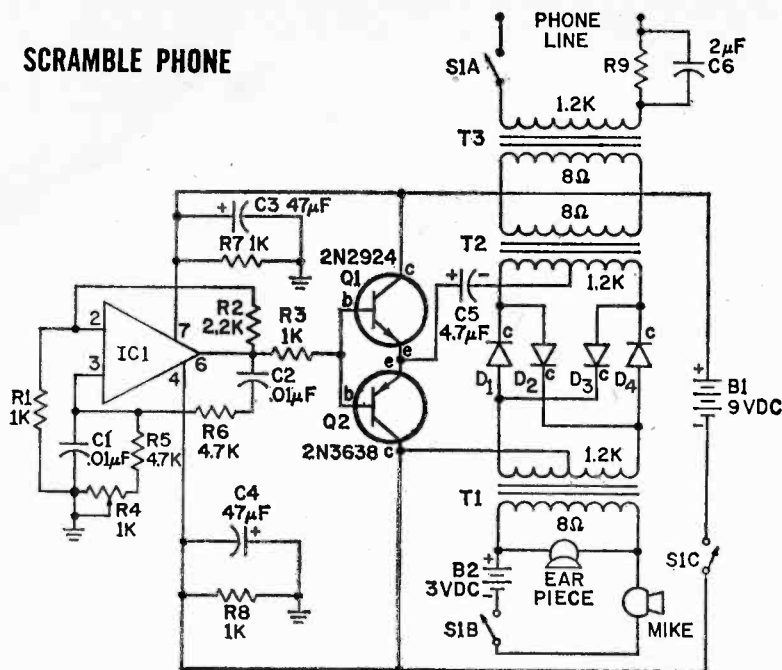

PARTS LIST FOR SCRAMBLE PHONE

B1—9-volt battery, Eveready 216 or equiv.
 B2—3-volt battery, two AA penlight cells in series
 C1, C2—0.01 μ F polystyrene capacitor, 100 VDC or better
 C3, C4—47 μ F electrolytic capacitor, 25 VDC or better
 C5—4.7 μ F electrolytic capacitor, 25 VDC or better
 C6—2 μ F paper or mylar capacitor, 50 VDC or better
 D1 to D4—Diode, IN914, HEP-156
 IC1—Integrated circuit, Signetics N5741K or equiv.
 Q1—NPN transistor, 2N2924, HEP-724
 Q2—PNP transistor, 2N3638, HEP-716
 R1, R3, R7, R8—1000-ohm, $\frac{1}{2}$ -watt resistor
 R2—2,200-ohm $\frac{1}{2}$ -watt resistor

R4—1000-ohm potentiometer
 R5, R6—4,700-ohm, $\frac{1}{2}$ -watt resistor
 R9—Limit line current to 25mA (see text)
 S1A, S1B, S1C—Phone hook switch (see text)
 T1 to T3—Small transistor audio transformer; 8-ohm primary, 1,200-ohm center taped secondary.
 Misc.—Surplus telephone (see Lafayette, Radio Shack, EDI, BA catalogs); battery holders, hardware, knob, wire, solder, etc.

An etched and drilled printed circuit board is available for \$4.95 (includes postage and handling). A complete kit of all parts that mount on the PC board, plus the drilled board and R4 are available for \$16.95 (one kit) and \$30.95 (two kits). Add one dollar (Canadians add \$2) for handling when ordering the complete kit(s). Postal Money Order speeds shipment. Order from KRYSTAL KITS, Highway 102 East, Bentonville AR 72712.

ers T2 and T3, and on to the telephone network. The only purpose of T3 is to match the impedance offered by most telephone lines.

Trim potentiometer R4 is used to make a fine frequency adjustment of the oscillator so that two scrambler units may be synchronized to the same carrier frequency. Both oscillators must be operating at the same frequency to produce the best decoded speech quality. This control is referred to as the speech *clarity* control.

The best overall carrier frequency range to use for speech scrambling is between 2 kHz and 3.5 kHz.

Listening In. If the scramble phone is to be used for only receiver speech decoding, then only one unit is required. The operation is much the same as for telephone encoder/decoder purposes, with the exception that it is used only as a decoder. The carrier oscillator is made variable so the decoder may be synchronized to the same carrier frequency as is used in the encoder. The output of the receiver is connected to the 8-ohm winding of T2 (T3 is not required for this use) and the decoded information is developed across the 8-ohm winding of T1. A small speaker may be connected across this winding, or a low impedance ear-

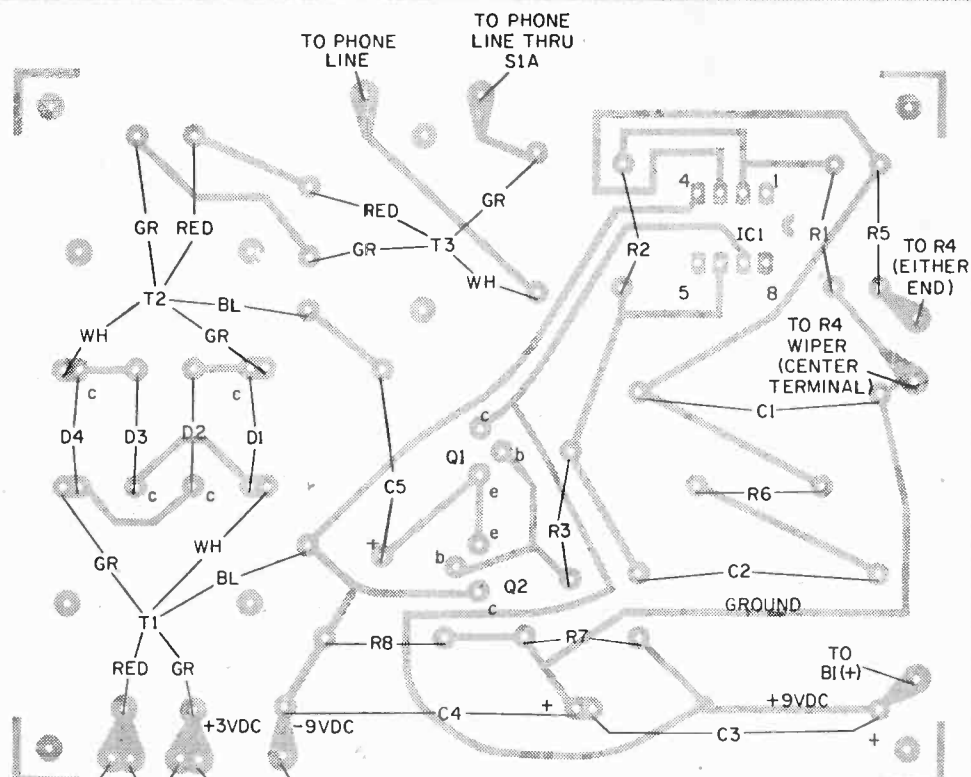

For exact part placement on PC board, see diagram above. View is from component (top) side of board. Layout below shows a completed scrambler board.

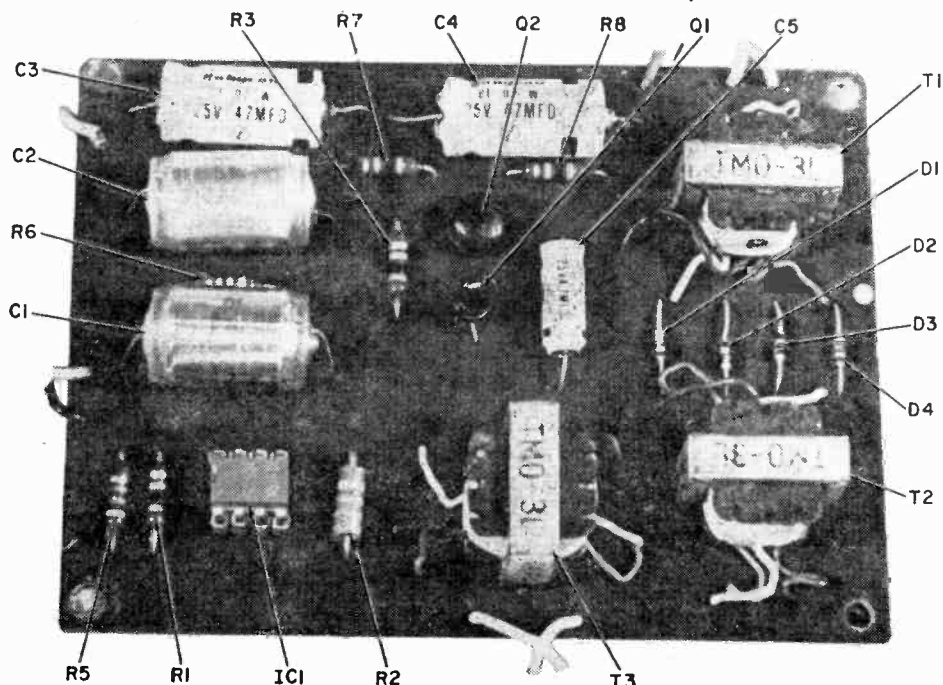

SCRAMBLE PHONE

MODIFICATION 1.

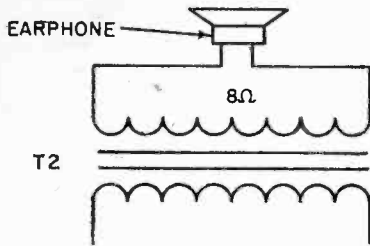

REMOVE T3, ADD EARPHONE

MODIFICATION 2.

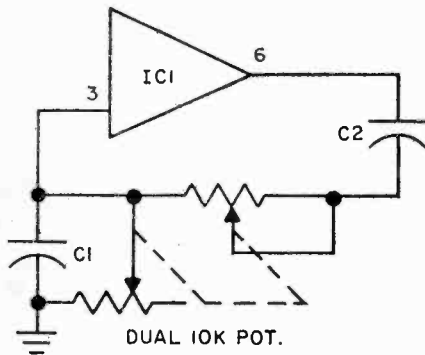

ADD DUAL POT, REMOVE R4, R5 AND R6.

MODIFICATION 3.

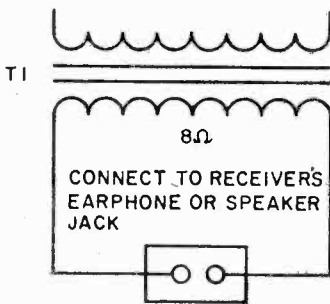

REMOVE PHONE HANDSET AND 3-VOLT BATTERY, ADD TERMINAL STRIP

It is possible to decode some older scrambler systems heard on 2-way radio bands. However, this single inversion mode circuit will not work with multi-inversion systems also in use. Dual pot is Allen-Bradley CJK1N200P103U or equiv.

phone will do for monitoring the decoded speech. No mike or 3-volt battery is necessary for decoding operations.

Putting It Together. The circuit layout isn't critical and any suitable scheme can be followed, but the layout shown for the PC board would be a good one to use. No matter what construction plan is used, PC board or bread board, extra care should be taken when connecting the IC, diodes, and transistors to the circuit. Care should also be taken when connecting the three transformers, so that the low and high impedance windings are not reversed.

The size of the PC board allows the

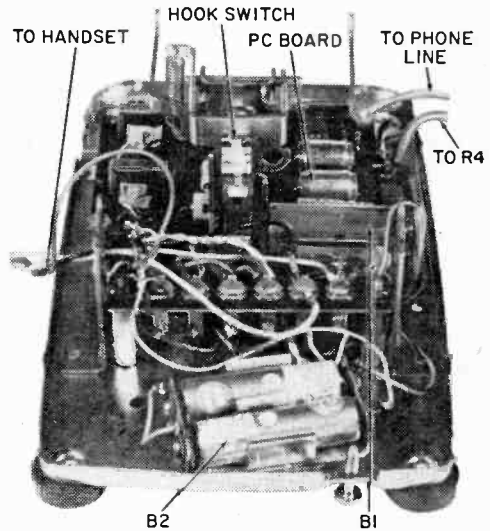

Inside completed Scramble Phone. Surplus phones are available from a number of mail order firms as well as their local stores.

scrambler to be mounted in the base of a standard telephone. All parts located inside the phone, with the exception of the hook switch, can be removed to make the construction job an easy one. Check the pictures when mounting the board and batteries.

In some telephones, the hook switch contains enough switch contacts to function as the three switches, S1A, S1B, and S1C; but if you have one that does not contain enough contacts, a separate switch must be added to switch the battery power. For the scramble phone to automatically bridge the telephone line when the handset is off-hook, at least one section of the hook switch must be used for S1A.

If a dial telephone is selected, the dial
(Continued on page 119)

SUPER SCA ADAPTOR

by
Herbert Friedman

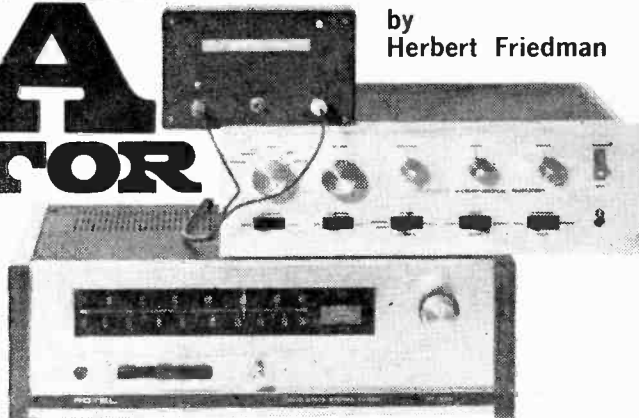

Hot Enough For DXing

You can build a Super SCA detector that's powerful enough for DXing! It's a two-IC circuit in an *amplifier* and *phase locked loop* detector configuration. And it's superior to many other PLL detector circuits because it has an IC amplifier to boost and *lift* the relatively weak 67 kHz sub-carrier signal from the FM signal. That makes it a must for fringe areas.

But let's go back to what SCA is. When a Subsidiary Communication Authorization (known as SCA) is granted to an FM station by the FCC, that station is permitted to transmit a second program *in addition* to its regular program by a special method of modulation. A standard FM radio, even a stereo radio, cannot detect these special broadcasts. The regular listening audience hears only the standard mono or stereo programming. In fact, there is no way of even telling whether or not a station engages in SCA programming. That is, not without a special SCA adaptor that you can build!

If you think you'd like to tune to these hidden broadcasts, we've provided this special project. Special because its high sensitivity permits reception of SCA signals that other low cost adaptors miss.

What You Can Hear. For some time now, SCA has been used to transmit educational programs and continuous weather reports to specialized audiences; however, it is *primarily* used for background music—the type heard in restaurants and shopping centers. For example, in the New York City area there are FM stations with SCA programming in light popular music, while others specialize in music of India and Greece.

Best of all, this pleasant, interesting music is never interrupted by an endless barrage of commercials or the patter of an announcer in love with his own voice.

How it's done. SCA programming is transmitted by a 67 kHz FM sub-carrier that is impressed on the main FM carrier. When a station broadcasting SCA is received by a standard FM tuner, the SCA sub-carrier is simply wiped out—the listener has no idea it exists. To receive SCA, the FM tuner's output is usually passed through a filter that wipes out everything except the SCA sub-carrier and its modulation. When the sub-carrier is demodulated, the output is only the SCA program; to the SCA listener, the standard programming doesn't exist.

Until recently it took a lot of expensive hardware to receive SCA programs: a very sensitive receiver and a rock-steady detector. (A good receiver is needed because the SCA carrier is only 10% of the total FM signal.) Though many low cost SCA

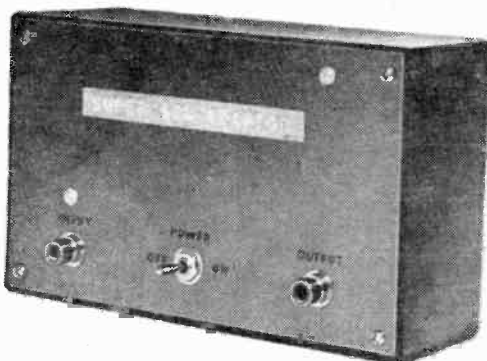

Adaptor above is teamed with Rotel RT-620 AM/FM tuner and Dynaco SCA-80Q amplifier

SUPER SCA ADAPTOR

adaptors have been available in project or wired form, most had a tendency to burp, gargle or distort on the very weak signal level of the SCA.

While the radio-astronomy crowd had a great weak-signal detector known as the phase locked loop, it was also true that the astronomical phase lock detector was astronomical in price. But thanks to modern solid-state techniques, the Signetics Corpor-

ation has come up with a phase locked loop detector specifically intended for SCA detection that is priced well under ten dollars.

Available in the standard 8 pin round and 14 pin DIP IC packages, the Signetics SE/NE565 requires virtually no external hardware for SCA detection. Most important, since the phase lock detector automatically locks on the incoming SCA carrier frequency, the Signetics SE/NE565 will demodulate SCA subcarriers of either 65 kHz or 67kHz without adjustment; whichever subcarrier frequency the broadcasting station uses will be received equally

PARTS LIST FOR SUPER SCA ADAPTOR

- B1,B2—6-volt battery, RCA VSO68 or equiv.
- C1,C9—470 pF disc capacitor, 15 VDC or better
- C2—47 or 50 pF disc capacitor, 15 VDC or better
- C3—0.005 uF disc capacitor, 15 VDC or better
- C4,C7—0.1 uF disc or Mylar capacitor, 15 VDC
- C5,C6—100 uF electrolytic, 15 VDC or better
- C8—7 or 10 pF disc capacitor, 15 VDC or better
- C10,C11—0.001 uF disc or Mylar, 15 VDC
- C12,C14—0.02 uF disc, 15 VDC or better (see text)
- C13,C17—0.05 uF disc or Mylar, 15 VDC or better
- C15,C16—2000 uF electrolytic capacitor, 15 VDC or better
- IC1—Integrated circuit amplifier, NE531T (Signetics). Write to Circuit Specialists Co., Box 3047, Scottsdale AZ 85257 for IC prices.
- IC2—Integrated circuit PLL, NE565A (Signetics)
- R1,R5,R6—4700-ohms, 1/4-watt resistor, 5%
- R2,R4—47,000-ohms, 1/4-watt resistor, 5%
- R3—470-ohm, 1/4-watt resistor, 5%

- R7—1800-ohm, 1/4-watt resistor, 5%
- R8—5000-ohm potentiometer, PC board mounting
- R9,R10,R11—1000-ohms, 1/4-watt resistor, 5%
- SR1 to SR4—Silicon diodes, HEP-154 or equal
- S1—Toggle or slide switch, SPDT
- T1—Small filament transformer, 12.6 volt center tapped
- Misc.—6 x 3 1/2 x 2-in. case, printed circuit material, etchant, RCA phono jacks, push-in clips, hardware, wire, solder, etc.

The printed circuit board for the Super SCA project is available direct from Electronics Hobby Shop, Box 587, Brooklyn NY 11202 for only \$4.95 (includes postage and handling). Canadian shipments add \$1 extra. New York state residents must add sales tax. No foreign orders, please. Postal money orders will speed delivery of Super SCA PC board.

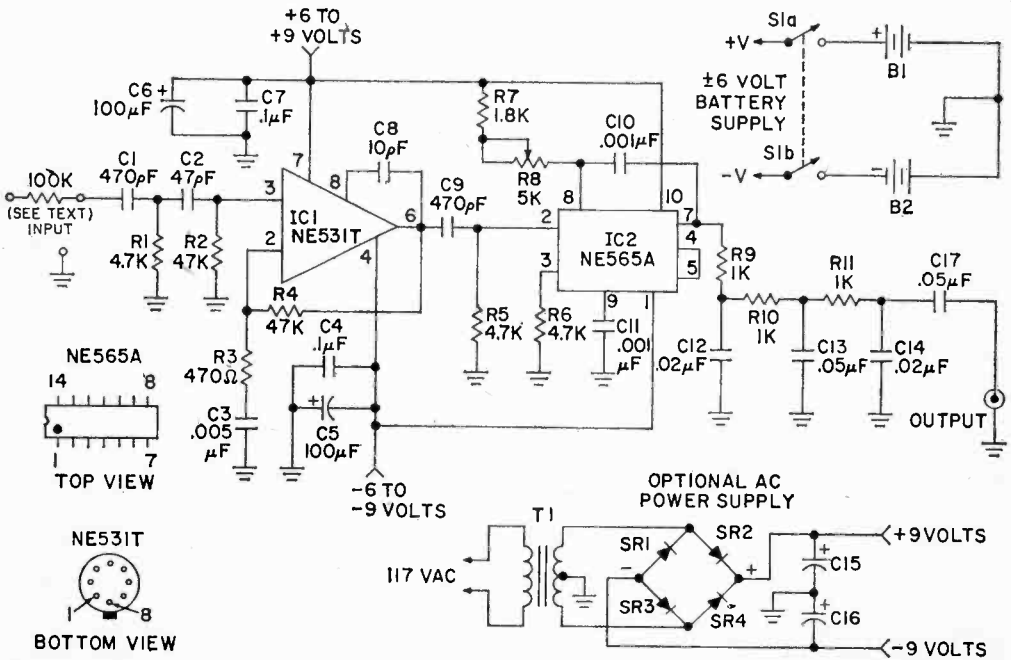

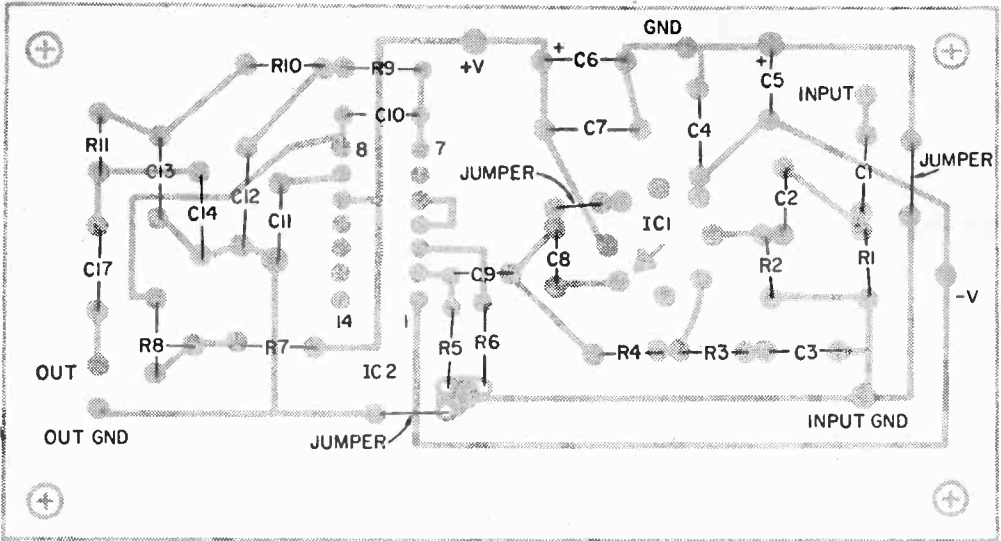

JUMPER WIRES

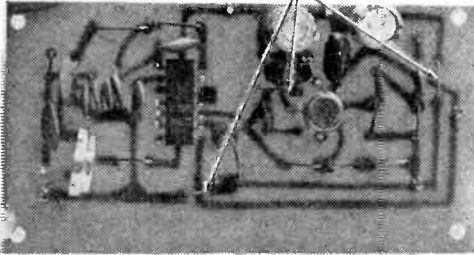

Strong backlighting, left, shows printed circuit wiring through a completed circuit board. Layout above and photo on next page show where to place components.

well with this unit.

Combination Gets Results. Unfortunately, the phase lock detector requires at least 80 mV for good reception, and this means that usually only one or two stronger or local SCA stations can be received. To make our SCA adaptor the best there is, we have combined the phase lock detector with a high gain operational amplifier. The result is

a Super SCA Adaptor that can receive SCA programs on a real cheap FM tuner and an indoor rabbit-ear antenna.

Another plus feature for our Super SCA Adaptor is that no large filter coils are needed to suppress the main channel program. Even SCA programming on stereo stations is received cleanly and with no trace of stereo hash. And because large, bulky coils are not needed, the entire adaptor can be assembled on a 2 1/4-in. x 4 1/4-in. printed circuit board for which we provide the template.

Because our adaptor gain is high, it must be assembled on a PC board exactly as

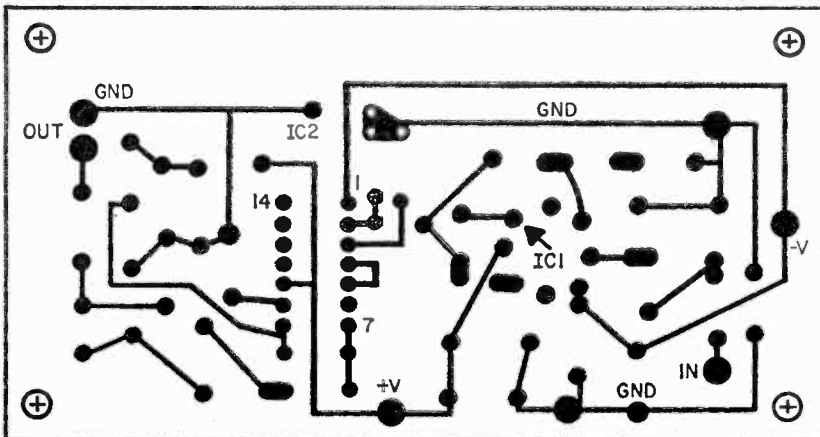

Exact PC board size. Transfer image to copper clad board using carbon paper. This is the bottom (copper) side of your board.

SUPERSCA ADAPTOR

described to insure complete stability.

Some Tech Talk. The signal from your FM tuner's detector before de-emphasis is applied to operational amplifier IC1 through a high pass filter consisting of C1, C2, R1 and R2. The filter's rollover frequency is 60 kHz, which removes a substantial part of the main channel information. Frequency response of the amplifier is tailored by the feedback loop through R3 and C3 to further suppress main channel information. IC1's output is fed through high pass filter C9 and R5 to IC2, the phase lock loop detector. IC2's output is passed through a low pass filter consisting of C12, C13, C14, R9, R10 and R11 which provides de-emphasis and noise suppression. The output level at C15 is about 50 to 100 mV, depending on the signal, and can be fed to your hi-fi or utility amplifier.

Since SCA frequency response is limited to 7 kHz, just about any amplifier can be used.

Note that the adaptor requires a bi-polar power supply in the range of ± 6 to ± 9 volts. The power supply can be either batteries or a power line bridge rectifier using a center-tapped 12 volt filament transformer as shown on the schematic. Since the adaptor requires only about 10 mA of current, any small transformer can be used.

How to Etch a Circuit. Your first step is to prepare the PC board. Since the board must be precise, we suggest you work directly from the supplied template rather than through an intermediate tracing. Cut a section of any type copper clad board to 2 1/4-in. x 4 1/4-in., clean the copper surface with a strong household cleanser such as Ajax or Comet and place a piece of carbon paper, carbon side towards the copper, on the board. Tape the board under the template and, using a sharply pointed tool such as a scribe, indent the copper foil at each component mounting hole by pressing the point of the tool through the template into the foil. (Each indent will serve to mark the hole's location when the board is drilled.) Using a ball point pen and firm pressure, trace the outline of the foil areas.

Continue. . . . Remove the board from under the template, discard the carbon paper and, using a resist pen such as the Kepro RMP-700, available from Allied Radio, fill in the foil areas with resist. Note that some of the IC1 and IC2 pins are not used, though they must pass through the board. Place a drop of resist over the indents so you'll know where to drill after the unwanted copper is etched away. Similarly, mark the indents at the corner mounting hole locations. Make certain you mark IC1 terminal number 8; you can use a drop of resist.

Immerse the PC board under at least 1/4-in. of etchant for about 45 minutes and then inspect the board. If all the unwanted

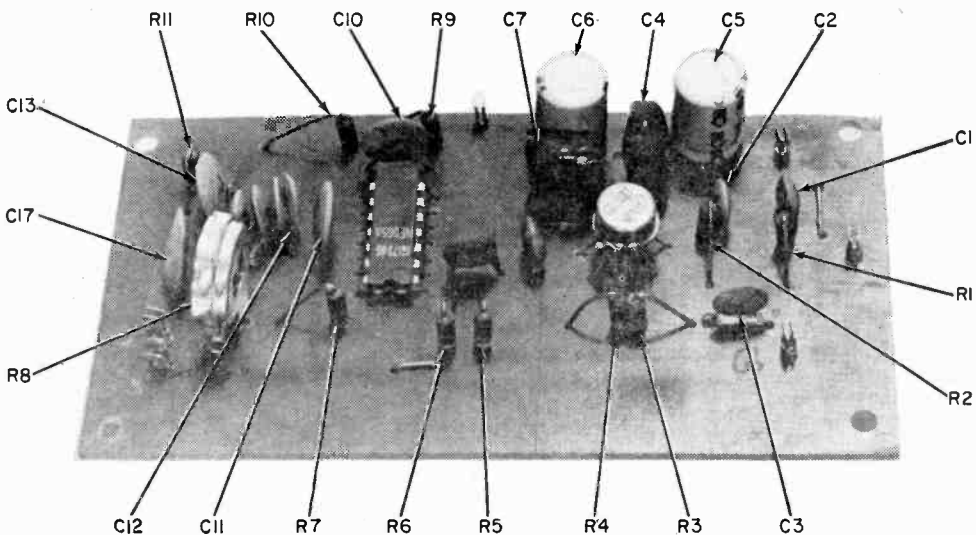

Completed circuit board. Resistor R8 easily adjusts frequency of PLL to 67 kHz.

copper has not been etched away, re-immerses the board in five minute intervals until all the copper not protected by resist has been removed. Then rinse the board under running water and remove the resist by scrubbing briskly with a steel wool pad such as Brillo.

Using a #56 drill bit, drill the holes for the connecting terminals (push-in terminals) and trimmer potentiometer R8. Drill the corner mounting holes to clear a #4 or #6 screw and drill the remaining component holes with a #58, #59 or #60 bit.

You Can Buy the Board. You don't have to make a printed circuit board for the Super SCA—you can buy one. The Electronics Hobby Shop is offering the PC board completely etched ready for drilling and assembly. This beats trying to copy the author's board layout exactly, and the mess and expense of etching copper.

Mount the Components. Install IC1 and IC2 before any other components. Note that the IC1 lead opposite the case tab is number 8. Insert the leads (begin with number 8) and push IC1 toward the board until there is about 3/8-in. between IC1 and the board. Solder the wires and cut off the excess.

Hold the PC board so you are looking at the top with IC1 to the left. Hold IC2 so the notch is away from you and insert IC2's leads into the matching holes. *Doublecheck the notch before soldering.* It is correct if the distance from the notch to the edge of the PC board is greater than that of the unnotched end to the opposite edge of the PC board. If all is okay, solder IC2.

Install trimmer potentiometer R8 and solder. Make certain you use sufficient soldering heat to flow solder to R8's terminals.

Then install the three wire jumpers and, finally, the remaining components taking extreme care that the polarity of capacitors C5 and C6 is correct. Note that C5 has the positive lead connected to ground.

While capacitors C12 and C14 are indicated as 0.02 μF , they are not the easiest to obtain in miniature size. You can substitute two parallel-connected 0.01 μF capacitors. Simply twist their leads together and insert them into the matching holes. Do not tin the twisted leads prior to soldering as they will not fit into the holes if tinned.

Set-up and Checkout. Either a bi-polar battery power source or a standard bi-polar power supply can be used. Since there is

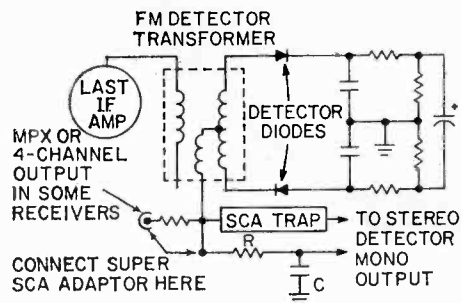

Always connect SCA adaptor before de-emphasis network R, C as shown above. Most tuners, receivers do have an MPX jack for a home SCA, or 4-channel use.

essentially no difference in performance between a $\pm 6\text{ V}$ and $\pm 9\text{ V}$ power supply, use whatever you have available. For long-term battery life we suggest Burgess type Z4 6 volt batteries (or their equivalent).

The Super SCA adaptor connects to your mono FM tuner or receiver detector *before* the de-emphasis. If you connect after the de-emphasis network, you will find the 67 kHz subcarrier has been filtered from the signal, so you will get nothing but noise from the adaptor. The figure shows a typical FM detector output, the de-emphasis network and the correct connecting point for the adaptor. Since it is possible the adaptor might load down the detector for normal FM reception, we suggest a switch be installed, so the adaptor can be removed from the circuit for normal FM listening.

The adaptor is most conveniently connected through a phono jack installed in the tuner's rear apron, though you can use a direct wire connection.

Note that if you have one of the older mono FM tuners with an "MPX output" you already have the correct connection as the MPX output is the non de-emphasized detector output. Similarly, if you have a modern FM Stereo tuner with a "4-channel decoder" or a "quadrasound decoder" output you also have the correct connection; they are also non de-emphasized detector outputs.

Connect the tuner's detector output to the adaptor with the shortest possible length of shielded cable or ordinary zip cord, or install the adaptor directly in the receiver if there is sufficient room. Connect the adaptor's output to any high gain amplifier; for example, the microphone input of your hi-fi amplifier, or a utility amplifier is fine, or maybe an old tape recorder. (See page 40)

USE IT ALL AS YOU GET READY FOR A NEW CAREER...

\$1,500.00 worth of two-way radio electronic communications equipment!

Bell & Howell Schools announces a new learn-at-home program that gives you "hands on" experience with commercial-grade equipment—as you prepare for a business of your own in two-way radio electronic communications servicing.

You need "hands on" experience with a real, commercial-band FM transceiver and actual commercial-grade test equipment—to take full advantage of growing opportunities in electronic communications.

Two-way radio communications is a healthy growth area in electronics. And it's lucrative. Almost two million commercial two-way radio systems now serve as vital communications links for trucks, planes, boats and taxis. And the FCC requires each system to have its equipment serviced regularly by a licensed technician. That's where you come in. But you need career-oriented training—plus your FCC license.

Knowing how to put an amateur radio kit together won't help when you're "on the job"—servicing two-way radio systems for aircraft or advising trucking companies about their land-mobile communications system. For that, you need "hands on" experience with the real thing. This unique new Bell & Howell Schools learn-at-home program that gives you just that. You can work with the equipment by attending one of our special "help sessions" or by dropping by one of the Bell & Howell resident schools. If neither of these plans



is convenient, you can have the equipment shipped to your home in return for a \$100 deposit, which is refundable when you return the equipment.

Find out more about this exciting new Bell & Howell Schools program. There's no obligation.

For free facts, mail attached card today!

Let Bell & Howell Schools help you get ready for an exciting career or business of your own in two-way radio electronic communications!

Bell & Howell Schools has helped thousands of people prepare for careers—and businesses of their own—in electronics. You can have absolute confidence in the thorough training you get.

Expert instructors at Bell & Howell Schools plan each program to answer a single question: "What qualifications will you need to take advantage of *actual career opportunities* in electronics?" They then build each program to give you those exact qualifications.

To get ready for a business of your own in two-way radio, you need: 1) career-oriented training; 2) FCC License; 3) "hands on" experience with commercial-grade equipment. Bell & Howell Schools now offers this new at-home training program that gives you all three. (See FCC License Guarantee on attached card.)

JUST LOOK AT ALL THE EQUIPMENT YOU'LL WORK WITH DURING YOUR TRAINING PROGRAM WITH BELL & HOWELL SCHOOLS!

Commercial-Band FM Transceiver . . . exactly the kind of two-way radio you'll service throughout your career

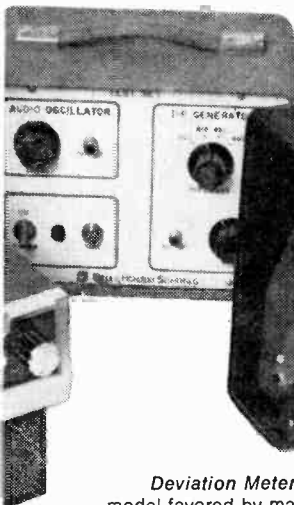

Deviation Meter . . . model favored by many working technicians to check modulation of transmitted signal.

Frequency Meter . . . highly sensitive instrument used to check signal frequency within precise tolerances established by government standards.

Power Output Meter . . . meter used almost universally by trained and licensed technicians to check power output—or wattage—of signal.

Alignment Generator . . . a custom-designed unit you use to generate test signals for transceiver alignment.



FCC REGULATIONS GIVE YOU THE OPPORTUNITY TO START YOUR OWN BUSINESS!

The Federal Communications Commission requires that all commercial two-way communications systems be checked and serviced by a licensed technician at regular intervals.

As a Bell & Howell Schools graduate, you'll have the technical know-how you need. With your FCC license, you can go out and eventually build your own business—signing contracts with companies that use two-way radio. FCC regulations could mean security and regular income for you!

BELL & HOWELL SCHOOLS OFFERS YOU THESE SPECIAL ADVANTAGES:

Help Sessions Scheduled regularly every few Saturdays at the Bell & Howell Schools and in many other cities throughout the U.S. and Canada. Top instructors give you personal help and guidance.

Transfer Privileges After completion, you can transfer to any of the resident schools for more advanced study, if you wish.

Lifetime National Placement Assistance Helps you locate a job where you want to anytime after you complete program.

Veterans' Benefits We are approved by the state approval agency for Veterans' Benefits.

Student Financial Aid We are an eligible institution under the Federally Insured Student Loan Program.

EXCLUSIVE ELECTRO-LAB®—YOURS TO KEEP!

To make sure you get practical experience with instruments used daily by professionals, we've integrated into your program three precision instrument kits you assemble yourself and keep:

Design Console Use this to rapidly "breadboard" circuits without soldering. *Oscilloscope* Offers bright, sharp screen images, 3-way jacks for leads, plugs.

Transistorized Meter Registers current, voltage and resistance.

FOR FULL INFORMATION, TODAY! THE ATTACHED CARD MAIL! OR WRITE:

An Electronics Home Study School
DeVRY INSTITUTE OF TECHNOLOGY



ONE OF THE
BELL & HOWELL SCHOOLS
4141 Belmont, Chicago, Illinois 60641

406

SUPER SCA ADAPTOR

Continued from page 35

R8 Locks Loop. Tune in a station you know is transmitting an SCA program (a call to your local station should get you the info.) and adjust trimmer potentiometer R8 for best sound quality. Normally, the reception will be almost completely garbled, then fade into a clean signal as R8 is adjusted, then fade into garbling again as R8 is further adjusted. Set R8's wiper so it is approximately midway between the two points of garbled sound. Usually, the best sound will occupy a broad part of the R8 adjustment range, so don't try to be too fussy.

If you don't know which station(s) are transmitting SCA, set R8 to the mid position and tune every station very carefully and slowly. When you hear anything that sounds like distorted music, try adjusting R8; if it is real SCA, it will turn *clean* as R8 is adjusted. Some stereo stations might cause sound bursts that you think are SCA.

If adjusting R8 doesn't bring in a clean signal, it's not SCA. Note that once R8 is adjusted there is no stereo hash interference on SCA signals. Hash will only be heard from non SCA signals.

Problems? The high sensitivity of this system may require desensitizing procedures; in the event you cannot receive *any* SCA stations, you either have none in your area or you have made a construction error. If the non-SCA program from the tuned-in station is heard breaking through the SCA programming, follow the suggestions in our troubleshooting box. If your adaptor doesn't work at all, beg, borrow or steal an oscilloscope and check input and output waveforms as shown in the scope photos. Just be sure to return the scope so we don't get in trouble with John Law for inciting a felony!

What's Your Beef? Here are some hints to help you steer clear of trouble—straight toward your musical enjoyment and SCA DXing!

☞ *If your problem is a weak signal re-*
(Continued on page 119)

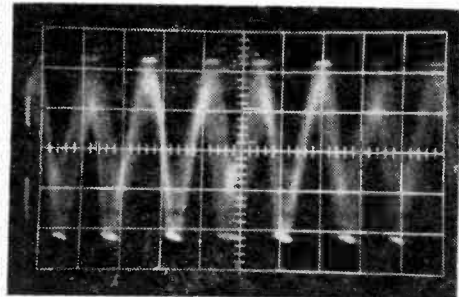

A

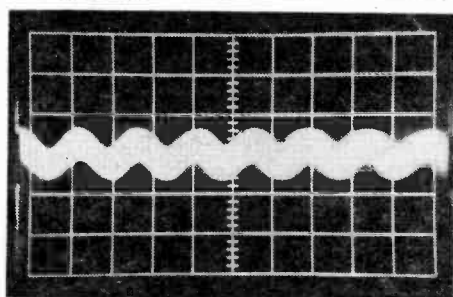

B

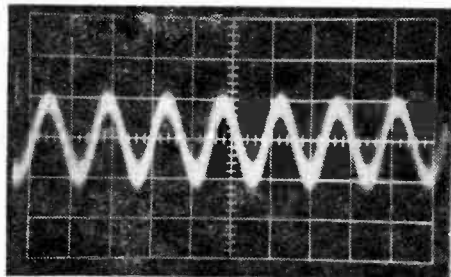

C

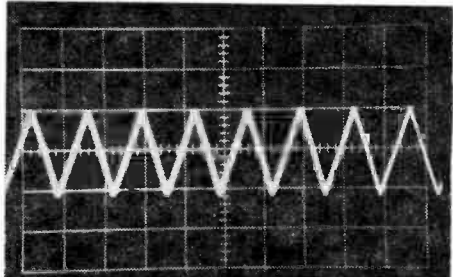

D

Oscilloscope patterns quickly locate any possible difficulty. You can use a general purpose scope since the signals are under 100 kHz. With "triggered" scopes, set the time base to 10 μ sec/cm. Photos B and C are input and output of IC1, the 67 kHz amplifier. If signal is clipped as in A, main channel program may break through—see text for cures. Normal IC2 pin 9 waveform at D. Vert. sens: B, 20mV/cm; C, 1V/cm.

BUILD IT FAST...



AUTO ALARM FOR YOUR CAR TAPE PLAYER

by Herbert Friedman

The police estimate that in a large city such as New York the life expectancy of an unattended Corvette is about 10 minutes—after that it has a new “owner.” The life expectancy of a mobile cassette or 8-track tape player is about 24 hours, for they are really hot resale items.

Actually, most of the fancy tape player lock-alarms are useless—they are too obvious, too easily bypassed, and are often stolen along with the tape player! Our AutoAlarm sounds a car's horn continuously if anyone removes the tape player. And once triggered, the horn can be turned off only by the AutoAlarm's switch.

All it takes is a few dollars worth of experimenter's components to throw together an AutoAlarm that will give you just about as much protection as you can get because it doesn't look like an alarm. Tucked away in the glove compartment or under the seat, a single wire runs to the tape player's case—a wire that looks as if it's an ordinary ground wire.

The entire AutoAlarm is assembled directly on the back of a SPST slide switch. The assembly can then be installed in any small metal or plastic cabinet. Silicon Controlled Rectifier SCR1 can be just about any type rated at 25 PIV (peak inverse volts), 5-Amps

(Continued on next page)

AUTO ALARM

or higher, such as the HEP-R1220.

To identify the SCR leads, lay it flat on the table so the side with the metal rim (around the mounting hole) faces up; the side *without* a rim should be against the table. The SCR leads will now conform to the layout shown.

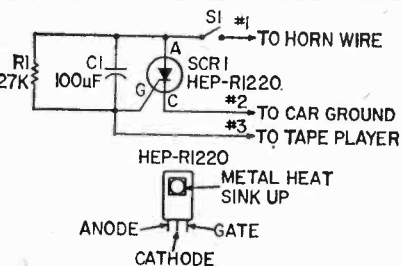

This simple circuit can be wired quickly. Switch S1 is closed for normal operation.

PARTS LIST FOR MOBILE TAPE AUTO ALARM

- C1—100 uF electrolytic capacitor 15 VDC or better
- R1—27,000-ohms, 1/2-watt resistor
- SCR1—HEP-R1220 or equiv (see text)
- S1—SPST slide switch (alarm off)
- Misc.—Metal or plastic cabinet, wire, hardware, solder etc.

No wiring precautions are necessary other than to doublecheck that the C1 polarity is correct; its positive terminal connects to SCR1's anode (A) terminal.

The other figure shows how to connect the AutoAlarm. Note that AutoAlarm wire #2, from SCR1's cathode, must connect to the car body (ground) while the #3 wire also connects to ground *but* through the tape player's case. Wire #1 connects to the horn control wire which generally enters at the bottom of the steering column (sometimes in the engine compartment, sometimes under the dash).

How It Works. There is a positive voltage from the car battery across a horn button when it is open. By closing the horn button, the circuit is completed and the horn will sound. This positive voltage is applied to SCR 1's anode. The SCR's gate is grounded through the tape player's case, so the SCR is normally off. When the tape player is removed from its mount, the auto-alarm's #3 wire is disconnected from

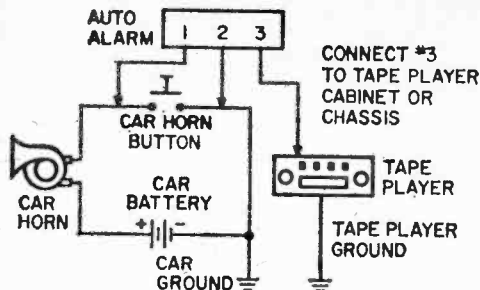

Intermediate solenoid found on most autos in place of horn in our simple diagram does not alter operation. Connect #1 to button. Remember, the curved side of electrolytic capacitor symbols, such as C1, represents the terminal that must be connected to the negative voltage (with respect to the plus capacitor connection). In this circuit, it means the negative terminal of capacitor C1 must be connected to the gate terminal of Silicon Control Rectifier SCR1 at left.

ground. The SCR gate is no longer grounded, so current can flow through R1 to the gate. The SCR turns on, effectively shorting its anode to its cathode. This means the horn control wire is now grounded, so the horn will sound.

Once the horn is sounded it can only be turned off by opening switch SW1.

To make it easy for the thief to trigger the AutoAlarm we suggest that the #3 wire be 22 or 24 gauge stranded—thin enough to be easily broken when the player is removed. The #1 and #2 wires should be 18 gauge stranded.

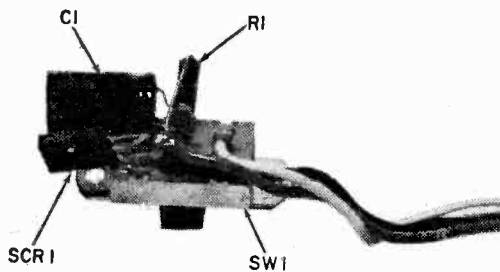

Here you can see just why we say, "Build it fast." And a simple three point installation means you install it fast, too! Count 'em, just four components and some wire make up this protective device that can save you a lot of grief over a lost, expensive player.

So the next time you park your wheels in a rough place, lock the car and take the keys with you. You can't expect to protect your tape player when the whole car is heisted!

Super Booster

Add this devilishly simple RF booster to any Broadcast Band rig, and watch the once dead BC Band come alive—by Lars Jorgensen

Imagine your receiver's broadcast band dial jammed from end to end with a solid wall of signals! Pip-squeek stations that normally can't be heard with headphones can come booming into your shack at \$9. A dream? Nope! That's just the kind of performance you'll get with Electronics Hobbyist's Super Booster.

Here's a preamplifier specifically designed for BC DX'ers. Whether you live in a concrete and steel tower, or out in the boondocks with plenty of space for a long-wire antenna, the Super Booster will dig out signals you've never heard before. The average gain of Super Booster is almost 42 dB—that's 7 S-units "extra" sensitivity!

As shown in our figure, the booster can function either as an "electronic antenna", with signals received only by loopstick antenna coil L1, or as a preamplifier, with long-wire antenna signals coupled to L1 through L2. Coil L2 is supplied as part of the specified antenna loopstick; you have no coil winding problems.

Signal voltage appearing across L1 and C1 is coupled to Field Effect Transistor Q1 which provides approximately 20 dB gain on top of the L1/C1 resonant gain. The output of Q1 feeds

transistor Q2, connected as an emitter-follower. This transistor stage provides an additional 10 to 15 dB power gain, and also provides a low-impedance output for connection to the relatively low impedance receiver input.

Though intended for direct connection to a receiver's antenna input terminals, CW's super Booster can also be used with "loop antenna radios" by connecting the booster's output to a loopstick antenna (a duplicate of L1), and then positioning this loopstick near the radio. We'll show how both connections are used.

The total current drain of Super Booster is less than 2 mA. Power is provided by a standard 9V transistor radio battery. The 2U6 type will last at least 3 months, even under heavy service. An "activator" type battery can last a year or more. With such low power consumption, there is no reason to build an external AC power supply for Super Booster.

—Construction. Though the circuit appears very simple, extreme care must be taken in the circuit board preparation. Reason is, the very high gain can cause total instability if a single component, or printed foil-circuit is out of position. We suggest that no attempt be made to use point-to-point wiring; use a PC board which is an exact copy of the supplied template. The board can be of type XXXP; there is no need for a more expensive board.

Make *no* component substitutions; Q1 and Q2 should be the specified types. Through the circuit might work with some "general purpose replacement type NPN and MOS tran-

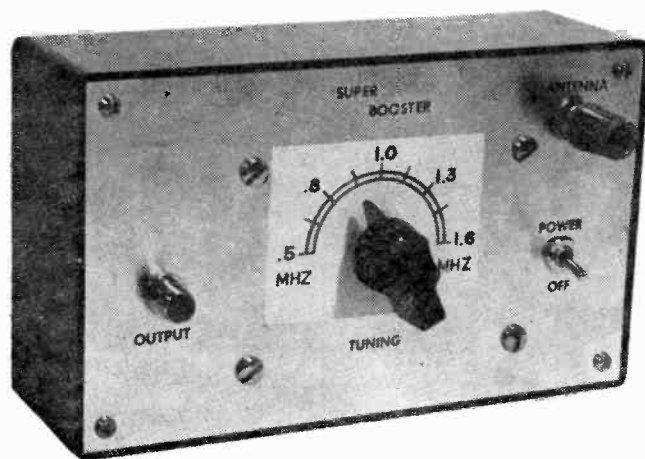

SUPER BOOSTER

Placement diagram for SB's parts.
If the output is fed to an AC/DC-type rig, disconnect the link and ground J2's cold end separately.

sistors," it probably won't work with other dime-a-cheapies. Worse yet, it might work only on very weak signals while distorting on strong signals.

The specified components will provide distortion-free performance on signals as high as 80,000 μ V. You can expect Super Booster to provide its great performance until the battery voltage falls below 6 volts.

The circuit board and a *very short* connection to output jack J2 are the only critical assemblies. You may make mechanical modifications to Super Booster as long as the general layout approximates the unit shown in the photographs. Any cabinet can be used; the PC board has a built-in hand-capacitance shield. For maximum stability, though, a metal front panel will reduce the possibility of RF instability caused by the signal being fed into the receiver radiating back into the booster's input

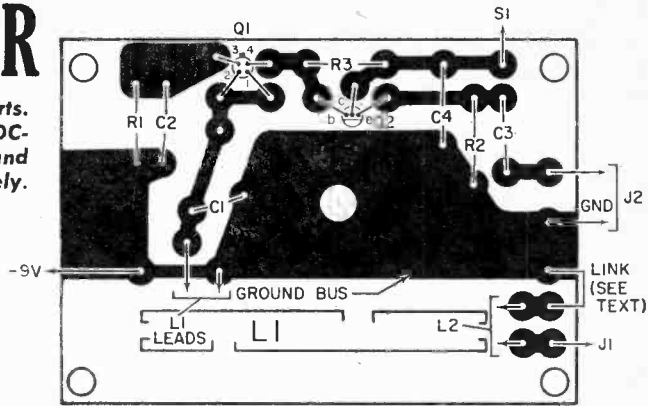

—**Making the PC Board.** Cut a piece of copper-clad board to the size of the template and scrub the copper surface clean with a strong household cleanser such as Ajax. Or, use steel wool and a liquid detergent. Place a piece of carbon paper (carbon side towards the copper) over the board and tape the board under the template. Next, find a sharp pointed instrument, such as an ice-pick or scribe, and indent the copper foil at each component mounting hole by forcing the point of the tool through the template and into the copper. Use only hand pressure, not a hammer. Then, using a ball

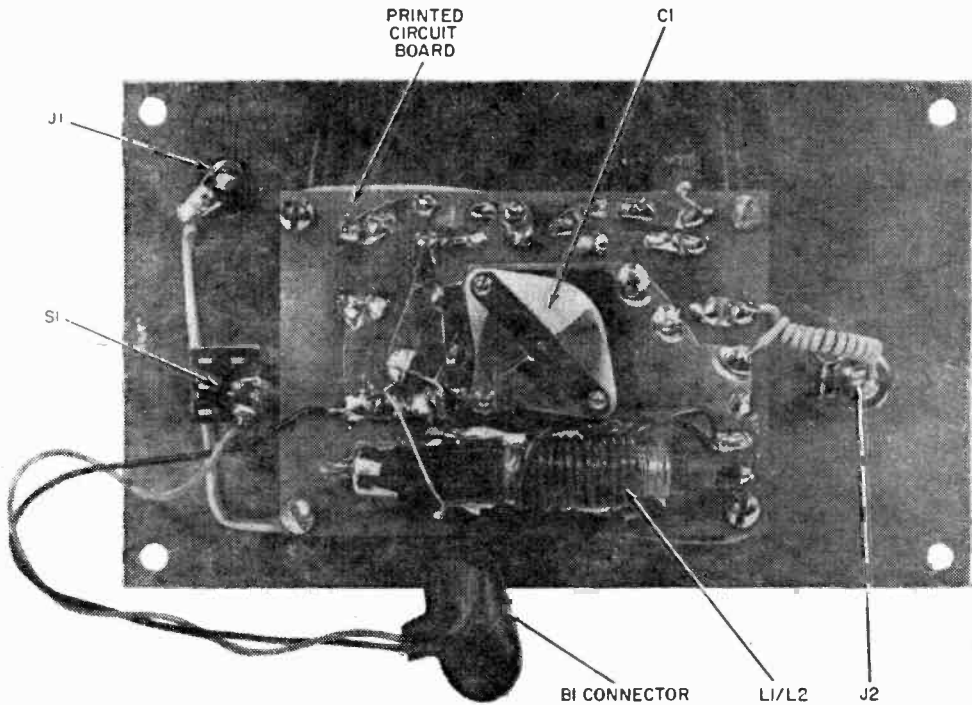

This is Super Booster's printed circuit board drawn full-size. If you make your own PC board, follow this pattern exactly; RF instability, or regeneration, could result if you don't. Our diagram on page 44 shows where the various components are mounted on this PC board. Follow the layout carefully.

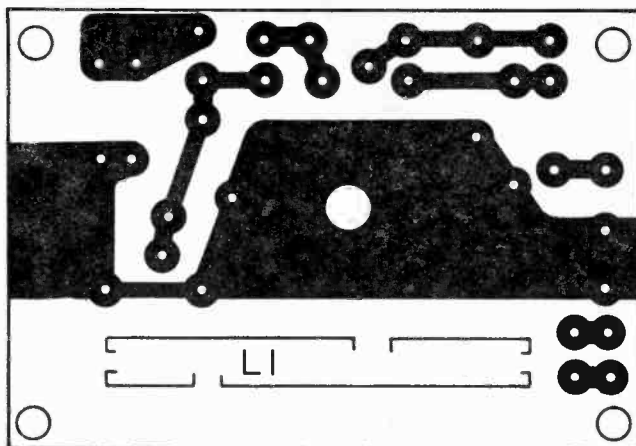

point pen, trace the outline of each foil area.

Remove the board, discard the carbon paper, and fill in the outlines with a resist pen such as supplied in the Allied Radio Shack printed circuit board kits. Allow about 15 minutes for the resist to dry and then immerse the board under at least $\frac{1}{4}$ " of etchant.

When all the excess copper is dissolved—about 45 minutes later—rinse the board thoroughly and remove the resist with a cloth moistened in rubber

cement thinner or by scrubbing with steel wool.

All of Super Booster's component mounting holes, except the one for tuning capacitor C1, are drilled with a number 58, 59 or 60 bit. Capacitor C1 requires a $\frac{5}{16}$ " mounting hole. The holes in the corner of the PC board, used for mounting the completed PC assembly, should clear #4 or #6 screws—which ever you prefer.

The PC board is best assembled in the following manner: install capaci-

PARTS LIST FOR SUPER BOOSTER

- B1—9 volt transistor radio battery (Burgess type 2U6 or equiv.)
- C1—365 pF subminiature poly-type variable capacitor
- C2,C3,C4—0.05 μ F, 50 VDC disc ceramic capacitor
- J1—5-way universal binding post
- J2—RCA-type phono jack
- L1—loopstick antenna
- L2—loopstick antenna (optinal for radios without antenna terminals—see text)
- PL1—RCA-type phono plug—see text
- Q1—dual gate mosfet n-channel transistor (RCA 40600)
- Q2—bipolar npn transistor (G.E. 2N 3394)

- R1—1,000-ohms, $\frac{1}{2}$ -watt composition resistor, 10% tolerance
- R2,R3—4,700-ohms $\frac{1}{2}$ -watt composition resistor, 10% tolerance
- S1—single pole, single throw switch

A complete set of components, including J1,J2, S1,B1, and an undrilled printed circuit board is available for \$12.95 (includes postage) from the Electronic Hobby Shop, Box 587, Brooklyn, N.Y. 11202. Add \$1 for antenna loopstick L3 if needed. Canadian add \$1 extra. New York state residents must add sales tax. No foreign orders, please. Speedy service offered when postal money order accompanies order.

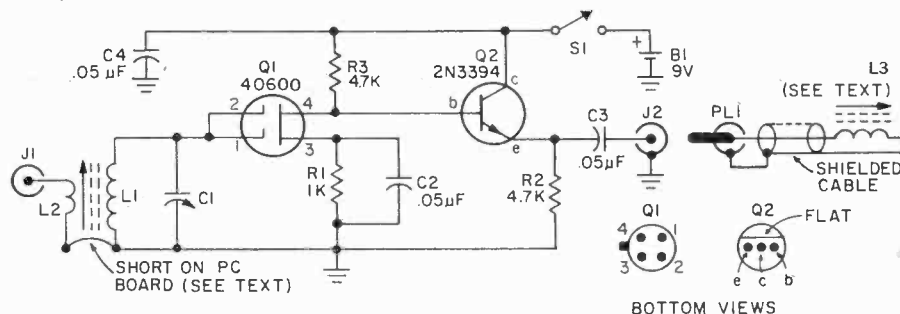

SUPER BOOSTER

tor C1 first, then all other components except Q1. Then push Q1's leads through the holes in the PC board and solder them home. Finally, solder the two power leads to their respective points if you intend to check out the booster before installation in the cabinet.

Note that Q1 is supplied with a shorting clip around all the leads. *This clip must be left in position until the booster is completed and ready for operation.* If the clip is removed, a high static voltage from the tip of the soldering iron, or a voltage generated through normal handling, might destroy Q1.

Position transistor Q1 so that the tab sticking out from the case faces the nearest edge of the PC board. Position transistor Q2 so that the round side of the case faces the nearest edge of the PC board; the flat side faces the far edge of the PC board.

Note that there are no crossed leads for Q1 and Q2. When they are oriented so the tab and round end are properly aligned, the transistor leads will plug straight into the board.

Note that L2's leads have individual printed foil connections. Normally, one foil is connected to the boosters' ground through a shorting wire. The remaining foil connects to antenna jack J1. If, for some reason, you prefer a separate antenna ground, open the shorting wire and install a "ground" jack on the panel. Connect the proper foil to the ground jack.

Because the components are mounted on the side of the pc board facing the cabinet panel, stand-offs must space the board away from the panel. You'll find, however, that C1's tuning shaft will be too short to pass through the panel for application of a tuning knob. But the cure's simple enough; simply cut off a section of shaft from an old potentiometer and epoxy-cement the section to C1's shaft. Or, use a plastic extension sleeve (such as the type supplied for "insulated shaft" potentiometers); the sleeve is sufficiently rigid to support a knob.

The loopstick coil is cemented to the board with General Electric's RTV

Silicon Rubber adhesive. Use no other brand or type of adhesive. Other brands, such as Dow-Corning's Silastic, are conductive at RF frequencies, and will ruin the electrical properties of the coil.

Check that the foil area outlined on the board has the indicated "breaks". You don't want a closed loop. If you forgot and made a closed loop, cut four breaks as indicated with a knife or hand grinder. Apply a thin layer of Silicon Rubber adhesive inside the marked coil area and press L1-L2 into the adhesive. Make certain L1's connection terminals are parallel to the board, with L2's leads away from the board. Then allow sufficient time for the adhesive to dry.

We suggest you check out the PC assembly before it is installed in a cabinet. Remember to remove Q1's shorting clip! Simply pull on the end of the clip with long nose pliers and the clip will unwind from around Q1's leads.

Connect a DC milliammeter rated at 5 mA or higher between the battery's positive terminal and the board's positive foil. Connect the battery's negative terminal to the board's negative foil. The meter should indicate slightly less than 2 mA. If the meter indicates 1 mA or less, or more than 2.5 mA, check for a component mixup or incorrect installation of Q1 and Q2. If the meter reading is correct, disconnect power and install the board in a cabinet.

We recommend a plastic cabinet with aluminum panel such as shown in the photographs. The plastic cabinet allows direct signal pickup by the loopstick, which will be more than adequate for most DX'ing. Keep antenna jack J1 as far as possible from coil L1. Keep output jack J2 as close as possible to the board's output terminals. The power and antenna input leads should be flat against the panel.

Make up a short, shielded output lead by wrapping a solid-conductor, insulated wire around another wire. Keep the wrap turns against each other. Using the shortest possible length of this shielded wire, connect J2 to the board's output terminals. Make certain the "ground" wire goes from J2's ground lug to the ground foil.

Adjust L1's slug clockwise with a small screwdriver until only $\frac{1}{4}$ " of the slug's adjusting screw sticks out of the coil form. The other end of this screw,

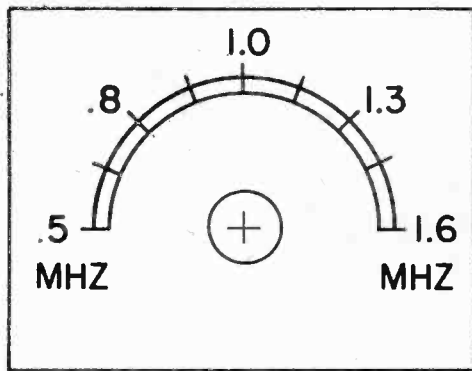
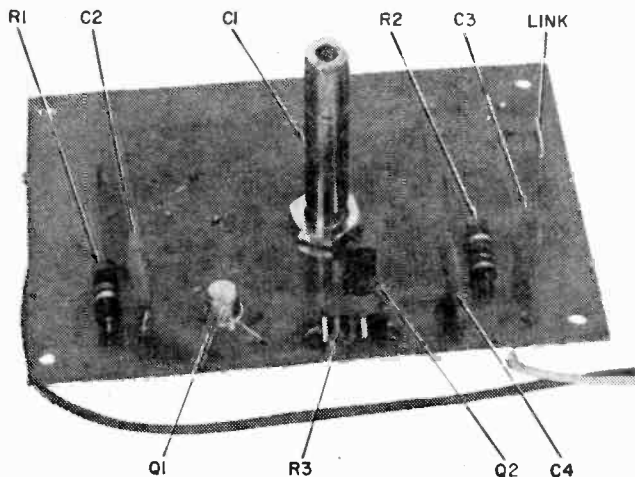

Here's what finished PC board looks like before it's mounted to front panel with standoffs. Tuning dial faceplate can be used as is; just paste it down!

the slug itself, will protrude about $\frac{1}{4}$ " out the end of the form. The slug is generally secured with wax, so the first turn or two might require a little extra force; don't be afraid to adjust the slug if it "feels" tight.

Make up a connecting lead to go from output jack J2 to the receiver's antenna terminals. Any shielded wire or coaxial cable can be used. Install a phono plug on one end. For least signal attenuation, the lead should not exceed 15 inches.

If the Super Booster will be used with a transistor radio having a built-in loop antenna and no external antenna terminals, connect the free end of the output lead to a loopstick antenna—merely an exact duplicate of L1! If the loopstick has an antenna winding, such as found on the specified loopstick, simply unwind the few turns and connect the output lead to the coil's solder terminals. Position this coil on the radio's case opposite its built-in antenna and tape the coil in position.

—Using Super Booster. Turn on both the receiver and booster and tune in the desired station. Adjust tuning capacitor C1 for maximum signal strength or highest S-meter reading. As a general rule, the direct signal pickup by L1 will be more than adequate. If greater sensitivity is needed, connect 6 to 15 feet of wire to antenna jack J1. If you have the space needed for an outdoor longwire antenna, take note that the signal level into the receiver can be so high as to overload the receiver.

If there is a strong local station in

your area, it is possible that its signal strength will be so greatly boosted that it might swamp the receiver when listening to a weak signal on the other end of the dial. If this occurs, simply detune the booster away from the strong local until its interference is gone. While this might sacrifice some gain on the desired station, the actual loss will be slight.

It is possible that the booster's output might radiate back into the input (particularly when using a loopstick coupling coil). You'll know when this happens—the booster breaks into self-oscillation—as evidenced by receiver blocking, or signals being tuned in and then "lost" when C1 is adjusted. If this happens, position the booster as far away from the receiver as possible. And, keep an external antenna, if used, well away from the receiver and the booster's output. Do this, and under normal conditions, there should be no instability.

Under certain conditions Super Booster will provide an additional benefit which should not be construed as improper operation. Some inexpensive rigs are highly prone to marine band "image" interference when signals at the high end of the BC band are received. The booster, by providing tuned pre-selection, will eliminate or suppress these images while providing signal amplification. Do not assume the loss of image interference means reduced sensitivity; actually, the desired signal will be getting full boost while the image signals are squashed. ■

by Francois Markette

THE BEEPER



One of the easiest ways to troubleshoot a defective amplifier or radio is with a signal injector. Here's a device that generates, simultaneously, AF and RF signals. You feed the injected signal into the stage closest to the speaker, and then work back towards the input or antenna. At the point where you can no longer ram a signal through the equipment, you've found the defective stage. Then you proceed with standard volt-ohm measurements to determine which component is disabling the stage.

A simple, easy-to-use signal injector, dubbed *Beeper*, costs about \$7, exclusive of

the battery and power switch. *Beeper* is a simple blocking oscillator, like the garden variety found in early TV receiver vertical oscillators. The fundamental frequency of this oscillator type is in the audio range, but since the output waveform is so distorted, it's output voltage contains harmonics well up into the RF spectrum.

Fact is, *Beeper's* output extends from approximately 1kHz to the top of the standard AM Broadcast Band. Our little tube shaped injector's ideal for servicing tube or transistorized radios.

In the model shown, a mercury cell sup-

Check out *Beeper* for shorts, other wiring errors, before slipping unit into its case.



plies power rather than a flashlight-size battery. Seems the small batteries, such as the AA and N size, which would fit into the probe, are highly prone to leakage which would destroy the components. A mercury cell will last several years without leaking, so it's the author's choice and is, therefore, suggested. In the model shown, a standard mercury cell holder is used. Reason is, you want to avoid soldering leads directly to the mercury cell, which could destroy the cell.

Except for battery B1 and push-button switch PB1, all component values are critical and *no* substitutions should be made. Push-button switch PB1 can be any normally open (NO) type you have lying around. The probe handle is supplied pre-drilled with a 13/32-in. hole for a standard 3/8" PB switch. But, by using a 3/8-in. grommet to fill the hole, a miniature type 3/8-in. PB switch can be used. If you prefer, an on-off miniature switch can be substituted to avoid having to hold the switch down when using our *Beeper*.

Construction. The *Beeper* is assembled on a 3/8-in. x 3-in. printed circuit board for which a template is supplied. To make the PC board, cut a piece of copper-clad board

instrument, indent the copper at the indicated component mounting holes by forcing the point of the instrument through the template into the copper. Then, using a ball-point pen, trace the foil outlines.

Remove the PC board, and using a resist pen, or a brush dipped in resist, fill in the outlined areas of foil to be protected. Let the resist dry for a few minutes and then immerse the board under at least 1/4-in. of etchant.

Etch for about 45 minutes, agitating the board frequently. Then check to see if all undesired copper is removed. If it isn't, re-immerses the board for 5 minute intervals until every trace of the undesired copper has been etched away.

Rinse the board thoroughly under running water and then drill the component mounting holes, which are indicated in the copper foil by the indents.

The holes for the mercury cell holder requires a #39 bit for #2 or #3 screws. The holes for transformer T1's mounting tabs use a #27 bit. The remaining component holes are made with a #57, #58 or #59 bit.

Install transformer T1 first. Note that the secondary is center-tapped. The center-tapped lead is not used; cut it off at the

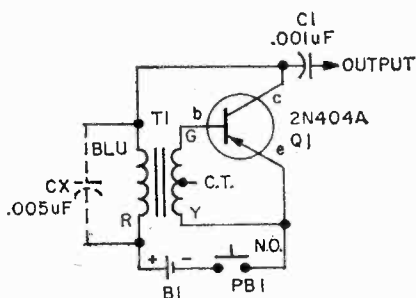

If *Beeper* doesn't oscillate, reverse T1's secondary leads. Or, add Cx (see text).

PARTS LIST FOR THE BEEPER

- B1—Mercury cell, Mallory type RM625 or PX-13
 - C1—.001 uF, 500 VDC disc capacitor
 - Cx—.005 uF, 25 VDC capacitor, see text
 - PB1—Push-button switch, see text
 - Q1—Transistor, 2N404A
 - T1—10000 ohm primary, 2000 ohm C.T. secondary sub-miniature transistor transformer. (Custom Electronics 442-3390).
 - I—Keystone type 117 mercury cell holder
 - I—Keystone test probe kit
- A kit containing all the above components except B1 and PB1 is available for \$6.98 plus 75¢ postage and handling from the Electronics Hobby Shop, Box 587, Brooklyn, N.Y. 11202. Canadian shipments, add \$1 extra. Postal money order speeds delivery.

(any type) to the specified dimensions and clean the copper surface thoroughly with a coarse household cleanser; then rinse the board and dry.

Place a piece of carbon paper, carbon side towards the copper foil, on the board and tape the board under the supplied template, or a copy of the template. Using a sharp

transformer. Though we have given the color codes for T1's leads in the schematic, note that manufacturers do change their color codes, so double-check the particular transformer you use before installation. Regardless of the color codes, the secondary is center-tapped, and the leads on both sides of the center-tap are the secondary leads.

THE BEEPER

Orient the PC board horizontally so that you face the top of the board (copper foil is underneath) with the holes for the mercury cell holder to the right. The extreme right side of the board has three component holes—one for the holder connection and two for the switch.) Hold T1 so you face the top of the transformer with the center-tap lead on top. Then push T1's mounting tabs into their respective holes.

Using a screwdriver or long nose pliers, fold the tabs over so that T1 is secured to the board. Then install T1's leads, C1, Q1

a 1½-in. bare solid wire to the output PC terminal.

Checkout. Using an amplifier, tape recorder, or any other audio device, check out the *Beeper* by touching the output wire to the amplifier input. You should hear a tone of approximately 1 kHz. If you get a deep growl, connect capacitor Cx across T1's primary terminals on the *under-side* of the board—the foil side. (Tack solder Cx's leads to the foil.)

Using the BEEPER. Since the peak output of the *Beeper* is 2V—a voltage that can damage some transistors—always try to inject the signal without directly touching a transistor lead. Bring the probe tip *near* the appropriate transistor lead until the signal

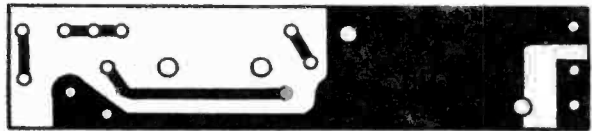

Top Right—Full-size foil outline for *Beeper's* printed circuit board.

Right—Topside view of printed circuit board showing location of components. Hold board with foil pattern as shown; flip over for correct parts placement.

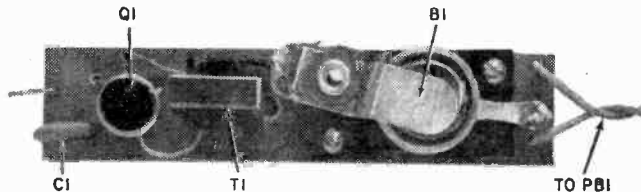

and the battery holder in that order. If the holder is supplied with the "solder lug" off to one side, carefully bend it in so the lug cuts through the center of the holder's insulating block.

Note carefully the construction of the holder. When the cell is installed, the positive terminal seats into the holder. The solder lug is the positive terminal. The heavy spring clamp that secures the cell is the negative terminal. Make certain the holder is installed so that the heavy spring clamp faces T1 while the solder lug faces the end of the PC board.

Capacitor Cx, a 0.005 uF disc ceramic unit, is not used or installed at this time. It is needed to compensate for possible variations in the transistor or transformer, and its use, depending on the checkout, might not be required.

Solder a 1½-in. stranded twist pair to switch PB1; then connect the free ends to the appropriate PC board terminals. Solder

is heard in the speaker. If this "capacity" coupling does not inject the signal, you can then bring the probe tip in contact with the transistor lead. Tubed circuits aren't critical in this respect and the tube pins can be touched directly with the probe tip.

In RF circuits, such as a superhet radio's IF amplifier, *Beeper's* signal can often be injected by simply placing the probe tip near an IF can or connecting wire.

If you work primarily with tube circuits, or any high-impedance-type circuit, and find that touching the probe tip to a low-level amplifier grid causes excess hum in the amplifier, install a ground lead for the *Beeper* by soldering a short flexible wire to Q1's emitter PC tab. Drill a small hole in the probe body, bring the wire through the hole and install an alligator clip to the free end. The ground lead has not been made part of the basic *Beeper* since accidental contact of the ground lead when working on solid-state gear will disable the *Beeper*. ■

GREAT IC PROJECTS

by the ELEMENTARY ELECTRONICS Staff

Integrated circuits are growing bigger every day—while growing smaller. Higher and higher orders of packing density now put major circuits in tiny packages.

The actual function of the IC depends on the overall design. Some ICs, particularly those known as “operational amplifiers,” have their function determined by a simple change in external components or wiring connection. For example, changing just one component of an operational amplifier make the device function as an amplifier, oscillator, or flip-flip multivibrator. It is much more difficult to pull this “change of function” trick with a discrete transistor circuit by simply changing one component or connection.

One difficult problem with ICs the experimenter rarely runs across when dealing with transistors is *high frequency instability*. Many IC devices have extremely wide bandwidths, often extending into the VHF spectrum. Direct Current to 30, 50 or even 100 MHz bandwidth is not uncommon. While transistors have similar bandwidths, they don't have the gain of many linear ICs. Furthermore, they can be stabilized on an individual basis, or the component layout

of individual transistors can be arranged so that various stages are physically isolated. Or shielding or other isolation techniques can be used. This is not necessarily true of ICs where the input terminal is about one-half inch from the output terminal. And, to compound the problem, the open loop (no feedback) gain of many linear ICs run from 5000 to 50,000—and even higher!

All is not roses. When you combine extreme high gain with extreme bandwidth, just the length of the IC's power supply terminal can become a high frequency inductor. The L and C of a bypass capacitor's foil can even become a resonant circuit. This is the reason why some of the IC circuits you build have a 0.1 uF capacitor shown in parallel with the electrolytic power supply bypass capacitor. The 0.1 uF capacitor is installed directly to the IC's plug-in socket terminals and serves as the high frequency bypass.

All ICs used in the projects are currently available as “standard stock.” To avoid the common problem of trying to buy ICs from non-consumer or industrial-only sources, where *you*, the reader, cannot locate the IC, the ICs in this IC projects section are from

9 GREAT IC PROJECTS

major manufacturers. They make their "line" available through local stocking distributors, in addition to mail order houses such as Newark Electronics, EDI, BA and others.

From time to time you will see ads from surplus or close out distributors offering the ICs for our projects at rock bottom prices. As a general rule, these ICs are either "over-runs" or units which did not quite meet manufacturer's specifications. But, for all practical purposes, they are perfectly usable for our projects because the project's design is well within the maximum specifications of the IC. There's no good reason why you can't save a dollar by buying surplus ICs.

For all the projects, we have specified the easiest case configuration to handle. However, if you can get a good buy on one of the other configurations, by all means use it. Keep in mind, however, that the TO-55 and inline configurations are relatively easy to handle. But the flatpack is often more trouble than the whole project is worth, and it should be avoided unless it's impossible to do so. (The flatpack IC is designed only for automated installation at a factory.)

Socket! Though the ICs can be soldered directly into the circuit, they are extremely difficult to remove without damage. And, it generally takes special desoldering equipment to remove an IC from a printed circuit board. Although IC sockets cost just a few cents more, we suggest they be used at all times. Should there be a wiring error, the most you will lose is a low-cost socket—

rather than an expensive IC. Another benefit you'll gain is that the socket also allows you to easily substitute another IC for the first when you have a hanker to experiment with the circuit.

Take particular care in noting an IC's lead arrangement. This is the knottiest problem you'll encounter with ICs as lead arrangement is even less standard than those of transistors. The circular TO-55 type IC has an index tab; however, the terminal number opposite the tab might be the first—or last—terminal. For example, if the IC has 10 leads, the lead opposite the tab might be number 1 or number 10. So note carefully the lead arrangement provided specifically for each project.

Do *not* assume one manufacturer's lead arrangement is that of another. And further, do not assume one manufacturer has followed the same arrangement on two different IC types. Stick with the arrangement provided for each project!

All the projects presented on the following pages are built around inexpensive and readily obtained ICs. Follow the instructions given for each project, and observe IC base diagrams carefully. Note circuit voltage polarity, and use a 40-watt maximum soldering iron. The projects are:

1. *Remote Gain Control*
2. *Professional Remote Amplifier*
3. *Protect-a-Volt*
4. *Super 15 Amplifier*
5. *Comm-press Log Amplifier*
6. *Great Equalizer*
7. *Stereo Mike Preamplifier*
8. *Gain Master Mike Preamplifier*
9. *Micro-Mini Amplifier*

1—Remote Gain Control

One of the problems of locating a volume control in a remote location is that of hum and noise pickup; as a general rule, the greater the wire length the greater the hum and noise picked up. With an electronic attenuator the entire problem is eliminated, for the volume control wires carry only a DC control voltage which causes an integrated circuit amplifier's gain to vary by as much as 90 dB. Hum and noise picked up in the DC control wires are not impressed on the amplified audio signal. No layout precautions are required and any type of assembly can be used. If desired, the amplifier gain can be voltage controlled by elimi-

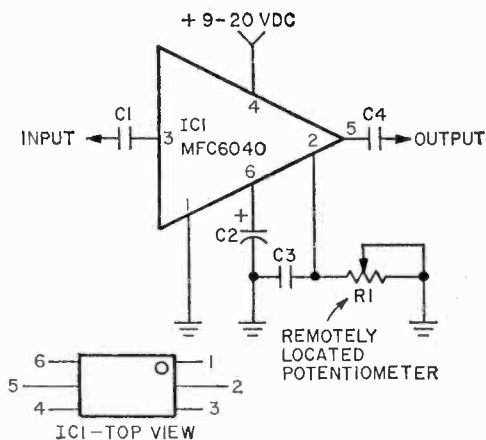

nating potentiometer R1 and applying 3.5 to 6 volts DC directly to pin 2. With 3.5 VDC the amplifier works at full gain. The attenuation increases to a maximum of 90 dB as the control voltage is increased to 6 VDC.

**PARTS LIST FOR
REMOTE GAIN CONTROL**

- C1—0.47 μ F, 25 VDC capacitor
- C2—50 μ F, 25 VDC capacitor
- C3—680 pF, 500 VDC ceramic disc capacitor
- C4—0.1 μ F, 75 VDC Mylar capacitor
- IC1—Motorola MFC 6040
- R1—50,000-ohm potentiometer

2—Professional Remote Amplifier

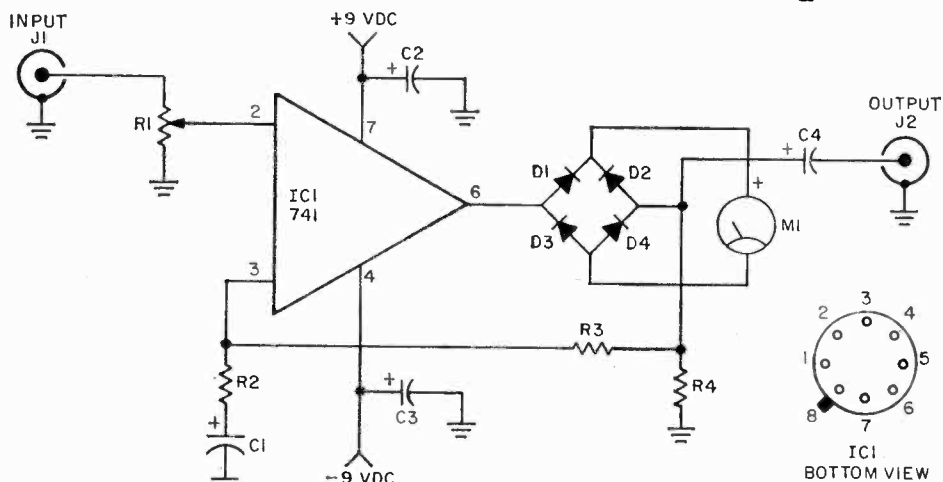

Here's a professional performance remote amplifier suitable for the hobbyist, amateur recordist or professional broadcast engineer. The input is any microphone with an output impedance up to 50,000 ohms, or for professional use, the input can be at line level. When the distance between the remote amplifier and its associated equipment is less than 25 feet the amplifier can be connected to any hi-fi type high impedance input (10,000-ohms or higher). For long line or professional applications, connect a 500/500 line matching transformer to output jack J2. Capacitor C4 is 0.1 μ F for all applications except when used with a line matching transformer. When a transformer is used C4 is 25 μ F. Better results can be obtained with a line matching transformer if the transformer primary replaces R4 (eliminating C4). M1 is a standard VU meter whose internal rec-

tifier has been removed (open the case and unsolder the rectifier). Total current drain is less than 5 mA and the bi-polar power supply can consist of two transistor radio type 9 volt batteries.

**PARTS LIST FOR
PROFESSIONAL REMOTE AMPLIFIER**

- C1—200 or 250 μ F, 3 VDC electrolytic capacitor
- C2, C3—50 μ F, 12 VDC electrolytic capacitor
- C4—0.1 μ F or 25 μ F, 12 VDC capacitor (see text)
- D1 to D4—Diode, general purpose Silicon, HEP-154 or equiv.
- IC1—Type 741 operational amplifier (Fairchild μ A741, Radio Shack No. 276-010)
- J1, J2—Shielded jacks
- M1—VU meter with internal rectifier removed
- R1—50,000-ohm audio taper potentiometer
- R2—100-ohm, 1/2 watt resistor
- R3—15,000-ohm, 1/2 watt resistor
- R4—560-ohm, 1/2 watt resistor

3—Protect-A-Volt

A simple turn of a knob sets Protect-a-Volt's output voltage anywhere in the 3 to 20 volt range—and with full short circuit protection! Should there be a wiring error in the powered project, this supply auto-

matically shuts down the output voltage until the overload is removed. The maximum output current (short circuit protection) has been established by resistor R3's value at 200 mA. Power transformer T1's rating

9 GREAT IC PROJECTS

should not exceed 200 mA as extra current capacity could not be handled by the integrated circuit. To make this project easy to build, and to sharply reduce total cost, it was necessary to eliminate a fully off, or zero output, setting for voltage adjust control R1. The minimum output voltage is 3V. The maximum voltage from T1's secondary must be 30V rms if the secondary is center-tapped; 15V rms if there is no center-tap and a bridge-rectifier is substituted for sili-

con rectifiers SR1 and SR2. Capacitor C1's voltage rating must be 25 volts minimum. Do not eliminate high-frequency-compensation network components R4/C3.

PARTS LIST FOR PROTECT-A-VOLT

- C1—2000 μ F, 25 VDC (see text)
- C2, C3—0.1 μ F, 75 VDC disc or Mylar
- IC1—Motorola MC-1461R
- IC1—Motorola MC 1461 R
- R1—50,000 ohm linear potentiometer
- R2—6,800-ohms, 1/2-watt resistor
- R3—3-ohms, 1/2-watt resistor
- R4—27-ohms, 1/2-watt resistor
- SR1, SR2—Silicon rectifier, 50 PIV, 500 mA
- T1—Power transformer; 117 VAC primary, 30 V C.T., 200 mA secondary (see text)

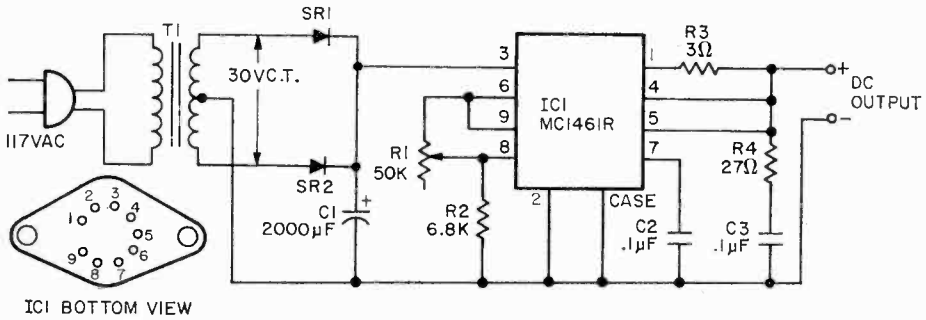

4—Super 15 Amplifier

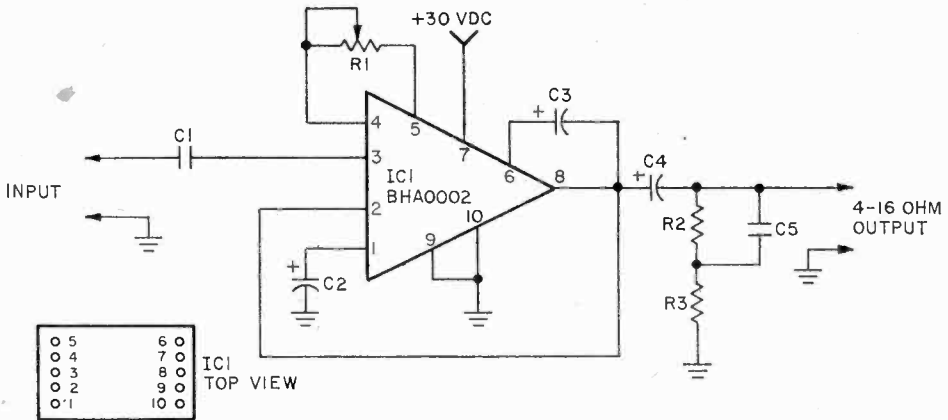

Just 350 millivolts input is all it takes for the Super 15 to push 15 watts output into a 4 ohm load or 10 watts into an 8 ohm load. Frequency response is better than +0/-3 dB 20 to 20,000 Hz and distortion at full power is a smidgen over 0.5% THD. The input impedance is about 20,000-ohms, and should be driven by a low impedance source such as a 600-ohm output transistor pre-amplifier. The power supply should be rated

at least 1.2 amperes for mono and 2.5 amperes for a stereo pair. Bias adjust potentiometer R1 must be set in the following manner—set R1 so the full resistance is in the circuit, then connect a voltmeter (0-25 VDC) from pin 8 to ground. Adjust R1 so that the meter indicates exactly one half the supply voltage; for example, if the supply voltage at pin 7 is 30 volts there should be 15 volts from pin 8 to ground.

PARTS LIST FOR SUPER 15 AMPLIFIER

- C1—0.22 μ F, 75 VDC Mylar capacitor
- C2—250 μ F, 3 VDC electrolytic capacitor
- C3—50 μ F, 30 VDC electrolytic capacitor
- C4—2000 μ F, 30 VDC electrolytic capacitor
- C5—0.05 μ F, 75 VDC Mylar capacitor

- IC1—Solitron BHA0002—Send \$5.70 to Solitron Devices, 256A Oak Tree Road, Tappan NY 10983.
- R1—1000-ohm trimmer potentiometer
- R2—470-ohm, 1/2 watt resistor
- R3—22-ohm, 1/2 watt resistor

5—Comm-press Log Amplifier

A log amplifier is a device that takes a large change in input signal and converts it to a small change in output. Hook one into a communications system and both low and loud sounds come out at almost the same level giving you a lot more talk power; it sounds just like the hard-sell commercials on TV. The input level should be about 0.1 volt peak for an output voltage of about 1 volt peak. Since this is a high frequency device, lead dress and good power supply bypassing at the power supply terminals are required. Keep the ground leads short. If a microphone preamplifier is used before the log amplifier, connect a volume control before the log amp's input. Some experimen-

tion will be needed for optimum P.A. operation. Because of the much higher average voice power, a P.A. system using a log amp compressor might appear to be more sensitive to acoustic feedback (howling). Actually, you will have much more voice output before the howling starts.

PARTS LIST FOR THE COMM-PRESS LOG AMPLIFIER

- C1—1 μ F, 6 VDC electrolytic capacitor
- C2—10 μ F, 6 VDC electrolytic capacitor
- C3—0.1 μ F, 75 VDC Mylar capacitor
- D1, D2—Diode, Silicon, 1N914
- IC1—Signetics NE501K
- R1—510-ohm, 1/2 watt resistor

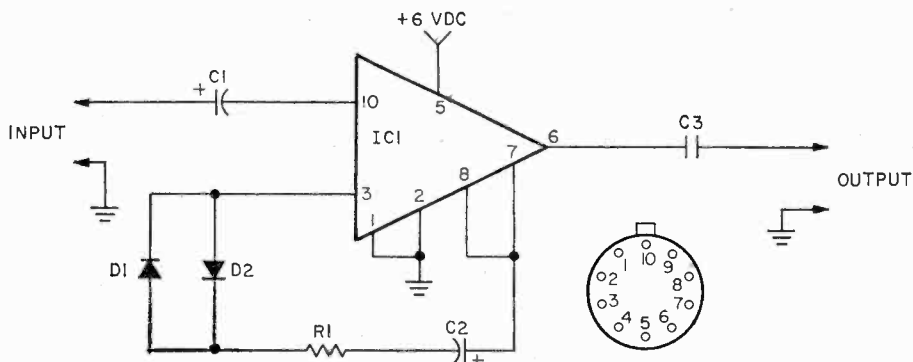

6—Great Equalizer

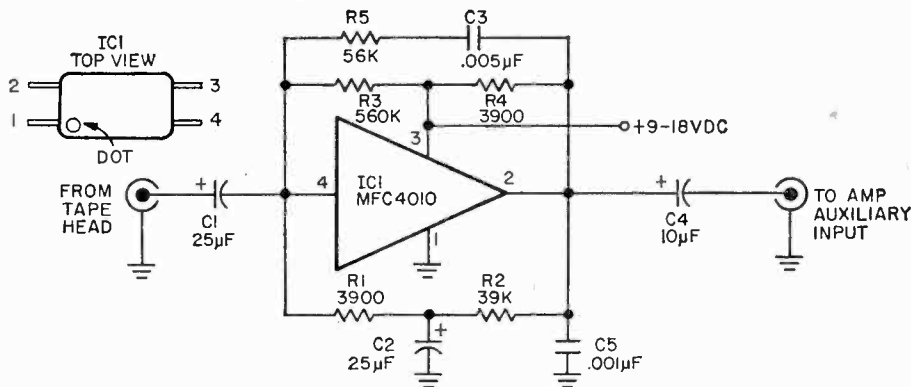

9 GREAT IC PROJECTS

From time to time you'll find bargains at dealers selling tape and cassette deck mechanisms at rock bottom prices—often less than \$20! Complete with heads, these decks need only the electronics to get them working. The Great Equalizer provides both the amplification and equalization. You can feed its output directly into an amplifier's auxiliary input. The Great Equalizer's over-all frequency response is suitable for cassettes and 3¼ IPS reel-to-reel tapes. Since the actual required equalization is determined partially by the playback head characteristics, it might be necessary to modify or "tailor" the equalization; this is done by small changes in the value of capacitor C3 and resistor R5.

If assembled on a small printed circuit board, the Great Equalizer can be tucked under the tape mechanism's base plate. The power supply can be anything from 9 to 18 volts at approximately 3mA. Transistor type radio batteries will do; if batteries are used they must be bypassed with a 25 μ F capacitor. And, be sure you observe proper battery polarity.

PARTS LIST FOR THE GREAT EQUALIZER

- C1, C2—25 μ F, 6 VDC
- C3—0.005 μ F disc
- C4—10 μ F, 20 VDC
- C5—0.001 μ F disc
- IC1—Motorola MFC-4010
- R1, R4—3,900 ohms, ½-watt resistor
- R2—39,000-ohms, ½-watt resistor
- R3—560,000-ohms, ½-watt resistor
- R5—56,000-ohms, ½-watt resistor

7—Stereo Mike Preamp

A dual IC gives our stereo mike preamplifier its hi-fi amplification for a stereo microphone pair. Low distortion and full-fidelity frequency response characterize this mike preamp. With resistors R1 and R2 providing a center-tap for the power supply, the IC can be powered from a standard single-ended power supply or series connected batteries. Be very careful to observe the correct polarity for capacitors C2 and C3. In the event the unit motorboats (low frequency oscillation), install a 0.1 μ F capacitor from pin 14 to ground. The connections for one of the two amplifiers is shown circled; the connections for the second amplifier are uncircled. Pins 7 and 14 are common to both amplifiers. Capacitor Cx's value is determined by the load impedance. It should be

of such value as to provide the desired over-all low frequency response; 0.1 μ F is suggested for high impedance output loads (100K and higher), while 10 μ F is suggested for low impedance loads.

PARTS LIST FOR STEREO MIKE PREAMPLIFIER

- C1—0.1 μ F, 100 VDC
- C2, C3—25 μ F, 25 VDC
- C4—680 pF disc
- C5—50 μ F, 25 to 50 VDC
- C6—33pF disc
- Cx—See text
- IC1—Motorola MC1303L
- J1—Microphone jack
- R1, R2—2,200-ohms, ½-watt resistor
- R3, R5—100,000-ohms, ½-watt resistor
- R4—1000-ohm, ½-watt resistor

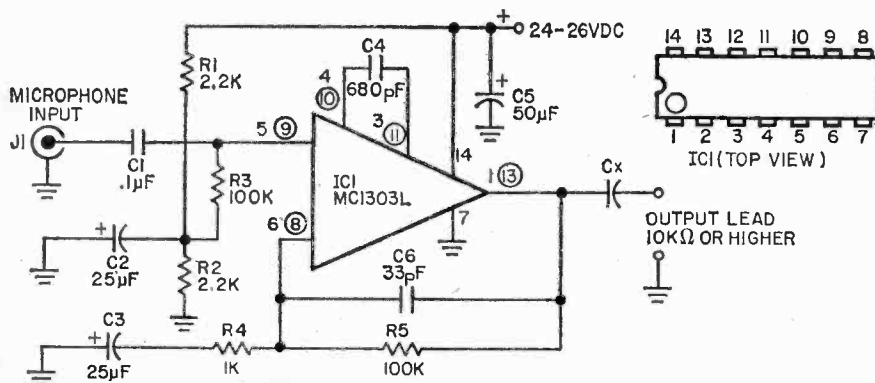

8—Gain Master Mike Preamplifier

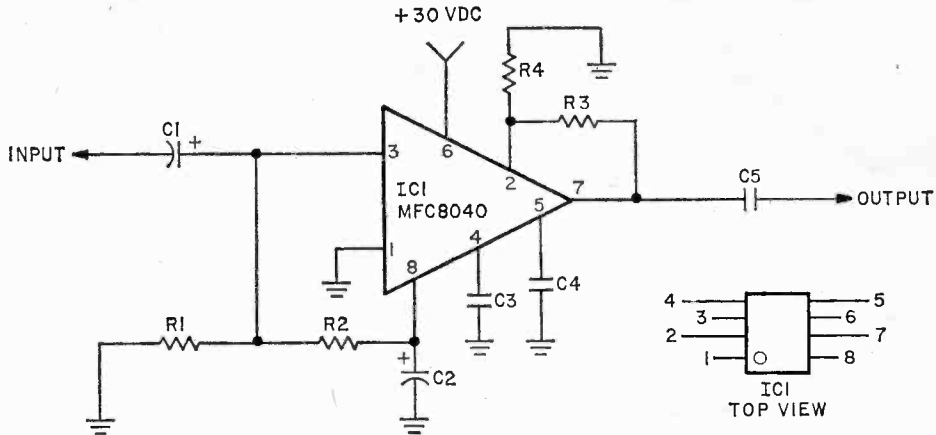

Packing a walloping 60 dB gain with a 7 volt output. This mike preamplifier nevertheless is almost dead quiet. The input impedance is about 75,000-ohms; output impedance about 100-ohms. Actual maximum output voltage depends upon the load resistance, ranging from 7 volts output into a 10,000-ohm load to 4 volts output into a 1000-ohm load. Parts layout is not critical and any type of assembly can be used. The power supply current is typically 8 mA, with a maximum of 12 mA. Use the Gain Master in front of a number of mixer-connected potentiometers to make a high impedance microphone mixer. Passive-type mixers—those using potentiometers only and with-

out a built-in amplifier—are available from electronic parts dealers and through mail order and are relatively inexpensive. With a Gain Master in front of each input, you upgrade these cheapie mixers to full-fledged audio tools.

PARTS LIST FOR

THE GAIN MASTER MIKE PREAMPLIFIER

- C1—1 µF, 3 VDC electrolytic capacitor
- C2—100 µF, 6 VDC electrolytic capacitor
- C3—0.05 µF, 75 VDC Mylar capacitor
- C4, C5—0.1 µF, 75 VDC Mylar capacitor
- IC1—Motorola MFC 8040
- R1—75,000-ohm, ½ watt resistor
- R2—270,000-ohm, ½ watt resistor
- R3—110,000-ohm, ½ watt resistor
- R4—100-ohm, ½ watt resistor

9—Micro-Mini Amplifier

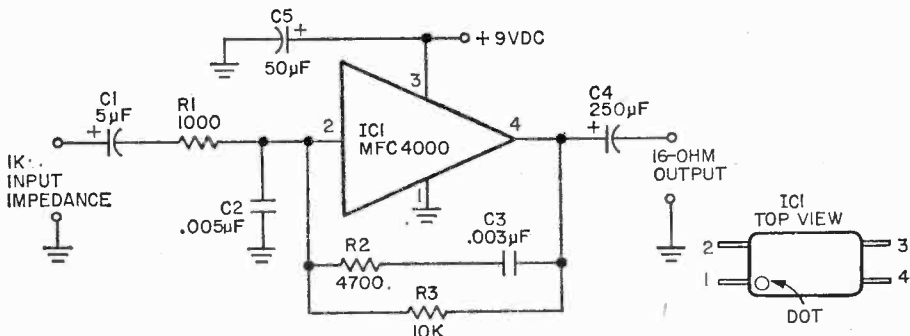

Using an IC no larger than a fly, Micro-Mini Amplifier delivers almost 250 mW into a 16-ohm speaker. A 50 mV input signal coming from a source whose output impedance is 1000 ohms or lower is required for maximum output. The power supply can be a 9 volt type 2U6 battery; the idling current is no higher than 6mA. Best way to keep

things small is to use a printed circuit board assembly.

This amplifier can serve as a general utility amplifier for checking out low-level audio projects, or it can serve as a monitoring amplifier for tape and cassette decks. Even professional-type reel-to-reel recorders with-

(Continued on page 118)

Keep a Light Flashing in the Window

□ The night is dark, rain is falling and the parking lot is dismal. Where the heck is your car? That's easy—right over there under that twinkling star! Well, it's not a star but one of those 3-volt thermal-blink lights found in so many kids toys.

You, too, can be fortunate if you plan in advance. In fact, plan for others. Build a blinking light for your doorway or driveway, if all the houses on your street are similar. This way visitors can look for the twinkling star and find you pronto.

Hyman Wallin of Silver Spring, Maryland did just that and sent a sample to the Editors of ELEMENTARY ELECTRONICS. He soldered the bulb directly to a terminal strip yanked from a defective transistor battery. Next, he snapped it to a two-cell battery holder that mated the snap terminals on the battery strip. It's that easy. Mr. Wallin used C cells, but anything larger will be good and last longer. You can cement an alligator clip for fastening purposes. Lights out!
—Emmett Fluffin

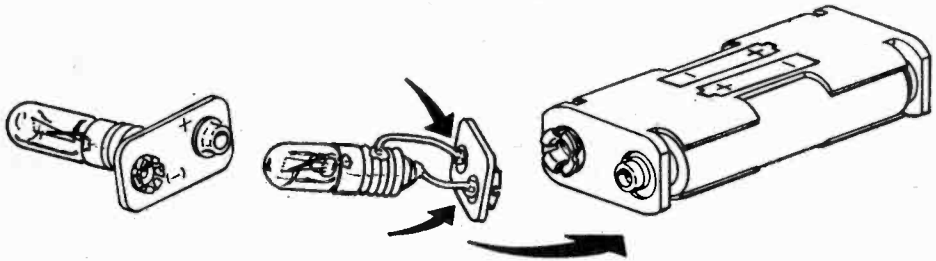

Groove Booster

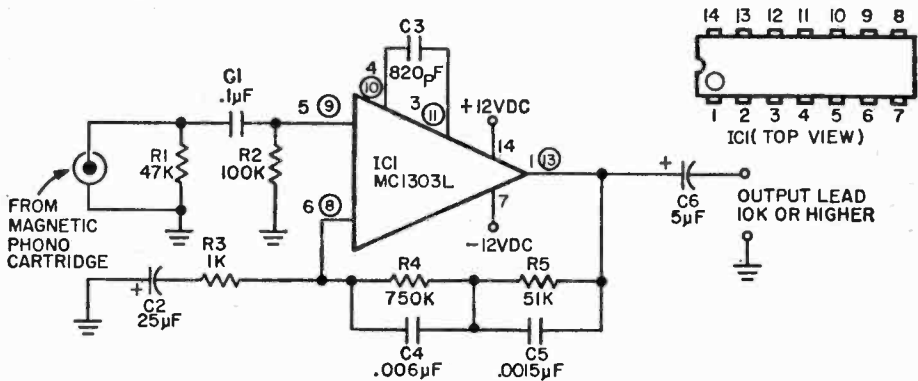

Using a dual operational amplifier IC, the Groove Booster will provide a fully equalized 1 V rms output from standard phono magnetic pickups. The terminal numbers which are circled on the schematic are the connections for one of the two independent stereo amplifiers on the single IC chip. The uncircled numbers are the terminals for the stereo second IC. Power supply terminals #14 and #7 are common to both stereo amplifiers. Note that the power supply is ± 12 volts to ground. Two 6 volt batteries in series can be used for each side of the power supply. If batteries are used, connect 25 μ F capacitors from

pins 7 and 14 to ground—and get their polarity correct. ■

PARTS LIST

- C1—0.1 μ F, 3 VDC
- C2—25 μ F, 3 VDC
- C3—820 pF, 500V VDC disc
- C4—0.006 μ F, 100V VDC disc
- C5—0.0015 μ F, 100V VDC disc
- C6—5 μ F, 25 VDC
- IC1—Motorola MC1303L
- R1—47,000-ohms, 1/2-watt
- R2—100,000-ohms, 1/2-watt
- R3—1,000-ohms, 1/2-watt
- R4—750,000-ohms, 1/2-watt
- R5—51,000-ohms, 1/2-watt

PIGGYBACK AMP

Easy-to-build circuit
has many uses—
we put together a
two-station intercom!

by Herb Friedman, W2ZLF/KBI9547

CAN you imagine a power amplifier no larger than a fly? It's easy—just mount a fly-sized integrated circuit (IC) on a $1\frac{1}{8}$ x $1\frac{1}{2}$ -in. PC board, and along with it add a single transistor preamplifier. The whole bit adds up to a *complete* amplifier small enough to cement right on the back of the magnet of a small speaker. Depending on the input circuit used, our *Piggyback Amp* can be an intercom, a utility amp, a signal tracer, or even a monitor amplifier small enough to be built into a tape deck.

The possibilities for using Piggyback Amp are endless because its power requirement is only 9 V at a minimum of 3.5 mA idling current, which is easily obtained from a small power supply or 9-V battery for a transistor radio. Our photo shows a typical application, the Piggyback Intercom. The schematic details the input circuit modification for the basic Piggyback Amp when used as a signal tracer, tape monitor, etc.

Secret of such a wide latitude in application is the power amplifier, a Motorola integrated circuit (MFC4000). As shown in our photo, the IC takes up no more room on the tip of your finger than a fly, measuring just 0.26 x 0.21 x 0.14 -in. (HWD). Yet small as it is, this IC develops an output signal up to 250 mW into 16 ohms—that's about equal to a fairly loud transistor radio. The MFC4000 IC consists of an output stage with drivers and an input amplifier stage for a total of six transistors. Five resistors and

three diodes are also packed into its fly-sized case.

Unfortunately, you can't get everything for nothing. The MFC4000 requires 150 mV (rms) input drive for full power output. The IC's input impedance appears as 1000 ohms. A preamplifier is needed to increase its sensitivity for universal applications. Our schematic includes the preamplifier stage. Transistor Q1 is biased by R1 and R2 to act as a variable resistor. Bias for IC1's input transistor is derived from its output through the R3/R4/R5 network and Q1.

Since the bias voltage is derived from the amplifier output, the circuit is automatically temperature stabilized. Reason for this is that heating effects on the IC, which result in a change in DC, raise the amplifier's output. Thus the output signal, in turn, controls the amplifier's gain by being fed back to its input. If the DC output voltage attempts to rise because of temperature rise, the feedback to the input biases the amplifier to reduce the drive and thus keeps the DC output voltage constant.

Because transistor Q1 is in the feedback loop, you can use just about any pnp silicon transistor having gain in the 100 to 300

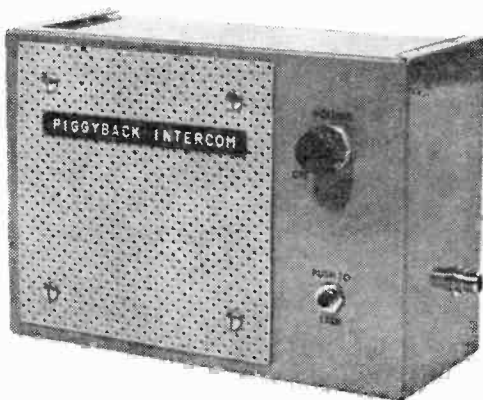

In case cut-out for speaker opening isn't perfectly round use a piece of perfboard as we did to make unit look professional.

PIGGYBACK AMP

With Piggyback Amp cemented to back of speaker, about all you'll need to house this combo plus the few controls and battery is a small Mini-box. We used one 7 x 5 x 3-in. for our intercom.

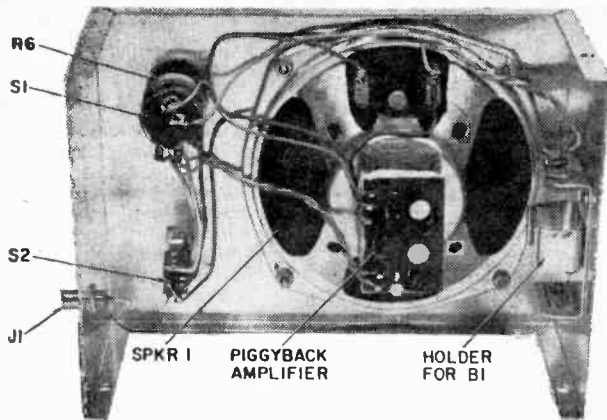

range (we used a 2N5355). The amplifier will continue to operate even if the power source falls to about 4 volts. Naturally, its output will be lower.

The overall frequency response is established by the capacitance of C5. Response will be essentially flat from 100 to 20,000

kHz when C5 is 500 μ F. Response will be down about 6 dB at 100 Hz when C5 is 100 μ F. However, since Piggyback Amp was intended for use with small speakers which can't reproduce lows, anyway, there's really no need for an oversize and expensive capacitor. Further, if C5's capacity will be

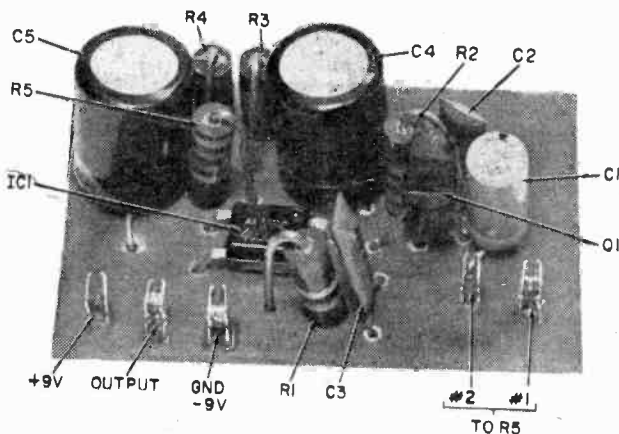
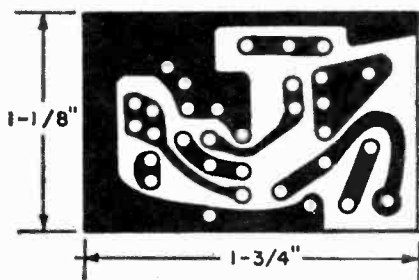
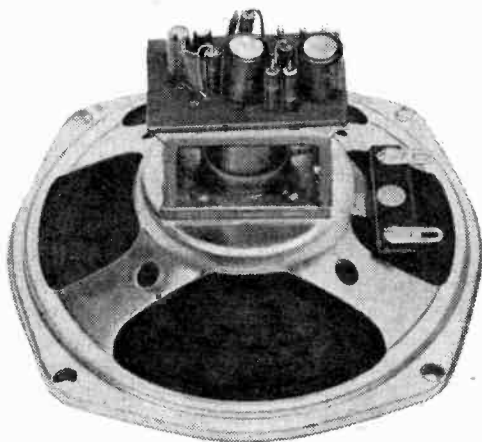

Above—full size pattern for making Piggyback's circuit board. But why bother when factory-made board as well as complete kit of parts for Piggyback universal amplifier can be purchased just by filling out coupon on page 61, thus saving walking and working time. Upper left—see how easy Piggyback Amp fits on back of speaker. Lower left—parts lay-out for basic amplifier.

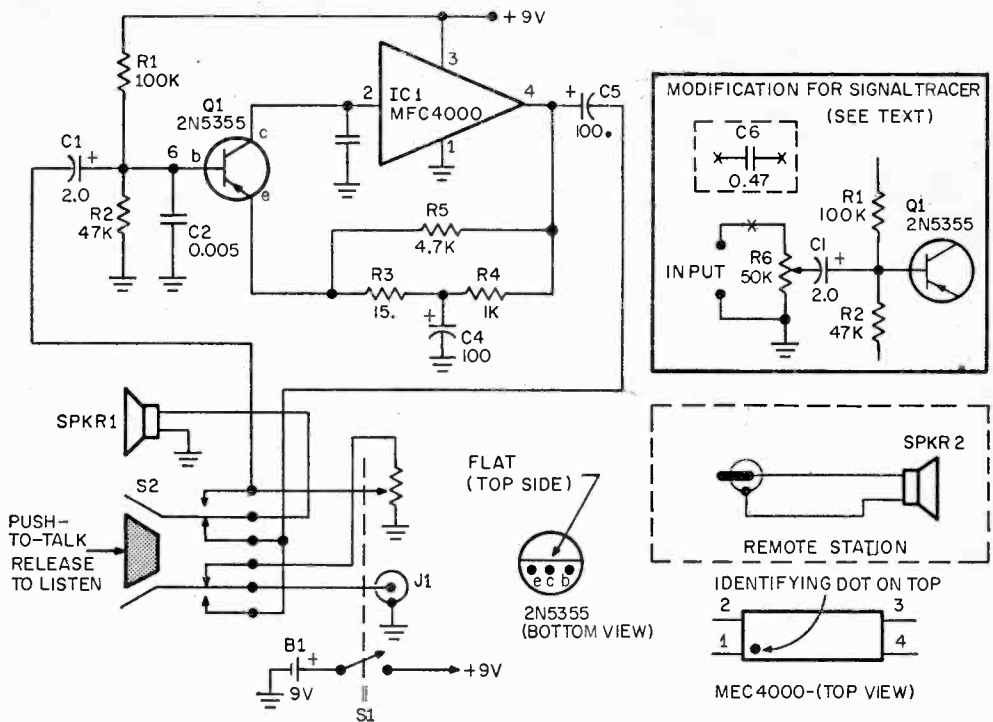

Circuit above covers application of Piggyback Amp to a two-way intercommunication system. We've also included a modification when unit is used as signal tracer.

greater than 100 μ F, much more will have to be provided on the PC board. Of course, you can use perfboard construction which easily accommodates any size components.

Construction. First step is to order or make the PC board. Easy way out is to order one using our coupon, but those who are venturesome may choose to *roll their own*. To help we've included a full-scale pattern for etching, and we refer you to page 32 of the September/October 1969 ELEMENTARY ELECTRONICS for detailed instructions in the art of etching printed circuit boards.

Drill the holes for the components to be mounted on the board. The IC's leads require a hole made by a #55 drill; the rest of the components need holes drilled by a #58 drill. Type T-28 terminals or flea clips are used for terminating external connections and you'll need a #50 drill for mounting them.

Mount all components, saving the IC for the last. All resistors are end mounted in a position perpendicular to the board; the capacitors are the printed circuit type with both leads on one end. Transistor Q1 is

mounted using the full length of its leads. After the T-28 terminals or flea clips are soldered, the excess lead wire protruding through the foil side of the board is cut off. Final step is to mount the IC.

After doublechecking for correct polarity of capacitors, the orientation of Q1 and IC1, and making sure there are no cold solder joints, you can now cement the PC assembly to the back of a speaker. Use a silicon rubber adhesive such as GE's RTV or Silastic Bathtub Calk. To prevent the leads that stick out from the foil side of the board from shorting to the speaker frame, insulate the bottom of the board with a single layer of plastic electrical tape. Place a small blob of RTV adhesive on the foil side of the board, cover the board with tape, and then apply it against the speaker magnet. Pack the RTV around the edges of the board, using a screwdriver to tamp it down. Allow the adhesive to dry for at least 24 hours.

Piggyback as an Intercom. The speaker can be mounted in any convenient enclosure. *Talk listen* switch S2 is a spring-loaded pushbutton type; the N.C. (normally closed) contacts are the *listen* connection, connecting

PARTS LIST FOR PIGGYBACK AMP

Amplifier Parts Kit (parts mounted on PC Board)

- C1**—2- μ F, 3 to 50-VDC electrolytic capacitor for PC board (Aerovox BCD-5002 or equiv.)
C2, C3—0.005- μ F, 75-VDC subminiature square ceramic capacitor (Lafayette 33E69048 or equiv.)
C4, C5—100- μ F, 12 to 15-VDC electrolytic capacitor for PC board (Aerovox BCD-15100 or equiv.)
C6—0.47- μ F, 100-VDC dipped mylar capacitor—see text (Lafayette 34E67248 or equiv.)
IC1—Silicon monolithic integrated circuit (Motorola MFC4000)
Q1—Pnp silicon transistor (GE 2N5355)
R1—100,000-ohm, 1/2-watt resistor
R2—47,000-ohm, 1/2-watt resistor
R3—15-ohm, 1/2-watt resistor
R4—1000-ohm, 1/2-watt resistor

- R5**—4700-ohm, 1/2-watt resistor
R6—50,000-ohm, audio taper potentiometer with spst switch (Mallory U-33 control with US-26 switch or equiv.)

Intercom Parts

- B1**—9-V transistor radio battery (Eveready 216 or equiv.)
J1—RCA type phono jack (Lafayette 99E62341 or equiv.)
P1—Single-contact jack for J1 (Lafayette 32E64579 or equiv.)
S2—Dpdt momentary pushbutton switch (Lafayette 30E41167 or equiv.)
SPKR1, SPKR2—16-ohm, 5-in. diameter PM speaker

Misc.—Wire, hardware, perfboard or other grille screening, solder, interconnecting cable, etc.

remote speaker SPKR2 as the microphone. The sound originating at SPKR2 is amplified by the Piggyback Amp and monitored through SPKR1. When S2 is pushed, SPKR1 is transferred from the output of the amplifier to its input. Result is that SPKR1 now serves as a microphone and the amplifier output is transferred to the line feeding SPKR2 at the remote station.

Note that volume control R6 is connected so that it is in the circuit when receiving signals from the remote station to control received volume. When transmitting to the printed circuit board is used as is; however, the input connections are modified as shown in the schematic. Actually, all that's done is to connect the volume control ahead of the amplifier at its input. Volume control R6 can be a potentiometer from 25,000 to 50,000 ohms. If the Piggyback Amp is to be used as a signal tracer, it will probably

be connected into DC circuits and therefore a DC blocking capacitor should be used ahead of R6 as shown by the dotted lines as C6 in the schematic; in 0.47- μ F capacitor rated at 200 or 400 VDC is adequate.

With no signal the amplifier idles at approximately 3.5 mA, peaking up to almost 100 mA at full power output. An ordinary transistor radio 9-volt battery such as type 2U6 can be used, though larger batteries naturally give longer life. For permanent installations a small 117-VAC power supply such as a 9-V battery eliminator for transistor radios, can be used. Under no conditions should the voltage applied to terminal 3 of the IC exceed 9 volts.

Unlike many IC power amplifiers, Piggyback Amp is rock-stable—provided the unit is built as shown in our photos using the layout as designed into the printed circuit board. ■

PIGGYBACK AMPLIFIER PARTS KIT & PRINTED CIRCUIT BOARD ORDER BLANK

ELECTRONICS HOBBY SHACK

PO BOX 587

Brooklyn NY 11202

Speed service offered
when Postal Money Order
accompanies your order.

- Please rush Printed Circuit Board for Piggyback Amp at once. I am enclosing \$3.65 to cover costs for the board, handling, and postage.
- Please rush Amplifier Kit (parts that mount on the PC board) at once. I am enclosing \$8.25 to cover costs for the parts, handling, and postage.
- Please rush Printed Circuit Board and Amplifier Kit (parts that mount on PC board) for the Piggyback Amp at once. I am enclosing \$10.90 to cover costs of board, parts handling, and postage.

Name _____

Address _____

City _____

State _____

Zip _____

Canadian Residents please add \$1.00 for special handling.

easy-to-build... **Basket of Sound**

**Our redwood speaker
opens the outdoors
to Beethoven or Rock.
Build it with an
inexpensive planter box
from your local
garden nursery**

by Herman F. Johnson

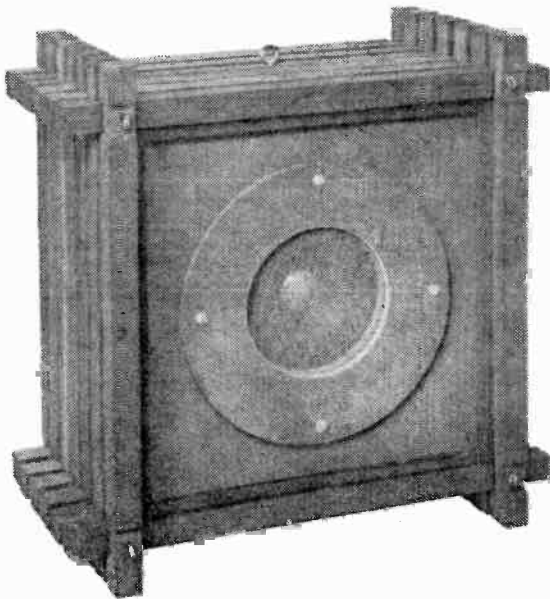

Would you like something different in a loudspeaker? Here is one like none other. It is so radically different from those oiled walnut, small box speakers we usually encounter, it may be compared to the commercial varieties only by its size. In appearance, it is equally at home in a small listening room or in a 4-channel arrangement around a swimming pool. Or, hang it beneath the eaves of your house, preferably at an inside corner, to enhance the low frequency response.

Everyone likes small size loudspeakers because of their portability. When you attempt to build one from scratch however there is rarely enough room inside to hold a screwdriver! Finishing an enclosure to suit one's decor can also be quite a problem. But one way to avoid construction difficulties, yet build a better-than-average small speaker, is to start with a pre-assembled box or two (or four). That way most of your effort is simply fitting a speaker baffle.

Green Thumb Ground Supply. One type of box that is suitable for a speaker enclosure can be found in your garden nursery store. The redwood planters. They are sturdily built to hold soil for a number of years. Redwood is less susceptible to warping than other forest materials, and planter boxes are usually made of $\frac{3}{4}$ -in. board securely joined. The planter employed in this application has side walls that are $\frac{5}{16}$ -inch thick, and the bottom is a $\frac{3}{4}$ -inch solid board. Inside dimensions are $9\frac{3}{4}$ -in. square by 6-in. deep. About an inch of the

Basket of Sound

depth is lost when speaker mounting pieces are installed, but a sufficient volume of about 480 cubic inches remains available for the speaker.

Construction. It is a good idea to inspect the inside areas of the box to determine if there are any crevice openings along the inside corners. Seal these openings while running a bead of caulking full length along all the mating surfaces. Silicone rubber is ideal for this purpose, though other non-hardening caulking may be used. It is important that a speaker enclosure be made airtight to insure adequate low frequency sound.

Pencil-line the perimeter inside the box $\frac{3}{4}$ -in. from the edge of the open end with an adjustable square. This will locate the front face of the cleats after you cut them to length (piece numbers 1 and 2 in the drawing). Fit the cleats in place for a snug fit. Then pencil-line the perimeter once more using the inside edge of the cleats as a guide. These locator lines are a help when you are ready to glue the cleats in place. Plastic resin glue is the best bonding agent for this purpose, it is stronger than the wood when dry. You will find sufficient room to drive one inch long nails through the cleats to compress the glued joints and hold them in place.

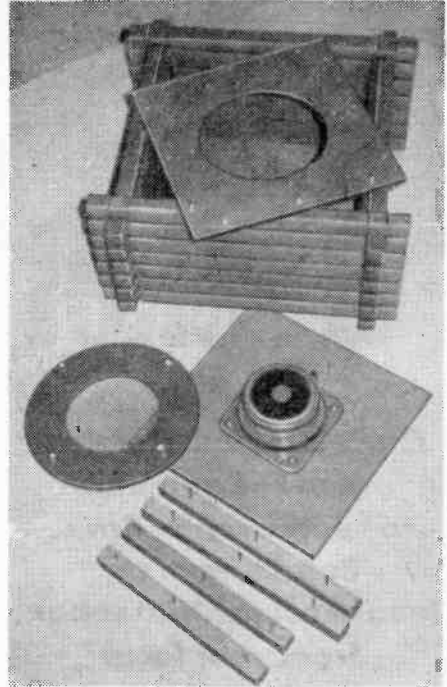

Your redwood planter comes completely put together ready to be turned into one great indoor/outdoor speaker. Sounds great, too!

Gate the Drain Source. All planter boxes have at least one drain hole in the bottom. Install a terminal strip over the hole and caulk this opening on the inside after a length of speaker hook-up wire has been installed. However, if you intend to use the

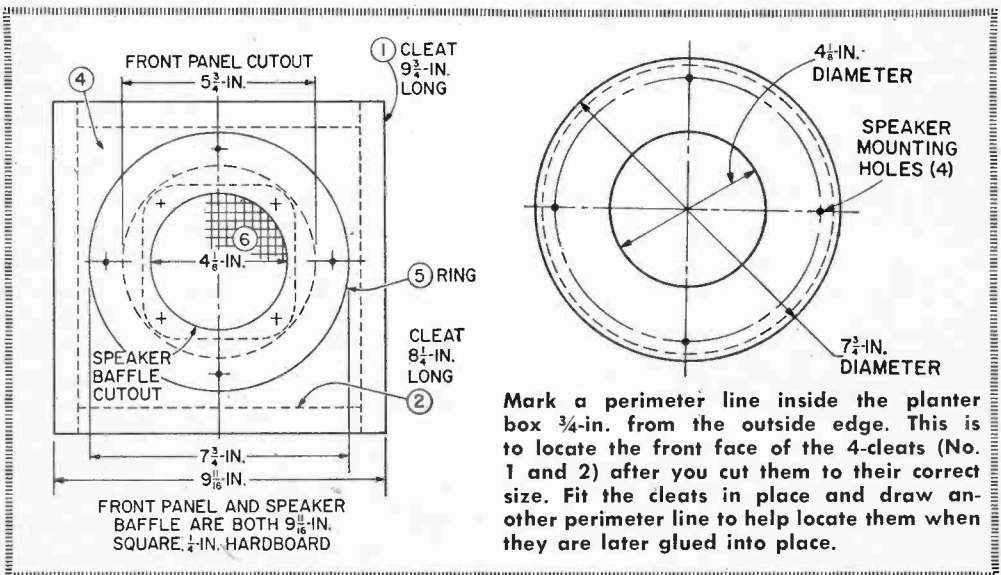

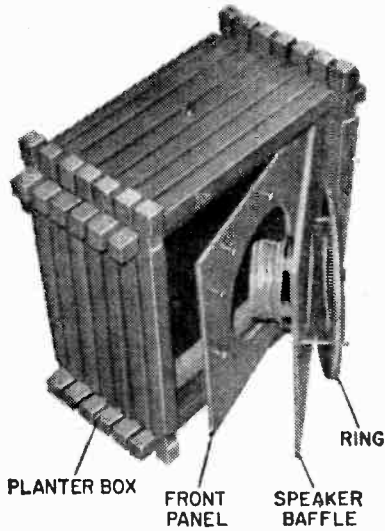

Fan-out view of front area illustrates how simple construction really is. Front ring is added to improve enclosure's appearance.

speaker outdoors, it is best to plug the drain hole with a wood dowel or a cork. Then designate a side as the underside and drill a 1/4-in. hole about two inches from the open end for hook-up wire.

Standard 1/4-inch hardboard is ideal for mounting the speaker to the front face of the planter. This material has a smooth flat surface on the front and a waffle-like pattern embossed on the back. Note in the photograph that the speaker is mounted with three parts—front panel, speaker baffle, and a front facing ring (piece numbers 3, 4 and 5 respectively). Mark the hole locations and cut-outs on the smooth face and make the cuts. Your front panel should make a snug fit inside the box, but your speaker baffle should fit loosely in the opening. It is a good idea to clamp these two parts together when drilling the four outside mounting holes. Then, all four holes in the front panel should be redrilled to fit the tee nuts.

Speaker Mountings. Locations for the four machine screw holes in the speaker baffle should be templated from the speaker's frame with the speaker centered over the 4 1/8-inch diameter cut-out, while holes in the ring can be templated from the four holes in either the front panel or the speaker baffle. The flat heads of the screws should be flush with the surface of the hardboard. When assembling these parts note that tee nuts are pressed into place on the embossed side of the front panel. The front panel is then glued and screwed to the cleats (embossed side toward cleats). Your speaker is back-mounted to the smooth surface of the baffle. This provides a seal without the use of a gasket. Note that the speaker baffle covers all of the flathead wood screws in the front panel. The ring has been added for esthetic reasons, to cover flat head screws and bolts and to secure the fiberglass cone protector screen. Only four round head screws are exposed at the front.

Before the front panel is permanently installed, fill the inside cavity with 5 layers of one-inch fiberglass. The front two layers should be cut out in the center to clear the magnet structure of the speaker. High compliance speakers operate most efficiently in small enclosures when damped with fiberglass. *(turn page)*

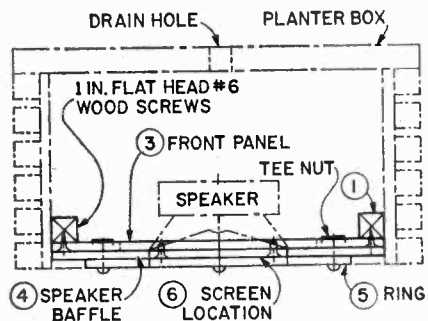

Planter box drain holes should be plugged to prevent turning your enclosure into a bird's nest if you put it to use outdoors.

OPTIONAL FINISHING

If the speaker is to be used outdoors, it is advisable to give all of the hardboard pieces a coating of resin sealer. A pleasing front appearance can be had by coating the embossed surfaces of the speaker baffle and the ring with a color-toned penetrating sealer to match the prefinished planter. If the redwood color is not appealing, you can paint-decorate all of the outside surfaces, or give it a coating of charcoal resin sealer to obtain a dark, woody finish.

Basket of Sound

For ease of handling or support for hanging the speaker, predrill a hole, centered on the top surface, to receive a 1/8-in. screw eye, or install four small screw eyes since wire hangers are furnished with the planter listed in the Bill of Materials.

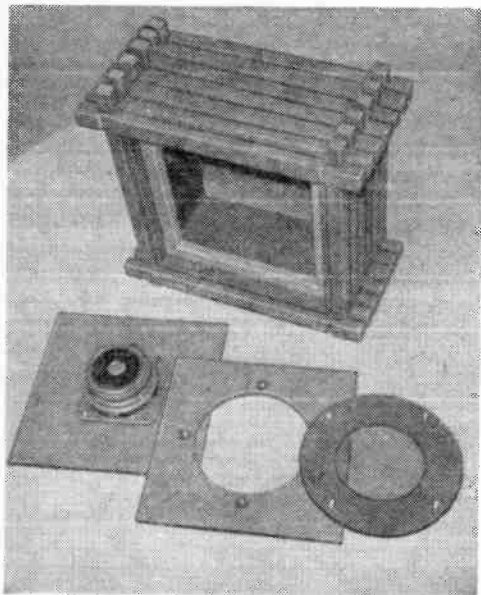

Ready for final assembly. An Altec 405A speaker with its smooth frequency response and weatherproofing treatment is suggested

Sound Source. Dimensions given in the drawing will fit a 4-inch Altec 405A. There are several high compliance 4 or 5-inch full range speakers available that can be expected to operate with satisfaction in this application. However, the Altec speaker is recommended for this system if it is to be used outdoors. It is a speaker that has gained wide acceptance among audiophiles who demand fine music and voice reproduction in their automobiles since its high efficiency provides low frequency output and smooth frequency response equal to many larger speakers. And, a water-resistant cone prevents distortion during periods of high humidity. Smooth distribution is provided by its shallow cone and aluminum center dome. High efficiency in a speaker is very important when it is necessary to connect it at a location that is likely to be up to 125 feet from the source of audio power. Do not use antenna lead-in wire; the wire size is too small. A 1/4-in. diameter #16 gauge vinyl-jacketed cable such as Belden 8471 is recommended for outdoor cable runs. It may be used up to 125 feet with less than 15 percent loss of audio power.

Tie a knot in the cable or build up its diameter by tightly wrapping rubber tape about a foot from the end, then solder the speaker terminals and caulk the inside where the cable enters the enclosure. Push the baffle-speaker assembly into the front panel opening and insert the four round head screws and tighten them. Now you're ready to lie back and enjoy good listening from your own hanging basket. ■

Bill of Materials for Basket of Sound

Key to Drawing	Description
1	Fir cleat, 3/4-in. x 3/4-in. x 9 1/16-in. Two required.
2	Fir cleat, 3/4-in. x 3/4-in. x 8 1/4-in. Two required.
3, 4, 5	Masonite hardboard, 1/4-in. thick. Three square feet required.
6	Grill cloth. One square foot required.
	8-32 Tee nut. Four required.
	8-32 x 1/2-in. flat head machine screw. Four required.
	No. 6 x 1-in. flat head wood screw. Ten required.
	Fiberglass damping material. Four square feet of 1-in. material required.
	8-32 nut and washer. Four required.
	Redwood planter, No. HB1-12 or similar. (Distributed to garden nurseries by Germain's, Inc., 4820 50th Street, Los Angeles CA 90058) About \$4.
	Altec 405A 4-in. wide range speaker. (Altec-Lansing, 1515 South Manchester Avenue, Anaheim CA 92803) About \$12.

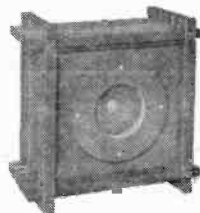

Roto-Stat

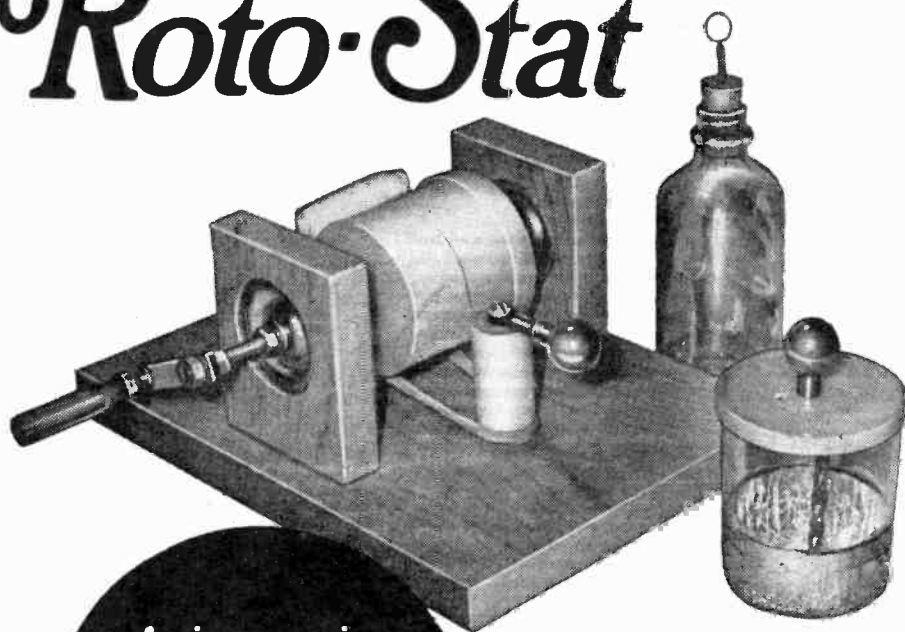

**An inexpensive
efficient
hand-powered
electrostatic
generator**

From the earliest days of experimenting with electrostatic electricity—say in the 4th Century B.C., when Plato mentioned the wonderful attracting power of amber—electrostatic electricity was produced by laboriously rubbing glass rods or other electrostatic producing objects with dry fur or cloth. In 1663, in Germany, Otto von Guericke used a large ball of sulphur to generate electrostatic electricity by rotating the sulphur ball and rubbing it with his fingers. In 1706, in England, Francis Hauksbee employed rotating glass globes and cylinders to generate static

**by Charles Green
W6FFQ**

SPRING-SUMMER, 1973

Roto-Stat

electricity, and he used a metallic conductor to collect the generated static electricity from the generator.

In 1744, in Germany, J.H. Winkler invented a mechanical rubbing device to use in place of rubbing the glass cylinder with the fingers. His *rubber* used a leather-covered cushion pressed against the rotating globe. In America, in 1747, Ben Franklin used an electrostatic generator in some of his electrical experiments; it contained a rotating glass cylinder with a mechanical *rubber*.

Even in this day and age, electrostatic experiments still fascinate the avid experimenter. You can perform electrostatic electricity experiments by building and using our Roto-Stat electrostatic generator, instead of generating the electrostatic charges by hand-rubbed glass or plastic rods. Our Roto-Stat, designed for easy construction, uses a plastic cosmetic or similar jar in place of a glass

ball or cylinder. The generator is built on a 3/4-in. white pine base and uses a wool cloth *rubber* and a copper wire electrostatic collector that's formed round the jar.

How It Works. Turning the generator handle rapidly in a clockwise direction causes the wool cloth to rub against the plastic jar's surface. The friction of this rubbing releases electrons which electrostatically charge the jar's surface. As the jar is rotated, the pickup wire mounted on the ceramic standoff collects electrostatic charges from its surface and conducts them to the metal ball output electrode. A Leyden jar can be charged by contacting its terminals to the metal ball output electrode and ground. (For complete construction details for a Leyden jar and an electroscope see *Ben Franklin's Leyden Jars*, Dec./Jan. 1970 SCIENCE AND ELECTRONICS.)

Plastic Power. We used a plastic jar 2 3/4-in. high x 2 3/4 in. diameter with plastic screw top for the rotating element of our Roto-Stat. If another size plastic jar is used, scale the dimensions of your unit proportionately. Since different types of plastic vary in their ability to generate electrostatic electricity,

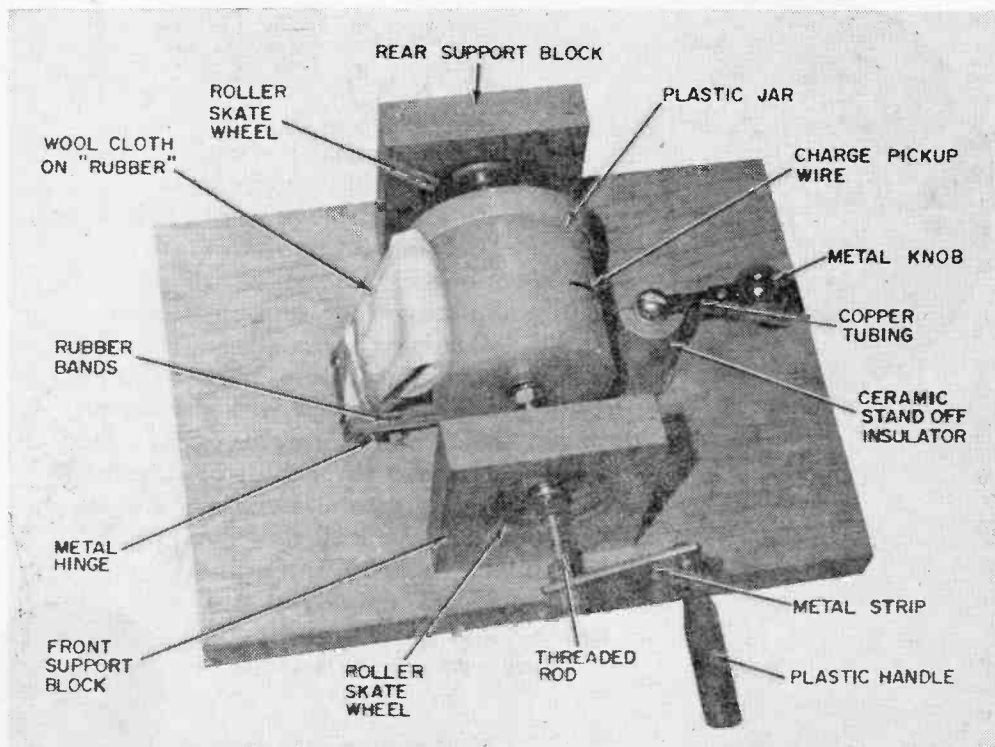

Our Roto-Stat electrostatic generator, though not as huge as original ones built in early 18th Century, is quite efficient. From details in photo and drawing you can build it.

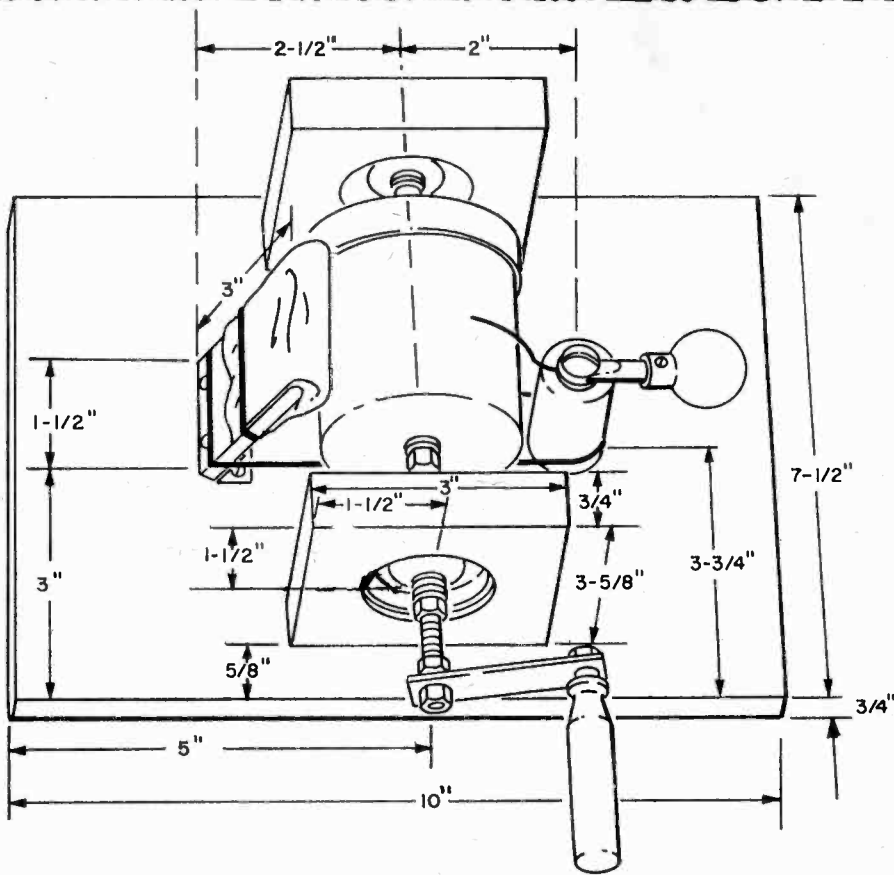

MATERIALS LIST FOR ROTO-STAT

- 1—Ceramic (L5 glazed) standoff insulator, threaded at both ends, 2-in. high x 1-in. dia. (JAN type NS5WO416, E.F. Johnson 135-503, or equiv.)
- 1—Hard rubber or plastic handle, 2-in. long x 1/2-in. dia. (we used handle from radio aligning tool)
- 1—1 1/2 x 1/2-in. metal hinge
- 1—Plastic jar with screw-on or snap-on plastic lid, 2 3/4-in. high x 2 3/4-in. dia. (you may also want to use this size for Leyden jar and electroscope—see text)
- 2—Metal knobs, approx. 7/8-in. dia. (available as automobile dash control or seat control knobs at auto parts stores)
- 1—2 1/4 x 1/2 x 1/8-in. metal strip for mounting handle
- 1—NE2 neon lamp
- 2—Roller skate wheels, ball bearing (available as replacement wheels at toy stores and toy counters in department stores)
- 1—Threaded metal rod, 8-in. long x 1/4-in. dia.
- Misc.—1 1/2 x 4-in. wool cloth strips, wood screws, nuts and washers for threaded rod, screws to fit ceramic insulator, cement, rubber bands, #18 to #22 bare copper wire, 3/4-in. thick pine for base, etc.

test the jar you've selected by rubbing it with a wool cloth and noting whether the jar attracts small pieces of paper when the jar is moved over them. If it doesn't, try a jar made of different plastic material.

Any type of soft wood can be used for the base. Just make sure that the wood is clean and dry. The dimensions given in our drawing are approximate, to serve as a guide. Any size generator unit can be built, but for best results it's suggested you follow

the general layout of our unit.

Begin construction by cutting a 7 1/2 x 10-in. base of 3/4-in. thick pine or other soft wood, then cut two 3 5/8 x 3 x 3/4-in. wood blocks. Roller skate wheels, available as replacements at most hardware or bicycle shops, are used as driveshaft bearings. Cut a hole in each wood block to fit roller skate wheel used for this purpose. The hole in each block of our unit is made just large enough to force-fit the wheel into the hole in the

Roto-Stat

block. Duco cement or Elmer's Glue is used to hold the wheel securely in place. You may prefer to use long sheet metal screws through the sides of the mounting blocks to hold the wheel.

Cone Or Cylinder. Drill holes in the center of the bottom of the plastic jar, and also its lid, to fit the $\frac{3}{8}$ -in. threaded metal rod. Cut and drill a conical wood section to fit inside the plastic jar if the jar isn't straight-sided (if it is, then you'll need a wooden cylinder), extending from the jar bottom to the jar lid for internal support. A clearance hole for the metal rod, which serves as the axle for the jar, is drilled through the center of this wooden block.

Mount front supporting block on the base as shown in our drawing. We used two wood screws through the base to hold the block to the base. Insert threaded metal rod through jar and skate wheel bearing and hold them in position on the rod with a nut and washer top and bottom of the jar and on either side of the bearing mounted in the

wood block. Don't tighten the nuts now; you'll probably reposition the jar.

Position the rear block-mounted bearing on threaded metal rod with a nut and washer on both sides of the bearing. Adjust spacing of nuts on the metal rod so that the jar is in the center of the base as shown in photos and drawing. Position the rear wood block so that metal rod and jar can turn freely without binding, and fasten this block in position to the base with wood screws. Make sure that about $1\frac{3}{4}$ in. of metal rod projects out from the front bearing for attaching the metal strip that holds the handle, then tighten nuts against the jar and bearings.

Plastic Handle. We made the plastic handle from an alignment tool and bolted it to a $2\frac{1}{4} \times \frac{1}{2} \times \frac{1}{8}$ -in. metal strip with washers to allow the handle to rotate freely. Fasten a $3 \times 1\frac{1}{2} \times \frac{1}{4}$ -in. piece of plywood to a hinge, and mount the hinged plywood section to the wood base adjacent to one side of the jar. Mount a 2-in. high \times 1-in. diameter ceramic standoff to the base on the opposite side of the jar as shown in our drawing and photos.

Mount a small unpainted metal knob onto a piece of copper tubing, flatten the free end of the copper tubing, and mount it on

About Leyden Jars and Electroscopes

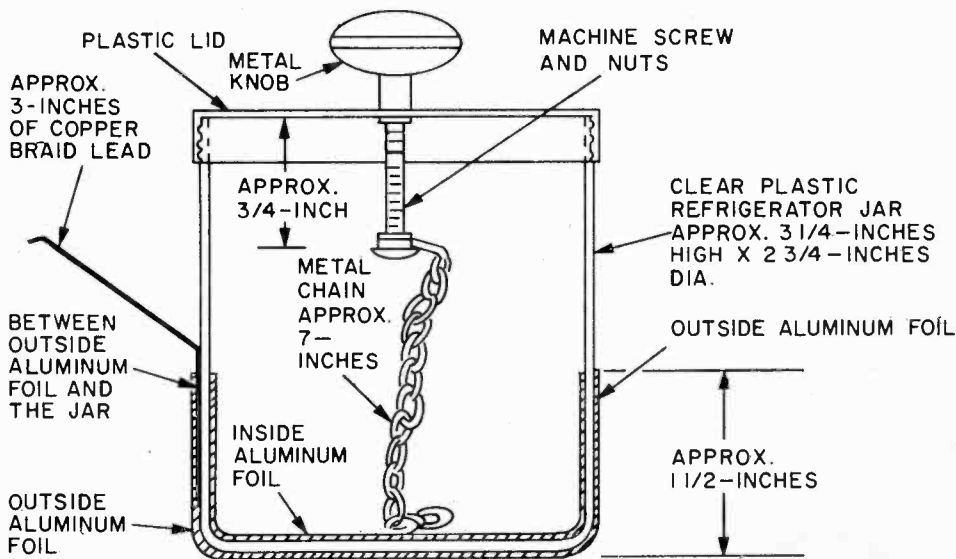

Even though we used materials found either in kitchen or bathroom this Leyden jar can store electrostatic charge generated by our Roto-Stat, so be sure it's discharged when stored.

the ceramic standoff. Also fasten a length of #22 or larger copper wire to the ceramic standoff and bend it so that it curves around the jar for a length of about 1½ in. but doesn't touch it. Position the wire approximately 1/16 in. away from the jar's surface and cut off the excess length of wire. Small rubber bumpers are fastened to each of the corners on the bottom of the base.

Fold a piece of clean, dry wool cloth over the top end of the hinged plywood piece, holding the cloth in place by means of a rubber band. Clean the surface of the jar carefully. Place several rubber bands around the base of the ceramic standoff and stretch them 'round the bottom of the hinged plywood section so that the wool cloth that is folded over its free end will be seated firmly against the side of the jar.

Rotate the jar by turning the handle, making sure that the jar turns freely, but with a slight resistance from the wool cloth *rubber*, and that the pickup wire does not touch the surface of the jar. Do not touch the surface of the jar or the wool cloth after the jar has been cleaned, because of the possibility of transferring moisture on your hands to either or both.

Experiment 1. Before performing any ex-

periment, make sure that both the cloth on the *rubber* and the jar's surface are clean and dry. If necessary, expose both cloth and jar to the rays of a heat lamp to dry up any moisture. These experiments may not work as well, or may not work at all in a humid area, since a dry environment is necessary for best results. We suggest you perform them in an air-conditioned room if at all possible for driest atmosphere.

Rotate generator handle rapidly in a clockwise direction, and hold the electroscope so that its electrode makes contact with generator's metal ball. Observe that the electroscope leaves deflect away from each other. This indicates that the electrostatic generator is operating and producing an electrostatic output voltage.

Experiment 2. Connect the outer foil of a Leyden jar to ground or a large metal object, and bring the Leyden jar top electrode in contact with the generator metal ball. Rotate generator handle rapidly in a clockwise direction for a few minutes, then move the Leyden jar away from the generator. Make sure you do not touch Leyden jar top electrode with your fingers. Carefully disconnect the Leyden jar outer foil lead from the ground. Then move the outer foil lead very

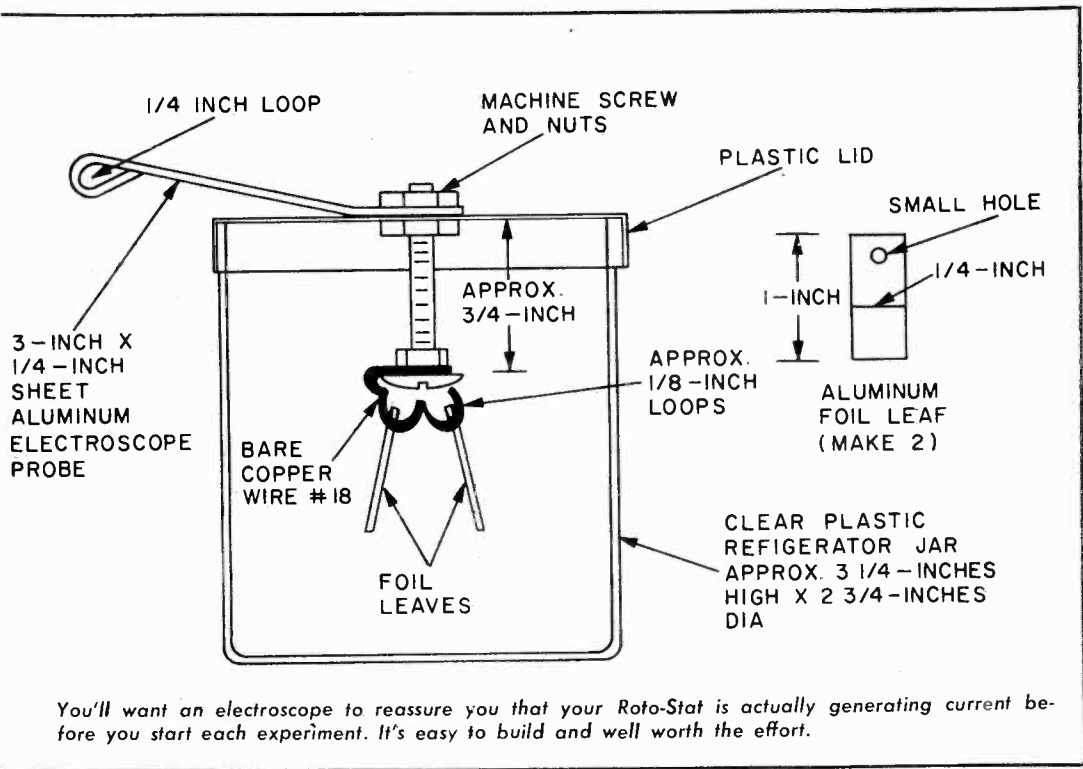

You'll want an electroscope to reassure you that your Roto-Stat is actually generating current before you start each experiment. It's easy to build and well worth the effort.

Roto-Stat

close to the top electrode. Note that a small spark will jump between the top electrode and the outer foil lead of the Leyden jar. This indicates that the Leyden jar was charged with the electrostatic output voltage from the generator.

Repeat the experiment, except connect a VTVM (preferably with a high voltage

clockwise direction, and momentarily bring one lead of an NE-2 neon lamp in contact with the generator metal ball while you hold the other lamp lead. The neon lamp should flash momentarily, indicating that the generator is operating.

Move one of the neon lamp leads around the surface of the rotating plastic jar. Note that the neon lamp flashes, indicating the electrostatically charged areas.

Remove the neon lamp lead from the jar, rotate generator handle rapidly for a minute, and then stop. Now move neon lamp lead

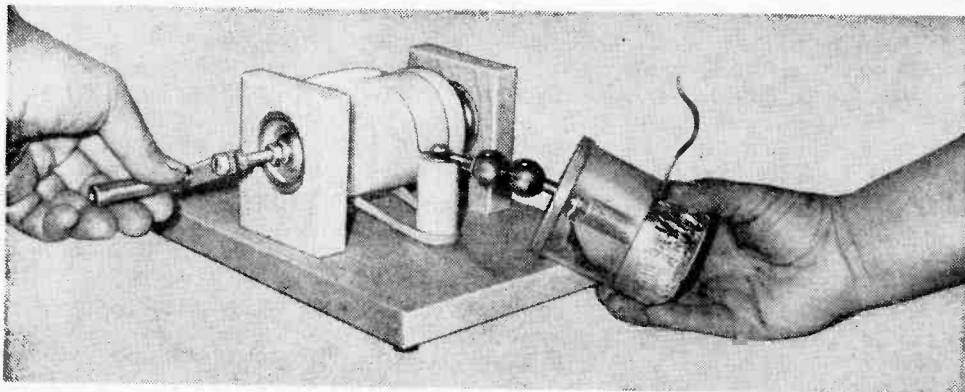

Here's how to hold your Leyden jar when you charge it from your Roto-Stat. Keep two metal balls in constant contact while turning handle to generate charge.

probe) between the Leyden jar outside foil and its top electrode, after Leyden jar has been charged. Fasten one lead to ground strap and touch top electrode with the other lead of the VTVM. Observe that the VTVM momentarily indicates a large negative voltage. This shows that the generator has a negative electrostatic output voltage.

Experiment 3. This experiment requires a dimly lit area in order to best see the neon lamp. Rotate generator handle rapidly in a

around on the surface, noting that the neon lamp still flashes, indicating that the electrostatically charged areas on the plastic jar will remain active for a period of time after the surface of the jar is excited by rubbing.

Try different types of cloths for the rubber in place of the wool cloth and compare their operation with that of a wool cloth. Note rotation speed affects size of charge. You can also try different configurations of the wire collector. ■

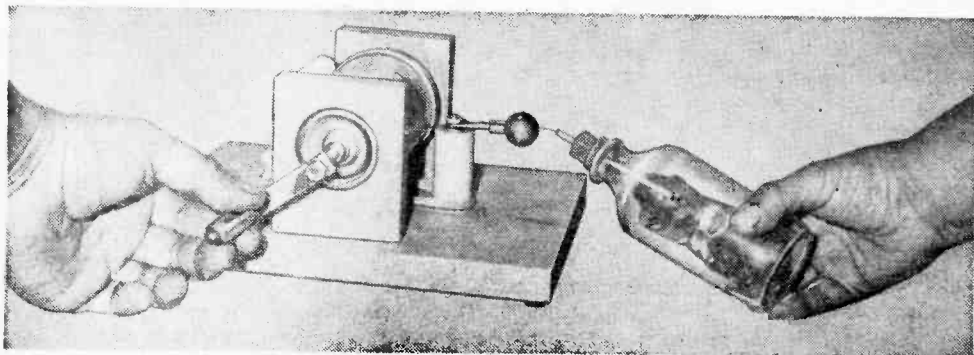

If there's a doubting Thomas amongst those you're showing your Roto-Stat, prove it's generating by placing Electrostat's collector against Roto-Stat's output ball.



Automatic Headlighter

Don't end your trip in a fall!

By William R. Dodd, Jr.

THE night may be dark and dismal when you pull in your driveway, but thanks to your Automatic Headlighter you'll have no trouble seeing the way to your doorstep. This automatic headlight timer is a two-transistor circuit that keeps your headlights illuminated for 60 seconds after you leave your car. A simple ten-dollar project (all new parts), it's connected in parallel with your existing auto headlight switch and is operated by a single pushbutton. The timer has been field-tested for over a year and has been proven extremely reliable. It is for installation in a 12-Volt negative ground electrical system, but installing the unit in positive ground systems is a snap for hobbyists.

THE HOW OF IT. When the driver depresses pushbutton switch S1, timing capacitor C1 charges to 12 volts and turns on transistor Q1, which drives power transistor Q2 into conduction. This, in turn, energizes the relay which has its contacts connected in parallel with the headlight switch. The relay will stay energized until C1 discharges to the Q1 turn-off level. The lights-on period is determined by the value of C1, R1, and the characteristics of transistor Q1. With values shown on the schematic, about 60 lights-on seconds are provided.

WHAT TO DO. Construct the timer in a small 3¼-in. x 2½-in. x 1½-in. mini-box where all components except the relay and pushbutton switch S1 are mounted on a 1⅞-in. x 1⅞-in. printed circuit card. The circuit card may be made by any of the conventional methods.

Special attention must be given in mounting some of the components on the printed circuit card. Capacitor C1 must be mounted with its + terminal connected to R1. Also, special attention must be given to spacing the transistors at least ⅞-in. away from the circuit card to avoid overheating during soldering. Two insulated washers are used to mount power

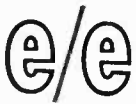

AUTOMATIC HEADLIGHTER

transistor Q2 to the printed circuit board.

Interconnecting wires from the circuit board should each be at least 4-in. long. They can be cut to proper length just before wiring in the mini-box. Mount RY1 and S1 in the mini-box, with heavy gauge (#14) wires soldered to the relay terminals as shown on the schematic. Make these wires about 24-in. long and mark "+" and "Lights" for easy identification during installation. The last step is to mount and connect the printed circuit card in the mini-box.

Under the Dash. The protruding mounting screw of RY1 may be used to mount the timer under your dash, or make a bracket of your own design for your particular automobile and installation. Just make sure the timer chassis is well grounded to the dashboard frame before proceeding.

At the headlight switch, find the wire coming from the headlamps and select a

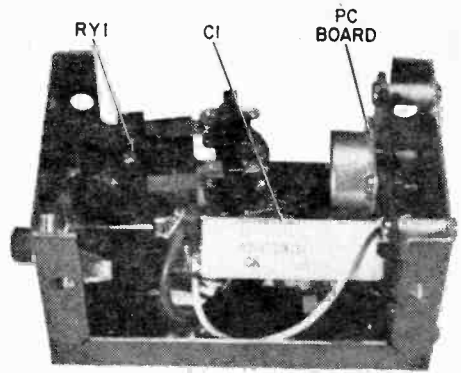

With the relay mounted on left, PC board at right, all parts fit conveniently into the 3¼-in. x 2½-in. x 1½-in. minibox case.

convenient point (probably a wire right on the switch) to tap into the 12-Volt battery power. You can locate these two wires by checking for voltages with a VOM at the headlight switch. A +12-Volt battery wire will be the only wire that will read +12 volts with the headlight switch in the *off* (Continued on page 114)

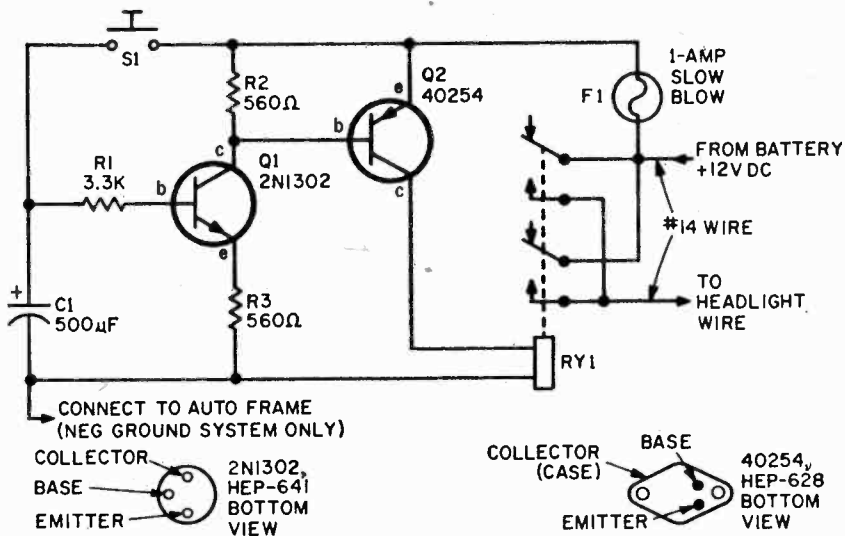

PARTS LIST FOR AUTOMATIC HEADLIGHTER

C1—500 µF electrolytic capacitor, 15 VDC or better

Q1—NPN transistor, 2N1302, HEP-641

Q2—PNP transistor, RCA 40254, HEP-628

R1—3,300-ohm, ½-watt resistor

R2, R3—560-ohm, ½-watt resistor

RY1—Relay, DPDT, 10-amp contacts, 12 VDC coil resistance at least 100-ohms, Potter and Brumfield type MR11D or equiv. (BA stock no.

19A387, Lafayette stock no. 30-20047 or Allied type KN105-2C-12D.)

S1—SPST pushbutton switch, normally open (time-start switch)

Misc.—3¼-in. x 2½-in. x 1½-in. case, 1-amp SB fuse with pigtail leads, #14 wire, hook-up wire, printed circuit material, hardware, solder, etc.



BUILD TV amp

Donald A. Smith W3UZN

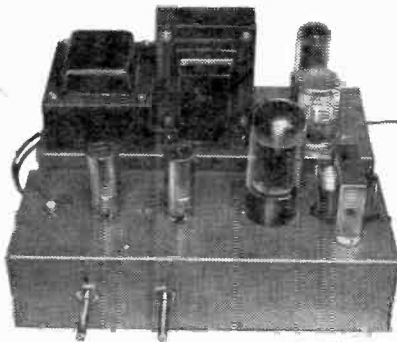

- adds pleasure to your viewing
- lets you enjoy TV's true hi-fi sound

WHO SAYS the radio-TV industry has removed the incentive to experiment with new circuits and devices? Just because the electronics manufacturers make such broad product lines is no reason there's little left for the experimenter to create or build. For proof, you're about to meet a project that presents real challenge—our TV amp. When you

TELEVISION AMP

listen to the average TV set, it's hard to believe that the sound coming out of its speaker is actually derived from high-quality FM normally associated with hi-fi reproduction. To be sure, most modern sets produce excellent pictures. Thing is, the sound portion of the program, as reproduced by many TVs, leaves much to be desired.

Odd as it may seem, if you take the sound off at the FM demodulator and feed it to a good quality amplifier and speaker system, you get quite acceptable sound quality. This really is easy to explain. Competition forces the TV manufacturer to cut corners, and this usually is done in the audio rather than the video section of the TV set. The push has been to please the viewer's eyes, maybe because many people have tin ears anyway. Besides, because viewers are still enthralled by getting pictures through the ether, why spend money for good audio in order to stimulate sales?

At best, the audio sections in TV sets are minimal. Just their 3½-in. speakers are evidence enough that they were never intended for full-range reproduction. Add to this the poor baffling for the speaker because of lack of proper acoustic design in the cabinet, and you have most of the elements contributing to the overall poor audio quality of the average TV set. If you raise the volume to approach that necessary for good orchestral reproduction, the distortion usually is so high you can't enjoy the music.

In some instances, feed the audio from the FM demodulator into a good-quality

audio amplifier and speaker system, and you wish you'd left well enough alone. This certainly is true in the case of sets that have inadequate filtering in their power supply, resulting in much too high a hum level. And it's hard to tell if a set is in this category until tested because the limited range of both the audio amplifier and speaker in the TV set spell death to the lows. Only when you feed its output to audio equipment with extended range will the deficiency in filtering show up. Best thing to do in such a situation is to get rid of the TV set. It's cheaper in the long run than trying to improve its basic design.

What Can Be Accomplished. If you're reasonably sure that your TV has adequate filtering and basically good design all the way through the FM demodulator to the audio, be venturesome, build our *TVamp* amplifier and add new dimensions to that TV. *TVamp* is a wide-range, low-distortion, medium-power amplifier especially designed to fit within the confines of the average TV set cabinet. In spite of its size, it has sufficient output to drive the popular bookshelf speaker systems (which are relatively inefficient).

In order to fit the *TVamp* into available space in the TV cabinet, the power supply is built on a separate chassis from the amplifier. Also, *TVamp* was designed so that it's possible to connect it to a TV with a minimum change in the TV's wiring. This permits quick restoration of the TV to its original state, in the event you dispose of the TV and want to keep the amplifier for another application.

How It Works. *TVamp* is a conventional class-A, beam-power output power ampli-

Here's amplifier chassis in all its glory. We've identified all major parts and tubes that are on view when looking at top side of TVamp. You can't tell how good it works from how good it looks, so go ahead and build it.

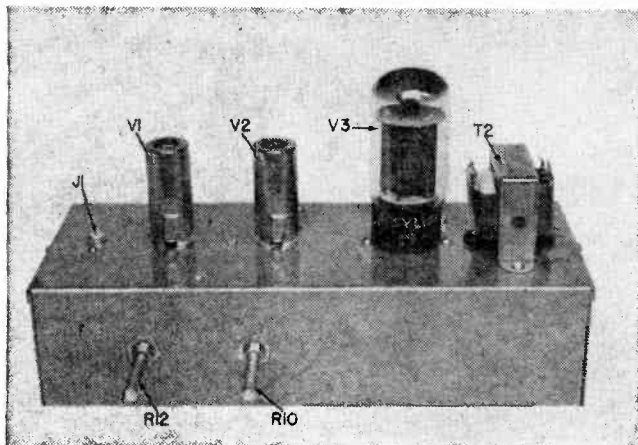

Separate power supply looks just as good as amplifier chassis and it produces hum-free high-voltage DC needed to excite tubes in amplifier. Husky components make it reliable.

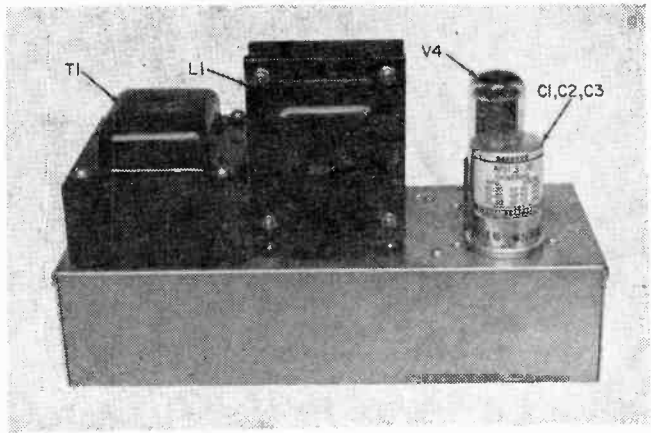

er. Two 6AV6 tubes are connected in cascade as voltage amplifiers to drive a single 6L6 beam-power output stage. The 6AV6s were used because they are readily available, either from the average experimenter's inventory or from supply houses. Resistor R15 and capacitor C13 provide inverse feedback from the output stage to its driver, the second 6AV6. Separate bass and treble boost and cut controls are used to adjust the amplifier's response to the listener's taste.

A separate power supply is used for several reasons. You might ask why not use the TV's power supply? For one, in most cases the low-voltage B supply of the TV set isn't designed for the extra load *TVamp* would place on it. Another reason is that many TV sets have tube heaters connected in series across the 117-VAC power line and it would be necessary to redesign the series circuit to power the heaters of *TVamp* (unless, of course, a separate filament transformer were used). This would be costly since there are plenty of power transformers

available at bargain prices that have both heater and high-voltage windings; in fact, you may even have one in your shop that would do the job. With such a transformer you can build a separate supply for both heater and plate power.

Since most TV cabinets are built to surround the chassis and picture tube, there is little unused space within the cabinet. By mounting *TVamp's* power supply on a separate chassis from the amplifier you have a better chance of locating each of the two smaller chassis in unused spaces in the cabinet than if the unit were mounted on a single large chassis. Also, since the name of the game is to improve the audio response of the TV with minimal changes in its original circuitry, and to maintain loading on the set's power supply so as not to disturb voltage limits designed into the set, it's wisest to use a separate power supply.

In fact, when you connect the new amplifier across the TV's volume control (described under the paragraph on connecting

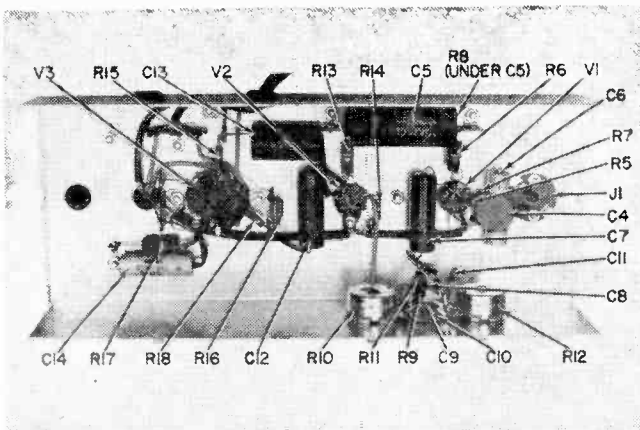

Here's what important side of amplifier looks like if you use same parts we did and decided to follow our layout. Just stick to good wiring practices in hooking it up. There's nothing critical to need special precautions.

TELEVISION AMP

TVamp to the TV set), don't forget one important step. Even though you've removed the need for audio amplification in the TV, be sure to substitute a 3 to 5 ohm, 5-W resistor in place of the voice coil of the speaker but leave the audio tubes still operating. This is necessary to maintain the load on the power supply so the voltages required for the RF portion remain at their design levels for stable TV operation.

Building TVamp. We used two chassis, each 10 x 4 x 2½ in. Lay out all parts as shown in our photos and use a sharp, pointed awl to mark the centers of all holes. After

center punching the holes, drill and deburr them. We purposely didn't include a pictorial layout since you have a wide choice of parts that could have different mounting dimensions.

Since the circuit isn't especially critical as to layout, we leave this to your discretion to suit the parts you purchase (or already have). Shielded 2-conductor cable is used to feed the heater voltage from the power-supply transformer windings to the amplifier chassis to reduce the possibility of stray induced hum from these leads. The value of R3 is based on the high voltage output of the particular power transformer you use. The transformer listed in the Parts List develops 300 VAC either side of the CT and we used a value of 50 ohms for R3. To calculate the value of R3 for higher volt.

PARTS LIST FOR TVAMP

- C1, C2, C3** 20-20-20- μ F, 450-V electrolytic capacitor (Lafayette 34E74236 or equiv.)
- C4, C10** 0.01- μ F, 600-V tubular paper capacitor (Lafayette 34E82510 or equiv.)
- C5** 16- μ F, 450-V electrolytic capacitor (Lafayette 34E55672 or equiv.)
- C6, C14** 25- μ F, 25-V electrolytic capacitor (Lafayette 34E55210 or equiv.)
- C7** 0.1- μ F, 600-V tubular paper capacitor (Lafayette 34E82700 or equiv.)
- C8** 470-pF, 1000-V ceramic disc capacitor (Lafayette 33E22997 or equiv.)

- C9** 0.001- μ F, 600-V tubular paper capacitor (Lafayette 34E82312 or equiv.)
- C11** 0.005- μ F, 600-V tubular paper capacitor (Lafayette 34E82445 or equiv.)
- C12** 0.05- μ F, 600-V tubular paper capacitor (Lafayette 34E82643 or equiv.)
- C13** 4- μ F, 450-V electrolytic capacitor (Lafayette 34E55631 or equiv.)
- F1** Type 3AG-2 amp fuse in panel mount fuse holder (holder Lafayette 13E11778, fuse Lafayette 13E10150 or equiv.)
- L1** 4.5-H, 200-mA filter choke (Stancor C1411 or equiv.)
- R1, R9** 220,000-ohm, ½-watt resistor

Here's hookup of power supply. Note we've also shown how to use TV's power switch to turn on TVamp.

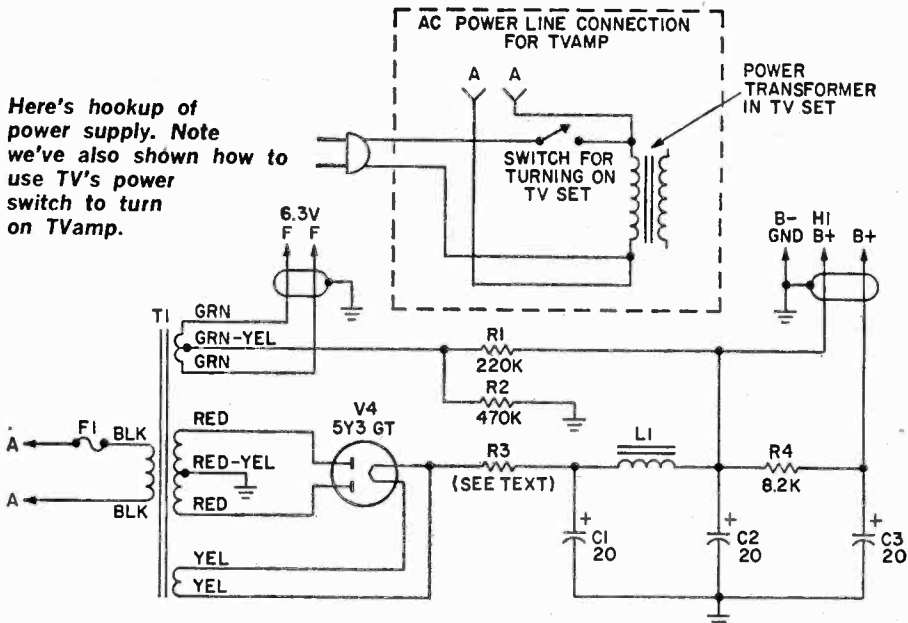

We showed you wiring side of amplifier on page 53, so here's what wiring side of power supply looks like. Simple, isn't it? With all that room under chassis you can do neat wiring job.

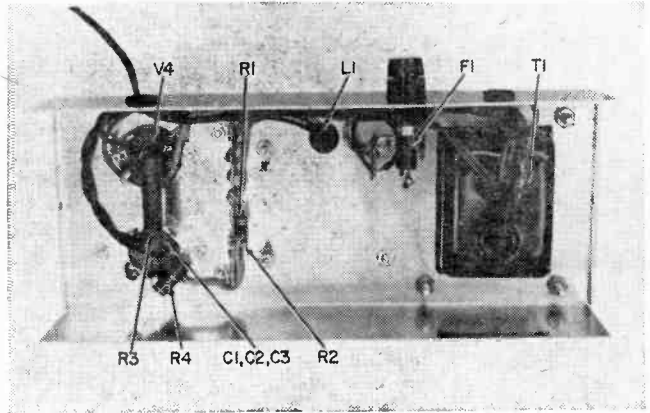

ages divide the amount of voltage in excess of 300 V by 0.075 (e.g. if voltage is

360 V the excess is 60 V so 60 V divided by 0.075=800 ohms). This is how you utilize

- R2 47,000-ohm, 1/2-watt resistor
- R3 10-W resistor (see text for resistance)
- R4 8200-ohm, 2-watt resistor
- R5 1,500,000-ohm, 1/2-watt resistor
- R6, R13 100,000-ohm, 1/2-watt resistor
- R7 1200-ohm, 1/2-watt resistor
- R8 12,000-ohm, 1/2-watt resistor
- R10, R12 500,000-ohm, linear taper potentiometer (Lafayette 33E11487 or equiv.)
- R11 22,000-ohm, 1/2-watt resistor
- R14 2200-ohm, 1/2-watt resistor
- R15 150,000-ohm, 1/2-watt resistor
- R16 470,000-ohm, 1/2-watt resistor
- R17 180-ohm, 2-watt resistor

- R18 10,000-ohm, 1/2-watt resistor
- T1 Power transformer; 600-V CT @ 90 mA, 5-VAC @ 1 A, 6.3-VAC @ 3 A (Stancor PM 8409 or equiv.)
- T2 Universal output transformer: primary, 1.5 to 10-K ohms; secondary to voice coils (Stancor A 3849 or equiv.)
- V1, V2 6AV6 vacuum tube
- V3 6L6GC vacuum tube

Misc. Two 10 x 4 x 2 1/2-in. interlocking chassis (LMB 144 or equiv.), shielded cable Belden #8450 hookup wire, solder, knobs, hardware, screws, nuts, etc.

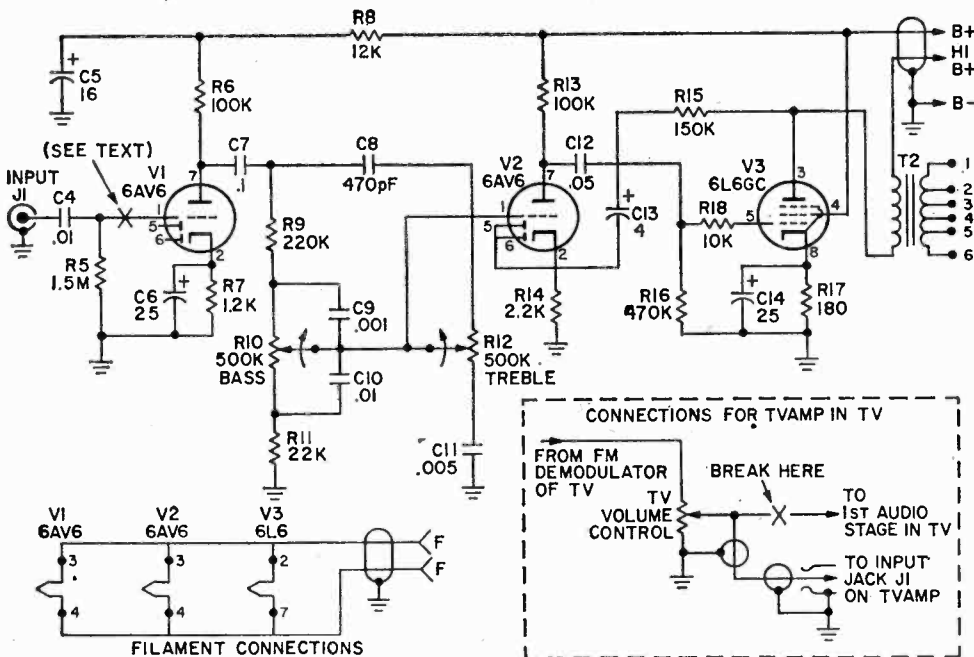

TELEVISION AMP

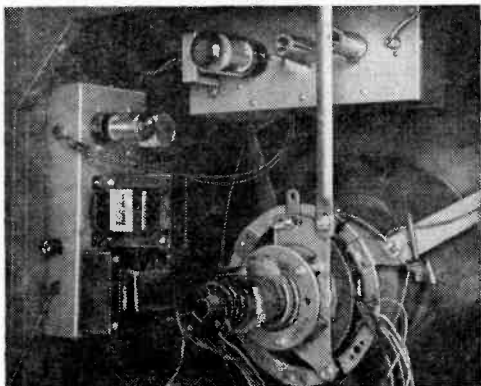

We mounted amplifier chassis on top of set so controls would be readily available. Power supply can go anywhere it fits.

whatever transformer is in your stock pile.

You may want to include a separate volume control on *TVamp* so you can use it as an auxiliary amp (say for playing records or handling the output of an AM/FM-stereo tuner in addition to the audio from the TV). Replace R5 with a 1.5-M pot. Connect its wiper to grid of V1 after breaking lead at X.

Installing *TVamp*. As mentioned previously, the purpose of mounting the amplifier and its power supply on separate chassis was to facilitate fitting it into available space within the TV cabinet. Our photo shows how we placed the units in an old model Philco set. We drilled holes in the top to let the controls extend outside the cabinet for ease in adjusting. The power supply was placed on the side of the cabinet, in a clear space near the top.

Again, the final choice of how you position your two chassis is left to you and is dependent on the available space in the particular TV you're using. The amplifier and power supply chassis are held in their respective locations in the cabinet by short bolts and nuts fastened through the chassis and the cabinet.

You will have to remove the TV chassis in order to make connections to its volume control and also to its power switch so that the amplifier will be turned *on* whenever the TV is *on*. Trace the power connections to the TV set's power transformer and connect the (primary) power leads of the *TVamp* transformer so that they will be connected to the power line in parallel with the power trans-

former of the TV through its switch. Use two different colors of hookup wire to connect the B+ and B- from the power supply to the amplifier chassis for easy identification.

Now that you have the modifications for using the TV's power switch to control power to *TVamp*, the only other change necessary to the TV while the chassis is out of the cabinet is to bring output from the FM demodulator to the input of *TVamp*. To do this, disconnect the wire or coupling capacitor now connected to the center contact of the TV's volume control; in its place connect the center lead of a piece of either coaxial cable or low-capacity shielded cable long enough to reach the input jack of *TVamp*. The shield of the cable is connected to the ground side of the volume control.

It's best to ground the lead removed from the volume control, thus removing the possibility of having stray signals induced into the audio portion of the TV. Danger is that they might be of sufficient magnitude to change the load on the TV's power supply and thus affect the overall operation of the set. Don't forget to disconnect the TV's speaker and substitute a 3 to 5 ohm resistor in its place.

When these connections have been made, the TV chassis can be put back in its cabinet. Remember, you need a pair of leads from the output transformer of *TVamp* to the external speaker system. And when locating this speaker system, remember to keep it near the picture tube so as not to ruin the illusion that the sound is coming from the picture. If you place the speaker across the room you won't affect the tone quality, but you'll most certainly ruin the illusion of the sound coming from the performer appearing on the picture tube.

Now that you've built the amplifier and tested it, sit back and really enjoy your TV. Look and listen to a musical group and find out what you've been missing. You'll be able to listen to it at reasonable volume and hear all of the instruments with little or no distortion; soloists will be more enjoyable because of the improvement in reproduction. You'll discover that what we said about the quality of sound available at the output of the FM demodulator is correct—it's truly high fidelity. Then, too, you've got a bonus if you decide to use this high-quality amplifier for a hi-fi phonograph. Why not take advantage of its excellence for this application too? ■

VISULERT

ADD A FLASHING LIGHT TO YOUR TELEPHONE BELL

by Robert S. Kelland

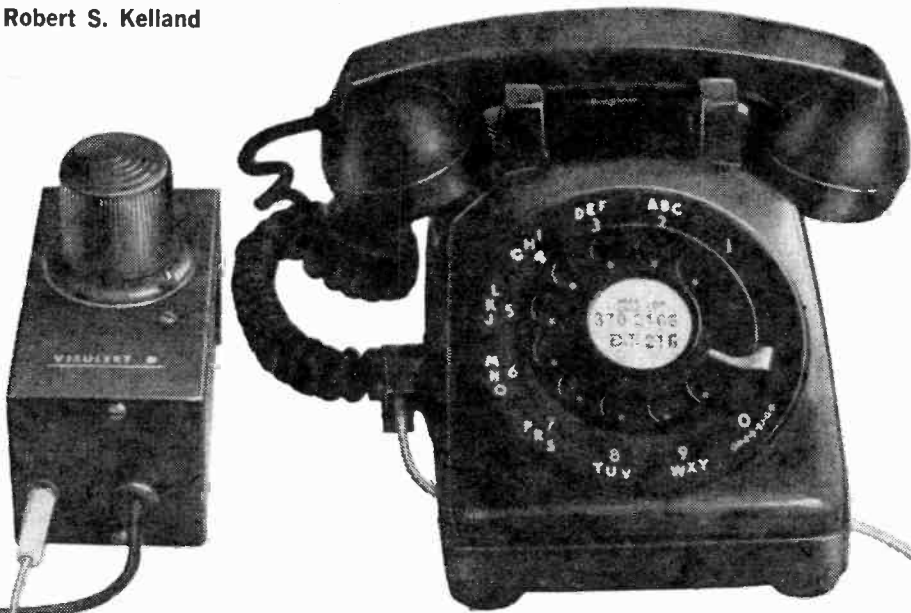

ARE there times when you'd like to turn down the telephone bell so that baby or grandma can nap, and yet you need to know when that important call comes in? Because high platform noise overrides the normal telephone bell, and you're skeptical of the effectiveness of so-called loud ringers, do you have need for another means of alerting the shipping clerk to take a telephone call? Or, perhaps you know a deaf person who can't hear the phone bell at all.

Our Visulert, a small, self-contained, easily constructed telephone accessory, solves all these problems. And the beauty of it is that you don't have to connect it directly to the telephone lines, a no-no rule of most telephone companies.

An inductive pickup coil ordinarily used for recording phone messages, placed on or under a telephone, picks up just the ringing pulses by magnetic induction and feeds them to an am-

VISULERT

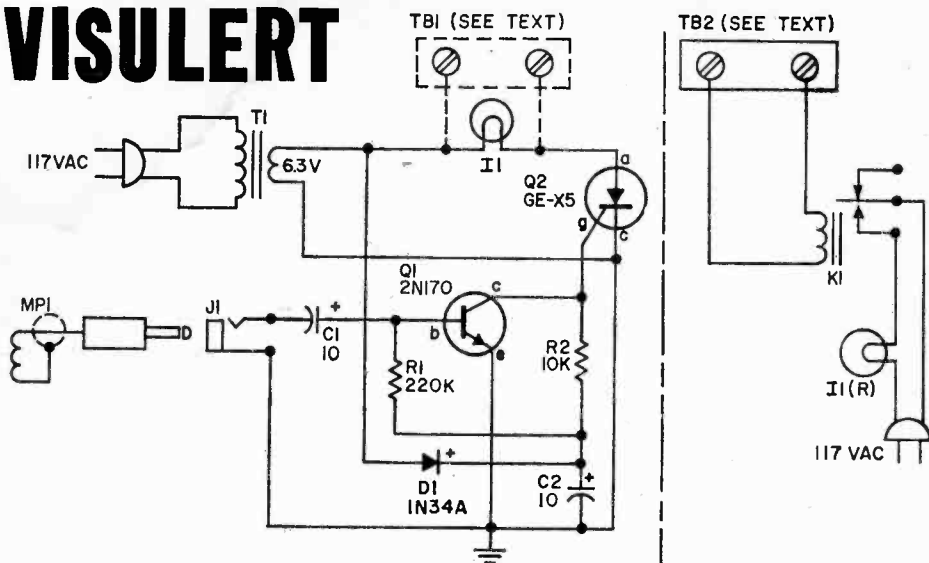

PARTS LIST FOR VISULERT

- C1, C2—10-uF, 35-VDC miniature electrolytic capacitor (Radio Shack 272-1025 or equiv.)
- D1—75-PIV, 50-mA silicon diode, type 1N34A
- I1—Panel-mounting pilot lamp assembly with clear plastic dome lens (Lafayette 99E63406 for miniature bayonet-base lamp 32E66194 or equiv.) (note: our model was adorned with the addition of a large plastic lens salvaged from a toy fire engine)
- J1—Miniature phone jack (Lafayette 99E63141 or equiv.—includes matching plug)
- MP1—Inductive pickup coil assembly (Radio Shack 44-533 or equiv.)
- Q1—GE 2N170 npn germanium transistor
- Q2—GE X5 silicon-controlled rectifier
- R1—220,000-ohm, 1/2-watt resistor
- R2—10,000-ohm, 1/2-watt resistor
- T1—Filament transformer; primary 117 V, 50-60 Hz; secondary 6.3 V at 1.2 A (Radio Shack 273-050 or equiv.)
- 1—4 x 2 1/4 x 2 1/4-in. aluminum minibox (Lafayette 12E83704 or equiv.)

- 1—AC power cord (Lafayette 12E39011 or equiv.)
- 1—2 point + ground lug tie strip (Lafayette 32E12073 or equiv.)
- 1—5 point + ground lug tie strip (Lafayette 32E12131 or equiv.)
- Misc.—Hookup wire, solder, hardware, spray paint or pressure-sensitive vinyl sheet (Contac or equiv.), grommets, etc.
- If remote lamp is used add following:
- I1(R)—50 to 250W, 117V lamp bulb in porcelain Edison base lamp socket, 3/4-in. diameter base (Lafayette 13E1359 or equiv.—mount on outer surface of junction box or cover panel of suitable box used)
- K1—Spdt miniature ruggedized remote control relay (Lafayette 99E60915 or equiv.—mount on inner surface of box cover panel)
- 1—Pane for box (Lafayette 19E37010 or equiv.)
- 1—6 1/4 x 5 1/4 x 2 1/4-in. Bakelite Box (Lafayette 19E20016 or equiv.)
- 2—2-contact screw terminal strip (Lafayette 32E644488 or equiv.) (TB1, TB2)

plifier in the Visulert. This amplifier triggers an SCR that switches a lamp on and off in step with the pulsing of the ringing signal.

How It Works. Provided magnetic pickup MP1 is properly located within the ringer's magnetic field an electrical voltage is induced in the coil of MP1 whenever the ringer of a telephone is energized. This voltage is fed via jack J1 to the base of transistor Q1. The resulting amplified signal output on the collector of Q1 is coupled to the gate of silicon controlled rectifier Q2 and triggers it on whenever the signal appears on its gate. Lamp I1 is turned on

each time Q2 is triggered on and remains on until Q2 is triggered off by a drop in the induced signal level. Since the ringer voltage is pulsating, the Visulert will flash its lamp on and off, following the ringer pulses.

Building Visulert. Our model is housed in a standard 4 x 2 1/4 x 2 1/4-in. aluminum minibox. Though the layout isn't critical, you will speed up your construction time by following our layout as shown in our photos.

All of the components are mounted either directly on the minibox or to tie strips, which
(Continued on page 116)

Cal-Trace



by Homer L. Davidson

**Disciplining
the signal injector
makes it
an inexpensive
signal generator**

No, it's not a miniature, radio-controlled rocket launcher, though at first glance a non-technical person may misconstrue it to be one.

Heart of our *Cal-Trace* is the EICO model PS1 Signal Injector probe. It's a pocket-sized, self-powered generator that's extremely handy for locating the faulted portion of an electronic circuit, be it a transistor radio, a hi-fi system, a tape recorder, a TV set, a CB rig, etc. The signal the PS1 generates is so rich in harmonics that it covers RF, IF, and audio ranges.

There's only one problem: as you move from stage-to-stage, starting from the speakers and working back towards the input, the build-up in signal level in your progression from stage-to-stage may be such that before arriving at the antenna or the input, a point is reached where this relatively large signal blocks the device. This creates a false impression as to where the trouble really lies.

An easy way to solve this problem is to use an attenuator to control the output level of the signal injector. We've gone one step further by providing a calibrated scale on the attenuator. This is a big help in determining first if a particular stage actually has gain and then in giving a relative value to the

Cal-Trace

measure of the amount of gain in the stage. The combination of PS1 with an attenuator is an easy way to make an inexpensive signal generator.

How To Make It. *Cal-Trace* is such a simple device that you should be able to build

PARTS LIST FOR CAL-TRACE

- J1—Tip jack (Lafayette 32E65113 or equiv.)
- J2—Open circuit phone jack (Lafayette 99E62135 or equiv.)
- P1—2-conductor phone plug to fit J2 (Lafayette 99E62218 or equiv.)
- P2—Phana needle test prod (Lafayette 32E65089 or equiv.)
- R1—1000-ohm, linear taper potentiometer (La-

- fayette 33E11149 or equiv.)
- 1—Dial plate (Lafayette 30E40953 or equiv.)
- 1—2¼ x 2¼ x 4-in. minibox (Lafayette 12E83704, 12E83878 or equiv.)

Misc.—Scrap aluminum strip ½ x 6⅞ in. for clamp K (could be brass or phosphor bronze), hookup wire, solder, screws, nuts, etc.

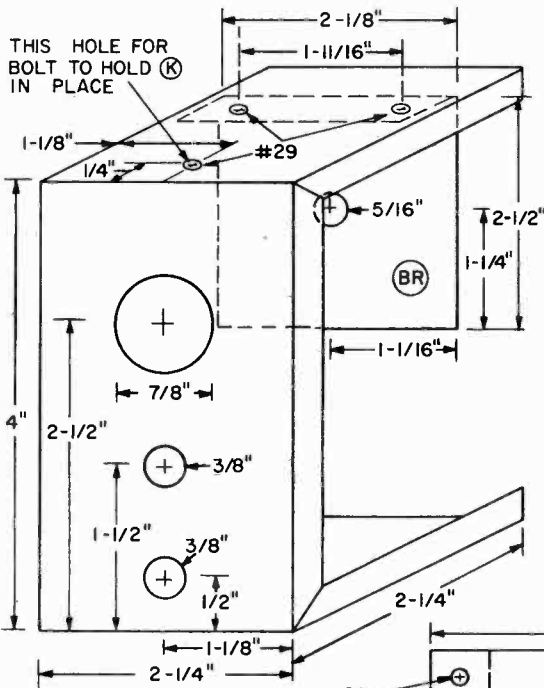

Cal-Trace's schematic shows simple hookup; however, one or two precautions are pointed out in text.

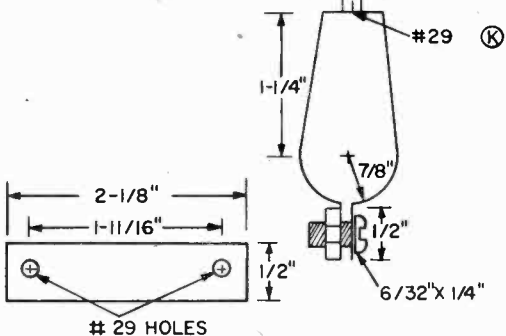
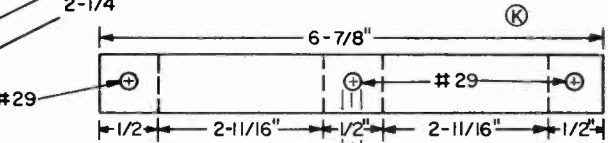
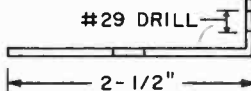
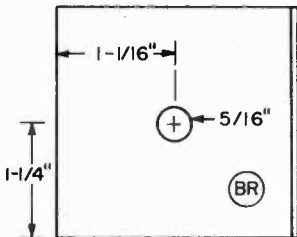
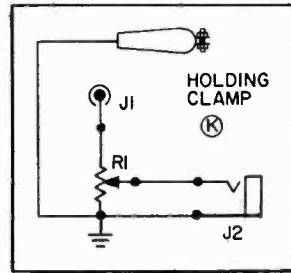

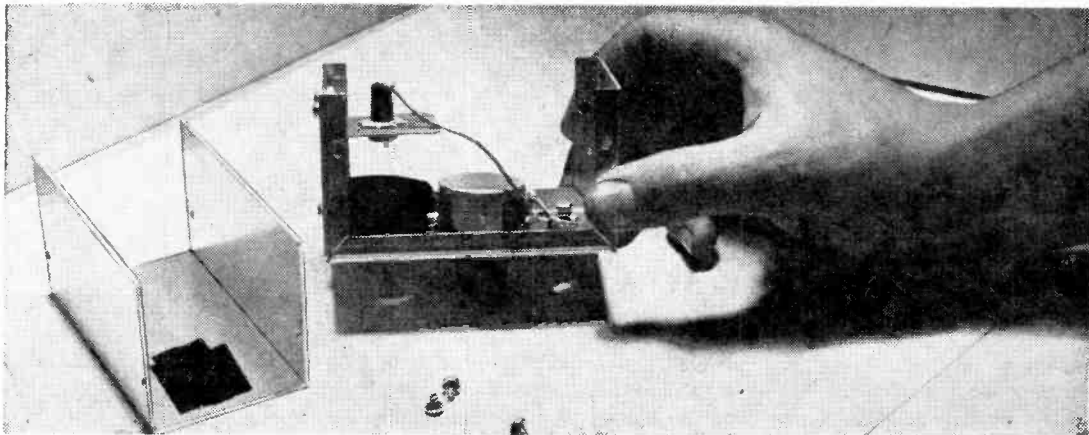

This innards view easily locates all parts needed to make Cal-Trace. You can see how tip jack is centered over spring clamp that holds signal injector.

it in little more than an hour. It's housed in a 2¼ x 2¼ x 4-in. minibox. Mark centers of holes on the front panel and top of box, then, being careful not to mar the finish of the minibox, drill and de-burr all the holes. Mount the potentiometer and its knob and calibration scale as well as the phone jack J2 on the front panel.

Make a bracket (Br) to fit inside the box on which tip jack J1 is centered. The tip jack makes contact with the output probe of the signal injector and also helps to hold it in position, centered in the hole in the front panel. Make spring clip (K) from an aluminum strip; a scrap of about the same thickness as the minibox will do nicely. Form it as shown in our drawing so that it grips the signal injector body snugly yet permits its free insertion and extraction when required. Mount the clip on front panel as shown in the assembly drawing.

Output test lead is made from two lengths of hookup wire approximately 3 ft. long. A phone plug to fit the J2 jack is connected to one end of these leads. On the opposite end of the lead connected to the sleeve of the plug, fasten an alligator clip. Fasten a standard test lead prod to the free end of the other lead, connected to the tip of the phone plug.

Wire the unit as shown in the schematic, taking care to connect the arm of the potentiometer (center lead) to J2 and the high side of the potentiometer (lead to the left when looking at the rear) is connected to J1. When mounting the spring clip to the panel be sure to remove any paint that may prevent metal-to-metal contact. This point is the ground return for the signal injector.

Now that you have completed this easy wiring and assembly you're ready to use *Cal-Trace*.

How To Use It. We'll just give the basics. Certainly you'll be able to go on from these and devise many ways to use this very handy service instrument.

Place the PC1 signal injector in its holder through the panel of *Cal-Trace*, being sure that its probe is firmly seated in J1, and plug in the test leads. Connect the alligator clip to the ground (in most instances the chassis) of the device you want to test and turn the probe on by locking its battery switch in the *on* position. Set the calibration control on its highest point for maximum signal.

Starting at the speaker, touch the probe of the test leads first to the speaker and then to the input of each stage from the speaker

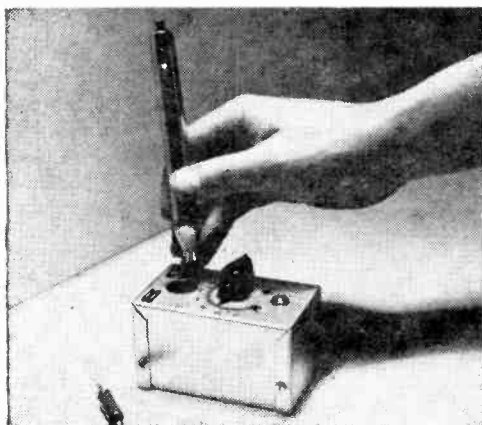

It's easier than threading a needle—just put the signal tracer in place and you're ready to check gains, trace circuits, etc.

Cal-Trace

until you reach the antenna or input. It might be wise to try the unit out first on a set that is working so you get the hang of it and get some idea as to how much, approximately, to reduce the control as you proceed back to the input. Now try a defective receiver. When you reach a faulted stage you will no longer hear the signal. Remember, you need maximum signal at the speaker for the gain of that stage. Bear one thing in mind: the lower the signal from the injector, the easier it's going to be to determine whether or not a particular stage is functioning properly.

You can measure the relative gain of a stage by comparing the setting of the control under test with the setting to give constant output for the preceding stage. If you require more attenuation to maintain constancy

of output it is obvious that the stage under test is functioning and that it is increasing the signal level in proportion to the amount of attenuation you have inserted to maintain constancy of output. This will be true for all amplifier stages.

If you cannot tune in a station on a receiver but can get the injector signal through from the antenna, then, most probably, the oscillator of the receiver is not working.

Defective transistors can be checked by injecting the signal first to the base and then to the collector. If no signal is heard from the base but is heard from the collector, the transistor is defective.

The same procedure can be followed in checking coupling capacitors, especially the tiny electrolytic types in transistor circuits. If the signal is weak or non-existent on the input side but normal on the output side of the coupling capacitor it should be replaced. These are just a few tips on how to use *Cal-Trace*. As you gain experience with it you will devise your own methods to use it to best advantage. ■

Current Swinger

Supplying a precise 9V at currents up to 300 mA DC, the Current Swinger power supply features laboratory grade regulation and overcurrent protection. Whenever the device being powered attempts to draw more than 300 mA—such as caused by a short circuit—the IC voltage regulator section of Current Swinger automatically removes the applied voltage from it. The 300 mA current limitation is determined by transformer T1's rating. If a transformer capable of delivering higher current is used, resistor R3 can be changed to 0.5 ohms for a 600 mA maximum output (the IC limit).

Leads to the IC should be as short as possible, with capacitor C2 installed directly

at terminal 7 and connected as close to ground as possible. The transformer we used in the Current Swinger supplies 20V rms centertapped. ■

PARTS LIST

- C1—1000 μ F, 15 VDC
- C2—0.1 μ F, 15 VDC
- C3—25 μ F, 15 VDC
- IC1—Motorola MC 1460R
- R1—12,000-ohms, 1/2-watt, 5%
- R2—6,800-ohms, 1/2-watt, 5%
- R3—1.8-ohms, 1/2-watt, 1 or 5% (see text)
- T1—Low voltage rectifier transformer. (see text)
- SR1, SR2—Silicon rectifier, 750 mA, 50 PIV

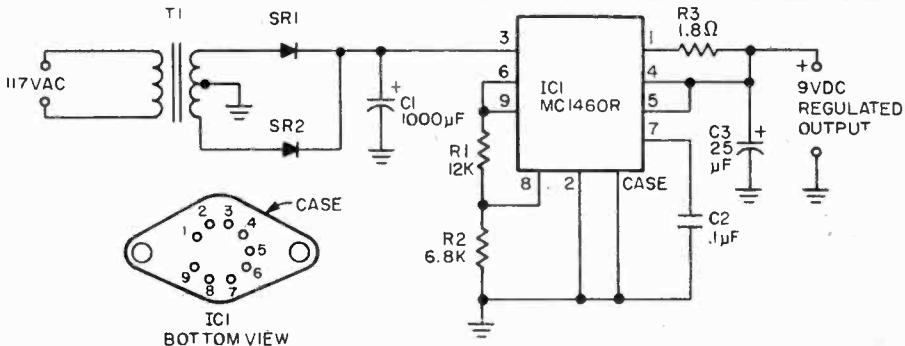

8 great new Heathkit products you can assemble yourself...and save

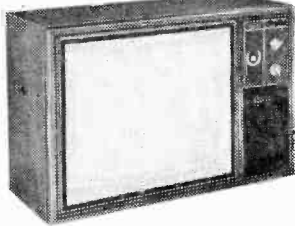

NEW Heathkit 21V Color TV — solid-state design plus detent UHF tuning

The new Heathkit GR-271 is the 21-in. (measured diagonally) version of our famous GR-900, the most advanced color TV we've ever offered. The GR-271 has the same state-of-the-art tuning convenience with power detent selection of all VHF and any 12 pre-selected UHF channels; exclusive angular tint control for consistently better flesh tones; voltage controlled varactor UHF tuner & MOSFET VHF tuner for unmatched sensitivity; ultra-rectangular matrix tube with full 226 sq. in. viewing area. Plus, the GR-271 has built-in dot generator, convergence panel and volt-ohm meter — full remote control options, too. It's Heathkit TV at its finest in a space-saving size.

Kit GR-271, less cabinet, 121 lbs. 499.95*
 Assembled GRA-501-21, table model cabinet shown, tough walnut Marlite® finish, 33 lbs. 54.95*

NEW Heathkit Digital Alarm Clock



The exciting Heathkit GC-1005 Digital Clock displays hours, minutes and seconds on highly visible cold-cathode readout tubes. A gentle "beeper" alarm can be set for 24-hour cycle and features a snooze switch that gives you seven more minutes of sleep before the alarm sounds off again. The all-solid-state circuitry is designed to display either conventional 12-hour or 24-hour international time (Manual shows you how to wire it for the readout you prefer). Includes am/pm indicator light to facilitate setting for time and alarm. Special fail-safe circuit flashes all "eights" on display if 60-cycle line voltage is interrupted.

Kit GC-1005, 4 lbs. 54.95*

NEW Heathkit 30 MHz Counter

The Heathkit IB-1100 gives 1 Hz to over 30 MHz counting on a full 5-digit readout with 8-digit capability. The lighted overrange indicator makes misreading virtually impossible. Stable time-base circuitry assures accuracy better than ±3 ppm from 22° to 37° C. Diode protected J-FET gives improved triggering over 100 mV to 150 V input range. Solid-state circuitry mounts on one large board.

Kit IB-1100, 6 lbs. 169.95*



NEW Heathkit C-D Ignition System

This simple, one-evening kit will increase spark-plug and point life up to 50,000 miles on any car or truck using a 12-volt negative ground system. The Heathkit CP-1060 automatically varies spark duration — longer for low-battery, cold-morning starts, shorter for high-rpm cruising. Screw-on terminals make installation easy; external pushbutton lets you override system without removing leads.

Kit CP-1060, 4 lbs. 39.95*

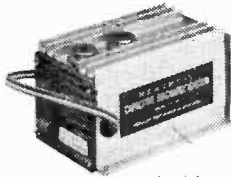

NEW Heathkit component-quality stereo for cars

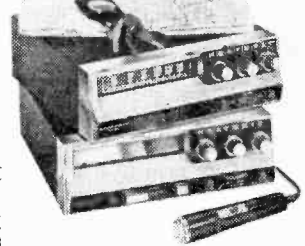

Mobile FM stereo tuner features clean 7 watts (3.5 W per channel) with less than 2% THD; frequency response ±1 dB; 30 Hz to 15 kHz; 3 uV sensitivity; 60 dB selectivity; 40 dB min. separation. Stereo cassette deck offers hi-fi stereo cassette entertainment plus single-channel dictation while you drive. Single stereo amp powers either or both units. Choice of 5" door mount or 6" x 9" rear deck speakers (19.95* the pair).

Kit CR-1000, tuner, 6 lbs. 164.95*
 Kit CT-1001, cassette deck, 9 lbs. 89.95*
 Kit CRA-1000-1, amplifier, 3 lbs. 29.95*

NEW Heathkit 2 1/2-Digit Digital Multimeter

A compact, solid-state multimeter with digital readout — at a fantastic kit-form price. The new Heathkit IM-1202 has four overlapping ranges to measure voltages from 10 mV to 1000 V on DC (either polarity), 10 mV to 700 V rms on AC, 10 uA to 2.5 A on AC or DC current. Five resistance ranges measure from 1 ohm to 2 megohms. Front panel polarity switch reverses inputs without changing leads. Simple to build (2 or 3

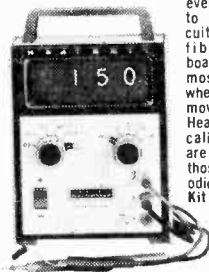

evenings) and simple to service. Most circuitry mounts on two fiberglass circuit boards which are almost totally exposed when the case is removed. And exclusive Heath built-in lifetime calibration standards are all you need for those initial and periodic adjustments.

Kit IM-1202, 6 lbs. 79.95*

NEW Heathkit Dolby Cassette Deck

A kit-form cassette deck utilizing the famous Dolby® noise reduction system. Accommodates the greater fidelity and dynamic range of chromium dioxide cassettes. Independent switches provide Dolby on/off and regular or CrO₂ bias control. Domestic-make tape transport comes preassembled for easy kit building.

Kit AD-1530, 21 lbs. 249.95*
 ADA-1530-1, dust cover, 1 lb. 4.95*

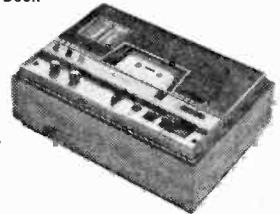

HEATHKIT ELECTRONIC CENTERS — ARIZ.: Phoenix, 2727 W. Indian School Rd.; CALIF.: Anaheim, 330 E. Ball Rd.; El Cerrito, 6000 Potrero Ave.; Los Angeles, 2309 S. Flower St.; Pomona, 1555 Orange Grove Ave. N.; Redwood City, 2001 Middlefield Rd.; San Diego (La Mesa), 8363 Center Dr.; Woodland Hills, 22504 Ventura Blvd.; COLO.: Denver, 5940 W. 38th Ave.; CONN.: Marlford (Avon), 395 W. Main St. (Rte. 44); FLA.: Miami (Hialeah), 4705 W. 16th Ave.; GA.: Atlanta, 5285 Roswell Rd.; ILL.: Chicago, 3462-66 W. Devon Ave.; Downers Grove, 224 Ogden Ave.; IND.: Indianapolis, 2112 E. 62nd Ave.; KANSAS: Kansas City (Mission), 5960 Lamar Ave.; MD.: Baltimore, 1713 E. Joppa Rd.; Rockville, 5542 Nicholson Lane; MASS.: Boston (Wellesley), 165 Worcester St.; MICH.: Detroit, 18545 W. Eight Mile Rd. & 18149 E. Eight Mile Rd.; MINN.: Minneapolis (Hopkins), 101 Shady Oak Rd.; MO.: St. Louis, 9296 Gravois Ave.; N.J.: Fair Lawn, 35-07 Broadway (Rte. 4). N.Y.: Buffalo (Amherst), 3476 Sheridan Dr.; New York City, 35 W. 45th St.; Jericho, L.I., 15 Jericho Turnpike; Rochester, Long Ridge Plaza; OHIO: Cincinnati (Woodlawn), 10133 Springfield Pike; Cleveland, 5444 Euclid Rd. PA.: Philadelphia, 6318 Roosevelt Blvd., Pittsburgh, 3482 Wm. Penn Hwy.; TEXAS: Dallas, 2715 Ross Ave.; Houston, 3705 Westheimer; WASH.: Seattle, 221 Third Ave.; WIS.: Milwaukee, 5215 Fond du Lac.

Send For Free '73 Heathkit Catalog



HEATH Schlumberger	
HEATH COMPANY, Dept. 26-1 Benton Harbor, Michigan 49022	
<input type="checkbox"/> Please send FREE Heathkit Catalog.	
<input type="checkbox"/> Enclosed is \$ _____, plus shipping.	
Please send model(s) _____	
Name _____	
Address _____	
City _____ State _____ Zip _____	
Prices & specifications subject to change without notice. *Mail order prices; F.O.B. factory.	
CL-449	

CIRCLE NO. 1 ON PAGE 17 OR 117

POP-UP TV MAKES THE SCENE

TV's big eye can bug the decor out of any room setting. The Mrs. spends considerable time and your hard cash to make the living room or play room an attractive area for the family to meet, entertain and be entertained. But the big ugly eye scans the scene even when not in use. So, H. L. Miller of Sarasota, Florida tells his TV to bug out.

It is easy to do provided you take the pains. Mr. Miller cut a hole in the top of his hi-fi console and installed a movable platform that goes up and down at the press of a button. Guide rails eliminate the shimmy and shake as the TV is raised and lowered on the platform. A fractional horsepower motor does the work by turning a drum that winds or unwinds a pulley system.

A limit switch at the top and bottom travel position of the platform turns off the motor automatically reversing it for the next trip. No modifications are required on the TV whatsoever—just be sure to leave enough slack in the power cord and antenna lead-in wire. Also, the platform trips an on/off power switch that controls the juice to the TV. Think of pop-up TV the next time you want to say, "Bye-bye," to the big eye!

By **Emmett Fluffin**

ELECTRONICS HOBBYIST

GEN-TRACE



Beginner's IC Project

Build this troubleshooting test unit that generates and traces signals

by Edward A. Morris, WA2VLU

Two of the most widely and easily used troubleshooting techniques popular today are the signal-substitution and the signal-tracing methods. Especially helpful on dead sets, these methods can be used on a wide variety of communications, entertainment, and industrial electronic equipment—just about everything, in fact, from the All American 5 BCB receiver to servo amplifiers! And best of all, you can put these two most practical troubleshooting techniques to work for you without having to invest in a yard or two of fancy, expensive test equipment.

Gen-Trace is both a broad-band signal generator and an audio signal tracer, all in one package. Output of the signal generator is a 1000-Hz square wave. Its fast rise-fall times produce harmonics extending well beyond 100 MHz (most garden-variety signal squirters poop out after only a few MHz). The buffered out-

put of the generator is short-circuit proof and is frequency-stable when driving low-impedance loads. Maximum output is 2 volts peak-to-peak.

The signal-tracer portion has a maximum gain of about 50 dB, more than enough for tracing through the circuit of most any device, even when dealing with small signal levels. When the RF demodulator probe (described later) is connected, the unit can be used to trace through RF and IF amplifiers. Audio output of Gen-Trace is about 5 mW, enough to drive a miniature headphone of the variety supplied with transistor radios. It won't burst eardrums, but it's more than adequate for most applications.

Gen-Trace is a self-contained, all-in-one compact package. It's small enough ($3\frac{3}{4} \times 3 \times 2\frac{1}{8}$ -in.) to drop into your tool kit for field work. Simple and non-critical to build, it will take about 3 hours to

GEN-TRACE

construct. Best of all, building it won't flatten your wallet, since parts run to just over ten dollars.

How It Works. *Gen-Trace* is built around a single Motorola MC798P RTL (resistor transistor logic) integrated circuit (IC). It replaces half a dozen transistors and a dozen resistors, all at a cost of \$1.08. That represents a savings well over \$3.00 at current prices.

Signal Generator Function. Integrated circuit IC1 is comprised of six inverters, each similar to an ordinary single-stage transistor amplifier. Two of the inverters, INV1 and INV2, are cross-coupled by capacitors C1 and C2 to form an *astable multivibrator*. The output frequency of the multivibrator is established by the time constants of R1/C1 and R2/C2; output of the multivibrator is a 1000-Hz square wave, which is coupled to the input of inverter INV3. Resistor R3 and inverter INV3 isolate the multivibrator from load variations at the output terminals and thus help ensure frequency stability.

The output of this buffer inverter is coupled to potentiometer R4, the generator's level control, by capacitor C3. The controlled output level is then coupled to output jack J3 via capacitor C4.

Signal Trace Function. Normally the inverters making up the integrated circuit are

used as *on/off* switches. Thus the output has two possible states, *on/off* or *positive voltage/no voltage*. While this is exactly what's needed for the square-wave generator function, it leaves a bit to be desired for use in the audio amplifier section. In order for the inverters to amplify audio signals without excessive distortion, suitable operating bias has to be provided for the inverters.

Audio input signals introduced at jack J1 are fed to the gain control, potentiometer R5, by capacitor C5. The audio at the wiper arm of the control is then coupled to the input of the first amplifier, inverter INV6, by capacitor C6. Inverter INV6 is biased for class A amplifier service by resistor R7, producing a voltage gain for this stage of about 20.

The amplifier output of INV6 is coupled to the input of INV5, which, with R6, is identical to the first amplifier. Overall audio output is fed to the headphone jack J4 by capacitor C8.

Two AA cells connected in series to provide about 3 volts make up the power supply for the instrument. The supply is decoupled at low and high frequencies by capacitors C9 and C10, respectively.

Mechanical Construction. Mechanical layout isn't critical and can be varied to fit the particular housing used. Beginners starting their first IC project, however, should not attempt to crowd the layout into a small housing. More experienced experimenters can, if they wish, go whole hog. It's possible to build the entire instrument in an alumi-

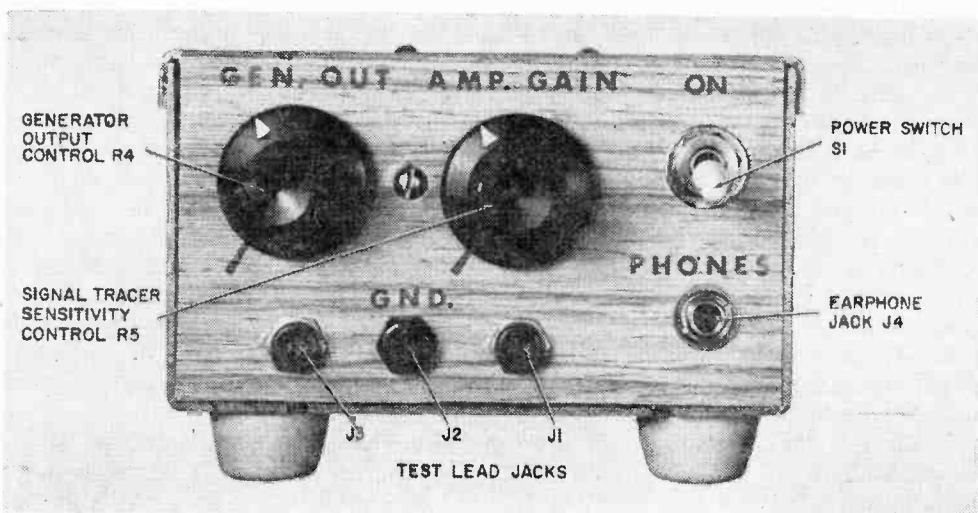

If hassling with your electric drill doesn't catch your fancy, S1's hole can be omitted by mounting substitute spst switch on rear of sensitivity control R5.

PARTS LIST FOR GEN-TRACE

- B1** 2 AA size mercury or alkaline cells (Lafayette 32-46857 or equiv.)
C1, C2, C9 0.1- μ F, 75-VDC miniature ceramic capacitor (Lafayette 33E69089 or equiv.)
C3, C6, C7, C8 10- μ F, 35-VDC miniature electrolytic capacitor (Radio Shack 272-1025 or equiv.)
C4, C4 5- μ F, 35-VDC miniature electrolytic capacitor (Radio Shack 272-1024 or equiv.)
C10 100- μ F, 35-VDC miniature electrolytic capacitor (Radio Shack 272-1028 or equiv.)
IC1 RTL integrated circuit (Motorola MC 789P or HEP573)
J1, J3 Red nylon tip jack (Amphenol 350-29200 or equiv.)
J2 Black nylon tip jack (Amphenol 350-29200 or equiv.)
J4 Subminiature phone jack (Lafayette

- 99E62119 or equiv.)
R1, R2 8200-ohm, 1/2-watt resistor
R3 1800-ohm, 1/2-watt resistor
R4 5000-ohm potentiometer, linear taper (Lafayette 33-1122A or equiv.)
R5 5000-ohm audio taper potentiometer (Lafayette 33-11216 or equiv.)
R6, R7 27,000-ohm, 1/2-watt resistor
S1 Dpdt miniature toggle switch, used as spst (Lafayette 99-61624 or equiv.)
 1 2 cell battery holder (Keystone 140 or equiv.)
 1 3 3/4 x 3 x 2 1/8-in. aluminum chassis (LMB 135 or equiv.)
 1 3000-ohm impedance earphone with 1/8-in. dia plug (Lafayette 99E25405 or equiv.)
 Misc. Rubber feet, wire, solder, perfboard (H or P pattern), knobs, push-in terminals, contact vinyl, press-on lettering (Datak or equiv.), etc.

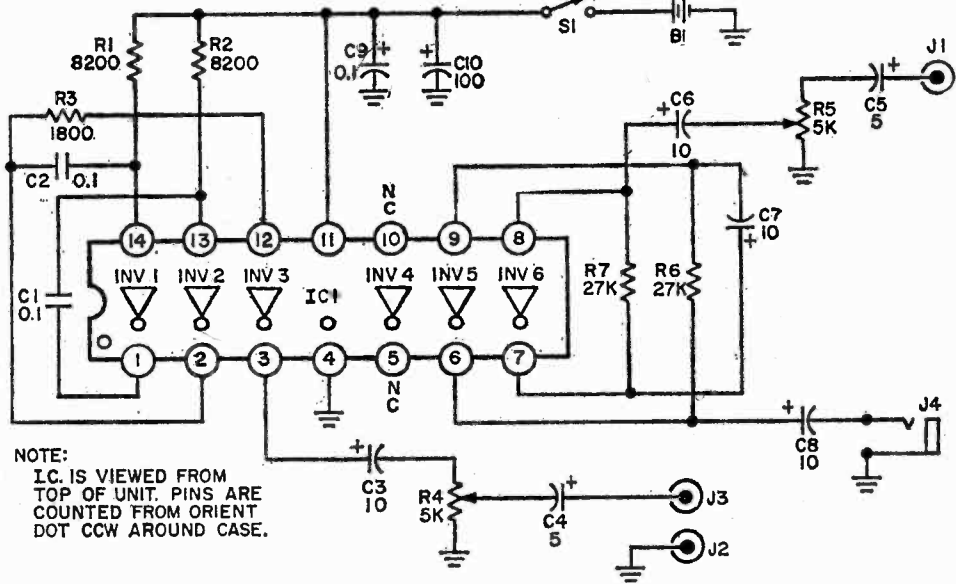

NOTE:
 IC IS VIEWED FROM
 TOP OF UNIT. PINS ARE
 COUNTED FROM ORIENT
 DOT CCW AROUND CASE.

num cigar tube by using sub- and micro-miniature components and controls!

The layout presented in this description is tailored for the housing specified in the Parts List and should provide suitable facilities for most applications of signal tracing or as a signal source. By following the mechanical details and dimensions shown, our layout can be used with a minimum of effort.

Lay out and center punch all of the holes to be drilled, according to the mechanical layout. The holes may be de-burred with a

pocket knife, file, or tapered reamer.

After completing the mechanical work on the housing, you're ready to spray-paint it or cover it with a contact adhesive vinyl material (Contac or equiv.) such as used on the model. Regardless of how much care is taken during all other phases of construction, the finished project will still look amateurish unless the housing is properly finished and lettered.

A little extra time spent on the appearance of the housing can work wonders. And while this doesn't necessarily improve the

GEN-TRACE

performance of the instrument, it makes it look more professional. It takes it out of the typical, run-of-the-mill, homebrew category.

If you elect to spray-paint the housing, care should be taken to ensure that it's clean and oil-free. A film of oil on the surface will prevent the paint from forming a good bond on the aluminum surface.

Spray on several light coats of a good quality paint. Two light coats work out much better than a single, heavy coat. Heavy coats tend to sag and run, spoiling the final finish. Allow each coat enough time to dry thoroughly before applying the next, as directed on the spray can.

A somewhat easier and faster way to finish the housing is to cover it with a contact adhesive material. This material is available in a variety of solid colors and wood tones similar to the material used on our model.

Covering the case with vinyl is very easy. Work with each half of the case separately. Cut a section of material large enough to

the material on the sides, or they can be removed with a pin prick through the vinyl. For the best adhesion press the vinyl firmly against the case.

After the case has been spray-painted or vinyl-covered, transfer lettering should be applied to really jazz up the appearance of *Gen-Trace*. If you are applying the transfer lettering over a painted finish, make very sure that the finish is thoroughly dry before adding the letters. A slightly tacky painted finish will tend to grab and hold all letters on the transfer sheet. After placing the letters where required, several light coats of a clear acrylic spray should be applied to protect the lettering from wear and abrasion. Remember to spray the protective finish with a light touch. A heavy coat will dissolve the lettering.

Electrical Construction. With the exception of S1, J1, J2, J3, J4, R5, and B1, all components are mounted on a small piece of perforated vector board. Boards with either H or P pattern are especially suited for IC projects. These hole patterns fit the IC's lead layout perfectly so that no extra holes have to be drilled.

Begin the electrical construction by wiring the circuit card according to the schematic diagram. Detailed parts placement can be determined from our photos. All wiring is effected by using small gauge bare copper wire, with insulated tubing added where necessary (crossovers of wiring or other parts) to prevent shorts. The IC is mounted by passing its leads through the pattern

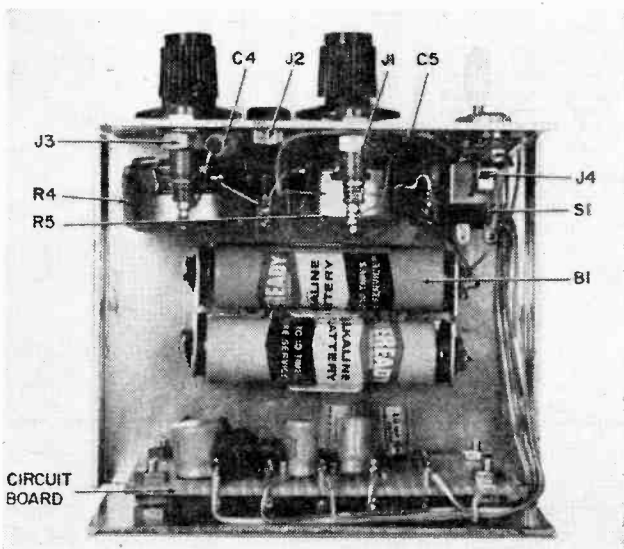

This prototype of Gen-Trace looks, works like instrument costing far more. For added versatility, substitute universal binding posts for tip jacks J1 through J3.

completely cover each half of the case. Lay the piece you have cut with the finish side down on a flat surface. Remove the paper backing and press the material over the surface of the housing. Fold material over the sides and trim off the excess with a sharp knife or razor blade. Small air bubbles should be rolled out before turning under

of holes in the board, bending them outward on the wiring side and cutting them off, leaving about a 1/4-in. tab for soldering circuit wiring. Connections to the IC are lap soldered to conserve space, reduce strain on the IC's leads, and to help prevent shorts between adjacent pins.

Soldering connections to the IC's leads

should be completed as quickly as possible. Use a low-wattage (under 50 watts) soldering iron with a small, well-tinned soldering tip. Soldering guns should not be used—they are just too big, both in heat and in size, for this sort of work.

We anchored other components in place with miniature eyelets, though you may prefer to use push pins. The ones used on the model had an 0.062-in. outside diameter. If you use the P pattern vector board, it'll be necessary to drill out the board's 0.042-in. holes to the proper size. The eyelets may be staked in place, if desired, with the aid of an automatic centerpunch. Support the eyelets' head on a rounded 1/8-in. diameter steel rod held in a vise. Centerpunching the eyelet from the opposite side will flare the eyelets' skirt while fastening it in place.

Component leads can then be inserted through the eyelets and soldered in place to complete a circuit connection. The leads are then clipped to about 1/8-3/16 in. The small protruding lead then serves as a suitable soldering terminal.

Depending on what type of test leads you may already have in your shop, you may wish to substitute jacks in your project that are compatible to these leads in place of the ones used in the model as J1, J2, J3. RCA phono jacks can be used to advantage if you prefer to use shielded input and

output cables. Likewise, J4, the phone jack, may be changed to mate with the type of plug on the earphone you are using.

After completing the wiring of the electronic card, it's best to recheck your work against the schematic for possible wiring errors. Check too for shorts and poor solder connections. Pay particular attention to pins 4 and 11 on the IC. Make certain that pin 11 connects to the battery positive through the switch S1, and that pin 4 goes to ground.

Install the completed and checked card in the housing using 4-40 x 3/4-in. bolts. Additional nuts or spacers are used under the card to raise it 1/4 to 3/8-in. from the housing to avoid shorts.

Mount potentiometers R4, R5, switch S1, the battery holding clip, and the various jacks in their respective locations. A dab of red paint (your wife's nail polish will be perfect) on the battery clip serves admirably to indicate the positive terminal of each battery. This will help you remember the correct way to insert the batteries.

Capacitors C4 and C5 are soldered in, supported only by their leads. Wire in the remaining connections between the electronics card and the various potentiometers, jacks, switch, and battery clip.

Checkout. When construction is completed, insert a pair of AA size cells into the battery holder. Be sure to observe correct polarity. Connect a medium- or high-

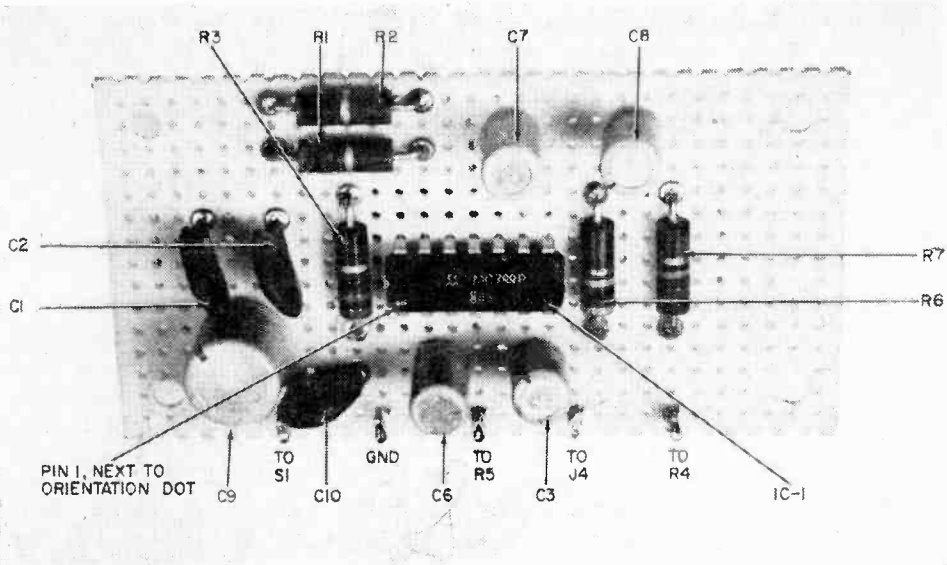

Note how IC mounting tabs slip perfectly into Vector type-H pattern perflboard. You could buy IC socket if you don't want to solder directly to IC mounting tabs as seen here. Normal axial lead electrolytics can be substituted for printed-circuit types.

GEN-TRACE

impedance headphone across the generator's output by plugging it into J4. Turn the instrument *on* and advance the level control. A clear tone in the phone will confirm proper operation of the signal generator.

To check out the operation of the signal trace section, couple the output of the generator (J1) into the input of the signal trace (J3). Again the tone will be heard if all is operating properly.

Should trouble develop in either section, check the wiring to that section. If the trouble appears to be in the signal generator

section, check the wiring to inverters INV1, INV2, INV3. If the trouble appears to be in the trace portion of *Gen Trace*, check INV5 and INV6. A failure of both sections could indicate reversed battery polarity, or wiring to pins 4 and 11 on the IC.

Add an RF Probe. The signal tracer can be used to check through audio stages without any special test leads. But it cannot be used to check RF, IF, and mixer stages. The usefulness of the signal tracer can be extended by the addition of an RF demodulator probe. The drawing for a suitable RF probe details a circuit for one we designed to be used with *Gen-Trace*.

In most applications, additional gain will
(Continued on page 115)

Extending usefulness of Gen-Trace's easy with RF demodulator probe. Solder all parts close to per-board; line interior of probe with card-board for short-circuit protection. Carefully separate inner conductor from cable shield; gently pry inner conductor through shield with pair of tweezers. After tinning, run grounded end of capacitor, diode, GND clip to cable braid. Inverter I4 boosts demodulator sensitivity. Solder 27k resistor across IC1 terminals 5, 10. Capacitor rating's not critical—10 μ F @ 35 VDC's sufficient.

RF DEMODULATOR PROBE

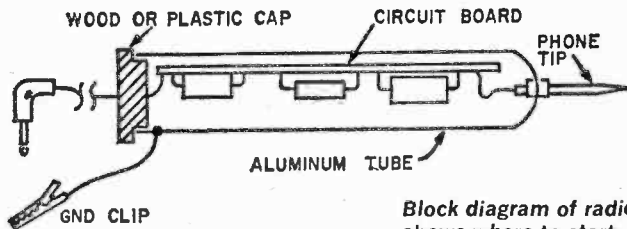
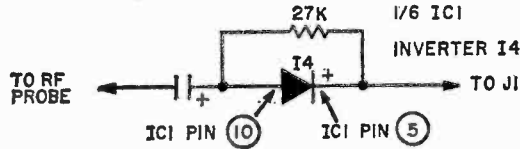
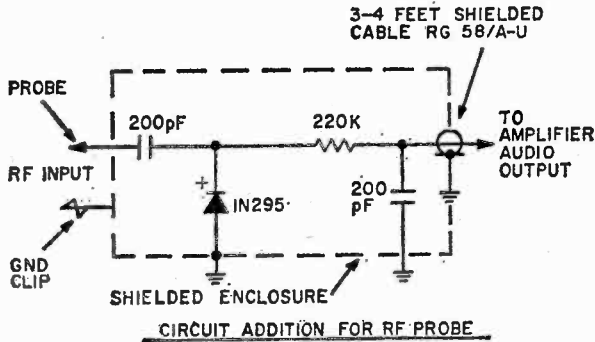
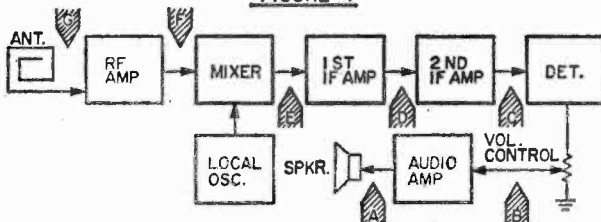

FIGURE 1



Block diagram of radio shows where to start testing when set dies. Connect leads from J1, J2 across speaker; tip of probe from J3 makes contact with input element of each successive stage, working back to antenna terminals.

Get out of the dark with the . . .

HOBBYIST'S NIGHT LIGHT

Night
Trips
This Light
So You
Don't

by Steve Daniels, WB2GIF

A bedside light is always a nice thing to have around. It keeps you from falling over wastebaskets, shoes, and other obstacles that might be scattered around. It's even nicer when you build it yourself. The Hobbyist's Night Light is a lamp that responds to large changes in ambient light and switches itself on whenever the light level goes below a point that you select.

A Light Response. In this circuit, light is detected by a cadmium-sulphide photocell which varies its resistance in *inverse* proportion to the light striking it. This simply means that, in the evening when the light gets dimmer and dimmer, the photocell resistance slowly increases. When the resistance of the photocell becomes greater than the total resistance of R1 and R5,

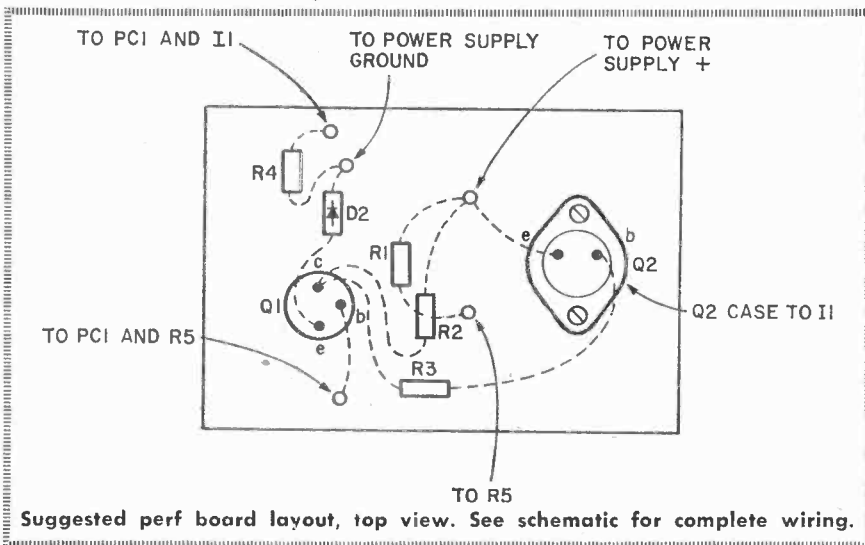

Suggested perf board layout, top view. See schematic for complete wiring.

NIGHT LIGHT

transistor Q1 will turn-on. Recalling basic transistor theory, an NPN transistor conducts (turns on) whenever the base is positive with respect to the emitter.

Whenever Q1 conducts, it makes Q2 conduct and turn on a small pilot lamp that serves as the night light. A night light need not be bright. We've chosen a common, inexpensive #47 pilot lamp for ours because a wide selection of sockets is available.

Quick Pick-up. By connecting the lamp to the junction of PC1 and R4, the circuit is made to switch rapidly from off to on because lamp current flowing through R4 develops a small positive bias voltage to help Q1 turn on and remain on.

Most of the circuitry for this project can be wired on a small piece of perforated board about 2-in. x 3-in. in size. A suggested layout is shown; notice that connections are required for power, sensitivity control, photocell and lamp.

Night Light Construction. Mount the transformer and the rest of the power supply components in the box you are using and wire the power supply leaving 6-in. terminations for connection to the board. Wire the

board. A heat sink for the power transistor is only necessary if you use a lamp rated over 300 milliamps. Mount the sensitivity pot on the box in a convenient location, secure the photocell in a hole with Duco cement where it will be exposed to room light, and screw the circuit board down on a couple of spacers. How you mount the lamp is up to you. A plastic reflector on the author's model came from his junk box; everything was just glued in place.

In any case, just make sure that light from the pilot lamp doesn't get back to the photocell; it would lower your unit's light sensitivity. Finish wiring the unit by connecting the photocell, power supply, sensitivity pot, and the lamp to the board. Screw the cover on and your night light is ready for use.

Adjustment is simple. Turn the unit on and set sensitivity pot R5 somewhat past the point at which the lamp goes out with the room lights on. It may be necessary to readjust things to account for ambient light conditions, but once set you'll be able to count on a light when you need it.

If you want to control an outside or porch light, substitute a 6-volt relay (Potter & Brumfield MR5D or equiv.) for the lamp and control the new lamp through its contacts.

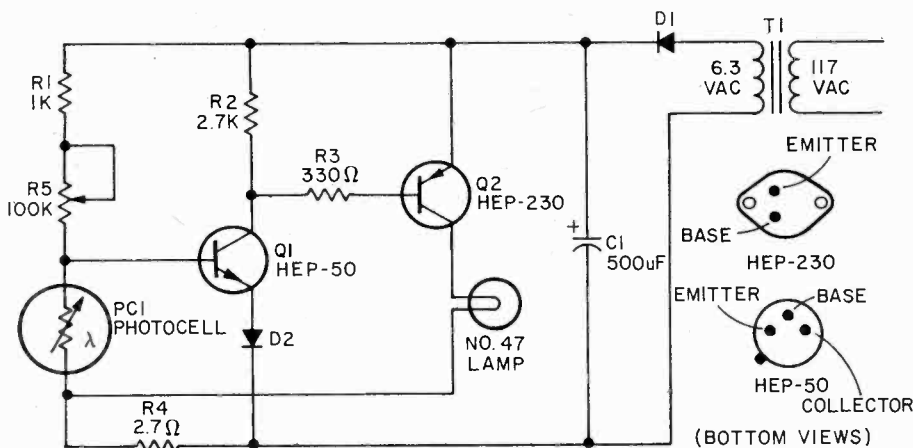

PARTS LIST FOR HOBBYIST'S NIGHTLIGHT

C1—500 uF, 15-VDC electrolytic capacitor
 D1—Silicon rectifier diode, 2-amp, 50-V
 D2—Diode, 1N34 or any general purpose germanium (Lafayette 19-49015 or equiv.)
 I1—Pilot lamp, #47
 PC1—Photocell, Clairex CL703L
 Q1—NPN transistor, Motorola HEP-50
 Q2—PNP transistor, Motorola HEP-230

R1—1000-ohm, 1/2-watt resistor, 10%
 R2—2,700-ohm, 1/2-watt resistor, 10%
 R3—330-ohm, 1/2-watt resistor, 10%
 R4—2.7-ohm, 1/2-watt resistor, 10%
 R5—100,000-ohm, linear taper potentiometer
 T1—Filament transformer, primary 117 VAC, secondary 6.3 VAC @ 1.2 amps (Stancor P-8190 or equiv.)

build

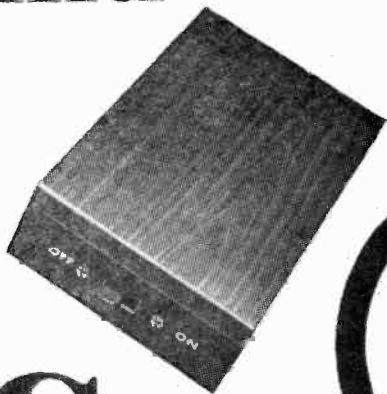

SimCon...

... the 1-FET converter that puts you where the real action is
by Edward A. Morris, WA2VLU

BY NOW, JUST about everyone who dabbles in electronics knows where the real action is. That's right—it's on the so-called emergency bands. Here's where you can listen in on the day-to-day communications of your local and state police and fire departments. Here, in fact, is where you can tune in on the drama of everyday life.

Our SimCon (for simplicity converter), designed to be used in conjunction with an auto radio, brings you close to the action. The converter can be used to receive any 1-MHz band between 25 to 55 MHz. No modifications to the radio it's used with are necessary and the converter even employs the same antenna.

Aside from the more casual listeners, some of the more serious types—rural volunteer firemen, say—will also be able to put the converter to good use. SimCon enables the volunteer fireman or Civil Defense worker to receive directions and information while en route, eliminating a possible stop at a central meeting point.

SimCon is packaged in a small attractive, vinyl-clad housing. It's compact enough to be mounted unobtrusively under the dash, and there's no chance in the world of it posing a threat to your knees.

Cost? About \$14.00 builds it. Construction time should be under 4 hours (say two evenings' work). Sound good? Read on.

How It Works. First, let's take an overall look before we go into circuit details. Our SimCon uses a field effect transistor, Q1, as a mixer. The input to the FET consists of two signals. One is the RF input signal we wish to receive; the other is generated by a crystal-controlled oscillator, consisting of transistor Q2 and its associated components. The two signals, which differ in frequency, are mixed by the FET.

(Continued overleaf)

SimCon

Among the FET's output products is a signal which is identical to the signal we wish to receive, except that its frequency is the difference frequency between the original frequency and the local oscillator frequency. By picking the proper frequency for the local oscillator, we can receive this new difference frequency on a BCB radio.

For a more detailed look, let's start at the beginning. With switch S1 *on*, power is applied to the circuit, and the converter is placed between the antenna and the receiver. RF input signals are coupled to the resonant circuit consisting of coil L2 and capacitor C1 by the antenna input coil L1. The desired signals are applied to the gate of Q1; undesired signals falling outside L2/C1's bandpass are rejected.

The FET is operated with its gate negative with respect to its source terminal. Bias is provided by the voltage drop of the source drain current across resistor R1. With the source positive with respect to ground and the gate at DC ground potential, the gate is negative with respect to the source terminal. The source resistor is bypassed for RF by capacitor C3.

Local Oscillator. Along with the desired RF input signal at the gate of the mixer, we also need a signal from the local oscillator (LO).

Graph gives some idea of how AM radio is able to detect FM signals. Secret is to detune receiver slightly so incoming signal falls on slope of radio's selectivity curve. Signal can then be detected and amplified.

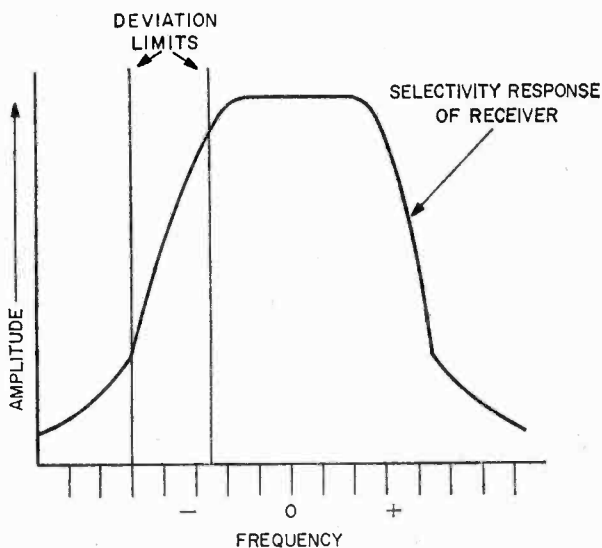

The LO signal is generated by transistor Q2 and its associated components. Most hams will recognize the circuit as that of a Clapp oscillator, widely used as a VFO. The version used here is its solid-state, crystal-controlled twin.

Operating bias for Q2 is provided by the voltage divider formed by resistors R2 and R3. The collector of Q2 is placed at RF ground by bypass capacitor C4. Frequency control is accomplished by X1, operating in

its series mode. Positive feedback, necessary for oscillation, is controlled by the ratio of the values of capacitors C6 and C7.

Emitter resistor R4 raises the impedance of Q2's emitter above RF ground, as is necessary for proper feedback and circuit operation. The RF output appears across the emitter resistor and is injected into the gate circuit of Q1 by coupling capacitor C2.

We now have two RF signals at the gate of the mixer: the signal we wish to receive, and the injection voltage from the local oscillator. As a result of the mixing action in the FET, one of the mixer's outputs will be the difference frequency of the two input signals. If we choose our local oscillator frequency properly, the difference frequency will fall in the standard broadcast band. This output appears at the drain terminal of the mixer, and is coupled to the output of the converter, output jack J2, by coupling capacitor C5.

The converted signal is then received and detected by the radio it's used with. At this point we may have some readers scratching their heads, wondering how a diode detector

in the auto radio is going to cope with FM-modulated stations in the emergency and business bands.

Slope Detection. Key to this problem is a little trick called slope detection. To receive FM transmissions, the auto radio is tuned a bit off to one side of the desired station. This places the received signal on the slope of the receiver's selectivity curve. Frequency deviation (FM modulation) is then converted into a varying-amplitude sig-

nal, which is detected and amplified just like an ordinary AM signal!

Though this method of detecting FM signals negates some of the benefits of FM, it is satisfactory for general use. It also has the advantage that no modifications are necessary to the radio it is to be used with.

Mechanical Construction. The author chose to construct his model in a small aluminum box chassis. The circuit layout isn't critical, however, so you have considerable freedom in picking your layout and packaging technique. Even so, a metal enclosure should be used to ensure proper shielding. And if you've had little or no previous ex-

perience in HF/VHF layout and construction, you'd do well to follow the general layout used by the author just to be on the safe side.

Construction is simple and goes easily. Begin by laying out the pattern of holes to be drilled in the case. A small T-square can come in handy here. Spot the holes with a centerpunch to ensure accurate placement of the drilled holes. The rectangular cutout for switch S1 is most easily made by first scribing the outline of the cutout onto the box. Then drill a connecting pattern of 1/16-in. holes just inside the scribed outline. Remove the material in the center, and fin-

PARTS LIST FOR SIMCON

- B1—9-V battery (Eveready 216BP or equiv.)
- C1—Dipped silver mica capacitor (Elmenco DM-10 or equiv.—see text and Table 1)
- C2—10-pF, 500-V dipped silver mica capacitor (Elmenco DM-10 or equiv.)
- C3, C4—0.0022- μ F, 1000-V miniature ceramic capacitor (Erie display card # A 23 or equiv.)
- C5, C6—100-pF, 500-V dipped silver mica capacitor (Elmenco DM-10 or equiv.)
- C7—62-pF, 500-V dipped silver mica capacitor (Elmenco DM-10 or equiv.)
- J1, J2—Motorola auto radio jack (Lafayette 11E66024 or equiv.)
- L1—3 turns #26 plain enameled wire, close wound over ground end of L2—see text
- L2—7 1/2 turns #26 wire close wound over 1/4-in. dia. form, ferrite slug tuned

- (Miller 20A687RB1 or equiv.)
- L3—2.5-mH RF choke (Miller 6302 or equiv.)
- Q1—HEP-802 transistor (Motorola)
- Q2—HEP-55 transistor (Motorola)
- R1—4700-ohm, 1/2-watt resistor
- R2—33,000-ohm, 1/2-watt resistor
- R3—47,000-ohm, 1/2-watt resistor
- R4—2200-ohm, 1/2-watt resistor
- S1—3-pdt slide switch (Lafayette 99E-6166 or equiv.)
- X1—Crystal—see text and Table 2 for instructions on calculating frequency. Available from Z-Tech Enterprises, P.O. Box 70EH, Hauppauge NY 11787, \$4.95 postpaid. Money order, speed delivery. Specify series resonant 3rd overtone crystal, type ZTE-1.
- 1—5 5/8 x 3/8 x 1 5/16-in. aluminum case
- Misc.—Crystal holder, battery holder, perforated board, push-in terminals, solder, hardware, wire, vinyl covering material, press-on lettering, etc.

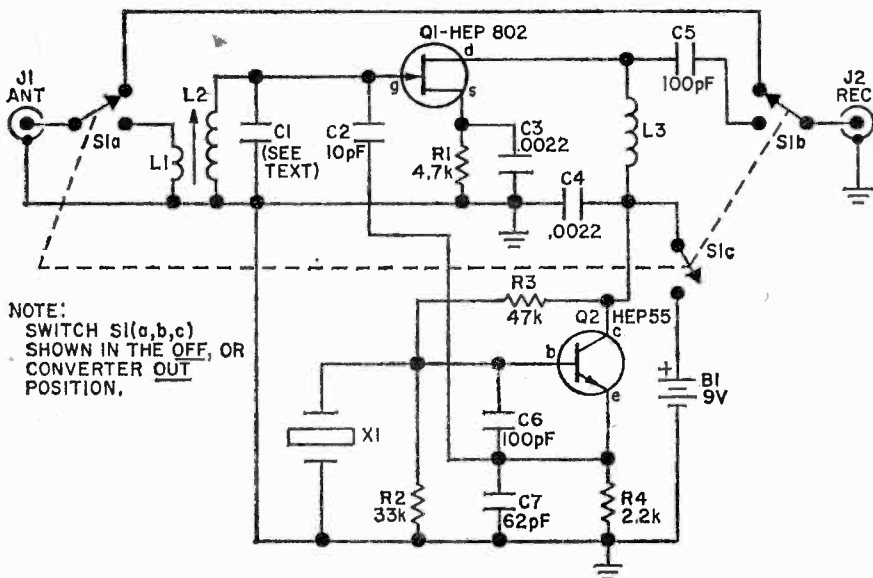

NOTE:
SWITCH S1(a,b,c)
SHOWN IN THE OFF, OR
CONVERTER OUT
POSITION,

SimCon

ish the sides of the cutout with a small file.

After the mechanical work has been completed, the case can be spray painted or covered with vinyl contact adhesive material, as was the author's model. The vinyl material looks great and is easier to apply than spray paint. A wide variety of wood grain and solid tone patterns are available.

In either event, the case should be thoroughly cleaned before it's covered or painted. Hot water and soap will do a good job. Rinse well, then dry thoroughly.

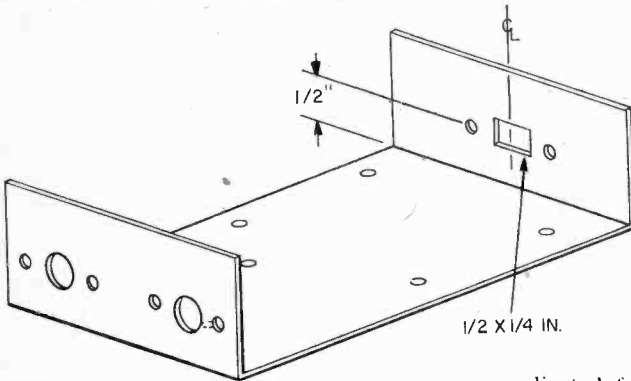

Chassis for SimCon is cinch to prepare. Hole at far end is for switch S1; two holes at near end are for jacks J1 and J2.

To cover the case with vinyl, first remove the paper backing from the vinyl material. Place the material adhesive side up on a flat surface, then place the case on the material. Alternately press each side of the case onto the material, and trim excess material with razor blade or pocket knife. Remove entrapped air bubbles by working them out to the edge of the material. In stubborn cases, try puncturing the vinyl by pricking the bubble with a small needle. For maximum adhesion and permanence, press the vinyl firmly against the case. Remove the material over the various holes and cutouts with a sharp knife blade.

Press-on lettering can then be applied to the case to lend a finished, professional appearance to the project. Follow the manufacturer's directions in applying the lettering. To protect the lettering from abrasion, spray on several light coats of a clear acrylic spray.

Electrical Construction. With the exception of switch S1, the input and output jacks, and the battery, all components are mounted on a small section of perforated

epoxy-glass board. Miniature push-in terminals are used to mount various components, as well as to serve as wiring terminals. Wiring is point-to-point, using small gauge bare wire, and is carried out on both sides of the board. Care should be taken to use short, direct leads whenever possible.

The general components layout can be determined from our photos. Though not exactly wide open, the layout shown allows even the beginner enough room to work.

Transistors Q1 and Q2 are soldered directly into the circuit. No special precautions are necessary: just a bit of solid-state-oriented common sense. Use a small (under 50 watt), well-tinned iron, and complete the job quickly. Beginners should perhaps use a heat sink on each lead while soldering.

Coil L2 can be store-bought or home brew, depending on how ambitious you feel. If you opt for the home-brew version, wind 7½ turns of #26 plain enameled wire, close wound, over a ¼-in. dia. ferrite slug tuned form. Position the coil on the form so that the ferrite slug can be adjusted from fully in, to fully out of the coil. Coil L1 consists of 3 turns of #26 plain enameled wire close wound over the cold (ground) end of coil L2.

Selecting Frequencies. Both the value of capacitor C1 and the frequency of the crystal will depend on what frequency(s) you want the converter to cover. Refer to the table at right to calculate the crystal frequency; the table above specifies the value of

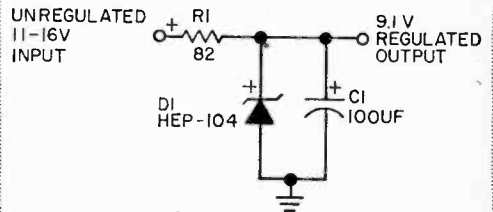

PARTS LIST FOR AUXILIARY POWER SUPPLY

- C1—100- μ F, 25-V miniature electrolytic capacitor (Sprague TE or equiv.)
- D1—9.1-V, 1-W, 10% Zener diode (Motorola HEP-104 or equiv.)
- R1—82-ohm, 1-watt resistor
- Misc.—Wire, solder, hardware, push-in terminals, perforated board, etc.

	25/35 MHz	35/45 MHz	45/55 MHz
C1	33 pF	15 pF	10 pF

C1 over the operating range of the converter. The actual value of C1 isn't critical, so long as it allows C1/L2 to tune to the signal input frequency.

Bypass capacitor C3 should be located close to the source terminal of Q1 and should have short, direct leads. Likewise, it's best if the collector bypass capacitor for

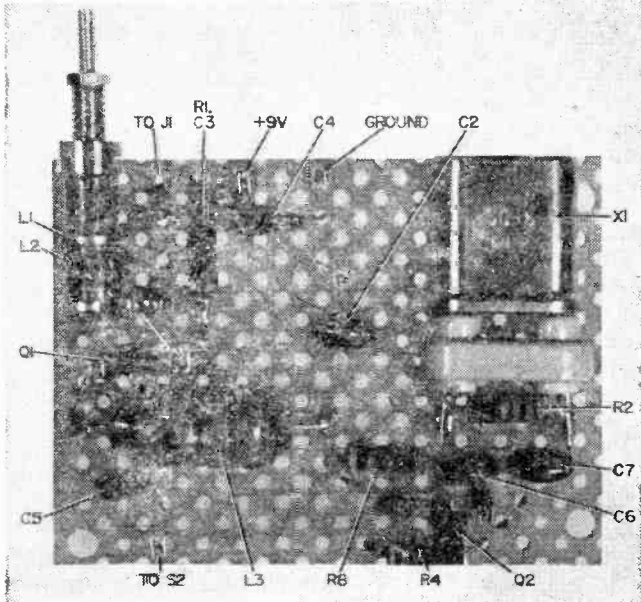

SimCon's perfboard, all wired up and ready for mounting in chassis. Since wiring is carried out on underside of perfboard, board must be spaced from chassis with nuts when mounted. Note that L1/L2 and L3 appear at right angles to each other.

Q2 (capacitor C4) is wired in close to the collector terminal and with short leads for proper circuit action.

After the electronics card has been wired according to the schematic diagram, recheck your work for possible errors and shorts. Remember, it's a rare builder who can

Calculating the Crystal Frequency

For spot frequency operation:

$$F_{XTAL} = F1 - F2$$

where F_{XTAL} is the frequency of the crystal to be ordered.

F1 is the spot frequency to be received.

F2 is the frequency (between .54 and 1.6 MHz) where you wish to receive the converted frequency on your radio.

For 1 MHz band operation:

$$F_{XTAL} = F1 - 0.55 \text{ MHz}$$

where F1 is the frequency of the lower edge of the 1 MHz band to be covered. The lower edge of the 1 MHz band to be covered will appear at 0.55 MHz, and the upper edge at 1.55 MHz on the auto radio.

honestly boast that he never ever makes a wiring mistake.

Final Assembly. Prior to installing the electronics card in the case, first mount switch S1, the battery clip, and jacks J1 and J2. The jacks specified in the Parts List will match most all auto-radio antenna systems.

When installing components with nuts and bolts, take care not to pull the vinyl material. The easiest way around this is to tighten up on the nut from the rear while holding the screw head in a fixed position with a screwdriver.

Mount the electronics card with 4-40 x 3/4-in. bolts and matching nuts. Space the card about 3/8 in. from the chassis using additional nuts to achieve the correct spacing. Take care to prevent possible shorts between wiring on the underside of the electronics card and the chassis.

Though not shown in the schematic diagram, an extension cable is needed to connect the output of the converter to the input of the auto radio. A short length of RG-58 coaxial cable can be used; however, better results will be obtained by using a length of

SimCon

low capacitance auto antenna lead-in cable. Terminate both ends with Motorola plugs.

Alignment. Connect the output of the converter to the input of the receiver, using the extension cable. If a signal generator is available, connect its output, through a 15-pF capacitor, to the input of the converter. Set the radio where you want the spot frequency to appear at, or to the center of the band if you want 1-MHz coverage. Set the generator approximately on frequency, then vary it a bit to obtain maximum signal output from the auto radio. Peak coil L2 for maximum output. Reduce the generator output and repeak L2. Continue the procedure until no further improvement is noted.

If a signal generator isn't available, connect the auto antenna to the converter. Tune L2 for maximum noise output from the receiver. Further improvements can be made by peaking L2 with the aid of an on-the-air signal.

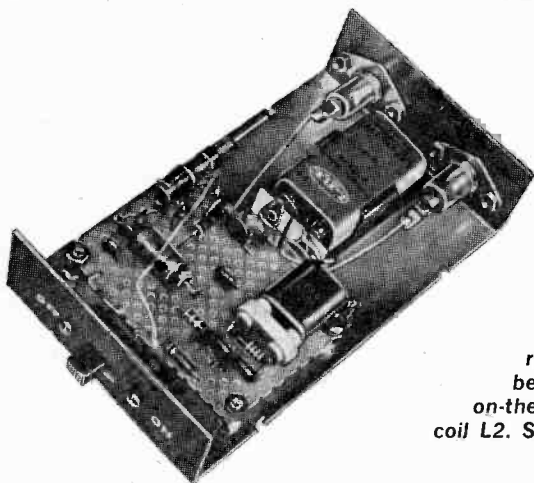

Operation and Use. Best results will be obtained if the auto antenna is extended to its maximum length. The auto radio's push-button selector can be taken advantage of and pre-set to frequencies of most interest. This is most handy when you want to switch frequencies rapidly.

In some locations, where the converter is used to receive only one frequency and a strong local broadcast station lies close to the converter's output frequency, the broadcast station may ride through and interfere with the desired station. The interference can be reduced by connecting a trap be-

tween the antenna and the input to the converter. Tune the trap until the offending station disappears or is greatly attenuated.

This type of interference can be prevented by picking a quiet spot on the broadcast band for the converter to work into, and picking the crystal for the local oscillator accordingly.

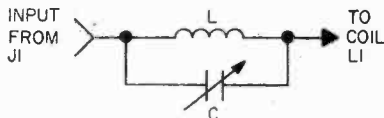

Interference trap for SimCon. L is Miller 2002 antenna coil or equivalent in parallel with 25-280 pF mica trimmer capacitor.

If desired, the converter can also be used with a portable radio. For temporary operation, good results can be obtained by wrapping several turns of insulated hookup wire around the portable's case, close to the radio's ferrite antenna. Connect one end of the wire to the hot (center conductor) output of jack J2.

A more permanent connection would involve wrapping 10-15 turns of #26 plain enameled wire, close wound, around the ferrite antenna rod inside the portable's case. The connection could be brought out through a small jack installed in the set's case.

Completed SimCon with perfbord neatly mounted on chassis, battery B1 installed, switch S1 mounted at front of chassis, jacks J1 and J2 at rear. As explained in text, unit is best aligned with signal generator, but on-the-air signal can also be used to peak coil L2. Signal should be weakest one on band.

Auxiliary Power Supply. Though the self-contained battery supply will be adequate for most uses, there are those—like the volunteer fireman or Civil Defense worker—who may want a more dependable source of power. Batteries have a habit of giving out when they are needed most. For these reasons we have included a Zener-regulated power supply (see page 60) which operates directly from the vehicle's 12-VDC electrical system. Note that the supply cannot be used with positive-ground electrical systems; this requires reversing the polarity of both D1 and C1. ■

SOUND POLLUTION TIPSTER

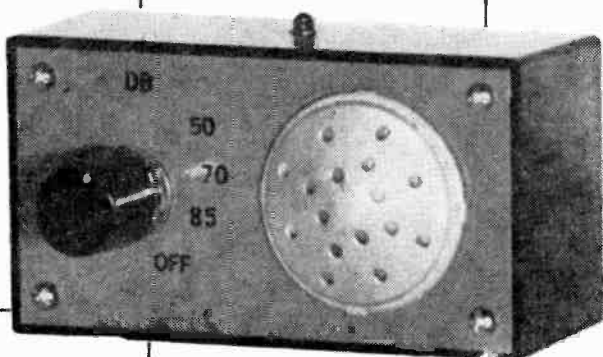

THERE'S BEEN a lot said lately about high-level sound and your ears. Much of the publicity and controversy centers around today's pop music with its electronic sound reinforcement and big-bass. But if loud sounds can be harmful, as experts say, just where does the danger cease? What about medium level sounds we come in contact with every day?

Quite recently the City of New York completed a study about noise. Some of the results are quite disquieting! Not only can noise levels in the city cause hearing loss, they can interrupt enough sleep to cause fatigue and possible personality changes. In addition, Massachusetts has

Blow the whistle on noise with this simple, portable detector; it measures local environmental noise levels with a flashing light emitting diode.

By Herb Cohen

just outlawed snowmobiles with a sound level of more than 82dB (decibels) and after July 1973, the ceiling is just 73dB.

What's a dB? In terms of sound, a dB describes the smallest increase or decrease that an ear can hear. Pile one dB on top of another and pretty soon you'll have a genuine ear splitting sound. At levels approaching 120dB you actually begin to feel the sound; at slightly higher levels, the threshold of pain occurs.

Would you like to know if you're living and working or playing in a danger zone? For about twenty dollars in parts and an evening of soldering fun you can build a noise pollution tipster to find out. It's a lightweight portable sound-level meter that uses the latest technology and comes straight from an electronic experimenters workbench. Based on data from the New York and other studies, we've built our tipster to flash when the sound intensity reaches certain minimum values. They are 50dB, 70dB, and 85dB.

For an idea of what some typical levels are, a whisper at 5 feet is about 35dB, a normal conversation is about

TIPSTER

60dB, a full symphony orchestra at front row center can average 94dB. The New York City subway is about 100 dB.

How-it-Works. The mike voltage is sent to a three-position divider, this selects the different dB levels that are amplified by the I.C.

The I.C. is an operational amplifier, the 741C. Here it is used as a 40dB audio amp. The amplifier gain is set by R8 and R6. The I.C. output is coupled to Q1, another audio amplifier, which adds another 30dB of gain to give us a total of 70dB.

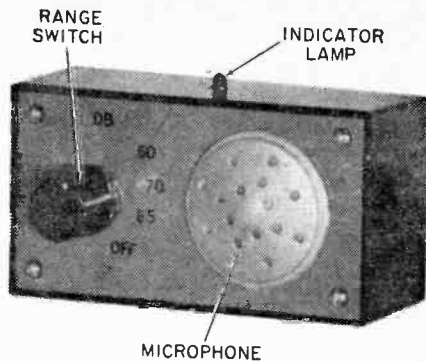

From here we go to a driver that fires the Light Emitting Diode on negative-going pulses. The LED draws about 25 milliamps on peaks, enough for viewing without placing an excessive drain on the battery.

Construction. In order to make the unit as compact as possible a 1 7/8-in. x 4-in. x 2 1/8 in. box is used. The circuitry is mounted on perf. board and secured to the box using double-backed adhesive tape. The battery is mounted the same way. Be sure to ground

Sound Pollution at Home

Source	Average dB
Air conditioner	55
Alarm clock	60
Blender—electric	93
Can opener—electric	78
Clothes dryer—automatic	64
Dishwasher	69
Doorbell	100
Drill—1/4" portable	70
Fan—12" portable	70
Fan—vent	63
Fan—wall exhaust	90
Furnace blower	100
Garbage disposer	78
Hair dryer	77
Knife sharpener	78
Mixer—electric	85
Pots and pans	73
Radio	78
Sander—belt	91
Sander—disc	93
Sander—orbital	70
Saw—8" radial	92
Saw—sabre	76
Sewing machine	64
Shaver—electric	85
Shower	78
Sink drain	86
Telephone ring (6 1/2 ft.)	78
TV	68
Vacuum cleaner	85
Washing machine—automatic	64
Water faucet	68
Whisper (5 ft.)	10

It should be noted that we are not talking about a linear scale when we discuss dB. We are talking about a measurement technique that uses logarithmic ratios. It means that each time a sound intensity doubles, the new sound measurement is just 3dB greater than before. For example, doubling the intensity of a 50dB sound level will increase the value to 53dB, not 100. This technique must be used because there is such a great difference between loud and soft sounds. By using a logarithmic system, the number describing the difference can be small. Why say an increase of 4,000,000 times when it's easier to convert to the logarithmic notation and say a 66dB increase?

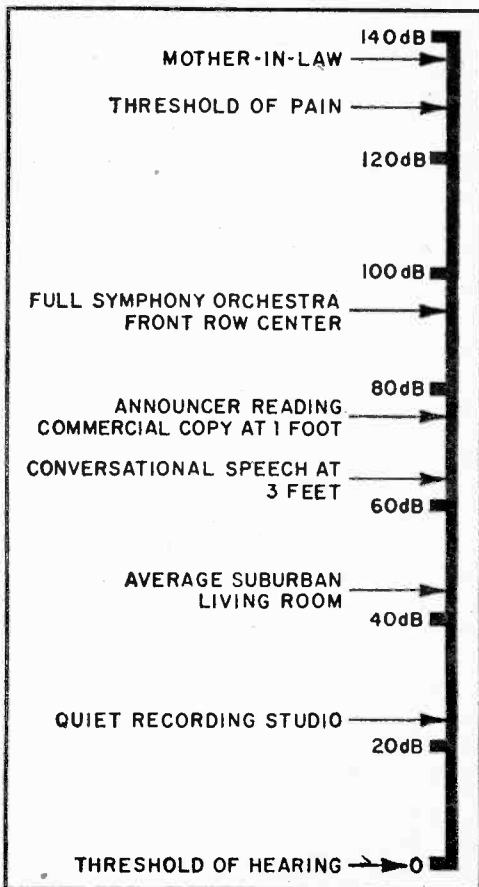

Our sound pollution tipster may not be as fancy as commercial units, but it doesn't cost 800 dollars either!

the aluminum panel and switch frame; also check which lead on the mike is common to the mike case and be sure it goes to ground. To mount the Light Emitting Diode, drill $\frac{1}{8}$ in. hole and ream it out until the LED fits snugly. Cement in place.

Scat! Cat. What do the three levels mean? Try the 85 dB level in the plant. If you listen to a sound level above 85dB for 8 hours a day over a period of time your hearing can be permanently damaged. You should be able to map out safety and danger areas. The

(Continued on page 113)

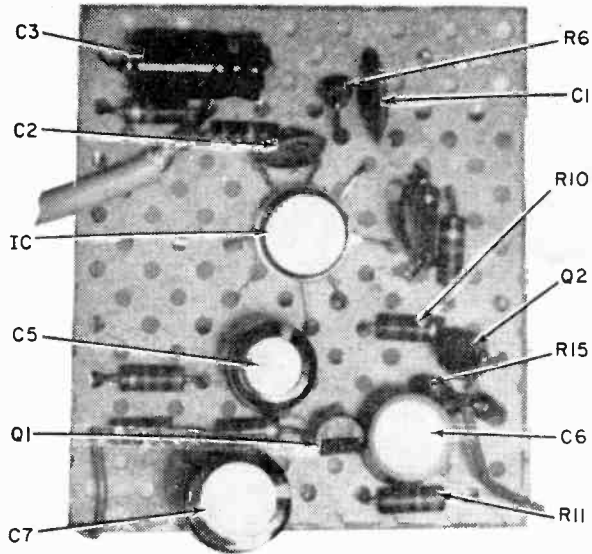

Most parts mount on this perf. board. Put R1, 2, 3 on switch S1, mount LED to case.

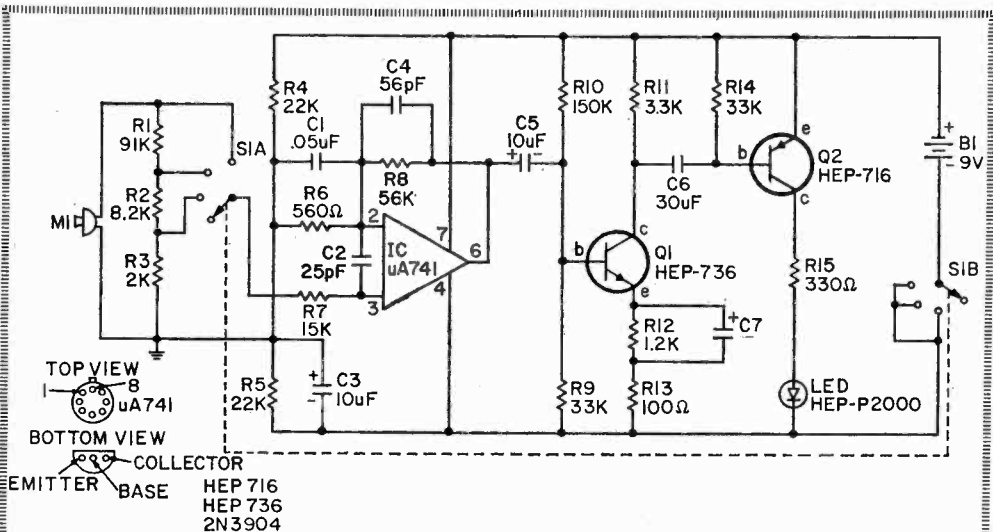

PARTS LIST FOR SOUND POLLUTION TIPSTER

- B1—9-volt battery, Eveready 216 or equiv.
- C1—0.05 μ F disc capacitor, 15 VDC or better
- C2—25 pF disc capacitor, 15 VDC or better
- C3, 5—10 μ F, 15 VDC electrolytic capacitor
- C4—56 pF disc capacitor, 15 VDC or better
- C6—30 μ F, 10 VDC electrolytic capacitor
- C7—150 μ F, 15 VDC electrolytic capacitor
- IC1—Operational amplifier, type 741 (Radio Shack No. 276-010, Fairchild uA 741, etc)
- LED—Light emitting diode, Motorola HEP-P2000
- M1—Microphone, crystal (Radio Shack No. 270-095)
- Q1—NPN transistor, 2N3904, HEP-736 or equal
- Q2—PNP transistor, HEP-716
- R1—91,000-ohm, $\frac{1}{2}$ -watt resistor, 5%
- R2—8,200-ohm, $\frac{1}{2}$ -watt resistor

- R3—2000-ohm, $\frac{1}{2}$ -watt resistor, 5%
- R4, 5—22,000-ohm, $\frac{1}{2}$ -watt resistor
- R6—560-ohm, $\frac{1}{2}$ -watt resistor
- R7—15,000-ohm, $\frac{1}{2}$ -watt resistor
- R8—56,000-ohm, $\frac{1}{2}$ -watt resistor
- R9, 14—33,000-ohm, $\frac{1}{2}$ -watt resistor
- R10—150,000-ohm, $\frac{1}{2}$ -watt resistor
- R11—3300-ohm, $\frac{1}{2}$ -watt resistor
- R12—1200-ohm, $\frac{1}{2}$ -watt resistor
- R13—100-ohm, $\frac{1}{2}$ -watt resistor
- R15—330-ohm, $\frac{1}{2}$ -watt resistor
- S1—Switch, 3-pole, 4-position (Mallory No. 3234J)

Misc.—Hardware, knobs, perforated board, push-in clips, wire, solder, etc.

VIBRA-TONE

Dig it! This pocket vibra-tone has three voices, an eleven note keyboard, real vibrato and uses only three IC's in a real Hep circuit. It builds with new stick-on printed circuit material.

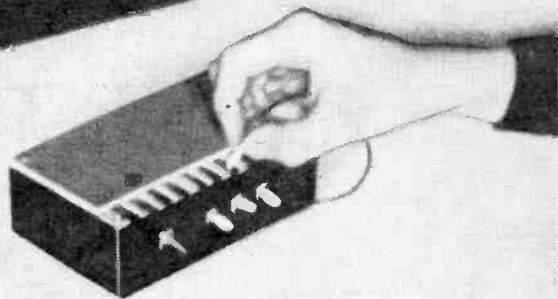

by Darrell Thorpe

Maybe, to make a hit at a party, to spring a surprise on the boys in the combo, or give the kids a terrific toy, all you need is this pocket Vibra-Tone. Made from three low-cost integrated circuits and only a few other parts, the vibra-tone provides a really excellent little musical instrument—and it includes the sophisticated effects of voicing and vibrato that you would expect to find only in rather expensive musical instruments.

This project is simplified by the use of integrated circuits and instant printed circuits. A new technique has recently become available to the hobbyist. It's a new concept of instant printed circuits that permits you to rapidly build projects directly from a schematic diagram. This new approach consists of a complete family of circuit sub-elements and associated circuit materials. With instant printed circuits there is no messy etching and in most instances you don't need to drill any holes.

How-it-Works. Dual buffer IC1 is the tone oscillator. Capacitor C1 and a set of tuning resistors—R9 through R19—provide a tuned musical scale. A note will sound-off when

ever a probe is touched to one of eleven pads on the vibra-tone's keyboard. Since C1 is fixed for all of the notes, the pitch or musical tone is proportional to the total resistance at each position.

A second oscillator, which is part of IC3, (pins 1 to 7) provides a fixed low frequency of about 6 Hz, with C3 and R1. This signal is filtered and attenuated in R2 and C4, and fed back to pin 12 of the tone oscillator, IC1. This provides a periodic frequency modulation to the tones, which is an excellent vibrato. The tone output from IC1, pins 5 and 10, passes through resistor R5 to switch SW2 that selects this particular tone when it is closed. This same output from IC1 also goes to pin 2 of IC2, a dual J-K flip-flop. This integrated circuit provides two flip-flops, and each of these, by the natural binary count action, can divide any input frequency exactly by 2. This division by 2 produces two new frequencies exactly $\frac{1}{2}$ and $\frac{1}{4}$ the input frequency, these are the same notes one and two octaves lower.

Changes Tone. The first flip-flop output, pin 13 of IC2, is the one octave lower output. This goes through R6 to switch SW3.

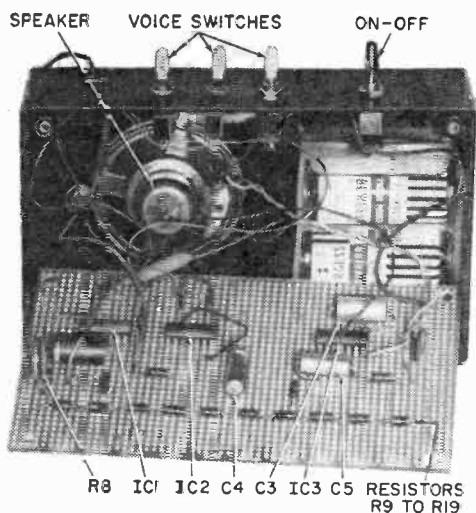

PHOTO BY MARTIN

Pin 13 also connects to pin 6 of IC2, the second flip-flop input. This provides a sec-

ond division by 2, providing a tone two octaves lower than the oscillator. The range switches, SW2 to SW4, are terminated on a common line which goes to pins 9 and 10 of IC3. Part of IC3 was used for the vibrato oscillator. However it also provides a simple two-stage audio amplifier. One of the gates (input 9, 10 and output pin 8) provides the first stage. Pin 8 drives pins 12 and 13 through C5. R4 provides bias. Pin 14 drives the 8-ohm speaker. C6 suppresses high frequency oscillations which might occur in this amplifier. The circuit operates on 3 volts, conveniently provided by two C cells in series, and draws approximately 120 mA standby current.

Quick Put Down. The instant printed circuit sub-elements consists of printed conductive patterns on a very thin epoxy glass board backed with pressure sensitive adhesive. Sub-elements are available for all types of integrated circuits, transistors, and other components, and, any combination of circuit element configuration can be mixed on one board. The circuit sub-elements are all pre-drilled with holes on a 0.100 inch grid. That is, they perfectly match the pattern of



Parts location suggestion when stick-on printed circuit construction is used. Wiring is applied to underside of board.

VIBRA-TONE

0.100 inch vectorboard.

For this project, three 14-lead dual in-line printed circuit sub-elements are used. To use one of these sub-elements, strip off the protective backing and stick it in position, matching the holes in the printed circuit sub-element with holes in the vectorboard.

To use the conductive tape, hold one end and strip off its protective paper as the tape is laid down. A knife blade is then used to cut the tape. For best adhesion, roll the tape down with the side or heel of the knife. The adhesive on the copper tape is electrically conductive and, provided it is burnished for good adhesion, will make electrical contact. However, to eliminate any possibility of opens or intermittents, solder is

(Continued on page 118)

PARTS LIST FOR VIBRATONE

- B1—Two C cells in series
- C1—0.1 μ F Mylar capacitor, 15 VDC or better
- C2—0.002 μ F disc capacitor, 15 VDC or better
- C3—10 μ F, 10 VDC electrolytic
- C4, C5—1 μ F, 10 VDC electrolytic
- IC1—Integrated circuit, HEP-571, MC799 or equal
- IC2—Integrated circuit, HEP-572, MC790 or equal
- IC3—Integrated circuit, HEP-570, MC724 or equal
- R1—6800-ohm, $\frac{1}{4}$ -watt resistor
- R2—120,000-ohm, $\frac{1}{4}$ -watt resistor
- R3—68,000-ohm, $\frac{1}{4}$ -watt resistor
- R4—3300-ohm, $\frac{1}{4}$ -watt resistor
- R5, 6, 7—22,000-ohm, $\frac{1}{4}$ -watt resistor
- R8—1000-ohm, trim pot
- R9—1500-ohm, $\frac{1}{4}$ -watt resistor, 5%
- R10—240-ohm, $\frac{1}{4}$ -watt resistor, 5%
- R11, 12, 13—300-ohm, $\frac{1}{4}$ -watt resistor, 5%
- R14—150-ohm, $\frac{1}{4}$ -watt resistor, 5%
- R15—360-ohm, $\frac{1}{4}$ -watt resistor, 5%
- R16—430-ohm, $\frac{1}{4}$ -watt resistor, 5%
- R17—510-ohm, $\frac{1}{4}$ -watt resistor, 5%
- R18, 19—620-ohm, $\frac{1}{4}$ -watt resistor, 5%
- SW1, 2, 3, 4—SPST toggle or slide switch
- Misc.—8-ohm speaker, battery holder, printed circuit material and board, cabinet, wire, solder, probe (banana plug or equal), etc.

Vectorboard and instant printed circuit material for this project are available for \$4.50 from Circuit Specialists Co., Box 3047, Scottsdale, AZ 85251

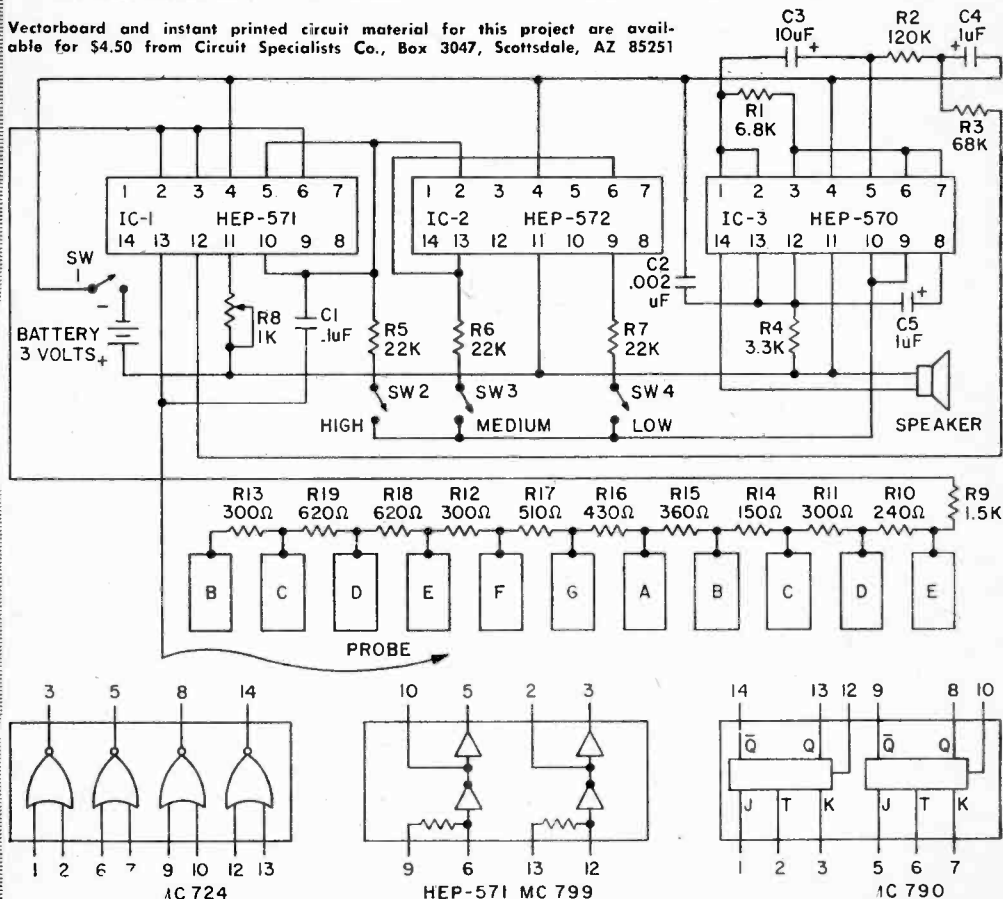

Tipster

Continued from page 107

50dB level is for testing your bedroom at night. Place the meter on your bed and switch to 50dB. If the LED stays on, or goes on periodically from vent noises, pipe gurgles, traffic noise, or a loud-mouth alley cat, your bedroom is too noisy for sleeping. The 70dB level is the point that will jolt a sleeper into wakefulness. Try this level on your desk at work. If the light goes on periodically, you probably have trouble concentrating.

Take Steps. To get an idea of what some typical dB levels for familiar sounds are, check the table. To help you reduce home noise pollution, here are some suggestions. Appliances make a lot of noise; refrigerators hum, washers rattle, and dryers whirl, so the kitchen and utility room are good places to start.

Try to use only one appliance at a time because the noise level is accumulative. When shopping for a new appliance, choose the one that makes the least noise, and let manufacturers know that this is an important factor in your purchase. Fiberglass padding for plumbing, and cork or rubber pads under major appliances can lower the noise levels. Consider installing thick, perforated sound-absorbing wall panels in noisy areas such as the laundry room.

In another part of the home, acoustical tiling, padded carpeting and lots of upholstered furniture will absorb noise. Weather

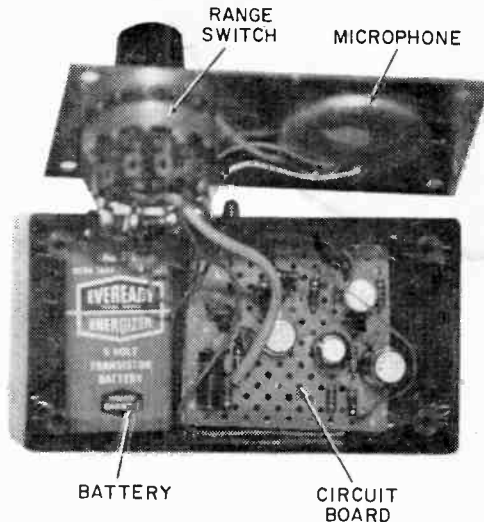

Solder leads to battery and save space. Microphone, LED mount to case with glue. Battery makes tight fit, watch for shorts.

strip an exterior door facing a noisy street. If you are building or remodeling, insist on solid inside doors and soft weather stripping at the tops and sides. Ask for fiberglass-lined heating and air ducts, which cost no more than metal ducts, to eliminate racket coming through them. Similar practices can line water pipes to cut down the noise. You can even use stereo headphones for listening to stereo, hi-fi and other home electronic entertainment units. Stereophones, which operate without the loudspeakers, bring the sound only to the listener's ears. ■

● A REGULATED NINE

Providing 9 volts at approximately 250 mA, this lab-type power supply will handle many experimenter projects. Actually, T1 can be a 6.3-V imported filament transformer since they usually give approximately 12 V peak at less than 500 mA output. Change the Zener diode to 12 or 6 volts (and possibly the value of R1) and you get a regulated 12- or 6-volt supply.

For 12 volts DC you must use a 12-V filament transformer. Filtering is very good since the electrical filter capacitor equals the value of C2 times the gain of Q1. It can add up to thousands of μF . In this case, about 10,000 μF . ■

PARTS LIST

- C1—500- μF , 25-VDC electrolytic capacitor
- C2—100- μF , 15-VDC electrolytic capacitor
- D1—Motorola HEP-175 50-PIV diode bridge rectifier
- D2—Motorola HEP-104, 9.1-V Zener diode
- Q1—Motorola HEP-240, 10-watt npn transistor
- R1—560-ohm, $\frac{1}{2}$ -watt resistor
- T1—12-V filament transformer (see text)

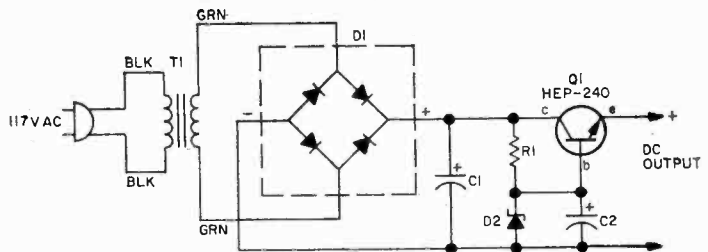

AUTO HEADLIGHTER

Continued from page 74

position. The wire that reads +12 Volts only when the headlights are on is the other correct one; it normally runs directly to the

Modifications Anyone? If more than 60 seconds delay is desired, a larger capacitor can be installed in place of C1. For example, a 1,000 μF capacitor will give two minutes or more of time delay. If you wish, a 10K trimmer resistor in series with R1 will allow exact adjustment of the time interval.

Several fixed timing periods such as 60,

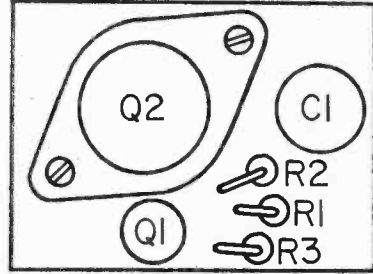
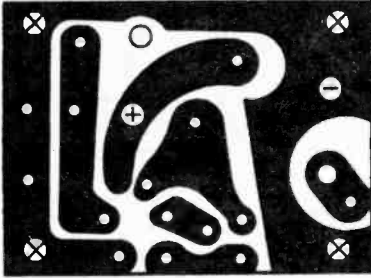

Actual size copper (bottom) side of your board on left and component (top) side on right.

foot dimmer switch. After locating these wires and marking them "+" and "Lights," disconnect the battery cable at the battery so there will be no accidental shorts. Remove 1/2-in. insulation from the two underdash headlamp and battery wires you have located. Now connect each timer wire to the corresponding automobile headlamp and battery wire. Wrap electrical tape over the exposed wires and arrange them in an out-of-the-way spot under the dash. Reconnect the + battery cable and the timer is ready for use.

30 and 15 seconds can be chosen with a switch wired to select different discharge resistors connected in parallel across capacitor C1. All of these modifications combined would give a longer delay period and a variable delay with your choice of lights-on times.

Positive Ground? To modify the basic timer for a 12-Volt positive ground system, do not ground the printed circuit board to the chassis. Instead, use insulated stand-

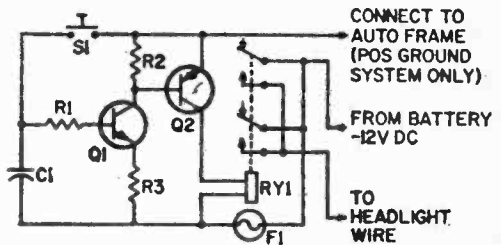
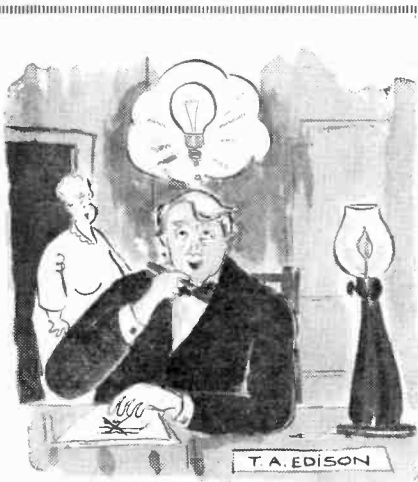

Use this schematic in positive ground cars only. There are no connections made to the normally open contacts of the relay. Use the same printed circuit board. All of the necessary changes are made around a board.

offs when mounting the circuit board in the mini-box. Ground the "+" point on the circuit card to the chassis using a solder lug mounted under one standoff. Run a wire from the circuit card negative points to the relay. Operation will be identical to negative ground systems.

GenTrace

Continued from page 96

be required when using the RF probe, due to the very low level of the signals involved. The schematic for the RF probe also outlines how the unused inverter INV4 of IC1 is used to provide the required additional gain when the RF probe is used.

An aluminum tube, used to protect a deluxe cigar or one used to dispense solder, or an old penlight case makes an ideal housing for the RF probe. Mount the capacitors, resistor, and diode on a narrow strip of perfboard. When placing this assembly inside the aluminum tube, make certain that these components aren't shorted against the metal tube. If you can't scrounge a cigar case, try a scrap of aluminum tubing and make either wood or Bakelite end pieces. You'll need a phone tip plug for the probe's contact point.

How You Use Gen-Trace. A typical method of troubleshooting a dead set using *Gen-Trace* as a signal generator would be to start at the speaker leads' output (point A in our drawing). A signal injected here will check the speaker for proper operation. The level of tone signal heard in the speaker, while quite low, will provide the proper indication that speaker is OK.

As you work back through the circuit from that point, at each successive stage

you should note an increase in level of the tone heard originally in the speaker (points B, C, D, etc. on the drawing). The wide-band noise produced by the harmonics of the 1000-Hz square wave make it possible to trace the signal through the IF, mixer, and RF stages. The harmonics extend to well beyond 100 MHz, making it useful in checking FM receivers and TV sets (on the lower channels) up to the antenna input.

When you come to a point where the signal disappears completely, or is greatly attenuated, you know you've pinpointed the defective stage. Let's say when you come to point E, the signal first heard in the speaker drops out here and the responses at points A, B, C and D are all good. This indicates that the first IF amplifier is the source of the trouble, though there's a possibility that the trouble may possibly be in the mixer output.

Troubleshooting with the signal tracer is just opposite that used to check through a set using the signal generator. In signal tracing, you start at the input and work toward the speaker.

Caution: Don't connect the signal generator or the signal tracer to a point that's at a DC potential higher than the DC voltage ratings of capacitors C4 or C5; if necessary, connect a 0.01- μ F capacitor rated at 1000 WVDC in series with the test lead. The capacitors specified the *Gen-Trace* are adequate for most equipment using transistors or integrated circuits that operate on relatively low voltages. ■

Ask Hank, He Knows

Continued from page 16

head cleaners contain an abrasive, which, in the long run, do more harm than good. Is this true? What other ways could I clean the head without wearing or damaging it?

—N.D.J., Richfield, KS

I use a cartridge tape head cleaner and it works fine. Also, I use a cassette type and never had any troubles. The abrasive is tough enough to rub off the junk that sticks to the head without damaging wear to the head. If you want to use liquid cleaners, go ahead, but use a long Q-tip.

A Question on Audio

I have a dual-channel stereo and I would like to know exactly what dual-channel is.

—D.P., Detroit, MI

That's the stereo set you have, Buster, that's what dual-channel is! Seriously, hi-fi manu-

facturers are notorious in assigning vague, meaningless names to audio equipment. The word stereo, or stereophonic means two channels of audio. The very nature of balanced audio output for stereo sound production demands "dual-channels". But here I go sounding like a hi-fi manufacturer. Why don't you pick up a copy of **HI-FI STEREO BUYERS' GUIDE** and get the inside facts straight. ■



Visulert

Continued from page 82

support them away from the metal to prevent shorts. Before soldering electrolytic capacitors and diodes, check to be sure that you have them properly polarized. Also, doublecheck that connections to Q1 and Q2 are correct before soldering to avoid application of too much heat, if you must unsolder and resolder them, since excessive heat can damage solid-state devices. In fact, we recommend that you use an alligator clip as a heat sink by temporarily clipping it to each lead being soldered.

Remote Lamp. In the event you require a brighter lamp than the standard bulb listed, or want the lamp located on a wall or site outside the area of the telephone—where it can be universally observed—make the following modification. Remove the bulb and connect the leads to terminal strip TB1 for connecting the remote lamp control leads. Mount a 6.3-VAC relay, a standard 110-V lamp socket, and TB2 in a container suitable for the remote location. Wire it as shown in the schematic. By using low voltage (6.3 VAC) the interconnecting remote control leads can be small-sized insulated wire. The 6.3 V that is switched by the SCR (Q2) to turn the low voltage lamp on and off will now be used to operate the remote relay, which will, in turn, control 117 VAC to the larger lamp bulb.

Checking Out Visulert. After doublechecking your hookup for possible errors, shorts, or cold soldered connections, plug the power



We used conventional round magnetic phone pickup. You may have a flat version available that can be conveniently placed under phone.

cord into an AC outlet, and plug magnetic pickup MP1 into J1. Now bring the pickup near power transformer T1. If the unit is working correctly the radiated AC field around the transformer will produce a signal in the magnetic pickup device, triggering the SCR (Q2) to turn on lamp I1. Each time you move the pickup close to the transformer, the lamp will be lit; as you move MP1 away from T1's magnetic field, the lamp will go out. When this checkup has been completed you can close up the mini-box and place Visulert in service.

Using Visulert. The suction cup on the pickup coil we used serves a dual purpose. It permits you to easily orient MP1 into the magnetic field of the telephone ringer and also holds it in position once the ideal location is found. If the pickup you use is one of the flat types, place it under the phone near the exit of the handset cable.

Regardless of the type, you'll have to move the pickup around the base of the phone to locate the magnetic field of the ringer. Remember, of course, the only time you can locate the pickup is when the phone is ringing. Reason is that Visulert's operation is dependent upon the relatively high magnetic field of the ringer to develop a control signal to fire the SCR. ■

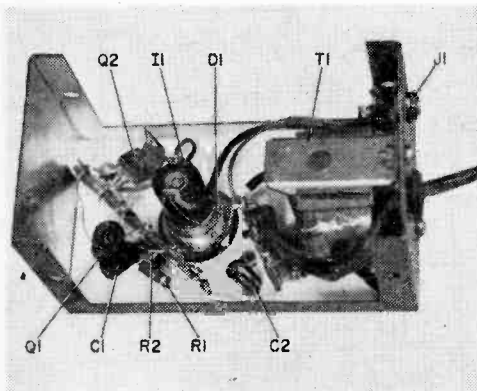

You can see how all of unit's parts are mounted either to tie strips or directly to mini-box in this opened up view of Visulert.

ELECTRONICS HOBBYIST

READER SERVICE PAGE

• The Editor of ELECTRONICS HOBBYIST offers readers an easy way to get additional information about products and services advertised in this issue. Also, if you would like more information about any new product mentioned in our new products column, it's yours for the asking. Just follow the instructions below and the material you requested will be sent to you promptly and at no cost.

• The coupon below is designed for your convenience. Just circle the numbers that appear next to the advertisement or editorial mention that interests you. Then, carefully print your name and address on the coupon. Cut out the coupon and mail to ELECTRONICS HOBBYIST, Box 886, Ansonia Station, New York, N.Y. 10023. Do it today!

Void after July 31, 1973

S/S 1972

ELECTRONICS HOBBYIST
Box 886, Ansonia Station, New York, N.Y. 10023

Please arrange to have literature whose numbers I have circled at right sent to me as soon as possible. I understand that this is a free service offered by the magazine.

1	2	3	4	5	6	7	8	9	10
11	12	13	14	15	16	17	18	19	20
21	22	23	24	25	26	27	28	29	30
31	32	33	34	35	36	37	38	39	40
41	42	43	44	45	46	47	48	49	50
51	52	53	54	55	56	57	58	59	60

Name (Print Clearly) _____

Address _____

City _____

State _____

Zip Code _____

Vibra-Tone

Continued from page 112

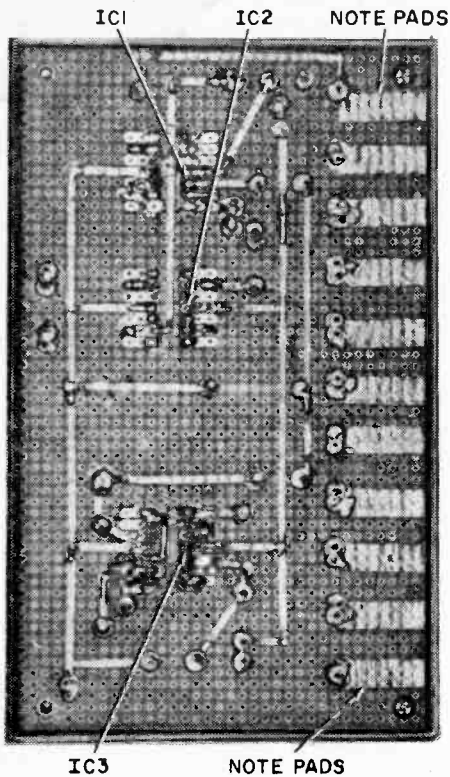

highly recommended at all points of termination.

Double Up. Note that in some instances two pads are required at some termination points. Be sure that these overlap and that solder flows between the pads for a good connection. The components terminated on the pads should be mechanically secure without support from the pad. That is, resistors and capacitors should be pushed through holes in the board so that the component rests firmly on the vectorboard.

Identify the IC's and insert them correctly in the board. Once the IC's are mounted, the other parts, resistors and capacitors can be mounted in any order. Electrolytic capacitors have a polarity marking. Be sure the positive (+) end is properly connected. Tuning resistors R9 to R19 must be the resistance values indicated, and be sure they are $\pm 5\%$ as specified, otherwise the tuning may be way out. The 5% resistors have a gold band. If the vibrato is too strong causing a break up on the lowest two or three notes, vary the size of resistor R3; an increase will decrease vibrato.

Tune Up. Trim pot R8 provides some adjustment of the tone over the entire scale. Adjust this control as required to tune the vibrato. If the resistance of R8 is set to low, the low notes may not play. Also, at least one of the switches must be closed for the unit to work. ■

Lead photo shows cardboard cover over suggested wiring layout for Vibra-Tone.

9 Great IC Projects

Continued from page 57

out built-in speaker monitor facilities could make good use of the Micro-Mini. There is plenty of space in those pro machines for a couple Micro-Minis and a pair of 3 x 5-inch general purpose speakers. It'll make recording that high school band or civic chorus from a remote location that much easier.

PARTS LIST FOR MICRO-MINI AMPLIFIER

- C1—5 μ F, 10 VDC
- C2—0.005 μ F, 10 VDC
- C3—0.003 μ F, 10 VDC
- C4—250 μ F, 10 VDC
- C5—50 μ F, 10 VDC
- IC1—Motorola MFC 4000
- R1—1,000-ohms, 1/2-watt resistor
- R2—4,700-ohms, 1/2-watt resistor
- R3—10,000-ohms, 1/2-watt resistor

INDEX TO ADVERTISERS

READER SERVICE NO.	ADVERTISER	PAGE NUMBER
	Bell & Howell Schools	36-39
3	Cleveland Institute of Electronics	18-21
4	Cornell Electronics	9
6	EDI Electronics	9
5	Eico Electronics	6
1	Heath Company	87-89
7	International Crystal	6
	Kent	105 & 106
2	Lafayette Radio	7
8	McGee Radio	9
	National Radio Institute	122 & 3rd Cover
9	Progressive Edu-Kits, Inc.	4th Cover
	R.C.A. Institute	1-3
10	Xcelite Company	5

Super SCA Adaptor

Continued from page 40

sulting in high frequency noise. Change C12 and C14 to 0.05 uF.

☞ If your problem is background breakthrough from the main program.

This problem is caused by clipping (white lines on waveform A). Simply change C1 and C9 to approximately 300 pf. This will attenuate the subcarrier and clean up the breakthrough on very strong signals, though very weak signals may get lost (well you can't win or hear em all!).

A second and simple corrective procedure is to put a 100,000-ohm resistor in series with the input from the FM radio. This effectively cuts down on the input signal to eliminate overload.

☞ If your problem is an inoperative adaptor (even after you've checked components, made sure power supply polarity and receiver connection are correct), you must determine at what point in the circuit your signal is at fault or is lost.

The three oscilloscope traces show what you can expect to get if you are tuned to an SCA station. Photo B is the input, IC1 pin 2; note the presence of a 67 kHz carrier. Photo C is IC1 pin 6; note the very strong 67 kHz carrier. Photo D is IC2 pin

9, the phase lock detector's voltage controlled oscillator triangular wave output.

If you don't get photo B, the trouble is the connection between the tuner and the adaptor. If you get photo B but not photo C, the trouble is in the IC1 circuit. If you get photo C but not photo D, the trouble is in IC2.

If you don't get photos C and D, there is most likely a major fault in the assembly; we have specifically designed the adaptor so a defective IC cannot disable another IC. ■



Scramble Phone

Continued from page 30

may easily be removed and replaced with a metal or plastic plate. The *clarity* potentiometer can be mounted at any convenient location on the phone's base plate, but be very careful not to let any component interfere with the operation of the hook switch.

Scrambling A Phone. Connect the two scramble phones together (phone line outputs connected to each other) but separated by at least twenty feet. Lift either of the hand sets and you should hear a low level tone; talk into the mike and you should hear your own unscrambled voice in the ear piece. This reception of your own voice is normal and occurs when using a standard telephone; it is called the *sidetone*.

Have a friend or another member of your family talk over the scramble phone. If your

reception isn't clear or sounds like Donald Duck, adjust the *clarity* control for the best voice quality. This simply puts the two oscillators on the same frequency.

Scrambler Hook-Up. This job is a simple one. All that's required is to parallel the output of transformer T3 with the telephone lines. But before doing so, make the following tests. If you are in doubt about which two wires on the telephone terminal block are the telephone circuit, take a DC volt meter and check between pairs until 24 to 48 volts is measured. This test must be performed with the telephone on hook. The second important check to make before connecting the scrambler phone determines the line current. This test is made as follows. Set the VOM to measure DC current on the 50 or 100mA range, and place the meter in *series* with a lead from the high (1.2 K) impedance winding of T3. Pick up the phone. If the circuit current is greater than 25mA, then the resistor/capacitor network

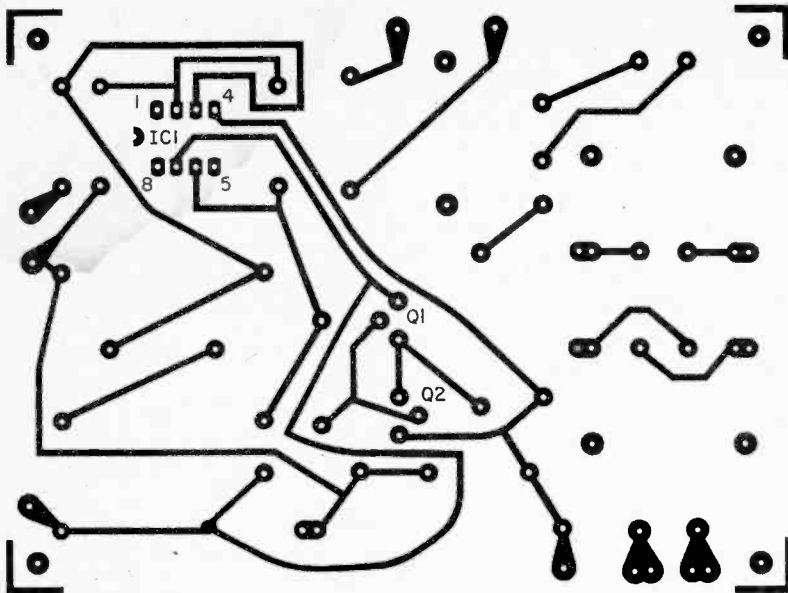

Exact PC board size. Transfer image to copper clad board using a piece of carbon paper. This is the bottom (copper) side of your scrambler board.

C6 and R9 must be added in series with the scrambler phone and the telephone circuit. This should reduce the circuit current to a value close to 25mA, but if not, adjust the value of R9 (start with a 1000-ohm, 1/2-watt resistor) until this current value is reached.

Security Link-Up. After connecting one of the scrambler phones at your location and another at the home of a friend, dial his number with your standard telephone. When the party answers and agrees to go to the scrambler mode, pick up your scramble phone, and have your friend do the same. You can now continue your conversation in complete secrecy. If either of the scrambler oscillators should drift in frequency, just set the *clarity* pot for the best voice quality.

Scrambled Signal Decoding. If you desire to use the ELEMENTARY ELECTRONICS scrambler for receiver speech decoding only, then make the modifications shown. Basically, the resistors, R4, R5, and R6 are removed and replaced with a 10K dual pot to allow the IC oscillator to be tuned over a wide frequency range. Connect the input of T1 to the output of your radio receiver and a small speaker or earphone to the output of T2. Transformer T3 is not required for speech decoding; it can be removed.

Tune the receiver to a station that is using the single inversion mode of speech scrambling, and adjust the oscillator's frequency slowly until the speech begins to sound normal. Even when the scrambled information is decoded, the quality will not be up to

hi-fi standards. But if you are able to understand every word spoken, then you're right up town with the troops! Lots of luck—and remember to hang up all four phones when you're through. ■

Laser

(Continued from page 26)

communication. Atmospheric temperature variations can also cause the beam to wander off the receiver target; however, such beam wandering can be minimized by use of a simple, large lens.

On the Beam. The best time to line up the transmitter and receiver is at night when the red spot is easy to see. In the daytime, locate the distant spot by keeping it on a cardboard as you walk from the transmitter toward the receiver position. If you wish to use the communicator in other than a single, fixed position during the daytime—and especially over rough terrain where tracking the beam with a cardboard screen would be impossible—consider adding a sighting scope of the type used to put astronomic telescopes on target. Calibrate the scope at night for various distances up to the range of the communicator.

For more information about the Metrologic's many different types of lasers and accessory equipment, including collimating optics circle No. 58 on Reader Service Coupon on page 17 or 117. ■

CLASSIFIED Market Place

**FOR BIGGER PROFITS! NEW CAREER OPPORTUNITIES!
READ AND REPLY TO THESE CLASSIFIED ADS**

Classified Ads 65¢ per word, each insertion, minimum 10 words, payable in advance. For information on Classified ads—to be included in our next ELECTRONIC HOBBYIST—write R. S. Wayner, Mgr., Classified Advertising, 229 Park Avenue South, New York N.Y. 10003.

ADDITIONAL INCOME

TELEPHONE Reporters needed immediately. Set own fees. Enjoy prestige. Information \$2.00. Dollarsavers. Ten Paddock, Hudson, New York 12534.

BOOKS & PERIODICALS

1971 CB YEARBOOK—A magazine for the buyers of Citizen's Band Electronic Equipment. Send \$1.25—(includes Postage) to CB Yearbook, 229 Park Avenue South, New York, New York 10003.

BUSINESS OPPORTUNITIES

I made \$40,000.00 Year by Mailorder! Help others make money! Start with \$10.00—Free Proof! Terrey, Box 318-T, Ypsilanti, Michigan 48197.

MAKE Magnetic Signs. Big profits. Details. Universal, Lenora, Kansas 67645.

1000% PROFIT Bronzing Keepsakes. Free Literature. NBC, Box C-4-0, Coral Springs, Florida 33065.

MAILORDER: How to prepare your own catalog for pennies! Free catalog! Obie-Pl, Booklyn, New York 11219.

FREE BOOK '999 Successful, Little-Known Businesses. Work Home! Plymouth Pl, Box K, Brooklyn, New York 11204.

\$100 WEEKLY possible addressing, mailing. Sparetime. Free details. Send self addressed stamped envelope. Newby, Box 277177-SM, San Antonio, Texas 78227.

CANADIANS ONLY! Little known service needed most areas. Box 7122M, Edmonton, Alberta, T5E 5S9.

ASK For Money (Never Repay) International, 2148 Lawrence Dr., Benton Harbor, Michigan 49022.

ADDRESSERS, Commission—Mallers Wanted. Send Stamp, Walker's 5302 First Street Northwest, Washington 20011.

HOW TO START AND FINANCE A NEW BUSINESS. Rush \$10.00 to: SIMS Publications, Box 55, Washington, D. C. 20044.

ADDRESSERS and Mappers needed. Details 10¢. Lindbloom Services, 3636 Peterson, Chicago 60659.

MAKE \$2,000 MONTHLY in fabulous new business. Write: J & J Gift Company Box 699SC Rimpau Station, Los Angeles, California 90019.

DO-IT-YOURSELF

SOLID STATE & HOBBY CIRCUITS MANUAL \$1.95 postpaid to your door. The new Manual HM 91 offers over 400 pages of circuits for the hobbyist, engineer experimenter and do it yourself kit builder. HURRY—Supply limited. Free catalog. FRAZER & ASSOCIATES, 3809 Surfwood Rd., Malibu, Calif. 90265.

EDUCATION & INSTRUCTION

UNIVERSITY Degrees By Mail. Free Information. Norman, Dept. 63, Box 3199, Pasadena, California 91103.

LIFETIME Ordination D. D. Charters. Details 25¢. Life Science, 2207 Cardinal, Rolling Meadow, Illinois 60008.

HIGH SCHOOL DIPLOMA for adults. Earn State Diploma. Accepted by Civil Service, business, colleges. Low Cost. No tedious study. Money-back guarantee. Details: H-S Program, Suite 25 22, 1221 Avenue of Americas, New York, N. Y. 10029.

FARMS, ACREAGE & REAL ESTATE

CARIBBEAN! Only \$25.00 buys 1 sq. ft. land plus equivalent interest luxury hotel building scheduled construction thereon. Buy one or more sq. ft. at \$1.00 per sq. ft. monthly terms. Good Income Vacation Benefits. McEvoy, Box 2483, Dallas, Texas 75221.

GOVERNMENT LANDS—Low as \$125 Acres! Buy, lease or homestead—Free Details! LAND DIGEST Box 1555-JC, Tacoma, Washington 98401.

GIFTS THAT PLEASE

DIGITAL Watch—17 Jewel—Shock Resistant. \$19.95. Lawson's, 403-M Harding, Lyndhurst, N.J. 07071.

HEARING AIDS

HUGE SAVINGS! BUY DIRECT! Eliminate dealer markups. 20 days FREE Trial. Terms arranged. No salesman will call LLOYD'S-79, Rockford, Illinois 61108.

INVENTIONS WANTED

WE either sell your invention or pay cash bonus. Write for details. Universal Inventions, 298-3, Marlon, Ohio 43302.

MAIL-ORDER OPPORTUNITIES

MAIL ORDER DISTRIBUTORS available for \$150.00 investment. Free brochure Dept. 103-EH, Audit Controls, Inc., 28 Brookside Avenue, Fair-Lawn, New Jersey 07410.

MONEYMAKING OPPORTUNITIES

MAKE BIG MONEY raising Chinchillas, Cavies, Rabbits for us. Catalog 25¢. Kweny Brothers, New Freedom, Penna. 17349.

START small, highly profitable electronic production in your basement. Investment, knowledge unnecessary. Postcard brings facts. Barta-SMC, Box 248, Walnut Creek, California 94597.

Make Your Classified Ad Pay Get "How To Write a Classified Ad That Pulls" Includes certificate worth \$2.00 toward classified ad in S & M. Send \$1.25 (includes postage) to R. S. Wayner, Science & Mechanics, 229 Park Ave., South, New York 10003.

MONEYMAKING OPPORTUNITIES—Cont.

GUARANTEED INCOME—at home. Details \$1.00 refundable. Chinchilla, 11DC, Port Richey, Florida 33568.

MAKE Money on Government Surplus. How and Where to Buy. Send \$1.00. Murdock Enterprises, Dept. 173, 32107 Poplar, Wittmann, Arizona 85361.

OF INTEREST TO WOMEN

\$25.00 DAILY Possible addressing-stuffing envelopes. Typewriter-longhand also Clipping News items at home. Information: Send stamped addressed envelope. Ame-7, Box 310, Le Mars, Iowa 51031.

\$100 WEEKLY possible addressing, mailing Sparetime. Free details. Send self addressed stamped envelope. Newby, Box 277177-SM, San Antonio, Texas 78227.

PERSONAL

ELIMINATE Debts Without Borrowing! Particulars 25¢. Helper, Box 9308, No. Hollywood, California 91609.

ORIENTAL introductions! Photographs, descriptions, questionnaire, brochure, details \$1.00 INTER-PACIFIC, Box 30 SC, Birmingham, Michigan 48012.

PRINTING, MIMEOGRAPHING & MULTIGRAPHING

BUSINESS Cards Beautifully Embossed \$8.95/M. Ellis Company, 10020 Prairie, Inglewood, California 90303.

RADIO & TELEVISION

HEAR POLICE/FIRE Dispatchers, catalog, shows receivers; exclusive directories of "confidential" channels. Send 8¢ stamp. Communications, Box 56-DA, Commack, New York 11725.

BUILD Distance Crystal Sets. 10 plans—25¢; Handbook 18 different—50¢; 20 different—50¢. Catalog 25¢, refundable. Laboratories, 1477-EH, Garden Grove, Calif. 92642.

TV TUBES 36¢ each. Send for Free 48 page color catalog. Cornell, 4217-W University, San Diego, California 92105.

TELEVISION PROJECTOR KIT. Beve Electronics Corp., 138 Hialeah Drive, Hialeah, Florida 33010.

REMAILING SERVICE

RECEIVING - Forwarding - Remailing. monthly rates. Norflex, Drawer 430, Weatherford, Texas 76088.

THERE is no charge for the Zip Code. Please use it in your Classified Ad.

STAMP COLLECTING

\$5.00 CATALOG Value for \$1.00. Approvals. Thisfeld, Box 130, Roseau, Minnesota 56751.

Discover the ease and excitement of learning Electronics with programmed equipment NRI Sends you

When you train at home with NRI, you train with your hands as well as your head. You learn the WHY of Electronics, Communications, TV-Radio the NRI pioneering "3-Dimensional" way. NRI training is the result of more than half a century of simplifying, organizing, dramatizing subject matter, and providing personal services unique for a home study school. You get the kind of technical training that gives you priceless confidence as you gain experience equal to many, many months of training on the job.



NRI—The Leader in Electronics Training for more than Fifty Years

APPROVED UNDER NEW GI BILL

If you served since January 31, 1955, or are in service, check GI line in postage-free card.



BUILD YOUR OWN RADIO

and Electronics Circuits

PROGRESSIVE HOME RADIO-T.V. COURSE

Reg. U. S. Pat. Off.



Training Electronics Technicians Since 1946

Now Includes

- ★ 12 RECEIVERS
- ★ 3 TRANSMITTERS
- ★ SQ. WAVE GENERATOR
- ★ SIGNAL TRACER
- ★ AMPLIFIER
- ★ SIGNAL INJECTOR
- ★ CODE OSCILLATOR

- ★ No Knowledge of Radio Necessary
- ★ No Additional Parts or Tools Needed
- ★ EXCELLENT BACKGROUND FOR TV
- ★ SCHOOL INQUIRIES INVITED
- ★ Sold In 79 Countries

YOU DON'T HAVE TO SPEND HUNDREDS OF DOLLARS FOR A RADIO COURSE

The "Edu-Kit" offers you an outstanding PRACTICAL HOME RADIO COURSE at a rock-bottom price. It is designed for the Radio & Electronics Technicians, making use of the most modern methods of home training. You will learn radio theory, construction practice and servicing. THIS IS A COMPLETE RADIO COURSE IN EVERY DETAIL. You will learn how to build radios, using regular schematics; how to wire and solder in a professional manner; how to service radios. You will work with the standard type of punched metal chassis as well as the latest development of Printed Circuit chassis. You will learn using the Progressive Radio & Electronics Tester, Signal Injector, Progressive Dynamic Radio & Electronics Tester, Square Wave Generator and the accompanying instructional material.

You will receive a complete course for the Novice, Technician and General Classes of F.C.C. Radio Amateur Licenses. You will build Receiver, Transmitter, Square Wave Generator, Code Oscillator, Signal Tracer and Signal Injector circuits, and learn how to operate them. You will receive an excellent background for television, Hi-Fi and electronics.

Absolutely no previous knowledge of radio or science is required. The "Edu-Kit" is the product of many years of teaching and engineering experience. The "Edu-Kit" will provide you with a complete education in Radio and Electronics, which is sold at the low price you pay. The Signal Tracer alone is worth more than the price of the kit.

THE KIT FOR EVERYONE

You do not need the slightest background in radio or science. Whether you are interested in Radio & Electronics because you want an interesting hobby, a well paying business or a job with a future, you will find the "Edu-Kit" a worth-while investment. Many thousands of individuals of all

ages and backgrounds have successfully used the "Edu-Kit" in more than 79 countries of the world. The "Edu-Kit" has been carefully designed, step by step, so that you cannot make a mistake. The "Edu-Kit" allows you to teach yourself at your own rate. No instructor is necessary.

PROGRESSIVE TEACHING METHOD

The Progressive Radio "Edu-Kit" is the foremost educational radio kit in the world, and is universally accepted as the standard in the field of electronics training. The "Edu-Kit" uses the modern educational principle of "Learn by Doing." Therefore you construct, learn schematics, study theory, practice trouble shooting. All in a closely integrated program designed to provide an easily-learned, thorough and interesting background in radio. You begin by examining the various radio parts of the "Edu-Kit." You then learn the function, theory and wiring of these parts. Then you build a simple radio. With this first set you will enjoy listening to regular broadcast stations, learn theory, practice testing and trouble-shooting. Then you build a more advanced radio, learn more advanced theory and techniques. Gradually, in a progressive manner, and at your own rate, you will find yourself constructing more advanced multi-tube radio circuits, and doing work like a professional Radio Technician.

Included in the "Edu-Kit" course are Receiver, Transmitter, Code Oscillator, Signal Tracer, Square Wave Generator and Signal Injector Circuits. These are not unprofessional "breadboard" experiments, but genuine radio circuits, constructed by means of professional wiring and soldering on metal chassis, plus the new method of radio construction known as "Printed Circuitry." These circuits operate on your regular AC or DC house current.

THE "EDU-KIT" IS COMPLETE

You will receive all parts and instructions necessary to build twenty different radio and electronics circuits, each guaranteed to operate. Our Kits contain tubes, tube sockets, variable, electrolytic, mica, ceramic and paper dielectric condensers, resistors, tie strips, hardware, tubing, punched metal chassis, Instruction Manuals, hook-up wire, solder, selenium rectifiers, coils, volume controls and switches, etc.

In addition, you receive Printed Circuit materials, including Printed Circuit chassis, special tube sockets, hardware and instructions. You also receive a useful set of tools, a professional electric soldering iron, and a self-powered Dynamic Radio and Electronics Tester. The "Edu-Kit" also includes Code Instructions and the Progressive Code Oscillator, in addition to F.C.C. Radio Amateur License training. You will also receive lessons for servicing with the Progressive Signal Tracer and the Progressive Signal Injector, a High Fidelity Guide with a Quiz Book. You receive Membership in Radio-TV Club, Free Consultation Service, Certificate of Merit and Discount Privileges. You receive all parts, tools, instructions, etc. Everything is yours to keep.

Progressive "Edu-Kits" Inc., 1189 Broadway, Dept. 512EN, Hewlett, N. Y. 11557

UNCONDITIONAL MONEY-BACK GUARANTEE

Please rush my expanded "Edu-Kit" to me, as indicated below:

Check one box to indicate choice of model:

- Deluxe Model \$31.95
- New Expanded Model \$34.95 (Same as Deluxe Model Plus Television Servicing Course and valuable Radio & TV Tube Checker).

Check one box to indicate manner of payment:

- I enclose full payment. Ship "Edu-Kit" post paid.
- I enclose \$5 deposit. Ship "Edu-Kit" C.O.D. for balance plus postage.
- Send me FREE additional information describing "Edu-Kit."

Name

Address

City & State

Zip

PROGRESSIVE "EDU-KITS" INC.

1189 Broadway, Dept. 512EN, Hewlett, N. Y. 11557

FREE EXTRAS

• SET OF TOOLS

- SOLDERING IRON
- ELECTRONICS TESTER
- PLIERS-CUTTERS
- VALUABLE DISCOUNT CARD
- CERTIFICATE OF MERIT
- TESTER INSTRUCTION MANUAL
- HIGH FIDELITY GUIDE + QUIZZES
- TELEVISION BOOK + RADIO
- TROUBLE-SHOOTING BOOK
- MEMBERSHIP IN RADIO-TV CLUB
- CONSULTATION SERVICE + FCC
- AMATEUR LICENSE TRAINING
- PRINTED CIRCUITRY

SERVICING LESSONS

You will learn trouble-shooting and servicing in a progressive manner. You will practice repairs on the sets that you construct for my friends, and made causes of trouble in home, portable and car radios. You will learn how to use the professional Signal Tracer, the unique Signal Injector and the dynamic Radio & Electronics Tester. While you are learning in this practical way, you will be able to do many a repair job for your friends and neighbors, and charge fees which will far exceed the price of the "Edu-Kit." Our Consultation Service will help you with any technical problems you may have.

FROM OUR MAIL BAG

J. Statistis, of 25 Poplar Pl., Waterbury, Conn., writes: "I have repaired several sets for my friends, and made money. The "Edu-Kit" paid for itself. I was ready to spend \$240 for a course, but I found your ad and sent for your Kit."

Ben Valerio, P. O. Box 21, Magna, Utah: "The Edu-Kits are wonderful. Here I am sending you the questions and also the answers for them. I have been in Radio for the last seven years, but like to work with Radio Kits, and like to build Radio Testing Equipment. I enjoyed every minute I worked with the different kits; the Signal Tracer works fine. Also like to let you know that I feel proud of becoming a member of your Radio-TV Club."

Robert L. Shuff, 1534 Monroe Ave., Huntington, W. Va.: "Thought I would drop you a few lines to say that I received my Edu-Kit, and was really amazed that such a bargain can be had at such a low price. I have already started repairing radios and photographs. My friends were really surprised to see me get into the swing of it so quickly. The Trouble-shooting Tester that comes with the Kit is really swell, and finds the trouble, if there is any to be found."

PRINTED CIRCUITRY

At no increase in price, the "Edu-Kit" now includes Printed Circuitry. You build a Printed Circuit Signal Injector, a unique servicing instrument that can detect many Radio and TV troubles. This revolutionary new technique of radio construction is now becoming popular in commercial radio and TV sets.

Printed Circuitry is a special insulated chassis on which has been deposited a conducting material which takes the place of wiring. The various parts are merely plugged in and soldered to terminals.

Printed Circuitry is the basis of modern Automation Electronics. A knowledge of this subject is a necessity today for anyone interested in Electronics.